

MoldMaking

TECHNOLOGY

2020

Technology Review and Sourcing Guide

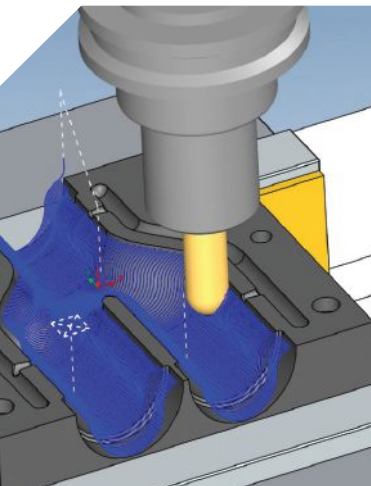

**MORE THAN
1,000 COMPANIES**
In Print & Online!

A review of this year's moldmaking product and service developments alongside a supplier sourcing grid



MOLD MONITORING HAS NEVER BEEN SO SUITE!

Processors and OEM's throughout the world are turning to Progressive's range of mold monitoring innovations to control and improve their tooling investment:

CVe® Monitoring

- On-mold display of cycles, temps, OEE, PM alerts.
- Maintenance tracking reduces mold stoppages.
- View status remotely from any mobile device or PC.

Remote Validation Kit

- A portable kit allowing reduction in repeated travel to suppliers' sites for mold qualifications.
- Remotely view real-time mold performance activity.
- Speeds the PPAP or IQ/OQ/PQ approval process.

System Cooling

- Conveniently test, analyze, and certify each of the mold's individual cooling circuits.
- Utilize pressure control to simulate production.

ProFile®

- Asset Tags with QR codes access critical mold data.
- Store CAD models, documents, and GPS location.
- A standalone approach or can synch with current ERP systems.

Visit procomps.com/monitoring to learn more, or contact Progressive at 1-800-269-6653 or via email at tech@procomps.com for a proposed solution to your team.

PROGRESSIVE
C O M P O N E N T S

HURCO®

PRACTICAL JOB SHOP AUTOMATION

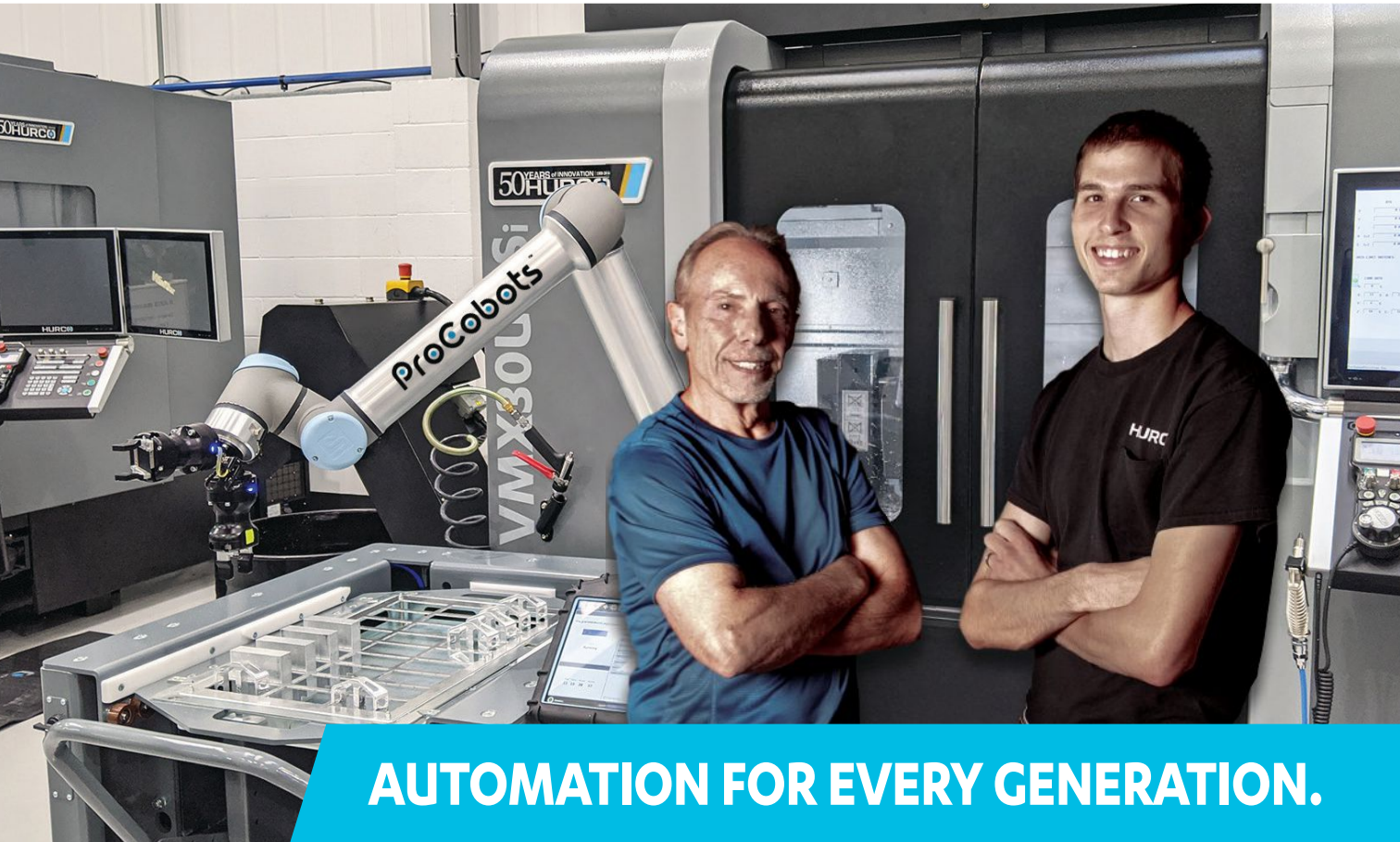

AUTOMATION FOR EVERY GENERATION.

Hurco has eliminated all of the obstacles associated with traditional automation. With Hurco's job shop automation, high-mix manufacturing can have all the benefits of advanced robotics without the hassle (and cost) associated with traditional automation. The collaborative robots (cobots) from ProCobots, combined with Hurco technology, ensure the cobots are easy to set up and easy to program.

[Hurco.com/Automation](https://www.hurco.com/Automation)



Double Column

Boring Mills

Horizontals

3-Axis Vertical

5-Axis

Double Column Bridge Turning Centers

Your 2020 Technology and Service Connection



As North American mold builders continue to look for new business opportunities, investigate different end markets and explore new product development, they will win additional work and require expansion plans. This growth can mean a need for more or new technology or services to stay competitive, which is where *MoldMaking Technology's* annual *Technology Review and Sourcing Guide* comes into play.

This year we've taken the past 12 months' worth of moldmaking product developments and organized them into the following sections: software, additive manufacturing, mold materials, hot runners, mold components, cutting tools, machining, EDM, inspection/measurement, and maintenance, repair and surface treatment. And, new this year: service providers.

Due to the increased need for North American manufacturing capacity and capabilities since the onset of the coronavirus, we added a service providers section focused on suppliers of blow, compression, extrusion blow, foam, injection, liquid injection blow, stretch blow and thermoform molds, as well as die-cast, dies, prototype tooling and prototype/short-run/injection molding services. We've also highlighted the service categories (columns) within each of our technology grids to ease your services search. For example, machining, design, 3D printing, EDM, polishing, welding and heat-treating, to name a few.

This is also an appropriate time to mention our Amerimold Assistance Sourcing Program (ASAP), an online sourcing tool to help connect manufacturers (OEMs) looking for service suppliers and service suppliers (mold builders and molders) with capacity and capabilities looking to take on more work. Completing a simple form will get you into this free program.

Each of the 11 sections include key supplier profiles preceding a sourcing grid tailored to match suppliers with their respective product/service offerings (*advertisers are noted in boldface type*), followed by relevant technical product and service reviews, tips and features. Keep in mind that the grids represent only a portion of our entire online database. The entirety of the data appears online at moldmakingtechnology.com/suppliers. *MoldMaking Technology* surveys and updates its supplier database every spring with the latest company contact information and product/service offerings to keep this information current.

This printed guide, along with our online database, connects readers with almost 1,000 manufacturers, distributors and suppliers of more than 200 product and service categories that the mold manufacturing supply chain uses every day.

We hope this annual guide eases your search for your next technology or service investment. Please feel free to contact me via e-mail at cfuges@gardnerweb.com with any comments or feedback. [MMT](#)

Christina Fuges

Christina M. Fuges
Editorial Director

Follow MMT on: [f](#) [Follow @MMT_ChristinaF](#)

THIS MONTH ON moldmakingtechnology.com

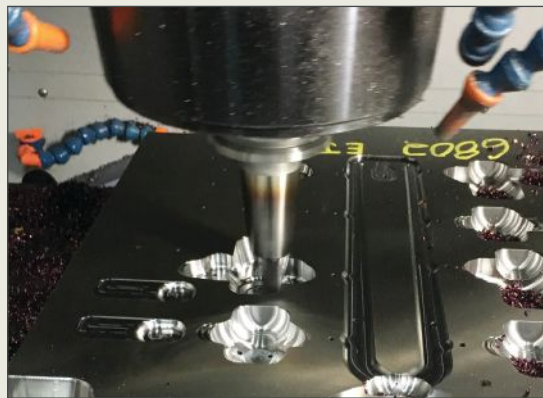

SUPPLIERS

Browse our entire database of moldmaking suppliers at moldmakingtechnology.com/suppliers. You can search by company name or by product category name, including automation, CAD/CAM, cutting tools and toolholders, EDM, hot runner systems, inspection/measurement, machining centers, mold components, mold maintenance, repair and surface treatment, mold materials, molds/tools/dies and additive manufacturing.

NEW PRODUCTS

At moldmakingtechnology.com/products/new you can access hundreds of product announcements provided to us by companies. Browse the most recent write-ups or search by category to keep up on what's currently on the market.

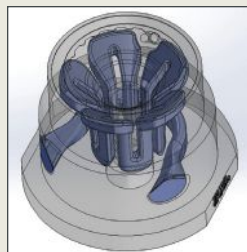

ZONES

Visit moldmakingtechnology.com/zones to view a special area of *MoldMaking Technology* online where you'll be able to find deep collections of information on technology-specific suppliers, products and other important business and management topics, which includes past *MoldMaking Technology* articles relevant to the topic, products and suppliers. Plus, you can search articles within each zone for more specific information.



- Additive Manufacturing
- Automation
- Software
- CAD for Die/Mold
- ERP Management & Related Software
- Cutting Tools
- EDM
- Hot Runners
- Inspection/Measurement
- Machining
- CNC and Machine Controls
- Mold Components
- Mold Maintenance & Repair
- Mold Materials
- Surface Treatment
- Business Strategies
- The Next Generation

8 **MMT Connect: Life of a Mold**
9 **Product/Service Sections**

Products and services are grouped into 11 categories.

In each Section, relevant supplier profiles precede a sourcing grid tailored to match a supplier with their respective products and services. To more easily spot services versus products and equipment, we highlighted the columns for each service category. Advertisers are noted in rows with **boldface** type. This is followed by a sampling of related product releases and tips.

- 9** Service Providers
- 15** Software
- 21** Additive Manufacturing
- 29** Mold Materials
- 37** Hot Runners
- 51** Mold Components
- 65** Cutting Tools
- 75** Machining
- 91** EDM
- 97** Inspection/Measurement
- 103** Mold Maintenance, Repair & Surface Treatment

112 **MoldMaking Marketplace**

112 **Ad Index**

For more product and supplier information, visit moldmakingtechnology.com.



Cover images (left to right) courtesy of HCL Technologies, Precise Tooling Solutions, Michiana Global Mold and Scholle IPN.

Publisher
Ryan Delahanty rdelahanty@gardnerweb.com

Editorial Director
Christina M. Fuges cfuges@gardnerweb.com

Assistant Editor
Heather Wintle hwintle@gardnerweb.com

Contributing Writer
Peggy Malnati pmalnati@garpub.com

European Correspondent
Barbara Schulz bschulz@gardnerweb.com

Art Director
Carla M. Turner cturner@gardnerweb.com

Advertising Production Manager
Chris Larkins clarkins@gardnerweb.com



6915 Valley Avenue
Cincinnati OH 45244-3029
P 513-527-8800
Fax 513-527-8801
gardnerweb.com
moldmakingtechnology.com

Richard G. Kline | Chairman
Richard G. Kline, Jr. | President
Melissa Kline Skavlem | Chief Marketing Officer
Steve Kline, Jr. | Chief Data Officer
Ernest Brubaker | Chief Financial Officer
Phil Louis | Chief Technology Officer
Tom Beard | Director of Custom Content
Bill Caldwell | Advertising and Production Director
Kate Hand | Director of Content and Web
Allison Miller | Director of Events
Dave Necessary | Director of Strategic Engagement
Jeff Norgord | Marketing and Creative Director
Jan Schafer | Director of Market Research
Julie Ball | Audience Development Manager

Subscription Inquiries:

For questions or issues related to your subscription, please call 513-527-8800 or email subscribe@moldmakingtechnology.com

ALSO PUBLISHER OF

- Modern Machine Shop
- Products Finishing
- Plastics Technology / PT Handbook
- Production Machining
- CompositesWorld
- Additive Manufacturing
- IMTS Directory
- Products Finishing Directory
- NPE Official Show Directory
- Automotive Design & Production
- Modern Machine Shop Mexico
- Products Finishing Mexico
- Techspex

MoldMaking Technology (ISSN 1098-3198) is published monthly and copyright © 2020 by Gardner Business Media Inc. 6915 Valley Ave., Cincinnati, OH 45244-3029. Telephone: (513) 527-8800. Printed in U.S.A. Periodicals postage paid at Cincinnati, OH and additional mailing offices. All rights reserved.

POSTMASTER: Send address changes to *MoldMaking Technology* Magazine, 6915 Valley Ave., Cincinnati, OH 45244-3029. If undeliverable, send Form 3579.

CANADA POST: Canada Returns to be sent to IMEX Global Solutions, P.O. Box 25542, London, ON N6C 6B2. Publications Mail Agreement #40612608.

The information presented in this edition of *MoldMaking Technology* is believed to be accurate. In applying recommendations, however, you should exercise care and normal precautions to prevent personal injury and damage to facilities or products. In no case can the authors or the publisher accept responsibility for personal injury or damages which may occur in working with methods and/or materials presented herein, nor can the publisher assume responsibility for the validity of claims or performance of items appearing in editorial presentations or advertisements in this publication. Contact information is provided to enable interested parties to conduct further inquiry into specific products or services.





**THE COMPETITIVE ADVANTAGE
FOR U.S. MOLD BUILDERS.**

**American Mold Builders Association
7321 Shadeland Station Way, #285
Indianapolis, IN 46256**

Phone: 317-436-3102
Fax: 317-913-2445

AMBA.org

PRODUCTS/SERVICES

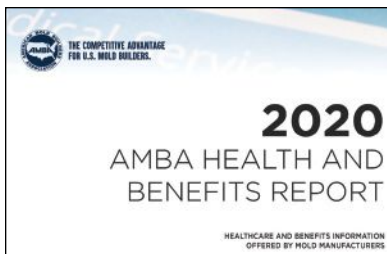

Sharing Best Practices and Reports

Through the sharing of industry data and peer insight, AMBA connects mold manufacturers with the knowledge they need to stay competitive in today's marketplace. By providing access to timely reports, such as the *AMBA 2020 Health and Benefits Report*, peer knowledge through roundtable discussions, guidance on legal and tax policy and more, members and industry professionals are able to access a wealth of timely knowledge that impacts their bottom line.



Advocacy

AMBA, in combination with a Washington D.C.-based bipartisan lobbying firm, advocates for the U.S. mold building industry on Capitol Hill, from trade reform and tax relief to state and federal funding of workforce development programs and initiatives. AMBA's efforts to organize a collective voice not only assures visibility for the mold building industry but helps to fuel reshoring efforts and strengthen the domestic supply chain by confirming the industry's open capacity and diverse capabilities.



AMBA Emerging Leaders Network

Developed for 40-and-under industry professionals, the AMBA Emerging Leaders Network addresses the need to support and develop the industry's next generation of leaders. Through the offering of exclusive plant tour and workshop opportunities, peer connections, personal and professional growth and more, participants are able to pursue a leadership path that illuminates new opportunities and strengthens their ability to lead and empower others.

WEBSITE

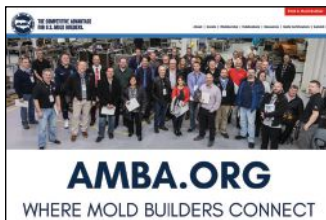

The American Mold Builders website represents the heart of the AMBA community and its powerful opportunities to connect, learn and share. Through access to roundtable discussions, in-person forums, industry benchmarks and other resources, mold builders can obtain critical industry data, allowing them the ability to stay in-the-know in today's increasingly competitive marketplace.

PRODUCT CATEGORIES

- **Find a Mold Builder (online search tool)**
- **Annual AMBA Conference**
- **Industry Advocacy**
- **Plant Tour Workshops**
- **Peer-to-Peer Roundtable Discussions**
- **Benchmarking Reports**
- **The *American Mold Builder* magazine**
- **State and National Grant Opportunities**
- **Cost-Reduction Programs**
- **Recruitment Tools**



**THE COMPETITIVE ADVANTAGE
FOR U.S. MOLD BUILDERS.**

JULY 2020 | ADVOCACY UPDATE



ONE VOICE, ONE INDUSTRY

AMBA ADVOCATES FOR U.S. MOLD MANUFACTURERS ON CAPITOL HILL

- Tax Breaks for Reshoring Initiatives
- Tariff Policies and Enforcement
- National Recognition of Apprenticeship Programs
- Tax Incentive and Relief Legislation

LEARN MORE AT [AMBA.ORG](https://www.amba.org)

GET THE COMPETITIVE ADVANTAGE FOR YOUR COMPANY.

AMBA.ORG | INFO@AMBA.ORG | 317.436.3102

Transform Tomorrow



Plastics improve peoples' lives in transformative ways.
At NPE2021, you'll discover the latest technologies, materials, processes,
and sustainable methods that are revolutionizing the medical industry.

Register Today

NPE.org | Orange County Convention Center
May 17–21, 2021 | #NPE2021



NPE2021
The Plastics Show



This year may have
thrown us all for a loop.

But we have a plan.



We understand that it is our responsibility to provide the IMTS exhibitors and visitors with connections, networking opportunities and technical knowledge. We do not take this responsibility lightly and, to that end, we will launch two NEW programs that will accomplish these goals.



We will host **IMTS Network**, a live-stream event bringing you a wide variety of features and human stories from the Manufacturing Technology sector.

► [IMTS.com/Network](https://www.imts.com/Network)



NEW - IMTS spark, a comprehensive digital platform that connects you with the latest manufacturing advancements, industry experts, educational deep dives, networking opportunities, and top notch experiences to ensure your business prospers.

► [IMTS.com/spark](https://www.imts.com/spark)





MMT

Follow MMT

in moldmakingtechnology

t MMTMag

f moldmakingtechnology

YouTube moldmakingtechnology

@ moldmakingtechnology

IfAMoldCouldTalk

I'm *Phil*-ing silly! Keep 'em coming!

Want to talk with Phil?
Use **#IfAMoldCouldTalk**

Here we are in the heat of the summer, entering another month of our #IfAMoldCouldTalk campaign. Phil's been tough to pin down this past month, as he's really gotten into jogging outside in the summer sun (while wearing his mask, of course). He heard you all talking about 'hot runners' and thought that's what you were talking about. He's young, he'll learn more as he gets older.

Besides getting into fitness, June was super busy for Phil since he got to take part in Amerimold Connects. I think a lot of you got to see Phil in the Forum and even chat with him a little bit. Since he doesn't have a voice, he was excited to chat with a lot of you virtually. Networking is one of the hallmarks of the moldmaking industry, and Phil has been all smiles since the show, clearly proud of the industry's ability to adapt to this strange world we're living in today



WE ASKED THE READERS: WHAT WOULD PHIL SAY TO A 3D PRINTED MOLD?

Mold: I'm afraid of the vertical axis. Phil: Why? Mold: *Starts screaming*

Bryan Whitaker, *iD Additives*

Hey Cousin—I hope you got enough support.

Steven Silvey, *Silveys Plastic Consulting*

That was fast and hot off the press!

Brenda Clark, *HASCO America, Inc.*

Don't let them pressure you too much, might be bad for your health.

Steven Silvey, *Silveys Plastic Consulting*

and participate in a new, exciting event. Phil loved being a part of Amerimold Connects, and he hopes you all did too!

Last month, Phil wanted to touch base with the community on the increasing usage and impact of 3D printing. He asked: what would Phil say to a 3D printed mold? As usual, the community came through in a big way and had Phil laughing so hard he nearly cracked his plate. Some of his favorite responses from the community are listed here.

Phil wants you all to make sure you're paying attention to our social media channels this month, as he'll be checking in regularly to see what kind of craziness you all have on your minds for his latest questions. He knows you won't let him down!

We're hopefully moving closer to getting back to normal. Phil hopes you all are staying safe and taking care of each other. Have a great month!



Image courtesy of Creative Technology.

Service Providers



COMPANY	Advertisers are listed in bold type.	See Ad	Blow Molds	Compression Molds	Die Cast Dies	Extrusion Blow Molds	Extrusion Molds
			1	2	3	4	5
A1 Tool Corporation	– Melrose Park, IL, 708-345-5000		1	2	3		
Aalbers Tool & Mold	– Oldcastle, ON, Canada, 519-737-1369			2			
Accede Mold & Tool Co., Inc.	– Rochester, NY, 585-254-6490						
Ameritech Die & Mold	– Mooresville, NC, 704-664-0801		1				
Armin Tool	– South Elgin, IL, 847-742-1864		1	2	3		5
B A Die Mold	– Aurora, IL, 630-978-4747			2			
Byrne Tool	– Rockford, MI, 616-866-4479				3		
Cavalier Tool & Manufacturing, Ltd.	– Windor, ON, Canada, 519-944-2144			2			
CDM Tool & Mfg. Co. LLC	– Hartford, WI, 262-673-5620						
Chicago Mold Engineering Co., Inc.	– St. Charles, IL, 630-584-1311			2	3		
Commercial Tool & Die	– Comstock Park, MI, 616-785-5400			2	3		5
Concept Molds, Inc.	– Schoolcraft, MI, 269-679-2100						
Creative Blow Mold Tooling	– Lee's Summit, MO, 816-525-4220		1				
Crest Mold Technology Inc.	– Old Castle, ON, Canada, 519-737-1546						
Custom Mold & Manufacturing Inc.	– Milwaukee, WI, 414-384-6299						
Dynamic Tool & Design	– Menomonee Falls, WI, 262-783-6340						
Electroform Co.	– Rockford, IL, 815-533-4223						
Extreme Tool & Engineering	– Wakefield, MI, 906-229-9100						
Industrial Molds	– Rockford, IL, 815-397-2971				3		
Intex Tooling Technologies	– Aurora, ON, Canada, 289-840-1095			2			
Janler Corp.	– Chicago, IL, 773-774-0166						
JMMS, Inc.	– Easley, SC, 864-855-0450		1	2	3	4	
Liberty Molds, Inc.	– Portage, MI, 269-327-0997						
M&M Tool and Mold LLC	– Greenbay, WI, 920-336-6474				3		5
M.R. Mold & Engineering Corp.	– Brea, CA, 714-996-5511						
Max3 LLC	– Benton Harbor, MI, 269-925-2044		1	2	3		
MGS Mfg. Group	– Germantown, WI, 262-255-5790						
Michael Tool & Mold Ltd.	– Oldcastle, ON, Canada, 519-737-1269						
Michiana Global Mold	– Mishawaka, IN, 574-259-6262			2			
Minco Tool & Mold, Inc.	– Dayton, OH, 937-890-7905			2	3		
Mold Craft, Inc.	– Willernie, MN, 651-426-3216			2	3		5
Nypromold Inc.	– Clinton, MA, 978-365-4547						
Omega Tool Inc.	– Menomonee Falls, WI, 262-255-0205			2			
Precise Tooling Solutions, Inc.	– Columbus, IN, 812-378-0247			2	3		
R & D / Leverage	– Lee's Summit, MI, 586-744-0881		1				
Triangle Tool Corporation	– Milwaukee, WI, 414-357-7117		1	2	3		
United Tool and Mold Inc.	– Easley, SC, 864-859-8300		1	2			
Wepco Plastics Inc.	– Middlefield, CT, 860-349-3407						
X-Cell Tool Mold Inc.	– Fairview, PA, 814-474-9100						
Xcentric Mold & Engineering Inc.	– Clinton Twp., MI, 586-598-4636						

For more supplier listings, go to moldmakingtechnology.com/suppliers.

<i>Foam Molds</i>	<i>Injection Molds</i>	<i>Liquid Injection Blow Molds</i>	<i>Stretch Blow Molds</i>	<i>Thermoform Molds</i>	<i>Prototype Tooling Services</i>	<i>Prototype/Short-run/Injection Molding Services</i>	
6	7	8	9	10	11	12	WEBSITE
	7					12	altoolcorp.com
	7			10			aalberstool.com
	7					12	accedemold.com
	7					12	amdiemold.com
	7	8					armin-ind.com
	7				11	12	badiemold.com
	7				11		byrne-tool.com
	7				11	12	cavalierstool.com
	7					12	cdmtool.com
	7			10			chicagomold.com
	7			10			commercialtoolgroup.com
	7					12	conceptmolds.com
			9				creativeblowmold.com
	7						crestmold.com
	7						checkitgauge.com
	7				11	12	dyntool.com
						12	injectionmoldmaking.com
	7						extremetool.com
	7						industrialmolds.com
	7						intextooling.ca
	7				11	12	janler.com
	7						jmmsinc.com
	7				11	12	libertymolds.com
					11		mmtolandmold.com
	7					12	mrmold.com
	7					12	max3.us
	7				11	12	mgsmfg.com
	7					12	michaeltool.com
	7						mgmold.com
	7					12	mincogroup.com
	7			10			mold-craft.com
	7				11	12	nypromold.com
	7			10		12	omega-tool.com
	7			10	11	12	precisetooling.com
	7		9			12	rdleverage.com
	7	8			11		triangletoolcorp.com
6	7						utminc.com
						12	wecoplastics.com
	7					12	xctam.com
	7				11	12	xcentricmold.com

Image courtesy of 3DTech.

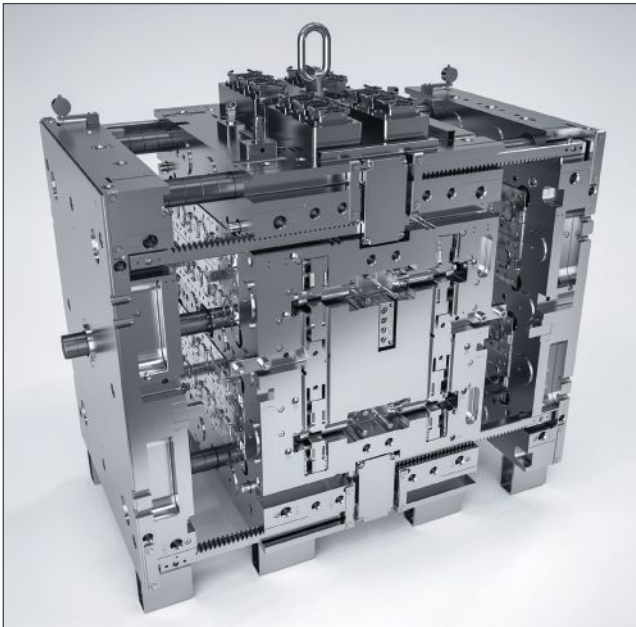

Turnkey Mold and Tool Solutions Are Delivered Ready for Production

Roth Mold + Automation Inc. offers the manufacture of high-precise and turnkey mold and tool solutions. A quick payback, environmental benefits and an increase in productivity are some of the key drivers for each project. The family-owned business combines traditional, highly experienced craftsmanship with a cutting-edge technology in designing and producing high-quality and "made in Germany" molds and tools for injection molding, avoiding readjustment and running-in times. Solutions are delivered ready for series production, which ensures a trouble-free and smooth manufacturing start. The company has a broad field of experiences within several industries, including automotive, packaging and medical appliances.

Roth Mold + Automation Inc. / 248-419-4332 / roth-mold.com

Engineering Department Focuses on Design for Assembly and Tool Cost Savings

Best Tool & Engineering Company, Inc. provides engineering services, tool manufacturing, injection molding and plastic bonding services in the form of vibration welding and hot-plate welding. The company has a fully staffed engineering department to focus on design for assembly and tool cost savings. Tooling is manufactured in house utilizing the current five-axis CNC technology and wire EDM capability. The company also provides linear vibration welding

and hot-plate welding tooling. Part designs are reviewed for best practices in this discipline prior to tool build. The company can also supply finish molded parts to 500 US Ton, with secondary vibration and hot-plate welding operations.

Best Tool & Engineering / 586-792-6500 / bteplastics.com



Wire EDM Accommodates Parts with Larger Machine Travels

Decatur Mold provides quality molds and services, operating 24/7 for short leading lead times for builds and repairs. The company operates in the automotive, appliance, container, medical, electrical, military and consumer industries. The company's experience includes over-molding, hydraulic ejection, unscrewing, gas assist, insert molding, two shot tools and more. Not only does the company typically build molds for 1000 ton presses and under, but it has repair capabilities.



Its service department has 30-ton crane capacity, laser and traditional welding, multiple CMM machines and a spotting press to ensure the best quality repair.

The company purchased a new Makino U86 CNC wire EDM, which provides larger machine travels and work tank to accommodate parts. While the machine has the physique to tackle extremely large part details, it retains the fineness and precision capabilities of smaller machines. The machine utilizes a stationary work table design that improves accuracy by eliminating variables such as workpiece and di-electric weight shifting that can negatively impact machine movement.

Decatur Mold, Tool & Engineering, Inc. / 812-346-5188 / decaturmold.com

Sourcebook Publication Provides Access to Valuable Resources

The **American Mold Builders Association** announces that its annual 2020 Sourcebook publication is available in both a digital and hard copy format. The 2020 Sourcebook provides professionals in the mold manufacturing industry access to valuable resources necessary for doing business.

This year's all-new digital version makes connecting easy and includes embedded website and email address

hyperlinks for all member and supplier listings, as well as within all display ads.

Readers can access U.S. mold manufacturers, suppliers to the trade, geographic member listing by state, member capabilities and industries served and instant connection opportunities.

American Mold Builders Association / 317-436-3102 / amba.org





Expert Molding Technicians Ensure Quick Project Turnaround

Wepco Plastics offers expert molding technicians to finish the process and ensure a quick turnaround. The company specializes in rapid prototyping and short-to-medium run injection production, and its aluminum molds are best for companies that are looking for low-volumes, bridge tooling, low-cost alternatives, prototypes or backup molds for a production tool. Wepco manufactures both aluminum and steel tooling, specializing in quick turnaround prototyping by creating inserts that fit into its standard frames. Working closely with aluminum tooling, the company understands and advocates for the many advantages it offers from low cost, to better heat dissipation leading to uniform cooling times and less defective parts, to ease in repairs and modifications.

Wepco Plastics Inc. / 860-349-3407 / wepcoplastics.com

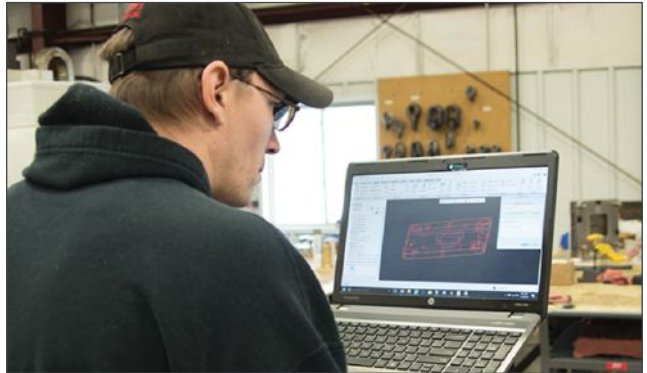

Laser Welder Performs Internal Mold Repairs and Engineering Changes

M&M Tool and Mold LLC has expanded its customer-based capabilities with the addition of an ID1 450-watt fiber laser welder from Alliance Specialties. Used to perform timely internal mold repairs and engineering changes it not only benefits customers, but also its sister companies, Forest Tool Inc. in Crandon, WI and Rowley Tool & Die in Green Lake, WI. The company's strategic tooling team offers professional 3D design, manufacture, project management and final inspection capabilities from start to satisfaction. M&M Tool is a member of AMBA, ITAR Registered, QMED Approved that prides itself on combining the craftsmanship of the past with the technology of today to manufacture "Quality Tooling for the Molding Industry".

M&M Tool and Mold LLC / 920-336-6474 / mmtolandmold.com



Precision Machined Components Support Variety of Molding Technologies

Custom Mold & Design designs and builds high precision, fast cycling molds and precision machined components to support a variety of molding technologies, including thermoplastic, elastomeric, silicone, metal injection molding, rubber and ceramics. The company specializes in cold deck systems, which provide advantages such as being easier to clean and maintain, eliminating issues and shortcomings, reducing lead times and longevity due to robust design. A cold runner system in a liquid silicone injection mold is the equivalent of a hot runner system in a thermoplastic injection mold.

Custom Mold & Design / 651-757-4000 / custommold.net

Shop Tackles Complex Projects with Technology Arsenal

Precise Tooling Solutions offers high quality tooling with state-of-the-art five-axis machining centers and the latest design software to meet evolving customer expectations and reduce setup and machining times, while improving CNC project quality and consistency. The company builds a broad spectrum of tooling, and the majority of its new tools are for automotive lighting companies, especially those launching LED products.

Precise Tooling Solutions / 812-378-0247 / precisetooling.com



Upping Your Mold Purchasing Skills

By James Jergens
 Mold buyers have a unique job in which they can either set up a manufacturing process for success or cause the company to lose profitability. A lack of understanding exactly what they are purchasing hurts productivity. Purchasing only on price and delivery is not the proper matrix for evaluating a mold. Putting part size, the number of slide actions, steel type and manufacturing location into a spreadsheet does not calculate the best mold price. The calculation is much more complex than that.

Here are six questions every purchasing manager should answer to improve his or her buying skills and create more value for the company.

1. What is the function of an injection mold? A cooling fixture that forms a part out of heated plastic. The faster a mold can dissipate the heat of the melted plastic, the faster the cycle time will be. My goal is to find suppliers who will engineer melt delivery systems and cooling systems to reduce cycle time and scrap. I recommend working with your tool engineers or suppliers to gain a better understanding of what you are purchasing and how to justify the costs. Sometimes paying more for the mold will increase productivity in production and increase overall company profitability.

2. How many suppliers do you utilize? I have reduced my supplier base to increase my buying power. I approved each supplier based on what type of molds they were best at building and by location. Sourcing into the supplier's sweet spot allows me to negotiate the best cost, quality and delivery balance.

3. Do you pay suppliers on time? Another way to reduce cost is by having a reputation for paying promptly. Not paying on-time increases the risk the supplier has in collecting its money and the need to use bank financing. I recommend talking to your suppliers and negotiating a cost down for early or prompt payment.

		Vendor Scoring and Rating				
		21.00	30.50	9.50	14.50	6.00
Key Criteria	Importance Rating	Supplier 1	Supplier 2	Supplier 3	Supplier 4	Supplier 5
Quality - overall tool appearance, types of components used, surface machining, handwork, and ability of tools to meet EGI customer specification.	10	Same	+	-	+	Same
Design and Programming - software and staffing.	7	Same	Same	+	Same	-
Project Management - systems, procedures and staffing.	7	Same	+	Same	Same	Same
Manufacturing - equipment, procedures, and staffing.	8	+	Same	Same	+	Same
Tool tryout	5	Same	-	-	Same	Same
Delivery - Ability to meet timing and proven to consistently meet delivery date with design, first sample, maturation, shipping, texture and final delivery	9	Same	+	+	Same	Same
Management, company culture, and company health	9	+	Same	Same	Same	+
Supplier experience in manufacturing tools of that produce similar parts.	6	Same	Same	+	Same	Same
Support of manufacturing plant after tool delivery. Higher rating for suppliers with support shops near manufacturing site.	9	Same	Same	Same	Same	Same
Suppliers overall impact on project cost	7	Same	+	Same	-	Same
Section Group	Total Score	21.00	30.50	9.50	14.50	6.00

This decision matrix provides a method for evaluating a tooling vendor's cost, quality, delivery, experience level, business type, company culture, financial health and ability to meet objectives.

Image courtesy of Ernie Green Industries.

4. Does your company need extended payment terms? Some shops are large and financially stable enough to offer extended payment terms. Another means to get extended terms is factoring the receivable to a bank that understands the automotive tooling process. By using this process, I was able to reduce the initial tool cost, which paid for the cost to factor the receivables. I encourage you to work with your finance team and suppliers to find a solution that helps you meet your objectives.

5. Is your supplier healthy and going to be around to meet your needs? One of the worst things that could happen during a mold build is a supplier going out of business. I look for financially healthy suppliers who maintain a culture that empowers employees, invest in the future through equipment and apprenticeship programs and have a succession plan in place.

6. How do you know you chose the right supplier? I use a Pugh matrix to create a selection method that not only evaluates cost, quality and delivery, but the supplier's experience level, along with the type of business, company culture, financial health and ability to meet objectives. This selection process allows me to be more objective about my decision-making process and provides a quantifiable reason for choosing one supplier over another. [MMT](#)

FOR MORE INFORMATION
 Ernie Green Industries / 585-295-8951 x 6226 / egindustries.com
 James Jergens, Operations Manager

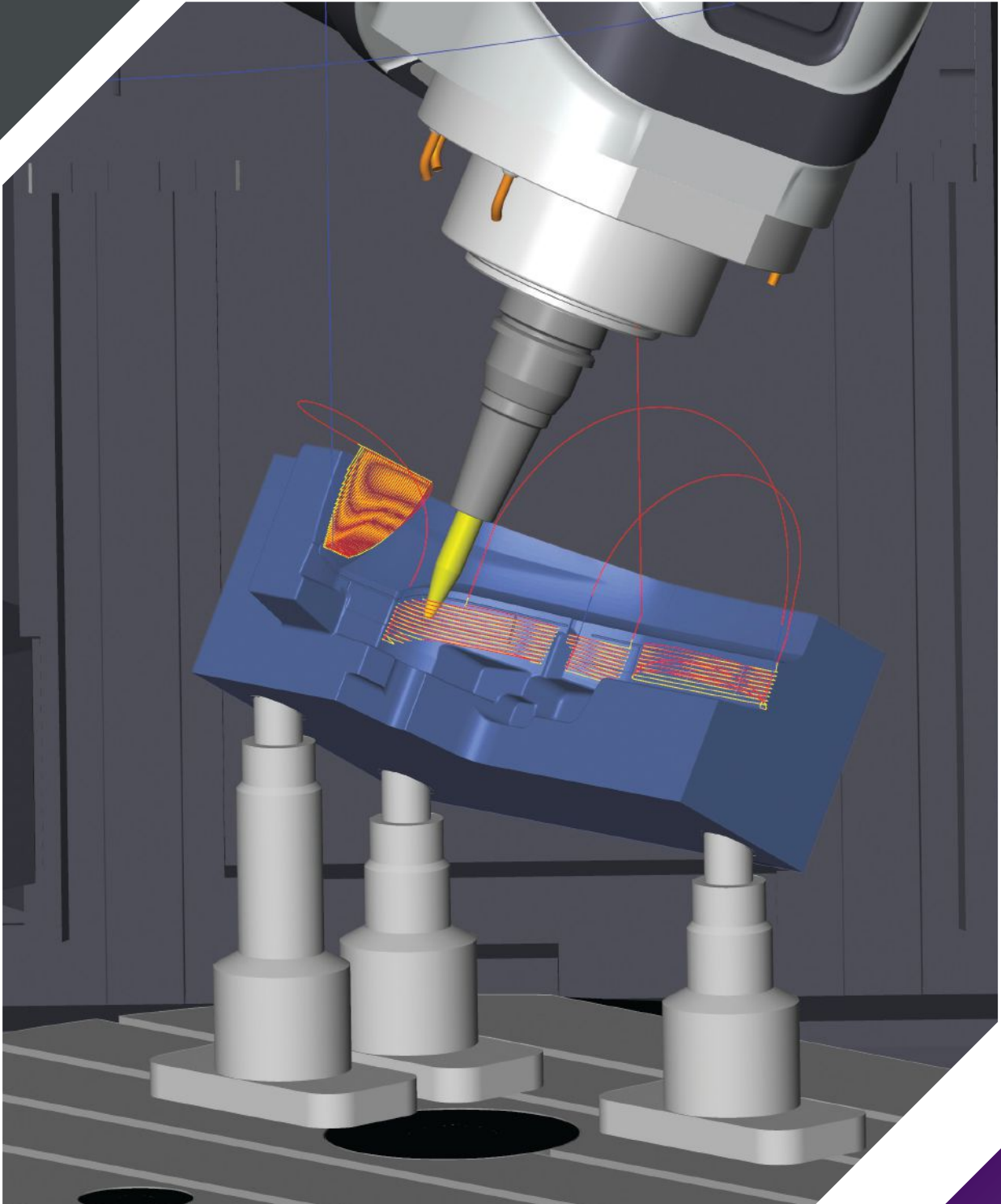
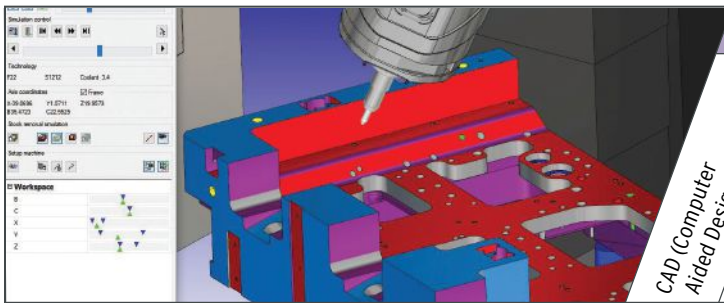

Image courtesy of Open Mind Technologies USA.



		Design									
		CAD (Computer Aided Design)	CAE (Computer Aided Engineering)	CAM (Computer Aided Manufacturing)	CIM (Computer Integrated Manufacturing)	Data Management Services	Mold Design Services	Mold Flow and Simulation Services	Reverse Engineering Software		
COMPANY	Advertisers are listed in bold type.	See Ad	1	2	3	4	5	6	7	8	
3D Systems	Rock Hills, SC - 803-326-3900		1		3						
Autodesk	San Rafael, CA, 415-507-5000		1	2	3						
Beaumont Technologies, Inc.	Erie, PA, 814-899-6390			2							
BobCAD-CAM	Clearwater, FL, 727-442-3554		1		3						
CAE Services Corporation	Batavia, IL, 630-761-9898			2							
CAM-Tool by CGS North America	Oldcastle, ON, Canada, 519-737-6009		1		3						
CAMWorks/Geometric Americas, Inc.	Scottsdale, AZ, 480-367-0132		1	2	3	4					
CGTech	Irvine, CA, 949-753-1050		1	2	3						
Creative CNC LLC	Hartland, WI, 262-347-3939		1		3					8	
Dassault Systemes	Waltham, MA, 781-810-5011		1	2	3						
DME Company	Madison Heights, MI, 248-398-6000	Back Cover							7		
DZynSource LLC	Lincoln, New Zealand, +64 219 68013		1	2							
EDGECAM Hexagon Mfg. Intelligence	Forest Lake, MN, 866-675-6551		1		3						
Epicor Software Corporation	Austin, TX, 512-328-2300										
ESPRIT by DP Technology	Camarillo, CA, 805-388-6000		1	2	3	4					
JDL Technical Services	LaSalle, ON, 519-919-7391										
JobBoss	Bloomington, MN, 800-777-4334		1								
Kubotek3D	Marlborough, MA, 508-229-2020		1		3					8	
Master3DGage	Anaheim, CA, 714-970-1683		1		3					8	
Mastercam	Tolland, CT, 860-875-5006		1	2	3					8	
Moldex3D, EPS FloTek	Naperville, IL, 630-778-7773		1	2	3	4					
MoldTrax LLC	Ashland, OH, 419-291-0790										
OPEN MIND Technologies USA Inc.	Needham, MA, 339-225-4557		1		3						
SARATECH	Mission Viejo, CA - 949-481-3267		1	2	3	4	5	6	7	8	
Siemens Digital Industry Software	Plano, TX, 800-498-5351		1	2	3					8	
Sigma Plastic Services Inc.	Schaumburg, IL, 847-558-5600			2							
Simcon Kunststofftechnische	Weurlese, Germany, +49 2405 645710										
Smart Attend Inc.	Aurora, ON, Canada, 866-210-9630										
SolidCAM Inc.	Newtown, PA, 866-975-1115		1	2	3						
SpaceClaim Corp.	Concord, MA, 978-482-2100		1	2	3						
SURFCAM Hexagon Mfg. Intelligence	Forest Lake, MN, 866-675-6551		1		3						
Synergetic Eng. & Mfg. Services	Windsor, ON, Canada, 519-903-0303		1	2	3			6		8	
Tebis America Inc.	Troy, MI, 248-524-0430		1		3					8	
TopSolid / Missler Software, Inc.	Lombard, IL, 630-889-8055		1	2	3	4					
TST Tooling Software Technology, LLC	Clarkston, MI, 248-922-9293		1	2	3			6		8	
Verisurf Software, Inc.	Anaheim, CA, 714-970-1683		1		3	4				8	
VISI Hexagon Manufacturing Intelligence	Clarkston, MI, 248-922-9293		1	2	3			6		8	
Volume Graphics Inc.	Charlotte, NC, 704-248-7736									8	
WorkNC Hexagon Manufacturing Intelligence	Novi, MI, 248-351-9300		1		3	4					
XMD - Expert Mold Designer	Windsor, ON, Canada, 519-903-0303		1	2	3			6			

For more supplier listings, go to moldmakingtechnology.com/suppliers.

Manufacturing Software					Other Software						
CNC Software	Coordinate Measuring Machine (CMM) Software	Manufacturing Automation Software	NC Simulation and Verification Software	Data Management Software	Data Translation Software	Mold Flow and Simulation Software	Mold Quoting Software	Production/Inventory Control Software	Scheduling Software	Shop Floor/Plant Layout Software	
9	10	11	12	13	14	15	16	17	18	19	WEBSITE
9			12		14	15				19	3dsystems.com
		11	12	13	14	15					autodesk.com
						15					beaumontinc.com
						15					bobcad.com
						15					caeservices.com
			12		14						camtool.com
			12	13		15					camworks.com
9			12	13	14	15					cgtech.com
			12	13	14	15					creativecnc.net
											solidworks.com
											dme.net
9		11	12								dzynsource.com
		11		13			16	17	18		edgecam.com
			12								epicor.com
		11		13			16	17	18		espritcam.com
		11		13			16	17	18	19	jobboss.exactamerica.com
					14						kubotek3d.com
	10	11			14						verisurf.com
9		11	12								mastercam.com
						15					epsflotek.com
				13							moldtrax.com
			12								openmind-tech.com
9	10	11	12	13	14	15				19	saratech.com
9	10	11	12	13	14	15	16			19	siemens.com/software
						15					virtualmolding.us
						15					simcon-worldwide.com
		11		13				17			smartattend.com
			12								solidcam.com
											spaceclaim.com
9		11	12								surfcam.com
			12		14						synergeticgroup.com
			12	13	14						tebis.com
					14						topsolid.com
9	10		12	13	14	15	16		18		tst-software.com
	10				14						verisurf.com
9		11	12	13	14	15	16				visicadcam.com
	10					15					volumegraphics.com
9		11	12	13	14	15	16				worknc.com
					14						synergetic-xmd.com

Service categories are noted in the highlighted columns.

Image courtesy of Precision Mold & Machining Services Inc.

Software Enhancements Increase Power and Improve Efficiency

CGTech's Vericut 9.0 simulates real NC data on digital twin machines to prevent crashes, identify conflicts between setups and tooling, and ensure machined parts match engineering designs. According to the company, the software's graphics display provides crisp views, which can be rotated or zoomed while cutting, and it features several enhancements designed to increase power and improve efficiency. Instant access to viewing the workpiece, CNC machine or both saves time, and improved connectivity to tooling websites and cloud repositories auto-configures Vericut for optimization. Major functions can be used in any view and can easily switch between workpiece and machine views, layouts and docking arrangements.

The software provides more ways to section the part, streamlines setup for toolpath optimization and significant enhancements for lathe and mill-turn tooling. Vericut's force optimization reduces machining times up to 70%, even for superalloy metals. It enforces manufacturer's recommended cutting conditions to greatly extend tool life. The software also detects collisions and near-misses between all machine tool components. It simulates all types of CNC machining, including drilling and trimming of composite parts, water jet, riveting, robots, mill/turn and parallel kinematics. The software operates independently but can also be integrated with leading CAM systems.

CGTech / 949-753-1050 / cgttech.com

Software Improves Five Axis Movements for High Accuracy Parts

CAM-TOOL by **CGS North America, Inc.** has improved its simultaneous five-axis conversion (auto) function. The process has been updated to decrease movement of unnecessary axis when unnecessary. This reduced movement in the machine resulting in smoother more accurate tool paths. Having less axis to control makes the tool paths easier for the user to create.

With the ongoing movement toward the barrel cutters, CAM-TOOL has expanded its functionality of barrel cutters by adding "3D Offset Cutting" and "Curve Control Along Surface" to the list of many other tool paths that support barrel and lens cutters. When it is combined with simultaneous five-axis machining, this can show large reductions in cycle times all while increasing surface finish.

Component point (control point) rearrangement has been implemented to achieve the smooth movement of the machine tool and obtain the best surface finish possible. It arranges component points at equal intervals to ensure perfect tool paths at the machine. Rearrangement type is "Aligned" and "Alternate", enabling the user to control points even more than before.

Improving the drilling functions in CAM-TOOL has been updated with the addition of G01 cross hole drilling. G01 cross hole drilling controls the feed rate when crossing holes. It recognizes the crossing section of previous processes and changes the feed rates accordingly. This is all done automatically by using the stock model to understand where to apply this strategy. This improves deep hole drilling by reducing the feed rate only at the crossing section, while improving tool life by avoiding chipping when breaking through cross holes.

CAM-TOOL by CGS North America, Inc. / 844-737-6009 / camtool.com

Software Update Suited for Industrial Computed Tomography

Volume Graphics announces the latest generation of its software solutions for non-destructive quality assurance with industrial computed tomography (CT): Version 3.3 of VGStudio Max, VGStudio, VGMetrology and VGINLine. Updates in 3.3 include multi-material dimensioning, native Q-DAS support, OCR-based automation and high-quality volume meshing.

VGStudio Max software is used for analysis and visualization of industrial CT data and covers all requirements related to metrology, defect detection and assessment, material properties and simulation. Using the latest version, users can determine the surfaces of multi-material components, export measurement and analysis results to store them centrally in quality-management software, automate inspection processes more flexibly based on text recognition and translate real CT data into volume meshes for simulation. The latest updates facilitate segmentation of multi-material objects and includes native support

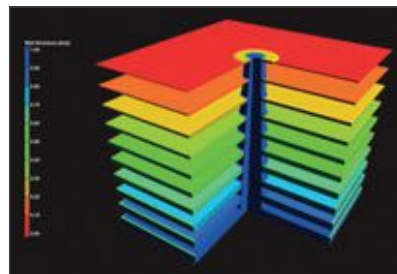

for data export in Q-DAS format for both VGStudio Max and the VGMetrology metrology solution, as well as the VGINLine solution for automated CT inspection. Optical character recognition enables users to read out text in CT scans and store it in meta information. With the volume meshing module, users can create accurate and high-quality tetrahedral volume meshes from CT scans for use in mechanical, fluid, thermal, electrical and other FEM simulations in third party software. This is based directly on the subvoxel-accurate surface determination for scanned parts or material samples consisting of one or more materials. The individual components of multi-material objects are translated into volume meshes with congruent tetrahedron faces and shared nodes at material interfaces. Each cell of the generated volume mesh can be loaded with additional information required for simulation, such as fiber orientations, fiber volume fractions, porosity volume fractions or gray values. To further support users, the company has also added a new technical consulting unit that provides professional consulting and evaluation services.

Volume Graphics Inc. / 704-248-7736 / volumegraphics.com

Software Package Offers Design Validation Behind the Desk

Moldex3D's eDesign solution package offers an interactive interface, which facilitates part and mold modeling, provides auto meshing technology and enables users without advanced CAD knowledge to work. With 3D models, users can visualize flow and thermal properties, design products with quality, reduce development costs and shorten time to market. Other benefits include modeling a part with complete runner and cooling systems, performing 3D numerical analyses with accuracy, and generating reports automatically.

Moldex3D, EPS FloTek / 888-66533933 / epsflo.com

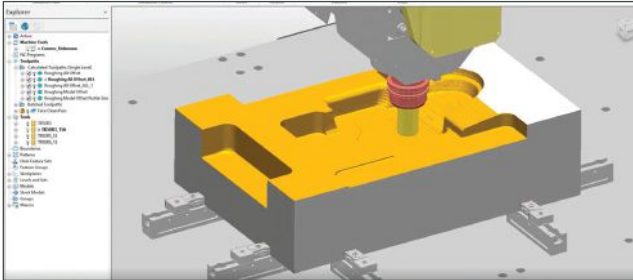

CAM Software Provides Expert CNC Programming Strategies

PowerMill five-axis CAM software from **Autodesk, Inc.** provides expert CNC programming strategies for complex three- and five-axis subtractive, high-rate additive and hybrid machining. Features in the latest software release enable easier three- and five-axis programming, simulation and verification, including accessing a vast library of CNC strategies to reduce programming times with rapid toolpath calculation. The release offers shortening machining times, improving control with advanced toolpath editing and automating programming with customizable templates and macros, prolonged tool life and reduced maintenance costs with interactive tools to help identify and repair toolpath motion.

Autodesk, Inc. / 877-335-2261 / autodesk.com/solutions/manufacturing

Software Features Automation Functionality

NCSIMUL from Hexagon Manufacturing Intelligence is designed to streamline CNC programming and increase shop-floor flexibility. Based on client-server scheduling architecture, the NCSIMUL machining module now includes automation functionality that provides wider control for jobs across various devices by communicating with distant servers. A dedicated graphical user interface now allows tasks such as simulation, cut analysis and 3D movies to be performed on any device. This enables users to follow the status of jobs and receive notifications when they are complete. The NCSIMUL Automation Module enables users to implement automation rules and production priorities, and tasks are featured in a command file that can be customized.

SPRING Technologies Inc. (NCSIMUL SOLUTIONS) / 617-401-2197 / ncsimul.com

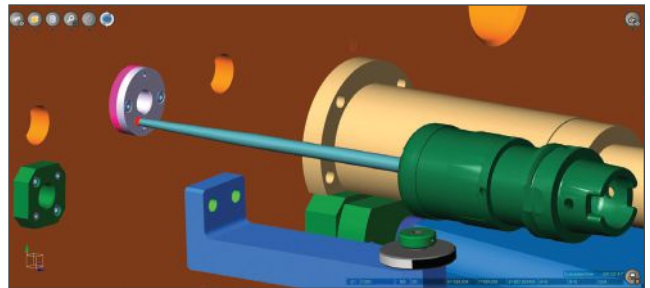

The Insight That Matters Most to Your Business



Whether you are a manufacturer, equipment supplier or finance professional, we provide deep, rich, actionable insights about durable goods manufacturing.

- Industrial Reports
- Economic Trends
- Surveying
- Custom Modeling

Leverage the power of industry-leading intelligence in your operation.



513-527-8800 | gardnerintelligence.com

5 Ways to Cut Programming Time

By Matthew Raleigh

If you are a mold builder looking for ways to reduce programming times and improve your machining processes, then consider these five steps:

1. Import CAD Files

Use CAD to design and help program faster rather than doing the math on your own. Working with a variety of customer file types that may come your way is a huge time saver, especially when working with solid model files or wireframe drawings. If you can open them, you can measure them, edit them and even convert them to g-code.

2. Cross-Posting

Write a g-code for multiple types of machines, machine configurations and controllers, and easily switch between control types and machine configurations using a postprocessor. This step gives you the ability to wire g-code for the machine you currently have and the one you'll get in the future. Writing

hundreds of lines of g-code in seconds, programming all kinds of two-axis, three-axis and beyond CNC movements is possible. So is cutting everything from basic hole cycles to complex hard milling on full full-axis and multi-axis machines.

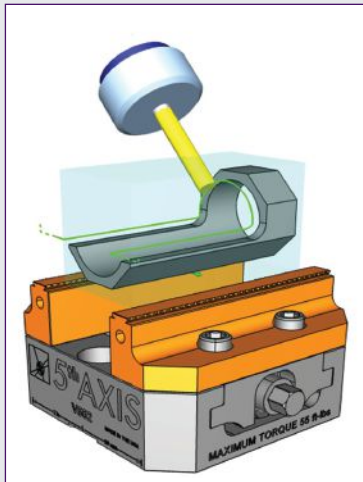

Flexible programming workflow eliminates redundant tasks and allows machinists to reuse toolpath settings and establish standard processes.

3. Simulate and Report

Document your programming process with live feedback as you fine-tune your toolpath features. Prove out processes

before the job material, equipment or tooling is available. Seeing what's going on before you get out to the machine can make a huge difference. Thinking something through is one thing; seeing it in real-time is another. Before you set up a single work offset or optimize

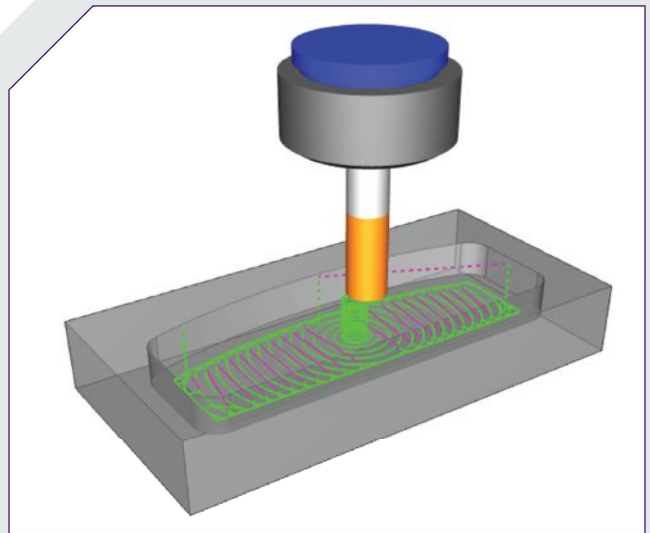

Images courtesy of BobCAD-CAM.

Reduce your cycle times, extend tool life and minimize wear and tear on your equipment with modern toolpath strategy.

fixturing for a production run, don't you want to see what you planned out in your head? For example, the direction the tool is moving, length the tool is sticking out, clamp fixtures or work holding obstacles, the time it takes, amount of stock and clearance. Simulating and reporting helps you avoid costly mistakes and gain a greater understanding of job requirements.

4. Save and Load Machining Features

Create single operations per feature or customize multiple operations tied to a single feature. This flexible programming workflow eliminates redundant tasks. Reuse your toolpath settings and establish standard processes. Each tool, material, setup and machine must work together to achieve a delicate balance. For example, how aggressively you cut, the stock you leave for the finish and how quickly you move. Testing, experience and learning from the experience of others will help you capture best practices and continually apply them.

5. Use Adaptive Tool Paths

Take advantage of what current technology has to offer modern cutting strategies on today's powerful and fast CNC machines. Cut deeper, run smoother and increase material removal rates. For example, adaptive tool paths are quickly becoming the standard for two-, three-, four- and five-axis roughing. Reduce your cycle times, extend tool life and minimize wear and tear on your equipment with this modern toolpath strategy. [MMT](#)

FOR MORE INFORMATION

BobCAD-CAM Inc. / 877-262-2231 / bobcad.com
Matthew Raleigh, Training Manager

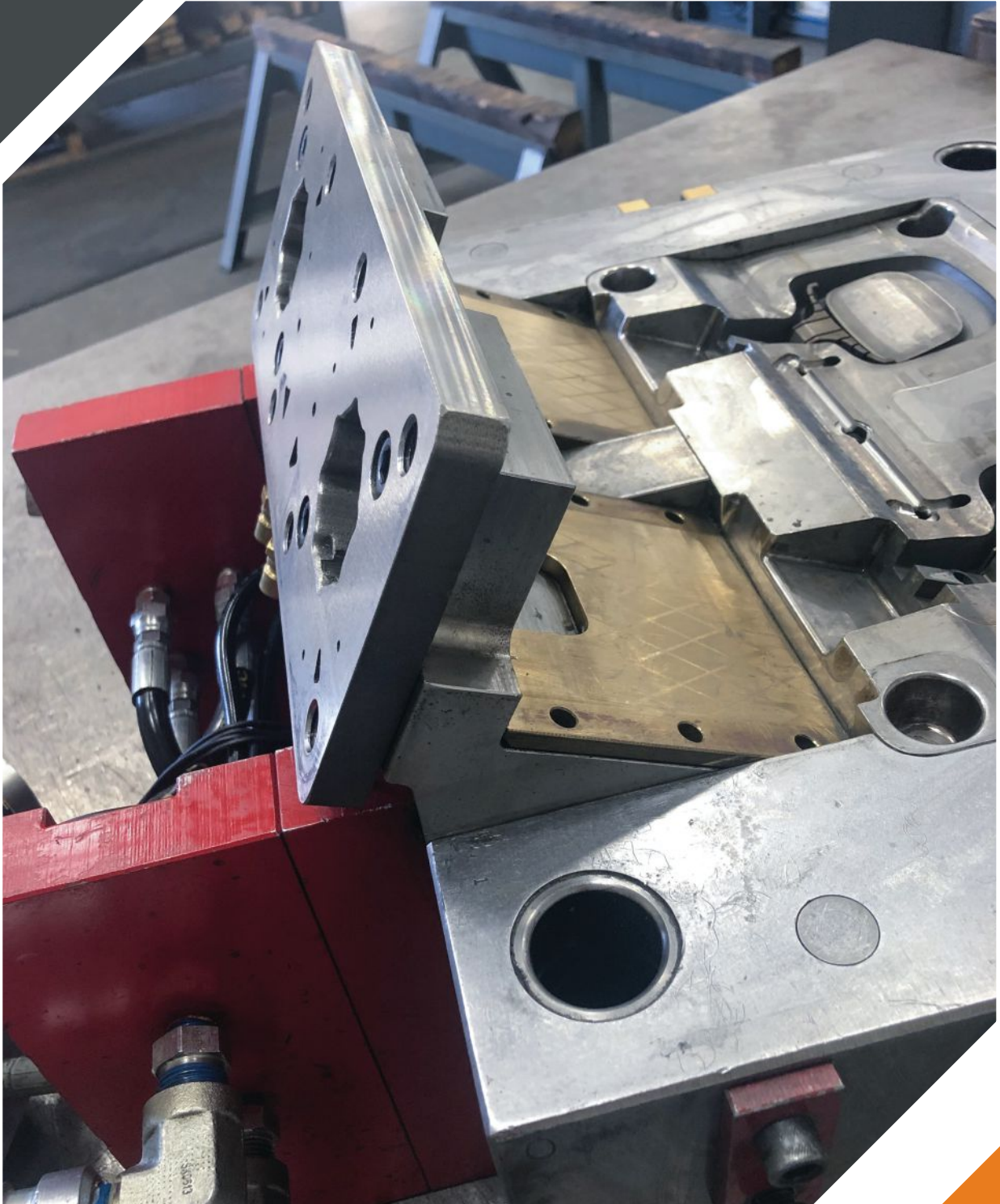
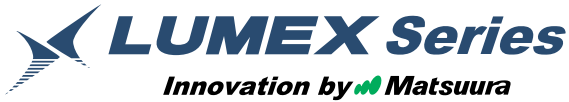

Image courtesy of Next Chapter Manufacturing.



Matsuura Machinery USA, Inc.
325 Randolph Ave.
St. Paul, MN 55102

Phone: 651-289-9700

MatsuuraUSA.com

PRODUCTS/SERVICES



Matsuura LUMEX Avance-25

Matsuura's cutting-edge technology is transformative in today's world of 3D Metal Additive Manufacturing. With Matsuura's combination of best-in-class CNC Milling and high speed Direct Laser Melting, Matsuura has fundamentally revolutionized the AM marketplace.

Matsuura's unique combination of technology platforms enables the production of parts and component geometries in a method that has never been possible nor imagined.

Matsuura LUMEX Avance-60

Matsuura customers are seeing the value that comes with implementing additive manufacturing technology into their tools. These include conformal cooling channels, porous venting, and virtually no concerns over deep ribs. Additionally, it is quick-turn manufacturing, which means the ability to build a production tool in days versus weeks or months, with reduced tooling costs. Finally, those toolmakers who are also injection molders are reaping the additional benefits of cycle time savings, thanks to an additively manufactured mold's far greater cooling capability.



Matsuura Machinery USA LUMEX Additive Manufacturing Center

Matsuura's Additive Manufacturing laboratory and demonstration facility is located within Matsuura's corporate headquarters in St. Paul, MN.

The Center functions as a showroom and as a development center. Matsuura USA is developing new powders and new hybrid technologies at the location. In addition, Matsuura engineers perform service bureau work for customers and test cuts to prove out the hybrid process.

Learn more about Matsuura's LUMEX Technology by contacting your exclusive Matsuura Distributor.

WEBSITE



Matsuura USA delivers unmatched excellence in 5-axis, vertical, horizontal, linear motor, multi-tasking CNC machine tools and machines with a powder bed metal AM platform and machining capability.

MatsuuraUSA.com

PRODUCT CATEGORIES

- **Five-Axis Machining Centers**
- **Horizontal Machining Centers**
- **Vertical Machining Centers**
- **Linear Motor Machines**
- **Additive Manufacturing (AM)**
- **3D Printing**
- **Hybrid Machines**

 **Matsuura**

 **LUMEX Series**
Metal Laser Sintering Hybrid Manufacturing

**PERFORM
HIGH-PRECISION
MACHINING**

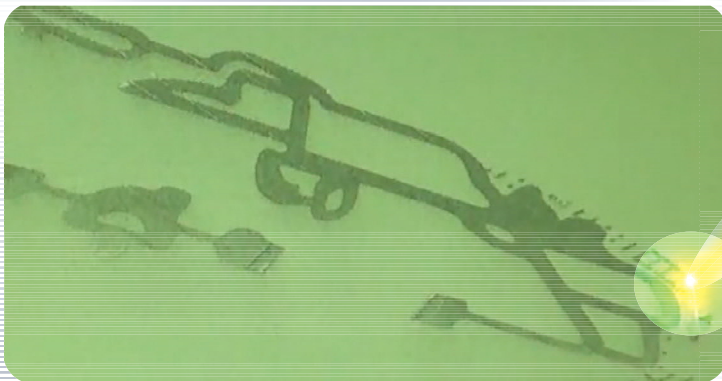

The **LUMEX Avance-25** – the world's first 3D Printing, Metal Laser Sintering Milling Hybrid CNC machine tool – is a truly innovative platform in Net Shape Form and Additive Manufacturing with the integration of a proven **Matsuura** high-speed milling spindle for subtractive machining processes.

- ✓ Minimize mold assembly by combining multiple inserts into one with **precise accuracy**
- ✓ Make density changes using porous sintering **without restriction** allowing improved gas venting conventional methods
- ✓ Perform **high-precision** machining of deep and thin ribs without EDM
- ✓ Create **superior mold performance** through integrated cooling channels and structures
- ✓ **Reduce** design to finish lead time

Learn more about our LUMEX series at:

MatsuuraUSA.com | MatsuuraLUMEXAM@matsuurausa.com | 800.518.4584



COMPANY	Advertisers are listed in bold type.	See Ad	<div style="display: flex; justify-content: space-between;"> <div style="writing-mode: vertical-rl; transform: rotate(180deg); font-size: 8px;">Additive Manufacturing Machines- Binder Jetting</div> <div style="writing-mode: vertical-rl; transform: rotate(180deg); font-size: 8px;">Additive Manufacturing Machines- Directed Energy Deposition</div> <div style="writing-mode: vertical-rl; transform: rotate(180deg); font-size: 8px;">Additive Manufacturing Machines- Material Extrusion</div> <div style="writing-mode: vertical-rl; transform: rotate(180deg); font-size: 8px;">Additive Manufacturing Machines- Material Jetting</div> <div style="writing-mode: vertical-rl; transform: rotate(180deg); font-size: 8px;">Additive Manufacturing Machines- Powder Bed Fusion</div> <div style="writing-mode: vertical-rl; transform: rotate(180deg); font-size: 8px;">Additive Manufacturing Machines- Vat Polymerization</div> <div style="writing-mode: vertical-rl; transform: rotate(180deg); font-size: 8px;">Additive Manufacturing Machines- for Ceramic Parts</div> <div style="writing-mode: vertical-rl; transform: rotate(180deg); font-size: 8px;">Additive Manufacturing Machines- for Composite Parts</div> <div style="writing-mode: vertical-rl; transform: rotate(180deg); font-size: 8px;">Additive Manufacturing Machines- for Metal Parts</div> </div>								
			1	2	3	4	5	6	7	8	9
3Dprintedparts.com	Grand Rapids, MI, 616-871-9889					4	5	6		9	
3D Hybrid Solutions	Seal Beach, CA, 309-264-4834		2							9	
3D Systems	Rock Hill, SC, 803-326-3900				4	5	6			9	
Absolute Machine Tools Inc.	Lorain, OH, 440-960-6911										
AddiFab	Jylinge, Hovedstaden, DK, 650-526-8120 (US)						6				
AddUp Inc.	Greenville, SC, 240-707-9147		2			5				9	
ARBURG, Inc.	Rocky Hill, CT, 860-667-6500			3							
Baker Industries	Macomb, MI, 586-286-4900										
BeAM Machines	Cincinnati, OH, 513-745-4510		2							9	
Centorr	Nashua, NH, 800-962-8631										
CGTech	Irvine, CA, 949-753-1050										
Coherent OR Laser	Dieburg, Germany, +49 6071 209 890		2			5					
Concept Laser	Grapevine, TX, 817-328-6500		2			5					
DMG MORI	Hoffman Estates, IL, 847-593-5400		2			5			8	9	
EnvisionTEC	Dearborn, MI, 313-436-4300						6	7	8		
EOS North America	Novi, MI, 877-388-7916					5				9	
Evolve Additive Solutions	Minnetonka, MN, 952-314-2061										
ExOne	North Huntingdon, PA, 724-863-9663		1					7	8	9	
Formlabs	Somerville, MA, 617-702-8476						6				
GE Additive	Mölnlycke, Sweden, +46 31 710 32 00		1	2		5				9	
GF Machining Solutions	Lincolnshire, IL, 847-913-5300					5				9	
GPI Prototype & Manufacturing Services, Inc.	Lake Bluff, IL, 847-615-8900					5				9	
Linear AMS	Livonia, MI, 734-422-6060									9	
Matsaura Machinery USA, Inc.	St. Paul, MN, 651-289-9700	23			3	5			8	9	
Mazak Corporation	Florence, KY, 859-342-1700										
Met-L-Flo Inc.	Sugar Grove, IL, 630-409-9860										
Methods 3D, Inc.	Sudbury, MA, 978-443-5388					5	6		8	9	
Proto Labs, Inc.	Maple Plain, MN, 763-479-3680									9	
Renishaw Inc.	West Dundee, IL, 847-286-9953		2			5				9	
SARATECH	Mission Viejo, CA, 949-481-3267				3	4	5		8	9	
Sciaky, Inc.	Chicago, IL, 708-594-3800		2							9	
SLM Solutions NA, Inc.	Wixom, MI, 248-243-5400					5				9	
Sodick, Inc.	Schaumburg, IL, 847-310-9000					5				9	
Star Rapid Ltd.	Guangdong, China, +86 760 2222 255						6				
Stratasys Direct Manufacturing	Valencia, CA, 661-295-4400					5	6				
Stratasys Inc.	Eden Prairie, MN, 800-937-3010				3	4					
Trumpf Inc.	Farmington, CT, 860-255-6000		2								
Velo3D	Campbell, CA, 408-610-3915					5				9	
voestalpine High Performance Metals Corp.	Elgin, IL, 630-883-3000					5				9	
Xometry	Gaithersburg, MD, 240-252-1138		1		3					9	

For more supplier listings, go to moldmakingtechnology.com/suppliers.

	Additive Manufacturing Machines for Polymer Parts	Hybrid Additive Manufacturing Machines	Material for Additive Manufacturing	Material for Additive Manufacturing-Composites	Material for Additive Manufacturing-Metal	Material for Additive Manufacturing-Polymer	Material-Handling Equipment for Additive Manufacturing	Part & Tooling Production Services-Additive Manufacturing	Postprocessing Equipment for Additive Manufacturing	Safety Equipment for Additive Manufacturing	Software for Additive Manufacturing- Job & File Management	Software for Additive Manufacturing- Manufacturing-Part Design	Training and Consultancy Services-Additive Manufacturing	
	10	11	12	13	14	15	16	17	18	19	20	21	WEBSITE	
	10			13	14		16						21	3dprintedparts.com
		11												3dhybridsolutions.com
	10			13	14		16	17				20	21	3dsystems.com
		11												absolutemachine.com
	10			13	14									addifab.com
				13			16		18				21	addupsolutions.com
	10						16							arburg.us
														bakerindustriesinc.com
								17						beam-machines.com
										19				vacuum-furnaces.com
		11												cgtech.com
														or-laser.com
														conceptlaserinc.com
		11												dmgmori.com
														envisiontec.com
	10			13	14	15							21	eos.info
	10				14									evolveadditive.com
							16							exone.com
	10							17						formlabs.com
				13										ge.com/additive
														gfms.com/us
							16							gpiprototype.com
	10						16						21	linearmold.com
		11												matsuurausa.com
		11												mazakusa.com
							16							metflo.com
														methods3d.com
	10		12	13			16							protolabs.com
				13						19	20	21		renishaw.com
	10		12	13	14		16			19	20	21		saratech.com
							16							sciaky.com
				13										slm-solutions.us
														sodick.com
				13	14		16							starrapid.com
				13	14		16							stratasysdirect.com
							16							stratasys.com
														us.trumpf.com
														velo3d.com
		11		13									21	voestalpine.com/highperformancemetals
10				13	14									xometry.com

Service categories are noted in the highlighted columns.

Image courtesy of Matt Danford.

Machining Center Combines Five-Axis Milling with Laser AM

Okuma America Corp.'s

MU-8000V Laser EX multitasking machine combines five-axis machining with a Trumpf laser, providing both additive and subtractive manufacturing capabilities. It enables complete part production on one machine.

The machine implements laser metal deposition (LMD) technology to provide users with the ability to cut parts of different sizes and shapes. LMD supplies powder from nozzles and performs laser melting and bonding to parent material. This enables the combination of various types of materials, as well as three-dimensional fabrication and cladding. Variable control of laser spot diameters (from 0.4 to 8.5 mm) increases efficiency and resolution, according to the company. This combination of features enables mid-process part inspection and material exchange, coolant use in the work envelope and greater process speed.

Okuma America Corporation / 704-588-7000 / okuma.com



3D Printer Offers Latest in Digital Light Processing Technology

Gesswein introduces the Evers desktop 3D printers, which use the latest in digital light processing technology. An intuitive user interface and self-calibration enables users to take designs from ideation to creation. Designed are printed layer by layer, from 25 to 200 micron depending upon which Sisma refillable resin used. Zero tilting technology (ZTT) ensures that parts are not pulled away from the vat when printing. In ZTT, the glass affixed to the vat tilts gradually between layers, separating the first printed layer from the bed. This avoids suction between the object and the print bed, reducing the amount of process-related mechanical stresses on the model, and promoting better layer adhesion throughout the part. Smart building platform provides self-alignment and self-zeroing of the build platform at every printing cycle, eliminating any human calibration intervention. The automatic detachment function also eliminates the risk of breaking the newly printed objects. The use of PTFE in the bottom of the vat, an inert material in the exothermic photo-curing process, allows for a non-degenerative printing, granting a very high dimensional precision, together with a high repeatability of the process. The alignment and zeroing of the building platform take place automatically for every print job, without the need for any manual intervention, thus limiting any possible human error. Resin cartridge types are automatically recognized by Tag RFID; the resin loading/unloading operations are automatically managed at the start and at the end of every single printing process. Available in 0.5L cartridges. Available in two models (Zero and Uno) which have different platform sizes. Made in Italy.

Gesswein & Company / 800-243-4466 / gesswein.com



Software Add-On Streamlines Design for Additive Manufacturing Cycle

3D Systems' latest software solution, 3DXpert for SolidWorks 15, prepares and optimizes users' designs for additive manufacturing. This enables users to design complex structures and accelerate the product design life-cycle with better automation and seamless bi-directional data exchange. These enhancements help provide an accelerated path

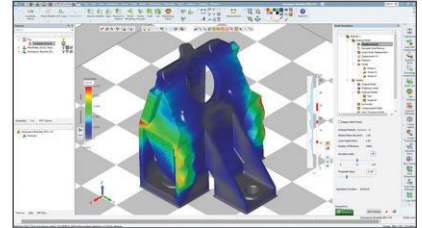

to design freedom, increased efficiency, reduced total cost of operation and gain competitive advantage for a range of applications and industries.

3DXpert is an add-on for SolidWorks, extending the program's design capabilities with a complete design for additive manufacturing toolset, equipping designers with everything they need to prepare and optimize their designs for 3D printing.

3D Systems / 888-337-9786 / 3dsystems.com

Software Combines Hybrid and Additive Manufacturing

OPEN MIND Technologies offers an additive manufacturing (AM) capability option in *hyperMill* CAM software to support 3D printing/additive processes that also provides efficient hybrid processing with simultaneous additive and subtractive processing on one machine. For highly complex five-axis simultaneous processing, the software enables an array of flexible options for directed energy deposition processes and wire arc additive manufacturing (WAAM).

The software also enables users to program the cladding and milling together. Key additive applications include repair of damaged components, cladding of additional surface skins or creation of new components from a substrate. This also creates options for combining different materials, such as when high-quality material layers have to be applied to carrier materials.

OPEN MIND Technologies USA Inc. / 888-516-1232 / openmind-tech.com

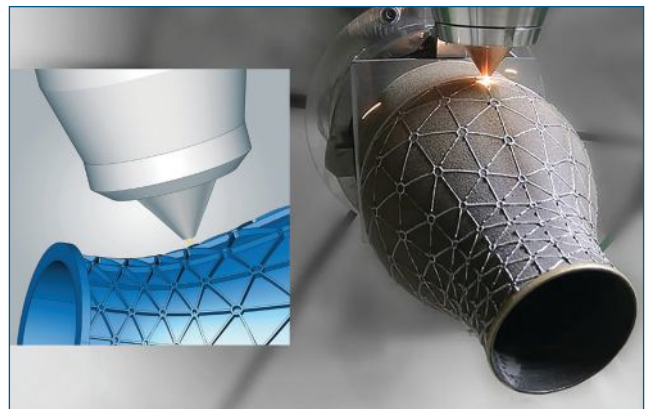

Freeform Injection Molding Creates Mold Cavities with High-Performance Materials

AddiFab has been working on freeform injection molding (FIM), a unique blend of AM and injection molding, and now the company is ready to step into the spotlight. The proprietary platform is used to create injection mold cavities. They are also dissolvable, which enables injection-molding components that are too complex for conventional tooling.

AddiFab has been doing extensive testing on specific grades of Tefabloc, one of Mitsubishi Chemical's high-performance TPE materials. The Tefabloc material parameters were quickly able to overmold, as well as demonstrate the geometric complexity that is possible with FIM.

AddiFab ApS / 452-680-3210 / addifab.com

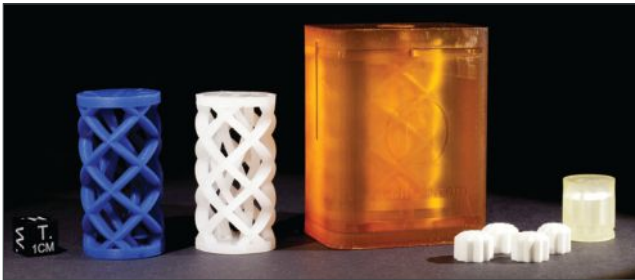

3D Printing System Incorporates H13 Tool Steel for Hot and Cold Tooling Applications

Desktop Metal announced the launch of H13 tool steel for the Studio System, a metal 3D-printing system for prototyping and low volume production. Characterized by its stability in heat treatment, exceptional hot hardness and abrasion resistance, H13 is a tool steel widely used in hot work applications. High toughness and hardness also make it an ideal metal for cold work tooling applications. According to the company, including H13 tool steel will enable designers and engineers to print such items as mold inserts for rapid iteration and reduction of manufacturing lead times, as well as achieve complex geometries.

With the company's 3D-printing system, the part can incorporate a conformal cooling channel, increasing the cooling rate of the mold and reducing the cycle time. It also reduces the wear on EDM tooling required to finish the mold, reducing both lead time and costs. Using the 3D-printing system with H13 tool steel enables design teams to quickly produce dies featuring complex extrusion profiles. With the system's high resolution nozzle, users can achieve the fine details required for molding fashion/consumer products, such as logos, textures and subtle draft angles, saving time and costs. H13's hot work capability also enables fabricating molds for die casting applications.

Desktop Metal / 978-224-1244 / desktopmetal.com

MMT
MoldMaking
TECHNOLOGY®

ENGINEER / BUILD / MAINTAIN

WEBINAR

PRESENTED BY:

formlabs 

formlabs.com

PRESENTERS:



Mack Mor
Senior Product Engineer, OXO



Analisa Russo
Technical Community Manager, Formlabs

Get to Market Faster: How to Create Silicone Parts with 3D Printed Molds

Short run production can be technically challenging, costly, and slow. By leveraging 3D printing, more efficient, and cost-effective workflows can be achieved. Companies like OXO are able to rapidly cast silicone parts using molds they've 3D printed in-house.

In this webinar, learn the step-by-step process of how to use RTV moldmaking and in-house 3D printing to rapidly produce silicone parts. You'll hear from senior product engineer at OXO, Mack Mor, who will teach you his tips and tricks with casting silicone into 3D printed molds.

You will learn about:

- The seven specific steps you can take to perform quick silicone casting with in-house 3D printed molds.
- How OXO created a gasket for a cocktail shaker using 3D printing.
- Best practices for mold design, alignment features, and material selection for RTV moldmaking.

DATE & TIME:

Monday, July 27, 2:00 PM EDT

Register at: short.moldmakingtechnology.com/formlabs07

How to Improve 3D-Printed Conformal-Cooled Mold Insert Performance

By John Marr

3D-printed molds with conformal cooling channels yield more efficient heat transfer, but the geometrically intricate channels may increase the likelihood of scaling. Scaling decreases flow and worsens the integrity of the cooling channel walls, which leads to leaking.

Maintenance solutions for eliminating scaling and corrosion range from cooling channels flushing with aggressive cleaning media that can damage the mold, to gentler ultrasonic cleaning that may be ineffective. Shops also opt to fix leaking cooling channels, which has high costs and downtime, and, in many cases, is not possible.

Another option for combating scaling and corrosion is to coat the inner diameter of the cooling channels. Most mold builders and parts manufacturers are familiar with electro-

Another option for combating scaling and corrosion is to coat the inner diameter of the cooling channels.

plating or PVD coating mold surfaces to increase hardness and to extend mold life, but many do not realize that a surface treatment to the inner cooling channels will improve the lifespan of a mold's interior as well.

Applying a thin layer of internal, ultra-thin, thermally conductive ceramic coating can provide several benefits that ultimately prolong the lifespan of the cooling channels, provide better uptime and save an injection molder money. The coating is thin enough (50-100 microns) that it has no measurable effect on heat transfer.

This coating in the cooling channels has the following characteristics and benefits:

- The coating creates smooth walls that decrease scaling, as dissolved minerals and impurities have difficulty gaining a foothold in the channels.
- The coating provides a layer between the cooling water and the metal wall, preventing dissolved metals from occurring.
- A uniform coating throughout the inner diameter of the cooling channels promotes a uniform thermal gradient.

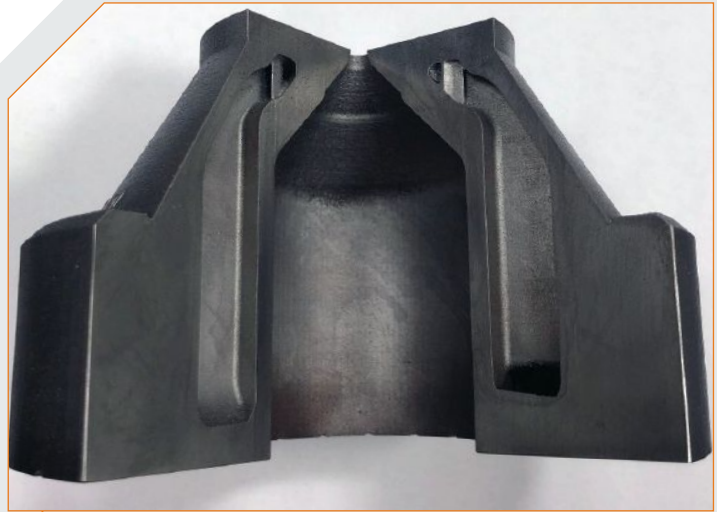

Image courtesy of Next Chapter Manufacturing.

Cleaning and protecting 3D-printing conformal cooling channels in tooling like this is a challenge, but the right surface treatment can help.

- The very hard coating (9.0 on Mohs Hardness Scale) limits pitting corrosion.
- The coating seals any micro cracks or voids that may have formed during fabrication or heat treating.
- The coating formulation is chemical- and solvent-resistant, allowing it to be used in conjunction with an aggressive chemical clean of the cooling channels during maintenance.
- After over 1,000 hours (ASTM B117) in a salt fog test the coating formulation exhibited no blistering, cracking, softening or delaminating, demonstrating robust resistance to water and mineral content.

The coating is also effective in fixing molds that leak as a result of inferior 3D prints with voids in the cooling channel walls or inadequate traditional mold fabrication. This coating application can serve as an inexpensive alternative to welding repair or mold replacement.

Before you start a production run with a new mold or retire a leaking mold, consider having the inner diameter of the cooling channels surface treated. This step will reduce maintenance stoppages, improve cycle times and reduce mold replacements. [MMT](#)

FOR MORE INFORMATION

Alcadyne LLC / 720-541-9872 / alcadyne.com
John Marr, CEO
Jason Thompson, Technical Sales

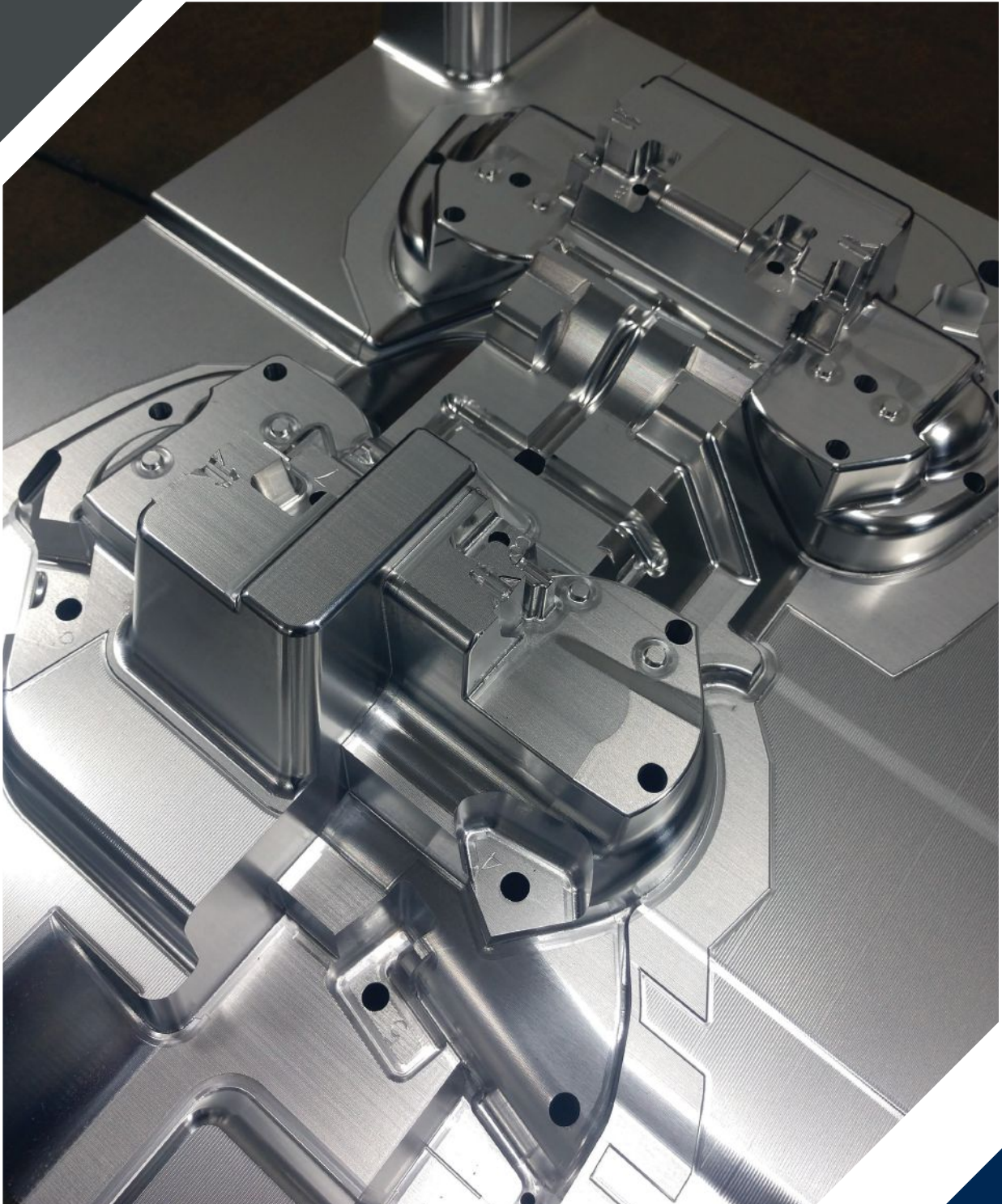

Image courtesy of Innovated Machining Solutions.



International Mold Steel
 1155 Victory Place
 Hebron KY, 41048

Phone: 859-342-6000
 Fax: 859-342-6006
 RFQs to: SalesDesk@imsteel.com
 Email: doug@imsteel.com

imsteel.com

PRODUCTS/SERVICES



Nak 55
 Pre-hardened to 38-42 HRC. Uniform hardness even in large cross sections of material. Never needs stress relieving. Machines 30-40% faster than P20. Highly weldable without showing any evidence on the plastic part. EDM layer is easy to remove. Material stocked up to 12-3/4" thick. Rounds available up to 22" in diameter.



Nak 80
 Pre-hardened to 38-42 HRC. Uniform hardness even in large cross sections of material. Never needs stress relieving. Machines 10-15% faster than P20. Highly weldable without showing any evidence on the plastic part. EDM layer is easy to remove. Polishes up to a lens-quality finish. Material stocked up to 12-3/4" thick. Rounds available up to 5" in diameter.



S-Star ESR
 Plate product comes in the annealed hardness range and can be heat-treated up to 50-53 HRC. Round product comes in the pre-hard condition (31-34 HRC), however this can also be heat-treated to 50-53 HRC.
 Excellent corrosion resistance, Superior mirror-finished surface. Minimal distortion, less than ±0.03% after heat treatment.

WEBSITE



International Mold Steel supplies specialty mold steels. IMS also provides value-added processes such as surface grinding, squaring, milling, laser engraving and CNC machining. imsteel.com

PRODUCT CATEGORIES

- Band Saws
- Grinding Machines
- Laser Engraving
- Milling Machines
- Tool Steel/Mold Steel
- Vertical Machining Centers

☆☆☆☆ KNOCK-OUT ☆☆☆☆

THE COMPETITION WITH THE ONE-TWO PUNCH!

FROM  DAIDO STEEL

PLASTIC & RUBBER MOLD STEELS

NAK80 & **NAK55**
(38-42 HRC) (38-42 HRC)

High Polish – lens quality SPI A-1 Finish
Easy to Machine – no hard spots

Very Stable – does not need stress relieving

Capable of the perfect weld – polished and textured surfaces

Easy to Machine – 30-50% easier than P20

Very Stable – does not need stress relieving

Capable of the perfect weld – polished and textured surfaces



INTERNATIONAL MOLD STEEL, INC.

☆☆☆☆☆☆☆☆ A DAIDO STEEL PARTNER COMPANY ☆☆☆☆☆☆☆☆

INTERNATIONAL MOLD STEEL, INC.



WWW.IMSTEEL.COM | 800.625.6653

		Aluminum Alloys	Aluminum Cast Plate	Beryllium Copper	Beryllium Copper Substitute Alloys	Brass
		1	2	3	4	5
COMPANY	Advertisers are listed in bold type.	See Ad				
Alimex Precision in Aluminum Inc. - Columbia, SC, 803-636-6479			1	2		
Alpase - Chino, CA, 951-685-2155			1	2		
Alro Steel Corporation - Jackson, MI, 517-787-5500			1	2	3	4 5
Ampco Metal Inc. - Sturtevant, WI, 847-437-6000					4	
BMS Burns - Medina, OH, 800-345-7693						
Buderus Edelstahl GmbH - Tecumseh, ON, Canada, 519-562-6651						
Clinton Aluminum and Stainless Steel - Clinton, OH, 330-882-6743			1	2		
Constellium - Ravenswood, WV, 304-531-0116			1	2		
Diehl Tool Steel Co. - Cincinnati, OH, 513-242-8900						
Dix Metals Inc. - Huntington Beach, CA, 888-810-9660			1	2		
DMS - Oldcastle, ON, Canada, 519-737-6743			1			
Dow Corning Corporation - Midland, MI, 989-496-6000						
Edro Engineering and Specialty Steels, Inc. - Walnut, CA, 909-594-5751			1	2	3	
Ellwood Specialty Steel - New Castle, PA, 724-657-1160				2		
Finkl & Sons Co., A - Chicago, IL, 773-975-2510						
HASCO America, Inc. - Fletcher, NC, 828-650-2600		55	1			
IBC Advanced Alloys - Franklin, IN, 317-738-2558				3	4	
Industeel USA, LLC (Arcelormittal) - Coatesville, PA, 610-383-3000						
International Mold Steel Inc. - Florence, KY, 859-342-6000		31				
Ipsco International - Attleboro, MA, 508-226-1776						
Materion Performance Alloys - Mayfield Heights, OH, 216-383-6800				3	4	
National Tool & Manufacturing - Wheeling, IL, 847-806-9800						
Omni Mold Systems - Lisbon, CT, 888-666-4755						
OnlineMetals.com - Seattle, WA, 206-285-8603			1	2	3	4 5
PCP Canada - Saguenay, QC, Canada, 418-677-3939				2		
Performance Alloys & Services Inc. - Germantown, WI, 262-255-6662					4	
Precision Marshall Steel - Washington, PA, 724-222-2100						
Rudolph Bros. & Co. - Canal Winchester, OH, 800-375-0605						
Schmolz+Bickenbach USA, Inc. - Carol Stream, IL, 630-682-3900				3		
Sturdell Industries - Rochester, NY, 585-464-0800						
Superior Die Set Corporation - Oak Creek, WI, 414-764-4900			1			
TCI Precision Metals - Gardena, CA, 800-234-5613			1	2		5
Tekcast Industries RI - Warwick, RI, 401-785-9500						
thyssenkrupp Materials - Copper and Brass Sales - Southfield, MI, 800-926-2600			1	2	3	4 5
Tremblay Tool Steel - Macedonia, OH, 330-467-4725						
Uddeholm USA - Elgin, IL, 630-883-3100				3	4	
Vista Metals Corp. - Fontana, CA, 909-823-4278			1	2		
voestalpine High Performance Metals Corp. - Elgin, IL, 630-883-3000						
Wacker Chemical Corp. - Adrian, MI, 517-264-8500						
Yarde Metals - Southington, CT, 860-406-6061			1	2		

For more supplier listings, go to moldmakingtechnology.com/suppliers.

<i>Bronze</i>	<i>Copper Alloys</i>	<i>Foams</i>	<i>Liquid Rubber</i>	<i>Polyurethane Prepolymers</i>	<i>Stainless Steel</i>	<i>Tool Steel/Mold Steel</i>	
6	7	8	9	10	11	12	WEBSITE
							alimexamericas.com
							alpase.com
6	7			10	11	12	alro.com
6	7						ampcometal.com
					11	12	bmsburns.com
						12	buderus-steel.com
					11		clintonaluminum.com
							constellium.com
					11	12	diehlsteel.com
					11	12	dixmetals.com
							dmscomponents.com
		8	9				dowcorning.com
	7				11	12	edro.com
					11	12	ess.elwd.com
						12	finkl.com
6					11	12	hasco.com
6	7						ibcadvancedalloys.com
					11	12	industeel.info
					11	12	imsteel.com
					11		ipscointernational.com
	7						materion.com
					11	12	ntm.com
					11	12	omnimold.com
6	7			10	11	12	onlinemetals.com
							pcp-canada.com
6	7						moldstar.com
						12	pmsteel.com
		8	9	10			rudolphbros.com
	7				11	12	schmolz-bickenbach.us
					11	12	sturdell.com
						12	superiordieset.com
6	7				11	12	tciprecision.com
			9	10			tekcast.com
6	7				11		tkmna.com
						12	tremblaytoolsteel.com
	7				11	12	uddeholm.com/us
							vistametals.com
						12	voestalpine.com/highperformancemetals/usa/en
			9				wacker.com
					11		yarde.com

Image courtesy of Poco Graphite.

Pre-Hardened Steel Designed for Machinability

Hasco's plate program, especially in the P1 range, has now been supplemented by a pre-hardened steel, 1.2714HH. This pre-hardened EU tool steel is designed for dimensional stability and toughness. Hasco says that with a maximum hardness of 400 HB, it makes for optimum processing properties in machinability.



Benefits to users include excellent material properties for machining, welding, surface coating and use in injection molding tools, the company says. Other applications for the material include the efficient production of cavity inserts, cores and sliders. The steel is also designed for wear resistance and polishing and etching properties. It can be nitrided, coated at temperatures below

510°C and has good thermal conductivity. Performance is enhanced by the high-precision machining and surface quality as well as the plane-parallelism. The tolerances are geared to modern manufacturing techniques. Plates made from this steel are readily available from stock in the usual measurements. Special dimensions as well as P and K20 plates of 1.2714HH are available on request.

HASCO / 877-427-2662 / hasco.com

Self-Venting Mold Steel Designed for Injection Molding Applications

Molder's World Inc. announces its upgraded Vortex, a self-venting mold steel specifically designed for injection molding applications. Using Vortex in appropriate areas eliminates gas buildup, reduces injection pressure, lowers cycle times and gloss levels, and substantially reduces scrap and reject rates. Though primarily used for speaker grill insert, interior automotive and medical applications across the globe, Vortex can be used in nearly every molding application where gas buildup is problematic. Vortex is available in a range of sizes, as well as square and rectangle stock, precision ground press fit vent pins and standard venting core pins.

Molder's World also offers design help at no charge as well as manufacturing and cleaning services for Vortex and Porcerax II applications.

Molder's World Inc. / 513-469-6653 / moldersworld.com



Modified Grade of Mold Steel Offers Consistent Surface Finishing

Ellwood Specialty Steel Co. introduces a P20 modified grade of mold steel. Improved Lens/Texture Quality (LTQ) alloy offers very consistent surface finishing properties. Recognizing the increased demands for flawless diamond polish finishes on lens molds and complex geometric and delicate texture patterns, the company's metallurgists have engineered a steel that will perform to your most stringent requirements. Employing a newly developed chemistry, state-of-the-art re-melting facilities, a proven forging process and a tightly controlled heat treatment this thru-hardened steel meets all challenges. In addition to consistent surface finishing, the material can be relied on for thermal conductivity, machinability and welding properties.

Ellwood Specialty Steel / 800-932-2188 / ess.elwd.com

Uniform Steel Hardness Offers Even Machinability

International Mold Steel, Inc. offers uniform hardness for even machinability and clean welds in molds and dies. Specific steels offer advantages for polished or textured finishes, prehardening for high-precision and no deformation. The company's Superplast Stainless is a prehardened, free-machining, stainless mold steel specially designed for plastic mold bases. The steel also provides improved performance compared to standard grades, as well as ensures corrosion resistance both in humid atmospheres and in corrosive molding environments.

International Mold Steel Inc. / 859-342-6000 / imsteel.com

Complete Solution of Mold Materials and Services Provides One Stop Shop

Edro Specialty Steels offers a complete solution of mold materials and services for the plastic tooling industry. The company's addition of Bohler tool steels, MoldMax copper alloys, and PVD/DLC coating services, as well as additive manufacturing, complement the existing business of Edro RoyAlloy, mold bases, aluminum and machining services. The one-stop-shop solution provides customers the freedom to order all their materials from one source and reduce critical lead times. The company also provides a team of highly educated material science engineers who work directly with customers on their tooling problems. These engineers have experience in all aspects of tooling, including mill production, heat treating, machining and maintenance, with the added benefit of a complete product portfolio ensuring a solution can be found for customers.

EDRO Engineering and Specialty Steels Inc. / 909-594-5751 / edro.com

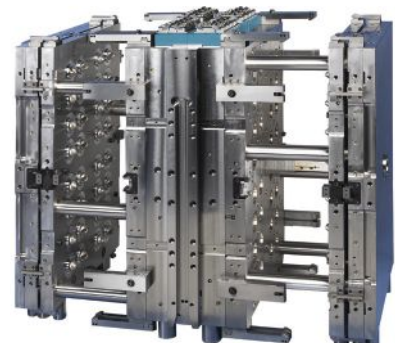

Additive Manufacturing Metal Powder Designed for Plastic Injection Molders

Uddeholm launches AM Corrax powder specifically designed with the needs of plastic injection molders in mind. This powder is purposefully made for additive manufacturing, making it the ultimate choice for tools where superior corrosion resistance combined with high hardness is needed, ideal in plastic extrusion and injection molding applications.

Bohler offers the growing AMPO family of additive powders, which features six powder types for a wide range of applications and printing technology. The AMPO product line is composed of tool steel, high-speed steel, corrosion resistant steel and nickel alloy AM powders. Through rigorous R&D methods, in-house testing facilities and stringent production process controls Bohler ensures a consistent spherical powder and particle size distribution to ensure optimal properties for the additive process.

Uddeholm USA / 800-638-2520 / uddeholm.com/usvoestalpine



High-Strength Aluminum Series Ideal for Various Mold Types

Constellium offers its Alumold series of high-strength aluminum. The material is specifically designed for toolmaking and two grades in particular stand out: one to provide the highest possible strength and hardness available and the other one to operate at high molding temperatures (up to 200°C).

Alumold is well-suited for series production in injection processes, with high clamping forces during the molding phase. The series also includes benefits such as polishing well, meeting high-transparency on plastic parts; injection cavities can be acid etched or laser engraved with simple textures or complex geometric patterns; offers strength, polishability and texturing options.

It is also ideal for processes such as composite molding, thermoforming, foam or EPS molding (expanding polystyrene) and RTM; fits series production in low and high pressure processes; and ensuring consistent properties across every thickness.

Constellium / 304-531-0116 / constellium.com

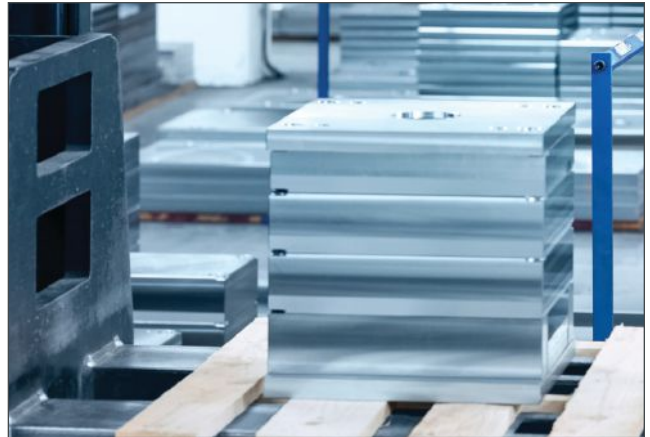

High-Quality Material Grades Suited for Machining

Meusburger presents a wide range of heat-treated for stress relief steels. A total of 31 different material grades are available and can be optimally matched to each other for customer projects. Many of these materials are available from stock as standard plates and bars, which provide a reliable basis for all applications. The comprehensive range at Meusburger includes not only standard plates but also special plates in customized dimensions.

In addition to the selection of plates and bars, the company also offers different machining technologies such as flame cutting, sawing, deep hole drilling, milling, grinding and turning. With flame cuts and milling operations already completed before delivery, customers can save their resources and concentrate on their core competencies.

Meusburger US, Inc. / 704-526-0330 / meusburger.us



Aluminum Plates Ideal for Molding and Tooling Industry

Vista Metals Corp. supplies a wide range of cast aluminum plate products to the molding and tooling industry. Duramold-2 is a premium grade of mold plate produced in a modified 2618 aluminum alloy. Duramold-5 is a more common grade of mold plate produced in an AA 5083 alloy. Both Duramold products are offered up to 38" thick and 94" in width. These can be combined with the company's ATP-5 tooling plate, also produced in an AA 5083 alloy for a large variety of gauges and tooling equipment.

Vista Metals Corp. / 909-829-6109 / vistametals.com

Steel Choice Matters for Corrosion Resistance

By Daniel Kipp and John Stocker

Tool steel resists condensation, and waterline corrosion, which is especially important as the use of corrosive materials like fire-retardant additives, PVC and aminoplast increases. However, with every positive there is typically a negative. For example, corrosion-resistant plastic injection mold steels require additional machining time that increases wear, and more complex mold bases cause 60% of the steel to become chips.

In general, manufacturers do not consider plastics chemically aggressive. However, the molding process can subject a mold to highly corrosive stresses under operating conditions. These conditions can range from extreme climatic influences to the use of PVC, which can release hydrogen chloride if exposed to temperatures of 170°C for a long time. Also, the humidity in the air can help to form hydrochloric acid during PVC production. Other influencing factors are a result of the physical mold design, such as by complex engraving or cooling channels.

To address these challenges, steel suppliers continue to develop specialty steels to combat the extremely corrosive injection molding environment while improving steel's machinability and stability. For example, a free-machining

C	Si	Mn	S	Cr	Additions
0.05	0.40	1.30	0.15	12.50	+

TABLE 1. Chemical composition in weight-%.

stainless steel that offers a balance between machinability and corrosion resistance by combining a special chemical composition with a special heat-treatment process.

Low-carbon content and alloying elements such as chromium, manganese and other additions play an important role in this free-machining stainless steel. The alloying elements are

Tool	Level Milling Ø 25 mm	Edge Milling Ø 120 mm	Round plate Ø 66 mm	Drilling
Cutting material	K 15	P 40 coated	P 40 coated	Solid carbide
Cutting speed v_c in m/min	80	140	140	60
Feed per tooth f_t in mm	0.3	0.7	0.6	0.2
Depth of cut a_p in mm	5.0	2.0	2.0	55.0
Width of cut a_w in mm	15.0	100.0	45.0	17.5
Stability of the machine clamping + workpiece	***	***	***	***

TABLE 2. Machining values for free-machining stainless steel (hardness 290 - 332 HB).

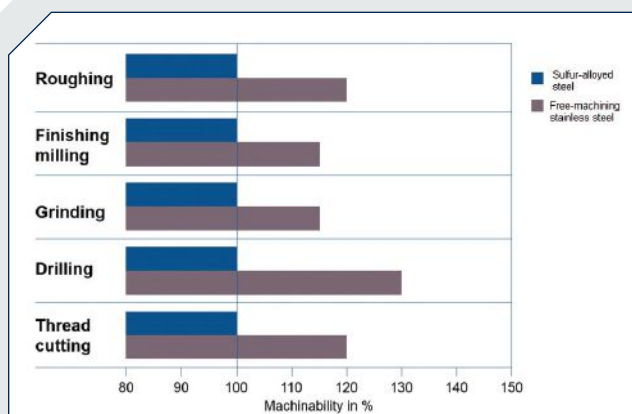

FIGURE 1. Comparing machinability in % (sulfur-alloyed steel 325 HB, free-machining stainless steel 370 HB).

added during production and combine to yield optimal hardness, machinability and corrosion resistance (see Table 1).

The heat treatment process further refines the steel at the final production process. The material is heated to a temperature of 1,475°F under controlled conditions and quenched in water or a polymer, which promotes the characteristic of a homogenous microstructure yielding material that is consistent throughout and extremely stable.

To assess corrosion resistance and determine the appropriate testing method, the mold builder must understand the type of corrosion that may occur. The corrosion behavior is a system property. The corresponding tests only reveal the classification of the steels in the same testing structure. Several tests were conducted on this free-machining stainless steel in laboratory conditions with media containing chloride, condensation and in slightly acidic conditions. A sulfur-alloyed steel was tested for comparison. The results indicated that the free-machining steel and the sulfur-alloyed steel are nearly identical in corrosion resistance. The free-machining steel also offers an increase in cost-effectiveness and productivity by decreasing machining cost and lead times (see Figure 1).

To optimize machining efficiencies and lead times, refer to the process recommendations in Table 2.

Mold material choice is one of the key variables influencing plastic part production profitability, so it may be time to consider the machinability, dimensional stability and weldability benefits of a free-machining stainless steel, which can also enhance mold performance with its toughness, minimal residual stresses and good corrosion resistance. [MMT](#)

FOR MORE INFORMATION

Schmolz + Bickenbach USA / 800-323-1233 / schmolz-bickenbach.us
Daniel Kipp, Technical Sales & Marketing USA
John Stocker, Director of Sales USA



Image courtesy of Barbara Schulz.



Mold-Masters Limited
233 Armstrong Ave.
Georgetown, ON L7G 4X5

Phone: 905-877-0185
 Email: info@moldmasters.com

moldmasters.com

PRODUCTS/SERVICES

Master[®] series

The benchmark in hot runner performance and reliability. Unlock your operations full potential. Proven to deliver consistent high performance processing capabilities for exceptional part quality. Compatible with a wide range of resins (including Bio-Resins). Advanced molding capabilities include high cavitation, tight pitch, inside gating, side gating, stack molds and multi-material.



FEATURES: iFLOW manifold technology offers best-in-class melt management capabilities delivering industry leading mold fill balance and rapid color change performance. Available with an industry leading 10-year warranty.

Fusion[®] series G2

Drop-in, connect and inject. A completely pre-assembled and pre-wired hot runner system which allows for quick and easy one step installation and connection. Focused on high quality economical production of small to large parts. Ideal for automotive, appliance and logistics applications. Supported by our global aftermarket network which includes rapid spare parts supply.



FEATURES: Nozzle lengths up to 1m. Compact nozzle bore cut-outs. NEW patent pending waterless HY/PN actuator technology simplifies mold construction and facilitates faster mold changes.

ThinPAK[®] series

Specifically engineered for producing exceptional, high quality, thin wall packaging products. Incorporating new MasterSHIELD Technology, ThinPAK-Series has the strength and durability to mold with complete reliability in high pressure applications up to 2,800 Bar. Capacity includes everything from small in mold labelled containers to large pails. Compatible with PP, PS, PE and other resins.

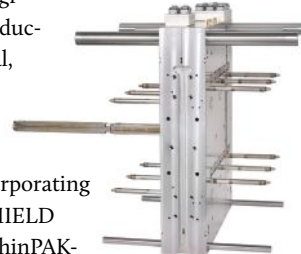

FEATURES: NEW patent pending MasterSHIELD Technology delivers exceptional leakage protection between the nozzle and manifold +/-100°C from processing temperature. Industry standard gate cut-outs available.

WEBSITE: THE FUTURE IS IN STORE



Mold-Masters eSTORE instantly connects you to the products you need, day or night. Our customers are able to quickly and easily order the standard spare parts they require to stay

in production as well as view order history, system BOM's and much more. Go online and see for yourself what the future has in-store.

store.milacron.com

PRODUCT CATEGORIES

- Hot Runners & Control Systems
- Hot Runner Manifolds
- Sprue Bushings
- Hot Halves
- Auxiliary Injection Units
- Temperature Controls, Monitors and Sensors



TempMaster™ series M3

ELIMINATE CONVENTIONAL TC MOLD CABLES

Save Money • Reduce Clutter • Save Space

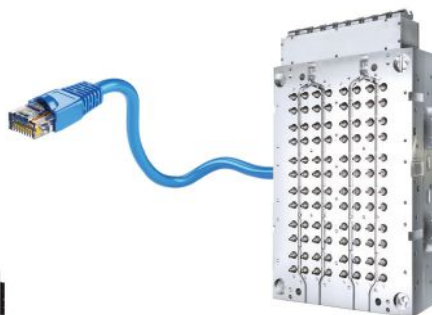

FEATURING
TC-CONNECT
TECHNOLOGY

TC-CONNECT Technology, available exclusively on TempMaster M3 hot runner temperature controllers, is a revolutionary new innovation that completely eliminates the need for conventional TC mold cables altogether. Eliminating these cables, which make up 50% of all mold cables, saves significant cost, weight and clutter from the molding cell. Wiring the hot runner system remains unchanged. This technology is compatible with new and existing Hot Runner Systems.

Contact us today with your application and see what we can accomplish together.

North America • South America • Europe • Asia

905-877-0185 • info@moldmasters.com

www.moldmasters.com



*Passion for
expertise*

HRSflow
920 74th Street SW
Unit 100
Byron Center, MI 49315

Phone: 1-616-228-6900

hrsflow.com

PRODUCTS/SERVICES

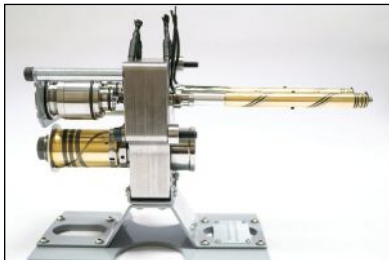

SA SERIES NOZZLES

With the new, small-sized hot runner SA series nozzles, HRSflow has expanded its range. The screwed-in nozzles are suitable for the injection molding of techno-polymers with a shot weight starting from 0.5 g and for wall thicknesses below 1 mm. The shape and material of the tip, the channel section and the contact surface of the end ring with the cavity are designed to have the optimal thermal conditions which enable a high flexibility in processing engineering polymers.



HRSCOOL

HRSCOOL is the innovative solution for hot runner injection molding in which the water cooling of the associated actuators can be eliminated. Support columns with optimized contact surfaces minimize the heat transfer from the hot tool plate to the cylinder, while a height-adjustable cover plate made of a highly thermally conductive material ensures the maximum heat dissipation from the cylinder to the plate. By removing all elements required for active cooling, HRSCOOL eliminates issues associated with clogged cooling circuits.



FLEXFLOW EVO ON FAMILY MOLD

FLEXflow Evo hot runner technology provides a broad potential to improve the quality of the parts, to avoid cost for additional process tuning, to broaden the process window and to extend lifetime of the tool. Using FLEXflow Evo servo driven valve gate technology to independently control stroke, timing and force of each individual pin, can overcome existing limitations in terms of close similarity in size, weight, wall section and volume, whilst ensuring all cavities are being filled simultaneously, preventing from overfeeding and flash formation.

WEBSITE



Discover HRSflow's innovative solutions for all your demanding applications on our multi-language website. The site features product information, worldwide customer service contacts, company news, case studies, downloads, and videos.

hrsflow.com

PRODUCT CATEGORIES

- Hot Halves
- Hot Runner Manifolds
- Hydraulic Valve Gate Nozzles
- Pneumatic Valve Gate Nozzles
- Servo Valve Gate Nozzles
- Temperature Controls, Monitors, Sensors
- Thermal Edge Gate Nozzles
- Thermal Hot Tip Nozzles
- Valve Gate Controllers
- Mold Flow and Simulation Services



Hot Runner expertise in every sector



Our best solution for all your applications. We design and manufacture **hot runner systems for industries like Logistics & Environmental, Domestic Appliances, Technical Applications, Mobility, Houseware & Gardening.** We are ready to welcome any market challenge, from standard components to the most complex design requirements. **Fast color change, high structural performance, lightweight applications, high process and product repeatability:** we offer the technology that best matches your needs.

hrsflow.com

HRSflow USA - Production Plant
920 74th Street, Byron Center, Michigan
Ph. +1 616 228 6900
usa@hrsflow.com



*Passion for
expertise*



HOT RUNNER SYSTEMS

INCOE Corporation
2850 High Meadow Circle
Auburn Hills, MI 48326

Phone: 248-616-0220
 Fax: 248-616-0227

incoe.com

PRODUCTS/SERVICES



INCOE Hot Runner Systems are the heart of the injection molding process, managing and controlling Melt Logistics® inside the mold. For over 60 years, the plastic injection molders for all markets have come to rely on the technology, service, filling simulation and on-site technical support INCOE offers. By providing innovative and creative solutions, INCOE helps ensure that customers remain productive and competitive. INCOE's global commitment is to be your partner, producing value in your process, and ultimately delivering satisfaction where it counts.

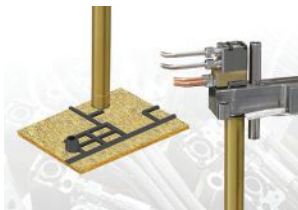

DIRECT-FLO™ Gold hot runner systems offer proven performance advantages, unitized leak-proof reliability and cost effectiveness in the most demanding applications. Features include custom and standard system configurations, non-valve and valve gate systems, mold flow analysis and exclusive OPTI-FLO® manifold systems; all designed to reduce cycle times with improved part quality.



HEM miniature hydraulics are powerful and highly compact and widen the choice of possible gating points while creating enough space for supply lines—not just because of the smaller dimensions, but because the outlets for the cooling lines can be arranged in four different directions. The new patented and improved thermal separation of distributors and cylinders prevents the hydraulic oil reaching critically high temperatures. This helps protect moving parts and seals and means no cooling down is required once production work is complete.

SoftGate® valve pin speed control is an important core product for process optimization through hot runner technology. Instead of an abrupt sudden opening of the valve gate nozzle, the flow cross-section is continually opened and released through SoftGate® and the nozzle opening time required for optimum quality can be set and a careful injection is thus reproducibly ensured. For example, all changes in pressure and speed of the melt occurring during the process are much better coordinated, resulting in a continuous melt stream reducing or eliminating hesitation marks.

WEBSITE



The multi-language website is a resource and information tool for customers in any market. Features include product search, RFQs, videos, and an array of product guides, manuals and brochures in PDF format for easy download.

incoe.com

PRODUCT CATEGORIES

- **Hot Runner Systems for Micro- to Large-Part Applications**
- **Thermal Tip, Sprue and Valve Gate Designs**
- **Temperature, Sequential and Valve Gate Controls**
- **Complete Hot-Half Systems**
- **Stack Molding Systems**
- **Single-Nozzle Systems**
- **Screen Pac Melt Filtration**
- **IMN (Injection Machine Nozzle)**



Your Melt Logistics® partner for successful mold making

For parts with shot sizes from a fraction of a gram to multiple kilograms, INCOE provides Hot Runner Technology solutions throughout the entire process — from engineering mold review and filling simulation to on-site technical support.

Our global commitment is to be your Melt Logistics® partner — producing value in your process — and ultimately delivering satisfaction where it counts.



HOT RUNNER SYSTEMS
www.incoe.com

North America | Europe | Asia | South America

mastip™

hot runner solutions

MASTIP INC
N171 W21055
Industrial Drive
Jackson, WI 53037

Phone: 262-644-9400

mastip.com

PRODUCTS/SERVICES



Nexus™ Systems

Nexus™ Pre-Assembled and Pre-Wired Systems are designed as a complete turn-key solution for quick and simple installation. Delivering fast, simple installation out of the box without requiring any further assembly, it features fully customizable frames, electrical connections, tip and nut options and nozzle lengths to suit your application requirements. Nexus Systems incorporate the advanced leak protection of FlowLoc Technology and benefits from a superior thermal profile providing a wide molding window for a broad range of polymers.



VeriShot™ Single Valve Gate

The VeriShot™ system sports an extremely compact design that significantly reduces mold height requirements as it acts as a locating ring housing the mechanics. This design feature ensures perfect alignment between mold and machine platens. Pre-assembled, VeriShot features Mastips FlowLoc threaded leak proof nozzles with advanced heating technology for optimum control with Stainless Steel flow channels for maximum service life. The VeriShot enables you to precisely control your injection process.



Hot Half Solutions

Hot Half Systems are delivered fully wired and assembled ready to integrate into your tooling design. All aspects of the hot half design, manufacture, assembly and testing is completed by our team of engineers to Mastip's exceedingly high standards ensuring we provide reliability and consistent performance. All systems include a key focus on plate design, cooling circuits and critical dimensions to ensure the successful integration and operation of the hot half with your mold.

WEBSITE

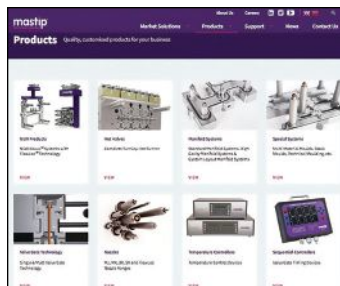

The multi-language website includes extensive CADs, information and specification guides in PDF for easy download.

mastip.com

PRODUCT CATEGORIES

- Hot runner systems with a range of flow bores and lengths
- Thermal gates, valve gates and multi-gate solutions
- Tip and nut construction to suit commodity or engineering polymers
- High cavity manifold systems
- Manifold systems designed to your specific layout
- Single nozzles including valve gate control
- Hot half construction for seamless integration with cavity plate
- Speciality systems including rheological balancing
- Stack hot runner systems
- Temperature controllers
- Sequential gate controllers



Precise Control for Flawless Molding

Mastip's range of Hot Half solutions are specifically engineered for molding precise, durable and consistent parts of exceptional quality.

Designed, manufactured and tested by our team of expert engineers, Hot Half solutions are available in thermal or valve gate configurations and delivered as a complete solution to integrate seamlessly into your mould.

For a flawless injection molding process, talk to the team about our range of high performance solutions at competitive prices backed by industry leading global service and support.



mastip[™]
hot runner solutions

www.mastip.com

Mastip Inc. | N171 W21055 Industrial Dr, Jackson, WI 53037 | 1 262 644 9400 | northamerica@mastip.com

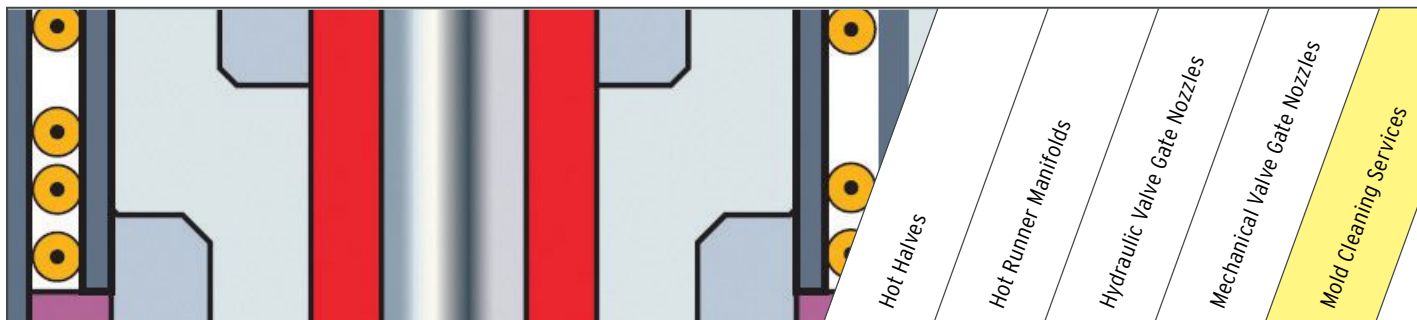

COMPANY Advertisers are listed in bold type.	See Ad	1	2	3	4	5
Alliance Specialties and Laser Sales Inc. - Wauconda, IL, 847-487-1945			2			5
Ampco Metal Inc. - Sturtevant, WI, 847-437-6000				3		
Athena Controls - Plymouth Meeting, PA, 610-828-2490						
Dalton Electric Heating Co., Inc. - Ipswich, MA, 978-356-9844						
DME Company - Madison Heights, MI, 248-398-6000	Back Cover	1	2	3		
Ewikon Molding Technologies, Inc. - Rockford, IL, 815-874-7270		1	2	3		
Extrude Hone - Irwin, PA, 724-863-5900			2			
Fast Heat Inc. - Elmhurst, IL, 630-359-6300						
Gammaflux - Sterling, VA, 703-471-5050						
Gunther Hot Runner Systems Inc. - Hoffman Estates, IL, 630-293-4650		1	2	3	4	
HASCO America Inc. - Fletcher, NC, 828-650-2600	55	1	2	3		
Hotset America Corp. - Swainsboro, GA, 912-289-1844			2			
HRS Flow - Byron Center, MI, 616-228-6900	41	1	2	3		
Husky Injection Molding Systems - Milton, VT, 802-859-8000		1	2	3	4	
IMS Company: Industrial Molding Supplies - Chagrin Falls, OH, 440-543-1615					4	
INCOE Corporation - Troy, MI, 248-616-0220	43	1	2	3		
Intex Tooling Technologies - Aurora, ON, Canada, 289-840-1095						
J-Tech Hotrunner Inc. - Caledon, ON, Canada, 519-927-1067		1	2	3	4	5
Manner USA, Inc. - Lawrenceville, GA, 770-449-1820		1	2	3	4	5
Mastip, Inc. - Slinger, WI, 262-644-9400	45	1	2	3		
Melt Design Inc. - St. Charles, IL, 630-443-4000		1	2			
MHS - Mold Hotrunner Solutions - Georgetown, ON, Canada, 905-873-1954		1	2	3	4	
Mold-Masters/Milacron - Georgetown, ON, Canada, 905-877-0185	39	1	2	3	4	
Molders Choice Inc. - Parma, OH, 216-458-1220						
Orycon Hot Runner Systems - Ocean, NJ, 732-922-2400		1	2	3	4	
OSCO Inc. Runnerless Molding Systems - Rochester Hills, MI, 248-852-7310		1	2	3	4	
PCS Company - Fraser, MI, 586-294-7780	57	1	2	3	4	5
Plastic Engineering & Technical Services - Auburn Hills, MI, 248-373-0800		1	2	3	4	
Plastic Process Equipment, Inc. - Macedonia, OH, 216-367-7000						
Polymer Cleaning Technology Inc. - Hillsborough, NJ, 908-281-0055						5
Polyshot Corporation - West Henrietta, NY, 585-292-5010		1	2	3	4	
Priamus System Technologies, LLC - Brunswick, OH, 877-774-2687						
Runipsys North America - Oldcastle, ON, Canada, 519-737-0874		1	2	3	4	
SISE Plastics Control Systems, Inc. - Atlanta, GA, 404-495-5968						
StackTeck Systems Limited - Brampton, ON, Canada, 416-749-1698		1	2			5
Synventive Molding Solutions - Peabody, MA, 978-750-8065		1	2	3		5
Technoject Machinery Corp. - Bolton, ON, Canada, 905-951-7144		1	2	3	4	5
Thermal-Tech Systems, Inc. - West Chicago, IL, 630-639-5115		1	2	3	4	5
Thermoplay S.P.A. - Pont Saint Martin (AO), Italy, +39 125 800311		1	2	3		
YUDO, Inc. - Livonia, MI, 734-744-8120			2	3		

For more supplier listings, go to moldmakingtechnology.com/suppliers.

	<i>Mold Maintenance and Repair Services</i>	<i>Pneumatic Valve Gate Nozzles</i>	<i>Servo Valve Gate Nozzles</i>	<i>Temperature Controls, Monitors, Sensors</i>	<i>Thermal Edge Gate Nozzles</i>	<i>Thermal Hot Tip Nozzles</i>	<i>Thermal Multi-Gate Nozzles</i>	<i>Valve Gate Controllers</i>	<i>Valve Gate Sequencers</i>	
6	7	8	9	10	11	12	13	14	WEBSITE	
6									alliancelasersales.com	
	7				11				ampcometal.com	
			9						athenacontrols.com	
			9						daltonelectric.com	
6	7		9		11		13	14	dme.net	
	7		9	10	11	12			ewikonusa.com	
									extrudhone.com	
			9						fastheat.com	
			9				13		gammaflux.com	
	7		9	10	11	12	13		gunther-usa.com	
	7		9	10	11	12	13	14	hasco.com/gb	
			9				13		hotset-worldwide.com	
	7	8	9		11		13	14	hrsflow.com	
	7	8	9	10	11	12	13	14	husky.co	
	7		9		11				imscompany.com	
	7		9	10	11	12	13	14	incoe.com	
6									intextooling.ca	
6	7		9	10	11	12	13	14	jtechhotrunner.com	
6	7		9				13	14	m-form.com	
	7		9	10	11	12			mastip.com	
	7		9	10	11	12			meltdesign.com	
	7		9	10	11	12	13	14	mhs-hotrunners.com	
	7		9	10	11	12		14	moldmasters.com	
			9						molderschoice.com	
	7		9	10	11	12	13	14	orycon.com	
	7		9		11	12	13	14	oscosystems.com	
6	7		9		11		13	14	pcs-company.com	
	7		9	10	11	12	13	14	petsinc.net	
			9						ppe.com	
									polymercleaning.com	
	7		9	10	11	12	13		polyshot.com	
			9						priamus.com	
					11	12		14	runipsys.com	
			9				13		sise-plastics.com	
6	7				11	12			stackteck.com	
	7		9		11	12	13	14	synventive.com	
	7	8	9	10	11	12	13	14	technoject.com	
6	7	8	9	10	11	12			thermal-tech.com	
	7		9				13	14	thermoplay.com	
	7		9	10	11	12	13	14	yudo.com	

Service categories are noted in the highlighted columns.

Image courtesy of Husky Injection Molding Systems.



Mold Components and Hot Runner Products Designed for Customer Specifications

Hasco offers mold base and hot runner technologies. The company's P1 plate range expands to include developments and additions that supplement the standard component portfolio. Innovations in the field of demolding, heating/cooling, high-temperature applications, sensors, hydraulics and cylinders round off the range and make a key contribution to boosting efficiency and achieving cost efficiency. The company offers variable and customer-specific configuration options for a wide range of installation spaces. DLC-coated components offer optimum gliding properties. Development of the company's app makes it possible to calculate thermal insulation sheet surface temperatures by entering individual parameters, such as plate type, mold temperature and plate thickness.

The company also provides products under the "Hasco hot runner" brand. The Single Shot individual nozzle has been designed as a single nozzle with maximum temperature homogeneity and generous flow channel cross-sections. Different tip geometries guarantee an optimum tear-off quality and ideal heat conduction right through to the gate. The Hot Half system with a single needle valve provides efficiency and safety with a complete, ready-to-connect system, suitable for immediate production. Another highlight is the screw-on Vario Shot nozzle, which permits ready-to-mount systems, designed and produced according to individual customer specifications.

HASCO America, Inc. / 877-427-2662 / hasco.com

Hot Runner Series Ideal for Molding with Challenging Resins

Mold-Masters/Milacron's Summit series is ideal for molding with challenging abrasive, corrosive, shear and temperature sensitive resins, as well as medical, personal care and technical molding applications. The series features nozzles with exceptional process control and repeatability, producing high quality parts and minimizing scrap. The full stainless-steel construction helps prevent contamination defects from premature wear and extends service life. With iFlow manifold technology, the series provides extensive flexibility for design optimization, patented melt flow geometry, flow path options and runner shapes, and reduced stack height. Brazed heater technology optimizes heat transfer, offers system thermal balance and eliminates spare heater costs.

Mold-Masters/Milacron / 800-387-2483 / milacron.com

Hot Runner Nozzles Suitable for Small Technical Components

HRSflow presents its small-sized SA series hot runner nozzles for injection molding small technical components with a very compact cut-out in the tool. The hot runner nozzles are suitable for injection molding technical parts with a shot weight of about 1 g and less, as well as for wall thicknesses below 1 mm. Their selectable gate versions open nozzle and valve gate are available with bushing through the cavity or gate on the cavity. The tip shape and material, the channel section and the contact surface of the end ring with the cavity are designed to have optimal thermal conditions for high flexibility in processing engineering polymers. The compact design enables a compact cut-out in the tool, and the large melt channel diameter enables the processing of highly reinforced or viscous plastics at high flow rates. The nozzle screwed on the manifold guarantees the seal at high injection pressure without requiring accuracy in machining.

The company also extends its cylinder portfolio, including compact hydraulic cylinders, which require small cut-outs in the tool and provide an increased thermal insulation due to components material and optimized contact surfaces, minimizing heat transfer to the manifold and reducing energy consumption. In addition to the basic version, a version with needle damping is also available. Further variants offer a microswitch version for the double needle end position detection, as well as an adjustable version for the possibility of compensating the position of the needle by ± 1 mm without mechanical reworking.

HRSflow / 616-228-6900 / hrsflow.com

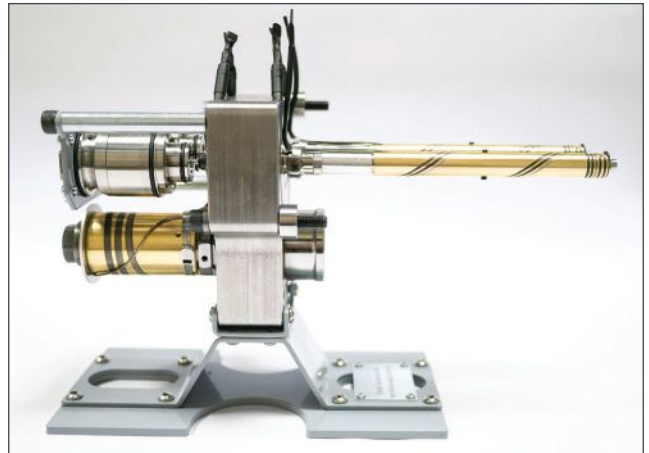

Valve Gate Hot Runner System Provides Common Design Platform

DME's Smart One valve gate hot runner system provides a common design platform. The system is available as a manifold and components offering, or as a complete hot half ready to integrate with an existing cavity plate. The system is available with pneumatic or hydraulic cylinders, and actuation options include individual or all open/all close. The cylinder design enables removal/setting of valve pins without system disassembly. Tips, retainers, heaters and thermocouples can be serviced while the system is in the machine for maximum up-time.

DME Company / 800-626-6653 / dme.net

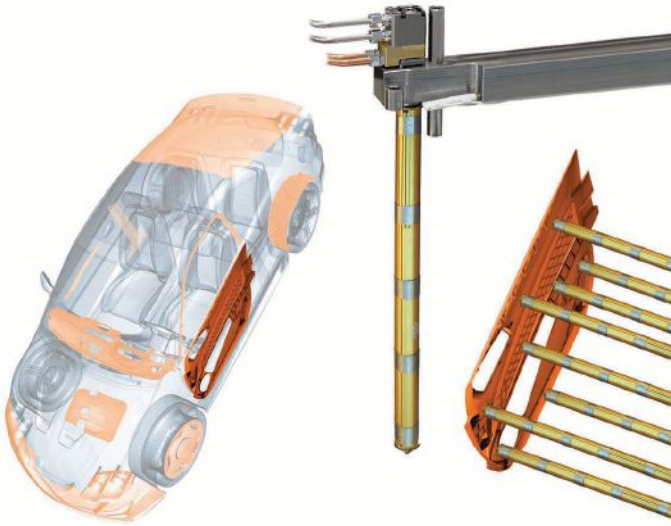

Compact Nozzle Design Simplifies Cutout Geometry

INCOE Corporation presents its DF nozzles with MultiPower heaters for the Direct-Flo product range. Available for the DF 8, 12, 18 and 22 nozzle series, the compact design simplifies the cutout geometry, lowering mold costs and increasing freedom in mold design. MultiPower products have multiple controlled temperature zones required for precision processing.

INCOE Corporation / 248-616-0220 / incoe.com

Electric Actuator Delivers Complete Pin Movement Control

Synventive announces the release of eGate 2.0, the latest addition to its activeGate control technologies, which delivers complete pin movement control for large part sequential valve gated applications. It provides clean, quiet and energy-efficient operation that is responsive, precise and repeatable. The eGate electric actuator bolts directly on the manifold for an easy install, offering both a compact footprint and small stack height. Precise all-electric control of each valve pin's position, speed, velocity and stroke delivers optimal cosmetics for class A surfaces, warpage reduction, clamp force reduction, part weight reduction and greater application flexibility.

eGate's intuitive interface includes a simple drag and drop editor for easy setup, recipe storage and mold overview, as well as varying levels of user control.

Synventive Molding Solutions / 800-367-5662 / synventive.com

Multi-Cavity Nozzle Solution Improves Thermal Profile and Efficiency

Taking advantage of the latest technological advances, **Mastip Inc.** continues to evolve its multi-cavity and hot-half solutions with a series of innovations and product upgrades.

The MX nozzle is a multi-cavity, close pitch solution for medical and consumer applications and has been redesigned to include a micro-coil heater embedded into a copper alloy sleeve requiring lower wattage, leading to an improved thermal profile and efficiency. The MX nozzle range has been extended to offer more standard lengths and will shortly be available in a select range of stainless steel.

Open valve tips have been redesigned to accommodate insulator caps while providing precise valve pin guidance. The redesign enables insulator caps to clip-on to a groove at the end of the tip.

When combined with a hot half as an all-in-one solution, MetiCom temperature controllers provide reduced molding risk, which the company backs by an extension of the system warranty from 3 to 5 years.

Mastip, Inc. / 262-644-9400 / mastip.com

Mold Controllers with Virtual Network Computing Enables Remote Access

Husky Injection Molding System's Altanium mold controllers are now available with virtual network computing (VNC) options. VNC is a screen sharing technology that enables remote access and control of another computer through transmitting all touch-screen movements from the controller to a client computer, such as an injection molding machine's operator interface. This enables one computer within an injection molding cell to become the central point of control for the entire operation.

Centralizing user interactions with molding equipment increases productivity by reducing movement between different devices critical to the molding processes. This setup also maximizes floor space.

Available with the Altanium Delta5 and Matrix5, VNC brings rich feature sets supported by these operator interfaces right to the machine's screen. This opens the possibility to supplement or replace the integrated hot runner controller of the injection molding machine with an Altanium mold controller, increasing processing capabilities by applying Altanium's active reasoning technology to control the hot runner system.

Husky Injection Molding Systems / 802-859-8000 / husky.ca



How to Make an Informed Hot Runner Decision

By Rick Hagfors

Evaluating the cost justification for a hot runner mold requires careful consideration of cycle time, material type, annual volume, available press size and power consumption, as well as the cost of utilities, resin pricing, allowable regrind percentage and labor rates. Here are three key areas to consider:

1. Cold Vs. Hot Process Considerations

Cycle time is the primary cost measure of the molding process, and cooling represents about 80% of the molding cycle (see **Figure 1**). The thicker the part, the longer the cycle time. However, the runner could determine the cooling time, and increase cycle time more than expected if the runner is thicker than the part.

The minute the resin leaves the machine barrel, the material starts to cool and solidify. This, in turn, causes injection pressures to climb and can yield unfilled parts, stress and warp. Limit the l/t ratio (length of flow versus part thickness) to avoid this outcome. Generally, a ratio under 100 is considered general-purpose molding and does not require increased injection pressures.

In a cold runner mold, the l/t ratio is measured from the start of the cold sprue, where the material leaves the heat source and begins to cool, which continues through the entire runner to the furthest point in the part (last point of fill). For example, 1 mm (0.039 inch) thick resin can flow easily 100 mm (3.94 inch). However, if a hot runner is used, the l/t ratio starts at the gate, reducing flow length and the injection pressure required to fill the part.

The higher the ratio, the more injection pressure is required to fill the part. A cold runner is included in the l/t calculation when the molder measures at the point of no added heat. This is one reason hot runners are appealing and can make the difference between molding a good or bad part.

2. Material Considerations

Most polyolefin resins can be reused without issue. Engineered materials can be limited in regrind content because each time the resin is processed, it experiences another heat history that can degrade melt quality and impact performance, color, rigidity, tensile strength, etc.

Keep in mind, not every runner makes it to the granulator, and not every pellet makes it back to the hopper. While eliminating the cold runner can reduce scrap, a complete hot runner system might not be cost-justified based on low annual volume. The cost of an entire hot runner system may take longer than a year for payback. It might be wise to consider a hot/

FIGURE 1

Wall Thickness		ABS	Nylon	HDPE	LDPE	PP	PS	PVC
Inch	mm							
.015	0.38			1.7		1.7	0.9	
.018	0.44			1.9		1.9	1	
.020	0.51			2.3		2.3	1.3	
.025	0.64			2.9	2.2	2.9	1.7	
.030	0.76	2.3	3.1	3.7	2.9	3.7	2.3	2.6
.035	0.89	2.9	3.9	4.6	3.6	4.6	2.9	
.040	1.02	3.6	4.8	5.6	4.4	5.6	3.6	4.1
.045	1.14	5.1	6.6	7.8	6.2	7.8	5.1	5.8
.050	1.27	7.1	8.8	10	8.3	10	7.1	7.9
.060	1.52	9.2	11	12.5	10.5	12.5	9.3	10
.070	1.78	12	14	16	13	16	11.6	13
.080	2.03	15	17	18	16	18	14	16
.090	2.29	17	20	22	19	22	17	19
.100	2.54	25	29	32	28	32	26	27
.125	3.18	35	40	43	39	43	36	38
.150	3.81	47	53	56	51	56	48	50
.175	4.45	61	67	72	66	72	61	64
.200	5.08	76	84	89	81	89	76	89
.250	6.35	94	101	106	99	106	94	97
inch	mm	seconds						

Chart Based On: Example: Material PS Wall Th. 0.045 in.

- ⊙ Injection Time = 5% From Chart T = 5.1 seconds
- ⊙ Cooling Time = 80% Injection = 0.255 seconds
- ⊙ Ejection Time = 15% Cooling = 4.08 seconds
- Ejection Time = 0.765 seconds

- ⊙ Optimum Cooling Time for Plastics
- ⊙ Maximum Wall Thickness of a specific part.

Considerations:

- ⊙ Optimum Cycle may be restricted by machine dry cycle
- ⊙ Optimum Cycle based on maximum cooling efficiency.
- ⊙ Different Surface Finishes may vary results.

cold combination or at least a heated sprue bushing. The sprue is typically the thicker portion of the runner, and eliminating that and/or a portion of the runner could have an impact on the cycle time, resin consumption, scrap, etc.

3. Energy Considerations

Hot runner systems run on electricity like granulators. An injection molding machine takes roughly 1 kiloWatt (kW) to process 1 kg (454 lbs) of resin. Reducing the shot size to parts only can have a significant impact on power consumption. It stands to reason that only heating, melting and processing parts takes less energy than parts and runners.

When deciding between a cold or hot runner system, consider all of these variables, which combined can increase productivity and energy savings, improve material utilization and reduce floor space and noise requirements on the shop floor. [MMT](#)

FOR MORE INFORMATION

RHH Advisor and Consulting—Injection Molding / 646-352-3021
rick.hagfors@gmail.com / Rick Hagfors, Manager



Image courtesy of PCS Co.



DME Co.
 2911 Stephenson Hwy, Madison Heights, MI 48071, USA
 Phone: 800-626-6653

dme.net

PRODUCTS/SERVICES



Mold Bases & Plates

With North America's largest selection of pre-engineered steel plates, assemblies, custom and standard mold bases and components DME® is able to meet all of your project requirements. Superior cavity tool steel ensures faster cutting times and extended tool life to help you maximize your profitability. Short lead times and reliable delivery using in-stock interchangeable plates provide you with maximum time to complete your job. Let us help you with your next project.



Mold Components

Offering the industry's widest range of mold components all manufactured to the highest standards, DME provides reliable product quality for long tool life performance. With millions of products available to ship next day and easy access on-line DME® has all your needs covered from ejector and core pins, slide action, tapered interlocks round and rectangle, mold-cooling, date inserts and many engineered molding solutions. Custom engineered parts are also available, contact us.



Industrial Supplies (MRO)

DME® Industrial Supplies includes products to boost productivity and enhance part quality, in all stages of the mold making, molding and mold repair processes. Auxiliary equipment such as conveyors and mold service tables, after-market tooling & machine supplies, safety products, ISO certified lift rings and eye bolts, purging compounds, mold cleaners and the Industry's first pioneering benchmarking coolant flow and cleaning machine service. DME® is your full product & service provider. How can we help you today?

WEBSITE

DME your *One-Stop-Shop*
 for Mold Bases & Components



DME eSTORE with Configurator
 Quickly and easily order your
 Components and Mold Bases

Configure, Price Order < 1min
 Available 24/7
 Visit dme.net/eStore

Open 24/7 - 365 - Order from anywhere, anytime. Registered users receive premium benefits including promotional discounts, order traceability, quick order and much more! dme.net

PRODUCT CATEGORIES

- **Mold Bases & Plates**
- **Mold Components**
- **Industrial Equipment & Supplies (MRO)**
- **MUD Systems & Quick-Change Prototyping Adapter**
- **Mold Making & Polishing Equipment**
- **Hot Runner & Control Systems**
- **Hot Runner Repair, Service & After-market Parts**
- **Conformal Cooling Products, Design & Service**
- **Mold Flow Analysis**

PROGRESSIVE COMPONENTS

**Progressive Components
International Corporation**
235 Industrial Drive
Wauconda, IL 60084

Toll-Free: 800-269-6653
Phone: 847-487-1000
Fax: 800-462-6653

procomps.com

PRODUCTS/SERVICES



Mold Monitoring

Progressive continues to advance their mold monitoring products:

- Cve Monitor, OnDemand, and Cve Live, provide access to a tool's activity and performance, and now offers a press management module and enhanced reporting options and alerts.
- ProFile, the new, comprehensive solution for managing tooling and production assets.
- Remote Validation Kit, the new plug and play tool that provides real-time data by connecting the portable system to a Cve Monitor on a mold.



Medical Components

Progressive offers unique products designed specifically for medical molds.

- Black Nitride Ejector Pins, Leader Pins, and Bushings that are greaseless for medical use and durable enough for die casters.
- Off-the-shelf, Stainless Steel Support Pillars available in a variety of styles and size options.
- Corrosion-resistant, black oxide treated Guided Support Pillars for small molds.
- Tapered Daters made from 420 SS to prevent flash with LSR, Nylon, etc.

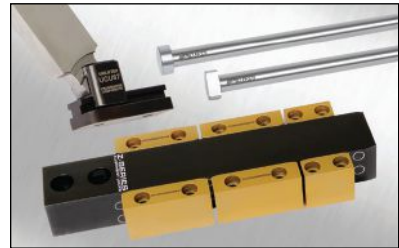

Tooling Standards

Progressive leads with innovation to help customers increase productivity and reduce costs. Many of these products have become industry standards:

- Through-Hardened Ejector Pins with increased core hardness of 48-50 HRC.
- Z-Series Alignment Locks, engineered to outperform others, are available in various styles and sizes.
- UniLifters, a popular, proven method for molding and releasing undercuts.
- Off-the-shelf cooling components such as Baffles, Cascades, Extension Plugs, and more.

WEBSITE



Progressive Components is the only American owned, independently operated supplier of components and software for molders and mold builders. To receive our most recent information, call 1-800-269-6653 or visit us at:

procomps.com/contact

PRODUCT CATEGORIES

- **Off-the-shelf Standards and Mold-Ready Components**
- **Alignment Locks and Plate Sequence Control Items**
- **Standard Lifters, CamActions and Collapsible Cores**
- **Expanded Mold Monitoring Capabilities**
- **Toolroom Supplies and Software**

HASCO®

Enabling with System.

HASCO America, Inc.
270 Rutledge Rd. Unit B
Fletcher, NC 28732

Phone: 877-427-2662
 Fax: 828-684-7960

hasco.com

PRODUCTS/SERVICES



New Hasco Slide Range Z18140

Some demanding injection molded parts with undercuts or recesses cannot simply be demolded in the mold open direction. Movable slides are required in the mold to allow the injection molded part to be removed. This is accomplished by use primarily of slide elements for this purpose. The variable HASCO slide unit range Z18140/... sets innovative standards in the flexible demolding of smaller undercuts or recesses. The extensive portfolio with slide housings (square and round) and slide locking heels (square, round and rectangular) offers a maximum ease in mounting options.



Hasco Z1780 Z1782 Round Latch Lock

On complex injection molds or die-casting tools sometimes a second parting plane or additional demolding plane is necessary, such as on three-plate molds or molds with dual ejector assemblies. For defined movement and latching of the moving plates, HASCO's new round latch lock units Z1780/... and Z1782/... are just for these applications. Compact round latch locks have multipoint locking around the circumference, which allows optimum holding power. The round latch lock Z1780/... with pulling and pushing action can be mounted in many ways.



Hasco H4016 Fully Screwed Together And Wired Hot Runner System

The fully assembled and wired hot runner systems H4016/... supplement HASCO's extensive range of ready-to-install systems and hot halves. They are an attractive solution with all the system components screwed together already. Advantages are that the connector cables for the individual nozzles and the hot runner pass through individually configured stable cable ducts to the connection box where they are wired according to the customer's specifications.

WEBSITE/APP



For almost 100 years, HASCO has been supporting its customers' success with agility, simplicity and performance. The company and products will be presented in a new, clear appearance. HASCO is the world's leading supplier of modular standard metric mold units, accessories and hot runner technology. The company's hallmark is based on state-of-the-art standardized mold products. With over 700 employees worldwide, HASCO supplies the highest quality products and services. Visit our website for more information.

hasco.com

PRODUCT CATEGORIES

- **Mold Components**
- **Mold Bases**
- **Mold Plates**
- **DLC Standard Components**
- **Collapsible Cores**
- **Unscrewing System**
- **Hot Runner Components**
- **Hot Runner Manifolds**
- **Temperature Controls, Monitors, Sensors**
- **Tool Steel/Mold Steels**

I am the Original.



Ever since the modular standard component system was invented and patented in 1960, we have been the pioneer for standardization in modern moldmaking.

- Standardized, modular system
- Rapid mold configuration with digital assistants
- Standard components guaranteeing maximum productivity
- More than 100,000 high-quality products available from stock

Your reliable partner for standardization – yesterday, today and tomorrow.

HASCO[®]

Enabling with System.

www.hasco.com



Turn To The Industry Experts

PCS Company
34500 Doreka Drive
Fraser, MI 48026

Phone: 800-521-0546
Email: sales@pcs-company.com

pcs-company.com

PRODUCTS/SERVICES



High-Performance Mold Chemicals

Innovative, high-performance mold maintenance products designed to make you much more efficient and productive. Significantly reduce cost with this new technology by eliminating waste using older, conventional methods. Chemical products include cleaners, degreasers, greasers, mold coating, mold release, and rust preventative products. Call us today to learn more or to request a sample!



Custom Components

We can custom design your specific mold components to your specifications. If you can't find a standard mold component replacement, we can create the exact component you need. Send us your design specifications, we'll quote it for you, and will manufacture exactly what you are looking for.



Ball Guided Ejection Bushing

Use this ball bearing guided ejection bushing for precise guidance of ejector plates and to support greater load capacity. This ball bushing is made of hardened ground steel and has an internal high-resistance bronze guide casing with roller bearings. The bearing surface consists of several rows of free moving precision ball bearings. This system allows for an enlarged contact area due to the bearing slots being at a slight angle, enabling greater load capacity.

WEBSITE

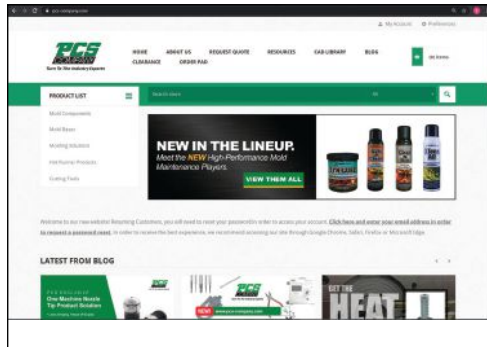

pcs-company.com

PRODUCT CATEGORIES

- Mold Bases (Standard & Custom)
- Mold Components (Standard & Custom)
- Molding Supplies
- Hot Runner Systems
- Cutting Tools
- Additive Manufacturing



Turn To The Industry Experts

Let us be your molding solutions expert, for each end market you serve.



Aerospace • Agriculture • Appliances • Automotive • Beverage • Building/Construction • Computers & Business Machines • Consumer Products • Containers/Closures • Electrical/Electronics • Food Services • Government/Defense • Industrial • Lawn & Garden • Medical/Pharmaceutical • Office Products • Other Transportation • Outdoor & Other Furniture • Packaging • Pallets • Plumbing • Recreation/Sporting Goods • Telecommunications • Waste Management



**MOLD BASES • MOLD COMPONENTS • MOLDING SUPPLIES
HOT RUNNERS • CUTTING TOOLS • ADDITIVE MANUFACTURING**

Providing molding solutions for the plastics & die casting industries for over 50 years.

1-800-521-0546 | www.pcs-company.com

Mold Components

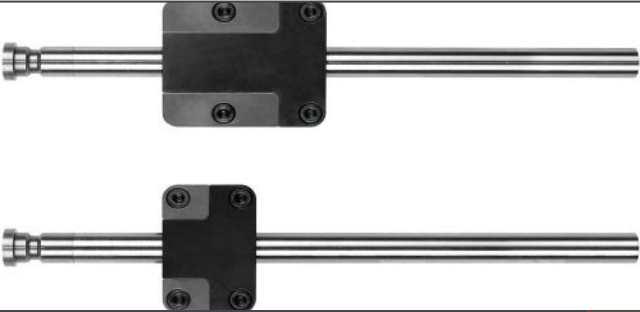
																
		Blades	Bushings	Cooling Systems	Core Pins	Counters	Date Inserts	Ejector or "Knock-out Pins"	Fixtures	Gaskets	Gate Inserts	Gears	Guides	Heating Equipment	Interlocks or	
COMPANY	Advertisers are listed in bold type.	See Ad	1	2	3	4	5	6	7	8	9	10	11	12	13	14
Agathon Machine Tools, Inc.	- Bethel, CT, 203-730-8741			2										12		
Alba Enterprises Inc.	- Torrence, CA, 909-941-0600				3					8						
Better Molding Solutions	- Ellington, CT, 860-454-8656															
BMS Burns	- Medina, OH, 800-345-7693		1	2	3	4		6	7	8	9			12	13	14
Choice Mold Components Inc.	- Clinton Twp., MI, 586-783-5600		1	2	3	4			7	8				12		14
Crafts Technology	- Elk Grove Village, IL, 847-758-3100			2		4						10				
Craftsman Tool & Mold Co.	- Aurora, IL, 630-851-8700															
Cross Tool & Manufacturing, Inc.	- Flagstaff, AZ, 928-779-4218			2												
CUMSA USA	- Troy, MI, 248-850-8385	63						6	7							
Dalton Electric Heating Co., Inc.	- Ipswich, MA, 978-356-9844														13	
DME Company	- Madison Heights, MI, 248-398-6000	Back Cover	1	2	3	4	5	6	7	8	9			12	13	14
DMS	- Oldcastle, ON, Canada, 519-737-6743		1	2		4		6				10		12	13	14
Edro Engineering and Specialty Steels, Inc.	- Walnut, CA, 909-594-5751															
eMoldino	- Seoul, KR, +82 70 7678 6388						5									
Ermanno Balzi Srl	- Mazzano, BS, Italy, +39 030 2120868		1		3			6	7							
Hasco America Inc.	- Fletcher, NC, 828-650-2600	55	1	2	3	4	5	6	7		10	11				14
Hawk Mold & Die Supply Inc.	- Pipersville, PA, 800-488-7757		1	2		4		6	7					12		14
Hotset America Corp.	- Swainsboro, GA, 912-289-1844			2					7		9		11	12	13	14
i-mold GmbH & Co. KG	- Erbach, Germany, +49 6062 80933-0											10				
IMS Company: Industrial Molding Supplies	- Chagrin Falls, OH, 440-543-1615		1	2	3	4	5	6	7						13	
Ipsco International	- Attleboro, MA, 508-226-1776			2		4										
Mac-Mold Base, Inc.	- Romeo, MI, 586-752-1956															
Meusburger US, Inc. Standard Molds	- Charlotte, NC, 704-526-0330		1	2	3	4	5	6	7	8	9	10	11	12		
Misumi USA, Inc.	- Schaumburg, IL, 847-843-9105			2	3	4		6	7							
Mold Base Industries Inc.	- Harrisburg, PA, 717-564-7960			2			5		7							14
Molders Choice Inc.	- Solon, OH, 800-809-4623														13	
National Tool & Manufacturing	- East Dundee, IL, 847-806-9800															
Nonnenmann Inc.	- Sterling Heights, MI, 586-977-8190		1	2	3	4			7							14
OMNI Mold Systems	- Lisbon, CT, 888-666-4755															
PCS Company	- Fraser, MI, 800-521-0546		1	2	3	4	5	6	7			10		12	13	14
PFA Inc.	- Germantown, WI, 262-250-4410															
Precision Ground Inc.	- Lakemoor, IL, 815-578-2613		1	2		4			7							
Precision Punch Corporation	- Berlin, CT, 860-229-9902					4			7							
PRIAMUS System Technologies, LLC	- Sterling, VA, 877-774-2687															
Progressive Components	- Wauconda, IL, 847-487-1000	Inside Cover	1	2	3	4		6	7					12		14
Roehr Tool Solutions, Inc.	- Leominster, MA, 978-562-4488					4										
SelfLube	- Coopersville, MI, 616-837-9721			2		4			7					12		
Smith Enterprises	- Wood Dale, IL, 630-595-0202		1	2		4			7							
Superior Die Set Corporation	- Oak Creek, WI, 414-764-4900			2		4						10				
Unitherm Insulation Systems	- Lewisville, TX, 972-436-1401															

For more supplier listings, go to moldmakingtechnology.com/suppliers.



Cavity Pressure Sensors Ideal for Monitoring During Injection Molding Process

Meusburger offers sensors for cavity pressure measurement, which includes two types for direct and indirect measurement. Cavity pressure sensors make it possible to convert the pressure in the cavity to a measurable charge. The sensors are equipped with high-precision quartz crystals, which release a charge under the influence of pressure or force. This charge, amplified by a charge amplifier, provides precise information about the pressure applied to the sensor and makes it possible to monitor the exact cavity pressure in the injection molding process. The ideal installation position in the mold depends on the application. For example, for general monitoring and process optimization, the sensor is placed as close as possible to the sprue or on a thicker section of the molded part. Other typical applications are strength monitoring and monitoring or controlling viscosity, compression or shrinkage.

Depending on the application, there are two types of pressure sensors: direct and indirect sensors, which serve for direct or indirect pressure measurement. For direct measurement, the pressure sensor is inserted directly into the cavity so the pressure can be measured directly in the respective area. The indirect measurement of the cavity pressure is carried out via a force sensor which is located outside the cavity and is indirectly actuated by a force. Unlike direct sensors, the cavity pressure is transmitted to the sensor as a force via an ejector pin.

The sensors are available from stock with simple CAD data download from the company web shop and are compatible with all piezoelectric pressure sensors, as well as their components currently available on the market. The sensors are available with suitable mounting accessories and connection cables.

Meusburger US, Inc. / 704-526-0330 / meusburger.us

Integrated Indexing Plate Drive Achieves Short Cycle Times

i-mold adds to its Servomold solutions portfolio a line-up of servomotor-powered indexing plate drives that can be fully integrated into multi-component injection molds in a space saving arrangement. Available in four standard system sizes, the units are suitable for plate weights up to 250 kg. They are built to provide fast and precise rotary motions to achieve short cycle times and smooth production workflows.

The indexing plate drives provide unlimited rotary motion through 360 degrees and beyond, offering a time-saving advantage as it eliminates the need to return to a zero position before a new cycle starts. The system is based on all-rotational action, consisting of the servo motor unit (SAK type), an elastic servo coupling (SEK type), the indexing plate drive (SID type) and the splined output shaft to the indexing plate. The system is firmly attached to the injection molding machine clamping plate, permitting indexing plate molds of similar size to be operated with a uniform indexing plate unit, i.e., without requiring a separate rotary mechanism for every mold. SID indexing plate drives come in four frame sizes and with two SAK servomotor units delivering different outputs. Depending on the combination, the system can actuate indexing plates with a maximum weight between 10 kg and 250 kg. All systems are equipped with a safety brake to prevent mold damage in the case of a power failure. The output shaft is splined but can be individually adapted at the customer's request.

i-mold GmbH & Co. KG / 49-6062-80933-0 / i-mold.de

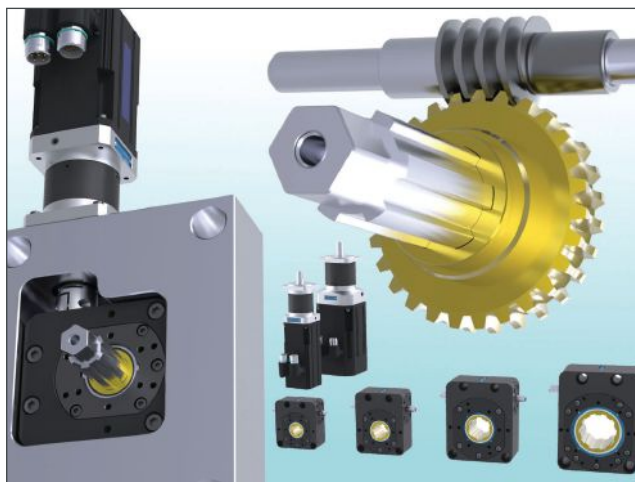

Identification Stamps Offer Clear Identification of Molded Parts

Hasco introduces identification stamps, which offer simple solutions for clear and direct identification of plastic injection molded parts. Stamps are available for the standard international food, recycling and CE symbols. The compact stamps are engraved and permit clean and clear impressions. Mounting is facilitated by a 10-degree insertion bevel which permits an interlocking connection via a mounting thread. The corrosion-resistant stainless steel ensures problem-free, continuous operation with a long service life and with an outstanding price to performance ratio.

HASCO America, Inc. / 877-427-2662 / hasco.com



EZ Slider Eliminates Need for Traditional Slide and Lifter Components

Michmar Engineering announces the EZ Slider, which eliminates the need for traditional slide and lifter components. The component simplifies 2D machining with no need for complex angular machining set ups. The slider replaces expensive hydraulic cylinders, external limit switches, mounting plates, and it eliminates the manufacture time and materials for additional components. Travel can be readjusted without the need to remanufacture horn



pins, slide travel stops or replace slide locks. The component comes in a compact system with limited real estate use, and easy installation and adjustment from parting lines. Full 3D CAD is available for ease of design, and integrated internal

stainless steel limit switches with LED illumination are available upon request to give a positive signal that it is safe to continue the molding process. The EZ Slider comes in standard 5 degree increments of deceleration up to 35 degrees, eliminating the need for costly mechanical or hydraulic drivers.

Michmar Engineering / 519-988-0404 / michmareng.com

Bronze Ejector Bushings Offer Superior Performance for Toughness

PCS Company offers both solid bronze and bronze-plated straight bushings, shoulder bushings and guided ejector bushings. The solid bronze guided ejector bushings offer superior performance for toughness, tensile strength and low coefficient of friction. Made of solid aluminum bronze, the bushings are available in nominal diameters ranging from ¼" to 2". Included internal grease grooves help prevent galling, which aids in smooth operation. Other features include keeping ejector assembly aligned, extending the life of ejection components and better performance than steel bushings.



The solid bronze shoulder bushings are made from premium solid bronze, and they feature increased lubricity and internal grease grooves. The shoulder bushings resist wear and abrasion on high compression loads.

Bronze-plated straight bushings and shoulder bushings are available in nominal diameters ranging from ¼" to 3". The shoulder bushings reduce friction on leader pins and are press-fit into place. The bushings are perfect for mold alignment, perform better than steel bushings and contain an internal grease groove to help prevent galling, aiding in smooth operation.

PCS Company / 800-521-0546 / pcs-company.com

MMT
MoldMaking
TECHNOLOGY®

ENGINEER / BUILD / MAINTAIN

WEBINAR

PRESENTED BY:

PROGRESSIVE
COMPONENTS

procomps.com

PRESENTERS:



Progressive's Engineering Team (L to R):
Paul Moreau, Glenn Starkey,
Kevin Kelly, Matt Finney,
DeAnn Springer, Trista Iodice,
Sebastian Jurczak and Ken Rumore

From Designers, To Designers: Medical Molds Are Different

Designing molds for the Medical sector requires unique approaches. The Engineering team at Progressive, headquartered in the northern Illinois medical corridor, has gathered tips and approaches to share with others in mold design.

You will learn about:

- Heading off potential flash areas when running high MFI resins—LSR, Nylon, Medical-grade flex PVC.
- Extending molding production between PM's while avoiding unscheduled mold stoppages.
- Doing the math on water flow: Tricks for sneaking water into crowded cores.
- Enabling tooling performance visibility before the mold is built and run.

DATE & TIME:

Tuesday, July 14, 1:00 PM CST

Register at: short.moldmakingtechnology.com/procomps07

Mini Hydraulic Locking Cylinder Provides Tremendous Preloading Capacity

PFA, Inc. announces the release of the 70 series “mini” hydraulic preloading and locking cylinder as part of the Kor-Lok side-action system product line. Providing tremendous preloading capacity in a small cylinder and locking in the preload are the product’s primary advantages.

The mini’s 8,000 lbs of preload activates force in a new narrow format, enabling multiple small cores to nest together and time independently. Smaller ports and low profile sensors ensure a large competitive advantage to standard compact hydraulic cylinders. Smaller ports and low profile sensors ensure a large competitive advantage to standard hydraulics and other compact hydraulic cylinders. Zero psi locking supports green technologies that save energy by dropping hydraulic pressure during injection. Eliminating the need for always-on independent hydraulic core pull pumps provides further energy savings.

The mini Kor-Lok is available with low profile PNP sensors and traditional mechanical SPDT switches, high-temperature seals, standard multiple and rear hydraulic porting and flexible mold flange mounting and core interfacing accessories.

PFA Inc. / 262-250-4410 / pfa-inc.com



3D Models in Components Library Eliminates Busy Work for Tool Designers

SelfLube announces 3D models for its entire product line of precision mold and die components are fully incorporated into the VISI CAD components library. VISI users will be able to use VISI’s powerful “Builder” tool to select a 3D model for any of the company’s 10,000+ components and quickly insert it into the 3D model for the tool being designed with a few mouse clicks. According to the company, this eliminates busy work for tool designers to provide more time to design great tools.

SelfLube / 800-690-3600 / selflube.com

Round Latch Lock Units Enable Optimum Movement

HASCO has developed the round latch lock units Z1780/ and Z1782/ especially for applications when a second parting line or additional ejector plate is necessary. For example, on three-plate or molds with dual ejector assemblies to enable defined movement and latching of the moving plates. The compact round latch locks have multipoint locking around the circumference, enabling optimum movement. The round latch locks with pulling and pushing action can be mounted in many different ways.

HASCO America, Inc. / 877-427-2662 / hasco.com



Insulator Block Protects Monitoring Devices in High Temperatures

Progressive Components announces the release of its insulator block, which installs on the outside of the mold and is used to protect the company’s CounterView and CVe monitor from temperatures when molding high-temperature resins.

The maximum temperature for a CounterView is 120°C/250°F, and a CVe monitor is 90°C/190°F. When using an insulator block, both units will perform with mold temperatures up to 180°C/360°F. The block can be installed on either half of the tool, but for the CVe monitor, the stationary side is recommended for optimal cable routing. It is available in both inch and metric versions, complete with 1/4-20 or M6 screws.

Progressive Components / 800-269-6653 / procomps.com



Cutting Sprue Bushing Removes Need for Secondary Operation

DMS adds Almo's cutting sprue bushing to its range of edge gate cutting components. The cutting sprue bushing enables feeding plastic components near the mold's center, virtually eliminating cold runners into a runnerless cold feed and trimming the gate as the mold opens, removing the need for secondary operation. It also provides a large edge gate area to reduce injection pressure and improve the packing and quality of the final plastic product.

DMS / 800-265-4885 / dmscomponents.com

eStore Offers Large Portfolio of Products

DME offers a large portfolio of products, all available with rapid delivery. The company's eSTORE offers a 24/7 one-stop-shop to thousands of products and tens of thousands of products with real-time order processing and status updates. Products available include p-pin ejector pins with tighter tolerances; cashew gate inserts; off-the-shelf mold bases for quick delivery, interchangeable plates, available in 42 sizes; and MUD quick-change prototype adapter that converts MUD mold bases to a simple to use prototype tool. Additionally, the company's innovative cashew gate inserts offer cost-reducing potential. The auto de-gating system saves operating costs and boosts out-put of high-quality parts.

DME Company/ 800-626-6653 / dme.net

Double Date Stamp Reduces Costs and Space

Cumsa showcases its Double Date Stamp Ø16 Blank. The stamp allows two different indications on the plastic part without the need for two date stamps, reducing costs and space required. The standard version (12 months + years) saves to periodically change the central insert during 5/6/10 consecutive years. The same height is always maintained between all the rings.

CUMSA USA / 248-850-8385 / cumsa.com



The ORIGINAL CUMSA™ Date Stamps

The most RELIABLE DATE STAMP on the market!
Over 25 years of exceptional quality



Buy ORIGINAL replacements directly in our NEW e-commerce

www.cumsausa.shop



Certified replacements engraved with a C for CUMSA



CUMSA
USA

+1 248 850 8385
info@cumsausa.com

WWW.CUMSA.COM

in y f

How to Use Hydraulic Locking Cylinders to Improve Plastic Injection-Molded Part Profitability

By Mark Scanlan

Profitability impacts everyone in the mold supply chain because the mold builder, molder and OEM must consider both mold cost *and* cost per part, which is highly dependent on mold complexity. The challenge is finding the most creative solution to meet requirements at the lowest overall cost for the mold builder, molder and OEM. Hydraulic locking cylinders can provide a solution.

Mold builders can easily produce right-sized *simple* molds because part size fundamentally defines mold size. *Complex* molds, however, often push the limits of design creativity with demanding part quality and larger side-action footprints. Higher quality demands better-performing fits to maintain part dimensionality, and complexity often makes action design more expansive for relatively small parts. When you increase both mold and machine size, you get higher mold costs, slower process speeds and higher costs per part.

Driving profitability in the right direction requires driving the mold base size back down to lower costs and preloading slides for optimal part quality.

Smaller mold bases and improved structural integrity equal increased value-add at lower costs.

Complex mold designs in smaller mold bases. A designer can easily solve the mold base problem by moving the majority of the side action to the outside of the mold base with standard NFPA-style or

compact hydraulic cylinders that mount to the mold base externally, but capturing slides takes room inside the mold base. Hydraulic preloading and locking cylinders mount fully external to the mold base and provide independent control to keep the mold base smaller, without the drawbacks of compact or standard cylinders. Locking cylinders can also be “quick mounted” to allow installation after setting the mold to fit into the smallest machines and accommodate long core strokes.

Complex interfaces with better part quality. Timing complex actions is challenging particularly those with multiple core shutoffs, due to core overtravel, sequencing and simultaneous insertion. A better option is to preload cores into position on a hard stop using hydraulic locking side-actions.



Image courtesy of PFA Inc.

Hydraulic locking cylinders capable of preloading side-action cores allow a mold to produce complex parts more profitably.

This method ensures zero movement of slide faces during placement and injection, while moving the mounting support locations away from the part to the more rigid outer mold base structure, enhancing the integrity of the mold cavity structure and fit.

Competitive advantages for the supply chain. An optimized mold can be placed in a smaller press that inherently runs faster, and a mold that performs better with a smaller footprint can command premium prices, yielding a lower cost to manufacture—a win for the entire supply chain.

For example, a mold that costs the builder less, but also runs at a lower cost per part in a smaller machine with improved part quality, justifies a higher performance-based price, benefiting the mold builder. Higher quality parts produced from a high-performance mold at competitive pricing supports lean manufacturing initiatives, increasing the molder's value as a supplier to the OEM customer. The optimized mold then eliminates waste and produces the most efficient cost structure and thus, more profitability. [MMT](#)

FOR MORE INFORMATION

PFA Inc. / 262-250-4410 / pfa-inc.com
Mark Scanlan, Vice President



Image courtesy of Walter USA, LLC.



Iscar USA
300 Westway Place
Arlington, TX 76018-1021

Phone: 817-258-3200
 Toll-Free: 877-294-7227
 Fax: 817-258-3221
 Email: info@iscarusa.com

iscarusa.com

PRODUCTS/SERVICES

Machining Intelligently

ISCAR is about productivity. Upon close collaboration with industry, cutting tool solutions that optimize productivity can be developed. This is how better, innovative, products are introduced.

Many variables come into play when applying tooling and ISCAR ensures that a high level of support is present to guarantee the best possible machining experience.

Become a Master—ISCAR LOGIQ Chess Lines

LOGIQ4FEED (designated FFX4) is a Fast Feed line from ISCAR that's an excellent fit for rough milling applications on small- to medium-sized moldmaking components, especially on light duty milling machines (i.e., CAT40, HSK63) that typically have spindles with horsepower constraints and which are commonly found within Moldmaking companies due to the machines ability to optimize finishing operations that operate at high RPM's. One of the main keys of LOGIQ4FEED is its insert design, which provides the ability to optimize the key variable for any roughing application—that is the ratio of cubic inches of material removed per unit of HP. The narrow, dog-bone, shape of the LOGIQ4FEED insert provides:

- double sided insert with 4 cutting edges
- internal cutting edge which is engaged during ramping and helical interpolation, thus eliminating the loss of cutting

edges that occurs when ramping or helically interpolating with high feed designs that use square inserts

- expanded product range (.500"–2.00"), especially effective for smaller diameters $\leq .750$ "
- extremely positive cutting edge/angles, which reduces power consumption and increases/optimize the ratio of cubic inches of material removed per unit of HP
- increased number of pockets/inserts within a given cutter diameter, which also typically increases/optimize the ratio of cubic inches of material removed per unit of HP
- increased core diameters, which increases rigidity of the cutter body and its resistance to bending/deflection

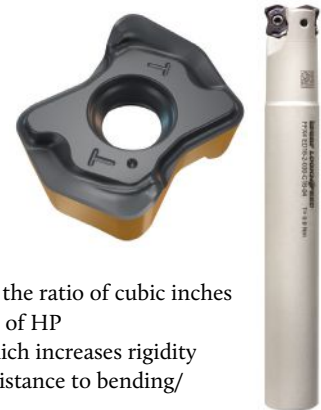

WEBSITE



Iscar is a dynamic full-line supplier of carbide metal cutting tools which cover a broad range of applications and industries. Browse Iscar's site to find the newest innovations in metal removal. Contact Iscar for more information.

iscarusa.com

PRODUCT CATEGORIES

- **Cutting Tools**
- **End Mills**
- **Inserts**
- **Lathe Tooling and Accessories**
- **Reamers**
- **Toolholders**
- **Tool Selection Software (ITA)**

LOGIQ MILL

ISCAR CHESS LINES

High Feed Milling Twist Master

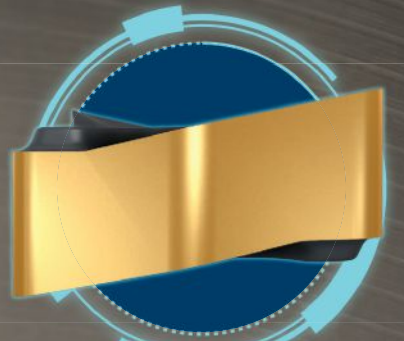

Twisted Shape
High Rake Angle

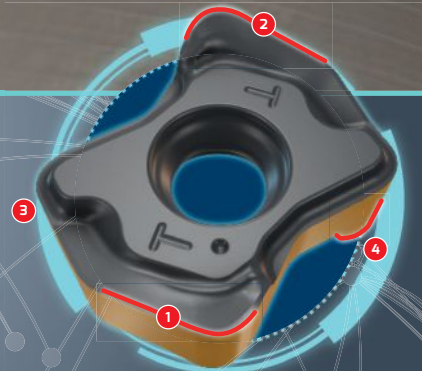

Unique Insert Shape

LOGIQ 4FEED

HIGH FEED MILLING

Twisted Shape Insert for High Feed Milling Guarantees Higher Productivity



High Positive Rake Angle



Large Body Core Ensures Stability and Rigidity



Double Sided Insert

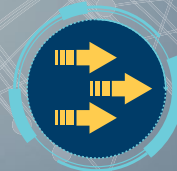

High Feed Milling

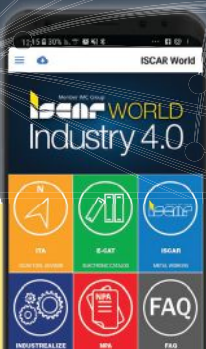

Download ISCAR WORLD Now!

All ISCAR's online apps, interfaces, and product catalogs in a single space.

Member IMC Group
iscar
www.iscarmetals.com

MACHINING IN INDUSTRY 4.0 INTELLIGENTLY



App Store



Play Store



Excellence in Technology

Horn USA Inc.
320 Premier Court
Suite 205
Franklin, TN 37067

Phone: 888-818-4676
 Fax: 615-771-4101
 Email: sales@hornusa.com

hornusa.com

PRODUCTS/SERVICES

HORN is the worldwide technology leader of indexable cutting tools with experience with more than 150,000 custom application solutions and engineering expertise, applied to more than 20,000 standardized tools for turning and milling. Our highly skilled application engineers provide a foundation of communication and reliable support in the field. Every application engineer is backed by a centrally located manufacturing facility with in-house technical specialists, customer service representatives and logistical support. Horn USA Inc. is committed to providing a prominent level of focused service in North America, with rapid and detailed response to your requirements.

ISO OOP

- Round milling system for the Die & mold industry
- Retention clamp for secure milling
- Advanced substrates matched to the application
- Optimized insert position for excellent contour precision
- Shellmill, cylindrical, & modular fixation 10-160 mm Ø
- Insert Sizes 5,7, 10,12, & 16

Broaching Geometries and Coolant

- Supermini® and S117 series inserts
- Geometries designed for broaching units and conventional broaching
- Superior coolant delivery for longer tool life
- Geometries for difficult to machine materials
- Wide range of broaching units supported
- Advanced AN25 Grade
- Supermini® 105 & 110 Geometry A & B
- S117 Geometry A & B
- Geometry A for broaching units
- Geometry B for conventional broaching
- SHM117 and SH117 with 3 outlet coolant



WEBSITE

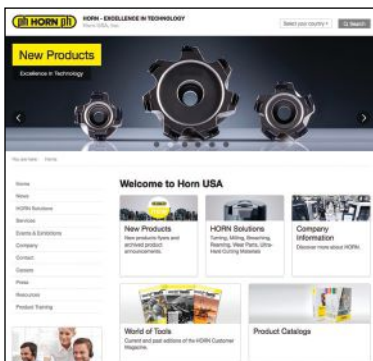

hornusa.com

PRODUCT CATEGORIES

- **Milling Tools**
- **Turning Tools**
- **Broaching Tools**
- **Drilling Tools**
- **Reaming Tools**
- **Whirling Tools**
- **PCD, CBN, MCD, CVD-D Tipped Tools**
- **Tools for Machining Sintered Carbide**

A person wearing a yellow helmet and a climbing harness is seen from behind, standing on a rocky ledge and looking out over a vast, dark, craggy rock face. The person is wearing a black t-shirt and tan cargo pants.

THE DIFFERENCE BETWEEN AN ATTEMPT AND AN ACHIEVEMENT

THE TOOL

HORN is outstanding cutting-edge technology, performance, and reliability. Accomplish more: our precision tools make the difference.

www.hornusa.com

Cutting Tools

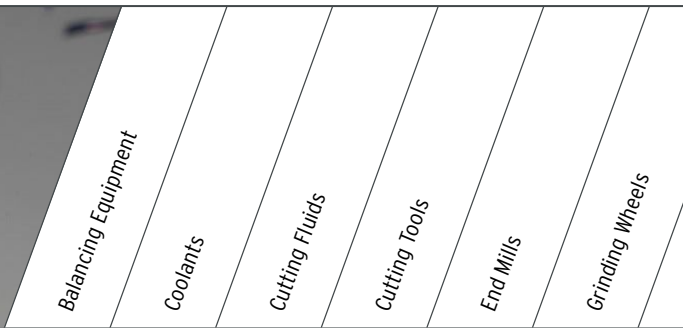

COMPANY	Advertisers are listed in bold type.	See Ad						
			1	2	3	4	5	6
BIG Kaiser Precision Tooling Inc.	Hoffman Estates, IL, 224-770-2999					4	5	
Cobra Carbide	Riverside, CA, 951-280-4700					4	5	
Cole Carbide Industries, Inc.	Orion Township, MI, 586-757-8700					4	5	
Crystallume	Santa Clara, CA, 408-653-1700					4	5	
CVD Diamond Corporation	London, ON, Canada, 519-457-9903					4	5	
Dapra Corporation	Bloomfield, CT, 860-242-8539					4	5	
Data Flute	Pittsfield, MA, 413-499-3895					4	5	
Drill Masters - Eldorado Tool	Milford, CT, 203-878-1711					4		
EDM Network Inc.	Sugar Grove, IL, 630-466-5588							
Emuge Corp.	West Boylston, MA, 508-595-3600			3		4	5	
Greenleaf Corporation	Saegertown, PA, 814-763-2915					4	5	
Haimer USA	Villa Park, IL, 630-833-1500		1			4	5	
Horn USA Inc. - Franklin, TN, 615-771-4100		69				4	5	
Ingersoll Cutting Tools	Rockford, IL, 815-387-6600					4	5	
Iscar USA - Arlington, TX, 817-258-3200		67				4	5	
JM Performance Products, Inc.	Fairport Harbor, OH, 440-357-1234					4		
Kennametal Inc.	Latrobe, PA, 800-446-7738			3		4	5	
LMT USA, Inc.	Waukegan, IL, 847-693-3270					4	5	
Micro 100 Tool Corp.	Meridian, ID, 208-888-7310					4	5	
Millstar	Orion Twp., MI, 586-573-9450					4	5	
Monster Tool Company	San Marcos, CA, 888-227-2433					4	5	
Niagara Cutter	Troy, MI, 248-528-5220					4	5	
NSK America Corp.	Hoffman Estates, IL, 847-843-7664							
OSG USA, Inc.	Glendale Heights, IL, 630-790-1400					4	5	
REGO-FIX Tool Corp.	Whitestown, IN, 317-870-5959		1					
RobbJack Corporation	Lincoln, CA, 916-645-6045					4	5	
RoundTool Laboratories	Huntington Beach, CA, 800-854-2431					4	5	
Sandvik Coromant Co.	Fair Lawn, NJ, 201-794-5000					4	5	
SCHUNK - Morrisville, NC, 919-572-2705		81				4		
Scientific Cutting Tools	Simi Valley, CA, 805-584-9495					4		
Seco Tools, LLC	Troy, MI, 248-528-5200					4	5	
Single Source Technologies	Auburn Hills, MI, 248-232-6232		1	2	3	4	5	
Sumitomo Electric Carbide, Inc.	Mt. Prospect, IL, 847-635-0044					4	5	6
Techniks Tool Group	Indianapolis, IN, 317-803-8000					4	5	
Tool Alliance	Huntington Beach, CA, 714-898-9224					4	5	
Tool-Flo Manufacturing Inc.	Houston, TX, 713-941-1080					4	5	
Transor Filter USA	Elk Grove Village, IL, 847-640-0273			3				
Tungaloy America	Arlington Heights, IL, 888-554-8394					4	5	
Walter USA, LLC	Waukesha, WI, 262-347-2400					4	5	
YG-1 Tool Co.	Vernon Hills, IL, 800-765-8665					4	5	

For more supplier listings, go to moldmakingtechnology.com/suppliers.

<i>Hard Milling</i>	<i>High-feed Milling</i>	<i>High-Speed Electric Spindles</i>	<i>Inserts</i>	<i>Lathe Tooling and Accessories</i>	<i>Profilers</i>	<i>Reamers</i>	<i>Tool Management Systems</i>	<i>Toolchangers</i>	<i>Toolholders</i>	WEBSITE
7	8	9	10	11	12	13	14	15	16	
			10	11			14		16	bigkaiser.com
			10			13			16	cobracarbide.com
7	8		10						16	colec Carbide.com
7			10							crystallume.com
										cvddiamond.com
7	8		10							dapra.com
7	8									dataflute.com
						13				dmetool.com
7	8									edmnetwork.com
7	8		10	11		13			16	emuge.com
7	8		10	11					16	greenleafcorporation.com
7	8						14		16	haimer-usa.com
7	8		10	11	12	13			16	hornusa.com
7	8		10	11		13	14		16	ingersoll-imc.com
7	8		10	11		13	14		16	iscarmetals.com
									16	jmperformanceproducts.com
			10	11	12	13			16	kennametal.com
			10	11						lmtusa.com
			10	11	12				16	micro100.com
			10						16	millstar.com
7	8					13				monstertool.com
7	8									niagaracutter.com
	8	9								nskamericacorp.com
7	8		10			13			16	osgtool.com
7				11					16	rego-fix.com
			10							robbjack.com
7	8									roundtool.com
			10	11					16	sandvik.coromant.com
				11					16	us.schunk.com
			10	11	12	13			16	sct-usa.com
7	8		10	11	12	13	14		16	secotools.com/us
		9	10					15	16	singlesourcetech.com
7	8		10	11		13			16	sumicarbide.com
			10	11					16	technikstoolgroup.com
7			10			13				toolalliance.com
			10		12				16	toolflo.com
										transorfilter.com
7	8		10	11		13	14		16	tungaloy.com/us
7	8		10	11	12	13			16	walter-tools.com/us
7	8		10	11					16	yglusa.com

Image courtesy of CNC Software Inc./Mastercam.



Octagon Face Milling Cutter Boosts Feed Rates

The M2028/M2029 octagon face milling cutters from **Walter** delivers high feed rates and lower tooling costs for a wide variety of roughing and finishing applications, thanks in large measure to their stable, negative, double sided inserts that feature 16 cutting edges.

The versatile M2028 for roughing and M2029 for finishing are suitable for use with ISO material groups P, M, K and S in a broad range of automotive, aerospace, energy, railway and general machining applications. The M2029 shows tool life increases in the number of machined parts from 30 to 80 for a turbo housing. It also yields a machining time reduction of 31%.

The inserts, which are available in Tigertec Gold, feature marks on the top for easy recognition of geometry and a depth of cut. Depending on the cutter, the geometries available are the D57 geometry for stable cutting at high feed rates in unfavorable conditions, the F57 geometry for universal use under medium conditions and the light cutting F67 geometry for low cutting forces and medium feed rates under good conditions. These geometries are available in grades WKP35G, WSP45S and WSM35S.

Walter USA, LLC / 800-945-5554 / walter-tools.com/us

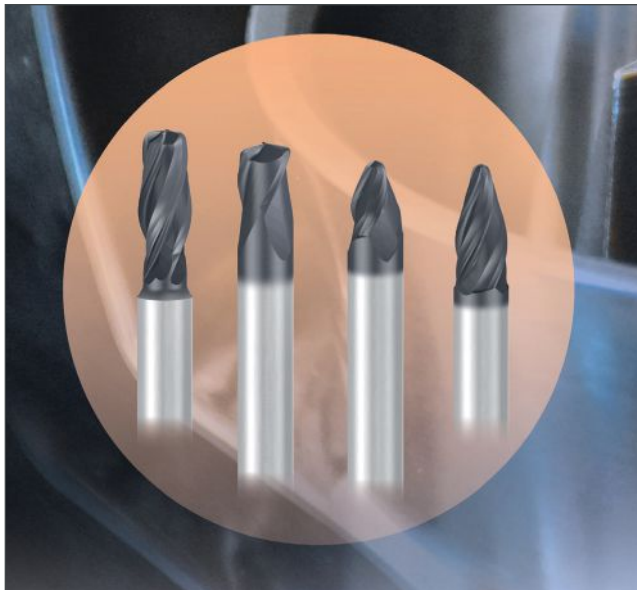

Circle-Segment End Mills Enable Faster Machining Cycles and Smoother Finishes

Emuge Corp.'s "circle-segment" cutters are a class of end mills designed to enable substantially more material removal with fewer passes in five-axis machining. The company says they also reduce cycle times by more than 80 percent and produce up to 50 percent smoother surface finishes.

Emuge says these cutters are ideal for mold making applications. They feature unique forms with large radii in the cutting area of the mills, allowing a larger axial depth of cut during pre-finishing and finishing operations.

Circle-segment solid-carbide end mills are offered standard in four geometries: barrel-shaped, oval form, taper form and lens shape. Oval and taper form mills are ideal for curved shapes such as straight-walled pockets, freely engaging more of the cutting edge. Barrel design mills provide highly effective flank milling to the sides of spiral grooves and similar applications, while lens shape mills excel in narrow channels or in lands on molds.

Emuge Corp. / 800-323-3013 / emuge.com

Solid Carbide End Mills Offer Four Cutting Actions in a Single Tool

Millstar's Quad Force Machining Tooling System provides maximum flexibility by way of its innovative hybrid geometry. The company says the line of solid carbide end mills is capable of four cutting actions in a single tool, making it a cost-efficient solution for diverse application challenges in mold and die making.

QFM's hybrid design combines high feed geometry, variable flute geometry, variable helix geometry and offset geometry. This unique combination allows users to seamlessly integrate multiple machining operations including high feed machining, trochoidal machining, side/slot milling and plunge milling.

Millstar's QFM end mills are said to offer superior metal removal rates in soft or hard tool/die steels, stainless steels and titanium. Their state-of-the-art geometry provides accuracy and repeatability while achieving greater depth of cut and preventing side vibrations. The durable QFM Tooling System also features a multi-layer hybrid nanocoating for excellent heat resistance and high hardness, which facilitates higher productivity and longer tool life.

Quad Force Machining end mills are made in the United States.

Millstar / 877-645-5782 / millstar.com

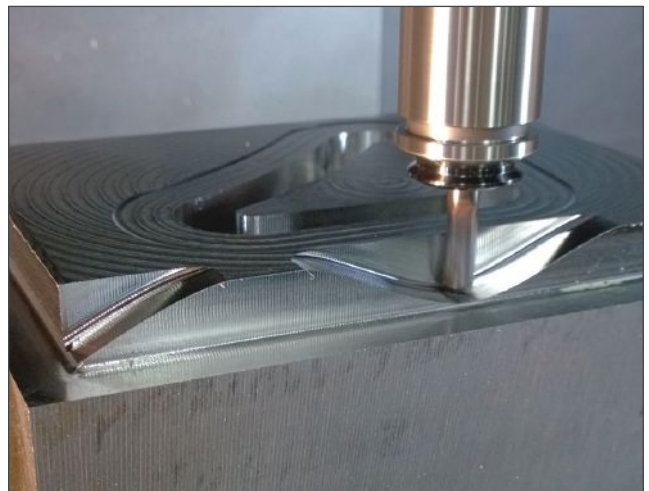



Digital Tooling Products Provide High Accuracy and Reliable Results

Big Kaiser offers digital tooling innovations, as well as cutting-edge products and accessories. The company's provides Ewe fine boring heads range; the Torque Fit tool assembly accessory that tightens fixtures for collet chucks with an integrated torque measuring system; the Level Master Wireless, which enables leveling information to be read from a separate display device and ensures correctly achieved precision levels; the Speroni Essentia tool presetting and measuring system that efficiently measures tools offline, permitting the operator to achieve full machine productivity; and hydraulic tool holders with peripheral jet coolant holes that are ideal for high-precision five-axis machining, including straight shank types made exclusively for Swiss-type lathes for cutting tool changes with high accuracy and reliable results. The company also offers the EWA system, which eliminates the need to stop the machine tool to take measurements and manually adjust the boring tool; the Mega Micro Coolant Nut, which enables more efficient coolant supply for the micro cutting tool; an updated hydraulic chuck with switchable coolant supply; smaller sizes of the C4 Turning Tools; the ChipFan, which provides a safer chip removal method; and C-Center Cutter Inserts, which include two new coated inserts, ACM250F for stainless steel and DS20 for aluminum, for expanded precision and versatility.

BIG KAISER Precision Tooling Inc. / 888-866-5776 / bigkaiser.com

Expanded Indexable Threading Tools Ensure Minimum Interference

Tungaloy expands its TungThread line of indexable threading tools to include 11ER external threading inserts as well as 8 by 8 mm and 10 by 10 mm square shank holders to accommodate the new inserts. These new 11ER threading inserts and two square shank holders are specifically designed with users of Swiss-type automatic lathes in mind. The 11ER insert is smaller than conventional 16ER inserts, and the insert holders are designed to ensure a minimum interference when machined towards the sub-spindle, which is an issue with a 16ER insert holder. This expansion will enhance the TungThread series to meet the needs of various threading applications on Swiss-type automatic lathes and other small-parts manufacturing equipment.

Tungaloy America, Inc. / 888-554-8394 / tungaloy.com/us



Cutting Tools Ideal for Surface Accuracy

OSG USA Inc. releases two products to the A Brand master tooling class. The A Brand ADO-Micro Drills provides better chip evacuation in the medical and electrical industries, and non-step drilling is made possible even for deep-hole applications, enabling high processing efficiency. For the die mold industry, the A Brand AE-H series offers heat resistance and toughness for high-hard steel milling. Its geometry enables milling by point, which prevents chattering and chipping, resulting in improvement of surface accuracy.

OSG USA Inc. / 800-837-2223 / osgtool.com



End Mill Series Reduces Wear and Lasts Longer

RobbJack highlights its die/mold series end mills. Made with a revolutionary coating technology, the company's DM/MDM carbide end mills reduce wear and last longer than comparable tools in hard metal applications. The end mill offers tighter tolerances, lasts longer in difficult areas like parting lines and produces better finishes that reduce or eliminate the need for polishing.

The company also announces the FMHV series end mills, designed for high horsepower and high velocity machining in aluminum moldmaking. The FMHV series feature mirror edge geometry, reducing vibration. The FMHV tools are ideal for high-speed machining of deep pockets and thin walls.

RobbJack/Crystallume / 916-645-6045 / robbjack.com

New End Mills Provide Cost-Effective High Performance on Tough Materials

Seco Tools' new Jabro-Solid2 JS 750 end mills are designed to provide longer tool life when machining tough materials. According to Seco, shops that struggle to maximize end-mill tool life when machining challenging materials can now achieve 25 percent to 40 percent longer life with this new family of end mills.

The JS754 and JS755 cutter geometries optimize conventional side milling, roughing and slotting, as well as advanced roughing and dynamic milling operations. Instead of struggling with chip formation, the smooth peripheral rake faces and strong radius design of these cutters evacuate chips efficiently while maintaining a true radius form. To avoid slow or unreliable cutting when interpolating or ramping for pocket machining, increased front back tapers enhance speed and reliability. The broad range of JS754 and JS755 variations and features ensure the highest cutting performance. Shops can match tool to application with various lengths, OD neck reduction sizes and corner radii, as well as chip splitters and through-coolant options.

Seco Tools, LLC / 800-832-8326 / secotools.com/us



Tips for Mitigating Chatter and Vibration

By Jack Burley

Vibration can be a common problem faced by shops. A resonance frequency issue, vibration happens as a tool is trying to move out of its designed path or center. As it does, the tool starts to deflect, which causes chatter. This can have an adverse impact on machining: tool life is negatively affected, spindle bearings take up vibration which affects their life, lost productivity from slowing the process down, and out-of-tolerance workpieces.

There are a few ways to combat vibration. One is to identify tool deflection as the root cause of the problem. This can take several forms, from cantilever deflection to holding being done with a pulling element. Since deflection is based on the amount of force, the higher the force, the greater the deflection.

Better programming reduces such forces, leading to a smoothly run operation. Better tool selection, sharper cutting edges, reducing length and applying five-axis technologies all can be beneficial in the anti-vibration fight. But keep in mind that three important forces play a role on tools—radial, axial and tangential.

As for starting points, programmers should consider the length to diameter ratio. Anything 4:1 and less, the manufacturer's recommendation is good to go. But for a ratio lower than 5:1, some changes are in order. Look at the insert radius and change to a sharper cutting edge. At a ratio of 6:1, chatter is very likely, and adjustments are necessary if over 7:1.

For small end mills, adjustment for chatter is still recommended. A few steps can be taken to reduce engagement. Reduce the number of flutes, use both a variable flute and helix end mill, which should break up the chattering. Reducing the depth of the cut can also help—focus on the axial and radial forces.

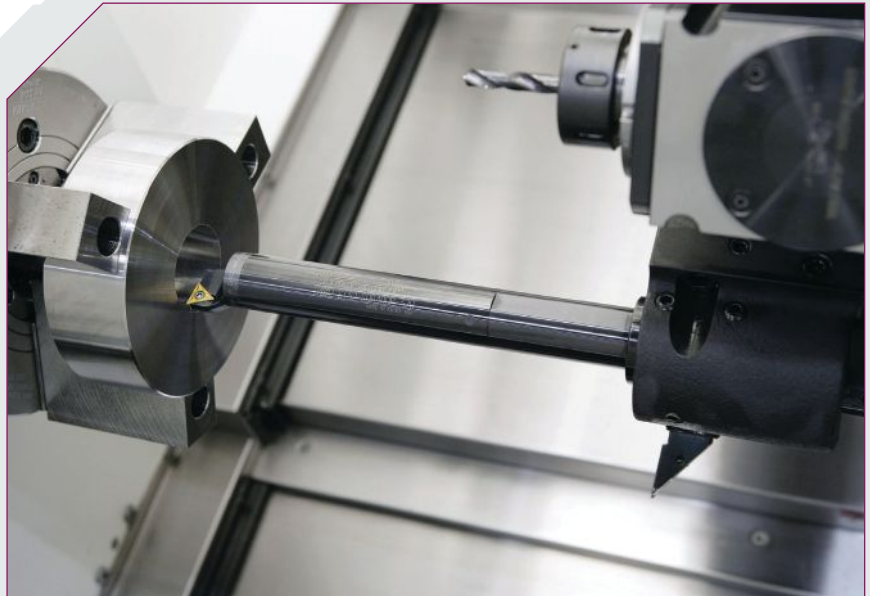

Image courtesy of BIG KAISER Precision Tooling.

There are several ways to eliminate vibration and chatter when machining, including by identifying tool deflection and better programming. Another solution is to employ damping technologies like the product pictured here, which is designed to dampen vibrations and reduce chatter in deep-hole finish boring and extended-reach face milling applications.

The biggest problem is when there is chatter in the shank. Cutter shank engagement in the tool holder should be at least $2 \frac{1}{2} \times D$. Using both the shortest tool holder possible and balanced tool holders, as well as minimizing runout are good options to reduce vibration.

Vibration reduction techniques extend into programming solutions. Among those is utilizing trochoidal milling programs, installing CAM software that maintains constant chip thickness, employing circular interpolation in corners with a smaller tool, and finding the tool assembly's "sweet spot"—all leading to finding the machine's natural frequency.

Ultimately, damping technologies offer the greatest possibility of eliminating vibration. Although not a new concept, damping can automatically identify the source of vibration and help with the frequency. [MMT](#)

FOR MORE INFORMATION

BIG KAISER / 224-770-2999 / bigkaiser.com
Jack Burley, Vice President of Sales and Engineering

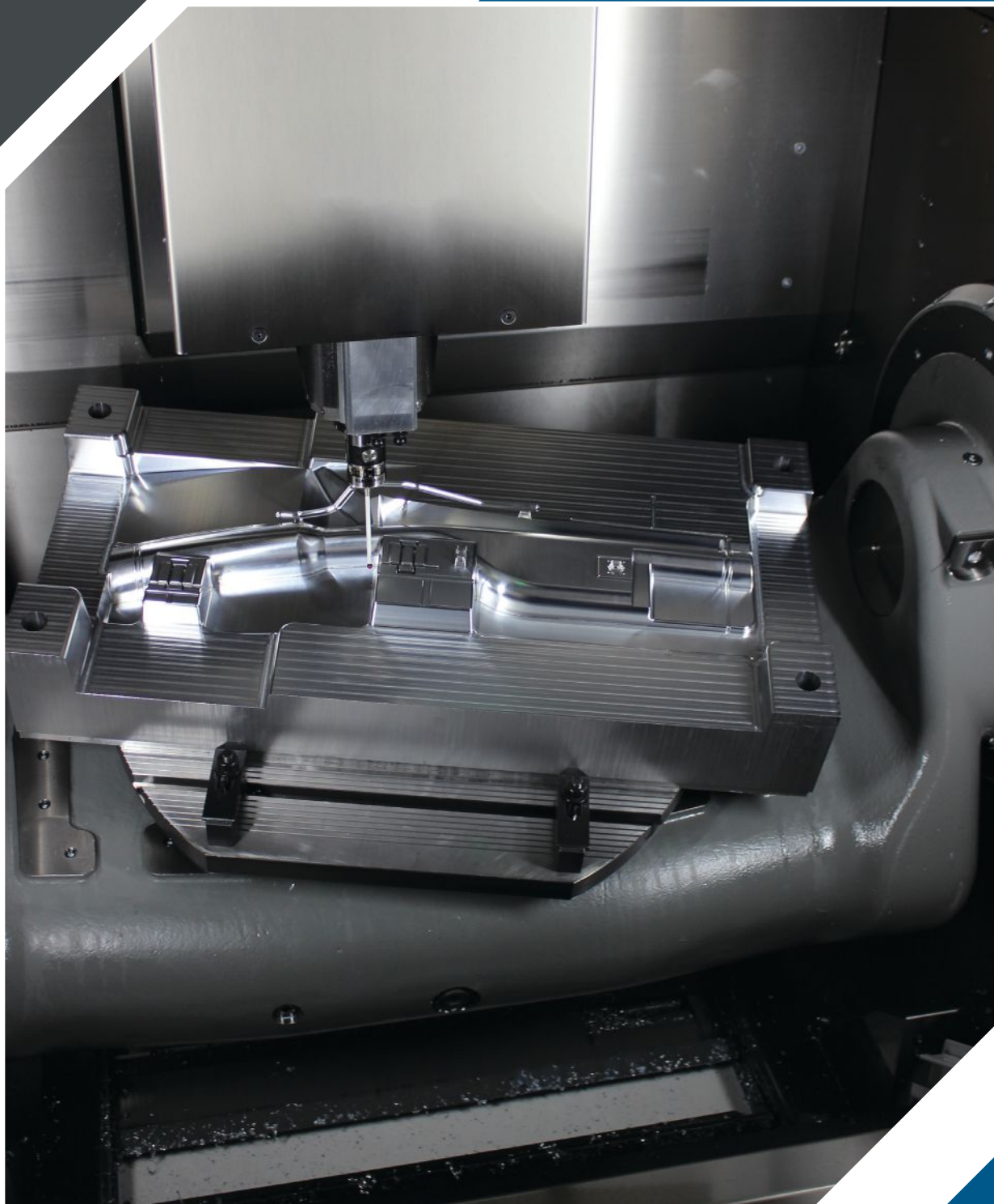

Image courtesy of Innovated Machining Solutions.

A NEW CAMX FOR A NEW TIME

SEPTEMBER

A VIRTUAL EXPERIENCE

2020

ATTEND VIRTUALLY FROM ANYWHERE IN THE WORLD

CAMX is more than a conference and tradeshow, and this year, it's going completely virtual. Discover new products, cost savings, increased performance and improved returns in a dynamic virtual marketplace.

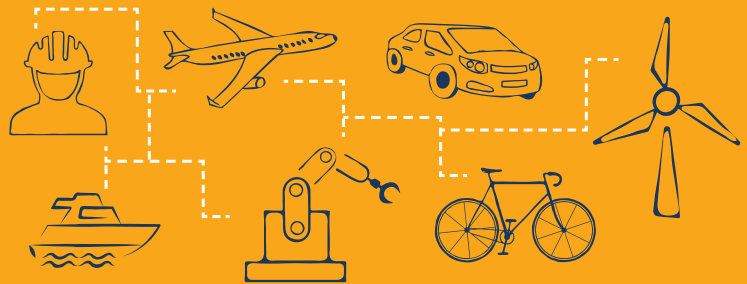

LEARN MORE

www.theCAMX.org

CAMX
THE COMPOSITES AND ADVANCED MATERIALS EXPO

COMBINED STRENGTH.
UNSURPASSED INNOVATION.

Powered by



Official Media
Partner





Hurco Companies, Inc.
One Technology Way
P.O. Box 68180
Indianapolis, IN 46268

Toll-Free: 800-634-2416
 Email: info@hurco.com

hurco.com

PRODUCTS/SERVICES

Hurco VMX42Di

Hurco has taken the workhorse VMXi Series of performance CNC machines and created a product line designed and built for die/mold shops where speed, accuracy, repeatability, and surface finish are critical. The Hurco VMXDi Series includes the VMX24Di (travels 24" x 20" x 24"), VMX30Di (travels 30" x 20" x 24"), and the VMX42Di (travels 42" x 24" x 24").

The VMXi series is known for its high level of performance whether customers are running batch production or die/mold work. With the new direct drive spindle, the VMXDi series boasts an even better surface finish, quieter spindle, and less head growth. It also includes a 15,000 RPM spindle, improved chip-to-chip time, faster spindle acceleration and deceleration. To download the VMXDi Series brochure, go to www.hurco.com/brochures.

The Hurco VMX42Di is equipped with the Hurco control powered by WinMax[®] software and the patented motion system called UltiMotion[®] (www.hurco.com/ultimotion). The control helps machinists and job shops be more productive and profitable by supporting many programming methods: conversational programming; NC programming; and a Hurco-specific feature called NC/Conversational Merge that optimizes efficiency even further. Additionally, the Hurco control's technical specifications lead the industry with 4GB RAM, 128GB Solid State Drive, and 10,000 block look ahead. To learn more about the integrated

Hurco control, go to www.hurco.com/winmax.

For over 50 years Hurco has been inventing technology that makes machining more efficient. UltiMotion is the sophisticated motion control system invented by Hurco that significantly reduces cycle time and improves surface finish quality by determining the optimal trajectory to run the tool, providing consistent programmed feed rates. With up to 10,000 blocks of dynamic variable look ahead, UltiMotion is smart enough to adapt as required by the tool path and achieves cornering velocity that is 2.5 times faster than conventional motion. UltiMotion is different than the smoothing features offered by CAD/CAM software and improves upon CAM output by providing better handling of the machine mechanics and dynamics. Hurco equips virtually all CNC machining centers with Ultimotion and it works automatically without any setup required. To learn more, go to www.hurco.com/ultimotion.



WEBSITE

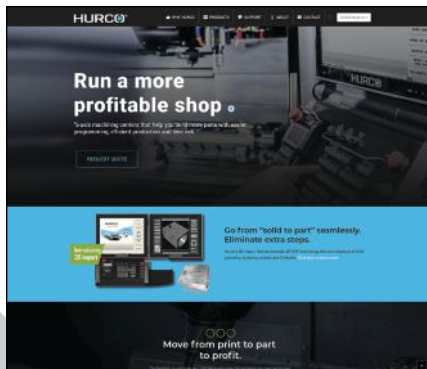

hurco.com

PRODUCT CATEGORIES

- **Horizontal Machining Centers**
- **Lathes**
- **Machine Control Software**
- **Machine Controls**
- **Milling Machines**
- **Vertical Machining Centers**



Jingdiao North America
 1400 E. Business Center Drive
 Ste. 103
 Mount Prospect, IL 60056

Phone: 847-906-8888
 Email: usa@jingdiao.com

us.jingdiao.com

PRODUCTS/SERVICES

Jingdiao CNC equipment has a significant advantage in precision mold and die machining, and provides guarantee for the machining effect. Strict control of machine assembly accuracy index, and using advanced vibration-resistance technology of machine, spindle and screw fine control technology, increase the grating ruler to constitute the full closed loop system and other means ensures that Jingdiao's high speed machining center achieve the high accuracy and high stability requirement, which makes the machining process more stable and efficient, greatly improving the machining accuracy.

The quality of die molds influences the product's quality directly. As the demands for better product quality continues to increase, it results in higher requirements on the surface effect and precision of mold. On one hand, good surface quality makes it easy to demold, improves product quality and extends service life. On the other hand, high precision and interchangeability can reduce manual participant in molding process, improve efficiency so that you can respond to your customers faster. These make it really necessary for you to transplant Jingdiao die mold solution to your sites. Not because we can help you to machine one pair of precision die mold, but because it's possible to realize standardized mold making without secondary operation by using our solution.



As we can accurately control the fitting tolerance within $5\mu\text{m}$ and stably machine optical mold with 10nm surface roughness.

The idea of our solution is controlling the tolerance of each process within $5\mu\text{m}$, because if each process is controlled precisely the mold will fit perfectly. By using Jingdiao's precision control technology, it won't be a difficult task since the temperature fluctuation inside the machine can be controlled less than 2μ , tool wear is smaller than $2\mu\text{m}$ and machining at the speed with lowest vibration. Moreover, Jingdiao OMIM technology can inspect machining tolerance of each process, based on the data shown on control system, and the operator can decide whether to carry out the next process or not, so that every decision is well-founded.

WEBSITE



us.jingdiao.com

PRODUCT CATEGORIES

- **Machining Centers**
- **Mold and Dies**
- **Inspection and Measurement**
- **Cutting Tools**
- **Toolholders**
- **Software**

WHICH METHOD SAVES MONEY?

Manual Measurement



— Have you finished the measurement?
It's already 45 minutes!!!

— Uh.....
Another 20 minutes please~

Hard Way

OR

JINGDIAO Way



On-Machine Measurement

Based on Professional Instruments
Reduce Setup Time
Measurement Achieves Micron Level Accuracy



Manual Measurement

Depends on Personal Experience
Measurement Time & Results Will Vary



“

Choose JINGDIAO



”

On-Machine Measurement

JINGDIAO's innovative On-Machine Measurement Technology reduces labor cost resulting in high-efficiency & high-quality production.



Contact Measurement on JINGDIAO Machine

- Coordinate System Establishment
- Workpiece Automatic Offset Adjustment
- Surface Remaining Stock Inspection
- Dimensional Inspection
- Detection of Geometric Tolerance
- 3D Curve Deformation Compensation
- Surface Deformation Compensation

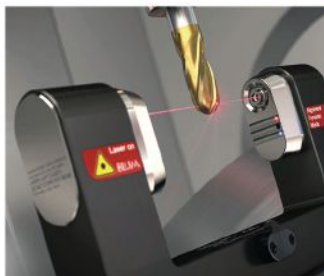

Tool 3D Corner Compensation

- Tool Length Measurement
- Tool Diameter Measurement
- Compensate Tool Contour Error
- Compensate Tool Diameter Error

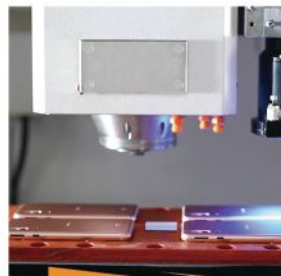

Non-Contact Measurement on JINGDIAO Machine

- Workpiece Positioning
- Logo Detection
- QR Code Recognition
- Dimensional Inspection



SCHUNK
 211 Kitty Hawk Drive
 Morrisville, NC 27560
 ISO9001:2015 Certified

Phone: 919-572-2705
 Email: info@us.schunk.com

schunk.com

PRODUCTS/SERVICES



EGL-C: Long Stroke Collaborative Gripper

The world's first industrial long-stroke gripper for collaborative operation. Its high gripping force combined with a large stroke opens new possibilities for human/robot collaboration and can handle weights beyond small parts assembly for the first time. The intelligent 24 V powerhouse can be used in a wide variety of applications.



Flexible End Of Arm Tooling

End of arm solutions that allow you to swap different sizes or styles of grippers, offering flexibility for applications with different parts ranging in weight and dimension. SCHUNK's Flex Grip Tools are ideal for fast flexible set up—add multiple grippers to a tool without designing or machining adapter plates.



EGM-M: Highest Holding Forces in Small Spaces

SCHUNK has extended its series of digitally controllable magnetic grippers with the compact EGM-M monopole gripper. With compact dimensions, it is still precise, powerful, and can handle parts <10 kg. Its magnetic field reaches to the outer edge, there are no interfering contours and can be positioned anywhere on the workpiece.

WEBSITE

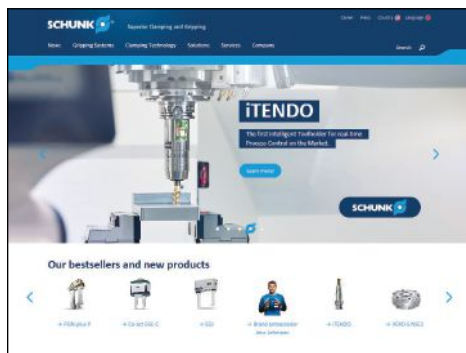

schunk.com

PRODUCT CATEGORIES

- Gripping Systems
- Robot Accessories
- Modular Assembly Automation
- Lathe Chucks and Jaws
- Quick Change Pallet Systems
- Precision Toolholders
- Stationary Clamping Technology



Equipped by
SCHUNK

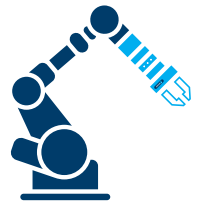

+ 90%
faster
gripper change
SWS
Quick-change
System



+ Up to 3°
maximum
deflection
TCU Tolerance
Compensation Unit



+ NEW: Up to 50%
higher gripping
force
PGN-plus-P
Universal
Gripper



© 2019 SCHUNK INTEC, INC

Superior Clamping and Gripping

Everything for your
Articulating Arm Robot
More than 3,000 components
for handling and assembly.

SCHUNK

schunk.com/equipped-by

EROWA[®]
system solutions



EROWA Technology Inc.
2535 S Clearbrook Dr.
Arlington Heights, IL 60005

Phone: 847-290-0295

erowa.com/en/

PRODUCTS/SERVICES



EROWA CleverClamp

The clamping elements of EROWA's CleverClamp system are specifically tailored to the manufacture of one-off and small batch parts while the basic rails are calibrated to fit the EROWA UPC and EROWA MTS production tooling systems. The wide range of clamping elements can be quickly positioned on the serrated base rails and be used horizontally or vertically. An added feature of the system is that it can be universally automated. This increases customer's machine utilization by making use of off-hours when combined with an EROWA automation solution.



EROWA Robot Easy 800

Features of the new EROWA Robot Easy 800 include its compact design, high degree of configurability and a transfer capacity of up to 800kg (1,760 lbs). Workpieces with a maximum weight of 800kg and a size of up to Ø850 x 1,000mm can be loaded onto a machine tool safely and reliably. The workpiece magazine can be configured with up to 12 magazine positions when using the EROWA MTS 400 pallets (400x460mm) and has a total maximum capacity of 7 tons. The Robot Easy 800 only requires 20 sq/ft of floor space while having a transfer axis reach of 2,000mm from the Robot's outer edge.



EROWA PowerChuck P

Whether on milling or drilling machines, profile or surface grinding machines, or on the spindles of dividing heads and lathes, the EROWA PowerChuck P workpiece palletizing system is the most flexible and precise interface between machine and workpiece. The 10,000 N clamping force in the PowerChuck P chuck guarantees a powerful and reliable hold during workpiece manufacturing. The compact, low profile design of the clamping system leaves plenty of room for workpieces and their machining.

WEBSITE



EROWA Technology, Inc. is a full service supplier of palletization and automation systems for the North American manufacturing market. Visit the official EROWA website for the latest news and product information.

erowa.com/en/

PRODUCT CATEGORIES

- **Coordinate Measuring Machine (CMM) Software**
- **Coordinate Measuring Machines (CMMs)**
- **Data Management Software**
- **Electrode Holders**
- **Fixtures**
- **Fixtures, EDM**
- **Lathe Tooling and Accessories**
- **Loading/Unloading Systems**
- **Manufacturing Automation Software**
- **Pallet Changers**
- **Robots**
- **Toolchangers**
- **Workholding Equipment**



Robot Easy 800

The **Robot Easy 800** features a compact design, high degree of configurability and a transfer weight of up to 800kg. The 7 ton magazine capacity can be configured with 6 to 12 positions using various pallet sizes.

The **Robot Easy 800** has 2,000mm of reach and only takes up 20 sq/ft of floorspace making it the ideal solution for heavy loading made easy.



YCM Technology (USA) Inc.
 20540 Belshaw Ave.
 Carson, CA 90746

Phone: 310-735-8610

ycmcnc.com

PRODUCTS/SERVICES

YCM CNC machine tool has been recognized worldwide for its superior precision, outstanding rigidity, and exceptional reliability since 1954. YCM offers a wide array of machines to serve a variety of industries, with growing list of more than 70 makes and models comprising of VMC, HMC, CNC turning centers, and 5-axis double column machining centers to satisfy every industry's unique requirements.

Through its largest R&D department in Taiwan, YCM continues to innovate cutting edge technology and combined with worldwide localized technical centers, distribution network, knowledgeable sales teams, and customer services, it is our goal to becoming one of the world class leader in machine tool manufacturers.

As the first Taiwanese manufacturer been awarded with the ISO-9001, ISO-14001, combined with advanced facilities, YCM has once again proved itself to set the highest standard in machine tool industries.



WEBSITE



ycmcnc.com

PRODUCT CATEGORIES

- Vertical Machining Center
- 5-Axis Vertical Machining Center
- High Efficiency Vertical Machining Center
- Traveling Column Vertical Machining Center
- Double Column Vertical Machining Center
- Horizontal Machining Center
- CNC Turning Center
- Turn-Mill Center
- Integrated Operation Control System
- Spindle Thermal Compensation
- Automation Solutions
- Smart Factory

Summer Deals

NEW LOW PRICING + SPECIAL OFFERING

Limited Time Offer. Contact Your Sales Representatives for Details.



DCV3016B • 4025B

Advanced Double Column High Performance Vertical Machining Center

- X-axis is directly driven by gearbox offering smooth axial response and high torque.
 - Roller type guideways on both X and Y Axes.
 - Turcite-B on Z-axis to strengthens rigidity, increases damping capacity, reducing overhang and vibration.
 - Horizontal and vertical support of the headstock.
 - Hardened and ground box guideway with enlarged contact interface on Z-axis.
- and so much more ...

30 HP **10,000** RPM **60T** ATC **40"** Z-Travel **250mm** Riser

CT50 Tapper **MXP-200FB** Control by FANUC

CTS Prep With Rotary Union



www.YCMCNC.com

YCM Technology (USA) Inc.

20540 Belshaw Avenue
Carson • CA • 90746

Tel: 310.735.8610
info.us@ycmcnc.com



a subsidiary of YEONG CHIN MACHINERY INDUSTRIES CO., LTD.

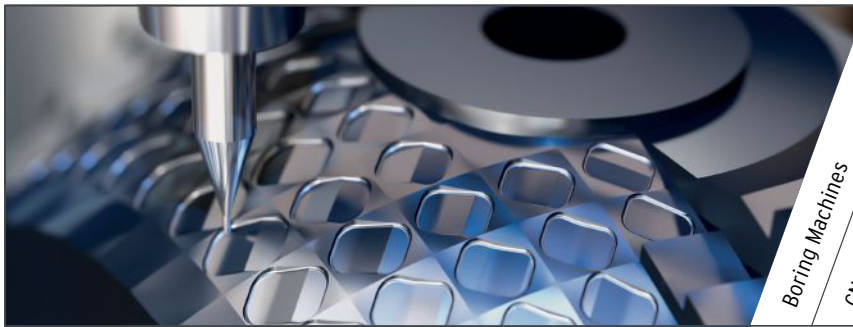

COMPANY	Advertisers are listed in bold type.	See Ad	Machining Equipment									
			1	2	3	4	5	6	7	8	9	10
Absolute Machine Tools Inc.	- Lorain, OH, 440-960-6911		1		3	4	5	6	7	8	9	10
Agathon Machine Tools, Inc.	- Bethel, CT, 203-730-8741								7			
CHETO Corporation	- Loureiro, Oliveira de Azemeis, Portugal, +351 256 247 970				3	4	5			8		10
Chevalier Machinery	- Sante Fe Springs, CA, 562-903-1929					4	5		7			10
DMG MORI	- Hoffman Estates, IL, 847-593-5400			2				5	7		9	10
Doosan Machine Tools	- Pine Brook, NJ, 973-618-2500		1			4	5					10
Erowa Technology Inc.	- Arlington Heights, IL, 847-290-0295	83										
FANUC America	- Rochester Hills, MI, 248-377-7000			2								
FCS North America	- Windsor, ON, Canada, 519-737-0372											
Fives Machining Systems	- Hebron, KY, 859-534-4600					4					9	10
GF Machining Solutions	- Lincolnshire, IL, 847-913-5300							5			9	10
Grob Systems Inc.	- Bluffton, OH, 419-358-9015							5				10
Haas Automation, Inc.	- Oxnard, CA, 805-278-1800					4	5	6			9	10
Hardinge	- Berwyn, PA, 800-843-8801							5	7			
Hurco Companies Inc.	- Indianapolis, IN, 317-293-5309	1		2								10
Hwacheon Machinery America	- Lincolnshire, IL, 847-573-0100										9	10
Hyundai WIA Machine America Corp.	- Carlstadt, NJ, 201-987-7298		1			4	5				9	10
Jingdiao North America	- Mt. Prospect, IL, 847-906-8888	79		2		4	5	6	7		9	
Kitagawa NorthTech, Inc.	- Schaumburg, IL, 847-310-8787			2								
Kitamura Machinery Of USA Inc.	- Wheeling, IL, 847-520-7755					4	5	6			9	10
Makino Inc.	- Mason, OH, 513-573-7200		1			4	5	6	7		9	10
Matsuura Machinery USA, Inc.	- St. Paul, MN, 651-289-9700	23					5					10
Mazak Corporation	- Florence, KY, 859-342-1700		1	2		4	5	6			9	10
MC Machinery Systems, Inc.	- Elk Grove, IL, 630-616-5920						5				9	
Methods Machine Tools Inc.	- Sudbury, MA, 978-443-5388		1	2		4	5	6			9	10
Milltronics USA, Inc.	- Waconia, MN, 952-442-6455		1					6				10
Mitsui Seiki (USA) Inc.	- Franklin Lakes, NJ, 201-337-1300		1				5		7		9	10
Okamoto Corporation	- Vernon Hills, IL, 847-235-3500								7			
Okuma America Corporation	- Charlotte, NC, 704-588-7000			2					7			10
SCHUNK	- Morrisville, NC, 919-572-2705	81							7			
Single Source Technologies	- Auburn Hills, MI, 248-232-6232		1			4	5	6		8	9	10
Sodick, Inc.	- Schaumburg, IL, 847-310-9000						5				9	
Takumi USA	- Indianapolis, IN, 317-614-1515						5				9	
Tarus Products Inc.	- Sterling Heights, MI, 586-977-1400			2	3		5			8	9	
Toyoda Americas Corporation	- Arlington Heights, IL, 847-253-0340						5		7		9	10
TRAK Machine Tools	- Rancho Dominguez, CA, 310-608-4422											
UNISIG	- Menomonee Falls, WI, 414-252-3802					4	5			8		
United Grinding	- Miamisburg, OH, 937-859-1975								7			
Yama Seiki USA, Inc.	- Chino, CA, 909-628-5568					4	5				9	
YCM Technology (USA) Inc.	- Carson, CA, 310-735-8610	85					5				9	10

For more supplier listings, go to moldmakingtechnology.com/suppliers.

Jig Boring Machines	Laser Cutting Machines	Lathes	Loading/Unloading Systems	Machine Controls	Machining Cells/Work Cells	Machining Services	Milling Machines	Mill-Turn Machines	Multi-Tasking Machines	Pallet Changers	Robots	Toolchangers	Turning Machines	Vertical Machining Centers	Waterjet Machines	Workholding Equipment	
11	12	13	14	15	16	17	18	19	20	21	22	23	24	25	26	27	WEBSITE
		13	14		16	17	18	19	20	21	22		24	25	26	27	absolutemachine.com
																	agathon.com
							18		20								cheto.eu
		13					18		20				24	25			chevalierusa.com
	12	13	14	15	16	17	18	19	20	21	22	23	24	25			dmgmori.com
		13					18				22		24	25			doosanmachinetools.com
			14							21	22	23				27	erowa.com
	12			15							22						fanucamerica.com
																27	fcssystem.com
			14						20	21				25	26		fivesmsi.com
							18			21	22	23		25			gfms.com/us
					16		18	19		21		23	24				grobgroup.com/en
		13					18							25			haascnc.com
		13					18						24	25		27	hardinge.com
		13		15			18							25			hurco.com
							18		20					25			hwacheon.com
		13			16		18		20				24	25			machine.hyundai-wia.com/usa
11			14	15	16	17	18				22			25			us.jingdiao.com
			14			17										27	kitagawa-usa.com
11					16		18							25			kitamura-machinery.com
							18							25			makino.com
																	matsuurausa.com
		13	14	15	16		18		20	21		23	24	25			mazakusa.com
	12	13	14		16		18			21	22		24	25			mcmachinery.com
11	12	13	14	15	16		18	19	20	21	22	23	24	25			methodsmachine.com
		13		15			18							25			milltronics.com
11			14		16		18	19		21	22	23		25			mitsuiseiki.com
																	okamotocorp.com
		13		15			18		20	21			24	25			okuma.com
	12	13			16		18			21						27	us.schunk.com
		13	14		16		18		20	21		23	24	25		27	singlesourcetech.com
																	sodick.com
		13					18							25			takumiusa.com
							18										tarus.com
			14		16					21			24	25			toyoda.com
		13		15			18							25			trakmachinetools.com
																	unisig.com
																	grinding.com
		13	14				18			21			24	25			yamaseiki.com
							18		20				24	25			ycmcnc.com

Service categories are noted in the highlighted columns.

Image courtesy of Heidenhain Corp.

Five-Axis Machine Achieves World-Class Performance for Tighter Tolerances

Takumi USA introduces the U800 to its five-axis product line-up. The U series was developed to achieve world-class performance for the die and mold, aerospace and other high speed applications that require tighter tolerances. The U800 is a high speed gantry machining center over the high torque table that includes an 80 rpm twin torque motor on the A-axis and a 100 rpm single torque motor on the C-axis.

The U800 is designed with a one-piece casting to absorb the thrust forces of high rapids and fast cutting feeds. The trunnion table with integral torque motors (instead of gear drives) provides quicker response, higher torque, better positioning accuracy and lower maintenance requirements. The roller type linear ways support faster feed rates, higher rigidity and smoother linear motion. A high performance 20,000 rpm motorized spindle is standard on the U800 to satisfy a multitude of machining requirements.



The U800 is equipped with the latest Heidenhain TNC 640 control that features optimized motion control, short block processing times and special control strategies.

Takumi USA / 844-302-3792 / takumiusa.com



Machine Series Features Direct Drive Spindle

Hurco launches the latest iteration of the VMXDi series, which features a direct drive spindle. This series includes the VMX24Di, VMX30Di and the VMX42Di. With the direct drive spindle, the VMXDi series boasts a better surface finish, quieter spindle and less head growth. It also includes a 15,000-rpm spindle, improved chip to chip time, faster spindle acceleration and deceleration.

The VMX42Di will use the Hurco control powered by WinMax software and the patented motion system called UltiMotion, which determines the optimal trajectory to run the tool, provides consistent programmed feed rates and reduces cycle time. The control helps machinists and job shops be more productive and profitable by supporting many programming methods: conversational programming; NC programming; and a feature called NC/Conversational Merge that optimizes efficiency even further.

Hurco Companies Inc. / 800-634-2416 / hurco.com

Machine Series Engineered to Simplify Gundrilling

UNISIG's next generation of UNE series gundrilling machines deliver operational flexibility, improved performance and effortless operation. The series is engineered and designed to simplify gundrilling, well-suited for various industries, including firearms, automotive, medical, energy, defense and aerospace. Each machine can fit in close proximity to a shop's existing machining center, lathe or Swiss-style machine for efficient part-processing strategies. For added flexibility to grow with future production needs, all UNE models are robot-ready. The single main spindle servo motor delivers necessary horsepower for two-spindle machines. The series features a programmable flow-based coolant delivery system designed to provide the right amount of coolant to the tool's cutting edge, so users can predict tool breakage and spend less downtime recovering an interrupted process. UNE series machines feature intuitive controls that give operators a full process picture at a glance on a rich color interface with touchscreen capabilities. All UNE bases are FEA optimized and machined on five sides in a single setup for the highest overall precision, enabling simplified installation with no foundation work required, and 3-point leveling on machines rated up to 1,000 mm length.

UNISIG / 262-252-3802 / unisig.com



Linear Five-Axis Machining Center Minimizes Crossbeam Deformation

The Linmax B-3040 linear five-axis machining center sold by **Dynamic International** offers a box in box, symmetrical design to drive at the center of gravity, minimizing crossbeam deformation after long periods of usage. The machining center provides advanced FEM analysis and design to optimize higher rigidity, response and stability of high speed cutting. The center's structural design minimizes the environment temperature affection, ensuring high precision during machining, and the Z axis equipped with four linear guideways enables each side to undertake the same cutting force, enhancing machine lifetime and accuracy.

Dynamic International / 262-521-1100 / dynamicintl.com



Automatic Tool Changer Designed to Increase Production Process Efficiency

Cheto Corporation's automatic tool changer enables automatic switching between drilling and milling for the company's machines. Users can change deep hole drilling tools and also automatically modify the deep hole drilling process mode into the milling one without any manual operator intervention. Before starting machining, the user can equip drilling tools up to 250 tools and up to five gundrills, and then the machine mills and drills automatically.

The company's developed software covers a range of control options: torque, feed, coolant, pressure and emulsion/oil flow, as well as vibrations. While aiming for efficiency and cost-saving, the software analyzes and evaluates processes. It then identifies intersections and variations and automatically adjusts the drilling parameters. In doing so, the software enables a continuous production process while protecting tool life.

CHETO Corporation, SA / 351256247970 / cheto.eu

Five-Axis Machining Requires Fewer Setups for Parts with Complex Geometry

Maximum Mold Group displays the benefits to having a large capacity five-axis CNC. By using the five-axis technology versus conventional three-axis machining, fewer setups are required to create a part with complex geometry. Five-axis machining eliminates the need and the cost of creating the fixtures because the part can be held once and rotated so that the geometry is created. Five-axis machining also enables the cutting tool to remain tangential to the cutting surface.

Maximum Mold Group / 269-468-6291 / maximummold.com



Internal Cylindrical Grinders Designed for High Production

United Grinding offers a full range of Studer internal cylindrical grinding machines that includes universal-type models, as well as those designed for high production and for radii grinding operations. Some models are well-suited for internal, surface and external grinding of chuck components, while others handle all other conceivable internal cylindrical grinding applications. The machines deliver the highest precision and efficiency, especially for flange parts, spindle shafts, spindle housings, rotor shafts, bushings and more. Three models specialize in high-precision internal cylindrical grinding of radii, spheres, balls, cones and diameters. Applications include the manufacture of die plates from carbide and ceramic as well as the production of hydraulic components such as axial pump pistons, guide plates and housings from hardened steel, cast iron and copper.

United Grinding / 937-859-1975 / grinding.com

How to Design and Analyze the Right Clamping System

By Peter Hoenig

The use of innovative clamping systems to optimize the moldmaking production process requires consideration of five factors based on Industry 4.0 principles.

1. Engineering: Engineers should be fully involved and invested in the process of workholding. The clamping setups should be established before the workpiece is clamped and secured to save time and confusion at the CNC machine table.

2. Clamping: Modular and standardized clamping systems should be available in both manual and automatic versions for all clamping needs and production equipment. A clamping system should establish the exact location of a work part, whether

The goal is to run lights out during unattended shifts at night and on weekends.

in manual or automation setups. There are many zero-point systems available, but a shop must consider the adaptability of the system for a full range of workpiece sizes.

3. Motion: Automatic handling and storage systems for workpiece products and production equipment, and tool-changer and pallet changer technologies will eventually be used in a shop's production process, so it is vital to ensure a

Benefits of Smart Workholding

- Reduced errors at the machine table level due to virtualization of the clamping in CAD that provides workpiece setup instructions.
- Flexibility and repeatability for all clamping scenarios in the manufacturing environment.
- Five workable surfaces with no obstacles from clamping components.
- Permanent references for all changeover requirements during the product life cycle.
- Work load optimization with accurate setup time estimation and job quoting.
- Increased spindle hours, reducing machine downtime and increasing machine optimization.
- Automated workflow to standardize the manufacturing process.

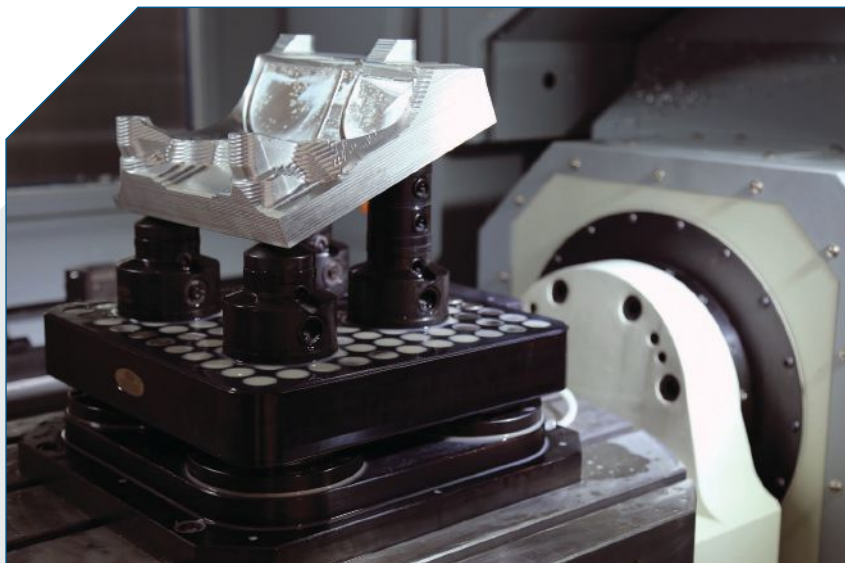

Smart workholding is Industry 4.0-enabled to offer quick clamping and reduced setup times.

Image courtesy of FCS North America.

smooth transition when integrating a workholding system into these automation systems. Implementing a smart workholding system changes the moldmaking workflow into a standardized production process. Standardizing the process eases the integration of automation.

With the influx of five-axis CNC machines continuing in mold manufacturing, the ability to machine all five sides of a workpiece should also be considered before investing in a workholding system solution. For example, the workholding system should be modular to allow multiple configurations for all necessary machining processes, such as vertical milling, horizontal milling, EDM and wire cutting operations.

4. Control: Without a flexible control software system for managing the production process, the achieved gains from the clamping solution will be nullified. The goal is to run lights out during unattended shifts at night and on weekends.

5. Online Support: The ability to find and obtain instant access to product information is critical, so a connection to a customer support area from their website is vital.

These five considerations establish an argument for investing in “smart” or Industry 4.0-enabled technology that offers quick clamping, thereby reducing setup times. A smart system knows locations, eliminating the time needed for probing the workpiece location. It also offers permanent references for rework, design changes and changeovers due to small errors. [MMT](#)

FOR MORE INFORMATION

FCS North America / 519-737-0372 / fcssystem.com
Peter Hoenig, Operations Director



Image courtesy of Del-Tool Co. Inc.