

# DISTRIBUTION CATALOG 2020

## TEST & MEASUREMENT



DISTRIBUTION CATALOG 2020 | TEST & MEASUREMENT | 10.00

**ROHDE & SCHWARZ**

Make ideas real





# CONTENTS

Chapter	Page
Company profile	3
Our business fields	3
Explanation of icons	4
Featured products	5
Learn more	5
Oscilloscopes	7
Oscilloscope portfolio	9
Featured content for the R&S®RTE1000	23
Oscilloscope probe compatibility	25
Power supplies	27
Power supply portfolio	29
Signal generators	47
Signal generator hardware and software options	53
Handheld analyzers	55
Handheld analyzer portfolio	56
Spectrum analyzers	65
Economy spectrum analyzer portfolio	67
Vector network analyzers	77
Vector network analyzer portfolio	79
EMC precompliance	87
Meters and counters	89
Service you can rely on	99
Extended warranty	99
Extended warranty and calibration coverage	100
Service	101
Contact	102
Trademarks	102



THANKS TO ITS INDUSTRY-LEADING TECHNOLOGICAL EXPERTISE, ROHDE & SCHWARZ IS A RELIABLE PARTNER FOR SHAPING THE FUTURE OF COMMUNICATIONS, INFORMATION AND SECURITY.

Rohde & Schwarz develops, produces and markets a wide range of electronic capital goods for industry, infrastructure operators and government customers. The independent group is among the technology and market leaders in all of its business fields, including wireless communications and RF test and measurement, broadcast and media, air traffic control and military radiocommunications, cybersecurity and network technology. A worldwide service and support network safeguards customer investments.

## OUR BUSINESS FIELDS

### TEST AND MEASUREMENT

T&M instruments and systems for wireless communications, aerospace and defense, automotive, research and industrial electronics applications

### BROADCAST AND MEDIA

Broadcast, post production and T&M equipment for network operators, broadcasters, studios, the film industry and manufacturers of entertainment electronics

### AEROSPACE | DEFENSE | SECURITY

Communications and signal monitoring technology for armed forces and air traffic control, security products for critical infrastructures as well as T&M equipment for A&D applications



















### NETWORKS AND CYBERSECURITY

Network technology for professional users as well as IT security products to protect communications and information



# EXPLANATION OF ICONS

In this catalog, the instrument interfaces are represented by icons underneath the picture of the respective instrument. These icons are explained below.

	Icon	Explanation
Remote control		<b>USB</b> The instrument can be connected to a computer via universal serial bus (USB) using a USB cable with a standard B type plug.
		<b>Mini USB</b> The instrument can be connected to a computer via universal serial bus (USB) using a USB cable with a mini-B type plug.
		<b>Micro USB</b> The instrument can be connected to a computer via universal serial bus (micro USB) using a micro USB cable.
		<b>RS-232</b> The instrument is equipped with an RS-232 interface.
		<b>TCP/IP</b> The instrument is equipped with an Ethernet interface that can be connected to a local area network (LAN).
		<b>IEEE-488</b> The instrument is equipped with an IEEE-488 interface, also referred to as general purpose interface bus (GPIB). This bus is widely used for controlling instruments in laboratories.
		<b>WLAN</b> The instrument can be remote controlled via a wireless local area network (WLAN).
Storage		<b>USB flash drive</b> The instrument is equipped with a universal serial bus (USB) upstream interface that can be used to connect a USB flash drive or other USB mass storage devices with a standard A type plug.
		<b>Removable hard disk</b> The instrument comes with a removable hard disk, e.g. for saving measurement results.
		<b>SD card</b> An SD card can be inserted, e.g. for saving measurement results.
		<b>Micro SD card</b> A micro SD card can be inserted, e.g. for saving measurement results.
Compatibility		<b>LabVIEW</b> The instrument can be controlled using the LabVIEW software from National Instruments.
Display		<b>Screen</b> Settings, results, etc. are shown on the integrated display (3.5" to 12.1").
		<b>Touchscreen</b> The user can control the instrument by touching the screen with a special pen and/or one or more fingers.
Miscellaneous		<b>DVI output</b> An external monitor can be connected via a digital visual interface (DVI).
		<b>VGA output</b> The instrument can be connected to a computer via the video graphics array (VGA) interface.
		<b>Kensington</b> The instrument can be locked with the Kensington lock.
	 	<b>50 Ω/1 MΩ</b> The input impedance of the instrument can be switched between 50 Ω and 1 MΩ.

# FEATURED PRODUCTS

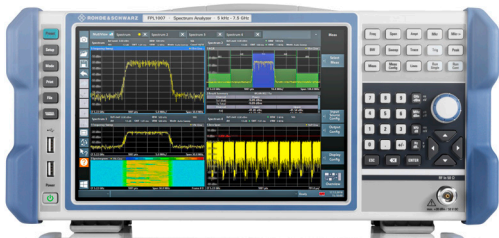

## R&S®FPL1000 signal and spectrum analyzer

The R&S®FPL1000 is a single measuring instrument for a variety of measurement tasks. It supports not only spectrum analysis, but also highly accurate power measurement with power sensors and analysis of analog and digitally modulated signals.

► [page 5](#)



## R&S®Cable Rider ZPH cable and antenna analyzer

The R&S®CableRider ZPH has all the essential basic measurement capabilities required for installing and maintaining antenna systems in the field. Two different R&S®ZPH models are available to suit different needs, a pure one-port cable and antenna analyzer and a two-port model with additional spectrum analysis and tracking generator features.

► [page 5](#)



## R&S®UPP audio analyzer

High measurement speed, parallel signal processing in multichannel applications, and high reliability in continuous operation are vital audio analyzer requirements – all met by the R&S®UPP audio analyzer.

► [page 5](#)

# LEARN MORE

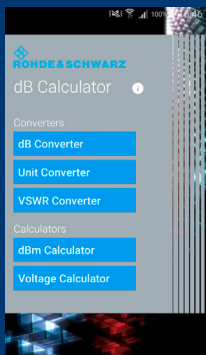

## dB or not dB?

True or false:  $30 \text{ dBm} + 30 \text{ dBm} = 60 \text{ dBm}$ ?

Why does 1% work out to be  $-40 \text{ dB}$  one time, but  $0.1 \text{ dB}$  or  $0.05 \text{ dB}$  the next time? Sometimes even experienced engineers have trouble answering these questions. Decibels are found everywhere – in power levels, voltages, reflection coefficients, noise figures, field strengths and more.

What is a decibel and how should we use it in our calculations? This application note provides a refresher on the subject of decibels.

► [www.rohde-schwarz.com/appnote/1MA98](http://www.rohde-schwarz.com/appnote/1MA98)

Get the highly rated calculator app for your everyday dB calculations now. Available on all platforms.



dB Calculator for Android



dB Calculator for iOS



dB Calculator for Windows Phone



### R&S®SMC100A signal generator

The analog R&S®SMC100A sets new standards for attractively-priced signal generators. It has the smallest size and the best price/performance ratio in its class.

► [page 6](#)



### R&S®NGP800 power supply series

The R&S®NGP800 DC power supply series, comprising five models with 400 W or 800 W, provides maximum power at a variety of operating points. The two or four 200 W outputs can each supply up to 64 V or up to 20 A. Electrically equivalent and galvanically isolated outputs can be wired in series or parallel for up to 250 V or 80 A.

► [page 6](#)



### RF & Bench Essentials Reference Guide

This guide includes a wide range of time-domain and RF test equipment. It covers most of the tools users want to understand in more detail.

This reference guide can also be a gateway to dig into some of the details contained in a more in-depth fundamental or primer guide on specific measuring instruments.

► [www.rohde-schwarz.com/rf-essentials](http://www.rohde-schwarz.com/rf-essentials)



### Want to know the latest news from Rohde & Schwarz? Find us at



[linkedin.com/company/rohde-&-schwarz](https://www.linkedin.com/company/rohde-&-schwarz)



[twitter.com/RohdeSchwarz](https://twitter.com/RohdeSchwarz)



[youtube.com/user/RohdeundSchwarz](https://www.youtube.com/user/RohdeundSchwarz)



[facebook.com/RohdeAndSchwarz](https://www.facebook.com/RohdeAndSchwarz)



# OSCILLOSCOPES

The Rohde & Schwarz oscilloscope portfolio offers options ranging from low-cost yet powerful 50 MHz oscilloscopes to full-featured 6 GHz oscilloscopes. Designed by the RF experts at Rohde & Schwarz, all oscilloscopes feature exceptional signal integrity, high value and excellent reliability.

Use the table on the following pages to see the differences between each family.

## Bandwidth

Bandwidth selection is typically the most crucial parameter when choosing an oscilloscope. Bandwidth is defined as the frequency at which a sine wave is attenuated by 3 dB or is approx. 30% smaller.

Since most signals are not sine waves (they look like square waves), you have to take into account the other frequency components that make up the signal. For example, you cannot measure a 1 GHz square wave with a 1 GHz oscilloscope – it will not look like a square wave.

**Rule of thumb:**  $\text{Bandwidth}_{\text{Oscilloscope}} = 3 \text{ to } 5 \text{ times } f_{\text{clk of the test signal}}$

The simplest way to determine how much bandwidth the oscilloscope needs is to take 3 to 5 times the clock frequency of the signal you want to measure. For example, a high-speed USB signal at 480 Mbit/s has a clock frequency of 240 MHz which would require a 720 MHz to 1.2 GHz oscilloscope.

## Update rate

The update rate, sometimes called dead time or blind time, is how fast the oscilloscope can trigger on a waveform (basically one screen's worth of data), process it and then plot it on the display. The faster it can do this, the more likely you are to see infrequent events. The update rate is specified in waveforms per second or waveforms/s. For example, with an update rate of 50 000 waveforms/s, an oscilloscope captures a waveform every 20  $\mu\text{s}$ . If the oscilloscope's timebase is set to acquire 100 ns of activity across the screen, the rest of that 20  $\mu\text{s}$  (20  $\mu\text{s}$  – 100 ns = 19.9  $\mu\text{s}$ ) is consumed by processing and plotting, which means the oscilloscope is dead for 99.5% of the time. If an infrequent anomaly happens during that dead time, the engineer will never see it.

**Rule of thumb:** Most engineers will want an update rate as fast as possible, assuming they do not have to trade off something else to get it (e.g. memory depth). If the engineer is just interested in single shot captures (e.g. power supply turn-on or low speed serial decode and trigger), then the update rate is not that important.

## Sample rate

Sample rate and memory depth are directly related. The sample rate defines how fast the oscilloscope samples and digitizes the waveform. Those samples have to be stored somewhere, which is where memory is important. The more memory you have, the higher you can keep your sample rate (which allows you to take advantage of the full bandwidth of the oscilloscope).

**Rule of thumb:** You typically want the sample rate to be 5 times the bandwidth of the oscilloscope to accurately reproduce the signal. For example, for a 1 GHz oscilloscope, you need a sample rate of 5 Gsample/s. There are a few times that you can get by with less (down to 2.5 times), but in general, look for a sample rate at least 5 times the bandwidth.

As mentioned, memory depth is directly related to the sample rate. The more memory depth you have, the longer you can capture at high sample rates.

**Rule of thumb:** Most engineers will want as much memory as they can get to maximize the amount of time captured at high sample rate.

### Vertical resolution

The vertical resolution, sometimes called bits, is the number of buckets, or vertical levels, an oscilloscope can put voltages into for a waveform. When the oscilloscope is sampling the waveform, it does not have an infinite number of levels to put the sample in. It has to choose a level to put that sample in. The more levels it has to choose from, the more precise it can be. An 8-bit oscilloscope has 256 levels. A 10-bit oscilloscope has 1024. A 12-bit oscilloscope has 4096. A 16-bit oscilloscope has 65 536 levels.

**Rule of thumb:** In general, additional vertical resolution is most useful for signals where you are trying to see a small signal riding on top of a much larger signal. Without the additional levels, the small signal would be lost in the larger signal. Typically, larger signals are very slow in frequency.

Type	Designation	Page
R&S®ScopeRider RTH	Handheld oscilloscope	11
R&S®RTC1000	Oscilloscope	13
R&S®RTB2000	Oscilloscope	15
R&S®RTM3000	Oscilloscope	17
R&S®RTA4000	Oscilloscope	19
R&S®RTE1000	Oscilloscope	21

## Oscilloscope portfolio



Multi Domain



Multi Domain

R&S®	RTH1000	RTC1000	RTB2000	RTM3000
<b>Vertical</b>				
Bandwidth	60/100/200/350/500 MHz <sup>1)</sup>	50/70/100/200/300 MHz <sup>1)</sup>	70/100/200/300 MHz <sup>1)</sup>	100/200/350/500 MHz/1 GHz <sup>1)</sup>
Number of channels	2 plus DMM/4	2	2/4	2/4
Resolution	10 bit	8 bit	10 bit	10 bit
V/div 1 MΩ	2 mV to 100 V	1 mV to 10 V	1 mV to 5 V	500 μV to 10 V
V/div 50 Ω	–	–	–	500 μV to 1 V
<b>Horizontal</b>				
Sampling rate per channel (in Gsample/s)	1.25 (4-channel model); 2.5 (2-channel model); 5 (all channels interleaved)	1; 2 (2 channels interleaved)	1.25; 2.5 (2 channels interleaved)	2.5; 5 (2 channels interleaved)
Max. memory (per channel/1 channel active)	125 ksample (4-channel model); 250 ksample (2-channel model); 500 ksample (50 Msample in segmented memory mode <sup>2)</sup> )	1 Msample; 2 Msample	10 Msample; 20 Msample (160 Msample in segmented memory mode <sup>2)</sup> )	40 Msample; 80 Msample (400 Msample in segmented memory mode <sup>2)</sup> )
Segmented memory	option	–	option	option
Acquisition rate (in waveforms/s)	50 000	10 000	50 000 (300 000 in fast segmented memory mode <sup>2)</sup> )	64 000 (2 000 000 in fast segmented memory mode <sup>2)</sup> )
<b>Trigger</b>				
Options	advanced, digital trigger (14 trigger types) <sup>2)</sup>	elementary (5 trigger types)	basic (7 trigger types)	basic (10 trigger types)
<b>Mixed signal option</b>				
No. of digital channels <sup>1)</sup>	8	8	16	16
Sampling rate of digital channels (in Gsample/s)	1.25	1	1.25	two logic probes: 2.5 on each channel; one logic probe: 5 on each channel
Memory of digital channels	125 ksample	1 Msample	10 Msample	two logic probes: 40 Msample per channel; one logic probe: 80 Msample per channel
<b>Analysis</b>				
Cursor meas. types	4	13	4	4
Stand. meas. functions	37	31	32	32
Mask test	elementary (tolerance mask around the signal)	elementary (tolerance mask around the signal)	elementary (tolerance mask around the signal)	elementary (tolerance mask around the signal)
Mathematics	elementary	elementary	basic (math on math)	basic (math on math)
Serial protocols triggering and decoding <sup>1)</sup>	I <sup>2</sup> C, SPI, UART/RS-232/RS-422/RS-485, CAN, LIN, CAN-FD, SENT	I <sup>2</sup> C, SPI, UART/RS-232/RS-422/RS-485, CAN, LIN	I <sup>2</sup> C, SPI, UART/RS-232/RS-422/RS-485, CAN, LIN	I <sup>2</sup> C, SPI, UART/RS-232/RS-422/RS-485, CAN, LIN, I <sup>2</sup> S, MIL-STD-1553, ARINC429
Display functions	data logger	–	–	–
Applications <sup>1), 2)</sup>	high-resolution frequency counter, advanced spectrum analysis, harmonics analysis, user scripting	digital voltmeter (DVM), component tester, fast Fourier transform (FFT)	digital voltmeter (DVM), fast Fourier transform (FFT), frequency response analysis	power, digital voltmeter (DVM), spectrum analysis and spectrogram, frequency response analysis
Compliance testing <sup>1), 2)</sup>	–	–	–	–
<b>Display and operation</b>				
Size and resolution	7", color, 800 × 480 pixel	6.5", color, 640 × 480 pixel	10.1", color, 1280 × 800 pixel	10.1", color, 1280 × 800 pixel
Operation	optimized for touchscreen operation, parallel button operation	optimized for fast button operation	optimized for touchscreen operation, parallel button operation	–
<b>General data</b>				
Dimensions in mm (W × H × D)	201 × 293 × 74	285 × 175 × 140	390 × 220 × 152	390 × 220 × 152
Weight in kg	2.4	1.7	2.5	3.3
Battery	lithium-ion, > 4 h	–	–	–

<sup>1)</sup> Upgradeable.

<sup>2)</sup> Requires an option.



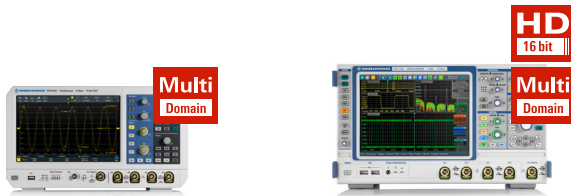

RTA4000	RTE1000
200/350/500 MHz/1 GHz <sup>1)</sup>	200/350/500 MHz/1/1.5/2 GHz <sup>1)</sup>
4	2/4
10 bit	8 bit (up to 16 bit with HD mode)
500 $\mu$ V to 10 V	500 $\mu$ V to 10 V
500 $\mu$ V to 1 V	500 $\mu$ V to 1 V
2.5; 5 (2 channels interleaved)	5
100 Msample; 200 Msample (1 Gsample in segmented memory mode)	50 Msample/200 Msample
standard	standard
64 000 (2 000 000 in fast segmented memory mode)	1 000 000 (1 600 000 in ultra-segmented memory mode)
basic (10 trigger types)	advanced, digital trigger (13 trigger types)
16	16
two logic probes: 2.5 on each channel; one logic probe: 5 on each channel	5
two logic probes: 100 Msample per channel; one logic probe: 200 Msample per channel	100 Msample
4	3
32	47
elementary (tolerance mask around the signal)	advanced (user-configurable, hardware based)
basic (math on math)	advanced (formula editor)
I <sup>2</sup> C, SPI, UART/RS-232/RS-422/ RS-485, CAN, LIN, I <sup>2</sup> S, MIL-STD-1553, ARINC 429	I <sup>2</sup> C, SPI, UART/RS-232/RS-422/RS-485, CAN, LIN, I <sup>2</sup> S, MIL-STD-1553, ARINC 429, FlexRay™, CAN-FD, USB 2.0/HSIC, Ethernet, Manchester, NRZ, SENT, SpaceWire, CXPI, USB Power Delivery, automotive Ethernet 100BASE-T1
–	histogram, trend, track <sup>2)</sup>
power, digital voltmeter (DVM), spectrum analysis and spectrogram, frequency response analysis	power, 16-bit high definition mode (standard), advanced spectrum analysis and spectrogram
–	–
10.1", color, 1280 × 800 pixel	10.4", color, 1024 × 768 pixel
optimized for touchscreen operation, parallel button operation	
390 × 220 × 152	427 × 249 × 204
3.3	8.6
–	–

## R&S®Scope Rider RTH Handheld Oscilloscope



### The perfect multipurpose tool for the lab or in the field.

When debugging embedded devices in the lab or analyzing complex problems in the field, the R&S®ScopeRider RTH offers the performance and capabilities of a lab oscilloscope as well as the form factor and ruggedness of a battery-operated handheld device.

#### Model overview

Model	Bandwidth	Channel (analog/digital)	Sample rate (analog/digital)	Memory depth	Update rate	Vertical resolution
R&S®RTH1002	60 MHz	2/8 (optional)	5 Gsample/s/1.25 Gsample/s	up to 12.5 Msample	50 000 waveforms/s	up to 10 bit
R&S®RTH1012	100 MHz					
R&S®RTH1022	200 MHz					
R&S®RTH1032	350 MHz					
R&S®RTH1052	500 MHz					
R&S®RTH1004	60 MHz	4/8 (optional)	5 Gsample/s/1.25 Gsample/s	up to 12.5 Msample	50 000 waveforms/s	up to 10 bit
R&S®RTH1014	100 MHz					
R&S®RTH1024	200 MHz					
R&S®RTH1034	350 MHz					
R&S®RTH1054	500 MHz					

#### Important facts

Specification	R&S®Scope Rider RTH	Why this is important
Update rate	50 000 waveforms/s	The faster the update rate, the faster users can find infrequent events.
Memory depth	up to 12.5 Msample	Allows capture of the longest period of time at high sample rate.
Integration	DMM, MSO, protocol analyzer, data logger	Allows debugging of low speed serial devices and mixed signal designs.
ADC resolution	10 bit	Allows users to see more detail and smaller signals.
Display	7", 800 × 480, touchscreen	Makes it easier to operate and see information on the display.

#### Scope of delivery

- ▶ User manual
- ▶ Power cord
- ▶ USB cable
- ▶ Passive probes for each channel

#### Recommended options/accessories

Description	Type
<b>Hardware options (plug-in)</b>	
Mixed signal option, 250 MHz, 8 digital channels	R&S®RTH-B1
<b>Software options</b>	
I <sup>2</sup> C/SPI serial decoding	R&S®RTH-K1
UART/RS-232/RS-422/RS-485 serial decoding	R&S®RTH-K2
CAN/LIN serial triggering and decoding	R&S®RTH-K3
History/segmented memory	R&S®RTH-K15

#### Recommended options/accessories

Description	Type
Spectrum analysis	R&S®RTH-K18
Advanced triggering	R&S®RTH-K19
Frequency counter	R&S®RTH-K33
Harmonics analysis	R&S®RTH-K34
User scripting	R&S®RTH-K38
Wireless LAN	R&S®RTH-K200/ R&S®RTH-K200US
Web interface remote control	R&S®RTH-K201
<b>Probes</b>	
Passive probe, 500 MHz, 10:1, isolated, 600 V CAT IV, 1000 V CAT III	R&S®RT-ZI10
Passive probe, 500 MHz, 100:1, isolated, 600 V CAT IV, 1000 V CAT III	R&S®RT-ZI11
Current probe, 100 kHz, 30 A, AC/DC	R&S®RT-ZC03



**The perfect choice for**

Electrical and electromechanical installation and maintenance	Education
Electronic field service and maintenance	Debugging and testing advanced power electronics

Your benefit	Features
Superior performance	<ul style="list-style-type: none"> <li>▶ Deep memory (up to 50 Msample) and high resolution (5 Gsample/s)</li> <li>▶ Fast acquisition rate: 50000 waveforms/s</li> <li>▶ 10-bit ADC</li> <li>▶ Excellent sensitivity: 2 mV/div to 100 V/div</li> <li>▶ Up to 200 V offset range</li> <li>▶ 37 automatic measurement functions</li> </ul>
Outstanding protection and excellent connectivity	<ul style="list-style-type: none"> <li>▶ Isolated channels: CAT IV 600 V/CAT III 1000 V</li> <li>▶ IP51 housing that meets military requirements</li> <li>▶ Wireless LAN and Ethernet for web based remote control and quick data access</li> </ul>
8 instruments in one handheld package	<ul style="list-style-type: none"> <li>▶ Lab performance oscilloscope</li> <li>▶ Logic analyzer</li> <li>▶ Protocol analyzer</li> <li>▶ Data logger</li> <li>▶ Digital multimeter<sup>1)</sup></li> <li>▶ Spectrum analyzer</li> <li>▶ Harmonics analyzer</li> <li>▶ Frequency counter</li> </ul>

<sup>1)</sup> Additional multimeter channel in two-channel model.



The high-speed acquisition system of the R&S®ScopeRider captures up to 50 000 waveforms/s and uncovers rare and unexpected signal anomalies

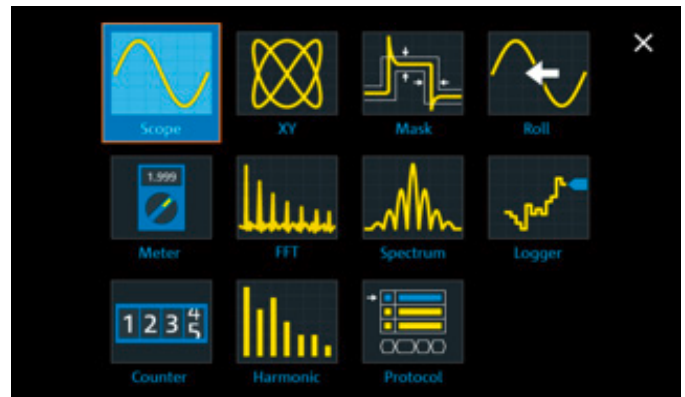

8 instruments in one – users can select the instrument they need at the push of a button

**10-bit A/D converter: uncovers even small signal details**

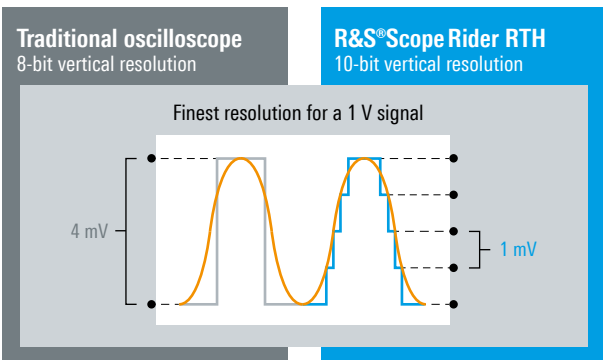

**Double insulation for maximum safety**

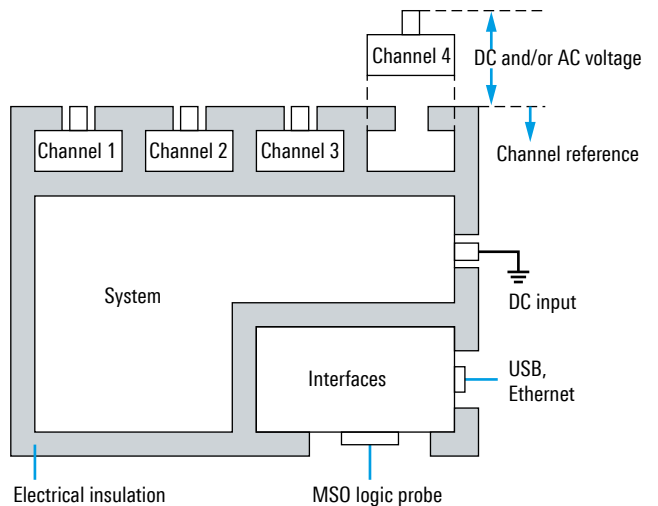



## R&S®RTC1000 Oscilloscope

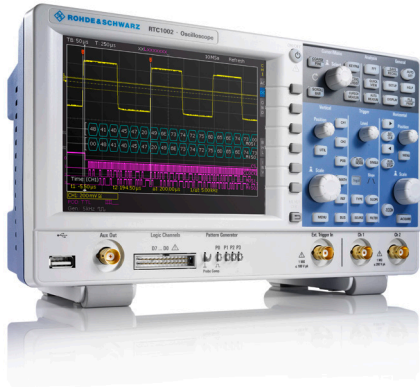

### Get your results quicker

What sets these oscilloscopes apart from all others in their class? New, advanced technology.

- ▶ Low-noise frontend for best results
- ▶ X-in-1 instrument that offers the functionality of an oscilloscope, logic analyzer, protocol analyzer, frequency analyzer, pattern generator, function generator, digital voltmeter and component tester

### Model overview

Model	Bandwidth	Channel (analog/digital)	Consists of	Max. sample rate (analog/digital)	Max. memory depth
R&S®RTC1002	50 MHz		R&S®RTC1000		
R&S®RTC1K-72	70 MHz		R&S®RTC1000 + R&S®RTC-B220		
R&S®RTC1K-102	100 MHz	2	R&S®RTC1000 + R&S®RTC-B221	2 Gsample/s	2 Msample
R&S®RTC1K-202	200 MHz		R&S®RTC1000 + R&S®RTC-B222		
R&S®RTC1K-302	300 MHz		R&S®RTC1000 + R&S®RTC-B223		
R&S®RTC1K-52M	50 MHz	2/8	R&S®RTC1000 + R&S®RTC-B1	2 Gsample/s/0.5 Gsample/s	2 Msample/0.5 Msample
R&S®RTC1K-72M	70 MHz		R&S®RTC1000 + R&S®RTC-B220 + R&S®RTC-B1		
R&S®RTC1K-102M	100 MHz		R&S®RTC1000 + R&S®RTC-B221 + R&S®RTC-B1		
R&S®RTC1K-202M	200 MHz		R&S®RTC1000 + R&S®RTC-B222 + R&S®RTC-B1		
R&S®RTC1K-302M	50 MHz		R&S®RTC1000 + R&S®RTC-B223 + R&S®RTC-B1		

### Important facts

Specification	R&S®RTC1000	Why this is important
Bandwidth	50/70/100/200/300 MHz (upgradeable, configurable)	Upgradeable bandwidth up to 300 MHz provides investment protection for future requirements.
Max. memory depth	2 Msample	Allows capture of the longest period of time at high sample rate.
Mixed signal option (MSO)	8 channels, upgradeable, 0.5 Gsample/s, 0.5 Msample	Ideal for analysis of digital buses and correlation with analog signals.
Multifunctional	DVM, counter, waveform generator, pattern generator, component tester	Saves desk space and is a smart investment.

### Scope of delivery

- ▶ User manual
- ▶ Power cord
- ▶ R&S®RT-ZP03 single-ended passive probes for each channel

### Recommended options/accessories

Description	Type
<b>Hardware options</b>	
Mixed signal upgrade for non-MSO models, 250 MHz	R&S®RTC-B1
Arbitrary waveform generator	R&S®RTC-B6
<b>Software options</b>	
I <sup>2</sup> C/SPI serial decoding	R&S®RTC-K1
UART/RS-232/RS-422/RS-485 serial decoding	R&S®RTC-K2
CAN/LIN serial triggering and decoding	R&S®RTC-K3
Application bundle (-K1, -K2, -K3, -B6)	R&S®RTC-PK1
<b>Option bundle</b>	
Plastic front cover	R&S®RTC-Z1
Soft carrying bag	R&S®RTC-Z3
Rackmount kit	R&S®ZZA-RTC1K



## The perfect choice for

R&D troubleshooting

Education

Production tests and repair

Electronic hobbyists

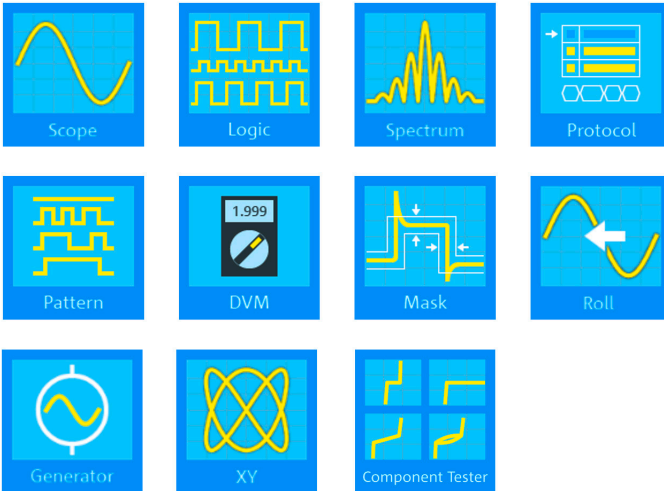

X-in-1 oscilloscope

Your benefit	Features
Get your results quicker	Fast boot and auto measurement for concise and comprehensive results
Investment protection	Expandable to your needs through software licenses
Compactness saves desk space	Highest integration of instruments in a small form factor

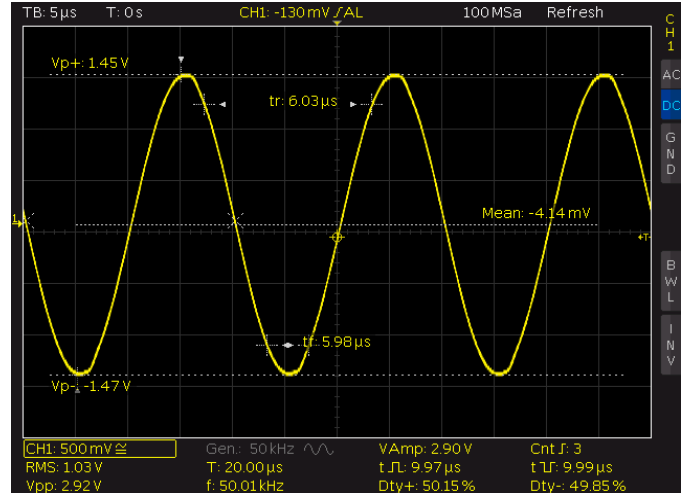

QuickView: automatic measurement and graphical display at the push of a button

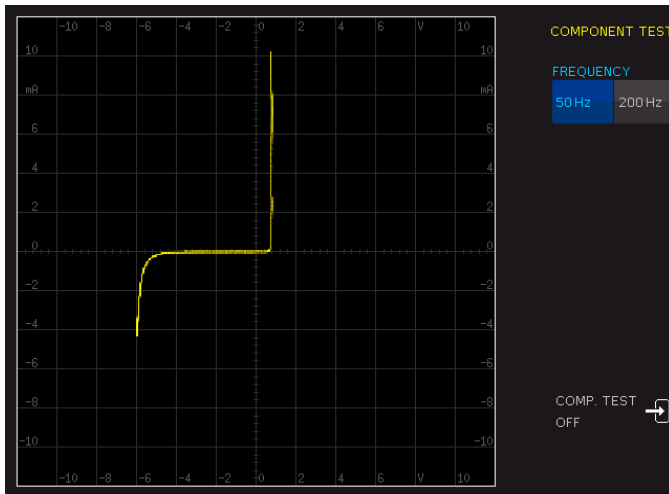

Quickly assesses your components with the integrated tester

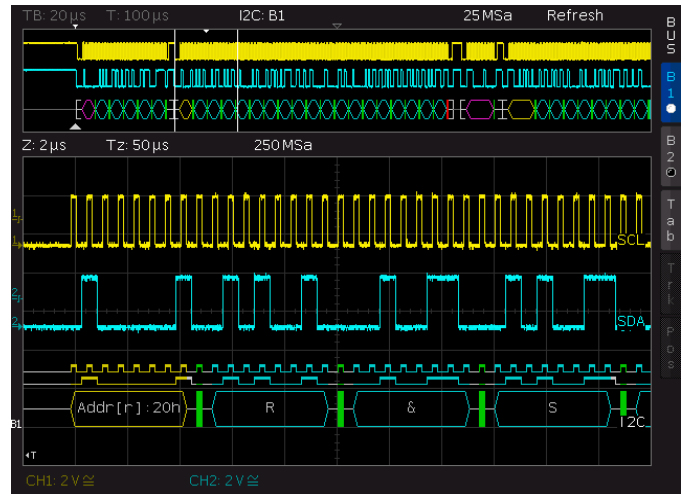

Gather insight into the digital communications on your circuitry



R&S®RTB2000 Oscilloscope



More signal details with the power of 10

What sets these oscilloscopes apart from all others in their class? New, advanced technology.

- ▶ 10-bit ADC – see small signal details in the presence of large signals
- ▶ 10 Msample acquisition memory depth on each channel (20 Msample when interleaved)
- ▶ Large 10.1" high-resolution capacitive touchscreen with gesture support

Model overview

Model	Bandwidth	Channel (analog/digital)	Sample rate (analog/digital)	Memory depth	Update rate	Vertical resolution
R&S®RTB2002	70 MHz	2/16 (optional)	2.5 Gsample/s/1.25 Gsample/s	up to 160 Msample	50 000 waveforms/s	10 bit
R&S®RTB2004	70 MHz	4/16 (optional)	2.5 Gsample/s/1.25 Gsample/s	up to 160 Msample	50 000 waveforms/s	10 bit

Important facts

Specification	R&S®RTB2000	Why this is important
Bandwidth	70/100/200/300 MHz, upgradeable	Upgradeable bandwidth up to 300 MHz provides investment protection for future requirements.
ADC resolution	10 bit	Allows users to see more detail and smaller signals.
Max. memory depth	20 Msample (160 Msample history)	Allows capture of the longest period of time at high sample rate.
Display	10.1", 1280 × 800 pixel, capacitive touchscreen	Makes it easier to operate and see information on the display.
Update rate	50 000 waveforms/s	The faster the update rate, the faster users can find infrequent events.
Integration	DVM, counter, function generator, pattern generator, 16 channels MSO	Allows debugging of low speed serial devices and mixed signal designs.
Interfaces	USB, LAN with fast web browser and MTP	Remote control makes updating and monitoring of the instrument easy.

Scope of delivery

- ▶ Single-ended passive probes for each channel
- ▶ Power cord
- ▶ USB cable
- ▶ User manual
- ▶ 3 year warranty

Recommended options/accessories

Description	Type
<b>Hardware options</b>	
Mixed signal upgrade for non-MSO models, 250 MHz, incl. 2 × R&S®RT-ZL03	R&S®RTB-B1
Arbitrary waveform generator	R&S®RTB-B6
<b>Software options</b>	
I <sup>2</sup> C/SPI serial triggering and decoding	R&S®RTB-K1
UART/RS-232/422/485 serial triggering and decoding	R&S®RTB-K2
CAN/LIN serial triggering and decoding	R&S®RTB-K3
History and segmented memory with 160 Msample	R&S®RTB-K15
Frequency response analysis (Bode plot)	R&S®RTB-K36
Application bundle (-K1,-K2,-K3,-K15,-K36,-B6)	R&S®RTB-PK1



**The perfect choice for**

R&D troubleshooting	Education
Production tests and repair	Electronic hobbyists

Your benefit	Features
See small signal details in the presence of large signals	<ul style="list-style-type: none"> <li>▶ 10-bit ADC</li> <li>▶ 1280 × 800 pixel display resolution</li> </ul>
Capture more time at full bandwidth	<ul style="list-style-type: none"> <li>▶ 2.5 Gsample/s max. sample rate with up to 20 Msample memory</li> <li>▶ 12 horizontal divisions</li> </ul>
Easier to see and collaborate; faster to operate and interpret results	<ul style="list-style-type: none"> <li>▶ 10.1" capacitive touchscreen with 1280 × 800 resolution</li> <li>▶ Grid annotation</li> <li>▶ Split dual window</li> </ul>

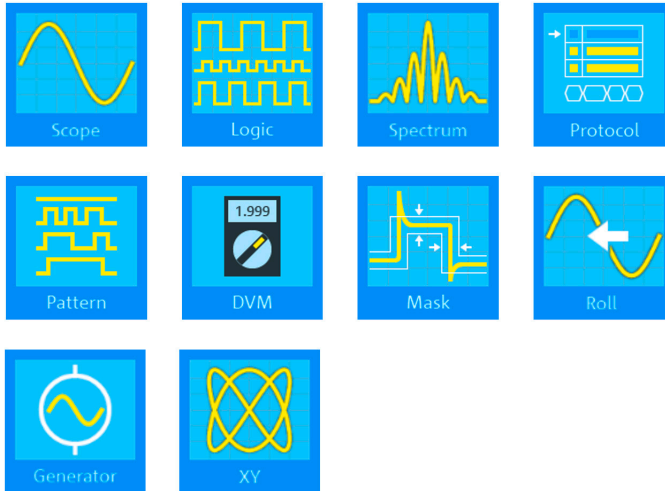

X-in-1 oscilloscope

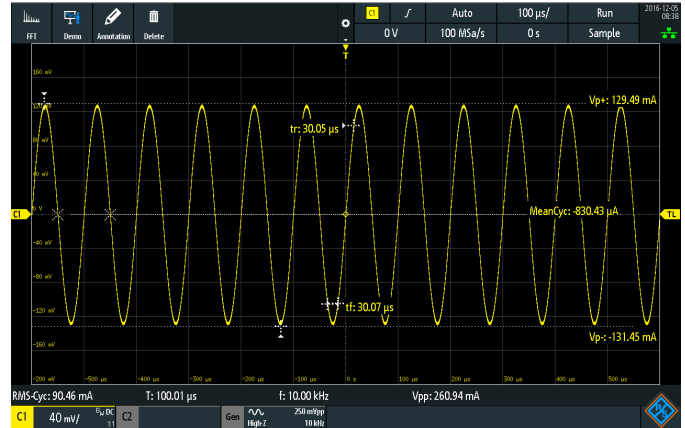

QuickMeas: automatic measurement and graphical display at the push of a button

**10 to 160 times more memory depth compared to traditional oscilloscopes in the same instrument class**

Capture the longest time periods with class-leading 160 Msample memory

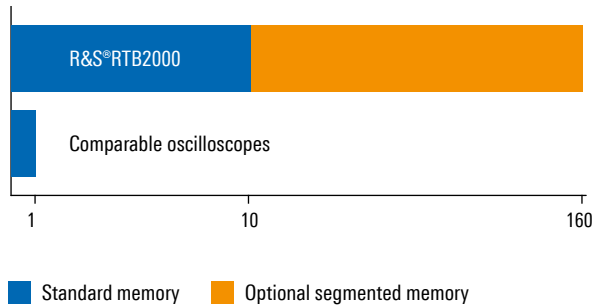

**10-bit A/D converter: uncovers even small signal details**

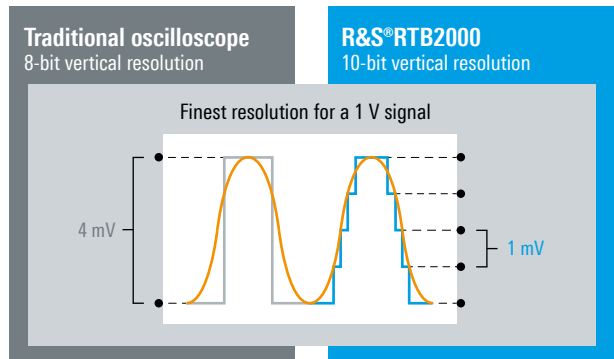

## R&S®RTM3000 Oscilloscope



### See more of your signal with the power of 10

What sets these oscilloscopes apart from all others in their class? New, advanced technology.

- ▶ Large 10.1" capacitive touchscreen
- ▶ 10-bit ADC designed by Rohde & Schwarz
- ▶ 40 Msample (all channels) and 80 Msample (interleaved) acquisition memory depth
- ▶ 10 s boot time

### Model overview

Model	Bandwidth	Channel (analog/digital)	Consists of	Max. sample rate (analog/digital)	Max. memory depth
R&S®RTM3002	100 MHz	2	R&S®RTM3002	5 Gsample/s	40 Msample/channel, 80 Msample interleaved standard, 400 Msample (optional)
R&S®RTM3004	100 MHz	4	R&S®RTM3004		
R&S®RTM3K-22	200 MHz	2	R&S®RTM3002 + R&S®RTM-B222		
R&S®RTM3K-24	200 MHz	4	R&S®RTM3004 + R&S®RTM-B242		
R&S®RTM3K-32	350 MHz	2	R&S®RTM3002 + R&S®RTM-B223		
R&S®RTM3K-34	350 MHz	4	R&S®RTM3004 + R&S®RTM-B243		
R&S®RTM3K-52	500 MHz	2	R&S®RTM3002 + R&S®RTM-B225		
R&S®RTM3K-54	500 MHz	4	R&S®RTM3004 + R&S®RTM-B245		
R&S®RTM3K-102	1 GHz	2	R&S®RTM3002 + R&S®RTM-B2210		
R&S®RTM3K-104	1 GHz	4	R&S®RTM3004 + R&S®RTM-B2410		
R&S®RTM3K-02M	100 MHz	2/16	R&S®RTM3002 + R&S®RTM-B1	5 Gsample/s/ 5 Gsample/s	
R&S®RTM3K-04M	100 MHz	4/16	R&S®RTM3004 + R&S®RTM-B1		
R&S®RTM3K-22M	200 MHz	2/16	R&S®RTM3002 + R&S®RTM-B222 + R&S®RTM-B1		
R&S®RTM3K-24M	200 MHz	4/16	R&S®RTM3004 + R&S®RTM-B242 + R&S®RTM-B1		
R&S®RTM3K-32M	350 MHz	2/16	R&S®RTM3002 + R&S®RTM-B223 + R&S®RTM-B1		
R&S®RTM3K-34M	350 MHz	4/16	R&S®RTM3004 + R&S®RTM-B243 + R&S®RTM-B1		
R&S®RTM3K-52M	500 MHz	2/16	R&S®RTM3002 + R&S®RTM-B225 + R&S®RTM-B1		
R&S®RTM3K-54M	500 MHz	4/16	R&S®RTM3004 + R&S®RTM-B245 + R&S®RTM-B1		
R&S®RTM3K-102M	1 GHz	2/16	R&S®RTM3002 + R&S®RTM-B2210 + R&S®RTM-B1		
R&S®RTM3K-10M	1 GHz	4/16	R&S®RTM3004 + R&S®RTM-B2410 + R&S®RTM-B1		

### Important facts

Specification	R&S®RTM3000	Why this is important
Bandwidth	100/200/350/500/1000 MHz (upgradeable)	Upgradeable bandwidth up to 1 GHz provides investment protection for future requirements.
ADC resolution	10 bit	Allows users to see more detail and smaller signals.
Max. resolution	16 bit with high resolution or averaging	Allows users to see more detail and smaller signals.
Max. memory depth	80 Msample	Allows capture of the longest period of time at high sample rate.
Segmented memory/history	optional, 400 Msample	Ideal for burst signals. Allows capture of the longest time periods at a high sample rate without wasting memory on idle periods.
Display	10.1", 1280 × 800, capacitive touchscreen	Makes it easier to operate and see information on the display.
Hardware dynamic range, full bandwidth	<ul style="list-style-type: none"> <li>▶ 1 MΩ: 5 mV to 100 V</li> <li>▶ 50 Ω: 5 mV to 10 V</li> </ul>	Smallest settings allow users to zoom in on small signals with full bandwidth. Largest settings allow users to properly scale a large waveform.
Boot time	approx. 10 s	Remote control makes updating and monitoring of the instrument easy.



## The perfect choice for

R&D debugging power

R&D debugging serial buses

Manufacturing test and repair

Education

## Power highlights

- ▶ Analysis of the input, output and transfer functions of switched-mode power supplies
- ▶ Measurement wizard for fast results
- ▶ Simple and fast documentation
- ▶ Analysis of the harmonic current in line with conventional EN, MIL and RTCA standards

## Scope of delivery

- ▶ User manual
- ▶ Power cord
- ▶ R&S®RT-ZP05S single-ended passive probes for each channel

## Recommended options/accessories

Description	Type
<b>Hardware options</b>	
Mixed signal upgrade for non-MSO models, 16 channels, 5 Gsample/s, up to 80 Msample	R&S®RTM-B1
Arbitrary waveform generator	R&S®RTM-B6
<b>Software options</b>	
I <sup>2</sup> C/SPI triggering and decoding	R&S®RTM-K1
UART/RS-232/422/485 triggering and decoding	R&S®RTM-K2
History and segmented memory with 400 Msample	R&S®RTM-K15
Spectrum analysis and spectrogram	R&S®RTM-K37
Frequency response analysis (Bode plot)	R&S®RTB-K36
<b>Option bundle</b>	
Application bundle <sup>1)</sup> , consists of the following options: (R&S®RTM-K1, R&S®RTM-K2, R&S®RTM-K3, R&S®RTM-K5, R&S®RTM-K6, R&S®RTM-K7, R&S®RTM-K15, R&S®RTM-K31, R&S®RTM-K36, R&S®RTM-K37, R&S®RTM-B6)	R&S®RTM-PK1US

<sup>1)</sup> The R&S®RTM-PK1US option is only distributed in North America.

## Your benefit

Easier to see and collaborate; faster to operate and interpret results

Capture more time at full bandwidth

See small signal details in the presence of large signals

Start working sooner

Troubleshoot and solve a wide range of problems with one instrument

## Features

10.1" capacitive touchscreen with 1280 × 800 resolution, Grid annotation, split dual window, SmartGrid

5 Gsample/s max. sample rate with up to 80 Msample memory, 12 horizontal divisions, 400 Msample history mode

10-bit ADC. 10.1", 1280 × 800 pixel display resolution

10 s boot time

8 instruments in one: oscilloscope, logic analyzer, spectrum analyzer, protocol analyzer, arbitrary waveform generator, pattern generator, counter, digital voltmeter

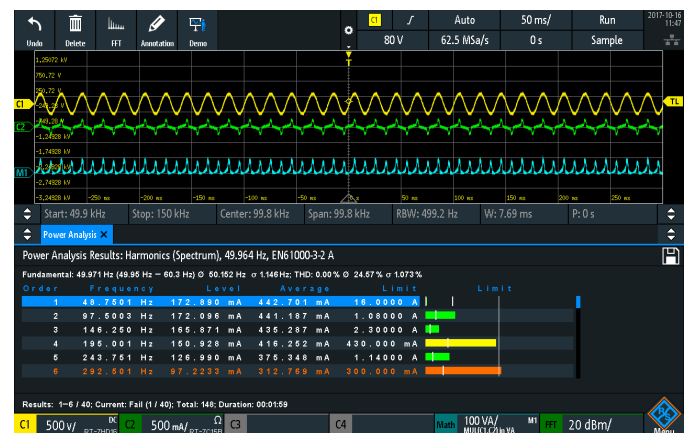

Power analysis measurement

## 8 instruments in one

Oscilloscope	standard
Logic analyzer (16-channel MSO)	R&S®RTM-B1 MSO option, includes cabling, lead sets and grabbers
Protocol analyzer	options for different serial buses
Spectrum analyzer	R&S®RTM-K37 option with spectrogram
Integrated digital voltmeter	standard
Trigger counter	standard
Waveform generator (25 MHz)	R&S®RTM-B6 option
Pattern generator (4 bit)	R&S®RTM-B6 option



## R&S®RTA4000 Oscilloscope



### See more of your signal with the power of 10

What sets these oscilloscopes apart from all others in their class? New, advanced technology.

- ▶ 10-bit ADC designed by Rohde&Schwarz
- ▶ 500  $\mu\text{V}/\text{div}$  sensitivity with full bandwidth and low noise
- ▶ 1000 Msample total standard memory, optimal for serial protocol analysis

### Model overview

Model	Bandwidth	Channel (analog/digital)	Consists of	Max. sample rate (analog/digital)	Max. memory depth
R&S®RTA4004	200 MHz	4	R&S®RTA4004	5 Gsample/s	100 Msample/channel, 200 Msample interleaved standard, 1 Gsample history
R&S®RTA4K-34	350 MHz	4	R&S®RTA4004 + R&S®RTA-B243		
R&S®RTA4K-54	500 MHz	4	R&S®RTA4004 + R&S®RTA-B245		
R&S®RTA4K-104	1 GHz	4	R&S®RTA4004 + R&S®RTA-B2410		
R&S®RTA4K-24M	200 MHz	4/16	R&S®RTA4004 + R&S®RTA-B1	5 Gsample/s/ 5 Gsample/s	
R&S®RTA4K-34M	350 MHz	4/16	R&S®RTA4004 + R&S®RTA-B243 + R&S®RTA-B1		
R&S®RTA4K-54M	500 MHz	4/16	R&S®RTA4004 + R&S®RTA-B245 + R&S®RTA-B1		
R&S®RTA4K-104M	1 GHz	4/16	R&S®RTA4004 + R&S®RTA-B2410 + R&S®RTA-B1		

### Important facts

Specification	R&S®RTA4000	Why this is important
Bandwidth	200/350/500/1000 MHz (upgradeable)	Upgradeable bandwidth up to 1 GHz provides investment protection for future requirements.
ADC resolution	10 bit	Allows users to see more detail and smaller signals.
Max. resolution	16 bit with high resolution	Allows users to see more detail and smaller signals.
Noise 1 mV/div, 200 MHz, 50 $\Omega$ , % full scale	0.7 %	Noise hides small signals and limits measurement accuracy.
Max. memory depth	200 Msample	Allows capture of the longest period of time at high sample rate.
Segmented memory/history	standard – 1000 Msample (1 Gsample)	Ideal for bursty signals. Allows capture of the longest period of time at high sample rate without wasting memory on idle periods.
Time base accuracy	$\pm 0.5$ ppm	The better the time base accuracy, the more accurate deep memory measurements.
Hardware dynamic range, full bandwidth	<ul style="list-style-type: none"> <li>▶ 1 M<math>\Omega</math>: 5 mV to 100 V</li> <li>▶ 50 <math>\Omega</math>: 5 mV to 10 V</li> </ul>	Smallest settings allow users to zoom in on small signals with full bandwidth. Largest settings allow users to properly scale a large waveform.

### Scope of delivery

- ▶ R&S®RT-ZP10 single-ended passive probes for each channel
- ▶ Power cord
- ▶ 3 year warranty

### Recommended options/accessories

Description	Type
<b>Hardware options</b>	
Mixed signal upgrade for non-MSO models, 16 channels, 5 Gsample/s, up to 200 Msample	R&S®RTA-B1
Arbitrary waveform generator	R&S®RTA-B6

### Recommended options/accessories

#### Software options

I <sup>2</sup> C/SPI serial triggering and decoding	R&S®RTA-K1
UART/RS-232/422/485 serial triggering and decoding	R&S®RTA-K2
Spectrum analysis and spectrogram	R&S®RTA-K37
Frequency response analysis (Bode plot)	R&S®RTB-K36

#### Option bundle

Application bundle <sup>1)</sup> , consists of the following options: (R&S®RTA-K1, R&S®RTA-K2, R&S®RTA-K3, R&S®RTA-K5, R&S®RTA-K6, R&S®RTA-K7, R&S®RTA-K31, R&S®RTA-K36, R&S®RTA-K37, R&S®RTA-B6)	R&S®RTA-PK1US
---	---------------

<sup>1)</sup> The R&S®RTA-PK1US option is only distributed in North America.



## The perfect choice for

R&D debugging power integrity

R&D debugging serial buses

Manufacturing test and repair

EMI debugging

## Unrivalled signal integrity and deep memory

- ▶ Superb noise values allow you to see more of your signal
- ▶ 10-bit ADC designed by Rohde&Schwarz
- ▶ 500  $\mu\text{V}/\text{div}$  sensitivity with full bandwidth and low noise
- ▶ Capture more time at full bandwidth
- ▶ Deep memory: standard 100 Msample per channel and 200 Msample interleaved
- ▶ Class-leading timebase accuracy ensures deep memory measurement accuracy
- ▶ Standard history function with over 1000 Msample of memory allows you to see back in time to potentially tens of thousands of trigger events

## 8 instruments in one

Oscilloscope	standard
Logic analyzer (16-channel MSO)	R&S®RTA-B1 MSO option, includes cabling, lead sets and grabbers
Protocol analyzer	options for different serial buses
Spectrum analyzer	R&S®RTA-K37 option with spectrogram
Integrated digital voltmeter	standard
Trigger counter	standard
Waveform generator (25 MHz)	R&S®RTA-B6 option
Pattern generator (4 bit)	R&S®RTA-B6 option

## Your benefit

See small signal detail in the presence of large signals  
Easier to see and collaborate; faster to operate and interpret results

Capture more time, accurately, at full bandwidth

## Features

10-bit ADC. Class-leading signal integrity  
10.1" capacitive touchscreen with 1280  $\times$  800 resolution. Grid annotation. Split window, SmartGrid  
5 Gsample/s max. sample rate with up to 200 Msample memory. 12 horizontal divisions. 1 Gsample history mode. Class-leading time-base accuracy

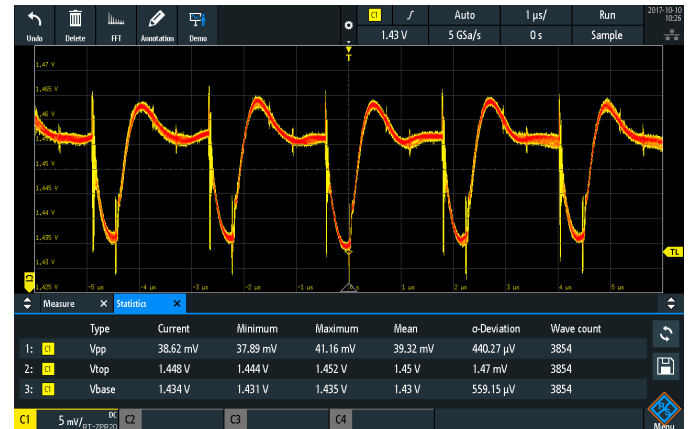

Power integrity measurement

## R&S®RTE1000 Oscilloscope

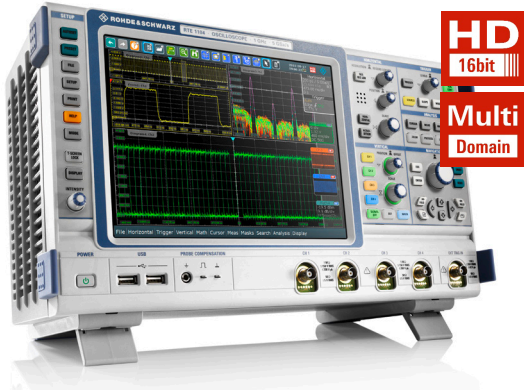

### Truly uncompromised performance

More reliable measurements, more tools and fast results, more fun to use – that’s the R&S®RTE oscilloscope. From embedded design development to power electronics analysis to general debugging, the R&S®RTE offers quick solutions for everyday T&M tasks.

### Model overview

Model	Bandwidth	Channel (analog/digital)	Sample rate (analog/digital)	Memory depth	Update rate	Vertical resolution
R&S®RTE1022	200 MHz	2/16 (optional)	5 Gsample/s/ 5 Gsample/s	up to 100 Msample	> 1 000 000 waveforms/s	up to 16 bit
R&S®RTE1024	200 MHz	4/16 (optional)		up to 200 Msample		
R&S®RTE1032	300 MHz	2/16 (optional)		up to 100 Msample		
R&S®RTE1034	300 MHz	4/16 (optional)		up to 200 Msample		
R&S®RTE1052	500 MHz	2/16 (optional)		up to 100 Msample		
R&S®RTE1054	500 MHz	4/16 (optional)		up to 200 Msample		
R&S®RTE1102	1 GHz	2/16 (optional)		up to 100 Msample		
R&S®RTE1104	1 GHz	4/16 (optional)		up to 200 Msample		
R&S®RTE1152	1.5 GHz	2/16 (optional)		up to 100 Msample		
R&S®RTE1154	1.5 GHz	4/16 (optional)		up to 200 Msample		
R&S®RTE1202	2 GHz	2/16 (optional)		up to 100 Msample		
R&S®RTE1204	2 GHz	4/16 (optional)		up to 200 Msample		

### Important facts

Specification	R&S®RTE	Why this is important
Update rate	> 1 000 000 waveforms/s	The faster the update rate, the faster users can find infrequent events.
Bits of vertical resolution	up to 16	Allows users to see more detail and smaller signals.
Four-channel sample rate	5 Gsample/s	Most accurate signal capture.
Memory depth	up to 200 Msample	Allows capture of the longest period of time at high sample rate.
Mask trigger in the time domain	up to 600 000 evaluations/s	If you can see it on the screen, you draw the trigger and capture it.

### Scope of delivery

- ▶ Passive probes for each channel
- ▶ Power cord
- ▶ USB cable
- ▶ User manual
- ▶ 3 year warranty

### Recommended options/accessories

Description	Type
<b>Hardware option (plug-in)</b>	
Mixed signal option, 400 MHz	R&S®RTE-B1
<b>Software options</b>	
I <sup>2</sup> C/SPI serial triggering and decoding	R&S®RTE-K1
UART/RS-232/RS-422/RS-485 serial triggering and decoding	R&S®RTE-K2
CAN/LIN serial triggering and decoding	R&S®RTE-K3

### Recommended options/accessories

#### Probes

Active, high-voltage, 100 MHz, differential, 8 MΩ, 3.5 pF, 1 kV (RMS) (CAT III)	R&S®RT-ZD01
Active, single-ended, 1.0 GHz, 1 MΩ, 0.8 pF	R&S®RT-ZS10E
Current, 10 MHz, current, AC/DC, 0.01 V/A, 150 A (RMS)	R&S®RT-ZC10

#### Analysis

High definition mode	R&S®RTE-K17
Power analysis	R&S®RTE-K31

#### Bundle

Trigger and decode bundle	R&S®RTE-TDBNDL
---------------------------	----------------



### The perfect choice for

Designing and debugging embedded systems

EMI debugging during daily development

Signal validation

Power integrity analysis

Your benefit	Features
No trade-offs	<ul style="list-style-type: none"> <li>▶ Longest signal sequences (200 Msample memory depth) at highest resolution (5 Gsample/s sampling rate)</li> <li>▶ Quick detection of signal faults: more than 1 000 000 waveforms/s</li> <li>▶ Most precise results: 16-bit vertical resolution in high definition mode</li> <li>▶ Drag &amp; drop signals and measurement results</li> </ul>
High-resolution 10.4" touchscreen	<ul style="list-style-type: none"> <li>▶ Results in only two clicks thanks to the powerful toolbar</li> <li>▶ Convenient tools such as QuickMeas, fingertip zoom and undo/redo</li> </ul>
Multichannel spectrum analysis	<ul style="list-style-type: none"> <li>▶ Analysis of up to four signals in parallel</li> <li>▶ Correlation of time and frequency signals</li> <li>▶ Spectrogram: display changes in power and frequency over time</li> <li>▶ Outstanding RF performance: high dynamic range and low inherent noise</li> </ul>

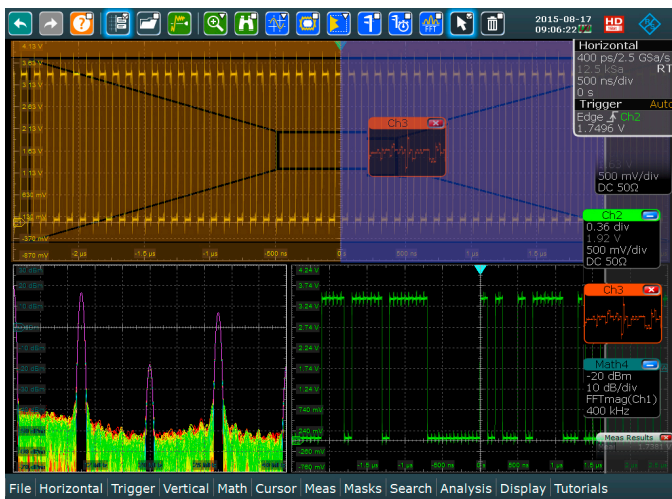

Users can drag & drop waveforms and result windows. The R&S®SmartGrid function helps users arrange multiple diagrams or tabs on the screen. The size of individual diagrams can be further optimized by dragging the edges of the windows.

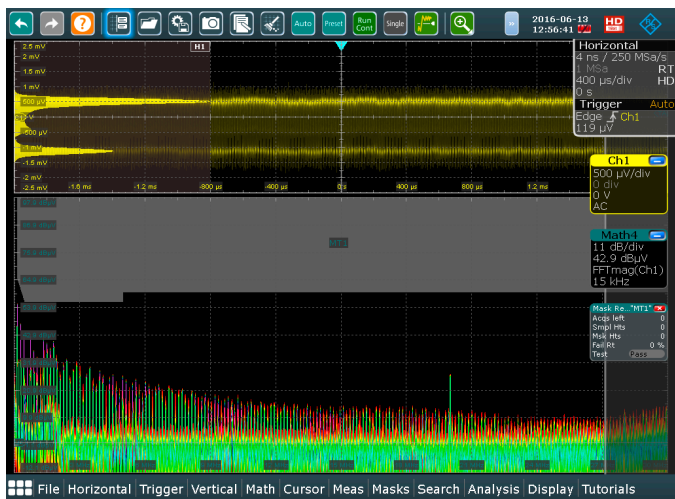

R&S®RTE oscilloscopes come with built-in spectrum analysis for up to four signals in parallel. Results can be correlated in the time and frequency domains. Analysis functions such as spectrogram (with R&S®RTE-K18 option), mask test and peak list are available.

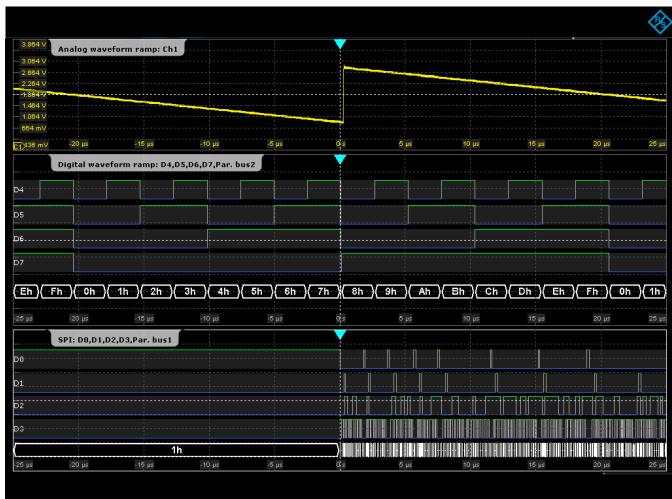

With the R&S®RTE-B1 option, every R&S®RTE can be turned into a mixed signal oscilloscope with 16 digital channels. This example shows the ramp signal of a 4-bit ADC with analog and digital channels correlated to an SPI bus that controls the ADC.

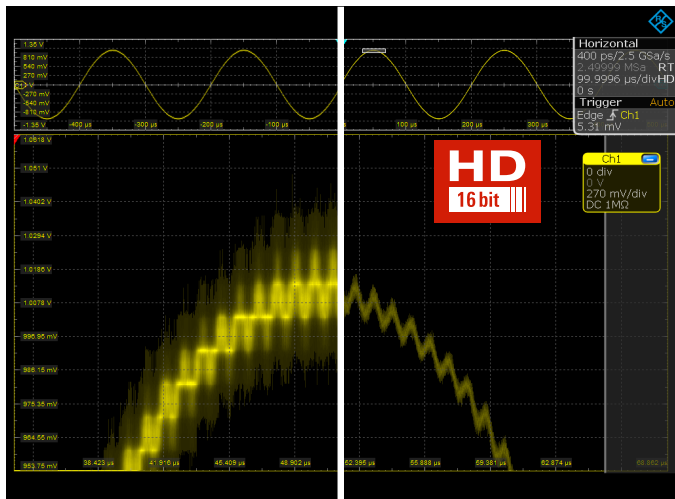

The HD mode increases the vertical resolution of the R&S®RTE to up to 16 bit. This results in sharper waveforms, showing signal details that would otherwise be masked by noise.

## Featured content for the R&S®RTE1000

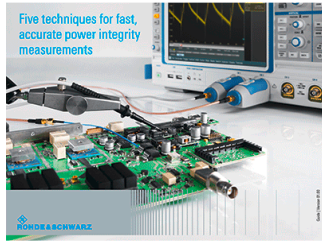

### Five techniques for fast, accurate power integrity measurements

Industry dynamics are driving both a decrease in rail voltage values as well as tighter tolerances across a wide range of power rails. Making an accurate ripple measurement on a 1 V rail with 2% tolerance, for example, is difficult on all oscilloscopes.

This guide describes how to set up your oscilloscope for accurate power integrity measurements.

- ▶ Tip 1: Adjust viewing characteristics
- ▶ Tip 2: Lower noise
- ▶ Tip 3: Achieve sufficient offset
- ▶ Tip 4: Evaluate switching and EMI
- ▶ Tip 5: Accelerate measurement time
- ▶ [www.rohde-schwarz.com/pi-ebook](http://www.rohde-schwarz.com/pi-ebook)

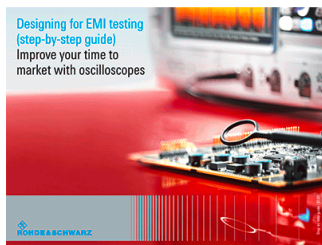

### Designed for EMI testing

R&D engineers: Are you missing your NPI deadlines due to EMI compliance issues? Learn how to use oscilloscopes to improve your time to market – brought to you by Rohde&Schwarz, the EMI/EMC market leader.

The challenges of testing EMI early in the product development cycle are multifold. In this guide, we break down the EMI design test process into locate, capture, and analyze. The guide enables engineers to discover and analyze EMI with a more systematic and methodical approach in order to solve their problems.

- ▶ [See figure below](#)
- ▶ [www.rohde-schwarz.com/emi-test](http://www.rohde-schwarz.com/emi-test)

## Overview of EMI testing steps

Settings	Locate ▶	Capture ▶	Analyze
<ul style="list-style-type: none"> <li>▶ Frequency band and RBW</li> <li>▶ Oscilloscope parameters</li> </ul>	<ul style="list-style-type: none"> <li>▶ Visualize with intensity grading</li> <li>▶ Locate with near-field probe</li> </ul>	<ul style="list-style-type: none"> <li>▶ Time domain trigger</li> <li>▶ Zone trigger</li> <li>▶ Mask violation</li> <li>▶ Serial, parallel and protocol trigger</li> </ul>	<ul style="list-style-type: none"> <li>▶ Identify narrowband and broadband signals</li> <li>▶ Analyze with FFT gating</li> <li>▶ Analyze correlated signal sources</li> <li>▶ Analyze with history function</li> </ul>

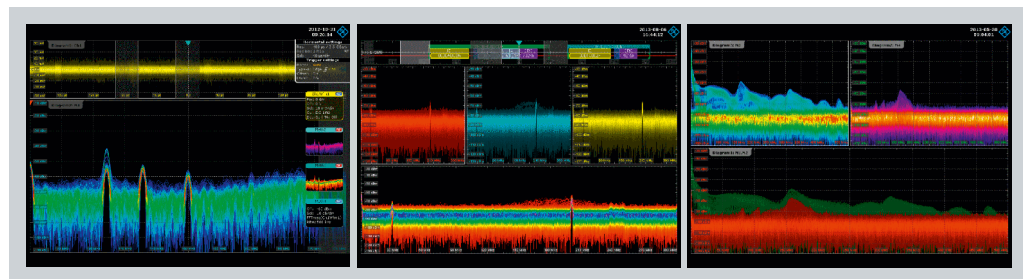





## Oscilloscope probe compatibility

Sensor		Oscilloscope (R&S®)					
		RTH	RTC1000	RTB2000	RTM3000	RTA4000	RTE
Passive probes	R&S®RT-ZP1X, 1:1, 38 MHz, 1 MΩ, 39 pF	U	U	U	U	U	U
	R&S®RT-ZP03, 10:1/1:1, 300 MHz/10 MHz, 10 MΩ/1 MΩ, 12 pF/82 pF		S	S	U	U	U
	R&S®RT-ZP05S, 10:1, 500 MHz, 10 MΩ, 9.5 pF		U	U	S	U	U
	R&S®RTM-ZP10, 500 MHz, 10 MΩ, 9.5 pF		U	U	U	U	U
	R&S®RT-ZP10, 10:1, 500 MHz, 10 MΩ, 9.5pF		U	U	U	S	S
	R&S®RT-ZI10, 500MHz, 10MΩ, 10:1, 12pF, 600 V CAT IV, 1000 V CAT III	S					
	R&S®RT-ZI10C, 500 MHz, 10 MΩ, 10:1, 11 pF, 300 V CAT III	U					
	R&S®RT-ZI11, 500 MHz, 10 MΩ, 100:1, 4.6 pF, 600 V CAT IV, 1000 V CAT III	U					
	R&S®RT-ZZ80, 8.0 GHz, 500 Ω, 0.3 pF				U	U	U
Single-ended active probes	R&S®RT-ZS10L, 1 GHz, 1 MΩ, 0.9 pF <sup>1)</sup>		U	U	U	U	U
	R&S®RT-ZS10E, 1 GHz, 1 MΩ, 0.8 pF				U	U	U
	R&S®RT-ZS10, 1 GHz, 1 MΩ, 0.8 pF, R&S®ProbeMeter				U	U	U
	R&S®RT-ZS20, 1.5 GHz, 1 MΩ, 0.8 pF, R&S®ProbeMeter				U	U	U
	R&S®RT-ZS30, 3 GHz, 1 MΩ, 0.8 pF, R&S®ProbeMeter				U	U	U
	R&S®RT-ZS60, 6 GHz, 1 MΩ, 0.3 pF, R&S®ProbeMeter				U	U	U
	R&S®RT-ZPR20, 2 GHz, power rail probe, R&S®ProbeMeter				U	U	U
	R&S®RT-ZPR40, 4 GHz, power rail probe, R&S®ProbeMeter				U	U	U
	R&S®RT-ZD02, 200 MHz, 1 MΩ, 3.5 pF <sup>1)</sup>		U	U	U	U	U
	R&S®RT-ZD08, 800 MHz, 200 kΩ, 1 pF <sup>1)</sup>		U	U	U	U	U
	R&S®RT-ZD10, 1 GHz, 1 MΩ, 0.6 pF, R&S®ProbeMeter, R&S®RT-ZA15 included				U	U	U
	R&S®RT-ZD20, 1.5 GHz, 1 MΩ, 0.6 pF, R&S®ProbeMeter, R&S®RT-ZA15 optional				U	U	U
	R&S®RT-ZD30, 3 GHz, 1 MΩ, 0.6 pF, R&S®ProbeMeter, R&S®RT-ZA15 optional				U	U	U
	R&S®RT-ZD40, 4.5 GHz, 1 MΩ, 0.4 pF, R&S®ProbeMeter, R&S®RT-ZA15 optional				U	U	U
	R&S®RT-ZM15 multi-mode, 1.5 GHz, 400 kΩ, modular, R&S®ProbeMeter						U
	R&S®RT-ZM30 multi-mode, 3 GHz, 400 kΩ, modular, R&S®ProbeMeter						U
R&S®RT-ZM60 multi-mode, 6 GHz, 400 kΩ, modular, R&S®ProbeMeter						U	
R&S®RT-ZM90 multi-mode, 9 GHz, 400 kΩ, modular, R&S®ProbeMeter						U	
R&S®RT-ZMA50 extreme temperature kit for use with R&S®RT-ZMxx						U	
R&S®RT-ZA15 external attenuator (±70 V DC/±46 V AC (V <sub>p</sub> )) <sup>2)</sup>				U	U	U	

- S Standard
- O Option
- R Optional, upgradeable at a Rohde&Schwarz service center
- U Optional, user-upgradeable
- Recommended

<sup>1)</sup> Probes need 50 Ω input coupling. For oscilloscopes with only 1 MΩ input, a BNC feedthrough adapter is required.

<sup>2)</sup> R&S®RT-ZA15 comes standard with the R&S®RT-ZD10.

Sensor		Oscilloscope (R&S®)					
		RTH	RTC1000	RTB2000	RTM3000	RTA4000	RTE
High voltage passive probes	R&S®RT-ZH03, 250 MHz, 100:1, 850 V, passive		U	U	U	U	U
	R&S®RT-ZH10, 400 MHz, 100:1, 1 kV, passive		U	U	U	U	U
	R&S®RT-ZH11, 400 MHz, 1000:1, 1 kV, passive		U	U	U	U	U
High voltage differential probes	R&S®RT-ZD002, 25 MHz, 10:1 or 100:1, 700 V		U	U	U	U	U
	R&S®RT-ZD003, 25 MHz, 20:1 or 200:1, 1.4 kV		U	U	U	U	U
	R&S®RT-ZD01, 100 MHz, 100:1 or 1000:1 selectable, 1.4 kV		U	U	U	U	U
	R&S®RT-ZHD07, 200 MHz, 25:1 or 250:1, 750 V				U	U	U
	R&S®RT-ZHD15, 100 MHz, 50:1 or 500:1, 1.5 kV				U	U	U
	R&S®RT-ZHD16, 200 MHz, 50:1 or 500:1, 1.5 kV				U	U	U
	R&S®RT-ZHD60, 100 MHz, 100:1 or 1000:1, 6 kV				U	U	U
Current probes	R&S®RT-ZC02, 20 kHz, 100/1000 A	U	U	U	U	U	U
	R&S®RT-ZC03, 100 kHz, 30 A	U	U	U	U	U	U
	R&S®RT-ZC05B, 2 MHz, 500 A, R&S®Probe Interface				U	U	U
	R&S®RT-ZC10, 10 MHz, 150 A <sup>1)</sup>	U	U	U	U	U	U
	R&S®RT-ZC10B, 10 MHz, 150 A, R&S®Probe Interface				U	U	U
	R&S®RT-ZC15B, 50 MHz, 30 A, R&S®Probe Interface				U	U	U
	R&S®RT-ZC20, 100 MHz, 30 A <sup>1)</sup>	U	U	U	U	U	U
	R&S®RT-ZC20B, 100 MHz, 30 A, R&S®Probe Interface				U	U	U
	R&S®RT-ZC30, 120 MHz, 5 A, $\mu$ A high sensitivity <sup>1)</sup>	U	U	U	U	U	U
Near-field probes	R&S®HZ-14, 9 kHz to 1 GHz <sup>2)</sup>	U	U	U	U	U	U
	R&S®HZ-15, 9 kHz to 3 GHz <sup>4)</sup>	U	U	U	U	U	U
	R&S®HZ-16, preamplifier for near-field probes	U	U	U	U	U	U
	R&S®HZ-17, 30 MHz to 3 GHz <sup>4)</sup>	U	U	U	U	U	U
Accessories	R&S®RT-ZA9, N type adapter for R&S®RT-Zxx probes	for use on spectrum and signal analyzer					
	R&S®RT-ZA10, SMA adapter				U	U	U
	R&S®RT-ZA13, power supply for current probes without R&S®Probe Interface		U	U	U	U	U
	Rackmount kit		U	U	U	U	U

S	Standard
O	Option
R	Optional, upgradeable at a Rohde&Schwarz service center
U	Optional, user-upgradeable
	Recommended

<sup>1)</sup> Current probes without R&S®Probe Interface require R&S®RT-ZA13 power supply.

<sup>2)</sup> Probes need 50  $\Omega$  input coupling. For oscilloscopes with only 1 M $\Omega$  input, a BNC feedthrough adapter is required.

# POWER SUPPLIES

## Number of channels

Depending on the application and requirements, you can select a power supply unit with 1, 2, 3 or 4 channels.

In many cases, a single output will be sufficient. However, multi-output supplies can deliver important advantages in applications that require, for example,  $\pm 15$  V simultaneously. A multi-output supply with independently controllable outputs is usually more versatile than a set of individual supplies. Using a single multi-output supply significantly reduces costs.

## Output power

The maximum power is determined by the maximum voltage and current demanded by the device. All multichannel Rohde&Schwarz power supplies allow parallel and serial operation to achieve higher voltage/current output.

## Readback accuracy and sense lines

Modern power supplies include a multimeter that measures the voltage/current consumed by the device under test (DUT). The readback accuracy specifies the accuracy of these measurements.

The output cables that connect a power supply's output to its load have some resistance, and as current flow increases there will be a voltage drop across the cables. The sense lines connected from the supply to the load compensate for these unwanted voltage drops since the voltage can be measured directly at the DUT.

Most Rohde&Schwarz power supplies are equipped with sense lines.

## Protection functions

To safeguard the instrument and the DUT, Rohde&Schwarz power supplies provide a variety of protection functions.

Depending on the model, users can separately set the maximum current (electronic fuse, overcurrent protection, OCP), the maximum voltage (overvoltage protection, OVP) and the maximum power (overpower protection, OPP) for each channel. When such a limit is reached, the affected output channel will be switched off.

Overtemperature protection prevents the instrument from overheating.

Type	Designation	Page
R&S®HM7042-5	Triple power supply	31
R&S®NGE100B	Power supply series	33
R&S®HMC804x	Power supply	35
R&S®HMP	Power supply series	37
R&S®NGL200	Power supply series	39
R&S®NGM200	Power supply series	41
R&S®NGP800	Power supply series	43
R&S®HM8143	Power supply	45

## Power supply portfolio



R&S®	Basic HM7042-5	NGE102B/103B	HMC8041/8042/8043	Performance HMP2020/2030
<b>Electrical specifications</b>				
Number of output channels	3	2/3	1/2/3	2/3
Total output power	max. 155.5 W	max. 66 W/100 W	max. 100 W	max. 188 W
Maximum output power per channel	CH1, CH3: 64 W <sup>1)</sup> ; CH2: 27.5 W	33.6 W	100 W/50 W/33 W	80 W; except R&S®HMP2020, CH1: 16
Output voltage per channel	CH1, CH3: 0 V to 32 V; CH2: 0 V to 5.5 V	0 V to 32 V	0 V to 32 V	0 V to 32 V
Maximum output current per channel	CH1, CH3: 2 A; CH2: 5 A	3 A	10 A/5 A/3 A	5 A; except R&S®HMP2020, CH1: 10
Voltage ripple and noise (20 Hz to 20 MHz)	< 1 mV (RMS) (meas.)	< 1.5 mV (RMS) (typ.)	R&S®HMC8041: < 1 mV (RMS); R&S®HMC8042/43: < 450 µV (RMS)	< 1.5 mV (RMS) (meas.)
Current ripple and noise (20 Hz to 20 MHz)	< 1 mA (RMS) (meas.)	< 2 mA (RMS) (meas.)	R&S®HMC8041: < 1.5 mA (RMS) (meas.); R&S®HMC8042/43: < 1 mA (RMS) (meas.)	< 1 mA (RMS) (meas.)
Load recovery time <sup>2)</sup>	< 30 µs (meas.)	< 200 µs (meas.)	< 1 ms (meas.)	< 1 ms (meas.)
Programming/readback resolution				
Voltage	10 mV	10 mV	1 mV	1 mV
Current	CH1, CH3: 1 mA; CH2: 10 mA	1 mA	< 1 A: 0.1 mA (R&S®HMC8041: 0.5 mA); ≥ 1 A: 1 mA	< 1 A: 0.1 mA (10 A CH: 0.2 mA); ≥ 1 A: 1 mA
Readback accuracy (± (% of output + offset))				
Voltage	< 0.1% + 30 mV	< 0.1% + 20 mV	< 0.05% + 2 mV	< 0.05% + 5 mV
Current	CH1, CH3: < 0.1% + 4 mA; CH2: < 0.1% + 40 mA	< 0.1% + 5 mA	< 0.05% + 4 mA (typ.) (R&S®HMC8041: < 0.15% + 10 mA) (typ.)	< 0.1% + 2 mA
<b>Special functions</b>				
Measurement functions	voltage, current	voltage, current, power	voltage, current, power, energy	voltage, current
Protection functions	OCP	OVP, OCP, OPP, OTP	OVP, OCP, OPP, OTP	OVP, OCP, OTP
FuseLink function	always linked	●	●	●
Fuse delay at output-on	–	●	●	●
Remote sensing	–	–	●	●
Sink mode	–	–	–	–
Output sequencing	–	–	● (R&S®HMC8042/8043)	–
Trigger input/output	–	○	●	–
Arbitrary function	–	● (CH1: EasyArb)	● (EasyArb)	● (EasyArb)
Analog/modulation interface	–	–	●	–
Data logging	–	–	● (standard mode)	–
<b>Display and interfaces</b>				
Display	7-segment LED	3.5" QVGA	3.5" QVGA	240 × 64 pixel LCD
Rear panel connections	–	–	connector block with 4 lines per channel	connector block with 4 lines per channel
Remote control interfaces	–	standard: USB; optional: LAN, WLAN	standard: USB, LAN; R&S®HMC804x-G models with IEEE-488 (GPIB)	standard: USB, LAN; optional: IEEE-488 (GPIB), RS-232
<b>General data</b>				
Dimensions (W × H × D)	285 × 90 × 388 mm	222 × 97 × 310 mm	222 × 97 × 291 mm	285 × 93 × 405 mm
Weight	7.0 kg	4.9 kg/5.0 kg	2.6 kg	7.8 kg/8.0 kg
Rack adapter	R&S®HZ42 option	R&S®HZC95 option	R&S®HZC95 option	R&S®HZ42 option

All data valid at +23°C (–3°C/+7°C) after 30 minutes warm-up time.

● yes – no ○ optional

<sup>1)</sup> CH: channel.

<sup>2)</sup> 10% to 90% load change within a band of ± 20 mV of set voltage.

<sup>3)</sup> In most sensitive measurement range.



	HMP4030/4040	NGP802/822/804/814/824	Specialty HM8143	NGL201/NGL202	NGM201/202
	3/4	2 or 4	3	1/2	1/2
	max. 384 W	max. 400 W/800 W	max. 130 W	max. 60 W/120 W	max. 60 W/120 W
0 W	160 W	200 W	CH1, CH3: 60 W; CH2: 10 W	60 W	60 W
	0 V to 32 V	0 V to 32 V (32 V channels), 0 V to 64 V (64 V channels)	CH1, CH3: 0 V to 30 V; CH2: 5 V (±50 mV)	0 V to 20 V	0 V to 20 V
A	10 A	20 A (32 V channels), 10 A (64 V channels)	2 A	≤ 6 V output voltage: 6 A; > 6 V output voltage: 3 A	≤ 6 V output voltage: 6 A > 6 V output voltage: 3 A
	< 1.5 mV (RMS) (meas.)	< 3 mV (RMS), < 30 mV (V <sub>pp</sub> ) (meas.)	CH1, CH3: < 1 mV (RMS) (meas.)	< 500 μV (RMS); < 2 mV (V <sub>pp</sub> ) (meas.)	< 500 μV (RMS), < 2 mV (V <sub>pp</sub> ) (meas.)
	< 1 mA (RMS) (meas.)	< 3.5 mA (RMS) (meas.)	CH1, CH3: < 1 mA (RMS) (meas.)	< 1 mA (RMS) (meas.)	< 1 mA (RMS) (meas.)
	< 1 ms (meas.)	< 400 μs (meas.)	< 45 μs (meas.)	< 30 μs (meas.)	< 30 μs (meas.)
	1 mV	1 mV	CH1, CH3: 10 mV	1 mV/10 μV	1 mV/5 μV <sup>3)</sup>
	< 1 A: 0.2 mA; ≥ 1 A: 1 mA	0.5 mA	CH1, CH3: 1 mA	0.1 mA/10 μA	0.1 mA/10 nA <sup>3)</sup>
	< 0.05% + 5 mV	< 0.05% + 5 mV (32 V channels), < 0.05% + 10 mV (64 V channels)	CH1, CH3: < 0.1% + 30 mV	< 0.02% + 2 mV	< 0.02% + 500 μV <sup>3)</sup>
	< 0.1% + 2 mA	< 0.1% + 20 mA (32 V channels), < 0.1% + 10 mA (64 V channels)	CH1, CH3: < 0.1% + 30 mA	< 0.05% + 250 μA	< 0.05% + 15 μA <sup>3)</sup>
	voltage, current	voltage, current, power, energy	voltage, current	voltage, current, power, energy	voltage, current, power, energy
	OVP, OCP, OTP	OVP, OCP, OPP, OTP	OCP, OTP	OVP, OCP, OPP, OTP	OVP, OCP, OPP, OTP
	•	•	always linked	•	•
	•	•	–	•	•
	•	•	• (CH1, CH3)	•	•
	–	–	• (CH1, CH3)	•	•
	–	•	–	• (R&S°NGL202)	• (R&S°NGM202)
	–	○	• (CH1, CH3)	○	○
	• (EasyArb)	• (QuickArb)	• (CH1)	• (QuickArb)	• (QuickArb)
	–	–	• (CH1, CH3)	–	–
	–	• (standard mode)	–	• (standard mode)	• (standard and fast mode)
	240 × 128 pixel LCD	TFT 5" 800 pixel – 480 pixel WVGA touch	4 × 4 digits, 7-segment LEDs	TFT 5" 800 × 480 pixel WVGA touch	TFT 5" 800 × 480 pixel WVGA touch
	connector block with 4 lines per channel	8-pin connector block per 2 channels	–	8-pin connector block per channel	8-pin connector block per channel
32	standard: USB, LAN; optional: IEEE-488 (GPIB), RS-232	standard: USB, LAN optional: W LAN, IEEE-488 (GPIB)	standard: RS-232, USB; alternatively: IEEE-488 (GPIB)	standard: USB, LAN; optional: WLAN, IEEE-488 (GPIB)	standard: USB, LAN optional: W LAN, IEEE-488 (GPIB)
	285 × 136 × 405 mm	362 × 100 × 451 mm	285 × 90 × 395 mm	222 × 97 × 436 mm	222 × 97 × 436 mm
	12.4 kg/12.8 kg	7.5 kg/8.0 kg	9 kg	7.1 kg/7.3 kg	7.2 kg/7.4 kg
	R&S°HZIP1 option	R&S°ZZA-GE23 option	R&S°HZ42 option	R&S°HZN96 option	R&S°HZN96 option



## R&S®HM7042-5 Triple Power Supply



### Lab performance in a rugged and portable design

- ▶ High-performance, inexpensive laboratory power supply
- ▶ Floating, overload and short-circuit proof outputs
- ▶ Separate voltage and current displays for each output
- ▶ Protection of sensitive loads by current limit or electronic fuse
- ▶ Pushbutton to activate/deactivate all outputs
- ▶ Low residual ripple, high output power, excellent regulation
- ▶ Parallel operation for higher current and serial operation for higher voltage
- ▶ Temperature-controlled fan

### Model overview

Model	Number of outputs	Voltage output	Current output	Total power output	Resolution
R&S®HM7042-5	3	<ul style="list-style-type: none"> <li>▶ channel 1, channel 3: 0 V to 32 V</li> <li>▶ channel 2: 0 V to 5.5 V</li> </ul>	<ul style="list-style-type: none"> <li>▶ channel 1, channel 3: 0 A to 2 A</li> <li>▶ channel 2: 0 A to 5 A</li> </ul>	155.5 W	<ul style="list-style-type: none"> <li>▶ channel 1, channel 3: 10 mV/ 1 mA</li> <li>▶ channel 2: 10 mV/ 10 mA</li> </ul>

### Scope of delivery

- ▶ Power cable
- ▶ Quick start guide
- ▶ 3 year warranty

### Recommended options/accessories

Description	Type
19" rack adapter, 2 HU	R&S®HZ42

### The perfect choice for

Education	Research and design
Maintenance and repair	Production testing

Your benefit	Features
Straightforward operation	All functions can be operated from the front panel; separate rotary knobs for each channel to adjust voltage and current
The separate output channels can work like individual power supplies	All channels are galvanically separated and can be combined for higher voltage or current
Small, compact and quiet	Combination of primary transformer, secondary switching regulator and additional linear control reduces weight and size

### Parallel and serial operating mode

Because all channels are galvanically separated, they can be combined:

- ▶ In the parallel operating mode, channels can be bundled to achieve higher currents
- ▶ In the serial operating mode, channels can be combined for higher output voltages





## R&S®NGE100B Power Supply Series



Brochure



Fact sheet



### Meets your daily needs

What sets these power supplies apart from others in their class?

- ▶ All channels are galvanically isolated and earth-free
- ▶ All channels are electrically equivalent with the same voltage, current and power
- ▶ Parallel and serial operation
- ▶ Protection functions to safeguard instrument and DUT
- ▶ Tracking and link functions
- ▶ Remote control via USB interface and optional LAN or wireless LAN, unique in this class

### Model overview

Model	Channel count	Max. voltage	Max. current	Max. power	Resolution
R&S®NGE102B	2	2 × 32 V	2 × 3 A	66 W	10 mV/1 mA
R&S®NGE103B	3	3 × 32 V	3 × 3 A	100 W	10 mV/1 mA

### Important facts

Specification	R&S®NGE100	Why this is important
Interface options	USB, LAN (optional) Wi-Fi (optional)	Modern and common interface capabilities allow quick and ready access to control and program the instrument.
Dimensions	½ 19" 2 HU	A small footprint for the power supply allows placement in tight lab space conditions or university settings as well as high-density manufacturing and rack applications.
Arbitrary function generation	EasyArb	Easily programmable time/voltage or time/current curves.

### Scope of delivery

- ▶ Power cable
- ▶ Quick start guide
- ▶ 3 year warranty

### Recommended options/accessories

Description	Type
<b>Base unit</b>	
Two-channel power supply	R&S®NGE102B
Three-channel power supply	R&S®NGE103B
<b>Software options</b>	
Ethernet remote control	R&S®NGE-K101
Wireless LAN remote control	R&S®NGE-K102
Digital I/O trigger	R&S®NGE-K103
<b>System components</b>	
19" rack adapter, 2 HU	R&S®HZC95



**The perfect choice for**

Education	R&D
Maintenance and repair	Manufacturing test

Your benefit	Features
Straightforward operation	All basic functions can be operated via direct keys on the front panel. The rotary knob can be used to adjust the desired voltage and current
The separate output channels can work like individual power supplies	All channels are electrically equivalent, galvanically isolated, earth-free and can be combined in serial or in parallel to achieve higher voltages or currents
Small, compact and quiet	Combination of primary transformer, secondary switching regulator and additional linear control reduces weight and size while maintaining robustness and low ripple

### EasyArb

EasyArb Mode on Ch 1 **Enabled**

EasyArb Repetition **1**

Number of Data Points **4**

N	Voltage	Current	Duration
1	5.00 V	0.900 A	1.00 s
2	10.00 V	0.700 A	5.00 s
3	3.00 V	1.000 A	0.03 s
4	10.00 V	0.800 A	60.00 s

Apply EasyArb Data **Apply**

Clear Data Points **Clear**

Comfort features for special applications: EasyArb allows the user to program time/voltage or time/current sequences

### EasyRamp

Ch 1 Ch 2 Ch 3

Output Ramping

Enabled Enabled Disabled

Ramping Time

10 ms 300 ms 10 ms

Comfort features for special applications: EasyRamp simulates operating conditions with controlled rise of supply voltage to prevent a sudden voltage surge

### Parallel and serial operation

Running in parallel, higher currents can be achieved; serial connected channels yield higher voltages.

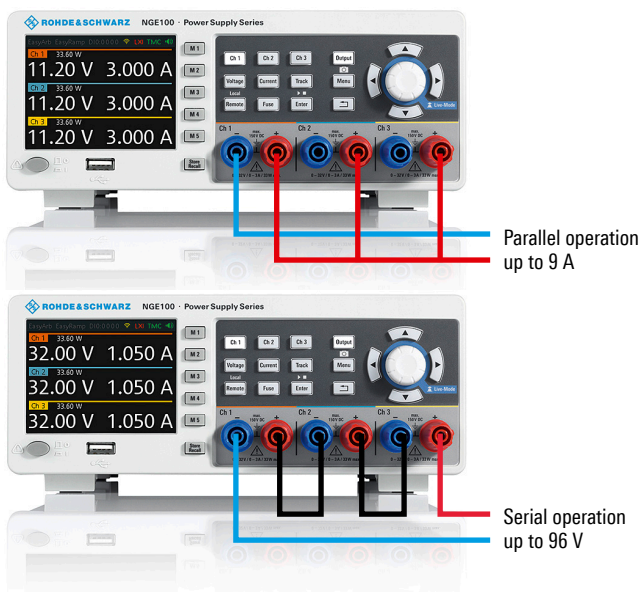

### Fuse

Ch 1 Ch 2 Ch 3

Fuse Delay

10 ms 20 ms 30 ms

Fuse Linking

Ch 2 Disabled Ch 1 & 2

Users can set the power supply so that all channels are switched off if one channel hits the limit; or it can be set to leave one channel working

## R&S®HMC804x Power Supply



Watch the video review from  
Elektor



### Compact and easy to use

One, two or three channels – the R&S®HMC804x power supplies with their specifications and wide range of functions are ideal for use in development labs and industrial environments. Thanks to their high energy efficiency, the linear power supplies remain cool and quiet, even at maximum load. Practical interfaces and connectors allow users to work quickly and conveniently with the R&S®HMC804x. Convenient functions enable the instruments to be used in special applications.

### Model overview

Model	Channel count	Max. voltage	Max. current	Max. power	Oversvoltage protection	IEEE-488 (GPIB)
R&S®HMC8041	1	1 × 32 V	1 × 10 A	100 W	adjustable for each channel	–
R&S®HMC8041G	1	1 × 32 V	1 × 10 A	100 W	adjustable for each channel	•
R&S®HMC8042	2	2 × 32 V	2 × 5 A	100 W	adjustable for each channel	–
R&S®HMC8042G	2	2 × 32 V	2 × 5 A	100 W	adjustable for each channel	•
R&S®HMC8043	3	3 × 32 V	3 × 3 A	99 W	adjustable for each channel	–
R&S®HMC8043G	3	3 × 32 V	3 × 3 A	99 W	adjustable for each channel	•

### Important facts

Specification	R&S®HMC804x	Why this is important
Channel combining	fuse link technology	Electronic fuses that can be individually combined for each channel allow the overcurrent or voltage surge protection to be set for each channel individually. For instance, a channel with a connected fan can continue to run while all other channels have been switched off.
Arbitrary V/I curves	available EasyArb function	Allows users to create individual arbitrary V/I curves directly on the device or through remote programming.

### Scope of delivery

- ▶ Power cable
- ▶ Printed operating manual
- ▶ Software CD
- ▶ 3 year warranty

### Recommended options/accessories

Description	Type
19" rackmount kit, 2 HU	R&S®HZC95



## The perfect choice for

Engineering lab

Production testing

Education

Maintenance and repair

Your benefit	Features
Clear display of all measured parameters	The brilliant color display shows voltage current and power values in real time
Flexible channel configurations for up to 90 V	All channels are galvanically isolated and can be combined to drive balanced circuitries or for higher voltages/currents
Flexible overcurrent protection	<ul style="list-style-type: none"> <li>▶ Fuse link technology allows you to individually combine the electronic fuses in each channel</li> <li>▶ A fuse delay can be set to prevent too early switch-off due to a short current spike</li> </ul>
Programmable time/voltage or time/current sequences	Arbitrary waveforms can be generated for voltage and current. Function can be configured and executed via control panel or external interface
EasyRamp function	After switching on the function, voltage will increase practically linear to the set value

### Electronic fuses, overvoltage protection

Overcurrent/overvoltage protection can be set for each channel individually. The electronic fuses can be linked to other channels. In this case, all linked channels will be switched off as soon as one reaches a limit. Even the delay time can be set to prevent premature switch-off due to short current spikes.

### EasyArb

EasyArb is the time/current flow or time/voltage curve that is individually programmable in each channel, with up to 512 points. Programming is possible via remote software or directly on the instrument.

### EasyRamp function

Sometimes test sequences should avoid the abrupt rise of the supply voltage. The EasyRamp function allows users to simulate a startup curve. After the channels are switched on, the increase in output voltage will be practically linear to the set voltage value within a defined time span.

### Sequencing function

The R&S®HMC804x power supply includes a sequencing function that can be adjusted via a menu. Sequencing enables users to automatically and consecutively connect available channels to the device under test, with adjustable time offsets when the MASTER on/off key is activated.



Ideal for industrial environment: Power supply units in industrial production are often found in 19" racks. All R&S®HMC804x models can be integrated into 19" racks with the R&S®HMC95 rackmounting kits.



WAGO cage clamp: To facilitate typical calibration setups, the rear panel connector was designed with a WAGO cage clamp.



## R&S®HMP Power Supply Series



### Up to four channels in a single instrument

The R&S®HMP power supplies are primarily designed for industrial use – for production environments as well as for development labs. These rugged instruments offer high efficiency with low residual ripple and many protection functions.

- ▶ Four models: 2 or 3 channels with 188 W total output power, 3 or 4 channels with 384 W total output power
- ▶ Galvanically isolated, floating outputs with overload and short-circuit protection
- ▶ Remote sensing eliminates voltage drops on the load leads
- ▶ Comfortable programming features and 19" rack adapters ensure perfect integration into production environments

### Model overview

Model	No. of channels	Output voltage per channel	Output current per channel	Total output power	Max. output power per channel	Max. voltage in serial operation	Max. current in parallel operation
R&S®HMP2020	2	0 V to 32 V	channel 1: 0 A to 10 A channel 2: 0 A to 5 A	188 W	channel 1: 160 W channel 2: 80 W	64 V	15 A
R&S®HMP2030	3		0 A to 5 A	188 W	80 W	96 V	15 A
R&S®HMP4030	3		0 A to 10 A	384 W	160 W	96 V	30 A
R&S®HMP4040	4		0 A to 10 A	384 W	160 W	128 V	40 A

### Important facts

Specification	R&S®HMP2020/2030; R&S®HMP4030/4040	Why this is important
Number of output channels	2/3 (all equal); 3/4 (all equal)	More channels in a compact package provide more flexibility for any specific application, especially with equal channels
Total output power	max. 188 W; max. 384 W	With more output power, DUTs with more power consumption can be driven
Max. output power per channel	80 W (R&S®HMP2020: 160 W); 160 W	Same output power on all channels provides more flexible configuration in specific applications
Max. output voltage	32 V (all channels); 32 V (all channels)	With the same output voltage on each channel, there are no limitations for using channels in different applications
Max. current per channel	5 A (R&S®HMP2020: 10 A); 10 A	With the same output current on each channel, there are no limitations for using channels in different applications
Sense function	yes, for each channel	Sense function provides more accurate voltage at the DUT especially when high current is needed
Dimensions (W × H × D)	285 mm × 95 mm × 405 mm; 285 mm × 136 mm × 405 mm	The size of the instrument determines how much space is left on the workbench for the measurement setup
Weight	7.8 kg/8.0 kg; 12.4 kg/12.8 kg	If the instrument has to be used in different places, it is better to have a lighter instrument

### Scope of delivery

- ▶ Quick start guide
- ▶ Set of power cables
- ▶ 3 year warranty
- ▶ Dual interface with USB and LAN is installed as standard.

### Recommended options/accessories

Description	Type
<b>Interfaces and system components</b>	
Dual interface (RS-232/USB)	R&S®HO720
IEEE-488 (GPIB) interface	R&S®HO740
19" rack adapter, 2 HU, for R&S®HMP2020/HMP2030	R&S®HZ42
19" rack adapter, 4 HU, for R&S®HMP4030/HMP4040	R&S®HWP91



The perfect choice for

Engineering lab

Production testing

Maintenance and repair

General purpose



Connections for all channels – including sense lines – are also provided on the rear panel (shown here: R&S®HMP4040)

All channels galvanically isolated and floating

The R&S®HMP power supply family consists of instruments with two, three or four channels. The circuitry of each channel is completely isolated from the others; there is no connection to chassis ground. This makes it easy to combine the channels to drive balanced circuitries that might need +12 V/–12 V, for example, and avoids any ground problems in complex DUTs.

Supplying balanced circuits

Two channels can be connected together to supply balanced circuits with e.g. +12 V/–12 V.

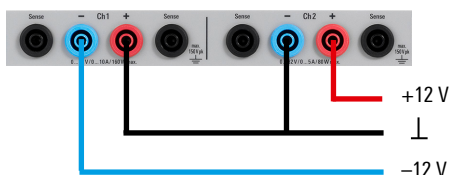

Your benefit	Features
Up to 4 channels in a single compact box	Flexible configuration for any specific application, including sense lines for each channel to compensate voltage drops over the supply leads
Channels galvanically isolated and floating	Serial operation with up to 128 V or parallel operation with up to 40 A
Overcurrent protection (electronic fuse) and overvoltage protection	To safeguard the instrument and the DUT. The fuse link technology switches off all selected channels when one of them reaches its current limit
Easily programmable time/voltage or time/current curves	To vary voltage or current during a test sequence; can be programmed manually via the user interface or via the external interfaces

Intuitive to use

All basic R&S®HMP power supply functions can be operated directly via keys on the front panel. It is only necessary to use the menu level for special functions that are needed less frequently.

Color coding of operating states

All settings and operating conditions, including the output power and the status of the protection functions, are shown on the display and indicated by the colors of the illuminated channel keys. The colors of the illuminated keys indicate the different operating conditions:

- ▶ Active channel in constant voltage mode: green
- ▶ Active channel in constant current mode: red
- ▶ Channel in setting mode: blue

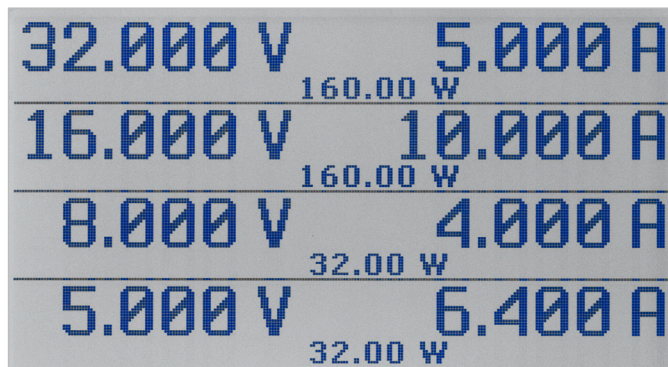

All settings and operating states are clearly visualized. Constant voltage mode is indicated by a green key, constant current mode is indicated by a red key. The key color changes to blue in setting mode.

## R&S®NGL200 Power Supply Series



### What sets these power supplies apart from others?

- ▶ Fast regulation of output voltage with minimum overshoot and very fast load recovery time
- ▶ Minimum residual ripple and noise to supply interference-free voltage to sensitive DUTs
- ▶ Readings with up to 6½ digit resolution are perfect for characterizing devices that have low power consumption in standby mode and high current in full load operation
- ▶ Two quadrants: operates as source or sink

### Model overview

Model	Number of channels	Max. output power	Output power per channel	Output voltage per channel	Output current per channel	Load recovery time	Resolution
R&S®NGL201	1	60 W	max. 60 W	0 V to 20 V	<ul style="list-style-type: none"> <li>▶ ≤ 6 V: 6 A</li> <li>▶ &gt; 6 V: 3 A</li> </ul>	< 30 μs	1 mV/0.1 mA
R&S®NGL202	2	120 W					

### Important facts

Specification	R&S®NGL200	Why this is important
Large high-resolution touchscreen	TFT 5" 800 × 480 pixels WVGA touch	Easy operation and display of a wide variety of additional information such as power values and statistics.
Various protection and safety functions	OVP, OCP, OPP, OTP, adjustable limits	Protect your DUT and the power supply.
Sense function for lead resistance compensation	<ul style="list-style-type: none"> <li>▶ R&amp;S®NGL201: front and rear panels</li> <li>▶ R&amp;S®NGL202: rear panel</li> </ul>	Regulate the voltage directly at the load, compensating for voltage drops over the supply leads.
QuickArb	<ul style="list-style-type: none"> <li>▶ dwell time: 1 ms to 10 s</li> <li>▶ maximum number of points: 4096</li> </ul>	Simulate different battery charging conditions or program very short voltage drops to test the power-up behavior of a DUT.
Remote control via various interfaces	USB, Ethernet, WLAN (optional), IEEE-488 (optional)	Key for integration into test systems and automated operation via scripts.
Fast command processing time	typ. < 6 ms	Complex measurement sequences require ever faster setting, measuring and command processing times.

### Scope of delivery

- ▶ Power cord
- ▶ Quick start guide
- ▶ 3 year warranty

### Recommended options/accessories

Description	Type
IEEE-488 (GPIB) interface	R&S®NGL-B105
Wireless LAN remote control	R&S®NGL-K102
Digital I/O trigger	R&S®NGE-K103
19" rack adapter, 2 HU	R&S®HZN96

### Optimized load recovery time

Power supplies usually respond to abrupt load changes with overshoot and slow recovery times. Thanks to specially optimized control circuits, the R&S®NGL200 series achieves recovery times of < 30 μs with minimal overshoot, making them perfect for supplying sensitive components

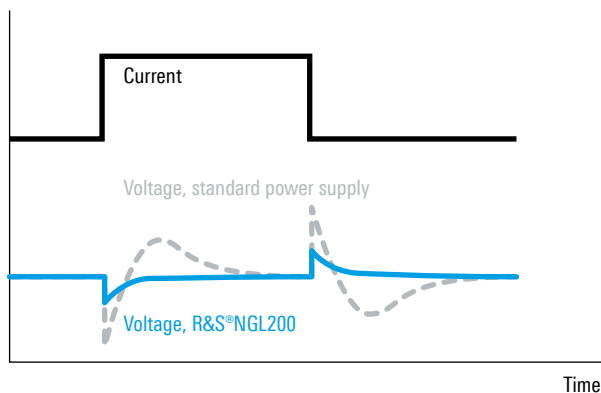

The perfect choice for	
Battery tests	Power consumption tests
Simulation of voltage drops	Supplying sensitive designs

### Overvoltage protection (OVP), overpower protection (OPP)

If the voltage/power exceeds the configured maximum value, the channel is switched off and the corresponding symbol flashes on the display.

### Overcurrent protection (electronic fuse, OCP)

The channels of R&S®NGL200 power supplies provide electronic fuses that can be set individually. If the channel current exceeds the set current, the channel is automatically switched off and a message is displayed.

### QuickArb function

The Arb function lets you configure time/voltage or time/current sequences. With up to 4096 points and a dwell time resolution of up to 1 ms, the QuickArb function sets new standards.

### Easy Ramp function

The output voltage can be increased continuously within a time frame of 10 ms to 10 s to avoid an abrupt rise of the supply voltage as is sometimes required by sensitive applications.

Your benefit	Features
Optimized load recovery time with minimal overshoot	Due to the optimized load recovery time of < 30 μs with minimal overshoot during challenging load conditions, the R&S®NGL200 is perfect when testing IoT and other battery-powered devices which require very little current in sleep mode and abruptly increase current when switching to transmit mode.
Low ripple and noise	To supply interference-free voltage to sensitive designs such as complex semiconductors and to support the development of power amplifiers and MMICs.
Sink and source operation	The linear two-quadrant output amplifier design of the R&S®NGL200 enables sink and source operation to simulate batteries and loads.
6½ digit resolution	With up to 6½ digit resolution when measuring voltage, current and power, the R&S®NGL200 is optimal for characterization of devices with low standby power consumption and high current in full load operation. It can replace an additional DMM in many applications.



Easy operation: The high-resolution capacitive touchscreen is the central operating element for R&S®NGL200 power supplies. Icons clearly show the status of the set protection levels or special functions.

Active channels in constant voltage mode light up green, while red is used for constant current mode. When the channels are switched on, the key lights up blue (active).



Readings with up to 6½ digit resolution: With a resolution of up to 6½ digits when measuring voltage, current and power, the R&S®NGL200 power supplies are perfect for measurements on devices that have low power consumption in standby mode and high current in full load operation. The large high-resolution display provides a lot of additional information such as power values and statistics.



Two-quadrant operation, minimum ripple and noise: The architecture of the R&S®NGL200 power supplies allows them to function both as a source and a sink. The power automatically switches from sink and source mode. In this example, channel 2 is operating as a load. The linear design of the output stages reduces residual ripple and noise to a minimum and makes the R&S®NGL the perfect tool to support the development of power amplifiers and MMICs.



## R&S®NGM200 Power Supply Series



### High-speed accuracy

What sets these power supplies apart from others in their class?

- ▶ All channels are galvanically isolated and earth-free
- ▶ All channels are electrically equivalent with the same voltage, current and power
- ▶ Parallel and serial operation
- ▶ Protection functions to safeguard instrument and DUT
- ▶ Tracking and link functions
- ▶ Remote control via USB interface and optional LAN or wireless LAN, unique in this class

### Model overview

Model	Channel count	Max. output power	Output power per channel	Output voltage per channel	Output current per channel	Load recovery time	Max. readback resolution
R&S®NGM201	1	60 W	max. 60 W	0 V to 20 V	≤ 6 V: 6 A; > 6 V: 3 A	< 30 μs	1 μV/10 nA
R&S®NGM202	2	120 W	3 x 3 A				

### Important facts

Specification	R&S®NGM200	Why this is important
Number of channels	1/2	More channels provide more flexibility for any specific application.
Max. output power per channel	60 W	With more output power, DUTs with more power consumption can be driven.
Voltage ripple and noise (20 Hz to 20 MHz)	< 500 μV (RMS), < 2 mV (V <sub>pp</sub> )	Allows the instrument to supply interference-free voltage to sensitive DUTs with advanced electronic circuitry that is often sensitive to interference on the supply lines.
Load recovery time (20 mV)	< 30 μs	Important to supply DUTs when switching from low power consumption in standby mode to high current in full load operation without creating voltage drops or overshoots.
Max. measurement speed	500 000 sample/s (2 μs)	High-speed acquisition, allows detection of spikes in the microsecond range that cannot be detected with slower instruments.
Protection functions	OCP/OVP/OPP/OTP	These functions safeguard the instrument and the device under test from damage.

### Scope of delivery

- ▶ Power cable
- ▶ Quick start guide
- ▶ 3 year warranty

### Recommended options/accessories

Description	Type
<b>Hardware option</b>	
IEEE-488 (GPIB) interface	R&S®NGM-B105
<b>Software options</b>	
Wireless LAN remote control	R&S®NGM-K102
Digital I/O trigger	R&S®NGM-K103
Digital voltmeter functionality	R&S®NGM-K104
Battery simulation	R&S®NGM-K106
<b>System components</b>	
19" rack adapter, 2 HU	R&S®HZN96

### Optimized load recovery time

Under challenging load conditions, most power supplies respond with slow recovery times and overshoots. Specially developed circuits in the R&S®NGM200 power supplies achieve a load recovery time of < 30 μs with minimal overshoot, making them perfect for supplying sensitive components.

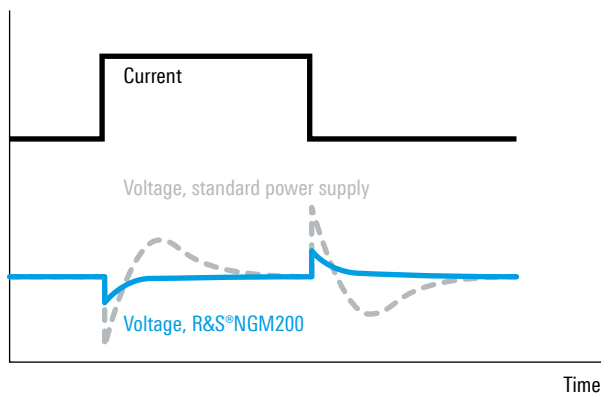

## The perfect choice for

Battery tests	Power consumption tests
Simulation of voltage drops	Supplying sensitive designs

Your benefit	Features
Minimal overshoot from abrupt load changes	<ul style="list-style-type: none"> <li>▶ Optimized load recovery time &lt; 30 μs</li> <li>▶ Handles abrupt load changes from a few μA to the ampere range without creating voltage drops or overshoots</li> </ul>
Supply interference-free voltage to sensitive designs	<p>Low ripple and noise values allow you to supply interference-free voltage to sensitive designs such as complex semiconductors and to support the development of power amplifiers and MMICs</p> <ul style="list-style-type: none"> <li>▶ Acquisition rate: up to 500 ksample/s</li> <li>▶ Voltage and current results available every 2 μs</li> <li>▶ On the two-channel R&amp;S®NGM202, data acquisition on both channels in parallel</li> </ul>
Capture fast variations in voltage/current	<ul style="list-style-type: none"> <li>▶ Simulate the actual battery output performance</li> <li>▶ Testing can be based on a selected battery model</li> <li>▶ Battery capacity, state of charge (SoC) and open circuit voltage (Voc) can be set to any state to test the device under specific circumstances</li> </ul>
Realistic battery simulation	

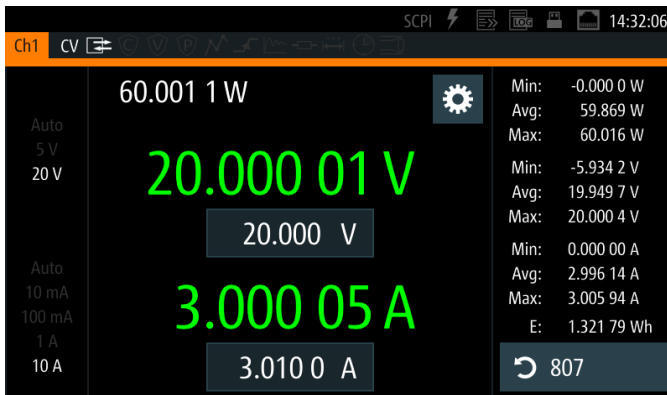

Readings with up to 6 ½ digit resolution:

With a resolution of up to 6 ½ digits when measuring voltage, current and power, the R&S®NGM200 power supplies are perfect for characterizing devices that have low power consumption in standby mode and high current in full load operation. Two voltage measurement ranges and four current measurement ranges provide high accuracy and resolutions down to 1 μV/10 nA.

The high-resolution display provides additional information such as power values and statistics.



Two-quadrant operation, minimum ripple and noise:

The architecture of the R&S®NGM200 power supplies allows them to function both as a source and a sink. The instruments automatically switch between sink and source operation. In this example, channel 2 works as a load.

The linear design of the output stages reduces residual ripple and noise to a minimum and makes them perfect for the development of power amplifiers and MMICs.

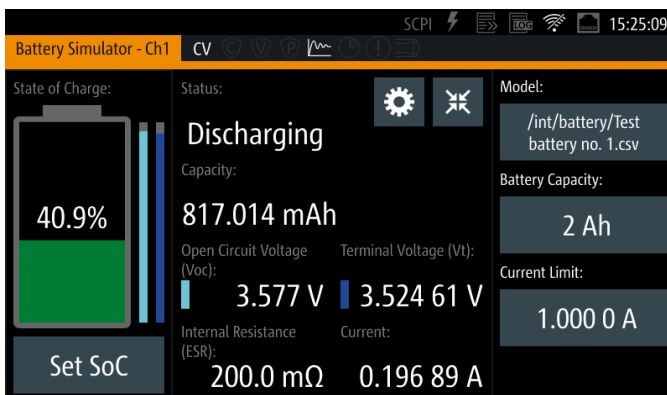

Battery simulation:

When battery-operated devices have to be optimized for lifecycle, the discharging behavior of the battery type needs to be considered. The battery simulator function makes it possible to simulate the real battery output performance. Testing can be based on a selected battery model, and battery capacity, SoC and Voc can be set to any state to test the device under specific circumstances.

The charging behavior of a battery can also be simulated, for example when designing battery chargers. In this application, the R&S®NGM200 is used in sink mode.

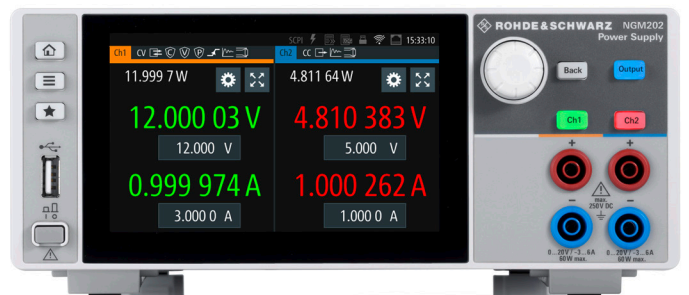

Easy operation:

The high-resolution capacitive touchscreen is the central operating element for the R&S®NGM200 power supplies. Icons clearly show the status of set protection levels or special functions. When the power supply is in constant voltage mode, the numbers and the keys light up green. Red is used for constant current mode. The Output button lights up blue to indicate that channels are switched on (active).



## R&S®NGP800 Power Supply Series



### Boost your efficiency with quad-core power

The R&S®NGP800 DC power supply series, comprising five models with 400 W or 800 W, provides maximum power at a variety of operating points. The two or four 200 W outputs can each supply up to 64 V or up to 20 A. Electrically equivalent and galvanically isolated outputs can be wired in series or parallel for up to 250 V or 80 A.

All R&S®NGP800 power supplies include remote sense terminals, USB and a LAN interface. A user-installable GPIB interface, a digital trigger I/O, an analog input and a wireless LAN interface are optional, making these instruments great on the bench or in an automated test system.

Model overview						
Model	Channel count	Total output power	Readback resolution	Voltage per channel	Output current per channel	Output power per channel
R&S®NGP802	2	400 W	▶ voltage: 1 mV ▶ current: 0.5 mA	0 V to 32 V	20 A	200 W
R&S®NGP804	2	400 W		0 V to 32 V	20 A	200 W
R&S®NGP814	4	800 W		▶ CH1, CH2: 0 V to 32 V ▶ CH3, CH4: 0 V to 64 V	▶ CH1, CH2: 20 A ▶ CH3, CH4: 10 A	▶ 200 W
R&S®NGP822	2	400 W		0 V to 64 V	10 A	200 W
R&S®NGP824	4	800 W		0 V to 64 V	10 A	200 W

Important facts		
Specification	R&S®NGP800	Why this is important
Max. output power	400 W/800 W	For power hungry devices
Number of outputs	2/4	Powers up to 4 DUTs simultaneously
Max. voltage per output	32 V/64 V	Covers 48 V applications
Max. current per output	20 A/10 A	Meets high current consumption requirements
Max. power per output	200 W	Gets the full 200 W on each output (no shared total power among channels)
Programming resolution	1 mV/0.5 mA	Accurately sets your supply voltage and current
Readback resolution	1 mV/0.5 mA	Replaces a DMM in many applications
Acquisition rate	125 sample/s	Great for in-depth post analysis
Display	5" 800 × 480 pixel touch	Enter values much faster with intuitive touch display

Scope of delivery
▶ Power cable
▶ Terminal blocks
▶ Quick start guide
▶ 3 year warranty









Recommended options/accessories	
Description	Type
<b>Hardware option</b>	
IEEE-488 (GPIB) interface	R&S®NG-B105
<b>Software options</b>	
Wireless LAN remote control	R&S®NGP-K102
Digital I/O trigger	R&S®NGP-K103
Analog input	R&S®NGP-K107
<b>System components</b>	
19" rack adapter, 2 HU	R&S®ZZA-GE23

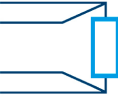

The perfect choice for	
R&D	Manufacturing
Automotive	General purpose

Your benefit	Features
Power four DUTs simultaneously	<ul style="list-style-type: none"> <li>▶ Up to four independent, floating outputs</li> <li>▶ All outputs galvanically isolated</li> <li>▶ Space, cost and time efficient</li> </ul>
Maximum power at various operating points	<ul style="list-style-type: none"> <li>▶ FlexPower</li> <li>▶ Up to 80 A when connected in parallel</li> <li>▶ Up to 250 V when connected in series</li> </ul>
All you need at a glance	<ul style="list-style-type: none"> <li>▶ Large high-resolution touchscreen</li> <li>▶ Built-in measurements</li> <li>▶ Detailed statistics</li> </ul>

### More functions

-  EasyRamp
-  Output delay
-  QuickArb
-  Remote sensing
-  Built-in measurements
-  Data logging
-  Save/recall device settings
-  User adjustment
-  Digital trigger I/O
-  Digital trigger I/O



#### Large high-resolution touchscreen:

The home screen gives you a clear overview of all your channels. Each channel can be selected for a more detailed view with a wide variety of additional information such as statistics and icons indicating the status of set protection levels or special functions.

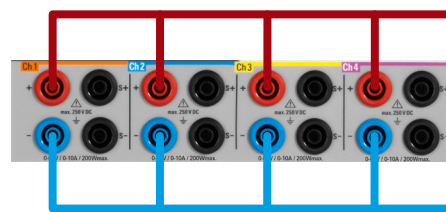

Parallel operation – max. 80 A

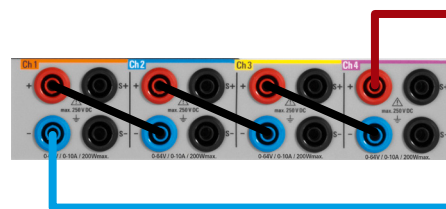

Serial operation – max. 250 V

#### Parallel and serial operation

In case your application requires more voltage or current, connect the outputs in series or parallel and get up to 250 V (R&S®NGP824) or 80 A (R&S®NGP804). Using the tracking function, voltage and current are adjusted on all selected channels simultaneously.

## R&S®HM8143 Power Supply



Data sheet



Fact sheet



### Flexible solution for special applications

The R&S®HM8143 power supply is the perfect choice whenever two-quadrant operation is needed. Besides the source functionality, it also provides electronic loads to accurately sink current and dissipate power in a controlled manner, for example to emulate the characteristics of a battery being charged or unloaded. The R&S®HM8143 offers two channels with up to 30 V source and sink functionality plus one source channel with 5 V. Electronic fuse and modulation inputs are additional features.

### Model overview

Model	Channel count	Max. voltage	Max. current	Max. power
R&S®HM8143	3	2 × 30 V, 1 × 5 V	3 × 2 A	130 W

### Important facts

Specification	R&S®HM8143	Why this is important
Two-channel and three-channel operation	<ul style="list-style-type: none"> <li>▶ 2 channels: 0 V to 30 V, 0 A to 2 A</li> <li>▶ 1 channel: 0 V to 5 V, 0 A to 2 A</li> </ul>	Multiple channels with output modulation and source/sink capabilities allow more complete design prototyping.

### Scope of delivery

- ▶ User manual
- ▶ Power cord
- ▶ 3 year warranty

### Recommended options/accessories

Description	Type
19" rackmount kit, 2 HU	R&S®HZ42



## The perfect choice for

Engineering lab

Production testing

Simulation of battery charging process

Maintenance and repair

Your benefit	Features
Two channels with source/sink functionality	Two-quadrant functionality can be used to source or sink current, e.g. to emulate any charging/unloading application
Additional 5 V source channel	Can be used to supply 5 V circuitries without needing another instrument
Electronic fuse	Overcurrent protection can be set to switch off all channels in case the configured current limit is overdriven
Modulation inputs	Via external modulation signals, the R&S®HM8143 can be used as a power amplifier, for example to supply AC motors

Power supplies

### Parallel and serial operating mode

In the parallel operating mode, channels can be bundled to achieve higher currents. In the serial operating mode, channels can be combined for higher output voltages.

### Modulation inputs

The R&S®HM8143 provides two modulation inputs on the rear, so it can be used as a power amplifier with a frequency range from DC to 50 kHz. Applications include testing of AC motors, relays, etc.

### Electronic fuse

In order to provide even better protection than current limiting, the R&S®HM8143 offers the feature of an electronic fuse. As soon as the current limit is reached, all outputs are simultaneously disabled.

### Arbitrary function

The arbitrary mode can be used to generate a time/voltage flow. A table comprising up to 1024 voltage and time values can be defined using external software tools.



R&S®HM8143 power supply

# SIGNAL GENERATORS

## Frequency range

The frequency range is the most important specification when selecting a suitable signal generator. The generator's upper and lower frequency limits must cover the needs of the application.

## Output power

Output power is another key specification for selecting a signal generator. The higher the available power, the more likely you will be able to compensate for losses in the setup caused by cabling and components.

Instruments equipped with an electronic step attenuator provide very accurate low power levels and are not subject to the wear and tear of conventional mechanical attenuators.

## Spectral purity

There are several measurements for assessing the spectral purity of a signal generator, including phase noise, spurious, harmonics and subharmonics. Phase noise measures the jitter of a signal. The better the spectral purity of a signal generator, the less it influences DUT measurements.

## CW or modulated

Continuous wave (CW) generators provide only an unmodulated carrier frequency whereas analog signal generators can modulate the carrier frequency with e.g. AM, FM,  $\phi$ M and pulse modulation.

Type	Designation	Page
R&S®HM8150	Function generator	48
R&S®HMF25xx	Arbitrary function generator	49
R&S®SMC100A	Signal generator	51

## R&amp;S®HM8150 Function Generator



Data sheet



Fact sheet



## Versatile and economical

- ▶ Waveforms: sine wave, square wave, triangle, pulse, sawtooth, arbitrary
- ▶ Rise and fall time: < 10 ns
- ▶ Pulse width adjustment: 100 ns to 80 s
- ▶ Arbitrary waveform generator: 40 Msample/s
- ▶ Burst, gating, external triggering, sweep
- ▶ Free software for creation of arbitrary waveforms
- ▶ External amplitude modulation (bandwidth 20 kHz)
- ▶ Intuitive operation with one touch of a button – quick change of signals

## Model overview

Model	Frequency range	Voltage output	Total harmonic distortion	DC offset	Arbitrary waveform resolution
R&S®HM8150	10 MHz to 12.5 MHz	<ul style="list-style-type: none"> <li>▶ 10 mV to 10 V (<math>V_{pp}</math>) (into 50 <math>\Omega</math>)</li> <li>▶ 20 mV to 20 V (<math>V_{pp}</math>) (open circuit)</li> </ul>	typ. 0.05% ( $f < 100$ kHz)	$\pm 75$ mV to +7.5 V	12 bit

## Scope of delivery

- ▶ User manual
- ▶ Power cord
- ▶ 3 year warranty

## Recommended options/accessories

Description	Type
<b>Options and system components</b>	
IEEE-488 (GPIB) interface	R&S®HO880
19" rackmount kit, 2 HU	R&S®HZ42

## The perfect choice for

General purpose

Education

Hobbyists

Maintenance and repair

Your benefit	Features
Easy to use	<ul style="list-style-type: none"> <li>▶ With the touch of one button, the R&amp;S®HM8150 offers six different waveforms</li> <li>▶ Frequency and amplitude can be varied for sawtooth (ramp), triangle, sine-wave and square-wave signals</li> <li>▶ The pulse function permits the pulse width to be modified</li> </ul>
Versatile functionality	<ul style="list-style-type: none"> <li>▶ In addition to the "continuous" operating mode, signals can be generated in response to a trigger and a gating signal</li> <li>▶ Frequency sweep is available for sine-wave, square-wave, sawtooth, pulse and arbitrary waveforms</li> <li>▶ Arbitrary signals can be defined by the user via the RS-232, IEEE-488 (GPIB) or USB interface</li> </ul>



USB



RS-232



Optional IEEE-488



## R&S®HMF25xx Arbitrary Function Generator

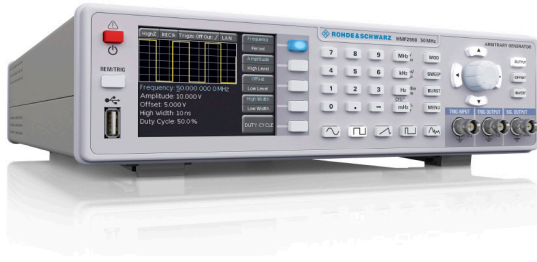

### Accurate, versatile and affordable

- ▶ Two models: the R&S®HMF2525 with 25 MHz and the R&S®HMF2550 with 50 MHz maximum frequency
- ▶ 14-bit resolution and 8 ns rise time
- ▶ As well as standard waveforms such as sine, rectangle and triangle, the instruments provide powerful arbitrary signal functionality. In addition to predefined signal shapes such as  $\sin(x)/x$ , white or pink noise, they can also output customer-specific, arbitrary shapes with a signal length of up to 256 ksample
- ▶ The burst, sweep, gating, internal and external triggering operating modes and the AM, FM, PM, PWM and FSK modulation functions (in each case internal and external) can be applied to all signals

Model overview						
Model	Frequency range	Output voltage	Total harmonic distortion	Arbitrary waveform vertical resolution	Arbitrary waveform signal memory length	Interface
R&S®HMF2525	10 $\mu$ Hz to 25 MHz	5 mV to 10 V ( $V_{pp}$ ) (into 50 $\Omega$ ) 10 mV to 20 V ( $V_{pp}$ ) (open circuit)	typ. 0.04% ( $f \leq 100$ kHz)	14 bit	up to 256k points	dual-interface USB/RS-232, opt. LAN/USB or IEEE-488 (GPIB)
R&S®HMF2550	10 $\mu$ Hz to 50 MHz	5 mV to 10 V ( $V_{pp}$ ) (into 50 $\Omega$ ) 10 mV to 20 V ( $V_{pp}$ ) (open circuit)	typ. 0.04% ( $f \leq 100$ kHz)	14 bit	up to 256k points	dual-interface USB/RS-232, opt. LAN/USB or IEEE-488 (GPIB)

Important facts		
Specification	R&S®HMF2525/2550	Why this is important
Widest measurement range across all functions	R&S®HMF2525 <ul style="list-style-type: none"> <li>▶ sine: 10 <math>\mu</math>Hz to 25 MHz</li> <li>▶ square: 10 <math>\mu</math>Hz to 25 MHz</li> <li>▶ pulse: 100 <math>\mu</math>Hz to 12.5 MHz</li> <li>▶ ramp/triangle: 10 <math>\mu</math>Hz to 5 MHz</li> </ul> R&S®HMF2550 <ul style="list-style-type: none"> <li>▶ sine: 10 <math>\mu</math>Hz to 50 MHz</li> <li>▶ square: 10 <math>\mu</math>Hz to 50 MHz</li> <li>▶ pulse: 100 <math>\mu</math>Hz to 25 MHz</li> <li>▶ ramp/triangle: 10 <math>\mu</math>Hz to 10 MHz</li> </ul>	Allows utilization of the function generator for more applications and use cases.
Crisp color display	3.5" color TFT QVGA	See crisp representation of the waveform and all parameters.

Scope of delivery
<ul style="list-style-type: none"> <li>▶ User manual</li> <li>▶ Power cord</li> <li>▶ 3 year warranty</li> </ul>

Recommended options/accessories	
Description	Type
<b>Options and system components</b>	
Dual Ethernet/USB interface	R&S®HO732
IEEE-488 (GPIB) interface	R&S®HO740
19" rackmount kit, 2 HU	R&S®HZ42



The perfect choice for

Engineering lab

Maintenance and repair

Education

General purpose

Your benefit	Features
Powerful pulse generator	Provides pulses with a recurrence rate of up to 12.5 MHz/25 MHz; the pulse width can be set from 15 ns to 999 s with a resolution of 5 ns. Rise/fall time can be selected from 8 ns to 500 ns – a very useful feature when characterizing input hysteresis of semiconductor devices
Easily create arbitrary waveforms	Arbitrary waveforms can be developed with PC software. Stored waveforms can be loaded via the front USB port or imported via the complementary HMEplorer software (available for download)

Signal examples

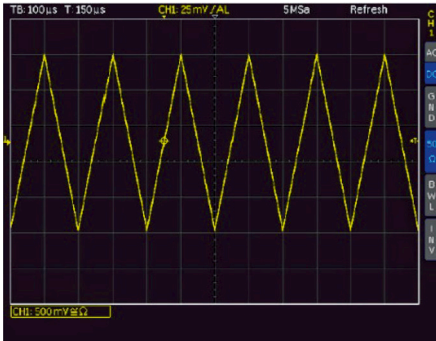

Triangle signal

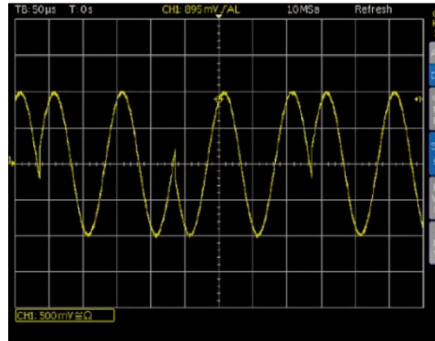

Phase modulation (PM)

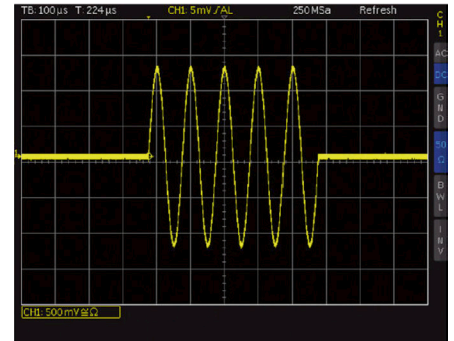

Burst example

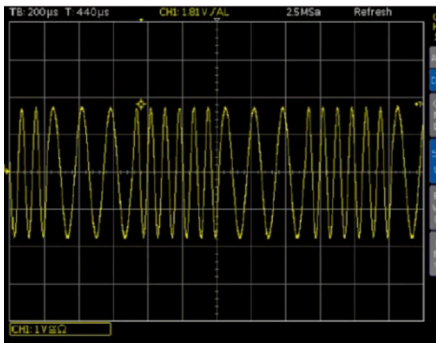

Frequency shift keying (FSK)

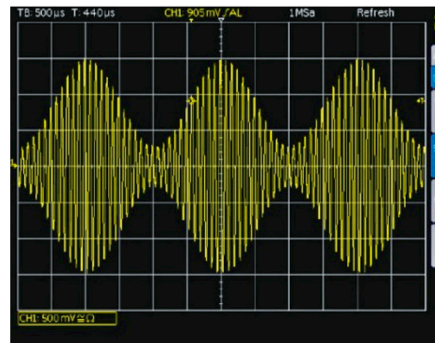

Amplitude modulation (AM)

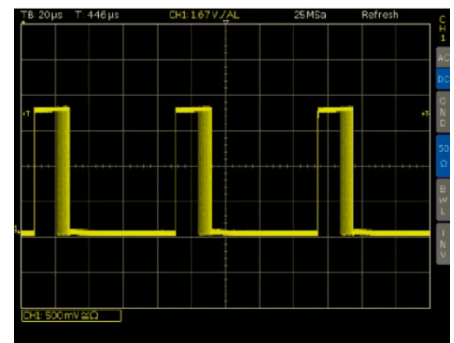

Pulse width modulation (PWM)

Signal generators

## R&S®SMC100A Signal Generator



**A generator for every environment – with the smallest size and best price/performance ratio**

- ▶ Outstanding RF performance
- ▶ Graphical user interface
- ▶ 3 year calibration cycle
- ▶ USB, Ethernet and IEEE-488 (GPIB) connectivity
- ▶ Small footprint, lightweight and power-efficient

### Model overview

Model (frequency range)	Configuration	Output power	Phase noise	Analog modulation
R&S®SMC100A (9 kHz to 1.1 GHz)	R&S®SMC100A + R&S®SMC-B101 RF path option	> +13 dBm	up to -105 dBc	AM, FM, phase, pulse
R&S®SMC100A (9 kHz to 3.2 GHz)	R&S®SMC100A + R&S®SMC-B103 RF path option	> +13 dBm	up to -105 dBc	AM, FM, phase, pulse

### Important facts

Specification	R&S®SMC100A	Why this is important
Signal creation	user workflow based	GUI follows the functional blocks of a transmitter, which is the device the generator is standing in for. This greatly simplifies and speeds up the setup of complex signals.
Performance	-105 dBc (spec.), typ. -111 dBc phase noise at 1 GHz	A generator with lower phase noise will add less unwanted noise to the DUT. This will show the true performance of the DUT. Test the device, not the generator.
	0.9 dBm amplitude error	Have confidence that you are applying the correct input power to your device.
	+17.5 dB output power	Output power: A higher power level allows a wider range of testing. In addition extra power enables compensation for fixtures and cables between the generator and the test point and removes the need for external amplifiers.
	typ. 5 ms, typ. 2 ms switching speed	Users typically step a source through hundreds or thousands of test frequencies. A faster switching speed has a dramatic effect on the ability to run tests quickly.
Calibration cycle	3 years	A longer calibration cycle reduces total cost of ownership.
Connectivity	USB, Ethernet, IEEE-488 (GPIB)	Integrate into current test setup without having to alter your connectivity interface.
Dimensions (W × H × D)	236 mm × 112 mm × 368 mm	A smaller footprint takes up less space on a crowded workbench.
Weight	3.9 kg	Low power consumption is important for test rack applications due to total consumption, and for bench use due to the heat generated. It also contributes to a quiet and cool instrument in the user environment.
Power consumption	45 W	

### Scope of delivery

- ▶ Power cable
- ▶ Quick start guide
- ▶ 3 year warranty

### Recommended options/accessories

Description	Type
Reference oscillator OCXO	R&S®SMC-B1
IEEE-488 (GPIB) interface	R&S®SMC-K4



The perfect choice for

RF teaching labs

A&D development/  
service/maintenance

Simple production  
applications

Service and  
maintenance



Versatile connectivity: Integration into current test setup without the need to alter the USB, Ethernet or IEEE-488 (GPIB) connectivity interface

Your benefit	Features
Graphical interface allows you to set up the signal the way you want it	<ul style="list-style-type: none"> <li>▶ Block diagram user interface</li> <li>▶ Graphic display of signals</li> <li>▶ Click, configure and control with a mouse</li> <li>▶ Mimics the functional blocks of a transmitter</li> </ul>
More performance across the board without costing more	<ul style="list-style-type: none"> <li>▶ Better phase noise (25 dB better)</li> <li>▶ Highly accurate (10% less amplitude error)</li> <li>▶ Fastest switching (changes frequency five times faster)</li> <li>▶ Outstanding output power</li> <li>▶ Vastly superior modulation capabilities</li> </ul>
Ideal for lab, production and field applications	<ul style="list-style-type: none"> <li>▶ Lab: better performance</li> <li>▶ Production: higher speed, better connectivity</li> <li>▶ Field: size, weight, power</li> </ul>

Measured maximum available power

The high output power of typ. > +17 dBm enables measurements on DUTs such as mixers that require a high level for the local oscillator.

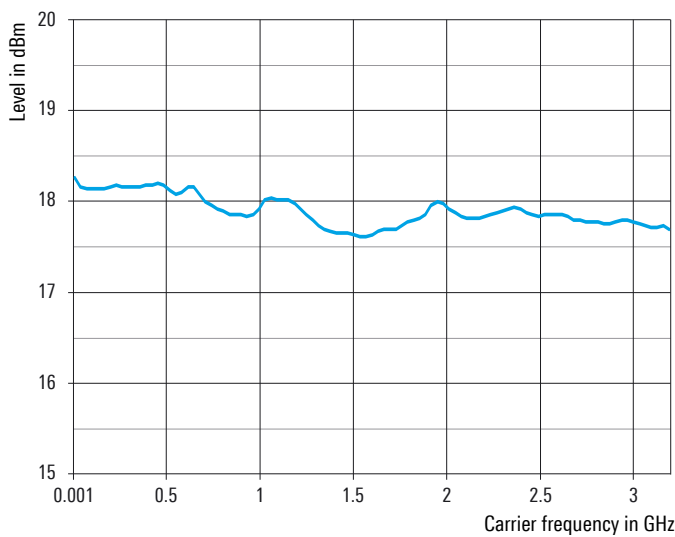

Minimized total cost of ownership: A minimum of modules in the R&S®SMC100A means high reliability and easy servicing

Signal generators

## Signal generator hardware and software options

Sensor		Signal generator (R&S®)
Frequency range	1 GHz	SMC100A
	1.1 GHz	O
	2.2 GHz	
	3 GHz	
	3.2 GHz	O
	6 GHz	
Performance enhancements	High output power	S
	Ultra high output power	
	Enhanced phase noise	
	OEXO reference oscillator	R
	Phase coherent	
Connectivity	Clock synthesizer	
	USB	S
	Ethernet	S
Analog modulation	IEEE-488 (GPIB)	U
	AM	S
	FM	S
	Phase modulation	S
	Pulse modulation	S
	ILS	
	VOR	
	DME	
FM Stereo/RDS		
Digital modulation	Cellular (2/3/4G)	
	Wireless LAN (802.11 a, b, ...)	
	5G NR	
	OFDM	
Additional capabilities	Multifunction generator	
	Pulse generator	S
	Pulse train	
	Multi carrier CW	
	AWGN	
	Integration of power sensors	S

- S Standard
- O Option
- R Optional, upgradeable at a Rohde&Schwarz service center
- U Optional, user-upgradeable





# HANDHELD ANALYZERS

## Frequency range

The frequency range specifies the range of frequencies over which the spectrum analyzer will operate. Different measurement applications may require a larger frequency range to evaluate harmonics, spurs or alternate channels. In this case, it makes sense to consider a higher frequency model in order to capture all potential signals of interest.

**Application example:** Detecting the third-order harmonics of a 915 MHz signal requires a spectrum analyzer of more than 2.745 GHz maximum frequency.

## Upgradeability

All handheld analyzers have various upgrade options. The analyzer's capability can be increased to meet the task's requirements. Some models even offer frequency upgrades without having to add hardware. All upgrades are done via keycode, which eliminates the need to send the analyzer to a Rohde & Schwarz service center – no downtime.

A simple upgrade can transform a basic analyzer into a multitasking analyzer. If the function is only needed temporarily, a temporary license is also available.

## Features and capabilities

Handheld analyzers provide a wide range of features and options to support different tasks in the field. Supported measurements include:

- ▶ Advanced spectrum measurements, e.g. channel power, occupied bandwidth, harmonic distortion
- ▶ Cable and antenna measurements, e.g. distance-to-fault, cable loss, VSWR
- ▶ Signal demodulation, e.g. AM/FM/PM demodulation and demodulation in line with specific wireless or mobile standards
- ▶ Vector signal analysis
- ▶ Spectrum monitoring and interference hunting

Some of the measurements require additional equipment, for example an antenna with the corresponding frequency range, a GPS receiver for position logging and a calibration kit to eliminate the influence of adapters.

## Operating duration

To facilitate measurements anytime, anywhere, handheld analyzers must be mobile. All handheld analyzers are battery operated. Depending on the task, measurements can take a few minutes or even a day. Typically, a battery can last 3 to 4.5 hours. Thanks to state-of-the-art design concepts, the newer handheld analyzer generation consumes considerably less power. Battery operating time for these analyzers is doubled. With a single charge, it is now possible to complete a full day's work in the field without having to take along an extra battery or look for a power source.

For longer operating periods (for example when a handheld spectrum analyzer is installed at a remote location for a week to perform spectrum recording), simply take out the battery and use a power adapter. If there is a power outage, the analyzer will automatically power up when AC power returns. There is no need to send someone to the site to power up the analyzer.

Type	Designation	Page
R&S®Spectrum Rider FPH	Handheld spectrum analyzer	57
R&S®FSH	Handheld spectrum analyzer	59
R&S®Cable Rider ZPH	Spectrum analyzer	61
R&S®ZVH	Cable and antenna analyzer	63

## Handheld analyzer portfolio



R&S®	Spectrum Rider FPH	FSH	Cable Rider ZPH	ZVH
<b>Spectrum analysis</b>				
Frequency	<ul style="list-style-type: none"> <li>▶ R&amp;S®FPH model .02: 5 kHz to 2 GHz</li> <li>▶ R&amp;S®FPH model .02 with R&amp;S®FPH-B3: 5 kHz to 3 GHz</li> <li>▶ R&amp;S®FPH model .02 with R&amp;S®FPH-B3 and R&amp;S®FPH-B4: 5 kHz to 4 GHz</li> <li>▶ R&amp;S®FPH model .06: 5 kHz to 6 GHz</li> <li>▶ R&amp;S®FPH model .06 with R&amp;S®FPH-B8: 5 kHz to 8 GHz</li> <li>▶ R&amp;S®FPH model .13: 5 kHz to 13.6 GHz</li> <li>▶ R&amp;S®FPH model .13 with R&amp;S®FPH-B20: 5 kHz to 20 GHz</li> <li>▶ R&amp;S®FPH model .26: 5 kHz to 26.5 GHz</li> <li>▶ R&amp;S®FPH model .26 with R&amp;S®FPH-B31: 5 kHz to 31 GHz</li> </ul>	<ul style="list-style-type: none"> <li>▶ R&amp;S®FSH4 models .04/.14: 9 kHz to 3.6 GHz</li> <li>▶ R&amp;S®FSH4 model .24: 100 kHz to 3.6 GHz</li> <li>▶ R&amp;S®FSH8 models .08/.18: 9 kHz to 8 GHz</li> <li>▶ R&amp;S®FSH8 model .28: 100 kHz to 8 GHz</li> <li>▶ R&amp;S®FSH13 models .13/.23: 9 kHz to 13.6 GHz</li> <li>▶ R&amp;S®FSH20 models .20/.30: 9 kHz to 20 GHz</li> </ul>	<ul style="list-style-type: none"> <li>▶ R&amp;S®ZPH model .12 (requires R&amp;S®ZPH-K1 option): 5 kHz to 3 GHz/4 GHz</li> <li>▶ with R&amp;S®ZPH-B4: 5 kHz to 4 GHz</li> </ul>	<ul style="list-style-type: none"> <li>▶ R&amp;S®ZVH4: 100 kHz to 3.6 GHz</li> <li>▶ R&amp;S®ZVH8: 100 kHz to 8 GHz</li> </ul>
Resolution bandwidth	1 Hz to 3 MHz			
Displayed average noise level	<ul style="list-style-type: none"> <li>▶ without preamplifier: typ. -146 dBm</li> <li>▶ with preamplifier: typ. -163 dBm</li> </ul>	<ul style="list-style-type: none"> <li>▶ without preamplifier: typ. -146 dBm</li> <li>▶ with preamplifier: typ. -165 dBm</li> </ul>	<ul style="list-style-type: none"> <li>▶ without preamplifier: typ. -146 dBm</li> <li>▶ with preamplifier: typ. -163 dBm</li> </ul>	<ul style="list-style-type: none"> <li>▶ without preamplifier: typ. -146 dBm</li> <li>▶ with preamplifier: typ. -165 dBm</li> </ul>
TOI	+10 dBm (meas.)	typ. +15 dBm	+10 dBm (meas.)	typ. +15 dBm
Phase noise	frequency = 500 MHz			
30 kHz carrier offset	typ. -95 dBc (1 Hz)	typ. -105 dBc (1 Hz)	typ. -95 dBc (1 Hz)	typ. -105 dBc (1 Hz)
100 kHz carrier offset	typ. -105 dBc (1 Hz)	typ. -110 dBc (1 Hz)	typ. -105 dBc (1 Hz)	typ. -110 dBc (1 Hz)
1 MHz carrier offset	typ. -125 dBc (1 Hz)	typ. -127 dBc (1 Hz)	typ. -125 dBc (1 Hz)	typ. -127 dBc (1 Hz)
Detectors	max. peak, min. peak, auto peak, sample, RMS			
Level measurement uncertainty	typ. 0.5 dB			
<b>CAT analysis</b>				
Frequency		<ul style="list-style-type: none"> <li>▶ R&amp;S®FSH4 model .24: 300 kHz to 3.6 GHz</li> <li>▶ R&amp;S®FSH8 model .28: 300 kHz to 8 GHz</li> <li>▶ R&amp;S®FSH13 model .23: 100 kHz to 8 GHz</li> <li>▶ R&amp;S®FSH20 model .30: 100 kHz to 8 GHz</li> </ul>	2 MHz to 3 GHz/4 GHz	<ul style="list-style-type: none"> <li>▶ R&amp;S®ZVH4: 100 kHz to 3.6 GHz</li> <li>▶ R&amp;S®ZVH8: 100 kHz to 8 GHz</li> </ul>
Port output power		-40 dBm (nom.)	-10 dBm (nom.)	-40 dBm (nom.)
Data points		631	101 to 2501	101, 201, 401, 601, 631, 801, 1001, 1201
Mode		<ul style="list-style-type: none"> <li>▶ reflection (<math>S_{11}</math>, <math>S_{22}</math>)<sup>1)</sup>, transmission (<math>S_{21}</math>, <math>S_{12}</math>)<sup>1)</sup></li> <li>▶ one-port cable loss</li> <li>▶ distance to fault</li> </ul>	<ul style="list-style-type: none"> <li>▶ reflection (<math>S_{11}</math>)</li> <li>▶ one-port cable loss</li> <li>▶ distance to fault</li> </ul>	<ul style="list-style-type: none"> <li>▶ reflection (<math>S_{11}</math>, <math>S_{22}</math>), transmission (<math>S_{21}</math>, <math>S_{12}</math>)</li> <li>▶ one-port cable loss</li> <li>▶ distance to fault</li> </ul>
<b>General data</b>				
Display	7" WVGA	6.5" color LCD with VGA resolution	7" WVGA	6.5" color LCD with VGA resolution
Battery operating time	> 6 h	<ul style="list-style-type: none"> <li>▶ 3 h (with R&amp;S®HA-Z204)</li> <li>▶ 4.5 h (with R&amp;S®HA-Z206)</li> </ul>	9 h <sup>2)</sup>	<ul style="list-style-type: none"> <li>▶ 3 h (with R&amp;S®HA-Z204)</li> <li>▶ 4.5 h (with R&amp;S®HA-Z206)</li> </ul>
Dimensions (W × H × D)	202 × 294 × 76 mm	194 × 300 × 144 mm	202 × 294 × 76 mm	194 × 300 × 144 mm
Weight	2.5 kg	3 kg	2.5 kg	3 kg

<sup>1)</sup>  $S_{22}$  and  $S_{12}$  measurements are possible only on the R&S®FSH13/20 models.

<sup>2)</sup> 6 h on two-port combi model .12, with cable and antenna analyzer mode.

# Learn about interference hunting in smart factories using the R&S®Spectrum Rider FPH



## R&S®Spectrum Rider FPH Handheld Spectrum Analyzer



### The three key Ps for lab and field environments

**Performance** – excellent DANL and phase noise

- ▶ Weak signals can be easily captured

**Portability** – weighs only 2.5 kg

- ▶ Carrying holster (R&S®HA-Z322) to free up hands
- ▶ Side strap included for easy transportation
- ▶ Selection of carrying cases available

**Price** – low starting price and optional software keycode upgrades

- ▶ Competitive and attractive price
- ▶ No downtime, no recalibration needed

### Model overview

Model (frequency range)	Preamplifier	Resolution bandwidth	Phase noise	Level measurement uncertainty	DANL	TOI
R&S®FPH (5 kHz to 2 GHz)	optional	1 Hz to 3 MHz	-88 dBc (1 Hz), typ. -95 dBc (1 Hz)	up to 1.25 dB, typ. 0.5 dB	-158 dBm, typ. -163 dBm	typ. +10 dBm
R&S®FPH (5 kHz to 3 GHz)						
R&S®FPH-P5 (5 kHz to 4 GHz)						
R&S®FPH (5 kHz to 6 GHz)						
R&S®FPH (5 kHz to 8 GHz)						
R&S®FPH (5 kHz to 13.6 GHz)						
R&S®FPH (5 kHz to 20 GHz)						
R&S®FPH (5 kHz to 26.5 GHz)						
R&S®FPH (5 kHz to 31 GHz)					-158 dBm, typ. -162 dBm	

### Important facts

Specification	R&S®Spectrum Rider FPH	Why this is important
Software upgradeable frequency ranges	•	Investment protection. Allows users to buy only what they need, when they need it.
Touchscreen (capacitive)	•	Allows faster measurement setup and configuration. Ability to pinch and zoom to set span.
Backlit keypad	•	Ability to use the equipment in all lighting conditions.
Fanless design	•	Quiet operation, sealed to protect against dust and water.

### Scope of delivery

- ▶ Lithium-ion battery pack
- ▶ Side strap for your hand
- ▶ Power cord
- ▶ USB cable
- ▶ User manual
- ▶ 3 year warranty (one year for battery and accessories)

### Recommended options/accessories

Description	Type
Power sensor support	R&S®FPH-K9
Channel power meter	R&S®FPH-K19
Pulse measurements with power sensor	R&S®FPH-K29
Interference analysis	R&S®FPH-K15
Signal strength mapping	R&S®FPH-K16



**The perfect choice for**

Spectrum clearance (5G ready)	Interference hunting
Pulse measurement	EMI debugging and RF design validation

Your benefit	Features
Battery life twice that of today's handheld spectrum analyzers	> 6 h battery life
Smartphone style capacitive touchscreen; also available with traditional interface	<ul style="list-style-type: none"> <li>▶ 7" antiglare capacitive color touchscreen</li> <li>▶ On-screen keyboard</li> <li>▶ Smartphone-like gestures</li> <li>▶ Adjustable display brightness</li> <li>▶ Backlit large button keypad</li> <li>▶ Multifunction rotary knob</li> </ul>
Buy only what you need; upgrade later without returning analyzer for servicing	<ul style="list-style-type: none"> <li>▶ Selection of 2/6/13.6/26.5 GHz base models</li> <li>▶ Frequency upgrade keycode options available for each base model</li> <li>▶ Channel power meter keycode option</li> </ul>

### Operation time

The analyzer has an innovate fanless concept – part of a rugged design that protects it from dust and water. Designed with power optimization in mind, the R&S®Spectrum Rider FPH consumes less power than competitor products and can be operated for a full working day without recharging.

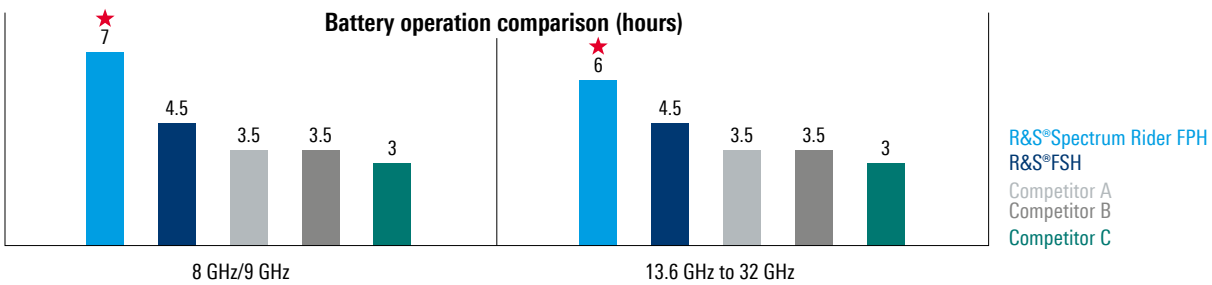

### Price comparison

The R&S®Spectrum Rider FPH is a high-quality spectrum analyzer. Its favorable price tag lowers the entry barrier for prospective premium analyzer owners. The unique frequency upgrade concept and software keycode options make it easy to upgrade the instrument.

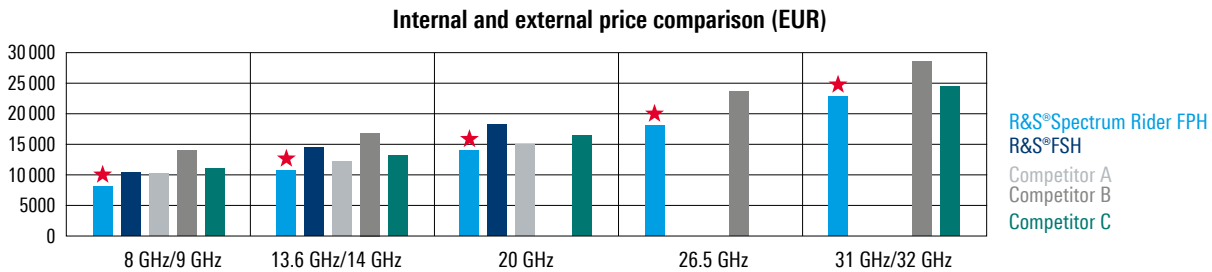

### Lightweight design

Every additional gram adds to user fatigue in the field. Thanks to the state-of-the-art design, each unit weighs only 2.5 kg – regardless of the frequency range.

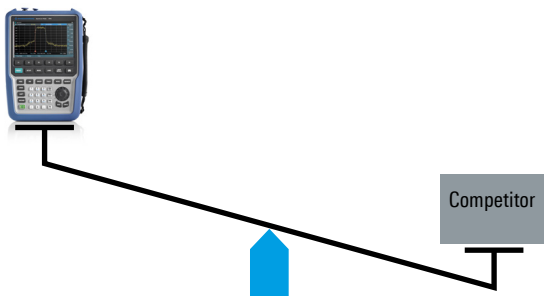

### Performance and features

The R&S®Spectrum Rider FPH has exceptional phase noise and DANL to capture known and unknown signals. The R&S®Spectrum Rider FPH easily measures a wide range of parameters such as total harmonic distortion, occupied bandwidth, output power and channel power, making it the ideal tool for field work.

### Other products to consider

- ▶ R&S®NRP power sensors – all models up to 110 GHz supported
- ▶ R&S®FSH – when you need digital modulation analysis

Handheld analyzers

# Learn how to perform precise pulse measurements using the R&S®FSH/ZVH



## R&S®FSH Handheld Spectrum Analyzer



Brochure



Data sheet



Fact sheet



Video



### Expandable platform that eliminates the need for multiple instruments

Depending on the model and options installed, the R&S®FSH can be used as a:

- ▶ Spectrum analyzer
- ▶ Interference hunting analyzer
- ▶ Cable and antenna analyzer
- ▶ Two-port vector network analyzer
- ▶ Power meter

### Model overview

Model (frequency range)	Tracking generator	Preamplifier included	Resolution bandwidth	Phase noise	Level measurement uncertainty	DANL	TOI
R&S®FSH4 (9 kHz to 3.6 GHz)		•					
R&S®FSH4 (9 kHz to 3.6 GHz)	•	•					> +10 dBm, typ. +15 dBm
R&S®FSH4 (100 kHz to 3.6 GHz)	•	•				-161 dBm, typ. -165 dBm	
R&S®FSH8 (9 kHz to 8 GHz)		•					
R&S®FSH8 (9 kHz to 8 GHz)	•	•	1 Hz to 3 MHz	-95 dBc (1 Hz), typ. -105 dBc (1 Hz)	up to 1 dB, typ. 0.5 dB		
R&S®FSH8 (100 kHz to 8 GHz)	•	•					
R&S®FSH13 (9 kHz to 13.6 GHz)		•					
R&S®FSH13 (9 kHz to 13.6 GHz)	•	•					> +3 dBm, typ. +10 dBm
R&S®FSH20 (9 kHz to 20 GHz)		•					
R&S®FSH20 (9 kHz to 20 GHz)	•	•				-158 dBm, typ. -162 dBm	

### Important facts

Specification	R&S®FSH	Why this is important
Demodulation	GSM/GPRS/EDGE, WCDMA, TD-SCDMA CDMA2000®, 1xEV-DO, LTE TDD, LTE FDD	Allows modulation measurements on relevant wireless standards.
VNA support	full two-port	Allows for cable loss and antenna testing and characterization, as well as distance to fault measurements. Two-port capability increases accuracy of transmission measurements.
Wizard support for common measurement functions	•	Increases repeatable field test patterns and reduces user error.
Entry level model	3.6 GHz	Determines lowest cost entry point into the family.
Preamplifier	•	Increases sensitivity for low signal level measurements.

### Scope of delivery

- ▶ Lithium-ion battery pack
- ▶ USB cable
- ▶ LAN cable
- ▶ AC power supply
- ▶ User manual
- ▶ 3 year warranty (one year for battery and accessories)

### Recommended options/accessories

Description	Type
Spectrum analyzer preamplifier	R&S®FPH-B22
Interference analysis	R&S®FPH-K15
Lithium-ion battery pack, 6.75 Ah	R&S®HA-Z206
Soft carrying bag	R&S®HA-Z220
Hard case	R&S®HA-Z221
Near-field probes	R&S®HZ-15
Yagi antenna, 824 MHz to 960 MHz	R&S®HA-Z900
Yagi antenna, 1710 MHz to 1990 MHz	R&S®HA-Z1900



### The perfect choice for

Installation and maintenance of transmitter stations

EMI debugging/  
RF design validation

Interference hunting

Electromagnetic fields measurements

Your benefit	Features
An expandable platform for every RF handheld measurement application	Expanded modes of operation for field strength measurements, power measurements, network analysis, interference analysis, vector voltmeter, pulse measurements
Extensive support for numerous wireless technologies	Modulation analysis for cellular technologies, including over-the-air LTE-Advanced carrier aggregation signal analysis
Most efficient instrument in the field	<ul style="list-style-type: none"> <li>▶ Sunlight readable display</li> <li>▶ Generation of user-defined test sequences (R&amp;S®FSH wizard)</li> <li>▶ Wizard streamlines test development</li> <li>▶ Remote control and data export with free R&amp;S®Instrument View software</li> <li>▶ Fast measurement mode switching</li> <li>▶ SD card and USB port for data storage</li> </ul>

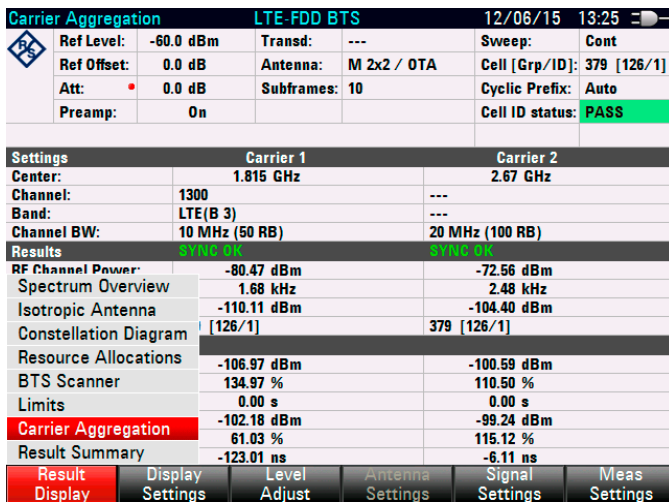

Support of numerous wireless communications standards: Modulation measurements on GSM/GPRS/EDGE, WCDMA, TD-SCDMA CDMA2000®, 1xEV-DO, LTE TDD, LTE FDD



Vector network analyzer mode: For cable loss and antenna testing and characterization as well as distance to fault measurements. Two-port capability for transmission measurements



Wizard support for common measurement functions: User-definable test sequences that reduce operating errors in the field



Remote control via LAN or USB: The R&S®FSH can be remotely controlled via the USB or LAN interface and integrated into user-specific programs

Handheld analyzers



## Learn more about reflection measurements here



### R&S®CableRider ZPH Cable and Antenna Analyzer



#### Save time in the field

The R&S®CableRider ZPH is a cable and antenna analyzer that is available in two models. The one-port model has all the essential basic measurement capabilities required for installing and maintaining antenna systems in the field. Its unique features ensure fast and efficient cable and antenna measurements. The two-port model offers more functionality and can perform spectrum analysis (R&S®ZPH-K1 option). It has an independent tracking source plus an integrated bias tee. All these add-ons make the R&S®CableRider ZPH the perfect field installation and maintenance tool.

Model overview						
Model	Frequency range	Frequency extension	Measurement speed	Data points	Measurement mode (standard)	Measurement mode (optional)
R&S®ZPH one-port model (model .02)	2 MHz to 3 GHz				DTF, return loss, VSWR, one-port cable loss, Smith chart, phase	power meter, power measurement with power sensor, pulse measurement
R&S®ZPH two-port model (model .12)	<ul style="list-style-type: none"> <li>CAT mode: 2 MHz to 3 GHz</li> <li>spectrum mode: 5 kHz to 3 GHz</li> </ul>	up to 4 GHz (R&S®ZPH-B4 option)	0.3 ms/point	101 to 2501	DTF, return loss, VSWR, one-port cable loss, Smith chart, phase, S <sub>21</sub>	power meter, power measurement with power sensor, pulse measurement, spectrum analysis, interference analysis, AM/FM/ASK/FSK modulation analysis

Important facts		
Specification	R&S®ZPH	Why this is important
Measurement speed	0.3 ms/point	Total overall test time is an important parameter impacted greatly by measurement speed. Faster measurement time per point increases overall throughput. This is especially important if hand-tuning of devices (antennas, resonators) is required.
Battery operation time	up to 6.5 h/9 h (mode dependent)	The advantages of having a long-lasting battery are obvious – no need to bring an extra battery with additional weight when climbing up a mast or tower, no dead batteries during measurement.
Automatic calibration unit	• <sup>1)</sup>	With little or no VNA experience, users can make a valid calibration and accurate measurements. An auto-cal unit also eliminates the need to deal with individual open, short, match and through calibration standards. Auto-cal based calibrations can be performed in the field or the lab to ensure consistent and reliable results.
Capacitive touchscreen with gesture support	•	Intuitive (smartphone-like) operation. Allows faster measurement setup and configuration. Ability to pinch and zoom to set span.

<sup>1)</sup> With R&S®ZN-Z103 calibration unit.

Scope of delivery
<ul style="list-style-type: none"> <li>Power cord</li> <li>Lithium-ion battery pack</li> <li>3 year warranty (one year for battery and accessories)</li> </ul>

Recommended options/accessories	
Description	Type
Frequency upgrade (3 GHz to 4 GHz)	R&S®ZPH-B4
Calibration unit, one-port, 2 MHz to 4 GHz	R&S®ZN-Z103
Combined open/short/50 Ω load calibration standard, for calibrating VSWR and DTF measurements, DC to 3.6 GHz	R&S®FSH-Z29
Soft carrying bag	R&S®HA-Z220
Rainproof carrying holster	R&S®HA-Z322



## The perfect choice for

RF transmitter installation and maintenance

Spectrum clearance/interference hunting <sup>1)</sup>

RF cable testing

Antenna measurement

<sup>1)</sup> Only with two-port model.

Your benefit	Features
Hybrid operation	Large keypads and sensitive capacitive touchscreen
Make the right measurement right away	Wizard function, settings preconfigured in advance
One-step calibration	No toggling between O/S/L standards with the R&S®ZN-Z103 automatic calibration unit
Shortest test time	Fastest measurement speed (0.3 ms/point), short boot and warm-up times
Work under bright or dim conditions	Non-reflective display with adjustable backlight, illuminated keypad
Buy what you need when you need it	Upgrade via keycode, no downtime, no recalibration required
Simple wireless remote operation	Free downloadable Android/iOS apps (third-party wireless router required)

## More functionality

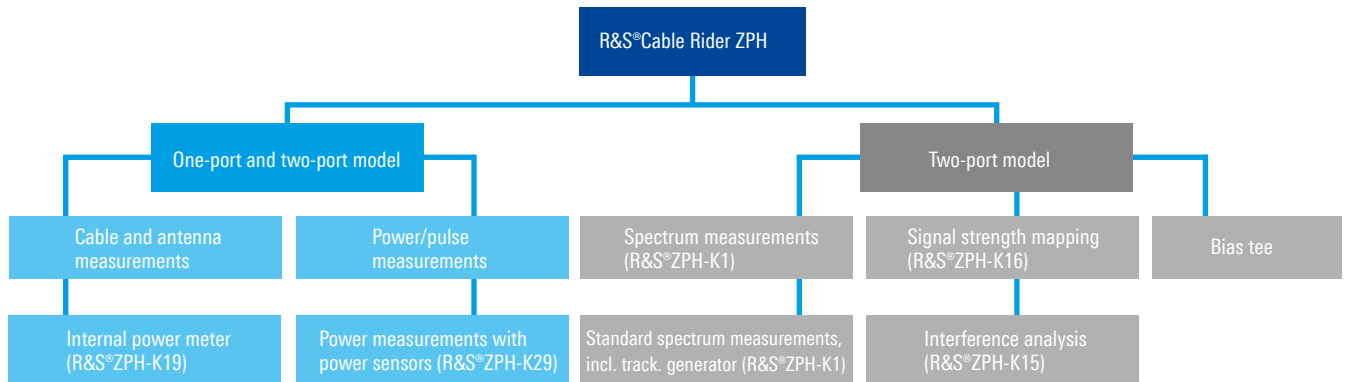

## Remote wireless control apps

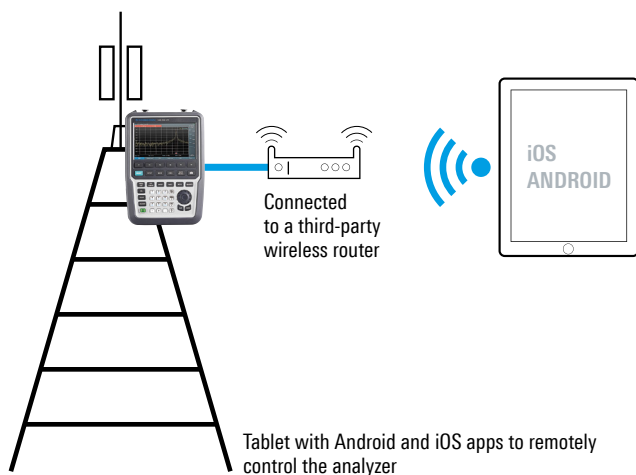

One-step calibration with automatic calibration unit (R&S®ZN-Z103)



Combined OSL calibration kit (R&S®FSH-Z29)

Handheld analyzers

# Learn how to perform convenient cable and antenna measurements with the R&S®ZVH wizard and report generator



## R&S®ZVH Cable and Antenna Analyzer



### For more efficiency in the field

Depending on the options installed, the R&S®ZVH can be a cable and antenna analyzer, a two-port vector network analyzer, a power meter or a spectrum analyzer. Free software and apps are available to conveniently remote control the analyzer. The wizard function also allows users to preconfigure test sequences for repeatability and reduce measurement and troubleshooting time.

### Model overview

Model (frequency range)	Number of ports	Dynamic range	Port output power	Data points	Measurement mode (standard)
R&S®ZVH4 (100 kHz to 3.6 GHz)	2	100 dB	0 dBm to -40 dBm	101 to 1201	reflection, DTF, one-port cable loss
R&S®ZVH8 (100 kHz to 8 GHz)	2	100 dB	0 dBm to -40 dBm	101 to 1201	reflection, DTF, one-port cable loss

### Important facts

Specification	R&S®ZVH	Why this is important
Factory calibration available	•	Ensures accurate measurements even if the field technician forgets the calibration procedure.
Wizard support for common measurement functions	•	Increases repeatable field test patterns and reduces user errors.
Entry bandwidth	3.6 GHz	Determines lowest cost entry point into the family.
Preamplifier	included	Increases sensitivity for low signal level measurements.

### Scope of delivery

- ▶ Lithium-ion battery pack
- ▶ LAN cable
- ▶ USB cable
- ▶ AC power supply
- ▶ CD-ROM with software and documentation
- ▶ Quick start guide
- ▶ 3 year warranty (one year for battery and accessories)

### Recommended options/accessories

Description	Type
<b>Options</b>	
Remote control via LAN or USB	R&S®ZVH-K40
Transmission measurement	R&S®ZVH-K39
Vector network analysis	R&S®ZVH-K42
Vector voltmeter	R&S®ZVH-K45
Spectrum analysis	R&S®ZVH-K1
Spectrogram measurement application	R&S®ZVH-K14
Power meter	R&S®ZVH-K9
<b>Popular accessories</b>	
Combined open/short/50 Ω load calibration standard, DC to 8 GHz	R&S®FSH-Z28
Combined open/short/50 Ω load calibration standard, DC to 3.6 GHz	R&S®FSH-K29
Lithium-ion battery pack, 6.75 Ah	R&S®HA-Z206
Soft carrying bag	R&S®HA-Z220
Hard case	R&S®HA-Z321
GPS receiver	R&S®HA-Z240



<b>The perfect choice for</b>	
Installation and maintenance of RF transmitter system	RF cable measurement
Antenna measurement	General purpose spectrum measurement

Your benefit	Features
Make the right measurement right away	Wizard function, preconfiguration of settings in advance
An expandable platform for every RF handheld measurement application	Expanded modes of operation for field strength measurements, power measurements, network analysis, vector voltmeter, pulse measurements
Simple wireless remote operation	Free downloadable Android/iOS apps, R&S®MobileView (third-party wireless router required)
Most efficient instrument in the field	<ul style="list-style-type: none"> <li>▶ Sunlight readable display</li> <li>▶ Wizard streamlines test development</li> <li>▶ Remote control and data export with free R&amp;S®Instrument View software</li> <li>▶ Fast switching of measurement modes</li> <li>▶ SD card and USB port for data storage</li> </ul>



Vector network analysis: Simultaneous display of four S-parameters ( $S_{11}$ ,  $S_{21}$ ,  $S_{12}$ ,  $S_{22}$ )

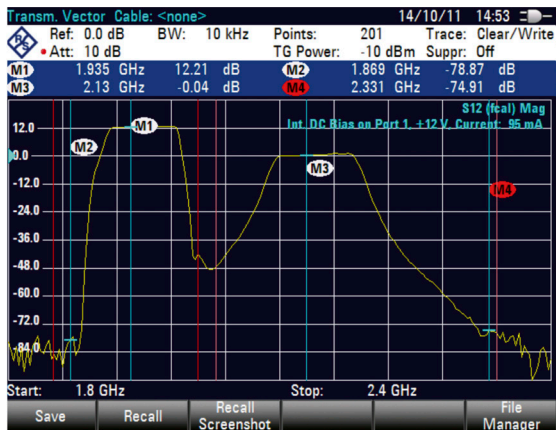

Two-port capability for transmission measurements



Remote control via LAN or USB: The R&S®ZVH can be remotely controlled via the USB or LAN interface and integrated into user-specific programs

### Remote wireless control apps

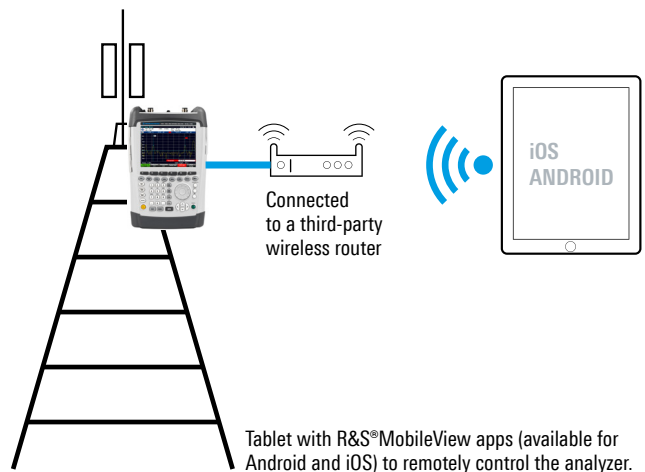

Tablet with R&S®MobileView apps (available for Android and iOS) to remotely control the analyzer.

### Wizard function: Fast and accurate measurements in three simple steps

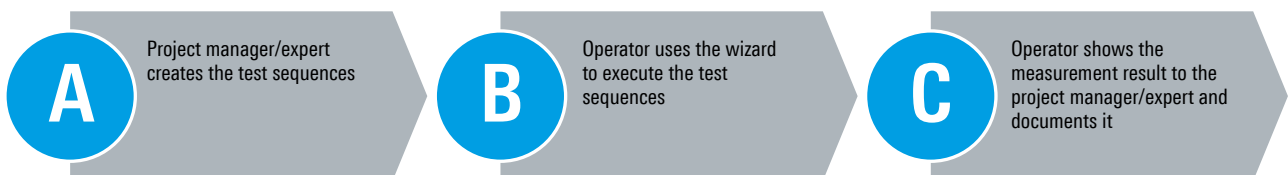

Handheld analyzers

# SPECTRUM ANALYZERS

## Frequency range

The frequency range specifies the range of frequencies over which the spectrum analyzer will operate. Different measurement applications may require a larger frequency range to evaluate harmonics, spurs or alternate channels. In this case, it makes sense to consider a higher frequency model in order to capture all potential signals of interest.

**Application example:** Detecting the third-order harmonics of a 915 MHz signal requires a spectrum analyzer with a maximum frequency greater than 2.745 GHz.

## Dynamic range

The dynamic range is the analyzer's ability to detect weak signals in the presence of strong signals. The dynamic range is limited on the lower end by the analyzer's inherent noise and spurs and on the upper end by nonlinearities. The inherent noise is specified by the displayed average noise level (DANL), given in dBm and normalized to 1 Hz resolution bandwidth.

The nonlinearities are given by the 1 dB compression point, second harmonic distortion and third-order intercept (TOI).

A preamplifier reduces the DANL, which helps detect weak signals but increases other distortions and reduces the overall dynamic range.

An input attenuator with a small step size helps use the maximum dynamic range.

**Application example:** Spurious emission measurements, EMI debugging. To detect a weak signal of  $-100$  dBm with a resolution bandwidth of 10 kHz and a signal to noise ratio (SNR) of 10 dB, the DANL must be below  $-110$  dBm/10 kHz, which is equivalent to  $-150$  dBm (1 Hz).

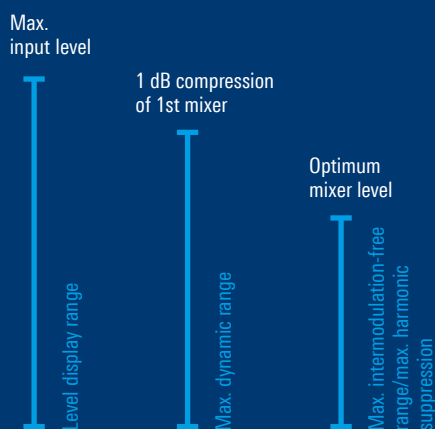

### Features and capabilities

Modern spectrum analyzers provide a wide range of options for enhanced signal analysis and ease of use. Possible firm-ware or software options include:

- ▶ Advanced spectrum measurements, e.g. spectrogram, channel power, occupied bandwidth, third-order intercept point
- ▶ I/Q analysis mode with a specific analysis bandwidth for capturing and analyzing signals, including phase information
- ▶ Software for signal demodulation, e.g. AM/FM/PM demodulation, vector signal analysis, signal demodulation in line with specific wireless or mobile standards
- ▶ Certain use cases and measurements require dedicated hardware. Possible hardware options include:
  - Battery operation or 12 V/24 V DC power for portable or vehicular operation
  - Tracking generator for scalar network analysis
  - 28 V DC output for noise figure measurements with a noise source
  - Remote control requires a IEEE-488 (GPIB), LAN or WLAN interface

**Application example:** Amplitude transmission measurements on an RF filter require a tracking generator.

### Phase noise

The spectrum analyzer's inherent phase noise limits measurements very close to a carrier since spurs at e.g. 1 kHz offset may be hidden in the analyzer's phase noise. The inherent phase noise also limits the ability to perform phase noise measurements on the signal source and it impacts error vector magnitude (EVM) measurements on digitally modulated signals, especially narrowband signals.

**Application example:** To detect a spur at a certain frequency offset at 70 dB below the carrier with a 10 dB SNR and 10 Hz RBW, the SSB phase noise must be below  $-90$  dBc (1 Hz).

Type	Designation	Page
R&S®FPC	Spectrum analyzer	69
R&S®FSC	Spectrum analyzer	71
R&S®FSL	Spectrum analyzer	73
R&S®FPL1000	Spectrum analyzer	75



## Economy spectrum analyzer portfolio

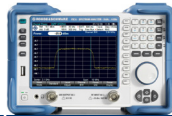

R&S®	FPC	FSC	FSL
<b>Frequency</b>			
Frequency range	5 kHz to 1/2/3 GHz	9 kHz to 3 GHz/6 GHz	9 kHz to 18 GHz
Phase noise at 100 kHz offset (1 Hz)	< -98 dBc, typ. -103 dBc	typ. < -110 dBc	< -98 dBc, typ. -105 dBc
Frequency resolution	0.1 Hz	0.1 Hz	1 Hz
<b>Bandwidth</b>			
Resolution bandwidth	1 Hz to 3 MHz in 1/3 sequence	10 Hz to 3 MHz in 1/3 sequence	<ul style="list-style-type: none"> <li>▶ 300 Hz to 10 MHz (-3 dB) in 1/3 sequence</li> <li>▶ 10 Hz to 10 MHz (-3 dB) in 1/3 sequence (optional)</li> <li>▶ 20 MHz additionally in zero span</li> </ul>
Analysis bandwidth	-	-	28 MHz
<b>Level</b>			
DANL at 1 GHz (1 Hz)	<ul style="list-style-type: none"> <li>▶ preamp off: typ. &lt; -150 dBm</li> <li>▶ preamp on: typ. &lt; -165 dBm</li> </ul>	<ul style="list-style-type: none"> <li>▶ preamp off: typ. &lt; -146 dBm</li> <li>▶ preamp on: typ. &lt; -165 dBm</li> </ul>	<ul style="list-style-type: none"> <li>▶ preamp off: &lt; -140 dBm</li> <li>▶ preamp on: &lt; -152 dBm, typ. -160 dBm</li> <li>▶ +10 dBm, typ. +18 dBm (R&amp;S®FSL3, FSL6)</li> <li>▶ +10 dBm, typ. +13 dBm (R&amp;S®FSL18)</li> </ul>
TOI	+7 dBm	typ. +15 dBm	
Total level uncertainty	typ. < 0.5 dB	typ. ±1 dB	< 0.8 dB
Spurious response	< -60 dBc (f ≤ 3 GHz, Δf ≥ 300 kHz)	< -60 dBc (f ≤ 3.6 GHz, Δf ≥ 300 kHz)	< -60 dBc (f ≤ 6 GHz, Δf ≥ 100 kHz)
Attenuator range	0 dB to 40 dB in 5 dB steps	0 dB to 40 dB in 5 dB steps	R&S®FSL3/R&S®FSL6: 0 dB to 50 dB in 5 dB steps
<b>Miscellaneous</b>			
Tracking generator	<ul style="list-style-type: none"> <li>▶ R&amp;S®FPC1000: -</li> <li>▶ R&amp;S®FPC1500: 5 kHz to 1/2/3 GHz</li> </ul>	models .13/.16: 100 kHz to 3 GHz/6 GHz	▶ model .28: 9 kHz to 18 GHz
Tracking generator independent source	<ul style="list-style-type: none"> <li>▶ R&amp;S®FPC1000: -</li> <li>▶ R&amp;S®FPC1500: yes</li> </ul>	-	-
Battery operation	-	-	optional
Dimensions (W × H × D)	<ul style="list-style-type: none"> <li>▶ without feet: 396 × 178 × 147 mm</li> <li>▶ with feet: 396 × 185 × 156 mm</li> </ul>	233 × 158.1 × 350 mm	<ul style="list-style-type: none"> <li>▶ with handle: 408.8 mm × 158.1 mm × 465.3 mm</li> <li>▶ without handle: 342.3 mm × 158.1 mm × 367.0 mm</li> </ul>
Display size	10.1"	5.7"	
Weight	3 kg	4.5 kg	with battery pack: < 8 kg
<b>Vector network analysis</b>			
Frequency range	2 MHz to 1/2/3 GHz	-	-
Port output power	-10 dBm (nom.)	-	-
Measurement points	101 to 2501	-	-
Modes	<ul style="list-style-type: none"> <li>▶ reflection (S<sub>11</sub>)</li> <li>▶ one-port cable loss</li> <li>▶ distance to fault</li> <li>▶ transmission (S<sub>21</sub>) (scalar measurement)</li> </ul>	-	-

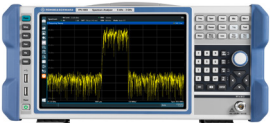

<b>FPL1000</b>	
5 kHz to 3 GHz/7.5 GHz	
< -113 dBc, typ. -116 dBc	
0.1 Hz	
1 Hz to 10 MHz in 1/2/3/5 sequence	
10 MHz (standard), 40 MHz (optional)	
<ul style="list-style-type: none"> <li>▶ preamp off: &lt; -149 dBm, -152 dBm</li> <li>▶ preamp on: &lt; -163 dBm, typ. -167 dBm</li> </ul>	
+ 17 dBm, typ. 20 dBm	
< 0.3 dB	
< -70 dBc	
0 dB to 45 dB in 5 dB steps, 1 dB steps (optional)	
-	
-	
R&S®FPL1-B31 option	
408 mm × 186 mm × 235 mm	
10.1"	
without options: 6 kg	
-	
-	
-	
-	

## R&S®FPC Spectrum Analyzer



### The value of three instruments in one

#### Signal generator

The R&S®FPC not only features standard tracking generator measurements with frequency offset functionality, its signal source is independent to enable signal generator functionality. A CW signal can be set within the frequency range, or in a coupled mode to follow the center frequency setting of the spectrum analyzer mode.

#### Spectrum analyzer

The R&S®FPC base instrument has a frequency range from 5 kHz to 1 GHz with keycode options to unlock up to 3 GHz and other features. Engineered in Germany, it provides the best dynamic range in its class. In combination with RBW settings down to 1 Hz, it resolves the finest details, which are displayed on the high-resolution 10.1" WXGA display. Wired or wireless remote control options are available for free.

#### Network analyzer

The R&S®FPC features an internal VSWR bridge that makes purchasing and mounting/dismounting an external bridge unnecessary.  $S_{11}$  reflection measurements are supported, including Smith chart and DTF features.

### Model overview

Model (frequency range)	Preamplifier included	Independent signal generator	Tracking generator	Resolution bandwidth	Phase noise	DANL	TOI
R&S®FPC1000 (5 kHz to 1 GHz)	optional	-	-	1 Hz to 3 MHz	< -103 dBc (1 Hz) (f = 500 MHz at 100 kHz offset)	down to typ. -165 dBm (with preamplifier)	+7 dBm
R&S®FPC1000 (5 kHz to 2 GHz, frequency upgrade)							
R&S®FPC1000 (5 kHz to 3 GHz, frequency upgrade)							
R&S®FPC1500 (5 kHz to 1 GHz)		•	•				
R&S®FPC1500 (5 kHz to 2 GHz, frequency upgrade)							
R&S®FPC1500 (5 kHz to 3 GHz, frequency upgrade)							

### Important facts

Specification	R&S®FPC1000	R&S®FPC1500	Why this is important
DANL (normalized to 1 Hz)	typ. < -165 dBm (power amplifier = on)		Most "economy" spectrum analyzers sacrifice premium components and superior RF design choices in favor of cost reduction. True RF performance in an economy instrument gives you the confidence of the most accurate measurements within your frequency needs.
TOI	+17 dBm (attenuation = 10 dB)		
Phase noise at 100 kHz offset	typ. < -103 dBc (1 Hz)		Visualizing important signal details is not just a matter of the RF specifications; the high-resolution display of the R&S®FPC spectrum analyzers allows hardware signal details to be displayed on screen.
Display	10.1" (1366 × 768 pixel)		
Modulation analysis	spectrum analysis and modulation analysis		A wider range of both modulation and spectrum analysis allow the spectrum analyzer to pair more suitably with a larger range of applications. Modulation analysis can allow demodulation of simple modulation formats such as ASK/FSK as well as AM/FM.
Tracking generator	-	tracking generator model with the unique value of three instruments in one	A spectrum analyzer with tracking generator is most useful for scalar transmission measurements, for example on filters. The R&S®FPC1500 comes with an extra: frequency conversion measurements (enabled by the independent type source of the instrument). This is great for RF mixer characterization.



## The perfect choice for

R&D and service labs

Test automation

Professionals, hobbyists

Education and training

### Scope of delivery

- ▶ Power cable
- ▶ 3 year warranty (one year for accessories)

### Recommended options/accessories

Description	Type
Spectrum analyzer frequency upgrade, 1 GHz to 2 GHz	R&S®FPC-B2
Spectrum analyzer frequency upgrade, 2 GHz to 3 GHz	R&S®FPC-B3
Spectrum analyzer preamplifier	R&S®FPC-B22
Wi-Fi connection support	R&S®FPC-B200

### Highlights

Class-leading spectrum analyzer engineered in Germany.

✓ Value of three	✓ 10.1" display
✓ Low noise floor	✓ Flexible upgrade concept
✓ High max. input power	✓ Easy to control

Your benefit	Features
Value of three	The R&S®FPC1500 combines the value of a spectrum analyzer, a vector network analyzer and a signal generator
More resolution for better measurements	Lowest noise floor in class down to typ. -165 dBm (with preamplifier), resolution bandwidth down to 1 Hz, 10.1" WXGA display
Investment protection	All upgrades available via keycode, no additional calibration required

### Recommended options/accessories

Description	Type
Modulation analysis	R&S®FPC-K7
Vector network analysis	R&S®FPC-K42
Receiver mode	R&S®FPC-K43
Advanced measurements	R&S®FPC-K55
19" rackmount kit	R&S®ZZA-FPC1
Near-field probes, 30 MHz to 3 GHz (set of 5 probes)	R&S®HZ-15
Amplifier, 100 kHz to 3 GHz	R&S®HZ-16
Near-field probes, 30 MHz to 3 GHz (set of 2 probes)	R&S®HZ-17
Carrying case	R&S®RTB-Z3

### Frequency extension using keycodes

Buy what you need when you need it.

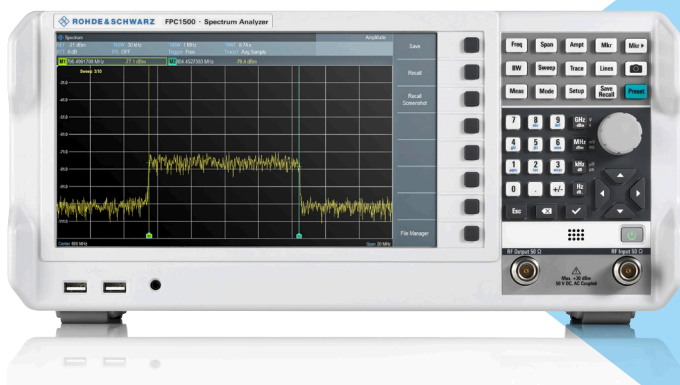
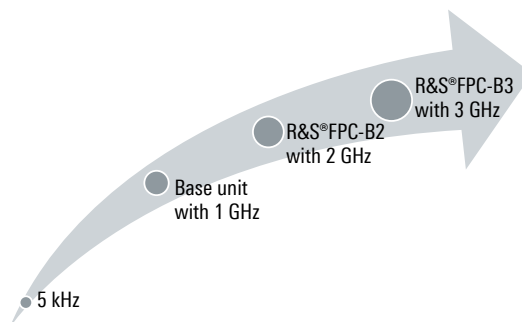

#### Spectrum analyzer

Investment protection

High resolution

Easy virtual control

#### Vector network analyzer

Internal VSWR bridge

One-port VNA (S<sub>11</sub>)

Smith chart

#### Signal generator

Tracking generator

Independent signal source

Coupled CW mode

## R&S®FSC Spectrum Analyzer

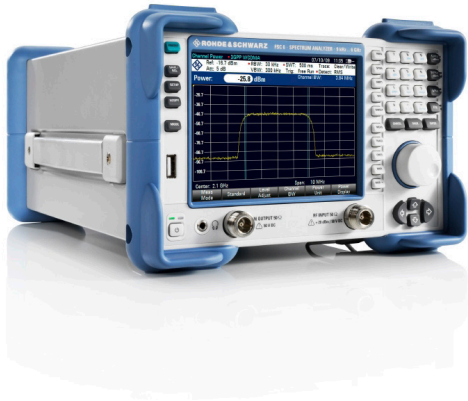

### Compact and cost-effective spectrum analyzer

- ▶ Performance
  - The R&S®FSC features very good RF performance. Its DANL, TOI and phase noise make it ideal for many standard measurement applications
  - General purpose spectrum analysis presets for spectral characteristics, e.g. harmonics, AM modulation depth and ACLR are included as standard
- ▶ Compact form factor:
 

The R&S®FSC has the smallest footprint in its class at only 3 HU, ½ 19". It takes up very little space on a bench. Two R&S®FSC analyzers or one R&S®FSC and an R&S®SMC signal generator fit in just 3 HU of rack space
- ▶ Cost-effective:
 

Total cost of ownership is excellent due to affordable initial and calibration costs, plus very low operating cost with only 12 W power consumption

#### Model overview

Model	Frequency range	Preamplifier	Resolution bandwidth	Phase noise	Level measurement uncertainty	DANL	TOI
R&S®FSC3, model .03 (base)	9 kHz to 3 GHz	optional	10 Hz to 3 MHz	–95 dBc (1 Hz), typ. –105 dBc (1 Hz)	up to 1 dB, typ. 0.5 dB	–161 dBm, typ. –165 dBm	> +10 dBm, typ. +15 dBm
R&S®FSC3, model .13 (tracking gen.)	9 kHz to 3 GHz				up to 1.5 dB, typ. 0.5 dB	–161 dBm, typ. –165 dBm	> +10 dBm, typ. +15 dBm
R&S®FSC6, model .06 (base)	9 kHz to 6 GHz				up to 1.5 dB, typ. 0.5 dB	–155 dBm, typ. –159 dBm	> +3 dBm, typ. +10 dBm
R&S®FSC6, model .16 (tracking generator)	9 kHz to 6 GHz				up to 1.5 dB, typ. 1 dB	–155 dBm, typ. –159 dBm	> +3 dBm, typ. +10 dBm

#### Important facts

Specification	R&S®FSC	Why this is important
Tracking generator dynamic range	typ. 90 dB	Provides higher dynamic range when performing filter measurements.
Phase noise		
30 kHz	up to –95 dBc (1 Hz)	Lower phase noise enables greater signal detection accuracy close to the carrier.
100 kHz	up to –100 dBc (1 Hz)	
1 MHz	up to –120 dBc (1 Hz)	

#### Recommended options/accessories

Description	Type
Preamplifier for spectrum analyzer	R&S®FSC-B22
19" rackmount kit for two R&S®FSC	R&S®ZZA-T33
19" rackmount kit for one R&S®FSC	R&S®ZZA-T34
Headphones	R&S®FSH-Z36
Near-field probes, 30 MHz to 3 GHz	R&S®HZ-15
Preamplifier for R&S®HZ-15, 100 kHz to 3 GHz	R&S®HZ-16



The perfect choice for	
R&D service labs	Test automation
Professionals, hobbyists	Education and training

Your benefit	Features
Easy to set up	Owing to its compact design, the R&S®FPC only takes up minimal bench space
Easy to operate	All important settings are available via proper hardkeys, supplemented by softkeys at the bottom of the display
Wide choice	4 base models to fit customer needs

### Highlights

Class-leading spectrum analyzer engineered in Germany.

✓ High RF performance	✓ Low power consumption
✓ Low noise floor	✓ Compact form factor
✓ High max. input power	✓ Easy to control



Tracking generator for scalar transmission measurements

Spectrum analyzers

### Easy virtual control<sup>1)</sup> – control it your way, be it wired or wirelessly

Wireless remote control with R&S®MobileView app



Wired/wireless remote control with R&S®InstrumentView PC software



Flexible remote control on demand, anywhere, anytime.

<sup>1)</sup> Via a wireless router connected to the instrument's LAN port.



## R&S®FSL Spectrum Analyzer



### Signal analysis functions in a lightweight, compact package

The R&S®FSL is an extremely lightweight and compact spectrum analyzer. Its low weight and optional battery/DC power make it the ideal instrument for the lab and in the field.

The R&S®FSL features many measurement options for analyzing signals in line with common standards. With an optional tracking generator, scalar network analysis up to 18 GHz is possible.

### Model overview

Model	Frequency range	Tracking generator	Resolution bandwidth	Phase noise	DANL	TOI
R&S®FSL18, model .18 (base)	9 kHz to 18 GHz	–	300 Hz to 10 MHz (–3 dB) in 1/3 sequence			
R&S®FSL18, model .28 (tracking generator)	9 kHz to 18 GHz	•	10 Hz to 10 MHz (–3 dB) in 1/3 sequence (optional), 20 MHz additionally in zero span	–98 dBc (1 Hz), typ. –105 dBc (1 Hz), f = 500 MHz	–162 dBm (1 Hz), f = 500 MHz, typical, preamplifier on	typ. +18 dBm

### Important facts

Specification	R&S®FSL	Why this is important
Frequency range	9 kHz to 18 GHz	Higher frequency range allows users to view signals within their application area. Having portable instruments at higher frequencies allows expanded measurements in the field.
Resolution bandwidth	1 Hz to 20 MHz	Wider resolution bandwidths offer more measurement versatility for applications such as pulse analysis in zero span.
Portable/battery power	•	Can be used in the lab and in the field with optional battery or DC power option.
Tracking generator	•, up to 18 GHz	A tracking generator allows access to a signal source coincident with the sweep frequency of the spectrum analyzer. This can be used for characterization of cables and filters up to microwave frequencies.

Use as a power meter: Turn the R&S®FSL into a power meter with R&S®NRP power sensors and the R&S®FSL-K9 option



The perfect choice for	
Research, education	Portable measurements in the field
Fast and easy integration into automated tests	Wireless communications standard signal analysis <sup>1)</sup>

<sup>1)</sup> Please see data sheet for supported standards.

### Highlights

Class-leading spectrum analyzer engineered in Germany.

	Portability		18 GHz tracking generator
	Low noise floor		1 Hz resolution bandwidth

Your benefit	Features
One instrument for multiple tasks	<ul style="list-style-type: none"> <li>▶ Spectrum analysis</li> <li>▶ Power meter</li> <li>▶ Analog and digital signal analysis</li> <li>▶ Scalar network analysis</li> </ul>
Can take it with you everywhere	<ul style="list-style-type: none"> <li>▶ Carrying handle and low weight</li> <li>▶ Optional battery pack</li> <li>▶ Optional 12 V/24 V DC power supply</li> </ul>
Signal analysis functions	Many measurement options for analyzing signals in line with IEEE (WLAN, WiMAX™ and Bluetooth®) and 3GPP standards <sup>1)</sup>

Recommended options/accessories	
Description	Type
OCXO frequency reference	R&S®FSL-B4
Additional interfaces	R&S®FSL-B5
Narrow resolution filters	R&S®FSL-B7
Gated sweep	R&S®FSL-B8
IEEE-488 (GPIB) interface	R&S®FSL-B10
RF preamplifier (3 GHz/6 GHz)	R&S®FSL-B22
DC power supply, 12 V to 28 V	R&S®FSL-B30
NiMH battery pack	R&S®FSL-B31
Options	
AM/FM/φM measurement demodulator	R&S®FSL-K7
Power sensor support	R&S®FSL-K9
Spectrogram measurements	R&S®FSL-K14
3GPP FDD BTS application firmware	R&S®FSL-K72
WLAN transmitter measurements for IEEE 802.11a, b, g, j	R&S®FSL-K91
Noise figure and gain measurements	R&S®FSL-K30

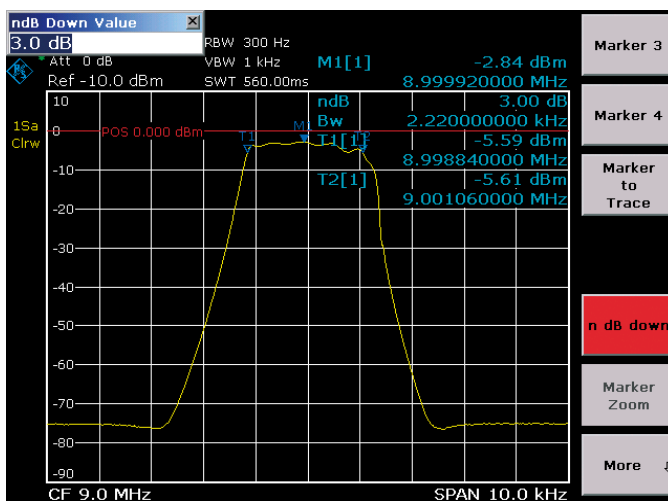

Scalar network analysis<sup>2)</sup>: With the optional tracking generator, users can quickly and easily measure frequency response, filters and attenuation. The “n dB down” marker determines the 3 dB bandwidth of a bandpass filter at the press of a button.

<sup>2)</sup> For reflection measurement, an external VSWR bridge is required.

The screenshot shows the 'Measurement Modes' menu. The 'Spectrum Analyzer' mode is selected and highlighted. Other available modes include: Analog Demod, Bluetooth, Cable TV Analyzer, Noise, 3G FDD BTS, WiMAX, and WLAN.

Many predefined measurements: The R&S®FSL offers many different firmware options. The user can switch between different applications.

Spectrum analyzers

## R&S®FPL1000 Spectrum Analyzer



### Easy to carry with benchtop performance

The R&S®FPL1000 spectrum analyzer combines excellent RF performance with a small footprint. The light weight and optional battery/DC power make it the ideal instrument for the lab and in the field.

Operating the multi-touchscreen instrument is intuitive and fun to use. The R&S®FPL1000 supports multiple tasks in one instrument at an attractive price.

### Model overview

Model	Frequency range	DANL at 1 GHz	Phase noise at 1 GHz (10 kHz offset)	TOI at 1 GHz	Spurious	Battery operation
R&S®FPL1003	5 kHz to 3 GHz	preamplifier off: < -149 dBm (typ. -152 dBm)	typ. -105 dBc (1 Hz)	+20 dBm (typ.)	< -70 dBc (typ.)	optional
R&S®FPL1007	5 kHz to 7.5 GHz	preamplifier on: < -163 dBm (typ. -167 dBm)				

### Important facts

Specification	R&S®FPL1000	Why this is important
Analysis bandwidth	▶ 10 MHz standard ▶ 40 MHz optional	Digital demodulation possible within the analysis bandwidth.
Spurious	< -70 dBc	Unambiguous detection of small signals.
Phase noise at 1 GHz (10 kHz offset)	< -105 dBc (1 Hz)	Analysis close to the carrier or of narrowband signals.
TOI at 1 GHz	> 17 dBm	Higher dynamic range to detect small signals in the presence of strong ones.
Dimensions (W x H x D)	408 mm x 186 mm x 235 mm	Smaller dimensions leave more space on the workbench and make it easier to integrate into a rack.
Weight	6 kg	Low weight for enhanced portability.
Battery operation	optional	Full portability.

### Recommended options/accessories

Description	Type
OCXO frequency reference	R&S®FPL1-B4
Additional interfaces	R&S®FPL1-B5
Internal generator up to 3 GHz for R&S®FPL1003 – factory fitted option	R&S®FPL1-B9
IEEE-488 (GPIB) interface	R&S®FPL1-B10
Second hard disk (SSD)	R&S®FPL1-B19
RF preamplifier	R&S®FPL1-B22
1 dB steps for electronic attenuator	R&S®FPL1-B25
DC power supply, 12 V/24 V	R&S®FPL1-B30
Internal lithium-ion battery with charging unit	R&S®FPL1-B31
40 MHz analysis bandwidth	R&S®FPL1-B40

### Recommended options/accessories

Description	Type
<b>Firmware options</b>	
AM/FM/φM measurement demodulator	R&S®FPL1-K7
Power sensor measurement with R&S®NRP-Zxx power sensors	R&S®FPL1-K9
Noise figure measurement application	R&S®FPL1-K30
<b>Software</b>	
License dongle	R&S®FSPC
Vector signal explorer base software	R&S®VSE
Vector signal analysis	R&S®VSE-K70
EUTRA/LTE NB-IoT analysis	R&S®VSE-K106



## The perfect choice for

Research, education,  
service and maintenance

General purpose  
signal analysis and  
demodulation

Fast and easy integration  
into automated tests

Basic function test  
and EMI debugging  
in R&D

Your benefit	Features
One instrument for multiple tasks	<ul style="list-style-type: none"> <li>▶ Spectrum analysis</li> <li>▶ Power meter</li> <li>▶ Analog and digital signal analysis</li> </ul>
More space on your test bench	▶ Smallest footprint in its class (depth of only 23.5 cm)
Take it with you everywhere	<ul style="list-style-type: none"> <li>▶ Top handle and low weight</li> <li>▶ Optional battery pack, over 3 hours operation</li> <li>▶ Optional 12 V/24 V DC power supply</li> </ul>

### Up to 40% more space on your desk

The R&S®FPL1000 leaves up to 40% more space on a typical 80 cm workbench than comparable analyzers. With 60% less weight than comparable analyzers, it is the most portable benchtop analyzer.

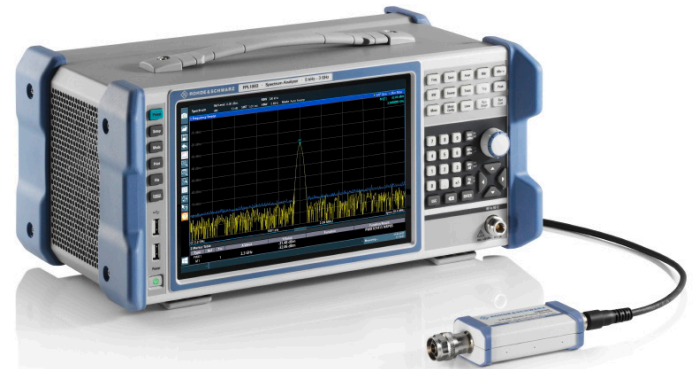
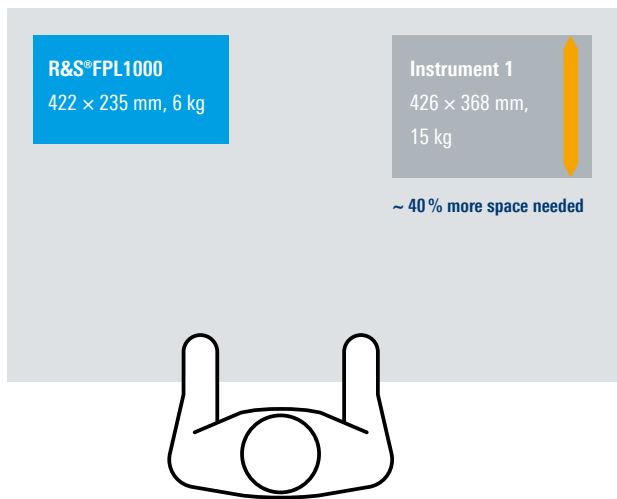

Use as a power meter: Turn the R&S®FPL1000 into a power meter with R&S®NRP power sensors and the R&S®FPL1-K9 option

Spectrum analyzers

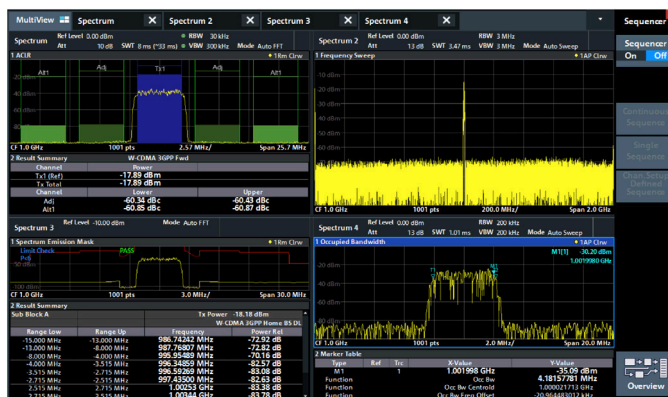

Flexible user interface: Configure your result windows the way you want. Display different measurement channels at once. Sequential channel updating allows parallel measurement of e.g. spectrum, spectrogram, I/Q analysis and analog demodulation.

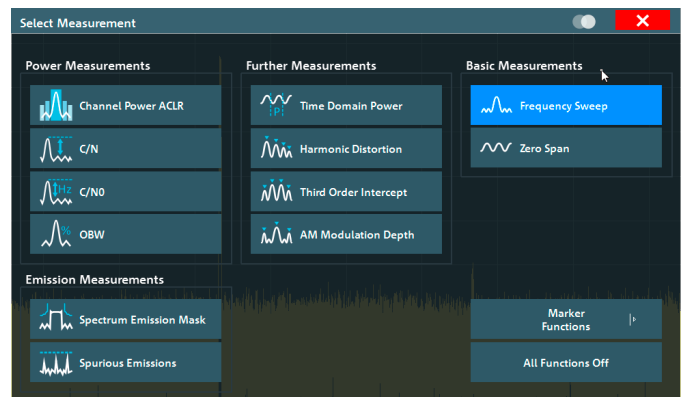

Many predefined measurements: Fast and easy access to a wealth of measurement and marker functions in the base model, including spectrogram measurements and I/Q analysis. Quick configuration through clear menus and touchscreen operation.

# VECTOR NETWORK ANALYZERS

## Frequency range

The frequency range of a VNA is defined as its maximum settable frequency values. This is important as it needs to cover the frequency range of the DUT.

Sometimes a value for overrange is given, which allows a wider frequency range than officially specified. The measurement can be configured, but the operator must be aware that there is no performance data specified for the overrange and there might not be a matching calibration kit.

**Rule of thumb:** The frequency range of a VNA has to match the DUT's requirements.

## Dynamic range

A high dynamic range is essential for measuring high blocking filters and large attenuators. The dynamic range is defined as the difference between the max. source power and the noise floor of the instrument. For the specification of the dynamic range, typically a noise floor at 10 Hz IF bandwidth (IFBW) is used. Since many engineers want to measure fast, they increase the IF bandwidth. But be aware that an increased IF bandwidth means a reduced dynamic range. If the IF bandwidth is increased by a factor of 10, the dynamic range is reduced by 10 dB.

**Rule of thumb:** For accurate measurements, the signal to noise ratio (SNR) needs to be considered and should be at least 20 dB.

## Measurement speed

The measurement speed tells you how fast a measurement can be performed. This is especially critical for production environments, but is also interesting in a laboratory environment.

In general, the measurement speed is mainly determined by the number of measurement points, the measurement bandwidth, whether a calibration is active and what type of calibration is used.

If you have a low number of points, a high IF bandwidth and no calibration is active, the total sweep time can be in the range of ms.

But if you have a measurement setup with many channels and traces, a high number of measurement points, a small IF bandwidth and an active calibration, the total test time can take several minutes.

**Rule of thumb:** One quick way to decrease the test time for one channel with one trace is to increase the IF bandwidth or reduce the number of points.

Approx.  $t_{Test} \approx \text{number of points} / \text{IFBW}$

### Passive and active components

The type of DUT that needs to be measured is important when choosing a VNA, as is its RF performance and test functions.

If passive components such as filters, cables and attenuators need to be measured, the VNA only needs to be able to perform standard S-parameter measurements. Depending on the DUT, you might just need reflection parameters such as S11 or you might also need transmission parameters such as S21. But even for a “simple” filter with a high blocking stopband, you need a VNA with a high-end dynamic range.

If active components need to be measured, you need to analyze the required test parameters even more carefully to find the appropriate VNA. If you want to measure the compression point of an amplifier, for example, you will need to be able to perform a power sweep and a power calibration, which is not a standard feature in all VNAs.

Another important aspect is the requirement for balanced ports and the number of test ports. With some two-port VNAs, you can perform one-port balanced reflection measurements. If you have more balanced ports, you will need more than two ports on your VNA.

Type	Designation	Page
R&S®ZNL	Vector network analyzer	81
R&S®ZVL	Vector network analyzer	83
R&S®ZNL	Vector network analyzer	85



## Vector network analyzer portfolio



R&S®	ZNLE	ZVL
Frequency range	1 MHz to 3 GHz/6 GHz	9 kHz to 13.6 GHz
Overrange	–	R&S®ZVL13: 5 kHz to 15 GHz
Ports	two N(f) 50 Ω	<ul style="list-style-type: none"> <li>▶ two N(f) 50 Ω</li> <li>▶ R&amp;S®ZVL3-75: two N(f) 75 Ω</li> </ul>
Test set	bidirectional ( $S_{11}$ , $S_{12}$ , $S_{21}$ , $S_{22}$ )	bidirectional ( $S_{11}$ , $S_{12}$ , $S_{21}$ , $S_{22}$ )
Dynamic range	<ul style="list-style-type: none"> <li>▶ up to 110 dB (spec.)</li> <li>▶ up to typ. 120 dB</li> </ul>	<ul style="list-style-type: none"> <li>▶ up to 115 dB (spec.)</li> <li>▶ up to typ. 123 dB</li> </ul>
Number of points	1 to 5001	2 to 4001
IF bandwidth	1 Hz to 500 kHz	1 Hz to 500 kHz
Trace noise	<ul style="list-style-type: none"> <li>▶ 0.005 dB (RMS) (spec.)</li> <li>▶ typ. 0.001 dB (RMS)</li> </ul>	0.005 dB (RMS) (spec.)
Measurement speed (201 points, 100 kHz IF bandwidth, 200 MHz span, two-port calibration)	9.6 ms	< 60 ms
Max. power	0 dBm	<ul style="list-style-type: none"> <li>▶ 0 dBm</li> <li>▶ –5 dBm (R&amp;S®ZVL13)</li> </ul>
Min. power	–10 dBm	<ul style="list-style-type: none"> <li>▶ –50 dBm</li> <li>▶ –35 dBm (R&amp;S®ZVL13)</li> </ul>
Power sweep range	–	–
Power sensor support	–	available in spectrum analyzer mode
Display	25.6 cm (10.1") diagonal WXGA color LCD with touchscreen, 1280 × 800 pixel	16.5 cm (6.49") color TFT, 640 × 480 pixel
Dimensions (W × H × D)	408 mm × 186 mm × 235 mm	408.8 mm × 158.1 mm × 465.3 mm
Weight	6 kg	7 kg to 8.4 kg
Calibration unit support	●	only R&S®ZVL3-75
User port	–	–
GPIB interface	○	○
Handler I/O interface	–	–
Time domain	–	○
Distance to fault	–	○
Spectrum analysis	–	○
Power range extension	–	–

● available/yes

– not available/no

○ optional



<b>ZNL</b>
5 kHz to 3 GHz/6 GHz
–
two N(f) 50 Ω
bidirectional ( $S_{11}$ , $S_{12}$ , $S_{21}$ , $S_{22}$ )
▶ up to 120 dB (spec.)
▶ up to typ. 130 dB
1 to 100001
1 Hz to 500 kHz
▶ 0.0035 dB (RMS) (spec.)
▶ typ. 0.0005 dB (RMS)
9.6 ms
▶ 0 dBm (spec.)
▶ typ. +3 dBm
▶ –10 dBm (base unit)
▶ –40 dBm (with R&S®ZNLx-B22)
–
available in spectrum analyzer mode
25.6 cm (10.1") diagonal WXGA color LCD with touchscreen, 1280 × 800 pixel
408 mm × 186 mm × 235 mm
6 kg to 8 kg
•
–
○
–
○
○
○
○
○

## R&S®ZNLE Vector Network Analyzer



### Measurements as easy as ABC

With the R&S®ZNLE, vector network analysis measurements become as easy as ABC: easy to use, easy to calibrate, easy to configure.

Fast measurement speeds, reliable RF performance and a clearly structured user interface make the R&S®ZNLE the perfect choice for vector network analysis measurements on passive components.

#### Model overview

Model	Frequency range	Dynamic range	Output power	No. of points	IF bandwidth	Measurement speed
R&S®ZNLE3	1 MHz to 3 GHz	110 dB (spec.), typ. 120 dB	0 dBm (spec.), up to typ. +2 dBm	1 to 5001	1 Hz to 500 kHz	16.7 ms <sup>1)</sup>
R&S®ZNLE6	1 MHz to 6 GHz	110 dB (spec.), typ. 120 dB	0 dBm (spec.), up to typ. +2 dBm	1 to 5001	1 Hz to 500 kHz	16.7 ms <sup>1)</sup>

<sup>1)</sup> 401 points, 200 MHz span, 100 kHz IF bandwidth, 2-port calibration on.

#### Important facts

Specification	R&S®ZNLE	Why this is important
Frequency	1 MHz to 3 GHz/6 GHz	The measuring instrument has to cover the working frequency range of the DUT.
Dynamic range	110 dB (spec.), typ. 120 dB	A high dynamic range is important for measuring high-blocking filters
Output power	0 dBm	High output power is needed for measuring high-blocking filters or very long cables.
Speed	9.6 ms (100 kHz IFBW), 10 µs per point	Especially in a production environment, it is important to measure fast. Because time is money.
Display	•	Having an integrated monitor reduces hassle when using the instrument. You can just plug it in and start measuring.
External PC required	–	The R&S®ZNLE just needs to be plugged in and users can start measuring without having to configure an external PC.
Dimensions (W × H × D)	187 mm × 399 mm × 229 mm	The size of the VNA determines how much space is left on the workbench for the measurement setup. More space is an advantage.
Weight	6 kg	If the instrument has to be used in different places, it is better to have a lighter instrument.



R&S®ZN-Zx calibration units can be used with the R&S®ZNLE to conveniently and quickly perform system error correction



#### Scope of delivery

- ▶ Power cable
- ▶ Operating manual
- ▶ CD with manual
- ▶ 3 year warranty

#### Recommended options/accessories

Description	Type
<b>Base unit</b>	
Vector network analyzer, 1 MHz to 3 GHz, two ports, N(f)	R&S®ZNLE3
Vector network analyzer, 1 MHz to 6 GHz, two ports, N(f)	R&S®ZNLE6
<b>Options</b>	
GPIB interface	R&S®FPL1-B10
Extended frequency range, lower end, 1 MHz to 100 kHz	R&S®ZNLE-B100
Time domain analysis	R&S®ZNL-K2
Distance-to-fault measurements	R&S®ZNL-K3

<b>The perfect choice for</b>	
Passive RF components tests	Education and training
Automated testing	Production environment

Your benefit	Features
Solid performance in an economic instrument	Standalone vector network analyzer with fast measurement speed and low trace noise
Clearly structured user interface with multi-touchscreen	Wide capacitive touchscreen for convenient configuration with multitouch gesturing. Undo/redo softkeys and fully integrated context-sensitive help menu for user-friendly operation
Standard instrument for use in the lab	De/embedding, fixture compensation, support of automatic calibration units and remote control via LAN or IEEE-488 (GPIB)

**Feature highlights**

- ▶ Compact standalone vector network analyzer with fully integrated computer
- ▶ Fast measurement speeds
- ▶ Innovative user interface and wide 10.1" multi-touchscreen
- ▶ Windows 10 operating system
- ▶ Use of calibration units

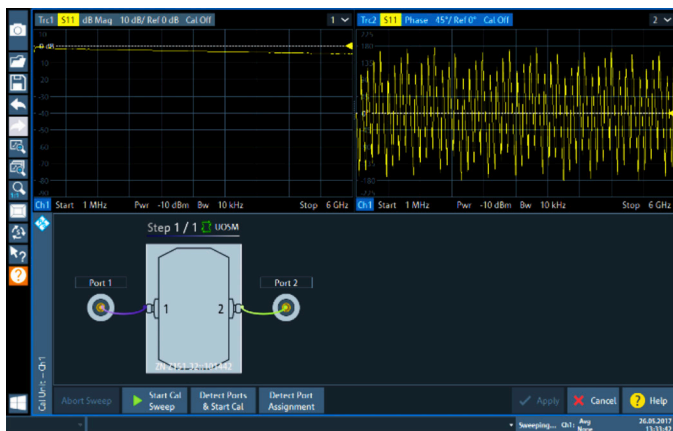

Automatic calibration unit support: Automatic calibration units supported for convenient automatic system error correction. To be even quicker, a one-step auto cal is available

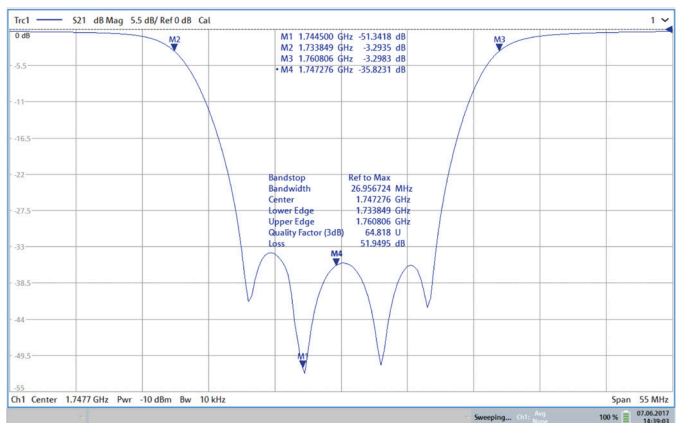

Vector network analysis: Automatic filter characterization with advanced marker functions: all important values in one step

**Up to 67% more space on your desk**

The R&S®ZNLE leaves up to 67% more space on a typical 80 cm workbench than comparable analyzers. Weighing 60% less than comparable analyzers, it is the most portable benchtop analyzer. The R&S®ZNLE fits easily on any desk for convenient everyday measurements such as tuning a filter.



<b>R&amp;S®ZNLE</b> 408 × 235 mm, 6 kg	<b>Instrument 1</b> 432 × 310 mm, 11.8 kg ~ 29% more space needed	<b>Instrument 2</b> 484 × 590 mm, 11 kg ~ 67% more space needed
--	--	--

Vector network analyzers

## R&S®ZVL Vector Network Analyzer



### Portable network analyzers with optional spectrum analyzer in one unit

The R&S®ZVL is a cost-efficient, portable network analyzer in the economy class that is ideal for use in R&D, production and service. It combines the functions of a network analyzer and spectrum analyzer in a single box and will tremendously increase work efficiency.

#### Model overview

Model	Frequency range	No. of ports	Dynamic range	Maximum power	Power sweep range	Damage CW RF power
R&S®ZVL13	9 kHz to 13.6 GHz	2	100 dB, typ. 105 dB	-5 dBm, typ. 0 dBm	-35 dBm to -5 dBm	27 dBm

#### Recommended options/accessories

Description	Type
Spectrum analysis	R&S®ZNLx-B1
Distance-to-fault measurements	R&S®ZNL-K3
Time domain analysis	R&S®ZNL-K2
Power sensor measurement with R&S®NRPxx power sensors	R&S®FPL1-K9
AM/FM/φM measurement demodulator	R&S®FPL1-K7
Noise figure and gain measurements	R&S®FPL1-K30
GPIB interface	R&S®FPL1-B10
Additional interfaces	R&S®FPL1-B5
DC power supply, 12 V/24 V	R&S®FPL1-B30
Internal lithium-ion battery	R&S®FPL1-B31



## The perfect choice for

Education

R&D

Maintenance and repair

Manufacturing testing

Your benefit	Features
2-in-1 instrument	The R&S®ZVL lets you add a spectrum analyzer option so you have just one box, but two instruments
75 Ω test set	The R&S®ZVL has 75 Ω connectors, which is what you need for TV/CATV measurements
Small, compact and portable	Weighing only 7 kg and being a 2-in-1 instrument, the R&S®ZVL is very compact. With the handle and battery pack, it can be carried around easily and be used even if there is no power outlet nearby

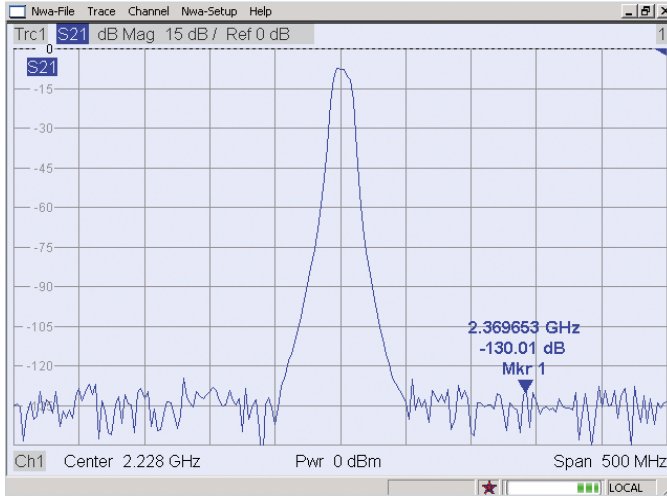

High throughput in production: Large measurement bandwidths up to 500 kHz and fast synthesizers make for short measurement times and high throughput in manual tuning and automated production sequences.

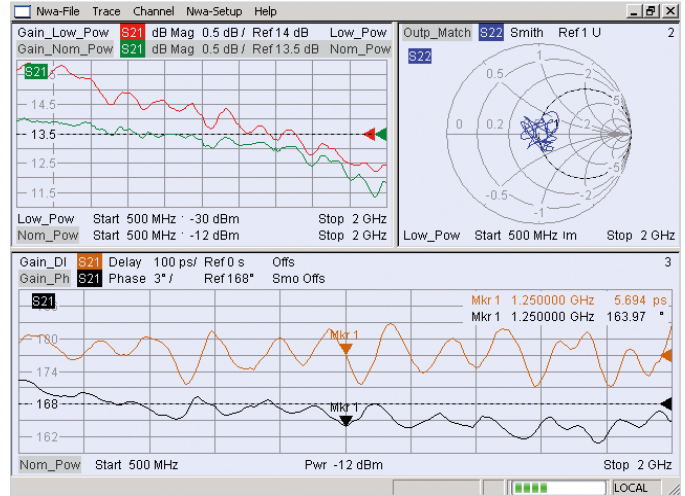

Multi-trace display for faster DUT characterization: Several traces can be combined in diagrams and assigned to different measurement channels.

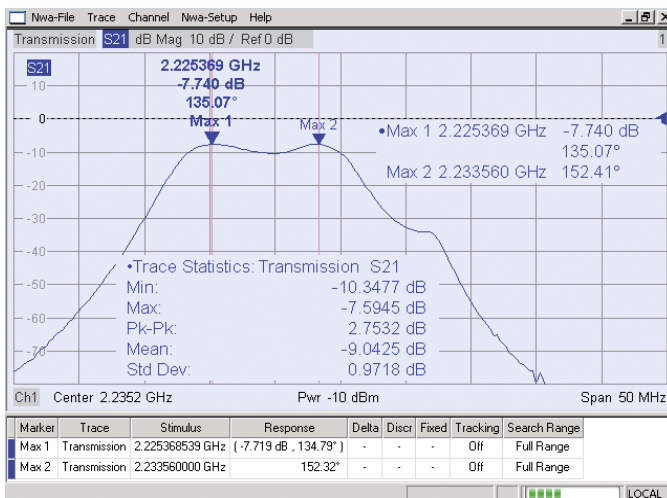

Easy and intuitive operation: Context-sensitive help, including detailed description of the active function and display of the associated remote control commands, supports even untrained users and simplifies programming.



# Learn about impedance measurements for power delivery networks using the R&S®ZNL



## R&S®ZNL Vector Network Analyzer



### The 3-in-1 allrounder

Measurement equipment for RF applications must fulfill high quality standards. Instruments should be easy to use and offer high versatility. Fast measurements and reliable performance are crucial.



With the R&S®ZNL, Rohde & Schwarz exceeds these expectations and offers even more: Vector network analysis, spectrum analysis and power meter measurements are unified in a single, compact instrument, making the R&S®ZNL a universal allrounder.

Model overview						
Model	Frequency range	Dynamic range	Output power	No. of points	IF bandwidth	Measurement speed
R&S®ZNL3	5 kHz to 3 GHz	120 dB (spec.), typ. 130 dB	0 dBm (spec.), up to typ. +3 dBm	1 to 10001	1 Hz to 500 kHz	16.7 ms <sup>1)</sup>
R&S®ZNL6	5 kHz to 6 GHz	120 dB (spec.), typ. 130 dB	0 dBm (spec.), up to typ. +3 dBm	1 to 10001	1 Hz to 500 kHz	16.7 ms <sup>1)</sup>

<sup>1)</sup> 401 points, 200 MHz span, 100 kHz IF bandwidth, 2-port calibration on.

Important facts		
Specification	R&S®ZNL	Why this is important
Frequency	5 kHz to 3 GHz/6 GHz	The measuring instrument has to cover the working frequency range of the DUT.
Dynamic range	120 dB (spec.), typ. 130 dB	A high dynamic range is important for measuring e.g. high-blocking filters. It also makes it possible to use a larger IF filter for faster measurement speed.
Output power	0 dBm	A high output power is needed if you need to measure high-blocking filters (requires more dynamic range) or very long cables.
Speed	9.6 ms (100 kHz IFBW), 10 µs per point	Especially in a production environment, it is important to measure fast. Because time is money.
Display	•	Having an integrated monitor reduces hassle when configuring the measurement setup.
External PC required	–	The R&S®ZNL just needs to be switched on and users can start measuring without having to configure an external PC.
Dimensions (W × H × D)	408 mm × 186 mm × 235 mm	The size of the VNA determines how much space is left on the workbench for the measurement setup. It is usually better to have more space.
Weight	6 kg to 8 kg	If the instrument needs to be moved around, it is better to have a lighter instrument.

Scope of delivery
<ul style="list-style-type: none"> <li>▶ Printed operating manual</li> <li>▶ CD with manual</li> <li>▶ Power cable</li> <li>▶ 3 year warranty (one year for battery and accessories)</li> </ul>

Recommended options/accessories	
Description	Type
<b>Spectrum analysis and related options</b>	
Spectrum analysis	R&S®ZNLx-B1
40 MHz analysis bandwidth	R&S®FPL1-B40
Additional interface	R&S®FPL1-B5
AM/FM/φM measurement demodulator	R&S®FPL1-K7



Recommended options/accessories	
Description	Type
Power sensor measurement with R&S®NRPxx power sensors	R&S®FPL1-K9
Noise figure and gain measurements	R&S®FPL1-K30
Time domain analysis	R&S®ZNL-K2
<b>R&amp;S®VSE options</b>	
R&S®VSE basic edition <sup>1)</sup>	R&S®VSE
R&S®VSE enterprise edition <sup>2)</sup>	R&S®VSE
Vector signal analysis	R&S®VSE-K70
EUTRA/LTE narrowband IoT analysis	R&S®VSE-K106
R&S®VSE software maintenance	R&S®VSE-SWM
License dongle	R&S®FSPC

<sup>1)</sup> R&S®FSPC required.  
<sup>2)</sup> R&S®FSPC or R&S®FSPC-FL required.

**The perfect choice for**

General purpose RF lab measurements	Low-cost volume manufacturing
Education and training	Service and maintenance

**Feature highlights**

- ▶ Frequency range from 5 kHz to 3 GHz (R&S®ZNL3) or 5 kHz to 6 GHz (R&S®ZNL6)
- ▶ Two-port vector network analyzer for bidirectional measurements
- ▶ 3 instruments in 1: vector network analyzer, spectrum analyzer and power meter
- ▶ MultiView operation
- ▶ Wide dynamic range up to typ. 130 dB
- ▶ Output power: from -40 dBm to 3 dBm (typ.)
- ▶ Fast measurements, e.g. 16.7 ms at 100 kHz IF bandwidth (401 points, 200 MHz span, two-port calibration)
- ▶ Compact size and low weight (6 kg to 8 kg)
- ▶ Optional battery pack



MultiView provides a convenient overview of all active R&S®ZNL modes. The figure shows a combination of spectrum analyzer and network analyzer. In this view, all modes can be updated sequentially.

Portable for use on the go: With batteries, the R&S®ZNL can be used outside the labs. Batteries are hot-swappable



Your benefit	Features
3 instruments in 1	A full two-port VNA that can be a true spectrum analyzer (hardware option) and also supports the use of power sensors (option), turning it into a power meter
Fully portable	The R&S®ZNL is very lightweight (6 kg to 8 kg) and very compact (408 mm × 235 mm footprint) and has a top handle for easy carrying. The battery pack allows it to be used on the go
Clearly structured user interface with multitouch	Wide capacitive touchscreen for convenient configuration with multitouch gesturing. Undo/redo softkeys and fully integrated context-sensitive help menu for user-friendly operation

**Compact, lightweight instrument**

The R&S®ZNL saves up to 67% of desk space, leaving plenty of room for the measurement setup.

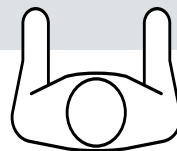
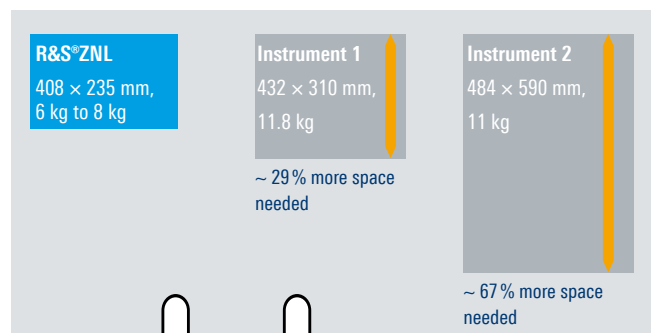

Vector network analyzers



A padded soft carrying bag for safe transportation of the R&S®ZNL

# EMC PRECOMPLIANCE

Type	Designation	Page
R&S®HM6050-2	Line impedance stabilization network	88

## R&S®HM6050-2 Line Impedance Stabilization Network



### To meet relevant standards

- ▶ Single-phase V-network to measure line-conducted interferences from 10 kHz to 30 MHz (based on CISPR 16, amplitude/frequency characteristics)
- ▶ Selectable transient limiter
- ▶ Artificial hand connector

### Model overview

Model	Version	Frequency range	Max. current	Line voltage	Line frequency	Artificial hand
R&S®HM6050-2D	EU	10 kHz to 30 MHz	16 A	230 V	50 Hz to 60 Hz	220 pF + 511 Ω
R&S®HM6050-2K	UK					
R&S®HM6050-2S	US					

### Scope of delivery

- ▶ User manual
- ▶ Power cord
- ▶ 3 year warranty

### The perfect choice for

EMI precompliance measurements in engineering lab

Remotely controlled EMI measurements for EMC diagnostics and precompliance

### Your benefit

Measurements in line with international standards  
Complete functionality

### Features

Meets VDE 0876 and CISPR Publ. 16 standards  
Contains air core inductance coils and features an artificial hand and a PE simulating network that can be bridged

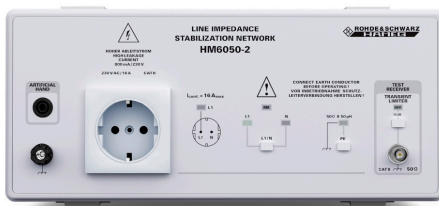

EU version

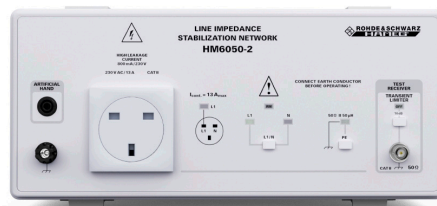

UK version

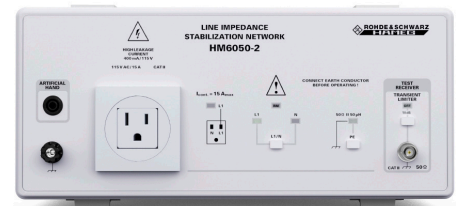

US version

EMC precompliance



# METERS AND COUNTERS

## What is a multimeter?

A multimeter measures electrical values such as voltage, current and resistance. A multimeter is a combination of a multirange DC voltmeter, multirange AC voltmeter, multirange ammeter and multirange ohmmeter. It is widely used for quick measurements or troubleshooting, either manually or remote controlled, in electric and electronic devices. A digital multimeter converts the analog signal under test to digital bits and analyzes it in the digital domain.

## What is a power analyzer?

Single phase power analyzers are designed to provide fast and efficient precision measurements of power consumption and test compliance with international standards.

## What is an LCR bridge/meter?

An LCR bridge measures impedance parameters such as inductance, capacitance and resistance of an electronic component. Benchtop LCR meters typically have selectable test frequencies of more than 100 kHz to create data points at multiple spot frequencies. They often include options to superimpose a DC voltage or current on the AC measuring signal. In addition, benchtop meters allow the usage of special fixtures to measure surface mount device (SMD) components, air core coils and transformers. Often used in a general capacity, LCR bridges/meters can be used to validate and test development components during incoming inspection and to determine variations between parts. With fast measurements that shorten test times and binning interfaces to control a handler/sorter, LCR bridges/meters are also ideal for production facilities.

## What is an arbitrary waveform generator?

An arbitrary waveform generator (AWG) generates electrical waveforms. It is usually used to test all aspects of a receive (RX) device to determine performance limits and unexpected behavior. AWGs can generate signals that closely approximate real-world signals, both wanted signals and interferers. The generated signals can be modified in precise ways to operate the receivers as usual or at performance limits.

Unlike function generators, AWGs can generate any arbitrarily defined waveform at their output. Some AWGs also operate as conventional function generators to produce standard waveforms such as sine, square, ramp, triangle, noise and pulse. Some units include additional built-in waveforms such as exponential rise and fall times,  $\sin x/x$  and ECG. Some AWGs allow users to retrieve waveforms from a number of digital and mixed-signal oscilloscopes.

## What is an audio analyzer?

An audio analyzer is a universal test instrument used to measure all kinds of audio equipment wherever music or speech is recorded, transmitted or processed. It usually includes a generator that produces all types of test signals and an analyzer that offers a variety of measurements such as level, frequency response, distortion and FFT analysis. Often the analog and digital interfaces on equipment need to be tested, including audio/video combining interfaces such as HDMI™.

Type	Designation	Page
R&S®HMC8012	Digital multimeter	91
R&S®HM8118	LCR bridge	93
R&S®HMC8015	Power analyzer	95
R&S®UPP	Audio analyzer	97



## R&S®HMC8012 Digital Multimeter



### See more – up to three results in parallel

- ▶ True RMS measurement, AC, AC + DC
- ▶ Simultaneous display of three measurement functions, e.g. DC + AC + statistics
- ▶ Measurement functions: DCV, DCI, ACV, ACI, frequency, resistance (2-wire and 4-wire), temperature, capacitance, diode and continuity test
- ▶ Mathematic functions: limit testing, minimum, maximum, average, offset, DC power, calculation of dB and dBm
- ▶ Data logging to internal memory or USB stick

### Model overview

Model	Measurement range	Basic accuracy	Number of digits	IEEE-488 (GPIB)	LabVIEW
R&S®HMC8012	DC to 100 kHz	0.015% in DC range	5.75 digits	–	•
R&S®HMC8012-G	DC to 100 kHz	0.015% in DC range	5.75 digits	•	•

### Important facts

Specification	R&S®HMC8012	Why this is important
Logging capability	saves up to 4 Gbyte of data directly to USB thumb drive, 200 measurements	Fast and large file capability for large data sets
Number of measurements displayed	3 simultaneous	More information visible at a glance; no need to toggle through measurements

### Scope of delivery

- ▶ R&S®HZ15 silicone test leads with safety connectors and test probe, length: 1 m (black + red)
- ▶ Operating manual
- ▶ Power cable
- ▶ 3 year warranty

### Recommended options/accessories

Description	Type
PT100 temperature probe, 2-wire	R&S®HZ812
PT100 temperature probe, 4-wire	R&S®HZ887
Silicone test leads (included with base unit)	R&S®HZ15
19" rackmount kit, 2 HU for R&S®HMC series	R&S®HZC95



The perfect choice for	
General purpose	Engineering lab
Production testing	Hobbyists

Your benefit	Features
See more at a glance with three values displayed on one screen	Measured voltage, measured current, calculated power
Limit testing on color display for easy minimum/maximum analysis	Programmable test functions such as limit and min./max.
10 A range as standard	One current input with up to 10 A and no need to change connectors for different ranges
Saves up to 4 Gbyte of data directly onto storage devices	Writes directly to USB thumb drive

Application	How the R&S®HMC8012 meets your needs
General purpose	<ul style="list-style-type: none"> <li>▶ Clear 5 3/4-digit display</li> <li>▶ Quick and easy measurements</li> <li>▶ High resolution and accuracy</li> <li>▶ Extremely useful in service and repair centers, training centers, universities and schools</li> </ul>
Engineering lab	<ul style="list-style-type: none"> <li>▶ Wide frequency range from DC to 100 kHz</li> <li>▶ Accurate four-wire resistance measurement</li> <li>▶ Long-term data logging capability</li> <li>▶ Fanless design</li> </ul>
Production environment	<ul style="list-style-type: none"> <li>▶ LXI-compliant Ethernet interface</li> <li>▶ USB and Ethernet interface, IEEE-488 (GPIB) (R&amp;S®HMC8012-G only)</li> <li>▶ SCPI remote control functionality</li> <li>▶ LabVIEW drivers available</li> </ul>



Simultaneous measurement display: Simultaneous display of three measurements, including DCI and ACI at the same time



Ideal for industrial environments: Easily slots into R&S®HZC95 2 HU 19" rackmount kit for production environment

Meters and counters

## R&S®HM8118 LCR Bridge

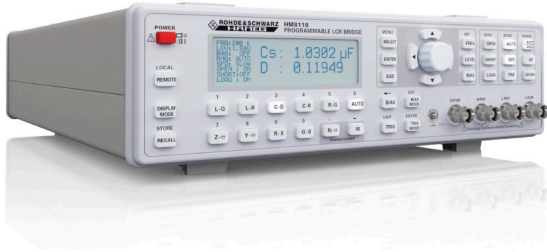

### Universal, flexible and easy to use

- ▶ Basic accuracy: 0.05%
- ▶ Up to 12 measurements per second
- ▶ Parallel and serial mode
- ▶ Internal programmable voltage and current bias
- ▶ Kelvin cable and four-terminal SMD test adapter included
- ▶ R&S®HO118 binning interface (optional) for automatic sorting of components

### Model overview

Model	Measurement range	Basic accuracy	Measurement functions	Measurement rate
R&S®HM8118	20 Hz to 200 kHz (69 steps)	0.05%	L, C, R,  Z , X,  Y , G, B, D, Q, φ, Δ, M, N	up to 12 values/s

### Important facts

Specification	R&S®HM8118	Why this is important
Triggers	continuous, manual or external control via interface, binning interface or trigger input	Accommodates more complex manufacturing setups
Interface	galvanically isolated RS-232, USB, IEEE-488 (GPIB) (available)	Most operations for an LCR meter are programmed. Having a modern and easy to use interface helps minimize input errors.

### Scope of delivery

- ▶ R&S®HZ184 four-terminal Kelvin test cable
- ▶ R&S®HZ188 four-terminal SMD component test fixture
- ▶ Operating manual
- ▶ Power cable
- ▶ 3 year warranty

### Recommended options/accessories

Description	Type
Binning interface (Rohde & Schwarz service center installation only)	R&S®HO118
Four-terminal test fixture including shorting plate	R&S®HZ181
Four-terminal transformer test cable	R&S®HZ186
IEEE-488 (GPIB) interface	R&S®HO880
19" rackmount kit, 2 HU	R&S®HZ42



R&S®HZ181 4-terminal test fixture including shorting plate



R&S®HZ186 4-terminal transformer test cable

## The perfect choice for

Engineering labs

Component validation

Production testing

General purpose

### Comfortable

Equivalent circuit and range selection, either manual or automatic

### Save/recall

Store and retrieve up to 10 instrument settings

### Trigger

Continuous, manual or external control via interface, binning interface or trigger input

### Complete

Internal voltage and current bias



The R&S®H0118 binning interface enables use with external hardware that sorts components by physical type after measurement. Data lines for eight sorting containers and control lines (ALARM, INDEX, EOM, TRIG)



R&S®HM8118 LCR bridge

Your benefit	Features
Versatile functionality, all usually needed measurements included	The R&S®HM8118 provides the full range of measurements to characterize resistors, capacitors and inductors; results are displayed in absolute, relative or average values
Easy to use	Frequently used functions are directly accessible via front panel keys
Easy to interface for remote control	RS-232/USB interface; optional IEEE-488 (GPIB)
Quiet on the bench	Fanless design



Direct control: The most important parameters are adjustable with the press of a button

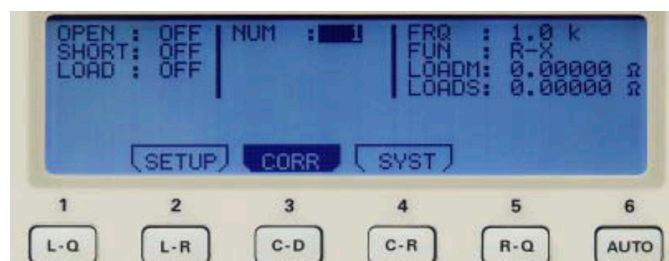

Ease of use: Activation and deactivation of OPEN, SHORT and LOAD correction

## R&S®HMC8015 Power Analyzer



### Comprehensive power analysis in a compact package

The R&S®HMC8015 power analyzer is the first compact tester for AC/DC load and standby current characterization that enables measurements without additional tools such as a computer or remote infrastructure. In addition to a numerical and graphical display with 26 key parameters, the instrument delivers performance and compliance protocols in line with IEC 62301, EN 50564 and EN 61000-3-2.

### Model overview

Model	Bandwidth	Sampling rate	Resolution	Voltage input	Current input	Basic accuracy	IEEE-488 (GPIB)
R&S®HMC8015	DC to 100 kHz	500 ksample/s	2 x 16-bit simultaneous sampling	up to 600 V (RMS)	up to 20 A (RMS)	0.05% of reading	-
R&S®HMC8015-G							•

### Important facts

Specification	R&S®HMC8015	Why this is important
Configurable user interface and display	fully configurable 3.5" QVGA color TFT display	Allows users to see the measurements. Also convenient for documentation and screenshot capture.
On-instrument policy testing	on-instrument energy star, IEC62301, EN 50564, EN 61000-3-2	Allows users to verify policies on the spot, without a PC and avoiding all of the associated IT and antivirus issues.
Broad set of advanced analysis	waveform mode, trendchart, inrush mode, harmonics view (using optional R&S®HVC151)	Gain insight into user problems quickly and easily with integrated analysis tools that are quick and easy to use.
Upgradeable voucher system	low base price plus options for advanced analysis, advanced I/O and policy testing	Gives users a low cost entry and allows them to purchase what they need, when they need it.

### Scope of delivery

- ▶ User manual
- ▶ Power cable
- ▶ 3 year warranty

### Recommended options/accessories

Description	Type
AC/DC current probe, 30 A, 4 mm connectors	R&S®HMC50
AC/DC current probe, 1000 A, 4 mm connectors	R&S®HMC51
Line adapters	
US version	R&S®HMC815-US
EU version	R&S®HMC815-EU
GB version	R&S®HMC815-GB
CHN/AUS version	R&S®HMC815-CHN
Advanced analysis, voucher upgrade	R&S®HOC/HVC151
Advanced I/O, voucher upgrade	R&S®HOC/HVC152
Compliance test, voucher upgrade	R&S®HOC/HVC153
19" rackmount kit, 2 HU	R&S®HMC95

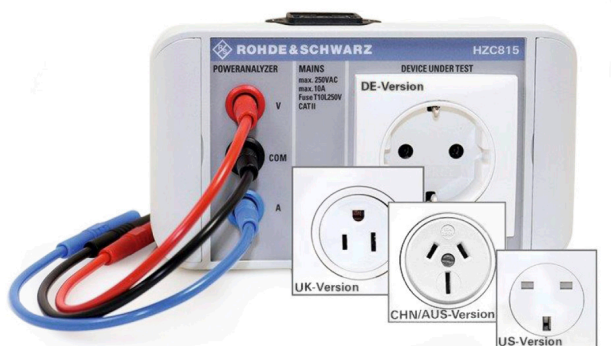

R&S®HMC815 adapter



## The perfect choice for

Engineering labs

General purpose

Production testing

Education



Inrush function

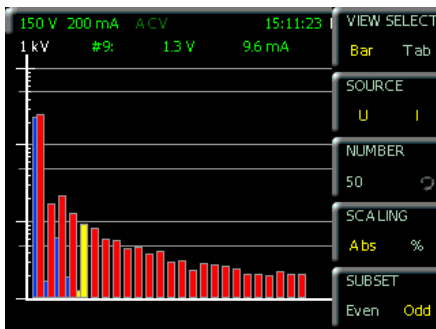

Harmonic analysis bargraph

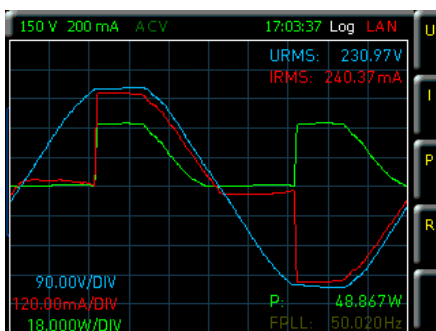

Waveform: load with phase-angle control

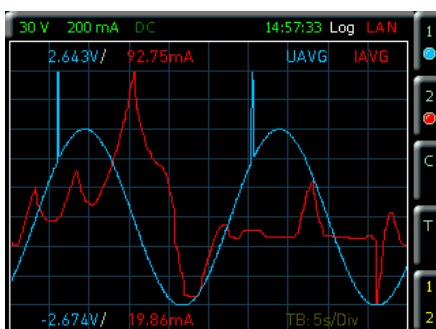

Trend chart function

Your benefit	Features
Clear display of all measured parameters	<ul style="list-style-type: none"> <li>▶ Simultaneous display of up to 10 numerical measurement functions</li> <li>▶ User-configurable measurement display</li> <li>▶ Graphical display modes for inrush, harmonic analysis, waveform and trend chart</li> </ul>
High measurement accuracy	<ul style="list-style-type: none"> <li>▶ Basic accuracy: 0.05%</li> <li>▶ Signal acquisition from DC to 100 kHz at a sampling rate of 500 ksample/s</li> <li>▶ Simultaneous display of current and voltage, each with 16-bit resolution</li> </ul>
Everyday measurement functions	<ul style="list-style-type: none"> <li>▶ 26 different measurement and mathematical functions</li> <li>▶ Limit testing with pass/fail indication for up to six selectable limits</li> </ul>

### Function overview with required options

Function	Description	Configuration
P	Active power (W)	Standard
S	Apparent power (VA)	Standard
Q	Reactive power (VAR)	Standard
PF	Power factor ( $\lambda$ )	Standard
PHI	Phase shift ( $\phi$ )	Standard
FU	Voltage frequency value (Hz)	Standard
FI	Current frequency value (Hz)	Standard
FPLL	Acquisition frequency (Hz)	Standard
URMS	RMS voltage (U RMS)	Standard
UAVG	Average voltage (U AVG)	Standard
IRMS	RMS current (I RMS)	Standard
IAVG	Average current (I AVG)	Standard
UTHD	Total harmonic distortion U	Standard
ITHD	Total harmonic distortion I	Standard
WHM, WHP, WH, AHM, AHP, AH	Energy counter (integrator values)	Standard
UPPeak	Maximum voltage (U PEAK)	R&S®HOC/HVC151
UMPeak	Minimum voltage (U PEAK)	R&S®HOC/HVC151
IPPeak	Maximum current (I PEAK)	R&S®HOC/HVC151
IMPeak	Minimum current (I PEAK)	R&S®HOC/HVC151
PPPeak	Maximum power (P PEAK)	R&S®HOC/HVC151
PMPeak	Minimum power (P PEAK)	R&S®HOC/HVC151
Harmonics	Bargraph of up to 50 harmonics	R&S®HOC/HVC151
Waveform	Waveform display (displays one period of voltage, current or power)	R&S®HOC/HVC151
Trend chart	Current and voltage displayed as a waveform	R&S®HOC/HVC151
Inrush	Triggered display of waveform (single shot)	R&S®HOC/HVC151
Sensor input	Input for current probe/external shunt	R&S®HOC/HVC152
DIN/AIN	Digital/analog inputs and outputs (BNC)	R&S®HOC/HVC152
Limit; pass/fail	Limit display	R&S®HOC/HVC152
IEC62301	Standby standard	R&S®HOC/HVC153
EN50564	Extended standby standard	R&S®HOC/HVC153
EN61000-3-2	Harmonic current for EMC, CE approval	R&S®HOC/HVC153

**Software options:** Can be ordered directly from the factory (R&S®HOC15x) or later (R&S®HVC15x) as a voucher.



## R&S®UPP Audio Analyzer



Brochure



Data sheet



Fact sheet



### Multichannel and cost-efficient, for use in the lab and in production

The compact, cost-efficient R&S®UPP200 audio analyzer is designed for system applications. It features low height and comes without front panel control elements or integrated display.

- ▶ Suitable for all interfaces: analog, digital and combined
- ▶ HDMI™ device testing
- ▶ Up to 80 kHz bandwidth and 200 kHz sampling rate

#### Model overview

Model	Channels	Analog analyzer frequency range	Analog analyzer voltage range (RMS, sine)	Analog audio inputs	Analog generator max. output level balanced (open circuit)	Audio monitor
R&S®UPP200	2	DC/20 Hz to 80 kHz	1 µV to 50 V	XLR female, balanced	14 V (RMS)	BNC connectors
R&S®UPP400	4	DC/20 Hz to 80 kHz	1 µV to 50 V	XLR female, balanced	14 V (RMS)	BNC connectors
R&S®UPP800	8	DC/20 Hz to 80 kHz	1 µV to 50 V	XLR female, balanced	14 V (RMS)	BNC connectors

#### Important facts

Specification	R&S®UPP200	Why this is important
Channels	2, 4 or 8 (up to 48 with optional cascading)	Ability to do multichannel testing for high throughput.
Max. analyzer bandwidth	80 kHz	Required by high-end broadband audio applications.
Sampling rate	200 kHz	The more samples provided, the better the frequency resolution you get.
FFT analysis	up to 256 ksample	Fast frequency response measurement implemented by means of an FFT provides a critical edge during this highly time-critical measurement.
Remote control interfaces	USB, LAN, IEEE-488 (GPIB)	Remote control capability is indispensable in production environments.

#### Scope of delivery

- ▶ Quick start guide
- ▶ CD with operating and service manual
- ▶ Power cable
- ▶ 3 year warranty

#### Recommended options/accessories

Hardware options	Type
Digital audio I/O	R&S®UPP-B2
HDMI™ and digital audio interfaces	R&S®UPP-B4
Software options	
Digital audio protocol for R&S®UPP-B2	R&S®UPP-K21
Dolby® data stream decoding for R&S®UPP-B4	R&S®UPP-K41
Extended audio/video measurements for R&S®UPP-B4	R&S®UPP-K45
1/n octave analysis	R&S®UPP-K601
System components	
XL/BNC adapter set, male	R&S®UP-Z1M
XL/BNC adapter set, male/female	R&S®UP-Z1MF
AES/EBU cable for R&S®UPP-B2	R&S®UP-Z2
I <sup>2</sup> S cable for R&S®UPP-B2/R&S®UPV-B41	R&S®UP-Z3
Eight-channel I <sup>2</sup> S cable for R&S®UPP-B4	R&S®UP-Z4



## The perfect choice for

Audio analysis

HDMI™ applications

Measurements on multichannel devices

Measurements on mixed interfaces

### Your benefit

Powerful and fast

All test signals and measurement functions in a single box

Convenient operation

### Features

- ▶ Parallel measurements for high throughput
- ▶ High measurement speed throughout the system
- ▶ Ideal for use in production
- ▶ Multichannel measurements by means of cascading
- ▶ Powerful and even multichannel FFT analysis
- ▶ User-programmable filters that can be adapted in seconds to the individual measurement task
- ▶ Integrated control PC
- ▶ State-of-the-art and intuitive user interface makes operation quick and easy to learn
- ▶ All measurement results at a glance
- ▶ Effective online help functions

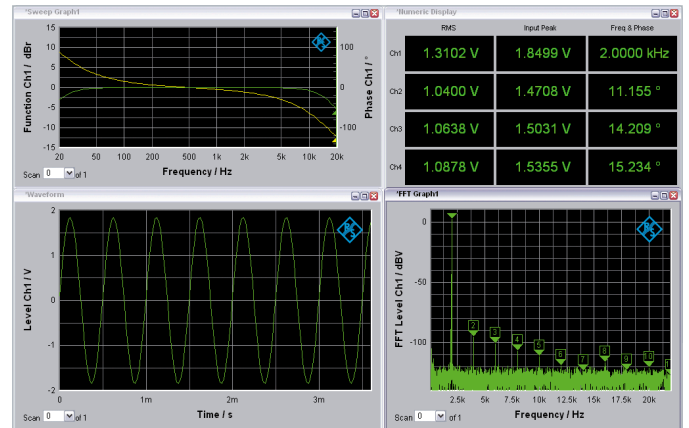
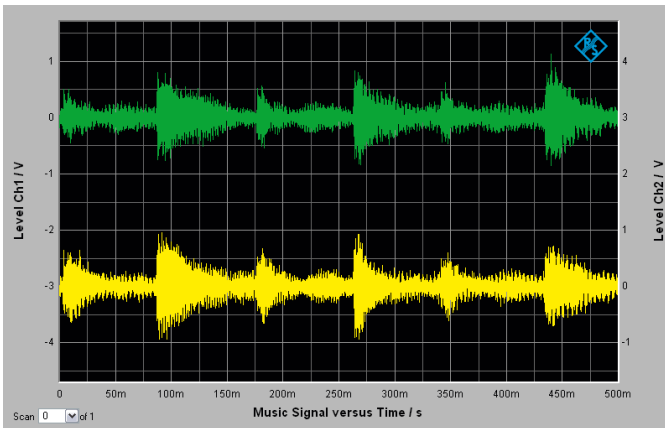

All test signals and measurement functions in a single box: Complex test signals from WAV files can be output at all interfaces; in this example, the waveform function shows the time characteristic of a dual-channel music signal

All measurement results at a glance: Multiple measurement diagrams can be arranged in any desired configuration on the screen; analyses in the frequency and the time domain can be displayed simultaneously

## Video pattern generator and four test patterns

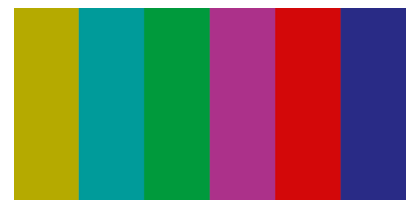
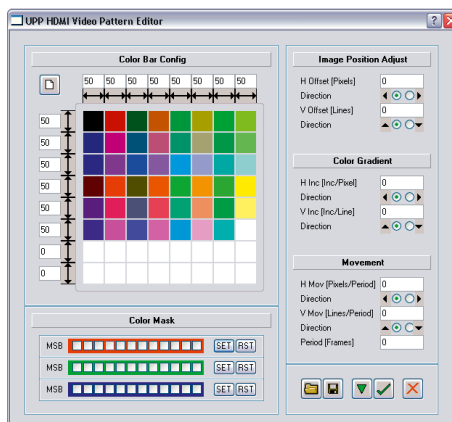
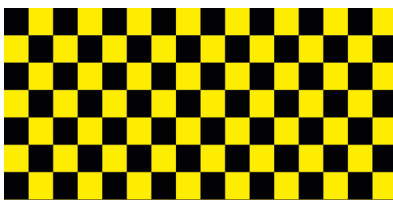

Meters and counters

# SERVICE YOU CAN RELY ON

## Extended warranty



### Long-term benefit: all the advantages of the R&S®Extended Warranty

Helping you get the best performance in your core business is our main focus. In addition to long-lived, high-end products, we offer very dependable service with our extended warranty. You can decide which of our high-performance service packages is right for you. The benefits of the R&S®Extended Warranty at a glance:

#### Low, predictable costs

With highly complex instruments or systems, it is not always possible to avoid problems. As the manufacturer, we are thoroughly familiar with the special features of our products and know where to look if there is a problem. Our R&S®Extended Warranty keeps the overall costs for your product transparent and consistent at all times. For example, a four-year warranty can often be cheaper than a single repair.

#### Added value

With every maintenance, repair and calibration, you benefit from efficient Rohde&Schwarz solutions. This can be very cost-effective in the long term.

#### Reliable and dependable

Lasting functionality and availability are fundamental to profitable operations. Regular maintenance and calibration of your Rohde&Schwarz instruments ensures dependable workflows that lose none of their precision even after many years. A four-year extended warranty with calibration coverage directly from the manufacturer ensures that your instruments are regularly checked and adjusted. You can depend on the highest precision and on everything going according to plan – now and in the future.

#### Added value

Nobody understands your instruments better than the manufacturer. Rohde&Schwarz service means that whenever we maintain or calibrate your instruments, we also check whether modifications and updates are called for, and bring them up to date. That's a service only the manufacturer can offer.

#### Transparent and flexible

Operation of your instruments can result in costs you did not originally factor in. The R&S®Extended Warranty makes it easy for you to keep an eye on your operating costs. Our knowledgeable representatives will help you find the right services for your business requirements. You can quickly find the best way to make sure your instruments always operate to their full potential, so you can focus on your core business.

#### Added value

The R&S®Extended Warranty makes it easy for you to budget by giving you absolute price stability for the term of the agreement. Our distribution partners can show you all of our service options.

## Extended warranty and calibration coverage

To make sure you get the full benefit of the functionality and precision of your instruments for the longest possible time, we offer a range of services that are tailored to your specific needs. Choose extended warranty (WE1 to WE2) for complete protection in the case of repairs, or the attractive extended warranty with calibration coverage package with R&S®Manufacturer Calibration (CW1 to CW2) for additional regular calibration of your instrument. All options are available with terms from one to two years depending on the duration of the standard warranty.

Description	Extended warranty (WE1-2)	Extended warranty with calibration coverage (CW1-2)
<b>Repair in case of malfunction</b> All repairs during the warranty period are free of charge.	•	•
<b>Calibration if necessary as part of repair</b> All necessary calibrations will be made during the repair.	•	•
<b>Planned calibrations in line with Rohde &amp; Schwarz guidelines and ISO/IEC 17025</b> With our precision test and diagnostics systems, we analyze your equipment in detail to detect and correct irregularities before they impact your measurements. Your instruments stay in top working condition.		•
<b>Calibration as needed as part of hardware upgrades</b> We take care that your Rohde & Schwarz product is regularly calibrated and maintained at the recommended intervals during the warranty period, including calibrations as part of hardware upgrades to the latest technologies.		•
<b>Firmware updates</b> As part of regular checks, we will update your instrument's firmware to improve product characteristics, enhance system performance and bring all functions up to date.	•	•
<b>Preventive maintenance and reliability modifications</b> To improve the performance and reliability of your instrument, we maintain it with the greatest care and precision. This naturally includes hardware updates, a service that only the manufacturer can offer.	•	•

### WE and CW for products with 3 year warranty

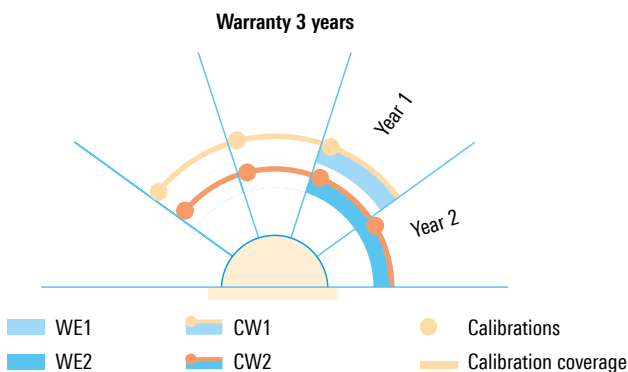

Get your products serviced within your region



# SERVICE

**Rohde & Schwarz stands for innovative service products throughout the entire product lifecycle, supported by a global service network.**

The following services are available in over 70 countries:

- ▶ Calibration
- ▶ Maintenance and repair
- ▶ Product updates and upgrades
- ▶ Remote service

Rohde & Schwarz regional service centers, plants and specialized subsidiaries provide a wide range of additional services for system customers:

- ▶ System integration
- ▶ Application support
- ▶ Development of customized modules, equipment and systems
- ▶ Software development
- ▶ Installation and commissioning
- ▶ Application support

During the product's useful life, Rohde & Schwarz supports its customers with service level agreements in the following areas:

- ▶ System support
- ▶ Training
- ▶ Maintenance
- ▶ Spare parts service
- ▶ Integrated logistics support
- ▶ Obsolescence management
- ▶ Technical documentation



## Service that adds value

- Worldwide
- Local and personalized
- Customized and flexible
- Uncompromising quality
- Long-term dependability



Repair service



Calibration lab

# CONTACT

## Rohde & Schwarz GmbH & Co. KG

[www.rohde-schwarz.com](http://www.rohde-schwarz.com)

## Corporate communications

Rohde & Schwarz GmbH & Co. KG  
Corporate Communications  
Mühlendorfstraße 15  
81671 Munich, Germany  
Phone +49 89 4129 139 58  
Fax +49 89 4129 135 63  
[press@rohde-schwarz.com](mailto:press@rohde-schwarz.com)

## Sales

The addresses of the local sales companies can be found at: [www.sales.rohde-schwarz.com](http://www.sales.rohde-schwarz.com)

## Rohde & Schwarz training

[www.training.rohde-schwarz.com](http://www.training.rohde-schwarz.com)

## Rohde & Schwarz customer support

Our customer support center will be happy to answer any questions regarding our products and service:  
[www.rohde-schwarz.com/support](http://www.rohde-schwarz.com/support)



## Plants

### Memmingen plant

[info.memmingen@rohde-schwarz.com](mailto:info.memmingen@rohde-schwarz.com)

### Teisnach plant

[info.teisnach@rohde-schwarz.com](mailto:info.teisnach@rohde-schwarz.com)

### Vimperk plant

[info.vimperk@rohde-schwarz.com](mailto:info.vimperk@rohde-schwarz.com)

# TRADEMARKS

## Trade names are trademarks of the owners

- ▶ R&S® is a registered trademark of Rohde & Schwarz GmbH & Co. KG.  
Example: R&S®FSC spectrum analyzer
- ▶ Windows is a registered trademark of Microsoft Corp., USA
- ▶ WiMAX Forum is a registered trademark of the WiMAX Forum. WiMAX, the WiMAX Forum logo, WiMAX Forum Certified and the WiMAX Forum Certified logo are trademarks of the WiMAX Forum
- ▶ The Bluetooth® word mark and logos are registered trademarks owned by Bluetooth SIG, Inc. and any use of such marks by Rohde & Schwarz is under license
- ▶ CDMA2000® is a registered trademark of the Telecommunications Industry Association (TIA-USA)
- ▶ The terms HDMI and HDMI High-Definition Multimedia Interface, and the HDMI Logo are trademarks or registered trademarks of HDMI Licensing LLC in the United States and other countries.

## Published by

Rohde & Schwarz GmbH & Co. KG  
Compilation, layout: Silke Knobloch, Department GF-BS1  
Translation: Department GF-BS2



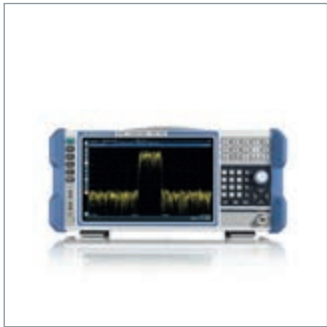

Rohde & Schwarz representative



R&S® is a registered trademark of Rohde & Schwarz GmbH & Co. KG  
Trade names are trademarks of the owners  
Printed in Germany (sk)  
PD 3609.4361.42 | Version 10.00 | March 2020  
Subject to change

© 2012 - 2020  
Rohde & Schwarz GmbH & Co. KG  
81671 Munich, Germany



PD 3609.4361.42 | Version 10.00 PDP: 1 en