

**STP 8-91W15-SM-TG**

# **SOLDIER'S MANUAL AND TRAINER'S GUIDE**

**MOS 91W**

**HEALTH  
CARE  
SPECIALIST**

**SKILL LEVELS 1/2/3/4/5**

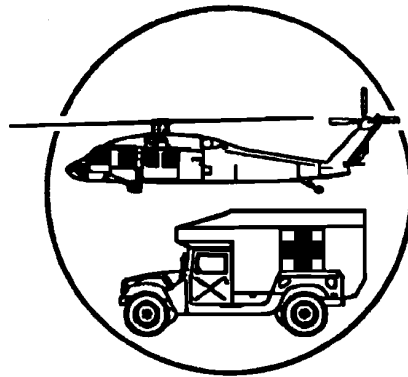

**HEADQUARTERS, DEPARTMENT OF THE ARMY**

**DISTRIBUTION RESTRICTION: Approved for public release; distribution is unlimited.**

\*SOLDIER TRAINING  
PUBLICATION  
No. 8-91W15-SM-TG

HEADQUARTERS  
DEPARTMENT OF THE ARMY  
Washington, DC, 10 October 2001

## SOLDIER'S MANUAL and TRAINER'S GUIDE

### MOS 91W

### Soldier's Manual, Skill Levels 1/2/3/4/5 and Trainer's Guide, MOS 91W, Health Care Specialist

### Skill Levels 1, 2, 3, 4 and 5

#### TABLE OF CONTENTS

	<u>PAGE</u>
<b>Table of Contents</b> .....	<b>i</b>
<b>Preface</b> .....	<b>vi</b>
<b>Chapter 1. Introduction</b> .....	<b>1-1</b>
1-1. General .....	1-1
1-2. Battle Focused Training.....	1-1
1-3. Relationship of Soldier Training Publications (STPs) to Battle Focused Training.....	1-1
1-4. Task Summaries.....	1-1
1-5. Soldier's Responsibilities .....	1-2
1-6. NCO Self-Development and the Soldier's Manual .....	1-2
1-7. Trainer's Responsibilities.....	1-3
1-8. Training Tips for the Trainer .....	1-5
1-9. Training Support .....	1-6
<b>Chapter 2. Trainer's Guide</b> .....	<b>2-1</b>
2-1. General .....	2-1
2-2. Part One, Section I. Subject Area Codes .....	2-3
2-3. Part One, Section II. Duty Position Training Requirements .....	2-4
2-4. Part Two. Critical Tasks List .....	2-5

---

\*DISTRIBUTION RESTRICTION: Approved for public release; distribution is unlimited.

\*This publication supersedes STP 8-91B15-SM-TG, 3 October 1995 and STP 8-91C25-SM-TG, 17 July 1990.

**Chapter 3. MOS/Skill Level Tasks ..... 3-1****Skill Level 1****Subject Area 1: Vital Signs**

081-831-0010	MEASURE A PATIENT'S RESPIRATIONS.....	3-1
081-831-0011	MEASURE A PATIENT'S PULSE.....	3-3
081-831-0012	MEASURE A PATIENT'S BLOOD PRESSURE .....	3-6
081-831-0013	MEASURE A PATIENT'S TEMPERATURE .....	3-9
081-833-0164	MEASURE A PATIENT'S PULSE OXYGEN SATURATION.....	3-12

**Subject Area 2: Emergency Medical Treatment**

081-831-0018	OPEN THE AIRWAY .....	3-14
081-831-0019	CLEAR AN UPPER AIRWAY OBSTRUCTION .....	3-16
081-831-0046	ADMINISTER EXTERNAL CHEST COMPRESSIONS.....	3-19
081-831-0048	PERFORM RESCUE BREATHING .....	3-23
081-833-0161	CONTROL BLEEDING .....	3-27
081-833-0167	PLACE A PATIENT ON A CARDIAC MONITOR .....	3-30
081-833-3027	MANAGE CARDIAC ARREST USING AED.....	3-32

**Subject Area 3: Basic Medical Care**

081-831-0007	PERFORM A PATIENT CARE HANDWASH .....	3-35
081-831-0008	PUT ON STERILE GLOVES.....	3-37
081-831-0033	INITIATE A FIELD MEDICAL CARD .....	3-40
081-833-0076	APPLY RESTRAINING DEVICES TO PATIENTS .....	3-42
081-833-0006	MEASURE A PATIENT'S INTAKE AND OUTPUT .....	3-45
081-833-0007	ESTABLISH A STERILE FIELD.....	3-48
081-833-0010	CHANGE A STERILE DRESSING .....	3-50
081-833-0012	PERFORM A WOUND IRRIGATION .....	3-54
081-833-0021	PERFORM ORAL AND NASOPHARYNGEAL SUCTIONING OF A PATIENT .....	3-57
081-833-0059	IRRIGATE AN OBSTRUCTED EAR.....	3-61
081-833-0145	DOCUMENT PATIENT CARE USING SUBJECTIVE, OBJECTIVE, ASSESSMENT, PLAN (SOAP) NOTE FORMAT .....	3-64
081-833-0165	PERFORM PATIENT HYGIENE.....	3-66
081-835-3007	OBTAIN AN ELECTROCARDIOGRAM.....	3-71

**Subject Area 4: Respiratory Dysfunction/Airway Management**

081-833-0016	INSERT AN OROPHARYNGEAL AIRWAY (J TUBE).....	3-78
081-833-0018	SET UP AN OXYGEN TANK.....	3-80
081-833-0142	INSERT A NASOPHARYNGEAL AIRWAY .....	3-86
081-833-0158	ADMINISTER OXYGEN .....	3-88
081-833-0169	INSERT A COMBITUBE .....	3-91
081-833-3006	PERFORM A NEEDLE CRICOTHYROIDOTOMY .....	3-93
081-833-3007	PERFORM NEEDLE CHEST DECOMPRESSION .....	3-96

**Subject Area 5: Venipuncture and IV Therapy**

081-833-0032	OBTAIN A BLOOD SPECIMEN USING A VACUTAINER.....	3-99
081-833-0033	INITIATE AN INTRAVENOUS INFUSION.....	3-104
081-833-0034	MANAGE A PATIENT WITH AN INTRAVENOUS INFUSION .....	3-109
081-835-3025	INITIATE A SALINE LOCK .....	3-114

**Subject Area 6: Casualty Management**

081-831-0035	MANAGE A CONVULSIVE AND/OR SEIZING PATIENT .....	3-118
081-833-0045	TREAT A CASUALTY WITH AN OPEN ABDOMINAL WOUND .....	3-121
081-833-0046	APPLY A DRESSING TO AN IMPALEMENT INJURY.....	3-123
081-833-0048	MANAGE AN UNCONSCIOUS CASUALTY .....	3-125
081-833-0049	TREAT A CASUALTY WITH A CLOSED CHEST WOUND.....	3-128
081-833-0050	TREAT A CASUALTY WITH AN OPEN CHEST WOUND.....	3-132
081-833-0052	TREAT A CASUALTY WITH AN OPEN OR CLOSED HEAD INJURY .....	3-135
081-833-0070	ADMINISTER INITIAL TREATMENT FOR BURNS .....	3-139
081-833-0103	PROVIDE CARE FOR A SOLDIER WITH SYMPTOMS OF BATTLE FATIGUE .....	3-144
081-833-0116	ASSIST IN VAGINAL DELIVERY .....	3-147
081-833-0143	TREAT A POISONED CASUALTY.....	3-151
081-833-0144	TREAT A DIABETIC EMERGENCY .....	3-154
081-833-0155	PERFORM A TRAUMA CASUALTY ASSESSMENT.....	3-157
081-833-0156	PERFORM A MEDICAL PATIENT ASSESSMENT.....	3-163
081-833-0159	TREAT A CARDIAC EMERGENCY .....	3-167
081-833-0160	TREAT A RESPIRATORY EMERGENCY.....	3-169
081-835-3030	DETERMINE A PATIENT'S LEVEL OF CONSCIOUSNESS USING THE GLASGOW COMA SCALE .....	3-171

**Subject Area 7: Eye Injuries**

081-833-0054	IRRIGATE EYES.....	3-174
081-833-0056	TREAT FOREIGN BODIES OF THE EYE.....	3-176
081-833-0057	TREAT LACERATIONS, CONTUSIONS, AND EXTRUSIONS OF THE EYE ....	3-178
081-833-0058	TREAT BURNS OF THE EYE .....	3-181

**Subject Area 8: Skeletal Dysfunction**

081-831-0044	APPLY A PNEUMATIC SPLINT TO A CASUALTY WITH A SUSPECTED FRACTURE OF AN EXTREMITY .....	3-183
081-833-0060	APPLY A ROLLER BANDAGE .....	3-185
081-833-0062	IMMOBILIZE A SUSPECTED FRACTURE OF THE ARM OR DISLOCATED SHOULDER.....	3-190
081-833-0064	IMMOBILIZE A SUSPECTED DISLOCATED OR FRACTURED HIP .....	3-193
081-833-0092	TRANSPORT A CASUALTY WITH A SUSPECTED SPINAL INJURY.....	3-196
081-833-0141	APPLY A TRACTION SPLINT .....	3-201
081-833-0154	PROVIDE BASIC EMERGENCY TREATMENT FOR A PAINFUL, SWOLLEN, DEFORMED EXTREMITY.....	3-208

**Subject Area 9: Environmental Injuries**

081-831-0038	TREAT A CASUALTY FOR A HEAT INJURY .....	3-210
081-831-0039	TREAT A CASUALTY FOR A COLD INJURY.....	3-213
081-833-0031	INITIATE TREATMENT FOR ANAPHYLACTIC SHOCK.....	3-217
081-833-0072	TREAT A CASUALTY FOR INSECT BITES OR STINGS.....	3-219
081-833-0073	TREAT A CASUALTY FOR SNAKEBITE.....	3-223

**Subject Area 10: Chemical Agent Injuries**

081-833-0083	TREAT A NERVE AGENT CASUALTY IN THE FIELD.....	3-226
081-833-0084	TREAT A BLOOD AGENT (HYDROGEN CYANIDE) CASUALTY IN THE FIELD.....	3-230
081-833-0085	TREAT A CHOKING AGENT CASUALTY IN THE FIELD .....	3-232
081-833-0086	TREAT A BLISTER AGENT CASUALTY (MUSTARD, LEWISITE, PHOSGENE OXIME) IN THE FIELD .....	3-234
081-833-0095	DECONTAMINATE A CASUALTY .....	3-237

**Subject Area 11: Shock**

081-833-0047	INITIATE TREATMENT FOR HYPOVOLEMIC SHOCK .....	3-244
081-833-3011	APPLY PNEUMATIC ANTI-SHOCK GARMENT .....	3-246

**Subject Area 12: Urinary Catheterization**

081-833-3017	INSERT A URINARY CATHETER.....	3-250
081-835-3010	MAINTAIN AN INDWELLING URINARY CATHETER.....	3-253

**Subject Area 13: Gastric Intubation**

081-833-3022	INSERT A NASOGASTRIC TUBE.....	3-256
081-835-3005	PERFORM A GASTRIC LAVAGE .....	3-259

**Subject Area 14: Triage and Evacuation**

071-334-4001	GUIDE A HELICOPTER TO A LANDING POINT.....	3-262
071-334-4002	ESTABLISH A HELICOPTER LANDING POINT.....	3-269
081-833-0080	TRIAGE CASUALTIES ON A CONVENTIONAL BATTLEFIELD .....	3-272
081-833-0082	TRIAGE CASUALTIES ON AN INTEGRATED BATTLEFIELD .....	3-276
081-833-0151	LOAD CASUALTIES ONTO GROUND EVACUATION PLATFORMS.....	3-278
081-833-0171	LOAD CASUALTIES ONTO NONSTANDARD VEHICLES, 1 1/4 TON, 4X4, M998.....	3-286
081-833-0172	LOAD CASUALTIES ONTO NONSTANDARD VEHICLES, 2 1/2 TON, 6X6 OR 5 TON, 6X6, CARGO TRUCK .....	3-289
081-833-0173	LOAD CASUALTIES ONTO NONSTANDARD VEHICLES, 5 TON M-1085, M-1093, 2 1/2 TON M-1081.....	3-291

**Subject Area 15: Medication Administration**

081-833-0088	PREPARE AN INJECTION FOR ADMINISTRATION .....	3-294
081-833-0089	ADMINISTER AN INJECTION (INTRAMUSCULAR, SUBCUTANEOUS, INTRADERMAL).....	3-299
081-833-0174	ADMINISTER MORPHINE .....	3-304
081-835-3001	ADMINISTER ORAL MEDICATIONS .....	3-306
081-835-3020	ADMINISTER TOPICAL MEDICATIONS .....	3-309
081-835-3021	ADMINISTER RECTAL OR VAGINAL MEDICATIONS .....	3-312
081-835-3022	ADMINISTER MEDICATED EYE DROPS OR OINTMENTS.....	3-315

**Subject Area 16: Force Protection/Risk Assessment**

081-831-0037	DISINFECT WATER FOR DRINKING.....	3-318
--------------	-----------------------------------	-------

**Skill Level 2**

**Subject Area 17: Advanced Procedures (SL 2)**

081-833-0170	PERFORM ENDOTRACHEAL SUCTIONING OF A PATIENT .....	3-320
081-835-3024	PROVIDE TRACHEOSTOMY CARE .....	3-323
081-835-3031	PROVIDE NURSING CARE FOR A PATIENT WITH A WATERSEAL DRAINAGE SYSTEM .....	3-326

**Skill Level 3**

**Subject Area 18: Advanced Procedures (SL 3)**

081-830-3016	INTUBATE A PATIENT .....	3-333
081-833-0093	SET UP A CASUALTY DECONTAMINATION STATION .....	3-339
081-833-0168	INSERT A CHEST TUBE.....	3-343
081-833-3005	PERFORM A SURGICAL CRICOTHYROIDOTOMY .....	3-345
081-833-3014	PERFORM A NEUROLOGICAL EXAMINATION ON A PATIENT WITH SUSPECTED CENTRAL NERVOUS SYSTEM (CNS) INJURIES .....	3-348
081-835-3000	ADMINISTER BLOOD .....	3-352
081-835-3002	ADMINISTER MEDICATIONS BY IV PIGGYBACK .....	3-357
081-833-3208	SUTURE A MINOR LACERATION.....	3-360
<b>Appendix A</b>	.....	<b>A-1</b>
<b>Appendix B</b>	.....	<b>B-1</b>
<b>Glossary</b>	.....	<b>Glossary-1</b>
<b>Supporting References</b>	.....	<b>References-1</b>

## PREFACE

This publication is for skill level 1, 2, 3, 4, and 5 soldiers holding military occupational specialty (MOS) 91W and for trainers and first-line supervisors. It contains standardized training objectives, in the form of task summaries, to train and evaluate soldiers on critical tasks that support unit missions during wartime. Trainers and first-line supervisors should ensure soldiers holding MOS/SL 91W1/2/3/4/5 have access to this publication. This STP is available for download from the Reimer Digital Library (RDL).

This manual applies to both Active and Reserve Component soldiers.

The proponent of this publication is HQ, TRADOC. Send comments and recommendations on DA Form 2028 (Recommended Changes to Publications and Blank Forms) directly to Academy of Health Sciences, ATTN: MCCS-HLD, 2250 Stanley Road, STE 326, Fort Sam Houston, TX 78234-6130.

## CHAPTER 1

### Introduction

#### 1-1. General

This manual identifies the individual MOS training requirements for soldiers in MOS 91W. Commanders, trainers, and soldiers should use it to plan, conduct, and evaluate individual training in units. This manual is the primary MOS reference to support the self-development and training of every soldier.

Use this manual with Soldier's Manuals of Common Tasks (STP 21-1-SMCT and STP 21-24-SMCT), Army Training and Evaluation Programs (ARTEPs), and FM 25-101, Battle Focused Training, to establish effective training plans and programs which integrate soldier, leader, and collective tasks.

#### 1-2. Battle Focused Training

As described in FM 25-100, Training the Force, and FM 25-101, Battle Focused Training, the commander must first define the mission essential task list (METL) as the basis for unit training. Unit leaders use the METL to identify the collective, leader, and soldier tasks which support accomplishment of the METL. Unit leaders then assess the status of training and lay out the training objectives and the plan for accomplishing needed training. After preparing the long- and short-range plans, leaders then execute and evaluate training. Finally, the unit's training preparedness is reassessed, and the training management cycle begins again. This process ensures that the unit has identified what is important for the wartime mission, that the training focus is applied to the necessary training, and that training meets established objectives and standards.

#### 1-3. Relationship of Soldier Training Publications (STPs) to Battle Focused Training

The two key components of enlisted STPs are the Trainer's Guide (TG) and Soldier's Manual (SM). The TG and SM give leaders important information to help in the battle focused training process. The TG relates soldier and leader tasks in the MOS and SL to duty positions and equipment. It provides information on where the task is trained, how often training should occur to sustain proficiency, and who in the unit should be trained. As leaders go through the assessment and planning stages, they should use the TG as an important tool in identifying what needs to be trained.

The execution and evaluation of soldier and leader training should rely on the Armywide training objectives and standards in the SM task summaries. The task summaries ensure that soldiers in any unit or location have the same definition of task performance and that trainers evaluate the soldiers to the same standard.

#### 1-4. Task Summaries

Task summaries contain information necessary to conduct training and evaluate soldier proficiency on tasks critical to the MOS. A separate task summary is provided for each critical task. These task summaries are, in effect, standardized training objectives which ensure that



soldiers do not have to relearn a task on reassignment to a new unit. The format for the task summaries included in this manual is as follows:

- **Task Title.** The task title identifies the action to be performed.
- **Task Number.** A 10-digit number identifies each task or skill. Include this task number, along with task title, in any correspondence relating to the task.
- **Conditions.** The task conditions identify all the equipment, tools, references, job aids, and supporting personnel that the soldier needs to perform the task in wartime. This section identifies any environmental conditions that can alter task performance, such as visibility, temperature, and wind. This section also identifies any specific cues or events that trigger task performance.
- **Standards.** The task standards describe how well and to what level you must perform a task under wartime conditions. Standards are typically described in terms of accuracy, completeness, and/or speed.
- **Performance Steps.** This section includes a detailed outline of information on how to perform the task.
- **Evaluation Preparation (when used).** This subsection indicates necessary modifications to task performance in order to train and evaluate a task that cannot be trained to the wartime standard under wartime conditions. It may also include special training and evaluation preparation instructions to accommodate these modifications and any instruction that should be given to the soldier before evaluation.
- **Performance Measures.** This evaluation guide identifies the specific actions that the soldier must do to successfully complete the task. These actions are listed in a GO/NO-GO format for easy evaluation. Each evaluation guide contains a feedback statement that indicates the requirements for receiving a GO on the evaluation.
- **References.** This section identifies references that provide more detailed and thorough explanations of task performance requirements than that given in the task summary description.

Additionally, some task summaries include safety statements and notes. Safety statements (danger, warning, and caution) alert users to the possibility of immediate death, personal injury, or damage to equipment. Notes provide a small, extra supportive explanation or hint relative to the performance measures.

### **1-5. Soldier's Responsibilities**

Each soldier is responsible for performing individual tasks which the first-line supervisor identifies based on the unit's METL. The soldier must perform the tasks to the standards listed in the SM. If a soldier has a question about how to do a task or which tasks in this manual he or she must perform, it is the soldier's responsibility to ask the first-line supervisor for clarification. The first-line supervisor knows how to perform each task or can direct the soldier to the appropriate training materials.

### **1-6. NCO Self-Development and the Soldier's Manual**

Self-development is one of the key components of the leader development program. It is a planned progressive and sequential program followed by leaders to enhance and sustain their military competencies. It consists of individual study, research, professional reading, practice, and self-assessment. Under the self-development concept, the NCO, as an Army professional,

has the responsibility to remain current in all phases of the MOS. The SM is the primary source for the NCO to use in maintaining MOS proficiency.

Another important resource for NCO self-development is the Army Correspondence Course Program (ACCP). Refer to DA Pamphlet 350-59 for information on enrolling in this program and for a list of courses, or write to: AMEDDC&S, ATTN: MCCS-HSN, 2105 11TH STREET SUITE 4191, FORT SAM HOUSTON TX 78234-5064.

Unit learning centers are valuable resources for planning self-development programs. They can help access enlisted career maps, training support products, and extension training materials. A life cycle management diagram for MOS 91W soldiers is on page 1-4. You can find more information and check for updates to this diagram at <http://das.cs.amedd.army.mil/ooc.htm> (scroll down to LIFE CYCLE MANAGEMENT, select ENLISTED, and find the appropriate tab along the bottom.) This information, combined with the MOS Training Plan in Chapter 2, forms the career development model for the MOS.

### **1-7. Trainer's Responsibilities**

Training soldier and leader tasks to standard and relating this training to collective mission-essential tasks is the NCO trainer's responsibility. Trainers use the steps below to plan and evaluate training.

- Identify soldier and leader training requirements. The NCO determines which tasks soldiers need to train on using the commander's training strategy. The unit's METL and ARTEP and the MOS Training Plan (MTP) in the TG are sources for helping the trainer define the individual training needed.
- Plan the training. Training for specific tasks can usually be integrated or conducted concurrently with other training or during "slack periods." The unit's ARTEP can assist in identifying soldier and leader tasks which can be trained and evaluated concurrently with collective task training and evaluation.
- Gather the training references and materials. The SM task summary lists all references which can assist the trainer in preparing for the training of that task.
- Determine risk assessment and identify safety concerns. Analyze the risk involved in training a specific task under the current conditions at the time of scheduled training. Ensure that your training preparation takes into account those cautions, warnings, and dangers associated with each task.
- Train each soldier. Show the soldier how the task is done to standard, and explain step-by-step how to do the task. Give each soldier one chance to do the task step-by-step.
- Emphasize training in mission-oriented protective posture (MOPP) level 4 clothing. Soldiers have difficulty performing even the very simple tasks in an NBC environment. The combat effectiveness of the soldier and the unit can degrade quickly when trying to perform in MOPP 4. Practice is the best way to improve performance. The trainer is responsible for training and evaluating soldiers in MOPP 4 so that they are able to perform critical wartime tasks to standards under NBC environment conditions.

**MOS 91W**  
**Health Care Specialist**  
**CAREER/TRAINING LIFE CYCLE**

RANK	AMEDD Course NR	TRAINING	LENGTH	LOCATION	ATTENDANCE REQUIREMENT	Self-Development Course NR	SELF-DEVELOPMENT	LENGTH	LOCATION	ATTENDANCE REQUIREMENT
E1 - E5		Basic Combat Training Course	9 wks	Ft. LW Ft. Sill Ft. Jackson Ft. Benning	IET		<b>TC-8-800 (Semi-Annual Combat Medical Skills Validation Test)</b>		Unit Training	Semi-Annual
	<a href="#">300-91W10</a>	Health Care Specialist	16 wks	FSH, TX	IET		<b>Army Correspondence Course Program</b>			
		SEE ASI N3, N9, P1, P2, P3, M6, Y6 PLDC	4 wks	Multiple sites	Leadership	<a href="#">MD0010</a>	Basic Medical Terminology		Correspondence	Optional
	<a href="#">300-F6</a>	Flight Medical Aidman	4 wks	USASAM	SQI-F /optional	MD1014	Exportable Sustainment Training/ Recertification Training Package		Unit Training	Sustainment
						MD1273	91B Rapid Train-Up		Unit Training	Just in Time
	<a href="#">6-8-C40</a>	BNCOC	17 wks, 1 day	FSH, TX	Leadership	MD1290	ASMART		Unit Training	Sustainment
		Transition Training					081-91W10 Medical Academic Preparatory Course		Correspondence	Preparatory
	<b>300-91W(Trauma AIMS)</b>	<b>Transition Training MOS Health Care Specialist, Trauma Aims</b>	<b>68 Hrs</b>	<b>Multiple sites</b>	<b>Prepares Soldiers holding Primary MOS 91B for transition to MOS 91W</b>		081-91W10 Medical Specialist Sustainment		Correspondence	Sustainment
	<b>300-91W(PHTLS)(ADV)</b>	<b>Transition Training MOS Health Care Specialist, Advanced Pre-Hospital Life Support</b>	<b>20 Hrs</b>	<b>Multiple sites</b>	<b>Prepares Soldiers holding Primary MOS 91B for transition to MOS 91W</b>		081-91W20/30 Medical NCO Sustainment		Correspondence	Sustainment
	<b>300-91W(EMT BRIDGE)</b>	<b>Transition Training MOS Health Care Specialist, EMT Bridge</b>	<b>60 Hrs</b>	<b>Multiple sites</b>	<b>Prepares Soldiers holding Primary MOS 91B for transition to MOS 91W</b>		Combat Life Saver (CLS)		Unit Training	Just in Time
	<b>300-91W(BTLS)(ADV)</b>	<b>Transition Training MOS Health Care Specialist, Advanced Basic Trauma Life Support</b>	<b>24 Hrs</b>	<b>Multiple sites</b>	<b>Prepares Soldiers holding Primary MOS 91B for transition to MOS 91W</b>		<b>PPSCP</b>			
	<b>300-91W(EMT-B)</b>	<b>Transition Training MOS Health Care Specialist, EMT Basic</b>	<b>120 Hrs</b>	<b>Multiple sites</b>	<b>Prepares Soldiers holding Primary MOS 91B for transition to MOS 91W</b>					
E6 - E9		<b>Instructor Courses</b>				<a href="#">300-A0704</a>	75/71 Personnel/Retention Legal/EO	4 days	SA, TX	Just in Time
	<a href="#">5K-F3/520-F3</a>	Instructor Training Course	10 days	AHS, FSH, TX	Just in time SQI-H	340-A0715	MEDCOM CSM/SGM NCO Short Course	4 days	SA, TX	Leadership
	<a href="#">5K-F6/520-F6</a>	Small Group Instruction Training	5 days	AHS, FSH, TX	Just in Time	<a href="#">340-A0743</a>	CSM/SGM SR NCO Course	4 days	Landstuhl, Germany	Leadership
		Battle Staff	6 wks, 2 days	USASMA	Just in time - ASI 2S	<a href="#">6A-300/A0130</a>	Emergency Med on the Riverwalk	5 days	SA, TX	Just in Time
		Recruiter	6 wks	USAREC	Just in time	<a href="#">6E-300/A0502</a>	Field Medicine Short Course	5 days	Ft Bragg, NC	Just in Time
		Master Fitness Trainer	2 wks	Multiple sites	Just in time ASI-P5	<a href="#">6H-300/A0406</a>	Sperandio POITS Short Course	5 days	Dallas, TX	Just in Time
		Drill Sgt School	9 wks	Multiple Sites	Just in Time SQI-X					
	<a href="#">6-8-C42</a>	ANCOC (SL4)	6 wks	FSH, TX	Leadership		<b>Specialty Courses</b>			
		First Sergeant Course	5 wks	USASMA	Just in time SQI-M	<a href="#">5K-F7/520-F7(PILOT)</a>	Advanced Instructor Training	1 Wk, 3 Days	Fort Sam Houston, TX	
		SGM Course	9 months	USASMA	Just in time MEL-A	<a href="#">5K-F8/520-F8(PILOT)</a>	Education and Training for the 21st Century	4 Weeks	Fort Sam Houston, TX	
		CSM Course	1 wk	USASMA	Just in time/leadership					

**NOTE: Must maintain EMT Certification.**

- Check each soldier. Evaluate how well each soldier performs the tasks in this manual. Conduct these evaluations during individual training sessions or while evaluating soldier proficiency during the conduct of unit collective tasks. This manual provides an evaluation guide for each task to enhance the trainer's ability to conduct year-round, hands-on evaluations of tasks critical to the unit's mission. Use the information in the MTP as a guide to determine how often to train the soldier on each task to ensure that soldiers sustain proficiency.
  - Record the results. The leader book referred to in FM 25-101, appendix B, is used to record task performance and gives the leader total flexibility on the method of recording training. The trainer may use DA Forms 5164-R (Hands-On Evaluation) and 5165-R (Field Expedient Squad Book) as part of the leader book. The forms are optional and locally reproducible. STP 21-24-SMCT contains a copy of the forms and instructions for their use.
  - Retrain and evaluate. Work with each soldier until he or she can perform the task to specific SM standards.

### **1-8. Training Tips for the Trainer**

Prepare yourself.

- Get training guidance from your chain of command on when to train, which soldiers to train, availability of resources, and a training site.
- Get the training objective (task, conditions, and standards) from the task summary in this manual.
- Ensure you can do the task. Review the task summary and the references in the reference section. Practice doing the task or, if necessary, have someone train you on the task.
- Choose a training method.
- Prepare a training outline consisting of informal notes on what you want to cover during your training session.
- Practice your training presentation.

Prepare the resources.

- Obtain the required resources identified in the conditions statement for each task.
- Gather equipment and ensure it is operational.
- Coordinate for use of training aids and devices.
- Prepare the training site according to the conditions statement and evaluation preparation section of the task summary, as appropriate.

Prepare the soldiers.

- Tell the soldier what task to do and how well it must be done. Refer to the standards statement and evaluation preparation section for each task as appropriate.
- Caution soldiers about safety, environment, and security.
- Provide any necessary training on basic skills that soldiers must have before they can be trained on the task.
- Pretest each soldier to determine who needs training in what areas by having the soldier perform the task. Use DA Form 5164-R and the evaluation guide in each task summary to make this determination.

**NOTE:** Deficiencies noted in soldiers' ability to perform critical tasks taught in schools or by extension training materials should be reported to the proponent school.

Train the soldiers who failed the pretest.

- Demonstrate how to do the task or the specific performance steps to those soldiers who could not perform to SM standards. Have soldiers study the appropriate materials.
- Have soldiers practice the task until they can perform it to SM standards.
- Evaluate each soldier using the evaluation guide.
- Provide feedback to those soldiers who fail to perform to SM standards and have them continue to practice until they can perform to SM standards.

Record results in the leader book.

## **1-9. Training Support**

This manual includes the following information which provides additional training support information.

- Appendix A, DA Form 5165-R (Field Expedient Squad Book). This appendix provides an overprinted copy of DA Form 5165-R for the tasks in this MOS. The NCO trainer can use this form to set up the leader book described in FM 25-101, appendix B.
- Appendix B contains information that is used in performing drug dosage calculations.
- Glossary. The glossary, which follows the last appendix, is a single comprehensive list of acronyms, abbreviations, definitions, and letter symbols.
- References. This section contains two lists of references, required and related, which support training of all tasks in this SM. Required references are listed in the conditions statement and are required for the soldier to do the task. Related references are materials which provide more detailed information and a more thorough explanation of task performance.

## CHAPTER 2

### Trainer's Guide

**2-1. General.** The MOS Training Plan (MTP) identifies the essential components of a unit training plan for individual training. Units have different training needs and requirements based on differences in environment, location, equipment, dispersion, and similar factors. Therefore, the MTP should be used as a guide for conducting unit training and not a rigid standard. The MTP consists of two parts. Each part is designed to assist the commander in preparing a unit training plan which satisfies integration, cross training, training up, and sustainment training requirements for soldiers in this MOS.

Part One of the MTP shows the relationship of an MOS skill level between duty position and critical tasks. These critical tasks are grouped by task commonality into subject areas.

Section I lists subject area numbers and titles used throughout the MTP. These subject areas are used to define the training requirements for each duty position within an MOS.

Section II identifies the total training requirement for each duty position within an MOS and provides a recommendation for cross training and train-up/merger training.

- **Duty Position column.** This column lists the duty positions of the MOS, by skill level, which have different training requirements.
- **Subject Area column.** This column lists, by numerical key (see Section I), the subject areas a soldier must be proficient in to perform in that duty position.
- **Cross Train column.** This column lists the recommended duty position for which soldiers should be cross trained.
- **Train-up/Merger column.** This column lists the corresponding duty position for the next higher skill level or MOSC the soldier will merge into on promotion.

Part Two lists, by general subject areas, the critical tasks to be trained in an MOS and the type of training required (resident, integration, or sustainment).

- **Subject Area column.** This column lists the subject area number and title in the same order as Section I, Part One of the MTP.
- **Task Number column.** This column lists the task numbers for all tasks included in the subject area.
- **Title column.** This column lists the task title for each task in the subject area.
- **Training Location column.** This column identifies the training location where the task is first trained to soldier training publications standards. If the task is first trained to standard in the unit, the word "Unit" will be in this column. If the task is first trained to standard in the training base, it will identify, by brevity code (ANCOC, BNCOC, etc.), the resident course where the task was taught. Figure 2-1 contains a list of training locations and their corresponding brevity codes.

<b>AIT</b>	Advanced Individual Training
<b>UNIT</b>	Trained in the Unit
<b>BNCOC</b>	Basic NCO Course

Figure 2-1. Training Locations

- **Sustainment Training Frequency column.** This column indicates the recommended frequency at which the tasks should be trained to ensure soldiers maintain task proficiency. Figure 2-2 identifies the frequency codes used in this column. Tasks designated "SA" must be sustained to support the Semi-Annual Combat Medic Skills Validation Test (SACMS-VT) to be conducted IAW TC 8-800.

<b>BA</b>	- Biannually
<b>AN</b>	- Annually
<b>SA</b>	- Semiannually
<b>QT</b>	- Quarterly
<b>MO</b>	- Monthly
<b>BW</b>	- Bi-weekly
<b>WK</b>	- Weekly

Figure 2-2. Sustainment Training Frequency Codes

- **Sustainment Training Skill Level column.** This column lists the skill levels of the MOS for which soldiers must receive sustainment training to ensure they maintain proficiency to soldier's manual standards.

**2-2. Part One, Section I. Subject Area Codes.**

**Skill Level 1**

- 1 Vital Signs
- 2 Emergency Medical Treatment
- 3 Basic Medical Care
- 4 Respiratory Dysfunction/Airway Management
- 5 Venipuncture and IV Therapy
- 6 Casualty Management
- 7 Eye Injuries
- 8 Skeletal Dysfunction
- 9 Environmental Injuries
- 10 Chemical Agent Injuries
- 11 Shock
- 12 Urinary Catheterization
- 13 Gastric Intubation
- 14 Triage and Evacuation
- 15 Medication Administration
- 16 Force Protection/Risk Assessment

**Skill Level 2**

- 17 Advanced Procedures (SL 2)

**Skill Level 3**

- 18 Advanced Procedures (SL 3)



**2-3. Part One, Section II. Duty Position Training Requirements.**

	<b>DUTY POSITION</b>	<b>SUBJECT AREAS</b>	<b>CROSS TRAIN</b>	<b>TRAIN-UP/ MERGER</b>
SL 1	Health Care Specialist	1-16	NA	91W2 Health Care Specialist
SL 2	Health Care Specialist	1-17	NA	91W3 Health Care Specialist
SL 3	Health Care Specialist	1-18	NA	NA
SL 4	Health Care Specialist	1-18	NA	NA
SL 5	Health Care Specialist	1-18	NA	91Z5 Chief Medical NCO

**2-4. Part Two. Critical Tasks List.****MOS TRAINING PLAN  
91W15****CRITICAL TASKS**

<b>Subject Area</b>	<b>Task Number</b>	<b>Title</b>	<b>Training Location</b>	<b>Sust Tng Freq</b>	<b>Sust Tng SL</b>
<b>Skill Level 1</b>					
1. Vital Signs	081-831-0010	MEASURE A PATIENT'S RESPIRATIONS	AIT	SA	1-5
	081-831-0011	MEASURE A PATIENT'S PULSE	AIT	SA	1-5
	081-831-0012	MEASURE A PATIENT'S BLOOD PRESSURE	AIT	SA	1-5
	081-831-0013	MEASURE A PATIENT'S TEMPERATURE	AIT	SA	1-5
	081-833-0164	MEASURE A PATIENT'S PULSE OXYGEN SATURATION	AIT	AN	1-5
2. Emergency Medical Treatment	081-831-0018	OPEN THE AIRWAY	AIT	SA	1-5
	081-831-0019	CLEAR AN UPPER AIRWAY OBSTRUCTION	AIT	SA	1-5
	081-831-0046	ADMINISTER EXTERNAL CHEST COMPRESSIONS	AIT	SA	1-5
	081-831-0048	PERFORM RESCUE BREATHING	AIT	SA	1-5
	081-833-0161	CONTROL BLEEDING	AIT	SA	1-5
	081-833-0167	PLACE A PATIENT ON A CARDIAC MONITOR	AIT	AN	1-5
	081-833-3027	MANAGE CARDIAC ARREST USING AED	AIT	SA	1-5
3. Basic Medical Care	081-831-0007	PERFORM A PATIENT CARE HANDWASH	AIT	SA	1-5
	081-831-0008	PUT ON STERILE GLOVES	AIT	SA	1-5
	081-831-0033	INITIATE A FIELD MEDICAL CARD	AIT	AN	1-5
	081-833-0006	MEASURE A PATIENT'S INTAKE AND OUTPUT	AIT	AN	1-5
	081-833-0007	ESTABLISH A STERILE FIELD	AIT	AN	1-5
	081-833-0010	CHANGE A STERILE DRESSING	AIT	AN	1-5
	081-833-0012	PERFORM A WOUND IRRIGATION	AIT	AN	1-5
	081-833-0021	PERFORM ORAL AND NASOPHARYNGEAL SUCTIONING OF A PATIENT	AIT	SA	1-5

**CRITICAL TASKS**

<b>Subject Area</b>	<b>Task Number</b>	<b>Title</b>	<b>Training Location</b>	<b>Sust Tng Freq</b>	<b>Sust Tng SL</b>
	081-833-0059	IRRIGATE AN OBSTRUCTED EAR	AIT	AN	1-5
	081-833-0076	APPLY RESTRAINING DEVICES TO PATIENTS	AIT	AN	1-5
	081-833-0145	DOCUMENT PATIENT CARE USING SUBJECTIVE, OBJECTIVE, ASSESSMENT, PLAN (SOAP) NOTE FORMAT	AIT	AN	1-5
	081-833-0165	PERFORM PATIENT HYGIENE	AIT	AN	1-5
	081-835-3007	OBTAIN AN ELECTROCARDIOGRAM	AIT	AN	1-5
4. Respiratory Dysfunction/ Airway Management	081-833-0016	INSERT AN OROPHARYNGEAL AIRWAY (J TUBE)	AIT	SA	1-5
	081-833-0018	SET UP AN OXYGEN TANK	AIT	SA	1-5
	081-833-0142	INSERT A NASOPHARYNGEAL AIRWAY	AIT	SA	1-5
	081-833-0158	ADMINISTER OXYGEN	AIT	SA	1-5
	081-833-0169	INSERT A COMBITUBE	AIT	SA	1-5
	081-833-3006	PERFORM A NEEDLE CRICOTHYROIDOTOMY	AIT	AN	1-5
	081-833-3007	PERFORM NEEDLE CHEST DECOMPRESSION	AIT	SA	1-5
5. Venipuncture and IV Therapy	081-833-0032	OBTAIN A BLOOD SPECIMEN USING A VACUTAINER	AIT	AN	1-5
	081-833-0033	INITIATE AN INTRAVENOUS INFUSION	AIT	SA	1-5
	081-833-0034	MANAGE A PATIENT WITH AN INTRAVENOUS INFUSION	AIT	SA	1-5
	081-835-3025	INITIATE A SALINE LOCK	AIT	AN	1-5
6. Casualty Management	081-831-0035	MANAGE A CONVULSIVE AND/OR SEIZING PATIENT	AIT	AN	1-5
	081-833-0045	TREAT A CASUALTY WITH AN OPEN ABDOMINAL WOUND	AIT	AN	1-5
	081-833-0046	APPLY A DRESSING TO AN IMPALEMENT INJURY	AIT	AN	1-5
	081-833-0048	MANAGE AN UNCONSCIOUS CASUALTY	AIT	AN	1-5

**CRITICAL TASKS**

<b>Subject Area</b>	<b>Task Number</b>	<b>Title</b>	<b>Training Location</b>	<b>Sust Tng Freq</b>	<b>Sust Tng SL</b>
	081-833-0049	TREAT A CASUALTY WITH A CLOSED CHEST WOUND	AIT	AN	1-5
	081-833-0050	TREAT A CASUALTY WITH AN OPEN CHEST WOUND	AIT	AN	1-5
	081-833-0052	TREAT A CASUALTY WITH AN OPEN OR CLOSED HEAD INJURY	AIT	AN	1-5
	081-833-0070	ADMINISTER INITIAL TREATMENT FOR BURNS	AIT	AN	1-5
	081-833-0103	PROVIDE CARE FOR A SOLDIER WITH SYMPTOMS OF BATTLE FATIGUE	AIT	AN	1-5
	081-833-0116	ASSIST IN VAGINAL DELIVERY	AIT	AN	1-5
	081-833-0143	TREAT A POISONED CASUALTY	AIT	AN	1-5
	081-833-0144	TREAT A DIABETIC EMERGENCY	AIT	AN	1-5
	081-833-0155	PERFORM A TRAUMA CASUALTY ASSESSMENT	AIT	SA	1-5
	081-833-0156	PERFORM A MEDICAL PATIENT ASSESSMENT	AIT	SA	1-5
	081-833-0159	TREAT A CARDIAC EMERGENCY	AIT	AN	1-5
	081-833-0160	TREAT A RESPIRATORY EMERGENCY	AIT	AN	1-5
	081-835-3030	DETERMINE A PATIENT'S LEVEL OF CONSCIOUSNESS USING THE GLASGOW COMA SCALE	AIT	AN	1-5
7. Eye Injuries	081-833-0054	IRRIGATE EYES	AIT	AN	1-5
	081-833-0056	TREAT FOREIGN BODIES OF THE EYE	AIT	AN	1-5
	081-833-0057	TREAT LACERATIONS, CONTUSIONS, AND EXTRUSIONS OF THE EYE	AIT	AN	1-5
	081-833-0058	TREAT BURNS OF THE EYE	AIT	AN	1-5
8. Skeletal Dysfunction	081-831-0044	APPLY A PNEUMATIC SPLINT TO A CASUALTY WITH A SUSPECTED FRACTURE OF AN EXTREMITY	AIT	AN	1-5
	081-833-0060	APPLY A ROLLER BANDAGE	AIT	AN	1-5
	081-833-0062	IMMOBILIZE A SUSPECTED FRACTURE OF THE ARM OR DISLOCATED SHOULDER	AIT	AN	1-5
	081-833-0064	IMMOBILIZE A SUSPECTED DISLOCATED OR FRACTURED HIP	AIT	AN	1-5

**CRITICAL TASKS**

<b>Subject Area</b>	<b>Task Number</b>	<b>Title</b>	<b>Training Location</b>	<b>Sust Tng Freq</b>	<b>Sust Tng SL</b>
	081-833-0092	TRANSPORT A CASUALTY WITH A SUSPECTED SPINAL INJURY	AIT	SA	1-5
	081-833-0141	APPLY A TRACTION SPLINT	AIT	SA	1-5
	081-833-0154	PROVIDE BASIC EMERGENCY TREATMENT FOR A PAINFUL, SWOLLEN, DEFORMED EXTREMITY	AIT	AN	1-5
9. Environmental Injuries	081-831-0038	TREAT A CASUALTY FOR A HEAT INJURY	AIT	AN	1-5
	081-831-0039	TREAT A CASUALTY FOR A COLD INJURY	AIT	AN	1-5
	081-833-0031	INITIATE TREATMENT FOR ANAPHYLACTIC SHOCK	AIT	AN	1-5
	081-833-0072	TREAT A CASUALTY FOR INSECT BITES OR STINGS	AIT	AN	1-5
	081-833-0073	TREAT A CASUALTY FOR SNAKEBITE	AIT	AN	1-5
10. Chemical Agent Injuries	081-833-0083	TREAT A NERVE AGENT CASUALTY IN THE FIELD	AIT	SA	1-5
	081-833-0084	TREAT A BLOOD AGENT (HYDROGEN CYANIDE) CASUALTY IN THE FIELD	AIT	SA	1-5
	081-833-0085	TREAT A CHOKING AGENT CASUALTY IN THE FIELD	AIT	SA	1-5
	081-833-0086	TREAT A BLISTER AGENT CASUALTY (MUSTARD, LEWISITE, PHOSGENE OXIME) IN THE FIELD	AIT	SA	1-5
	081-833-0095	DECONTAMINATE A CASUALTY	AIT	AN	1-5
11. Shock	081-833-0047	INITIATE TREATMENT FOR HYPOVOLEMIC SHOCK	AIT	SA	1-5
	081-833-3011	APPLY PNEUMATIC ANTI-SHOCK GARMENT	AIT	AN	1-5
12. Urinary Catheterization	081-833-3017	INSERT A URINARY CATHETER	AIT	AN	1-5
	081-835-3010	MAINTAIN AN INDWELLING URINARY CATHETER	AIT	AN	1-5
13. Gastric Intubation	081-833-3022	INSERT A NASOGASTRIC TUBE	AIT	AN	1-5
	081-835-3005	PERFORM A GASTRIC LAVAGE	AIT	AN	1-5

### CRITICAL TASKS

Subject Area	Task Number	Title	Training Location	Sust Tng Freq	Sust Tng SL
14. Triage and Evacuation	071-334-4001	GUIDE A HELICOPTER TO A LANDING POINT	AIT	AN	1-5
	071-334-4002	ESTABLISH A HELICOPTER LANDING POINT	AIT	AN	1-5
	081-833-0080	TRIAGE CASUALTIES ON A CONVENTIONAL BATTLEFIELD	AIT	SA	1-5
	081-833-0082	TRIAGE CASUALTIES ON AN INTEGRATED BATTLEFIELD	AIT	SA	1-5
	081-833-0151	LOAD CASUALTIES ONTO GROUND EVACUATION PLATFORMS	AIT	AN	1-5
	081-833-0171	LOAD CASUALTIES ONTO NONSTANDARD VEHICLES, 1 1/4 TON, 4X4, M998	AIT	AN	1-5
	081-833-0172	LOAD CASUALTIES ONTO NONSTANDARD VEHICLES, 2 1/2 TON, 6X6 OR 5 TON, 6X6, CARGO TRUCK	AIT	AN	1-5
	081-833-0173	LOAD CASUALTIES ONTO NONSTANDARD VEHICLES, 5 TON M-1085, M-1093, 2 1/2 TON M-1081	AIT	AN	1-5
15. Medication Administration	081-833-0088	PREPARE AN INJECTION FOR ADMINISTRATION	AIT	AN	1-5
	081-833-0089	ADMINISTER AN INJECTION (INTRAMUSCULAR, SUBCUTANEOUS, INTRADERMAL)	AIT	AN	1-5
	081-833-0174	ADMINISTER MORPHINE	AIT	SA	1-5
	081-835-3001	ADMINISTER ORAL MEDICATIONS	AIT	AN	1-5
	081-835-3020	ADMINISTER TOPICAL MEDICATIONS	AIT	AN	1-5
	081-835-3021	ADMINISTER RECTAL OR VAGINAL MEDICATIONS	AIT	AN	1-5
	081-835-3022	ADMINISTER MEDICATED EYE DROPS OR OINTMENTS	AIT	AN	1-5
16. Force Protection/ Risk Assessment	081-831-0037	DISINFECT WATER FOR DRINKING	AIT	AN	1-5

**CRITICAL TASKS**

<b>Subject Area</b>	<b>Task Number</b>	<b>Title</b>	<b>Training Location</b>	<b>Sust Tng Freq</b>	<b>Sust Tng SL</b>
<b>Skill Level 2</b>					
17. Advanced Procedures (SL 2)	081-833-0170	PERFORM ENDOTRACHEAL SUCTIONING OF A PATIENT	UNIT	AN	2-5
	081-835-3024	PROVIDE TRACHEOSTOMY CARE	UNIT	AN	2-5
	081-835-3031	PROVIDE NURSING CARE FOR A PATIENT WITH A WATERSEAL DRAINAGE SYSTEM	UNIT	AN	2-5
<b>Skill Level 3</b>					
18. Advanced Procedures (SL 3)	081-830-3016	INTUBATE A PATIENT	BNCOC	AN	3-5
	081-833-0093	SET UP A CASUALTY DECONTAMINATION STATION	BNCOC	AN	3-5
	081-833-0168	INSERT A CHEST TUBE	BNCOC	AN	3-5
	081-833-3005	PERFORM A SURGICAL CRICOTHYROIDOTOMY	BNCOC	AN	3-5
	081-833-3014	PERFORM A NEUROLOGICAL EXAMINATION ON A PATIENT WITH SUSPECTED CENTRAL NERVOUS SYSTEM (CNS) INJURIES	BNCOC	AN	3-5
	081-833-3208	SUTURE A MINOR LACERATION	BNCOC	AN	3-5
	081-835-3000	ADMINISTER BLOOD	BNCOC	AN	3-5
	081-835-3002	ADMINISTER MEDICATIONS BY IV PIGGYBACK	BNCOC	AN	3-5

## CHAPTER 3

### MOS/Skill Level Tasks

#### Skill Level 1

#### Subject Area 1: Vital Signs

### MEASURE A PATIENT'S RESPIRATIONS

#### 081-831-0010

**Conditions:** Necessary materials and equipment: a watch and appropriate forms.

**Standards:** Counted a patient's respirations for 1 full minute. Identified any abnormalities in respiration rate, depth, rhythm, pattern, and quality.

#### Performance Steps

1. Count the number of times the chest rises in 1 minute. Normal respirations for each age group are as follows:

*NOTE:* The patient should not be aware that respirations are being counted. If the patient is aware, he or she often becomes tense, and an accurate count becomes extremely difficult.

- a. Adult and adolescent (11-14 years old) = 12-20.
- b. School age (6-10 years old) = 15-30.
- c. Preschooler (3-5 years old) = 20-30.
- d. Toddler (1-3 years old) = 20-30.
- e. Infant (6-12 months old) = 20-30.
- f. Infant (0-5 months old) = 25-40.
- g. Newborn = 30-50.

2. Evaluate the respirations.

- a. Depth.
  - (1) Normal--deep, even movement of the chest.
  - (2) Shallow--minimal rise and fall of the chest and abdomen.
  - (3) Deep--the rib cage expands fully, and the diaphragm descends to create a maximum capacity.
- b. Rhythm and pattern.
  - (1) Healthy--exhalations are twice as long as inhalations.
  - (2) Irregular.
  - (3) Hypoventilation--slow and shallow respirations.
  - (4) Hyperventilation--sustained increased rate and depth of respiration.
  - (5) Sigh--deep inhalation followed by a slow audible exhalation.
  - (6) Apnea--temporary absence of breathing.
  - (7) Tachypnea--increased respiration rate, usually 24 or more breaths per minute.
- c. Quality.
  - (1) Normal--effortless, automatic, regular rate, even depth, noiseless, and free of discomfort.
  - (2) Dyspnea--difficult or labored breathing.
  - (3) Wheezing or whistling sound.
  - (4) Rattling or bubbling.



**Performance Steps**

3. Check for the physical characteristics of abnormal respirations.
  - a. Appearance--the casualty may appear restless, anxious, pale, ashen, or cyanotic.
  - b. Position--the casualty may alter his or her position by leaning forward or may be unable to lie flat.
  - c. Cough.
    - (1) Acute--comes on suddenly.
    - (2) Chronic--has existed for a long time.
    - (3) Dry--coughs without sputum.
    - (4) Productive--coughs which expel sputum.
      - (a) Normal sputum--clear, semiliquid mucus which may appear watery, frothy, or thick.
      - (b) Abnormal sputum--may be green, yellow, gray, or blood-tinged, and may have a foul or sweetish smell.
4. Record the rate of respirations and any observations noted on the appropriate forms.
5. Report any abnormal respirations to the supervisor immediately.

**Evaluation Preparation:**

Setup: You must count the rate with the soldier. If you are using a simulated patient, you may test step 2 by having him or her purposely exhibit abnormal breathing characteristics. A tolerance of plus or minus two counts will be allowed.

Brief soldier: Tell the soldier to count, evaluate, and record a patient's respirations.

**Performance Measures**

	<u>GO</u>	<u>NO GO</u>
1. Counted the number of times the chest rose in 1 minute.	_____	_____
2. Evaluated the respirations.	_____	_____
3. Checked for the physical characteristics of abnormal respirations.	_____	_____
4. Recorded the rate of respirations and any observations noted on the appropriate forms.	_____	_____
5. Reported any abnormal respirations to the supervisor immediately.	_____	_____

**Evaluation Guidance:** Score each soldier according to the performance measures in the evaluation guide. Unless otherwise stated in the task summary, the soldier must pass all performance measures to be scored GO. If the soldier fails any step, show what was done wrong and how to do it correctly.

**References**

**Required**  
None

**Related**  
EMERGENCY CARE

## MEASURE A PATIENT'S PULSE

### 081-831-0011

**Conditions:** Necessary materials and equipment: a watch, stethoscope, and appropriate forms.

**Standards:** Counted a patient's pulse for 1 full minute. Identified any abnormalities in the pulse rate, rhythm, and strength.

#### Performance Steps

1. Position the patient so that the pulse site is accessible.
2. Palpate the pulse site.
  - a. Place the tips of your index and middle fingers on the pulse site.

*NOTE:* You must use a stethoscope to monitor the apical site.

- b. Press the fingers, using moderate pressure, to feel the pulse.

3. Count for 1 full minute and evaluate the pulse.

*NOTE:* To detect irregularities, you must count for 1 full minute.

- a. Pulse rate.
  - (1) Normal adult rate--60 to 100 beats per minute.
  - (2) Infants and Children
    - (a) Adolescent 11-14 years--60 to 105
    - (b) School age 6-10 years-- 70 to 110
    - (c) Preschooler 3-5 years-- 80 to 120
    - (d) Toddler 1-3 years-- 80 to 130
    - (e) Infant 6-12 months--80 to 140
    - (f) Infant 0-5 months-- 90 to 140
    - (g) Newborn--120 to 160
  - (3) Bradycardia--less than 50 beats per minute.

**WARNING:** Patient presenting with bradycardia, medic must consider physical condition of patient. For example, the patient is and athlete an their normal at-rest pulse rate is between 40 to 50 beats per minute.

- (4) Tachycardia--more than 100 beats per minute.
- b. Pulse rhythm.
  - (1) Regular.
    - (a) Usually easy to find.
    - (b) Has a regular rate and rhythm.
    - (c) Varies with the individual.
  - (2) Irregular/intermittent--any change from a regular beating pattern.

*NOTE:* If a peripheral pulse is irregular or intermittent, you should take a second pulse at the carotid, femoral, or apical site. (See Figure 3-1.)

## Performance Steps

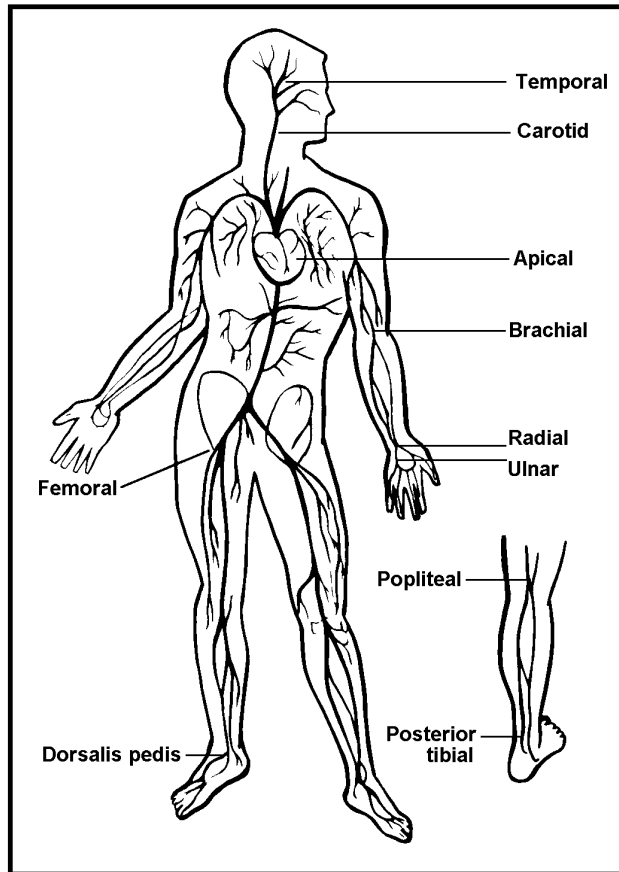

Figure 3-1

- c. Pulse strength.
  - (1) Strong or full pulse.
    - (a) Easy to find.
    - (b) Has even beats with good force.
  - (2) Bounding.
    - (a) Easy to find.
    - (b) Exceptionally strong heartbeats which make the arteries difficult to compress.
  - (3) Weak/thready
    - (a) weak and thin
    - (b) difficult to find
4. Record the rate, rhythm, strength, and any significant deviations from normal on the appropriate forms.
5. Report any significant pulse abnormalities to the supervisor immediately.

**Evaluation Preparation:**

Setup: While the soldier is palpating a pulse site, you must palpate the corresponding site. Specify which site the soldier is to palpate. If the apical site is chosen, either a double stethoscope or separate stethoscopes may be used. A tolerance of plus or minus two beats will be allowed.

Brief soldier: Tell the soldier to count, evaluate, and record the patient's pulse.

**Performance Measures**

	<u>GO</u>	<u>NO GO</u>
1. Positioned the patient so that the pulse site is accessible.	—	—
2. Palpated the pulse site.	—	—
3. Counted for 1 full minute and evaluated the pulse.	—	—
4. Recorded the rate, rhythm, strength, and any significant deviations from normal on the appropriate forms.	—	—
5. Reported any significant pulse abnormalities to the supervisor immediately.	—	—

**Evaluation Guidance:** Score each soldier according to the performance measures in the evaluation guide. Unless otherwise stated in the task summary, the soldier must pass all performance measures to be scored GO. If the soldier fails any step, show what was done wrong and how to do it correctly.

**References**

**Required**  
None

**Related**  
EMERGENCY CARE

## **MEASURE A PATIENT'S BLOOD PRESSURE**

### **081-831-0012**

**Conditions:** Necessary materials and equipment: sphygmomanometer, clean stethoscope, and appropriate forms.

**Standards:** Measured a patient's blood pressure and recorded the measurement on the appropriate forms.

#### **Performance Steps**

1. Explain the procedure to the patient, if necessary.
  - a. The length of time the procedure will take.
  - b. The site to be used.
  - c. The physical sensations the patient will feel.

2. Select the proper size of sphygmomanometer cuff.

*NOTE:* The cuff width should be two-thirds of the upper arm length if using the brachial artery and two-thirds of the upper leg if using the popliteal artery.

3. Check the equipment.

- a. Ensure that the cuff is deflated completely and fully retighten the thumbscrew.
- b. Ensure the sphygmomanometer gauge reads zero.

*NOTE:* Steps 2, 3, and 4 describe the procedure for taking the blood pressure at the brachial site. If the brachial site cannot be used, measure the blood pressure using a larger cuff applied to the thigh. The patient should be lying down (preferably on the stomach; otherwise, on the back with one knee flexed). Apply the cuff at mid-thigh, and place the stethoscope over the popliteal artery. The remainder of the procedure is the same as for the brachial artery site.

4. Position the patient.

- a. Place the patient in a relaxed and comfortable sitting, standing, or lying position.

*NOTE:* A reading obtained from a standing position will be slightly higher.

- b. Place the patient's arm palm up at approximately heart level. Support the arm so that it is relaxed.

5. Place the cuff at the brachial artery site.

- a. Place the cuff so the lower edge is 1 to 2 inches above the elbow and the bladder portion is over the artery.
- b. Wrap the cuff just tightly enough to prevent slippage.
- c. If applicable, clip the gauge to the cuff in alignment with the palm.

6. Position the stethoscope, if used.

- a. Palpate for the brachial pulse.
- b. Place the diaphragm of the stethoscope over the pulse site.

7. Inflate the cuff until the gauge reads at least 140 mm Hg or 10 mm Hg higher than the usual range for that patient, if known.

*NOTE:* If a pulsation is heard when the gauge reaches 140 mm Hg, continue to inflate the cuff 10 mm Hg beyond the point at which the last pulsation was heard.

**CAUTION:** The cuff should not remain inflated for more than 2 minutes.

8. Determine the blood pressure.
  - a. If a stethoscope is used, complete the following steps:
    - (1) Rotate the thumbscrew slowly in a counterclockwise motion, allowing the cuff to deflate slowly.
    - (2) Watch the gauge and remember the reading when the first distinct sound is heard (systolic pressure).
    - (3) Continue to watch the gauge and remember the reading where the sound changes again and becomes muffled or unclear (diastolic pressure).
    - (4) Release the remaining air.
  - b. If a stethoscope is not used, complete the following steps:
    - (1) Palpate for the radial pulse.
    - (2) Rotate the thumbscrew slowly in a counterclockwise motion, allowing the cuff to deflate slowly.
    - (3) Watch the gauge and remember the point at which the pulse returns (systolic pressure).

*NOTES:* 1. The diastolic pressure cannot be determined using this method. 2. If the procedure must be repeated, wait at least 1 minute before repeating steps 6 through 8.

9. Record the blood pressure on the appropriate forms.
  - a. Record the systolic reading over the diastolic reading, for example 120/80.
  - b. Record the readings in even numbers.
10. Evaluate the blood pressure reading by comparing it with one of the following:
  - a. The patient's previous reading.
  - b. An average of the patient's previous readings.
  - c. The normal range: 100-140/60-90 for males and 90-130/50-60 for females.
11. Report abnormal readings to the supervisor.

**Evaluation Preparation:**

Setup: A double stethoscope should be used if available. A tolerance of  $\pm 4$  mm Hg will be allowed. If other methods are used, such as independent measurements on different sites or at different times, the evaluator must apply discretion in applying the  $\pm 4$  mm Hg standard. You will allow the soldier to retake the blood pressure at least once if the soldier feels that it is necessary to obtain an accurate reading. You will use discretion in allowing additional repetitions based upon the difficulty of obtaining a reading on the patient.

Brief soldier: Tell the soldier to take a patient's blood pressure. Tell the soldier that the blood pressure may be retaken, if necessary, to obtain an accurate reading.

**Performance Measures**

	<u>GO</u>	<u>NO GO</u>
1. Explained the procedure to the patient, if necessary.	_____	_____
2. Selected the proper size of sphygmomanometer cuff.	_____	_____
3. Checked the equipment.	_____	_____
4. Positioned the patient.	_____	_____

**Performance Measures**

	<u>GO</u>	<u>NO</u> <u>GO</u>
5. Placed the cuff just tightly enough to prevent slippage.	—	—
6. Positioned the stethoscope, if used.	—	—
7. Inflated the cuff until the gauge read at least 140 mm Hg or 10 mm Hg higher than the usual range for that patient, if known.	—	—
8. Determined the blood pressure.	—	—
9. Recorded the blood pressure on the appropriate forms.	—	—
10. Evaluated the blood pressure.	—	—
11. Reported any abnormal readings to the supervisor.	—	—

**Evaluation Guidance:** Score each soldier according to the performance measures in the evaluation guide. Unless otherwise stated in the task summary, the soldier must pass all performance measures to be scored GO. If the soldier fails any step, show what was done wrong and how to do it correctly.

**References**

**Required**  
None

**Related**  
EMERGENCY CARE

## MEASURE A PATIENT'S TEMPERATURE

### 081-831-0013

**Conditions:** You have performed a patient care handwash. Necessary materials and equipment: disinfected mercury oral and rectal thermometers or an electronic thermometer, canisters marked "used," water soluble lubricant, gauze pads, a watch, and appropriate forms.

**Standards:** Recorded the patient's temperature to the nearest 0.2° F.

#### Performance Steps

1. Determine which site to use.
  - a. Take an oral temperature if the patient is a conscious adult or a child who can follow directions, and can breathe normally through the nose.

**CAUTION:** Do not take an oral temperature when the patient--

1. Has had recent facial or oral surgery.
2. Is confused, disturbed, or heavily sedated.
3. Is being administered oxygen by mouth or nose.
4. Is likely to bite down on the thermometer.
5. Has smoked, chewed gum, or ingested anything hot or cold within the last 15 to 30 minutes.
  - b. Tympanic method can be used with conscious or unconscious patients and is preferred temperature if the patient has recently had something to eat or drink.

**CAUTION:** Do not take a tympanic temperature if the patient has had recent facial or aural surgery, or has cerumen (ear wax).

- c. Take a rectal temperature if the oral or tympanic site is ruled out by the patient's condition.

**CAUTION:** Do not take a rectal temperature on a patient with a cardiac condition, diarrhea, a rectal disorder such as hemorrhoids, or recent rectal surgery. Do not take a rectal temperature on an infant unless directed to by medical guidance.

- d. Take an axillary temperature if the patient's condition rules out using the other methods.
2. Select the proper thermometer.
    - a. Tympanic thermometer.
    - b. An oral thermometer has a blue tip and may be labeled "Oral."
    - c. A rectal thermometer has a red tip and may be labeled "Rectal."
    - d. Axillary temperatures are taken with oral thermometers.
  3. Explain the procedure and position the patient.
    - a. Take a tympanic temperature with the patient's head turned toward side so that the ear canal is easily viewed.
    - b. Take an oral temperature with the patient seated or lying face up.
    - c. Take a rectal temperature with the patient lying on either side with the top knee flexed.
    - d. Take an axillary temperature with the patient lying face up with the armpit exposed.
  4. Measure the temperature.
    - a. Shake the thermometer down to below 94° F.
    - b. Place the thermometer at the proper site.
      - (1) If you are taking an oral temperature, place the thermometer in the heat pocket under the tongue and tell the patient to close his or her lips and not to bite down.
      - (2) If you are taking a rectal temperature on an adult, insert the thermometer 1 to 2 inches into his or her rectum.



**Performance Steps**

**CAUTION:** Lubricate the tip prior to insertion. Hold the thermometer in place.

- (3) If you are taking a tympanic temperature, pull the ear pinna back, up, and out; insert the speculum into the ear canal snugly to make a seal, pointing toward the nose.
- (4) If you are taking an axillary temperature, pat the armpit dry and then place the bulb end in the center with the glass tip protruding to the front of the patient's body. Place the arm across his or her chest.
- c. Leave the thermometer in place for the required time.
  - (1) Oral--at least 3 minutes.

**NOTE:** Leave digital thermometers in place until testing is complete. The unit will normally have an audible tone.

- (2) Rectal--at least 2 minutes.
  - (3) Tympanic--until an audible signal occurs and the patient's temperature appears on the digital display.
  - (4) Axillary--at least 10 minutes.
5. Remove the thermometer and wipe it down with a gauze square or discharge the protective plastic sheath.
  6. Read the scale.
  7. Put the thermometer in the proper "used" canister or dispose of the plastic sheath as appropriate.
  8. Record the temperature to the nearest 0.2° F on the appropriate forms and report any abnormal temperature change immediately to the supervisor.

**NOTES:** 1. The normal temperature range is--Oral - 97.0° to 99.0° F; Rectal - 98.0° to 100.0° F; Axillary - 96.0° to 98.0° F. 2. Record an axillary temperature with an "A" on the patient's record. Record a rectal temperature with an "R" on the patient's record.

**Evaluation Preparation:**

Setup: To test step 1 for evaluation purposes, create a scenario in which the patient's condition will dictate which site the soldier must choose.

Brief soldier: Tell the soldier to measure, evaluate, and record a patient's temperature.

**Performance Measures**

	<u><b>GO</b></u>	<u><b>NO GO</b></u>
1. Determined which site to use.	_____	_____
2. Selected the proper thermometer.	_____	_____
3. Explained the procedure and positioned the patient.	_____	_____
4. Measured the temperature.	_____	_____
5. Removed the thermometer and wiped it down with a gauze square.	_____	_____
6. Read the scale.	_____	_____
7. Placed the thermometer in the proper "used" canister or disposed of the plastic sheath as appropriate.	_____	_____

**Performance Measures**

<u><b>GO</b></u>	<u><b>NO</b></u>
<u>      </u>	<u><b>GO</b></u>

- 8. Recorded the temperature to the nearest 0.2° F on the appropriate forms and reported any abnormal temperature change immediately to the supervisor.

_____	_____
-------	-------

**Evaluation Guidance:** Score each soldier according to the performance measures in the evaluation guide. Unless otherwise stated in the task summary, the soldier must pass all performance measures to be scored GO. If the soldier fails any step, show what was done wrong and how to do it correctly.

**References**

**Required**  
None

**Related**  
EMERGENCY CARE

**MEASURE A PATIENT'S PULSE OXYGEN SATURATION  
081-833-0164**

**Conditions:** You encounter a patient showing signs of respiratory distress and have determined the need to measure the pulse oxygen saturation. You have taken body substance isolation precautions. Necessary materials and equipment: pulse oximetry monitor, oximetry sensors, and alcohol wipes.

**Standards:** Measured a patient's pulse oxygen saturation.

**Performance Steps**

1. Select a sensor appropriate to the patient's size.
  2. Select the appropriate sensor location.
    - a. For adults, adhesive sensors and finger tip sensors can be placed on the index, middle, or ring finger.
    - b. All adhesive sensors can be placed on the toe unless the patient has decreased circulation to the lower extremities.
    - c. Earlobe clip and neonate adhesive sensors for the foot are available for infants and newborns.
  3. Wipe the site with alcohol to ensure the site is clean and dry.  
*NOTE:* Remove any fingernail polish or acrylic nails on the finger to be used, if applicable.
  4. Place the sensor so that the emitting light is directly opposite to the detector.
  5. Attach the sensor cable to the machine and turn it on.
  6. Notify the MD or PA if the digital readout is below the prescribed parameters.  
*NOTE:* Usually, the goal is to maintain the patient's oxygen saturation at 95% or better.
  7. Document the oximeter reading, the location of the device, and the amount of oxygen being delivered (if applicable).
  8. Take appropriate measures for continuous monitoring, if applicable.
    - a. Ensure the alarms are on before leaving the patient.
- NOTE:* Monitors come with preset limits. These limits can be changed per physician's order.
- b. Move clip sensors every 2 hours. Move adhesive sensors every 4 hours.

**Performance Measures**

	<u>GO</u>	<u>NO GO</u>
1. Selected the appropriate size of sensor.	_____	_____
2. Selected the appropriate sensor location.	_____	_____
3. Cleaned and dried the site.	_____	_____
4. Applied the sensor.	_____	_____
5. Attached the sensor cable to the monitor and turned it on.	_____	_____
6. Notified the MD or PA of abnormal readings.	_____	_____

**Performance Measures**

	<u>GO</u>	<u>NO</u> <u>GO</u>
7. Documented the oximeter reading, the location of the device, and the amount of oxygen being delivered.	—	—
8. Performed measures for continuous monitoring.	—	—

**Evaluation Guidance:** Score each soldier according to the performance measures in the evaluation guide. Unless otherwise stated in the task summary, the soldier must pass all performance measures to be scored GO. If the soldier fails any step, show what was done wrong and how to do it correctly.

**References**

**Required**  
None

**Related**  
BASIC NURSING

Subject Area 2: Emergency Medical Treatment

**OPEN THE AIRWAY**

**081-831-0018**

**Conditions:** You are evaluating a casualty who is not breathing. You are not in an NBC environment.

**Standards:** Completed all of the steps required to open the casualty's airway without causing unnecessary injury.

**Performance Steps**

1. Roll the casualty onto his or her back if necessary.
  - a. Kneel beside the casualty.
  - b. Raise the near arm and straighten it out above the head.
  - c. Adjust the legs so that they are together and straight or nearly straight.
  - d. Place one hand on the back of the casualty's head and neck.
  - e. Grasp the casualty under the arm with the free hand.
  - f. Pull steadily and evenly toward yourself, keeping the head and neck in line with the torso.
  - g. Roll the casualty as a single unit.
  - h. Place the casualty's arms at his or her sides.

2. Establish the airway using the head-tilt/chin-lift or jaw thrust method.
  - a. Head-tilt/chin-lift method.

**CAUTION:** Do not use this method if a spinal or neck injury is suspected.

**NOTE:** Remove any foreign material or vomitus seen in the mouth as quickly as possible.

- (1) Kneel at the level of the casualty's shoulders.
- (2) Place one hand on the casualty's forehead and apply firm, backward pressure with the palm of the hand to tilt the head back.
- (3) Place the fingertips of the other hand under the bony part of the casualty's lower jaw, bringing the chin forward.

**CAUTIONS:** 1. Do not use the thumb to lift the lower jaw. 2. Do not press deeply into the soft tissue under the chin with the fingers. 3. Do not completely close the casualty's mouth.

- b. Jaw thrust.

**CAUTION:** Use this method if a spinal or neck injury is suspected.

- (1) Kneel at the top of the casualty's head.
- (2) Rest the elbows on the surface on which the casualty is lying.
- (3) Place one hand on each side of the casualty's lower jaw at the angle of the jaw, below the ears.
- (4) Stabilize the casualty's head with your forearms.
- (5) Use index fingers to push the angles of the patient's lower jaw forward.
- (6) Use thumb to keep the casualty's mouth open, if necessary.

**CAUTION:** Do not tilt or rotate the casualty's head.

3. Check for breathing within 3 to 5 seconds. While maintaining the open airway position, place an ear over the casualty's mouth and nose, looking toward the chest and stomach.
  - a. Look for the chest to rise and fall.
  - b. Listen for air escaping during exhalation.
  - c. Feel for the flow of air on the side of your face.

**Performance Steps**

4. Take appropriate action.
  - a. If the casualty resumes breathing, maintain the airway and place the casualty in the recovery position.
    - (1) Roll the casualty as a single unit onto his or her side.
    - (2) Place the hand of the upper arm under his or her chin.
    - (3) Flex the upper leg.

*NOTE:* Check the casualty for other injuries, if necessary.

- b. If the casualty does not resume breathing, perform rescue breathing. (See task 081-831-0048.)

**Evaluation Preparation:**

Setup: Place a CPR mannequin or another soldier acting as the casualty face down on the ground. For training and evaluation, you may specify to the soldier whether the casualty has a spinal injury to test step 2, or you may create a scenario in which the casualty's condition will dictate to the soldier how to treat the casualty. After step 3 tell the soldier whether the casualty is breathing or not and ask what should be done.

Brief soldier: Tell the soldier to open the casualty's airway.

**Performance Measures**

	<u>GO</u>	<u>NO GO</u>
1. Rolled the casualty onto his or her back, if necessary.	_____	_____
2. Established the airway using the head-tilt/chin-lift or jaw thrust method.	_____	_____
3. Checked for breathing within 3 to 5 seconds.	_____	_____
4. Took appropriate action.	_____	_____
5. Did not cause further injury to the casualty.	_____	_____

**Evaluation Guidance:** Score each soldier according to the performance measures in the evaluation guide. Unless otherwise stated in the task summary, the soldier must pass all performance measures to be scored GO. If the soldier fails any step, show what was done wrong and how to do it correctly.

**References**

**Required**  
None

**Related**  
EMERGENCY CARE

## CLEAR AN UPPER AIRWAY OBSTRUCTION

081-831-0019

**Conditions:** You are evaluating a casualty who is not breathing or is having difficulty breathing, and you suspect the presence of an upper airway obstruction.

**Standards:** Completed, in order, all the steps necessary to clear an object from a casualty's upper airway. Continued the procedure until the casualty could talk and breathe normally or until relieved by a qualified person.

### Performance Steps

1. Clear the airway.
  - a. Conscious casualty.
    - (1) Determine whether or not the casualty needs help. Ask the casualty whether he or she is choking.
      - (a) If the casualty has good air exchange (is able to speak, coughs forcefully, or wheezes between coughs), do not interfere except to encourage the casualty.
      - (b) If the casualty has poor air exchange (weak, ineffective cough; high-pitched noise while inhaling; increased respiratory difficulty; and possible cyanosis), continue with step 1a(2).
      - (c) If the casualty has a complete airway obstruction (is unable to speak, breathe, or cough and may clutch the neck between the thumb and fingers), continue with step 1a(2).
    - (2) If the casualty is lying down, bring him or her to a sitting or standing position.
    - (3) Apply abdominal or chest thrusts.

**NOTE:** Use abdominal thrusts unless the casualty is in the advanced stages of pregnancy, is very obese, or has a significant abdominal wound.

- (a) Abdominal thrusts.
  - 1) Stand behind the casualty and wrap your arms around his or her waist.
  - 2) Make a fist with one hand and place the thumb side of the fist against the casualty's abdomen in the midline slightly above the navel and well below the tip of the xiphoid process.
  - 3) Grasp the fist with your other hand and press the fist into the casualty's abdomen with quick backward and upward thrusts.
  - 4) Continue giving thrusts until the blockage is expelled or the casualty becomes unconscious.

**NOTE:** Make each thrust a separate, distinct movement given with the intent of relieving the obstruction.

- (b) Chest thrusts.
  - 1) Stand behind the casualty and encircle his or her chest with your arms just under the armpits.
  - 2) Make a fist with one hand and place the thumb side of the fist against the middle of the casualty's breastbone.
  - 3) Grasp the fist with your other hand and give backward thrusts.
  - 4) Continue giving thrusts until the blockage is expelled or the casualty becomes unconscious.

**Performance Steps**

**CAUTION:** Do not position the hand on the xiphoid process or the lower margins on the rib cage.

**NOTES:** 1. Administer each thrust with the intent of relieving the obstruction. 2. If the casualty becomes unconscious, position the casualty on his or her back, perform a finger sweep (see step 1b(2)), open the airway (see task 081-831-0018), and then start rescue breathing procedures (see task 081-831-0048).

b. Unconscious casualty.

**NOTE:** Perform abdominal or chest thrusts on the unconscious casualty only after attempts to open the airway and ventilate the casualty indicate that the airway is obstructed.

(1) Apply abdominal or chest thrusts.

**NOTE:** Use abdominal thrusts unless the casualty is in the advanced stages of pregnancy, is very obese, or has a significant abdominal wound.

(a) Abdominal thrusts.

- 1) Kneel astride the casualty's thighs.
- 2) Place the heel of one hand against the casualty's abdomen in the midline slightly above the navel and well below the tip of the xiphoid process.
- 3) Place the other hand directly on top of the first.
- 4) Press into the abdomen with quick upward thrusts up to five times.

(b) Chest thrusts.

- 1) Kneel close to either side of the casualty's body.
  - 2) With the middle and index fingers of the hand nearest the casualty's legs, locate the lower margin of the casualty's rib cage on the side nearest you.
  - 3) Move the fingers up the rib cage to the notch where the ribs meet the sternum in the center of the lower part of the chest.
  - 4) With the middle finger on this notch, place the index finger next to it on the lower end of the sternum.
  - 5) Place the heel of the other hand on the lower half of the sternum next to the index finger of the first hand.
  - 6) Remove the first hand from the notch and place it on top of the hand on the sternum so that the hands are parallel to each other.
- NOTE:** You may either extend or interlace your fingers but keep the fingers off the casualty's chest.
- 7) Lock your elbows into position, straighten your arms, and position your shoulders directly over your hands.
  - 8) Press straight down depressing the sternum 1.5 to 2 inches and then release the pressure completely without lifting the hands from the chest.
  - 9) Repeat the chest thrust up to five times.

**NOTE:** Make each thrust a separate, distinct movement given with the intent of relieving the obstruction.

(2) Perform a finger sweep.

- (a) Open the casualty's mouth by grasping both the tongue and lower jaw with your thumb and fingers and lifting.
- (b) Insert the index finger of your other hand down along the inside of the cheek and deeply into the throat to the base of the tongue.
- (c) Use a hooking motion to attempt to dislodge the foreign body and maneuver it into the mouth for removal.

**CAUTION:** Do not force the object deeper into the airway.

- (3) Attempt to ventilate. If the airway is still not clear, repeat the sequence of thrusts, finger sweep, and attempt to ventilate until the airway is cleared or you are relieved by qualified personnel.



**Performance Steps**

2. When the object is dislodged, check for breathing. Perform rescue breathing, if necessary (see task 081-831-0048) or continue to evaluate the casualty for other injuries.

**Evaluation Preparation:**

*NOTE:* Only the procedure for clearing an airway obstruction in a conscious casualty will be evaluated. The procedure for an unconscious casualty can be evaluated as a part of task 081-831-0048.

Setup: You will need another soldier to play the part of the casualty.

Brief soldier: Describe the symptoms of a casualty with good air exchange, poor air exchange, or a complete airway obstruction. Ask the soldier what should be done and score step 1 based on the answer. Then, tell the soldier to clear an upper airway obstruction. Tell the soldier to demonstrate how to position the casualty, where to stand, and how to position his or her hands for the thrusts. The soldier must tell you how they should be done and how many thrusts should be performed. Ensure that the soldier understands that he or she must not actually perform the thrusts. After completion of step 5, ask the soldier what must be done if the casualty becomes unconscious.

**Performance Measures**

	<u>GO</u>	<u>NO GO</u>
1. Determined whether the casualty needs help.	_____	_____
2. Moved the casualty to a sitting or standing position, if necessary.	_____	_____
3. Stood behind the casualty.	_____	_____
4. Positioned arms and hands properly to perform the thrusts.	_____	_____
5. Stated how to perform the thrusts and how many should be performed.	_____	_____
6. Stated that the following actions would be taken if the casualty becomes unconscious.	_____	_____
a. Reposition the casualty.		
b. Perform a finger sweep.		
c. Open the airway.		
d. Perform rescue breathing procedures.		
7. Completed all necessary steps in order.	_____	_____

**Evaluation Guidance:** Score each soldier according to the performance measures in the evaluation guide. Unless otherwise stated in the task summary, the soldier must pass all performance measures to be scored GO. If the soldier fails any step, show what was done wrong and how to do it correctly.

**References**

**Required**  
None

**Related**  
EMERGENCY CARE

## ADMINISTER EXTERNAL CHEST COMPRESSIONS

### 081-831-0046

**Conditions:** You are treating a casualty who is not breathing and has no pulse. The airway is open and is clear. Another soldier who is CPR qualified may be available to assist or may arrive while you are performing one-rescuer CPR. You are not in an NBC environment.

**Standards:** Continued CPR until the pulse was restored or until the rescuer(s) were relieved by other qualified persons, stopped by a physician, or too tired to continue.

#### Performance Steps

Perform one-rescuer CPR.

1. Ensure that the casualty is positioned on a hard, flat surface.
2. Position the hands for external chest compressions.
  - a. With the middle and index fingers of the hand nearest the casualty's feet, locate the lower margin of the casualty's rib cage on the side near the rescuer.
  - b. Move the fingers up the rib cage to the notch where the ribs meet the sternum in the center of the lower part of the chest.
  - c. With the middle finger on the notch, place the index finger next to it on the lower end of the sternum.
  - d. Place the heel of the other hand on the lower half of the sternum, next to the index finger of the first hand.
  - e. Remove the first hand from the notch and place it on top of the hand on the sternum so that both hands are parallel to each other.

**NOTE:** You may either extend or interlace your fingers but keep the fingers off the casualty's chest.

3. Position your body.
  - a. Lock your elbows with the arms straight.
  - b. Position your shoulders directly over your hands.
4. Give 15 compressions.
  - a. Press straight down to depress the sternum 1.5 to 2 inches.
  - b. Come straight up and completely release pressure on the sternum to allow the chest to return to its normal position. The time allowed for release should equal the time required for compression.

**CAUTION:** Do not remove the heel of your hand from the casualty's chest or reposition your hand between compressions.

- c. Give 15 compressions in 9 to 11 seconds (at a rate of 100 per minute).
5. Give two full breaths.
  - a. Move quickly to the casualty's head and lean over.
  - b. Open the casualty's airway. (See task 081-831-0018.)
  - c. Give two full breaths (1.5 to 2 seconds each).
6. Repeat steps 2 through 5 four times.
7. Assess the casualty.
  - a. Check for the return of the carotid pulse for 3 to 5 seconds.
    - (1) If the pulse is present, continue with step 7b.
    - (2) If the pulse is absent, continue with step 8.

### Performance Steps

- b. Check breathing for 3 to 5 seconds.
  - (1) If breathing is present, monitor breathing and pulse closely.
  - (2) If breathing is absent, perform rescue breathing only. (See task 081-831-0048.)

8. Resume CPR with compressions.

9. Recheck for pulse every 3 to 5 minutes.

10. Continue to alternate chest compressions and rescue breathing until--

- a. The casualty is revived.
- b. You are too tired to continue.
- c. You are relieved by competent person(s).
- d. The casualty is pronounced dead by an authorized person.
- e. A second rescuer states, "I know CPR," and joins you in performing two-rescuer CPR.

*NOTE:* A qualified second rescuer joins the first rescuer at the end of a cycle after a check for pulse by the first rescuer. The new cycle starts with one ventilation by the first rescuer, and the second rescuer becomes the compressor. Two-rescuer CPR is then initiated.

11. Perform two-rescuer CPR, if applicable.

- a. Compressor: Give 15 chest compressions at the rate of 100 per minute.  
Ventilator: Maintain an open airway and monitor the carotid pulse occasionally for adequacy of chest compressions.
- b. Compressor: Pause.  
Ventilator: Give two full breaths (over 2 seconds).
- c. Compressor: Continue to give chest compressions until a change in positions is initiated.  
Ventilator: Continue to give ventilations until the compressor indicates that a change is to be made.
- d. Compressor: Give a clear signal to change positions.  
Ventilator: Remain in the rescue breathing position.
- e. Compressor: Give the 15th compression.  
Ventilator: Give two breaths following the 15th compression.
- f. Compressor and ventilator simultaneously switch positions.
- g. New Ventilator: Check the casualty's carotid pulse for 5 seconds.
  - \* If present state, "There is a pulse," and perform rescue breathing.
  - \* If not present state, "No pulse." Tell the new compressor to give chest compressions.New compressor: Position the hands to begin chest compressions as directed by the ventilator.
- h. Ventilator: Continue to give two breaths on each 15th upstroke of chest compressions and ensure that the chest rises.  
Compressor: Continue to give chest compressions at the rate of 100 per minute.

*NOTE:* If signs of gastric distension are noted, do the following: 1. Recheck and reposition the airway. 2. Watch for the rise and fall of the chest. 3. Ventilate the casualty only enough to cause the chest to rise.

**CAUTIONS:** 1. Do not push on the abdomen. 2. If the casualty vomits, turn the casualty on the side, clear the airway, and then continue CPR.

*NOTE:* If the patient is intubated, the ratio of breaths to compressions becomes asynchronous. Give 100 compressions per minute with a ventilation rate of approximately 10 to 12 per minute.

12. Continue to perform CPR as stated in the task standard.

**Performance Steps**

*NOTE:* The rescuer doing rescue breathing should recheck the carotid pulse every 3 to 5 minutes.

13. When the pulse and breathing are restored, continue to evaluate the casualty. If the casualty's condition permits, place him or her in the recovery position. (See task 081-831-0018.)

**CAUTION:** During evacuation, CPR or rescue breathing should be continued en route if necessary. When pulse and breathing are restored, the casualty should be watched closely.

**Evaluation Preparation:**

Setup: For training and evaluation a CPR mannequin must be used. Place the mannequin face up on the floor. One-rescuer CPR, two-rescuer CPR, or a combination of both (see NOTE after step 10e) can be evaluated. If two soldiers are involved, they will be designated as "rescuer #1" and "rescuer #2." Rescuer #1 will start in the chest compression position and will be the only one scored during performance of the task. The evaluator will ensure that all aspects of the task are evaluated by indicating whether pulse is present and when the rescuers should change positions.

Brief soldier: If two soldiers are involved, tell them about their roles as rescuer #1 and #2. Ask rescuer #1 on what kind of surface the casualty should be positioned. Then, tell the soldier(s) to perform one-rescuer or two-rescuer CPR, as appropriate.

**Performance Measures**

	<u>GO</u>	<u>NO GO</u>
1. Positioned the casualty on a hard flat surface.	_____	_____
2. Properly positioned the hands during chest compressions.	_____	_____
3. Administered the correct number of chest compressions.	_____	_____
4. Gave the chest compressions at the rate of 80 to 100 per minute.	_____	_____
5. Administered the correct number of breaths.	_____	_____
6. Gave the breaths at the correct rate.	_____	_____
7. Checked the carotid pulse for about 5 seconds approximately 1 minute after starting CPR.	_____	_____
8. Rechecked the carotid pulse every 3 to 5 minutes.	_____	_____
9. Performed the transition to two-rescuer CPR correctly, if applicable.	_____	_____
10. Changed positions during two-rescuer CPR correctly, if applicable.	_____	_____
11. Continued CPR as stated in the task standard.	_____	_____

**Evaluation Guidance:** Score each soldier according to the performance measures in the evaluation guide. Unless otherwise stated in the task summary, the soldier must pass all performance measures to be scored GO. If the soldier fails any step, show what was done wrong and how to do it correctly.

**References**  
**Required**  
None

**Related**  
EMERGENCY CARE

## PERFORM RESCUE BREATHING

### 081-831-0048

**Conditions:** You are treating a casualty who is unconscious and is not breathing. You are not in an NBC environment.

**Standards:** Completed, in order, all the steps necessary to restore breathing. Continued the procedure until the casualty started to breathe or until relieved by another qualified person, stopped by a physician, required to perform CPR, or too exhausted to continue.

#### Performance Steps

1. Position yourself at the casualty's head.
2. Open the airway (see task 081-831-0018).
  - a. Head-tilt/chin-lift when no trauma is suspected.
  - b. Jaw thrust when trauma is suspected.
3. Ventilate the casualty using the mouth-to-mouth, mouth-to-nose, mouth-to-mask, bag-valve-mask, or flow-restricted oxygen-powered ventilation device (FROPVD or demand-valve), as appropriate.
  - a. Mouth-to-mouth method.
    - (1) Maintain the chin-lift while pinching the nostrils closed using the thumb and index fingers of the hand on the casualty's forehead.
    - (2) Take a deep breath and make an airtight seal around the casualty's mouth with your mouth.
    - (3) Blow one full breath (1.5 to 2 seconds) into the casualty's mouth, watching for the chest to rise and fall and listening and feeling for air to escape during exhalation.
    - (4) If the chest rises and air escapes--
      - (a) Give a second full breath.
      - (b) Go to step 6.
    - (5) If the chest does not rise or air does not escape, go to step 4.
  - b. Mouth-to-nose method.

**NOTE:** The mouth-to-nose method is recommended when you cannot open the casualty's mouth, there are jaw or mouth injuries, or you cannot maintain a tight seal around the casualty's mouth.

- (1) Maintain the head-tilt with the hand on the forehead while using the other hand to lift the casualty's jaw and close the mouth.
- (2) Take a deep breath and make an airtight seal around the casualty's nose with your mouth.
- (3) Blow one full breath (1.5 to 2 seconds) into the casualty's nose while watching for the chest to rise and fall and listening and feeling for air to escape during exhalation.

**NOTE:** It may be necessary to open the casualty's mouth or separate the lips to allow air to escape.

- (4) If the chest rises--
  - (a) Give a second full breath.
  - (b) Go to step 6.
- (5) If the chest does not rise, go to step 4.
- c. Mouth-to-mask.

### Performance Steps

**NOTE:** The face mask is an important part of infection control to the rescuer. Rescuer breaths are delivered to the casualty through the one-way valve of the mask. There is no direct contact with the casualty's mouth.

- (1) Insert an airway adjunct as necessary (see tasks 081-831-0016 and 081-833-0142).
- (2) Place the mask on the casualty.
  - (a) Position the apex of the mask on the bridge of the nose.
  - (b) Place the base of the mask at the chin between the lower lip and the chin prominence.
- (3) Create a seal while maintaining the airway.
  - (a) Place your thumbs over the top half of mask.
  - (b) Place your index and middle fingers over the bottom half of the mask.
  - (c) Use your fourth and fifth fingers to bring the jaw toward the mask.
- (4) Take a deep breath and exhale into the mask.

**NOTES:** 1. Remove your mouth from the valve to allow for exhalation. 2. Some masks have oxygen inlets. Providing supplemental oxygen significantly increases the concentration of oxygen delivered to the patient. Oxygen concentrations can reach 50% when the flow is set to 15 LPM.

- (a) If the breath goes in, give a second breath and go to step 6.
- (b) If the breath fails to go in, go to step 4.

#### d. Bag-valve-mask (BVM).

**NOTE:** Supplemental oxygen can be given while using the BVM to increase oxygen concentration levels to 50%. When BVM systems have a reservoir supply, oxygen concentrations can reach almost 100%.

- (1) Insert an airway adjunct as needed.
- (2) Select the proper size of mask.
- (3) Position the mask on the casualty's face.
- (4) Form a "C" around the ventilation port. Use the third, fourth, and fifth fingers under the casualty's jaw to hold the mask in place.

**NOTE:** The most difficult part of performing rescue breathing using a BVM is maintaining an adequate seal. The American Heart Association recommends two rescuer BVM ventilation. In this method, one rescuer maintains a two-hand seal while the other rescuer squeezes the bag.

- (5) Squeeze the bag.
- (6) Release pressure from the bag and allow the patient to exhale passively.
  - (a) If the chest rises and air goes in, squeeze the bag again to give a second breath and then go to step 6.
  - (b) If the chest fails to rise, go to step 4.

#### e. Flow-restricted oxygen-powered ventilation device.

**CAUTION:** Use caution when using the FROPVD on patients with chest injuries. Be careful not to force excess air into the stomach instead of the lungs. This may cause gastric distention and vomiting. Do not use on children.

- (1) Follow the same steps to position and seal the mask as with the BVM.
- (2) Push the trigger on the device once.
  - (a) If the chest rises, push the button again and proceed to step 6
  - (b) If the chest fails to rise, go to step 4.

4. Reposition the head to ensure an open airway and attempt the breath again.

**NOTE:** When using a BVM or FROPVD, it is also important to check the mask seal.

- a. If the chest rises, give another breath and go to step 6.
- b. If the chest does not rise, continue with step 5.

**Performance Steps**

5. Clear an airway obstruction, if necessary (see task 081-831-0019). When the obstruction has been cleared, continue with step 6.
6. Check the carotid pulse for 5 to 10 seconds.
  - a. While maintaining the airway, place the index and middle fingers of your hand on the casualty's throat.
  - b. Slide the fingers into the groove beside the casualty's Adam's apple and feel for a pulse for 5 to 10 seconds.
  - c. If a pulse is present, go to step 7.
  - d. If a pulse is not found, begin CPR (see task 081-831-0046).
7. Continue rescue breathing.
  - a. Ventilate the casualty at the appropriate rate.
    - (1) Adult - 10-12 per minute.
    - (2) Adolescent - 15 per minute.
    - (3) Children greater than a year of age - 20 per minute (mouth-to-mouth or mouth-to-nose).
    - (4) Children less than one year of age - 40 per minute (mouth-to-nose).
  - b. Watch for rising and falling of the chest.
  - c. Recheck for pulse and breathing after every 12 breaths.

*NOTE:* Although not evaluated, continue rescue breathing as stated in the task standard. When breathing is restored, watch the casualty closely, maintain an open airway, and check for other injuries. If the casualty's condition permits, place him or her in the recovery position. (See task 081-831-0018.)

**Evaluation Preparation:**

Setup: For training and evaluation, a CPR mannequin must be used. Position the mannequin on its back. To test step 3, you may specify to the soldier whether to use the mouth-to-mouth or mouth-to-nose method, or you may create a scenario in which the casualty's condition dictates which method is to be used. You may determine how much of the task is tested by telling the soldier whether the airway is clear or a pulse is found as the soldier proceeds through the task. However, you should ensure that the soldier is routed through the task far enough to continue rescue breathing after checking the carotid pulse.

Brief soldier: Tell the soldier to perform rescue breathing.

<b>Performance Measures</b>	<b><u>GO</u></b>	<b><u>NO GO</u></b>
1. Opened the airway	_____	_____
2. Ventilated the casualty using the mouth-to-mouth, mouth-to-nose, mouth-to-mask, BVM, or FROPVD method, as appropriate.	_____	_____
3. Repositioned the head to ensure an open airway and repeated ventilation attempt, if necessary.	_____	_____
4. Cleared an airway obstruction, if necessary.	_____	_____
5. Checked the carotid pulse for 5 to 10 seconds.	_____	_____



**Performance Measures**

GO      NO  
GO

- |  |       |       |
|--|-------|-------|
| 6. Continued rescue breathing.             | _____ | _____ |
| 7. Completed all necessary steps in order. | _____ | _____ |

**Evaluation Guidance:** Score each soldier according to the performance measures in the evaluation guide. Unless otherwise stated in the task summary, the soldier must pass all performance measures to be scored GO. If the soldier fails any step, show what was done wrong and how to do it correctly.

**References**

**Required**  
None

**Related**  
EMERGENCY CARE

## CONTROL BLEEDING

**081-833-0161**

**Conditions:** You have encountered a casualty who is bleeding externally and may also be bleeding internally. Body substance isolation precautions have been taken, as appropriate. Necessary materials: field dressings, cravats, gauze pads, gauze roller bandage, and materials for a tourniquet.

**Standards:** Controlled bleeding without further harming the casualty.

### Performance Steps

1. Determine if the bleeding is external or internal.
  - a. External bleeding (go to step 2).
  - b. Internal bleeding (see tasks 081-833-0047, 081-833-0062, 081-833-0064, and 081-833-0154).
    - (1) Large bruises on the trunk or abdomen indicating injury to underlying organs.
    - (2) Painful, swollen or deformed extremities indicating underlying fractures.
    - (3) Rigid and/or tender abdomen.
    - (4) Bleeding from the mouth, rectum, or other body orifice.
    - (5) Vomiting bright red or dark (like coffee grounds) blood.
    - (6) Bloody stool that is dark and tarry or bright red.

2. Apply direct pressure to the wound with a gauze pad or field dressing.

**NOTE:** If bleeding is profuse, apply direct pressure to the wound with your gloved hand. Do not waste time looking for a dressing.

3. Elevate the affected extremity above the level of the heart.

**CAUTION:** Do not elevate if there are suspected musculoskeletal injuries, impaled objects in the extremity, or spinal injury.

4. Apply additional dressings if the wound continues to bleed.

**CAUTIONS:** 1. Never remove a dressing once it has been applied to a wound. Removing the dressing may destroy any clotting that has begun, thus causing further injury to the site. In some cases, leaving the blood soaked dressing in place allows more bleeding. In this instance, remove the dressing and redress once to be sure direct pressure is being placed on the wound.

2. Once bleeding has been controlled it is important to check a distal pulse to make sure that the dressing has not been applied too tightly. If a pulse is not palpable, adjust the dressing to reestablish circulation.

**NOTE:** If using gauze pads or similar material to dress a wound, bandage the dressing in place.

5. Locate and apply pressure to the appropriate arterial pressure point, if the wound continues to bleed.

**NOTE:** Pressure points may not be effective if the wound is at the distal end of the limb. Blood is being sent to these areas from many smaller arteries.

- a. Brachial artery--used to control bleeding from the distal end of an upper extremity.
  - (1) Hold the casualty's arm out at a right angle to his or her body with the palm facing up.

**NOTE:** Do not use force to raise the arm if the movement causes pain.

- (2) Locate the groove between the humerus and the biceps muscle.
- (3) Hold the upper arm in the palm of your hand with your fingers positioned in the medial groove.

**Performance Steps**

- (4) Press your fingers into the groove to compress the artery against the underlying bone.

*NOTE:* If pressure is applied properly, the radial pulse will not be palpable.

- b. Femoral artery--used to control bleeding of a lower extremity.
  - (1) Locate the femoral artery on the medial side of the anterior thigh, just below the groin.
  - (2) Place the heel of your hand over the site and apply pressure toward the bone.

*NOTE:* More pressure is needed to compress the femoral artery than the brachial artery due to the amount of tissue and muscle in the thigh. Greater force is needed for obese and muscular individuals. If pressure is applied properly, a distal pulse will not be palpable.

- 6. Consider other conjunctive therapies to slow bleeding if necessary.
  - a. Splinting (see task 081-831-0044).

*NOTE:* Airsplints are effective in controlling venous and capillary bleeding. They are not usually effective in high pressure arterial bleeds. Airsplints are effective, however, in maintaining pressure once other manual methods, such as pressure dressings, have been applied.

- b. Cold application.

*NOTE:* Cold minimizes swelling and constricts blood vessels.

**CAUTION:** Never apply icepacks directly to the skin. Always wrap cold packs in cloth before applying to the skin. Do not apply ice for more than 20 minutes at a time.

- c. Pneumatic anti-shock garments (PASG) (see task 081-833-3011).

*NOTE:* Though controversial, PASG can be useful in controlling bleeding to lower extremities. Refer to local SOP for guidance on application.

**CAUTION:** Never inflate only the abdominal section. PASG are contraindicated in chest injuries.

- 7. Apply a tourniquet if the wound continues to bleed. See task 081-833-0047.

**CAUTION:** A tourniquet is a last resort for life-threatening injuries. Tourniquets cut off blood flow to and from the extremity and are likely to cause permanent damage to vessels, nerves, and muscles. Never loosen or remove the tourniquet after it has been applied.

*NOTE:* A blood pressure cuff can provide a temporary tourniquet to control bleeding until a pressure dressing is applied. Place the cuff above the wound and inflate it to 150 mm Hg. Deflate the cuff slowly once a bandage has been applied.

- 8. Initiate treatment for shock as needed (see task 081-833-0047).

- 9. Assess the need for evacuation.

- 10. If the source of bleeding was due to a traumatic amputation--
  - a. Wrap the amputated part in a sterile dressing.
  - b. Wrap or bag the amputated part in plastic.
  - c. Label the bag or plastic.
  - d. Transport the amputated part in a cool container with the patient.

**CAUTION:** Do not place the amputated part directly on ice. Do not submerge it directly in water. Do not allow the part to freeze.

**Performance Measures**

<u>GO</u>	<u>NO</u>
<u>GO</u>	<u>GO</u>

- 1. Determined the type of bleeding (internal or external).

_____	_____
-------	-------

**Performance Measures**

	<u>GO</u>	<u>NO</u> <u>GO</u>
2. Performed measures to control external bleeding.	_____	_____
a. Applied direct pressure to the wound.		
b. Elevated the extremity.		
c. Applied additional dressings to the wound, if needed.		
d. Located and applied pressure to the appropriate arterial pressure point, if needed.		
e. Applied a tourniquet, if needed.		
3. Initiated treatment for shock.	_____	_____
4. Assessed the need for transport.	_____	_____
5. Performed measures for continuous monitoring.	_____	_____
6. Caused no further injury.	_____	_____

**Evaluation Guidance:** Score each soldier according to the performance measures in the evaluation guide. Unless otherwise stated in the task summary, the soldier must pass all performance measures to be scored GO. If the soldier fails any step, show what was done wrong and how to do it correctly.

**References**

**Required**  
None

**Related**  
BTLS FOR PARAMEDICS  
EMERGENCY CARE

**PLACE A PATIENT ON A CARDIAC MONITOR**  
**081-833-0167**

**Conditions:** You have a conscious patient requiring continuous cardiac monitoring. Necessary equipment and materials: cardiac monitor, leads, and electrodes.

**Standards:** Correctly connected the patient to the monitor.

**Performance Steps**

1. Identify the patient.
  - a. Have the patient state his or her name.
  - b. Check the patient's arm band, if one is available.
  - c. Explain the procedure to the patient.
2. Prepare the equipment.
  - a. Turn the power switch to the on position. Make sure the cord is connected to a power source.
  - b. Attach the lead cable to the monitor and observe for flat line on the monitor.
  - c. Check for the presence of recording paper and replace it as needed.
  - d. Turn the lead selection knob to the Lead II position, if so equipped.
3. Attach the patient to the monitor.
  - a. Place an electrode on the right anterior superior chest just inferior to the clavicle (right arm lead).
  - b. Place a second electrode on the left anterior superior chest just inferior to the clavicle (left arm lead).
  - c. Place a third electrode on the left lateral aspect of the abdomen (this electrode may also be placed on the left upper leg).
  - d. Attach the cable from the monitor to the corresponding electrodes.
  - e. Observe the monitor and note the type of pattern.
  - f. Set the monitoring and alarm parameters IAW with local SOP.
4. Document the procedure.

**Performance Measures**

	<u>GO</u>	<u>NO GO</u>
1. Identified the patient.	_____	_____
2. Prepared the equipment.	_____	_____
3. Attached the patient to the monitor.	_____	_____
4. Documented the procedure.	_____	_____

**Evaluation Guidance:** Score each soldier according to the performance measures in the evaluation guide. Unless otherwise stated in the task summary, the soldier must pass all performance measures to be scored GO. If the soldier fails any step, show what was done wrong and how to do it correctly.

**References**  
**Required**  
None

**Related**  
BASIC NURSING

**MANAGE CARDIAC ARREST USING AED**  
**081-833-3027**

**Conditions:** You and an assistant arrive at a scene where an adult patient is in ventricular fibrillation or pulseless ventricular tachycardia and is receiving basic cardiac life support from a rescuer. You have already taken the necessary body substance isolation. Necessary materials and equipment: automatic external defibrillator (AED), oropharyngeal airway, bag-valve-mask, nonrebreather mask, and oxygen tank set up.

**Standards:** Completed all the steps necessary to perform cardiac defibrillation with an automatic external defibrillator in order.

**Performance Steps**

1. Briefly question the rescuer about the arrest event.
  - a. How long has the patient been in arrest?
  - b. How long has CPR been in progress?
  - c. Do you know two man CPR?
2. Direct the rescuer to stop CPR.

*NOTE:* Allow the rescuer to complete the current cycle.
3. Determine whether the patient is a candidate for an AED.

*NOTE:* If the patient has sustained trauma before collapse, do not attach the AED. Continue CPR and transport immediately.

  - a. Unresponsive.
  - b. Apneic.
  - c. Pulseless.
4. Direct the rescuer to resume CPR.
5. Turn the automatic external defibrillator on.
6. Attach the monitoring-defibrillation pads to the cables if the pads aren't attached.
7. Attach the AED to the patient.
  - a. Place the top right pad below the right mid-clavicular.
  - b. Place the lower pad over the lower left ribs.
8. Direct the rescuer to stop CPR.
9. Ensure all individuals are standing clear of the patient.
  - a. Give the order, "ALL CLEAR."
  - b. Visually check to ensure that no one is in contact with the patient.
  - c. Visually check to ensure no one is in direct contact with any electrically conductive material touching the patient, such as IV lines, monitor wires, or the bed frame.
10. Initiate analysis of rhythm.
  - a. Press the analysis button.
  - b. Wait for the machine to analyze the rhythm.
11. Press the button to deliver shock if advised by the defibrillator.

**Performance Steps**

**CAUTION:** Do not defibrillate if anyone is touching the patient or the patient is wet (dry the patient), touching metal (move away from metal), or wearing a nitroglycerin patch (remove the patch with a gloved hand).

- a. If shock is indicated, proceed to step 12.
- b. If no shock is indicated--

*NOTE:* The patient may be in asystole or pulseless electrical activity (PEA) which are not shockable rhythms.

- (1) Check the pulse.
- (2) If none, perform CPR for 1 minute.
- (3) Press the analyze button.
- (4) If no shock is indicated, repeat steps 11b(1)-(3).
- (5) If no shock is still indicated, check the pulse. If none, start CPR and transport.

12. Repeat steps 9 through 11 until three shocks have been delivered.

13. Check for pulse.

14. If no pulse, direct the assistant and rescuer to resume CPR.

15. Check the pulse during CPR to confirm effectiveness of CPR.

16. Insert an airway adjunct (see task 081-833-0016).

17. Ventilate the patient.

18. After 1 minute of CPR, repeat steps 9 through 12.

19. Check for pulse.

- a. If the patient has a pulse--
  - (1) Check the patient's breathing.
    - (a) If breathing is adequate, provide oxygen via nonrebreather mask.
    - (b) If breathing is inadequate or absent, ventilate the patient using a bag-valve-mask.
  - (2) Transport.

*NOTE:* If a resuscitated patient arrests during transport, repeat steps 9 through 18 until six shocks have been given or the patient regains a pulse.

- b. If the patient is pulseless--
  - (1) Resume CPR.
  - (2) Transport.

20. Perform ongoing assessment.

**Performance Measures**

	<u>GO</u>	<u>NO</u> <u>GO</u>
1. Questioned the rescuer about the arrest event.	_____	_____
2. Directed the rescuer to stop CPR.	_____	_____
3. Determined whether the patient was a candidate for an AED.	_____	_____
4. Directed the rescuer to resume CPR.	_____	_____
5. Turned the AED on.	_____	_____



<b>Performance Measures</b>	<b><u>GO</u></b>	<b><u>NO</u> <u>GO</u></b>
6. Attached the monitoring-defibrillation pads to the cables, if necessary.	_____	_____
7. Attached the AED to the patient.	_____	_____
8. Directed the rescuer to stop CPR.	_____	_____
9. Ensured all individuals were standing clear of the patient.	_____	_____
10. Initiated analysis of rhythm.	_____	_____
11. Pressed the button to deliver shock if advised by the AED.	_____	_____
12. Repeated steps 9 through 11 until three shocks were delivered.	_____	_____
13. Checked for pulse.	_____	_____
14. Directed the assistant and rescuer to resume CPR if no pulse was found.	_____	_____
15. Checked the pulse during CPR to confirm effectiveness.	_____	_____
16. Inserted an airway adjunct.	_____	_____
17. Ventilated the patient.	_____	_____
18. Repeated steps 9 through 12 after 1 minute of CPR.	_____	_____
19. Checked for pulse.	_____	_____
a. If the patient had a pulse, checked for breathing.		
(1) If the patient was breathing, provided oxygen via nonrebreather mask.		
(2) If breathing was inadequate or absent, ventilated the patient using a bag-valve-mask.		
b. If the patient was pulseless, resumed CPR.		
20. Performed ongoing assessment.	_____	_____

**Evaluation Guidance:** Score each soldier according to the performance measures in the evaluation guide. Unless otherwise stated in the task summary, the soldier must pass all performance measures to be scored GO. If the soldier fails any step, show what was done wrong and how to do it correctly.

**References**

**Required**  
None

**Related**  
EMERGENCY CARE

## Subject Area 3: Basic Medical Care

**PERFORM A PATIENT CARE HANDWASH****081-831-0007**

**Conditions:** You are about to administer patient care or have just had hand contact with a patient or contaminated material. Necessary materials and equipment: running water or two empty basins, a canteen, a water source, soap, towels (cloth or paper), and a towel receptacle or trash can.

**Standards:** Performed a patient care handwash without recontaminating the hands.

**Performance Steps**

1. Remove wristwatch and jewelry, if applicable.

*NOTE:* Rings should not be worn. If rings are worn, they should be of simple design with few crevices for harboring bacteria. Fingernails should be clean, short, and free of nail polish.

2. Roll shirt sleeves to above the elbows, if applicable.
3. Prepare to perform the handwash.
  - a. If using running water, turn on the warm water.
  - b. If running water is not available, set up the basins and open the canteen.
4. Wet your hands, wrists, and forearms.
  - a. If using running water, hold your hands, wrists, and forearms under the running water.
  - b. If running water is not available, fill one basin with enough water to cover your hands and refill the canteen.

5. Cover your hands, wrists, and forearms with soap.

*NOTE:* For routine patient care, use regular hand soap. For an invasive procedure such as a catheterization or an injection, use antimicrobial soap.

6. Wash your hands, wrists, and forearms.
  - a. Use a circular scrubbing motion, going from the fingertips toward the elbows for at least 15 seconds..
  - b. Give particular attention to creases and folds in the skin.
  - c. Wash ring(s) if present.

7. Rinse your hands, wrists, and forearms.
  - a. If using running water.
    - (1) Hold your hands lower than the elbows under the running water until all soap is removed.
    - (2) Do not touch any part of the sink or faucet.
  - b. If not using running water.
    - (1) Use a clean towel to grasp the canteen with one hand.
    - (2) Rinse the other hand, wrist, and forearm, letting the water run into the empty basin. Hold your hands lower than the elbows.
    - (3) Repeat the procedure for the other arm.
    - (4) Do not touch any dirty surfaces while rinsing your hands.

8. Dry your hands, wrists, and forearms.

**Performance Steps**

- a. Use a towel to dry one arm from the fingertips to the elbow without retracing the path with the towel.
  - b. Dispose of the towel properly without dropping your hand below waist level.
  - c. Repeat the process for the other arm using another towel.
9. Use a towel to turn off the running water, if applicable.
10. Reinspect your fingernails and clean them and rewash your hands, if necessary.

**Evaluation Preparation:**

Setup: None

Brief soldier: Tell the soldier to perform a patient care handwash. You may specify which method to use. The soldier need not perform both.

**Performance Measures**

	<u>GO</u>	<u>NO GO</u>
1. Removed wristwatch and jewelry, if applicable.	—	—
2. Rolled shirt sleeves to above the elbows, if applicable.	—	—
3. Prepared to perform the handwash.	—	—
4. Wet the hands, wrists, and forearms.	—	—
5. Covered the hands, wrists, and forearms with soap.	—	—
6. Washed the hands, wrists, and forearms.	—	—
7. Rinsed the hands, wrists, and forearms.	—	—
8. Dried the hands, wrists, and forearms.	—	—
9. Used a towel to turn off the running water, if applicable.	—	—
10. Reinspected the fingernails and cleaned them and rewash the hands, if necessary.	—	—

**Evaluation Guidance:** Score each soldier according to the performance measures in the evaluation guide. Unless otherwise stated in the task summary, the soldier must pass all performance measures to be scored GO. If the soldier fails any step, show what was done wrong and how to do it correctly.

**References**

**Required**  
None

**Related**  
BTLS FOR PARAMEDICS  
EMERGENCY CARE

## PUT ON STERILE GLOVES

### 081-831-0008

**Conditions:** Necessary materials and equipment: handwashing facilities, sterile gloves, and a flat, clean, dry surface.

**Standards:** Put on and removed sterile gloves without contaminating self or the gloves.

#### Performance Steps

1. Select and inspect the package.
  - a. Select the proper size of glove.
  - b. Inspect the package for possible contamination.
    - (1) Water spots.
    - (2) Moisture.
    - (3) Tears.
    - (4) Any other evidence that the package is not sterile.
2. Perform a patient care handwash.
3. Open the sterile package.
  - a. Place the package on a flat, clean, dry surface in the area where the gloves are to be worn.
  - b. Peel the outer wrapper open to completely expose the inner package.
4. Position the inner package.
  - a. Remove the inner package touching only the folded side of the wrapper.
  - b. Position the package so that the cuff end is nearest you.
5. Unfold the inner package.
  - a. Grasp the lower corner of the package.
  - b. Open the package to a fully flat position without touching the gloves.
6. Expose both gloves.
  - a. Grasp the lower corners or designated areas on the folder.
  - b. Pull gently to the side without touching the gloves.
7. Put on the first glove.
  - a. Grasp the cuff at the folded edge and remove it from the wrapper.
  - b. Step away from the table or tray.
  - c. Keeping your hands above the waist, insert the fingers of the other hand into the glove.
  - d. Pull the glove on touching only the exposed inner surface of the glove.

**NOTE:** If there is difficulty in getting your fingers fully fitted into the glove fingers, make the adjustment after both gloves are on.

8. Put on the second glove.
  - a. Insert the fingertips of the gloved hand under the edge of the folded over cuff.

**NOTE:** You may keep the gloved thumb up and away from the cuff area or may insert it under the edge of the folded over cuff with the fingertips.

- b. Keeping your hands above the waist, insert the fingers of the ungloved hand into the glove.
- c. Pull the glove on.
- d. Do not contaminate either glove.

**Performance Steps**

9. Adjust the gloves to fit properly.
  - a. Grasp and pick up the glove surfaces on the individual fingers to adjust them.
  - b. Pick up the palm surfaces and work your fingers and hands into the gloves.
  - c. Interlock the gloved fingers and work the gloved hands until the gloves are firmly on the fingers.

*NOTE:* If either glove tears while putting them on or adjusting the gloves, remove both gloves and repeat the procedure.

10. Remove the gloves.
  - a. Grasp one glove at the heel of the hand with the other gloved hand.
  - b. Peel off the glove, retaining it in the palm of the gloved hand.
  - c. Reach under the cuff of the remaining glove with one or two fingers of the ungloved hand.
  - d. Peel off the glove over the glove being held in the palm.
  - e. Do not contaminate yourself.

**CAUTION:** Do not "snap" the gloves while removing them.

11. Discard the gloves IAW local SOP.
12. Perform a patient care handwash.

**Evaluation Preparation:**

Setup: If performance of this task must be simulated for training and evaluation, the same gloves may be used repeatedly as long as they are properly rewrapped after each use. You may give the soldier a torn or moist glove package to test step 1.

*NOTE:* If the soldier does not know his or her glove size, have several different sizes available to try on to determine the correct size.

Brief soldier: Tell the soldier to put on and remove the sterile gloves.

**Performance Measures**

	<u>GO</u>	<u>NO GO</u>
1. Selected and inspected the package.	_____	_____
2. Performed a patient care handwash.	_____	_____
3. Opened the sterile package.	_____	_____
4. Positioned the inner package.	_____	_____
5. Unfolded the inner package.	_____	_____
6. Exposed both gloves.	_____	_____
7. Put on the first glove.	_____	_____
8. Put on the second glove.	_____	_____
9. Adjusted the gloves to fit properly.	_____	_____
10. Removed the gloves.	_____	_____

**Performance Measures**

	<u>GO</u>	<u>NO</u> <u>GO</u>
11. Discarded the gloves IAW local SOP.	_____	_____
12. Performed a patient care handwash.	_____	_____

**Evaluation Guidance:** Score each soldier according to the performance measures in the evaluation guide. Unless otherwise stated in the task summary, the soldier must pass all performance measures to be scored GO. If the soldier fails any step, show what was done wrong and how to do it correctly.

**References**

**Required**  
None

**Related**  
BASIC NURSING

## INITIATE A FIELD MEDICAL CARD

081-831-0033

**Conditions:** You have treated a casualty and must record the treatment given. Necessary materials and equipment: DD Form 1380 (Field Medical Card) and a pen or pencil.

**Standards:** Completed, as a minimum, blocks 1, 3, 4, 7, 9, and 11. Completed blocks 2, 5, 6, 8, 10, 12, 13, 14, 15, 16, and 17 as appropriate. Completed other blocks as time permits.

### Performance Steps

1. Remove the protective sheet from the carbon copy.
2. Complete the minimum required blocks.
  - a. Block 1. Enter the casualty's name, rank, and complete social security number (SSN). If the casualty is a foreign military person (including prisoners of war), enter his or her military service number. Enter the casualty's military occupational specialty (MOS) or area of concentration for specialty code. Enter the casualty's religion and sex.
  - b. Block 3. Use the figures in the block to show the location of the injury or injuries. Check the appropriate box(es) to describe the casualty's injury or injuries.

**NOTES:** 1. Use only authorized abbreviations. Except for those listed below, however, abbreviations may not be used for diagnostic terminology.

Abr W--Abraded wound.

Cont W--Contused wound.

FC--Fracture (compound) open.

FCC--Fracture (compound) open comminuted.

FS--Fracture (simple) closed.

LW--Lacerated wound.

MW--Multiple wounds.

Pen W--Penetrating wound.

Perf W--Perforating wound.

SL--Slight.

SV--Severe.

2. When more space is needed, attach another DD Form 1380 to the original. Label the second card in the upper right corner "DD Form 1380 #2." It will show the casualty's name, grade, and SSN.
  - c. Block 4. Check the appropriate box.
  - d. Block 7. Check the yes or no box. Write in the dose administered and the date and time that it was administered.
  - e. Block 9. Write in the information requested. If you need additional space, use Block 14.
  - f. Block 11. Initial the far right side of the block.
3. Complete the other blocks as time permits. Most blocks are self-explanatory. The following specifics are noted:
  - a. Block 2. Enter the casualty's unit of assignment and the country of whose armed forces he or she is a member. Check the armed service of the casualty, that is, A/T = Army, AF/A = Air Force, N/M = Navy, and MC/M Marine.
  - b. Block 5. Write in the casualty's pulse rate and the time that the pulse was measured.
  - c. Block 6. Check the yes or no box. If a tourniquet is applied, you should write in the time and date it was applied.

**Performance Steps**

- d. Block 8. Write in the time, date, and type of IV solution given. If you need additional space, use Block 9.
- e. Block 10. Check the appropriate box. Write in the date and time of disposition.
- f. Block 12. Write in the time and date of the casualty's arrival. Record the casualty's blood pressure, pulse, and respirations in the space provided.
- g. Block 13. Document the appropriate comments by the date and time of observation.
- h. Block 14. Document the provider's orders by date and time. Record the dose of tetanus administered and the time it was administered. Record the type and dose of antibiotic administered and the time it was administered.
- i. Block 15. The signature of the provider or medical officer is written in this block.
- j. Block 16. Check the appropriate box and enter the date and time.
- k. Block 17. This block will be completed by the United Ministry Team. Check the appropriate box of the service provided. The signature of the chaplain providing the service is written in this block.

**Evaluation Preparation:**

Setup: For training and evaluation have another soldier act as a casualty and have him or her respond to the soldier's questions on personal data.

Brief soldier: Tell the soldier to complete the FMC by asking appropriate questions of the casualty. Tell the soldier being tested any necessary information such as the nature of the wound and the treatment given. To test step 2, you may either have the soldier complete the minimum required blocks, or you may require the completion of all blocks. After step 2 ask the soldier what must be done with each copy of the FMC.

**Performance Measures**

	<u>GO</u>	<u>NO</u> <u>GO</u>
1. Removed the protective sheet from the carbon copy.	_____	_____
2. As a minimum, completed blocks 1, 3, 4, 7, 9, and 11.	_____	_____
3. Made proper distribution of the FMC copies.	_____	_____

**Evaluation Guidance:** Score each soldier according to the performance measures in the evaluation guide. Unless otherwise stated in the task summary, the soldier must pass all performance measures to be scored GO. If the soldier fails any step, show what was done wrong and how to do it correctly.

**References**

**Required**  
None

**Related**  
AR 40-66



## APPLY RESTRAINING DEVICES TO PATIENTS

081-833-0076

**Conditions:** You have identified the patient and explained the procedure. An assistant is available. Necessary materials and equipment: a bed, wrist and ankle restraining devices, ABD pads, padding materials, litters, flexible gauze (Kerlix/Kling), rifle slings, web belts, elastic bandages, bandoleers, cravats, and sheets.

**Standards:** Applied restraining devices to a patient without causing injury to the patient or yourself.

### Performance Steps

*NOTE:* In a field environment, the need for restraints may be your own decision, especially in the absence of senior medical personnel.

1. Apply wrist and ankle restraints.

*NOTE:* If you apply ankle restraints, also apply wrist restraints.

**WARNINGS:** 1. Do not attempt to apply restraining devices by yourself. Get adequate help. 2. A patient who is depressed or has an altered level of consciousness should be positioned on the stomach with the head turned to the side. 3. Position restraints to avoid causing further injury to a wound or interfering with IV lines, catheters, and tubes.

- a. Adjustable limb holders (cuff and strap).

- (1) Clean and powder the skin around the wrists and ankles, if possible.
- (2) Pad the limb with ABD pads or similar material.
- (3) Position the restraint cuff over the padded limb.
- (4) Thread the strap through the loop on the cuff. Pull the straps snugly enough to restrict free movement of the limb.

*NOTE:* If two fingers can be comfortably inserted under the cuff, the restraint is snug enough. The patient, however, must not be able to wiggle his or her hand out of the cuff.

- (5) Wrap the strap around the bedframe.
- (6) Lock the buckle and position it facing the outside of the bedframe for quick access.
- (7) Repeat steps 1a(2) through 1a(6) for each limb.

*NOTE:* The keys to the locked restraints must be readily available.

- b. Improvised restraints.

- (1) Clean and powder the skin around the wrists and ankles, if possible.
- (2) Pad the limb with any soft cloth such as towels, gauze, cravats, clean handkerchiefs, or clothing.
- (3) Secure the restraining material (gauze or roller bandage) to the limb with a clove hitch.
- (4) Pull the knot to fit the limb snugly.
- (5) Using a bow knot, tie both free ends to the bedframe in a location inaccessible to the patient.
- (6) Repeat steps 1b(2) through 1b(5) for each limb.

2. Apply mitt restraints.

- a. Place the patient's hand in a naturally flexed position.
- b. Place a soft rolled dressing or similar material in the patient's hand and close the hand.
- c. Wrap the entire hand snugly with a flexible gauze bandage (Kerlix, Kling).
- d. Secure the bandage with tape, not clips.

### Performance Steps

**CAUTION:** Remove and replace mitts at least every 8 hours. Clean the skin and perform range-of-motion exercises.

#### 3. Apply sheet restraints.

**NOTE:** This procedure requires the assistance of another person.

##### a. Litter or stretcher.

- (1) Unfold a sheet. Hold it at opposite corners and fold it lengthwise.
- (2) Twirl the sheet into a tight roll.
- (3) Place the patient on his or her stomach on a litter. Turn the head to the side.

**WARNING:** Check the patient frequently because he or she may suffocate while in the prone position.

- (4) Place the middle of the rolled sheet diagonally across the patient's upper back and one shoulder.
- (5) Bring both ends of the sheet under the litter, cross the ends, and bring the ends up over the other shoulder and upper back. Tie snugly in the middle of the upper back.
- (6) Secure one wrist to the litter, parallel to the thigh, using a wrist restraint.
- (7) Secure the other wrist above the head by attaching it to the nearest litter handle using a wrist restraint.

**CAUTION:** Use litter or stretcher restraints only as a temporary restraint for a patient who is combative or uncontrollable.

##### b. Bed.

- (1) Fold a sheet in half lengthwise.
- (2) Tuck approximately 2 feet of one end of the sheet under one side of the mattress at the patient's chest level.
- (3) Bring the other end of the sheet over the patient's chest, keeping the sheet over the arms. Tuck the free end of the sheet snugly under the other side of the mattress.
- (4) If further restriction is necessary, apply sheets in the same manner at the level of the patient's abdomen, legs, knees, and ankles.

**NOTE:** Use this method of restraint only for limiting movement. It is not a secure method of restraining a violent patient.

#### 4. Apply field expedient restraints.

**NOTE:** Field expedient restraints should not be used for long periods of time and should be replaced with regular restraining devices as soon as possible.

##### a. Mixed equipment. Restraints may be improvised from such items as rifle slings, web belts, bandoleers, or cravats.

- (1) Restrain the patient's arms and legs tight enough to restrict movement but not so tight as to restrict circulation.
- (2) Lay the patient on the ground.

##### b. Double litters.

- (1) Place the patient on his or her stomach on a litter. Turn the head to the side.
- (2) Place the patient's hands alongside the thighs and secure them to the litter with wrist restraints.
- (3) Place the other litter, carrying side down, on top of the patient.
- (4) Bind the litters together with two or more litter straps.
- (5) Place the litter strap buckles in a location inaccessible to the patient.

#### 5. Check the patient at least once every half hour for signs of distress and security of restraints.

**Performance Steps**

**WARNING:** The use of restraints has the following hazards: 1. Tissue damage under the restraints. 2. Development of pressure areas. 3. Nerve damage. 4. Injury or death in case of fire or other emergencies. 5. Inability to effectively resuscitate a patient. 6. Possibility of shoulder dislocations in combative patients or those with seizure activity.

- 6. Change the patient's position at least once every 2 hours, day and night. Exercise the limbs through normal range-of-motion activities.
- 7. Evacuate the patient, if necessary.

**Performance Measures**

	<u>GO</u>	<u>NO GO</u>
1. Applied wrist and ankle restraints, as applicable.	_____	_____
2. Applied mitt restraints, as applicable.	_____	_____
3. Applied sheet restraints, as applicable.	_____	_____
4. Applied field expedient restraints, as applicable.	_____	_____
5. Checked the patient.	_____	_____
6. Changed the patient's position.	_____	_____
7. Evacuated the patient, if necessary.	_____	_____
8. Did not cause further injury to the patient.	_____	_____

**Evaluation Guidance:** Score each soldier according to the performance measures in the evaluation guide. Unless otherwise stated in the task summary, the soldier must pass all performance measures to be scored GO. If the soldier fails any step, show what was done wrong and how to do it correctly.

**References**

**Required**  
None

**Related**  
EMERGENCY CARE

## MEASURE A PATIENT'S INTAKE AND OUTPUT

081-833-0006

**Conditions:** You have a physician's orders and have performed a patient care handwash. Necessary materials and equipment: DD Form 792, SF 511, or other appropriate forms, calibrated graduated container, gloves, common serving items, urinal, bedpan, urinary drainage bag, emesis basin, and nasogastric drainage container.

**Standards:** Accurately measured and recorded the patient's fluid intake and output on appropriate forms.

### Performance Steps

1. Explain the procedure to the patient.
  - a. Inform the patient of the length of time during which the intake and output will be measured and the purpose of taking the measurements.
  - b. Tell the patient of any physician's orders on fluid intake, such as forcing fluids or restricting the amount of intake.
2. Tell the patient what types of items require intake and/or output measurement.
  - a. Intake measurement.
    - (1) Items that are naturally fluid at room temperature such as jello, ice cream, ice, and infant cereals.
    - (2) Fluids consumed with and between meals, such as water, coffee, tea, broth, juice, milk, milk shakes, and carbonated beverages.
    - (3) IV infusion fluids and blood.
    - (4) Oral liquid medications.
    - (5) Irrigating solutions that are not returned.
  - b. Output measurement.
    - (1) Urine.
    - (2) Liquid stool.
    - (3) Vomitus.
    - (4) Drainage from wounds and suction devices.
3. Tell the patient to use specified containers, such as a bedpan or urinal, to save all fluid output.
4. Measure the intake.
  - a. Calculate the oral fluid intake.

**NOTE:** Check the water pitcher at the beginning and end of each shift. Check the meal tray for the amount of liquids consumed before removing it from the room.

- (1) Note the type and size of the oral fluid containers.
- (2) Check the container to find the fluid capacity.
- (3) Check the "Equivalents Table" on DD Form 792.

**NOTE:** If an unmarked container is not listed on DD Form 792, fill it with water and pour its contents into a graduate to check its capacity.

- b. Calculate the amount of IV solution or blood given.
- c. Calculate the amount of any irrigating solutions that are not returned, if applicable.
  - (1) Subtract the amount of solution returned from the known amount used for the irrigating procedure.
  - (2) Record the difference as intake.

**Performance Steps**

5. Record, in cubic centimeters (cc), the fluid intake under the appropriate heading on DD Form 792.

*NOTE:* To convert ounces to cc, multiply the number of fluid ounces by 30. Example: 12 fluid ounces multiplied by 30 equals 360 cc. One milliliter (ml) is approximately equal to one cc.

6. Measure the output.
  - a. Put on gloves.
  - b. Record the level of output (urine, liquid stool, or emesis) in a graduated container.

*NOTE:* If it is not possible to weigh or measure liquid stool, estimate the amount IAW local SOP. Estimate the amount of solid stool IAW local SOP.

- c. Estimate the amount of wound drainage, if present, IAW local SOP.
  - d. Estimate any output not in a container, such as on the floor, skin, or sheets, IAW local SOP.
  - e. Observe characteristics of the output.
    - (1) Color and odor of urine.
    - (2) Color, odor, and consistency of stool.
    - (3) Color and consistency of nasogastric drainage.

7. Remove gloves and perform a patient care handwash.

8. Record in cc, the amount and characteristics of output under the appropriate headings on DD Form 792.

*NOTE:* If no output was available to measure, enter this information in the "Remarks" section of DD Form 792.

9. Compute accumulated intake and output totals at the end of the 24-hour period and record on the appropriate forms IAW local SOP.

**Evaluation Preparation:**

Setup: If the performance of this task must be simulated for training and evaluation, premeasure at least two fluid items into common serving utensils. The soldier will use them as the remains of a patient's simulated intake. You may also partially empty a bag or bottle of intravenous (IV) solution and have the soldier calculate the amount of intravenous intake. Have at least two premeasured containers of simulated waste fluid to use for simulated output. Have the soldier explain steps 1 through 3 to you.

Brief soldier: Tell the soldier to measure and record the intake and output of a specified patient.

**Performance Measures**

	<u>GO</u>	<u>NO GO</u>
1. Explained procedures to the patient.	_____	_____
2. Told the patient what types of items require intake and/or output measurement.	_____	_____
3. Told the patient to use specific containers, such as a bedpan or urinal, to save all fluid.	_____	_____
4. Measured the intake.	_____	_____

**Performance Measures**

	<u>GO</u>	<u>NO</u> <u>GO</u>
5. Recorded, in cubic centimeters (cc), the fluid intake.	—	—
6. Measured the output.	—	—
7. Removed gloves and performed a patient care handwash.	—	—
8. Recorded, in cc, the amount and characteristics of output under the appropriate headings on DD Form 792.	—	—
9. Computed accumulated intake and output totals at the end of the 24-hour period and recorded on the appropriate forms IAW local SOP.	—	—

**Evaluation Guidance:** Score each soldier according to the performance measures in the evaluation guide. Unless otherwise stated in the task summary, the soldier must pass all performance measures to be scored GO. If the soldier fails any step, show what was done wrong and how to do it correctly.

**References**

**Required**  
None

**Related**  
BASIC NURSING

**ESTABLISH A STERILE FIELD**  
**081-833-0007**

**Conditions:** You have performed a patient care handwash. Necessary materials and equipment: sterile packs, sterile drapes and towels, small solution basin, sterile liquids, sterile needles and syringes, sterile gloves, and a flat, clean, dry surface.

**Standards:** Established a sterile field. Added items and liquids without violating aseptic technique.

**Performance Steps**

1. Obtain sterile equipment and supplies IAW local SOP.
2. Select a flat, clean, dry surface.

*NOTE:* Choose a surface away from drafts, if possible.

3. Create a sterile field with a double-wrapped sterile package.
  - a. Lift the top flap of the sterile pack away from the body without crossing the hand or arm over the sterile field.
  - b. Lift the remaining flaps, one at a time, away from the center without crossing the hand or arm over the sterile field.

4. Add sterile items to the sterile field.

*NOTE:* The outer one-inch border of the sterile field is considered contaminated. Items that fall in that area are considered contaminated and should not be used. If an item rolls from the one-inch border onto the sterile field, the sterile field is considered contaminated and the procedure must be stopped immediately. The procedure must be repeated using a new sterile pack.

- a. Commercially prepacked items.
  - (1) Keeping the hands on the outside of the sterile wrapper, grasp the opening edge of the package.
  - (2) Carefully fold each end of the wrapper back toward the wrist.
  - (3) Without contaminating the contents, drop them onto the sterile field.

*NOTE:* If the wrapper has been punctured or torn, the item is no longer sterile.

- b. Centralized Material Section (CMS) items (wrapped in double muslin wrappers).
  - (1) Remove the outer wrapper.
  - (2) Grasp the edge of the item being unwrapped, keeping the hand on the outside of the inner wrapper.
  - (3) Fold each edge of the wrapper slowly back over the wrist of the hand holding the item.
  - (4) Drop the item onto the sterile field.

5. Open sterile liquids.

*NOTES:* 1. Liquids prepared in CMS are considered sterile if a vacuum release sound is heard when the bottle is opened. If there is no sound, the bottle is considered unsterile, and a new bottle must be obtained before continuing the procedure. 2. Some commercially prepared bottles of sterile solution may not make a vacuum release sound.

- a. Remove the outer protective bottle seal, if necessary, and remove the cap.
- b. Hold the cap in one hand, or place the cap so the top rests on the table.

**Performance Steps**

*NOTE:* The bottle rim and inside of the cap are considered sterile.

**CAUTION:** Discard the sterile solution under any of the following conditions: 1. Anyone touches the bottle rim. 2. The lip of the bottle touches nonsterile items. 3. Someone touches the inside of the cap, or the part of the cap that touches the container is placed on the table.

6. Pour sterile liquids.
  - a. Hold the bottle with the label against the palm.
  - b. Pour a small amount of the liquid from the bottle into a waste receptacle.
  - c. Hold the bottle about 6 inches above the container into which the liquid is to be poured.
  - d. Slowly pour a steady stream to avoid splashing, thus preventing contamination.
  - e. Replace the cap without contaminating the bottle.
  - f. Write the date and time the bottle was opened and your initials on the label. Return the bottle to the storage area or discard it IAW local SOP.

*NOTE:* If the sterile field is contaminated at any time, the procedure must be stopped immediately. Repeat all steps using new sterile equipment.

**Performance Measures**

	<u>GO</u>	<u>NO GO</u>
1. Obtained sterile equipment and supplies IAW local SOP.	_____	_____
2. Selected a flat, clean, dry surface.	_____	_____
3. Created a sterile field with a double-wrapped sterile package.	_____	_____
4. Added sterile items to the sterile field.	_____	_____
5. Opened sterile liquids.	_____	_____
6. Poured sterile liquids.	_____	_____
7. Did not violate aseptic technique.	_____	_____

**Evaluation Guidance:** Score each soldier according to the performance measures in the evaluation guide. Unless otherwise stated in the task summary, the soldier must pass all performance measures to be scored GO. If the soldier fails any step, show what was done wrong and how to do it correctly.

**References**

**Required**  
None

**Related**  
BASIC NURSING



## **CHANGE A STERILE DRESSING**

### **081-833-0010**

**Conditions:** You have performed a patient care handwash. Necessary materials and equipment: protective pad, scissors, forceps, gloves, basin, sponges, face mask, swabs, towels, tape, dressings, sterile cleaning solution, adhesive solvent, and handwashing facilities.

**Standards:** Removed the dressing on a wound and cleaned and recovered the wound with a secure, sterile dressing without violating aseptic technique.

#### **Performance Steps**

1. Identify the patient.
2. Gather the equipment.
3. Prepare the patient.
  - a. Explain the procedure to the patient.
  - b. Expose the wound by moving the patient's clothing and folding the bed linens away from the wound area, if necessary.
  - c. Position the patient to provide maximum wound exposure.
  - d. Place a protective pad under the patient.
4. Prepare the work area.
  - a. Clear the bedside stand or table.
  - b. Cut the required tape strips and attach them where they are accessible.
5. Put on a mask and exam gloves.
6. Remove the outer dressing.
  - a. Loosen the ends of the tape by peeling toward the wound while supporting the skin around the wound.

**WARNING:** Do not peel the tape away from the wound.

- b. Grasp the edge of the dressing and gently remove it from the wound.
  - c. Note any drainage, color, and odor associated with the dressing.
  - d. If the dressing is grossly saturated, discard the dressing and the gloves in a contaminated waste container otherwise, dispose of in regular trash.
7. Perform a patient care handwash.
8. Establish a sterile field. (See task 081-833-0007.)
  - a. Open and place all sterile equipment and supplies on the sterile field.
  - b. Pour the sterile cleaning solution into a basin.
9. Put on a mask and sterile gloves.
10. Remove the inner dressings.
  - a. Using forceps, remove the dressings one at a time.
  - b. Note any drainage, color, and odor associated with the dressings.
  - c. Discard the dressings in a contaminated waste container.
  - d. Drop the forceps on the glove wrap.
11. Check the wound for the following conditions.
  - a. Redness, swelling, foul odor, and/or bleeding.

**Performance Steps**

- b. Drainage that contains blood, serum, or pus (usually yellow but may be blood-tinged, greenish, or brown).

**CAUTION:** Notify the supervisor if any of the above conditions are present.

- c. If drainage is present, seek permission from the physician to irrigate the wound. (See task 081-833-0012.)

12. Clean the wound with sterile gauze soaked with a sterile cleaning solution.

a. Linear wound.

- (1) First stroke. Clean the area directly over the wound with one wipe and discard the gauze.
- (2) Second stroke. Clean the skin area on one side next to the wound with one wipe and discard the gauze.
- (3) Third stroke. Clean the skin area on the other side next to the wound with one wipe and discard the gauze.
- (4) Continue the procedure alternating sides of the wound, working away from the wound until the area is cleaned.

b. Circular wound.

- (1) First stroke. Start at the center of the wound, wipe the wounded area with an outward spiral motion, and then discard the gauze.
- (2) Second stroke. Clean the skin area next to the wound using an outward spiral motion, approximately one and one half revolutions, and then discard the gauze.
- (3) Using successive outward, spiral strokes of approximately one and one half revolutions, clean the entire area around the wound.

13. Change gloves.

14. Remove adhesive from around the wound, if necessary.

- a. Using a solvent-soaked cotton tipped applicator or gauze pad, rub gently over the adhesive residue.
- b. Observe the skin for signs of irritation.

15. Apply a sterile dressing.

- a. Lay the first dressing over the wound so that it extends over the edge.
- b. Overlap the first dressing with a second dressing.
- c. Overlap the second dressing with a third dressing.
- d. Cover all of the dressings with a large outer dressing.

**NOTE:** If the wound has a drain inserted, cut the dressing halfway through and position it around the drain.

16. Remove sterile gloves and face mask.

17. Secure the dressing with tape.

**NOTE:** The tape should not form a constricting band around the wound.

- a. Apply tape to the edge of the dressing with half of the tape on the dressing and the other half on the skin.
- b. Write the date and time the dressing was changed on a piece of tape, initial it, and secure the tape to the dressing.

18. Dispose of contaminated materials in a contaminated waste container.

19. Perform a patient care handwash.

**Performance Steps**

20. Record the procedure on the appropriate form.
  - a. Enter the date and time of the dressing change.
  - b. Enter a description of the wound's appearance.
    - (1) Type and amount of drainage, if any.
    - (2) Characteristics of the wound before and after cleaning.

**Evaluation Preparation:**

Setup: If the performance of this task must be simulated for training or evaluation, have another soldier act as the patient. A moulage kit or similar materials may be used to simulate an injury. Apply a dressing to the patient.

*NOTE:* For testing purposes, the dressing may be reused.

Brief soldier: Tell the soldier to change the patient's sterile dressing.

**Performance Measures**

<u><b>GO</b></u>	<u><b>NO</b></u> <u><b>GO</b></u>
------------------	--------------------------------------

*NOTE:* Under combat conditions, dressings are not normally changed but are reinforced. The second dressing is labeled "Reinforcement." The date and time and the medic's initials are written on the dressing.

- |  |   |       |       |       |       |       |       |       |       |       |       |       |       |       |       |       |       |       |       |       |       |       |       |       |       |       |       |       |       |       |       |       |       |       |       |
|--|---|-------|-------|-------|-------|-------|-------|-------|-------|-------|-------|-------|-------|-------|-------|-------|-------|-------|-------|-------|-------|-------|-------|-------|-------|-------|-------|-------|-------|-------|-------|-------|-------|-------|-------|
| <ol style="list-style-type: none"> <li>1. Identified the patient.</li> <li>2. Gathered the equipment.</li> <li>3. Prepared the patient.</li> <li>4. Prepared the work area.</li> <li>5. Put on a mask and exam gloves.</li> <li>6. Removed the outer dressing.</li> <li>7. Performed a patient care handwash.</li> <li>8. Established a sterile field.</li> <li>9. Put on a mask and sterile gloves.</li> <li>10. Removed the inner dressings.</li> <li>11. Checked the wound.</li> <li>12. Cleaned the wound with sterile gauze soaked with a sterile cleaning solution.</li> <li>13. Changed gloves.</li> <li>14. Removed adhesive from around the wound, if necessary.</li> <li>15. Removed sterile gloves and face mask.</li> <li>16. Applied a sterile dressing.</li> </ol> | <table border="0"> <tr><td>_____</td><td>_____</td></tr> <tr><td>_____</td><td>_____</td></tr> <tr><td>_____</td><td>_____</td></tr> <tr><td>_____</td><td>_____</td></tr> <tr><td>_____</td><td>_____</td></tr> <tr><td>_____</td><td>_____</td></tr> <tr><td>_____</td><td>_____</td></tr> <tr><td>_____</td><td>_____</td></tr> <tr><td>_____</td><td>_____</td></tr> <tr><td>_____</td><td>_____</td></tr> <tr><td>_____</td><td>_____</td></tr> <tr><td>_____</td><td>_____</td></tr> <tr><td>_____</td><td>_____</td></tr> <tr><td>_____</td><td>_____</td></tr> <tr><td>_____</td><td>_____</td></tr> <tr><td>_____</td><td>_____</td></tr> <tr><td>_____</td><td>_____</td></tr> </table> | _____ | _____ | _____ | _____ | _____ | _____ | _____ | _____ | _____ | _____ | _____ | _____ | _____ | _____ | _____ | _____ | _____ | _____ | _____ | _____ | _____ | _____ | _____ | _____ | _____ | _____ | _____ | _____ | _____ | _____ | _____ | _____ | _____ | _____ |
| _____  | _____   |       |       |       |       |       |       |       |       |       |       |       |       |       |       |       |       |       |       |       |       |       |       |       |       |       |       |       |       |       |       |       |       |       |       |
| _____  | _____   |       |       |       |       |       |       |       |       |       |       |       |       |       |       |       |       |       |       |       |       |       |       |       |       |       |       |       |       |       |       |       |       |       |       |
| _____  | _____   |       |       |       |       |       |       |       |       |       |       |       |       |       |       |       |       |       |       |       |       |       |       |       |       |       |       |       |       |       |       |       |       |       |       |
| _____  | _____   |       |       |       |       |       |       |       |       |       |       |       |       |       |       |       |       |       |       |       |       |       |       |       |       |       |       |       |       |       |       |       |       |       |       |
| _____  | _____   |       |       |       |       |       |       |       |       |       |       |       |       |       |       |       |       |       |       |       |       |       |       |       |       |       |       |       |       |       |       |       |       |       |       |
| _____  | _____   |       |       |       |       |       |       |       |       |       |       |       |       |       |       |       |       |       |       |       |       |       |       |       |       |       |       |       |       |       |       |       |       |       |       |
| _____  | _____   |       |       |       |       |       |       |       |       |       |       |       |       |       |       |       |       |       |       |       |       |       |       |       |       |       |       |       |       |       |       |       |       |       |       |
| _____  | _____   |       |       |       |       |       |       |       |       |       |       |       |       |       |       |       |       |       |       |       |       |       |       |       |       |       |       |       |       |       |       |       |       |       |       |
| _____  | _____   |       |       |       |       |       |       |       |       |       |       |       |       |       |       |       |       |       |       |       |       |       |       |       |       |       |       |       |       |       |       |       |       |       |       |
| _____  | _____   |       |       |       |       |       |       |       |       |       |       |       |       |       |       |       |       |       |       |       |       |       |       |       |       |       |       |       |       |       |       |       |       |       |       |
| _____  | _____   |       |       |       |       |       |       |       |       |       |       |       |       |       |       |       |       |       |       |       |       |       |       |       |       |       |       |       |       |       |       |       |       |       |       |
| _____  | _____   |       |       |       |       |       |       |       |       |       |       |       |       |       |       |       |       |       |       |       |       |       |       |       |       |       |       |       |       |       |       |       |       |       |       |
| _____  | _____   |       |       |       |       |       |       |       |       |       |       |       |       |       |       |       |       |       |       |       |       |       |       |       |       |       |       |       |       |       |       |       |       |       |       |
| _____  | _____   |       |       |       |       |       |       |       |       |       |       |       |       |       |       |       |       |       |       |       |       |       |       |       |       |       |       |       |       |       |       |       |       |       |       |
| _____  | _____   |       |       |       |       |       |       |       |       |       |       |       |       |       |       |       |       |       |       |       |       |       |       |       |       |       |       |       |       |       |       |       |       |       |       |
| _____  | _____   |       |       |       |       |       |       |       |       |       |       |       |       |       |       |       |       |       |       |       |       |       |       |       |       |       |       |       |       |       |       |       |       |       |       |
| _____  | _____   |       |       |       |       |       |       |       |       |       |       |       |       |       |       |       |       |       |       |       |       |       |       |       |       |       |       |       |       |       |       |       |       |       |       |

**Performance Measures**

	<u>GO</u>	<u>NO</u> <u>GO</u>
17. Secured the dressing with tape.	_____	_____
18. Disposed of contaminated materials in the appropriate waste container.	_____	_____
19. Performed a patient care handwash.	_____	_____
20. Recorded the procedure on the appropriate form.	_____	_____
21. Did not violate aseptic technique.	_____	_____

**Evaluation Guidance:** Score each soldier according to the performance measures in the evaluation guide. Unless otherwise stated in the task summary, the soldier must pass all performance measures to be scored GO. If the soldier fails any step, show what was done wrong and how to do it correctly.

**References**

**Required**  
None

**Related**  
BASIC NURSING

## PERFORM A WOUND IRRIGATION

081-833-0012

**Conditions:** You have verified a physician's order to irrigate a wound. You have performed a patient care handwash. Necessary materials and equipment: protective pads, irrigating syringe, sterile gloves, mask, prescribed irrigating solution, sterile dressing, catch basin, sterile gauze sponges, and a sterile solution basin.

**Standards:** Irrigated the wound without violating aseptic technique or causing further injury to the patient.

### Performance Steps

1. Identify the patient.
  2. Explain the procedure to the patient.
  3. Provide privacy, if possible, and position the patient to provide maximum wound exposure.
  4. Place a protective pad directly under the wound area.
  5. Prepare the irrigation equipment.
    - a. Establish a sterile field using the wrapper of the sterile solution basin.
    - b. Open and place all other sterile equipment and supplies on the sterile field.
    - c. Verify the prescribed irrigating solution and pour it into the sterile basin.
  6. Put on a mask and exam gloves.
  7. Remove the soiled outer dressing.
  8. Remove the exam gloves.
  9. Place a catch basin on the protective pad, against the body, to collect the used solution.
  10. Put on sterile gloves.
  11. Use sterile forceps to remove the inner dressings.
  12. Irrigate the wound.
    - a. Fill the irrigating syringe with solution from the sterile basin.
    - b. Hold the tip of the syringe as close to the wound as possible without touching it. Depress the bulb or plunger, directing the flow of solution to all parts of the wound in a slow, steady stream.
    - c. Repeat steps 12a and 12b until all of the solution is used, or the wound is clear of debris and/or drainage.
    - d. Observe the drainage for blood or characteristics such as unusual color, odor, or consistency.
- CAUTION:** Use extra care when irrigating a wound in which an abscess has formed. Check all internal surfaces of the wound to inspect for "sinus tract" (resembles tunnels in which pus may be collected). This may require using the gloved hand or a sterile object to gently pull back the flesh. Be careful not to tear healing tissue.
13. Dry the wound and apply a sterile dressing.
    - a. Pat the wound dry with sterile gauze sponges.
      - (1) Start at the center of the wound.

**Performance Steps**

- (2) Move outward toward the wound edges.
  - b. Apply a sterile dressing to the wound. (See task 081-833-0010.)
  - c. Remove the catch basin and protective pad, if they are still in place.
- 14. Remove the mask and gloves.
- 15. Reposition the patient for comfort, if necessary.
- 16. Clean and store the equipment IAW local SOP.
- 17. Perform a patient care handwash.
- 18. Record the procedure on the appropriate form.

**Evaluation Preparation:**

Setup: If the performance of this task must be simulated for training or evaluation, have another soldier act as the patient. Designate a wound site or use a moulage kit or similar material to simulate an injury. Prepare a physician's order specifying the type and amount of solution to be used.

Brief soldier: Give the soldier the physician's order and tell the soldier to irrigate the wound.

**Performance Measures**

	<u>GO</u>	<u>NO GO</u>
1. Identified the patient.	_____	_____
2. Explained the procedure to the patient.	_____	_____
3. Provided privacy, if possible, and positioned the patient to provide maximum wound exposure.	_____	_____
4. Placed a protective pad directly under the wound area.	_____	_____
5. Prepared the irrigation equipment.	_____	_____
6. Put on a mask and exam gloves.	_____	_____
7. Removed the soiled outer dressing.	_____	_____
8. Removed the exam gloves.	_____	_____
9. Placed a catch basin on the protective pad, against the body, to collect the used solution.	_____	_____
10. Put on sterile gloves.	_____	_____
11. Used sterile forceps to remove the inner dressings.	_____	_____
12. Irrigated the wound.	_____	_____
13. Dried the wound and applied a sterile dressing.	_____	_____
14. Removed the mask and gloves.	_____	_____
15. Repositioned the patient for comfort, if necessary.	_____	_____

**Performance Measures**

	<u>GO</u>	<u>NO</u> <u>GO</u>
16. Cleaned and stored the equipment IAW local SOP.	_____	_____
17. Performed a patient care handwash.	_____	_____
18. Recorded the procedure on the appropriate form.	_____	_____
19. Did not violate aseptic technique.	_____	_____
20. Did not cause further injury to the patient.	_____	_____

**Evaluation Guidance:** Score each soldier according to the performance measures in the evaluation guide. Unless otherwise stated in the task summary, the soldier must pass all performance measures to be scored GO. If the soldier fails any step, show what was done wrong and how to do it correctly.

**References**

**Required**  
None

**Related**  
BASIC NURSING

**PERFORM ORAL AND NASOPHARYNGEAL SUCTIONING OF A PATIENT**  
**081-833-0021**

**Conditions:** A patient requires suctioning. You have identified the patient, explained the procedure, and performed a patient care handwash. Necessary materials and equipment: suction apparatus, suction catheter and tubing, "Y" adapter/connector, sterile saline, sterile solution basin, and sterile gloves.

**Standards:** Performed oral or nasopharyngeal suctioning without violating aseptic technique or causing injury to the patient.

**Performance Steps**

1. Position the patient in the semi-Fowler's (semi-sitting) position.

*NOTE:* In some cases, such as spinal injuries, the patient will have to remain in whatever position he or she is in at the time.

2. Check the pressure on the suction apparatus.
  - a. Turn the unit on, place a thumb over the end of the suction connecting tube, and observe the pressure gauge.
  - b. Ensure that the pressure reading is within the limits specified by local SOP and the recommendations of the equipment manufacturer.
  - c. Notify the supervisor if the pressure is not within the recommended limits.
  - d. Turn the unit off after verifying the correct pressure.

**WARNING:** If the suction pressure is too low, the secretions cannot be removed. If the pressure is too high, the mucous membranes may be forcefully pulled into the catheter opening.

3. Prepare the materials.

*NOTE:* Many disposable kits have all the items needed for suctioning if you are using a soft tip catheter.

- a. Open the solution basin package.
  - b. Pour saline solution into the basin.
  - c. Open the suction catheter package to expose the suction port of the catheter.
4. Explain to the patient the reason for suctioning.
  5. Oxygenate the patient.
    - a. If the patient is on oxygen therapy, increase the oxygen to 100% for 1 minute.
    - b. Monitor the patient's pulse oximeter reading during the entire procedure. (See task 081-833-0164.)
    - c. If the patient is not on oxygen therapy, have him or her take a minimum of five deep breaths or administer them with a bag-valve-mask.

*NOTE:* After each suctioning attempt or suctioning period, reoxygenate the patient.

6. Remove the catheter from the package using the dominant hand.
7. Grasp the suction connecting tubing with the other hand. Attach the tubing to the catheter.
8. Test the patency of the catheter.
  - a. Turn the suction unit on with the nondominant hand.
  - b. Insert the catheter tip into the sterile saline solution using the dominant hand.
  - c. Place the nondominant thumb over the suction port to create suction. Observe the saline entering the drainage bottle.



### Performance Steps

**NOTE:** If no saline enters the bottle, check the suction unit and/or replace the catheter and retest for patency.

9. Suction the patient.

a. Oral route.

(1) Rigid pharyngeal tip.

- (a) Instruct a conscious patient to cough to help bring secretions up to the back of the throat.
- (b) If the patient is unconscious, use the cross finger method of opening the airway (see task 081-831-0019).
- (c) Place the convex side of the rigid tip against the roof of the mouth and insert to the base of the tongue.

**NOTE:** A rigid tip does not need to be measured. Only insert the tip as far as you can see it. Be aware that advancing the catheter too far may stimulate the patient's gag reflex and cause him to vomit.

- (d) Apply suction by placing the thumb of the nondominant hand over the suction port.
- (e) Suction no longer than 15 seconds removing secretions from the back of the throat, along outer gums, cheeks and base of tongue.
- (f) Clear the secretions from the tip between suction by inserting tip into the saline solution and suction the solution through the catheter until the catheter is clear of secretions.
- (g) Repeat steps 9a(1)(a) - (g) until all secretions have been removed or until the patient's breathing becomes easier. Noisy, rattling or gurgling sounds should no longer be heard.
- (h) Place the catheter in a clean, dry place with suction turned off for reuse at a later time.

**NOTE:** It may also be placed within the patient's reach if the patient is conscious and is taught how to use it correctly.

(2) Flexible catheter.

- (a) Measure the catheter from the patient's earlobe to the corner of the mouth or the center of the mouth to the angle of the jaw.
- (b) Insert the catheter into the patient's mouth, without suction applied.

**NOTES:** 1. Hold the catheter with the sterile hand. Manipulate the suction connecting tubing and suction port with the non sterile hand. 2. If an oropharyngeal airway is in place, insert the catheter alongside the airway and then back into the pharynx.

- (c) Place the thumb of your nondominant hand over the suction control port on the catheter.
- (d) Apply intermittent suction by moving your thumb up and down over the suction control port.
- (e) Suction for no longer than 15 seconds removing secretions front the back of the throat, along outer gums, cheeks, and base of tongue.
- (f) Slowly and gently rotate the catheter between the thumb and index finger of your sterile hand as you withdraw the catheter.

**WARNINGS:** 1. Advancing the catheter too far into the back of the patient's throat may stimulate the gag reflex. This could cause vomiting and the aspiration of stomach contents. 2. Do not continue suctioning for more than 10 to 15 seconds because it removes oxygen as well as secretions. Longer periods of continuous suctioning may cause oxygen deprivation.

**Performance Steps**

- (g) Clear the secretions from the catheter between suctionings by inserting the tip into the saline solution and suction the solution through the catheter until the catheter is clear of secretions.
- (h) Repeat steps 9a(2)(a) through 9a(2)(g) until all secretions have been removed or until the patient's breathing becomes easier. Noisy, rattling, or gurgling sounds should no longer be heard.
- (i) Allow the patient to rest between each suctioning.

**NOTE:** If the patient is uncooperative, or oral entry is not possible due to injuries, nasopharyngeal suctioning may be required.

- b. Nasopharyngeal route.
  - (1) Measure the catheter from the tip of the earlobe to the nose.
  - (2) Lubricate the catheter by dipping the tip into the saline solution.
  - (3) Insert the catheter into one nostril without suction applied. If an obstruction is met, try the other nostril. If both are obstructed, seek assistance.
  - (4) Quickly and gently advance the catheter 3 to 5 inches.
  - (5) Perform steps 9a(2)(c) through 9a(2)(h) to suction secretions.

10. Observe the patient for hypoxemia.

**WARNING:** Discontinue suctioning immediately if severe changes in color or pulse rate occur.

- a. Color change.
  - b. Increased or decreased pulse rate.
11. Disconnect the catheter and remove the gloves.
- a. Hold the catheter in one hand.
  - b. Remove that glove by turning it inside out over the catheter to prevent the spread of contaminants.
  - c. Remove the other glove.
  - d. Discard them in contaminated trash.
12. Make the patient comfortable.
13. Discard, or clean and store, used items.
14. Record the procedure on the appropriate form.
- a. Date and time.
  - b. Respirations (rate and breath sounds before and after suctioning).
  - c. Type of suction performed.
  - d. Type and size of suctioning catheter used.
  - e. Type and amount of secretions.
  - f. Patient's toleration of the procedure.

**Performance Measures**

	<u>GO</u>	<u>NO GO</u>
1. Positioned the patient.	_____	_____
2. Checked the pressure on the suctioning apparatus.	_____	_____
3. Prepared the materials.	_____	_____
4. Explained the procedure to the patient.	_____	_____

<b>Performance Measures</b>	<u><b>GO</b></u>	<u><b>NO GO</b></u>
5. Oxygenated the patient, if necessary.	_____	_____
6. Removed the catheter from the package.	_____	_____
7. Attached the suction connecting tube to the catheter.	_____	_____
8. Tested the patency of the catheter.	_____	_____
9. Suctioned the patient (10-15 seconds).	_____	_____
10. Observed the patient for hypoxemia. If patient suctioning needed to be performed again, reoxygenated the patient.	_____	_____
11. Disconnected the catheter and removed the gloves.	_____	_____
12. Made the patient comfortable.	_____	_____
13. Discarded, cleaned, or stored used items.	_____	_____
14. Recorded the procedure on the appropriate form.	_____	_____
15. Did not cause further injury to the patient.	_____	_____

**Evaluation Guidance:** Score each soldier according to the performance measures in the evaluation guide. Unless otherwise stated in the task summary, the soldier must pass all performance measures to be scored GO. If the soldier fails any step, show what was done wrong and how to do it correctly.

**References**  
**Required**  
 None

**Related**  
 BTLS FOR PARAMEDICS  
 EMERGENCY CARE

## IRRIGATE AN OBSTRUCTED EAR

### 081-833-0059

**Conditions:** You have a physician's order to irrigate an obstructed ear. Necessary materials and equipment: irrigating syringe, catch basin, irrigating solution, towels, gauze sponges, and otoscope set.

**Standards:** Irrigated the obstructed ear until the obstructing material was removed from the external ear or until the prescribed amount of solution was used. Performed the procedure without causing further injury to the patient.

### Performance Steps

1. Gather the irrigation equipment.

*NOTE:* Common solutions used to irrigate the ear include water, normal saline, hydrogen peroxide and water, and prescribed medication solution. Alcohol may be used to shrink vegetable matter (associated with pediatric patients) and make it easier to expel. Oil may be used for other foreign bodies to make them slippery.

2. Perform a patient care handwash (081-831-0007).

3. Warm and test the solution.
  - a. Warm the solution to about body temperature (95° to 105° F) by placing the solution container in a container of warm water.
  - b. Test the temperature of the solution by running a small amount of it on the inner wrist.

**CAUTION:** Cold solutions are not only uncomfortable but may cause dizziness or nausea as a result of stimulation of the equilibrium sensors in the semicircular canals.

4. Identify the patient and explain the procedure.
  - a. Tell the patient that some discomfort may be experienced when the solution is instilled.
  - b. Emphasize to the patient that he or she must remain as still as possible.

**CAUTION:** If the patient moves when the solution is instilled, the syringe may damage the ear canal or tympanic membrane.

5. Insert the otoscope speculum into the external ear canal.
  - a. Position the patient to allow a good view into the ear.
  - b. Tilt the patient's head toward the shoulder opposite the ear to be irrigated.
  - c. Straighten the external ear canal by gently pulling the outer ear upward and backward for an adult or downward and backward for a child.

*NOTE:* Use the largest speculum that will fit comfortably in the patient's ear.

- d. Turn on the otoscope light and insert the speculum just inside the opening of the ear.

*NOTE:* To avoid causing pain, the speculum should be inserted gently and not too far into the ear canal.

- e. View the ear canal by looking through the lens of the otoscope.

6. Check for abnormalities.
  - a. Check the external ear canal for redness, swelling, drainage, or foreign bodies.
  - b. Check the tympanic membrane for any abnormal conditions.

*NOTE:* A normal eardrum is slightly cone-shaped, shiny, translucent, and pearly grey.

- (1) A blue, yellow, amber, red, or pink eardrum indicates disease or infection.
- (2) A bulge in the eardrum indicates possible pus or fluid in the middle ear.
- (3) A hole or tear indicates rupture of the tympanic membrane.

### Performance Steps

**CAUTION:** If an abnormal condition of the tympanic membrane is suspected, do not irrigate the ear. To do so could cause pain and carry debris or infectious discharge into the middle ear. Report the condition to the supervisor immediately.

7. Position the patient sitting or lying with the head slightly tilted toward the affected side.

**NOTE:** Do not tilt the head toward the unaffected side, as this interferes with the return of the irrigating solution.

8. Drape the patient's shoulder and upper arm area under the affected ear.

9. Clean the external ear and the entrance to the ear canal with 4 x 4 gauze sponges slightly moistened with the irrigating solution.

**WARNING:** If a cotton-tipped applicator is used to clean the ear, make sure it does not stick far enough into the ear to rupture the tympanic membrane.

10. Fill the irrigating syringe.

11. Test the flow of solution from the syringe by expelling a small amount back into the solution container.

12. Position the catch basin firmly against the neck just under the affected ear.

13. Straighten the external ear canal by gently pulling the outer ear upward and backward for an adult or downward and backward for a child.

14. Irrigate the patient's ear.

a. Place the tip of the irrigating syringe just inside the ear, with the tip directed toward the roof of the ear canal.

**WARNING:** Never allow the syringe to completely block the ear canal. If space is not left around the tip, the solution will not be able to return, and undue pressure will build up in the canal.

b. Depress the bulb or plunger of the syringe.

(1) Direct a slow, steady stream of solution against the roof of the ear canal.

(2) Repeat the procedure until the foreign body is removed, the solution returns free of wax or debris, or the proper amount of solution has been used.

15. Remove the catch basin and dry the external ear with a gauze sponge.

16. Instruct the patient to continue tilting the head toward the affected side for a few minutes to allow any remaining solution to drain from the ear.

17. Remove the drapes from the patient.

18. Dispose of, or clean and store, the equipment.

19. Perform a patient care handwash.

20. Document the procedure on the appropriate forms IAW local SOP.

a. Type and amount of solution used.

b. Nature of return flow.

<b>Performance Measures</b>	<b><u>GO</u></b>	<b><u>NO</u> <u>GO</u></b>
1. Gathered the irrigation equipment.	—	—
2. Performed a patient care handwash.	—	—
3. Warmed and tested the solution.	—	—
4. Identified the patient and explained the procedure.	—	—
5. Inserted the otoscope speculum into the external ear canal.	—	—
6. Checked for abnormalities.	—	—
7. Positioned the patient.	—	—
8. Draped the patient's shoulder and upper arm area under the affected ear.	—	—
9. Cleaned the external ear and the entrance to the ear canal.	—	—
10. Filled the irrigating syringe.	—	—
11. Tested the flow of solution.	—	—
12. Positioned the catch basin.	—	—
13. Straightened the external ear canal.	—	—
14. Irrigated the patient's ear.	—	—
15. Removed the catch basin and dried the external ear.	—	—
16. Instructed the patient to continue tilting the head toward the affected side.	—	—
17. Removed the drapes from the patient.	—	—
18. Disposed of, or cleaned and stored, the equipment.	—	—
19. Performed a patient care handwash.	—	—
20. Documented the procedure on the appropriate forms IAW local SOP.	—	—
21. Did not cause further injury to the patient.	—	—

**Evaluation Guidance:** Score each soldier according to the performance measures in the evaluation guide. Unless otherwise stated in the task summary, the soldier must pass all performance measures to be scored GO. If the soldier fails any step, show what was done wrong and how to do it correctly.

#### References

**Required**  
None

**Related**  
BASIC NURSING

**DOCUMENT PATIENT CARE USING SUBJECTIVE, OBJECTIVE, ASSESSMENT, PLAN  
(SOAP) NOTE FORMAT**

**081-833-0145**

**Conditions:** You are treating a patient and must record the treatment given. Necessary materials: documentation forms (as specified by local SOP) and a black ink pen.

**Standards:** Recorded patient care using SOAP note format.

**Performance Steps**

1. Record the patient's name, rank, SSN, date, and time.

*NOTE:* An addressograph card can be used on the patient identification block.

2. Write subjective data.
  - a. Chief complaint.
  - b. The patient's statements regarding the illness or injury history to include OPQRST.
3. Write objective data.
  - a. Observations by the medic to include sight, sound, touch, and smell.
  - b. Physical assessment data.
  - c. Lab and radiology results.
4. Write the assessment/analysis (conclusions reached based upon the data).
5. Write the plan.
  - a. Course of action to resolve the problem.
    - (1) Treatments made.
    - (2) Profiles.
    - (3) Medications.
  - b. Follow-up appointment or referral.

*NOTE:* Some treatment facilities use SOAPE format. The E stands for evaluation.

6. Correct recording errors, if applicable.
  - a. Draw a single line through the error.
  - b. Write the word error above it.
  - c. Initial next to the error.
  - d. Record the note correctly.
7. Finish the entry with your signature, rank, and title.

**Performance Measures**

	<u>GO</u>	<u>NO</u> <u>GO</u>
1. Recorded patient information.	_____	_____
2. Documented subjective data.	_____	_____
3. Documented objective data.	_____	_____
4. Wrote the assessment.	_____	_____
5. Wrote the plan.	_____	_____

**Performance Measures**

	<u>GO</u>	<u>NO</u> <u>GO</u>
6. Signed the entry.	_____	_____
7. Corrected errors, if applicable.	_____	_____
8. Made legible entries (typed or handwritten).	_____	_____
9. Used black or blue-black ink.	_____	_____
10. Did not skip lines or leave space between lines.	_____	_____

**Evaluation Guidance:** Score each soldier according to the performance measures in the evaluation guide. Unless otherwise stated in the task summary, the soldier must pass all performance measures to be scored GO. If the soldier fails any step, show what was done wrong and how to do it correctly.

**References**

**Required**  
None

**Related**  
BASIC NURSING



**PERFORM PATIENT HYGIENE**  
**081-833-0165**

**Conditions:** A patient requires assistance with personal hygiene. Necessary materials and equipment: washcloths, towels, bath blanket or cover sheet, toiletry items, clean hospital gown, gloves, wash basin, toothbrush or toothettes, emesis basin, suction equipment, water soluble lubricant, brush, comb, shampoo, razor, shaving cream, orange stick nail file, sheets, and waterproof pads.

**Standards:** Performed patient hygiene to the level indicated without causing further injury to the patient.

**Performance Steps**

1. Verify the activity with doctor's orders or nursing care plan.

2. Explain the procedure to the patient.

*NOTE:* Some of the following steps may be omitted based upon the client's condition. Patients should be encouraged to participate in self care to the extent that they are able.

3. Provide a bedbath.

a. Provide privacy.

(1) Close the door and draw a curtain around the patient.

(2) Expose only the areas being bathed.

b. Raise the entire bed to comfortable working height.

c. Place the bath blanket or sheet over the patient and remove top covers without exposing the patient.

d. Remove the patient's gown.

(1) If the patient has an IV, remove the gown from the arm without the IV first. Move the IV bag and the tubing through the sleeve and rehang the bag.

*NOTE:* If an IV pump is used, turn off the pump, clamp the tube, and then remove it as described above. Unclamp the tube, reinsert it into the pump, turn on the pump, and adjust the rate.

(2) If the patient has an injured extremity, remove the sleeve from the unaffected side first.

e. Place a towel under the patient's head.

f. Wash the face.

(1) Wash the patient's eyes from inner to outer canthus, using a clean part of the cloth for each eye.

*NOTE:* If the patient is unconscious, clean the eyes as above. Instill prescribed eye drops or ointment, if applicable (see task 081-835-3022). If the patient does not have a blink reflex, keep the eyelids closed and cover with a patch. Do not tape the eyelid.

(2) Wash, rinse, and dry the forehead, cheeks, ears, nose, and neck with plain warm water.

*NOTES:* 1. Soap tends to dry the face. 2. Men may want to be shaved (see step 6).

g. Wash the upper body.

(1) Remove the bath blanket from over the arm. Place a towel under the arm.

(2) Bathe the arm using long firm strokes from distal to proximal end.

(3) Lift the arm above the head if possible and wash and dry the axilla completely.

(4) Repeat steps 3f(1) through 3f(3) on other arm.

(5) Apply powder or deodorant to the axilla if applicable.

**Performance Steps**

(6) Bathe and dry the chest.

**NOTE:** Take special care to wash the skin under a female's breasts. Lift the breasts upward if necessary. Clean and dry thoroughly.

h. Wash the lower body.

(1) Place a bath towel over the chest and abdomen. Fold the blanket down to just above the patient's pubic region.

(2) Wash, rinse, and dry the abdomen paying attention to the umbilicus and the skin folds of the abdomen and groin.

(3) Wash and dry the leg nearest you.

(a) Place a towel under the leg.

(b) Support the leg at the knee and place the foot flat on the bed.

**NOTE:** The patient's foot may be placed in the basin to soak while the leg is being washed. However, soaking feet is NOT recommended for patients with diabetes mellitus or peripheral vascular disease.

(c) Wash and dry the leg using long firm strokes. Wash from ankle to knee and then from knee to thigh.

**CAUTION:** Avoid massaging the legs when the client is at risk for thrombosis or emboli.

(d) Wash and dry the foot completely.

(e) Move to the opposite side and repeat steps 3g(3)(a) through 3g(3)(d) for the other leg.

**NOTE:** Always raise the side rail for safety.

i. Change bath water and gloves.

j. Wash the perineum.

(1) Place the client in a side lying position and keep the patient covered with a bath blanket as much as possible.

(2) Wash the buttocks and anus from front to back.

**NOTE:** If feces is present, wrap it in underpad fold and remove as much as possible with disposable wipes first. Use as many wash cloths as necessary to clean completely. Ensure to cleanse the gluteal folds.

(3) Dry the area and replace the underpad with a clean one.

k. Wash the genitals.

(1) Female.

(a) Position the patient supine with a waterproof pad beneath the buttocks. Drape the patient with a bath blanket to maintain privacy.

(b) Wash the labia majora and then gently pull back the labia majora to wash the groin from perineum to rectum.

(c) Clean the pubic area from front to back.

**NOTE:** Clean around an indwelling catheter if applicable without pulling tension on it. Ensure the catheter is secured to the upper thigh or positioned over the thigh (not under it).

(2) Male.

(a) Gently grab the penis. Retract the foreskin if uncircumcised.

(b) Wash the tip of the penis and urinary meatus cleansing away from the meatus. Use a circular motion.

(c) Clean the penial shaft, scrotum, and underlying folds.

(d) Rinse and dry.

l. Change bath water and gloves.

m. Wash the back.

(1) Place the patient on his or her side.

(2) Clean and dry the back from neck to buttocks using long firm strokes.

n. Apply lotion to the skin if needed.

### Performance Steps

- o. Replace the gown.

#### 4. Provide oral care.

- a. Place the casualty in a side-lying position with a towel under the chin. Have an emesis basin available.
- b. Separate the upper and lower teeth.

*NOTE:* Oral suction must be available, especially if the patient has no gag reflex.

- c. Clean the mouth using a toothbrush, moistened 4 x 4 gauze, or toothette with water. Ensure the tongue, roof of mouth, inside cheeks, and tooth surfaces have been cleaned.

*NOTE:* The toothbrush should be soft bristled. Angle the brush at 45 degrees to clean the teeth. Avoid using glycerine or lemon swabs.

- d. Rinse with a clean toothette and water.

*NOTE:* Use as little water as possible to avoid aspiration.

- e. Suction the oral cavity as secretions accumulate if the patient is unable to remove them.
- f. Apply lip balm or water-soluble jelly to the lips.

#### 5. Provide hair care.

- a. Shampoo the hair.

- (1) Place a towel and waterproof pad under the head.
- (2) Comb or brush the patient's hair to release any tangles.
- (3) Position the patient supine with a plastic trough under the head.
- (4) Pour warm water over the head until completely wet.

*NOTES:* 1. Protect the patient's face and eyes by placing a towel or washcloth over them. 2. If hair is matted with blood, apply hydrogen peroxide to dissolve it, and then rinse with saline or water.

- (5) Apply shampoo and lather.
- (6) Massage gently starting at the hairline and working toward the back of the scalp.
- (7) Rinse the hair.
- (8) Apply conditioner if needed.
- (9) Dry the hair.
- (10) Complete styling of the hair as necessary.

*NOTE:* Braids may be helpful to prevent tangling of long hair.

- b. Shave the beard.

- (1) Position the patient into a sitting position if possible. Place a towel over the chest.
- (2) Place a moist, warm washcloth over the patient's face.
- (3) Apply shaving cream.
- (4) While pulling the skin taut, angle the razor to 45 degrees. Shave in the direction of hair growth.

*NOTE:* Ask the patient to direct you on his usual technique.

- (5) Rinse and dry the face. Apply aftershave if patient desires.

#### 6. Perform foot and nail care.

- a. Using an orange stick, gently clean under the patient's nails.
- b. Clip the nails straight and even with the digits. File the nails to shape and smooth rough edges.

**CAUTION:** Never cut the toenails. A patient with diabetes or hypertrophy should be referred to a podiatrist.

- c. Push the cuticle back gently with an orange stick.
- d. Apply lotion.

**Performance Steps**

7. Change the patient's linen (make an occupied bed).
  - a. Raise the entire bed to a comfortable working height.
  - b. Lower the head of the bed, if tolerated by the patient.
  - c. Remove the bedspread or blanket. Leave a sheet covering the patient.
  - d. Roll the patient to a side-lying position on the far side of the bed.

**NOTE:** Make sure any tubing is not pulled.

- e. Roll the bottom sheet, draw sheet, and underpad toward the patient as far as possible.
- f. Place a clean bottom sheet on the bed.
  - (1) The sheet may be fitted.
  - (2) Flat sheet. Center the sheet on the bed, and pull the bottom hem toward the foot of the bed. Open the sheet toward the patient. Tuck and miter the top under the head of the bed.
- g. Place draw sheets or waterproof pads on the center of the bed. Fan-fold toward the patient.
- h. Cover the unoccupied side of bed with the linen. Tuck the draw sheet under the mattress.
- i. Assist the patient to logroll over all the linen toward the other side of the bed.
- j. Raise the bed rail on the side facing the patient. Go to the other side and lower the bed rail.
- k. Remove soiled linens. Place them on the floor or in the hamper.

**CAUTION:** Never leave the patient alone with the side rails down.

- l. Pull clean linen toward you. Straighten the linen out.
  - m. Tuck and miter the corners.
  - n. Tuck in the draw sheet.
  - o. Straighten the waterproof pads.
  - p. Assist the patient to a supine position.
  - q. Place a clean top sheet and blanket over the patient.
  - r. Remove the original cover sheet.
  - s. Tuck the bottom of the covers under the mattress making a modified miter. Loosen the linen at the feet for comfort.
  - t. Change the patient's pillowcase.
8. Assist the patient to a position of comfort and place needed items within reach.
  9. Raise the side rails and lower the bed.
  10. Remove soiled supplies.
  11. Document what was performed and the patient's response. Inability to tolerate a procedure should be documented.

**Performance Measures**

	<u>GO</u>	<u>NO GO</u>
1. Verified the activity with doctor's orders or nursing care plan.	_____	_____
2. Provided a bedbath.	_____	_____
3. Provided oral care.	_____	_____
4. Provided hair care.	_____	_____

**Performance Measures**

	<u>GO</u>	<u>NO</u> <u>GO</u>
5. Provided foot and nail care.	_____	_____
6. Changed the patient's linen.	_____	_____
7. Assisted the client to a position of comfort and placed needed items within reach.	_____	_____
8. Raised the siderails and lowered the bed.	_____	_____
9. Removed soiled supplies.	_____	_____
10. Documented the procedures and the patient's response.	_____	_____

**Evaluation Guidance:** Score each soldier according to the performance measures in the evaluation guide. Unless otherwise stated in the task summary, the soldier must pass all performance measures to be scored a GO. If the soldier fails any step, show what was done wrong and how to do it correctly.

**References**

**Required**  
None

**Related**  
BASIC NURSING

## OBTAIN AN ELECTROCARDIOGRAM

### 081-835-3007

**Conditions:** You have verified a physician's orders to obtain an electrocardiogram on a patient. You have identified the patient and explained the procedure. A patient care handwash has been performed. Necessary materials and equipment: an EKG machine, electrodes, alcohol prep pads, towels, tape, OF 520, and the patient's clinical record.

**Standards:** Obtained an electrocardiogram in accordance with the physician's orders.

#### Performance Steps

1. Prepare the equipment.
  - a. Read the manufacturer's instructions for the proper use of the equipment on hand.
  - b. Plug in the machine and turn it on.
  - c. Allow it to perform its self-checks, if computerized, or warm up for 5 minutes if not computerized.
  - d. Obtain any other necessary materials.
2. Prepare the patient.
  - a. Provide for the patient's privacy.
  - b. Provide a female chaperon, if necessary, for female patients.
  - c. Ask or assist the patient to remove wristwatch, shoes, socks or hose, and all clothing from the waist up.
  - d. Provide a chest drape for female patients.
  - e. Ask or assist the patient to lie supine on the bed or examination table.
  - f. Ensure that the patient's body is not in contact with any metal objects, and that all limbs are firmly supported.

*NOTE:* Some metal objects, watches, or jewelry may interfere with the accurate recording of the electrical impulses.

- g. Instruct the patient to relax and breathe normally throughout the entire procedure.

3. Apply limb electrodes.
  - a. Clean the site for electrode placement by wiping with an alcohol prep pad to remove dead skin and oils as needed.

*NOTE:* An area of broken down or irritated skin should not be used for the electrode connection.

- b. Position the electrode.
  - (1) Secure the leg electrodes on the medial or lateral aspect of the calf.
  - (2) Secure the arm electrodes on the arm or forearm, ensuring that the connections are not on, or adjacent to, an IV site.
  - (3) Ensure that all the connections are made over a fleshy area, not over bone, as bone may interfere with conduction of the electrical impulse to the electrode.

*NOTE:* Make the usual electrode connection to a fleshy part of the stump if the patient is missing a limb. Secure the electrode with tape if necessary.

4. Apply the chest electrodes.
  - a. Clean the sites for electrode placement by wiping with an alcohol prep pad to remove dead skin and oils as needed.
  - b. Position the electrodes, being careful to place them over the intercostal spaces and not directly over the ribs (see Figure 3-2).

## Performance Steps

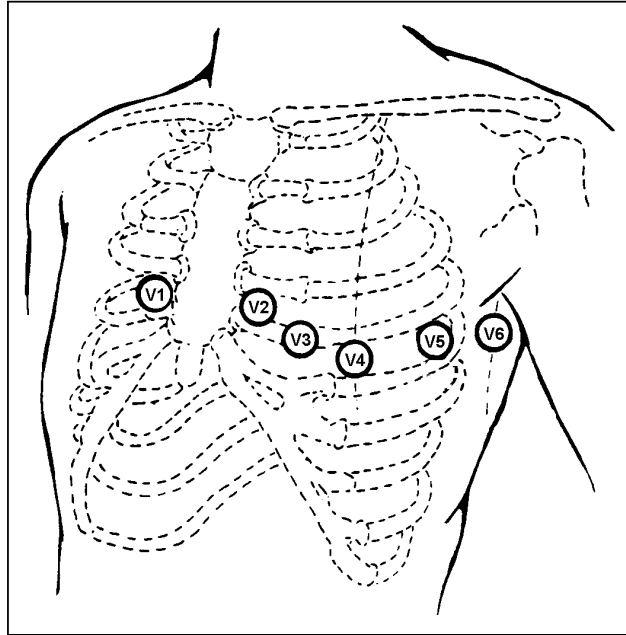

Figure 3-2

- (1) V1: 4th intercostal space at the right sternal border.
- (2) V2: 4th intercostal space at the left sternal border.
- (3) V3: Halfway between V2 and V4.
- (4) V4: 5th intercostal space at the left midclavicular line.
- (5) V5: 5th intercostal space at the left anterior axillary line.
- (6) V6: 5th intercostal space at the left midaxillary line.

*NOTE:* The standard EKG machine utilizes 12 "leads". These leads represent paths of electrical activity, and are designated as leads I, II, III, AVR, AVL, AVF, V1, V2, V3, V4, V5, and V6. Do not confuse these 12 leads with the 10 electrodes (sometimes referred to as "leads") that are attached to the patient.

5. Obtain the EKG tracing.
  - a. Operate the equipment in accordance with the manufacturer's operating instructions.
  - b. Ensure a complete and readable EKG tracing.
6. Observe and assess the EKG tracing as it is printed and take appropriate action.
  - a. Observe the tracing for the presence of the normal waves in each heartbeat.

*NOTE:* Each heartbeat is normally represented as 5 major waves: P, Q, R, S, and T. The Q, R, and S waves all represent the same portion of the heartbeat and are referred to as a unit: QRS complex. Occasionally, a 6th wave will appear. It is referred to as the U wave. Although it does not always appear, its presence is perfectly normal (see Figure 3-3).

## Performance Steps

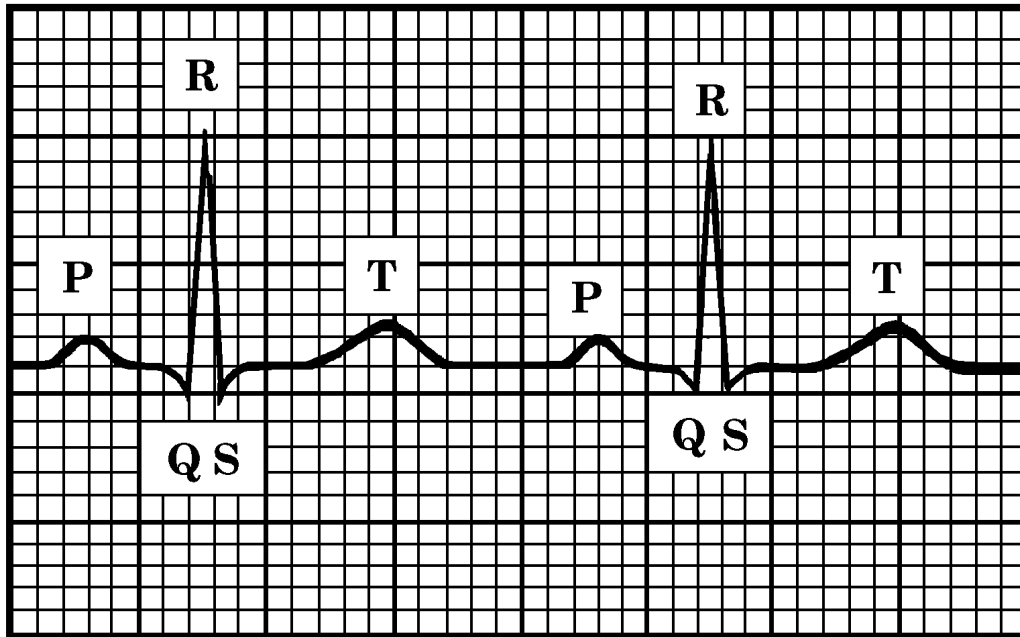

Figure 3-3

- b. Observe for irregularities that are a result of artifact, interference, or equipment malfunction.
  - (1) Check the patient's position.
  - (2) Check the placement of the electrodes.
  - (3) Obtain new equipment if necessary.
  - (4) Repeat the EKG.
- c. Observe for irregularities of the heart's rhythm.
  - (1) Notify the charge nurse or physician IMMEDIATELY if you note the presence of any of the life-threatening ventricular arrhythmias.

**NOTE:** Ventricular arrhythmias are characterized by an ectopic (out of place) focus in the wall of the ventricle which initiates ventricular contraction. A distorted and prolonged QRS complex occurs as a result of the aberrant conduction pathway.

- (a) Ventricular Fibrillation. V-Fib is an irregular and chaotic ventricular arrhythmia characterized by a rapid rate and disorganized conduction of impulses throughout the ventricular myocardium. Death will occur within minutes without immediate defibrillation or initiation of CPR (see Figure 3-4).



### Performance Steps

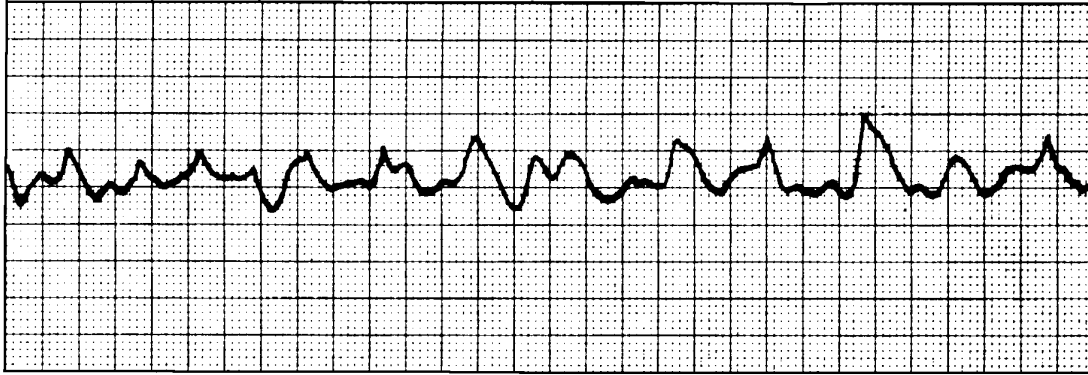

Figure 3-4

- (b) Ventricular Tachycardia. V-Tach is a ventricular arrhythmia characterized by broad QRS complexes and a regular rate that falls between 100 to 200 beats per minute. Immediate correction is essential, as V-Tach may lead to V-Fib (see Figure 3-5).

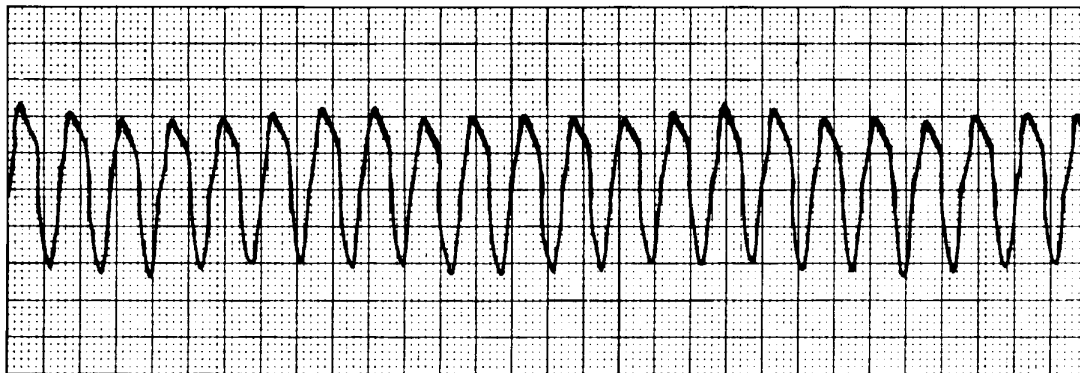

Figure 3-5

- (c) Premature Ventricular Contractions (PVCs). PVCs occur when an ectopic focus in one of the ventricles initiates contraction of the ventricles. When this occurs, there will be no atrial contraction associated with that beat, and no P wave will be seen in front of the QRS complex. A PVC usually has a tall, broad QRS complex. PVCs that come from different focal points in the ventricle will have different shapes on the EKG. PVCs may be harmless, but they may also be the forerunners of V-Tach and V-Fib. For this reason, even occasional PVCs should be considered important. PVCs are considered life threatening when they are frequent (more than 6 per minute), when they occur in groups of two or more (back-to-back), when they are multi-focal, and when they occur in a pattern of every other beat or every third beat (bigeminy, trigeminy) (see Figure 3-6).

**Performance Steps**

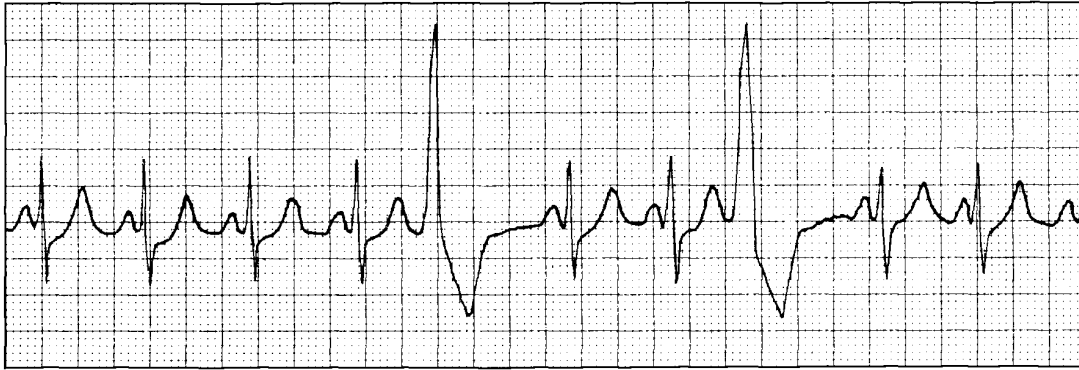

Figure 3-6

- (2) Notify the charge nurse or physician of any other irregularities of the heart's rhythm after you have completed the tracing, but before you remove the electrodes from the patient. (A second tracing may be ordered.)
7. Calculate the heart rate and report any abnormalities.
  - a. Time is measured on the horizontal axis of the EKG graph paper (see Figure 3-7).

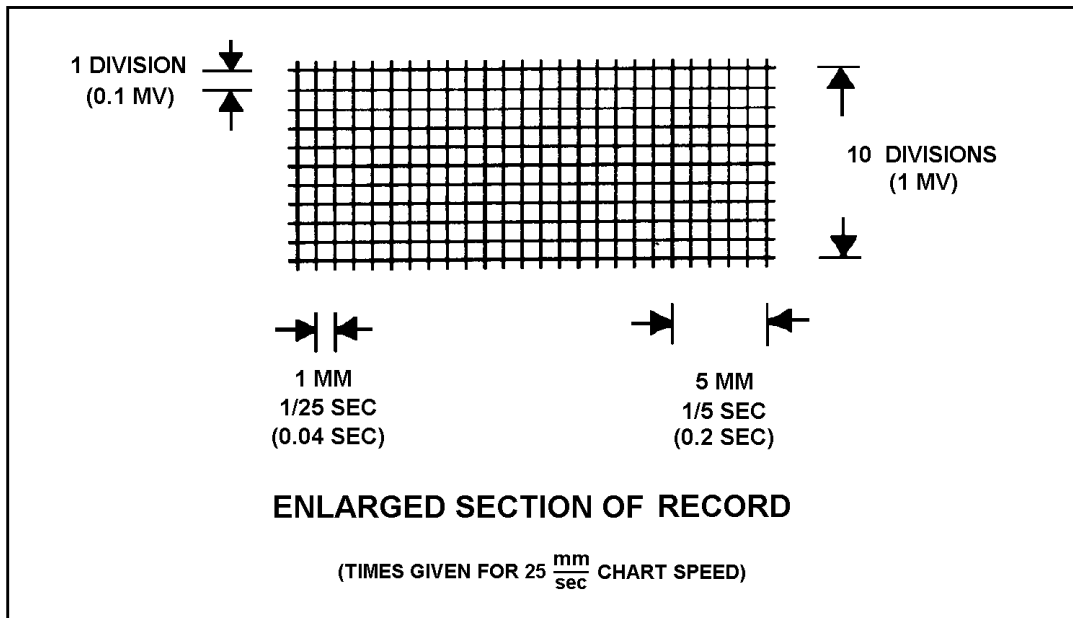

Figure 3-7

- (1) Each small box = 0.04 seconds.
- (2) Each large box = 5 small boxes = 0.20 seconds.
- (3) 5 large boxes = 1.0 second = 1 inch of graph paper.
- (4) 300 large boxes = 60 seconds = 1 minute.

- b. Calculate the heart rate using one of the following methods:
  - (1) Count the number of large boxes between any two R waves and divide that number into 300. Example: 300 divided by 5 large boxes = 60.
  - (2) Count the number of R waves in a 6 second strip and multiply by 10. Example: 6 R waves X 10 = 60.
- c. Notify the nurse of irregularities.
  - (1) Bradycardia--less than 60 beats per minute.
  - (2) Tachycardia--more than 100 beats per minute.

*NOTE:* Paper speed must be set on the normal (25 mm/sec) setting.

- 8. Remove the electrodes.
  - a. Remove all the chest and limb electrodes.
  - b. Wipe the patient's skin with a damp towel to remove the excess electrode paste.

*NOTE:* Instruct the patient to wash with soap and water as soon as convenient to avoid skin irritation from the EKG paste.

- 9. Ask or assist the patient to dress.

- 10. Prepare the report.
  - a. Remove the EKG tracing from the machine.
  - b. Mark the EKG tracing printout with the patient's identification.
  - c. Attach the completed OF 520 to the EKG tracing printout.
  - d. Make proper distribution of the report as directed by the physician's orders or IAW local SOP.

- 11. Store the equipment.
  - a. Dispose of used electrodes IAW local SOP.
  - b. Restock the machine with EKG paper, electrodes, alcohol prep pads, towels, and drapes, as necessary.
  - c. Store the machine in the area and manner directed by local policy.

- 12. Document the procedure and significant nursing observations on the appropriate forms IAW local SOP.

**Performance Measures**

	<u>GO</u>	<u>NO GO</u>
1. Prepared the equipment.	_____	_____
2. Prepared the patient.	_____	_____
3. Applied the limb electrodes.	_____	_____
4. Applied the chest electrodes.	_____	_____
5. Obtained the EKG tracing.	_____	_____
6. Assessed the EKG tracing.	_____	_____
7. Calculated the heart rate.	_____	_____
8. Removed the electrodes.	_____	_____
9. Asked or assisted the patient to dress.	_____	_____

**Performance Measures**

	<u>GO</u>	<u>NO</u> <u>GO</u>
10. Prepared the report.	_____	_____
11. Stored the equipment.	_____	_____
12. Documented the procedure.	_____	_____

**Evaluation Guidance:** Score each soldier according to the performance measures in the evaluation guide. Unless otherwise stated in the task summary, the soldier must pass all performance measures to be scored GO. If the soldier fails any step, show what was done wrong and how to do it correctly.

**References**

**Required**  
None

**Related**  
BASIC NURSING

Subject Area 4: Respiratory Dysfunction/Airway Management

**INSERT AN OROPHARYNGEAL AIRWAY (J TUBE)**

**081-833-0016**

**Conditions:** You are assessing an unconscious casualty who requires insertion of an oropharyngeal airway. Necessary materials and equipment: three sizes of oropharyngeal airways, gloves, and gauze pads or tongue blades.

**Standards:** Inserted the correct size of oropharyngeal airway and made it functional without causing further injury to the casualty.

**Performance Steps**

**WARNING:** Use an oropharyngeal airway for an unconscious casualty only. Do not use it on a conscious or semiconscious casualty because he or she may still have a gag reflex.

1. Select the correct size of airway.
  - a. Position the casualty's jaw in a normal closed mouth position.
  - b. Place the airway beside the outside of the casualty's jaw.
  - c. Ensure that the airway reaches from the corner of the casualty's mouth to the ear lobe.

**NOTE:** The measurement from the ear lobe to the corner of the casualty's mouth is equivalent to the depth of insertion in the airway.

2. Perform head-tilt/chin-lift to open the airway. (See task 081-831-0018.)

**WARNING:** If a neck or spinal injury is suspected, use the jaw thrust method to open the airway.

3. Open the casualty's mouth.

**WARNING:** Wear gloves for self-protection against transmission of contaminants whenever handling body fluids.

- a. Place the crossed thumb and index finger of one hand on the casualty's upper and lower teeth at the corner of the mouth.
- b. Use a scissors motion to pry the casualty's teeth apart.

**NOTE:** If the teeth are clenched, wedge the index finger behind the casualty's back molars to open the mouth.

4. Insert the airway.

- a. Place the tip end of the airway into the casualty's mouth over the tongue.
- b. Point the tip up toward the roof of the mouth.
- c. Slide the J tube along the roof of the mouth. Follow the natural curvature of the tongue past the soft palate.
- d. Rotate the airway 180° as the tip reaches the back of the tongue.

**NOTE:** The airway may be difficult to insert. If so, use a gauze pad to pull the tongue forward or a tongue blade to depress the tongue.

- e. Gently advance the airway and adjust it so the flange rests on the casualty's lips.

**NOTES:** 1. The tip of the airway should rest just above the epiglottis. 2. If the flange of the airway did not seat correctly on the lips or if the casualty gags, the airway may be the wrong size. Repeat the procedure using a different airway.

**WARNING:** If the casualty starts to regain consciousness and gags or vomits, remove the airway immediately.

**Performance Steps**

5. Evacuate the casualty.

*NOTE:* The airway may need to be taped or tied in place to avoid dislodgement during evacuation. If so, the casualty must be constantly monitored for the return of consciousness.

**Evaluation Preparation:**

Setup: For training and evaluation, use a CPR mannequin capable of accepting an oropharyngeal airway.

Brief soldier: Tell the soldier that the simulated casualty is unconscious and breathing. Tell the soldier to insert an oropharyngeal airway.

**Performance Measures**

	<u>GO</u>	<u>NO GO</u>
1. Selected the correct size of airway.	_____	_____
2. Performed head-tilt/chin-lift.	_____	_____
3. Opened the casualty's mouth.	_____	_____
4. Inserted the airway.	_____	_____
5. Evacuated the casualty.	_____	_____
6. Did not cause further injury to the casualty.	_____	_____

**Evaluation Guidance:** Score each soldier according to the performance measures in the evaluation guide. Unless otherwise stated in the task summary, the soldier must pass all performance measures to be scored GO. If the soldier fails any step, show what was done wrong and how to do it correctly.

**References**

**Required**  
None

**Related**  
BTLS FOR PARAMEDICS  
EMERGENCY CARE

**SET UP AN OXYGEN TANK**  
**081-833-0018**

**Conditions:** A patient care handwash has been performed. Necessary materials and equipment: full oxygen cylinders, nonsparking cylinder wrench, cylinder regulators, flowmeters for E and M tanks, yoke attachment, humidifier, sterile water, administration device, and warning signs.

**Standards:** Set up the oxygen tank without violating safety precautions or endangering patients or oneself.

**Performance Steps**

1. Obtain the necessary equipment.
  - a. Oxygen tank (cylinder). (See Figure 3-8.)

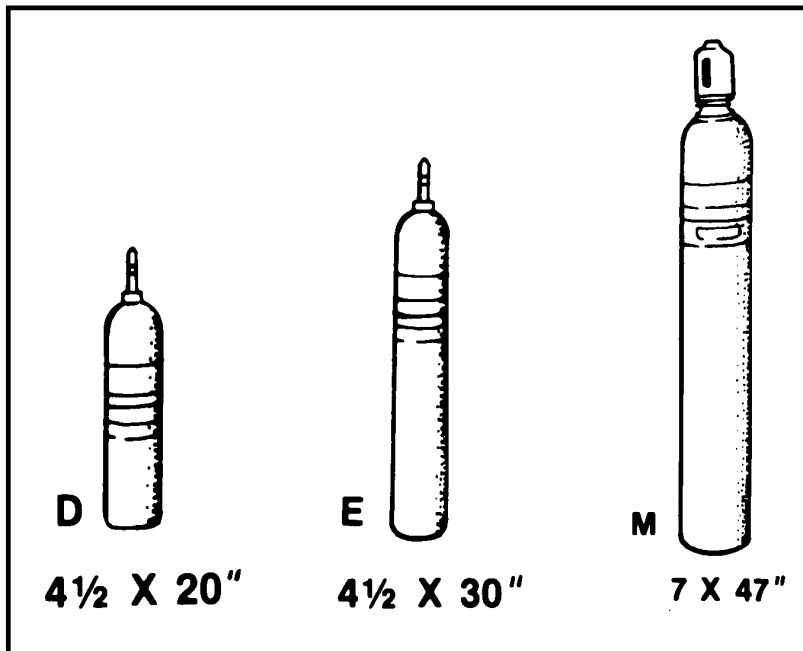

Figure 3-8

**NOTE:** Check the oxygen cylinder tag to determine whether the tank is "FULL", "IN USE" (partially full), or "EMPTY". (See Figure 3-9.)

**CAUTION:** Always ensure that the tank selected contains oxygen and not some other gas. United States oxygen tanks are color coded (painted) green. The international color code is white.

## Performance Steps

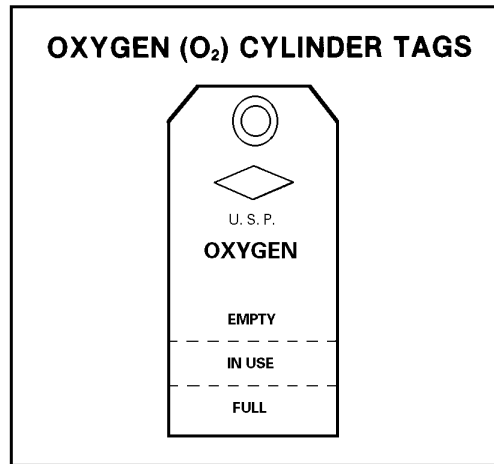

Figure 3-9

- b. Cylinder regulator with flowmeter. (See Figure 3-10.)

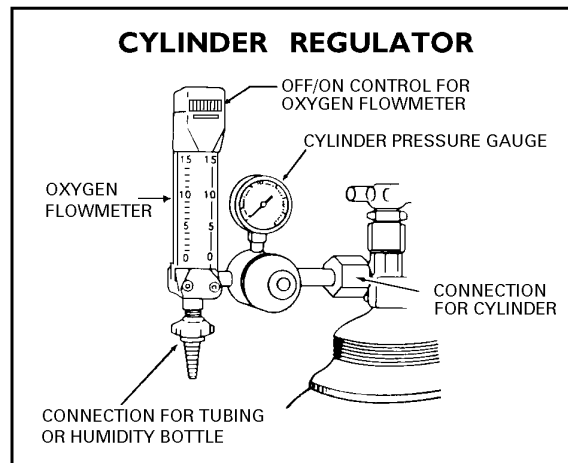

Figure 3-10

**NOTES:** 1. When the cylinder regulator pressure gauge reads 200 psi or lower, the oxygen tank is considered empty. 2. The pressure-compensated flowmeter is affected by gravity and must be maintained in an upright position. The Bourdon gauge flowmeter is not affected by gravity and can be used in any position.

- c. Humidifier.
- d. Sterile water.
- e. Nonsparking cylinder wrench.
- f. Oxygen tank transport carrier and/or stand.
- g. Oxygen delivery device ordered by the physician (nasal cannula or mask).
- h. Warning signs.
  - (1) "NO SMOKING."
  - (2) "OXYGEN IN USE".



### Performance Steps

**CAUTION:** Because of the extreme pressure in oxygen tanks, they should be handled with great care. Do not allow tanks to be banged together, dropped, or knocked over.

2. Secure the oxygen cylinder.
  - a. Upright position or IAW local SOP.
  - b. Secured with straps or in a stand.
  - c. Away from doors and areas of high traffic.

3. Remove the cylinder valve cap.

**NOTE:** The cylinder valve cap may be noisy or difficult to remove. However, the threads of the cylinder cap should never be oiled.

5. Use either the handwheel or a nonsparking wrench to "crack" (slowly open and quickly close) the cylinder to flush out any debris.

6. Attach the regulator to the cylinder.

- a. M cylinder.
  - (1) Hold the gauge in an upright position.
  - (2) Insert the cylinder regulator inlet into the oxygen cylinder's threaded outlet in an upright position.
  - (3) Hand-tighten the inlet nut, located on the cylinder regulator, and then completely tighten the inlet nut with a nonsparking wrench. (See Figures 3-11 and 3-12.)

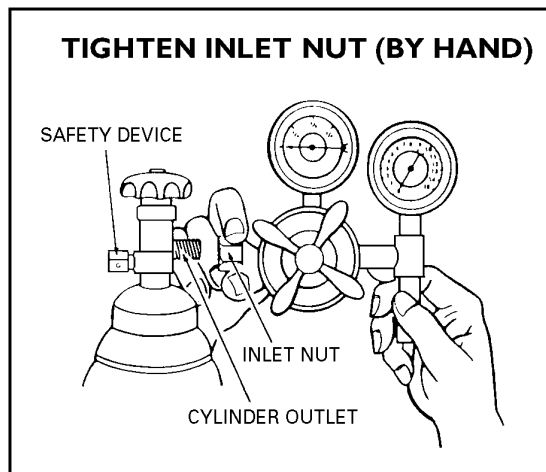

Figure 3-11

## Performance Steps

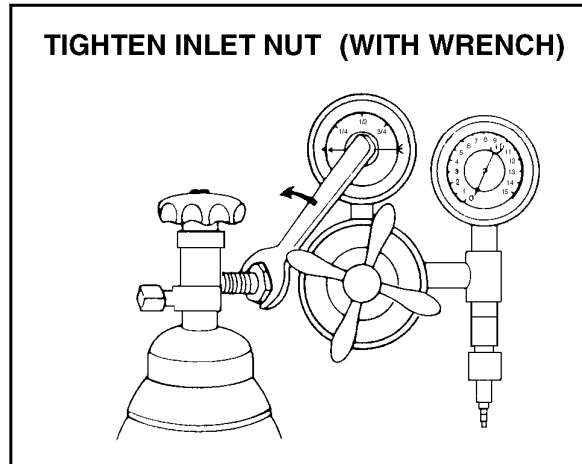

Figure 3-12

(4) Open the valve to test for leaks, and then close it.

**NOTE:** If there is a leak, check the regulator connection and obtain a new regulator and/or tank, if necessary.

b. D or E cylinder.

(1) Locate the three holes on the oxygen cylinder stem and ensure that an "O" ring is present. (See Figure 3-13.)

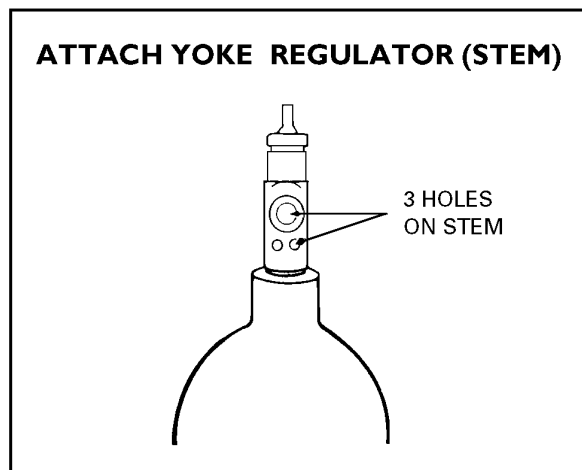

Figure 3-13

**NOTE:** If the "O" ring is not present, an oxygen leak will occur.

(2) Examine the yoke attachment and locate the three corresponding pegs on the yoke attachment. (See Figure 3-14.)

**Performance Steps**

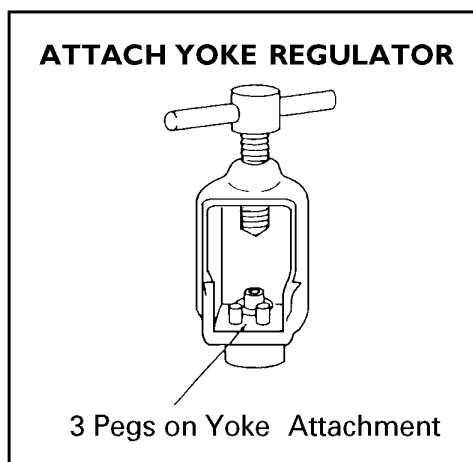

Figure 3-14

- (3) Slide the yoke attachment over the cylinder stem, ensuring that the pegs are seated in the proper holes.
- (4) Turn the vise-like screw on the side of the yoke attachment to secure it.
- (5) Open the valve to test for leaks, and then close it.

*NOTES:* 1. If there is a leak, check the regulator connection and obtain a new regulator and/or tank, if necessary. 2. When in-wall oxygen is available, the flowmeter will be attached to the oxygen outlet as follows: a. Turn the flow adjusting valve of the flowmeter to the OFF position. b. Insert the flowmeter adapter into the opening outlet and press until a firm connection is made.

7. Fill the humidifier bottle to the level indicated (about two-thirds full) with sterile water.

8. Attach the humidifier to the flowmeter.

*NOTE:* If an oxygen tube connector adapter is present, remove it from the flowmeter by turning the wing nut.

a. Attach the humidifier to the flowmeter with the wing nut on the humidifier.

*NOTE:* Not all humidifiers have "wing style nuts. Some have regular "bolt" style nuts.

b. Secure the nut by hand-tightening it.

*NOTE:* Humidifiers and tubing should be changed at least once every 24 hours (or more often IAW local SOP).

10. Post warning signs.

**CAUTION:** "OXYGEN" and "NO SMOKING" signs should be posted in the areas where oxygen is in use or stored.

12. Report and/or record completion of the procedure.

**Performance Measures**

1. Obtained the necessary equipment.
2. Secured the oxygen cylinder.

<u>GO</u>	<u>NO</u>
<u>GO</u>	<u>GO</u>

\_\_\_\_\_

\_\_\_\_\_

<b>Performance Measures</b>	<u><b>GO</b></u>	<u><b>NO GO</b></u>
3. Removed the cylinder valve cap.	_____	_____
4. Used either the handwheel or a nonsparking wrench to "crack" (slowly open and quickly close) the cylinder to flush out any debris.	_____	_____
5. Attached the regulator to the cylinder.	_____	_____
6. Filled the humidifier bottle to the level indicated (about two-thirds full) with sterile water.	_____	_____
7. Attached the humidifier to the flowmeter.	_____	_____
8. Attached the oxygen administration device.	_____	_____
9. Posted warning signs.	_____	_____
10. Reported and/or recorded completion of the procedure.	_____	_____

**Evaluation Guidance:** Score each soldier according to the performance measures in the evaluation guide. Unless otherwise stated in the task summary, the soldier must pass all performance measures to be scored GO. If the soldier fails any step, show what was done wrong and how to do it correctly.

**References**

**Required**  
None

**Related**  
BTLS FOR PARAMEDICS  
EMERGENCY CARE

**INSERT A NASOPHARYNGEAL AIRWAY**  
**081-833-0142**

**Conditions:** You encounter a casualty with a reduced level of consciousness who requires an airway adjunct. The casualty has a gag reflex. Body substance isolation precautions have been taken. Necessary materials and equipment: gloves, nasopharyngeal airway, and water-based lubricant.

**Standards:** Inserted a nasopharyngeal airway without causing further injury to the casualty.

**Performance Steps**

1. Place the casualty supine with the head in a neutral position.

**CAUTION:** Do not use the nasopharyngeal airway if there is clear fluid (cerebrospinal fluid - CSF) coming from the ears or nose. This may indicate a skull fracture.

2. Select the appropriate size of airway using one of the following methods:
  - a. Measure the airway from the patient's nostril to the earlobe.
  - b. Measure the airway from the patient's nostril to the angle of the jaw.

*NOTE:* Choosing the proper length ensures appropriate diameter. Standard adults sizes are 34, 32, 30, and 28 French.

3. Lubricate the tube with a water-based lubricant.

**CAUTION:** Do not use a petroleum-based or non-water-based lubricant. These substances can cause damage to the tissues lining the nasal cavity and pharynx thus increasing the risk for infection.

4. Insert the airway.
  - a. Push the tip of the nose upward gently.
  - b. Position the tube so that the bevel of the airway faces toward the septum.

*NOTE:* Most nasopharyngeal airways are designed to be placed in the right nostril.

- c. Insert the airway into the nostril and advance it until the flange rests against the nostril.

**CAUTION:** Never force the airway into the patient's nostril. If resistance is met, pull the tube out and attempt to insert it in the other nostril.

**Performance Measures**

	<u>GO</u>	<u>NO GO</u>
1. Positioned the casualty.	_____	_____
2. Measured and selected the appropriate size of airway.	_____	_____
3. Lubricated the nasal airway.	_____	_____
4. Fully inserted the airway	_____	_____

**Evaluation Guidance:** Score each soldier according to the performance measures in the evaluation guide. Unless otherwise stated in the task summary, the soldier must pass all performance measures to be scored GO. If the soldier fails any step, show what was done wrong and how to do it correctly.

**References**  
**Required**  
None

**Related**  
BTLS FOR PARAMEDICS  
EMERGENCY CARE

## ADMINISTER OXYGEN

081-833-0158

**Conditions:** You have a patient requiring oxygen therapy. Necessary materials and equipment: oxygen tank, pressure gauge, flowmeter, water, extension tubing, nonrebreather mask, and nasal cannula.

**Standards:** Administered oxygen therapy using a nonrebreather mask or nasal cannula to assist patient breathing without causing further injury to the patient. Calculated the duration of flow of the oxygen cylinder.

### Performance Steps

1. Explain the procedure to the patient.
2. Prepare the equipment.
  - a. Open the tank.
  - b. Check for leaks.
  - c. Check tank pressure.

*NOTE:* The safe residual level is the level of the oxygen at which the tank should be replaced. The level has been established to be 200 pounds per square inch (psi).

3. Position the casualty in the position of comfort in order to facilitate breathing unless contraindicated by the mechanism of injury.

4. Determine the delivery device.

*NOTE:* Humidifiers can be connected to flowmeters to provide moisture to dry oxygen. Oxygen can dry out mucous membranes with prolonged use. Humidified oxygen is usually more comfortable to patients and is particularly helpful for children and those patients who have COPD.

- a. A nonrebreather mask is the delivery system of choice for patients with signs of inadequate breathing, or who are cyanotic, have cool clammy skin, chest pain, severe injuries, or altered mental status. Go to step 5.
- b. Nasal cannula is appropriate for patients unable to tolerate the nonrebreather mask. Go to step 6.

5. Apply the nonrebreather mask.
  - a. Select the correct size of mask.

*NOTE:* The apex of the mask should fit over the bridge of the patient's nose and extend to rest on the chin thereby covering the mouth and nose completely. Nonrebreather masks come in different sizes for adults, children, and infants.

- b. Attach the tubing to the regulator.
- c. Start the oxygen flow and adjust it to the prescribed rate of 12 liters/minute or greater.

*NOTE:* The minimum flow is 8 liters/minute.

- d. Prefill the reservoir bag using your fingers to cover the connection between the mask and the reservoir, if applicable.
- e. Place the mask on the patient and adjust the straps.
- f. Instruct the patient to breathe normally.

6. Apply the nasal cannula.

- a. Attach the tubing to the regulator.
- b. Adjust the oxygen flow to the prescribed rate of 6 liters/minute or less.

**Performance Steps**

- c. Position the cannula so that the tips comfortably sit in the patient's nose.
- d. Adjust the nasal cannula to hold in place.

7. Continue to assess the patient for confusion, restlessness, level of consciousness, color, or changes in vital signs.

8. Check the equipment for security of tubing connections and administration device, oxygen flow, and humidifier water level as indicated.

**NOTE:** Change the delivery device and tubing every 24 hours or more often IAW local SOP. Humidifier water should be changed every shift. The water reservoir can become a breeding ground for harmful bacteria.

9. Calculate the duration of flow of the oxygen cylinder.

- a. Determine the remaining pressure in the tank by reading the regulator gauge.
- b. Determine the safe residual level of the oxygen tank.

**NOTE:** The safe residual level is the level of oxygen at which the tank should be replaced. This level has been established to be 200 pounds per square inch (psi).

- c. Determine the available cylinder pressure by subtracting the safe residual level from the remaining pressure. Example: 2000 psi remaining pressure minus 200 psi safe residual level = 1800 psi available pressure.

- d. Determine the conversion factor for the oxygen cylinder in use.

**NOTE:** Each type of oxygen cylinder, depending on its size, employs a specific conversion factor.

- (1) D size oxygen cylinder--0.16.
- (2) E size oxygen cylinder--0.28.
- (3) G size oxygen cylinder--2.41.
- (4) H size oxygen cylinder--3.14.
- (5) M size oxygen cylinder--1.56.

- e. Determine the available liters by multiplying the conversion factor by the amount of available pressure. Example: A "D" size cylinder is being used. A .16 conversion factor x 1800 psi available pressure = 288 liters of oxygen available for use.

- f. Determine the flow rate as prescribed by the physician's order.

- g. Determine the duration of the oxygen by dividing the available liters by the flow rate. Example: 288 available liters divided by the prescribed flow rate of 10 LPM = 28.8 (29) minutes duration of oxygen flow.

10. Follow safety precautions.

- a. Post "OXYGEN" and "NO SMOKING" signs wherever oxygen is used or stored.
- b. Inform the patient and visitors about the restrictions.

**WARNING:** The chief danger in using oxygen is fire. The presence of oxygen in increased concentrations makes all materials more combustible. Things that burn slowly in ordinary air will burn violently and even explosively in the presence of oxygen.

- c. Use only nonsparking wrenches on tanks.
- d. Ensure all electrical equipment is properly grounded.
- e. Position oxygen cylinders away from doors and high traffic areas.
- f. Do not use oil or grease around oxygen fittings.
- g. Secure oxygen cylinders in an upright position.



**Performance Measures**

	<u>GO</u>	<u>NO</u> <u>GO</u>
1. Explained the procedure to the patient.	_____	_____
2. Prepared the equipment.	_____	_____
3. Positioned the patient.	_____	_____
4. Selected the proper delivery device.	_____	_____
5. Applied the delivery device.	_____	_____
6. Monitored the patient.	_____	_____
7. Checked the equipment.	_____	_____
8. Calculated the duration of flow of the oxygen cylinder.	_____	_____
9. Followed safety precautions.	_____	_____

**Evaluation Guidance:** Score each soldier according to the performance measures in the evaluation guide. Unless otherwise stated in the task summary, the soldier must pass all performance measures to be scored GO. If the soldier fails any step, show what was done wrong and how to do it correctly.

**References**

**Required**  
None

**Related**  
BTLS FOR PARAMEDICS  
EMERGENCY CARE

## INSERT A COMBITUBE

### 081-833-0169

**Conditions:** An unconscious, nonbreathing casualty requires the insertion of an esophageal tracheal Combitube. An assistant is performing resuscitative measures. No cervical spine injury is present. Necessary materials and equipment: Combitube, 50 cc syringe, 10 cc syringe, gloves, eye protection, suction equipment, stethoscope, and bag-valve-mask (BVM).

**Standards:** Inserted the Combitube within 20 seconds and successfully ventilated the casualty without causing further injury.

### Performance Steps

1. Oxygenate the casualty.
  - a. Instruct the assistant to oxygenate the casualty using the BVM.
  - b. Instruct the assistant to count aloud for 20 seconds while intubation is performed.
  - c. At the end of 20 seconds, the assistant should immediately resume resuscitation if intubation is unsuccessful.
2. Prepare the Combitube.
  - a. Inspect the tube for breaks or cracks.
  - b. Attach the large syringe to the pharyngeal (proximal) cuff and inflate it with 100 cc of air. Check for leaks and then deflate completely.
  - c. Attach the small syringe to the tracheal (distal) cuff and inflate it with 15 cc of air. Check for leaks and then deflate completely.

**NOTE:** If a leak is present, replace the tube.

3. Put on gloves.
4. Kneel just above the casualty's head facing the casualty's feet.

**NOTE:** If casualty's neck has been hyperextended to open the airway, return it to a neutral position.

5. Insert the tube.
  - a. Have the assistant give the casualty two breaths and start counting for 20 seconds.
  - b. Lift the jaw and tongue straight upward without hyperextending the neck.
  - c. Pass the tube blindly following the pharyngeal curvature until the teeth are between the two black lines on the tube.

**CAUTION:** Do not force the tube at any time.

- d. Use the large syringe to inflate the pharyngeal cuff with 100 cc of air. The device will seat itself in the posterior pharynx behind the hard palate.
  - e. Use the small syringe to inflate the distal cuff with 10 to 15 cc of air.
6. Ventilate the casualty and check tube placement.
  - a. Attach the BVM device to the esophageal connector (marked #1).
  - b. Attempt to ventilate and listen for the presence of breath sounds in the lungs and absence of sounds from the epigastrium.
  - c. If there is an absence of breath sounds and presence of sounds in the epigastrium, the tube is in the trachea.
  - d. Attach the BVM to the tracheal connector (marked #2) and ventilate the casualty.
  - e. Listen for the presence of breath sounds.
  - f. Continue to ventilate the casualty every 3 to 5 seconds.

**Performance Steps**

7. Remove the Combitube if the casualty regains consciousness or regains a gag reflex.
  - a. Oxygenate the casualty with two slow breaths.
  - b. Turn the casualty to one side.
  - c. Deflate both cuffs.
  - d. Withdraw the tube in one quick motion following the curve of the pharynx.
  - e. Immediately clear the casualty's airway of any vomitus.

*NOTE:* Suction should be readily available when removing a Combitube.

**Performance Measures**

	<u>GO</u>	<u>NO GO</u>
1. Oxygenated the casualty.	_____	_____
2. Prepared the tube.	_____	_____
3. Put on gloves.	_____	_____
4. Kneeled at the casualty's head.	_____	_____
5. Inserted the tube within 20 seconds.	_____	_____
6. Ventilated the casualty and checked placement.	_____	_____
7. Removed the tube.	_____	_____

**Evaluation Guidance:** Score each soldier according to the performance measures in the evaluation guide. Unless otherwise stated in the task summary, the soldier must pass all performance measures to be scored GO. If the soldier fails any step, show what was done wrong and how to do it correctly.

**References**

**Required**  
None

**Related**  
EMERGENCY CARE

## PERFORM A NEEDLE CRICOTHYROIDOTOMY

### 081-833-3006

**Conditions:** You are in a field environment. A casualty has a total upper airway obstruction. The casualty's airway cannot be opened using manual methods or an endotracheal (ET) tube. Necessary materials and equipment: blanket, poncho, two large bore needles (10 to 14 gauge), povidone-iodine, 5 to 10 cc syringe, cannula-over-needle device (optional), gloves, and tape.

**Standards:** Established an emergency airway without causing unnecessary injury to the casualty. Completed steps 3 through 8 in order.

### Performance Steps

1. Hyperextend the casualty's neck.

**WARNING:** Do not hyperextend the casualty's neck if a cervical injury is suspected.

- a. Place the casualty in a supine position.
  - b. Place a blanket or poncho rolled up under the casualty's neck or between the shoulder blades so the airway is straight.
2. Put on gloves, if available.
3. Locate the cricothyroid membrane.
    - a. Place a finger of the nondominant hand on the thyroid cartilage (Adam's apple) and slide the finger down to the cricoid cartilage.
    - b. Palpate for the "V" notch of the thyroid cartilage.
    - c. Slide the index finger down into the depression between the thyroid and cricoid cartilages.
    - d. Prep the casualty's neck with povidone-iodine. Clean a 3 to 4 inch area using a circular motion, starting from the center and working outward.

4. Stabilize the larynx.

- a. Place the thumb and index finger of the nondominant hand on each side of the larynx.
- b. Apply enough pressure to keep the larynx in place.

**WARNING:** Holding the larynx too long or too tightly could cause the larynx to spasm or swell.

5. Insert a large bore needle (10 to 14 gauge) into the cricothyroid membrane.

- a. Hold the needle with the point directed 45 degrees caudally.
- b. Insert the needle through the cricothyroid membrane until no resistance is met.

**CAUTIONS:** 1. This procedure is more risky on a casualty with a large thick neck or one who has a tendency to bleed readily. 2. If resistance is met after having passed through the cricothyroid membrane, the needle has punctured the other side of the tracheal cartilage.

- c. Once the needle has penetrated the cricothyroid membrane, direct the needle inside the larynx downward and posteriorly to avoid penetration of the esophagus.

**NOTE:** This procedure may be varied by using a cannula-over-needle device. The catheter is advanced into the larynx.

6. Listen and feel for free airflow through the needle.

7. Insert a second needle, if necessary, and recheck for air flow. (If the airway formed by the first needle is not sufficient, a second needle may be inserted next to the first one following the procedure in step 5.)

**NOTE:** If air does not flow through the cricothyroidotomy needles, a surgical cricothyroidotomy must be performed. (See task 081-833-3005.) No more than two needles will be inserted.

**Performance Steps**

8. Stabilize the needle(s).
  - a. Wrap a 6 to 8 inch strip of tape around the needles one time where they exit the skin.
  - b. Press the ends of the tape to the skin so they do not come off and so the needles are held in place.

*NOTE:* Adequate ventilation of the casualty cannot be maintained simply by establishing an airway through the use of a needle cricothyroidotomy. The plunger of a syringe may be removed and mouth to barrel ventilation may be used. If equipment is available, the casualty can be ventilated using an ambu bag or oxygen. Approximately 12 respirations per minute should be administered.

9. Keep the casualty's head immobilized.

*NOTE:* If an airway needs to be artificially maintained for a prolonged period of time, and endotracheal intubation is not possible, perform a surgical cricothyroidotomy or tracheostomy.

**Evaluation Preparation:**

Setup: For training and evaluation, use a mannequin or have another soldier act as the casualty. Under no circumstances will the needle be inserted in another soldier. Have the soldier demonstrate and explain what he or she would do.

Brief soldier: Tell the soldier to perform a needle cricothyroidotomy.

**Performance Measures**

	<u>GO</u>	<u>NO GO</u>
1. Hyperextended the casualty's neck.	_____	_____
2. Put on gloves, if available.	_____	_____
3. Located the cricothyroid membrane.	_____	_____
4. Stabilized the larynx.	_____	_____
5. Inserted a large bore needle into the cricothyroid membrane.	_____	_____
6. Listened and felt for free airflow through the needle.	_____	_____
7. Inserted a second needle, if necessary and rechecked for air flow. (If the airway formed by the first needle is not sufficient, a second needle may be inserted next to the first one following the procedure in step 5.)	_____	_____
8. Stabilized the needle(s).	_____	_____
9. Completed steps 3 through 8 in order.	_____	_____
10. Kept the casualty's head immobilized.	_____	_____

**Evaluation Guidance:** Score each soldier according to the performance measures in the evaluation guide. Unless otherwise stated in the task summary, the soldier must pass all performance measures to be scored GO. If the soldier fails any step, show what was done wrong and how to do it correctly.

**References**  
**Required**  
None

**Related**  
BTLS FOR PARAMEDICS

## PERFORM NEEDLE CHEST DECOMPRESSION

### 081-833-3007

**Conditions:** You have a conscious, breathing casualty with chest trauma who requires needle chest decompression. Necessary materials and equipment: stethoscope, large bore needle (10 to 14 gauge), 35 to 60 cc Luer-Lock syringe with 3-way stopcock, povidone-iodine swab, sterile gloves, and Field Medical Card.

**Standards:** Completed all the steps necessary to perform a needle chest decompression in order, without causing unnecessary injury to the casualty.

### Performance Steps

*NOTE:* Pneumothorax is defined as the presence of air within the pleural space. Air may enter the pleural cavity either from the lungs through a rupture, laceration, or from the outside through a sucking chest wound. Trapped air in the pleural space compresses the lung beneath it. Unrelieved pressure will push the contents of the mediastinum in the opposite direction, away from the side of the tension pneumothorax. This, in turn, will compromise venous return to the heart and interfere with respiration.

1. Verify the presence of tension pneumothorax by checking for indications of the condition.

**WARNING:** Correct assessment is essential. Insertion of a needle into the pleural space of a nonaffected person will result in pneumothorax.

- a. Question a conscious casualty about difficulty in breathing, pain on the affected side, or coughing up blood.
- b. Observe a bared anterior chest and upper abdomen for respiratory rate and depth.
- c. Look for mediastinal shift manifested as a tracheal deviation and/or jugular distension.
- d. Look and listen for gasping for air (dyspnea) and progressive respiratory distress.

*NOTE:* Dyspnea may be, but is not always, an indication of pneumothorax.

- e. Look at and feel the patient's chest for signs of subcutaneous emphysema.
- f. Check for lack of chest excursion.
  - (1) Observe the rising and falling of the chest on respiration.
  - (2) Compare chest excursion bilaterally.
- g. Look for unilateral distension.
  - (1) Place one hand on the affected side.
  - (2) Place the other hand on the unaffected side.
  - (3) Observe the height of each hand.
  - (4) Determine if the height of the hand on the affected side is greater during expiration than the height of the hand on the unaffected side.
- h. Use a stethoscope to listen to breath sounds.
  - (1) Compare the sides for equality.
  - (2) Auscultate both sides of the chest.
  - (3) If breath sounds are unequal, percuss both sides to determine the difference in tone.

*NOTE:* Breath sounds will be diminished or absent on the affected side.

- i. Check for progressive distension of the abdomen that is not relieved by gastric aspiration and endotracheal intubation.
- j. Look for deep cyanosis.
- k. Look for signs and symptoms of shock.

## Performance Steps

2. Locate the insertion site. Locate the second intercostal space (between the second and third ribs) at the midclavicular line (approximately in line with the nipple) on the affected side of the patient's chest.
3. Thoroughly cleanse a 3 to 4 inch area around the insertion site. Begin in the center and work outward using a circular motion.
4. Insert a large bore (10 to 14 gauge) needle with attached syringe.
  - a. Place the needle tip, bevel up, on the insertion site (2nd intercostal space, midclavicular line).
  - b. Lower the proximal end of the needle to permit the tip to enter the skin just above the third rib margin.
  - c. Firmly insert the needle into the skin over the third rib, until the pleura has been penetrated, as evidenced by feeling a "pop" as the needle enters the pleural space.

**WARNING:** Proper positioning of the needle is essential to avoid puncturing blood vessels and/or nerves.

5. Decompress the affected side by aspirating as much air as is necessary to relieve the patient's acute symptoms.

**NOTES:** 1. If you are using a catheter-over-needle, hold the needle still and push the catheter into the plural space until resistance is felt. Withdraw the needle along the angle of insertion while holding the catheter still. 2. If you are using a three-way stopcock, additional air can be aspirated from the plural cavity by turning the stopcock lever to allow expulsion of the air from the syringe.

6. Initiate closed chest drainage with underwater seal, if available. Proceed to step 7 if improvisation is required.
7. If an underwater seal drainage is not available, use a commercial one-way flutter valve or improvise one.
  - a. Cut a finger casing from a sterile glove.
  - b. Cut off the finger tip.
  - c. Tie or tape the finger casing to the needle hub.
  - d. Check the operation of the improvised flutter valve.
    - (1) Ensure that air passes through the needle-valve assembly and improvised flutter valve on expiration.
    - (2) Ensure that the flutter valve collapses against itself on inspiration.

**NOTE:** This will prevent air from entering the pleural cavity.

8. Secure the needle or catheter to the chest.
9. Record the treatment on the Field Medical Card.

## Evaluation Preparation:

**Setup:** For training and evaluation, use a mannequin or have another soldier act as the casualty. Under no circumstances will the needle be inserted. Have the soldier demonstrate and explain what he or she would do.

**Brief soldier:** Tell the soldier to perform needle chest decompression.



**Performance Measures**

	<u>GO</u>	<u>NO</u> <u>GO</u>
1. Verified the presence of tension pneumothorax.	_____	_____
2. Located the insertion site.	_____	_____
3. Thoroughly cleaned the area.	_____	_____
4. Inserted a large bore needle.	_____	_____
5. Decompressed the affected chest.	_____	_____
6. Initiated closed chest drainage or applied a flutter valve.	_____	_____
7. Secured the needle or catheter to the chest.	_____	_____
8. Recorded the treatment on the Field Medical Card.	_____	_____
9. Completed all steps in order.	_____	_____

**Evaluation Guidance:** Score each soldier according to the performance measures in the evaluation guide. Unless otherwise stated in the task summary, the soldier must pass all performance measures to be scored GO. If the soldier fails any step, show what was done wrong and how to do it correctly.

**References**

**Required**  
None

**Related**  
BTLS FOR PARAMEDICS

## Subject Area 5: Venipuncture and IV Therapy

**OBTAIN A BLOOD SPECIMEN USING A VACUTAINER****081-833-0032**

**Conditions:** Necessary materials and equipment: blood specimen tubes, constricting band, vacutainer adapter, vacutainer needles, disinfectant pads, sterile 2 x 2 gauze sponges, betadine or alcohol, adhesive bandage strips, protective pad, labels, and gloves.

**Standards:** Obtained a blood specimen without causing injury to the patient or violating aseptic technique.

**Performance Steps**

1. Verify the request to obtain a blood specimen. Select the proper blood specimen tube for the test to be performed.
2. Label the blood specimen tube with the information necessary to identify the patient.
3. Perform a patient care handwash.

**WARNING:** Gloves should be worn for self-protection against transmission of contaminants whenever handling body fluids.

4. Assemble the vacutainer adapter, the needle, and the blood specimen tube.
  - a. Inspect the needle for nicks or barbs. Replace the needle if it is flawed or dull.
  - b. Insert the rubber stoppered end of the specimen tube into the vacutainer holder and advance the tube until it is even with the guideline.

**NOTE:** The needle is now partially imbedded into the stopper. If the tube is pushed beyond the guideline, the vacuum of the tube may be broken.

5. Identify the patient.
  - a. Ask the patient his or her name and compare the name to the bed card and identification band or tags.
  - b. If the specimen is being obtained from an outpatient, identify the patient by asking his or her name and comparing the name with the medical records or the laboratory request.

**NOTE:** Ask the patient about allergies to such things as iodine or alcohol.

6. Explain the procedure and purpose for collecting the blood specimen to the patient.
7. Position the patient.
  - a. Assist the patient into a comfortable sitting or lying position.

**WARNING:** Never attempt to draw blood from a standing patient.

8. Expose the area for venipuncture.
9. Select and palpate one of the prominent veins in the bend of the arm (antecubital space).
  - a. The first choice is the median cubital vein. It is well supported and least apt to roll.
  - b. The second choice is the cephalic vein.

### Performance Steps

- c. The third choice is the basilic vein. Although it is often the most prominent, it tends to roll easily and makes venipuncture difficult.

**WARNINGS:** 1. Avoid veins that are infected, irritated, injured, or have an IV running distal to the proposed venipuncture site. 2. Do not use the vacutainer to draw blood from small or fragile veins, because this can cause the vein walls to collapse. Use a needle and syringe instead.

10. Prepare the sponges for use.
  - a. Open the betadine or alcohol and 2 X 2 gauze sponge packages.
  - b. Place them within easy reach (still in the packages).
11. Apply the constricting band with enough pressure to stop venous return without stopping the arterial flow (a radial pulse will be present).
  - a. Wrap latex tubing around the limb approximately 2 inches above the proposed venipuncture site.
  - b. Stretch the tubing slightly and pull one end so that it is longer than the other.
  - c. Form a loop with the longer end and draw the loop under the shorter end so that the tails of the tubing are turned away from the proposed site.

**NOTE:** If a commercial band is used, wrap it around the limb as in step 11a and then secure the band by overlapping the Velcro ends.

- d. Instruct the patient to form a fist, clench and unclench several times, and then hold the fist in a clenched position.
12. Palpate the selected vein lightly with the index finger, moving an inch or two in either direction so that the size and direction of the vein can be determined. The vein should feel like a spongy tube.
13. With a disinfectant soaked pad, cleanse the area around the puncture site using an outward circular motion.

**CAUTION:** After cleansing the skin, do not repalpate the area.

**WARNING:** Do not leave the constricting band on for more than 2 minutes.

14. Prepare to puncture the vein.
  - a. Grasp the vacutainer unit and remove the protective needle cover.
  - b. Position the needle directly in line with the vein. Using the free hand, grasp the patient's arm below the expected point of entry.
  - c. Place the thumb of the free hand approximately 1 inch below the expected point of entry and pull the skin taut toward the hand.
15. Puncture the vein.
  - a. Place the needle, bevel up, in line with the vein and pierce the skin at a 15 to 30 degree angle.
  - b. Decrease the angle until the needle is almost parallel to the skin surface. Direct it toward the vein and pierce the vein wall.

**NOTE:** A faint "give" will be felt when the vein is entered and blood will appear in the hub of the needle.

- (1) If the venipuncture is unsuccessful, pull the needle back slightly (not above the skin surface) and attempt to pierce the vein again.

**CAUTION:** If the needle is withdrawn above the skin surface, quickly release the constricting band and stop the procedure. Begin again with a new needle.

**Performance Steps**

- (2) If the venipuncture is still unsuccessful, release the constricting band, place a gauze sponge lightly over the site, quickly withdraw the needle, and immediately apply pressure to the site.
- (3) Notify the supervisor before attempting to enter another vein.
- c. Instruct the patient to unclench the fist.

## 16. Collect the specimen.

## a. Single specimen sample.

- (1) With the dominant hand, hold the vacutainer unit and the needle steady.
- (2) Place the index and middle fingers of the free hand behind the flange of the vacutainer and ease the tube as far forward as possible. Blood will enter the tube.

**WARNING:** If the unit and needle are not held steady while pushing in the tube, the needle may either slip out of the vein or puncture the opposing vein wall.

- (3) After the tube is approximately two-thirds full of blood or the flow of blood stops, prepare to withdraw the needle.

## b. Multiple specimen samples (multiple tubes).

- (1) Follow steps 16a(1) and 16a(2) for collecting a single specimen.
- (2) Remove the first tube and insert another tube into the vacutainer.
- (3) Repeat this procedure until the desired number of tubes are filled or blood stops flowing.
- (4) Release the constricting band using the nondominant hand.
- (5) After the last tube is approximately two-thirds full of blood or the flow stops, prepare to withdraw the needle.

**NOTE:** If the blood flow starts to slow down between samples, remove the constricting band.

## 17. Withdraw the needle.

- a. Release the constricting band by pulling on the long, looped end of the tubing or pulling the Velcro fasteners open.

**WARNING:** Never withdraw the needle prior to removing the constricting band because this will cause blood to be forced out of the venipuncture site with resulting blood loss and/or hematoma formation.

- b. Place a gauze sponge lightly over the venipuncture site.
- c. Keeping the patient's arm fully extended, withdraw the needle smoothly and quickly. Immediately apply firm manual pressure over the venipuncture site with the sponge.
- d. Instruct the patient to elevate the arm slightly and keep the arm fully extended. Continue to apply firm manual pressure to the site for 2 to 3 minutes.

## 18. Remove the specimen tube from the vacutainer.

- a. Replace the protective cover over the needle.

**NOTE:** Dispose of the uncapped needle IAW local SOP.

**WARNING:** If accidentally punctured by a used needle, force the puncture site to bleed, wash it thoroughly, and report the incident to your supervisor immediately.

- b. Pull the tube from the vacutainer.
- c. If the tube contains an anticoagulant, gently invert the tube several times to mix it with the blood.

## 19. Apply an adhesive bandage strip to the venipuncture site after the bleeding has stopped. Adhesive bandage strips do not take the place of pressure and therefore, are not applied until the bleeding has stopped.

## 20. Provide for the patient's safety and comfort.

- a. Remove the protective pad.

**Performance Steps**

- b. Assist the patient to assume a comfortable position.
- 21. Dispose of and/or store the equipment.
  - a. Collect all the equipment and remove it from the area.
  - b. Place the used gauze sponge, alcohol or betadine sponge, and the protective pad in the trash receptacle.
  - c. Store the constricting band and vacutainer adapter IAW local SOP and dispose of the needle and syringe IAW local SOP.
- 22. Remove the gloves.
- 23. Perform a patient care handwash.
- 24. Complete the laboratory request.
  - a. Patient identification.
  - b. Requesting physician's name.
  - c. Ward number, clinic, or dispensary.
  - d. Date and time of specimen collection.
  - e. Test(s) requested.
  - f. Specimen source--blood.
  - g. Remarks. Write in the admission diagnosis or the type of surgery in this section.
  - h. Complete the "urgency" box. (Routine, today, preop, STAT, or ASAP.)

*NOTE:* There are many lab request slips which are used for requesting specific blood tests. All slips must be checked for the minimum information, as given.

- 25. Forward the specimen to the laboratory.
    - a. Attach the lab request to the specimen tube(s) with a rubber band or paper clip.
- NOTE:* Ensure that the lab requests and blood tubes are appropriately labeled with infectious warning labels IAW local SOP.
- b. Arrange for the specimen to be sent to the lab or transport the specimen to the lab IAW local SOP.

- 26. Perform a patient care handwash.
- 27. Record the procedure on the appropriate form.

**Performance Measures**

	<u>GO</u>	<u>NO GO</u>
1. Selected the proper blood specimen tube.	_____	_____
2. Labeled the blood specimen tube.	_____	_____
3. Performed a patient care handwash.	_____	_____
4. Assembled the vacutainer unit, needle, and blood specimen tube.	_____	_____
5. Identified the patient.	_____	_____
6. Explained the procedure and purpose for collecting the blood.	_____	_____
7. Positioned the patient.	_____	_____
8. Exposed the venipuncture site.	_____	_____

<b>Performance Measures</b>	<b><u>GO</u></b>	<b><u>NO</u> <u>GO</u></b>
9. Selected and palpated the vein.	—	—
10. Prepared sponges for use.	—	—
11. Applied the constricting band.	—	—
12. Palpated the selected vein.	—	—
13. Cleaned the venipuncture site.	—	—
14. Prepared to puncture the vein.	—	—
15. Punctured the vein.	—	—
16. Collected the specimen.	—	—
17. Withdrew the needle.	—	—
18. Removed the specimen tube from the vacutainer.	—	—
19. Applied an adhesive bandage strip to the site.	—	—
20. Provided for the patient's safety and comfort.	—	—
21. Disposed of and/or stored equipment.	—	—
22. Removed the gloves.	—	—
23. Performed a patient care handwash.	—	—
24. Completed the laboratory request.	—	—
25. Forwarded the specimen to the laboratory.	—	—
26. Performed a patient care handwash.	—	—
27. Recorded the procedure on the appropriate form.	—	—
28. Did not violate aseptic technique.	—	—
29. Did not cause further injury to the patient.	—	—

**Evaluation Guidance:** Score each soldier according to the performance measures in the evaluation guide. Unless otherwise stated in the task summary, the soldier must pass all performance measures to be scored GO. If the soldier fails any step, show what was done wrong and how to do it correctly.

#### References

**Required**  
None

**Related**  
BASIC NURSING

## INITIATE AN INTRAVENOUS INFUSION

081-833-0033

**Conditions:** You have performed a patient care handwash. Necessary materials and equipment: IV injection set, IV solution, needle or catheter-over-needle, constricting band, antiseptic sponges, 2 x 2 gauze sponges, tape, IV stand or substitute, armboard, and gloves.

**Standards:** Initiated an intravenous infusion without causing further injury or unnecessary discomfort to the patient. Did not violate aseptic technique.

### Performance Steps

1. Identify the patient and explain the procedure.
  - a. Ask the patient's name.
  - b. Check the identification band against the patient's chart, as appropriate.
  - c. Explain the reason for IV therapy.
  - d. Explain the procedure and caution the patient against manipulating the equipment.
  - e. Ask about any known allergies to such things as betadine or medication.
  - f. Reassure the patient that this is a common procedure.
2. Select and inspect the equipment for defects, expiration date, and contamination.
  - a. IV fluid of choice (check doctor's orders, as appropriate). Discard containers that have cracks, scratches, leaks, sedimentation, condensation, or fluid which is not crystal clear and colorless.
  - b. IV injection set.
    - (1) Spike, drip chamber, tubing, and needle adapter. Discard them if there are cracks or holes or if any discoloration is present.
    - (2) Tubing clamp. Ensure that the clamp releases and catches.
    - (3) Needle or catheter-over-needle. Discard them if they are flawed with barbs or nicks.

**NOTE:** Place the stand to the side of the patient and close to the IV site.

3. Prepare the equipment.
  - a. Clamp the tubing 6 to 8 inches below the drip chamber.
  - b. Remove the protective covers from the spike and from the outlet of the IV container.

**CAUTION:** Do not touch the spike or the outlet of the IV container.

- c. Insert the spike into the container.
  - (1) If using a bag, push the spike firmly into the container's outlet tube.
  - (2) If using a bottle, push the spike firmly through the container's diaphragm.

**CAUTION:** If no vacuum release sound is heard when puncturing bottled solution, discard the solution. Bagged solution makes no vacuum release sound.

- d. Hang the container at least 2 feet above the level of the patient's heart, if possible.

**NOTE:** An IV bag container may be placed under the patient's body if there is no way to hang it.

- e. Squeeze the drip chamber until it is half full of the IV fluid.
- f. Prime the tubing.

**NOTE:** Ensure that all air is expelled from the tubing.

- (1) Hold the tubing above the level of the bottom of the container.
- (2) Loosen the protective cover from the needle adapter to allow the air to escape.
- (3) Release the clamp on the tubing.

**Performance Steps**

- (4) Gradually lower the tubing until the solution reaches the end of the needle adapter.
- (5) Clamp the tubing.
- (6) Retighten the needle adapter's protective cover.
- (7) Loop the tubing over the IV stand or holder.
- g. Cut several pieces of tape and hang them in a readily accessible place.

## 4. Select the infusion site.

- a. Put on gloves for body substance isolation.
- b. Choose the most distal and accessible vein of an uninjured arm or hand.
- c. Avoid sites over joints.
- d. Avoid veins in infected, injured, or irritated areas.
- e. Use the nondominant hand or arm, whenever possible.

**CAUTION:** Do not use an arm that may require an operative procedure.

- f. Select a vein large enough to accommodate the size of needle/catheter to be used.

## 5. Prepare the infusion site.

- a. Apply the constricting band.

**NOTE:** When applying the constricting band, use soft-walled latex tubing about 18 inches in length.

- (1) Place the tubing around the limb, about 2 inches above the site of venipuncture. Hold one end so that it is longer than the other, and form a loop with the longer end.
- (2) Pass the looped end under the shorter end of the constricting band.

**NOTE:** When placing the constricting band, ensure that the tails of the tubing are turned away from the proposed site of venipuncture.

- (3) Apply the constricting band tight enough to stop venous flow but not so tightly that the radial pulse cannot be felt.
- (4) Tell the patient to open and close his or her fist several times to increase circulation.

**CAUTION:** Do not leave the constricting band in place for more than 2 minutes.

- b. Select a prominent vein.

**NOTES:** 1. Wet the area with germicide to facilitate palpation of the vein with the fingertips. Touch the distended vein with the fingertips and estimate tissue support. 2. If the vein rolls, select another vein.

- c. Tell the patient to close his or her fist and keep it closed until instructed to open the fist.
- d. Clean the skin over the selected area with 70% alcohol or betadine, using a firm circular motion from the center outward.
- e. Allow the skin to dry and discard the gauze.
- f. Put on gloves for self-protection against transmission of contaminants.

## 6. Prepare to puncture the vein.

- a. Pick up the assembled needle and remove the protective cover with the other hand.
  - (1) Ensure the needle is bevel up.
  - (2) Place the forefinger on the needle hub to guide it during insertion through the skin and into the vein.
- b. Position yourself so as to have a direct line of vision along the axis of the vein to be entered.

## 7. Puncture the vein.



### Performance Steps

**CAUTION:** Keep the needle at the same angle to prevent through-and-through penetration of the vein walls.

**NOTE:** You may position the needle directly above the vein or slightly to one side of the vein.

- a. Draw the skin below the cleaned area downward to hold the skin taut over the site of venipuncture.
- b. Position the needle point, bevel up, parallel to the vein and about 1/2 inch below the site of venipuncture.
- c. Hold the needle at a 20 to 30 degree angle and insert it through the skin.
- d. Decrease the angle of the needle until it is almost parallel to the skin surface and direct it toward the vein.
- e. Move the needle forward about 1/2 inch into the vein.

8. Confirm the puncture.

**NOTE:** A faint "give" will be felt as the needle enters the lumen of the vein.

- a. Check for blood in the flash chamber. If successful, proceed to step 9.
- b. If the venipuncture is unsuccessful, pull the needle back slightly (not above the skin surface) and attempt to pierce the vein again.
- c. If the venipuncture is still unsuccessful, release the constricting band and tell the patient to open and relax his or her clenched fist.
  - (1) Place a sponge lightly over the site and quickly withdraw the needle.
  - (2) Immediately apply pressure to the site.
- d. Notify your supervisor before attempting a venipuncture at another site.

9. Advance the needle or the catheter.

- a. Grasp the hub and advance the needle into the vein up to the hub.
- b. If using the catheter-over-needle, grasp the hub and with a slight twisting motion fully advance the catheter.
- c. While continuing to hold the hub, press lightly on the skin over the needle or catheter tip with the fingers of the other hand.

**NOTE:** This prevents the backflow of blood from the hub.

- d. If using a catheter-over-needle, remove the needle from inside the catheter.

10. Remove the protective cover from the needle adapter on the tubing. Quickly and tightly connect the adapter to the catheter or needle hub.

**WARNING:** Do not allow air to enter the blood stream.

11. Tell the patient to unclench the fist, and then release the constricting band.

12. Unclamp the IV tubing and adjust the flow rate to keep the vein open (TKO or KVO).

**NOTE:** A rate of about 30 cc per hour, or 7 to 10 drops per minute using standard drip tubing, is adequate to keep the vein open.

13. Check the site for infiltration. If it is painful, swollen, red, cool to the touch, or if fluid is leaking from the site, stop the infusion immediately.

14. Secure the site IAW local SOP.

- a. Apply a sterile dressing over the puncture site, leaving the hub and tubing connection visible.
- b. Loop the IV tubing onto the extremity and secure the loop with tape.
- c. Splint the arm loosely on a padded splint, if necessary, to reduce movement.

15. Readjust the flow rate.

- a. Determine the total time over which the patient is to receive the dosage.

**Performance Steps**

Example: The patient is to receive the dosage over a 3 hour period.

- b. Determine the total IV dosage the patient is to receive by checking the doctor's orders.

Example: The patient is to receive 1000 cc of IV fluid.

- c. Check the IV tubing package to determine the number of drops of IV fluid per cc the set has been designed to deliver.

Example: The set is designed to give 10 drops of IV fluid per cc (10 gtts/cc).

- d. Multiply the total hours (step 15a) by 60 minutes to determine the total minutes over which the IV dosage is to be administered.

Example: 3 hours X 60 min = 180 min.

- e. Divide the total IV dosage (step 15b) by the total minutes over which the IV dosage is to be administered (step 15d) to determine the cc of fluid to be administered per minute.

Example: 1000 cc / 180 min = 5.5 cc/min.

- f. Multiply the cc/min (step 15e) by the number of drops of IV fluid per cc delivered by the tubing (step 15c) to determine the number of drops per minute to be administered.

Example: 5.5 cc/min X 10 drops/cc = 55 drops/min.

*NOTE:* Always round drops per minute off to the nearest whole number. If drops per minute equal .5, round up to the next whole number.

16. Prepare and place the appropriate label.

- a. Dressing.

(1) Print the information on a piece of tape.

(a) Date and time the IV was started.

(b) Initials of the person initiating the IV.

(2) Secure the tape to the dressing.

- b. IV solution container.

(1) Print the information on a piece of tape.

(a) Patient's identification.

(b) Drip rate.

(c) Date and time the IV infusion was initiated.

(d) Initials of the person initiating the IV.

(2) Secure the tape to the IV container.

- c. IV tubing.

(1) Wrap a strip of tape around the tubing, leaving a tab.

(2) Print the date and time the tubing was put in place and the initials of the person initiating the IV.

*NOTE:* Place disposable items in an appropriate receptacle and clean and store equipment IAW local SOP.

17. Recheck the site for infiltration.

18. Perform a patient care handwash.

19. Record the procedure on the appropriate form.

a. Date and time the IV infusion was initiated.

b. Type and amount of IV solution initiated.

c. Drip rate and total volume to be infused.

d. Type and gauge of needle or cannula.

e. Location of the infusion site.

f. Patient's condition.

g. Name of the person initiating the IV.

<b>Performance Measures</b>	<u><b>GO</b></u>	<u><b>NO GO</b></u>
1. Inspected the equipment.	_____	_____
2. Prepared the equipment.	_____	_____
3. Identified the patient and explained the procedure.	_____	_____
4. Selected the infusion site.	_____	_____
5. Prepared the infusion site.	_____	_____
6. Prepared to puncture the vein.	_____	_____
7. Punctured the vein.	_____	_____
8. Confirmed the puncture.	_____	_____
9. Advanced the needle or the catheter.	_____	_____
10. Connected the tubing to the catheter or needle hub.	_____	_____
11. Released the constricting band.	_____	_____
12. Unclamped the IV tubing and adjusted the flow rate TKO.	_____	_____
13. Checked the site for infiltration.	_____	_____
14. Secured the site.	_____	_____
15. Readjusted the flow rate.	_____	_____
16. Prepared and placed the appropriate labels.	_____	_____
17. Rechecked the site for infiltration.	_____	_____
18. Performed a patient care handwash.	_____	_____
19. Recorded the procedure on the appropriate form.	_____	_____
20. Did not violate aseptic technique.	_____	_____
21. Did not cause further injury to the patient.	_____	_____

**Evaluation Guidance:** Score each soldier according to the performance measures in the evaluation guide. Unless otherwise stated in the task summary, the soldier must pass all performance measures to be scored GO. If the soldier fails any step, show what was done wrong and how to do it correctly.

**References**

**Required**  
None

**Related**  
BASIC NURSING

**MANAGE A PATIENT WITH AN INTRAVENOUS INFUSION**  
**081-833-0034**

**Conditions:** Necessary materials and equipment: dressings, antiseptic swabs, sterile gauze, IV tubing, IV solution, tape, antimicrobial ointment, and exam gloves.

**Standards:** Properly managed a patient with an IV infusion, accurately documented the IV therapy, properly assessed for the complications of IV therapy, and initiated appropriate interventions when necessary. Did not violate aseptic technique and did not cause further injury to the patient.

**Performance Steps**

1. Assess for signs and symptoms of IV therapy complications.
  - a. Infiltration is an accumulation of fluids in the tissue surrounding an IV needle site. It is caused by penetration of the vein wall by the needle/catheter or later dislodgement of the needle/catheter.
    - (1) Solution flows sluggishly or not at all.
    - (2) Discoloration or cool feeling around the infusion site.
    - (3) Swollen extremity.
    - (4) Fluid leaking from the infusion site.
    - (5) Patient complains of pain, tenderness, irritation, or burning at the infusion site.
  - b. Phlebitis is an inflammation of the wall of the vein. It is caused by injury to the vein during puncture, from later needle movement, or from irritation to the vein caused by long term therapy, incompatible additives, or use of a vein that is too small to handle the amount or type of solution.
    - (1) Swelling, redness, and/or tenderness around the venipuncture site.
    - (2) Sluggish flow rate.
  - c. Infection is a yellowish, foul-smelling discharge (pus) from the venipuncture site.
  - d. Air embolism is the obstruction of a blood vessel by air carried via the bloodstream (usually occurring in the lungs or heart). It is caused by conditions such as air bubbles in the IV tubing, a solution container that has run dry, or disconnected IV tubing.
    - (1) Abrupt drop in blood pressure.
    - (2) Chest pain.
    - (3) Weak, rapid pulse.
    - (4) Cyanosis.
    - (5) Loss of consciousness.
  - e. Circulatory overload is an increased blood volume that is caused by excessive IV fluid infused too rapidly into the vein (overhydration).
    - (1) Elevated blood pressure.
    - (2) Distended neck veins.
    - (3) Rapid breathing, shortness of breath, tachycardia.
    - (4) Fluid intake is much greater than urine output.
2. Perform the nursing interventions for IV therapy complications.
  - a. Infiltration.
    - (1) Stop the infusion.
    - (2) Notify your supervisor.
    - (3) Record observations and action taken.
  - b. Phlebitis.
    - (1) Stop the infusion.

### Performance Steps

- (2) Report observations to your supervisor.
- (3) Record observations and actions taken.
- c. Infection.
  - (1) Report observations to your supervisor.
  - (2) Record observations and actions taken.
- d. Air embolism.
  - (1) Report observations to your supervisor.
  - (2) Record observations and actions taken.
- e. Circulatory overload.
  - (1) Slow the infusion rate to TKO.
  - (2) Place the patient in the semi-Fowler's position.
  - (3) Notify the physician or supervisor.
  - (4) Record observations and actions taken.

### 3. Document the IV therapy.

- a. Frequency.
  - (1) When the IV is initiated.
  - (2) Each time any part of the IV equipment is changed.
- b. Label the dressing.
  - (1) Cut adhesive tape and place it on a flat surface.

**NOTE:** Never write on the tape after it has been placed on the dressing.

- (2) Record the information on the piece of tape.
  - (a) The gauge of the catheter/needle.
  - (b) The time and date the dressing was applied.
  - (c) Your initials.
- (3) Place the labeled tape over the dressing.
- c. Label the solution container.
  - (1) Cut adhesive tape and place it on a flat surface.
  - (2) Record the information on the piece of tape.
    - (a) The patient's name.
    - (b) The patient's identification number and room/ward number, as appropriate.
    - (c) The infusion rate.
    - (d) The time and date the solution container was hung.
    - (e) Your initials.
  - (3) Place the label on the solution container.
  - (4) Prepare the timing label.
    - (a) Place a strip of adhesive tape vertically along the length of the solution container.
    - (b) Determine how long the solution container will last. (See task 081-833-0033.)
    - (c) Write on the tape the approximate times at which the solution level will reach the volume markings on the solution container.
    - (d) At the bottom of the label write the approximate time the solution container will be empty.
- d. Label the tubing.
  - (1) Place a strip of adhesive tape around the tubing, leaving a tab.
  - (2) Write on the tab the date and time the tubing was changed.
- e. Record the information on the appropriate forms (Nursing Notes/Field Medical Card).
  - (1) The date and time the IV was initiated.
  - (2) The amount and type of solution.
  - (3) The infusion rate.

**Performance Steps**

- (4) The type and gauge of the needle/catheter.
- (5) The insertion site.
- (6) The patient's condition.
- (7) Your name.
- f. Record the amount of infusion on DD Form 792, if applicable.

## 4. Replace the solution container (only).

**NOTE:** Change the solution container every 24 hours when running a slow infusion in which the container may not be depleted in 24 hours.

- a. Perform a patient care handwash.
- b. Select or prepare the new solution. (See task 081-833-0033.)
- c. Clamp the IV tubing shut.
- d. Remove the used container from the IV hanger.
- e. Remove the spike from the used container.
- f. Insert the IV spike into a new IV container.

**CAUTION:** The old tubing is still connected to the catheter or needle. Use care to maintain sterility. To prevent backflow of blood, keep the spike and tubing elevated.

- g. Hang the new container.
- h. Adjust the infusion rate.
- i. Label the solution container and prepare a timing label.
- j. Record the amount of solution received from the previous container, and the time, type, and amount of new solution.

## 5. Change the dressing.

**NOTE:** Change the dressing every 24 hours or IAW local SOP.

- a. Perform a patient care handwash.
- b. Remove the tape and the old dressing without dislodging the catheter/needle.

**NOTE:** Tubing should remain taped in place to reduce the chance of accidental dislodgement of the catheter or needle.

- c. Clean the area around the infusion site IAW local SOP.
- d. Examine the site for infiltration.
- e. Cover the infusion site with sterile gauze and secure with tape, or dress IAW local SOP.
- f. Secure the dressing to the site without encircling the wrist or arm.
- g. Label the dressing.

## 6. Replace the solution container and tubing.

**NOTE:** Change the tubing every 48 hours or IAW local SOP. Time the tubing change to coincide with the time the solution container will be changed.

- a. Perform a patient care handwash.
- b. Spike the new tubing into a new solution container and hang it from the IV pole.
- c. Prime the tubing and clamp it.
- d. Clamp the old tubing shut.
- e. Connect the new tubing to the needle hub.

**WARNING:** Wear gloves for self-protection against transmission of contaminants whenever handling body fluids.

- (1) Loosen the tape on the old tubing without dislodging the catheter and needle.
- (2) Place a sterile gauze pad under the catheter or needle hub to provide a small sterile field for the needle hub.
- (3) Grasp the new tubing between the fingers of one hand.

**Performance Steps**

- (4) Grasp the catheter or needle hub with a sterile gauze pad between the thumb and index finger and carefully disconnect the old adapter.
- (5) Press the fingers over the catheter or needle tip to help prevent dislodgement and backflow of blood.
- (6) Remove the protective cap from the new tubing adapter and quickly connect it to the catheter or needle hub.

**CAUTION:** Do not remove the protective cap with your teeth.

- (7) Remove the pressure over the catheter or needle tip.
- (8) Remove the gauze pad from under the needle hub and clean the site, if necessary.
- (9) Secure the tubing to the arm and reinforce the dressing, as necessary.
- (10) Adjust the infusion rate.

7. Discontinue the infusion.

- a. Perform a patient care handwash.
- b. Put on exam gloves.
- c. Clamp the IV tubing.
- d. Remove the tape and dressing without dislodging the needle and catheter.
- e. Place a sterile gauze pad over the injection site.
- f. Smoothly pull out the needle, following the course of the vein.

**WARNING:** Do not twist, raise, or lower the needle.

- g. Apply pressure to the site with the gauze.
- h. Examine the needle or catheter to ensure that it was removed intact.
- i. Apply an adhesive bandage to the site, if necessary.
- j. Dispose of the used equipment IAW local SOP.

8. Record the procedure on the appropriate form.

**NOTE:** Ensure that the fluids received have been recorded on the appropriate form(s).

**Evaluation Preparation:**

Setup: If the performance of this task must be simulated for training or evaluation, assemble the IV materials and equipment as indicated in task 081-833-0033. It is not necessary to have the catheter or needle inserted into a person. A simulated arm or other material may be used.

Brief soldier: Tell the soldier to manage a patient with an intravenous infusion.

**Performance Measures**

	<u>GO</u>	<u>NO GO</u>
1. Assessed for signs and symptoms of IV therapy complications.	—	—
2. Performed the nursing interventions for IV therapy complications.	—	—
3. Documented the IV therapy.	—	—
4. Replaced the solution container, as necessary.	—	—
5. Changed the dressing, as required.	—	—
6. Replaced the solution container and tubing, as necessary.	—	—
7. Discontinued the infusion, as required.	—	—

**Performance Measures**

	<u>GO</u>	<u>NO</u> <u>GO</u>
8. Recorded the procedure on the appropriate form.	_____	_____
9. Did not violate aseptic technique.	_____	_____
10. Did not cause further injury to the patient.	_____	_____

**Evaluation Guidance:** Score each soldier according to the performance measures in the evaluation guide. Unless otherwise stated in the task summary, the soldier must pass all performance measures to be scored GO. If the soldier fails any step, show what was done wrong and how to do it correctly.

**References**

**Required**  
None

**Related**  
BASIC NURSING



## **INITIATE A SALINE LOCK**

### **081-835-3025**

**Conditions:** You have a physician's orders to establish and maintain a saline lock for intermittent infusion therapy. Necessary materials and equipment: an intermittent infusion needle or an IV catheter and a saline lock adapter plug, sterile saline for injection, needles, syringes, antiseptic wipes, tourniquet, antiseptic ointment, tape, sterile 2 X 2 gauze, nonsterile gloves, and the patient's clinical record.

**Standards:** Established a saline lock and maintained it in accordance with the physician's orders and without causing further injury to the patient.

### **Performance Steps**

1. Prepare to establish a saline lock.
  - a. Verify the physician's orders.
  - b. Assemble the necessary equipment.
    - (1) An intermittent infusion needle, or an IV catheter and a saline lock adapter plug (if you are inserting a new IV for the saline lock).
    - (2) A saline lock adapter plug (if you are converting an existing IV site into a saline lock).
    - (3) A syringe filled with 5 cc of sterile saline for injection.
    - (4) Sterile dressing materials.
    - (5) A tourniquet, if necessary.
  - c. Identify the patient by asking his or her name and by checking the identification on the wristband.
  - d. Explain the procedure and the purpose of the saline lock to the patient.
  - e. Place the patient in a comfortable position with the arms supported.
2. Insert a saline lock using an intermittent infusion needle.
  - a. Perform a patient care handwash and put on gloves.
  - b. Clean the rubber diaphragm on the end of the intermittent infusion needle with an antiseptic wipe.
  - c. Uncap the needle of the prefilled saline syringe and insert the needle into the rubber diaphragm.
  - d. Perform the venipuncture.
  - e. Aspirate with the saline syringe and check for a blood return.
  - f. Slowly inject the saline, and then remove the needle and syringe.
  - g. Tape the needle securely in place.
  - h. Apply a dressing to the site in accordance with local SOP.
3. Insert a saline lock using an IV catheter and adapter plug.
  - a. Perform a patient care handwash and put on gloves.
  - b. Perform the venipuncture.
  - c. Using aseptic technique, remove the metal stylet after advancing the plastic catheter into the vein.
  - d. Quickly uncap and insert the male end of the adapter plug into the hub of the needle.
  - e. Tape the needle securely in place.
  - f. Clean the rubber diaphragm of the plug with an antiseptic wipe.
  - g. Uncap the needle of the saline syringe and insert it into the rubber diaphragm.

**Performance Steps**

- h. Aspirate with the saline syringe to remove all air from the adapter plug and check for a blood return.
- i. Remove the needle and syringe and expel all of the air from the syringe.
- j. Rewipe the diaphragm, reinsert the needle of the saline syringe, and inject the sterile saline. Remove the needle and syringe.
- k. Rewipe the diaphragm, uncap the needle of the saline syringe, and insert the needle into the diaphragm.
- l. Inject the saline, and then remove the needle and syringe.
- m. Apply a dressing to the site in accordance with local SOP.

## 4. Convert an existing IV to a saline lock.

- a. Perform a patient care handwash and put on gloves.
- b. Clean the junction of the tubing and IV catheter with an antiseptic wipe.
- c. Close the roller clamp on the IV tubing.
- d. Loosen the tubing from the hub of the needle.
- e. Using aseptic technique, quickly remove the tubing from the needle and insert the male end of the adapter plug securely into the hub of the needle.
- f. Clean the rubber diaphragm on the plug with an antiseptic wipe.
- g. Inject 1-5 cc of saline into the lock and apply a dressing to the site by following steps 3g through 3m.

## 5. Maintain the saline lock.

*NOTE:* When the saline lock is not being used at regular intervals for administration of medication or IV solution, it must be flushed with saline to maintain patency. This is normally done once per shift (every 8 hours). When used for administration of medication or IV fluids, the saline lock is normally flushed after each administration. Follow the local SOP for your facility to determine when to flush the saline lock.

- a. Assemble the necessary equipment and take it to the patient's bedside.
  - (1) Antiseptic wipes.
  - (2) Syringe of sterile saline for injection.
- b. Identify the patient and explain the procedure.
- c. Place the patient in a comfortable position with the arms supported and the saline lock site exposed.
- d. Wipe the rubber diaphragm with an antiseptic wipe.
- e. Uncap the needle of the saline syringe and insert it into the rubber diaphragm.
- f. Aspirate to check for IV patency.

*NOTE:* Blood return, or "flashback", should be evident.

- g. Inject the saline, and then remove the needle and syringe.
- h. Discard the used equipment in the appropriate receptacles.

*NOTE:* Document the administration of a saline flush by initialing the appropriate box on the patient's care sheet IAW local SOP.

## 6. Maintain the IV site.

- a. Change the dressing and inspect the IV site once every 24 hours. Assess for redness, swelling, warmth, tenderness, and drainage. Apply fresh sterile dressings and antiseptic ointment as directed by the local policy in your facility.

*NOTE:* It is a good habit to take a look at the IV site each time you encounter the patient. A quick glance is all that is necessary to observe for redness or swelling.

- b. Assess the IV site for evidence of subcutaneous infiltration each time the saline lock is used or flushed.
- c. Investigate any patient complaint of discomfort at the IV site.

### Performance Steps

- d. IV needles should generally be replaced every 72 hours. This will vary with local policy and the physician's orders. Follow the local SOP for your facility when a specific physician's order has not been written.

7. Remove the saline lock.

- a. Verify the physician's orders.
- b. Assemble the sterile dressing material.
- c. Identify the patient and explain the procedure.
- d. Perform a patient care handwash and put on gloves.
- e. Carefully remove all tape and lift off the dressing. Discard it into the appropriate receptacle.
- f. Note the condition of the puncture site and surrounding area.
- g. Loosen or remove the tape securing the catheter.
- h. Place a sterile 2 X 2 gauze square over the puncture site, applying slight pressure.
- i. Withdraw the IV catheter, apply more pressure to the site, and elevate the extremity.
- j. Examine the IV catheter to ensure that it was removed intact.
- k. Lower the extremity to a supported position and apply a sterile dressing to the puncture site.

8. Convert the saline lock to a continuous infusion IV.

- a. Verify the physician's order.
- b. Assemble the necessary equipment.
  - (1) Sterile dressing materials.
  - (2) A container of the prescribed IV solution with primed tubing and a syringe filled with 5 cc of sterile saline for injection.
- c. Identify the patient and explain the procedure.
- d. Perform a patient care handwash and put on gloves.
- e. Clean the rubber diaphragm of the saline lock with an antiseptic wipe.
- f. Uncap the needle on the saline syringe, insert it into the rubber diaphragm, and aspirate to assess patency of the IV. (Blood return should be evident.)

*NOTE:* If the IV is not patent, do not continue with the conversion. Remove the saline lock and establish a new IV site.

- g. Carefully remove the tape and loosen the adapter plug from the hub of the needle.
- h. Using aseptic technique, quickly remove the adapter plug and insert the end of the IV tubing securely into the needle hub.
- i. Set the roller clamp on the IV tubing to the prescribed rate and observe the site to ensure that normal flow is occurring.
- j. Apply a fresh sterile dressing over the IV site IAW local SOP.

9. Document the procedure and significant nursing observations on the appropriate forms IAW local SOP.

- a. The type and size of needle inserted.
- b. The location of the venipuncture site.
- c. The date and time of insertion.
- d. The date and time an existing IV was converted to a saline lock.
- e. An assessment of the condition of the venipuncture site.
- f. Date and time of each saline lock flush administered.
- g. Date and time the saline lock was removed.
- h. Date and time the saline lock was converted to a continuous infusion IV and the type and amount of IV solution hung.
- i. The patient's reaction to the procedure.

**Performance Measures**

	<u>GO</u>	<u>NO GO</u>
1. Prepared to establish a saline lock.	_____	_____
2. Established a saline lock.	_____	_____
3. Maintained a saline lock.	_____	_____
4. Maintained the IV site.	_____	_____
5. Removed or converted a saline lock.	_____	_____
6. Documented all procedures on the appropriate forms IAW local SOP.	_____	_____

**Evaluation Guidance:** Score each soldier according to the performance measures in the evaluation guide. Unless otherwise stated in the task summary, the soldier must pass all performance measures to be scored GO. If the soldier fails any step, show what was done wrong and how to do it correctly.

**References**

**Required**  
None

**Related**  
BASIC NURSING

Subject Area 6: Casualty Management

**MANAGE A CONVULSIVE AND/OR SEIZING PATIENT**

**081-831-0035**

**Conditions:** You have already taken the appropriate body substance isolation precautions.  
Necessary materials and equipment: None.

**Standards:** Completed all steps to manage a convulsive and/or seizing patient without allowing or causing unnecessary injury to the patient.

**Performance Steps**

1. Identify the type of convulsions and/or seizures based upon the following characteristic signs and symptoms:
  - a. Petit mal.
    - (1) Brief loss of concentration or awareness without loss of motor tone.
    - (2) Found chiefly in children and rarely an emergency.
  - b. Focal.
    - (1) No loss of consciousness.
    - (2) Tingling, stiffening, or jerking in just one part of the body (arm, leg or face).
    - (3) May rapidly progress to generalized convulsions.
  - c. Grand mal (generalized).
    - (1) May be preceded by an aura.
    - (2) Has three distinct phases.
      - (a) Tonic phase--characterized by rigidity and stiffening of the body.
      - (b) Clonic phase--characterized by jerking about violently, foaming at the mouth, drooling, and cyanosis around the face and lips.
      - (c) Postictal phase--begins when convulsions stop. The patient may regain consciousness and enter a state of drowsiness and confusion or remain unconscious for several hours.
    - (3) May involve incontinence, biting of the tongue (rare), cyanosis, or mental confusion.

**CAUTION:** Never place anything in the mouth of a seizing patient.

- d. Status epilepticus.
  - (1) Two or more seizures without an intervening period of consciousness.
  - (2) A dire medical emergency, if untreated it may lead to--
    - (a) Aspiration of secretions.
    - (b) Cerebral or tissue hypoxia.
    - (c) Brain damage or death.
    - (d) Fractures of long bones.
    - (e) Head trauma.
    - (f) Injured tongue from biting.

**NOTE:** Mentally note the aspects of seizure activity for recording after the seizure.

2. Place the patient on his or her side, if possible.
  - a. Observe the patient to prevent aspiration and suffocation.
  - b. The patient's mouth and throat should be suctioned by trained personnel, if possible.

**CAUTIONS:** 1. Do not elevate the patient's head. 2. Do not restrain the patient's limbs during seizures.

**Performance Steps**

3. Prevent injury to tissue and bones by padding or removing objects on which the patient may injure himself or herself.
4. Manage the patient after the convulsive state has ended.
  - a. Place the patient on his or her side, if necessary.
  - b. Continue to maintain the patient's airway.

*NOTE:* A patient who has just had a grand mal seizure will sometimes drool and will usually be drowsy so you must be prepared to suction, if equipment is available.

- c. Administer supplemental oxygen, if available, via nonrebreather mask or bag-valve-mask as appropriate.
- d. If possible, place the patient in a quiet, reassuring atmosphere.

**CAUTION:** Sudden, loud noises may cause another seizure.

5. Record the seizure activity.
  - a. Duration of the seizure.
  - b. Presence of cyanosis, breathing difficulty, or apnea.
  - c. Level of consciousness before, during, and after the seizure.
  - d. Whether preceded by aura (ask the patient).
  - e. Muscles involved.
  - f. Type of motor activity.
  - g. Incontinence.
  - h. Eye movement.
  - i. Previous history of seizures, head trauma, and/or drug or alcohol abuse.
6. Evacuate the patient.
  - a. Position the patient on his or her side.
  - b. Arrange for the administration of oxygen or suction, if available and necessary.

**Evaluation Preparation:**

Setup: For training and evaluation, have another soldier act as a patient.

Brief soldier: Tell the soldier to manage the patient.

**Performance Measures**

	<u>GO</u>	<u>NO GO</u>
1. Identified the type of convulsions and/or seizures.	—	—
2. Maintained the airway of a patient exhibiting tonic-clonic movement.	—	—
3. Placed the patient on his or her side, if possible.	—	—
4. Prevented injury to tissue and bones by padding or removing objects on which the patient may injure himself or herself.	—	—
5. Managed the patient after the convulsive state ended.	—	—
6. Recorded the seizure activity.	—	—
7. Evacuated the patient.	—	—
8. Did not cause further injury to the patient.	—	—

**Evaluation Guidance:** Score each soldier according to the performance measures in the evaluation guide. Unless otherwise stated in the task summary, the soldier must pass all performance measures to be scored GO. If the soldier fails any step, show what was done wrong and how to do it correctly.

**References**

**Required**

None

**Related**

EMERGENCY CARE

## TREAT A CASUALTY WITH AN OPEN ABDOMINAL WOUND

### 081-833-0045

**Conditions:** All other more serious injuries have been treated. You are not in an NBC environment. Necessary materials and equipment: field dressings, cravats, scissors, gauze, saline solution, and intravenous (IV) equipment.

**Standards:** Treated an open abdominal wound, minimized the effects of the injury, and stabilized the casualty without causing additional injury.

#### Performance Steps

1. Treat for shock. (See task 081-833-0047.)

**WARNING:** The most important concern in the initial management of abdominal injuries is shock. Shock may be present initially or develop later. Neither the presence or absence of a wound, nor the size of the external wound are safe guidelines for judging the severity of the wound.

- a. Ensure the casualty has a patent airway.
  - b. Initiate two large bore (16 gauge) IVs if the casualty is exhibiting signs and symptoms of shock.
2. Position the casualty.
    - a. Place the casualty on his or her back (face up).
    - b. Flex the casualty's knees.
    - c. Turn the casualty's head to the side and keep the airway clear if vomiting occurs.
  3. Expose the wound.

**CAUTION:** Do not attempt to replace protruding internal organs or remove any protruding foreign objects.

4. Stabilize any protruding objects. (See task 081-833-0046.)

5. Apply a sterile abdominal dressing.

**NOTE:** Protruding abdominal organs should be kept moist to prevent the tissue from drying out. A moist, sterile dressing should be applied if available.

- a. Using the sterile side of the dressing, or other clean material, place any protruding organs near the wound.
- b. Ensure that the dressing is large enough to cover the entire mass of protruding organs or area of the wound.
- c. If large enough to cover the affected area, place the sterile side of the plastic wrapper directly over the wound.
- d. Place the dressing directly on top of the wound or plastic wrapper, if used.
- e. Tie the dressing tails loosely at the casualty's side.

**CAUTION:** Do not apply pressure on the wound or expose internal parts.

- f. If two dressings are needed to cover a large wound, repeat steps 5a through 5e. Ensure that the ties of additional dressings are not tied over each other.
  - g. If necessary, loosely cover the dressings with cravats. Tie them on the side of the casualty opposite that of the dressing ties.
6. Do not cause further injury to the casualty.
    - a. Do not touch any exposed organs with bare hands.
    - b. Do not try to push any exposed organs back into the body.



**Performance Steps**

- c. Do not tie the dressing tails tightly or directly over the dressing.
- d. Do not give the casualty anything by mouth (NPO).

*NOTE:* Continue to assess the casualty, if necessary.

- 7. Prepare the casualty for evacuation.
  - a. Place the casualty on his or her back (face up) with the knees flexed.
  - b. If evacuation is delayed, check the casualty for signs of shock every 5 minutes.
- 8. Record the treatment given on the Field Medical Card.

**Performance Measures**

	<u>GO</u>	<u>NO GO</u>
1. Treated for shock.	_____	_____
2. Positioned the casualty.	_____	_____
3. Exposed the wound.	_____	_____
4. Stabilized any protruding objects.	_____	_____
5. Applied a sterile abdominal dressing.	_____	_____
6. Prepared the casualty for evacuation.	_____	_____
7. Recorded the treatment given on the Field Medical Card.	_____	_____
8. Did not cause further injury to the casualty.	_____	_____

**Evaluation Guidance:** Score each soldier according to the performance measures in the evaluation guide. Unless otherwise stated in the task summary, the soldier must pass all performance measures to be scored GO. If the soldier fails any step, show what was done wrong and how to do it correctly.

**References**

**Required**  
None

**Related**  
BTLS FOR PARAMEDICS  
EMERGENCY CARE

## APPLY A DRESSING TO AN IMPALEMENT INJURY

### 081-833-0046

**Conditions:** The casualty you are assessing has an impalement injury. All other more serious injuries have been treated. You are not in an NBC environment. Necessary materials and equipment: field dressings, cravats, bandages, gauze, scissors, splinting equipment, and oxygen delivery device.

**Standards:** Immobilized the impaled object and minimized the effect of the injury without causing further injury to the casualty.

#### Performance Steps

**WARNING:** Do not exert any force on or attempt to remove the impaled object unless the object is impaled in the cheek and both ends of the object can be seen or unless the object is blocking the airway. Severe bleeding or nerve and muscle damage may result.

1. Prepare the casualty.
  - a. Tell the casualty to remain still and not to move the impaled object.
  - b. Expose the injury by cutting away or removing clothing or equipment around the wound site.
  - c. If the impalement injury is on an extremity, check the pulse distal to the injury site.
  - d. If the impalement is found in the cheek and both ends of the object can be seen.
    - (1) Remove the object in the direction it entered the cheek.
    - (2) Position the patient to allow for drainage and be prepared to suction the patient.
  - e. If both ends of the object in the cheek cannot be seen, go to step 2.

2. Immobilize the impaled object.

**NOTE:** If an assistant is available, one person should immobilize the object while the other applies the dressings and bandages.

- a. If necessary, apply direct pressure using gloved hands on either side of the object.

**WARNING:** Do not exert force on the impaled object.

- b. Place several layers of bulky dressing around the injury site so that the dressings surround the object.
- c. Use additional bulky materials or dressings to build up the area around the object.

3. Apply the support bandages.

- a. Apply the bandage over the bulky support material to hold it in place.
- b. Apply the bandage tightly but not so tight as to impair circulation or breathing.

**WARNING:** Do not anchor the bandage on or exert pressure on the impaled object.

- c. Check the circulation after applying the support bandages.

**NOTE:** If a pulse was palpated in step 1c and it cannot be palpated after the bandage has been applied, the bandage must be loosened until a pulse can be palpated.

4. Immobilize the affected area with a splint or sling, if applicable.

**WARNINGS:** 1. Do not anchor a splint or sling to the impaled object. 2. Avoid undue motion of the impaled object when applying a splint.

5. Check for a pulse distal to the injury site.

6. Provide oxygen.

7. Treat for shock, if necessary.

**Performance Steps**

8. Record the treatment on the Field Medical Card.
9. Evacuate the casualty.

**Evaluation Preparation:**

Setup: For training and evaluation, have another soldier act as the casualty. Use a moulage set or similar materials to create a simulated impalement injury. You may also have another soldier assist in immobilizing the object.

Brief soldier: Tell the soldier to treat the casualty for an impalement injury and to direct the actions of the assistant, if applicable.

**Performance Measures**

	<u>GO</u>	<u>NO</u> <u>GO</u>
1. Prepared the casualty.	_____	_____
2. Immobilized the impaled object.	_____	_____
3. Applied the support bandages.	_____	_____
4. Immobilized the affected area with a splint or sling, if applicable.	_____	_____
5. Checked for a pulse distal to the injury site.	_____	_____
6. Provided oxygen.	_____	_____
7. Treated for shock, if necessary.	_____	_____
8. Recorded the treatment on the Field Medical Card.	_____	_____
9. Evacuated the casualty.	_____	_____
10. Did not cause further injury to the casualty.	_____	_____

**Evaluation Guidance:** Score each soldier according to the performance measures in the evaluation guide. Unless otherwise stated in the task summary, the soldier must pass all performance measures to be scored GO. If the soldier fails any step, show what was done wrong and how to do it correctly.

**References**

**Required**  
None

**Related**  
BTLS FOR PARAMEDICS  
EMERGENCY CARE

## MANAGE AN UNCONSCIOUS CASUALTY

**081-833-0048**

**Conditions:** You have an unconscious casualty in a field environment. You are not in an NBC environment. Necessary materials and equipment: blanket, field jacket, poncho, Ringer's lactate, and Field Medical Card.

**Standards:** Managed and stabilized an unconscious casualty and arranged prompt evacuation.

### Performance Steps

1. Establish unresponsiveness.
2. Establish and maintain an open airway.

**CAUTION:** Maintain C-spine control. Suspect C-spine injury with trauma involving the head and neck, motor vehicle accidents (MVs), falls, and diving accidents.

- a. Open the airway. (See task 081-831-0018.)
- b. Clear any upper airway obstruction. (See task 081-831-0019.)
- c. Insert an oropharyngeal airway, if necessary, to maintain the airway. (See task 081-833-0016.)
- d. Perform artificial respiration if breathing is absent. (See task 081-831-0048.)

3. Assess the casualty.

4. Position the casualty.

- a. Place the casualty on his or her side or face down, if the injury permits, to prevent aspiration of vomitus.
- b. Maintain good body alignment by using padding for head and limb support. Use a folded or rolled blanket, field jacket, or poncho.
- c. In extended care situations, turn the casualty from side to side every hour.

**NOTE:** Protect the casualty against extremes of heat or cold.

5. Observe the casualty.

- a. Check for drainage of blood or cerebrospinal fluid (CSF) from the ears and nose.

**WARNING:** Do not attempt to control cerebrospinal/bloody drainage with a dressing. The dressing may cause increased pressure on the brain and collection of fluids between the brain and skull.

- b. Take the vital signs.

**NOTE:** Check the vital signs every 15 to 20 minutes and record the data on the Field Medical Card.

- c. Assess the casualty's level of consciousness using the AVPU scale.

- (1) A--alert. The casualty responds spontaneously to stimuli and is able to answer questions in a clear manner.
- (2) V--verbal. The casualty does not respond spontaneously, but is responsive to verbal stimuli.
- (3) P--pain. The casualty does not respond spontaneously or to verbal stimuli, but is responsive to painful stimuli.
- (4) U--unresponsive. The casualty is unresponsive to any stimuli.

**NOTE:** Even if the casualty is unresponsive, assume the casualty can hear you, and explain the procedures.

- d. Assess the casualty's pupils.
  - (1) Observe the size of each pupil.

**Performance Steps**

*NOTE:* A variation of pupil size may indicate a brain injury. In a very small percentage of people, unequal pupil size is normal.

(2) Shine a light into each eye to observe the pupillary reaction to light.

*NOTE:* The pupils should constrict promptly when exposed to bright light. Failure of the pupils to constrict may indicate brain injury.

e. Check movement of the extremities.

*NOTE:* Record which movements are spontaneous and which are stimulus related.

f. Observe for seizure activity.

6. Obtain the casualty's history, if possible.
  - a. Events immediately preceding current condition.
  - b. Recent illness or infection.
  - c. History of epilepsy, diabetes, or other medical conditions.
  - d. Prior periods of unconsciousness.
  - e. Drug or alcohol abuse (evacuate any medications with the casualty).
7. Initiate an IV of Ringer's lactate and run it slowly to keep the vein open (TKO). (See task 081-833-0033.)
8. Administer supplemental oxygen without pressure, if available.
9. Record the treatment on the Field Medical Card.

10. Evacuate the casualty.

*NOTE:* An unconscious casualty should have an artificial airway inserted prior to evacuation and must be constantly monitored during evacuation.

**Performance Measures**

	<u>GO</u>	<u>NO GO</u>
1. Established unresponsiveness.	_____	_____
2. Established and maintained an open airway.	_____	_____
3. Assessed the casualty.	_____	_____
4. Positioned the casualty.	_____	_____
5. Observed the casualty.	_____	_____
6. Obtained the casualty's history.	_____	_____
7. Initiated an IV.	_____	_____
8. Administered oxygen, if available.	_____	_____
9. Recorded the treatment.	_____	_____
10. Evacuated the casualty.	_____	_____

**Evaluation Guidance:** Score each soldier according to the performance measures in the evaluation guide. Unless otherwise stated in the task summary, the soldier must pass all performance measures to be scored GO. If the soldier fails any step, show what was done wrong and how to do it correctly.

**References**  
**Required**  
None

**Related**  
BTLS FOR PARAMEDICS  
EMERGENCY CARE

## TREAT A CASUALTY WITH A CLOSED CHEST WOUND

081-833-0049

**Conditions:** All other more serious injuries have been treated. Necessary materials and equipment: cravats, field jacket, poncho, blanket, or similar material, and oxygen.

**Standards:** Treated a closed chest wound, minimizing the effects of the injury, without causing additional injury to the casualty.

### Performance Steps

1. Check the casualty for signs and symptoms of closed chest injuries.
  - a. Pleuritic pain that is increased by or occurs with respirations and is localized around the injury site.
  - b. Labored or difficult breathing.
  - c. Diminished or absent breath sounds.
  - d. Cyanotic lips, fingertips, or fingernails.
  - e. Rapid, weak pulse and low blood pressure.
  - f. Coughing up blood or bloody sputum.
  - g. Failure of one or both sides of the chest to expand normally upon inhalation.
  - h. Paradoxical breathing--the motion of the injured segment of a flail chest, opposite to the normal motion of the chest wall.
  - i. Enlarged neck veins.
  - j. Bulging tissue between the ribs and above the clavicles.
  - k. Tracheal deviation--shift of the trachea from the midline toward the unaffected side due to pressure buildup on the injured side.
  - l. Mediastinal shift--shift of the heart, great vessels, trachea, and esophagus from the midline to the unaffected side due to pressure buildup on the injured side.

**WARNING:** Evidence of mediastinal shift indicates excessive pressure within the chest cavity. Compression of the heart and great vessels will impair blood flow through the heart. Immediate relief of the pressure (chest decompression) must be accomplished by trained medical personnel or death will result.

2. Determine the type of injury.
  - a. Rib fracture--generally caused by a direct blow to the chest or compression of the chest. Severe coughing can also cause rib fracture.
    - (1) Signs and symptoms.
      - (a) Pain is aggravated by respirations and coughing.
      - (b) Crepitus is present.
      - (c) The casualty will take a defensive posture to protect the injury.
    - (2) Complications.
      - (a) Internal bleeding (hemothorax).
      - (b) Shock.
    - (3) Treatment.
      - (a) Use a sling and swathe to immobilize the affected side.
      - (b) Administer oxygen as necessary.

**NOTE:** The broken rib may puncture the lung or the skin.

**WARNING:** Do not tape, strap, or bind the chest.

- b. Flail chest involves three or more ribs fractured in two or more places or a fractured sternum.
  - (1) Signs and symptoms.

**Performance Steps**

- (a) Severe pain at the site.
- (b) Rapid shallow breathing.
- (c) Paradoxical respirations.
- (2) Complications.
  - (a) Respiratory insufficiency.
  - (b) Traumatic asphyxia.
- (3) Treatment.
  - (a) Establish and maintain an airway.
  - (b) Administer oxygen.
  - (c) Assist the casualty's respirations, if necessary.
  - (d) Monitor the casualty for signs of hemothorax or tension pneumothorax, as necessary.
  - (e) Stabilize the flail segment using one of the following methods:
    - 1) Apply manual pressure.
    - 2) Tape a pillow, folded blanket, field jacket, or poncho in place.
    - 3) Place the casualty on the injured side.

**WARNING:** Do not wrap the casualty's chest with tape. This will interfere with the casualty's ability to breathe.

- c. Hemothorax is caused by the bleeding from lacerated blood vessels in the chest cavity and/or lungs. It results in the accumulation of blood in the chest cavity but outside the lungs.
  - (1) Signs and symptoms.
    - (a) Hypotension due to blood loss.
    - (b) Shock.
    - (c) Cyanosis.
    - (d) Tightness in the chest.
    - (e) Mediastinal shift may produce deviated trachea away from the affected side.
    - (f) Coughing up frothy red blood.
  - (2) Complications.
    - (a) Possibility of hypovolemic shock.
    - (b) Frequently accompanies a pneumothorax.
  - (3) Treatment.
    - (a) Establish and maintain an airway.
    - (b) Administer oxygen.
    - (c) Assist the casualty's breathing, as necessary.
- d. Injuries to the back of the chest can result from a direct blow on the back of the chest. Contusions or rib fractures may occur.

**WARNING:** Spinal injury should be suspected.

- (1) Signs and symptoms.
  - (a) Rib fracture.
  - (b) Lacerations on the back.
  - (c) Muscle strain.
  - (d) Fractured scapula.
  - (e) Spinal injury.
  - (f) Respiratory distress.
- (2) Complications.
  - (a) Spinal injury.
  - (b) Hemothorax.
  - (c) Pneumothorax.
- (3) Treatment.



**Performance Steps**

*NOTE:* The main concern with this injury is the spine.

- (a) Establish and maintain an airway.

*NOTE:* Use the jaw thrust technique if a spinal injury is suspected.

- (b) Administer oxygen.
- (c) Assist the casualty's respirations, if necessary.
- (d) Treat suspected spinal injuries. (See task 081-833-0092.)

e. Tension pneumothorax.

- (1) Condition in which air enters the chest cavity (pleural space) through a hole in the lung(s), expanding the space with every breath the casualty takes.
- (2) The air becomes trapped and cannot escape.
- (3) Increased pressure in the chest causes the lung(s) to collapse.
- (4) May result from the laceration of the lung by a broken rib or by spontaneous rupture of a bleb or lesion on the lung.
- (5) Position the casualty for evacuation.
  - (a) Conscious--in a comfortable position.
  - (b) Unconscious--on the injured side.
- (6) Treatment.
  - (a) Establish and maintain an airway.
  - (b) Administer oxygen.
  - (c) Assist the casualty's respirations, as necessary.
  - (d) Monitor the casualty for evidence of a mediastinal shift.

3. Treat the casualty for shock.

4. Record the care provided on the appropriate form.

5. Evacuate the casualty.

*NOTE:* Continue to assess the casualty, if necessary.

**Evaluation Preparation:**

Setup: For training and evaluation, have another soldier act as the casualty. To test step 1, have the soldier tell you the signs of a closed chest wound.

Brief soldier: Tell the soldier to treat a casualty with a closed chest wound. Tell the soldier whether the wound involves a simple rib fracture, a flail chest, a compression injury, an injury to the back of the chest, a pneumothorax, or a hemothorax.

**Performance Measures**

	<u>GO</u>	<u>NO</u> <u>GO</u>
1. Checked the casualty for signs and symptoms of closed chest injuries.	—	—
2. Determined the type of injury.	—	—
3. Initiated treatment for a closed chest injury.	—	—
4. Treated the casualty for shock.	—	—
5. Recorded the care provided on the appropriate form.	—	—
6. Evacuated the casualty.	—	—

**Performance Measures**

<u><b>GO</b></u>	<u><b>NO</b></u>
<u>      </u>	<u><b>GO</b></u>
_____	_____

7. Did not cause further injury to the casualty.

**Evaluation Guidance:** Score each soldier according to the performance measures in the evaluation guide. Unless otherwise stated in the task summary, the soldier must pass all performance measures to be scored GO. If the soldier fails any step, show what was done wrong and how to do it correctly.

**References**

**Required**  
None

**Related**  
BTLS FOR PARAMEDICS  
EMERGENCY CARE

## TREAT A CASUALTY WITH AN OPEN CHEST WOUND

081-833-0050

**Conditions:** All other more serious injuries have been treated. Necessary materials and equipment: scissors, adhesive tape, field dressings, padding, ace bandage, and cravats.

**Standards:** Treated an open chest wound, minimizing the effects of the injury. Sealed the entry and exit wounds.

### Performance Steps

1. Check the casualty for signs and symptoms of an open chest wound.
  - a. A "sucking" or "hissing" sound when the casualty inhales.
  - b. Difficulty breathing.
  - c. A puncture wound of the chest.
  - d. An impaled object protruding from the chest.
  - e. Froth or bubbles around the injury.
  - f. Coughing up blood or blood tinged sputum.
  - g. Pain in the chest or shoulder.
2. Expose the wound.
  - a. Cut or unfasten the clothing that covers the wound.
  - b. Disrupt the wound as little as possible.

**NOTE:** Do not remove clothing stuck to the wound.

**CAUTION:** Do not remove protective clothing in a contaminated environment. Mask the casualty. Cut back protective clothing so that the wound is exposed and the dressing can be applied.

3. Check for an exit wound.
  - a. Feel and/or look at the casualty's chest and back.
  - b. Remove the casualty's clothing, if necessary.

4. Seal the wound(s), covering the larger wound first.

**NOTE:** All penetrating chest wounds should be treated as if they were sucking chest wounds.

- a. Cut the dressing wrapper on one long and two short sides and remove the dressing.

**NOTE:** In an emergency, any airtight material can be used. It must be large enough so it is not sucked into the chest cavity.

- b. Apply the inner surface of the wrapper to the wound when the casualty exhales.
- c. Ensure that the covering extends at least 2 inches beyond the edges of the wound.
- d. Seal by applying overlapping strips of tape to three sides of the plastic covering to provide a flutter-type valve.
- e. Cover the exit wound in the same way, if applicable.

**NOTE:** Assess the effectiveness of the flutter valve when the casualty breathes. When the casualty inhales, the plastic should be sucked against the wound, preventing the entry of air. When the casualty exhales, trapped air should be able to escape from the wound and out the untaped side of the dressing.

5. Dress the wound.
  - a. Place the field first aid dressing over the seal and tie the ends directly over the wound. (See Figure 3-15.)

## Performance Steps

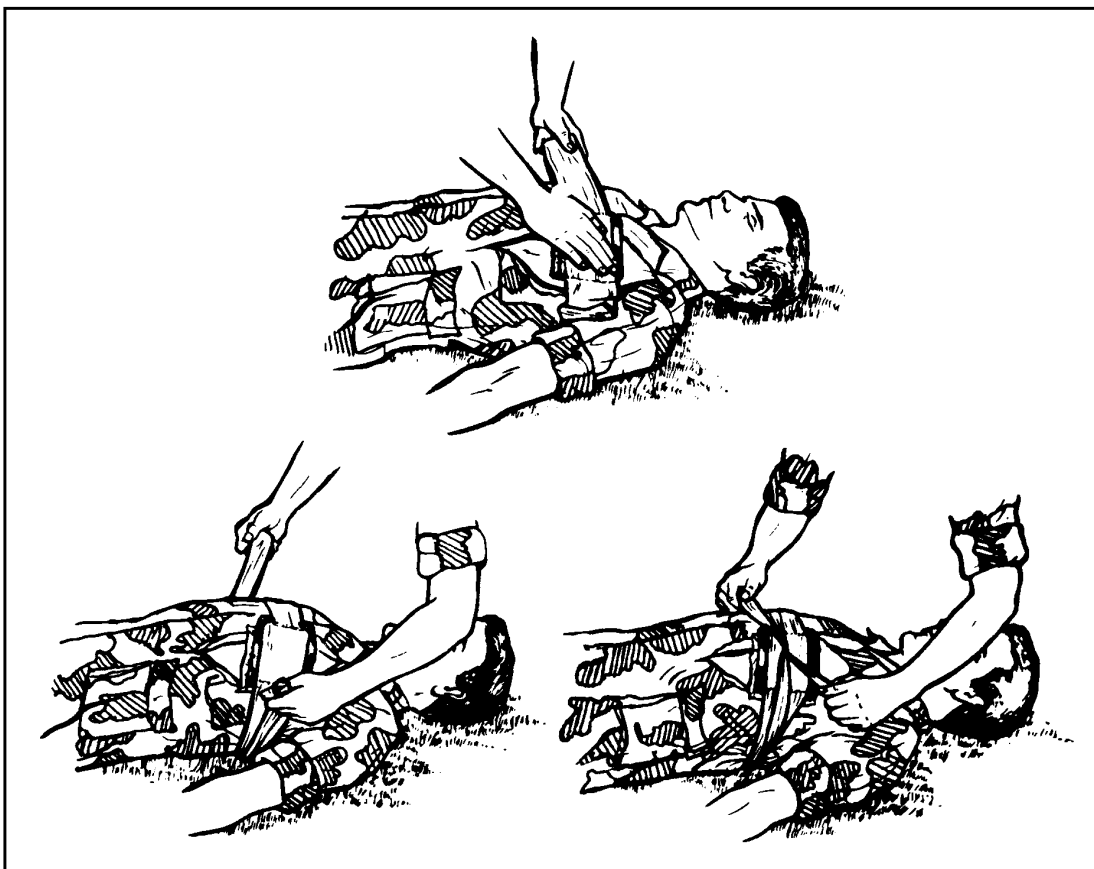

Figure 3-15

- b. Use padding material and another dressing for additional pressure and stability, if required.
- c. Dress the exit wound in the same way, if applicable.

**CAUTION:** Ensure that the dressings are not tied so tightly that they interfere with the breathing process or the flutter-type valve.

6. Place the casualty on the injured side.
7. Monitor the casualty.
  - a. Monitor breathing and the wound seal.
  - b. Assess the effectiveness of the flutter valve.
  - c. Check vital signs.
  - d. Observe for signs of shock.

8. Record the treatment on the appropriate form.

**NOTE:** Continue to assess the casualty, if necessary. The casualty should be evacuated by the most expedient means.

**Evaluation Preparation:**

Setup: For training and evaluation, have a mannequin or another soldier act as the casualty. Use a moulage kit or similar materials to simulate entry and exit wounds. To test step 1, have the soldier tell you the signs and symptoms of an open chest wound.

Brief soldier: Tell the soldier to treat a casualty for an open chest wound.

*NOTE:* Do not tell the soldier whether an exit wound exists.

**Performance Measures**

	<u>GO</u>	<u>NO GO</u>
1. Checked the casualty for signs and symptoms of an open chest wound.	_____	_____
2. Exposed the wound.	_____	_____
3. Checked for an exit wound.	_____	_____
4. Sealed the wound(s), covering the larger wound first.	_____	_____
5. Dressed the wound.	_____	_____
6. Placed the casualty on the injured side.	_____	_____
7. Monitored the casualty.	_____	_____
8. Recorded the treatment on the appropriate form.	_____	_____
9. Did not cause further injury to the casualty.	_____	_____

**Evaluation Guidance:** Score each soldier according to the performance measures in the evaluation guide. Unless otherwise stated in the task summary, the soldier must pass all performance measures to be scored GO. If the soldier fails any step, show what was done wrong and how to do it correctly.

**References**

**Required**  
None

**Related**  
BTLS FOR PARAMEDICS

## TREAT A CASUALTY WITH AN OPEN OR CLOSED HEAD INJURY

### 081-833-0052

**Conditions:** The casualty you are assessing has a head injury. All other more serious injuries have been treated. Necessary materials and equipment: field dressings, cravats, stethoscope, sphygmomanometer, oxygen tank set up, oropharyngeal airway, nonrebreather, bag-valve-mask, and intravenous (IV) setup.

**Standards:** Treated a head injury, minimizing the effects of the injury, and stabilized the casualty without causing additional injury.

#### Performance Steps

**WARNING:** Treat casualties with any type of traumatic head injury or loss of consciousness as if they have a spinal injury

1. Take appropriate body substance isolation precautions.
2. Check for the signs and symptoms of head injuries.
  - a. Superficial wound.
    - (1) Lacerated, torn, ragged, or mangled skin tissue.
    - (2) Copious bleeding, possible exposed skull.

**WARNING:** Do not manipulate the wound to observe the skull.

- b. Closed head injury--caused by a direct blow to the head.

**WARNING:** Brain injury, leading to a loss of function or death, often occurs without evidence of a skull fracture or scalp injury. Because the skull cannot expand, swelling of the brain or a collection of fluid pressing on the brain can cause pressure. This can compress and destroy the brain tissue.

- (1) Deformity of the head.
      - (2) Clear fluid or blood escaping from the nose and/or ear(s).
      - (3) Periorbital discoloration (raccoon eyes).
      - (4) Bruising behind the ears, over the mastoid process (battle sign).
      - (5) Lowered pulse rate if the casualty has not lost a significant amount of blood.
      - (6) Signs of increased intracranial pressure.
        - (a) Headache, nausea, and/or vomiting.
        - (b) Possible unconsciousness.
        - (c) Change in pupil size or symmetry.
        - (d) Lateral loss of motor nerve function--one side of the body becomes paralyzed.

**NOTE:** Lateral loss may not happen immediately but may occur later.

- (e) Change in the casualty's respiratory rate or pattern.
        - (f) A steady rise in the systolic blood pressure if the casualty hasn't lost significant amounts of blood.
        - (g) A rise in the pulse pressure (systolic pressure minus diastolic pressure).
        - (h) Elevated body temperature.
        - (i) Restlessness--indicates insufficient oxygenation of the brain.

- c. Concussion--caused by a violent jar or shock.

**NOTE:** A direct blow to the skull may bruise the brain.

- (1) Temporary unconsciousness followed by confusion.
      - (2) Temporary, usually short term, loss of some or all brain functions.
      - (3) The casualty has a headache or is seeing double.
      - (4) The casualty may or may not have a skull fracture.

### Performance Steps

- d. Contusion--an internal bruise or injury. It is more serious than a concussion. The injured tissue may bleed or swell. Swelling may cause increased intracranial pressure that may result in a decreased level of consciousness and even death.
  - e. Open head injury.
    - (1) Penetrating wound--an entry wound with no exit wound.
    - (2) Perforating wound--the wound has both entry and exit wounds.
    - (3) Visibly deformed skull.
    - (4) Exposed brain tissue.
    - (5) Possible unconsciousness.
    - (6) Paralysis or disability on one side of the body.
    - (7) Change in pupil size.
3. Direct manual stabilization of the casualty's head.
  4. Check the casualty's vital signs.
  5. Assess the casualty's level of consciousness using the AVPU scale.
    - a. A--alert. The casualty responds spontaneously to stimuli and is able to answer questions in a clear manner.
    - b. V--verbal. The casualty does not respond spontaneously but is responsive to verbal stimuli.
    - c. P--pain. The casualty does not respond spontaneously or to verbal stimuli but is responsive to painful stimuli.
    - d. U--unresponsive. The casualty is unresponsive to any stimuli.
  6. Assess the casualty's pupil size.
    - a. Observe the size of each pupil.

*NOTE:* A variation of pupil size may indicate a brain injury. In a very small percentage of people, unequal pupil size is normal.
    - b. Shine a light into each eye to observe the pupillary reaction to light.

*NOTE:* The pupils should constrict promptly when exposed to bright light. Failure of the pupils to constrict may indicate brain injury.
  7. Assess the casualty's motor function.
    - a. Evaluate the casualty's strength, mobility, coordination, and sensation.
    - b. Document any complaints, weakness, or numbness.

*NOTE:* Progressive loss of strength or sensation is an important indicator of brain injury.
  8. Treat the head injury.
    - a. Treat a superficial head injury.
      - (1) Apply a dressing.
      - (2) Observe for abnormal behavior or evidence of complications.
    - b. Treat a head injury involving deep trauma.
      - (1) Maintain a patent airway using the jaw thrust maneuver (see task 081-831-0018).
      - (2) If the patient is unconscious, insert an oropharyngeal airway without hyperextending the neck (see task 081-833-0016).
      - (3) Administer high concentration oxygen by nonrebreather mask and evaluate the need for artificial ventilations with supplemental oxygen.

*NOTE:* If the casualty shows signs of brain injury (increased pulse, decreased blood pressure, and an decreased level of consciousness), hyperventilate the patient with supplemental oxygen at a rate of at least 25 ventilations per minute.
      - (4) Apply a cervical collar (see task 081-833-0092).

**Performance Steps**

- (5) Dress the head wound(s).
- (6) Control bleeding.

**WARNING:** Do not apply pressure to or replace exposed brain tissue.

- (7) Treat for shock.
- (8) Monitor the casualty for convulsions or seizures. (See task 081-831-0035.)
- (9) Position the casualty with the head elevated 6 inches to assist with the drainage of blood from the brain.

**CAUTION:** Do not give the casualty anything by mouth.

- 9. Continue to monitor the casualty and check and record the following at 5 minute intervals.
  - a. Level of consciousness.
  - b. Pupillary responsiveness and equality.
  - c. Vital signs.
  - d. Motor functions.

10. Record the treatment on the appropriate form.

11. Evacuate the casualty.

**Evaluation Preparation:**

Setup: For training and evaluation, have another soldier act as the casualty. Use a moulage kit or similar materials to simulate a head wound. To test steps 2 and 7, coach the simulated casualty on how to answer the soldier's questions regarding such symptoms as headache. Tell the soldier what signs, such as changes in pupil size, the casualty is exhibiting.

Brief soldier: Tell the soldier to identify the type of head injury and treat the casualty for a head injury.

**Performance Measures**

	<u>GO</u>	<u>NO</u> <u>GO</u>
1. Took appropriate body substance isolation procedures.	—	—
2. Checked for the signs and symptoms of head injuries.	—	—
3. Directed manual stabilization of the casualty's head.	—	—
4. Checked the casualty's vital signs.	—	—
5. Assessed the casualty's level of consciousness using the AVPU scale.	—	—
6. Assessed the casualty's pupil size.	—	—
7. Assessed the casualty's motor function.	—	—
8. Treated the head injury.	—	—
9. Continued to monitor the casualty at 5 minute intervals.	—	—
10. Recorded the treatment on the appropriate form.	—	—
11. Evacuated the casualty.	—	—
12. Did not cause further injury to the casualty.	—	—



**Evaluation Guidance:** Score each soldier according to the performance measures in the evaluation guide. Unless otherwise stated in the task summary, the soldier must pass all performance measures to be scored GO. If the soldier fails any step, show what was done wrong and how to do it correctly.

**References**

**Required**

None

**Related**

BTLS FOR PARAMEDICS  
EMERGENCY CARE

**ADMINISTER INITIAL TREATMENT FOR BURNS**  
**081-833-0070**

**Conditions:** You are in a field environment. Necessary materials and equipment: field dressings, sterile dressings, Ringer's lactate or normal saline, and an intravenous (IV) setup. You are not in an NBC environment..

**Standards:** Administered initial treatment IAW the type and extent of the casualty's burns. Stabilized the casualty without causing further injury to the casualty or injuring self.

**Performance Steps**

1. Determine the cause of the burns.
  - a. Assess the scene.
  - b. Question the casualty and/or bystanders.
  - c. Determine if the casualty has been exposed to smoke, steam, or combustible products.
  - d. Determine if the cause was open flame, hot liquid, chemicals, or electricity.
  - e. Determine whether the casualty was struck by lightning.

**NOTE:** If the burn was caused by an explosion or lightning, the casualty may also have been thrown some distance from the original spot of the incident. He or she may, therefore, have associated internal injuries, fractures, or spinal injuries.

2. Stop the burning process.
  - a. Thermal burns.
    - (1) Have the casualty STOP, DROP, and ROLL.
      - (a) Do not permit the casualty to run, as this will fan the flames.
      - (b) Do not permit the casualty to stand, as the flames may be inhaled or the hair ignited.
      - (c) Place the casualty on the ground or floor and roll the casualty in a blanket or in dirt, and/or splash with water.
    - (2) Remove all smoldering clothing and articles that retain heat, if possible.
    - (3) Cut away clothing to expose the burned area.

**CAUTIONS:** 1. Do not remove clothing that is stuck to the burned area. If the clothing and skin are still hot, immerse in clean, cold water or cover with a wet dressing, if available. Do not immerse the burned area for more than 10 minutes. Prolonged cold water immersion, particularly of an extensive burn, can cause hypothermia (loss of body heat). 2. Immerse third degree burns only if they are still burning. Infection is the greatest danger of a third degree burn. Immersion other than to stop the burning may increase the risk of infection.

- b. Electrical burns.
  - (1) Turn off the current, if possible.
  - (2) If the current cannot be turned off, stand on a dry surface and move the casualty with nonconductive material such as rubber gloves or a wooden pole.

**WARNING:** Do not directly touch a casualty receiving a shock. To do so will conduct the current to you.

- (3) If necessary and/or possible, remove the electrical source from the casualty.

**WARNING:** Electrical shock may cause the casualty to go into cardiac arrhythmia or arrest. Initiate CPR as appropriate. Casualties of lightning strikes may require prolonged CPR and extended respiratory support.

- c. Chemical burns.

**WARNING:** A chemical will burn as long as it is in contact with the skin.

### Performance Steps

- (1) Flush the area of contact immediately with water. Do not delay flushing by removing the casualty's clothing first.

**NOTE:** If a solid chemical, such as lime, has been spilled on the casualty, brush it off before flushing. A dry chemical is activated by contact with water and will cause more damage to the skin.

- (2) Flush with cool water for 10 to 15 minutes while removing contaminated clothing or other articles.

**NOTES:** 1. Flush longer for alkali burns because they penetrate deeper and cause more severe injury. 2. Many chemicals have a delayed reaction. They will continue to cause injury even though the casualty no longer feels pain.

**WARNING:** Do not use a hard blast of water. Extreme water pressure can add mechanical injury to the skin.

- d. White phosphorus burns.

**NOTE:** White phosphorus (WP) will stick to the skin and continue to burn until it is deprived of air. WP burns are usually multiple and deep, usually producing second and third degree burns.

- (1) Deprive the WP of oxygen.
  - (a) Splash with a nonpetroleum liquid (such as water, mud, or urine).
  - (b) Submerge the entire area.
  - (c) Cover the affected area with a moistened cloth, if available, or mud.
- (2) Remove the WP particles from the skin by brushing with a wet cloth or using forceps, stick, or knife.

**WARNING:** Do not use any type of petroleum product to smother the WP. This will cause it to be more rapidly absorbed into the body.

3. Maintain an open airway, if necessary. (See task 081-831-0018.)

**NOTE:** As long as 30 to 40 minutes may elapse before edema obstructs the airway and respiratory distress is noted.

- a. Check for signs and symptoms of inhalation injury.
    - (1) Facial burns.
    - (2) Singed eyebrows, eyelashes, and/or nasal hairs.
    - (3) Carbon deposits and/or redness in the mouth and/or oropharynx.
    - (4) Sooty carbon deposits in the sputum.
    - (5) Hoarseness, noisy inhalation, brassy sounding cough, or dyspnea.
  - b. Check for signs and symptoms of carbon monoxide poisoning.
    - (1) Dizziness, nausea, and/or headache.
    - (2) Cherry-red colored skin and mucous membranes.
    - (3) Tachycardia or tachypnea.
    - (4) Respiratory distress or arrest.
  - c. Administer humidified oxygen at a high flow rate. (See tasks 081-833-0018 and 081-833-0019.)
4. Determine the percent of body surface area (BSA) burned.
    - a. Cut the casualty's clothing away from the burned areas.
    - b. Determine the percentage of BSA burned using the Rule of Nines. (See Figure 3-16.)

## Performance Steps

Rule of Nines		
1. Head and neck	=	9%
2. Anterior trunk	=	18%
3. Posterior trunk	=	18%
4. Upper extremities	=	18% (each 9%)
5. Lower extremities	=	36% (each 18%)
6. Perineum	=	1%

Figure 3-16

5. Determine the degree of the burns.
  - a. First degree.
    - (1) Superficial skin only.
    - (2) Red and painful, like a sunburn.
  - b. Second degree.
    - (1) Partial thickness of the skin.
    - (2) Penetrates the skin deeper than first degree.
    - (3) Blisters and pain.
    - (4) Some subcutaneous edema.
  - c. Third degree.
    - (1) Damage to or the destruction of a full thickness of skin.
    - (2) Involves underlying muscles, bones, or other structures.
    - (3) The skin may look leathery, dry, and discolored (charred, brown, or white).
    - (4) Nerve ending destruction causes a lack of pain.
    - (5) Massive fluid loss.
    - (6) Clotted blood vessels may be visible under the burned skin.
    - (7) Subcutaneous fat may be visible.

**CAUTIONS:** 1. Check for entry and exit burns when treating electrical burns and lightning strikes. 2. The amount of injured tissue in an electrical burn is usually far more extensive than the appearance of the wound would indicate. Although the burn wounds may be small, severe damage may occur to deeper tissues. (High voltage can destroy skin and muscles to such an extent that amputation may eventually be necessary.)

6. Treat for shock those casualties who have second or third degree burns of 20% BSA or more.
  - a. Initiate treatment for hypovolemic shock. (See task 081-833-0047.)
  - b. Keep the casualty flat.
  - c. Initiate an IV. (See task 081-833-0033.)
    - (1) Use Ringer's lactate, if available. Normal saline is the second fluid of choice.
    - (2) Use a large gauge (#16 or #18) needle.
    - (3) Initiate the IV in an unburned area, if possible.

### Performance Steps

- (4) Use a large peripheral vein.

**NOTE:** The presence of overlying burned skin should not deter the use of an accessible vein. The upper extremities are preferable to lower extremities.

- d. Infuse fluids for a casualty based on fluid replacement calculations.

- (1) Calculate the casualty's body weight in kilograms (kg).

(a) Determine or estimate the casualty's body weight in pounds.

(b) Divide the casualty's body weight by 2.2. For example, the casualty weighs about 165 pounds.  $165/2.2 = 75$  kg.

- (2) Calculate the amount of fluid to infuse per hour for the next 8 hours.

(a) Determine the percentage of BSA burned (see step 4b). For example, the casualty's BSA burned is 36%.

(b) Multiply 1 milliliter of fluid (1.00 cc) by the percentage of BSA burned. For example,  $1.00 \text{ cc} \times 36 = 36$  cc.

(c) Multiply the above figure by the casualty's weight, found in step 6d(1). For example,  $36 \text{ cc} \times 75 \text{ kg} = 2700$  cc. The casualty will require this much fluid over the next 8 hours.

(d) Divide the above figure by 8 to determine the amount of fluid to give per hour. For example,  $2700/8 = 337.5$ , rounded to 338 cc of fluid per hour (cc/hr).

- e. Assess the circulatory blood volume.

**NOTE:** Urine output is a reliable guide to assess circulating blood volume.

- (1) Measure the casualty's urine output in cc per hour.

- (2) Adjust the IV fluid flow to maintain 30 to 50 cc of urine output per hour.

7. Stabilize the casualty and perform a secondary assessment.

a. Measure and record the casualty's vital signs.

b. Assess the casualty for associated injuries. (See task 081-833-0151)

c. Check the distal circulation by checking pulses in all extremities.

8. Remove potentially constricting items such as rings and bracelets.

**CAUTION:** The swelling of burns on extremities can cause a tourniquet-like effect, and the swelling of a burned throat can impair breathing.

9. Apply cold soaks, if applicable.

a. Use for casualties with second degree burns of 10% BSA or less only.

b. Apply the soaks for 10 to 15 minutes only.

**CAUTION:** Do not immerse or apply cold water to a casualty with extensive burns.

10. Dress the burns.

a. Apply a dry sterile dressing to the burns.

**CAUTION:** Do not put ointment on the burns and do not break blisters.

b. Cover extensive burns with a sterile sheet, if available, or clean linen.

11. Administer oxygen, if available. (See task 081-833-0019.)

12. Record the treatment given.

13. Evacuate the casualty.

**Evaluation Preparation:**

Setup: For training and evaluation, have another soldier act as the casualty. You may use a moulage kit or similar material to simulate burns on the casualty, or you may describe to the soldier the area(s) of the body burned. Create a scenario which describes the cause and depth of the burns. For step 2, have the soldier describe what actions should be taken to prevent further injury. To test step 5, describe the depth of the burns and have the soldier tell you if they are first, second, or third degree. When testing step 6, have the soldier describe what actions should be taken when administering IV therapy, if necessary. When testing step 7, have the soldier describe what action is taken.

Brief soldier: Tell the soldier to determine the extent of the casualty's burns and the treatment required.

<b>Performance Measures</b>	<u><b>GO</b></u>	<u><b>NO GO</b></u>
1. Determined the cause of the burns.	_____	_____
2. Stopped the burning process.	_____	_____
3. Maintained the airway, if necessary.	_____	_____
4. Determined the percent of BSA burned.	_____	_____
5. Determined the degree of the burns.	_____	_____
6. Treated the casualty for shock, if necessary.	_____	_____
7. Stabilized the casualty and performed a secondary assessment.	_____	_____
8. Removed potentially constricting items.	_____	_____
9. Applied cold soaks, if applicable.	_____	_____
10. Dressed the burns.	_____	_____
11. Administered oxygen, if available.	_____	_____
12. Recorded the treatment given.	_____	_____
13. Evacuated the casualty.	_____	_____
14. Did not cause further injury to the casualty.	_____	_____

**Evaluation Guidance:** Score each soldier according to the performance measures in the evaluation guide. Unless otherwise stated in the task summary, the soldier must pass all performance measures to be scored GO. If the soldier fails any step, show what was done wrong and how to do it correctly.

**References**

**Required**  
None

**Related**  
BTLS FOR PARAMEDICS

**PROVIDE CARE FOR A SOLDIER WITH SYMPTOMS OF BATTLE FATIGUE**  
**081-833-0103**

**Conditions:** A soldier in a combat environment displays signs and symptoms of battle fatigue.

**Standards:** Classified the degree of battle fatigue and treated the soldier accordingly.

**Performance Steps**

*NOTE:* Battle fatigue refers to combat stress symptoms and reactions which may manifest as emotional and/or physical conditions. The soldier's mission performance may not be affected. Battle fatigue is considered a "normal" condition which could occur in anyone subjected to the physical and emotional stress of combat.

1. Identify contributing causes of battle fatigue.

*NOTE:* These are factors that have been historically identified as contributors to increasing battle fatigue rates.

- a. Sudden exposure to the intense fear, stimuli, and life/death consequences of battle.
- b. Cumulative exposure to dangers, responsibilities, and consequences of combat, including repeated grief and guilt over loss of comrades, friends, or patients.

*NOTE:* This may lead to the sense that one's own luck, skill, and courage have been used up.

- c. Physical stressors.
  - (1) Sleep loss.
  - (2) Lack of food and/or water.
  - (3) Physical exhaustion or excessive physical demands.
  - (4) Inclement weather.
  - (5) Lack of facilities for personal hygiene.
  - (6) Environmental illnesses.
  - (7) Cumulative exposure to combat conditions (noise, odor, and discomfort).
- d. Psychosocial factors.
  - (1) Worry about family members and friends.
  - (2) Homefront worries (debts, "Dear John" letters, and family illness/death).
  - (3) Lack of confidence in oneself, leaders, comrades, and/or equipment.

2. Check the casualty for signs and symptoms of battle fatigue.

- a. Simple fatigue.
  - (1) Loss of initiative.
  - (2) Tiredness.
  - (3) Indecisiveness.
  - (4) Inattention.
- b. Anxiety.
  - (1) Marked startle response.
  - (2) Tremors.
  - (3) Sweating.
  - (4) Insomnia with terror dreams.
  - (5) Rapid heartbeat.
- c. Depression.
  - (1) Self-doubt.
  - (2) Self-blame.
  - (3) Hopelessness.
  - (4) Grief.
  - (5) Bereavement.

**Performance Steps**

- d. Memory loss.
  - (1) Ranges from inability to remember recent instructions to loss of memory of well learned skills.
  - (2) Loss of memory of a traumatic event or period of time.
  - (3) Total amnesia or fugue state (soldier leaves his post, forgets his own past, goes somewhere else, and may assume a new identity).
- e. Physical function disturbance.

*NOTE:* These symptoms are not due to a physical cause and may have a clear symbolic relationship to a specific trauma or conflict of motivation.

- (1) Motor functions.
  - (a) Weakness or paralysis of hands, limbs, or body.
  - (b) Gross tremors.
  - (c) Sustained contractions of muscles.
- (2) Sensory functions.
  - (a) Visual symptoms--tunnel vision or total blindness.
  - (b) Auditory symptoms--dizziness, ringing in the ears, or deafness.
  - (c) Tactile changes--loss of sensations or abnormal sensations.
  - (d) Speech--stuttering, hoarseness, or muteness.

### 3. Classify battle fatigue cases.

*NOTE:* Classification labels are based on where the soldiers can be treated and therefore, depend as much on the situation of the unit as on the symptoms of the soldier. The classification has only transient significance due to the quickly changing nature of the battle fatigue symptoms.

- a. Duty--can be treated within the small unit while remaining on duty status.
- b. Rest--treated in a nonmedical support unit on a limited duty status for 1 to 2 days.
- c. Hold--requires holding for restorative treatment in the medical unit where the soldier is being evaluated.
- d. Refer--requires transfer to the next echelon medical facility for further evaluation.

### 4. Use basic treatment principles for battle fatigue.

*NOTE:* The acronym "PIES" is a method of remembering how to treat soldiers with battle fatigue.

- a. Proximity. Treat as close to the soldier's unit and the battle as possible to reduce overevacuation.
- b. Immediacy. Treat immediately, without delay.
- c. Expectancy. Express positive expectation of a full, rapid recovery.
- d. Simplicity. Use simple, brief methods to restore physical well-being and self-confidence, and use nonmedical terminology and techniques with the soldier.

### 5. Perform appropriate treatment interventions for battle fatigue.

- a. Maintain a military atmosphere.
  - (1) Have the soldier dress in a field uniform.
  - (2) Have the soldier maintain his or her field equipment.
  - (3) Keep the soldier busy with physical exercise, useful work details, and military training.
  - (4) Maintain appropriate military rank distinctions and courtesies.
- b. Encourage the soldier to--
  - (1) Sleep or rest.
  - (2) Eat and drink to replenish lost fluids.
  - (3) Shower and clean up, if possible.



**Performance Steps**

- c. Reassure the soldier that other soldiers have had the same experience and symptoms and have recovered and returned to duty.
- d. Encourage the soldier to talk about what has happened and about his or her emotions and unacceptable feelings.
  - (1) Maintain an accepting attitude.
  - (2) Assist the soldier in finding a more adaptive perspective to what has happened.
  - (3) Focus on lessons learned and alternative methods of coping.
- e. Recognize that some physical or mental illnesses may resemble battle fatigue.
  - (1) Hypothermia.
  - (2) Blunt trauma injury.
  - (3) Substance abuse.
  - (4) Laser eye injury.
  - (5) Nerve agent or atropine poisoning.
  - (6) Psychiatric and personality disorders.

**Performance Measures**

	<u>GO</u>	<u>NO GO</u>
1. Identified contributing causes of battle fatigue.	_____	_____
2. Checked the soldier for signs and symptoms of battle fatigue.	_____	_____
3. Classified the battle fatigue case.	_____	_____
4. Used basic treatment principles for battle fatigue.	_____	_____
5. Performed appropriate treatment interventions for battle fatigue.	_____	_____

**Evaluation Guidance:** Score each soldier according to the performance measures in the evaluation guide. Unless otherwise stated in the task summary, the soldier must pass all performance measures to be scored GO. If the soldier fails any step, show what was done wrong and how to do it correctly.

**References**

**Required**  
None

**Related**  
FM 8-10

## ASSIST IN VAGINAL DELIVERY

**081-833-0116**

**Conditions:** You encounter a pregnant female who is in labor. Necessary materials and equipment: sterile obstetric kit (if kit is not available, you will need clean sheets and towels, heavy flat twine or new shoelaces, plastic bag, and clean, unused gloves).

**Standards:** Assisted with cephalic vaginal delivery

### Performance Steps

1. Assist with the first stage of labor assessment.

*NOTES:* 1. All scene size-up, initial assessment, focused history, examination, detailed physical examination, ongoing assessment, and evacuate assessment steps must be taken to ensure that injury(ies) or illness is/are not over looked resulting in further injury to the patient. 2. Evacuate an expecting mother unless delivery is expected within a few minutes.

- a. Interview the pregnant woman. Request health history.
  - (1) Present pregnancy history: Is this your first pregnancy? Has there been complications during your pregnancy?
  - (2) Medical history: History of diabetes, hypertension, or chronic diseases?
  - (3) Obstetric history: How many times have you been pregnant?
- b. Assess general appearance and behavior.
- c. Check vital signs: monitor blood pressure.
- d. Assess the labor pattern status.
  - (1) Contractions: initial onset, frequency, and duration.
  - (2) Discomfort or pain.
- e. Assess fetal status: Apply monitor for fetal heart tones.
- f. Assess amniotic membranes status: Inquire if the patient has experienced constant leakage or rupture of vaginal fluid.

2. Assist with the second stage of labor assessment.

- a. Monitor continuously:
  - (1) Fetal heart rate and interval.
  - (2) Contractions.
  - (3) Patient's response.
  - (4) Patient's comfort or pain.
  - (5) Vital signs of the patient between contractions. If hypertension occurs, place the patient on her left side, administer oxygen (if available), and notify health care provider immediately.
- b. Maintain intravenous fluids.
- c. Assist to provide safety and position of comfort to the patient.

3. Assist with the third stage of labor assessment.

- a. Recognize precautions.
  - (1) Use body substance isolation.
  - (2) Do not let the mother go to bathroom.
  - (3) Do not hold the mother's legs together.
- b. Assist with delivery of the infant as directed by health care provider.

*NOTE:* If the medic is in an isolated environment and is unable to evacuate the patient, the medic will deliver the infant.

### Performance Steps

- (1) Determine if the umbilical cord is around the infant's neck as the infant is being born. Slip over the shoulder.
  - (2) Support the head after the infant's head is born.
  - (3) Suction the mouth two or three times and the nostrils. Avoid contact with the back of the mouth.
  - (4) Support the infant with both hands as the torso and full body are born.
  - (5) Wipe blood and mucus from the mouth and nose with sterile gauze. Suction the mouth and nose again.
  - (6) Clamp, tie, and cut the umbilical cord (between the clamps) as pulsation cease approximately four finger widths from the infant.
  - (7) Wrap the infant in a warm blanket and place on its side, head slightly lower than trunk.
  - (8) Observe for delivery of the placenta while preparing the mother and infant for evacuation.
  - (9) Place a sterile pad over the vaginal opening and lower patient's legs.
  - (10) Record the time of delivery and evacuate the mother, infant, and placenta to the hospital.
4. Assist with the fourth stage of labor assessment.
- a. Provide care to the mother.
    - (1) Complete assessment for the following every 15 minutes:
      - (a) Fundus.
      - (b) Lochia.
      - (c) Perineum.
      - (d) Vital signs.
      - (e) Pulse.
      - (f) Bladder extension.
      - (g) Deep tendon reflexes, if needed.
    - (2) Assess and provide for comfort and emotional response.
    - (3) Maintain intravenous fluids.
  - b. Provide initial care for the newborn.
    - (1) Position, dry, wipe, and wrap the newborn in a blanket and cover the head.
    - (2) Assessment findings
      - (a) Appearance--color: no central (trunk) cyanosis.
      - (b) Pulse--greater than 100/min.
      - (c) Grimace--vigorous and crying.
      - (d) Activity--good motion in extremities.
      - (e) Breathing effort--normal, crying.
5. Monitor for complications during labor.
- a. Identify prolapsed cord.
    - (1) Pulsating, protruding cord from vagina.
    - (2) Abnormal fetal heart rate and pattern.
  - b. Identify abruptio placentae.
    - (1) Vaginal bleeding may be dark red.
    - (2) Amniotic fluid may be red in color.
    - (3) Firm, rigid abdomen.
    - (4) Pain: mild to severe.
    - (5) Associated complications.
      - (a) Hypovolemic shock.

**Performance Steps**

- (b) Fetal distress.
- c. Identify placenta previa.
  - (1) Painless, bright-red uterine bleeding.
  - (2) Non-tender uterus: soft abdomen while in labor.
- 6. Identify additional gynecological emergencies.
  - a. Ectopic pregnancy.
    - (1) Assessment findings.
      - (a) Acute abdominal pain.
      - (b) Vaginal bleeding.
      - (c) Rapid and weak pulse.
      - (d) Low blood pressure.
    - (2) Consider immediate transport.
    - (3) Treat for shock if indicated.
  - b. Miscarriage and abortion.
    - (1) Assessment status.
      - (a) Cramping abdominal pains.
      - (b) Vaginal bleeding ranging from moderate to severe.
    - (2) Save all tissues expelled.
    - (3) Provide emotional support.
    - (4) Consider immediate transport.

**Performance Measures**

	<u>GO</u>	<u>NO</u> <u>GO</u>
1. Assisted with the first stage of labor assessment.	_____	_____
a. Interviewed the pregnant woman.		
b. Assessed general appearance and behavior.		
c. Checked vital signs.		
d. Assessed the labor pattern status.		
e. Assessed fetal status.		
f. Assessed amniotic membranes status.		
2. Assisted with the second stage of labor assessment.	_____	_____
a. Monitored continuously.		
b. Maintained intravenous fluids.		
c. Assisted to provide safety and positions of comfort to the patient.		
3. Assisted with the third stage of labor assessment.	_____	_____
a. Recognized precautions.		
b. Assisted with delivery of infant as directed by health care provider.		
4. Assisted with the fourth stage of labor assessment.	_____	_____
a. Provided care to the mother.		
b. Provided initial care for the newborn.		
5. Monitored for complications during labor.	_____	_____
a. Identified prolapsed cord.		
b. Identified abruptio placentae.		
c. Identified placenta previa.		

**Performance Measures**

GO      NO  
GO

- 6. Identified additional gynecological emergencies.
  - a. Ectopic pregnancy.
  - b. Miscarriage and abortion.

\_\_\_\_\_

**Evaluation Guidance:** Score each soldier according to the performance measures in the evaluation guide. Unless otherwise stated in the task summary, the soldier must pass all performance measures to be scored GO. If the soldier fails any step, show what was done wrong and how to do it correctly.

**References**

**Required**  
None

**Related**  
EMERGENCY CARE

## TREAT A POISONED CASUALTY

### 081-833-0143

**Conditions:** You have taken body substance isolation precautions. You have performed an initial assessment. Necessary materials and equipment : activated charcoal, airway adjuncts, oxygen, IV catheter, IV tubing, .9 percent normal saline, water source, and suction equipment.

**Standards:** Determined the type of poisoning and provided treatment, minimizing the effects of the poisoning, without causing further injury to the casualty.

### Performance Steps

1. Determine the type of poisoning.

**CAUTION:** If determination cannot be made to the type of poisoning, the patient should be treated by the symptoms presented.

- a. Ingested poisons.
  - (1) Altered mental status.
  - (2) Nausea/vomiting.
  - (3) Abdominal pain.
  - (4) Diarrhea.
  - (5) Chemical burns around the mouth.
  - (6) Unusual breath odors.
- b. Inhaled poisons.
  - (1) Carbon monoxide.
    - (a) Headache.
    - (b) Dizziness.
    - (c) Dyspnea.
    - (d) Nausea/vomiting.
    - (e) Cyanosis.
    - (f) Coughing.
  - (2) Smoke Inhalation.
    - (a) Dyspnea.
    - (b) Coughing.
    - (c) Breath that has a smoky smell or the odor of chemicals involved at the scene.
    - (d) Black residue in any sputum coughed up by the patient.
    - (e) Nose-hairs singed from super-heated air.
- c. Injected poisons.
  - (1) Uppers.
    - (a) Excitement.
    - (b) Tachycardia.
    - (c) Tachypnea.
    - (d) Dilated pupils.
    - (e) Sweating.
  - (2) Downers.
    - (a) Sluggish.
    - (b) Sleepy typical coordination of body and speech.
    - (c) Pulse and breathing rates are low, often to the point of a true emergency.
  - (3) Hallucinogens.
    - (a) Tachycardia.
    - (b) Dilated pupils.

### Performance Steps

- (c) Flushed face.
  - (d) Often sees or hears things, has very little concept of time.
  - (4) Narcotics.
    - (a) Reduced rate of breathing.
    - (b) Dyspnea.
    - (c) Low skin temperature.
    - (d) Muscles relaxed.
    - (e) Pinpoint pupils.
    - (f) Very sleepy and doesn't want to do anything.
  - d. Absorbed poisons.
    - (1) Liquid or powder on the patient's skin.
    - (2) Burns.
    - (3) Itching.
    - (4) Irritation.
    - (5) Redness.
2. Administer emergency care.
- a. Ingested poisons.
    - (1) Maintain the airway.
    - (2) Gather all information about the type of ingested poisoning.
    - (3) Initiate IV therapy.
    - (4) Administer activated charcoal.

**CAUTION:** Activated charcoal is contraindicated for patients that have an altered mental status, that you suspect have swallowed acids or alkalis, or that are unable to swallow.

**NOTE:** Be prepared to provide oral suctioning if the patient starts to vomit. All vomitus must be saved.

- (a) Adults and children: 1 gram of activated charcoal/kg of body weight.
  - (b) Usual adult dose: 25 - 50 grams.
  - (c) Usual pediatric dose: 12.5 - 25 grams.
  - (5) Record the name, dose, and time of administration of medication.
  - (6) Transport to the nearest medical treatment facility.
- b. Inhaled poisons.
    - (1) Remove the patient from the unsafe environment.
      - (a) Maintain the airway.
      - (b) Administer high concentrations of oxygen.

**NOTE:** This is the most important treatment for inhalation poisoning.

- (c) Transport to the nearest medical treatment facility.
- (d) Document interventions.

- c. Absorbed poisons.
  - (1) Remove the patient from the source.
  - (2) Remove contaminated clothing.
  - (3) Brush off any powders from the patient's skin.
  - (4) Flush the skin with large amounts of water for at least 20 minutes.

**NOTE:** Flushing the skin with water may be contraindicated with some dry chemicals. Water may actually activate the chemical.

- d. Injected poisons.
  - (1) Maintain the airway and be prepared to provide assisted ventilations.
  - (2) Initiate IV therapy.
  - (3) Look for gross soft tissue damage ("tracks").
  - (4) Protect the patient from harming self and others.

**Performance Steps**

*NOTE:* Be prepared to use restraints.

(5) Transport to the nearest medical treatment facility.

3. Document procedures (see tasks 081-831-0033 and 081-833-0145).

**Evaluation Preparation:**

Setup: For training and evaluation, have another soldier act as the casualty.

Brief soldier: Tell the soldier that the patient has an ingested or inhaled poison. Have the soldier state what actions should be taken when an IV infusion is initiated.

**Performance Measures**

	<u>GO</u>	<u>NO GO</u>
1. Determined the type of poisoning.	_____	_____
2. Maintained the airway.	_____	_____
3. Initiated an IV.	_____	_____
4. Administered proper medical intervention.	_____	_____
a. Ingested poisons - administered activated charcoal.		
b. Absorbed poisons - brushed off powder and flushed, if appropriate.		
c. Inhaled poisons - administered high concentration of oxygen.		
5. Provided suctioning, if necessary.	_____	_____
6. Documented the procedure.	_____	_____

**Evaluation Guidance:** Score each soldier according to the performance measures in the evaluation guide. Unless otherwise stated in the task summary, the soldier must pass all performance measures to be scored GO. If the soldier fails any step, show what was done wrong and how to do it correctly.

**References**

**Required**

None

**Related**

BTLS FOR PARAMEDICS  
EMERGENCY CARE



## TREAT A DIABETIC EMERGENCY

081-833-0144

**Conditions:** You have taken body substance isolation precautions. You have performed an initial assessment, focused history, and physical exam. Necessary materials and equipment: oral glucose and a tongue depressor.

**Standards:** Initiated treatment for hypoglycemia or hyperglycemia, stabilized the casualty, and minimized the effects without causing further injury to the casualty.

### Performance Steps

1. Identify the signs and symptoms of a diabetic emergency.

a. Hypoglycemia. (Low blood sugar)

*NOTE:* Hypoglycemia is the most common of all diabetic emergencies.

(1) Rapid onset of altered mental status.

*NOTE:* This is especially so after missing a meal, vomiting, or an unusual amount of physical exertion.

(2) Intoxicated appearance, staggering, slurred speech, or unconsciousness.

(3) Elevated heart rate.

(4) Cold, clammy skin.

(5) Hunger.

(6) Seizures.

(7) Uncharacteristic behavior.

(8) Anxiety.

(9) Combativeness.

b. Hyperglycemia. (High blood sugar)

(1) Slow onset.

(2) Warm, red, dry skin.

(3) Sweet, fruity breath odor (acetone).

(4) Deep, rapid breathing.

(5) Dry mouth.

(6) Intense thirst.

(7) Abdominal pain.

(8) Nausea and vomiting.

2. Administer the appropriate treatment.

*NOTE:* If you are unsure whether the patient has hyperglycemia or hypoglycemia, it is safer to treat the patient for hypoglycemia.

a. Hypoglycemia.

(1) If conscious, administer oral glucose in accordance with local protocol.

*NOTE:* Give it only if the patient has a history of diabetes, the patient has an altered mental status, and the patient is awake enough to swallow.

(a) Apply glucose to a tongue depressor and place it in the patient's mouth between the cheek and gum.

(b) Or if the patient is able, let the patient squeeze the glucose from the tube directly into his or her mouth.

(2) Monitor the patient for complications.

(3) If unconscious--

(a) Secure the airway and administer oxygen, if necessary.

(b) Start an IV at TKO rate.

**Performance Steps**

- (c) Place the patient in the recovery position.
- (d) Transport to the nearest medical treatment facility.
- b. Hyperglycemia.
  - (1) Maintain an open airway and administer oxygen, if necessary.
  - (2) Start an IV at TKO rate.
  - (3) Place the patient on a cardiac monitor, if available.
  - (4) Transport to the nearest medical treatment facility.
- 3. Document all treatment given.

*NOTE:* Document the patient's mental status using the AVPU throughout the contact. A change in mental status may indicate an alteration in the patient's blood sugar level.

**Evaluation Preparation:**

Setup: For training and evaluation, have another soldier act as the casualty and exhibit signs and symptoms of hyperglycemia or hypoglycemia.

Brief Soldier: Tell the soldier to state the signs and symptoms of hypoglycemia or hyperglycemia, and then treat the casualty.

**Performance Measures**

	<u>GO</u>	<u>NO GO</u>
1. Identified the type of diabetic emergency (hypoglycemia or hyperglycemia).	_____	_____
2. Administered appropriate treatment for hypoglycemia (conscious patient). <ul style="list-style-type: none"> <li>a. Administered oral glucose.</li> <li>b. Monitored the patient for complications.</li> </ul>	_____	_____
3. Administered appropriate treatment for hypoglycemia (unconscious patient). <ul style="list-style-type: none"> <li>a. Secured the airway and administered oxygen, if necessary.</li> <li>b. Started an IV at TKO rate.</li> <li>c. Placed the patient in a recovery position.</li> <li>d. Documented all treatment given.</li> <li>e. Transported the patient to the nearest medical treatment facility.</li> </ul>	_____	_____
4. Administered appropriate treatment for hyperglycemia. <ul style="list-style-type: none"> <li>a. Maintained an open airway and administered oxygen, if necessary.</li> <li>b. Started an IV at TKO rate.</li> <li>c. Placed the patient on a cardiac monitor, if available.</li> <li>d. Documented all treatment given.</li> <li>e. Transported the patient to the nearest medical treatment facility.</li> </ul>	_____	_____

**Evaluation Guidance:** Score each soldier according to the performance measures in the evaluation guide. Unless otherwise stated in the task summary, the soldier must pass all performance measures to be scored GO. If the soldier fails any step, show what was done wrong and how to do it correctly.

**References**  
**Required**  
None

**Related**  
EMERGENCY CARE

**PERFORM A TRAUMA CASUALTY ASSESSMENT**  
**081-833-0155**

**Conditions:** You find a casualty with multiple injuries. You are not in an NBC environment. You have available the necessary materials and equipment.

**Standards:** Assessed the casualty, identified all life threatening injuries, and treated them appropriately without causing further injury. Performed the assessments in the correct order.

**Performance Steps**

1. Take body substance isolation precautions.
2. Perform a Scene Assessment.
  - a. Determine the safest route to access the casualty.
  - b. Determine the mechanism of injury.
  - c. Determine the number of casualties.
  - d. Request additional help, if necessary.
  - e. Consider stabilization of the spine.

*NOTE:* If the mechanism of injury is significant, direct other soldiers to provide in line stabilization of the cervical spine.

3. Perform an Initial Assessment.

*NOTE:* Life threatening injuries should be treated as they are identified.

- a. Verbalize a general impression of the patient and of the patient's environment.
- b. Assess the patient's mental status using the AVPU scale.
  - (1) A - Alert and oriented.
  - (2) V - Responsive to verbal stimuli.
  - (3) P - Responsive to painful stimuli.
  - (4) U - Unresponsive (see task 081-833-0048).
- c. Determine the chief complaint.
- d. Assess the airway.
  - (1) Perform appropriate maneuver to open and maintain the airway (see task 081-831-0018).
  - (2) Insert an appropriate airway adjunct, if necessary. (See tasks 081-833-0016, 081-833-0142, and 081-833-0169. If skill level 30, see task 081-830-3016 also.)
- e. Assess breathing.
  - (1) Determine the rate, rhythm, and quality of breathing.
  - (2) Administer oxygen if necessary using the appropriate delivery device (see tasks 081-833-0158 and 081-831-0048).
- f. Assess circulation.
  - (1) Skin color, condition, and temperature.
  - (2) Assess the pulse for rhythm and force.
    - (a) Check the radial pulse in adults.
    - (b) Check the radial pulse and capillary refill in children.
    - (c) Check the brachial pulse and capillary refill in infants.
  - (3) Check for major bleeding.
  - (4) Control major bleeding (see tasks 081-833-0161 and 081-833-0046).
  - (5) Treat for shock (see task 081-833-0047).
- g. Identify patient priority and make a transport decision (load and go or stay and play).

### Performance Steps

**NOTE:** High priority conditions that require immediate transport include poor general impression, unresponsive, responsive but not following commands, difficulty breathing, shock, complicated childbirth, chest pain with systolic blood pressure less than 100, uncontrolled bleeding, and severe pain.

4. If the mechanism of Injury is significant, perform a Rapid Trauma Assessment.

**NOTE:** Significant mechanisms of injury include ejection from a vehicle, death in the same passenger compartment, falls of more than 15 feet or three times the patient's height, roll over of vehicle, high-speed vehicle collision, vehicle-pedestrian collision, motorcycle crash, unresponsive or altered mental status, and penetrations of the head, chest, or abdomen (e.g., stab and gunshot wounds). Additional significant mechanisms of injury for a child include falls from more than 10 feet, bicycle collision, and vehicles in medium speed collision.

a. Head.

- (1) Inspect for deformities, contusions, abrasions, punctures or penetration, burns, tenderness, lacerations, swelling (DCAP-BTLS).
- (2) Inspect for crepitus.

b. Neck.

- (1) Inspect for DCAP-BTLS.
- (2) Palpate spine step-offs.
- (3) Inspect for jugular vein distention (JVD).
- (4) Inspect for tracheal deviation.
- (5) Apply a cervical collar, if necessary

c. Chest.

- (1) Inspect for DCAP-BTLS.
- (2) Inspect for crepitus.
- (3) Inspect for paradoxical motion.
- (4) Inspect breath sounds (absent/present, equal).

d. Abdomen.

- (1) Inspect for DCAP-BTLS.
- (2) Inspect for tenderness.
- (3) Inspect for rigidity.
- (4) Inspect for distention.

e. Pelvis.

**NOTE:** If a conscious patient complains of pain or if an unconscious patient responds as if in pain at anytime during the assessment, do not continue the exam. Treat for pelvic fracture.

**CAUTION:** Do not log roll patients suspected of having a pelvic fracture.

- (1) Inspect for DCAP-BTLS.
- (2) Gently compress to detect instability and crepitus.
- (3) Determine the level of pain.
- (4) Inspect for priapism.

f. Extremities.

- (1) Inspect for DCAP-BTLS.
- (2) Check the distal pulse.
- (3) Check distal motor function.
- (4) Check distal sensation.

g. Posterior.

**NOTE:** The patient must be log rolled to do this portion of the assessment. If necessary, the patient should be placed on a long spine board after assessment. If PASGs were deemed necessary, they should be positioned on the long spine board before patient placement. If a patient has a suspected pelvic fracture, place in a scoop litter and then assess the posterior.

**Performance Steps**

- (1) Inspect for DCAP-BTLS.
  - (2) Inspect for rectal bleeding.
5. If there is no significant mechanism of injury, perform a Focused History and Physical Exam.
    - a. Based on chief complaint.
    - b. Focus on the areas that the patient tells you are painful or that you suspect may be painful due to the mechanism of injury.
  6. Obtain baseline vital signs (see tasks 081-831-0013, 081-831-0011, 081-831-0010, and 081-831-0012).
  7. Obtain a SAMPLE history.

*NOTE:* A SAMPLE history is obtained by questioning the patient. If the patient is unable to answer, search the scene or ask bystanders and/or family members for information.

- a. Signs/Symptoms.
  - (1) Ask the patient what's wrong.
  - (2) Observe the patient.
- b. Allergies.
  - (1) Ask the patient if there are any allergies to medications, foods, or environmental.
  - (2) Look for a medical identification tag.
- c. Medications.
  - (1) Ask the patient if he or she is taking any medications (prescription, over the counter, or illegal).
  - (2) Ask a female patient if she is taking birth control pills.
  - (3) Search for an identification tag with medications on it or medications in the area.
- d. Pertinent past history.
  - (1) Ask the patient if there are any medical problems (past and present).
  - (2) Ask the patient if he or she has been feeling ill.
  - (3) Ask the patient about recent surgery or injuries.
  - (4) Ask the patient if he or she is currently seeing a doctor and, if so, what is the doctor's name.
- e. Last oral intake.
  - (1) Ask the patient when his or her last meal or drink was.
  - (2) Ask the patient what he or she drank or ate.
- f. Events leading to the injury or illness.
  - (1) If the patient is unable to answer, search the scene for anything that may help.
  - (2) Ask about the sequence of events that led up to the current problem.

8. Perform a Detailed Physical Examination

*NOTE:* This is done only if time permits during evacuation or while waiting for evacuation. Do not delay evacuation to perform this exam.

- a. Assess the scalp and cranium.
  - (1) Inspect for DCAP-BTLS.
  - (2) Inspect for crepitation.
- b. Assess the ears.
  - (1) Inspect for DCAP-BTLS.
  - (2) Inspect for drainage.
    - (a) Blood.
    - (b) Clear fluid.
- c. Assess the face for DCAP-BTLS.

### Performance Steps

- d. Assess the eyes.
  - (1) Inspect for DCAP-BTLS.
  - (2) Inspect for discoloration.
  - (3) Inspect for unequal pupils.
  - (4) Inspect for foreign bodies.
  - (5) Inspect for blood in anterior chamber.
- e. Assess the nose.
  - (1) Inspect for DCAP-BTLS.
  - (2) Inspect for drainage of blood and/or clear fluid.
- f. Assess the mouth.
  - (1) Inspect for DCAP-BTLS.
  - (2) Inspect for loose or broken teeth.
  - (3) Inspect for objects that could cause obstruction.
  - (4) Inspect for swelling or laceration of the tongue.
  - (5) Inspect for unusual breath odor.
  - (6) Inspect for discoloration.
- g. Assess the neck.
  - (1) Inspect for DCAP-BTLS.
  - (2) Inspect for jugular vein distention (JVD).
  - (3) Inspect for tracheal deviation.
  - (4) Inspect for crepitation.
- h. Reassess the chest.
  - (1) Inspect for DCAP-BTLS.
  - (2) Palpate.
  - (3) Auscultate breath sounds.
  - (4) Assess for flail chest.
- i. Reassess the abdomen.
  - (1) Inspect for DCAP-BTLS.
  - (2) Inspect for tenderness.
  - (3) Inspect for rigidity.
  - (4) Inspect for distention.
- j. Reassess the pelvis.

**NOTE:** If pain, instability, or crepitus was noticed in the rapid trauma assessment, ensure the pelvis is properly stabilized and do not reassess.

- (1) Inspect for DCAP-BTLS.
  - (2) Inspect for instability.
  - (3) Inspect for crepitation.
  - (4) Determine the level of pain.
- k. Reassess the extremities.
  - (1) Inspect for DCAP-BTLS.
  - (2) Inspect motor function.
  - (3) Check sensation.
  - (4) Check circulation.
- l. Reassess the posterior.

**NOTE:** If the patient is secured to a long spine board, do not remove from the board. Reassess the flanks and as much of the spine as you can without moving the patient.

- (1) Inspect for DCAP-BTLS.
  - (2) Inspect for rectal bleeding.

**Performance Steps**

- m. Manage secondary injuries and wounds appropriately (see tasks 081-831-0044, 081-833-0045, 081-833-0046, 081-833-0049, 081-833-0050, 081-833-0052, 081-833-0056, 081-833-0057, 081-833-0058, 081-833-0060, 081-833-0062, 081-833-0064, 081-833-0154, and 081-833-3011).
- n. Reassess vital signs.

**Evaluation Preparation:**

Setup: For training and evaluation, have another soldier act as the casualty or use a trauma manikin. Describe a general scenario to the soldier. The casualty must have more than one injury or condition. Wounds may be simulated using moulage or other available materials. A "conscious" casualty can be coached to show signs of such conditions as shock, and to respond to the soldier's questions about the location of pain and other symptoms of injury. The evaluator will cue the soldier during the assessment of an "unconscious" casualty as to whether the casualty is breathing, and describe such conditions as shock to the soldier as he or she is making the checks.

Brief soldier: Tell the soldier to tell you what action he or she would take for each wound or condition identified.

**Performance Measures**

	<u>GO</u>	<u>NO GO</u>
1. Took body substance isolation precautions.	_____	_____
2. Performed a Scene Assessment.	_____	_____
3. Assessed for spinal protection.	_____	_____
4. Performed an Initial Assessment.	_____	_____
5. Administered high concentration of oxygen, if necessary.	_____	_____
6. Managed problems associated with the airway, breathing, hemorrhage, or shock (hypovolemic).	_____	_____
7. Differentiated the patient's need for transportation versus continued assessment at the scene.	_____	_____
8. If the mechanism of injury was significant, performed a Rapid Trauma Assessment.	_____	_____
9. If there was no significant mechanism of injury, performed a Focused History and Physical Exam.	_____	_____
10. Obtained baseline vital signs.	_____	_____
11. Obtained the SAMPLE history.	_____	_____
12. Performed a Detailed Physical Exam.	_____	_____
13. Performed the assessments in order.	_____	_____



**Evaluation Guidance:** Score each soldier according to the performance measures in the evaluation guide. Unless otherwise stated in the task summary, the soldier must pass all performance measures to be scored GO. If the soldier fails any step, show what was done wrong and how to do it correctly.

**References**

**Required**

None

**Related**

BTLS FOR PARAMEDICS  
EMERGENCY CARE

**PERFORM A MEDICAL PATIENT ASSESSMENT**  
**081-833-0156**

**Conditions:** You have a patient with a complaint that is medical in nature and no significant mechanism of injury. You have available the necessary materials and equipment to treat or stabilize the patient.

**Standards:** Assessed the patient and identified and treated the present illness without causing further injury.

**Performance Steps**

1. Take body substance isolation precautions.
2. Perform scene size-up.
  - a. Determine the safest route to access the casualty.
  - b. Determine the mechanism of injury/nature of illness.
  - c. Determine the number of patients.
  - d. Request additional help if necessary.
  - e. Considers stabilization of the spine.
3. Perform an Initial Assessment.
  - a. Verbalize general impression of the patient and the patient's environment.
  - b. Assess the patient's mental status using the AVPU scale.
    - (1) A - Alert and oriented.
    - (2) V - Responsive to verbal stimuli.
    - (3) P - Responsive to painful stimuli.
    - (4) U - Unresponsive (see task 081-833-0048).
  - c. Determine the chief complaint/apparent life threatening condition.
  - d. Assess the airway.
    - (1) Perform an appropriate maneuver to open and maintain the airway if necessary (see task 081-831-0018).
    - (2) Insert an appropriate airway adjunct, if necessary. (See tasks 081-833-0016, 081-833-0142, and 081-833-0169. If skill level 30, see task 081-830-3016 also.)
  - e. Assess breathing.
    - (1) Determine the rate, rhythm, and quality of breathing.
    - (2) Administer oxygen if necessary using the appropriate delivery device (see tasks 081-833-0158 and 081-831-0048).
  - f. Assess circulation.
    - (1) Skin color and temperature.
    - (2) Assess the pulse for rhythm and force.
      - (a) Check the radial pulse in adults.
      - (b) Check the radial pulse and capillary refill in children under 6 years old.
      - (c) Check the brachial pulse and capillary refill in infants.
    - (3) Check for major bleeding.
    - (4) Control major bleeding (see tasks 081-833-0161 and 081-833-0046).
    - (5) Treat for shock (see task 081-833-0047).
  - g. Identify priority patients and make a transport decision (load and go or stay and play).

### Performance Steps

**NOTE:** High priority conditions that require immediate transport include poor general impression, unresponsive, responsive but not following commands, difficulty breathing, shock, complicated childbirth, chest pain with systolic blood pressure less than 100, uncontrolled bleeding, and severe pain.

4. Conduct a rapid physical exam if the patient is unconscious. Inspect each of the following areas for deformities, contusions, abrasions, punctures or penetration, burns, tenderness, lacerations, swelling (DCAP-BTLS).
  - a. Assess the head.
  - b. Assess the neck.
  - c. Assess the chest.
  - d. Assess the abdomen.
  - e. Assess the pelvis.
  - f. Assess the extremities.
  - g. Assess the posterior.

5. Gather a SAMPLE history from the patient.

**NOTE:** If the patient is unable to give you this information, gather as much information about the SAMPLE history as you can from the patient's family and/or bystanders.

- a. Signs and symptoms. Gather history of the present illness (OPQRST) from the patient.

(1) RESPIRATORY.

- (a) Onset - When did it begin?
- (b) Provocation - What were you doing when this came on?
- (c) Quality - Can you describe the feeling you have?
- (d) Radiation - Does the feeling seem to spread to any other part of your body?  
Do you have pain or discomfort anywhere else in your body?
- (e) Severity - On a scale of 1 to 10, how bad is your breathing trouble (10 is worst, 1 is best)?
- (f) Time - How long have you had this feeling?
- (g) Interventions - Have you taken any medication to help you breathe? Did it help?

(2) CARDIAC.

- (a) Onset - When did it begin?
- (b) Provocation - What were you doing when this came on?
- (c) Quality - Can you describe the feeling you have?
- (d) Radiates - Does the feeling seem to spread to any other part of your body?  
Do you have pain or discomfort anywhere else in your body?
- (e) Severity - On a scale of 1 to 10, how bad is your breathing trouble (10 is worst, 1 is best)?
- (f) Time - How long have you had this feeling?
- (g) Interventions - Have you taken any medication to help you? Did it help?

(3) ALTERED MENTAL STATUS.

- (a) Description of the episode - Can you tell me what happened? How did the episode occur?
- (b) Onset - How long ago did it occur?
- (c) Duration - How long did it last?
- (d) Associated symptoms - Was the patient sick or complaining of not feeling well before this happened?
- (e) Evidence of trauma - Was the patient involved in falls or accidents recently?

**Performance Steps**

- (f) Interventions - Has the patient taken anything to help with this problem? Did it help?
- (g) Seizures - Did the patient have a seizure?
- (h) Fever - Did the patient have a fever? What was the patient's temperature?
- (4) ALLERGIC REACTION.
  - (a) History of allergies - Do you have any allergies?
  - (b) What were you exposed to - Is there any chance that you were exposed to something that you may be allergic to?
  - (c) How were you exposed - How did you come into contact with \_\_\_\_\_ (whatever the patient is allergic to)?
  - (d) Effects - What kind of symptoms are you having? How long after you were exposed did the symptoms start?
  - (e) Progression - How long after you were exposed did the symptoms start? Are they worse now than they were before?
  - (f) Interventions - Have you taken anything to help? Did it help?
- (5) POISONING/OVERDOSE.
  - (a) Substance - What substance was involved?
  - (b) When did you ingest/become exposed - When did the exposure/ingestion occur?
  - (c) How much did you ingest - How much did the patient ingest?
  - (d) Over what time period - Over how long a period did the ingestion occur?
  - (e) Interventions - What interventions did the family or bystanders take?
  - (f) Estimated weight - What is the patient's estimated weight?
- (6) ENVIRONMENTAL EMERGENCY.
  - (a) Source - What caused the injury?
  - (b) Environment - Where did the injury occur?
  - (c) Duration - How long were you exposed?
  - (d) Loss of consciousness - Did you lose consciousness at any time?
  - (e) Effects (general or local) - What signs and symptoms are you having? What effect did being exposed have on the patient?
- (7) OBSTETRICS.
  - (a) Are you pregnant?
  - (b) How long have you been pregnant?
  - (c) Are you having pain or contractions?
  - (d) Are you bleeding? Are you having any discharge?
  - (e) Do you feel the need to push?
  - (f) When was your last menstrual period?
- (8) BEHAVIORAL.
  - (a) How do you feel?
  - (b) Determine suicidal tendencies - Do you have a plan to hurt yourself or anyone else? .
  - (c) Is the patient a threat to self or others?
  - (d) Is there a medical problem?
  - (e) Interventions?
- b. Allergies.
- c. Medications.
- d. Past pertinent history.
- e. Last oral intake.
- f. Event(s) leading to present illness.

**Performance Steps**

6. Perform a focused physical examination on the affected body part/system.
7. Obtain baseline vital signs (see tasks 081-831-0013, 081-831-0011, 081-831-0010, and 081-831-0012).
8. Provide medication interventions and treatment as needed (see tasks 081-831-0035, 081-833-0103, 081-833-0116, 081-833-0143, 081-833-0144, 081-833-0159, 081-833-0160, 081-833-0163, 081-833-0166, 081-833-0054, 081-831-0038, 081-831-0039, 081-833-0031, 081-833-0073, and 081-833-3206) .
9. Reevaluate the transport decision.
10. Consider completing a detailed physical examination.
11. Perform Ongoing Assessment.
  - a. Repeat the initial assessment.
  - b. Repeat vital signs.
  - c. Repeat the focused assessment regarding the patient's complaint or injuries.

**Performance Measures**

	<u>GO</u>	<u>NO GO</u>
1. Took body substance isolation precautions.	_____	_____
2. Performed a scene size up.	_____	_____
3. Obtained medical direction or used standing orders for medical interventions.	_____	_____
4. Provided high concentration of oxygen.	_____	_____
5. Found and managed problems associated with the airway, breathing, hemorrhage, or shock.	_____	_____
6. Differentiated the patient's need for transportation versus continued assessment at the scene.	_____	_____
7. Performed a detailed or focused history/physical examination before assessing the airway, breathing, and circulation.	_____	_____
8. Asked questions concerning the present illness.	_____	_____
9. Administered appropriate interventions.	_____	_____

**Evaluation Guidance:** Score each soldier according to the performance measures in the evaluation guide. Unless otherwise stated in the task summary, the soldier must pass all performance measures to be scored GO. If the soldier fails any step, show what was done wrong and how to do it correctly.

**References**

**Required**  
None

**Related**  
EMERGENCY CARE

## TREAT A CARDIAC EMERGENCY

**081-833-0159**

**Conditions:** You have a conscious patient who is complaining of chest pain. You have already taken the appropriate body substance isolation precautions. You have already done the initial patient assessment, focused history, and physical. Necessary materials and equipment: oxygen tank setup, nonrebreather mask, and IV materials.

**Standards:** Completed all necessary steps to manage a patient with a cardiac emergency, without causing any further injury.

### Performance Steps

1. Identify the signs and symptoms of cardiac emergency or compromise.
  - a. Pain, pressure, or discomfort in the chest or upper abdomen (epigastrium).
  - b. Dyspnea.
  - c. Palpitations.
  - d. Sudden onset of sweating with nausea or vomiting.
  - e. Anxiety (feeling of impending doom or irritability).
  - f. Abnormal pulse (arrhythmia).
    - (1) Bradycardia (less than 60 beats per minute).
    - (2) Tachycardia (greater than 100 beats per minute).
  - g. Abnormal blood pressure.
    - (1) Hypotensive (systolic pressure less than 90).
    - (2) Hypertensive (systolic pressure greater than 150).
  - h. Pulmonary edema.
    - (1) Shortness of breath.
    - (2) Dyspnea.
    - (3) Rales upon auscultation.
    - (4) Blood tinged sputum.
  - i. Pedal edema.
2. Administer the appropriate treatment.
  - a. Place the patient in a position of comfort.
  - b. Apply a high concentration of oxygen via a nonrebreather mask.
  - c. Assist the patient in taking nitroglycerin, if available.

**NOTE:** Administer the nitroglycerin only if ALL of the following conditions are met:

1. Patient complains of chest pain.
2. Patient has a history of cardiac problems.
3. Patient has a current prescription for nitroglycerin.
4. Patient has the nitroglycerin with him or her.
5. Patient's systolic blood pressure is greater than 100.
  - (1) Check the five rights.
  - (2) Remove the oxygen mask.
  - (3) Ask the patient to open his or her mouth and lift his or her tongue.
  - (4) Place the tablet or spray (if using mist) under the tongue with a gloved hand.

**CAUTION:** Avoid contacting the nitroglycerin tablet or mist with bare skin. The vasodilation affects could cause unconsciousness.

- (5) Have the patient close his or mouth and hold the tablet under the tongue.
- (6) Replace the oxygen mask.

**Performance Steps**

(7) Recheck the blood pressure within 2 minutes.

**NOTE:** If the blood pressure falls below 100, treat the patient for shock and transport immediately.

- d. If the patient experiences no relief, repeat step 2c every 5 minutes until the patient has taken a total of three tablets.
  - e. If the patient experiences no relief after three nitroglycerin tablets or their condition worsens, initiate an IV at TKO rate (see task 081-833-0033) or establish a saline lock, if available (see task 081-835-3025).
3. Transport promptly to the nearest medical treatment facility.
  4. Perform an ongoing assessment while en route.
  5. Document all interventions.

**Evaluation Preparation:**

**Setup:** Have one soldier be the patient while the soldier being tested administers treatment. Tell the soldier who is acting as the patient the signs and symptoms he should exhibit and how to answer the questions asked by the soldier being tested.

**Brief soldier:** Tell the soldier to treat the patient for a cardiac emergency.

**Performance Measures**

	<u>GO</u>	<u>NO GO</u>
1. Identified the signs and symptoms of cardiac emergency or compromise.	_____	_____
2. Administered the appropriate treatment.	_____	_____
3. Transported promptly to the nearest medical treatment facility.	_____	_____
4. Performed an ongoing assessment while en route.	_____	_____
5. Documented all interventions.	_____	_____

**Evaluation Guidance:** Score each soldier according to the performance measures in the evaluation guide. Unless otherwise stated in the task summary, the soldier must pass all performance measures to be scored GO. If the soldier fails any step, show what was done wrong and how to do it correctly.

**References**

**Required**  
None

**Related**  
BTLS FOR PARAMEDICS  
EMERGENCY CARE

## TREAT A RESPIRATORY EMERGENCY

### 081-833-0160

**Conditions:** You have a conscious casualty experiencing trouble breathing. You are not in an NBC environment. Necessary equipment and materials: stethoscope, pulse oximeter, oxygen tank, nasal cannula, oxygen mask and tubing, hand held metered dose inhaler (MDI) with spacer, nebulizer set up, and medicated solution and normal saline for inhalation therapy.

**Standards:** Correctly identified and treated a respiratory emergency without causing further harm to the casualty.

#### Performance Steps

1. Examine the casualty.

- a. Assess the airway and open it, if necessary. (See task 081-831-0018.)

**CAUTION:** A casualty experiencing respiratory distress can rapidly progress to full arrest. Always be prepared to move quickly to a more definitive step such as intubation.

- (1) Ask the casualty a question requiring more than a yes or no answer.
- (2) Note whether or not the casualty can speak in full sentences.
- (3) Look for the presence of drooling that may indicate a partial or complete airway obstruction.

- b. Assist with artificial ventilations if respiratory effort and rate are inadequate.

- (1) Look for the rise and fall of the chest during inspiration and expiration.
- (2) Listen for the presence of noisy respirations (e.g., stridor, wheezing).

- c. Apply supplemental oxygen by mask or nasal cannula.

**NOTE:** Any casualty complaining of difficulty breathing should receive supplemental oxygen.

- d. Place the casualty in the position of comfort.

**NOTE:** Most casualties experiencing difficulty breathing prefer to remain in a seated position.

- e. Obtain a complete set of vital signs to include pulse oximetry, if available.

2. Perform a focused physical examination.

- a. Listen to the anterior and posterior lung fields with the stethoscope.
- b. Look at the chest and abdomen and note the presence of any retractions.
- c. Check the skin for the presence of cyanosis.
- d. Check the lower extremities for the presence of edema. This could indicate heart failure.

3. Obtain a focused history.

- a. Ask the casualty if there is an existing condition such as asthma.
- b. Ask the casualty if he or she is taking any medications.
- c. Question the casualty about allergies to medications.
- d. Ask the casualty if difficulty breathing was of sudden or gradual onset.

4. Assist the casualty in using a metered dose inhaler.

- a. Perform the five rights of medication usage.
- b. Have the casualty exhale deeply.
- c. Have the casualty place his or her lips around the opening and press the inhaler to activate the spray as he or she inhales deeply.
- d. Instruct the casualty to hold his or her breath as long as possible before exhaling.
- e. Repeat steps 4b through 4d.

5. Administer a nebulizer treatment.



**Performance Steps**

- a. Set up the nebulizer per manufacturer's guidelines.
- b. Instill the appropriate medicine IAW with local SOP.
- c. Connect the nebulizer to an oxygen source.

*NOTE:* Compressed air can be used but it doesn't supply the casualty with supplemental oxygen.

- d. Turn on the flow of oxygen and check for the formation of mist (smoke).
- e. Have the casualty place his or her lips on the mouth piece and slowly inhale and exhale the mist.
- f. Monitor the casualty's vital signs every 5 minutes. If available, attach the casualty to a pulse oximeter.

6. Document the procedure.

**Performance Measures**

	<u>GO</u>	<u>NO GO</u>
1. Examined the casualty.	_____	_____
2. Performed a focused physical examination.	_____	_____
3. Obtained a focused history.	_____	_____
4. Assisted the casualty in using a metered dose inhaler.	_____	_____
5. Administered a nebulizer treatment.	_____	_____
6. Documented the procedure.	_____	_____

**Evaluation Guidance:** Score each soldier according to the performance measures in the evaluation guide. Unless otherwise stated in the task summary, the soldier must pass all performance measures to be scored a GO. If the soldier fails any step, show what was done wrong and how to do it correctly.

**References**

**Required**  
None

**Related**  
BTLS FOR PARAMEDICS  
EMERGENCY CARE

**DETERMINE A PATIENT'S LEVEL OF CONSCIOUSNESS USING THE GLASGOW COMA SCALE****081-835-3030**

**Conditions:** You have a patient who is in an altered state of consciousness. Necessary materials and equipment: the patient's clinical record, stethoscope, blood pressure cuff, and a watch with a second hand.

**Standards:** Accurately determined and recorded a patient's level of consciousness in accordance with the standardized response scale.

**Performance Steps**

1. Determine best eye response in accordance with the following response grading scale.
  - a. Eyes open spontaneously--4 points.
  - b. Eyes open in response to speech--3 points.
  - c. Eyes open in response to painful stimuli--1 point.
2. Determine best verbal response in accordance with the following response grading scale.
  - a. The patient is oriented to person, place, and time--5 points.
  - b. The patient is not oriented (is confused), but is able to communicate--4 points.
  - c. The patient speaks in a disorganized manner (inappropriate speech)--3 points.
  - d. The patient responds with moaning or groaning sounds (incomprehensible sounds)--2 points.
  - e. The patient has no verbal response--1 point.
3. Determine best motor response in accordance with the following response grading scale.
  - a. The patient obeys commands appropriately and is able to move all extremities equally and spontaneously--6 points.
  - b. The patient is still able to obey commands, but exhibits weakness (for example, drifting of an upper extremity)--5 points.
  - c. The patient attempts to withdraw from the source of the painful stimulus (flexor withdrawal)--4 points.
  - d. The patient flexes an extremity abnormally--3 points.
  - e. The patient extends an extremity abnormally--2 points.
  - f. The patient has no motor response to painful stimuli (flaccid)--1 point.
4. Determine the total consciousness level score by adding the points determined in steps 1 through 3. (See Figure 3-17.)

**Performance Steps**

<b>ABBREVIATED RESPONSE SCALE</b>		
<b>EYE OPENING</b>		Eye Score
Spontaneous	=4	
To sound	=3	
To pain	=2	
None	=1	
<b>BEST VERBAL RESPONSE</b>		Verbal Score
Oriented	=5	
Not Oriented (confused)	=4	
Inappropriate speech	=3	
Incomprehensible sounds	=2	
None	=1	
<b>BEST MOTOR RESPONSE</b>		Motor Score
Obeys commands	=6	
Localizes stimulus	=5	
Withdrawal from stimulus	=4	
Abnormal flexion	=3	
Abnormal extension	=2	
Flaccid	=1	
		<b>TOTAL SCORE</b>
<p>The patient's total "consciousness level" score will be a minimum of 3 points and a maximum of 15 points.</p>		

Figure 3-17

5. Record and/or graph the patient's response.
6. Report any changes in level of consciousness to the charge nurse immediately.
7. Document significant nursing observations on the appropriate forms IAW local SOP.

**Performance Measures**

	<u>GO</u>	<u>NO</u> <u>GO</u>
1. Determined best eye response.	_____	_____
2. Determined best verbal response.	_____	_____
3. Determined best motor response.	_____	_____
4. Determined the total consciousness level score by adding the points determined in steps 1 through 3.	_____	_____

**Performance Measures**

	<u>GO</u>	<u>NO</u> <u>GO</u>
5. Recorded and/or graphed the patient's response.	_____	_____
6. Reported any changes in level of consciousness to the charge nurse immediately.	_____	_____
7. Documented significant nursing observations on the appropriate forms IAW local SOP.	_____	_____

**Evaluation Guidance:** Score each soldier according to the performance measures in the evaluation guide. Unless otherwise stated in the task summary, the soldier must pass all performance measures to be scored GO. If the soldier fails any step, show what was done wrong and how to do it correctly.

**References**

**Required**  
None

**Related**  
BTLS FOR PARAMEDICS  
EMERGENCY CARE

Subject Area 7: Eye Injuries

**IRRIGATE EYES**

**081-833-0054**

**Conditions:** You have performed a patient care handwash. Necessary materials and equipment: draping materials, catch basin, light source, gauze or cotton balls, irrigating syringe or similar equipment, gloves, and irrigating solution (normal saline, water, or other prescribed solution).

**Standards:** Irrigated the eyes without contaminating or injuring the eyes.

**Performance Steps**

1. Identify the casualty and explain the procedure.
2. Verify the type, strength, and expiration date of the medication, as appropriate.

**CAUTION:** Do not irrigate an eye that has an impaled object.

3. Ask the casualty to remove contact lenses or glasses, if necessary.
4. Position the casualty.
  - a. If lying on the back, tilt the head slightly to the side that is to be irrigated.
  - b. If seated, tilt the head slightly backward and to the side that is to be irrigated.
5. Position the equipment.
  - a. Drape the areas of the casualty that may be splashed by the solution.
  - b. Place a catch basin next to the face on the affected side.
  - c. Position the light so that it does not shine directly into the casualty's eyes.

6. Put on gloves.

**WARNING:** Wear gloves for self-protection against transmission of contaminants whenever handling body fluids.

7. Clean the eyelids with gauze or cotton balls, and rinse debris from the outer eye.
8. Separate the eyelids using the thumb and forefinger, and hold the lids open.

**CAUTION:** Do not put pressure on the eyeball.

9. Irrigate the eye.
  - a. Hold the irrigating tip 1 to 1 1/2 inches away from the casualty's eye.
  - b. Direct the irrigating solution gently from the inner canthus to the outer canthus.
  - c. Use only enough pressure to maintain a steady flow of solution and to dislodge the secretions or foreign bodies.
  - d. Instruct the casualty to look up to expose the conjunctival sac and lower surface of the eye.
  - e. Instruct the casualty to look down to expose the upper surface of the eye.

10. Dry the area around the eye by gently patting with gauze sponges.

**CAUTION:** Do not touch the eye.

11. Remove the gloves, and perform a patient care handwash.

12. Record the treatment given on the appropriate form.

<b>Performance Measures</b>	<b><u>GO</u></b>	<b><u>NO GO</u></b>
1. Identified the casualty and explained the procedure.	—	—
2. Verified the type, strength, and expiration date of the medication, as appropriate.	—	—
3. Asked the casualty to remove contact lenses or glasses, if necessary.	—	—
4. Positioned the casualty.	—	—
5. Positioned the equipment.	—	—
6. Put on gloves.	—	—
7. Cleaned the eyelids with gauze or cotton balls, and rinsed debris from the outer eye.	—	—
8. Separated the eyelids using the thumb and forefinger, and held the lids open.	—	—
9. Irrigated the eye.	—	—
10. Dried the area around the eye by gently patting with gauze sponges.	—	—
11. Removed the gloves and performed a patient care handwash.	—	—
12. Recorded the treatment given on the appropriate form.	—	—
13. Did not injure or contaminate the eye.	—	—

**Evaluation Guidance:** Score each soldier according to the performance measures in the evaluation guide. Unless otherwise stated in the task summary, the soldier must pass all performance measures to be scored GO. If the soldier fails any step, show what was done wrong and how to do it correctly.

**References**  
**Required**  
 None

**Related**  
 BASIC NURSING

## TREAT FOREIGN BODIES OF THE EYE

081-833-0056

**Conditions:** You have performed a patient care handwash. Necessary materials and equipment: cotton-tipped swabs, clean cloth, sterile irrigation solution (normal saline, water, or other prescribed solution), bandages, and a paper cup or cardboard cone.

**Standards:** Treated foreign bodies of the eye, minimizing the effects of the injury, without causing additional injury to the eye.

### Performance Steps

**WARNING:** Wear gloves for self-protection against transmission of contaminants whenever handling body fluids.

1. Locate the foreign bodies.
  - a. Method one.
    - (1) Pull the lower lid down.
    - (2) Tell the casualty to look up and to both sides and check for foreign bodies.
    - (3) Pull the upper lid up.
    - (4) Tell the casualty to look down and to both sides and check for foreign bodies.
  - b. Method two.
    - (1) Tell the casualty to look down.
    - (2) Grasp the casualty's upper eyelashes and gently pull the eyelid away from the eyeball.
    - (3) Place a cotton-tipped swab horizontally along the outer surface of the upper lid and fold the lid back over the swab.
    - (4) Look for the foreign bodies or damage to the eyeball.

**CAUTION:** If the foreign bodies cannot be located, bandage both eyes and seek further medical aid immediately.

2. Remove the foreign bodies.

**CAUTION:** Do not put pressure on the eyeball.

- a. Small foreign body on an anterior surface.
  - (1) Hold the casualty's eye open.
  - (2) Irrigate the eye.
- b. Foreign body stuck to the cornea or lying under the upper or lower eyelid.
  - (1) For a foreign body under the lower eyelid, pull the lower lid down.
  - (2) For a foreign body under the upper eyelid, pull the upper lid up.
  - (3) Remove the foreign body with a moistened, sterile cotton-tipped swab.

**CAUTION:** Bandage both eyes if foreign bodies are not easily removed by these methods or if there is pain or loss of vision in the eye. Seek further medical aid immediately.

**NOTE:** In hazardous conditions, leave the good eye uncovered long enough to ensure the casualty's safety.

- c. Foreign body stuck or impaled in the eye.

**CAUTION:** Do not attempt to remove a foreign body stuck to or sticking into the eyeball. A physician must remove such objects.

- (1) Apply dry sterile dressings to build around and support the object.

**NOTE:** This will help prevent further contamination and minimize movement of the object.

- (2) Cover the injured eye with a paper cup or cardboard cone.
- (3) Cover the uninjured eye with a dry dressing or eye patch.

**Performance Steps**

*NOTE:* In hazardous conditions, leave the good eye uncovered long enough to ensure the casualty's safety.

(4) Reassure the casualty by explaining why both eyes are being covered.

*NOTE:* The eyes move together. If the casualty uses (moves) the uninjured eye, the injured eye will move as well. Covering both eyes will keep them still and will prevent undue movement on the injured side.

(5) Seek further medical aid immediately.

3. Obtain details about the injury.
  - a. Source and type of the foreign bodies.
  - b. Whether the foreign bodies were wind-blown or high velocity.
  - c. Time of onset and length of discomfort.
  - d. Any previous injuries to the eye.
4. Record the procedure on the appropriate form.
5. Evacuate the casualty, as required.
6. Do not cause additional injury to the eye.
  - a. Do not probe for foreign bodies.
  - b. Do not put pressure on the eyeball.
  - c. Do not remove an impaled object.

**Performance Measures**

	<u>GO</u>	<u>NO GO</u>
1. Located the foreign bodies.	_____	_____
2. Removed the foreign bodies.	_____	_____
3. Obtained details about the injury.	_____	_____
4. Recorded the procedure on the appropriate form.	_____	_____
5. Evacuated the casualty, as required.	_____	_____
6. Did not cause additional injury to the eye.	_____	_____

**Evaluation Guidance:** Score each soldier according to the performance measures in the evaluation guide. Unless otherwise stated in the task summary, the soldier must pass all performance measures to be scored GO. If the soldier fails any step, show what was done wrong and how to do it correctly.

**References**

**Required**  
None

**Related**  
EMERGENCY CARE



## TREAT LACERATIONS, CONTUSIONS, AND EXTRUSIONS OF THE EYE

### 081-833-0057

**Conditions:** You have performed a patient care handwash. Necessary materials and equipment: eye pads, field dressings, padding materials, scissors, and sterile water or sterile normal saline.

**Standards:** Treated an eye injury, minimizing the effects of the injury, without causing additional injury to the eye.

### Performance Steps

1. Position the casualty and remove his or her headgear, if necessary.
  - a. Conscious--seated.
  - b. Unconscious--lying on his or her back with the head slightly elevated.
2. Examine the eyes for the following:
  - a. Objects protruding from the globe.
  - b. Swelling of or lacerations on the globe.
  - c. Bloodshot appearance of the sclera.
  - d. Bleeding.
    - (1) Surrounding the eye.
    - (2) Inside the eyeball.
    - (3) Coming from the eyeball.
  - e. Contact lenses. Ask the casualty if he or she is wearing contact lenses but do not force the eyelids open. Record that they are being worn, if appropriate..
  - f. Extrusion (the eye is protruding from the socket).
3. Categorize the injury.
  - a. Injury to the tissue surrounding the eye (lacerations and contusions).
  - b. Injury to the eyeball.
  - c. Extrusion or avulsion.
  - d. Protruding (impaled) objects.
4. Treat the injury.

**NOTE:** Torn eyelids should be handled carefully. Wrap any detached fragments in a separate moist dressing and evacuate with the casualty.

- a. Lacerations and contusions of tissue surrounding the eye.
  - (1) Close the lid of the affected eye.
  - (2) Cover the injury with an eye pad or a small sterile dressing.

**CAUTION:** Do not put pressure on the eyeball.

- (3) Cover torn eyelids with a loose dressing.
- (4) Place a field dressing over the eye pad or dressing of the affected eye.
- b. Injury to the eyeball.
  - (1) Cover the injured eyelid with a sterile dressing soaked in saline to keep the wound from drying.
  - (2) Place a field dressing over the eye pad.
  - (3) Cover the uninjured eye to prevent sympathetic eye movement.

**NOTE:** In hazardous conditions, leave the good eye uncovered long enough to ensure the casualty's safety.

- (4) Tell the casualty not to squeeze the eyelids together.
- c. Extrusion or avulsion.

**Performance Steps**

**CAUTION:** Do not attempt to reposition the eyeball or replace it in the socket.

- (1) Position the casualty face up.
- (2) Cut a hole in several layers of dressing material, and then moisten it. Use sterile liquid, if available.
- (3) Place the dressing so the injured globe protrudes through the hole, but does not touch the dressing. The dressing should be built up higher than the globe.

*NOTE:* If available, place a paper cup or cone-shaped piece of cardboard over the eye. Do not apply pressure to the injury site. Apply roller gauze to hold the cup in place.

- (4) Cover the uninjured eye to prevent sympathetic eye movement.

*NOTE:* In hazardous conditions, leave the good eye uncovered long enough to ensure the casualty's safety.

- d. Protruding object. (See task 081-833-0056.)

**CAUTION:** Do not attempt to remove the protruding object.

- (1) Immobilize the object.
- (2) Dress the injured eye.
- (3) Cover the uninjured eye to prevent sympathetic movement.

*NOTE:* In hazardous conditions, leave the good eye uncovered long enough to ensure the casualty's safety.

- 5. Record the procedure on the appropriate form.
- 6. Evacuate the casualty.
  - a. Transport the casualty on his or her back, with the head elevated and immobilized.
  - b. Evacuate eyeglasses with the casualty, even if they are broken.

**Evaluation Preparation:**

Setup: For training and evaluation, have another soldier act as the casualty. Use a moulage kit or similar material to simulate the injury, or describe the type of injury to the soldier.

Brief soldier: Tell the soldier to treat the eye injury.

**Performance Measures**

	<u>GO</u>	<u>NO GO</u>
1. Positioned the casualty.	_____	_____
2. Examined the eyes.	_____	_____
3. Categorized the injury.	_____	_____
4. Treated the injury.	_____	_____
5. Recorded the procedure on the appropriate form.	_____	_____
6. Evacuated the casualty.	_____	_____
7. Did not cause further injury to the casualty.	_____	_____

**Evaluation Guidance:** Score each soldier according to the performance measures in the evaluation guide. Unless otherwise stated in the task summary, the soldier must pass all performance measures to be scored GO. If the soldier fails any step, show what was done wrong and how to do it correctly.

**References**  
**Required**  
None

**Related**  
BTLS FOR PARAMEDICS  
EMERGENCY CARE

## TREAT BURNS OF THE EYE

### 081-833-0058

**Conditions:** All other more serious injuries have been treated. You have performed a patient care handwash. Necessary materials and equipment: irrigation equipment, irrigation solution, and field dressings.

**Standards:** Treated burns of the eyes and stabilized the casualty without causing further injury to the casualty.

### Performance Steps

1. Reassure the casualty and check for signs and symptoms to determine the type of burns.
  - a. Chemical--such as acid, alkali, or petroleum.

**CAUTION:** The chemical may stick to the eye.

- (1) Pain and redness.
- (2) Watering or tearing.
- (3) Possible erosion of the corneal surface.
- b. Radiant burns.
  - (1) Electric burns--electric welding processor.
    - (a) Gritty feeling.
    - (b) Severe pain.
    - (c) Inability to tolerate light.
    - (d) Redness, swelling.
    - (e) Watering or tearing.
    - (f) Immediate decrease in vision.

**NOTE:** Electrical burns often do not appear until several hours after exposure.

- (2) Laser burns--bright, visible light and invisible light such as ultraviolet or infrared.
  - (a) Immediate decrease in vision.
  - (b) No pain.
- c. Thermal burns.
  - (1) Charred or swollen eyelids.
  - (2) Singed eyelashes.
  - (3) Pain or irritation.

2. Treat the burn.

- a. Chemical burn.

- (1) Gently hold the casualty's eye(s) open.
- (2) Tilt the casualty's head toward the affected side if only one eye is involved.
- (3) Irrigate the eye(s) for 20 minutes with copious amounts of water. If the patient's complaint is renewed after 20 minutes, irrigate an additional 5 minutes.

**NOTE:** Irrigate the eye(s) with sterile water or sterile normal saline, if available. If not available, use any potable water.

**CAUTION:** Do not attempt to neutralize the chemical.

- (4) Cover the injured eye with a clean, sterile dressing.
- b. Radiant energy burn (electric/laser).

- (1) No specific treatment is recommended.
- (2) Bandage the eyes with sterile, moist pads.

**NOTE:** In a combat environment, the eyes may have to remain uncovered so the casualty can see to get away from danger.

- (3) Avoid further light exposure.

**Performance Steps**

- (4) Evacuate the casualty for further examination.
- c. Thermal burn.

- (1) Do not bandage the eyes.

*NOTE:* Burned eyelids swell to protect the underlying eyes. If the patient can be evacuated immediately, the eyes may be loosely covered with sterile dressings moistened with sterile saline.

- (2) Protect the casualty from exposure to light.

**WARNING:** Casualties with severe burns to the eyes may have additional respiratory burns due to spontaneous inhalation.

- 3. Record the treatment given on the appropriate forms.
- 4. Evacuate the casualty.

**Performance Measures**

	<u>GO</u>	<u>NO GO</u>
1. Reassured the casualty and checked for signs and symptoms to determine the type of burns.	_____	_____
2. Treated the burn.	_____	_____
3. Recorded the treatment given on the appropriate forms.	_____	_____
4. Evacuated the casualty.	_____	_____

**Evaluation Guidance:** Score each soldier according to the performance measures in the evaluation guide. Unless otherwise stated in the task summary, the soldier must pass all performance measures to be scored GO. If the soldier fails any step, show what was done wrong and how to do it correctly.

**References**

**Required**

None

**Related**

BTLS FOR PARAMEDICS  
EMERGENCY CARE

## Subject Area 8: Skeletal Dysfunction

**APPLY A PNEUMATIC SPLINT TO A CASUALTY WITH A SUSPECTED FRACTURE OF AN EXTREMITY****081-831-0044**

**Conditions:** You are evaluating a casualty who has a suspected fractured extremity.  
Necessary equipment: pneumatic splint.

**Standards:** Immobilized an extremity without causing unnecessary injury or impairing circulation.

**Performance Steps**

1. Check the equipment both visually and manually for the following:
  - a. Holes.
  - b. Function of the air valve.
  - c. Function of the zipper.
2. Open the splint completely and place it next to the injured extremity.
3. Lift and support the injured extremity.
4. Place the splint under the injured extremity and position the splint around the injured area.
5. Inflate the splint.
  - a. Draw the zipper completely closed.
  - b. Inflate the splint by mouth until a slight indentation can be made with a thumb or finger.

**CAUTION:** Do not use an air pump.

6. Monitor the splint.
  - a. Partially deflate the splint every 20 to 30 minutes to reestablish peripheral circulation.
  - b. In an aircraft limit the inflation pressure to that which is adequate for fracture support only.

**CAUTION:** Do not overinflate. Temperature and air pressure may cause too much pressure to be exerted, thereby cutting off circulation to the extremity.

7. Check for peripheral circulation.
  - a. Check the color and temperature of the limb distal to the splint.
  - b. Question the casualty about numbness and tingling sensations.
  - c. If the circulation is impaired, partially deflate the splint.

**Evaluation Preparation:**

Setup: For training and evaluation have another soldier act as the casualty and specify the location of the fracture.

Brief soldier: Tell the soldier to apply the pneumatic splint to the specified fractured extremity. To test step 6, have the soldier tell you what he or she would do to monitor the splint under normal conditions and in an aircraft.

<b>Performance Measures</b>	<u><b>GO</b></u>	<u><b>NO GO</b></u>
1. Checked the equipment both visually and manually.	_____	_____
2. Opened the splint completely and placed it next to the injured extremity.	_____	_____
3. Lifted and supported the injured extremity.	_____	_____
4. Placed the splint under the injured extremity and positioned the splint around the injured area.	_____	_____
5. Inflated the splint.	_____	_____
6. Monitored the splint.	_____	_____
7. Checked for peripheral circulation.	_____	_____
8. Did not cause further injury to the casualty.	_____	_____

**Evaluation Guidance:** Score each soldier according to the performance measures in the evaluation guide. Unless otherwise stated in the task summary, the soldier must pass all performance measures to be scored GO. If the soldier fails any step, show what was done wrong and how to do it correctly.

**References**

**Required**

None

**Related**

BTLS FOR PARAMEDICS

## APPLY A ROLLER BANDAGE

### 081-833-0060

**Conditions:** Necessary materials and equipment: roller bandages, tape, and scissors.

**Standards:** Selected and applied the appropriate bandage and wrap without causing further injury to the casualty.

#### Performance Steps

1. Select the appropriate bandage material for the injury.

*NOTE:* The width of the bandage to use is determined by the size of the part to be covered. As a general rule, the larger the part or area, the wider the bandage.

- a. Use gauze or a flex roller for bleeding injuries of the forearm, upper arm, thigh, and lower leg.
- b. Use a flexible roller bandage (Kling or Kerlix) for bleeding injuries of the hand, wrist, elbow, shoulder, groin, knee, ankle, and foot.
- c. Use an elastic roller bandage for amputations, arterial bleeding, sprains, and torn muscles.
  - (1) Hand - 2 inch bandage.
  - (2) Lower arm, lower leg, and foot - 3 inch bandage.
  - (3) Thigh and chest - 4 to 6 inch bandage.

*NOTE:* Elastic roller bandages may be used wherever pressure support or restriction of movement is needed. They should not be used to secure dressings.

2. Prepare the patient for bandaging.
  - a. Position the body part to be bandaged in a normal resting position (position of function).

*NOTE:* Bending a bandaged joint changes the pressure of the bandage in places of stress (elbow, knee, ankle).

- b. Ensure that the body part that is to be bandaged is clean and dry.
- c. Place pads over bony places or between the skin surfaces to be bandaged (such as fingers and armpits).

3. Apply the anchor wrap.

**CAUTION:** Do not wrap too tightly. The roller bandage may act as a tourniquet on an injured limb, causing further damage.

- a. Lay the bandage end at an angle across the area to be bandaged. (See Figure 3-18A.)
- b. Bring the bandage under the area, back to the starting point, and make a second turn. (See Figure 3-18B.)
- c. Fold the uncovered triangle of the bandage end back over the second turn. (See Figure 3-18C.)
- d. Cover the triangle with a third turn, completing the anchor. (See Figure 3-18D.)



**Performance Steps**

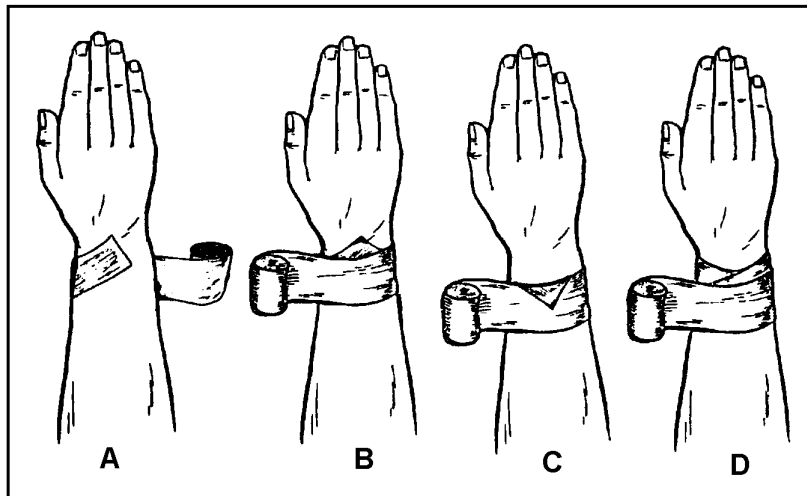

Figure 3-18

4. Apply the bandage wrap to the injury.
  - a. Use a circular wrap to end other bandage patterns, such as a pressure bandage, or to cover small dressings. (See Figure 3-19.)

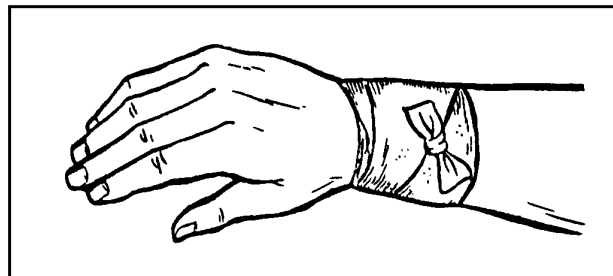

Figure 3-19

- b. Use a spiral wrap for a large cylindrical area such as a forearm, upper arm, calf, or thigh. The spiral wrap is used to cover an area larger than a circular wrap can cover. (See Figure 3-20.)

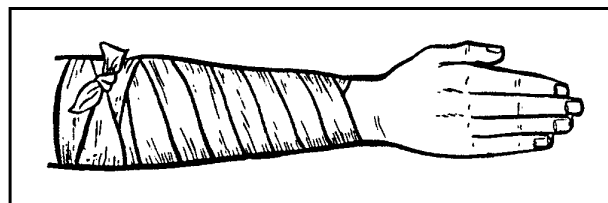

Figure 3-20

**Performance Steps**

- c. Use a spiral reverse wrap to cover small to large conical areas, for example, from ankle to knee. (See Figure 3-21.)

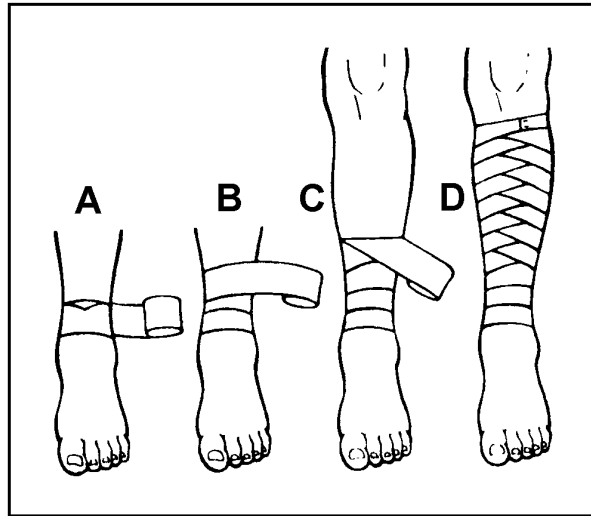

Figure 3-21

- d. Use a figure eight wrap to support or limit joint movement at the hand, elbow, knee, ankle, or foot. (See Figure 3-22.)

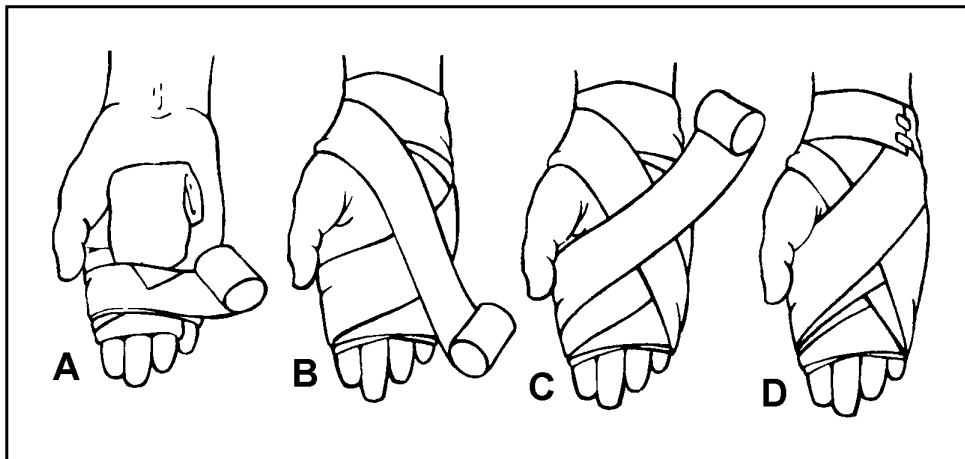

Figure 3-22

- e. Use a spica wrap (same as the figure eight wrap) to cover a much larger area such as the hip or shoulder.
- f. Use a recurrent wrap for anchoring a dressing on fingers, the head, or on a stump. (See Figure 3-23.)

**Performance Steps**

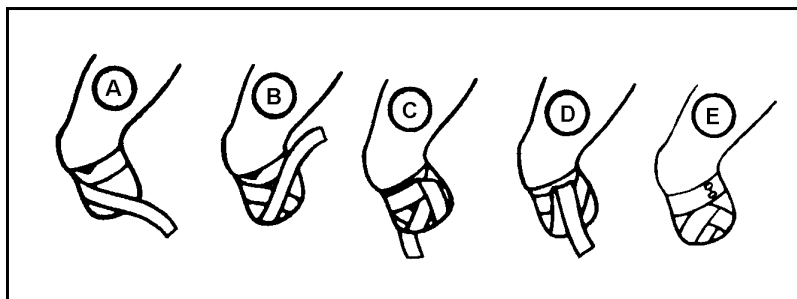

Figure 3-23

**NOTE:** Bandage width depends on the site: 1 inch wide for fingers and 3, 4, or 6 inches wide for the stump or head.

5. Check the circulation after application of the bandage.
  - a. Check the pulse distal to the injury.
  - b. Blanch the fingernail or toenail, if applicable.
  - c. Inspect the skin below the bandaging for discoloration.
  - d. Ask the patient if any numbness, coldness, or tingling sensations are felt in the bandaged part.
  - e. Remove and reapply the bandage, if necessary.
6. Check for irritation.
  - a. Ask the casualty if the bandage rubs.
  - b. Check for bandage wrinkles near the skin surface.
  - c. Check for red skin or sores when the bandage is removed.
  - d. Remove and reapply the bandage, if necessary.
7. Elevate the injured extremities to reduce swelling (edema) and control bleeding, if appropriate.
8. Record the treatment given on the appropriate form.

**Performance Measures**

	<u>GO</u>	<u>NO GO</u>
1. Selected the appropriate bandage material.	—	—
2. Prepared the patient for bandaging.	—	—
3. Applied the anchor wrap.	—	—
4. Applied the bandage wrap.	—	—
5. Checked circulation.	—	—
6. Checked for irritation.	—	—
7. Elevated the injured extremity, if appropriate.	—	—
8. Recorded the treatment given.	—	—

**Performance Measures**

<u><b>GO</b></u>	<u><b>NO</b></u>
<u>      </u>	<u><b>GO</b></u>
_____	_____

9. Did not cause further injury to the casualty.

**Evaluation Guidance:** Score each soldier according to the performance measures in the evaluation guide. Unless otherwise stated in the task summary, the soldier must pass all performance measures to be scored GO. If the soldier fails any step, show what was done wrong and how to do it correctly.

**References**

**Required**  
None

**Related**  
BTLS FOR PARAMEDICS  
EMERGENCY CARE

## **IMMOBILIZE A SUSPECTED FRACTURE OF THE ARM OR DISLOCATED SHOULDER**

### **081-833-0062**

**Conditions:** Necessary materials and equipment: wire ladder splint, cravat bandages, basswood splint, and materials for improvising a splint.

**Standards:** Completed all the steps necessary to immobilize a suspected fracture of the arm or dislocated shoulder without causing additional injury.

### **Performance Steps**

1. Check the casualty's radial pulse. If no pulse is felt, bandage and/or splint the extremity and arrange for immediate evacuation.
2. Position the injury.
  - a. Position a fractured arm by having the casualty support it with the uninjured arm and hand in the least painful position, if possible.

**CAUTION:** Do not try to reduce or set the fracture. Splint it where it lies unless a severe deformity makes it necessary to reposition the limb to keep it within the confines of the litter and/or evacuation vehicle.

- b. Position the arm for shoulder dislocations.

**CAUTION:** Do not use force when moving the limb.

- (1) Posterior. Position the forearm across the midsection of the casualty's body with the hand or wrist slightly higher than the elbow.
    - (2) Anterior. Maintain the arm in a fixed, locked position away from the body.
    - (3) Turn the palm of the hand in towards the body, if possible.
3. Immobilize the injury.
  - a. Use an arm sling to immobilize a dislocated shoulder.
  - b. Use a basswood or an improvised splint for a fractured forearm.
    - (1) Pad the splint.
    - (2) Place the padded splint under the casualty's forearm so that it extends from the elbow to beyond the fingertips.
    - (3) Place a rolled cravat or similar material in the palm of the cupped hand.
    - (4) Apply the cravats in the following order and recheck the radial pulse after each cravat is applied.
      - (a) Above the fracture site near the elbow.
      - (b) Below the fracture site near the wrist.
      - (c) Over the hand and tied in an "X" around the splint.
    - (5) Apply an arm sling and swathe.

**NOTE:** Ensure that the fingernails are left exposed so that a blanch test may be performed.

- c. Use a wire ladder splint for a fractured humerus, and for multiple fractures of an arm or a forearm when the elbow is bent.
    - (1) Prepare the splint using the uninjured arm for measurements.
      - (a) Bend the prong ends of the splint away from the smooth side, about 1 1/2 inches down on the outside of the splint.
      - (b) With the smooth side against the elbow, place one end of the splint even with the top of the uninjured shoulder.
      - (c) Select a point slightly below the elbow.
      - (d) Remove the splint from the arm and bend the splint at the measured point to form an "L".

**Performance Steps**

(e) Pad the splint.

*NOTE:* If padding is unavailable, apply the splint anyway.

(2) Position the splint on the outside of the injured arm, extending from the shoulder to beyond the fingertips.

*NOTES:* 1. Extend the "L" angle of the splint beyond but do not touch the elbow of the injured arm. Extend the leg of the angle touching the forearm beyond the ends of the fingers. If the splint is too short, extend it with a basswood splint. 2. If possible, have the casualty support the splint.

- (3) Place a rolled cravat or similar material in the palm of the cupped hand.
- (4) Check the radial pulse. Make a note on the Field Medical Card if the pulse is absent or if the pulse was lost after treatment.
- (5) Apply the cravats in the following order and recheck the radial pulse after each cravat is applied.
  - (a) On the humerus above any fracture site.
  - (b) On the humerus below any fracture site.
  - (c) On the forearm above any fracture of the forearm.
  - (d) On the forearm below any fracture site.
  - (e) Around the hand and splint.

(6) Tie each cravat on the outside edge of the splint.

*NOTE:* If the pulse is weaker or absent after tying the cravat, loosen and retie the cravat.

(7) Apply an arm sling and swathe.

d. Use a wire ladder splint for a fractured or dislocated humerus, elbow, or forearm when the elbow is straight.

- (1) Prepare the splint as in step 3c(1) but bend it only enough to fit the injured arm.
- (2) Position the splint on the outside of the arm against the back of the hand.
- (3) Apply the cravats in the following order and recheck the radial pulse after each cravat is applied.
  - (a) Above the injury.
  - (b) Below the injury.
  - (c) High on the humerus, above the first cravat.
  - (d) Around the hand and wrist.
- (4) Tie each cravat on the outside of the splint.

*NOTE:* If the pulse is weaker or absent after tying the cravat, loosen and retie the cravat.

(5) Apply swathes.

- (a) Place the arm toward the midline in front of the body. Bind the forearm to the pelvic area with a cravat. Tie the knot on the uninjured side.
- (b) Apply an additional cravat above the elbow. Secure it on the uninjured side at breast pocket level.

4. Record the treatment given on the Field Medical Card (FMC).

5. Evacuate the casualty.

**Performance Measures**

	<u>GO</u>	<u>NO GO</u>
1. Positioned the injury.	_____	_____
2. Checked the radial pulse.	_____	_____
3. Immobilized the injury.	_____	_____

**Performance Measures**

	<u>GO</u>	<u>NO</u> <u>GO</u>
4. Recorded the treatment on the FMC.	_____	_____
5. Evacuated the casualty.	_____	_____
6. Did not cause further injury to the casualty.	_____	_____

**Evaluation Guidance:** Score each soldier according to the performance measures in the evaluation guide. Unless otherwise stated in the task summary, the soldier must pass all performance measures to be scored GO. If the soldier fails any step, show what was done wrong and how to do it correctly.

**References**

**Required**  
None

**Related**  
BTLS FOR PARAMEDICS

## IMMOBILIZE A SUSPECTED DISLOCATED OR FRACTURED HIP

### 081-833-0064

**Conditions:** You have a casualty with a suspected dislocated or fractured hip. Three other soldiers are available to assist you. Necessary materials and equipment: litter, splints, cravats or commercial straps, padding material, spine board or other rigid object, a traction splint, and pneumatic anti-shock garment (PASG).

**Standards:** Immobilized a suspected dislocated or fractured hip without impairing circulation or causing further injury to the casualty.

### Performance Steps

1. Check for the signs and symptoms of a hip injury.

**CAUTION:** Both a dislocated and a fractured hip are accompanied by considerable pain. The casualty will resist any movement because of pain. It is essential that medical personnel take all possible precautions, using the best available materials at hand while preparing the casualty to be immediately evacuated.

- a. Anterior dislocation (abduction).

**NOTE:** Anterior dislocation is very rare and is caused by the legs suddenly being forced widely apart.

- (1) Hip pain.
- (2) Severe deformity of the affected leg.
  - (a) The knee is turned outward.
  - (b) The affected leg is shortened.
  - (c) The hip is drawn away from the midline of the body.
  - (d) The leg has rotated away from the midline of the body.
- (3) Impaired circulation in the affected extremity.
  - (a) Loss of pulse distal to the injury.
  - (b) Coolness and/or cyanosis.
  - (c) Swelling due to internal blood loss.
  - (d) Hypovolemic shock.

**WARNING:** Significant blood loss may occur before swelling is evident. Take the casualty's vital signs as soon as possible and monitor them during stabilization and transport.

- (4) Impaired sensation in the affected extremity.
  - (a) Tingling or other abnormal sensations (paresthesia).
  - (b) Loss of sensation.

- b. Posterior dislocation (abduction).

**NOTE:** Posterior dislocation is the most common type of hip dislocation.

- (1) Hip pain.
- (2) Severe deformity of the affected leg.
  - (a) The hip joint is flexed with the knee drawn up.
  - (b) The hip is drawn toward the midline of the body.
  - (c) The leg has rotated toward the midline of the body.
- (3) Impaired circulation in the affected extremity.
  - (a) Loss of pulse distal to the injury.
  - (b) Coolness and/or cyanosis.
  - (c) Swelling due to internal blood loss.
- (4) Impaired sensation in the affected extremity.
  - (a) Paresthesia.



### Performance Steps

- (b) Loss of sensation.

**NOTE:** Weakness of muscles that raise the foot may occur. This condition, known as "foot drop," may be a sign of damage to the sciatic nerve.

- c. Fracture.

**NOTE:** Some of the most common fractures are those that occur at the upper end of the femur. These have been called "hip fractures" even though the hip joint is rarely involved.

- (1) Hip pain.
- (2) The casualty is unable to walk on or move the affected leg.
- (3) Deformity.
  - (a) The affected leg has rotated toward the midline of the body.
  - (b) The affected leg will usually be shorter than the uninjured one.

**NOTE:** Fractures of the femur are often open. Whether closed or open, they are always associated with a loss of large amounts of blood.

- (4) Impaired circulation in the affected extremity.
  - (a) Loss of pulse in the femoral or popliteal arteries distal to the injury.
  - (b) Coolness and/or cyanosis.
  - (c) Swelling due to internal blood loss.
- (5) Impaired sensation in the affected extremity.
  - (a) Paresthesia.
  - (b) Loss of sensation.

2. Check for circulation in the affected leg by checking the femoral and popliteal pulses and observing for swelling or cyanosis.

3. Check for impaired sensation by asking the casualty if he or she has tingling, abnormal sensations, or loss of sensation in the affected limb.

4. Immobilize the injury.

**CAUTION:** Do not log roll a casualty with a hip injury onto the injured side. If available, place the casualty on a spine board using a scoop litter.

- a. Hip dislocations.

- (1) Place the casualty on a firm surface, such as a spine board. See task 081-833-0092
- (2) Support the leg in its abnormal position using pillows, blankets, or similar material.
- (3) Secure the support material with cravats.

- b. Hip fracture.

- (1) Place the casualty on a firm surface.
- (2) Place support material under the buttocks to reduce abdominal pain only if there are no other major fractures in the lower extremities.
- (3) Place bulky support material between the casualty's legs and strap them together.
- (4) Bring the casualty's knees up.
- (5) Place bulky support material underneath the knees.

5. Check for complications.

- a. Impaired circulation in the affected limb.
- b. Neurological deficit.
- c. Hypovolemic shock.

6. Record the treatment given.

**WARNING:** Spontaneous reduction of dislocation may occur during any movement. This may be accompanied by additional damage to nerves and blood vessels. The receiving facility must be informed if this occurs.

**Performance Steps**

7. Evacuate the casualty.
  - a. Position the casualty and spine board on a litter.
  - b. Position the casualty resting slightly on the uninjured side.
  - c. Support the injured side with padding material.
  - d. Secure the casualty and spine board to the litter.

**WARNING:** Avoid any bumping or jerking during transport. Excessive movement of a fracture or dislocation can increase blood loss and pain. Hip and leg injuries allow for a greater area of pooling of blood that is not evident early on, and may result in the casualty going in to hypovolemic shock.

**Performance Measures**

	<u>GO</u>	<u>NO GO</u>
1. Checked for the signs and symptoms of a hip injury.	_____	_____
2. Checked for circulation in the affected leg.	_____	_____
3. Checked for impaired sensation.	_____	_____
4. Immobilized the injury.	_____	_____
5. Checked for complications.	_____	_____
6. Recorded the treatment given.	_____	_____
7. Evacuated the casualty.	_____	_____
8. Did not cause further injury to the casualty.	_____	_____

**Evaluation Guidance:** Score each soldier according to the performance measures in the evaluation guide. Unless otherwise stated in the task summary, the soldier must pass all performance measures to be scored GO. If the soldier fails any step, show what was done wrong and how to do it correctly.

**References**

**Required**  
None

**Related**  
BTLS FOR PARAMEDICS  
EMERGENCY CARE

## TRANSPORT A CASUALTY WITH A SUSPECTED SPINAL INJURY

081-833-0092

**Conditions:** All other more serious injuries or conditions have been treated. Three or four soldiers are available for assistance. Necessary materials and equipment: straps, cravats, towels, long and short spine boards, safety pins, and materials to improvise a cervical collar and head supports.

**Standards:** Completed all the steps necessary to immobilize and transport a casualty with a suspected spine injury without causing additional injury to the casualty.

### Performance Steps

1. Check for the signs and symptoms of a spinal injury.

**WARNING:** If you suspect that the casualty has a spinal injury, treat him or her as though he or she does have a spinal injury.

- a. Spinal deformity. Its presence indicates a severe spinal injury, but its absence does not rule one out.
- b. Tenderness and/or pain in the spinal region.
  - (1) Detect it by palpation or ask the casualty.
  - (2) The presence of any pain is sufficient cause to suspect the presence of a spinal injury.
- c. Lacerations and/or contusions in the spinal region indicate severe trauma and usually accompany a spinal injury.

**NOTE:** The absence of lacerations and/or contusions does not rule out a spinal injury.

- d. Weakness, loss of sensation, and/or paralysis.
  - (1) A neck level (cervical) spine injury may cause numbness or paralysis in all four extremities.
  - (2) A waist level spinal injury may cause numbness or paralysis below the waist.
  - (3) Ask the casualty to try to move the fingers and toes to check for paralysis.
- e. Palpate the spine for pain.
  - (1) Carefully insert the hand under the neck and feel along the cervical spine as far as can be done without disturbing the casualty's spine.
  - (2) Carefully insert the hand into the cavity formed by the small of the back and feel along the thoracic spine and down the lumbar spine as far as possible without disturbing the spine.
  - (3) If the casualty says that an area of the spine is tender, consider that he or she has a spinal injury.

2. Secure the casualty to a short spine board (if using Kendrick Extrication Device (KED) go to step 3).

**NOTE:** Apply a short spine board when extricating a casualty from a vehicle or location that will not accommodate the use of a long spine board. If available use a KED which is a commercial spine board.

- a. Direct an assistant to immobilize the casualty's head and neck using manual stabilization.
  - (1) Place the hands on both sides of the casualty's skull, with the palms over the ears.
  - (2) Support the jaw (mandible) with the fingers.
  - (3) Maintain manual stabilization until directed to release the stabilization.
- b. Apply a cervical collar, if available, or improvise one.

**Performance Steps**

- c. Push the board as far into the area behind the casualty as possible.
- d. Tilt the upper end of the board toward the head.
- e. Direct the assistant to position the back of the casualty's head against the board, maintaining manual stabilization, by moving the head and neck as one unit.

**NOTE:** If the cervical collar or improvised collar does not fit flush with the spine board, place a roll in the hollow space between the neck and board. The roll should only be large enough to fill the gap, not to exert pressure on the neck.

- f. Secure the casualty's head and head supports to the board with straps or cravats.

**WARNING:** Ensure that the cravats or head straps are firmly in place before the assistant releases stabilization.

- (1) Apply head supports.
- (2) Use two rolled towels, blankets, sandbags, or similar material.
- (3) Place one close to each side of the head.
- (4) Using a cravat-like material across the forehead, make the supports and head one unit by tying to the board.
- g. Secure the casualty to the short spine board.
  - (1) Place the buckle of the first strap in the casualty's lap.
  - (2) Pass the other end of the strap through the lower hole in the board, up the back of the board, through the top hole, under the armpit, over the shoulder, and across the back of the board at the neck.
  - (3) Buckle the second strap to the first strap and place the buckle on the side of the board at the neck.
  - (4) Pass the other end over the shoulder, under the armpit, through the top hole in the board, down the back of the board, through the lower hole, and across the lap. Secure it by buckling it to the first strap.
- h. Tie the casualty's hands together and place them in his or her lap.

**NOTE:** When positioning a casualty who is secured to a short spine board, on a long spine board, line up the hand grip holes of the short spine board with the holes of the long spine board, if possible, and secure the two boards together.

### 3. Secure the casualty to a KED.

- a. Direct an assistant to immobilize the casualty's head and neck using manual stabilization.
  - (1) Place the hands on both sides of the casualty's skull, with the palms over the ears.
  - (2) Support the jaw (mandible) with the fingers.
  - (3) Maintain manual stabilization until directed to release the stabilization.
- b. Position the immobilization device behind the patient.
- c. Secure the device to the patient's torso.
  - (1) Immobilize the torso, from the top to the bottom strap.
  - (2) Apply the pelvic straps, ensuring to pad the groin area.
- d. Secure the patient's head to the device.
  - (1) Pad behind the patient's head as necessary.
  - (2) Place one cravat across the chin angle towards the ear, ensuring the cravat does not interfere with the airway. Tie cravats to the side of the device.
  - (3) Place a cravat across the forehead angle towards the base of the head, and tie it to the side of device.
- e. Evaluate and adjust the straps. They must be tight enough so the device does not move excessively up, down, left, or right, but not so tight as to restrict the patient's breathing.

## Performance Steps

**NOTE:** The pelvic straps must be released after being placed on a long spine board.

4. Place the casualty on a long spine board.

**NOTE:** If a spine board is not available, utilize a standard litter or improvised litter made from a board or door. A hard surface is preferable to one that gives with the casualty's weight.

a. The log roll technique.

- (1) Place the spine board next to, and parallel with, the casualty.
- (2) Immobilize the casualty's head and neck using manual stabilization.
  - (a) Place your hands on both sides of the casualty's skull, with the palms over the ears.
  - (b) Support the jaw (mandible) with the fingers.
  - (c) Maintain manual stabilization until the casualty has been placed on the spine board.
- (3) Apply a cervical collar, if available, or improvise one. (See steps 2b(1) through 2b(5).)
- (4) Brief each of the three assistants on their duties and instruct them to kneel on the same side of the casualty, with the spine board on the opposite side of the casualty.
  - (a) First assistant. Place the near hand on the shoulder and the far hand on the waist.
  - (b) Second assistant. Place the near hand on the hip and the far hand on the thigh.
  - (c) Third assistant. Place the near hand on the knee and the far hand on the ankle.
- (5) On your command, and in unison, the assistants roll the casualty slightly toward them. Turn the casualty's head slightly, keeping it in a straight line with the spine.
- (6) Instruct the assistants to reach across the casualty with one hand, grasp the spine board at its closest edge, and slide it against the casualty. Instruct the number two assistant to reach across the board to the far edge and hold it in place to prevent board movement.
- (7) Instruct the assistants to slowly roll the casualty back onto the board. Keep the head and spine in a straight line.
- (8) Place the casualty's wrists together at the waist and tie them together loosely.

**NOTE:** If the cervical collar or improvised collar does not fit flush with the spine board, place a roll in the hollow space between the neck and board. The roll should only be large enough to fill the gap, not to exert pressure on the neck.

b. The straddle-slide technique.

**NOTE:** Use this method when limited space makes it impossible to use the log roll technique.

- (1) Stand at the head of the casualty with your feet wide apart.
- (2) Apply stabilization to the casualty's head and apply a cervical collar. (See steps 3a(2) through 3a(3).)
- (3) Instruct the first assistant to stand behind you (facing your back), to line up the spine board, and to gently push the spine board under the casualty at your command.
- (4) Instruct the second assistant to straddle the casualty while facing you and gently elevate the shoulders so that the spine board can be slid under them.
- (5) Instruct the third assistant (facing you) to carefully elevate the hips while the spine board is being slid under the casualty.
- (6) Instruct the fourth assistant (facing you) to carefully elevate the legs and ankles while the board is being slid into place under the casualty.

### Performance Steps

**WARNING:** Complete all movements simultaneously, keeping the head and spine in a straight line. **NOTE:** If the cervical collar or improvised collar does not fit flush with the spine board, place a roll in the hollow space between the neck and board. The roll should only be large enough to fill the gap, not to exert pressure on the neck.

5. Secure the casualty to the long spine board.

a. Secure the casualty's head and head supports to the board with straps or cravats.

**WARNING:** Do not release manual stabilization until the cravats or head straps are firmly in place.

- (1) Apply head supports.
- (2) Use two rolled towels, blankets, sandbags, or similar material.
- (3) Place one close to each side of the head.
- (4) Using a cravat-like material across the forehead, make the supports and head one unit by tying to the board. (See Figure 3-24.)

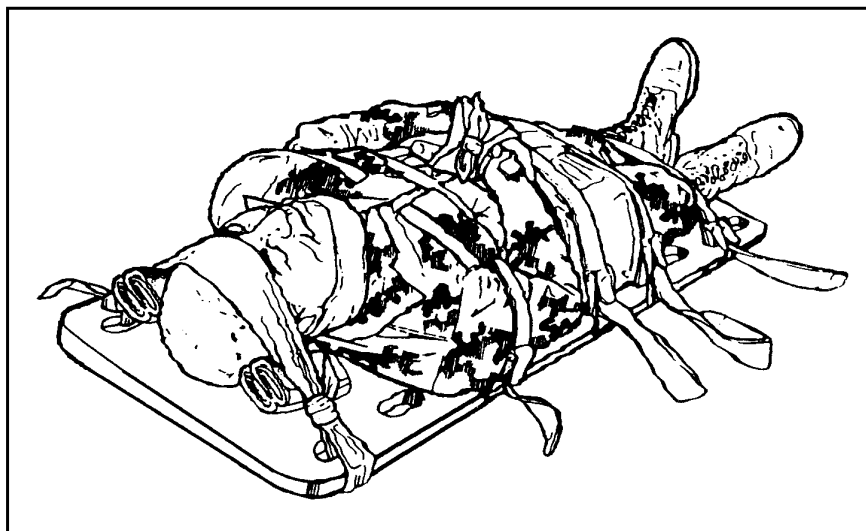

Figure 3-24

b. Secure the casualty with straps across the chest, hips, thighs, and lower legs.

**NOTE:** Include the arms if the straps are long enough. If the spine board is not provided with straps and fasteners, use cravats or other long strips of cloth.

**WARNING:** Securely immobilize the casualty's head and neck. Fill socks with sand and place them on both sides of the head and neck to keep it from moving.

6. Record the treatment on the Field Medical Card.

7. Evacuate the casualty.

### Evaluation Preparation:

Setup: For training and evaluation, have another soldier act as the casualty. You will need three or four soldiers to act as the assistants. The soldier being tested is to act as the team leader and direct the actions of the assistants. The casualty may be placed in a vehicle or other scenario, depending on available resources and the technique you are testing. Tell the casualty not to assist the soldiers in any way.

Brief soldier: To test step 1, tell the soldier to state the signs and symptoms of a spinal injury. Tell the soldier that the casualty has a suspected spinal injury. Then tell the soldier to position the casualty on a spine board and to direct the actions of the assistants.

<b>Performance Measures</b>	<b><u>GO</u></b>	<b><u>NO</u> <u>GO</u></b>
1. Checked for signs and symptoms of a spinal injury.	_____	_____
2. Secured the casualty on a short spine board or KED, if appropriate.	_____	_____
3. Placed the casualty on the long spine board.	_____	_____
4. Secured the casualty on the long spine board.	_____	_____
5. Recorded the treatment on the Field Medical Card.	_____	_____
6. Evacuated the casualty.	_____	_____
7. Did not cause further injury to the casualty.	_____	_____

**Evaluation Guidance:** Score each soldier according to the performance measures in the evaluation guide. Unless otherwise stated in the task summary, the soldier must pass all performance measures to be scored GO. If the soldier fails any step, show what was done wrong and how to do it correctly.

**References**  
**Required**  
 None

**Related**  
 BTLS FOR PARAMEDICS  
 EMERGENCY CARE

## APPLY A TRACTION SPLINT

### 081-833-0141

**Conditions:** You and an assistant have encountered a casualty. You have done your initial assessment and you suspect a femur fracture. Necessary materials and equipment: traction splint, long spine board, securing devices, and padding material.

**Standards:** Applied the splint without restricting circulation. Immobilized the fracture and maintained traction throughout the procedure, minimizing the effect of the injury.

### Performance Steps

1. Take body substance isolation precautions.
2. Direct the assistant to manually stabilize the injured leg. (See Figure 3-25.)

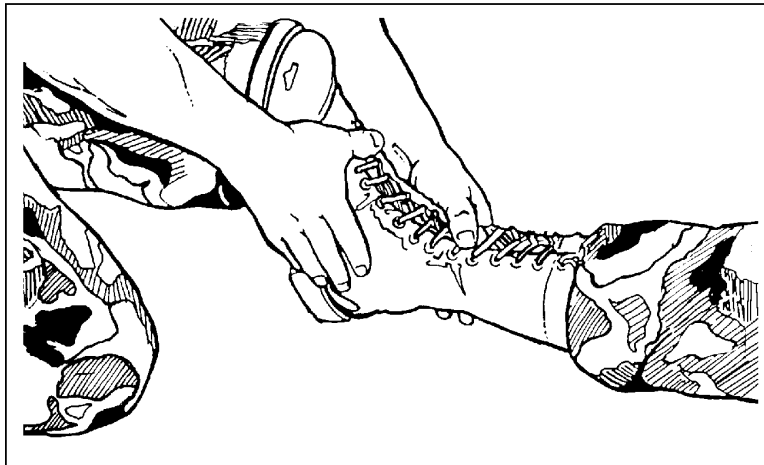

Figure 3-25

3. Assess motor, sensory, and distal circulation of the injured leg. (See Figure 3-26.)

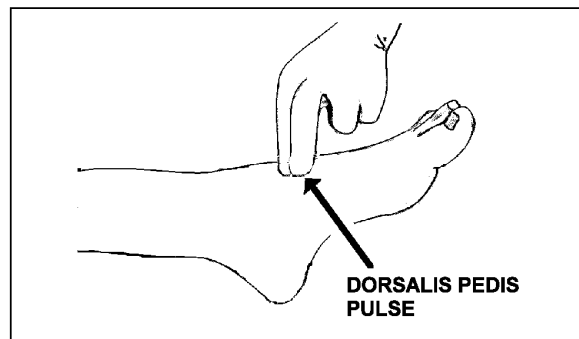

Figure 3-26

4. Adjust the splint to the proper length.



**Performance Steps**

- a. Loosen the sleeve locking device.
- b. Place the splint next to the uninjured leg so that the ischial pad of the splint is next to the patient's iliac crest.
- c. Extend the splint until the bend in the splint is level with the casualty's heel. (See Figure 3-27.)

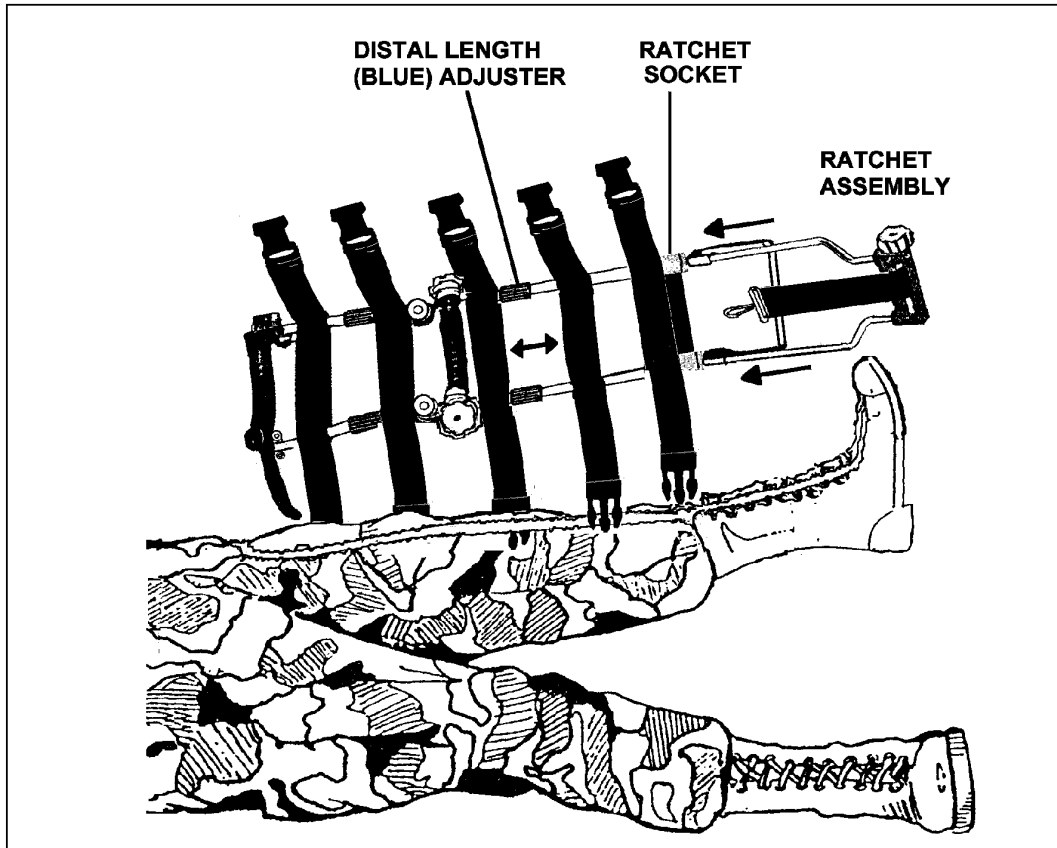

Figure 3-27

**NOTE:** The distal end of the splint should be 8 to 12 inches beyond the foot.

- d. Lock the sleeve.
5. Position the splint.
  - a. Open and position all straps.
    - (1) One strap above the fracture site.
    - (2) One strap above the knee but below the fracture site.
    - (3) One strap below the knee.
    - (4) One strap at mid-calf.
  - b. Unfasten the ischial strap.
  - c. Pull the release ring on the ratchet and release the traction strap.
  - d. Move the splint between the assistant's legs so that it is aligned with the casualty's injured leg.
6. Apply the ankle hitch.
  - a. Direct the assistant to maintain manual stabilization.

**Performance Steps**

- b. Thread the ankle hitch under the casualty's ankle at the void created by the heel. (See Figure 3-28.)

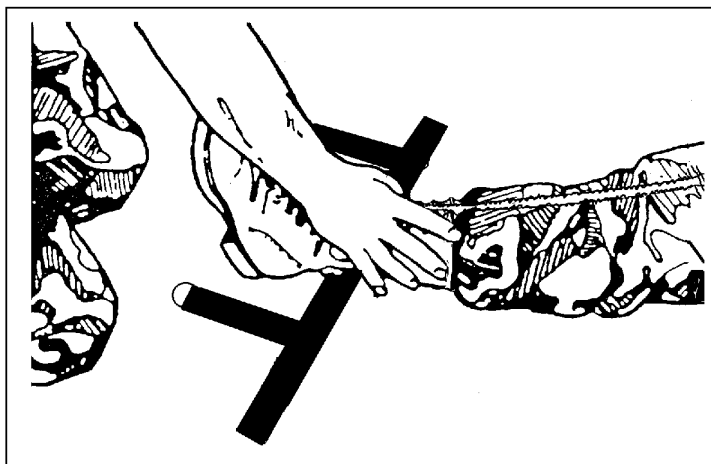

Figure 3-28

- c. Place the lower edge of the ankle hitch even with the bottom of the heel.
- d. Crisscross the side straps high on the instep. (See Figure 3-29.)

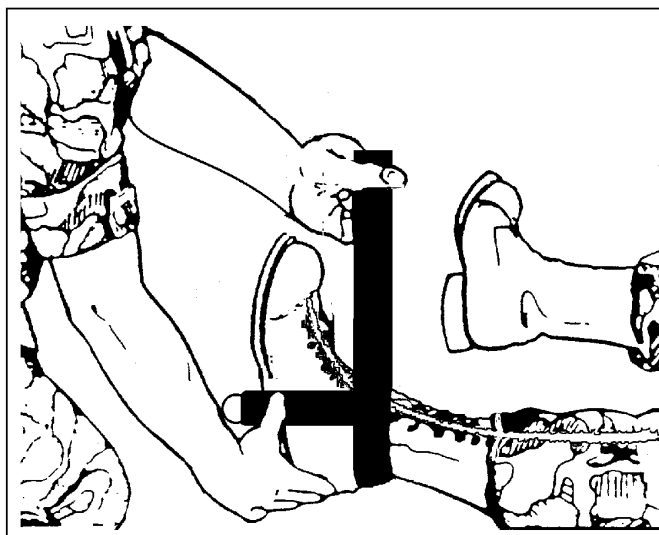

Figure 3-29

- e. Bring the crisscrossed straps down to meet the center strap and hold them in place.
7. Apply manual traction.
    - a. Move your hands under the fracture site (one hand above the site and one hand below the site) in order to support the fracture as traction is pulled and the leg is lifted.
    - b. Direct the assistant to indicate when he is ready to lift (i.e., on your count of three, we will lift the leg). (See Figure 3-30.)

## Performance Steps

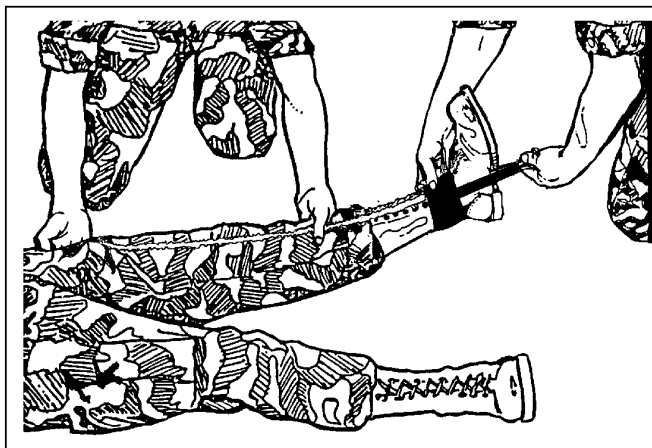

Figure 3-30

- c. Apply gentle traction and lift the casualty's leg enough to fit the splint into place. (See Figure 3-31.)

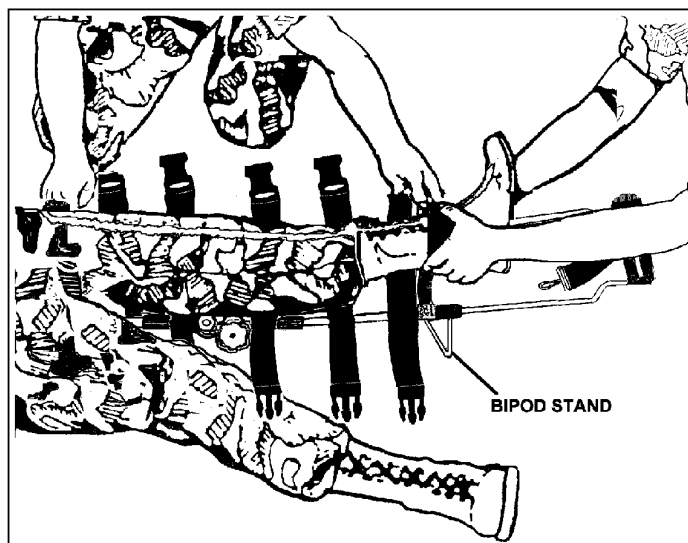

Figure 3-31

**CAUTION:** Apply only enough traction to align the limb to fit into the splint. Do not attempt to align the fracture fragments anatomically. Once manual traction has been applied, it must remain constant until the traction splint has been put in place and is providing traction.

- d. Move one hand from the fracture site and pull the splint from between the assistant's legs.
- e. Slide the splint under the leg until the ischial ring is at the buttock.
- NOTE:** Make sure the splint is aligned with the leg.
- f. When the splint is in place, position the hand back under the fracture site for stabilization only.
- g. On the assistant's signal, lower the leg into the cradle of the splint while maintaining manual traction.

**Performance Steps**

h. Extend and position the heel stand after the splint is in position under the leg.

8. Apply the ischial strap. (See Figure 3-32.)

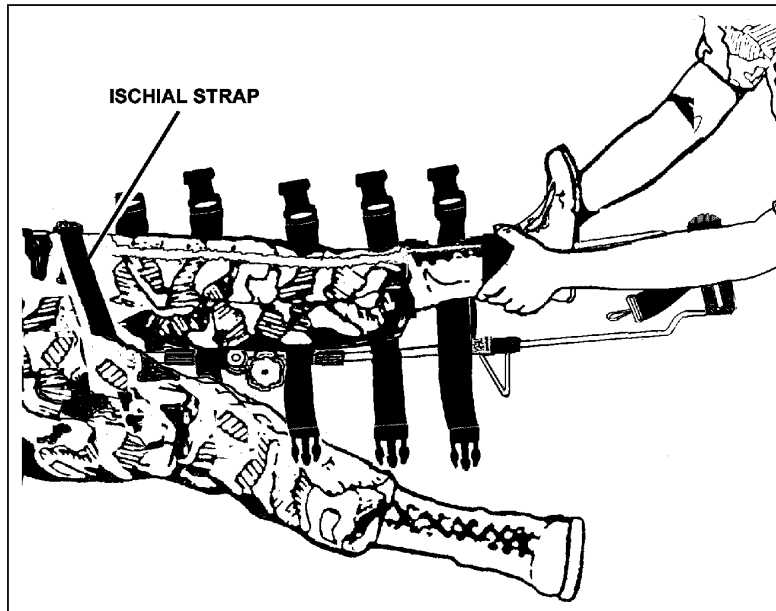

Figure 3-32

9. Apply mechanical traction. (See Figure 3-33.)

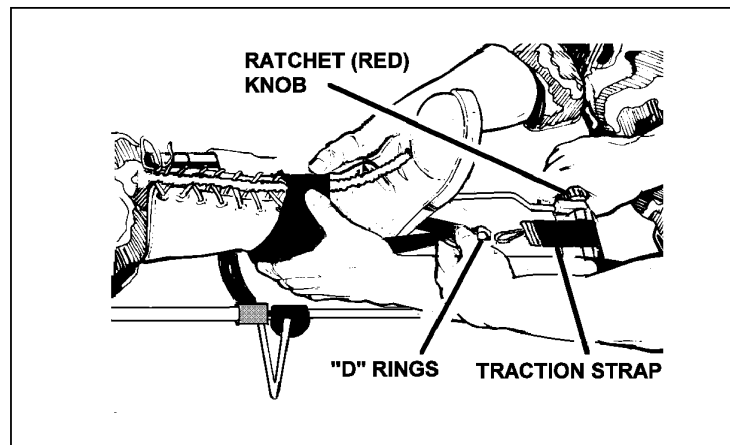

Figure 3-33

- a. Insert the rings from the ankle hitch into the "S" hook from the splint.
- b. Direct the assistant to alert you when mechanical traction is equal to his or her manual traction.
- c. Twist the ratchet until the assistant alerts you that mechanical traction is equal to manual traction.

**Performance Steps**

10. Position and secure the leg support straps. (See Figure 3-34.)

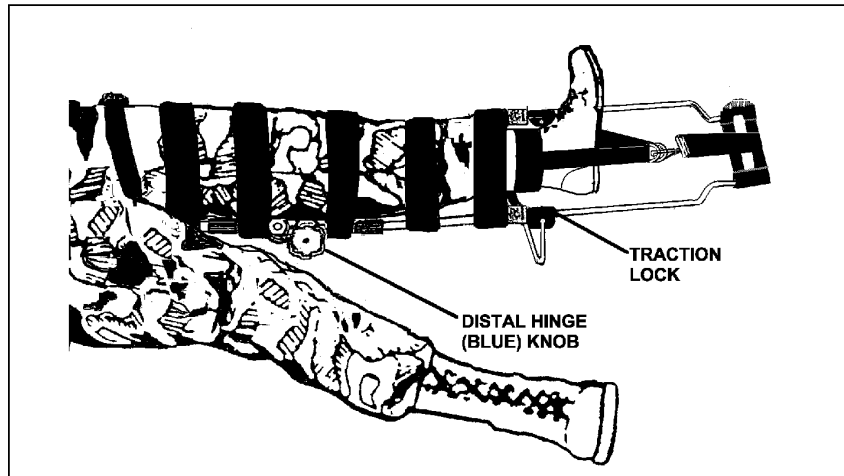

Figure 3-34

- a. Direct the assistant to maintain manual stabilization until the straps are secure.
  - b. Secure the support straps.
11. Reevaluate the ischial strap and ankle hitch.
  12. Assess the distal pulse, motor function, and sensation of the injured leg.
  13. Secure the torso to the long board to immobilize the hip.
  14. Secure the splint to the long board to prevent movement of the splint.

**Performance Measures**

	<u>GO</u>	<u>NO GO</u>
1. Took body substance isolation precautions.	—	—
2. Directed the assistant to manually stabilize the injured leg.	—	—
3. Assessed distal circulation, motor function, and sensation of the injured leg.	—	—
4. Adjusted the splint to the proper length.	—	—
5. Positioned the splint.	—	—
6. Applied the ankle hitch.	—	—
7. Applied manual traction.	—	—
8. Applied the ischial strap.	—	—
9. Applied mechanical traction.	—	—
10. Secured the leg straps.	—	—

**Performance Measures**

	<u>GO</u>	<u>NO GO</u>
11. Reevaluated the ankle hitch and ischial strap.	—	—
12. Assessed distal circulation, motor function, and sensation of the injured leg.	—	—
13. Secured the torso to the long board to immobilize the hip.	—	—
14. Secured the splint to the long board to prevent movement of the splint.	—	—

**Evaluation Guidance:** The soldier will be retrained if a NO-GO is received in any of the following areas: failure to maintain traction after it has been assumed, failure to reassess the distal pulse, motor function, and sensation before and after splinting, failure to secure the ischial strap before taking traction, failure to apply mechanical traction before securing the leg straps, or if final immobilization fails to support the femur or prevent rotation of the injured leg.

**References**

**Required**  
None

**Related**  
BTLS FOR PARAMEDICS  
EMERGENCY CARE

## **PROVIDE BASIC EMERGENCY TREATMENT FOR A PAINFUL, SWOLLEN, DEFORMED EXTREMITY**

**081-833-0154**

**Conditions:** You have encountered a patient who presents with a musculoskeletal injury. You have already taken body substance isolation precautions and done your initial assessment. Necessary materials and equipment: cravats, splinting materials, oxygen, nonrebreather mask, and IV materials.

**Standards:** Provided treatment without causing further injury to the patient. Immobilized the extremity, minimizing the effect to the patient.

### **Performance Steps**

1. Identify the signs and symptoms of a musculoskeletal injury.
  - a. Pain and tenderness, especially when the injured part is touched or moved.
  - b. Deformity or angulation.

*NOTE:* When in doubt, look at the uninjured side and compare it to the injured one.

- c. Crepitus.
- d. Swelling.
- e. Bruising.
- f. Exposed bone ends.
- g. Joints locked into position.
- h. Impaired circulation, motor function, and sensation.

2. Splint the extremity (see tasks 081-833-0141, 081-831-0044, 081-833-0061, 081-833-0062, and 081-833-0064).

*NOTES:* 1. In order for any splint to be effective, it must immobilize the adjacent joints and bone ends. 2. If the patient is unstable, immobilize on a long spine board and transport immediately.

- a. Manually stabilize the injury site. This can be done by you, your assistant, or the patient.

*NOTE:* Maintain manual stabilization or traction during positioning and until the splinting process is complete.

- b. Assess pulse, motor function, and sensation.
  - (1) Check for a pulse.
  - (2) Ask if the patient can feel your touch distal to the injury.
  - (3) Ask the patient to wiggle the fingers or toes, grasp your fingers, or push the feet against your hands.
- c. Attempt to realign once, if necessary.

*NOTE:* Attempt to realign only if there is impaired circulation or the extremity is so deformed that splinting would not be effective.

- (1) Gently grasp the distal extremity while your assistant places one hand above and one hand below the injury site.
- (2) Gently pull manual traction in the direction of the long axis of the bone.
- (3) If resistance is felt or it appears that the bone ends will come through the skin, stop and splint the extremity in the position found.
- (4) If no resistance is felt, maintain gentle traction until the extremity is properly splinted.
- d. Measure or adjust the splint.
- e. Apply and secure the splint to immobilize adjacent bones.

**Performance Steps**

- f. Reassess pulse, motor function, and sensation distal to the injury.
- 3. Treat for shock (see task 081-833-0047).
- 4. Consider administration of pain medication.
- 5. Transport to the nearest medical treatment facility.
- 6. Document all care given (see tasks 081-833-0145 and 081-831-0033).

**Evaluation Preparation:**

Setup: For training and evaluation, have one soldier be the patient with a musculoskeletal injury. Brief the patient on the location and complaints of a musculoskeletal injury. Use moulage if available.

Brief soldier: Ask the soldier for signs and symptoms of a musculoskeletal injury and have him perform the appropriate treatment.

**Performance Measures**

	<u>GO</u>	<u>NO</u> <u>GO</u>
1. Identified the signs and symptoms of a musculoskeletal injury.	_____	_____
2. Splinted the extremity.	_____	_____
3. Treated for shock.	_____	_____
4. Considered administration of pain medication.	_____	_____
5. Transported to the nearest medical treatment facility.	_____	_____
6. Documented all care given.	_____	_____

**Evaluation Guidance:** Score each soldier according to the performance measures in the evaluation guide. Unless otherwise stated in the task summary, the soldier must pass all performance measures to be scored GO. If the soldier fails any step, show what was done wrong and how to do it correctly.

**References**

**Required**  
None

**Related**  
BTLS FOR PARAMEDICS  
EMERGENCY CARE



Subject Area 9: Environmental Injuries

**TREAT A CASUALTY FOR A HEAT INJURY**

**081-831-0038**

**Conditions:** A casualty is suffering from a heat injury. No other more serious injuries or conditions are present. Necessary materials and equipment: water, salt, a thermometer, a stethoscope, and a sphygmomanometer.

**Standards:** Provided the correct treatment based upon the signs and symptoms of the injury.

**Performance Steps**

1. Identify the type of heat injury based upon the following characteristic signs and symptoms:
  - a. Heat cramps--muscle cramps of the arms, legs, and/or abdomen.
  - b. Heat exhaustion.
    - (1) Often--
      - (a) Profuse sweating and pale (or gray), moist, cool skin.
      - (b) Headache.
      - (c) Weakness or faintness.
      - (d) Dizziness.
      - (e) Loss of appetite or nausea.
    - (2) Sometimes--
      - (a) Heat cramps.
      - (b) Nausea (with or without vomiting).
      - (c) Urge to defecate.
      - (d) Chills.
      - (e) Rapid breathing.
      - (f) Tingling sensation of the hands and feet.
      - (g) Confusion.
  - c. Heat stroke.
    - (1) Rapid onset with the core body temperature rising to above 106° F within 10 to 15 minutes.
    - (2) Hot, dry skin.
    - (3) Headache.
    - (4) Dizziness.
    - (5) Nausea (stomach pains).
    - (6) Confusion.
    - (7) Weakness.
    - (8) Loss of consciousness.
    - (9) Possible seizures.
    - (10) Pulse and respirations are weak and rapid.
2. Provide the proper first aid for the heat injury.
  - a. Heat cramps.
    - (1) Move the casualty to a cool shaded area, if possible.
    - (2) Loosen the casualty's clothing unless he or she is in a chemical environment.
    - (3) Give the casualty at least one canteen of salt solution. Dissolve 1/4 teaspoon (one MRE packet) of salt in one canteen of water. If salt is unavailable, give plain water.

**Performance Steps**

- (4) Evacuate the casualty if the cramps are not relieved after treatment.
- b. Heat exhaustion.
  - (1) Conscious casualty.
    - (a) Move the casualty to a shaded area, if possible.
    - (b) Loosen and/or remove the casualty's clothing and boots unless he or she is in a chemical environment.
    - (c) Pour water on the casualty and fan him or her, if possible.
    - (d) Slowly give the casualty one canteen of salt solution. (See step 2a(3).)
    - (e) Elevate the casualty's legs.
  - (2) An unconscious casualty or one who is nauseated, unable to retain fluids, or whose symptoms have not improved after 20 minutes.
    - (a) Cool the casualty as in step 2b(1).
    - (b) Evacuate the casualty to an MTF for IV therapy or if qualified, initiate an IV infusion of Ringer's lactate or sodium chloride.
- c. Heat stroke.

**CAUTION:** Heat stroke is a medical emergency. If the casualty is not cooled rapidly, the body cells, especially the brain cells, are literally cooked; irreversible damage is done to the central nervous system. The casualty must be evacuated to the nearest medical treatment facility immediately.

- (1) Conscious casualty.
  - (a) Remove the casualty's outer garments and/or protective clothing, if possible.
  - (b) Keep the casualty out of the direct sun, if possible.
  - (c) Immerse the casualty in cold water, if available, and massage him or her.

**WARNING:** Cooling with cold water immersion may produce shivering, increasing the core temperature.

- (d) Lay the casualty down and elevate his or her legs.
- (e) Have the casualty slowly drink at least one canteen of salt solution. (See step 2a(3).)
- (f) Evacuate the casualty to an MTF for IV therapy or, if qualified, initiate an IV infusion of Ringer's lactate or sodium chloride to maintain a systolic blood pressure of at least 90 mm Hg.
- (2) Unconscious casualty or one who is vomiting or unable to retain oral fluids.
  - (a) Cool the casualty as in step 2c(1) but give nothing by mouth.
  - (b) Initiate an IV, if qualified.
  - (c) Evacuate the casualty.

3. Record the treatment given. (See task 081-831-0033.)

**Evaluation Preparation:**

Setup: For training and evaluation, describe to the soldier the signs and symptoms of heat cramps, heat exhaustion, or heat stroke and ask the soldier what type of heat injury is indicated.

Brief soldier: Ask the soldier what should be done to treat the heat injury.

**Performance Measures**

	<u>GO</u>	<u>NO</u> <u>GO</u>
1. Identified the type of heat injury.	_____	_____
2. Provided the proper first aid for the heat injury.	_____	_____

**Performance Measures**

<u>GO</u>	<u>NO</u>
_____	<u>GO</u>
_____	_____

- 3. Recorded the treatment given.

**Evaluation Guidance:** Score each soldier according to the performance measures in the evaluation guide. Unless otherwise stated in the task summary, the soldier must pass all performance measures to be scored GO. If the soldier fails any step, show what was done wrong and how to do it correctly.

**References**

**Required**  
None

**Related**  
EMERGENCY CARE

**TREAT A CASUALTY FOR A COLD INJURY**  
**081-831-0039**

**Conditions:** No other more serious injuries or conditions are present. Necessary materials and equipment: dry clothing or similar material, sterile dressings, and a thermometer.

**Standards:** Provided correct treatment based upon the signs and symptoms of the injury.

**Performance Steps**

1. Recognize the signs and symptoms of cold injuries.
  - a. Chilblain is caused by repeated prolonged exposure of bare skin to low temperatures from 60° F down to 32° F.
    - (1) Acutely red, swollen, hot, tender, and/or itching skin.
    - (2) Surface lesions with shedding of dead tissue, or bleeding lesions.
  - b. Frostbite is caused by exposure of the skin to cold temperatures that are usually below 32° F depending on the windchill factor, length of exposure, and adequacy of protection.

*NOTE:* The onset is signaled by a sudden blanching of the skin of the nose, ears, cheeks, fingers, or toes followed by a momentary tingling sensation. Frostbite is indicated when the face, hands, or feet stop hurting.

- (1) Superficial (first and second degree).
  - (a) Redness of the skin in light-skinned individuals and grayish coloring of the skin in dark-skinned individuals, followed by a flaky sloughing of the skin.
  - (b) Blister formation 24 to 36 hours after exposure followed by sheet-like sloughing of the superficial skin (second degree).
- (2) Deep.
  - (a) Loss of feeling.
  - (b) Pale, yellow, waxy look if the affected area is unthawed.
  - (c) Solid feel of the frozen tissue.
  - (d) Blister formation 12 to 36 hours after exposure unless rewarming is rapid.
  - (e) Appearance of red-violet discoloration 1 to 5 days after the injury.

*NOTE:* Gangrene and residual nerve damage will result without proper treatment.

- c. Generalized hypothermia is caused by prolonged exposure to low temperatures, especially with wind and wet conditions, and it may be caused by immersion in cold water.

**CAUTION:** With generalized hypothermia, the entire body has cooled with the core temperature below 95° F. This is a medical emergency.

- (1) Moderate hypothermia.

*NOTE:* This condition should be suspected in any chronically ill person who is found in an environment of less than 50° F.

- (a) Conscious, but usually apathetic or lethargic.
- (b) Shivering, with pale, cold skin, slurred speech, poor muscle coordination, faint pulse..
- (2) Severe hypothermia.
  - (a) Unconscious or stuporous.
  - (b) Ice cold skin.
  - (c) Inaudible heart beat or irregular heart rhythm.
  - (d) Unobtainable blood pressure.
  - (e) Unreactive pupils.

## Performance Steps

- (f) Very slow respirations.
  - d. Immersion syndrome (immersion foot, trench foot and hand) is caused by fairly long (hours to days) exposure of the feet or hands to wet conditions at temperatures from about 50° F down to 32° F.
    - (1) First phase (anesthetic).
      - (a) There is no pain sensation, but the affected area feels cold.
      - (b) The pulse is weak at the affected area.
    - (2) Second phase (reactive hyperemic)--limbs feel hot and/or burning and have shooting pains.
    - (3) Third phase (vasospastic).
      - (a) Affected area is pale.
      - (b) Cyanosis.
      - (c) Pulse strength decreases.
    - (4) Check for blisters, swelling, redness, heat, hemorrhage, or gangrene.
  - e. Snow blindness.
    - (1) Scratchy feeling in the eyes as if from sand or dirt.
    - (2) Watery eyes.
    - (3) Pain, possibly as late as 3 to 5 hours later.
    - (4) Reluctant or unable to open eyes.
2. Treat the cold injury.
- a. Chilblain.
    - (1) Apply local rewarming within minutes.
    - (2) Protect lesions (if present) with dry sterile dressings.

**CAUTION:** Do not treat with ointments.

- b. Frostbite.

- (1) Apply local rewarming using body heat.

**CAUTION:** Avoid thawing the affected area if it is possible that the injury may refreeze before reaching the treatment center.

- (2) Loosen or remove constricting clothing and remove jewelry.
- (3) Increase insulation and exercise the entire body as well as the affected body part(s).

**CAUTION:** Do not massage the skin or rub anything on the frozen parts.

- (4) Move the casualty to a sheltered area, if possible.
- (5) Protect the affected area from further cold or trauma.
- (6) Evacuate the casualty.

**NOTE:** For frostbite of a lower extremity, evacuate the casualty by litter, if possible.

**CAUTION:** Do not allow the casualty to use tobacco or alcohol.

- c. Generalized Hypothermia.

- (1) Moderate.
  - (a) Remove the casualty from the cold environment.
  - (b) Replace wet clothing with dry clothing.
  - (c) Cover the casualty with insulating material or blankets.
  - (d) If available, apply heating pads to the casualty's armpits, groin, and abdomen.

**NOTE:** If far from a medical treatment facility and the situation and facilities permit, immerse the casualty in a tub of 105° F water.

- (e) If available, slowly give sugar and sweet warm fluids.

**CAUTION:** Do not give the casualty alcohol.

- (f) Wrap the casualty from head to toe.

**Performance Steps**

- (g) Evacuate the casualty lying down.
- (2) Severe.

**CAUTION:** Handle the casualty very gently.

- (a) Cut away wet clothing and replace it with dry clothing.
- (b) Maintain the airway. (See task 081-831-0018.)
  - 1) Administer oxygen if trained personnel and equipment are available.
  - 2) Assist with ventilation if the casualty's respiration rate is less than five per minute.

*NOTE:* Do not use artificial airways or suctioning devices.

**CAUTION:** Do not hyperventilate the casualty. Keep the rate of artificial ventilation at approximately 8 to 10 per minute.

- (c) Monitor the patient's pulse. (See task 081-831-0011.) If none is detected, apply AED, if available. (See task 081-833-3027.) Begin CPR. (See tasks 081-831-0046 and 081-831-0048.)
- (d) Evacuate the casualty positioned on his or her back with the head in a 10 degree head-down tilt.

*NOTE:* The treatment of moderate hypothermia is aimed at preventing further heat loss and rewarming the casualty as rapidly as possible. Rewarming a casualty with severe hypothermia is critical to saving his or her life, but the kind of care rewarming requires is nearly impossible to carry out in the field. Evacuate the casualty promptly to a medical treatment facility. Use stabilizing measures en route.

d. Immersion syndrome.

- (1) Dry the affected part immediately and gradually rewarm it in warm air.

**CAUTION:** Never massage the skin. After rewarming the affected part, it may become swollen, red, and hot. Blisters usually form due to circulation return.

- (2) Protect the affected part from trauma and secondary infection.
- (3) Elevate the affected part.
- (4) Evacuate the casualty as soon as possible.
- e. Snow blindness. Cover the eyes with a dark cloth and evacuate the casualty to a medical treatment facility.

**Evaluation Preparation:**

Setup: For training and evaluation have another soldier act as the casualty. Select one of the types of cold injuries on which to evaluate the soldier. Coach the simulated casualty on how to answer questions about symptoms. Physical signs and symptoms that the casualty cannot readily simulate, for example blisters, must be described to the soldier.

Brief soldier: Tell the soldier to determine what cold injury the casualty has. After the cold injury has been identified, ask the soldier to describe the proper treatment.

**Performance Measures**

	<u>GO</u>	<u>NO GO</u>
1. Identified the type of cold injury.	_____	_____
2. Provided proper first aid treatment for the injury.	_____	_____

*NOTE:* Although not evaluated, the soldier would record the treatment given on the appropriate form and evacuate the casualty as necessary.

**Evaluation Guidance:** Score each soldier according to the performance measures in the evaluation guide. Unless otherwise stated in the task summary, the soldier must pass all performance measures to be scored GO. If the soldier fails any step, show what was done wrong and how to do it correctly.

**References**

**Required**

None

**Related**

EMERGENCY CARE

## INITIATE TREATMENT FOR ANAPHYLACTIC SHOCK

### 081-833-0031

**Conditions:** Necessary materials and equipment: needle, syringe, epinephrine (1:1000 solution), stethoscope, sphygmomanometer, bag-valve-mask system, and oxygen equipment.

**Standards:** Initiated treatment for anaphylactic shock, stabilized the casualty, and minimized the effects of anaphylaxis without causing further injury to the casualty.

#### Performance Steps

*NOTE:* Anaphylactic reactions occur within minutes or even seconds after contact with the substance to which the casualty is allergic. Reactions occur in the skin, respiratory system, and circulatory system.

1. Check the casualty for signs and symptoms of anaphylactic shock.
  - a. Skin.
    - (1) Flushed or ashen.
    - (2) Burning or itching.
    - (3) Edema (swelling), especially in the face, tongue, or airway.
    - (4) Urticaria (hives) spreading over the body.
    - (5) Marked swelling of the lips and cyanosis about the lips.
  - b. Respiratory.
    - (1) Tightness or pain in the chest.
    - (2) Sneezing and coughing.
    - (3) Wheezing, stridor, or difficulty in breathing (dyspnea).
    - (4) Sputum (may be blood tinged).
    - (5) Respiratory failure.
  - c. Circulatory.
    - (1) Weak, rapid pulse.
    - (2) Falling blood pressure.
    - (3) Hypotension.
    - (4) Dizziness or fainting.
    - (5) Coma.

2. Transport the casualty to the aid station.

**WARNING:** Do not attempt to transport the casualty to an aid station unless the station can be reached within 4 minutes. Otherwise, start supportive treatment immediately and transport the casualty as soon as possible.

3. Open the airway, if necessary.

*NOTE:* In cases of airway obstruction from severe glottic edema, a cricothyroidotomy may be necessary. (See task 081-833-3006.)

4. Administer high concentration oxygen. (See task 081-833-0158.)

5. Administer epinephrine.

- a. Administer 0.5 ml of epinephrine, 1:1000 solution, subcutaneously (SQ) or intramuscularly (IM).

*NOTE:* Annotate the time of injection on the Field Medical Card (FMC).

- b. Additional epinephrine may be required as anaphylaxis progresses. Additional incremental doses may be administered every 5 to 15 minutes IAW local SOP.



**Performance Steps**

6. Initiate an IV. (See task 081-833-0033.)

*NOTE:* If the anaphylaxis is due to an insect bite or sting on an extremity, a constricting band should be applied 2 to 3 inches above and below the site. The band should be loose enough to allow arterial flow but tight enough to restrict venous circulation. A distal pulse must be palpable.

- 7. Provide supportive measures for the treatment of shock, respiratory failure, circulatory collapse, or cardiac arrest.
  - a. Infuse additional IV fluid if blood pressure continues to drop.
  - b. Position the patient in the supine position with legs elevated if injuries permit.
  - c. Apply pneumatic anti-shock garment, if necessary. (See task 081-833-3011.)
  - d. Perform rescue breathing , if necessary. (See task 081-831-0048.)
  - e. Administer external chest compressions, if necessary. (See task 081-831-0046.)
- 8. Check the casualty's vital signs every 3 to 5 minutes until the casualty is stable.
- 9. Record the procedure on the appropriate form.
- 10. Evacuate the casualty, providing supportive measures en route.

**Performance Measures**

	<u>GO</u>	<u>NO GO</u>
1. Checked the casualty for signs and symptoms of anaphylactic shock.	_____	_____
2. Transported the casualty to the aid station, if feasible.	_____	_____
3. Opened the airway, if necessary.	_____	_____
4. Administered oxygen.	_____	_____
5. Administered epinephrine.	_____	_____
6. Initiated an IV.	_____	_____
7. Provided supportive measures for the treatment of shock, respiratory failure, circulatory collapse, or cardiac arrest.	_____	_____
8. Checked the casualty's vital signs every 3 to 5 minutes until the casualty was stable.	_____	_____
9. Recorded the procedure on the appropriate form.	_____	_____
10. Evacuated the casualty and provided supportive measures en route.	_____	_____

**Evaluation Guidance:** Score each soldier according to the performance measures in the evaluation guide. Unless otherwise stated in the task summary, the soldier must pass all performance measures to be scored GO. If the soldier fails any step, show what was done wrong and how to do it correctly.

**References**

**Required**  
None

**Related**  
EMERGENCY CARE

## TREAT A CASUALTY FOR INSECT BITES OR STINGS

### 081-833-0072

**Conditions:** Necessary materials and equipment: constricting bands, antiseptic cleanser, tourniquet, tweezers, pin or needle, calamine lotion, sphygmomanometer, stethoscope, thermometer, and ice packs.

**Standards:** Treated the casualty, minimizing the effect of insect bites or stings, without causing further injury.

#### Performance Steps

1. Remove the casualty's clothing, shoes, or jewelry to expose the sting or bite area.

*NOTE:* Remove rings, watches, and other constricting items that are in the area of the bite or sting to prevent circulatory impairment in the event swelling of an extremity occurs.

2. Ask the casualty to identify, if possible, what bit or stung him or her.

3. Check the casualty for the signs and symptoms of insect bites and stings.

- a. Black widow spider.

*NOTE:* There are five species of widow spiders. Most are a glossy black with a red or orange hourglass shape on the underside of the abdomen. The brown widow may be either gray or light brown with a red or orange hourglass marking. The red widow has brilliant red spots or a yellow marking on its back.

- (1) An immediate pin-prick sensation from the bite.
- (2) A dull, numbing pain at the bite site.
- (3) Two red puncture marks.
- (4) Severely painful muscular or abdominal spasms.
  - (a) Begin in 10 to 40 minutes.
  - (b) Peak in 1 to 3 hours.
  - (c) Persist for 12 to 48 hours.
- (5) Rigid, board-like abdomen.
- (6) Tightness in the chest and painful breathing.
- (7) Dizziness.
- (8) Nausea.
- (9) Vomiting.
- (10) Sweating.
- (11) Skin rash.

- b. Brown recluse spider.

*NOTE:* The brown recluse spider is medium sized, yellowish to medium dark brown, and covered with fine short hairs. It has a distinct groove between its chest and abdominal body parts, and a violin shaped mark on its back.

- (1) Mild to severe pain within hours.
- (2) The area becomes red, swollen, and tender.
- (3) The area develops a pale, mottled, cyanotic center.
- (4) A small blister may form.
- (5) A large scab of dead skin, fat, and debris forms (over several days).

- c. Scorpion.

*NOTE:* There are two general types of scorpions. The Arizona (black) scorpion is the only deadly type in the United States.

- (1) Harmless species.

### Performance Steps

- (a) Severe pain and burning sensation at the sting site.
- (b) Local swelling and discoloration.
- (c) The symptoms last for 24 to 72 hours.
- (2) Deadly species.
  - (a) "Pins and needles" sensation at the sting site.
  - (b) No swelling at the sting site.
  - (c) Excessive salivation.
  - (d) Severe muscle contractions.
  - (e) Hypertension.
  - (f) Convulsions.
  - (g) Circulatory collapse.
  - (h) Cardiac failure.

d. Bee, wasp, hornet, and yellow jacket.

*NOTE:* A wasp or yellow jacket (slender body with elongated abdomen) retains its stinger and can sting repeatedly. A honey bee (rounded abdomen) usually leaves its stinger in the casualty.

- (1) Mild reaction.
  - (a) Pain at the sting site.
  - (b) A wheal, redness, and swelling.
  - (c) Itching.
  - (d) Anxiety.
- (2) Severe reaction.
  - (a) Generalized itching and burning.
  - (b) Urticaria (hives).
  - (c) Chest tightness and cough.
  - (d) Swelling around the lips and tongue.
  - (e) Bronchospasm and wheezing.
  - (f) Dyspnea.
  - (g) Abdominal cramps.
  - (h) Anxiety.
  - (i) Respiratory failure.
  - (j) Anaphylactic shock.

e. Fire ant.

*NOTE:* Fire ants inject a very irritating toxin into the skin. They bite repeatedly and in a very short period of time.

- (1) Burning sensation.
- (2) Wheal within minutes.
- (3) Clear, fluid-filled bubble or blister within minutes.
- (4) Cloudy, fluid-filled bubble within 2 to 4 hours.
- (5) Bubble on red base within 8 to 10 hours.
- (6) Ulceration (with scarring after healing).
- (7) Anaphylactic shock.

f. Tick.

*NOTE:* Hard ticks can transmit Rocky Mountain Spotted Fever and Lyme's disease, and may even cause anemia if the infestation is severe enough.

- (1) Itching and redness at the site.
- (2) Headache.
- (3) Moderate to high fever, which may last 2 to 3 weeks.
- (4) Pain in the joints or legs.
- (5) Swollen lymph nodes in the bitten area.

**Performance Steps**

- (6) Paralysis and other central nervous system disorders are possible after several days.

**NOTE:** Generally, a tick must remain attached to the body for 4 to 6 hours in order to transmit infections. Early detection and proper removal may prevent transmission.

- g. Unknown, nonspecific insects.

- (1) Pain and swelling at the site.
- (2) Breathing difficulty.
- (3) Shock.

- 4. Treat the bite or sting.

- a. Black widow spider, brown recluse spider and scorpion.

- (1) Keep the casualty quiet and calm.
- (2) Remove jewelry.
- (3) Apply constricting band(s).
  - (a) Place 2 inches above and below the site. Bands should be 3/4 to 1.5 inches wide.
  - (b) Use a single band above the ankle or wrist if the site is on a foot or hand.
  - (c) Tighten the bands enough to stop superficial venous circulation but not enough to interfere with the distal pulse.
  - (d) Advance the bands, as necessary, to remain at the edge(s) of the swelling.
- (4) Cleanse the bite site using antiseptic.
- (5) Apply ice or an ice pack to the site.
- (6) Treat the casualty for anaphylactic shock, if necessary.

- b. Bee, wasp, hornet, and yellow jacket.

- (1) Scrape the stinger from the site, if still in place.

**CAUTION:** Do not squeeze the stinger or attempt to pull it out. More venom will be injected into the casualty.

- (2) Cleanse the site with soap and water.
- (3) Apply ice or an ice pack to the site.
- (4) Treat the casualty for anaphylactic shock, if necessary.

- c. Fire ant.

- (1) Cleanse the bite site using antiseptic.
- (2) Apply ice, an ice pack, or a cold compress to the site.
- (3) Treat the casualty for anaphylactic shock, if necessary.

- d. Tick.

- (1) Remove all parts of the tick. Leave nothing embedded in the skin.

**NOTE:** Debride the area if the tick's head remains in the skin.

- (a) Using tweezers, grasp the tick as close to the skin as possible. Using steady pressure, pull the tick straight out.
- (b) If tweezers are not available, use an absorbent material (gauze, toweling) to protect your skin. Grasp the tick as close to the skin as possible and pull straight out using steady pressure.

- (2) If the tick breaks, thoroughly clean your hands with antiseptic.

- (3) Cleanse the bite site using antiseptic.

**NOTE:** Ticks harbor pathogenic bacteria in their bodies. Adequate removal and cleansing is essential to prevent infection.

- e. Unknown, nonspecific insect.

- (1) Cleanse the site using antiseptic.
- (2) Apply ice, an ice pack, or a cold compress to the site.
- (3) Monitor the vital signs.

**Performance Steps**

(4) Treat the casualty for anaphylactic shock, if necessary.

5. Record the treatment on the appropriate form.

6. Evacuate the casualty, if necessary.

*NOTE:* It is necessary to evacuate any casualty who shows signs of respiratory distress, shock, anaphylaxis, or who does not respond to initial treatment.

**Evaluation Preparation:**

Setup: For training and evaluation, have another soldier act as the casualty. Indicate the area of the bite or sting. To test step 3, coach the casualty on how to answer the soldier's questions regarding signs and symptoms such as pain. Tell the soldier what signs and symptoms, such as respiratory distress or shock, the casualty is exhibiting.

Brief soldier: Tell the soldier to treat the casualty for an insect bite or sting.

**Performance Measures**

	<u>GO</u>	<u>NO GO</u>
1. Exposed the bite or sting site.	_____	_____
2. Asked the casualty what bit or stung him or her.	_____	_____
3. Checked for the signs and symptoms of the insect bite or sting.	_____	_____
4. Treated the bite or sting.	_____	_____
5. Recorded the treatment on the appropriate form.	_____	_____
6. Evacuated the casualty, if necessary.	_____	_____

**Evaluation Guidance:** Score each soldier according to the performance measures in the evaluation guide. Unless otherwise stated in the task summary, the soldier must pass all performance measures to be scored GO. If the soldier fails any step, show what was done wrong and how to do it correctly.

**References**

**Required**  
None

**Related**  
EMERGENCY CARE

## TREAT A CASUALTY FOR SNAKEBITE

### 081-833-0073

**Conditions:** Necessary materials and equipment: two constricting bands, antiseptic cleaning solution, iodine, water, soap, and ice packs.

**Standards:** Determined the type of snakebite and provided treatment, minimizing the effects of the snakebite, without causing further injury to the casualty.

### Performance Steps

1. Expose the injury site.
2. Determine the type of snakebite.

**CAUTION:** If the bite cannot be positively identified as nonpoisonous, the bite should be treated as a poisonous bite.

- a. Nonpoisonous.
  - (1) Four to six rows of teeth.
  - (2) No fangs.
- b. Poisonous.
  - (1) Two rows of teeth.
  - (2) Two fangs which create puncture wounds.

**NOTES:** 1. Coral snakes are neurotoxic and leave only one or more tiny scratch marks in the area of the bite. 2. If the snake can be killed without risk of another bite, it should be brought to the MTF for identification.

3. Check the casualty for signs and symptoms of a poisonous bite.

**NOTE:** The casualty may exhibit any or all of the symptoms. Symptoms may develop in 1 to 8 hours.

- a. Pain and progressive swelling at the bite site.
- b. Drowsiness.
- c. General skin discoloration.
- d. Blurred vision.
- e. Difficulty hearing.
- f. Fever, chills, or sweating.
- g. Nausea and vomiting.
- h. Shock.
- i. Difficulty breathing.
- j. Paralysis.
- k. Seizures.
- l. Coma.

**CAUTION:** Antivenom is indicated in patients who, within 30 to 60 minutes following the bite, show progressive swelling involving the injured area, complain of paresthesia of the mouth, scalp, fingertips, or toes, or who have any signs or symptoms of poisoning.

4. Initiate treatment.

**CAUTION:** Do not give the casualty any sedatives, alcohol, food, or tobacco.

- a. Nonpoisonous bite.
  - (1) Clean and disinfect the wound.
    - (a) Use soap and water or antiseptic solution.
    - (b) Apply iodine (betadine) if the casualty is not allergic to it.
  - (2) If the casualty has a current tetanus toxoid series, return the casualty to duty.

### Performance Steps

- (3) If the casualty does not have a current tetanus toxoid series or does not know, refer the casualty to a medical treatment facility for an immunization.

#### b. Poisonous bites.

- (1) Immobilize the casualty.
  - (a) Have the casualty lie down, if possible.
  - (b) Tell the casualty not to move.
  - (c) Keep the casualty calm and reassured.

**NOTE:** Keeping the casualty calm and still will delay venom absorption.

- (d) If the bite is on an extremity, do not elevate the limb but rest it in a position of function at heart level.

- (e) Explain to the casualty what will be done.

**NOTE:** Remove jewelry.

- (2) Apply constricting band(s).

**NOTE:** A constricting band should be 3/4 to 1.5 inches wide.

- (a) Place constricting bands 2 inches above and below the fang marks.

**NOTE:** Use a single band above the wrist or ankle if the site is on a hand or foot.

- (b) Tighten the bands enough to stop superficial venous circulation, but not enough to interfere with the distal pulse.

**NOTE:** Use constricting bands to slow the spread of the venom by restricting lymphatic and venous flow. Do not restrict arterial blood flow. Verify this by palpating for a distal pulse.

- (c) Advance the bands, if necessary, to remain at the edges of the swelling.

- (3) Clean the wound with soap and water or antiseptic solution.

- (4) Apply cold treatment.

- (a) Use an ice bag or chemical ice pack only.

- (b) Place the ice bag over the bite area.

- (c) Monitor the casualty to prevent cold injury.

**CAUTIONS:** 1. Do not use dry ice, ethyl chloride, or wet ice brine. 2. Do not place ice in direct contact with the skin. 3. Do not leave the ice pack in place for more than a few hours. 4. Do not pack the affected extremity in ice.

- (5) Monitor the casualty for development of breathing problems.

- (6) Check the distal pulse.

**WARNING:** Antivenom, if available, may be administered only by specifically authorized personnel. Sensitivity testing should be conducted prior to administration. Use of antivenom may cause anaphylactic shock.

5. Record the procedure on the appropriate form.

6. Evacuate the casualty, if necessary.

### Evaluation Preparation:

**Setup:** For training and evaluation, have another soldier act as the casualty. Simulate a snakebite on the casualty's arm or leg or describe its appearance to the soldier. Coach the casualty on how to answer the soldier's questions regarding signs and symptoms such as pain. To test step 2, ask the soldier what type of bite the casualty has. To test step 3, have the soldier tell you the symptoms of a poisonous snakebite. You may vary the testing by telling the soldier that the casualty cannot be evacuated for more than 1 hour, or that the casualty is having difficulty breathing.

**Brief soldier:** Tell the soldier to treat a casualty for a snakebite.

**Performance Measures**

	<u>GO</u>	<u>NO</u> <u>GO</u>
1. Exposed the injury site.	_____	_____
2. Determined the type of snakebite.	_____	_____
3. Checked the casualty for signs and symptoms of a poisonous bite.	_____	_____
4. Initiated treatment.	_____	_____
5. Recorded the procedure on the appropriate form.	_____	_____
6. Evacuated the casualty, if necessary.	_____	_____

**Evaluation Guidance:** Score each soldier according to the performance measures in the evaluation guide. Unless otherwise stated in the task summary, the soldier must pass all performance measures to be scored GO. If the soldier fails any step, show what was done wrong and how to do it correctly.

**References**

**Required**  
None

**Related**  
EMERGENCY CARE



Subject Area 10: Chemical Agent Injuries

**TREAT A NERVE AGENT CASUALTY IN THE FIELD**

**081-833-0083**

**Conditions:** You are in a chemical environment and have a casualty who is lying on the ground wearing protective outer garments, overboots, and mask carrier. You are wearing MOPP level 4 gear. Necessary materials and equipment: aid bag, impermeable litter cover, litter, and blanket.

**Standards:** Completed all the steps necessary to treat a nerve agent casualty in the field without causing further injury to the casualty. Did not kneel when providing treatment.

**Performance Steps**

1. Assess the casualty for the signs and symptoms of nerve agent poisoning.

*NOTE:* If the casualty has been exposed to vapor or aerosol, the pupils will become pinpointed immediately. However, if the nerve agent is absorbed through the skin only or by ingesting contaminated food or water, the pinpointing of the pupils will be delayed or absent.

a. Vapor exposure.

*NOTE:* Effects from vapor exposure will occur within seconds to minutes after being exposed and will not normally worsen after being removed from the exposure for 15 to 20 minutes.

(1) Mild.

*NOTE:* Exposure to small amounts of vapor for a brief period usually causes effects in the eyes, nose, and lungs.

- (a) Unexplained runny nose.
- (b) Unexplained sudden headache.
- (c) Sudden drooling.
- (d) Difficulty in seeing (dimness of vision and miosis).
- (e) Tightness in the chest or difficulty in breathing.
- (f) Stomach cramps.
- (g) Nausea with or without vomiting.
- (h) Tachycardia or bradycardia.

(2) Moderate.

- (a) All or most of the mild symptoms.
- (b) Fatigue.
- (c) Weakness.
- (d) Muscular twitching.

(3) Severe.

*NOTE:* Effects may occur after one breath but normally take place within several seconds of a large vapor exposure.

- (a) All or most of the mild and moderate symptoms.
- (b) Strange or confused behavior.
- (c) Wheezing, dyspnea, and coughing.
- (d) Severely pinpointed pupils.
- (e) Red eyes with tearing.
- (f) Vomiting.
- (g) Severe muscular twitching and general weakness.
- (h) Involuntary urination and defecation.
- (i) Convulsions.

**Performance Steps**

- (j) Unconsciousness.
- (k) Respiratory failure.
- (l) Bradycardia.
- (m) Paralysis.

b. Skin (percutaneous) exposure.

*NOTES:* 1. It is difficult to separate this type of exposure into categories due to the continued absorption of nerve agent into skin layers. Due to continued absorption, the effects from the nerve agent may be progressive in nature. They may occur from minutes up to 18 hours after exposure and continue even after the skin has been decontaminated. 2. The greater the amount exposure to nerve agent, the shorter the onset time of symptoms with increased severity.

- (1) Mild exposure.
  - (a) Localized sweating at the exposure site.
  - (b) Muscular twitching at the exposure site.
  - (c) Stomach cramps and nausea.
- (2) Moderate exposure.
  - (a) Fatigue.
  - (b) Weakness.
  - (c) Muscular twitching.
- (3) Severe exposure.
  - (a) Sudden loss of consciousness.
  - (b) Vomiting.
  - (c) Convulsions.
  - (d) Severe muscular twitching and general weakness.
  - (e) Difficulty breathing or cessation of respirations.

*NOTE:* Death would be the result of complete respiratory system failure.

- 2. Mask the casualty.
  - a. Instruct the casualty to mask self if he or she is able.
  - b. Position the casualty face up and mask the casualty. Do not fasten the hood at this time.
- 3. Check the casualty's pocket flaps and the area around the casualty for expended autoinjectors.
- 4. Administer the antidote.
  - a. Mild symptoms. Instruct the casualty to administer one Mark I Nerve Agent Antidote Kit. (See STP 21-1-SMCT, task 081-831-1044.)
  - b. Severe symptoms. Administer three Mark I Nerve Agent Antidote Kits and one Convulsant Antidote for Nerve Agent (CANA) autoinjector to the casualty. (See STP 21-1-SMCT, task 081-831-1044.)

*NOTE:* Removal of any liquid nerve agent on the skin, on clothing, or in the eyes should be accomplished as soon as possible after administration of the antidote. Decontamination should be performed by the casualty, if able, or by a buddy.

- 5. Check the casualty for signs of effectiveness of treatment.
  - a. Atropinization.
    - (1) Heart rate above 90 beats per minute (carotid pulse).
    - (2) Reduced bronchial secretions.
    - (3) Reduced salivation.
  - b. Cessation of convulsions.

**Performance Steps**

6. Administer additional atropine or CANA, if needed.
  - a. Administer additional atropine at approximately 15 minute intervals until atropinization is achieved.
  - b. Administer additional atropine at intervals of 30 minutes to 4 hours to maintain atropinization or until the casualty is evacuated to an MTF.
  - c. Administer a second and, if needed, a third CANA at 5 to 10 minute intervals to casualties suffering convulsions.

**CAUTION:** Do not give more than two additional CANA injections for a total of three.

*NOTE:* Additional atropine and the two additional CANA injections can be administered by a Combat Lifesaver, the combat medic, or other medical personnel.

7. Provide assisted ventilation for severely poisoned casualties, if equipment is available.

*NOTE:* Far forward in the field, a cricothyroidotomy is the most practical means of providing an airway for assisted ventilation using a hand-powered ventilator equipped with an NBC filter. When the casualty reaches an MTF where oxygen and a positive pressure ventilator are available, these should be employed continuously until adequate spontaneous respiration is resumed.

8. Record the number of injections given and all other treatment given on the FMC.
9. Evacuate the casualty.

**Performance Measures**

	<u>GO</u>	<u>NO GO</u>
1. Assessed the casualty for the signs and symptoms of nerve agent poisoning.	_____	_____
2. Masked the casualty.	_____	_____
3. Checked the casualty's pocket flaps and the area around the casualty for expended autoinjectors.	_____	_____
4. Administered the antidote.	_____	_____
5. Checked the casualty for signs of effectiveness of treatment.	_____	_____
6. Administered additional atropine or CANA, if needed.	_____	_____
7. Provided assisted ventilation for severely poisoned casualties, if equipment was available.	_____	_____
8. Recorded the number of injections given and all other treatment given on the FMC.	_____	_____
9. Evacuated the casualty.	_____	_____
10. Did not kneel while treating the casualty.	_____	_____
11. Did not cause further injury to the casualty.	_____	_____

**Evaluation Guidance:** Score each soldier according to the performance measures in the evaluation guide. Unless otherwise stated in the task summary, the soldier must pass all performance measures to be scored GO. If the soldier fails any step, show what was done wrong and how to do it correctly.

**References****Required**

None

**Related**

STP 21-1-SMCT

**TREAT A BLOOD AGENT (HYDROGEN CYANIDE) CASUALTY IN THE FIELD**  
**081-833-0084**

**Conditions:** You are in a chemical environment and have a casualty who is lying on the ground wearing protective overgarments, overboots, and mask carrier. You are wearing MOPP level 4 gear.

**Standards:** Completed all the steps necessary to treat a blood agent casualty in the field.

**Performance Steps**

**CAUTION:** Blood agent (hydrogen cyanide) causes symptoms ranging from convulsions to coma. After inhaling a high concentration of blood agent, a person may become unconscious and die within minutes. Blood agents in high concentration act quickly and death may result in 15 seconds. These agents release an odor of bitter almonds or peach kernels. Anyone smelling the odors should mask immediately.

1. Check for signs and symptoms of blood agent poisoning.
  - a. Vertigo.
  - b. Nausea.
  - c. Increased respirations.
  - d. Headache.
  - e. Pink color of the skin.
  - f. Violent convulsions.
  - g. Coma.
  - h. Respiratory arrest.
  - i. Cardiac arrest.
2. Mask the casualty immediately.
3. Administer positive pressure ventilation, if available.

**CAUTION:** No device currently exists that can provide medical assistance in a contaminated environment.

4. Record the treatment given on the Field Medical Card.
5. Evacuate the casualty.

**Evaluation Preparation:**

Setup: For training and evaluation, have another soldier act as the casualty and exhibit symptoms, such as hyperventilation. Tell the soldier that the casualty is exhibiting symptoms such as slow pulse rate. You may decide whether the casualty is already masked or not.

Brief soldier: Tell the soldier to state the signs and symptoms of blood agent poisoning, and then treat the casualty.

**Performance Measures**

	<u>GO</u>	<u>NO</u> <u>GO</u>
1. Checked for the signs and symptoms of blood agent poisoning.	_____	_____
2. Masked the casualty immediately.	_____	_____

**Performance Measures**

	<u>GO</u>	<u>NO</u> <u>GO</u>
3. Administered positive pressure ventilation, if available.	_____	_____
4. Recorded the treatment given on the Field Medical Card.	_____	_____
5. Evacuated the casualty.	_____	_____

**Evaluation Guidance:** Score each soldier according to the performance measures in the evaluation guide. Unless otherwise stated in the task summary, the soldier must pass all performance measures to be scored GO. If the soldier fails any step, show what was done wrong and how to do it correctly.

**References:** None

## TREAT A CHOKING AGENT CASUALTY IN THE FIELD

081-833-0085

**Conditions:** You are in a chemical environment and have a casualty who is lying on the ground wearing protective overgarments, overboots, and mask carrier. You are wearing MOPP level 4 gear.

**Standards:** Completed all the steps necessary to treat a choking agent casualty in the field, without causing further injury to the casualty.

### Performance Steps

**NOTE:** The treatment available for the choking agent casualty in the field is limited. It is essential that the casualty be masked and evacuated to increase the possibility of survival.

1. Check for the signs and symptoms of choking agent poisoning.

a. Immediate signs and symptoms.

**NOTE:** Although heavy concentrations of poison bring on these symptoms very quickly, small doses may take up to 2 to 6 hours before there is any sign of poisoning.

- (1) Watery eyes.
- (2) Coughing.
- (3) Choking.
- (4) Tightness in the chest.
- (5) Nausea.
- (6) Vomiting.
- (7) Headache.
- (8) Transient blindness.
- (9) Increased salivation.
- (10) Tingling burning sensation on the skin.

b. Delayed signs and symptoms.

- (1) Rapid shallow breathing.
- (2) Cyanosis.
- (3) Apprehension.
- (4) Severe coughing, producing frothy fluid.
- (5) Weak and rapid pulse.
- (6) Chest wall retractions.
- (7) Pulmonary edema.

c. Asymptomatic. The casualty has been exposed, but shows no signs or symptoms.

2. Mask the casualty, but do not fasten the hood.

3. Position the casualty.

a. Supine.

b. In a semisitting position if dyspnea or orthopnea make the supine position impractical.

4. Treat the casualty.

a. Asymptomatic.

(1) Restrict the casualty's activities to light duties to avoid stress to the respiratory system.

(2) Monitor the casualty for the onset of symptoms.

b. Symptomatic.

(1) Keep the casualty at rest in a sitting position.

(2) Provide intermittent positive pressure ventilation, if equipment is available.

**Performance Steps**

- (3) Keep the casualty warm.
- 5. Record the treatment given on the Field Medical Card.
- 6. Evacuate the casualty.

**Evaluation Preparation:**

Setup: For training and evaluation, have another soldier act as the casualty and exhibit signs such as choking or coughing (coach the casualty on how to answer the soldier's questions on symptoms such as headache). Tell the medic the casualty is exhibiting symptoms such as cyanosis. You may decide whether the casualty is already masked or not.

Brief soldier: Tell the soldier to state the signs and symptoms of a choking agent casualty, and then treat the casualty.

**Performance Measures**

	<u>GO</u>	<u>NO GO</u>
1. Checked for signs and symptoms of choking agent poisoning.	_____	_____
2. Masked the casualty but did not fasten the hood.	_____	_____
3. Positioned the casualty.	_____	_____
4. Treated the casualty.	_____	_____
5. Recorded the treatment given on the Field Medical Card.	_____	_____
6. Evacuated the casualty.	_____	_____

**Evaluation Guidance:** Score each soldier according to the performance measures in the evaluation guide. Unless otherwise stated in the task summary, the soldier must pass all performance measures to be scored GO. If the soldier fails any step, show what was done wrong and how to do it correctly.

**References:** None



## TREAT A BLISTER AGENT CASUALTY (MUSTARD, LEWISITE, PHOSGENE OXIME) IN THE FIELD

081-833-0086

**Conditions:** You are in a chemical environment and are treating a casualty who is lying on the ground wearing MOPP level 4 gear. You are wearing MOPP level 4 gear. Necessary materials and equipment: casualty's canteen and a personal decontamination kit.

**Standards:** Completed all the steps necessary to treat a blister agent casualty in the field, without causing further injury to the casualty. Did not kneel when providing treatment.

### Performance Steps

1. Check for the signs and symptoms of blister agent poisoning.

*NOTE:* Moist areas of the body are highly susceptible to blister agents. Therefore, during hot weather, blister agents can cause a greater number of casualties.

a. Skin.

(1) Itching.

(2) Redness.

(3) Blisters.

(4) Pain.

(a) Intense and immediate if contaminated by lewisite (L) (arsenical) or phosgene oxime.

(b) Delayed from 1 hour to days if contaminated by mustard (HD).

b. Eyes (L--immediate, HD--1 hour).

(1) Extremely sensitive to light.

(2) Gritty feeling.

(3) Painful.

(4) Watery.

(5) Involuntary spasms of the eyelids.

(6) Swelling and blistering of eyelids.

(7) Corneal lesion.

(8) Permanent blindness (direct contact).

(9) Redness.

c. Respiratory tract (L--immediate, HD--4 to 6 hours).

(1) Coughing.

(2) Sore throat.

(3) Frothy sputum.

(4) Phlegm.

(5) Nasal secretions.

(6) Adema.

d. Systemic disorders.

(1) Malaise.

(2) Headache.

(3) Nausea and vomiting.

(4) Severe skin burns.

(5) Drop or increase in white blood cells (fever, infection).

(6) Bloody diarrhea.

(7) Liver necrosis (L).

**CAUTION:** Seek overhead protection, or heavy forage if available.

**Performance Steps**

2. Tell the casualty to take a deep breath, hold it, and close the eyes.

**CAUTION:** While the eyes are being irrigated, the breath should be held and the mouth kept closed to prevent contamination and absorption through mucous membranes.

3. Lift the casualty's mask.

4. Irrigate the casualty's eyes.

a. Use water from the casualty's canteen.

*NOTE:* If the casualty's water has been contaminated, use sterile water or sterile normal saline from the aid bag.

b. Tilt the casualty's head to one side.

c. Tell the casualty to open the eyes as much as possible.

d. Pour water slowly into one eye.

e. To avoid spreading contamination, let the water run off the side of the face.

f. Repeat steps 4a through 4e for the other eye.

*NOTE:* It may be necessary for the casualty to remask and take additional breaths if unable to hold the breath until both eyes are irrigated.

5. Use the casualty's personal decontamination kit on both the face and the portion of the mask in contact with the face. (See STP 21-1-SMCT, task 031-503-1013.)

6. Replace the casualty's mask.

7. Tell the casualty to clear and check the mask.

8. Tell the casualty to breathe normally.

*NOTE:* Further decontamination procedures will be performed by the casualty (self-aid) or buddy aid.

9. Record the treatment given on the Field Medical Card.

10. Evacuate the casualty, if necessary.

**Evaluation Preparation:**

Setup: For training and evaluation, have another soldier act as the casualty and exhibit signs such as coughing. Coach the casualty on how to answer the soldier's questions on symptoms such as headache. Tell the soldier that the casualty is exhibiting signs such as blisters. Training decontamination kits must be used.

Brief soldier: Tell the soldier to state the signs and symptoms of blister agent poisoning, and then treat the casualty. For step 4, have the soldier tell you what should be done.

**Performance Measures**

	<u>GO</u>	<u>NO GO</u>
1. Checked for signs and symptoms of blister agent poisoning.	_____	_____
2. Told the casualty to take a deep breath, hold it, and close the eyes.	_____	_____
3. Lifted the casualty's mask.	_____	_____
4. Irrigated the casualty's eyes.	_____	_____

<b>Performance Measures</b>	<u><b>GO</b></u>	<u><b>NO</b></u> <u><b>GO</b></u>
5. Used the casualty's personal decontamination kit on both the face and the portion of the mask in contact with the face.	—	—
6. Replaced the casualty's mask.	—	—
7. Told the casualty to clear and check the mask.	—	—
8. Told the casualty to breathe normally.	—	—
9. Repeated steps 1-8 until decontamination was complete.	—	—
10. Recorded the treatment given on the Field Medical Card.	—	—
11. Evacuated the casualty, if necessary.	—	—
12. Did not kneel at any time.	—	—

**Evaluation Guidance:** Score each soldier according to the performance measures in the evaluation guide. Unless otherwise stated in the task summary, the soldier must pass all performance measures to be scored GO. If the soldier fails any step, show what was done wrong and how to do it correctly.

**References**

**Required**

None

**Related**

STP 21-1-SMCT

## DECONTAMINATE A CASUALTY

081-833-0095

**Conditions:** You are supervising the contaminated side of an established chemical decontamination station. Medical personnel and nonmedical augmentees are in MOPP level 4. Chemically contaminated casualties have been triaged by the senior medic and have been routed to your area for decontamination. Necessary materials and equipment: M258A1 or M291 decontamination kit, 5% chlorine solution, 0.5% chlorine solution, butyl rubber aprons, butyl rubber gloves, stainless steel buckets, cellulose sponges, water source, plastic bags, litters, litter stands, bandage scissors, M8 chemical detection paper, chemical agent monitor (CAM), contaminated disposal containers, bandages, gauze, and tourniquets.

**Standards:** Removed the casualty's clothing without further contaminating the casualty or contaminating decontamination team personnel. Removed dressings, replaced tourniquets, and decontaminated splints. Effectively decontaminated and transferred the casualty across the shuffle pit without contaminating the clean side of the hot line.

### Performance Steps

**NOTES:** 1. The supported unit must provide a minimum of 8 nonmedical personnel to augment the decontamination station as the decontamination team. Although casualty decontamination is routinely performed by these nonmedical personnel, the supervision of and final determination as to the completeness of the decontamination rests with medical personnel. 2. Steps 1 through 17 will be performed by personnel in the clothing removal area. At the clothing removal area two to four persons will be working together as a team, one or two on either side of the casualty.

1. Decontaminate the casualty's hood.
  - a. Cover the mask air inlets with your hand. Instruct the casualty to do this if he or she is able.
  - b. Wipe off the front, sides, and top of the hood with a cellulose sponge soaked with 5% calcium hypochlorite solution or use the M258A1 or M291 skin decontaminating kit.

**NOTE:** The medical equipment set (MES) for chemical agent patient decontamination contains powdered calcium hypochlorite (high test hypochlorite or HTH). It is mixed with water to make the 5% and 0.5% decontaminating solutions. Liquid chlorine bleach (household bleach), a 5% solution of sodium hypochlorite, may also be used.

- c. Uncover the mask air inlets.
2. Cut off the casualty's hood.

- a. Dip scissors in the 5% solution.

**CAUTION:** Dip and scrub the scissors in the 5% solution after each separate cutting procedure and rinse your gloves in the same solution in order to reduce the spread of contamination.

- b. Cut the neck cord.
  - c. Cut away the drawstring below the voicemitter.
  - d. Release or cut the hood shoulder straps.
  - e. Unzip the hood zipper.
  - f. Begin cutting at the zipper, below the voicemitter.
  - g. Proceed cutting upward, close to the filter inlet covers and eye lens outserts.
  - h. Cut upward to the top of the eye lens outserts.
  - i. Cut across the forehead to the outer edge of the next eye outsert.
  - j. Cut downward toward the patient's shoulder, staying close to the eye lens outserts and filter inlet covers.

### Performance Steps

- k. Cut across the lower part of the voicemitter to the zipper.
- l. Dip the scissors and rinse your gloves in the 5% solution.
- m. Cut from the center of the forehead, over the top of the head.
- n. Fold the left and right sides of the hood to the sides of the casualty's head, laying the sides of the hood on the litter.

- 3. Decontaminate the casualty's mask and exposed skin.
  - a. Use the M258A1 or M291 skin decontamination kit or 0.5% solution.
  - b. Cover the mask air inlets as in step 1a.

**CAUTION:** Use only the 0.5% solution to decontaminate the skin and the parts of the mask that touch the face. The 5% solution is corrosive and may burn the skin.

- c. Decontaminate the exterior of the mask.
  - d. Wipe down all the exposed skin areas, to include the neck and behind the ears.
  - e. Uncover the mask air inlets.
- 4. Remove the casualty's Field Medical Card (FMC).
    - a. Cut the FMC tie-wire, allowing the FMC to fall into a plastic bag. If possible, do not allow any of the tie-wire to remain attached to the card. This will prevent the wire from poking a hole in the bag.
    - b. Seal the plastic bag and rinse the plastic bag with the 0.5% solution.
    - c. Place the plastic bag under the protective mask head straps.
  - 5. Remove gross contamination on the overgarment by wiping all visible contamination spots with a sponge soaked in 5% solution.

- 6. Remove the casualty's protective overgarment jacket.

**CAUTION:** Dip and scrub the scissors in the 5% solution before doing each cutting procedure to avoid contaminating the inner garment or the casualty's skin.

- a. Cut the sleeves from the cuff up to the shoulder of the jacket, and then through the collar. Keep the cuts close to the inside of the arms so that most of the sleeve material can be folded outward.

**CAUTION:** Medical items are not removed at the clothing removal area. Cut around medical items such as dressings, splints, and tourniquets.

- b. Unzip the jacket (or cut alongside the jacket's zipper).
- c. Roll the chest sections to the respective sides, with the inner black liner outward. Carefully tuck the cut jacket between the arm and the chest.
- d. Roll the cut sleeves away from the arms, exposing the black liner.

- 7. Remove the casualty's protective overgarment trousers.

**CAUTION:** Dip and scrub the scissors in the 5% solution before doing each cutting procedure to avoid contaminating the inner garment or the casualty.

- a. Cut the trouser legs from the ankle to the waist. Keep the cuts near the insides of the legs, along the inseam, to the crotch.
  - (1) Cut up the right leg and across the crotch of the trousers.
  - (2) Cut up the left leg, cross over the crotch cut, and continue to cut up through the waistband.

**NOTE:** Avoid cutting through the pockets.

- b. Fold the cut trouser halves onto the litter with the contaminated sides away from the casualty. Make sure the outer side of the protective overgarment does not touch the skin or undergarments of the casualty.
- c. Roll the inner leg portion under and between the legs.

## Performance Steps

8. Remove the casualty's butyl rubber gloves.
  - a. Decontaminate your butyl rubber gloves in the 5% solution.
  - b. Lift the casualty's arm up and out of the cutaway sleeve unless contraindicated by the casualty's condition.
  - c. Pull the butyl rubber gloves off by rolling the cuff over the fingers, turning the glove inside out. Do not remove the white glove liners at this time.
  - d. Lower the casualty's arms and fold them across the chest.

**CAUTION:** Do not allow the arms to come into contact with the exterior of the protective overgarments.

- e. Place the gloves in a contaminated disposal container.
- f. Decontaminate your butyl rubber gloves in the 5% solution.

9. Remove the casualty's protective overboots.
  - a. Stand at the foot of the litter facing the casualty.
  - b. Cut the protective overboot laces.
  - c. Grasp the heel of the protective overboot with one hand and the toe of the protective overboot with the other hand.
  - d. Pull the heel downward, and then toward you until the overboot is removed.

**NOTE:** While you and another team member hold the casualty's raised feet, have a third member wipe down the end of the litter with the 5% solution before lowering the feet to the litter.

- e. Place the overboots in a contaminated disposal container.

10. Remove and secure the casualty's personal effects.
  - a. Remove the casualty's personal articles from the overgarment and BDU pockets.
  - b. Place the articles in plastic bags.
  - c. Label the bags with the casualty's name and SSN. (Print the information on a piece of paper and place the paper in the plastic bag.)
  - d. Seal the plastic bags.
  - e. If the articles are not contaminated, return them to the casualty. If the articles may be contaminated, place the bags in the contaminated holding area until they can be decontaminated. The articles will then be returned to the casualty.

11. Remove the combat boots following the same procedures as for removing the protective overboots.

**NOTE:** Remove the boots without touching the patient's inner clothing or exposed skin.

12. Cut off the casualty's battle dress uniform (BDU).

**CAUTION:** Decontaminate your butyl rubber gloves in the 5% solution before you touch the casualty's garments or exposed skin.

- a. Cut off the BDU shirt.
  - (1) Uncross the patient's arms.
  - (2) Cut the BDU shirt using the same procedure as for the protective overgarment jacket.
  - (3) Recross the casualty's arms over the chest.
- b. Unbuckle or cut the belt material.
- c. Cut off the BDU trousers following the same procedure as for the protective overgarment trousers.

13. Cut off the casualty's undergarments.

**CAUTION:** Decontaminate your butyl rubber gloves in 5% solution before you touch the casualty's garments or exposed skin.

### Performance Steps

- a. Cut off the underpants.
- b. Cut off the T-shirt.
- c. Cut off the brassiere, if necessary.
  - (1) Lift the casualty's arm off the chest.
  - (2) Cut between the cups.
  - (3) Cut both shoulder straps where they attach to the cup.
  - (4) Lay the cups away from the casualty onto the litter.
  - (5) Lay shoulder straps up and over the shoulders onto the litter.

**NOTE:** At this point, the white glove inner liners for a female may be removed while the casualty's arms are lifted off her chest.

14. Remove the casualty's glove inner liners.
    - a. Remove the glove liners using the same procedure as for removing butyl rubber gloves.
    - b. Cross the casualty's arms over the chest.
  15. Remove the casualty's socks.
    - a. Decontaminate your butyl rubber gloves in 5% solution.
    - b. Position yourself at the foot of the litter.
    - c. Remove each sock by rolling it down over the foot, turning it inside out or by cutting the sock off.
    - d. Place the socks into a contaminated disposal container.
  16. Decontaminate the casualty's ID tags.
    - a. Decontaminate your butyl rubber gloves in the 5% solution.
    - b. Wipe the ID tags with the 0.5% solution.
  17. Move the casualty to the skin decontamination area.
- CAUTION:** Observe proper body mechanics to avoid injury to your back. Use your legs instead of your back to lift the casualty.
- a. Decontaminate your butyl rubber aprons and gloves in the 5% solution.
  - b. Lift the casualty out of the cutaway garments, using a three person arms carry.
    - (1) Lifter #1 slides his or her arms (palms turned upward) under the casualty's head/neck and shoulders.
    - (2) Lifter #2 slides his or her arms (palms turned upward) under the casualty's back and buttocks.
    - (3) Lifter #3 slides his or her arms (palms turned upward) under the casualty's thighs and calves.
    - (4) On the command of Lifter, bearer #1, lift the casualty. (PREPARE TO LIFT: LIFT.)
  - c. Once the casualty has been lifted off the litter, all three lifters stand upright and turn the casualty in against their chests.

**NOTE:** At this point, the casualty has nothing on his or her body except the protective mask and medical items (dressings, splints, tourniquets).

- d. While the casualty is being held, another team member quickly removes the contaminated litter and replaces it with a clean litter. A decontaminatable mesh litter should be positioned, if available.
- e. Lower the casualty onto the clean litter, in a supine position, on the command of lifter #1.
- f. Carry the litter to the skin decontamination area, and then return to the clothing removal area.

**Performance Steps**

- g. Dispose of all contaminated material at the clothing removal area.
  - (1) The casualty's contaminated clothing is placed in a bag and put in a contaminated disposal container.
  - (2) The dirty litter is rinsed with the 5% decontamination solution and placed in a dirty litter storage area.

**CAUTION:** Before obtaining another casualty, the clothing removal team should rinse their gloves and aprons in the 5% decontaminating solution and drink enough water to compensate for the heat and workload.

**NOTE:** Steps 18 through 23 are performed by personnel in the skin decontamination area. At the skin decontamination area, two to four persons will be working together as a team, one or two on either side of the casualty.

18. Perform spot skin decontamination.
  - a. Spot decontaminate potential areas of chemical contamination with the M258A1 or M291 Skin Decontaminating Kit or the 0.5% solution.
  - b. Pay particular attention to areas where gaps exist in the MOPP gear, such as the neck, lower part of the face, waistline, wrists, and ankles.

19. Remove field dressings and bandages.

**NOTE:** This step must be performed by medical personnel.

- a. Carefully cut off dressings and bandages.
- b. Cut off any remaining clothing that was covered by the dressings and bandages.
- c. Decontaminate the exposed areas of skin with the 0.5% solution.
- d. Irrigate the wound with the 0.5% solution if the wound is suspected to be contaminated.

**NOTE:** Bandages are not replaced unless there is a critical medical need (for example, to control bleeding). Bandages are replaced when the casualty is in the clean (uncontaminated) treatment area.

- e. Place removed dressings and clothing in a contaminated disposal container.

20. Replace any tourniquets.

**NOTE:** Medical personnel must perform this step.

- a. Decontaminate an area above the existing tourniquet.
- b. Place a new tourniquet 1/2 to 1 inch above the old tourniquet.
- c. Remove the old tourniquet.
- d. Remove any remaining clothing or dressings covered by the old tourniquet.
- e. Decontaminate the newly exposed areas.
- f. Place the removed tourniquet, dressings, and clothing in a contaminated disposal container.

21. Decontaminate any splints.

**NOTE:** Splints are only removed by a physician.

- a. Stabilize the splinted extremity.
- b. Decontaminate the splint and the extremity by liberally flushing them with the 0.5% solution.

**CAUTION:** Do not remove any part of a traction splint from a femoral fracture.

22. Check the casualty for contamination.

- a. Use M8 chemical agent detector paper or the chemical agent monitor (CAM).
- b. Decontaminate any areas of detected contamination, as necessary.



**Performance Steps**

**CAUTION:** Under no circumstances should a casualty who has not been entirely decontaminated be moved across the hot line. If a wound or splinted area cannot be entirely decontaminated, inform the senior medic. Do not move the casualty across the hot line. He must be treated on the contaminated side of the casualty decontamination station.

23. Transfer the casualty to the shuffle pit.
  - a. Personnel decontaminate themselves by rinsing their butyl rubber gloves and apron with the 5% solution.
  - b. Carry the patient to the shuffle pit on the skin decontamination litter.
  - c. Place the litter on the litter stand located in the shuffle pit.
  - d. Lift the casualty from the decontamination litter using the same technique described in step 17.
  - e. Remove the decontamination litter from the stand and a medic from the clean side will replace it with a clean litter.
  - f. Lower the casualty onto the clean litter and move back from the hot line.

**NOTE:** Do not step across the hot line. Personnel from the clean side of the hot line will take the casualty to the clean treatment station.

**Performance Measures**

	<u>GO</u>	<u>NO GO</u>
1. Decontaminated the casualty's hood.	_____	_____
2. Cut off the casualty's hood.	_____	_____
3. Decontaminated the casualty's mask and exposed skin.	_____	_____
4. Removed the casualty's Field Medical Card (FMC).	_____	_____
5. Removed gross contamination.	_____	_____
6. Removed the casualty's protective overgarment jacket.	_____	_____
7. Removed the casualty's protective overgarment trousers.	_____	_____
8. Removed the casualty's butyl rubber gloves.	_____	_____
9. Removed the casualty's protective overboots.	_____	_____
10. Removed and secured the casualty's personal effects.	_____	_____
11. Removed the casualty's combat boots.	_____	_____
12. Removed the casualty's battle dress uniform (BDU).	_____	_____
13. Cut off the casualty's undergarments.	_____	_____
14. Removed the casualty's glove inner liners.	_____	_____
15. Removed the casualty's socks.	_____	_____
16. Decontaminated the casualty's ID tags.	_____	_____
17. Moved the casualty to the skin decontamination area.	_____	_____
18. Performed spot skin decontamination.	_____	_____

**Performance Measures**

	<u>GO</u>	<u>NO</u> <u>GO</u>
19. Removed field dressings and bandages.	_____	_____
20. Replaced any tourniquets.	_____	_____
21. Decontaminated any splints.	_____	_____
22. Checked the casualty for contamination.	_____	_____
23. Transferred the casualty to the shuffle pit.	_____	_____

**Evaluation Guidance:** Score each soldier according to the performance measures in the evaluation guide. Unless otherwise stated in the task summary, the soldier must pass all performance measures to be scored GO. If the soldier fails any steps, show what was done wrong and how to do it correctly.

**References**

**Required**  
None

**Related**  
STP 21-1-SMCT

Subject Area 11: Shock

**INITIATE TREATMENT FOR HYPOVOLEMIC SHOCK**

**081-833-0047**

**Conditions:** You are in the field and are assessing a casualty who is suffering from a severe loss of body fluids. All other more serious injuries have been treated. Necessary materials and equipment: intravenous (IV) infusion set, IV fluids, splints, stethoscope, sphygmomanometer, and a blanket or poncho.

**Standards:** Initiated treatment for hypovolemic shock, stabilized the casualty, minimized the effect of shock, and prepared for immediate evacuation without further injury to the casualty.

**Performance Steps**

*NOTE:* Hypovolemic shock results when there is a decrease in the volume of circulating fluids (blood and plasma) in the body. If dehydration (loss of body water) is present at the time of injury, shock will develop more rapidly.

1. Maintain the airway.

*NOTE:* Administer oxygen, if available. (See task 081-833-0019).

2. Reassure the casualty to reduce anxiety.

*NOTE:* Anxiety increases the heart rate, which worsens the casualty's condition.

3. Initiate two large bore (16 gauge) IVs. (See task 081-833-0033).

*NOTE:* To replace fluid loss accompanying injury, Ringer's lactate is the fluid of choice. Normal saline is the second choice.

4. Maintain the IV flow.

- a. Continue the flow wide open until the systolic blood pressure stabilizes at greater than 90 mm Hg.

- (1) The usual amount is 1 to 2 liters of fluid or 300 ml for each 100 ml of blood loss.

- (2) A palpable radial pulse usually indicates that the casualty has a systolic blood pressure of about 80 mm Hg.

- b. Once the blood pressure has stabilized, decrease the IV flow rate to maintain the systolic blood pressure above 90 mm Hg.

5. Elevate the casualty's legs.

- a. Elevate the casualty's legs above chest level, without lowering the head below chest level.

*NOTE:* Splint leg or ankle fractures before elevating the legs, if necessary.

- b. If the casualty is on a litter, elevate the foot of the litter.

6. Maintain normal body temperature.

- a. Watch for signs of sweating or chilling.

- b. Cover the casualty in cold weather.

- c. Do not cover the casualty in hot weather unless signs of chilling are noted.

7. Monitor the casualty.

*NOTE:* Give nothing by mouth. Moisten the casualty's lips with a wet cloth.

- a. Check vital signs every 5 minutes until they return to normal, and then check every 15 minutes.

**Performance Steps**

- b. Check the casualty's level of consciousness.
- c. Check capillary refill.

*NOTE:* If the blood pressure is unstable or drops, the pneumatic anti-shock garment should be applied by qualified personnel.

- 8. Record the procedure on the Field Medical Card.
- 9. Evacuate the casualty.

**Evaluation Preparation:**

Setup: For training and evaluation, have another soldier act as the casualty. For step 3, have the soldier state what actions are taken when an IV infusion is initiated.

Brief soldier: Tell the soldier to initiate treatment for hypovolemic shock.

**Performance Measures**

	<u>GO</u>	<u>NO GO</u>
1. Maintained the airway.	_____	_____
2. Reassured the casualty to reduce anxiety.	_____	_____
3. Initiated two large bore IVs.	_____	_____
4. Maintained the IV flow.	_____	_____
5. Elevated the casualty's legs.	_____	_____
6. Maintained normal body temperature.	_____	_____
7. Monitored the casualty.	_____	_____
8. Recorded the procedure on the Field Medical Card.	_____	_____
9. Evacuated the casualty.	_____	_____

**Evaluation Guidance:** Score each soldier according to the performance measures in the evaluation guide. Unless otherwise stated in the task summary, the soldier must pass all performance measures to be scored GO. If the soldier fails any step, show what was done wrong and how to do it correctly.

**References**

**Required**  
None

**Related**  
BTLS FOR PARAMEDICS  
EMERGENCY CARE

## APPLY PNEUMATIC ANTI-SHOCK GARMENT

081-833-3011

**Conditions:** A soldier has signs or symptoms of shock. Life saving measures have been completed, but the casualty has not responded to treatment for shock. Another soldier is available to assist. Necessary materials and equipment: pneumatic anti-shock garment, backboard, watch, stethoscope, and sphygmomanometer.

**Standards:** Applied the pneumatic anti-shock garment without causing further injury to the casualty. Completed all steps in order.

### Performance Steps

**WARNINGS:** 1. Do not use the pneumatic anti-shock garment for psychogenic, anaphylactic, or septic shock. Do not apply the pneumatic anti-shock garment if the casualty's injury will be further aggravated by the pneumatic anti-shock garment, for example if the casualty has a protruding, impaled object such as a stick or a knife in the leg or abdomen, or an open fracture of a lower extremity. 2. If the pneumatic anti-shock garment is applied incorrectly, death could result. 3. The pneumatic anti-shock garment should not be used without direction of a physician if: a. Trauma involves significant head injury, b. Bleeding into the chest or chest wound is present, c. The casualty is in heart failure with pulmonary edema, d. Trauma is above the level of the pneumatic anti-shock garment application, e. Pregnancy exists or is suspected, f. Aortic aneurysm is suspected. 4. If the casualty has an injury to which you must have access, do not apply the pneumatic anti-shock garment to the injury. 5. If the femur of either leg is fractured, a traction splint should be applied before the pneumatic anti-shock garment is applied.

1. Open the pneumatic anti-shock garment kit and remove the trousers and accessories.

**NOTE:** There are several different models of pneumatic anti-shock garments. The models may have one, two, or three chambers. Follow the manufacturer's instructions on the pneumatic anti-shock garment container.

2. Unfold the pneumatic anti-shock garment and unfasten the Velcro closures.

**NOTE:** The use of a back board under the pneumatic anti-shock garment will help in positioning the trousers. The backboard will have the effect of splinting the whole body.

3. Lay the trousers flat.

- a. Unfold the trousers so the left leg of the pneumatic anti-shock garment overlaps the right leg.
- b. Ensure that the outside Velcro fasteners face the ground and that the valves are on the outside adjacent to the ground.
- c. If there is sufficient space below the casualty's feet, lay the trousers out with the leg sections in the same direction as the casualty's legs.
- d. If there is insufficient space below the casualty's feet, lay the trousers beside the casualty with the leg sections in the same direction as the casualty's legs. Position the top of the trousers just below the casualty's lowest rib.

**CAUTION:** To prevent squeezing the chest of an extremely short casualty, slide the trousers past the lowest rib and do not use the abdominal section.

**NOTE:** If there are sharp objects in the casualty's pants, remove them before applying the pneumatic anti-shock garment.

4. Place the casualty on the trousers in the supine position.

### Performance Steps

**NOTE:** Restrictive or bulky clothing could prevent pneumatic anti-shock garment application from stabilizing the casualty. Cut away any clothing which will interfere with the trousers.

**WARNING:** If a back injury is suspected, log-roll the casualty onto the pneumatic anti-shock garment.

- a. Lift the casualty's legs high enough to slide the trousers underneath.
- b. Slide the trousers under the casualty's legs and up to the buttocks area.
- c. Lift the casualty's buttocks high enough to slide the trousers under the buttocks.
- d. Slide the pneumatic anti-shock garment up toward the casualty's waist. Position the garment so the top of the trousers is just below the casualty's lowest rib.

**WARNING:** Do not lift the casualty any higher than is absolutely necessary. If the casualty has a pelvic injury or a traction splint, serious injury or extreme discomfort can result when the pneumatic anti-shock garment is applied to the casualty. With this type of injury the medic should position the casualty and direct the assistant to slide the trousers into position.

#### 5. Wrap the casualty's legs.

**NOTE:** Either of the casualty's legs may be wrapped first; however, normally the left leg is wrapped first.

- a. Wrap the pneumatic anti-shock garment around the casualty's leg.
- b. Smooth the leg of the pneumatic anti-shock garment around the casualty's leg.
- c. Align the Velcro strips.
- d. Press the Velcro strips firmly together to secure the seam of the trouser leg.
- e. Repeat steps 5a through 5d for the other leg.

#### 6. Apply the abdominal section of the pneumatic anti-shock garment.

- a. Wrap the abdominal section of the pneumatic anti-shock garment.
- b. Align the Velcro strips.
- c. Press the Velcro strips firmly together to secure the pneumatic anti-shock garment.

#### 7. Attach the foot pump hoses.

- a. Connect each short tube on the pump to a leg tube on the trousers using a twisting motion.
- b. Connect the long tube on the foot pump to the abdominal section using a twisting motion.

#### 8. Inflate the leg sections of the trousers.

**CAUTION:** Do not inflate the pneumatic anti-shock garment if the casualty's systolic blood pressure is higher than 90 mm Hg.

- a. Open the stopcock valve on each leg section by turning the valve knob to the "OPEN" position.

**NOTE:** Ensure that the stopcock valve to the abdominal section is closed.

- b. Check the casualty's vital signs and foot (pedal) pulses while inflating the leg section.
- c. Close the stopcock valve to the leg section(s).
- d. Continue inflation until the air release valves open, or until the Velcro starts to crackle or stretch apart.

#### 9. Inflate the abdominal section, if necessary.

**NOTE:** If inflation of the leg sections alone was not adequate to stabilize the casualty, the abdominal section should be inflated.

- a. Open the stopcock valve to the abdominal section.
- b. Inflate the abdominal section following the same procedure used for the leg sections.
- c. Recheck the vital signs.
- d. Close the stopcock valve to the abdominal section

**Performance Steps**

10. Initiate an IV using Ringer's lactate, if not already done.
11. Monitor the casualty's blood pressure to ensure it remains stable.
12. Monitor the pneumatic anti-shock garment pressure.
  - a. If the pneumatic anti-shock garment looks and feels soft, reinflate it until the Velcro strips start to stretch apart.
  - b. Stop inflating the pneumatic anti-shock garment if a loud, constant sound is heard coming from the air release valve.

*NOTE:* A loud, constant sound coming from the air release valve indicates the pneumatic anti-shock garment is overinflated.

**CAUTIONS:** 1. Do not remove the pneumatic anti-shock garment until ordered to do so by a physician. 2. If the casualty must be evacuated by air, it should be done at a low altitude and at low pneumatic anti-shock garment pressure.

**Evaluation Preparation:**

Setup: For training and evaluation, a mannequin will be used. Under no circumstances will another soldier act as a simulated casualty. Select a scenario that will allow you to evaluate the soldier.

Brief soldier: Tell the soldier to apply the pneumatic anti-shock garment. Ask the soldier to describe and explain his actions.

<b>Performance Measures</b>	<u><b>GO</b></u>	<u><b>NO GO</b></u>
1. Opened the pneumatic anti-shock garment kit and removed the trousers and accessories.	—	—
2. Opened the folded trousers and unfastened the Velcro closures.	—	—
3. Laid the trousers flat.	—	—
4. Placed the casualty in the supine position on the trousers.	—	—
5. Wrapped the casualty's legs.	—	—
6. Applied the abdominal section of the pneumatic anti-shock garment.	—	—
7. Attached the foot pump hoses.	—	—
8. Inflated the leg sections.	—	—
9. Inflated the abdominal section, if necessary.	—	—
10. Monitored the casualty's blood pressure.	—	—
11. Initiated an IV, if not already done.	—	—
12. Monitored the pneumatic anti-shock garment pressure.	—	—
13. Did all steps in order.	—	—
14. Did not cause unnecessary injury to the casualty.	—	—

**Evaluation Guidance:** Score each soldier according to the performance measures in the evaluation guide. Unless otherwise stated in the task summary, the soldier must pass all performance measures to be scored GO. If the soldier fails any step, show what was done wrong and how to do it correctly.

**References****Required**

None

**Related**BTLS FOR PARAMEDICS  
EMERGENCY CARE



Subject Area 12: Urinary Catheterization

**INSERT A URINARY CATHETER**

**081-833-3017**

**Conditions:** You have verified a doctor's order to insert a urinary catheter. The patient has been draped and all equipment has been prepared. You are wearing sterile gloves. Necessary materials and equipment: a container for contaminated waste.

**Standards:** Inserted a urinary catheter without violating aseptic technique or causing further injury to the patient.

**Performance Steps**

1. Clean the urinary meatus with the prepared cotton balls or swabs.

*NOTE:* Cotton balls should be held with forceps.

- a. Females.

- (1) Gently spread the labia open with the nondominant hand.

*NOTE:* This hand is now considered contaminated.

- (a) Place the thumb and forefinger between the labia minora.

- (b) Separate the labia and pull up slightly.

- (2) With the dominant hand, clean the labia with cotton balls or swabs, moving from the clitoris toward the anus.

- (3) Use a cotton ball or swab to clean down the center, directly over the urinary meatus.

- (4) Keep the labia spread throughout the remainder of the procedure.

- b. Males.

- (1) Support the penis with the nondominant hand.

*NOTE:* This hand is now considered contaminated.

- (2) With the dominant hand, clean the penis with a cotton ball or swab, moving in a circular motion from the urinary meatus toward the base of the penis.

- (3) Repeat the procedure, using a second and third cotton ball or swab.

2. Lubricate the catheter.

- a. Pick up the catheter with the dominant hand about 4 inches from the tip.

- b. Keep the distal end of the catheter coiled in the palm of the hand.

- c. Apply lubricant to the catheter tip.

3. Instruct the patient to relax and breathe through the mouth.

4. Insert the catheter.

- a. Female.

- (1) Gently insert the catheter into the urethra about 2 to 3 inches until resistance is met.

- (2) Continue to advance the catheter until urine begins to flow (about 2 to 3 inches further).

- (3) Release the labia and hold the catheter securely with the nondominant hand.

- (4) Place the distal end of the catheter in the collection basin.

*NOTE:* If the vagina is inadvertently catheterized, do not remove the catheter. Assemble new equipment and repeat the procedure. Leaving the first catheter in place temporarily will prevent catheterizing the vagina a second time.

**Performance Steps**

## b. Male.

- (1) Draw the penis upward and forward to a 60 to 90 degree angle to the legs.
- (2) Gently insert the catheter into the urethra, advancing it about 7 to 8 inches or until resistance is felt.
- (3) Continue to advance the catheter until urine begins to flow (about 2 to 3 inches further).
- (4) Lower the penis and hold the catheter securely with the nondominant hand, resting the hand on the patient's pubis for support.
- (5) Place the distal end of the catheter in the collection basin.

**NOTE:** With some commercially prepared catheterization kits, the catheter is preconnected to the drainage tubing of the collecting bag.

## 5. Obtain a urine specimen, if ordered.

- a. Place the sterile specimen container from the kit into the collection basin.
- b. Pinch the catheter with the nondominant hand to stop urine flow.
- c. With the dominant hand, pick up the distal end of the catheter and hold it over the specimen container.
- d. Release the pinch and allow sufficient urine to drain into the specimen container (about 30 cc).
- e. Repinch the catheter, place the distal end into the collection basin, and release the pinch, allowing the urine to flow.
- f. Place the lid on the specimen container and set it aside.

**NOTE:** If using a commercial kit with the catheter and drainage set preconnected, do not disconnect the catheter to obtain a specimen. Obtain the specimen from the drainage bag at the end of the procedure. The first specimen taken from a new sterile drainage set is considered sterile.

## 6. Inflate the balloon if an indwelling catheter has been inserted.

- a. Inflate the balloon with the water in the prefilled syringe.

**NOTE:** If the balloon is difficult to inflate, advance the catheter another 1/2 to 1 inch to ensure that the catheter tip is fully within the bladder.

- b. Tug gently on the catheter to ensure that the balloon is fully inflated and seated in the bladder.
- c. Remove the syringe from the catheter using a twisting motion.

## 7. Attach the distal end of the catheter to the drainage tubing of the collection set, if not preconnected by the manufacturer.

## 8. Remove the drapes and gloves.

## 9. Tape the catheter in place.

- a. Female--to the inner thigh.
- b. Male--to the abdomen or inner thigh.

**NOTE:** The penis may be positioned up or down (facing the patient's head or feet), depending upon the patient's diagnosis, the physician's order, and/or the patient's comfort preference.

## 10. Secure the drainage bag to the side of the bed on the bottom of the bed frame.

**CAUTION:** Do not secure the drainage bag to the bed siderails or loop the drainage tubing over or through the siderails.

## 11. Reposition the patient.

## 12. Dispose of the used equipment and clean the area.

**Performance Steps**

*NOTE:* Destroy the syringe and dispose of it IAW local SOP for infectious waste.

13. Report and record the procedure.

**Performance Measures**

	<u>GO</u>	<u>NO GO</u>
1. Cleaned the urinary meatus with the prepared cotton balls or swabs.	_____	_____
2. Lubricated the catheter.	_____	_____
3. Instructed the patient to relax and breathe through the mouth.	_____	_____
4. Inserted the catheter.	_____	_____
5. Obtained a urine specimen, if ordered.	_____	_____
6. Inflated the balloon if an indwelling catheter has been inserted.	_____	_____
7. Attached the distal end of the catheter to the drainage tubing of the collection set, if not preconnected by the manufacturer.	_____	_____
8. Removed the drapes and gloves.	_____	_____
9. Taped the catheter in place.	_____	_____
10. Secured the drainage bag to the side of the bed on the bottom of the bed frame.	_____	_____
11. Repositioned the patient.	_____	_____
12. Disposed of the used equipment and cleaned the area.	_____	_____
13. Reported and recorded the procedure.	_____	_____
14. Did not violate aseptic technique.	_____	_____
15. Did not cause further injury to the patient.	_____	_____

**Evaluation Guidance:** Score each soldier according to the performance measures in the evaluation guide. Unless otherwise stated in the task summary, the soldier must pass all performance measures to be scored GO. If the soldier fails any step, show what was done wrong and how to do it correctly.

**References**

**Required**  
None

**Related**  
BASIC NURSING

**MAINTAIN AN INDWELLING URINARY CATHETER**  
**081-835-3010**

**Conditions:** You have a patient with a urinary catheter in place. You have performed a patient care handwash and have explained the procedure to the patient. Necessary materials and equipment: a basin of water, soap, a hand towel, a wash cloth, antibacterial ointment, protective pads, 4 X 4 gauze, clamps, a drainage set, gloves, sterile needle and syringe, sterile specimen container, thermometer, DD Form 792, and the patient's clinical record.

**Standards:** Performed catheter care and maintained the indwelling catheter without contaminating the equipment or causing further injury to the patient.

**Performance Steps**

1. Provide privacy for the patient.
2. Perform a patient care handwash (see task 081-831-0007).
3. Place the patient in a comfortable position for catheter care.
  - a. If the patient is awake and alert, place him or her in the semi-Fowler's position.
  - b. If the patient is unconscious, place him or her in the supine position.

**NOTE:** Catheter care should be performed as a part of the normal morning and evening patient care, and as necessary.

4. Inspect the catheter, drainage tubing, all connections, and the drainage bag for cracks, leaks, kinks, or obstruction of drainage.

**CAUTION:** Wears gloves for self-protection against the transmission of contaminants whenever handling body fluids.

5. Observe the urinary meatus and the surrounding area for erythema, and leakage of urine.
6. Clean the urinary meatus and the surrounding area with a cleaning solution (IAW local SOP), rinse thoroughly, and blot dry.

**NOTE:** Apply antibacterial ointment to the urinary meatus only if ordered by the physician or IAW local SOP.

7. Ensure that the catheter is secured to the patient without causing pressure within the bladder.
  - a. Tape the catheter to the skin of the inner thigh for a female patient.
  - b. Tape the catheter to the skin of the lower abdomen or inner thigh for a male patient.

**NOTE:** The penis may be positioned up or down (facing the patient's head or feet), depending upon the patient's diagnosis, the physician's order, and/or the patient's comfort preference.

8. Maintain patency of the drainage tubing.
  - a. Keep the tubing free from kinks and twists.
  - b. Keep the tubing free of pressure caused by bed rails, mattress, or the patient's body.
  - c. Keep the tubing above the level of the drainage bag to ensure free gravity drainage.

9. Maintain the correct position of the drainage bag at all times.
  - a. Hang the drainage bag from the bed frame, not the bed rails.
  - b. Do not allow the drainage bag to rest on the floor.

**CAUTION:** The drainage bag must be kept below the level of the patient's bladder to prevent urinary reflux. If the bag must be raised to bladder level for any reason, it must be clamped first.

**Performance Steps**

10. Assess the patient for indications of urinary tract infections: chills, fever, back or flank pain, hematuria, and cloudy or foul smelling urine.

*NOTE:* If a urinary tract infection is suspected, collect a urine specimen for culture.

- 11. Collect a sterile urine specimen without contaminating or disconnecting the closed system.
  - a. Clamp off the drainage tubing just below the aspiration port.
  - b. Wait until a sufficient quantity of urine has pooled above the aspiration port (about 15 minutes).

*NOTE:* Post a sign at the patient's bed indicating the urinary drainage system is temporarily clamped off.

- c. Swab the aspiration port with alcohol.
- d. Withdraw the desired amount of urine using a sterile needle and syringe.
- e. Remove the clamp from the drainage tubing.
- f. Transfer the urine in the syringe to a sterile specimen container.

12. Irrigate the catheter with the prescribed sterile solution IAW the physician's orders.

- 13. Empty the drainage bag.
  - a. Empty the drainage bag without disconnecting or contaminating the closed system.
  - b. Measure and discard, or save, the urine as indicated by the physician's orders.

*NOTE:* The drainage bag must be emptied before it overfills to prevent reflux of urine into the drainage tubing.

14. Replace the urinary bag and tubing IAW local SOP.

15. Perform a patient care handwash (see task 081-831-0007).

16. Maintain an accurate I & O record (see task 081-833-0006).

17. Document the procedure and all significant nursing observations on the appropriate forms IAW local SOP.

**Performance Measures**

	<u>GO</u>	<u>NO GO</u>
1. Provided privacy for the patient.	_____	_____
2. Performed a patient care handwash.	_____	_____
3. Placed the patient in a comfortable position for catheter care.	_____	_____
4. Inspected the catheter, drainage tubing, all connections, and the drainage bag for cracks, leaks, kinks, or obstruction of drainage.	_____	_____
5. Observed the urinary meatus and the surrounding area for erythema, and leakage of urine.	_____	_____
6. Cleaned the urinary meatus and the surrounding area IAW local SOP, rinsed thoroughly, and blotted dry.	_____	_____
7. Ensured that the catheter was secured to the patient without causing pressure within the bladder.	_____	_____
8. Maintained patency of the drainage tubing.	_____	_____

<b>Performance Measures</b>	<b><u>GO</u></b>	<b><u>NO</u> <u>GO</u></b>
9. Maintained the correct position of the drainage bag at all times.	—	—
10. Assessed the patient for indications of urinary tract infections: chills, fever, back or flank pain, hematuria, and cloudy or foul smelling urine.	—	—
11. Collected a sterile urine specimen without contaminating or disconnecting the closed system.	—	—
12. Irrigated the catheter with the prescribed sterile solution IAW the physician's orders.	—	—
13. Emptied the drainage bag.	—	—
14. Replaced the urinary bag and tubing IAW local SOP.	—	—
15. Replaced the urinary catheter IAW local SOP.	—	—
16. Performed a patient care handwash.	—	—
17. Maintained an accurate I & O record.	—	—
18. Documented the procedure and all significant nursing observations on the appropriate forms IAW local SOP.	—	—

**Evaluation Guidance:** Score each soldier according to the performance measures in the evaluation guide. Unless otherwise stated in the task summary, the soldier must pass all performance measures to be scored GO. If the soldier fails any step, show what was done wrong and how to do it correctly.

**References**  
**Required**  
 None

**Related**  
 BASIC NURSING

Subject Area 13: Gastric Intubation

**INSERT A NASOGASTRIC TUBE**

**081-833-3022**

**Conditions:** You have a doctor's order to insert a nasogastric tube. Necessary materials and equipment: handwashing facilities, water soluble lubricant, stethoscope, 10 cc syringe, nasogastric tube, container for contaminated waste, a 50 cc syringe, stethoscope, adhesive tape, gloves, a cup containing water, and a straw.

**Standards:** Inserted a nasogastric tube without causing further injury to the patient.

**Performance Steps**

1. Assemble equipment.
2. Explain the procedure to the patient.
  - a. Tell the patient that a tube will be inserted along the nasal passage.
  - b. Explain that the procedure may cause him or her to gag and bring tears to his or her eyes.
  - c. Explain that mouth breathing, panting, and swallowing will make it easier to insert the tube.
  - d. Ask about any history of nasal injury or septal deviation.
3. Wash hands and take body substance isolation procedures.
4. Position the patient.
  - a. If the patient is responsive, awake, and alert, place him or her in the Fowler's position (elevate the bed to approximately a 30 to 45 degree angle).
  - b. If the patient is unconscious, place him or her on the left side with the uppermost arm flexed across the abdomen or supported on the body and hip.
5. Measure the tube for insertion.
  - a. Use the tip to measure from the tip of the nose to the tip of the earlobe.
  - b. Measure from the tip of the earlobe to the xiphoid process.
  - c. Mark the total length with a piece of tape or an indelible marker.
6. Cut a piece of tape about 4 inches long and split one half of it into two pieces so that it forms a Y.
7. Curve the end of the tube (about 4 to 6 inches) tightly around your fingers, hold for a few seconds, and then release.

**NOTE:** This reduces the stiffness of the tube.

8. Lubricate about 4 inches of the end of the tube with a water soluble lubricant.
9. Perform a patient care handwash and put on gloves.

**WARNING:** Wear gloves for self-protection against transmission of contaminants whenever handling body fluids.

10. Insert the lubricated tip of the tube into the selected nostril.
11. Advance the tube into the nostril.

**Performance Steps**

- a. Gently rotate the tube at the point where the nostril drops into the pharynx, if necessary.
- b. Instruct the patient to swallow to aid advancement of the tube.

*NOTE:* The patient may take sips of water through a straw, if permitted.

- c. Advance the tube 3 to 5 inches with each swallow.

**CAUTIONS:** 1. Do not force advancement of the tube. 2. Remove the tube completely and relubricate it if the patient chokes, coughs, or if resistance is felt. Allow the patient to rest for 2 to 3 minutes and repeat the procedure. If a second attempt at insertion fails, notify the doctor immediately.

- 12. Continue advancing the tube until the tape marker touches the nostril.
- 13. Check the placement of the tube.
  - a. Aspiration.
    - (1) Attach a syringe to the end of the tube. (If a bulb syringe is used, the bulb must be depressed prior to attaching it to the tube.)
    - (2) Aspirate the stomach contents.

*NOTE:* The presence of stomach contents in the tube or syringe indicates correct placement.

  - (3) Remove the syringe.
  - b. Auscultation.
    - (1) Position the diaphragm of the stethoscope over the patient's stomach (about 2 inches below the sternum).
    - (2) Inject 10 cc of air into the tube.
    - (3) Listen for the sound of the air entering the stomach (gurgling or whooshing sound) which indicates correct tube placement. Proceed to step 14 if placement is correct.
    - (4) Check for tube placement in the trachea if air is not heard entering the stomach.
      - (a) Reinject 10 cc of air into the tube.
      - (b) Auscultate over the lung field.
      - (c) Remove the tube if air injection is heard over the lungs.
    - (5) Repeat steps 10 through 13b(3) to insert the tube.
- 14. Secure the tube to the patient's nose with the tape and wrap the two ends of tape around the tube.
- 15. Connect the tube to the suction apparatus, if ordered.
- 16. Remove gloves and wash hands.
- 17. Report and record the procedure.

**Performance Measures**

	<u>GO</u>	<u>NO</u> <u>GO</u>
1. Assembled equipment.	—	—
2. Explained the procedure to the patient.	—	—
3. Washed hands and took body substance isolation precautions.	—	—
4. Positioned the patient.	—	—
5. Measured the tube for insertion.	—	—



<b>Performance Measures</b>	<u><b>GO</b></u>	<u><b>NO GO</b></u>
6. Cut a piece of tape about 4 inches long and split one half of it into two pieces so that it formed a Y.	—	—
7. Curved the end of the tube (about 4 to 6 inches) tightly around the fingers, held it for a few seconds, and then released it.	—	—
8. Introduced the lubricated tip of the tube into the selected nostril.	—	—
9. Advanced the tube into the nostril.	—	—
10. Continued advancing the tube until the tape marker touched the nostril.	—	—
11. Checked the placement of the tube.	—	—
12. Secured the tube to the patient's nose with the tape and wrapped the two ends of tape around tube.	—	—
13. Connected the tube to the suction apparatus, if ordered.	—	—
14. Removed gloves and washed hands.	—	—
15. Reported and recorded the procedure.	—	—
16. Did not cause further injury to the patient.	—	—

**Evaluation Guidance:** Score each soldier according to the performance measures in the evaluation guide. Unless otherwise stated in the task summary, the soldier must pass all performance measures to be scored GO. If the soldier fails any step, show what was done wrong and how to do it correctly.

**References**

**Required**  
None

**Related**  
BASIC NURSING

## PERFORM A GASTRIC LAVAGE

### 081-835-3005

**Conditions:** You have verified a physician's orders requiring a gastric lavage. A patient care handwash been performed. Necessary materials and equipment: Ewald tube, nasogastric tubes, water-soluble lubricant, 50 cc catheter-tip syringes, basins, protective pads, towels, sphygmomanometer, stethoscope, thermometer, graduated containers, ice, prescribed lavage solution, gloves, and the patient's clinical record.

**Standards:** Performed the gastric lavage in accordance with the physician's orders and without causing further injury to the patient.

### Performance Steps

1. Assemble the necessary equipment and set it up at the patient's bedside.
  - a. Ensure that there is enough irrigating solution on hand.

*NOTE:* In most cases, the physician's order will be to lavage "until clear". Lavage will continue until the stomach contents return clear (nothing is returned but the irrigating solution itself). This requires preparation of at least 6 liters of the prescribed irrigating solution (usually normal saline).

- b. Ensure that ice or chilled solution is available when the physician orders "ice lavage".

*NOTE:* When lavage is done to control gastric bleeding, the order is usually for "ice lavage". Chilling the irrigating solution promotes vasoconstriction, thereby helping to control bleeding.

2. Explain the procedure to the patient.
3. Establish baseline vital signs.
4. Position the patient.
  - a. A patient who is alert should be placed in the Fowler's or semi-Fowler's position.
  - b. A patient who is not alert, or too weak to sit, should be positioned on the left side, with the head of the bed elevated 15 degrees.

*NOTE:* This left lateral recumbent position will allow the tip of the tube to lie in the greater curvature of the stomach.

5. Insert the appropriate tube if one is not already in place.
  - a. For a stomach wash, the physician will specify insertion of large lumen nasogastric tube or the Ewald stomach tube.

*NOTE:* The Ewald stomach tube is normally inserted through the mouth rather than the nose, because it is a large bore tube.

- b. For control of gastric bleeding, the physician will specify insertion of a large lumen nasogastric tube.
  - c. In the event of severe bleeding, as in the case of esophageal varices, the physician will specify insertion of a nasogastric tube that has gastric and esophageal balloons (Blakemore tube, for example).

*NOTE:* In any situation, a large lumen tube is indicated. Particles of food, mucous, or blood may occlude the lumen of a small tube.

**CAUTION:** Gloves should be worn for self-protection against transmission of contaminants whenever handling body fluids.

## Performance Steps

6. Aspirate all stomach contents.
  - a. Using a 50 cc syringe, aspirate stomach contents and place the aspirate in a measured container.
  - b. Repeat until all stomach contents have been aspirated.
  - c. Record the total amount as output on the I & O worksheet.
  - d. Save the aspirate for disposition as directed by the physician.
7. Instill the irrigating solution, using the method specified by the physician's orders or local SOP.
  - a. Syringe method. Using a 50 cc catheter-tip syringe, instill 100 cc of the solution. (Instillation and withdrawal are repeated 100 cc at a time, until clear or IAW physician's orders).
  - b. Funnel method. Using a funnel (or syringe barrel), instill up to 500 cc of the solution by pouring it slowly into the funnel.

**CAUTION:** When using the funnel method, it is imperative that the patient be carefully assessed for abdominal distention. The size and tolerance of the patient will determine how much fluid can be instilled at one time.

8. Withdraw the irrigating solution.
  - a. Syringe method.
    - (1) Using a 50 cc catheter-tip syringe, withdraw all the irrigating solution and stomach contents.
    - (2) Place the aspirate into a measured container.
    - (3) Note the amount and character of the aspirate.

**NOTE:** If syringe aspiration is difficult, or no aspirate can be obtained, the gastric tube may be resting against the gastric mucosa. Reposition the patient and aspirate again. If aspiration is still difficult, reposition the tube by advancing or withdrawing it slightly.

- b. Funnel method.
  - (1) Lower the funnel end of the tube below the level of the patient's stomach to facilitate gravity drainage.

**NOTE:** If the solution does not begin to drain by gravity, aspirate with a syringe (creating a siphon effect) to start the backflow of solution. If gravity drainage cannot be established, withdraw the solution by the syringe method.

- (2) Allow the irrigating solution and stomach contents to drain into a measured container.
- (3) Note the amount and character of the return solution.

9. Continue the lavage by repeating steps 7 and 8 in accordance with the physician's orders. That is, continue until the stomach contents are clear, the prescribed amount of solution has been administered, or as otherwise directed.
10. Clamp the tubing.
  - a. Clamp and secure the tube if it is to remain in place.
  - b. Clamp and withdraw the tube if it is to be removed.
11. Remove all used equipment from the bedside.
12. Measure the lavage return.
  - a. Measure and record the total lavage return.
  - b. Estimate the amount of stomach contents by subtracting the known amount of irrigating solution used from the measured amount of total lavage return.

**Performance Steps**

- c. Record the amount of stomach contents as output on the I & O worksheet.
- 13. Dispose of the initial stomach aspirate and all lavage solution returned as directed by the physician's orders or local SOP. That is, hold it for examination by the physician, send fluid samples to the laboratory, or discard it into the appropriate receptacle.
- 14. Document the procedure and significant nursing observations on the appropriate forms IAW local SOP.
  - a. Note the type and amount of lavage solution used.
  - b. Note the color, odor, character, and amount of initial stomach contents aspirated.
  - c. Note the color, odor, character, and amount of lavage return.
  - d. Describe the patient's tolerance of the procedure.
  - e. Note the disposition of any specimens.

**Performance Measures**

	<u>GO</u>	<u>NO GO</u>
1. Assembled the equipment.	_____	_____
2. Explained the procedure to the patient.	_____	_____
3. Established baseline vital signs.	_____	_____
4. Positioned the patient.	_____	_____
5. Inserted the tube, if necessary.	_____	_____
6. Aspirated the initial stomach contents.	_____	_____
7. Instilled the irrigating solution.	_____	_____
8. Withdrew the irrigating solution.	_____	_____
9. Continued the lavage as directed by the physician's orders.	_____	_____
10. Clamped the tubing.	_____	_____
11. Removed the equipment.	_____	_____
12. Measured the lavage return.	_____	_____
13. Disposed of the initial aspirate and lavage return as directed by the physician's orders.	_____	_____
14. Documented the procedure.	_____	_____

**Evaluation Guidance:** Score each soldier according to the performance measures in the evaluation guide. Unless otherwise stated in the task summary, the soldier must pass all performance measures to be scored GO. If the soldier fails any step, show what was done wrong and how to do it correctly.

**References**

**Required**  
None

**Related**  
BASIC NURSING

Subject Area 14: Triage and Evacuation

**GUIDE A HELICOPTER TO A LANDING POINT**

**071-334-4001**

**Conditions:** Given a prepared landing site for a UH-1 or UH-60 helicopter (the location of which is known to the pilot), individual TOE equipment, night vision goggles, FM radio (SINCGAR), and the appropriate arm-and-hand signals to guide the helicopter to the landing site and land the helicopter on the landing site.

**Standards:** Guided the helicopter to a safe landing by MEDEVAC request, identifying the landing site to the pilot and controlling the landing using the correct arm-and-hand signals.

**Performance Steps**

**CAUTION:** During training, dispose of all batteries IAW unit SOP.

1. As the aircraft approaches, provide the pilot with tactical and security information. Tell him of conditions that may affect his landing such as terrain, weather, landing site markings, and possible obstacles.
  - a. Confirm information or answer any questions the pilot may have pertaining to the landing site.
  - b. Maintain communications with the pilot during the entire operation.
2. Identify the landing site and guide the pilot in.
  - a. Once the pilot is within your area, he establishes radio contact with the unit for positive identification.
  - b. The pilot will be oriented to the landing site by using the clock method (12 o'clock is always the direction of flight). Tell the pilot the time position of your location. (For example: "The LZ is now at 3 o'clock to your position.")
  - c. Mark or identify the landing site:
    - (1) Day. The only signals required are colored smoke and a signalman. VS-17 marker panels may be used to mark the landing site, but are NOT used any closer than 50 feet to the touchdown point. In addition to identifying the landing site, the colored smoke shows the pilot the wind direction and speed.
    - (2) Night. The landing site and touchdown point are marked by an inverted "Y" composed of four lights (Figure 3-35).

## Performance Steps

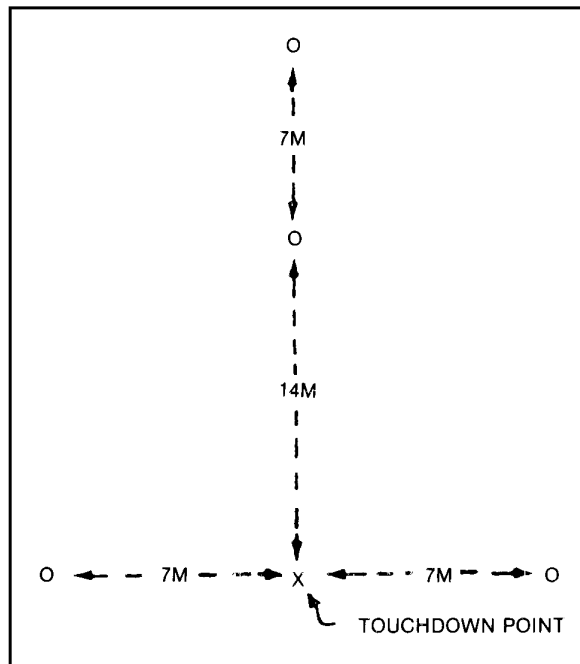

Figure 3-35

3. Use arm-and-hand signals. (See Figures 3-36 through 3-43.)
  - a. The signalman's position when directing a helicopter is to the right front of the aircraft where he can be seen best by the pilot. The signalman's position for utility helicopters is 30 meters to the right front of the aircraft during day or night operations.
  - b. Signals at night are given using lighted batons or flashlights. In the illustrations, one of the men is using a lighted wand. This is a flashlight with a plastic wand attached to the end. The flashlight is used when visibility is decreased.
  - c. The speed of the arm movement indicates the desired speed of aircraft compliance with the signal.

**Performance Steps**

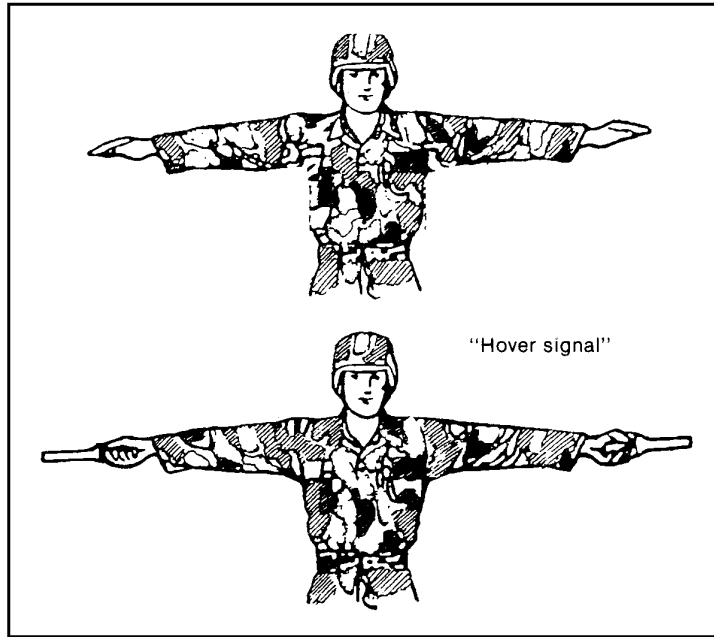

Figure 3-36

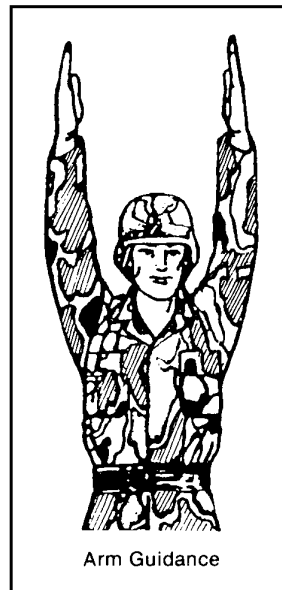

Figure 3-37

Performance Steps

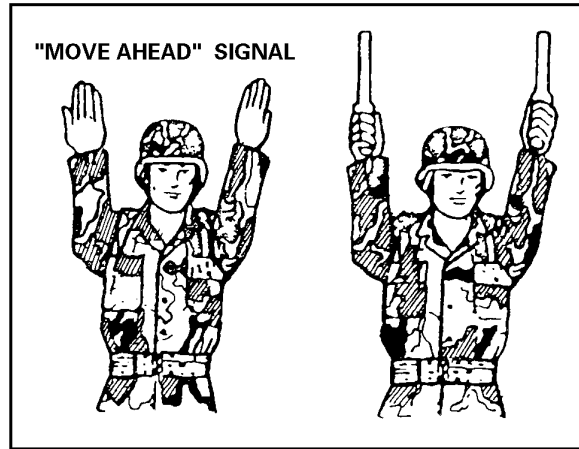

Figure 3-38

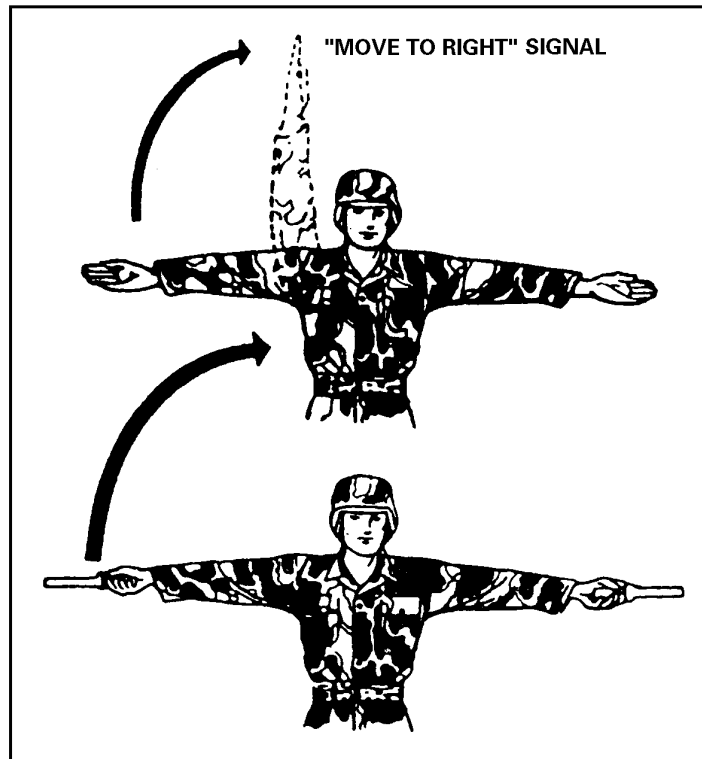

Figure 3-39



**Performance Steps**

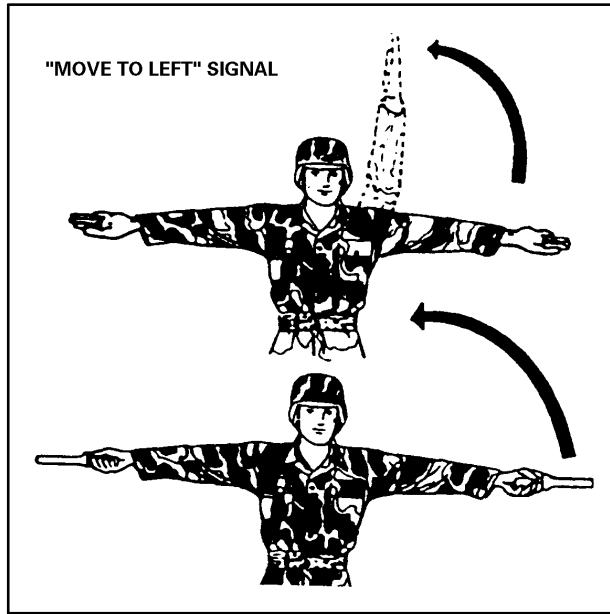

Figure 3-40

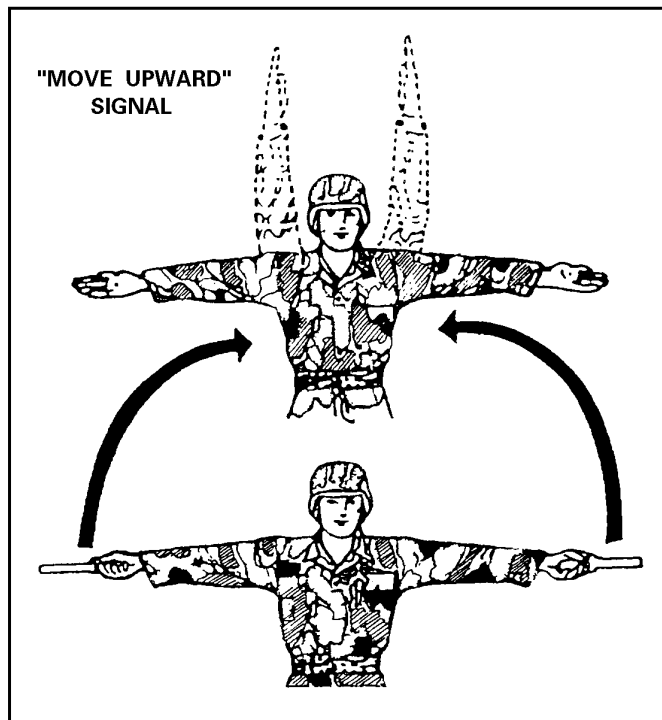

Figure 3-41

## Performance Steps

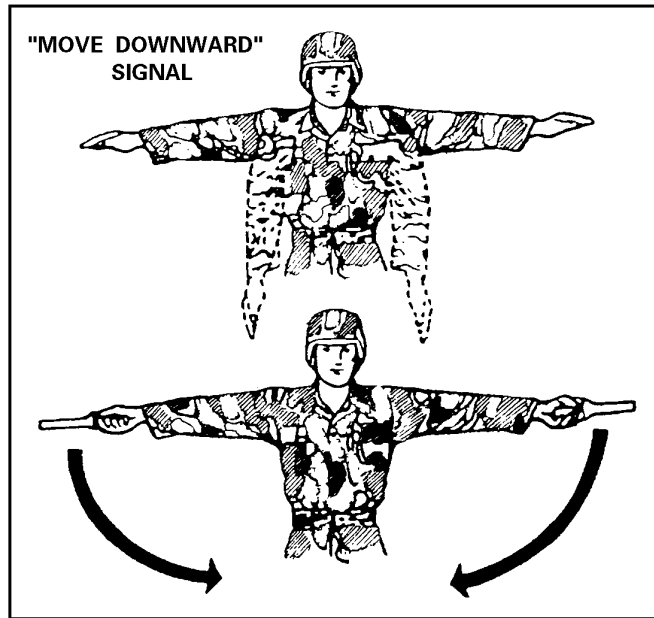

Figure 3-42

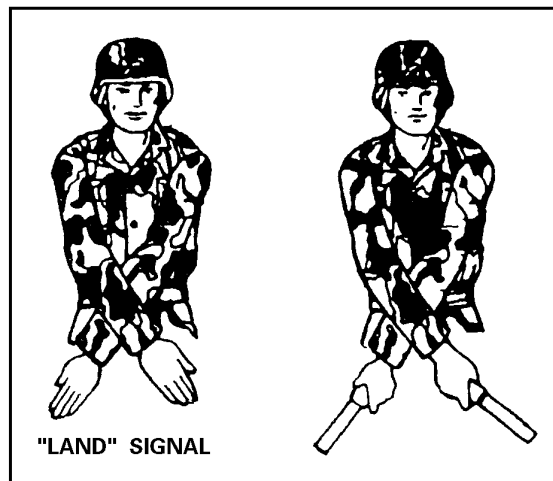

Figure 3-43

*NOTE:* The "hover" signal should be used to change from one arm-and-hand signal to another. For example, assume that the signalman wants to land an approaching helicopter and has given the helicopter the "move ahead" signal. The helicopter is now positioned directly over the desired landing area. Before giving the helicopter the signal to move downward, the signalman should execute the "hover" signal. This gives the pilot time to change from the "move ahead" to the "move downward" signal.

**Evaluation Preparation:**

Setup: At the test site, provide all equipment and information given in the task conditions statement. For test purposes, the tester may act as the pilot.

Brief Soldier: Tell the soldier that he is to land the helicopter using arm-and-hand signals.

**Performance Measures**

	<u>GO</u>	<u>NO</u> <u>GO</u>
1. Advised the pilot of changes to the information given.	_____	_____
2. Identified the landing site to the pilot.	_____	_____
3. Controlled the landing using arm-and-hand signals.	_____	_____

**Evaluation Guidance:** Score each soldier according to the performance measures in the evaluation guide. Unless otherwise stated in the task summary, the soldier must pass all performance measures to be scored GO. If the soldier fails any step, show what was done wrong and how to do it correctly.

**References**

**Required**  
None

**Related**  
FM 21-60  
FM 57-38  
FM 7-8

## ESTABLISH A HELICOPTER LANDING POINT

### 071-334-4002

**Conditions:** Given an area to be prepared for the landing site; smoke grenades; strobe lights, flashlights, or vehicle lights; marker panels; and equipment and personnel to clear the site when required.

**Standards:** The site is large enough for a helicopter to land and take off. All obstacles that cannot be removed are marked or identified, and the touchdown point on the landing site is identified.

#### Performance Steps

**CAUTIONS:** 1. During training, dispose of all batteries IAW unit SOP. 2. Comply with unit SOP and or local regulations concerning the cutting of live vegetation, digging holes, and/or erosion prevention.

1. Select the landing site. The factors which should be considered are:
  - a. The size of the landing site.
    - (1) A helicopter requires a relatively level landing area 30 meters in diameter. This does not mean that a loaded helicopter can land and take off from an area of that size. Most helicopters cannot go straight up or down when fully loaded. Therefore, a larger landing site and better approach and departure routes are required.
    - (2) When obstacles are in the approach or departure routes, a 10 to 1 ratio must be used to lay out the landing site (Figure 3-44). For example, during the approach and departure, if the helicopter must fly over trees that are 15 meters high, the landing site must be at least 150 meters long ( $10 \times 15 = 150$  meters).

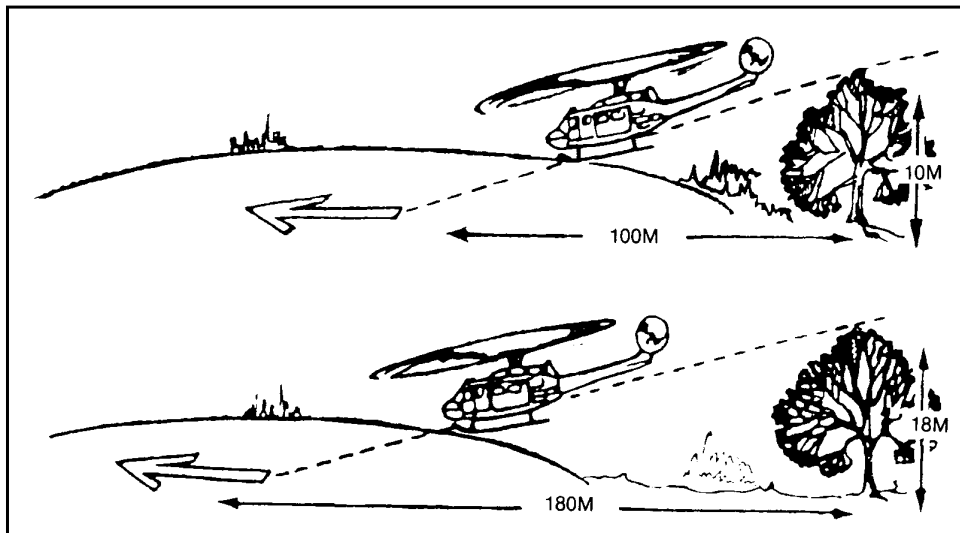

Figure 3-44

- b. The ground slope of the landing site (Figure 3-45). When selecting the landing site, the ground slope must be no more than 15 degrees. Helicopters cannot safely land on a slope of more than 15 degrees.

**Performance Steps**

- (1) When the ground slope is under 7 degrees, the helicopter should land upslope. (See Figure 3-45A.)
- (2) When the ground slope is 7 to 15 degrees, the helicopter must land sideslope. (See Figure 3-45B.)

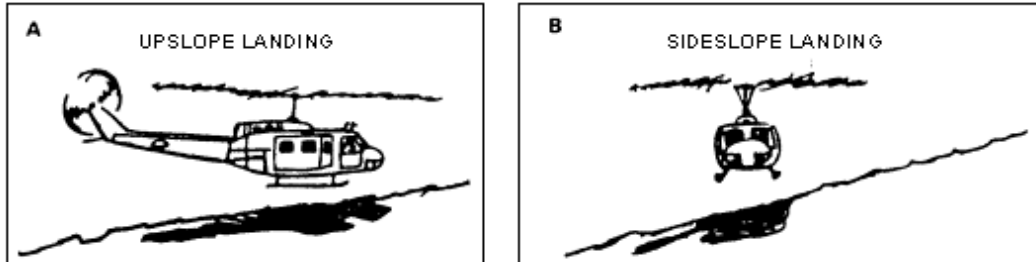

Figure 3-45

- c. Surface conditions.
    - (1) The ground must be firm enough that the helicopter does not bog down during loading or unloading. If firm ground cannot be found, the pilot must be told. He can hover at the landing site during the loading or unloading.
    - (2) Rotor wash on dusty, sandy, or snow-covered surfaces may cause loss of visual contact with the ground. Therefore, these areas should be avoided.
    - (3) Loose debris that can be kicked up by the rotor wash must be removed from the landing site. Loose debris can cause damage to the blades or engines.
  - d. Obstacles.
    - (1) Landing sites should be free of tall trees, telephone lines, power lines or poles, and similar obstructions on the approach or departure ends of the landing site.
    - (2) Obstructions that cannot be removed (such as large rocks, stumps, or holes) must be marked clearly within the landing site.
2. Establish security for the landing site. Landing sites should offer some security from enemy observation and direct fire. Good landing sites will allow the helicopter to land and depart without exposing it to unneeded risks. Security is normally established around the entire landing site.
  3. Mark the landing site and touchdown point.
    - a. When and how the landing site should be marked is based on the mission, capabilities, and situation of the unit concerned. Normally, the only mark or signals required are smoke (colored) and a signalman. VS-17 marker panels may be used to mark the landing site, but **MUST NOT** be used any closer than 50 feet to the touchdown point. In addition to identifying the landing site, smoke gives the pilot information on the wind direction and speed.
    - b. At night, the landing site and touchdown point are marked by an inverted "Y" composed of four lights (Figure 3-46). Strobe lights, flashlights, or vehicle lights may also be used to mark the landing site. The marking system used will be fully explained to the pilot when contact is made.

**Performance Steps**

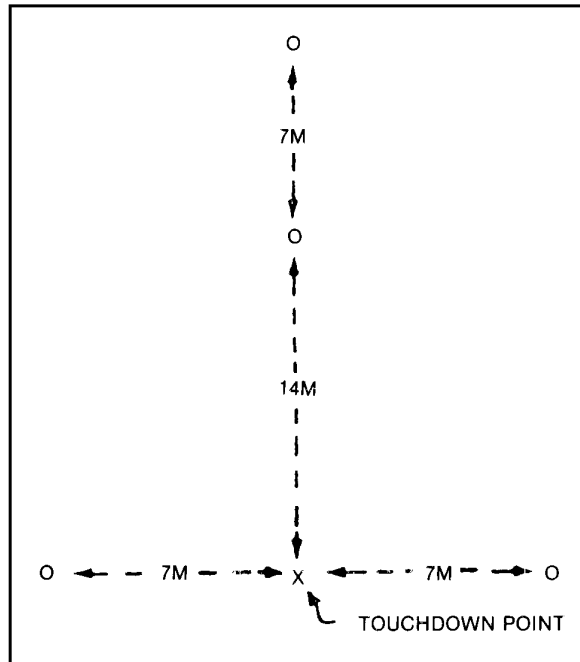

Figure 3-46

**Evaluation Preparation:**

Setup: At the test site, provide all equipment, information, and personnel given in the task conditions statement.

Brief soldier: Tell the soldier that he or she is to select and prepare a helicopter landing site.

**Performance Measures**

	<u>GO</u>	<u>NO GO</u>
1. Selected a site large enough to permit the helicopter to land and take off.	—	—
2. Removed or marked all obstacles and debris.	—	—
3. Marked or identified the landing site and the touchdown point.	—	—

**Evaluation Guidance:** Score each soldier according to the performance measures in the evaluation guide. Unless otherwise stated in the task summary, the soldier must pass all performance measures to be scored GO. If the soldier fails any step, show what was done wrong and how to do it correctly.

**References**

**Required**  
None

**Related**  
FM 21-60  
FM 57-38  
FM 7-8

**TRIAGE CASUALTIES ON A CONVENTIONAL BATTLEFIELD**  
**081-833-0080**

**Conditions:** You are in the field and have several casualties with conventional injuries. You are not in an NBC environment.

**Standards:** Completed all the steps necessary to establish priorities for the treatment and evacuation of casualties.

**Performance Steps**

1. Assess the situation.
  - a. Sort the casualties and allocate treatment.
    - (1) Assess and classify the casualties for the most efficient use of available medical personnel and supplies.
    - (2) Give available treatment first to the casualties who have the best chance of survival.
    - (3) A primary goal is to locate and return to duty troops with minor wounds. However, at no time should abandonment of a single casualty be considered.
    - (4) Triage establishes the order of treatment, not whether treatment is given. It is usually the responsibility of the senior medical person.
  - b. Determine the tactical and environment situation.
    - (1) Whether casualties must be transported to a more secure area for treatment.
    - (2) The number and location of the injured and severity of injuries.
    - (3) Available assistance (self-aid, buddy-aid, and medical personnel).
    - (4) Evacuation support capabilities and requirements.

*NOTE:* Nuclear weapons exposure will not be used as a criteria for sorting. Field experience with these injuries does not exist.

2. Assess the casualties and establish priorities for treatment.
  - a. Immediate--casualties whose conditions demand immediate treatment to save life, limb, or eyesight. This category has the highest priority.
    - (1) Airway obstruction.
    - (2) Respiratory and cardiorespiratory distress from otherwise treatable injuries (for example, electrical shock, drowning, or chemical exposure).

*NOTE:* A casualty with cardiorespiratory distress may not be classified "Immediate" on the battlefield. The casualty may be classified "Expectant", contingent upon such things as the situation, number of casualties, and support.

- (3) Massive external bleeding.
- (4) Shock.
- (5) Burns on the face, neck, hands, feet, or perineum and genitalia.

*NOTE:* After all life or limb threatening conditions have been successfully treated, give no further treatment to the casualty until all other "Immediate" casualties have been treated.

Salvage of life takes priority over salvage of limb.

- b. Delayed--casualties who have less risk of loss of life or limb if treatment is delayed.
  - (1) Open wounds of the chest without respiratory distress.
  - (2) Open or penetrating abdominal injuries without shock.
  - (3) Severe eye injuries without hope of saving eyesight.
  - (4) Other open wounds.
  - (5) Fractures.

**Performance Steps**

- (6) Second and third degree burns (not involving the face, hands, feet, genitalia, and perineum) covering 20% or more of the total body surface area.
- c. Minimal--"Walking wounded", can be treated by self-aid or buddy-aid.
  - (1) Minor lacerations and contusions.
  - (2) Sprains and strains.
  - (3) Minor combat stress problems.
  - (4) First or second degree burns (not involving the face, hands, feet, genitalia, and perineum) covering under 20% of the total body surface area.
- d. Expectant--casualties who are so critically injured that only complicated and prolonged treatment can improve life expectancy. This category is to be used only if resources are limited. If in doubt as to the severity of the injury, place the casualty in one of the other categories.
  - (1) Massive head injuries with signs of impending death.
  - (2) Burns, mostly third degree, covering more than 85% of the total body surface area.

*NOTE:* Provide ongoing supportive care if the time and condition permits; keep separate from other triage categorized casualties. (See Common Core task 101-515-0002.)

3. Record all treatment given on the Field Medical Card.
4. Establish MEDEVAC priorities by precedence category.
  - a. Urgent. Evacuation is required as soon as possible, but within 2 hours, to save life, limb, or eyesight. Generally, casualties whose conditions cannot be controlled and have the greatest opportunity for survival are placed in this category.
    - (1) Cardiorespiratory distress.
    - (2) Shock not responding to IV therapy.
    - (3) Prolonged unconsciousness.
    - (4) Head injuries with signs of increasing intracranial pressure.
    - (5) Burns covering 20% to 85% of the total body surface area.
  - b. Urgent Surgical. Evacuation is required for casualties who must receive far forward surgical intervention to save life and stabilize for further evacuation.
    - (1) Decreased circulation in the extremities.
    - (2) Open chest and/or abdominal wounds with decreased blood pressure.
    - (3) Penetrating wounds.
    - (4) Uncontrollable bleeding or open fractures with severe bleeding.
    - (5) Severe facial injuries.
  - c. Priority. Evacuation is required within 4 hours or the casualty's condition could get worse and become an "urgent" or "urgent surgical" category condition. Generally, this category applies to any casualty whose condition is not stabilized or who is at risk of trauma-related complications.
    - (1) Closed-chest injuries, such as rib fractures without a flail segment, or other injuries that interfere with respiration.
    - (2) Brief periods of unconsciousness.
    - (3) Soft tissue injuries and open or closed fractures.
    - (4) Abdominal injuries with no decreased blood pressure.
    - (5) Eye injuries that do not threaten eyesight.
    - (6) Spinal injuries.
    - (7) Burns on the hands, face, feet, genitalia, or perineum even if under 20% of the total body surface area.



**Performance Steps**

- d. Routine. Evacuation is required within 24 hours for further care. Immediate evacuation is not critical. Generally, casualties who can be controlled without jeopardizing their condition or who can be managed by the evacuating facility for up to 24 hours.
  - (1) Burns covering 20% to 80% of the total body surface area if the casualty is receiving and responding to IV therapy.
  - (2) Simple fractures.
  - (3) Open wounds including chest injuries without respiratory distress.
  - (4) Psychiatric cases.
  - (5) Terminal cases.
- e. Convenience. Evacuation by medical vehicle is a matter of convenience rather than necessity.
  - (1) Minor open wounds.
  - (2) Sprains and strains.
  - (3) Minor burns under 20% of total body surface area.
- 5. Prepare the evacuation request. (See STP 21-24-SMCT, task 081-831-0101.)
  - a. Pickup location--provided by the unit leader.
  - b. Radio frequency, call sign, and suffix--provided by the radio/telephone operator (RTO).
  - c. Number of patients by precedence category.
  - d. Special equipment required--none, hoist, extraction equipment, ventilator.
  - e. Number of patients by type--litter, ambulatory.
  - f. Security of the pickup site.
  - g. Method of marking the pickup site--provided by the unit leader.
  - h. Patients' nationality and status.
  - i. NBC contamination, if any.

*NOTE:* As a minimum, the first five items must be provided in the exact sequence listed.

**Performance Measures**

	<u>GO</u>	<u>NO GO</u>
1. Assessed the situation.	_____	_____
2. Assessed the casualties.	_____	_____
3. Initiated treatment in the correct sequence.	_____	_____
4. Recorded the treatment given.	_____	_____
5. Assigned the MEDEVAC priorities.	_____	_____
6. Prepared the evacuation request.	_____	_____

**Evaluation Guidance:** Score each soldier according to the performance measures in the evaluation guide. Unless otherwise stated in the task summary, the soldier must pass all performance measures to be scored GO. If the soldier fails any step, show what was done wrong and how to do it correctly.

**References**  
**Required**  
None

**Related**  
STP 21-24-SMCT  
COMMON CORE  
FM 8-10

## **TRIAGE CASUALTIES ON AN INTEGRATED BATTLEFIELD**

### **081-833-0082**

**Conditions:** You are in a chemical environment and have casualties with conventional injuries and/or signs and symptoms of chemical agent poisoning. Both you and the casualties are in MOPP level 4. Necessary materials and equipment: aid bag.

**Standards:** Completed all the steps necessary to correctly establish priorities for the treatment and evacuation of casualties on an integrated battlefield.

### **Performance Steps**

1. Assess the situation.
    - a. Number and location of the injured.
    - b. Severity of the injuries.
    - c. Assistance available (self-aid or buddy-aid).
    - d. Evacuation support capabilities.
    - e. Type of chemical agents used, if known.
  2. Assess the individual casualties.
    - a. Assess for conventional injuries.
    - b. Assess for signs and symptoms of chemical agent poisoning.
      - (1) Determine if the casualty responds to commands.
        - (a) Check the casualty's response to simple directions, such as "Hold up your right arm."
        - (b) Ask the casualty to describe any symptoms.
      - (2) Check for symptoms of chemical agent poisoning. (See tasks 081-833-0083 through 081-833-0086.)
  3. Establish priorities for treatment.
    - a. Immediate.
      - (1) No signs and symptoms of chemical agent poisoning.
      - (2) Presence of life-threatening conventional injuries.
    - b. Chemical immediate.
      - (1) Presence of signs and symptoms of severe chemical agent poisoning.
      - (2) No conventional injuries.
    - c. Delayed.
      - (1) Presence of mild signs and symptoms of chemical agent poisoning.
      - (2) Presence of conventional injuries that are not life-threatening.
    - d. Minimal.
      - (1) No signs and symptoms of chemical agent poisoning.
      - (2) Presence of minor conventional injuries.
    - e. Expectant.
      - (1) Presence of severe signs and symptoms of both chemical agent poisoning and life-threatening conventional injuries.
      - (2) No conventional injuries and not breathing due to chemical agent poisoning.
- NOTE:* Expectant casualties are so critically injured that only prolonged and complicated treatment may offer increased life expectancy.
4. Initiate treatment in the following order.
    - a. Chemical agent poisoning.
    - b. Conventional injuries.

**Performance Steps**

*NOTES:* 1. Employ casualties who have only minor injuries or minimal chemical agent exposure to provide buddy-aid for those with more severe injuries. 2. Sorting and treatment should be done almost simultaneously.

- 5. Move the casualties to the collection point.
- 6. Record all observations and treatment on the appropriate form.
- 7. Establish evacuation priorities. (See task 081-833-0080.)

**Evaluation Preparation:**

Setup: You will need several soldiers in MOPP level 4 to act as the casualties. Use a moulage kit or similar materials to simulate conventional wounds. Coach the soldiers on signs and symptoms of nerve agent poisoning to exhibit.

Brief soldier: Tell the soldier to triage casualties on an integrated battlefield.

**Performance Measures**

	<u>GO</u>	<u>NO GO</u>
1. Assessed the situation.	_____	_____
2. Assessed the individual casualties.	_____	_____
3. Established priorities for treatment.	_____	_____
4. Initiated treatment.	_____	_____
5. Moved the casualties to the collection point.	_____	_____
6. Recorded all observations and treatment on the appropriate form.	_____	_____
7. Established evacuation priorities.	_____	_____

**Evaluation Guidance:** Score each soldier according to the performance measures in the evaluation guide. Unless otherwise stated in the task summary, the soldier must pass all performance measures to be scored GO. If the soldier fails any step, show what was done wrong and how to do it correctly.

**References**

**Required**  
None

**Related**  
FM 8-10

## LOAD CASUALTIES ONTO GROUND EVACUATION PLATFORMS

### 081-833-0151

**Conditions:** You have completed treating and triaging multiple patients. You are in charge of loading litter and ambulatory patients on a standard ground transport platform (M996, M997, or M113).

**Standards:** Configured the vehicle properly and loaded and unloaded patients in the correct sequence for the transport platform.

### Performance Steps

1. Determine ambulance load capacities.
  - a. Truck, ambulance, 4X4, 2 litter, utility (M996).
    - (1) 2 litter patients.
    - (2) 6 ambulatory patients.
    - (3) 1 litter and 3 ambulatory patients.
  - b. Truck, ambulance, 4X4, 4 litter, utility (M997).
    - (1) 4 litter patients.
    - (2) 8 ambulatory patients.
    - (3) 2 litter and 4 ambulatory patients.
  - c. Carrier, personnel, full tracked, armored (M113, T113E2).
    - (1) 4 litter patients.
    - (2) 10 ambulatory patients.
    - (3) 2 litter and 5 ambulatory patients.

**NOTE:** Patients are normally loaded head first. They are less likely to experience motion sickness or nausea with the head in the direction of travel. When en route care is required for an injury on one side, it may be necessary to load feet first to access from the aisle. Patients with wounds of the chest or abdomen or those receiving IV fluids are loaded in lower berths to provide gravity flow. Patients wearing bulky splints should be placed on lower berths.

2. Determine the loading sequence.
  - a. M996.
    - (1) Load patients in the right berth first and then the left.
    - (2) Load the most seriously injured patient last.
    - (3) Go to step 3.
  - b. M997.
    - (1) Load patients in the upper right, lower right, upper left, and then the lower left berths.
    - (2) Load the most seriously injured patients last.

**CAUTION:** To install the litter suspension kit in the M113 ambulance, the spall liner must be removed. Litter patients cannot be safely moved if the litter suspension kit is not installed.

- (3) Go to step 4.

**NOTE:** Unload the M113 ambulance in reverse sequence.

- c. M113, T113E2.
  - (1) Load patients in the upper right, lower right, upper left, and then the lower left berths.
  - (2) Load the most seriously injured patients last.

3. Load and unload the M996 for ambulatory or litter patients.
  - a. Prepare the M996 for ambulatory patients (Figures 3-47 and 3-48).

## Performance Steps

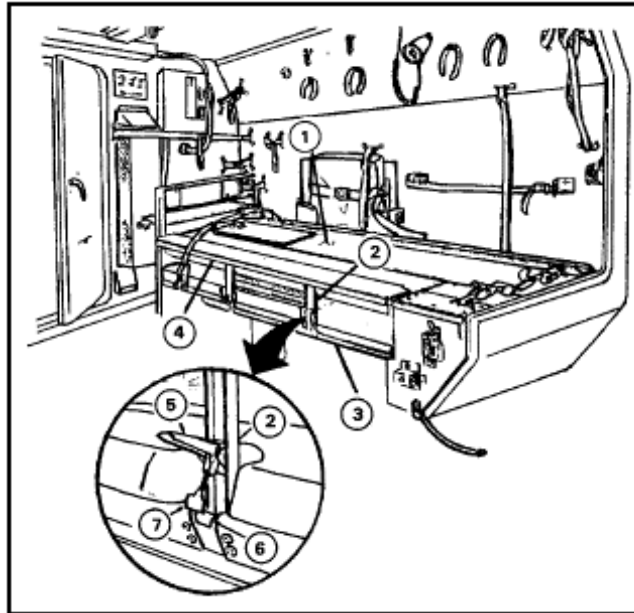

Figure 3-47

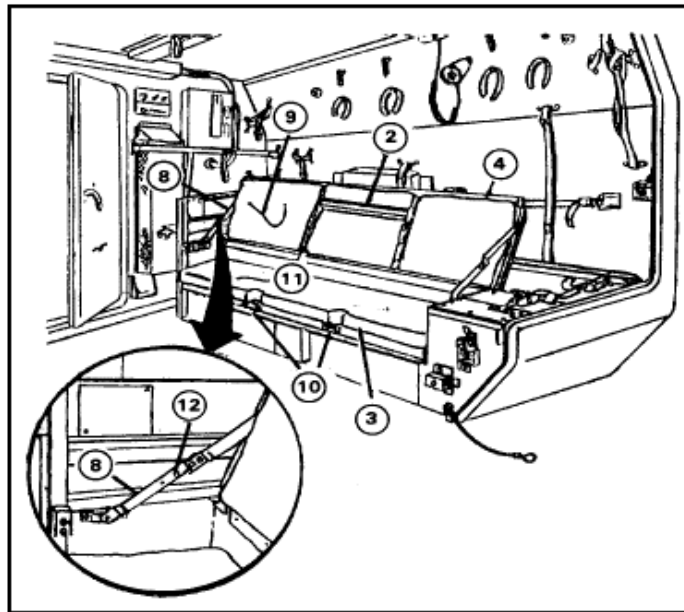

Figure 3-48

- (1) Ensure litters are in stowed position.
  - (2) Pull out and up on seat latch handle (5) and remove latch (7) from catch (6).
  - (3) Lift seat back (4) to open position and fold seat back support (2) into recesses between seat cushions (9).
  - (4) Ensure that seat braces (8) are fully extended and locked in position.
- b. Prepare the M996 for litter patients (Figures 3-47 and 3-48).

**Performance Steps**

- (1) Press lock buttons (12) on seat braces (8) and fold braces (8) toward seat back (4).
  - (2) Fold seat back support (2) outward and fold seat back (4) into closed position. Ensure that guide pins (11) on seat back support engage holes (10) in seat base (3).
  - (3) Install seat back (4) to seat base (3) with seat latch (7) and secure with latch handle (5). If necessary to ensure security of seat back (4), adjust seat latch (7) to proper length by turning clockwise or counterclockwise.
- c. Prepare the M996 to utilize the litter rail extension for loading and unloading of patients.
- (1) Assemble litter rail extension for M996 (Figures 3-49 and 3-50).

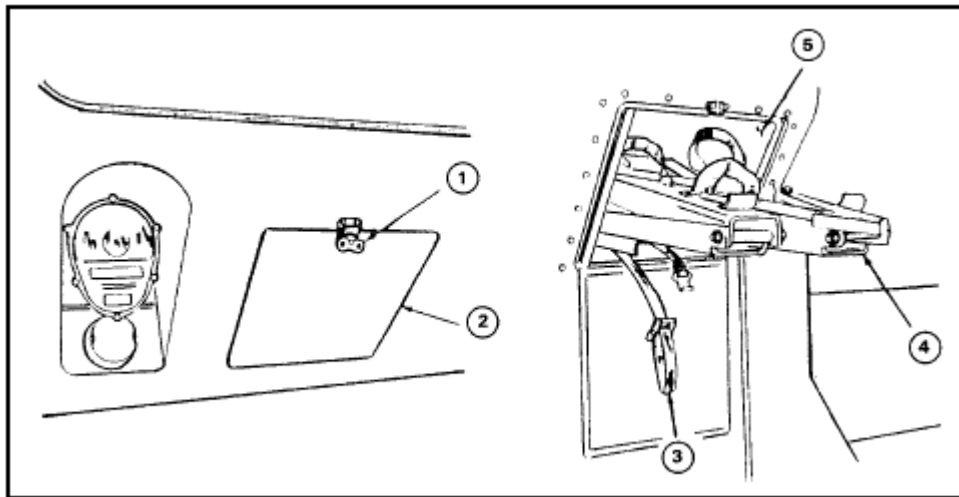

Figure 3-49

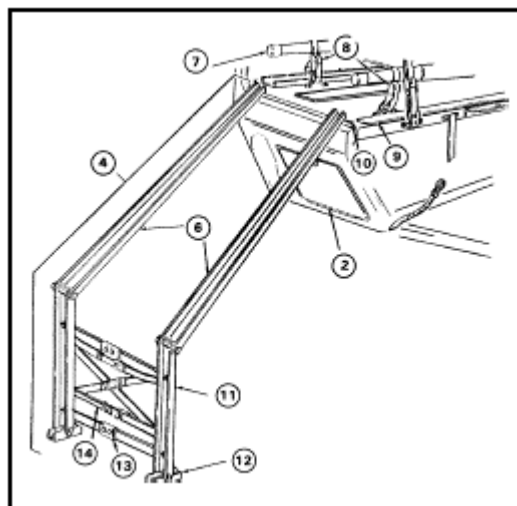

Figure 3-50

**Performance Steps**

- (a) Turn latch (1) counterclockwise and open stowage compartment door (2).
- (b) Loosen and disconnect securing strap (3) and remove folded litter rail extension (4) from stowage compartment (5).
- (c) Pull left and right rails (6) apart and let legs (11) drop down. Ensure feet (12) are flat on ground.
- (d) Lock support braces (13) and adjust straps (14) as necessary.
- (2) Load litters on litter rack (Figure 3-50).
  - (a) Secure both rails (6) of litter rail extension (4) into slots (10) on litter rack (9).
  - (b) Place litter (7) on litter rail extension (4).

**WARNING:** Ensure straps and equipment do not inhibit litter loading operations. Load litters carefully to prevent patient injury.

- (c) Slide litter (7) onto litter rack (9).
- (d) Secure litter (7) to litter rack (9) with front and rear litter handle straps (8).
- (3) Unload litters from the litter rack (Figure 3-50).
  - (a) Release front and rear litter handle straps (8) securing litter (7) to litter rack (9).
  - (b) Secure both rails (6) of litter rail extension (4) into slots (10) on lower litter rack (9).
  - (c) Slide litter (7) from lower litter rack (9) onto litter rail extension (4). Lift up and remove litter (7) from litter rail extension (4).
- (4) Fold and stow litter rail extension for M996 (Figures 3-49 and 3-50).
  - (a) Unlock support braces (13).
  - (b) Fold left and right rails (6) together.
  - (c) Fold left and right litter rail legs (11) and feet (12) against rails (6).
  - (d) Place folded litter rail extension (4) into stowage compartment (5) and secure with strap (3).
  - (e) Close door (2) and turn latch (1) clockwise to secure door (2).

4. Load and unload the M997 for litter and ambulatory patients.

- a. Prepare the upper litter rack (Figure 3-51).
  - (1) Unhook tension strap (23) from footman loop (30) on lower litter rack (9).
  - (2) Pull out upper litter rack handle (17) and support weight of upper litter rack (21).

**WARNING:** The rear end of the upper litter must be supported before releasing the suspension strap hook. Injury to personnel may result if rear end of upper litter is not supported.

- (3) Unhook rear suspension strap hook (27) from loop (22) on upper litter rack (21). Clip suspension strap hook (27) to eye (26).
- (4) Release litter support latch stop (25), push latch (24) in, and lower upper litter rack (21) onto lower litter rack (9).
- (5) Slide litter rack handle (17) into upper litter rack (21).



**Performance Steps**

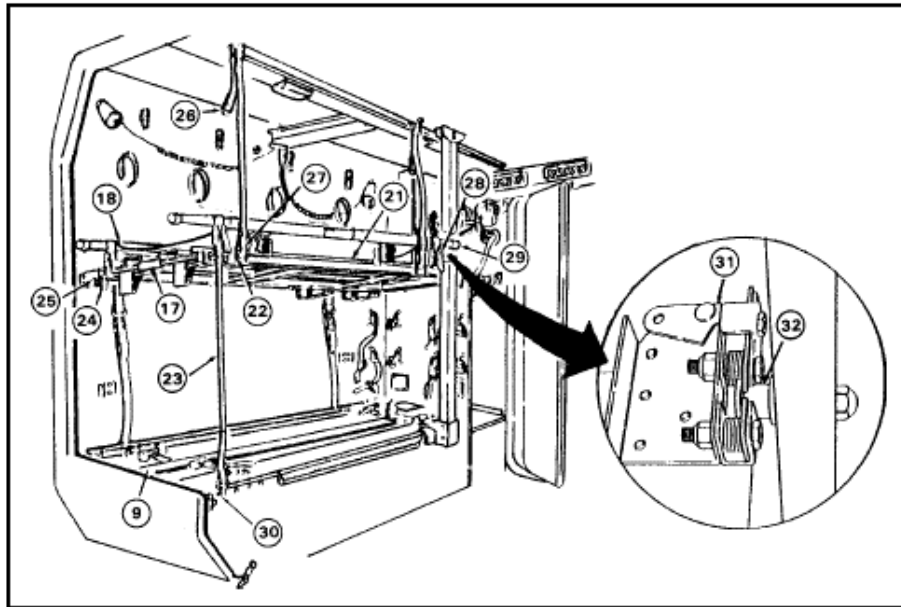

Figure 3-51

- b. Assemble the litter rail extension (Figures 3-50 and 3-52).

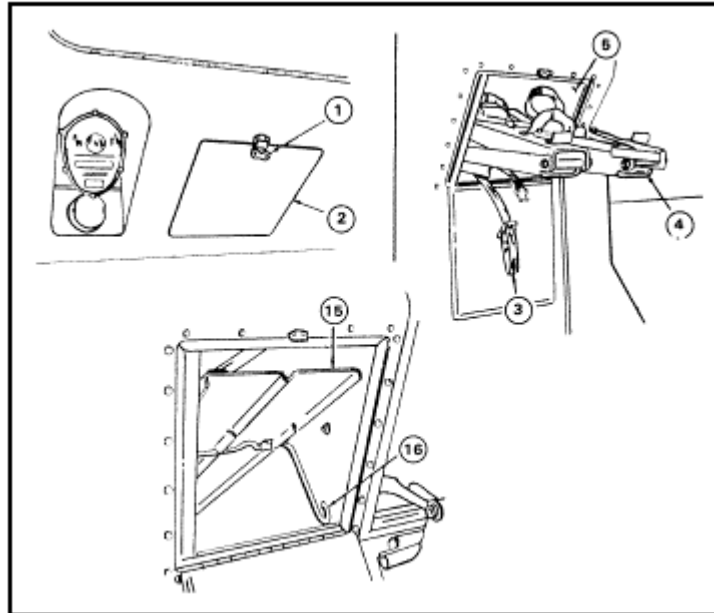

Figure 3-52

- (1) Turn latch (1) counterclockwise and open stowage compartment door (2).
- (2) Loosen and disconnect securing strap (3) and remove folded litter rail extension (4) from stowage compartment (5).

**Performance Steps**

- (3) Lift tray (15) slightly and push in tray supports (16) to lower tray (15) for access to stowed litters.
  - (4) Pull left and right rails (6) apart and let legs (11) drop down. Ensure feet (12) are flat on ground.
  - (5) Lock support braces (13) and adjust straps (14) as necessary.
- c. Load litters on upper litter racks (Figures 3-51 and 3-53).

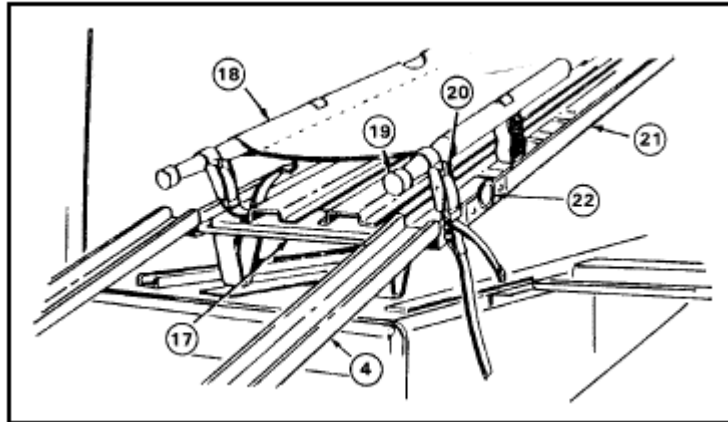

Figure 3-53

- (1) Secure both rails of litter extension (4) into slots in upper litter rack (21).
  - (2) Place litter (18) on litter rail extension (4).
  - (3) Slide litter (18) up rails (4) until litter (18) is clear of litter rail extension (4).
  - (4) Secure rear litter handles (19) to upper litter rack (21) with rear litter handle straps (20).
  - (5) Remove litter rail extension (4) from upper litter rack (21).
  - (6) Unhook suspension strap hook (27) from eye (26).
  - (7) Pull out upper litter rack handle (17).
  - (8) Raise upper litter rack (21), push into litter support latch (24), and secure with latch stop (25).
  - (9) Secure front litter handles (29) to litter rack (21) with front litter handle straps (28).
  - (10) Hook tension strap (23) to footman loop (30) on lower litter rack (9) and adjust strap.
  - (11) Slide litter rack handle (17) into upper litter rack (21).
- d. Load litters on lower litter rack (Figure 3-50).
- (1) Secure both rails (6) of litter rail extension (4) into slots (10) on lower litter rack (9).
  - (2) Place litter (7) on litter rail extension (4).
  - (3) Slide litter (7) onto lower litter rack (9).
  - (4) Secure litter (7) to lower litter rack (9) with front and rear litter handle straps (8).
- e. Unload litters from the lower litter rack (Figure 3-50).

**WARNING:** When unloading more than two litter patients, lower litter rack patients must be unloaded first. Ensure that straps and equipment do not inhibit unloading operations. Unload litters carefully to prevent patient injury.

- (1) Release front and rear litter handle straps (8) securing litter (7) to lower litter rack (9).
- (2) Secure both rails (6) of litter rail extension (4) into slots (10) on lower litter rack (9).

**Performance Steps**

- (3) Slide litter (7) from lower litter rack (9) onto litter rail extension (4). Lift up and remove litter (7) from litter rail extension (4).
- f. Unload litters from upper litter racks (Figures 3-51 and 3-53).
  - (1) Release litter support latch stop (28) from litter handles (29).
  - (2) Unhook tension strap (23) from footman loop (30) on lower litter rack (9).
  - (3) Pull out upper litter rack handle (17) and support weight of upper litter rack (21).
  - (4) Unhook rear suspension strap hook (27) from loop (22) on upper litter rack (21). Clip suspension strap hook (27) to eye (26).
  - (5) Release litter support latch stop (25), push latch (24) in, and lower upper litter rack (21) onto lower litter rack (9).
  - (6) Slide litter rack handle (17) into upper litter rack (21).
  - (7) Secure rails of litter rail extension (4) into slots in upper litter rack (21).
  - (8) Release rear litter handle straps (20) from litter handles (19).
  - (9) Slide litter (18) down litter rail extension (4) until litter (18) is clear of upper litter rack (21).
  - (10) Lift and remove litter (18) from litter rail extension (4).
  - (11) Remove litter rail extension (4) from upper litter rack (21).
- g. Fold and stow litter rail extension (Figures 3-50 and 3-52).
  - (1) Unlock support braces (13).
  - (2) Fold left and right rails (6) together.
  - (3) Fold left and right litter rail legs (11) and feet (12) against rail (6).
  - (4) Lift tray (15) and push tray supports (16) in, and lower tray (15).
  - (5) Slide litters into stowage compartments (5) on top of lift tray (15). Pull out supports (16) to place lift tray (15) in raised position.
  - (6) Place folded litter rail extension (4) into stowage compartment (5) and secure with strap (3).
  - (7) Close door (2) and turn latch (1) clockwise to secure door (2).
- h. Fold upper litter rack to the backrest position (Figure 3-51).
  - (1) Unhook litter rack tension strap (23) from lower litter rack footman loop (30).
  - (2) Unhook two upper litter rack suspension straps hooks (27) from loops (22) on upper litter rack (21) and reattach strap hooks (27) to eyes (26).
  - (3) Release upper litter rack latch (31) and disengage rack striker (32) from latch (31).
  - (4) Lower upper litter rack (21) onto the lower litter rack (9), forming a backrest.
- i. Cover backrest to upper litter rack (Figure 3-51).
  - (1) Raise upper litter rack (21) and engage rack striker (32) into upper litter rack latch (31). Ensure striker (32) is locked in latch (21).
  - (2) Unhook two upper litter rack suspension strap hooks (27) from eyes (26) and hook to loops (22) on upper litter rack (21).
  - (3) Hook upper litter rack tension strap (23) to footman loop (30) on lower litter rack (9).
  - (4) Adjust straps (23 and 27) for proper tension.

**Performance Measures**

	<u>GO</u>	<u>NO GO</u>
1. Assessed the casualties to determine loading sequence.	—	—
2. Prepared the ambulance to receive the casualties.	—	—

**Performance Measures**

	<u>GO</u>	<u>NO</u> <u>GO</u>
3. Acted as the number one person and with assistance of the noncandidate soldiers:	_____	_____
a. Loaded the casualties head first, in the proper sequence, and used the proper berths.		
b. Secured the casualties for transport.		
c. Unloaded the casualties in the proper sequence.		
4. Did not cause further injury to the casualties.	_____	_____

**Evaluation Guidance:** Score each soldier according to the performance measures in the evaluation guide. Unless otherwise stated in the task summary, the soldier must pass all performance measures to be scored GO. If the soldier fails any step, show what was done wrong and how to do it correctly.

**References**

**Required**

None

**Related**

FM 8-10-6

**LOAD CASUALTIES ONTO NONSTANDARD VEHICLES, 1 1/4 TON, 4X4, M998  
081-833-0171**

**Conditions:** You have completed treating and triaging multiple patients. You are in charge of loading litter or ambulatory patients onto a nonstandard transport vehicle (M998).

**Standards:** Configured the vehicle properly and loaded and unloaded in the correct sequence.

**Performance Steps**

1. Determine vehicle load capacities.
  - a. M998 (four-man configuration)--three litters.
  - b. M998 (two-man configuration)--five litters.
2. Direct nonmedical soldiers to load an M998 (four-man configuration). (See Figure 3-54.)

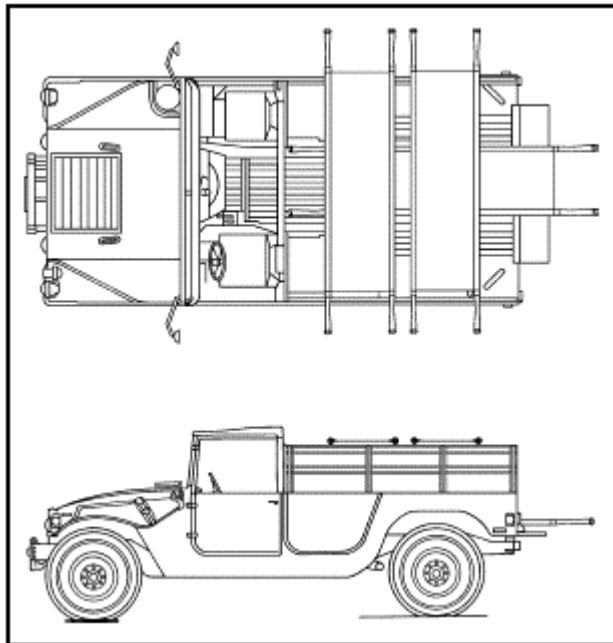

Figure 3-54

- a. Remove the cargo cover and metal bows. Secure them in the vehicle and lower the tailgate.
  - b. Place two litters side-by-side across the back of the truck with the litter handles resting on the sides of the truck.
  - c. Secure the litters to the vehicle with any available material.
  - d. Place one litter lengthwise, head first, in the bed of the truck. Secure it in place.
  - e. Leave the tailgate open. It is supported by the two tailgate chain hooks.
3. Direct nonmedical soldiers to load an M998 (two-man configuration). (See Figure 3-55.)

**Performance Steps**

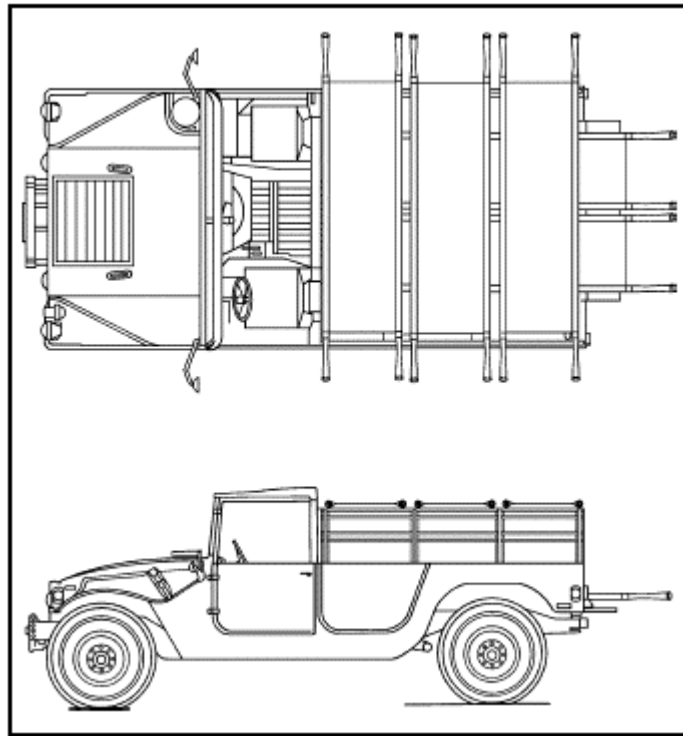

Figure 3-55

- a. Fold the fabric cover and metal bows forward and together as an assembly. Secure them in place. Lower the tailgate.
  - b. Place three litters side-by-side across the sideboards. Secure them in place with any material available.
  - c. Place two litters lengthwise, head first, in the bed of the truck. Secure them in place.
  - d. Leave the tailgate open. It is supported by the two tailgate chain hooks.
4. Direct nonmedical soldiers to unload the vehicle in reverse sequence.

**Performance Measures**

	<u>GO</u>	<u>NO GO</u>
1. Determined vehicle load capacity.	_____	_____
2. Prepared the vehicle to receive patients.	_____	_____
3. Directed nonmedical soldiers to--	_____	_____
a. Load the casualties in the proper sequence.		
b. Load casualties side-by-side across the back of the truck.		
c. Load casualties lengthwise on the floor, head first.		
d. Secure the casualties for transport.		
4. Did not cause further injury to the casualties.	_____	_____

**Evaluation Guidance:** Score each soldier according to the performance measures in the evaluation guide. Unless otherwise stated in the task summary, the soldier must pass all performance measures to be scored GO. If the soldier fails any step, show what was done wrong and how to do it correctly.

**References**

**Required**

None

**Related**

FM 8-10-6

**LOAD CASUALTIES ONTO NONSTANDARD VEHICLES, 2 1/2 TON, 6X6 OR 5 TON, 6X6,  
CARGO TRUCK  
081-833-0172**

**Conditions:** You have completed treating and triaging multiple patients. You are in charge of loading litter patients onto a nonstandard transport vehicle (2 1/2 ton or 5 ton cargo truck).

**Standards:** Configured the vehicle properly and unloaded in the correct sequence.

**Performance Steps**

1. Determine vehicle load capacities.
  - a. 12 litters.
  - b. 16 ambulatory.
2. Direct nonmedical soldiers to load the vehicle.
  - a. Remove the canvas cover. (The cover can be rolled toward the front of the truck and secured.)
  - b. Lower the seats.
  - c. Place three litters crosswise on the seats as far forward as possible and three litters lengthwise in the bed of the truck as far forward as possible.
  - d. Secure the litters individually to the seats.
  - e. Place three additional litters crosswise on the seats and three additional litters lengthwise in the bed of the truck.
  - f. Secure the litters individually to the seats.
  - g. Raise and secure the tailgate as high as possible to help secure the litters in place.
3. Direct nonmedical soldiers to unload the vehicle in reverse sequence.

**Performance Measures**

	<u>GO</u>	<u>NO GO</u>
1. Determined vehicle load capacity.	_____	_____
2. Prepared the vehicle to receive patients.	_____	_____
3. Directed the nonmedical soldiers to--	_____	_____
a. Load the casualties in the proper sequence crosswise on the seats as far forward as possible and three litters lengthwise in the bed of the truck as far forward as possible.		
<i>NOTE:</i> Patients may be loaded either head to head or head to toe.		
b. Secure the casualties for transport.		
c. Load three additional litters crosswise on the seats and three additional litters lengthwise in the bed of the truck.		
d. Secure the casualties for transport.		
e. Unload patients in the proper sequence.		
4. Did not cause further injury to the casualties.	_____	_____



**Evaluation Guidance:** Score each soldier according to the performance measures in the evaluation guide. Unless otherwise stated in the task summary, the soldier must pass all performance measures to be scored GO. If the soldier fails any step, show what was done wrong and how to do it correctly.

**References**

**Required**

None

**Related**

FM 8-10-6

## LOAD CASUALTIES ONTO NONSTANDARD VEHICLES, 5 TON M-1085, M-1093, 2 1/2 TON M-1081

081-833-0173

**Conditions:** You have completed treating and triaging multiple patients. You are in charge of loading litter patients onto a nonstandard transport vehicle. (M-1085, M-1093, M-1081)

**Standards:** Configured the vehicle properly and unloaded in the correct sequence.

### Performance Steps

1. Determine vehicle load capacities.
  - a. Long Wheelbase, 5-Ton, M-1085.
    - (1) 12 litter.
    - (2) 22 ambulatory.
  - b. Light Vehicle Air Drop/Air Delivery, 5 Ton, M-1093.
    - (1) 8 litters.
    - (2) 14 ambulatory.
  - c. Light Vehicle Air Drop/Air Delivery, 2 1/2 Ton, M-1081.
    - (1) 7 litters.
    - (2) 12 ambulatory.
2. Direct nonmedical soldiers to load an M-1085. (See Figure 3-56.)

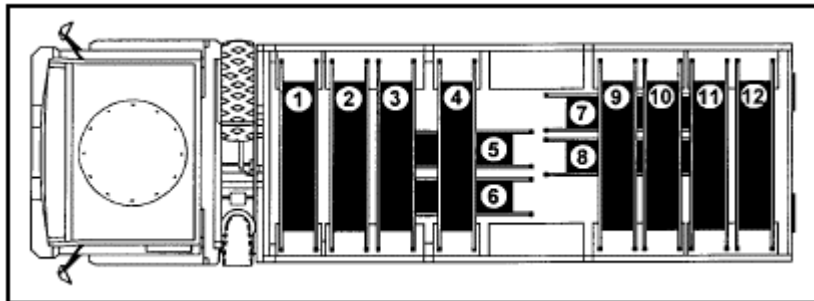

Figure 3-56

- a. Lower the seats and secure the vertical support brackets in place.
- b. Place four litters (litter numbers 1 through 4) crosswise on the seats, forward, next to the cab. Secure the litters individually to the seats.
- c. Place two litters (litter numbers 5 and 6) lengthwise on the floor, forward toward the cab, feet first, ensuring that patients' heads are exposed from under the upper litters. Secure the litters together and to the vertical seat supports.
- d. Place litter number 7 crosswise on the seats near the rear of the vehicle. Slide the litter as far forward as possible. Do not secure the litter at this time.
- e. Follow the same procedures in step 2d above for litter numbers 8 and 9.
- f. Place litter number 10 crosswise on the furthest seat rearward. Secure the litter to the seat.
- g. Slide litters (litter numbers 7, 8, and 9) rearward next to litter number 10. Secure the litters to the seats individually.

**Performance Steps**

- h. Place two litters lengthwise on the floor, head first, ensuring that the patient's head is exposed to the center opening, between the upper litters. Secure the litters together and to the vertical seat supports.

*NOTE:* The combat medic or combat lifesaver rides in the center of the vehicle to monitor the patients. If the vehicle is loaded with the maximum number of patients, the combat medic will not be able to attend to the patients.

3. Direct nonmedical soldiers to load an M-1093. (See Figure 3-57.)

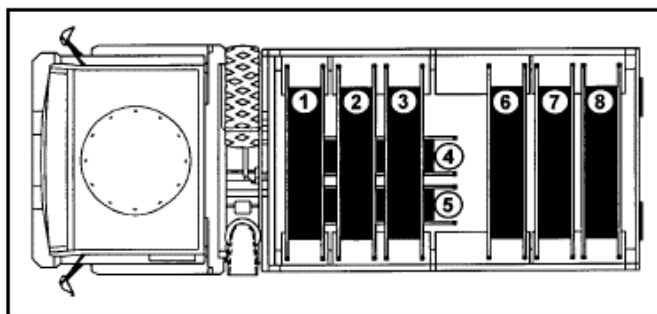

Figure 3-57

- a. Lower the seats and secure the vertical support bracket into place.
- b. Place three litters (litter numbers 1 through 3) crosswise on the seats, forward, next to the cab. Secure the litters individually to the seats.
- c. Place two litters (litter numbers 4 and 5) lengthwise on the floor, forward toward the cab, feet first. Secure the litters together and to the vertical seat support.
- d. Place litter number 6 crosswise on the seats near the rear of the vehicle. Slide the litter as far forward as possible. Do not secure the litter at this time.
- e. Place litter number 7 crosswise on the seats near the rear of the vehicle and slide it forward as in step 3d above. Secure the litter to the seats.
- f. Place litter number 8 crosswise on the seats as far rearward as possible. Secure the litter to the seats.
- g. Glide litter numbers 6 and 7 rearward next to litter number 8. Secure the litters to the seats.
- h. Raise and secure the tailgate.

*NOTE:* The combat medic or combat lifesaver rides in the center of the vehicle to monitor the patients.

4. Direct nonmedical soldiers to load an M-1081. (See Figure 3-58.)
  - a. Lower the seats and secure the vertical support bracket into place.
  - b. Place three litters (litter numbers 1 through 3) crosswise on the seats, forward, next to the cab. Secure the litters individually to the seats.
  - c. Place two litters (litter numbers 4 and 5) lengthwise on the floor, forward toward the cab, feet first. Secure the litters together and to the vertical seat support.
  - d. Place litter number 6 crosswise on the seats near the rear of the vehicle. Slide the litter as far forward as possible. Do not secure the litter at this time.
  - e. Place litter number 7 crosswise on the seats as far rearward as possible. Secure the litter to the seats.
  - f. Slide litter number 6 rearward next to litter number 7. Secure the litter to the seats.
  - g. Raise and secure the tailgate.

**Performance Steps**

*NOTE:* The combat medic or combat lifesaver rides in the center of the vehicle to monitor the patients.

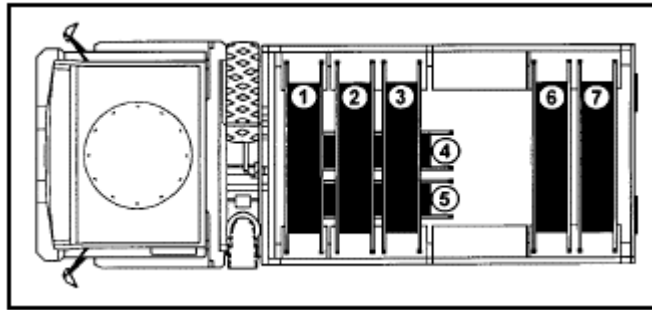

Figure 3-58

5. Direct nonmedical soldiers to unload vehicle in reverse sequence.

**Performance Measures**

	<u>GO</u>	<u>NO GO</u>
1. Determined vehicle load capacity.	_____	_____
2. Prepared the vehicle to receive patients.	_____	_____
3. Directed nonmedical soldiers to--	_____	_____
a. Load the casualties in the proper sequence.		
b. Load casualties side-by-side across the back of the truck.		
c. Load casualties lengthwise on the floor.		
d. Secure the casualties for transport.		
4. Did not cause further injury to the casualties.	_____	_____

**Evaluation Guidance:** Score each soldier according to the performance measures in the evaluation guide. Unless otherwise stated in the task summary, the soldier must pass all performance measures to be scored GO. If the soldier fails any step, show what was done wrong and how to do it correctly.

**References**

**Required**  
None

**Related**  
FM 8-10-6

Subject Area 15: Medication Administration

**PREPARE AN INJECTION FOR ADMINISTRATION**

**081-833-0088**

**Conditions:** You have performed a patient care handwash. Necessary materials and equipment: needles and syringes, medication, alcohol sponges, dry sterile gauze, and physician's orders.

**Standards:** Selected, inspected, and assembled the appropriate needle and syringe. Drew the correct medication. Followed aseptic technique throughout the procedure.

**Performance Steps**

1. Select an appropriate needle.
  - a. Select a needle with the proper length based upon the following factors:
    - (1) The type of injection to be given (subcutaneous, intramuscular, or intradermal).
    - (2) The size of the patient (thin, obese).
    - (3) The injection site (1 inch for deltoid, 1 1/2 inches for gluteus maximus).
  - b. Select a needle with the proper gauge based upon the thickness of the medication to be injected.

*NOTE:* The gauge of the needle is indicated by the numbers 14 through 27. The higher the number, the smaller the diameter (bore) of the needle. A small bore needle is indicated for thin medications. A large bore needle is indicated for thick medications.

2. Select an appropriate syringe.
  - a. Check the drug manufacturer's specifications to determine whether a glass or plastic syringe should be used for the medication.

*NOTE:* Some medications deteriorate in a plastic syringe. Drug manufacturer's specifications provide guidance.

- b. Ensure that the total capacity of the syringe, usually measured in cubic centimeters (cc), is appropriate for the amount of medication to be administered.
  - c. Check the intervals of the calibration marks on the syringe.

3. Inspect the needle and syringe packaging for defects such as open packages, holes, and water spotting. Discard the equipment if any defect is found.

4. Unpack the syringe.
  - a. If the syringe is in a flexible wrapper, peel the sides of the wrapper apart to expose the rear end of the syringe barrel.
  - b. Grasp the syringe by the barrel with the free hand.

**CAUTION:** The needle adapter and the shaft of the plunger are sterile. Contamination could cause infection in the patient. The outside of the syringe barrel does not have to be kept sterile.

- c. Pull the syringe from the packaging.
  - d. If the syringe is packaged in a hard plastic tube container, press down and twist the cap until a distinct "pop" is heard. If the "pop" is not heard, the seal has been previously broken and the equipment must be discarded.

5. Inspect the syringe.
  - a. Grasp the flared end of the syringe and pull the plunger back and forth to test for smooth, easy movement.

**Performance Steps**

- b. Visually check the rubber stopper (inside the syringe) to ensure that it is attached securely to the top end of the plunger, forming a seal.
- c. If the plunger is stuck or does not move smoothly, discard the syringe.
- d. Push the plunger fully into the barrel until ready to fill the syringe with medication.

## 6. Unpack the needle.

**CAUTION:** All parts of the needle are sterile. Be careful not to touch the hub. This would contaminate the needle and possibly pass an infection to the patient. Only the outside of the needle cover may be touched.

- a. If the needle is packaged in a flexible wrapper, peel the sides of the wrapper apart to expose the needle hub.
- b. If the needle is packaged in a hard plastic tube, twist the cap of the tube until a "pop" is heard. Remove the cap to expose the needle hub. If a "pop" is not heard, the seal has been previously broken, and the equipment must be discarded.

## 7. Join the needle and the syringe.

- a. Insert the needle adapter of the syringe into the hub of the needle.
- b. Tighten the needle by turning 1/4 of a turn to ensure that it is securely attached.

## 8. Inspect the needle.

- a. Hold the needle and syringe upright and remove the protective cover from the needle by pulling it straight off.

**NOTE:** A twisting motion may pull the needle off the hub.

- b. Visually inspect the needle for burrs, barbs, damage, and contamination. If the needle has any defects or damage, replace it with another sterile needle.
- c. Place the protective cover back on the needle.

## 9. Place the assembled needle and syringe on the work surface.

- a. Leave the protective cover on the needle.
- b. Leave the plunger pushed fully into the barrel.
- c. Keep the assembled needle and syringe continually within range of vision.

**NOTE:** When you assemble a needle and syringe, you are responsible for maintaining sterility and security of the equipment.

## 10. Verify the drug label and check the container for defects.

- a. Compare the medication with the doctor's orders. The medication label must be verified three times.
  - (1) When obtained from the place of storage.
  - (2) When withdrawing the medication.
  - (3) When returning the container to storage.
- b. Examine the container.
  - (1) Examine the rubber stopper for defects, such as small cores or plugs torn from the stopper.
  - (2) Hold the vial to the light to check for foreign particles and changes in color and consistency. If the solution is in a dark vial, withdraw some solution to perform the checks.
  - (3) Check the date a multidose vial was opened and check the expiration date of the medication.
  - (4) Determine whether the medication was stored properly, such as under refrigeration.

**NOTE:** If there is any evidence of contamination, discard the container and obtain another.

## Performance Steps

### 11. Prepare and draw the medication.

- a. Draw medication from a stoppered vial which contains a prepared solution.
  - (1) Remove the protective cap.
  - (2) Clean the stopper and neck of the vial with an alcohol sponge.
  - (3) Pick up the assembled needle and syringe and remove the protective needle cover.
  - (4) Slowly draw the plunger to the prescribed cc mark of medication.
  - (5) Pick up the vial and insert the needle into the rubber stopper, exerting slight downward and forward pressure. Ensure that the needle tip passes completely through the cap.

*NOTE:* To avoid contamination, the hub of the needle should not touch the rubber cap.

- (6) Push the plunger fully into the barrel to inject the air.
  - (7) With the vial inverted (and keeping the needle tip in the solution), pull the plunger back to the desired cc mark, withdrawing the medication.
  - (8) Withdraw the needle from the container.
  - (9) Verify the correct dosage against the doctor's orders by raising the syringe to eye level and ensuring that the forward edge of the plunger is exactly on the prescribed cc mark.
- b. Draw medication from a stoppered vial which contains a powdered medication which must be prepared.
  - (1) Remove the protective caps from the vial containing the powdered medication and the vial containing the sterile diluent.
  - (2) Clean the stoppers of both vials with alcohol sponges.
  - (3) Withdraw the required diluent, using the same procedure as for a stoppered vial. (See steps 11a(3) through 11a(8).)
  - (4) Hold the vial with the powdered medication horizontally, insert the needle through the stopper, and inject the diluent.

*NOTE:* If the vial with powdered medication contains air, the diluent may be difficult to inject. Air may have to be withdrawn to allow the diluent to be injected.

- (5) Withdraw the needle.
  - (6) Gently invert the vial several times until all the powder is dissolved. Visually inspect the solution to ensure that it is well-mixed.
  - (7) Change the needle (or needle and syringe) and insert it into the vial of reconstituted solution.
  - (8) Withdraw the prescribed amount of medication. (See step 11a(7).)
  - (9) Withdraw the needle from the container.
  - (10) Verify the correct dosage. (See step 11a(9).)
- c. Draw medication from an ampule.
  - (1) Lightly tap the upright ampule to force any trapped medication from the ampule neck and top.
  - (2) Clean the neck of the ampule with an alcohol sponge and wrap it with the same sponge.
  - (3) Grasp the ampule with both hands and snap the neck by bending it away from the breakline, directing it away from yourself and others.
  - (4) Inspect the ampule for minute glass particles. If any are found, discard the ampule.
  - (5) Remove the protective cover from the assembled needle and syringe.
  - (6) Insert the needle and withdraw the medication by holding the ampule vertically or by placing the ampule upright on a flat surface.

**Performance Steps**

- (7) Withdraw the prescribed medication, being careful not to touch the outside edge or bottom of the ampule with the needle.
  - (8) Withdraw the needle and verify the correct dosage. (See step 11a(9).)
12. Check the syringe for air bubbles.
    - a. Hold the syringe with the needle pointing up.
    - b. Pull back on the plunger slightly to clear all the medication from the needle shaft.
    - c. Tap the barrel lightly to force bubbles to the top of the barrel.
    - d. Pull the plunger back slightly and push it forward until the solution is in the needle hub, clearing it of bubbles.
  13. Reverify the correct dosage. (See step 11a(9).)
  14. Cover the needle with the protective needle cover.

**Evaluation Preparation:**

Setup: If the performance of this task must be simulated for training and evaluation, colored solutions may be used to simulate medications. Have several sizes of needles and syringes available. Tell the soldier what type of medication is being simulated and what the route of administration would be. Have him or her select the appropriate needle and syringe. To test step 2, tell the soldier of any manufacturer's specifications. Testing may be varied by using various medications to be administered by different routes. Needles and syringes may be reused.

Brief soldier: Tell the soldier to assemble the proper needle and syringe and draw the medication.

**Performance Measures**

	<u>GO</u>	<u>NO GO</u>
1. Selected the appropriate needle.	_____	_____
2. Selected the appropriate syringe.	_____	_____
3. Inspected the packaging for defects.	_____	_____
4. Unpacked the syringe.	_____	_____
5. Inspected the syringe.	_____	_____
6. Unpacked the needle.	_____	_____
7. Joined the needle and syringe.	_____	_____
8. Inspected the needle.	_____	_____
9. Placed the assembled needle and syringe on the work surface.	_____	_____
10. Verified the drug label and checked the container for defects.	_____	_____
11. Prepared and drew the medication.	_____	_____
12. Checked the syringe for air bubbles.	_____	_____
13. Reverified the correct dosage.	_____	_____



**Performance Measures**

GO      NO  
GO

14. Covered the needle with the protective needle cover.

\_\_\_\_\_

15. Did not violate aseptic technique.

\_\_\_\_\_

**Evaluation Guidance:** Score each soldier according to the performance measures in the evaluation guide. Unless otherwise stated in the task summary, the soldier must pass all performance measures to be scored GO. If the soldier fails any step, show what was done wrong and how to do it correctly.

**References**

**Required**

None

**Related**

BASIC NURSING

**ADMINISTER AN INJECTION (INTRAMUSCULAR, SUBCUTANEOUS, INTRADERMAL)**  
**081-833-0089**

**Conditions:** You have performed a patient care handwash and have verified the physician's orders. Necessary materials and equipment: syringe(s) with the prepared medication(s), antiseptic pads, alcohol sponge swabs, sterile gauze, adhesive tape, and the patient's record.

**Standards:** Administered the injection IAW the physician's orders without violating aseptic technique or causing injury to the patient.

**Performance Steps**

1. Verify the required injection(s) with the physician's orders.
2. Identify the patient by asking the patient's name and checking the identification tag or band.  
Ask the patient if he or she has any allergies or has experienced a drug reaction.

**WARNINGS:** 1. If there is a known allergy, do not administer the injection. Consult your supervisor. 2. Determine if a female patient is pregnant because of possible side effects of certain immunizing agents on the unborn child. If there is a question, do not administer the injection without written authorization.

3. Verify that the appropriate needle, syringe, and medication are being used. (See task 081-833-0088.)

**NOTE:** Strict aseptic technique must be employed whenever foreign bodies (the needle and medications) are introduced into body tissues.

**WARNING:** Have an emergency tray available for the immediate treatment of serious reactions. Include a constricting band and a syringe containing a 1:1000 solution of epinephrine. Have a tracheotomy set available since the majority of fatalities reported involve asphyxiation due to laryngeal edema.

4. Select and expose the injection site.
  - a. Intramuscular injection.
    - (1) The upper arm deltoid muscle--the outer 1/3 of the arm between the lower edge of the shoulder bone and the armpit. Approximately three fingerwidths below the shoulder bone is the safe area.
    - (2) Buttocks--the upper-outer quadrant of either buttock.

**NOTE:** To identify the injection site, draw an imaginary horizontal line across the buttocks from hip bone to hip bone. Then divide each buttock in half with an imaginary vertical line. (See Figure 3-59.)

**Performance Steps**

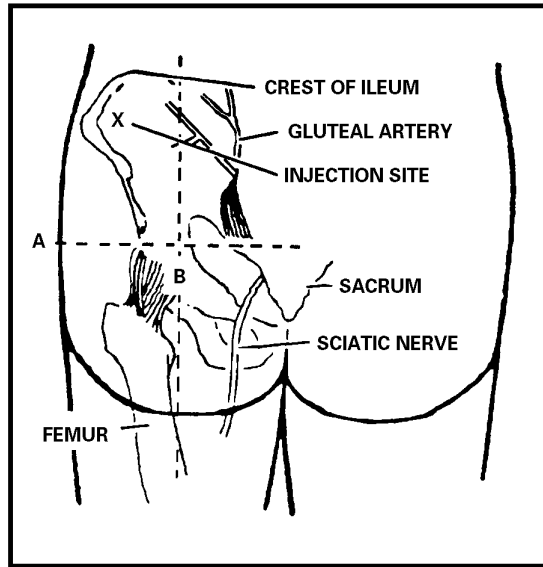

Figure 3-59

**WARNING:** Do not give the injection in an area outside the upper-outer quadrant. The needle may do irreparable damage to the sciatic nerve or pierce the gluteal artery and cause significant bleeding.

- (3) Outer thigh--the area between a hand's width above the knee and a hand's width below the groin.
- b. Subcutaneous injection.
  - (1) Upper arm.
  - (2) Anterior thigh.
  - (3) Abdomen.
- c. Intradermal injection.
  - (1) Inner forearm.
  - (2) Back of the upper arm.
  - (3) On the back below the shoulder blades.

5. Position the patient.

- a. Intramuscular.
  - (1) Upper arm--standing or sitting with the area completely exposed, muscles relaxed, and the arm at the side.
  - (2) Buttocks--lying face down or leaning forward and supported by a stable object with the weight shifted to the leg that will not be injected. The area is completely exposed.

**NOTE:** If the patient is lying in a prone position (face down), place the toes together with the heels apart. This will relax the muscles of the buttocks.

- (3) Outer thigh- -lying face up or seated with the area completely exposed.
- b. Subcutaneous.
  - (1) Upper arm--see step 5a(1).
  - (2) Outer thigh--lying face up or seated, with the area completely exposed.
- c. Intradermal.
  - (1) Inner forearm--standing, sitting, or lying. Palm up, with the arm supported and relaxed.

**Performance Steps**

- (2) Upper arm--see step 5a(1).
- (3) Back--seated, leaning forward and supported on a stable object, or lying face down.

## 6. Clean the injection site.

- a. Intramuscular and subcutaneous.
  - (1) Open the antiseptic pad package.
  - (2) Begin at the injection site and with a spiral motion, clean outward 3 inches.
- b. Intradermal.
  - (1) Use ethyl alcohol or acetone germicide and a sterile sponge.
  - (2) Begin at the injection site and with a spiral motion, clean outward 3 inches.

**NOTE:** The antiseptic pad may be held between the last two fingers for use when the needle is removed.

## 7. Pull the needle cover straight off without bending or touching the needle.

## 8. Prepare the skin for the injection.

- a. Intramuscular and subcutaneous. Form a fold of skin at the injection site by pinching the skin gently between the thumb and the index finger of the nondominant hand. Do not touch the injection site.
- b. Intradermal. Using the thumb of the nondominant hand, apply downward pressure directly below and outside the prepared injection site. Hold the skin taut until the needle has been inserted.

**CAUTION:** Do not retract or move the skin laterally.

## 9. Insert the needle.

- a. Intramuscular. With the dominant hand, position the needle, bevel up, at a 90 degree angle to, and about 1/2 inch from, the skin surface. Plunge the needle firmly and quickly straight into the muscle.
- b. Subcutaneous. With the dominant hand, position the needle, bevel up, at a 45 degree angle to the skin surface. Plunge the needle firmly and quickly into the fatty tissue below the skin.
- c. Intradermal. With the dominant hand, position the needle, bevel up, at a 15 to 20 degree angle to the skin surface. Insert it just under the skin until the bevel is covered. Do not move the skin.

## 10. Release the hold on the skin.

## 11. Administer the medication.

- a. Intramuscular and subcutaneous.
  - (1) Aspirate by pulling back slightly on the plunger of the syringe.
    - (a) If blood appears, stop the procedure. Go to step 3 and begin the procedure again. Use a new needle, syringe, and medication, and select a different injection site.
    - (b) If no blood appears, continue the procedure.

**WARNING:** Failure to aspirate could cause the medication to be injected into the blood stream.

- (2) Using a slow continuous movement, completely depress the plunger, injecting the medication.

**NOTE:** Rapid pressure may cause a burning pain.

**Performance Steps**

- (3) Place an antiseptic pad (or sterile 2 x 2) lightly over the injection site and withdraw the needle at the same angle at which it was inserted. Gently massage the injection site with the pad, unless this is contraindicated for the medication that has been injected.
- (4) Put an adhesive bandage strip over the injection site if bleeding occurs.

b. Intradermal.

**NOTE:** Do not aspirate.

- (1) Push the plunger slowly forward until all medication has been injected and a wheal appears at the site of the injection.
  - (a) If no wheal appears, go to step 3 and begin the procedure again. Use a new needle, syringe, and medication and select a different injection site.
  - (b) If a wheal appears, continue the procedure.
- (2) Quickly withdraw the needle at the same angle at which it was inserted.
- (3) Without applying pressure, cover the injection site with dry sterile gauze.
- (4) Instruct the patient not to scratch, rub, or wash the injection site.
- (5) If appropriate, instruct the patient when and where to have the test read IAW local SOP.

- 12. Check the site for bleeding.
- 13. Observe the patient for anaphylactic shock symptoms IAW local SOP. (See task 081-833-0031.)
- 14. Dispose of the needle and syringe IAW local SOP.
- 15. Record the procedure on the appropriate form.

**Evaluation Preparation:**

Setup: If the performance of this task must be simulated for training and evaluation, have another soldier act as the patient. If so, ensure that the prepared syringes contain no more than 0.2 cc of a safe, sterile, injectable solution. Tell the soldier which type of injection to give. Ensure that medical coverage is available in case of reaction.

Brief soldier: Tell the soldier to administer the injection.

**WARNING:** If the soldier violates aseptic technique or starts to do something which could injure the patient, stop the evaluation immediately.

**Performance Measures**

	<u>GO</u>	<u>NO GO</u>
1. Verified the required injection(s) with the physician's orders.	_____	_____
2. Identified the patient and asked the patient about allergies or drug reactions.	_____	_____
3. Verified the appropriate needle, syringe, and medication.	_____	_____
4. Selected and exposed the injection site.	_____	_____
5. Positioned the patient.	_____	_____

**Performance Measures**

	<u>GO</u>	<u>NO</u> <u>GO</u>
6. Cleaned the injection site.	_____	_____
7. Removed the needle cover.	_____	_____
8. Prepared the skin for injection.	_____	_____
9. Inserted the needle.	_____	_____
10. Released the skin.	_____	_____
11. Administered the medication.	_____	_____
12. Checked the site for bleeding.	_____	_____
13. Observed the patient for adverse reactions.	_____	_____
14. Disposed of the needle and syringe.	_____	_____
15. Recorded the procedure on the appropriate form.	_____	_____
16. Did not violate aseptic technique.	_____	_____
17. Did not cause further injury to the patient.	_____	_____

**Evaluation Guidance:** Score each soldier according to the performance measures in the evaluation guide. Unless otherwise stated in the task summary, the soldier must pass all performance measures to be scored GO. If the soldier fails any step, show what was done wrong and how to do it correctly.

**References**

**Required**  
None

**Related**  
BASIC NURSING

## ADMINISTER MORPHINE

081-833-0174

**Conditions:** You are supporting a combat or peacekeeping operation. You are caring for a conscious casualty who has sustained an injury and is suffering from severe pain. You have gained authorization from a licensed provider to administer morphine to the casualty (authorization may have already been delegated to you in certain combat operations).

Necessary materials and equipment: morphine cartridge, injector device (or autoinjector), alcohol wipes, a semi-permanent marking device.

**Standards:** Correctly prepared and administered morphine without causing further injury to the casualty.

### Performance Steps

1. Verify five rights of medication administration.
  - a. Right patient - verify that the casualty does not have any contraindications that preclude use of morphine.
  - b. Right medication - check to ensure the medication you are about to administer is correct.
  - c. Right dosage.
    - (1) Administer an initial dose of 5 to 10 mg intramuscularly.
    - (2) Repeat the dose after a suitable interval of time has elapsed if the patient is still complaining of pain (intramuscular absorption rate for this drug is 10 to 30 minutes, pain control peaks within 30 to 60 minutes).

**CAUTION:** Dosage must not exceed 20 mg within a 4 hour period of time.

- d. Right time - check casualty's forehead and Field Medical Card to ensure that casualty has not received more than 20 mg of morphine within the last 4 hours.
  - e. Right route - inject intramuscularly (subcutaneous injection is acceptable but this method takes longer for the effects of the medication to peak..)
2. Load the pre-filled cartridge into the injector device.
  - a. Insert the cartridge into the body and guard assembly.
  - b. Align the finger grip assembly notches and snap into place.
3. Lock the cartridge into the injector device by turning the plunger rod until the plunger is securely in place).

4. Place the casualty in a supine position.

**NOTE:** Once morphine has been administered, the casualty is considered nonambulatory.

5. Select the site for an intramuscular injection.
  - a. Deltoid muscle.
  - b. Buttocks.
  - c. Outer thigh.
6. Administer the injection (see task 081-833-0089).
7. If using an autoinjector, complete the following steps.
  - a. Remove the safety cap.
  - b. Place purple end on outer thigh and press firmly to deliver the dosage.
8. Monitor for adverse reaction.

**Performance Steps**

*NOTE:* The most common adverse reaction is severe respiratory depression. The casualty may require assisted ventilations.

- 9. Write the letter "M" and time of injection on the casualty's forehead.
- 10. Document on DD Form 1380 (see task 081-831-0033).

**Performance Measures**

	<u>GO</u>	<u>NO GO</u>
1. Verified five rights of medication administration.	_____	_____
2. Loaded the pre-filled cartridge into the injector device (eliminate this step if using autoinjector).	_____	_____
3. Locked the cartridge into the injector device turning the plunger rod until the plunger was securely in place (eliminate this step if using autoinjector).	_____	_____
4. Positioned the casualty.	_____	_____
5. Selected the site for an intramuscular injection.	_____	_____
6. Administered the injection.	_____	_____
7. Monitored for adverse reaction.	_____	_____
8. Wrote the letter "M" and time of injection on the casualty's forehead.	_____	_____
9. Documented the administration of morphine on DD Form 1380.	_____	_____

**Evaluation Guidance:** Score each soldier according to the performance measures in the evaluation guide. Unless otherwise stated in the task summary, the soldier must pass all performance measures to be scored GO. If the soldier fails any step, show what was done wrong and how to do it correctly.

**References**

**Required**  
None

**Related**  
BASIC NURSING



## ADMINISTER ORAL MEDICATIONS

### 081-835-3001

**Conditions:** A patient care handwash has been performed. Necessary materials and equipment: calibrated medicine cups, disposable medicine cups, tray, medications, DA Form 3949, and the patient's clinical record.

**Standards:** Prepared and administered medications IAW the physician's orders. Observed the "five rights" (the right drug, the right dose, the right patient, the right route, and the right time).

### Performance Steps

1. Check the medication sheet (DA Form 4678) against the physician's orders.  
(Abbreviations commonly used in prescribing medications can be found in [Appendix B](#).)
  - a. Name of the medication.
  - b. Amount (dose) of medication.
  - c. Route of administration.
  - d. Right patient.
  - e. Time to be administered.
2. Select the medication.
  - a. Check the medication label three times to ensure that the correct medication is being prepared for administration.
    - (1) First time--when removing the container from the storage shelf.
    - (2) Second time--when preparing the medication dose.
    - (3) Third time--when returning the container to the storage shelf.
  - b. Check the expiration date of the medication.
  - c. Handle only one medication at a time.

*NOTE:* If unfamiliar with a medication, look it up to determine contraindications, precautions, and side effects before preparing it for administration.

3. Calculate the amount of medication required to equal the prescribed dose.  
(See [Appendix B](#).)
4. Prepare the prescribed dose of medication.
  - a. Tablets or capsules. Transfer the prescribed dose of tablets or capsules to the medicine cup.
  - b. Liquids.
    - (1) Pour the prescribed dose of liquid medication into the medicine cup.

*NOTE:* When liquid is poured into a cylinder, it forms a meniscus. In determining the volume of liquid, a reading must be made at the bottom of the meniscus, with the level of the liquid at eye level.

- (2) Small amounts of liquid medication should be drawn up in a syringe.
  - c. Powders.
    - (1) Pour the correct dose of powdered or granulated medication into the medicine cup.
    - (2) Pour the required amount of water or juice into a paper cup.

*NOTE:* Reconstitute the medication at the patient's bedside.

5. Place all the prepared medications on a tray or the medication cart.

*NOTE:* When preparing medication for more than one patient, mark each container with the patient's identification.

**Performance Steps**

6. Sign for controlled drugs on DA Form 3949, IAW local SOP.
7. Correctly identify the patient.
8. Locate the correct medication.
9. Give the medication to the patient at the prescribed time.
  - a. Tablets, capsules, or liquids. Observe the patient swallow the tablets, capsules, or liquids.
  - b. Sublingual medications. Instruct the patient to allow sublingual medications to dissolve in the mouth.
  - c. Powdered medication. Reconstitute powdered or granulated medications in the prepared juice or water and observe the patient drink the preparation.

**CAUTION:** Do not leave any medications at the patient's bedside without a specific physician's order to do so.

*NOTE:* If a patient refuses a medication, offer it again in 5 minutes. If refused a second time, record the omission on DA Form 4678 and document the reason for the omission in the nursing notes.

10. Record the administration of all medications on the appropriate medical forms.

*NOTE:* Administration of all scheduled and nonscheduled (PRN) medication must be documented.

- a. Initial the medication sheet (DA Form 4678).
  - b. Annotate the nursing notes when administering controlled drugs, nonscheduled (PRN) medications, and other medications as required by local policy.
    - (1) Name of the medication.
    - (2) Time the medication was administered.
    - (3) Reason for the medication.
11. Record the omission of a medication on the appropriate medical forms whenever a scheduled medication is not administered.
    - a. Annotate the medication sheet (DA Form 4678) by placing a circle in the initial block.
    - b. Annotate the nursing notes.
      - (1) Name of the medication.
      - (2) Time it should have been administered.
      - (3) Reason it was not administered.
      - (4) Follow-up action taken.

**Performance Measures**

	<u>GO</u>	<u>NO GO</u>
1. Checked the medication sheet (DA Form 4678) against the physician's orders.	—	—
2. Selected the medication.	—	—
3. Calculated the amount of medication required to equal the prescribed dose.	—	—
4. Prepared the prescribed dose of medication.	—	—
5. Placed all the prepared medications on a tray or the medication cart.	—	—

<b>Performance Measures</b>	<u><b>GO</b></u>	<u><b>NO GO</b></u>
6. Signed for controlled drugs on DA Form 3949, IAW local SOP.	—	—
7. Correctly identified the patient.	—	—
8. Located the correct medication.	—	—
9. Gave the medication to the patient at the prescribed time.	—	—
10. Recorded the administration of all medications on the appropriate medical forms.	—	—
11. Recorded the omission of a medication on the appropriate medical forms whenever a scheduled medication is not administered.	—	—

**Evaluation Guidance:** Score each soldier according to the performance measures in the evaluation guide. Unless otherwise stated in the task summary, the soldier must pass all performance measures to be scored GO. If the soldier fails any step, show what was done wrong and how to do it correctly.

**References**

**Required**  
None

**Related**  
BASIC NURSING

## ADMINISTER TOPICAL MEDICATIONS

### 081-835-3020

**Conditions:** A patient care handwash has been performed. Necessary materials and equipment: calibrated medicine cups, disposable medicine cups, tray, medications, medicated pads or patches, application papers, tape, DA Form 3949, and the patient's clinical record.

**Standards:** Prepared and administered medications IAW the physician's orders. Observed the "five rights" (the right drug, the right dose, the right patient, the right route, and the right time).

#### Performance Steps

1. Check the medication sheet (DA Form 4678) against the physician's orders.  
(Abbreviations commonly used in prescribing medications can be found in [Appendix B.](#))
  - a. Name of the medication.
  - b. Amount (dose) of medication.
  - c. Route of administration.
  - d. Time to be administered.
2. Select the medication.
  - a. Check the medication label three times to ensure that the correct medication is being prepared for administration.
  - b. Check the expiration date of the medication.
  - c. Handle only one medication at a time.

*NOTE:* If unfamiliar with a medication, look it up to determine contraindications, precautions, and side effects.

3. Prepare the prescribed dose of topical medication.

*NOTE:* Perform pharmaceutical calculations as necessary to determine the amount of medication required to equal the prescribed dose. (See [Appendix B.](#))

- a. Obtain single dose packets of topical medication.
- b. Obtain the required number of medicated patches or pads.
- c. Apply the prescribed size ribbon of ointment to an application paper.
- d. Obtain the jar or tube of medication identified for that individual patient's use.
- e. Aseptically transfer the required amount of topical medication from the bulk storage container to a sterile, disposable container.

4. Place all the prepared medications on a tray or the medication cart.

*NOTE:* When preparing medication for more than one patient, mark the prepared medications with the patient's identification.

5. Sign for controlled drugs on DA Form 3949, as appropriate.
6. Correctly identify the patient and explain procedure.
7. Prepare the skin.
  - a. Provide privacy or screen the patient, as necessary.
  - b. Expose the prescribed area of the patient's skin.
  - c. Clean the skin IAW the physician's orders, if required.
8. Apply the medication to the patient.
  - a. Locate the correct medication.
  - b. Apply the medication to the prescribed area IAW the physician's orders or local SOP.

**Performance Steps**

*NOTE:* Wear gloves when appropriate.

- (1) Secure patches, pads, and application papers with tape.
- (2) Cover topical applications with sterile dressings IAW the physician's orders, if required.

**CAUTION:** Do not leave any medication at the patient's bedside without a specific physician's order to do so.

*NOTE:* If a patient refuses the application of a medication, offer it again in five minutes. If refused a second time, record the omission on DA Form 4678 and document the reason for the omission in the nursing notes.

9. Record the administration of all medications on the appropriate medical forms.

*NOTE:* Administration of all scheduled and nonscheduled (PRN) medication must be documented.

- a. Initial the medication sheet (DA Form 4678).
  - b. Make a nursing note entry describing the location of the application and the condition of the skin at the time of application.
  - c. Annotate the nursing notes when administering controlled drugs, nonscheduled (PRN) medications, and other medications as required by local policy.
    - (1) Name of the medication.
    - (2) Time the medication was administered.
    - (3) Reason for the medication.
10. Record the omission of a medication on the appropriate medical forms whenever a scheduled medication is not administered.
- a. Annotate the medication sheet (DA Form 4678) by placing a circle in the initial block.
  - b. Annotate the nursing notes.
    - (1) Name of the medication.
    - (2) Time it should have been administered.
    - (3) Reason it was not administered.
    - (4) Follow-up action taken.

**Performance Measures**

	<u>GO</u>	<u>NO GO</u>
1. Checked the medication sheet (DA Form 4678) against the physician's orders.	—	—
2. Selected the medication.	—	—
3. Prepared the prescribed dose of topical medication.	—	—
4. Placed all the prepared medications on a tray or the medication cart.	—	—
5. Signed for controlled drugs on DA Form 3949, as appropriate.	—	—
6. Correctly identified the patient.	—	—
7. Prepared the skin.	—	—
8. Applied the medication to the patient.	—	—
9. Recorded the administration of all medications on the appropriate medical forms.	—	—

**Performance Measures**

<u><b>GO</b></u>	<u><b>NO</b></u>
<u>      </u>	<u><b>GO</b></u>

10. Recorded the omission of a medication on the appropriate medical forms whenever a scheduled medication was not administered.

_____	_____
-------	-------

**Evaluation Guidance:** Score each soldier according to the performance measures in the evaluation guide. Unless otherwise stated in the task summary, the soldier must pass all performance measures to be scored GO. If the soldier fails any step, show what was done wrong and how to do it correctly.

**References****Required**

None

**Related**

BASIC NURSING

## **ADMINISTER RECTAL OR VAGINAL MEDICATIONS**

### **081-835-3021**

**Conditions:** A patient care handwash has been performed. Necessary materials and equipment: disposable medicine cups, tray, medications, applicators, nonsterile gloves, water-soluble jelly, DA Form 3949, and the patient's clinical record.

**Standards:** Prepared and administered medications IAW the physician's orders. Observed the "five rights" (the right drug, the right dose, the right patient, the right route, and the right time).

### **Performance Steps**

1. Check the medication sheet (DA Form 4678) against the physician's orders.  
(Abbreviations commonly used in prescribing medications can be found in [Appendix B.](#))
  - a. Name of the medication.
  - b. Amount (dose) of medication.
  - c. Route of administration.
  - d. Time to be administered.
2. Select the medication.
  - a. Check the medication label three times to ensure that the correct medication is being prepared for administration.
  - b. Check the expiration date of the medication.
  - c. Handle only one medication at a time.

*NOTE:* If unfamiliar with a medication, look it up to determine contraindications, precautions, and side effects.

3. Prepare the prescribed dose of medication.

*NOTE:* Perform pharmaceutical calculations as necessary to determine the amount of medication required to equal the prescribed dose. (See [Appendix B.](#))

- a. Place the suppository medication in the medication cup.
- b. Draw the correct dose of cream or foam medication into the applicator device.
- c. Prepare the prescribed amount of medicated solution for a vaginal irrigation (douche) or an enema.
- d. Obtain the prescribed single use, disposable douche or enema.

*NOTE:* Leave medication wrapped or covered until ready to administer.

4. Place all the prepared medications on a tray or the medication cart.

*NOTE:* When preparing medication for more than one patient, mark each cup or applicator with the patient's identification.

5. Sign for controlled drugs on DA Form 3949, as appropriate.
6. Correctly identify the patient.
7. Provide for privacy.
8. Position the patient, as appropriate.
  - a. Supine, with the legs spread and bent at the knees, for vaginal administration.
  - b. Lateral, with the upper leg bent at the knee to facilitate spread of the buttocks, for rectal administration.
9. Put on exam gloves.

## Performance Steps

10. Insert the medication.

a. Suppositories.

- (1) Lubricate the suppository with water-soluble jelly.
- (2) Insert the suppository into the appropriate orifice and advance it with the index finger.

**NOTE:** Rectal suppositories must be advanced past the sphincter muscles (about 2 inches).

b. Cream or foam applications.

- (1) Lubricate the tip of the applicator device with water-soluble jelly.
- (2) Insert the applicator into the appropriate orifice.
- (3) Push the applicator plunger to instill the medication.
- (4) Withdraw the applicator.

c. Vaginal irrigation (douche).

**NOTE:** Place a catch basin or bedpan under the patient to collect return solution.

- (1) Lubricate the douche tip with water-soluble jelly.
- (2) Gently insert the douche tip into the vagina.
- (3) Release the clamp on the tubing and allow solution to flow slowly. (If using a disposable douche, gently squeeze the container to dispense the solution.)
- (4) Rotate the douche tip to direct fluid over all parts of the vagina.
- (5) Administer all the solution and gently withdraw the douche tip.
- (6) Remove the bedpan or catch basin and place a sanitary pad over the vulva.

d. Enema.

**NOTE:** Provide a bedpan if the patient is unable to ambulate to the latrine to expel the solution.

- (1) Lubricate the rectal tip with water-soluble jelly.
- (2) Insert the rectal tip into the rectum about 3 to 4 inches.
- (3) Release the clamp on the tubing and allow the solution to flow slowly. (If using a disposable enema, squeeze the container to dispense the solution.)
- (4) Slow the flow of solution if the patient complains of cramping.
- (5) Administer all the solution and withdraw the enema tip.
- (6) Tell the patient how long the solution must be retained.

**CAUTION:** Do not leave any medication at the patient's bedside without a specific physician's order.

**NOTE:** If a patient refuses the instillation of a medication, offer it again in five minutes. If refused a second time, record the omission on DA Form 4678 and document the reason for the omission in the nursing notes.

11. Record the administration of all medications on the appropriate medical forms.

**NOTE:** Document the administration of all scheduled and nonscheduled (PRN) medication.

a. Initial the medication sheet (DA Form 4678).

b. Annotate the nursing notes when administering controlled drugs, nonscheduled (PRN) medications, and other medications as required by local policy.

- (1) Name of the medication.
- (2) Time the medication was administered.
- (3) Reason for the medication.

12. Record the omission of a medication on the appropriate medical forms whenever a scheduled medication is not administered.

a. Annotate the medication sheet (DA Form 4678) by placing a circle in the initial block.

b. Annotate the nursing notes.

- (1) Name of the medication.
- (2) Time it should have been administered.



**Performance Steps**

- (3) Reason it was not administered.
- (4) Follow-up action taken.

**Performance Measures**

	<u>GO</u>	<u>NO GO</u>
1. Checked the medication sheet (DA Form 4678) against the physician's orders.	—	—
2. Selected the medication.	—	—
3. Prepared the prescribed dose of medication.	—	—
4. Placed all the prepared medications on a tray or the medication cart.	—	—
5. Signed for controlled drugs on DA Form 3949, as appropriate.	—	—
6. Correctly identified the patient.	—	—
7. Provided for privacy.	—	—
8. Positioned the patient, as appropriate.	—	—
9. Put on exam gloves.	—	—
10. Inserted the medication.	—	—
11. Recorded the administration of all medications on the appropriate medical forms.	—	—
12. Recorded the omission of a medication on the appropriate medical forms whenever a scheduled medication is not administered.	—	—

**Evaluation Guidance:** Score each soldier according to the performance measures in the evaluation guide. Unless otherwise stated in the task summary, the soldier must pass all performance measures to be scored GO. If the soldier fails any step, show what was done wrong and how to do it correctly.

**References**

**Required**  
None

**Related**  
BASIC NURSING

## ADMINISTER MEDICATED EYE DROPS OR OINTMENTS

### 081-835-3022

**Conditions:** A patient care handwash has been performed. Necessary materials and equipment: tissues, sterile gauze, sterile normal saline, dressing materials, the prescribed medications, and the patient's clinical record.

**Standards:** Administered eye drops and ointments without contamination and without causing further injury to the patient. Observed the "five rights" of medication administration (the right drug, the right dose, the right patient, the right route, and the right time).

### Performance Steps

1. Check the medication sheet (DA Form 4678) against the physician's orders.  
(Abbreviations commonly used in prescribing medications can be found in [Appendix B](#).)
  - a. Name of the medication.
  - b. Amount (dose) of medication.
  - c. Route of administration.
  - d. Time to be administered.
2. Select the medication.
  - a. Check the medication label three times to ensure that the correct medication is being prepared for administration.
  - b. Check the expiration date of the medication.

*NOTE:* If unfamiliar with a medication, look it up to determine contraindications, precautions, and side effects.

3. Take the medication and other supplies to the patient's bedside.
4. Identify the patient and explain the procedure.
5. Position the patient.
  - a. Supine in bed.
  - b. Sitting, with the head supported.

*NOTE:* The head must be supported for stability if the patient is seated. Support may be provided by a head rest or a high-back chair.

6. Remove eye dressings, if present.
  - a. Gently pull the dressing away from the forehead, and then pull it down and away from the eye area.
  - b. Discard the contaminated dressing.
  - c. Perform a patient care handwash.
7. Remove accumulation of secretions, if present.
  - a. Apply sterile gauze moistened with sterile normal saline to the closed eyes to soften the secretions.
  - b. Remove loosened secretions by blotting with additional moistened gauze.
8. Prepare the medication.
  - a. Ointment tube.
    - (1) Remove the cap from the tube and place the cap on a piece of sterile gauze to prevent contamination.

### Performance Steps

- (2) Squeeze a small amount of ointment onto a piece of sterile gauze to remove any crust that may have formed.
    - (3) Discard this gauze.
  - b. Eye dropper.
    - (1) Draw the prescribed amount of the medication into the dropper.
    - (2) Do not invert the dropper after withdrawing the solution.
  - c. Squeeze vial.
    - (1) Remove the cap and place it on a piece of sterile gauze.
    - (2) Invert the vial.
9. Administer the medication.
  - a. Instruct the patient to tilt the head back and look upward with the eyes open.
  - b. Steady the hand holding the medication container against the patient's forehead.
  - c. Place a finger on the skin below the lower eyelid and apply gentle, downward pressure to create a small conjunctival pocket.
  - d. Instill the correct number of drops or amount of ointment into the conjunctival pocket.
  - e. Apply ointment in a thin ribbon from the inner aspect to the outer aspect of the conjunctival pocket.
  - f. Do not instill medication directly onto the eyeball.
10. Instruct the patient to close the eyes gently and "roll" them to distribute the medication.  
*NOTE:* Instruct the patient not to squeeze the eyes tightly shut.
11. Remove any excess solution or ointment by blotting gently with a clean tissue or gauze square.
12. Apply fresh dressings or patches, if required.  
*NOTE:* If a patient refuses a medication, offer it again in 5 minutes. If refused a second time, record the omission on DA Form 4678 and document the reason for the omission in the nursing notes.
13. Remove all equipment from the bedside.  
**CAUTION:** Do not leave any medication at the patient's bedside without a specific physician's order.
14. Record the administration of all medications on the appropriate medical forms.  
*NOTE:* Administration of all scheduled and nonscheduled (PRN) medication must be documented.
  - a. Initial the medication sheet (DA Form 4678).
  - b. Annotate the nursing notes when administering controlled drugs, nonscheduled (PRN) medications, and other medications as required by local policy.
    - (1) Name of the medication.
    - (2) Time the medication was administered.
    - (3) Reason for the medication.
15. Record the omission of a medication on the appropriate medical forms whenever a scheduled medication is not administered.
  - a. Annotate the medication sheet (DA Form 4678) by placing a circle in the initial block.
  - b. Annotate the nursing notes.
    - (1) Name of the medication.
    - (2) Time it should have been administered.
    - (3) Reason it was not administered.

**Performance Steps**

(4) Follow-up action taken.

**Performance Measures**

	<u>GO</u>	<u>NO GO</u>
1. Checked the medication sheet (DA Form 4678) against the physician's orders.	—	—
2. Selected the medication.	—	—
3. Took the medication and other supplies to the patient's bedside.	—	—
4. Identified the patient and explained the procedure.	—	—
5. Positioned the patient.	—	—
6. Removed eye dressings, if present.	—	—
7. Removed accumulation of secretions, if present.	—	—
8. Prepared the medications.	—	—
9. Administered the medication.	—	—
10. Instructed the patient to close the eyes gently and "roll" them to distribute the medication.	—	—
11. Removed any excess solution or ointment by blotting gently with a clean tissue or gauze square.	—	—
12. Applied fresh dressings or patches, if required.	—	—
13. Removed all equipment from the bedside.	—	—
14. Recorded the administration of all medications on the appropriate medical forms.	—	—
15. Recorded the omission of a medication on the appropriate medical forms whenever a scheduled medication was not administered.	—	—

**Evaluation Guidance:** Score each soldier according to the performance measures in the evaluation guide. Unless otherwise stated in the task summary, the soldier must pass all performance measures to be scored GO. If the soldier fails any step, show what was done wrong and how to do it correctly.

**References****Required**

None

**Related**

BASIC NURSING

Subject Area 16: Force Protection/Risk Assessment

**DISINFECT WATER FOR DRINKING**

**081-831-0037**

**Conditions:** You are a member of a field sanitation team. You have just filled a Lyster bag or Water Buffalo from a source that is not safe for drinking. Necessary materials and equipment: calcium hypochlorite, clean stirring implement, mess kit spoon, a canteen cup, and a field chlorination kit.

**Standards:** Disinfected water to a chlorine residual of 5 parts per million (ppm) or as ordered by the command surgeon.

**Performance Steps**

1. Mix the stock disinfecting solution.
  - a. Add the prescribed dosage of calcium hypochlorite to 1/2 canteen cup of water.
    - (1) 3 ampules per 36 gallons of water.
    - (2) 22 ampules or 3 plastic MRE spoonfuls (from a bulk container) in 400 gallons of water.
  - b. Stir the stock solution.
2. Add the stock solution to the water container.
  - a. Pour the stock solution into the water container.
  - b. Mix the solution vigorously with a clean implement.
  - c. Cover the container.
3. Flush the faucets.
4. Test the chlorine residual after 10 minutes.
  - a. Follow the manufacturer's instructions on the color comparator in the chlorination kit to test the chlorine residual.
  - b. Retest the chlorine residual after 20 minutes.
5. Retest the water two or three times daily.

**Evaluation Preparation:**

Setup: Test this task only when there is a need to disinfect water for drinking. Do not simulate this task for training or evaluation.

Brief soldier: Tell the soldier to disinfect the water. After the soldier completes step 5, ask him or her how often the water should be retested.

**Performance Measures**

	<u>GO</u>	<u>NO</u> <u>GO</u>
1. Mixed the stock disinfecting solution.	_____	_____
2. Added the stock solution to the water container.	_____	_____
3. Flushed the faucets.	_____	_____

**Performance Measures**

	<u>GO</u>	<u>NO</u> <u>GO</u>
4. Tested the chlorine residual after 10 minutes.	_____	_____
5. Retested the chlorine residual after 20 minutes.	_____	_____
6. Retested the water two or three times daily.	_____	_____

**Evaluation Guidance:** Score each soldier according to the performance measures in the evaluation guide. Unless otherwise stated in the task summary, the soldier must pass all performance measures to be scored GO. If the soldier fails any step, show what was done wrong and how to do it correctly.

**References:** None

Skill Level 2

Subject Area 17: Advanced Procedures (SL 2)

**PERFORM ENDOTRACHEAL SUCTIONING OF A PATIENT**

**081-833-0170**

**Conditions:** You have done an assessment and determined your patient needs suctioning. You have already done a patient care handwash. Necessary materials and equipment: suction unit, suction catheter, sterile basin, sterile water, sterile gloves, or a disposable suction kit.

**Standards:** Performed endotracheal suctioning without violating aseptic technique or causing injury to the patient

**Performance Steps**

1. Explain the procedure to the patient.

2. Position the patient in the semi-Fowler's (semi-sitting) position.

*NOTE:* In some cases, such as spinal injuries, the patient will have to remain in whatever position he or she is in at the time.

3. Check the pressure on the suction apparatus.

- a. Turn the unit on, place a thumb over the end of the suction connecting tube, and observe the pressure gauge.
- b. Ensure that the pressure reading is within the limits specified by local SOP and the recommendations of the equipment manufacturer.
- c. Notify the supervisor if the pressure is not within the recommended limits.
- d. Turn the unit off after verifying the correct pressure.

**WARNING:** If the suction pressure is too low, the secretions cannot be removed. If the pressure is too high, the mucous membranes may be forcefully pulled into the catheter opening.

4. Prepare the sterile materials. (See task 081-833-0007.)

- a. Open the sterile solution basin package on the bedside stand or table to create a sterile field.
- b. Pour sterile saline solution into the basin.
- c. Open the suction catheter package to expose the suction port of the catheter.
- d. Open the sterile glove package.

*NOTE:* Disposable suctioning kits contain the same items.

5. Oxygenate the patient.

- a. Hyperventilate the patient for 1 to 2 minutes.
- b. Monitor the patient's pulse oximeter reading during the entire procedure. (See task 081-833-0164).

6. Put on sterile gloves. (See task 081-831-0008.)

7. Remove the catheter from the package using the dominant hand, keeping the catheter coiled to prevent contamination.

*NOTE:* This hand must remain sterile.

8. Measure the length of the suction catheter so that it will be approximately at the carina.

**Performance Steps**

**CAUTION:** Do not touch the patient while measuring the length of the catheter. This will violate aseptic technique.

- a. Tip of catheter to the ear.
- b. From the ear to the nipple line.

9. Attach the tubing to the catheter with the nondominant hand.

*NOTE:* This hand does not have to remain sterile. The glove is for your protection.

10. Test the patency of the catheter.

- a. Turn the suction unit on with the nonsterile hand.
- b. Insert the catheter tip into the sterile saline solution using the sterile hand.
- c. Place the nonsterile thumb over the suction port to create suction. Observe the saline entering the drainage bottle.

*NOTE:* If no saline enters the bottle, check the suction unit and/or replace the catheter and retest for patency.

11. Suction the patient.

- a. Remove the oxygen delivery device with the nondominant hand.
- b. Lubricate the catheter tip by dipping it into the saline solution.
- c. Gently insert the catheter into the airway to the measured length without suctioning.
- d. Apply intermittent suction by placing and releasing the nondominant hand over the vent of the catheter while withdrawing the catheter in a twisting motion.

**CAUTION:** Do not suction any longer than 15 seconds.

- e. Replace the oxygen delivery device and hyperventilate the patient.
- f. Repeat steps 10a through 10e until secretions are removed.

12. Observe the patient for hypoxemia.

**WARNING:** Discontinue suctioning immediately if severe changes in color or pulse rate occur.

13. Disconnect the catheter and remove the gloves.

- a. Hold the catheter in one hand.
- b. Remove that glove by turning it inside out over the catheter to prevent the spread of contaminants.
- c. Remove the other glove.
- d. Discard them in contaminated trash.

14. Make the patient comfortable.

15. Discard, or clean and store, used items.

16. Record the procedure on the appropriate form.

- a. Respirations (rate and breath sounds before and after suctioning).
- b. Type and amount of secretions.
- c. Patient's toleration of the procedure.

**Performance Measures**

	<u>GO</u>	<u>NO GO</u>
1. Explained the procedure to the patient.	—	—
2. Positioned the patient.	—	—
3. Checked the pressure on the suctioning apparatus.	—	—



<b>Performance Measures</b>	<b><u>GO</u></b>	<b><u>NO</u> <u>GO</u></b>
4. Prepared the sterile materials.	—	—
5. Oxygenated the patient.	—	—
6. Put on sterile gloves.	—	—
7. Removed the catheter from the package using the dominant hand, keeping the catheter coiled to prevent contamination.	—	—
8. Measured the length of the suction catheter so that it will be approximately at the carina.	—	—
9. Attached the tubing to the catheter using the nondominant hand.	—	—
10. Tested the patency of the catheter.	—	—
11. Suctioned the patient.	—	—
12. Observed the patient for hypoxemia.	—	—
13. Disconnected the catheter and removed the gloves.	—	—
14. Made the patient comfortable.	—	—
15. Discarded, or cleaned and stored, used items.	—	—
16. Recorded the procedure on the appropriate form.	—	—
17. Did not violate aseptic technique.	—	—
18. Did not cause further injury to the patient.	—	—

**Evaluation Guidance:** Score each soldier according to the performance measures in the evaluation guide. Unless otherwise stated in the task summary, the soldier must pass all performance measures to be scored GO. If the soldier fails any step, show what was done wrong and how to do it correctly.

**References**

**Required**  
None

**Related**

BTLS FOR PARAMEDICS  
EMERGENCY CARE

**PROVIDE TRACHEOSTOMY CARE**  
**081-835-3024**

**Conditions:** You have an adult patient requiring tracheostomy care. You have explained the procedure to the patient and a patient care handwash has been performed. An assistant may be available. Necessary materials and equipment: tracheostomy cleaning kit, sterile and nonsterile gloves, masks, protective eyewear, suctioning equipment, neck tapes, sterile gauze, sterile normal saline, sterile water, hydrogen peroxide, pulse oximetry monitor, oximetry sensor, alcohol wipes, and the patient's clinical record.

**Standards:** Provided tracheostomy care without contamination and without causing further injury to the patient.

**Performance Steps**

1. Position the patient.
  - a. Elevate the bed to a working height.
  - b. Place the patient in the semi-Fowler's position.
  - c. Monitor the patient's pulse oximeter reading throughout the procedure. (See task 081-833-0164.)
2. Suction the patient's tracheostomy and oropharynx. (See tasks 081-833-0170 and 081-833-0021.)

**CAUTION:** Suctioning should always be done immediately prior to tracheostomy care.

3. Prepare the sterile materials for tracheostomy care.
  - a. Open the tracheostomy cleaning kit or tray and use the inner wrapper to set up a sterile field.
  - b. Open sterile dressings and other supplies and place them on the sterile field.
  - c. Pour hydrogen peroxide into one basin and sterile saline into another.
4. Put on a mask and protective eyewear.
5. Remove the soiled tracheostomy dressing.
  - a. Put on nonsterile gloves.
  - b. Carefully remove the soiled dressing, observing it for type and amount of drainage, if any.
  - c. Discard the contaminated dressing.
  - d. Remove and discard the nonsterile gloves.
  - e. Observe the condition of the tracheostomy site.
6. Clean the tracheostomy site.
  - a. Put on sterile gloves.
  - b. Using sterile swabs that have been moistened with saline solution, carefully clean around the tracheostomy site.

**NOTE:** If encrustations are present around the stoma site, it may be necessary to remove them with sterile swabs that have been moistened with hydrogen peroxide. Rinse the area with saline soaked swabs after the encrustations have been removed. Take care to let none of the solution enter the tracheostomy.

- c. Pat the area dry with sterile gauze.
7. Remove the inner cannula.
  - a. Put on fresh sterile gloves if the gloves were contaminated in the previous step.

**Performance Steps**

- b. Unlock the inner cannula.
- c. Gently and carefully pull out the inner cannula.

*NOTE:* Not all tracheostomy tubes have an inner cannula.

- 8. Clean the inner cannula.
  - a. Immerse the inner cannula in hydrogen peroxide or appropriate solution IAW local SOP.
  - b. Clean the inner cannula with the sterile brush from the tracheostomy cleaning kit.
  - c. Ensure the removal of all secretions and encrustations from both the inside and outside of the inner cannula.
  - d. Rinse the inner cannula thoroughly with sterile saline.

*NOTE:* If an assistant is available, instruct him or her to suction the outer cannula to remove accumulated secretions.

- 9. Reinsert the inner cannula.
  - a. Insert the inner cannula into the outer cannula.
  - b. Lock the inner cannula into place.

- 10. Replace soiled neck tapes.
  - a. Direct your assistant to hold the outer cannula securely in position while you change the tapes.

*NOTE:* If an assistant is not available to hold the outer cannula, apply the new neck ties prior to cutting and removing the old neck ties. This will prevent accidental dislodgement of the tracheostomy tube.

- b. Remove and discard the neck tapes.
- c. Secure the new tapes to the flanges of the outer cannula and tie the knot at the side of the neck.

*NOTE:* The neck tapes should not be tied so tightly that they cause discomfort to the patient. You should be able to slip one or two fingers under the neck tapes.

- 11. Apply a sterile dressing.
  - a. Apply the prepared sterile dressing from the kit or sterile gauze folded in a V-shape.
  - b. Position the dressing under the flanges of the outer cannula.

*NOTE:* The gauze dressing is placed under the tube to absorb secretions. This piece of gauze should be changed as often as necessary.

- 12. Position the patient for comfort and safety.
  - a. Lock the bed rails in the up position.
  - b. Lower the bed to its lowest position.

**CAUTION:** The call bell must be within reach at all times, as the patient cannot speak or call out for help.

- 13. Discard disposable equipment.

- 14. Document the care provided and significant observations on the appropriate forms IAW local SOP.
  - a. Note the type and amount of drainage on the dressing, if any.
  - b. Describe the appearance of the tracheostomy site.
  - c. Note the type and amount of secretions suctioned.
  - d. Describe the patient's tolerance of the procedure.

**Performance Measures**

	<u>GO</u>	<u>NO GO</u>
1. Positioned the patient.	_____	_____
2. Suctioned the patient.	_____	_____
3. Prepared the sterile equipment.	_____	_____
4. Put on a mask and protective eyewear.	_____	_____
5. Removed the soiled dressing.	_____	_____
6. Cleaned the tracheostomy site.	_____	_____
7. Removed the inner cannula.	_____	_____
8. Cleaned the inner cannula.	_____	_____
9. Reinserted the inner cannula.	_____	_____
10. Replaced soiled neck tapes.	_____	_____
11. Applied a sterile dressing.	_____	_____
12. Positioned the patient for comfort and safety.	_____	_____
13. Discarded disposable equipment.	_____	_____
14. Documented the care provided.	_____	_____

**Evaluation Guidance:** Score each soldier according to the performance measures in the evaluation guide. Unless otherwise stated in the task summary, the soldier must pass all performance measures to be scored GO. If the soldier fails any step, show what was done wrong and how to do it correctly.

**References**

**Required**  
None

**Related**  
BASIC NURSING

**PROVIDE NURSING CARE FOR A PATIENT WITH A WATERSEAL DRAINAGE SYSTEM**  
**081-835-3031**

**Conditions:** You have a patient with a waterseal drainage system. A patient care handwash has been performed. Necessary materials and equipment: sterile petroleum gauze, rubber padded hemostats, safety pins, water-soluble lubricant, thermometer, stethoscope, sphygmomanometer, sterile dressing materials, tape, pillow, antiseptic wipes, and the patient's clinical record.

**Standards:** Provided patient care without causing further injury to the patient. Provided emergency care when the waterseal drainage system was disrupted, minimizing the effects to the patient.

**Performance Steps**

1. Review the patient's clinical record to determine the reason for the patient's waterseal drainage system.
  - a. Chest injury.
  - b. Chest surgery.
  - c. Spontaneous pneumothorax.
2. Explain all safety checks and procedures to the patient.
3. Assess the waterseal drainage system to ensure proper setup and functioning. (See Figure 3-60.)

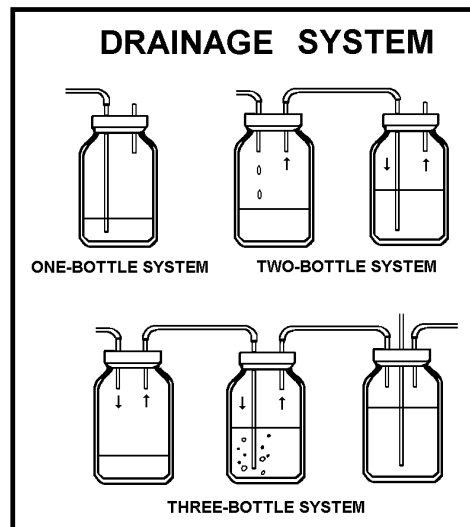

Figure 3-60

**NOTE:** Chest drainage can be accomplished with one, two, or three bottle (or chamber) systems. All can be used with or without suction.

- a. Single bottle system.
  - (1) The end of the patient's chest tube is attached to drainage (connecting) tubing.
  - (2) The drainage tubing is attached to a long glass rod which protrudes through the cap of a sterile bottle.

**Performance Steps**

- (3) The long glass rod extends into the bottle and is submerged in sterile water to a depth of approximately 2.5 cm (1 inch).
  - (a) Fluid fluctuation should be observable in the long glass rod as the patient breathes. It goes up when the patient inhales and down when the patient exhales. This indicates effective communication between the chest cavity and the waterseal system.
  - (b) Bubbling at the submerged end of the long glass rod may or may not occur. Vigorous bubbling, when suction is not in use, indicates an air leak in the system or the lung.
- (4) A short glass rod protrudes from the bottle cap.
  - (a) If controlled suction is not in use, this rod is left open to the atmosphere to allow the escape of air.
  - (b) If controlled suction is being used, the connection to the suction apparatus is made at the short glass rod.

*NOTE:* This bottle is called the waterseal bottle. The submerged rod acts as a seal to prevent draining air and blood from being drawn back into the pleural space.

b. Two bottle system.

- (1) The end of the patient's tube is attached to drainage (connecting) tubing.
- (2) The drainage tubing is attached to a short glass rod which protrudes through the cap of a sterile bottle.

*NOTE:* This bottle is called the drainage bottle. It collects fluid and shunts air to the waterseal bottle. The fluid level in the waterseal bottle does not change, as fluid is collected in the drainage bottle.

- (3) A second short glass rod protrudes through the bottle cap and is connected to the long glass rod of the waterseal bottle described above.
- (4) The short glass rod from the waterseal bottle is vented or attached to suction as described in step 3a(4).

c. Three bottle system.

- (1) Bottles one and two are the same as in the two bottle system, except that the short glass rod from the waterseal bottle is attached to a short glass rod protruding from the cap of a third sterile bottle.

*NOTE:* This third bottle is called the manometer bottle, as it provides suction control.

- (2) A second short glass rod protrudes the cap and acts as a vent or is attached to suction.
- (3) A long glass rod protrudes through the cap and is submerged in sterile water to a prescribed depth.

*NOTE:* When suction is applied at the vent tube, air is drawn into the manometer bottle through the long glass rod, assisting the controlled suction.

d. Commercial systems. When using one of the commercially available disposable chest drainage systems, refer to the manufacturer's instructions to ensure correct setup.

e. Suction.

- (1) Suction attachments must be made at the appropriate connection points, as described above.
- (2) Suction must be controlled. The physician will order the amount of suction to be applied, and whether it is to be continuous or intermittent suction.

4. Observe safety precautions.

- a. The bottles must be below the level of the chest.
- b. The bottles must be secured in a holding device.
- c. Emergency equipment must be immediately available at the bedside.

**Performance Steps**

- (1) Bottle of sterile water.
- (2) Rubber padded hemostats.
- (3) Sterile petroleum gauze.
- (4) Flutter (Heimlich) valve.

**NOTE:** An emergency flutter valve may be devised from a penrose drain or the finger of a sterile glove. (See Figure 3-61.)

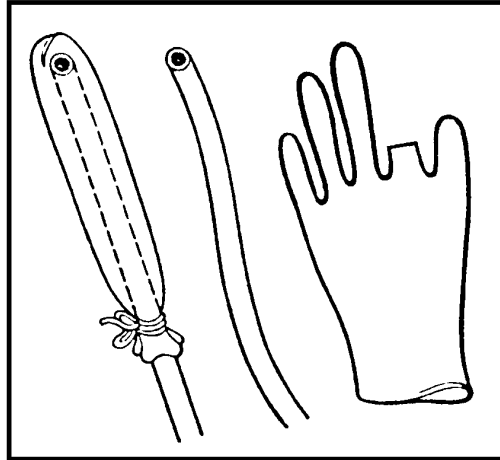

Figure 3-61

5. Observe the dressing at the chest tube insertion site.
    - a. Note air leakage and drainage.
    - b. Reinforce or change the dressing IAW the physician's orders. Note the condition of the insertion site and surrounding skin when the dressing is removed.
  6. Observe the drainage tubing.
    - a. Tubing should not be kinked or compressed by the bed or the patient's body.
    - b. Tubing should not loop below the level of the top of the bottle(s).
    - c. Tubing should be loosely fastened to the bed sheet, not the side rail.
    - d. Drainage tubing connections should be taped for added security.
  7. Milk the drainage tubing if IAW the physician's orders.
    - a. Lubricate the drainage tubing with water-soluble lubricant for about 12 inches.
    - b. Pinch the tubing above the lubricated area with one hand.
    - c. With the other hand, compress the tubing and slide your fingers down the lubricated area toward the bottle.
    - d. Release both hands.
- NOTE:** Mechanical devices, such as the Lundy roller, may be available for milking the tubing.
8. Observe the chest drainage.
    - a. Note the color and consistency.
    - b. Note the amount of drainage and measure the drainage at the prescribed time intervals. (See Figure 3-62.)

## Performance Steps

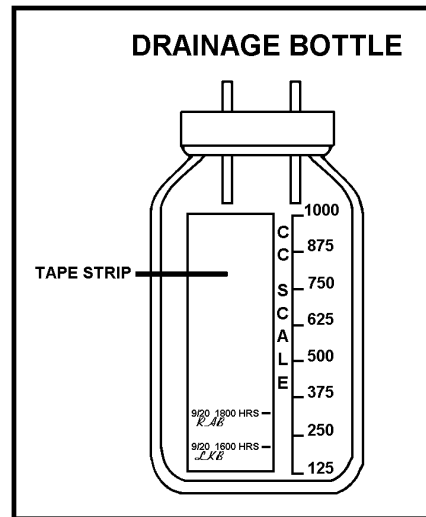

Figure 3-62

- (1) Mark the level of the drainage on the tape affixed to the bottle collecting the drainage.
- (2) Write the date and time and your initials at the drainage level mark.
- (3) Do not empty the collecting bottle unless directed to do so by the physician.

**CAUTION:** Notify the charge nurse or physician if chest drainage exceeds 100 cc/hr or changes in the drainage color indicate an active bleeding problem.

9. Assess the patient for signs and symptoms of distress.
  - a. Monitor vital signs at least every 4 hours or more frequently IAW local SOP.
  - b. Observe the patient's color for evidence of cyanosis from hypoxemia.
  - c. Observe the patient's respiratory effort.
  - d. Question the patient about pain or chest pressure.
10. Auscultate the patient's lungs.
  - a. Auscultate the lungs at least every 4 hours or more frequently if warranted by the patient's condition or IAW local SOP.
  - b. Auscultate both anteriorly and posteriorly, covering all lobes. Listen to at least one cycle of inspiration and expiration over each area (lung field). (See Figure 3-63.)



## Performance Steps

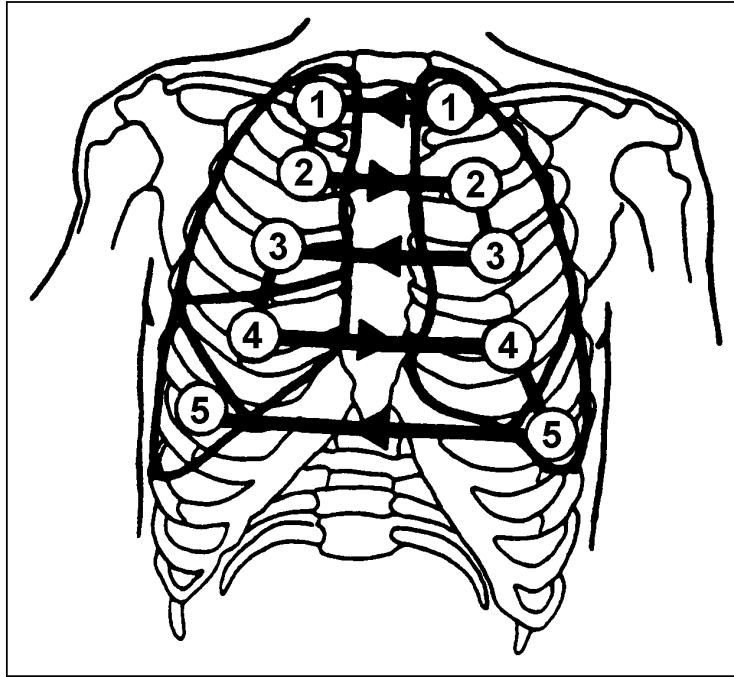

Figure 3-63

c. Note absence of breath sounds and abnormal sounds.

11. Assist the patient with coughing and deep breathing exercises every 2 hours.
  - a. Assist the patient to a semi-Fowler's or Fowler's position to facilitate effective coughing.
  - b. Instruct the patient to splint the affected side with a pillow to reduce the discomfort of coughing.

*NOTE:* Coughing and deep breathing remove secretions from the tracheobronchial tree, with resultant of the lungs and prevention of atelectasis.

12. Change the patient's position at least every 2 hours.
  - a. Maintain proper body alignment.
  - b. Ensure the patient is as comfortable as possible.
  - c. Ensure that the chest tube and drainage tubing are not kinked or compressed.

*NOTE:* Changing the patient's position promotes drainage, facilitates air exchange, and prevents complications.

13. Assist the patient with range-of-motion (ROM) exercises.
  - a. Encourage the patient to perform active ROM of the arm and shoulder on the affected side in order to maintain joint mobility.
  - b. Put the arm and shoulder of the affected side through passive ROM if the patient is unable to perform active ROM.
  - c. If the patient is confined to bed, encourage active ROM of all joints.

14. Ambulate and/or transport the patient as required.

**Performance Steps**

- a. Attach rubber padded hemostats to the patient's hospital clothing and place a package of sterile petroleum gauze in the patient's pocket for immediate access in an emergency.
- b. Disconnect suction from the system and leave the vent tube open to the atmosphere.
- c. Bottles must be kept below the level of the patient's chest.
- d. Bottles must be kept upright at all times.
- e. Nursing personnel must accompany the patient and assist personnel from other departments when transporting the patient.

15. Perform emergency intervention as required.

- a. Chest tube is pulled out of the chest.

- (1) Cover the insertion site with a sterile petroleum gauze square.

**CAUTION:** The chest tube insertion site must be covered immediately. Use your hand if no other material is available.

- (2) Notify the charge nurse and physician immediately.

- (3) Monitor the patient for signs of respiratory distress.

- b. Chest tube is disconnected from the system.

- (1) Immediately clamp the chest tube with the rubber padded hemostats.

- (2) Apply a flutter valve to the end of the chest tube and release the clamp.

- (3) Notify the charge nurse and physician immediately.

- (4) Observe the patient for signs of respiratory distress.

- c. Waterseal unit becomes broken.

- (1) Clamp the chest tube with the rubber padded hemostats and disconnect the drainage tubing from the broken system.

- (2) Immerse the end of the drainage tubing in a container of sterile water and release the chest tube clamp. Ensure that the container of sterile water remains below the level of the chest.

- (3) Notify the charge nurse and physician immediately.

- (4) Monitor the patient for signs of respiratory distress.

- d. Waterseal unit is tipped over.

- (1) Return the waterseal unit to an upright position.

- (2) Instruct the patient to deep breathe and cough in order to force air out of the pleural space.

- (3) Notify the charge nurse and physician immediately.

- (4) Monitor the patient for signs of respiratory distress.

16. Document all procedures and significant nursing observations in the patient's clinical record.

- a. Presence or absence of fluctuation in the long glass rod of the waterseal bottle.

- b. Presence or absence of air leaks or bubbling in the waterseal system.

- c. Condition of the chest tube insertion site and dressing.

- d. Time and results of chest tube milking.

- e. Amount, color, and consistency of the chest drainage.

- f. Specific observations about the patient to include the vital signs, breath sounds, and skin color.

- g. Results of coughing and deep breathing.

- h. Activity and position changes, to include ROM.

**Performance Measures**

	<u>GO</u>	<u>NO</u> <u>GO</u>
1. Reviewed the patient's clinical record.	—	—
2. Explained all safety checks and procedures.	—	—
3. Assessed setup and functioning of the system.	—	—
4. Observed safety precautions.	—	—
5. Observed the dressing at the chest tube insertion site.	—	—
6. Observed the drainage tubing.	—	—
7. Milked the drainage tubing.	—	—
8. Observed the drainage.	—	—
9. Assessed the patient for signs and symptoms of distress.	—	—
10. Auscultated the lungs.	—	—
11. Instructed the patient to cough and deep breathe.	—	—
12. Repositioned the patient.	—	—
13. Assisted the patient with ROM.	—	—
14. Ambulated and/or transported the patient.	—	—
15. Performed emergency interventions.	—	—
16. Documented the procedure on the appropriate forms IAW local SOP.	—	—

**Evaluation Guidance:** Score each soldier according to the performance measures in the evaluation guide. Unless otherwise stated in the task summary, the soldier must pass all performance measures to be scored GO. If the soldier fails any step, show what was done wrong and how to do it correctly.

**References**

**Required**  
None

**Related**  
BASIC NURSING

## Skill Level 3

## Subject Area 18: Advanced Procedures (SL 3)

**INTUBATE A PATIENT****081-830-3016**

**Conditions:** You have an unconscious, nonbreathing casualty with no gag reflex. A qualified assistant is performing CPR. Suction equipment is available and ready for use. A laryngoscope and endotracheal (ET) tube have been prepared. You are not in an NBC environment.

Necessary materials and equipment: bag-valve-mask (BVM) resuscitator or oxygen with demand valve, gloves, oral bite block or J tube, suction equipment, adhesive tape, benzoin, stethoscope, pressure manometer, and a 10 cc syringe.

**Standards:** Completed all the steps necessary to establish an endotracheal tube airway in sequence and without causing further injury to the patient.

**Performance Steps**

**CAUTION:** Wear gloves to protect yourself against the transmission of contaminants whenever handling body fluids.

1. Put on gloves.
2. Oxygenate the patient with the bag-valve-mask for 1 minute.

**CAUTION:** Do not deprive the patient of oxygen for longer than 20 seconds at any time during the procedure.

3. Position the patient's head by hyperextending the neck.
4. Open the patient's mouth and hold it open.
5. Insert the laryngoscope blade. (See Figure 3-64.)

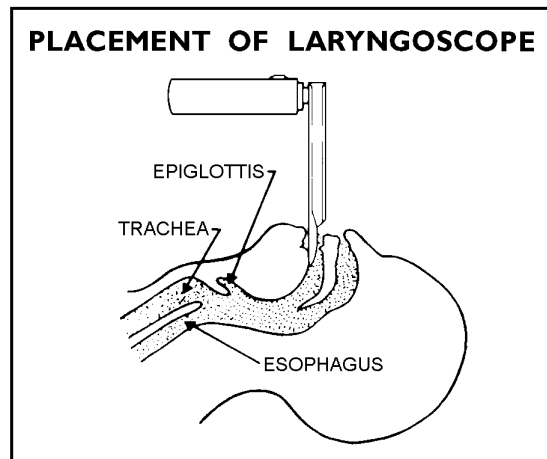

Figure 3-64

- a. Stand or kneel at the top of the patient's head.
- b. Hold the laryngoscope with your left hand.

**Performance Steps**

- c. Open and lock the blade at a 90 degree angle to turn the light on.
- d. Place the blade into the right side of the patient's mouth.
- e. Move the laryngoscope to the center of the patient's mouth by moving the patient's tongue to the left side of his or her mouth with the laryngoscope blade.
- f. Advance the blade a short distance to observe the epiglottis. (See Figure 3-65.)

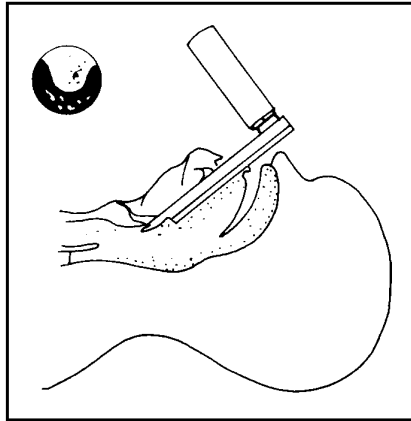

Figure 3-65

- 6. Retract the epiglottis and inspect the vocal cords. (See Figure 3-66.)

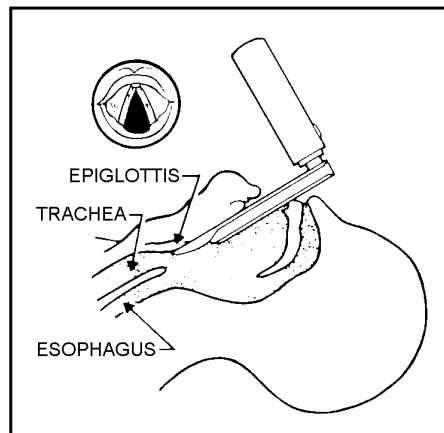

Figure 3-66

- a. When using a curved laryngoscope blade (McIntosh), apply anterior pressure to the vallecula with the tip of the laryngoscope blade to fold back the epiglottis and expose the vocal cords. (See Figure 3-67.)

## Performance Steps

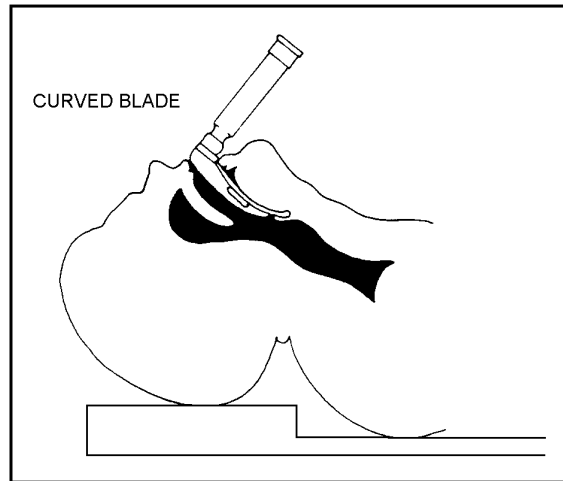

Figure 3-67

- b. When using a straight laryngoscope blade (Miller), hook the blade tip under the epiglottis and pull up to fold back the epiglottis and expose the vocal cords. (See Figure 3-68.)

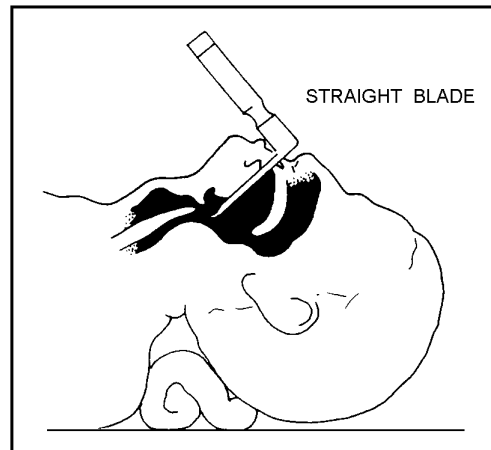

Figure 3-68

**WARNING:** Exert upward traction on the handle to expose the glottic opening. Never use the handle with a prying motion. Do not use the patient's teeth as a fulcrum.

7. Insert the ET tube into the trachea.
  - a. Grasp the ET tube with your right hand.
  - b. Insert the ET tube and carefully guide the tip of the tube between the vocal cords until the cuff is just below the level of the vocal cords. (See Figure 3-69.)

## Performance Steps

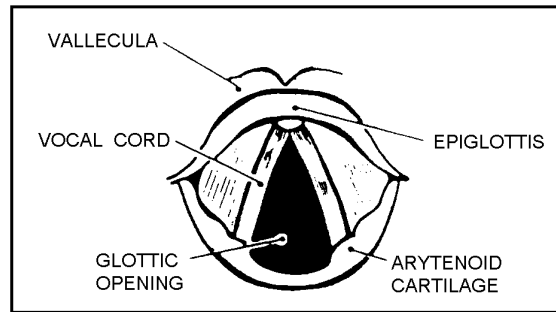

Figure 3-69

8. Remove the laryngoscope.
9. Remove the stylet from the ET tube.
  - a. Hold the ET tube securely with your right hand.
  - b. Pull the stylet straight out with your left hand.
10. Inject the required amount of air to inflate the cuff (5 to 10 cc) by pressing the plunger of the syringe. (See Figure 3-70.)

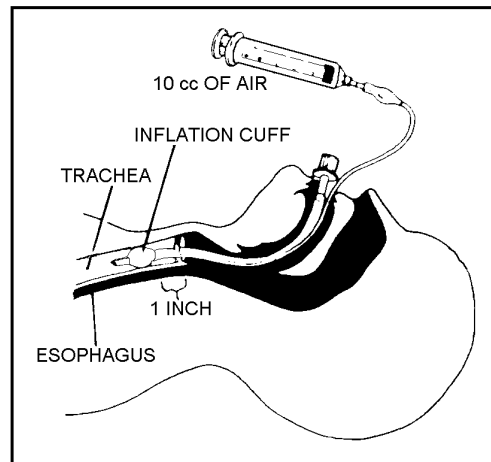

Figure 3-70

11. Check placement of the ET tube.
  - a. Place the resuscitative equipment over the end of the ET tube and blow air into the tube to inflate the lungs.
  - b. Instruct an assistant to auscultate the patient's lung fields and epigastric area while you manually ventilate the patient through the ET tube.
    - (1) If the patient's chest rises and bilateral breath sounds are heard without any abnormal sounds heard over the epigastric area, proceed to step 12.
    - (2) If sound is heard over only one lung field, then you must partially deflate the cuff, withdraw the tube a little, reinflate the cuff, and listen again.

**NOTE:** A misplaced ET tube is most likely to be in the right main stem bronchus.

**Performance Steps**

- (3) If a rushing sound is heard over the epigastric area, withdraw the tube completely, reoxygenate the patient, and wait at least three minutes before repeating the procedure.

## 12. Check cuff pressure.

## a. Use a pressure manometer.

- (1) Connect a pressure manometer to the pilot balloon to ensure the cuff pressure is less than 25 cm H<sub>2</sub>O. Either inflate or deflate the pilot balloon to achieve the desired pressure.

- (2) Remove the pressure manometer from the pilot balloon.

## b. Use the minimal leak technique.

*NOTE:* Benzoin may be applied to the skin to prevent the tape from coming off.

- (1) Suction the patient thoroughly first.
- (2) Attach and partially deflate the cuff using a 10 cc syringe.
- (3) During the positive pressure ventilation, add air until only a slight leak is heard around the cuff during peak inspiration.

*NOTE:* Due to possible prolonged intubation, it is recommended that you use a tube with a high-volume/low pressure cuff to prevent possible necrosis at the cuff site. Using cuff pressures above 30 cm H<sub>2</sub>O may produce a decrease in capillary mucosal blood flow resulting in ischemia.

- (4) Hold the cuff valve in one hand and simultaneously twist and pull the syringe with your other hand to remove the syringe.

## 13. Reoxygenate the patient.

14. Wedge a bite block or J tube between the back teeth to prevent biting of the ET tube which may cause partial or complete obstruction of the tube. (See Figure 3-71.)

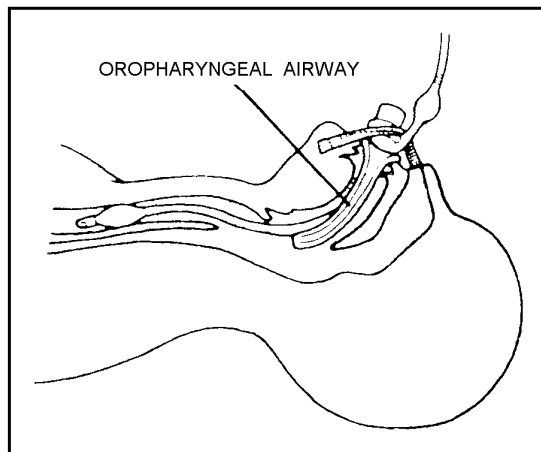

Figure 3-71

## 15. Secure the ET tube.

- a. Wrap the middle of a long piece of tape around the ET tube.
- b. Attach each end of the tape to the patient's face.

*NOTE:* Benzoin may be applied to the skin to prevent the tape from coming off.

## 16. Ventilate the patient once every 5 seconds.



**Performance Steps**

17. Monitor the patient and ensure correct tube placement is maintained by auscultating the lungs and epigastric area.

*NOTE:* The tip of the tube should be 2 to 3 centimeters above the carina. Proper tube placement is confirmed by taking an x-ray of the patient's chest.

18. Record the procedure.

**Performance Measures**

	<u>GO</u>	<u>NO GO</u>
1. Put on sterile gloves.	_____	_____
2. Oxygenated the patient.	_____	_____
3. Positioned the patient's head.	_____	_____
4. Opened the patient's mouth.	_____	_____
5. Inserted the laryngoscope blade.	_____	_____
6. Retracted the epiglottis and inspected the vocal cords.	_____	_____
7. Inserted the ET tube into the trachea.	_____	_____
8. Removed the laryngoscope.	_____	_____
9. Removed the stylet from the ET tube.	_____	_____
10. Inflated the cuff.	_____	_____
11. Checked the placement of the ET tube.	_____	_____
12. Checked the cuff pressure.	_____	_____
13. Reoxygenated the casualty.	_____	_____
14. Wedged a bite block or a J tube between the back teeth.	_____	_____
15. Secured the ET tube.	_____	_____
16. Ventilated the patient once every 5 seconds.	_____	_____
17. Monitored the casualty.	_____	_____
18. Recorded the procedure.	_____	_____
19. Completed all necessary steps in order.	_____	_____

**Evaluation Guidance:** Score each soldier according to the performance measures in the evaluation guide. Unless otherwise stated in the task summary, the soldier must pass all performance measures to be scored GO. If the soldier fails any step, show what was done wrong and how to do it correctly.

**References:** None

## SET UP A CASUALTY DECONTAMINATION STATION

### 081-833-0093

**Conditions:** You are assigned to a division level medical facility (battle aid station (BAS) or division clearing station (DCS)). Chemical agents are being used against the units supported by your medical treatment facility. The commander has ordered that a decontamination station and protective shelter be established. Your current location is in a noncontaminated area, upwind from the chemical hazard. Necessary materials and equipment: medical equipment sets (MES) for patient decontamination and patient treatment, protective shelter, tentage, plastic sheeting, supertropical bleach (STB), shovels, chemical agent alarms, chemical agent monitors, engineer tape or wire, field radio or telephone, windsock, camouflage netting, water source, plastic bags, litters, litter stands, and contaminated disposal containers.

**Standards:** Set up a fully operational decontamination station in a noncontaminated area upwind from the chemical hazard. Established the decontamination area on the downwind side of the protective shelter or other clean treatment area and clearly marked a hot line. Constructed a shuffle pit as the only point of access to the clean areas. Installed chemical agent alarms.

### Performance Steps

1. Select sites for the location of the operation.
  - a. Primary and alternate sites must be selected in advance of operations.

*NOTE:* Alternate sites must be selected in conjunction with selection of the primary site. If the prevailing winds change direction, use of the primary site may no longer be possible.

- b. Site selection factors.
  - (1) The direction of the prevailing winds.
  - (2) The downwind chemical hazard.
  - (3) The availability of protective shelters or buildings to house clean treatment facilities.
  - (4) The terrain.
  - (5) Availability of cover and concealment.

*NOTE:* The protective shelter may possess visual, audible, and infrared signatures. Therefore, concealment may be compromised.

- (6) The general tactical situation.
- (7) The availability of evacuation routes (contaminated and clean).
- (8) The location of the supported unit's vehicle decontamination point, personnel decontamination point, and MOPP exchange point.

*NOTE:* It is sometimes best to collate with these unit decontamination sites. The arrangement of the operational areas must be kept flexible and adaptable to both the medical and tactical situations.

2. Set up the decontamination area. (See Figure 3-72.)

**Performance Steps**

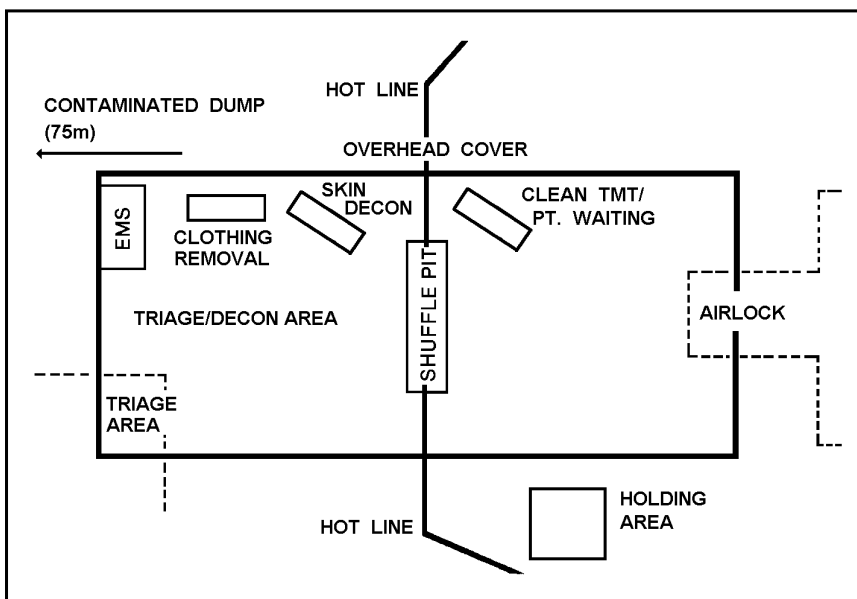

Figure 3-72

- a. Triage area.
  - b. Emergency treatment area.
- NOTE:* Sometimes, triage and emergency treatment are conducted in the same area.
- c. Clothing removal area.
  - d. Skin decontamination area.
  - e. Overhead cover.

- (1) Erect an overhead cover, at least 20 x 50 feet, to cover the decontamination area and the clean waiting and treatment area. If the protective shelter is used, the overhead cover should overlap the air lock entrance.
- (2) If plastic sheeting is not available, alternate materials such as trailer covers, ponchos, or tarpaulins may be used.

- 3. Set up the clean side of the decontamination station on the upwind side of the contaminated areas.

*NOTE:* Erect a windsock for easy determination of wind direction.

- a. Clean waiting area.
- b. Clean treatment area.

- 4. Set up the shuffle pit as the only point of access between the decontamination area and the clean waiting and treatment area.

- a. Turn over the soil in an area that is 1 to 2 inches deep, and of sufficient length and width to accommodate a litter stand.

*NOTE:* The shuffle pit should be wide enough that the litter bearers are not able to straddle the pit.

- b. Mix super tropical bleach (STB) with the soil in a ratio of two parts STB to three parts soil.

**Performance Steps**

5. Set up the protective shelter on the upwind side of the clean waiting and treatment area.
  - a. Set up the protective shelter with the air lock adjoining the clean side of the decontamination station.
  - b. When a protective shelter is not available for use, set up a protected medical treatment facility 30 to 50 meters upwind from the shuffle pit.
6. Set up the evacuation holding area.
  - a. Set up an overhead cover of plastic sheeting at least 20 x 25 feet.
  - b. Make sure the cover overlaps part of the clean treatment area and part of the protective shelter.
  - c. When the protective shelter is used, set up the cover on the side opposite the generator.
7. Mark the hot line.
  - a. Use wire, engineer's tape, or other similar material to mark the entire perimeter of the hot line.
  - b. Ensure that the hot line is clearly marked.
8. Establish ambulance points on both the "clean" and "dirty" evacuation routes.
  - a. Establish a "dirty" ambulance point downwind from the triage area in the decontamination station.
  - b. Establish a "clean" ambulance point upwind from the evacuation holding area on the clean side of the decontamination station.
9. Set up a contaminated (dirty) dump.
  - a. Establish the contaminated dump 75 to 100 meters downwind from the decontamination station.
  - b. Clearly mark the dump with NATO chemical warning markers.
10. Place chemical agent alarms upwind from the clean treatment area.
11. Camouflage areas IAW tactical directives.

**Performance Measures**

	<u>GO</u>	<u>NO GO</u>
1. Selected primary and alternate sites.	—	—
2. Set up the decontamination area.	—	—
3. Set up the clean treatment/waiting area.	—	—
4. Set up the shuffle pit.	—	—
5. Set up the protective shelter.	—	—
6. Set up the evacuation holding area.	—	—
7. Marked the hot line.	—	—
8. Established ambulance points.	—	—
9. Set up a contaminated (dirty) dump.	—	—

**Performance Measures**

GO      NO  
GO

10. Placed chemical agent alarms.

\_\_\_\_\_

11. Camouflaged areas.

\_\_\_\_\_

**Evaluation Guidance:** Score each soldier according to the performance measures in the evaluation guide. Unless otherwise stated in the task summary, the soldier must pass all performance measures to be scored GO. If the soldier fails any step, show what was done wrong and how to do it correctly.

**References:** None

## INSERT A CHEST TUBE

### 081-833-0168

**Conditions:** You have a casualty suffering from a hemothorax or pneumothorax who requires the insertion of a chest tube. Necessary materials and equipment: chest tube (16-36 French), gloves, one-way valve, scalpel handle and blades (#10 and #15), Kelly forceps, large hemostat, betadine solution, suture material (size 0 nylon), lidocaine 1% with epinephrine for injection, and needle and syringe.

**Standards:** Inserted a chest tube and corrected the hemothorax or pneumothorax without causing further injury to the casualty.

### Performance Steps

1. Assess the casualty.
  - a. If necessary, open the airway (see task 081-831-0018).
  - b. Ensure adequate respiration and assist as necessary.
  - c. Provide supplemental oxygen, if available.
  - d. Connect the casualty to a pulse oximeter, if available.
  - e. Initiate an IV (see task 081-833-0033).
2. Prepare the casualty.
  - a. Place the casualty in the supine position.
  - b. Raise the arm on the affected side above the casualty's head.
  - c. Select the insertion site at the anterior axillary line over the 4th or 5th intercostal space.
  - d. Clean the site with betadine solution.
  - e. Put on sterile gloves.
  - f. Drape the area.
  - g. Liberally infiltrate the area with the 1% lidocaine solution.
3. Insert the tube.
  - a. Make a 2 to 3 cm transverse incision over the selected site and extend it down to the intercostal muscles.

**NOTE:** The skin incision should be 1 to 2 cm below the interspace through which the tube will be placed.

- b. Insert the Kelly forceps through the intercostal muscles in the next intercostal space.
- c. Puncture the parietal pleura with the tip of the forceps and slightly enlarge the hole by opening the clamp 1.5 to 2 cm.

**CAUTION:** Avoid puncturing the lung. Always use the superior margin of the rib to avoid the intercostal nerves and vessels.

- d. Immediately insert a gloved finger in the incision to clear any adhesions, clots, etc.
  - e. Grasp the tip of the chest tube with Kelly forceps. Insert the tip of the tube in the incision as you withdraw your finger.
  - f. Advance the tube until the last side hole is 2.5 to 5 cm inside the chest wall.
  - g. Connect the end of the tube to a one-way drainage valve (e.g., Heimlich valve).
  - h. Secure the tube using the suture materials.
  - i. Apply an occlusive dressing to the site.
  - j. Radiograph the chest to confirm placement, if available.
4. Reassess the casualty.
    - a. Check for bilateral breath sounds.

**Performance Steps**

- b. Monitor and record vital signs every 15 minutes.
- 5. Document the procedure.

**Performance Measures**

	<u>GO</u>	<u>NO</u> <u>GO</u>
1. Assessed the casualty.	_____	_____
2. Prepared the casualty.	_____	_____
3. Inserted the tube.	_____	_____
4. Reassessed the casualty.	_____	_____
5. Documented the procedure.	_____	_____

**Evaluation Guidance:** Score each soldier according to the performance measures in the evaluation guide. Unless otherwise stated in the task summary, the soldier must pass all performance measures to be scored GO. If the soldier fails any step, show what was done wrong and how to do it correctly.

**References**

**Required**  
None

**Related**  
BTLS FOR PARAMEDICS

**PERFORM A SURGICAL CRICOTHYROIDOTOMY**  
**081-833-3005**

**Conditions:** You are in a field environment. A casualty has an upper airway obstruction. The casualty's airway cannot be opened using manual methods or an endotracheal (ET) tube. A cricothyroidotomy needle is not available or performing a needle cricothyroidotomy is not effective. Necessary materials and equipment: cutting instrument (scalpel, knife blade, or tin can edge), suctioning apparatus, povidone-iodine, hemostats, needle holders, cannula (noncollapsible tube to maintain airway), knife handle, blanket, gloves, and tape.

**Standards:** Established an emergency airway without causing unnecessary injury to the casualty. Completed steps 3 through 10 in order.

**Performance Steps**

**CAUTION:** Consider only casualties with a total upper airway obstruction or casualties with inhalation burns for a surgical cricothyroidotomy.

1. Hyperextend the casualty's neck.

**WARNING:** Do not hyperextend the casualty's neck if a cervical injury is suspected.

- a. Place the casualty in the supine position.
- b. Place a blanket or poncho rolled up under the casualty's neck or between the shoulder blades so the airway is straight.

2. Put on gloves, if available.

3. Locate the cricothyroid membrane.

- a. Place a finger of the nondominant hand on the thyroid cartilage (Adam's apple) and slide the finger down to the cricoid cartilage.
- b. Palpate for the "V" notch of the thyroid cartilage.
- c. Slide the index finger down into the depression between the thyroid and cricoid cartilage.
- d. Prep the skin over the membrane with povidone-iodine.
- e. Raise the skin to form a tent-like appearance over the cricothyroid space, using the index finger and thumb.

4. With a cutting instrument in the dominant hand, make a 1 1/2 inch horizontal incision through the raised skin to the cricothyroid space.

**CAUTION:** Do not cut the cricothyroid membrane with this incision.

5. Relocate the cricothyroid space by touch and sight.

6. Stabilize the larynx with one hand and make a 1/2 inch horizontal incision through the elastic tissue of the cricothyroid membrane.

7. Insert a dilator (hemostat or needle holder) through the opening.

8. Separate the blades of the dilator to make a larger opening.

**NOTE:** A rush of air may be felt through the opening.

9. Insert the end of a cannula (or improvised substitute) between the blades of the dilator. The cannula should be in the trachea and directed toward the lungs.

10. Secure the cannula in place to reduce movement in the opening and to prevent inhalation of the cannula.



**Performance Steps**

*NOTE:* Reflex coughing may be stimulated by the insertion of the cannula. This may aid in clearing the airway but necessitates proper securing of the cannula.

11. Suction the casualty's airway, as necessary.
  - a. Insert the suction catheter 4 to 5 inches into the cannula.
  - b. Apply suction only while withdrawing the catheter.
  - c. Administer 1 cc of saline solution into the airway to loosen secretions and help facilitate suctioning.

*NOTE:* Allow the casualty to take several breaths between suctionings.

12. Administer oxygen, as necessary.

*NOTE:* Mouth-to-cannula resuscitation may be performed if needed.

13. Apply a sterile dressing under the casualty's cannula by making a V-shaped fold in a 4 X 4 gauze pad and placing it under the edge of the cannula to prevent irritation to the casualty.

**Evaluation Preparation:**

Setup: For training and evaluation, use a mannequin or have another soldier act as the casualty. Under no circumstances will the skin be incised. Have the soldier demonstrate and explain what he or she would do.

Brief soldier: Tell the soldier to perform a surgical cricothyroidotomy.

<b>Performance Measures</b>	<b><u>GO</u></b>	<b><u>NO GO</u></b>
1. Hyperextended the casualty's neck.	_____	_____
2. Put on gloves, if available.	_____	_____
3. Located the cricothyroid membrane.	_____	_____
4. With a cutting instrument in the dominant hand, made a 1 1/2 inch horizontal incision through the raised skin to the cricothyroid space.	_____	_____
5. Relocated the cricothyroid space by touch and sight.	_____	_____
6. Stabilized the larynx with one hand and made a 1/2 inch horizontal incision through the elastic tissue of the cricothyroid membrane.	_____	_____
7. Inserted a dilator (hemostat or needle holder) through the opening.	_____	_____
8. Separated the blades of the dilator to make a larger opening.	_____	_____
9. Inserted the end of a cannula (or improvised substitute) between the blades of the dilator.	_____	_____
10. Secured the cannula in place.	_____	_____
11. Completed steps 3 through 10 in order	_____	_____
12. Suctioned the casualty's airway, as necessary.	_____	_____
13. Administered oxygen, as necessary.	_____	_____

**Performance Measures**

<u><b>GO</b></u>	<u><b>NO</b></u>
<u>      </u>	<u><b>GO</b></u>
_____	_____

14. Applied a sterile dressing under the casualty's cannula.

**Evaluation Guidance:** Score each soldier according to the performance measures in the evaluation guide. Unless otherwise stated in the task summary, the soldier must pass all performance measures to be scored GO. If the soldier fails any step, show what was done wrong and how to do it correctly.

**References**

**Required**  
None

**Related**  
BTLS FOR PARAMEDICS

## PERFORM A NEUROLOGICAL EXAMINATION ON A PATIENT WITH SUSPECTED CENTRAL NERVOUS SYSTEM (CNS) INJURIES

081-833-3014

**Conditions:** You have a conscious casualty with a head injury but without neck injuries. The vital signs have been taken. Necessary materials and equipment: a flashlight or penlight, a pin or sharp object, and a rubber hammer.

**Standards:** Performed a neurological examination on a casualty with a suspected CNS injury without causing further injury to the casualty.

### Performance Steps

1. Look for the cause(s) of the injury.
  - a. Observe the casualty's position.
  - b. Observe the environmental conditions.

**NOTE:** If the casualty is unconscious, ask bystanders for information.

2. Evaluate the casualty's mental status.
  - a. Determine the level of consciousness.
    - (1) Alert--awake and responsive (verbal and motor). The casualty responds immediately, fully, and appropriately to commands.
    - (2) Lethargic--sleepy or drowsy. The casualty can be aroused and responds appropriately, but will fall asleep again as soon as he or she is left alone.
    - (3) Comatose--partial to complete unconsciousness. Use the Glasgow Coma Scale to determine the level of coma. (See task 081-835-3030.)
  - b. Ask the casualty to perform calculations (basic math) to assess cognition. For example, have the casualty count backward from 100 by three or sevens.
  - c. Observe the casualty's verbal and nonverbal behavioral responses to evaluate affect (mood). For example:
    - (1) Does the casualty laugh inappropriately?
    - (2) Does the casualty display excessive or inappropriate anger, fear, anxiety, or confusion?
    - (3) Does the casualty respond to stimuli in a normal manner?
  - d. Question the casualty to evaluate long and short term memory.
    - (1) Discuss the casualty's past to evaluate remote recall (long term memory). Verify the casualty's response with information on what company or unit he or she is assigned to and the company's mission or with the unit's members.
    - (2) Discuss current events to evaluate recent recall (short term memory). For example, ask the casualty what he or she was doing just before being injured, or what his or her unit was doing the previous day.
  - e. Question the casualty to evaluate his or her orientation to person, place, and time.
    - (1) Ask the casualty to spell his or her name, name family or unit members, and recite his or her home or unit address. (This determines whether the patient knows who he or she is and who others are.)
    - (2) Ask the casualty to identify his or her location, naming the city, state, or country. (This determines whether the casualty knows where he or she is.)
    - (3) Ask the casualty to identify the day of the week, month, and year.
3. Evaluate the casualty's cerebellar functions.
  - a. Test coordination and balance.

### Performance Steps

- (1) Ask the casualty to extend both arms, close the eyes, and alternately touch the index finger to the nose.
- (2) Ask the casualty to slap the palms of the hands on his or her legs, and then the backs of the hands on the legs, alternating in a rapid motion.
- (3) Ask the casualty to stand relaxed with the eyes open. Watch for movement.
- (4) Perform the "Romberg test".
  - (a) Have the casualty stand up and relax. Instruct the casualty to close his or her eyes.
  - (b) If the casualty cannot maintain balance when the eyes are closed, the test is positive.

**NOTE:** The medic should stand close to the casualty to support the casualty if he or she starts to fall.

- b. Check the casualty for normal gait and heel-toe-heel walking.
  - (1) Ask the casualty to walk a straight line both forward and backward.
  - (2) Observe the casualty for coordination, balance, and posture. Note inability to walk heel-toe-heel with one foot in front of the other.
4. Evaluate the casualty's motor function.
  - a. Check for mild weakness.
    - (1) Have the casualty stand with the arms outstretched, palms upward, and eyes closed for 20 to 30 seconds.
    - (2) Observe the casualty's arms for the "pronator sign" (the arm starts dropping and the hand turns over slightly).
  - b. Test muscle tone.
    - (1) Ask the casualty to relax.
    - (2) If the casualty is ambulatory, have him or her sit on the edge of the examining table. Watch the freedom of movement of the legs. This indicates tone.
    - (3) If the casualty is in bed, lift the casualty's arm, drop it, and observe the arm as it falls. Look for atrophy--loss of muscle tone or strength.
  - c. Test muscle strength.
    - (1) Ask the casualty to walk on his or her heels.
    - (2) Ask the casualty to walk on his or her toes.
    - (3) Extend your hands to the casualty, and ask the casualty to firmly grip and squeeze your hands. Note strength and equality of grip.
    - (4) Ask the casualty to alternately flex and extend the feet while providing resistance with your hands. Look for atrophy.
5. Evaluate the casualty's cranial nerve function.
  - a. Test pupillary reflexes.
    - (1) Dim the lighting and shine a light into one of the casualty's eyes.
    - (2) Observe the pupillary response.
    - (3) Repeat the procedure on the other eye.
    - (4) If the pupils are unreactive or unequal, they are abnormal.
    - (5) If the pupils are equal and reactive, record PERRLA (pupils equal, round, and reactive to light and accommodation).
  - b. Test facial nerves.
    - (1) Ask the casualty to smile and raise his or her eyebrows.
    - (2) Look for weakness or drooping on either side of the face when smiling.
    - (3) Look to see if there is even movement of both eyebrows.
6. Evaluate the casualty's sensory functions.

### Performance Steps

**NOTE:** When doing this test, ask the casualty not to watch what you are doing.

- a. Allow the casualty to assume a comfortable position with the eyes closed.
  - b. Test perception of pain by using a safety pin. Lightly touch the skin with the sharp and dull areas of the pin.
    - (1) Ask the casualty to identify the sensation felt (sharp or dull).
    - (2) Ask the casualty to identify where the sensations were felt.
  - c. Test perception of touch by using a cotton ball to lightly brush the skin, asking the casualty to tell you when and where he or she felt the sensation.
7. Check for the presence of a Babinski reflex.
- a. Grasp the ankle with your left hand.
  - b. With a blunt point and moderate pressure, stroke the sole near its lateral border, from the heel toward the ball of the foot. The course of the stroke should curve to the middle to follow the bases of the toes.
  - c. Normal reflex--toes curl. (Recorded as the absence of a Babinski reflex.)
  - d. Abnormal reflex. (Recorded as the presence of a Babinski reflex.)
    - (1) Dorsiflexion of the great toe.
    - (2) Fanning of all the toes.
    - (3) Dorsiflexion of the ankle.
    - (4) Flexion of the knee and hip.
8. Evaluate the casualty's deep tendon reflexes (DTRs).
- a. Biceps.
    - (1) Position the elbow at about a 90 degree angle of flexion with the arm slightly pronated.
    - (2) Grasp the elbow with your left hand so the fingers are behind it and your abducted thumb presses the biceps brachia tendon.
    - (3) Strike your thumb a series of blows with the rubber hammer, varying your thumb pressure with each blow until the most satisfactory response is obtained.
    - (4) A normal response will be elbow flexion.
  - b. Triceps.
    - (1) Grasp the casualty's wrist with your left hand and pull the arm across the chest so the elbow is flexed about 90 degrees and the forearm is partially pronated.
    - (2) Tap the triceps brachia tendon directly above the olecranon process.
    - (3) A normal response is elbow extension.
  - c. Knee.
    - (1) Legs dangling.
      - (a) Have the casualty sit on a table, high bed, or litter to permit free swinging of the legs.
      - (b) Tap the patellar tendon directly.
        - (c) A normal response is extension of the knee.
    - (2) Lying supine.
      - (a) With your hand under the popliteal fossa, lift the knee from the table.
      - (b) Tap the patellar tendon directly.
      - (c) A normal response is extension.
  - d. Ankle.
    - (1) Legs dangling.
      - (a) With your left hand, grasp the foot and pull it in dorsiflexion. Find the degree of stretching of the Achilles tendon that produces the optimal response.

**Performance Steps**

- (b) Tap the Achilles tendon directly.
- (c) A normal response is contraction of the gastrocnemius and plantar flexion of the foot.
- (2) Lying supine.
  - (a) Partially flex the hip and knee. Rotate the knee outward as far as comfort permits.
  - (b) With your left hand, grasp the foot and pull it in dorsiflexion.
  - (c) Tap the Achilles tendon directly.
  - (d) A normal response is plantar flexion.

**Performance Measures**

	<u>GO</u>	<u>NO GO</u>
1. Looked for the cause(s) of the injury.	_____	_____
2. Evaluated the casualty's mental status.	_____	_____
3. Evaluated the casualty's cerebellar functions.	_____	_____
4. Evaluated the casualty's motor function.	_____	_____
5. Evaluated the casualty's cranial nerve functions.	_____	_____
6. Evaluated the casualty's sensory functions.	_____	_____
7. Checked for the presence of a Babinski reflex.	_____	_____
8. Evaluated the casualty's deep tendon reflexes.	_____	_____

**Evaluation Guidance:** Score each soldier according to the performance measures in the evaluation guide. Unless otherwise stated in the task summary, the soldier must pass all performance measures to be scored GO. If the soldier fails any step, show what was done wrong and how to do it correctly.

**References**

**Required**  
None

**Related**  
BTLS FOR PARAMEDICS  
EMERGENCY CARE

**ADMINISTER BLOOD**  
**081-835-3000**

**Conditions:** You have verified a physician's orders requiring the administration of blood. You have identified the patient and explained the procedure. A patient care handwash has been performed. Necessary materials and equipment: blood pack with SF 518, thermometer, blood pressure cuff, stethoscope, blood transfusion recipient set ("Y" type), IV stand, tourniquet, needle and syringe, IV catheter, tape, alcohol and betadine prep pads, gloves, a container of 0.9% normal saline for injection, and the patient's clinical record.

**Standards:** Administered the blood IAW the physician's orders and without causing injury to the patient.

**Performance Steps**

1. Verify and inspect the blood pack received from the laboratory.
  - a. Note the time the blood pack was received and record the time on the SF 518.  
*NOTE:* Infusion of a blood pack should be initiated within 30 minutes of being issued.
  - b. Two people must verify and match the information on the blood pack label with the data on the requisition form (SF 518).  
*NOTE:* One of the verifiers must be a Registered Nurse when directed by local policy.
  - c. Inspect the blood for abnormalities such as gas bubbles or black or gray colored sediment (indicative of bacterial growth).  
*NOTE:* Return the blood pack to the blood bank if any abnormality is present or suspected.
  - d. Match the blood pack with the patient's identification.
    - (1) The same two people must compare the information on the blood unit with the data on the patient's wristband. Ensure the patient's name, blood type, and hospital number positively match the data on the blood pack.
    - (2) Sign the SF 518 IAW local policy when all the data has been confirmed as a positive match.
2. Establish baseline data.
  - a. Reconfirm data from the patient's history regarding allergies or previous reactions to blood or blood products.
  - b. Measure and evaluate the vital signs.
  - c. Record the vital signs on the SF 518 and in the nursing notes.
3. Prepare the blood and the blood recipient set.  
*NOTE:* Use only tubing that is designed for the administration of blood products. It is equipped with a filter designed for the fine filtration required for blood products.
  - a. Close all three clamps on the "Y" tubing.
  - b. Aseptically insert one of the tubing spikes into the container of normal saline. Invert and hang this container about 3 feet above the level of the patient.
  - c. Open the clamp on the normal saline line and prime the upper line and the blood filter.
  - d. Open the clamp on the empty line on which you will eventually hang the blood.  
Normal saline will flow up the empty line to prime that portion of the tubing.  
*NOTE:* Use only 0.9% normal saline for injection with blood. Other solutions are not compatible.
  - e. Once the blood line is primed with saline, close the clamp on the blood line.
  - f. Leave the clamp on the normal saline line open.
  - g. Open the main roller clamp to prime the lower infusion tubing.

**Performance Steps**

- h. Close the main roller clamp.
- i. Aseptically expose the blood port on the blood pack.
- j. Aseptically insert the remaining spike into the blood port and hang the blood at the same level as the normal saline container.

*NOTE:* If "Y" type recipient tubing is not available, use regular infusion tubing for the normal saline and the available blood recipient tubing for the blood pack. Prime each set. Attach a sterile, large bore (16 or 18 gauge) needle to the end of the blood tubing and "piggyback" the blood into the normal saline line below the level of the roller clamp. Hang the blood pack at least 6 inches higher than the normal saline.

4. Perform the venipuncture (see task 081-833-0033).

*NOTE:* Insert a large gauge IV catheter (14, 16, or 18) for administering blood to an adult patient. This will enhance the flow of blood and prevent hemolysis of the cells.

5. Begin the infusion of blood.

- a. Attach the primed infusion set to the catheter, tape it securely, and open the main roller clamp.

*NOTE:* If a preexisting catheter is being used, run in 50 cc of normal saline to flush out any incompatible solution. If a new catheter was inserted, this step is not required.

- b. Close the roller clamp to the normal saline and open the roller clamp to the blood.
- c. Adjust the flow rate with the main roller clamp.

- (1) Set the flow rate to deliver approximately 10 to 25 cc of blood over the first 15 minutes.

*NOTE:* When delivering blood by piggyback, begin the infusion by opening the roller clamp on the normal saline line and setting it to a TKO rate. Adjust the roller clamp on the blood line to deliver 10 to 25 cc of blood over the first 15 minutes.

- (2) Monitor the vital signs closely for the first 15 minutes and observe for indications of an adverse reaction to the blood (see Figure 3-73).



**Performance Steps**

PATIENT'S SYMPTOMS	REACTION TIME	TYPE OF REACTION
<ul style="list-style-type: none"> <li>* Nausea</li> <li>* Severe chills</li> <li>* Rapid elevation of temperature</li> <li>* Pain in the lumbar region</li> <li>* Flushed appearance</li> <li>* Tachycardia</li> <li>* Hypotension</li> </ul>	<ul style="list-style-type: none"> <li>* After only 25 cc of blood have been transfused</li> </ul>	<p style="text-align: center;"><b>HEMOLYTIC</b></p> <ul style="list-style-type: none"> <li>* Extremely serious</li> <li>* Can be fatal</li> <li>* Transfusion of incompatible RBCs</li> <li>* RBC destruction</li> </ul>
<ul style="list-style-type: none"> <li>* Mild to severe chills</li> <li>* Normal to elevated temperature</li> <li>* Headache</li> <li>* Flushed appearance</li> <li>* Anxiety</li> <li>* Hypotension</li> </ul>	<ul style="list-style-type: none"> <li>* During the transfusion or 30 to 60 minutes after the transfusion is completed.</li> </ul>	<p style="text-align: center;"><b>PYROGENIC</b></p> <ul style="list-style-type: none"> <li>* Serious</li> <li>* Contaminants may have been introduced into the blood or the IV equipment</li> </ul>
<ul style="list-style-type: none"> <li>* Flushed appearance</li> <li>* Edema of the face and lips</li> <li>* Dyspnea (from laryngeal edema)</li> <li>* Wheezing</li> <li>* Anxiety</li> <li>* Itching</li> <li>* Hives</li> <li>* Anaphylaxis</li> </ul>	<ul style="list-style-type: none"> <li>* During the transfusion or 1 to 2 hours after the transfusion is completed</li> </ul>	<p style="text-align: center;"><b>ALLERGIC</b></p> <ul style="list-style-type: none"> <li>* Serious</li> <li>* Allergic response (hypersensitivity) by the recipient to substances in the donor blood.</li> </ul>

Figure 3-73

**CAUTION:** Any time an adverse reaction is suspected, immediately stop the blood and infuse normal saline. Notify the charge nurse and physician immediately.

- (3) Set the main roller clamp to deliver the prescribed flow rate if, after the first 15 minutes, no adverse reaction is suspected and the vital signs are stable.

**NOTE:** Use the correct formula to calculate flow rate.

$$\text{gtt/min} = \frac{\text{volume to be infused X gtt/cc of administration set}}{\text{infusion time in minutes}}$$

6. Monitor and evaluate the patient throughout the procedure.
  - a. Monitor vital signs every hour or more frequently IAW local SOP.
  - b. Compare the vital signs with previous and baseline vital signs.
  - c. Observe for changes that indicate an adverse reaction to the blood.

**Performance Steps**

- d. Stop the blood, infuse normal saline, and notify the charge nurse and physician if a reaction is suspected.

**CAUTION:** When a transfusion reaction occurs or is suspected, the unused blood and recipient tubing must be sent to the laboratory along with a 10 ml specimen of the patient's venous blood and a post transfusion urine specimen.

- 7. Discontinue the infusion of blood.
  - a. When the blood pack has emptied, close the clamp to the blood and open the clamp to the normal saline.
  - b. Flush the tubing and filter with approximately 50 cc of normal saline to deliver the residual blood.
  - c. After the residual blood has been delivered, run the normal saline at a TKO rate or hang another solution, if one has been prescribed.
  - d. Take and record the vital signs at the completion of the transfusion and 1 hour after completion.

*NOTE:* As a rule, a unit of blood should be infused within 2 to 4 hours unless contraindicated by risk of circulatory overload. If the prescribed flow rate will deliver the blood within a shorter or longer period of time, verify the order with the charge nurse or prescribing physician.

- 8. Dispose of the used blood pack IAW local SOP.
  - a. Return it to the laboratory blood bank with a copy of SF 518.
  - b. Discard it in a container for contaminated waste.
- 9. Document the procedure and significant nursing observations on the appropriate forms IAW local SOP.
  - a. Complete the SF 518.
    - (1) Return one copy to the laboratory blood bank.
    - (2) Place one copy in the patient's chart.
  - b. Record the procedure and the patient's response in a nursing note entry.

**Performance Measures**

	<u>GO</u>	<u>NO GO</u>
1. Verified and inspected the blood pack.	_____	_____
2. Established baseline data.	_____	_____
3. Prepared the blood and transfusion recipient sets.	_____	_____
4. Performed the venipuncture.	_____	_____
5. Began the infusion of blood.	_____	_____
6. Monitored and evaluated the patient.	_____	_____
7. Discontinued the infusion of blood.	_____	_____
8. Disposed of the used blood pack IAW local SOP.	_____	_____
9. Documented the procedure on the appropriate forms IAW local SOP.	_____	_____

**Evaluation Guidance:** Score each soldier according to the performance measures in the evaluation guide. Unless otherwise stated in the task summary, the soldier must pass all performance measures to be scored GO. If the soldier fails any step, show what was done wrong and how to do it correctly.

**References**

**Required**

None

**Related**

BASIC NURSING

**ADMINISTER MEDICATIONS BY IV PIGGYBACK**  
**081-835-3002**

**Conditions:** You have a physician's orders requiring the administration of a medication by the IV piggyback route. You must prepare the piggyback unit. A patient care handwash has been performed. Necessary materials and equipment: medication, diluent, needle, syringe, alcohol (or other antiseptic) prep pads, label, container of IV solution, IV administration tubing, tape, and the patient's clinical record.

**Standards:** Prepared the IV piggyback unit without contamination and administered it to the patient without complications.

**Performance Steps**

1. Identify the patient, explain the procedure, and ask about allergies.
2. Check the medication sheet (DA Form 4678) against the physician's orders.
  - a. Name of the medication.
  - b. Amount (dose) of medication.
  - c. Route of administration.
  - d. Time to be administered.
3. Select the medication.
  - a. Check the medication label three times to ensure that the correct medication is being prepared for administration.
  - b. Check the expiration date of the medication.
  - c. Handle only one medication at a time.

*NOTE:* If unfamiliar with a medication, look it up to determine contraindications, precautions, and side effects.

4. Prepare the medication.
  - a. Calculate the amount of medication required to equal the prescribed dose.

*NOTE:* If the medication is in powdered form, prepare it for use by adding the diluent specified on the drug information instructions.

  - b. Draw the prescribed amount of the prepared medication into a syringe.
  - c. Check the medication and calculations again to ensure that the correct medication and correct dose have been prepared.

5. Prepare the piggyback unit.

*NOTE:* Refer to the drug manufacturer's instructions to determine the type and amount of solution to be used as the piggyback unit.

- a. Use an alcohol prep pad to swab the injection port on the container of IV solution to be used as the piggyback unit.
  - b. Inject the prepared medication into the container of IV solution.
  - c. Mix the solution and medication into the container of IV solution.
  - d. Label the piggyback unit with the name of the medication, the amount added, the time added, the date added, and the initials of the person who prepared the piggyback unit.
  - e. Dispose of the needle and syringe IAW local SOP.
6. Prime the piggyback infusion tubing.
    - a. Close the clamp on the piggyback tubing.

**Performance Steps**

- b. Aseptically insert the spike on the piggyback tubing into the solution port on the piggyback unit.
- c. Squeeze the drip chamber to fill it half full.
- d. Open the clamp on the piggyback tubing, allowing the solution to prime the tubing.
- e. Close the clamp on the piggyback tubing when the solution reaches the end of the tubing.

*NOTE:* Attach a sterile needle to the end of the piggyback tubing if one is not provided by the manufacturer.

**CAUTION:** Take care not to waste any medicated IV solution while priming the tubing.

- 7. Connect the piggyback unit to the primary tubing.
  - a. Swab the injection port on the primary tubing with an alcohol prep pad.
  - b. Insert the needle into the injection port of the primary tubing.
  - c. Secure the connection with tape.

*NOTE:* Attach the piggyback tubing to the primary tubing below the level of the roller clamp. This will allow the piggyback unit to flow at its set rate without adjusting the flow rate of the primary solution.

- 8. Hang the piggyback unit on the IV pole, ensuring that the piggyback unit is at least 6 inches higher than the primary container.
- 9. Ensure patency of the primary IV.
- 10. Begin the secondary (piggyback) infusion.
  - a. Calculate the flow rate in accordance with the physician's orders.

*NOTE:* If the physician does not specify a flow rate, set the flow rate IAW the drug manufacturer's instructions.

- b. Adjust the roller clamp on the piggyback tubing to regulate the flow rate of the piggyback solution.

**CAUTION:** Do not adjust the flow rate of the primary container.

*NOTE:* When fluid from the secondary line enters the primary tubing, the primary infusion is automatically interrupted. When all the solution in the piggyback unit has been delivered, the primary infusion will resume flow at the set rate.

- 11. Label the piggyback infusion tubing with the time and date the medication was initiated.
- 12. Observe the patient for signs of infusion complications or reaction to the medicine. (See task 081-833-0034.)
- 13. Document the procedure and significant nursing observations on the appropriate forms IAW local SOP.

**Performance Measures**

	<u>GO</u>	<u>NO GO</u>
1. Identified the patient, explained the procedure, and asked about allergies.	—	—
2. Checked the medication sheet (DA Form 4678) against the physician's orders.	—	—
3. Selected the medication.	—	—
4. Prepared the medication.	—	—

<b>Performance Measures</b>	<b><u>GO</u></b>	<b><u>NO</u> <u>GO</u></b>
5. Prepared the piggyback unit.	—	—
6. Primed the piggyback infusion tubing.	—	—
7. Connected the piggyback unit to the primary tubing.	—	—
8. Hung the piggyback unit on the IV pole, ensuring that the piggyback unit is at least 6 inches higher than the primary container.	—	—
9. Ensured patency of the primary IV.	—	—
10. Began the secondary (piggyback) infusion.	—	—
11. Labeled the piggyback infusion tubing with the time and date the medication was initiated.	—	—
12. Observed the patient for signs of infusion complications or reaction to the medicine.	—	—
13. Documented the procedure and significant nursing observations on the appropriate forms IAW local SOP.	—	—

**Evaluation Guidance:** Score each soldier according to the performance measures in the evaluation guide. Unless otherwise stated in the task summary, the soldier must pass all performance measures to be scored GO. If the soldier fails any step, show what was done wrong and how to do it correctly.

**References**  
**Required**  
 None

**Related**  
 BASIC NURSING

## **SUTURE A MINOR LACERATION**

### **081-833-3208**

**Conditions:** You have a casualty with a minor laceration requiring closure. The laceration does not involve the face, hands, feet, or genitalia. You are not in an NBC environment. Necessary materials and equipment: sterile suture set, appropriate type and size of suture, staples, skin adhesive, steri strips, lidocaine 1% with and without epinephrine, saline irrigation solution, antiseptic solution, sterile gloves, antibiotic ointment, and sterile dressing.

**Standards:** Properly cleaned, anesthetized, and closed the laceration without causing further harm.

### **Performance Steps**

1. Prepare the site.
  - a. Expose the area to be sutured.
  - b. Gently scrub the site with an antiseptic solution using circular motions for a minimum of 5 minutes.

*NOTE:* Use ample pressure to remove dirt and microorganisms.

- c. Irrigate the wound with a copious amount of normal saline at a low pressure.
- d. Dry the site using sterile gauze pads.

2. Anesthetize the area.
  - a. Cryoanesthesia.
    - (1) Apply a moistened ice cube to the skin for about 5 minutes.
    - (2) Spray the area with commercial refrigerants, as directed.
  - b. Topical applications.
    - (1) Apply the agent directly to the mucus membrane, serous surface, or onto the open wound.
    - (2) Slightly saturate a gauze with the appropriate agent and place it on the wound for 5 to 10 minutes.
    - (3) Check the area for tissue blanching which indicates adequate anesthesia.

*NOTE:* Often topical application is suboptimal for suture placement.

- c. Simple infiltration.
  - (1) Ensure the casualty does not have an allergy to the agent.
  - (2) Using a needle and syringe, draw up an adequate amount of 1% lidocaine.

*NOTE:* Lidocaine with epinephrine is never used on the tip of the nose, ears, fingers, toes, or genitalia due to vasoconstriction.

- (3) Enter directly into the dermis through the laceration.
- (4) Aspirate prior to injecting the solution to ensure the needle is not in a vessel. (If blood returns into the syringe, withdraw, change the needle, and try a new site.)
- (5) Slowly inject solution beneath the skin surface, raising a wheal in the area to be anesthetized.
- (6) Repeat steps 2c(3) through 2c(5) depending on the size of the laceration.

3. Select the method of closure.
  - a. Skin adhesive.
    - (1) Hold the wound edges together and slightly everted with tissue forceps.
    - (2) Apply adhesive with the applicator tip by lightly wiping along the long axis of the wound.

**Performance Steps**

*NOTE:* Three to four thin layers should be applied successively. Avoid droplets or a single thick layer.

- (3) Hold the wound edges together for approximately 1 minute.
- (4) Instruct the casualty not to apply ointment or dressing to the wound.

## b. Steri strips.

- (1) Apply benzoin to a 2 to 3 cm area beyond the wound edges. Do not allow benzoin to enter the wound.
- (2) Using forceps, attach the strip to the skin on one side and then pull it across the wound to close the wound edges.
- (3) Start in the center and progress toward each end. Leave some space between individual strips.
- (4) Instruct the casualty not to get the area wet.

## c. Staples.

- (1) Hold the wound edges together with tissue forceps.
- (2) Place the stapling device gently against the skin surface.
- (3) Slowly squeeze the trigger.
- (4) Evenly place only the necessary amount of staples to close the wound.

*NOTE:* There is little to no benefit to locally infiltrating an area for 1 to 2 staple placement. The anesthetic is more discomforting than the procedure.

## d. Suture.

- (1) Select the proper size and type of material.
- (2) Check for adequate anesthesia by grasping the wound edges with tissue forceps. Note if the casualty can feel pain.
- (3) Grasp the needle with the needle holder about 1/2 to 1/3 the distance from where the suture is attached.
- (4) Hold the needle holder in the palm, using the index finger for fine control.
- (5) Enter the skin at approximately a 90 degree angle on the far side of the wound and exit on the near side.

*NOTE:* You should enter and exit the skin about 2 mm from the edge. Entry and exit points should be directly across from each other.

- (6) Pull the suture through the wound until approximately a 2 cm tail remains on the far side of wound.
- (7) Hold the end of the suture attached to the needle in the nondominant hand.
- (8) Hold the needle holder in the dominant hand.
- (9) Loop the suture twice around the needle holder.
- (10) Grasp the free end of the suture with the blades of the needle holder.
- (11) Cross the hands so that the hand holding the swagged end is on the far side and the hand holding the needle holder and free end are on the near side of the wound.
- (12) Pull upward on the suture ends when clinching the first throw.
- (13) Adjust the tension of the first throw so that the wound edges come together snugly but not tightly.
- (14) For the second throw of the knot, the needle end is on the far side of the wound and the free end on the near side.
- (15) Hold the needle end of the suture in the nondominant hand and lay the needle holder on top.
- (16) Loop the suture only once around the needle holder.
- (17) Grasp the free ends with the blades of the holder.
- (18) Cross the hands so that the sutures smoothly intertwine.
- (19) Cinch down the throw.



**Performance Steps**

**CAUTION:** Take care not to cinch down too tightly on the second throw because the tightness will be transmitted to the wound.

- (20) Pull the knot to the side so that it will not directly overlie the laceration.
  - (21) The pattern of looping the suture around the holder on alternate sides of the wound is repeated until the desired number of throws are completed.
  - (22) Cut the ends of the suture material to approximately 3 to 5 cm length..
4. Apply antibiotic ointment to the site.
  5. Apply a sterile dressing to the site.
  6. Document the procedure.

**Performance Measures**

	<u>GO</u>	<u>NO GO</u>
1. Prepared the skin.	_____	_____
2. Anesthetized the area.	_____	_____
3. Selected the method of closure.	_____	_____
4. Applied antibiotic ointment.	_____	_____
5. Sutured the laceration.	_____	_____
6. Applied a sterile dressing.	_____	_____
7. Documented the procedure.	_____	_____

**Evaluation Guidance:** Score each soldier according to the performance measures in the evaluation guide. Unless otherwise stated in the task summary, the soldier must pass all performance measures to be scored GO. If the soldier fails any step, show what was done wrong and how to do it correctly.

**References**

**Required**  
None

**Related**  
BASIC NURSING

**APPENDIX A**

**FIELD EXPEDIENT SQUAD BOOK**

**FIELD EXPEDIENT SQUAD BOOK**

For use of this form, see AR 350-37; the proponent agency is DCSOPS

SHEET

1 OF 9

USER APPLICATION	SOLDIER'S NAME					
	GO	NO-GO	GO	NO-GO	GO	NO-GO

TASK NUMBER AND SHORT TITLE	STATUS												
	GO	NO-GO	GO	NO-GO	GO	NO-GO	GO	NO-GO	GO	NO-GO	GO	NO-GO	
081-831-0010 Measure a Patient's Respirations													
081-831-0011 Measure a Patient's Pulse													
081-831-0012 Measure a Patient's Blood Pressure													
081-831-0013 Measure a Patient's Temperature													
081-833-0164 Measure a Patient's Pulse Oxygen Saturation													
081-831-0018 Open the Airway													
081-831-0019 Clear an Upper Airway Obstruction													
081-831-0046 Administer External Chest Compressions													
081-831-0048 Perform Rescue Breathing													
081-833-0161 Control Bleeding													
081-833-0167 Place a Patient on a Cardiac Monitor													
081-833-3027 Manage Cardiac Arrest Using AED													
081-831-0007 Perform a Patient Care Handwash													

EDITION OF DEC 82 TO BE USED

**DA FORM 5165-R, SEP 85**

**FIELD EXPEDIENT SQUAD BOOK**  
 For use of this form, see AR 350-37; the proponent agency is DCSOPS

SHEET 2 OF 9

USER APPLICATION

SOLDIER'S NAME

TASK NUMBER AND SHORT TITLE	STATUS															
	GO	NO-GO	GO	NO-GO	GO	NO-GO	GO	NO-GO	GO	NO-GO	GO	NO-GO	GO	NO-GO	GO	NO-GO
081-831-0008 Put on Sterile Gloves																
081-831-0033 Initiate a Field Medical Card																
081-833-0076 Apply Restraining Devices to Patients																
081-833-0006 Measure a Patient's Intake and Output																
081-833-0007 Establish a Sterile Field																
081-833-0010 Change a Sterile Dressing																
081-833-0012 Perform a Wound Irrigation																
081-833-0021 Perform Oral and Nasopharyngeal Suctioning of a Patient																
081-833-0059 Irrigate an Obstructed Ear																
081-833-0145 Document Patient Care Using Subjective, Objective, Assessment, Plan (SOAP) Note Format																
081-833-0165 Perform Patient Hygiene																
081-835-3007 Obtain an Electrocardiogram																
081-833-0016 Insert an Oropharyngeal Airway (J Tube)																

**DA FORM 5165-R, SEP 85** EDITION OF DEC 82 TO BE USED

**FIELD EXPEDIENT SQUAD BOOK**

For use of this form, see AR 350-37; the proponent agency is DCSOPS

SHEET

3 OF 9

USER APPLICATION

SOLDIER'S NAME

STATUS

TASK NUMBER AND SHORT TITLE	GO		NO-GO		GO		NO-GO		GO		NO-GO		GO		NO-GO		GO		NO-GO		
	GO	NO-GO	GO	NO-GO	GO	NO-GO	GO	NO-GO	GO	NO-GO	GO	NO-GO	GO	NO-GO	GO	NO-GO	GO	NO-GO	GO	NO-GO	
081-833-0018 Set Up an Oxygen Tank																					
081-833-0142 Insert a Nasopharyngeal Airway																					
081-833-0158 Administer Oxygen																					
081-833-0169 Insert a Combitube																					
081-833-3006 Perform a Needle Cricothyroidotomy																					
081-833-3007 Perform Needle Chest Decompression																					
081-833-0032 Obtain a Blood Specimen Using a Vacutainer																					
081-833-0033 Initiate an Intravenous Infusion																					
081-833-0034 Manage a Patient with an Intravenous Infusion																					
081-835-3025 Initiate a Saline Lock																					
081-831-0035 Manage a Convulsive and/or Seizing Patient																					
081-833-0045 Treat a Casualty with an Open Abdominal Wound																					
081-833-0046 Apply a Dressing to an Impalement Injury																					

EDITION OF DEC 82 TO BE USED

DA FORM 5165-R, SEP 85

**FIELD EXPEDIENT SQUAD BOOK**

For use of this form, see AR 350-37; the proponent agency is DCSOPS

SHEET

4 OF 9

USER APPLICATION

SOLDIER'S NAME

--	--	--	--	--	--	--	--	--	--	--	--	--	--	--	--	--	--	--	--	--

STATUS

TASK NUMBER AND SHORT TITLE	GO	NO-GO	GO	NO-GO	GO	NO-GO	GO	NO-GO	GO	NO-GO	GO	NO-GO	GO	NO-GO	GO	NO-GO	GO	NO-GO	GO	NO-GO	
081-833-0048 Manage an Unconscious Casualty																					
081-833-0049 Treat a Casualty with a Closed Chest Wound																					
081-833-0050 Treat a Casualty with an Open Chest Wound																					
081-833-0052 Treat a Casualty with an Open or Closed Head Injury																					
081-833-0070 Administer Initial Treatment for Burns																					
081-833-0103 Provide Care for a Soldier with Symptoms of Battle Fatigue																					
081-833-0116 Assist in Vaginal Delivery																					
081-833-0143 Treat a Poisoned Casualty																					
081-833-0144 Treat a Diabetic Emergency																					
081-833-0155 Perform a Trauma Casualty Assessment																					
081-833-0156 Perform a Medical Patient Assessment																					
081-833-0159 Treat a Cardiac Emergency																					
081-833-0160 Treat a Respiratory Emergency																					

EDITION OF DEC 82 TO BE USED

DA FORM 5165-R, SEP 85

**FIELD EXPEDIENT SQUAD BOOK**

For use of this form, see AR 350-37; the proponent agency is DCSOPS

SHEET

5 OF 9

USER APPLICATION

SOLDIER'S NAME

TASK NUMBER AND SHORT TITLE	STATUS													
	GO	NO-GO	GO	NO-GO	GO	NO-GO	GO	NO-GO	GO	NO-GO	GO	NO-GO	GO	NO-GO
081-835-3030 Determine a Patient's Level of Consciousness Using the Glasgow Coma Scale														
081-833-0054 Irrigate Eyes														
081-833-0056 Treat Foreign Bodies of the Eye														
081-833-0057 Treat Lacerations, Contusions, and Extrusions of the Eye														
081-833-0058 Treat Burns of the Eye														
081-831-0044 Apply a Pneumatic Splint to a Casualty with a Suspected Fracture of an Extremity														
081-833-0060 Apply a Roller Bandage														
081-833-0062 Immobilize a Suspected Fracture of the Arm or Dislocated Shoulder														
081-833-0064 Immobilize a Suspected Dislocated or Fractured Hip														
081-833-0092 Transport a Casualty with a Suspected Spinal Injury														
081-833-0141 Apply a Traction Splint														
081-833-0154 Provide Basic Emergency Treatment for a Painful, Swollen, Deformed Extremity														
081-831-0038 Treat a Casualty for a Heat Injury														

EDITION OF DEC 82 TO BE USED

**DA FORM 5165-R, SEP 85**

**FIELD EXPEDIENT SQUAD BOOK**

For use of this form, see AR 350-37; the proponent agency is DCSOPS

SHEET  
6 OF 9

USER APPLICATION	SOLDIER'S NAME					

TASK NUMBER AND SHORT TITLE	STATUS												
	GO	NO-GO	GO	NO-GO	GO	NO-GO	GO	NO-GO	GO	NO-GO	GO	NO-GO	
081-831-0039 Treat a Casualty for a Cold Injury													
081-833-0031 Initiate Treatment for Anaphylactic Shock													
081-833-0072 Treat a Casualty for Insect Bites or Stings													
081-833-0073 Treat a Casualty for Snakebite													
081-833-0083 Treat a Nerve Agent Casualty in the Field													
081-833-0084 Treat a Blood Agent (Hydrogen Cyanide) Casualty in the Field													
081-833-0085 Treat a Choking Agent Casualty in the Field													
081-833-0086 Treat a Blister Agent Casualty (Mustard, Lewisite, Phosgene Oxime) in the Field													
081-833-0095 Decontaminate a Casualty													
081-833-0047 Initiate Treatment for Hypovolemic Shock													
081-833-3011 Apply Pneumatic Anti-Shock Garment													
081-833-3017 Insert a Urinary Catheter													
081-835-3010 Maintain an Indwelling Urinary Catheter													

**DA FORM 5165-R, SEP 85** EDITION OF DEC 82 TO BE USED



**FIELD EXPEDIENT SQUAD BOOK**

For use of this form, see AR 350-37; the proponent agency is DCSOPS

SHEET

7 OF 9

USER APPLICATION

SOLDIER'S NAME

--	--	--	--	--	--	--	--	--	--	--	--	--	--	--	--	--	--	--	--

STATUS

TASK NUMBER AND SHORT TITLE	GO	NO-GO	GO	NO-GO	GO	NO-GO	GO	NO-GO	GO	NO-GO	GO	NO-GO	GO	NO-GO	GO	NO-GO	GO	NO-GO	
	GO	NO-GO	GO	NO-GO	GO	NO-GO	GO	NO-GO	GO	NO-GO	GO	NO-GO	GO	NO-GO	GO	NO-GO	GO	NO-GO	
081-833-3022 Insert a Nasogastric Tube																			
081-835-3005 Perform a Gastric Lavage																			
071-334-4001 Guide a Helicopter to a Landing Point																			
071-334-4002 Establish a Helicopter Landing Point																			
081-833-0080 Triage Casualties on a Conventional Battlefield																			
081-833-0082 Triage Casualties on an Integrated Battlefield																			
081-833-0151 Load Casualties onto Ground Evacuation Platforms																			
081-833-0171 Load Casualties onto Nonstandard Vehicles, 1 1/4 Ton, 4x4, M998																			
081-833-0172 Load Casualties onto Nonstandard Vehicles, 2 1/2 Ton, 6x6 or 5 Ton, 6x6, Cargo Truck																			
081-833-0173 Load Casualties onto Nonstandard Vehicles, 5 Ton M-1085, M-1093, 2 1/2 Ton M-1081																			
081-833-0088 Prepare an Injection for Administration																			
081-833-0089 Administer an Injection (Intramuscular, Subcutaneous, Intradermal)																			
081-833-0174 Administer Morphine																			

EDITION OF DEC 82 TO BE USED

DA FORM 5165-R, SEP 85

**FIELD EXPEDIENT SQUAD BOOK**

For use of this form, see AR 350-37; the proponent agency is DCSOPS

SHEET

8 OF 9

USER APPLICATION

SOLDIER'S NAME

--	--	--	--	--	--	--	--	--	--	--	--	--	--	--	--	--	--	--	--

TASK NUMBER AND SHORT TITLE	STATUS																		
	GO	NO-GO	GO	NO-GO	GO	NO-GO	GO	NO-GO	GO	NO-GO	GO	NO-GO	GO	NO-GO	GO	NO-GO	GO	NO-GO	
081-835-3001 Administer Oral Medications																			
081-835-3020 Administer Topical Medications																			
081-835-3021 Administer Rectal or Vaginal Medications																			
081-835-3022 Administer Medicated Eye Drops or Ointments																			
081-831-0037 Disinfect Water for Drinking																			
081-833-0170 Perform Endotracheal Suctioning of a Patient																			
081-835-3024 Provide Tracheostomy Care																			
081-835-3031 Provide Nursing Care for a Patient with a Waterseal Drainage System																			
081-830-3016 Intubate a Patient																			
081-833-0093 Set Up a Casualty Decontamination Station																			
081-833-0168 Insert a Chest Tube																			
081-833-3005 Perform a Surgical Cricothyrotomy																			
081-833-3014 Perform a Neurological Examination on a Patient with Suspected Central Nervous System Injuries																			

**DA FORM 5165-R, SEP 85** EDITION OF DEC 82 TO BE USED



## APPENDIX B

### DRUG DOSAGE CALCULATIONS

#### ***Calculate Intravenous Drip Rates***

1. To calculate the drip rate per minute (flow rate) of intravenous (IV) fluids, first obtain the following information:

a. Delivery rate (drops per cc) of the IV tubing set being used. This is also referred to as the "tubing factor." (The IV tubing package will state the rate of delivery for that particular IV set; for example, 10 drops per cc for standard drip tubing or 60 drops per cc for mini drip tubing.)

b. Volume of fluid (in cc) to be infused. (This can be expressed in an hourly amount or in a total volume; for example, "100 cc/hour" or "2 liters over 6 hours.")

c. Amount of time (in minutes) the fluid is to be infused. (This can be expressed in an hourly rate or total time; for example, "150 cc per hour" or "infuse 1 liter over 4 hours.")

2. Calculate the flow rate in drops per minute using the following formula:

$$\text{gtt/min} = \frac{\text{volume to be infused X gtt/cc of administration set}}{\text{infusion time in minutes}}$$

1. To convert grams (Gm) to milligrams (mg), multiply Gm by 1000 and move the decimal point three places to the right; for example, 0.075 Gm = 75 mg and 0.25 Gm = 250 mg.

2. To convert milligrams to grams, divide milligrams by 1000 and move the decimal point three places to the left; for example, 1000 mg = 1 Gm and 500 mg = .5 Gm.

**Calculation of Doses from Drugs in Solution**

1. Some drugs are dispensed as solutions. The strength of the solution is written on the label of the drug container; for example, "10 mg per ml." The problem is to determine what quantity of solution will contain the required dose of the drug. The method of solving the problem is by ratio and proportion. The formula is as follows:

$$\begin{array}{ccccccc} \text{Required} & : & \text{Unknown} & :: & \text{ratio of strength} & & \\ \text{amount of drug} & & \text{amount of solution} & & \text{of solution on hand} & & \\ \hline & \text{is to} & & \text{as} & & \text{is to} & \hline \end{array}$$

2. EXAMPLE: The physician has ordered Benadryl Elixir, 25 mg p.o. The Benadryl Elixir on hand contains 10 mg per ml. How many ml (cc) of the Elixir must be administered to achieve the required dose?

a. Write out the formula.

$$25 \text{ mg} : x \text{ ml} :: 10 \text{ mg} : 1 \text{ ml}$$

b. Multiply the inner values.

$$x \text{ times } 10 \text{ (} 10x \text{)}$$

c. Multiply the outer values.

$$25 \text{ times } 1 \text{ (} 25 \text{)}$$

d. The multiplied inner values equal the multiplied outer values, so:

$$10x = 25$$

e. Divide 25 by 10 to find x.

$$x = \frac{25}{10} \text{ or } 2.5$$

f. 2.5 ml of Benadryl Elixir must be administered to achieve the required dose of 25 mg.

**Convert from Apothecary to Metric**

1. To convert grains to milligrams, multiply grains by 60 to obtain milligrams; for example, 1/4 grain = 15 milligrams.

2. To convert milligrams to grains, divide milligrams by 60 to obtain grains; for example, 30 mg = 1/2 grain.

Liquid Measure		Liquid Measure	
Metric	Approximate Apothecary Equivalents	Metric	Approximate Apothecary Equivalents
1,000 ml	1 quart	3 ml	45 minims
750 ml	1 1/2 pints	2 ml	30 minims
500 ml	1 pint	1 ml	15 minims
250 ml	8 fluid ounces	0.75 ml	12 minims
200 ml	7 fluid ounces	0.6 ml	10 minims
100 ml	3 1/2 fluid ounces	0.5 ml	8 minims
50 ml	1 3/4 fluid ounces	0.3 ml	5 minims
30 ml	1 fluid ounce	0.25 ml	4 minims
15 ml	4 fluid drams	0.2 ml	3 minims
10 ml	2 1/2 fluid drams	0.1 ml	1 1/2 minims
8 ml	2 fluid drams	0.06 ml	1 minim
5 ml	1 1/4 fluid drams	0.05 ml	3/4 minim
4 ml	1 fluid dram	0.03 ml	1/2 minim
Weight		Weight	
Metric	Approximate Apothecary Equivalents	Metric	Approximate Apothecary Equivalents
30 Gm	1 ounce	30 mg	1/2 grain
15 Gm	4 drams	25 mg	3/8 grain
10 Gm	2 1/2 drams	20 mg	1/3 grain
7.5 Gm	2 drams	15 mg	1/4 grain
6 Gm	90 grains	12 mg	1/5 grain
5 Gm	75 grains	10 mg	1/6 grain
4 Gm	60 grains/1 dram	8 mg	1/8 grain
3 Gm	45 grains	6 mg	1/10 grain
2 Gm	30 grains/1/2 dram	5 mg	1/12 grain
1.5 Gm	22 grains	4 mg	1/15 grain
1 Gm	15 grains	3 mg	1/20 grain
0.75 Gm	12 grains	2 mg	1/30 grain
0.6 Gm	10 grains	1.5 mg	1/40 grain
0.5 Gm	7 1/2 grains	1.2 mg	1/50 grain
0.4 Gm	6 grains	1 mg	1/60 grain
0.3 Gm	5 grains	0.8 mg	1/80 grain
0.25 Gm	4 grains	0.6 mg	1/100 grain
0.2 Gm	3 grains	0.5 mg	1/120 grain
0.15 Gm	2 1/2 grains	0.4 mg	1/150 grain
0.12 Gm	2 grains	0.3 mg	1/200 grain
0.1 Gm	1 1/2 grains	0.25 mg	1/250 grain
75 mg	1 1/4 grains	0.2 mg	1/300 grain
60 mg	1 grain	0.15 mg	1/400 grain
50 mg	3/4 grain	0.12 mg	1/500 grain
40 mg	2/3 grain	0.1 mg	1/600 grain

## ABBREVIATIONS

ac	before meals
ad lib	as much as desired
bid	twice a day
c	with
cc	cubic centimeter
caps	capsule
Gm	gram
gr	grain
gtt	drop
h	hour
hs	bedtime (hour of sleep)
kg	kilogram
l	liter
mg	milligram
ml	milliliter
od	right eye (oculo dextro)
os	left eye (oculo sinistro)
ou	both eyes (oculus uterque)
pc	after meals
po	by mouth
prn	when needed/as necessary
qd	every day (daily)
qid	four times daily
qod	every other day
qs	in sufficient quantity
q2h	every 2 hours
q4h	every 4 hours
q6h	every 6 hours
q8h	every 8 hours
s	without
stat	at once/immediately
sq or sc	subcutaneously
ss	one half
tab	tablet
tsp	teaspoon
tbsp	tablespoon
tid	three times daily

## GLOSSARY

**ACCP** The Army Correspondence Course Program

**AED** automatic external defibrillator

**Army Training and Evaluation Program (ARTEP).**

The Army's collective training program that establishes unit training objectives critical to unit survival and performance in combat. They combine the training and the evaluation process into one integrated function. The ARTEP is a training program and not a test. The sole purpose of external evaluation under this program is to diagnose unit requirements for future training.

**AVPU** alertness, responsiveness to vocal stimuli, responsiveness to painful stimuli unresponsiveness

**BAS** battalion aid station

**Battle focus**

A process to guide the planning, execution, and assessment of the organization's training program to ensure they train as they are going to fight.

**BDU** battle dress uniform

**BSA** body surface area

**BVM** bag-valve-mask

**CAM** chemical agent monitor

**CANA** convulsant antidote for nerve agents

**cc** cubic centimeter

**cc/hr** cubic centimeters of fluid per hour

**cm** centimeter

**cm H<sub>2</sub>O** centimeter of water

**CMS** Centralized Materiel Service/Section (depends on use)

**CNS** central nervous system

**Collective training**

Training, either in institutions or units, that prepares cohesive teams and units to accomplish their missions on the battlefield and in operations other than war.

**Common task**

A critical task that is performed by every soldier in a specific skill level regardless of MOS.



**COPD** chronic obstructive pulmonary disease

**CPR** cardiopulmonary resuscitation

**Critical task**

A collective or individual task determined to be essential to wartime mission, duty accomplishment, or survivability. Critical individual tasks are trained in the training base and/or unit, and they are reinforced in the unit.

**Cross training**

The systematic training of soldiers on tasks related to another duty position.

**CSF** cerebrospinal fluid

**DCS** division clearing station

**DTR** deep tendon reflex

**EKG** electrocardiogram/electrocardiograph

**ET** endotracheal/endotracheal tube/evebt template (depends on use)

**F** Fahrenheit

**FMC** field medical card

**FROPVD** flow-restricted oxygen-powered ventilation device

**gtts** drops

**HTH** high test hypochlorite

**I & O** intake and output

**IAW** in accordance with

**ID** identification; infantry division

**IM** intramuscular

**Individual training**

Training which prepares the soldier to perform specified duties or tasks related to assigned duty position or subsequent duty positions and skill level.

**Integration training**

The completion of initial entry training in skill level 1 tasks for an individual newly arrived in a unit, but limited specifically to tasks associated with the mission, organization, and equipment of the unit to which the individual is assigned. It may be conducted by the unit using training materials supplied by the school, by troop schools, or by inservice or contract mobile training teams. In all cases, this training is supported by the school proponent.

<b>IV</b>	intravenous
<b>JVD</b>	jugular vein distention
<b>KED</b>	Kendrick Extrication Device
<b>kg</b>	kilogram(s)
<b>KVO</b>	keep the vein open
<b>LPM</b>	liters per minute
<b>LZ</b>	landing zone
<b>MD</b>	medical doctor
<b>MDI</b>	metered dose inhaler
<b>MEDEVAC</b>	medical evacuation
<b>MES</b>	medical equipment set(s)
<b>METL</b>	mission essential task list

**Mission essential task list**

A compilation of collective mission essential tasks which must be successfully performed if an organization is to accomplish its wartime mission(s).

<b>ml</b>	milliliter
<b>mm Hg</b>	millimeters of mercury
<b>mm/sec</b>	millimeters per second
<b>MOPP</b>	mission-oriented protective posture
<b>MOS</b>	military occupational specialty
<b>MOSC</b>	military occupational specialty code
<b>MRE</b>	meal, ready to eat
<b>MTF</b>	medical treatment facility
<b>MVA</b>	motor vehicle accident
<b>NATO</b>	North Atlantic Treaty Organization
<b>NBC</b>	nuclear, biological, and chemical
<b>NCO</b>	noncommissioned officer

<b>NPO</b>	nothing by mouth
<b>PA</b>	physician assistant
<b>PASG</b>	pneumatic anti-shock garments
<b>PEA</b>	pulseless electrical activity
<b>ppm</b>	parts per million
<b>prn</b>	as necessary
<b>psi</b>	pounds per square inch
<b>PVC</b>	premature ventricular contraction
<b>ROM</b>	range of motion
<b>RTO</b>	radio/telephone operator

**Self-Development**

Self-development is a planned, progressive, and sequential program followed by leaders to enhance and sustain their military competencies. Self-development consists of individual study, research, professional reading, practice, and self-assessment.

<b>SL</b>	skill level
<b>SM</b>	soldier's manual
<b>SMCT</b>	soldier's manual of common tasks
<b>SOP</b>	standing operating procedures
<b>SQ</b>	subcutaneous
<b>SSN</b>	social security number
<b>STAT</b>	immediately
<b>STB</b>	supertropical bleach

**Sustainment training.**

The provision of training to maintain the minimum acceptable level of proficiency required to accomplish a critical task.

<b>TG</b>	trainer's guide
<b>TKO</b>	to keep open

**Train-up**

The process of increasing the skills and knowledge of an individual to a higher skill level in the appropriate MOS. It may involve certification.

**Unit training**

Training (individual, collective, and joint or combined) conducted in a unit.

**WP** white phosphorus

## REFERENCES

New reference material is being published all the time. Present references, as listed below may become obsolete. To keep up-to-date, see DA Pam 25-30. Many of these publications and forms are available in electronic format from the sites listed below:

### [U.S. Army Publishing Agency](#)

Administrative Departmental Publications and Forms  
(ARs, Cir, Pams, OFs, SFs, DD & DA Forms)

### [General Dennis J. Reimer Training and Doctrine Digital Library \(RDL\)](#)

Army Doctrinal and Training Publications  
(FMs, PBs, TCs, STPs)

## Required Publications

Required publications are sources that are listed in task conditions statements and are required for the soldier to perform the task.

### Department of Army Forms

DA FORM 3949	Controlled Substances Record
DA FORM 4678	Therapeutic Documentation Care Plan (Medication)

### Other Product Types

DD FORM 1380	US Field Medical Card
DD FORM 792	Twenty-Four Hour Patient Intake and Output Worksheet
OF 520	Medical Record--Electrocardiographic Record
SF 511	Medical Record - Vital Signs Record
SF 518	Medical Record--Blood or Blood Component Transfusion

## Related Publications

Related publications are sources of additional information. They are not required in order to perform the tasks in this manual.

### Army Regulations

AR 40-66	Medical Record Administration and Healthcare Documentation 3 May 1999
----------	--

### Department of Army Forms

DA FORM 2028	Recommended Changes to Publications and Blank Forms
DA FORM 5164-R	Hands-On Evaluation
DA FORM 5165-R	Field Expedient Squad Book

### Department of Army Pamphlets

DA PAM 350-59	Army Correspondence Course Program Catalog 1 October 2000
---------------	---

**Field Manuals**

FM 21-60	Visual Signals 30 September 1987
FM 25-100	Training the Force 15 November 1988
FM 25-101	Battle Focused Training 30 September 1990
FM 57-38	Pathfinder Operations 9 April 1993
FM 7-8	Infantry Rifle Platoon and Squad 22 April 1992
FM 8-10	Health Service Support in a Theater of Operations 1 March 1991
FM 8-10-6	Medical Evacuation in a Theater of Operations: Tactics, Techniques, and Procedures 14 April 2000

**Other Product Types**

BASIC NURSING	Rosdahl, Textbook of Basic Nursing, 6th Edition, Lippincott 1 August 1997
BTLS FOR PARAMEDICS	Campbell, Basic Trauma Life Support for Paramedics and Other Advanced Providers, 4th Edition, Prentice Hall. 1 August 1999
EMERGENCY CARE	O'Keefe (Editor), Brady Emergency Care, 8th Edition, Prentice Hall 1 July 1997

**Soldier Training Publications**

COMMON CORE	Common Core Tasks - General Dennis J. Reimer Training and Doctrine Digital Library ( <a href="http://155.217.58.58/atdls.htm">http://155.217.58.58/atdls.htm</a> )
STP 21-1-SMCT	Soldier's Manual of Common Tasks (Skill Level 1) 1 October 2001
STP 21-24-SMCT	Soldier's Manual of Common Tasks (Skill Levels 2-4) 1 October 2001

**Training Circulars**

TC 8-800	Semi-Annual Combat Medic Skills Validation Test (SACMS-VT) (to be published)
----------	--

**STP 8-91W15-SM-TG**  
**10 October 2001**

By Order of the Secretary of the Army:

ERIC K. SHINSEKI  
*General, United States Army*  
*Chief of Staff*

Official:

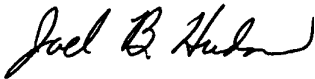

JOEL B. HUDSON  
*Administrative Assistant to the*  
*Secretary of the Army*  
0130601

DISTRIBUTION:

*Active Army, Army National Guard, and US Army Reserve:* Not to be distributed. To be published by electronic means only.