



2019 INDUSTRIAL EQUIPMENT



At Mi-T-M our goal is to continue to build the best equipment made right here in America's heartland, where workers take pride in their everyday job of manufacturing pressure washers, air compressors, generators and the multitude of other equipment with the familiar black and gold logo. But this logo is more than a name. It means quality and craftsmanship. It stands for pride in what we do. Proud that what we do matters to the hard working men and women in our industry.

Nearly every day, we take our places at the Peosta, Iowa facility next to 450 of our coworkers who come to do their best work. Striving for that quality, that standard we hold ourselves to. After all, this is Mi-T-M. Our reputation and our customers depend on it.



PERFORMANCE UNDER PRESSURE.®

Product Index

Pressure Washers	p. 3-41	Portable Heaters	p. 97-104
Air Compressors	p. 42-60	Water Pumps	p. 105-108
Air Compressor/Generators	p. 61-67	Ordering & Warranty Information	p. 109
Air Compressor/Generator/Welders	p. 68-71	Safety Certifications	p. 110
Air Compressor Accessories	p. 72-78		
Portable Generators	p. 79-87		
Wet/Dry Vacuums	p. 88-93		
Jobsite Boxes	p. 94-96		



Our Promise

We promise to deliver unmatched performance - from the quality of our products to the dedication of each employee who does what's right for our customer - every time.



Sales Department

Front row (left to right): Vaughn Grimm, Government/Export Division Manager | Laura Runde, Sales Operations Manager | Cole Schlitzer, Territory Account Sales Representative (TASR) | Wenda Beadle, Sales Administrative Coordinator | Gerry Hess, Project Manager, OEM Division | Jodi Bergfeld, Administrative Assistant | Matt Hofer, Equipment Division Manager

Second row (left to right): Justin Schrack, TASR | Bill Murray, OEM Division Manager | Ryan Recker, TASR | Clint Francois, Assistant Rental/Equipment Division Manager | Dennis Waller, Consumer Division Manager | Lucas Willett, TASR | Karl Loeffelholz, Distributor Division Manager | Jeff Schlichte, Paint Division Manager

Back row (left to right): Aaron Auger, Water Treatment Division Manager | Chris Rondeau, Account Sales Representative | Bryan McCarron, Air Compressor Division Manager | Don Holdridge, National Paint Division Manager | Ron Snyder, Assistant Distributor Division Manager | Luke McCarron, TASR

Not shown: Kevin Anstoetter, Rental Division Manager



Technical Service Department

Left to right: Kenny Davis, Technical Service Representative (TSR) | Jeff Eudaley, TSR | Matt Meyers, TSR | Kyle Kohl, TSR | Jim Abitz, TSR | Jeff Riesberg, Product Support Manager | Charlie Wehrspann, Service Technician



Marketing Department

Front row (left to right): Nicky Barta, Literature Coordinator | Teresa Gottschalk, Graphic Designer | Kelly Rice, Literature Coordinator | Hilary Van Praag, Graphic Designer

Back row (left to right): Sarah Swift, Marketing Project Manager | Karen Anderson, Marketing Manager



Customer Service Department

Front row (left to right): Travis Steffens, Customer Service Representative (CSR) | Karen Steger, Receptionist | Allen Alcantara, CSR | Amy Soppe, CSR | Sean Fitzgerald, CSR

Back row (left to right): JJ Connolly, Customer Service Manager | Alex Simpson, CSR | Chris Oberender, CSR | JD Reynolds, CSR | Jordan Langel, CSR | Keith Kegerreis, CSR

Pressure Washers



CD Series

Cold Water – Gasoline – Direct Drive



CD-2003-3MHH

This compact, hand-carry pressure washer is designed to tackle most cleaning jobs around your property. Easy to carry and easy to store, it's also the perfect tool for small cleaning contractor jobs.

- Pump:**
Forged brass manifold | Thermal relief valve | In-line water strainer | Low pressure detergent injector
- Frame:**
Powder coated steel mounting plate with center balanced lift and four rubber isolators
- Unit Includes:**
Quick connect nozzles - 0°, 15°, 25° and detergent nozzle | 50-foot x 3/8-inch non-marking high pressure hose with quick connects | Professional-grade insulated trigger gun with safety lock-off
- Limited Warranties:**
3 year Honda engine | 7 year AR pump
- Certification:**
Intertek - Certified to UL-1776



PRESSURE WASHERS

MODEL NUMBER	PSI	GPM	DISPLACEMENT/ENGINE	PUMP	Mi-T-M NO.	UNLOADER	LANCE	DIMENSIONS (LxWxH)	SHIP WT.	NET WT.
CD-2003-3MHH	2000	2.7	196cc Honda GX200 OHV	AR	3-0360	Adjustable pressure	36in.	18x14.5x18in.	75 lb.	56 lb.

Accessories:

PART NUMBER	DESCRIPTION	FITS MODEL
50-0161	High pressure detergent injector	CD-2003-3MHH
851-0338	50-ft. x 3/8-in. non-marking high pressure hose	CD-2003-3MHH

JP Series

Cold Water – Gasoline – Direct Drive

Pump:

Equipped with the Mi-T-M Pressure Relief Start which eliminates pressure build-up in the system | Forged brass manifold | Thermal relief valve | In-line water strainer

Frame:

Powder coated steel frame and base plate with 1¼-inch tube handles | Convenient gun/wand holder and hose wrap | 13-inch flat-free tires (10-inch tires on 2400, 2700 and 3000-PSI models)

Unit Includes:

Quick connect nozzles - 0°, 15° and 25° | 50-foot x ¾-inch non-marking high pressure hose with quick connects | Professional-grade insulated trigger gun with safety lock-off

Limited Warranties:

1 year Mi-T-M unloader | 3 year Honda engine | 7 year AR and Mi-T-M pumps

Certification:

Intertek - Certified to UL-1776



JP-2703-3MHB



The powerful JP Series is ideal for removing dirt, mud, mold and mildew from almost any surface. Contractors love it because its portable design makes it easy to move from one job to the next.

MODEL NUMBER	PSI	GPM	DISPLACEMENT/ENGINE	PUMP	Mi-T-M NO.	UNLOADER	LANCE	DIMENSIONS (LxWxH)	SHIP WT.	NET WT.
JP-2403-3MHB	2400	2.4	196cc Honda GX200 OHV	Mi-T-M	3-0415	Mi-T-M, adjustable pressure	36in.	37x21x24.5in.	100 lb.	75 lb.
JP-2703-3MHB	2700	2.4	196cc Honda GX200 OHV	Mi-T-M	3-0415	Mi-T-M, adjustable pressure	36in.	37x21x24.5in.	110 lb.	85 lb.
JP-3003-3MHB	3000	3.0	270cc Honda GX270 OHV	AR	3-0389	Mi-T-M, adjustable pressure	36in.	40x22.5x24.5in.	180 lb.	130 lb.
JP-3504-3MHB	3500	3.5	389cc Honda GX390 OHV	AR	3-0310	Mi-T-M, adjustable pressure	48in.	40x22.5x24.5in.	192 lb.	142 lb.
JP-4004-3MHB	4000	3.5	389cc Honda GX390 OHV	AR	3-0310	Mi-T-M, adjustable pressure	48in.	40x22.5x24.5in.	192 lb.	142 lb.

Accessories & Options:

PART NUMBER	DESCRIPTION	FITS MODELS	PART NUMBER	DESCRIPTION	FITS MODELS
50-0161	High pressure detergent injector	All models	CX-0005	36-in. insulated dual lance	2400 to 3000-PSI models
851-0338	50-ft. x ¾-in. non-marking high pressure hose	All models	CX-0083	External bypass system	JP-2403-3MHB & JP-2703-3MHB
AW-8400-0021	Low pressure detergent injector	All models	CX-0084	External bypass system	JP-3504-3MHB & JP-4004-3MHB

CA Aluminum Series

Cold Water – Gasoline – Direct Drive



CA-3003-1MAK

Lightweight and powerful, the CA Aluminum Series is an excellent choice for cleaning contractors who are on the move. Use it to remove old and peeling paint or mold and mildew from any surface.

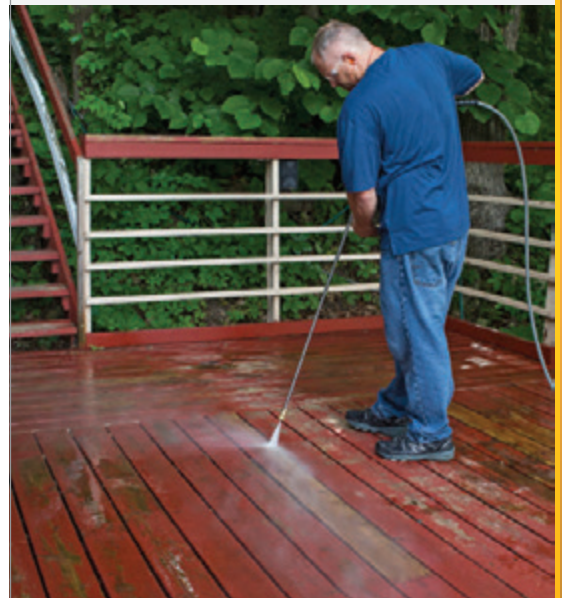

Pump:

Equipped with the Mi-T-M Pressure Relief Start which eliminates pressure build-up in the system (Not available on General pump models) | Forged brass manifold | Thermal relief valve | In-line water strainer

Frame:

Lightweight, corrosion-resistant aluminum frame and base plate with 1¼-inch tube handles | Patented vibration isolation plate with four rubber isolators | Convenient gun/wand holder | 13-inch flat-free tires (10-inch tires on 2400, 2700 and 3000-PSI models)

Unit Includes:

Quick connect nozzles - 0°, 15° and 25° | 50-foot x ¾-inch non-marking high pressure hose with quick connects | Professional-grade insulated trigger gun with safety lock-off

Limited Warranties:

1 year Mi-T-M unloader | 3 year Honda and Kohler engines | 7 year AR, General and Mi-T-M pumps

Certification:

Intertek - Certified to UL-1776

MODEL NUMBER	PSI	GPM	DISPLACEMENT/ENGINE	PUMP	Mi-T-M NO.	UNLOADER	LANCE	DIMENSIONS (LxWxH)	SHIP WT.	NET WT.
CA-2403-1MMH	2400	2.4	196cc Honda GX200 OHV	Mi-T-M	3-0415	Mi-T-M, adjustable pressure	36in.	39x20.5x24.5in.	100 lb.	73 lb.
CA-2703-1MMH	2700	2.4	196cc Honda GX200 OHV	Mi-T-M	3-0415	Mi-T-M, adjustable pressure	36in.	39x20.5x24.5in.	100 lb.	73 lb.
CA-2703-1MMK	2700	2.4	208cc Kohler CH270 OHV	Mi-T-M	3-0415	Mi-T-M, adjustable pressure	36in.	39x20.5x24.5in.	100 lb.	73 lb.
CA-3003-1MAH	3000	3.0	270cc Honda GX270 OHV	AR	3-0389	Mi-T-M, adjustable pressure	36in.	42.5x23.5x24.5in.	155 lb.	105 lb.
CA-3003-1MAK	3000	3.0	277cc Kohler CH395 OHV	AR	3-0389	Mi-T-M, adjustable pressure	36in.	42.5x23.5x24.5in.	155 lb.	105 lb.
CA-3504-1MAH	3500	3.5	389cc Honda GX390 OHV	AR	3-0310	Mi-T-M, adjustable pressure	48in.	42.5x23.5x24.5in.	175 lb.	125 lb.
CA-3504-1MGH*	3500	4.0	389cc Honda GX390 OHV	General	3-0350	Mi-T-M, adjustable pressure	48in.	42.5x23.5x24.5in.	175 lb.	125 lb.
CA-4004-1MAH	4000	3.5	389cc Honda GX390 OHV	AR	3-0310	Mi-T-M, adjustable pressure	48in.	42.5x23.5x24.5in.	175 lb.	125 lb.
CA-4004-1MAK	4000	3.5	429cc Kohler CH440 OHV	AR	3-0310	Mi-T-M, adjustable pressure	48in.	42.5x23.5x24.5in.	175 lb.	125 lb.
CA-4004-1MGH*	4000	4.0	389cc Honda GX390 OHV	General	3-0350	Mi-T-M, adjustable pressure	48in.	42.5x23.5x24.5in.	175 lb.	125 lb.

*Model comes standard with external bypass system.

Accessories & Options:

PART NUMBER	DESCRIPTION	FITS MODELS	PART NUMBER	DESCRIPTION	FITS MODELS
50-0161	High pressure detergent injector	All models	CX-0097	External bypass system	2400 to 2700-PSI models
851-0338	50-ft. x ¾-in. non-marking high pressure hose	All models	CX-0098	External bypass system	3500 to 4000-PSI models except 1MGH
AW-8400-0021	Low pressure detergent injector	All models	CX-0099	External bypass system	3000-PSI models
CX-0005	36-in. insulated dual lance	2400 to 3000-PSI models			

CBA Aluminum Series

Cold Water – Gasoline – Belt Drive

Pump:

Equipped with the Mi-T-M Pressure Relief Start which eliminates pressure build-up in the system (Not available on General pump models) | Forged brass manifold | Thermal relief valve | Water filter with clear sleeve for screen inspection

Frame:

Lightweight, corrosion-resistant aluminum frame and base plate with 1¼-inch tube handles | Patented vibration isolation plate with four rubber isolators | Convenient gun/wand holder | Two-piece belt guard for quick access to belts | 13-inch flat-free tires

Unit Includes:

Quick connect nozzles - 0°, 15°, 25° and 40° | 50-foot x ¾-inch non-marking high pressure hose with quick connects | Professional-grade insulated trigger gun with safety lock-off

Limited Warranties:

1 year Mi-T-M unloader | 3 year Honda and Kohler engines | 7 year AR and General pumps

Certification:

Intertek - Certified to UL-1776



CBA-4004-1MAK



The industrial and lightweight CBA Aluminum Series is a high-powered workhorse that delivers performance on a routine basis. Perfect for removing the toughest stains on brickwork and concrete.

MODEL NUMBER	PSI	GPM	DISPLACEMENT/ENGINE	PUMP	Mi-T-M NO.	UNLOADER	LANCE	DIMENSIONS (LxWxH)	SHIP WT.	NET WT.
CBA-3504-1MAH	3500	3.7	389cc Honda GX390 OHV	AR	3-0308	Mi-T-M, adjustable pressure	48in.	47x27.5x28.5in.	215 lb.	165 lb.
CBA-3504-1MAK	3500	3.7	429cc Kohler CH440 OHV	AR	3-0308	Mi-T-M, adjustable pressure	48in.	47x27.5x28.5in.	215 lb.	165 lb.
CBA-3504-1MGH*	3500	4.0	389cc Honda GX390 OHV	General	3-0393	Mi-T-M, adjustable pressure	48in.	47x27.5x28.5in.	215 lb.	165 lb.
CBA-4004-1MAH	4000	3.4	389cc Honda GX390 OHV	AR	3-0308	Mi-T-M, adjustable pressure	48in.	47x27.5x28.5in.	215 lb.	165 lb.
CBA-4004-1MAK	4000	3.4	429cc Kohler CH440 OHV	AR	3-0308	Mi-T-M, adjustable pressure	48in.	47x27.5x28.5in.	215 lb.	165 lb.
CBA-4004-1MGH*	4000	4.0	389cc Honda GX390 OHV	General	3-0393	Mi-T-M, adjustable pressure	48in.	47x27.5x28.5in.	215 lb.	165 lb.

*Model comes standard with external bypass system.

Accessories & Options:

PART NUMBER	DESCRIPTION	FITS MODELS	PART NUMBER	DESCRIPTION	FITS MODELS
50-0161	High pressure detergent injector	All models	AW-8400-0021	Low pressure detergent injector	All models
851-0338	50-ft. x ¾-in. non-marking high pressure hose	All models	CX-0082	External bypass system	All models except 1MGH

JCW Series

Cold Water – Gasoline – Belt Drive



JCW-3504-2MHB

The belt-drive JCW Series is designed for industrial cleaning jobs. It can easily handle tough and demanding jobs on construction jobsites, agricultural locations or commercial cleaning applications.

Pump:

Equipped with the Mi-T-M Pressure Relief Start which eliminates pressure build-up in the system (3000, 3500 and 4000-PSI models) | Forged brass manifold | Thermal relief valve | Water filter with clear sleeve for screen inspection

Frame:

Powder coated steel frame and base plate with 1¼-inch tube handles | Convenient gun/wand holder and hose wrap | Two-piece belt guard for quick access to belts | 13-inch flat-free tires (10-inch on 2400, 2700 and 3000-PSI models)

Unit Includes:

Quick connect nozzles - 0°, 15°, 25° and 40° | 50-foot x ¾-inch non-marking high pressure hose with quick connects | Professional-grade insulated trigger gun with safety lock-off

Limited Warranties:

1 year Mi-T-M unloader (3000, 3500 and 4000-PSI models) | 3 year Honda engine | 7 year AR pump

Certification:

Intertek - Certified to UL-1776



PRESSURE WASHERS

MODEL NUMBER	PSI	GPM	DISPLACEMENT/ENGINE	PUMP	Mi-T-M NO.	UNLOADER	LANCE	DIMENSIONS (LxWxH)	SHIP WT.	NET WT.
JCW-2403-0MHB	2400	2.8	196cc Honda GX200 OHV	AR	3-0228	Adjustable pressure	36in.	37.5x22x25in.	171 lb.	121 lb.
JCW-2703-0MHB	2700	2.4	196cc Honda GX200 OHV	AR	3-0228	Adjustable pressure	36in.	37.5x22x25in.	171 lb.	121 lb.
JCW-3003-2MHB	3000	3.0	270cc Honda GX270 OHV	AR	3-0308	Mi-T-M, adjustable pressure	36in.	39.5x28.5x26in.	232 lb.	178 lb.
JCW-3504-2MHB	3500	3.7	389cc Honda GX390 OHV	AR	3-0308	Mi-T-M, adjustable pressure	48in.	39.5x28.5x26in.	249 lb.	195 lb.
JCW-4004-2MHB	4000	3.5	389cc Honda GX390 OHV	AR	3-0308	Mi-T-M, adjustable pressure	48in.	39.5x28.5x26in.	249 lb.	195 lb.

Accessories & Options:

PART NUMBER	DESCRIPTION	FITS MODELS	PART NUMBER	DESCRIPTION	FITS MODELS
50-0161	High pressure detergent injector	All models	CX-0005	36-in. insulated dual lance	2400 to 3000-PSI models
851-0338	50-ft. x ¾-in. non-marking high pressure hose	All models	CX-0082	External bypass system - attaches to pump	3000 to 4000-PSI models
AW-8400-0021	Low pressure detergent injector	All models	CX-0085	External bypass system - attaches to base plate	3000 to 4000-PSI models

CW Premium Series

Cold Water – Gasoline – Belt Drive

Pump:

External bypass system allows more water into the system to protect from heat build-up | Forged brass manifold (Nickel plated brass on 4000-PSI models) | Thermal relief valve | Water filter with clear sleeve for screen inspection

Frame:

Powder coated steel frame and base plate with 1¼-inch tube handles | Convenient gun/wand holder and hose wrap | Two-piece belt guard for quick access to belts | 13-inch flat-free tires

Component:

Heavy-duty belt drive system

Unit Includes:

Quick connect nozzles - 0°, 15°, 25° and 40° | 50-foot x ¾-inch non-marking high pressure hose with quick connects | Professional-grade insulated trigger gun with safety lock-off

Limited Warranties:

1 year Mi-T-M unloader (3500 and 4000-PSI models) | 3 year Honda and Vanguard engines | 10 year General pump

Certification:

Intertek - Certified to UL-1776



CW-4004-5MGH



Known as the workhorse of the Mi-T-M industrial pressure washers, the durable CW Premium Series is built for extended cleaning applications. It's great for blasting away mud and muck from equipment, buildings and most any surface.

MODEL NUMBER	PSI	GPM	DISPLACEMENT/ENGINE	PUMP	Mi-T-M NO.	UNLOADER	LANCE	DIMENSIONS (LxWxH)	SHIP WT.	NET WT.
CW-2505-4MGH	2500	4.4	389cc Honda GX390 OHV	General	3-0202	Factory preset	36in.	45.5x28x26in.	290 lb.	216 lb.
CW-3004-4MGH	3000	3.5	389cc Honda GX390 OHV	General	3-0202	Factory preset	36in.	45.5x28x26in.	290 lb.	216 lb.
CW-3504-5MGH	3500	3.8	389cc Honda GX390 OHV	General	3-0203	Mi-T-M, factory preset	48in.	46x28x30in.	290 lb.	216 lb.
CW-4004-5MGH	4000	3.5	389cc Honda GX390 OHV	General	3-0075	Mi-T-M, factory preset	48in.	46x28x30in.	290 lb.	216 lb.
CW-4004-5MVO	4000	4.0	480cc Vanguard OHV, electric start - battery included	General	3-0075	Mi-T-M, factory preset	48in.	46x28x30in.	330 lb.	256 lb.

Accessories & Options:

PART NUMBER	DESCRIPTION	FITS MODELS	PART NUMBER	DESCRIPTION	FITS MODELS
50-0161	High pressure detergent injector	All models	CX-0005	36-in. insulated dual lance	CW-2505-4MGH & CW-3004-4MGH
851-0338	50-ft. x ¾-in. non-marking high pressure hose	All models	CX-0045	Electric start - battery included	All Honda models
AW-8400-0021	Low pressure detergent injector	All models	CX-0054	Roll cage	All Honda models
			CX-0055	Roll cage	CW-4004-5MVO

CWC Premium Series

Cold Water – Gasoline – Belt Drive



CWC-7004-4MGH

One of the most durable cold water pressure washers on the market today, the CWC Premium Series is equipped with a durable roll cage. It is perfect for industrial jobsites where heavy-duty cleaning is needed.



Pump:

External bypass system allows more water into the system to protect from heat build-up | Forged brass manifold | Thermal and safety relief valves | Water filter with clear sleeve for screen inspection (High capacity water filter on CWC-3008-4MGH)

Engine:

Electric start - battery included

Frame:

Powder coated steel frame with 1¼-inch roll cage, handles and lifting hook | Convenient gun/wand holder and hose wrap | Two-piece belt guard for quick access to belts | 13-inch flat-free tires with locking tire brake

Components:

Fuel tank has powder coated outside and aluminized steel inside to prevent rusting | 13-gallon fuel tank capacity for 9½ hour run time

Unit Includes:

Quick connect nozzles - 0°, 15°, 25° and 40° | 50-foot x ¾-inch high pressure hose with quick connects (CWC-5000 models have a non-marking hose; CWC-6004 and CWC-7004 models have a black hose) | 50-foot x ½-inch high pressure black hose with quick connects (CWC-3008-4MGH) | Professional-grade insulated trigger gun with safety lock-off

Limited Warranties:

3 year Honda engine | 7 year AR and General pumps

Certification:

Intertek - Certified to UL-1776 (CWC-5004-4MAH, CWC-5004-4MGH and CWC-5005-4MGH)

MODEL NUMBER	PSI	GPM	DISPLACEMENT/ENGINE	PUMP	Mi-T-M NO.	UNLOADER	LANCE	DIMENSIONS (LxWxH)	SHIP WT.	NET WT.
CWC-3008-4MGH	3000	8.0	688cc Honda GX630 OHV, electric start*	General	3-0279	Factory preset	48in.	43x27.75x36in.	504 lb.	438 lb.
CWC-5004-4MAH	5000	4.0	688cc Honda GX630 OHV, electric start*	AR	3-0213	Factory preset	48in.	43x27.75x36in.	499 lb.	433 lb.
CWC-5004-4MGH	5000	4.0	688cc Honda GX630 OHV, electric start*	General	3-0261	Factory preset	48in.	43x27.75x36in.	515 lb.	449 lb.
CWC-5005-4MGH	5000	5.0	688cc Honda GX630 OHV, electric start*	General	3-0262	Factory preset	48in.	43x27.75x36in.	515 lb.	449 lb.
CWC-6004-4MGH	6000	3.7	688cc Honda GX630 OHV, electric start*	General	3-0261	Factory preset	48in.	43x27.75x36in.	515 lb.	449 lb.
CWC-7004-4MGH	7000	3.8	688cc Honda GX690 OHV, electric start*	General	3-0430	Factory preset	48in.	43.25x28.5x39.25in.	515 lb.	449 lb.

*Battery included

Accessories:

PART NUMBER	DESCRIPTION	FITS MODELS	PART NUMBER	DESCRIPTION	FITS MODELS
851-0089	50-ft. x ½-in. high pressure hose	CWC-3008-4MGH	AW-0018-0375	Rotating nozzle	CWC-7004-4MGH
851-0317	50-ft. x ¾-in. non-marking high pressure hose	CWC-5004, CWC-5005 & CWC-6004 models	AW-7500-0035	Rotating nozzle	CWC-5004 models
851-0420	50-ft. x ¾-in. high pressure hose	CWC-7004-4MGH	AW-7500-0045	Rotating nozzle	CWC-5005-4MGH

CW Premium Series

Cold Water – Diesel – Belt Drive

Pump:

External bypass system allows more water into the system to protect from heat build-up | Forged brass manifold | Thermal relief valve | Water filter with clear sleeve for screen inspection

Frame:

Powder coated steel frame and base plate with 1¼-inch tube handles | Convenient gun/wand holder and hose wrap | Enclosed belt guard | 13-inch flat-free tires

Unit Includes:

Quick connect nozzles - 0°, 15°, 25° and 40° | 50-foot x ¾-inch non-marking high pressure hose with quick connects | Professional-grade insulated trigger gun with safety lock-off

Limited Warranties:

3 year Kohler engine | 10 year General pump

Certification:

Intertek - Certified to UL-1776



CW-3004-0MKD



Perfect for shipping yards and marine applications, this CW Premium Series uses diesel power to remove unwanted grime, algae and scale from boats, docks and heavy-duty equipment. It is also in high demand for oil and mining industry applications.

MODEL NUMBER	PSI	GPM	HORSEPOWER/ENGINE	PUMP	Mi-T-M NO.	UNLOADER	LANCE	FUEL TANK CAP.	DIMENSIONS (LxWxH)	SHIP WT.	NET WT.
CW-3004-0MKD	3000	3.9	9.1 HP Kohler KD440 OHV, electric start - battery included	General	3-0203	Factory preset	36in.	1.3 gallons	46x28x30in.	321 lb.	245 lb.

Accessories & Options:

PART NUMBER	DESCRIPTION	FITS MODEL	PART NUMBER	DESCRIPTION	FITS MODEL
50-0161	High pressure detergent injector	CW-3004-0MKD	AW-8400-0021	Low pressure detergent injector	CW-3004-0MKD
851-0338	50-ft. x ¾-in. non-marking high pressure hose	CW-3004-0MKD	CX-0005	36-in. insulated dual lance	CW-3004-0MKD
			CX-0054	Roll cage	CW-3004-0MKD

ChoreMaster® Series

Cold Water – Electric – Direct Drive



CM-1400-OMEC



NEMA 5-15P,
15-amp plug

Tackle cleaning jobs around your property with the electric CM Series pressure washer. Easy-to-use and lightweight, this pressure washer is the perfect tool for any small business or homeowner.

Pump:

Thermal relief valve | In-line water strainer | Built-in low pressure detergent injector | Oil drain, fill port and sight glass

Motor:

Totally enclosed fan-cooled electric motor | 35-foot power cord with GFCI and 15-amp plug

Frame:

Powder coated steel mounting plate with center balanced lift and four rubber isolators (Hand carry models) | Powder coated steel frame with upright tilt back design and two rubber isolators (CM-1400-OMEC) | Quick release gun/wand holder, hose wrap and convenient nozzle holder (CM-1400-OMEC)

Unit Includes:

Variable high/low pressure nozzle with adjustable spray pattern 0-60° (Hand carry models) | Quick connect nozzles - 0°, 15°, 25° and 40° (CM-1400-OMEC) | 25-foot x 3/8-inch non-marking high pressure hose | Professional-grade trigger gun | Two-piece, 36-inch lance

Limited Warranties:

1 year pump | 1 year electric motor

Certification:

CSA Certified - US and Canada



CM-1400-OMEH

PRESSURE WASHERS

HAND CARRY MODELS

MODEL NUMBER	PSI	GPM	DISPLACEMENT/ENGINE	PUMP	UNLOADER	PLUG TYPE	LANCE	DIMENSIONS (LxWxH)	SHIP WT.	NET WT.
CM-1400-OMEH	1400	1.5	1.5 HP, 120V, 1Ø, 13.5A	Triplex crankshaft	Adjustable pressure	NEMA 5-15P	36in.	14x11x10in.	52 lb.	45 lb.
CM-1400-1MEH	1400	1.5	1.5 HP, 120V, 1Ø, 13.5A	Triplex crankshaft	Adjustable pressure	NEMA 5-15P	36in.	14x11x10in.	52 lb.	45 lb.

CART-MOUNT MODEL

MODEL NUMBER	PSI	GPM	DISPLACEMENT/ENGINE	PUMP	UNLOADER	PLUG TYPE	LANCE	DIMENSIONS (LxWxH)	SHIP WT.	NET WT.
CM-1400-OMEC	1400	1.5	1.5 HP, 120V, 1Ø, 13.5A	Triplex crankshaft	Adjustable pressure	NEMA 5-15P	36in.	26x18x38in.	65 lb.	54 lb.

CD Series

Cold Water – Electric – Direct Drive

Pump:

Forged brass manifold (Nickel plated brass on 2MUH models) | Thermal and safety relief valves | Low pressure detergent injector

Motor:

Totally enclosed fan-cooled electric motor with thermal overload protection | 35-foot, 15-amp power cord (20-amp on CD-1502 models) with GFCI

Frame:

Powder coated steel mounting plate with center balanced lift and four rubber isolators

Unit Includes:

Variable high/low pressure nozzles (3MUH models) | 15° high/low pressure nozzle (2MUH models) | 25-foot x 3/8-inch non-marking high pressure hose with quick connects | Professional-grade insulated trigger gun with safety lock-off

Limited Warranties:

1 year electric motor | 7 year AR and General pumps

Certification:

CSA Certified - US and Canada



CD-1502-2MUH

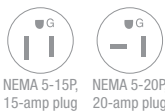

NEMA 5-15P, 15-amp plug
NEMA 5-20P, 20-amp plug

The lightweight and portable design of the CD Electric Series makes it a great choice for all-purpose cleaning around the home or small business. So easy to use almost anyone can tackle these cleaning jobs.



MODEL NUMBER	PSI	GPM	HORSEPOWER/MOTOR	PUMP	Mi-T-M NO.	UNLOADER	PLUG TYPE	LANCE	DIMENSIONS (LxWxH)	SHIP WT.	NET WT.
CD-1002-3MUH	1000	2.0	1.5 HP, 120V, 1Ø, 12.5A	AR	3-0362	Adjustable pressure	NEMA 5-15P	36in.	20x11.5x14in.	70 lb.	58 lb.
CD-1002-2MUH*	1000	2.0	1.5 HP, 120V, 1Ø, 12.5A	General	3-0278	Adjustable pressure	NEMA 5-15P	36in.	20x11.5x14in.	71 lb.	66 lb.
CD-1502-3MUH	1500	2.0	2.0 HP, 120V, 1Ø, 17.0A	AR	3-0362	Adjustable pressure	NEMA 5-20P	36in.	20x11.5x14in.	76 lb.	70 lb.
CD-1502-2MUH*	1500	2.0	2.0 HP, 120V, 1Ø, 17.0A	General	3-0278	Adjustable pressure	NEMA 5-20P	36in.	20x11.5x14in.	76 lb.	70 lb.

*Pump accepts incoming water up to 175°F.

Accessories & Options:

PART NUMBER	DESCRIPTION	FITS MODELS	PART NUMBER	DESCRIPTION	FITS MODELS
18-0370	Rotating nozzle	CD-1502 models	CX-0030	50-ft. x 3/8-in. non-marking high pressure hose	All models
18-0371	Rotating nozzle	CD-1002 models			
50-0161	High pressure detergent injector	All models			

JP Series

Cold Water – Electric – Direct Drive



JP-1502-2ME1

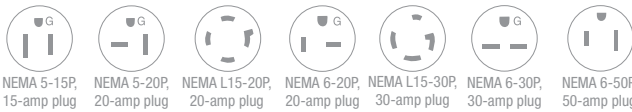

NEMA 5-15P, 15-amp plug | NEMA 5-20P, 20-amp plug | NEMA L15-20P, 20-amp plug | NEMA 6-20P, 20-amp plug | NEMA L15-30P, 30-amp plug | NEMA 6-30P, 30-amp plug | NEMA 6-50P, 50-amp plug

Take your pressure washer indoors to clean floors and prep all kinds of surfaces. This is the perfect tool for food and beverage processing facilities where fumes and smoke are prohibited. Contractors love it for its versatility.



PRESSURE WASHERS

Pump:

Forged brass manifold (Nickel plated brass on 2ME1 models) | Thermal and safety relief valves | Low pressure detergent injector

Motor:

Totally enclosed fan-cooled electric motor | 35-foot power cord (GFCI on 1.5 to 6.0 HP single-phase models) (10-foot power cord on 8.0-HP models)

Frame:

Powder coated steel frame and base plate with 1/4-inch tube handles | Convenient gun/wand holder and hose wrap | 13-inch flat-free tires (10-inch on JP-1002, JP-1502 and JP-2003 models)

Unit Includes:

Variable high/low pressure nozzle (JP-1002, JP-1502 and JP-2003 models) | Quick connect nozzles - 0°, 15° and 25° (JP-2503 and JP-3004 models) | 50-foot x 3/8-inch non-marking high pressure hose with quick connects (25-foot on JP-1002, JP-1502 and JP-2003 models) | Professional-grade trigger gun with safety lock-off

Limited Warranties:

1 year electric motor | 7 year AR and General pumps

Certification:

CSA Certified - US and Canada (JP-1002 and JP-1502 models) | CSA Certified - US only (JP-2003, JP-2503 and JP-3004 models)

MODEL NUMBER	PSI	GPM	HORSEPOWER/MOTOR	PUMP	MI-T-M NO.	UNLOADER	PLUG TYPE	LANCE	DIMENSIONS (LxWxH)	SHIP WT.	NET WT.
JP-1002-3ME1	1000	2.0	1.5 HP, 120V, 1Ø, 15.0A	AR	3-0362	Adjustable pressure	NEMA 5-15P	36in.	37x21x24.5in.	120 lb.	90 lb.
JP-1002-2ME1*	1000	2.0	1.5 HP, 120V, 1Ø, 15.0A	General	3-0278	Adjustable pressure	NEMA 5-15P	36in.	37x21x24.5in.	120 lb.	90 lb.
JP-1502-3ME1	1500	2.0	2.0 HP, 120V, 1Ø, 17.0A	AR	3-0362	Adjustable pressure	NEMA 5-20P	36in.	37x21x24.5in.	120 lb.	90 lb.
JP-1502-2ME1*	1500	2.0	2.0 HP, 120V, 1Ø, 17.0A	General	3-0278	Adjustable pressure	NEMA 5-20P	36in.	37x21x24.5in.	120 lb.	90 lb.
JP-2003-3ME1	2000	2.6	4.0 HP, 230V, 1Ø, 16.0A	AR	3-0364	Adjustable pressure	NEMA 6-20P	36in.	37x21x24.5in.	162 lb.	112 lb.
JP-2503-1ME1	2500	3.2	6.0 HP, 230V, 1Ø, 24.1A	AR	3-0307	Adjustable pressure	NEMA 6-30P	36in.	44x26x27in.	275 lb.	225 lb.
JP-2503-0ME3	2500	3.2	6.0 HP, 230V, 3Ø, 15.0A or 6.0 HP, 460V, 3Ø, 7.5A	AR	3-0307	Adjustable pressure	NEMA L15-20P	36in.	44x26x27in.	275 lb.	225 lb.
JP-3004-1ME1	3000	3.9	8.0 HP, 230V, 1Ø, 34.5A	AR	3-0207	Adjustable pressure	NEMA 6-50P	36in.	44x26x27in.	275 lb.	225 lb.
JP-3004-0ME3	3000	3.9	8.0 HP, 230V, 3Ø, 20.0A or 8.0 HP, 460V, 3Ø, 10.0A	AR	3-0207	Adjustable pressure	NEMA L15-30P	36in.	44x26x27in.	275 lb.	225 lb.

*Pump accepts incoming water up to 175°F.

Accessories & Options:

PART NUMBER	DESCRIPTION	FITS MODELS	PART NUMBER	DESCRIPTION	FITS MODELS
50-0161	High pressure detergent injector	All models	CX-0066	460V on 6.0-HP, 3-phase model	JP-2503-0ME3
CX-0005	36-in. insulated dual lance	All models	CX-0067	460V on 8.0-HP, 3-phase model	JP-3004-0ME3
CX-0030	50-ft. x 3/8-in. non-marking high pressure hose	1000 to 2000-PSI models			

CW Premium Series

Cold Water – Electric – Belt Drive

Pump:

External bypass system allows more water into the system to protect from heat build-up | Forged brass manifold | Thermal relief valve | Water filter with clear sleeve for screen inspection

Motor:

Totally enclosed fan-cooled electric motor with thermal overload protection | 10-foot power cord

Frame:

Powder coated steel frame and base plate with 1¼-inch tube handles | Convenient gun/wand holder and hose wrap | Totally enclosed belt guard | 13-inch flat-free tires

Unit Includes:

Quick connect nozzles - 0°, 15°, 25° and 40° | 50-foot x ¾-inch non-marking high pressure hose with quick connects | Professional-grade insulated trigger gun with safety lock-off | 36-inch lance (48-inch on CW-4004 and CW-5004 models)

Limited Warranties:

1 year Mi-T-M unloader (CW-4004-1ME3) | 1 year electric motor | 7 year General pump (CW-4004-1ME3 and CW-5004-0ME3) | 10 year General pump (CW-2405, CW-3004 and CW-3005 models)



CW-3004-4ME3

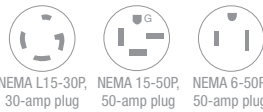

NEMA L15-30P, 30-amp plug | NEMA 15-50P, 50-amp plug | NEMA 6-50P, 50-amp plug



Perfect for cleaning heavily soiled equipment located inside commercial facilities. Use it to clean grimy floors and concrete walls of garages and service shops. It is even a great tool to keep indoor pools free from dirt, mold and mildew.

MODEL NUMBER	PSI	GPM	HORSEPOWER/MOTOR	PUMP	Mi-T-M NO.	UNLOADER	PLUG TYPE	DIMENSIONS (LxWxH)	SHIP WT.	NET WT.
CW-2405-4ME1	2400	4.6	7.5 HP, 230V, 1Ø, 32.0A	General	3-0202	Factory preset	NEMA 6-50P	46x28x30in.	345 lb.	333 lb.
CW-2405-4ME3*	2400	4.6	8.0 HP, 230V, 3Ø, 20.0A or 8.0 HP, 460V, 3Ø, 10.0A	General	3-0202	Factory preset	NEMA L15-30P	45.5x32.5x30in.	355 lb.	343 lb.
CW-3004-4ME1	3000	3.5	7.5 HP, 230V, 1Ø, 32.0A	General	3-0202	Factory preset	NEMA 6-50P	46x28x30in.	350 lb.	338 lb.
CW-3004-4ME3*	3000	3.5	8.0 HP, 230V, 3Ø, 20.0A or 8.0 HP, 460V, 3Ø, 10.0A	General	3-0202	Factory preset	NEMA L15-30P	45.5x32.5x30in.	403 lb.	301 lb.
CW-3005-0ME1	3000	4.8	10.0 HP, 230V, 1Ø, 41.5A	General	3-0202	Factory preset	NEMA 6-50P	45.5x32.5x30in.	470 lb.	396 lb.
CW-3005-0ME3*	3000	4.8	10.0 HP, 230V, 3Ø, 26.0A or 10.0 HP, 460V, 3Ø, 13.0A	General	3-0202	Factory preset	NEMA 15-50P	45.5x32.5x30in.	450 lb.	376 lb.
CW-4004-1ME3	4000	3.9	15.0 HP, 230V, 3Ø, 40.0A or 15.0 HP, 460V, 3Ø, 20.0A	General	3-0075	Factory preset	NEMA 15-50P	45.5x32.5x30in.	505 lb.	431 lb.
CW-5004-0ME3*	5000	4.0	15.0 HP, 230V, 3Ø, 40.0A or 15.0 HP, 460V, 3Ø, 20.0A	General	3-0261	Factory preset	NEMA 15-50P	45.5x32.5x30in.	505 lb.	431 lb.

*460V motors available as options.

Accessories & Options:

PART NUMBER	DESCRIPTION	FITS MODELS	PART NUMBER	DESCRIPTION	FITS MODELS
50-0161	High pressure detergent injector	All models	CX-0005	36-in. insulated dual lance	2400 to 3000-PSI models
851-0317	50-ft. x ¾-in. non-marking high pressure hose	CW-5004-0ME3	CX-0057	460V on 15.0-HP, 3-phase models	CW-4004-1ME3 & CW-5004-0ME3
851-0338	50-ft. x ¾-in. non-marking high pressure hose	2400 to 4000-PSI models	CX-0062	460V on 10.0-HP, 3-phase model	CW-3005-0ME3
AW-8400-0021	Low pressure detergent injector	All models	CX-0093	Stationary option	CW-2405 & CW-3004 models
CX-0003	460V on 8.0-HP, 3-phase models	CW-2405-4ME3 & CW-3004-4ME3	CX-0094	Stationary option	CW-3005, CW-4004 & CW-5004 models

CW Premium Series

Cold Water – Electric – Belt Drive – Stationary



CW-2004-SME1

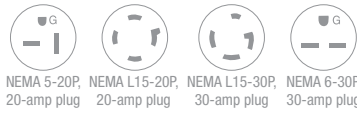

NEMA 5-20P, NEMA L15-20P, NEMA L15-30P, NEMA 6-30P,
20-amp plug 20-amp plug 30-amp plug 30-amp plug

Designed for use in wash bays to clean vehicles and equipment and restaurants to keep floors and worktables clean, this stationary CW Premium Series is constructed of stainless-steel to resist rust and corrosion.



PRESSURE WASHERS

Pump:

Forged brass manifold | Thermal relief valve | Quick connect low pressure detergent injector | Pump accepts incoming water up to 175°F

Motor:

Open drip-proof electric motor (1000 and 3000-PSI models) | Totally enclosed fan-cooled electric motor with manual thermal overload protection (2000-PSI models) | 4-foot power cord with GFCI

Frame:

Stainless-steel cabinet design with removable panel | Four rubber isolators

Component:

Time delay shutdown

Unit Includes:

Quick connect nozzles - 0°, 15°, 25° and 40° | 50-foot x 3/8-inch high pressure black hose with quick connects | Professional-grade insulated trigger gun with safety lock-off

Limited Warranties:

1 year electric motor | 10 year General pump

Certification:

CSA Certified - US only

MODEL NUMBER	PSI	GPM	HORSEPOWER/MOTOR	PUMP	Mi-T-M NO.	UNLOADER	PLUG TYPE	LANCE	DIMENSIONS (LxWxH)	SHIP WT.	NET WT.
CW-1003-SME1	1000	2.5	2.0 HP, 120V, 1Ø, 18.8A	General	3-0203	Factory preset	NEMA 5-20P	Adjustable, dual	29.5x20.5x15in.	222 lb.	172 lb.
CW-2004-SME1	2000	3.9	6.0 HP, 230V, 1Ø, 22.0A	General	3-0202	Factory preset	NEMA 6-30P	Adjustable, dual	29.5x20.5x15in.	272 lb.	214 lb.
CW-2004-SME3*	2000	3.9	6.0 HP, 230V, 3Ø, 15.0A	General	3-0202	Factory preset	NEMA L15-20P	Adjustable, dual	29.5x20.5x15in.	262 lb.	204 lb.
CW-3004-SME3*	3000	3.5	8.0 HP, 230V, 3Ø, 20.0A	General	3-0202	Factory preset	NEMA L15-30P	Adjustable, dual	29.5x20.5x15in.	292 lb.	234 lb.

*460V motors available as options.

Accessories & Options:

PART NUMBER	DESCRIPTION	FITS MODELS	PART NUMBER	DESCRIPTION	FITS MODELS
AW-9501-0000	Stainless-steel wall mounting bracket	All models	CX-0077	460V on 8.0-HP, 3-phase model	CW-3004-SME3
AW-9502-0000	Powder coated steel wall mounting bracket	All models	CX-0078	Remote box	All models
AW-9502-0001	Powder coated steel floor stand	All models	CX-0096	Hour meter	All models
CX-0069	Auto start/stop	All models	CX-0109	Additional remotes (up to 3)	All models
CX-0076	460V on 6.0-HP, 3-phase model	CW-2004-SME3			

HSP Series

Hot Water – Gasoline – Direct Drive

Pump:

Preset stainless-steel and brass unloader valve |
 Forged brass manifold | Thermal relief valve |
 Low pressure detergent injector (Available as an
 option on HSP-2503-0MMH)

Frame:

Reinforced powder coated steel tube frame with center
 balanced lift | Convenient gun/wand holder and hose
 wrap | 13-inch flat-free tires

Components:

Top-fired powder coated heat exchanger | No. 1 or
 No. 2 diesel or kerosene fired burner (Not approved
 for bio-fuel)

Miscellaneous:

Temperature rise 150°F/66°C above ambient, maximum
 outlet temperature is 200°F

Unit Includes:

Quick connect nozzles - 0°, 15°, 25° and 40° |
 50-foot x 3/8-inch steel wire-braided high pressure hose
 with quick connects | Professional-grade insulated
 trigger gun with safety lock-off | Adjustable pressure
 insulated dual lance

Limited Warranties:

3 year coil | 3 year Honda and Kohler engines |
 7 year AR and Mi-T-M pumps

Certification:

CSA Certified - US and Canada



HSP-3504-3MGH

The Electro Magnetic Firing (EMF) system of the HSP Series, along with its unique burner design, makes this popular hot water pressure washer one of the most "in-demand" in the industry. It's a great solution for removing heavy mud from construction and ag equipment.



MODEL NUMBER	PSI	GPM	DISPLACEMENT/ENGINE	PUMP	Mi-T-M NO.	FUEL TANK CAPACITY	BURNER FUEL TANK CAP.	BURNER FUEL CONS.	BTU PER HOUR	DIMENSIONS (LxWxH)	SHIP WT.	NET WT.
HSP-2503-0MMH	2500	2.6	196cc Honda GX200 OHV	Mi-T-M	3-0417	0.95 gallon	4.0 gallons	1.53 gph	210,000	43x29.5x36.5in.	411 lb.	295 lb.
HSP-3003-3MGH	3000	2.9	270cc Honda GX270 OHV	AR, external bypass	3-0241	1.59 gallons	5.5 gallons	1.84 gph	253,000	43x30x41in.	530 lb.	407 lb.
HSP-3504-3MGH	3500	3.3	389cc Honda GX390 OHV	AR, external bypass	3-0194	1.70 gallons	5.5 gallons	2.14 gph	294,000	43x30x41in.	551 lb.	428 lb.
HSP-3504-3MGK	3500	3.3	429cc Kohler CH440 OHV	AR, external bypass	3-0194	1.70 gallons	5.5 gallons	2.14 gph	294,000	43x30x41in.	551 lb.	428 lb.

Accessories & Options:

PART NUMBER	DESCRIPTION	FITS MODELS	PART NUMBER	DESCRIPTION	FITS MODELS
20-0464A52	Rain cap	3000 to 3500-PSI models	HX-0234	Low pressure detergent injector	HSP-2503-0MMH
50-0161	High pressure detergent injector	All models	HX-0236	Hour meter	HSP-2503-0MMH
850-0433	50-ft. x 3/8-in. high pressure hose	3500-PSI models	HX-0274	Rain cap	3000 to 3500-PSI models
851-0262	50-ft. x 3/8-in. high pressure hose	2500 to 3000-PSI models	HX-0279	Hour meter	3000 to 3500-PSI models
HX-0098	Electric start - battery included	HSP-3504-3MGH	HX-0280	Adjustable thermostat	3000 to 3500-PSI models
HX-0233	Adjustable thermostat	HSP-2503-0MMH	HX-0281	Hour meter / adjustable thermostat	3000 to 3500-PSI models

HSP Series

Hot Water Designs

HSP Series EMF System

In 1999, Mi-T-M Corporation designed a unique ignition/firing system, called the Electro Magnetic Firing (EMF) System, which produces enough voltage for operation and proper burning of the HSP Series hot water pressure washers.

This system is designed with two sets of magnets that are used to produce electricity. The first set of magnets produce a low voltage of about 12 to 14-volts when passed by a coil known as a stator. This voltage is required for operation of the on/off switch, pressure and high limit switches and the fuel solenoid.

The second set of magnets pass by an ignition coil which produces a high voltage in the tens of thousands of volts. The spark is generated across the electrode gap and is enough to create proper ignition of either No. 1 diesel, No. 2 diesel fuel or kerosene.

1. Engine sheave, dual set screw mount, maintains proper alignment of pump shaft key.
2. The belt tension sheave creates proper belt tension so fuel pump discharges fuel upon demand.
3. The long lasting, non-corrosive flexible drive coupler protects EMF system if fuel pump locks up.
4. Fuel pump is a durable high quality pump that will deliver No. 1 or No. 2 diesel fuel or kerosene.
5. Stator coil/magnets are a low maintenance system that provides solenoid control voltage.
6. Fan provides burner air for proper combustion and clean exhaust smoke. It has an easily accessible air flow control.
7. Ignition coil provides voltage to electrodes for proper spark voltage, allowing accurate ignition of fuel every time the trigger is pulled. The ignition coil has a long life, is easily replaced and has a proven track record in the industry.

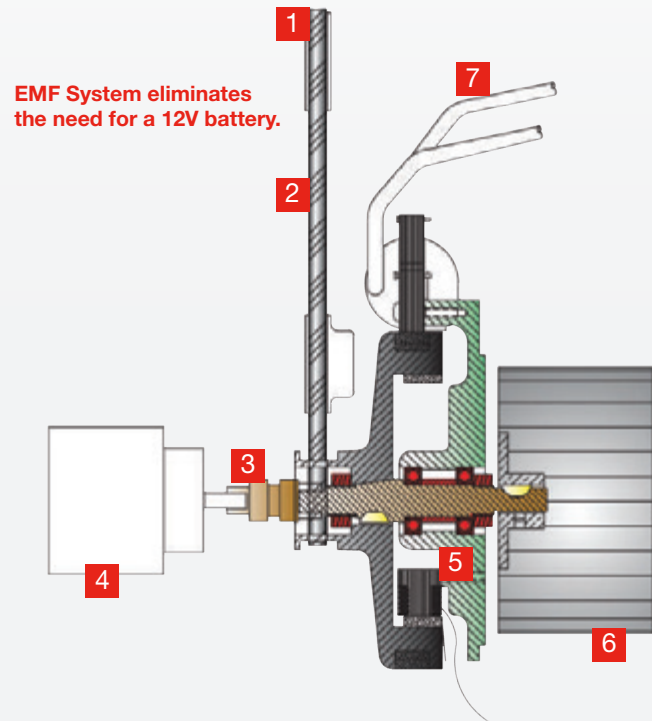

HSP Series Burner Design

1. Large capacity exhaust tubes allow for proper exhausting of combustion gases.
2. When troubleshooting a burner problem, the spark can easily be checked within seconds through the convenient sight glass.
3. Continuous wrap tubing coil eliminates butt welds that can cause leaks. The coil is lightweight and designed for easy replacement and durability.
4. The insulation pad is designed for easy replacement and durability.
5. Coil inlet/outlet connections and convenient coil drain allow for easy draining of all water in coil to prevent freezing.
6. The combustion chamber drain allows for easy draining of water and fuel build-up.
7. With Mi-T-M's triple air flow design, the temperatures on the outer wrap are kept low enough to eliminate the need for coil insulation. This also increases the efficiencies of the fuel being burned by the ignition on the down-flow and the exhaust on the up-flow of the burner chamber.
8. Single wire-braided fuel hose prevents leakage, protects the system and won't crack or kink.
9. Electrodes and nozzle assembly are at the top of the burner for easy maintenance and troubleshooting.

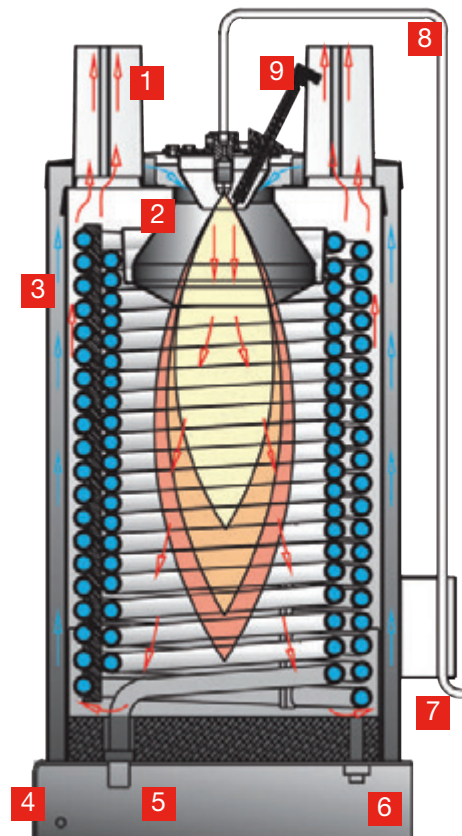

HS Series

Hot Water – Gasoline/Diesel – Belt Drive

Pump:

External bypass system allows more water into the system to protect from heat build-up | Factory preset unloader | Forged brass manifold | 80-mesh, high-volume, stainless-steel screen inlet water strainer

Engine:

Electric start - battery included

Frame:

Heavy-duty powder coated steel 1½-inch square tube frame

Components:

2900-watt generator | Heavy-duty dual cogged belt drive system | No. 1 or No. 2 diesel or kerosene fired burner (Not approved for bio-fuel) | ½-inch schedule 80-coil with stainless-steel wrap

Miscellaneous:

Temperature rise 150°F/66°C above ambient, maximum outlet temperature is 200°F

Unit Includes:

Quick connect nozzles - 0°, 15°, 25° and 40° | 50-foot x ¾-inch steel wire-braided high pressure hose with quick connects | Professional-grade insulated trigger gun with safety lock-off | Adjustable pressure insulated dual lance

Limited Warranties:

3 year coil | 3 year Honda, Kubota and Vanguard engines | 7 year AR and General pumps

Certification:

CSA Certified - US and Canada



HS-4005-OMDK



The rugged skid frame of the HS Series makes it a popular option for mounting on a water trailer so you can take this cleaning powerhouse on the road. Blast away grease, oil and grime literally anywhere.

GASOLINE MODELS					FUEL TANK	BURNER FUEL	BURNER	BTU PER	DIMENSIONS	SHIP WT.	NET WT.	
MODEL NUMBER	PSI	GPM	DISPLACEMENT/ENGINE	PUMP	MI-T-M NO.	CAPACITY	TANK CAP.	FUEL CONS.	HOUR	(LxWxH)		
HS-3005-OMGV	3000	4.8	480cc Vanguard OHV	General	3-0202	10.0 gallons	10.0 gallons	3.37 gph	471,800	50x34x46in.	816 lb.	710 lb.
HS-3505-1MGH	3500	4.7	688cc Honda GX630 OHV	General	3-0202	10.0 gallons	10.0 gallons	3.37 gph	471,800	50x34x46in.	854 lb.	750 lb.
HS-3506-1MGH	3500	5.6	688cc Honda GX630 OHV	General	3-0202	10.0 gallons	10.0 gallons	3.37 gph	471,800	50x34x46in.	864 lb.	760 lb.
HS-4004-1MAH*	4000	4.0	688cc Honda GX630 OHV	AR	3-0213	10.0 gallons	10.0 gallons	2.76 gph	386,400	50x34x46in.	854 lb.	750 lb.

DIESEL MODELS					FUEL TANK	BURNER FUEL	BURNER	BTU PER	DIMENSIONS	SHIP WT.	NET WT.	
MODEL NUMBER	PSI	GPM	HORSEPOWER/ENGINE	PUMP	MI-T-M NO.	CAPACITY	TANK CAP.	FUEL CONS.	HOUR	(LxWxH)		
HS-3006-OMDK	3000	5.6	16.8 HP Kubota Z602 OHV	General	3-0202	10.0 gallons	10.0 gallons	3.37 gph	471,800	56.5x34x46in.	940 lb.	836 lb.
HS-3505-OMDK	3500	4.7	16.8 HP Kubota Z602 OHV	General	3-0202	10.0 gallons	10.0 gallons	3.37 gph	471,800	56.5x34x46in.	940 lb.	836 lb.
HS-4005-OMDK*	4000	4.5	16.8 HP Kubota Z602 OHV	General	3-0262	10.0 gallons	10.0 gallons	3.37 gph	471,800	56.5x34x46in.	940 lb.	836 lb.

*Model equipped with trapping unloader, all other models equipped with K7 flow actuated unloader.

HS Series

Hot Water – Gasoline/Diesel – Belt Drive



HS-3505-1MGH shown on dual-axle trailer, AW-9000-0003 with hose reels

PRESSURE WASHERS

Accessories & Options:

PART NUMBER	DESCRIPTION	FITS MODELS	PART NUMBER	DESCRIPTION	FITS MODELS
20-1070A18	Removable painted front panel	All models	HX-0140*	Steam combination 250°F	HS-3506-1MGH
20-1366A52	Black powder coated painted rain cap, octagonal	All models	HX-0141*	Steam combination 250°F	HS-3006-0MDK
50-0177	Stack adapter	All models	HX-0142	Steam combination 250°F	4000-PSI models
850-0324	Gasket (for 50-0177)	All models	HX-0143	Trapping unloader	HS-3006 & HS-3506 models
AW-5740-0000	Wheel kit	All models	HX-0144*	Dual gun	HS-3006 & HS-3506 models
AW-6000-1006	Hot water skid equipment cover	All models	HX-0145	Adjustable thermostat, 86°-248°F	All models
AW-8400-0021	Low pressure detergent injector	All models, except HS-3506 & HS-3006	HX-0146	Hour meter	All models
HX-0130	Three-way ball valve	All models	HX-0147	Four point lifting capability	All models
HX-0131	High pressure detergent injector, K7	3000 to 3500-PSI models	HX-0148*	Adjustable detergent valve	All models
HX-0133	Steam combination 250°F, K7	HS-3005 & HS-3505 models	HX-0200	Trapping unloader	HS-3005 & HS-3505 models
HX-0135	Steam combination 250°F, K7	HS-3506-1MGH	HX-0252	Pressure washer option for PWR-10-OME1 trailer-mount package	HS-3505-1MGH
HX-0136	Steam combination 250°F, K7	HS-3006-0MDK			
HX-0138*	Steam combination 250°F	HS-3005-0MGV			
HX-0139*	Steam combination 250°F	HS-3505 models			

***Requires trapping unloader.**

Note: To order options HX-0138 to HX-0141 or HX-0144 you must order option HX-0143 or HX-0200 (not required for 4000-PSI models, which already come equipped with trapping unloader.)

Single & Dual-Axle Trailers

Pressure Washer Accessories

Features:

Jack with pad | 2-inch ball hitch | Rubber mounted sealed lights | Tanks are enclosed in a powder coated steel frame | Will fit all Mi-T-M belt-driven pressure washers | ¼-inch solid steel trailer deck plate | Aluminum treadplate steps for access to water tank | Storage area located under the water tanks (AW-9000-0003 and AW-9000-0004 trailers) | (2) 200-gallon water tanks are plumbed together (AW-9000-0003 and AW-9000-0004 trailers)

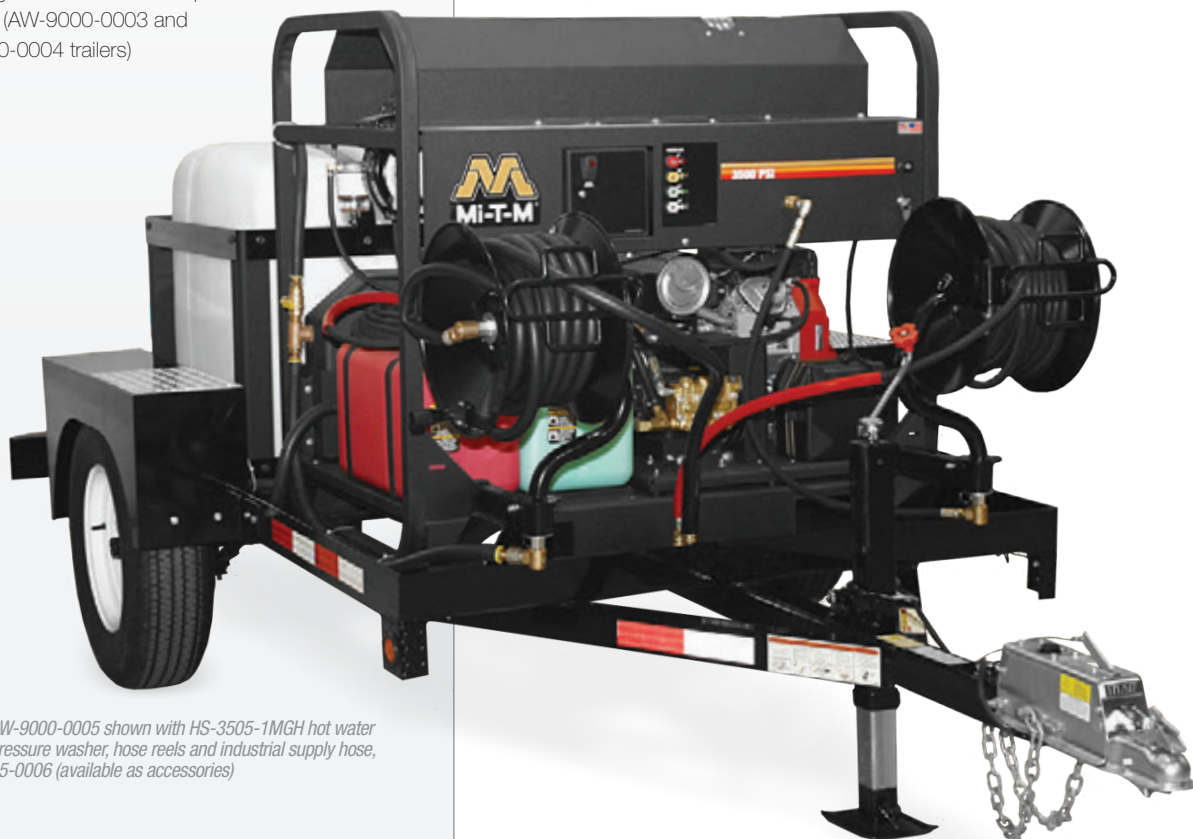

AW-9000-0005 shown with HS-3505-1MGH hot water pressure washer, hose reels and industrial supply hose, 15-0006 (available as accessories)

Accessories & Options:

- Pressure washers
- Hose reels
- Backflow preventers
- Trailer tank bypass
- Trailer hitches

These customizable mobile pressure washer trailers are rugged, convenient and the perfect solution for on-site cleaning. Pair them with an industrial pressure washer to clean dirt and grime anywhere, anytime.

SINGLE-AXLE TRAILERS

MODEL NUMBER	WATER TANK	BRAKES	HITCH	TIRES	AXLE	ANGLE FRAME	TRAILER BED DIM.	GROSS VEHICLE WT.
AW-9000-0005	200-gallon	Surge	2in., ball	(2) ST205-75R 15-in. radial	(1) 3,500 lb.	3in.x4.25in.	5ft.x8.5ft.	3,500 lb.
AW-9000-0006	200-gallon	Electric	2in., ball	(2) ST205-75R 15-in. radial	(1) 3,500 lb.	3in.x4.25in.	5ft.x8.5ft.	3,500 lb.
AW-9000-0007	200-gallon	None	2in., ball	(2) ST205-75R 15-in. radial	(1) 3,500 lb.	3in.x4.25in.	5ft.x8.5ft.	3,500 lb.

DUAL-AXLE TRAILERS

MODEL NUMBER	WATER TANKS	BRAKES	HITCH	TIRES	AXLES	STORAGE AREA	ANGLE FRAME	TRAILER BED DIM.	GROSS VEHICLE WT.
AW-9000-0003	(2) 200-gallon	Surge	2in., ball	(4) ST205-75R 15in.	(2) 3,500 lb.	5ft.x4ft.x12in.	3in.x4.25in.	5ft.x8.5ft.	7,000 lb.
AW-9000-0004	(2) 200-gallon	Electric	2in., ball	(4) ST205-75R 15in.	(2) 3,500 lb.	5ft.x4ft.x12in.	3in.x4.25in.	5ft.x8.5ft.	7,000 lb.
AW-9000-0008	(1) 200-gallon	Surge	2in., ball	(4) ST205-75R 15in.	(2) 3,500 lb.	None	3in.x4.25in.	5ft.x8.5ft.	7,000 lb.

As a company we continually strive for advancements in technology, therefore the design of Mi-T-M trailers may change after the publication of this catalog.

Single & Dual-Axle Trailers

Accessories and Options

High Pressure Hose Reels

These high pressure hose reels include a jumper hose and mounting bracket.

TX-0001 (13-inch reel for use with all trailers)

TX-0002 (16-inch reel for use with all trailers)

Low Pressure Hose Reels

These low pressure hose reels include a mounting bracket and plumbing.

TX-0003 (16-inch reel for use with AW-9000-0003 and AW-9000-0004 trailers)

TX-0013 (16-inch reel for use with AW-9000-0005, AW-9000-0006, AW-9000-0007 and AW-9000-0008 trailers)

Replacement Hose Reel Parts

When adding hose reels to single or dual-axle trailers, use the following jumper hose and mounting bracket.

15-0159 (Jumper hose)

13-0179A01 (Mounting bracket)

50-0195 (13-inch hose reel, 150-foot maximum hose length, rated for units up to 4000-PSI)

50-0196 (16-inch hose reel, 200-foot maximum hose length, rated for units up to 4000-PSI)

Backflow Preventers

A backflow preventer is required on trailer units in California.

TX-0011

- Adds a backflow preventer to trailers that have the TX-0013 low pressure hose reel option
- Mounts to hose reel

TX-0012

- Adds a backflow preventer to AW-9000-0005, AW-9000-0006, AW-9000-0007 and AW-9000-0008 trailers that do not have the TX-0013 low pressure hose reel option
- Mounts to inlet plumbing on trailer

Trailer Tank Bypass

TX-0005 (For use on AW-9000-0003 and AW-9000-0004 trailers with HS Series pressure washers)

TX-0007 (For use on AW-9000-0005, AW-9000-0006, AW-9000-0007 and AW-9000-0008 trailers with a HS Series pressure washer)

- Removes the float system, while adding the necessary plumbing
- Water bypasses back to water tank

Deluxe Trailer Options

TX-0015 (For use on AW-9000-0003 and AW-9000-0004 trailers with HS Series pressure washers)

TX-0017 (For use on AW-9000-0005, AW-9000-0006, AW-9000-0007 and AW-9000-0008 trailers with a HS Series pressure washer)

- Adds a ball valve, trailer tank bypass and low pressure hose reel to the trailer

Trailer Hitches

Replaces the standard 2-inch ball hitch with an adjustable trailer coupler hitch or lunette ring hitch. Includes hitch with brackets and hardware.

TX-0009 (Adjustable trailer coupler hitch for use with AW-9000-0006 and AW-9000-0007 trailers)

TX-0010 (Adjustable trailer coupler hitch for use with AW-9000-0003, AW-9000-0004 and AW-9000-0008 trailers)

- Heavy-duty, 2-inch trailer hitch with pin-style fastener trailer coupler and hinged ball socket with visual indication of proper closure around the ball - all to ensure a quick, easy and secure hook-up

TX-0018 (Lunette ring hitch for use with AW-9000-0006 and AW-9000-0007 trailers)

TX-0019 (Lunette ring hitch for use with AW-9000-0003, AW-9000-0004 and AW-9000-0008 trailers)

- 3-inch integrated lunette ring for use with pintle hitches



AW-9000-0003 shown with HS-3505-1MGH hot water pressure washer and hose reel (available as accessories)

HSE Series

Hot Water – Electric – Direct Drive

Pump:

Equipped with the Mi-T-M Pressure Relief Start which eliminates pressure build-up in the system (OMM11 models) | Forged brass manifold | Thermal relief valve | High pressure detergent injector (Available as an option on OMM11 models)

Motor:

Totally enclosed fan-cooled electric motor with manual thermal overload protection | 35-foot power cord

Frame:

Reinforced powder coated steel tube frame with center balanced lift | Convenient gun/wand holder and hose wrap | 13-inch flat-free tires

Components:

Energy-efficient top-fired heat exchanger | No. 1 or No. 2 diesel or kerosene fired burner (Not approved for bio-fuel)

Miscellaneous:

Temperature rise 150°F/66°C above ambient, maximum outlet temperature is 200°F

Unit Includes:

Quick connect nozzles - 0°, 15°, 25° and 40° | 50-foot x 3/8-inch steel wire-braided high pressure hose with quick connects | Professional-grade insulated trigger gun with safety lock-off | Adjustable pressure insulated dual lance

Limited Warranties:

1 year electric motor | 3 year coil | 7 year General and Mi-T-M pumps

Certification:

CSA Certified - US and Canada



HSE-2003-OMG10

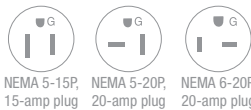

NEMA 5-15P, 15-amp plug | NEMA 5-20P, 20-amp plug | NEMA 6-20P, 20-amp plug

The HSE Series of direct drive hot water electric pressure washers are built for industrial cleaning on construction sites, farms, mining and oil fields. Known for their efficiency and longevity, they feature a top-fired heat exchanger that is completely accessible for troubleshooting.

MODEL NUMBER	PSI	GPM	HORSEPOWER/MOTOR	PUMP	Mi-T-M NO.	PLUG TYPE	BURNER FUEL TANK CAP.	BURNER FUEL CONS.	BTU PER HOUR	DIMENSIONS (LxWxH)	SHIP WT.	NET WT.
HSE-1002-OMG10	1000	2.0	1.5 HP, 120V, 1Ø, 15.0A	General	3-0071	NEMA 5-15P	4.0 gallons	1.33 gph	186,000	43x29.5x36.5in.	418 lb.	295 lb.
HSE-1002-OMM11	1000	2.0	1.5 HP, 120V, 1Ø, 15.0A	Mi-T-M	3-0383	NEMA 5-15P	4.0 gallons	1.33 gph	186,000	43x29.5x36.5in.	410 lb.	237 lb.
HSE-1502-OMG10	1500	2.0	2.0 HP, 120V, 1Ø, 19.0A	General	3-0071	NEMA 5-20P	4.0 gallons	1.21 gph	169,000	43x29.5x36.5in.	422 lb.	299 lb.
HSE-1502-OMM11	1500	2.0	2.0 HP, 120V, 1Ø, 19.0A	Mi-T-M	3-0383	NEMA 5-20P	4.0 gallons	1.21 gph	169,000	43x29.5x36.5in.	414 lb.	291 lb.
HSE-2003-OMG10	2000	2.8	4.0 HP, 230V, 1Ø, 18.0A	General	3-0168	NEMA 6-20P	4.0 gallons	1.48 gph	207,200	43x29.5x36.5in.	439 lb.	316 lb.
HSE-2003-OMM11	2000	2.8	4.0 HP, 230V, 1Ø, 18.0A	Mi-T-M	3-0420	NEMA 6-20P	4.0 gallons	1.48 gph	207,200	43x29.5x36.5in.	431 lb.	308 lb.

Accessories & Options:

PART NUMBER	DESCRIPTION	FITS MODELS	PART NUMBER	DESCRIPTION	FITS MODELS
50-0161	High pressure detergent injector	All models	HX-0240	300°F steam	HSE-2003-OMG10
850-0433	50-ft. x 3/8-in. high pressure hose	All models	HX-0241	300°F steam	HSE-2003-OMM11
HX-0232	300°F steam	HSE-1002-OMG10	HX-0243	Auto start/stop	2000-PSI models
HX-0233	Adjustable thermostat, 86°-248°F	All models	HX-0244	Time delay shutdown	2000-PSI models
HX-0235	Hour meter	All models	HX-0245	300°F steam	HSE-1502-OMM11
HX-0237	Auto start/stop	HSE-1002-OMM11	HX-0246	300°F steam	HSE-1502-OMG10
HX-0238	Time delay shutdown	HSE-1002-OMM11	HX-0275	Auto start/stop	HSE-1502-OMM11
HX-0239	300°F steam	HSE-1002-OMM11	HX-0276	Time delay shutdown	HSE-1502-OMM11

HSE Series

Hot Water – Electric – Belt Drive



HSE-2504-0M30

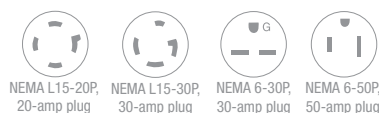

The HSE Series of belt driven hot water pressure washers are ideal for cleaning applications requiring 20 or more hours of use a week. Recommended for heavy, consistent cleaning applications this model is great for industrial and commercial jobs where you need to tackle nasty grime, oil and dirt.

Pump:

External bypass system allows more water into the system to protect from heat build-up | Forged brass manifold | Thermal relief valve | High pressure detergent injector

Motor:

Totally enclosed fan-cooled electric motor with manual thermal overload protection | 35-foot power cord

Frame:

Reinforced powder coated steel tube frame with center balanced lift | Convenient gun/wand holder and hose wrap | 13-inch flat-free tires

Components:

Energy-efficient top-fired heat exchanger | No. 1 or No. 2 diesel or kerosene fired burner (Not approved for bio-fuel)

Miscellaneous:

Temperature rise 150°F/66°C above ambient, maximum outlet temperature is 200°F

Unit Includes:

Quick connect nozzles - 0°, 15°, 25° and 40° | 50-foot x 3/8-inch steel wire-braided high pressure hose with quick connects | Professional-grade insulated trigger gun with safety lock-off | Adjustable pressure insulated dual lance

Limited Warranties:

1 year electric motor | 3 year coil | 7 year General pump

Certification:

CSA Certified - US and Canada

MODEL NUMBER	PSI	GPM	HORSEPOWER/MOTOR	PUMP	Mi-T-M NO.	PLUG TYPE	BURNER FUEL TANK CAP.	BURNER FUEL CONS.	BTU PER HOUR	DIMENSIONS (LxWxH)	SHIP WT.	NET WT.
HSE-2504-0M10	2500	3.2	6.0 HP, 230V, 1Ø, 25.0A	General	3-0202	NEMA 6-30P	10.0 gallons	2.10 gph	294,000	49.5x28x40.5in.	699 lb.	569 lb.
HSE-2504-0M30	2500	3.2	6.0 HP, 230-460V, 3Ø, 16.0A	General	3-0202	NEMA L15-20P	10.0 gallons	2.10 gph	294,000	49.5x28x40.5in.	688 lb.	558 lb.
HSE-3004-0M10	3000	3.5	8.0 HP, 230V, 1Ø, 36.0A	General	3-0202	NEMA 6-50P	10.0 gallons	2.10 gph	294,000	49.5x28x40.5in.	737 lb.	607 lb.
HSE-3004-0M30	3000	3.5	8.0 HP, 230-460V, 3Ø, 24.0A	General	3-0202	NEMA L15-30P	10.0 gallons	2.10 gph	294,000	49.5x28x40.5in.	732 lb.	602 lb.
HSE-3504-0M10	3500	3.3	10.0 HP, 230V, 1Ø, 39.0A	General	3-0202	NEMA 6-50P	10.0 gallons	2.10 gph	294,000	49.5x28x40.5in.	761 lb.	631 lb.
HSE-3504-0M30	3500	3.3	10.0 HP, 230-460V, 3Ø, 28.0A	General	3-0202	NEMA L15-30P	10.0 gallons	2.10 gph	294,000	49.5x28x40.5in.	742 lb.	612 lb.

Accessories & Options:

PART NUMBER	DESCRIPTION	FITS MODELS	PART NUMBER	DESCRIPTION	FITS MODELS
850-0433	50-ft. x 3/8-in. high pressure hose	All models	HX-0076	Auto start/stop - steam - CAD cell	3000-PSI models
HX-0070	Auto start/stop	All models	HX-0077	Auto start/stop - steam - CAD cell	3500-PSI models
HX-0071	Auto start/stop - steam	2500-PSI models	HX-0085	460V on 6.0-HP, 3-phase model	HSE-2504-0M30
HX-0072	Auto start/stop - steam	3000-PSI models	HX-0086	460V on 8.0-HP, 3-phase model	HSE-3004-0M30
HX-0073	Auto start/stop - steam	3500-PSI models	HX-0087	460V on 10.0-HP, 3-phase model	HSE-3504-0M30
HX-0074	Auto start/stop - CAD cell	All models	HX-0088	Skid feet	All models
HX-0075	Auto start/stop - steam - CAD cell	2500-PSI models	HX-0161	Hour meter	All models

HAE Series

Hot Water – All-Electric – Belt Drive

Pump:

Factory preset unloader | Stainless-steel and brass unloader valve | Forged brass manifold | Thermal relief valve

Motor:

Open drip-proof electric motor (HAE-2503-0E4G) | Totally enclosed fan-cooled electric motor with manual thermal overload protection (HAE-3004-0E4G) | On/Off power switch

Frame:

Stainless-steel base and frame with rubber isolators

Component:

Time delay shutdown

Heat Exchanger:

Used for consistent and efficient on-demand hot water | 120°F to 130°F temperature rise above in-take water, obtained within 3 to 5 minutes | Adjustable thermostat | On/Off power switch | Powder coated steel frame | Revolutionary cartridge design | Low maintenance, stainless-steel coils in aluminum casings for maximum efficiency | Eliminates constant cleaning | Eliminates heat loss

Unit Includes:

Quick connect nozzles - 0°, 15°, 25° and 40° | External downstream detergent injector, AW-8400-0021, with detergent nozzle | 50-foot x 3/8-inch wire-braided high pressure black hose with quick connects | Professional-grade insulated trigger gun with safety lock-off | Adjustable pressure insulated dual lance

Limited Warranties:

1 year electric motor | 10 year General pump

Certification:

CSA Certified - US and Canada



HAE-3004-0E4G

The all-electric HAE Series offers a fast and effective cleaning method without the emission of fuel and exhaust fumes. A patented heat exchange cartridge design provides consistent on-demand hot water, perfect for cleaning food and beverage facilities.



MODEL NUMBER	PSI	GPM	HORSEPOWER/MOTOR	UNIT AMPERAGE	PUMP	Mi-T-M NO.	HEATER kW	TEMPERATURE RISE	DIMENSIONS (LxWxH)	SHIP WT.	NET WT.
HAE-2503-0E4G	2500	2.8	6.0 HP, 460V, 3Ø	66.0A	General	3-0203	48	120°F	36x25x49in.	725 lb.	625 lb.
HAE-3004-0E4G	3000	3.9	8.0 HP, 460V, 3Ø	98.0A	General	3-0202	72	130°F	36x25x49in.	830 lb.	725 lb.

Options:

PART NUMBER	DESCRIPTION	FITS MODELS
CX-0069	Auto start/stop	All models
CX-0078	Remote box	All models

HAE Series

Heat Exchanger Design

HAE Series Patented Heat Exchanger Design

In 2018, Mi-T-M Corporation received the patent for a unique dual coil heat exchanger design which allows each cartridge to heat the water twice, keeping the internal heat of the cartridges constant throughout the system. Heat is transferred into the aluminum casting so the heating element does not come into contact with the water. Since the water does not have direct contact with the heating element this eliminates calcium and build-up on the coils.

- The HAE Series is designed to eliminate one of the industries most common problems. Direct contact of the water to the heat element that drastically shortens the life of the element.
- The tubing that carries the water through the heating element is made up of 316 stainless-steel which is the preferred spec of the industry.
- The alternate water flow through each heat exchanger allows for even heat distribution across each exchanger.
- The HAE Series heat exchanger system eliminates the water/oil bath maintenance and the stagnant odor of most competitive designs.
- The HAE Series will develop 20% higher temperature rise versus most competitive designs and maintains a constant temperature required to satisfy the performance needed to efficiently complete any hot water application.

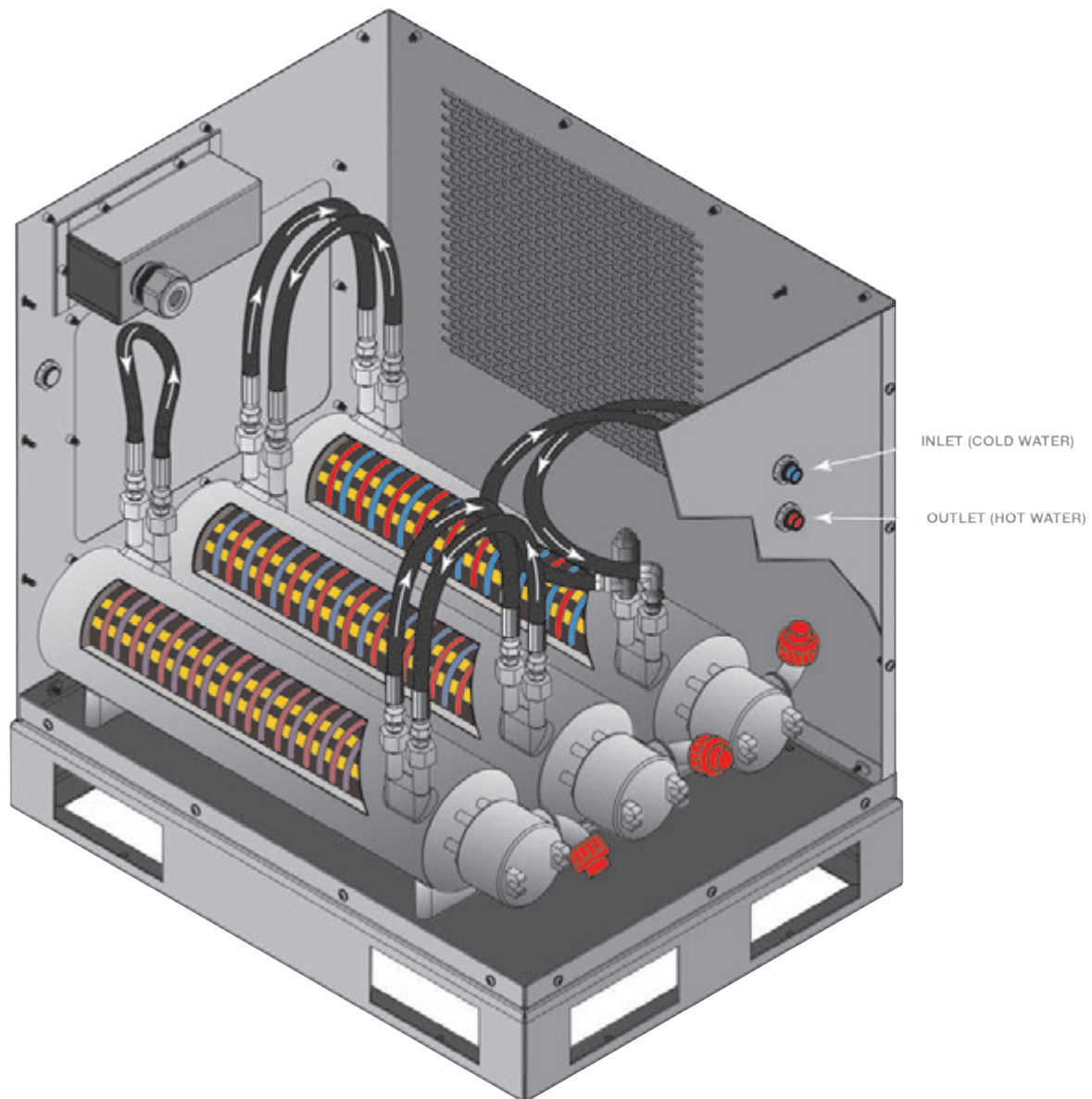

HG Series

Hot Water – Natural Gas/LP – Belt Drive

Pump:

Factory preset unloader | Thermal relief valve | Adjustable high pressure detergent injector

Motor:

Open drip-proof electric motor with thermal overload protection

Frame:

Powder coated steel side panels and frame

Components:

Natural gas or LP gas-fired (vapor only) natural draft with aspirating-type burner, 10-inch stack | 24 volt control system | ½-inch schedule 80-coil heat exchanger | Electronic ignition with an intermittent pilot

Miscellaneous:

Maximum outlet temperature is 200°F (250°F/121°C outlet temperature with steam option)

Unit Includes:

Quick connect nozzles - 0°, 15°, 25° and 40° | 50-foot x ¾-inch steel wire-braided high pressure hose with quick connects | Professional-grade insulated trigger gun with safety lock-off | Adjustable pressure insulated dual lance

Limited Warranties:

1 year electric motor | 3 year coil | 7 year General pump

Certification:

CSA Certified for 0 to 2000-feet above sea level - US and Canada



HG-3004-3460



The stationary HG Series is available in either natural gas or propane making it an ideal choice for applications that need a steady fuel source. Offering maximum cleaning power, this hot water machine is perfect for wash bays.

MODEL NUMBER	PSI	GPM	HORSEPOWER/MOTOR	PUMP	MI-T-M NO.	NATURAL GAS BTU PER HR.	LP GAS BTU PER HR.	DRAFT DIVERTER	DIMENSIONS (LxWxH)	SHIP WT.	NET WT.
HG-3004-1208	3000	3.9	8.0 HP, 208V, 1Ø, 40.5A	General	3-0202	338,000	326,000	21in.	56.5x29x49.75in.	878 lb.	758 lb.
HG-3004-3208	3000	3.9	8.0 HP, 208V, 3Ø, 23.0A	General	3-0202	338,000	326,000	21in.	56.5x29x49.75in.	878 lb.	758 lb.
HG-3004-1230	3000	3.9	8.0 HP, 230V, 1Ø, 37.0A	General	3-0202	338,000	326,000	21in.	56.5x29x49.75in.	878 lb.	758 lb.
HG-3004-3230	3000	3.9	8.0 HP, 230V, 3Ø, 20.0A	General	3-0202	338,000	326,000	21in.	56.5x29x49.75in.	878 lb.	758 lb.
HG-3004-3460	3000	3.9	8.0 HP, 460V, 3Ø, 10.0A	General	3-0202	338,000	326,000	21in.	56.5x29x49.75in.	878 lb.	758 lb.

Options:

PART NUMBER	DESCRIPTION	FITS MODELS	PART NUMBER	DESCRIPTION	FITS MODELS
HX-0104	K7 unloader, flow activated (auto start/stop N/A)	All models	HX-0110	Additional remotes (up to 3)	All models
HX-0105	Liquid propane - vapor only	All models	HX-0111	Auto start/stop	All models
HX-0106	Hour meter	All models	HX-0121	250°F steam upgrade	All models
HX-0107	Time delay shutdown	All models	HX-0124	Auto start/stop and first remote option	All models
HX-0108	(1) Remote station (auto start/stop N/A)	All models	Note: You cannot order HX-0107 and HX-0108 together, you will need to order HX-0109 instead. HX-0107 and HX-0108 can be ordered separately.		
HX-0109	Time delay shutdown and first remote box	All models			

Pressure Washer Accessories

Rotary Surface Cleaners

Rotary Surface Cleaners – Walk-Behind

Clean large surfaces faster and easier than with a standard cleaning nozzle. The Mi-T-M rotary surface cleaners are equipped with strong-bristled brushes for long life and easy glide control. This cleaning accessory can be used on decks, patios, sidewalks, driveways, pool decks, parking lots and any other horizontal surface.

20-Inch Diameter

AW-7020-8003

AW-7020-8005 (Includes shut-off ball valve, 50-0210)

- 4000-PSI rated
- Heavy-duty anodized aluminum handle
- Professional-grade high pressure trigger gun
- Heat-treated sealed pressure swivel - requires no maintenance
- 180°F maximum temperature
- 3.0 to 5.0-GPM water volume



AW-7020-8006

24-Inch Diameter

AW-7020-8006

- 2-nozzle arm spray bar
- 4.0-GPM water volume

AW-7020-8007

- 3-nozzle arm spray bar
- 6.0-GPM water volume

24-Inch Additional Features:

- 4000-PSI rated
- Lightweight, portable frame
- Stainless-steel construction with 4 casters for easy mobility
- Heavy-duty anodized aluminum handle
- Professional-grade high pressure trigger gun
- Shut-off ball valve standard
- Heat-treated sealed pressure swivel - requires no maintenance
- 180°F maximum temperature



AW-7020-8001

28-Inch Diameter

AW-7020-8001

- 4000-PSI rated
- Lightweight, portable frame
- Large wheels for mobility
- Professional-grade aluminum housing
- Heat-treated sealed pressure swivel - requires no maintenance
- 212°F maximum temperature
- 4.0 to 10.0-GPM water volume



AW-7020-8003

Shut-Off Ball Valve

While cleaning, this valve will allow you to switch back and forth from one of our walk-behind rotary surface cleaners to a gun and wand.



50-0210

- 4000-PSI maximum operating pressure
- 3/8-inch male quick connect steel plug inlet
- 3/8-inch male quick connect brass coupler outlet

Rotary Surface Cleaner

Attaches easily to your pressure washer wand and is very operator friendly. It eliminates over-spraying while reducing water consumption.

AW-7020-8009

- 14-inch diameter
- 4200-PSI maximum operating pressure
- Two 25° nozzles
- Underside dual arm
- Quick connects for easy installation
- 180°F maximum temperature
- 8.0-GPM maximum water volume

AW-7020-8009



Pressure Washer Accessories

Nozzles, Brush & Injectors



AW-7510-0035

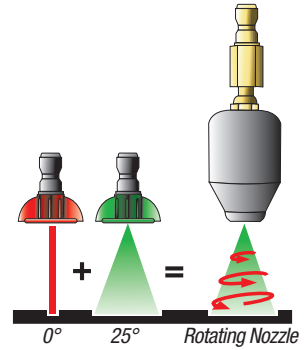

Rotating Nozzles

Increase your cleaning power and decrease your cleaning time with rotating nozzles. They offer 0° spray impact with 25° coverage. Nozzles include filter with quick connect and heavy-duty components for long life and reliability. Can be used on sidewalks, driveways, track vehicles, muddy areas, old peeling paints and concrete surfaces. ***Consult factory for correct orifice size.**

AW-7004-Series*

- 6000-PSI rated
- 212°F temperature rating

AW-7500-Series*

- 6000-PSI rated
- 212°F temperature rating

AW-7510-0035

- 3.5 orifice size
- 5100-PSI rated
- 212°F temperature rating

AW-7510-0004

- 4.0 orifice size
- 5100-PSI rated
- 212°F temperature rating

AW-0018-0375

- 4.0 orifice size
- 7300-PSI rated
- 194°F temperature rating



AW-7004-Series



AW-7500-Series



AW-7510-0035



AW-0018-0375

Multi-Function Nozzles

Designed with six high pressure nozzles that are stainless-steel for longer life and durability, its compact design gives you the convenience of six nozzles in one: 0°, 15°, 25° and 40° plus soap and rinse.

***Consult factory for correct orifice size.**

AW-7200-0035*

- 3.5 orifice size
- 4200-PSI rated

AW-7200-0004*

- 4.0 orifice size
- 4200-PSI rated



AW-7200-0004



AW-7200-0035

Rotating Brush

Offering low pressure rotation for hard to remove debris on sensitive surfaces. This brush can be used on painted surfaces, fiberglass, wood and brick.

AW-7003-1500

- Natural hair bristles
- Quick connect
- Adjustable angle
- 3.0 to 6.0-GPM flow rate
- 176°F temperature rating
- Can be used with low pressure detergent injector



Low Pressure Detergent Injectors

Apply recommended detergents with a low pressure detergent injector. Can be used on cars, boats, vans and engines.

AW-8400-0021 (4500-PSI)

AW-8000-0001 (3500-PSI)

- Adjustable chemical draw
- Clear, pliable detergent hose
- Solid brass body with stainless-steel orifice for durability
- Quick connects for easy installation



Sand Injector

Wet sandblasting is efficient and dust-free. Remove coatings from steel and concrete surfaces. Can be used on rust, paint, stains and graffiti.

AW-3000-0000 (Sand injector - carbide tip)

- Includes sand probe and clear hose
- 5500-PSI rated
- Consult factory before ordering

18-0113 (Carbide replacement nozzle)



High Pressure Detergent Injector

Large tasks become small with a high pressure detergent injector. High pressure water mixes with detergent to clean even the heaviest build-up. Can be used on farm equipment, tractor trailers, RVs and bridges.

50-0161

- Brass and stainless-steel construction
- 2.0 to 6.0-GPM operating capacity
- Steel mesh in-line water strainer



Pressure Washer Accessories

Detergents & Pump Oil

Detergents

All detergents are hard water stable to prevent spotting. They are environmentally friendly, will not harm plants and are biodegradable.

All Purpose Cleaner

All Purpose Cleaner is the most versatile and efficient all-around cleaner. Use on vehicles, glass, stainless-steel, aluminum, painted surfaces and lawn equipment.

AW-4018-0026
AW-4018-0026-C*

- 1-gallon, 4 per case

AW-4018-0005
AW-4018-0005-C*

- 5-gallons

AW-4018-0055
AW-4018-0055-C*

- 55-gallons

Heavy-Duty Degreaser

Heavy-Duty Degreaser is great for the removal of oil and grease. It is capable of handling all your equipment and automotive cleaning needs. Contains rust inhibitors to reduce corrosion.

AW-4059-0026
AW-4059-0026-C*

- 1-gallon, 4 per case

AW-4059-0005
AW-4059-0005-C*

- 5-gallons

AW-4059-0055
AW-4059-0055-C*

- 55-gallons

**Available in Canada only.*

Deck & House Wash

Deck & House Wash removes mildew and dirt. It is recommended for decks, homes and wooden surfaces.

AW-4034-0026
AW-4034-0026-C*

- 1-gallon, 4 per case

AW-4034-0005
AW-4034-0005-C*

- 5-gallons

AW-4034-0055
AW-4034-0055-C*

- 55-gallons



Pump Oil

Specially designed for pressure washer pumps. It will keep pumps cooler than with regular oil and is suitable for all climates.

AW-4085-0016
(1-pint, 6 or 12 per case)

- Convenient pour spout and resealable cap
- Contains rust and corrosion additives, anti-wear additives, foam suppressant and dispersant for system cleanliness



Pump Saver

Provides longer pump life, prevents harmful build-up of hard water mineral deposits, preserves seals and pistons and protects against freezing for safe, cold weather storage.

AW-4070-0004 (16-oz.)

- For use with all pressure washers
- Protects pressure washer when not in use



Foamer

The foamer combines high pressure water mixed with detergent and air to produce thick, clinging foam. This can be utilized to wash cars, motorcycles, windows, driveways, roofs, and siding.

AW-0018-0459

- 4000-PSI rated
- Adjustable flow control
- Includes stainless-steel 1.2mm and 1.5mm nozzles plus 4 connection options



Long Range Chemical Nozzle

18-0373

- Quick connects to the end of the wand
- Low pressure
- Has a range of 30-feet while drawing chemical



AW-0018-0459 foamer with all purpose cleaner

Pressure Washer Accessories

Extension Wands

Aluminum Wand Extensions

These lightweight, aluminum extension wands allow you to clean hard to reach areas with ease.

AW-7105-3600 (36-inch) **AW-7105-7200** (72-inch)
AW-7105-4800 (48-inch) **AW-7105-9600** (90-inch)

- 1/4-inch lance saver socket with quick connect plug
- 4000-PSI rated
- 12.0-GPM flow rate
- 300°F temperature rating



Gutter Cleaner

Turn your wand into an efficient rain gutter cleaner. Clean your gutters from the ground and blow out dirt, grime, leaves and anything else that may be stuck inside.

50-0201

- 4000-PSI maximum pressure
- 1/4-inch quick connect socket outlet
- 1/4-inch quick connect plug inlet



50-0201



AW-7105-4800 shown on cold water gun and lance, 851-0371

Extended Reach Wands

Clean hard to reach places like house siding and eaves, large farm equipment, semi-tractor trailers and multi-story buildings.

Fiberglass Wands

AW-7018-1200 (12-foot)
AW-7018-1800 (18-foot)
AW-7018-2400 (24-foot)

- Professional-grade trigger gun with safety lock-off
- Complete with quick connects
- Extends from 6-feet, 8-inches to 12, 18 or 24-feet
- Lightweight and easy to control
- Compatible with all makes of pressure washers rated up to 4000-PSI
- Easy hose retraction
- Can handle water up to 200°F

Aluminum Wands

AW-7017-1800 (18-foot)
AW-7017-2400 (24-foot)

- Professional-grade trigger gun with safety lock-off
- Complete with quick connects
- Extends from 6-feet, 5-inches to 18 or 24-feet
- Lever locks
- Compatible with all makes of pressure washers rated up to 4000-PSI
- Includes belt for additional support

Telescoping Wand Belt

The telescoping wand belt holds the telescoping wand to reduce operator fatigue and strain. It provides better operator control, optimizing cleaning performance.

AW-7015-0001

- Works with both fiberglass and aluminum wands
- Includes three plastic snap-on clips that snap to your shoulder, waist and the wand



AW-7018-1800

Pressure Washer Accessories

Replacements Guns & Wands



851-0095

Cold Water Gun and Wand Assemblies

Replaces your existing gun and wand assembly.

851-0095 (36-inch, 4000-PSI rated)

851-0371 (48-inch, 4000-PSI rated)

851-0309 (48-inch, 5000-PSI rated)

851-0361 (48-inch, 4000-PSI rated)

- Professional-grade insulated trigger gun with safety lock-off and quick connects
- Wand includes rubber grip and quick connects



Hot Water Dual Lance Assemblies

Replaces your existing gun and dual lance assembly.

850-0435 (36-inch, 4500-PSI rated)

850-0436 (48-inch, 4500-PSI rated)

- Professional-grade insulated trigger gun with safety lock-off and quick connects
- Adjustable pressure insulated dual lance



850-0436



850-0436

Replacement Trigger Gun

Replacement gun only.

16-0001

- Trigger gun
- Rated up to 5000-PSI



16-0001

High Temperature O-Rings

O-rings ensure a tight fit and prevent leaks with quick connect sockets.

25-0594 (3/8-inch high temp silicon)

- Fits quick connect socket, 17-0004, on hot water outlet

25-0595 (1/4-inch high temp silicon)

- Fits quick connect socket, 17-0028, on wand



25-0594

Pressure Washer Accessories

Hour Meter, Roll Cage & Extension Hoses



Digital Hour Meter/ Tachometer

32-0416

- Simple hour meter with tachometer
- Updates every 3 seconds
- RPM to 9,900

Roll Cages

Designed to protect cold water pressure washers.

CX-0054 (Fits CW Premium Series)

CX-0055 (Fits CW-4004-5MV0)

- Lifting hook
- 1 1/4-inch powder coated steel tubing
- Retro-fits to existing frame



*CW-3004-0MKD shown
with roll cage, CX-0054*

Extension Hoses

When you need extra mobility and length.



851-0338



15-0365



15-0006

Cold Water Extension Hoses

851-0338 (4000-PSI, R1)

851-0006 (4500-PSI, R2)

851-0317 (6000-PSI, R2)

- 50-foot x 3/8-inch ID
- Non-marking
- Includes quick connects, swivel and bend restrictors
- Chemical resistant
- Wire-braided

15-0273 (4000-PSI, R1)

- 100-foot x 3/8-inch ID

- Non-marking

- Includes quick connects

- 250°F temperature rating

15-0365 (7200-PSI, R3, black)

- 50-foot x 3/8-inch ID

851-0420 (7000-PSI, R2, black)

- 50-foot x 3/8-inch ID

- Includes quick connects

15-0006 (Industrial water supply)

- 50-foot x 3/8-inch



15-0077



850-0433



15-0161

Hot Water Extension Hoses

Steam Hose

15-0077 (Steam combination, 3000-PSI, R1)

- 50-foot x 3/8-inch
- 250°F temperature rating

Hoses with Screw Connects

850-0174 (2500-PSI, R1)

850-0199 (4500-PSI, R2)

- 50-foot x 3/8-inch ID
- 250°F temperature rating
- Includes screw connects, swivel and bend restrictors

Hoses with Quick Connects

850-0433 (4500-PSI, R2)

851-0262 (3000-PSI, R1)

- 50-foot x 3/8-inch ID
- 250°F temperature rating
- Includes quick connects, swivel and bend restrictors

Bare Hoses

15-0146 (3000-PSI, 50-foot x 3/8-inch, R1)

15-0160 (5800-PSI, 75-foot x 3/8-inch, R2)

15-0161 (5800-PSI, 100-foot x 3/8-inch, R2)

15-0162 (5800-PSI, 150-foot x 3/8-inch, R2)

15-0163 (5800-PSI, 200-foot x 3/8-inch, R2)

- 3/8-inch male swivel
- 250°F temperature rating
- For use with hose reels

Pressure Washer Accessories

Hose Reels

Hose Reels

A convenient way to store your pressure washer hose. Reel capacities based on R1 MI-T-M hoses.

50-0195 (13-inch hose reel, 150-foot maximum hose length, rated for 4000-PSI units and lower)

50-0196 (16-inch hose reel, 200-foot maximum hose length, rated for 4000-PSI units and lower)

50-0164 (13-inch hose reel without swivel, 100-foot maximum hose length)

50-0165 (16-inch hose reel without swivel, 200-foot maximum hose length)

- Frame mount
- 360° pivoting action on 50-0195 and 50-0196 hose reels
- Non-pivoting action on 50-0164 and 50-0165 hose reels
- Easy-mount bracket design
- Clean hands hose guide
- Live system

Note: Hose reels 50-0164 and 50-0165 must be mounted with 13-0208A01 (45° bracket) or 13-0210A01 (90° bracket). 24-0105 (elbow) is required for jumper hose mounting.



HSP-3003-3MGH



1
AW-0050-0138
Bracket -
Universal mount fits
HSP-2503-0MMH,
HS Series and HSE
Direct Drive Series



13-0208A01
Bracket - 45°
for mounting
reels without
swivel



2
13-0207A01
Bracket -
Wall mount fits
HG Series



13-0210A01
Bracket -
90° for mounting
reels without
swivel



HSE-2003-0MG10



3
13-0175A01
Bracket -
Cold water
base mount
fits JCW and
CW Premium
Series



AW-0050-0140
Bracket - 29-inch
Bar fits CWC
Premium Series



24-0105
Elbow

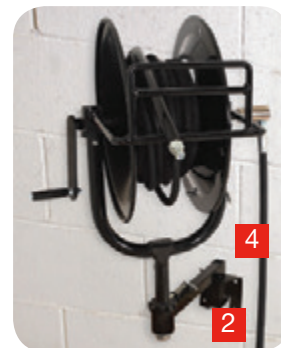

Jumper Hoses

4 **852-0139** Quick connect, 57-inch fits Cold Water Pressure Washers, HSP Series and HSE Belt Drive Series

5 **850-0278** Quick connect, 85-inch fits HS and HSE Direct Drive Series

Note: 852-0139 and 850-0278 jumper hoses are not rated for steam applications.



CW-3504-5MGH

Pressure Washer Accessories

Packaged Accessories



Pivot Coupler

The quick connect pivot coupler adjusts to three different cleaning angles to get those hard-to-reach areas.

50-0208

- 1/4-inch quick connect
- For most cold water pressure washers rated up to 4500-PSI
- Connects between the wand and high pressure nozzle

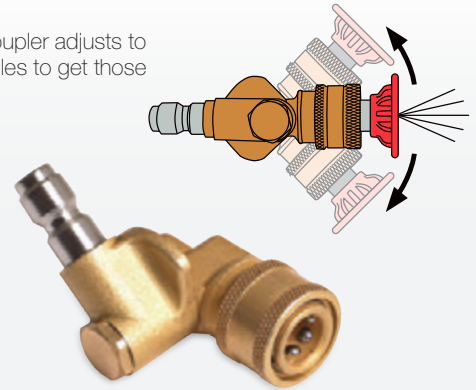

High Pressure Swivel Connector

Prevents hose from tangling or twisting.

AW-0023-0507

- 5000-PSI maximum pressure
- 42.0-GPM flow rate
- 3/8-inch MNPT x 3/8-inch FNPT
- Nickel-plated with stainless-steel internal

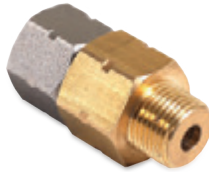

O-rings

O-rings ensure a tight fit and prevent leaks with quick connect sockets.

AW-0025-0122 (3/8-inch x 3/8-inch, 10 qty.)

- Fits quick connect socket, 17-0001

AW-0025-0123 (1/2-inch x 1/16-inch, 10 qty.)

- Fits quick connect socket, 17-0004



Increase sales and brand recognition with the Mi-T-M packaged accessory program. Mi-T-M has a full line of accessories in full color packaging. Each part is clearly identified with its name, part number and which unit it is used on.

Quick Connect Nozzles

Quick connect nozzles give you a choice of spray angles for precise cleaning power.

Spray Nozzles

- Available in orifice size: 3.0, 3.5, 4.0, 4.5, 5.0, 5.5, 6.0, 6.5 and 7.0

Individual Nozzles

- Available in 0°, 15°, 25° or 40° spray angles

3-Pack Nozzles

- Sold in packs of three: 0°, 15°, 25° or 40° spray angles

4-Pack Nozzles

- Sold in packs of four: 0°, 15°, 25° or 40° spray angles

Chemical Nozzle

AW-0018-0148

- 65°
- Sold individually



4-Pack Nozzles
0°, 15°, 25° and 40°

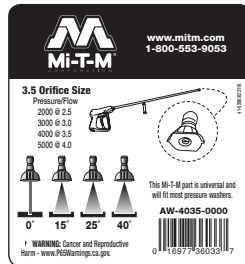

Back view of accessory packaging

Fittings

Add the ability to easily connect and disconnect your pressure washer wands and hoses.

AW-0017-0001 (1/4-inch F x 1/4-inch socket)

AW-0017-0002 (1/4-inch M x 1/4-inch plug)

AW-0017-0004 (3/8-inch F x 3/8-inch socket)

AW-0017-0005 (3/8-inch M x 3/8-inch plug)

AW-0017-0006 (3/8-inch F x 3/8-inch plug)

AW-0017-0028 (1/4-inch M x 1/4-inch socket)

AW-0017-0029 (1/2-inch M x 3/8-inch socket)

- Sockets and plugs are quick connect

AW-0017-0035 (M22 x 3/8-inch FNPT)

- Screw connect

- 2-piece

AW-0023-0017 (3/8-inch M x 1/4-inch F adapter)

AW-0023-0410 (3/8-inch M x 1/4-inch BSP-F adapter)

AW-0024-0251 (3/8-inch M x 1/4-inch BSP-M adapter)



AW-0017-0002



AW-0017-0035

Gun and Wand

Replacement gun and wand for continued cleaning capability.

AW-0016-0001 (Trigger gun, rated up to 5000-PSI)

AW-0851-0096 (36-inch wand assembly, includes quick connect socket)



Pressure Washer Accessories

Replacement Parts Boxes

Pressure Washer Replacement Parts Box

Everything you need for your pressure washer.

- Secure case locking system to keep lid attached and parts secure
- Diagram card includes Mi-T-M part numbers for quick reorder reference
- Hinged lid
- Storage compartments with adjustable plastic separators, keeps parts organized for easy access
- Case is made of heavy, durable plastic

PART NUMBER	DESCRIPTION
AW-1162-0174	Replacement parts box

AW-1162-0174 includes the following parts:

PART NUMBER	DESCRIPTION	QUANTITY
17-0001	QC socket, 1/4-inch F x 1/4-inch, brass	2
17-0002	QC plug, 1/4-inch M x 1/4-inch, stainless-steel	2
17-0004	QC socket, 3/8-inch F x 3/8-inch, brass	2
17-0007	QC socket, 3/8-inch M x 3/8-inch, brass	2
17-0028	QC socket, 1/4-inch M x 1/4-inch, brass	2
17-0074	QC plug, 3/8-inch M x 3/8-inch, plated	2
17-0075	QC plug, 3/8-inch F x 3/8-inch, plated	2
18-0386	Chemical nozzle, 3.0 orifice, 65°	2
18-0387	Spray nozzle, 3.0 orifice, 0° (red)	2
18-0388	Spray nozzle, 3.0 orifice, 15° (yellow)	2
18-0390	Spray nozzle, 3.0 orifice, 25° (green)	2
18-0391	Spray nozzle, 3.0 orifice, 40° (white)	2
18-0392	Spray nozzle, 3.5 orifice, 0° (red)	2
18-0393	Spray nozzle, 3.5 orifice, 15° (yellow)	2
18-0395	Spray nozzle, 3.5 orifice, 25° (green)	2
18-0396	Spray nozzle, 3.5 orifice, 40° (white)	2
18-0397	Spray nozzle, 4.0 orifice, 0° (red)	2
18-0399	Spray nozzle, 4.0 orifice, 15° (yellow)	2
18-0400	Spray nozzle, 4.0 orifice, 25° (green)	2
18-0401	Spray nozzle, 4.0 orifice, 40° (white)	2
19-0206	Filter inlet valve, 1/2-inch M x 3/4-inch F	1
22-0005	Thermal relief valve, 1/2-inch M, 145°F	2
25-0122	O-ring, 3/8-inch x 3/8-inch, fits 17-0001	10
25-0123	O-ring, 1/2-inch x 1 1/4-inch, fits 17-0004	10



Buddy Box - Pressure Washer Parts Box

Great selection of pressure washer parts.

- Secure case locking system to keep lid attached and parts secure
- Diagram card includes Mi-T-M part numbers for quick reorder reference
- Hinged lid
- Storage compartments with adjustable plastic separators, keeps parts organized for easy access
- Case is made of heavy, durable plastic

PART NUMBER	DESCRIPTION
AW-1162-0194	Buddy Box - Pressure Washer Parts Pack

AW-1162-0194 includes the following parts:

PART NUMBER	DESCRIPTION	QUANTITY
17-0001	QC socket, 1/4-inch F x 1/4-inch, brass	2
17-0004	QC socket, 3/8-inch F x 3/8-inch, brass	2
17-0074	QC plug, 3/8-inch M x 3/8-inch, plated	2
17-0075	QC plug, 3/8-inch F x 3/8-inch, plated	2
18-0373	Long range chemical nozzle	1
18-0386	Chemical nozzle, 3.0 orifice, 65°	1
18-0392	Spray nozzle, 3.5 orifice, 0° (red)	1
18-0393	Spray nozzle, 3.5 orifice, 15° (yellow)	1
18-0395	Spray nozzle, 3.5 orifice, 25° (green)	1
18-0396	Spray nozzle, 3.5 orifice, 40° (white)	1
19-0206	Filter inlet valve, 1/2-inch M x 3/4-inch F	1
22-0005	Thermal relief valve, 1/2-inch M, 145°F	1
23-0095	Garden hose connector, 1/2-inch M x 3/4-inch F	1
25-0122	O-ring, 3/8-inch x 3/8-inch, fits 17-0001	5
25-0123	O-ring, 1/2-inch x 1 1/4-inch, fits 17-0004	5



Pressure Washer Accessories

Parts & Equipment Displays

Parts Display Cabinet

Perfect for displaying and securing pressure washer parts.

AW-9300-0049

- Durable, powder coated steel frame
- Custom lock keeps merchandise safe and secure
- Versatile peg and grid system keeps parts organized
- Includes product hooks
- 16-in. W x 9-in. D x 24-in. H

Parts sold separately



Suggested Stocking Parts:

PART NUMBER	DESCRIPTION	QUANTITY
AW-0016-0001	Trigger gun assembly, 5000-PSI, 12.0 GPM	2
AW-0017-0001	QC socket, brass, 1/4-inch F x 1/4-inch	4
AW-0017-0004	QC socket, brass, 3/8-inch F x 3/8-inch	4
AW-0017-0005	QC plug, stainless-steel, 3/8-inch M x 3/8-inch	4
AW-0017-0006	QC plug, stainless-steel, 1/2-inch F x 3/8-inch	4
AW-0017-0007	QC socket, brass, 3/8-inch M x 3/8-inch	4
AW-0018-0148	Detergent nozzle, 40° orifice, 65°	4
AW-0018-0257	Spray nozzle, 3.5 orifice, 0° (red)	4
AW-0018-0258	Spray nozzle, 3.5 orifice, 15° (yellow)	4
AW-0018-0259	Spray nozzle, 3.5 orifice, 25° (green)	4
AW-0018-0260	Spray nozzle, 3.5 orifice, 40° (white)	4
AW-4035-0000	Spray nozzles, 3.5 orifice, one of each: 0°, 15°, 25° & 40°	4
AW-0025-0122	O-ring, 3/8-inch x 3/8-inch	4
AW-0025-0123	O-ring, 1/2-inch x 1 1/8-inch	4
AW-7200-0035	Multi-function nozzle, 4200-PSI, 3.5 orifice	2
AW-7510-0035	Rotating nozzle, 5100-PSI, 3.5 orifice	3
AW-8400-0021	Low pressure detergent injector, 4500-PSI	2



Equipment Display Rack

A perfect way to present Mi-T-M industrial equipment to your customers. Compact yet strong enough to hold an assortment of Mi-T-M equipment.

AW-9300-0018 (3-tier powder coated display rack only)

13-0204A18 (Peg and grid system)

41-0466 (Product display signs)

64-6043 (Acrylic literature holder)

64-6044 (Mi-T-M industrial equipment pocket guides; 25-qty.)

AW-9300-0027 (Rack kit; includes 41-0466, 60-6043 and 64-6044)

- Mesh powder coated steel shelves to hold equipment
- Includes literature holder for pocket guides and display signs
- Optional versatile peg and grid system keeps parts organized

Rack Dimensions: 26.81-in. W x 43-in. D x 69.75-in. H

Shelf Dimensions:

Top Shelf 24-in. W x 20.875-in. D

Middle Shelf 24-in. W x 31.25-in. D

Bottom Shelf 24-in. W x 42.625-in. D

Equipment and parts sold separately



Pressure Washer Replacement Parts Rack

Maximize your Mi-T-M pressure washer accessory sales with this industrial parts rack.

AW-9300-0001 (Powder coated display rack; includes product holders, storage tray, wand holder and header sign)

- Increase profit margins
- Versatile peg and grid system keeps parts organized
- Convenient storage tray for hoses and pump oil
- Four-slot wand holder for all sizes of wands

Rack Dimensions (includes storage tray and wand holder): 41-in. W x 24-in. D x 68-in. H

Storage Tray Dimensions: 33-in. W x 15-in. D x 4.5-in. H

Wand Holder Dimensions: 6-in. W x 6-in. D x 24.5-in. H

Parts sold separately

Pressure Washer Accessories

Equipment Displays

Equipment Display Risers

The perfect way to elevate Mi-T-M industrial equipment. Compact and sturdy to hold air compressors, portable generators, pressure washers, portable heaters and wet/dry vacuums. Stackable for multi-level displays of your Mi-T-M equipment.

AW-9300-0019 (Powder coated display riser)

- Durable wrinkle-resistant powder coated steel frame and top
- Occupies a modest amount of valuable floor space
- Stackable design for grouped displays at various heights
- Raises equipment off of floor
- Heavy-duty base construction

Riser Dimensions: 26-in. W x 26-in. D x 12-in. H

Equipment sold separately



Equipment Rental Rack

Compact rental display rack solves your limited retail floor space issues.

AW-9300-0029 (Powder coated display rack)

41-0485 (Pressure washer rental sign)

64-6078 (Mi-T-M pressure washer rental pocket guides; 15-qty.)

64-6057 (Plastic literature holder)

64-6059 (Eraser)

64-6060 (Dry erase marker)

AW-9300-0034 (Rack kit; includes 41-0485, 64-0644, 64-6057, 64-6059 and 64-6060)

- Easy-to-assemble
- Requires only 7½-square-feet of floor space
- Constructed of powder coated metal square tubing
- Can hold up to 18 - 1-gallon detergent bottles
- Erasable area for half-day and full-day rental prices or equipment purchase price
- Includes literature holder for pocket guides

Rack Dimensions: 27-in. W x 42-in. D x 40-in. H

Detergents and pressure washer sold separately



Product Display Rack

Compact display rack makes the most of your retail floor space.

AW-9300-0013 (Powder coated display rack; includes header sign, magnets and literature holder)

AW-0013-0154 (Display shelves; 2 maximum)

13-0176A18 (Generator stop bracket; 4 maximum)

- Easy-to-assemble
- Requires only 15-square-feet of floor space
- Constructed of powder coated metal square tubing

Rack Dimensions: 61-in. W x 36-in. D x 62-in. H

Equipment sold separately

Water Trailer

Tank:

510-gallon elliptical low profile 3/8-inch thick polyethylene | 16-inch manhole with 4-inch vent and sump pump

Central Manifold:

Easy-to-operate butterfly brass valves

Plumbing:

1 1/2-inch fire hose hook-up with 50-foot x 1 1/2-inch hose and fog nozzle | Break-away hydrant fill with 25-foot x 2 1/2-inch hose | Dual rear spray heads | Garden hose connector | Manifold discharge system | Water hammer prevention valve

Trailer:

DOT approved | 12-inch under-clearance at axle | 7,000-lb. side-mount crank jack | Dual leaf spring suspension | Rubber mounted sealed lights | Wire storage basket | Two safety chains with snap hooks

Semi-Trash Pump:

2-inch suction and discharge that handles solids up to 3/4-inch diameter | Heavy-duty powder coated wraparound frame with 1-inch steel tubing | Silicon carbide mechanical seals | Precision molded cast iron impeller and volute for reduced vibration and wear

Limited Warranties:

1 year trailer | 2 year pump | 3 year Honda engine | 3 year water tank

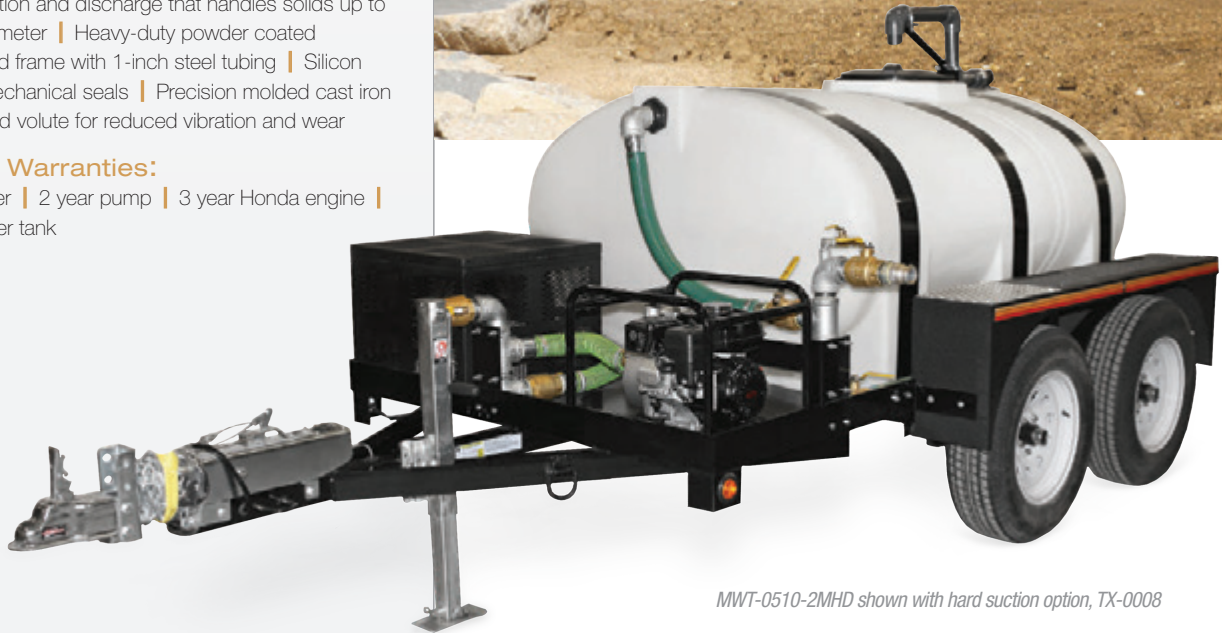

MWT-0510-2MHD shown with hard suction option, TX-0008

The dual-axle water trailer features a 510-gallon water tank and features rear spray, fire and garden hose hook-ups and hydrant fill capabilities. It is great for dust control, cleaning parking lots and transporting water to remote locations.

MODEL NUMBER	DISPLACEMENT/ ENGINE	PUMP	HITCH	TIRES	AXLES	BED FRAME	DIMENSIONS (LxWxH)	TRAILER WT. (EMPTY)	TRAILER WT. (LOADED)
MWT-0510-2MHD	118cc Honda GX120 OHV	2in. semi-trash	2in., ball	(4) ST225-75 15in.	(2) 3,500 lb. tandem with hydraulic surge brakes	5ft.x8ft.	13ft. 7in.x82in.x70in.	1,580 lb.	5,900 lb.

Options:

PART NUMBER	DESCRIPTION
TX-0008	Hard suction option - Allows you to draw water from an auxiliary source (pond, water pit, etc.). The fire hose is designed to be used with pressurized water and lays flat for easy storage.
TX-0010	Adjustable trailer coupler hitch - Replaces the standard 2-inch ball hitch with a 2-inch trailer hitch with pin-style fastener trailer coupler and hinged ball socket
TX-0019	Lunette ring hitch - Replaces the standard 2-inch ball hitch with an 3-inch integrated lunette ring for use with pintle hitches

As a company we continually strive for advancements in technology, therefore the design of the Mi-T-M water trailer may change after the publication of this catalog.

PWR Series

Recovery & Recycle System

PWR Series Trailer Package



PWR-10-0ME1 shown with standard accessories: oil absorbing boom, 33-0529; stainless-steel suction head, 21-0306; 50-ft. vacuum hose, 855-0057; and 20-ft. water berm, 33-0520; also shown with wheel kit option, WX-0106 and dual filters option, WX-0109

The Portable Water Recovery Series is the ideal tool for remote cleaning applications. It efficiently captures and reclaims wash water for reuse or proper disposal if necessary. The compact design makes it an easy addition to trailer packages.

The PWR Series allows for wash water to be reclaimed on the jobsite. Water is reclaimed by using the 20-foot water berm (included) to stop water from flowing down a drain or away from your area. The suction head draws wash water into a holding chamber where a second pump forces the water through an optional 10-micron bag filter before returning it to the holding tank for reuse or proper disposal.

Features:

- 1/3 HP transfer pump | Oil absorbing boom/sock |
- Vacuum tank drain | 3-stage vacuum motor |
- Stainless-steel suction head | Cam lock fittings |
- 50-foot vacuum hose | 55-gallon capacity |
- 20-foot water berm

Limited Warranties:

- 1 year motor, transfer pump and all components

PWR Series Trailer Package Includes:

Portable Water Recovery Trailer AW-9000-0010

- 5-foot x 8½-foot dual-axle trailer
- 200-gallon water tank enclosed in powder coated steel frame
- Swivel jack with stand
- Rubber mounted sealed lights
- 50-foot inlet garden hose with hose reel
- 100-foot high pressure hose with hose reel
- Tank feed for pressure washer
- Option to direct feed water from inlet hose reel

PWR-10-0ME1 with WX-0129 Option for Trailer

Includes all standard PWR Series features, as well as:

- Mounts to AW-9000-0010 trailer
- 2 bag filters - 10 and 50-micron (other bags are available down to 1.0-micron, consult factory)
- Automatic discharge to outlet valve for reuse or discharge

Hot Water Pressure Washer, HS-3505-1MGH with HX-0252 Option for Trailer

- 3500 PSI @ 4.2 GPM
- 688cc Honda GX630 OHV gasoline engine
- Belt drive triplex piston clutch driven General pump
- Trailer tank feed
- 80-mesh inlet Y-strainer
- Generator wired for burner and PWR-10-0ME1 with WX-0129 dual filters option
- Consult factory for additional options available for the HS-3505-1MGH

MODEL NUMBER	VACUUM MOTOR	TANK CAPACITY	FILTER PUMP	WATER BERM	DIMENSIONS (LxWxH)	SHIP WT.	NET WT.
PWR-10-0ME1	3-stage, 1500W, 12.5A full load	55-gallons	1/3 HP, 8.0A, 120VAC, 60Hz, 10	6in.x20ft.	48x42x60in.	340 lb.	290 lb.

Accessories & Options:

PART NUMBER	DESCRIPTION	PART NUMBER	DESCRIPTION
19-0249	10-micron filter bag - 1 qty., fits inside WX-0108 and WX-0109 filters	TX-0019	Lunette ring hitch - Replaces the standard 2-inch ball hitch with an 3-inch integrated lunette ring for use with pintle hitches; for AW-9000-0010 trailer package
19-0267	50-micron filter bag - 1 qty., fits inside WX-0109 filter	WX-0106	Wheel kit - Includes two flat-free tires with powder coated steel frame and handle
21-0306	Stainless-steel suction head	WX-0108	Single bag filter - Uses 10-micron bag #19-0249
33-0520	Water berm - 6-in. x 20-ft.	WX-0109	Dual filters - Uses 10-micron bag #19-0249 and 50-micron bag #19-0267
33-0529	Oil absorbing boom - Oil sock for inside of tank	WX-0129	Dual filters for PWR-10-0ME1 trailer-mount package
855-0057	50-ft. X 1½-in. vacuum hose - Can have up to 100-ft. of extension hose		
TX-0010	Adjustable trailer coupler hitch - Replaces the standard 2-inch ball hitch with a 2-inch trailer hitch with pin-style fastener trailer coupler and hinged ball socket, for AW-9000-0010 trailer package		

Air Compressors



Work Pro® Series

Single Stage – Electric/Gasoline – 3, 4 or 5-Gallon



AM1-HM04-05WP



NEMA 5-15P,
15-amp plug

The perfect size for jobs around the house or small workshop. Completely portable, the Work Pro Series delivers great air power for drills, grinders and nail guns. This single stage compressor is built to perform and built to last.



AM1-PE02-05M

Compressor Pump:

Oil lubricated aluminum crankcase | Copper discharge hose (Electric models) | Stainless-steel braided discharge hose (Gasoline models) | Cartridge air filter

Motor:

Thermal overload motor protection

Frame:

Powder coated tank design | Protective pump/motor housing

Components:

Regulator and two gauges for tank and outlet pressure | Drain and pressure relief valves | Industrial interchange quick connect fittings (Electric models) | Start/stop control set at 95 to 125-PSI

Limited Warranties:

1 year compressor pump | 1 year electric motor | 1 year Mi-T-M engine | 3 year Honda engine

Certification:

CSA Certified - US and Canada (AM1-HE02-04M and AM1-PE02-05M)

ELECTRIC MODELS										
MODEL NUMBER	CFM @ PSI	HORSEPOWER/MOTOR	COMPRESSOR	CYLINDER	TANK SIZE	TYPE	PLUG TYPE	DIMENSIONS (LxWxH)	SHIP WT.	NET WT.
AM1-HE15-03M	3.0 @ 90	1.5 HP, 120V, 15.0A	Single stage	Cast iron	3-gallon	Hand carry	NEMA 5-15P	22.5x10.5x22.25in.	46 lb.	41 lb.
AM1-HE02-04M	4.2 @ 90	2.0 HP, 120V, 15.0A	Single stage	Cast iron	4-gallon	Hand carry	NEMA 5-15P	21.5x16x15.75in.	68 lb.	60 lb.
AM1-PE02-05M	4.2 @ 90	2.0 HP, 120V, 15.0A	Single stage	Cast iron	5-gallon	Portable	NEMA 5-15P	19.75x19x33.5in.	79 lb.	69 lb.

GASOLINE MODELS										
MODEL NUMBER	CFM @ PSI	DISPLACEMENT/ENGINE	COMPRESSOR	TANK SIZE	ENGINE IDLE CONTROL	DIMENSIONS (LxWxH)	SHIP WT.	NET WT.		
AM1-HH04-05WP	4.8 @ 90	118cc Honda GX120 OHV	Single stage, aluminum	5-gallon	Pneumatic	21x17.25x21.75in.	85 lb.	77 lb.		
AM1-HM04-05WP	4.8 @ 90	136cc Mi-T-M OHV	Single stage, aluminum	5-gallon	Pneumatic	21x17.25x21.75in.	85 lb.	77 lb.		

Accessory:

PART NUMBER	DESCRIPTION	FITS MODELS
70-0357	Engine oil drain extension	AM1-HH04-05WP & AM1-HM04-05WP

Work Pro® Series

Single or Two Stage – Electric/Gasoline – 8-Gallon

Compressor Pump:

Splash oil lubricated aluminum crankcase | Stainless-steel braided discharge hose | Oil level sight indicator

Motor:

Thermal overload motor protection

Frame:

Powder coated 8-gallon twin tank receivers | 3/16-inch base plate to reduce vibration | 16-gauge powder coated two-piece belt guard | 10-inch flat-free tire (Two-stage models have two tires)

Components:

Regulator and two gauges for tank and outlet pressure | Drain and pressure relief valves | Fly wheel | Industrial-grade pressure switch (Electric model) | Quality pilot valve unloader (Gasoline models)

Limited Warranties:

1 year compressor pump | 1 year electric motor | 1 year Mi-T-M engine | 3 year Honda engine

Certification:

CSA Certified - US and Canada (AM1-PE15-08WP)



AM2-PH09-08WP



NEMA 5-15P,
15-amp plug



AM1-PM65-08WP

The high performing Work Pro Series is offered in an 8-gallon electric or gas-driven air compressor. Available as a single or two-stage compressor it can power everything from impact wrenches and nail guns to paint sprayers and staplers.

ELECTRIC MODEL								
MODEL NUMBER	CFM @ PSI	HORSEPOWER/MOTOR	COMPRESSOR	TANK SIZE	PLUG TYPE	DIMENSIONS (LxWxH)	SHIP WT.	NET WT.
AM1-PE15-08WP	7.3 @ 90	1.5 HP, 115V, 13.2A	Single stage, aluminum	8-gallon	NEMA 5-15P	44.5x18.5x25in.	160 lb.	140 lb.
GASOLINE MODELS								
MODEL NUMBER	CFM @ PSI	DISPLACEMENT/ENGINE	COMPRESSOR	TANK SIZE	ENGINE IDLE CONTROL	DIMENSIONS (LxWxH)	SHIP WT.	NET WT.
AM1-PH06-08WP	9.0 @ 90	196cc Honda GX200 OHV	Single stage, aluminum	8-gallon	Pneumatic	44.5x18.5x27in.	160 lb.	135 lb.
AM1-PM06-08WP	9.0 @ 90	212cc Mi-T-M OHV	Single stage, aluminum	8-gallon	Cable throttle	44.5x18.5x27in.	160 lb.	135 lb.
AM1-PH65-08WP	13.9 @ 90	196cc Honda GX200 OHV	Single stage, aluminum	8-gallon	Pneumatic	44.5x18.5x27in.	170 lb.	145 lb.
AM1-PM65-08WP	13.9 @ 90	212cc Mi-T-M OHV	Single stage, aluminum	8-gallon	Cable throttle	44.5x18.5x27in.	170 lb.	145 lb.
AM2-PH09-08WP	17.2 @ 175*	270cc Honda GX270 OHV	Two stage, aluminum	8-gallon	Pneumatic	44x26x31in.	200 lb.	175 lb.
AM2-PM09-08WP	17.2 @ 175*	300cc Mi-T-M OHV	Two stage, aluminum	8-gallon	Pneumatic	44x26x31in.	200 lb.	175 lb.

*Equipped with 150-PSI maximum rated regulator.

Accessories & Options:

PART NUMBER	DESCRIPTION	FITS MODELS	PART NUMBER	DESCRIPTION	FITS MODELS
70-0357	Engine oil drain extension	Single stage models	IX-0055	Remote start/choke: 6-ft. wire extension for key switch. You will also need to order electric start option, AX-0015.	AM2-PH09-08WP
70-0358	Engine oil drain extension	Two stage models			
AW-6000-1002	Equipment cover	All models			
AX-0002	Auto drain/regulator/plastic bowl	AM1-PE15-08WP	IX-0059	Remote start/choke: 6-ft. wire extension for key switch, sealed cable. You will also need to order electric start option, AX-0015.	AM2-PH09-08WP
AX-0003	Manual drain/regulator/metal bowl	All models			
AX-0015	Electric start - battery and cables not included	AM2-PH09-08WP			

5-Gallon

Single Stage – Gasoline



AM1-HM04-05M

This little powerhouse is ready to tackle even the most demanding jobs. Its portability makes it a great choice for remote jobsites. Use the hand-carry 5-gallon air compressor to get jobs done around your home and workshop.



Compressor Pump:

Oil lubricated aluminum crankcase | Stainless-steel braided discharge hose | Cartridge air filter

Frame:

Powder coated steel frame and roll cage design | 5-gallon powder coated tank receivers

Components:

Regulator and two gauges for tank and outlet pressure | Drain and pressure relief valves | Quality pilot valve unloader

Limited Warranties:

1 year compressor pump | 1 year Mi-T-M engine | 3 year Honda engine

MODEL NUMBER	CFM @ PSI	DISPLACEMENT/ENGINE	COMPRESSOR	CYLINDER	TANK SIZE	ENGINE IDLE CONTROL	DIMENSIONS (LxWxH)	SHIP WT.	NET WT.
AM1-HH04-05M	4.8 @ 90	118cc Honda GX120 OHV	Single stage	Cast iron	5-gallon	Pneumatic	21x17.5x22.25in.	85 lb.	77 lb.
AM1-HM04-05M	4.8 @ 90	136cc Mi-T-M OHV	Single stage	Cast iron	5-gallon	Pneumatic	21x17.5x22.25in.	85 lb.	77 lb.

Accessory:

PART NUMBER	DESCRIPTION	FITS MODELS
70-0357	Engine oil drain extension	All models

8-Gallon

Single Stage – Gasoline

Compressor Pump:

Splash lubricated | Stainless-steel braided discharge hose | Large canister intake filter | Oil level sight indicator

Frame:

Powder coated 8-gallon twin tank receivers | 3/16-inch base plate to reduce vibration | 16-gauge powder coated two-piece belt guard | 10-inch flat-free tire

Components:

Regulator and two gauges for tank and outlet pressure | Manual drain valves for proper maintenance | 12-inch fly wheel | Quality pilot valve unloader

Limited Warranties:

2 year pump exchange (see page 73 for more information) | 3 year Honda and Kohler engines

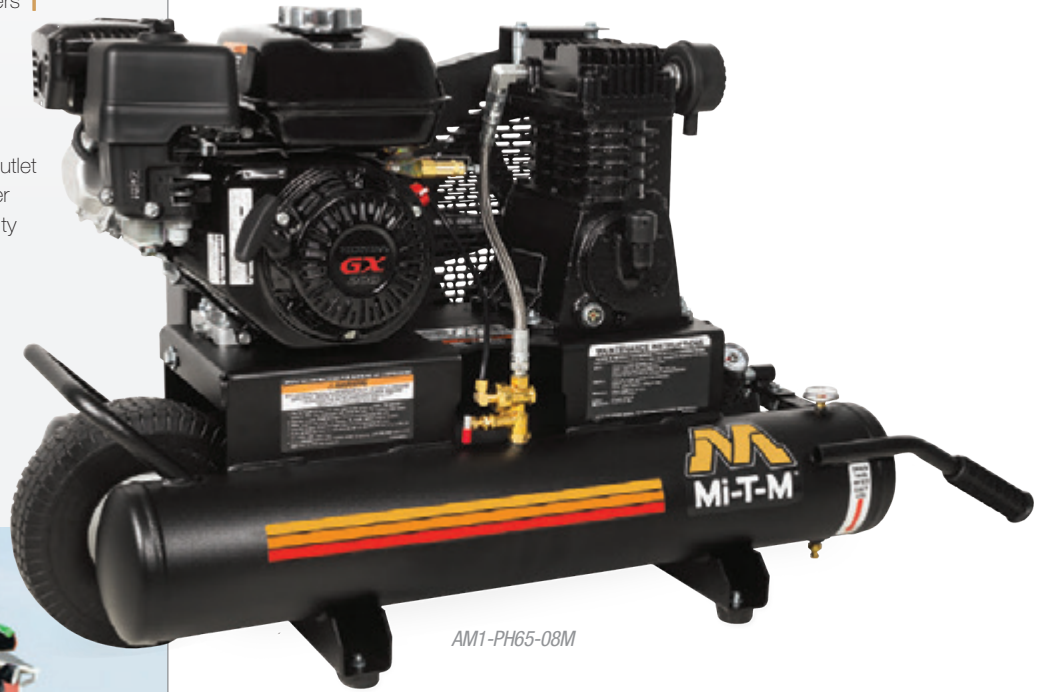

AM1-PH65-08M



Contractors love the portability of this wheelbarrow style 8-gallon air compressor. It is designed for maximum efficiency to provide essential air power for multiple tools around most construction sites.

MODEL NUMBER	CFM @ PSI	DISPLACEMENT/ENGINE	COMPRESSOR	TANK SIZE	ENGINE IDLE CONTROL	DIMENSIONS (LxWxH)	SHIP WT.	NET WT.
AM1-PH65-08M	13.9 @ 90	196cc Honda GX200 OHV	Single stage, cast iron	8-gallon	Pneumatic	44.5x18.5x27in.	200 lb.	175 lb.
AM1-PK07-08M	13.9 @ 90	208cc Kohler CH270 OHV	Single stage, cast iron	8-gallon	Cable throttle	44.5x18.5x27in.	200 lb.	175 lb.

Accessories & Options:

PART NUMBER	DESCRIPTION	FITS MODELS
70-0357	Engine oil drain extension	All models
854-0093	Service mount truck kit - <i>recommended for models that are mounted in service truck applications. You will also need to order stationary option, AX-0078.</i>	All models
AW-6000-1002	Equipment cover	All models
AX-0003	Manual drain/regulator/metal bowl	All models
AX-0078	Stationary option	All models

20-Gallon

Single Stage – Gasoline



AM1-PH65-20M

If you need a lot of air capacity on the go this machine is for you. This model features a powerful single stage compressor that is designed for maximum productivity. It is the ideal tool for large construction sites.



Compressor Pump:

Splash lubricated | Stainless-steel braided discharge hose | Large canister intake filter | Oil level sight indicator

Frame:

Powder coated ASME coded 20-gallon receiver tank | $\frac{3}{8}$ -inch base plate to reduce vibration | 16-gauge powder coated two-piece belt guard | 10-inch flat-free tires

Components:

Regulator and two gauges for tank and outlet pressure | Manual drain valves for proper maintenance | 12-inch fly wheel | Quality pilot valve unloader

Limited Warranties:

2 year pump exchange (see page 73 for more information) | 3 year Honda engine

Certification:

ASME Boiler and Pressure Vessel Code - UM

MODEL NUMBER	CFM @ PSI	DISPLACEMENT/ENGINE	COMPRESSOR	TANK SIZE	ENGINE IDLE CONTROL	DIMENSIONS (LxWxH)	SHIP WT.	NET WT.
AM1-PH65-20M	13.9 @ 90	196cc Honda GX200 OHV	Single stage, cast iron	20-gallon	Pneumatic	37x23.5x33in.	272 lb.	212 lb.

Accessories & Options:

PART NUMBER	DESCRIPTION	FITS MODEL	PART NUMBER	DESCRIPTION	FITS MODEL
7-0228A01	Rear lifting handle	AM1-PH65-20M	AX-0003	Manual drain/regulator/metal bowl	AM1-PH65-20M
70-0357	Engine oil drain extension	AM1-PH65-20M	AX-0027	Stationary kit	AM1-PH65-20M
AW-6000-1002	Equipment cover	AM1-PH65-20M			

8-Gallon

Two Stage – Gasoline

Compressor Pump:

Splash lubricated | Stainless-steel braided discharge hose | Large canister intake filter | Oil level sight indicator

Frame:

Powder coated 8-gallon twin tank receivers | 3/16-inch base plate to reduce vibration | 14-gauge powder coated two-piece belt guard | 10-inch flat-free tires

Components:

Regulator and two gauges for tank and outlet pressure | Manual drain valves for proper maintenance | 16 1/2-inch fly wheel | Quality pilot valve unloader

Limited Warranties:

2 year pump exchange (see page 73 for more information) | 3 year Honda and Kohler engines



AM2-PK95-08M



The two stage wheelbarrow style 8-gallon air compressor is ideal for both contractors and remodelers where a higher CFM and air pressure is a must. Use it to power a multitude of air tools such as air hammers and impact wrenches.

MODEL NUMBER	CFM @ PSI*	DISPLACEMENT/ENGINE	COMPRESSOR	TANK SIZE	ENGINE IDLE CONTROL	DIMENSIONS (LxWxH)	SHIP WT.	NET WT.
AM2-PH09-08M	17.2 @ 175	270cc Honda GX270 OHV	Two stage, cast iron	8-gallon	Pneumatic	44x26x31in.	330 lb.	260 lb.
AM2-PK95-08M	17.2 @ 175	277cc Kohler CH395 OHV	Two stage, cast iron	8-gallon	Cable throttle	44x26x31in.	330 lb.	260 lb.

*Equipped with 150-PSI maximum rated regulator.

Accessories & Options:

PART NUMBER	DESCRIPTION	FITS MODELS
AW-6000-1002	Equipment cover	All models
AX-0003	Manual drain/regulator/metal bowl	All models
AX-0015	Electric start - battery and cables not included	AM2-PH09-08M
IX-0055	Remote start/choke: 6-ft. wire extension for key switch. You will also need to order electric start option, AX-0015.	AM2-PH09-08M
IX-0059	Remote start/choke: 6-ft. wire extension for key switch, sealed cable. You will also need to order electric start option, AX-0015.	AM2-PH09-08M

20-Gallon

Two Stage – Gasoline



AM2-SH09-20M

This model features a powerful and efficient two stage compressor designed to maximize productivity. The versatility of the 20-gallon air compressor offers extra air storage and comes in stationary or portable models.

Compressor Pump:

Splash lubricated | Stainless-steel braided discharge hose | Large canister intake filter | Oil level sight indicator

Frame:

Powder coated ASME coded 20-gallon receiver tank | 3/8-inch base plate to reduce vibration | 14-gauge powder coated two-piece belt guard | 13-inch flat-free tires (AM2-PH09-20M)

Components:

Regulator and two gauges for tank and outlet pressure | Manual drain valves for proper maintenance | 16 1/2-inch fly wheel | Quality pilot valve unloader

Limited Warranties:

2 year pump exchange (see page 73 for more information) | 3 year Honda engine

Certification:

ASME Boiler and Pressure Vessel Code - UM



PORTABLE MODEL

MODEL NUMBER	CFM @ PSI*	DISPLACEMENT/ENGINE	COMPRESSOR	TANK SIZE	ENGINE IDLE CONTROL	DIMENSIONS (LxWxH)	SHIP WT.	NET WT.
AM2-PH09-20M	17.2 @ 175	270cc Honda GX270 OHV	Two stage, cast iron	20-gallon	Pneumatic	46x26x39.5in.	356 lb.	306 lb.

STATIONARY MODEL

MODEL NUMBER	CFM @ PSI*	DISPLACEMENT/ENGINE	COMPRESSOR	TANK SIZE	ENGINE IDLE CONTROL	DIMENSIONS (LxWxH)	SHIP WT.	NET WT.
AM2-SH09-20M	17.2 @ 175	270cc Honda GX270 OHV	Two stage, cast iron	20-gallon	Pneumatic	37x18x38in.	356 lb.	306 lb.

**Equipped with 150-PSI maximum rated regulator.*

Accessories & Options:

PART NUMBER	DESCRIPTION	FITS MODELS	PART NUMBER	DESCRIPTION	FITS MODELS
854-0093	Service mount truck kit - recommended for models that are mounted in service truck applications	AM2-SH09-20M	AX-0017	Electric start - battery and cables included	All models
AW-0007-0196	Rear lifting handle (N/A for models with AX-0017 option)	AM2-PH09-20M	IX-0055	Remote start/choke: 6-ft. wire extension for key switch. You will also need to order electric start option, AX-0015.	All models
AW-6000-1002	Equipment cover	All models	IX-0059	Remote start/choke: 6-ft. wire extension for key switch, sealed cable. You will also need to order electric start option, AX-0015.	All models
AX-0003	Manual drain/regulator/metal bowl	All models			
AX-0015	Electric start - battery and cables not included	All models			

30 & 80-Gallon / Base-Mount Two Stage – Gasoline

Compressor Pump:

Splash lubricated | Stainless-steel braided discharge hose | Large canister intake filter | Oil level sight indicator

Engine:

Electric start - battery and cables not included

Frame:

Powder coated ASME coded 30 or 80-gallon receiver tank (Tank-mounted models only) | 3/16-inch base plate to reduce vibration | 16-gauge powder coated two-piece belt guard | Removable base plate offers flexible installation

Components:

Regulator and two gauges for tank and outlet pressure | ASME safety valves | 16 1/2-inch fly wheel | Tank drain valve | Service truck mount kit (Standard on base-mount models only)

Limited Warranties:

1 year Mi-T-M engine | 2 year pump exchange (see page 73 for more information) | 3 year Honda and Kohler engines

Certifications:

ASME Boiler and Pressure Vessel Code - UM (30-gallon models) | ASME Boiler and Pressure Vessel Code - U (80-gallon models)



ABS-13H-30H



ABS-13H-B

The 30-gallon, 80-gallon and base-mount air compressors are designed to provide high capacity air flow required for most commercial, industrial and automotive industries. Mount one in a service truck and take it to the most demanding jobsite.

TANK-MOUNTED MODELS

MODEL NUMBER	CFM @ PSI*	DISPLACEMENT/ENGINE	COMPRESSOR	TANK SIZE	ENGINE IDLE CONTROL	DIMENSIONS (LxWxH)	SHIP WT.	NET WT.
ABS-13H-30H	29.0 @ 175	389cc Honda GX390 OHV	Two stage, cast iron	30-gallon	Pneumatic	38x23x46in.	480 lb.	416 lb.
ABS-14K-30H	29.0 @ 175	429cc Kohler CH440 OHV	Two stage, cast iron	30-gallon	Cable throttle	38x23x46in.	480 lb.	416 lb.
ABS-14M-30H	29.0 @ 175	420cc Mi-T-M OHV	Two stage, cast iron	30-gallon	Pneumatic	38x23x46in.	480 lb.	416 lb.
ABS-13H-80H	29.0 @ 175	389cc Honda GX390 OHV	Two stage, cast iron	80-gallon	Pneumatic	52x26.5x53in.	560 lb.	496 lb.
ABS-14M-80H	29.0 @ 175	420cc Mi-T-M OHV	Two stage, cast iron	80-gallon	Pneumatic	52x26.5x53in.	560 lb.	496 lb.

BASE-MOUNTED MODELS

MODEL NUMBER	CFM @ PSI*	DISPLACEMENT/ENGINE	COMPRESSOR	TANK SIZE	ENGINE IDLE CONTROL	DIMENSIONS (LxWxH)	SHIP WT.	NET WT.
ABS-13H-B	29.0 @ 175	389cc Honda GX390 OHV	Two stage, cast iron	Base-mount	Pneumatic	36.5x19x28in.	279 lb.	215 lb.
ABS-14M-B	29.0 @ 175	420cc Mi-T-M OHV	Two stage, cast iron	Base-mount	Pneumatic	36.5x19x28in.	279 lb.	215 lb.

*Equipped with 150-PSI maximum rated regulator.

Accessories & Options:

PART NUMBER	DESCRIPTION	FITS MODELS	PART NUMBER	DESCRIPTION	FITS MODELS
AW-6000-1002	Equipment cover	30-gallon & base-mount models	IX-0055	Remote start/choke: 6-ft. wire extension for key switch	Honda models
AX-0077	Battery box and tray	30 & 80-gallon models	IX-0059	Remote start/choke: 6-ft. wire extension for key switch, sealed cable. You will also need to order electric start option, AX-0015.	Honda models
IX-0001	Vibration isolator pads - Isolators protect the unit from vibration during use; Recommended for models that are mounted in service truck applications	30 & 80-gallon models			

30-Gallon

Two Stage – Diesel



ABS-9KD-30H

This diesel-powered machine supplies consistent air flow required for commercial and industrial applications. It is designed for optimum performance and productivity and features a large-capacity ASME coded tank.

Compressor Pump:

Splash lubricated | Stainless-steel braided discharge hose | Large canister intake filter | Oil level sight indicator

Engine:

Electric start - battery, box and cables not included | Glow plug equipped engine for easy starting in cold temperatures

Frame:

Powder coated ASME coded 30-gallon receiver tank | $\frac{3}{8}$ -inch base plate to reduce vibration | 16-gauge powder coated two-piece belt guard | Removable base plate offers flexible installation

Components:

Regulator and two gauges for tank and outlet pressure | ASME safety valves | Tank drain valve

Limited Warranties:

2 year pump exchange (see page 73 for more information) | 3 year Kohler engine

Certification:

ASME Boiler and Pressure Vessel Code - UM



MODEL NUMBER	CFM @ PSI*	HORSEPOWER/ENGINE	COMPRESSOR	ENGINE IDLE CONTROL	DIMENSIONS (LxWxH)	SHIP WT.	NET WT.
ABS-9KD-30H	29.0 @ 175	9.1 HP Kohler KD440 OHV	Two stage, cast iron	Cable throttle	38x23x46.5in.	540 lb.	483 lb.

**Equipped with 150-PSI maximum rated regulator.*

Accessory & Options:

PART NUMBER	DESCRIPTION	FITS MODEL
AW-6000-1002	Equipment cover	ABS-9KD-30H
AX-0079	Battery box, cables and tray	ABS-9KD-30H
IX-0001	Vibration isolator pads - Isolators protect the unit from vibration during use. Recommended for models that are mounted in service truck applications	ABS-9KD-30H

Rotary Screw

Single Stage – Gasoline

Compressor Pump:

Integrated air/oil separator | Integrated thermostatic bypass valve | Integrated oil filter | Banded 4 V-belt drive system | Easy-to-read oil level indicator | High oil temperature shutdown

Engine:

Electric start - battery and cables included | Low-oil level shutdown

Frame:

Powder coated steel frame with 1¼-inch roll cage, handle, 4-point lifting hook, winch point and tie-down anchors | 15-inch pneumatic tires

Components:

10½-gallon aluminized steel fuel tank | Oil cooler with guard | Pressure gauge | Ball valve controlled ¾-inch outlet | Adjustable pilot valve adjusts engine RPM based on air power needed

Limited Warranties:

3 year standard when RotorLub™ oil, filters and parts are used at the prescribed intervals | 3 year Kohler engine



AR1-PK37-M



Powered by industry proven components, the patented Mi-T-M Rotary Screw Compressor works great in a wide variety of applications. This compact machine produces 115 CFM @ 100 PSI, and the 10½-gallon fuel tank gives you the extended run time needed on many jobsites.

MODEL NUMBER	CFM @ PSI	DISPLACEMENT/ENGINE	COMPRESSOR	ENGINE IDLE CONTROL	DIMENSIONS (LxWxH)	SHIP WT.	NET WT.
AR1-PK37-M	115 @ 100	999cc Kohler CH1000 OHV	Single stage, rotary screw	Pneumatic	50.75x30.5x43.5in.	770 lb.	698 lb.

Accessories & Options:

PART NUMBER	DESCRIPTION	FITS MODEL
19-0278	Oil filter	AR1-PK37-M
19-0279	Air/oil separator	AR1-PK37-M
AW-2200-0001	Wye ball valve assembly	AR1-PK37-M
AW-2200-0002	Water separator assembly	AR1-PK37-M
AW-2200-0003	Pressure regulator assembly	AR1-PK37-M
AW-2200-0004	Champion RotorLub™ 8000, 5-gallon pail	AR1-PK37-M
AW-2200-0005	Champion RotorLub™ 8000, 1-gallon bottle	AR1-PK37-M
AX-0076	Skid feet	AR1-PK37-M

5-Gallon

Single Stage – Electric



AM1-HE02-05M



NEMA 5-15P,
15-amp plug

Easy to use yet big on performance this 5-gallon air compressor is the perfect tool for any jobsite where electricity is accessible. Perfect for finishing work it provides enough power for nail guns and drills.

Compressor Pump:

Oil lubricated aluminum crankcase | Stainless-steel braided discharge hose | Inlet air filter

Motor:

Thermal overload motor protection

Frame:

Powder coated tank assembly | Protective pump/motor housing

Components:

Regulator and two gauges for tank and outlet pressure | Drain and pressure relief valves | Industrial interchange quick connect fittings | Start/stop control set at 95 to 125-PSI

Limited Warranties:

1 year compressor pump | 1 year electric motor

Certification:

CSA Certified - US and Canada



MODEL NUMBER	CFM @ PSI	HORSEPOWER/MOTOR	COMPRESSOR	CYLINDER	TANK SIZE	PLUG TYPE	DIMENSIONS (LxWxH)	SHIP WT.	NET WT.
AM1-HE02-05M	4.2 @ 90	2.0 HP, 120V, 15.0A	Single stage	Cast iron	5-gallon	NEMA 5-15P	20.5x15.5x17.5in.	70 lb.	61 lb.

8-Gallon

Single Stage – Electric

Compressor Pump:

Splash lubricated | Stainless-steel braided discharge hose | Large canister intake filter | Oil level sight indicator

Motor:

Auto start/stop - continuous run optional | Thermal overload motor protection

Frame:

Powder coated 8-gallon twin tank receivers | 3/16-inch base plate to reduce vibration | 16-gauge powder coated two-piece belt guard | 10-inch flat-free tire

Components:

Regulator and two gauges for tank and outlet pressure | Manual drain valves for proper maintenance | 10-inch fly wheel | Industrial-grade pressure switch | Start/stop control set at 95 to 125-PSI (Not on continuous run models)

Limited Warranties:

1 year electric motor | 2 year pump exchange (see page 73 for more information)

Certification:

CSA Certified - US and Canada



AM1-PE15-08M

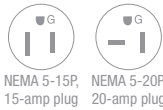

NEMA 5-15P, 15-amp plug | NEMA 5-20P, 20-amp plug

The popular 8-gallon electric air compressor features advanced technology and performance so you can power up everything from drills to grinders and paint guns. Its portability makes it a great choice on many jobsites.

MODEL NUMBER	CFM @ PSI	HORSEPOWER/MOTOR	COMPRESSOR	TANK SIZE	PLUG TYPE	DIMENSIONS (LxWxH)	SHIP WT.	NET WT.
AM1-PE15-08M	7.3 @ 90	1.5 HP, 120V, 13.2A	Single stage, cast iron	8-gallon	NEMA 5-15P	44.5x18.5x25in.	190 lb.	170 lb.
AM1-PE02-08M	9.2 @ 90	2.0 HP, 120V, 18.8A	Single stage, cast iron	8-gallon	NEMA 5-20P	44.5x18.5x25in.	203 lb.	183 lb.

Accessory & Options:

PART NUMBER	DESCRIPTION	FITS MODELS
AW-6000-1002	Equipment cover	All models
AX-0002	Auto drain/regulator/plastic bowl	All models
AX-0003	Manual drain/regulator/metal bowl	All models
AX-0005	Dual control - continuous run & auto start/stop	All models
AX-0078	Stationary option	All models

20-Gallon

Single Stage – Electric



AM1-PE02-20M

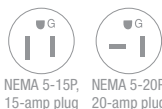

Designed for tough jobs with enough air capacity to run multiple air tools at once, this air compressor is easy to transport yet maintains the power needed for really big projects.

Compressor Pump:

Splash lubricated | Stainless-steel braided discharge hose | Large canister intake filter | Oil level sight indicator

Motor:

Auto start/stop - continuous run optional | Thermal overload motor protection

Frame:

Powder coated ASME coded 20-gallon receiver tank | 3/8-inch base plate to reduce vibration | 16-gauge powder coated two-piece belt guard | 10-inch flat-free tires

Components:

Regulator and two gauges for tank and outlet pressure | Manual drain valves for proper maintenance | 10-inch fly wheel | Industrial-grade pressure switch

Limited Warranties:

1 year electric motor | 2 year pump exchange (see page 73 for more information)

Certifications:

CSA Certified - Canada only | ASME Boiler and Pressure Vessel Code - UM



AIR COMPRESSORS

MODEL NUMBER	CFM @ PSI	HORSEPOWER/MOTOR	COMPRESSOR	TANK SIZE	PLUG TYPE	DIMENSIONS (LxWxH)	SHIP WT.	NET WT.
AM1-PE15-20M	7.3 @ 90	1.5 HP, 120V, 13.2A	Single stage, cast iron	20-gallon	NEMA 5-15P	40x24x32in.	265 lb.	196 lb.
AM1-PE02-20M	9.2 @ 90	2.0 HP, 120V, 18.8A	Single stage, cast iron	20-gallon	NEMA 5-20P	40x24x32in.	272 lb.	203 lb.

Accessory & Options:

PART NUMBER	DESCRIPTION	FITS MODELS
AW-6000-1002	Equipment cover	All models
AX-0002	Auto drain/regulator/plastic bowl	All models
AX-0003	Manual drain/regulator/metal bowl	All models
AX-0008	Dual control - continuous run & auto start/stop	All models
AX-0027	Stationary kit	All models

80 & 120-Gallon

Two Stage – Electric – Simplex & Duplex

Compressor Pump:

Splash lubricated | Stainless-steel braided discharge hose | Large canister intake filter | Oil level sight indicator

Motor:

Industrial low RPM motor | Magnetic start for thermal overload protection

Frame:

Powder coated ASME coded 80 or 120-gallon receiver tank | 3/16-inch base plate to reduce vibration | Totally enclosed powder coated belt guard

Components:

ASME safety valves | Tank pressure gauge | Hour meter | Large fly wheel | Intake filter/silencer | Tank shut-off valve | 3 position switch - compressor 1 (lead motor pump), automatic alternating and compressor 2 (lead motor pump) (Duplex models)

Limited Warranties:

1 year electric motor | 2 year pump exchange (see page 73 for more information)

Certification:

ASME Boiler and Pressure Vessel Code - U



ACS-23105-80V



The horizontal and vertical 80-gallon and 120-gallon air compressors can be installed in service shops where compressed air is a required utility. Powerful and efficient they are designed to maximize production.

SIMPLEX HORIZONTAL MODELS

MODEL NUMBER	CFM @ PSI	HORSEPOWER/MOTOR	PUMP RPM	COMPRESSOR	TANK SIZE	DIMENSIONS (LxWxH)	BOLT DOWN (LxW)	SHIP WT.	NET WT.
ACS-23105-80H	18.0 @ 175	5.0 HP, 230V, 1Ø, 23.0A	860	Two stage, cast iron	80-gallon	52x26.5x53in.	20.75x23.5in.	585 lb.	514 lb.
ACS-20305-80H	18.0 @ 175	5.0 HP, 200V, 3Ø, 16.1A	860	Two stage, cast iron	80-gallon	52x26.5x53in.	20.75x23.5in.	585 lb.	514 lb.
ACS-23305-80H	18.0 @ 175	5.0 HP, 230V, 3Ø, 13.8A	860	Two stage, cast iron	80-gallon	52x26.5x53in.	20.75x23.5in.	585 lb.	514 lb.
ACS-46305-80H	18.0 @ 175	5.0 HP, 460V, 3Ø, 6.9A	860	Two stage, cast iron	80-gallon	52x26.5x53in.	20.75x23.5in.	585 lb.	514 lb.
ACS-23175-80H	23.5 @ 175	7.5 HP, 230V, 1Ø, 31.0A	1250	Two stage, cast iron	80-gallon	52x26.5x53in.	20.75x23.5in.	665 lb.	594 lb.
ACS-20375-80H	23.5 @ 175	7.5 HP, 200V, 3Ø, 23.0A	1250	Two stage, cast iron	80-gallon	52x26.5x53in.	20.75x23.5in.	665 lb.	594 lb.
ACS-23375-80H	23.5 @ 175	7.5 HP, 230V, 3Ø, 20.0A	1250	Two stage, cast iron	80-gallon	52x26.5x53in.	20.75x23.5in.	665 lb.	594 lb.
ACS-46375-80H	23.5 @ 175	7.5 HP, 460V, 3Ø, 10.0A	1250	Two stage, cast iron	80-gallon	52x26.5x53in.	20.75x23.5in.	665 lb.	594 lb.
ADS-23110-120H	34.2 @ 175	10.0 HP, 230V, 1Ø, 39.0A	990	Two stage, cast iron	120-gallon	74x26.5x58in.	34.5x23.5in.	904 lb.	785 lb.
ADS-20310-120H	34.2 @ 175	10.0 HP, 200V, 3Ø, 30.8A	990	Two stage, cast iron	120-gallon	74x26.5x58in.	34.5x23.5in.	904 lb.	785 lb.
ADS-23310-120H	34.2 @ 175	10.0 HP, 230V, 3Ø, 26.8A	990	Two stage, cast iron	120-gallon	74x26.5x58in.	34.5x23.5in.	904 lb.	785 lb.
ADS-46310-120H	34.2 @ 175	10.0 HP, 460V, 3Ø, 13.4A	990	Two stage, cast iron	120-gallon	74x26.5x58in.	34.5x23.5in.	904 lb.	785 lb.
AES-20315-120H	46.5 @ 175	15.0 HP, 200V, 3Ø, 44.0A	776	Two stage, cast iron	120-gallon	74x26.5x58in.	34.5x23.5in.	995 lb.	876 lb.
AES-23315-120H	46.5 @ 175	15.0 HP, 230V, 3Ø, 38.0A	776	Two stage, cast iron	120-gallon	74x26.5x58in.	34.5x23.5in.	995 lb.	876 lb.
AES-46315-120H	46.5 @ 175	15.0 HP, 460V, 3Ø, 19.0A	776	Two stage, cast iron	120-gallon	74x26.5x58in.	34.5x23.5in.	995 lb.	876 lb.

80 & 120-Gallon

Two Stage – Electric – Simplex & Duplex



ADD-23310-120H

SIMPLEX VERTICAL MODELS

MODEL NUMBER	CFM @ PSI	HORSEPOWER/MOTOR	PUMP RPM	COMPRESSOR	TANK SIZE	DIMENSIONS (LxWxH)	BOLT DOWN (LxW)	SHIP WT.	NET WT.
ACS-23105-80V	18.0 @ 175	5.0 HP, 230V, 1Ø, 23.0A	860	Two stage, cast iron	80-gallon	33x25x73in.	15.63x15.63in.	585 lb.	514 lb.
ACS-20305-80V	18.0 @ 175	5.0 HP, 200V, 3Ø, 16.1A	860	Two stage, cast iron	80-gallon	33x25x73in.	15.63x15.63in.	585 lb.	514 lb.
ACS-23305-80V	18.0 @ 175	5.0 HP, 230V, 3Ø, 13.8A	860	Two stage, cast iron	80-gallon	33x25x73in.	15.63x15.63in.	585 lb.	514 lb.
ACS-46305-80V	18.0 @ 175	5.0 HP, 460V, 3Ø, 6.9A	860	Two stage, cast iron	80-gallon	33x25x73in.	15.63x15.63in.	585 lb.	514 lb.
ACS-23175-80V	23.5 @ 175	7.5 HP, 230V, 1Ø, 31.0A	1250	Two stage, cast iron	80-gallon	33x25x73in.	15.63x15.63in.	665 lb.	594 lb.
ACS-20375-80V	23.5 @ 175	7.5 HP, 200V, 3Ø, 23.0A	1250	Two stage, cast iron	80-gallon	33x25x73in.	15.63x15.63in.	665 lb.	594 lb.
ACS-23375-80V	23.5 @ 175	7.5 HP, 230V, 3Ø, 20.0A	1250	Two stage, cast iron	80-gallon	33x25x73in.	15.63x15.63in.	665 lb.	594 lb.
ACS-46375-80V	23.5 @ 175	7.5 HP, 460V, 3Ø, 10.0A	1250	Two stage, cast iron	80-gallon	33x25x73in.	15.63x15.63in.	665 lb.	594 lb.

DUPLEX HORIZONTAL MODELS

MODEL NUMBER	CFM @ PSI	HORSEPOWER/MOTOR	PUMP RPM	COMPRESSOR	TANK SIZE	DIMENSIONS (LxWxH)	BOLT DOWN (LxW)	SHIP WT.	NET WT.
ACD-23105-120H	36.0 @ 175	5.0 HP, 230V, 1Ø, 46.0A	860	Two stage, cast iron	120-gallon	74x26.5x58in.	34.5x23.5in.	920 lb.	841 lb.
ACD-20305-120H	36.0 @ 175	5.0 HP, 200V, 3Ø, 32.2A	860	Two stage, cast iron	120-gallon	74x26.5x58in.	34.5x23.5in.	920 lb.	841 lb.
ACD-23305-120H	36.0 @ 175	5.0 HP, 230V, 3Ø, 27.6A	860	Two stage, cast iron	120-gallon	74x26.5x58in.	34.5x23.5in.	920 lb.	841 lb.
ACD-46305-120H	36.0 @ 175	5.0 HP, 460V, 3Ø, 13.8A	860	Two stage, cast iron	120-gallon	74x26.5x58in.	34.5x23.5in.	920 lb.	841 lb.
ACD-23175-120H	46.4 @ 175	7.5 HP, 230V, 1Ø, 62.0A	1250	Two stage, cast iron	120-gallon	74x26.5x58in.	34.5x23.5in.	900 lb.	821 lb.
ACD-20375-120H	46.4 @ 175	7.5 HP, 200V, 3Ø, 46.0A	1250	Two stage, cast iron	120-gallon	74x26.5x58in.	34.5x23.5in.	900 lb.	821 lb.
ACD-23375-120H	46.4 @ 175	7.5 HP, 230V, 3Ø, 40.0A	1250	Two stage, cast iron	120-gallon	74x26.5x58in.	34.5x23.5in.	900 lb.	821 lb.
ACD-46375-120H	46.4 @ 175	7.5 HP, 460V, 3Ø, 20.0A	1250	Two stage, cast iron	120-gallon	74x26.5x58in.	34.5x23.5in.	900 lb.	821 lb.
ADD-23110-120H	68.4 @ 175	10.0 HP, 230V, 1Ø, 78.0A	990	Two stage, cast iron	120-gallon	74x26.5x58in.	34.5x23.5in.	1200 lb.	1121 lb.
ADD-20310-120H	68.4 @ 175	10.0 HP, 200V, 3Ø, 61.6A	990	Two stage, cast iron	120-gallon	74x26.5x58in.	34.5x23.5in.	1200 lb.	1121 lb.
ADD-23310-120H	68.4 @ 175	10.0 HP, 230V, 3Ø, 53.6A	990	Two stage, cast iron	120-gallon	74x26.5x58in.	34.5x23.5in.	1200 lb.	1121 lb.
ADD-46310-120H	68.4 @ 175	10.0 HP, 460V, 3Ø, 26.8A	990	Two stage, cast iron	120-gallon	74x26.5x58in.	34.5x23.5in.	1200 lb.	1121 lb.
AED-20315-120H	93.0 @ 175	15.0 HP, 200V, 3Ø, 88.0A	810	Two stage, cast iron	120-gallon	74x26.5x58in.	34.5x23.5in.	1550 lb.	1471 lb.
AED-23315-120H	93.0 @ 175	15.0 HP, 230V, 3Ø, 76.0A	810	Two stage, cast iron	120-gallon	74x26.5x58in.	34.5x23.5in.	1550 lb.	1471 lb.
AED-46315-120H	93.0 @ 175	15.0 HP, 460V, 3Ø, 38.0A	810	Two stage, cast iron	120-gallon	74x26.5x58in.	34.5x23.5in.	1550 lb.	1471 lb.

Accessories & Options:

PART NUMBER	DESCRIPTION	FITS MODELS	PART NUMBER	DESCRIPTION	FITS MODELS
3-0312	Pump	ACS horizontal & vertical models & ACD models	IX-0032	Pneumatic tank drain	ADS, AES, ACD, ADD & AED models
3-0313	Pump	ADS & ADD models	IX-0033	After cooler	ACD models
3-0314	Pump	AES & AED models	IX-0034	After cooler	ADD models
IX-0001	Vibration isolator pads	All models	IX-0035	After cooler	AED models
IX-0002	After cooler	ACS vertical models	IX-0036	Low oil monitor	ADS, AES, ADD & AED models
IX-0003	After cooler	ADS models	IX-0051	Pneumatic tank drain	ACS vertical models
IX-0004	After cooler	AES models	IX-0052	After cooler	ACS horizontal models
IX-0006	Electric tank drain	All models	IX-0056	Pneumatic tank drain	ACS horizontal models
IX-0008	Low oil monitor	ACD horizontal & vertical models & ACD models	IX-0057	Pneumatic tank drain	ACS horizontal models
			IX-0058	Pneumatic tank drain, requires IX-0002 after cooler option	ACS vertical models

M Series

Two Stage – Electric – 80 & 120-Gallon – Simplex & Duplex

Compressor Pump:

Splash lubricated | Stainless-steel braided discharge hose | Large canister intake filter | Oil level sight indicator

Motor:

Industrial low RPM motor | Magnetic start for thermal overload protection

Frame:

Powder coated ASME coded 80 or 120-gallon receiver tank | $\frac{3}{16}$ -inch base plate to reduce vibration | Totally enclosed powder coated belt guard

Components:

ASME safety valves | Tank pressure gauge | Hour meter | Large fly wheel | Intake filter/silencer | Tank shut-off valve | 3 position switch - compressor 1 (lead motor pump), automatic alternating and compressor 2 (lead motor pump) (Duplex models)

Limited Warranties:

1 year electric motor | 2 year pump exchange (see page 73 for more information)

Certification:

ASME Boiler and Pressure Vessel Code - U

Loaded with standard features, the M Series air compressors are available in many motor configurations. Offered with vertical or horizontal tank options, this series comes complete to meet the most demanding industrial applications.



ADS-23110-120HM

M Series

Standard Features

These standard features are what sets the M Series air compressors apart from our standard line-up.



Air-cooled after cooler removes up to 65% of moisture and drops temperature within 10°F of ambient



Low oil sensor does not allow unit to start when oil levels fall below an adequate level



Tank drain automatically drains liquid from the air receiver



Vibration isolator pads protect the tank from stress



ACS-23105-80VM

M Series

Two Stage – Electric – 80 & 120-Gallon – Simplex & Duplex

SIMPLEX HORIZONTAL MODELS

MODEL NUMBER	CFM @ PSI	HORSEPOWER/MOTOR	PUMP RPM	COMPRESSOR	TANK SIZE	DIMENSIONS (LxWxH)	BOLT DOWN (LxW)	SHIP WT.	NET WT.
ACS-23105-80HM	18.0 @ 175	5.0 HP, 230V, 1Ø, 23.0A	860	Two stage, cast iron	80-gallon	52x26.5x53in.	20.75x23.5in.	615 lb.	544 lb.
ACS-20305-80HM	18.0 @ 175	5.0 HP, 200V, 3Ø, 16.1A	860	Two stage, cast iron	80-gallon	52x26.5x53in.	20.75x23.5in.	615 lb.	544 lb.
ACS-23305-80HM	18.0 @ 175	5.0 HP, 230V, 3Ø, 13.8A	860	Two stage, cast iron	80-gallon	52x26.5x53in.	20.75x23.5in.	615 lb.	544 lb.
ACS-46305-80HM	18.0 @ 175	5.0 HP, 460V, 3Ø, 6.9A	860	Two stage, cast iron	80-gallon	52x26.5x53in.	20.75x23.5in.	615 lb.	544 lb.
ACS-23175-80HM	23.5 @ 175	7.5 HP, 230V, 1Ø, 31.0A	1250	Two stage, cast iron	80-gallon	52x26.5x53in.	20.75x23.5in.	780 lb.	709 lb.
ACS-20375-80HM	23.5 @ 175	7.5 HP, 200V, 3Ø, 23.0A	1250	Two stage, cast iron	80-gallon	52x26.5x53in.	20.75x23.5in.	780 lb.	709 lb.
ACS-23375-80HM	23.5 @ 175	7.5 HP, 230V, 3Ø, 20.0A	1250	Two stage, cast iron	80-gallon	52x26.5x53in.	20.75x23.5in.	780 lb.	709 lb.
ACS-46375-80HM	23.5 @ 175	7.5 HP, 460V, 3Ø, 10.0A	1250	Two stage, cast iron	80-gallon	52x26.5x53in.	20.75x23.5in.	780 lb.	709 lb.
ADS-23110-120HM	34.2 @ 175	10.0 HP, 230V, 1Ø, 39.0A	990	Two stage, cast iron	120-gallon	74x26.5x58in.	34.5x23.5in.	890 lb.	811 lb.
ADS-20310-120HM	34.2 @ 175	10.0 HP, 200V, 3Ø, 30.8A	990	Two stage, cast iron	120-gallon	74x26.5x58in.	34.5x23.5in.	890 lb.	811 lb.
ADS-23310-120HM	34.2 @ 175	10.0 HP, 230V, 3Ø, 26.8A	990	Two stage, cast iron	120-gallon	74x26.5x58in.	34.5x23.5in.	890 lb.	811 lb.
ADS-46310-120HM	34.2 @ 175	10.0 HP, 460V, 3Ø, 13.4A	990	Two stage, cast iron	120-gallon	74x26.5x58in.	34.5x23.5in.	890 lb.	811 lb.
AES-20315-120HM	46.5 @ 175	15.0 HP, 200V, 3Ø, 44.0A	990	Two stage, cast iron	120-gallon	74x26.5x58in.	34.5x23.5in.	935 lb.	856 lb.
AES-23315-120HM	46.5 @ 175	15.0 HP, 230V, 3Ø, 38.0A	990	Two stage, cast iron	120-gallon	74x26.5x58in.	34.5x23.5in.	935 lb.	856 lb.
AES-46315-120HM	46.5 @ 175	15.0 HP, 460V, 3Ø, 19.0A	990	Two stage, cast iron	120-gallon	74x26.5x58in.	34.5x23.5in.	935 lb.	856 lb.

SIMPLEX VERTICAL MODELS

MODEL NUMBER	CFM @ PSI	HORSEPOWER/MOTOR	PUMP RPM	COMPRESSOR	TANK SIZE	DIMENSIONS (LxWxH)	BOLT DOWN (LxW)	SHIP WT.	NET WT.
ACS-23105-80VM	18.0 @ 175	5.0 HP, 230V, 1Ø, 23.0A	860	Two stage, cast iron	80-gallon	33x25x73in.	15.63x15.63in.	615 lb.	544 lb.
ACS-20305-80VM	18.0 @ 175	5.0 HP, 200V, 3Ø, 16.1A	860	Two stage, cast iron	80-gallon	33x25x73in.	15.63x15.63in.	615 lb.	544 lb.
ACS-23305-80VM	18.0 @ 175	5.0 HP, 230V, 3Ø, 13.8A	860	Two stage, cast iron	80-gallon	33x25x73in.	15.63x15.63in.	615 lb.	544 lb.
ACS-46305-80VM	18.0 @ 175	5.0 HP, 460V, 3Ø, 6.9A	860	Two stage, cast iron	80-gallon	33x25x73in.	15.63x15.63in.	615 lb.	544 lb.
ACS-23175-80VM	23.5 @ 175	7.5 HP, 230V, 1Ø, 31.0A	1250	Two stage, cast iron	80-gallon	33x25x73in.	15.63x15.63in.	780 lb.	709 lb.
ACS-20375-80VM	23.5 @ 175	7.5 HP, 200V, 3Ø, 23.0A	1250	Two stage, cast iron	80-gallon	33x25x73in.	15.63x15.63in.	780 lb.	709 lb.
ACS-23375-80VM	23.5 @ 175	7.5 HP, 230V, 3Ø, 20.0A	1250	Two stage, cast iron	80-gallon	33x25x73in.	15.63x15.63in.	780 lb.	709 lb.
ACS-46375-80VM	23.5 @ 175	7.5 HP, 460V, 3Ø, 10.0A	1250	Two stage, cast iron	80-gallon	33x25x73in.	15.63x15.63in.	780 lb.	709 lb.

DUPLEX HORIZONTAL MODELS

MODEL NUMBER	CFM @ PSI	HORSEPOWER/MOTOR	PUMP RPM	COMPRESSOR	TANK SIZE	DIMENSIONS (LxWxH)	BOLT DOWN (LxW)	SHIP WT.	NET WT.
ACD-23105-120HM	36.0 @ 175	5.0 HP, 230V, 1Ø, 46.0A	860	Two stage, cast iron	120-gallon	74x26.5x58in.	34.5x23.5in.	950 lb.	871 lb.
ACD-20305-120HM	36.0 @ 175	5.0 HP, 200V, 3Ø, 32.2A	860	Two stage, cast iron	120-gallon	74x26.5x58in.	34.5x23.5in.	950 lb.	871 lb.
ACD-23305-120HM	36.0 @ 175	5.0 HP, 230V, 3Ø, 27.6A	860	Two stage, cast iron	120-gallon	74x26.5x58in.	34.5x23.5in.	950 lb.	871 lb.
ACD-46305-120HM	36.0 @ 175	5.0 HP, 460V, 3Ø, 13.8A	860	Two stage, cast iron	120-gallon	74x26.5x58in.	34.5x23.5in.	950 lb.	871 lb.
ACD-23175-120HM	46.4 @ 175	7.5 HP, 230V, 1Ø, 62.0A	1250	Two stage, cast iron	120-gallon	74x26.5x58in.	34.5x23.5in.	1000 lb.	921 lb.
ACD-20375-120HM	46.4 @ 175	7.5 HP, 200V, 3Ø, 46.0A	1250	Two stage, cast iron	120-gallon	74x26.5x58in.	34.5x23.5in.	1000 lb.	921 lb.
ACD-23375-120HM	46.4 @ 175	7.5 HP, 230V, 3Ø, 40.0A	1250	Two stage, cast iron	120-gallon	74x26.5x58in.	34.5x23.5in.	1000 lb.	921 lb.
ACD-46375-120HM	46.4 @ 175	7.5 HP, 460V, 3Ø, 20.0A	1250	Two stage, cast iron	120-gallon	74x26.5x58in.	34.5x23.5in.	1000 lb.	921 lb.
ADD-23110-120HM	68.4 @ 175	10.0 HP, 230V, 1Ø, 78.0A	990	Two stage, cast iron	120-gallon	74x26.5x58in.	34.5x23.5in.	1300 lb.	1221 lb.
ADD-20310-120HM	68.4 @ 175	10.0 HP, 200V, 3Ø, 61.6A	990	Two stage, cast iron	120-gallon	74x26.5x58in.	34.5x23.5in.	1300 lb.	1221 lb.
ADD-23310-120HM	68.4 @ 175	10.0 HP, 230V, 3Ø, 53.6A	990	Two stage, cast iron	120-gallon	74x26.5x58in.	34.5x23.5in.	1300 lb.	1221 lb.
ADD-46310-120HM	68.4 @ 175	10.0 HP, 460V, 3Ø, 26.8A	990	Two stage, cast iron	120-gallon	74x26.5x58in.	34.5x23.5in.	1300 lb.	1221 lb.
AED-20315-120HM	93.0 @ 175	15.0 HP, 200V, 3Ø, 88.0A	810	Two stage, cast iron	120-gallon	74x26.5x58in.	34.5x23.5in.	1650 lb.	1571 lb.
AED-23315-120HM	93.0 @ 175	15.0 HP, 230V, 3Ø, 76.0A	810	Two stage, cast iron	120-gallon	74x26.5x58in.	34.5x23.5in.	1650 lb.	1571 lb.
AED-46315-120HM	93.0 @ 175	15.0 HP, 460V, 3Ø, 38.0A	810	Two stage, cast iron	120-gallon	74x26.5x58in.	34.5x23.5in.	1650 lb.	1571 lb.

Accessories:

PART NUMBER	DESCRIPTION	FITS MODELS
3-0312	Pump	ACS horizontal & vertical models & ACD models
3-0313	Pump	ADS & ADD models
3-0314	Pump	AES & AED models



ACD-23375-120HM

Air Compressor/Generator Combinations



8-Gallon / Base-Mount Single or Two Stage – Gasoline

Compressor Pump:

Cast iron compressor pump | Splash lubricated |
Stainless-steel braided discharge hose | Large canister
intake filter | Oil level sight indicator

Generator:

Brushless alternator | Total harmonic distortion (THD) less
than 5% | 100% copper windings | Comes standard
with (2) 120V, 20A and (1) 240V, 20A receptacles
(Two-stage models)

Frame:

Powder coated 8-gallon
twin tank receivers
(Portable and stationary
models) | 3/16-inch base
plate to reduce vibration |
16-gauge powder coated
two-piece belt guard |
13-inch flat-free tires (Two-stage
portable models) (10-inch on
AG1-PH65-08M1)

Components:

Regulator and two gauges for tank and
outlet pressure | Manual drain valves for
proper maintenance | 12 or 16 1/2-inch fly
wheel | Quality pilot valve unloader

Limited Warranties:

1 year Mi-T-M engine | 2 year alternator |
2 year pump exchange (see page 73 for
more information) | 3 year Honda and
Kohler engines



AG2-SM14-08M1



NEMA 5-20R,
125V



NEMA L6-20R,
240V

Increase your productivity by merging two vital pieces of equipment into one versatile machine. Ideal for every industrial application requiring both air and electrical power, you'll save space and save money with one machine. Available in stationary, base-mount or portable. Choose the model that best fits your needs.

8-Gallon / Base-Mount

Single or Two Stage – Gasoline

PORTABLE MODELS		ALTERNATOR WATTAGE					RECEPTACLES	DISPLACEMENT/ENGINE	COMPRESSOR	DIMENSIONS (LxWxH)	SHIP WT.	NET WT.
MODEL NUMBER	CFM @ 90 PSI	CFM @ 125 PSI	MAX. OUTPUT	CONT. WITH COMP. ON-LOAD	CONT. WITH COMP. OFF-LOAD							
AG1-PH65-08M1	11.9	10.9	1800 watts	600 watts	1600 watts	(2) NEMA 5-20R	196cc Honda GX200 OHV	Single stage	44.5x26x27.5in.	257 lb.	207 lb.	
AG2-PH13-08M1	16.4	15.7 @ 175*	4000 watts	2300 watts	3500 watts	(2) NEMA 5-20R, (1) NEMA L6-20R	389cc Honda GX390 OHV	Two stage	52x28x34in.	450 lb.	375 lb.	
AG2-PK14-08M1	16.4	15.7 @ 175*	4000 watts	2300 watts	3500 watts	(2) NEMA 5-20R, (1) NEMA L6-20R	429cc Kohler CH440 OHV	Two stage	52x28x34in.	450 lb.	375 lb.	
AG2-PM14-08M1	16.4	15.7 @ 175*	4000 watts	2300 watts	3500 watts	(2) NEMA 5-20R, (1) NEMA L6-20R	420cc Mi-T-M OHV	Two stage	52x28x34in.	450 lb.	375 lb.	

STATIONARY MODELS		ALTERNATOR WATTAGE					RECEPTACLES	DISPLACEMENT/ENGINE	COMPRESSOR	DIMENSIONS (LxWxH)	SHIP WT.	NET WT.
MODEL NUMBER	CFM @ 90 PSI	CFM @ 175 PSI*	MAX. OUTPUT	CONT. WITH COMP. ON-LOAD	CONT. WITH COMP. OFF-LOAD							
AG2-SH13-08M1	16.4	15.7	4000 watts	2300 watts	3500 watts	(2) NEMA 5-20R, (1) NEMA L6-20R	389cc Honda GX390 OHV	Two stage	44x22x34in.	465 lb.	365 lb.	
AG2-SK14-08M1	16.4	15.7	4000 watts	2300 watts	3500 watts	(2) NEMA 5-20R, (1) NEMA L6-20R	429cc Kohler CH440 OHV	Two stage	44x22x34in.	465 lb.	365 lb.	
AG2-SM14-08M1	16.4	15.7	4000 watts	2300 watts	3500 watts	(2) NEMA 5-20R, (1) NEMA L6-20R	420cc Mi-T-M OHV	Two stage	44x22x34in.	465 lb.	365 lb.	

BASE-MOUNT MODELS		ALTERNATOR WATTAGE					RECEPTACLES	DISPLACEMENT/ENGINE	COMPRESSOR	DIMENSIONS (LxWxH)	SHIP WT.	NET WT.
MODEL NUMBER	CFM @ 90 PSI	CFM @ 175 PSI*	MAX. OUTPUT	CONT. WITH COMP. ON-LOAD	CONT. WITH COMP. OFF-LOAD							
AG2-SH13-B	16.4	15.7	4000 watts	2300 watts	3500 watts	(2) NEMA 5-20R, (1) NEMA L6-20R	389cc Honda GX390 OHV	Two stage	47x22x28in.	390 lb.	325 lb.	
AG2-SK14-B	16.4	15.7	4000 watts	2300 watts	3500 watts	(2) NEMA 5-20R, (1) NEMA L6-20R	429cc Kohler CH440 OHV	Two stage	47x22x28in.	390 lb.	325 lb.	
AG2-SM14-B	16.4	15.7	4000 watts	2300 watts	3500 watts	(2) NEMA 5-20R, (1) NEMA L6-20R	420cc Mi-T-M OHV	Two stage	47x22x28in.	390 lb.	325 lb.	

*Equipped with 150-PSI maximum rated regulator.

Accessories & Options:

PART NUMBER	DESCRIPTION	FITS MODELS	PART NUMBER	DESCRIPTION	FITS MODELS
70-0357	Engine oil drain extension	AG1-PH65-08M1	AX-0072*	Electric start - battery box and cables included, battery not included	Kohler models
70-0358	Engine oil drain extension	Two stage models	AX-0073	Electric start - battery, box and cables not included	Mi-T-M engine models
854-0093	Service truck mount kit - recommended for models that are mounted in service truck applications	Two stage portable & stationary models	AX-0074*	Electric start - battery box and cables included, battery not included	Mi-T-M engine models
AW-6000-1002	Equipment cover	All models	AX-0075	Idle down - includes electric start - battery not included	Mi-T-M engine models
AX-0019	Electric start - battery, box and cables not included	Two stage Honda models	IX-0055	Remote start/choke: 6-ft. wire extension for key switch. You will also need to order electric start option, AX-0019 or idle down option, AX-0068.	Two stage Honda models
AX-0028	Lifting hook	Two stage portable & stationary models	IX-0059	Remote start/choke: 6-ft. wire extension for key switch, sealed cable. You will also need to order electric start option, AX-0019 or idle down option, AX-0068.	Two stage Honda models
AX-0063	Lifting hook	Base-mount models			
AX-0064*	Electric start - battery box and cables included, battery not included	Two stage Honda models			
AX-0068	Idle down - includes electric start - battery not included	Two stage Honda models			
AX-0071	Electric start - battery, box and cables not included	Kohler models			

*Note: Battery box cannot be mounted at the factory but can be shipped with the unit for custom mounting. Consult factory for more information.

30-Gallon Two Stage – Gasoline

Compressor Pump:

Splash lubricated | Stainless-steel braided discharge hose | Large canister intake filter | Oil level sight indicator

Generator:

Brushless alternator | Total harmonic distortion (THD) less than 6% | 100% copper windings | Comes standard with (2) 120V, 20A and (1) 240V, 20A receptacles

Frame:

Powder coated ASME coded 30-gallon receiver tank | 3/16-inch base plate to reduce vibration | 16-gauge powder coated two-piece belt guard

Components:

Regulator and two gauges for tank and outlet pressure | Manual drain valves for proper maintenance | 16 1/2-inch fly wheel | Quality pilot valve unloader

Limited Warranties:

1 year Mi-T-M engine | 2 year alternator | 2 year pump exchange (see page 73 for more information) | 3 year Honda and Kohler engines

Certification:

ASME Boiler and Pressure Vessel Code - UM



AG2-SH13-30M



NEMA 5-20R,
125V



NEMA L6-20R,
240V



Featuring an industrial air compressor and generator combination, this machine is durable even in the toughest environments. Whether it's oil fields or farm fields, this versatile machine will deliver enough power to get the job done. Engineered to reduce the space necessary to fit in work and service trucks, this combination unit will meet the needs of mobile mechanics.

30-Gallon

Two Stage – Gasoline



AG2-SK14-30M

MODEL NUMBER	CFM @		MAX. OUTPUT	CONT. WITH COMP.		RECEPTACLES	DISPLACEMENT/ENGINE	COMPRESSOR	DIMENSIONS (LxWxH)	SHIP WT.	NET WT.
	90 PSI	175 PSI*		ON-LOAD	OFF-LOAD						
AG2-SH13-30M	16.4	15.7	4000 watts	2300 watts	3500 watts	(2) NEMA 5-20R, (1) NEMA L6-20R	389cc Honda GX390 OHV	Two stage, cast iron	40x24.5x45in.	550 lb.	450 lb.
AG2-SK14-30M	16.4	15.7	4000 watts	2300 watts	3500 watts	(2) NEMA 5-20R, (1) NEMA L6-20R	429cc Kohler CH440 OHV	Two stage, cast iron	40x24.5x45in.	550 lb.	450 lb.
AG2-SM14-30M	16.4	15.7	4000 watts	2300 watts	3500 watts	(2) NEMA 5-20R, (1) NEMA L6-20R	420cc Mi-T-M OHV	Two stage, cast iron	40x24.5x45in.	550 lb.	450 lb.

*Equipped with 150-PSI maximum rated regulator.

Accessories & Options:

PART NUMBER	DESCRIPTION	FITS MODELS	PART NUMBER	DESCRIPTION	FITS MODELS
70-0358	Engine oil drain extension	All models	AX-0074	Electric start - battery box and cables included, battery not included	AG2-SM14-30M
AW-6000-1002	Equipment cover	All models	AX-0075	Idle down - includes electric start - battery not included	AG2-SM14-30M
AX-0019	Electric start - battery, box and cables not included	AG2-SH13-30M	IX-0001	Vibration isolator pads - <i>Isolators protect the unit from vibration during use. Recommended for models that are mounted in service truck applications</i>	All models
AX-0063	Lifting hook	All models	IX-0055	Remote start/choke: 6-ft. wire extension for key switch. You will also need to order electric start option, AX-0019 or idle down option, AX-0068.	AG2-SH13-30M
AX-0064	Electric start - battery box and cables included, battery not included	AG2-SH13-30M	IX-0059	Remote start/choke: 6-ft. wire extension for key switch, sealed cable. You will also need to order electric start option, AX-0019 or idle down option, AX-0068.	AG2-SH13-30M
AX-0068	Idle down - includes electric start - battery not included	AG2-SH13-30M			
AX-0070	Battery tray, box and 2-ft. of cables	All models			
AX-0071	Electric start - battery, box and cables not included	AG2-SK14-30M			
AX-0072	Electric start - battery box and cables included, battery not included	AG2-SK14-30M			
AX-0073	Electric start - battery, box and cables not included	AG2-SM14-30M			

30-Gallon Two Stage – Diesel

Compressor Pump:

Splash lubricated | Stainless-steel braided discharge hose | Large canister intake filter | Oil level sight indicator

Generator:

Brushless alternator | Total harmonic distortion (THD) less than 6% | 100% copper windings | Comes standard with (2) 120V, 20A and (1) 240V, 20A receptacles

Engine:

Electric start - battery, box and cables not included | Glow plug equipped engine for easy starting in cold temperatures

Frame:

Powder coated ASME coded 30-gallon receiver tank | 3/16-inch base plate to reduce vibration | 16-gauge powder coated two-piece belt guard

Components:

Regulator and two gauges for tank and outlet pressure | Manual drain valves for proper maintenance | 1 1/2-inch fly wheel | Quality pilot valve unloader

Limited Warranties:

2 year alternator | 2 year pump exchange (see page 73 for more information) | 3 year Kohler engine

Certification:

ASME Boiler and Pressure Vessel Code - UM



AG2-SKD9-30M



NEMA 5-20R,
125V



NEMA L6-20R,
240V



Designed for the agricultural, construction and industrial industries, the 30-gallon air compressor/generator is powered by a diesel engine. This machine fits on the back of a service truck for big jobs in remote locations.

ALTERNATOR WATTAGE

MODEL NUMBER	CFM @ 90 PSI	CFM @ 175 PSI*	MAX. OUTPUT	CONT. WITH COMP.		RECEPTACLES	HORSEPOWER/ENGINE	COMPRESSOR	DIMENSIONS (LxWxH)	SHIP WT.	NET WT.
				ON-LOAD	OFF-LOAD						
AG2-SKD9-30M	16.4	15.7	3000 watts	2300 watts	2750 watts	(2) NEMA 5-20R, (1) NEMA L6-20R	9.1 HP Kohler KD440 OHV	Two stage, cast iron	41x23x47in.	554 lb.	489 lb.

***Equipped with 150-PSI maximum rated regulator.**

Accessories & Options:

PART NUMBER	DESCRIPTION	FITS MODEL	PART NUMBER	DESCRIPTION	FITS MODEL
70-0380	Engine oil drain extension	AG2-SKD9-30M	IX-0001	Vibration isolator pads - Isolators protect the unit from vibration during use. Recommended for models that are mounted in service truck applications	AG2-SKD9-30M
AW-6000-1002	Equipment cover	AG2-SKD9-30M			
AX-0070	Battery tray, box and 2-ft. of cables	AG2-SKD9-30M			

Uses & Benefits

Air Compressor/Generator Combination Units

Uses for an Air Compressor/Generator Combination

Air Compressor

- Impact wrenches, grinders, drills and nailers
- Shops
- Tires
- Sand blasters
- Paint sprayers
- Air/hydraulic pumps
- Air tools
- Air jacks
- Grease pumps

Generator

- Jobsites
- Power tools
- Offices
- Farms
- Industrial plants
- Homes
- Battery chargers
- Fans
- Electric/hydraulic pumps
- Saws, drills and grinders
- Mobile lights



Benefits of an Air Compressor/Generator Combination

- Compressor/generator combinations double the convenience - you can operate air tools and at the same time power lights in your work area
- Save money by purchasing one combination unit instead of an air compressor and generator separately
- Offers a relatively small footprint compared to owning two pieces of equipment
- Only one unit to maintain, therefore saving time and money on troubleshooting and parts
- Handy for remote locations where air and power are both required but not available
- Travels well - the stationary models can be mounted on the back of a service truck or work trailer
- The 20-amp outlets on the large AG2 models can run a small wire-feed welder typically used on farms
- Commonly used in the following industries/applications:
 - Agricultural
 - Construction
 - Auto service industry/roadside assistance
 - Virtually any service truck that repairs equipment in the field or on a farm or construction site



AG2-SH13-B

Air Compressor/Generator/ Welder Combinations



Uses & Benefits

Air Compressor/Generator/Welder Combination Units

Uses for an Air Compressor/Generator/Welder Combination

Air Compressor

- Impact wrenches, grinders, drills and nailers
- Shops
- Tires
- Sand blasters
- Paint sprayers
- Air/hydraulic pumps
- Air tools
- Air jacks
- Grease pumps

Generator

- Jobsites
- Power tools
- Offices
- Farms
- Industrial plants
- Homes
- Battery chargers
- Fans
- Electric/hydraulic pumps
- Saws, drills and grinders
- Mobile lights

Welder

This stick welder will work for construction or field repair with the following materials:

- Carbon steel
- Stainless-steel
- Low and high alloy steel
- Ductile iron
- Cast iron



Benefits of an Air Compressor/Generator/Welder Combination

- Compressor/generator/welder combinations offer convenience - you can operate air tools and at the same time power lights or weld in your work area
- Save money by purchasing one combination unit instead of an air compressor, generator and welder separately
- Offers a relatively small footprint compared to owning three pieces of equipment
- Only one unit to maintain, therefore saving time and money on troubleshooting and parts
- Used in remote locations where air, power and welding are required but not available
- Travels well - the stationary models can be mounted on the back of a service truck or work trailer
- The 20-amp outlets can run a small wire-feed welder typically used on farms
- Commonly used in the following industries/applications:
 - Agricultural
 - Construction
 - Auto service industry/roadside assistance
 - Virtually any service truck that repairs equipment in the field or on a farm or construction site



AGW Series

Two Stage – Gasoline – 20-Gallon, 30-Gallon or Base-Mount

Compressor Pump:

Splash lubricated | Stainless-steel braided discharge hose | Large canister intake filter | Oil level sight indicator

Generator:

Brush-type 2 pole 120V/240V alternator | Total harmonic distortion (THD) less than 6% | 100% copper windings

Welder:

Amperage selection switch, 170A or 220A maximum

Frame:

Powder coated ASME coded receiver tanks (Not available on AGW-SM14-B) | 16-gauge powder coated belt guard (14-gauge on AGW-SH22-20M)

Components:

Regulator and two gauges for tank and outlet pressure | Manual drain valves for proper maintenance | 16½-inch fly wheel

Limited Warranties:

1 year Mi-T-M engine | 2 year alternator | 2 year pump exchange (see page 73 for more information) | 3 year Honda engine

Certification:

ASME Boiler and Pressure Vessel Code - UM (20 and 30-gallon models)

Dependability of high quality equipment is vital in every industry, so is working with equipment that can save both time and money. The combination air compressor, generator, and arc welder is the ideal tool for emergency field repairs in remote locations. Save room on your service truck with this versatile all-in-one solution.



AGW-SH22-20M

AGW Series Operation

Generator Mode

- AC current only
- Selector switch set to idle down
- Switch is set to full throttle

Welder Mode

- DC current only
- Engine must be running full throttle
- Selector switch must be set to full throttle

AGW Series

Two Stage – Gasoline – 20-Gallon, 30-Gallon or Base-Mount



AGW-SM14-30M

MODEL NO.	AGW-SH22-20M	AGW-SM14-30M	AGW-SM14-B
ENGINE			
DISPLACEMENT/ENGINE	688cc Honda GX690 OHV with electric start - battery cables included; battery not included	420cc Mi-T-M OHV with electric start - battery and battery cables not included	420cc Mi-T-M OHV with electric start - battery and battery cables not included
RATED SPEED	3600 RPM	3600 RPM	3600 RPM
COMPRESSOR			
CFM @ 90 PSI	30.5	16.4	16.4
CFM @ 175 PSI*	29.0	15.7	15.7
COMPRESSOR	Two stage, cast iron	Two stage, cast iron	Two stage, cast iron
TANK SIZE	20-gallon receiver tank	30-gallon receiver tank	Not applicable – base-mount model
GENERATOR			
MAX. AC OUTPUT	5000 watts	5000 watts	5000 watts
RATED AC OUTPUT	4500 watts	4500 watts	4500 watts
ALTERNATOR WATTAGE			
CONT. ON-LOAD @ 90 PSI	4500 watts	3000 watts	3000 watts
CONT. ON-LOAD @ 175 PSI	4500 watts	2500 watts	2500 watts
FREQUENCY/VOLTAGE	60Hz/120V/240V	60Hz/120V/240V	60Hz/120V/240V
MAX. AMPS (120V/240V)	41.5/20.8	41.5/20.8 off-load	41.5/20.8 off-load
CONT. AMPS (120V/240V)	37.5/18.8	37.5/18.8 off-load	37.5/18.8 off-load
RECEPTACLES	(2) 120V, 20A GFCI duplex (1) 120V/240V, 20A twist lock	(2) 120V, 20A GFCI duplex (1) 120V/240V, 20A twist lock	(2) 120V, 20A GFCI duplex (1) 120V/240V, 20A twist lock
WELDER			
DUTY CYCLE (10 MIN. RUN TIME)	220A @ 40%, 190A @ 60%, 150A @ 100%	150A @ 100%	150A @ 100%
DC VOLTAGE	50-220A working range	50-170A working range	50-170A working range
MISCELLANEOUS			
FUEL TANK	10-gallon	1.85-gallon	1.85-gallon
DIMENSIONS (LxWxH)	47x24x50in.	46x22x47in.	49x22x28.5in.
SHIP WT.	870 lb.	650 lb.	449 lb.
NET WT.	803 lb.	585 lb.	384 lb.

*Equipped with 150-PSI maximum rated regulator.

Accessories & Options:

PART NUMBER	DESCRIPTION	FITS MODELS
70-0358	Engine oil drain extension	Mi-T-M engine models
AW-6000-1002	Equipment cover	Mi-T-M engine models
AW-6000-1003	Equipment cover	AGW-SH22-20M
AX-0070	Battery tray, box and 2-ft. of cables	Mi-T-M engine models
IX-0001	Vibration isolator pads - Isolators protect the unit from vibration during use. Recommended for models that are mounted in service truck applications	AGW-SH22-20M & AGW-SM14-30M

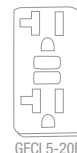

GFCI 5-20R



NEMA L14-20R
120V/240V

Certified Vessel Testing Facility

Mi-T-M's Commitment to Quality

Mi-T-M is certified by the American Society of Mechanical Engineers (ASME), Section VIII, Division 1 to design and manufacture "U" and "UM" pressure vessels (air compressor tanks) ranging in size from 20 gallon up to 90 gallon.

Mi-T-M's pressure vessels for the 20, 30 and 80-gallon air compressors are produced by ASME certified welders using state-of-the-art welding equipment such as automatic seam and robotic welders. Each tank is inspected and hydrostatically tested in accordance with the ASME Code.

This design and inspection process has been implemented in a continued commitment by Mi-T-M to produce only the best designed and highest quality of products for our customers.

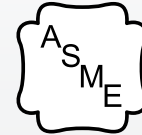

UM
20 & 30-Gallon
Models



U
80 & 120-Gallon
Models

Automated CNC Roll Former rolls up to $\frac{3}{16}$ -inch steel to create the shell of an air compressor vessel



Of the 11 robotic welders at Mi-T-M, one is dedicated to welding air compressor vessels



16 ASME certified welders are qualified to weld with robotic welders and perform manual MIG welding and TIG welder repair



Advanced hydrostatic testing is performed on every air compressor vessel manufactured at Mi-T-M for strength and leaks



A 7-stage powder coating system applies superior finish that is harder and more durable than conventional paint



Every air compressor manufactured by Mi-T-M is tested after the final assembly stage



Compressor Pumps

The Mi-T-M Difference

Best Pump Warranty in the Industry

The Mi-T-M Pump Exchange Program provides Mi-T-M customers pump replacement for the warranty period of two years from the date of purchase. If the air compressor pump fails due to a manufacturing defect during the two year warranty period, Mi-T-M will replace the pump at no charge.

The air compressor should be returned to the Mi-T-M authorized dealer where it was purchased. The dealer will remove the pump and replace it with another single or two stage Mi-T-M pump at no charge. The Pump Exchange Program is not transferable and covers all pump problems with the exception of abuse or lack of basic general maintenance as stated in the owners manual and warranty statement.

2 YEAR PUMP EXCHANGE PROGRAM

Single Stage Cast Iron Compressor Pump

- The sturdy cast iron crankcase is CNC machined and anchored on both sides for balance
- An oversized cast iron crankcase creates a large oil reservoir for reliable lubrication
- Oversized ball-bearing style shaft bearings allow for smooth operation and longer life
- Crankcase is vented to atmosphere through an exclusive labyrinth system, avoiding the presence of oil into the streamline
- High profile fin design on cylinders optimizes heat dissipation
- Reversible cylinder head allows discharge to right or left side of pump
- Large stainless-steel valves offer less restriction to flow, giving greater volumetric efficiency, cooler running temperatures and longer valve life
- Oil sight glass for easy monitoring of the correct oil level
- Industrial-duty inlet filter/silencer for remarkably low sound levels

Cast iron construction with all components precision CNC machined

Two Stage Cast Iron Compressor Pump

1. The sturdy cast iron crankcase is bi-supported for smooth running, longer bearing life and less maintenance.
 2. An oversized cast iron crankcase creates a large oil reservoir for reliable lubrication.
 3. Crankcase is vented to atmosphere.
 4. Oversized ball-bearing style shaft bearings allow for smooth operation and longer life.
 5. Venting system reduces crankcase temperature and pressure.
 6. High profile fin design on cylinders optimizes heat dissipation.
 7. Large stainless-steel valves offer less restriction to flow, giving greater volumetric efficiency, cooler running temperatures and longer valve life.
- Oil sight glass for easy monitoring of the correct oil level (not pictured)
 - Finned copper intercooler for heat dissipation (not pictured)

Low operating speed reduces wear and extends the life of all components

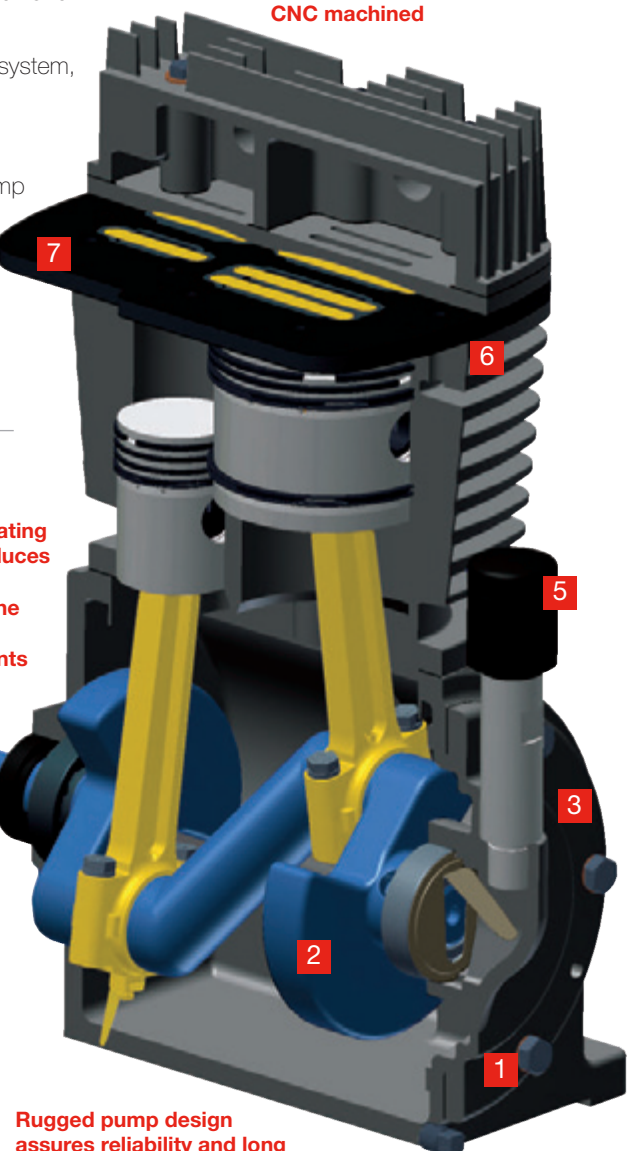

Rugged pump design assures reliability and long maintenance intervals

Air Compressor Accessories

Plugs, Couplers & Fittings

From fittings to drains, pumps to air chucks and everything in between, Mi-T-M is a one-stop shop for all your air compressor accessory needs.



Plugs and Couplers

Add the ability to easily connect and disconnect your air tools and air hoses.

- 17-0049 (1/4-inch MPT - 1/4-inch Industrial Interchange Style plug)
- 17-0043 (1/4-inch MPT - 1/4-inch Industrial Interchange Style coupler)
- 17-0053 (1/4-inch FPT - 1/4-inch Industrial Interchange Style plug)
- 17-0045 (1/4-inch FPT - 1/4-inch Industrial Interchange Style coupler)
- 17-0061 (3/8-inch MPT - 3/8-inch Industrial Interchange Style plug)
- 17-0059 (3/8-inch MPT - 3/8-inch Industrial Interchange Style coupler)
- 17-0062 (3/8-inch FPT - 3/8-inch Industrial Interchange Style plug)
- 17-0060 (3/8-inch FPT - 3/8-inch Industrial Interchange Style coupler)
- 17-0067 (3/8-inch FPT - 1/4-inch Industrial Interchange Style coupler)
- 17-0068 (3/8-inch MPT - 1/4-inch Industrial Interchange Style coupler)
- 17-0050 (1/4-inch MPT - 1/4-inch Automotive Style plug)
- 17-0044 (1/4-inch MPT - 1/4-inch Automotive Style coupler)
- 17-0054 (1/4-inch FPT - 1/4-inch Automotive Style plug)
- 17-0046 (1/4-inch FPT - 1/4-inch Automotive Style coupler)
- 17-0051 (1/4-inch MPT - 1/4-inch Lincoln Style plug)
- 17-0055 (1/4-inch FPT - 1/4-inch Lincoln Style plug)
- 17-0047 (1/4-inch FPT - 1/4-inch Lincoln Style coupler)
- 17-0052 (1/4-inch MPT - 1/4-inch ARO Style plug)
- 17-0056 (1/4-inch FPT - 1/4-inch ARO Style plug)
- 17-0048 (1/4-inch FPT - 1/4-inch ARO Style coupler)
- 23-0017 (3/8-inch to 1/4-inch reducer)



Coupler/Plug Sets

Add the ability to easily connect and disconnect your air tools and air hoses.

- AW-0017-0045K (1/4-inch FPT - 1/4-inch Industrial Interchange Style coupler / 1/4-inch MPT - 1/4-inch Industrial Interchange Style plug)
- AW-0017-0046K (1/4-inch FPT - 1/4-inch Automotive Style coupler / 1/4-inch MPT - 1/4-inch Automotive Style plug)



Coupler Test Bar

Coupler test bar includes four 1/4-inch plugs; Tru-flate Automatic Style, Industrial Interchange Style, ARO Style and Lincoln Style.

17-4952



Barbed Hose Splicers

Repair damaged hoses by combining hose sections together with our barbed hose splicers. Corrosion-resistant brass construction.

23-0415 (Fits 1/4-inch hose ID)

23-0416 (Fits 3/8-inch hose ID)

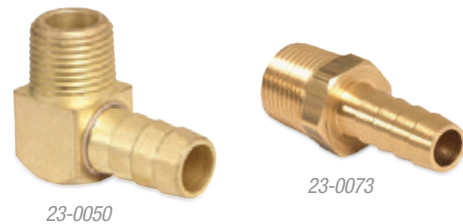

Barbed Hose Fittings

Threaded end connects tools, fittings, couplers and plugs. Barbed hose fittings repair damaged hoses and assemble bulk hose. Corrosion-resistant brass construction.

23-0050 (3/8-inch MNPT x 1/2-inch hose ID)

23-0051 (1/4-inch MNPT x 1/4-inch hose ID)

23-0052 (3/8-inch MNPT x 1/4-inch hose ID)

23-0069 (1/4-inch MNPT x 3/8-inch hose ID)

23-0073 (3/8-inch MNPT x 3/8-inch hose ID)



Brass Couplings

Use to combine two short hoses into one long hose. Corrosion-resistant brass construction.

23-0002 (1/4-inch FNPT x 1/4-inch FNPT)

23-0103 (1/4-inch MNPT x 1/4-inch MNPT)



Steel Hex Nipples

Used for when you have a female NPT thread and need a male NPT thread. Corrosion-resistant steel construction.

24-0010 (3/8-inch x 3/8-inch)

24-0024 (1/2-inch x 3/8-inch)

24-0031 (1/2-inch x 1/2-inch)

24-0145 (1/4-inch x 1/4-inch)

24-0146 (3/8-inch x 1/4-inch)

24-0265 (1/2-inch x 1/4-inch)

Air Compressor Accessories

Air Chucks, Hoses, Blow Guns & Drains



Air Chucks

Use air chucks to help maintain proper tire pressure.

AT-3001 (Dual foot - 1/4-inch FPT)

AT-3002 (Ball foot - 1/4-inch FPT)

AT-3003 (Deluxe air inflator with 12-inch hose; 12 to 120-PSI)



Engine Oil Drain Extensions

14-inch flexible drain hose makes oil changes cleaner and easier.

70-0357

- 118cc Honda GX120 OHV and 196cc Honda GX200 OHV engines
- 136cc and 212cc Mi-T-M OHV engines
- 208cc Kohler CH270 OHV engines

70-0358

- 270cc Honda GX270 OHV and 389cc Honda GX390 OHV engines
- 420cc Mi-T-M OHV engines
- 429cc Kohler CH440 OHV engines

70-0380

- 9.1 HP Kohler KD440 OHV engines



Air Hoses

Ideal for most compressor lines and pneumatic tools. Non-conductive oil and abrasion resistant outer cover.

15-0230 (50-foot x 3/8-inch PVC)

854-0085 (50-foot x 3/8-inch PVC includes quick connects)

15-0231 (25-foot x 3/8-inch PVC)

15-0328 (50-foot x 3/8-inch Hybrid polymer, 1/4-inch MPT)

15-0327 (25-foot x 3/8-inch Hybrid polymer, 1/4-inch MPT)

- 3/8-inch NPT fittings
- Bend restrictors



Air/Liquid Adapter Kit

Used for filling tires with liquids. Connects a standard tractor valve to 3/4-inch garden hose bibb. Push-button bleeder valve releases trapped air. Two extra bushings included to fit standard air/water valves, new style gas flow valves, large bore valves and extensions or standard valve stems.

23-0414



Leader Hose

Our leader hose attaches between the air hose and your tool, allowing for more flexibility and safety.

15-0229

- 24-inch leader hose with swivel
- Flexible hose
- 360° swivel fitting



Electronic Compressor Drain

Automatically drains filters, compressor tanks, drip legs, after coolers and receivers.

AT-4012

- 1/4-inch NPT connector
- For electric air compressors when 110V of power is available



Blow Guns

Our blow guns provide a leak-proof seal for blowing dirt and debris from lines with high pressure air.

AT-3004 (Blow gun, standard rubber tip)

AT-3005 (Blow gun, safety tip)

AT-3007 (AT-3004 with 1-foot extension)

AT-3008 (AT-3004 with 2-foot extension)

AT-3009 (AT-3004 with 4-foot extension)

Air Compressor Accessories

Filters, Regulators, Gauges & Lubricators



19-0217

19-0225

Air Filter Canisters

Houses air filter elements.

19-0215 (2½-inch diameter x ¾-inch M)

- Plastic filter canister

19-0217 (2½-inch diameter x ¾-inch M)

19-0083 (3¼-inch diameter x ½-inch M)

19-0240 (4½-inch diameter x ½-inch M)

19-0219 (4½-inch diameter x 1-inch M)

19-0225 (6-inch diameter x ¾-inch M)

- Metal filter canister



19-0082

Air Filter Elements

Paper air filter replacement elements. The paper passes air through the filter with low restriction, and any dust or dirt in the air is deposited on the pleated outer surface of the element.

19-0218 (2½-inch diameter x ¾-inch M)

- Replacement filter for 19-0217

19-0082 (3¼-inch diameter x ½-inch M)

- Replacement filter for 19-0083

19-0220 (4½-inch diameter x 1-inch M)

- Replacement filter for 19-0219 and 19-0240

19-0226 (6-inch diameter x ¾-inch M)

- Replacement filter for 19-0225



22-0271

22-0257

22-0446

Gauges

Use our gauges to monitor tank and outlet pressures.

22-0257 (200-PSI maximum rating)

22-0271 (300-PSI maximum rating)

22-0446 (250-PSI maximum rating)

- ½-inch MPT



AT-4005-M

AT-4008-M

Filters

Our air compressor filters remove dirt, debris and water from air lines.

AT-4004-M (¼-inch poly bowl)

- Includes bowl guard and manual drain
- 150-psig maximum supply pressure

AT-4005-M (½-inch metal bowl)

- Main line filter
- Includes sight glass and manual drain
- 250-psig maximum supply pressure

AT-4006-M (¾-inch poly bowl)

- General purpose filter
- Includes bowl guard and manual drain
- 150-psig maximum supply pressure

AT-4007-M (Disposable in-line filter)

- ¼-inch MPT x ¼-inch FPT
- Desiccant, disposable filter and regulator in one compact unit

AT-4008-M (Air tool filter)

- ¼-inch MPT x ¼-inch FPT



22-0231

22-0326

Regulators

Regulators reduce and maintain pressure levels to safely operate air tools.

22-0326

- ¼-inch inlet/outlet
- ⅝-inch gauge port
- 250-psig maximum inlet/125-psig maximum outlet

22-0231

- ⅝-inch inlet/outlet
- ⅝-inch gauge port
- 300-psig maximum inlet/150-psig. maximum outlet

22-0358

- ½-inch inlet/outlet
- ¼-inch gauge port
- 300-psig maximum inlet/250-psig. maximum outlet

In-Line Lubricators

Ideal for air tool lubrication.

AT-4009-M (¼-inch poly bowl with bowl guard)

AT-4010-M (⅝-inch poly bowl with bowl guard)

- 150-psig maximum supply pressure

AT-4009-M



Filter/Regulator

Our combination air compressor filter/regulator removes dirt, debris and water from the air line while reducing and maintaining pressure levels to safely operate air tools.

AT-4011-M

- ⅝-inch
- Poly bowl with manual drain
- 150-psig maximum supply pressure



Air Compressor Accessories

Replacement Pumps & Air Estimating Guide

Single Stage Replacement Pumps

Aluminum

3-0425

- Fits single stage electric and gasoline Work Pro Series models

Cast Iron with Cast Iron Head

3-0303

- Fits AM1-PH65-08M and AM1-PK07-08M models

3-0315

- Fits electric models up to 2.0 HP

Two Stage Replacement Pumps

Aluminum

3-0427

- Fits two stage gasoline Work Pro Series models

Cast Iron with Cast Iron Head

3-0298

- Fits 270cc gasoline or 9.1 HP Kohler KD440 diesel engines

3-0304

- Fits gasoline models 389cc up to 429cc

3-0312

- Fits ACS and ACD Series

3-0313

- Fits ADS and ADD Series

3-0314

- Fits AES and AED Series



3-0303

Air Equipment Estimating Guide

Always use free air (CFM) and pressure (PSI) specifications from the nameplate on the device or from the manufacturer. Free air figures (in the table below) are averages and may differ by specific brand.

INDUSTRIAL EQUIPMENT CFM REQUIREMENTS BASED ON NORMAL USAGE

Miscellaneous Portable Tools at 70 to 90 PSI

TOOLS	CFM
Drill, 1/8" to 3/8"	6.3
Drill, 3/8" to 5/8"	8.8
Screwdriver, #2 to #6 Screw	3.0
Screwdriver, #6 to 3/16" Screw	6.0
Tapper, to 3/8"	5.0
Nutsetters, to 3/8"	6.0
Nutsetters, to 3/4"	7.5
Impact Wrench, 1/4"	3.8
Impact Wrench, 3/8"	5.0
Impact Wrench, 1/2"	7.5
Impact Wrench, 3/4"	8.8
Impact Wrench, 1 1/4"	13.8
Die Grinder, Small	3.8
Die Grinder, Medium	6.0
Horizontal Grinder, 2"	5.0
Horizontal Grinder, 4"	15.0
Horizontal Grinder, 6"	15.0
Horizontal Grinder, 8"	20.0
Vertical Grinders and Sander, 5" Pad	8.8
Vertical Grinders and Sander, 7" Pad	15.0
Vertical Grinders and Sander, 9" Pad	17.5
Burring Tool, Small	3.8
Burring Tool, Large	6.0
Rammers, Small	3.3
Rammers, Medium	8.5
Rammers, Large	10.0
Backfill Tamper	6.3
Compression Riveter	0.2 cu. ft. per cycle
Nailer or Stapler	5.0 to 8.0
Riveter	6.0
Paint Spray Gun	5.0
Scaling Hammer	3.0
Chipping Hammer	7.5
Riveting Hammer	7.5
Circular Saw, 8"	11.3
Circular Saw, 12"	16.3
Lightweight Chain Saw	7.0
Heavy-Duty Chain Saw	21.8

AUTOMOTIVE EQUIPMENT CFM REQUIREMENTS BASED ON TOOLS BEING USED 25% OF THE TIME

TOOLS	PSI RANGE	CFM
Air Filter Cleaner	70 to 100	3.0
Body Polisher	70 to 100	2.0
Body Sander, Orbital	70 to 100	5.0
Brake Tester	70 to 100	3.5
Carbon Remover	70 to 100	3.0
Dusting Blow Gun	90 to 100	2.5
Drill, 1/16" to 3/8"	70 to 90	4.0
Impact Wrench, 3/8" Square Drive	70 to 90	2.0
Impact Wrench, 1/2" Square Drive	70 to 90	3.5
Impact Wrench, 3/4" Square Drive	70 to 90	7.5
Impact Wrench, 1" Square Drive	70 to 90	10.0
Die Grinder	70 to 90	5.0
Vertical Disc Sander	90 to 100	10.0
Filing/Sawing Machine, Small	90 to 100	3.0
Filing/Sawing Machine, Large	90 to 100	5.0
Burring Tool	90 to 100	5.0
Tire Rim Stripper	125 to 150	6.0
Tire Changer	125 to 150	5.5
Tire Inflation Line	125 to 150	1.5
Tire Spreader	125 to 150	1.0
Air Hammer	90 to 100	4.0
Tire Hammer	90 to 100	12.0
Bead Breaker	125 to 150	12.0
Spring Oiler	90 to 100	4.0
Spray Gun Engine Cleaner	90 to 100	5.0
Production Paint Spray Gun	90 to 100	8.5
Touch-Up Paint Spray Gun	90 to 100	3.5
Undercoat Paint Spray Gun	90 to 100	19.0
Grease Gun	120 to 150	3.0
Hydraulic Lift	145 to 175	6.0
Hydraulic Floor Jack	125 to 150	6.0
Pneumatic Garage Door	120 to 150	3.0
Radiator Tester	90 to 100	1.0
Transmission/Differential Flusher	70 to 100	3.0
Fender Hammer	70 to 100	9.0
Medium-Duty Sander	70 to 100	40.0

Air System Set-up

Building an Efficient Air System

Compressed-air-powered equipment and machinery are critical elements in the productivity, efficiency and economy of today's industry. Quality air is the essential element for effective operation of this equipment. Water and dirt can cause major problems in compressed air lines. The use of filters that remove moisture and impurities from the air help high-speed pneumatic production lines operate more efficiently. Regulators and lubricators may also be added to control and lubricate downstream equipment. A quality air system can save time, money and keep equipment operating at maximum efficiency.

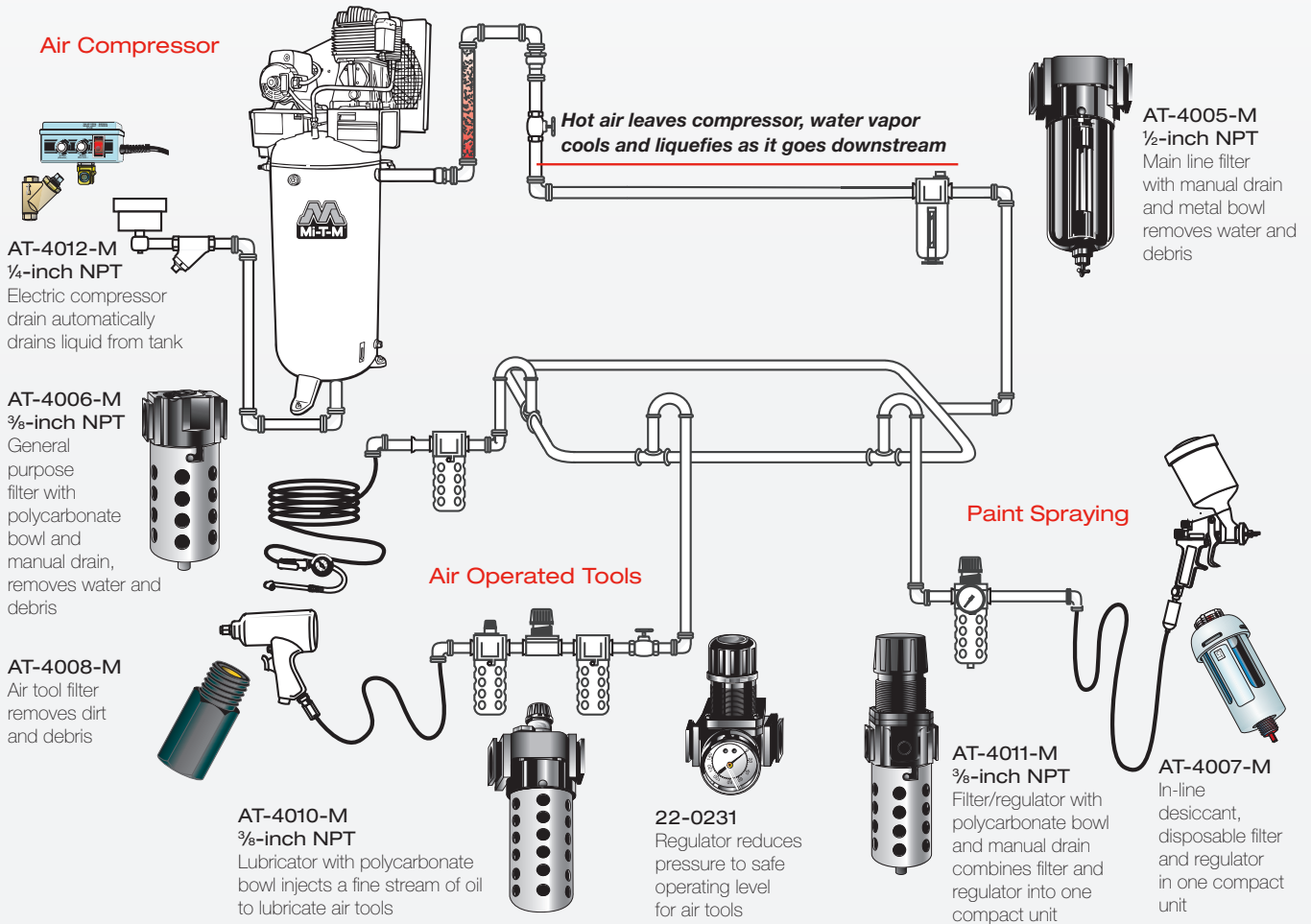

Important Steps for an Air System Set-up

1. Main-line filter and regulator should be installed at least 20-feet from the compressor. The air will cool down, allowing much of the water vapor to condense naturally for removal by filtration.
2. All line-drops (workstations) should be taken from the top of the main line. This prevents water from flowing into branch lines.
3. Galvanized pipe is recommended when building an air system.

Follow illustration to the right when building a workstation drop.

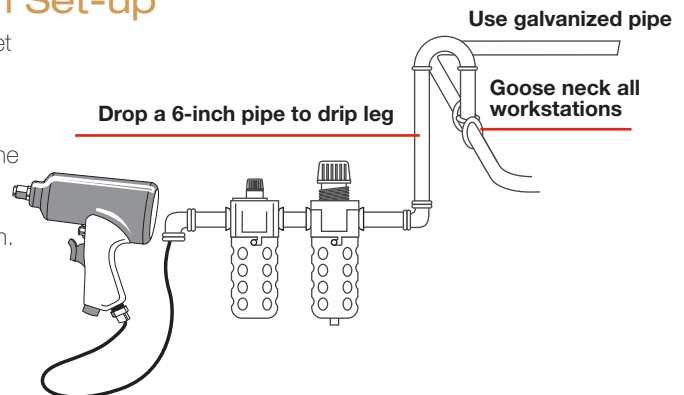

Portable Generators



Inverters

2000 & 3000-Watt – Gasoline

Inverter Technology:

Reduced size, weight, noise and fuel consumption | Produces commercial quality AC power for sensitive electronic equipment

Alternator:

Total harmonic distortion (THD) less than 3% | Copper windings

Engine:

Low-oil shutdown | Recoil start

Frame:

Insulated side panels to reduce noise | Easy grip handle integrated into frame (Two-handles on GEN-3000-IMMO) | Rear folding handle and two wheels for easy transport (GEN-3000-IMMO)

Components:

DC/battery charging | USB port for electronics | Idle control

Miscellaneous:

USDA/USFS-approved spark arrestors

Limited Warranties:

1 year alternator | 1 year Mi-T-M engine

Certification:

CSA Certified



GEN-3000-IMMO

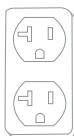

120V Duplex
All Models



NEMA L5-30R
120VAC
GEN-3000-IMMO

Smaller, lighter, quieter and more efficient than conventional generators, the power of a Mi-T-M inverter generator is ultra-clean and in a form that can be used to power sensitive electronic equipment like smartphones, tablets, computers and medical devices.

MODEL NO.	GEN-2000-IMMO	GEN-3000-IMMO
MAX. AC OUTPUT	2000 watts	3000 watts
RATED AC OUTPUT	1600 watts	2800 watts
DISPLACEMENT/ENGINE	79cc Mi-T-M OHV	212cc Mi-T-M OHV
ALTERNATOR	Copper windings	Copper windings
MAX. AMPS (120V)	16.7	25.0
CONT. AMPS (120V)	13.3	23.3
RECEPTACLES	(1) 120V, 20A duplex (1) 12V DC 8.0A	(1) 120V, 20A duplex (1) 120V, 30A twist lock (1) 12V DC 8.3A
MAIN CIRCUIT BREAKER	Yes	Yes
RATED SPEED	3600 RPM	3600 RPM
DECIBEL RATING	68.0	68.0
FUEL CAPACITY	1.1 gallons	1.9 gallons
RUN TIME (AT HALF LOAD)	6.0 hours	6.8 hours
DIMENSIONS (LxWxH)	19.6x11.4x18in.	23.8x17x19.4in.
SHIP WT.	53 lb.	90 lb.
NET WT.	48 lb.	84 lb.

Inverter generator ratings represent no-load sound levels. Noise level tested at seven meters (75% load). Rating represents minimum noise level rating.

Accessories:

PART NUMBER	DESCRIPTION	FITS MODELS
AW-5100-0001	Parallel port box - The AW-5100-0001 can be used on either inverter model or combination of both inverters. Includes a 30A, 120V outlet and a 20A, 120V duplex receptacle. The largest appliance that can be run is 3600 watts – even with (2) GEN-3000 inverters. It is limited by the 30A outlet.	All models
AW-5100-0002	Parallel port box - The AW-5100-0002 can be used on either inverter model or combination of both inverters. Includes a 50A, 120V outlet and a 20A, 120V duplex receptacle. The largest appliance that can be run is 5600 watts – limited by the combined ratings of the machines connected.	All models



GEN-3000-IMMO and GEN-2000-IMMO shown with parallel port box accessory, AW-5100-0002

ChoreMaster® Series

3600, 6000 & 8000-Watt – Gasoline



GEN-3600-0MMO

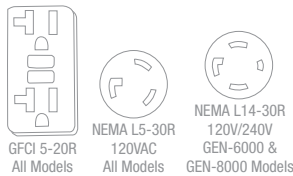

GFCI 5-20R
All Models

NEMA L5-30R
All Models

NEMA L14-30R
120V/240V
GEN-6000 &
GEN-8000 Models

Featuring 3600, 6000 and 8000-watt generators, the ChoreMaster Series come with a Mi-T-M OHV engine and are designed to provide maximum power for contractors and electrical back-up for power outages.



GEN-6000-0MMO

MODEL NO.	GEN-3600-0MMO	GEN-6000-0MMO	GEN-8000-0MMO
MAX. AC OUTPUT	3600 watts	6000 watts	8000 watts
RATED AC OUTPUT	3000 watts	5500 watts	7000 watts
DISPLACEMENT/ENGINE	212cc Mi-T-M OHV	389cc Mi-T-M OHV	420cc Mi-T-M OHV with electric start - battery included
ALTERNATOR	Brushed 120V, 60Hz	Brushed 120V/240V, 60Hz	Brushed 120V/240V, 60Hz
MAX. AMPS (120V/240V)	30.0	50.0/25.0	66.6/33.3
CONT. AMPS (120V/240V)	25.0	45.8/22.9	58.3/29.2
RECEPTACLES	(2) 120V, 20A GFCI duplex (1) 120V, 30A twist lock	(2) 120V, 20A GFCI duplex (1) 120V, 30A twist lock (1) 120V/240V, 30A twist lock	(2) 120V, 20A GFCI duplex (1) 120V, 30A twist lock (1) 120V/240V, 30A twist lock
CIRCUIT BREAKERS	(1) Main circuit breaker (2) 20A circuit breakers, single pole (1) 10A DC breaker	(1) Main circuit breaker (2) 20A circuit breakers, single pole (1) 10A DC breaker	(1) Main circuit breaker (2) 20A circuit breakers, single pole (1) 10A DC breaker
RATED SPEED	3600 RPM	3600 RPM	3600 RPM
DECIBEL RATING	72.0	74.0	74.0
FUEL CAPACITY	4.0 gallons	6.6 gallons	6.6 gallons
RUN TIME (AT FULL LOAD)	8.5 hours	6.5 hours	6.0 hours
IDLE CONTROL	No	Yes	Yes
WHEEL KIT	No	Yes, includes tires and rubber gripped handles	Yes, includes tires and rubber gripped handles
DIMENSIONS (LxWxH)	24.9x17.6x17.9in.	39.1x28.7x30.6in.*	39.1x28.7x30.6in.*
SHIP WT.	134 lb.	228 lb.	237 lb.
NET WT.	102 lb.	180 lb.	195 lb.

Noise level tested at seven meters (75% load). Rating represents minimum noise level rating.
*Dimensions include the wheel kit with the handles in the down position.

Accessories:

PART NUMBER	DESCRIPTION	FITS MODELS	PART NUMBER	DESCRIPTION	FITS MODELS
32-0915	RV generator adapter	All models	AW-6000-1002	Equipment cover	6000 & 8000-watt models
AW-5090-0009	Lifting hook	GEN-3600-0MMO			

Portable Generators

3000 & 5000-Watt – Gasoline

Alternator:

Total harmonic distortion (THD) less than 5% |
100% copper windings

Frame:

Heavy-duty powder coated wraparound frame with
1-inch steel tubing | Angled isolator design features
four neoprene isolators

Components:

Easy-access and protected control panel with magnetic
circuit breakers and GFCI-protected receptacles |
Large low tone muffler | Fuel shut-off valve | Easy-to-
read fuel gauge | Heavy-duty industrial air cleaner

Miscellaneous:

USDA/USFS-approved spark arrestors

Limited Warranties:

2 year alternator | 3 year Honda and Kohler engines

Certification:

CSA Certified



GEN-3000-1MK0



GFCI 5-20R



NEMA L14-20R
120V/240V
GEN-5000
Models



NEMA L5-30R
120VAC
GEN-5000
Models

Perfect for powering a multitude of tools on any jobsite, the 3000-watt and 5000-watt generators were designed with contractors in mind. Long run times mean you don't have to take a refuel break.

MODEL NO.	GEN-3000-1MH0	GEN-3000-1MK0	GEN-5000-0MH0	GEN-5000-0MK0
MAX. AC OUTPUT	3000 watts	3000 watts	5000 watts	5000 watts
RATED AC OUTPUT	2450 watts	2450 watts	4400 watts	4400 watts
DISPLACEMENT/ENGINE	163cc Honda GX160 OHV	208cc Kohler CH270 OHV	270cc Honda GX270 OHV	277cc Kohler CH395 OHV
ALTERNATOR	Brushless 120V, 60Hz	Brushless 120V, 60Hz	Brushless 120V/240V, 60Hz	Brushless 120V/240V, 60Hz
MAX. AMPS (120V/240V)	25.0	25.0	41.7/20.8	41.7/20.8
CONT. AMPS (120V/240V)	20.4	20.4	36.7/18.3	36.7/18.3
RECEPTACLES	(1) 120V, 20A GFCI duplex	(1) 120V, 20A GFCI duplex	(2) 120V, 20A GFCI duplex (1) 120V/240V, 20A twist lock (1) 120V, 30A twist lock	(2) 120V, 20A GFCI duplex (1) 120V/240V, 20A twist lock (1) 120V, 30A twist lock
CIRCUIT BREAKERS	(1) 20A push-button	(1) 20A push-button	(2) 20A toggle circuit breakers, single pole (1) 20A toggle circuit breaker, double pole (1) 30A toggle circuit breaker, single pole	(2) 20A toggle circuit breakers, single pole (1) 20A toggle circuit breaker, double pole (1) 30A toggle circuit breaker, single pole
RATED SPEED	3600 RPM	3600 RPM	3600 RPM	3600 RPM
DECIBEL RATING	74.8	74.8	73.8	73.8
FUEL CAPACITY	2.6 gallons	2.6 gallons	5.7 gallons	5.7 gallons
RUN TIME (AT FULL LOAD)	7.4 hours	7.4 hours	6.8 hours	6.8 hours
FULL POWER SWITCH	No	No	Yes	Yes
DIMENSIONS (LxWxH)	25x18x18in.	25x18x18in.	29x19.75x22.5in.	29x19.75x22.5in.
SHIP WT.	146 lb.	146 lb.	198 lb.	198 lb.
NET WT.	130 lb.	130 lb.	176 lb.	176 lb.

Noise level tested at seven meters (75% load). Rating represents minimum noise level rating.

Accessories & Options:

PART NUMBER	DESCRIPTION	FITS MODELS	PART NUMBER	DESCRIPTION	FITS MODELS
32-0915	RV generator adapter	5000-watt models	AW-5740-0009	Wheel kit with flat-free tires	5000-watt models
AW-5090-0003	Lifting hook	5000-watt models	GX-0004	Hour meter	5000-watt models

Portable Generators

6000, 7500 & 8000-Watt – Gasoline



GEN-7500-0MHE



GFCI 5-20R
All Models



NEMA L14-20R
120V/240V
GEN-6000
Models



NEMA L14-30R
120V/240V
GEN-7500 &
8000 Models



NEMA L5-30R
120VAC
All Models

Jobsites need electric power when it's not readily available from a utility. With the durable 6000-watt, 7500-watt and 8000-watt generators from Mi-T-M, you can have power all day and run multiple tools with quality power that won't let you down.

Alternator:

Total harmonic distortion (THD) less than 5% | 100% copper windings

Frame:

Heavy-duty powder coated wraparound frame with 1-inch steel tubing | Angled isolator design features four neoprene isolators

Components:

Easy-access and protected control panel with magnetic circuit breakers and GFCI-protected receptacles | Large low tone muffler | Fuel shut-off valve | Easy-to-read fuel gauge | Idle control | Voltmeter/hour meter | Heavy-duty industrial air cleaner

Miscellaneous:

USDA/USFS-approved spark arrestors

Limited Warranties:

2 year alternator | 3 year Honda and Kohler engines

Certification:

CSA Certified



GEN-6000-0MHO shown with wheel kit option, AW-5740-0010 and lifting hook option, AW-5090-0004

MODEL NO.	GEN-6000-0MHO / GEN-6000-0MHE / GEN-6000-0MKO	GEN-7500-0MHO / GEN-7500-0MHE	GEN-8000-0MKO / GEN-8000-0MKE
MAX. AC OUTPUT	6000 watts	7500 watts	8000 watts
RATED AC OUTPUT	5000 watts	6500 watts	6900 watts
DISPLACEMENT/ENGINE	389cc Honda GX390 OHV / 389cc Honda GX390 OHV with electric start - battery included / 429cc Kohler CH440 OHV	389cc Honda GX390 OHV / 389cc Honda GX390 OHV with electric start - battery included	429cc Kohler CH440 OHV / 429cc Kohler CH440 OHV with electric start - battery included
ALTERNATOR	Brushless 120V/240V, 60Hz	Brushless 120V/240V, 60Hz	Brushless 120V/240V, 60Hz
MAX. AMPS (120V/240V)	50.0/25.0	62.5/31.3	66.7/33.3
CONT. AMPS (120V/240V)	41.7/20.8	54.2/27.1	57.5/28.8
RECEPTACLES	(2) 120V, 20A GFCI duplex (1) 120V/240V, 20A twist lock (1) 120V, 30A twist lock	(2) 120V, 20A GFCI duplex (1) 120V, 30A twist lock (1) 120V/240V, 30A twist lock	(2) 120V, 20A GFCI duplex (1) 120V, 30A twist lock (1) 120V/240V, 30A twist lock
CIRCUIT BREAKERS	(1) Main circuit breaker (2) 20A toggle circuit breakers, single pole (1) 20A toggle circuit breaker, double pole (1) 30A toggle circuit breaker, single pole	(2) 20A toggle circuit breakers, single pole (1) 30A toggle circuit breaker, single pole (1) 30A toggle circuit breaker, double pole	(2) 20A toggle circuit breakers, single pole (1) 30A toggle circuit breaker, single pole (1) 30A toggle circuit breaker, double pole
RATED SPEED	3600 RPM	3600 RPM	3600 RPM
DECIBEL RATING	77.1	80.0	78.2
FUEL CAPACITY	7.3 gallons	7.3 gallons	7.3 gallons
RUN TIME (AT FULL LOAD)	8.0 hours	6.9 hours	6.9 hours
DIMENSIONS (LxWxH)	29x24.4x22.5in.	29x24.4x22.5in.	29x24.4x22.5in.
SHIP WT.	232 lb. / 240 lb. / 232 lb.	255 lb. / 263 lb.	255 lb. / 259 lb.
NET WT.	210 lb. / 218 lb. / 210 lb.	233 lb. / 241 lb.	233 lb. / 237 lb.

Noise level tested at seven meters (75% load). Rating represents minimum noise level rating.

Accessories:

PART NUMBER	DESCRIPTION	FITS MODELS	PART NUMBER	DESCRIPTION	FITS MODELS
32-0915	RV generator adapter	All models	AW-5740-0010	Wheel kit with flat-free tires	All models
AW-5090-0004	Lifting hook	All models	AW-6000-1002	Equipment cover	All models

Portable Generators

14000-Watt – Gasoline

Alternator:

Total harmonic distortion (THD) less than 5% |
100% copper windings

Frame:

Reinforced 1 1/4-inch powder coated steel tube frame |
13-inch flat-free tires

Components:

Easy-access and protected control panel with magnetic
circuit breakers and GFCI-protected receptacles |
Large low tone muffler | Easy-to-read fuel gauge |
Idle control | Voltmeter/hour meter | Heavy-duty
industrial air cleaner

Miscellaneous:

USDA/USFS-approved spark arrestors

Limited Warranties:

2 year alternator | 3 year Honda engine

Certification:

CSA Certified



GEN-14000-1MHE



The Mi-T-M 14000-watt generator is a virtual power plant. Built for industrial applications with the portability to move from one job to the next, this generator will never let you down. It's the perfect tool for professional contractors.

MODEL NO.	GEN-14000-1MHE
MAX. AC OUTPUT	14000 watts
RATED AC OUTPUT	12000 watts
DISPLACEMENT/ENGINE	688cc Honda GX630 OHV with electric start - battery included
ALTERNATOR	Brushless 120V/240V, 60Hz
MAX. AMPS (120V/240V)	116.7/58.3
CONT. AMPS (120V/240V)	100.0/50.0
RECEPTACLES	(2) 120V, 20A GFCI duplex / (1) 120V, 30A twist lock (1) 120V/240V, 30A twist lock / (1) 120V/240V, 50A
CIRCUIT BREAKERS	(2) 20A toggle circuit breakers single pole / (1) 30A toggle circuit breaker, single pole / (1) 30A toggle circuit breaker, double pole / (1) 50A toggle circuit breaker, double pole
RATED SPEED	3600 RPM
DECIBEL RATING	77.5
FUEL CAPACITY	13.2 gallons
RUN TIME (AT FULL LOAD)	8.0 hours
DIMENSIONS (LxWxH)	31.5x30.5x37.5in.
SHIP WT.	568 lb.
NET WT.	508 lb.

Noise level tested at seven meters (75% load). Rating represents minimum noise level rating.

Accessories & Options:

PART NUMBER	DESCRIPTION	FITS MODEL	PART NUMBER	DESCRIPTION	FITS MODEL
32-0915	RV generator adapter	GEN-14000-1MHE	GX-0003	Skid feet	GEN-14000-1MHE
AW-6000-1002	Equipment cover	GEN-14000-1MHE	GX-0005	50-amp twist lock receptacle	GEN-14000-1MHE



GFCI 5-20R



NEMA L14-30R
120V/240V



NEMA 14-50R
50A



NEMA L5-30R
120VAC



GX-0005 option CS6369A
50A twist lock receptacle

Portable Generators

6000-Watt – Diesel



GEN-6000-0MKD

Portable gasoline generators tend to be the most popular among contractors, but this portable diesel generator provides heavy-duty power for long life and extended operation. Plus, it costs less to operate than its gasoline counterparts.

Alternator:

Total harmonic distortion (THD) less than 5% | 100% copper windings

Frame:

Heavy-duty powder coated wraparound frame with 1-inch steel tubing | Angled isolator design features six neoprene isolators

Components:

Easy-access and protected control panel with magnetic circuit breakers and GFCI-protected receptacles | Fuel shut-off valve | Easy-to-read fuel gauge | Voltmeter/hour meter | Heavy-duty industrial air cleaner

Limited Warranties:

2 year alternator | 3 year Kohler engine

Certification:

CSA Certified



PORTABLE GENERATORS

MODEL NO.	GEN-6000-0MKD
MAX. AC OUTPUT	6000 watts
RATED AC OUTPUT	5000 watts
HORSEPOWER/ENGINE	9.1 HP Kohler KD440 OHV with electric start - battery included
ALTERNATOR	Brushless 120V/240V, 60Hz
MAX. AMPS (120V/240V)	50.0/25.0
CONT. AMPS (120V/240V)	41.7/20.8
RECEPTACLES	(2) 120V, 20A GFCI duplex (1) 120V/240V, 20A twist lock (1) 120V, 30A twist lock
CIRCUIT BREAKERS	(1) Main circuit breaker (2) 20A toggle circuit breakers, single pole (1) 20A toggle circuit breaker, double pole (1) 30A toggle circuit breaker, single pole
RATED SPEED	3600 RPM
DECIBEL RATING	85.0
FUEL CAPACITY	2.6 gallons
RUN TIME (AT FULL LOAD)	6.8 hours
DIMENSIONS (LxWxH)	29x21.62x22.5in.
SHIP WT.	295 lb.
NET WT.	273 lb.

Noise level tested at seven meters (75% load). Rating represents minimum noise level rating.

Accessories:

PART NUMBER	DESCRIPTION	FITS MODEL	PART NUMBER	DESCRIPTION	FITS MODEL
32-0915	RV generator adapter	GEN-6000-0MKD	AW-5740-0006	Wheel kit with flat-free tires	GEN-6000-0MKD
AW-5090-0007	Lifting hook	GEN-6000-0MKD	AW-6000-1002	Equipment cover	GEN-6000-0MKD

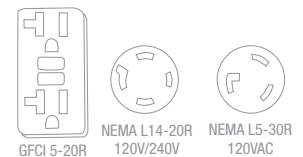

Finding the Right Generator

To select an engine-driven generator, you'll need to determine the power (kilowatt) requirements that must be met under operating conditions.

Undersizing the generator can be avoided by considering all of the loads that will be connected to the generator, and determining the starting requirements (motor start) of electric motor-operated devices.

Be sure the generator you select is large enough to handle your present requirements and anticipated needs.

To determine the right size generator, add up the total watts of all lights, appliances, tools or other equipment to be connected to the generator.

Check the nameplates to determine wattage. If wattage is not shown but amps and volts are given, the following simplified formula may be used:

$$\text{Amps} \times \text{Volts} = \text{Watts}$$

(Ex. 12.5 Amps x 120 Volts = 1500 Watts)

To determine kilowatts (kW), use the following formula:

$$1000 \text{ Watts} = 1 \text{ Kilowatt}$$

(Ex. 1500 Watts/1000 Watts = 1.5 kW)

Charts 1, 2, and 3 will help you select the proper size generator. With lights, heaters and small appliances, simply add the nameplate ratings or see Chart 1 for average wattage requirements. For portable electric tools and equipment, check the nameplate rating or use Chart 2 for average requirements. If watts and/or amps are not given and only the horsepower is shown, use Chart 3 to determine the starting and running watts.

Chart 4 is a guide for selecting the proper size of insulated copper wire when extension cords are used. We recommend the use of outdoor-rated (UL) cable, recognized type SJTW-A.

Chart 1: Home applications - approximate wattage requirements

EQUIPMENT	WATTAGE
Air conditioner (10,000 BTU)	2000–3000
Blanket, electric	150
Broiler	1400
Clothes dryer, electric	5000–10000
Coffee maker	850
Dishwasher	1500–2500
Fan, attic	375
Fan, furnace	800–1200
Fan, window	200
Freezer, food	300–500
Heater, radiant	1300
Hot plate	1250
Refrigerator/freezer	600–2000
Sump pump	400–3000
Toaster	1100–1700
TV, color	100–350
Water heater	3000–4500
Water pump	1000–3000

Chart 2: Portable electric tools - approximate wattage requirements

EQUIPMENT	WATTAGE	EQUIPMENT	WATTAGE
Blower, electric	½–3 hp	Pump, electric	½ hp and up
Compressors	¼–3 hp	Routers	900–1100
Concrete vibrators, ¾-hp	840	Sanders, belt	600–1500
Concrete vibrators, 1-hp	1080	Sanders, disc	1200
Concrete vibrators, 2-hp	1560	Sanders, orbital	250
Concrete vibrators, 3-hp	2400	Saws, chain	800–1500
Drain cleaners	250	Saws, circular, 6-inch	1000–2500
Drills, ¼-inch	250–600	Saws, cutoff	2500
Drills, ⅜-inch	300–600	Saws, jig	200–800
Drills, ½-inch	350–1200	Saws, masonry	2–5 hp
Drills, 1-inch	1000	Saws, radial arm	1–5 hp
Grinders, bench	¼–1 hp	Saws, table	1–3 hp
Grinders, portable	1000–2500	Screwdrivers	550
Hammers, demolition	1260	Shears, metal-cutting	750
Hammers, rotary	1200	Wrenches, impact, ½-inch	600
Heaters, space	¼–2 hp	Wrenches, impact, ¾-inch	720
Lights	check wattage on bulb	Wrenches, impact, 1-inch	1200

Chart 3: Motor starting requirements

MOTOR (HP)	RUNNING WATTS	WATTS REQUIRED TO START MOTOR		
		REPULSION INDUCTION	CAPACITOR	SPLIT PHASE
1/8	275	600	850	1200
1/6	275	600	850	2050
1/4	400	850	1050	2400
1/3	450	975	1350	2700
1/2	600	1300	1800	3600
3/4	850	1900	2600	–
1	1100	2500	3300	–

Chart 4: Insulated copper wire size

CURRENT IN AMPS	LOAD IN WATTS		#4 WIRE	#6 WIRE	#8 WIRE	#10 WIRE	#12 WIRE	#14 WIRE	#16 WIRE	#18 WIRE
	@ 120V	@ 240V								
2.5	300	600	–	–	–	1000	600	375	250	150
5.0	600	1200	–	–	–	500	300	200	125	75
7.5	900	1800	–	–	–	330	200	125	80	50
10.0	1200	2400	–	625	400	250	150	100	50	35
15.0	1800	3600	650	400	265	165	100	50	–	–
20.0	2400	4800	500	300	200	125	80	–	–	–
25.0	3000	6000	400	250	150	100	–	–	–	–
30.0	3600	7200	325	200	125	–	–	–	–	–
35.0	4200	8400	275	175	100	–	–	–	–	–
40.0	4800	9600	250	150	–	–	–	–	–	–
45.0	5400	10800	225	–	–	–	–	–	–	–
50.0	6000	12000	200	–	–	–	–	–	–	–

Portable Generator Accessories

Wheel Kits, Lifting Hooks & Parallel Port Boxes

Wheel Kits

For easier portability.

- AW-5740-0006** (Fits GEN-6000-0MKD)
- AW-5740-0009** (Fits 5000-watt models)
- AW-5740-0010** (Fits 6000, 7500 and 8000-watt gasoline models)
 - Two 10-inch flat-free tires
 - Dual rubber isolator feet
 - Powder coated and rubber gripped handles for comfort

Lifting Hooks

For easier portability.

- AW-5090-0003** (Fits 5000-watt models)
- AW-5090-0004** (Fits 6000, 7500 and 8000-watt gasoline models)
- AW-5090-0007** (Fits GEN-6000-0MKD)
- AW-5090-0009** (Fits GEN-3600-0MM0)
- Made with 1/4-inch powder coated steel
- Bolts to generator with U-bolts
- Folds down and out of the way when not in use



GEN-6000-0MH0 shown with wheel kit option, AW-5740-0010 and lifting hook option, AW-5090-0004

Equipment Cover

The equipment cover will keep your generator clean, dry and looking like new.

- AW-6000-1002**
- Fits generators 6000-watts up to 14000-watts
- Made from 600 denier vinyl-backed polyester



RV Generator Adapter

Use the RV generator adapter to connect RV cordsets to 30A generators.

- 32-0915**
- Fits generators 3200-watts or higher
- 30A/125V female/male

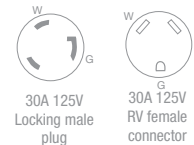

Generator Display Risers

These display risers are the perfect way to elevate Mi-T-M portable generators. Compact and sturdy for multi-level displays of your Mi-T-M equipment.

- AW-9300-0041** (Dimensions: 30-in. W x 26-in. D x 26.5-in. H)
- AW-9300-0042** (Dimensions: 30-in. W x 26-in. D x 12-in. H)
- AW-9300-0043** (Dimensions: 30-in. W x 26-in. D x 6-in. H)
- 41-0594** (Equipment Center display sign; dimensions: 30.5-in. W x 24-in. H)
 - Durable wrinkle-resistant powder coated steel frame and top
 - Occupies a modest amount of valuable floor space
 - Allows for displays at various heights
 - Raises equipment off of floor
 - Heavy-duty base construction



Equipment sold separately

Inverter Parallel Port Boxes

AW-5100-0001

- Can be used on either GEN-2000-IMM0 or GEN-3000-IMM0 or combination of both inverters
- Includes a 30A, 120V outlet and a 20A, 120V duplex receptacle
- The largest appliance that can be run is 3600 watts - even with (2) GEN-3000-IMM0 inverters, it is limited by the 30A outlet

AW-5100-0002

- Can be used on either GEN-2000-IMM0 or GEN-3000-IMM0 or combination of both inverters
- Includes a 50A, 120V outlet and a 20A, 120V duplex receptacle
- The largest appliance that can be run is 5600 watts - limited by the combined ratings of the machines connected



(2) GEN-3000-IMM0 shown with parallel port box accessory, AW-5100-0002

Wet/Dry Vacuums



9-Gallon

Small but mighty, use the 9-gallon wet/dry vacuum to clean up dirt, debris and water without changing the filter. Its rugged construction offers great durability and its low noise level makes it a popular addition to any home workshop.

Motor:

Self-cooling motor design | Quiet operation

Components:

Exhaust air ducting reduces the possibility of motor contamination by dirt or moisture | Industrial-grade caster wheels | Wet and dry filter - no conversion necessary

Construction:

High impact poly canister

Unit Includes:

10-foot x 1¼-inch hose with inlet cuff | 14¼-inch curved plastic wand | 2-piece aluminum/plastic extension wand | 12-inch combination floor tool | 8½-inch crevice tool | 12-inch commercial squeegee floor tool | Cartridge filter | 1 paper filter bag (replacement bags sold in packs of 5 qty.)

Limited Warranties:

2 year - excludes normal wear items | Lifetime on canister

Certification:

CSA Certified - US and Canada



MV-900-OMEV shown with standard accessories

MODEL NUMBER	MOTOR	CFM	WATERLIFT	CAPACITY	WATER RECOVERY	DECIBEL RATING*	ELECTRICAL CORD	DIMENSIONS (LxWxH)	SHIP WT.	NET WT.
MV-900-OMEV	1.3 HP, 120V, 7.5A, 60Hz	101	87in.	9.0 gallons	6.0 gallons	57.4	25ft.	14x14x22in.	36 lb.	25 lb.

**Most wet/dry vacuums have a decibel rating of 63.4 dB(a).*

9-Gallon Accessories

Suction Hose & Fitting

Suction Hose - Bulk

15-0242

- 1½-inch hose without fittings
- Sold in 10-foot increments; 50-foot maximum length

Inlet Cuff

50-0178

- For bulk hose; to connect to vacuum



Inlet cuff, 50-0178 shown on bulk suction hose, 15-0242

Filters

Cartridge Filter

19-0221

- For wet and dry use

Paper Filter Bags

19-0222

- 5 per pack
- Disposable for dry use only
- Recommended for fine dusts



19-0221



19-0222

Wands

Aluminum/Plastic Extension Wand

16-0402

- Plastic wand with aluminum inserts
- Quantity of two required to create the wand

Curved Plastic Wand

16-0403

- 14¼-inch
- Connects hand tools to hose



16-0402



16-0403

Tools

Commercial Squeegee Floor Tool

33-0410

- 12-inch high impact plastic
- Connects directly to extension wand

Combination Floor Tool

33-0411

- 12-inch high impact plastic
- Connects directly to extension wand

Crevice Tool

33-0412

- 8½-inch high impact plastic
- Connects directly to curved plastic wand

Dusting Brush

33-0422

- 2½-inch nylon brush
- Connects directly to curved plastic wand



33-0410



33-0411



33-0412



33-0422

13 & 18-Gallon

Truly the best in their class, the powerful 13-gallon and 18-gallon wet/dry vacuums from Mi-T-M are equipped with a hydro flow filter for both wet and dry applications. These vacuums offer superior cleaning power, yet are rated as some of the quietest on the market.



MV-1300-0MEV shown with standard accessories

Motor:

Self-cooling motor design | Quiet operation

Components:

Exhaust air ducting reduces the possibility of motor contamination by dirt or moisture | Industrial-grade polyolefin wheels with stainless-steel shafts | Hydro flow filter for wet and dry applications - no conversion necessary | Filter decreases airborne particles through exhaust | Filter efficiency 99.5% to 1.0-micron (Optional HEPA filter 99.97% to 0.3-micron)

Construction:

High impact poly canister

Unit Includes:

10-foot x 1½-inch crushproof hose | 2-piece aluminum extension wand | 14-inch commercial squeegee floor tool | 12-inch combination floor tool | 10¾-inch crevice tool | 5-inch upholstery tool | Cartridge filter | 1 paper filter bag (replacement bags sold in packs of 10 qty.)

Limited Warranties:

5 year - excludes normal wear items | Lifetime on canister

Certification:

CSA Certified - US and Canada

MODEL NUMBER	MOTOR	CFM	WATERLIFT	CAPACITY	WATER RECOVERY	DECIBEL RATING*	ELECTRICAL CORD	DIMENSIONS (LxWxH)	SHIP WT.	NET WT.
MV-1300-0MEV	1.6 HP, 120V, 8.6A, 60Hz	108	111in.	13.0 gallons	9.0 gallons	51.2	25ft.	22x19x28in.	50 lb.	38 lb.
MV-1800-0MEV	1.6 HP, 120V, 8.6A, 60Hz	108	111in.	18.0 gallons	13.0 gallons	51.2	25ft.	22x19x31in.	55 lb.	44 lb.

**Most wet/dry vacuums have a decibel rating of 63.4 dB(a).*

Options:

PART NUMBER	DESCRIPTION	FITS MODELS
VX-0001	Vacuum accessories with paper filter bags - Includes 25-ft. x 1½-in. crushproof vacuum hose, 10 disposable paper filter bags (19-0610), crevice tool (33-0326) and "claw" suction hand tool (33-0371)	All models
VX-0002	Vacuum accessories with cloth filter bag - Includes 25-ft. x 1½-in. crushproof vacuum hose, cloth filter bag (19-0611), crevice tool (33-0326) and "claw" suction hand tool (33-0371)	All models
VX-0003	Vacuum accessories with vacuum bag liner - Includes 25-ft. x 1½-in. crushproof vacuum hose, vacuum bag liner (19-0235), crevice tool (33-0326) and "claw" suction hand tool (33-0371)	All models

Note: These options will remove the two-piece aluminum extension wand (16-0391), combination floor tool (33-0360), commercial squeegee floor tool (33-0359) and the upholstery tool (33-0327) that comes standard with the vacuum.

13 & 18-Gallon Accessories

Suction Hose and Fittings

Suction Hose

15-0207

- 10-foot x 1½-inch crushproof hose with fittings

Suction Hose - Bulk

15-0223

- 1½-inch crushproof hose without fittings
- Sold by the foot; 50-foot maximum length

Tapered Cuff End

50-0167

- Hose fitting - connects hose to wand or to hose connector

Hose Connector

50-0168

- Hose fitting - connects tapered cuff end to hose extension

Inlet Cuff Fitting

50-0169

- Hose fitting - connects hose to vacuum

Hose Adapter Kit

852-0156

- For when you need to add extra hose to your existing suction hose
- Includes one hose connector, 50-0168 and one inlet cuff fitting, 50-0169



15-0207

How to attach the hose connection kit:

A = Suction Hose (15-0223), sold per foot

B = Tapered Cuff End (50-0167)

C = Inlet Fittings, 2 qty. (50-0169)

D = Hose Connector, 1 qty. (50-0168)

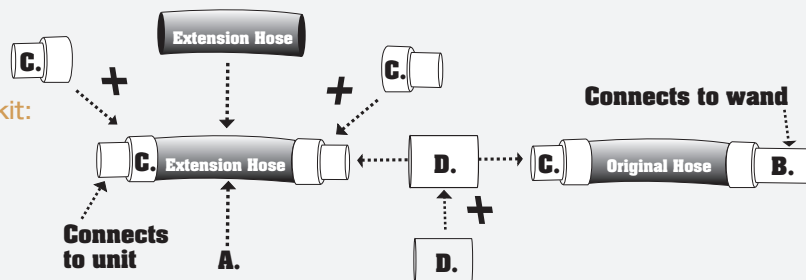

Filters

Hydro Flow Filter

19-0230

- Designed for continuous water pick-up
- Will not clog or deteriorate
- Maintains maximum air flow
- Water resistant
- For wet and dry use
- Completely washable
- 99.5% efficient to 1.0-micron
- 1.0-micron rating prevents drywall dust from damaging motor
- Decreases airborne particles through exhaust



19-0230

High Efficiency Particulate Air (HEPA) Filter

19-0234

- Recommended for fine dust and clean room applications
- Will not clog or deteriorate
- Maintains maximum air flow
- Water resistant
- Completely washable
- 99.97% efficient to 0.3-micron
- 0.3-micron rating captures solid particulates, not allowing them back into the air



19-0234

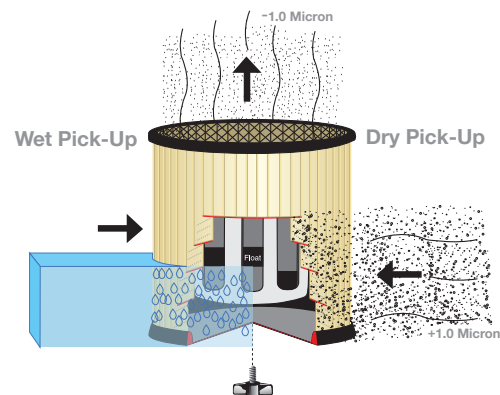

Filter Bags

Paper Filter Bags

19-0610

- 10 per pack
- Disposable for dry use only
- Recommended for fine dust

Cloth Filter Bag

19-0611

- Reusable for dry use only
- Machine washable

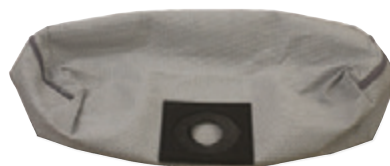

19-0611



19-0610

13 & 18-Gallon Accessories

Vacuum Bag Liner

19-0235

- Fits inside canister to keep filter cartridge clean
- Dry use only - do not use with paper filter bag



Aluminum Extension Wand

16-0391

- 2-piece friction fit
- Chrome-plated



Tools

Crevice Tool

33-0326

- 10¾-inch high impact plastic
- Connects directly to hose

Upholstery Tool

33-0327

- 5-inch width; serrated edge
- High impact plastic
- Connects directly to hose

Dusting Tool

33-0328

- 2¾-inch nylon brush
- High impact plastic
- Connects directly to hose

Commercial Squeegee Floor Tool

33-0359

- 14-inch with replaceable rubber blades
- High impact plastic
- Connects directly to extension wand

Replaceable Rubber Blades (not shown)

33-0397 (Front blade)

33-0398 (Rear blade)

- Fits commercial squeegee floor tool, 33-0359

Combination Floor Tool

33-0360

- 12-inch with adjustable brush height
- High impact plastic
- Connects directly to extension wand

Commercial Nylon Brush Floor Tool

33-0361

- 14-inch nylon brush insert
- High impact plastic
- Connects directly to extension wand

Power Floor Tool

33-0362

- 10¾-inch, air-powered, belt drive
- High impact plastic
- Connects directly to extension wand

"Claw" Suction Hand Tool

33-0371

- 4-inch high impact plastic
- Connects directly to hose



Vacuum Bag and Hose Hanger

AW-9500-0001

- Fits both 13 and 18-gallon vacuums
- Vacuum hose hanger attaches to top handle
- Accessory bag holds two-piece aluminum extension wand, standard floor and hand tools
- Made from 600 denier vinyl-backed polyester
- Easy to clean with soap and water



Wall Mount Bracket

AW-9500-0000

- Allows for permanent work cleaning station
- Save space by mounting vacuum to a wall
- Powder coated steel bracket



Jobsite Boxes



Jobsite Boxes

Heavy-Duty Steel

Optimize your tool storage and keep them secure with Mi-T-M jobsite boxes. The heavy-duty, powder coated steel construction makes them a popular choice when looking to protect your investments. Available in several sizes to fit your truck, garage or workshop.

Construction:

Special tamper-proof armored locking system | Convenient swing-out handles | Reinforced support skids | Heavy-duty solid steel construction with full arc welded seams | Full-length concealed hinges are riveted | Special powder coated finish for extreme durability | Predrilled skids for easy caster installation | Optional removable tool trays to assist in tool management and increase your inside storage space



MB-4822 shown with tool tray, MX-22

MODEL NUMBER	CUBIC FEET	DIMENSIONS (LxWxH)	SHIP WT.	NET WT.
MB-3619	6.33	36x19x16in.	83 lb.	81 lb.
MB-4822	13.44	48x22x22in.	128 lb.	123 lb.
MB-4830	25.00	48x30x30in.	174 lb.	168 lb.
MB-6024	21.66	60x24x26in.	177 lb.	169 lb.

Padlocks not included. Mi-T-M recommends No. 5 padlocks.



MB-3619

Jobsite Box Accessories

Tool Trays

Help sort and organize your jobsite boxes with tool trays and increase your inside storage space. Offers a convenient transportable tray for jobs when you only need select tools.

MX-19

- One tray fits MB-3619
- 16.5-in. L x 11-in. W x 3-in. H
- 7 lb.

MX-22

- Two trays fit MB-4822
- 19.45-in. L x 11-in. W x 3-in. H
- 9 lb.

MX-30

- Two trays fit MB-4830
- 27.5-in. L x 11-in. W x 3-in. H
- 12 lb.

MX-24

- Two trays fit MB-6024
- 21.5-in. L x 11-in. W x 3-in. H
- 8 lb.



Casters

Built with heavy-duty components, casters feature durable ball bearing wheels for smooth and effortless mobility. Each set includes two swivel and two rigid casters with locks.

MX-4 (4-inch)

- Rated for 700 lb.

MX-5 (5-inch)

MX-6 (6-inch)

- Rated for 800 lb.



Jobsite Box Dimensions



Portable Heaters



Kerosene Forced Air

75,000 up to 600,000 BTU

Motor:

Heavy-duty, high quality cast aluminum enclosed electric motor

Burner Head:

1-piece cast aluminum

Components:

High performance fan | Built-in temperature control thermostat with control dial | Integral overheat and flame-out safety | Fuel gauge | Sure start ignition for cold temperature starts | Dual connector ignition

Limited Warranty:

1 year

Certification:

CSA Certified - US and Canada

Factory Tested for Multiple Fuels:

Kerosene | JP8/Jet A fuel | No. 1 and No. 2 fuel oil | No. 1 and No. 2 diesel fuel

Important Notes:

- Not for use in residential living areas or inadequately ventilated areas
- Proper ventilation required during operation
- Must be plugged into an approved standard electrical outlet for operation



MH-0190-0M10



MH-0075-0M10 shown with inverter generator, GEN-2000-IMMO

Heat when and where you want it. Portable kerosene forced air heaters provide consistent and reliable heat for a comfortable work environment. Available in many sizes, they are perfect for heating everything from garages and workshops to warehouses and construction sites.

MODEL NO.	MH-0075-0M10	MH-0135-0M10	MH-0190-0M10	MH-0215-0M10	MH-0400-0M10	MH-0600-0M10
HEAT OUTPUT	75,000 BTU	135,000 BTU	190,000 BTU	215,000 BTU	400,000 BTU	600,000 BTU
HOT-AIR FLOW	240 CFM	540 CFM	630 CFM	670 CFM	1,400 CFM	3,000 CFM
AIR PUMP PRESSURE	3.8 PSI	5.5 PSI	8.5 PSI	9.0 PSI	125 PSI	128 PSI
AC POWER	120V, 60Hz, 1.5 Amps	120V, 60Hz, 2.3 Amps	120V, 60Hz, 2.7 Amps	120V, 60Hz, 2.8 Amps	120V, 60Hz, 3.0 Amps	120V, 60Hz, 5.5 Amps
MOTOR SIZE	1/8 HP	1/5 HP	1/4 HP	1/3 HP	1/2 HP	5/8 HP
FUEL TANK CAPACITY	5.0 gallons	10.0 gallons	13.0 gallons	13.0 gallons	24.0 gallons	40.0 gallons
FUEL CONSUMPTION	0.56 gal./hr.	1.00 gal./hr.	1.42 gal./hr.	1.63 gal./hr.	3.00 gal./hr.	4.50 gal./hr.
MAX. OPERATING HOURS	8.9 hours	10.0 hours	9.1 hours	8.0 hours	8.0 hours	8.9 hours
HEATING AREA	1,700 sq. ft.	3,100 sq. ft.	4,300 sq. ft.	5,300 sq. ft.	10,000 sq. ft.	15,000 sq. ft.
MULTI-FUEL CAPABLE	Yes	Yes	Yes	Yes	Yes	Yes
DIGITAL TEMP. READ-OUT	No	Yes	Yes	Yes	No	No
ERROR INDICATOR READ-OUT	No	Yes	Yes	Yes	Yes	Yes
PARTS STORAGE SYSTEM	No	Yes	Yes	Yes	Yes	Yes
DIMENSIONS (LxWxH)	30x13x15in.	43x22x28in.	47x22x28in.	47x22x28in.	53x30x36in.	75x34x43in.
SHIP WT.	33 lb.	57 lb.	68 lb.	68 lb.	159 lb.	376 lb.
NET WT.	28 lb.	51 lb.	60 lb.	60 lb.	150 lb.	320 lb.

Specifications subject to change without notice. Use in accordance with any and all state or local codes, regulations and/or ordinances. Please see heater "Owner's Manual" included with each heater for a complete list of important safety information. These specifications are estimates only.

Propane Forced Air

40,000 up to 375,000 BTU



MH-0375-LM10

Convenient and easy-to-use, Mi-T-M propane forced air heaters come in a variety of heat outputs. The sleek design puts heat right where you need it. Just add a propane cylinder and plug into the nearest outlet.



MH-0150-LM10

MODEL NO.	MH-0060-LM10	MH-0150-LM10	MH-0150-LMT0*	MH-0150-NM10*	MH-0375-LM10*
HEAT OUTPUT	40-50-60,000 BTU	120-135-150,000 BTU	150,000 BTU	150,000 BTU	225-375,000 BTU
HOT-AIR FLOW	300 CFM	400 CFM	400 CFM	435 CFM	1,500 CFM
AC POWER	120V, 60Hz, Less than 1.0 Amp	120V, 60Hz, Less than 1.0 Amp	120V, 60Hz, Less than 1.0 Amp	120V, 60Hz, Less than 1.0 Amp	120V, 60Hz, 1.45 Amps
MOTOR SIZE	1/10 HP	1/9 HP	1/9 HP	1/9 HP	1/5 HP
FUEL	Propane	Propane	Propane	Natural Gas	Propane
FUEL CONSUMPTION	1.9/2.3/2.8 lb./hr.	5.5/6.2/6.9 lb./hr.	6.9 lb./hr.	146 cu. ft./hr.	10.4 to 17.4 lb./hr.
REQUIRED CYLINDER SIZE	20 lb.	100 lb.	100 lb.	N/A	(2) 100 lb.
MAX. OPERATING HOURS (PER REQUIRED CYLINDER SIZE)	10.5 hours	18.0 hours	18.0 hours	N/A	11.5 hours
HEATING AREA	1,500 sq. ft.	3,800 sq. ft.	3,800 sq. ft.	3,800 sq. ft.	9,000 sq. ft.
ADJUSTABLE THERMOSTAT	No	No	Yes	Yes	Yes
ADJUSTABLE HEIGHT ANGLE	Yes	Yes	Yes	Yes	No
10-FOOT HOSE & REGULATOR	Yes	Yes	Yes	No	Yes
DIMENSIONS (LxWxH)	18.1x7.1x13.0in.	25.1x8.7x15.4in.	25.1x8.7x15.4in.	25.1x9x15.5in.	34x12.6x18.5in.
SHIP WT.	19 lb.	29 lb.	29 lb.	35 lb.	49 lb.
NET WT.	15 lb.	23 lb.	23 lb.	24 lb.	41 lb.

*Includes thermostat.

Specifications subject to change without notice. Use in accordance with any and all state or local codes, regulations and/or ordinances. Please see heater "Owner's Manual" included with each heater for a complete list of important safety information. These specifications are estimates only.

Accessory:

PART NUMBER	DESCRIPTION	FITS MODELS
68-5010	Two cylinder manifold	All models

Frame:

Heavy-duty steel construction | Easy-lift handle for portability at home or on the jobsite

Components:

High performance fan | Automatic shut-off if power is interrupted or flame is extinguished | Enclosed gas controls | Electronic ignition | One-touch ignition and heat control for easy operation

Limited Warranty:

1 year

Certifications:

CSA Certified - US and Canada | CSA Blue Star Certified - US only | CSA Blue Flame Certified - Canada only

Important Notes:

- Not for use in residential living areas or inadequately ventilated areas
- Proper ventilation required during operation
- Must be plugged into an approved standard electrical outlet for operation

Gas-Fired Convection

50,000 up to 200,000 BTU

Frame:

Quick assembly 2-piece burn chamber | Durable steel housing | Inner windshield protects burner flame from being extinguished

Heat Output:

Variable heat settings | 360-degree heat radius for even heating of room

Components:

Matchless piezo spark ignition | Automatic shut-off if flame is extinguished

Limited Warranty:

1 year

Certifications:

CSA Certified - US and Canada | CSA Blue Star Certified - US only | CSA Blue Flame Certified - Canada only

Important Notes:

- Not for use in residential living areas or inadequately ventilated areas
- Proper ventilation required during operation
- Extremely hot during operation. Keep children, animals and all combustible objects away from heater.



MH-0080-CM10

Effectively heat small spaces with the gas-fired convection heater. Extremely quiet and portable, this little heater can warm up a workshop or garage in a matter of minutes. Easy to set up, it's the perfect choice to keep your workshop comfortable when the weather turns cold.



MH-0200-CM10

MODEL NO.	MH-0080-CM10
HEAT OUTPUT	60-80,000 BTU
HOT-AIR FLOW	N/A
IGNITION TYPE	Automatic (integral)
FUEL	Propane
FUEL CONSUMPTION	2.3 / 3.7 lb./hr.
OPERATING TIME (100 LB. CYL.)	43 / 27 hours
OPERATING TIME (40 LB. CYL.)	17 / 11 hours
OPERATING TIME (20 LB. CYL.)	8 / 5 hours
SUGGESTED CYLINDER SIZE	100 lb.
INLET GAS PRESSURE	N/A
HEATING AREA	1,800 sq. ft.
STAINLESS-STEEL BURNER	No
HOSE & REGULATOR	Yes, 10 ft.
DIMENSIONS (LxWxH)	15.7x15.7x21.8in.
SHIP WT.	17 lb.
NET WT.	11.5 lb.

MODEL NO.	MH-0200-CM10
HEAT OUTPUT	50-200,000 BTU
HOT-AIR FLOW	N/A
IGNITION TYPE	Push-button
FUEL	Propane
FUEL CONSUMPTION	3.24 / 9.25 lb./hr.
OPERATING TIME (100 LB. CYL.)	31 / 11 hours
OPERATING TIME (40 LB. CYL.)	N/A
OPERATING TIME (20 LB. CYL.)	N/A
SUGGESTED CYLINDER SIZE	100 lb.
INLET GAS PRESSURE	N/A
HEATING AREA	4,600 sq. ft.
STAINLESS-STEEL BURNER	No
HOSE & REGULATOR	Yes, 10 ft.
DIMENSIONS (LxWxH)	16x16x26.4in.
SHIP WT.	20 lb.
NET WT.	14 lb.

Specifications subject to change without notice. Use in accordance with any and all state or local codes, regulations and/or ordinances. Please see heater "Owner's Manual" included with each heater for a complete list of important safety information. These specifications are estimates only.

Accessory:

PART NUMBER	DESCRIPTION	FITS MODELS
68-5010	Two cylinder manifold	All models

Kerosene Radiant

125,000 BTU



MH-0125-3M1R

This kerosene radiant heater produces an impressive 125,000 BTU to warm virtually any space. It produces clean, quiet, instant radiant heat for up to 20 hours. Great for large vented areas, its compact design helps make it completely portable.

Motor:

Fully enclosed motor for longer life

Frame:

Compact design | Two tires for easy mobility | Heat safety grille | Easy-lift handle for portability at home or on the jobsite

Heat Output:

Adjustable heat height | Clean, quiet, instant radiant heat

Components:

Ultra quiet fuel pump | Power switch | Electronic controls | Error indicator light | Integral overheat and flame-out safety | Contractor-grade fuel cap | Easy access filter

Limited Warranty:

1 year

Certification:

CSA Certified - US and Canada

Factory Tested for Multiple Fuels:

Kerosene | JP8/Jet A fuel | No. 1 and No. 2 fuel oil | No. 1 and No. 2 diesel fuel

Important Notes:

- Not for use in residential living areas or inadequately ventilated areas
- Proper ventilation required during operation
- Must be plugged into an approved standard electrical outlet for operation

MODEL NO.	MH-0125-3M1R
HEAT OUTPUT	125,000 BTU
HEAT FLOW	Radiant
AC POWER	120V, 60Hz, 5.0 Amps
FUEL TANK CAPACITY	14.0 gallons
FUEL CONSUMPTION	0.85 gal./hr.
MAX. OPERATING HOURS	20.0 hours
HEATING AREA	3,125 sq. ft.
MULTI-FUEL CAPABLE	Yes
DIMENSIONS (LxWxH)	37x28x42in.
SHIP WT.	91 lb.
NET WT.	68 lb.

Specifications subject to change without notice. Use in accordance with any and all state or local codes, regulations and/or ordinances. Please see heater "Owner's Manual" included with each heater for a complete list of important safety information. These specifications are estimates only.

Propane Tank-Top Radiant

9,000 up to 32,000 BTU

Frame:

Heavy-duty construction | Rust-proof chrome emitter guard | Rear burner safety guard

Heat Output:

Variable heat control valve | Clean, quiet, instant radiant heat

Components:

Standard propane tank connection | High efficiency heat reflector | Hand wheel valve connection

Limited Warranty:

1 year

Certification:

CSA Certified - US and Canada

Important Notes:

- Not for use in residential living areas or inadequately ventilated areas
- Proper ventilation required during operation



MH-0015-IM10



MH-0030-IM10

Keep your outdoor space warm and comfortable with the versatile propane tank-top heater. It features a compact design and can be easily assembled. Variable heat controls give you the right amount of heat when you need it most.

MODEL NO.	MH-0015-IM10	MH-0030-IM10
HEAT OUTPUT (SINGLE BURNER)*	L-9,000 / M-12,000 / H-16,000 BTU	L-9,000 / M-12,000 / H-16,000 BTU
HEAT OUTPUT (DOUBLE BURNER)*	N/A	L-18,000 / M-24,000 / H-32,000 BTU
IGNITION TYPE	Match light	Match light
HEAT SETTINGS	3	6
PROPANE CYLINDER SIZE	20 lb.	20 lb.
MAX. OPERATING HOURS (20 LB. CYL.)*	L-48 / M-36 / H-27 hours	L-48 / M-18 / H-14 hours
SWIVEL BURNER HEAD	No	Yes
SAFETY SHUT-OFF VALVE	Yes	Yes
HEAT REGULATOR KNOB	Yes	Yes
MANIFOLD	Cast aluminum	Cast aluminum
DIMENSIONS (LxWxH)	8.4x7.4x12in.	17.5x5.5x12in.
SHIP WT.	3 lb.	6 lb.
NET WT.	2 lb.	5 lb.

*Heat output and operating hours have Low, Medium and High settings.

Specifications subject to change without notice. Use in accordance with any and all state or local codes, regulations and/or ordinances.

Please see heater "Owner's Manual" included with each heater for a complete list of important safety information. These specifications are estimates only.

Propane Radiant Outdoor Patio

22,500 up to 40,000 BTU



MH-0040-PM10

Extend your outdoor season with this sleek patio heater. It comes with a convenient wheel kit so you can move it from the patio to the deck or anywhere you want to entertain. It is attractive and functional, heating up to 210 square feet.

Frame:

Heavy-duty stainless-steel emitter screen | Rust resistant reflector material | 5-piece reflector assembly | Large diameter support post | Wheel kit for easy maneuverability

Heat Output:

Variable heat settings

Components:

Wind resistant burner system prevents flame from being extinguished and has automatic shut-off if flame is extinguished | Built-in safety tip-over switch | Piezo spark push-button controls

Limited Warranty:

1 year

Certifications:

CSA Certified - US and Canada | CSA Blue Star Certified - US only | CSA Blue Flame Certified - Canada only

Important Notes:

- Not for use in residential living areas or inadequately ventilated areas
- Proper ventilation required during operation
- Extremely hot during operation. Keep children, animals and all combustible objects away from heater.



MODEL NO.	MH-0040-PM10
HEAT OUTPUT*	L-22,500 / H-40,000 BTU
FUEL	Propane
FUEL CONSUMPTION	1.86 lb./hr.
MANIFOLD PRESSURE	11in. WC
OPERATING TIME (20 LB. CYL.)	10.8 hours
SUGGESTED CYLINDER SIZE	20 lb.
HEATING AREA	210 sq. ft.
HEAT RADIUS	360°
WHEEL KIT	Yes
HOSE & REGULATOR	Yes
BASE DIAMETER	18in.
DIMENSIONS (LxWxH)	32.3x32.3x88in.
SHIP WT.	68 lb.
NET WT	59 lb.

***Heat output is at Low and High settings.**

Specifications subject to change without notice. Use in accordance with any and all state or local codes, regulations and/or ordinances. Please see heater "Owner's Manual" included with each heater for a complete list of important safety information. These specifications are estimates only.

Propane Cabinet Utility

18,000 BTU

Frame:

Heavy-duty construction | Cast aluminum manifold | Powder coated cabinet | 4 rolling casters - 2 locking

Heat Output:

Clean, quiet, instant radiant heat | Wind resistant burner system | Secured fully insulated ignition connection

Components:

Variable heat control knob | No electricity required | Safety auto-extinguish tip-over switch | Hose and regulator | Piezo spark ignition | Requires 20-lb. LP tank (Not included)

Limited Warranty:

1 year

Important Notes:

- Not for use in residential living areas or inadequately ventilated areas
- Proper ventilation required during operation



MH-0018-0M10



The 18,000 BTU propane cabinet utility heater is great for portable supplemental heat in a ventilated workshop, garage or other outdoor space. This unit heats areas up to 600 square feet and is easy to move because of its unique rolling caster design.

MODEL NO.	MH-0018-0M10
HEAT OUTPUT	18,000 BTU
FUEL TANK CAPACITY	20 lb. propane cylinder (not included)
FUEL CONSUMPTION	Low 65 hours/20 lb. High 24 hours/20 lb.
MAX. OPERATING HOURS	65 hours/20 lb.
HEATING AREA	600 sq. ft.
DIMENSIONS (LxWxH)	13.6x17.7x23in.
SHIP WT.	34.9 lb.
NET WT.	22 lb.

Specifications subject to change without notice. Use in accordance with any and all state or local codes, regulations and/or ordinances. Please see heater "Owner's Manual" included with each heater for a complete list of important safety information. These specifications are estimates only.



MH-0018-0M10 back view, shown with 20-lb. LP tank (not included)

Water Pumps



Semi-Trash Pumps

2-Inch

Frame:

Heavy-duty powder coated wraparound frame with 1-inch steel tubing | Rubber isolators minimize vibration

Components:

Silicon carbide mechanical seals | Precision molded cast iron impeller and volute for reduced vibration and wear

Limited Warranties:

1 year Mi-T-M engine | 2 year pump | 3 year Honda engine



WTP-S02-1MGM



The compact, lightweight and portable Mi-T-M 2-inch semi-trash pump is an excellent choice for homeowners, hobby farmers, contractors or anyone who needs to remove water quickly and efficiently. This pump can handle solids up to 3/4-inch.

MODEL NUMBER	SUCTION		MAX. TOTAL HEAD	SUCTION LIFT	DISPLACEMENT/ENGINE	PSI	MAX. CAPACITY	FUEL TANK CAPACITY	DIMENSIONS (LxWxH)	SHIP WT.	NET WT.
	DISCHARGE SIZE										
WTP-S02-1MGH	2in.x2in.		115ft.	28ft.	118cc Honda GX120 OHV	50	9,720 gph	0.53 gallon	20.5x17x16.25in.	71 lb.	62 lb.
WTP-S02-1MGM	2in.x2in.		115ft.	28ft.	136cc Mi-T-M OHV	50	9,720 gph	0.71 gallon	20.5x17x16.25in.	72 lb.	63 lb.

Accessories:

PART NUMBER	DESCRIPTION	FITS MODELS
15-0293	20-ft. x 2-in. green PVC hard suction hose with fittings	All models
15-0295	50-ft. x 2-in. blue PVC soft discharge hose	All models
19-0628	2-in. steel suction strainer with round openings	All models
70-0524	2-in. suction and discharge kit	All models



Suction and discharge kit, 70-0524

Semi-Trash Pumps

3-Inch



WTP-S03-1MGH

Handle unwanted water and debris on any jobsite with the powerful 3-inch semi-trash pumps. These models offer quality components like silicon carbide seals, rubber isolators to minimize vibration and a heavy-duty wraparound frame.

Frame:

Heavy-duty powder coated wraparound frame with 1-inch steel tubing | Rubber isolators minimize vibration

Components:

Silicon carbide mechanical seals | Precision molded cast iron impeller and volute for reduced vibration and wear

Limited Warranties:

1 year Mi-T-M engine | 2 year pump | 3 year Honda engine



WTP-S03-1MGH shown with 3-inch suction and discharge kit, 70-0525

MODEL NUMBER	SUCTION DISCHARGE SIZE	MAX. TOTAL HEAD	SUCTION LIFT	DISPLACEMENT/ENGINE	PSI	MAX. CAPACITY	FUEL TANK CAPACITY	DIMENSIONS (LxWxH)	SHIP WT.	NET WT.
WTP-S03-1MGH	3in.x3in.	104ft.	28ft.	196cc Honda GX200 OHV	45	16,560 gph	0.83 gallon	21.25x17.25x18.25in.	82 lb.	73 lb.
WTP-S03-2MGM	3in.x3in.	104ft.	28ft.	212cc Mi-T-M OHV	45	16,560 gph	1.0 gallon	21.25x17.25x18.25in.	82 lb.	73 lb.

Accessories:

PART NUMBER	DESCRIPTION	FITS MODELS
15-0294	20-ft. x 3-in. green PVC hard suction hose with fittings	All models
15-0296	50-ft. x 3-in. blue PVC soft discharge hose	All models
19-0629	3-in. steel suction strainer with round openings	All models
70-0525	3-in. suction and discharge kit	All models



Suction and discharge kit, 70-0525

Trash Pumps

3 & 4-Inch

Frame:

Heavy-duty powder coated wraparound frame with 1-inch steel tubing | Rubber isolators minimize vibration

Components:

Durable silicon carbide mechanical seals | Cast iron impeller and volute for reduced vibration and wear | Die cast aluminum pump is lightweight and portable | The clean-out cover and volute can be removed for easy cleaning of debris

Limited Warranties:

2 year pump | 3 year Honda engine



WTP-T04-OMGH shown with wheel kit accessory, AW-5740-0017

WTP-T03-OMGH shown with 3-inch suction and discharge kit, 70-0525



Built to be extremely durable and easy to transport, these trash pumps quickly remove unwanted water and waste and can handle solids up to 1-inch in diameter. Available in two sizes, they are highly dependable when you need them.

MODEL NUMBER	SUCTION DISCHARGE SIZE	MAX. TOTAL HEAD	SUCTION LIFT	DISPLACEMENT/ENGINE	PSI	MAX. CAPACITY	FUEL TANK CAPACITY	DIMENSIONS (LxWxH)	SHIP WT.	NET WT.
WTP-T03-OMGH	3in.x3in.	95ft.	26ft.	270cc Honda GX270 OHV	38	370 GPM	1.39 gallons	29x21.8x22.5in.	177 lb.	152 lb.
WTP-T04-OMGH	4in.x4in.	95ft.	26ft.	389cc Honda GX390 OHV	38	580 GPM	1.6 gallons	29x21.8x22.5in.	192 lb.	167 lb.

Accessories:

PART NUMBER	DESCRIPTION	FITS MODELS
15-0294	20-ft. x 3-in. green PVC hard suction hose with fittings	WTP-T03-OMGH
15-0296	50-ft. x 3-in. blue PVC soft discharge hose	WTP-T03-OMGH
19-0629	3-in. steel suction strainer with round openings	WTP-T03-OMGH
70-0525	3-in. suction and discharge kit	WTP-T03-OMGH
AW-5740-0017	Wheel kit	All models
15-0356	20-ft. x 4-in. green PVC hard suction hose with fittings	WTP-T04-OMGH
15-0357	50-ft. x 4-in. blue PVC soft discharge hose	WTP-T04-OMGH
19-0277	4-in. steel suction strainer with round openings	WTP-T04-OMGH
70-0661	4-in. suction and discharge kit	WTP-T04-OMGH



Suction and discharge kit, 70-0661

Ordering Information

Extended Hours

To serve you better, our customer service hours of operation are:

Monday - Friday 7:30 am to 5:30 pm CST

Products may be ordered and inquiries may be sent 24 hours a day, 7 days a week via fax or e-mail.

How To Order

Units and accessories are ordered through authorized Mi-T-M dealers and distributors.

- Be prepared to advise the Mi-T-M Customer Service Representative of your Mi-T-M account number, model numbers, parts and descriptions.
- Indicate your purchase order number and full name on order.
- Specify exact shipping instructions.
- With fax and/or mail-in orders, give full name, Mi-T-M account number, zip code and telephone number.

Phone

563-556-7484
800-553-9053

Fax

563-556-1235

Mail

50 Mi-T-M Drive, P.O. Box 50
Peosta, IA 52068

Internet

www.mitm.com

E-mail

corp@mitm.com

Internet – www.mitm.com

Our website may be instantly accessed and offers:

- 4-color viewing of products and specifications
- A listing of service centers throughout the country
- A site search to find the equipment that's right for you
- How-To Videos
- Quick e-mail access for questions and information requests about specific models or product lines
- On-line parts ordering and access to parts listings for the full Mi-T-M product lines

Sales Policy

Products are sold through authorized Mi-T-M Dealers, National Accounts and Original Equipment Manufacturer's (OEMs) as recognized by Mi-T-M. All new customers must complete a credit application. Mi-T-M will perform a credit check, and upon approval the customer will receive an account number and a line of credit.

Production Schedule

Customers can anticipate a lead time of one week for cold water pressure washers, air compressors, air compressor/generator combinations, air compressor/generator/welder combinations, portable generators, portable heaters, jobsite boxes, wet/dry vacuums and water pumps; a two week lead time for hot water pressure washers. Special units will require additional lead time.

Shipping

Orders shipped without specific shipping instructions are shipped "best way" as determined by the Mi-T-M shipping department. Mi-T-M assumes no responsibility and makes no guarantees regarding air freight deliveries. Please allow seven working days before requesting tracking on lost or late shipments. In an effort to deliver Mi-T-M products to our customers in a timely manner, Mi-T-M developed a program where whole goods (pressure washers, air compressors, air compressor/generator combinations, air compressor/generator/welder combinations, portable generators, portable heaters, jobsite boxes, wet/dry vacuums and water pumps) and parts are shipped from separate locations in our facility. Our freight policy has not changed. Our customers are still responsible for outgoing freight on parts and whole goods. This may be altered by minimum qualifying freight programs. Our goal is to process all orders as soon as we receive them, our system will no longer allow additional items to be added to a previously processed order. Any additional orders will be handled as new orders.

Freight Terms

- All water treatment systems and parts – F.O.B. Peosta
- Any combination of pressure washers, air compressors, air compressor/generator combinations, air compressor/generator/welder combinations, portable generators, portable heaters, wet/dry vacuums or water pumps – may qualify for prepaid freight
- Jobsite boxes – prepaid on 1,000 lbs. or more
- Detergents – prepaid on twelve cases
- Parts – prepaid and add
- Trailer units – prepaid and add

Warranty

All warranty claims and returns of goods for repair shall be governed by the express terms of the Mi-T-M warranty, limited to the replacement of defective parts, as provided in the conditions of the Mi-T-M warranty. To submit a warranty claim online go to www.mitm.com and click on Warranty Claims link on the home page.

Merchandise Return

Mi-T-M must be contacted before any product is returned. The customer will receive a Returned Goods Authorization (RGA) number prior to the item being returned. Mi-T-M reserves the right to refuse returned products. Products must be in new and resalable condition. Products must be current production components. All products must be returned freight prepaid at shippers expense. Products returned C.O.D. for any reason will be refused. Credit not to exceed original purchase price will be issued for approved returned products. Returns are subject to a 20% restocking fee.

Submission of Claims

All damages to merchandise – either internal or external – must be reported to the carrier shipping such merchandise to permit an inspection report to be filed immediately. Claims of shortage of cartons, crates or boxes must be properly submitted to the carrier. Claims for errors or shortages of contents must be submitted to Mi-T-M within 24 hours after delivery of such merchandise.

In a continued commitment to improve quality, Mi-T-M reserves the right to make component and design changes when necessary.

Product & Safety Certifications

Mi-T-M builds safe and reliable products. In the United States, the UL, CSA International and ETL are accredited by the Occupational Health and Safety Administration (OSHA), as a Nationally Recognized Testing Laboratory (NRTL). Generally speaking, all OSHA accredited laboratories conduct their tests against the same set of US standards and codes, regardless of who authors or publishes them. Having undergone detailed scrutiny of our technical competence, integrity and certification testing facility, Mi-T-M is authorized by CSA to perform much of the product certification work in-house with NRTL audits to guarantee credibility. The mark of CSA, ETL or UL on a Mi-T-M product is an added assurance of safety.



CSA Group - the Canadian Standards Association - for standards development, information products, sale of publications, training and membership services.

CSA International - for product testing and certification; also test to applicable US standards, which include ANSI, UL, CSA, NSF and others.

QMI - for management systems registration. CSA marks appear on over one million products worldwide.



Intertek's ETL Semko division has been the global leader in the testing, inspection and certification of products for over 100 years, dating back to Thomas Edison's **Electrical Testing Laboratories (ETL)**. The ETL listed mark is the legal equivalent of the UL-listed and CSA-listed marks, designated by OSHA and the Standards Council of Canada. When Mi-T-M products bear Intertek's proprietary ETL-listed mark, the letters ETL will carry with them a long history of innovation, influence and independence.



UL, "Underwriters Laboratories Inc." the trusted source across the globe for product compliance. UL has tested products for public safety for more than a century. UL offers one of the conformity assessment industry's broadest portfolios of capabilities and certification marks. Their unique mix of local expertise in global markets and deep industry knowledge helps bring safer products to market.



CETA is an international non-profit trade association made up of manufacturers, suppliers, distributors, contractors/end users and associates. All these members coordinate efforts to promote public awareness, professionalism, industry-wide safety standards and education for the advancement of the powered cleaning equipment industry.



The **International Boiler and Pressure Vessel Code** establishes rules of safety governing the design, fabrication and inspection of boilers and pressure vessels, and nuclear power plant components during construction. In the formulation of its rules and in the establishment of maximum design and operating pressures, the Committee considers technological advances including materials, construction, methods of fabrication, inspection, certification and overpressure protection.

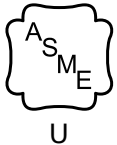

The objective of the rules is to provide a margin of deterioration in service. Advancements in design and material and the evidence of experience are constantly being added by Addenda.

Originating in 1914, the **ASME Boiler and Pressure Vessel Code** is now adopted in part or in its entirety, by 49 states and numerous municipalities and territories of the United States and all the provinces of Canada.



CSA International is the principal product testing, certification and standards development organization serving the gas industry in the US and Canada.

They are the number one source for gas product approvals in North America and the only organization that issues the familiar **Blue Star Mark** for the US and **Blue Flame Mark** for Canada.



CSA International is uniquely qualified to test and certify that gas appliances and accessories meet applicable US standards. Since 1925, the **Blue Star Mark** of approval has been the mark of choice for gas-fired appliances and accessories in the US. We test products for conformance with all applicable ANSI and CSA gas standards. CSA marked products are used and sold in the US everyday.



The **Warnock Hersey Mark (WH)** is North America's leading product safety and performance mark for building and construction products. Products bearing the WH Mark indicate compliance to relevant building codes, association criteria, and product safety and performance standards.

The WH Mark can be found on more than 6,500 products ranging from fire doors and builders hardware to hearth, plumbing and construction products. Having Intertek's WH Mark on your product reflects your commitment to product safety, performance and quality to inspectors, builders and end users. The mark also signifies that the products manufacturing site(s) undergo periodic follow-up inspections to ensure ongoing compliance of the originally certified product.

Thank You To Our Suppliers

We would like to take this opportunity to say thank you to our dedicated suppliers. The Mi-T-M brand is very important to us and only the highest quality components are considered for our equipment.

We appreciate your commitment and support and look forward to doing business with you for many years to come.

KOHLER® IN POWER. SINCE 1920.

With over 90 years of engine innovation, Kohler Engines has earned a reputation for quality and performance. Their extensive product range of 3.5 HP to 75 HP, air-cooled or liquid-cooled, diesel or gas engines have global support with 13,000+ distribution and service centers. Kohler Engines - Powerful Tradition, Advanced Innovation, Global Support.



AR, recognized worldwide as the leading manufacturer of triplex plunger pumps, is renowned for their high level of quality, consistency and flexibility. Distinctions in technological design and methods have contributed to leading the industry standards of today. Innovative and effective advancements in pump design are attributed to AR.



Suttner, the leading manufacturer of pressure washer parts and accessories, and has been producing German engineered connectors, guns, wands, tips and attachments for over 50 years. Manufactured for top performance, Suttner components are a valuable addition to keep your customer's equipment up and running, year in and year out. Suttner America Company provides timely shipping throughout North America from our fully stocked warehouse.



Since 1854 CURTIS-TOLEDO, Inc. has been designing and manufacturing solutions for our industry. The FSCURTIS Air Compressors brand continues to be the symbol of quality and excellence in the design and manufacturing of reciprocating air compressors, rotary screw compressors and oil-free compressors.



The R. Conrader Company is an industry leader in the manufacturing of pneumatic controls for compressed air systems. Conraders' 75+ years of experience have set the industry standard of quality and performance.



Quality Craft Industries is one of the leaders in innovation and design for the storage and organization category. Our focus, is on high quality product designed and built for the demands of the professional. We bring those features into lines specifically designed for the agricultural and industrial consumers that recognize quality as their primary focus in selection storage products for themselves.

POWERED by HONDA™

Honda Engines have long been recognized as the industry leader in providing reliable, easy-starting and fuel-efficient small engines. You'll find Honda GX Series engines on a wide variety of rental, construction and premium power equipment.



General Pump offers the highest standard of customer service, pumps, components and technology available in the industry. GP is dedicated to exceeding the needs of the pressure washer industry today and in the future.



POWER MOVING FORWARD™

Embracing change and innovation, ProPulse – a Schieffer Company, engineers and manufactures custom high pressure hose solutions for various applications in the field of fluid conveying. Known for their superior quality and customer support, ProPulse is a recognized leader and preferred choice of major OEM customers in the pressure washing industry.



Control Devices is a leading manufacturer of high quality valves serving the compressed air, pressure washer, automotive, fluid power, fire protection, specialty gas and pneumatic industries. Control Devices offers a line of standard products that has grown over the years, but pride ourselves in our ability to design and manufacture valves for custom applications.



RATO Engine, a Division of Chongqing RATO Power Co., Ltd., was established in 2007 to meet the growing demands of the high technology requirements in current general-purpose machinery market. RATO products have been exported to 80 countries and regions including America, Germany, France, Spain, Mexico, Argentina, Turkey, and Nigeria, winning high international praise.



Danau Industries specializes in the research and manufacturing of superior quality industrial, commercial and consumer high pressure pumps. Established in 2007 Danau has a 60-person R&D team that is dedicated to the advancement in design and development of pumps for the pressure washing industry.



PERFORMANCE UNDER PRESSURE®

www.mitm.com

50 Mi-T-M Drive • Peosta, IA 52068
ph 800-553-9053 • fax 563-556-1235
corp@mitm.com

**Cold & Hot Water Pressure Washers • Air Compressors
Portable Generators • Air Compressor/Generator Combinations
Air Compressor/Generator/Welder Combinations
Wet/Dry Vacuums • Jobsite Boxes • Portable Heaters
Water Pumps • Water Treatment Systems**