

Miami-Dade County FOG Control Program & FOG Control Ordinance

October 18, 2017

Prepared by

Division of Environmental Resources Management (DERM)

Miami-Dade County Department of Regulatory and Economic Resources

Prepared for

United States Environmental Protection Agency and

Florida Department of Environmental Protection

THIS PAGE INTENTIONALLY LEFT BLANK

Miami-Dade County FOG Control Program & PROPOSED FOG Control Ordinance

PREPARED BY:

Division of Environmental Resources Management (DERM)

Miami-Dade County Department of Regulatory and Economic Resources

The information contained in this document is solely for the use of the client identified on the cover sheet, and for the purposes specified herein.

All rights reserved. No section or element of this document may be removed from this document, reproduced, electronically stored, or transmitted in any form without the written permission of DERM.

Quality Information

Status: Final

Document	Miami-Dade County FOG Control Program and Ordinance		
Ref	TBD	Date	10.18.17
Prepared by	Carlos L. Hernandez, PE	Reviewed by	Rashid Istambouli, PE

Revision History

Revision	Revision Date	Status	Revised by:	Authorized by:
0.0	06.04.15	1 st Submittal	Carlos L. Hernandez, PE	 Lee N. Hefty, DERM Director
0.1	10.18.17	Final	Carlos L. Hernandez, PE	

THIS PAGE INTENTIONALLY LEFT BLANK

Table of Contents

00.	Acronyms/Glossary.....	00-2
00.01	Acronyms/Abbreviations -----	00-2
00.02	Glossary-----	00-2
01.	Introduction.....	01-3
02.	FOG Program Organizational Chart	02-6
03.	FOG Characterization Study	03-9
04.	Legal Authority	04-13
05.	Specification of Accepted FOG Control Devices	05-14
06.	Standards for the Design and Construction of FOG Control Devices.....	06-15
07.	FOG Control Device Management, Operation and Maintenance Standards.....	07-15
08.	FOG Control Device Construction Inspection Protocols	08-16
09.	Compliance Inspection Protocol.....	09-17
10.	FOG Disposal Manifest.....	10-20
11.	Enforcement/Regulatory Programs.....	11-21
12.	Compliance Assistance Program.....	12-22
13.	Comprehensive Public Education	13-23
13.01	Residential Public Education -----	13-23
13.02	Stakeholder Outreach -----	13-24
14.	Staffing and Equipment Requirements.....	14-1
15.	List of Current Commercial Establishments FOG Generators	4
16.	Performance Indicators.....	4
17.	Annual FOG Control Program Review.....	5
17.01	FOG Control Program Review Committee-----	5
17.02	FOG Control Program Review Criteria-----	6
18.	Conclusions.....	7

Attachments

- Attachment 1. Approved FOG Control Ordinance
- Attachment 2. DERM, WASD, FDEP and EPA Meeting Materials, meeting held on December 8, 2016.
- Attachment 3. December 29, 2016, FDEP and EPA comments to the proposed ordinance and FOG Control Program.
- Attachment 4. May 1, 2017, DERM's response to FDEP and EPA comments.
- Attachment 5. FDEP and EPA letter of approval of the FOG Control Program and FOG Ordinance dated September 7, 2017
- Attachment 6. Outreach Meetings & URT Flyers
- Attachment 7. FOG Control Device Guidance Manual
- Attachment 8. Utility Round Table (URT) Meeting Presentation October 11, 2017
- Attachment 9. Best Management Practices
- Attachment 10. MDWASD Hot Spots Maps & Sample Monthly Meeting Report (June 2, 2015 meeting)
- Attachment 11. FOG Inspection Manual
- Attachment 12. Liquid Waste Transporters Manual
- Attachment 13. Liquid Waste Transporter Septage & FOG Waste Manifest Guide.
- Attachment 14. FOG Enforcement Response Plan
- Attachment 15. Summary of Inspection Task Actions (Enforcement)
- Attachment 16. List of FOG Generators as of 10/10/2017
- Attachment 17. Maps Showing Location of FOG Generators

00. Acronyms/Glossary

00.01 Acronyms/Abbreviations

Abbreviation	Description
ASME	American Society of Mechanical Engineers
CD	Consent Decree
County	Miami-Dade County
CSA	Canadian Standards Association
DEP	Florida Department of Environmental Protection
DERM	Miami-Dade County Department of Regulatory Economic Resources, Division of Environmental Resource Management
FOG	Fats, Oils, and Grease
GIS	Geographic Information Systems
HDT	Hydraulic Detention Time
KPI	Key Performance Indicator
MDWASD	Miami-Dade County Water and Sewer Department
O&M	Operations and Maintenance
PDI	Plumbing And Drainage Institute
UTR	Utility Round Table
VSC	Volume Sewer Customer
WCTS	Wastewater Collection and Transmission System
WPA	Wellfield Protection Area

00.02 Glossary

All terms used in the Approved FOG Control Ordinance are included in the Ordinance, incorporated as **Attachment 1**.

01. Introduction

The Miami-Dade County Department of Regulatory and Economic Resources, Division of Environmental Resources Management (DERM) prepared this final FOG Control Program and FOG Control Ordinance (herein FOG Control Program and Ordinance) in compliance with Florida Department of Environmental Protection (FDEP) and Environmental Protection Agency (EPA) letter dated September 7, 2017, received September 18, 2017. The FDEP/EPA September 7, 2017 letter approved DERM's submittal dated May 1, 2017, which addressed FDEP/EPA's December 29, 2016 comments, of DERM's June 5, 2015 New FOG Control Program and PROPOSED Ordinance. The June 5, 2015 submittal was in response to Section 19(a) of the Consent Decree (CD) between Miami-Dade County (County) and the United States of America, the State of Florida (State), and the FDEP, adjudicated by the United States District Court for the Southern District of Florida in Case No. 1:12-cv-24400-FAM. The CD required the County to review, evaluate and revise its Grease Trap Ordinance and FOG Control Program and submit to FDEP and EPA for review and comments a FOG Control Program by June 6, 2015.

This FOG Control Program and Ordinance incorporate program and ordinance revisions proposed by DERM in the meeting held between DERM, WASD, FDEP and EPA (Copy of meeting materials included as **Attachment 2**) and DERM's submittal dated May 1, 2017, as approved by FDEP/EPA on September 7, 2017.

The December 29, 2016 FDEP and EPA comments are included as **Attachment 3**. DERM's response to the December 29, 2016 comments, dated May 1, 2017 is included as **Attachment 4**. FDEP and EPA final approval letter dated September 7, 2017 is included as **Attachment 5**.

The FOG Control Program applies county-wide and includes the following:

- (i) A FOG Characterization study that identified sources of FOG causing problems in the wastewater collection and transmission system (WCTS) and wastewater

- collection and transmission systems of the Volume Sewer Customers and most appropriate method or mechanisms to control the discharge of FOG.
- (ii) The legal authority to control discharges of FOG, including ability to implement a permit and enforcement program for commercial and industrial sources.
 - (iii) Specifications of accepted FOG control devices.
 - (iv) Establishment of standards for the design and construction of FOG control devices.
 - (v) Establishment of FOG control device management, operations and maintenance standards or best management practices.
 - (vi) Establishment of construction inspection protocols.
 - (vii) Establishment of compliance inspection protocols.
 - (viii) Establishment of FOG disposal manifest system, with included requirement that FOG and Septage not be commingled.
 - (ix) Establishment of an enforcement program.
 - (x) Establishment of a compliance assistance program.
 - (xi) Establishment of a comprehensive public education program.
 - (xii) Establishment of staffing (technical and legal) and equipment requirements for the FOG Control Program.

- (xiii) A regularly maintained list of current commercial establishment FOG generators, including FOG generating processes and estimated average quantity of FOG generated.
- (xiv) Establishment of performance indicators to be used by Miami-Dade to measure effectiveness of FOG Control Program.
- (xv) A schedule to review, evaluate and revise the FOG Control Program on at least an annual basis. Revisions to the FOG Control Program will be submitted to EPA and DEP in accordance with Paragraph 15 of this Consent Decree.

Many of the FOG Control Program requirements were implemented concurrently with the development of the Ordinance. Specifically, FOG plan review improvements and technical guidance for design professionals, FOG stakeholder outreach, FSEs compliance assistance, utility coordination, and FOG manifesting were implemented. DERM will continue to develop these improvements as described in this report.

02. FOG Program Organizational Chart

The FOG Control Program is managed by the Pollution Regulation Division (PRD) of DERM and is divided among two (2) PRD sections: Environmental Permitting, and Water and Wastewater Permitting. The table of organization for DERM's Pollution Regulation Division and for the Water and Wastewater section is shown below.

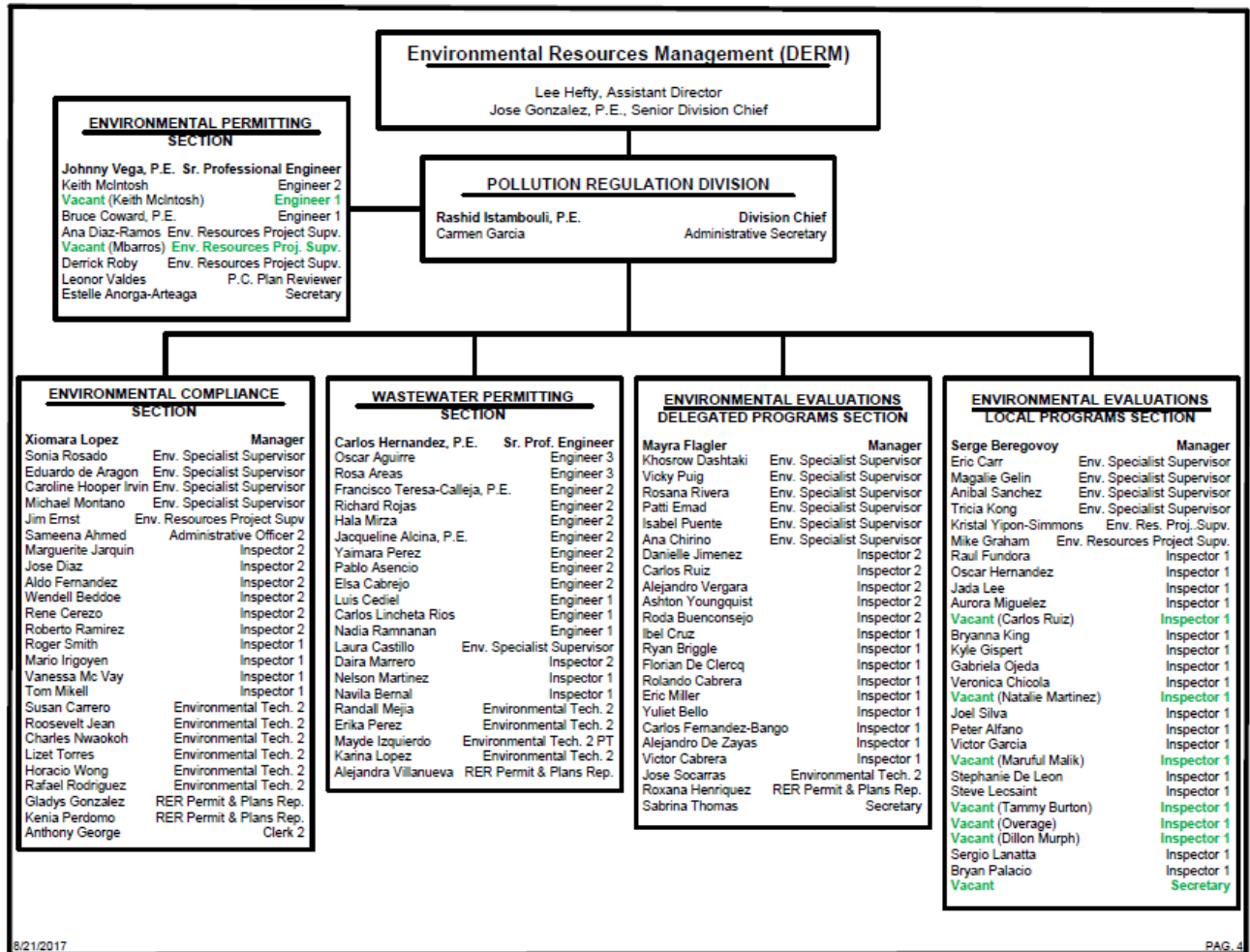

Figure 1. DERM's Pollution Regulation Division Table of Organization

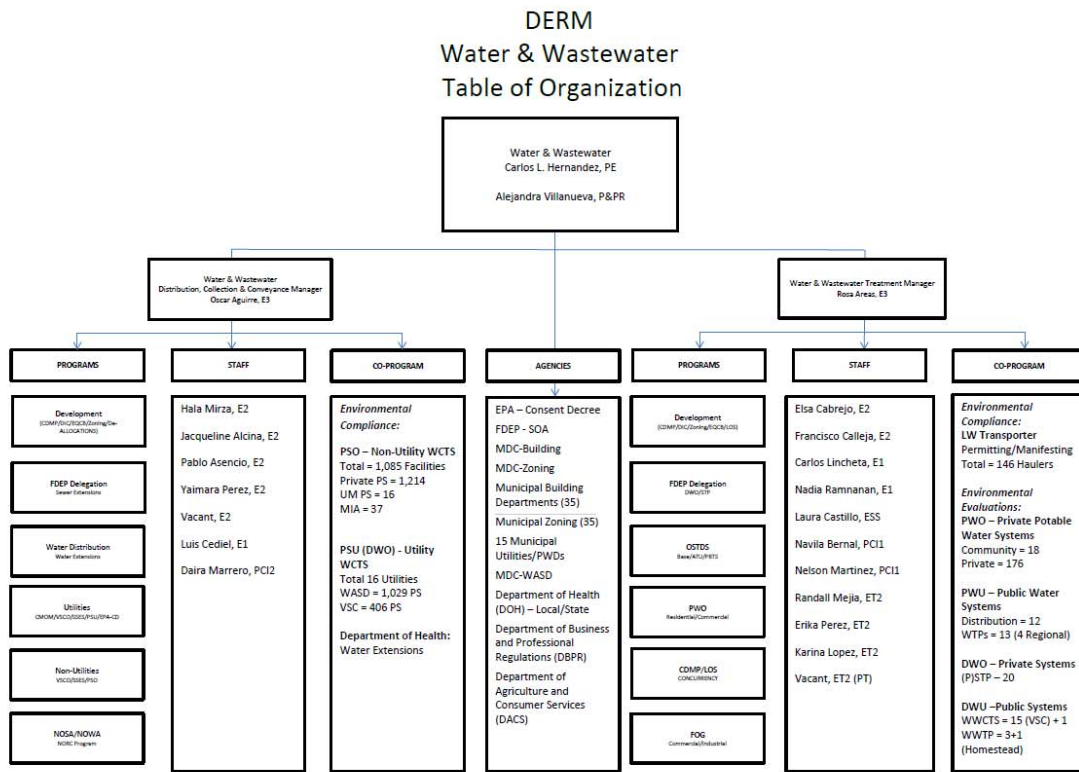

Figure 2. Water and Wastewater Section Table of Organization

The primary responsibilities of each section under the FOG Control Program are summarized below (Table 1).

This structure has provided a more effective line of communication between Engineering and technical support staff, facilitating coordination of field inspections and sampling events. This interaction has resulted in improved efficiency, including:

- Improved design requirements resulting from field observations made by inspectors being communicated directly to Engineering staff (e.g., no parallel grease interceptor installations and a minimum capacity established for hydromechanical grease interceptors).
- Reduced time to identify root cause for blockages and sanitary sewer overflows associated with FOG by performing joint inspections, inspectors and Engineers.

Table 1. FOG Control Program and Sections Responsibilities

FOG Control Program Responsibilities by Section	
Section	Primary FOG Program Function ⁽¹⁾
FOG Plan Review & Engineering (technical) Support	Water & Wastewater Permitting
Establish GDO Permit Conditions	Water & Wastewater Permitting
Establish GDO Permit Shells	Water & Wastewater Permitting
Issue GDO Permits and Renewals	Environmental Permitting
GDO Construction Inspections	Water & Wastewater Permitting
GDO Compliance Inspections	Water & Wastewater Permitting
GDO Compliance Assistance	Water & Wastewater Permitting
Field Notice of Violation	Water & Wastewater Permitting
Tickets (UCVN)	Water & Wastewater Permitting
Notice of Violation	Enforcement Section
Consent Agreement	Enforcement Section

(1) Each section has additional responsibilities and manages other programs.

FOG Control program staff works closely with DERM's Enforcement Section to obtain compliance for cases where progressive enforcement actions are required, such as Consent Agreements.

The EPA and FDEP will be notified of all organizational changes pursuant to Section 19 (a)(xv) of the CD (herein section 17, Annual FOG Control Program Review).

03. FOG Characterization Study

A review of DERM, Miami-Dade County Water and Sewer Department (MDWASD), and fifteen Volume Sewer Customer (VSC) records were performed to identify the sources of FOG causing problems in the wastewater collection and transmission systems within the County. Other sources of information included the DERM Utility Round Table (URT), the FOG Round Table, the Coffee Shops' Study, Malls and Shopping centers' sweep, Tea Study, outreach meetings, and targeted facility inspections.

DERM established the URT in October 2013, as a forum for exchange of information and coordination between DERM, Design Professionals and all Utilities. URT meetings are held quarterly, the most recent meeting was held on October 11th, 2017. The topic of FOG sources was addressed at many of these meetings.

The FOG Round Table was established on September 2016, to serve as a forum to facilitate discussions among FOG Control Program stakeholders. These meetings are held quarterly, with the most recent meeting being held on June 7th, 2017.

Other outreach events included meetings with food service establishments, liquid waste transporters, utilities, equipment manufacturers, design professionals, Miami-Dade and Broward County plumbing chiefs and plan reviewers, and Miami-Dade and Broward County liquid waste disposal facility staff. A list of outreach events and copies of URT and FOGRT flyers are included in **Attachment 6**.

Below is a summary of each FOG source identified, the most appropriate method or mechanism for addressing each, and applicable sections of the FOG Ordinance.

FOG SOURCES		
FOG Source	Methods/Mechanism For Addressing	PROPOSED Ordinance Section
Single Family/Duplex Residential	Education/Outreach/Compliance Assistance	24-42.6 (1) & (3)
Apartments/Condominiums	Education/Outreach/Compliance Assistance/Enforcement	24-42.6 (1) & (3)
Food Service Establishments (Commercial) and Food Processing Operations (Industrial)	Education/Outreach/Compliance Assistance/Enforcement	24-42.6 (1) & (3)
	FOG Control Device Required	24-42.6 (4), (5) & (7)
	Design Requirements for FOG Control Device	24-42.6 (8) & (9)
	Construction Inspections	24-42.6 (7)(a)(ii)
	Operation & Maintenance	24-42.6 (10)

Additional findings from the FOG characterization study are summarized below.

Additional FOG Characterization Study Findings		
Original FOG Control Program	New FOG Control Program	Ordinance Section(s)
Design professionals do not generally understand the design requirements for FOG control devices or the long-term consequences of poorly designed systems (e.g., undersized systems).	Detailed design requirements are provided for design professionals in the Ordinance and FOG Control Device Guidance Manual (Attachment 7).	Sections 24-42.6(8) and (9)
Current design standards are flow based and do not include mass rates of FOG and solids.	Among other requirements, new Design requirements include flow rate, mass rates, and cleaning frequency for sizing grease interceptors.	Sections 24-42.6(8) and (9)
Solids accumulation in grease interceptors reduce system performance and results in discharge of FOG to wastewater collection and transmission systems.	Solids separation required.	Sections 24-42.6(7) and (8)
FOG control device certification for hydromechanical grease interceptors do not correlate with sanitary sewer discharge limitations and pretreatment standards; i.e., certification is based on 90% capture using gravimetric standards and sewer discharge limitations are 150 mg/L.	Design requirements include compliance with sanitary sewer discharge limits and pretreatment standards and hydromechanical grease interceptors certification requires 99% capture.	Section 24-42.6(8)
FOG control device design for gravity interceptors did not include hydraulic detention time (HDT).	Design requirements include peak flow and minimum HDT.	Section 24-42.6(9)
Operating permits (GDO) did not include mandatory FOG control device cleaning frequency. Lack of cleaning and generally undersized FOG control devices are a primary reason for excess FOG discharges to wastewater collection and transmission systems.	Starting in 2016, the Operating permits include cleaning requirements and frequencies. Cleaning frequency is a key design parameter for all new grease interceptors.	Section 24-42.6(10)

Additional FOG Characterization Study Findings (cont'd)		
Original FOG Control Program	New FOG Control Program	Ordinance Section(s)
Routine FOG inspection frequency was once every two (2) to five (5) years. This has resulted in poorly maintained systems and FOG discharges to wastewater collection and transmission systems.	Routine FOG inspection frequency will be, at a minimum, once every year starting 2019.	Not Specified
Approximately nine (9) percent of all facilities with a Grease Discharge Operating permit did not have a FOG control device, directly discharging FOG to wastewater collection and transmissions systems.	In 2014 DERM notified all permitted facilities lacking a FOG control device and required installation by June 30, 2015. The notice also advised that 2016 Grease Discharge Operating permits would not be renewed for facilities that had not installed a FOG control device or had not submitted plans for installation prior to the renewal date. Through 2016 and 2017 education and enforcement efforts resulted in reducing the number of known facilities without grease interceptor from - 496 as of February 2016, to 225 as of October 2017. To date all these facilities are under progressive enforcement.	Section 24-42.6 (4)
FOG Control Program inspections did not include measuring solids and FOG layers so FOG control equipment performance was generally unknown, making inspections ineffective.	Inspection by FOG technicians/inspectors includes measuring solids and FOG layers. Starting April 2017, this is also required of liquid waste transporters.	Section 24-42.6(11)
FOG blockages occur in collection system and transmission systems. Transmission system blockages typically occur in air release valves.	FOG inspections, with support from Engineering, evaluate FOG blockage records to define root cause. FOG blockages will be reported monthly by the Utilities starting April 2018 (see Attachment 8).	Section 24-42.6(3), (4), & (13)

Additional FOG Characterization Study Findings (cont'd)		
Original FOG Control Program	Original FOG Control Program	Original FOG Control Program
Coordination between utilities, plumbing, municipal code compliance, and DERM is limited.	Regular coordination with stakeholders is accomplished by the Utility Round Table and the FOG Round table.	Section 24-42.6(13) for Utilities to provide information to assist coordination
FOG Public outreach was lacking.	Starting in 2013 FOG public outreach has been a high priority for DERM. FOG outreach will continue to be a high priority. Refer to Section 13 herein.	Not Specified

04. Legal Authority

The legal authority which provides for control of FOG discharges into the wastewater collection and transmission systems of all utilities, including the ability to implement a permit and enforcement program for commercial and industrial sources is Chapter 24, Code of Miami-Dade County. Specifically, the applicable sections of Chapter 24 that provide the legal framework to implement an effective FOG Control Program include, but are not limited to:

- Section 24-5 Definitions*
- Section 24-8 Environmental Quality Control Board*
- Section 24-11 Appeals from actions or decisions of the Director of the MDC-DERM*
- Section 24-15 Plan approval required*
- Section 24-18 Operating Permits*
- Section 24-25 Violations of rules and regulations of the State of Florida, DERM, Florida Department of Health, and the US EPA*
- Section 24-27 Nuisance prohibited.*
- Section 24-28 Nuisances injurious to health (sanitary nuisances)*
- Section 24-29 Enforcement; procedure, remedies*
- Section 24-30 Penalties generally*

Section 24-31 Civil liability; joint and several liability; attorneys' fees.

Section 24-42.3 Certification of sanitary sewer system collection, transmission and treatment capacity

Section 24-42.4 Sanitary sewer discharge limitations and pretreatment standards

Section 24-42.6 Fats, Oil and Grease Control Program

Section 24-46 Regulation of liquid waste transporters

The approved FOG Control Ordinance is included in **Attachment 1**.

05. Specification of Accepted FOG Control Devices

For the purpose of defining accepted FOG control devices and providing consistency and clarity in the Ordinance, specific terms are defined in Section 24-5, Definitions. Specifically, grease Interceptor shall mean a FOG control device connected to a building grease waste drain. Two (2) broad categories related to FOG control devices are defined: hydromechanical grease interceptor and gravity grease interceptor.

Based on a review of national and international standards (e.g., Plumbing and Drainage Institute (PDI), American Society of Mechanical Engineers (ASME), and Canadian Standards Association (CSA)), existing FOG regulations, information gathered from numerous meetings held with equipment manufactures and design professionals (e.g., American Society of Plumbing Engineers, ASPE), accepted FOG control devices are defined as follows:

- a. Hydromechanical grease interceptor: a FOG control device that is third party tested and certified to 99% removal efficiency, and relies on the difference in specific gravity between wastewater and FOG to affect separation of FOG from wastewater, and may incorporate a flow control device, air entrainment, and other means or principles to improve the efficacy of separation as demonstrated by third-party testing, validation and certification devices certified by an independent testing entity recognized by the Director or Director's designee. Certifying entities can include, but are not limited to, the PDI, ASME or CSA. Hydromechanical devices can be automatic or manual.

- b. Gravity Grease Interceptors: a FOG control device that primarily relies on the difference in specific gravity between wastewater and FOG and HDT to affect separation of FOG from wastewater. Gravity interceptors shall have a designated approval number from the State's Health Office to comply with Florida Administrative Code FAC Rule 64E-6.013(3) and Florida Department of Transportation (for concrete cast tanks).

06. Standards for the Design and Construction of FOG Control Devices

Standards for the design and construction of FOG control devices are included in the DERM guide entitled "FOG^{2.0} Control Device Guidance Manual" and codified in Sections 24-42.6. A copy of the guidance manual is included as **Attachment 7**. This manual will be reviewed by DERM from time to time as necessary and will be amended to incorporate updates as appropriate. All updates will be posted at:

<http://www.miamidade.gov/environment/fats-oils-grease.asp>

07. FOG Control Device Management, Operation and Maintenance Standards

Management, operation and maintenance of FOG control devices are included in Section 24-42.6(10). In addition to the requirements stipulated in Paragraph 19(a)(v) of the CD, the following requirements are included in Section 24-42.6(10):

- a. Inclusion of Best Management Practices in operating permits, included as **Attachment 9**;
- b. Maintenance of grease waste drains, building sanitary drains and building sewers;
- c. Maintenance of kitchen exhausts hoods;
- d. Maintenance of solids separators;
- e. Maintenance of yellow grease areas; and
- f. Maintenance of mat and equipment wash-down areas.

The Ordinance prohibits the use of additives and provides that disposal shall only be at approved facilities (refer to Sections 24-42.6(10)(d)(ii) and 24-42.6(12)).

The Ordinance also provides that grease interceptors shall be cleaned regularly by a liquid waste transporter permitted by the DERM and that the cleaning requires the complete removal of the contents of the interceptor. Cleaning frequency is included in the annual operating permits and is prescribed as every 30 days for hydromechanical interceptors (manual and automatic), and every 60 days for gravity interceptors. Alternative cleaning frequencies, not to exceed 90 days, may be approved by the Director or Director's designee based on a complete engineering analysis (refer to Sections 24-42.6(10)(d)(ii) and 24-42.6(12)). Furthermore, interceptors equipped with a functional Interceptor Monitoring Device may be cleaned by a liquid waste transporter permitted by the DERM at a greater frequency, not to exceed one hundred eighty (180) days, if applicable standards in Section 24-42.4 are not exceeded.

Cleaning of interceptors by a liquid waste transporter permitted by the DERM include completely evacuating all liquids, solids, and FOG and pressure washing or scrapping, as required, to remove material attached to the interior walls, baffles, and pipes. The Ordinance also provides that FOG waste from jetting, rodding, kitchen exhaust hoods maintenance, or other cleaning activities shall be collected and transported by a liquid waste transporter, permitted by the DERM, to an approved disposal facility.

An exception to the cleaning by a liquid waste transporter was established for FSEs, with no cooking and fryers, that are equipped with a FCD rated at 20 gpm or less; in which case regular and documented maintenance by the operator of the food service establishment is allowed (Section 24-42.6(10)).

Cleaning and maintenance records keeping requirements are included in Section 24-42.6(10)(d)(iii).

08. FOG Control Device Construction Inspection Protocols

The DERM will perform construction inspections as stipulated in the May 1, 2017 submittal to FDEP/EPA, and codified in Section 24-42.6(7)(a)(ii). FOG control devices shall be inspected by DERM inspectors for compliance with Section 24-42.6(8) and with DERM approved construction plans pursuant to 24-42.6(6)(a)(i).

DERM will work with all Building Officials, unincorporated and municipal, to finalize a process by which permit holders contact DERM to schedule (FOG) inspections. No building/plumbing permit final inspection, certificate of occupancy or certificate of completion shall be issued prior to the DERM's inspection finding that the FOG control devices have been installed in compliance with DERM approved construction plans. The final inspection process will be implemented no later than March 2018, six (6) months after FDEP/EPA Approval of the Ordinance.

09. Compliance Inspection Protocol

Compliance inspections under the FOG Control Program will be expanded by leveraging technology and utility reports and records. The inspection frequency will be increased from once every two (2) to (5) years to annually by September 30, 2019. Prior to September 2019 the DERM will continue to focus on analyzing root causes of FOG blockages and correcting "hot spot" areas. Hot spots are those areas where accelerated maintenance (refer to Section 24-5, Definitions) is required to minimize or prevent blockages caused by FOG. Section 24-42.6(13) provides the specific reporting requirement for utilities, associated with hot spots, and Section 24-42.3 provides penalties for utilities that do not report to DERM. Maps of hot spots are included as **Attachment 10**. These locations are not stagnant and will be updated as applicable, during the monthly MDWASD utility blockage meetings and with the monthly reports provided by all utilities pursuant Section 24-42.6(13). Staff from DERM began attending the monthly MDWASD meeting in 2015 and will continue to attend to assure coordination and improve the effectiveness and efficiency of the FOG Control Program. In addition, starting October 2017 the quarterly URT includes as a regular topic in the agenda an item referring to the Review of Utilities' Hot Spot data. This data will continue to be incorporated in the compliance inspection process.

As commercial hot spot areas are addressed, inspections will shift to routine compliance visits, construction inspections (refer to Section 24-42.6(7) (c)) and residential inspections (i.e., FOG blockages caused by apartment and residential condominium buildings). While this approach will be dynamic and adjusted based on actual field conditions, a tentative timeline is included as **Graph** below.

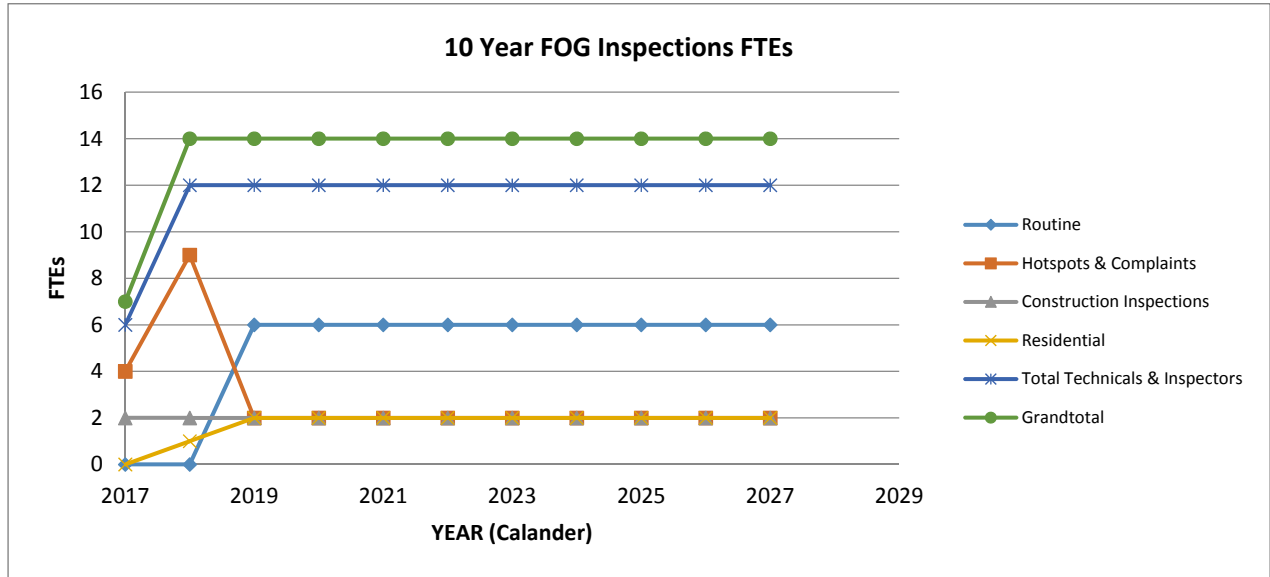

10 Year FOG Inspections FTEs												
Inspection Category	Classifications	2017	2018	2019	2020	2021	2022	2023	2024	2025	2026	2027
Routine	Fog Technician	0	0	6	6	6	6	6	6	6	6	6
	FOG Inspector	0	0	0	0	0	0	0	0	0	0	0
	Subtotal	0	0	6	6	6	6	6	6	6	6	6
Hotspots & Complaints	Fog Technician	4	8	1	1	1	1	1	1	1	1	1
	FOG Inspector	0	1	1	1	1	1	1	1	1	1	1
	Subtotal	4	9	2	2	2	2	2	2	2	2	2
Construction Inspections	Fog Technician	0	0	0	0	0	0	0	0	0	0	0
	FOG Inspector	2	2	2	2	2	2	2	2	2	2	2
	Subtotal	2	2	2	2	2	2	2	2	2	2	2
Upgrades	Fog Technician	0	0	0	0	0	0	0	0	0	0	0
	FOG Inspector	0	0	0	0	0	0	0	0	0	0	0
	Subtotal	0	0	0	0	0	0	0	0	0	0	0
Residential	Fog Technician	0	0	1	1	1	1	1	1	1	1	1
	FOG Inspector	0	1	1	1	1	1	1	1	1	1	1
	Subtotal	0	1	2	2	2	2	2	2	2	2	2
Total Technicians & Inspectors		6	12	12	12	12	12	12	12	12	12	12
Supervisors		1	2	2	2	2	2	2	2	2	2	2
Grand Total		7	14	14	14	14	14	14	14	14	14	14

Compliance inspection reporting forms are electronic and deployed using the Environmental Resources Management (ERM) Mobile application and tablets. Staff enter inspections results and field notices in the field using ERM Mobile. The DERM deployed on December 2015.

Compliance inspections will include, but not be limited to, verifying:

1. Posting of GDO Permit.
2. Use of Best Management Practices.
3. Record keeping, including disposal manifest records and electronic reporting.
4. FOG control device construction, operation, maintenance and cleaning.
5. Sampling point located after no further treatment.
6. FOG Control Device effluent quality (e.g., effluent sampling).
7. Back of house fixtures connected (e.g., dye testing fixtures).
8. Waste drains are not surcharged/blocked.
9. Yellow/brown grease storage and storage area maintenance.
10. Mat and equipment wash-down areas prevent the release of FOG to ground, groundwater, and surface waters.
11. Waste disposal.
12. Training completed.

More detailed information about compliance inspection process is provided in the FOG Inspection Manual, included as **Attachment 11**.

10. FOG Disposal Manifest

On April 1, 2015, DERM implemented a FOG and Septage disposal manifesting process. A guidance document, titled “Liquid Waste Transporter Septage and FOG Waste Manifest Guidance Manual”, was developed and provided to all of the permitted liquid waste transporters and posted on the County’s web site for liquid waste transporters. To develop the disposal manifest process, DERM coordinated meetings with liquid waste transporters and Miami-Dade Water and Sewer Department and Broward County staff responsible for managing the two waste disposal facilities currently used by the liquid waste transporters: Miami-Dade County

South District Wastewater Treatment Plant operated by MDWASD and Broward County Septage Receiving Facility operated and managed by the Compliance and Monitoring Section - Environmental Standards & Technology (EST) Division of Water & Wastewater Services (Powerline Road Facility, Pompano Beach). The paper manifest form was also designed to be used with future private and public facilities as they become available. A copy of the guidance document is included in **Attachment 12**.

Beginning April 1, 2017, commingling of FOG and septage is no longer permitted. All liquid waste transporters and disposal facilities were notified approximately six (6) months in advance of this requirement.

Also beginning April 1, 2017, DERM implemented an electronic disposal manifest system (eManifest), complimenting the paper based system, implemented April 1, 2015. Training sessions were made available for all liquid waste transporters six (6) months prior to full scale implementation, and after the implementation. Support via telephone or e-mail is provided in a continuous basis by DERM personnel. The eManifest system requires all liquid waste transporters to report all data electronically, including assessment of the FOG control devices.

Starting January 2018, the eManifest system will be utilized by FSEs to report (1) the liquid waste transporter company and (2) date of cleaning. This data will be compared with data provided by the liquid waste transporters and disposal facilities. Discrepancies in data will be utilized to schedule additional compliance inspections.

A revised guidance manual, replacing the aforementioned manual is under final development for submittal to FDEP/EPA on or before October 31, 2017 as part of the County's CMOM submittal requirements. The updated manual will be incorporated herein as **Attachment 13**, once approved by FDEP/EPA.

11. Enforcement/Regulatory Programs

In addition to the existing Chapter 24 regulations and DERM's current enforcement policy, a FOG Enforcement Response Plan was included with the original submittal (**Attachment 14**).

The FOG Enforcement Response Plan is not a stagnant plan and will continue to evolve, as DERM implements the Ordinance, with the focused goal of accomplishing compliance to reduce FOG discharges, blockages and sanitary sewer overflows. A brief summary of inspection task actions (enforcement), as discussed in the December 2016 meeting is provided below and **Attachment 15**.

Routine FOG Inspection			
Task	Task Result	Task Action	Task Outcome
Verify ALL FSEs have GDO	Identify FSEs w/out GDO Permit	<ul style="list-style-type: none"> Inspect & Issue Field Notice (FN) 	All FSEs permitted
	Identify FSEs w/GDO Permit	<ul style="list-style-type: none"> Inspect 	
Check Posting of GDO Permit	Not Posted	<ul style="list-style-type: none"> 1st-time = Warning Notice (WN) 2nd += Ticket 	Awareness & Comply w/Permit Conditions
	Posted	<ul style="list-style-type: none"> Review with GDO 	Awareness of Requirements
Request 3 Last Pump-Out Receipts	Not Available At Facility	<ul style="list-style-type: none"> 1st-time = WN 2nd += Ticket 	Maintain System
	Provided & Insufficient	<ul style="list-style-type: none"> 1st-time = WN 2nd += Ticket 	
	Provided & Sufficient	<ul style="list-style-type: none"> Review Receipts Check Liquid Waste Transporter (LWT) Approved by DERM 	
Inspect FCD: <ul style="list-style-type: none"> Visual Condition Assessment of System (+System Outlet/Sampling Port) Effluent Sampling Dye Test Fixtures FOG & Solids Levels (dipstick pro or equal) Downstream Manhole(s) Assessment 	System NOT Maintained but no FOG Discharge	<ul style="list-style-type: none"> 1st-time = FN to clean system and provide disposal receipt w/in 48 hrs. 2nd += Ticket Follow-Up Inspection to Confirm Compliance 	Maintain System & Protect WCTS
	System NOT Maintained & FOG Discharge	<ul style="list-style-type: none"> Samples collected 1st-time = FN to clean system and provide disposal receipt w/in 48 hrs. 2nd += Ticket System Upgrade Follow-Up Inspection to Confirm Compliance 	
	System Maintained	Review with GDO	

12. Compliance Assistance Program

To assure the effectiveness of compliance assistance, the staff performing regulatory/compliance inspections will not be the same staff performing compliance/educational assistance. This separation in duties provides a clear direction for the regulated facilities. Compliance assistance will include the development of training materials and compliance assistance visits for FOG generators (e.g., food service establishments), liquid waste transporters, and FOG disposal facilities. Refer to Sections 24-42.6(10), 24-42.6(11) and 24-42.6(12).

DERM will make training materials available for FOG generators (e.g., food service establishments), liquid waste transporters, and FOG disposal facilities within twelve (12) months of the Board of County Commissioners approving the NEW Ordinance (approximately eighteen (18) months after 9/7/2017, date the EPA approved the FOG Ordinance).

13. Comprehensive Public Education

13.01 Residential Public Education

Public education and clear requirements for residential facilities will serve to assist in reducing the amount of FOG entering public sanitary sewer systems. Refer to Section 24-42.6(3) for the residential requirements. Public education will include the following components:

1. Public advertising campaigns (e.g., Signs on Public Buses);
2. Web-based education and outreach programs;
3. Public school/student outreach;
4. Attending apartment/condominium association meetings;
5. Water bill mailers; and
6. Door hangers.

Public education efforts will be coordinated with utilities to maximize their impact. While public education programs are an important part of an effective FOG Control Program, experience has shown that targeted identification of FOG hot spots and compliance assistance visits are most effective in changing behavior. Therefore, as part of the hot spot root-cause identification process, sources of FOG identified to be from residential sources will result in targeted public education and outreach which will include DERM staff meetings with property managers and association members, attending regularly scheduled apartment/condominium association meetings, and placement of informational door hangers or equivalent notices. Coupling this approach with requirements included in Section 24-42.6(3) will serve to change behavior and thereby reduce the amount of FOG entering the public sanitary sewer systems.

Within twenty-four (24) months of the Board of County Commissioners approving the FOG Ordinance (approximately thirty (30) months after 9/7/2017, date the EPA approved the FOG Ordinance), DERM will fully implement the public education program.

Excluding labor cost for FOG technicians, inspectors, and supervisors, public education costs will be funded from the utility service fee.

13.02 Stakeholder Outreach

Lack of stakeholder outreach was one of the findings in the FOG Characterization Study. Beginning in 2013, DERM initiated a stakeholder outreach program. Stakeholder outreach will continue with a minimum of six (6) events planned annually. Key stakeholders and planned events include: quarterly Utility Round Table, quarterly FOG Round Table, Utilities FOG Blockages monthly meetings, liquid waste transporters training sessions, and participation in Plumbing associations, and professional meetings.

Stakeholder Outreach	
Stakeholder	Outreach Events
Professional Engineers	<ul style="list-style-type: none"> FOG Control Device Design, 2 FBPE Continuing Education Credits
Plumbing Professionals	<ul style="list-style-type: none"> FOG Control Device Construction Inspection Process FOG Round Table
Sanitary Sewer Utilities/Public Works	<ul style="list-style-type: none"> Reporting FOG Blockages Utility Round Table
Liquid Waste Transporters & Disposal Facilities	<ul style="list-style-type: none"> eManifest No Commingling Rule
Food Service Establishments	<ul style="list-style-type: none"> FOG Compliance Made Easy FOG Round Table
Code Enforcement Officers	<ul style="list-style-type: none"> FOG Compliance Assistance

14. Staffing and Equipment Requirements

Compliance inspections and assistance are performed by FOG technicians and inspectors. This staff is dedicated to FOG related inspections, including wastewater collection and transmission system inspections when FOG impacts are the source of surcharge, blockages and sanitary sewer overflows. This is a significant improvement over past approaches where by inspectors that performed multi-program inspections.

The number of inspection staff and supervisors was determined based on past performance, performance metrics for similar programs in the State, and careful process analysis. The basis for analysis is summarized below.

Weeks/Year =	52 weeks	Inspections/day =	6 per inspector
Holidays =	2 weeks	Inspection days/week =	4 per inspector
Annual Leave =	2 weeks	Inspections/week =	24 per inspector
Sick Leave =	2 weeks	No. Inspections/year =	1008 per inspector
FOG Training =	2 week	No. Inspectors =	8
Other Training =	2 week	No. Inspections & Re-inspections/year =	8064
Annual Work =	42 weeks		

Based on the above, a total of eight (8) full-time FOG technicians, and four (4) FOG inspectors and two (2) supervisors are required. Equipment requirements are summarized below.

1. One (1) vehicle per inspector.
2. Manhole puller.
3. Sludge judge or equivalent measuring device.
4. Tablet with internet connection to office systems (e.g., ARCGIS and databases).
5. Wi-Fi device for Internet connection.
6. Portable printers.

7. Antennas for cars.
8. AVL for vehicle tracking.
9. Digital camera (or tablet camera).
10. Tape measure.
11. High-power flashlight.
12. Sampling equipment, laboratory kits (bottles, labels, etc.), and cooler.
13. Dye tablets
14. LED flashlights
15. Infrared thermometers
16. Hydrogen Sulfide kits
17. pH Paper and pH meter
18. Flat and Philips screw drivers

The staffing numbers above provide approximately one (1) FOG technician/inspector for approximately 700 FOG generators. This ratio will be used to maintain adequate staffing levels if the number of FOG generators increase.

Costs and funding source for inspection group is summarized below.

MIAMI-DADE COUNTY PAY PLAN 2017/2018										Proposed	
Occu. Code	Occupational Title	Step 1		Step 10		Step 20		Step 8		No.	Lab Cost
		2 weeks	Annual	2 weeks	Annual	2 weeks	Annual	Step 8	Annual		
006360	Envir. Tech. 1	\$ 993	\$ 25,826	\$ 1,391	\$ 36,162	\$ 2,098	\$ 54,541	\$ 1,289	\$ 33,509	0	\$ -
006361	Envir. Tech. 2	\$ 1,152	\$ 29,940	\$ 1,630	\$ 42,380	\$ 2,504	\$ 65,092	\$ 1,503	\$ 39,086	8	\$ 312,691
001534	Poll Control Inspector 1	\$ 1,503	\$ 39,076	\$ 2,287	\$ 59,459	\$ 3,664	\$ 95,265	\$ 2,082	\$ 54,130	4	\$ 216,521
001535	Poll Control Inspector 2	\$ 1,719	\$ 44,688	\$ 2,636	\$ 68,527	\$ 4,196	\$ 109,103	\$ 2,398	\$ 62,357		\$ -
001554	RES Proj Supervisor							\$ 2,887	\$ 75,073		\$ -
001562	Envir. Spec Supv							\$ 2,902	\$ 75,447	2	\$ 150,894
001547	Code Enforcement Officer 1										
001548	Code Enforcement Officer 2							\$ 2,902	\$ 75,447	0.50	\$ 37,723
001022	Engineer 3							\$ 3,815	\$ 99,193	0.25	\$ 24,798
001051	Sr. Professional Engineer							\$ 5,070	\$ 131,816	0.20	\$ 26,363
Direct Labor											\$ 768,990
Labor x 1.8 (fringe + overhead)											\$ 1,384,181
Vehicle cost (10 vehicles)											\$ 45,000
Other Cost (15% of salaries)											\$ 115,348
Total Cost											\$ 1,544,530
No. of Facilities (10/10/2017)											6,934
Cost/Facility											\$ 223
Current Average Fee (10/10/2017)											\$ 195
Adjusted cost to Inspect All Facilities Annually											\$ 1,544,530
Projected Fee Revenue											\$ 1,352,130
Balance: Gain (Deficit)											\$ (192,400)

As proposed, the program generated funds and utility service fee are sufficient. Not included above are plan review costs since these are funded through plan review fees. The fee for each FOG construction plan review is \$120.00.

15. List of Current Commercial Establishments FOG Generators

A current list of FOG generators is included in **Attachment 16**. Maps showing the location of FOG Generators and MDWASD hot spots are also included in **Attachment 17** and **Attachment 10**. The list is updated each time an existing FOG generator changes ownership, FOG control device is installed, changed or upgraded, or facility is upgraded, expanded or enlarged. The list is also updated each time a new facility is permitted.

16. Performance Indicators

Performance measures (PMs), which compare actual performance against an established performance standard, benchmark, or target, help identify the relative effectiveness of a FOG Control Program. PMs include a subset of measures termed Key Performance Indicators (KPIs). FOG supervisors will utilize KPI to justify, allocate, and/or reallocate resources to maximize the effectiveness of the FOG Control Program. DERM will implement a PM target system to evaluate FOG inspection compliance and compliance assistance effectiveness of reducing wastewater collection and transmission system blockages (e.g., gravity sewer system blockages and force main air release valve blockages) and sanitary sewer overflows. The KPIs are summarized below:

PM	KPI	Method	DERM Target
Collection System SSOs Primarily Caused by FOG		MDWASD Monthly Report/Meeting	Annual Reduction
Collection System Blockages Primarily Caused by FOG		MDWASD Monthly Report/Meeting	Annual Reduction

PM	KPI	Method	DERM Target
	Number of FOG Generators without FOG Control Device	FOG Inspections	Annual Reduction Goal is to have None by end of 2018
	FOG Inspection Frequency	FOG Inspections	100% Annually by 2019
	FOG Education (Residential)	Education	Six (6) Events Annually
	FOG Stakeholder Outreach (commercial/industrial)	Outreach	Six (6) Events Annually

17. Annual FOG Control Program Review

17.01 FOG Control Program Review Committee

An annual review of the FOG Control Program effectiveness will be performed by a FOG Control Program Review Committee. The committee will be composed of five members, each from one of the following Departments/Sections:

- DERM Wastewater Permitting Section
- DERM Director or Director’s Designee
- RER Administration
- MDWASD Wastewater Collection and Transmission Line Division , Chief
- One Volume Sewer Customer (Municipal Utility) selected at the 8th Utility Round Table meeting: City of Coral Gables

The findings and recommendations of the committee will be provided to the DERM Pollution Regulation Division Chief who will evaluate the recommendations and prepare a final annual

report for submittal to EPA and FDEP by June 30th of each year, starting **June 30, 2018**. Implementation of the FOG Control Program will also be reported in accordance with Paragraph 33 and 34 of the CD. All committee findings will be included in the annual report, including justifications for accepting or rejecting recommendations.

17.02 FOG Control Program Review Criteria

The FOG Control Program Review Committee will meet in March of each year to review the prior calendar year’s PM and KPIs (refer to **Section 16**) and make recommendations to the Pollution Regulation Division Chief. The committee will also review the progress made implementing the following requirements:

Implementation Schedule	
April 1, 2017	Commingling of FOG and septage will no longer be permitted
April 1, 2017	DERM implemented an electronic disposal manifest system, replacing the paper based system implemented April 1, 2015
October/November 2017	Compliance assistance visits to active FSEs to bring awareness of the new requirement of reporting data electronically (eManifest).
January 1, 2018	FSEs shall utilize eManifest to report electronically (Liquid Waste Transporter and Cleaning Date).
January 30, 2018	Guidelines for the Monthly Hot Spots Report will be made available to the Utilities.
March 31, 2018	Procedure and Checklist for the Construction Inspections will be finalized and implemented.

Implementation Schedule	
On April 1, 2018 or by the date (+10 day appeal period) the Board of County Commissioners approves the NEW Ordinance (approximately six (6) months after 9/7/2017, date the EPA approved the PROPOSED Ordinance)	Construction Inspections start to cover all construction permits approved for grease waste systems.
On April 1, 2018 or by the date (+10 day appeal period) the Board of County Commissioners approves the NEW Ordinance (approximately six (6) months after 9/7/2017, date the EPA approved the PROPOSED Ordinance)	Monthly Hot Spots Report will be submitted by the Utilities per requirements in Section 24-42.6(13)
Within twelve (12) months of the Board of County Commissioners approving the NEW Ordinance (approximately eighteen (18) months after 9/7/2017, date the EPA approved the PROPOSED Ordinance)	DERM will make training materials available for FOG generators (e.g., food service establishments), liquid waste transporters and FOG disposal facilities
September 30, 2019	Compliance Inspections to FSEs will be conducted annually.
January 1, 2019	To comply with Section 24-42.6(10)(iv) each FOG generator and FOG control device operator shall have one (1) trained person in the staff with knowledge in FOG reporting and maintenance requirements.

18. Conclusions

Building on DERM’s experience with the existing FOG control program, established in 1994, and with the findings of the FOG characterization study, DERM developed the NEW FOG control program to further reduce the discharge of FOG from commercial and residential sources. By implementing the new FOG control program, the County will reduce costly impacts of FOG discharges to wastewater collection and transmission systems and reduce the number of sanitary sewer overflows caused by FOG blockages.

Through continuous communication with the Stakeholders, the annual FOG Control Program review, the FOG program will continue improving in its different areas of action.

- a. Construction plan review procedures;
- b. Compliance inspection and compliance assistance protocols;
- c. Construction inspections;
- d. FOG disposal manifesting;
- e. Utility and Municipal coordination; and
- f. Public education and outreach.

ATTACHMENTS

Attachment 1
Approved FOG Control Ordinance

1 ORDINANCE NO. _____

2

3 ORDINANCE RELATED TO THE FATS, OILS AND GREASE PROGRAM
4 AND GREASE TRAP ORDINANCE; AMENDING SECTION 24-5 OF THE
5 CODE OF MIAMI-DADE COUNTY TO PROVIDE CERTAIN DEFINITIONS
6 AND MODIFYING OTHER DEFINITIONS RELATING TO FATS, OILS AND
7 GREASE; AMENDING SECTION 24-8 TO REFINE THE STATED DUTIES
8 AND POWERS OF THE ENVIRONMENTAL QUALITY CONTROL BOARD;
9 AMENDING SECTION 24-11 OF THE CODE OF MIAMI-DADE COUNTY
10 AMENDING THE RIGHT TO APPEAL; AMENDING SECTION 24-15 PLAN
11 APPROVAL; AMENDING SECTION 24-15.3, STANDARDS FOR
12 PREPARATION OF PLANS; AMENDING SECTION 24-18, OPERATING
13 PERMITS; AMENDING SECTION 24-25 RELATING TO REFERENCED
14 RULES AND REGULATIONS; AMENDING SECTION 24-42.3,
15 CERTIFICATION OF SANITARY SEWER SYSTEM COLLECTION,
16 TRANSMISSION AND TREATMENT CAPACITY; AMENDING SECTION
17 24-42.4 RELATING TO SANITARY SEWER DISCHARGE LIMITATIONS
18 AND PRETREATMENT STANDARDS; ADDING SECTION 24-42.6,
19 RELATING TO FATS, OILS AND GREASE CONTROL PROGRAM;
20 PROVIDING SEVERABILITY, INCLUSION IN THE CODE, AND AN
21 EFFECTIVE DATE
22

23 **NOW, THEREFORE, BE IT ORDAINED BY THE BOARD OF COUNTY**
24 **COMMISSIONERS OF MIAMI-DADE COUNTY, FLORIDA:**

25 Section 1. Section 24-5 of the Code of Miami-Dade County, Florida is hereby
26 amended to read as follows:¹

27 **Sec. 24-5. Definitions**

28 In construing the provisions of this chapter, where the context will permit and
29 no definition is provided herein, the definitions provided in Chapter 403, Florida
30 Statutes, as may be amended from time to time, and in rules and regulations
31 promulgated thereunder, as may be amended from time to time, shall apply. The
32 following words and phrases when used in this chapter shall have the meanings
33 ascribed to them in this section:
34

35
36 ¹Words stricken through and/or [[double bracketed]] shall be deleted. Words underscored and/or
37 >>double arrowed<< constitute the amendment proposed. Remaining provisions are now in

38 effect and remain unchanged.

39 >>Accelerated FOG maintenance shall mean cleaning performed by utilities
40 to prevent sanitary sewer overflows caused by FOG blockages in sanitary sewer
41 systems, including but not limited to laterals, gravity mains, pump stations, and
42 air release valves.<<

43 * * *

44
45
46 >>Back of the House shall mean all areas where food is stored, processed,
47 cooked, prepared, and assembled, and cleanup areas. It does not include offices,
48 dry storage or front of the house areas.<<

49 * * *

50
51
52 >>Best Management Practices shall mean a schedule of activities,
53 prohibitions of practices, maintenance procedures, and other management
54 practices to prevent or minimize pollution.<<

55 * * *

56
57
58 >>Black Grease shall mean any FOG commingled with septic wastes
59 (bathroom wastes).<<

60 * * *

61
62
63 >>Brown Grease shall mean FOG waste collected in, or removed from, a
64 FOG control device.<<

65 * * *

66
67
68 >>Building Sewer shall mean the part of the building drainage system that
69 extends from the end of the building drain and conveys the discharge to utility or
70 non-utility owned or operated sanitary sewer system.

71
72 Building Sanitary Drains shall mean the pipes intended to receive sanitary
73 wastewater and effluent from FOG control devices where FOG control devices
74 are installed or required. FOG or food waste shall not be discharged into the
75 building sanitary drains.<<

76 * * *

77
78
79 >>Dishmachine shall mean equipment used to sanitize and does not actually
80 wash the items put inside.

81
82 Dishwasher shall mean equipment that washes and sanitizes.<<

83

* * *

>>Fats, Oils and Grease (FOG) shall mean any substance such as vegetable or animal product used in, or a byproduct of, the cooking, ~~or~~ food preparation, or cleaning process, that can cause or lead to corrosion, blockages, reduced flow, or interference with the sanitary sewer system when discharged alone or combined with other materials or waste which turns or may turn viscous or solidifies with a change in temperature or other conditions.<<

* * *

>>FOG Capacity Limit shall mean the combined FOG and solids depth equal to twenty-five (25) percent of the design hydraulic depth in any location of a FOG control device ~~designed pursuant to Chapter 64E-6, Florida Administrative Code,~~ or seventy-five (75) percent of the rated FOG and solids capacity established by third party certification.

FOG Control Device shall mean equipment designed to remove, hold and prevent the passage of FOG to onsite sewage treatment and disposal systems and sanitary sewer systems ~~FOG control devices include grease traps and grease interceptors.~~

FOG Control Device Operator shall mean a person or entity which has management control for FOG control devices which serve other FOG generators.

FOG Generator shall mean any nonresidential facility, including, but not limited to, restaurants, bakeries, hotel and cafeteria kitchens, commercial kitchens, kitchens serving hospitals, nursing homes, daycares, assisted living facilities and other healthcare facilities, food processing plants or such other nonresidential facilities that can introduce food waste or FOG into building sanitary drains, building sewers, onsite sewage treatment and disposal systems, or non-utility or utility sanitary sewer systems. A FOG generator also includes those nonresidential facilities that produce yellow grease. ~~An industrial user subject to industrial pretreatment requirements under section 24-42.4 is not included herein.~~

FOG Generator Certified Staff shall mean a FOG generator employee which has attended training prescribed by the Director or Director's designee, and has received certification for training.

FOG Liquid Waste Transporter Certified Staff shall mean a FOG Liquid Waste Transporter employee which has attended training prescribed by the Director or Director's designee, and has received certification for training.

FOG Operating Permit shall mean an operating permit issued to FOG generators or FOG control device operators pursuant to Sections 24-18 and 24-42.6.

130 FOG Sampling Point shall mean a reasonably accessible location for sampling
131 the effluent of a FOG control device.<<

132 * * *

133
134
135 >>Front of the House shall mean office space, dry storage, but shall not
136 include areas defined as all areas not included in the back of the house.<<

137 * * *

138
139
140 >>Gravity Grease Interceptor shall mean a FOG control device that primarily
141 relies on the difference in specific gravity between wastewater and FOG to affect
142 separation of FOG from wastewater.<<

143 * * *

144
145
146 >>Grease Interceptor shall mean a FOG control device,
147 connected to a building grease waste drain.

148 Grease Trap shall mean a FOG control device located between one or more
149 fixtures (e.g., three compartment sink) and a building sanitary drain or grease
150 waste drain. A grease trap does not receive waste from a building grease waste
151 drain and can be located above or below ground.

152
153 Grease Waste Drains shall mean the pipes intended to receive FOG and food
154 waste. They convey the discharge to solids separators, when installed, and FOG
155 control devices.<<

156 * * *

157
158
159 >>Hydromechanical Grease Interceptor shall mean a FOG control device that
160 is third party tested and certified, and relies on the difference in specific gravity
161 between wastewater and FOG to affect separation of FOG from wastewater, and
162 may incorporate a flow control device, air entrainment, and other means or
163 principles to improve the efficacy of separation as demonstrated by third-party
164 testing, validation and certification.<<

165 * * *

166
167
168 >>Interceptor Monitoring Alarm shall mean a system and its components
169 capable of monitoring floating and settled solids levels in a FOG control device
170 on a regular interval. The system shall trigger a visual and audible alarm at the
171 FOG Capacity Limit.

172
173 Interceptor Monitoring Device shall mean a system and its components
174 capable of monitoring floating and settled solids in a FOG control device on a
175 regular interval, triggering a visual and audible alarm at the FOG Capacity Limit,

176 and reporting data electronically to the Department at a frequency and format
177 approved by the Director or Director's designee.<<

178 * * *

181 >>Residential FOG Source shall mean a residential kitchen that can introduce
182 food waste or FOG into a building drain, building sewer, onsite sewage treatment
183 and disposal system, or non-utility or utility sanitary sewer system.<<

184 * * *

185 >>Solids Separator shall mean a separator intended to capture solids and
186 allow ~~grease~~ FOG to pass through. It is installed at the source or on the grease
187 waste drains prior to a FOG control device ~~grease trap or grease intercepter.~~<<

188 * * *

189 >>Third Party Certified shall mean a certification by an independent entity
190 that specific equipment or devices have been tested and meet or exceed standards
191 established by the certifying entity and which the certifying entity has reviewed or
192 audited the manufacturing process. The certifying entity shall be recognized by
193 the Director or Director's designee and can include, but is not limited to, the
194 National Sanitation Foundation (NSF), American Society of Mechanical
195 Engineers (ASME), Plumbing and Drainage Institute (PDI) or Canadian
196 Standards Association (CSA) or combination of these and other entities to include
197 the aforementioned requirements.<<

198 * * *

199 >>Wash-Down Area shall mean an area where FOG generators wash the back
200 of the house mats or equipment.<<

201 * * *

202 >>Yellow Grease shall mean FOG generated as a byproduct from cooking or
203 food preparation that is not mixed with water, wastewater or other waste.<<

204 * * *

205 Section 2. Section 24-8 of the Code of Miami-Dade County, Florida, is hereby

206 amended to read as follows:

207 **Sec. 24-8. Environmental Quality Control Board.**

208 A Miami-Dade County Environmental Quality Control Board is hereby
209

220 created and established, consisting of five (5) members appointed by the County
221 Commission.

222 * * *

223
224
225 (5) *Duties and powers of the Environmental Quality Control Board.* The
226 Environmental Quality Control Board shall have the following duties, functions,
227 powers and responsibilities:

228
229 (a) To hear appeals by any person aggrieved by any action or decision of
230 the Director as provided in Section 24-11.

231
232 (b) To hear and pass upon all applications for variances and extensions of
233 time in the manner provided by Sections 24-13 and 24-14, except for
234 compliance with >>the regulations set forth in Section 24-25,
235 Adoption of rules and regulations of the State of Florida Department
236 of Environmental Protection, Florida Department of Health, or the
237 United States Environmental Protection Agency, or applicable federal
238 or state binding agreement<< ~~[[Federal Pretreatment Regulations set~~
239 ~~forth in 40 CFR 403 as incorporated in this chapter]].~~

240
241 (c) To hear and pass upon all applications for extension of time for
242 compliance with the provisions of this chapter. All such applications
243 shall be filed in accordance with the provisions of this chapter and
244 shall be heard and considered by the Environmental Quality Control
245 Board at a public hearing pursuant to notice. In considering such
246 applications, the Board shall take into account such factors as
247 practicability, availability of equipment, and relative benefits to the
248 community. The Board shall not have the power and authority to grant
249 any application for extension of time to comply with the prohibitions
250 against open burning (Section 24-41.4), or the prohibitions against
251 reduction of animal matter (Section 24-41.8), or the prohibitions
252 against a nuisance (Section 24-27), or the prohibitions against the
253 discharge of cyanides or other toxic chemicals into the waters in
254 excess of the standards set forth in Section 24-42(3). Applications for
255 extension of time for compliance shall be considered on the basis of
256 public interest and not merely on economic benefit to the applicant;
257 applications shall be granted only when it is established that the
258 requested extension of time for compliance will not be detrimental to
259 the public health, welfare and safety, and will not create or permit the
260 continuation of a nuisance, or that no technically feasible,
261 economically reasonable means of compliance are readily available to
262 the applicant. The Board shall not have the power and authority to
263 grant extensions of time for compliance with the >>regulations set
264 forth in Section 24-25, Adoption of rules and regulations of the State
265 of Florida Department of Environmental Protection, Florida

266
267
268
269
270
271
272
273
274
275

276

277
278
279
280
281
282
283
284
285
286
287
288
289
290
291
292
293
294
295
296
297
298
299
300
301
302
303
304
305
306
307
308
309

Department of Health, or the United States Environmental Protection Agency, or applicable federal or state binding agreement<<[[~~Federal Pretreatment Regulations set forth in 40 CFR 403 as incorporated in this chapter~~]]. Any person aggrieved by any decision of the Environmental Quality Control Board shall be entitled to judicial review in accordance with the Florida Rules of Appellate Procedure.

* * *

Section 3. Section 24-11 of the Code of Miami-Dade County, Florida, is hereby

amended to read as follows:

Sec. 24-11. Appeals from actions or decision of the Director of the Miami-Dade County Department of Environmental Resources Management.

Any person aggrieved by any action or decision of the Director, may appeal to the Environmental Quality Control Board by filing within fifteen (15) days after the date of the action or decision complained of, a written notice of appeal which shall set forth concisely the action or decision appealed from and the reasons or grounds for the appeal. The Environmental Quality Control Board shall set such appeal for hearing at the earliest possible date, and cause notice thereof to be served upon the appellant and the Director. The Environmental Quality Control Board shall hear and consider all facts material to the appeal, and render a decision promptly. The Environmental Quality Control Board may affirm, reverse or modify the action or decision appealed from provided that the Environmental Quality Control Board shall not take any action which conflicts with or nullifies any of the provisions of this chapter >>, or applicable federal or state law, or binding agreement between the County and any Federal or State Agency governing any applicable law<<. The decision of the Environmental Quality Control Board shall constitute final administrative review and no hearing or reconsideration shall be considered. Any person aggrieved by any decision of the Environmental Quality Control Board on an appeal shall be entitled to judicial review in accordance with the Florida Rules of Appellate Procedure. The words "action" and "decision" as used herein shall not include the filing of any action by the Director, in any court. The Board shall not have jurisdiction to reconsider the subject matter of any appeal after its final administrative determination for a period of six (6) months from the date of the Board's final action, unless the Board determines that there has been a material and substantial change in the circumstances; provided, however, any action taken or decision made by the Director at any time may be reconsidered by the Director and the Director may therefore modify any such action or decision.

* * *

310 Section 4. Section 24-15 of the Code of Miami-Dade County, Florida, is hereby
311 amended to read as follows:

312 **Sec. 24-15. Plan approval required.**

313 (1) *Intent.* It is the intent and purpose of this section to require that all new
314 facilities, equipment and processes constructed or operated after the effective date
315 of this chapter shall comply with the requirements herein contained, and that any
316 ~~[[major or substantial]]~~ enlargement, expansion or addition to existing facilities
317 also shall comply with the requirements herein contained. Any building permit
318 issued by the County or a municipality in violation of the provisions of this
319 chapter is hereby determined to be void.

320
321 (2) *Waste water facilities.* It shall be unlawful for any person to ~~[[enter~~
322 ~~into or let a contract for or to]]~~ commence the installation, extension, or operation
323 of any sewerage system ~~>>~~including collection, conveyance, transmission or
324 treatment~~<<~~ or waste treatment facility or any industrial waste disposal facility
325 without first obtaining the prior written approval of the Director or the Director's
326 designee. It shall be unlawful for any person to make any enlargement, alteration
327 or addition to any ~~>>~~sewerage system including collection, conveyance,
328 transmission or treatment or waste treatment facility or any industrial waste
329 disposal~~<<~~ facility, or commence the construction of any ~~>>~~such systems or
330 facilities~~<<~~~~[[facility]]~~, that will reasonably be expected to be a source of water
331 pollution without first obtaining the prior written approval of the Director or the
332 Director's designee. No building permit involving the generation or discharge of
333 effluents shall be issued by the County or any municipality unless the application
334 for a building permit has been approved by the Director or the Director's
335 designee.

336
337 The provisions of this section shall not apply to facilities discharging only
338 domestic wastes to a ~~>>~~utility or non-utility~~<<~~~~[[public sewer system]]~~ ~~>>~~through
339 a single lateral~~<<~~ approved by the Director or the Director's designee.
340 Notwithstanding the foregoing, the provisions of this section shall apply to
341 facilities discharging only domestic wastes to a ~~>>~~utility or non-utility~~<<~~~~[[public~~
342 ~~sewer system]]~~ ~~>>~~through a single lateral~~<<~~ approved by the Director or the
343 Director's designee if the facilities ~~<<~~have or require a FOG control device in
344 accordance with Section 24-42.6~~>>~~~~[[provide any form of pretreatment in~~
345 ~~conjunction with a grease trap]]~~.

346 * * *

347
348
349 Section 5. Section 24-15.3 of the Code of Miami-Dade County, Florida, is hereby
350 amended to read as follows:

351 **Sec. 24-15.3 Standards for preparation of plans.**

352
353 (1) Waste treatment works shall be designed in accordance with the
354 sewerage guide promulgated by the Florida State Board of Health, or similar
355 professional publication, recommended standards for sewage works and water
356 pollution control federation manuals of practice numbered eight (8) and nine (9),
357 as applicable to conditions prevailing within Miami-Dade County, and in
358 accordance with good engineering practices.

359
360 (2) Outfalls shall be extended or carried to the channel of a stream or to
361 deep water where outlet is submerged at all times. The extent and length of the
362 outfall shall conform to the requirements of the Director or the Director's
363 designee. No outfall shall be approved unless satisfactory evidence is presented to
364 establish that solids or other objectionable pollutants will not be deposited on the
365 shore, and that other forms of pollution will not be caused.

366
367 (3) ~~>>FOG control devices<< [[Grease traps]] shall be provided and~~
368 ~~installed in accordance with >>Section 24-42.6<<[[the rules and regulations~~
369 ~~promulgated under the provisions]] of this chapter. [[At a minimum, all grease~~
370 ~~traps discharging to publicly or privately owned or operated sanitary sewer~~
371 ~~collection systems shall be provided with a sampling point on the effluent~~
372 ~~discharge side of the grease trap. Wastes containing sizable quantities of grease~~
373 ~~such as those produced by restaurants shall not be deemed suitable for disposal~~
374 ~~into tile drainfields]].~~

375
376 (4) Drainage or disposal wells shall not be used for disposal of treated or
377 untreated wastes except as approved by the Director or the Director's designee.

378 * * *

379
380 Section 6. Section 24-18 of the Code of Miami-Dade County, Florida, is hereby

381 amended to read as follows:

382
383 **Sec. 24-18. Operating permits.**

384
385 (A) *Permit Required*>>.<< No person shall operate, maintain or permit,
386 cause, allow, let or suffer the operation or maintenance of a public water system,
387 public sewerage system, a location where a site rehabilitation action has been
388 completed in accordance with the provisions set forth in Section 24-44(2)(k)(ii)
389 >>.<< or any of the following facilities, all of which will reasonably be expected
390 to be a source of air pollution, ground pollution or water pollution, without a valid
391 operating permit issued by the Director or the Director's designee or in violation
392 of any condition, limitation or restriction which is part of an operating permit:

393
394 (1) Interim package sewage treatment plants;

395
396
397
398
399
400
401
402
403
404
405
406
407
408
409
410
411
412
413
414
415
416
417
418
419
420
421
422
423
424
425
426
427
428
429
430
431
432
433
434
435
436
437
438

* * *

(18) ~~[[Any nonresidential facility, including, but not limited to, restaurants, bakeries, hotel and cafeteria kitchens, processing plants or such other nonresidential facilities discharging into a publicly or privately owned or operated sanitary sewer collection system, if oil and grease can be introduced into a sewer by such nonresidential facility in quantities which have the potential to affect or hinder the operation of sewage collecting, transmission or treatment facilities.]]~~ >>FOG generator discharging to a utility or non-utility owned or operated sanitary sewer collection system or onsite sewage treatment and disposal system located in ~~the basic~~ a wellfield protection area of any utility or non-utility potable water supply wells. Refer to Section 24-42.6(9) for FOG generator operating permit requirements;<<

* * *

- (20) >>FOG Liquid Waste Transporter;
- (21) Liquid Waste Transporter;
- (22) FOG, Yellow Grease, Brown Grease, or other Grease Storage, Transfer or Treatment facility;
- (23) FOG Control Device Operator.<<

* * *

Section 7. Section 24-25 of the Code of Miami-Dade County, Florida, is hereby amended to read as follows:

Sec. 24-25. Violations of rules and regulations of the State of Florida Department of Environmental Protection, Florida Department of Health, and the United States Environmental Protection Agency.

- (1) **All of the following rules and regulations are hereby adopted and are incorporated herein by reference hereto as same may be amended from time to time:**
 - (a) Chapter 62-160 of the Florida Administrative Code
 - (b) Chapter 62-550 of the Florida Administrative Code

- 439 (c) Chapter 62-713 of the Florida Administrative Code
- 440
- 441 (d) Chapter 62-761 of the Florida Administrative Code
- 442
- 443 ~~[(e) Chapter 64E-8 of the Florida Administrative Code]~~
- 444
- 445 >>(e)<<[[(+)] Chapter 62-770 of the Florida Administrative Code
- 446
- 447 >>(f)<<[[(+)] Chapter 62-777 of the Florida Administrative Code
- 448
- 449 >>(g)<<[[(+)] Chapter 62-782 of the Florida Administrative Code
- 450
- 451 >>(h)<<[[(+)] Chapter 62-785 of the Florida Administrative Code
- 452
- 453 >>(i) Chapter 64E-6 of the Florida Administrative Code
- 454
- 455 (j) Chapter 64E-8 of the Florida Administrative Code<<
- 456

458 * * *

459
460 Section 8. Section 24-42.3 of the Code of Miami-Dade County, Florida, is hereby
461
462 amended to read as follows:

463 **Sec. 24-42.3. Certification of sanitary sewer system collection, transmission**
464 **and treatment capacity.**

465 (1) Notwithstanding any provision of this Code, no county or municipal
466 officer, agent, employee or board shall approve, grant or issue any building
467 permit, certificate of occupancy, >>certificate of completion,<< certificate of use
468 (except for changes in ownership) or municipal occupational license (except for
469 changes in ownership) for any land use served or to be served by a utility or non-
470 utility owned or operated wastewater collection and transmission system until the
471 county or municipal officer, agent, employee or board has obtained the prior
472 written unconditional approval or prior written conditional approval of the
473 Director or the Director's designee. Notwithstanding any provision of this Code,
474 no person shall construct, utilize, operate, occupy or cause, allow, let, permit or
475 suffer to be constructed, utilized, operated or occupied any land use served or to
476 be served by a utility or non-utility owned or operated wastewater collection and
477 transmission system until the person has obtained the prior written unconditional
478 approval or the prior written conditional approval of the Director or the Director's
479 designee.
480

481 * * *

483
484 (3) No new additional sewage flows shall be authorized for any sanitary
485 sewer basin, sewage pump station, or system pursuant to Section 24-42.3 unless
486 and until:

487
488 >>(a)<<[[†]] >>T<<[[‡]]he official responsible for issuing certificates of
489 occupancy, certificates of use or equivalent municipal occupational
490 licenses provides a monthly report that identifies projects that have
491 been issued a certificate of occupancy, >>certificate of completion,<<
492 certificate of use or an equivalent municipal occupational license that
493 have also received a conditional or unconditional written approval, and
494

495 >>(b)<<[[‡]] >>A<<[[a]]ll actions or reports required by Section 24-42.2
496 >>and Section 24-42.6(13)<< for the basin, pump station, or system
497 have been completed according to the schedules required therein.
498

499 * * *

500 Section 9. Section 24-42.4 of the Code of Miami-Dade County, Florida, is hereby

501 amended to read as follows:

502
503 **Sec. 24-42.4. Sanitary sewer discharge limitations and pretreatment**
504 **standards**

505 (1) *Definitions.* The following definitions shall be applicable only to the
506 provisions of Section 24-42.4:

507
508 (a) *Pollutant* shall mean dredged spoil, solid waste, incinerator residue,
509 filter backwash, sewage, garbage, sewage sludge, munitions, chemical
510 wastes, biological materials, radioactive materials, heat, wrecked or
511 discarded equipment, rock, sand, cellar dirt, and industrial, municipal,
512 and agricultural wastes discharged into water.

513 * * *

514
515 (2) *General Pretreatment Standards and Local Limits.*

516 * * *

517
518 (d) It shall be unlawful for any person to throw, drain, run or otherwise
519 discharge into a sanitary sewer, or to cause, permit, allow or suffer
520 to >>seep, to<< be thrown, run, drained, ~~[[allowed to seep,]]~~ or
521 otherwise discharged into such sewer any of the following
522 substances:
523
524
525

- 526 (i) Any gasoline, naphtha, fuel oil or other flammable or
 527 explosive liquid, solid or gas; any pollutants which may
 528 create a fire or explosion hazard in the POTW, including
 529 waste streams with a closed cup flash point of less than one
 530 hundred forty (140) degrees Fahrenheit or sixty (60)
 531 degrees Centigrade using the test methods in 40 CFR
 532 261.21.
- 533
- 534 (ii) Any waters or wastes containing any pollutant, a toxic or
 535 poisonous substance in sufficient quantity or flow rate to
 536 injure or interfere with any sewage treatment process,
 537 constitute a hazard to humans or animals, or create any hazard
 538 in the receiving waters of the sewage treatment plant or
 539 deteriorate quality of the sewage sludge to prevent sludge use
 540 or disposal.
- 541
- 542 (iii) Any pollutant in amounts which alone or in combination
 543 with other discharges will cause obstruction to the flow in
 544 the POTW.
- 545
- 546 (iv) Any substance that will pass through the sewage treatment
 547 plant and exceed State or Federal requirements for the
 548 receiving water.
- 549
- 550 (v) Any water or waste which contains substances which may
 551 solidify and become viscous at temperatures between
 552 thirty-three (33) degrees Fahrenheit and one hundred fifty
 553 (150) degrees Fahrenheit (10—65 degrees Centigrade).
- 554
- 555 (vi) Any effluents in excess of the following local limits:
- 556

<i>Chemical, Physical or Biological Characteristic</i>	<i>Standards</i>
Biochemical oxygen demand	145 lbs/day at a concentration not to exceed 200 mg/l unless allowed by the POTW
Total suspended solids	145 lbs/day at a concentration level not to exceed 200 mg/l unless allowed by the POTW
Oil and grease EPA Method 1664 (Hexane Extractable Materials)	100.0 mg/l

>> Fats, Oils and Grease (FOG) EPA Method 1664 (Hexane Extractable Materials) for facilities strictly subject to Section 24-42.6 <<	>> 150.0 mg/l <<
Total Recoverable Petroleum Hydrocarbons EPA Method 1664 (Silica Gel Treated Hexane Extractable Materials)	50.0 mg/l
Ammonia (un-ionized)	100.0 mg/l
Temperature	150°F and shall not cause the plant influent to exceed 104°F (40°C) or inhibit biological activity
pH	5.5—11.5, and shall not cause damage to or create a hazard to structures, equipment, or personnel of the POTW
Arsenic	0.325 mg/l
Cadmium	0.187 mg/l
Chromium (Total)	7.6 mg/l
Copper	0.5 mg/l
Lead	0.7 mg/l
Mercury	0.01 mg/l
Molybdenum	0.4 mg/l
Manganese	1.9 mg/l
Nickel	0.39 mg/l
Selenium	0.65 mg/l
Silver	0.6 mg/l
Thallium	0.0005 mg/l
Zinc	6.8 mg/l
Cyanides, total	0.5 mg/l
Poly chlorinated biphenyls	0.008 mg/l
Benzene	0.2 mg/l

Carbon Tetrachloride	0.22 mg/l
1,2-c-Dichloroethylene	3.75 mg/l
Tetrachloroethylene	0.125 mg/l
Trichloroethylene	0.16 mg/l
Vinyl Chloride	0.08 mg/l

557
558
559
560
561
562
563
564
565
566
567
568
569
570
571
572
573
574
575
576
577
578
579
580
581
582
583
584
585
586
587
588
589
590

* * *

Section 10. Section 24-42.6 of the Code of Miami-Dade County, Florida, is hereby added to read as follows:

>>**Sec. 24-42.6. Fats, Oils and Grease Control Program**

The intent and purpose of this Section is to safeguard public health, safety and welfare, and protect the sanitary sewer collection, transmission and treatment systems by setting minimum requirements and standards for the design and operation of FOG generating facilities not classified by the Director or Director's designee as a Significant Industrial User pursuant to Section 24-42.4.

(1) No person shall dispose of any FOG or food waste, or cause, let, permit, suffer or allow disposal or discharge of any FOG or food waste to be disposed or discharged into any stormwater drainage system, ground or groundwater, surface water, private street, public right of way, or any other location not approved by the Director or Director's designee.

(2) When a breached FOG control device is the source of FOG or wastewater discharge as prohibited above to ground or groundwater, the FOG generator or FOG control device operator shall:

(a) Make temporary repairs within seven (7) days of the date the Director or the Director's designee determines that the FOG control device is breached.

(b) Within thirty (30) days of the date the Director or the Director's designee determines that the FOG control device is breached discharged FOG or wastewater to ground or groundwater, the FOG generator or FOG control device operator shall submit plans to the Department for review and approval for the installation of a new FOG control device that complies with design requirements in Section 24-42.6(8).

591 (c) Within ninety (90) days of the date the Director or the Director's
592 designee determines that the FOG control device is breached, the FOG
593 generator or FOG control device operator shall obtain all required
594 approvals and permits and install the Department approved FOG
595 control device.

596
597 (d) Cease the discharge of FOG and wastewater as prohibited above.
598 Failure to stop the discharge of FOG and wastewater as prohibited
599 above shall result in the Director or the Director's designee directing
600 the FOG generator or FOG control device operator to cease operating
601 or ordering the utility providing water service to the facility to cease
602 providing such service.

603
604 (3) No person shall dispose of any FOG, or cause, let, permit, suffer or
605 allow disposal or discharge of any FOG into any onsite sewage treatment and
606 disposal system, non-utility or utility sanitary sewer system in quantities ~~or~~
607 concentrations which affects negatively or hinders the operation of any onsite
608 sewage treatment and disposal system, sewage collection, transmission or
609 treatment system, exceeds the FOG sanitary sewer discharge limitation and
610 pretreatment standards in Section 24-42.4, or causes a sanitary nuisance.

611
612 (a) When a FOG generator or a FOG control device operator is found to
613 have violated Section 24-42.6(2), the FOG generator or FOG control
614 device operator shall immediately cease and desist from discharging
615 FOG in such quantities or concentrations. The FOG generator or FOG
616 control device operator shall submit a corrective action plan to the
617 Department within thirty (30) days of the date the Director or the
618 Director's designee determines that the FOG generator or FOG control
619 device operator discharged FOG in such quantities or concentrations.
620 The corrective action plan shall include equipment, process or
621 procedure modifications proposed to prevent discharging FOG in such
622 quantities or concentrations. The corrective action plan shall be
623 implemented within the timeframe provided in the Department's
624 approval of the corrective action plan. Until the corrective action plan
625 is approved by the Director or Director's designee and implemented in
626 accordance with the Director or Director designee's approval, the FOG
627 generator or FOG control device operator shall take all necessary
628 actions to prevent the discharge of FOG in such quantities or
629 concentrations and to prevent causation of a sanitary nuisance.

630
631 (b) When a Residential FOG Source is found to have violated Section 24-
632 42.6(2), the Residential FOG Source shall immediately cease and
633 desist from discharging FOG in such quantities or concentrations.

634
635 (i) When a Residential FOG Source is located in an apartment
636 building or condominium, the building manager, association,

637 property owner, or other responsible party shall submit a
638 corrective action plan to the Department within thirty (30) days
639 of the date the Director or the Director's designee determines
640 that the FOG residential source has violated Section 24-
641 42.6(2). The corrective action plan shall be implemented within
642 the timeframe provided in the Department's approval of the
643 corrective action plan.

644
645 (ii) The corrective action plan shall include equipment, process or
646 procedure modifications proposed to correct the FOG
647 discharge.

648
649 (iii) Until the corrective action plan is approved by the Director or
650 Director's designee and implemented in accordance with the
651 Director or Director designee's approval, the building manager,
652 association, property owner, or other responsible party shall
653 take all necessary actions to prevent violation of Section 24-
654 42.6(2) and to prevent causation of a sanitary nuisance.

655
656 (4) Existing FOG generators with a current FOG operating permit issued
657 prior to (CLERK TO INSERT EFFECTIVE DATE), not proposing to increase
658 seating capacity, dining area or drive-thru capacity, nor proposing to make any
659 other modification, any of which will increase the discharge of FOG, shall comply
660 with the following:

661
662 (a) Where there is an existing FOG control device and sampling point, the
663 sampling point shall be located after the point of no further treatment
664 and shall be directly accessible for visual inspection and sampling.

665
666 (b) Where there is no FOG control device, plans shall be submitted to the
667 Department for the installation of a FOG control device which shall
668 be installed in accordance with plans approved by the Director or
669 Director's designee, within ninety (90) days of the date the Director or
670 the Director's designee determines that there is no FOG control device.
671 The FOG generator shall take all necessary actions to prevent the
672 discharge of FOG to the building sanitary drains and to prevent
673 causing a sanitary nuisance until a FOG control device is properly
674 installed.

675
676 (c) Where the discharge from a FOG control device exceeds the FOG
677 sanitary sewer discharge limitation and pretreatment standards in
678 Section 24-42.4, or causes the accumulation of FOG in building
679 sanitary drains or building sewer, the FOG control device shall be
680 repaired, upgraded or replaced within ninety (90) days of the date the
681 Director or the Director's designee determines that Section 24-42.4
682 FOG sanitary sewer discharge limitation and pretreatment effluent

683 standards have been exceeded, or from the date the Director or the
684 Director's designee determines that FOG has accumulated in building
685 sanitary drains or building sewer. Repairs or upgrades shall not render
686 third party certifications or approvals null and void.

687
688 (d) Where the Director or Director's designee determines that there is no
689 sampling point or the existing sampling point is not reasonably
690 accessible or adequate for sampling, a new reasonably accessible
691 sampling point shall be installed within sixty (60) ~~thirty (30)~~ days of
692 the determination of the Director or Director's designee.

693
694 (e) Where a FOG control device or sampling point are required to be
695 repaired, replaced or installed, plans shall be submitted to the
696 Department for review and approval and all required permits shall be
697 obtained prior to repair, replacement or installation. Replacement or
698 new FOG control devices shall be designed pursuant to Section 24-
699 42.6(8). Repairs or upgrades shall not render third party certifications
700 or approvals null and void.

701
702 (f) FOG generators shall comply with their current FOG generator
703 operating permit conditions until the permit expires. Thereafter, FOG
704 generators shall comply with permit conditions based on Section 24-
705 42.6(9) requirements.

706
707 (5) Existing FOG generators and FOG control device operators that do not
708 hold a valid FOG operating permit issued prior to (CLERK TO INSERT
709 EFFECTIVE DATE), that discharge to a utility or non-utility owned or operated
710 sanitary sewer system, shall comply with the following:

711
712 (a) Submit as-built plans prepared by a ~~licensed plumber or Florida~~
713 Professional Engineer and condition assessment prepared by a licensed
714 plumber or Florida Professional Engineer within sixty (60) days from
715 the Director or the Director designee's determination that the FOG
716 generator or FOG control device operator does not have a valid FOG
717 operating permit. As-built plans and condition assessment shall
718 demonstrate the following, where applicable:

719
720 (i) That all existing back of the house fixtures discharge to
721 existing FOG control devices and not directly to the building
722 sanitary drains or building sewers.

723
724 (ii) That existing FOG control devices comply with Section 24-
725 42.6(8).

726

727 (iii) That the FOG control device is functioning in accordance with
728 the manufacture's specifications and instructions and that the
729 sampling point complies with Section 24-42.6(7).

730
731 (iv) That a sampling point is located after the point of no further
732 treatment and is reasonably accessible for visual inspection and
733 sampling.

734
735 (v) That existing yellow and brown grease storage areas prevent
736 the release of FOG to ground, groundwater, surface waters or
737 storm sewers.

738
739 (vi) That existing mat and equipment wash-down areas prevent the
740 release of FOG to ground, groundwater, surface waters or
741 storm sewers and prevent inflow of stormwater.

742
743 (b) FOG generators or FOG control device operators that cannot comply
744 with Sections 24-42.6(4)(a) shall submit plans to upgrade the facility
745 pursuant to Section 24-42.6(6)(a)(i), (ii) and (iii) within ninety (90)
746 days of the date the Director or the Director's designee determines that
747 the FOG generator or FOG control device operator does not have a
748 valid FOG operating permit. The facility upgrade shall be completed
749 within 180 ~~ninety (90)~~ days of the date the Director or the Director's
750 designee ~~determines that the FOG generator or FOG control device~~
751 ~~operator does not hold a valid FOG operating permit~~ approves the
752 plans.

753
754 (c) Within five (5) days of the Director or the Director designee's
755 approval of the as-built plans ~~or plans to upgrade the facility pursuant~~
756 to Section 24-42.6(4)(b), a FOG operating permit application shall be
757 submitted to the Department pursuant to Sections 24-18(A)(18) and
758 24-42.6(9).

759
760 (6) Existing FOG generators and FOG control device operators that do not
761 hold a valid FOG operating permit issued prior to (CLERK TO INSERT
762 EFFECTIVE DATE), that discharge to an onsite sewage treatment and disposal
763 system located in a wellfield protection area of any utility potable water supply
764 wells, shall comply with the following within one (1) year ~~180 days~~ of
765 Department notification:

766
767 (a) Submit as-built plans prepared by a ~~licensed plumber or Florida~~
768 Professional Engineer and condition assessment prepared by a licensed
769 plumber or Florida Professional Engineer. As-built plans and condition
770 assessment shall demonstrate the following, where applicable:

771

- 772 (i) That all existing back of the house fixtures discharge to
773 existing FOG control devices and not directly to the building
774 sanitary drains or building sewers.
- 775
- 776 (ii) That existing FOG control devices comply with Chapter 64E-6,
777 FAC.
- 778
- 779 (iii) That the FOG control device is functioning in accordance with
780 the manufacture's specifications and instructions and that the
781 sampling point complies with Section 24-42.6(7).
- 782
- 783 (iv) That the outlet tee of the last grease interceptor is reasonably
784 accessible for visual inspection and sampling.
- 785
- 786 (iv) That existing yellow and brown grease storage areas prevent
787 the release of FOG to ground, groundwater, surface waters or
788 storm sewers.
- 789
- 790 (vi) That existing mat and equipment wash-down areas prevent the
791 release of FOG to ground, groundwater, surface waters or
792 storm sewers and prevent inflow of stormwater.
- 793
- 794 (b) FOG generators or FOG control device operators that cannot comply
795 with Sections 24-42.6(5)(a) shall submit plans to upgrade the facility
796 pursuant to Section 24-42.6(6)(a)(i), (ii) and (iii) and implement
797 upgrades within one (1) year of Department notification (~~CLERK TO~~
798 INSERT EFFECTIVE DATE).
- 799
- 800 (c) Within five (5) days of the Director or the Director designee's
801 approval of the as-built plans or plans to upgrade the facility pursuant
802 to Section 24-42.6(5)(b), a FOG operating permit application shall be
803 submitted to the Department pursuant to Sections 24-18(A)(18) and
804 24-42.6(9).
- 805
- 806 (7) Notwithstanding any provision of this Code, no county or municipal
807 officer, agent, employee or board shall approve, grant or issue any building
808 permit, certificate of occupancy, certificate of completion, certificate of use or
809 municipal occupational license for a FOG generator or FOG control device
810 operator until prior written approval of the Director or the Director's designee has
811 been obtained. Furthermore, no person shall construct, utilize, operate, occupy or
812 cause, allow, let, permit or suffer to be constructed, utilized, operated or occupied
813 any FOG generator or FOG control device until prior written approval of the
814 Director or the Director's designee has been obtained.
- 815
- 816 (a) For new FOG generators or FOG control operators discharging to a
817 utility or non-utility owned or operated sanitary sewer collection

818 system or to an onsite sewage treatment and disposal system located in
819 a the basic wellfield protection area of any utility potable water supply
820 wells, the Director or the Director's designee shall not issue a written
821 approval until the Director or the Director's designee finds that:

822
823 (i) Construction plans comply with Section 24-42.6(7).

824
825 (ii) FOG control devices have been inspected by the Department
826 and found to be in compliance with Section 24-42.6(8) and
827 with Department approved construction plans pursuant to 24-
828 42.6(6)(a)(i). Compliance with approved plans shall be
829 determined by construction inspection. Persons performing
830 construction inspections for FOG control devices shall be
831 trained to perform such inspections. Training shall be
832 prescribed by the Director or the Director's designee. No
833 building/plumbing permit final inspection, certificate of
834 occupancy or certificate of completion shall be issued prior to
835 the Department's inspection finding that the FOG control
836 devices have been installed in compliance with Department
837 approved construction plans.

838
839 (iii) FOG operating permit applications shall be submitted pursuant
840 to Sections 24-18 (A)(18) and 24-42.6(9).

841
842 (b) For existing FOG generators discharging to a utility or non-utility
843 owned or operated sanitary sewer system or discharging to an onsite
844 sewage treatment and disposal system located in a the basic
845 wellfield protection area of any utility potable water supply wells, proposing to
846 increase seating capacity, dining area or drive-thru capacity, or other
847 modification any of which will increase the discharge of FOG, the
848 Director or the Director's designee shall not issue a written approval
849 until the Director or the Director's designee finds that the proposed
850 increased seating capacity, dining area or drive-thru capacity, or other
851 modification any of which will increase the discharge of FOG,
852 complies with Section 24-42.6 (6)(a)(i), (ii) and (iii).

853
854 (c) For changes in ownership or other changes that require the issuance of
855 a certificate of use, municipal occupational license, or equivalent
856 municipal approval to operate or use a business, the Director or the
857 Director's designee shall not issue a written approval until the Director
858 or the Director's designee finds that:

859
860 (i) The prior use had a valid FOG operating permit within the last
861 twelve (12) months.

862
863 (ii) There is no construction proposed or required.

864
865
866
867
868
869
870
871
872
873
874
875
876
877
878
879
880
881
882
883
884
885
886
887

888
889
890
891
892
893
894
895
896
897
898
899
900
901
902
903
904
905
906
907

(iii) There are no changes to the back of house.

(iv) No changes have been made, or are proposed, to the plumbing system, use, or facility operations that will impact the FOG control device.

(v) A FOG control device condition assessment is performed by a licensed plumber or Florida Professional Engineer and the findings, submitted to the Department in a form prescribed by the Director or the Director's designee, show that the FOG control device is functioning in accordance with the manufacturer's specifications and instructions and that the sampling point complies with Section 24-42.6(7).

(d) For changes in ownership or other changes that require the issuance of a certificate of use, municipal occupational license, or equivalent municipal approval to operate or use a business, that do not comply with 24-42.6(6)(c) shall be required to comply with Section 24-42.6(6)(a)(i), (ii) and (iii) prior to the Department approval of the change in ownership or other changes that require the issuance of a certificate of use, municipal occupational license, or equivalent municipal approval to operate or use a business.

~~On or before January 1, 2018, FOG generators discharging to a utility or non-utility owned or operated sanitary sewer system or onsite sewage treatment and disposal system located in the basic wellfield protection area of any utility potable water supply wells that are not subject to 24-42.6(5)(a) or (b), shall comply with the following requirements:~~

~~(i) All back of the house fixtures and other fixtures, including wash down areas, which can discharge food waste or FOG, shall be connected to a FOG control device that complies with Section 24-42.6(7).~~

~~(ii) A sampling point shall be located after the point of no further treatment. The sampling point shall be directly accessible for visual inspection and sampling.~~

~~(iii) Yellow and brown grease storage areas and wash down areas shall be designed to prevent the release of FOG or wash water to ground, groundwater, surface waters or storm sewers.~~

908 ~~(iv) Solids separation shall be provided prior to FOG control~~
909 ~~devices that require a flow control device or are not certified to~~
910 ~~handle solids.~~

911
912 ~~(vi) Sanitary wastes from bathrooms and stormwater shall not~~
913 ~~discharge to grease waste drains, solids separators or FOG~~
914 ~~control devices.~~

915
916 ~~(vii) Submit Certification to the Department in a form prescribed by~~
917 ~~the Director or the Director's designee and prepared by a~~
918 ~~Florida Professional Engineer or master plumber, attesting to~~
919 ~~compliance with Sections 24 42.6(5)(c)(i) through (vi) above.~~
920 ~~Furthermore, confirmation of compliance with Section 24~~
921 ~~42.6(7) shall be signed and sealed by a Florida Professional~~
922 ~~Engineer.~~

923
924 ~~(viii) Where the existing FOG control device was approved pursuant~~
925 ~~to Section 24 42.6(7), certification of Section 24 42.6(5)(c)(i)~~
926 ~~shall not be required.~~

927
928 (8) Plans. Where required in Section 24-42.6, plans shall include the
929 following minimum information:

930
931 (a) Florida Professional Engineer signature, seal and date. ~~Signature and~~
932 ~~seal of a Florida Professional Engineer.~~

933
934 (b) All existing and proposed back of the house and front of the house
935 areas and drive-thru lanes are shown and labeled.

936
937 (c) Plan and isometric drawings showing and labeling all existing and
938 proposed drainage pipes, fixtures, sumps, pumps, ejectors, solids
939 separators, FOG control devices and sampling points are shown and
940 labeled. All drainage pipes that receive or can receive waste from back
941 of the house fixtures, and other fixtures that can discharge food waste
942 or FOG, shall be labeled grease waste drains or GW and shall include
943 slope, diameter and drainage fixture units. Back of the house fixtures
944 include floor drains, floor sinks, trough drains, mop sinks, three-
945 compartment sinks, hand sinks, pre-rinse station/sink, preparation sink,
946 pot sink, wok sink, self-cleaning kitchen exhaust hoods, and any and
947 all fixtures, appurtenances and equipment that have the potential to
948 introduce food waste or FOG into drainage pipes. Screens shall be
949 shown and labeled in all sinks and drains. Where multiple users/tenant
950 spaces connect to a common FOG control device, the plans shall
951 include all users/tenant spaces.
952

- 953 (d) Where multiple users/tenant spaces connect to a common FOG control
954 device, the plans shall include all users/tenant spaces.
955
- 956 (e) Plan and isometric drawings showing grease waste drains and sanitary
957 drains from bathrooms and other non-FOG drains connecting to
958 building drain and include slope, diameter and drainage fixture units.
959
- 960 ~~(e) Isometric diagrams showing and labeling all existing and proposed~~
961 ~~plumbing pipes, fixtures, pipe diameter and drainage fixture units,~~
962 ~~solids separators, FOG control devices and sampling points. Grease~~
963 ~~waste drains shall be labeled grease waste drain or GW.~~
964
- 965 ~~(f) Screens are shown and labeled in all sinks and drains.~~
966
- 967 (f) All grease waste drains are connected to a FOG control device that
968 complies with Section 24-42.6(8). FOG control devices shall not
969 receive flow under pressure. No pump, ejector or any equipment that
970 can mechanically emulsify FOG, or reduce the efficiency of a FOG
971 control device, shall connect directly or indirectly to a FOG control
972 device.
973
- 974 (g) FOG control devices installed below ground/grade to intersect the
975 building grease waste drain. When installation below grade is not
976 physically possible, the Director or Director's designee may approve a
977 single above grade installation if the FOG control device required
978 pursuant to Section 24-42.6(8) is rated at twenty-five (25) gallons per
979 minute or less and includes an air gap or air break.
980
- 981 (h) At least one (1) sampling point, located after the point of no further
982 treatment, shown and labeled. The sampling point shall be directly
983 accessible for visual inspection and sampling.
984
- 985 (i) Profiles, sections and details of FOG control device and sampling
986 point drawn to scale. FOG control devices and sampling points shall
987 be accessible for cleaning pursuant to Section 24-42.6(9). At a
988 minimum, four (4) feet of vertical clearance and three (3) feet of
989 horizontal clearance shall be provided for each.
990
- 991 (j) Where FOG control device access risers are required, the riser height
992 shall not exceed thirty (30) inches. A greater riser height may be
993 approved by the Director or Director's designee where access for
994 inspection and cleaning can be achieved and demonstrated.
995
- 996 (k) Construction material for FOG control devices shall be labeled and
997 shall be compatible with all waste, including waste with a pH of 3 or
998 less.

999
1000
1001
1002
1003
1004
1005
1006
1007
1008
1009
1010
1011
1012
1013
1014
1015
1016
1017
1018
1019
1020
1021
1022
1023
1024
1025
1026
1027
1028
1029
1030
1031
1032
1033
1034
1035
1036
1037
1038
1039
1040
1041
1042
1043
1044

- (l) The point and method of wastewater discharge for kiosk and booths using holding tanks shall be ~~are~~ shown and labeled. The point of discharge shall be a grease waste drain or FOG control device sized for the quantity of waste generated. All waste containers shall be shown on plans.

- (m) FOG control device sizing calculations and assumptions, including peak flow rate, temperature, FOG and solids loading rates, and frequency of FOG and solids removal shall be ~~are~~ shown and labeled. Where the FOG control device will serve multiple users/tenants, each user/tenant shall be identified and their flows and loading rates shall also be included on the plans. Loading rates shall include waste from food preparation and cleaning associated with eat-in, take-out and drive-thru meals. FOG loading shall include all FOG sources, including kitchen exhaust hoods. For self-cleaning kitchen exhaust hoods, the manufacturer’s specifications for peak discharge shall be included.

- (n) Manufacturer’s and third party certification installation requirements.

- (o) FOG control device model numbers and third party certifications ~~are~~ shall be shown and labeled. Plan profiles and sections shall demonstrate how all labels and markings on FOG control devices remain visible during and after installation.

- (p) State Health Office’s designated approval/tank numbers for grease interceptors designed in accordance with 64E-6, Florida Administrative Code, shall be ~~are~~ shown and labeled. All labels and markings on FOG control devices shall be visible before and after installation.

- (q) For concrete precast FOG control devices, the precast concrete plant name and precast concrete plant certifying agency accepted by the Florida Department of Transportation shall be ~~are~~ shown and labeled accordingly. Site cast FOG control devices are not permitted.

- (r) ~~Dishmachines are not required to be connected to a FOG control device where washing and rinsing are performed in a two (2) or three (3) compartment sink and the dishmachine connects to grease waste drain prior to a sampling point. Dishwashers with dedicated soiled-dish table or pre-rinse station, where all food solids and liquids are removed, are not required to be connected to a FOG control device when connected to a grease waste drain prior to a sampling point. All other and~~ dishwashers shall be connected to a FOG control device sized to account for emulsified grease FOG.

1045
1046
1047
1048
1049
1050
1051
1052
1053
1054
1055
1056
1057
1058
1059
1060
1061
1062
1063
1064
1065
1066
1067
1068
1069
1070
1071
1072
1073
1074
1075
1076
1077
1078
1079
1080
1081
1082
1083
1084
1085
1086
1087
1088
1089
1090

~~(q) At least one (1) sampling point located after the point of no further treatment shown and labeled. The sampling point shall be directly accessible for visual inspection and sampling. At a minimum, four (4) feet of vertical clearance and three (3) of horizontal clearance shall be provided.~~

(s) Locations and details for all stored waste, including yellow and brown grease, shall be are shown and labeled. Storage areas shall be designed to prevent the release of FOG to ground, groundwater, surface waters or storm sewers. Storage containers shall be identified by waste type and capacity in gallons and sized to prevent overfilling. All storage containers shall have a lid that prevents rainwater inflow and that can be locked to prevent vandalism.

(t) Locations and details for all wash-down areas shall be are shown and labeled. All wash-down areas shall be designed to prevent the release of wash-water and FOG to ground, groundwater, surface waters, storm sewer or any other location not approved by the Director or Director's designee. Where mat and equipment wash-down is to be performed in a mop sink, the mop sink shall be sized and labeled.

(u) Solids separation is provided prior to existing or proposed FOG control devices that require a flow control device or that are not certified to handle solids.

(v) Access is provided for cleaning of ~~food solids and congealed grease~~ FOG in grease waste drains where the horizontal run from the source of food waste and FOG is greater than ~~twenty-five (25)~~ fifty (50) feet from the solids separator or FOG control device. Access points shall not be spaced greater than ~~twenty-five (25)~~ fifty (50) feet, measured center-to-center. Location of access points and details for access point shall be provided in drawings. Where the horizontal run from the source of food waste and FOG is greater than one hundred (100) feet, plans shall include provisions for preventing clogging by ~~congealed FOG and other waste~~. Where the FOG control device is located at a remote location, it shall be equipped with a functional Interceptor Monitoring Alarm or Device. Remote locations include a different floor, or any horizontal distance exceeding one hundred (100) feet from the back of the house area.

(w) Sanitary wastes from bathrooms and stormwater are not discharged into grease waste drains, solids separators, ~~or~~ FOG control devices or ~~sampling point~~. Only grease waste lines and drains shall connect to a FOG control device.

1091 (9) FOG Control Device Sizing. Where required in Section 24-42.6, FOG
1092 control devices shall be sized for all intended users, facilities and tenants using
1093 one of the following criteria and approved by the Director or Director's designee:
1094

1095 (a) Gravity Grease Interceptors: The minimum volume for gravity grease
1096 interceptors shall be the largest of the following:
1097

1098 (i) Calculations or selection based on the Florida Building Code,
1099 latest edition; or
1100

1101 ~~(ii) Calculations prepared by a Florida Professional Engineer~~
1102 ~~demonstrate that the FOG effluent concentration is equal to or~~
1103 ~~less than the FOG sanitary sewer discharge limitation and~~
1104 ~~pretreatment standard referenced in Section 24-42.4.~~
1105 ~~Calculations shall include peak flow rate; temperature and~~
1106 ~~temperature driven flow patterns; rising and settling velocities;~~
1107 ~~short circuiting induced by inlet, baffle and outlet effects and~~
1108 ~~velocity distribution; FOG and solids loading rate; and~~
1109 ~~frequency of FOG and solids removal; or~~
1110

1111 (ii) Alternative calculations:
1112

1113 1. Calculations prepared by a Florida Professional
1114 Engineer that include projected peak flow rate, thirty
1115 (30)-minute hydraulic detention time calculated using
1116 net wet volume, temperature, FOG and solids loading
1117 rates, and proposed frequency of FOG and solids
1118 removal. Net wet volume shall be total wet volume
1119 minus the maximum volume of waste stored between
1120 cleaning cycles, and third party certification of FOG
1121 removal efficiency and containment capacity; or
1122

1123 2. Calculations prepared by a Florida Professional
1124 Engineer that include projected peak flow rate;
1125 temperature; FOG and solids loading rates; proposed
1126 frequency of FOG and solids removal; and third party
1127 certification of the maximum FOG containment
1128 capacity; and third party certification of the effluent
1129 concentration or of the FOG removal efficiency. The
1130 certified effluent concentration shall be equal to or less
1131 than the FOG sanitary sewer discharge limitation and
1132 pretreatment standards referenced in Section 24-42.4.
1133 The minimum FOG removal efficiency shall be 99% at
1134 the third party certified flow rate and minimum required
1135 FOG containment capacity.
1136

1137
1138
1139
1140
1141
1142
1143
1144
1145
1146
1147
1148
1149
1150
1151
1152
1153
1154
1155
1156
1157
1158
1159
1160
1161
1162
1163
1164
1165
1166
1167
1168
1169
1170
1171
1172
1173
1174
1175
1176
1177
1178
1179
1180
1181
1182

(iii) Where Chapter 64E-6, Florida Administrative Code, applies, as determined by the Director or Director’s designee, total volume shall be calculated using seats and meals, where meals are used to calculate the volume associated with take out, drive through and other FOG loads not accounted for in seats, and the total volume is increased to account for the maximum volume of waste stored between cleaning cycles. ~~total wet volume, minus the maximum volume of waste stored between cleaning cycles, is the greater of the following:~~ As an alternative to calculating the maximum volume of waste stored between cleaning cycles, the following multiplication factors can be used to increase the volume calculated by seats and meals:

<u>Cleaning Cycle</u>	<u>Multiplication Factor</u>
<u>Every 30 days</u>	<u>1.0</u>
<u>Every 60 days</u>	<u>1.15</u>
<u>Every 90 days</u>	<u>1.25</u>

(b) Where more than one (1) gravity grease interceptor is required to provide the largest volume calculated in Section 24-42.6(8)(a), they shall be installed in series with consideration given to minimize disturbance between tanks by utilizing appropriately sized pipes and influent and effluent appurtenances that maximize FOG separation.

~~(i) Seven hundred and fifty (750) gallons; or~~

~~(ii) Volume calculated based on Chapter 64E-6; or~~

(c) Hydromechanical Grease Interceptors: The minimum size and number of hydromechanical grease interceptors shall be the greatest of the following:

(i) Twenty gallons per minute.

(ii) Calculations or selection based on the Florida Building Code, latest edition.; or

~~(ii) Calculations prepared by a Florida Professional Engineer demonstrate that the FOG effluent concentration is equal to or less than the FOG sanitary sewer discharge limitation and pretreatment standard referenced in Section 24-42.4. Calculations shall include peak flow rate; temperature and temperature driven flow patterns; rising and settling velocities; short-circuiting induced by inlet, baffle and outlet effects and velocity distribution; FOG and solids loading rate; and frequency of FOG and solids removal; or~~

1183
1184
1185
1186
1187
1188
1189
1190
1191
1192
1193
1194
1195
1196
1197
1198
1199
1200
1201
1202
1203
1204
1205
1206
1207
1208
1209
1210
1211
1212
1213
1214
1215
1216
1217
1218
1219
1220
1221
1222
1223
1224
1225
1226
1227
1228

(iii) Calculations prepared by a Florida Professional Engineer that include projected peak flow rate; temperature; FOG and solids loading rates; proposed frequency of FOG and solids removal; third party certification of the maximum FOG containment capacity; and third party certification of the effluent concentration or of the FOG removal efficiency. The certified effluent concentration shall be equal to or less than the FOG sanitary sewer discharge limitation and pretreatment standards referenced in Section 24-42.4. The minimum FOG removal efficiency shall be 99% at the third party certified flow rate and minimum required FOG containment capacity;~~or~~

~~Calculations prepared by a Florida Professional Engineer that include projected peak flow rate, temperature, FOG and solids loading rates, proposed frequency of FOG and solids removal, and third party certification of FOG removal efficiency and containment capacity. The minimum FOG removal efficiency shall be 99% at the third party certified flow rate and minimum required FOG containment capacity.~~

(d) Where more than one (1) hydromechanical grease interceptor is required to provide the required removal efficiency, they shall be installed in series and the removal efficiency shall be based on the third party testing of the proposed configuration and number of grease interceptors proposed. The test configuration, including flow control, air entrainment and other appurtenances, shall match the proposed field installation.

(e) FOG Control Devices not classified by the Director or Director's designee as hydromechanical or gravity grease interceptors: The minimum size and number of FOG control devices shall be the greatest of the following:

(i) Calculations or selection based on the Florida Building Code, latest edition;~~or~~

(ii) Calculations prepared by a Florida Professional Engineer that include ~~projected~~ peak flow rate; temperature; FOG and solids loading rates; FOG and solids biological and chemical removal rates; frequency of FOG and solids removal; and third party certification of maximum FOG containment capacity and effluent concentration. The certified effluent concentration shall be equal to or less than the FOG sanitary sewer discharge limitation and pretreatment standards referenced in Section 24-42.4.

1229
1230
1231
1232
1233
1234
1235
1236
1237
1238
1239
1240
1241
1242
1243
1244
1245
1246
1247
1248
1249
1250
1251
1252
1253
1254
1255
1256
1257

- (f) Where more than one (1) FOG control device, not classified by the Director or Director’s designee as hydromechanical or gravity grease interceptors, is required to provide the required effluent concentration, it shall be based on third party testing of the proposed configuration and number of grease interceptors proposed. The test configuration, including flow control, air entrainment and other appurtenances, shall match the proposed field installation.

- (g) Peak Flow Rate. Where peak flow rate is required in Section 24-42.6, it shall be estimated as follows:
 - (i) Shell buildings. Peak flow shall be calculated using Manning’s Formula for full pipe flow for the grease waste drain nominal diameter and slope and a roughness coefficient of 0.0113.

 - (ii) Plans with complete plumbing design. Peak flow shall be estimated as provided above for shell building, total fixture flow rate using one (1) or two minute (2) drain time, or drainage fixture units (DFUs). For DFUs, the peak flow rate shall be calculated by multiplying the proposed DFUs by the flow rate calculated using Manning’s Formula for full pipe flow and a roughness coefficient of 0.0113 and divided by the maximum number of DFUs allowed under the Florida Building Code, latest edition, for the grease waste drain diameter and slope.

 - (iii) Minimum Peaks flows.

<u>Nominal pipe size in inches</u>	<u>Minimum Total Flow Rate at Grease Interceptor Influent</u>
<u>1.25 – 2.5</u>	<u>20 gpm</u>
<u>3</u>	<u>23 gpm</u>
<u>4</u>	<u>50 gpm</u>
<u>5</u>	<u>91 gpm</u>
<u>6</u>	<u>147 gpm</u>
<u>8</u>	<u>317 gpm</u>
<u>10</u>	<u>576 gpm</u>
<u>12</u>	<u>936 gpm</u>
<u>15</u>	<u>1,697 gpm</u>

1258
1259

1260 (10) Operating Permits for FOG Generators and FOG Control Device
1261 Operators. No person shall operate, cause, let, permit, suffer or allow the
1262 operation of a FOG generating facility or FOG control devices serving FOG
1263 generators ~~discharging to a utility or non-utility owned or operated sanitary sewer~~
1264 system or an onsite sewage treatment and disposal system located in a wellfield
1265 protection area of any utility potable water supply wells without a valid FOG
1266 operating permit issued by the Director or the Director's designee or in violation
1267 of any condition, limitation or restriction which is part of a FOG operating permit.
1268 ~~FOG operating permits are valid for up to one year, expire December 31 of each~~
1269 ~~year, and shall be renewed annually by January 1 of each calendar year.~~
1270

1271 (a) Existing FOG generators and FOG control device operators that do not
1272 hold a valid FOG operating permit issued prior to (CLERK TO
1273 INSERT EFFECTIVE DATE), that discharge to an onsite sewage
1274 treatment and disposal system located in a wellfield protection area of
1275 any utility potable water supply wells, shall apply for a FOG operating
1276 permit within 180 days of (CLERK TO INSERT EFFECTIVE DATE)
1277 using a form prescribed by the Director or Director's designee in
1278 accordance with Section 24-42.6(5).
1279

1280 (b) Applications for new FOG generators and new FOG control device
1281 operators and renewals of same shall be in a form prescribed by the
1282 Director or Director's designee. When the FOG operating permit
1283 applicant is a tenant, the application shall be completed and signed by
1284 the tenant(s) and property owner(s) as co-applicants. The owner's
1285 section of the application shall include a statement acknowledging that
1286 the property owner(s) is responsible for the proper closure of a FOG
1287 generator pursuant to Section 24-42.6(8)(c)(vi).
1288

1289 (c) Renewal applications shall include a certification form, which is
1290 prescribed by the Director or the Director's designee. ~~Where made~~
1291 available by the Department, certification shall be completed using a
1292 secure online system or by an equivalent system developed by the
1293 Department. Said form shall be prepared by a Florida Professional
1294 Engineer or licensed plumber or liquid waste transporter, attesting that
1295 the existing FOG control devices are functioning as designed and are
1296 in good working order. ~~Where required in this Section, the renewal~~
1297 shall also include training certificates for staff trained pursuant to
1298 Section 24-42.6(8)(c)(iv).
1299

1300 (d) Operating permits for new FOG generators and new FOG control
1301 device operators, and renewal of same, discharging to a utility or non-
1302 utility owned or operated sanitary sewer system or an onsite sewage
1303 treatment and disposal system located in a wellfield protection area of
1304 any utility potable water supply wells shall include the following:
1305

1306
1307
1308
1309
1310
1311
1312
1313
1314
1315
1316
1317
1318
1319
1320
1321
1322
1323
1324
1325
1326
1327
1328
1329
1330
1331
1332
1333
1334
1335
1336
1337
1338
1339
1340
1341
1342
1343
1344
1345
1346
1347
1348
1349
1350
1351

(i) Best management practices. The Director or Director's designee shall maintain a list of approved best management practices and update the list ~~annually or as required-necessary.~~

(ii) Maintenance. All FOG control devices and equipment shall be serviced to function properly and continuously to prevent the discharge of FOG into building sanitary drains, building sewers, utility or non-utility owned or operated sanitary sewer systems, ~~or and~~ onsite sewage treatment and disposal systems. Where cleaning of FOG control devices is required in Section 24-42.6, cleaning shall include the complete removal of the full contents of the FOG control device, including settled solids, wastewater and floating materials. Side walls, baffle walls, cross-pipes, and inlet and outlet pipes shall be pressure washed or scraped to remove all attached materials. Decanting, skimming, or backflushing is prohibited. Emulsifiers, grease cutters or other chemicals or detergents which could cause FOG to pass through the system to the building sanitary drains or building sewers are prohibited and shall not be used. At a minimum, the following maintenance shall be performed:

1. Grease Waste Drains, Building Sanitary Drains and Building Sewers. When jetting, rodding or other cleaning activities are required, FOG shall not be flushed, discharged, conveyed or allowed to pass through to utility or non-utility owned or operated sanitary sewer systems or onsite sewage treatment and disposal systems. All FOG shall be collected and transported by a liquid waste transporter, permitted by the Department, to an approved disposal facility.

2. Kitchen Exhaust Hoods. All waste generated by manual hood cleaning shall not be flushed, discharged, conveyed or allowed to pass through to utility or non-utility owned or operated sanitary sewer systems or onsite sewage treatment and disposal systems. All wastes shall be collected and transported by a liquid waste transporter permitted by the Department to an approved disposal facility. Where a hood is designed to be self-cleaning, the FOG control device shall be designed for the maximum cold water and hot water flow rates. Where a surfactant/detergent is used, the FOG control device shall be sized to provide sufficient detention time to allow FOG waste separation so that the effluent does not exceed the standards set forth in Section 24-42.4.

1352
1353
1354
1355
1356
1357
1358
1359
1360
1361
1362
1363
1364
1365
1366
1367
1368
1369
1370
1371
1372
1373
1374
1375
1376
1377
1378
1379
1380
1381
1382
1383
1384
1385
1386
1387
1388
1389
1390
1391
1392
1393
1394
1395
1396
1397

3. Yellow and Brown Grease Storage Areas. Yellow and brown grease storage areas shall be maintained free of debris and storage containers shall not be overfilled. Storage containers shall be visually inspected daily and emptied before they reach ninety (90) percent capacity. Spills shall be contained and cleaned using absorbent materials. Wet cleanup methods shall not be used. Storage container lids shall be maintained to prevent rainwater inflow and locked to prevent vandalism.

4. Mat and Equipment Wash-Down Areas. Mat and equipment wash-down areas shall be maintained free of debris and wash-water shall not be released to ground, groundwater, surface waters, storm sewer or any other location not approved by the Director or Director's designee. Wash-down areas shall not allow stormwater or rainwater to enter the building sanitary drains, building sewers, utility or non-utility owned or operated sanitary sewer systems, or onsite sewage treatment and disposal systems.

5. Solids Separators. Where installation of a solids separator is required or approved pursuant to Section 24-42.6(7), solids separators shall be serviced to function as designed and shall not be missing or have defective elements or components that reduce its ability to separate solids. All solids separators shall be visually inspected daily to prevent excessive accumulation and discharge of food solids to FOG control devices, building sanitary drains, building sewers, utility or non-utility owned or operated sanitary sewer systems, or onsite sewage treatment and disposal systems. Solids shall be properly discarded as solid waste or removed by a liquid waste transporter permitted by the Department.

6. Hydromechanical Grease Interceptors Traps. Cleaning of grease traps interceptors shall be performed as follows:

a. Automatic grease interceptors traps shall be cleaned by a liquid waste transporter, permitted by the Department, — Automatic grease traps shall be cleaned monthly or more frequently so that the FOG capacity limit or FOG sanitary

1398
1399
1400
1401
1402
1403
1404
1405
1406
1407
1408
1409
1410
1411
1412
1413
1414
1415
1416
1417
1418
1419
1420
1421
1422
1423
1424
1425
1426
1427
1428
1429
1430
1431
1432
1433
1434
1435
1436
1437
1438
1439
1440
1441
1442

sewer discharge limitation and pretreatment effluent standards in Section 24-42.4 are not exceeded. The contents of the strainer/screen and automatic storage receptacles shall be emptied by the FOG generator or FOG control device operator on a daily basis and transferred to waste containers intended and approved for such use to prevent overflowing or spills. If at any time the automatic elements or components do not function as intended and designed, the malfunctioning automatic grease interceptor trap shall be operated and reported as a manual grease interceptor trap and cleaned by a liquid waste transporter, permitted by the Department, on a daily basis until the system is repaired. In no instance shall the automatic grease interceptor trap operate as a manual grease interceptor trap for more than thirty (30) days or be allowed to cause a sanitary nuisance at any time. In the event of a sanitary nuisance, such conditions shall be abated within twenty-four (24) hours pursuant to Section 24-28. The automatic grease interceptor trap shall be repaired within thirty (30) days of malfunctioning. If the automatic grease interceptor trap is not capable of repair, it shall be replaced within ninety (90) days of malfunctioning. Plans for replacement shall be reviewed and approved by the Director or Director's designee pursuant to Section 24-42.6(7).

- b. Manual grease interceptor traps shall be cleaned monthly by a liquid waste transporter permitted by the Department or more frequently when necessary to avoid exceeding the FOG capacity limit or effluent standards in Section 24-42.4. The FOG generator or FOG control device operator shall may remove floating materials and settled solids on a regular daily basis, between cleaning intervals performed by a liquid waste transporter, and may transfer the waste to containers intended and approved for such use to prevent overflowing or spills.

1443 c. Alternative cleaning frequencies, not to exceed
1444 90 days, may be approved by the Director or
1445 Director's designee based on a complete
1446 engineering analysis, pursuant to Section 24-
1447 42.6(8), or the results of a field study approved
1448 by the Director or Director's designee that
1449 demonstrates that less frequent cleaning is
1450 appropriate and will not result in an exceedance
1451 of the FOG sanitary sewer discharge limitation
1452 and pretreatment standards referenced in
1453 Section 24-42.4.

1454
1455 d. Exception: A FOG generator that does not have
1456 fryers; is not required by the Florida Building
1457 Code Mechanical (latest addition) to have a
1458 Type I kitchen exhaust hood; the ~~peak flow rate~~
1459 ~~to the grease interceptor-trap~~ is rated ~~at does~~
1460 ~~not exceed~~ twenty (20) gallons per minute ~~or~~
1461 ~~less~~, and cleans the grease ~~interceptor-trap~~ daily
1462 is not required to have a liquid waste transporter
1463 clean the grease ~~interceptor as required above in~~
1464 ~~Section 24-42.6(10)(d)(ii)(6)-trap~~ monthly if the
1465 FOG generator does not discharge FOG or food
1466 waste in quantities ~~or concentrations~~ which
1467 affects negatively or hinders the operation of
1468 any onsite sewage treatment and disposal
1469 system, sewage collection, transmission or
1470 treatment system, ~~or exceeds FOG sanitary~~
1471 ~~sewer discharge limitation and pretreatment~~
1472 ~~standards in Section 24-42.4, or causes a~~
1473 sanitary nuisance.

1474
1475 7. Gravity Grease Interceptors. Cleaning of gravity grease
1476 interceptors shall be performed as follows:

1477
1478 a. Gravity grease interceptors ~~shall be~~ shall be
1479 cleaned every sixty (60) days by a liquid waste
1480 transporter permitted by the Department or more
1481 frequently when necessary to avoid exceeding
1482 the FOG capacity limit or FOG sanitary sewer
1483 discharge limitation and pretreatment effluent
1484 standards in Section 24-42.4.

1485
1486 b. Single and grouped gravity grease interceptors
1487 equipped with a functional Interceptor
1488 Monitoring Device shall ~~all~~ be cleaned by a

1489
1490
1491
1492
1493
1494
1495
1496
1497
1498
1499
1500
1501
1502
1503
1504
1505
1506
1507
1508
1509
1510
1511
1512
1513
1514
1515
1516
1517
1518
1519
1520
1521
1522
1523
1524
1525
1526
1527
1528
1529
1530
1531
1532

liquid waste transporter permitted by the Department at an interval not to exceed every one hundred eighty (180) days, by a liquid waste transporter permitted by the Department or more frequently when necessary to avoid exceeding the FOG capacity limit, or FOG sanitary sewer discharge limitation and pretreatment effluent standards in Section 24-42.4.

e. Grouped grease interceptors, in parallel or series, shall all be cleaned every sixty (60) days by a liquid waste transporter permitted by the Department or more frequently when necessary to avoid exceeding the FOG capacity limit or effluent standards in Section 24-42.4. Where functional Interceptor Monitoring Devices are used, all grease interceptors shall be cleaned every one hundred eighty (180) days by a liquid waste transporter permitted by the Department or more frequently when necessary to avoid exceeding the FOG capacity limit or effluent standards in Section 24-42.4

c. Alternative cleaning frequencies may be approved pursuant to Section 24-42.6(9)(d)(ii)6.c.

8. FOG Control Devices not classified by the Director or Director's designee as hydromechanical or gravity grease interceptors: FOG control devices shall be cleaned pursuant Section 24-42.6(9)(d)(ii)6.

(iii) Record Keeping. Each FOG generator and FOG control device operator shall maintain records of maintenance and repair activities, service calls and staff training. All records shall be retained onsite for a period of not less than three years and made available onsite to Department staff upon request. Offsite records shall not be an acceptable substitute for onsite records required herein. At a minimum, each FOG generator and FOG control device operator shall maintain the following records using forms prescribed by the Director or Director's designee.

1533
1534
1535
1536
1537
1538
1539
1540
1541
1542
1543
1544
1545
1546
1547
1548
1549
1550
1551
1552
1553
1554
1555
1556
1557
1558
1559
1560
1561
1562
1563
1564
1565
1566
1567
1568
1569
1570
1571
1572
1573
1574
1575
1576
1577
1578

1. Scheduled and unscheduled service calls to clean grease waste drains, building sanitary drains, or building sewers.
2. Repairs required resulting from food or FOG accumulation or blockages.
3. Kitchen exhaust hood cleaning.
4. FOG control device cleaning, maintenance and repair.
5. Waste manifest forms pursuant to Sections 24-42.6(9)(c)(v) and 24-46.
6. Staff training records pursuant to Section 24-42.6(9)(c)(iv).

(iv) Training Requirements. Each FOG generator and FOG control device operator~~s~~ shall maintain trained staff to ensure compliance with the requirements of Section 24-42.6(9). The content and form of training shall be prescribed by the Director or Director's designee. Training shall include orientation of new employees and quarterly training of existing employees. On or before January 1, 2019, each FOG generator and FOG control device operator shall have one (1) trained person on staff which has working knowledge of the following where applicable:

1. Kitchen exhaust hoods,
2. Solids separators.
3. FOG control devices.
4. Best management practices.
5. Yellow and brown grease storage.
6. Mat and equipment wash-down areas.
7. Record keeping and reporting.

(v) Reporting. Each FOG generator and FOG control device operator shall submit ~~monthly~~ reports to the Department using forms prescribed by the Director or Director's designee pursuant to maintenance schedules in Section 24-

1579 42.6(10)(d)(ii). Where made available by the Department,
1580 reporting shall be completed using a secure online system or by
1581 an equivalent system developed by the Department. Monthly
1582 Reports shall include ~~total volume of each waste stream~~
1583 ~~disposed, transported or collected,~~ the date and the name of
1584 liquid waste transporter.

1585
1586 (vi) Closure Requirements. No more than thirty (30) days after a
1587 FOG generator closes, the property owner shall notify the
1588 Department to perform a closure inspection. On or before the
1589 closure inspection, the property owner shall have all yellow
1590 and brown grease containers and bins emptied, storage areas
1591 cleaned and FOG control devices cleaned. Decanting,
1592 skimming, or backflushing is prohibited. Emulsifiers, grease
1593 cutters or other chemicals and detergents which could cause
1594 FOG to pass through the system to the drain lines are
1595 prohibited and shall not be used. All waste shall be disposed at
1596 a permitted facility, using an approved liquid waste transporter
1597 with manifests submitted to ~~the~~ Department.

1598
1599 (e) Existing FOG generators with a current FOG operating permit, issued
1600 prior to (CLERK TO INSERT EFFECTIVE DATE), proposing to
1601 increase seating capacity, dining area or drive-thru capacity, or other
1602 modification, any of which will increase the discharge of FOG, shall
1603 comply with Sections 24-42.6(6)(a)(i), (ii) and (iii), and 24-42.6(9)(c).

1604
1605 (f) FOG generators discharging to an onsite sewage treatment and
1606 disposal system located in ~~the basic~~ a wellfield protection area of any
1607 utility potable water supply wells, proposing to increase seating
1608 capacity, dining area or drive-thru capacity, or other modification, any
1609 of which will increase the discharge of FOG, shall comply with
1610 Sections 24-42.6(6)(b), and 24-42.6(9)(c).

1611
1612 (g) FOG generators discharging to an onsite sewage treatment and
1613 disposal system located in ~~the basic~~ a wellfield protection area of any
1614 utility potable water supply wells, not proposing to increase seating
1615 capacity, dining area or drive-thru capacity, or other modification, any
1616 of which will increase the discharge of FOG, shall apply for an
1617 operating permit ~~by January 1, 2018~~ pursuant to Section 24-42.6(5).

1618
1619 (h) Any FOG operating permit approved and issued by the Department
1620 may be revoked for failure to comply with permit conditions or
1621 conditions established in Section 24-42.6. Cause for revoking an
1622 operating permit may include, but not be limited to, the following:
1623

- 1624 (i) Falsifying information on any record or document required by
1625 the county; or
1626
- 1627 (ii) Failure to have a FOG control device cleaned properly or in a
1628 timely manner as described in Section 24-42.6(9); or
1629
- 1630 (iii) Having a FOG control device cleaned by a person not
1631 permitted by the Department to perform such cleaning; or
1632
- 1633 (iv) Utilizing a liquid waste transporter not permitted by the
1634 Department; or
1635
- 1636 (v) Failure to comply with any permit condition; or
1637
- 1638 (vi) Violation of any federal, state, or local regulation governing
1639 the handling of FOG wastes; or
1640
- 1641 (vii) Failure to pay invoices, fees, fines, judgments or liens owed to
1642 the county.
1643
- 1644 (viii) The revocation of an operating permit shall be in addition to
1645 any penalties assessed for violation of this Chapter, or provided
1646 elsewhere in the Code of Miami-Dade County.
1647

1648 (11) FOG Liquid Waste Transporters. Notwithstanding any provision of
1649 this Code, no person shall collect, pump, transport, or cause, let, permit, suffer or
1650 allow any FOG, yellow grease, brown grease or black grease to be collected,
1651 pumped or transported without a valid operating permit issued by the Department
1652 pursuant to Sections 24-18, ~~24-42.6(8)~~ and 24-46. In addition to the requirements
1653 enumerated in Section 24-46, FOG liquid waste transporters shall comply with the
1654 following:
1655

- 1656 (a) All waste transported and FOG control device condition assessments
1657 shall be manifested using forms prescribed by the Director or
1658 Director's designee and ~~Where made available by the Department,~~
1659 ~~reporting shall be completed using a secure online system or by an~~
1660 ~~equivalent system developed by the Department. Reporting shall be~~
1661 ~~completed no later than 20 days after the end of the month during~~
1662 ~~which cleaning was performed.~~
1663
- 1664 (b) FOG, yellow grease, black grease and brown grease shall only be
1665 stored or disposed at private or public facilities approved by the
1666 Department.
1667
- 1668 (c) FOG control device cleaning shall include completely removing the
1669 full contents of the FOG control device, including settled solids,

1670 wastewater and floating materials, pressure washing or scraping side
1671 walls, baffle walls, cross-pipes, and inlet and outlet pipes to remove all
1672 attached materials. Decanting, skimming, or backflushing is
1673 prohibited. Emulsifiers, grease cutters or other chemicals and
1674 detergents which could cause FOG to pass through the system to the
1675 building sanitary drains or building sewers are prohibited and shall not
1676 be used.

1677
1678 (d) Effective January 12, 2017~~9~~, liquid waste transporter staff shall be
1679 trained to ensure compliance with the requirements of Section 24-
1680 42.6(9)(c)(ii) and 24-42.6(10)(c). The content and form of training
1681 shall be prescribed by the Director or Director's designee. At a
1682 minimum, one trained staff member shall be present while ~~grease traps~~
1683 ~~or grease interceptors~~ FOG control devices are being cleaned. Staff
1684 performing assessments of the condition of any system or part thereof
1685 (condition assessments) stipulated in Section 24-42.6(10) shall be
1686 trained in accordance with this Section.

1687
1688 (e) ~~Effective January 2, 2017, s~~ Septage or other waste shall not be
1689 commingled with yellow or brown grease.

1690
1691 ~~(f) Effective January 2, 2017, where made available by the~~
1692 ~~Department, waste manifesting shall be completed using a secure~~
1693 ~~online system or by equivalent system developed by the Department.~~

1694
1695 (f) ~~Effective January 2, 2017, l~~ Liquid waste transporters shall perform
1696 FOG control device condition assessments when cleaning is required
1697 pursuant to Section 24-42.6(9)(c)(ii). The condition assessment shall
1698 be performed and reported ~~using forms prescribed by the Director or~~
1699 ~~Director's designee, including the online forms pursuant to Section 24-~~
1700 ~~42.6(10)(a) where made available by the Department.~~ At a minimum,
1701 the condition assessment shall document the following:

1702
1703 (i) The water level and thickness of floating FOG and settled
1704 solids prior to cleaning.

1705
1706 1. Where FOG control devices are installed below ground
1707 and the water level prior to cleaning is below the invert
1708 of the outlet pipe, or groundwater infiltration is
1709 observed during or after cleaning, the condition
1710 assessment shall document leaks.

1711
1712 2. Where FOG control devices are installed above ground
1713 and leaks are observed, the condition assessment shall
1714 document leaks.

1715

1716
1717
1718
1719
1720
1721
1722
1723
1724
1725
1726
1727
1728
1729
1730
1731
1732
1733
1734
1735
1736
1737
1738
1739
1740
1741
1742
1743
1744
1745
1746
1747
1748

1749
1750
1751
1752
1753
1754
1755
1756
1757
1758
1759
1760
1761

~~3. All leaks shall be reported to the Department within twenty four (24) hours of being detected or observed and the FOG control device repaired within forty eight (48) hours. Until the FOG control device is repaired, the FOG control device shall not receive any flow or be bypassed.~~

3. Should a leak cause a sanitary nuisance, the sanitary nuisance shall be removed, abated or corrected within twenty-four (24) hours or such other reasonable time as the Director or the Director's designee may determine.

(ii) Integrity of solids separators and FOG control devices, including the inlet and outlet appurtenances; interior, bottom, top, side walls, baffle walls, and cross-pipes; manhole rings, extenders and covers; sampling points and cleanouts; interceptor monitoring alarms and devices; and other elements and equipment approved by the Department.

~~Where a solids separator or FOG control device is observed to be malfunctioning so that solids or FOG are being discharged to the building sanitary drains or building sewers, the Department shall be notified.~~

~~In no instance shall the unpermitted discharge be permitted to continue or result in a building sanitary drain or building sanitary drain back up or a sanitary nuisance.~~

~~(iii) All repairs performed by the liquid waste transporter.~~

(iii*) The condition of yellow and brown grease containers and bins.

(12) FOG Disposal Facilities. All facilities accepting, storing, transferring or treating FOG, yellow grease or brown grease shall obtain an operating permit pursuant to Section 24-18(A)(23) and comply with the following:

(a) Maintain trained staff to assure compliance with the requirements of Section 24-42.6. The content and form of training shall be prescribed by the Director or Director's designee. Training shall be completed prior to permit renewal starting January 1, 2019. At a minimum, one (1) trained staff member shall be present during maintenance and repair of the system and/or system components.

(b) Submit monthly reports to the Department using forms prescribed by the Director or Director's designee. Where made available by the

1762 Department, reporting shall be completed using a secure online system
1763 or by an equivalent system developed by the Department. Monthly
1764 reports shall include total volume of each waste stream accepted,
1765 collected, stored, treated, disposed, or transported and include waste
1766 manifests for all waste transported. Waste manifests shall track waste
1767 from the point of origin to the final disposal facility.

1768
1769 (13) Utilities. Utilities shall submit a monthly report to the Department that
1770 includes the following minimum information:

1771
1772 (a) A list with dates and locations where accelerated FOG maintenance
1773 was performed to prevent a sanitary sewer overflow. Locations shall
1774 also be identified in a geographical information system (GIS) format
1775 based on the utilities atlas pursuant to Section 24-42.2.

1776
1777 (b) A description of accelerated FOG maintenance performed, including
1778 quantities of waste FOG removed, recovered, collected or treated to
1779 prevent a sanitary sewer overflow. The information shall be provided
1780 in text and GIS form.

1781
1782 (c) Cost of accelerated FOG maintenance, including labor, equipment and
1783 materials. Labor shall include field and office staff.<<

Attachment 2
DERM, WASD, FDEP and EPA Meeting Materials,
meeting held on December 8, 2016.

FOG

Control EPA / FDEP / DERM Meeting December 8, 2016

AGENDA

- Improvements Implemented
 - Team FOG
 - Evolution of FOG Control
 - FOG Timeline
 - FCD Requirements
 - Plan Review/CU Review Process
 - DERM Inspections
 - eManifest
 - Continuity
- Findings (**post June 5, 2016**)
- Proposed Modifications
- EPA & FDEP Comments



DERM
Water & Wastewater
Table of Organization

FOG

Team

Water & Wastewater
Carlos L. Hernandez, PE
Alejandra Villanueva, P&PR

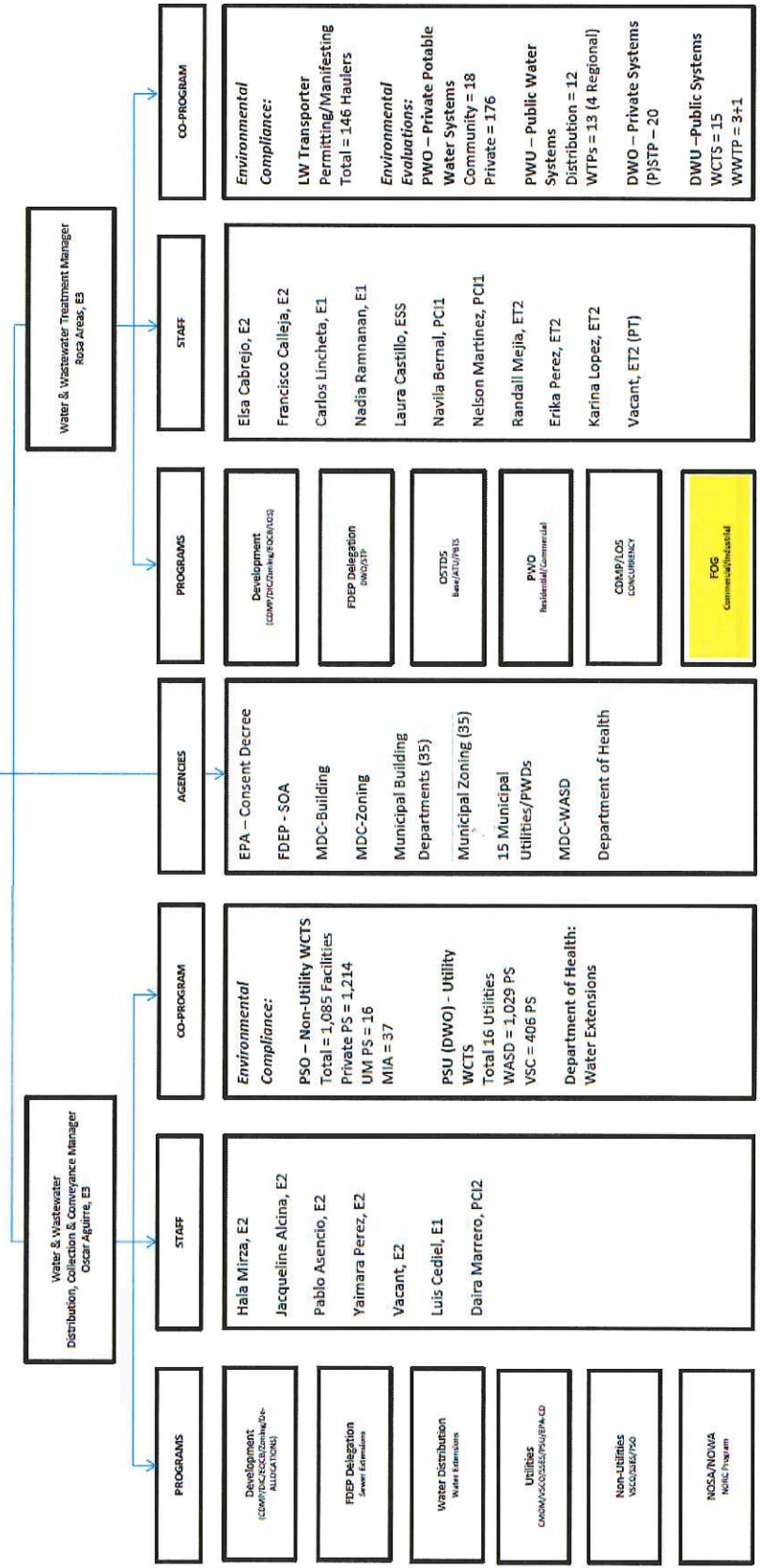

MDC-FOG Control Program 2016/2017: Improvements Implemented

The Evolution of FOG CONTROL

FOG 1.0 {94 FOG Control Program & Ordinance}

Agenda Item No. 7 (S)
6-21-34

ORDINANCE NO. 94-132

ORDINANCE RELATING TO GREASE TRAPS; AMENDING SECTION 24-33 OF THE CODE OF METROPOLITAN DADE COUNTY, FLORIDA, RELATING TO APPROVAL OF PLANS; AMENDING SECTION 24-33 OF THE CODE OF METROPOLITAN DADE COUNTY, FLORIDA, RELATING TO STANDARDS FOR PREPARATION OF PLANS; AMENDING SECTION 24-33.1 OF THE CODE OF METROPOLITAN DADE COUNTY, FLORIDA, RELATING TO OPERATING PERMITS; AMENDING SECTION 24-37(2) OF THE CODE OF METROPOLITAN DADE COUNTY, FLORIDA, RELATING TO ABNORMAL OCCURRENCES; PROVIDING EFFECTIVE DATE; INCLUSION IN THE CODE, AND AN EFFECTIVE DATE

BE IT OBTAINED BY THE BOARD OF COUNTY COMMISSIONERS OF DADE COUNTY, FLORIDA:

Section 24-30 of the Code of Metropolitan Dade County, Florida, is hereby amended as follows:

Sec. 24-30 Plan approval required

(1) Waste water facilities. It shall be unlawful for any person to enter into or let a contract for or to commence the installation, erection, or operation of any sewage disposal facility without first obtaining the prior written approval of the Director of the Department of Environmental Resources Management or his designee. It shall be unlawful for any person to make any change, enlargement or addition to any facility, or commence the construction of any facility, that will reasonably be expected to be a source of water pollution without first obtaining the prior written approval of the Director of the Department of Environmental Resources Management or his designee. No building permit involving the generation or discharge of effluents shall be issued by

Words stricken through shall be deleted. Unenclosed words constitute the amendment proposed. Remaining provisions are now in effect and remain unchanged

Agenda Item No. 7 (S)
Page 2

the County or any municipality unless the application for a building permit has been approved by the Director of the Department of Environmental Resources Management or his designee.

The provisions of this section shall not apply to facilities discharging only domestic wastes to a public sewer system approved by the Director of the Department of Environmental Resources Management or his designee. Notwithstanding the foregoing, the provisions of this section shall apply to facilities discharging only domestic wastes to a public sewer system approved by the Director of the Department of Environmental Resources Management or his designee, if the facilities provide any form of pretreatment in conjunction with a grease trap.

Section 24-33 of the Code of Metropolitan Dade County, Florida, is hereby amended as follows:

Sec. 24-33 Standards for preparation of plans.

(3) Grease traps shall be provided and installed in accordance with the rules and regulations promulgated under the provisions of this Chapter. At a minimum, all grease traps discharging to publicly or privately-owned or operated sanitary sewer collection systems shall be provided with a sampling point on the effluent discharge side of the grease trap. Wastes containing sizable quantities of grease such as those produced by restaurants shall not be deemed suitable for disposal into tile drainfields.

Agenda Item No. 7 (S)
Page 3

Section 24-35.1 of the Code of Metropolitan Dade County, Florida, is hereby amended as follows:

Sec. 24-35.1 Operating permits.

(18) Any nonresidential facility, including, but not limited to, restaurants, bakeries, hotel and cafeteria kitchens, processing plants or such other nonresidential facilities discharging into a publicly or privately-owned or operated sanitary sewer collection system. If oil and grease can be introduced into a sewer by such nonresidential facility in quantities which have the potential to affect or hinder the operation of sewage collection, transmission or treatment facilities.

Section 24-37(2) of the Code of Metropolitan Dade County, Florida, is hereby amended as follows:

Sec. 24-37(2) Abnormal Occurrences

(2) Power to stop operation of facility. If in the judgment of the Director, Environmental Resources Management, the abnormal operation of any facility, equipment, process, or plant is causing or will cause air pollution or water pollution to such extent as to be or become dangerous to the public health, safety or welfare, he may require such corrective measures as may be necessary for the protection of the public on an emergency basis, and he shall have the power and authority to cause all operation of the facility or plant to cease until appropriate corrective measures have been taken by issuing an order to the owner or operator thereof directing the cessation of the operation, or by ordering the utility providing water service to the facility or plant to cease providing such service.

MDC-FOG Control Program 2016/2017: Improvements Implemented

The Evolution of FOG CONTROL

FOG 2.0 {2017 FOG Control Program & Ordinance}

1 June 2, 2016
2 Strike thru Text II {text I} are deletions and underlined text >>{text}<< is new/proposed
3 language.

4
5 **Sec. 24-5. Definitions**

6
7 >>>Accelerated FOG maintenance shall mean cleaning performed by utilities to prevent sanitary
8 sewer overflows caused by FOG blockages in sewer laterals, gravity mains, pump stations, and
9 air release valves.

10 Back of the House shall mean all areas where food is stored, processed, cooked, prepared, and
11 assembled and cleanup areas. It does not include offices, dry storage or front of the house
12 areas.

13 Best Management Practices shall mean a schedule of activities, prohibitions of practices,
14 maintenance procedures, and other management practices to prevent or minimize pollution.

15 Back Grease shall mean any FOG commingled with septic wastes (bathroom wastes),
16 Brown Grease shall mean FOG waste collected in, or removed from, a FOG control device.

17 Building Sewer shall mean the part of the building drainage system that extends from the end of
18 the building drain and conveys the discharge to utility or non-utility owned or operated sanitary
19 sewer system.

20 Building Sanitary Drains shall mean the pipes intended to receive sanitary wastewater and
21 effluent from FOG control devices where FOG control devices are installed or retained. FOG or
22 food waste shall not be discharged into the building sanitary drains.

23 Dishwashers shall mean equipment used to sanitize and does not actually wash the items but
24 inside.

25 Dishwasher shall mean equipment that washes and sanitizes.

26 Fats, Oil and Grease (FOG) shall mean any substance such as vegetable or animal product
27 used in, or a byproduct of, the cooking or food preparation process, which turns or may turn
28 viscous or solidifies with a change in temperature or other conditions.

29 FOG Capacity Limit shall mean the combined FOG and solids depth equal to twenty-five (25)
30 percent of the design hydraulic depth in any location of a FOG control device designed pursuant
31 to Chapter 64E-8, Florida Administrative Code, or seven-tenths (75) percent of the rated FOG
32 and solids capacity established by third party certification.

33 FOG Control Device shall mean equipment designed to remove, hold and prevent the passage
34 of FOG to onsite sewage treatment and disposal systems and sanitary sewer systems. FOG
35 control devices include grease traps and grease interceptors.

36 FOG Control Device Operator shall mean a person or entity which has management control for
37 FOG control devices which serve either FOG generators,

38 FOG Generator shall mean any nonresidential facility, including, but not limited to, restaurants,
39 bakeries, hotels and catering operations, commercial laboratories, doctors' offices, hospitals, nursing
40 homes, daycares, assisted living facilities and other healthcare facilities, processing plants or
41 such other nonresidential facilities that can introduce food waste or FOG into building sanitary
42 drains, building sewers, onsite sewage treatment and disposal systems, or non-utility or utility
43 sanitary sewer system. A FOG generator also includes those facilities that produce yellow
44 grease.

45 FOG Generator Certified Staff shall mean a FOG generator employee which has attended
46 training prescribed by the Director or Director's designee, and has received certification for
47 training.

48 FOG Liquid Waste Transporter-Certified Staff shall mean a FOG Liquid Waste Transporter
49 employee which has attended training prescribed by the Director or Director's designee, and
50 has received certification for training.

51 FOG Operating Permit shall mean an operating permit issued to FOG generators or FOG
52 control device operators pursuant to Sections 24-18 and 24-42.

53 FOG Sampling Point shall mean a reasonably accessible location for sampling the effluent of a
54 FOG control device.

55 Front of the House shall mean all areas not included in the back of the house.
56 Grease Interceptor shall mean a FOG control device connected to a building grease waste
57 drain.

(11) Utilities shall submit a monthly report to the Department that includes the
following minimum information:

(a) A list with dates and locations where accelerated FOG maintenance was performed to
prevent a sanitary sewer overflow. Locations shall also be identified in a geographical
information system (GIS) format based on the utilities files pursuant to Section 24-42.2.

(b) A description of accelerated FOG maintenance performed, including quantities of FOG
removed, recovered, collected or treated, to prevent a sanitary sewer overflow. The
information shall be provided in text and GIS form.

(c) Cost of accelerated FOG maintenance, including labor, equipment and materials. Labor
shall include field and office staff.

END

Suppification

MDC-FOG Control Program 2016/2017: Improvements Implemented

The Evolution of FOG CONTROL

FOG 1.0 {94 FOG Control Program & Ordinance}

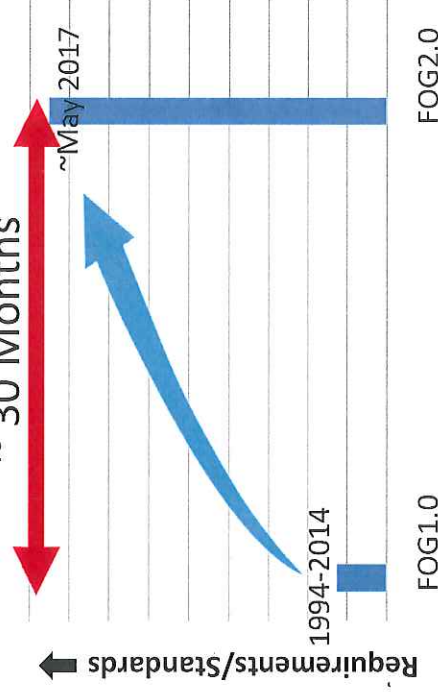

FOG 2.0 {2017 FOG Control Program & Ordinance}

MDC-FOG Control Program 2016/2017: Improvements Implemented

The Evolution of FOG CONTROL

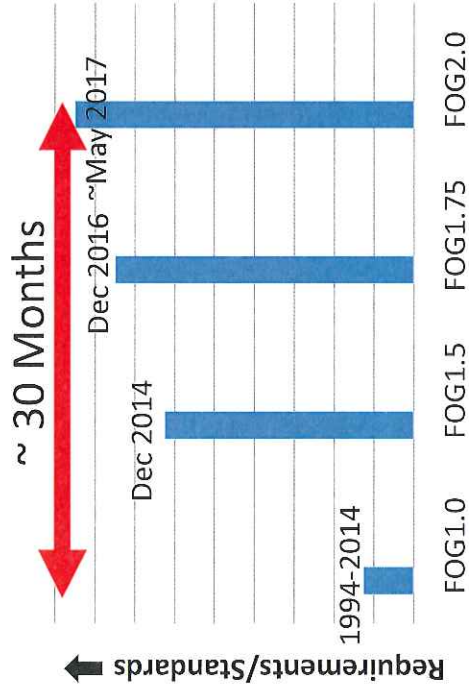

↑ **FOG1.0 {94 FOG Control Program & Ordinance}**

↑ **FOG1.5**

↑ **FOG1.75**

↑ **FOG2.0 {2017 FOG Control Program & Ordinance}**

Continuous Program Improvement by:
Observing, Learning, Evaluating & Integrating!

MDC-FOG Control Program **2016/2017: Improvements Implemented**

The FOG TIMELINE - What We Have Accomplished!

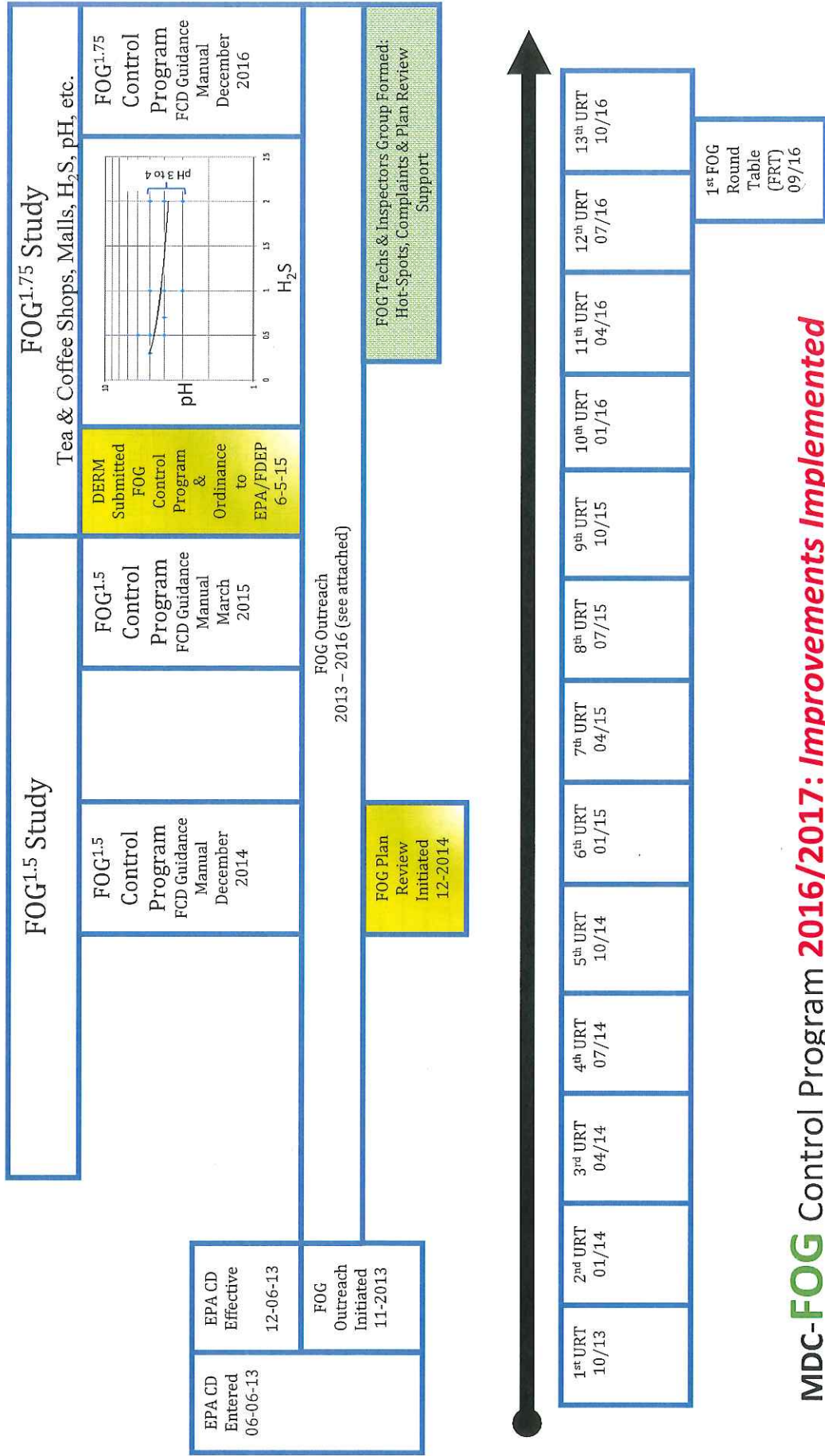

MDC-FOG Control Program 2016/2017: Improvements Implemented

FOG CONTROL DEVICE REQUIREMENTS

No.	Item / Description	FOG			
		1.0	1.5	1.75	2.0
1.0	General Criteria				
1.1	New Construction Plans signed/sealed/dated by FL PE			X	X
1.2	FOG Control Device (FCD) required for all establishment preparing or serving food/drink and/or cleaning		X	X	X
1.3	Facilities required to have 2 and/or 3-compartment sink or dishwasher (64E-11.006, FAC) require FCD		X	X	X
1.4	FCD Sampling Point required		X	X	X
1.5	FCD Maintenance (cleaning/Pump-Out) schedule required		X	X	X
1.6	Yellow Grease Storage Design				X
1.7	Mat/Equipment Wash down Areas Design				X
1.8	Outdoor Sinks: NO Stormwater (plumbing permit to correct violation)			X	X
1.9	Training: FSEs, Haulers, Storage/Treatment Facilities, & <u>Plumbing Inspectors</u>				X
2.0	FCD Design Criteria				
2.1	Accessible - for cleaning: Included in plans			X	X
2.2	Flow Rate: By Fixture Units and/or Fixture Drain Time (1 or 2 minutes)		X	X	X
2.3	Mass Rate: Low, Medium & High FOG (lbs/day)		X	X	X
2.4	Sizing a Function of Cleaning Frequency, Mass Rate & Flow Rate		X	X	X
2.5	Gravity FCDs				
2.5.1	Sized based on Volume: Seats, Takeout, Drive-Thru, Banquet, Room Service, etc.		X	X	X
2.5.2	Size adjusted for Cleaning Frequency: 30 days (1.0), 45 days (1.15) & 90 days (1.25)		X	X	X
2.5.3	FCDs installed in series and outside buildings, smallest tank 750 gal, largest 1,250 gal		X	X	X
2.5.4	Each tank shall include DOH Approval Number on drawings		X	X	X
2.5.5	Each "Concrete" tank shall include FDOT Casting facility Name/Number on drawings				X
2.5.6	Concrete Tanks shall be designed for pH 3 - 5			X	XX
2.5.7	Each tank shall include plan/section showing details: openings, tee 8" from bottom, etc.		X	X	X
2.5.8	Dish machines (sanitize ONLY) need not be connected to an individual Grease Interceptor				X
2.5.9	Dishwashers with pre-wash station can connect to GW drain				X
2.5.10	Dishwashers connect to an individual Grease Interceptor				X
2.5.11	For new projects or never permitted facilities, All back-of-house fixtures connected to Grease Interceptor		X	X	X
2.5.12	Existing GDOs with No plumbing changes: 3-compartment sinks, sinks and mop sink connected		X	X	X
2.5.14	Existing GDOs to connect all fixtures by 2018				XX
2.5.14	Existing GDOs with NO plumbing changes, No cooking, No frying and No hood required, floor drains need not connect		X	X	XX
2.5.15	Existing GDOs proposing changes to plumbing, All back-of-house connected		X	X	X

MDC-FOG Control Program 2016/2017: Improvements Implemented

FOG CONTROL DEVICE REQUIREMENTS

No.	Item / Description	FOG			
		1.0	1.5	1.75	2.0
2.6	Hydromechanical FCDs				
2.6.1	Size based on Peak (Full) Pipe Flow (by DFU) or Fixture Drain Time + <u>Cleaning Frequency</u>		X	X	X
2.6.2	Cleaning Frequency a function of Seats, Takeout, Drive-thru, Banquet, Room service, etc. & FOG/meal (or unit)		X	X	X
2.6.3	FCDs installed in series/parallel and inside/outside buildings		X		
2.6.3.1	FCDs installed in series and inside/outside buildings (NOT PARALLEL)			XX	XX
2.6.4	Flow Capacity based on parallel arrangement		X	XX	XX
2.6.4.1	Flow Capacity based on one device with all devices of equal size (same model)			XX	XX
2.6.5	Include solid separation prior to flow control device				X
2.6.6	Third (3rd) Party Certified to comply with Local Limit for FOG (currently 100 mg/L)				X
3.0	FOG Sampling Point				
3.1	Sized for sampling bottle & collect non-stagnant wastewater		X	X	X
3.2	Four (4) feet vertical clearance & three (3) feet horizontal clearance			X	X
4.0	FCD Maintenance (cleaning/Pump-Out)				
4.1	Must be included in plans and accounted for in sizing		X	X	X
4.2	Can't exceed 90 days without IMD (interceptor monitoring device)		X	X	X
4.3	Up to 180 days with IMD (must comply with 100 mg/L and pH)		X	X	X
5.0	Other Plumbing Requirements				
5.1	Access provided for cleaning where distance between FCD and fixtures > 25 ft (25 ft spacing)				X
5.2	Where distance between FCD and fixtures > 100 ft, include provisions to prevent clogging (e.g., Heat Tracer)				X
5.3	Where distance between FCD and fixtures > 100 ft, include Alarm				X
5.4	Where FCD on different floor from FSE, include Alarm				X

MDC-FOG Control Program 2016/2017: Improvements Implemented

The CONSENT DECREE

Case 1:12-cv-24400-FAM Document 25-1 Entered on FLSD Docket 06/06/2013

FOG^{1.0} Plan REVIEW PROCESS

Facility Status	GDO Permit Status	Plans for Remodeling/Renovation that DO NOT impact FOG Generation or FOG Control System ⁽³⁾	Plans for Remodeling/Renovation that impacts FOG Generation or FOG Control System ⁽³⁾	Plans for New Construction ⁽²⁾
Existing Facility	NGT or UNKN ⁽⁴⁾ [Status 13]	NO REVIEW – Rely on Plumbing Plan Reviewers & Inspectors with the following outcomes:		
	Active GDO Permit [Status 1 to 5]	<ul style="list-style-type: none"> FSEs with NO Grease Interceptor [No Grease Trap (NGT) GDO Permit Issued – Uncontrolled FOG Discharges] No Design Guidance – No Standards! FSEs with undersized Grease Interceptors [Excess FOG Discharge to WCTS] Septic Tanks used as Grease Interceptors! 		
	Closed GDO Permit 3 or less years [Status 7]			
	Closed GDO permit > 3 yrs [Status 7]			
	No GDO permit			
New Facility	Second User [Any Status]			
	N/A			

NOTES

⁽¹⁾ All submittals for facilities with Status 13 shall be routed to FOG Review.

⁽²⁾ New construction and change of use (last use not an FSE).

⁽³⁾ Increasing square feet, increasing dining areas seating (chairs and/or stools), modifying (adding or subtracting) plumbing system, adding or expanding drive-thru lanes capacity; or adding, replacing or modifying FOG control devices. Any of these impacts FOG generation and therefore require Engineering FOG review.

⁽⁴⁾ Includes Municipal Equivalent Applications

⁽⁵⁾ NGT facilities are placed under Status 16, after plans are approved, to indicate that DERM inspection is required.

⁽⁶⁾ Grease interceptor condition assessment, forms provided by WPS, must be signed by PE, Certified Plumber, Licensed Septic Tank Contractor

MDC-FOG Control Program 2016/2017: Improvements Implemented

FOG^{1.5} Plan REVIEW PROCESS

Facility Status	GDO Permit Status	Plans for Remodeling/Renovation that DO NOT impact FOG Generation or FOG Control System ⁽³⁾	Plans for Remodeling/Renovation that impacts FOG Generation or FOG Control System ⁽³⁾	Plans for New Construction ⁽²⁾
Existing Facility	NGT or UNKN ⁽¹⁾ [Status 13]	Activate DERM FOG Review Inspection by Plumbing	Activate DERM FOG Review Inspection by Plumbing * Finding FCD w/Final Plumbing Inspection that DO NOT comply with Approved Plans!	Activate DERM FOG Review Inspection by Plumbing * Finding FCD w/Final Plumbing Inspection that DO NOT comply with Approved Plans!
	Active GDO Permit [Status 1 to 5]	FOG Review NOT Required (Contact WPS if uncertain)		
	Closed GDO Permit 3 or less years [Status 7]	Activate DERM FOG Review Inspection by Plumbing		
	Closed GDO permit > 3 yrs [Status 7]			
New Facility	No GDO permit Second User [Any Status]	Activate DERM FOG Review Inspection by Plumbing		
	N/A			

NOTES

- ⁽¹⁾ All submittals for facilities with Status 13 shall be routed to FOG Review.
- ⁽²⁾ New construction and change of use (last use not an FSE).
- ⁽³⁾ Increasing square feet, increasing dining areas seating (chairs and/or stools), modifying (adding or subtracting) plumbing system, adding or expanding drive-thru lanes capacity, or adding, replacing or modifying FOG control devices. Any of these impacts FOG generation and therefore require Engineering FOG review.
- ⁽⁴⁾ Includes Municipal Equivalent Applications
- ⁽⁵⁾ NGT facilities are placed under Status 16, after plans are approved, to indicate that DERM inspection is required.
- ⁽⁶⁾ Grease interceptor condition assessment, forms provided by WPS, must be signed by PE, Certified Plumber, Licensed Septic Tank Contractor

MDC-FOG Control Program 2016/2017: Improvements Implemented

FOG^{1.5} Plan REVIEW PROCESS

1994 to December 2014 to November 2016 FOG Plans Reviewed

1994 – Dec 2014	Dec 2014	2015	2016
By Plumbing	45	1,184	1,477

MDC-FOG Control Program **2016/2017: Improvements Implemented**

The CONSENT DECREE

Case 1:12-cv-24400-FAM Document 25-1 Entered on FLSD Docket 06/06/2013

FOG 1.75 & 2.0 Plan REVIEW PROCESS

Facility Status	GDO Permit Status	Plans for Remodeling/Renovation that DO NOT impact FOG Generation or FOG Control System ⁽³⁾	Plans for Remodeling/Renovation that impacts FOG Generation or FOG Control System ⁽³⁾	Plans for New Construction ⁽²⁾
Existing Facility	NGT or UNKN ⁽⁴⁾ [Status 13]	Activate DERM FOG Review Inspection by Plumbing	Activate DERM FOG Review Inspection by Plumbing * Finding FCD w/Final Plumbing Inspection that DO NOT comply with Approved Plans!	Activate DERM FOG Review Inspection by Plumbing * Finding FCD w/Final Plumbing Inspection that DO NOT comply with Approved Plans!
	Active GDO Permit [Status 1 to 5]	FOG Review NOT Required (Contact WPS if uncertain)		
	Closed GDO Permit 3 or less years [Status 7]	Activate DERM FOG Review Inspection by Plumbing		
	Closed GDO permit > 3 yrs [Status 7]			
New Facility	No GDO permit Second User [Any Status]	Activate DERM FOG Review Inspection by Plumbing		
	N/A			

NOTES

- ⁽¹⁾ All submittals for facilities with Status 13 shall be routed to FOG Review.
- ⁽²⁾ New construction and change of use (last use not an FSE).
- ⁽³⁾ Increasing square feet, increasing dining areas seating (chairs and/or stools), modifying (adding or subtracting) plumbing system, adding or expanding drive-thru lanes capacity, or adding, replacing or modifying FOG control devices. Any of these impacts FOG generation and therefore require Engineering FOG review.
- ⁽⁴⁾ Includes Municipal Equivalent Applications
- ⁽⁵⁾ NGT facilities are placed under Status 16, after plans are approved, to indicate that DERM inspection is required.
- ⁽⁶⁾ Grease interceptor condition assessment, forms provided by WPS, must be signed by PE, Certified Plumber, Licensed Septic Tank Contractor

MDC-FOG Control Program 2016/2017: Improvements Implemented

FOG1.0 CU REVIEW PROCESS

Facility Status	GDO Permit Status	CU Review	Action
Existing Facility	NGT or UNKN ⁽¹⁾ [Status 13]		
	Active GDO Permit [Status 1 to 5]		
	Closed GDO Permit ≤ 3 years [Status 7]		
	Closed GDO permit > 3 yrs [Status 7]		
New Facility	No GDO permit Second User [Any Status] No GDO permit		

Accept GDO Application Completed by Tenant

Specifics NOT Verified:

Rely on Plumbing Plan Reviewers & Inspectors with the following outcome:

- FSEs with NO Grease Interceptor (**No Grease Trap (NGT) GDO Permit Issued by DERM**)
- FSEs with undersized Grease Interceptors (**Excess FOG Discharge to WCTS**)

NOTES

⁽¹⁾ All submittals for facilities with Status 13 shall be routed to FOG Review.

⁽²⁾ New construction and change of use (last use not an FSE).

⁽³⁾ Increasing square feet, increasing dining areas seating (chairs and/or stools), modifying (adding or subtracting) plumbing system, adding or expanding drive-thru lanes capacity, or adding, replacing or modifying FOG control devices. Any of these impacts FOG generation and therefore require Engineering FOG review.

⁽⁴⁾ Includes Municipal Equivalent Applications

⁽⁵⁾ NGT facilities are placed under Status 16, after plans are approved, to indicate that DERM inspection is required.

⁽⁶⁾ Grease Interceptor condition assessment, forms provided by WPS, must be signed by PE, Certified Plumber, Licensed Septic Tank Contractor

MDC-FOG Control Program 2016/2017: Improvements Implemented

FOG^{1.5} CU REVIEW PROCESS

December 2014 to November 2016
FOG CUs Approved *

Year	2014	2015	2016
Actual CUs Approved	0	137	142
* Actual CU Reviews is >>> CUs Approved			

MDC-FOG Control Program 2016/2017: Improvements Implemented

FOG^{1.5} CU REVIEW PROCESS

Facility Status	GDO Permit Status	CU Review	Action
Existing Facility	NGT or UNKN ⁽¹⁾ [Status 13]	FSE with Status 13 (NGT/UNKN)	CU NOT approved, Plan Review Required.
	Active GDO Permit [Status 1 to 5]	1. NO change in FSE type, NO change in seating, NO change in area, & NO open enforcement	OK to Approve CU
		2. GDO Application is completed properly.	Activate FOG Review, CU NOT approved.
	Closed GDO Permit ≤ 3 years [Status 7]	Change in FSE type, change in seating, change in area, OR open enforcement: Plans approved by DERM under FOG ^{1.5} or FOG ^{1.75}	Activate FOG Review to Confirm Plans Match GDO Application. CU Approved if they match.
		NO change in FSE type, NO change in seating, NO change in area, NO open enforcement:	Activate FOG Review. FOG Review to include Grease Interceptor Condition Assessment . CU Approved if system is in satisfactory condition. Otherwise CU NOT approved.
		Change in FSE type, change in seating, change in area, OR open enforcement:	Activate FOG Review, CU NOT approved.
		Plans approved by DERM under FOG ^{1.5} or FOG ^{1.75}	Activate FOG Review to Confirm Plans Match GDO Application. CU Approved if they match.
	Closed GDO permit > 3 yrs [Status 7]	Plans approved by DERM under FOG ^{1.5} or FOG ^{1.76}	Activate FOG Review to Confirm Plans Match GDO Application. CU Approved if they match.
		NO record of plans approved by DERM under FOG ^{1.5} or FOG ^{1.75}	Activate FOG Review, CU NOT approved.
	No GDO permit	Plans approved by DERM under FOG ^{1.5} or FOG ^{1.76}	Activate FOG Review to Confirm Plans Match GDO Application. CU Approved if they match.
NO record of plans approved by DERM under FOG ^{1.5} or FOG ^{1.75}		CU NOT approved, Plan Review Required.	
FSE proposing secondary user		Activate FOG Review, CU NOT approved.	
New Facility	Plans approved by DERM under FOG ^{1.5} or FOG ^{1.76}	Activate FOG Review to Confirm Plans Match GDO Application. CU Approved if they match.	
	NO record of plans approved by DERM under FOG ^{1.5} or FOG ^{1.75}	CU NOT approved, Plan Review Required.	

NOTES

- ⁽¹⁾ All submittals for facilities with Status 13 shall be routed to FOG Review.
- ⁽²⁾ New construction and change of use (last use not an FSE).
- ⁽³⁾ Increasing square feet, increasing dining areas seating (chairs and/or stools), modifying (adding or subtracting) plumbing system, adding or expanding drive-thru lanes capacity, or adding, replacing or modifying FOG control devices. Any of these impacts FOG generation and therefore require Engineering FOG review.
- ⁽⁴⁾ Includes Municipal Equivalent Applications
- ⁽⁵⁾ NGT facilities are placed under Status 16, after plans are approved, to indicate that DERM inspection is required.
- ⁽⁶⁾ Grease Interceptor condition assessment, forms provided by WPS, must be signed by PE, Certified Plumber, Licensed Septic Tank Contractor

MDC-FOG Control Program 2016/2017: Improvements Implemented

FOG 1.75 & 2.0 CU REVIEW PROCESS

Facility Status	GDO Permit Status	CU Review	Action
Existing Facility	NGT or UNKN ⁽¹⁾ [Status 13]	FSE with Status 13 (NGT/UNKN)	CU NOT approved, Plan Review Required.
	Active GDO Permit [Status 1 to 5]	1. NO change in FSE type, NO change in seating, NO change in area, & NO open enforcement 2. GDO Application is completed properly.	OK to Approve CU
		Change in FSE type, change in seating, change in area, OR open enforcement:	Activate FOG Review, CU NOT approved.
	Closed GDO Permit ≤ 3 years [Status 7]	Plans approved by DERM under FOG ^{1.5} or FOG ^{1.75}	Activate FOG Review to Confirm Plans Match GDO Application. CU Approved if they match.
		NO change in FSE type, NO change in seating, NO change in area, NO open enforcement:	Activate FOG Review. FOG Review to include Grease Interceptor Condition Assessment . CU Approved if system is in satisfactory condition. Otherwise CU NOT approved.
		Change in FSE type, change in seating, change in area, OR open enforcement:	Activate FOG Review, CU NOT approved.
		Plans approved by DERM under FOG ^{1.5} or FOG ^{1.75}	Activate FOG Review to Confirm Plans Match GDO Application. CU Approved if they match.
	Closed GDO permit > 3 yrs [Status 7]	Plans approved by DERM under FOG ^{1.5} or FOG ^{1.75}	Activate FOG Review to Confirm Plans Match GDO Application. CU Approved if they match.
		NO record of plans approved by DERM under FOG ^{1.5} or FOG ^{1.75}	Activate FOG Review, CU NOT approved.
		Plans approved by DERM under FOG ^{1.5} or FOG ^{1.76}	Activate FOG Review to Confirm Plans Match GDO Application. CU Approved if they match.
NO record of plans approved by DERM under FOG ^{1.5} or FOG ^{1.75}		CU NOT approved, Plan Review Required.	
New Facility	Second User [Any Status]	FSE proposing secondary user	Activate FOG Review, CU NOT approved.
	No GDO permit	Plans approved by DERM under FOG ^{1.5} or FOG ^{1.76}	Activate FOG Review to Confirm Plans Match GDO Application. CU Approved if they match.
		NO record of plans approved by DERM under FOG ^{1.5} or FOG ^{1.75}	CU NOT approved, Plan Review Required.

NOTES

- ⁽¹⁾ All submittals for facilities with Status 13 shall be routed to FOG Review.
- ⁽²⁾ New construction and change of use (last use not an FSE).
- ⁽³⁾ Increasing square feet, increasing dining areas seating (chairs and/or stools), modifying (adding or subtracting) plumbing system, adding or expanding drive-thru lanes capacity; or adding, replacing or modifying FOG control devices. Any of these impacts FOG generation and therefore require Engineering FOG review.
- ⁽⁴⁾ Includes Municipal Equivalent Applications
- ⁽⁵⁾ NGT facilities are placed under Status 16, after plans are approved, to indicate that DERM inspection is required.
- ⁽⁶⁾ Grease Interceptor condition assessment, forms provided by WPS, must be signed by PE, Certified Plumber, Licensed Septic Tank Contractor

MDC-FOG Control Program 2016/2017: Improvements Implemented

FOG 1.5 FORMS

Page 1/2

FOG CONTROL PROGRAM - DERM
EXISTING HYDROMECHANICAL GREASE INTERCEPTOR
CONDITION ASSESSMENT

DATE: _____

PUMP-OUT INFORMATION:
The contents (Fats, Oils & Grease, Wastewater and Sludge) of the Grease Interceptor/Grease Trap being assessed shall be completely pumped-out prior to performing visual inspection.

Liquid Waste Transporter Company Name: _____
DERM LWT Permit No.: LWT- _____
Pump-Out Date: _____

Attach: 1) Pump Out Receipt
2) Disposal Facility Ticket
3) FOG Waste Manifest (see page 2of3)
4) Photographs of interceptor's location

CONDITION ASSESSMENT CERTIFICATION
The Condition Assessment shall be certified by a Professional Engineer or Licensed Plumber.

Company Name: _____ Email: _____
Company Address: _____
 Professional Engineer Licensed Plumber Septic Tank Contractor
License/Registration No.: _____ Phone No.: _____
Name: _____ Date: _____
Signature: _____

By signing above, I certify that I performed the assessment and visually inspected the tanks listed below.

GREASE DISCHARGE OPERATING PERMIT (GDO) SITE INFORMATION

GDO# Facility Name: _____ GDO No.: _____
GDO# Facility Address: _____

INSPECTION REPORT
Complete checklist below for each grease trap(s)/grease interceptor. (G). Attach sheets if >5 Tanks

Item No.	Item	Tank 1	Tank 2	Tank 3	Tank 4	Tank 5
		Yes/No/NA	Yes/No/NA	Yes/No/NA	Yes/No/NA	Yes/No/NA
1	Flow control device observed?	>	>	>	>	>
2	If metallic unit, corrosion observed?	>	>	>	>	>
3	If automatic unit, power provided? Or N/A	>	>	>	>	>
4	Unit accessible? (Show vertical clearance in back page).	>	>	>	>	>
5	Inlet and outlet chambers accessible?	>	>	>	>	>
6	Watertight manholes? If indoor unit, answer N/A	>	>	>	>	>
7	Baffle observed?	>	>	>	>	>
8	Below grade installation?	>	>	>	>	>
9	Evidence of water infiltration? If indoor unit, answer N/A	>	>	>	>	>
10	Indicate tank's material:	>	>	>	>	>
	Metal <input type="checkbox"/> Polyethylene <input type="checkbox"/> Other _____					

List All Fixtures Connected to Grease Interceptor: _____
List All Fixtures NOT Connected to: _____

Registered pursuant to Part III of Chapter 489 of Florida Statutes, and Part III of Rule 64E-6, FAC.

Updated: 10/22/2015

Page 2/2

GREASE INTERCEPTOR PLAN VIEW (N.T.S.)
Show internal components in place, label all parts.

Dimensions (Feet):
L = _____
W = _____
H = _____

Grease Trap / Grease Interceptor:
Manufacturer: _____
Model: _____
Capacity (GPM): _____
Grease Retention (Min): _____

GREASE INTERCEPTOR SECTION (N.T.S.)
Show internal components in place, label all parts.

Inlet Pipe Diameter: _____
Outlet Pipe Diameter: _____
H = _____

INCLUDE SITE SKETCH HERE (N.T.S.)
For outdoor units show building footprint, main streets, and location of the interceptor.
For indoor units show site plan of main area where the unit is located (i.e. kitchen). Include vertical clearance of the unit.

MDC-FOG Control Program 2016/2017: Improvements Implemented

FOG^{1.5} FORMS

Page 1/2

FOG CONTROL PROGRAM - DERM
EXISTING GRAVITY GREASE INTERCEPTOR
CONDITION ASSESSMENT

DATE: _____

PUMP-OUT INFORMATION:
 The contents (Fats, Oils & Grease, Wastewater and Sludge) of the Grease Interceptors being assessed shall be completely pumped-out prior to performing visual inspection.

Attach: 1) Pump Out Receipt
 2) Disposal Facility Ticket
 3) FOG Waste Manifest (see page 3of3)

Liquid Waste Transporter Company Name: _____
 DERM LWT Permit No.: LWT- _____
 Pump-Out Date: _____

The Condition Assessment shall be certified by a Professional Engineer or Licensed Plumber.

Company Name: _____ Email: _____
 Company Address: _____
 Professional Engineer Licensed Plumber Septic Tank Contractor
 License/Registration No.: _____ Phone No.: _____
 Name: _____ Date: _____
 Signature: _____

By signing above, I certify that I performed the assessment and visually inspected the units listed below. The tanks were empty during the inspection.

GREASE DISCHARGE OPERATING PERMIT (GDO) SITE INFORMATION
 Facility with GDO Permit: _____ GDO No.: _____

INSPECTION REPORT
 Complete checklist below for each tank (attach sheets if > 5 Tanks)

Item No.	Item	Tank 1	Tank 2	Tank 3	Tank 4
1	Tank material** Please provide photos				
2	Cracks on walls, top or bottom? (Yes/No)				
3	Exposed rebar and wire mesh? (Yes/No)				
4	Warping on walls, top or bottom? (Yes/No)				
5	Inlet and outlet chambers accessible/manholes provided? (Yes/No)				
6	Watertight manholes? (Yes/No)				
7	Outlet tee's material** Please provide photos				
8	Outlet (effluent) tee observed? (Yes/No)				
9	Outlet (effluent) tee accessible through the outlet manhole? (Yes/No)				
10	Outlet tee extends to within 8" of the bottom of the tank (ft)? (Yes/No)				
11	Evidence of water infiltration? (Yes/No)				

List All Fixtures Connected to Grease Interceptor: _____
 List All Fixtures NOT Connected to Grease Interceptor: _____

**Registered pursuant to Part III of Chapter 469 of Florida Statutes, and Part III of Rule 64E-6, FAC.
 **Tank material: concrete, fiberglass, steel, plastic, etc.

Update: 10/23/2015

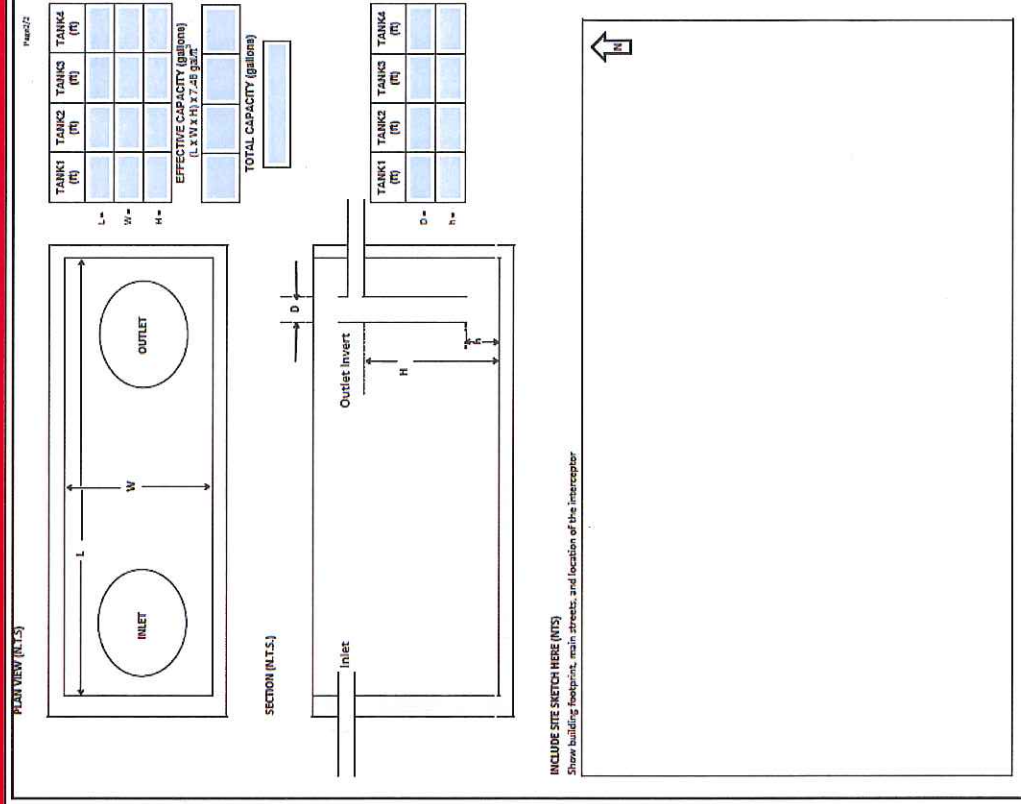

MDC-FOG Control Program 2016/2017: Improvements Implemented

FOG 1.5 FORMS



Grease Discharge Operating Permit Affidavit

Department of Regulatory and Economic Resources
Division of Environmental Resources
Permitting
724 NW 1ST Court 7th Floor
Miami, Florida 33136-8313
T 305-375-8600 F 305-375-8410
mde@mda.gov

GDO No.: _____ DER# OI/CIU _____

Business Owner Information (GDO Operating Authority, Corporation, LLC, etc.)

Business Owner: _____

(or) Authorized Representative: _____ Title: _____

Mailing (Street) Address: _____

City: _____ Zip: _____ Unit: _____

Email: _____ Phone #: _____

Property Information (GDO Establishment Location)

Street Address: _____

City: _____ Zip: _____ Unit: _____

Property Tax Folio #: _____

Business Owner Affidavit

The undersigned Business Owner (or authorized representative of the Business Owner*) of _____

(Business Name of OI/CIU Applicant) is fully aware that the approval of the OI/CIU and issuance of a Grease Discharge Operating (GDO) permit requires the installation of an accessible sampling point after the point of no further treatment, and that all fixtures capable of discharging Fats, Oils, and Grease (FOG) shall be connected to a FOG Control Device (e.g., grease interceptor). If the Department determines by physical inspection (e.g., dye test) that fixtures capable of discharging FOG are not connected to a FOG Control Device (e.g., grease interceptor), or that there is no sampling point, the Business Owner shall obtain all applicable permits to connect said fixtures, and/or install sampling point, and upon receipt of all applicable permits, cause the connection of said fixtures and/or installation of sampling point in accordance with the orders of the Director of the Department of Regulatory and Economic Resources, Division of Environmental Resources Management.

Signature _____ Typed/Printed Name _____ Date _____

Subscribed & sworn to and subscribed before me this _____ day of _____ 20 _____

Personally known _____ or produced identification _____ DL #: _____

Notary Signature _____ Notary Commission Expires _____

Notary Seal _____



Grease Discharge Operating Permit Affidavit

Department of Regulatory and Economic Resources
Division of Environmental Resources
Permitting
724 NW 1ST Court 7th Floor
Miami, Florida 33136-8313
T 305-375-8600 F 305-375-8410
mde@mda.gov

* If signed by a Authorized Representative, Letter of Authorization must be attached

Property Owner Affidavit

The undersigned Owner (or authorized representative of the Property Owner**) of the Property located at _____

(GDO Establishment Location) is fully aware that a sampling point after the point of no further treatment is required, and all fixtures capable of discharging Fats, Oils, and Grease (FOG) shall be connected to a FOG Control Device (e.g., grease interceptor). If the Department determines by physical inspection (e.g., dye test) that fixtures capable of discharging FOG are not connected to a FOG Control Device (e.g., grease interceptor), or that there is no sampling point, the Business Owner shall obtain all applicable permits to connect said fixtures and upon receipt of all applicable permits, cause the connection of said fixtures and/or install sampling point, in accordance with the orders of the Director of the Department of Regulatory and Economic Resources, Division of Environmental Resources Management.

Signature _____ Typed/Printed Name _____ Date _____

Subscribed & sworn to and subscribed before me this _____ day of _____ 20 _____

Personally known _____ or produced identification _____ DL #: _____

Notary Signature _____ Notary Commission Expires _____

Notary Seal _____

** If signed by a Authorized Representative, Letter of Authorization must be attached

FOG^{1.0} DERM INSPECTIONS

Routine FOG Inspection			
Task	Task Result	Task Action	Task Outcome
Verify ALL FSEs have GDO			
Check Posting of GDO Permit		NOT APPLICABLE (NA)	
Request 3 Last Pump-Out Receipts	Not Available At Facility	<ul style="list-style-type: none"> • WN 	
<ul style="list-style-type: none"> • Review Receipts • Check LWT Approved by DERM 	Provided & Insufficient	<ul style="list-style-type: none"> • WN 	
	Provided & Sufficient	<ul style="list-style-type: none"> • NA 	
Inspect FCD: <ul style="list-style-type: none"> • Visual Condition Assessment of System (+System Outlet/Sampling Port) 	System NOT Maintained but no FOG Discharge	<ul style="list-style-type: none"> • FN to clean system & Fax disposal receipt 	NA
	System NOT Maintained & FOG Discharge		
	System Maintained	<ul style="list-style-type: none"> • NA 	

MDC-FOG Control Program 2016/2017: Improvements Implemented

FOG^{1.5} DERM INSPECTIONS

Routine FOG Inspection

Task	Task Result	Task Action	Task Outcome
Verify ALL FSEs have GDO	Identify FSEs w/out GDO Permit Identify FSEs w/GDO Permit	<ul style="list-style-type: none"> Inspect & Issue Field Notice (FN) Inspect 	All FSEs permitted
Check Posting of GDO Permit	Not Posted Posted	<ul style="list-style-type: none"> 1st-time = Warning Notice (WN) 2nd + = Ticket Review with GDO 	Awareness & Comply w/Permit Conditions Awareness of Requirements
Request 3 Last Pump-Out Receipts	Not Available At Facility Provided & Insufficient Provided & Sufficient	<ul style="list-style-type: none"> 1st-time = WN 2nd + = Ticket 1st-time = WN 2nd + = Ticket Review Receipts Check Liquid Waste Transporter (LWT) Approved by DERM 	Maintain System
Inspect FCD: <ul style="list-style-type: none"> Visual Condition Assessment of System (+System Outlet/Sampling Port) Effluent Sampling Dye Test Fixtures FOG & Solids Levels (dipstick pro or equal) Downstream Manhole(s) Assessment 	System NOT Maintained but no FOG Discharge System NOT Maintained & FOG Discharge	<ul style="list-style-type: none"> 1st-time = FN to clean system and provide disposal receipt w/in 48 hrs. 2nd + = Ticket Follow-Up Inspection to Confirm Compliance Samples collected 1st-time = FN to clean system and provide disposal receipt w/in 48 hrs. 2nd + = Ticket System Upgrade Follow-Up Inspection to Confirm Compliance 	Maintain System & Protect WCTS
	System Maintained	Review with GDO	

Thank You for Protecting your Public Infrastructure Card if ALL PASS to encourage Ongoing Compliance!

MDC-FOG Control Program 2016/2017: Improvements Implemented

FOG^{1.5} DERM INSPECTIONS

March 2016 to November 2016 NGTs/UKNs + Hot-Spots + Complaints + CU & Plan Review Support				
No. of FOG Techs	No. of FOG Tech Inspections	No. of WN/FN/NOV	No. Tickets	Formal NOV's issued to Upgrade System
3	663	853	21	9

MDC-FOG Control Program 2016/2017: Improvements Implemented

FOG eMANIFEST

eMANIFEST

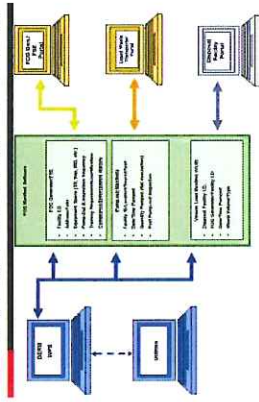

FSE Selects: DATE/LWT



Step 1



LWT arrives on site and starts paperwork



Collects Measurements as part of Inspection Report (25% & 75% Rules)



Pumps all contents from FCD



Pressure washes FCD (N/A for small MGRUs/AGRUs)



Inspects FCD & Finals Status Report

Step 2&3



Leaves FSE & repeats Step 1 until truck full

Step 4



Truck arrives at Disposal Facility, completes paperwork and empties truck

Step 5



LWT enters data using DERM Web Application

Step 6



Supervisor runs discrepancy Report using data uploaded by:

- LWT
- FSE
- Disposal Facility

Supervisor schedules inspections accordingly!

DERM FOG Single Lead Liquid Waste Transporter - eManifest

Transporter ID	Facility Name	Facility Address	Facility City	Facility State	Facility Zip	Facility Phone	Facility Email	Facility Website	Facility Type	Facility Status	Facility Date	Facility LWT	Facility FSE	Facility Disposal Facility

MDC-FOG Control Program 2016/2017: Improvements Implemented

FOG eMANIFEST

DRAFT FOG Single Load Liquid Waste Transporter eManifest

DERM_V2.00_10-11-2016

A: Liquid Waste Transporter Information		C: FOG Control Device										D: Gallons & Date			
Company Name: _____		Hydro?	Grav?	Device Capacity?	FOG found in outlet device? (Y or N)	H - measure from bottom to outlet invert (inches)	W - measure from bottom to water level (inches)	G - FOG layer thickness (inches)	S - Sludge layer thickness (inches)	Outlet device missing or damaged? (Y or N)	Automatic unit missing or damaged? (NA, Y or N)	Corrosion or other tank damage? (Y or N)	Tank Breached? (Y or N)	Total Gallons Waste Pumped	Date Pumped
DERM Decal No.: _____															
Vehicle License Plate: _____															
Vehicle Full Load Capacity: _____ Gallons															
B: Origination of Waste															
GDO #: _____															
Complete Facility Address: _____ (If no GDO#)															
GDO #: _____															
Complete Facility Address: _____ (If no GDO#)															
GDO #: _____															
Complete Facility Address: _____ (If no GDO#)															
GDO #: _____															
Complete Facility Address: _____ (If no GDO#)															
GDO #: _____															
Complete Facility Address: _____ (If no GDO#)															
Attach Additional Sheets if more than 5 sites Pumped this Load															
Total Waste this Load: _____ Gallons															

E: Transporter Certification

Print Driver Name: _____ Driver Signature: _____

Total Waste Unloaded: _____ Gallons Date Waste Unloaded: _____ Time Waste Unloaded: _____ AM or PM

By signing Section E, I certify that the information in Section A, B, C & D above is true and accurate, and that only the facilities listed in the "Origination of Waste" section is contained in this service vehicle/hailer/truck tank. I also certify that the attached disposal ticket corresponds with this information. I warrant that the discharge of any waste other than grease waste, septic tank waste, or portable toilet waste from customers in the Miami-Dade County jurisdiction must be approved before the waste is transported to the South District Wastewater Treatment facility. I am aware that falsification of this manifest may result in prosecution.

F: Disposal Facility Certification

Disposal Location: _____ Ticket No.: _____ Date Waste Unloaded: _____

DERM Decal No.: _____ Vehicle Full Load Capacity: _____ Gallons Total Waste Unloaded: _____ Gallons

Operator Name: _____ Operator Signature: _____

By signing Section F, I certify that the information in Section F is true and accurate.

>>>>>>Attach Disposal Facility Ticket<<<<<<

FOG CONTINUITY

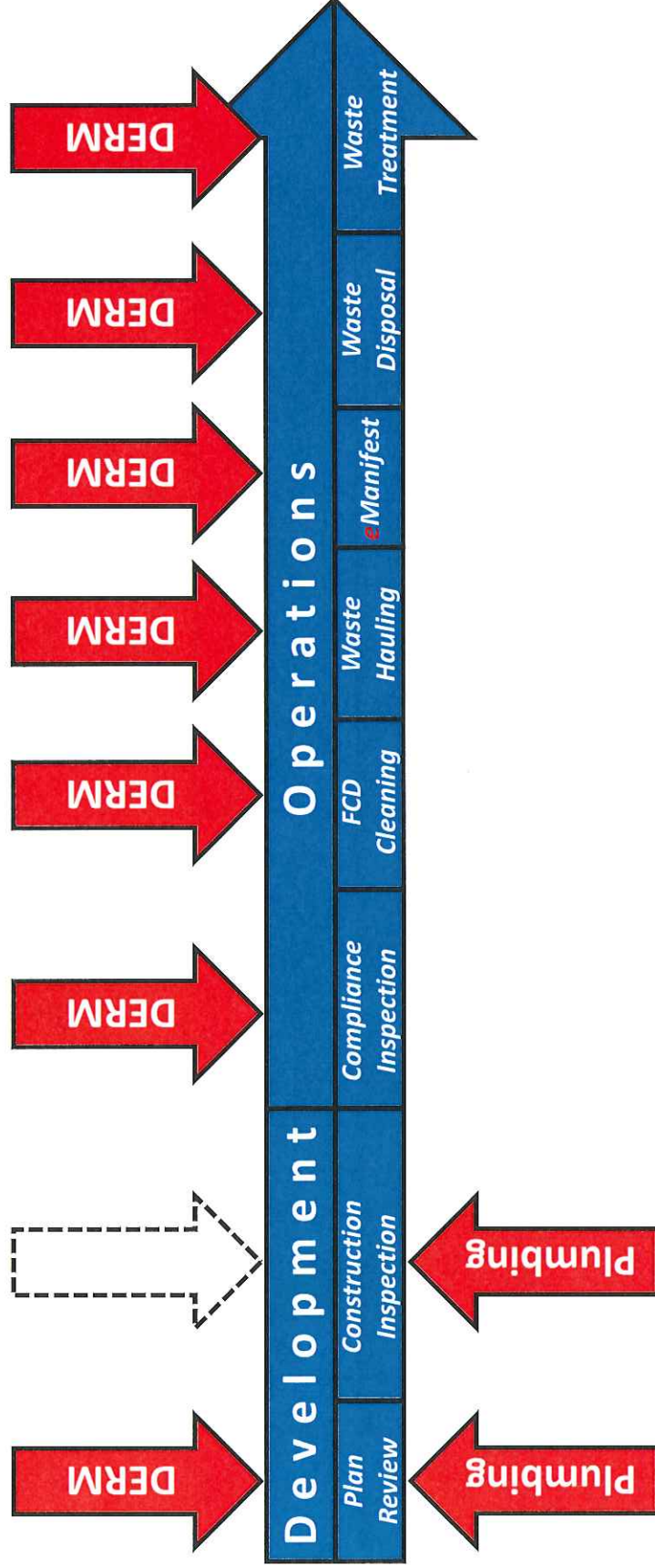

MDC-FOG Control Program 2016/2017: Improvements Implemented

FOG FINDINGS POST JUNE 6, 2015

Findings	Action
<p>Design Professionals & Plumbing Officials have limited understanding of <u>Design Requirements</u> and the outcome of poor designs. <u>Both are disconnected from OPERATIONS – they do not see how systems fail when overloaded with FOG.</u></p>	<p>With more than 20 years with no guidance, training and effective outreach, Design Professionals continue to “NOT” design FOG Control Systems.</p> <ul style="list-style-type: none"> Plans submitted with <u>NO FCD – Plumbing Approves.</u> Plans submitted <u>without design calculations or incorrect design calculations – Plumbing Approves.</u> Plans for new FSEs are submitted with “<u>connect to existing Grease Interceptor</u>” with NO consideration to the existing systems capacity to treat existing and new (additional) loads – <u>Plumbing Approves.</u> <p>DERM will continue to schedule Design Seminars. An updated FOG Control Design Guidance Manual will be released in December 2016 (FOG^{1.75}).</p> <p>DERM will continue to review all development plans and not rely on Plumbing.</p>
<p>Lack of Effective FOG Control Device (Grease Interceptor) <u>Construction Inspection.</u></p>	<p>The current and future process involves plumbing department staff continuing to perform Construction Inspections. Problems identified include:</p> <ul style="list-style-type: none"> Plumbing Inspector approves smaller size grease interceptor (e.g., DERM approves 75 gpm unit and plumbing construction inspector approves 25 gpm unit). Plumbing Inspector approves Septic Tank where plans call for Grease Interceptor (e.g., DERM approves four 1,250 gallons grease interceptors for new McDonald and Plumbing Inspector approves four 1,350 gallon septic tanks).
<p>Lack of Grease Interceptor Cleaning continues to be a significant problem.</p>	<ul style="list-style-type: none"> Many FSEs do not have Grease Interceptors cleaned or cleaned at interval required in GDO permit. Many Liquid Waste Transporters fail to clean grease interceptors. Some Liquid Waste Transporters dispose of waste inappropriately. <p>DERM will implement eManifest in two (2) phases: LWT followed by GDOs.</p>
<p>FSEs with NO Cooking can generate significant FOG.</p>	<p>Facilities that do not cook can generate significant FOG. However, existing facilities that do not cook do not generate appreciable quantities of FOG by way of floor drains - most FOG is by sinks.</p> <p>Recommend to not require existing facilities that are currently in compliance to upgrading to FOG^{2.0} (e.g., connect floor drains) unless “Documented” FOG problem or effluent exceedance.</p>
<p>High FSE Turnover</p>	<p>Makes proposed requirement to have all FSEs demonstrate compliance with new requirements a challenge. Provides opportunity for implementing effective improvements at time of ownership changes.</p>

MDC-FOG Control Program 2016/2017: Findings

FOG PROPOSED MODIFICATIONS

FOG Ordinance

Criteria	FOG ^{1.0}	FOG ^{1.5 / 1.75}	FOG ^{2.0}	FOG ^{2.0+}
Breached Tank – 30 days Emergency Repair + Replacement 90 days	NO	YES	NO	Yes Update 24-42.6
Grease Interceptor Materials compatible with pH = 3	NO	YES – 1.75	NO	Yes Update 24-42.6(6)
All Grease Interceptors in Series	NO	YES – 1.75	NO	Update 24-42.6(7)
ALL GDOs Upgrade to FOG ^{2.0}	NO	NO	YES – BY 2018	NO**
FOG Plan Review - Plumbing	YES	YES	YES	YES
FOG Plan Review - DERM	NO	YES	YES	YES
FOG Construction Inspection - Plumbing	By Plumbing	By Plumbing	By Plumbing	By Plumbing
FOG Construction Inspection - DERM	NO	NO	NO	NO
FOG CU Review - Plumbing	NO	NO	NO	NO
FOG CU Review - DERM	NO	YES	NO	Yes Update 24-42.6(5)

** Section 24-42.6(3) & (4) require that existing FSE don't exceed discharge standards & unpermitted facilities comply, respectively.

MDC-FOG Control Program 2016/2017: Proposed Modifications

FOG PROPOSED MODIFICATIONS

eMANIFEST				
Criteria	FOG ^{1.0}	FOG ^{1.5 / 1.75}	FOG ^{2.0}	FOG ^{2.0+}
Paper Manifest	NO	YES	YES	YES
eManifest for LWT	NO	NO	Jan 2017	April 1, 2017*
eManifest for GDO/FSE	NO	NO	Jan 2017	Jan 1, 2018**
Commingling FOG Prohibited	NO	NO	YES	April 1, 2017***

* LWT: January 2017 Soft Launch with requirement included in LWT Permit issued April 1, 2017 (LWT Permit issued April 2017 to March 2018)
 ** GDO/FSE: January 2017 Soft Launch with requirement included in GDO Permit issued January 1, 2018 (GDO Permit issued January 2017 to December 2017)
 *** LWT: January 2017 Soft Launch with requirement included in LWT Permit issued April 1, 2017 (LWT Permit issued April 2017 to March 2018)

MDC-FOG Control Program **2016/2017: Proposed Modifications**





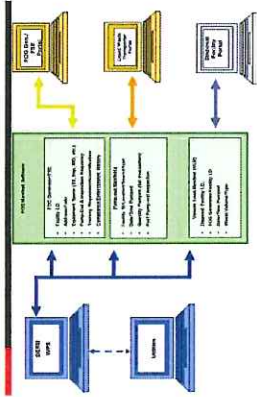



FOG PROPOSED MODIFICATIONS

eMANIFEST



January 2018

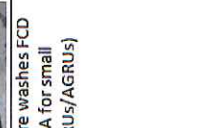

Step 1	Step 2&3	Step 4	Step 5	Step 6
 LWT arrives on site and starts paperwork	 Pumps all contents from FCD	 Truck arrives at Disposal Facility, completes paperwork and empties truck	 LWT enters data using DERM Web Application	 Supervisor runs discrepancy Report using data uploaded by: <ul style="list-style-type: none"> • LWT • FSE • Disposal Facility Supervisor schedules inspections accordingly!
 Collects Measurements as part of Inspection Report (25% & 75% Rules)	 Pressure washes FCD (N/A for small MGRUs/AGRUs)	 Inspects FCD & Final Status Report	 Leaves FSE & repeats Step 1 until truck full	 Disposal Facility Submits Monthly Report

April 2017

MDC-FOG Control Program 2016/2017: Proposed Modifications

The CONSENT DECREE Case 1:12-cv-24400-FAM Document 25-1 Entered on FLSD Docket 06/06/2013

FOG EPA & FDEP COMMENTS?



MDC-FOG Control Program **2016/2017: EPA & FDEP Comments?**

Attachment 3
December 29, 2016, FDEP and EPA comments to the
proposed ordinance and FOG Control Program.



UNITED STATES ENVIRONMENTAL PROTECTION AGENCY
REGION 4
ATLANTA FEDERAL CENTER
61 FORSYTH STREET
ATLANTA, GEORGIA 30303-8960

DEC 22 2016

CERTIFIED MAIL 7016 0600 0000 3846 7817
RETURN RECEIPT REQUESTED

Mr. Lee Hefty
Assistant Director
Department of Regulatory and Economic Resources
Division of Environmental Resources Management
Miami-Dade County
701 NW 1st Court, 4th floor
Miami, Florida 33136-3912

RECEIVED
DEC 29 2016
RER - Division of Environmental
Resources Management
DERM

Re: Consent Decree (Case: No.: 1:12-cv-24400-FAM)
Reference DOJ Case No.: 90-5-1-1-4022
Section VI – Fats, Oils and Grease Control Program, Paragraph 19(a)

Dear Mr. Hefty:

The United States Environmental Protection Agency Region 4 and the Florida Department of Environmental Protection (FDEP) are in receipt of Miami-Dade County's (Miami-Dade) June 5, 2015 submittal of the Fats, Oils and Grease (FOG) Control Program set forth in Paragraph 19.(a). of the above-referenced Consent Decree (CD). In addition, the EPA and FDEP appreciate Miami-Dade coming to Atlanta on December 8, 2016 to discuss the FOG Control Program as it has been implemented. The EPA has consulted with FDEP and we have the following comments and/or questions on the FOG Control Program:

Comments on FOG Control Program submitted 6/5/2015 and follow-up to 12/8/2016 meeting

1. Paragraph 19.(a).(vi). of the CD requires that the FOG Control Program provide compliance inspection protocols, including scheduling. Currently, Miami-Dade inspects all commercial and industrial sources of FOG every three to five years. In the FOG Control Program, Miami-Dade proposes to ramp up inspections for the first two years to address FOG "hot spots" within the WCTS and the Volume Sewer Customers' sanitary sewers. After that two year effort, Miami-Dade proposes to switch some staff to routine compliance visits, upgrade verification inspections and residential inspections (apartments and residential condominiums). The graph showing staff devoted to each type inspection (Graph 1, pg. 09-15) shows the total number of staff staying constant at 8 full-time equivalents (FTEs) and shows the trend described above, but contains an error because in 2018-2025, there will be 6 FTEs devoted to routine inspections and only 1 FTE devoted to 2018 upgrades and/or residential inspections. That only totals to 7 FTEs; especially concerning given the number of Food Service Establishments (FSE) that are in Miami-Dade's service area.
2. Paragraph 19.(a).(viii). of the CD requires that the FOG Control Program provide establishment of a FOG disposal manifest system, including the requirement that FOG and septage not be comingled.

The FOG Control Program states that Miami-Dade will give waste haulers until January 2, 2017 to cease comingling FOG and septage. During the December 8, 2016 meeting, Miami-Dade proposed to issue a FOG hauler permit by 4/1/2017 and issue the FSE permits in January 2018. Miami-Dade shall explain why this grace period has been so long.

3. Paragraph 19.(a).(xv). Of the CD requires that the FOG Control Program provide a schedule to review, evaluate and revise the FOG Control Program on at least an annual basis. Miami-Dade proposes to provide an annual update to the EPA and FDEP by June 30th of each year, starting on June 30, 2018. The EPA reminds Miami-Dade that implementation of the FOG Control Program shall be also reported in the Semi-Annual and/or Annual Reports required by Paragraphs 33 and 34 of the CD.
4. In reviewing the proposed FOG Ordinance (Attachment 2 of the FOG Control Program), the following comment is made:
 - Section 24-42.6.(8)(c)(ii) (Maintenance for new FOG generators or operators) requires that "All FOG control devices and equipment shall be serviced to function properly and continuously to prevent the discharge of FOG into building sanitary drains, building sewers, utility or non-utility owned or operated sanitary sewer systems, and onsite sewage treatment and disposal systems." The underlined "and" should be an "or."
5. During the December 8, 2016 meeting, Miami-Dade mentioned that many of its environmental ordinances are open to variances or extensions if heard by the Environmental Quality Control Board. Miami-Dade should severely limit or restrict what deadlines in the FOG Ordinance are subject to variances or extensions of time and this should be outlined in the FOG Ordinance itself.
6. The EPA and FDEP has serious concerns about Miami-Dade's Department of Regulatory and Economic Resources conducting FOG inspections after construction, but not being a part of the construction inspection process when a facility is installing a grease interceptor.
7. Grease traps should be located outside the building. Also, specifically prohibit grease traps above the ground floor. Neither would be able to be cleaned effectively and the County should consider odor issues when cleaning.
8. Sec.24-42.6 (2): Specific limits in the pretreatment ordinance should be referenced in this grease trap ordinance, as the language is too vague. What quantity or concentration does the County believe will cause negative effects or hinder the operation of any onsite sewage treatment and disposal system, sewage collection, transmission or treatment system or cause a sanitary nuisance?
9. FDEP believes FOG generators should not be served by onsite disposal systems. We suggest that existing FOG generators should be only allowed on existing onsite disposal systems for a set amount of time after the effective date of the ordinance (e.g. 10 years after the effective date). This allows the owner time to connect to public sewer or relocate the business.
10. Sec.24-42.6 (2) (b) (iii): The submittal of the corrective action plan is 30 days. However, there is no deadline to obtain the approval or complete the corrective action(s) We suggest a time frame be given. After a defined period of time, the occupational license could be withdrawn.
11. Sec.24-42.6 (4) (a): The as-built plans should be signed and sealed by a professional engineer.

CA.
ENT
ELY

- copy text*
12. Sec.24-42.6 (4) (c): The operating permit application should be submitted with the as-built plans.
- ✓ 13. Sec.24-42.6 (8) (c) (iii) and (v): The monthly report as required in (v) should include attachments to the report of the following:
- a. Scheduled and unscheduled service calls to clean grease waste drains, building sanitary drains. or building sewers.
 - b. Repairs required resulting from food or FOG accumulation or blockages.
 - c. FOG control device cleaning, maintenance and repair.
 - d. Waste manifest forms pursuant to Sections 24-42.6(9) and 24-46
- ✓ 14. Sec.24-42.6 (8) (c) (vi): Miami Dade is requiring the property owner to perform the work. However, the property owner may not be party to the operating permit. Therefore, the property owner should be party of the operating permit. When the FOG generator is not the property owner, the operating permit should have two parties, the property owner and the FOG generator. The specific requirements of each party should be spelled out. Finally, the property owner should be responsible if the FOG generator does not perform.
- ✓ 15. Sec.24-42.6 (11) (c): What is the purpose and use for requiring cost of accelerated FOG maintenance? If you plan to require some kind of reimbursement to the utility, the ordinance should include that.

The EPA and FDEP will give final approval of the FOG Control Program and proposed Ordinance pending answers to the above comments and/or questions. If you should have any questions regarding this matter, please contact Mr. Brad Ammons of the EPA at (404) 562-9769 or via email at ammons.brad@epa.gov.

Sincerely,

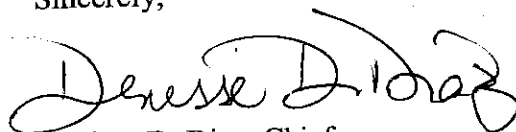

Denisse D. Diaz, Chief
NPDES Permitting and Enforcement Branch
Water Protection Division
U.S. Environmental Protection Agency, Region 4

cc: Mr. Jonathan A. Glogau
Office of the Attorney General

Mr. Kirk White
Florida Department of Environmental Protection

Ms. Lisa Self
Florida Department of Environmental Protection

Mayor Carlos A. Gimenez
Miami-Dade County

Mr. Lester Sola
Miami-Dade Water and Sewer Department

Mr. Jack Osterholt
Miami-Dade Regulatory and Economic Resources

Ms. Abigail Price-Williams
Miami-Dade County Attorney

Mr. William A. Weinischke
U.S. Department of Justice

Ms. Rachael Amy Kamons
U.S. Department of Justice

Attachment 4
May 1, 2017, DERM's response to FDEP/EPA
Comments



miamidade.gov

Water and Sewer
PO Box 330316 • 3071 SW 38 Avenue
Miami, Florida 33233-0316
T 305-665-7471

VIA ELECTRONIC CORRESPONDENCE

May 1, 2017

CCN: 61037
File No: 8.DC.52 & 77

Chief, Environmental Enforcement Section
Environment and Natural Resources Division
U.S. Department of Justice
P.O. Box 7611
Ben Franklin Station
Washington, D.C. 20044-7611
RE: DOJ No. 90-5-1-1-4022/1
Tom.Mariani@usdoj.gov

Chief, Clean Water Enforcement Branch
Water Protection Division
Attn: Brad Ammons
U.S. Environmental Protection Agency, Region 4
61 Forsyth Street, S.W.
Atlanta, Georgia 30303
Ammons.Brad@epa.gov

Rachael Amy Kamons
Environmental Enforcement Section
U.S. Department of Justice
P.O. Box 7611
Ben Franklin Station
Washington, D.C. 20044-7611
Rachael.Kamons@usdoj.gov

Florida Department of Environmental Protection
Southeast District – West Palm Beach
3301 Gun Club Road, MSC 7210-1
West Palm Beach, FL 33406
Attn: Compliance/Enforcement Section
Jason.Andreotta@dep.state.fl.us

**RE: Consent Decree (Case: No.: 1:12-cv-24400-FAM)
Reference DOJ Case No.: 90-5-1-1-4022
Section VI – Fats, Oils and Grease (“FOG”) Control Program, Paragraphs 19(a)**

Dear Sir/Madam:

The Miami-Dade County (County) is in receipt of your request for additional information related to the June 8, 2015, submittal of the Fats, Oils and Grease (“FOG”) Control Program as required by Paragraph 19.(a) of the above referenced Consent Decree (CD). Following please find the restatement of EPA/FDEP comments and the County’s responses, clarification, and/or additional information to your questions and/or comments.

To facilitate the review process, the following terms are used to refer to the ordinance submitted on June 5, 2015 (included as **Attachment 1A**) and the latest ordinance (included as **Attachment 1B**): *Proposed Ordinance* and *Revised Ordinance*, respectively. Where a response to EPA/FDEP Comments includes a change to the *Proposed Ordinance*, line numbers are included to identify the changes. All changes to the *Proposed Ordinance* included in the *Revised Ordinance* are identified as tracked changes.

- Black underlined text is “new” text added to Chapter 24 as included in the *Proposed Ordinance*.

- Blue underlined text is “new” text added to the *Proposed Ordinance* and submitted as the *Revised Ordinance*.
- ~~Black strikethrough text~~ is text deleted from Chapter 24 as included in the *Proposed Ordinance*.
- ~~Blue strikethrough text~~ is text deleted from the *Proposed Ordinance* and submitted as the *Revised Ordinance*.

1. Paragraph 19.(a).(vi). of the CD requires that the FOG Control Program provide compliance inspection protocols, including scheduling. Currently, Miami-Dade inspects all commercial and industrial sources of FOG every three to five years. In the FOG Control Program, Miami-Dade proposes to ramp up inspections for the first two years to address FOG "hot spots" within the WCTS and the Volume Sewer Customers' sanitary sewers. After that two year effort, Miami-Dade proposes to switch some staff to routine compliance visits, upgrade verification inspections and residential inspections (apartments and residential condominiums). The graph showing staff devoted to each type inspection (Graph I, pg. 09-15) shows the total number of staff staying constant at 8 full-time equivalents (FTEs) and shows the trend described above, but contains an error because in 2018-2025, there will be 6 FTEs devoted to routine inspections and only 1 FTE devoted to 2018 upgrades and/or residential inspections. That only totals to 7 FTEs; especially concerning given the number of Food Service Establishments (FSE) that are in Miami-Dade's service area.

RESPONSE: The June 5, 2015 submittal included an arithmetic error as noted in EPA's December 22, 2016 letter. Subsequent to the June 5, 2015 submittal, RER-DERM has continued to evaluate staffing and inspection procedures. The proposed staffing for the next ten (10) years (2017 through 2027) is shown below in graphic and tabular forms. The starting point on the timeline below assumes that that the *Revised Ordinance* will be approved by EPA and FDEP in 2017.

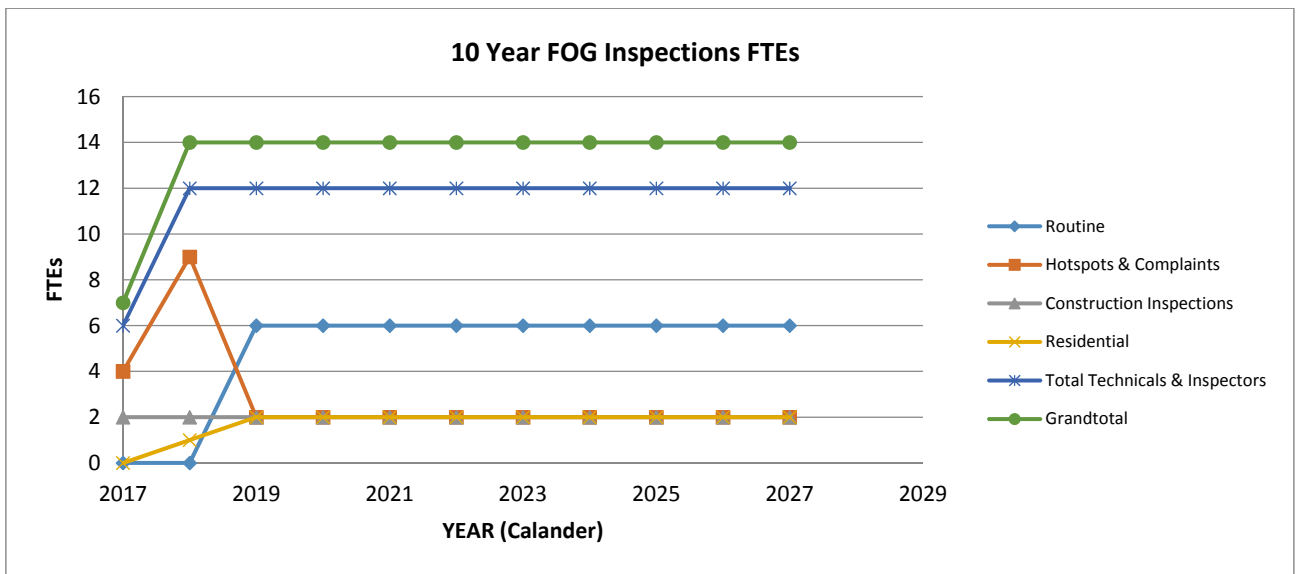

Response to EPA and FDEP Comments on the FOG Control Program

May 1, 2017

Page 3

10 Year FOG Inspections FTEs												
Inspection Category	Classifications	2017	2018	2019	2020	2021	2022	2023	2024	2025	2026	2027
Routine	Fog Technician	0	0	6	6	6	6	6	6	6	6	6
	FOG Inspector	0	0	0	0	0	0	0	0	0	0	0
	Subtotal	0	0	6	6	6	6	6	6	6	6	6
Hotspots & Complaints	Fog Technician	4	8	1	1	1	1	1	1	1	1	1
	FOG Inspector	0	1	1	1	1	1	1	1	1	1	1
	Subtotal	4	9	2	2	2	2	2	2	2	2	2
Construction Inspections	Fog Technician	0	0	0	0	0	0	0	0	0	0	0
	FOG Inspector	2	2	2	2	2	2	2	2	2	2	2
	Subtotal	2	2	2	2	2	2	2	2	2	2	2
Upgrades	Fog Technician	0	0	0	0	0	0	0	0	0	0	0
	FOG Inspector	0	0	0	0	0	0	0	0	0	0	0
	Subtotal	0	0	0	0	0	0	0	0	0	0	0
Residential	Fog Technician	0	0	1	1	1	1	1	1	1	1	1
	FOG Inspector	0	1	1	1	1	1	1	1	1	1	1
	Subtotal	0	1	2	2	2	2	2	2	2	2	2
Total Technicians & Inspectors		6	12	12	12	12	12	12	12	12	12	12
Supervisors		1	2	2	2	2	2	2	2	2	2	2
Grand Total		7	14	14	14	14	14	14	14	14	14	14

In response to Comment No. 6 of EPA's December 22, 2016 letter and December 8, 2016 meeting discussions regarding removing upgrade requirements (Line 306 to 337 of the *Proposed Ordinance*), two inspections types have been modified: FOG inspectors have been added (construction inspections category) and no staff have been assigned to upgrades. Refer to response No. 6 for further discussion on construction inspections and below for discussion on removal of upgrade requirements.

As discussed during the December 8, 2016 meeting, RER-DERM is proposing to remove the requirement that existing facilities upgrade - by date certain – from the *Proposed Ordinance*, Lines 306 to 337. The basis for this proposed change is supported by observations and findings made by RER-DERM from June 2015 to date. Specifically, RER-DERM has found that:

- Food service establishments (FSEs) have a high turnover rate and this turnover provides the opportunity to require upgrades based on the proposed operations. This approach results in upgrades at the time other upgrades are typically being proposed.
- FSEs with no cooking can generate significant FOG. However, the source of FOG is generally limited to three (3)-compartment sinks. Requiring this type of establishment to connect all back of house fixtures will not appreciably increase FOG interception.
- As proposed, the FOG Ordinance requires upgrading an FSE that is found to be in non-compliance. That is, an FSE that is discharging excessive FOG (refer to Response No. 8 for discussion on quantity or concentration of FOG considered excessive) will be required to upgrade. FSEs that discharge excessive FOG are identified by routine inspections, liquid waste transporter reports, complaints and hot-spot assessments. It should be noted that the RER-DERM has implemented this requirement successfully. Samples of enforcement action taken in this regard are included as **Attachment 2**.
- Hot-Spot and complaint inspections identify areas with excessive FOG discharges.

Based on the above, establishing a date-certain for all establishments to upgrade, independent of how they are being operated or their actual impact, is not warranted. Therefore, the *Revised Ordinance* does not include this requirement.

2. Paragraph 19.(a).(viii). of the CD requires that the FOG Control Program provide establishment of a FOG disposal manifest system, including the requirement that FOG and septage not be comingled. The FOG Control Program states that Miami-Dade will give waste haulers until January 2, 2017 to cease comingling FOG and septage. During the December 8, 2016 meeting, Miami-Dade proposed to issue a FOG hauler permit by 4/1/2017 and issue the FSE permits in January 2018. Miami-Dade shall explain why this grace period has been so long.

RESPONSE: Paragraph 19.(a).(viii) of the CD required that Miami-Dade submit to EPA and FDEP for review and comment a new FOG Control Program within 18-months after the effective date of the CD, and that said new program establish a FOG disposal manifest system with the included requirement that FOG and septage not be comingled. The June 5, 2015 submittal included these requirements and proposed an effective date of January 2017 to implement the no comingling requirement.

The January 2017 start date was proposed knowing that implementing a no commingling requirement would require extensive public outreach to affected stakeholders, the most significant being the liquid waste transporters and disposal facilities. These stakeholders would need time to adjust or modify current practices and contractual obligations and requirements with their respective customers. At the December 8, 2016 meeting, RER-DERM stated that the no commingling requirement would be implemented on April 1, 2017 to coincide with the Liquid Waste Transporter Operating Permit renewal cycle (April 2017 – March 2018) and the implementation of an electronic manifest system. The new manifest system was implemented on April 1, 2015 (ahead of the June 5, 2015 submittal) and the electronic manifest system and process (eManifest) are scheduled to go live on April 1, 2017, also coinciding with the Liquid Waste Transporter Operating Permit renewal cycle (April 2017 – March 2018). The significance of aligning these requirements with the new permit cycle is that specific operating conditions can be incorporated in the new operating permits and thereby facilitate compliance and enforcement of the no commingling requirement and eManifest system.

A copy of the 2017/2018 Liquid Waste Transporter permit conditions and eManifest forms are included as **Attachment 3**.

3. Paragraph 19.(a).(xv). Of the CD requires that the FOG Control Program provide a schedule to review, evaluate and revise the FOG Control Program on at least an annual basis. Miami-Dade proposes to provide an annual update to the EPA and FDEP by June 30th of each year, starting on June 30, 2018. The EPA reminds Miami-Dade that implementation of the FOG Control Program shall be also reported in the Semi-Annual and/or Annual Reports required by Paragraphs 33 and 34 of the CD.

RESPONSE: Miami-Dade will (1) review, evaluate and revise the FOG Control Program annually as previously proposed and (2) report on the implementation of the program in accordance with Paragraph 33 and 34 of the CD.

4. In reviewing the proposed FOG Ordinance (Attachment 2 of the FOG Control Program), the following comment is made:
 - Section 24-42.6.(8)(c)(ii) (Maintenance for new FOG generators or operators) requires that "All FOG control devices and equipment shall be serviced to function properly and continuously to prevent the discharge of FOG into building sanitary drains, building sewers, utility or non-utility owned or operated sanitary sewer systems, and onsite sewage treatment and disposal systems." The underlined "and" should be an "or."

RESPONSE: As noted in Comment No. 4, Line No. 516 of the *Proposed Ordinance* was modified as follows in the *Revised Ordinance*:

"1279 systems, or and onsite sewage treatment and disposal systems. Where cleaning of"

5. During the December 8, 2016 meeting, Miami-Dade mentioned that many of its environmental ordinances are open to variances or extensions if heard by the Environmental Quality Control Board. Miami-Dade should severely limit or restrict what deadlines in the FOG Ordinance are subject to variances or extensions of time and this should be outlined in the FOG Ordinance itself.

RESPONSE: RER-DERM has revised Sections 24-8 and 24-11 of Chapter 24 to prohibit time extensions and/or variances of requirements originating from the CD.

Refer to Lines 217 – 306 of the *Revised Ordinance*.

6. The EPA and FDEP has serious concerns about Miami-Dade's Department of Regulatory and Economic Resources conducting FOG inspections after construction, but not being a part of the construction inspection process when a facility is installing a grease interceptor.

RESPONSE: RER-DERM has revised Chapter 24 to clarify that RER-DERM will perform construction inspections. This inspection will also serve as the first “routine” inspection.

Refer to Lines 825 – 837 of the *Revised Ordinance*.

7. Grease traps should be located outside the building. Also, specifically prohibit grease traps above the ground floor, Neither would be able to be cleaned effectively and the County should consider odor issues when cleaning.

RESPONSE: RER-DERM concurs that for some facilities the preferred location for a grease interceptor is immediately outside and below grade/ground to intersect the building drain. However, for many locations having a grease interceptor located outside the building is (1) impossible due to a lack of space or (2) problematic if the distance between the fixtures generating FOG and the grease interceptor is excessive. RER-DERM has observed that locating a grease interceptor outside the facility generating FOG can result in a “disconnect” between the facility and the condition of the grease interceptor (out of sight and smell – out of mind). For this reason, RER-DERM has included provisions to require new grease interceptors to be installed below ground/grade to intersect the building/grease drain and be placed as close as possible to the FOG source. Where a grease interceptor can't be located close to the FOG source, provision are included for maintenance access, monitoring and alarms.

Refer to Lines 974 – 979 of the *Revised Ordinance*.

8. Sec.24-42.6 (2): Specific limits in the pretreatment ordinance should be referenced in this grease trap ordinance, as the language is too vague. What quantity or concentration does the County believe will cause negative effects or hinder the operation of any onsite sewage treatment and disposal system, sewage collection, transmission or treatment system or cause a sanitary nuisance?

RESPONSE: Section 24-42.6(2) has been revised to include a concentration of 150 mg/L, the concentration above which the County believes “will cause negative effects or hinder the operation of an onsite sewage treatment and disposal system, sewage collection, transmission or treatment system or cause a sanitary nuisance.”

Refer to Lines 604 – 610 of the *Revised Ordinance*.

This concentration is included in Section 24-42.4(2)(d)(vi), and also proposed for the design of FOG control devices in Section 24-42.6(8) of the *Revised Ordinance*.

The *Proposed Ordinance* included the standards in Section 24-42.4(2)(a)(vi), Miami-Dade County Environmental Code (Code), as the standards for the design and operation of grease

interceptors. This section of Code includes a standard for FOG of 100 mg/L Hexane Extractable Materials (EPA Method 1664). For an example, refer to Section 24-42.6(7)(b), Lines 446 to 451 of the Proposed Ordinance.

The basis for the *Proposed Ordinance* was the FOG Study completed prior to June 5, 2015. However, the Department continued to research and investigate FOG Control, resulting in further refinement of the FOG Control Program. One such area of refinement is the FOG effluent limit. While a 100 mg/L standard should apply to significant industrial users, it may not be the most appropriate standard for facilities required to operate under Section 24-42.6: restaurants, cafeterias, day cares, etc. Facilities operating under Section 24-42.6 have the following characteristics:

- Wastewater flow is less than 25,000 gallons average annual daily flow,
- Are NOT subject to Categorical Pretreatment Standards,
- FOG is the pollutant of concern, and
- Are required to obtain an annual Grease Discharge Operating (GDO) permit.

For facilities required to obtain a GDO permit, additional analysis was performed to better define the appropriate effluent limit/standard. This analysis involved reviewing existing standards in Florida and further evaluating mechanisms for FOG impacts to the wastewater collection, transmission and treatment systems.

Below is a summary of several jurisdictions in Florida that have a standard for FOG.

City	Oil & Grease Standard	Code
Fort Lauderdale	400 mg/L	Sec. 28-204. - Prohibited discharges
Tampa	400 mg/L	Sec. 26-306. - Grease traps and interceptors
Orlando	250 mg/L	Sec. 30.03. - Pretreatment of Wastewater
Port St. Lucie	100 mg/L	Sec. 64.04. - Prohibitions and limitations on discharge into the wastewater system
Rivera Beach	100 mg/L	Sec. 20-144. - Prohibitions and limitations on discharge into the CRBSS
Palm Bay	100 mg/L	§ 201.21 PROHIBITED DISCHARGE STANDARDS
Mexico Beach	60 mg/L	§ 54.06 GENERAL SEWER USE REQUIREMENTS
Oldsmar	50 mg/L	Sec. 70-229. - Specific pollutant limitations

With regards to evaluating mechanisms for FOG impacts, FOG in the collection and transmission system is known to cause blockages, pipe and pump capacity reduction, corrosion, air release valve failure, wet-well level control interference, and increases operation and maintenance cost. FOG in the wastewater treatment plant interferes with instruments (e.g., flow meters and probes), reduces treatment efficiency, causes corrosion, and increases operation and maintenance cost. With regards to biological treatment processes, FOG can impact floc formation and lead to poor settling in secondary clarifiers.

In determining the most appropriate FOG effluent limit for facilities required to obtain a GDO permit, two (2) FOG impact mechanisms were evaluated:

1. The concentration of FOG at which deposition, blockage and corrosion are negligible.
2. The concentration of FOG at which impacts to the wastewater treatment operations are negligible.

Both mechanisms are discussed below.

FOG Effluent Limit Based on Grease Interceptor Efficiency

Determining the concentration of FOG at which deposition, blockage and corrosion are negligible is not possible given the number of contributing physical, mechanical, chemical and biological variables and unknowns. Instead, a deterministic analysis of grease interceptor effectiveness can be performed to determine a range of possible effluent concentrations that can be achieved using currently available and approved grease interceptors.

Existing FOG Control Devices (e.g., grease interceptors) are tested and certified using standards developed by the Plumbing and Drainage Institute (PDI), American Society of Mechanical Engineers (ASME), or Canadian Standards Association (CSA). All standards share common criteria for certification (i.e., passing):

- 90 percent FOG retention efficiency
- Total retention (pounds, Lbs) of no less than two (2) times the flow rate (gpm); e.g., a 25 gpm unit shall retain no less than 50 Lbs FOG.

Most grease interceptors are tested to a greater retention efficiency than 90 percent. Some are tested to 96 percent or higher. The CSA has a standard testing method that incorporates effluent concentration – but no grease interceptors are currently available that have been tested accordingly.

To evaluate FOG effluent limit, the following assumptions were used:

- Testing of grease interceptors is done with an influent concentration of approximately 12,000 mg/L.
- Retention efficiency typically ranges from 90 to 96 percent.
- Single grease interceptor FOG effluent concentration can be estimated as follows:
 - $C_{EFF} = C_{IN} (1-r) = C_{IN} (R)$
 - C_{IN} = Influent concentration, mg/L
 - r = retention efficiency (90 to 96%)
 - $R = 1 - r$
- Multiple grease interceptor FOG effluent concentration can be estimated as follows:
 - If r is constant:
 - $C_{EFF} = C_{IN} (1-r)^n = C_{IN} (R)^n$
 - n = number of grease interceptors with equal reduction efficiency.
 - If r is not constant:
 - $C_{EFF} = C_{IN} (1-r_1)(1-r_2)$

Considering a single grease interceptor, the effluent concentration for r ranging between 90 and 96 percent is:

$$C_{EFF90\%} = C_{IN} (1-r) = 12,000 \text{ mg/L} (1 - 0.90) = 1,200 \text{ mg/L}$$

$$C_{EFF96\%} = C_{IN} (1-r) = 12,000 \text{ mg/L} (1 - 0.96) = 480 \text{ mg/L}$$

For two (2) grease interceptors in series, considering that retention is not constant ($r_2 = 2/3 \times r_1$):

$$C_{EFF90\%} = C_{IN} (1-r_1)(1-r_2) = 12,000 \text{ mg/L} (1 - 0.90)(1-0.60) = 480 \text{ mg/L}$$

$$C_{EFF96\%} = C_{IN} (1-r_1)(1-r_2) = 12,000 \text{ mg/L} (1 - 0.96)(1-0.64) = 172 \text{ mg/L}$$

For two (2) grease interceptors in series, considering that retention is not constant ($r_2 = 3/4 \times r_1$):

$$C_{EFF90\%} = C_{IN} (1-r_1)(1-r_2) = 12,000 \text{ mg/L} (1 - 0.90)(1-0.675) = 390 \text{ mg/L}$$

$$C_{EFF96\%} = C_{IN} (1-r_1)(1-r_2) = 12,000 \text{ mg/L} (1 - 0.96)(1-0.72) = 134 \text{ mg/L}$$

For two (2) grease interceptors in series, considering that retention is constant ($r_2 = r_1$):

$$C_{EFF90\%} = C_{IN} (1-r_1)^n = 12,000 \text{ mg/L} (1 - 0.90)^2 = 120 \text{ mg/L}$$

$$C_{EFF96\%} = C_{IN} (1-r_1)^n = 12,000 \text{ mg/L} (1 - 0.96)^2 = 19.2 \text{ mg/L}$$

Based on the above analysis, the estimated FOG effluent concentration for a single grease interceptor ranges from 1,200 mg/L to 480 mg/L. For two grease interceptors in series, the estimated FOG effluent concentration ranges from 480 mg/L to 19.2 mg/L.

Based on the above and field observations and sampling results, an appropriate FOG effluent limit for GDO facilities utilizing available grease interceptors is 150 mg/L. For many facilities, upgrading to two (2) or more interceptors in series will be required to comply with 150 mg/L.

It is important to note that third-party testing of interceptors arranged in series was not available to DERM during the preparation of the *Proposed Ordinance*. To address this, DERM engaged the National Sanitation Foundation (NSF) and one manufacturer volunteered to test units in series. Data from the series test is included as **Attachment 4**. The test results show that achieving one hundred percent (100%) retention efficiency in a laboratory setting is possible when interceptors are arranged in series. Specifically, the units tested in series are rated at 100 gallons per minute and are therefore required to achieve a minimum grease capacity of 200Lbs. The testing demonstrated that the units tested achieved a grease capacity of 1,417.54 Lbs, exceeding the required minimum grease capacity by 700 percent at 99% retention efficiency or 1,191 percent at 94%.

Furthermore, the average retention efficiency over the duration of the test for the series configuration tested was 99.3%, which is considered an exceptional level of performance. On an incremental (drop by drop) basis, drop #32 saw efficiency at >99% before a slow decline began on a drop by drop to 94% on drop #45. Based on calculation using the accumulated grease value of 1417.54 Lbs recorded at drop #32, this represents 196-202 US Gallons of FOG capacity based on a specific gravity range of 0.87 to 0.84. This compares well with the maximum allowed FOG and solids storage capacity of gravity

grease interceptor when applying the 25% FOG capacity limit. As such, the performance of the series configuration tested demonstrates that third-party certification of FOG control devices to 99% is achievable and included in the *Revised Ordinance*.

FOG Effluent Limit Based on Wastewater Treatment Plant

The evaluation to determine the concentration of FOG at which impacts to the wastewater treatment operations are negligible was based on Miami-Dade Water and Sewer Department Design Criteria of 34 mg/L (**Attachment 5**) and EPA's publication *The Impact of Oily Materials on Activated Sludge Systems, EPA Water Quality Office Project No. 12050 DSH, March 1971*. This publication provides that *"the influent to the biological system should contain less than 75 mg/L hexane extractable materials and preferably less than 50 mg/L."*

To evaluate FOG effluent limit based on wastewater treatment plants, two (2) mass rate loadings were estimated: Maximum Allowable Headworks Loading (MAHL) and Maximum Allowable FOG Control Device Loading (MAFCDL). The MAFCDL was evaluated in terms of MAHL. FOG contributions to the wastewater treatment plants include industrial, residential and commercial users (refer to schematic below, Treatment Users). To simplify the process of evaluating MAHL and MAFCDL, a simplified treatment users schematic was utilized (refer to schematic below, Treatment Users, Simplified). For the purpose of evaluating FOG contributions, users were grouped into two groups: GDO and non-GDO. Non-GDO uses include industrial, residential and commercial (other than GDO).

Treatment Users

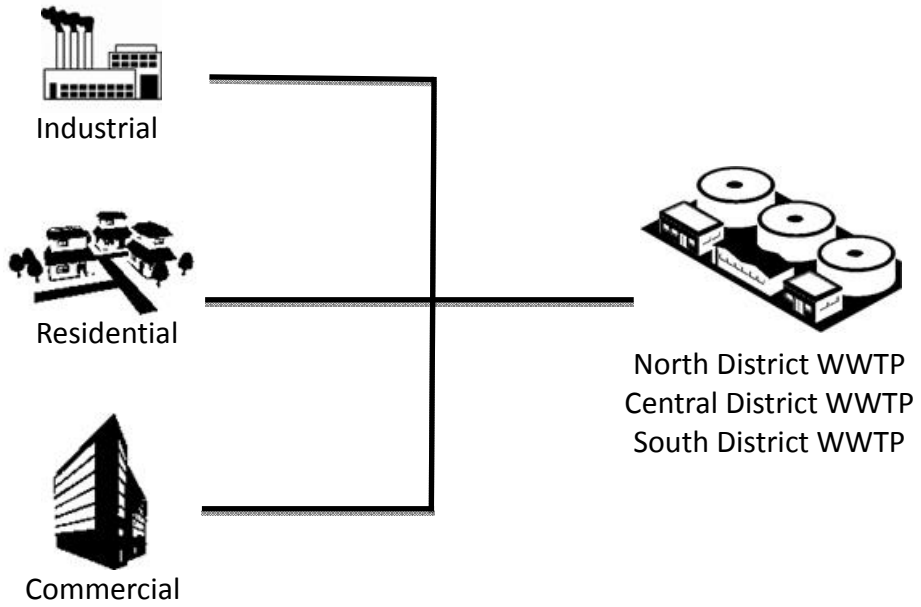

Treatment Users Simplified

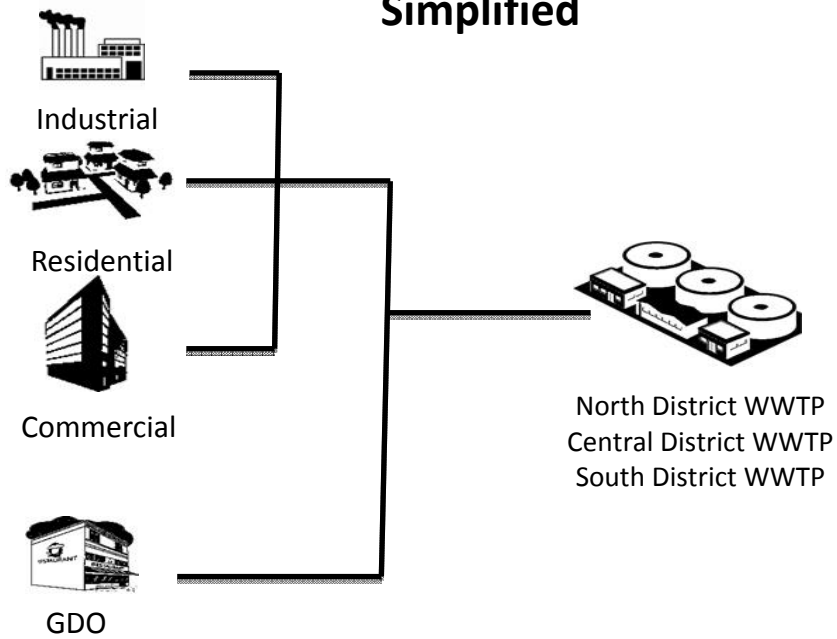

The simplified treatment user schematic can be expressed mathematically as follows:

$$Q_{WWTP} = Q_{NON-GDO} + Q_{GDO}$$

$$QC_{WWTP} = QC_{NON-GDO} + QC_{GDO} \quad \text{OR} \quad M_{WWTP} = M_{NON-GDO} + M_{GDO}$$

$$M_{WWTP} < MAHL$$

Where,

$Q_{NON-GDO}$ = AADF from all users other than GDOs (MGD)

Q_{GDO} = AADF from all GDOs (MGD)

Q_{WWTP} = AADF to all WWTPs (NDWWTP, CDWWTP and SDWWTP) (MGD)

$C_{NON-GDO}$ = Average FOG concentration from all users other than GDOs (mg/L)

C_{GDO} = Average FOG concentration from all GDOs (mg/L)

C_{WWTP} = Average FOG concentration to all WWTPs (mg/L)

$M_{NON-GDO}$ = Mass Rate of FOG contributed by non-GDO users (lbs_{FOG}/day).

M_{GDO} = Mass Rate of FOG contributed by GDO users (lbs_{FOG}/day) or MAFCDL

M_{WWTP} = Mass Rate of FOG to WWTPs (lbs_{FOG}/day).

MAHL = Maximum Allowable Headworks Loading (lbs_{FOG}/day).

Average FOG concentration from all GDOs was estimated from sampling results obtained by the Department from operating GDOs with grease interceptors; i.e., FOG Control Device effluent. Sampling data is summarized below and included in **Attachment 6**.

GDO FOG Effluent Summary

Number of Samples: 141
 Max FOG Concentration: 13,300 mg/L
 Minimum FOG Concentration: 1.5 mg/L
 Average FOG Concentration: 768 mg/L

GDO flow rates were taken from the Department's permitting database and are summarized below and included in **Attachment 7**.

Mark	Description	Value
A	Total Number of Active GDO Facilities:	6,456
B	Total Number of Active GDO Facilities with Flow Data:	5,643 (87%)
C	Average Annual Daily Flow Rate (GDOs with data):	12,250,021 gpd
D = C/B	Average Annual Daily Flow Rate per GDO (unit rate):	2,171 gpd
E = A X D	Total Average Annual Daily Flow Rate (all GDOs):	14,014,910 gpd

GDO FOG and flow rate estimates are used to calculate the FOG mass rate based on current conditions:

$$M_{GDO} = 8.34 Q C_{GDO} = 8.34 \times 14 \text{ MGD} \times 768 \text{ mg/L} = 89,672 \text{ lbs/day}$$

Average FOG concentrations and annual average flow rates for WWTPs were estimated from sampling results and flow meter data obtained for years 2014, 2015 and 2016. Sampling results and flow rate data are summarized below and included in **Attachment 8**.

Wastewater Treatment Plant	2014			2015			2016		
	AADF (MGD)	CFOG (mg/L)	MFOG (lb/day)	AADF (MGD)	CFOG (mg/L)	MFOG (lb/day)	AADF (MGD)	CFOG (mg/L)	MFOG (lb/day)
NDWWTP	92	28.2	21,604	89	31.8	23,673	85	19.1	13,545
CDWWTP	115	26.5	25,416	128	29.9	32,021	126	23.2	24,252
SDWWTP	98	25.1	20,433	98	22.3	18,250	99	63.9	52,968

Given that there is limited data available, a conservative assumption was made to utilize the highest concentration to represent the FOG concentration for all WWTPs: 63.9 mg/L (2016). Therefore, the FOG mass rate at the WWTPs was estimated as follows:

$$M_{WWTP} = 8.34 Q C_{WWTP}$$

$$Q_{WWTP} = (85 + 126 + 99) = 310 \text{ MGD}$$

$$C_{WWTP} = 63.9 \text{ mg/L}$$

$$M_{WWTP} = 8.34 \times 310 \text{ MGD} \times 63.9 \text{ mg/L} = 165,207 \text{ lbs/day}$$

The mass rate contributed by non-GDO users:

$$M_{NON-GDO} = M_{WWTP} - M_{GDO} = 165,207 - 89,672 = 75,535 \text{ lbs/day}$$

Utilizing the current condition estimate for $M_{NON-GDO}$ and M_{GDO} , the impact to MAHL for a range of MAFCDL can be evaluated:

$$MAHL = M_{NON-GDO} + M_{GDO} = 75,535 \text{ lbs/day} + M_{GDO}$$

$$M_{GDO} = 8.34 Q C_{GDO}$$

$$M_{GDO100} \text{ (100 mg/L), } M_{GDO} = 8.34 \times 14 \text{ MGD} \times 100 \text{ mg/L} = 11,676 \text{ lbs/day}$$

$$MAHL_{100} = 75,535 \text{ lbs/day} + 11,676 \text{ lbs/day} = 87,211 \text{ lbs/day}$$

$$C_{WWTP} = 87,211 / (8.34 \times 310) = 34 \text{ mg/L}$$

$$M_{GDO150} \text{ (150 mg/L), } M_{GDO} = 8.34 \times 14 \text{ MGD} \times 150 \text{ mg/L} = 17,514 \text{ lbs/day}$$

$$MAHL_{150} = 75,535 \text{ lbs/day} + 17,514 \text{ lbs/day} = 93,049 \text{ lbs/day}$$

$$C_{WWTP} = 93,049 / (8.34 \times 310) = 36 \text{ mg/L}$$

$$M_{\text{GDO}200} (200 \text{ mg/L}), M_{\text{GDO}} = 8.34 \times 14 \text{ MGD} \times 200 \text{ mg/L} = 23,352 \text{ lbs/day}$$

$$\text{MAHL}_{200} = 75,535 \text{ lbs/day} + 23,352 \text{ lbs/day} = 98,887 \text{ lbs/day}$$

$$C_{\text{WWTP}} = 98,887 / (8.34 \times 310) = 38 \text{ mg/L}$$

The calculations show that setting the FOG limit to 150 mg/L and utilizing conservative assumptions, the calculated MAHL is well below the recommended limit of 50 to 75 mg/L published by EPA (*The Impact of Oily Materials on Activated Sludge Systems, EPA Water Quality Office Project No. 12050 DSH, March 1971*) and within 2 mg/L of WASD's wastewater treatment plant design criteria.

Based on field observations, FCD sampling and analysis of FOG impact mechanisms, changing the numerical FOG standard for GDO facilities is warranted. The *Revised Ordinance* includes proposed changes to Section 24-42.4 to reflect a numeral standard for facilities subject to Section 24-42.6 of 150 mg/L. This standard reflects what can be accomplished by maximizing current FOG Control Device technology while being protective of wastewater treatment facilities.

9. FDEP believes FOG generators should not be served by onsite disposal systems. We suggest that existing FOG generators should be only allowed on existing onsite disposal systems for a set amount of time after the effective date of the ordinance (e.g. 10 years after the effective date). This allows the owner time to connect to public sewer or relocate the business.

RESPONSE: Chapter 64E-6, Florida Administrative Code, allows FSEs to utilize onsite sewage treatment and disposal systems (OSTDS), including grease interceptors, when public sanitary sewers are not available. Florida Statutes defines availability for public sewer connection as follows:

381.0065 Onsite sewage treatment and disposal systems; regulation

(a) "Available," as applied to a publicly owned or investor-owned sewerage system, means that the publicly owned or investor-owned sewerage system is capable of being connected to the plumbing of an establishment or residence, is not under a Department of Environmental Protection moratorium, and has adequate permitted capacity to accept the sewage to be generated by the establishment or residence; and:

- 1. For a residential subdivision lot, a single-family residence, or an establishment, any of which has an estimated sewage flow of 1,000 gallons per day or less, a gravity sewer line to maintain gravity flow from the property's drain to the sewer line, or a low pressure or vacuum sewage collection line in those areas approved for low pressure or vacuum sewage collection, exists in a public easement or right-of-way that abuts the property line of the lot, residence, or establishment.*
- 2. For an establishment with an estimated sewage flow exceeding 1,000 gallons per day, a sewer line, force main, or lift station exists in a public easement or right-of-way that abuts the property of the establishment or is within 50 feet of the property line of the establishment as accessed via existing rights-of-way or easements.*

Section 24-43.1(7) of the Code requires connection to "available" public sewer and abandonment of OSTDS.

(7) Notwithstanding any provision of this code, when an approved public gravity sanitary sewer or approved sanitary sewer force main is available and operative in a public right-of-way or easement abutting the property, the use of any liquid waste storage, disposal or treatment methods shall cease within ninety (90) days of the date the Director or the Director's designee determines that the approved public sanitary sewer is available and operative. Thereafter, all liquid wastes that are generated, handled, disposed of, discharged or stored on the property shall be discharged to an approved and operative gravity sanitary sewer or approved sanitary sewer force main except those liquid wastes, other than domestic sewage, that are permitted by this chapter to be generated, handled, treated or stored on the property. Notwithstanding the foregoing, graywater may, at the option of the property owner, be discharged to a graywater disposal system approved by the Director or the Director's designee.

Available, when used in Section 24-43.1(7) shall mean the following:

(c) Non-residential land uses that generate only domestic sewage: (including residential with mixed use):

(i) For properties complying with the sewage loading provisions of Section 24-43.1(4)(b) using the sewage flows set forth in Section 24-43.1(5) and with sewage flow less than or equal to 1,000 gallons per day (gpd) calculated using unit rates in Chapter 64E-6, Florida Administrative Code, as may be amended from time to time, a public gravity sewer shall be considered available if it is located within any portion of any public right-of-way or easement abutting the property, but not on the opposite side of a roadway divided by a raised median or on the opposite side of a roadway which has four (4) lanes or more. A public force main shall not be considered available.

(ii) For properties not complying with the sewage loading provisions of Section 24-43.1(4)(b) using the sewage flows set forth in Section 24-43.1(5) or with a sewage flow greater than 1,000 gallons per day (gpd) calculated using unit rates in Chapter 64E-6, Florida Administrative Code, as may be amended from time to time, a public gravity sewer or a public force main shall be considered available if it is located within any portion of any public right-of-way or easement abutting the property.

The Florida Administrative Code, Florida Statutes and Chapter 24 of the Code allow FSEs to operate with an OSTDS if public sewer is not available. While there is a preference for FSEs to be connected to public sewers, there is no legal basis for establishing a timeframe for connection or relocation if public sewer is not “available.”

Recognizing that overloading septic tanks and drainfields with FOG could result in groundwater contamination and/or sanitary nuisance conditions, RER-DERM included provisions for issuing operating permits (GDOs) to FSEs served by OSTDSs and located in a basic wellfield protection area. This approach provides protection of groundwater in WPAs.

10. Sec.24-42.6 (2) (b) (iii): The submittal of the corrective action plan is 30 days. However, there is no deadline to obtain the approval or complete the corrective action(s) We suggest a time frame be given. After a defined period of time, the occupational license could be withdrawn.

RESPONSE: Sections 42.6(2)(a) and 42.6(2)(b) have been revised to include timeframes for implementation of corrective action plans. Refer to Lines 612 to 629 and 635 to 643 of the *Revised Ordinance*.

11. Sec.24-42.6 (4) (a): The as-built plans should be signed and sealed by a professional engineer.

RESPONSE: Section 42.6(4)(a) was revised to remove licensed plumber. As-built plans shall be signed and sealed by a professional engineer. Refer to Lines 712 to 718 and 767 to 770 of the *Revised Ordinance*.

12. Sec.24-42.6 (4) (c): The operating permit application should be submitted with the as-built plans.

RESPONSE: FOG generators and FOG control device operators that do not have a valid GDO permit and cannot demonstrate compliance based on as-built conditions, are required to submit plans to upgrade the facility pursuant to Section 41.6(3), (4), (5), and (6). Upgrades approved will be inspected by RER-DERM and therefore as-built plans will not be required. However, if the construction inspection identifies deviations from approved plans, as-built plans will be

required and reviewed by RER-DERM. Refer to Lines 825 to 837 of the *Revised Ordinance* for the Department's inspection requirements.

13. Sec.24-42.6 (8) (c) (iii) and (v): The monthly report as required in (v) should include attachments to the report of the following:

- Scheduled and unscheduled service calls to clean gease waste drains, building sanitary drains. or building sewers.
- Repairs required resulting from food or FOG accumulation or blockages.
- FOG control device cleaning, maintenance and repair.
- Waste manifest forms pursuant to Sections 24-42.6(9) and 24-46

RESPONSE: Section 42.6(8)(c)(v) reporting requirements are intended to provide information to supplement the information provided by liquid waste transporters and disposal facilities as part of the eManifest system. The list of items in Section 42.6(9)(c)(iii) are reviewed by RER-DERM inspection staff (FOG Technicians) during every routine and unscheduled inspection. Therefore, submittal of these items is not warranted.

14. Sec.24-42.6 (8) (c) (vi): Miami Dade is requiring the property owner to perform the work. However, the property owner may not be party to the operating permit. Therefore, the property owner should be party of the operating permit. When the FOG generator is not the property owner, the operating permit should have two parties, the property owner and the FOG generator. The specific requirements of each party should be spelled out. Finally, the property owner should be responsible if the FOG generator does not perform.

RESPONSE: Section 42.6(9)(a) has been revised to require the property owner to be party to the operating permit. Refer to Lines 1280 to 1287 of the *Revised Ordinance*.

15. Sec.24-42.6 (11) (c): What is the purpose and use for requiring cost of accelerated FOG maintenance? If you plan to require some kind of reimbursement to the utility, the ordinance should include that.

RESPONSE: The purpose of requiring utilities to report cost of accelerated FOG maintenance is (1) to increase awareness on the impact of FOG on the water collection, transmission, and treatment systems and (2) document and report cost as a key performance indicator.

The above responses serve to clarify the intent of the FOG Control program submitted to EPA/FDEP on June 8, 2015, to fully comply with the requirements set forth in Paragraph 19(a) of the CD. Should you have any further questions regarding this matter, please call me at (305) 372-6789.

I certify under penalty of law that this document and all attachments were prepared under my direction or supervision in accordance with a system designed to assure that qualified personnel properly gather and evaluate the information submitted. Based on my inquiry of the person or persons who manage the system, or those persons directly responsible for gathering such information, the information submitted is, to the best of my knowledge and belief, true, accurate

and complete. I am aware that there are significant penalties for submitting false information, including the possibility of fine and imprisonment for knowing violations.

Sincerely,



Lee N. Hefty, RER-Assitant Director
Division of Environmental Resources Management

Attachments: FOG Control Program and FOG Ordinance

ec: Jonathan A. Glogau
Special Counsel
Chief, Complex Litigation
Office of the Attorney General
PL-01, The Capitol
Tallahassee, FL 32399-1050
850-414-3817
Jon.Glogau@myfloridalegal.com

Florida Department of Environmental Protection
Southeast District – West Palm Beach
3301 Gun Club Road, MSC 7210-1
West Palm Beach, FL 33406
Attn: Compliance/Enforcement Section
Lisa.M.Self@dep.state.fl.us
Sed.wastewater@dep.state.fl.us

Mayor Carlos A. Gimenez
Miami-Dade County
111 NW First Street 29th Floor
Miami, Florida 33128

Lester Sola, Director
Miami-Dade Water and Sewer Department
3071 SW 38th Avenue
Miami, Florida 33146

Jack Osterholt, Deputy Mayor/Director
Miami-Dade Regulatory and

Economic Resources
111 NW 1st Street. 29th Floor
Miami, FL 33128
Josterholt@miamidade.gov

Henry Gillman
Miami-Dade County Attorney
Miami-Dade County Attorney's Office
111 NW First Street Suite 2810
Miami, Florida 33128

William Bush
Associate Regional Counsel
U.S. EPA, Region 4
61 Forsyth Street, SW
Atlanta, Georgia 30303
Bush.William@epa.gov

William A. Weinischke
Senior Trial Attorney
Environmental Enforcement Section
Environment and Natural Resources Division
U.S. Department of Justice
P.O. Box 7611
Washington, D.C. 20044
Bill.Weinischke@usdoj.gov

Attachment 1A

Proposed Ordinance Submitted June 5, 2015

1 June 2, 2015

2 **Strike-thru Text** [~~text~~] are deletions and **underlined text** >>text<< is new/proposed
3 language.

4 =====

5 **Sec. 24-5. Definitions**

6

7 >>Accelerated FOG maintenance shall mean cleaning performed by utilities to prevent sanitary
8 sewer overflows caused by FOG blockages in sewer laterals, gravity mains, pump stations, and
9 air release valves.

10 Back of the House shall mean all areas where food is stored, processed, cooked, prepared, and
11 assembled and cleanup areas. It does not include offices, dry storage or front of the house
12 areas.

13 Best Management Practices shall mean a schedule of activities, prohibitions of practices,
14 maintenance procedures, and other management practices to prevent or minimize pollution.

15 Black Grease shall mean any FOG commingled with septic wastes (bathroom wastes).

16 Brown Grease shall mean FOG waste collected in, or removed from, a FOG control device.

17 Building Sewer shall mean the part of the building drainage system that extends from the end of
18 the building drain and conveys the discharge to utility or non-utility owned or operated sanitary
19 sewer system.

20 Building Sanitary Drains shall mean the pipes intended to receive sanitary wastewater and
21 effluent from FOG control devices where FOG control devices are installed or required. FOG or
22 food waste shall not be discharged into the building sanitary drains.

23 Dishmachine shall mean equipment used to sanitize and does not actually wash the items put
24 inside.

25 Dishwasher shall mean equipment that washes and sanitizes.

26 Fats, Oil and Grease (FOG) shall mean any substance such as vegetable or animal product
27 used in, or a byproduct of, the cooking or food preparation process, which turns or may turn
28 viscous or solidifies with a change in temperature or other conditions.

29 FOG Capacity Limit shall mean the combined FOG and solids depth equal to twenty-five (25)
30 percent of the design hydraulic depth in any location of a FOG control device designed pursuant
31 to Chapter 64E-6, Florida Administrative Code, or seventy-five (75) percent of the rated FOG
32 and solids capacity established by third party certification.

33 FOG Control Device shall mean equipment designed to remove, hold and prevent the passage
34 of FOG to onsite sewage treatment and disposal systems and sanitary sewer systems. FOG
35 control devices include grease traps and grease interceptors.

36 FOG Control Device Operator shall mean a person or entity which has management control for
37 FOG control devices which serve other FOG generators.

38 FOG Generator shall mean any nonresidential facility, including, but not limited to, restaurants,
39 bakeries, hotel and cafeteria kitchens, commercial kitchens, kitchens serving hospitals, nursing
40 homes, daycares, assisted living facilities and other healthcare facilities, processing plants or
41 such other nonresidential facilities that can introduce food waste or FOG into building sanitary
42 drains, building sewers, onsite sewage treatment and disposal systems, or non-utility or utility
43 sanitary sewer system. A FOG generator also includes those facilities that produce yellow
44 grease.

45 FOG Generator Certified Staff shall mean a FOG generator employee which has attended
46 training prescribed by the Director or Director's designee, and has received certification for
47 training.

48 FOG Liquid Waste Transporter Certified Staff shall mean a FOG Liquid Waste Transporter
49 employee which has attended training prescribed by the Director or Director's designee, and
50 has received certification for training..

51 FOG Operating Permit shall mean an operating permit issued to FOG generators or FOG
52 control device operators pursuant to Sections 24-18 and 24-42.6.

53 FOG Sampling Point shall mean a reasonably accessible location for sampling the effluent of a
54 FOG control device.

55 Front of the House shall mean all areas not included in the back of the house.

56 Grease Interceptor shall mean a FOG control device connected to a building grease waste
57 drain.

58 Grease Trap shall mean a FOG control device located between one or more fixtures (e.g.,
59 three-compartment sink) and a building sanitary drain or grease waste drain. A grease trap does
60 not receive waste from a building grease waste drain and can be located above or below
61 ground.

62 Grease Waste Drains shall mean the pipes intended to receive FOG and food waste. They
63 convey the discharge to solids separators and FOG control devices.

64 Interceptor Monitoring Alarm shall mean a system and its components capable of monitoring
65 floating and settled solids in a FOG control device on a regular interval. The system shall
66 trigger a visual and audible alarm at the FOG Capacity Limit.

67 Interceptor Monitoring Device shall mean a system and its components capable of monitoring
68 floating and settled solids in a FOG control device on a regular interval, triggering a visual and
69 audible alarm at the FOG Capacity Limit, and reporting data electronically to the Department at
70 a frequency and format approved by the Director or Director's designee.

71 Residential FOG Source shall mean a residential kitchen that can introduce food waste or FOG
72 into a building drain, building sewer, onsite sewage treatment and disposal system, or non-utility
73 or utility sanitary sewer system.

74 Solids Separator shall mean a separator intended to capture solids and allow grease to pass
75 through. It is installed at the source or on the grease waste drains prior to a grease trap or
76 grease interceptor.

77 Third Party Certified shall mean a certification by an independent entity that specific equipment
78 or devices have been tested and meet or exceed standards established by the certifying entity.
79 The certifying entity shall be recognized by the Director or Director's designee and can include,
80 but is not limited to, the American Society of Mechanical Engineers (ASME), Plumbing and
81 Drainage Institute (PDI) or Canadian Standards Association (CSA).

82 Wash-Down Area shall mean an area where FOG generators wash the back of the house mats
83 or equipment.

84 Yellow Grease shall mean FOG generated as a byproduct from cooking or food preparation that
85 is not mixed with water, wastewater or other waste.<<

86

87

88 **Sec. 24-18. Operating permits**

89 (A) *Permit Required.* No person shall operate, maintain or permit, cause, allow, let or suffer
90 the operation or maintenance of a public water system, public sewerage system, a location
91 where a site rehabilitation action has been completed in accordance with the provisions set forth
92 in **Section 24-44(2)(k)(ii)** or any of the following facilities, all of which will reasonably be
93 expected to be a source of air pollution, ground pollution or water pollution, without a valid
94 operating permit issued by the Director or the Director's designee or in violation of any
95 condition, limitation or restriction which is part of an operating permit:

96

97 (1) Interim package sewage treatment plants;

98

99 * * *

100

101 (18) ~~[[Any nonresidential facility, including, but not limited to, restaurants, bakeries, hotel~~
102 ~~and cafeteria kitchens, processing plants or such other nonresidential facilities~~
103 ~~discharging into a publicly or privately owned or operated sanitary sewer collection~~
104 ~~system, if oil and grease can be introduced into a sewer by such nonresidential facility~~
105 ~~in quantities which have the potential to affect or hinder the operation of sewage~~
106 ~~collecting, transmission or treatment facilities]]. >>FOG generator discharging to a~~
107 ~~utility or non-utility owned or operated sanitary sewer collection system or onsite~~
108 ~~sewage treatment and disposal system located in the basic wellfield protection area of~~
109 ~~any utility or non-utility potable water supply wells. Refer to Section 24-42.6(8) for FOG~~
110 ~~generator operating permit requirements;<<~~

111

112 * * *

113

114 (21) >>FOG Liquid Waste Transporter;<<

115 (22) >>Liquid Waste Transporter;<<

116 (23) >>FOG, Yellow Grease, Brown Grease, or other Grease Storage, Transfer or
117 Treatment facility;<<

118 (24) >>FOG Control Device Operator;<<

119

120 * * *

121

122 **Sec. 24-42.3. Certification of sanitary sewer system collection, transmission and**
123 **treatment capacity.**
124

125 (1) Notwithstanding any provision of this Code, no county or municipal officer, agent,
126 employee or board shall approve, grant or issue any building permit, certificate of occupancy,
127 certificate of use (except for changes in ownership) or municipal occupational license (except for
128 changes in ownership) for any land use served or to be served by a utility or non-utility owned or
129 operated wastewater collection and transmission system until the county or municipal officer,
130 agent, employee or board has obtained the prior written unconditional approval or prior written
131 conditional approval of the Director or the Director's designee. Notwithstanding any provision of
132 this Code, no person shall construct, utilize, operate, occupy or cause, allow, let, permit or suffer
133 to be constructed, utilized, operated or occupied any land use served or to be served by a utility
134 or non-utility owned or operated wastewater collection and transmission system until the person
135 has obtained the prior written unconditional approval or the prior written conditional approval of
136 the Director or the Director's designee.

137 * * *

138 (3) No new additional sewage flows shall be authorized for any sanitary sewer basin,
139 sewage pump station, or system pursuant to Section 24-42.3 unless and until:

140 (a) The official responsible for issuing certificates of occupancy, certificates of use or
141 equivalent municipal occupational licenses provides a monthly report that identifies
142 projects that have been issued a certificate of occupancy, certificate of use or an
143 equivalent municipal occupational license that have also received a conditional or
144 unconditional written approval, and

145
146 (b) All actions or reports required by Section 24-42.2 >>and Section 24-42.6(11)<< for the
147 basin, pump station, or system have been completed according to the schedules
148 required therein.

149
150 * * *

151

152 >>**Sec. 24-42.6. Fats, Oil and Grease Control Program**

153 The intent and purpose of this Section is to safeguard public health, safety and welfare, and
154 protect the sanitary sewer collection, transmission and treatment systems by setting minimum
155 requirements and standards for the design and operation of FOG generating facilities.

156
157 (1) No person shall dispose of any FOG or food waste, or cause, let, permit, suffer or allow
158 disposal or discharge of any FOG or food waste to be disposed or discharged into any
159 stormwater drainage system, ground or groundwater, surface water, private street, public right
160 of way, or any other location not approved by the Director or Director's designee.

161
162 (2) No person shall dispose of any FOG, or cause, let, permit, suffer or allow disposal or
163 discharge of any FOG into any onsite sewage treatment and disposal system, non-utility or
164 utility sanitary sewer system in quantities or concentrations which negatively affects or hinders
165 the operation of any onsite sewage treatment and disposal system, sewage collection,
166 transmission or treatment system, or causes a sanitary nuisance.

167
168 (a) When a FOG generator is found to have violated Section 24-42.6(2), the FOG generator
169 shall immediately cease and desist from discharging FOG in such quantities or
170 concentrations. The FOG generator shall submit a corrective action plan to the
171 Department within thirty (30) days of the date the Director or the Director's designee
172 determines that the FOG generator discharged FOG in such quantities or
173 concentrations. The corrective action plan shall include equipment, process or procedure
174 modifications proposed to prevent discharging FOG in such quantities or concentrations.
175 Until the corrective action plan is approved by the Director or Director's designee and
176 implemented in accordance with the Director or Director designee's approval, the FOG
177 generator shall take all necessary actions to prevent discharge of FOG in such quantities
178 or concentrations.

179
180 (b) When a Residential FOG Source is found to have violated Section 24-42.6(2), , the
181 Residential FOG Source shall immediately cease and desist from discharging FOG in
182 such quantities or concentrations.

183

184 (i) When a Residential FOG Source is located in an apartment building or
185 condominium, the building manager, association or other responsible party shall
186 submit a corrective action plan to the Department within thirty (30) days of the date
187 the Director or the Director's designee determines that the FOG residential source
188 has violated Section 24-42.6(2).

189
190 (ii) The corrective action plan shall include equipment, process or procedure
191 modifications proposed to correct the FOG discharge.

192
193 (iii) Until the corrective action plan is approved by the Director or Director's designee and
194 implemented in accordance with the Director or Director designee's approval, the
195 building manager, association or other responsible party shall take all necessary
196 actions to prevent violation of Section 24-42.6(2).

197
198 (3) Existing FOG generators with a current FOG operating permit issued prior to (CLERK
199 TO INSERT EFFECTIVE DATE), not proposing to increase seating capacity, dining area or
200 drive-thru capacity, or other modification, any of which will increase the discharge of FOG, shall
201 comply with the following:

202
203 (a) Where there is an existing FOG control device and sampling point, the sampling point
204 shall be located after the point of no further treatment and shall be directly accessible for
205 visual inspection and sampling.

206
207 (b) Where there is no FOG control device, plans shall be submitted to the Department for
208 the installation of a FOG control device which shall be installed in accordance with plans
209 approved by the Director or Director's designee, within ninety (90) days of the date the
210 Director or the Director's designee determines that there is no FOG control device. The
211 FOG generator shall take all necessary actions to prevent discharge of FOG to the
212 building sanitary drains and to prevent causing a sanitary nuisance until a FOG control
213 device is properly installed.

214
215 (c) Where the discharge from a FOG control device exceeds sanitary sewer discharge
216 limitation and pretreatment standards in Section 24-42.4, or causes the accumulation of
217 FOG in building sanitary drains or building sewer, the FOG control device shall be

218 repaired, upgraded or replaced within ninety (90) days of the date the Director or the
219 Director's designee determines that Section 24-42.4 effluent standards have been
220 exceeded or FOG has accumulated in building sanitary drains or building sewer.

221
222 (d) Where the Director or Director's designee determines that there is no sampling point or
223 the existing sampling point is not reasonably accessible or adequate for sampling, a
224 new reasonably accessible sampling point shall be installed within thirty (30) days of the
225 determination of the Director or Director's designee.

226
227 (e) Where a FOG control device or sampling point are required to be repaired, replaced or
228 installed, plans shall be submitted to the Department for review and approval. New FOG
229 control devices shall be designed pursuant to Section 24-42.6(7).

230
231 (f) FOG generators shall comply with their current FOG generator operating permit
232 conditions until the permit expires, thereafter FOG generators shall comply with permit
233 conditions based on Section 24-42.6(8) requirements.

234
235 (4) Existing FOG generators and FOG control device operators that do not hold a valid FOG
236 operating permit issued prior to (CLERK TO INSERT EFFECTIVE DATE), that discharge to a
237 utility or non-utility owned or operated sanitary sewer system, shall comply with the following:

238
239 (a) Submit as-built plans prepared by a licensed plumber or Florida Professional Engineer
240 within sixty (60) days from the Director or the Director designee's determination that the
241 FOG generator or FOG control device operator does not have a valid FOG operating
242 permit. As-built plans shall demonstrate, where applicable:

243
244 (i) All existing back of the house fixtures discharge to existing FOG control devices
245 and not directly to the building sanitary drains or building sewers.

246
247 (ii) Existing FOG control devices comply with Section 24-42.6(7).

248
249 (iii) A sampling point is located after the point of no further treatment and is reasonably
250 accessible for visual inspection and sampling.

251

252 (iv) Existing yellow and brown grease storage areas prevent the release of FOG to
253 ground, groundwater, surface waters or storm sewers.

254
255 (v) Existing mat and equipment wash-down areas prevent the release of FOG to
256 ground, groundwater, surface waters or storm sewers and prevent inflow of
257 stormwater.

258
259 (b) Within five (5) days of the Director or the Director designee's approval of the as-built
260 plans, a FOG operating permit application shall be submitted pursuant to Sections 24-
261 18(A)(18) and 24-42.6(8).

262
263 (c) FOG generators or FOG control device operators that cannot comply with Sections 24-
264 42.6(4)(a) shall submit plans to upgrade the facility pursuant to Section 24-42.6(5) within
265 ninety (90) days of the date the Director or the Director's designee determines that the
266 FOG generator or FOG control device operator does not have a valid FOG operating
267 permit. The facility upgrade shall be completed within ninety (90) days of the date the
268 Director or the Director's designee approves the plans.

269
270 (5) Notwithstanding any provision of this Code, no county or municipal officer, agent,
271 employee or board shall approve, grant or issue any building permit, certificate of occupancy,
272 certificate of use or municipal occupational license for a FOG generator until prior written
273 approval of the Director or the Director's designee has been obtained. Furthermore, no person
274 shall construct, utilize, operate, occupy or cause, allow, let, permit or suffer to be constructed,
275 utilized, operated or occupied any FOG generator until prior written approval of the Director or
276 the Director's designee has been obtained.

277
278 (a) For new FOG generators discharging to a utility or non-utility owned or operated sanitary
279 sewer collection system or to an onsite sewage treatment and disposal system located
280 in the basic wellfield protection area of any utility potable water supply wells, the Director
281 or the Director's designee shall not issue a written approval until the Director or the
282 Director's designee finds that:

283
284 (i) Construction plans comply with Section 24-42.6(6).

285

286 (ii) FOG control devices have been inspected and found to be in compliance with
287 Section 24-42.6(7) and with construction plans pursuant to 24-42.6(5)(a)(i).
288 Compliance with approved plans shall be determined by construction inspection.
289 Persons performing construction inspections for FOG control devices shall be
290 trained to perform such inspections. Training shall be prescribed by the Director or
291 the Director's designee.

292
293 (iii) FOG operating permit applications shall be submitted pursuant to Sections 24-18
294 (A)(18) and 24-42.6 (8).

295
296 (b) For existing FOG generators discharging to a utility or non-utility owned or operated
297 sanitary sewer system or discharging to an onsite sewage treatment and disposal
298 system located in the basic wellfield protection area of any utility potable water supply
299 wells, proposing to increase seating capacity, dining area or drive-thru capacity, or other
300 modification any of which will increase the discharge of FOG, the Director or the
301 Director's designee shall not issue a written approval until the Director or the Director's
302 designee finds that the proposed increased seating capacity, dining area or drive-thru
303 capacity, or other modification any of which will increase the discharge of FOG, complies
304 with Section 24-42.6 (5)(a).

305
306 (c) On or before January 1, 2018, FOG generators discharging to a utility or non-utility
307 owned or operated sanitary sewer system or onsite sewage treatment and disposal
308 system located in the basic wellfield protection area of any utility potable water supply
309 wells that are not subject to 24-42.6(5)(a) or (b), shall comply with the following
310 requirements:

311
312 (i) All back of the house fixtures and other fixtures, including wash-down areas, which
313 can discharge food waste or FOG, shall be connected to a FOG control device that
314 complies with Section 24-42.6(7).

315
316 (ii) A sampling point shall be located after the point of no further treatment. The
317 sampling point shall be directly accessible for visual inspection and sampling.

318

319 (iii) Yellow and brown grease storage areas and wash-down areas shall be designed
320 to prevent the release of FOG or wash-water to ground, groundwater, surface
321 waters or storm sewers.

322
323 (iv) Solids separation shall be provided prior to FOG control devices that require a flow
324 control device or are not certified to handle solids.

325
326 (vi) Sanitary wastes from bathrooms and stormwater shall not discharge to grease
327 waste drains, solids separators or FOG control devices.

328
329 (vii) Submit Certification to the Department in a form prescribed by the Director or the
330 Director's designee and prepared by a Florida Professional Engineer or master
331 plumber, attesting to compliance with Sections 24-42.6(5)(c)(i) through (vi) above.
332 Furthermore, confirmation of compliance with Section 24-42.6(7) shall be signed
333 and sealed by a Florida Professional Engineer.

334
335 (viii) Where the existing FOG control device was approved pursuant to Section 24-
336 42.6(7), certification of Section 24-42.6(5)(c)(i) shall not be required.

337
338 (6) Plans. Where required in Section 24-42.6, plans shall include the following minimum
339 information:

340
341 (a) Signature and seal of a Florida Professional Engineer.

342
343 (b) All existing and proposed back of the house and front of the house areas and drive-thru
344 lanes are shown and labeled.

345
346 (c) All existing and proposed drainage pipes, fixtures, solids separators, FOG control
347 devices and sampling points are shown and labeled. All drainage pipes that receive or
348 can receive waste from back of the house fixtures, and other fixtures that can discharge
349 food waste or FOG, shall be labeled grease waste drains or GW. Back of the house
350 fixtures include floor drains, floor sinks, trough drains, mop sinks, three-compartment
351 sinks, hand sinks, pre-rinse station/sink, preparation sink, pot sink, wok sink, self-
352 cleaning kitchen exhaust hoods, and any and all fixtures, appurtenances and equipment

353 that have the potential to introduce food waste or FOG into drainage pipes. Where
354 multiple users/tenant spaces connect to a common FOG control device, the plans shall
355 include all users/tenant spaces.

356

357 (d) Screens are shown and labeled in all sinks and drains.

358

359 (e) All grease waste drains are connected to a FOG control device that complies with
360 Section 24-42.6(7).

361

362 (f) FOG control device plan, profiles, sections and details are shown to scale and labeled.
363 FOG control devices shall be accessible for cleaning pursuant to Section 24-42.6(8).

364

365 (g) The point of wastewater discharge for kiosk and booths are shown and labeled. The
366 point of discharge shall be a grease waste drain or FOG control device sized for the
367 quantity of waste generated. All waste containers shall be shown on plans.

368

369 (h) FOG control device sizing calculations and assumptions, including peak flow rate,
370 temperature, FOG and solids loading rates, and frequency of FOG and solids removal
371 are shown and labeled. Where the FOG control device will serve multiple users/tenants,
372 each user/tenant shall be identified and their flows and loading rates shall also be
373 included on the plans. Loading rates shall include waste from food preparation and
374 cleaning associated with eat-in, take-out and drive-thru meals. FOG loading shall include
375 all FOG sources, including kitchen exhaust hoods. For self-cleaning kitchen exhaust
376 hoods, the manufacturer's specifications for peak discharge shall be included.

377

378 (i) FOG control device model numbers and third party certifications are shown and labeled.

379

380 (j) State Health Office's designated approval/tank numbers for grease interceptors
381 designed in accordance with 64E-6, Florida Administrative Code, are shown and
382 labeled.

383

384 (k) For concrete precast FOG control devices, the precast concrete plant name and precast
385 concrete plant certifying agency accepted by the Florida Department of Transportation
386 are shown and labeled accordingly. Site cast FOG control devices are not permitted.

387
388
389
390
391
392
393
394
395
396
397
398
399
400
401
402
403
404
405
406
407
408
409
410
411
412
413
414
415
416
417
418
419

- (l) Dishmachines are not required to be connected to a FOG control device where washing and rinsing are performed in a two (2) or three (3) compartment sink and the dishmachine connects to grease waste drain prior to a sampling point. Dishwashers with dedicated soiled-dish table or pre-rinse station, where all food solids and liquids are removed, are not required to be connected to a FOG control device when connected to a grease waste drain prior to a sampling point. All other dishwashers shall be connected to a FOG control device sized to account for emulsified grease.
- (m) At least one (1) sampling point located after the point of no further treatment shown and labeled. The sampling point shall be directly accessible for visual inspection and sampling.
- (n) Isometric diagrams showing and labeling all existing and proposed plumbing pipes, fixtures, solids separators, FOG control devices and sampling points. Grease waste drains shall be labeled grease waste drain or GW.
- (o) Locations and details for all stored waste, including yellow and brown grease, are shown and labeled. Storage areas shall be designed to prevent the release of FOG to ground, groundwater, surface waters or storm sewers. Storage containers shall be identified by waste type and capacity in gallons and sized to prevent overfilling. All storage containers shall have a lid that prevents rainwater inflow and that can be locked to prevent vandalism.
- (p) Locations and details for all wash-down areas are shown and labeled. All wash-down areas shall be designed to prevent the release of wash-water and FOG to ground, groundwater, surface waters, storm sewer or any other location not approved by the Director or Director's designee. Where mat and equipment wash-down is to be performed in a mop sink, the mop sink shall be sized and labeled.
- (q) Solids separation is provided prior to existing or proposed FOG control devices that require a flow control device or that are not certified to handle solids.

420 (r) Access is provided for cleaning of food solids and congealed grease in grease waste
421 drains where the horizontal run from the source of food waste and FOG is greater than
422 twenty-five (25) feet from the solids separator or FOG control device. Access points shall
423 not be greater than twenty-five (25) feet, measured center-to-center. Location of access
424 points and details for access point shall be provided in drawings. Where the horizontal
425 run from the source of food waste and FOG is greater than one hundred (100) feet,
426 plans shall include provisions for preventing clogging by congealed FOG. Where the
427 FOG control device is located at a remote location, it shall be equipped with a functional
428 Interceptor Monitoring Alarm or Device. Remote locations include a different floor or
429 horizontal distance exceeding one hundred (100) feet from the back of the house area.

431 (s) Sanitary wastes from bathrooms and stormwater are not discharged into grease waste
432 drains, solids separators or FOG control devices.

434 (7) FOG Control Device Sizing. Where required in Section 24-42.6, FOG control devices
435 shall be sized for all intended users, facilities and tenants using one of the following criteria and
436 approved by the Director or Director's designee:

438 (a) Calculations prepared by a Florida Professional Engineer demonstrate that the FOG
439 effluent concentration is equal to or less than the oil and grease sanitary sewer
440 discharge limitation and pretreatment standard referenced in Section 24-42.4.
441 Calculations shall include peak flow rate; temperature and temperature driven flow
442 patterns; rising and settling velocities; short-circuiting induced by inlet, baffle and outlet
443 effects and velocity distribution; FOG and solids loading rate; and frequency of FOG and
444 solids removal, or

446 (b) Calculations prepared by a Florida Professional Engineer that include projected peak
447 flow rate; temperature; FOG and solids loading rates; proposed frequency of FOG and
448 solids removal; and third party certification of maximum FOG containment capacity and
449 effluent concentration. The certified effluent concentration shall be equal to or less than
450 the oil and grease sanitary sewer discharge limitation and pretreatment standard
451 referenced in Section 24-42.4; or

452

453 (c) Calculations prepared by a Florida Professional Engineer that include projected peak
454 flow rate, five (5)-minute hydraulic detention time, temperature, FOG and solids loading
455 rates, proposed frequency of FOG and solids removal, and third party certification of
456 FOG removal efficiency and containment capacity; or

457
458 (d) Chapter 64E-6, Florida Administrative Code, provided that the total wet volume, minus
459 the maximum volume of waste stored between cleaning cycles, is the greater of the
460 following:

461
462 (i) Seven hundred and fifty (750) gallons; or

463
464 (ii) Volume calculated based on Chapter 64E-6; or

465
466 (iii) Volume calculated by multiplying the projected peak flow, in gallons per minute
467 (gpm), by thirty (30) minutes retention time. Peak flow shall not be less than the
468 flow rate calculated by dividing the number of drainage fixture units (DFUs) by the
469 appropriate factor below.

470

<u>Nominal pipe size in</u>	<u>DFU/gpm</u>
<u>inches</u>	
<u>3</u>	<u>0.8</u>
<u>4</u>	<u>1.7</u>
<u>5</u>	<u>2.1</u>
<u>6</u>	<u>2.3</u>
<u>8</u>	<u>2.4</u>

471

472 As an alternative to calculating the maximum volume of waste stored between
473 cleaning cycles, required in Section 24-42.6(7)(d) above, the greatest wet volume
474 calculated shall be multiplied by the following factors:

475

<u>Cleaning Cycle</u>	<u>Factor</u>
<u>Every 30 days</u>	<u>1.0</u>
<u>Every 60 days</u>	<u>1.15</u>

478

479
480

Every 90 days

1.25

DRAFT

481 (8) Operating Permits for FOG Generators and FOG Control Device Operators. No person
482 shall operate, cause, let, permit, suffer or allow the operation of a FOG generating facility or
483 FOG control devices serving FOG generators without a valid FOG operating permit issued by
484 the Director or the Director's designee or in violation of any condition, limitation or restriction
485 which is part of a FOG operating permit. FOG operating permits are valid for up to one year,
486 expire December 31 of each year, and shall be renewed annually by January 1 of each calendar
487 year.

488
489 (a) Applications for new FOG generators and new FOG control device operators and
490 renewals of same shall be in a form prescribed by the Director or Director's designee.
491 When the FOG operating permit applicant is a tenant, the application shall be completed
492 and signed by the tenant(s) and property owner(s). The owner's section of the
493 application shall include a statement acknowledging that the property owner(s) is
494 responsible for the proper closure of a FOG generator pursuant to Section 24-
495 42.6(8)(c)(vi).

496
497 (b) Renewal applications shall include a certification form, which is prescribed by the
498 Director or the Director's designee. Said form shall be prepared by a Florida
499 Professional Engineer or licensed plumber, attesting that the existing FOG control
500 devices are functioning as designed and are in good working order. Where required in
501 this Section, the renewal shall also include training certificates for staff trained pursuant
502 to Section 24-42.6(8)(c)(iv).

503
504 (c) Operating permits for new FOG generators and new FOG control device operators, and
505 renewal of same, discharging to a utility or non-utility owned or operated sanitary sewer
506 system or an onsite sewage treatment and disposal system located in the basic wellfield
507 protection area of any utility potable water supply wells shall include the following:

508
509 (i) *Best management practices.* The Director or Director's designee shall maintain a
510 list of approved best management practices and update the list annually or as
511 required.

512
513 (ii) *Maintenance.* All FOG control devices and equipment shall be serviced to function
514 properly and continuously to prevent the discharge of FOG into building sanitary

515 drains, building sewers, utility or non-utility owned or operated sanitary sewer
516 systems, and onsite sewage treatment and disposal systems. Where cleaning of
517 FOG control devices is required in Section 24-42.6, cleaning shall include the
518 complete removal of the full contents of the FOG control device, including settled
519 solids, wastewater and floating materials. Side walls, baffle walls, cross-pipes, and
520 inlet and outlet pipes shall be pressure washed or scraped to remove all attached
521 materials. Decanting, skimming, or backflushing is prohibited. Emulsifiers, grease
522 cutters or other chemicals or detergents which could cause FOG to pass through
523 the system to the building sanitary drains or building sewers are prohibited and
524 shall not be used. At a minimum, the following maintenance shall be performed:

525
526 1. *Grease Waste Drains, Building Sanitary Drains and Building Sewers.* When
527 jetting, rodding or other cleaning activities are required, FOG shall not be
528 flushed, discharged, conveyed or allowed to pass through to utility or non-utility
529 owned or operated sanitary sewer systems or onsite sewage treatment and
530 disposal systems. All FOG shall be collected and transported by a liquid waste
531 transporter, permitted by the Department, to an approved disposal facility.

532
533 2. *Kitchen Exhaust Hoods.* All waste generated by manual hood cleaning shall
534 not be flushed, discharged, conveyed or allowed to pass through to utility or
535 non-utility owned or operated sanitary sewer systems or onsite sewage
536 treatment and disposal systems. All wastes shall be collected and transported
537 by a liquid waste transporter permitted by the Department to an approved
538 disposal facility. Where a hood is designed to be self-cleaning, the FOG control
539 device shall be designed for the maximum cold water and hot water flow rates.
540 Where a surfactant/detergent is used, the FOG control device shall be sized to
541 provide sufficient detention time to allow FOG waste separation so that the
542 effluent does not exceed the standards set forth in Section 24-42.4.

543
544 3. *Yellow and Brown Grease Storage Areas.* Yellow and brown grease storage
545 areas shall be maintained free of debris and storage containers shall not be
546 overfilled. Storage containers shall be visually inspected daily and emptied
547 before they reach ninety (90) percent capacity. Spills shall be contained and
548 cleaned using absorbent materials. Wet cleanup methods shall not be used.

549 Storage container lids shall be maintained to prevent rainwater inflow and
550 locked to prevent vandalism.

551
552 4. *Mat and Equipment Wash-Down Areas.* Mat and equipment wash-down areas
553 shall be maintained free of debris and wash-water shall not be released to
554 ground, groundwater, surface waters, storm sewer or any other location not
555 approved by the Director or Director's designee. Wash-down areas shall not
556 allow stormwater or rainwater to enter the building sanitary drains, building
557 sewers, utility or non-utility owned or operated sanitary sewer systems, or
558 onsite sewage treatment and disposal systems.

559
560 5. *Solids Separators.* Where installation of a solids separator is required or
561 approved pursuant to Section 24-42.6(5), solids separators shall be serviced to
562 function as designed and shall not be missing or have defective elements or
563 components that reduce its ability to separate solids. All solids separators shall
564 be visually inspected daily to prevent excessive accumulation and discharge of
565 food solids to FOG control devices, building sanitary drains, building sewers,
566 utility or non-utility owned or operated sanitary sewer systems, or onsite
567 sewage treatment and disposal systems. Solids shall be properly discarded as
568 solid waste or removed by a liquid waste transporter permitted by the
569 Department.

570

571
572
573
574
575
576
577
578
579
580
581
582
583
584
585
586
587
588
589
590
591
592
593
594
595
596
597
598
599
600
601
602
603
604

6. Grease Traps. Cleaning of grease traps shall be performed as follows:

a. Automatic grease traps shall be cleaned by a liquid waste transporter, permitted by the Department. Automatic grease traps shall be cleaned monthly or more frequently so that the FOG capacity limit or effluent standards in Section 24-42.4 are not exceeded. The contents of the strainer/screen and automatic storage receptacles shall be emptied by the FOG generator on a daily basis and transferred to waste containers intended and approved for such use to prevent overfilling or spills. If at any time the automatic elements or components do not function as intended and designed, the malfunctioning automatic grease trap shall be operated and reported as a manual grease trap and cleaned by a liquid waste transporter, permitted by the Department, on a daily basis until the system is repaired. In no instance shall the automatic grease trap operate as a manual grease trap for more than thirty (30) days or cause a sanitary nuisance at any time. In the event of a sanitary nuisance, such conditions shall be abated within twenty-four (24) hours pursuant to Section 24-28. The automatic grease trap shall be repaired within thirty (30) days of malfunctioning. If the automatic grease trap is not capable of repair, it shall be replaced within ninety (90) days of malfunctioning. Plans for replacement shall be reviewed and approved by the Director or Director's designee pursuant to Section 24-42.6(7).

b. Manual grease traps shall be cleaned monthly by a liquid waste transporter permitted by the Department or more frequently when necessary to avoid exceeding the FOG capacity limit or effluent standards in Section 24-42.4. The FOG generator shall remove floating materials and settled solids on a daily basis and transfer the waste to containers intended and approved for such use to prevent overfilling or spills.

Exception: A FOG generator that does not have fryers, is not required by the Florida Building Code Mechanical (latest addition) to have a Type I kitchen exhaust hood, the peak flow rate to the grease trap does not

605 exceed twenty (20) gallons per minute, and cleans the grease trap daily is
606 not required to have a liquid waste transporter clean the grease trap
607 monthly if the FOG generator does not discharge FOG or food waste in
608 quantities or concentrations which negatively affects or hinders the
609 operation of any onsite sewage treatment and disposal system, sewage
610 collection, transmission or treatment system, or causes a sanitary nuisance.

611
612

613 7. Grease Interceptors. Cleaning of grease interceptors shall be performed as
614 follows:

615

616 a. Grease interceptors shall be shall be cleaned every sixty (60) days by a
617 liquid waste transporter permitted by the Department or more frequently
618 when necessary to avoid exceeding the FOG capacity limit or effluent
619 standards in Section 24-42.4.

620

621 b. Grease interceptors equipped with a functional Interceptor Monitoring
622 Device shall be cleaned every one hundred eighty (180) days by a liquid
623 waste transporter permitted by the Department or more frequently when
624 necessary to avoid exceeding the FOG capacity limit or effluent standards
625 in Section 24-42.4.

626

627 c. Grouped grease interceptors, in parallel or series, shall all be cleaned every
628 sixty (60) days by a liquid waste transporter permitted by the Department or
629 more frequently when necessary to avoid exceeding the FOG capacity limit
630 or effluent standards in Section 24-42.4. Where functional Interceptor
631 Monitoring Devices are used, all grease interceptors shall be cleaned every
632 one hundred eighty (180) days by a liquid waste transporter permitted by
633 the Department or more frequently when necessary to avoid exceeding the
634 FOG capacity limit or effluent standards in Section 24-42.4.

635

636 (iii) Record Keeping. Each FOG generator and FOG control device operator shall
637 maintain records of maintenance and repair activities, service calls and staff
638 training. All records shall be retained onsite for a period of not less than three years

639 and made available onsite to Department staff upon request. Offsite records shall
640 not be an acceptable substitute for onsite records required herein. At a minimum,
641 each FOG generator and FOG control device operator shall maintain the following
642 records using forms prescribed by the Director or Director's designee.

643
644 1. Scheduled and unscheduled service calls to clean grease waste drains,
645 building sanitary drains, or building sewers.

646
647 2. Repairs required resulting from food or FOG accumulation or blockages.

648
649 3. Kitchen exhaust hood cleaning.

650
651 4. FOG control device cleaning, maintenance and repair.

652
653 5. Waste manifest forms pursuant to Sections 24-42.6(9) and 24-46.

654
655 6. Staff training records pursuant to Section 24-42.6(8)(c)(iv).

656
657 (iv) Training Requirements. Each FOG generator and FOG control device operators
658 shall maintain trained staff to ensure compliance with the requirements of Section
659 24-42.6(8). The content and form of training shall be prescribed by the Director or
660 Director's designee. Training shall include orientation of new employees and
661 quarterly training of existing employees. On or before January 1, 2019, each FOG
662 generator and FOG control device operator shall have one (1) trained person on
663 staff which has working knowledge of the following where applicable:

664
665 1. Kitchen exhaust hoods,

666
667 2. Solids separators.

668
669 3. FOG control devices.

670
671 4. Best management practices.

672

673 5. Yellow and brown grease storage.

674

675 6. Mat and equipment wash-down areas.

676

677 7. Record keeping and reporting.

678

679 (v) Reporting. Each FOG generator and FOG control device operator shall submit
680 monthly reports to the Department using forms prescribed by the Director or
681 Director's designee. Where made available by the Department, reporting shall be
682 completed using a secure online system or by an equivalent system developed by
683 the Department. Monthly reports shall include total volume of each waste stream
684 disposed, transported or collected, the date and the name of liquid waste
685 transporter.

686

687 (vi) Closure Requirements. No more than thirty (30) days after a FOG generator
688 closes, the property owner shall notify the Department to perform a closure
689 inspection. On or before the closure inspection, the property owner shall have all
690 yellow and brown grease containers and bins emptied, storage areas cleaned and
691 FOG control devices cleaned. Decanting, skimming, or backflushing is prohibited.
692 Emulsifiers, grease cutters or other chemicals and detergents which could cause
693 FOG to pass through the system to the drain lines are prohibited and shall not be
694 used. All waste shall be disposed at a permitted facility, using an approved liquid
695 waste transporter with manifests submitted to Department.

696

697 (d) Existing FOG generators with a current FOG operating permit, issued prior to (CLERK
698 TO INSERT EFFECTIVE DATE), proposing to increase seating capacity, dining area or
699 drive-thru capacity, or other modification, any of which will increase the discharge of
700 FOG, shall comply with Sections 24-42.6(5)(a) and 24-42.6(8)(c).

701

702 (e) FOG generators discharging to an onsite sewage treatment and disposal system located
703 in the basic wellfield protection area of any utility potable water supply wells, proposing
704 to increase seating capacity, dining area or drive-thru capacity, or other modification, any
705 of which will increase the discharge of FOG, shall comply with Sections 24-42.6(5)(a)
706 and 24-42.6(8)(c).

707
708
709
710
711
712
713
714
715
716
717
718
719
720
721
722
723
724
725
726
727
728
729
730
731
732
733
734

735
736

737
738
739

(f) FOG generators discharging to an onsite sewage treatment and disposal system located in the basic wellfield protection area of any utility potable water supply wells, not proposing to increase seating capacity, dining area or drive-thru capacity, or other modification, any of which will increase the discharge of FOG, shall apply for an operating permit by January 1, 2018.

(g) Any FOG operating permit approved and issued by the Department may be revoked for failure to comply with permit conditions or conditions established in Section 24-42.6. Cause for revoking an operating permit may include, but not be limited to, the following:

- (i) Falsifying information on any record or document required by the county; or
- (ii) Failure to have a FOG control device cleaned properly or in a timely manner as described in Section 24-42.6(8); or
- (iii) Having a FOG control device cleaned by a person not permitted by the Department to perform such cleaning; or
- (iv) Utilizing a liquid waste transporter not permitted by the Department; or
- (v) Failure to comply with any permit condition; or
- (vi) Violation of any federal, state, or local regulation governing the handling of FOG wastes; or
- (vii) Failure to pay invoices, fees, fines, judgments or liens owed to the county.

The revocation of an operating permit shall be in addition to any penalties assessed for violation of this Chapter, or provided elsewhere in the Code of Miami-Dade County.

(9) FOG Liquid Waste Transporters. Notwithstanding any provision of this Code, no person shall collect, pump, transport, or cause, let, permit, suffer or allow any FOG, yellow grease,

740 brown grease or black grease to be collected, pumped or transported without a valid operating
741 permit issued by the Department pursuant to Sections 24-18, 24-42.6(8) and 24-46. In addition
742 to the requirements enumerated in Section 24-46, FOG liquid waste transporters shall comply
743 with the following:

744
745 (a) All waste transported shall be manifested using forms prescribed by the Director or
746 Director's designee. Where made available by the Department, reporting shall be
747 completed using a secure online system or by an equivalent system developed by the
748 Department.

749
750 (b) FOG, yellow grease and brown grease shall only be stored or disposed at private or
751 public facilities approved by the Department.

752
753 (c) FOG control device cleaning shall include completely removing the full contents of the
754 FOG control device, including settled solids, wastewater and floating materials, pressure
755 washing or scraping side walls, baffle walls, cross-pipes, and inlet and outlet pipes to
756 remove all attached materials. Decanting, skimming, or backflushing is prohibited.
757 Emulsifiers, grease cutters or other chemicals and detergents which could cause FOG to
758 pass through the system to the building sanitary drains or building sewers are prohibited
759 and shall not be used.

760
761 (d) Effective January 2, 2017, liquid waste transporter staff shall be trained to ensure
762 compliance with the requirements of Section 24-42.6(8)(c). The content and form of
763 training shall be prescribed by the Director or Director's designee. At a minimum, one
764 trained staff member shall be present while grease traps or grease interceptors are
765 being cleaned. Staff performing assessments of the condition of any system or part
766 thereof (condition assessments) stipulated in Section 24-42.6(9) shall be trained in
767 accordance with this Section.

768
769 (e) Effective January 2, 2017, septage or other waste shall not be commingled with yellow
770 or brown grease.

771

772 (f) Effective January 2, 2017, where made available by the Department, waste manifesting
773 shall be completed using a secure online system or by equivalent system developed by
774 the Department.

775
776 (g) Effective January 2, 2017, liquid waste transporters shall perform FOG control device
777 condition assessments when cleaning is required pursuant to Section 24-42.6(8)(c). The
778 condition assessment shall be performed and reported using forms prescribed by the
779 Director or Director's designee, including online forms where made available by the
780 Department. At a minimum, the condition assessment shall document the following:

781
782 (i) The water level and thickness of floating FOG and settled solids prior to cleaning.

783
784 1. Where FOG control devices are installed below ground and the water level prior
785 to cleaning is below the invert of the outlet pipe, or groundwater infiltration is
786 observed during or after cleaning, the condition assessment shall document
787 leaks.

788
789 2. Where FOG control devices are installed above ground and leaks are observed,
790 the condition assessment shall document leaks.

791
792 3. All leaks shall be reported to the Department within twenty-four (24) hours of
793 being detected or observed and the FOG control device repaired within forty-
794 eight (48) hours. Until the FOG control device is repaired, the FOG control device
795 shall not receive any flow or be bypassed.

796
797 4. Should a leak cause a sanitary nuisance, the sanitary nuisance shall be
798 removed, abated or corrected within twenty-four (24) hours or such other
799 reasonable time as the Director or the Director's designee may determine.

800
801 (ii) Integrity of solids separators and FOG control devices, including the inlet and outlet
802 appurtenances; interior, bottom, top, side walls, baffle walls, and cross-pipes;
803 manhole rings, extenders and covers; sampling points and cleanouts; interceptor
804 monitoring alarms and devices; and other elements and equipment approved by the
805 Department.

806
807
808
809
810
811
812
813
814
815
816
817
818
819
820
821
822
823
824
825
826
827
828
829
830
831
832
833
834
835
836
837
838

1. Where a solids separator or FOG control device is observed to be malfunctioning so that solids or FOG are being discharged to the building sanitary drains or building sewers, the Department shall be notified within twenty-four (24) hours of discovery of the unpermitted discharge and the malfunctioning device shall be repaired within forty-eight (48) hours.

2. In no instance shall the unpermitted discharge be permitted to continue or result in a building sanitary drain or building sanitary drain back-up or a sanitary nuisance.

(iii) All repairs performed by the liquid waste transporter.

(iv) The condition of yellow and brown grease containers and bins.

(10) FOG Disposal Facilities. All facilities accepting, storing, transferring or treating FOG, yellow grease or brown grease shall obtain an operating permit pursuant to Section 24-18(A)(23) and comply with the following:

(a) Maintain trained staff to assure compliance with the requirements of Section 24-42.6. The content and form of training shall be prescribed by the Director or Director's designee. Training shall be completed prior to permit renewal starting January 1, 2019. At a minimum, one (1) trained staff member shall be present during maintenance and repair of the system and/or system components.

(b) Submit monthly reports to the Department using forms prescribed by the Director or Director's designee. Where made available by the Department, reporting shall be completed using a secure online system or by an equivalent system developed by the Department. Monthly reports shall include total volume of each waste stream accepted, collected, stored, treated, disposed, or transported and include waste manifests for all waste transported. Waste manifests shall track waste from the point of origin to the final disposal facility.

839 (11) Utilities. Utilities shall submit a monthly report to the Department that includes the
840 following minimum information:

841
842 (a) A list with dates and locations where accelerated FOG maintenance was performed to
843 prevent a sanitary sewer overflow. Locations shall also be identified in a geographical
844 information system (GIS) format based on the utilities atlas pursuant to Section 24-42.2.

845
846 (b) A description of accelerated FOG maintenance performed, including quantities of FOG
847 removed, recovered, collected or treated to prevent a sanitary sewer overflow. The
848 information shall be provided in text and GIS form.

849 (c) Cost of accelerated FOG maintenance, including labor, equipment and materials. Labor
850 shall include field and office staff.<<

851 **END**

Attachment 1B
Revised Ordinance

Attachment 2

***NOVs Issued by Enforcement Requiring FOG System to be
Evaluated and/or Replaced***

#	WG	WG#	NAME
1	AW	174	Trump Doral
2	GDO	154	Wendy's 1711
3	GDO	218	Pollo
4	GDO	577	Esther's
5	GDO	580	McDonald's
6	GDO	1097	David's Café
7	GDO	1879	Starbucks
8	GDO	2261	Casablanca
9	GDO	2339	Garcia's Seafood
10	GDO	2378	DiPapa's
11	GDO	3376	China Buffet
12	GDO	3414	Dolores
13	GDO	3452	Dade County Public Schools
14	GDO	3455	Dade County Public Schools
15	GDO	3490	Dade County Public Schools
16	GDO	3562	Dade County Public Schools
17	GDO	3595	Dade County Public Schools
18	GDO	3596	Dade County Public Schools
19	GDO	3629	Dade County Public Schools
20	GDO	3652	Dade County Public Schools
21	GDO	3729	Dade County Public Schools
22	GDO	3745	Dade County Public Schools
23	GDO	3768	Dade County Public Schools
24	GDO	3774	Dade County Public Schools
25	GDO	3857	Dade County Public Schools
26	GDO	4230	Le Minotenn
27	GDO	4419	Roca Café - Cacique
28	GDO	4516	Cantinetta
29	GDO	5457	Pizza Rustica
30	GDO	6035	Divino Ceviche
31	GDO	7590	Red South Beach
32	GDO	9349	Dade County Public Schools
33	GDO	10086	Dade County Public Schools

AW-174



Carlos A. Gimenez, Mayor

Department of Regulatory and Economic Resources
Environmental Resources Management
701 NW 1st Court, 6th Floor
Miami, Florida 33136-3912
T 305-372-6567 F 305-372-6407

miamidade.gov

August 24, 2016

Samuel A. Rubert, Permittee
Trump Endeavor 12, LLC
4400 NW 87 Avenue
Doral, FL 33178

Certified Mail No. 7014 1200 0000 1637 2617
Return Receipt Requested

Re: Unauthorized discharges to the sanitary sewer system, Private Sanitary Sewer Operating Permit violations and violation of Environmental Quality Control Board Order No. 99-13 at, near, or in the vicinity of Trump National Doral Miami resort, 4400 NW 87 Avenue, Doral, Miami-Dade County, Florida (DERM PSO-850, AW-174, GDO-247).

Dear Mr. Rubert:

Inspections of the above-referenced facility, conducted by Department of Regulatory and Economic Resources, Division of Environmental Resources Management's (DERM) representatives during May and July 2016, have revealed numerous environmental concerns which require your immediate attention. Miami-Dade County is under a Federal Court Order to reduce the amounts of fats, oils and grease (FOG) in our public sanitary sewer system, and any non-residential facility that handles, prepares or processes food and has the potential to discharge FOG to the sewer system is required to secure a FOG Discharge Control operating permit. This permit, which provides for County inspections of FOG control facilities and requires the routine maintenance and record-keeping for all FOG control equipment, helps to eliminate blocked wastewater flows and costly and unsanitary clogged sanitary sewer pipes in the County's sanitary sewer system.

On May 9th and 10th and July 11, 2016, DERM inspections identified eight restaurant and kitchen facilities serving the subject premises. However, a review of DERM records revealed that six of the eight kitchen and restaurant facilities do not have the required DERM FOG Discharge Control Permit. While DERM inspections documented various pretreatment devices and methods for FOG control across the premises, kitchen fixtures located in the Pritikin Longevity Center were confirmed to be bypassing the in-ground FOG pretreatment "grease tanks" and discharging directly to sewers in violation of Miami-Dade County Code. Furthermore, these DERM inspections revealed that several of the on-site FOG pretreatment devices were inaccessible for inspection and that maintenance and disposal records for many of the FOG control devices were not available as required. The inspections also documented that the FOG pretreatment in-ground grease trap utilized by three facilities (Champions Bar and Grill, BLT Prime and Ivanka Kitchen and Ballroom) was inadequately treating the wastewater from the multiple combined operations. Samples collected by DERM representatives on July 11, 2016 revealed levels of FOG in the effluent to sewers which greatly exceeded Miami-Dade County Sewer Pretreatment Standards.

The subject premises are also served by eight private sanitary sewer pump stations. Private pump stations are permitted, monitored and inspected throughout Miami-Dade County in order to help ensure the continued operation of the entire County sewer system. On July 14, 2016, DERM conducted inspections of the eight private pump stations on-site and documented numerous operating permit violations, including inoperable stations, stations containing unacceptable levels of FOG, stations which

Delivering Excellence Every Day

Trump Doral
August 24, 2016

were allowing stormwater to infiltrate the sewers and stations with unauthorized, missing and/or defective equipment. A subsequent review of DERM records revealed that one of the eight pump stations is not permitted, and that the required monthly Elapsed Time (ET) readings, which are station-specific reports collected and submitted to DERM each month, have not been submitted for all stations as required. Additionally, a *Sewer System Evaluation Survey (SSES)*, which is vital for identifying and if needed rehabilitating any deficiencies in the entire on-site private sewer system, was due to be submitted to DERM in 2012. Miami-Dade County Code requires this survey to be performed every ten years, however to date the survey has not been submitted to DERM as required.

On May 10th, 2016 DERM inspections also documented that an unpermitted lift station was located in the facility's loading dock area. According to the facility's Chief Engineer, this lift station was designed and constructed to pump stormwater from a loading dock area into an adjacent private sanitary sewer station. The inspection also documented garbage collection and compaction containers in the loading dock area, with leachate from these containers leaking into the loading dock stormwater drain. Miami-Dade County Code prohibits both the discharge of stormwater into a sewer designed to carry sanitary waste and the discharge of industrial waste into a sewer designed to carry stormwater.

Lastly, a review of DERM records reveals that an on-site golf course lawn equipment maintenance area is subject to an Environmental Quality Control Board (EQCB) Order (No. 99-13), which grants a variance from the sanitary sewer connection requirements of Chapter 24 of the Miami-Dade County Code. The variance, which allows for the non-residential use of the maintenance area while served by a septic tank system, requires compliance with multiple Board Order conditions including the requirement to submit a covenant to DERM. A review of DERM records reveals that a covenant was never submitted as required, and therefore the Board Order is deemed null and void and the Miami-Dade County Code variance afforded therein is no longer in effect.

Please be advised that the above constitutes violations of Chapter 24 of the Miami-Dade County Environmental Protection Ordinance, specifically:

Section 24-18(A)(18), of said Chapter, inasmuch as no person shall operate, maintain or permit, cause, allow, let or suffer the operation or maintenance of any nonresidential facility which can introduce oil and grease into a sewer in quantities which have the potential to affect or hinder the operation of sewage collecting, transmission or treatment facilities, without a valid operating permit issued by the Director or the Director's designee;

Section 24-29, of said Chapter, inasmuch as it shall be unlawful for any person to violate any of the provisions of this chapter, any lawful rules and regulations promulgated under this chapter, any lawful order of the Director of the Department of Environmental Resources Management or his designee, or any conditions, limitation or restriction which is part of an operating permit;

Section 24-42.2(3), of said Chapter, inasmuch as each utility or non-utility owned or operated sanitary sewer collection system shall be evaluated in order to identify and reduce infiltration and inflow into the sanitary sewer collection system. The utility or non-utility shall implement a sewer system evaluation survey (SSES) and submit a report

Trump Doral
August 24, 2016

summarizing the findings of the SSES to DERM for review and Approval. SSES reports are due on or before each and every ten (10) year anniversary of November 12, 2002;

Section 24-42.4(2)(a)(i), of Chapter 24, inasmuch as it shall be unlawful for any person to throw, drain, run or otherwise discharge into a sewer designed to carry storm water, or to cause, permit, allow or suffer to be thrown, run, drained, allowed to seep, or otherwise discharged into such sewer domestic sewage, industrial waste, liquid waste or other waste.

Section 24-42.4(2)(b), of said Chapter, inasmuch as it shall be unlawful for any person to throw, drain, run or otherwise discharge into a sanitary sewer, or to cause, permit allow or suffer to be thrown, run, drained, allowed to seep, or otherwise discharged into such sewer any storm water.

Section 24-42.4(2)(d)(vi), of said Chapter, inasmuch as it shall be unlawful for any person to throw, drain, run or otherwise discharge into a sanitary sewer, or to cause, permit allow or suffer to be thrown, run, drained, allowed to seep, or otherwise discharged into such sewer oil and grease in excess of 100 mg/l; and

Sections 24-43.1(4), of Chapter 24, inasmuch as no person shall construct, utilize, operate, occupy, or cause, allow, let, permit or suffer to be constructed, utilized, operated or occupied, any nonresidential land use served or to be served by any source of public water and a septic tank without obtaining the prior written approval of the Director or the Director's designee.

Therefore, pursuant to the authority granted to me under Chapter 24 of the Code of Miami-Dade County, you are hereby ordered to:

1. **Within thirty (30) days** of receipt of this Notice, reinstate the variance afforded to the maintenance area in EQCB Board Order 99-13 by executing and recording the attached "COVENANT RUNNING WITH THE LAND IN FAVOR OF MIAMI-DADE COUNTY" in its entirety with the Miami-Dade County Clerk of Courts. Submit a stamped copy of the recorded Covenant to: DERM, Code Coordination and Public Hearings, 701 NW 1st Court, 4th Floor, Miami, FL 33136.

FOR STORMWATER FACILITIES

2. Upon receipt of this Notice, immediately Cease and Desist from discharging stormwater, including but not limited to the stormwater collected from the facility's loading dock and garbage collection/compaction area, into the private sanitary sewer system. Please refer to the attached "Exhibit A" for the Loading Dock location.
3. **Within sixty (60) days** of receipt of this Notice, submit to DERM for review and approval process changes for leachate control in the loading dock and garbage collection/compaction area which shall bring your facility into compliance with the provisions of this Chapter.

Trump Doral
August 24, 2016

4. **Within sixty (60) days** of receipt of this Notice, submit to DERM for review and approval formal plans for changes to the stormwater management system in the Loading Dock area which shall bring your facility into compliance with the provisions of this Chapter. The formal plans must be signed and sealed by a Professional Engineer certified in the State of Florida, and must be submitted with the appropriate review fee to: Miami-Dade County DERM West Dade Plan Review Office, at 11805 SW 26 Street, Miami, Florida.

FOR FOG FACILITIES

5. Upon receipt of this Notice, immediately implement a 30-day maintenance and disposal routine, which incorporates the removal of all accumulated waste, including FOG, wastewater and settled solids, for all FOG treatment devices on-site.
6. Upon receipt of this Notice, immediately implement and maintain a FOG Maintenance Log (attached) for each of the eight kitchen/restaurant facilities serving the premises.
7. **Within thirty (30) days** of receipt of this Notice, submit a completed "*Fat, Oil & Grease Discharge Control-Operating Permit*" application (attached) for each of the following six facilities: *Champions Bar and Grill, Palm Grill, Marketplace Café, Ivanka Kitchen & Ballroom, Trump Café* and *Donald J. Trump Ballroom and Kitchen*.
8. **Within sixty (60) days** of receipt of this Notice, provide influent and effluent inspection access points and effluent sampling points for all FOG treatment systems and devices on-site, including but not limited to the in-ground tanks (IGTs) and hydromechanical units serving the *Champions Bar and Grill*, the hydromechanical unit serving the *Marketplace Café*, the IGTs serving the *Pritikin Longevity Center* and the automatic grease recovery unit serving the *Trump Cafe*. Please refer to the attached "Exhibit A" for approximate FOG pretreatment device locations.
9. **Within ninety (90) days** of receipt of this Notice, submit to DERM formal plans identifying all FOG treatment systems and devices on the premises. The plans shall include, at a minimum, the requirements enumerated in "Exhibit B," and shall be signed and sealed by a Florida Professional Engineer and submitted to: DERM, Wastewater Permitting Section, 701 NW 1st Court, 7th Floor, Miami, FL 33136.

FOR PRIVATE SANITARY SEWER FACILITIES

10. **Within fifteen (15) days** of receipt of this Notice, replace missing and/or inoperable pumps in all pump stations, including but not limited to pump station B. Please refer to the attached "Exhibit A" for pump station locations.
11. **Within fifteen (15) days** of receipt of this Notice, properly secure with a suitable locking mechanism the wet wells, valve box covers and control panels on all pump stations, including but not limited to stations B, C, D, E, G and H.

Trump Doral
August 24, 2016

12. **Within fifteen (15) days** of receipt of this Notice, remove any and all debris in pump station wet wells, including but not limited to wet wells in stations D and G, and maintain all wet wells free from debris with regular service intervals.
13. **Within thirty (30) days** of receipt of this Notice, submit all past-due monthly ET meter readings for all private sanitary sewer pump stations on-site, including but not limited to stations B, G and H, in accordance with Specific Condition No. 2 of your annual operating permit (attached). Please refer to "Exhibit C" for specific reporting months required for delinquent pump stations.
14. **Within thirty (30) days** of receipt of this Notice, provide a proper cover for the open and unsafe wet well in pump station E.
15. **Within sixty (60) days** of receipt of this Notice, install the required signage on all pump stations, including but not limited to stations A, F and H, in accordance with Specific Condition No. 7 of your annual operating permit (attached).
16. **Within ninety (90) days** of receipt of this Notice, submit to DERM for review and approval an updated Operation & Maintenance (O&M) Manual for the entire Private Sanitary Sewer collection system serving the subject premises. Said O&M Manual shall be prepared in accordance with Specific Condition No. 4 of your annual operating permit, and shall include pump characteristics for each pump utilized within the system.
17. **Within ninety (90) days** of receipt of this Notice, install a standard wet well cover in pump station A which will prohibit rainwater from entering the sanitary sewer system.
18. **Within ninety (90) days** of receipt of this Notice, provide proper ventilation for wet wells in pump stations F, G and H.
19. **Within ninety (90) days** of receipt of this Notice, install emergency electrical connections and emergency pump connections on all pump stations, including but not limited to stations A, B, C, D, E, F, G and H.
20. **Within ninety (90) days** of receipt of this Notice, submit to DERM for review and approval, a Sewer System Evaluation Survey (SSES) that meets the standards set forth in Chapter 24 of the Code of Miami-Dade County. The SSES shall be signed and sealed by a Florida Professional Engineer, and shall be submitted to: DERM, Wastewater Permitting Section, 701 NW 1st Court, 7th Floor, Miami, FL 33136. A report cover which includes the reference "PSO-850," along with a review fee of one hundred and twenty dollars (\$120.00) shall be included with the submittal.

Please be advised failure to comply with the above may result in this case being referred to the Office of the County Attorney for further enforcement action, or you may be issued a Uniform Civil Violation

Trump Doral
August 24, 2016

Notice (UCVN) pursuant to Chapter 8CC, Miami-Dade County Code, which carries a mandatory civil penalty and a requirement to correct the violation.

Any person aggrieved by any action or decision of the DERM Director may appeal said action or decision to the Environmental Quality Control Board (EQCB) by filing a written notice of appeal along with submittal of the applicable fee, to the Code Coordination and Public Hearings Section of DERM within fifteen (15) days of the date of the action or decision by DERM.

Please contact the undersigned at (305) 372-6516 or via email at Anderj@miamidade.gov if you have any questions of if you would like to schedule a meeting to discuss these matters further.

Sincerely,

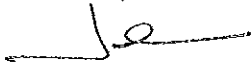

John D. Andersen
Code Enforcement Officer

Cc: Carlos Hernandez, P.E., Oscar Aguirre, Laura Castillo, DERM
Arbelio Tejeda, Chief Engineer (atejeda@trumphotels.com)

Trump Doral
August 24, 2016

EXHIBIT A

Approximate Pump Station and FOG device locations

(South side of Maintenance area
North of course)

(Adjacent to Golf School)

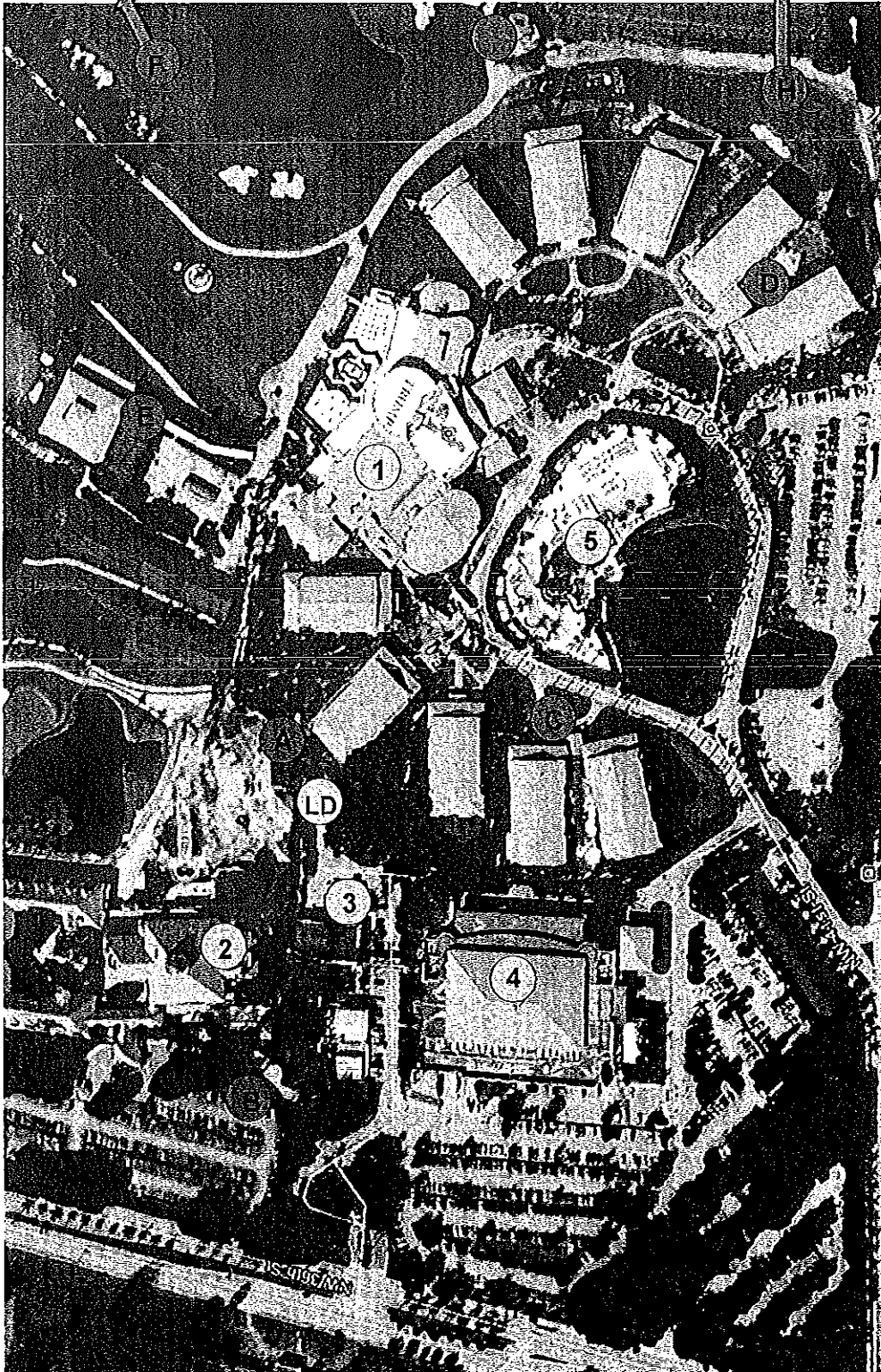

LOADING DOCK (LD)

PUMP STATIONS

A: PS 99-850A

B: PS 99-850B

C: PS 99-850C

D: PS 99-850D

E: PS 99-850E

F: PS 99-850F

G: PS 99-850G

H: PS 99-850H

FOG FACILITIES

1: GDO-4347, 7258, 11110, 11112: Champions, Ivanka Ball Room, BLT Prime, Market Place

2: GDO-451: Pritikin

3: GDO-11134: Trump Café

4: GDO-11196 DJT Ballroom

5: GDO-11111: Palm Grill

Trump Doral
August 24, 2016

EXHIBIT B

FOG PRETREATMENT SYSTEMS PLAN REQUIREMENTS

Plans signed and sealed by a Florida Professional Engineer shall include, at a minimum, all requirements enumerated below:

1. Complete plumbing drawings, plan and isometric, for the entire facility. Drains/pipes shall be labelled Sanitary or GW (Grease Waste). All lines that receive or can receive waste from fixtures that can discharge food waste or Fats, Oils and Grease (FOG) shall be labeled grease waste GW to distinguish from sanitary waste.
2. Complete building sewer plans, showing all connections from the facility to the public sanitary sewer system.
3. All plumbing fixtures, solids separators, grease interceptors/grease traps and sampling points.
4. Calculations for the existing FOG Control Devices (e.g., grease interceptors). Calculations shall include peak flow rates, FOG and solids loading rates, and pump-out (cleaning) frequency and demonstrate that the final effluent will comply with Section 24-42.4 (e.g., 100 mg/L Oil & Grease). FOG loading shall include all FOG sources, including FOG generated by preparing meals and cleaning associated with eat-in and take-out meals. FOG generated by cleaning shall include exhaust hood cleaning.
5. The FOG Control Devices shall be located to allow uninterrupted maintenance and inspection; i.e., the system shall be accessible all times and not require intervention to access, clean and inspect.
6. All drainage fixtures located in food and beverage preparation areas shall be connected to the proposed FOG Control Device. Drainage fixtures include, but are not limited to: floor drains, floor sinks, mop sinks, three-compartment sinks, hand sinks, pre-rinse station/sink, preparation sink, pot sink, wok sink, and self-cleaning exhaust hoods.
7. Sampling points located after the point of no further treatment. The sampling points shall be directly accessible for visual inspection and sampling. Sampling points shall have sufficient depth and access to allow sample collection using a 3-inch diameter x 6-inch long sample bottle.
8. Solids separation prior to existing or proposed FOG control devices that require a flow control device or are not certified to handle solids.

Trump Doral
August 24, 2016

EXHIBIT C

Elapsed Time (ET) Meter Readings Due

Pump Station

- PS 99-00850B
- PS 99-00850G
- PS 99-00850H

ET Readings due

Jan 2016, Feb 2016 Mar 2016,
Apr 2016, May 2016, June 2016,
July 2016

May 2015 to July 2016

May 2015 to July 2016

COVENANT RUNNING WITH THE
LAND IN FAVOR OF
MIAMI-DADE COUNTY

The undersigned, Trump Endeavor 12 LLC; being the present owner of the following described real property (hereinafter called "the property"):

See Exhibit "A"

Located at approximately N.W. 104^h Avenue and N.W. 48^h Street, Miami-Dade County, Florida, pursuant to a variance from the requirements of Section 24-43.1(4) granted by the Miami-Dade County Environmental Quality Control Board, hereby submits this executed covenant running with the land in favor of Miami-Dade County:

The undersigned agrees and covenants to the following:

1. This portion of the property shall only be used as a vehicle equipment maintenance facility ancillary to a golf course. No paint and body work, steam cleaning, engine or transmission overhauls shall be allowed until such time as the property is connected to an operable public water main and an operable public sanitary sewer, unless a separate variance is granted by the Environmental Quality Control Board, pursuant to Chapter 24 of the Code of Miami-Dade County, Florida.
2. The only liquid waste other than domestic sewage, which shall be generated, disposed of, discharged or stored on the property shall be that liquid waste generated from vehicle equipment maintenance ancillary to a golf course.
3. Prior to the entry into a landlord-tenant relationship with respect to the Property, the undersigned agree(s) to notify in writing all proposed tenants of the Property of the existence and contents of this Covenant.
4. The undersigned agree(s) and covenant(s) that this Covenant and the provisions contained herein may be enforced by the Director of Environmental Resources Management by preliminary, permanent, prohibitory, and mandatory injunctions as well as otherwise provided for by law or ordinance.
5. This agreement and Covenant shall be recorded in the Public Records of Miami-Dade County, Florida and the provisions hereof shall constitute a Covenant Running with the Land and shall remain in full force and effect and be binding upon the undersigned, their heirs, legal representatives, estates, successors, grantees and assigns.
6. This agreement and Covenant shall upon request by the undersigned be released by the Director of Environmental Resources Management or his designee when the Property has been connected to an operable public water main and an operable public sanitary sewer.

7. This Covenant is to run with the land and shall be binding on all parties and all persons claiming under it for a period of thirty (30) years from the date this Covenant is recorded after which time it shall be extended automatically for successive periods of ten years each, unless an instrument signed by the, then, owner(s) of the Property has been recorded agreeing to change the Covenant in whole, or in part, provided that the Covenant has first been modified or released by Miami-Dade County as specified herein.

IN WITNESS WHEREOF, the undersigned have caused this Covenant to be executed this _____ day of _____, 2016.

Limited Liability Corporation

WITNESSES:

Sign _____
Print _____
Sign _____
Print _____

Managing Partner _____
Sign _____
Print _____
Title _____
Address _____

WITNESSES:

Sign _____
Print _____
Sign _____
Print _____

Managing Partner _____
Sign _____
Print _____
Title _____
Address _____

STATE OF FLORIDA, COUNTY OF MIAMI-DADE

The foregoing instrument was acknowledged before me this _____ day of _____, 2016, by _____, as _____ of _____ on behalf of the Florida Limited Liability Corporation.

He or she is personally known to me or has produced _____ as identification and did take an oath.

NOTARY PUBLIC:

Sign _____
Print _____
State of Florida at Large (Seal)
My Commission Expires:

THIS INSTRUMENT PREPARED BY:

Mirna Leal
DERM - Code Coordination and Public Hearings
701 N.W. 1st Court, 4th Floor
Miami, Florida 33136

BEFORE THE MIAMI-DADE COUNTY ENVIRONMENTAL QUALITY CONTROL BOARD

AW - 174

IN RE: Board Order No. 99-13
Doral Park Joint Venture

THIS MATTER came before the Board upon a request by Petitioner, Doral Park Joint Venture for a variance from the requirements of Sections 24-13(4) and 24-13(7) of the Code of Miami-Dade County, Florida.

Section 24-13(4) of the Code prohibits the approval of any building permit, certificate of use and occupancy, municipal occupational license, platting action or zoning action for any non-residential land use served or to be served by any source of potable water supply and a septic tank without obtaining the prior written approval of the Director of DERM.

Section 24-13(7) of the aforementioned Code requires connection to a public sanitary sewer system whenever sanitary sewers are available and operative in a public right-of-way abutting the property.

The Board finds that Petitioner's property is served by an abutting public water main. The Board also finds that the closest public sanitary sewer main is a 24-inch force main located along NW 107th Avenue.

The Board finds that current vehicle maintenance activities that are grandfathered on the subject property, include repairs to tractors, mowers, sprayers and service vehicles.

OFF. REC. 1871484802

the waste discharge. The Board also finds that despite the increase in waste flow, the total flow to be generated by this facility is not sufficient to make it technically feasible for Petitioner to connect to the existing sanitary sewer abutting force main.

Finally, the Board finds that the requested variance will not be detrimental to the public health, welfare and safety, will not create a nuisance and will not materially increase the level of pollution in this County.

ACCORDINGLY, IT IS

ORDERED AND ADJUDGED that based upon the evidence and testimony presented and the foregoing findings, Petitioner's requested variance be and the same is hereby granted, subject to the following conditions:

1. The landowner shall execute a covenant running with the land in favor of Miami-Dade County restricting the use of the facility to a vehicle equipment maintenance facility ancillary to a golf course.
2. Paint and body work, steam cleaning, engine or transmission overhauls shall not be performed at this facility.
3. Prior to the start of operations at this facility, DERM approved secondary containment shall be installed in areas designated for the storage of hazardous materials and liquid wastes other than domestic sewage.
4. All liquid waste generating vehicle maintenance activities shall be performed inside maintenance bays where approved spill prevention measures have been implemented.
5. Within six (6) months of the start of operations at this facility, Petitioner shall submit a plan for the installation of a monitoring well in the vicinity of the septic tank drainfield. Within sixty (60) days of approval of said plan, the monitoring well shall be installed. Said monitoring well shall be maintained in an operable condition at all times.
6. Petitioner shall obtain groundwater samples from the above referenced monitoring well within sixty (60) days of installation and one per year thereafter. The samples shall be analyzed by an independent, certified laboratory for the following parameters: Oil and Grease, Volatile Aromatic Organic Compounds, Volatile Halogenated Organic Compounds and Total Metals including lead, copper, arsenic and manganese. The samples shall be analyzed using EPA approved methodologies.
7. An Annual Operating Permit shall be obtained from the DERM.
8. The facility shall operate in accordance with the applicable portions of the DERM's Best Management Practices for Mechanical Repair Facilities as amended from time to time.
9. Prior to the start of operations at this facility, a plan shall be submitted to DERM detailing the manner in which the floor inside the maintenance building will be cleaned.

REG: 18714PG4803

10. If the operations at this facility include agrochemical mixing and loading, DERM approval shall be required prior to the implementation of said mixing and loading practices.

Done and Ordered this 8th day of April 1999 in Miami-Dade County, Florida.

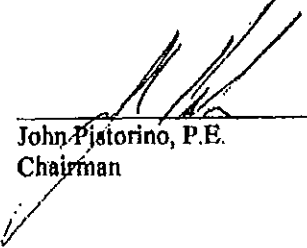

John Pistorino, P.E.
Chairman

FILING AND ACKNOWLEDGEMENT

Filed on this 8th day of April, 1999 with the Secretary of the Board as Clerk of the Environmental Quality Control Board, receipt of which is hereby acknowledged and the seal of the Board affixed below.

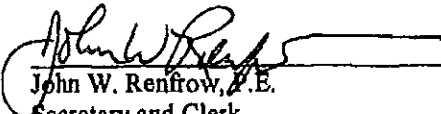

John W. Renfrow, P.E.
Secretary and Clerk

SEAL



Approved as to form and legal sufficiency:

Robert A. Ginsburg
County Attorney
Attorney for the Board

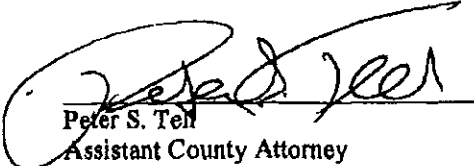

Peter S. Ten
Assistant County Attorney

OFF. 18714914804
REC. 18714914804

EXHIBIT "A"

LEGAL DESCRIPTION

PARCEL 14

A PORTION OF THE WEST 3/4 OF SECTION 20, TOWNSHIP 53 SOUTH, RANGE 40 EAST, DADE COUNTY, FLORIDA, BEING MORE described as follows:

FROM THE SOUTHWET CORNER OF SAID SECTION 20, RUN NORTH 0°00'05" WEST, ALONG THE WEST LINE OF SAID SECTION 20 FOR 67.79 FEET TO THE POINT OF BEGINNING OF THE FOLLOWING DESCRIBED PARCEL OF LAND; THENCE CONTINUE NORTH 0°00'05" WEST FOR 2072.28 FEET TO THE WEST 1/4 CORNER OF SAID SECTION 20; THENCE RUN NORTH 0°01'16" EAST, ALONG THE WET LINE OF THE NORTHWEST 1/4 OF SAID SECTION 20, FOR 1078.85 FEET; THENCE RUN 89°58'44" EAST FOR 330.36 FEET TO THE POINT OF CURVATURE OF A CIRCULAR CURVE TO THE RIGHT; THENCE SOUTHEASTERLY ALONG SAID CURVE HAVING A RADIUS OF 1145.92 FEET AND A CENTRAL ANGLE OF 3°16'16" WEST, RADIAL TO THE LAST DESCRIBED CURVE FOR 290.00 FEET; THE RUN SOUTH 16°41'18" WEST FOR 595.42 FEET; THENCE RUN SOUTH 83°33'32" EAST FOR 290.00 FEET; THENCE RUN SOUTH 77°00'00" EAST FOR 460.00 FEET; THENCE RUN SOUTH 88°33'32" EAST, PARALLEL WITH AND 130.00 FEET NORTH OF THE SOUTH LINE FO THE NORTHWEST 1/4 OF SAID SECTION 20, FOR 280.00 FEET; THENCE RUN NORTH 40°00'00" EAST FOR 135.00 FEET; THENCE RUN NORTH 23°00'00" WEST FOR 185.00 FEET; THENCE RUN NORTH 41° 32'37" WEST FOR 453.76 FEET; THENCE RUN NORTH 38°01'33" EAST FOR 155.00 FEET; THENCE RUN SOUTH 51°58'22" EAST FOR 813.92 FEET TO THE POINT OF CURVATURE OF A CIRCULAR CURVE TO THE LEFT; THENCE RUN SOUTHEASTERLY, EASTERLY AND NORTHEASTERLY ALONG SAID CURVE HAVING A RADIUS OF 716.20 FEET AND A CENTRAL GNLE OF 68°47'05" FOR AN ARC DISTANCE OF 859.81 FEET; THENCE RUN SOUTH 30°45'27" EAST, RADIAL TO THE LAST DESCRIBED CURVE FOR 252.89 FEET; THENCE RUN SOUTH 88°33'32" EAST, PARALLEL WITH AND 130.00 FEET NORTH OF THE SOUTH LINE OF THE NORTH 1/2 OF SAID SECTION 20, FOR 755.79 FEET TO A POINT OF A CURVE, THE CENTER POINT OF THIS CURVE BEARS SOUTH 82°07'37" WEST FROM THIS LAST DESCRIBED POINT; THENCE RUN SOUTHERLY, ALONG A CIRCULAR CURVE TO THE RIGHT HAVING A RADIUS OF 1145.92 FEET AND A CONTROL ANGLE OF .13°02'37" FOR AN ARC DISTANCE OF 260.87 FEET; THENCE RUN NORTH 88°33'32" WEST , PARALLEL WITH AND 130.00 FEET SOUTH OF THE NORTH LINE OF THE SOUTH 1/2 OF SAID SECTION 20, FOR 1370.00 FEET; THENCE RUN SOUTH 50°15'25" WEST FOR 308.70 FEET; THENCE RUN DUE WEST FOR 345.00 FEET; THENCE RUN 43°30'00" WEST FOR 180.00 FEET; THENCE RUN SOUTH 87°15'00" WEST FOR 330.00 FEET; THENCE RUN SOUTH 42°15'00" WEST FOR 141.42 FEET THENCE RUN SOUTH 2°45'00" EAST FOR 150.00 FEET; THENCERUN SOUTH 47°45'00" FEET FOR 141.42 FEET, THENCE 87°15'00" EAST FOR 384.01 FEET TO A POINT ON A CURVE; THE CENTER POINT OF SAID CURVE BEARS NORTH 74°54'07" WEST FROM THIS LAST DESCRIBED POINT; THENCE RUN SOUTHWESTERLY ALONG SAID CURVE HAVING A RADIUS OF 350 FEET AND A CENTRAL ANGLE OF 65°09'07" FOR AN ARC DISTANCE OF 397.99 FEET TO A POINT OF TANGENCY; THENCE RUN SOUTH

DEF. REC. 18714PM4805

80°15'00" WEST FOR 190.00 FEET; THENCE RUN NORTH 23°00'00" WEST FOR 315.00 FEET; THENCE RUN NORTH 68°00'00" WEST FOR 141.42 FEET; THENCE RUN 67°09'00" WEST FOR 150.00 FEET; THENCE RUN SOUTH 22°00'00" WEST FOR 141.42 FEET THENCE RUN SOUTH 23°00'00" EAST FOR 180.00 FEET; THENCE RUN SOUTH 41°30'00" WEST FOR 155.00 FEET; THENCE RUN SOUTH 6°51'37" EAST FOR 396.07 FEET; THENCE RUN NORTH 67°00'00" EAST FOR 250.00 FEET; THENCE RUN SOUTH 23°00'00" EAST FOR 115.00 FEET; THENCE RUN SOUTH 63°00'00" EAST FOR 141.42 FEET; THENCE RUN NORTH 67°00'00" EAST FOR 150.00 FEET; THENCE RUN NORTH 22°00'00" EAST FOR 141.42 FEET THENCE RUN NORTH 23°00'00" WEST FOR 345.00 FEET; THENCE RUN NORTH 80°15'00" EAST FOR 155.00 FEET; THENCE RUN SOUTH 23°00'00" EAST FOR 455.00 FEET; THENCE RUN NORTH 84°43'00" EAST FOR 372.90 FEET; THENCE RUN NORTH 22°02'34" EAST FOR 850.00 FEET; THENCE RUN 71°15'00" EAST FOR 425.00 FEET; THENCE RUN DUE SOUTH FOR 135.00 FEET; THENCE RUN SOUTH 10°00'00" WEST FOR 600.00 FEET; THENCE RUN DUE SOUTH FOR 605.00 FEET; THENCE RUN NORTH 70°15'40" EAST FOR 399.45 FEET; THENCE RUN 67°08'34" RADIAL TO THE NEXT DESCRIBED CURVE TO THE LEFT HAVING A RADIUS FOR 1145.92 FEET AND A CENTRAL ANGLE OF 18°56'23" FOR AN ARC DISTANCE OF 378.80 FEET; THENCE RUN NORTH 86°04'57" WEST, RADIAL TO THE LAST DESCRIBED CURVE, FOR 211.52 FEET THE POINT OF CURVATURE OF A CIRCULAR CURVE TO THE LEFT; THENCE RUN WESTERLY AND SOUTHWESTERLY, ALONG SAID CURVE HAVING A RADIUS OF 350.00 FEET AND A CENTRAL ANGLE OF 35°25'03" FOR AN ARC DISTANCE OF 216.35 FEET TO A POINT OF TANGENCY; THENCE RUN SOUTH 58°30'00" WEST FOR 100.00 FEET TO THE POINT OF CURVATURE OF A CIRCULAR CURVE TO THE RIGHT; THENCE SOUTHWESTERLY, WESTERLY AND NORTHWESTERLY ALONG SAID CURVE HAVING A RADIUS OF 150.00 FEET AND A CENTRAL ANGLE OF 90°00'00" FOR AN ARC DISTANCE OF 235.62 FEET TO A POINT OF TANGENCY; THENCE RUN 31°30'00" WEST, FOR 227.99 FEET TO A POINT OF CURVATURE OF A CIRCULAR CURVE TO THE LEFT; THENCE RUN NORTHWESTERLY AND WESTERLY ALONG SAID CURVE HAVING A RADIUS OF 350.00 FEET AND A CENTRAL ANGLE OF 58°30'00" FOR AN ARC DISTANCE OF 357.36 FEET TO A POINT OF TANGENCY; THENCE RUN DUE WEST FOR 770.00 FEET; THENCE RUN SOUTH 45°00'00" EAST FOR 212.13 FEET; THENCE RUN DUE WEST FOR 649.68 FEET TO THE POINT OF BEGINNING.

RECORDED IN OFFICIAL RECORDS BOOK
OF DALLAS COUNTY, FLORIDA
RECORDED AT THE
HARVEY RUBIN
CLERK OF THE COUNTY



GDO No: _____

Fats, Oil & Grease Discharge Control - Operating Permit Application

INSTRUCTIONS: Provide the appropriate information for all fields denoted as required in each section of the form. Incomplete applications will NOT be accepted by the department until all required information is provided. Refer to the permit application guidelines sheet for processing locations, fees, and other relevant information pertinent to the completion of this form.

A. Application Type (select one)

- New Business/Operator
- Transfer of Ownership or Name Change of Existing Permitted Facility
- Modification of Existing Permitted Facility (includes modifications to FOG control devices, modifications to facility size/area and changes of use)

B. Applicant Information

¹Applicant (corporation, LLC, LLP, sole proprietor) : _____

Applicant Mailing Address : _____

²Authorized Representative Name : _____ Title : _____

Email : _____ Phone No. : _____

**Denotes Required Field

- If applicant is a company, corporation, partnership or similar, the name specified shall match the name of the corporate entity that is registered with the State of Florida Division of Corporations. A fictitious name specified on the form shall be preceded by the name of the entity or individual (if sole proprietor) that owns said fictitious name. For example, "ABC, Inc. d/b/a XYZ Store", where "ABC, Inc." is the name of the registered entity that owns the registered fictitious name "XYZ Store". Please refer to www.sunbiz.org for the listing of corporate entities and fictitious names registered with the State of Florida Division of Corporations
- A separate letter of authorization shall be attached to the application form if the individual specified is not a registered officer of the corporate entity applying for the permit. This requirement is not applicable if applicant is a sole proprietor provided that the sole proprietor is the individual signing the form. Note that names of contractors, expediting services providers, or any other individual providing similar services that is not involved in the management or operation of the facility shall not be listed as an authorized representative.

C. Facility Information

Facility Address (Street, City, Zip, Unit) : _____

Facility Phone No. : _____ Facility Email: _____ Property Folio No. : _____

Days and Hours of Operation : _____

**Denotes Required Field

D. Facility Use Information

Select/Describe Use that best describes the Facility**

- | | | | |
|---|---|---|---|
| <input type="checkbox"/> Apartment/Condo/Club House | <input type="checkbox"/> Banquet Hall | <input type="checkbox"/> Child/Adult Day Care | <input type="checkbox"/> Full Service Restaurant |
| <input type="checkbox"/> Assisted Living | <input type="checkbox"/> Cafe/Coffee Shop | <input type="checkbox"/> Commercial/Industrial Bakery | <input type="checkbox"/> Processing/Manufacturing |
| <input type="checkbox"/> Bakery (non-commercial) | <input type="checkbox"/> Cafeteria | <input type="checkbox"/> Convenient Store/Gas Station | <input type="checkbox"/> Supermarket/Market/Grocery |
| <input type="checkbox"/> Butcher/Fish/Meat Market | <input type="checkbox"/> Catering | <input type="checkbox"/> Fast Food Restaurant | <input type="checkbox"/> Take-Out Restaurant |
| <input type="checkbox"/> Other _____ | | | |

**Indoor Area: _____ ft² **Outdoor Area: _____ ft² No. of Seats: _____ Drive Thru Lanes: Yes No

E. Fats, Oils & Grease Control Device Information

List all FOG control devices serving the facility**

No.	Make & Model	Material (Metal, Plastic, Concrete, other)	Capacity (gpm or gallons)	Location (Indoor or outdoor)

**Denotes Required Field; an operating permit will not be issued until the facility has a department approved control device.

F. CERTIFICATION BY APPLICANT

****COMPLETION OF THIS SECTION IS REQUIRED****

The undersigned authorized representative of (name of applicant) _____ is fully aware that the statements made in this application for an operating permit are true, correct and complete. The undersigned understands that discharges of Fats, Oils and Grease to the public sanitary sewer that exceed the standards set forth in Chapter 24 of the Code of Miami-Dade County (Code) or in quantities that may affect or hinder the operation of the sewage collection, transmission or treatment facilities is a violation of Chapter 24 of the Code. The undersigned certifies that he/she is fully aware that the submittal of a permit application does not guarantee issuance of a Grease Discharge Control operating permit until it is determined that the permit application is complete and a Fats, Oils & Grease Control Device(s) is(are) approved by the department for the facility. It is further acknowledged that a permit, if granted by the Department, is not transferable and that notification shall be provided to the Department upon sale, change of ownership or relocation of the permitted facility.

Name of Authorized Representative* _____ Signature of Authorized Representative* _____ Date _____
Subscribed & sworn to and subscribed before me this _____ day of _____ 20_____
Personally known _____, or produced identification _____, DL #: _____
Notary Signature: _____ Notary Commission Expires _____

Notary Seal

*A notarized letter of authorization shall be attached if the name of the individual does not correspond to a registered officer of the corporate entity applying for the permit, as indicated in section B. This letter is not required for sole proprietors provided that the "Applicant" and "Authorized Representative" specified on the form match and that the application is signed by the same individual. Names of contractors, expediting services providers, or any other individual providing similar services that is not involved in the management or operation of the facility shall not be listed as an authorized representative.

G. CERTIFICATION BY PROPERTY OWNER

****THIS SECTION IS NOT APPLICABLE IF APPLICANT IS SAME AS PROPERTY OWNER****

The undersigned authorized representative of (legal property owner name) _____ is fully aware that the discharges of Fats, Oils and Grease to the public sanitary sewer in quantities that exceed the standards set forth in Chapter 24 of the Code of Miami-Dade County (the Code) or in quantities that may affect or hinder the operation of the sewage collection, transmission or treatment facilities is a violation of Chapter 24 of the Code. The undersigned certifies that the operation and maintenance (cleaning) of the Fats, Oils and Grease Control Device(s) serving the facility is (select one of the options below):

- The responsibility of the Legal Property Owner.
- The responsibility of the Applicant listed in Sections B and F of this form.

Furthermore, the undersigned is fully aware that the legal property owner is responsible for the operation & maintenance of the Fats, oils, and Grease Control Device(s) if the referenced Applicant fails to properly maintain said device(s).

Name of Authorized Representative* _____ Signature of Authorized Representative* _____ Date _____
Subscribed & sworn to and subscribed before me this _____ day of _____ 20_____
Personally known _____, or produced identification _____, DL #: _____
Notary Signature: _____ Notary Commission Expires _____

Notary Seal

*A notarized letter of authorization shall be attached if the name of the individual does not correspond to a registered officer of the corporate entity having legal ownership of the property. This letter is not required for sole proprietors provided that the Authorized Representative specified in this section of the form is that of the legal property owner.

H. PERMIT APPLICATION SUBMITTAL CHECKLIST

- All required fields of permit application form are completed.
- Zoning Certificate of Use/Occupational License Application Form.
- Applicant has read the instructions provided in the permit guidelines sheet.
- Permit Fee (see guidelines sheet and fee schedule).
- FOG control device information is specified.
- Form is signed/certified by a duly authorized representative of Applicant.
- Notarized letter of authorization by Applicant is enclosed (as applicable).
- Form is signed/certified by a duly authorized representative of Property Owner (not required if applicant and property owner are the same).
- Notarized letter of authorization by Property Owner is enclosed (as applicable).



Fats, Oil & Grease Discharge Control Program - Permit Application Completion/Submittal Guidelines

A. Regulatory Requirement

Pursuant to the provisions of Section 24-18 of the Code of Miami-Dade County (the Code), an operating permit is required for any non-residential facility with the potential to introduce oil and grease into the public sanitary sewer system in quantities that have the potential to affect or hinder the operation of sewage collection, transmission or treatment facilities. The intent of the Fats, Oil and Grease Discharge Control program is to regulate facilities with the potential to introduce oil and grease, commonly referred to as "Fats, Oil and Grease" or "FOG," to the public sanitary sewer systems of Miami-Dade County. Facilities with said potential are required to obtain an operating permit issued pursuant to the provisions of Chapter 24 of the Code.

B. Permit Application Form - Important Terms to Know

The terms listed below are referenced in the permit application and are hereby defined to assist the reader in understanding the scope of the various sections of the form and to ensure that the required information is specified accurately.

Fats, Oil and Grease (FOG): common industry/regulatory term that is synonymous to the term "oil & grease".

FOG Control Device: pertains to any equipment designed to remove, hold and prevent passage of FOG to the public sanitary sewer system; this includes grease traps and grease interceptors.

FOG Generator: pertains to any non-residential facility that can introduce FOG to the public sanitary sewer system.

Applicant: is the person or entity intended to be permitted by the department that shall be responsible for complying with the conditions of a FOG discharge control operating permit. This includes sole proprietors and entities registered with the State of Florida Division of Corporations such as companies, corporations, partnerships, etc.

Facility: refers to the establishment (place of business) where a FOG generating activity is conducted; see "FOG Generator" definition above.

Property Owner: refers to the legal owner of the facility (premises) where the FOG generating activity is conducted.

Authorized Representative: is a registered corporate officer (e.g., managing member, president, vice-president, etc.) of an entity that is duly registered with the State of Florida Division of Corporations (e.g., corporation, etc.), or a sole proprietor. If the individual listed on the "Authorized Representative" fields of the permit application does not meet the aforementioned criteria, a notarized letter of authorization issued by a registered corporate officer or sole proprietor (as applicable) shall be attached to the form.

C. Permit Application Form - When is the submittal of a permit application required?

The submittal of a permit application is required for:

- Any new business/operator (FOG generator) intending to operate within Miami-Dade County.
- Transfers of ownership or name changes of an existing permitted entity (i.e., permit holder).
- Updates to permit or facility information, including (but not limited to) modifications to FOG Control Devices, modifications to facility size/area and changes of use.

D. Permit Application Completion and Submittal Instructions

General Information

All sections of the "Fats, Oil and Grease Discharge Control Program Permit Application" form shall be properly completed and certified by all parties responsible for the operation of the regulated facility/establishment, management of the FOG control device(s), and having legal ownership of the facility/establishment. An operating permit shall **NOT** be issued until the department has determined that the application is complete and a FOG control device is approved for the facility.

Zoning Licensing Requirements

The FOG Discharge Control Operating Permit Application form shall be submitted in person to one of the locations listed below. If your facility is located within a municipality, the application form shall be accompanied by a completed Certificate of Use form (a/k/a as "Local Business Tax Receipt" or "Occupational License") from the municipal zoning authority having jurisdiction over the property. If your facility is located within unincorporated Miami-Dade County, note that the submittal of a Zoning Certificate of Use application will be required at the time of submittal of the permit application form. In order to process the permit application, please ensure that the information captured on the permit application form matches the information referenced on the zoning application form (either municipal or unincorporated).

Processing Location	Address	Serves Facilities Located Within:
RER/DERM - Overtown Transit Village	701 NW 1st Court, 2nd Floor, Miami	Municipalities Only
RER/DERM - Hialeah Satellite Office	601 Palm Avenue, 2nd Floor, Hialeah	Municipalities Only
RER/DERM West Dade Office (MDPIC)	11805 SW 26th Street, Miami	Municipalities and Unincorporated Areas

Permit Fees

The list of fees pertinent to the issuance of Fats, Oil and Grease Discharge Control operating permits is found under the "operating permit fees" section of the most current version of the department's Fee Schedule. The fee schedule is available online at: http://www.miamidade.gov/permits/library/fees/schedule_environmental.pdf

Miami-Dade Department of Regulatory and Economic Resources - Division of Environmental Resources Management (DERM)

MAINTENANCE LOG FOR ALL TYPES OF GREASE TRAPS/INTERCEPTORS AT DERM-PERMITTED FACILITIES

- This Maintenance Log is to be used at all facilities with GDO Permits and staff/operator/owner/permittee is responsible for completing.
- This Maintenance Log must capture every Fats, Oils, Grease (FOG) removal and/or maintenance action (e.g., replacement of broken/missing baffle, pump out, etc.) performed on the grease trap/interceptor by staff/operator/owner/permittee or approved liquid waster hauler. The Maintenance Log will be checked by DERM staff during inspections (see DERM GDO permit condition #6). Permittee must follow the maintenance schedule provided by grease trap/interceptor manufacturer/installer.
- This Maintenance Log must be placed near your trap/interceptor and must be visible so staff/operators/owners or liquid waste haulers can record maintenance actions and so that it is easily accessible by DERM staff during inspections.
- Make photo copies of the blank Maintenance Log sheets if you need more blank rows or go to <http://www.miamidade.gov/environment/fats-oils-grease.asp> to download a blank version of this Log.
- If you use a DERM-permitted hauler to remove grease, you must keep all pump-out/maintenance receipts available at the facility available for inspection for a minimum of 3 years in addition to keeping this Log.

FACILITY NAME:

DERM GDO PERMIT NUMBER:

PERMITTED FACILITY ADDRESS:

DATE	TYPE OF MAINTENANCE PERFORMED (e.g., pump-out, manual FOG removal, repair – provide details)	VOLUME OF WASTE REMOVED – GALLONS (if manually removing FOG, estimate vol. If not, hauler will provide)	GREASE DISPOSAL LOCATION (if manually removing FOG, provide disposal location (trash). If not, ask hauler to provide disposal location)	NAME OF APPROVED HAULER/TRANSPORTER (Provide name of hauler. If removing FOG manually, column not applicable)	OTHER COMMENTS

FACILITY NAME:

DERM GDO PERMIT NUMBER:

PERMITTED FACILITY ADDRESS:

DATE	TYPE OF MAINTENANCE PERFORMED <small>(e.g., pump-out, manual FOG removal, repair — provide details)</small>	VOLUME OF WASTE REMOVED — GALLONS <small>(if manually removing FOG, estimate vol. If not, hauler will provide)</small>	GREASE DISPOSAL LOCATION <small>(if manually removing FOG, provide disposal location (trash). If not, ask hauler to provide disposal location)</small>	NAME OF APPROVED HAULER/TRANSPORTER <small>(Provide name of hauler. If removing FOG manually, column not applicable)</small>	OTHER COMMENTS



Regulatory and Economic Resources
Environmental Resources Management
.701 NW 1st Court • 7th Floor
Miami, Florida 33136-3912
T 305-372-6600 F 305-372-6893

miamidade.gov

PERMIT NO: PSO-000850-2015/2016 (PSC)-PVT
TRUMP DORAL/TRUMP DORAL GOLF CLUB AND RESORT MIAMI
4400 NW 87 AVE
DORAL, FL 33178-

PERMITTEE:
Mr. Samuel A Rubert
TRUMP DORAL/TRUMP DORAL GOLF CLUB AND RESORT MIAMI/ TRUMP ENDEAVOR 12.LLC
4400 NW 87 AVENUE
MIAMI, FL 33178-2192

**PRIVATE SANITARY SEWERS OPERATING PERMIT
ANNUAL OPERATING PERMIT**

DESCRIPTION OF FACILITY/EQUIPMENT

This document, issued under the provisions of Chapter 24, Miami-Dade County Code (Dade County Pollution Control Ordinance), shall be valid from 01-OCT-2015 through 30-SEP-2016. The above named permittee is hereby authorized to operate the pollution control facility at the above location which consists of the following:

- PUMP STATION(S):
- Number of Stations:7
 - Number of Pumps:14
 - Pump Type:Submersible
 - Alarm System:AUDIO/VISUAL
 - Number of Sewer MH:9
- COLLECTION SYSTEM:
- 10 Inch Diameter Pipe: 125.00 ft.
 - 4 Inch Diameter Pipe: 1,271.00 ft.
 - 6 Inch Diameter Pipe: 614.00 ft.
 - 8 Inch Diameter Pipe: 947.00 ft.

This facility is subject to conditions listed below and in the following pages (if any) of this permit.

SPECIFIC CONDITIONS

1. The collection/transmission facility shall be operated continuously in such a manner that maximum level of efficiency is maintained at all times and in full compliance with Rule 62-604, Florida Administrative Code.
2. All privately-owned or operated sanitary sewer collection systems which have sanitary sewer pumping stations, shall provide each pump with a fully operational and working non-resettable elapsed time (ET) meter as required by Section 24-42.2(2) (a) of the Miami-Dade County Code. Monthly totalized ET meter readings of the total number of hours for each pump shall be recorded and reported as required by Section 24-42.2(1) (f) (i) and entered by the permittee via an Internet specifically created for this purpose. As of Oct 1, 2012, this facility is required to start entering the ET readings utilizing the new Web application. The Web address to start entering the ET readings and/or to obtain the Web application guidelines is: https://www.miamidade.gov/xer/psu_psu_et_filings/
3. The Permittee shall obtain a Domestic Wastewater Collection/Transmission System Construction permit and notify this Department before making any modifications of the sanitary sewer

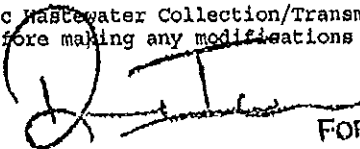
FOR

Lee N. Hefty, Assistant Director
Department of Regulatory and Economic Resources,
Environmental Resources Management



collection system that may change the capacity of the system.

4. The Permittee shall provide an Operations and Maintenance Manual for this collection/transmission facility. A copy of the approved manual shall be maintained at the facility site. The manual shall be updated annually whenever the system is modified or enlarged, or as required by new regulatory actions pursuant to Chapter 24-42.2(5)(b) of the Code. The facility shall be maintained in accordance with the practices described in the approved Operations and Maintenance Manual. Logbooks required by the manual shall be maintained at the facility in a location protected from the weather.
5. The Permittee shall submit an annual report to the Director or his designee which sets forth a map and a list of all sewer service areas and sewer subsystems, including the total length (in feet) of gravity sewer lines according to pipe diameter and type of material, and number of manholes in each service area. This information shall be submitted only if there have been changes in the service area.
6. The Permittee shall provide a Sanitary Sewer Evaluation Survey (SSES) for this collection/transmission facility. Such evaluation activities shall be conducted in a manner so that the total length of the gravity sewer lines and associated manholes in the sanitary sewer collection system is evaluated once every ten year period, pursuant to Chapter 24-42.2 (1)(a) of the Miami-Dade County Code. You may contact the PSO Program at (305)372-6600 in order to obtain a copy of the SSES Guidelines.
7. The Permittee shall create, post, maintain, update and secure the EMERGENCY CONTACT SIGN. You shall include in the Emergency Contact Sign, the PSO Permit number, your Emergency Maintenance Contact Person and DERM's 24 hour complaint desk telephone number (305-372-6955) wherever possible, the sign shall be posted on a flat surface and visible at and around the pump station. In any case, the sign shall be within twenty (20) feet of the wet well of the station, three(3) feet to six (6) feet above ground level and clear of immediate obstructions. The Permittee shall update the contact number displayed on the sign, as required, with a durable marker.
8. No additional sanitary sewer connection(s) shall be made to the existing private sanitary sewer collection system from other facilities or properties without a review and prior written approval by the DERM.

GENERAL CONDITIONS

9. The applicant, by acceptance of this document, agrees to operate and maintain the subject operation so as to comply with the requirements of Chapter 24 of the Code of Miami-Dade County.
10. If for any reason, the applicant does not comply with or will be unable to comply with any condition or limitation specified on this document the applicant shall immediately notify and provide the department with the following information: (a) a description of and cause of non-compliance; and (b) the period of non-compliance including exact dates and times; or, if not corrected, the anticipated time the non-compliance is expected to continue, and steps taken to reduce, eliminate, and prevent recurrence of the non-compliance. The applicant shall be responsible for any and all damages which may result and may be subject to enforcement action by the department for penalties or revocation of this document.
11. As provided in Section 24-15 of the Code of Miami-Dade County, the prior written approval of the Department shall be obtained for any alteration to this facility.
12. The issuance of this document does not convey any vested rights or any exclusive privileges. Nor does it authorize any injury to public or private property or any invasion of personal rights, nor any infringement of federal, state or local laws or regulations. Nor does it relieve the applicant from liability for harm or injury to human health or welfare or property.
13. This document is required to be posted in a conspicuous location at the facility site during the entire period of operation.
14. This document is not transferable. Upon sale or legal transfer of the property or facility covered by this document, the applicant shall notify the department within thirty(30) days. The new owner must apply for a permit within thirty (30) days. The applicant shall be liable for any non-compliance of the source until the transferee applies for and receives a transfer of this document.
15. The applicant, by acceptance of this document, specifically agrees to allow access to the named source at reasonable times by department personnel presenting credentials for the purposes of inspection and testing to determine compliance with this document and department rules.
16. This document does not indicate a waiver of or approval of any other department permit that may be required for other aspects of this facility.
17. This document does not constitute an approval by the Department or certification that the



Regulatory and Economic Resources
Environmental Resources Management
701 NW 1st Court • 7th Floor
Miami, Florida 33136-3912
T 305-372-6600 F 305-372-6893

miamidade.gov

PERMIT NO: PSC-000850-2015/2016 (PSC)
TRUMP DORAL/TRUMP DORAL GOLF CLUB AND RESORT MIAMI

PERMITTEE:

Mr. Samuel A Rubert
TRUMP DORAL/TRUMP DORAL GOLF CLUB AND RESORT MIAMI/ TRUMP ENDEAVOR 12.LLC
4400 NW 87 AVENUE
MIAMI FL, 33178-2192

applicant is in compliance with applicable laws, ordinances, rules or regulations. The applicant acknowledges that separate enforcement actions may be initiated by the Department and that this document does not constitute compliance with orders issued in conjunction with enforcement actions for correction of violations.

18. Failure to comply with any condition of this document, or the requirements of Chapter 24, Code of Miami-Dade County may subject the applicant to the penalty provisions of said Chapter including civil penalties up to \$25,000 per day per offense and/or criminal penalties of \$500 per day or not less than \$1000 per day for violations of Section 24-42.4, Sanitary Sewer Discharge Limitations and Pretreatment Standards and/or sixty (60) days in jail.



Carlos A. Gimenez, Mayor

Department of Regulatory and Economic Resources
Environmental Resources Management
701 NW 1st Court, 6th Floor
Miami, Florida 33136-3912
T 305-372-6902 F 305-372-6630
miamidade.gov

November 20, 2015

Emil J. Brolick, Manager
Wendy's International, LLC
One Dave Thomas Blvd.
Dublin, Ohio 43017

Certified Mail No. 7004 2510 0001 7495 2038
Return Receipt Requested

Juan C. Cachoua, Manager
Brickell City Rentals, LLC
777 Brickell Avenue, Suite 950
Miami, Florida 33131

Certified Mail No. 7004 2510 0001 7495 1284
Return Receipt Requested

Re: Unauthorized discharge to the sanitary sewer system from Wendy's Restaurant #1711 located at, near or in the vicinity of 200 SW 8 Street, Miami, Florida (folio # 01-0205-080-1010). DERM file no. GDO-154.

Dear Mr. Brolick and Mr. Cachoua:

NOTICE OF VIOLATION
AND
ORDERS FOR CORRECTIVE ACTION

On July 13, 2015 a representative of the Miami-Dade County Department of Regulatory and Economic Resources, Division of Environmental Resources Management (DERM), responded to a complaint from the Miami-Dade Water and Sewer Department that a sanitary sewer manhole adjacent to the above-referenced facility was overflowing. Said inspection revealed the on-site grease recovery unit was not functioning properly resulting in the unauthorized discharge of grease to the sanitary sewer system servicing the subject property. Said discharge caused an obstruction to the sanitary sewer system resulting in a backup to the system and triggering a sewage overflow. A crew from the Miami-Dade Water and Sewer Department was dispatched to the scene to clean-out the sewer line and disinfect the impacted areas.

Be advised that discharging, or allowing the discharge of any Fats, Oils or Grease into a sanitary sewer system constitutes violations the facility's Grease Discharge Operating Permit (GDO-154) and of Chapter 24, Miami-Dade County Environmental Protection Ordinance, specifically:

Section 24-29, of said Ordinance, which states in pertinent part: "It shall be unlawful for any person to violate any of the provisions of this chapter, any lawful rules and regulations promulgated under this chapter, any lawful order of the Director of DERM or his designee, or any condition, limitation or restriction which is part of an operating permit."

Section 24-42.4(2)(d)(iii), of said Ordinance, which states in pertinent part: "It shall be unlawful for any person to throw, drain, run or otherwise discharge into a sanitary sewer, or to cause, permit, allow or suffer to be thrown, run, drained or allowed to seep, or otherwise discharged into such sewer any pollutant in amounts which alone or in combination with other discharges will cause obstruction to the flow in the publicly owned treatment works."

Delivering Excellence Every Day

Section 24-42.4(2)(d)(vi), of said Ordinance, which states in pertinent part: "It shall be unlawful for any person to throw, drain, run or otherwise discharge into a sanitary sewer, or to cause, permit, allow or suffer to be thrown, run, drained or allowed to seep, or otherwise discharged into such sewer any effluents in excess of local limits."

Pursuant to the provisions of Section 24-31(6) of Chapter 24, Miami-Dade County Code, whenever a violation of this chapter occurs or exists, or has occurred or existed, any person, individually or otherwise, who has legal, beneficial, or equitable interest in the real property upon which such violation occurs or exists, or has occurred or existed, shall be jointly and severally liable for said violation regardless of fault and regardless of knowledge of the violation.

Based on the above and pursuant to the authority granted to me under Chapter 24, Miami-Dade County Environmental Protection Ordinance, I am hereby ordering you to:

1. Upon receipt of this NOTICE, "CEASE and DESIST" from allowing any further unauthorized discharges to the publicly owned sanitary sewer system at the subject location.
2. Within sixty days (60) of receipt of this NOTICE, submit to this Department for review, formal plans signed and sealed by a Florida Professional Engineer for changes in equipment and/or processes, which shall correct the current violations and prevent future violations of the provisions of Chapter 24 at the subject facility. Said plans shall include at a minimum the following:
 - a. All existing plumbing lines, drainage fixtures, solids separators, grease interceptors / grease traps and sampling points. All lines that receive or can receive waste from fixtures that can discharge food waste or Fats, Oil and Grease (FOG) shall be labeled grease waste (GW) to distinguish it from sanitary waste.
 - b. A FOG control device sized based on calculations that include peak flow rates, FOG and solids loading rate, and a pump-out frequency. FOG loading shall include contribution from eat-in, take-out and drive-thru operations and all fixture sources, including exhaust hoods. For self-cleaning exhaust hoods, the manufacturer's specifications for peak discharge shall be included.
 - c. All drainage fixtures located in food and beverage preparation areas shall be routed through a grease interceptor. Drainage fixtures include, but are not limited to: floor drains, floor sinks, mop sinks, three-compartment sinks, hand sinks, pre-rinse station/sink, preparation sink, pot sink, wok sink, and self-cleaning exhaust hoods.
 - d. Sampling point located after the point of no further treatment. The sampling point shall be directly accessible for visual inspection and sampling. Sampling point shall have sufficient depth and access to allow sample collection using a 3-inch diameter x 6-inch long sample bottle. An alternative to a manufactured sampling point (device) is a double sanitary cross with a PVC-CAP on the bottom of the vertical axis to create the sampling sump and a cleanout cap on top. Minimum diameter for the vertical axis is 4-inches; minimum depth of the sump is 6 inches.
 - e. Isometric diagram(s) with existing and proposed plumbing lines, fixtures, solids separators, FOG control devices and sampling points. Grease waste lines shall be labeled GW.
 - f. Solids separation prior to existing or proposed FOG control devices that require a flow control device or are not certified to handle solids.

3. Upon approval by this Department, obtain the appropriate permits and commence with the implementation of the required improvements.
4. Within one hundred eighty (180) days of receipt of this Notice, complete the required improvements.

For appropriate handling, include the subject permit number (GDO-154) referencing this facility on all submittals filed with this Department and direct said submittals to DERM, attn. Carlos Hernandez, P.E., Chief, Wastewater Permitting Section, 701 NW 1st Court, 7th Floor, Miami, Florida 33136-3912

BE ADVISED THAT FAILURE TO COMPLY WITH THE ABOVE MAY RESULT, AT A MINIMUM, IN CIVIL PENALTIES AND THE PAYMENT OF ALL DEPARTMENTAL COSTS INCURRED IN THE INVESTIGATION AND SETTLEMENT OF THIS CASE. IN ADDITION, FAILURE TO COMPLY MAY RESULT IN YOUR CASE BEING PREPARED FOR FORMAL ENFORCEMENT ACTION IN A COURT OF COMPETENT JURISDICTION PURSUANT TO THE ENFORCEMENT AND PENALTY PROVISIONS OF SECTION 24-29, MIAMI DADE COUNTY ENVIRONMENTAL PROTECTION ORDINANCE.

Any person aggrieved by any action or decision of the DERM Director may appeal said action or decision to the Environmental Quality Control Board (EQCB) by filing a written notice of appeal along with submittal of the applicable fee, to the Code Coordination and Public Hearings Section of DERM within fifteen (15) days of the date of the action or decision by DERM.

If you have any questions concerning the above, please contact Carlos Hernandez, P.E., Chief of the Wastewater Permitting Section of this office at 305-372-6714 or via email at Hernac@miamidade.gov.

Sincerely,

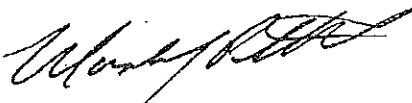

Mark J. Pettit
Environmental Code Enforcement Officer II
Regulatory Services



Carlos A. Gimenez, Mayor

Department of Regulatory and Economic Resources
Environmental Resources Management
701 NW 1st Court, 6th Floor
Miami, Florida 33136-3912
T 305-372-6567 F 305-372-6407
miamidade.gov

June 14, 2016

Glenn Rozansky, Permittee
Pollo Operations Inc. DBA Pollo Tropical Restaurant
7300 N. Kendall Drive, 8th Floor
Miami, FL 33156

Certified Mail No. 7014 1200 0000 1637 1382
Return Receipt Requested

Timothy Taft, President
Pollo Operations Inc.
14800 Landmark Blvd.
Dallas, TX 75254

Certified Mail No. 7014 1200 0000 1637 1399
Return Receipt Requested

Carol G. Wyllie, Director
The Graham Companies (Property Owner)
6843 Main Street
Miami Lakes, FL 33014

Certified Mail No. 7014 1200 0000 1637 1405
Return Receipt Requested

Re: Unlawful discharges to the public sanitary sewer system and operating permit violations at the Pollo Tropical Restaurant facility (GDO-218) located at, near, or in the vicinity of 16495 NW 67 Ave, Miami Lakes, Miami-Dade County, Florida (Folio 32-2013-004-2410).

Dear Messrs. Rozansky & Taft and Ms. Wyllie:

NOTICE OF VIOLATION AND ORDERS FOR CORRECTIVE ACTION

Inspections of the above-referenced facility, conducted by Department of Regulatory and Economic Resources, Division of Environmental Resources Management's (DERM) representatives between 2010 to present, have documented chronic operating permit violations relating to the grease trap interceptor (GTI) serving the facility. The facility's Miami-Dade County Fats, Oils and Grease Discharge Control Annual Operating Permit requires that the GTI be routinely serviced, that all maintenance records be kept on site and provided to DERM upon request, and that the GTI treatment system not allow fats, oils and grease (FOG) to bypass the GTI or contribute to sanitary sewer line blockages. DERM inspections on March 18, 2010, February 3, 2012, May 13, 2014, October 16, 2014, April 3, 2015, April 15, 2016 and May 16, 2016 have consistently documented both FOG in the sewer discharge point of the GTI and a lack of service records demonstrating the required maintenance for the treatment system.

Additionally, records obtained from Miami-Dade County Water and Sewer Department (WASD) indicate that WASD has been required to routinely respond to chronic sewer line blockages and sewer manhole overflows in the public sanitary sewer system immediately downstream of the subject facility. A review of WASD records reveals that since 2012, twenty-four responses were required to address sewer line malfunctions due to FOG obstruction in the sewer line.

Delivering Excellence Every Day

Pollo Tropical
GDO-218

Furthermore, DERM has determined that the GTI serving the subject property is inadequately-sized for the on-site restaurant processes. Samples of the GTI effluent collected by DERM on April 15, 2016 revealed the presence of oil and grease in levels 39 times higher than allowable limits established in Miami-Dade County Sewer Pretreatment Standards. On May 16, 2016 DERM resampled the GTI effluent five days after a service of the treatment system, and again documented oil and grease in levels exceeding allowable standards. The presence of oil and grease in the effluent immediately after maintenance of the on-site treatment system verifies that the existing GTI cannot adequately treat the wastewater flows from the restaurant, thereby allowing FOG to bypass the GTI and enter the public sanitary sewer system.

Be advised that the unauthorized discharges to the public sanitary sewer system and the repeated violations of the operating permit constitutes violations of Chapter 24 of the Miami-Dade County Environmental Protection Ordinance, specifically:

Section 24-29, of said Chapter, inasmuch as it shall be unlawful for any person to violate any of the provisions of this chapter, any lawful rules and regulations promulgated under this chapter, any lawful order of the Director of the Department of Environmental Resources Management or his designee, or any conditions, limitation or restriction which is part of an operating permit; and

Section 24-42.4(2)(d)(vi), of said Ordinance, inasmuch as it shall be unlawful for any person to throw, drain, run or otherwise discharge into a sanitary sewer any effluent in excess of the limits set forth in the Sanitary Sewer Discharge Limitations and Pretreatment Standards.

Based on the above and pursuant to the authority granted to me under Chapter 24 of the Code of Miami-Dade County, you are hereby ordered to:

1. Upon receipt of this NOTICE, immediately **CEASE and DESIST** from allowing any further unauthorized discharges to the publicly owned sanitary sewer system at the subject location.
2. **Within forty-five (45) days** of receipt of this NOTICE, submit to DERM for review formal plans, signed and sealed by a Florida Professional Engineer, for changes in equipment and/or processes which shall correct the current violations and prevent future violations of the provisions of Chapter 24 at the subject facility. Said plans shall include, at a minimum, all requirements enumerated in the following ATTACHMENT to this NOTICE.
3. **Within one hundred twenty (120) days** of receipt of this NOTICE, complete all required improvements to the on-site FOG treatment system.

BE ADVISED THAT FAILURE TO COMPLY WITH THE ABOVE MAY RESULT, AT A MINIMUM, IN ASSESSMENT OF CIVIL PENALTIES AND THE PAYMENT OF ALL DEPARTMENTAL COSTS INCURRED IN THE INVESTIGATION AND SETTLEMENT OF THIS CASE. IN ADDITION, FAILURE TO COMPLY MAY RESULT IN YOUR CASE BEING PREPARED FOR FORMAL ENFORCEMENT ACTION IN A COURT OF COMPETENT JURISDICTION PURSUANT TO THE ENFORCEMENT AND PENALTY PROVISIONS OF SECTION 24-29, OF CHAPTER 24 OF THE CODE OF MIAMI-DADE COUNTY, FLORIDA, THE MIAMI-DADE COUNTY ENVIRONMENTAL PROTECTION ORDINANCE.

Pollo Tropical
GDO-218

Any person aggrieved by any action or decision of the DERM Director may appeal said action or decision to the Environmental Quality Control Board (EQCB) by filing a written notice of appeal along with submittal of the applicable fee, to the Code Coordination and Public Hearings Section of DERM within fifteen (15) days of the date of the action or decision by DERM.

For further information about the EQCB, please contact Mirna Leal of DERM's Code Coordination and Public Hearings Section at (305) 372-6764, or via email at EQCB@miamidade.gov. For any other questions related to this matter, you may contact the undersigned at (305) 372-6516 or via email at Anderj@miamidade.gov.

Sincerely,

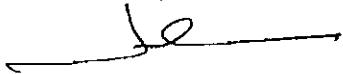

John D. Andersen
Code Enforcement Officer

Cc: Carlos Hernandez, P.E., Laura Castillo, DERM
Windmill Gate HOA (gerard.churchill@gmail.com)
WASD

Pollo Tropical
GDO-218

ATTACHMENT

PLAN REQUIREMENTS

Grease Trap Interceptor

Plans signed and sealed by a Florida Professional Engineer shall include, at a minimum, all requirements enumerated below:

1. Complete plumbing drawings, plan and isometric, for the entire facility. Drains/pipes shall be labelled Sanitary or GW (Grease Waste). All lines that receive or can receive waste from fixtures that can discharge food waste or Fats, Oils and Grease (FOG) shall be labeled grease waste GW to distinguish from sanitary waste.
2. Complete building sewer plans, showing all connections from the facility to the public sanitary sewer system.
3. All plumbing fixtures, solids separators, grease interceptors/grease traps and sampling points.
4. Calculations for the proposed FOG Control Device (e.g., grease interceptors). Calculations shall include peak flow rates, FOG and solids loading rates, and pump-out (cleaning) frequency and demonstrate that the final effluent will comply with Section 24-42.4 (e.g., 100 mg/L Oil & Grease). FOG loading shall include all FOG sources, including FOG generated by preparing meals and cleaning associated with eat-in, take-out and drive-through meals. FOG generated by cleaning shall include exhaust hood cleaning.
5. The FOG Control Device shall be located to allow uninterrupted maintenance and inspection; i.e., the system shall be accessible all times and not require intervention to access, clean and inspect.
6. All drainage fixtures located in food and beverage preparation areas shall be connected to the proposed FOG Control Device. Drainage fixtures include, but are not limited to: floor drains, floor sinks, mop sinks, three-compartment sinks, hand sinks, pre-rinse station/sink, preparation sink, pot sink, wok sink, and self-cleaning exhaust hoods.
7. Sampling point located after the point of no further treatment. The sampling point shall be directly accessible for visual inspection and sampling. Sampling point shall have sufficient depth and access to allow sample collection using a 3-inch diameter x 6-inch long sample bottle.
8. Solids separation prior to existing or proposed FOG control devices that require a flow control device or are not certified to handle solids.



miamidade.gov

Department of Environmental Resources Management
 Pollution Regulation and Enforcement Division
 701 NW 1st Court, 7th Floor
 Miami, Florida 33136-3912
 T 305-372-6600 F 305-372-6893

ENFORCEMENT NOTICE

October 6, 2011

Tony Suarez, President
 4546 Properties, Inc.
 4530 NW 7 Ave.
 Miami, Fl. 33127

CERTIFIED MAIL NO. 7009 0080 0000 1045 0648
 RETURNED RECEIPT REQUESTED

Re: The Esther's Catering Services facility (DERM GDO-577/COM-57393) located at, near or in the vicinity of 4530-4540 NW 7 Avenue, Miami, Miami-Dade County, Florida (Folios 01-3123-022-0170 & 01-3123-022-0180).

Dear Mr. Suarez:

NOTICE OF VIOLATION AND ORDERS FOR CORRECTIVE ACTION

This notice is being reissued to correct the mailing label on the Department's September 22, 2011 correspondence. On April 25, 2011 and August 26, 2011, representatives of this Department inspected the above-referenced facility and documented oily wastewater in the effluent pipe of the on-site grease trap. Samples collected of this effluent confirmed the presence of Oil and Grease in levels greatly exceeding the Miami-Dade County sewer pretreatment standards. Furthermore, a review of Department records has revealed that since 2004, routine inspections of the subject site have documented a pattern of improper discharges to the sanitary sewer system from the facility's frequently surcharged and malfunctioning grease trap. These documented discharges have resulted in the issuance of multiple field violation notices by this Department.

Additionally, a review of Miami-Dade Water and Sewer Department (WASD) records for the above-referenced location revealed that WASD has repeatedly responded to surcharged and blocked sewer lines serving the subject facility. The frequent sanitary sewer system obstruction by fat, oil and grease from said facility operations has required the repetitive maintenance of the sanitary sewer line by WASD.

Be advised that the above constitutes violations of Chapter 24, Miami-Dade County Environmental Protection Ordinance, to wit:

Section 24-29, of said Ordinance, inasmuch as it shall be unlawful for any person to violate any of the provisions of this chapter, any lawful rules and regulations promulgated under this chapter, any lawful order of the Director of the Department of Environmental Resources Management or his designee, or any conditions, limitation or restriction which is part of an operating permit; and

Section 24-42.4(2)(d)(iii), of said Ordinance, inasmuch as it shall be unlawful for any person to throw, drain, run or otherwise discharge into a sanitary sewer, or cause, permit, allow or suffer to be thrown, run drained, allowed to seep, or otherwise discharged into such sewer any pollutant in amounts which alone or in combination with other discharges will cause obstruction to the flow in the POTW; and

Section 24-42.4(2)(d)(vi), of said Ordinance, inasmuch as it shall be unlawful for any person to throw, drain, run or otherwise discharge into a sanitary sewer, or cause, permit, allow or suffer to be thrown, run drained, allowed to seep, or otherwise discharged into such sewer Oil and Grease in excess of 100.0 mg/l.

Delivering Excellence Every Day

Based on the above and pursuant to the authority granted to me under Chapter 24, the Miami-Dade County Environmental Protection Ordinance, I am hereby ordering you to:

- 1) Immediately upon receipt of the Notice, **CEASE AND DESIST** from any unauthorized discharges to the public sanitary sewer system at the subject location.

- 2) **Within thirty (30) days** of receipt of this Notice, submit to the *Plan Review & Development Approvals Division* of this Department formal plans for changes in equipment and processes which shall correct the subject violations and bring your facility into compliance with the provisions of Chapter 24. Said plans are to be accompanied by a timetable for implementation of the corrective measures, and shall include but not be limited to, the development and implementation of appropriate Best Management Practices for the facility and address all processes related to the storage, treatment and disposal of fat, oil and grease at the subject location.

BE ADVISED THAT FAILURE TO COMPLY WITH THE ABOVE MAY RESULT, AT A MINIMUM, IN ASSESSMENT OF CIVIL PENALTIES AND THE PAYMENT OF ALL DEPARTMENTAL COSTS INCURRED IN THE INVESTIGATION AND SETTLEMENT OF THIS CASE. IN ADDITION, FAILURE TO COMPLY MAY RESULT IN YOUR CASE BEING PREPARED FOR FORMAL ENFORCEMENT ACTION IN A COURT OF COMPETENT JURISDICTION PURSUANT TO THE ENFORCEMENT AND PENALTY PROVISIONS OF SECTION 24-29, OF CHAPTER 24 OF THE CODE OF MIAMI-DADE COUNTY, FLORIDA, THE MIAMI-DADE COUNTY ENVIRONMENTAL PROTECTION ORDINANCE.

If you have any questions concerning the above, please contact the undersigned Code Enforcement Officer for this case at (305) 372-6516 or via email at anderj@miamidade.gov.

Sincerely,

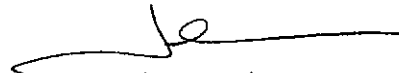

John D. Andersen
Code Enforcement Officer

Cc: Eddie Spann, WASD (EsSpan@miamidade.gov)

ENFORCEMENT NOTICE

900-577

MIAMIDADE COUNTY
Delivering Excellence Every Day
 Environmental Resources Management
 Enforcement Section
 701 NW 1st Court
 Miami Florida 33136
DESIGNED BY: 01-17-2006

PERMITTED MAIL

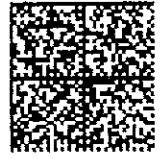
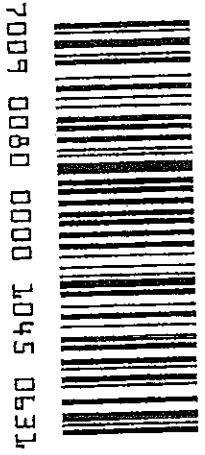

UNITED STATES POSTAGE
 PRIORITY BOARDS
 \$ 05.590
 SEP 26 2011
 MAILED FROM ZIP CODE 33128
 02 1M
 0004283397
RECEIVED

OCT 05 2011

DERM
 CODE ENFORCEMENT SECTION

*NO SUCH NUMBER
 RETURN TO SENDER
 BIENA VISTA STATION 33137Z*

TONY SUAREZ, PRESIDENT
 4546 PROPERTIES, INC.
 4350 NW 7 AVENUE
 MIAMI, FL 33127

NIXIE 931 DE 1 00 10/04/11
 RETURN TO SENDER
 NO SUCH NUMBER
 UNABLE TO FORWARD
 EC: 93136390299 *0708-08750-26-41
 |||||

PS Form 3811, February 2004 102585-02-M-1540

Domestic Return Receipt

1. Article Addressed to:
 TONY SUAREZ, PRESIDENT
 4546 PROPERTIES, INC.
 4350 NW 7 AVENUE
 MIAMI, FL 33127

2. Article Addressed to:
 TONY SUAREZ, PRESIDENT
 4546 PROPERTIES, INC.
 4350 NW 7 AVENUE
 MIAMI, FL 33127

3. Service Type
 Certified Mail Express Mail
 Registered Return Receipt for Merchandise
 Insured Mail C.O.D.

4. Restricted Delivery? (Extra Fee) Yes No

5. Signature: *Anderson*

6. Received by (Printed Name): _____

7. Date of Delivery: _____

8. Is delivery address different from item 1? Yes No
 If YES, enter delivery address below: _____

9. Tracking Number: 7009 0080 0000 1045 0631

10. Barcode: |||||

COMPLETE THIS SECTION ON DELIVERY

SENDER: COMPLETE THIS SECTION

- Complete items 1, 2, and 3. Also complete item 4 if Restricted Delivery is desired.
- Print your name and address on the reverse so that we can return the card to you.
- Attach this card to the back of the mailpiece, or on the front if space permits.

- A. Signature Agent Addressee
- B. Received by (Printed Name) _____
- C. Date of Delivery _____
- D. Is delivery address different from item 1? Yes No
 If YES, enter delivery address below: _____

OFFICIAL MAIL ADDRESS: 701 NW 1ST COURT MIAMI, FL 33136



Carlos A. Gimenez, Mayor

Department of Regulatory and Economic Resources
Environmental Resources Management
701 NW 1st Court, 6th Floor
Miami, Florida 33136-3912
T 305-372-6902 F 305-372-6630
miamidade.gov

October 19, 2016

Pedro Menendez, President
Menendez Management Corp.
1430 South Dixie Highway, Suite 311
Coral Gables, Florida 33146

Certified Mail No. 7012 3050 0000 9635 9990
Return Receipt Requested

Stephen Easterbrook, CEO
Mc Donald's Corporation
2111 Mc Donald's Drive, Dept. 28T
Oak Brook, IL 60523

Certified Mail No. 7012 3050 0000 9635 9983
Return Receipt Requested

Re: Unauthorized discharge to the sanitary sewer system from Mc Donald's Restaurant #7409 located at, near or in the vicinity of 5700 NW 79 Avenue, Doral, Florida (folio # 35-3022-000-0210). DERM file no. GDO-580.

Dear Mr. Menendez and Mr. Easterbrook:

NOTICE OF VIOLATION
AND
ORDERS FOR CORRECTIVE ACTION

On June 23, 2016 and July 25, 2016 a representative of the Miami-Dade County Department of Regulatory and Economic Resources, Division of Environmental Resources Management (DERM), inspected the above-referenced facility and collected samples from the final discharge point of the on-site grease recovery unit. Sample results revealed that the on-site grease recovery unit is not functioning properly and/or sized correctly for the facility resulting in the unauthorized discharge of grease to the sanitary sewer system servicing the subject property.

Be advised that discharging, or allowing the discharge of any industrial wastes into a sanitary sewer system constitutes violations the facility's Grease Discharge Operating Permit (GDO-580) and of Chapter 24, Miami-Dade County Environmental Protection Ordinance, specifically:

Section 24-29, of said Ordinance, which states in pertinent part: "It shall be unlawful for any person to violate any of the provisions of this chapter, any lawful rules and regulations promulgated under this chapter, any lawful order of the Director or the Director's designee."

Section 24-42.4(2)(d)(iii), of said Ordinance, which states in pertinent part: "It shall be unlawful for any person to throw, drain, run or otherwise discharge into a sanitary sewer, or to cause, permit, allow or suffer to be thrown, run, drained or allowed to seep, or otherwise discharged into such sewer any pollutant in amounts which alone or in combination with other discharges will cause obstruction to the flow in the publicly owned treatment works."

Section 24-42.4(2)(d)(vi), of said Ordinance, which states in pertinent part: "It shall be unlawful for any person to throw, drain, run or otherwise discharge into a sanitary sewer, or to cause, permit, allow or suffer to be thrown, run, drained or allowed to seep, or otherwise discharged into such sewer any effluents in excess of local limits."

Pursuant to the provisions of Section 24-31(6) of Chapter 24, Miami-Dade County Code, whenever a violation of this chapter occurs or exists, or has occurred or existed, any person, individually or otherwise, who has legal, beneficial, or equitable interest in the real property upon which such violation occurs or exists, or has occurred or existed, shall be jointly and severally liable for said violation regardless of fault and regardless of knowledge of the violation.

Delivering Excellence Every Day

Based on the above and pursuant to the authority granted to me under Chapter 24, Miami-Dade County Environmental Protection Ordinance, I am hereby ordering you to:

1. Upon receipt of this NOTICE, "CEASE and DESIST" from allowing any further unauthorized discharges to the publicly owned sanitary sewer system at the subject location.
2. Within forty-five days (45) of receipt of this NOTICE, submit to this Department for review, formal plans signed and sealed by a Florida Professional Engineer for plumbing, equipment and/or processes changes, which shall correct the current violations and prevent future violations of the provisions of Chapter 24 at the subject facility. Said submittal shall include, at a minimum, the following.
 - A. Existing facility plan showing all food and beverage preparation areas (back of house areas) and kitchen equipment/appliances.
 - B. Existing facility sanitary drainage (plumbing) drawings, plan and isometric, that include:
 - i. Existing drains/lines, plumbing fixtures, solids separators, Fats, Oils and Grease (FOG) Control Devices (e.g., grease interceptors) and sampling point.
 - ii. All existing drains/lines not connected to a FOG Control Device (e.g., grease interceptor) labeled Existing Sanitary.
 - iii. All existing drains/lines connected to a FOG Control Device (e.g., grease interceptor) labelled Existing GW (Grease Waste).
 - C. Existing building sewer plan showing all connections from the facility to the public sanitary sewer system.
 - D. An evaluation of the existing FOG Control Device (e.g., grease interceptor) capacity. The evaluation shall incorporate proposed equipment and/or processes changes and include peak flow rate, FOG and solids loading rate, and pump-out (cleaning) frequency (e.g., 30, 60 or 90 days). FOG loading shall include all FOG sources: FOG generated by preparing meals and cleaning associated with eat-in, take-out and drive-through meals. The capacity of FOG Control Device (e.g., grease interceptor) shall be sufficient to produce an effluent that complies with Section 24-42.4 (e.g., 100 mg/L Oil & Grease).
 - E. If the evaluation demonstrates that the existing FOG Control Device (e.g., grease interceptor) does not provide sufficient capacity, submit "proposed" sanitary drainage (plumbing) drawings, plan and isometric, that include:
 - i. Existing and proposed drains/lines, plumbing fixtures, solids separators, FOG Control Devices (e.g., grease interceptors) and sampling point.
 - ii. All existing and proposed drains/lines not connected to a FOG Control Device (e.g., grease interceptor) labeled Existing Sanitary.
 - iii. All existing and proposed drains/lines connected to a FOG Control Device (e.g., grease interceptor) labelled Existing GW (Grease Waste).
 - iv. Sizing calculations for the proposed FOG Control Device (e.g., grease interceptor). The calculations shall incorporate proposed equipment and/or processes changes and include peak flow rate, FOG and solids loading rate, and pump-out (cleaning) frequency (e.g., 30, 60 or 90 days). FOG loading shall include all FOG sources: FOG generated by preparing meals and cleaning associated with eat-in, take-out and drive-through meals. The capacity of FOG Control Device (e.g., grease interceptor) shall be sufficient to produce an effluent that complies with Section 24-42.4 (e.g., 100 mg/L Oil & Grease).
 - v. The FOG Control Device (e.g., grease interceptor) shall be located to allow uninterrupted maintenance and inspection; i.e., the system shall be accessible all times and not require intervention to access, clean and inspect.
 - vi. Sampling point located after the point of no further treatment. The sampling point shall be directly accessible for visual inspection and sampling. Sampling point shall have sufficient depth and access to allow sample collection using a 3-inch diameter x 6-inch long sample bottle.
 - vii. All drainage fixtures located in food and beverage preparation areas (back of house areas) shall be connected to a FOG Control Device. Drainage fixtures include, but are not limited to: floor

drains, floor sinks, mop sinks, three-compartment sinks, hand sinks, pre-rinse station/sink, preparation sink, pot sink, wok sink, and self-cleaning exhaust hoods.

3. Upon approval by this Department, obtain the appropriate permits and commence with the implementation of the required improvements.
4. Within one hundred twenty (120) days of receipt of this Notice, complete the required improvements.

For appropriate handling, include the subject permit number (GDO-580) referencing this facility on all submittals filed with this Department and direct said submittals to DERM, attn. Carlos Hernandez, P.E., Chief, Wastewater Permitting Section, 701 NW 1st Court, 7th Floor, Miami, Florida 33136-3912

BE ADVISED THAT FAILURE TO COMPLY WITH THE ABOVE MAY RESULT, AT A MINIMUM, IN CIVIL PENALTIES AND THE PAYMENT OF ALL DEPARTMENTAL COSTS INCURRED IN THE INVESTIGATION AND SETTLEMENT OF THIS CASE. IN ADDITION, FAILURE TO COMPLY MAY RESULT IN YOUR CASE BEING PREPARED FOR FORMAL ENFORCEMENT ACTION IN A COURT OF COMPETENT JURISDICTION PURSUANT TO THE ENFORCEMENT AND PENALTY PROVISIONS OF SECTION 24-29, MIAMI DADE COUNTY ENVIRONMENTAL PROTECTION ORDINANCE.

Any person aggrieved by any action or decision of the DERM Director may appeal said action or decision to the Environmental Quality Control Board (EQCB) by filing a written notice of appeal along with submittal of the applicable fee, to the Code Coordination and Public Hearings Section of DERM within fifteen (15) days of the date of the action or decision by DERM.

If you have any questions concerning the above, please contact Carlos Hernandez, P.E., Chief of the Wastewater Permitting Section of this office at 305-372-6714 or via email at Hernac@miamidade.gov.

Sincerely,

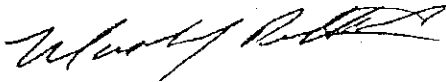

Mark J. Pettit
Environmental Code Enforcement Officer II
Regulatory Services



Carlos A. Gimenez, Mayor

Permitting, Environment and Regulatory Affairs
Environmental Services
701 NW 1st Court, 7th Floor
Miami, Florida 33136-3912
T 305-372-6600 F 305-372-6893

miamidade.gov

February 8, 2012

Gonzalez Family Investment, LLC
David's Café, Inc., Managing Member
Alfredo Gonzalez, President and Permittee
1058 Collins Avenue
Miami Beach, Florida 33139

Certified Mail No. 7004 2510 0001 7494 3135
Return Receipt Requested

Re: Grease Discharge Violations at, near or in the vicinity of 1058 Collins Avenue, Miami Beach, Miami-Dade County, Florida (Folio # 02-3234-008-1210)(PERA GDO-1097).

Dear Mr. Gonzalez:

NOTICE OF VIOLATION AND ORDERS FOR CORRECTIVE ACTION

On August 4, 2011 and January 30, 2012, representatives of this Department conducted inspections of the above-referenced property and performed dye testing of the wastewater system. The results confirmed that at least one grease recovery unit in use at this facility and other drainage structures in food preparation areas are not connected to the existing in-ground grease trap. The in-ground grease trap is intended as a pretreatment system to restrict direct oil and grease discharge to the sanitary sewer system. At present, this pretreatment system is being by-passed. In addition, an effluent sampling point from the in-ground grease trap was not available.

Be advised that the above constitutes violations of Chapter 24, of the Code of Miami-Dade County, specifically:

Section 24-18, of said Ordinance, inasmuch as no person shall operate, maintain or permit, cause, allow, let or suffer the operation or maintenance of any industrial waste facility in violation of any condition, limitation or restriction which is part of an operating permit;

Section 24-29, of said Ordinance, inasmuch as it shall be unlawful for any person to violate any of the provisions of this chapter, any lawful rules and regulations promulgated under this chapter, any lawful order of the Director of the Department of Environmental Resources Management or his designee, or any condition, limitation or restriction, which is part of an operating permit; and

Section 24-42.5, of said Ordinance, inasmuch as it shall be unlawful to by-pass the facility or any portion thereof and to discharge untreated or inadequately treated wastes to the waters the facility was designed to protect.

Based on the above, and pursuant to the authority granted to me under Chapter 24, of the Code of Miami-Dade County, you are hereby ordered to:

- 1. Upon receipt of this NOTICE, Cease and Desist from discharging untreated wastewater from food preparation areas into the sanitary sewer system in violation of Chapter 24, at the subject location.

Delivering Excellence Every Day

2. Within **thirty (30) days** of receipt of this NOTICE, submit to this office for review, formal plans for changes in equipment and/or processes and engineering drawings which shall correct the current violations and prevent future violations of the provisions of Chapter 24 at the subject facility. Said plans shall include connection of all appropriate fixtures and equipment to the in-ground grease trap pretreatment system. Appropriate fixtures and equipment include those that receive drainage from grease-laden waste located in food preparation areas. Drawings shall also include an approvable sampling point for the effluent from the in-ground grease trap just prior to sanitary sewers.
3. Pursuant to PERA's review and response to the plan submittal in item #2 above, implement necessary corrective actions to ensure food preparation wastewater pretreatment prior to sanitary sewer discharge.

Be advised that failure to comply with the above may result, at a minimum, in civil penalties and the payment of all department costs incurred in the investigation and settlement of this case, or in issuance of a Uniform Civil Violation Notice (UCVN) pursuant to the provisions of 8CC of the Code of Miami-Dade County which carries a mandatory civil penalty and requirement to correct the violation. In addition, failure to comply may result in your case being prepared for formal enforcement action in a court of competent jurisdiction pursuant to the enforcement and penalty provisions of Section 24-29, Code of Miami-Dade County.

If you have any questions concerning the above, please contact me at 305-372-6514 or email brownb@miamidade.gov.

Sincerely,

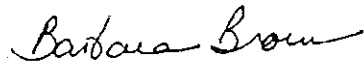

Barbara Brown
Code Enforcement Officer
Pollution Regulation & Enforcement Division



Carlos A. Gimenez, Mayor

Department of Regulatory and Economic Resources
Environmental Resources Management
701 NW 1st Court, 6th Floor
Miami, Florida 33136-3912
T 305-372-6902 F 305-372-6630
miamidade.gov

January 17, 2017

Kevin R. Johnson, President
Starbucks Coffee Company
2401 Utah Avenue South
MS: S-LA1, Suite 800
Seattle, WA 98134

Certified Mail No. 7014 1200 0000 1637 4390
Return Receipt Requested

Simon Karam, Manager
Upper Edge Holdings, LLC
Manager of Biscayne Acquisitions, LLC
4955 SW 83 Street
Miami, Florida 33131

Certified Mail No. 7014 1200 0000 1637 4406
Return Receipt Requested

Re: Unauthorized discharge to the sanitary sewer system from Starbucks Coffee Shop #13824 located at, near or in the vicinity of 2937 Biscayne Boulevard, Miami, Florida (folio # 01-3230-013-1020). DERM file no. GDO-1879.

Dear Mr. Johnson and Mr. Karam:

NOTICE OF VIOLATION
AND
ORDERS FOR CORRECTIVE ACTION

A representative of the Miami-Dade County Department of Regulatory and Economic Resources, Division of Environmental Resources Management (DERM), recently inspected the above-referenced facility and documented that the drainage fixtures associated with the food and beverage preparation areas are not connected to the on-site grease recovery unit resulting in the unauthorized discharge of grease to the sanitary sewer system servicing the subject property. Furthermore, dye testing confirmed that the facility's bathroom drainage fixtures are connected to the grease recovery unit indicating a problem with the building's sanitary drainage system.

Be advised that discharging, or allowing the discharge of any industrial wastes into a sanitary sewer system constitutes violations the facility's Grease Discharge Operating Permit (GDO-1879) and of Chapter 24, Miami-Dade County Environmental Protection Ordinance, specifically:

Section 24-29, of said Ordinance, which states in pertinent part: "It shall be unlawful for any person to violate any of the provisions of this chapter, any lawful rules and regulations promulgated under this chapter, any lawful order of the Director or the Director's designee or any condition, limitation or restriction which is part of an operating permit."

Section 24-42.4(2)(d)(iii), of said Ordinance, which states in pertinent part: "It shall be unlawful for any person to throw, drain, run or otherwise discharge into a sanitary sewer, or to cause, permit, allow or suffer to be thrown, run, drained or allowed to seep, or otherwise discharged into such sewer any pollutant in amounts which alone or in combination with other discharges will cause obstruction to the flow in the publicly owned treatment works."

Section 24-42.4(2)(d)(vi), of said Ordinance, which states in pertinent part: "It shall be unlawful for any person to throw, drain, run or otherwise discharge into a sanitary sewer, or to cause, permit, allow or suffer to be thrown, run, drained or allowed to seep, or otherwise discharged into such sewer any effluents in excess of local limits."

Delivering Excellence Every Day

Pursuant to the provisions of Section 24-31(6) of Chapter 24, Miami-Dade County Code, whenever a violation of this chapter occurs or exists, or has occurred or existed, any person, individually or otherwise, who has legal, beneficial, or equitable interest in the real property upon which such violation occurs or exists, or has occurred or existed, shall be jointly and severally liable for said violation regardless of fault and regardless of knowledge of the violation.

Based on the above and pursuant to the authority granted to me under Chapter 24, Miami-Dade County Environmental Protection Ordinance, I am hereby ordering you to:

1. Upon receipt of this NOTICE, **"CEASE and DESIST"** from allowing any further unauthorized discharges to the publicly owned sanitary sewer system at the subject location.
2. Within forty-five days (45) of receipt of this NOTICE, submit to this Department for review, formal plans signed and sealed by a Florida Professional Engineer for plumbing, equipment and/or processes changes, which shall correct the current violations and prevent future violations of the provisions of Chapter 24 at the subject facility. Said submittal shall include, at a minimum, the following.
 - A. Existing facility plan showing all food and beverage preparation areas (back of house areas) and kitchen equipment/appliances.
 - B. Existing facility sanitary drainage (plumbing) drawings, plan and isometric, that include:
 - i. Existing drains/lines, plumbing fixtures, solids separators, Fats, Oils and Grease (FOG) Control Devices (e.g., grease interceptors) and sampling point.
 - ii. All existing drains/lines not connected to a FOG Control Device (e.g., grease interceptor) labeled Existing Sanitary.
 - iii. All existing drains/lines connected to a FOG Control Device (e.g., grease interceptor) labelled Existing GW (Grease Waste).
 - C. Existing building sewer plan showing all connections from the facility to the public sanitary sewer system.
 - D. An evaluation of the existing FOG Control Device (e.g., grease interceptor) capacity. The evaluation shall incorporate proposed equipment and/or processes changes and include peak flow rate, FOG and solids loading rate, and pump-out (cleaning) frequency (e.g., 30, 60 or 90 days). FOG loading shall include all FOG sources: FOG generated by preparing meals and cleaning associated with eat-in, take-out and drive-through meals. The capacity of FOG Control Device (e.g., grease interceptor) shall be sufficient to produce an effluent that complies with Section 24-42.4 (e.g., 100 mg/L Oil & Grease).
 - E. If the evaluation demonstrates that the existing FOG Control Device (e.g., grease interceptor) does not provide sufficient capacity, submit "proposed" sanitary drainage (plumbing) drawings, plan and isometric, that include:
 - i. Existing and proposed drains/lines, plumbing fixtures, solids separators, FOG Control Devices (e.g., grease interceptors) and sampling point.
 - ii. All existing and proposed drains/lines not connected to a FOG Control Device (e.g., grease interceptor) labeled Existing Sanitary.
 - iii. All existing and proposed drains/lines connected to a FOG Control Device (e.g., grease interceptor) labelled Existing GW (Grease Waste).
 - iv. Sizing calculations for the proposed FOG Control Device (e.g., grease interceptor). The calculations shall incorporate proposed equipment and/or processes changes and include peak flow rate, FOG and solids loading rate, and pump-out (cleaning) frequency (e.g., 30, 60 or 90 days). FOG loading shall include all FOG sources: FOG generated by preparing meals and cleaning associated with eat-in, take-out and drive-through meals. The capacity of FOG Control Device (e.g., grease interceptor) shall be sufficient to produce an effluent that complies with Section 24-42.4 (e.g., 100 mg/L Oil & Grease).
 - v. The FOG Control Device (e.g., grease interceptor) shall be located to allow uninterrupted maintenance and inspection; i.e., the system shall be accessible all times and not require intervention to access, clean and inspect.

- vi. Sampling point located after the point of no further treatment. The sampling point shall be directly accessible for visual inspection and sampling. Sampling point shall have sufficient depth and access to allow sample collection using a 3-inch diameter x 6-inch long sample bottle.
 - vii. All drainage fixtures located in food and beverage preparation areas (back of house areas) shall be connected to a FOG Control Device. Drainage fixtures include, but are not limited to: floor drains, floor sinks, mop sinks, three-compartment sinks, hand sinks, pre-rinse station/sink, preparation sink, pot sink, wok sink, and self-cleaning exhaust hoods.
3. Upon approval by this Department, obtain the appropriate permits and commence with the implementation of the required improvements.
 4. Within one hundred twenty (120) days of receipt of this Notice, complete the required improvements.

For appropriate handling, include the subject permit number (GDO-1879) referencing this facility on all submittals filed with this Department and direct said submittals to DERM, attn. Carlos Hernandez, P.E., Chief, Wastewater Permitting Section, 701 NW 1st Court, 7th Floor, Miami, Florida 33136-3912

BE ADVISED THAT FAILURE TO COMPLY WITH THE ABOVE MAY RESULT, AT A MINIMUM, IN CIVIL PENALTIES AND THE PAYMENT OF ALL DEPARTMENTAL COSTS INCURRED IN THE INVESTIGATION AND SETTLEMENT OF THIS CASE. IN ADDITION, FAILURE TO COMPLY MAY RESULT IN YOUR CASE BEING PREPARED FOR FORMAL ENFORCEMENT ACTION IN A COURT OF COMPETENT JURISDICTION PURSUANT TO THE ENFORCEMENT AND PENALTY PROVISIONS OF SECTION 24-29, MIAMI DADE COUNTY ENVIRONMENTAL PROTECTION ORDINANCE.

Any person aggrieved by any action or decision of the DERM Director may appeal said action or decision to the Environmental Quality Control Board (EQCB) by filing a written notice of appeal along with submittal of the applicable fee, to the Code Coordination and Public Hearings Section of DERM within fifteen (15) days of the date of the action or decision by DERM.

If you have any questions concerning the above, please contact Carlos Hernandez, P.E., Chief of the Wastewater Permitting Section of this office at 305-372-6714 or via email at Hernac@miamidade.gov.

Sincerely,

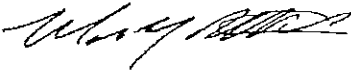

Mark J. Pettit
Environmental Code Enforcement Officer II
Regulatory Services

2261



Carlos A. Gimenez, Mayor

Department of Regulatory and Economic Resources
Environmental Resources Management
701 NW 1st Court, 6th Floor
Miami, Florida 33136-3912
T 305-372-6902 F 305-372-6630
miamidade.gov

April 12, 2017

LAZARO SANCHEZ, JR; DIRECTOR
WEE'S BROTHERS, INC.
400 NW NORTH RIVER DR.
MIAMI, FLORIDA 33128

Certified Mail No. 7014 1200 0000 1637 2037
Return Receipt Requested

LAZARO SANCHEZ, JR; DIRECTOR
CASABLANCA SEAFOOD BAR & GRILL, INC.
400 NW NORTH RIVER DR.
MIAMI, FL 33128

Re: Casablanca Seafood Bar & Grill, Inc located at, near, or in the vicinity of 400 NW North River Dr., Miami, Miami-Dade County, Florida (Folio No. 01-0107-010-1190) (GDO-2261).

Dear Mr. Sanchez:

**NOTICE OF VIOLATION AND ORDERS
FOR CORRECTIVE ACTION**

On April 8, 2016 and on November 14, 2016, inspections performed by Department of Regulatory and Economic Resources Division of Environmental Resources Management (DERM) staff found the current in-ground fat, oil and grease (FOG) control pretreatment device does not meet the minimum requirements for the subject facility. During the inspections samples taken from the effluent of the facility's current FOG control device revealed levels above the standard for oil and grease (O&G) discharges to the public sanitary sewer system (specifically, the sample results were 250.8 mg/L and 477.4 mg/L respectively, while the O&G sanitary sewer standard is 100 mg/L) which is also a violation of the facility's DERM Fat, Oil and Grease Discharge Control Annual Operating Permit (GDO Permit #2261).

Be advised that discharging, or allowing discharges in excess of the sanitary sewer standards constitutes violations of the facility's Fats, Oils and Grease Discharge Control Annual Operating Permit (GDO #2261) and of Chapter 24, Miami-Dade County Environmental Protection Ordinance, specifically:

Section 24-29, of Chapter 24, inasmuch as it shall be unlawful for any person to violate any of the provisions of this chapter, any lawful rules and regulations promulgated under this chapter, any

Delivering Excellence Every Day

lawful order of the Director of the Department of the Environmental Resources Management (DERM) or his designee, or any condition, limitation or restriction which is part of an operating permit.

Section 24-42.4.(2)(d)(vi) of Chapter 24, inasmuch as it shall be unlawful for any person to throw, drain, run or otherwise discharge into a sanitary sewer, or to cause, permit, allow or suffer to be thrown, run, drained, allowed to seep, or otherwise discharged into such sewer any effluents in excess of local limits.

Based on the above and pursuant to the authority granted to me under Chapter 24, Miami-Dade County Environmental Protection Ordinance, I am hereby ordering you to:

- 1) Upon receipt of this NOTICE, immediately CEASE and DESIST from any further unauthorized discharges to the publicly owned sanitary sewer system at the subject location.
- 2) Within sixty (60) days of receipt of this Notice, submit to this Department for review, formal plans signed and sealed by a Florida Professional Engineer for changes in equipment and/or processes, which shall correct the current violations and prevent future violations of the provisions of Chapter 24 at the subject facility. Said plans shall include at a minimum the following:
 - a) All existing plumbing lines, drainage fixtures, solids separators, grease interceptors/ grease traps and sampling points. All lines that receive or can receive waste from fixtures that can discharge food waste or Fats, Oil and Grease (FOG) shall be labeled grease waste (GW) to distinguish it from sanitary waste.
 - b) A FOG control device sized bases on calculations that include peak flow rates, FOG and solids loading rate, and a maximum pump out frequency of sixty (60) days. FOG loading shall include all FOG sources, including exhaust hoods. For self-cleaning exhaust hoods, the manufacturer's specifications for peak discharge shall be included.
 - c) All drainage fixtures located in food and beverage preparation areas shall be routed through a grease interceptor. Drainage fixtures include, but are not limited to: floor drains, floor sinks, mop sinks, three-compartment sinks, hand sinks, pre-rinse station/sink, preparation sink, pot sink, wok sink, and self-cleaning exhaust hoods
 - d) Sampling point located after the point of no further treatment. The sampling point shall have sufficient depth and access to allow sample collection using a 3-inch diameter x 6-inch long sample bottle. An alternative to a manufactured sampling point (device) is a double sanitary cross with a PVC-CAP on the bottom of the vertical axis to create the sampling sump and a clean-out cap on top. Minimum diameter for the vertical axis is 4-inches; minimum depth of the sump is 6 inches.
 - e) Isometric diagram(s) with existing and proposed plumbing lines, fixtures, solids separators, FOG control devices and sampling points. Grease waste lines shall be labeled GW.
 - f) Solids separation prior to existing or proposed FOG control devices that require a flow control device or are not certified to handle solids.

- 3) Upon approval by this Department, obtain the appropriate permits and commence with the implementation of the required improvements.
- 4) Within one hundred and eighty (180) days of receipt of this Notice, complete the required improvements.

For appropriate handling, include the subject permit number (GDO-2261) referencing this facility on all submittals filled with this Department and direct said submittals to DERM, attn. Carlos Hernandez, P.E., Chief, Wastewater Permitting Section, 701 NW 1st Court, 7th Floor, Miami, FL 33136-3912.

BE ADVISED THAT FAILURE TO COMPLY WITH THE ABOVE MAY RESULT, AT A MINIMUM, IN ASSESSMENT OF CIVIL PENALTIES AND THE PAYMENT OF ALL DEPARTMENTAL COSTS INCURRED IN THE INVESTIGATION AND SETTLEMENT OF THIS CASE. IN ADDITION, FAILURE TO COMPLY MAY RESULT IN YOUR CASE BEING PREPARED FOR FORMAL ENFORCEMENT ACTION IN A COURT OF COMPETENT JURISDICTION PURSUANT TO THE ENFORCEMENT AND PENALTY PROVISIONS OF SECTION 24-29, OF CHAPTER 24 OF THE CODE OF MIAMI-DADE COUNTY, FLORIDA, THE MIAMI-DADE COUNTY ENVIRONMENTAL PROTECTION ORDINANCE.

Any person aggrieved by any action or decision of the DERM Director may appeal said action or decision to the Environmental Quality Control Board (EQCB) by filing a written notice of appeal along with submittal of the applicable fee, to the Code Coordination and Public Hearings Section of DERM within fifteen (15) days of the date of the action or decision by DERM.

If you have any questions concerning the above, please contact the undersigned at 305-372-6546 or via email at StreetE@miamidade.gov.

Sincerely,



Eric T. Streett
Environmental Code Enforcement Officer II
Division of Environmental Resources Management
Regulatory Services

CC: L. Castillo , DERM PRD

2339



Carlos A. Gimenez, Mayor

Department of Regulatory and Economic Resources
Environmental Resources Management
701 NW 1st Court, 6th Floor
Miami, Florida 33136-3912
T 305-372-6902 F 305-372-6630
miamidade.gov

April 12, 2017

ESTEBAN L. GARCIA, PRESIDENT
GARCIA HOLDINGS, INC.
1450 BRICKELL AVE. 18TH FLOOR
MIAMI, FLORIDA 33131

Certified Mail No. 7014 1200 0000 1637 2044
Return Receipt Requested

ESTEBAN L. GARCIA, PRESIDENT
GARCIA SEAFOOD GRILLE & FISH MARKET, INC.
1450 BRICKELL AVE. 18TH FLOOR
MIAMI, FLORIDA 33131

Re: Garcia Seafood Grille & Fish Market, Inc located at, near, or in the vicinity of 398 NW North River Dr., Miami, Miami-Dade County, Florida (Folio No. 01-0107-010-1180) (GDO-2339).

Dear Mr. Garcia:

**NOTICE OF VIOLATION AND ORDERS
FOR CORRECTIVE ACTION**

On March 9, 2016, May 24, 2016, July 15, 2016 and on November 14, 2016, inspections performed by Department of Regulatory and Economic Resources Division of Environmental Resources Management (DERM) staff found the current in-ground fat, oil and grease (FOG) control pretreatment device does not meet the minimum requirements for the subject facility. During the inspections samples taken from the effluent of the facility's current FOG control device revealed levels above the standard for oil and grease (O&G) discharges to the public sanitary sewer system (specifically, the sample results were 162.6 mg/L, 221.9 mg/L, 224 mg/L and 679.7 mg/L respectively, while the O&G sanitary sewer standard is 100 mg/L) which is also a violation of the facility's DERM Fat, Oil and Grease Discharge Control Annual Operating Permit (GDO Permit #2339).

Be advised that discharging, or allowing discharges in excess of the sanitary sewer standards constitutes violations of the facility's Fats, Oils and Grease Discharge Control Annual Operating Permit (GDO #2339) and of Chapter 24, Miami-Dade County Environmental Protection Ordinance, specifically:

Delivering Excellence Every Day

Section 24-29, of Chapter 24, inasmuch as it shall be unlawful for any person to violate any of the provisions of this chapter, any lawful rules and regulations promulgated under this chapter, any lawful order of the Director of the Department of the Environmental Resources Management (DERM) or his designee, or any condition, limitation or restriction which is part of an operating permit.

Section 24-42.4.(2)(d)(vi) of Chapter 24, inasmuch as it shall be unlawful for any person to throw, drain, run or otherwise discharge into a sanitary sewer, or to cause, permit, allow or suffer to be thrown, run, drained, allowed to seep, or otherwise discharged into such sewer any effluents in excess of local limits.

Based on the above and pursuant to the authority granted to me under Chapter 24, Miami-Dade County Environmental Protection Ordinance, I am hereby ordering you to:

- 1) Upon receipt of this NOTICE, immediately CEASE and DESIST from any further unauthorized discharges to the publicly owned sanitary sewer system at the subject location.
- 2) Within sixty (60) days of receipt of this Notice, submit to this Department for review, formal plans signed and sealed by a Florida Professional Engineer for changes in equipment and/or processes, which shall correct the current violations and prevent future violations of the provisions of Chapter 24 at the subject facility. Said plans shall include at a minimum the following:
 - a) All existing plumbing lines, drainage fixtures, solids separators, grease interceptors/ grease traps and sampling points. All lines that receive or can receive waste from fixtures that can discharge food waste or Fats, Oil and Grease (FOG) shall be labeled grease waste (GW) to distinguish it from sanitary waste.
 - b) A FOG control device sized bases on calculations that include peak flow rates, FOG and solids loading rate, and a maximum pump out frequency of sixty (60) days. FOG loading shall include all FOG sources, including exhaust hoods. For self-cleaning exhaust hoods, the manufacturer's specifications for peak discharge shall be included.
 - c) All drainage fixtures located in food and beverage preparation areas shall be routed through a grease interceptor. Drainage fixtures include, but are not limited to: floor drains, floor sinks, mop sinks, three-compartment sinks, hand sinks, pre-rinse station/sink, preparation sink, pot sink, wok sink, and self-cleaning exhaust hoods
 - d) Sampling point located after the point of no further treatment. The sampling point shall have sufficient depth and access to allow sample collection using a 3-inch diameter x 6-inch long sample bottle. An alternative to a manufactured sampling point (device) is a double sanitary cross with a PVC-CAP on the bottom of the vertical axis to create the sampling sump and a clean-out cap on top. Minimum diameter for the vertical axis is 4-inches; minimum depth of the sump is 6 inches.
 - e) Isometric diagram(s) with existing and proposed plumbing lines, fixtures, solids separators, FOG control devices and sampling points. Grease waste lines shall be labeled GW.

- f) Solids separation prior to existing or proposed FOG control devices that require a flow control device or are not certified to handle solids.
- 3) Upon approval by this Department, obtain the appropriate permits and commence with the implementation of the required improvements.
- 4) Within one hundred and eighty (180) days of receipt of this Notice, complete the required improvements.

For appropriate handling, include the subject permit number (GDO-2339) referencing this facility on all submittals filed with this Department and direct said submittals to DERM, attn. Carlos Hernandez, P.E., Chief, Wastewater Permitting Section, 701 NW 1st Court, 7th Floor, Miami, FL 33136-3912.

BE ADVISED THAT FAILURE TO COMPLY WITH THE ABOVE MAY RESULT, AT A MINIMUM, IN ASSESSMENT OF CIVIL PENALTIES AND THE PAYMENT OF ALL DEPARTMENTAL COSTS INCURRED IN THE INVESTIGATION AND SETTLEMENT OF THIS CASE. IN ADDITION, FAILURE TO COMPLY MAY RESULT IN YOUR CASE BEING PREPARED FOR FORMAL ENFORCEMENT ACTION IN A COURT OF COMPETENT JURISDICTION PURSUANT TO THE ENFORCEMENT AND PENALTY PROVISIONS OF SECTION 24-29, OF CHAPTER 24 OF THE CODE OF MIAMI-DADE COUNTY, FLORIDA, THE MIAMI-DADE COUNTY ENVIRONMENTAL PROTECTION ORDINANCE.

Any person aggrieved by any action or decision of the DERM Director may appeal said action or decision to the Environmental Quality Control Board (EQCB) by filing a written notice of appeal along with submittal of the applicable fee, to the Code Coordination and Public Hearings Section of DERM within fifteen (15) days of the date of the action or decision by DERM.

If you have any questions concerning the above, please contact the undersigned at 305-372-6546 or via email at StreeE@miamidade.gov.

Sincerely,

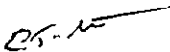

Eric T. Streett
Environmental Code Enforcement Officer II
Division of Environmental Resources Management
Regulatory Services

CC: L. Castillo , DERM PRD

ECM - GDO - 2378



Carlos A. Gimenez, Mayor

Department of Regulatory and Economic Resources
Environmental Resources Management
701 NW 1st Court, 6th Floor
Miami, Florida 33136-3912
T 305-372-6902 F 305-372-6630

miamidade.gov

November 18, 2016

Jorge Louro Vice President
Di Papa's, Inc.
9877 N Kendall Drive
Miami, FL 33176

Certified Mail No. 7014 1200 0000 1637 3379
Return Receipt Requested

Steven Levy and Hayun Amir, Managers
Natalie Real Estate, LLC
1355 West 44th Place, Office 100
Hialeah, FL 33012

Certified Mail No. 7014 1200 0000 1637 3386
Return Receipt Requested

Re: Unauthorized discharge to the sanitary sewer system from Di Papa's Restaurant located at, near or in the vicinity of 9871-9877 N Kendall Drive, Miami, Florida (folio # 030-4032-009-0100). DERM file no. GDO-2378.

Dear Messrs. Louro, Levy and Hayun:

NOTICE OF VIOLATION
AND
ORDERS FOR CORRECTIVE ACTION

Inspections of the subject property by representatives of this department on July 21, 2016 and August 26, 2016 revealed discharges of oil and grease of 3110 mg/l and 2030 mg/l respectively, above the sanitary sewer discharge limit of 100 mg/l, in violation of condition no. 9 of your Fats, Oil and Grease Discharge Control Annual Operating Permit (GDO-2378) and in violation of Chapter 24, Miami-Dade County Code.

Be advised that the above constitutes violations of Chapter 24, Miami-Dade County Environmental Protection Ordinance, specifically:

Section 24-29, of said Ordinance, which states in pertinent part: "It shall be unlawful for any person to violate any of the provisions of this chapter, any lawful rules and regulations promulgated under this chapter, any lawful order of the Director of DERM or his designee, or any condition, limitation or restriction which is part of an operating permit.

Section 24-42.4(2)(d)(vi), of said Ordinance, which states in pertinent part: "It shall be unlawful for any person to throw, drain, run or otherwise discharge into a sanitary sewer, or to cause, permit, allow or suffer to be thrown, run, drained or allowed to seep, or otherwise discharged into such sewer any effluents in excess of local limits."

Based on the above and pursuant to the authority granted to me under Chapter 24, Miami-Dade County Environmental Protection Ordinance, you are hereby ordered to:

1. Upon receipt of this NOTICE, "CEASE and DESIST" from allowing any further unauthorized discharges to the publicly owned sanitary sewer system at the subject location.

Delivering Excellence Every Day

2. Within forty-five days (45) of receipt of this NOTICE, submit to this Department for review, formal plans signed and sealed by a Florida Professional Engineer for plumbing, equipment and/or processes changes, which shall correct the current violations and prevent future violations of the provisions of Chapter 24 at the subject facility. Said submittal shall include, at a minimum, the following.
 - A. Existing facility plan showing all food and beverage preparation areas (back of house areas) and kitchen equipment/appliances.
 - B. Existing facility sanitary drainage (plumbing) drawings, plan and isometric, that include:
 - i. Existing drains/lines, plumbing fixtures, solids separators, Fats, Oils and Grease (FOG) Control Devices (e.g., grease interceptors) and sampling point.
 - ii. All existing drains/lines not connected to a FOG Control Device (e.g., grease interceptor) labeled Existing Sanitary.
 - iii. All existing drains/lines connected to a FOG Control Device (e.g., grease interceptor) labelled Existing GW (Grease Waste).
 - C. Existing building sewer plan showing all connections from the facility to the public sanitary sewer system.
 - D. An evaluation of the existing FOG Control Device (e.g., grease interceptor) capacity. The evaluation shall incorporate proposed equipment and/or processes changes and include peak flow rate, FOG and solids loading rate, and pump-out (cleaning) frequency (e.g., 30, 60 or 90 days). FOG loading shall include all FOG sources: FOG generated by preparing meals and cleaning associated with eat-in, take-out and drive-through meals. The capacity of FOG Control Device (e.g., grease interceptor) shall be sufficient to produce an effluent that complies with Section 24-42.4 (e.g., 100 mg/L Oil & Grease).
 - E. If the evaluation demonstrates that the existing FOG Control Device (e.g., grease interceptor) does not provide sufficient capacity, submit "proposed" sanitary drainage (plumbing) drawings, plan and isometric, that include:
 - i. Existing and proposed drains/lines, plumbing fixtures, solids separators, FOG Control Devices (e.g., grease interceptors) and sampling point.
 - ii. All existing and proposed drains/lines not connected to a FOG Control Device (e.g., grease interceptor) labeled Existing Sanitary.
 - iii. All existing and proposed drains/lines connected to a FOG Control Device (e.g., grease interceptor) labelled Existing GW (Grease Waste).
 - iv. Sizing calculations for the proposed FOG Control Device (e.g., grease interceptor). The calculations shall incorporate proposed equipment and/or processes changes and include peak flow rate, FOG and solids loading rate, and pump-out (cleaning) frequency (e.g., 30, 60 or 90 days). FOG loading shall include all FOG sources: FOG generated by preparing meals and cleaning associated with eat-in, take-out and drive-through meals. The capacity of FOG Control Device (e.g., grease interceptor) shall be sufficient to produce an effluent that complies with Section 24-42.4 (e.g., 100 mg/L Oil & Grease).

- v. The FOG Control Device (e.g., grease interceptor) shall be located to allow uninterrupted maintenance and inspection; i.e., the system shall be accessible all times and not require intervention to access, clean and inspect.
 - vi. Sampling point located after the point of no further treatment. The sampling point shall be directly accessible for visual inspection and sampling. Sampling point shall have sufficient depth and access to allow sample collection using a 3-inch diameter x 6-inch long sample bottle.
 - vii. All drainage fixtures located in food and beverage preparation areas (back of house areas) shall be connected to a FOG Control Device. Drainage fixtures include, but are not limited to: floor drains, floor sinks, mop sinks, three-compartment sinks, hand sinks, pre-rinse station/sink, preparation sink, pot sink, wok sink, and self-cleaning exhaust hoods.
3. Upon approval by this Department, obtain the appropriate permits and commence with the implementation of the required improvements.
 4. Within one hundred twenty (120) days of receipt of this Notice, complete the required improvements.

For appropriate handling, include the subject permit number (GDO-2378) referencing this facility on all submittals filed with this Department and direct said submittals to DERM, attn. Carlos Hernandez, P.E., Chief, Wastewater Permitting Section, 701 NW 1st Court, 7th Floor, Miami, Florida 33136-3912

BE ADVISED THAT FAILURE TO COMPLY WITH THE ABOVE MAY RESULT, AT A MINIMUM, IN CIVIL PENALTIES AND THE PAYMENT OF ALL DEPARTMENTAL COSTS INCURRED IN THE INVESTIGATION AND SETTLEMENT OF THIS CASE. IN ADDITION, FAILURE TO COMPLY MAY RESULT IN YOUR CASE BEING PREPARED FOR FORMAL ENFORCEMENT ACTION IN A COURT OF COMPETENT JURISDICTION PURSUANT TO THE ENFORCEMENT AND PENALTY PROVISIONS OF SECTION 24-29, MIAMI DADE COUNTY ENVIRONMENTAL PROTECTION ORDINANCE.

Any person aggrieved by any action or decision of the DERM Director may appeal said action or decision to the Environmental Quality Control Board (EQCB) by filing a written notice of appeal along with submittal of the applicable fee, to the Code Coordination and Public Hearings Section of DERM within fifteen (15) days of the date of the action or decision by DERM.

If you have any questions concerning the above, please contact Carlos Hernandez, P.E., Chief of the Wastewater Permitting Section of this office at 305-372-6714 or via email at Hernac@miamidade.gov.

Sincerely,



Francisco Verrine
Code Enforcement Officer

pc: Carlos Hernandez, P.E., DERM
Laura Castillo, DERM



Carlos A. Gimenez, Mayor

Department of Regulatory and Economic Resources
Environmental Resources Management
701 NW 1st Court, 6th Floor
Miami, Florida 33136-3912
T 305-372-6902 F 305-372-6630

miamidade.gov

January 30, 2017

DAVID LUKES, CEO
EQY PORTFOLIO INVESTOR (GRI) INC.
GRI-EQY (CONCORD) LLC
1600 NE MIAMI GARDENS DR
NORTH MIAMI BEACH, FL 33179

Certified Mail No. 7009 0080 0000 1045 2673
Return Receipt Requested

ZHANG XIAO, MGR.
BUFFET MIAMI LLC DBA ROYAL BUFFET & GRILL
11379 SW 40 ST.
MIAMI, FL 33165

Certified Mail No. 7009 0080 0000 1045 2680
Return Receipt Requested

YANG GUO, MGRM
GUO FOOD SERVICE LLC DBA CHINA BUFFET
3363 SHERIDAN ST. STE. 214
HOLLYWOOD, FL 33021

Certified Mail No. 7009 0080 0000 1045 2697
Return Receipt Requested

Re: Buffet Miami, LLC DBA Royal Buffet & Grill, formerly Guo Food Service LLC DBA China Buffet located at, near, or in the vicinity of 11379 SW 40 St., Miami-Dade County, Florida (Folio No. 30-4018-094-0010) (GDO-3376).

Dear Messrs. Lukes, Xiao and Guo:

**NOTICE OF VIOLATION AND ORDERS
FOR CORRECTIVE ACTION**

Inspections conducted by staff of the Department of Regulatory and Economic Resources, Division of Environmental Resources Management (DERM) during the period May 12 through June 14, 2016 revealed the on-site restaurant was being operated with violations including, a breached and leaking in-ground fat, oil and grease (FOG) control devices (i.e grease trap).. There were also no records available on site for the servicing of the FOG control devices and an outdoor mop sink was observed in the open, allowing for rain water collection and subsequent discharges to the public sanitary sewers. Field Notices of Violation were issued on May 12, 2016 to Guo Food Services, LLC DBA China Buffet and on May 24, 2016, to GRI-EQY (Concord) LLC. Due to continued non-compliance, Uniform Civil Violation Notices (UCVN) #B100660 and UCVN #B100661 were issued to GUO Food Service LLC DBA China Buffet and GRI EQY, LLC c/o EQY Portfolio Investor (GRI) Inc. respectively. On August 18, 2016 a Notice of Intended Court Action (NOICA) was issued to both GRI-EQY (Concord) LLC c/o EQY Portfolio Investor (GRI) Inc. and Guo Food Service, LLC that were posted at the subject site on August 19, 2016.

Working on it every day

Be advised, these findings constitute violation of the facility's Fats, Oils and Grease Discharge Control Annual Operating Permit (GDO #3376) and/or Chapter 24, Miami-Dade County Environmental Protection Ordinance, specifically:

Section 24-18, of Chapter 24, inasmuch as no person shall operate or permit, cause or allow the operation of any facility which will reasonable be expected to be a source of air pollution, ground pollution or water pollution, without a valid operating permit;

Section 24-21, of Chapter 24, inasmuch as the owner or operator of any facility installed or operating under the provisions of this chapter shall cause to be maintained and kept such records of the operation data and control tests as may be required by the Director to indicate the operating efficiency of such facility, and to show whether or not such facility is causing pollution as herein defined, and to furnish all such information and data concerning the operation of the facility as the Director may require from time to time.

Section 24-29, of Chapter 24, inasmuch as it shall be unlawful for any person to violate any of the provisions of this chapter, any lawful rules and regulations promulgated under this chapter, any lawful order of the Director of the Department of the Environmental Resources Management (DERM) or his designee, or any condition, limitation or restriction which is part of an operating permit.

Section 24-42 (1), of Chapter 24, inasmuch as it shall be unlawful for any person to throw, drain, run or otherwise discharge into any of the waters of this County, or to cause, permit or suffer to be thrown, run, drained, allowed to seep, or otherwise discharged into such water any organic or inorganic matter which shall: (a) Breach the values set forth in Section 24-42(2); (b) Cause water pollution as herein defined; or (c) Cause a nuisance or sanitary nuisance as herein defined.

Section 24-42.4(2)(b), of Chapter 24, inasmuch as it shall be unlawful for any person to throw, drain, run or otherwise discharge into a sanitary sewer, or to cause, permit, allow or suffer to be thrown, run, drained, allowed to seep, or otherwise discharged into such sewer any storm water.

Based on the above and pursuant to the authority granted to me under Chapter 24, Miami-Dade County Environmental Protection Ordinance, I am hereby ordering you to:

- 1) Immediately upon receipt of this NOTICE, cease and desist from all activities which allows the discharge of storm water into the sanitary sewer system.
- 2) Within seven (7) days of receipt of this NOTICE, provide to this Department the last three (3) service/pump out receipts for the facility's FOG control system.
- 3) Within seven (7) days of receipt of this NOTICE, complete temporary emergency repairs to all three (3) breached in-ground tanks (IGT's) that are part of the facility's FOG control system. The temporary repairs shall eliminate all discharges to ground or groundwater. If emergency repairs cannot be made or do not eliminate all discharges to ground and/or groundwater, the facility shall cease and desist from all discharges to the breached IGTs within seven (7) days from receipt of this NOTICE.
- 4) Within eight (8) days of receipt of this NOTICE, contact this Department to perform a fieldinspection of the tanks to confirm that emergency temporary repairs have been completed. All IGTs shall be clean and empty during the field inspection. If emergency

repairs are not completed or do not eliminate all discharges to ground and/or groundwater, the facility shall immediately cease and desist from all discharges to the breached IGTs..

- 5) Within thirty (30) days of receipt of this NOTICE, submit proof that improvements have been made to the external sink area to prevent storm water from entering the sanitary sewer system or that the external sink has been removed and/or the line leading to sanitary sewers has been sealed.
- 6) Within thirty (30) days of receipt of this Notice, submit to this Department for review, formal plans signed and sealed by a Florida Professional Engineer for the replacement of the FOG control system at the subject facility, which shall correct the current violations and prevent future violations of the provisions of Chapter 24 at the subject facility. Said plans shall include at a minimum the following:
 - a) All existing plumbing lines, drainage fixtures, solids separators, grease interceptors/ grease traps and sampling points. All lines that receive or can receive waste from fixtures that can discharge food waste or Fats, Oil and Grease (FOG) shall be labeled grease waste (GW) to distinguish it from sanitary waste.
 - b) A FOG control device (i.e., grease interceptor(s)) sized based on calculations that include peak flow rates, FOG and solids loading rates, and a maximum pump out frequency of sixty (60) days. FOG loading shall include all FOG sources, including food preparation and cleaning associated with eat-in and take-out meal. For self-cleaning exhaust hoods, the manufacturer's specifications for peak discharge shall be included in the sizing of the grease interceptors.
 - c) All drainage fixtures located in food and beverage preparation areas shall be routed through a grease interceptor. Drainage fixtures include, but are not limited to: floor drains, floor sinks, mop sinks, three-compartment sinks, hand sinks, pre-rinse station/sink, preparation sink, pot sink, wok sink, and self-cleaning exhaust hoods
 - d) Sampling point located after the point of no further treatment. The sampling point shall have sufficient depth and access to allow sample collection using a 3-inch diameter x 6-inch long sample bottle.
 - e) Isometric diagram(s) with existing and proposed plumbing lines, fixtures, solids separators, FOG control devices and sampling points. Grease waste lines shall be labeled GW.
 - f) Solids separation prior to existing or proposed grease interceptors that require a flow control device or are not certified to handle solids.
- 7) Upon approval by this Department, obtain the appropriate permits and commence with the implementation of the required improvements/replacements.
- 8) Within ninety (90) days of receipt of this Notice, complete the required improvements.

For appropriate handling, include the subject permit number (GDO-3376) referencing this facility on all submittals filled with this Department and direct said submittals to DERM, attn. Carlos Hernandez, P.E., Chief, Wastewater Permitting Section, 701 NW 1st Court, 7th Floor, Miami, FL 33136-3912.

BE ADVISED THAT FAILURE TO COMPLY WITH THE ABOVE MAY RESULT, AT A MINIMUM, IN ASSESSMENT OF CIVIL PENALTIES AND THE PAYMENT OF ALL DEPARTMENTAL COSTS INCURRED IN THE INVESTIGATION AND SETTLEMENT OF THIS CASE. IN ADDITION,

FAILURE TO COMPLY MAY RESULT IN YOUR CASE BEING PREPARED FOR FORMAL ENFORCEMENT ACTION IN A COURT OF COMPETENT JURISDICTION PURSUANT TO THE ENFORCEMENT AND PENALTY PROVISIONS OF SECTION 24-29, OF CHAPTER 24 OF THE CODE OF MIAMI-DADE COUNTY, FLORIDA, THE MIAMI-DADE COUNTY ENVIRONMENTAL PROTECTION ORDINANCE.

Any person aggrieved by any action or decision of the DERM Director may appeal said action or decision to the Environmental Quality Control Board (EQCB) by filing a written notice of appeal along with submittal of the applicable fee, to the Code Coordination and Public Hearings Section of DERM within fifteen (15) days of the date of the action or decision by DERM.

If you have any questions concerning the above, please contact the undersigned at 305-372-6546 or via email at StreeE@miamidade.gov.

Sincerely,

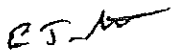

Eric T. Streett
Environmental Code Enforcement Officer II
Division of Environmental Resources Management
Regulatory Services

CC: L. Castillo , DERM PRD



Department of Regulatory and Economic Resources
Division of Environmental Resources Management (DERM)
701 NW 1st Court
Miami, Florida 33136-3912
T 305-372-6600 F 305-372-6545

GREASE DISCHARGE OPERATING PERMIT FIELD NOTICE OF VIOLATION

Date: May 12, 2016 GDO#: 3376 Facility Contact: Mr. Yang Guo

Facility Name: Guo Food Service, LLC DBA China Buffet

Facility Address: 11379 SW 40 Street Miami, Fl 33165

Permit (check): [X] IGT [] AGT [] MGRU [] AGRU [] NGT

YOU ARE HEREBY NOTIFIED that an inspection on 5/12/2016 of the premises listed above revealed the following conditions in violations of Sections 24-15.3 and/or 24-18 of Chapter 24, of the Miami-Dade County Code.

- [] Accumulated wastes in grease pretreatment system utilized by this facility must be removed (record in Maintenance Log, provide receipts).
[] Grease pretreatment system has the following structural/mechanical deficiencies:

[Empty box for structural/mechanical deficiencies]

- [] Grease pretreatment system is not maintained according to approved plans, and/or drawings, and/or manufacturer's specifications.

[Empty box for maintenance details]

- [X] Grease pretreatment system maintenance records and maintenance log not kept on site/not maintained for 3 years/ insufficient information recorded on Log. Please submit the last 3 pump out receipts.

[Empty box for maintenance log details]

- [] Access to the facility is required/Access to grease pretreatment system is required.
[] Grease pretreatment sampling point is not accessible/improperly constructed.

[Empty box for access details]

- [] Other violations or additional comments (if citing other violations, describe violation and corrective actions):

[Empty box for other violations]

Corrective actions to address violations noted below may require approval from appropriate Building Department and DERM

- [] No grease pretreatment system available.
[] Grease pretreatment system does not have a sampling point.
[] Fixtures having the potential to introduce grease into sewers are not connected to a grease pretreatment system.

Be advised that you are required to correct the above violation(s) within 7 days/hours of receipt of this NOTICE. Failure to correct the violation(s) noted above within the above-referenced time period may result in enforcement action pursuant Section 24-29, Miami-Dade County Code. Documentation (e.g. photographs, waste disposal manifests, invoices for work performed, etc.) which demonstrates the above-noted have been corrected, may be submitted by facsimile to Attn: Navila Bernal at (305) 372-6545, or mailed to the address indicated above, or scanned and emailed to: Navila.Bernal@miamidade.gov within the above-referenced time period in order to avoid additional penalties.

Failure to comply with the above may result in either the issuance of a Uniform Civil Notice (UCVN), pursuant to Chapter 8-CC of the Miami-Dade County Code, requiring corrective action(s) and payment of a civil penalty and/or the initiation of formal enforcement action by, DERM, subjecting you to the enforcement and penalty provisions of Sections 24-29 and 24-30, Miami-Dade County Code.

Any person aggrieved by any action or decision of the DERM Director may appeal said action or decision to the Environmental Quality Control Board (EQCB) by filing a written notice of appeal along with submittal of the applicable fee, to the Code Coordination and Public Hearings Section of DERM within fifteen (15) days of the date of the action or decision by DERM.

PLEASE GOVERN YOURSELF ACCORDINGLY

Lee N. Hefty, Director
Environmental Resources Management

Received By: _____
Recipient's Signature

Issued by: _____
Signature

Print: Mr. Yang Guo
Recipient's Name

Print: Navila Bernal
Name

Title: Permittee

Section/Phone: 305-372-6600

Posted: Y [] N [] Photographed: Y [] N []



Department of Regulatory and Economic Resources
 Division of Environmental Resources Management (DERM)
 701 NW 1st Court
 Miami, Florida 33136-3912
 T 305-372-6600 F 305-372-6545

GREASE DISCHARGE OPERATING PERMIT FIELD NOTICE OF VIOLATION

Date: May 12, 2016 GDO#: 3376 Facility Contact: Mr. Yang Guo
 Facility Name: Guo Food Service, LLC DBA China Buffet
 Facility Address: 11379 SW 40 Street Miami, Fl 33165
 Permit (check): IGT AGT MGRU AGRU NGT

YOU ARE HEREBY NOTIFIED that an inspection on 5/12/2016 of the premises listed above revealed the following conditions in violations of Sections 24-15.3 and/or 24-18 of Chapter 24, of the Miami-Dade County Code.

- Accumulated wastes in grease pretreatment system utilized by this facility must be removed (record in Maintenance Log, provide receipts).
- Grease pretreatment system has the following structural/mechanical deficiencies:

Be advised that the grease pretreatment system is breached. All three tanks must be temporarily repaired within 7 days (receipts must be submitted for review.) Tanks must be replaced with 90 days. NOTE: Replacement requires approval from DERM and building department.

- Grease pretreatment system is not maintained according to approved plans, and/or drawings, and/or manufacturer's specifications.

- Grease pretreatment system maintenance records and maintenance log not kept on site/not maintained for 3 years/insufficient information recorded on Log.

- Access to the facility is required/Access to grease pretreatment system is required.
- Grease pretreatment sampling point is not accessible improperly constructed.

- Other violations or additional comments (If citing other violations, describe violation and corrective actions):

Corrective actions to address violations noted below may require approval from appropriate Building Department and DERM

- No grease pretreatment system available.
- Grease pretreatment system does not have a sampling point.
- Fixtures having the potential to introduce grease into sewers are not connected to a grease pretreatment system.

Be advised that you are required to correct the above violation(s) within 90 days/hours of receipt of this NOTICE. Failure to correct the violation(s) noted above within the above-referenced time period may result in enforcement action pursuant Section 24-29, Miami-Dade County Code. Documentation (e.g. photographs, waste disposal manifests, invoices for work performed, etc.) which demonstrates the above-noted have been corrected, may be submitted by facsimile to Attn: Navila Bernal at (305) 372-6545, or mailed to the address indicated above, or scanned and emailed to: Navila.Bernal@miamidade.gov within the above-referenced time period in order to avoid additional penalties.

Failure to comply with the above may result in either the issuance of a Uniform Civil Notice (UCVN), pursuant to Chapter 8-CC of the Miami-Dade County Code, requiring corrective action(s) and payment of a civil penalty and/or the initiation of formal enforcement action by, DERM, subjecting you to the enforcement and penalty provisions of Sections 24-29 and 24-30, Miami-Dade County Code.

Any person aggrieved by any action or decision of the DERM Director may appeal said action or decision to the Environmental Quality Control Board (EQCB) by filing a written notice of appeal along with submittal of the applicable fee, to the Code Coordination and Public Hearings Section of DERM within fifteen (15) days of the date of the action or decision by DERM.

PLEASE GOVERN YOURSELF ACCORDINGLY

Lee N. Hefty, Director
 Environmental Resources Management

Received By: _____
 Recipient's Signature

Issued by: _____
 Signature

Print: Mr. Yang Guo
 Recipient's Name

Print: Navila Bernal
 Name

Title: Permittee

Section/Phone: 305-372-6600

Posted: Y N Photographed: Y N



Department of Regulatory and Economic Resources
 Division of Environmental Resources Management (DERM)
 701 NW 1st Court
 Miami, Florida 33136-3912
 T 305-372-6600 F 305-372-6545

STORMWATER FIELD NOTICE OF VIOLATION AND ORDER TO CEASE AND DESIST

NAME: Mr. YANG GUO (GDO-3376) Date: May 12, 2016

ADDRESS: 11379 SW 40 ST Miami, FI 33165

PREMISES: GUO FOOD SERVICES, LLC DBA CHINA BUFFET, Miami-Dade County, Florida

YOU ARE HEREBY NOTIFIED that an inspection on 5/12/2016 of the premises listed above revealed the following conditions:

1. Immediately upon receipt of this Notice, CEASE and DESIST from all activities which allows the discharge of storm water into sanitary sewer system. As per permit conditions and Chapter 24 of the Code of Miami-Dade County no storm water should be allowed to discharge into the sewers drain system, open ground, or septic tanks. If construction is needed to prevent further impact to the sewer system, related plans are to be submitted to and approved by Miami-Dade County at 11805 SW 26th Street, Miami, FL 33175 (Tel: 786-315-2800) and the Department's Plan Review Section. These agencies are to be contacted for appropriate instructions PRIOR to construction.
 2. Within 24 hours of receipt of this Notice, implement the necessary corrective actions to ensure that no rain water enters the sewer system.
 3. Within 24 hours of receipt of this Notice, submit the necessary receipts or photos showing violation has been corrected.
- Failure to comply with above orders will result in the issuance of a UCVN (uniform civil violation notice).

in violation of the referenced Sections of Chapter 24, of the Miami-Dade County Code.

- Section 24-42.4(2)(b)**, which states in pertinent part, "It shall be unlawful for any person to throw, drain run or otherwise discharge into a sanitary sewer, or to cause, permit, allow or suffer to be thrown, run drained, allowed to seep, or otherwise discharged into such sewer any storm water."
- Section 24-42.4(2)(a)(i)**, which states in pertinent part, "It shall be unlawful for any person to throw, drain run or otherwise discharge into a sewer designed to carry storm water, or to cause, permit, allow or suffer to be thrown, run, drained, allowed to seep, or otherwise discharged into such sewer: Domestic sewage, industrial waste, liquid waste or other waste."

Therefore, pursuant to Chapter 24, of the Code of Miami-Dade County, you are hereby ordered to:

1. Upon receipt of this Order, immediately CEASE AND DESIST the above-specified violation(s);

AND

2. Within 1 days of receipt of this NOTICE, submit in writing to the Pollution Regulation Division, information regarding the action(s) undertaken to correct the above stated condition(s).

Failure to comply with the above may result in either the issuance of a Uniform Civil Violation Notice (UCVN), pursuant to Chapter 8-CC of Miami-Dade County Code, requiring corrective action(s) and payment of a civil penalty and/or the initiation of formal enforcement action by DERM, subjecting you to the enforcement and penalty provisions of Sections 24-29 and 24-30, Miami-Dade County Code.

Any person aggrieved by any action or decision of the DERM Director may appeal said action or decision to the Environmental Quality Control Board (EQCB) by filing a written notice of appeal along with submittal of the applicable fee, to the Code Coordination and Public Hearings Section of DERM within fifteen (15) days of the date of the action or decision by DERM.

PLEASE GOVERN YOURSELF ACCORDINGLY

Lee N. Hefty, Director
 Environmental Resources Management

Received By: _____
 Recipient's Signature

Print: Mr. Yang Guo
 Recipient's Name

Title: Permittee

Issued by: _____
 Signature

Print: Navila Bernal
 Name

Posted: Y N Photographed: Y N

Section/Phone: 305-372-6600

MIAMI-DADE COUNTY, FLORIDA
UNIFORM CIVIL VIOLATION NOTICE

GDD-3376 B 100660

DATE ISSUED 5/24/16 11:53	TIME	CODE INSPECTOR NAME LAURA Castillo	DEPARTMENT & DIVISION REG/DERM	BADGE # 907		
NAME OF VIOLATOR(S) GVO FOOD SERVICE, LLC DBA CHINA BUFFET C/O Yang Guo, MGRM		FOLIO # 30-4018-094-0010				
		REPEAT VIOLATION <input type="checkbox"/> YES <input checked="" type="checkbox"/> NO	REFERENCE 1768			
MAILING ADDRESS OF VIOLATOR (Street, City, State, and Zip) 3363 Sheridan St. Suite #214 Hollywood, FL 33021						
DOB	SEX	RACE	WEIGHT	HEIGHT	HAIR	DRIVER'S LICENSE #
THIS NOTICE SUMMONS YOU TO ANSWER THE COMPLAINT THAT ON <u>5-12-16</u> AT <u>12:55 N.B.</u> YOU COMMITTED A VIOLATION OF SECTION <u>22-29</u> DATE TIME					CODE OF METROPOLITAN DADE COUNTY TO WIT: <u>Failure to comply with orders of the Director of DERM, specifically perform temporary repairs to grease traps, and submit receipts (FN-Attached)</u> DESCRIPTION	
AT <u>11379 SW 40 St</u> LOCATION OF VIOLATION						

YOU SHALL:

1. PAY THE CIVIL PENALTY OF \$ 100.00 PLUS A \$10.00 SURCHARGE (PURSUANT TO COUNTY ORDINANCE 99-55) TOTALING \$ 110.00 ON OR BEFORE 30 days upon receipt AND CORRECT THE ABOVE VIOLATION ON OR BEFORE 7 days upon receipt OR:

2. YOU MAY REQUEST AN ADMINISTRATIVE HEARING BEFORE A HEARING OFFICER TO APPEAL THE DECISION OF THE CODE INSPECTOR OFFICER ON OR BEFORE 20 days upon receipt
(SEE INSTRUCTIONS ON REVERSE SIDE)

FAILURE TO PAY CIVIL PENALTY AND CORRECT VIOLATION OR FILE A REQUEST FOR ADMINISTRATIVE HEARING BY DATES SHOWN SHALL CONSTITUTE A WAIVER OF YOUR RIGHT TO HEARING AND SUCH WAIVER SHALL CONSTITUTE AN ADMISSION OF VIOLATION. EACH DAY OF CONTINUED VIOLATION AFTER THE TIME PERIOD FOR CORRECTION SHALL BE DEEMED A CONTINUING VIOLATION SUBJECT TO ADDITIONAL PENALTY IN THE SAME AMOUNT WITHOUT THE NEED FOR ISSUANCE OF ADDITIONAL CIVIL VIOLATION NOTICE.

I ACKNOWLEDGE RECEIPT OF THIS CIVIL VIOLATION NOTICE. I UNDERSTAND THAT ACCEPTANCE OF THIS VIOLATION NOTICE IS NOT AN ADMISSION OF GUILT.

5/24/16 Lily SW 5/24/16 VIOLATOR DATE SERVICE: PERSONAL MAIL POSTING
L Castillo 305-372-6600 5/24/16
CODE INSPECTOR SIGNATURE PHONE NUMBER DATE



Department of Regulatory and Economic Resources
Division of Environmental Resources Management (DERM)
701 NW 1st Court
Miami, Florida 33136-3912
T 305-372-6600 F 305-372-6545

GREASE DISCHARGE OPERATING PERMIT FIELD NOTICE OF VIOLATION

VG 9

Date: May 24, 2016 GDO#: 3376 Facility Contact: Mr. DAVID LUKES

Facility Name: GRI-EQY (CONCORD) LLC

Facility Address: 1600 NE MIAMI GARDENS DRIVE NORTH MIAMI BEACH, FL 33179 (Property Owner) Le

Permit (check): IGT AGT MGRU AGRU NGT

YOU ARE HEREBY NOTIFIED that an inspection on 5/12/2016 of the premises listed above revealed the following conditions in violations of Sections 24-15.3 and/or 24-18 of Chapter 24, of the Miami-Dade County Code.

- Accumulated wastes in grease pretreatment system utilized by this facility must be removed (record in Maintenance Log, provide receipts).
- Grease pretreatment system has the following structural/mechanical deficiencies:

Be advised that the grease pretreatment system is breached. All three tanks must be temporarily repaired within 7 days (receipts must be submitted for review.) Tanks must be replaced with 90 days. NOTE: Replacement requires approval from DERM and building department.

- Grease pretreatment system is not maintained according to approved plans, and/or drawings, and/or manufacturer's specifications.

- Grease pretreatment system maintenance records and maintenance log not kept on site/not maintained for 3 years/insufficient information recorded on Log.

- Access to the facility is required/Access to grease pretreatment system is required.
- Grease pretreatment sampling point is not accessible/improperly constructed.

- Other violations or additional comments (If citing other violations, describe violation and corrective actions):

Violation regarding facility located at 11379 SW 40 ST Miami, FL 33165 DBA China Buffet C/o Mr. Yang Guo. Folio # 30-4018-094-0010 Uniform Civil Violation # B100660 Issued on 5/24/2016.

Corrective actions to address violations noted below may require approval from appropriate Building Department and DERM

- No grease pretreatment system available.
- Grease pretreatment system does not have a sampling point.
- Fixtures having the potential to introduce grease into sewers are not connected to a grease pretreatment system.

Be advised that you are required to correct the above violation(s) within 90 days/hours of receipt of this NOTICE. Failure to correct the violation(s) noted above within the above-referenced time period may result in enforcement action pursuant Section 24-29, Miami-Dade County Code. Documentation (e.g. photographs, waste disposal manifests, invoices for work performed, etc.) which demonstrates the above-noted have been corrected, may be submitted by facsimile to Attn: Navila Bernal at (305) 372-6545, or mailed to the address indicated above, or scanned and emailed to: Navila.Bernal@miamidade.gov within the above-referenced time period in order to avoid additional penalties.

Failure to comply with the above may result in either the issuance of a Uniform Civil Notice (UCVN), pursuant to Chapter 8-CC of the Miami-Dade County Code, requiring corrective action(s) and payment of a civil penalty and/or the initiation of formal enforcement action by, DERM, subjecting you to the enforcement and penalty provisions of Sections 24-29 and 24-30, Miami-Dade County Code.

Any person aggrieved by any action or decision of the DERM Director may appeal said action or decision to the Environmental Quality Control Board (EQCB) by filing a written notice of appeal along with submittal of the applicable fee, to the Code Coordination and Public Hearings Section of DERM within fifteen (15) days of the date of the action or decision by DERM.

PLEASE GOVERN YOURSELF ACCORDINGLY

Received By: Chen
Recipient's Signature

Print: Lin Shu
Recipient's Name

Title: _____

Lee N. Hefty, Director
Environmental Resources Management

Issued by: [Signature]
Signature

Print: Navila Bernal
Name

Section/Phone: 305-372-6600

Posted: Y N Photographed: Y N

GDO - 3376.

MIAMI-DADE COUNTY, FLORIDA
UNIFORM CIVIL VIOLATION NOTICE

GDO-3376

B 100661

DATE ISSUED 5/14/16 8:46	TIME	CODE INSPECTOR NAME	DEPARTMENT & DIVISION E. RIDERM	BADGE #
NAME OF VIOLATOR(S) ERI EQY, LLC dba EQ4		FOLIO # 30-4318-094-0016		
REPEAT VIOLATION <input type="checkbox"/> YES <input checked="" type="checkbox"/> NO		REFERENCE 1260		
MAILING ADDRESS OF VIOLATOR (Street, City, State, and Zip) 11379 SW 40th St Miami FL 33165				
DOB	SEX	RACE	WEIGHT	HEIGHT
				HAIR
DRIVER'S LICENSE #				
THIS NOTICE SUMMONS YOU TO ANSWER THE COMPLAINT THAT ON 6/13/2016 AT 1157A YOU COMMITTED A VIOLATION OF SECTION 24-29 CODE OF METROPOLITAN DADE COUNTY TO WIT: Description specifically no compliance with Field Notice issued on 5/24/2016 (see attached) at 11379 SW 40th Miami FL 33165 LOCATION OF VIOLATION				

YOU SHALL:

1. PAY THE CIVIL PENALTY OF \$100.00 PLUS A \$10.00 SURCHARGE (PURSUANT TO COUNTY ORDINANCE 99-55) TOTALING \$110.00 ON OR BEFORE 30 days upon receipt AND CORRECT THE ABOVE VIOLATION ON OR BEFORE 30 days upon receipt OR;
2. YOU MAY REQUEST AN ADMINISTRATIVE HEARING BEFORE A HEARING OFFICER TO APPEAL THE DECISION OF THE CODE INSPECTOR OFFICER ON OR BEFORE 20 days upon receipt

(SEE INSTRUCTIONS ON REVERSE SIDE)

FAILURE TO PAY CIVIL PENALTY AND CORRECT VIOLATION OR FILE A REQUEST FOR ADMINISTRATIVE HEARING BY DATES SHOWN SHALL CONSTITUTE A WAIVER OF YOUR RIGHT TO HEARING AND SUCH WAIVER SHALL CONSTITUTE AN ADMISSION OF VIOLATION. EACH DAY OF CONTINUED VIOLATION AFTER THE TIME PERIOD FOR CORRECTION SHALL BE DEEMED A CONTINUING VIOLATION SUBJECT TO ADDITIONAL PENALTY IN THE SAME AMOUNT WITHOUT THE NEED FOR ISSUANCE OF ADDITIONAL CIVIL VIOLATION NOTICE

I ACKNOWLEDGE RECEIPT OF THIS CIVIL VIOLATION NOTICE. I UNDERSTAND THAT ACCEPTANCE OF THIS VIOLATION NOTICE IS NOT AN ADMISSION OF GUILT.

~~7014 1200 0002 0827 4057~~ LC

VIOLATOR <i>[Signature]</i>	DATE 06/14/2016	SERVICE: PERSONAL MAIL POSTING
CODE INSPECTOR SIGNATURE	PHONE NUMBER	DATE

CLXCT 801 REV. 6/01

CODE INSPECTOR COPY

7014 1200 0002 0827 4057

U.S. Postal Service™ CERTIFIED MAIL™ RECEIPT (Domestic Mail Only; No Insurance Coverage Provided)	
For delivery information visit our website at www.usps.com	
OFFICIAL USE	
Postage \$	Postmark Here
Certified Fee	
Return Receipt Fee (Endorsement Required)	
Restricted Delivery Fee (Endorsement Required)	
Total Postage & Fees \$	
Sent To	
Street, Apt. No., or PO Box No.	
City, State, ZIP+4	
PS Form 3800, August 2009 See Reverse for Instructions	



Carlos A. Gimenez, Mayor

Department of Regulatory and Economic Resources
Environmental Resources Management
701 NW 1st Court, 6th Floor
Miami, Florida 33136-3912
T 305-372-6902 F 305-372-6630
miamidade.gov

August 18, 2016

GRI-EQY (Concord) LLC
c/o EQY Portfolio Investor (GRI) Inc., MGR
c/o David Lukes, CEO
3363 Sheridan St, Suite 214
Hollywood, FL 33021

POSTED
DATE: 8-19-16

Re: Uniform Civil Violation Notice (UCVN) No. B100661 issued for a violation at the property located at, near or in the vicinity of 11379 SW 40 St, Miami-Dade County, Florida, identified by Folio # 30-4018-094-0010.

NOTICE OF INTENDED COURT ACTION

Dear Mr. Lukes:

A review of Department records revealed that you have failed to complete the necessary requirements to achieve compliance with the above referenced UCVN issued on June 14, 2016 (copy enclosed).

In order to redress the violation, the Department will at this time provide you with the opportunity to enter into an administrative Consent Agreement within 15 (fifteen) days of receipt of this NOTICE. Said agreement shall provide, at a minimum, for correction of the violation and payment of accrued penalties and administrative costs.

This NOTICE constitutes your final opportunity to resolve this case. If you fail to enter into a Consent Agreement, or if the violation is not corrected within the time period specified above, your case may be prepared and forwarded for further enforcement action in a court of competent jurisdiction without further notice.

Sincerely,

Richard Eguino
Code Enforcement Officer

File: GDO-3376

Delivered to Eguino on 8/19/16



Carlos A. Gimenez, Mayor

Department of Regulatory and Economic Resources
Environmental Resources Management
701 NW 1st Court, 6th Floor
Miami, Florida 33136-3912
T 305-372-6902 F 305-372-6630
miamidade.gov

August 18, 2016

Yang Guo, Manager
Guo Food Service LLC
3363 Sheridan St, Suite 214
Hollywood, FL 33021

POSTED
DATE: 8-19-16

Re: Uniform Civil Violation Notice (UCVN) No. B100660 issued for a violation at the property located at, near or in the vicinity of 11379 SW 40 St, Miami-Dade County, Florida, identified by Folio # 30-4018-094-0010.

NOTICE OF INTENDED COURT ACTION

Dear Mr. Guo:

A review of Department records revealed that you have failed to complete the necessary requirements to achieve compliance with the above referenced UCVN issued on May 24, 2016.

In order to redress the violation, the Department will at this time provide you with the opportunity to enter into an administrative Consent Agreement within 15 (fifteen) days of receipt of this NOTICE. Said agreement shall provide, at a minimum, for correction of the violation and payment of accrued penalties and administrative costs.

This NOTICE constitutes your final opportunity to resolve this case. If you fail to enter into a Consent Agreement, or if the violation is not corrected within the time period specified above, your case may be prepared and forwarded for further enforcement action in a court of competent jurisdiction without further notice.

Sincerely,

[Handwritten signature]

Richard Eguino
Code Enforcement Officer

File: GDO-3376



Carlos A. Gimenez, Mayor

Department of Regulatory and Economic Resources
Environmental Resources Management
701 NW 1st Court, 6th Floor
Miami, Florida 33136-3912
T 305-372-6902 F 305-372-6630
miamidade.gov

October 24, 2016

Carlos Galan, Manager
Dolores, But You Can Call Me Lolita, LLF
1000 S. Miami Avenue
Miami, FL 33130-4109

CERTIFIED MAIL NO. 7012 3050 0000 9635 8627
RETURN RECEIPT REQUESTED

Larry J. Harris, Managing Member
New Spanish Concepts, LLC
P.O. Box 565428
Pinecrest, FL 33256

CERTIFIED MAIL NO. 7012 3050 0000 9635 8610
RETURN RECEIPT REQUESTED

DERM File No. GDO-3414

Re: Unauthorized discharge to the sanitary sewer system from Dolores, But You Can Call Me Lolita Restaurant located at, near or in the vicinity of 1000 S. Miami Avenue, Miami, Miami-Dade County, Florida (folio #01-0207-040-1010)

Dear Messrs. Galan & Harris:

**NOTICE OF VIOLATION AND
ORDERS FOR CORRECTIVE ACTION**

On July 13, 2016, a representative of the Miami-Dade County Department of Regulatory and Economic Resources, Division of Environmental Resources Management (DERM) conducted an inspection at the above-referenced facility. Based on sample results, this inspection revealed that the grease interceptor for the in-ground grease trap (IGT) is not functioning properly. Sample results (1,820 mg/l) showed an exceedance of local limits for oil and grease discharges to sanitary sewer. DERM conducted a follow-up inspection on September 2, 2016, less than thirty days from the last pump-out of the IGT. Sample results (906 mg/l) from this inspection revealed a repeated violation of sanitary sewer standards for oils and grease. Pursuant to Section 24-42.4, Code of Miami-Dade County, effluent from the grease interceptor shall not exceed the sanitary sewer standard for oil and grease (EPA Method 1664) of 100 mg/l.

Be advised that discharging, or allowing the discharge of any industrial wastes into a sanitary sewer system constitutes violations of the facility's Grease Discharge Operating Permit (GDO-3414) and of Chapter 24, Code of Miami-Dade County, specifically:

Section 24-29, Code of Miami-Dade County, which states in pertinent part: "It shall be unlawful for any person to violate any of the provisions of this chapter, any lawful rules and regulations promulgated under this chapter, any lawful order of the Director or the Director's designee, or any condition, limitation or restriction which is part of an operating permit."

Section 24-42.4(2)(d)(III), Code of Miami-Dade County, which states in pertinent part: "It shall be unlawful for any person to throw, drain, run or otherwise discharge into a sanitary sewer, or to cause, permit, allow or suffer to be thrown, run, drained or allowed to seep, or otherwise discharged into such sewer ... any pollutant in amounts which alone or in combination with other discharges will cause obstruction to the flow in the publicly owned treatment works."

Section 24-42.4(2)(d)(VI), Code of Miami-Dade County, which states in pertinent part: "It shall be unlawful for any person to throw, drain, run or otherwise discharge into a sanitary sewer, or to cause, permit, allow or suffer to be thrown, run, drained or allowed to seep, or otherwise discharged into such sewer any effluents in excess of local limits."

Delivering Excellence Every Day

Pursuant to the provisions of Section 24-31(6) of Chapter 24, Miami-Dade County Code, whenever a violation of this chapter occurs or exists, or has occurred or existed, any person, individually or otherwise, who has legal, beneficial, or equitable interest in the real property upon which such violation occurs or exists, or has occurred or existed, shall be jointly and severally liable for said violation regardless of fault and regardless of knowledge of the violation.

Based on the above and pursuant to the authority granted to me under Chapter 24, Code of Miami-Dade County, I am hereby ordering you to:

1. Upon receipt of this Notice, "CEASE and DESIST" from allowing any further unauthorized discharges to the publicly owned sanitary sewer system at the subject location.
2. Within forty-five days (45) of receipt of this Notice, submit to this Department for review, formal plans signed and sealed by a Florida Professional Engineer for plumbing, equipment and/or processes changes, which shall correct the current violations and prevent future violations of the provisions of Chapter 24 at the subject facility. Said submittal shall include, at a minimum, the following:
 - A. Existing facility plan showing all food and beverage preparation areas (back of house areas) and kitchen equipment/appliances.
 - B. Existing facility sanitary drainage (plumbing) drawings with plan and isometric views, that include:
 - i. Existing drains/lines, plumbing fixtures, solids separators, Fats, Oils and Grease ("FOG") Control Devices (e.g., grease interceptors) and sampling point.
 - ii. All existing drains/lines not connected to a FOG Control Device (e.g., grease interceptor) labeled "Existing Sanitary".
 - iii. All existing drains/lines connected to a FOG Control Device (e.g., grease interceptor) labelled "Existing GW" (Grease Waste).
 - C. Existing building sewer plan showing all connections from the facility to the public sanitary sewer system.
 - D. An evaluation of the existing FOG Control Device (e.g., grease interceptor) capacity. The evaluation shall incorporate proposed equipment and/or processes changes and include peak flow rate, FOG and solids loading rate, and pump-out (cleaning) frequency (e.g., 30, 60 or 90 days). FOG loading shall include all FOG sources: FOG generated by preparing meals and cleaning associated with eat-in, take-out and drive-through meals. The capacity of FOG Control Device (e.g., grease interceptor) shall be sufficient to produce an effluent that complies with Section 24-42.4, Code of Miami-Dade County sewer standards for Oil and Grease EPA Method 1664 (i.e. 100 mg/L).
 - E. If the evaluation demonstrates that the existing FOG Control Device (e.g., grease interceptor) does not provide sufficient capacity, submit "proposed" sanitary drainage (plumbing) drawings, plan and isometric, that include:
 - i. Existing and proposed drains/lines, plumbing fixtures, solids separators, FOG Control Devices (e.g., grease interceptors) and sampling point.
 - ii. All existing and proposed drains/lines not connected to a FOG Control Device (e.g., grease interceptor) labeled Existing Sanitary.
 - iii. All existing and proposed drains/lines connected to a FOG Control Device (e.g., grease interceptor) labelled Existing GW (Grease Waste).
 - iv. Sizing calculations for the proposed FOG Control Device (e.g., grease interceptor). The calculations shall incorporate proposed equipment and/or processes changes and include peak flow rate, FOG and solids loading rate, and pump-out (cleaning) frequency (e.g., 30, 60 or 90 days). FOG loading shall include all FOG sources: FOG generated by preparing meals and cleaning associated with eat-in, take-out and drive-through meals. The capacity of FOG Control Device (e.g., grease interceptor) shall be sufficient to produce an effluent that complies with Section 24-42.4, Code of Miami-Dade County sewer standards for Oil and Grease EPA Method 1664 (i.e. 100 mg/L).

- v. The FOG Control Device (e.g., grease interceptor) shall be located to allow uninterrupted maintenance and inspection and shall be accessible at all times and not require intervention to access, clean and inspect the system.
 - vi. Sampling point located after the point of no further treatment. The sampling point shall be directly accessible for visual inspection and sampling. Sampling point shall have sufficient depth and access to allow sample collection using a 3-inch diameter x 6-inch long sample bottle.
 - vii. All drainage fixtures located in food and beverage preparation areas (back of house areas) shall be connected to a FOG Control Device. Drainage fixtures include, but are not limited to: floor drains, floor sinks, mop sinks, three-compartment sinks, hand sinks, pre-rinse station/sink, preparation sink, pot sink, wok sink, and self-cleaning exhaust hoods.
3. Upon approval by this Department, obtain the appropriate permits and commence with the implementation of the required improvements.
 4. Within one hundred twenty (120) days of receipt of this Notice, complete the required improvements.

For appropriate handling, include the subject permit number (GDO-3414) referencing this facility on all submittals filed with this Department and direct said submittals to DERM, Attn. Carlos Hernandez, P.E., Chief, Wastewater Permitting Section, 701 NW 1st Court, 7th Floor, Miami, Florida 33136-3912.

BE ADVISED THAT FAILURE TO COMPLY WITH THE ABOVE MAY RESULT, AT A MINIMUM, IN CIVIL PENALTIES AND THE PAYMENT OF ALL DEPARTMENTAL COSTS INCURRED IN THE INVESTIGATION AND SETTLEMENT OF THIS CASE. IN ADDITION, FAILURE TO COMPLY MAY RESULT IN YOUR CASE BEING PREPARED FOR FORMAL ENFORCEMENT ACTION IN A COURT OF COMPETENT JURISDICTION PURSUANT TO THE ENFORCEMENT AND PENALTY PROVISIONS OF SECTION 24-29, CODE OF MIAMI-DADE COUNTY.

Any person aggrieved by any action or decision of the DERM Director may appeal said action or decision to the Environmental Quality Control Board (EQCB) by filing a written notice of appeal along with submittal of the applicable fee, to the Code Coordination and Public Hearings Section of DERM within fifteen (15) days of the date of the action or decision by DERM.

If you have any questions concerning the technical requirements contained in the orders of this Notice, please contact Carlos Hernandez, P.E., Chief of the Wastewater Permitting Section of this office at 305-372-6714 or via email at Hernac@miamidade.gov. If you have any questions regarding the enforcement action, please contact the undersigned at (305) 372-6917 or by email at clingj@miamidade.gov. For further information on DERM's FOG program, please go to the following link: <http://www.miamidade.gov/permits/grease-discharge.asp>.

Sincerely,



JoAnne Clingerman
Environmental Code Enforcement Officer 2
Regulatory Services

ec: Barbara L. Min, Deputy City Attorney, City of Miami Office of the City Attorney



Carlos A. Gimenez, Mayor

Department of Regulatory and Economic Resources
 Environmental Resources Management
 701 NW 1st Court, 6th Floor
 Miami, Florida 33136-3912
 T 305-372-6902 F 305-372-6630

miamidade.gov

March 31, 2014

Michael A. Krtausch, Facilities Operations Director
 The School Board of Miami-Dade County
 12525 NW 28th Avenue, Room 500
 Miami, Florida 33167

Certified Mail No. 7009 0080 0000 1050 5942
 Return Receipt Requested

Re: Required repair and maintenance of grease interceptors and associated appurtenances for Miami-Dade County Public Schools.

Dear Mr. Krtausch:

Representatives of the Department of Regulatory and Economic Resources, Division of Environmental Resources Management (DERM) conducted inspections relative to grease discharge annual operating permits held for select Miami-Dade County Public Schools. Results of these inspections revealed various issues that adversely impact the successful operation of grease pretreatment systems that discharge to sanitary sewers at the sites listed below:

#	SCHOOL	GDO #	ADDRESS	DOCUMENTED ISSUE	CAT
1	Hialeah Gardens Ele	3455	9702 NW 130 St	Compromised tanks 2 & 3	1
2	Miami Lakes Technical Cntr	3595	5780 NW 158 St	No outlet tee - Bakery system	1
3	Miami Springs Middle	3629	150 S Royal Poinciana Blvd	Compromised tank structure	1
4	Madison Middle	3652	3400 NW 87 St	Compromised outlet tee	1
5	Hadley PLC "A"	3745	8400 NW 7 St	Compromised tank	1
6	Dunbar Elementary	3774	505 NW 20 St	Compromised interceptor	1
7	Fulford Elementary	3452	16140 NE 18 Ave	Use of metal lid not MH cover	2
8	Doctor Krop Senior High	3562	1410 NE 215 St	Two ill-fitting clean-out caps	2
9	County Club Middle	9349	18305 NW 75 Pl	Uncovered outdoor mop basin	2
10	Lake Stevens Middle	3490	18484 NW 48 Pl	Grease in effluent	3
11	Scott Lake Elementary	3596	1160 NW 175 St	Grease in effluent	3
12	Flagami Elementary	3729	920 SW 76 Ave	Grease in effluent	3
13	Frederick Douglass Elem	3768	314 NW 12 St	Grease in effluent	3
14	Jane S. Roberts Elementary	3857	14850 Cottonwood Circle	Grease in effluent	3
15	Westland Hialeah Senior	10086	4000 W 18 Ave	Grease in adjacent storm drain	3

It is anticipated that resolution of these issues will require the repair or replacement of in-ground grease interceptor structures (Category 1), modification of external structures (Category 2) and routine pump out of grease wastes (Category 3). Field notices previously issued for problems with these systems during the years 2011, 2012 and 2013 are attached.

Be advised that the above constitutes violations of Chapter 24 of the Code of Miami-Dade County, specifically:

Delivering Excellence Every Day

Section 24-18, of said ordinance, inasmuch as no person shall operate or permit, cause or allow the operation of any facility which will reasonably be expected to be a source of air pollution, ground pollution or water pollution, in violation of any condition, limitation or restriction which is part of an operating permit; and

Section 24-27, of said Ordinance, which states in pertinent part: "No person shall cause, or allow to be caused, any nuisance or sanitary nuisance as defined in Sections 24-5 and/or 24-28 herein"; and

Section 24-28, of said Ordinance, inasmuch as it shall be unlawful for any person to cause, maintain or allow to be caused or maintained any sanitary nuisance as defined in Section 24-5 herein; and

Section 24-29, of said Ordinance, inasmuch as it shall be unlawful for any person to violate any of the provisions of this chapter, any lawful rules and regulations promulgated under this chapter, any lawful order of the Director or the Director's designee, or any condition, limitation or restriction, which is part of an operating permit; and

Section 24-42.4(2)(a), of said Ordinance, inasmuch as it shall be unlawful for any person to throw, drain, run or to cause, permit or suffer to be thrown, run, drained or allowed to seep or otherwise discharge domestic sewage, industrial waste, liquid waste or other waste into a sewer designed to carry storm water; and

Section 24-42.4(2)(b), of said Ordinance, inasmuch as it shall be unlawful for any person to throw, drain, run or otherwise discharge into a sanitary sewer, or to cause, permit, allow or suffer to be thrown, run, drained, allowed to seep, or otherwise discharged into such sewer any storm water.

Based on the above, and pursuant to the authority granted to me under Chapter 24 of the Code of Miami-Dade County and in order to comply with your Miami-Dade County permits and the June 6, 2013 Federal Clean Water Act Consent Decree, you are hereby ordered to:

1. Within **ten (10) days** of receipt of this notice, submit to this office for review, a timeline for the required repairs and/or maintenance of grease interceptor systems for each school listed above.
2. Upon approval of the above-mentioned timeline by this Department, submit appropriate engineering plans for approval, and complete maintenance, repair or replacement of the pretreatment systems in a timely fashion. Engineering plans signed and sealed by a Professional Engineer are required for structural repairs or replacement.
3. Within **thirty (30) days** of completing the required actions for the fifteen (15) schools listed above, provide written notification, documentation and disposal receipts for actions taken to comply with this Notice.

Any person aggrieved by any action or decision of the DERM Director, may appeal said action or decision to the Environmental Quality Control Board (EQCB) by filing a written notice of appeal along with submittal of the applicable fee, to the Code Coordination and Public Hearings Section of DERM within fifteen (15) days of the date of the action or decision by DERM.

March 31, 2014

If you have any questions concerning the above, please contact me at 305-372-6514 or email brownb@miamidade.gov. Thank you for your attention to this matter.

Sincerely,

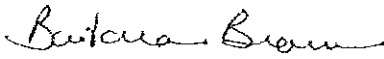

Barbara Brown
Code Enforcement Officer
Regulatory Services

Enclosures



miamidade.gov

Regulatory and Economic Resources
Environmental Services
701 NW 1st Court, Suite 700
Miami, Florida 33136-3912
T 305-372-6600 F 305-372-6410

GREASE DISCHARGE OPERATING PERMIT FIELD NOTICE OF VIOLATION

Inspection Date: 10/22/13 GDO# 3455
Facility Name: Hialeah Gardens Elementary
Facility Contact: Rachel Autler
Address: 9702 NW 130 St Hialeah Gardens, Fl 33018
Permit (check): IGT AGT MGRU AGRU NGT

You are hereby NOTIFIED that an inspection of the above PREMISES revealed violations of the conditions of your operating permit GDO# 3455 and/or requires specific documentation noted below:

- Grease pretreatment device is not in operational status.
- Contents of automatic/manual grease recovery unit require removal.
- Contents of grease interceptor require removal by a PERA Permitted Liquid Waste Transporter. A receipt for proper disposal shall be submitted to this Department.
- Outlet tee in grease interceptor requires repair.
- Breached wall or bottom of grease interceptor requires repair.
- Access to grease pretreatment device is required.
- Access to the facility is required.
- *Official documentation or approved plans from the appropriate building department indicating that the facility has been approved with no grease pretreatment must be submitted to this Department. (For NGT)

Other A receipt indicating that the grease interceptor was repaired. (see notice of violation issued 2/20/13)

Be advised that you are required to correct the above violation(s) within 7 days/hours of receipt of this NOTICE. Failure to correct the violation(s) noted above within the above-referenced time period shall result in enforcement action under Section 24-29, of the code of Miami-Dade County. Documentation (e.g. photographs, waste disposal manifests, invoices for work performed, etc.) which demonstrates the above-noted violation(s) have been corrected must be submitted by facsimile to Attn: Vivian Mendez EE & C Section at (305) 372-6410 (or mailed to the address indicated above) within the above-referenced time period in order to void additional penalties. 6545

Failure to comply with the above may result in either the issuance of a Uniform Civil Notice (UCVN), pursuant to Chapter 8CC of Miami-Dade County, requiring corrective action(s) and payment of a civil penalty of the initiation of formal enforcement action by this Department, subjecting you to the enforcement and penalty provisions of Sections 24-29 and 24-30. of the Code of Miami-Dade County.

Jack Osterholt, Director
REGULATORY AND ECONOMIC
RESOURCES

PLEASE GOVERN YOURSELF ACCORDINGLY

Received by: Rachel Autler Recipient's Signature
Delivered by: [Signature] Signature
Print Name: Rachel Autler Recipient's Name
Print Name: Vivian Mendez Name
Title: Assistant Principal Delivering Employee (Print Name)
Phone: [Handwritten]
Posted: Y N Photographed: Y N

Fax: 305-372-6545
mendez@miamidade.gov



Carlos Alvarez, Mayor

Follow up
08/05/2011

Environmental Resources Management
Pollution Regulation & Enforcement Division
701 NW 1st Court, Suite 700
Miami, Florida 33136-3912
T-305-372-6600 F-305-372-6410

miamidade.gov

GREASE DISCHARGE OPERATING PERMIT
FIELD NOTICE OF VIOLATION

Inspection Date: 06/27/2011 GDO#- 3455
Facility Name: DCPS - Hialeah Gardens Elementary
Facility Contact: Kenia Perez
Address: 9102 NW 130 St

Permit (check): IGT AGT MGRU AGRU NGT*

You are hereby NOTIFIED that an inspection of the above PREMISES revealed violations of the conditions of your operating permit GDO# 3455 and/or requires specific documentation noted below:

- Grease pretreatment device is not in operational status.
- Contents of automatic/manual grease recovery unit require removal.
- Contents of grease interceptor require removal by a DBRM Permitted Liquid Waste Transporter. A receipt for proper disposal shall be submitted to this Department.
- Outlet tee in grease interceptor requires repair.
- Breached wall or bottom of grease interceptor requires repair.
- Access to grease pretreatment device is required.
- Access to the facility is required.
- *Official documentation or approved plans from the appropriate building department indicating that the facility has been approved with no grease pretreatment must be submitted to this Department. (For NGT)

(Other) E-MAIL SmithV@miamidade.gov. (for Receipts)

Be advised that you are required to correct the above violation(s) within 15 (days) hours of receipt of this NOTICE. Failure to correct the violation(s) noted above within the above-referenced time period shall result in enforcement action under Chapter 24-29, Miami-Dade County Environmental Protection Ordinance. Documentation (e.g. photographs, waste disposal manifests, invoices for work performed, etc.) which demonstrates the above-noted violation(s) have been corrected must be submitted by facsimile to Attn: Ross Smith EE & C Section at (305) 372-6410 (or mailed to the address indicated above) within the above-referenced time period in order to avoid additional penalties.

Failure to comply with the above may result in either the issuance of a Uniform Civil Violation Notice (UCVN), pursuant to Chapter 8CC of Miami-Dade County, requiring corrective action(s) and payment of a civil penalty or the initiation of formal enforcement action by this Department, subjecting you to the enforcement and penalty provisions of Sections 24-29 and 24-30 of the Code of Miami-Dade County.

Carlos Espinosa, P.E., Director
ENVIRONMENTAL RESOURCES MANAGEMENT

PLEASE GOVERN YOURSELF ACCORDINGLY

Received by: [Signature]
Recipient's Signature

Delivered By: [Signature]
Signature

Print Name: Kenia Perez
Recipient's Name

Print Name: Ross Smith
Name

Title: Treasurer

Posted: Y NX Photographed: Y NX

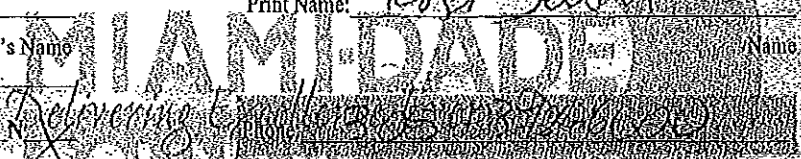



Carlos Alvarez, Mayor

Environmental Resources Management
701 NW 1st Court
Miami, Florida 33136-3912
T 305-372-6600 F 305-372-6410

miamidade.gov/derm

POLLUTION PREVENTION FIELD NOTICE

GENERAL CONDITIONS

Mr. Jaime Torrens
Miami-Dade County Public Schools
1450 NE 24 Ave Suite 923
Miami, FL 33132

DATE: 3/23/12
PERMIT #: SDS-3595
FILE #: ---

RE: Grease traps at Miami Lakes Educational Center
5780 NW 158 St Miami FL, 33014

Dear Mr. Torrens:

As the owner or operator of the above-referenced facility, this NOTICE is to advise you that an inspection of the subject facility on March 23, 2012 found the following condition(s) which require(s) your immediate attention:

- ① The grease trap (five tanks in series) located behind the school cafeteria needs to be pumped out.
- ② Grease trap behind the school bakery does not have an outlet "T" installed. Discharges of grease from this grease trap (two tanks in parallel) into the sewer system must cease immediately. The grease trap must be pumped out and the inlet pipe must be installed.

7010 1870 0000 2683 3167

Please note that in order to avoid further enforcement action, you are required to submit in writing to the appropriate Section indicated below, within (30) days of receipt of this NOTICE, information regarding the action(s) undertaken to correct the above stated condition(s). Be advised that failure to comply with any of the aforementioned requirement(s) and/or to correct these condition(s) may result in the Department Issuing a Uniform Civil Violation Notice which carries a mandatory civil penalty and a requirement to correct the violation.

FAX number: 305-372-6476

If the facility requires a DERM Operating Permit and additional inspections must be conducted due to continuing code violations beyond the time frame allotted, the above-referenced facility may be required to pay an additional fee at the time of permit renewal.

If you have any questions, please contact the appropriate Section as marked below.

Received By: sent via
Recipient's Signature
Print: certified
Recipient's Name
Macl
Title

Issued by: [Signature]
Signature
Print: Oscar Hernandez
Name

Section/Phone





Ms. Kimberly F. Emmanuel
Principal
150 S. Royal Poinciana Blvd
Miami, FL 33166

Regulatory and Economic Resources
Environmental Services
701 NW 1st Court, Suite 700
Miami, Florida 33136-3912
T 305-372-6600 F 305-372-6410

Kimberly F. Emmanuel
Kimberly F. Emmanuel

**GREASE DISCHARGE OPERATING PERMIT
FIELD NOTICE OF VIOLATION**

Inspection Date: July-15-2013 GDO# 3629
Facility Name: DCPS-Miami Springs Middle School
Facility Contact: Mr. Jaime Torres - Miami Dade County Public Schools
Address: 1450 NE 2nd Ave., 3rd Floor, Miami, FL 33132
Permit (check): IGT AGT MGRU AGRU NGT

You are hereby NOTIFIED that an inspection of the above PREMISES revealed violations of the conditions of your operating permit GDO# 3629 and/or requires specific documentation noted below:

- Grease pretreatment device is not in operational status.
- Contents of automatic/manual grease recovery unit require removal.
- Contents of grease interceptor require removal by a PERA Permitted Liquid Waste Transporter. A receipt for proper disposal shall be submitted to this Department.
- Outlet tee in grease interceptor requires repair.
- Breached wall or bottom of grease interceptor requires repair.
- Access to grease pretreatment device is required.
- Access to the facility is required.
- *Official documentation or approved plans from the appropriate building department indicating that the facility has been approved with no grease pretreatment must be submitted to this Department. (For NGT)

Other Placement on the west side of the tank broken, rain water intrusion into the
Grease Trap Tank. Needs to be repair.

Be advised that you are required to correct the above violation(s) within 30 days/hours of receipt of this NOTICE. Failure to correct the violation(s) noted above within the above-referenced time period shall result in enforcement action under Section 24-29, of the code of Miami-Dade County. Documentation (e.g. photographs, waste disposal manifests, invoices for work performed, etc.) which demonstrates the above-noted violation(s) have been corrected must be submitted by facsimile to Attn: Elsa Y. Cabrera EE & C Section at (305)-372-6410 (or mailed to the address indicated above) within the above-referenced time period in order to void additional penalties. FOX at 305-372-6957

Failure to comply with the above may result in either the issuance of a Uniform Civil Notice (UCVN), pursuant to Chapter 8CC of Miami-Dade County, requiring corrective action(s) and payment of a civil penalty of the initiation of formal enforcement action by this Department, subjecting you to the enforcement and penalty provisions of Sections 24-29 and 24-30 of the Code of Miami-Dade County.

Jack Osterholt, Director
REGULATORY AND ECONOMIC
RESOURCES

PLEASE GOVERN YOURSELF ACCORDINGLY

Received by: Kimberly F. Emmanuel Delivered by: [Signature]
Recipient's Signature Signature
Print Name: Kimberly F. Emmanuel Print Name: Elsa Y. Cabrera
Recipient's Name Name
Title: Principal Phone: Delivering to Osterholt on 7/15/13



miamidade.gov

File # _____ Permit # 000-3652

Regulatory and Economic Resources
Environmental Services
701 NW 1st Court, Suite 700
Miami, Florida 33136-3912
T 305-372-6600 F 305-372-6410

GREASE DISCHARGE OPERATING PERMIT FIELD NOTICE OF VIOLATION

Inspection Date: 7/10/2013 GDO#: 3652
Facility Name: Jops - Madison Middle School
Facility Contact: Nickolas Gibson
Address: 3400 NW 81 St Miami, FL 33147
Permit (check): NGT AGT MGRU AGRU NGT

You are hereby NOTIFIED that an inspection of the above PREMISES revealed violations of the conditions of your operating permit GDO# 3652 and/or requires specific documentation noted below:

- Grease pretreatment device is not in operational status.
- Contents of automatic/manual grease recovery unit require removal.
- Contents of grease interceptor require removal by a PERA Permitted Liquid Waste Transporter. A receipt for proper disposal shall be submitted to this Department.
- Outlet tee in grease interceptor requires repair.
- Breached wall or bottom of grease interceptor requires repair.
- Access to grease pretreatment device is required.
- Access to the facility is required.
- *Official documentation or approved plans from the appropriate building department indicating that the facility has been approved with no grease pretreatment must be submitted to this Department. (For NGT)
- Other Grease trap needs to be pumped out and outlet tee repaired

Be advised that you are required to correct the above violation(s) within 15 days/hours of receipt of this NOTICE. Failure to correct the violation(s) noted above within the above-referenced time period shall result in enforcement action under Section 24-29, of the code of Miami-Dade County. Documentation (e.g. photographs, waste disposal manifests, invoices for work performed, etc.) which demonstrates the above-noted violation(s) have been corrected must be submitted by facsimile to Attn: Cynthia Deane EE & C Section at (305) 372-6410 or mailed to the address indicated above) within the above-referenced time period in order to void additional penalties. 6957

Failure to comply with the above may result in either the issuance of a Uniform Civil Notice (UCVN), pursuant to Chapter 8CC of Miami-Dade County, requiring corrective action(s) and payment of a civil penalty of the initiation of formal enforcement action by this Department, subjecting you to the enforcement and penalty provisions of Sections 24-29 and 24-30 of the Code of Miami-Dade County.

Jack Osterholt, Director
REGULATORY AND ECONOMIC
RESOURCES

PLEASE GOVERN YOURSELF ACCORDINGLY

Received by: [Signature] Delivered by: [Signature]
 Recipient's Signature Signature
 Print Name: Nickolas Gibson Print Name: Cynthia Deane
 Recipient's Name Name
 Title: evl, m Title: Delivering to Zoellner every 2 days
 Posted: Y N Photographed: Y N



miamidade.gov

Permitting, Environment and Regulatory Affairs
Environmental Services
701 NW 1st Court, Suite 700
Miami, Florida 33136-3912
T 305-372-6600 F 305-372-6410

**GREASE DISCHARGE OPERATING PERMIT
FIELD NOTICE OF VIOLATION**

Inspection Date: NOV 16, 2012 GDO# 3745
Facility Name: DCPS - HADLEY PLC "A"
Facility Contact: MR. SAUL TORRENS
Address: 8400 NW 7 ST - MIAMI, FL 33126
Permit (check): IGT AGT MGRU AGRU NGT

You are hereby NOTIFIED that an inspection of the above PREMISES revealed violations of the conditions of your operating permit GDO# 3745 and/or requires specific documentation noted below:

- Grease pretreatment device is not in operational status.
- Contents of automatic/manual grease recovery unit require removal.
- Contents of grease interceptor require removal by a PERA Permitted Liquid Waste Transporter.
A receipt for proper disposal shall be submitted to this Department.
- Outlet tee in grease interceptor requires repair.
- Breached wall or bottom of grease interceptor requires repair.
- Access to grease pretreatment device is required.
- Access to the facility is required.
- *Official documentation or approved plans from the appropriate building department indicating that the facility has been approved with no grease pretreatment must be submitted to this Department. (For NGT)
- Other Call RONALD PABILLA ST 786-218-8844 WHEN TOW
IS REQUIRED TO REINSPECT THE IGT.

Be advised that you are required to correct the above violation(s) within 30 days/hours of receipt of this NOTICE. Failure to correct the violation(s) noted above within the above-referenced time period shall result in enforcement action under Section 24-29, of the code of Miami-Dade County. Documentation (e.g. photographs, waste disposal manifests, invoices for work performed, etc.) which demonstrates the above-noted violation(s) have been corrected must be submitted by facsimile to Attn: RONALD PABILLA EE & C Section at (305) 372-~~6410~~ (or mailed to the address indicated above) within the above-referenced time period in order to void additional penalties. 6957

Failure to comply with the above may result in either the issuance of a Uniform Civil Notice (UCVN), pursuant to Chapter 8CC of Miami-Dade County, requiring corrective action(s) and payment of a civil penalty of the initiation of formal enforcement action by this Department, subjecting you to the enforcement and penalty provisions of Sections 24-29 and 24-30 of the Code of Miami-Dade County.

Jack Osterholt, Director
PERMITTING, ENVIRONMENT
AND REGULATORY AFFAIRS

PLEASE GOVERN YOURSELF ACCORDINGLY

Received by: Mary Menchero Delivered by: [Signature]
 Recipient's Signature Signature
 Print Name: MARY MENCHERO Print Name: Ronald Pabilla
 Recipient's Name Name
 Title: Principal Believing Excellence Every Day Phone: 305-392-0572
 Posted: Y ___ N ___ Photographed: Y ___ N ___



miamidade.gov

Claudio Tellechea
786-232-1424
(grease trap & pump out)
Claudio Carnegie - 305-995-4091

Permitting, Environment and Regulatory Affairs
Environmental Services
701 NW 1st Court, Suite 700
Miami, Florida 33136-3912
T 305-372-6600 F 305-372-6410

GREASE DISCHARGE OPERATING PERMIT
FIELD NOTICE OF VIOLATION

Inspection Date: 11/28/2012 QDO# 3774
Facility Name: DCPS Dunbar Elementary
Facility Contact: Mr. James Thomas / Mrs. Anna Levin
Address: 505 NW 20th

Permit (check): IGT AGT MGRU AGRU NGT

You are hereby NOTIFIED that an inspection of the above PREMISES revealed violations of the conditions of your operating permit QDO# 3774 and/or requires specific documentation noted below:

- Grease pretreatment device is not in operational status.
- Contents of automatic/manual grease recovery unit require removal.
- Contents of grease interceptor require removal by a PERA Permitted Liquid Waste Transporter. A receipt for proper disposal shall be submitted to this Department.
- Outlet tee in grease interceptor requires repair.
- Breached wall or bottom of grease interceptor requires repair.
- Access to grease pretreatment device is required.
- Access to the facility is required.
- *Official documentation or approved plans from the appropriate building department indicating that the facility has been approved with no grease pretreatment must be submitted to this Department. (For NGT)

Other Call to School operation manager to repair the grease trap

Be advised that you are required to correct the above violation(s) within 30 days/hours of receipt of this NOTICE. Failure to correct the violation(s) noted above within the above-referenced time period shall result in enforcement action under Section 24-29, of the code of Miami-Dade County. Documentation (e.g. photographs, waste disposal manifests, invoices for work performed, etc.) which demonstrates the above-noted violation(s) have been corrected must be submitted by facsimile to Attn: Hurova Miguel, BE & C Section at (305) 372-6410 (or mailed to the address indicated above) within the above-referenced time period in order to void additional penalties.

Failure to comply with this above may result in either the issuance of a Uniform Civil Notice (UCVN), pursuant to Chapter 8CC of Miami-Dade County, requiring corrective action(s) and payment of a civil penalty of the initiation of formal enforcement action by this Department, subjecting you to the enforcement and penalty provisions of Sections 24-29 and 24-30 of the Code of Miami-Dade County.

Charles Dangor, Interim Director
PERMITTING, ENVIRONMENT
AND REGULATORY AFFAIRS

PLEASE GOVERN YOURSELF ACCORDINGLY

Received by: [Signature] Delivered by: [Signature]
 Recipient's Signature
 Print Name: X Mariade Armas Print Name: [Signature]
 Recipient's Name
 Title: X Assistant Principal Title: [Signature]
 Posted: Y ___ N ___ Photographed: Y ___ N ___

RECEIVED
2012/11/29 PM 2:58

Nov 2012



miamidade.gov

Regulatory and Economic Resources
Environmental Services
701 NW 1st Court, Suite 700
Miami, Florida 33136-3912
T 305-372-6600 F 305-372-6410

GREASE DISCHARGE OPERATING PERMIT
FIELD NOTICE OF VIOLATION

Inspection Date: 07/25/2013 GDO# 3452
Facility Name: DCPS - Tullford Elementary
Facility Contact: Mr. Jaime Torrens c/o Mr. Michael A. Krtausch
Address: 1450 NE 2nd Ave, 3rd floor Miami, FL 33132

Permit (check): IGT AGT MGRU AGRU NGT

You are hereby NOTIFIED that an inspection of the above PREMISES revealed violations of the conditions of your operating permit GDO# 3452 and/or requires specific documentation noted below:

- Grease pretreatment device is not in operational status.
- Contents of automatic/manual grease recovery unit require removal.
- Contents of grease interceptor require removal by a PERA Permitted Liquid Waste Transporter. A receipt for proper disposal shall be submitted to this Department.
- Outlet tee in grease interceptor requires repair.
- Breached wall or bottom of grease interceptor requires repair.
- Access to grease pretreatment device is required.
- Access to the facility is required.
- *Official documentation or approved plans from the appropriate building department indicating that the facility has been approved with no grease pretreatment must be submitted to this Department. (For NGT)
- Other Install proper lid on manhole to avoid collection of storm water in the sanitary sewer system.

Be advised that you are required to correct the above violation(s) within 15 days/hours of receipt of this NOTICE. Failure to correct the violation(s) noted above within the above-referenced time period shall result in enforcement action under Section 24-29, of the code of Miami-Dade County. Documentation (e.g. photographs, waste disposal manifests, invoices for work performed, etc.) which demonstrates the above-noted violation(s) have been corrected must be submitted by facsimile to Attn: Marie Manasse EE & C Section at (305) 372-6410 (or mailed to the address indicated above) within the above-referenced time period in order to void additional penalties.

7005 1160 0500 2622 1118
Failure to comply with the above may result in either the issuance of a Uniform Civil Notice (UCYN), pursuant to Chapter 8CC of Miami-Dade County, requiring corrective action(s) and payment of a civil penalty of the initiation of formal enforcement action by this Department, subjecting you to the enforcement and penalty provisions of Sections 24-29 and 24-30 of the Code of Miami-Dade County.

Jack Osterholt, Director
REGULATORY AND ECONOMIC
RESOURCES

PLEASE GOVERN YOURSELF ACCORDINGLY

Received by: _____
Recipient's Signature

Delivered by: Marie Manasse
Signature

Print Name: Ma Dial
Recipient's Name

Print Name: Marie Manasse
Name

Title: Out
Phone: Delivering Excel 305-372-6410

Posted: Y N Photographed: Y N



Vci

Department of Regulatory and Economic Resources
701 NW 1st Court
Miami, Florida 33136-3912
T 305-372-6600 F 305-372-6410

miamidade.gov/derm

**POLLUTION PREVENTION FIELD NOTICE
GENERAL CONDITIONS**

MDCPS - Country Club Middle School
18305 NW 75 PL
Hialeah

DATE: 7/9/13
PERMIT #: 600-9349
FILE #: _____

RE: Outdoor Map Sinks

Dear Mr. Tuff

As the owner or operator of the above-referenced facility, this NOTICE is to advise you that an inspection of the subject facility on July 9, 2013 found the following condition(s) which require(s) your immediate attention:

Rainwater cannot enter the sanitary sewer system. Please correct this violation with regard to your outdoor map sinks.
Call me when this is corrected so we can schedule a time for me to visit and photo-document the correction.

Please note that in order to avoid further enforcement action, you are required to submit in writing to the appropriate Section indicated below, within 30 days of receipt of this NOTICE, information regarding the action(s) undertaken to correct the above-stated condition(s). Be advised that failure to comply with any of the aforementioned requirement(s) and/or to correct these condition(s) may result in the Department issuing a Uniform Civil Violation Notice which carries a mandatory civil penalty and a requirement to correct the violation.

If the facility requires a PERA Operating Permit and additional inspections must be conducted due to continuing code violations beyond the time frame allotted, the above-referenced facility may be required to pay an additional fee at the time of permit renewal.

If you have any questions, please contact the appropriate Section as marked below:

Received By [Signature]
Recipient's Signature

Issued by [Signature]
Signature

Print Marisol Pino
Recipient's Name

Print Elizabeth Rogers
Name

Title Data Input

Section/Phone: 305-372-6519 (office #)

Delivering Excellence Every Day



miamidade.gov

Regulatory and Economic Resources
Environmental Services
701 NW 1st Court, Suite 700
Miami, Florida 33136-3912
T 305-372-6600 F 305-372-6410

**GREASE DISCHARGE OPERATING PERMIT
FIELD NOTICE OF VIOLATION**

Inspection Date: 05/01/13 GDO# 3490
Facility Name: Miami-Dade County Public Schools
Facility Contact: Mr. Jaime Torrens
Address: 7450 NE 2nd Ave 3rd Floor, Miami, FL 33132

Permit (check): IGT AGT MGRU AGRU NGT

You are hereby NOTIFIED that an inspection of the above PREMISES revealed violations of the conditions of your operating permit GDO# 3490 and/or requires specific documentation noted below:

- Grease pretreatment device is not in operational status.
- Contents of automatic/manual grease recovery unit require removal.
- Contents of grease interceptor require removal by a PBRA Permitted Liquid Waste Transporter.
A receipt for proper disposal shall be submitted to this Department.
- Outlet tee in grease interceptor requires repair.
- Breached wall or bottom of grease interceptor requires repair.
- Access to grease pretreatment device is required.
- Access to the facility is required.
- *Official documentation or approved plans from the appropriate building department indicating that the facility has been approved with no grease pretreatment must be submitted to this Department. (For NGT)
- Other Fax ramp-out receipt to # 305-372-6957 or send by email to Joel.Silva@miamidade.gov

Be advised that you are required to correct the above violation(s) within 7 (days) hours of receipt of this NOTICE. Failure to correct the violation(s) noted above within the above-referenced time period shall result in enforcement action under Section 24-29, of the code of Miami-Dade County. Documentation (e.g. photographs, waste disposal manifests, invoices for work performed, etc.) which demonstrates the above-noted violation(s) have been corrected must be submitted by facsimile to Attn: Joel Silva EE & C Section at (305) 372-6410 (or mailed to the address indicated above) within the above-referenced time period in order to void additional penalties. 6957

Failure to comply with the above may result in either the issuance of a Uniform Civil Notice (UCVN), pursuant to Chapter 8CC of Miami-Dade County, requiring corrective action(s) and payment of a civil penalty of the initiation of formal enforcement action by this Department, subjecting you to the enforcement and penalty provisions of Sections 24-29 and 24-30 of the Code of Miami-Dade County.

Jack Osterholt, Director
REGULATORY AND ECONOMIC
RESOURCES

PLEASE GOVERN YOURSELF ACCORDINGLY

Received by: _____
Recipient's Signature

Delivered by: Joel Silva
Signature

Print Name: _____
Recipient's Name

Print Name: Joel Silva
Name

Title: _____

Delivered to excellent customer service

Posted: Y ___ N ___ Photographed: Y ___ N ___

Joel.Silva@miamidade.gov
305-372-1112



miamidade.gov

Regulatory and Economic Resources
Environmental Services
701 NW 1st Court, Suite 700
Miami, Florida 33136-3912
T 305-372-6600 F 305-372-6410

**GREASE DISCHARGE OPERATING PERMIT
FIELD NOTICE OF VIOLATION**

Inspection Date: 09/26/13 GDO# 3596
Facility Name: Miami Dade County Public Schools
Facility Contact: Mr. Jaime Torrens
Address: 1450 NE 2nd Ave, 3rd Floor, Miami, FL 33132

Permit (check): IGT AGT MGRU AGRU NGT

You are hereby NOTIFIED that an inspection of the above PREMISES revealed violations of the conditions of your operating permit GDO# 3596 and/or requires specific documentation noted below:

- Grease pretreatment device is not in operational status.
- Contents of automatic/manual grease recovery unit require removal.
- Contents of grease interceptor require removal by a PERA Permitted Liquid Waste Transporter.
A receipt for proper disposal shall be submitted to this Department.
- Outlet tee in grease interceptor requires repair.
- Breached wall or bottom of grease interceptor requires repair.
- Access to grease pretreatment device is required.
- Access to the facility is required.

*In reference to
Scott Lake Elementary
1160 NW 175 St
Miami, FL 33169*

*Official documentation or approved plans from the appropriate building department indicating that the facility has been approved with no grease pretreatment must be submitted to this Department. (For NGT)

Other Fax dump-on receipt to 305-372-6957 or email
Joel.Silva@miamidade.gov

Be advised that you are required to correct the above violation(s) within 2 days/hours of receipt of this NOTICE. Failure to correct the violation(s) noted above within the above-referenced time period shall result in enforcement action under Section 24-29, of the code of Miami-Dade County. Documentation (e.g. photographs, waste disposal manifests, invoices for work performed, etc.) which demonstrates the above-noted violation(s) have been corrected must be submitted by facsimile to Attn: Joel Silva EE & C Section at (305) 372-6410 (or mailed to the address indicated above) within the above-referenced time period in order to void additional penalties 6957

Failure to comply with the above may result in either the issuance of a Uniform Civil Notice (UCYN), pursuant to Chapter 8CC of Miami-Dade County, requiring corrective action(s) and payment of a civil penalty of the initiation of formal enforcement action by this Department, subjecting you to the enforcement and penalty provisions of Sections 24-29 and 24-30 of the Code of Miami-Dade County.

Jack Osterholt, Director
REGULATORY AND ECONOMIC
RESOURCES

PLEASE GOVERN YOURSELF ACCORDINGLY

Received by: Lakesha W. Rochelle Recipient's Signature
 Delivered by: Joel Silva Signature
 Print Name: Lakesha W. Rochelle Recipient's Name
 Print Name: Joel Silva Name
 Title: Principal
 Posted: Y ___ N ___ Photographed: Y ___ N ___
 Phone: Delivering to post office Monday
 Email: Joel.Silva@miamidade.gov 11/12



miamidade.gov

Department of Regulatory and Economic Resources
Division of Environmental Resources Management (DERM)
701 NW 1st Court
Miami, Florida 33136-3912
T 305-372-6600 F 305-372-6545

GREASE DISCHARGE OPERATING PERMIT FIELD NOTICE OF VIOLATION

Inspection Date: 12/19/2013 GDO# 3729

Facility Name: DCPS - Flagmi Elementary

Facility Contact: Mr. Jaime Torres

Address: 920 SW 76 Ave Miami, FL 33144

Permit (check): [X] NGT [] AGT [] MGRU [] AGRU [] NGT

You are hereby NOTIFIED that an inspection of the above PREMISES revealed violations of the conditions of your operating permit GDO# 3729 and/or requires specific documentation noted below:

- Grease pretreatment device is not in operational status.
Contents of automatic/manual grease recovery unit require removal.
[X] Contents of grease interceptor require removal by a PERA Permitted Liquid Waste Transporter.
Outlet tee in grease interceptor requires repair.
Breached wall or bottom of grease interceptor requires repair.
Access to grease pretreatment device is required.
Access to the facility is required.
Official documentation or approved plans from the appropriate building department...
Other: must submit receipt of cleaning via fax or email

Be advised that you are required to correct the above violation(s) within 21 days/hours of receipt of this NOTICE. Failure to correct the violation(s) noted above within the above-referenced time period shall result in enforcement action under Section 24-29, Miami-Dade County Code.

Failure to comply with the above may result in either the issuance of a Uniform Civil Notice (UCVN), pursuant to Chapter 8CC of the Miami-Dade County Code, requiring corrective action(s) and payment of a civil penalty of the initiation of formal enforcement action by, DERM, subjecting you to the enforcement and penalty provisions of Sections 24-29 and 24-30, Miami-Dade County Code.

Any person aggrieved by any action or decision of the DERM Director may appeal said action or decision to the Environmental Quality Control Board (EQCB) by filing a written notice of appeal along with submittal of the applicable fee, to the Code Coordination and Public Hearings Section of DERM within fifteen (15) days of the date of the action or decision by DERM.

PLEASE GOVERN YOURSELF ACCORDINGLY

Received by: [Signature] Recipient's Signature

Print: Elizabeth Trujillo Recipient's Name

Title: A.P.

Date: 12/19/13

Posted: Y N Photographed Y N

Lee N. Hefly, Director
Environmental Resources Management

Delivered by: [Signature] Signature

Print Name: Sussette Tricany Name

Phone: (305) 372-6600

Delivering Excellence Every Day



miamidade.gov

Regulatory and Economic Resources
Environmental Services
701 NW 1st Court, Suite 700
Miami, Florida 33136-3912
T 305-372-6600 F 305-372-6410

**GREASE DISCHARGE OPERATING PERMIT
FIELD NOTICE OF VIOLATION**

Inspection Date: 5/21/2013 GDO# 3768
Facility Name: DPS-Fredrick Douglass Elementary
Facility Contact: Jaime Torrens - Chief Facilities Operator
Address: 314 NW 12th ST

Permit (check): IGT AGT MGRU AGRU NGT

You are hereby NOTIFIED that an inspection of the above PREMISES revealed violations of the conditions of your operating permit GDO# 3768 and/or requires specific documentation noted below:

- Grease pretreatment device is not in operational status.
- Contents of automatic/manual grease recovery unit require removal.
- Contents of grease interceptor require removal by a PERA Permitted Liquid Waste Transporter.
A receipt for proper disposal shall be submitted to this Department.
- Outlet tee in grease interceptor requires repair.
- Breached wall or bottom of grease interceptor requires repair.
- Access to grease pretreatment device is required.
- Access to the facility is required.

*Official documentation or approved plans from the appropriate building department indicating that the facility has been approved with no grease pretreatment must be submitted to this Department. (For NGT)

Other pumpout IGTs on site + pressure clean outlet tee
Fax work order to me.

Be advised that you are required to correct the above violation(s) within 7 days/hours of receipt of this NOTICE. Failure to correct the violation(s) noted above within the above-referenced time period shall result in enforcement action under Section 24-29, of the code of Miami-Dade County. Documentation (e.g. photographs, waste disposal manifests, invoices for work performed, etc.) which demonstrates the above-noted violation(s) have been corrected must be submitted by facsimile to Attn: Lina Chambers EE & C Section at (305) 372-6410 (or mailed to the address indicated above) within the above-referenced time period in order to void additional penalties. 6957

Failure to comply with the above may result in either the issuance of a Uniform Civil Notice (UCVN), pursuant to Chapter 8CC of Miami-Dade County, requiring corrective action(s) and payment of a civil penalty of the initiation of formal enforcement action by this Department, subjecting you to the enforcement and penalty provisions of Sections 24-29 and 24-30 of the Code of Miami-Dade County.

Jack Osterholt, Director
REGULATORY AND ECONOMIC
RESOURCES

PLEASE GOVERN YOURSELF ACCORDINGLY

Received by: SENT Delivered by: [Signature]
 Recipient's Signature: [Signature] Signature
 Print Name: Lina Chambers Print Name: Lina Chambers Name
 Title: Delivering to Osterholt Title: Director
 Phone: 786-821-6137 Phone: 786-821-6137
 Posted: Y X N Photographed: Y X N
 #700-3768-0003-4084-3273
 7010 2780 0003 4084 3273
 161.01.122 11/12



miamidade.gov

va

Permitting, Environment and Regulatory Affairs
Environmental Services
701 NW 1st Court, Suite 700
Miami, Florida 33136-3912
T 305-372-6600 F 305-372-6410

GREASE DISCHARGE OPERATING PERMIT FIELD NOTICE OF VIOLATION

Inspection Date: 9/6/2013 GDO# 3857
Facility Name: Jane S. Roberts Elem
Facility Contact: Mr. Jaime Torrens
Address: 14850 Cottonwood Circle Miami, FL 33185
Permit (check): IGT AGT MGRU AGRU NGT

You are hereby NOTIFIED that an inspection of the above PREMISES revealed violations of the conditions of your operating permit GDO# 3857 and/or requires specific documentation noted below:

- Grease pretreatment device is not in operational status.
- Contents of automatic/manual grease recovery unit require removal.
- Contents of grease interceptor require removal by a PERA Permitted Liquid Waste Transporter.
A receipt for proper disposal shall be submitted to this Department.
- Outlet tee in grease interceptor requires repair.
- Breached wall or bottom of grease interceptor requires repair.
- Access to grease pretreatment device is required.
- Access to the facility is required.

*Official documentation or approved plans from the appropriate building department indicating that the facility has been approved with no grease pretreatment must be submitted to this Department. (For NGT)

Other the grease trap connected to the middle school must be raised out. please submit a receipt of the cleaning via fax or email

Be advised that you are required to correct the above violation(s) within 7 days/hours of receipt of this NOTICE. Failure to correct the violation(s) noted above within the above-referenced time period shall result in enforcement action under Section 24-29, of the code of Miami-Dade County. Documentation (e.g. photographs, waste disposal manifests, invoices for work performed, etc.) which demonstrates the above-noted violation(s) have been corrected must be submitted by facsimile to Attn: Sussette Truancy EE & C Section at (305) 372-6410 (or mailed to the address indicated above) within the above-referenced time period in order to void additional penalties.

Failure to comply with the above may result in either the issuance of a Uniform Civil Notice (UCVN), pursuant to Chapter 8CC of Miami-Dade County, requiring corrective action(s) and payment of a civil penalty of the initiation of formal enforcement action by this Department, subjecting you to the enforcement and penalty provisions of Sections 24-29 and 24-30 of the Code of Miami-Dade County.

Jack Osterholt, Director
PERMITTING, ENVIRONMENT
AND REGULATORY AFFAIRS

PLEASE GOVERN YOURSELF ACCORDINGLY

Received by: Ana Othon
Recipient's Signature
Print Name: Ana Othon
Recipient's Name
Title: Principal
Posted: Y N Photographed: Y N

Delivered by: Sussette Truancy
Signature
Print Name: Sussette Truancy
Name
Phone: 305 372 6410
Fax: (305) 372-6413



miamidade.gov

Department of Regulatory and Economic Resources
Division of Environmental Resources Management (DERM)
701 NW 1st Court
Miami, Florida 33136-3912
T 305-372-6600 F 305-372-6545

POLLUTION PREVENTION FIELD NOTICE-GENERAL CONDITIONS

M-DCPS Westland Hialeah SHS
4000 W 18 Ave
Hialeah, FL 33012

DATE: 12/18/13
PERMIT #: GDO-10086

RE: Storm drain in back of cafeteria near grease traps

Dear Michael Krtausch :

As the owner or operator of the above-referenced facility, this NOTICE is to advise you that an inspection of the subject facility on December 13, 2013 found the following condition(s) which require(s) your immediate attention:

Due to photographic evidence of the presence of garbage and an oily sheen within the storm drain in back of your cafeteria (close to the grease traps), please pump out the contents of this storm drain and fax or email me a copy of this receipt for this service. As per Chapter 24 of the Miami Dade County Code, only rainwater is allowed to enter the stormwater system.

Please note that in order to avoid further enforcement action, you are required to submit in writing to the appropriate Section indicated below, within (7) days of receipt of this NOTICE, information regarding the action(s) undertaken to correct the above-stated condition(s). Be advised that failure to comply with any of the aforementioned requirement(s) and/or to correct these condition(s) may result in the DERM issuing a Uniform Civil Violation Notice which carries a mandatory civil penalty and a requirement to correct the violation.

7005116000026032469
If the facility requires a DERM Operating Permit and additional inspections must be conducted due to continuing code violations beyond the time frame allotted, the above-mentioned referenced facility may be required to pay an additional fee at the time of permit renewal.

Any person aggrieved by any action or decision of the DERM Director may appeal said action or decision to the Environmental Quality Control Board (EQCB) by filing a written notice of appeal along with submittal of the applicable fee, to the Code Coordination and Public Hearings Section of DERM within fifteen (15) days of the date of the action or decision by DERM.

PLEASE GOVERN YOURSELF ACCORDINGLY

Received by: _____
Recipient's Signature

Print: _____
Recipient's Name

Title: _____

Lee N. Hefty, Director
Environmental Resources Management
Issued by: Elizabeth Rogers
Signature
Print: Elizabeth Rogers
Name
Phone: _____

Delivering Excellence Every Day



Carlos A. Gimenez, Mayor

Department of Regulatory and Economic Resources
Environmental Resources Management
701 NW 1st Court, 6th Floor
Miami, Florida 33136-3912
T 305-372-6902 F 305-372-6630

miamidade.gov

September 30, 2016

MELVYN SCHLESSER, MGR
LINCOLN CENTER ASSOCIATES, LLC.
1300 COLLINS AVE. SUITE 100
MIAMI BEACH, FLORIDA 33139

Certified Mail No. 7009 0080 0000 1044 7297
Return Receipt Requested

STEFANO FRITTELLA, MGR.
LE MINOTENN, LLC. DBA IL BOLOGNESE
850 OCEAN DR. SUITE 203
MIAMI BEACH, FL 33139

Certified Mail No. 7009 0080 0000 1044 7303
Return Receipt Requested

Re: Le Minotenn, LLC DBA Il Bolognese located at, near, or in the vicinity of 626 Lincoln Rd.,
Miami Beach, Miami-Dade County, Florida (Folio No. 02-3234-003-0060) (GDO-4230).

Dear Messrs. Schlessler and Frittella:

**NOTICE OF VIOLATION AND ORDERS
FOR CORRECTIVE ACTION**

On May 19, 2016, an inspection performed by Department of Regulatory and Economic Resources Division of Environmental Resources Management (DERM) staff found the current in-ground fat, oil and grease (FOG) control pretreatment device does not meet the minimum requirements for the subject facility. During the inspection a sample taken from the effluent of the facility's current FOG control device revealed levels above the standard for oil and grease (O&G) discharges to the public sanitary sewer system (specifically, the sample result was 796.8 mg/L while the O&G sanitary sewer standard is 100 mg/L) which is also a violation of the facility's DERM Fat, Oil and Grease Discharge Control Annual Operating Permit (GDO Permit #4230).

Be advised that discharging, or allowing discharges in excess of the sanitary sewer standards constitutes violations of the facility's Fats, Oils and Grease Discharge Control Annual Operating Permit (GDO #4230) and of Chapter 24, Miami-Dade County Environmental Protection Ordinance, specifically:

Section 24-29, of Chapter 24, inasmuch as it shall be unlawful for any person to violate any of the provisions of this chapter, any lawful rules and regulations promulgated under this chapter, any lawful order of the Director of the Department of the Environmental Resources Management (DERM) or his designee, or any condition, limitation or restriction which is part of an operating permit.

Section 24-42.4.(2)(d)(vi) of Chapter 24, inasmuch as it shall be unlawful for any person to throw, drain, run or otherwise discharge into a sanitary sewer, or to cause, permit, allow or suffer

Delivering Excellence Every Day

7

to be thrown, run, drained, allowed to seep, or otherwise discharged into such sewer any effluents in excess of local limits.

Based on the above and pursuant to the authority granted to me under Chapter 24, Miami-Dade County Environmental Protection Ordinance, I am hereby ordering you to:

- 1) Upon receipt of this NOTICE, immediately CEASE and DESIST from any further unauthorized discharges to the publicly owned sanitary sewer system at the subject location.
- 2) Within sixty (60) days of receipt of this Notice, submit to this Department for review, formal plans signed and sealed by a Florida Professional Engineer for changes in equipment and/or processes, which shall correct the current violations and prevent future violations of the provisions of Chapter 24 at the subject facility. Said plans shall include at a minimum the following:
 - a) All existing plumbing lines, drainage fixtures, solids separators, grease interceptors/ grease traps and sampling points. All lines that receive or can receive waste from fixtures that can discharge food waste or Fats, Oil and Grease (FOG) shall be labeled grease waste (GW) to distinguish it from sanitary waste.
 - b) A FOG control device sized based on calculations that include peak flow rates, FOG and solids loading rate, and a maximum pump out frequency of sixty (60) days. FOG loading shall include all FOG sources, including exhaust hoods. For self-cleaning exhaust hoods, the manufacturer's specifications for peak discharge shall be included.
 - c) All drainage fixtures located in food and beverage preparation areas shall be routed through a grease interceptor. Drainage fixtures include, but are not limited to: floor drains, floor sinks, mop sinks, three-compartment sinks, hand sinks, pre-rinse station/sink, preparation sink, pot sink, wok sink, and self-cleaning exhaust hoods
 - d) Sampling point located after the point of no further treatment. The sampling point shall have sufficient depth and access to allow sample collection using a 3-inch diameter x 6-inch long sample bottle. An alternative to a manufactured sampling point (device) is a double sanitary cross with a PVC-CAP on the bottom of the vertical axis to create the sampling sump and a clean-out cap on top. Minimum diameter for the vertical axis is 4-inches; minimum depth of the sump is 6 inches.
 - e) Isometric diagram(s) with existing and proposed plumbing lines, fixtures, solids separators, FOG control devices and sampling points. Grease waste lines shall be labeled GW.
 - f) Solids separation prior to existing or proposed FOG control devices that require a flow control device or are not certified to handle solids.
- 3) Upon approval by this Department, obtain the appropriate permits and commence with the implementation of the required improvements.
- 4) Within one hundred and eighty (180) days of receipt of this Notice, complete the required improvements.

For appropriate handling, include the subject permit number (GDO-4230) referencing this facility on all submittals filed with this Department and direct said submittals to DERM, attn. Carlos Hernandez, P.E., Chief, Wastewater Permitting Section, 701 NW 1st Court, 7th Floor, Miami, FL 33136-3912.

BE ADVISED THAT FAILURE TO COMPLY WITH THE ABOVE MAY RESULT, AT A MINIMUM, IN ASSESSMENT OF CIVIL PENALTIES AND THE PAYMENT OF ALL DEPARTMENTAL COSTS INCURRED IN THE INVESTIGATION AND SETTLEMENT OF THIS CASE. IN ADDITION, FAILURE TO COMPLY MAY RESULT IN YOUR CASE BEING PREPARED FOR FORMAL ENFORCEMENT ACTION IN A COURT OF COMPETENT JURISDICTION PURSUANT TO THE ENFORCEMENT AND PENALTY PROVISIONS OF SECTION 24-29, OF CHAPTER 24 OF THE CODE OF MIAMI-DADE COUNTY, FLORIDA, THE MIAMI-DADE COUNTY ENVIRONMENTAL PROTECTION ORDINANCE.

Any person aggrieved by any action or decision of the DERM Director may appeal said action or decision to the Environmental Quality Control Board (EQCB) by filing a written notice of appeal along with submittal of the applicable fee, to the Code Coordination and Public Hearings Section of DERM within fifteen (15) days of the date of the action or decision by DERM.

If you have any questions concerning the above, please contact the undersigned at 305-372-6546 or via email at StreeE@miamidade.gov.

Sincerely,



Eric T. Streett
Environmental Code Enforcement Officer II
Division of Environmental Resources Management
Regulatory Services

CC: L. Castillo , DERM PRD

4419



Carlos A. Gimenez, Mayor

Department of Regulatory and Economic Resources
Environmental Resources Management
701 NW 1st Court, 6th Floor
Miami, Florida 33136-3912
T 305-372-6902 F 305-372-6630
miamidade.gov

March 30, 2015

Reinaldo Rocha, Director
Roca Café, Inc. d/b/a Cacique's Corner Restaurant
100 West Flagler Street
Miami, Florida 33130

Certified Mail No. 7004 2510 0001 7495 1277
Return Receipt Requested

David N. Blount, Jr., Director
Blount Realty Management Inc., General Partner of
Blount Realty Partners, Ltd.
6136 South Dixie Highway
South Miami, Florida

Certified Mail No. 7004 2510 0001 7495 1284
Return Receipt Requested

Re: Unauthorized discharge to the sanitary sewer system from Cacique's Corner Restaurant located at, near or in the vicinity of 100 West Flagler Street, Miami, Florida (folio # 01-0113-070-1070). DERM file no. GDO-4419.

Dear Mr. Roca and Mr. Blount:

NOTICE OF VIOLATION
AND
ORDERS FOR CORRECTIVE ACTION

On March 20, 2015 a representative of the Miami-Dade County Department of Regulatory and Economic Resources, Division of Environmental Resources Management (DERM), responded to a complaint of a sewage over flow at the above-referenced facility. Said inspection revealed the on-site manual grease recovery unit (MGRU) was not functioning properly resulting in the unauthorized discharge of grease to the sanitary sewer system servicing the subject property. Said discharge caused an obstruction to the sanitary sewer system resulting in a backup to the system and triggering a sewage overflow. A crew from the Miami-Dade Water and Sewer Department was dispatched to the scene to clean-out the sewer line and disinfect the impacted areas.

Be advised that discharging, or allowing the discharge of any industrial wastes into a sanitary sewer system constitutes violations the facility's Grease Discharge Operating Permit (GDO-4419) and of Chapter 24, Miami-Dade County Environmental Protection Ordinance, specifically:

Section 24-29, of said Ordinance, which states in pertinent part: "It shall be unlawful for any person to violate any of the provisions of this chapter, any lawful rules and regulations promulgated under this chapter, any lawful order of the Director of DERM or his designee, or any condition, limitation or restriction which is part of an operating permit."

Section 24-42.4(2)(d)(iii), of said Ordinance, which states in pertinent part: "It shall be unlawful for any person to throw, drain, run or otherwise discharge into a sanitary sewer, or to cause, permit, allow or suffer to be thrown, run, drained or allowed to seep, or otherwise discharged into such sewer any pollutant in amounts which alone or in combination with other discharges will cause obstruction to the flow in the publicly owned treatment works."

Delivered to Recipient Every 2

Section 24-42.4(2)(d)(vi), of said Ordinance, which states in pertinent part: "It shall be unlawful for any person to throw, drain, run or otherwise discharge into a sanitary sewer, or to cause, permit, allow or suffer to be thrown, run, drained or allowed to seep, or otherwise discharged into such sewer any effluents in excess of local limits."

Pursuant to the provisions of Section 24-31(6) of Chapter 24, Miami-Dade County Code, whenever a violation of this chapter occurs or exists, or has occurred or existed, any person, individually or otherwise, who has legal, beneficial, or equitable interest in the real property upon which such violation occurs or exists, or has occurred or existed, shall be jointly and severally liable for said violation regardless of fault and regardless of knowledge of the violation.

Based on the above and pursuant to the authority granted to me under Chapter 24, Miami-Dade County Environmental Protection Ordinance, I am hereby ordering you to:

1. Upon receipt of this NOTICE, "**CEASE and DESIST**" from allowing any further unauthorized discharges to the publicly owned sanitary sewer system at the subject location.
2. Within sixty days (60) of receipt of this NOTICE, submit to this Department for review, formal plans signed and sealed by a Florida Professional Engineer for changes in equipment and/or processes, which shall correct the current violations and prevent future violations of the provisions of Chapter 24 at the subject facility. Said plans shall include at a minimum the following:
 - a. All existing plumbing lines, drainage fixtures, solids separators, grease interceptors / grease traps and sampling points. All lines that receive or can receive waste from fixtures that can discharge food waste or Fats, Oil and Grease (FOG) shall be labeled grease waste (GW) to distinguish it from sanitary waste.
 - b. A FOG control device sized based on calculations that include peak flow rates, FOG and solids loading rate, and a maximum pump-out frequency of sixty (60) days. FOG loading shall include all FOG sources, including exhaust hoods. For self-cleaning exhaust hoods, the manufacturer's specifications for peak discharge shall be included.
 - c. All drainage fixtures located in food and beverage preparation areas shall be routed through a grease interceptor. Drainage fixtures include, but are not limited to: floor drains, floor sinks, mop sinks, three-compartment sinks, hand sinks, pre-rinse station/sink, preparation sink, pot sink, wok sink, and self-cleaning exhaust hoods.
 - d. Sampling point located after the point of no further treatment. The sampling point shall be directly accessible for visual inspection and sampling. Sampling point shall have sufficient depth and access to allow sample collection using a 3-inch diameter x 6-inch long sample bottle. An alternative to a manufactured sampling point (device) is a double sanitary cross with a PVC-CAP on the bottom of the vertical axis to create the sampling sump and a cleanout cap on top. Minimum diameter for the vertical axis is 4-inches; minimum depth of the sump is 6 inches.
 - e. Isometric diagram(s) with existing and proposed plumbing lines, fixtures, solids separators, FOG control devices and sampling points. Grease waste lines shall be labeled GW.
 - f. Solids separation prior to existing or proposed FOG control devices that require a flow control device or are not certified to handle solids.

3. Upon approval by this Department, obtain the appropriate permits and commence with the implementation of the required improvements.
4. Within one hundred eighty (180) days of receipt of this Notice, complete the required improvements.

For appropriate handling, include the subject permit number (GDO-4419) referencing this facility on all submittals filed with this Department and direct said submittals to DERM, attn. Carlos Hernandez, P.E., Chief, Wastewater Permitting Section, 701 NW 1st Court, 7th Floor, Miami, Florida 33136-3912

BE ADVISED THAT FAILURE TO COMPLY WITH THE ABOVE MAY RESULT, AT A MINIMUM, IN CIVIL PENALTIES AND THE PAYMENT OF ALL DEPARTMENTAL COSTS INCURRED IN THE INVESTIGATION AND SETTLEMENT OF THIS CASE. IN ADDITION, FAILURE TO COMPLY MAY RESULT IN YOUR CASE BEING PREPARED FOR FORMAL ENFORCEMENT ACTION IN A COURT OF COMPETENT JURISDICTION PURSUANT TO THE ENFORCEMENT AND PENALTY PROVISIONS OF SECTION 24-29, MIAMI DADE COUNTY ENVIRONMENTAL PROTECTION ORDINANCE.

Any person aggrieved by any action or decision of the DERM Director may appeal said action or decision to the Environmental Quality Control Board (EQCB) by filing a written notice of appeal along with submittal of the applicable fee, to the Code Coordination and Public Hearings Section of DERM within fifteen (15) days of the date of the action or decision by DERM.

If you have any questions concerning the above, please contact Carlos Hernandez, P.E., Chief of the Wastewater Permitting Section of this office at 305-372-6714 or via email at Hernac@miamidade.gov.

Sincerely,



Mark J. Pettit
Environmental Code Enforcement Officer II
Regulatory Services

ECM GDO-6035



Carlos A. Gimenez, Mayor

Department of Regulatory and Economic Resources
Environmental Resources Management
701 NW 1st Court, 6th Floor
Miami, Florida 33136-3912
T 305-372-6902 F 305-372-6630

miamidade.gov

November 9, 2016

Frank Encalada, President
Divino Ceviche Coral Gables, Inc.
160 Giralda Avenue
Coral Gables, FL 33134

Certified Mail No. 7014 1200 0000 1637 3355
Return Receipt Requested

Yolanda L. Yarur, Trustee
Yolanda Lolos Yarur Revocable Trust
c/o Kerdyk Real Estate, Inc.
2631 Ponce De Leon Boulevard
Coral Gables, FL 33134-6002

Certified Mail No. 7014 1200 0000 1637 3362
Return Receipt Requested

Re: Unauthorized discharge to the sanitary sewer system from Divino Ceviche Restaurant located at, near or in the vicinity of 160 Giralda Avenue, Coral Gables, Florida (folio # 03-4108-007-3340). DERM file no. GDO-6035.

Dear Mr. Encalada and Ms. Yarur:

NOTICE OF VIOLATION
AND
ORDERS FOR CORRECTIVE ACTION

Inspections of the subject property by representatives of this department on March 29, 2016 and July 13, 2016 revealed discharges of oil and grease of 288 mg/l and 1060 mg/l respectively, above the sanitary sewer discharge limit of 100 mg/l, in violation of condition no. 9 of your Fats, Oil and Grease Discharge Control Annual Operating Permit (GDO-6035) and in violation of Chapter 24, Miami-Dade County Code.

Be advised that the above constitutes violations of Chapter 24, Miami-Dade County Environmental Protection Ordinance, specifically:

Section 24-29, of said Ordinance, which states in pertinent part: "It shall be unlawful for any person to violate any of the provisions of this chapter, any lawful rules and regulations promulgated under this chapter, any lawful order of the Director of DERM or his designee, or any condition, limitation or restriction which is part of an operating permit.

Section 24-42.4(2)(d)(vi), of said Ordinance, which states in pertinent part: "It shall be unlawful for any person to throw, drain, run or otherwise discharge into a sanitary sewer, or to cause, permit, allow or suffer to be thrown, run, drained or allowed to seep, or otherwise discharged into such sewer any effluents in excess of local limits."

Based on the above and pursuant to the authority granted to me under Chapter 24, Miami-Dade County Environmental Protection Ordinance, you are hereby ordered to:

1. Upon receipt of this NOTICE, "CEASE and DESIST" from allowing any further unauthorized discharges to the publicly owned sanitary sewer system at the subject location.

Discharge Evidence Every Day

2. Within forty-five days (45) of receipt of this NOTICE, submit to this Department for review, formal plans signed and sealed by a Florida Professional Engineer for plumbing, equipment and/or processes changes, which shall correct the current violations and prevent future violations of the provisions of Chapter 24 at the subject facility. Said submittal shall include, at a minimum, the following.
 - A. Existing facility plan showing all food and beverage preparation areas (back of house areas) and kitchen equipment/appliances.
 - B. Existing facility sanitary drainage (plumbing) drawings, plan and isometric, that include:
 - i. Existing drains/lines, plumbing fixtures, solids separators, Fats, Oils and Grease (FOG) Control Devices (e.g., grease interceptors) and sampling point.
 - ii. All existing drains/lines not connected to a FOG Control Device (e.g., grease interceptor) labeled Existing Sanitary.
 - iii. All existing drains/lines connected to a FOG Control Device (e.g., grease interceptor) labelled Existing GW (Grease Waste).
 - C. Existing building sewer plan showing all connections from the facility to the public sanitary sewer system.
 - D. An evaluation of the existing FOG Control Device (e.g., grease interceptor) capacity. The evaluation shall incorporate proposed equipment and/or processes changes and include peak flow rate, FOG and solids loading rate, and pump-out (cleaning) frequency (e.g., 30, 60 or 90 days). FOG loading shall include all FOG sources: FOG generated by preparing meals and cleaning associated with eat-in, take-out and drive-through meals. The capacity of FOG Control Device (e.g., grease interceptor) shall be sufficient to produce an effluent that complies with Section 24-42.4 (e.g., 100 mg/L Oil & Grease).
 - E. If the evaluation demonstrates that the existing FOG Control Device (e.g., grease interceptor) does not provide sufficient capacity, submit "proposed" sanitary drainage (plumbing) drawings, plan and isometric, that include:
 - i. Existing and proposed drains/lines, plumbing fixtures, solids separators, FOG Control Devices (e.g., grease interceptors) and sampling point.
 - ii. All existing and proposed drains/lines not connected to a FOG Control Device (e.g., grease interceptor) labeled Existing Sanitary.
 - iii. All existing and proposed drains/lines connected to a FOG Control Device (e.g., grease interceptor) labelled Existing GW (Grease Waste).
 - iv. Sizing calculations for the proposed FOG Control Device (e.g., grease interceptor). The calculations shall incorporate proposed equipment and/or processes changes and include peak flow rate, FOG and solids loading rate, and pump-out (cleaning) frequency (e.g., 30, 60 or 90 days). FOG loading shall include all FOG sources: FOG generated by preparing meals and cleaning associated with eat-in, take-out and drive-through meals. The capacity of FOG Control Device (e.g., grease interceptor) shall be sufficient to produce an effluent that complies with Section 24-42.4 (e.g., 100 mg/L Oil & Grease).

- v. The FOG Control Device (e.g., grease interceptor) shall be located to allow uninterrupted maintenance and inspection; i.e., the system shall be accessible all times and not require intervention to access, clean and inspect.
 - vi. Sampling point located after the point of no further treatment. The sampling point shall be directly accessible for visual inspection and sampling. Sampling point shall have sufficient depth and access to allow sample collection using a 3-inch diameter x 6-inch long sample bottle.
 - vii. All drainage fixtures located in food and beverage preparation areas (back of house areas) shall be connected to a FOG Control Device. Drainage fixtures include, but are not limited to: floor drains, floor sinks, mop sinks, three-compartment sinks, hand sinks, pre-rinse station/sink, preparation sink, pot sink, wok sink, and self-cleaning exhaust hoods.
3. Upon approval by this Department, obtain the appropriate permits and commence with the implementation of the required improvements.
 4. Within one hundred twenty (120) days of receipt of this Notice, complete the required improvements.

For appropriate handling, include the subject permit number (GDO-6035) referencing this facility on all submittals filed with this Department and direct said submittals to DERM, attn. Carlos Hernandez, P.E., Chief, Wastewater Permitting Section, 701 NW 1st Court, 7th Floor, Miami, Florida 33136-3912

BE ADVISED THAT FAILURE TO COMPLY WITH THE ABOVE MAY RESULT, AT A MINIMUM, IN CIVIL PENALTIES AND THE PAYMENT OF ALL DEPARTMENTAL COSTS INCURRED IN THE INVESTIGATION AND SETTLEMENT OF THIS CASE. IN ADDITION, FAILURE TO COMPLY MAY RESULT IN YOUR CASE BEING PREPARED FOR FORMAL ENFORCEMENT ACTION IN A COURT OF COMPETENT JURISDICTION PURSUANT TO THE ENFORCEMENT AND PENALTY PROVISIONS OF SECTION 24-29, MIAMI DADE COUNTY ENVIRONMENTAL PROTECTION ORDINANCE.

Any person aggrieved by any action or decision of the DERM Director may appeal said action or decision to the Environmental Quality Control Board (EQCB) by filing a written notice of appeal along with submittal of the applicable fee, to the Code Coordination and Public Hearings Section of DERM within fifteen (15) days of the date of the action or decision by DERM.

If you have any questions concerning the above, please contact Carlos Hernandez, P.E., Chief of the Wastewater Permitting Section of this office at 305-372-6714 or via email at Hernac@miamidade.gov.

Sincerely,

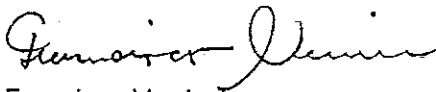

Francisco Verrire
Code Enforcement Officer

pc: Carlos Hernandez, P.E., DERM
Laura Castillo, DERM



Carlos A. Gimenez, Mayor

Department of Regulatory and Economic Resources
Environmental Resources Management
701 NW 1st Court, 6th Floor
Miami, Florida 33136-3912
T 305-372-6902 F 305-372-6630

miamidade.gov

November 30, 2016

Stefano Frittella, Manager
607 Lincoln Road., LLC
d/b/a Cantinetta
850 Ocean Drive, Suite 203
Miami Beach, Florida, 33139

Certified Mail No. 7012 3050 0000 9722 0084
Return Receipt Requested

Re: Unauthorized discharge to the sanitary sewer system from Cantinetta Restaurant located at, near or in the vicinity of 607 Lincoln Road, Miami Beach, Miami-Dade Florida (folio # 02-3234-005-0030). DERM file no. GDO-4516.

Dear Mr. Frittella:

**NOTICE OF VIOLATION
AND
ORDERS FOR CORRECTIVE ACTION**

On May 19, 2016 and July 20, 2016 a representative of the Miami-Dade County Department of Regulatory and Economic Resources, Division of Environmental Resources Management (DERM), inspected the above-referenced facility and collected samples from the final discharge point of the on-site grease recovery unit. Sample results revealed that the on-site grease recovery unit is not functioning properly and/or sized correctly for the facility resulting in the unauthorized discharge of grease to the sanitary sewer system servicing the subject property. Additionally, on May 20, 2016, DERM issued an Educational Field Notice of Violation ((Edu-FNOV) requiring that the referenced facility maintain maintenance records and logs for three (3) years.

Be advised that discharging, or allowing the discharge of any industrial wastes into a sanitary sewer system and failure to maintaining required records constitute violations of the facility's Grease Discharge Operating Permit (GDO-4516) and of Chapter 24, Miami-Dade County Environmental Protection Ordinance, specifically:

Section 24-18(18), of said Ordinance, which states in pertinent part : "It shall be unlawful for any source of... potential pollution to operate in violation of any condition, limitation or restriction which is part of an operating permit...issued by the Director or the Director's designee."

Section 24-29, of said Ordinance, which states in pertinent part: "It shall be unlawful for any person to violate any of the provisions of this chapter, any lawful rules and regulations promulgated under this chapter, any lawful order of the Director or the Director's designee."

Section 24-42.4(2)(d)(iii), of said Ordinance, which states in pertinent part: "It shall be unlawful for any person to throw, drain, run or otherwise discharge into a sanitary sewer, or to cause, permit, allow or suffer to be thrown, run, drained or allowed to seep, or otherwise discharged into such sewer any pollutant in amounts which alone or in combination with other discharges will cause obstruction to the flow in the publicly owned treatment works."

Section 24-42.4(2)(d)(vi), of said Ordinance, which states in pertinent part: "It shall be unlawful for any person to throw, drain, run or otherwise discharge into a sanitary sewer, or to cause, permit, allow or suffer to be thrown, run, drained or allowed to seep, or otherwise discharged into such sewer any effluents in excess of local limits."

Pursuant to the provisions of Section 24-31(6) of Chapter 24, Miami-Dade County Code, whenever a violation of this chapter occurs or exists, or has occurred or existed, any person, individually or otherwise, who has legal, beneficial, or equitable interest in the real property upon which such violation occurs or exists, or has occurred or existed, shall be jointly and severally liable for said violation regardless of fault and regardless of knowledge of the violation.

Based on the above and pursuant to the authority granted to me under Chapter 24, Miami-Dade County Environmental Protection Ordinance, I am hereby ordering you to:

1. Upon receipt of this NOTICE, "**CEASE and DESIST**" from allowing any further unauthorized discharges to the publicly owned sanitary sewer system at the subject location.
2. Within forty-five days (45) of receipt of this NOTICE, submit to this Department for review, formal plans signed and sealed by a Florida Professional Engineer for plumbing, equipment and/or processes changes, which shall correct the current violations and prevent future violations of the provisions of Chapter 24 at the subject facility. Said submittal shall include, at a minimum, the following.
 - A. Existing facility plan showing all food and beverage preparation areas (back of house areas) and kitchen equipment/appliances.
 - B. Existing facility sanitary drainage (plumbing) drawings, plan and isometric, that include:
 - i. Existing drains/lines, plumbing fixtures, solids separators, Fats, Oils and Grease (FOG) Control Devices (e.g., grease interceptors) and sampling point.
 - ii. All existing drains/lines not connected to a FOG Control Device (e.g., grease interceptor) labeled Existing Sanitary.
 - iii. All existing drains/lines connected to a FOG Control Device (e.g., grease interceptor) labelled Existing GW (Grease Waste).
 - C. Existing building sewer plan showing all connections from the facility to the public sanitary sewer system.
 - D. An evaluation of the existing FOG Control Device (e.g., grease interceptor) capacity. The evaluation shall incorporate proposed equipment and/or processes changes and include peak flow rate, FOG and solids loading rate, and pump-out (cleaning) frequency (e.g., 30, 60 or 90 days). FOG loading shall include all FOG sources: FOG generated by preparing meals and cleaning associated with eat-in, take-out and drive-through meals. The capacity of FOG Control Device (e.g., grease interceptor) shall be sufficient to produce an effluent that complies with Section 24-42.4 (e.g., 100 mg/L Oil & Grease).
 - E. If the evaluation demonstrates that the existing FOG Control Device (e.g., grease interceptor) does not provide sufficient capacity, submit "proposed" sanitary drainage (plumbing) drawings, plan and isometric, that include:
 - i. Existing and proposed drains/lines, plumbing fixtures, solids separators, FOG Control Devices (e.g., grease interceptors) and sampling point.
 - ii. All existing and proposed drains/lines not connected to a FOG Control Device (e.g., grease interceptor) labeled Existing Sanitary.
 - iii. All existing and proposed drains/lines connected to a FOG Control Device (e.g., grease interceptor) labelled Existing GW (Grease Waste).
 - iv. Sizing calculations for the proposed FOG Control Device (e.g., grease interceptor). The calculations shall incorporate proposed equipment and/or processes changes and include peak flow rate, FOG and solids loading rate, and pump-out (cleaning) frequency (e.g., 30, 60 or 90 days). FOG loading shall include all FOG sources: FOG generated by preparing meals and cleaning associated with eat-in, take-out and drive-through meals. The capacity of FOG Control Device (e.g., grease interceptor) shall be sufficient to produce an effluent that complies with Section 24-42.4 (e.g., 100 mg/L Oil & Grease).
 - v. The FOG Control Device (e.g., grease interceptor) shall be located to allow uninterrupted maintenance and inspection; i.e., the system shall be accessible all times and not require intervention to access, clean and inspect.
 - vi. Sampling point located after the point of no further treatment. The sampling point shall be directly accessible for visual inspection and sampling. Sampling point shall have sufficient depth and access to allow sample collection using a 3-inch diameter x 6-inch long sample bottle.

- vii. All drainage fixtures located in food and beverage preparation areas (back of house areas) shall be connected to a FOG Control Device. Drainage fixtures include, but are not limited to: floor drains, floor sinks, mop sinks, three-compartment sinks, hand sinks, pre-rinse station/sink, preparation sink, pot sink, wok sink, and self-cleaning exhaust hoods.
3. Upon approval by this Department, obtain the appropriate permits and commence with the implementation of the required improvements.
4. Within one hundred twenty (120) days of receipt of this Notice, complete the required improvements.

For appropriate handling, include the subject permit number (GDO-4516) referencing this facility on all submittals filed with this Department and direct said submittals to DERM, attn. Carlos Hernandez, P.E., Chief, Wastewater Permitting Section, 701 NW 1st Court, 7th Floor, Miami, Florida 33136-3912

In addition to complying with the above orders, immediately initiate record keeping in accordance with GDO-4516 requirements.

BE ADVISED THAT FAILURE TO COMPLY WITH THE ABOVE MAY RESULT, AT A MINIMUM, IN CIVIL PENALTIES AND THE PAYMENT OF ALL DEPARTMENTAL COSTS INCURRED IN THE INVESTIGATION AND SETTLEMENT OF THIS CASE. IN ADDITION, FAILURE TO COMPLY MAY RESULT IN YOUR CASE BEING PREPARED FOR FORMAL ENFORCEMENT ACTION IN A COURT OF COMPETENT JURISDICTION PURSUANT TO THE ENFORCEMENT AND PENALTY PROVISIONS OF SECTION 24-29, MIAMI DADE COUNTY ENVIRONMENTAL PROTECTION ORDINANCE.

Any person aggrieved by any action or decision of the DERM Director may appeal said action or decision to the Environmental Quality Control Board (EQCB) by filing a written notice of appeal along with submittal of the applicable fee, to the Code Coordination and Public Hearings Section of DERM within fifteen (15) days of the date of the action or decision by DERM.

If you have any questions concerning the above, please contact Carlos Hernandez, P.E., Chief of the Wastewater Permitting Section of this office at 305-372-6714 or via email at Hernac@miamidade.gov.

Sincerely,



Sharon Crabtree
Code Enforcement Officer



Carlos A. Gimenez, Mayor

Department of Regulatory and Economic Resources
Environmental Resources Management
701 NW 1st Court, 6th Floor
Miami, Florida 33136-3912
T 305-372-6902 F 305-372-6630

miamidade.gov

October 13, 2016

Joseph L. Piroso, Director
Sasun, Inc. d/b/a Pizza Rustica
605 Lincoln Road, Ste. 240
Miami Beach, FL 33139

CERTIFIED MAIL NO. 7012 3050 0000 9635 8054
RETURN RECEIPT REQUESTED

Joseph J. Sitt, Manager Member
Thor Equities, LLC
663 Lincoln Road, LLC
25 West 39th Street
New York, NY 10018

CERTIFIED MAIL NO. 7012 3050 0000 9635 8528
RETURN RECEIPT REQUESTED

DERM File No. GDO-5457

Re: Unauthorized discharge to the sanitary sewer system from Pizza Rustica Restaurant located at, near or in the vicinity of 667 Lincoln Road, Miami, Florida (folio #02-3234-219-0030)

Dear Messrs. Piroso and Sitt:

**NOTICE OF VIOLATION AND
ORDERS FOR CORRECTIVE ACTION**

On May 19, 2016, a representative of the Miami-Dade County Department of Regulatory and Economic Resources, Division of Environmental Resources Management (DERM) responded to a referral from the City of Miami Beach regarding grease blockages in the public sanitary sewer line. This inspection revealed that the onsite manual grease recovery unit (MGRU) was not functioning properly and a "Grease Discharge Operating Permit Field Notice of Violation" was issued requiring the replacement of the grease pretreatment system. On May 24, 2016, DERM conducted a follow-up inspection within five days of the MGRU being serviced and cleaned. Samples collected at the sampling point revealed violations of sanitary sewer standards pursuant to Section 24-42.4, Code of Miami-Dade County.

Be advised that discharging, or allowing the discharge of any industrial wastes into a sanitary sewer system constitutes violations of the facility's Grease Discharge Operating Permit (GDO-5457) and of Chapter 24, Code of Miami-Dade County, specifically:

Section 24-29, Code of Miami-Dade County, which states in pertinent part: "It shall be unlawful for any person to violate any of the provisions of this chapter, any lawful rules and regulations promulgated under this chapter, any lawful order of the Director or the Director's designee, or any condition, limitation or restriction which is part of an operating permit."

Section 24-42.4(2)(d)(iii), Code of Miami-Dade County, which states in pertinent part: "It shall be unlawful for any person to throw, drain, run or otherwise discharge into a sanitary sewer, or to cause, permit, allow or suffer to be thrown, run, drained or allowed to seep, or otherwise discharged into such sewer ... any pollutant in amounts which alone or in combination with other discharges will cause obstruction to the flow in the publicly owned treatment works."

Section 24-42.4(2)(d)(vi), Code of Miami-Dade County, which states in pertinent part: "It shall be unlawful for any person to throw, drain, run or otherwise discharge into a sanitary sewer, or to cause, permit, allow or suffer to be thrown, run, drained or allowed to seep, or otherwise discharged into such sewer any effluents in excess of local limits."

Delivering Excellence Every Day

Pursuant to the provisions of Section 24-31(6) of Chapter 24, Miami-Dade County Code, whenever a violation of this chapter occurs or exists, or has occurred or existed, any person, individually or otherwise, who has legal, beneficial, or equitable interest in the real property upon which such violation occurs or exists, or has occurred or existed, shall be jointly and severally liable for said violation regardless of fault and regardless of knowledge of the violation.

Based on the above and pursuant to the authority granted to me under Chapter 24, Code of Miami-Dade County, I am hereby ordering you to:

1. Upon receipt of this Notice, **"CEASE and DESIST"** from allowing any further unauthorized discharges to the publicly owned sanitary sewer system at the subject location.
2. Within forty-five days (45) of receipt of this Notice, submit to this Department for review, formal plans signed and sealed by a Florida Professional Engineer for plumbing, equipment and/or processes changes, which shall correct the current violations and prevent future violations of the provisions of Chapter 24 at the subject facility. Said submittal shall include, at a minimum, the following:
 - A. Existing facility plan showing all food and beverage preparation areas (back of house areas) and kitchen equipment/appliances.
 - B. Existing facility sanitary drainage (plumbing) drawings with plan and isometric views, that include:
 - i. Existing drains/lines, plumbing fixtures, solids separators, Fats, Oils and Grease ("FOG") Control Devices (e.g., grease interceptors) and sampling point.
 - ii. All existing drains/lines not connected to a FOG Control Device (e.g., grease interceptor) labeled "Existing Sanitary".
 - iii. All existing drains/lines connected to a FOG Control Device (e.g., grease interceptor) labeled "Existing GW" (Grease Waste).
 - C. Existing building sewer plan showing all connections from the facility to the public sanitary sewer system.
 - D. An evaluation of the existing FOG Control Device (e.g., grease interceptor) capacity. The evaluation shall incorporate proposed equipment and/or processes changes and include peak flow rate, FOG and solids loading rate, and pump-out (cleaning) frequency (e.g., 30, 60 or 90 days). FOG loading shall include all FOG sources: FOG generated by preparing meals and cleaning associated with eat-in, take-out and drive-through meals. The capacity of FOG Control Device (e.g., grease interceptor) shall be sufficient to produce an effluent that complies with Section 24-42.4, Code of Miami-Dade County sewer standards for Oil and Grease EPA Method 1664 (i.e. 100 mg/L).
 - E. If the evaluation demonstrates that the existing FOG Control Device (e.g., grease interceptor) does not provide sufficient capacity, submit "proposed" sanitary drainage (plumbing) drawings, plan and isometric, that include:
 - i. Existing and proposed drains/lines, plumbing fixtures, solids separators, FOG Control Devices (e.g., grease interceptors) and sampling point.
 - ii. All existing and proposed drains/lines not connected to a FOG Control Device (e.g., grease interceptor) labeled Existing Sanitary.
 - iii. All existing and proposed drains/lines connected to a FOG Control Device (e.g., grease interceptor) labeled Existing GW (Grease Waste).
 - iv. Sizing calculations for the proposed FOG Control Device (e.g., grease interceptor). The calculations shall incorporate proposed equipment and/or processes changes and include peak flow rate, FOG and solids loading rate, and pump-out (cleaning) frequency (e.g., 30, 60 or 90 days). FOG loading shall include all FOG sources: FOG generated by preparing meals and cleaning associated with eat-in, take-out and drive-through meals. The capacity of FOG Control Device (e.g., grease interceptor) shall be sufficient to produce an effluent that complies with Section 24-42.4, Code of Miami-Dade County sewer standards for Oil and Grease EPA Method 1664 (i.e. 100 mg/L).

- v. The FOG Control Device (e.g., grease interceptor) shall be located to allow uninterrupted maintenance and inspection and shall be accessible at all times and not require intervention to access, clean and inspect the system.
 - vi. Sampling point located after the point of no further treatment. The sampling point shall be directly accessible for visual inspection and sampling. Sampling point shall have sufficient depth and access to allow sample collection using a 3-inch diameter x 6-inch long sample bottle.
 - vii. All drainage fixtures located in food and beverage preparation areas (back of house areas) shall be connected to a FOG Control Device. Drainage fixtures include, but are not limited to: floor drains, floor sinks, mop sinks, three-compartment sinks, hand sinks, pre-rinse station/sink, preparation sink, pot sink, wok sink, and self-cleaning exhaust hoods.
3. Upon approval by this Department, obtain the appropriate permits and commence with the implementation of the required improvements.
 4. Within one hundred twenty (120) days of receipt of this Notice, complete the required improvements.

For appropriate handling, include the subject permit number (GDO-5457) referencing this facility on all submittals filed with this Department and direct said submittals to DERM, Attn. Carlos Hernandez, P.E., Chief, Wastewater Permitting Section, 701 NW 1st Court, 7th Floor, Miami, Florida 33136-3912.

BE ADVISED THAT FAILURE TO COMPLY WITH THE ABOVE MAY RESULT, AT A MINIMUM, IN CIVIL PENALTIES AND THE PAYMENT OF ALL DEPARTMENTAL COSTS INCURRED IN THE INVESTIGATION AND SETTLEMENT OF THIS CASE. IN ADDITION, FAILURE TO COMPLY MAY RESULT IN YOUR CASE BEING PREPARED FOR FORMAL ENFORCEMENT ACTION IN A COURT OF COMPETENT JURISDICTION PURSUANT TO THE ENFORCEMENT AND PENALTY PROVISIONS OF SECTION 24-29, CODE OF MIAMI-DADE COUNTY.

Any person aggrieved by any action or decision of the DERM Director may appeal said action or decision to the Environmental Quality Control Board (EQCB) by filing a written notice of appeal along with submittal of the applicable fee, to the Code Coordination and Public Hearings Section of DERM within fifteen (15) days of the date of the action or decision by DERM.

If you have any questions concerning the technical requirements contained in the orders of this Notice, please contact Carlos Hernandez, P.E., Chief of the Wastewater Permitting Section of this office at 305-372-6714 or via email at Hernac@miamidade.gov. If you have any questions regarding the enforcement action, please contact the undersigned at (305) 372-6917 or by email at clingj@miamidade.gov. For further information on DERM's FOG program, please go to the following link: <http://www.miamidade.gov/permits/grease-discharge.asp>.

Sincerely,

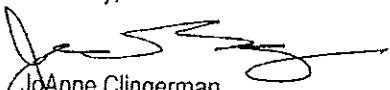
JoAnne Clingerman
Environmental Code Enforcement Officer 2
Regulatory Services



Carlos A. Gimenez, Mayor

ECM GDO-6035

Department of Regulatory and Economic Resources
Environmental Resources Management
701 NW 1st Court, 6th Floor
Miami, Florida 33136-3912
T 305-372-6902 F 305-372-6630

miamidade.gov

November 9, 2016

Frank Encalada, President
Divino Ceviche Coral Gables, Inc.
160 Giralda Avenue
Coral Gables, FL 33134

Certified Mail No. 7014 1200 0000 1637 3355
Return Receipt Requested

Yolanda L. Yarur, Trustee
Yolanda Lolas Yarur Revocable Trust
c/o Kerdyk Real Estate, Inc.
2631 Ponce De Leon Boulevard
Coral Gables, FL 33134-6002

Certified Mail No. 7014 1200 0000 1637 3362
Return Receipt Requested

Re: Unauthorized discharge to the sanitary sewer system from Divino Ceviche Restaurant located at, near or in the vicinity of 160 Giralda Avenue, Coral Gables, Florida (folio # 03-4108-007-3340). DERM file no. GDO-6035.

Dear Mr. Encalada and Ms. Yarur:

NOTICE OF VIOLATION
AND
ORDERS FOR CORRECTIVE ACTION

Inspections of the subject property by representatives of this department on March 29, 2016 and July 13, 2016 revealed discharges of oil and grease of 288 mg/l and 1060 mg/l respectively, above the sanitary sewer discharge limit of 100 mg/l, in violation of condition no. 9 of your Fats, Oil and Grease Discharge Control Annual Operating Permit (GDO-6035) and in violation of Chapter 24, Miami-Dade County Code.

Be advised that the above constitutes violations of Chapter 24, Miami-Dade County Environmental Protection Ordinance, specifically:

Section 24-29, of said Ordinance, which states in pertinent part: "It shall be unlawful for any person to violate any of the provisions of this chapter, any lawful rules and regulations promulgated under this chapter, any lawful order of the Director of DERM or his designee, or any condition, limitation or restriction which is part of an operating permit.

Section 24-42.4(2)(d)(vi), of said Ordinance, which states in pertinent part: "It shall be unlawful for any person to throw, drain, run or otherwise discharge into a sanitary sewer, or to cause, permit, allow or suffer to be thrown, run, drained or allowed to seep, or otherwise discharged into such sewer any effluents in excess of local limits."

Based on the above and pursuant to the authority granted to me under Chapter 24, Miami-Dade County Environmental Protection Ordinance, you are hereby ordered to:

- 1. Upon receipt of this NOTICE, "CEASE and DESIST" from allowing any further unauthorized discharges to the publicly owned sanitary sewer system at the subject location.

Handwritten signature/initials

2. Within forty-five days (45) of receipt of this NOTICE, submit to this Department for review, formal plans signed and sealed by a Florida Professional Engineer for plumbing, equipment and/or processes changes, which shall correct the current violations and prevent future violations of the provisions of Chapter 24 at the subject facility. Said submittal shall include, at a minimum, the following.
 - A. Existing facility plan showing all food and beverage preparation areas (back of house areas) and kitchen equipment/appliances.
 - B. Existing facility sanitary drainage (plumbing) drawings, plan and isometric, that include:
 - i. Existing drains/lines, plumbing fixtures, solids separators, Fats, Oils and Grease (FOG) Control Devices (e.g., grease interceptors) and sampling point.
 - ii. All existing drains/lines not connected to a FOG Control Device (e.g., grease interceptor) labeled Existing Sanitary.
 - iii. All existing drains/lines connected to a FOG Control Device (e.g., grease interceptor) labeled Existing GW (Grease Waste).
 - C. Existing building sewer plan showing all connections from the facility to the public sanitary sewer system.
 - D. An evaluation of the existing FOG Control Device (e.g., grease interceptor) capacity. The evaluation shall incorporate proposed equipment and/or processes changes and include peak flow rate, FOG and solids loading rate, and pump-out (cleaning) frequency (e.g., 30, 60 or 90 days). FOG loading shall include all FOG sources: FOG generated by preparing meals and cleaning associated with eat-in, take-out and drive-through meals. The capacity of FOG Control Device (e.g., grease interceptor) shall be sufficient to produce an effluent that complies with Section 24-42.4 (e.g., 100 mg/L Oil & Grease).
 - E. If the evaluation demonstrates that the existing FOG Control Device (e.g., grease interceptor) does not provide sufficient capacity, submit "proposed" sanitary drainage (plumbing) drawings, plan and isometric, that include:
 - i. Existing and proposed drains/lines, plumbing fixtures, solids separators, FOG Control Devices (e.g., grease interceptors) and sampling point.
 - ii. All existing and proposed drains/lines not connected to a FOG Control Device (e.g., grease interceptor) labeled Existing Sanitary.
 - iii. All existing and proposed drains/lines connected to a FOG Control Device (e.g., grease interceptor) labeled Existing GW (Grease Waste).
 - iv. Sizing calculations for the proposed FOG Control Device (e.g., grease interceptor). The calculations shall incorporate proposed equipment and/or processes changes and include peak flow rate, FOG and solids loading rate, and pump-out (cleaning) frequency (e.g., 30, 60 or 90 days). FOG loading shall include all FOG sources: FOG generated by preparing meals and cleaning associated with eat-in, take-out and drive-through meals. The capacity of FOG Control Device (e.g., grease interceptor) shall be sufficient to produce an effluent that complies with Section 24-42.4 (e.g., 100 mg/L Oil & Grease).

- v. The FOG Control Device (e.g., grease interceptor) shall be located to allow uninterrupted maintenance and inspection; i.e., the system shall be accessible all times and not require intervention to access, clean and inspect.
 - vi. Sampling point located after the point of no further treatment. The sampling point shall be directly accessible for visual inspection and sampling. Sampling point shall have sufficient depth and access to allow sample collection using a 3-inch diameter x 6-inch long sample bottle.
 - vii. All drainage fixtures located in food and beverage preparation areas (back of house areas) shall be connected to a FOG Control Device. Drainage fixtures include, but are not limited to: floor drains, floor sinks, mop sinks, three-compartment sinks, hand sinks, pre-rinse station/sink, preparation sink, pot sink, wok sink, and self-cleaning exhaust hoods.
3. Upon approval by this Department, obtain the appropriate permits and commence with the implementation of the required improvements.
 4. Within one hundred twenty (120) days of receipt of this Notice, complete the required improvements.

For appropriate handling, include the subject permit number (GDO-6035) referencing this facility on all submittals filed with this Department and direct said submittals to DERM, attn. Carlos Hernandez, P.E., Chief, Wastewater Permitting Section, 701 NW 1st Court, 7th Floor, Miami, Florida 33136-3912

BE ADVISED THAT FAILURE TO COMPLY WITH THE ABOVE MAY RESULT, AT A MINIMUM, IN CIVIL PENALTIES AND THE PAYMENT OF ALL DEPARTMENTAL COSTS INCURRED IN THE INVESTIGATION AND SETTLEMENT OF THIS CASE. IN ADDITION, FAILURE TO COMPLY MAY RESULT IN YOUR CASE BEING PREPARED FOR FORMAL ENFORCEMENT ACTION IN A COURT OF COMPETENT JURISDICTION PURSUANT TO THE ENFORCEMENT AND PENALTY PROVISIONS OF SECTION 24-29, MIAMI DADE COUNTY ENVIRONMENTAL PROTECTION ORDINANCE.

Any person aggrieved by any action or decision of the DERM Director may appeal said action or decision to the Environmental Quality Control Board (EQCB) by filing a written notice of appeal along with submittal of the applicable fee, to the Code Coordination and Public Hearings Section of DERM within fifteen (15) days of the date of the action or decision by DERM.

If you have any questions concerning the above, please contact Carlos Hernandez, P.E., Chief of the Wastewater Permitting Section of this office at 305-372-6714 or via email at Hernac@miamidade.gov.

Sincerely,

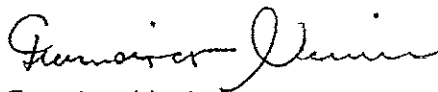

Francisco Verrire
Code Enforcement Officer

pc: Carlos Hernandez, P.E., DERM
Laura Castillo, DERM



Carlos A. Gimenez, Mayor

Department of Regulatory and Economic Resources
Environmental Resources Management
701 NW 1st Court, 6th Floor
Miami, Florida 33136-3912
T 305-372-6902 F 305-372-6630

miamidade.gov

September 11, 2015

Simon Nemni, Manager
3010 Collins, LLC
3010 Collins Avenue
Miami Beach, Florida 33140

Certified Mail No. 7004 2510 0001 7495 1796
Return Receipt Requested

Re: Unauthorized discharge to the sanitary sewer system from Red South Beach Hotel located at, near or in the vicinity of 3010 Collins Avenue, Miami Beach, Florida (folio # 02-3226-001-1200). DERM file no. GDO-7590.

Dear Mr. Nemni:

**NOTICE OF VIOLATION
AND
ORDERS FOR CORRECTIVE ACTION**

On September 1, 2015 a representative of the Miami-Dade County Department of Regulatory and Economic Resources, Division of Environmental Resources Management (DERM), responded to a complaint of a grease overflow from the on-site grease recovery system at the above-referenced facility. Said inspection did not reveal evidence that the on-site grease recovery system had overflowed but apparently the discharge of grease to the sidewalk and street occurred when an employee accidentally spilled used fryer oil while in the process of transferring the oil to the yellow grease container. The impacted areas were subsequently cleaned and disinfected. However, Department staff did observe that the on-site grease recovery system is a prohibited system, allowing the unauthorized discharge of grease to the sanitary sewer system servicing the subject property.

Be advised that discharging, or allowing the discharge of any industrial wastes into a sanitary sewer system constitutes violations the facility's Grease Discharge Operating Permit (GDO-7590) and of Chapter 24, Miami-Dade County Environmental Protection Ordinance, specifically:

Section 24-29, of said Ordinance, which states in pertinent part: "It shall be unlawful for any person to violate any of the provisions of this chapter, any lawful rules and regulations promulgated under this chapter, any lawful order of the Director of DERM or his designee, or any condition, limitation or restriction which is part of an operating permit."

Section 24-42.4(2)(d)(iii), of said Ordinance, which states in pertinent part: "It shall be unlawful for any person to throw, drain, run or otherwise discharge into a sanitary sewer, or to cause, permit, allow or suffer to be thrown, run, drained or allowed to seep, or otherwise discharged into such sewer any pollutant in amounts which alone or in combination with other discharges will cause obstruction to the flow in the publicly owned treatment works."

Section 24-42.4(2)(d)(vi), of said Ordinance, which states in pertinent part: "It shall be unlawful for any person to throw, drain, run or otherwise discharge into a sanitary sewer, or to cause, permit, allow or suffer to be thrown, run, drained or allowed to seep, or otherwise discharged into such sewer any effluents in excess of local limits."

Delivering Excellence Every Day

Based on the above and pursuant to the authority granted to me under Chapter 24, Miami-Dade County Environmental Protection Ordinance, I am hereby ordering you to:

1. Upon receipt of this NOTICE, "CEASE and DESIST" from allowing any further unauthorized discharges to the publicly owned sanitary sewer system at the subject location.
2. Within sixty days (60) of receipt of this NOTICE, submit to this Department for review, formal plans signed and sealed by a Florida Professional Engineer for changes in equipment and/or processes, which shall correct the current violations and prevent future violations of the provisions of Chapter 24 at the subject facility. Said plans shall include at a minimum the following:
 - a. All existing plumbing lines, drainage fixtures, solids separators, grease interceptors / grease traps and sampling points. All lines that receive or can receive waste from fixtures that can discharge food waste or Fats, Oil and Grease (FOG) shall be labeled grease waste (GW) to distinguish it from sanitary waste.
 - b. A FOG control device sized based on calculations that include peak flow rates, FOG and solids loading rate, and a maximum pump-out frequency of sixty (60) days. FOG loading shall include all FOG sources, including exhaust hoods. For self-cleaning exhaust hoods, the manufacturer's specifications for peak discharge shall be included.
 - c. All drainage fixtures located in food and beverage preparation areas shall be routed through a grease interceptor. Drainage fixtures include, but are not limited to: floor drains, floor sinks, mop sinks, three-compartment sinks, hand sinks, pre-rinse station/sink, preparation sink, pot sink, wok sink, and self-cleaning exhaust hoods.
 - d. Sampling point located after the point of no further treatment. The sampling point shall be directly accessible for visual inspection and sampling. Sampling point shall have sufficient depth and access to allow sample collection using a 3-inch diameter x 6-inch long sample bottle. An alternative to a manufactured sampling point (device) is a double sanitary cross with a PVC-CAP on the bottom of the vertical axis to create the sampling sump and a cleanout cap on top. Minimum diameter for the vertical axis is 4-inches; minimum depth of the sump is 6 inches.
 - e. Isometric diagram(s) with existing and proposed plumbing lines, fixtures, solids separators, FOG control devices and sampling points. Grease waste lines shall be labeled GW.
 - f. Solids separation prior to existing or proposed FOG control devices that require a flow control device or are not certified to handle solids.
3. Upon approval by this Department, obtain the appropriate permits and commence with the implementation of the required improvements.
4. Within one hundred eighty (180) days of receipt of this Notice, complete the required improvements.

For appropriate handling, include the subject permit number (GDO-7590) referencing this facility on all submittals filed with this Department and direct said submittals to DERM, attn. Carlos Hernandez, P.E., Chief, Wastewater Permitting Section, 701 NW 1st Court, 7th Floor, Miami, Florida 33136-3912.

BE ADVISED THAT FAILURE TO COMPLY WITH THE ABOVE MAY RESULT, AT A MINIMUM, IN CIVIL PENALTIES AND THE PAYMENT OF ALL DEPARTMENTAL COSTS INCURRED IN THE INVESTIGATION AND SETTLEMENT OF THIS CASE. IN ADDITION, FAILURE TO COMPLY MAY RESULT IN YOUR CASE BEING PREPARED FOR FORMAL ENFORCEMENT ACTION IN A COURT OF COMPETENT

**JURISDICTION PURSUANT TO THE ENFORCEMENT AND PENALTY PROVISIONS OF SECTION 24-29,
MIAMI DADE COUNTY ENVIRONMENTAL PROTECTION ORDINANCE.**

Any person aggrieved by any action or decision of the DERM Director may appeal said action or decision to the Environmental Quality Control Board (EQCB) by filing a written notice of appeal along with submittal of the applicable fee, to the Code Coordination and Public Hearings Section of DERM within fifteen (15) days of the date of the action or decision by DERM.

If you have any questions concerning the above, please contact Carlos Hernandez, P.E., Chief of the Wastewater Permitting Section of this office at 305-372-6714 or via email at Hernac@miamidade.gov.

Sincerely,



Mark J. Pettit
Environmental Code Enforcement Officer II
Regulatory Services

Attachment 3

***2017 Liquid Waste Transporter Permit Conditions and
eManifest Forms with Instructions***



miamidade.gov

Regulatory and Economic Resources
 Environmental Resources Management
 701 NW 1st Court • 7th Floor
 Miami, Florida 33136-3912
 T 305-372-6600 F 305-372-6893

PERMIT NO: LW-000546-2016/2017 (ST)-ST
 ROS OPERATING COMPANY, LLC
 8300 NW 93 ST
 MEDLEY, FL 33166-

PERMITTEE:

Mr. Jorge Benezam
 ROS OPERATING COMPANY LLC D/B/A ECO SERVICES & FILTERS
 PO BOX 126338
 HIALEAH, FL 33012-

**LIQUID WASTE TRANSPORTERS
 ANNUAL OPERATING PERMIT**

DESCRIPTION OF FACILITY/EQUIPMENT

This document, issued under the provisions of Chapter 24, Miami-Dade County Code (Dade County Environmental Protection Ordinance), shall be valid from April 01, 2016 through March 31, 2017. The above named permittee, is hereby authorized to operate as a Liquid Waste Transportation business from the above location, and with the equipment bearing the 2 identifying sticker(s) included with this permit.

This facility is subject to conditions listed below and in the following pages (if any) of this permit.

SPECIFIC CONDITIONS

1. Correctly completed monthly reporting forms and corresponding fees are required to be submitted to the Department on/or before the 20th of the following month.
2. Monthly reports shall include the LW monthly reporting form, a copy of the disposal manifest for each time waste is dumped, copies of the dump tickets from the disposal facility, and a summary sheet of the amount of waste dumped on each trip to the disposal facility, along with the appropriate monthly permit fees.
3. No waste other than residential septic tank, restaurant grease trap and RER approved industrial waste waters shall be transported under this permit.
4. No waste from an industrial facility or industrial holding tank shall be pumped out unless previous approval is obtained from this department. All approved industrial waste waters transported shall be listed separately on the Liquid Waste Transporters Monthly Report, detailing name of source, address, date, amount of waste, and location of disposal.
5. No hazardous waste shall be transported under this permit.
6. All waste transportation equipment shall be maintained in good working order at all times. Valves, hoses, tanks, etc., shall be properly maintained and shall not leak.
7. All waste material shall be deposited (dumped) at an approved disposal site. The only approved disposal sites in Miami-Dade County are: Virginia Key and Black Point sewage treatment plants.
8. No waste shall be deposited at any other site or structure in Miami-Dade County.

GENERAL CONDITIONS

9. The applicant, by acceptance of this document, agrees to operate and maintain the subject

A handwritten signature in black ink, appearing to read "Lee N. Hefty". The signature is written over a horizontal line.

Lee N. Hefty, Assistant Director **FOR**
 Department of Regulatory and Economic Resources,
 Environmental Resources Management

operation so as to comply with the requirements of Chapter 24 of the Code of Miami-Dade County.

10. If for any reason, the applicant does not comply with or will be unable to comply with any condition or limitation specified on this document the applicant shall immediately notify and provide the department with the following information: (a) a description of and cause of non-compliance; and (b) the period of non-compliance including exact dates and times; or, if not corrected, the anticipated time the non-compliance is expected to continue, and steps taken to reduce, eliminate, and prevent recurrence of the non-compliance. The applicant shall be responsible for any and all damages which may result and may be subject to enforcement action by the department for penalties or revocation of this document.
11. As provided in Section 24-15 of the Code of Miami-Dade County, the prior written approval of the Department shall be obtained for any alteration to this facility.
12. The issuance of this document does not convey any vested rights or any exclusive privileges. Nor does it authorize any injury to public or private property or any invasion of personal rights, nor any infringement of federal, state or local laws or regulations. Nor does it relieve the applicant from liability for harm or injury to human health or welfare or property.
13. This document is required to be posted in a conspicuous location at the facility site during the entire period of operation.
14. This document is not transferable. Upon sale or legal transfer of the property or facility covered by this document, the applicant shall notify the department within thirty(30) days. The new owner must apply for a permit within thirty (30) days. The applicant shall be liable for any non-compliance of the source until the transferee applies for and receives a transfer of this document.
15. The applicant, by acceptance of this document, specifically agrees to allow access to the named source at reasonable times by department personnel presenting credentials for the purposes of inspection and testing to determine compliance with this document and department rules.
16. This document does not indicate a waiver of or approval of any other department permit that may be required for other aspects of this facility.
17. This document does not constitute an approval by the Department or certification that the applicant is in compliance with applicable laws, ordinances, rules or regulations. The applicant acknowledges that separate enforcement actions may be initiated by the Department and that this document does not constitute compliance with orders issued in conjunction with enforcement actions for correction of violations.
18. Failure to comply with any condition of this document, or the requirements of Chapter 24, Code of Miami-Dade County may subject the applicant to the penalty provisions of said Chapter including civil penalties up to \$25,000 per day per offense and/or criminal penalties of \$500 per day or not less than \$1000 per day for violations of Section 24-42.4, Sanitary Sewer Discharge Limitations and Pretreatment Standards and/or sixty (60) days in jail.

2017 Fats, Oils and Grease (FOG) Single Load Liquid Waste Transporter eManifest

A: Liquid Waste Transporter Information			C: FOG Control Device											D: Gallons & Date			
Company Name: _____			FOG Control Device Type? Hydro (HM) or Gravity?	FOG Control Device Capacity		FOG Control Device Wet Volume (gallons)	FOG found in outlet device? (Y or N)	H - measure from bottom to outlet invert (inches)	W - measure from bottom to water level (inches)	G - FOG layer thickness (inches)	S - Sludge layer thickness (inches)	Outlet device missing or damaged? (Y or N)	Automatic unit missing or damaged? (NA, Y or N)	Corrosion or other tank damage? (Y or N)	Tank Breached? (Y or N)	Total Gallons Waste Pumped	Date Pumped
DERM Decal No.: _____	Vehicle License Plate: _____	Vehicle Full Load Capacity: _____ Gallons		Hydro (HM) (gpm)	Gravity (gallons)												
B: Origination of Waste																	
GDO #: _____	Facility Name (if no GDO#): _____																
Complete Facility Address (if no GDO#): _____																	
GDO #: _____	Facility Name (if no GDO#): _____																
Complete Facility Address (if no GDO#): _____																	
GDO #: _____	Facility Name (if no GDO#): _____																
Complete Facility Address (if no GDO#): _____																	
GDO #: _____	Facility Name (if no GDO#): _____																
Complete Facility Address (if no GDO#): _____																	
GDO #: _____	Facility Name (if no GDO#): _____																
Complete Facility Address (if no GDO#): _____																	
Attach Additional Sheets if more than 6 Grease Interceptors Pumped!															Total Waste this Load:	Gallons	
E: Liquid Waste Transporter Certification																	
Total Waste Unloaded: _____ Gallons			Date Waste Unloaded: _____			Time Waste Unloaded: _____			AM or PM								
<p>I certify that the information in Section A, B, C, D & E herein is true and accurate, and that only <u>grease interceptor</u> waste from facilities listed in the "<u>Origination of Waste</u>" Section B is contained in this service vehicle load/transporter truck/tank. I understand that comingling <u>grease interceptor</u> waste with any other waste is prohibited. I am aware that falsification of this manifest may result in prosecution.</p>																	
Driver Name (PRINT): _____									Driver Signature: _____								
F: Disposal Facility Certification																	
Disposal Facility Name: _____ Address: _____																	
Ticket No.: _____						Date Waste Unloaded: ____ / ____ /2017			Total Waste Unloaded: _____ Gallons								
<p>I certify that the information in Sections A & F is true and accurate. I am aware that falsification of this manifest may result in prosecution.</p>																	
Operator Name (PRINT): _____									Operator Signature: _____								

>>>>>Attach Disposal Facility Ticket<<<<<<

2017 Septage, Stormwater and Other Non-Hazardous Waste Single Load Liquid Waste Transporter eManifest

A: Liquid Waste Transporter Information	C: WASTE - ANY WASTE IDENTIFIED AS "OTHER WASTE" HEREIN REQUIRES PRIOR APPROVAL FROM RER-DERM/WASD											D: Gallons & Date					
Company Name: _____	Septage					Stormwater			Subtotal Septage & Stormwater (gallons)	OTHER WASTE*				Subtotal OTHER Waste (gallons)	Subtotal ALL Waste	Date Pumped	
DERM Decal No.: _____	Biosolids (e.g., Package Sewage Treatment Plants)	Sewage (e.g., manholes, mains, pump stations)	Onsite Sewage Treatment & Disposal Systems	Grey Water (e.g., Cruise Ship Grey Water)	Portable / Chemical Toilets	Catch Basins / Storm Drains	Retention / Detention Basins	Pump Stations									
Vehicle License Plate: _____																	
Vehicle Full Load Capacity: _____ Gallons																	
B: Origination of Waste																	
Facility Name: _____																	
Facility Address: _____																	
Facility Name: _____																	
Facility Address: _____																	
Facility Name: _____																	
Facility Address: _____																	
Facility Name: _____																	
Facility Address: _____																	
Facility Name: _____																	
Facility Address: _____																	
Attach Additional Sheets if more than 6 Facilities/Locations Pumped!									Gallons Septage & Stormwater this Load: _____			Gallons "OTHER WASTE" this Load: _____					Gallons

E: Liquid Waste Transporter Certification

OTHER WASTE*: YES NO Total Waste Unloaded: _____ Gallons Date Waste Unloaded: _____ Time Waste Unloaded: _____ AM or PM

I certify that the information in **Section A, B, C, D & E** herein is true and accurate, and that only waste included in Section C from facilities listed in the "**Origination of Waste**" Section B is contained in this service vehicle load/transporter truck/tank. I understand that comingling **grease interceptor** waste with any other waste is prohibited. If "OTHER WASTE" is identified above, I have attached RER-DERM/WASD approval letter(s) to this manifest. I am aware that hauling/transporting/disposing of any waste other than Septage and Stormwater without RER-DERM/WASD approval is prohibited and may result in enforcement and prosecution. Furthermore, I am aware that falsification of this manifest may result in enforcement and prosecution.

Driver Name (PRINT): _____ Driver Signature: _____

F: Disposal Facility Certification

Disposal Facility Name: _____ Address: _____

Ticket No.: _____ Date Waste Unloaded: ____/____/2017 Total Waste Unloaded: _____ Gallons

I certify that the information in **Sections A & F** is true and accurate. I am aware that falsification of this manifest may result in prosecution.

Operator Name (PRINT): _____ Operator Signature: _____

*** Attach RER-DERM/WASD Approval Letters for OTHER WASTE
>>>>>Attach Disposal Facility Ticket<<<<<<**

Liquid Waste Transporter Electronic Manifest

1. Click on the link below

<https://www8.miamidade.gov/apps/rer/LiquidWasteTransporterElectronicManifest/Default>

The following window will open

The screenshot shows the application's home page. At the top right is the Miami-Dade County logo. Below the title are links for 'Home' and 'Help'. The main content area includes a 'Home' section with introductory text and a 'Login' section. The login section has radio buttons for 'DERM LWT Permit #' (selected) and 'LWT Company Name'. Below these are input fields for 'DERM LWT Permit #' (a dropdown menu), 'email', 'Password', and 'Waste Type' (another dropdown menu). There are 'Submit' and 'Clear' buttons, and links for 'Forgot Password?' and 'Change Password'.

2. Select your permit number from the drop down menu.

This close-up screenshot shows the 'DERM LWT Permit #' dropdown menu open. A red arrow points to the dropdown arrow icon. The menu lists several permit numbers and their corresponding company names:

- 4 - UNITED SITE SERVICES OF FLORIDA, INC.
- 5 - NECA PORTABLE TOILET
- 15 - ROSE SEPTIC TANK CO., INC.
- 18 - P & R SMITH CORP.
- 19 - CARLOS RIVERO PLUMBING & SEPTIC TANK CONTRACTOR, INC.
- 29 - BAY PLUMBING CO.
- 32 - JOE'S SEPTIC TANK
- 33 - FRIENDLY JOHN, INC.

3. If the permit number is unknown then select LWT Company Name and use the dropdown menu

Refer to your Liquid Waste Transporter Operating Permit for additional reporting requirements.

Login

Select By DERM LWT Permit # LWT Company Name

DERM LWT Permit #

email

Password

Waste Type

- Select an item --
- Non Listed Liquid Waste Transporter --
- 24/7 ENVIRONMENTAL SERVICES, LLC.
- 3RD GENERATION PLUMBING, INC.
- A AARON SUPER ROOTER, INC.
- A AMERICAN SEPTIC & PLUMBING, INC.
- A TO Z STATEWIDE PLUMBING
- A&P SITE SERVICES LLP D/B/A ELITE SITE SERVICES
- A-1 ABLE ROOTER, INC.
- A-ALLIGATOR,INC.
- A. BETTER AIM SEPTIC, INC.

4. Enter your email

Refer to your Liquid Waste Transporter Operating Permit for additional reporting requirements.

Login

Select By DERM LWT Permit # LWT Company Name

DERM LWT Permit #

email

Confirm email

Password

Waste Type

[Forgot Password?](#) [Change Password](#)

5. Enter Default Password if FIRST time: **L@t12345**

Select Waste Type from drop down menu and Submit

Home

In accordance with Section 24-46, Miami-Dade County Environmental Protection Ordinance (Code), all Liquid Waste Transporters are required to complete and submit a Liquid Waste Transporter Electronic Manifest monthly on or before the 20th of each month (e.g., by February 20th for the reporting period January 1 – January 31).

Refer to your Liquid Waste Transporter Operating Permit for additional reporting requirements.

Login

Select By DERM LWT Permit # LWT Company Name

DERM LWT Permit #

email

Confirm email

1 Password

Waste Type
-- Select an item --
Fats, Oils, and Grease
Septage / Stormwater
No Monthly Activity

2

3

[Forgot Password?](#) [Change Password](#)

6. Change the password.

The new password should have **at least eight characters** and include an upper case letter, a lower case letter, a special character, and a number (i.e. A@a12345).

Examples of special characters: **!, @, #, \$, %, ^, &, ***

Change Password

Current Password

New Password

Confirm Password

7. Report also for Months **Without Activity**

In the **Home** page, under Waste Type, select **No Monthly Activity**

And then **SUBMIT**

Liquid Waste Transporter Electronic Manifest

Home Help Search Manifest List of Grease Discharge Operating Facilities Admin Logout

Home

In accordance with Section 24-46, Miami-Dade County Environmental Protection Ordinance (Code), all Liquid Waste Transporters are required to complete and submit a Liquid Waste Transporter Electronic Manifest monthly on or before the 20th of each month (e.g., by February 20th for the reporting period January 1 – January 31).

Refer to your Liquid Waste Transporter Operating Permit for additional reporting requirements.

Login

Waste Type -- Select an item --
-- Select an item --
Fats, Oils, and Grease
Septage / Stormwater
No Monthly Activity

[Forgot Password?](#) [Change Password](#)

You will be prompted to **select Month with No Activity**

Submit Your FOG Single-Load Manifest

* Required fields

Liquid Waste Transporter Information

Company Name **LWT Miami, Inc.**

Liquid Waste Transporter Permit # **999**

Select Month With No Activity * **02/2017**

2017
Jan Feb Mar Apr
May Jun Jul Aug
Sep Oct Nov Dec

[Privacy Statement](#) | [Disclaimer](#) | [ADA](#)

© 2017 Miami-Dade County. All rights reserved

Then **Preview**,

Submit Your FOG Single-Load Manifest

* Required fields

Liquid Waste Transporter Information

Company Name

Liquid Waste Transporter Permit #

Select Month With No Activity *



Accept* and **Submit**

Preview

Liquid Waste Transporter Information

Company Name

Liquid Waste Transporter Permit #

Disposal Facility Ticket #

Disposal Facility

Date Waste Unloaded

Vehicle Full Load Capacity (gallons)

Origination Of Waste - Detailed Information

Single Load Total Waste (gallons) 0

Liquid Waste Transporter Certification

I certify that the information above is true and accurate.

Accept * 



The following message will appear:

Report Submitted

Your manifest has been accepted.

You will be receiving a confirmation email soon.

[Submit Another Report](#)

The system will send you an e-mail :

This message was sent with High importance.

From: fog@miamidade.gov Sent: Mon 3/27/2017 3:56 PM

To: **Pepe.Perez@gmail.com**

Cc:

Subject: Miami-Dade County Grease Discharge Operating report submitted.

Dear Liquid Waste Transporter,

Your information for the LWT Manifest has been successfully entered.

Disposal Date Waste Unloaded:

Regards,
DERM

DERM Liquid Waste Transporter Permit #: **999**

Facility Name: **LWT-miami**

8. Entering Data

Submit Your FOG Single-Load Manifest

* Required fields

Liquid Waste Transporter Information

Company Name	LWT Miami, Inc.
Liquid Waste Transporter Permit #	999
Disposal Facility Ticket # *	242424
Disposal Facility *	SOUTH DISTRICT - MDWASD
Date Waste Unloaded *	2/4/2017
Vehicle Full Load Capacity (gallons) *	4500

Origination Of Waste - Detailed Information

GDO Permit # *	134
Facility Name *	DENNY'S, INC. DBA DENNY'S #1063
New Facility Name	
Facility Address *	1000 W 49 ST
New Facility Address	

FOG Control Device Type *	Gravity
FOG Control Device Capacity * (HM=gpm & Gravity=gallons)	1500
FOG Control Device Wet Volume (gallons) *	1490
FOG found in outlet device *	N
H - Measure from bottom to outlet level (inches) *	75
W - Measure from bottom to water level (inches) *	76
G - FOG layer thickness (inches) *	6
S - Sludge layer thickness (inches) *	2
Outlet device missing or damaged *	N
Automatic unit missing or damaged *	N/A
Corrosion or other tank damage *	N
Tank breached *	N
Waste Loaded (gallons) *	1500
Date Pumped *	2/4/2017
	Add Record 
Single Load Total Waste (gallons)	0
	Preview

Once finished entering data, **PREVIEW**

[Add Record](#)

Single Load Total Waste (gallons)

[Preview](#) 

System will generate the following

Origination Of Waste - Detailed Information

GDO Facility Information	FOG Control Device Information	Tank Measures	Outlet device missing or damaged	Automatic unit missing or damaged	Corrosion or other tank damage	Tank breached	Waste Loaded (gallons)	Date Pumped
GDO Permit # N/A	Type Gravity	H 73	N	N/A	N	N	1500	02/04/2017
Facility Name WINN DIXIE #203	Capacity 1500	W 74						
Facility Address 1055 HALLANDALE BEACH, FL 33009	Wet Volume 1450	G 2						
	FOG found in outlet device N	S 2						
GDO Permit # N/A	Type Gravity	H 73	N	N/A	N	N	1500	02/04/2017
Facility Name DENNY'S # 1063	Capacity 1500	W 74						
Facility Address 1000 W 49 ST	Wet Volume 1450	G 2						
	FOG found in outlet device N	S 2						
GDO Permit # 134	Type Gravity	H 75	N	N/A	N	N	1500	02/04/2017
Facility Name DENNY'S, INC. DBA DENNY'S #1063	Capacity 1500	W 76						
Facility Address 1000 W 49 ST	Wet Volume 1490	G 6						
	FOG found in outlet device N	S 2						

Single Load Total Waste (gallons)

Liquid Waste Transporter Certification

I certify that the information above is true and accurate.

Accept *

[Submit](#) [Edit](#)

If information is correct, Accept and Submit if not EDIT

The system will send you an e-mail:

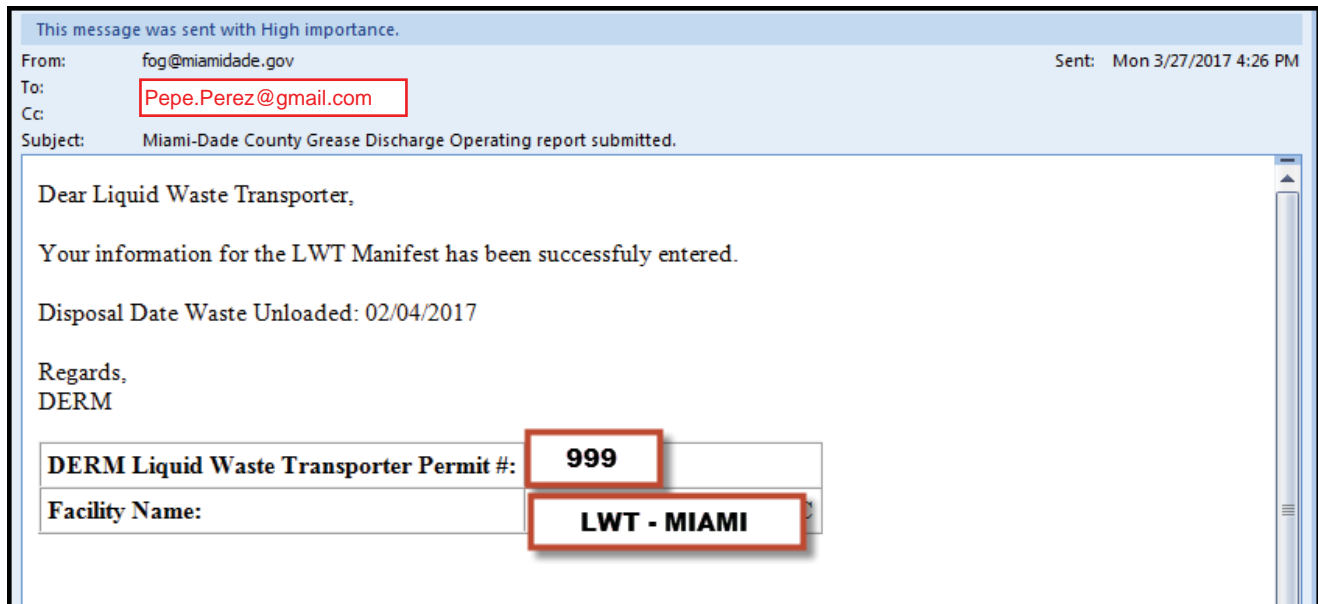

To submit another report select:

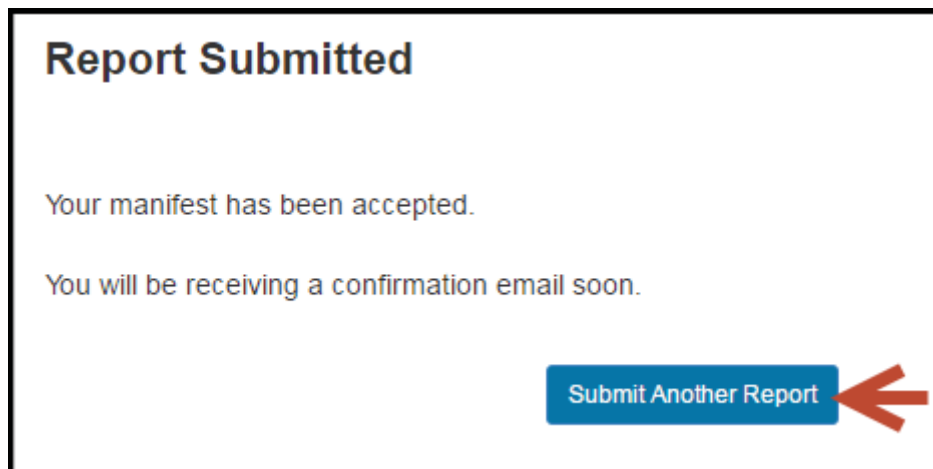

Attachment 4

Third Party Testing Grease Interceptors

Data Collected



Send to: C0006197

Mr. Tim Bach
Canplas Industries Ltd.
500 Veterans Drive
Barrie, Ontario L4M 4V3
Canada

Facility: C0006199

Canplas Industries Ltd.
31 Patterson Road
Barrie ON L4M 4V3
Canada

Result:	COMPLETE	Report Date:	28-APR-2017
----------------	-----------------	---------------------	--------------------

Customer Name:	Canplas Industries Ltd.
Test To:	NSF SE 15741-2016 Accelerated Grease Interceptor Protocol
Description:	Model 40100A04 Two 100 GPM Grease Interceptors Plumbed In Series
Test Type:	Test Only
Test Location:	NSF International, Ann Arbor, MI
Job Number:	J-00256010
Project Number:	W0403380
Project Manager:	Ann O'Brien

Executive Summary:	ASME A112.14.3 -2000 NSF Accelerated Protocol	PASS PASS
--------------------	--	----------------------

Thank you for having your product tested by NSF International.

Please contact your Project Manager if you have any questions or concerns pertaining to this report.

Report Authorization:

David Orton - Senior Engineer, Engineering Lab

Authority:

Paul Anderson - Director, Engineering Lab

This report shall not be reproduced, except in its entirety, without the written approval of NSF. This report does not represent NSF Certification or authorization to use the NSF Mark. Authorization to use the NSF Mark is limited to products appearing in the Company's Official NSF Listing (www.nsf.org). The results relate only to those items tested, in the condition received at the laboratory.



Executive Summary of Results

The NSF Accelerated Protocol was used in order to evaluate the capacity of two 100 GPM interceptors plumbed in series.

Capacity at 45 increments	2382 lbs
Average Efficiency at 45 increments	99%
Incremental Efficiency at 45 increments	94%

NSF Accelerated Rating Test Protocol - Purpose and summary:

The purpose of the accelerated test protocol is to evaluate the capacity of large grease interceptors above the rating requirements found in ASME A112.14.3 and PDI G101. The protocol consists of two phases. During phase 1, the minimum allowable capacity is established according to ASME A112.14.3 (2 lbs/gpm) and/or PDI G101 (2.25 lbs/gpm). Phase 1 concludes at breakthrough or 15 increments, whichever comes first. During phase 2, the increments are accelerated by adding lard directly through the lid in quantities specified by the manufacturer. Then a standard test increment is run using the test sinks and melted lard (0.2 lbs/gpm). Phase 2 concludes at breakthrough or 30 additional increments, whichever comes first.

Detailed grease quantities added during each phase

Phase 1	Pounds per increment added to sinks	20 lbs
Phase 2	Pounds per increment added to sinks	20 lbs
	Pounds per increment added through lid	50 lbs

ASME A112.14.3 Section 3.3.1 Media Analysis

COMPLETE

pH value	7.1
Lard specific gravity	0.881
Viscosity	n/a



ASME A112.14.3 Section 3.3.4 Computation of Flow Rates

COMPLETE

Type of Grease Interceptor	Type A	
Size of Flow Controller	NA	inches
Flow Time 1 Sink 1+2	112.9	sec
Flow Time 2 Sink 1+2	112.3	sec
Flow Time 3 Sink 1+2	113.2	sec
Flow Time Average Sink 1+2	112.8	sec
Flow Rate Average Sink 1+2	101.1	gpm
Deviation from Req Average Sink 1+2	1.1	%
Flow Time 1 Sink 2+1	110.9	sec
Flow Time 2 Sink 2+ 1	111.0	sec
Flow Time 3 Sink 2+ 1	110.0	sec
Flow Time Average Sink 2+1	110.6	sec
Flow Rate Average Sink 2+1 (gpm)	103.0	gpm
Deviation from Req Average Sink 2+1	3.0	%
Max allowable deviation from average	5	%
Max allowable deviation between runs	5.0	%
Max deviation between runs	0.8	%
Flow rate acceptable?	Yes	

ASME A112.14.3 Section 3.5 Rating Test (Phase 1)

PASS

Model	40100A04	
Flow	100	GPM
Flow Restrictor Type	A	
Flow Restrictor ID	NA	inches
Breakdown Increment Number *	15	
Pounds Grease Retained	299	lbs.
Incremental Efficiency	100	%
Average Efficiency	100	%
Efficiency A	100	%
Efficiency B	NA	%
Required Amount of Grease Retained	200	lbs.
Actual Amount of Grease Retained	299	lbs.

* Results are reported at 15 increments. Breakdown was not actually achieved in phase 1.



ASME A112.14.3 Section 3.5 Rating Test (Phase 2)

PASS

Flow	100	GPM
Breakdown Increment Number	45	
Pounds Grease Retained	2382	lbs.
Incremental Efficiency at 45th increment	94	%
Average Efficiency	99	%
Average of the Incremental Efficiencies	NA	%
Efficiency A	99	%
Efficiency B	NA	%
Required Amount of Grease Retained	200	lbs.
Actual Amount of Grease Retained	2382	lbs.

* Average efficiency = (total grease retained)/(total grease added).

STANDARD ASME A112.14.3 GREASE INTERCEPTOR RATING TEST FORM - PAGE 1

Interceptor Manufacturer: Canplas Industries Ltd.					Model Number: 40100A04				GPM Size: 100		Report No.: J-00256010					
Sink Capacity and Flow					****Lard Data****				****Flow Control Data****				***Test Lab Information***			
Capacity No. 1	100	gal	Spec. Gravity	0.881	Orifice Size:				Test Lab: NSF International				Test Date:	Apr 18-20,2017		
Capacity No. 2	100	gal	Viscosity	NA	Internal flow controller								Notes:			
Separate No. 1	76.1	GPM	Two interceptors plumbed in series								Test Technicians: Kyle Crenshaw Robert Harris Jon McGaugh				1. Drainage gauged on clear compartment	
Separate No. 2	83.8	GPM													2. The "amount retained" is a calculation of "Added" minus "Skimmed"	
Simultaneous	101.1	GPM														
Simultaneous	103.0	GPM														
					***** INCREMENTAL *****				***** ACCUMULATED *****							
					(drop-skim)/ drop x 100 = efficiency				(drop-skim) / drop x 100 = efficiency							
No.	Test	Clear	Sec.	Rate:GPM	lb. Added	lb. Skimmed	lb. Retained	Efficiency	lb. Added	lb. Skimmed	lb. Retained	Efficiency	3. All Skimmed weights taken after de-watering by Seperatory funnel and chilling.			
1	1	2	110.57	103.1	20	0.00	20.00	100.0	20.00	0.00	20.00	100	Summary & Adjusted Results based on the totals at the increment when Grease retained equals 2 times rated capacity Req retention: 200 Increment No: 11 1) Total Skimmed: 0.33 2) Total Retained : 219.67 3) Total Added: 220.00 Eff. = (line 3 – line1) / line 3 Efficiency % = 99.9			
2	2	1	112.45	101.4	20	0.00	20.00	100.0	40.00	0.00	40.00	100				
3	1	2	110.18	103.5	20	0.00	20.00	100.0	60.00	0.00	60.00	100				
4	2	1	111.60	102.2	20	0.01	19.99	100.0	80.00	0.01	79.99	100				
5	1	2	108.70	104.9	20	0.03	19.97	100.0	100.00	0.04	99.96	100				
6	2	1	111.51	102.2	20	0.05	19.95	100.0	120.00	0.09	119.91	100				
7	1	2	111.07	102.6	20	0.05	19.95	100.0	140.00	0.14	139.86	100				
8	2	1	111.32	102.4	20	0.04	19.96	100.0	160.00	0.18	159.82	100				
9	1	2	110.30	103.4	20	0.06	19.94	100.0	180.00	0.24	179.76	100				
10	2	1	112.57	101.3	20	0.05	19.95	100.0	200.00	0.29	199.71	100				
11	1	2	110.36	103.3	20	0.04	19.96	100.0	220.00	0.33	219.67	100				
12	2	1	112.03	101.8	20	0.04	19.96	100.0	240.00	0.37	239.63	100				
13	1	2	110.10	103.5	20	0.04	19.96	100.0	260.00	0.41	259.59	100				
14	2	1	112.26	101.5	20	0.06	19.94	100.0	280.00	0.47	279.53	100				
15	1	2	109.89	103.7	20	0.10	19.90	100.0	300.00	0.57	299.43	100				
16	2	1	110.92	102.8	20	0.05	19.95	100.0	370.00	0.62	369.38	100				
17	1	2	111.73	102.0	20	0.07	19.93	100.0	440.00	0.69	439.31	100				
18	2	1	111.82	101.9	20	0.06	19.94	100.0	510.00	0.75	509.25	100				
19	1	2	111.07	102.6	20	0.08	19.92	100.0	580.00	0.83	579.17	100				
20	2	1	111.32	102.4	20	0.08	19.92	100.0	650.00	0.91	649.09	100				
21	1	2	109.82	103.8	20	0.10	19.90	100.0	720.00	1.01	718.99	100				
22	2	1	111.86	101.9	20	0.08	19.92	100.0	790.00	1.09	788.91	100				
23	1	2	110.86	102.8	20	0.08	19.92	100.0	860.00	1.17	858.83	100				
24	2	1	112.21	101.6	20	0.11	19.89	99.0	930.00	1.28	928.72	100				
25	1	2	110.76	102.9	20	0.10	19.90	100.0	1000.00	1.38	998.62	100				
26	2	1	110.26	103.4	20	0.14	19.86	99.0	1070.00	1.52	1068.48	100				
27	1	2	110.16	103.5	20	0.12	19.88	99.0	1140.00	1.64	1138.36	100				
28	2	1	110.64	103.0	20	0.17	19.83	99.0	1210.00	1.81	1208.19	100				
29	1	2	111.51	102.2	20	0.17	19.83	99.0	1280.00	1.98	1278.02	100				
30	2	1	111.44	102.3	20	0.28	19.72	99.0	1350.00	2.26	1347.74	100				
31	1	2	111.17	102.5	20	0.20	19.80	99.0	1420.00	2.46	1417.54	100				
Average Or Total			111.05	102.7	620	2.46	617.54									

STANDARD ASME A112.14.3 GREASE INTERCEPTOR RATING TEST FORM - PAGE 2

Interceptor Manufacturer: Canplas Industries Ltd.			Model Number: 40100A04		GPM Size: 100	Report No.: J-00256010			
Sink Capacity and Flow			****Lard Data****		****Flow Control Data****		***Test Lab Information***		
Capacity No. 1	100	gal	Spec. Gravity	0.881	Orifice Size:	Test Lab: NSF International		Test Date: Apr 18-20,2017	
Capacity No. 2	100	gal	Viscosity	NA	Internal flow controller		Notes:		
Separate No. 1	76.1	GPM	Two interceptors plumbed in series			Test Technicians:		1. Drainage gauged on clear compartment	
Separate No. 2	83.8	GPM				Kyle Crenshaw		Robert Harris	2. The "amount retained" is a calculation of "Added" minus "Skimmed"
Simultaneous	101.1	GPM				Jon McGaugh			
Simultaneous	103.0	GPM							

					***** INCREMENTAL *****				***** ACCUMULATED *****							
					(drop-skim)/ drop x 100 = efficiency				(drop-skim) / drop x 100 = efficiency							
No.	Test	Clear	Sec.	Rate:GPM	lb. Added	lb. Skimmed	lb. Retained	Efficiency	lb. Added	lb. Skimmed	lb. Retained	Efficiency	3. All Skimmed weights taken after de-watering by Seperatory funnel and chilling.			
32	1	2	110.42	103.2	20	0.57	19.43	97.0	1490.00	3.03	1486.97	100	Summary & Adjusted Results based on the totals at the increment when Grease retained equals 2 times rated capacity Req retention: 200 Increment No: #N/A 1) Total Skimmed: #N/A 2) Total Retained : #N/A 3) Total Added: #N/A Eff. = (line 3 – line1) / line 3 Efficiency % = #N/A			
33	2	1	112.20	101.6	20	0.71	19.29	96.0	1560.00	3.74	1556.26	100				
34	1	2	111.12	102.6	20	0.96	19.04	95.0	1630.00	4.70	1625.30	100				
35	2	1	112.45	101.4	20	1.08	18.92	95.0	1700.00	5.78	1694.22	100				
36	1	2	110.00	103.6	20	1.00	19.00	95.0	1770.00	6.78	1763.22	100				
37	2	1	111.21	102.5	20	1.11	18.89	94.0	1840.00	7.89	1832.11	100				
38	1	2	112.16	101.6	20	1.14	18.86	94.0	1910.00	9.03	1900.97	100				
39	2	1	111.19	102.5	20	1.14	18.86	94.0	1980.00	10.17	1969.83	99				
40	1	2	110.70	103.0	20	1.11	18.89	94.0	2050.00	11.28	2038.72	99				
41	2	1	110.63	103.0	20	1.32	18.68	93.0	2120.00	12.60	2107.40	99				
42	1	2	110.92	102.8	20	1.28	18.72	94.0	2190.00	13.88	2176.12	99				
43	2	1	110.29	103.4	20	1.25	18.75	94.0	2260.00	15.13	2244.87	99				
44	1	2	110.26	103.4	20	1.20	18.80	94.0	2330.00	16.33	2313.67	99				
45	2	1	110.32	103.3	20	1.29	18.71	94.0	2400.00	17.62	2382.38	99				
	1	2													Summary and Results based on the testing to "maximum grease capacity." Break down Increment No. 45 1) Total Skimmed : 17.62 2) Total Retained : 2382.38 3) Total Added : 2400.00 Eff. = (line 3 – line1) / line 3 Efficiency % = 99.3	
	2	1														
	1	2														
	2	1														
	1	2														
	2	1														
	1	2														
	2	1														
	1	2														
	2	1														
Average Or Total				110.99	102.7	280	15.16	264.84								

Attachment 5

WASD FOG Design Criteria

MIAMI-DADE WATER AND SEWER AUTHORITY DEPARTMENT
NORTH DISTRICT WASTEWATER TREATMENT PLANT
 2575 N.E. 151 STREET, NORTH MIAMI, DADE COUNTY, FLORIDA

IN SERVICE DATE: November, 1979

BASIC DESIGN DATA
 1986

I.	Type of Treatment	Primary and Pure Oxygen Activated Sludge		
II.	Plant Capacity, mgd	80		
	Design Peaking Factor, design peak hourly flow/rated capacity	2.4		
	Historical Peaking Factor, peak hourly flow/annual average day flow	2.0		
III.	Raw Wastewater Characteristics	<u>Avg.</u>	<u>Max.</u>	<u>Min.</u>
	BOD ₅ Raw	mg/l	200	290
	BOD ₅ Recycled Sludge Waste	mg/l	30	30
	BOD ₅ Total (Entering Process)	mg/l	230	320
	Soluble BOD ₅ (41% estimated)	mg/l	90	130
	T.S.S.	mg/l	220	390
	V.S.S.	mg/l	175	300
	C.O.D.	mg/l	500	670
	H ₂ S-Raw	mg/l	10.0	15.0
	pH	---	7.0	7.7
	Temperature	°F	85	86
	Grease	mg/l	32	34
	Chlorides	mg/l	700	1500
IV.	Inlet Works			
	a. Screens			
	Number of Screens	6		
	Normal Operation	4		
	Average Flow each Screen, mgd	20		
	Screen Width, ft.	6		
	Bar Size, in.	3/8		
	Bar Screen Opening, in.	3/4		
	b. Grit Removal Facilities - Removal from Primary Sludge			
	Number of Cyclone Degritter - Classifiers	6		
	Normal Operation	4		
	Flow Capacity each Unit, mgd	0.5		
	Grit Removal Particle Size	250 mesh		
	c. Raw Sewage Flow Measurement - Primary Clarifier Influent			
	Number of Magnetic Flow Meters	4		

Total Minimum Horsepower, each Train 250

c. Oxygenation System Performance

Food to Biomass Ratio, f/m	0.4 to 0.95
Average Dissolved Oxygen, mg/l	5
Minimum Effluent Dissolved Oxygen, mg/l	4
Oxygen Utilization, % of Supply	90
Oxygen Supplied, tons/day/train	25
Oxygen Dissolution Capacity, tons/day	22.5
Recirculation Ratio, percent of ADF	30 - 50
Detention Time with 30% recirc. sludge, hrs.	1.2
Volumetric Loading, pounds of BOD per 1000 cu.ft./day	184
Oxygen to BOD Ratio, pounds applied per pound applied	1.3

d. Oxygen Generation Facilities

Number of Cryogenic Plants	2
Capacity, tons/day	50
Oxygen Purity, percent	95
Output Pressure, psig	2.5
Number of Air Compressors	3
Normal Operation	1
Number of Storage Tanks	1
Capacity of Storage Tanks, ton	300
Liquid Vaporization Capacity, tons/day	100

VII. Secondary Clarifiers - Center Drive, Multiple Pick-Up Points

a. Tanks

Number of Tanks	8
Average Flow, each Tank, mgd	10
Design Peak Flow, each Tank, mgd	24
Historical Peak Flow, each Tank, mgd	20.4
Diameter of Tank, ft.	160
Depth, ft.	12
Surface Area, each Tank, sq. ft.	20,100
Volume, cu. ft.	271,200
Volume, mg	2.02
Detention Time with 30% recirc. sludge, hrs.	4.8
Average Overflow Rate, gpd/sq. ft.	495
Design Peak Overflow Rate, gpd/sq. ft.	1,188
Historical Peak Overflow Rate gpd/sq.ft.	990
Weir Length, ft.	500
Average Weir Overflow Rate, gpd/ft.	20,000
Design Peak Weir Overflow Rate, gpd/ft.	48,000
Historial Peak Weir Overflow Rate, gpd/ft.	40,000

b. Sludge Recirculation Pumps - Variable Speed (centrifugal)

Number of Pumping Stations	2
Number of Pumps, each Station	3
Normal Operation, each Station	2
Capacity, each Pump, mgd	10
TDH, ft.	40

Number	7
Capacity, each, lbs/day	8,000

Chlorinators

Number, Total	7
Number of 8,000 lbs/day units	4
Number of 2,000 lbs/day units	3
Units - Effluent Disinfection, 8000 lbs/day	4
Units - Odor Control, 2000 lbs/day	1
Units - Non Potable Water Disinfection, 2000 lbs/day	1
Units - Standby, 2000 lbs/day	1

XI. Effluent Pumping Station - Variable Speed Centrifugal, Eddy Current Drive

Number of Pumps	4
Normal Operation	3
Capacity, each Pump, mgd	75
TDH, ft.	47
HP, each Pump	900
Firm Capacity of Station, mgd	225

XII. Outfall Dispersal System

Diameter, in.	90
Total Length, ft.	22,550
Distance Off Shore, ft.	11,000
Dispersal Depth, Invert, ft.	108
Diffuser - Right Angle to Outfall - Center Feed	
Length, ft.	370
Number of Outlets	12
Distance between Outlets, ft.	40
Size of Outlets, in.	24

XIII. Electric Generators - Stand-by Operation

Diesel Engine Generators	
Number of Generators	4
Normal Operation	3
Capacity, each Generator, KW	2,750

XIV. Odor Control

Hydrogen Sulfide Scrubbers

Pretreatment Building, Number of Scrubbers	2
Primary Tanks - Domes, Number of Scrubbers	4
Primary Tanks - Effluent Troughs, Number of Scrubbers	1
Secondary Clarifiers - Domes and Troughs, Number of Scrubbers	8

XV. Process Water System

Service (Non-Potable) Pumps - Variable Speed (centrifugal)

Number of Pumps	2
Normal Operation	1
Capacity, each Pump, gpm	6,000
TDH, ft.	160
HP, each Pump	350

MIAMI-DADE WATER AND SEWER AUTHORITY DEPARTMENT

CENTRAL DISTRICT WASTEWATER TREATMENT PLANT, PLANT NO. 1
VIRGINIA KEY, MIAMI, DADE COUNTY, FLORIDA

IN SERVICE DATE: October, 1956

BASIC DESIGN DATA
1986

I. Type of Treatment:	High Rate Activated Sludge		
II. Plant Capacity, mgd, annual average	48		
Design Peaking Factor, design peak hourly flow/rated capacity	1.5		
Historical Peaking Factor, peak hourly flow/annual average day flow	1.5		
III. Raw Wastewater Characteristics	<u>Avg.</u>	<u>Max.</u>	<u>Min.</u>
BOD ₅ Raw	mg/l 190	290	50
BOD ₅ Recycled Sludge Waste	mg/l 30	30	30
BOD ₅ Total (Entering Process)	mg/l 220	320	80
Soluble BOD ₅ (41% estimated)	mg/l 90	130	35
T.S.S.	mg/l 195	390	60
V.S.S.	mg/l 175	300	55
C.O.D.	mg/l 500	670	225
H ₂ S-Raw	mg/l 10.0	15.0	7.0
H ₂ S-After Aerated Grit Chamber	mg/l 6.5	10	4.5
pH	---	7.0 7.7	6.3
Temperature	°F 85	86	78
Grease	mg/l 32	34	31
Chlorides	mg/l 1150	1600	440
IV. Inlet Works			
a. Screens	N/A		
Screening performed at Regional Pumping Stations			
b. Aerated Grit Chamber Channels			
Number of Chamber Channels	2		
Width, ft.	22.67		
Depth, ft.	13		
Length, ft.	64		
Detention Time at 76 mgd, min.	2.61		
Air, maximum cfm/lineal ft.	8.1		
Grit Removal Particle Size	250 mesh		
c. Parshall Flumes - Raw Sewage Flow Measurement			
Number of Flumes	2		
Width of Throat, ft.	5		
Head at 76 mgd, ft.	3		

Detention Time at 48 mgd, hrs.	2.44
Surface Area, each Tank, sq.ft.	14,875
Average Overflow Rate, gpd/sq.ft.	800
Design Peak Overflow Rate, gpd/sq.ft.	1,200
Historical Peak Overflow Rate, gpd/sq.ft.	1,200
Weir Length, ft.	846
Average Weir Overflow Rate, gpd/ft.	14,184
Design Peak Weir Overflow Rate, gpd/ft.	21,277
Historical Peak Weir Overflow Rate, gpd/ft.	17,730

b. Recirculation and Waste Pumps - Constant Speed (centrifugal)

Number of Pumping Stations - One each Two Tanks	2
Number of Pumps, each Station	3
Normal Operation, each Station	2
Capacity, each Pump, mgd	1.4
TDH, ft.	14
HP, each Pump	20

c. Scum Pumps - Constant Speed

Number of Pumps	2
Normal Operation	1
HP, each Pump	15

VIII. Sludge Treatment Facilities

a. Concentration Tanks

Number of Tanks	2
Average Flow, each Tank, mgd	1.4
Average Loading, each Tank, lbs/day	45,880
Capture Rate, percent	90
Diameter of Tank, ft.	55
Depth, ft.	13
Surface Area, each Tank, sq.ft.	2,376
Volume, each Tank, cu.ft.	30,800
Detention Time, hrs.	3.9
Surface Loading, gpd/sq.ft.	600
Solids Loading, ss lbs/sq.ft.	19.3

b. Concentrated Sludge Pumps - Variable Speed (plunger)

Number of Pumps	3
Normal Operation	2
Capacity, each Pump, gpm	175
TDH, ft.	60
HP, each Pump	10

c. Sludge Wastewater Pumps - Constant Speed (centrifugal)

Number of Pumps	3
Normal Operation	2
Capacity, each Pump, gpm	2,000
TDH, ft.	16
HP, each Pump	20

XI. Effluent Pumping Station

Included in Central District Plant No. 2 Design Data

XII. Outfall Dispersal System

Included in Central District Plant No. 2 Design Data

XIII. Electric Generators - Stand-by Operation

Included in Central District Plant No. 2 Design Data

XIV. Process Water System - Low Pressure Flushing Water System

Service (Non-Potable) Pumps - Constant Speed (centrifugal)

Number of Pumps	4
Normal Operation	3
Capacity, each Pump, gpm	200
TDH, ft.	66
HP, each Pump	15

MIAMI-DADE WATER AND SEWER AUTHORITY DEPARTMENT

SOUTH DISTRICT WASTEWATER TREATMENT PLANT
8950 S.W. 232 STREET, DADE COUNTY, FLORIDA

IN SERVICE DATE: February, 1983

BASIC DESIGN DATA
1986

I. Type of Treatment	Pure Oxygen Activated Sludge			
II. Plant Capacity, mgd	75			
Design Peaking Factor, design peak hourly flow/rated capacity	1.9			
Historical Peaking Factor, peak hourly flow/annual average day flow	1.7			
III. Raw Wastewater Characteristics		<u>Avg.</u>	<u>Max.</u>	<u>Min.</u>
BOD ₅ Raw	mg/l	200	290	50
BOD ₅ Recycled Sludge Waste	mg/l	30	30	30
BOD ₅ Total (Entering Process)	mg/l	230	320	80
Soluble BOD ₅ (41% estimated)	mg/l	95	130	35
T.S.S.	mg/l	200	390	60
V.S.S.	mg/l	190	300	55
C.O.D.	mg/l	500	670	225
H ₂ S-Raw	mg/l	10.0	15.0	7.0
H ₂ S-After Aerated Grit Chamber	mg/l	6.5	10	4.5
pH	---	7.0	7.7	6.3
Temperature	°F	85	86	78
Grease	mg/l	32	34	31
Chlorides	mg/l	100	300	50
IV. Inlet Works				
a. Screens				
Number of Screens	4			
Normal Operation	2			
Average Flow, each Screen, mgd	16.67			
Screen Width, ft.	4			
Channel width, ft.	4			
Bar Size, in.	3/8			
Bar Screen Opening, in.	1			
b. Aerated Grit Chamber Channels				
Number of Chamber Channels	2			
Width, ft.	22.67			
Average Water Depth, ft.	13			
Length, ft.	64			
Detention Time at 76 mgd, min	2.61			
Air, maximum cfm/lineal ft.	8.1			
Grit Removal Particle Size	250 mesh			

Average Flow, each Tank, mgd	18.75
Design Peak Flow, each Tank, mgd	35.8
Historical Peak Flow, each Tank, mgd	31.9
Diameter of Tank, ft.	195
Depth, ft.	15
Surface Area, each Tank, sq. ft.	29,865
Volume, cu. ft.	500,000
Volume, mg	3.74
Detention Time, hrs.	4.8
Average Overflow Rate, gpd/sq. ft.	630
Design Peak Overflow Rate, gpd/sq. ft.	1,200
Historical Peak Overflow Rate, gpd/sq.ft.	1,040
Weir Length, ft.	612
Average Weir Overflow Rate, gpd/ft.	30,637
Design Peak Weir Overflow Rate, gpd/ft.	58,500
Historical Peak Weir Overflow Rate, gpd/ft.	47,180

b. Recirculation and Waste Pumps - Variable Speed (centrifugal)

Number of Pumping Stations	1
Number of Pumps, each Station	8
Normal Operation, each Station	6
Capacity, each Pump, mgd	6.25
TDH, ft.	88
HP, each Pump	150

c. Final Clarifier Dewatering - Constant Speed (centrifugal)

Number of Pumps, each Station	4
Normal Operation	2
Capacity, each Pump, gpm	2,400
TDH, ft.	55
HP, each Pump	75

d. Final Clarifier Scum Pumps - Constant Speed (centrifugal)

Number of Pumps, each Station	8
Normal Operation	4
Capacity, each Pump, gpm	330
TDH, ft.	39
HP, each Pump	7.5

VIII. Sludge Treatment Facilities

a. Concentration Tanks

Number of Tanks	2
Average Flow, each Tank, mgd	1.17
Average Loading, each Tank, lbs/day	63,677
Capture Rate, with Polymers, percent	90
Diameter of Tank, ft.	55
Depth, ft.	13
Surface Area, each Tank, sq. ft.	2,376
Volume, each Tank, cu. ft.	30,800
Detention Time, hrs.	4.7
Surface Loading, gpd/sq.ft.	161
Solids Loading - ss lbs/sq. ft.	26.8

X. Chlorination Facilities

a. Chlorine Storage

Number of One Ton Cylinders 16

b. Chlorination Equipment

Evaporators

Number 4

Capacity, each, lbs/day 8,000

Chlorinators

Number 4

Number of 8,000 lbs/day units 3

Number of 500 lbs/day units 1

XI. Effluent Pumping Station

Number of Pumps 6

Variable Speed Centrifugal - Eddy Current Drive 4

Constant Speed 2

Normal Operation 5

Capacity, each Pump, mgd 23

TDH, ft. 120

HP, each Pump 900

Firm Peak Capacity of Station, mgd 115

XII. Deep Well Disposal System

Number of Wells 9

Depth of Wells, ft. 3,200

Diameter of Wells

8 ft, in. 24

1 ft, in. 20

Capacity, each Well, mgd 9

Firm Peak Capacity of Wells, mgd 112

XIII. Electric Generators - Stand-by Operation

Diesel Engine Generators

Number of Generators 4

Normal Operation 3

Capacity, each Generator, KW 2,750

Attachment 6

FOG Control Device Effluent Sampling Data

FOG EFFLUENT (Oil & Grease Samples)

	PERMIT CLASS	PERMIT #	NAME	LOCATION	DATE	RESULT (mg/L)
1	GDO	9263	Redland Meat LLC dba Stop & Shop Meat Market	Sampling point	12/13/2016	1.5
2	GDO	1441	Fritanga Castillo Corp	Outlet tee	04/12/2016	3.6
3	GDO	1442	Publix @ 15750 SW 72 St	Outlet tee	12/28/2016	15.6
4	GDO	8015	Anthony's Prod. Corp. DBA Banana's Café & Grill	Outlet tee	11/22/2016	17.0
5	GDO	157	Wendy's @ 6601 Red Rd	clean out	01/03/2017	21.2
6	GDO	7076	Livewell Operation II INC. DBA Livewell at Courtyard	Outlet tee	04/15/2016	23.2
7	GDO	1830	The Sushi Bar	Outlet tee	12/05/2016	28.2
8	GDO	380	Cafeteria Rest. Mi Cafetal	SP	01/05/2017	37.1
9	GDO	8938	7-Eleven	Samp.point	11/23/2016	38.8
10	GDO	4362	Starbucks @ 8442 SW 8 St	Sampling point	12/12/2016	39.8
11	GDO	9351	MDCPS- JOSE DE DIEGO MIDDLE SCHOOL	Outlet tee	09/02/2016	42.2
12	GDO	2184 & 1590	Miss Saigon Bistro & Casteluccio	Outlet tee (SHARED)	07/25/2016	43.3
13	N/A	N/A	Teavana @ Village of Merrick Park	Grease trap	04/14/2016	55.5
14	GDO	2389	Shinju Japanese Buffet	Outlet tee	12/15/2016	56.2
15	GDO	484	Winn Dixie (IGT @ SW corner of Building)	Outlet tee	09/28/2016	58.1
16	GDO	10960	Mi Colombia	Samp. Point	11/29/2016	59.0
17	GDO	626	Domino's Pizza # 3889	Outlet tee	05/06/2016	67.4
18	GDO	485	UMCG-Hecht Dining Hall	Outlet tee	10/28/2016	69.0
19	GDO	2260	Sushi Samba Dromo	Outlet tee	05/23/2016	69.6
20	GDO	695	Sunshine Rest. Merger Sub LLC dba/ lhop #36-078	Outlet tee	11/28/2016	74.3
21	GDO	5888	Subway @ 8768 SW 72 St	Outlet tee	12/15/2016	76.4
22	GDO	2186 & 1590	Miss Saigon Bistro & Casteluccio	Soakage Pit	03/29/2016	77.4
23	GDO	700	Papa John's Pizza	Samp. point	11/30/2016	82.9
24	GDO	9722	Hemmingway warehouse DBA Seasalt and Pepper	Outlet tee	12/23/2016	85.9
25	GDO	1442	Publix @ 15750 SW 72 St	OUTLET TEE	12/28/2016	87.2
26	GDO	4812	Graziano's Gourmet in the Gables	Outlet tee	03/31/2016	88.4
27	N/A	N/A	Teavana @ Dolphin Mall	Grease trap	04/13/2016	88.5
28	GDO	8886	Starbucks @ 52 Curtiss Pky	Sampling point	12/13/2016	93.8
29	GDO	487	UMCG- Lime	Outlet tee	10/28/2016	96.8
30	GDO	5044	51 Hoil China Steak House III	Outlet tee	07/25/2016	100.0
31	GDO	5044	51 Hoil China Steak House III	Outlet tee	07/25/2016	100.0
32	GDO	2017	El Brazo Fuerte Bakery ENT, INC	Storm drain	04/26/2016	106.0
33	GDO	1343	Subway	Outlet tee	12/16/2016	106.5
34	GDO	8330	Gourmet by J & D, DBA Gourmet Gourmet	Outlet tee	08/26/2016	129.7
35	GDO	10251	Pei Wei Asian Dinner, LLC	Outlet tee	07/20/2016	131.5
36	GDO	2412	Rinconcito Latino Café & Restaurant Corp	Storm drain	08/12/2016	132.7
37	GDO	4577	Flying Food Servair Miami, LLC	Outlet tee	03/01/2016	137.2
38	GDO	1368	Monduq, LLC	Outlet tee	11/04/2016	142.4
39	GDO	6892	Starbucks 17760 NW 57 Ave	Outlet tee	11/10/2016	142.7
40	GDO	2917	Orsillo Enterprises Inc. DBA Bird Road Dairy Queen	Outlet tee	10/03/2016	143.5
41	GDO	3916	The Chinese Restaurant	Outlet tee	01/04/2017	144.9
42	GDO	9494	Amisoa, LLC DBA Lique	Storm drain	08/05/2016	161.1
43	GDO	43	Canton Restaurant of Coral Gables	Outlet tee	12/20/2016	161.5
44	GDO	2339	Garcia's Seafood Grille & Fish Market	Outlet tee	03/09/2016	162.6
45	GDO	9688	The Fresh Market INC	Outlet tee	04/08/2016	164.6
46	GDO	2561	Fritanga Cocina de Doña Angela	OT	01/23/2017	167.8
47	GDO	3916	The Chinese Restaurant	Outlet tee	12/02/2016	169.0
48	GDO	9161	Duffy's of North Miami Beach, Inc DBA Intercostal Mall	Outlet tee	08/05/2016	171.8
49	GDO	10538	Coyo Taco	SP	01/06/2017	176.7
50	GDO	697	Bangkok City Thai & Seafood Restaurant	Outlet tee	12/16/2016	177.0
51	GDO	9257	BGM Collins, LLC Burger Fi	Outlet tee	02/16/2016	178.6
52	GDO	4574	La Fogata (Mall of the Americas)	Outlet tee	01/09/2017	180.2
53	GDO	8851	Pete's Kitchen	Outlet tee	11/01/2016	180.7
54	GDO	1837	Jamaican Kitchen	Outlet tee	12/14/2016	182.2
55	GDO	1164	Poon's Corp. DBA Florida Grill	Outlet tee	08/11/2016	183.2
56	GDO	4610	CAJIO'S CUBAN CUISINE	Outlet tee	01/09/2017	184.9
57	GDO	5223	Adrienne Arsht Center DBA Brava	Outlet tee	11/08/2016	191.8
58	GDO	2561	Fritanga Cocina de Doña Angela	Outlet tee	11/16/2006	192.0
59	GDO	6984	Sushi Gables, Inc.	Storm drain	03/30/2016	194.0
60	GDO	5044	51 Hoil China Steak House III	Outlet tee	05/10/2016	198.7
61	GDO	5877	Meridian Market	Outlet tee	11/15/2016	202.8
62	GDO	4516	607 Lincoln Rd, LLC DBA Cantinetta	Outlet tee	07/20/2016	205.6
63	GDO	10905	UMCG- Mahoney Pearson Dining Hall	Outlet tee	10/28/2016	208.0
64	GDO	5877	NH, Inc DBA Meridian Food Market	Outlet tee	08/02/2016	211.8
65	GDO	5223	Adrienne Arsht Center DBA Brava	Outlet tee	12/09/2016	215.1
66	GDO	9688	The Fresh Market INC	Outlet tee	02/19/2016	218.0
67	GDO	2788	Ruson Japanese Stakehouse	Outlet tee	04/07/2016	219.0
68	GDO	2339	Garcia's Seafood Grille & Fish Market	Outlet tee	05/24/2016	221.9
69	GDO	2339	Garcia's Seafood Grille & Fish Market	Outlet tee	07/15/2016	224.0
70	GDO	2186 & 1590	Miss Saigon Bistro & Casteluccio	Outlet tee (SHARED)	03/29/2016	226.1
71	GDO	25	AFP-101 Court DBA Double Tree Miami	Outlet tee	08/26/2016	233.1
72	GDO	9638	Taste Buds of India IV, Inc.	Outlet tee	12/21/2016	234.0
73	GDO	5969	CG Brickell, LLC BDA Komodo	Outlet tee	07/27/2016	240.6
74	GDO	2261	Casablanca Seafood Bar & Grill, INC	Outlet tee	04/08/2016	250.8
75	GDO	11020	Plant Based Restaurant, LLC	Outlet tee	11/14/2016	257.4
76	GDO	218	POLLO TROPICAL	Outlet tee	12/14/2016	270.5

FOG EFFLUENT (Oil & Grease Samples)

	PERMIT CLASS	PERMIT #	NAME	LOCATION	DATE	RESULT (mg/L)
77	GDO	2961	Danny Restaurant	Outlet tee	07/06/2016	274.2
78	GDO	6035	Divino Ceviche Coral Gables	Outlet tee	03/29/2016	288.3
79	GDO	2538	Wei Eileen INC DBA Kyojin Japanese Seafood Buffet	Storm drain	04/20/2016	294.2
80	GDO	2261	Casablanca Seafood Bar & Grill, INC	Outlet tee	03/10/2016	304.0
81	GDO	9257	BGM Collins, LLC Burger Fi	Outlet tee	07/05/2016	304.0
82	GDO	5850	Chicken Kitchen	Outlet tee	12/02/2016	314.5
83	GDO	5457	Sasun, INC DBA Pizza Rustica	Outlet tee	05/24/2016	334.0
84	GDO	2186 & 1590	Miss Saigon Bistro & Casteluccio	Outlet tee (SHARED)	06/07/2016	347.1
85	GDO	11177	New Randy's Inc. DBA Randy's Restaurant	Outlet tee	06/16/2016	360.0
86	GDO	4516	607 Lincoln Rd, LLC DBA Cantinetta	Outlet tee	05/19/2016	370.5
87	GDO	3983	Sub Shack	Outlet tee	08/31/2016	396.0
88	GDO	7975	Target Miami Gardens	Outlet tee	10/14/2016	408.6
89	GDO	10921	Brasil Mania Inc.	Sampling point	01/06/2017	416.6
90	GDO	33, 9726, 10019	Anthony's Coal Fired Pizza- et al	Outlet tee	12/20/2016	419.0
91	GDO	701	Pascal's on Ponce	Outlet tee	12/21/2016	425.0
92	GDO	2088	Sunset Bakery	Outlet tee	12/15/2016	441.0
93	GDO	2088	Sunset Bakery	OT	12/28/2016	441.0
94	GDO	5192	150 Giralda LLC DBA The Local	Outlet tee	05/24/2016	476.8
95	GDO	2261	Casablanca Seafood Bar & Grill, INC	Outlet tee	11/14/2016	477.4
96	GDO	1488	Salmon & Salmon Restaurant	Outlet tee	06/29/2016	492.1
97	GDO	3560	Tropical Chinese Restaurant Corp	Outlet tee	08/03/2016	509.6
98	GDO	695	Sunshine Rest. Merger Sub LLC dba/ Ihop #36-078	Outlet tee	08/15/2016	557.6
99	GDO	2538	Wei Eileen INC DBA Kyojin Japanese Seafood Buffet	Outlet tee	04/19/2016	617.6
100	GDO	9722	Hemmingway warehouse DBA Seasalt and Pepper	Storm drain	03/07/2016	619.6
101	GDO	484	Winn Dixie (IGT @ SE corner of Building)	Outlet tee	09/28/2016	635.9
102	GDO	1751	Koning Restaurants Intl. DBA Pizza Hut	Outlet tee	11/07/2016	650.5
103	GDO	2339	Garcia's Seafood Grille & Fish Market	Outlet tee	11/14/2016	679.7
104	GDO	2921	JL Slang Inc. DBA Grand View Chinese Rest.	Outlet tee	08/18/2016	769.7
105	GDO	10251	Pei Wei Asian Dinner, LLC	Outlet tee	03/24/2016	791.2
106	GDO	697	Bangkok City Thai & Seafood Restaurant	Outlet tee	08/15/2016	796.0
107	GDO	4230	Le Monitenn, LLC DBA Il Bolognese	Outlet tee	05/19/2016	796.8
108	GDO	2743	Domino's Pizza	Outlet tee	04/06/2016	811.6
109	GDO	218	POLLO TROPICAL	Outlet tee	09/27/2016	826.0
110	GDO	2226	Wendy's #1712	Outlet tee	10/03/2016	859.7
111	GDO	3414	Dolores But you can Call Me Lolita LLC	Outlet tee	09/02/2016	906.0
112	GDO	165	IHOP	Outlet tee	09/27/2016	1010.0
113	GDO	154	Wendy's #1711	Outlet tee	08/17/2016	1010.0
114	GDO	6035	Divino Ceviche Coral Gables	Outlet tee	07/13/2016	1060.0
115	GDO	8911	Yakko-San, LLC. DBA Yoko -San Sushi Japanese	Outlet tee	08/24/2016	1140.0
116	GDO	11094	Carolina Ale House	Outlet tee	09/28/2016	1140.0
117	GDO	5192	150 Giralda LLC DBA The Local	Outlet tee	08/02/2016	1160.0
118	GDO	9671	Due Baci	Sampling point	11/14/2016	1200.0
119	GDO	7457	Prime Italian	Outlet tee	06/16/2016	1290.0
120	GDO	580	Menendez Management Corp. DBA Mcdonal's #7409	Outlet tee	07/22/2016	1300.0
121	GDO	11	Benihana National Corp. DBA Samurai Japanese Steak & Seafood	Outlet tee	06/30/2016	1360.0
122	GDO	707	Delicias de Espana 2, Inc.	Outlet tee	08/17/2016	1420.0
123	GDO	5192	150 Giralda LLC DBA The Local	Outlet tee	03/29/2016	1500.0
124	GDO	3414	Dolores But you can Call Me Lolita LLC	Outlet tee	07/13/2016	1820.0
125	GDO	9671	Due Baci	Sampling point	12/16/2016	1870.0
126	GDO	580	Menendez Management Corp. DBA Mcdonal's #7409	Outlet tee	06/23/2016	1950.0
127	GDO	4580	Los Verdes Restaurant	Outlet tee	05/12/2016	2000.0
128	GDO	2378	Di Papa's Inc.	Outlet tee	08/26/2016	2030.0
129	GDO	8396	Rok Burger Gastro Pub	OT	01/13/2017	2040.0
130	GDO	2412	Rinconcito Latino Café & Restaurant Corp	Outlet tee	08/12/2016	2490.0
131	GDO	55	One Washington Ave Corp DBA Smith & Wollensky	Outlet tee	08/19/2016	2850.0
132	GDO	2378	Di Papa's Inc.	Outlet tee	07/21/2016	3110.0
133	GDO	4347	Trump National Doral	Sampling point	07/11/2016	3210.0
134	GDO	3345	Fritanga Montelimar Plaza, Inc.	Outlet tee	12/28/2016	3840.0
135	GDO	697	Bangkok City Thai & Seafood Restaurant	Outlet tee	10/25/2016	4340.0
136	GDO	4366	Latin Group Inc. DBA Latin Café 2000	Outlet tee	09/28/2016	4450.0
137	GDO	6889	Bryson's	Storm drain	07/14/2016	5670.0
138	GDO	475	Winn Dixie @ 8710 SW 72 St	Outlet tee	12/14/2016	9340.0
139	GDO	8663	TUOFIC & Rima Inc. DBA Daily Bread	Storm drain	03/24/2016	13300.0
140	N/A	N/A	Manhole 6-46	Sanitary Sewer Manhole	04/08/2016	73.0
141	GDO	11390	Dunkin Donuts 343978	Storm drain	11/15/2016	U
					AVERAGE	768.0
					HIGHEST	13300.0
					LOWEST	1.5

Attachment 7

GDO Facilities Flow Rates

No.	FACILITY_NAME	PERMIT	PERMIT_NUMBER	ADDRESS	TOTAL_GPD
1	MIAMI BEACH RESORT OWNER, LLC	GDO	1	4833 COLLINS AVE	2,750
2	THE ALEXANDER HOTEL	GDO	2	5225 COLLINS AVE	0
3	OSI/OUTBACK STEAKHOUSE OF FL, LLC DBA OUTBACK STEAKHOUSE #1077	GDO	4	13145 SW 89 PL	0
4	HONG KONG CITY OF MING HUA, LLC	GDO	5	7373 NW 36 ST	502
5	EL POLLO INKA, INC.	GDO	6	7285 NW 36 ST	1,300
6	ARGENTINA STEAKHOUSE RESTAURANT, INC.	GDO	7	7369 NW 36 ST	30,200
7	TWELVE MIAMI, LLC	GDO	8	7335 NW 36 ST	2,296
8	A.G.A. OF FLORIDA, INC. DBA EL RINCONCITO LATINO DORAL	GDO	9	7387 NW 36 ST	988
9	BAL-ROD ENTERPRISES, INC. DBA WENDY'S #1722	GDO	10	7393 NW 36 ST	1,035
10	BENIHANA NATIONAL CORP. DBA SAMURAI JAPANESE STEAK & SEAFOOD	GDO	11	8717 SW 136 ST	3,750
11	MARRIOTT INTERNATIONAL, INC. DBA MIAMI BISCAYNE BAY MARRIOTT	GDO	15	1633 N BAYSHORE DR	4,500
12	HPT TRS IHG-3, INC. DBA CROWN PLAZA	GDO	16	950 NW LE JEUNE RD	1,500
13	MIA BL HOTEL PARTNERS, LLC DBA PULLMAN MIAMI AIRPORT	GDO	17	5800 BLUE LAGOON DR	738
14	BRINKER FLORIDA, INC. DBA CHILI'S GRILL & BAR	GDO	18	8696 NW 13 TER	5,125
15	CEC ENTERTAINMENT, INC. DBA CHUCK E. CHEESE'S #424	GDO	20	3890 W 18 AVE	10,650
16	VALLE HOLDINGS II, INC. DBA LITTLE HOOLIE'S PUB	GDO	21	13135 SW 89 PL	4,250
17	LA CARRETA RESTAURANT IV, INC.	GDO	24	5350 W 16 AVE	5,625
18	MIAMI AIRPORT, LLC DBA HILTON MIAMI AIRPORT	GDO	26	5101 BLUE LAGOON DR	5,000
19	HOTEL INTER-CONTINENTAL MIAMI	GDO	28	100 CHOPIN PLZ	5,000
20	KILLINKERE, INC. DBA JOHN MARTIN'S	GDO	29	253 MIRACLE MILE	5,750
21	FRANCIS ROSS TRS DBA STADIUM HOTEL	GDO	32	21485 NW 27 AVE	938
22	ANTHONY'S PIZZA HOLDINGS, LLC	GDO	33	2626 PONCE DE LEON BLVD A	965
23	GIONI, INC. DBA CAFFE ABBRACCI	GDO	34	318 ARAGON AVE	1,001
24	HYATT REGENCY MIAMI-CONVENTION	GDO	35	400 SE 2 AVE	3,750
25	POLLO OPERATIONS, INC. DBA POLLO TROPICAL #8	GDO	37	4211 NW 36 ST	923
26	RESORT WORLD OMNI, LLC DBA DOWNTOWN MIAMI HILTON	GDO	38	1601 BISCAYNE BLVD HOTEL	505
27	RODEO ANGUS, LLC DBA EL CHURRASCO STEAKHOUSE	GDO	39	801 BRICKELL BAY DR #16 4CL41	3,120
28	JIGS INVESTMENTS, LTD DBA JOE'S STONE CRAB RESTAURANT	GDO	40	11 WASHINGTON AVE	12,875
29	FONDA LA CHISMOSA, LLC	GDO	41	981 SW 8 ST	1,320
30	MONTY'S SUNSET, LLC DBA MONTY'S ON THE BEACH & RAW BAR	GDO	42	300 ALTON RD	1,250
31	CANTON RESTAURANT OF CORAL GABLES	GDO	43	2614 PONCE DE LEON BLVD	7,325
32	7-ELEVEN, INC. DBA 7-ELEVEN #34493A	GDO	44	195 NW 199 ST	0
33	LITTLE CAESAR'S ENTERPRISES, INC. DBA LITTLE CAESAR'S PIZZA #2244	GDO	45	1812 NE MIAMI GARDENS DR	12
34	FLORIBBEAN TROPICAL FOOD, LLC	GDO	46	8391 NW 12 ST	1,629
35	GW HIALEAH HOTEL, LLC DBA HOWARD JOHNSON PLAZA HOTEL&	GDO	47	7707 NW 103 ST	4,500
36	PUBLIX SUPERMARKETS, INC. DBA PUBLIX STORE #0094	GDO	50	1401 MONZA BLVD	0
37	SIAM BAYSHORE, INC. DBA SIAM BAYSHORE RESTAURANT	GDO	51	1524 79 ST	2,000
38	JJ SWASHBUCKLERS, LLC DBA JIMMY JOHNS	GDO	52	1050 NW 14 ST #6-A	325
39	SMG ENTERTAINMENT, INC. DBA MIAMI GOLD	GDO	53	17450 BISCAYNE BLVD	1,518
40	VIRGINIA STATION, INC. DBA THE GROVE SPOT	GDO	54	3324 VIRGINIA ST 1	97,475
41	ONE WASHINGTON AVE CORP. DBA SMITH & WOLLENSKY	GDO	55	1 WASHINGTON AVE	5,213
42	IPANEMA GRILL OF KENDALL, INC. DBA IHOP #36-130	GDO	58	12755 SW 88 ST	3,950
43	BRINKER FLORIDA, INC. DBA CHILI'S BAR & GRILL #231	GDO	60	11900 SW 88 ST	5,425
44	SHELBORNE OPERATING ASSOCIATES, LLC DBA GRAND SOUTH BEACH	GDO	63	1801 COLLINS AVE	2,250
45	PENROD BROTHERS, INC. DBA NIKKI BEACH CLUB	GDO	66	1 OCEAN DR	12,500
46	TMC FOOD SERVICES, LLC	GDO	67	4410 W 16 AVE #28B	300
47	MEXICAN GASTRONOMY INTERNATIONAL, LLC DBA LA CANTINA LA VEINTE	GDO	68	495 BRICKELL AVE CU-1	3,420
48	HOPE'S HUNGRY BEAR SUB SHOP	GDO	73	10521 SW 109 CT	0
49	LOS RANCHOS RESTAURANT, INC.	GDO	74	125 SW 107 AVE	5,750
50	FLORIDA SE, LLC DBA OLIVE GARDEN ITALIAN RESTAURANT #1244	GDO	75	8201 W FLAGLER ST	2,275
51	CHAI & ZENG, LLC DBA SOUTH GARDEN CHINESE RESTAURANT	GDO	76	10855 SW 72 ST 10	1,013
52	THE BOOKSTORE IN THE GROVE, LLC	GDO	77	3390 MARY ST #166	1,692
53	MUCHACHOS NEW SUPERMARKET, INC. DBA AMIGOS SUPERMARKET	GDO	78	12630 SW 8 ST	1,850
54	DONA NELI MIAMI, LLC	GDO	79	12652 SW 8 ST	375
55	ARCOL CORPORATION DBA ILUSIONES SUPER CLUB	GDO	80	12540 SW 8 ST	1,040
56	DOHERTY APPLE SOUTH FLORIDA LLC DBA APPELBEES NEIGHBORHOOD	GDO	81	9815 NW 41 ST	1,369
57	TAMURA CORPORATION DBA TAMURA JAPANESE BUFFET	GDO	85	6728 MAIN ST	1,607
58	TROPICAL SUPERMARKET #15, INC.	GDO	87	10855 SW 72 ST	2
59	CASAVANA KENDALL, INC.	GDO	90	8202 MILLS DR	4,000
60	MAC ACQUISITION OF DELAWARE, LLC DBA ROMANO'S MACARONI GRILL	GDO	91	12100 SW 88 ST	1,850
61	3900 NW, LLC DBA SHERATON MIAMI AIRPORT & EXECUTIVE MEETING	GDO	93	3900 NW 21 ST	5,000
62	RED LOBSTER HOSPITALITY, LLC DBA RED LOBSTER #797	GDO	94	8705 SW 136 ST	6,875
63	ATLANTA RESTAURANT PARTNERS, LLC DBA T.G.I. FRIDAY'S	GDO	97	8888 HOWARD DR #340	2,141
64	CBC REST FALLS, LLC DBA SOKAI PERUVIAN SUSHI BAR	GDO	98	8888 SW 136 ST #383	1,136
65	BRAVO BRIO RESTAURANT GROUP, INC. DBA BRIO TUSCAN GRILLE	GDO	100	8888 SW 136 ST SP 380	1,983
66	LA CARRETA RESTAURANT #2, INC.	GDO	102	8650 SW 40 ST	3,750
67	YUCA RESTAURANT COMPANY	GDO	103	501 LINCOLN RD	5,000
68	BAPTIST HEALTH SOUTH FLORIDA/SOUTH MIAMI HOSPITAL	GDO	107	7401 SW 62 AVE	2,100
69	SOUTH BEACH QSR, LLC DBA TACO BELL #25738	GDO	108	6740 SW 8 ST	896
70	OCEAN 150, INC.	GDO	109	350 OCEAN DR	468
71	HAMPTONS WEST CONDOMINIUM ASSN. INC.	GDO	110	20281 E COUNTRY CLUB DR COMM1	1,125
72	NEEQ ENTERPRISES, INC. DBA DENNY'S #1618	GDO	111	1150 S DIXIE HWY	3,300
73	RED LOBSTER HOSPITALITY, LLC DBA RED LOBSTER #6373	GDO	112	11550 SW 88 ST	4,875
74	KFC CORPORATION DBA KFC #X975034	GDO	113	7360 SW 117 AVE	525
75	THE BRASSERIE RESTAURANT, LLC	GDO	114	605 BRICKELL KEY DR	850
76	KENDALL ALE HOUSE & RAW BAR	GDO	119	11625 SW 88 ST	5,050
77	LA CARRETA RESTAURANT #5	GDO	120	11740 SW 88 ST	5,500
78	EC INVESTMENTS, LLC DBA MIAMI BEACH DELI	GDO	121	300 ALTON RD #100	600
79	MDM HOTEL GROUP, LTD DBA MIAMI COURTYARD DADELAND	GDO	122	9090 S DADELAND BLVD	5,100
80	DENNY'S, INC. DBA DENNY'S RESTAURANT #6868	GDO	123	12000 SW 88 ST	3,125
81	HNS PARTNERS #27421, LLC DBA SUBWAY #27421	GDO	124	996 SW 67 AVE	700
82	RED LOBSTER HOSPITALITY, LLC DBA RED LOBSTER # 0246	GDO	125	1760 W 49 ST	1,880
83	TACO BELL OF AMERICA, LLC DBA TACO BELL #003599	GDO	126	18750 NW 67 AVE	840
84	TACO BELL OF AMERICA, LLC DBA TACO BELL #015451	GDO	127	7350 SW 117 AVE	700
85	WINN DIXIE STORES, INC. DBA WINN DIXIE STORE #242	GDO	130	1201 E 10 AVE	12
86	J & J HOSPITALITY GROUP, LLC DBA JAKE & THE CAKE	GDO	131	6800 SW 57 AVE	450
87	WEST GABLES REHABILITATION HOSPITAL	GDO	132	2525 SW 75 AVE	0
88	EL PATIO CAFE CORP.	GDO	133	3198 NW 71 ST	213

No.	FACILITY_NAME	PERMIT	PERMIT_NUMBER	ADDRESS	TOTAL_GPD
89	DENNY'S, INC. DBA DENNY'S #1063	GDO	134	1000 W 49 ST	3,725
90	POLLO OPERATIONS, INC. DBA POLLO TROPICAL #5	GDO	135	18710 S DIXIE HWY	1,792
91	UNIVERSITY OF MIAMI (RSMAS)	GDO	136	4600 RICKENBACKER CSWY	2,100
92	JAE MIAMI DADE, LLC DBA WENDY'S #1706	GDO	137	7901 W FLAGLER ST	47,726
93	PALACE AT KENDALL NURSING/REHAB.	GDO	138	11215 SW 84 ST	0
94	MATTHEW GUAN 138, INC. DBA CHEF CHEN RESTAURANT	GDO	139	11557 SW 88 ST	360
95	CASA PACO, INC. DBA PACOS HOUSE	GDO	141	8868 SW 40 ST	4,075
96	EL ARTE BAKERY ENTERPRISES, INC.	GDO	142	8718 SW 40 ST	182
97	WREST 2, LLC DBA WENDY'S #1699	GDO	147	10829 SW 72 ST	1,176
98	JAE MIAMI DADE, LLC DBA WENDY'S #1708	GDO	148	13890 SW 88 ST	900
99	WENDY'S INTERNATIONAL, INC. DBA WENDY'S #1703	GDO	149	1532 N MIAMI BEACH BLVD	1,008
100	JAE MIAMI DADE, LLC DBA WENDY'S #1892	GDO	150	2400 NW 87 AVE	788
101	WENDY'S INTERNATIONAL, INC. DBA WENDY'S #1970	GDO	151	340 SE 1 AVE	1,120
102	LUAR ENTERPRISES, INC. DBA WENDY'S #1707	GDO	152	18880 S DIXIE HWY	980
103	BAL-ROD ENTERPRISES, INC. DBA WENDY'S #1705	GDO	153	3301 BISCAYNE BLVD	1,204
104	WENDY'S INTERNATIONAL, INC. DBA WENDY'S #1711	GDO	154	200 SW 8 ST	1,470
105	WENDY'S INTERNATIONAL, INC. DBA WENDY'S #1719	GDO	155	18181 NW 27 AVE	2,086
106	JAE MIAMI DADE, LLC DBA WENDY'S #1709	GDO	157	6601 RED RD	1,031
107	WENDY'S INTERNATIONAL, INC. DBA WENDY'S #1713	GDO	158	7801 BISCAYNE BLVD	1,456
108	WENDY'S INTERNATIONAL, INC. DBA WENDY'S #1716	GDO	160	1730 W 49 ST	2,002
109	SAZON CUBAN CUISINE, LLC	GDO	161	7305 COLLINS AVE	86,700
110	SOUTH BEACH QSR, LLC DBA TACO BELL #25743	GDO	162	6310 S DIXIE HWY	840
111	TACO BELL OF AMERICA, LLC DBA TACO BELL #004467	GDO	163	2935 SW 32 AVE	868
112	EDITION MANAGEMENT, LLC DBA THE MIAMI BEACH EDITION-TROPICAL	GDO	168	2901 COLLINS AVE FAC.A	453
113	CLAUDIA & SONS CORPORATION DBA CHE TITO'S PIZZERIA & GRILL	GDO	170	12018 SW 88 ST	900
114	JAE MIAMI DADE, LLC DBA WENDY'S #2455	GDO	172	7401 NW 73 ST	794
115	JAE RESTAURANT HOLDINGS, LLC DBA WENDY'S #1710	GDO	173	365 W 78 RD	769
116	THOMPSON HOSPITALITY SERVICES, LLC DBA FLORIDA MEMORIAL COLLEGE	GDO	176	15800 NW 42 AVE	375
117	RAMADA PLAZA/OCEAN TERRACE RESTAURANT	GDO	177	19201 COLLINS AVE FAC.A	3,750
118	SOUTH BEACH QSR, LLC. DBA TACO BELL #25745	GDO	178	987 N HOMESTEAD BLVD	980
119	MONTES DE OCA ORIGINAL PIZZA CUBANA #2, INC.	GDO	179	5241 SW 8 ST	644
120	SENIOR HEALTH PROPERTIES-SOUTH, INC.DB A TREASURE ISLE CARE CENTER	GDO	183	1735 N TREASURE DR	25
121	3RD VENTURE, LLC DBA SPORTS GRILL	GDO	189	11481 SW 40 ST	5,000
122	KFC CORPORATION DBA KFC #X975058	GDO	190	19775 S DIXIE HWY	1,050
123	WEN-NORTH HOLDINGS, INC. DBA WENDY'S #8445	GDO	193	1856 NE MIAMI GARDENS DR	575
124	MARRIOTT INTERNATIONAL, INC. DBA MIAMI AIRPORT MARRIOTT	GDO	194	1201 NW 42 AVE	3,875
125	LUCKY STAR RESTAURANT, INC. DBA CANTON STAR	GDO	195	15718 SW 72 ST	1,000
126	DENNY'S, INC. DBA DENNY'S #1106	GDO	200	19313 S DIXIE HWY	3,725
127	MELIMAX, LLC DBA LA BRASA CUTLER BAY	GDO	201	19169 S DIXIE HWY	529
128	ROCCAN CORP. DBA LA ISLA KENDALL	GDO	203	9525 N KENDALL DR	1,825
129	TACO BELL OF AMERICA, LLC DBA TACO BELL #005555	GDO	205	8699 SW 24 ST	1,456
130	ANTHONY'S COAL FIRED PIZZA OF KENDALL, LLC	GDO	207	12502 SW 88 ST	369
131	JAE MIAMI DADE, LLC DBA WENDY'S #1702	GDO	208	697 NW 37 AVE	773
132	OGP LATIN 3 CORP. DBA LUIS GALINDO LATIN AMERICAN #3	GDO	209	9606 SW 72 ST	1,625
133	FAMITOR CORP. DBA DON BURRITO	GDO	210	10855 SW 72 ST #43	431
134	WENDY'S INTERNATIONAL, INC. DBA WENDY'S #2013	GDO	213	16601 NW 57 AVE	1,120
135	POLLO OPERATIONS, INC. DBA POLLO TROPICAL #7	GDO	216	1785 NE 163 ST	1,540
136	CORAL PARK INN, LLC DBA HOLIDAY INN - U. OF M.	GDO	217	1350 S DIXIE HWY	3,750
137	POLLO OPERATIONS, INC. DBA POLLO TROPICAL #10	GDO	218	16495 NW 67 AVE	1,073
138	SSC353151, LLC DBA DUNKIN DONUTS #353151	GDO	220	1190 NW 62 ST	425
139	BROWN/MCKENNA MANAGEMENT, LLC DBA KFC #09	GDO	221	6195 NW 27 AVE	420
140	TACO BELL OF AMERICA, LLC DBA TACO BELL #003684	GDO	222	10580 SW 8 ST	1,036
141	KFC CORPORATION DBA KFC #X975021	GDO	223	444 HIALEAH DR	690
142	POLLO OPERATIONS, INC. DBA POLLO TROPICAL #1	GDO	225	741 NW 37 AVE	980
143	POLLO OPERATIONS, INC. DBA POLLO TROPICAL #2	GDO	226	9520 SW 137 AVE	868
144	POLLO OPERATIONS, INC. DBA POLLO TROPICAL #4	GDO	227	8700 SW 40 ST	2,100
145	POLLO OPERATIONS, INC. DBA POLLO TROPICAL #9	GDO	228	2710 S DIXIE HWY	1,820
146	POLLO OPERATIONS, INC. DBA POLLO TROPICAL #18	GDO	229	1454 ALTON RD	1,064
147	POLLO OPERATIONS, INC. DBA POLLO TROPICAL #24	GDO	230	1555 NW 87 AVE	1,694
148	POLLO OPERATIONS, INC. DBA POLLO TROPICAL #26	GDO	231	13998 SW 56 ST	1,680
149	TACO BELL OF AMERICA, LLC DBA TACO BELL #000243	GDO	233	1075 W 49 ST	420
150	JAE RESTAURANT HOLDINGS, LLC DBA WENDY'S #7962	GDO	234	555 HIALEAH DR	711
151	HOOTERS OF DORAL, INC.	GDO	235	8695 NW 13 TER	3,750
152	RARE HOSPITALITY MANAGEMENT, LLC DBA LONGHORN STEAKHOUSE OF	GDO	236	15135 SW 88 ST	1,500
153	TACO BELL OF AMERICA, LLC DBA TACO BELL #002936	GDO	238	710 NW 37 AVE	754
154	TACO BELL OF AMERICA, LLC DBA TACO BELL #003669	GDO	239	3595 BISCAYNE BLVD	1,036
155	OASIS GRILL @ METRO-ZOO	GDO	245	12400 SW 152 ST	280
156	CAROUSEL CAFE @ METRO-ZOO	GDO	246	12400 SW 152 ST	0
157	TRUMP ENDEAVOR 12, LLC DBA TRUMP DORAL GOLF CLUB AND RESORT	GDO	247	4400 NW 87 AVE FAC. A	0
158	WILLIAMS ISLAND, A PRIVATE CLUB, LTD, DBA ISLANDER RESTAURANT	GDO	248	4500 ISLAND BLVD	5,375
159	POLLO OPERATIONS, INC. DBA POLLO TROPICAL #30	GDO	249	581 NW 57 AVE	1,442
160	POLLO OPERATIONS, INC. DBA POLLO TROPICAL #19	GDO	250	985 HOMESTEAD BLVD	1,512
161	POLLO OPERATIONS, INC. DBA POLLO TROPICAL #25	GDO	251	19911 NW 2 AVE	1,414
162	POLLO OPERATIONS, INC. DBA POLLO TROPICAL #11	GDO	252	2490 W 60 ST	868
163	POLLO OPERATIONS, INC. DBA POLLO TROPICAL #21	GDO	253	11670 SW 152 ST	1,498
164	POLLO OPERATIONS, INC. DBA POLLO TROPICAL #3	GDO	254	8975 S DIXIE HWY	1,190
165	JACKSON SOUTH COMMUNITY HOSPITAL	GDO	255	9333 SW 152 ST	1,036
166	FLORIDA SE, LLC DBA THE OLIVE GARDENS ITALIAN RESTAURANT #1839	GDO	256	17985 BISCAYNE BLVD	1,860
167	MAGNAR HOLDINGS, LLC DBA LA BRASA MGW	GDO	257	6694 NW 186 ST	565
168	AMARILIS COFFEE SHOP, INC.	GDO	260	3501 NW 17 AVE	196
169	PLAZA SEAFOOD MARKET AND FRESH FISH, INC.	GDO	262	3114 NW 17 AVE	0
170	PRESIDENTE SUPERMARKET #31, INC.	GDO	263	3001 NW 17 AVE	7,125
171	OLD LISBON RESTAURANT & BAR, LLC	GDO	267	1698 SW 22 ST	2,000
172	PAN'S FAMILY MARKET, INC.	GDO	268	2293 SW 17 AVE	700
173	THE ART OF MAKING BUSINESS INC. DBA LA BONGA RESTAURANT	GDO	269	1684 SW 22 ST	375
174	MYKONOS, INC. DBA MYKONOS GREEK RESTAURANT	GDO	270	1201 SW 22 ST	1,250
175	BACKLOT 305, LLC DBA NANCY	GDO	275	2007 SW 8 ST	553
176	EL GALLEG0 SUPERMARKET	GDO	277	15138 SW 56 ST #9	0

No.	FACILITY_NAME	PERMIT	PERMIT_NUMBER	ADDRESS	TOTAL_GPD
177	LOS PRIMOS CAFETERIA & GRILL CORP. DBA LOS PRIMOS CAFETERIA & GRILL	GDO	278	1864 SW 8 ST	180
178	EXUPERY BURGER & PIZZA, LLC	GDO	279	1782 SW 8 ST	250
179	KAMIKO2, LLC	GDO	280	1401 SW 22 ST CU 101	325
180	CRISS CROSS LANDEN CORP. DBA MR. YUM	GDO	281	1945 SW 8 ST	675
181	MERO RESTAURANT, INC.	GDO	282	1933 SW 8 ST	500
182	KARMEN BAKERY CORP.	GDO	283	1854 SW 8 ST	1
183	OMAR AND MANUEL CORP. DBA PRESIDENTE SUPERMARKET #03	GDO	284	1895 SW 8 ST	0
184	EL COLADITO RESTAURANT	GDO	285	1837 SW 8 ST	750
185	PETRAS PLACE, LLC DBA LUNG YAI TAPAS	GDO	287	1731 SW 8 ST	152
186	TACO BELL OF AMERICA, LLC DBA TACO BELL #017108	GDO	288	7745 SW 40 ST	2,250
187	SOUTH BEACH QSR, LLC. DBA TACO BELL #25739	GDO	289	630 NE 79 ST	882
188	SOUTH BEACH QSR, LLC. DBA TACO BELL #25742	GDO	290	3190 SW 22 ST	910
189	FLORIDA BELLS, LLC DBA TACO BELL #26468	GDO	291	1650 NE 163 ST	565
190	POLLO OPERATIONS, INC. DBA POLLO TROPICAL #71	GDO	292	17084 COLLINS AVE	1,260
191	MILLER'S ALE HOUSE, INC.	GDO	294	13603 S DIXIE HWY	2,189
192	ST ANDREW GREEK ORTHODOX CHURCH OF KENDALL, INC.	GDO	295	7901 N KENDALL DR	1,600
193	TACO BELL OF AMERICA, LLC DBA TACO BELL #016100	GDO	299	13550 SW 152 ST	1,120
194	POLLO OPERATIONS, INC. DBA POLLO TROPICAL #6	GDO	300	11521 SW 88 ST	1,876
195	BURGER KING CORPORATION DBA BURGER KING #0090	GDO	301	11595 SW 40 ST	2,086
196	STARBUCKS COFFEE COMPANY, INC. DBA STARBUCKS #24531	GDO	302	11585 SW 40 ST	620
197	SHORTY'S III BBQ RESTAURANT	GDO	303	11575 SW 40 ST	3,700
198	NUNZIO'S RESTAURANT, INC.	GDO	304	11433 SW 40 ST	1,500
199	ORIGINAL RIO CRYSTAL RESTAURANT, INC.	GDO	305	9872 SW 40 ST	3,725
200	PUBLIX SUPERMARKETS, INC. DBA PUBLIX STORE #0204	GDO	307	11495 BIRD RD	0
201	MCDONALD'S CORPORATION DBA MCDONALD'S #4181	GDO	309	10855 CARIBBEAN BLVD	2,086
202	CASA PANZA CAFE, INC.	GDO	310	1618-1620 SW 8 ST	125,000
203	SUBWAY #20116, INC. DBA SUBWAY #20116	GDO	311	1575 SW 8 ST B	280
204	ORIENTAL CHINESE RESTAURANT, INC.	GDO	312	1642 SW 8 ST	3,725
205	TALMUDIC COLLEGE 4000 ALTON ROAD INC. DBA TALMUDIC COLLEGE 4000	GDO	313	4000 ALTON RD	500
206	CHIPOTLE MEXICAN GRILL OF COLORADO, LLC DBA CHIPOTLE #1058	GDO	315	6290 S DIXIE HWY	1,428
207	RAMALCO CORPORATION DBA BURGER KING #0984	GDO	316	7955 W FLAGLER ST	1,386
208	MILOS ENTERPRISES DBA MCDONALD'S #26889	GDO	318	7995 W FLAGLER ST	46,200
209	CANCUN GRILL, INC.	GDO	319	15406 NW 77 CT	5,000
210	ORCHID OF SIAM, INC. DBA KING & I THAI RESTAURANT	GDO	320	15508 NW 77 CT	2,125
211	HOUSE OF SUN, INC.	GDO	321	15440 NW 77 CT	2,100
212	PIZZERIAS, LLC DBA PAPA JOHN'S PIZZA #377	GDO	322	15428 NW 77 CT	0
213	WINN DIXIE STORES, INC. DBA WINN DIXIE STORE #262	GDO	323	15450 NW 77 CT	3
214	FOURTH VENTURE GROUP, LLC DBA SPORTS GRILL	GDO	324	15462 NW 77 CT	850
215	AMPY ENTERPRISES, INC. DBA MCDONALD'S #7408	GDO	326	1400 SW 8 ST	1,087
216	EL EXQUISITO NUEVO, INC. DBA EXQUISITO RESTAURANT	GDO	327	1510 SW 8 ST	1,325
217	NIKKI'S CAFE CORP.	GDO	329	1226 SW 8 ST	224
218	LA PINARENA GALLO PINTO CORP.	GDO	331	4747 W FLAGLER ST	750
219	VILLA SOTA CORAL WAY, LLC	GDO	336	1242 SW 22 ST	625
220	EL CANTONES RESTAURANT	GDO	337	11865 SW 26 ST E-3	1,750
221	VIGOA SUBWAY, LLC DBA SUBWAY #25082	GDO	338	11865 SW 26 ST #J-8	300
222	CABARCENO ENTERPRISES, INC. DBA SEDANO'S SUPERMARKET #18	GDO	339	12175 SW 26 ST	3
223	LAS VEGAS RESTAURANT VII DBA LAS VEGAS CUBAN CUISINE	GDO	340	11995 SW 26 ST	1,075
224	AMERICAN MULTI-CIMENA, INC. DBA AMC THEATRES	GDO	341	11865 SW 26 ST D-E2	1,672
225	TACO BELL OF AMERICA, LLC DBA TACO BELL #005485	GDO	342	599 NE 167 ST	639
226	BJ & J FOODS, LLC DBA LA BRASA	GDO	343	2320 SW 87 AVE	500
227	L.C.L. FOOD SERVICES, INC. DBA MCDONALD'S #17014	GDO	345	15715 SW 88 ST	672
228	SAMBA CORAL GABLES, LLC DBA SUSHI SAMBA	GDO	346	180 ARAGON AVE	2,000
229	LARKIN COMMUNITY HOSPITAL, INC.	GDO	348	7031 SW 62 AVE	775
230	NEW PIMENT BOUK RESTAURANT	GDO	351	5961 NE 2 AVE	1,050
231	COLLINS FISH & SEA FOOD MARKET, INC.	GDO	352	328 NE 70 ST	0
232	TIPICO CENTRO AMERICANO CAFE CORP.	GDO	354	1680 NW 36 ST	2,250
233	ORWALL INDUSTRIES, INC. DBA BURGER KING #0022	GDO	358	891 W 49 ST	1,316
234	SKYLAKE FOODS CORPORATION DBA MCDONALD'S #1583	GDO	359	18350 NE 18 AVE	1,036
235	CHECKERS DRIVE-IN RESTAURANTS, INC. DBA CHECKERS #6235	GDO	360	6692 NW 186 ST	420
236	SOUTH BEACH QSR, LLC DBA TACO BELL #25740	GDO	362	15295 S DIXIE HWY	840
237	JAVISA'S KREW, LLC DBA TACOS & TATTOOS	GDO	364	10720 SW 113 PL	188
238	LUIHN FOUR, INC. DBA ALL-IN-ONE TACO BELL #133	GDO	365	8363 W FLAGLER ST	1,327
239	TACO BELL OF AMERICA, LLC DBA TACO BELL #004258	GDO	366	18407 S DIXIE HWY	1,008
240	CAFE CHANTILLY, INC.	GDO	367	12618 SW 8 ST	0
241	HEALTHY CUISINE BY ANA AMAT, INC.	GDO	371	9351 SW 56 ST	1,000
242	SOUTH BEACH QSR, LLC. DBA TACO BELL #4009	GDO	372	3750 NW 79 AVE	840
243	MENENDEZ MANAGEMENT CORP. DBA MCDONALD'S #11333	GDO	376	9341 SW 56 ST	1,526
244	FRITANGA LA GATA CORP.	GDO	378	2175 SW 1 ST	441
245	FIESTA COFFEE SHOP, INC.	GDO	379	1715 SW 1 ST	250
246	CAFETERIA RESTAURANTE MI CAFETAL, INC.	GDO	380	1784 SW 1 ST	0
247	LOS LAURELES SUPERMARKET	GDO	381	1910 SW 1 ST	140
248	CONCHITA CAFETERIA CORPORATION II DBA LA CONCHITA CAFETERIA #2	GDO	382	101 SW 17 AVE	0
249	IM NEW YORK FLORIDA, LLC DBA IL MULINO	GDO	384	17875 COLLINS AVE	4,650
250	WHITE STONE FOODS, LLC DBA LONG JOHN SILVERS	GDO	387	601 W 49 ST	1,850
251	B-TWINNS BAKERY CORP.	GDO	388	1550 SW 1 ST	0
252	DELICIAS CATRACHAS, INC.	GDO	389	872 SW 1 ST	125
253	SABOR CATRACHO RESTAURANT & MERCADITO CORP.	GDO	392	1550 SW 1 ST #1-7	875
254	LOLY'S RESTAURANT CORP.	GDO	393	30394 OLD DIXIE HWY	266
255	WINN DIXIE STORES, INC. DBA WINN DIXIE STORE #378	GDO	394	3805 NE 163 ST	1
256	WINN DIXIE STORES, INC. DBA WINN DIXIE STORE #353	GDO	395	9565 W FLAGLER ST	0
257	WINN DIXIE STORES, INC. DBA WINN DIXIE STORE #246	GDO	396	17221 NW 27 AVE	3
258	JAE MIAMI DADE, LLC DBA WENDY'S #2272	GDO	397	13650 SW 26 ST	955
259	JACOBS-LESTER CORPORATION DBA BURGER KING #0066	GDO	398	13705 NW 27 AVE	2,086
260	COMBO ENTERPRISE, INC. DBA MCDONALD'S #12309	GDO	400	12198 SW 117 AVE	1,036
261	GOAR CORPORATION DBA HOLIDAY BAKERY	GDO	401	5931 W 16 AVE	0
262	RTM OPERATING COMPANY DBA ARBY'S #307	GDO	402	1486 NE 163 ST	1,120
263	SEAHORSE GRILL, LLC DBA SEA GRILL	GDO	404	3913 NE 163 ST	1,770
264	SUNSHINE RESTAURANT MERGER SUB, LLC DBA INTERNATIONAL HOUSE OF	GDO	406	9696 SW 72 ST	875

No.	FACILITY_NAME	PERMIT	PERMIT_NUMBER	ADDRESS	TOTAL_GPD
265	YAMBO RESTAURANT-CLUB	GDO	407	1643 SW 1 ST	2,000
266	WINN DIXIE STORES, INC. DBA WINN DIXIE STORE #235	GDO	409	3401 NW 18 AVE	0
267	THE GLOBE CAFE & BAR, LLC	GDO	411	377 ALHAMBRA CIR	700
268	FEDERAL BUSINESS SERVICE, INC. DBA MARY CAFETERIA	GDO	412	1008 SW 1 ST	188
269	TAMMY'S BAKERY, INC.	GDO	414	9443 SW 56 ST	0
270	EMBASSY SUITES - MIAMI AIRPORT	GDO	415	3974 S RIVER DR	3,725
271	CHIPOTLE MEXICAN GRILL OF COLORADO, LLC DBA CHIPOTLE #1290	GDO	417	405 W 49 ST	874
272	ALIGNED BAYSHORE RAW BAR, LLC DBA MONTY'S RAW BAR	GDO	421	2550 S BAYSHORE DR	2,000
273	AVIMARKABE CORP. DBA FUEGO BY MANA	GDO	422	3585 NE 207 ST #C-3	688
274	CIC INVESTORS #13, LTD DBA FLANIGAN'S SEAFOOD BAR & GRILL	GDO	423	11415 S DIXIE HWY	4,500
275	WINN DIXIE STORES, INC. DBA WINN DIXIE STORE #285	GDO	426	5850 SW 73 ST	0
276	90 MILLAS RESTAURANT & CAFE CORP.	GDO	427	5904 W 20 AVE	575
277	PUBLIX SUPERMARKETS, INC. DBA PUBLIX STORE #1429	GDO	428	9420 SW 56 ST	0
278	WINN DIXIE STORES, INC. DBA FRESCO Y MAS #243	GDO	429	541 W 49 ST	0
279	BODY CAFE I, INC. DBA NRGIZE LIFESTYLE CAFE	GDO	432	630 W 49 ST	113
280	MCDONALD'S CORPORATION DBA MCDONALD'S #6917	GDO	433	1101 W 49 ST	1,036
281	WINN DIXIE STORES, INC. DBA WINN DIXIE STORE #283	GDO	434	8855 SW 24 ST	0
282	CHINA BISTRO	GDO	436	3565 NE 207 ST A5	5,075
283	ARGO MANAGEMENT, INC. DBA MCDONALD'S #11487	GDO	437	2300 SW 87 AVE	1,400
284	FAMILY HERNANDEZ COLON #3 CORP.	GDO	438	324 SW 12 AVE	500
285	BURGER KING CORPORATION DBA BURGER KING #0074	GDO	440	2275 SW 87 AVE	1,260
286	RTM OPERATING COMPANY DBA ARBY'S #167	GDO	441	6760 SW 8 ST	1,120
287	DELPA, INC. DBA BURGER KING #0080	GDO	442	6800 SW 8 ST	700
288	KONING RESTAURANTS INTERNATIONAL, LC DBA PIZZA HUT #12344	GDO	443	7333 SW 152 AVE	2,400
289	FRITANGA MINI MARKET TREJOS, INC.	GDO	444	21 SW 8 AVE	225
290	LA CEIBA RESTAURANT BAR & GRILL, LLC	GDO	446	815 W FLAGLER ST	625
291	LOS PAISANOS RESTAURANT	GDO	447	824 W FLAGLER ST	1,900
292	LOS CATRACHOS RESTAURANT, INC.	GDO	454	755 W FLAGLER ST	750
293	LA LIBERTAD MARKET CAFETERIA, INC.	GDO	456	701 W FLAGLER ST	0
294	GOLDFINGER'S SOUTH, INC. DBA SHOWGIRLS INC.	GDO	458	19995 S DIXIE HWY	3,750
295	WINN DIXIE STORES, INC. DBA WINN DIXIE STORE #286	GDO	459	948 SW 67 AVE	0
296	WINN DIXIE STORES, INC. DBA WINN DIXIE STORE #384	GDO	460	12107 SW 152 ST	1
297	WINN DIXIE STORES, INC. DBA WINN DIXIE STORE #237	GDO	461	12254 SW 8 ST	0
298	ARGO MANAGEMENT, INC. DBA MCDONALD'S #01098	GDO	463	7281 SW 8 ST	1,036
299	GOMEZ MOYA, INC. DBA WAJIRO'S RESTAURANT	GDO	464	12670 SW 8 ST	2,150
300	PUBLIX SUPERMARKETS, INC. DBA PUBLIX STORE #0084	GDO	465	2551 S LE JEUNE RD	0
301	EL MANISERO COMPANY DBA EL REINO DE LAS FRUTAS	GDO	466	10110 W FLAGLER ST	150
302	AMERRISQUE, INC. DBA LA FRITANGA AMERRISQUE	GDO	467	10404 W FLAGLER ST #9	225
303	BURGER KING CORPORATION DBA BURGER KING #0007	GDO	468	3051 SW 22 ST	885
304	THE ORIGINAL FRITAS DOMINO, INC.	GDO	469	936 SW 67 AVE	750
305	NEW LATIN AMERICAN FOOD & BAKERY #2, INC.	GDO	473	1143 NW 22 AVE	415
306	POLARIS CAFETERIA CORPORATION	GDO	474	1153 NW 22 AVE	265
307	WINN DIXIE STORES, INC. DBA WINN DIXIE STORE #370	GDO	475	8710 SW 72 ST	0
308	MR. ZB CORPORATION DBA EL MOCHO SUPERMARKET	GDO	476	1139 NW 22 AVE	1,250
309	WINN-DIXIE STORES, INC. DBA WINN-DIXIE STORE #361	GDO	477	15050 SW 72 ST	3
310	VICTORIA BRUZON'S BAKERY, INC. DBA MAYRA BAKERY	GDO	478	11300 NW 87 CT #133	300
311	WINN DIXIE STORES, INC. DBA WINN DIXIE STORE #359	GDO	479	7480 SW 117 AVE	3
312	STIR MOON SUSHI & NOODLE & STIR, INC.	GDO	481	1100 S DIXIE HWY	1,850
313	MCDONALD'S RESTAURANT OF FL, INC. DBA MCDONALD'S #6266	GDO	482	6150 S DIXIE HWY	2,086
314	NEW ERA COMMUNITY HEALTH CENTER, LLC	GDO	483	1351 N KROME AVE	750
315	WINN DIXIE STORES, INC. DBA WINN DIXIE STORE #249	GDO	484	6770 SW 40 ST	1
316	UMCG - HECHT DINNING HALL	GDO	485	1239 DICKINSON DR	79,140
317	BRYAN CAFETERIA RESTAURANT CORP.	GDO	486	450 E 4 AVE	850
318	KARY & KELLY, INC. DBA CARY'S CAFFE	GDO	489	11865 SW 26 ST J-10	775
319	CARNE ASADA TORTILLERIA NICA, INC.	GDO	491	10404 W FLAGLER ST BAY 5	0
320	PANDEBANO 2000 CORP. CIEN ANOS DE PANDEBANO BAKERY	GDO	492	10748 SW 72 ST	1
321	HAVANA SUNSET RESTAURANT CORP.	GDO	494	10734 SW 72 ST	800
322	WINN DIXIE STORES, INC. DBA WINN DIXIE STORE #287	GDO	497	14655 SW 104 ST	0
323	NICARAGUITA'S TORTILLAS & FRITANGA CORP.	GDO	498	10310 W FLAGLER ST	1
324	MENENDEZ MANAGEMENT CORP. DBA MCDONALD'S #13051	GDO	499	9501 NW 41 ST	1,092
325	BURGER KING CORPORATION DBA BURGER KING #0094	GDO	500	10710 SW 72 ST	2,086
326	EL FOGON VENEZOLANO, LLC	GDO	501	10404 W FLAGLER ST #19	188
327	BOSTON MARKET CORPORATION DBA BOSTON MARKET #636	GDO	502	8070 NW 36 ST	952
328	JENELLE'S KITCHEN CORP.	GDO	504	715 E 9 ST	450
329	PUNTA SAL CORP. DBA LAS TOTORITAS RESTAURANT	GDO	508	7367 NW 36 ST	2,150
330	TARGET CORPORATION DBA TARGET STORE #0746	GDO	509	15135 SW 88 ST	560
331	BOSTON MARKET CORPORATION DBA BOSTON MARKET #0190	GDO	510	18601 S DIXIE HWY	896
332	SAILORMEN, INC. DBA POPEYE'S CHICKEN #167	GDO	511	18403 S DIXIE HWY	560
333	L.C.L. FOOD SERVICES, INC. DBA MCDONALD'S #10946	GDO	512	15295 SW 104 ST	1,400
334	EL BUEN PAN	GDO	513	10354 W FLAGLER ST	225
335	LA ESQUINITA HABANERA RESTAURANT, INC.	GDO	518	200 SW 107 AVE	406
336	GIVAM, INC. DBA LATIN CAFETERIA RESTAURANT	GDO	519	10720 W FLAGLER ST # 1	2,050
337	L.C.L. FOOD SERVICES, INC. DBA MCDONALD'S #11810	GDO	520	13708 SW 152 ST	1,190
338	CASAVANA CORAL REEF, INC. DBA CASAVANA CUBAN CUISINE	GDO	521	13600 SW 152 ST	2,300
339	RTM OPERATING COMPANY DBA ARBY'S #39	GDO	522	11500 SW 72 ST	755
340	ANDMOR CULINARY CONCEPTS, LLC DBA ISLE CARIBE RESTAURANT	GDO	523	11227 SW 152 ST	425
341	SAILORMEN, INC. DBA POPEYE'S CHICKEN #0004	GDO	524	11205 SW 152 ST	266
342	MCDONALD'S RESTAURANTS OF FL., INC. DBA MCDONALD'S #7097	GDO	525	11207 SW 152 ST	2,086
343	PACK SUPERMARKET & CAFETERIA, INC.	GDO	526	8235 NE 2 AVE	0
344	RINCONCITO CUBANO OF KENDALL, INC.	GDO	528	12061 SW 117 AVE	300
345	BURGER KING CORPORATION DBA BURGER KING #4867	GDO	529	8770 MILLS DR	1,386
346	RONY SUPERMARKET CORP. DBA EL CRIOLLO SUPERMARKET	GDO	530	1651 W FLAGLER ST	2
347	MCDONALD'S CORPORATION DBA MCDONALD'S #4179	GDO	531	11575 SW 186 ST	771
348	BURGER KING CORPORATION DBA BURGER KING #6896	GDO	532	11200 SW 137 AVE	1,092
349	KONING RESTAURANTS INTERNATIONAL, LC DBA PIZZA HUT #12386	GDO	533	1604 ALTON RD	0
350	RAMALCO CORPORATION DBA BURGER KING #5329	GDO	534	11400 SW 186 ST	1,120
351	GABY'S CAFE	GDO	536	1351 SW 1 ST	300
352	PUBLIX SUPERMARKETS, INC. DBA PUBLIX STORE #0261	GDO	537	8250 MILLS DR	10,176

No.	FACILITY_NAME	PERMIT	PERMIT_NUMBER	ADDRESS	TOTAL_GPD
353	BURGER KING CORPORATION DBA BURGER KING #4152	GDO	538	8050 NW 36 ST	2,058
354	HAVANA RICKS CAFE RESTAURANT, INC.	GDO	539	1311 SW 107 AVE	412
355	AIRPORT REGENCY MANAGEMENT, INC.	GDO	541	1000 NW 42 AVE	3,750
356	THE TWO PIZZA MEN CORP. DBA STEVE'S PIZZA SOUTH	GDO	542	18063 S DIXIE HWY	686
357	LOPEZ RESTAURANTS, INC. DBA MCDONALD'S #1856	GDO	543	18295 S DIXIE HWY	1,465
358	WENDY'S INTERNATIONAL, INC. DBA WENDY'S #9322	GDO	545	3600 S DIXIE HWY	980
359	BREAD PARTNERS 16, INC. DBA AU BON PAIN	GDO	549	8950 SW 88 ST	910
360	DORAL BOULEVARD HOTEL, LLC DBA COMFORT INN & SUITES MIAMI	GDO	550	5301 NW 36 ST	688
361	TUNG LE, INC. DBA CHINA GATE CHINESE RESTAURANT	GDO	551	13649 S DIXIE HWY	3,725
362	BURGER KING CORPORATION DBA BURGER KING #0008	GDO	552	18240 S DIXIE HWY	1,036
363	PRIMOS ENTERPRISES MX, LLC DBA MIAMI SUBS GRILL	GDO	553	18660 S DIXIE HWY	784
364	DRAGON MA, INC. DBA DRAGON 1	GDO	554	10162 W FLAGLER ST	300
365	CHECKERS DRIVE-IN RESTAURANTS, INC. DBA CHECKERS #C-354	GDO	555	1650 BISCAYNE BLVD	560
366	BURGER KING CORPORATION DBA BURGER KING #0033	GDO	556	1700 BISCAYNE BLVD	2,086
367	ARGO MANAGEMENT, INC. DBA MCDONALD'S #16794	GDO	557	1021 E 10 AVE	868
368	E.C. MANAGEMENT CORP. DBA MCDONALD'S #7166	GDO	559	3501 BISCAYNE BLVD	1,059
369	THE CHILEAN CORNER CORP.	GDO	560	17331 S DIXIE HWY	323
370	POLLO OPERATIONS, INC. DBA POLLO TROPICAL #59	GDO	561	10705 W FLAGLER ST	793
371	ASIAN MAMA, INC. DBA HONG KONG RESTAURANT	GDO	562	10720 W FLAGLER ST #15	750
372	LA PULPERIA CORP.	GDO	563	10780 W FLAGLER ST #21	0
373	LATIN BAKERY, INC. DBA ALL BAKERY	GDO	564	360 SW 109 AVE	500
374	RAMALCO CORPORATION DBA BURGER KING #8296	GDO	565	11650 SW 152 ST	1,120
375	ARREDONDO INVESTMENTS, INC. DBA ANKAR PASTRY SHOP RESTAURANT	GDO	566	9710 SW 88 ST	0
376	MADRONO RESTAURANT CORPORATION	GDO	567	10780 W FLAGLER ST #1617	1,000
377	COKIL, INC. DBA PLAYWRIGHT PUB AND RESTAURANT	GDO	568	1265 WASHINGTON AVE	5,050
378	LA MOCANA SUPERMARKET, INC.	GDO	569	2602 PALM AVE	8
379	MIAMI SLICE, LLC	GDO	570	3201 NW 7 AVE	525
380	BURGER KING CORPORATION DBA BURGER KING #0063	GDO	571	3700 CURTISS PKY	2,086
381	J.C. CHINESE RESTAURANT, INC.	GDO	574	14802 SW 88 ST	1,150
382	BURGER KING CORPORATION DBA BURGER KING #0030	GDO	575	5401 NW 7 AVE	954
383	W.Z. ENTERPRISES, INC. DBA MEKONG CHINESE RESTAURANT	GDO	576	18073 S DIXIE HWY	750
384	ESTHER CATERING SERVICES, INC.	GDO	577	4546 NW 7 AVE	5
385	CAJUN OPERATING COMPANY DBA CHURCH'S CHICKEN #0343	GDO	578	2899 NW 7 AVE	0
386	LOS COMALES, INC. DBA LOS COMALES CARNE ASADA	GDO	579	340 SW 109 AVE	0
387	MENENDEZ MANAGEMENT CORP. DBA MCDONALD'S #7409	GDO	580	5700 NW 79 AVE	1,610
388	MCDONALD'S CORPORATION DBA MCDONALD'S #4534	GDO	581	6700 SW 40 ST	1,638
389	KFC CORPORATION DBA KFC #X975049	GDO	582	15402 NW 77 CT	34,020
390	PUEBLITO VIEJO #2, INC.	GDO	584	8285 SW 40 ST	2,800
391	LITTLE CAESAR'S ENTERPRISES, INC. DBA LITTLE CAESAR'S PIZZA #2223	GDO	587	20517 OLD CUTLER RD	0
392	BURGER KING CORPORATION DBA BURGER KING #6872	GDO	588	20505 OLD CUTLER RD	1,036
393	DOVA CORPORATION DBA LA PALMA RESTAURANT	GDO	589	6091 SW 8 ST	750
394	SIAM PALACE SHIVA, INC.	GDO	590	9999 SW 72 ST	575
395	SAILORMEN, INC. DBA POPEYE'S CHICKEN #02	GDO	593	2490 NW 79 ST	420
396	KIDS DELI, INC.	GDO	595	4854 SW 75 AVE	430
397	CAJUN OPERATING COMPANY DBA CHURCH'S CHICKEN #1542	GDO	598	21595 S DIXIE HWY	420
398	BISTRO FUSION RESTAURANT, INC.	GDO	599	27077 S DIXIE HWY	3,725
399	L.C.L. FOOD SERVICES, INC. DBA MCDONALD'S #3383	GDO	601	9681 SW 72 ST	2,086
400	BOSTON MARKET CORPORATION DBA BOSTON MARKET #489	GDO	602	16709 NW 67 AVE	1,008
401	DRUNKEN DRAGON, LLC	GDO	606	1424 ALTON RD FAC. A	710
402	WINN DIXIE STORES, INC. DBA WINN DIXIE STORE #371	GDO	607	19167 S DIXIE HWY	0
403	LE JEUNE LATIN CAFE, INC. DBA LATIN CAFE 2000	GDO	608	875 NW 42 AVE	665
404	ALBEEANN CORP. DBA MCDONALD'S #7205	GDO	609	599 NW 62 ST	1,080
405	CC AVENTURA, INC. DBA CLASSIC RESIDENCE BY HYATT @ AVENTURA	GDO	610	19333 W COUNTRY CLUB DR	2,125
406	LEMON PEPPERS, INC.	GDO	611	2701 NW 54 ST	0
407	DOMINO'S PIZZA, LLC DBA DOMINO'S PIZZA #8631	GDO	614	13623 S DIXIE HWY #144	332
408	JOY WALLACE CATERING PRODUCTION	GDO	615	8501 SW 129 TER	1
409	WINN DIXIE STORES, INC. DBA WINN DIXIE STORE #291	GDO	616	20417 BISCAYNE BLVD	0
410	WINN DIXIE STORES, INC. DBA WINN DIXIE STORE #357	GDO	618	980 IVES DAIRY RD	0
411	CAJUN OPERATING COMPANY DBA CHURCH'S CHICKEN #0411	GDO	621	1155 NW 54 ST	140
412	BURGER KING CORPORATION DBA BURGER KING #0036	GDO	622	730 NW 36 ST	0
413	CHAN AND SO CORPORATION DBA GOLD CHINA RESTAURANT	GDO	623	15055 S DIXIE HWY	2,500
414	KONING RESTAURANTS INTERNATIONAL, LC DBA PIZZA HUT #12408	GDO	624	15065 S DIXIE HWY	0
415	BENSON INNOVATIONS, INC. DBA CHOPSTICKS HOUSE RESTAURANT	GDO	625	20553 OLD CUTLER RD	350
416	DOMINO'S PIZZA LLC DBA DOMINO'S PIZZA #3889	GDO	626	1426 ALTON RD	0
417	TWO GUYS RESTAURANT, INC.	GDO	627	1490 NW 3 AVE #108	320
418	LA SALLE HIGH SCHOOL CAFETERIA	GDO	628	3601 S MIAMI AVE	600
419	THE PALACE RENAISSANCE & ROYALE DBA PALACE AT KENDALL (ACLF)	GDO	629	11355 SW 84 ST	0
420	WINN DIXIE STORES, INC. DBA WINN DIXIE STORE #385	GDO	630	27359 S DIXIE HWY	0
421	EINSTEIN AND NOAH CORP. DBA EINSTEIN BROS. BAGELS #0780	GDO	632	1500 ALTON RD	1,050
422	VIA EMILIA 9, LLC	GDO	633	1120 15 ST	174
423	BLUE WATER INVESTMENT CORP. DBA SPRING CHICKEN	GDO	634	1439 ALTON RD C	728
424	BELLA NAPOLI, INC.	GDO	635	1443 ALTON RD	750
425	WINN DIXIE STORES, INC. DBA WINN DIXIE STORE #387	GDO	639	18801 SW 117 AVE	0
426	DOG HOUSE FAST FOOD CORP.	GDO	640	7672 NW 186 ST	2
427	LAKAY INC. OF MIAMI DBA LAKAY TROPICAL ICE CREAM & BAKERY	GDO	641	91 NE 54 ST	800
428	PUBLIX SUPERMARKETS, INC. DBA PUBLIX STORE #0478	GDO	643	20711 S DIXIE HWY	0
429	YELLOWTAIL SUBS & GRILL, INC.	GDO	644	27275 S DIXIE HWY	200
430	WILEO, INC. DBA BURGER KING #0026	GDO	646	4727 NW 167 ST	896
431	L.C.L. FOOD SERVICES, INC. DBA MCDONALD'S #4664	GDO	649	13101 SW 88 ST	2,086
432	REY'S PIZZA CORPORATION DBA REY PIZZA #5	GDO	650	296 SW 107 AVE	6
433	MSB RESTAURANT CORP. DBA MISS SAIGON BISTRO	GDO	651	9503 S DIXIE HWY	2,750
434	MEJSTE ENTERPRISES, LLC DBA MIYAKO JAPANESE RESTAURANT	GDO	652	9533 S DIXIE HWY	1,625
435	CHEF CHUNG INCORPORATED DBA HAPPY HOUSE	GDO	653	28708 S DIXIE HWY	1,000
436	PIZZERIAS, LLC DBA PAPA JOHN'S PIZZA #673	GDO	654	829 N HOMESTEAD BLVD	0
437	FLANIGAN'S KENDALL	GDO	655	12790 SW 88 ST	4,025
438	CATERING LA SEGURA, INC. DBA CAFETERIA LA SAGUERA	GDO	656	3001 W 12 AVE #6	150
439	BURGER KING CORPORATION DBA BURGER KING #2328	GDO	657	2801 SW 27 AVE	2,086
440	LITTLE CAESAR'S ENTERPRISES, INC. DBA LITTLE CAESAR'S PIZZA #2231	GDO	658	4100 SW 67 AVE	0

No.	FACILITY_NAME	PERMIT	PERMIT_NUMBER	ADDRESS	TOTAL_GPD
441	KONING RESTAURANTS INTERNATIONAL, LC DBA PIZZA HUT #12402	GDO	659	9672 SW 72 ST	0
442	DENNY'S, INC. DBA DENNY'S #0219	GDO	660	3600 BISCAYNE BLVD	3,725
443	PALM SPRINGS KENTUCKY FRIED CHICKEN	GDO	661	811 W 49 ST	700
444	HUA HAI, INC. DBA CHINA GARDEN CHINESE RESTAURANT	GDO	662	27100 S DIXIE HWY	1,250
445	SW 120-88, INC. DBA SUBWAY #18415	GDO	664	12046 SW 88 ST	168
446	J & D MANAGEMENT CORP. DBA KFC #G984002	GDO	665	6725 W 28 AVE	756
447	SAILORMEN, INC. DBA POPEYE'S CHICKEN #0005	GDO	666	130 NE 8 ST	1,400
448	CUBAVANA CAFE, LLC	GDO	668	20445 OLD CUTLER RD	441
449	YABORUB CORP. DBA LA NUEVA VICTORIA BAKERY	GDO	669	2750 W 68 ST #117	1
450	KONING RESTAURANTS INTERNATIONAL, LC DBA PIZZA HUT #12389	GDO	671	2750 W 68 ST	0
451	ABANTO FOOD CORP. DBA EL CHALAN RESTAURANT	GDO	672	7971 SW 40 ST #17-19	1,550
452	ZALAMERIA CORP. DBA ZALAMERIA	GDO	674	7950 SW 8 ST	419
453	TREBOL PIZZERIA 12 Y 29	GDO	675	1167 W 29 ST	200
454	WINN DIXIE STORES, INC. DBA WINN DIXIE STORE #366	GDO	678	3701 NW 7 ST	0
455	BURGER KING CORPORATION DBA BURGER KING #3029	GDO	679	701 NW 37 AVE	1,036
456	TU PAN BAKERY CAFETERIA	GDO	680	1199 W 29 ST	0
457	MENENDEZ MANAGEMENT CORP. DBA MCDONALD'S #5859	GDO	682	13702 SW 56 ST	2,086
458	WINGS OF HIALEAH, INC. DBA HOOTERS @ HIALEAH	GDO	683	680 W 49 ST	1,132
459	WINN DIXIE STORES, INC. DBA WINN DIXIE STORE #270	GDO	686	2750 W 68 ST	0
460	HIALEAH LATIN AMERICAN, INC.	GDO	687	675 E 9 ST	1,300
461	ORWALL ENTERPRISES, INC. DBA BURGER KING #0010	GDO	690	775 E 9 ST	1,204
462	EL ESCORIAL RESTAURANT CORP. DBA KAMPAI JAPANESE RESTAURANT	GDO	691	8735 SUNSET DR	1,850
463	RU YI CHINESE CAFE, INC. DBA CAFE RU YI	GDO	692	5300 NW 7 AVE	225
464	CORAL CAY RESTAURANTS, LLC DBA BURGER KING #1903	GDO	693	40 SE 1 AVE	719
465	PUBLIX SUPERMARKETS, INC. DBA PUBLIX STORE #0260	GDO	694	18485 S DIXIE HWY	8
466	SUNSHINE REST. MERGER SUB, LLC DBA IHOP #36-078	GDO	695	7376 SW 40 ST	750
467	BANGKOK CITY THAI & SEAFOOD REST.	GDO	697	7378-80 SW 40 ST	1,850
468	MITHA INVESTMENT COMPANY DBA SWENSEN'S OF SOUTH MIAMI	GDO	698	1586 S DIXIE HWY	1,950
469	PIZZERIAS, LLC DBA PAPA JOHN'S PIZZA #888	GDO	700	1100 15 ST	225
470	HAUTE CUISINE, INC. DBA PASCAL'S ON PONCE	GDO	701	2611 PONCE DE LEON BLVD	1,850
471	PUBLIX SUPERMARKETS, INC. DBA PUBLIX STORE #0031	GDO	702	9755 NW 41 ST	0
472	L.C.L FOOD SERVICES, INC. DBA MCDONALD'S #7230	GDO	703	11500 SW 88 ST	980
473	WINN DIXIE STORES, INC. DBA WINN DIXIE STORE #319	GDO	704	30346 OLD DIXIE HWY	0
474	MONUMENT RESTAURANTS VI CG, LLC DBA FIVE GUYS BURGERS & FRIES	GDO	705	1540 S DIXIE HWY	653
475	BURGER KING CORPORATION DBA BURGER KING #7299	GDO	706	16025 S DIXIE HWY	1,064
476	DELICIAS DE ESPANA 2, INC.	GDO	707	7384 SW 40 ST	520
477	KONING RESTAURANTS INTERNATIONAL, LC DBA PIZZA HUT #12401	GDO	709	6625 S DIXIE HWY	294
478	JJS INVESTMENTS, INC. DBA SHIVER'S BAR-B-Q	GDO	711	28001 S DIXIE HWY	1,975
479	WINN DIXIE STORES, INC. DBA WINN DIXIE STORE #239	GDO	713	14555 SW 42 ST	0
480	MIAMI VA HEALTHCARE SYSTEM	GDO	714	1201 NW 16 ST	11,000
481	PUBLIX SUPERMARKETS, INC. DBA PUBLIX STORE #0069	GDO	715	13820 SW 88 ST	0
482	BURGER KING CORPORATION DBA BURGER KING #7702	GDO	716	4032 SW 137 AVE	630
483	PHOENIX OF MIAMI LAKES, LLC	GDO	717	16700 NW 67 AVE	725
484	CANTON RESTAURANT #6 CHINESE RESTAURANT OF MIAMI LAKES	GDO	718	16780 NW 67 AVE	5,000
485	MCDONALD'S #7495	GDO	719	10530 W FLAGLER ST	2,086
486	MCDONALD'S #6921	GDO	720	16701 NW 67 AVE	2,086
487	BURGER KING CORPORATION DBA BURGER KING #0041	GDO	721	1309 NW 20 ST	375
488	BURGER KING CORPORATION DBA BURGER KING #13152	GDO	722	13704 SW 56 ST	1,036
489	LA BODEGUITA DE HIALEAH, INC.	GDO	723	1044 W 23 ST	213
490	RTM OPERATING COMPANY DBA ARBY'S #71	GDO	724	3333 W OKEECHOBEE RD	826
491	AMPY ENTERPRISES, INC. DBA MCDONALD'S #11716	GDO	727	3350 W 18 AVE	1,050
492	SAM'S COUNTRY KITCHEN, INC.	GDO	730	1320 N KROME AVE	575
493	SIMON AND TONY, INC. DBA CHINA MEI CHINESE RESTAURANT	GDO	731	17852 S DIXIE HWY	200
494	SUPERIOR CAKE, INC. DBA GRAN PARIS BAKERY	GDO	732	3026 NW 7 ST	8
495	TORINO ITALIAN RESTAURANT, INC. DBA IL BAMBINO RISTORANTE	GDO	734	7921 SW 40 ST #51	2,125
496	SUBRAGEOUS CUTLER BAY, INC.	GDO	735	18683 S DIXIE HWY	675
497	ARCOUB, INC. DBA PIZZAFIORE RESTAURANT	GDO	736	703 71 ST	0
498	HO'S BROTHERS, LLC DBA GRAND CHINA RESTAURANT	GDO	737	18643 S DIXIE HWY	900
499	PHILLY STEAK SUB SHOP III, INC.	GDO	738	8351 NW 12 ST	5
500	MCDONALD'S #4458	GDO	739	3747 NW 7 ST	1,330
501	KONING RESTAURANTS INTERNATIONAL, LC DBA PIZZA HUT #12345	GDO	741	25 N HOMESTEAD BLVD	3,725
502	FQSR, LLC DBA KBP FOODS	GDO	742	232 SE 1 AVE	575
503	STARBUCKS COFFEE COMPANY, INC. DBA STARBUCKS #13939	GDO	743	76 E PALM DR	644
504	LUCHETTI BAKERY CORP. DBA PAN PA'KA	GDO	744	7971 SW 40 ST #16	250
505	TACO RICO RESTAURANTS OF BIRD ROAD, INC. DBA TACO RICO	GDO	745	7921 SW 40 ST #46-48	350
506	HRV FOOD CORP. DBA SABOR TROPICAL SUPERMARKET # 6	GDO	746	1410 N KROME AVE	0
507	AM SERVICES ASSOCIATION CORP. DBA MONTES DE OCA PIZZERIA	GDO	747	2865 NW 7 ST	575
508	BEACH HOTEL ASSOCIATES, LLC DBA BIANCA	GDO	749	1685 COLLINS AVE	2,544
509	PUBLIX SUPERMARKETS, INC. DBA PUBLIX STORE #0328	GDO	750	20425 OLD CUTLER RD	0
510	TU COCINITA CATERING, INC.	GDO	752	2750 W 68 ST #105	250
511	INCA GROUP, LLC DBA MACHU PICCHU RESTAURANT	GDO	753	10855 SW 72 ST #27	330
512	MAEWOOD FOOD, INC. MCDONALD'S #6589	GDO	756	2200 NW 36 ST	616
513	PUBLIX SUPERMARKETS, INC. DBA PUBLIX STORE #0127	GDO	758	2270 SW 27 AVE	0
514	RRF, LLC DBA DENNY'S #7462	GDO	762	9545 W FLAGLER ST	3,725
515	BLESSED TRINITY CHURCH	GDO	763	4020 CURTISS PKY	75
516	WENDY'S INTERNATIONAL, INC. DBA WENDY'S #9390	GDO	764	9655 W FLAGLER ST	625
517	MAX 17 CORPORATION #3 DBA EXXON	GDO	765	27975 S DIXIE HWY	500
518	BURGER KING CORPORATION DBA BURGER KING #0071	GDO	766	395 ALCAZAR AVE	2,086
519	A.F.S.K., INC. DBA PIZZA KITCHEN	GDO	769	9951 SW 142 AVE	228
520	CARNICERIA LOS PAISAS & DELI MARKET CORP.	GDO	771	9945 SW 142 AVE	280
521	RINCONCITO LATINO CAFETERIA, INC.	GDO	772	9979 SW 142 AVE	700
522	TAIPAN SERVICES CORP. DBA EL RINCONCITO DEL GORDO	GDO	773	14657 SW 42 ST	350
523	KONING RESTAURANTS INTERNATIONAL, LC DBA PIZZA HUT #12409	GDO	774	19151 S DIXIE HWY #107	0
524	MEGA BAKERY, INC.	GDO	775	19615 NW 57 AVE	235
525	MENENDEZ MANAGEMENT CORP. DBA MCDONALD'S #6961	GDO	776	7901 SW 40 ST	1,470
526	TARGET CORPORATION DBA TARGET STORE #1039	GDO	777	8458 S DIXIE HWY	448
527	LA GRAN SENORA SEAFOOD RESTAURANT, INC.	GDO	778	29363 SW 152 AVE	625
528	COLONEL HARRY ZUBKOFF COMMUNITY CENTER	GDO	779	55 NW 199 ST	2,000

No.	FACILITY_NAME	PERMIT	PERMIT_NUMBER	ADDRESS	TOTAL_GPD
529	LA HERRADURA RESTAURANT CORP. DBA LA HORMIGA DE ORO	GDO	780	18530 NW 67 AVE	1,250
530	NK FOOD & GAS, INC. DBA REDLAND CHEVRON	GDO	781	1360 W MOWRY DR	200
531	SUBWAY #18656, INC. DBA SUBWAY #18656	GDO	782	16850 COLLINS AVE #110	252
532	PIZZERIAS, LLC DBA PAPA JOHN'S PIZZA #1136	GDO	783	16850 COLLINS AVE #103	0
533	MEXICO BRAVO	GDO	784	16850 COLLINS AVE #104	2,200
534	DELICIAS COLOMBIANAS BAKERY, INC.	GDO	785	16850 COLLINS AVE #102	300
535	RUSACO 27, INC. DBA DON PAN UNITY	GDO	786	590 NW 27 AVE	0
536	MORRO CASTLE CORPORATION	GDO	787	2500 NW 7 ST	350
537	EL ATLAKAT RESTAURANT CORP.	GDO	789	2273 NW 7 ST	625
538	BOUZA-DIAZ, INC.	GDO	790	2339 NW 7 ST	208
539	ROY'S SUPER MARKET OF MIAMI, INC.	GDO	792	2349 NW 7 ST	500
540	CMTG, INC. DBA MCDONALD'S #4598	GDO	794	425 SE 1 AVE	1,442
541	FQSR, LLC DBA KFC #5297	GDO	795	16215 NE 15 AVE	699
542	ALLAN J. BENNETT CORPORATION DBA MUTINEER RESTAURANT	GDO	796	11 SE 1 AVE	4,875
543	LA CARRETA ENTERPRISES, INC. DBA LA CARRETA RESTAURANT	GDO	798	10633 NW 12 ST	3,750
544	HIALEAH CML, LLC DBA DUNKIN DONUTS	GDO	799	1022 E 27 ST	1,016
545	WINN DIXIE STORES, INC. DBA WINN DIXIE STORE #318	GDO	800	604 CRANDON BLVD 22	0
546	LITTLE CAESAR'S ENTERPRISES, INC. DBA LITTLE CAESAR'S PIZZA #2267	GDO	802	17223 NW 27 AVE	0
547	CHOICES KITCHEN, INC.	GDO	803	711 NW 27 AVE	446
548	CAJUN OPERATING COMPANY DBA CHURCH'S CHICKEN #1109	GDO	804	17495 NW 27 AVE	280
549	CARIBE RESTAURANT OF 27 AVE, INC. DBA ISLAS CANARIAS RESTAURANT	GDO	805	285 NW 27 AVE	500
550	EL SEGUNDO BAKERY, INC.	GDO	808	5001 E 4 AVE	0
551	ROBLAJ BAKERY CORP.	GDO	811	2328 NW 7 ST	0
552	MENENDEZ MANAGEMENT CORP. DBA MCDONALD'S #10424	GDO	812	8403 NW 12 ST	1,512
553	CHEVY'S FRESH MEX	GDO	813	8191 NW 12 ST	7,375
554	ENCANTADA RESTAURANT, INC.	GDO	815	1901 W FLAGLER ST #6	141
555	VICKY BAKERY III, INC.	GDO	817	445 E 49 ST	0
556	COVEN FINANCIAL CORP. DBA JERRY & JOE'S PIZZA	GDO	818	9873 SW 184 ST	2
557	CARNITAS DE NICARAGUA, FRITANGA, TORTILLERIA	GDO	819	1885 W FLAGLER ST	300
558	STVN MANAGEMENT CORP. DBA EL CRISTO RESTAURANT	GDO	820	1543 SW 8 ST	1,350
559	KENDALL 162 AVENUE CORPORATION DBA SEDANO'S SUPERMARKET #29	GDO	821	16255 SW 88 ST	0
560	DAVE & BUSTER'S, INC. DBA DAVE & BUSTER'S	GDO	823	11401 NW 12 ST E-622	10,900
561	CHECKERS DRIVE-IN RESTAURANTS, INC. DBA CHECKERS #C-269	GDO	824	236 NE 8 ST	0
562	SUANCES ENTERPRISES, INC. DBA SEDANO'S SUPERMARKET #22	GDO	828	5360 W 16 AVE	0
563	ICE CREAM, LLC DBA PARAISO TROPICAL PIZZERIA RESTAURANT	GDO	829	5370 W 16 AVE	1,700
564	DAVID'S FAST FOOD, INC. DBA LA CAMPANA PIZZERIA & ITALIAN FOOD	GDO	832	5395 W 20 AVE	213
565	YOYITO CAFE RESTAURANT OF MIAMI CORP.	GDO	833	8190 SW 8 ST #101-102	840
566	CHOCOLATE FASHION, INC.	GDO	834	248 ANDALUSIA AVE	488
567	BELLA VISTA BAKERY, INC.	GDO	836	2220 NW 82 AVE	5
568	CARRILLO BROTHER CORP. DBA MARCELO'S RESTAURANT PESCADERIA	GDO	837	2273 NW 28 ST	800
569	SABORES DE MI CUBA CAFE, INC. DBA VILLA DE SABORES	GDO	839	5241 NW 79 AVE	375
570	LA CUCINA MANAGEMENT, INC. DBA PERRICONE'S MARKETPLACE	GDO	843	15 SE 10 ST	6,250
571	EL CENTRO AMERICANO II CORP.	GDO	844	155 SW 107 AVE	5,000
572	AN FOOD MARKET, INC. DBA JERUSALEM DELI	GDO	848	16275 BISCAYNE BLVD	1
573	CROSS ROADS INDUSTRIES, LLC	GDO	849	12807 SW 42 ST	428
574	WEN-SOUTH HOLDINGS, INC. DBA WENDY'S OLD FASHIONED HAMBURGERS	GDO	850	13530 SW 152 ST	980
575	OCEAN HOTELS INVESTMENTS CORP. DBA LESLIE HOTEL	GDO	853	1244 OCEAN DR	423
576	WALLACE CORPORATION DBA RICHMOND HOTEL CAFE	GDO	854	1757 COLLINS AVE	800
577	MCDONALD'S USA, LLC. DBA MCDONALD'S #6271	GDO	856	1020 W FLAGLER ST	1,013
578	RED LOBSTER HOSPITALITY, LLC DBA RED LOBSTER #6282	GDO	857	1695 NW 87 AVE	1,861
579	CLARIMOISES CORP. DBA CERRO NEGRO RESTAURANT	GDO	860	9613 W FLAGLER ST	2,725
580	CAFETERIA RAUL CORP.	GDO	862	1800 PALM AVE	750
581	PINA TONDO ENTERPRISE CORP. DBA PINA'S PIZZA	GDO	863	12041 SW 117 AVE	248
582	JAEA RESTAURANT HOLDINGS, LLC DBA WENDY'S #1910	GDO	864	2390 W 68 ST	769
583	GOLDEN RESTAURANT CORP. DBA MCDONALD'S #6477	GDO	865	4300 E 4 AVE	1,218
584	SHA SHA CUISINE, LLC	GDO	866	16614 N MIAMI AVE	188
585	RAY'S CAKES AND CATERING, LLC	GDO	867	16606 N MIAMI AVE	343
586	ACDALA, INC. DBA ESTRELLA CUBANA RESTAURANT	GDO	870	1284 PALM AVE	1,000
587	RESTAURANTE EL FAMILIAR CORP.	GDO	871	1003 W FLAGLER ST	1,000
588	COMBOS CAFE CORP.	GDO	872	1225 W FLAGLER ST	401
589	LA CAMARONERA	GDO	874	1952 W FLAGLER ST	375
590	TIC DISTRIBUTING, INC. DBA CAFE PILIPINAS	GDO	875	100 S BISCAYNE BLVD #109	131
591	POLLO OPERATIONS, INC. DBA POLLO TROPICAL #36	GDO	877	320 SE 1 ST	1,652
592	CHONG'S CHINESE RESTAURANT, INC.	GDO	879	1164 W FLAGLER ST	1,850
593	IL ITALIANO, LLC	GDO	880	1120 W FLAGLER ST	155
594	DESTINEE CAFFE, INC.	GDO	881	1440 W FLAGLER ST	250
595	PUBLIX SUPERMARKETS, INC. DBA PUBLIX STORE #1382	GDO	883	6876 COLLINS AVE	11,400
596	JACK CHEN, LLC DBA SUN SUN RESTAURANT	GDO	884	4661 NW 199 ST	0
597	WAYRICH, INC. DBA TASTEE PATTIES & PASTRIES	GDO	885	17847 NW 27 AVE	0
598	FATIN, INC. DBA FOURTH AVENUE SUPERMARKET	GDO	886	1992 E 4 AVE	0
599	MARLIN COFFEE SHOP, INC.	GDO	888	901 E 2 AVE	3
600	ATLANTIC HEALTH MEDICAL NETWORK, INC. DBA ESCAMBRAY	GDO	889	1300 PALM AVE	0
601	SANPOCHO RESTAURANT, INC.	GDO	892	901-925 SW 8 ST	2,119
602	HONG WEI, INC. DBA CHINA RESTAURANT	GDO	893	176 NE 167 ST	750
603	BURGER KING CORPORATION DBA BURGER KING #4239	GDO	894	1 SW 24 AVE	2,086
604	VITO'S BAKERY, INC.	GDO	895	3934 CURTISS PKY	3
605	SAILORMEN, INC. DBA POPEYE'S CHICKEN #0003	GDO	897	3285 NW 183 ST	560
606	CHIU EXPRESS, INC. DBA CANTON EXPRESS	GDO	899	5484 W 16 AVE	900
607	MACY'S-WESTLAND MALL DBA STARBUCKS COFFEE	GDO	901	1777 W 49 ST	208
608	TARDES CALENAS LATIN FOOD CORP.	GDO	902	9941 SW 142 AVE	449
609	CHECKERS DRIVE-IN RESTAURANTS, INC. DBA CHECKERS #C-258	GDO	903	829 E 49 ST	219
610	YUNIER'S CAFETERIA & LAUNDRY, INC.	GDO	905	2710 SW 1 ST	0
611	WEI FAMILY, INC. DBA CHOP SUEY INTERNATIONAL	GDO	906	90 SW 27 AVE	628
612	REYMANA CORP. DBA ANTIGUA GUATEMALA	GDO	907	2741 W FLAGLER ST	2,250
613	TAQUERIA EL CARNAL #3 CORP.	GDO	909	2601 W FLAGLER ST	275
614	PUBLIX SUPERMARKETS, INC. DBA PUBLIX STORE #0794	GDO	912	9050 BISCAYNE BLVD	3
615	TROPICAL SUPERMARKET #13 DBA EL PRESIDENTE SUPERMARKET #11	GDO	913	4275 W FLAGLER ST	0
616	EVENTS7DAYS, INC. DBA MADRID TAPAS Y VINOS RESTAURANT	GDO	914	525 NW 42 AVE	500

No.	FACILITY_NAME	PERMIT	PERMIT_NUMBER	ADDRESS	TOTAL_GPD
617	LA ROSA CAKE, INC.	GDO	915	4259 W FLAGLER ST	5
618	AMPY ENTERPRISES, INC. DBA MCDONALD'S #2163	GDO	916	14401 S DIXIE HWY	650
619	DELICES DE FRANCE, INC.	GDO	917	14453 S DIXIE HWY #19	1
620	BG BROTHERS, LLC DBA FIRST HONG KONG CAFE	GDO	919	117 SE 2 ST	213
621	C.G.H. HOSPITAL LTD.	GDO	921	3100 DOUGLAS RD	1,176
622	RODRIQUEZ GROCERIES	GDO	924	101 E 10 ST	0
623	LA PERLA DEL SUR BAKERY, INC.	GDO	925	1988 E 4 AVE	228
624	CANTON CHINESE RESTAURANT	GDO	927	6661 S DIXIE HWY	3,725
625	KONING RESTAURANTS INTERNATIONAL, LC DBA PIZZA HUT #710039	GDO	930	18857 SW 117 AVE	0
626	BISTRONOMY, LLC DBA 1ST BISTRO	GDO	931	2 S BISCAYNE BLVD #104	574
627	SMART BITES ENTERPRISES, LLC	GDO	933	791 NW 20 ST	750
628	TOY SHAN CHINESE RESTAURANT	GDO	935	18514 NW 67 AVE	2,000
629	PAPPA RICCO'S, INC. DBA PAPPA RICCO'S RESTAURANT	GDO	937	14415 S DIXIE HWY	700
630	BURGER KING CORPORATION DBA BURGER KING #0001	GDO	938	3601 NW 27 AVE	1,036
631	FAR EAST CAFE	GDO	940	1061 NW 20 ST	504
632	HOUSE OF BAGELS AND BIALYS, INC.	GDO	941	14449 S DIXIE HWY	0
633	SAL Y PIMIENTA SABOR LATINO, LLC	GDO	942	12533-35 W OKEECHOBEE RD	534
634	Y & J CAKE DESIGNS CORP. DBA EL JARDIN BAKERY	GDO	943	12539 W OKEECHOBEE RD	540
635	ARISAN ENTERPRISE, LLC DBA SABOR PLAYA RESTAURANT	GDO	944	7315 COLLINS AVE	274
636	EL DIVINO MIAMI CORP.	GDO	945	835 NW 37 AVE	350
637	CARA MIA SOBE, LLC DBA CARA MIA TRATTORIA	GDO	950	1040 ALTON RD	464
638	MACALUSO'S INC. DBA MACALUSO'S RESTAURANT	GDO	951	1747-51 ALTON RD	898
639	SFIZIO, LLC DBA SFIZIO BAR BISTRO ITALIAN ROTISSERIE	GDO	952	941 WASHINGTON AVE	275
640	JAE MIAMI DADE, LLC DBA WENDY'S #2454	GDO	953	10680 NW 41 ST	788
641	COLONY THEATER CAFE, INC. DBA SEGAFREDO ESPRESSO	GDO	954	1040 LINCOLN RD	1,750
642	EAST 49TH STREET, LLC DBA DUNKIN DONUTS	GDO	958	845 E 49 ST	449
643	W & E CONCEPTS DBA SUBWAY #1360	GDO	961	775 W 49 ST #6	336
644	JAE MIAMI DADE, LLC DBA WENDY'S #1717	GDO	962	30130 S DIXIE HWY	779
645	POLLO OPERATIONS, INC. DBA POLLO TROPICAL	GDO	964	825 E 49 ST	47,922
646	ZHANG JIA XING, LLC DBA LUCKY CHINA	GDO	965	10848 SW 104 ST	304
647	CHEZ JOSEITO CATERING	GDO	966	496 E 9 ST	1
648	PUBLIX SUPERMARKETS, INC. DBA PUBLIX STORE #0375	GDO	967	1525 SW 107 AVE	0
649	RINCONCITO PAISA RESTAURANT, INC.	GDO	968	12825 SW 42 ST	450
650	KONING RESTAURANTS INTERNATIONAL, LC DBA PIZZA HUT #12394	GDO	969	1215 W 44 PL	0
651	NAMI TRADING, INC. DBA SUBWAY #1456	GDO	970	239 NE 167 ST	308
652	TATI 2000, INC. DBA SARUSSI RESTAURANT	GDO	971	3670 W 12 AVE	600
653	BAMBOO GARDEN, INC. DBA BAMBOO GARDEN CHINESE RESTAURANT	GDO	972	1232 NE 163 ST	1,950
654	MARY ANN BAKERY HOUSE, INC.	GDO	973	1284 NE 163 ST	1
655	EL RODEO MEXICAN RESTAURANT, INC.	GDO	974	29607 SW 162 AVE	725
656	ASAKA CORPORATION DBA ASAKA JAPANESE RESTAURANT	GDO	976	20355 BISCAYNE BLVD	2,250
657	POLLO OPERATIONS, INC. DBA POLLO TROPICAL	GDO	977	20403 BISCAYNE BLVD	807
658	CAFE MOJITOS, INC. DBA MOJITOS LATIN AMERICAN CAFE	GDO	978	11401 NW 12 ST E-502	5,825
659	PUBLIX SUPERMARKETS, INC. DBA PUBLIX STORE #0030	GDO	979	2952 AVENTURA BLVD	0
660	BISTROTTERS, LLC	GDO	980	6345 COLLINS AVE	1,125
661	AVENTURA EATERY, LLC DBA SICILIAN OVEN	GDO	981	20475 BISCAYNE BLVD G11-12	745
662	AVENTURA D'LITES, INC. DBA D'LITES	GDO	982	20695 BISCAYNE BLVD #6	313
663	MORRO CASTLE CAFETERIA CORP.	GDO	984	1201 W 44 PL	1,850
664	SHERMUHD OF DADE COUNTY, INC. DBA SUBWAY #24547	GDO	986	155 S MIAMI AVE #100	308
665	ULTRAMONT PROPERTIES, (USA) INC. DBA ULTRAMONT MALL	GDO	989	100 SE 1 ST	4,200
666	SOBARZO ENTERPRISES, INC. DBA SEDANO'S SUPERMARKET #14	GDO	991	1263 W FLAGLER ST	0
667	CHOW DOWN GRILL, INC. DBA JOSH'S DELI	GDO	992	9517 HARDING AVE	266
668	MI PEQUENO SAN SALVADOR CORP.	GDO	994	1777 W FLAGLER ST	600
669	SAN JUAN AND ASSOCIATES CORP. DBA CAFE SAN JUAN	GDO	995	1807 W FLAGLER ST	375
670	CEC ENTERTAINMENT, INC. DBA CHUCK E. CHEESE'S #435	GDO	996	20335 BISCAYNE BLVD	4,578
671	MABY'S CAFE, INC.	GDO	1000	4120 PALM AVE	188
672	L AMERICAN CORP. DBA RANCHO LUNA	GDO	1003	45 NW 22 AVE	625
673	TROPICAL SUPERMARKET #7, INC.	GDO	1005	2294 W FLAGLER ST	0
674	BEN & GABY, INC. DBA PAQUITO'S MEXICAN RESTAURANT	GDO	1006	16265 BISCAYNE BLVD	5,000
675	L.C.L. FOOD SERVICES, INC. DBA MCDONALD'S #7296	GDO	1007	2940 SW 8 ST	1,582
676	HOS COMPANY DBA NEW CHINA ROSE RESTAURANT	GDO	1009	1736 W 68 ST	0
677	LATIN FEVA, INC. DBA CARIBE LATIN FOOD	GDO	1010	1750 W 68 ST	1,175
678	D.M.V. PIZZA, INC. DBA JERRY AND JOE'S PIZZA OF NEW YORK #3	GDO	1012	1772 W 68 ST	0
679	HOLIDAY BAKERY III	GDO	1013	2360 W 68 ST #107	1
680	ROSE & SONS, INC. DBA RINCON NICA	GDO	1015	41 NW 12 AVE	750
681	ELA BAKERY CAFE CORP.	GDO	1017	505 NW 12 AVE	450
682	J & N MASTERS CORP. DBA CRYSTAL SUPERMARKET	GDO	1018	403-405 NW 12 AVE	724
683	FOOD PROVISION, LLC DBA THE GOLDEN HOG	GDO	1020	91 HARBOR DR	1,100
684	TACO PALACE, INC. DBA CASITA TEJAS MEXICAN RESTAURANT	GDO	1024	27 N KROME AVE	1,500
685	KENJA II, INC. DBA PT'S SHOWCLUB	GDO	1026	7565 W 20 AVE	1,200
686	DORAL ISLES COMMUNITY ASSOCIATION, INC.	GDO	1027	6450 NW 110 AVE	20,000
687	PUERTO VALLARTA, LLC	GDO	1029	24811 S FEDERAL HWY	375
688	WINN DIXIE STORES, INC. DBA WINN DIXIE STORE #254	GDO	1030	11241 SW 40 ST	0
689	SELIN, LLC DBA GROOVY'S PIZZA & BAR	GDO	1031	938 LINCOLN RD	250
690	GAM FHS, LLC DBA FIREHOUSE SUBS	GDO	1033	1429 WASHINGTON AVE	816
691	PRI MIAMI, LLC DBA TACO BELL	GDO	1034	17950 NW 27 AVE	728
692	PEKING RESTAURANT II, INC.	GDO	1035	3640 NW 7 ST	550
693	DAIAN CORP. DBA BRUNO'S CAFE	GDO	1036	9464 NW 13 ST #71	476
694	CAFETERIA EL COLIBRI CORP.	GDO	1037	330 W 9 ST #2	188
695	EL TROPICO CUBAN CUISINE, INC.	GDO	1039	17020 COLLINS AVE	3,400
696	BEZAT FRESH FOOD, LLC DBA OTENTIC FRESH FOOD RESTAURANT	GDO	1040	538 WASHINGTON AVE	300
697	1223 LINCOLN CAFE, LLC DBA COLETTE FRENCH BISTRO	GDO	1041	1223 LINCOLN RD	1,250
698	RJP BAKERY, LLC DBA VICKY BAKERY	GDO	1044	3765 W FLAGLER ST	438
699	TANI THAI RESTAURANT	GDO	1050	12269 S DIXIE HWY	1,875
700	PINOLANDIA CORP. DBA TORTILLAS PINOLANDIA	GDO	1051	119 NW 12 AVE	1
701	LORENZO CG, LLC	GDO	1053	127 GIRALDA AVE	765
702	LUZA CORPORATION DBA DONUT GALLERY DINER	GDO	1054	83 HARBOR DR	8
703	RESTAURANTE SANTA BARBARA, INC.	GDO	1055	311 SW 12 AVE	28,750
704	POTOSI ENTERPRISES CORP.	GDO	1057	445 NW 12 AVE	125

No.	FACILITY_NAME	PERMIT	PERMIT_NUMBER	ADDRESS	TOTAL_GPD
705	FAMIGLID BUSINESS CORP. DBA LA REINA RESTAURANT	GDO	1058	529 NW 12 AVE	300
706	THE COLORS OF THE SOUL, LLC DBA MILANGA'S RESTAURANT	GDO	1059	2901 SW 8 ST #101-103	473
707	EL ATLACATL RESTAURANT CORP.	GDO	1062	466 SW 17 AVE	1,250
708	CAFETERIA CARIBE 2 CORP.	GDO	1064	1400 W FLAGLER ST	350
709	FINALE INVESTMENT CORP. DBA FINALE	GDO	1066	1738 W 68 ST	581
710	BURGER KING CORPORATION DBA BURGER KING #0091	GDO	1070	14095 SW 88 ST	2,086
711	CVI CHE 105 DBA CEVICHE	GDO	1071	105 NE 3 AVE	683
712	MANOLO & RENE CAFETERIA	GDO	1072	281 NE 1 ST	420
713	BROS FOOD INDUSTRIES, LLC	GDO	1076	19 SE 2 AVE #4	188
714	CWC OF MIAMI, INC. DBA LAS PALMAS RESTAURANT	GDO	1079	209 SE 1 ST	406
715	B & R SUPERMARKETS, INC. DBA MILAM'S MARKET #3	GDO	1083	2969 SW 32 AVE	0
716	PRESIDENTE SUPERMARKET NO. 17, INC.	GDO	1084	8370 NW 27 AVE	0
717	PINCHO FACTORY 3 HIALEAH, LLC	GDO	1085	4950 W 12 AVE	695
718	FAST GRILL ENTERPRISES OF HIALEAH, INC.\DBA LA GRANJA POLLOS A LA	GDO	1086	4975 W 12 AVE	468
719	CRABMAN 305, INC.	GDO	1087	2006 OPA LOCKA BLVD	188
720	CONSUMER MEATS	GDO	1088	18115 NW 27 AVE	0
721	MCDONALD'S RESTAURANT OF FLORIDA, INC. DBA MCDONALD'S #4402	GDO	1089	18250 NW 27 AVE	840
722	BURGER KING CORPORATION DBA BURGER KING #6877	GDO	1092	2210 W 68 ST	1,050
723	LA LIBERTAD RESTAURANT, INC.	GDO	1094	2516 SW 8 ST	500
724	SHAPE LOVERS, LLC	GDO	1095	5485 NW 79 AVE	1,000
725	ANTICO PIZZA MIAMI, LLC	GDO	1097	1058 COLLINS AVE	1,500
726	HARD ROCK CAFE INTERNATIONAL (USA), INC.	GDO	1099	401 BISCAYNE BLVD R-200	15,001
727	BREAD PARTNERS 21, INC. DBA AU BON PAIN	GDO	1100	3663 S MIAMI AVE	420
728	VERSAILLES RESTAURANT	GDO	1101	3535 SW 8 ST	3,750
729	CAFE LA CARRETA @ MERCY	GDO	1103	3663 S MIAMI AVE	1,036
730	LAURENZO BROS., INC. DBA LAURENZO'S ITALIAN MARKET	GDO	1104	16385 W DIXIE HWY	1,036
731	EL TORO TACO, INC.	GDO	1108	1 S KROME AVE	1,850
732	AROMAS DEL PERU WEST MIAMI CORP.	GDO	1110	5757 SW 8 ST #105-109	100,000
733	VIA FETUCCINI CORP. DBA PASTA FACTORY COMPANYY	GDO	1111	5725 SW 8 ST	3,650
734	ANTON SANTANIELLO, LLC	GDO	1112	3411 SW 8 ST	300
735	AMERICAN LEGION POST #43 DBA JOHN G. SALLEY POST #43	GDO	1116	399 S KROME AVE	3,200
736	SUSHI SAKE, INC.	GDO	1117	14629 SW 42 ST	350
737	MALOFF, INC. DBA DELI LANE CAFE & TAVERN	GDO	1119	7230 SW 59 AVE	2,000
738	LA NUEVA CATRACHITA RESTAURANT, INC.	GDO	1120	1462 NW 17 AVE	150
739	SANTA LUCIA BAKERY, LLC	GDO	1122	27309 S DIXIE HWY	1
740	RIVIERA SUPERMARKET AND CAFETERIA	GDO	1124	1710 NW 17 AVE	420
741	KONING RESTAURANTS INTERNATIONAL, LC DBA PIZZA HUT #12406	GDO	1127	9580 SW 137 AVE	0
742	KONING RESTAURANTS INTERNATIONAL, LC DBA PIZZA HUT #12336	GDO	1128	5731 NW 36 ST	3,725
743	LUCY'S CAFE RESTAURANT, INC.	GDO	1129	4201 W 16 AVE	800
744	YITON, LLC	GDO	1132	14643 SW 104 ST	350
745	EL HUARIKE PERUANO, INC.	GDO	1133	7371 NW 36 ST	300
746	HILLSTONE RESTAURANT GROUP, INC. DBA HOUSTON'S RESTAURANT	GDO	1135	17355 BISCAYNE BLVD	5,000
747	K-MART CORPORATION DBA K-MART #3613	GDO	1137	900 N MIAMI BEACH BLVD	616
748	PIZZERIAS, LLC DBA PAPA JOHN'S PIZZA #367	GDO	1141	19625 NW 57 AVE	0
749	CHICO CAFETERIA, INC.	GDO	1145	395 E 10 ST	1
750	163 STREET FOODS CORPORATION DBA MCDONALD'S #18490	GDO	1146	2201 NE 163 ST	250
751	PIZZA BUFFET FLAGLER, LLC DBA CICI'S PIZZA #815	GDO	1148	9609-9611 W FLAGLER ST	1,004
752	TOSCA BAKERY	GDO	1149	545 SW 8 ST	2
753	TAQUERIAS EL MEXICANO RESTAURANT	GDO	1150	521 SW 8 ST	5,000
754	SHELL GAS STATION FOOD MART	GDO	1152	1345 NE 79 ST	0
755	DELPA, INC. DBA BURGER KING #4642	GDO	1153	7390 SW 24 ST	1,036
756	MACARON, LLC DBA CAFE BONJOUR	GDO	1156	6222 S DIXIE HWY	289
757	SUBS ON THE RUN CORP.	GDO	1158	2801 NW 7 AVE	532
758	STARBUCKS COFFEE COMPANY, INC. DBA STARBUCKS #8275	GDO	1160	19501 BISCAYNE BLVD SPC 1685	4
759	SERVING THE SOUL CORP.	GDO	1162	12039 SW 117 AVE	248
760	POON'S CORP. DBA FLORIDA GRILL	GDO	1164	4299 COLLINS AVE FACILITY B	250
761	CAKE UNICOS, INC. DBA CAKEWORLD BAKERY	GDO	1166	10603 SW 40 ST	0
762	ED & FER CORPORATION DBA LA COPA NUEVA SUPERMARKET	GDO	1167	650 E 9 ST	1,800
763	TASTEBUDS & CREAATIONS, INC. DBA TROPICAL TASTEBUDS	GDO	1168	499 NE 167 ST	188
764	ASERE BATIDOS II CORP.	GDO	1169	3783 E 4 AVE	163
765	VALERIE'S CAFE, LLC	GDO	1171	2148 NW 17 AVE #2	113
766	SANTANDER ENTERPRISES, INC. DBA SEDANO'S SUPERMARKET #11	GDO	1172	950 E 4 AVE	6,442
767	CASMOL, LLC DBA MI GALLITO BAKERY	GDO	1173	7962 SW 8 ST	0
768	LA EXQUISITA CAFE, LLC	GDO	1175	476-78 PALM AVE	450
769	CASA CHAN, INC.	GDO	1176	445 PALM AVE	325
770	LA CASCADA DE PALM AVENUE, INC.	GDO	1178	798 PALM AVE	2
771	E.C. MANAGEMENT CORP. DBA MCDONALD'S #791	GDO	1181	200 NE 167 ST	1,232
772	TWENTY-SEVEN BIRDS CORP. DBA LAUGHING LOGGERHEAD	GDO	1182	2721 BIRD AVE	775
773	BFW, INC. DBA CARO MIO	GDO	1183	3398 SW 22 ST	500
774	MO'S BAGELS, INC.	GDO	1186	2780 NE 187 ST	4,200
775	ARGO MANAGEMENT, INC. DBA MCDONALD'S #12932	GDO	1188	345 NE 2 AVE	2,086
776	STICK CORP. DBA MCDONALD'S #14768	GDO	1190	8505 NW 186 ST	868
777	7 STARS PRODUCTIONS CORP. DBA YARUMBA RESTAURANT & LOUNGE	GDO	1191	4740-44 NW 167 ST	1,300
778	SERGIO'S RESTAURANT #2, INC.	GDO	1192	3252 SW 22 ST	2,500
779	TIQUICIA COMMODITIES CORP. DBA CABALLO BLANCO CAFE	GDO	1195	4085 E 8 AVE	250
780	EL RINCONCITO DE SANTA BARBARA CORP.	GDO	1196	2050 W 56 ST #33	2,050
781	DEL SUR MARKET, LLC	GDO	1197	12257 S DIXIE HWY	375
782	TAQUITOS MEXICANOS EL PASO, INC.	GDO	1202	2200 NW 22 AVE	315
783	CHINA EXPRESS OF WESTON, INC.	GDO	1203	3006 NW 2 AVE	225
784	LA ESPECIAL BAKERY, INC.	GDO	1204	3008 NW 2 AVE	1
785	ALMONTE SUPERMARKET CORP. DBA LA FAMA SUPER MARKET	GDO	1205	3040 NW 2 AVE	950
786	E & C RESTAURANT, INC. DBA LAS BOTELLITAS RESTAURANT	GDO	1207	2150 NW 22 AVE	1,500
787	6208 SOUTH DIXIE, LLC DBA HOLE IN THE WALL GRILL	GDO	1209	12055 SW 117 AVE	51,250
788	MAVIK RESTAURANTS, LLC DBA MI FONDITA	GDO	1210	16786 NW 67 AVE	280
789	LOS TRES CONEJITOS BAKERY	GDO	1212	1912 W 60 ST	1
790	JAYGA ENTERPRISES, INC. DBA EL NUEVO SIGLO SUPERMARKET/CAFE	GDO	1216	1305 SW 8 ST	0
791	GALIANO ENTERPRISES, INC. DBA GALIANO RESTAURANT	GDO	1221	2432 NW 27 AVE	750
792	EL OSO BLANCO CAFETERIA, INC.	GDO	1222	2418 NW 27 AVE	15,525

No.	FACILITY_NAME	PERMIT	PERMIT_NUMBER	ADDRESS	TOTAL_GPD
793	JOLAR, INC. DBA BIG SLICK'S DELI	GDO	1223	15455 W DIXIE HWY BAY-I	3
794	MARTHA'S COURT HOUSE CAFE, INC.	GDO	1227	3136 NW 27 AVE	280
795	MIDNITE CAFE, INC. DBA CAFE NOSH	GDO	1228	36 NE 1 ST #132	675
796	AJJA, LLC DBA SOYA & POMODORO	GDO	1230	120 NE 1 ST	125
797	LATINOS 305 CAFE, LLC	GDO	1233	44 NE 1 ST	430
798	LOS HERMANOS SALVADORENOS RESTAURANT, INC.	GDO	1235	398 E 33 ST #101	12,825
799	JOSEPH BARACK CORP. DBA JOSEPH CLUB	GDO	1236	1971 NW 7 ST	5,250
800	HING'S CHINESE FOOD, INC.	GDO	1238	2156 NW 7 ST	750
801	BOSTON MARKET CORPORATION DBA BOSTON MARKET #1067	GDO	1239	3600 SW 22 ST	715
802	MAYAMEX LINDA, LLC	GDO	1240	886 KROME AVE	140
803	FRUTERIA LATIN PROUD, LLC	GDO	1242	4290-92 E 4 AVE	1,200
804	SANDRA'S CAFE, INC.	GDO	1246	3104 NW 2 AVE	625
805	MONCHEESE PIZZA CORP.	GDO	1248	9459 HARDING AVE	2
806	CHE BEST FRIENDS CORP.	GDO	1249	18900 SW 114 AVE	500
807	ROASTERS DELI ENTERPRISES, INC.	GDO	1251	9465 S DIXIE HWY	2,000
808	MIAMI DADE COLLEGE - NEW WORLD CENTER CAMPUS	GDO	1253	300 NE 2 AVE	100
809	CAJUN OPERATING COMPANY DBA CHURCH'S CHICKEN #1101	GDO	1254	13200 NW 27 AVE	308
810	BURGER KING CORPORATION DBA BURGER KING #0029	GDO	1255	7070 SW 40 ST	1,036
811	SUSHILICO, LLC DBA SUSHILICO	GDO	1256	15892 SW 137 AVE	400
812	LA ESQUINA HONDURENA RESTAURANT	GDO	1258	2240 SW 32 AVE	875
813	RAIN BOW 33, INC. DBA HONG KONG NOODLES	GDO	1261	1242 NE 163 ST	2,375
814	BRINKER FLORIDA, INC. DBA CHILI'S GRILL & BAR #396	GDO	1264	19905 BISCAYNE BLVD	6,075
815	KB CHEF, LLC DBA BISTRO AT OCEAN III	GDO	1265	18911 COLLINS AVE	75
816	ROONY'S RESTAURANT CORP. DBA KHOURY'S RESTAURANT	GDO	1266	5887 SW 73 ST	1,500
817	TAT TIM TONG, INC. DBA KAM KEE RESTAURANT	GDO	1267	3640 PALM AVE	1,125
818	LA ESTRELLA BAKERY CAFE CORP.	GDO	1269	7183-85 SW 8 ST	400
819	BAHAMAMA'S FISH MARKET #1	GDO	1270	7200 SW 8 ST	3,975
820	EL GALLEGO SPANISH RESTAURANT, INC.	GDO	1271	7173 SW 8 ST	875
821	MUNNE APONTE GROUP, INC.	GDO	1272	2331 SW 32 AVE	477
822	C.D.C. PIZZA, INC. DBA SUPER PIZZERIA RESTAURANT	GDO	1273	2255 SW 32 AVE	1,275
823	KONING RESTAURANTS INTERNATIONAL, LC DBA PIZZA HUT #12417	GDO	1276	1600 NE 163 ST	650
824	KASALTA 305 CORP.	GDO	1280	12835 SW 42 ST #108	325
825	CANTON VILLAGE RESTAURANT, INC.	GDO	1281	3405 E 4 AVE	1,850
826	SSC304593, LLC DBA DUNKIN DONUTS #304593	GDO	1286	95 NW 167 ST	456
827	WIFEMI, LLC DBA LA PERUANITA RESTAURANT	GDO	1287	16630 NE 2 AVE	450
828	SAMANTHA CAFETERIA CORP.	GDO	1288	1771 NW 7 ST	181
829	HAVANA VIEJA BAKERY AND COFFEE CORP.	GDO	1289	1550 W 84 ST #72	375
830	OLE-OLE CAFE, CORP.	GDO	1290	1550 W 29 ST	750
831	CAFE TARAMAR CORP.	GDO	1291	602-606 W 28 ST	750
832	SABOR NICA RESTAURANT CORPORATION	GDO	1292	49 NW 12 AVE	150
833	LA ESPIRITUANA CAFE, INC.	GDO	1293	1598 W 37 ST	657
834	TAHITI RESTAURANT @ OCEAN TWO CONDOMINIUM	GDO	1294	19111 COLLINS AVE	583
835	MACOVI, LLC DBA BLOKS PIZZA DELI	GDO	1295	1447 WASHINGTON AVE	200
836	SEA TOWN OF GARDENS CORP.	GDO	1296	17990 NW 27 AVE	0
837	CANTON OF EIGHTH STREET, INC.	GDO	1297	921 SW 87 AVE	0
838	J & J INVESTMENTS, LLC DBA BAGLE EMPORIUM GRILL	GDO	1299	1238 S DIXIE HWY	1,000
839	STARBUCKS COFFEE COMPANY, INC. DBA STARBUCKS #8256	GDO	1300	1122 S DIXIE HWY	0
840	EDY'S BAKERY AND COFFEE SHOP, INC.	GDO	1301	1561 W OKEECHOBEE RD	0
841	NUUESTRA FAMILIA MARKET CORPORATION DBA LA FAMILIA SUPERMARKET	GDO	1302	1505 W OKEECHOBEE RD	0
842	KUNG FU RESTAURANT CORP.	GDO	1304	1098 W 29 ST	1,850
843	SPORT FRITANGA RESTAURANT & EVENTS CORP.	GDO	1305	86 W 29 ST	375
844	LA MINUTERA FISH & CHIPS CORP.	GDO	1306	2839 W 2 AVE	450
845	ALICIA G, INC. DBA EL YAYASO CAFETERIA	GDO	1307	1087 E 25 ST	650
846	EL NICA BAKERY & GROCERY CORP.	GDO	1308	1073 E 25 ST	195
847	TRUVINE CONSULTING, LLC DBA PIZZA PROJECT	GDO	1309	10716 SW 113 PL	275
848	SOUTH FLORIDA STADIUM, LLC DBA SUN LIFE STADIUM	GDO	1310	2269 NW 199 ST	42,000
849	SUSHI KO JAPANESE RESTAURANT	GDO	1311	7971 SW 40 ST 12	1,750
850	PANNA CAFE EXPRESS TO GO, INC.	GDO	1313	15421 W DIXIE HWY BAY 18-20	1,000
851	PAMANES ENTERPRISES, INC. DBA SEDANO'S SUPERMARKET #16	GDO	1315	3925 PALM AVE	0
852	PRESIDENTE SUPERMARKETS MANAGEMENT, INC. DBA PRESIDENTE	GDO	1316	1550 W 84 ST #32	196
853	SALVATORE PIZZA & PASTA	GDO	1317	1550 W 84 ST 1	672
854	SSC306893, LLC DBA DUNKIN DONUTS #306893	GDO	1319	8290 W FLAGLER ST	423
855	EL RINCONCITO RESTAURANT CORP.	GDO	1320	13593 SW 248 ST	300
856	JOFRAN CORPORATION DBA EL TEJADITO BAKERY #1	GDO	1321	5691 SW 137 AVE	1
857	THE RIVER OYSTER HOUSE & WOOD GRILL, INC.	GDO	1322	650 S MIAMI AVE	1,000
858	E.C. MANAGEMENT CORP. DBA MCDONALD'S #2421	GDO	1323	20101 NW 2 AVE	952
859	PEKING RESTAURANT, INC.	GDO	1326	3003 NW 7 ST	225
860	GACC GROUP, INC. DBA EUROPEAN CORNER BAKERY/CAFE	GDO	1327	5889 SW 73 ST	1
861	ATLANTIC FISH HEALTH, INC. DBA ATLANTIC RESTAURANT SPORTS LOUNGE	GDO	1330	3716-3732 W 12 AVE	1,080
862	FUNGGHI AMERICANA, INC. DBA PORTOBELLO RESTAURANT	GDO	1331	2841 CORAL WAY	500
863	LUO'S CORPORATION DBA YUM YUM CHINESE RESTAURANT	GDO	1333	3104 SW 22 ST	1,450
864	SUSHI CHEF JAPANESE RESTAURANT	GDO	1334	3100 SW 22 ST	1,125
865	LA CARIDAD DEL DORAL CO.	GDO	1336	8275 NW 56 ST	0
866	MANDUJANO CH, INC. DBA CEVICHE HOUSE	GDO	1337	13856 SW 56 ST	500
867	TROPICAL RESTAURANT	GDO	1339	650 E 9 ST	3,000
868	SUBWAY 11296, INC.	GDO	1343	201 NW 1 AVE A	250
869	EL CHALECITO RESTAURANT, INC.	GDO	1344	2113 W FLAGLER ST	500
870	DURAND COMPANY, LLC DBA 1ST AVENUE BISTRO	GDO	1345	201 NW 1 AVE	2,250
871	SALT AND SUGAR CAFE, LLC	GDO	1346	20 W FLAGLER ST	786
872	DOWNTOWN FLAGLER RESTAURANT CORP. DBA LA LOGGIA RISTORANTE	GDO	1347	68 W FLAGLER ST	3,000
873	RINCON ARGENTINO RESTAURANT, INC.	GDO	1350	2345 SW 37 AVE	1,975
874	PALM AVENUE RESTAURANT, LLC DBA BUEN TIEMPO CAFE	GDO	1352	5376 PALM AVE	350
875	TB ISLE RESORT, LP DBA TB ISLE RESORT & GOLF CLUB	GDO	1353	18501 COLLINS AVE	538
876	JMR FOODS, INC. DBA BOTTEGA EXPRESS FOOD COURT	GDO	1358	111 NW 1 ST	4,900
877	HARBOR RESTAURANT PARTNERS, LLC DBA MAKOTO	GDO	1361	9700 COLLINS AVE #107	1,683
878	SEDANO'S SUPERMARKET, LLC DBA SEDANO'S SUPERMARKET #42	GDO	1362	3801 W FLAGLER ST	0
879	PUBLIX SUPERMARKETS, INC. DBA PUBLIX STORE #0024	GDO	1363	10201 HAMMOCKS BLVD #111	4
880	PUBLIX SUPERMARKETS, INC. DBA PUBLIX STORE #1151	GDO	1364	8682 SW 24 ST	1

No.	FACILITY_NAME	PERMIT	PERMIT_NUMBER	ADDRESS	TOTAL_GPD
881	BLUE SKY FOOD BY THE POUND #7	GDO	1365	3803 W FLAGLER ST	1,850
882	PUBLIX SUPERMARKETS, INC. DBA PUBLIX STORE #0222	GDO	1366	13890 SW 56 ST	0
883	MONDUA, LLC	GDO	1368	236 NE 1 AVE	56,250
884	PUBLIX SUPERMARKETS, INC. DBA PUBLIX STORE #0293	GDO	1369	13735 SW 152 ST	6
885	LUIS GALINDO LATIN AMERICAN RESTAURANT	GDO	1370	898 SW 57 AVE	1,800
886	YAN & TIM COMPANY, INC. DBA CANTON PALACE RESTAURANT	GDO	1373	7980 SW 8 ST	1,850
887	PACIFICO CHINESE RESTAURANT	GDO	1374	3824 W 12 AVE	3,250
888	S & M NIMAR CORP. DBA ZAZY CAFETERIA	GDO	1375	9999 NW 89 AVE	532
889	DCN, INC. DBA NORTH WEST SEAFOOD	GDO	1377	14075 NW 27 AVE	0
890	FRITANGA CANA BRAVE 3 CORP.	GDO	1378	2795 NW 7 ST	710
891	MI BANDEJA LATINA CORP.	GDO	1383	10550 NW 77 CT #101-104	550
892	RYTA FOOD CORP. DBA TOP VALUE	GDO	1385	13931 NW 27 AVE	0
893	MIAMI CHILDRENS HOSPITAL	GDO	1390	3100 SW 62 AVE	0
894	EL POLINESIO BAR RESTAURANT, INC.	GDO	1391	3120 W 16 AVE	500
895	LA MIA RESTAURANT, INC.	GDO	1392	7911 NW 72 AVE #101A	506
896	CRISTY'S CAFE CORP.	GDO	1393	9801 NW 79 AVE	900
897	SAILORMEN, INC. DBA POPEYE'S CHICKEN #0011	GDO	1396	1501 NW 20 ST	672
898	BOLIVIAN RESTAURANT CORP.	GDO	1397	2772 SW 8 ST	942
899	MIAMI JUICE CORP.	GDO	1399	18660 COLLINS AVE UNIT-101	991
900	PUBLIX SUPERMARKETS, INC. DBA PUBLIX STORE #0550	GDO	1400	9041 SW 107 AVE	0
901	LITTLE CAESAR'S ENTERPRISES, INC. DBA LITTLE CAESAR'S PIZZA #2217	GDO	1402	8290 W FLAGLER ST FAC. A	280
902	MCDONALD'S CORPORATION DBA MCDONALD'S #7635	GDO	1405	1660 W 68 ST	1,134
903	CARNIVAL CORPORATION DBA CARNIVAL CRUISE LINES	GDO	1406	3655 NW 87 AVE	2,100
904	DENNY'S, INC. DBA DENNY'S #1804	GDO	1407	1 MIRACLE MILE	3,275
905	LANDRY'S RESTAURANTS, INC. DBA CAPTAIN CRAB #402	GDO	1408	4775 NW 183 ST	0
906	NEW PIMENT FLORIDA BAKERY, INC.	GDO	1409	46 NE 62 ST	1,014
907	SURI 921, INC. DBA GROOVY'S PIZZA	GDO	1410	921 WASHINGTON AVE	271
908	PUBLIX SUPERMARKETS, INC. DBA PUBLIX STORE #0091	GDO	1411	1045 DADE BLVD	0
909	WFM-WO, INC. DBA WHOLE FOODS MARKET #09	GDO	1412	11701 S DIXIE HWY	14
910	PUBLIX SUPERMARKETS, INC. DBA PUBLIX STORE #0262	GDO	1413	18496 NW 67 AVE	0
911	PUBLIX SUPERMARKETS, INC. DBA PUBLIX STORE #1129	GDO	1414	15000 MIAMI LAKES DR	0
912	PUBLIX SUPERMARKETS, INC. DBA PUBLIX STORE #0223	GDO	1415	14601 S DIXIE HWY	0
913	VIA DEL RIO #1 CORPORATION	GDO	1416	1673 NW 27 AVE	1,000
914	MI RANCHITO CASTILLO, LLC	GDO	1418	1710 NW 27 AVE	500
915	RINCON ASTURIANO CORP.	GDO	1421	215 SW 17 AVE #225	500
916	FRESH ZONE IV, INC.	GDO	1423	244 BISCAYNE BLVD #E-4	1,750
917	L & B BISCAYNE TOWER GROUP TRUST	GDO	1424	2 S BISCAYNE BLVD	6,250
918	SAVOY HOTEL PARTNERS, LLC	GDO	1427	455 OCEAN DR	3,134
919	GREEN COMET, LLC DBA LORD BALFOUR HOTEL	GDO	1428	350 OCEAN DR	799
920	EL INDIO BAKERY AND CAFETERIA CORP.	GDO	1429	4164 E 4 AVE	2
921	1830 RESTAURANT CORP. DBA 1830 RESTAURANT	GDO	1430	1366 E 4 AVE	650
922	LIU'S GENERATION CORP. DBA CHINA CAFE	GDO	1431	4174 E 4 AVE	10
923	B L BAKERY, INC.	GDO	1432	4015 NW 7 ST	1
924	CARIBE CAFE RESTAURANT, INC.	GDO	1433	3953 NW 7 ST	2,075
925	A & A SUPERMARKET CORP.	GDO	1434	3945 NW 7 ST	1,064
926	ESTHER'S 27TH AVENUE, INC.	GDO	1435	17751 NW 27 AVE	900
927	CUBA LIVES RESTAURANT, INC.	GDO	1438	4590 W 12 AVE	4,000
928	DENY'S BAKERY CORP.	GDO	1439	4552 W 12 AVE	0
929	LA CUEVA DEL PIRATA CAFE, INC.	GDO	1440	1255 W 46 ST #27	1,075
930	FRITANGA CASTILLO CORP.	GDO	1441	1255 W 46 ST 21-22	350
931	PUBLIX SUPERMARKETS, INC. DBA PUBLIX STORE #0529	GDO	1442	15750 SW 72 ST	4
932	THE IRISH TIMES, INC.	GDO	1443	5850 SW 72 ST A	529
933	PUBLIX SUPERMARKETS, INC. DBA PUBLIX STORE #0010	GDO	1445	8341 W FLAGLER ST	0
934	LA QUEBRADITA RESTAURANT	GDO	1446	702 N KROME AVE	600
935	LITTLE SAIGON, INC.	GDO	1449	16752 N MIAMI AVE	0
936	P.S.J., INC. DBA LUCKY MEAT II	GDO	1450	291 W MOWRY DR	0
937	STARBOARD GROUP OF SE FL LLC DBA WENDY'S #412	GDO	1451	1515 NW 7 ST	896
938	FAMILY HERNANDEZ MAYABEQUE CORP.	GDO	1452	2000 PALM AVE	0
939	BARRIO LATINO AVENTURA, INC.	GDO	1453	20475 BISCAYNE BLVD #1,2,3	875
940	CIARA'S LATIN CAFETERIA, INC.	GDO	1454	2100 PALM AVE	225
941	TORTILLERIA-FRITANGA GONZALEZ	GDO	1456	153 W 21 ST UNIT-A	1
942	SOUTH DADE SNAPPERS 2, INC.	GDO	1457	6700 NW 7 AVE	700
943	PERCEPTION ENTERPRISES, INC. DBA LOS PERROS	GDO	1459	13313 SW 42 ST	1,250
944	SEAWAYS BILTMORE PARTNERS DBA BILTMORE HOTEL	GDO	1460	1200 ANASTASIA AVE	3,750
945	LOS PINOS RESTAURANT CORP.	GDO	1461	1300 E 4 AVE	875
946	K-MART CORPORATION DBA K-MART #3074	GDO	1463	14091 SW 88 ST	560
947	JAVISAS KREW, LLC	GDO	1464	10712 SW 113 PL	550
948	BATABANO GROUP, INC. MONTES DE OCA ORIGINAL PIZZA CUBANA	GDO	1465	455 HIALEAH DR	1,350
949	CASA BLANCA BAKERY	GDO	1466	590 E 4 AVE	0
950	EL NUEVO PRADO CAFETERIA, INC.	GDO	1467	419 E HIALEAH DR	0
951	RODBENDERS RAW BAR & GRILL	GDO	1472	20400 OLD CUTLER RD	3,425
952	PUBLIX SUPERMARKETS, INC. DBA PUBLIX STORE #0080	GDO	1473	850 N MIAMI BEACH BLVD	4
953	KONING RESTAURANTS INTERNATIONAL, LC DBA PIZZA HUT #12355	GDO	1474	10691 SW 40 ST	2,725
954	PUBLIX SUPERMARKETS, INC. DBA PUBLIX STORE #0327	GDO	1475	13850 SW 8 ST	0
955	RAVELO'S CATERING CORP.	GDO	1476	1002 E 24 ST	125
956	TONY NINOSKA CORP. DBA NINO'S PIZZA E PASTA	GDO	1478	1081 E 25 ST	2
957	SOLARES ENTERPRISES, INC. DBA SEDANO'S SUPERMARKET #10	GDO	1480	1690 W 68 ST	0
958	MARIA CAFETERIA, INC.	GDO	1482	3082 NW 7 ST	250
959	INDUSTRIAS HAPPY CORP. DBA EMS RESTAURANT	GDO	1483	2152 NW 27 AVE	1,850
960	LA CASITA CAFETERIA, INC.	GDO	1485	3210 NW 7 ST	550
961	PIZZERIAS, LLC DBA PAPA JOHN'S PIZZA #551	GDO	1486	3236 NW 7 ST	0
962	KHANTEL ENTERPRISES DBA CARVEL STORE #2509	GDO	1487	3781 W FLAGLER ST	0
963	SALMON & SALMON RESTAURANT, INC.	GDO	1488	2907 NW 7 ST	750
964	CHATO'S CAFE RESTAURANT, INC.	GDO	1489	2917 NW 7 ST	750
965	DINARAGA GROUP, INC. DBA ERNESTO'S TACO SHOP	GDO	1491	20095 S DIXIE HWY	450
966	ROMANZA QUALITY, LLC DBA TRATTORIA ROMANZA	GDO	1492	14501 S DIXIE HWY	2,375
967	SSC302052, LLC DBA DUNKIN DONUTS #302052	GDO	1493	18099 S DIXIE HWY	500
968	BURGER KING CORPORATION DBA BURGER KING #2775	GDO	1495	233 NE 167 ST	1,064

No.	FACILITY_NAME	PERMIT	PERMIT_NUMBER	ADDRESS	TOTAL_GPD
969	SODEXOMAGIC, LLC	GDO	1497	9100 NW 36 ST	2,689
970	NEW HONG KONG CHINESE RESTAURANT	GDO	1499	6868 NW 169 ST	0
971	ILLOS MIRAMAR, LLC DBA CUBA LATIN CAFE	GDO	1500	9636 SW 24 ST	188
972	LOUIE'S CHINA HOUSE, LLC	GDO	1501	17849 NW 27 AVE	156
973	RAMA ENTERPRISES, INC. DBA LA VINA ARAGON RESTAURANT	GDO	1503	8121-55 W 8 AVE	1,850
974	HIALEAH REY'S PIZZA #2	GDO	1504	6781 W 12 AVE	784
975	GALAXY RG CORP. DBA GALAXY BAKERY	GDO	1506	14631 SW 104 ST	1
976	HAMMOCKS GRILL, INC.	GDO	1507	14617 SW 104 ST	700
977	TPS OUTSOURCING AND SERVICES, LLC DBA THE ORIGINAL PANCAKE HOUSE	GDO	1508	11510 SW 72 ST	3,750
978	OSI/OUTBACK STEAKHOUSE OF FL, LLC DBA OUTBACK STEAKHOUSE #1075	GDO	1509	3161 NE 163 ST	5,175
979	TROPICAL SUPERMARKET NO. 16, INC.	GDO	1510	18350 NW 7 AVE	0
980	ROMACORP, INC. DBA TONY ROMA'S #3010	GDO	1514	18050 COLLINS AVE	6,950
981	M.P.S.I. USA CORP. DBA THUNDERBIRD RESTAURANT	GDO	1515	18401 COLLINS AVE	1,875
982	ZHANG YANG FUJI, INC. DBA CHINA APPLE BUFFET	GDO	1516	1635 SW 107 AVE 105 B	4,200
983	COMMODORE 3157, LLC DBA THE CRUZ BUILDING COCONUT GROVE	GDO	1517	3157 COMMODORE PLZ	3,000
984	US COAST GUARD AIR STATION MIAMI	GDO	1518	103	1,176
985	CARIBBEAN FUELS, INC. DBA KROME EXXON	GDO	1520	19900 SW 177 AVE	0
986	AR & AR CORPORATION DBA LA CRIOLLITA CAFETERIA	GDO	1521	3701 NW 79 ST	420
987	FLANIGAN'S SEAFOOD BAR/GRILL	GDO	1522	1550 W 84 ST #09	4,075
988	NATAYAN INVESTMENT, LLC DBA PASTA VINO	GDO	1524	1624 79 ST	1,063
989	EL SUBMARINO SEAFOOD CORPORATION	GDO	1525	1922 W 60 ST	420
990	C & C AMAYA INVESTMENTS, INC. DBA MACITAS RESTAURANT	GDO	1526	14685 SW 104 ST	1,200
991	EL GAITERO SUPERMARKET II	GDO	1528	8121 W 8 AVE	0
992	CATALANA BAKERY CORP.	GDO	1529	19760 SW 177 AVE	562
993	BAKERY GROUP, LLC DBA CASA POTIN BAKERY	GDO	1533	3984 PALM AVE	875
994	PRESIDENTE SUPERMARKET NO. 27, INC.	GDO	1534	495 W 29 ST	0
995	MOE & MOE, INC. DBA 747 CAFETERIA	GDO	1538	4675 NW 7 ST	420
996	MESA'S BBQ CORP.	GDO	1539	1125 W 29 ST	750
997	G-SPOT, INC.	GDO	1541	4545 NW 7 ST #5	172
998	PEI WEI ASIAN DINER, LLC	GDO	1542	18801 BISCAYNE BLVD #260	810
999	SAYED FOOD ENTERPRISES, INC. DBA KENTUCKY FRIED CHICKEN	GDO	1545	18108 COLLINS AVE	649
1000	STARBUCKS COFFEE COMPANY, INC. DBA STARBUCKS #8290	GDO	1548	17100 COLLINS AVE #101-102	812
1001	W2 TEAM, LLC DBA MR. CHEF'S	GDO	1554	18800 NE 29 AVE BAY 10-11	2,250
1002	EL TAMALITO CUBANO, INC.	GDO	1559	1095 W 29 ST	133
1003	LA PAISANA RESTAURANT, INC.	GDO	1561	200 NW 8 AVE	625
1004	PANAMENO ROMERO, INC. DBA GALLITO'S CAFE & GRILL	GDO	1562	2100 NW 36 ST	625
1005	SUVICHE INTERNATIONAL, INC.	GDO	1565	675 W FLAGLER ST	326
1006	TRATTORIA LUNA RESTAURANT	GDO	1566	9477 S DIXIE HWY	1,950
1007	ALY'S BAKERY, INC.	GDO	1567	1740 PALM AVE	1
1008	CKC FOOD STORES, INC. DBA CKC MIAMI VICTORY	GDO	1569	2 NE 79 ST	38
1009	WAH FAI, INC. DBA CHINA LAKES RESTAURANT	GDO	1570	19589 NW 57 AVE	420
1010	CANNONBALL CAFE, INC.	GDO	1571	9471 S DIXIE HWY	300
1011	GUMI, INC. DBA DON Q FOOD BY POUND	GDO	1575	6452 NW 186 ST	875
1012	CHINA EXPRESS RESTAURANT, INC.	GDO	1579	5301 NE 2 AVE	300
1013	CORAL RESTAURANT	GDO	1580	6350 NW 82 AVE	1,850
1014	RED CARPET RESTAURANT CORP.	GDO	1581	3438-40 SW 8 ST	750
1015	EL BURRITO CORP.	GDO	1582	3015 GRAND AVE #8	310
1016	D.I. TRINIDAD ENTERPRISES, INC. DBA LITTLE PERU	GDO	1583	6832 NW 169 ST	1,625
1017	BAPTIST HEALTH SOUTH FLORIDA DBA OASIS DINING ROOM	GDO	1584	8900 SW 88 ST	0
1018	CARIBE INTERNATIONAL FOOD INC. DBA PALACIO DE LOS JUGOS	GDO	1585	5721 W FLAGLER ST	826
1019	BURGER KING CORPORATION DBA BURGER KING #4214	GDO	1586	4201 NW 36 ST	1,050
1020	PIZZERIAS, LLC DBA PAPA JOHN'S PIZZA #546	GDO	1589	10756 SW 72 ST	0
1021	GABLES INVESTMENT 24, LLC DBA CASTELLUCCIO RESTAURANT	GDO	1590	146 GIRALDA AVE	375
1022	MILLER'S CORAL GABLES ALE HOUSE, INC.	GDO	1592	101 MIRACLE MILE	2,000
1023	PALMETTO GENERAL HOSPITAL	GDO	1593	2001 W 68 ST	1,680
1024	LA FONDITA DEL MEDIO, INC.	GDO	1594	1939 W 60 ST	750
1025	BURGER KING CORPORATION DBA BURGER KING #5249	GDO	1595	18730 NW 67 AVE	1,288
1026	SUN WAH CHINESE RESTAURANT, INC. DBA SIN HUA	GDO	1596	2360 W 68 ST #121	188
1027	DELICIAS RESTAURANT CENTRO AMERICANO CORP.	GDO	1599	3034 NW 7 AVE	200
1028	STEAK 'N SHAKE RESTAURANT	GDO	1600	8701 SW 157 AVE	1,386
1029	ANYELO CORP. DBA LA MOON	GDO	1601	97 SW 8 ST	531
1030	CASOLA PIZZA, INC.	GDO	1602	2437 SW 17 AVE	0
1031	BELEN JESUIT PREPARATORY SCHOOL	GDO	1604	500 SW 127 AVE	200
1032	WEST MOWRY RESTAURANT	GDO	1605	328 W MOWRY DR	500
1033	E & D ROYAL BALLROOMS, INC.	GDO	1606	7137 W FLAGLER ST	703
1034	CARIBE RESTAURANT, INC.	GDO	1607	7173 W FLAGLER ST	2,875
1035	CAPRI RESTAURANT, INC.	GDO	1608	935 N KROME AVE	7,500
1036	BABALU KAFE, INC.	GDO	1610	5396 W 12 AVE	213
1037	FLORIDA GROCERS, INC. DBA SUPER ECONOMICO SUPERMARKET	GDO	1611	5370 W 12 AVE	1
1038	PENGUIN HOTEL MANAGEMENT, LLC DBA PURPLE PENGUIN RESTAURANT	GDO	1612	1418 OCEAN DR	496
1039	BREEZEWAY OF PALMED, LLC DBA BREEZEWAY RESTAURANT & DELI	GDO	1615	7160 W 20 AVE	351
1040	NUEVA CASA LATINA, LLC	GDO	1616	19541 NW 57 AVE	640
1041	CASA JUANCHO RESTAURANT	GDO	1617	2436 SW 8 ST	3,750
1042	EL TALISMAN CAFETERIA	GDO	1618	3887 W 16 AVE	825
1043	K THAI & CHINESE RESTAURANT, INC. DBA KAM WAH RESTAURANT	GDO	1621	12895 SW 42 ST	1,000
1044	RINCONCITO LATINO CAFE & RESTAURANT, INC.	GDO	1622	12899 SW 42 ST	1,875
1045	LA NUEVA FE BAKERY	GDO	1623	2975 W 4 AVE	224
1046	EVOS PINECREST MIA, LLC DBA EVOS PINECREST	GDO	1624	9537 S DIXIE HWY	486
1047	JIL DINO DISTRIBUTORS, INC. DBA CHICKEN KITCHEN LATINO	GDO	1625	701 W 49 ST	462
1048	MIWI CUBAN & AMERICAN SANDWHICH SHOP	GDO	1626	10201 HAMMOCKS BLVD #105	5
1049	BREADMAN MIAMI BAKERY CORP.	GDO	1628	5804 W 20 AVE	263
1050	BK WHOPPER BAR, LLC DBA BK WHOPPER BAR STORE #17402	GDO	1629	1101 WASHINGTON AVE	627
1051	GRAND CONDOMINIUM ASSOC.	GDO	1630	1717 N BAYSHORE DR	0
1052	IRMA BAKERY, INC.	GDO	1631	7133 W FLAGLER ST	1
1053	VILLA CANDADO, INC.	GDO	1636	231 E 4 AVE	323
1054	RHRC, LLC DBA THE RANCH HOUSE RESTAURANT	GDO	1637	1548 W 84 ST	800
1055	LOS SUIZOS CORP. DBA LA SUIZA BAKERY	GDO	1638	8566 SW 8 ST	875
1056	SUPREME BAKERY, INC. DBA LE FOURNIL FRENCH BAKERY	GDO	1639	8743 SW 9 TER	0

No.	FACILITY_NAME	PERMIT	PERMIT_NUMBER	ADDRESS	TOTAL_GPD
1057	LA FAMOSA CAFETERIA INVESTMENT, INC.	GDO	1642	3040 NW 2 AVE	420
1058	RINCONCITO CUBANO CRIOLLO RESTAURANT & CAFETERIA, INC.	GDO	1643	890 SW 87 AVE #1-6	625
1059	RINCONCITO LATINO 8TH STREET, INC.	GDO	1644	8488 SW 8 ST	1,025
1060	CK @ BRICKELL, LLC DBA CHICKEN KITCHEN	GDO	1645	842 BRICKELL PLZ	840
1061	LA PAVAS CAFETERIA & RESTAURANT	GDO	1647	2220 NW 7 ST	213
1062	BURGER KING CORPORATION DBA BURGER KING #0051	GDO	1650	4141 W FLAGLER ST	1,036
1063	BIG PINK, INC. DBA BIG PINK RESTAURANT	GDO	1651	157 COLLINS AVE	5,625
1064	SABORES LATINOS RESTAURANT	GDO	1655	2927 NW 7 AVE	420
1065	NATIONAL SUPERMARKET #05	GDO	1656	19565 NW 57 AVE	2
1066	PALMETTO AUTO TRUCK STOP	GDO	1657	9010 NW SOUTH RIVER DR	140
1067	PIZZERIAS, LLC DBA PAPA JOHN'S PIZZA #944	GDO	1660	9459 W FLAGLER ST	0
1068	LES TROIS AMIS DU SUD, INC. DBA BARU URBANO	GDO	1664	1001 S MIAMI AVE	1,368
1069	RICO BAKERY GOODS, LLC DBA RICO BAKERY	GDO	1665	405-425 SW 22 AVE	3
1070	LOS 4 AMIGOS CORP. DBA LAS 4 HERMANAS SUPERMARKET	GDO	1670	810 E 41 ST	0
1071	TBS MIAMI, LLC DBA BONDING	GDO	1671	638 S MIAMI AVE	230
1072	MASTER'S DELI PIZZERIA, INC.	GDO	1673	1720 ALTON RD	750
1073	JUAREZ H, LLC DBA SAZON LATINO CAFETERIA RESTAURANT	GDO	1676	1101 SW 8 ST	420
1074	LA ESQUINA TROPICAL MARKET & CAFETERIA	GDO	1677	1060 SW 8 ST	500
1075	LATIN MUSIC CAFE, INC.	GDO	1678	496 W 29 ST	625
1076	FRITERIAS CORP. DBA EL REY DE LAS FRITAS RESTAURANT	GDO	1679	421 W 29 ST	750
1077	HIALEAH BAKERY CORP.	GDO	1680	445 W 29 ST	440
1078	REY'S PIZZA CORPORATION DBA REY PIZZA #2	GDO	1681	2900 W 3 AVE	3,125
1079	CAFE ESPANA RESTAURANT PANADERIA, INC.	GDO	1682	498 W 28 ST	625
1080	LOS PERROS HEADQUARTERS, LLC	GDO	1683	6828 NW 169 ST	975
1081	PUBLIX SUPERMARKETS, INC. DBA PUBLIX STORE #0510	GDO	1684	891 N HOMESTEAD BLVD	11
1082	HABANA FUSION CAFE, INC.	GDO	1687	66 W 29 ST	331
1083	TACO BELL OF AMERICA, LLC DBA TACO BELL #18554	GDO	1688	15201 SW 104 ST	728
1084	ROYAL PALM GRILL & DELI	GDO	1690	806 N KROME AVE	700
1085	BRICKELL MONTI, LLC DBA 100 MONTADITOS BRICKELL	GDO	1694	1401 BRICKELL AVE #130	921
1086	TROPICAL SUPERMARKET CORP.	GDO	1695	500 SW 8 ST	0
1087	FAMAG, INC. DBA CABANAS RESTAURANT #2	GDO	1697	435 SW 8 ST	1,750
1088	YUMMY TANG, INC. DBA CAFE WONG'S	GDO	1698	2739 NW 54 ST	375
1089	PALM SPRINGS BAKERY	GDO	1699	8125 W 8 AVE	3
1090	LOS SEIS NIETOS, INC. DBA PAQUITOS TACOS CANTINA	GDO	1702	651 WASHINGTON AVE	150
1091	CHINESE GARDEN, INC. DBA EMPIRE SZECHUAN RESTAURANT	GDO	1703	3427 NE 163 ST	3,250
1092	SIAM RIVER THAI CUISINE, INC.	GDO	1704	3455 NE 163 ST	650
1093	PUBLIX SUPERMARKETS, INC. DBA PUBLIX STORE #1072	GDO	1705	155 E 2 AVE	0
1094	JA & RO RESTAURANT, INC. DBA CAFE VINALES	GDO	1707	995 SW 67 AVE	2,200
1095	A2COOL, LLC DBA VINO'S PIZZA & BREW	GDO	1709	731 WASHINGTON AVE	300
1096	NOPI ENTERPRISES, INC. DBA PIZZA RUSTICA RESTAURANT	GDO	1710	863 WASHINGTON AVE	126
1097	HABANA CAFE MIAMI 2, LLC	GDO	1712	914 E 25 ST	385
1098	FOOD STAR SUPERMARKET, INC. DBA FOOD STAR SUPERMARKET #06	GDO	1713	10751 W FLAGLER ST	0
1099	HILDA CATERING SERVICES	GDO	1714	960 E 25 ST	168
1100	TORRELAVEGA ENTERPRISES, INC. DBA SEDANO'S SUPERMARKET #17	GDO	1717	10720 W FLAGLER ST # 12	0
1101	RINCONCITO 107 LATINO CORP.	GDO	1718	70 NW 107 AVE	105,000
1102	SUN CUISINE, LLC DBA ZEST RESTAURANT & ZEST MARKET	GDO	1719	200 S BISCAYNE BLVD #200	1,008
1103	SPRIS ARTISANAL PIZZA, LLC DBA SPRIS PIZZA	GDO	1720	200 BISCAYNE BLVD #500-A	378
1104	INDEPENDENT ENTERPRISES, INC. DBA SEDANO'S SUPERMARKET #05	GDO	1721	9688 SW 24 ST	0
1105	MARIO THE BAKER, INC.	GDO	1722	10741 W FLAGLER	525
1106	ON PAN FLAGLER, INC. DBA DON PAN	GDO	1723	1 SW 107 AVE #1	500
1107	CHEBERE APPETITE, INC. DBA SERGIO'S CAFETERIA	GDO	1724	4720 NW 167 ST	2,225
1108	GUO XIN, LLC DBA CHINA STAR RESTAURANT	GDO	1727	9640 SW 24 ST	213
1109	WINN DIXIE STORES, INC. DBA WINN DIXIE STORE #231	GDO	1730	5850 NW 183 ST	0
1110	DORAL STATION II CORP.	GDO	1731	10690 NW 41 ST	1,377
1111	MYA ENTERPRISES CORPORATION DBA DONA PAULINA I	GDO	1732	8263 SW 40 ST	325
1112	CACHITAS CAFE, INC. DBA CACHITAS RESTAURANT	GDO	1734	409 E OKEECHOBEE RD	213
1113	NANA'S INT'L CREATIONS BAKERY, INC.	GDO	1735	7954 SW 8 ST	1
1114	ALTON RD SUPREME SERVICES, INC.	GDO	1739	1840 ALTON RD	35
1115	VICKY BAKERY IV, INC.	GDO	1740	13925 NW 67 AVE	0
1116	REM LEARNING CENTER SOUTH DAY CARE	GDO	1744	16400 SW 147 AVE	100
1117	WINN DIXIE STORES, INC. DBA WINN DIXIE STORE #252	GDO	1745	1525 SW 22 ST	1,125
1118	NARCOBOLLO RESTAURANT, INC.	GDO	1746	150 W FLAGLER ST #175	432
1119	AKASHI JAPANESE RESTAURANT, INC.	GDO	1747	5830 S DIXIE HWY	1,500
1120	EL NOVILLO RESTAURANT	GDO	1748	6830 SW 40 ST	5,000
1121	EPSILON OMEGA, INC. DBA IHOP 36-54	GDO	1750	399 S HOMESTEAD BLVD	750
1122	KONING RESTAURANTS INTERNATIONAL, LC DBA PIZZA HUT #12410	GDO	1751	28640 S DIXIE HWY	0
1123	PIZZERIAS, LLC DBA PAPA JOHN'S PIZZA #1014	GDO	1752	19343 S DIXIE HWY	0
1124	MENENDEZ MANAGEMENT CORP. DBA MCDONALD'S #6486	GDO	1755	7405 NW 36 ST	1,526
1125	NOI TRE CATERING, LLC DBA VERO ITALIAN	GDO	1756	90 SE 1 ST	200
1126	BRASINT, LLC	GDO	1757	9796 SW 24 ST	1,071
1127	PARDO'S GRILL CAFE, INC. DBA CEVICHE 7 MARES	GDO	1758	7451 SW 8 ST	320
1128	COTRINA USA, INC. DBA LA VIDA DE DON POLLO	GDO	1759	19361 S DIXIE HWY	300
1129	SOUTH BEACH DINER, INC. DBA 11TH STREET DINER	GDO	1760	1065 WASHINGTON AVE	1,500
1130	ROCC DOWNTOWN, LLC DBA THE CHEESE COURSE	GDO	1762	200 S BISCAYNE BLVD #450-A	382
1131	PIZZERIAS, LLC DBA PAPA JOHN'S PIZZA #889	GDO	1764	2201 SW 22 ST	0
1132	ALMANAC, LLC DBA THE MIGHTY	GDO	1765	2224 SW 22 ST	524
1133	HOUSE OF PORTUGAL, LLC	GDO	1767	2257 SW 22 ST	375
1134	MENENDEZ MANAGEMENT CORP. DBA MCDONALD'S #15144	GDO	1771	14699 SW 42 ST	910
1135	MENENDEZ MANAGEMENT CORP. DBA MCDONALD'S #11599	GDO	1772	5640 NW 7 ST	1,456
1136	MENENDEZ MANAGEMENT CORP. DBA MCDONALD'S #7295	GDO	1773	11301 SW 40 ST	977
1137	PUERTO SAGUA RESTAURANT	GDO	1775	700 COLLINS AVE	3,475
1138	LE CHIC FRENCH BAKERY	GDO	1777	1043 WASHINGTON AVE	4
1139	THAI HOUSE SOUTH BEACH, INC.	GDO	1778	1137 WASHINGTON AVE	500
1140	MIAMI SEAQUARIUM-MAIN CAFETERIA	GDO	1781	4400 RICKENBACKER CSWY	54
1141	PUBLIX SUPERMARKETS, INC. DBA PUBLIX STORE #0343	GDO	1786	2414 W 60 ST	0
1142	DEZDEZ CORPORATION DBA NATIONAL SUPERMARKET #2	GDO	1787	5400 PALM AVE	0
1143	SOLACHE CORPORATION DBA LOS MAGUEYES MEXICAN RESTAURANT	GDO	1788	6870 NW 169 ST	775
1144	PUBLIX SUPERMARKETS, INC. DBA PUBLIX STORE #0454	GDO	1789	18995 BISCAYNE BLVD	6

No.	FACILITY_NAME	PERMIT	PERMIT_NUMBER	ADDRESS	TOTAL_GPD
1145	LOS BOBOS CAFETERIA & DELI	GDO	1791	5600 NW 79 AVE	420
1146	CHIPOTLE MEXICAN GRILL OF COLORADO, LLC DBA CHIPOTLE #1508	GDO	1792	18815 BISCAYNE BLVD SP 255	655
1147	900 AVENTURA RESTAURANT, LLC DBA NOVECIENTO	GDO	1793	18831 BISCAYNE BLVD SP 220	1,544
1148	PUBLIX SUPERMARKETS, INC. DBA PUBLIX STORE #0237	GDO	1794	13001 SW 112 ST	0
1149	YUN JI, INC. DBA CHINA TOKYO	GDO	1796	2454 W 60 ST	296
1150	TB ISLE RESORT LP DBA TB ISLE RESORT & CLUB POOL GRILL	GDO	1799	19999 W COUNTRY CLUB DR	838
1151	J MARY J FOOD CORP.	GDO	1800	1900 W 60 ST	3,000
1152	EL DON PEPE RESTAURANT CORP.	GDO	1801	9090 NW SOUTH RIVER DR #1-3	855
1153	ALKIDA, INC. DBA ODALY'S DELIGHT	GDO	1802	9754 SW 24 ST	300
1154	AVK ENTERPRISES, INC.	GDO	1804	1337 WASHINGTON AVE	0
1155	FRITANGA MANAGUA EL MERCADO, INC.	GDO	1806	2470 W 60 ST	8
1156	ROSITA'S RESTAURNT	GDO	1808	199 W PALM DR	2
1157	FARMERS MARKET RESTAURANT	GDO	1811	300 N KROME AVE	1,250
1158	GUJOR, INC. DBA SF CATERING N'EVENTS	GDO	1812	5451 NW 72 AVE	500
1159	COMMONWEALTH MIAMI, LLC	GDO	1813	1216 WASHINGTON AVE	510
1160	LA PARRILLA LIBERTY II, INC.	GDO	1814	1255 WASHINGTON AVE	1,225
1161	CAFE CATULA, LLC	GDO	1817	7190 SW 87 AVE #102	771
1162	BEV-CO ENTERPRISES, INC. DBA TRATTORIA DI CAMPO	GDO	1818	9533 NW 41 ST	525
1163	LOS HORNOS RESTAURANT, INC.	GDO	1819	4615 NW 72 AVE #113	550
1164	SUBWAY 60052, LLC	GDO	1821	1870 W 60 ST UNIT-C	308
1165	CONTRERAS TRUST, LLC DBA POLLO RIKO	GDO	1824	1990 W 60 ST	375
1166	LIMONCELLO ITALIAN RESTAURANT, LLC	GDO	1826	19088 NE 29 AVE	1,078
1167	RESTAURANT BRISTO NEIGHBORHOOD CORP.	GDO	1828	2779 BIRD AVE	750
1168	THE SUSHI BAR	GDO	1830	8748 SW 72 ST	750
1169	TWENTY SEVEN BIRDS CORPORATION DBA E-Z KWIK MARKET/BIG DADDY'S	GDO	1833	2988 SW 27 AVE	965
1170	CHC RESTAURANTS, INC.	GDO	1835	6450 NW 186 ST	1,250
1171	PENACABARGA ENTERPRISES, INC. DBA SEDANO'S SUPERMARKET #20	GDO	1836	6430 NW 186 ST	0
1172	JAMICAN KITCHEN, INC.	GDO	1837	8736 SW 72 ST	0
1173	EPICURE COMMISSARY WHOLESALE	GDO	1838	1680 ALTON RD	0
1174	NATIONAL DELI CORP. DBA EPICURE MARKET & COMMISSARY WHOLESALE	GDO	1839	1656 ALTON RD	0
1175	MI CALI BAKERY, INC.	GDO	1840	2350 W 60 ST #14	0
1176	STARBUCKS COFFEE COMPANY, INC. DBA STARBUCKS #8430	GDO	1841	13503 BISCAYNE BLVD	488
1177	SOUTH FLORIDA BAKERY, INC.	GDO	1842	14159 SW 144 ST	3
1178	TACO BELL OF AMERICA, LLC DBA TACO BELL #18574	GDO	1843	5705 NW 163 ST	728
1179	SUNSET FAST FOODS, INC. DBA BURGER KING #10483	GDO	1844	15170 SW 72 ST	1,120
1180	CUESTA ENTERPRISES, INC. DBA SUBWAY #6561	GDO	1848	7500 NW 25 ST #107	672
1181	SUPER CAFETERIA, INC.	GDO	1850	10016 W FLAGLER ST	500
1182	ALEX ELECTRIC, INC. DBA XPRESS CAFE	GDO	1851	8200 NW 25 ST	280
1183	LOS JIMAGUAS BAKERY, INC. DBA WILLY'S BAKERY	GDO	1852	380 E 9 ST #10	1
1184	VIP DEVELOPMENT CORP.	GDO	1853	19755 TURNBERRY WAY	235
1185	UNIVERSAL TRUTH CENTER FOR BETTER LIVING, INC.	GDO	1854	21310 NW 37 AVE	0
1186	RINCONCITO LATINO, LLC	GDO	1855	15956 SW 137 AVE	1,475
1187	DADDY'S GRILL FLAVOR, INC.	GDO	1857	4680 W 17 CT	420
1188	BONI'S COFFEE SHOP, INC.	GDO	1858	16155 SW 117 AVE #8	0
1189	MCDONALD'S CORP. DBA MCDONALD'S #5723	GDO	1859	3355 W 80 ST	630
1190	DAYS INN SOUTH BEACH	GDO	1860	100 21 ST	3,750
1191	P & L HOSPITALITY, LLC DBA THE BIG CHEESE OF HOMESTEAD	GDO	1863	350 N HOMESTEAD BLVD	1,225
1192	OVALLE'S BAKERY	GDO	1864	11454 QUAIL ROOST DR	3
1193	GALINDO FOOD CORP. DBA GALINDO'S CAFE	GDO	1865	30530 S DIXIE HWY	9
1194	PORTOFINO SUPERMARKET CORP.	GDO	1868	2900 W 12 AVE #1-3	4
1195	REAL HOLDING MANAGEMENT, INC. DBA SEDANO'S SUPERMARKET #08	GDO	1869	3950 W 12 AVE	0
1196	GUADAMUZ GROUP CORP. DBA NICOYA NICARAGUAN GRILL	GDO	1870	2900 W 12 AVE #8	625
1197	LA BARCA CAFETERIA CORP.	GDO	1872	1681 W 37 ST 24	406
1198	SABOR MELIAN RESTAURANT, INC.	GDO	1873	3970 W 16 AVE	600
1199	LITTLE CAESAR'S ENTERPRISES, INC. DBA LITTLE CAESAR'S PIZZA #2232	GDO	1874	4100 W 12 AVE	8
1200	NIKKO, INC. DBA NIKKO JAPANESE RESTAURANT	GDO	1876	827 N HOMESTEAD BLVD	1,250
1201	STARBUCKS COFFEE COMPANY, INC. DBA STARBUCKS #8506	GDO	1877	901 S MIAMI AVE	280
1202	CHICO'S RESTAURANT	GDO	1878	4070 W 12 AVE	3,725
1203	STARBUCKS COFFEE COMPANY, INC. DBA STARBUCKS #13824	GDO	1879	2937 BISCAYNE BLVD	588
1204	HOMESTEAD CORRECTIONAL INSTITUTION	GDO	1882	19000 SW 377 ST	0
1205	DOMINO'S PIZZA, LLC DBA DOMINO'S PIZZA #4919	GDO	1883	13715 SW 152 ST	0
1206	NADIA, INC. DBA CARVEL ICE CREAM #2721	GDO	1884	1407 W 49 ST	0
1207	VILLAGE CHINESE RESTAURANT	GDO	1885	13775 SW 152 ST	1,200
1208	SYLSOR CORPORATION DBA SUBWAY #21218	GDO	1886	13769 SW 152 ST	532
1209	GERONIMO GROUP CORP. DBA NEW L'BOULEVARD CAFE	GDO	1891	3632-34 NW 25 AVE	1,625
1210	METRO LATIN AMERICAN, LLC	GDO	1892	6600 NW 72 AVE	1,000
1211	A-MARI-MIX, LLC	GDO	1893	9700 SW 24 ST D	350
1212	EL QUITRIN CAFE, INC. DBA CAFE QUITRIN	GDO	1894	667 W 25 ST	400
1213	LOS PALACIOS RESTAURANT, INC.	GDO	1895	5394-96 NW 72 AVE	1,200
1214	MINAPE, LLC DBA EL METRO RESTAURANT	GDO	1896	5355 NW 72 AVE	438
1215	TAJAMA CORP. DBA RINCONCITO PAIZA #4	GDO	1897	9700 SW 24 ST #E	500
1216	TELEMUNDO CAFE	GDO	1898	2430 W 8 AVE	1,875
1217	SSC307873, LLC DBA DUNKIN DONUTS	GDO	1901	1606 ALTON RD	275
1218	WFM-WO, INC. DBA WHOLE FOODS MARKET #082	GDO	1902	1020 ALTON RD	3
1219	PLAYA CAFE CORP.	GDO	1903	1515 WASHINGTON AVE	4
1220	MIAMI CUBANO, LLC DBA HAVANA 1957	GDO	1904	1446 WASHINGTON AVE	467
1221	GABLES JUICE BAR, INC.	GDO	1905	230 ALMERIA AVE	175
1222	MANUGIO CORP. DBA BOTECO COPACABANA	GDO	1906	437 ESPANOLA WAY	270
1223	SSC351430, LLC DBA DUNKIN DONUTS #351430	GDO	1907	11698 SW 152 ST	195
1224	RINKIN LUNCH TRUCK CORP. DBA RINKIN CATERING RESTAURANT	GDO	1909	7258 NW 25 ST	1,000
1225	AMPY ENTERPRISES, INC. DBA MCDONALD'S #25649	GDO	1911	4185 W 16 AVE	980
1226	FUJI TEMPLE, LLC DBA FUJIYA JAPANESE RESTAURANT	GDO	1912	13750 SW 88 ST	650
1227	BOHIO FOOD, INC. DBA LE LAMBI RESTAURANT OF MIAMI	GDO	1913	13720 SW 88 ST	300
1228	PUBLIX SUPERMARKETS, INC. DBA PUBLIX STORE #0188	GDO	1914	8601 NW 186 ST	4
1229	MIGAR CORPORATION DBA LUIS GALINDO LATIN AMERICAN #2	GDO	1915	10700 SW 24 ST	575
1230	CHOY FAMILY CORP. DBA LOS PARADITOS RESTAURANT	GDO	1917	5006 W 12 AVE	1,125
1231	SUPER CAFETERIA J.N. INC.	GDO	1918	1426 W 49 ST	900
1232	MIAMI-DADE CORRECTIONS MIAMI-DADE COUNTY JAIL	GDO	1919	1321 NW 13 ST	1,600

No.	FACILITY_NAME	PERMIT	PERMIT_NUMBER	ADDRESS	TOTAL_GPD
1233	JIT FAMILY, INC. DBA LA BARATA MARKET	GDO	1920	5961 W 16 AVE	0
1234	CHECKERS DRIVE-IN RESTAURANTS, INC. DBA CHECKERS #C-175	GDO	1921	10695 SW 40 ST	224
1235	RICKY BAKERY, INC.	GDO	1922	12761-63 SW 42 ST	992
1236	KONING RESTAURANTS INTERNATIONAL, LC DBA PIZZA HUT #12412	GDO	1923	12733 SW 42 ST	0
1237	KING FUNG CORP. DBA MR. LEE'S	GDO	1925	6560 NW 186 ST	0
1238	BURGER KING CORPORATION DBA BURGER KING #5991	GDO	1926	7195 NW 74 ST	1,064
1239	LITTLE CAESAR'S ENTERPRISES, INC. DBA LITTLE CAESAR'S PIZZA #2243	GDO	1928	6556 NW 186 ST	0
1240	TURNER GUILFORD KNIGHT CORRECTIONAL CENTER	GDO	1929	7000 NW 41 ST	24,000
1241	DI PIAZZA PIZZARIA, INC.	GDO	1930	1408 W 49 ST	750
1242	LA CABANA PAISA GRILL CORP.	GDO	1931	12743-45 SW 42 ST	1,200
1243	SPICE LOUNGE, INC. DBA FUSION LOUNGE	GDO	1934	5985 W 25 CT 101-104	1,000
1244	CHINA STEAK HOUSE II	GDO	1935	4262 W 12 AVE	1,225
1245	HOT SOBE LTD. DBA GRAFA PIZZA	GDO	1937	1357 WASHINGTON AVE	123
1246	DOMINO'S PIZZA, LLC DBA DOMINO'S PIZZA #5170	GDO	1939	1615 NE 8 ST	0
1247	CHRISTIAN BAKERY, INC. DBA CUBA BAKERY	GDO	1940	1641 NE 8 ST	3
1248	CANTON CHINESE RESTAURANT OF HOMESTEAD	GDO	1941	1611 NE 8 ST	1,850
1249	HIBACHI GRILL OF FLORIDA CITY, LLC DBA HIBACHI BUFFET AND GRILL	GDO	1943	326 SE 1 AVE	1,988
1250	PUBLIX SUPERMARKETS, INC. DBA PUBLIX STORE #0714	GDO	1945	4870 BISCAYNE BLVD	6,891
1251	ART-DECO SUPERMARKET 2014, INC.	GDO	1947	1435 WASHINGTON AVE	2,325
1252	CHARLOTTE BAKERY, INC.	GDO	1948	1499 WASHINGTON AVE	0
1253	REY CHAVEZ #2, INC.	GDO	1950	780 W 17 ST A-5	369
1254	GOLDEN BOAR PRODUCT CORP.	GDO	1951	7224 NW 25 ST	1,000
1255	RIVER PARK HOTEL & SUITES, INC.	GDO	1956	100 SE 4 ST	2,200
1256	LITTLE CAESAR'S ENTERPRISES, INC. DBA LITTLE CAESAR'S PIZZA #239	GDO	1958	9477 SW 160 ST	0
1257	CHECKERS DRIVE-IN RESTAURANTS, INC. DBA CHECKERS #C-257	GDO	1960	16790 S DIXIE HWY	0
1258	LA TUTELAR CAFETERIA CORP.	GDO	1963	330 W 23 ST	252
1259	6781 RED ROAD, INC. DBA SUBSTANTIAL SUBS	GDO	1966	10015 SW 72 ST	112
1260	E.T. LIMITED DBA SPORTS GRILL	GDO	1968	10005 SW 72 ST	2,500
1261	WINN DIXIE STORES, INC. DBA WINN DIXIE STORE #251	GDO	1969	3275 SW 22 ST	3
1262	TROPICAL OASIS RESTAURANT	GDO	1970	20737 NW 2 AVE	1,000
1263	PERUVIAN CUISINE MIAMI, LLC DBA PACHAMAMMA	GDO	1972	17040 COLLINS AVE	406
1264	STAR CHIGUA'S PIZZA, LLC	GDO	1974	1570 W 43 PL #1&2	250
1265	MAVY CAFETERIA, INC.	GDO	1975	3501 E 10 CT	336
1266	CHURCH OF JESUS CHRIST OF LATTER DAY SAINTS	GDO	1977	8201 NW 186 ST	38
1267	SPORTS GRILL PALMETTO GOLF COURSE, LLC	GDO	1978	9300 SW 152 ST	375
1268	MAR AZUL CAFETERIA	GDO	1979	6701 NW 37 AVE	686
1269	PRETZEL TWISTER @ WESTLAND MALL	GDO	1980	1673 W 49 ST SP 1412	0
1270	T & J CATERING & DELIVERY CORP. DBA CASITAS CAFE	GDO	1982	4793 NW 167 ST #1	210
1271	SANTA FE FOODS, INC. DBA EL PINOLERO MARKET	GDO	1984	11347 W FLAGLER ST	188
1272	MIAMI BEEF COMPANY, INC.	GDO	1986	4870 NW 157 ST	0
1273	RICO PAN, INC.	GDO	1988	18636 NW 67 AVE	0
1274	NINE BEACH, LLC DBA 9 BEACH	GDO	1991	1626 COLLINS AVE	183,875
1275	GABLES BANQUET HALL, INC. DBA SOTO'S WINDOW CAFE	GDO	1993	7360 SW 24 ST 19	0
1276	YING HAO CHINESE RESTAURANT, INC.	GDO	1994	862-864 E 41 ST	716
1277	EL ATAKAT FOOD SERVICES	GDO	1995	10855 SW 72 ST #28	1,750
1278	AMPY ENTERPRISES, INC. DBA MCDONALD'S #1789	GDO	1997	3280 SW 22 ST	1,750
1279	PIZZERIAS, LLC DBA PAPA JOHN'S PIZZA #890	GDO	1998	13716 SW 88 ST B	0
1280	MARJIM ENTERPRISES CORP. DBA CHALAN ON THE BEACH	GDO	1999	1580 WASHINGTON AVE	493
1281	ADRIAN'S CORPORATION DBA MAR Y TIERRA	GDO	2000	266 NE 1 ST	500
1282	TWO CHEF'S RESTAURANT, INC.	GDO	2002	8279 S DIXIE HWY	1,875
1283	CALLAO CORPORATION DBA CEBICHE'S PLACE	GDO	2003	8342 SW 8 ST	5
1284	SEDANO'S SUPERMARKET, INC. DBA SEDANO'S SUPERMARKET #01	GDO	2004	840 E 41 ST	0
1285	CORAL REEF YACHT & CLUB	GDO	2005	2484 S BAYSHORE DR	3,750
1286	560 BABYLON, LLC	GDO	2006	560 WASHINGTON AVE	1,223
1287	YU CHOU HAI CORP. DBA CAFE HUBEI RESTAURANT	GDO	2010	2230 NW 62 ST	0
1288	HOUSE OF PRAYER APOST. FAITH, INC.	GDO	2011	2445 NW 62 ST	0
1289	RINCONCITO SUPERLATINO 4, INC.	GDO	2012	3791 SW 40 ST	900
1290	GIGI'S GOURMET CATERING, INC.	GDO	2014	1082 NW 54 ST	0
1291	YELES BAKERY, INC.	GDO	2016	6440 NW 186 ST	875
1292	MARIOBY'S RESTAURANT CAFE CORP.	GDO	2018	3694 W 12 AVE	433
1293	SANDWICH VICTORIA & RESTAURANT, INC.	GDO	2019	4256 W 12 AVE	420
1294	1701 MIAMI OPERATOR, LLC DBA HYDE BEACH BAR	GDO	2020	1701 COLLINS AVE FAC. A	1,825
1295	ELMIRA MIAMI, LLC DBA THE RALEIGH HOTEL	GDO	2021	1775 COLLINS AVE	1,540
1296	SAGAMORE HOTEL CORPORATION	GDO	2023	1671 COLLINS AVE	3,500
1297	SOUTH BEACH MUNCHIES RESTAURANT	GDO	2024	324-326 LINCOLN RD	1
1298	DS NORTH KENDALL, LLC DBA MARGARITA MINI MARKET	GDO	2025	9869 SW 88 ST	169
1299	FAST GRILL ENTERPRISES OF KENDALL DRIVE, INC. DBA LA GRANJA POLLOS A	GDO	2026	10501 SW 88 ST A-101	747
1300	SUBS 88, LLC	GDO	2027	9895 SW 88 ST	0
1301	MIAMI SURFCOMBER SOUTH BEACH	GDO	2029	1717 COLLINS AVE	2,775
1302	LAS CUEVAS DE BELLAMAR, LLC	GDO	2031	2725 W 3 CT	313
1303	PESCAITO EXPRESS, LLC DBA DISCO FISH & GRILL RESTAURANT & FISH	GDO	2032	1540 SW 67 AVE	550
1304	RARE HOSPITALITY MANAGEMENT, LLC DBA LONGHORN STEAK HOUSE	GDO	2037	1630 NW 87 AVE	1,619
1305	PINHO INVESTMENT, INC. DBA LUNCH BREAK CAKES	GDO	2039	9682 NW 25 ST	563
1306	RENAISSANCE BALLROOMS, INC.	GDO	2041	5910 SW 8 ST	2,000
1307	LA TABERNA, INC. DBA LA TABERNA DE IGNACIO	GDO	2045	1800 W 68 ST #123	1,025
1308	DJJ RESTAURANT CORP. DBA EL NOVILLO RESTAURANT	GDO	2046	15450 NEW BARN RD	5,000
1309	CHENG HUI, LLC DBA DUMPLING HOUSE	GDO	2047	8341 NW 12 ST	600
1310	GOLD APPLE ENTERPRISES, INC. DBA CENTRAL SUPERMARKET	GDO	2049	4675 NW 199 ST	3,125
1311	CAKELAND, INC. DBA CARVEL STORE #1850	GDO	2051	13071 SW 88 ST	0
1312	PUERTO MADERO, INC.	GDO	2053	12879 SW 88 ST	1,750
1313	JAAP ENTERPRISES, INC. DBA GATEAUX MAISON	GDO	2055	11629 SW 88 ST	238
1314	PUBLIX SUPERMARKETS, INC. DBA PUBLIX STORE #0066	GDO	2057	18330 COLLINS AVE	0
1315	MARSEILLES HOTEL	GDO	2059	1741 COLLINS AVE	750
1316	VILLAGIO AT DADELAND CORP. DBA VILLAGIO	GDO	2063	7535 SW 88 ST 7491	117,500
1317	SPORT BAR GRILL GRG'S CORP.	GDO	2064	2846 PALM AVE	900
1318	HACIENDA GRILL & RESTAURANT CORP.	GDO	2065	3828 W 16 AVE	550
1319	MOJITOS CALLE 8, INC.	GDO	2070	8000 SW 8 ST	1,500
1320	NENO'S BAKERY, INC. DBA LA CATALANA BAKERY	GDO	2071	4895 NW 183 ST	0

No.	FACILITY_NAME	PERMIT	PERMIT_NUMBER	ADDRESS	TOTAL_GPD
1321	FQSR, LLC DBA KBP FOODS KFC #5298	GDO	2073	17701 NW 27 AVE	430
1322	FQSR, LLC DBA KFC #5299	GDO	2074	13801 BISCAYNE BLVD	585
1323	PALMS SOUTH BEACH, INC.	GDO	2075	3025 COLLINS AVE	5,775
1324	MIAMI DADE COLLEGE - NORTH CAMPUS	GDO	2076	11380 NW 27 AVE BLDG 4000	0
1325	MIAMI DADE COLLEGE - SOUTH CAMPUS	GDO	2077	11011 SW 104 ST	0
1326	BREAD AND CHOCOLATE, LLC DBA GRANIER BAKERY	GDO	2079	18230 COLLINS AVE	875
1327	LOS PERROS SUNNY ISLES, LLC DBA LOS PERROS	GDO	2080	18146 COLLINS AVE	425
1328	BURGER KING CORPORATION DBA BURGER KING #3423	GDO	2081	18194 COLLINS AVE	1,456
1329	LA NONNA CORPORATION	GDO	2082	117 SW 107 AVE	2,125
1330	88 WANG, INC. DBA NEW CHINA II RESTAURANT	GDO	2085	9632 SW 77 AVE	0
1331	MLK RESTAURANT, INC.	GDO	2087	2469 NW 62 ST	420
1332	NORTH MIAMI BAKERY, INC. DBA SUNSET BAKERY	GDO	2088	8788 SW 72 ST	0
1333	LEE'S CHINESE RESTAURANT, INC.	GDO	2090	7102 SW 117 AVE	0
1334	DI CRESPO, LLC	GDO	2092	13772 SW 152 ST	538
1335	REGAL CINEMAS SOUTHLAND MALL 16 THEATRES	GDO	2093	20505 S DIXIE HWY	0
1336	CANTABRIA ENTERPRISES, INC. DBA SEDANO'S SUPERMARKET #21	GDO	2094	13794 SW 152 ST	0
1337	PINECREST BAKERY, LLC	GDO	2095	6718 SW 40 ST	300
1338	MAZ RESTAURANT, INC. DBA CANTON ROSE RESTAURANT	GDO	2097	4038 SW 67 AVE	1,350
1339	J.R. ONE, INC. DBA JOHNNY ROCKETS #1	GDO	2098	7501 SW 88 ST	1,800
1340	WINN DIXIE STORES, INC. DBA WINN DIXIE STORE #201	GDO	2099	6500 W 4 AVE	0
1341	PARTY CAKE BAKERY IV, INC.	GDO	2100	13798 SW 152 ST	1
1342	LA PERLA DEL RINCON DEL MAR, INC.	GDO	2101	13742-46 SW 152 ST	900
1343	HYATT REGENCY CORAL GABLES	GDO	2105	50 ALHAMBRA PLZ HOTEL	1,880
1344	GOOD ITALIAN FOOD, LLC	GDO	2107	17082 COLLINS AVE	1,375
1345	J.M. BAKERY CORP. DBA BABY BAKERY II	GDO	2108	4809 NW 167 ST	8
1346	BURGER KING CORPORATION DBA BURGER KING #9869	GDO	2110	1100 5 ST	980
1347	WISE SPICE CATERING COMPANY	GDO	2114	196-98 W 25 ST	1
1348	CARMACUATRO, LLC DBA THE KNIFE	GDO	2116	1455 NW 107 AVE #206	5,950
1349	SAN LAZARO CAFETERIA, INC.	GDO	2118	2400 W 2 AVE # 5	750
1350	CHENTE ENTERPRISES II, INC. DBA CICI'S PIZZA	GDO	2120	410 W 49 ST #107	4,600
1351	CRUNCHY KIOSK PIZZA CORP.	GDO	2121	1455 NW 107 AVE #68	0
1352	PHOENIX 90, LLC DBA JUNGLE JUICE CAFE	GDO	2125	17100 COLLINS AVE #110	300
1353	MILAM'S SUPERMARKET #4	GDO	2126	17100 COLLINS AVE #119	0
1354	LITTLE CAESAR'S ENTERPRISES, INC. DBA LITTLE CAESAR'S PIZZA #2277	GDO	2127	901 E 8 AVE	0
1355	LA CARNE ASADA CORP.	GDO	2130	1680 PALM AVE	623
1356	LI'S COMPANY, INC. DBA RESTAURANTE DELICIAS LA CABANA	GDO	2131	1442 W 49 ST	1,500
1357	SABOR ANDINO CORPORATION DBA SABOR ANDINO	GDO	2133	7868 NW 52 ST	448
1358	PFOW COMPANIES, LLC DBA OASIS LOUNGE	GDO	2134	2977 MCFARLAND RD	775
1359	SAILORMEN, INC. DBA POPEYE'S CHICKEN #0018	GDO	2137	1000 NE 163 ST	700
1360	HUI CI, INC. CHINA CITY	GDO	2139	4793 NW 167 ST #2	975
1361	GYROVILLE 9, LLC	GDO	2140	8841 SW 107 AVE	250
1362	100% KEY BISCAYNE, LLC DBA 100% NATURAL RESTAURANT	GDO	2142	180 CRANDON BLVD #101-102	400
1363	DE SILVA & CARDINALE, INC. DBA LA SCALA RESTAURANT	GDO	2143	180 CRANDON BLVD #109	216
1364	MOZART GRILL EXPRESS, INC.	GDO	2144	18120 COLLINS AVE	500
1365	RICE ASIAN HOUSE & SUSHI BAR	GDO	2145	17100 COLLINS AVE #114-115	500
1366	TORCHAV, INC. DBA LUCERNA BAKERY	GDO	2147	6727 W 4 AVE	1
1367	TACO BELL OF AMERICA, LLC DBA TACO BELL #31023	GDO	2148	7405 W 4 AVE	516
1368	WU'S FAMILY, INC.	GDO	2150	5223 NW 79 AVE	0
1369	LA UCHIRENA FAST FOOD USA, INC.	GDO	2153	7880 NW 52 ST	225
1370	COUP D'ETAT, LLC DBA LULU	GDO	2154	3105 COMMODORE PLZ	250
1371	CHUNG'S CORP. DBA CAFE NANKING	GDO	2157	6471 NW 7 AVE	850
1372	SAILORMEN, INC. DBA POPEYE'S CHICKEN #0001	GDO	2158	5534 NW 7 AVE	420
1373	MAD ENTERPRISES GROUP, INC. DBA MERCEDES RESTAURANT	GDO	2159	8199 NW 54 ST	1,850
1374	ITALIAN BOUTIQUE RESTAURANTS, LLC	GDO	2160	260 CRANDON BLVD C29-30	540
1375	ITALIAN BOUTIQUE RESTAURANTS, LLC DBA PUNTINO PIZZA	GDO	2161	260 CRANDON BLVD E35	165
1376	ALHANAN, INC. DBA CHACAITO	GDO	2162	260 CRANDON BLVD #47	214
1377	KEG SOUTH OF KENDALL, INC.	GDO	2165	12805 SW 136 AVE	600
1378	MARLIN'S BAKERY OF OLGA, INC. DBA MARLIN'S BAKERY	GDO	2166	12857 SW 88 ST	0
1379	AZG PETROLEUM, LLC DBA COUNTRY WALK MOBIL	GDO	2167	13698 SW 152 ST	500
1380	MOBIL 57 AVE, INC.	GDO	2168	16691 NW 57 AVE	300
1381	7-ELEVEN, INC. DBA 7-ELEVEN #34986A	GDO	2169	11680 SW 72 ST	764
1382	7-ELEVEN, INC. DBA 7-ELEVEN #34984A	GDO	2170	15199 S DIXIE HWY	0
1383	ACADEMICA CORP. DBF THE DORAL ACADEMY, INC.	GDO	2171	2450 NW 97 AVE	0
1384	J & S AUTO LEASING, INC. DBA MANHATTAN BAKERY	GDO	2172	18240 COLLINS AVE	465
1385	KEY BISCAYNE SMOOTHIE CORP. DBA A YESHA JUICE CENTER	GDO	2177	328 CRANDON BLVD #108	0
1386	WENDY'S INTERNATIONAL, INC. DBA WENDY'S #2339	GDO	2178	6720 SW 8 ST	980
1387	PALSOR GROUP CORP. DBA EL 20 DE MAYO	GDO	2181	2238 NW 82 AVE	1,050
1388	LAS ACACIAS GOURMET ARGENTINO, LLC	GDO	2182	8200 NW 14 ST	648
1389	MISS SAIGON BISTRO	GDO	2184	148 GIRALDA AVE	1,250
1390	AB & JOE'S PIZZA, LLC	GDO	2187	3792 W 12 AVE	225
1391	HAPPY FISHERIES, INC. DBA HAPPY FISH RESTAURANT	GDO	2191	18916 SW 114 AVE	0
1392	STARBUCKS COFFEE COMPANY, INC. DBA STARBUCKS #8227	GDO	2192	7708 SW 88 ST	420
1393	CORAL WAY REY'S PIZZA, INC. DBA REY PIZZA #2	GDO	2193	1050 E 8 AVE	672
1394	RINCONCITO DE ALEX EL PAISA, INC.	GDO	2195	13037 SW 112 ST	234
1395	DOMINO'S PIZZA, LLC DBA DOMINO'S PIZZA #5090	GDO	2196	5877 PONCE DE LEON BLVD	0
1396	BARMELI TAPAS & WINE BAR CORP.	GDO	2201	6927 BISCAYNE BLVD	575
1397	CARPACCIO, INC.	GDO	2202	9700 COLLINS AVE	4,500
1398	HILLSTONE RESTAURANT GROUP, INC. DBA THE GRILL AT BAL HARBOUR	GDO	2203	9700 COLLINS AVE #233-235	1,692
1399	NEIMAN MARCUS GROUP, INC. DBA ZODIAC ROOM NEIMAN MARCUS	GDO	2204	9700 COLLINS AVE #175	542
1400	LAGOS CAFE, LLC	GDO	2205	9333 NW 12 ST	410
1401	MMDO CORP. DBA MONTE DE OCA ORIGINAL PIZZA	GDO	2207	4360 NW 7 ST	0
1402	LITTLE CAESAR'S ENTERPRISES, INC. DBA LITTLE CAESAR'S PIZZA #2245	GDO	2208	1551 SW 107 AVE	5
1403	SUBRAGIOUS, INC. DBA SUBRAGIOUS RESTAURANT	GDO	2209	1553 SW 107 AVE	504
1404	LA PUPUSA FACTORY	GDO	2210	1804 W 68 ST SPC 1	1,500
1405	EL PRADO CORP. DBA EL PRADO BAKERY	GDO	2211	3707 NW 7 ST	1,036
1406	PALM AVENUE BUSINESS, LLC DBA SUBWAY #48711	GDO	2212	3333 PALM AVE #5	350
1407	LA FOGATA BBQ SPECIALTIES	GDO	2220	8239 W FLAGLER ST #62	1,875
1408	RUYI, INC. DBA CAFE RUYI	GDO	2221	14401 NW 27 AVE	532

No.	FACILITY_NAME	PERMIT	PERMIT_NUMBER	ADDRESS	TOTAL_GPD
1409	KONING RESTAURANTS INTERNATIONAL, LC DBA PIZZA HUT #12351	GDO	2223	14699 SW 104 ST	2,450
1410	MAMMA MIA PIZZERIA RESTAURANT, INC.	GDO	2224	13755 SW 152 ST	1,100
1411	MACY'S FLORIDA STORES, LLC DBA MACY'S TASTE BAR	GDO	2225	7303 SW 88 ST	0
1412	WENDIUM OF FLORIDA, INC. DBA WENDY'S #1712	GDO	2226	6898 SW 40 ST	1,260
1413	KONING RESTAURANTS INTERNATIONAL, LC DBA PIZZA HUT #12347	GDO	2228	807 SW 8 ST	2,500
1414	MAJA ENTERPRISES, INC. DBA SEDANO'S SUPERMARKET #04	GDO	2229	6709 W FLAGLER ST	0
1415	TRIANON RESTAURANT, INC. DBA PALOMILLA GRILL	GDO	2230	6890 W FLAGLER ST	3,750
1416	LA GRAN PELOTA, LLC	GDO	2231	6752 W FLAGLER ST	25,000
1417	PRESIDENTE SUPERMARKET NO. 29, INC.	GDO	2234	14778 SW 56 ST	5,974
1418	LIGHTHOUSE CAFE, INC.	GDO	2235	1200 S CRANDON BLVD	2,300
1419	MILANEZZA, LLC DBA MILANEZZA RESTAURANT	GDO	2236	700 CRANDON BLVD #4-5	563
1420	SPECIALTY RESTAURANT, INC. DBA RUSTY PELICAN RESTAURANT	GDO	2237	3201 RICKENBACKER CSWY	8,750
1421	SIR PIZZA ENTERPRISES, INC. DBA SIR PIZZA RESTAURANT	GDO	2238	712 CRANDON BLVD	1,850
1422	ISLAS CANARIAS SOUTH, INC.	GDO	2240	13695 SW 26 ST	6,250
1423	SUN-TAVERN, LLC DBA DELI LANE CAFE & TAVERN	GDO	2241	7232 SW 59 AVE	3,725
1424	LIERGANES ENTERPRISES, INC. DBA SEDANO'S SUPERMARKET #15	GDO	2242	13659 SW 26 ST	0
1425	EL ARTE BAKERY ENTERPRISES, INC. DBA TROPICANA FOOD BY THE POUND	GDO	2243	8323 W FLAGLER ST	7
1426	KONING RESTAURANTS INTERNATIONAL, LC DBA PIZZA HUT #12337	GDO	2244	200 NW LE JEUNE RD	3,725
1427	CHOBORRAS CORP. DBA AMPY BAKERY	GDO	2245	4665 NW 199 ST	0
1428	ROSSY'S RESTAURANT	GDO	2246	8586 SW 8 ST	950
1429	KPK SUNSET FOOD LTD DBA FUJI HANA RESTAURANT	GDO	2250	11768 SW 88 ST	1,225
1430	PEOPLE'S DRUG STORE, INC.	GDO	2251	360 NW 8 ST	560
1431	S & N VEGETABLES	GDO	2257	360 W 29 ST	0
1432	MK RESTAURANT CONCEPTS, LLC DBA LOKAL BURGERS & BEER	GDO	2259	3190 COMMODORE PLZ	421
1433	SUSHI SAMBA DROMO	GDO	2260	600 LINCOLN RD	7,825
1434	CASABLANCA SEAFOOD BAR & GRILL, INC.	GDO	2261	400 NW NORTH RIVER DR	5,000
1435	SABRINA CORPORATION DBA RESTAURANT SELVA NEGRA	GDO	2262	2025 W FLAGLER ST	2,000
1436	OCEAN RESTAURANT CORPORATION	GDO	2264	740 OCEAN DR	376
1437	COURTYARD MANAGEMENT CORP. DBA COURTYARD BY MARRIOTT	GDO	2265	2649 S BAYSHORE DR RESTAURANT	1,650
1438	JAQUE MATE, LLC DBA FREDDO	GDO	2266	610 LINCOLN RD	383
1439	CAROL CITY FOODS CORPORATION DBA MCDONALD'S #6204	GDO	2269	4686 NW 183 ST	1,344
1440	PRIME CAFE & ICE CREAM	GDO	2270	250 E PALM DR #F-10	233
1441	CHANPRASERT, INC. DBA SIAM BISTRO	GDO	2271	7348 SW 117 AVE	1,700
1442	LA DORADA CORAL GABLES, INC.	GDO	2272	177 GIRALDA AVE	5,000
1443	POLLO OPERATIONS, INC. DBA POLLO TROPICAL #38	GDO	2273	2350 SW 37 AVE	1,064
1444	DIXIE DISCOUNT MEAT MARKET	GDO	2275	24727 S DIXIE HWY	0
1445	SAKPASE RESTAURANT	GDO	2276	27156 S DIXIE HWY	225
1446	BREAD PARTNERS #32, INC. DBA AU BON PAIN	GDO	2277	11750 SW 40 ST #100	391
1447	LITTLE CAESAR'S ENTERPRISES, INC. DBA LITTLE CAESAR'S PIZZA #2275	GDO	2278	2402 W 60 ST	0
1448	FERNANDEZ MEAT DISTRIBUTOR	GDO	2279	1049 E 41 ST	0
1449	E.B. CAFETERIA, INC. DBA REY CAFETERIA	GDO	2280	1055 E 41 ST	420
1450	SINGH GROUP CORPORATION DBA AMBROSIA DOVES	GDO	2281	4542 PALM AVE	375
1451	LA VINO TINTO SPORTS RESTAURANT, INC.	GDO	2287	201 W 22 ST A & B	460
1452	BURGER KING CORPORATION DBA BURGER KING #3624	GDO	2289	900 IVES DAIRY RD	980
1453	FOOD INDUSTRIES, LLC DBA CRABS & SEAFOOD BROS	GDO	2290	20723 NW 2 AVE	240
1454	PIZZERIAS, LLC DBA PAPA JOHN'S PIZZA #555	GDO	2292	20312 NW 2 AVE	350
1455	SAILORMEN, INC. DBA POPEYE'S CHICKEN #0009	GDO	2293	20690 NW 2 AVE	980
1456	JUSTIN'S BARBEQUE BARN, LLC	GDO	2294	20601 NW 2 AVE	150
1457	FORTUNE ONE HUNDRED, INC. DBA CHINA JADE	GDO	2295	20703 NW 2 AVE	200
1458	SWEET HAND KATHY'S RESTAURANT & BAKERY, LLC	GDO	2297	20316 NW 2 AVE	311
1459	WONG LI CORPORATION DBA CAFE MEKONG	GDO	2301	18587 NW 27 AVE	0
1460	JHM FLORIDA HOTEL MANAGEMENT INC. DBA COURTYARD BY MARRIOTT	GDO	2302	2051 LE JEUNE RD	38
1461	PIZZERIAS, LLC DBA PAPA JOHN'S PIZZA #1621	GDO	2303	1596 S DIXIE HWY	400
1462	S & S DINER, INC.	GDO	2304	1757 NE 2 AVE	420
1463	OASIS CAFE AT KEY BISCAUNE, LLC DBA OASIS CAFE KB	GDO	2307	19 HARBOR DR	625
1464	AUTONATION USA OF PERRINE, INC. DBA AUTONATION NISSAN KENDALL	GDO	2308	17305 S DIXIE HWY	0
1465	PANERA, LLC DBA PANERA BREAD #1124	GDO	2311	9717 NW 41 ST	1,650
1466	SUNSHINE RESTAURANT PARTNERS, INC. DBA IHOP	GDO	2313	1645 W 49 ST #1302	4,000
1467	OTTOMAN, INC. DBA SULTAN KEBAB RESTAURANT	GDO	2314	1903 COLLINS AVE	750
1468	SETAI HOTEL ACQUISITIONS, LLC DBA SETAI SOUTH BEACH RESORT &	GDO	2315	2001 COLLINS AVE	774
1469	GAMP, LLC DBA INDOMANIA RESTAURANT	GDO	2317	2601 COLLINS AVE	238
1470	FARAYA GROUP, LLC	GDO	2319	8398 NW 58 ST	2,375
1471	YUEN & BAI DONG, INC. DBA WONDER WOK	GDO	2320	21313 NW 2 AVE	950
1472	BAKERY MANAGEMENT CORP.	GDO	2322	15625 NW 15 AVE	0
1473	FANCY LOAF CARIBBEAN BAKERY, INC.	GDO	2323	1014 NE 215 ST	0
1474	EAP MANAGEMENT CORP. DBA KENTUCKY FRIED CHICKEN #5	GDO	2324	20285 NW 2 AVE	812
1475	ABEMCO INCORPORATED DBA STEPHEN'S RESTAURANT	GDO	2326	1000 E 16 ST	3,725
1476	EL CASTILLO DE LAS FRUTAS LATIN PROUD, LLC.	GDO	2327	1004 E 16 ST	550
1477	MONTES DE OCA ORIGINAL PIZZA CUBANA #3	GDO	2328	1740 PALM AVE #10	1,450
1478	REALTY RESOURCES GROUP S.E. FL., LLC DBA DENNY'S #7467 RRSF - LLC	GDO	2329	5825 NW 36 ST	3,725
1479	CAFE TABERNA, INC.	GDO	2330	7939 W 28 AVE	750
1480	DON FAVIO'S PIZZA CORP.	GDO	2331	4685 NW 7 ST	194
1481	KENDALL REGIONAL MEDICAL CENTER	GDO	2332	11750 SW 40 ST	1,386
1482	LACERDA & SILVA CORP. DBA MAIA'S CAFE BISTRO	GDO	2333	6100 BLUE LAGOON DR #135	0
1483	RDP GROUP CORP. DBA SAMMI'S CAFE	GDO	2334	5200 BLUE LAGOON DR 130	700
1484	CARIBE CAFETERIA RESTAURANT, INC.	GDO	2335	2660 SW 137 AVE	625
1485	CHINA VILLAGE	GDO	2336	7909 NW 2 ST	750
1486	REINA ENTERPRISES, LLC	GDO	2337	7925-31 NW 2 ST	1,125
1487	GARCIA'S SEAFOOD GRILLE & FISH MARKET	GDO	2339	398 NW NORTH RIVER DR	1,200
1488	SHUCKERS BAR & GRILL	GDO	2341	1819 79 ST	1,850
1489	HAIFA MANAGER, LLC DBA BAGEL COVE	GDO	2345	19003 BISCAYNE BLVD	1,023
1490	PHOENIX DINING OF MIAMI GARDENS, LLC DBA DENNY'S #7466	GDO	2346	1450 NE MIAMI GARDENS DR	125,700
1491	PIZZERIAS, LLC DBA PAPA JOHN'S PIZZA #517	GDO	2347	1498 NE MIAMI GARDENS DR	325
1492	KONING RESTAURANTS INTERNATIONAL, LC DBA PIZZA HUT #12403	GDO	2348	9600 SW 8 ST #23	371
1493	LA CAMPANA RESTAURANT, INC. DBA CHEF RAMON	GDO	2349	9610 SW 8 ST	1,350
1494	ARGO MANAGEMENT, INC. DBA MCDONALD'S #2263	GDO	2350	9850 SW 8 ST	1,036
1495	SUSHI CAFE, LLC.	GDO	2353	7917 NW 2 ST	1,750
1496	GUAN WU, LLC DBA SUM YUM GAI	GDO	2357	1403 WASHINGTON AVE	350

No.	FACILITY_NAME	PERMIT	PERMIT_NUMBER	ADDRESS	TOTAL_GPD
1497	CRUST US, LLC DBA CRUST	GDO	2358	668 NW 5 ST	640
1498	YELLOWTAIL SUBS AND GRILL, INC.	GDO	2360	11609 SW 216 ST	223
1499	TELEMUNDO TELEVISION STUDIOS, LLC	GDO	2362	7355 NW 41 ST	375
1500	MIAMI FINGA LICKING 176, LLC	GDO	2363	17647 NW 27 AVE	282
1501	THE HOTEL OF COLLINS AVENUE, LLC DBA WISH	GDO	2365	801 COLLINS AVE	1,531
1502	GOURMET 305, LLC DBA 305 RESTAURANT	GDO	2367	7744 NW 64 ST	300
1503	MEI GAMMA, LLC DBA U MAMI	GDO	2368	1400 NW 87 AVE	1,270
1504	LA ESQUINA LATINA CAFETERIA, INC.	GDO	2369	7925 W 2 CT	450
1505	SUBWAY #1916, INC.	GDO	2370	7400 NW SOUTH RIVER DR B7	476
1506	BURGER KING CORPORATION DBA BURGER KING #2531	GDO	2373	955 SW 107 AVE	2,086
1507	ANSA FINANCIAL CONSULTING, LLC DBA CHE PIKE GOURMET PRODUCTS	GDO	2374	1001 E 28 ST B	350
1508	PORTO VITA PROPERTY OWNERS ASSN DBA VILLA GRANDE CLUBHOUSE	GDO	2375	20105 NE 38 CT	3,175
1509	CREPES AND CRABS CORP. DBA THE ORIGINAL CRAB HOUSE	GDO	2376	9636 SW 77 AVE	245
1510	THE ORIGINAL HONEY BAKED HAM CO. OF GEORGIA, INC.	GDO	2377	9385 SW 40 ST	840
1511	DI PAPA'S, INC.	GDO	2378	9871-77 SW 88 ST	2,000
1512	KONING RESTAURANTS INTERNATIONAL, LC DBA PIZZA HUT #12395	GDO	2379	1801 E 4 AVE	0
1513	LATIN HOUSE GRILL, LLC DBA LATIN HOUSE GRILL BURGER/TACO BAR	GDO	2382	9565 SW 72 ST	875
1514	KIDDIE LUNCHBOX, LLC	GDO	2383	13640 NW 19 AVE #1A	313
1515	SUBWAY 39079, INC.	GDO	2386	7900 NW 27 AVE #A-5	375
1516	PHIMICO COMPANY, LLC DBA SHINJU JAPANESE BUFFET	GDO	2389	8800 SW 72 ST	1,575
1517	A.D.B. WORKS, LLC DBA GIARDINO GOURMET SALADS	GDO	2390	169 E FLAGLER ST #66	275
1518	BAIRES SUNNY ISLES, LLC	GDO	2391	18090 COLLINS AVE T1/T2/T3	565
1519	EINSTEIN AND NOAH CORP. DBA EINSTEIN BROS. BAGELS #3320	GDO	2392	16840 COLLINS AVE	1,400
1520	POSEIDON FISH MARKET, INC.	GDO	2395	18250 COLLINS AVE	979
1521	EL NUEVO PIO PIO CAFE CORP.	GDO	2397	11300 NW 87 CT #134	0
1522	SSC330411, LLC DBA DUNKIN DONUTS #330411	GDO	2400	341 41 ST	529
1523	COPPER CHIMNEY, INC.	GDO	2401	18090 COLLINS AVE T22	1,000
1524	DND, INC. DBA PORTERHOUSE BAR & GRILL	GDO	2402	17004 COLLINS AVE	6,500
1525	MI PERU GOURMET, INC.	GDO	2403	1754 NE MIAMI GARDENS DR	700
1526	CITY OF MIAMI FIRE STATION #04	GDO	2406	1105 SW 2 AVE	0
1527	NU SUN SHINE, INC. DBA NU SUNSHINE INDO PAK GROCERY	GDO	2407	1813 NE 164 ST	0
1528	PRETZEL MAN, INC. DBA AUNTIE ANNE'S PRETZELS	GDO	2408	20505 S DIXIE HWY 789	0
1529	AO & CHEN CORP. DBA CHINA LAKE RESTAURANT	GDO	2409	1560 NE 165 ST	1,250
1530	GARCIA'S CAFE, INC. DBA FISHERMAN'S CAFE	GDO	2410	7903 NW 64 ST	462
1531	CHECKERS DRIVE-IN RESTAURANTS, INC. DBA CHECKERS #C-388	GDO	2411	450 NW 42 AVE	126
1532	RINCONCITO LATINO CAFE & RESTAURANT CORP.	GDO	2412	10481 SW 40 ST	700
1533	A_LEXZA CAFE	GDO	2416	2676 W 12 AVE	213
1534	TACO BELL OF AMERICA, LLC DBA TACO BELL #17721	GDO	2417	2700 W 68 ST	896
1535	STARBUCKS COFFEE COMPANY, INC. DBA STARBUCKS #8548	GDO	2419	8888 SW 136 ST #486	0
1536	BETTER DAYZ, INC. DBA HAAGEN DAZS #612	GDO	2420	8888 SW 136 ST	6
1537	LA PERLA DEL SUR, INC.	GDO	2423	5762 W FLAGLER ST	1,000
1538	S.S.M. GROUP, INC. DBA KALINKA DELICATESSEN	GDO	2424	18090 COLLINS AVE T24	1,625
1539	180 STATION, INC.	GDO	2425	18090 COLLINS AVE T26	1,028
1540	RUBEN'S SWEET SHOP, LLC DBA HERSHEY'S ICE CREAM	GDO	2426	18090 COLLINS AVE T-17	214
1541	KFC CORPORATION DBA KFC #Y309029	GDO	2428	3855 NW 27 AVE	709
1542	C & M CATERING, LLC DBA JADE OCEAN	GDO	2430	17121 COLLINS AVE	250
1543	SONIA'S SEAFOOD MARKET	GDO	2431	7501 SW 8 ST	3,750
1544	GREGOMARC, LLC DBA LA SIN RIVAL BAKERY	GDO	2432	9772 SW 8 ST	406
1545	BIANCA RESTAURANT PIZZERIA CORP. DBA MAMA'S PIZZERIA	GDO	2433	5679 W FLAGLER ST	375
1546	Z & Z FOOD MART, INC. DBA ROCKET FUEL	GDO	2434	5695 W FLAGLER ST	402
1547	PANDEBONO BAKERY, INC.	GDO	2435	7473 SW 8 ST	84
1548	PALISADE GROUP, INC. DBA PABLO'S CAFE	GDO	2436	8061 NW 66 ST	420
1549	SAMAN MIAMI, LLC DBA SAMAN AREPAS BISTRO	GDO	2437	4709 NW 79 AVE	200
1550	EL FARO LATIN CAFE, INC.	GDO	2438	5305 NW 79 AVE	1,775
1551	CEVICHINOS, LLC DBA CEVICHINOS RESTAURANT	GDO	2439	4729 NW 79 AVE	383
1552	CHICKEN EXPERTS, LLC DBA GRANPOLLO	GDO	2440	7890 NW 52 ST	700
1553	CALOGERO, INC. DBA CAFE AVANTI	GDO	2441	732 ARTHUR GODFREY RD	2,900
1554	DOUBLE DECKER DELI, LLC	GDO	2442	740 ARTHUR GODFREY RD	475
1555	BEST COLOMBIAN FOOD, INC. DBA RINCONCITO PAISA #1 RESTAURANT	GDO	2443	15108 SW 72 ST	300
1556	DOMINO'S PIZZA, LLC. DBA DOMINO'S PIZZA #3829	GDO	2444	453 SW 8 ST	0
1557	PARTY CAKE BAKERY IX, INC.	GDO	2445	15130 SW 72 ST	450
1558	DORAL SEAFOOD, INC.	GDO	2446	9743 NW 41 ST	1,650
1559	FRITANGA EL CHELE, INC.	GDO	2448	4617 NW 199 ST	275
1560	PIZZERIAS, LLC DBA PAPA JOHN'S PIZZA #1270	GDO	2449	9619 NW 41 ST	0
1561	MARY'S CUBAN CAFE CORP.	GDO	2451	808 SE 8 ST	625
1562	VICKY BAKERY V, INC.	GDO	2452	860 SE 8 ST	3
1563	DISCHI, INC. DBA EL AREPAZO 2	GDO	2453	3900 NW 79 AVE #124	4,875
1564	RUMARA CORPORATION DBA MAS UNIDOS SUPERMARKET	GDO	2454	820 SE 8 ST	0
1565	CONSTRUCTION CATERING, INC.	GDO	2455	490 SE 10 CT	950
1566	MOE'Z EXPRESS #2, INC. DBA MOE'Z EXPRESS RESTAURANT #2	GDO	2456	10544 SW 8 ST	750
1567	SAN GALLAN, INC.	GDO	2457	10600 SW 8 ST	625
1568	KFC CORPORATION DBA KFC #X975031	GDO	2458	949 SW 107 AVE	704
1569	YNTO FOOD CORP. DBA PRICE CHOICE FOODMARKET # 5	GDO	2460	1851 NE 2 AVE	125
1570	DIAZ SUPERMARKET, INC.	GDO	2465	151 OPA LOCKA BLVD	3,000
1571	BLANCO RESTAURANT CORP. DBA SAN LORENZO RESTAURANT	GDO	2466	601 SW 12 AVE	700
1572	WATERFRONT GROVE, LLC	GDO	2468	3385 PAN AMERICAN DR	5,000
1573	PASHA'S, INC.	GDO	2472	860 NE 79 ST #A	1,250
1574	Y & J CAFETERIA, INC. DBA LA PALAPA HONDURENA	GDO	2473	2699 BISCAYNE BLVD #2	300
1575	MC KITCHEN, LLC	GDO	2474	4141 NE 2 AVE 101A	1,487
1576	CHEF DB, INC. DBA OAK TAVERN	GDO	2475	35 NE 40 ST	275
1577	3819 N MIAMI AVE, LLC DBA HARRY'S PIZZERIA	GDO	2476	3918 N MIAMI AVE	275
1578	R.C.A. CULINARY SERVICES, INC.	GDO	2477	4400 BISCAYNE BLVD	875
1579	CITY SUBWAY CORP. DBA SUBWAY #798	GDO	2478	421 SE 1 AVE	224
1580	BROTHER TWO, LLC DBA LUCKY CHINA ONE	GDO	2479	9796 SW 8 ST	625
1581	DENNY'S, INC. DBA DENNY'S RESTAURANT #6796	GDO	2480	401 SE 1 AVE	100,000
1582	FRIENDS INTERNATIONAL, INC. DBA MERCY SUPERMARKET	GDO	2483	6600 BISCAYNE BLVD	670
1583	AGHIOS GERASIMOS, INC. DBA JIMMY'S EAST-SIDE DINER	GDO	2485	7201 BISCAYNE BLVD	1,125
1584	SEDANO'S SUPERMARKET #32-BAKERY	GDO	2486	14655 SW 56 ST FAC. A	0

No.	FACILITY_NAME	PERMIT	PERMIT_NUMBER	ADDRESS	TOTAL_GPD
1585	RICOR ENTERPRISES, INC. DBA EL PUB RESTAURANT	GDO	2487	1548 SW 8 ST	890
1586	TARGET CORPORATION DBA TARGET STORE #0968	GDO	2490	7795 SW 40 ST	560
1587	PUBLIX SUPERMARKETS, INC. DBA PUBLIX STORE #0044	GDO	2491	7805 SW 40 ST	0
1588	FRITANGA & RASPADERIA NICA, INC.	GDO	2493	11030 W FLAGLER ST	140
1589	BLANCO & SILVIA INC. DBA CHONTALES RESTAURANT	GDO	2494	11180 W FLAGLER ST #9	252
1590	BROTHER'S DISCOUNT MARKET CORP. DBA LATIN DISCOUNT MARKET	GDO	2496	11006 W FLAGLER ST	1,485
1591	MATEUS ENTERPRISES, INC. DBA MOZZARELLA	GDO	2497	7930 NW 36 ST #30	140
1592	LA CATALINA BAKERY CORP.	GDO	2500	4518 NW 183 ST	323
1593	PRICE CHOICE SUPERMARKET #8	GDO	2501	4500 NW 183 ST	0
1594	O'RICE CHINESE RESTAURANT	GDO	2502	4530 NW 183 ST	750
1595	PUBLIX SUPERMARKETS, INC. DBA PUBLIX STORE #0588	GDO	2509	4260 SW 152 AVE	0
1596	18001 HOLDINGS, LLC DBA TRUMP INTERNATIONAL BEACH RESORT	GDO	2510	18001 COLLINS AVE	406
1597	OCEAN FOUR CONDO ASSOC. INC. DBA OCEAN FOUR CONDOMINIUM	GDO	2512	17201 COLLINS AVE	370
1598	CRAFT SOCIAL CLUB CORP.	GDO	2514	100 COLLINS AVE CU-2	525
1599	A.D.O., INC. DBA BARI PIZZA RESTAURANT	GDO	2515	17168 W DIXIE HWY	3
1600	E.C. MANAGEMENT CORPORATION DBA MCDONALD'S #12111	GDO	2516	17730 COLLINS AVE	560
1601	JUICE AND JAVA SUNNY ISLES, LLC	GDO	2517	17608-12 COLLINS AVE	858
1602	BUKHARA FOOD, INC.	GDO	2519	18200 NW 27 AVE #A-25	125
1603	BIG FIVE CLUB, INC.	GDO	2520	600 SW 92 AVE	1,375
1604	SARUSSI'S CAFE	GDO	2521	6795 SW 8 ST	1,800
1605	SUSHI SAKE WESTCHESTER, INC. DBA SUSHI SAKE	GDO	2522	8679 SW 24 ST	450
1606	MEJE ENTERPRISE, INC. DBA SUBWAY #1584	GDO	2523	7277 NW 36 ST	0
1607	YOSI'S RESTAURANT CORP.	GDO	2524	3397 NW 151 TER	37,500
1608	REY'S PIZZA CORPORATION DBA REY PIZZA #7	GDO	2525	6340 SW 8 ST	546
1609	NEW CHINATOWN RESTAURANT, LLC DBA CHINATOWN WEST II	GDO	2526	15104 SW 72 ST	300
1610	KAI TSU JAPANESE CUISINE, INC.	GDO	2529	8150 SW 8 ST #115	750
1611	SUNSET AUTO CENTER, INC.	GDO	2531	6180 SW 72 ST	0
1612	CANDY'S PLACE RESTAURANT & CAFETERIA CORP.	GDO	2533	709 OPA LOCKA BLVD	378
1613	CHARLY CAFETERIA CORP.	GDO	2534	13175 NW 42 AVE	476
1614	NEJMA CORPORATION DBA KWIK STOP #44	GDO	2537	2891 NW 135 ST	0
1615	WEI EILEEN, INC. DBA KYOJIN JAPANESE SEAFOOD BUFFET	GDO	2538	6212 S DIXIE HWY	1,347
1616	SHAKE SHACK CORAL GABLES, LLC	GDO	2540	1450 S DIXIE HWY	1,465
1617	CHINA KITCHEN OF MIAMI, INC.	GDO	2542	4303 NW 7 ST A	450
1618	PEPPERS BURRITO GRILL BRICKELL, LLC	GDO	2544	229 SW 8 ST	425
1619	VEMAR MARKET, INC.	GDO	2545	1553 WASHINGTON AVE	550
1620	EL CAMINANTE RESTAURANT CAFETERIA, INC.	GDO	2546	11351 W FLAGLER ST	750
1621	DHAKA BARISAL, INC. DBA KEBAB INDIAN RESTAURANT	GDO	2547	514 NE 167 ST	1,900
1622	LATIN AMERICAN GRILL	GDO	2550	15342 NW 79 CT	3,125
1623	PANYA THAI, INC.	GDO	2551	520 NE 167 ST	1,225
1624	LA HIJA DE LA VIRGEN DE MERCEDES, INC. DBA EL ENCANTO RESTAURANT	GDO	2552	2200 NW 12 AVE	200
1625	BRICKELL FAST FOODS, INC. DBA BURGER KING #9866	GDO	2555	10 SW 8 ST	1,036
1626	PF CHANG'S CHINA BISTRO, INC.	GDO	2557	901 S MIAMI AVE #104	1,877
1627	V & M ENTERPRISES, INC. DBA LA CARRETA RESTAURANT	GDO	2558	3632 SW 8 ST	3,750
1628	INTERNATIONAL SCHOOL OF BRICKELL, LLC DBA KEY POINT ACADEMY	GDO	2559	609 BRICKELL AVE	5,000
1629	CAFE 701	GDO	2560	701 BRICKELL AVE	980
1630	JARQUIN SOTELO CORP. DBA FRITANGA "COCINA DE DONA ANGELA"	GDO	2561	8387 SW 40 ST	0
1631	LA CADENA SUPERMARKET #3, INC. DBA LA MILAGROSA	GDO	2563	3641 SW 8 ST	1,500
1632	NEXTDAY SOLUTIONS, INC. DBA CHOP SUEY	GDO	2564	18053 NW 27 AVE	7
1633	INARO, INC. DBA LA SUPER BARATA MARKET	GDO	2565	387-395 E 1 AVE	275
1634	TACO BELL OF AMERICA, LLC DBA TACO BELL #031772	GDO	2567	966 SW 8 ST	474
1635	PINES NURSING HOME 2015, LLC	GDO	2568	301 NE 141 ST	213
1636	ORIGINAL JUNE'S RESTAURANT, INC.	GDO	2570	18400 NW 2 AVE #11	925
1637	SOUTHWEST REY'S PIZZA, INC.	GDO	2571	2482-86 SW 137 AVE	71,250
1638	RICKY BAKERY, INC.	GDO	2572	12759 SW 42 ST	495
1639	GRK #PIZZA, LLC DBA EAT GREEK SOUVLAKI	GDO	2573	30 SW 8 ST	441
1640	CAKE N BAKE BAKERY CORP.	GDO	2574	13375-77 SW 42 ST	550
1641	BAHAMA'S FISH MARKET #2	GDO	2575	13387-99 SW 42 ST	3,275
1642	KONGO'S PIZZA CORP.	GDO	2577	240 E 1 AVE #123	875
1643	POLLO BRASA Y SAZON CORP.	GDO	2579	1618 W 68 ST	532
1644	ALAMO RESTAURANT CAFETERIA CORP.	GDO	2580	1665 W 68 ST	300
1645	MI CAFETERIA NO. 1 CORP. DBA MI CAFETERIA #1 RESTAURANT	GDO	2581	13349 SW 42 ST	6
1646	PIZZERIAS, LLC DBA PAPA JOHN'S PIZZA #1145	GDO	2582	15900 SW 137 AVE	0
1647	COCONUT GROVE WINES CORP. DBA HAPPY WINE IN THE GROVE	GDO	2583	2833 SW BIRD RD	375
1648	CHINA WOK RESTAURANT	GDO	2584	3855 SW 137 AVE BAY #3	0
1649	PANADERIA LOS TRES MONITOS INTERNATIONAL, INC.	GDO	2586	5374 W 12 AVE	2
1650	PAN PA YA BAKERY, INC.	GDO	2588	26 SW 8 ST	347
1651	ANTOJITOS MEXICANOS TEMORIO, LLC	GDO	2590	4095 SW 137 AVE #1	224
1652	POWER FOOD MARKET, INC.	GDO	2591	14566 NW 22 AVE	0
1653	PARTY CAKE BAKERY	GDO	2592	10000 SW 56 ST #17	0
1654	LA FIESTA RESTAURANT, INC.	GDO	2593	10930 W FLAGLER ST #310	375
1655	MARIA'S GREEK RESTAURANT, INC.	GDO	2594	2359 SW 22 ST	1,300
1656	TUTTO PASTA, INC.	GDO	2596	1751 SW 3 AVE	1,125
1657	STARBOARD GROUP OF SOUTHEAST FL, LLC DBA WENDY'S	GDO	2597	11925 NW 27 PL	875
1658	TASTE RITE, INC.	GDO	2599	18400 NW 2 AVE #4	0
1659	MC CAFETERIA, INC. DBA LATIN CUBAN CAFETERIA	GDO	2600	3323 W 80 ST	1,175
1660	SMOULAR, LLC DBA LATIN CAFETERIA RESTAURANT	GDO	2601	7360 SW 24 ST #1	800
1661	LARKIN COMMUNITY HOSPITAL II, LLC DBA FLORIDIAN GARDENS	GDO	2604	17250 SW 137 AVE	980
1662	EINSTEIN AND NOAH CORP. DBA EINSTEIN BROS. BAGELS #1265	GDO	2606	7970 NW 154 ST	1,850
1663	FRITERIAS CORP. DBA EL REY DE LAS FRITAS	GDO	2608	1821 SW 8 ST	1,300
1664	TOMMY'S BAKERY CORP.	GDO	2609	2349 W 52 ST	0
1665	POLLO OPERATIONS, INC. DBA POLLO TROPICAL #39	GDO	2610	1592 W 49 ST	1,792
1666	PUBLIX SUPERMARKETS, INC. DBA PUBLIX STORE #0595	GDO	2612	13005 SW 89 PL	0
1667	P.F. CHANG'S CHINA BISTRO, INC.	GDO	2614	8888 SW 136 ST T100	7,475
1668	P.F. CHANG'S CHINA BISTRO REST.	GDO	2615	17455 BISCAYNE BLVD	5,500
1669	DEBY GAS & OIL CORP.	GDO	2617	13401 SW 184 ST	375
1670	BOBBY'S MEAL	GDO	2618	2109 OPA LOCKA BLVD	0
1671	YENIS WALTER BAKERY, INC.	GDO	2620	780-784 E 57 ST	350
1672	ISLAND MONKEY MARKETPLACE & CAFE, LLC	GDO	2621	10686 SW 186 LN	396

No.	FACILITY_NAME	PERMIT	PERMIT_NUMBER	ADDRESS	TOTAL_GPD
1673	SUSHI REPUBLIC RESTAURANT	GDO	2623	9583 HARDING AVE	420
1674	LAS DELICIAS BAKERY CORP.	GDO	2624	608 E 9 ST	350
1675	AGAVE PARTNERS, LLC DBA SALSA FIESTA	GDO	2626	18167 BISCAYNE BLVD	540
1676	LE RENDEZ-VOUS BAKERY & CUISINE, LLC	GDO	2632	17851 BISCAYNE BLVD	416
1677	ANTHONY'S COAL FIRED PIZZA OF AVENTURA, INC.	GDO	2633	17901 BISCAYNE BLVD	3,725
1678	MARA'S FISH HOUSE, LLC	GDO	2636	7400 NW SOUTH RIVER DR B6	444
1679	STARBUCKS COFFEE COMPANY, INC. DBA STARBUCKS #13940	GDO	2638	5711 NW 7 ST	625
1680	HIALEAH GARDENS MOBIL, INC.	GDO	2639	3321 W 80 ST	250
1681	FRITANGA MONIMBO KENDALL RESTAURANT	GDO	2640	7173 SW 117 AVE	1,450
1682	THE FAR EAST SIDE, LLC DBA SUSHIN JAPANESE RESTAURANT	GDO	2641	7175 SW 117 AVE	375
1683	MAS GROUP CORP. DBA MASA TAQUERIA	GDO	2642	3036 GRAND AVE	395
1684	CANTINA GRILL AT AIRPARK PLAZA, LLC	GDO	2643	5761 NW 7 ST	1,250
1685	MAGARI, LLC DBA BELLA CAPRI	GDO	2644	5749 NW 7 ST	375
1686	CARPE CAFETERIA, INC. DBA TIFFANY'S LATIN CAFE	GDO	2645	7400 SW 42 ST	8
1687	LA BAMBA CAFE, INC.	GDO	2646	7380 SW 42 ST	450
1688	JARABACOA CAFE CORP. DBA LA ESQUINA CARIBENA RESTAURANT	GDO	2647	13290 NW 43 AVE A	750
1689	LORNA'S RESTAURANT, INC.	GDO	2648	2732 NW 183 ST	300
1690	HIDALGO'S CAFETERIA & RESTAURANT	GDO	2649	24961 S DIXIE HWY	875
1691	ALIF MIAMI GARDENS, LLC DBA STOP N SHOP FOOD STORE	GDO	2656	3251 NW 183 ST	600
1692	PANERA, LLC DBA PANERA BREAD #1583	GDO	2658	18538 NW 67 AVE	0
1693	CIBONEY, INC.	GDO	2659	18474 NW 67 AVE	2,125
1694	FIU - GRAHAM CENTER	GDO	2660	11200 SW 8 ST	4,200
1695	EL FLORIDITA SEAFOOD RESTAURANT	GDO	2662	8393 SW 40 ST	1,225
1696	POLLO OPERATIONS, INC. DBA POLLO TROPICAL #150	GDO	2663	1277 SW 8 ST	1,188
1697	VIVA MEXICO, INC.	GDO	2664	542 SW 12 AVE	99
1698	EL RINCONCITO LATINO	GDO	2665	6741 CORAL WAY #1	2,400
1699	BU YU XU, INC. DBA CASA CHINA RESTAURANT	GDO	2666	6500 W 4 AVE #10	750
1700	GRATIGNY ROAD OPERATING, LLC	GDO	2669	2755 NW 119 ST	50
1701	MDFR - FIRE RESCUE STATION #16	GDO	2670	325 NW 2 ST	120
1702	MDFR - FIRE RESCUE STATION #05	GDO	2671	13150 SW 238 ST	0
1703	MDFR - FIRE RESCUE STATION #06	GDO	2672	15890 SW 288 ST	128,620
1704	MDCAD - FIRE RESCUE STATION #59 NORTH SIDE	GDO	2673	5680 NW 36 ST 846	0
1705	MDFR - FIRE RESCUE STATION #44	GDO	2674	7700 NW 186 ST	0
1706	CITY OF MIAMI FIRE RESCUE #05	GDO	2677	1200 NW 20 ST	0
1707	CITY OF MIAMI-FIRE RESCUE #09	GDO	2678	69 NE 62 ST	0
1708	CITY OF MIAMI-FIRE RESCUE #12	GDO	2679	1455 NW 46 ST	0
1709	CITY OF MIAMI FIRE RESCUE #06	GDO	2680	701 NW 36 ST	0
1710	BURGER KING CORPORATION DBA BURGER KING #0025	GDO	2681	17951 NW 27 AVE	3,725
1711	NS NORTHWEST QUALITY MEATS, INC.	GDO	2682	14025 NW 27 AVE	0
1712	CIC INVESTORS #90, LTD DBA FLANIGAN'S SEAFOOD BAR & GRILL	GDO	2683	9857 SW 40 ST	1,075
1713	GOOD WAY COFFEE SHOP, INC.	GDO	2685	10932 NW 7 AVE	490
1714	WINN DIXIE STORES, INC. DBA WINN DIXIE STORE #233	GDO	2686	11030 NW 7 AVE	0
1715	RESTAURANTE UNIVERSAL MARIA'S CORP.	GDO	2687	2072 OPA LOCKA BLVD	525
1716	JACKSON SOUL FOOD II, LLC	GDO	2691	14511 NW 27 AVE	370
1717	HOME STYLE RESTAURANT, INC.	GDO	2693	14905 NW 22 AVE	532
1718	F & L RUIZ CORPORATION DBA FOOD TOWN CENTER	GDO	2694	1960 OPA LOCKA BLVD	0
1719	GGA INVESTMENT, LLC. DBA CAFFE PORTOFINO	GDO	2695	13615 S DIXIE HWY	1,750
1720	STAUB RESTAURANTS, INC. DBA PEPPERMILL RESTAURANT R BAR	GDO	2697	350 BAYVIEW DR	1,375
1721	KAROL'S CAFETERIA, INC.	GDO	2698	11640 SW 186 ST	335
1722	MDFR - FIRE RESCUE STATION #08	GDO	2699	2900 AVENTURA BLVD	2,325
1723	MC MIAMI ENTERPRISES, LLC DBA MR. CHOW	GDO	2700	2201 COLLINS AVE HOTEL	7,300
1724	MILLER SQUARE SUBS, INC. DBA QUIZNOS #13049	GDO	2702	13710 SW 56 ST	625
1725	LITOWITZ GROUP, INC. DBA COMFORT SUITES	GDO	2703	3901 SW 117 AVE	672
1726	OPH - SOUTH FLORIDA, INC. DBA ORIGINAL PANCAKE HOUSE	GDO	2704	21215 BISCAYNE BLVD	3,750
1727	MCYAI, INC. DBA DORAL THAI RESTAURANT	GDO	2706	2613 NW 79 AVE	1,250
1728	TROPICAL FEAST, INC.	GDO	2707	18400 NW 2 AVE BAY #5	0
1729	FISHER ISLAND CLUB, INC./GOLF CLUB	GDO	2708	1 FISHER ISLAND DR	3,750
1730	DANNIVH'S CORPORATION DBA SUBWAY #18355	GDO	2709	5730 NW 176 ST	252
1731	FISHER ISLAND CLUB, INC./BEACH BAR	GDO	2710	1 FISHER ISLAND DR	3,750
1732	HERMON ENTERPRISES CORP. DBA HERMON BAKERY AND TAKE-OUT FOOD	GDO	2711	8410 W FLAGLER ST STE #106	2
1733	ST. MARGARET'S EPISCOPAL CHURCH	GDO	2713	15650 MIAMI LAKEWAY NORTH	900
1734	LA PATAGONIA ARGENTINA RESTAURANT	GDO	2714	4802 NW 7 ST	336
1735	RED BRICK LIQUORS CORP.	GDO	2716	4351 NW 7 ST	0
1736	HEREFORD GRILL RESTAURANT	GDO	2717	782 NW 42 AVE	5,500
1737	RANCHO LOS COCOS, INC. DBA EL PALACIO DE LOS JUGOS	GDO	2719	7085 SW 24 ST	411
1738	MARUCH SUPERMARKET & CAFETERIA, INC.	GDO	2720	92 E 8 ST	1,008
1739	K-MART CORPORATION DBA K-MART #7711	GDO	2721	20505 S DIXIE HWY	700
1740	CHOKA'S CARIBBEAN RESTAURANT & LOUNGE	GDO	2722	710 WASHINGTON AVE #3	170
1741	TERIYAKI NINJA, INC. DBA TERIYAKI NINJA	GDO	2724	20505 S DIXIE HWY #1865	191
1742	LUMIS HOLDING, LLC DBA KENDALL LATIN FOOD	GDO	2727	12758 SW 88 ST	313
1743	FASA SUPERMARKET, LLC	GDO	2728	1967-69 71 ST	789
1744	CSM SONS GROUP, LLC DBA SUN SUSHI ASIAN & GRILL	GDO	2729	1211 71 ST	250
1745	CACHITA RESTAURANT CORP.	GDO	2732	1116 NORMANDY DR	448
1746	EUROPEAN BREAD CO.	GDO	2734	2323 NW 17 AVE	0
1747	SIXTO INVESTMENT CORP. DBA LA ISLA CAFETERIA	GDO	2737	2008 NW 20 ST	200
1748	CAMILA ROSELYN, INC. DBA I AM LATIN CAFE	GDO	2738	2022 NW 21 AVE	75,000
1749	MONTECARLO XPRESS, LLC DBA CUSO'S LATIN GRILL	GDO	2740	2645 NW 79 AVE	475
1750	NSDI MANAGEMENT, INC. DBA DOMINOS PIZZA	GDO	2743	8737 SW 24 ST	0
1751	BJ'S WHOLESALE CLUB, INC. DBA BJ'S WHOLESALE CLUB #51	GDO	2745	7007 SW 117 AVE	336
1752	BABY SUPERMARKET III, INC.	GDO	2746	4805 NW 167 ST	0
1753	HEAVENLY CAFE & BAKERY, LLC	GDO	2749	5901 NW 151 ST #104B	200
1754	VENEGUACHITO, LLC	GDO	2750	4315 NW 7 ST #21-25	87,500
1755	THE EVENT GROUP, LLC	GDO	2751	10320 W FLAGLER ST	300
1756	YOGURT LIFE, INC.	GDO	2753	7795 W FLAGLER ST M-57-A	110
1757	MIAMI SPRINGS RESORTS ASSN., LTD DBA HOLIDAY INN - MIAMI SPRINGS	GDO	2756	1111 ROYAL POINCIANA BLVD	3,750
1758	ARCHBISHOP CARROLL MANOR INC.	GDO	2758	3667 S MIAMI AVE	0
1759	FISHER ISLAND - PORTO CERVO	GDO	2760	1 FISHER ISLAND DR	2,350
1760	ROSUA BAKERY, INC. DBA GOURMET BAKERY	GDO	2761	10684 NW 7 ST	488

No.	FACILITY_NAME	PERMIT	PERMIT_NUMBER	ADDRESS	TOTAL_GPD
1761	JARDINES DE CONFUCIO	GDO	2762	10658 FONTAINEBLEAU BLVD	5,000
1762	PIZZERIAS, LLC DBA PAPA JOHN'S PIZZA #785	GDO	2764	104 CURTISS PKY	0
1763	KIKAR TEL AVIV RESTAURANT	GDO	2766	5005 COLLINS AVE C-1	3,300
1764	MONKEYS BOGOTA, INC. DBA MONKEYS BUBBLE TEA	GDO	2767	954 NORMANDY DR	2
1765	MIAMI VEN PIZZA, LLC	GDO	2769	966 NORMANDY DR	225
1766	CAFE FLOR DE PINO, INC. DBA EL DISCO CAFE	GDO	2772	1713 W FLAGLER ST	3
1767	TACO BELL OF AMERICA, LLC DBA TACO BELL #027690	GDO	2774	13710 SW 88 ST	627
1768	MYRIAM'S BAKERY, LLC	GDO	2775	4245 E 4 AVE	655
1769	ICE PARADISE, INC. DBA POLO NORTE	GDO	2777	540 W 29 ST	756
1770	ROBEL BAKERY, INC. DBA LA MIA BAKERY	GDO	2778	2969 NW 17 AVE	2
1771	JACKSON HEALTH SYSTEM/DIAGNOSTIC TREATMENT CENTER	GDO	2779	1611 NW 12 AVE	0
1772	NURSING CENTER AT MERCY	GDO	2780	3671 S MIAMI AVE	0
1773	EL RAPIDO FOOD CORP.	GDO	2781	3196 NW 72 AVE	267
1774	JJ & J FAMILY FOOD CORP. DBA PRICE CHOICE SUPERMARKET	GDO	2782	18351 NW 27 AVE	6,000
1775	7220 NW 36 ST HOSPITALITY, LLC DBA WXYZ LOUNGE	GDO	2786	7220 NW 36 ST	488
1776	LOS LATINOS, LLC	GDO	2787	8248 W 8 AVE	750
1777	LEUNG-XUAN, INC. DBA RUSON JAPANESE STEAKHOUSE	GDO	2788	13856 SW 88 ST	2,000
1778	RESTAURANT GROUP OF MIAMI, LLC DBA DENNY'S RESTAURANT	GDO	2790	3850 SW 137 AVE	3,450
1779	OCEAN CLUB BAR & GRILL	GDO	2793	795 CRANDON BLVD	1,560
1780	EL CORTADITO CAFE CORP.	GDO	2794	9873 SW 40 ST	420
1781	DOMINO'S PIZZA, LLC DBA DOMINO'S PIZZA #5183	GDO	2795	1237 W 49 ST	0
1782	SUSHI MAKI KENDALL MARKETPLACE, LLC DBA SUSHI MAKI	GDO	2796	11531 SW 88 ST	714
1783	CHOCOLATE FASHION BAKERY II, INC.	GDO	2797	5868 SW 72 ST	1
1784	RANDAZZO CATERING, INC. DBA CREATIVE TASTES CATERING	GDO	2799	12229 SW 131 AVE	600
1785	FAROFA CORP. DBA FAROFA TASTE OF BRAZIL	GDO	2800	11865 SW 26 ST J-1	400
1786	MANGER CREOLE, INC.	GDO	2805	1051 NW 14 ST #121	600
1787	JACKSON FOOD SERVICES, LLC	GDO	2808	1051 NW 14 ST #125	378
1788	DEERING BAY YACHT/COUNTRY CLUB	GDO	2811	13610 DEERING BAY DR	3,125
1789	GILGANJAM INTERNATIONAL, LLC DBA BAMBOO SHACK	GDO	2814	18450 NW 2 AVE	632
1790	TB ISLE RESORT LP DBA HARRY SOFFER ROOM	GDO	2815	19999 W COUNTRY CLUB DR	2,000
1791	FRITANGA LAS PIEDRECITAS CORP.	GDO	2816	8230 NW 103 ST	280
1792	RAINBOW CAFETERIA CORP.	GDO	2817	1898 W 8 AVE	1,250
1793	LEJEUNE ENTERPRISE, INC.	GDO	2820	801 SW 42 AVE	125
1794	CUBAN BUFFET, LLC	GDO	2822	345 E 49 ST	28,000
1795	FUTURO SUPERMARKET #11	GDO	2825	13660 SW 56 ST	0
1796	NEO CONDO PH-15 INVESTMENT, LLC DBA JESSY BAKERY	GDO	2826	8587 SW 24 ST	450
1797	SSC335051, LLC DBA DUNKIN DONUTS #335051	GDO	2827	8565 SW 24 ST #102	413
1798	SABOR CUBANO	GDO	2828	12848 SW 8 ST	375
1799	EXTRA SUPERMARKET GROUP, INC. DBA EXTRA SUPERMARKET	GDO	2829	12890 SW 8 ST	0
1800	TREBOL CAFE CORP.	GDO	2833	410-20 FISHERMAN ST	750
1801	EL PORTON DE LA FLACA, INC.	GDO	2834	1460 NW 107 AVE 29B & 30C	650
1802	LUCKY TAC, INC. DBA HITCHING POST BARBECUE	GDO	2835	445 E OKEECHOBEE RD	300
1803	Y & YG INVESTMENTS CORP. DBA LOS CANEYES RESTAURANT	GDO	2837	4070 NW 37 AVE	638
1804	DELICIOSA BAKERY, INC.	GDO	2840	12820 SW 8 ST	1
1805	SMOOTHIE SPOT II, LLC	GDO	2841	15708 SW 72 ST	360
1806	PINECREST BAKERY, LLC	GDO	2842	14764 SW 56 ST	600
1807	FEDGE GROUP, LLC DBA EL PARADOR FOOD BY THE POUND	GDO	2843	14744 SW 56 ST	581
1808	MIA ROCKY CORP DBA CASUELITA	GDO	2844	4421 SW 75 AVE #12	238
1809	LA GATA CAFETERIA, LLC	GDO	2845	4351 SW 75 AVE A	700
1810	PUBLIX SUPERMARKETS, INC. DBA PUBLIX STORE #0581	GDO	2846	134 SW 13 ST	0
1811	LOS VERDES CORP.	GDO	2851	2426-2428 SW 137 AVE	672
1812	BROTHER VENTURES, INC. DBA SUBWAY #6913	GDO	2852	13876 SW 8 ST	5
1813	LA PALMA RISTORANTE CORAL GABLES, LLC	GDO	2853	116 ALHAMBRA CIR	1,643
1814	TEMPTATION BAKERY, INC.	GDO	2854	11865 SW 26 ST E-9	1
1815	DOMINO'S PIZZA, LLC DBA DOMINO'S PIZZA # 3157	GDO	2858	827 ARTHUR GODFREY RD	424
1816	PIRATES RAW BAR & GRILLE, LLC	GDO	2859	17850 W DIXIE HWY	1,850
1817	ROBERT A. BALLARD ARMORY	GDO	2860	700 NW 28 ST	0
1818	ANA PAZ, LLC DBA ANA PAZ CAKES	GDO	2861	1460-D NW 107 AVE	0
1819	EL JARDIN SUPERMARKET, INC.	GDO	2863	12551 W OKEECHOBEE RD	0
1820	FERCOR, INC. DBA FRITANGA TISCAPA	GDO	2864	1281 W FLAGLER ST	450
1821	REAL HOLDING MANAGEMENT CORP. DBA SEDANO'S SUPERMARKET #07	GDO	2865	4801 SW 8 ST	0
1822	CARNICERIA ARGENTINA, INC.	GDO	2867	5999 W 16 AVE	0
1823	PARRILLA ARGENTINA BBQ & CAFETERIA	GDO	2868	5993 W 16 AVE	3,000
1824	MIAMI FUSION CUISINE, INC. DBA DIEGO'S ANDALUCIA TAPAS &	GDO	2869	4825 SW 8 ST	500
1825	PALM LAKES CAFE, INC. DBA MUNCHIES CAFE & RESTAURANT	GDO	2873	16504 NW 49 AVE	750
1826	MICHEAL RAYMOND DESSERTS	GDO	2874	15986 NW 49 AVE	0
1827	PUBLIX SUPERMARKETS, INC. DBA PUBLIX STORE #0590	GDO	2875	9510 SW 160 ST	0
1828	MAC ACQUISITION OF DELAWARE, LLC DBA ROMANO'S MACARONI GRILL	GDO	2876	8700 NW 18 TER	6,550
1829	HAM LEE, INC. DBA CHINA EXPRESS RESTAURANT	GDO	2877	4731 NW 183 ST	0
1830	A.G.T. INTERNATIONAL, INC. DBA CAO CHOCOLATES	GDO	2878	9800 SW 77 AVE	75
1831	LA CURVA RESTAURANT CORP.	GDO	2879	4201 SW 75 AVE	750
1832	JACKY'S CAFE, INC.	GDO	2881	2822 NW 7 AVE	250
1833	DINAJ QUIK MART, INC. DBA DINAJ QUIK MART #4	GDO	2882	7791 BISCAYNE BLVD	0
1834	DORAL BAKERY & CAFETERIA CORP.	GDO	2883	2737 NW 79 AVE	1
1835	LAGUNA RESTAURANT, INC.	GDO	2884	2800 NW 7 AVE	1,050
1836	J.C.'S PIZZERIA, LLC	GDO	2885	11865 SW 26 ST C-45	1,000
1837	KID'S UNIVERSITY PRESCHOOL CORP.	GDO	2889	3300 W 84 ST #13	700
1838	ALSAGI CORPORATION DBA FRENCH BISTRO	GDO	2890	13611 S DIXIE HWY	1,400
1839	DTM ENTERPRISES, INC. DBA CAFE FARAYA	GDO	2891	4250 NW 72 AVE	392
1840	PIZZERIAS, LLC DBA PAPA JOHN'S PIZZA #563	GDO	2892	12798 SW 8 ST	0
1841	ISLAND CUISINE, LLC DBA ISLAND CUISINE	GDO	2893	13740 SW 152 ST	171
1842	TUTTO'S PLACE CAFETERIA	GDO	2894	13216 SW 8 ST	6
1843	K-MART CORPORATION DBA KMART #3793	GDO	2895	12350 SW 8 ST	420
1844	CASA POTIN BAKERY	GDO	2896	839 SW 132 AVE	0
1845	UPTOWN BUFFET ACQUISITION CORP.	GDO	2897	8275 W FLAGLER ST #43	1,725
1846	KFC CORPORATION DBA KFC #X975048	GDO	2898	13200 SW 8 ST	626
1847	FABIA FOOD MARKET CORP.	GDO	2900	279 NE 79 ST #2	500
1848	HOLLYWOOD EXPRESS @ OPA-LOCKA FLEA MARKET	GDO	2901	12691 NW 42 AVE L-22	1,400

No.	FACILITY_NAME	PERMIT	PERMIT_NUMBER	ADDRESS	TOTAL_GPD
1849	LOS RANCHOS SEAFOOD RESTAURANT	GDO	2904	12705 NW 42 AVE #13-14-15	1,120
1850	LA TABERNA BAR & GRILL	GDO	2905	12705 NW 42 AVE AAA-23-26	625
1851	BEVERLY HILLS CAFE, INC.	GDO	2906	7321 MIAMI LAKES DR	3,725
1852	FIU - WOLF CENTER CAFETERIA	GDO	2907	3000 NE 151 ST	420
1853	FIU - ROZ KOVENS CONFERENCE CTR	GDO	2908	3000 NE 151 ST	1,400
1854	NEWS CAFE, INC.	GDO	2909	800 OCEAN DR	3,075
1855	FIU - HOSPITALITY COMPLEX CENTER	GDO	2910	3000 NE 151 ST	700
1856	SORARE, LLC	GDO	2911	3023 BISCAYNE BLVD	225
1857	LIMON Y SABOR PERUVIAN SEAFOOD, LLC	GDO	2912	3045 BISCAYNE BLVD	3,725
1858	BEST FRIENDS MIDTOWN, LLC	GDO	2913	4770 BISCAYNE BLVD #10	1,250
1859	KARLA BAKERY CORPORATION	GDO	2914	6474 W FLAGLER ST	0
1860	KONING RESTAURANTS INTERNATIONAL, LC DBA PIZZA HUT #12396	GDO	2915	6500 SW 8 ST	0
1861	C & R SEAFOOD CORPORATION, INC. DBA COVADONGA RESTAURANT	GDO	2916	6480 SW 8 ST	1,850
1862	ORSILLO ENTERPRISES, INC. DBA BIRD ROAD DAIRY QUEEN	GDO	2917	4040 SW 67 AVE	0
1863	XIAN JUN, LLC DBA CANTON LEE	GDO	2918	13862 SW 56 ST	510
1864	MAYI'S CAFE, INC.	GDO	2919	11880 SW 40 ST #111	750
1865	JL SLANG, INC. DBA GRAND VIEW CHINESE RESTAURANT	GDO	2921	9842 SW 40 ST	0
1866	FAST GRILL ENTERPRISES, INC DBA LA GRANJA POLLOS A LA BRASA	GDO	2922	13822 SW 56 ST	1,650
1867	JJ FOOD VENTURES DBA NATURAL CHICKEN GRILL	GDO	2923	13790 SW 56 ST	575
1868	WRAPIDO CORPORATION DBA SUSHI MAKI RESTAURANT	GDO	2924	5812 SW 72 ST	1,625
1869	AYESHA FINE DINING, INC.	GDO	2925	14151 S DIXIE HWY	2,300
1870	OLD LISBON SUNSET, LLC	GDO	2926	5837 SW 72 ST	1,850
1871	KARLA BAKERY III	GDO	2928	7004 SW 4 ST	1
1872	BECKMAN COULTER, INC. - CAFETERIA	GDO	2929	11800 SW 147 AVE	5,000
1873	WESLEY'S SPORTS BAR, INC. DBA STYX SPORTS BAR	GDO	2930	15346 W DIXIE HWY	1,500
1874	RESTAURANTE UNIVERSAL DEL PUEBLO, INC.	GDO	2931	300 W 21 ST	325
1875	LA CASITA RESTAURANT #1	GDO	2933	3805 SW 8 ST	3,725
1876	MIA-NYC INVESTMENT, LLC DBA CAVA RESTAURANTS	GDO	2934	3850 SW 8 ST	105,000
1877	KONING RESTAURANTS INTERNATIONAL, LC DBA PIZZA HUT #12397	GDO	2935	3830 SW 8 ST	0
1878	FLORIDA BAPTIST CONVENTION, INC.	GDO	2936	631 E 1 AVE	0
1879	SANTILLANA ENTERPRISES, INC. DBA SEDANO'S SUPERMARKET #23	GDO	2937	2425 SW 8 ST	750
1880	QUESILLOS GUILIGUISTE CORP.	GDO	2938	11323 W FLAGLER ST	625
1881	KONING RESTAURANTS INTERNATIONAL, LC DBA PIZZA HUT DELIVERY	GDO	2939	11327 W FLAGLER ST	0
1882	EL NOVILLETE, INC. DBA EL NOVILLETE MEAT MARKET	GDO	2940	11329 W FLAGLER ST	0
1883	EL BAKERY, INC. DBA BAKERY @ 186	GDO	2941	7606 NW 186 ST	825
1884	KORN ENTERPRISES, INC. DBA SUBWAY #11094	GDO	2942	8527 NW 186 ST	242
1885	CORAL TERRACE ALF, INC. DBA CORAL TERRACE ALF	GDO	2944	6744 SW 22 ST	440
1886	RESTAURANT MONSERRATE, INC.	GDO	2946	9545 NW 41 ST	1,950
1887	PECLAU, LLC DBA BOCAS GRILL	GDO	2950	3399 NW 72 AVE SPC 128	384
1888	PASEO CATRACHO USA, INC.	GDO	2952	824 SW 8 ST	1,125
1889	KONING RESTAURANTS INTERNATIONAL, LC DBA PIZZA HUT #12390	GDO	2954	13715 NW 7 AVE	0
1890	RTM OPERATING COMPANY DBA ARBY'S #250	GDO	2956	20203 S DIXIE HWY	1,900
1891	27 SOUTH, INC. DBA EL PALACIO DE LOS JUGOS	GDO	2957	1545 SW 27 AVE	1,315
1892	MALBORK'S FRIEND, LLC DBA LA SORPRESA SUPERMARKET	GDO	2960	4501 NW 7 ST	50
1893	DANY RESTAURANT, INC.	GDO	2961	122 NW 79 ST	230
1894	82ND STREET FOOD CORP. DBA MCDONALD'S #11511	GDO	2962	8116 BISCAYNE BLVD	1,190
1895	CAKE'S THAI KITCHEN, INC.	GDO	2963	7919 BISCAYNE BLVD	175
1896	THE PIOUS PIG RESTAURANT GROUP, LLC	GDO	2964	5132 BISCAYNE BLVD	500
1897	SOUTH BEACH WET WILLIE'S	GDO	2965	760 OCEAN DR	2,500
1898	SMW RESTAURANT HOLDINGS, LLC	GDO	2967	8001 BISCAYNE BLVD	775
1899	MACCA TREE CARIBBEAN RESTAURANT, INC.	GDO	2968	18055 NW 27 AVE	84
1900	EL COMPADRE RESTAURANT, INC.	GDO	2970	3174 NW 7 ST	295
1901	CONSTRUCTION CATERING INC.	GDO	2971	2472 NW 21 TER	5
1902	KONING RESTAURANTS INTERNATIONAL, LC DBA PIZZA HUT #12418	GDO	2974	4837 NW 183 ST	0
1903	LUCY'S CAFE, INC.	GDO	2975	1185 W 35 ST	371
1904	SBA MARKET, INC. DBA KIKIRIKI SUPERMARKET	GDO	2977	1177 W 35 ST	225
1905	KONING RESTAURANTS INTERNATIONAL, LC DBA PIZZA HUT #12393	GDO	2978	3901 E 4 AVE	0
1906	CAFFE ITALIA	GDO	2979	3800 SW 8 ST	1,875
1907	THE FISH HOUSE, INC. DBA FISH HOUSE RESTAURANT	GDO	2980	10000 SW 56 ST #41	672
1908	EXPANSION GROUP, LLC DBA LOS MAGUEYE'S MEXICAN REST.	GDO	2981	9817 SW 40 ST	240
1909	TRIPLE SIAM, INC. DBA ROCK A BANGKOK	GDO	2982	13718 SW 88 ST	225
1910	ROMACORP. INC. DBA TONY ROMA'S #3058	GDO	2983	3300 NW 87 AVE	5,000
1911	MOUNT SINAI MEDICAL CENTER	GDO	2985	4300 ALTON RD	0
1912	JERRY'S FAMOUS DELI, INC. DBA EPICURE MARKET SUNNY ISLES BEACH	GDO	2986	17190 COLLINS AVE	975
1913	MIAMI ARTCC & CHILD CARE CENTER	GDO	2987	7500 NW 58 ST	840
1914	MDFR - FIRE RESCUE STATION #36	GDO	2991	10001 HAMMOCKS BLVD	0
1915	MDFR - FIRE RESCUE STATION #14	GDO	2993	5860 SW 70 ST	0
1916	MDFR - FIRE RESCUE STATION #09	GDO	2994	7777 SW 117 AVE	0
1917	STARBUCKS COFFEE COMPANY, INC. DBA STARBUCKS #8254	GDO	2997	3015 GRAND AVE #177	280
1918	LOS TOCAS CORP. DBA SABOR A COLOMBIA	GDO	2998	10662 FONTAINEBLEAU BLVD	255
1919	STARBUCKS COFFEE COMPANY, INC. DBA STARBUCKS #8251	GDO	2999	749 LINCOLN RD	3
1920	LEDESMA CORPORATION DBA BON APPETIT BAKERY	GDO	3002	2408 SW 137 AVE	1
1921	DOGMA PLUS, LLC. DBA DOGMA GRILL	GDO	3003	7030 BISCAYNE BLVD	100
1922	CASA CAFE ALTO CORP.	GDO	3005	1830 SW 3 AVE	188
1923	OLSEN HOTEL RESTAURANT GROUP, LLC DBA RONI'S BY THE OCEAN	GDO	3006	7300 OCEAN TER	425
1924	XIXON CAFE, LLC. DBA XIXON	GDO	3010	2101 SW 22 ST	1,338
1925	MI RANCHITO CENTROAMERICANO	GDO	3011	800 ALI BABA AVE	475
1926	EL PALACIOS DE LA COMIDA, LLC	GDO	3013	1325 E 4 AVE	450
1927	POLO NORTE FLAGLER, INC.	GDO	3014	10302 W FLAGLER ST	700
1928	RUNWAY GRILLE, INC.	GDO	3015	7415 NW 19 ST	6,800
1929	TARGET CORPORATION DBA TARGET STORE #1074	GDO	3016	21265 BISCAYNE BLVD	392
1930	CASA CANI, INC. DBA CASA KNI	GDO	3017	925 SW 87 AVE	800
1931	CHEESECAKE FACTORY RESTAURANTS, INC.	GDO	3018	7497 DADELAND BLVD	7,650
1932	87 AVENUE HOSPITALITY LLC DBA HOLIDAY INN	GDO	3019	3255 NW 87 AVE	375
1933	LIGERO EXPRESS CORP.	GDO	3024	201 PARK BLVD	350
1934	PRONTO PIZZA EXPRESS CORP.	GDO	3025	10660 FONTAINEBLEAU BLVD	255
1935	ORGULLO COLOMBIANO BAKERY	GDO	3026	11270 SW 137 AVE	1
1936	THIEN-NGUYEN, INC. DBA LOTUS GARDEN RESTAURANT	GDO	3027	318 MIRACLE MILE	1,500

No.	FACILITY_NAME	PERMIT	PERMIT_NUMBER	ADDRESS	TOTAL_GPD
1937	D & J DISCOUNT FOOD MARKET, INC.	GDO	3030	18083 NW 27 AVE	0
1938	TROPICAL SUPERMARKET #12, INC.	GDO	3032	1060 W 29 ST #216	13
1939	MI YARD CARIBBEAN & AMERICAN RESTAURANT, INC.	GDO	3035	18085 NW 27 AVE	500
1940	BJ'S WHOLESALE CLUB, INC. DBA BJ'S WHOLESALE CLUB #91	GDO	3036	10425 MARLIN RD	0
1941	FLANIGAN'S SEAFOOD BAR & GRILL	GDO	3038	9516 HARDING AVE	2,750
1942	SUNSHINE GASOLINE DIST., INC. DBA SUNSHINE 30071	GDO	3039	10191 SW 72 ST	0
1943	PRB ENTERTAINMENT, INC. DBA JOHNSON'S MIAMI	GDO	3040	726-28 NW 79 ST	2,110
1944	HALLEY CAFE, INC.	GDO	3043	12500 SW 130 ST #1	140
1945	MORTON'S OF CHICAGO/MIAMI, LLC DBA MORTON'S STEAKHOUSE	GDO	3044	1200 BRICKELL AVE	5,825
1946	GREATER MIAMI ACADEMY SCHOOL	GDO	3048	500 NW 122 AVE	100
1947	MILOS ENTERPRISES, INC. DBA MCDONALD'S #18734	GDO	3049	1930 OPA LOCKA BLVD	49,532
1948	LA REAL TORTILLAS	GDO	3050	13011 SW 122 AVE	1
1949	SUNSHINE CAFETERIA EXPRESS CORP.	GDO	3052	8180 NW 36 ST SUITE 104	0
1950	BACALLAO'S CAFETERIA-RESTAURANT, LLC	GDO	3053	4765 NW 183 ST	325
1951	7-ELEVEN, INC. DBA 7-ELEVEN #34657A	GDO	3054	890 WASHINGTON AVE	750
1952	VENFUSSION ENTERPRISES, INC. DBA AREPA ONE	GDO	3055	3141 W 76 ST #9	300
1953	TORRO FOODS, INC. DBA PIZZA SCENE	GDO	3056	6725 MAIN ST	3
1954	CHICK-FIL-A @ DORAL	GDO	3057	3995 NW 107 AVE	818
1955	DOKSOZ, INC. DBA MEZE EAGEAN BISTRO	GDO	3059	413 WASHINGTON AVE	159
1956	BALANS, LC DBA BALANS RESTAURANT	GDO	3060	1022 LINCOLN RD	524
1957	MAX & FRANK, LLC DBA LA LOCANDA	GDO	3062	419 WASHINGTON AVE	1,225
1958	MDFR - FIRE RESCUE STATION #47	GDO	3064	9361 SW 24 ST	137,080
1959	LIN'S CORP. DBA MIYAKO SUSHI & HIBACHI	GDO	3067	18090 COLLINS AVE T-23	1,600
1960	BARRY UNIVERSITY, INC.	GDO	3068	11300 NE 2 AVE	1,125
1961	HEBREW HOME SINAI DBA SINAI PLAZA NURSING & REHAB CT	GDO	3069	201 NE 112 ST	0
1962	N. NAFISA, INC.	GDO	3071	918 NW 36 ST	1,142
1963	RINCON PROGRESENO CORP.	GDO	3072	1169 NW 36 ST	518
1964	K & W RESTAURANT, INC. DBA THAI HOUSE II RESTAURANT	GDO	3074	2250 NE 163 ST UNIT 16	5,000
1965	RINCON CATRACHO RESTAURANT, INC.	GDO	3075	1025 NW 36 ST	449
1966	DELICIAS RESTAURANT CENTRO AMERICANO CORP.	GDO	3076	1260 NW 36 ST	300
1967	EL MEJOR PAN CON LECHON, INC.	GDO	3078	2928 NW 17 AVE	300
1968	EL TAQUITO RESTAURANT, INC.	GDO	3081	10314 W FLAGLER ST	1,150
1969	TRATTORIA PAMPERED CHEF MIAMI LAKES, INC.	GDO	3083	7347 MIAMI LAKES DR	1,125
1970	BIG FISH RESTAURANT, INC.	GDO	3087	620 NE 78 ST	1,000
1971	DIAZ COIN LAUNDRY & CAFETERIA, INC.	GDO	3096	1664 NW 17 AVE	0
1972	MCDONALD'S OF RIVERSIDE	GDO	3098	299 SW 8 ST	560
1973	ALBE'AR BAKERY, INC.	GDO	3101	2403 NW 27 AVE	0
1974	BURGER KING CORPORATION DBA BURGER KING #0067	GDO	3102	410 W 84 ST	1,288
1975	FUN TIME BILLARD RESTAURANT, INC.	GDO	3103	11300 NW 87 CT #137	280
1976	PALMA AZUL CORP. DBA BLUE SKY #4	GDO	3104	11300 NW 87 CT #144	0
1977	ROCIO RESTAURANT & CAFETERIA, INC.	GDO	3105	1144 SW 8 ST	350
1978	CAKE DESIGNS BY EDDA, INC.	GDO	3106	4305-4315 SW 72 AVE	500
1979	KFC CORPORATION DBA KFC #X975059	GDO	3107	14790 SW 56 ST	725
1980	LAS PALMERAS CAFE, INC.	GDO	3109	1927 W 60 ST	475
1981	SKM MANAGEMENT CORPORATION DBA MIKE'S AT VENETIA	GDO	3110	555 NE 15 ST #935	2,200
1982	DON PAN KENDALL, LLC DBA DON PAN INT'L BAKERY	GDO	3111	7702 SW 88 ST	3
1983	CITY CHEF CATERING, LLC	GDO	3113	1321 NW 155 DR	425
1984	J & J GRILLMASTER SOUL & SEA FOOD	GDO	3114	3600 NW 183 ST	130
1985	SHAWARMA FOOD, INC.	GDO	3115	11752 SW 88 ST	1,500
1986	THE PERFECT SEASON AT DON SHULAS HOTEL & GOLF CLUB	GDO	3117	7601 NW 154 ST FAC. A	1,250
1987	MARINO'S PIZZA, INC.	GDO	3119	13821 SW 88 ST	1,850
1988	TOTAL CAFETERIA	GDO	3121	1401 NW 23 ST	75
1989	EL CASTILLO CAFETERIA, INC.	GDO	3123	2300 NW 17 AVE	750
1990	PIZZERIAS, LLC DBA PAPA JOHN'S PIZZA #692	GDO	3124	14786 SW 56 ST	0
1991	ECPS GROUP, INC. DBA ALAPPATTAH COIN LAUNDRY & CAFE	GDO	3125	1946 NW 17 AVE	50
1992	CANO HOLDINGS, INC. DBA DELICIAS BAR AND GRILL	GDO	3128	15000 COLLINS AVE	253
1993	KENDALL DONUTS, LLC DBA DUNKIN DONUTS #306614	GDO	3132	11790 SW 88 ST	482
1994	TAQUERIA EL CARNAL NO.2 CORPORATION	GDO	3133	1128 SW 8 ST	50
1995	VIEIRA LA ROCCA, LLC DBA PLAZA'S MARKET	GDO	3138	1515 NW 27 AVE	1,250
1996	NACHA CAFETERIA	GDO	3141	3296 NW 36 ST	168
1997	EL NUEVO ROMANCE CORP.	GDO	3143	3451 NW 36 ST	1,100
1998	NURYS ENTERPRISES OF SOUTH FLORIDA, INC. DBA LA CENIZA RESTAURANT	GDO	3144	2450 NW 36 ST	1,000
1999	HAYDEN'S BBQ, LLC	GDO	3146	12461 SW 130 ST A3	225
2000	MARCO BAKERY CONCEPTS, INC. DBA PORTOFINO BAKERY	GDO	3147	1539 NW 27 AVE	697
2001	KAMIKO SUSHI BAR	GDO	3148	2669 NW 79 AVE	1,025
2002	CANABACOA, LLC DBA LAS VEGAS CUBAN CUISINE	GDO	3149	7390 SW 117 AVE	1,289
2003	DOMINO'S PIZZA LLC DBA DOMINO'S PIZZA #5180	GDO	3151	850 E 9 ST	0
2004	CIRO MEAT MARKET, INC.	GDO	3153	18904 SW 114 AVE	0
2005	LAS TERRAZAS CAFETERIA RESTAURANT, INC.	GDO	3155	12260 SW 8 ST #100	300
2006	JANETH CORP. DBA EL EDEN RESTAURANT	GDO	3156	10755 SW 190 ST #45	224
2007	JCF TOWER, INC. DBA SPRIZ	GDO	3157	2305 PONCE DE LEON BLVD	1,250
2008	AREPA ROYAL CORP.	GDO	3158	255 W 27 ST	0
2009	7K CORP. DBA GOLDEN KRUST CARIBBEAN GRILL	GDO	3161	9534 SW 160 ST	0
2010	MATER ACADEMY HIGH SCHOOL & MIDDLE SCHOOL	GDO	3162	7901 NW 103 ST	68
2011	LUCRE, LLC DBA MOM'S FOOD	GDO	3164	9612 FONTAINEBLEAU BLVD	250
2012	BOYS & GIRLS CLUBS OF MIAMI-DADE, INC.	GDO	3165	2805 SW 32 AVE	700
2013	BAHAMA BREEZE HOLDINGS, LLC	GDO	3167	12395 SW 88 ST	4,228
2014	KRINAC, INC. DBA MOBIL GAS STATION	GDO	3168	20155 NW 67 AVE	0
2015	MIAMI JEWISH HOME & HOSPITAL - ICT	GDO	3169	5200 NE 2 AVE	0
2016	FISHER ISLAND CLUB, INC./MAIN CLUB	GDO	3170	1 FISHER ISLAND DR	0
2017	G. GIRON CORP. DBA LA PORTENA CAFETERIA	GDO	3173	1985 SW 8 ST	750
2018	ABE SERVICES, LLC DBA COSTA MED	GDO	3176	260 CRANDON BLVD # 45-46	625
2019	YOGEN KEY BISCAYNE, LLC DBA YOGEN FRUZ	GDO	3177	328 CRANDON BLVD #109	248
2020	REY'S PIZZA CORPORATION DBA REY'S PIZZA #1	GDO	3178	2391 W FLAGLER ST	420
2021	GAUNG HENG, INC. DBA YEUNG'S CHINESE RESTAURANT	GDO	3179	954 41 ST	2,000
2022	CON SABOR A CAFE, INC.	GDO	3189	9558 SW 137 AVE	800
2023	TORRI'S KITCHEN & CATERING, LLC	GDO	3190	6005 NW 7 AVE	489
2024	MARLA INVESTMENTS CORPORATION DBA DELICIAS COLOMBIANAS BAKERY	GDO	3191	9546 SW 137 AVE	1

No.	FACILITY_NAME	PERMIT	PERMIT_NUMBER	ADDRESS	TOTAL_GPD
2025	WRAPIDO CORPORATION DBA SUSHI MAKI CORAL GABLES	GDO	3192	2334 PONCE DE LEON BLVD	1,001
2026	CLAUDY'S BAKERY CORP.	GDO	3193	14637 SW 42 ST	350
2027	SOUTH BEACH QSR, LLC DBA TACO BELL #25746	GDO	3194	13720 SW 8 ST	980
2028	YI WONG CHINESE RESTAURANT	GDO	3195	13760 SW 8 ST	4
2029	MERLET INVESTMENTS, LLC DBA BROADWAY BAGELS	GDO	3196	13854 SW 88 ST	500
2030	DON SEBAS, LLC DBA CHIFAN'S	GDO	3197	13868 SW 88 ST	400
2031	RMD FOOD, INC. DBA EL PALACIO SUPERMARKET	GDO	3198	995 SW 5 ST	0
2032	EL RIO LINDO CAFE CORP.	GDO	3200	639-41 SW 12 AVE	405
2033	TRITON SUPERMARKET #111, INC.	GDO	3201	478 SW 17 AVE	1,250
2034	LOS BROTHERS, INC. DBA LOS MARLINS RESTAURANT	GDO	3202	503 SW 17 AVE	706
2035	TERRACES AT TURNBERRY	GDO	3204	20191 E COUNTRY CLUB DR	308
2036	LA TROPICAL COFFEE SHOP	GDO	3205	1862 W FLAGLER ST	0
2037	THE GROCERY SPECIALIST, INC. DBA BEACH MARKET	GDO	3206	247 COLLINS AVE	0
2038	SPECIALTY RESTAURNT CORP. DBA WHISKEY JOE'S MIAMI	GDO	3207	3301 RICKENBACKER CSWY	2,500
2039	SABOR DE CUBA RESTAURANT CORP.	GDO	3208	11710 NW SOUTH RIVER DR 108	500
2040	PERUVIAN DELICACIES RESTAURANT, INC. DBA CEVICHE INCA	GDO	3209	4204 W 16 AVE	188
2041	LOS NUEVOS JARRITOS CAFE AND RESTAURANT CORP.	GDO	3210	2189 SW 1 ST	295
2042	SAKURA JAPANESE BUFFET, INC.	GDO	3211	1335 NE 79 ST	2,375
2043	CASTEL DOLCE, LLC DBA TUTTI FRUTTI FROZEN YOGURT	GDO	3213	8370 MILLS DR E-2	374
2044	CHARCOAL'S LATIN GRILL, INC. DBA LA FOGATA	GDO	3214	8732 MILLS DR 1530	2,875
2045	PENZA, INC. DBA TWO BROTHERS PIZZERIA	GDO	3215	8424 MILLS DR	158
2046	2700 COCONUT AVENUE, LLC	GDO	3217	2890 SW 27 AVE	5,000
2047	HOYOS & ASSOCIATES INVESTMENTS, LLC DBA CVICHE 105 SOUTH BEACH	GDO	3218	1245 LINCOLN RD	895
2048	A & L UNITED INVESTMENT GROUP, LLC DBA MARATHON	GDO	3221	5 NW 167 ST	50
2049	2671 SUBWAY, INC. DBA SUBWAY #2671	GDO	3222	1424 ALTON RD FAC. B	375
2050	TIKAL RESTAURANT, INC.	GDO	3223	421 NW 36 ST	300
2051	NICA FRITANGA, INC. DBA LAS TEJAS RESTAURANT	GDO	3224	11865 SW 26 ST A-8	248
2052	NORTH MIAMI GOOD SERVICES CORP. DBA LA GRANJA PARRILLA ON 167TH	GDO	3225	105 NE 167 ST	269
2053	LARKIN COMMUNITY HOSPITAL/PALM SPRINGS CAMPUS	GDO	3226	1475 W 49 ST	952
2054	TRIGO CAFE CORP.	GDO	3227	839 W 49 ST	925
2055	AMOR DI PASTA, LLC	GDO	3228	536 NW 57 AVE	238
2056	SUBWAY 1160, INC. DBA SUBWAY #1160	GDO	3229	18710 NW 67 AVE	420
2057	WHITE HALL MIAMI, INC.	GDO	3230	16850 COLLINS AVE 106-A	3,052
2058	EPICENTRO CAFE CORP.	GDO	3233	6905 W 12 AVE #1-3	112
2059	FRITANGA & RASPADERIA NICA II & TORTILLERIA CORP.	GDO	3234	6905 W 12 AVE #10	213
2060	MODOLU INVESTMENT LLC DBA BARBIE BAKERY	GDO	3235	3970 W 12 AVE	0
2061	EL ATACATL RESTAURANT SALVADORENO	GDO	3237	3199 SW 8 ST	625
2062	VISMARCK CORPORATION DBA MING VILLAGE CHINESE RESTAURANT	GDO	3238	7624 NW 186 ST	1,875
2063	LIBERTY ENTERPRISES INCORPORATED	GDO	3241	1629 NW 42 ST	0
2064	SABORES CHILENOS CORPORATION	GDO	3242	10760 W FLAGLER ST #6-7	1
2065	WILLMAR SEAFOOD, INC. DBA HEADS OR TAILS SEAFOOD	GDO	3245	3621 NW 54 ST	500
2066	ALBION HOTEL SNACK BAR	GDO	3246	1650 JAMES AVE	98
2067	REINOSA ENTERPRISES, INC. DBA SEDANO'S SUPERMARKET #28	GDO	3247	3140 W 76 ST	0
2068	FABULOSO ICE CREAM & CAFE CORP.	GDO	3248	3818 SW 137 AVE	325
2069	MIAMI BANQUET HALL, INC.	GDO	3250	13758 SW 84 ST	25
2070	TROPICAL SUPERMARKET #3, INC.	GDO	3253	28945 S DIXIE HWY	4
2071	TARGET CORPORATION DBA TARGET STORE #1075	GDO	3254	20500 SW 112 AVE	420
2072	LOS MEGA PERROS, INC.	GDO	3257	9511 W FLAGLER ST	400
2073	KONING RESTAURANTS INTERNATIONAL, LC DBA PIZZA HUT #12405	GDO	3260	13870 SW 8 ST	0
2074	PEPE LUZARRAGA CATERING CORP.	GDO	3269	4631 SW 75 AVE	0
2075	STROWA, INC. DBA MAINZER'S DELICATESSEN	GDO	3270	12113 S DIXIE HWY	0
2076	ISLAND'S PARADISE RESTAURANT & ROTI SHOP, INC.\DBA EL DOS RUEDAS	GDO	3271	9561 SW 160 ST	750
2077	6681 STORE, INC. DBA SUBWAY RESTAURANT	GDO	3272	9546 SW 160 ST	275
2078	IMANSYL CORPORATION DBA SUBWAY #17888	GDO	3273	20505 S DIXIE HWY	420
2079	GABLES JUICE BAR & MUSCLE PIZZA, INC.	GDO	3274	3635 W FLAGLER ST	300
2080	FOUR "A" ASHRAF HALAL DBA ASHRAF HALAL MEAT CENTER	GDO	3276	20705 NW 2 AVE	0
2081	FAIRFIELD INN & SUITES	GDO	3278	4101 COLLINS AVE	3,750
2082	FUJISAN, INC. DBA SAKURA JAPANESE RESTAURANT	GDO	3286	8225 SW 124 ST	750
2083	PHO-THANG RESTAURANT, INC.	GDO	3289	9539 SW 160 ST	1,850
2084	MARIE PATTIES, INC.	GDO	3290	9493 SW 160 ST	0
2085	CHUCK WAGON RESTAURANT	GDO	3291	11230 SW 137 AVE	3,000
2086	VIGIANO, INC. DBA MEKONG II CHINESE RESTAURANT	GDO	3292	11274 SW 137 AVE	98
2087	THE RUSTIC PERUVIAN MIX CORP. DBA ZONA INKA RESTAURANT	GDO	3293	11238 SW 137 AVE	750
2088	KWIK STOP #218, INC.	GDO	3294	11256 SW 137 AVE	0
2089	SANGO JAMAICAN & CHINESE RESTAURANT	GDO	3298	9485 SW 160 ST	0
2090	CARIBBEAN DELITE, INC.	GDO	3300	9491 SW 160 ST	0
2091	CASTLE NOVO PIZZA	GDO	3301	3001 W 12 AVE BAY 9-10	42
2092	SUNSHINE RESTAURANT PARTNERS, INC. DBA IHOP #36-143	GDO	3302	7450 NW 186 ST	2,500
2093	GILDA INDUSTRIES	GDO	3304	2525 W 4 AVE	0
2094	KFC CORPORATION DBA KFC #X975047	GDO	3306	14081 N KENDALL DR	608
2095	VILLA SOTA, LLC DBA LA NOUVELLE BOULANGERIE	GDO	3307	328 CRANDON BLVD #125	302
2096	TAVOALEX INVESTMENT, LLC DBA STEFANO'S WINE & LIQUOR	GDO	3308	328 CRANDON BLVD #122-124	304
2097	CEVICHE'S BY DIVINO, INC.	GDO	3309	3380 NW 72 AVE	275
2098	HHA, LLC DBA REAL CHEF RESTAURANT	GDO	3310	486 NE 167 ST	1,175
2099	TACO SHOP, INC.	GDO	3311	831 W 49 ST	750
2100	SUBWAY 19711 OF DADE COUNTY, INC. DBA SUBWAY #19711	GDO	3312	3300 W 84 ST #20	5
2101	STARBUCKS COFFEE COMPANY, INC. DBA STARBUCKS #8271	GDO	3313	1455 OCEAN DR	0
2102	CHRISTLAND, INC. DBA JOE'S PLACE	GDO	3314	2491 NW 72 AVE	750
2103	MARIN SUPERMARKET & CAFETERIA, INC. DBA LAS BRISAS GUEMBO'S CAFE	GDO	3315	2055 NW 22 AVE	1,225
2104	RP PARTNERS INTERNATIONAL CORP. DBA MANKA PERUVIAN RESTAURANT	GDO	3317	10648-50 FONTAINEBLEAU BLVD	483
2105	TWO BROTHER'S KENDALE LAKES, INC.	GDO	3318	13740 SW 84 ST	1,250
2106	DANDY BEAR & CO.	GDO	3319	13700 SW 84 ST	4,060
2107	RTK MANAGEMENT, INC.	GDO	3320	18090 COLLINS AVE T-8	200
2108	FOUR WHEELS RESTAURANT CORP. DBA EL PALACIO DE LOS JUGOS	GDO	3321	15110 SW 56 ST	1,750
2109	MEKATO'S GROUP, INC. DBA MEKATO'S BAKERY	GDO	3322	15190 SW 56 ST	0
2110	WINN DIXIE STORES, INC. DBA WINN DIXIE STORE #280	GDO	3324	10505 NW 41 ST	0
2111	BPH BURGER, LLC DBA BURGER KING #21129	GDO	3325	1611 NW 12 AVE #G	600
2112	LITTLE CAESAR'S ENTERPRISES, INC. DBA LITTLE CAESAR'S PIZZA #226	GDO	3328	9362 SW 56 ST	0

No.	FACILITY_NAME	PERMIT	PERMIT_NUMBER	ADDRESS	TOTAL_GPD
2113	HABANA ABIERTA CORP.	GDO	3330	2114 W 68 ST	363
2114	DINY BAKERY	GDO	3332	4202 W 16 AVE	1
2115	YOU KI, INC. DBA IRON SUSHI	GDO	3334	840 WASHINGTON AVE	750
2116	U.S. COAST GUARD BASE MIAMI BEACH	GDO	3335	100 MAC ARTHUR CSWY	0
2117	SUKHOTHAI EXPRESS II, LLC	GDO	3336	1570 ALTON RD C	275
2118	DUO EPSILON, INC. DBA EAT GREEK	GDO	3337	1570 ALTON RD SPC B	288
2119	STARBUCKS COFFEE COMPANY, INC. DBA STARBUCKS #8242	GDO	3338	1570 ALTON RD SPC A	280
2120	CR VENTURES, INC. DBA SUBSTANTIAL SUBS	GDO	3339	5616 NW 167 ST	532
2121	SEAFOOD ON THE TABLE, INC. DBA AROMAS DEL PERU	GDO	3342	13823 SW 88 ST	1,075
2122	FRITANGA MONTELMAR PLAZA, INC.	GDO	3345	15722 SW 72 ST #12	500
2123	TTS FOOD, LLC. DBA VENFOOD	GDO	3346	15990 NW 49 AVE	0
2124	OSI/OUTBACK STEAKHOUSE OF FL, LLC DBA OUTBACK STEAKHOUSE #1087	GDO	3347	15490 NW 77 CT	5,550
2125	LASSO THE MOON, INC.	GDO	3348	3390 MARY ST #182	279
2126	HERMANOS MENDOZA FRITANGA	GDO	3349	1356 PALM AVE	420
2127	FRANKY'S DELI WAREHOUSE CORP.	GDO	3350	2596 W 84 ST 1A	0
2128	WAL-MART STORES EAST, LP. DBA WAL-MART SUPERCENTER #5854	GDO	3351	8400 SW 24 ST	3,256
2129	K-MART CORPORATION DBA K-MART #4295	GDO	3352	10700 BISCAYNE BLVD	532
2130	E.G. DIXIE HWY CORP. DBA MARATON	GDO	3353	26398 S DIXIE HWY	673
2131	POLLO OPERATIONS, INC. DBA POLLO TROPICAL #44	GDO	3354	10575 NW 41 ST	1,568
2132	THE BLONDE TULIP, INC.	GDO	3358	3390 MARY ST #136	67
2133	BICE BISTRO OF COCONUT GROVE, LLC DBA BICE BISTRO	GDO	3361	3015 GRAND AVE 120-120 A	4,500
2134	DON SHULA'S HOTEL STEAKHOUSE	GDO	3363	6842 MAIN ST	3,750
2135	DOLZAR CORP. DBA BOMBAY DARBAR INDIAN RESTAURANT	GDO	3364	2901 FLORIDA AVE	1,919
2136	CAPITAL GRILLE HOLDINGS, INC. DBA CAPITAL GRILLE # 8006	GDO	3365	444 BRICKELL AVE	2,836
2137	PUBLIX SUPERMARKETS, INC. DBA PUBLIX STORE #0586	GDO	3368	3339 W 80 ST	0
2138	DISCO Y EMPANADAS ARGENTINAS, INC.	GDO	3370	2181 NW 10 AVE	1,125
2139	PAMPANGUENA, INC. DBA PAMPANGUENA CATERING	GDO	3371	18623 SW 107 AVE	2
2140	YAMAGUCHI, INC. DBA HIRO'S JAPANESE RESTAURANT	GDO	3373	3007 NE 163 ST	2,250
2141	PORTOFINO CAFE, INC. DBA ROSINELLA RESTAURANT	GDO	3374	525 LINCOLN RD	750
2142	MOSHI MOSHI CORAL WAY, LLC	GDO	3375	1744 SW 3 AVE	300
2143	BUFFET MIAMI, LLC DBA ROYAL BUFFET & GRILL	GDO	3376	11379 SW 40 ST	1,575
2144	GOLDEN KRUST BAKERY	GDO	3378	18316 NW 7 AVE	0
2145	KAREN CAFE, INC.	GDO	3380	340 NW 12 AVE	294
2146	VICTORIA FRIEND, LLC	GDO	3382	13595 SW 137 AVE	700
2147	VLAP CORP. DBA MIKE'S ITALIAN NEW YORK STYLE PIZZERIA & REST	GDO	3383	13712 SW 84 ST	1,500
2148	TASTE BUDS OF INDIA III, INC.	GDO	3385	946 NORMANDY DR	55,000
2149	CHEESECAKE FACTORY RESTAURANTS, INC.	GDO	3387	3015 GRAND AVE # 201	5,000
2150	ISABELLE MOURTADA, LLC DBA LE MACARON FRENCH PASTRIES	GDO	3390	3015 GRAND AVE #110	236
2151	DON SHULA'S GOLF CLUB STEAK HOUSE	GDO	3391	7601 NW 154 ST FAC. B	3,250
2152	AREPAS Y MUCHO MAS, INC.	GDO	3393	14431 COUNTRY WALK DR	227
2153	PORTOVINO, INC.	GDO	3394	3439 NE 163 ST	563
2154	SONIA'S PATTIES, INC.	GDO	3395	10852 SW 104 ST	0
2155	SUBWAY 3783, INC. DBA SUBWAY #3783	GDO	3397	10846 SW 104 ST	0
2156	PIZZERIA TWIN TOWER BIG AND TASTY, LLC	GDO	3401	12519 W OKEECHOBEE RD	347
2157	PALM GARDENS OF NORTH MIAMI	GDO	3402	21251 E DIXIE HWY	0
2158	DOMINO'S PIZZA, LLC DBA DOMINO'S PIZZA #3128	GDO	3403	27339 S DIXIE HWY	0
2159	DOMINO'S PIZZA, LLC DBA DOMINO'S PIZZA #3871	GDO	3404	6544 COLLINS AVE	0
2160	BRANTO & ASSOCATES, INC. DBA RINCON PORTENO	GDO	3406	12214 SW 8 ST	375
2161	JUVENTUD RESTAURANT, INC.	GDO	3407	6599 NW 74 AVE	0
2162	CAFE VILLA CLARA RESTAURANT	GDO	3408	10523 SW 109 CT	1,125
2163	DOMINO'S PIZZA, LLC DBA DOMINO'S PIZZA #3851	GDO	3411	1105 NW 22 AVE	0
2164	DOMINO'S PIZZA, LLC DBA DOMINO'S PIZZA #5094	GDO	3412	13417 SW 56 ST	0
2165	DOLORES, BUT YOU CAN CALL ME LOLITA, LLC	GDO	3414	1000 S MIAMI AVE	3,066
2166	ROMA GROCERIES, INC. DBA PRESIDENTE SUPERMARKET #06	GDO	3416	11300 72 QUAIL ROOST DR	0
2167	DOMINO'S PIZZA, LLC. DBA DOMINO'S PIZZA #5191	GDO	3419	1400 PONCE DE LEON BLVD	0
2168	FRENCH RESTO, LLC DBA EL POLLO SUPREMO	GDO	3420	95 NW 1 ST	688
2169	DONA AREPA, INC.	GDO	3423	1785 NW 21 TER	0
2170	CHC, INC. DBA COMMUNITY HABILITATION CENTER	GDO	3425	11450 SW 79 ST	1,600
2171	18555 COLLINS AVENUE CONDOMINIUM ASSOCIATION, INC.	GDO	3426	18555 COLLINS AVE	490
2172	LOS PERROS AQUI, LLC	GDO	3427	10855 SW 72 ST #47	700
2173	CRISCARY BAKERY	GDO	3428	29359 SW 152 AVE	1
2174	MAS POR MENOS, LLC	GDO	3429	29351-57 SW 152 AVE	1,000
2175	EMIL FRANC, INC. DBA CAFE RAGAZZI	GDO	3435	9500 HARDING AVE	2,250
2176	SPECCHIO GOURMET, INC. DBA SPECCHIO CAFE	GDO	3436	9485 HARDING AVE	1,000
2177	B & H PIZZA, INC.	GDO	3437	233 95 ST	175
2178	WHOLE FOODS MARKET GROUP, INC.	GDO	3439	21035 BISCAYNE BLVD	0
2179	9460 RESTAURANT PARTNERS, LLC DBA THE BACKYARD BBQ	GDO	3440	9460 HARDING AVE	453
2180	AMERICAN MULTI-CINEMA, INC. DBA AMC THEATRES AVENTURA 24	GDO	3441	19501 BISCAYNE BLVD	0
2181	BLOOMINGDALE'S AT AVENTURA MALL	GDO	3442	19555 BISCAYNE BLVD	700
2182	CHEVRON USA, INC. DBA CHEVRON #202-688	GDO	3443	8700 NW 122 ST	0
2183	CK KENDALL MALL, LLC. DBA CHICKEN KITCHEN	GDO	3445	9067 SW 107 AVE	588
2184	RITA'S RESTAURANT CORP.	GDO	3468	4080 E 4 AVE	750
2185	NYEMA CAFETERIA AND LOUNGE, INC.	GDO	3472	TAX ST 10 3010	172
2186	HOST TINSLEY JOINT VENTURE DBA JOSE CUERVO TO GO	GDO	3484	D-10/12 N.TERM	600
2187	NUEVA SAN SALVADOR #3 CORP.	GDO	3493	483 E 1 AVE	175
2188	MASTER CARWASH, LLC DBA TEXACO SERVICE STATION	GDO	3494	15200 BISCAYNE BLVD	196
2189	PUBLIX SUPERMARKETS, INC. DBA PUBLIX STORE #0073	GDO	3495	9400 HARDING AVE	0
2190	BEACH HOUSE HOTEL, LLC DBA GRAND BEACH HOTEL SURFSIDE	GDO	3497	9449 COLLINS AVE	429
2191	CLY MINIMARKET CORP.	GDO	3498	6039 COLLINS AVE	463
2192	PEKING HOUSE RESTAURANT	GDO	3501	899 N HOMESTEAD BLVD	1,000
2193	CAN GROUP, LLC DBA ROMEO & JULIET ITALIAN GELATO	GDO	3503	3015 GRAND AVE #180	225
2194	CHARITIN BAKERY, INC.	GDO	3508	5755 W FLAGLER ST 101	0
2195	HARBOR PITA, INC. DBA THE HARBOUR GRILL	GDO	3509	9415-9419 HARDING AVE	750
2196	NARCOBOLLO RESTAURANT, INC.	GDO	3510	2557 NW 79 AVE	560
2197	37 ENTERPRISES, LLC DBA MI CAFETERIA	GDO	3523	4865 NW 37 AVE	950
2198	GRILL CONCEPTS, INC. DBA THE GRILL ON THE ALLEY	GDO	3526	19501 BISCAYNE BLVD #783	6,325
2199	ELKIS CAFE, INC.	GDO	3530	425 SW 22 AVE #C	150
2200	BERTONI GELATO KEY BISCAYNE, LLC	GDO	3531	260 CRANDON BLVD #C-13	272

No.	FACILITY_NAME	PERMIT	PERMIT_NUMBER	ADDRESS	TOTAL_GPD
2201	ASAADA CORP. DBA NAHUEN	GDO	3532	260 CRANDON BLVD D20 C21-22	750
2202	NUEVA SAN SALVADOR RESTAURANT #4 CORP.	GDO	3533	1147 NW 22 AVE	1,075
2203	LOTUS HOUSE RESTAURANT	GDO	3536	9061 SW 107 AVE	750
2204	OUTRAGEOUS BAGLES CO.	GDO	3537	8843 SW 107 AVE	4
2205	YUMMY TUMMY, LLC DBA SUB ZERO ICE CREAM & YOGURT	GDO	3538	9065 SW 107 AVE #400	0
2206	MEXICAN FOOD CORP. DBA ERNESTO'S TACO SHOP	GDO	3540	8845 SW 107 AVE	518
2207	ITALY TODAY, INC.	GDO	3541	6743 MAIN ST	3,750
2208	K-MART CORPORATION DBA K-MART #4728	GDO	3542	3825 NW 7 ST	0
2209	DORAL PARK COUNTRY CLUB ASSOCIATION, INC.	GDO	3543	5001 NW 104 AVE	3,750
2210	WEST 68TH DONUTS, LLC DBA DUNKIN DONUTS	GDO	3544	2360 W 68 ST #101	375
2211	UNIVERSITY OF MIAMI HOSPITAL (MAIN CAFE)	GDO	3548	1400 NW 12 AVE	1,178
2212	ONE FOOD STOP MARKETPLACE CORP.	GDO	3549	350 SW 109 AVE	375
2213	VJ & SONS, INC. DBA FIRST HONG KONG EXPRESS	GDO	3550	3015 GRAND AVE #122	482
2214	STAR SEAFOOD RESTAURANT & CAFE, INC.	GDO	3552	4709 NW 183 ST	240
2215	HOMESTEAD CHRISTIAN ACADEMY - CARIBBEAN BANQUET HALL	GDO	3554	255 NE 2 DR	0
2216	EINSTEIN AND NOAH CORP. DBA EINSTEIN BROS. BAGELS #2984	GDO	3555	5946 S DIXIE HWY	448
2217	MASTER CONCESSIONAIR, LLC DBA FC BAR/KFC/PIZZA HUT/TACO BELL	GDO	3556	N. TERM E	113,925
2218	TROPICAL SUPERMARKET NO.14, INC. DBA PRESIDENTE SUPERMARKET NO.	GDO	3559	9875 SW 40 ST	0
2219	TROPICAL CHINESE RESTAURANT CORP.	GDO	3560	7991 SW 40 ST	3,500
2220	TAWAKAL II ENTERPRISES, INC. DBA NATURAL CHICKEN GRILL	GDO	3561	1673 SW 107 AVE #108/109	364
2221	LOS PARAGUAS CORPORATION	GDO	3563	8240 W 30 CT	650
2222	DON DAVIS MEAT MARKET CO. DBA DON DAVIS STEAKHOUSE II	GDO	3580	1200 NW 78 AVE #116	5,000
2223	JE-GO CORP. DBA LATIN AMERICAN MARKET	GDO	3582	7365 W FLAGLER ST	0
2224	DCPS BUNCHE PARK ELEMENTARY	GDO	3609	16001 BUNCHE PARK DR	419
2225	SUSHI CORNER, INC.	GDO	3630	15066 SW 56 ST	283
2226	MARINE EXHIBIT CORP. DBA MIAMI SEAQUARIUM-WHALE SPOT CAFE	GDO	3655	4400 RICKENBACKER CSWY	2,996
2227	TAQUERIA EL PASTOR, INC. DBA LA FRITANGA	GDO	3661	7187 SW 8 ST	250
2228	BEZOOM CORP. DBA SUNOCO	GDO	3674	22025 SW 112 AVE	2,075
2229	PUBLIX SUPERMARKETS, INC. DBA PUBLIX STORE #0655	GDO	3675	10755 NW 58 ST	0
2230	PUBLIX SUPERMARKETS, INC. DBA PUBLIX STORE #0657	GDO	3676	16870 SW 88 ST	0
2231	PUBLIX SUPERMARKETS, INC. DBA PUBLIX STORE #0669	GDO	3677	1700 NE MIAMI GARDENS DR	0
2232	MORENO'S MEXICAN SHOP, INC.	GDO	3678	439 W PALM DR	0
2233	E & J SOUTH CORPORATION DBA MOJITO GRILL	GDO	3679	7318 SW 57 AVE	280
2234	MIDWEST PETROL GROUP, INC. DBA BP	GDO	3681	11605 SW 147 AVE	0
2235	PARAMOUNT DELI, LLC DBA THE ORIGINAL LOTS OF LOX	GDO	3682	14995 S DIXIE HWY	625
2236	EL CARIBE CAFETERIA CORP.	GDO	3692	299 W 27 ST	300
2237	LA BACHATA ROSA RESTAURANT	GDO	3694	885 W 29 ST	750
2238	LOS LAGOS DE MAYAJIGUA RESTAURANT CORP.	GDO	3695	1932 W 60 ST	213
2239	NW 87TH DONUTS, LLC DBA DUNKIN DONUTS #336117	GDO	3696	2600 NW 87 AVE #7-8	336
2240	AUNTIE ANNE'S PRETZELS	GDO	3697	19575 BISCAYNE BLVD #393	0
2241	ALE HOUSE MANAGEMENT, INC. DBA NORTH MIAMI ALE HOUSE & RAW BAR	GDO	3709	3227 NE 163 ST	5,300
2242	SIMON CAFE & CATERING	GDO	3710	12258 SW 131 AVE	0
2243	SPECIAL EVENTS CATERING BY LES, INC.	GDO	3711	7049 SW 47 ST	0
2244	J.R. FOURTEEN, INC. DBA JOHNNY ROCKETS #122	GDO	3712	5701 SW 72 ST #H101	3,000
2245	M AND G SUPERMARKET, INC.	GDO	3724	764 NW 29 ST	625
2246	HOLIDAY BAKERY	GDO	3726	7313 MIAMI LAKES DR	1
2247	LATIN AMERICAN 8 ST, INC.	GDO	3727	2545 W 80 ST BAY 9	0
2248	LA MEJOR DE HIALEAH RESTAURANT, INC.	GDO	3743	1000 E 15 ST	378
2249	OMEGA PATIO ENTERPRISES, INC. DBA UNIVERSITY RESTAURANT	GDO	3744	1025 NW 20 ST	370
2250	NYCBL, LLC DBA GRANNY FEELGOOD'S	GDO	3770	25 W FLAGLER ST	975
2251	SAFA SUBS CORP. DBA SUBWAY #19612	GDO	3772	253 SW 8 ST	504
2252	MIAMI-DADE REGIONAL JUVENILE JUSTICE CENTER	GDO	3781	3300 NW 27 AVE #1213	0
2253	ZUNIGREG ENTERPRISES, INC. DBA PLAZA BAKERY	GDO	3789	9654 SW 24 ST	0
2254	JORANJES ENTERPRISE, INC. DBA PIZZAFIORE RESTAURANT	GDO	3790	1653 WASHINGTON AVE	375
2255	LA ORO VERDE, INC.	GDO	3793	1806 SW 22 AVE	0
2256	FONTAINEBLEAU FOOD CORP. DBA SABOR TROPICAL SUPERMARKET	GDO	3794	10692 FONTAINEBLEAU BLVD	2,972
2257	STK SOUTH BEACH, LLC DBA SOBE MEAT MARKET	GDO	3796	915 LINCOLN RD	3,950
2258	CRAZY ABOUT YOU, LLC	GDO	3797	1155 BRICKELL BAY DR #101	4,150
2259	PRO PLAYERS ENTERTAINMENT DBA HEADS OR TAILS GENTLEMEN LOUNGE	GDO	3798	766 E 25 ST	1,210
2260	LA MORENITA OF HOMESTEAD, INC. DBA LA MORENITA SUPERMARKET	GDO	3799	29609-11 SW 162 AVE	0
2261	CHRISTY'S RESTAURANT	GDO	3801	3101 PONCE DE LEON BLVD	3,750
2262	MESA MAR, LLC.	GDO	3802	264 GIRALDA AVE	1,076
2263	GARA INVESTMENT, LLC DBA LATIN BOHEMIA GRILL	GDO	3803	3894 SW 8 ST	1,098
2264	SANTAS FAST FOOD CORPORATION DBA LOS CHUZOS FAST FOOD	GDO	3804	2644 SW 137 AVE	126
2265	O. YOUNG'S JAMAICAN RESTAURANT, INC.	GDO	3805	17325 NW 27 AVE #104	250
2266	CHIVAS EXPRESS #2, LLC	GDO	3807	7269 NW 36 ST	420
2267	DORAL FRANCHISE CORP. DBA LA GRANJA DORAL	GDO	3808	10355 NW 41 ST	1,041
2268	ARGO MANAGEMENT, INC. DBA MCDONALD'S #7266	GDO	3809	11990 SW 8 ST	1,372
2269	BEST ASIAN FOOD, INC. DBA MAIN MOON BUFFET	GDO	3810	18423 S DIXIE HWY	3,750
2270	MOE'Z EXPRESS, INC.	GDO	3818	13810 SW 8 ST	400
2271	ZHENG & LIANG, LLC DBA SILVER PALACE CHINESE RESTAURANT	GDO	3824	5771 SW 137 AVE	1,850
2272	INGMELEC USA, LLC	GDO	3829	10541 SW 40 ST	0
2273	LM KITCHEN PLUS, INC.	GDO	3830	13804 SW 56 ST	495
2274	ESPERANZA'S CAFETERIA	GDO	3831	1048 E 26 ST	750
2275	LA ESQUINA LATINA CORP.	GDO	3833	1781 W 32 PL	420
2276	ATLANTA RESTAURANT PARTNERS LLC DBA TGI FRIDAY'S #0292	GDO	3834	1200-1250 S DIXIE HWY	1,830
2277	DELUCCA ENTERPRISES, INC. DBA MELREESE GOLF COURSE	GDO	3835	1802 NW 37 AVE	1,833
2278	THE BAKLAVA FACTORY, INC.	GDO	3836	1777 SW 3 AVE	4,975
2279	CACIQUE HOLDINGS, INC. DBA SUBWAY SUBS & SALAD #1352	GDO	3838	292 NW 42 AVE	7
2280	RINCONCITO SUPERLAYINO 1, LLC	GDO	3839	11356 QUAIL ROOST DR	875
2281	WENDIUM OF FLORIDA, INC. DBA WENDY'S #8480	GDO	3840	25 NE 167 ST	1,120
2282	GALVEZ & BARBOZA CORP. DBA GALVEZ BARBOZA SEAFOOD TAKE-OUT	GDO	3867	17490 SW 104 AVE	1,100
2283	MARIAN CENTER SERVICES FOR DH & MR	GDO	3868	15701 NW 37 AVE	400
2284	VICKY BAKERY III, INC.	GDO	3871	4943 E 4 AVE	0
2285	WELCOME FOOD AND DRINK CORPORATION	GDO	3874	5445 COLLINS AVE CU-6	0
2286	SOUTH FLORIDA PIZZA, LLC DBA DOMINO'S PIZZA #3121	GDO	3905	17845 NW 27 AVE	238
2287	786 MALL, INC. DBA SUBWAY #20605	GDO	3907	1675 W 49 ST #1250	0
2288	RICARDO CATERING SERVICE, INC.	GDO	3908	6708 W FLAGLER ST	1,189

No.	FACILITY_NAME	PERMIT	PERMIT_NUMBER	ADDRESS	TOTAL_GPD
2289	BEALL SANDWICH, LLC DBA JIMMY JOHNS #2546	GDO	3911	8343 W FLAGLER ST	6
2290	OSI/OUTBACK STEAKHOUSE OF FL, LLC DBA OUTBACK STEAKHOUSE #1078	GDO	3913	8255 W FLAGLER ST	5,000
2291	VIDA Y ESTILO CORP. DBA OH MEXICO	GDO	3915	410-412 ESPANOLA WAY	642
2292	THE CHINESE RESTAURANT, INC.	GDO	3916	12963 SW 112 ST	904
2293	TAPAS ESPANOLAS, LLC DBA TAPAS & TINTOS	GDO	3917	448 ESPANOLA WAY	650
2294	ALAMEDA LATIN CAFE, INC. DBA ALAMEDA BAKERY	GDO	3933	5915 W 25 CT #105-106	463
2295	CASA MIGUEL CORP.	GDO	3934	3300 E 4 AVE #2	213
2296	COSTA PERUANA RESTAURANT, INC.	GDO	3935	17713 NW 78 AVE	0
2297	LA GENEROSA CAFETERIA, INC. DBA LATIN BAKERY	GDO	3936	1275 W FLAGLER ST	450
2298	CATALINA'S BAKE SHOP, LLC	GDO	3937	8453 SW 132 ST	155
2299	ROYAL CARIBBEAN CRUISES, LTD.	GDO	3940	1080 PORT BLVD	2,310
2300	MICHAEL-ANN RUSSELL JEWISH COMMUNITY CENTER	GDO	3941	18900 NE 25 AVE	0
2301	HOST TINSLEY JOINT VENTURE DBA SBARRO'S	GDO	3942	TERMINAL CC-F	610
2302	HOST TINSLEY JOINT VENTURE, INC. DBA CON H PIZZA HUT	GDO	3943	H-12\H-14 CC-H	184
2303	LA PROVENCE BISCAYNE, LLC	GDO	3944	2200 BISCAYNE BLVD #160	1,100
2304	BAGEL BARN OF BRICKELL, INC.	GDO	3945	185 SE 14 TER #102	560
2305	DRSN, LLC DBA EL MALECON RESTAURANT	GDO	3946	5791 SW 137 AVE	510
2306	MENENDEZ MANAGEMENT CORP. DBA MCDONALD'S #23752	GDO	3947	11390 NW 41 ST	1,372
2307	BOCAS DORAL, LLC	GDO	3948	10200 NW 25 ST #101	804
2308	CAKE DESIGNS CORPORATION	GDO	3949	2549 NW 79 AVE	2
2309	Y & H, INC. DBA CORAL SUPERMARKET	GDO	3951	275 SW 37 AVE	0
2310	TIERRA BOMBA BAR AND GRILL, INC.	GDO	3952	3399 NW 72 AVE #104	650
2311	PANIZZA, LLC	GDO	3953	1229 LINCOLN RD	224
2312	MIAMI LAKES SUBWAY ENTERPRISES, INC. DBA SUBWAY #1406	GDO	3954	15416 NW 77 CT	245
2313	ASIAN EXPRESS CORP. DBA MISS SAIGON	GDO	3956	710 WASHINGTON AVE #13	375
2314	LA GUIRA CAFETERIA CORP.	GDO	3957	425 NW 12 AVE SECTION A	900
2315	WINGS ON FIRE CORPORATION	GDO	3958	6580 NW 22 AVE	200
2316	MDFR - FIRE RESCUE STATION #53	GDO	3959	11600 SW 130 ST	0
2317	7-ELEVEN, INC. DBA 7-ELEVEN STORE #37572H	GDO	3960	13795 SW 88 ST	0
2318	HOFBRAU BEERHALL MIAMI, LLC	GDO	3961	943 LINCOLN RD	3,425
2319	FUTURE HOPES, INC. DBA SUBWAY #2893	GDO	3962	801 E 8 AVE	560
2320	SAMBA GOURMET SWEETS, INC.	GDO	3965	2196-98 NW 21 ST	900
2321	MILLER'S ALE HOUSE, INC. DBA DORAL ALE HOUSE	GDO	3966	3271 NW 87 AVE	5,250
2322	PEREZ & SENRA CORPORATION DBA GROWING TREASURES LEARNING	GDO	3967	8318 NW 103 ST	0
2323	LOEWS MIAMI BEACH HOTEL	GDO	3968	1601 COLLINS AVE	0
2324	PUBLIX SUPERMARKETS, INC. DBA PUBLIX STORE #0658	GDO	3969	9105 S DADELAND BLVD	0
2325	CURRAMBA RESTAURANT, INC.	GDO	3970	1928 W 60 ST	500
2326	7-ELEVEN, INC. DBA 7-ELEVEN STORE #37750H	GDO	3971	13695 SW 288 ST	1,000
2327	RONALD MCDONALD HOUSE CHARITIES OF SOUTH FLORIDA, INC.	GDO	3972	1145 NW 14 TER	357
2328	BREAD PARTNERS #41, INC. DBA AU BON PAIN	GDO	3973	901 NW 17 ST STE. B	266
2329	LA FLOR DE TAMARINDO CORP.	GDO	3978	1365 W 49 ST	87
2330	MARITZA RESTAURANT CORP. DBA DON PINO RESTAURANT	GDO	3979	6746 W FLAGLER ST	37,850
2331	SLKL, INC. DBA LYON & LYON	GDO	3980	5663 NW 35 CT	2
2332	SUBWAY AT WEST FLAGLER, LLC	GDO	3981	6790 W FLAGLER ST	1,850
2333	BRETTMUM CORPORATION DBA MELTING POT RESTAURANT	GDO	3985	11520 SW 72 ST	3,025
2334	ARCHDIOSES OF MIAMI DBA COLEMAN CARROLL HIGH SCHOOL	GDO	3989	10300 SW 167 AVE	200
2335	DORALMEX, LLC DBA SALSA FIESTA	GDO	3990	6769 MAIN ST	600
2336	KLIMA, LLC	GDO	3992	210 23 ST	1,119
2337	JACKSON MEMORIAL LONG TERM CARE CENTER	GDO	3993	2500 NW 22 AVE	45
2338	YOLY'S RESTAURANT CORP.	GDO	4000	2900 NW 12 AVE	581
2339	DOLA TRADING, INC. DBA THE CORNER FOOD MARKET	GDO	4001	1200 NW 29 ST	600
2340	EJEN CORP. DBA EL MAYIMBE FRITANGA TORTILLA	GDO	4002	304 SW 8 AVE	531
2341	ERES PROSPERITY ENTERPRISES DBA MEXICO 1810	GDO	4003	1778 NW 36 ST	650
2342	CLUB TIPICO DOMINICANO, INC.	GDO	4004	1344 NW 36 ST	1,878
2343	LA CALIDAD CORP. DBA EL CAMPESINO RESTAURANT	GDO	4005	2001 NW 36 ST	275
2344	RESTAURANT EL HONDURENO II, INC.	GDO	4006	2298 NW 36 ST	1,650
2345	EL HONDURENO RESTAURANT, INC.	GDO	4007	2391-2395 NW 36 ST	400
2346	SELF MADE GLOBAL, LLC DBA THE ANDERSEN	GDO	4008	709 NE 79 ST	588
2347	EASTSIDE PIZZA, INC.	GDO	4009	731 NE 79 ST	427
2348	ANTOJITOS KTRACHO'S RESTAURANT, INC.	GDO	4010	2817 NW 7 AVE	500
2349	HIME ENTERPRISES, LLC DBA LAN PAN ASIAN CAFE	GDO	4012	8334 S DIXIE HWY	625
2350	MABEL'S CAFETERIA, INC.	GDO	4016	2264 NW 26 AVE	250
2351	NICARAGUA TRADER CORP. DBA SAN MIGUEL CAFETERIA & MARKET	GDO	4017	2600 NW 21 TER	800
2352	REGO INVESTMENTS, INC. DBA LA GRAN PARADA CAFETERIA	GDO	4018	2345 NW 27 AVE	420
2353	LINDO SUPERMARKET, INC.	GDO	4020	2925 NW 27 AVE	1,106
2354	LA NUEVA ALAMEDA CAFETERIA	GDO	4022	2400 NW 27 AVE	1,000
2355	LA SELECTA BAKERY, INC.	GDO	4025	9825 SW 40 ST	400
2356	CITY OF HIALEAH - HIALEAH FIRE STATION #6	GDO	4029	780 W 25 ST	0
2357	CITY OF HIALEAH DBA HIALEAH FIRE STATION #7	GDO	4030	7590 W 24 AVE	83
2358	LUMP SUM GROUP, INC. DBA RED KOI THAI & SUSHI LOUNGE	GDO	4031	317 MIRACLE MILE	3,750
2359	CALDER RACE COURSE, INC.	GDO	4032	21001 NW 27 AVE	0
2360	RED ROBIN INTERNATIONAL, INC. DBA RED ROBIN GOURMET BURGERS - THE	GDO	4033	9050 SW 136 ST	1,600
2361	BRAZILIAN TASTE GRILL, LLC	GDO	4036	7490 NW 25 ST	683
2362	BELLA MIA, INC. DBA PINK PONY	GDO	4037	7971 NW 33 ST	5,000
2363	BISCAYNE GAS & OIL CORP.	GDO	4039	16297 BISCAYNE BLVD	700
2364	CRAZY SHARK OF MIAMI CORP.	GDO	4040	2325 NW 27 AVE	35,000
2365	SUBWAY #57573, INC.	GDO	4041	11506 QUAIL ROOST DR	450
2366	DOMINO'S PIZZA, LLC DBA DOMINO'S PIZZA #5179	GDO	4042	7309 SW 107 AVE	0
2367	PSYCHO SOCIAL-REHABILITATION, INC.	GDO	4043	27255 SW 144 AVE	280
2368	SHULA'S STEAK HOUSE RESTAURANT	GDO	4044	5225 COLLINS AVE	3,750
2369	PUBLIX SUPERMARKETS, INC. DBA PUBLIX STORE #0629	GDO	4046	19955 NW 2 AVE	0
2370	GERARDO'S MARKETPLACE, INC.	GDO	4047	15509 BULL RUN RD	280
2371	CORRA ENTERPRISES, INC. DBA SEDANO'S SUPERMARKET #09	GDO	4051	4040 E 4 AVE	0
2372	RRF, LLC DBA DENNY'S #7459	GDO	4052	7411 NW 36 ST	3,725
2373	MY GENESIS, LLC DBA SUN JUICE	GDO	4053	1405 SW 72 ST	0
2374	KRAZY CHICKEN PLUS, LLC	GDO	4056	15030 NE 6 AVE	200
2375	JAM-ROCK DELITE, INC. DBA JAM-ROCK CUISINE	GDO	4058	12560 SW 88 ST	225
2376	BANGKOK BANGKOK RESTAURANT	GDO	4059	12584 SW 88 ST	1,875

No.	FACILITY_NAME	PERMIT	PERMIT_NUMBER	ADDRESS	TOTAL_GPD
2377	GOL 71, LLC DBA GOL	GDO	4060	940 71 ST	1,050
2378	HARVEST VALLEY, INC.	GDO	4061	5151 NW 165 ST	0
2379	MONA LISA PIZZERIA	GDO	4062	4751 SW 8 ST	1
2380	JINQIU, INC. DBA HOT MAMA'S KITCHEN	GDO	4065	3207 NE 163 ST	2,660
2381	LAZEEZ ASIAN CUISINE, INC.	GDO	4066	13919 SW 66 ST	650
2382	SPILLOVER RESTAURANT CONCEPTS, LLC	GDO	4069	2911 GRAND AVE #400-D	588
2383	SPORTS GRILL SOUTH MIAMI, LLC	GDO	4070	1559 SW 72 ST	1,163
2384	KARLA BAKERY IV, INC.	GDO	4072	8353 W FLAGLER ST	0
2385	CHINATOWN WEST CHEN, INC. DBA CHINATOWN WEST	GDO	4073	4210 SW 152 AVE	0
2386	SMOOTHIE SPOT, LLC	GDO	4074	228 NE 1 AVE	500
2387	LOS LATINOS 2000, LTD #3 DBA LATIN CAFE 2000 #3	GDO	4075	1192 W 49 ST	3,325
2388	CAFFE MILANO, LLC	GDO	4079	850 OCEAN DR	2,750
2389	THE ITALIAN SPORTS GRILL, INC.	GDO	4080	7921-23 NW 2 ST	675
2390	LITTLE CAESAR'S ENTERPRISES, INC. DBA LITTLE CAESAR'S PIZZA #2259	GDO	4084	19975 NW 2 AVE	0
2391	TOMASA CORPORATION	GDO	4085	5401 NW 79 AVE	1,025
2392	KFC CORPORATION DBA KFC #Y309222	GDO	4086	10725 NW 41 ST	684
2393	CACAO EXPRESS, INC.	GDO	4087	7165 SW 47 ST #312	600
2394	EL MAGO DE LAS FRITAS CORPORATION	GDO	4088	5828 SW 8 ST	750
2395	LA MARINA MARKET & RESTAURANT CORP.	GDO	4089	5779 SW 8 ST	474
2396	ANGELO BUFFETT, INC.	GDO	4090	6013 SW 8 ST	0
2397	ORIENTAL GOURMET, LLC DBA CHINA BUFFET	GDO	4093	18690 NW 67 AVE	1,850
2398	LOS MOLCAJETES RESTAURANT CORP.	GDO	4095	27879 S DIXIE HWY	1,350
2399	CAMAGUEY CAFETERIA RESTAURANT CORP.	GDO	4097	5757 SW 8 ST #121	125
2400	COSTCO WHOLESale CORP. DBA COSTCO WHOLESale #92	GDO	4098	8300 PARK BLVD	672
2401	KONING RESTAURANTS INTERNATIONAL, LC DBA PIZZA HUT #12544	GDO	4099	14433 COUNTRY WALK DR	0
2402	CATEY RESTAURANT, INC.	GDO	4101	202 SW 57 AVE	163
2403	LE PARIS CAKE DESIGN, INC.	GDO	4102	6180 SW 8 ST	445
2404	VARADERO SUPERMARKET DBA TROPICAL SUPERMARKET #05	GDO	4103	6190 SW 8 ST	0
2405	ELITE CATERING, INC.	GDO	4104	130 SW 57 AVE	237
2406	LA SORPRESA CUBANA, INC.	GDO	4105	609 SW 57 AVE	375
2407	THE BEST WINE SHOP, LLC	GDO	4107	6421 SW 8 ST	550
2408	RINCON ANTIOQUEÑO RESTAURANT, INC.	GDO	4108	6521 SW 8 ST	1,175
2409	YARURO, LLC	GDO	4111	8775 W FLAGLER ST	50
2410	FA&M WEST INDIAN AND AMERICAN GROCERY, INC.	GDO	4112	18400 NW 2 AVE #8	0
2411	ST. AGATHA CATHOLIC SCHOOL	GDO	4114	1111 SW 107 AVE	0
2412	IMNY SOUTH BEACH, LLC DBA IL MULINO NEW YORK	GDO	4115	840 1 ST	572
2413	347 SOMI, LLC DBA SHULA'S 347 GRILL	GDO	4116	6901 SW 57 AVE	5,000
2414	VIALETTA, INC. DBA CAFE VIALETTA	GDO	4117	4019 LE JEUNE RD	560
2415	LA BODEGUITA DE CHACHI, INC.	GDO	4120	4995 E 4 AVE	225
2416	BOCE GROUP, LC DBA NEXXT CAFE	GDO	4121	700 LINCOLN RD	5,925
2417	RESCARE, INC. DBA MIAMI JOB CORPS CENTER	GDO	4123	3050 NW 183 ST	15
2418	CAI BAO ZI, LLC DBA CHINESE GUY	GDO	4124	10340 W FLAGLER ST	0
2419	BRICKELL TRADING POST, INC. DBA BRICKELL BP	GDO	4126	1245 SW 2 AVE	0
2420	PESKARA, LLC DBA DENNY'S #7134	GDO	4127	15235 SW 137 AVE	3,075
2421	PERRINE-PETERS UNITED METHODIST CHURCH DBA PERRINE-PETER UNITED	GDO	4128	18301 S DIXIE HWY	2,000
2422	MCDONALD'S #6920	GDO	4129	7155 W 4 AVE	1,204
2423	DOUBLETREE OCEAN POINT RESORT & SPA	GDO	4131	17375 COLLINS AVE	420
2424	HHLP BLUE MOON LESSEE, LLC DBA BLUE MOON HOTEL	GDO	4133	944 COLLINS AVE	3,150
2425	THE INTERNATIONAL PARTY, LLC DBA LA COVACHA	GDO	4134	10730 NW 25 ST	2,500
2426	STAR CAFE MARKET, LLC	GDO	4137	1600 ALTON RD A	250
2427	ABEND PARTS CORP. DBA HAAGEN DAZS #295	GDO	4140	16407 NW 67 AVE	5
2428	PARADOR DE LA COLINA CORP.	GDO	4141	11200 W FLAGLER ST #113	224
2429	YEPES ENTERPRISES OF MIAMI, INC. DBA MI PUEBLO RESTAURANT	GDO	4144	10910 W FLAGLER ST #102	1,126
2430	MATILEN CORP. DBA MATILEN CAFE	GDO	4146	300 SW 107 AVE #107	225
2431	TACO BELL OF AMERICA, LLC DBA TACO BELL #20501	GDO	4149	785 E 9 ST	1,036
2432	LA ESTRELLA CHINA CAFETERIA & RESTAURANT	GDO	4150	10920 W FLAGLER ST #210	750
2433	GEMINI LTA CORP. DBA LA BODEGA BESTWAY	GDO	4152	11400 W FLAGLER ST #119	0
2434	PINOCHO BAKERY	GDO	4155	5236 W FLAGLER ST	0
2435	FRU MANAGEMENT DBA HOLIDAY INN	GDO	4156	4333 COLLINS AVE	858
2436	ZORBA RESTAURANT @ FOUR POINTS SHERATON HOTEL	GDO	4157	4343 COLLINS AVE	2,850
2437	RAW SOUTH JUICE, CO.	GDO	4160	9804 SW 77 AVE	60
2438	HBN SERVICES, INC. DBA TROPICAL CAFE	GDO	4161	5895 NW 167 ST	61
2439	CAYO ESQUIVEL SEAFOOD RESTAURANT	GDO	4163	11890 NW 87 CT #1	2,425
2440	FRITANGA LOS NICAS, LLC	GDO	4165	11364 QUAIL ROOST DR	300
2441	SUBWAY #1030, INC.	GDO	4166	16395 NW 67 AVE	560
2442	FIU - CENTER FOR ENGINEERING & APPLIED SCIENCES	GDO	4168	10555 W FLAGLER ST	0
2443	A & E ADVENTURES, LLC DBA GAMETIME	GDO	4169	5701 SW 72 ST #330	1,000
2444	KIMBERLY ENTERPRISES, INC. DBA VICTORIA'S BORINQUEN CAFE	GDO	4171	27855 S DIXIE HWY	475
2445	FIRST UNITED METHODIST CHURCH OF CORAL GABLES	GDO	4173	536 CORAL WAY	25
2446	AMC THEATRES SUNSET PLACE 24	GDO	4176	5701 SW 72 ST #300	0
2447	LATIN SANDWICH EXPRESS - CITGO GAS STATION	GDO	4178	1690 NW 87 AVE	0
2448	BARNES AND NOBLE, INC.	GDO	4179	5701 SW 72 ST #196	420
2449	KFC CORPORATION DBA KFC #Y309125	GDO	4181	3535 SW 22 ST	576
2450	DOMINO'S PIZZA, LLC DBA DOMINO'S PIZZA #4931	GDO	4182	3820 SW 137 AVE	0
2451	JOEY'S WYNWOOD, LLC DBA JOEY'S	GDO	4183	2506 NW 2 AVE	510
2452	KFC CORPORATION DBA KFC #309004	GDO	4184	2375 SW 8 ST	757
2453	SSC332292, LLC DBA DBA DUNKIN DONUTS #332292	GDO	4185	10754 SW 24 ST	521
2454	MIAMI-DADE COUNTY FAIR EXPOSITION	GDO	4186	10901 SW 24 ST	0
2455	THE PANTHER'S BLVD, INC. DBA THE PANTHER'S BOULEVARD	GDO	4188	529 SW 109 AVE	238
2456	1250 OCEAN DR, LLC DBA THE CARLYLE CAFE	GDO	4190	1250 OCEAN DR REST	4,975
2457	SWINE GABLES, LLC DBA SWINE SOUTHERN TABLE & BAR	GDO	4191	2415 PONCE DE LEON BLVD	1,009
2458	ROSY'S BAKERY, INC.	GDO	4192	11400 W FLAGLER ST #118	0
2459	TRADE FAIR SUPERMARKET CAFETERIA	GDO	4193	12396 QUAIL ROOST DR	0
2460	MARLON'S CAFE, INC.	GDO	4194	11398 W FLAGLER ST #106	88
2461	L.M. BURGER CORP. DBA FLAGLER CHARBROIL BURGER & CHICKEN	GDO	4195	7795 W FLAGLER ST 58	250
2462	BEBO & TITA CAFE, LLC	GDO	4196	2590 PALM AVE	213
2463	SUSHI SAKE HAMMOCKS, INC.	GDO	4198	14649 SW 104 ST #19	325
2464	DELLWAN, LLC DBA OPEN STAGE CLUB	GDO	4199	2325 GALIANO ST	948

No.	FACILITY_NAME	PERMIT	PERMIT_NUMBER	ADDRESS	TOTAL_GPD
2465	SOHO HOUSE BEACH HOUSE, LLC	GDO	4200	4385 COLLINS AVE	1,503
2466	PIZZERIAS, LLC DBA PAPA JOHN'S PIZZA #2184	GDO	4201	16834 SW 88 ST	0
2467	HIJO DEL PAISITA GROUP CORP. DBA EL GUSTAZO	GDO	4203	13366 SW 128 ST 9	250
2468	CAFFE DI NOTTE	GDO	4204	9793 SW 72 ST	1,950
2469	AURA LINCOLN ROAD, LLC DBA MORECO CORP.	GDO	4205	613 LINCOLN RD	692
2470	LA TERRAZA LATINA, LLC	GDO	4206	2410 E 8 AVE	155
2471	STARBUCKS COFFEE COMPANY, INC. DBA STARBUCKS #8306	GDO	4207	9709 NW 41 ST #101	602
2472	TARGET CORPORATION DBA TARGET STORE #1038	GDO	4209	14075 BISCAYNE BLVD	420
2473	LA VOGLIA FINE FOODS CORP. DBA FARFALLE	GDO	4211	333 SE 2 ST	499
2474	STARBUCKS COFFEE COMPANY, INC. DBA STARBUCKS #8294	GDO	4212	110 SE 3 AVE	4
2475	COSTCO WHOLESALE CORP. DBA COSTCO WHOLESALE #0181	GDO	4213	16580 NW 59 AVE	840
2476	CENTRO AMERICA COFFEE SHOP, INC.	GDO	4214	1745 W FLAGLER ST	1,000
2477	PRINCETON FAA, INC. DBA CHEVRON GAS STATION	GDO	4217	24798 SW 129 AVE	294
2478	POLLO OPERATIONS, INC. DBA POLLO TROPICAL #46	GDO	4218	3499 BISCAYNE BLVD	1,120
2479	BRINKER FLORIDA, INC. DBA CHILI'S GRILL & BAR	GDO	4221	1675 W 49 ST #1504-D	5,650
2480	MAMMA MIA PIZZERIA & RESTAURANT, INC.	GDO	4222	538 WASHINGTON AVE	2,500
2481	KHAMKHAND, INC. DBA SUSHI ROCK	GDO	4224	11293 S DIXIE HWY	900
2482	ST. TIMOTHY CATHOLIC CHURCH	GDO	4225	5400 SW 102 AVE	0
2483	M & A JOINT VENTURE CORP. DBA KROME SPORT BAR & GRILL	GDO	4226	19750 SW 177 AVE	192
2484	AUTHENTIC FLAIR RESTAURANT, LLC DBA CASA MAIZ RESTAURANT	GDO	4228	7395 W 4 AVE	881
2485	LE MINOTEN, LLC DBA IL BOLOGNESE	GDO	4230	626 LINCOLN RD	4,800
2486	LATIN AMERICAN MEATS AND FOODS CORP.	GDO	4232	6939 NW 82 AVE	450
2487	KASALTA PIZZA & SHAKES, LLC	GDO	4233	7045 W 4 AVE	213
2488	ROCKOLAS GROUP, LLC DBA FONDA LA ROCKOLA & SANTAS NIGHTCLUB	GDO	4236	6854 NW 169 ST	1,225
2489	CLARA M. MADRIGAL, INC. DBA CLARITA'S CAFE	GDO	4237	1666 W 31 PL	300
2490	DANET KRYSTAL CORP. DBA CAFE KRYSTAL	GDO	4238	3804 W 12 AVE	263
2491	MONUMENT RESTAURANTS VI, LLC DBA FIVE GUYS BURGERS AND FRIES	GDO	4239	19501 BISCAYNE BLVD #3204-A	450
2492	LE JARDIN RESTAURANT, INC.	GDO	4240	195-97 NE 78 ST	331
2493	FRITZ & FRANZ BIERHAUS	GDO	4244	60 MERRICK WAY	5,000
2494	JACKSON HEALTH SYSTEM DBA JACKSON NORTH MEDICAL CENTER	GDO	4248	160 NW 170 ST	7,640
2495	GAYOU'S RESTAURANT, LLC	GDO	4249	5734 NW 2 AVE	342
2496	STARBUCKS COFFEE COMPANY, INC. DBA STARBUCKS #8323	GDO	4252	401 BISCAYNE BLVD #1270	6
2497	PAN Y LUNCH BAKERY CORP.	GDO	4254	1571 E 4 AVE	0
2498	MORTON'S OF CHICAGO/NORTH MIAMI BEACH DBA MORTON'S THE STEAK	GDO	4256	17399 BISCAYNE BLVD	5,300
2499	VALERIA'S SERVICES CORP. DBA DYLAN'S RESTAURANT	GDO	4257	7380 W 20 AVE #101	515
2500	CITY OF MIAMI-FIRE STATION #01	GDO	4259	144 NE 5 ST	50
2501	CITY OF MIAMI FIRE STATION #07	GDO	4261	314 BEACOM BLVD	0
2502	CITY OF MIAMI-FIRE STATION #08	GDO	4262	2975 OAK AVE	0
2503	CITY OF MIAMI-FIRE STATION #10	GDO	4263	4101 NW 7 ST	0
2504	CITY OF MIAMI-FIRE STATION #11	GDO	4264	5920 W FLAGLER ST	50
2505	CITY OF MIAMI FIRE STATION #03	GDO	4265	1103 NW 7 ST	140
2506	KID'S UNIVERSITY PRESCHOOL CORP.	GDO	4268	2800 W 84 ST #13	700
2507	SAPORI GROUP, LLC DBA SAPORI D'ITALIA CAFE	GDO	4269	2800 W 84 ST #6	400
2508	CONCHITA ESPINOSA ACADEMY	GDO	4270	12975 SW 6 ST	50
2509	SPEEDWAY, LLC DBA SPEEDWAY #6439	GDO	4272	7550 NW 186 ST	40
2510	GRAND, INC. DBA CHINA BUFFET	GDO	4274	1032 SW 67 AVE	2,250
2511	SUPREME SMOOTHIE, INC.	GDO	4275	15536 NW 77 CT	4
2512	FRIENDSHIP MISSIONARY BAPTIST CHURCH	GDO	4277	740 NW 58 ST	0
2513	SSC308305, LLC DBA DUNKIN DONUTS #308305	GDO	4278	1496 NE MIAMI GARDENS DR	275
2514	GREEN GABLES CAFE, LLC	GDO	4279	325-27 ALHAMBRA CIR	500
2515	LA TINAJITA CAFE RESTAURANT, INC.	GDO	4280	1536 E 4 AVE	240
2516	1400 OCEAN DRIVE, LLC DBA IL BOLOGNESE RESTAURANT	GDO	4281	1400 OCEAN DR	617
2517	LA LEONESA FRITANGA, INC.	GDO	4286	1 SW 12 AVE	338
2518	HAPPY COOKING CORP. DBA LAS DOS PALMAS RESTAURANT	GDO	4288	12992 SW 89 AVE	1,150
2519	OLANCHO CAFETERIA, INC.	GDO	4289	240 NW 8 AVE	625
2520	POPSY, LLC DBA POPY ICE CREAM SHOP	GDO	4290	1527 SW 8 ST	84
2521	TELVA SWEET BAKERY, LLC	GDO	4291	543 SW 12 AVE	200
2522	LA BODEGUITA ALEGRIA, INC.	GDO	4292	140 SW 16 AVE	250
2523	KONING RESTAURANTS INTERNATIONAL, LC DBA PIZZA HUT #012399	GDO	4293	1529 SW 8 ST	0
2524	KRIS MINI-MARKET & CAFE	GDO	4295	19595 NE 10 AVE BLDG-5G	425
2525	MERCADO ORIENTAL, INC.	GDO	4297	201 SW 8 AVE	0
2526	G.G. NEW CORP. DBA HONEY BEE RESTAURANT	GDO	4298	7400 NW SOUTH RIVER DR #8	200
2527	WEST KENDALL BAPTIST CHURCH, INC.	GDO	4299	14955 SW 88 ST	0
2528	EL MAMEY FRUTERIA	GDO	4302	4410 W 16 AVE #10	0
2529	WAL-MART STORES EAST, LP DBA WAL-MART SUPERCENTER #2814	GDO	4303	9300 NW 77 AVE	0
2530	LIANGS FAMILY, INC. DBA BEIJING GARDENS	GDO	4305	832 W FLAGLER ST	1,000
2531	720 OCEAN DRIVE, LLC DBA THE PLACE	GDO	4306	720 OCEAN DR	3,250
2532	MANHATHAN CHICAGO KENDALL, LLC DBA MANHATHAN CHICAGO PIZZA	GDO	4307	10481 SW 88 ST #100D	455
2533	RELIANCE RESTAURANT GROUP, INC. DBA BRAZAVIVA CHURRASCARIA	GDO	4308	7910 NW 25 ST #102	1,375
2534	TERRA DOLCI, LLC DBA CHEF ADRIANNE'S	GDO	4309	11510 SW 147 AVE 21-23	1,500
2535	MEDIA NARANJA CAFE, INC.	GDO	4310	900 W 49 ST	25
2536	ST. STEPHENS EPISCOPAL SCHOOL	GDO	4312	3439 MAIN HWY	315
2537	ESSENCE CATERERS, LLC	GDO	4313	2114 NW 13 AVE	528
2538	8 STREET MUCHO SALES, INC. DBA BURGER KING #12778	GDO	4314	1701 SW 8 ST	560
2539	SUZANNE MICHAEL CATERING	GDO	4317	12205 SW 131 AVE #3	548
2540	TROPICANA FIESTAS, INC. DBA RECEPTION PALACE BALLROOMS	GDO	4318	14375 SW 42 ST	1,250
2541	HEALTHY DELIGHTS II, LLC	GDO	4319	1455 NW 107 AVE #432	0
2542	INVERSIONES LA ABUNDANCIA CORP. DBA RINCONCITO PAISA #3	GDO	4320	15148 SW 72 ST	1,025
2543	PARADISE INTERNATIONAL USA CORP.	GDO	4321	10701 NW 58 ST	400
2544	SAFRON, LLC	GDO	4322	1049 WASHINGTON AVE	550
2545	ANDREINAS CAFE, INC. DBA SABOR PERUANO	GDO	4324	18446 SW 97 AVE	150
2546	MUNDO LATINO RESTAURANT	GDO	4326	2075 BRIGHT DR	750
2547	GARNISH HOSPITALITY GROUP, INC. DBA PINCH RESTAURANT	GDO	4328	8601 BISCAYNE BLVD	347
2548	CK AT DORAL, LLC DBA CHICKEN KITCHEN	GDO	4329	9741 NW 41 ST	546
2549	PRESIDENT HOTEL, INC.	GDO	4332	1423 COLLINS AVE	625
2550	WORLDWIDE CONCESSIONS DBA PIZZA HUT	GDO	4334	E-4 CC-E	45
2551	RCSH OPERATIONS, LLC DBA RUTH'S CHRIS STEAK HOUSE	GDO	4336	2320 SALZEDO ST	5,725
2552	THE FONTAINEBLEAU FLORIDA HOTEL, LLC FONTAINEBLEAU RESORT - MIAMI	GDO	4337	4441 COLLINS AVE	14,000

No.	FACILITY_NAME	PERMIT	PERMIT_NUMBER	ADDRESS	TOTAL_GPD
2553	786 STATION, INC. DBA SUBWAY #22258	GDO	4338	900 E 65 ST	280
2554	834 OCEAN DRIVE, LLC DBA FOX CAFE	GDO	4342	834 OCEAN DR	3,225
2555	HNS PARTNERS 19650, LLC DBA SUBWAY #19650	GDO	4344	508 WASHINGTON AVE	168
2556	LPF INVESTMENTS, LLC DBA LOS PERROS	GDO	4345	8410 W FLAGLER ST #113-B	1,250
2557	IMPERIAL CLUB RETIREMENT COMMUNITY	GDO	4346	2751 NE 183 ST	0
2558	ADVERTISING SERVICES GROUP, INC. DBA LA FORTUNA PIZZERIA	GDO	4348	10783 NW 58 ST	140
2559	DOGGI'S & MORE, LLC	GDO	4350	1246 SW 22 ST	213
2560	KURVA'S BAR & GRILL CORP.	GDO	4351	2150 W 10 CT	375
2561	CK AT PINECREST, LLC DBA CHICKEN KITCHEN	GDO	4352	11403 S DIXIE HWY	560
2562	ALDRSGATE HEALTHCARE, INC. DBA SUSANNA WESLEY HEALTH CENTER	GDO	4354	5300 W 16 AVE	0
2563	RITZ CARLTON HOTELS, LLC	GDO	4355	3300 SW 27 AVE	5,000
2564	J.R. SEVEN, INC. DBA JOHNNY ROCKETS #07	GDO	4357	728 OCEAN DR	1,876
2565	EL SOL, LLC DBA ISLAS CANARIAS GRILL & BAKERY	GDO	4358	3804 SW 137 AVE #1	1,000
2566	HHLF MIAMI BEACH LESSEE, LLC DBA COURTYARD BY MARIOTT - MIAMI	GDO	4359	3925 COLLINS AVE	998
2567	MYRA P. & COMPANY CAFE DELI	GDO	4361	7313 SW 59 CT	560
2568	LATIN GROUP, INC. DBA LATIN CAFE 2000	GDO	4366	2501 BISCAYNE BLVD	5,200
2569	LANDMARK SERVICE CENTER, INC. (SUBWAY)	GDO	4367	8695 NW 58 ST	420
2570	COBB THEATRES III, LLC. DBA MIAMI LAKES 17 THEATER	GDO	4368	6711 MAIN ST	0
2571	CHINA LEE RESTAURANT, INC.	GDO	4369	559 SW 8 ST	234
2572	POMODORO'S PIZZA SUBS AND MORE I CORP.	GDO	4370	3737 NE 163 ST	325
2573	PELICAN DRIVE, INC. DBA PELICAN HOTEL MIAMI (RESTAURANT)	GDO	4371	826 OCEAN DR	1,418
2574	EL CACIQUE LUNCH RESTAURANT	GDO	4372	112 W FLAGLER ST	2,850
2575	THE BILLIARD CLUB, INC.	GDO	4373	15532 NW 77 CT #440	37
2576	SUBWAY 10181, INC.	GDO	4381	2720 S DIXIE HWY	400
2577	MAJESTIC HOTEL CORP. DBA FISH CALLED AVALON	GDO	4382	700 OCEAN DR	1,500
2578	ELBAR, INC. DBA SHEMTOV'S PIZZA	GDO	4383	514 41 ST	1,097
2579	SOBE USA, LLC DBA OCEAN TEN'S RESTAURANT	GDO	4384	960 OCEAN DR	842
2580	LARIOS ON THE BEACH, INC.	GDO	4386	820 OCEAN DR	5,725
2581	AMALIA'S BAKERY, INC. DBA NATIONAL CAKES BAKERY II	GDO	4389	11300 QUAIL ROOST DR	750
2582	POLLO OPERATIONS, INC. DBA POLLO TROPICAL #47	GDO	4390	16201 SW 88 ST	1,008
2583	DORAKU LINCOLN ROAD, LLC DBA DORAKU SUSHI	GDO	4393	1104 LINCOLN RD	3,025
2584	AIR CATERING INTERNATIONAL, INC.	GDO	4394	455 E OKEECHOBEE RD	3,000
2585	CENTURIAN COLLINS PROPERTY OWNER, LLC DBA ALOFT HOTEL	GDO	4396	2360 COLLINS AVE	1,334
2586	EL BODEGON DE SANCHO CORPORATION	GDO	4397	13202-04 SW 8 ST	500
2587	VIVA BURGER, LLC	GDO	4398	11510 SW 147 AVE #15	177
2588	3500 HOTEL, LLC DBA CLARIDGE HOTEL	GDO	4400	3500 COLLINS AVE	270
2589	SL STERLING, LLC DBA THE STERLING	GDO	4401	2777 NE 183 ST	2,550
2590	DOWNSTAIRS CAFE HIALEAH, INC.	GDO	4402	2390 W 76 ST #1	2,225
2591	MANGO'S TROPICAL CAFE, INC.	GDO	4405	900 OCEAN DR	4,000
2592	BRIGGS OF SOUTH BEACH, INC. DBA FAT TUESDAY	GDO	4406	918 OCEAN DR	3,200
2593	2K CLEVELANDER, LLC DBA CLEVELANDER HOTEL	GDO	4407	1020 OCEAN DR	11,175
2594	OCEAN FIVE BISTRO, LLC	GDO	4409	444 OCEAN DR	225
2595	OCEAN CC, LLC DBA CAVALLI RESTAURANT & LOUNGE	GDO	4410	150 OCEAN DR	1,917
2596	JAE MIAMI DADE, LLC DBA WENDY'S #8156	GDO	4411	16203 SW 88 ST	759
2597	DON JOSE	GDO	4412	1427 SW 107 AVE	1,000
2598	CORDIS, A JOHNSON & JOHNSON COMPANY	GDO	4413	14201 NW 60 AVE	2,240
2599	C.Y.L. CORPORATION DBA DAVE'S JAMAICAN RESTAURANT & BAKERY	GDO	4415	700 NW 183 ST	1,000
2600	BEST SUB AND SANDWICH SHOP	GDO	4416	9802 SW 77 AVE	420
2601	OFF THE GRILLE CORP.	GDO	4417	12578 SW 88 ST	400
2602	SANDRA DELUCCA DEVELOPMENT CENTER	GDO	4418	4560 NW 4 TER	0
2603	ROCA CAFE, INC. DBA CACIQUE'S CORNER	GDO	4419	102 W FLAGLER ST	68,025
2604	IL GIARDINO, LLC	GDO	4421	1230-36 OCEAN DR	1,770
2605	MOONLITE DINER THREE, LLC	GDO	4422	8695 SW 124 AVE	1,050
2606	JAE MIAMI DADE, LLC DBA WENDY'S #8155	GDO	4424	13090 SW 120 ST	812
2607	WENDY'S INTERNATIONAL, INC. DBA WENDY'S #2522	GDO	4425	1651 SW 107 AVE	980
2608	BJ'S WHOLESALE CLUB, INC. DBA BJ'S WHOLESALE CLUB #111	GDO	4426	8005 NW 95 ST	532
2609	HUME ENTERPRISES, INC. DBA TOM'S NFL CLUB	GDO	4428	5001 NW 36 ST	4,000
2610	FRATELLINO, LLC	GDO	4429	264 MIRACLE MILE	344
2611	MEDLEY TALL SALES, INC. DBA BURGER KING #2500	GDO	4430	11600 NW SOUTH RIVER DR	1,120
2612	KFC CORPORATION DBA KFC #Y309134	GDO	4433	11975 SW 152 ST	680
2613	BIG LOAF CORP. DBA HAVANA BAKERY	GDO	4434	133 W 22 ST	1
2614	WENDIUM OF FLORIDA, INC. DBA WENDY'S	GDO	4436	2000 NW 10 AVE	1,316
2615	AFG ADVANCE CORPORATION DBA VALERO	GDO	4437	4401 SW 8 ST	0
2616	DRAWING ROOM RESTAURANT @ RITZ CARLTON	GDO	4438	455 GRAND BAY DR	0
2617	BOBADILLA, INC. DBA HOSTERIA DEL TEATRO	GDO	4440	1200 COLLINS AVE	475
2618	CG TIDES LLC DBA TIDES SOUTH BEACH	GDO	4441	1220 OCEAN DR	1,173
2619	HE & HO, INC. DBA KON CHAU RESTAURANT	GDO	4442	8376 SW 40 ST	800
2620	EL PARAISO DE LAS FRUTAS CORP.	GDO	4443	2303 NW 7 ST	613
2621	TRATTORIA ROSALIA	GDO	4445	19575 BISCAYNE BLVD #793	1,890
2622	SWEET ART HOLDINGS, LLC	GDO	4446	4300 SW 75 AVE	0
2623	SUBWAY 6698, INC. DBA SUBWAY #6698	GDO	4447	7795 W FLAGLER ST 60	0
2624	AGACCITI CORPORATION DBA FIESTA MEXICAN GRILL	GDO	4448	10433 NW 41 ST 13	1,075
2625	MAGU OF FLORIDA INVESTMENT, LLC DBA RINCON ARGENTINO	GDO	4449	7744 SW 88 ST	550
2626	MOLTO MIAMI, INC.	GDO	4450	1237 LINCOLN RD	670
2627	STARBUCKS COFFEE COMPANY, INC. DBA STARBUCKS #8316	GDO	4456	19127 BISCAYNE BLVD	11
2628	1052, LLC DBA PAPAGAYO	GDO	4458	1052 OCEAN DR	1,322
2629	TUONG MI CORPORATION DBA GREEN PAPAYA VIETNAMESE CUISINE	GDO	4459	16893 NW 67 AVE	255
2630	JAPANESE RESTAURANT SHIMA, INC. DBA SHIMA JAPANESE RESTAURANT	GDO	4460	16873 NW 67 AVE	1,000
2631	DALTORO MIAMI, LLC DBA DALTORO RESTAURANT	GDO	4461	719 LINCOLN RD	2,881
2632	1300 OCEAN DRIVE, LLC DBA CARDOZO BAR & GRILL	GDO	4462	1300 OCEAN DR	653
2633	SOBE CORSICA, LLC DBA I PAPAARAZZI	GDO	4463	940 OCEAN DR	1,155
2634	SUSHI SAKE CW, INC. DBA SUSHI SAKE	GDO	4464	15461 SW 137 AVE #27	688
2635	GAETANO'S PIZZERIA, INC.	GDO	4465	9808 SW 77 AVE	300
2636	SANTA FE NEWS & ESPRESSO	GDO	4468	9700 COLLINS AVE #243	0
2637	SAILORMEN, INC. DBA POPEYE'S CHICKEN & BISCUITS	GDO	4470	27101 S DIXIE HWY	700
2638	DON DOMINGO CAFE PARRILLADA ARGENTINA, INC.	GDO	4471	10817 SW 40 ST	950
2639	TOWNHOUSE HOTEL, LLC	GDO	4472	150 20 ST	532
2640	CHEVRON @ 9TH STREET	GDO	4476	1025 E 9 ST	0

No.	FACILITY_NAME	PERMIT	PERMIT_NUMBER	ADDRESS	TOTAL_GPD
2641	NEW TESTAMENT BAPTIST CHURCH, INC.	GDO	4477	6601 NW 167 ST	8,000
2642	YUTH AND ANDY, INC. DBA SUSHI SIAM OF AVENTURA	GDO	4479	19501 BISCAYNE BLVD 3205-C	2,800
2643	LAS 5 HERMANAS CAFETERIA, INC.	GDO	4480	10119 W OKEECHOBEE RD	2
2644	TODAY'S FROZEN DESSERTS	GDO	4481	7156 NW 50 ST	0
2645	CEC ENTERTAINMENT, INC. DBA CHUCK E. CHEESE'S #725	GDO	4482	18575 S DIXIE HWY	6,342
2646	LA CHURRASQUERIA, INC.	GDO	4483	250 E PALM DR #F-60	163
2647	TEXAS TACO FACTORY	GDO	4484	1608 ALTON RD UNIT-A	630
2648	404 SB, LLC DBA LOBSTER BAR SEA GRILL	GDO	4485	404 WASHINGTON AVE	2,613
2649	J.D. THE PIZZA HOUSE, INC.	GDO	4487	8825 SW 107 AVE	140
2650	LAS CUATRO ESQUINAS CAFETERIA CORP.	GDO	4489	1001 E 27 ST	625
2651	CAYO ESQUIVEL SEAFOOD RESTAURANT	GDO	4492	7725 SW 40 ST	2,000
2652	FIGOGAMA, INC. DBA HAAGEN-DAZS #604	GDO	4493	1451 OCEAN DR 101	0
2653	RB FOOD MANAGEMENT, INC. DBA MAROOSH	GDO	4495	223 VALENCIA AVE	2,000
2654	CELLINI & VERSACE, LLC DBA VERSACE GELATERIA ITALIANA	GDO	4497	1455 NW 107 AVE #132	151
2655	PINA'S RESTAURANT CORP.	GDO	4499	7575 W 36 AVE	750
2656	HIALEAH SNF, LLC DBA PALMETTO REHAB & HEALTH CENTER	GDO	4501	6750 W 22 CT	1,000
2657	SERA'S LATIN CAFE, LLC DBA LEO'S HOUSE RESTAURANT	GDO	4502	7911 W 26 AVE	800
2658	DIANA'S CAFE, INC.	GDO	4503	99 NW 1 ST	630
2659	XPLOSION CAFE, LLC	GDO	4504	2601 W 76 ST	213
2660	DIMENSION DEVELOPMENT CORP. DBA COURTYARD BY MARRIOTT	GDO	4505	200 SE 2 AVE	2,500
2661	ROC RESTAURANTS, LLC DBA DICED	GDO	4509	2342 SW 67 AVE	178
2662	ROYAL KIDS ACADEMY	GDO	4510	3141 W 76 ST #3	0
2663	1 CACHE RESTAURANT AND CAFETERIA, INC.	GDO	4512	1500 PALM AVE	800
2664	CRP NASH, LLC DBA HOTEL NASH	GDO	4514	1120 COLLINS AVE	750
2665	607 LINCOLN RD, LLC DBA CANTINETTA	GDO	4516	607 LINCOLN RD	4,750
2666	BURGER KING CORPORATION DBA BURGER KING #13121	GDO	4517	16730 SW 88 ST	1,064
2667	OLE OLA CATERING CORP DBA OLE OLA CAFE	GDO	4518	13920 SW 47 ST A-103	646
2668	LOS TANITOS, INC.	GDO	4519	9562-64 SW 137 AVE	625
2669	EVERGLADES I CHILD DEVELOPMENT CENTER	GDO	4524	19420 SW 379 ST	0
2670	REDLANDS CHRISTIAN MIGRANT ASSOCIATION	GDO	4525	19280 SW 378 ST	86
2671	TROPICAL BAKERY WHOLESALE CORP.	GDO	4526	2460 W 1 AVE	1
2672	EL PATIO DE OSHUN CORP.	GDO	4527	64 W 49 ST	357
2673	7-ELEVEN, INC. DBA 7-ELEVEN STORE #37250A	GDO	4530	7520 NW 186 ST	845
2674	HOMESTEAD DONUTS, LLC DBA DUNKIN DONUTS #330261	GDO	4532	417 SE 1 AVE	275
2675	CHARANGA CATERING, LLC DBA BROCHE OO1	GDO	4533	2551-55 W 3 AVE	600
2676	SURFSIDE BAKERY, LLC DBA DUNKIN DONUTS	GDO	4535	2352-56 W 78 ST #101	1,425
2677	HIALEAH MOBIL, INC.	GDO	4537	6800 W 24 AVE	750
2678	EL SEGUNDO POLO NORTE, INC. DBA POLO NORTE PIZZA RESTAURANT	GDO	4539	2050 W 56 ST UNIT-23	1,725
2679	THE KID GOURMET, INC.	GDO	4540	8015 W 21 LN	0
2680	JLGS ENTERPRISES, LLC DBA FRITANGA MANAGUITA	GDO	4541	11373 SW 211 ST #13-14	348
2681	POWERFUL FIT NUTRITION CORP.	GDO	4544	2085 W 76 ST #6	51,900
2682	HIGH SPADES, LLC	GDO	4546	1311 WASHINGTON AVE	600
2683	ARCHDIOCESE OF MIAMI - SACRED HEART PARISH CENTER	GDO	4547	106 SE 1 DR	625
2684	MCDONALD'S #2348	GDO	4550	5995 W 24 AVE	840
2685	TONY'S SUSHI, INC. DBA TONY'S SUSHI BAR	GDO	4552	1208 WASHINGTON AVE	1,600
2686	OTB ACQUISITION, LLC DBA ON THE BORDER MEXICAN GRILL & CANTINA	GDO	4554	12295 SW 88 ST	1,775
2687	J.R. MIA, INC. DBA JOHNNY ROCKETS	GDO	4555	1455 NW 107 AVE #454	201
2688	SPEEDWAY, LLC DBA SPEEDWAY #6414	GDO	4557	10675 NW 41 ST	1,080
2689	SUSHI YAMA JAPANESE RESTAURANT	GDO	4561	1448 WASHINGTON AVE	1,400
2690	E.C. MANAGEMENT CORPORATION DBA MCDONALDS #10664	GDO	4562	1650 WASHINGTON AVE	1,398
2691	UNCLE TOM'S BBQ KROME AVENUE, INC.	GDO	4563	128-134 N KROME AVE	0
2692	EL GRAN ASHE INVESTMENTS, LLC	GDO	4565	1427 ALTON RD B	375
2693	3262 ENERGY, LLC	GDO	4570	6345 NW 32 AVE	0
2694	HILLSTONE RESTAURANT GROUP, INC. DBA HILLSTONE RESTAURANT	GDO	4571	201 MIRACLE MILE	5,900
2695	YIHI WESTLAND, INC. DBA YIHI JAPAN	GDO	4573	1635 W 49 ST #1238	75
2696	LA FOGATA RESTAURANT	GDO	4574	7795 W FLAGLER ST 59	0
2697	FLYING FOOD SERVAIR MIAMI, LLC	GDO	4577	1650 NW 70 AVE	0
2698	ENTREPRENEURS GROUP, LLC DBA LOS VERDES RESTAURANT	GDO	4580	15453-55 SW 137 AVE	536
2699	UNQUERA ENTERPRISES, INC. DBA SEDANO'S SUPERMARKET #26	GDO	4581	2301 W 52 ST	2
2700	A & S ENTERTAINMENT, LLC DBA THE OFFICE	GDO	4582	250 NE 183 ST	1,250
2701	THE SUCO GROUP, INC. DBA WOODY'S WEST END TAVERN	GDO	4583	600 PAYNE DR	672
2702	BEIT JACOB SAFRA SEPHARDIC SYNAGOGUE	GDO	4584	19275 MYSTIC POINTE DR	0
2703	LA BUONA PASTA, INC.	GDO	4585	1781-B W 32 PL	350
2704	SJF DADELAND FOOD, INC. DBA SARKU JAPAN	GDO	4586	7535 SW 88 ST #1410	0
2705	REDLANDS CHRISTIAN MIGRANT ASSN. CENTRO VILLAS	GDO	4587	35501 SW 187 AVE	50
2706	PAN PA YA BAKERY, INC.	GDO	4588	10425 NW 41 ST #15	325
2707	INKA'S GRILL CORP.	GDO	4591	250 E PALM DR #F-20	0
2708	FFG ENTERPRISES CORP. DBA NIKMARY'S PIZZA	GDO	4593	250 E PALM DR #F-40	0
2709	TRISKELL, LLC DBA SPRING BROTHERS IRISH PUB	GDO	4597	1248-1256 WASHINGTON AVE	1,055
2710	ASTOR EB-5, LLC DBA ASTOR HOTEL	GDO	4598	956 WASHINGTON AVE	1,500
2711	SFILATINO, LLC DBA SFILATINO ITALIAN GOURMET	GDO	4599	1450 WASHINGTON AVE	319
2712	SCHENZHEN NATURALHOME, LLC	GDO	4600	2600 NW 87 AVE #26	1,050
2713	HOSHI AND SEO MIAMI CORP.	GDO	4602	5401 COLLINS AVE #CU-5	254
2714	HOMESTEAD-MIAMI SPEEDWAY, LLC	GDO	4603	1 SPEEDWAY BLVD	1,380
2715	INDIAN ACCENT OF FLORIDA, LLC	GDO	4606	12663 S DIXIE HWY	350
2716	POTATOES PLUS	GDO	4607	7795 W FLAGLER ST 61	0
2717	VISA INTERNATIONAL LATIN AMERICAN	GDO	4608	1004 NW 65 AVE	2,850
2718	MAGIC GRILL, INC.	GDO	4609	7795 W FLAGLER ST 67	448
2719	CAJIO'S CUBAN CUISINE II, INC.	GDO	4610	7795 W FLAGLER ST 66	195
2720	MOTA PIZZA, LLC	GDO	4611	7795 W FLAGLER ST #65	0
2721	PASEO CATRACHO II, INC.	GDO	4612	7795 W FLAGLER ST #62	225
2722	JJ ENTERTAINMENT GROUP, INC. DBA LAS TABERNAS DE WANCHO	GDO	4613	2100 W 76 ST #512	1,750
2723	PAJEOLY CORP. DBA LA VENTANA	GDO	4614	710 WASHINGTON AVE #2	110
2724	DAIRY QUEEN	GDO	4617	10371 HAMMOCKS BLVD	168
2725	AMBER DJ INTERNATIONAL CORP. DBA ROMANO'S PIZZA #1	GDO	4618	110 N HOMESTEAD BLVD	0
2726	CASA MIGUEL CORP. DBA LA BODEGUITA RESTAURANT	GDO	4620	2005 W 4 AVE	550
2727	PIETRO'S CEVICHE BAR & GRILL, INC.	GDO	4625	13762 SW 88 ST	500
2728	KFC CORPORATION DBA KFC #Y309024	GDO	4626	4800 NW 183 ST	688

No.	FACILITY_NAME	PERMIT	PERMIT_NUMBER	ADDRESS	TOTAL_GPD
2729	MVN HOSPITALITY, INC.	GDO	4627	2995 NE 163 ST	825
2730	STARBUCKS COFFEE COMPANY, INC. DBA STARBUCKS #11040	GDO	4630	20505 S DIXIE HWY #1261	0
2731	MONUMENT RESTAURANTS VI, LLC DBA FIVE GUYS BURGERS & FRIES	GDO	4631	1500 WASHINGTON AVE	1,050
2732	STARBUCKS COFFEE COMPANY, INC. DBA STARBUCKS #8296	GDO	4632	8442 SW 8 ST	9
2733	FAMILY HERNANDEZ COLON CORP.	GDO	4633	405 E OKEECHOBEE RD	168
2734	B & B BISTRO, INC.	GDO	4636	1023 KANE CONCOURSE	450
2735	WENDY'S INTERNATIONAL, INC. DBA WENDY'S #2434	GDO	4638	1100 NW 54 ST	1,036
2736	WENDY'S OLD FASHIONED HAMBURGERS	GDO	4639	7560 NW 186 ST	1,036
2737	HIGH VOLUME SALES, INC. DBA BURGER KING #14091	GDO	4640	5398 BISCAYNE BLVD	1,120
2738	CITY OF HIALEAH DBA HIALEAH FIRE STATION #2	GDO	4643	4200 E 8 AVE	65
2739	KONING RESTAURANTS INTERNATIONAL, LC DBA PIZZA HUT #13576	GDO	4644	254 SE 1 ST	252
2740	CITY OF CORAL GABLES DBA FIRE STATION #1	GDO	4645	2801-2815 SALZEDO ST	5,747
2741	KOSHER KINGDOM	GDO	4646	3021 AVENTURA BLVD	0
2742	CFN MIAMI, INC. DBA EXXON FOODMART	GDO	4647	17700 NW 2 AVE	475
2743	CAPEA CORP.	GDO	4648	2234 W 3 AVE	249
2744	SWEET NOTE CAFE, LLC DBA CAFE N' CLAVE	GDO	4649	524 W 27 ST	625
2745	LA MONTINA, INC. DBA EL TIGRE RESTAURANT	GDO	4650	1445 NW 22 ST	0
2746	RAMALCO CORPORATION DBA BURGER KING #4490	GDO	4653	12500 SW 8 ST	1,344
2747	SUGAR FACTORY LINCOLN ROAD, LLC	GDO	4654	647 LINCOLN RD	3,750
2748	HOMESTEAD SUPERMARKET, INC. DBA SEDANO'S SUPERMARKET #31	GDO	4659	831 NE 8 ST	0
2749	NOBLE I/HY MIAMI OP CO, LLC DBA HYATT SUMMERFIELD SUITES MIAMI	GDO	4660	5710 BLUE LAGOON DR	292
2750	FENG DRAGON, INC. DBA NEW DRAGON RESTAURANT	GDO	4661	5902 W 16 AVE	1,050
2751	OLLA MIAMI, LLC DBA OLLA	GDO	4662	1231-1235 LINCOLN RD	1,157
2752	SAZONES, INC. DBA LA ESQUINITA COLOMBIANA	GDO	4669	4276 SW 152 AVE	400
2753	AROMAS A LA BRASA, LLC	GDO	4670	10201 HAMMOCKS BLVD #119	451
2754	LATIN AMERICAN JR. CORP.	GDO	4673	4195 PALM AVE	1,375
2755	TRINI & MIMO CORPORATION DBA CARIBBEAN CAFE	GDO	4674	1675 W 49 ST #1240	658
2756	GALILEE GOURMET, LLC DBA KELLY'S CAJUN GRILL	GDO	4675	1635 W 49 ST #1242	155
2757	PIZZA & PASTA AT WESTLAND MALL, INC.	GDO	4676	1675 W 49 ST #1244	157
2758	MIGA-MIGA PARTNERS, INC. DBA CHARLEY'S GRILLED SUBS	GDO	4678	1675 W 49 ST #1248	152
2759	MOBIL OIL	GDO	4680	4701 NW 167 ST	0
2760	KENDALL DONUTS, LLC DBA DUNKIN DONUTS #334776	GDO	4682	15469 SW 137 AVE	357
2761	SAFARI BAR @ CHESTERFIELD HOTEL	GDO	4683	855 COLLINS AVE	1,500
2762	EL RINCON DE JALISCO CORPORATION	GDO	4684	30360 OLD DIXIE HWY	650
2763	MANIE FOOD, INC. DBA MCDONALDS #14372	GDO	4685	1601 ALTON RD	1,400
2764	SOUTH BEACH NURSING & REHABILITATION CENTER, INC.	GDO	4686	42 COLLINS AVE	58
2765	THE KEG SOUTH AFTER HOURS, INC.	GDO	4690	27591 S DIXIE HWY	2,125
2766	LOLA RESTAURANT GRILL, INC.	GDO	4691	5555 COLLINS AVE	510
2767	EL TROVADOR RESTAURANT, INC.	GDO	4692	1530-32 NE 8 ST	1,250
2768	SMOOTHIE KING CO., INC. DBA SMOOTHIE KING #0042	GDO	4694	1525 ALTON RD	350
2769	DYLAN'S CANDY BAR	GDO	4696	801 LINCOLN RD	804
2770	HOBO, LLC DBA MAYA TAPAS AND GRILL	GDO	4698	809 LINCOLN RD	3,000
2771	LA PROVENCE, LLC DBA LA PROVENCE FRENCH BAKERY	GDO	4702	1627 COLLINS AVE	750
2772	SUSHI SIAM OF KEY BISCAYNE, INC.	GDO	4704	632 CRANDON BLVD 10	2,125
2773	1351 COLLINS RESTAURANT, LLC DBA ON THE ROCKS BAR	GDO	4705	1351 COLLINS AVE	474
2774	LA SANDWICHIERIE	GDO	4706	1403 WASHINGTON AVE	0
2775	CUBITA LINDA CAFETERIA & DELI CORP.	GDO	4708	5962 W 16 AVE	420
2776	SALSA SAL Y PIMIENTA, CO.	GDO	4709	29347-49 SW 152 AVE	630
2777	HERCASTE, INC. DBA MARIO'S LATIN CAFE	GDO	4710	1090 HOMESTEAD BLVD	3,000
2778	TAMIAMI AMOCO	GDO	4712	12795 SW 137 AVE	0
2779	PAN INVESTMENT & TRADE CORP., INC. DBA CHUNG HING ORIENTAL MART	GDO	4718	1851 NE 163 ST	0
2780	DELICIAS DEL CARIBE RESTAURANT CORP. DBA LOS GORDITOS CAFE	GDO	4719	1570 W 43 PL #20	285
2781	GORDITAS CORP. DBA GORDITAS MEXICAN KITCHEN	GDO	4720	16790 SW 88 ST	300
2782	AVENTURA TROPICAL RIBS, LLC DBA TONY ROMA'S EXPRESS	GDO	4724	19501 BISCAYNE BLVD #1393	0
2783	THE CHEESECAKE FACTORY RESTAURANTS, INC.	GDO	4728	19501 BISCAYNE BLVD #791	4,774
2784	GRAND LUX CAFE, LLC	GDO	4730	19575 BISCAYNE BLVD #1109	8,150
2785	ROCC AVENTURA, LLC DBA THE CHEESE COURSE	GDO	4731	19575 BISCAYNE BLVD #383	572
2786	SBARRO AMERICA, INC. DBA SBARRO ITALIAN EATERY	GDO	4734	19575 BISCAYNE BLVD #375	1,372
2787	CHINA CHAO, INC. DBA ASIAN CHAO #89	GDO	4739	19501 BISCAYNE BLVD #1432	420
2788	CK AT AVENTURA MALL, LLC DBA CHICKEN KITCHEN	GDO	4740	19575 BISCAYNE BLVD #1451	700
2789	AREA CODE 55 CORP.	GDO	4743	16375 BISCAYNE BLVD	1,750
2790	CRAZY LOBSTER, INC. DBA BELLA LUNA RESTAURANT	GDO	4746	19575 BISCAYNE BLVD #1097	5,600
2791	TROPIC GRILL	GDO	4750	9700 NW 25 ST	1,375
2792	MIAMI JEWISH HOME & HOSPITAL - MAIN KITCHEN	GDO	4751	5200 NE 2 AVE	0
2793	MIAMI JEWISH HOME & HOSPITAL - HAZEL CYPEN TOWER	GDO	4753	5200 NE 2 AVE	1,500
2794	CATALINA HOTEL, LLC	GDO	4754	1756 COLLINS AVE	1,000
2795	PAPIRO CORPORATION DBA AZURRO ITALIAN RESTAURANT & BAR	GDO	4756	17901 COLLINS AVE	2,325
2796	VIDA Y ESTILLO CORP. DBA CAFFE NUVO	GDO	4757	412 ESPANOLA WAY	0
2797	PUBLIX SUPERMARKETS, INC. DBA PUBLIX STORE #0621	GDO	4758	1920 WEST AVE	0
2798	SSC350285, LLC DBA DUNKIN DONUTS #350285	GDO	4760	8190 SW 40 ST	0
2799	LA CUBANITA PIZZERIA	GDO	4761	11300 NW 87 CT #135-136	812
2800	17749 COLLINS AVENUE, A CONDOMINIUM, INC. DBA MANSION AT	GDO	4765	17749 COLLINS AVE	425
2801	WENDIUM OF FLORIDA, INC. DBA WENDY'S	GDO	4767	46 E 49 ST	1,288
2802	LE CENIS, LLC DBA FL CAFE	GDO	4768	1360 COLLINS AVE	325
2803	BEN-ZAKEN CORP. DBA KASTNER'S PASTRY SHOP	GDO	4770	9465 HARDING AVE	0
2804	ROLLING PIN BAKERY, INC.	GDO	4771	9523 HARDING AVE	1
2805	WESTON RESTAURANT GROUP, LLC DBA DENNY'S #7428	GDO	4772	11350 NW 41 ST	3,500
2806	HABANA LINCOLN, LLC DBA HAVANA 1957	GDO	4773	819 LINCOLN RD	522
2807	WINN DIXIE STORES, INC. DBA WINN DIXIE STORE #292	GDO	4776	1630 W 49 ST	3
2808	BOSTON MARKET CORPORATION DBA BOSTON MARKET #0194	GDO	4781	16251 W DIXIE HWY	784
2809	VANDE CORP. DBA LATIN AMERICAN RESTAURANT	GDO	4782	1590 CORAL WAY	40,000
2810	SAMBOR'S RESTAURANT, INC.	GDO	4785	748 W 49 ST	850
2811	MDC-CORRECTIONS & REHABILITATION DEPT. - METRO WEST DETENTION	GDO	4786	13850 NW 41 ST	363
2812	MIAMI-DADE CO. CORRECTIONS TRAINING & TREATMENT CT	GDO	4787	6950 NW 41 ST	25,340
2813	LOS RANCHOS AT WESTLAND MALL, LLC DBA LOS RANCHOS STEAKHOUSE	GDO	4790	1645 W 49 ST #1376	1,175
2814	GARDEN PARTNERS, LLC DBA PEACOCK GARDENS CAFE	GDO	4792	2889 MCFARLANE RD CU-2	1,815
2815	WINN DIXIE STORES, INC. DBA WINN DIXIE STORE #247	GDO	4795	1155 NW 11 ST	0
2816	PERILI KOSK, LLC DBA LOKUM MEDITERRANEAN & GRILL	GDO	4796	1629 ALTON RD	362

No.	FACILITY_NAME	PERMIT	PERMIT_NUMBER	ADDRESS	TOTAL_GPD
2817	ST. BRENDAN HIGH SCHOOL	GDO	4797	2950 SW 87 AVE	426
2818	G & R RESTAURANT I, INC. DBA BURGER KING #0077	GDO	4799	21000 SW 112 AVE	1,800
2819	THE FORGE	GDO	4802	432 41 ST	3,750
2820	ARNIE & RICHIE DELI	GDO	4803	525 ARTHUR GODFREY RD	1,050
2821	MIAMI BEACH SUBWAY 41, LLC DBA SUBWAY	GDO	4806	917 41 ST	280
2822	BURGER KING CORPORATION DBA BURGER KING #0038	GDO	4807	910 ARTHUR GODFREY RD	963
2823	TAKI INVESTMENT GROUP, LLC DBA POKEBAR	GDO	4810	1558 S DIXIE HWY	250
2824	VITORI PRODUCTIONS, INC. DBA CHEESEBURGER BABY	GDO	4811	1505 WASHINGTON AVE	252
2825	GRAZIANO'S GOURMET IN THE GABLES, LLC	GDO	4812	2301 GALIANO ST	1,000
2826	LA CUEVA TABERNA INTERNATIONAL CORP.	GDO	4813	2742 SW 8 ST #4-5	250
2827	JALISCO RESTAURANT CORP.	GDO	4815	1661-63 NE 8 ST	350
2828	D M LAKES CORP. DBA MCDONALD'S #16209	GDO	4817	7435 MIAMI LAKES DR	876
2829	FRITANGA EL MALECON, INC.	GDO	4819	315 E 49 ST UNIT-A	750
2830	EPWORTH VILLAGE RETIREMENT COMMUNITY	GDO	4821	5300 W 16 AVE FACILITY B	0
2831	SIAM RIVER THAI CUISINE, INC. DBA MOON THAI & JAPANESE RESTAURANT	GDO	4822	1118 S DIXIE HWY	4,075
2832	JB CHURRO COMPANY, INC. DBA CHURROMANIA	GDO	4824	1665 W 49 ST #1416	0
2833	AM NORTH, LLC DBA KRISPY KRUNCHY CHICKEN	GDO	4825	10 NE 167 ST	88
2834	CHAMBAAO USA, LLC DBA CHAMBAAO RESTAURANT	GDO	4826	8800 SW 56 ST	2,382
2835	WAL-MART STORES EAST, LP DBA WAL-MART STORE #2727	GDO	4829	33501 S DIXIE HWY	980
2836	HALAL BROTHER'S, LLC DBA AL BASHA GRILL	GDO	4831	1533 WASHINGTON AVE	230
2837	ST. AGNES PARISH CENTER & ACADEMY	GDO	4832	110 HARBOR DR	50
2838	AIDAN, INC. DBA CARVEL ICE CREAM STORE #788	GDO	4834	4900 E 4 AVE	280
2839	MEDITERRANEA HOSTELERIA CORP.	GDO	4838	13035 SW 112 ST	297
2840	1906 COLLINS AVE, LLC DBA BAOLI VITA	GDO	4840	1906 COLLINS AVE	5,150
2841	CANTINA GRILL @ CORAL REEF, INC. DBA VILLAGE DBA CANTINA FRESH MEX	GDO	4843	15465 SW 137 AVE	329
2842	INTREPIRLONI, LLC. DBA CANTINA 27	GDO	4846	2701 COLLINS AVE	4,100
2843	CORPORATE FOOD, LLC DBA UNION RESTAURANT & CAFE	GDO	4849	150 SE 3 AVE #120-B	350
2844	NAT'S CATERING SERVICE	GDO	4850	1739 OPA LOCKA BLVD	0
2845	PARTY CAKE BAKERY	GDO	4851	10676 SW 24 ST	4
2846	GAMP MIAMI, LLC DBA ITALYMANIA RESTAURANT	GDO	4852	1130 COLLINS AVE #C	88
2847	RIU FLORIDA, INC. DBA CORAL RESTAURANT	GDO	4853	3101 COLLINS AVE	6,250
2848	JAMAICAN BAKERY WHOLESale, LLC	GDO	4855	18667 SW 107 AVE	0
2849	FRITANGA PALMETTO BAY, INC.	GDO	4858	15801 S DIXIE HWY #3	375
2850	ANACAPRI MIAMI LAKES, LLC	GDO	4860	6125 MIAMI LAKES DR	1,043
2851	OUR LADY OF THE LAKES SCHOOL	GDO	4861	15801 NW 67 AVE	601
2852	MDFR - FIRE RESCUE STATION #01	GDO	4862	16599 NW 67 AVE	0
2853	VENEMERK2, LLC. DBA Q'HUBO CAFE	GDO	4864	10201 HAMMOCKS BLVD #156	400
2854	RUBY TUESDAY, INC. DBA RUBY TUESDAY #2223	GDO	4865	12075 SW 152 ST	5,000
2855	GRILL TIME, LLC	GDO	4868	16145 BISCAYNE BLVD	3,100
2856	3201 HOTEL, LLC DBA FAENA HOTEL MIAMI BEACH	GDO	4870	3201 COLLINS AVE	4,727
2857	CASA TUA PARTNERS, LTD DBA CASA TUA HOTEL & RESTAURANT	GDO	4876	1700 JAMES AVE	1,250
2858	MIYAKO JAPANESE RESTAURANT	GDO	4877	5844 SW 73 ST	1,225
2859	ABIR'S TRADING, INC. DBA PITA POCKETS	GDO	4878	180 CRANDON BLVD #117	336
2860	GIOVANNI'S ITALIAN RESTAURANT, INC.	GDO	4879	8520-22 SW 8 ST	450
2861	BAMIA 1, LLC DBA BUNS AND BUNS	GDO	4880	5748 SUNSET DR #6-7	43,000
2862	HOSTERIA ROMANA, INC.	GDO	4884	429 ESPANOLA WAY	1,500
2863	ROVIRA RESTAURANT LATIN FOOD	GDO	4885	10389 SW 186 ST	750
2864	THE PATIO, LLC	GDO	4886	100 S POINT DR	500
2865	PUBGRILL, LLC	GDO	4891	18503 S DIXIE HWY	425
2866	SOJO SAR, INC. DBA CHEVRON	GDO	4893	17800 COLLINS AVE	0
2867	TARIACURI, INC. DBA TARIACURI TAQUERIA	GDO	4896	19766 SW 177 AVE	875
2868	SUNSET CHURCH OF CHRIST, INC.	GDO	4899	12001 SW 72 ST	1,597
2869	WREST 1, LLC DBA WENDY'S OLD FASHIONED HAMBURGERS	GDO	4900	8922 SW 24 ST	1,120
2870	JR'S GOURMET BURGERS, LLC	GDO	4902	7 WESTWARD DR	475
2871	DASHEL, INC. DBA PALMETTO BAY FOOD SERVICE	GDO	4904	18001 OLD CUTLER RD #362	500
2872	GULLIVER SCHOOLS, INC. DBA GULLIVER PREPARATORY SCHOOL	GDO	4906	6575 SW 88 ST	150
2873	9800 CORP, INC. DBA HARVEST CAFE	GDO	4912	9800 NW 41 ST #130	225
2874	R V INTERNATIONAL, INC. DBA PIZZA D'LIGHT	GDO	4913	1888 79 ST	1
2875	NOBU ASSOCIATES (SOUTH BEACH), L.P. DBA NOBU	GDO	4914	4525 COLLINS AVE	1,719
2876	MA & A ENTERPRISES, LLC DBA OPA-LOCKA EXXON	GDO	4916	3705 NW 135 ST	250
2877	GRILLFISH OF MIAMI BEACH	GDO	4917	1444 COLLINS AVE	2,250
2878	MIMOSA CONDOMINIUM ASSOCIATION, INC.	GDO	4919	4747 COLLINS AVE	700
2879	CEFRA, INC. DBA BAY SUPERMARKET	GDO	4920	909 NORMANDY DR	0
2880	EXECUTIVE CONDOMINIUM ASSOCIATION, INC. DBA THE EXECUTIVE	GDO	4921	4925 COLLINS AVE	1,000
2881	ELECTRA'S PIZZA, INC. DBA JERRY & JOE'S PIZZA	GDO	4923	1755 NW 79 AVE	1
2882	JERRY & JOE'S PIZZA, INC.	GDO	4925	4799 PALM AVE	1,036
2883	KONING RESTAURANTS INTERNATIONAL, LC DBA PIZZA HUT #13721	GDO	4926	10379 NW 41 ST	1,900
2884	TEMAVI, INC. DBA FRITANGA MOMOTOMBO	GDO	4928	15888 SW 137 AVE	400
2885	LA GLORIA RESTAURANT PESCADERIA, INC.	GDO	4929	852 E 41 ST	1,225
2886	A.B.P. CARIBBEAN, INC. DBA AU BON PAIN	GDO	4933	1001 BRICKELL BAY DR LOBBY	868
2887	KRITSADA, LLC DBA SIAM RICE THAI & SUSHI RESTAURANT	GDO	4935	7941 BISCAYNE BLVD	210
2888	ST. GEORGE ANTIOCHIAN ORTHODOX CATHEDRAL	GDO	4936	320 PALERMO AVE	0
2889	RAINBOW COFFEE SHOP	GDO	4939	3718 PALM AVE	0
2890	ABBAY HOTEL ACQUISITION, LLC	GDO	4940	300 21 ST	1,300
2891	WEN-SOUTH HOLDINGS, INC. DBA WENDY'S #06	GDO	4942	8100 W 33 AVE	1,120
2892	KOSH PARTNERS, INC. DBA KOSH RESTAURANT	GDO	4943	9477 HARDING AVE	625
2893	ANVISAL, INC. DBA VICTOR'S CUBA CAFE	GDO	4944	11865 SW 26 ST E-1	750
2894	RESTAURANT RINCON LATINO CORP.	GDO	4947	180 NW 183 ST #121	1,000
2895	ANDIAMO PIZZA	GDO	4949	5600 BISCAYNE BLVD	700
2896	CHILI'S RESTAURANT	GDO	4951	5705 NW 173 DR	5,425
2897	WESTCHESTER CAFETERIA, INC.	GDO	4952	8665 SW 24 ST	138
2898	BAGUETTE INTERNATIONAL BAKERY	GDO	4953	15998 SW 137 AVE	0
2899	COUNTRY COOKIN IN THE CITY, LLC	GDO	4954	17640 HOMESTEAD AVE	200
2900	SILVER SPOON TAKE-OUT RESTAURANT, INC.	GDO	4955	18334 HOMESTEAD AVE	0
2901	J & D MANAGEMENT CORP. DBA KFC/TACO BELL	GDO	4956	8001 NW 95 ST	840
2902	CEC ENTERTAINMENT, INC. DBA CHUCK E CHEESE'S #438	GDO	4957	8701 SW 124 AVE	12,950
2903	MODELO CAFE AND TAKE-OUT CORP.	GDO	4958	4488 E 10 CT	420
2904	LAS MERCEDES RESTAURANT #2	GDO	4960	9270 NW SOUTH RIVER DR	700

No.	FACILITY_NAME	PERMIT	PERMIT_NUMBER	ADDRESS	TOTAL_GPD
2905	GULL-TREE INVESTMENT HOLDINGS, LLC DBA MCDONALD'S #16795	GDO	4962	20315 OLD CUTLER RD	994
2906	WEN-RAM, INC. DBA WENDY'S #8172	GDO	4963	20975 S DIXIE HWY	1,036
2907	CAFE PRIMA PASTA, INC. DBA PRIMA PASTA	GDO	4965	414 71 ST	1,850
2908	SOUTHERN LONG GONG RESTAURANT, LLC	GDO	4966	11920 SW 8 ST	500
2909	CUBAN GUYS 103, LLC DBA CUBAN GUYS SANDWICHES & MORE	GDO	4968	1678 NE MIAMI GARDENS DR	386
2910	LA CATALANA CAFE, INC.	GDO	4969	850 E 41 ST	420
2911	CANTINA GRILL AT KENDALL VILLAGE SQUARE, INC. DBA CANTINA FRESH	GDO	4970	10471 SW 88 ST B-104	400
2912	SWEET IDEAS MIAMI, LLC	GDO	4972	5227 NW 79 AVE	0
2913	B&B INVESTMENTS MGMT SVC, INC. DBA VENECIA DELI	GDO	4973	747 PONCE DE LEON BLVD	100
2914	AROMA DEL PERU OF CORAL GABLES CORP.	GDO	4974	1930 PONCE DE LEON BLVD	813
2915	CARIBBEAN DELI-MART	GDO	4975	9845 SW 184 ST	1
2916	C.M.F. HOLDINGS, LLC DBA GEORGE'S ON SUNSET RESTAURANT	GDO	4977	1549 SUNSET DR	2,275
2917	GOLDEN LEAF CORPORATION DBA KELLY'S CAJUN GRILL	GDO	4978	20505 S DIXIE HWY #1879	204
2918	MAMA PANDA CORPORATION DBA YEUNG'S LOTUS EXPRESS	GDO	4979	20505 S DIXIE HWY #1845	0
2919	DAIRY QUEEN TREAT CENTER	GDO	4980	20505 S DIXIE HWY #1887	0
2920	ARDI V INTERNATIONAL, LLC DBA CHARLEY'S GRILLED SUBS	GDO	4981	20505 S DIXIE HWY #1871	0
2921	G & R RESTAURANTS III, INC. DBA BURGER KING	GDO	4982	20505 S DIXIE HWY #1883	0
2922	CAJIO'S CUBAN CUISINE, INC.	GDO	4983	20505 S DIXIE HWY #1851	189
2923	MRK ENTERPRISES, INC. DBA TACO BELL	GDO	4984	20505 S DIXIE HWY #1875	240
2924	STARBUCKS COFFEE COMPANY, INC. DBA STARBUCKS #8273	GDO	4989	5796 SW 72 ST	350
2925	AMERICAS BAKERY, INC.	GDO	4991	12228 SW 8 ST	300
2926	OKEECHOBEE UNION CORP.	GDO	4994	3425 OKEECHOBEE RD	210
2927	WENDIUM OF FLORIDA, INC. DBA WENDY'S #8436	GDO	4995	645 NW 57 AVE	1,036
2928	ZHENG & YU, INC. DBA PEKING ONE	GDO	4996	16229 SW 88 ST	280
2929	LINCOLN-MARTI SCHOOLS, LLC	GDO	4997	969 SW 1 ST	112
2930	KENDALL FOODS, LLC DBA ASADOS EL PAISA	GDO	4998	13726 SW 88 ST	791
2931	REPRESENTATION RM, LLC	GDO	4999	5 S FLAGLER AVE	990
2932	MM ASOCIADOS, LLC DBA EL MANANTIAL MARKET PLACE	GDO	5001	6778 W FLAGLER ST	0
2933	LA NUEVA ARGENTINA	GDO	5003	10121 SW 72 ST	0
2934	MATER CENTER SCHOOL C/O ACADEMIA CORP.	GDO	5005	7700 NW 98 ST	145
2935	SARIVE, INC. DBA SUBWAY #23075	GDO	5009	16219 SW 88 ST #113	182
2936	DOMINO'S PIZZA, LLC DBA DOMINO'S PIZZA #3155	GDO	5010	3400 NE 2 AVE	0
2937	JL INVESTMENT GROUP, LLC DBA OLIVOS RESTAURANT	GDO	5012	10455 NW 41 ST #5	2,500
2938	SUNNY SUBS GRILL, INC.	GDO	5013	8581 NW SOUTH RIVER DR	375
2939	FIRST FLORIDA CHICKEN, INC. DBA PARDO'S CHICKEN REST.	GDO	5020	2312 PONCE DE LEON BLVD	1,250
2940	MEDLEY RESTAURANT AND CAFETERIA, INC.	GDO	5023	7441 NW 72 AVE	352
2941	N.G.M. LA CARIDAD CORP. DBA EL CANAL CAFE	GDO	5024	8401 NW SOUTH RIVER DR	371
2942	SHORE CLUB PROPERTY OWNER, LLC DBA SHORE CLUB HOTEL	GDO	5025	1901 COLLINS AVE	1,042
2943	ALBATROSS INVESTMENT GROUP, LLC DBA SUBWAY #36733	GDO	5026	6542 COLLINS AVE	234
2944	BIOFOOD'S INTERNATIONAL, INC. DBA RESTAURANT CAFETERIA MI TIERRA	GDO	5027	601 71 ST	560
2945	NEW RIVER CAFE, LLC	GDO	5028	19333 COLLINS AVE	113
2946	PIZZERIAS, LLC DBA PAPA JOHNS PIZZA #2636	GDO	5029	3120 W 76 ST	84
2947	BUENOS AIRES BAKERY CORP.	GDO	5030	7134 COLLINS AVE	950
2948	PARTY CAKE BAKERY III	GDO	5033	10815 SW 40 ST	475
2949	44 & ASSOCIATED CORP DBA CAFE MELAO RESTAURANT & LOUNGE	GDO	5034	7874 NW 52 ST	350
2950	HOLE IN THE WALL TAVERN, LLC	GDO	5035	9821 SW 184 ST	500
2951	EAST OCEAN RESTAURANT CORP.	GDO	5037	325 71 ST	725
2952	PINECREST BAKERY, LLC	GDO	5040	1144 SW 67 AVE	638
2953	DORAL SUPERMARKET, INC. DBA SEDANO'S SUPERMARKET #33	GDO	5041	10780 NW 58 ST	0
2954	CAROLINA BBQ DOLPHIN, LLC DBA BROTHER JIMMY'S BBQ	GDO	5042	11401 NW 12 ST E-528	7,300
2955	COCO BALEADAS CORP.	GDO	5043	1721 SW 22 ST	618
2956	51 HOIL, LLC DBA CHINA STEAK HOUSE 3	GDO	5044	8565 SW 24 ST #103	600
2957	ST SIMEON SERBIAN ORTHODOX CHURCH	GDO	5045	175 NW 154 ST	0
2958	MONICA CATERING GROUP CORP. DBA RINCON TROPICAL	GDO	5047	374 W 65 ST	213
2959	AMEEN MARKETING CORP. DBA KEN & MIKE'S PIZZA PASTA & MORE	GDO	5048	16393 NW 67 AVE	1,100
2960	GYRO & PITA, LLC	GDO	5049	140 SE 1 AVE #B	274
2961	TAJONA, INC. DBA SUNSET CAFE & GRILL	GDO	5053	10300 SW 72 ST #340	350
2962	FONS SEAFOOD CORPORATION	GDO	5055	2265 W 9 AVE #2	0
2963	JOMARA SEAFOOD, INC.	GDO	5056	2265-75 W 9 AVE #1	500
2964	EBLB, LLC DBA E.B.L.B. ASIAN EATERY	GDO	5057	7100 COLLINS AVE	850
2965	TOTAL ACCOUNT SERVICES CORP. DBA CHAMOS CAFE	GDO	5058	10895 NW 41 ST	30
2966	J.R. NINE, INC. DBA JOHNNY ROCKETS RESTAURANT	GDO	5059	11401 NW 12 ST E-508	840
2967	TENANGO'S TAQUERIA, INC.	GDO	5060	8349 NW 12 ST	150
2968	RANDALL BAKERY CORP.	GDO	5061	275 W 28 ST	0
2969	SUKI HANA OF DOLPHIN MALL, INC.	GDO	5062	11401 NW 12 ST # 107	194
2970	TANGO GRILL PARRILLADA OF DOLPHIN MALL, INC.	GDO	5063	11401 NW 12 ST #108	194
2971	CHICKEN CONNECTION OF DOLPHIN MALL, INC.	GDO	5064	11401 NW 12 ST #105	261
2972	KCG OF DOLPHIN MALL, INC. DBA KELLY'S CAJUN GRILL	GDO	5065	11401 NW 12 ST #103	227
2973	S & S CREAMERY'S, INC. DBA COLD STONE CREAMERY #20416	GDO	5066	9059 S DIXIE HWY	0
2974	HOST TINSLEY JOINT VENTURE DBA STARBUCK E-SAT	GDO	5067	E-23/25 CC-E	184
2975	EXPRESS RICE ENTERPRISES, LLC DBA CONFUCIO EXPRESS	GDO	5069	1810 SW 3 AVE	0
2976	KIMY DESSERTS, INC.	GDO	5070	146 SE 1 AVE	150
2977	SB CAFE BRAZIL, INC.	GDO	5071	152 SE 1 AVE	300
2978	FLC HOSPITALITY, LLC	GDO	5072	154 SE 1 ST	500
2979	SERVIKO M, LLC	GDO	5075	95 SE 2 ST	350
2980	STARBLUE, LLC DBA C3VICH3 TOWN	GDO	5076	194 SE 1 AVE	225
2981	BURGER KING CORPORATION DBA BURGER KING #13874	GDO	5077	5711 NW 176 ST	1,232
2982	GIOVANA'S CAFE, INC.	GDO	5080	190 SE 1 AVE	1,000
2983	STATION 28, LLC	GDO	5081	91 SE 2 ST	125
2984	CHEF CHEN R.C., INC. DBA CHEF CHEN CHINESE RESTAURANT	GDO	5082	11302 SW 186 ST	1,200
2985	LAS VINAS BBQ, INC.	GDO	5083	3935 E 4 AVE	1,000
2986	SUPER AREPA DORAL, LLC	GDO	5084	2600 NW 87 AVE #9	428
2987	VIVARIA FLORIDA, LLC DBA SBARRO	GDO	5085	11401 NW 12 ST FC-101	0
2988	PANADERIA 20 DE JULIO, INC.	GDO	5089	15415 SW 137 AVE	250
2989	COLD STONE CREAMERY	GDO	5090	6723 MAIN ST	3
2990	DUFFY'S OF KENDALL, INC.	GDO	5091	8575 SW 124 AVE	2,925
2991	PIZZA BIANCO RESTAURANT	GDO	5093	19201 COLLINS AVE FAC.B	378
2992	AMBOY DISTRIBUTORS CORP. DBA HABITUE	GDO	5094	9769 NW 41 ST	300

No.	FACILITY_NAME	PERMIT	PERMIT_NUMBER	ADDRESS	TOTAL_GPD
2993	A LA FOLIE, INC.	GDO	5101	516 ESPANOLA WAY	372
2994	COLOMBIAN DISTRIBUTIONS, INC. DBA MERY'S ICE CREAM	GDO	5103	749 NW 37 AVE	0
2995	SHIBUI, A JAPANESE RESTAURANT	GDO	5107	10141 SW 72 ST	1,850
2996	HOMETOWN BAR-B-Q, LLC	GDO	5108	33505 S DIXIE HWY	78,582
2997	PIZZA JOHNNY'S, INC.	GDO	5109	9529 SW 72 ST	210
2998	ARMAAN, LLC DBA GROOVY'S PIZZA	GDO	5111	332 LINCOLN RD	603
2999	CROUTONS, INC. DBA FRATELLI MILANO	GDO	5112	213 SE 1 ST	308
3000	OASIS BANQUET HALL, CORP.	GDO	5114	10776 SW 24 ST	1,000
3001	32ND AVENUE EXXON, INC.	GDO	5115	1121 SW 32 AVE	0
3002	MDFR - MIAMI-DADE FIRE RESCUE STATION #37	GDO	5117	4200 SW 142 AVE	107,460
3003	F. YMBERT, INC. DBA AGUACATES RESTAURANT	GDO	5118	2600 NW 87 AVE #27	428
3004	CASTILLO FAMILY #2, LLC DBA EL LIBANES 2 SUPERMARKET	GDO	5120	6815 W 4 AVE	525
3005	EL SALVADOR DEL MUNDO II CORP.	GDO	5121	4532 PALM AVE	425
3006	LOS DOS AMIGOS CUBANOS, INC.	GDO	5122	1000 E 47 ST	275
3007	LA BARRA, INC.	GDO	5126	17032 COLLINS AVE	730
3008	MIAMI HOUSE OF MEATS, INC.	GDO	5127	11637-41 SW 216 ST	0
3009	MR. BAKERY, INC.	GDO	5129	3158 W 76 ST #106A	1
3010	ENERGY STATION 49 ST, LLC DBA AMERIKA HIALEAH	GDO	5130	875 E 49 ST	0
3011	EURO TABLE, INC. DBA LA FICELLE	GDO	5132	701 NW 62 AVE #120	770
3012	HURRICANES SUBWAY, INC. DBA SUBWAY #1182	GDO	5136	1552 S DIXIE HWY	210
3013	DOMINGA TROPICAL, INC.	GDO	5137	16075 NW 57 AVE	630
3014	1801 PURDY, LLC DBA SARDINIA ENOTECA RISTORANTE	GDO	5138	1801 PURDY AVE	2,400
3015	ROMAZI CORPORATION DBA ARIES SUPERMARKET 2	GDO	5143	5945 W 25 CT	125
3016	JYP ENTERPRISES, INC. DBA CHARLEY'S PHILLY STEAKS	GDO	5149	1455 NW 107 AVE #462	150
3017	COBB THEATRES III, LLC DBA COBB HIALEAH GRAND 18 THEATRES	GDO	5150	17355 NW 59 AVE	0
3018	DIAMOND SECURITY INTERNATIONAL, LLC DBA ABC FOOD MARKET	GDO	5151	163 NW 14 ST	771
3019	IAE MIAMI DADE, LLC DBA WENDY'S #2336	GDO	5155	3805 NW 27 AVE	848
3020	CAFETERIA LATINA SAN NICOLAS, INC.	GDO	5156	1116 PALM AVE	300
3021	BLACK STORE CORP. DBA SANDWI 2 GO	GDO	5157	1711 SW 22 ST	167
3022	PICANHA NA BRASA, INC.	GDO	5163	234 NE 1 ST	500
3023	RICCARDO INTERNATIONAL BAKERY CORP.	GDO	5165	15421 W DIXIE HWY #16	875
3024	THE CORNER COFFEE & PANTRY NO.2, LLC	GDO	5173	800 DOUGLAS RD #145	100
3025	COBB THEATRES IV, LLC DBA CINEBISTRO @ DOLPHIN MALL	GDO	5174	11401 NW 12 ST E-615	2,000
3026	HEP MACARON, LLC DBA LE MACARON FRENCH PASTRIES	GDO	5175	11401 NW 12 ST K-101	39
3027	BON APPETITE CREPES & BAGUETTES, LLC DBA APROPO	GDO	5176	11401 NW 12 ST E-310	0
3028	LA RUMBA RESTAURANT & LOUNGE, INC.	GDO	5177	2200 NW 27 AVE	1,125
3029	BANK UNITED CENTER AT UNIVERSITY OF MIAMI	GDO	5178	1245 WALSH AVE	1,125
3030	VENEGEO ONE CORP.	GDO	5179	1148 SW 27 AVE	534
3031	BET SHIRA CONGREGATION	GDO	5180	7500 SW 120 ST	0
3032	KATAY #7, INC. DBA CAPTAIN FISH & CHICKEN	GDO	5181	19747 NW 37 AVE	392
3033	FAROLITO, INC. DBA FAROLITO PERUVIAN RESTAURANT	GDO	5183	2885 SW 22 ST	1,100
3034	QUALITY ICE CREAM CORP. DBA HAAGEN DAZS	GDO	5185	11401 NW 12 ST K-107	0
3035	QUALITY ICE CREAM CORP. DBA HAAGEN DAZS	GDO	5186	11401 NW 12 ST K-102	0
3036	CAKELAND BAKERY	GDO	5188	16279 SW 88 ST	0
3037	AMYEL, LLC DBA LE CAFE VERT	GDO	5189	9490 HARDING AVE	280
3038	MERCEDES BROTHER'S, INC. DBA MILLY'S RESTAURANT & CAFE	GDO	5190	2742 SW 8 ST #30	625
3039	SORSYL CORP. DBA SUBWAY #22488	GDO	5191	11463 SW 40 ST	0
3040	150 GIRALDA, LLC DBA THE LOCAL	GDO	5192	150 GIRALDA AVE	400
3041	LA CREMITA CAFETERIA	GDO	5194	2761 SW 22 ST	600
3042	ELBA INTERNATIONAL INVESTMENTS, INC. DBA CHARLEY'S GRILLED SUBS	GDO	5195	11401 NW 12 ST FC-106	0
3043	CHARCOALS LATIN GRILL	GDO	5196	11401 NW 12 ST E-510	1,120
3044	OMERTA CUCINE & BAR, INC. DBA OMERTA CUCINE & BAR MIAMI	GDO	5204	4285 NW 107 AVE	1,050
3045	NEW YORK ROMA PIZZA & PASTA CORP. DBA NEW YORK ROMA PIZZA &	GDO	5208	2985 MCFARLAND RD	500
3046	MDAD-INTERNATIONAL WASTE TRANSFER STATION	GDO	5210	728	0
3047	J.M. CRUZ, INCORPORATED DBA JAMAICA BAKERY	GDO	5212	565 W 27 ST	0
3048	TEIXEIRA PORTUGAL RESTAURANT, INC.	GDO	5215	1569 SUNSET DR	300
3049	JACKSON SOUL FOOD RESTAURANT, INC.	GDO	5217	950 NW 3 AVE	575
3050	THREEFOLD CAFE, LLC	GDO	5219	141 GIRALDA AVE	725
3051	H B HOUSE, INC. DBA THE BAR	GDO	5220	172 GIRALDA AVE	2,875
3052	THAI CORPORATION DBA BANGKOK BANGKOK II	GDO	5221	157 GIRALDA AVE	2,000
3053	PUBLIX SUPERMARKETS, INC. DBA PUBLIX STORE #0835	GDO	5222	12100 SW 127 AVE	0
3054	PERFORMING ARTS CENTER TRUST/KNIGHT CONCERT HALL	GDO	5224	1301 BISCAYNE BLVD	0
3055	ACADEMIA CORP. FOR PINECREST PREPARATORY ACADEMY	GDO	5225	14301 SW 42 ST	650
3056	LAS REINAS DEL CAFE CORP.	GDO	5227	12 NE 1 ST	188
3057	Y & R SABORES, INC. DBA LA TABERNA GIRALDA	GDO	5229	254 GIRALDA AVE	495
3058	MARIPOSA-CANELA COFFEE SHOP & GROCERY CORP.	GDO	5231	1200 PALM AVE	2
3059	ALFREDO ENTERPRISES, INC. DBA CAFE COLON	GDO	5233	969 PALM AVE	750
3060	SPEEDWAY, LLC DBA SPEEDWAY #6447	GDO	5236	955 E 49 ST	250
3061	FLANIGAN'S SEAFOOD BAR & GRILL	GDO	5237	8695 NW 12 ST	4,875
3062	PERU PLACE RESTAURANT, INC.	GDO	5239	4579 NW 36 ST	1,200
3063	JAAN HOSPITALITY, LLC	GDO	5240	276 ALHAMBRA CIR	1,250
3064	CAFE DEMETRIO, INC.	GDO	5241	300 ALHAMBRA CIR	1,600
3065	BTS NORTH, INC. DBA BOOBY TRAP	GDO	5243	5325 NW 77 AVE	504
3066	GRAZIANO'S IN THE GABLES, LLC	GDO	5244	394 GIRALDA AVE	5,000
3067	SUNSHINE RESTAURANT PARTNERS, INC. DBA INT'L HOUSE OF PANCAKES	GDO	5245	6928 COLLINS AVE	3,725
3068	BLUE VICTORY, LLC. DBA 7-ELEVEN STORE #39428	GDO	5246	6800 W 16 AVE	350
3069	SUPER CAKE BAKERY CORP. DBA MOULIN ROSE BAKERY	GDO	5248	9869 SW 72 ST	0
3070	ZUCCA MIAMI CORP. DBA ZUCCA	GDO	5250	162 ALCAZAR AVE	1,000
3071	PJ BIRDS, INC. DBA JUNGLE ISLAND	GDO	5251	1111 PARROT JUNGLE TRL	4,900
3072	JR'S CAFETERIA, INC. DBA FRITANGA PONELOYA CAFETERIA	GDO	5253	10170 W FLAGLER ST	0
3073	PATIO TIPICO, INC.	GDO	5256	4591 NW 36 ST #1	1,625
3074	VENEZIA PIZZA & CAFE, INC.	GDO	5257	6646-50 COLLINS AVE	1,093
3075	AROMI SAPORI ITALIA, INC. DBA VALENTINO SUL MARE	GDO	5259	7330 OCEAN TER #5	378
3076	SUNNY SUBS SNAPPER CREEK, LLC DBA SUBWAY #23150	GDO	5261	7098 SW 117 AVE	154
3077	SUSHI RAO USA, INC. DBA SUSHI RAO	GDO	5262	801 BRICKELL BAY DR LOBBY	88
3078	SABOR LATINO BAR & GRILL CORP.	GDO	5263	301 PALM AVE	616
3079	LA MACARENA RESTAURANT, INC.	GDO	5264	13769 SW 139 CT	950
3080	MIMA'S COIN LAUNDRY, INC. (CAFE)	GDO	5265	391 PALM AVE	0

No.	FACILITY_NAME	PERMIT	PERMIT_NUMBER	ADDRESS	TOTAL_GPD
3081	LATIN DOLLAR FOOD STORE MARKET	GDO	5266	535 NW 12 AVE	0
3082	BAY PARK PLAZA MARKET, LLC	GDO	5270	1756 N BAYSHORE DR #124	224
3083	YISELL BAKERY, LLC DBA YISELL GUERRERO	GDO	5272	1356 SW 8 ST	300
3084	EL TABLAZO RESTAURANT	GDO	5273	6780 COLLINS AVE	1,000
3085	MARIEBLUE INVESTMENT, LLC DBA MESON RIA DE VIGO	GDO	5275	1363 SW 22 ST	500
3086	LOPEZ-SALDIERNA, LLC DBA MR. TACO MEXICAN FOOD	GDO	5276	6974 COLLINS AVE	240
3087	CHOLIN CORP. DBA CHOLOS ON THE BEACH	GDO	5277	216 71 ST	438
3088	ASTRID & STEPHANIE, LLC	GDO	5278	6772 COLLINS AVE	500
3089	ROXY. E, LLC DBA LULA KEBAB HOUSE	GDO	5280	18100 COLLINS AVE	1,650
3090	QUIRCH FOODS CO.	GDO	5283	7600 NW 82 PL	0
3091	LAS VEGAS BEACH CORP. DBA LAS VEGAS RESTAURANT IV	GDO	5284	6970 COLLINS AVE	1,850
3092	URBIETA STORE OPERATIONS LLC DBA WEST HIALEAH CIRCLE K	GDO	5285	7950 W 28 AVE	0
3093	JIBARITO FOOD MARKET	GDO	5286	3299 NW 2 AVE	0
3094	ARCHIMEDEAN ACADEMY, INC.	GDO	5288	12425 SW 72 ST	680
3095	ARTEMISA FOOD COMPANY, INC.	GDO	5289	1691 W 37 ST #29	256
3096	LITTLE BRAZIL USA, CORP. DBA LITTLE BRAZIL	GDO	5291	6984 COLLINS AVE	550
3097	THE PCOCK BROTHER'S, LLC DBA DAAZKEN	GDO	5293	13920 SW 139 CT	1,055
3098	ZAI & COMPANY, LLC	GDO	5294	1040 S MIAMI AVE	450
3099	AMERICAN DA TANG UNIQUE RESTAURANT, LLC	GDO	5295	801 BRICKELL BAY DR #11	977
3100	DIVINO CEVICHE, INC. DBA UNIVERSAL PLAZA	GDO	5297	2629 NW 79 AVE	590
3101	MAIDO JAPANESE RESTAURANT	GDO	5298	4267 NW 107 AVE	925
3102	VARANDA'S CAFETERIA, INC.	GDO	5299	6616 COLLINS AVE	237
3103	SC GABLES, LLC DBA SON CUBANO RESTAURANT	GDO	5300	2530 PONCE DE LEON BLVD	1,360
3104	MKCH ENTERPRISES, INC.	GDO	5303	8601 SW 124 AVE G-2	1,497
3105	KINDERCARE LEARNING CENTERS, INC. DBA KINDERCARE LEARNING CENTER	GDO	5304	15005 SW 122 AVE	300
3106	NORTH BEACH TAVERN, LLC DBA NORMAN'S TAVERN	GDO	5305	6766-70 COLLINS AVE	3,250
3107	N.Y. BAGEL DELI	GDO	5306	6546 COLLINS AVE	308
3108	LO MEJOR DEL CARIBE, INC.	GDO	5315	1099 E 23 ST	300
3109	GOURMET STATION, INC.	GDO	5317	7601 BISCAYNE BLVD	500
3110	ORIENTAL BAKERY & GROCERY CO.	GDO	5318	1760 SW 3 AVE	504
3111	DOWN & DIRTY TACOS & TEQUILA BAR OCEAN DRIVE, LLC	GDO	5322	1144 OCEAN DR	367
3112	DIVINE DELICACIES CUSTOM CAKES, INC.	GDO	5323	1659 SW 107 AVE	1
3113	GROVE ISLE CLUB, INC. DBA GIBRALTAR	GDO	5325	4 GROVE ISLE DR	1,424
3114	ARCHIE'S KEY BISCAYNE, LLC	GDO	5326	600 CRANDON BLVD 130	750
3115	CEVICHE BAR EL SENORIAL, INC.	GDO	5329	1750-52 SW 3 AVE	500
3116	MENENDEZ MANAGEMENT CORP. DBA MCDONALD'S #26184	GDO	5330	2405 NW 87 AVE	1,036
3117	WHITE COFFEE CORP. DBA NEW CAMPO ARGENTINO	GDO	5332	6954 COLLINS AVE	1,075
3118	BASILICO RISTORANTE AL DORAL, INC.	GDO	5333	10405 NW 41 ST	750
3119	SINJEL JENIN, INC. DBA ALTA HABANA SUPERMARKET	GDO	5337	498 E 25 ST	0
3120	CELEAN, INC. DBA DOMINO'S PIZZA	GDO	5339	180 CRANDON BLVD #110	0
3121	ELIO CAFETERIA CORP.	GDO	5341	50 E 10 AVE	200
3122	DOLCI DI SICILIA, LLC	GDO	5342	725 71 ST	334
3123	KEY BISCAYNE YACHT CLUB	GDO	5343	180 HARBOR DR	1,235
3124	ADL GASTRONOMIC SERVICE INC. DBA FRANCESCO AT THE TOWER	GDO	5344	1111 CRANDON BLVD	750
3125	SEÑOR FROGS MIAMI, LLC	GDO	5346	1450 COLLINS AVE	1,321
3126	EL CARIBE CORP. DBA LA CARIBENA RESTAURANT	GDO	5348	12104-06 SW 117 CT	600
3127	TAMIAMI PETROL, INC.	GDO	5351	12805 SW 137 AVE	800
3128	CIRO'S PIZZA & ITALIAN RESTAURANT	GDO	5352	13025 SW 89 PL	686
3129	CHEF'S KITCHEN, INC.	GDO	5355	8765 SW 132 ST	350
3130	FANCY GOOSE GROUP, LLC DBA LA FRESA FRANCESA	GDO	5356	59 W 3 ST	160
3131	AL CARBON CORP.	GDO	5357	2280 SW 22 ST	2,000
3132	MAZZAWI BROS., INC. DBA DAILY BREAD	GDO	5359	2400 SW 27 ST	0
3133	2601 TOWER CAFE, INC.	GDO	5361	2601 S BAYSHORE DR #270	322
3134	HIALEAH GARDENS TOP SALES, LLC DBA BURGER KING #14599	GDO	5362	9490 W OKEECHOBEE RD	1,036
3135	MAMA JO'S, INC. DBA BERRIES RESTAURANT	GDO	5363	2884 SW 27 AVE	1,000
3136	MARRIOTT RESIDENCE INN	GDO	5364	19900 W COUNTRY CLUB DR	0
3137	NMO DINNERS, INC. DBA DREAM DINNERS	GDO	5366	12727 S DIXIE HWY	0
3138	SPRIS, INC.	GDO	5367	731 LINCOLN RD	658
3139	DOUGLAS SUBS, LLC DBA SUBWAY #59061	GDO	5368	2717 SW 37 AVE	275
3140	GALIANO SUPERMARKET	GDO	5369	2537 SW 37 AVE	0
3141	FETEN GROUP CORPORATION DBA HABANA VIEJA RESTAURANT	GDO	5371	2475 SW 37 AVE	938
3142	IL FORNO RISTORANTE CORP.	GDO	5372	9380 NW 25 ST	3,225
3143	FISHER ISLAND CLUB, INC. - ISLAND MARKET	GDO	5375	1 FISHER ISLAND DR	0
3144	WESTSIDE BAGLES TOO PINECREST, LLC	GDO	5377	12729 S DIXIE HWY	888
3145	INTERNATIONAL PETROL GROUP, INC. DBA BP	GDO	5378	1890 NW 107 AVE	0
3146	SEA SIAM, INC.	GDO	5379	12735 S DIXIE HWY	5,000
3147	THE MUFFIN TIN RESTAURANT, INC.	GDO	5380	12655 S DIXIE HWY	2,000
3148	FRENCH RIVERA PASTRIES, INC. DBA ANACARPI ITALIAN RESTAURANT	GDO	5381	12669 S DIXIE HWY	1,000
3149	GUADALAJARA MEXICAN RESTAURANT, INC.	GDO	5383	8461 SW 132 ST	1,500
3150	MALANGA CAFE, INC.	GDO	5384	12313 S DIXIE HWY	1,350
3151	MCDONALD'S CORPORATION DBA MCDONALD'S #7731	GDO	5388	3200 S DIXIE HWY	1,512
3152	SSC300797, LLC DBA DUNKIN DONUTS #300797	GDO	5390	2720 S DIXIE HWY E	250
3153	LAGO EXPRESS, INC. DBA MARATHON	GDO	5392	2445 W FLAGLER ST	720
3154	ATLANTA RESTAURANT PARTNERS, LLC DBA TGI FRIDAY'S #0345	GDO	5395	11401 NW 12 ST E-516	5,000
3155	DOUGLAS GARDENS COMMUNITY MENTAL HEALTH CENTER	GDO	5396	17000 NE 21 AVE	0
3156	OASIS CAFE & LOUNGE	GDO	5397	6900 NW 18 AVE	250
3157	RUBYS STORE, LLC	GDO	5399	11191 SW 176 ST	0
3158	STARBUCKS COFFEE COMPANY, INC. DBA STARBUCKS #8419	GDO	5401	11401 NW 12 ST E-194	5
3159	HONGTAI GROUP, LLC DBA DYNASTY BUFFET	GDO	5402	1656 NE MIAMI GARDENS DR	375
3160	SUPERWHEELS MIAMI, LLC DBA SUPERWHEELS SKATING CENTER	GDO	5403	12265 SW 112 ST	0
3161	IT'S A TOSS UP LLC DBA GIARDINO GOURMET SALAD	GDO	5404	5787 NW 7 ST	242
3162	TINTA Y CAFE, INC.	GDO	5406	1315 PONCE DE LEON BLVD	413
3163	BALANCE WHEEL CORP. DBA SUBWAY #25904	GDO	5407	5789 NW 7 ST	336
3164	SAINT MARYS METHODIST CHURCH	GDO	5409	4798 NW 8 AVE	0
3165	HERITAGE NURSING AND REHABILITATION CENTER	GDO	5410	2201 NE 170 ST	0
3166	MASTERS CONCESSION AIR\DBA CHILI'S TOO	GDO	5411	TERMINAL CC-G	2,408
3167	ORTANIQUE ON THE MILE	GDO	5412	278 MIRACLE MILE	3,300
3168	MICOCOS 2600 CORP. DBA MICOCOS CAFE	GDO	5413	2600 DOUGLAS RD #102	206

No.	FACILITY_NAME	PERMIT	PERMIT_NUMBER	ADDRESS	TOTAL_GPD
3169	EL CASTILLO DE LA FRUTAS II CORP.	GDO	5415	1140 W 68 ST	700
3170	GHF AMERICA CORP. DBA TUTTI FRUTTI	GDO	5416	11429 S DIXIE HWY	315
3171	MUNCHIES CAFE, INC.	GDO	5419	11367 SW 40 ST	280
3172	MR. FOOD STORE #2	GDO	5420	9617 FONTAINEBLEAU BLVD	0
3173	GDC FOODS PINECREST, LLC DBA BIG TOMATO	GDO	5422	12447 S DIXIE HWY	250
3174	BURGER KING CORPORATION DBA BURGER KING #0064	GDO	5424	5721 NW 7 ST	2,086
3175	COBB THEATERS @ DOLPHIN MALL	GDO	5425	11471 NW 12 ST # 100	0
3176	SUBWAY BOLIVAR RESTAURANT CORP. DBA SUBWAY #23555	GDO	5426	1498 NW 54 ST	114
3177	MI BUENOS AIRES QUERIDO RESTAURANT CORP.	GDO	5427	3458 SW 8 ST	350
3178	CAFE BELLA ARTE CORP. DBA COSME CAFE	GDO	5429	8390 SW 40 ST	268
3179	SOUTH FLORIDA PIZZA, LLC DBA DOMINO'S PIZZA	GDO	5431	18505 S DIXIE HWY	0
3180	NIK & SITA, INC. DBA BALI CAFE	GDO	5432	109 NE 2 AVE	0
3181	H & V VILARINO, INC. DBA LA GIRALDILLA RESTAURANT	GDO	5436	4292 SW 152 AVE #4292	5,000
3182	PLACERES & SON'S	GDO	5442	750 W 20 ST	0
3183	DENNY'S, INC. DBA DENNY'S #1337	GDO	5444	8503 SW 40 ST	3,725
3184	SPEEDBOLEA, LLC DBA BERNARDINO'S	GDO	5445	1664 W 31 PL	0
3185	DORAL ACADEMY CHARTER HIGH SCHOOL	GDO	5446	11100 NW 27 ST	0
3186	CK AT WEST BIRD, LLC DBA CHICKEN KITCHEN	GDO	5448	11425 SW 40 ST	700
3187	KIDWORKS USA, INC.	GDO	5450	8155 W 28 AVE	0
3188	SSC304649, LLC DBA DUNKIN DONUTS #304649	GDO	5452	658 NW 103 ST	6
3189	VARACOS, INC. DBA PS GREEN	GDO	5454	13067 SW 112 ST	436
3190	M & R INVESTMENTS TRADE, INC. DBA SABORES DE MI TIERRA	GDO	5455	12239 SW 112 ST	217
3191	JOE'S RESTAURANT CORP.	GDO	5456	3300 NW SOUTH RIVER DR	300
3192	SASUN, INC. DBA PIZZA RUSTICA	GDO	5457	667 LINCOLN RD	2,800
3193	VERONA PIZZA, LLC	GDO	5459	10575 SW 109 CT	1,225
3194	CHESTNUT LAND COMPANY DBA AUNTIE ANNE'S PRETZELS	GDO	5460	7535 SW 88 ST 1320	0
3195	RIO VERDE CAFETERIA, INC.	GDO	5461	3305 NW 32 AVE	850
3196	ICE ARENA OF KENDALL, INC. DBA KENDALL ICE ARENA	GDO	5465	10355 HAMMOCKS BLVD	0
3197	TASTE BAKERY CAFE, LLC	GDO	5466	900 ALTON RD	388
3198	DOMINO'S PIZZA, LLC DBA DOMINO'S PIZZA #5186	GDO	5468	1575 SW 8 ST A	0
3199	CK AT COUNTRY WALK, LLC DBA CHICKEN KITCHEN	GDO	5470	15467 SW 137 AVE	672
3200	DAMI BAKERY, INC. DBA MILLER FOOD MART	GDO	5476	13425 SW 56 ST	230
3201	MARE BELLO HOLDINGS, LLC	GDO	5477	8701 NW 13 TER	540
3202	LA BAGUETTE DOREE II	GDO	5478	550 BILTMORE WAY	500
3203	DS MIAMI MANAGEMENT, LLC DBA CHINA MAX	GDO	5479	1455 NW 107 AVE #466	150
3204	COOKING BY ISIS, LLC DBA LE CAFE LIMOGES	GDO	5480	1455 NW 107 AVE #492	420
3205	FHHE INVESTMENT GROUP, INC. DBA MIAMI GARDENS CITGO GAS STATION	GDO	5482	18553 NW 27 AVE	575
3206	SARUSSI 2012 CORP. DBA SARUSSI CAFE	GDO	5486	9836 SW 40 ST	330
3207	CHOICES CAFE COCONUT GROVE, LLC	GDO	5487	2895 MCFARLAND RD	740
3208	WAGONS WEST, INC.	GDO	5488	11311 S DIXIE HWY	1,850
3209	235 SOBE HOSPITALITY, LLC DBA SOBE HOSTEL & BAR	GDO	5492	235 WASHINGTON AVE	223
3210	HIBACHI GRILL, INC.	GDO	5493	50 BISCAYNE BLVD CU-8	116
3211	CORBETT COMPANIES, INC. DBA CORBETT'S SPORTS BAR & GRILL	GDO	5497	12721 S DIXIE HWY	2,250
3212	BALTER MEAT COMPANY, INC.	GDO	5499	12390 SW 128 ST	0
3213	ZENG & SU, LLC DBA MAGIC WOK CHINESE RESTAURANT	GDO	5500	10201 HAMMOCKS BLVD 142	0
3214	KING BBQ OF INTERNATIONAL MALL	GDO	5501	1455 NW 107 AVE #470	148
3215	PRIMAL ORGANIC, LLC	GDO	5502	7191 SW 44 ST	0
3216	TOKYO MIAMI, INC. DBA ASIAN CHAO	GDO	5504	1455 NW 107 AVE #488	190
3217	U-ENERGIZE INTERNATIONAL, LLC DBA FRESHII	GDO	5505	1455 NW 107 AVE #496	139
3218	TERE'S CAFE CORP.	GDO	5506	5167 E 11 AVE	213
3219	ISLAND RESTAURANT AND VARIETY FOOD STORE	GDO	5507	10201 HAMMOCKS BLVD 143	5
3220	STARBUCKS COFFEE COMPANY, INC. DBA STARBUCKS #8470	GDO	5510	9055 S DIXIE HWY 101	196
3221	PERUVIAN TASTE RESTAURANT CORP.	GDO	5515	9947 SW 142 AVE	375
3222	A.B.D.M. & P, INC.	GDO	5516	8872 SW 24 ST	1,449
3223	MILLER MEAT & FISH MARKET	GDO	5517	13445 SW 56 ST	0
3224	JADE MIAMI, LLC DBA DI NAPOLI RESTAURANT	GDO	5519	11755 S DIXIE HWY	750
3225	MENENDEZ MANAGEMENT CORP. DBA MCDONALD'S #14892	GDO	5520	8651 NW 13 TER	756
3226	AROMA CAFE CORP.	GDO	5522	10759 SW 56 ST	225
3227	FOR KIDZ ONLY OF MIAMI, INC. DBA THE JOY OF LEARNING	GDO	5524	3631 NW 114 AVE	64
3228	LATIN CORNER CAFE CORP.	GDO	5525	6305 E 8 AVE #2-3	523
3229	SPEEDWAY, LLC. DBA SPEEDWAY #6872	GDO	5526	19880 NW 27 AVE	0
3230	SUNOCO, INC. (R & M) #7714	GDO	5532	1106 N HOMESTEAD BLVD	0
3231	WINN DIXIE STORES, INC. DBA WINN DIXIE STORE #214	GDO	5533	1100 NW 54 ST	0
3232	SUSHI SAKE KILLIAN, LLC	GDO	5536	10834 SW 104 ST	417
3233	NOSTRA PIZZERIA CORP.	GDO	5537	8373 NW 12 ST	353
3234	GOODFELLAS BAR & GRILL, INC.	GDO	5539	10442 SW 186 ST	1,000
3235	CHAI WOK, INC.	GDO	5541	1688-92 NE 164 ST	504
3236	YANGS FOOD SERVICES, INC. DBA SARKU JAPAN	GDO	5542	1455 NW 107 AVE #440	0
3237	PRONTO FOODS CORP. DBA PRONTO PIZZA EXPRESS	GDO	5545	10770 SW 24 ST	0
3238	SUBWAY #24548, INC.	GDO	5546	8540 SW 8 ST	588
3239	MIAMI BEACH PIZZA, INC.	GDO	5548	247 71 ST	28
3240	YANG ELEMENT, INC.	GDO	5549	125 SE 2 AVE	242
3241	LUCKY LIN 888, INC.	GDO	5554	760 NW 183 ST	375
3242	BT'S ON THE RIVER, LLC	GDO	5555	3615 NW SOUTH RIVER DR	2,681
3243	WINN DIXIE STORES, INC. DBA WINN DIXIE STORE #388	GDO	5562	18300 SW 137 AVE	0
3244	JUDY & JOE CORP. DBA CHINA MOON RESTAURANT	GDO	5563	1540 ALTON RD	0
3245	VECINOS CAFE CORP.	GDO	5564	5600 COLLINS AVE	457
3246	HOST TINSLEY JOINT VENTURE PIZZA HUT CONCOURSE B	GDO	5565	TERMINAL 2 N.TERM	116
3247	SUSHI SAKE DORAL, INC.	GDO	5566	2600 NW 87 AVE #17	425
3248	EL TROPICO RESTAURANT, INC.	GDO	5567	7902 NW 36 ST #106	5,125
3249	POKE BUN, LLC DBA POKEBAO	GDO	5568	153 GIRALDA AVE	395
3250	LAS OLAS CAFE, LLC	GDO	5572	644 6 ST	210
3251	ALEANI, LLC DBA BRISA DE ESPANA	GDO	5574	8726 NW 26 ST #21-22	1,129
3252	HOST TINSLEY JOINT VENTURE, INC. DBA PIZZA HUT E-SAT	GDO	5575	E-23 CC-E	184
3253	PUBLIX SUPERMARKETS, INC. DBA PUBLIX STORE #051	GDO	5576	1500 SW 27 AVE	0
3254	36TH STREET, INC. DBA SUBRAGEOUS	GDO	5577	5885 NW 36 ST	308
3255	SUNSHINE RESTAURANT PARTNERS, LLC. DBA IHOP RESTAURANT #36-163	GDO	5578	11927 S DIXIE HWY	3,400
3256	DEMVAS, LLC DBA POSEIDON GREEK TABLE & BAR	GDO	5579	1131 WASHINGTON AVE	975

No.	FACILITY_NAME	PERMIT	PERMIT_NUMBER	ADDRESS	TOTAL_GPD
3257	LA BODEGA RESTAURANT CORP.	GDO	5581	13774 SW 88 ST	95,550
3258	PUNTO SUR GOURMET, LLC	GDO	5587	7902 NW 36 ST UNIT 7-8	952
3259	ARAC MIAMI CORP. DBA MIYAKO JAPANESE RESTAURANT	GDO	5589	7902 NW 36 ST 11 & 12	656
3260	EL PATACON PIZAO RESTAURANT #2	GDO	5592	7902 NW 36 ST D-10	840
3261	RASPAOS, INC.	GDO	5593	12536 SW 88 ST	750
3262	SUSHI ON THE ROAD, INC.	GDO	5594	4715 NW 79 AVE	0
3263	POLLO OPERATIONS, INC. DBA POLLO TROPICAL #65	GDO	5596	8200 NW 27 AVE	1,036
3264	THE HOPPY CLOWN, LLC DBA 305 BREWS	GDO	5598	3535 NE 2 AVE	655
3265	TIA CACHA CAFE CORPORATION	GDO	5600	7241 SW 24 ST	476
3266	KENDALL DONUTS, LLC DBA DUNKIN DONUTS #302999	GDO	5601	13730 SW 88 ST	497
3267	ORIENTAL EXPRESS TAKEOUT CHINESE FOOD	GDO	5602	3962 NW 57 AVE	0
3268	LASTRETO & GONZALEZ CORP.	GDO	5603	3946-48 CURTISS PKY	300
3269	YUKA DELI RESTAURANT, INC. DBA LATIN YUKA DELI	GDO	5604	5899 NW 36 ST	446
3270	ROCA BOCA, INC. DBA BASILICO RISTORANTE	GDO	5605	5879 NW 36 ST	1,200
3271	DOLPHIN FISHERIES, INC.	GDO	5606	1790 NW 54 ST	0
3272	KERLUI CORPORATION DBA SECRETO	GDO	5608	11652 SW 88 ST	700
3273	ORDIZ CORP. DBA DAYS'S CAFE, BAKERY AND CATERING	GDO	5609	1657 NW 79 AVE	660
3274	OLIVERA, INC. DBA MIAMI SUBS & GRILL #24	GDO	5610	5875 NW 36 ST	840
3275	HUNGRY BEAR SUB SHOP	GDO	5612	3399 NW 72 AVE #112	560
3276	TANGO GRILL PARRAILLADA OF DADELAND, INC.	GDO	5614	7535 SW 88 ST #1450	171
3277	BLUE OCEAN PETROLEUM, LLC	GDO	5616	1005 W 29 ST	495
3278	WARINEZ, LLC DBA TENEDOR LIBRE LAS BRASAS RESTAURANT	GDO	5617	7905 NW 36 ST	3,150
3279	FRANCESCO, INC. DBA FRANCESCO RESTAURANT	GDO	5618	325 ALCAZAR AVE	1,650
3280	INTERCONTINENTAL MIAMI AIRPORT WEST	GDO	5619	2505 NW 87 AVE	4,750
3281	G.R. ENTERTAINMENT GROUP, INC. DBA PARTY LAND SPORT GAMES & GRILL	GDO	5621	4677-81 NW 199 ST	2,205
3282	RESTAURANTE RICO PAN, INC.	GDO	5622	7682 NW 186 ST	1,500
3283	CINE CITTA, LLC	GDO	5625	9544 HARDING AVE	2,225
3284	NICMAC RESTAURANTS, INC. DBA MCDONALD'S RESTAURANT	GDO	5626	12185 SW 26 ST	1,372
3285	BAGEL EXPRESS, INC.	GDO	5630	11616 SW 88 ST	250
3286	IRMG BURGER RESTAURANTS, INC. DBA BURGER KING	GDO	5631	11401 NW 12 ST FC-109	196
3287	LATIN GRILL OF DOLPHIN MALL, INC.	GDO	5632	11401 NW 12 ST FC-102	222
3288	IMCMV MIA AIRPORT, LLC DBA VIENA	GDO	5637	7TH FLOOR CC-E	750
3289	CAFE ESSPRESSO OF MIAMI DBA CAFE VERSAILLES	GDO	5639	TERMINAL CC-F	0
3290	HOST TINSLEY JOINT VENTURE DBA BUD BREW HOUSE BAR	GDO	5640	H-12 CC-H	487
3291	HOST TINSLEY JOINT VENTURE, INC. DBA BURGER KING E	GDO	5643	FOOD CT. CC-E	184
3292	JS EL COQUI IS HERE, LLC	GDO	5644	800 N FLAGLER AVE	325
3293	CARLITO'S CAFE, INC.	GDO	5647	9045 SW 107 AVE	0
3294	GLOBAL MIAMI JOINT VENTURE DBA VILLA PIZZA	GDO	5648	D-45 FAC.A N.TERM	0
3295	DINNER 33 CORP.	GDO	5653	3195 COMMODORE PLZ	1,250
3296	SUBWAY INTERNATIONAL MALL, INC.	GDO	5655	1455 NW 107 AVE #436	0
3297	EAST RIDGE RETIREMENT VILLAGE	GDO	5656	19301 SW 87 AVE	300
3298	HONG AN, INC. DBA DAIRY QUEEN #18245	GDO	5657	11608 SW 88 ST	350
3299	METZ CULLINARY MANAGEMENT CORP. @ ST. THOMAS UNIVERSITY	GDO	5660	16400 NW 32 AVE	5,400
3300	MI HABANA CAFE CORP.	GDO	5665	10302 NW 87 AVE	675
3301	DTR OF FLA DBA TIMO RESTAURANT	GDO	5669	17624 COLLINS AVE	931
3302	DOHERTY APPLE SOUTH FLORIDA LLC DBA APPELBEES NEIGHBORHOOD	GDO	5672	20505 S DIXIE HWY	5,300
3303	ENGY, INC.	GDO	5674	2721 NW 79 AVE	420
3304	JUICE & JAVA II, INC.	GDO	5677	1346 WASHINGTON AVE	200
3305	LA RUMBA CAFETERIA	GDO	5678	2441 NW 77 TER	300
3306	ZITROV, INC. DBA IHOP RESTAURANTS 36-166	GDO	5679	14505 SW 42 ST	2,950
3307	POLLO OPERATIONS, INC. DBA POLLO TROPICAL #55	GDO	5681	11875 SW 26 ST	1,008
3308	54 EAST HIALEAH, INC. DBA VALERO	GDO	5685	995 HIALEAH DR	56
3309	GOURMET 3005, INC.	GDO	5686	2315 W 77 ST	1,253
3310	NEWPORT HOSPITALITY, LLC DBA NEWPORT BEACHSIDE RESORT	GDO	5688	16701 COLLINS AVE	2,026
3311	LG 3540, LLC DBA SPASSO	GDO	5689	3540 MAIN HWY C102	1,000
3312	DELICES DE FRANCE BAKERY	GDO	5691	14419 S DIXIE HWY #19	1
3313	GERMAN'S ADVENTURE, LLC	GDO	5692	3511 NW 17 AVE	219
3314	REGAL PALACE BANQUET HALL, INC.	GDO	5694	7590 NW 186 ST #204	1,293
3315	ULTIMATE BUFFET, INC.	GDO	5695	2121 PONCE DE LEON BLVD #100	1,549
3316	HIALEAH TOMATOES MARKET DISTRIBUTORS, INC.	GDO	5696	774 W 84 ST	750
3317	LE BOUCHON DU GROVE	GDO	5698	3430 MAIN HWY	1,600
3318	CHEF LEO CAFE, LLC	GDO	5705	600 W 27 ST	420
3319	STARBUCKS COFFEE COMPANY, INC. DBA STARBUCKS #8499	GDO	5707	47 W FLAGLER ST	84
3320	FRESCO Y MAS, INC.	GDO	5709	4425 W 20 AVE	140
3321	17050 SUBWAY, INC. DBA SUBWAY #17050	GDO	5710	28700 S DIXIE HWY	350
3322	RIO STATION JUICE BAR, INC.	GDO	5712	625 LINCOLN RD	250
3323	NORDSTROM, INC. DBA NORDSTROM BAZILLE	GDO	5715	4310 PONCE DE LEON BLVD	2,975
3324	CHUCK WAGON RESTAURANT, INC.	GDO	5716	7628 SW 117 AVE	3,725
3325	AHE RESTAURANT MANAGEMENT GROUP LLC DBA BEACHSIDE-CAFE	GDO	5717	100 BAYVIEW DR	492
3326	PATRIOT SURF CORP. DBA MANOLO	GDO	5718	7300 COLLINS AVE	1,357
3327	LUJHN FOUR, INC. DBA TACO BELL #137	GDO	5721	1350 NW 87 AVE	1,036
3328	HILLEL COMMUNITY DAY SCHOOL, INC.	GDO	5725	19000 NE 25 AVE	436
3329	WASHMONBO, INC. DBA FRONT PORCH CAFE	GDO	5726	1458 OCEAN DR	380
3330	STARBUCKS COFFEE COMPANY, INC. DBA STARBUCKS #8267	GDO	5727	8686 SW 72 ST	5
3331	BARNES AND NOBLE, INC. DBA BARNES AND NOBLE BOOKSELLERS #2792	GDO	5729	12405 SW 88 ST	13
3332	MILTO, LLC DBA STRADA IN THE GROVE	GDO	5730	3176 COMMODORE PLZ	428
3333	DELFOSE & NGUYEN ASSOCIATES, LLC DBA GEORGES IN THE GROVE	GDO	5732	3145 COMMODORE PLZ	454
3334	ERGON SOUTH FLORIDA, LLC DBA ERGON GREEK DELI & CUISINE	GDO	5734	2982 GRAND AVE	610
3335	RICKY BAKERY III, INC.	GDO	5737	7388 SW 117 AVE	425
3336	NOUGATINE, LLC DBA LE ROYAL BAKERY	GDO	5739	7370 SW 57 AVE	1
3337	STARBUCKS COFFEE COMPANY, INC. DBA STARBUCKS #8238	GDO	5740	6603 S DIXIE HWY	8
3338	CHINA OCEAN RESTAURANT, INC.	GDO	5742	15098 SW 56 ST	112
3339	STOP SEVENTEEN, INC. DBA EL JARDIN LATINO RESTAURANT	GDO	5744	3200 NW 17 AVE	1,750
3340	PRECIOUS, LLC DBA SIAM OISHI AT COCONUT GROVE	GDO	5745	3425 MAIN HWY	1,050
3341	COMMODORE, INC. DBA GREENSTREET CAFE	GDO	5747	3468 MAIN HWY	5,000
3342	PANERA, LLC DBA PANERA BREAD #1425	GDO	5748	137 MIRACLE MILE	999
3343	AROMAS DEL PERU OF HAMMOCKS CORP.	GDO	5752	10201 HAMMOCKS BLVD #140	465
3344	OPPORTUNITY CAFETERIA, INC.	GDO	5755	950 NW 36 ST	0

No.	FACILITY_NAME	PERMIT	PERMIT_NUMBER	ADDRESS	TOTAL_GPD
3345	CANES BAR & GRILL OF SOUTH FLORIDA, INC.\DBA SANDBAR SPORTS GRILL	GDO	5756	3426 MAIN HWY	1,125
3346	PUBLIX SUPERMARKETS, INC. DBA PUBLIX STORE #0832	GDO	5757	1585 W 49 ST	0
3347	RIVIERA LATIN BAKERY CORP. DBA RIVIERA BAKERY	GDO	5758	1700 NW 17 ST	250
3348	TRIPLE J UNITED III, INC. DBA TEXACO FOOD MART	GDO	5764	905 E 8 AVE	0
3349	ACTION CONVENIENCE ENTERPRISES CORP.	GDO	5765	801 E 25 ST	50
3350	GOLDEN GLADES EXPRESS, INC.	GDO	5766	17080 NW 7 AVE	0
3351	TURNPIKE STATION, LLC	GDO	5767	12700 SW 120 ST	100
3352	DIXIE CONVENIENT STORE, LLC DBA WESTAR GAS STATION	GDO	5768	21100 S DIXIE HWY	0
3353	ALBEAR 2301, LLC DBA CAFE ENRIQUE	GDO	5769	7501 SW 88 ST FC #1380	420
3354	FOOD SPOT STORE #1	GDO	5770	7400 RED RD	0
3355	KING PALACE CHINESE BBQ	GDO	5771	330 NE 167 ST	1,850
3356	CHICK-FIL-A OF DADELAND MALL	GDO	5773	7501 SW 88 ST #1440	275
3357	MANDARIN EXPRESS RESTAURANT DADELAND	GDO	5774	7535 SW 88 ST #1400	0
3358	PUBLIX SUPERMARKETS, INC. DBA PUBLIX STORE #0054	GDO	5776	311 SW 7 ST	0
3359	SUBWAY #24546, INC.	GDO	5777	10505 NW 112 AVE	644
3360	CARLONE'S FOODS, INC. DBA PAPA PICCOLO	GDO	5779	8016 SW 81 DR	544
3361	SUNNY SUBS SUNSET, LLC DBA SUBWAY #819	GDO	5780	7311 SW 97 AVE	336
3362	CAFE PASTIS	GDO	5781	7310 SW 57 AVE	560
3363	D & D HOSPITALITY, INC. DBA DA BURGER SHACK	GDO	5783	9753 SW 72 ST	459
3364	ROSA RESTAURANT HOLDINGS, LLC DBA LA ROSA RESTAURANT	GDO	5784	4041 NW 7 ST	735
3365	LA MIA FOODS CORP. DBA DON CAMARON SEAFOOD GRILL & MARKET	GDO	5786	9491 NW 77 CT	2,900
3366	NEIMAN MARCUS GROUP, LLC DBA MARIPOSA RESTAURANT	GDO	5791	390 SAN LORENZO AVE	3,100
3367	CAJUN GRILL OF AMERICA, LLC DBA CAJUN GRILL OF DADELAND	GDO	5792	7501 DADELAND MALL FC #3	158
3368	ARGO CAFE DADELAND, LLC DBA AROMA EXPRESSO BAR	GDO	5795	7535 SW 88 ST #2380	406
3369	HAPPY DAZE VII, INC. DBA HAAGEN DAZS	GDO	5799	7501 SW 88 ST SPC 17	0
3370	GENESIS BAKERY & CAFE	GDO	5801	60 N HOMESTEAD BLVD	1
3371	UMCG - LAW SCHOOL BLDG (EINSTEIN BROS BAGELS)	GDO	5803	1311 MILLER DR E	595
3372	UMCG - MAHONEY-PEARSON DINNING HALL-730 CAFETERIA	GDO	5807	1101 STANFORD DR	472
3373	MOARA, LLC DBA DBA MY YOGURT BLISS	GDO	5808	1554 S DIXIE HWY	250
3374	COSTCO WHOLESALE CORP. DBA COSTCO WHOLESALE #182	GDO	5809	14585 BISCAYNE BLVD	1,064
3375	MARRIOTT INTERNATIONAL, INC. SOUTH BEACH MARRIOTT	GDO	5810	161 OCEAN DR	4,000
3376	NEW IMPERIAL BUFFET, INC.	GDO	5812	218 NE 8 ST	1,875
3377	TITIANA BAKERY, INC. DBA NATIONAL CAKE BAKERY	GDO	5813	18845 SW 117 AVE	0
3378	ATLANTIC FOOD MARKET CORP. DBA DIAZ SUPERMARKET #2	GDO	5814	1215 NE 8 ST	336
3379	SABOR VENEZOLANO II, LLC	GDO	5815	250-52 SW 8 ST	675
3380	JUMBO BUFFET, INC.	GDO	5819	13699 BISCAYNE BLVD	1,610
3381	PALMER PREP SCHOOL, INC. DBA PALMER TRINITY SCHOOL	GDO	5820	7900 SW 176 ST	200
3382	PRIME FISH 100, INC.	GDO	5822	100 COLLINS AVE CU-15	2,000
3383	COLUMBUS RESTAURANT, LLC	GDO	5823	736 OCEAN DR	916
3384	PADEL CORP. DBA STOP RESTAURANT	GDO	5826	9101 W OKEECHOBEE RD	625
3385	STARLITE PARTNERSHIP LTD. DBA STARLITE CAFE SOUTHBEACH	GDO	5829	750 OCEAN DR	420
3386	GC FRIDAYS FLORIDA, LLC DBA TGI FRIDAY #1288	GDO	5830	500 OCEAN DR	128,125
3387	STK MIAMI, LLC DBA STK MIAMI BEACH	GDO	5831	2305 COLLINS AVE 43	2,729
3388	TITANIC BREWERY & RESTAURANT	GDO	5833	5813 PONCE DE LEON BLVD	2,100
3389	CRACKERS OFF THE BEATEN PATH CORP.	GDO	5834	78 CANAL ST	750
3390	QUINOA CORNER, LLC	GDO	5835	134 HIALEAH DR	190
3391	C.O.D. SEAFOOD & GRILL CORP.	GDO	5836	5881 NW 37 AVE	625
3392	DB HOSPITALITY, LLC DBA DREAM SOUTH BEACH	GDO	5837	1111 COLLINS AVE	2,510
3393	QUE RIKURA'S PRODUCTS CORP.	GDO	5839	2260 W 80 ST # 2	375
3394	THIERRY'S, INC. DBA A THIERRY'S CATERING & EVENT DESIGN	GDO	5840	915-65 NW 72 ST	4,125
3395	OLALA PASTRIES CORP.	GDO	5841	5811 SW 72 ST	275
3396	SUNSHINE RESTAURANT PARTNERS, INC. DBA IHOP RESTAURANT	GDO	5843	285 NW 42 AVE	2,550
3397	JC BAKESHOP, INC.	GDO	5846	500 W 18 ST	0
3398	860 OCEAN DRIVE, LLC DBA PRIME TIME	GDO	5848	860 OCEAN DR	533
3399	PY FOOD CONCEPTS, INC.	GDO	5849	7100 BISCAYNE BLVD	50,000
3400	CHICKEN 4 U, LLC DBA CHICKEN KITCHEN	GDO	5850	12957 SW 112 ST	868
3401	L & I. CAFE CORP. DBA LATIN CAFE ON THE BEACH	GDO	5851	441 W 41 ST	575
3402	LATIN GOURMET NUTRITION, INC.	GDO	5852	8200 W 33 AVE #16	463
3403	KONING RESTAURANTS INTERNATIONAL, LC DBA PIZZA HUT	GDO	5853	6602 COLLINS AVE	476
3404	GC PARTNERS, INC. DBA GOLDEN CORRAL OF FLORIDA CITY	GDO	5854	33525 S DIXIE HWY	7,500
3405	SUBWAY 30425, INC. DBA SUBWAY #30425	GDO	5856	16650 NW 27 AVE #200	700
3406	ROMANO INVESTMENTS GROUP, INC. DBA SPIGA RISTORANTE ITALIANO	GDO	5858	1228 COLLINS AVE	2,000
3407	TONY'S PLACE, INC.	GDO	5859	17721 NW 78 AVE	1,600
3408	LA PROVENCE 41 ST, LLC	GDO	5860	433 W 41 ST	252
3409	FINNEGAN'S WAY, INC.	GDO	5864	1344 OCEAN DR	2,750
3410	PLANET SUSHI, LLC	GDO	5867	860 WASHINGTON AVE	1,500
3411	GRILL ENTERPRISES, LLC DBA LOS PARRILLEROS RESTAURANT	GDO	5868	10775 NW 41 ST	377
3412	OFFERDAHL'S CAFE GRILL, INC.	GDO	5869	14685 S DIXIE HWY	406
3413	MICCOSUKEE GOLF AND COUNTRY CLUB	GDO	5874	6401 KENDALE LAKES DR #1	1,750
3414	LA BODEGA MARKET CORP.	GDO	5876	3001 E 4 AVE	0
3415	N. H., INC. DBA MERIDIAN FOOD MARKET	GDO	5877	812 E 6 ST	0
3416	MACCHIALINA RESTAURANT, LLC	GDO	5879	820 ALTON RD	340
3417	MARLIN'S FOOD MARKET & CAFE, INC.	GDO	5884	1635 WASHINGTON AVE	0
3418	FERNANDEZ FRUIT AND MARKET	GDO	5885	1407 WASHINGTON AVE	0
3419	SUBWAY #26295, INC.	GDO	5888	8768 SW 72 ST	252
3420	JIMMY'Z KITCHEN, INC.	GDO	5889	1542 ALTON RD	140
3421	ALTON 1671, LLC DBA MASARU SUSHI & THAI	GDO	5890	1671 ALTON RD	700
3422	LOS BALKANES BAKERY, INC.	GDO	5892	16241 NW 57 AVE	2
3423	RIC BUSINESS ENTERPRISES, INC. DBA CASANOVA RESTAURANT	GDO	5893	10405 SW 186 ST	375
3424	SOBE FRANCHISE CORP. DBA LA GRANJA RESTAURANT	GDO	5896	1710 ALTON RD	275
3425	FOREX FOREIGN TRADE CORP. DBA CAFE BONJOUR	GDO	5901	865 COLLINS AVE B	750
3426	BISTRO TEAM 100, LLC DBA LA ROUTA	GDO	5902	10802-04 NW 58 ST	353
3427	MIAMI FUTURE INVEST, LLC DBA SEAFOOD & CRABS STORE	GDO	5903	168-170 NE 167 ST	300
3428	LO DE LEA, LLC	GDO	5904	7001 BISCAYNE BLVD	900
3429	VILLA WOODBINE	GDO	5906	2167 S BAYSHORE DR	1,004
3430	SUSHI SIAM MORNINGSIDE, INC.	GDO	5908	5582 NE 4 CT	2,500
3431	YARD HOUSE USA, INC. DBA YARD HOUSE #8323	GDO	5909	320 SAN LORENZO AVE #1320	2,207
3432	ASENCIO LEON CO., LLC	GDO	5910	4005 E 4 AVE	50

No.	FACILITY_NAME	PERMIT	PERMIT_NUMBER	ADDRESS	TOTAL_GPD
3433	FLORIDA MEGA, INC. DBA WOLSEN CAFE	GDO	5911	17100 COLLINS AVE #105	290
3434	BOSTON MARKET CORPORATION DBA BOSTON MARKET #3213	GDO	5912	21175 BISCAYNE BLVD	1,750
3435	SUBWAY 24131, INC. DBA SUBWAY #24131	GDO	5914	11281 SW 152 ST	2
3436	JENNY'S FRUTERIA, INC.	GDO	5917	882 E 41 ST	0
3437	CANARIA'S FOODS CORP.	GDO	5918	14361 SW 142 ST	725
3438	BALANS BRICKELL, LLC DBA BALANS BRICKELL	GDO	5920	901 S MIAMI AVE #108	675
3439	JAMS GROUP US, LLC DBA VALERO FOOD MART	GDO	5926	11100 SW 216 ST	168
3440	CHURCH OF JESUS CHRIST OF LATTER DAY SAINTS	GDO	5927	8515 BISCAYNE BLVD	3,600
3441	LA GORCE COUNTRY CLUB, INC.	GDO	5930	5685 ALTON RD	3,750
3442	WAKIYA CORP. DBA MARATHON GAS STATION	GDO	5933	26001 S DIXIE HWY	0
3443	EXXON SERVICE STATIONS CORP.	GDO	5934	1176 NW 79 ST	648
3444	ORE'S ENTERPRISES, INC. DBA EL TAMBO GRILL	GDO	5936	7118-26 SW 117 AVE	600
3445	FAT BUSTERS, INC.	GDO	5937	12234 SW 8 ST	125
3446	GREATER MIAMI CATERERS, INC.	GDO	5939	4001 NW 31 AVE	0
3447	SPEEDWAY, LLC DBA SPEEDWAY #6893	GDO	5941	1508 79 ST	0
3448	RINCON CARIBENO RESTAURANT CAFE CORP.	GDO	5942	11180 W FLAGLER ST 1	125
3449	ESTHER MARIA TABOADA BAKERY	GDO	5943	11200 W FLAGLER ST 114	0
3450	KFC CORPORATION DBA KFC #Y309312	GDO	5944	11585 QUAIL ROOST DR	779
3451	DOGGI'S BISCAYNE CORP.	GDO	5946	7281 BISCAYNE BLVD	473
3452	PALMETTO SUBACUTE CARE CENTER	GDO	5947	7600 SW 8 ST	1,000
3453	TODD EN UNO, LLC	GDO	5950	6601 W FLAGLER ST	375
3454	WILLIAM SONOMA, INC. DBA WILLIAM SONOMA #13	GDO	5954	350 SAN LORENZO AVE 2005	1,350
3455	KNIGHTMD, INC. DBA JUICY GYROS	GDO	5956	6944 COLLINS AVE	188
3456	THE CHEESECAKE FACTORY RESTAURANT, INC.	GDO	5957	11401 NW 12 ST E-512	3,288
3457	COFFEE PIZZA LA ESPANOLA CORP.	GDO	5959	2281 W 4 AVE	194
3458	JT & LS CORP. DBA SABORES RESTAURANT & LOUNGE	GDO	5960	1 CURTISS PKY	1,250
3459	CREMA GABLES, LLC DBA CREMA GOURMET ESPRESSO BAR	GDO	5965	169 MIRACLE MILE	331
3460	SUVI THAI & SUSHI RESTAURANT, INC.	GDO	5967	5683 NW 36 ST	1,875
3461	CEVICHE & GRILLE 2 CORP.	GDO	5968	13521 BISCAYNE BLVD	7
3462	CG BRICKELL, LLC DBA KOMODO	GDO	5969	801 BRICKELL AVE	3,228
3463	STONPSY'S OF ATHENS	GDO	5977	350 SE 1 ST	1,350
3464	C'EST BON	GDO	5978	330 SAN LORENZO AVE 2300	214
3465	FRAIOLI & ASSOCIATES, LLC DBA LA CREMA DE LAS EMPANADAS	GDO	5981	10674 SW 24 ST	313
3466	STARBUCKS COFFEE COMPANY, INC. DBA STARBUCKS #8543	GDO	5984	959 WEST AVE	476
3467	COTTON WAVES SMOKE, LLC DBA HAZE HOOKAH CAFE AND SHOP	GDO	5985	4801 W 8 AVE	566
3468	ESPIBARI CORPORATION DBA ROYAL KIDS ACADEMY	GDO	5987	12503 W OKEECHOBEE RD	0
3469	D & D CATERING, INC.	GDO	5989	267 W 28 ST	300
3470	FLORIDA BAPTIST CHILDREN'S HOME	GDO	5990	7748 SW 95 TER	320
3471	SIGA LA VACA	GDO	5991	121 ALHAMBRA PLZ 160	1,325
3472	NEW MARCO FOODS, INC. DBA FASHION IMPORTS	GDO	5994	3270 E 11 AVE	2,442
3473	LCL FOOD SERVICES, INC. DBA MCDONALDS #32830	GDO	5995	18340 SW 137 AVE	834
3474	PIZZA ROMA AVENTURA, LLC	GDO	5998	19090 NE 29 AVE	394
3475	CORAL REEF SUBWAY, INC. DBA SUBWAY SANDWICH & SALAD	GDO	6001	15063 S DIXIE HWY	448
3476	CAFE CHARLOTTE, LLC	GDO	6002	1497 WASHINGTON AVE	750
3477	LA TABERNA DE SAN ROMAN, INC.	GDO	6005	7800 NW 25 ST #2	651
3478	EUROAMERICA UNIVERSE, LLC	GDO	6006	7800 NW 25 ST #9	556
3479	CHINA WOK	GDO	6007	10739 NW 58 ST	168
3480	REZKA CORPORATION DBA M M MEAT MARKET	GDO	6008	989 LUCY ST	0
3481	AUTO BEST DEAL, LLC DBA CHEVRON CORAL WAY	GDO	6010	6901 SW 24 ST	50
3482	STARBUCKS COFFEE COMPANY, INC. DBA STARBUCKS #8557	GDO	6011	416 LINCOLN RD	400
3483	MDM BRICKELL HOTEL GROUP. DBA INTERMEZZO	GDO	6012	1111 BRICKELL AVE #155	521
3484	EL RINCONCITO ARGENTINO BAKERY, INC.	GDO	6013	1839 NE 185 ST	293
3485	RAJA'S INDIAN CUISINE INC. DBA RAJAS RESTAURANT	GDO	6015	33 NE 2 AVE	150
3486	GOODWILL INDUSTRIES OF SOUTH FLORIDA, INC.	GDO	6019	2121 NW 21 ST	0
3487	WEI XING RESTAURANT, INC. DBA CHINA WIND	GDO	6022	12830 SW 120 ST	300
3488	LA BOTTEGA ON THE BAY, LLC	GDO	6025	1800 N BAYSHORE DR CP-2	455
3489	MILLER'S ALE HOUSE, INC. DBA MILLER'S MIAMI LAKES ALE HOUSE	GDO	6030	15251 NW 67 AVE	2,248
3490	24/7 SEAFOOD DISTRIBUTORS CORP.	GDO	6031	265 W 27 ST	0
3491	PARTY CAKE BAKERY V, INC.	GDO	6033	8592 SW 40 ST	700
3492	DIVINO CEVICHE CORAL GABLES, INC.	GDO	6035	160 GIRALDA AVE	470
3493	POWER TWO, INC. DBA POWER PIZZA	GDO	6036	7400 SW 57 AVE #2	375
3494	CATERING TO KIDS, INC.	GDO	6039	12320 SW 132 CT B-3	0
3495	SACHA'S CAFE, INC.	GDO	6040	2525 PONCE DE LEON BLVD #130	625
3496	GLOBAL MIA J.V.\DBA GLOBAL CONCESSIONS OFFICE	GDO	6044	TERMINAL CC-D/E	938
3497	PUBLIX SUPERMARKETS, INC. DBA PUBLIX STORE #889	GDO	6046	15755 SW 56 ST	0
3498	BAIRES BRICKELL, LLC	GDO	6052	1010 S MIAMI AVE	1,025
3499	E.C. MANAGEMENT CORPORATION DBA MCDONALD'S #5112	GDO	6054	9250 NW 7 AVE	1,400
3500	DORAL OPH, LLC DBA THE ORIGINAL PANCAKE HOUSE	GDO	6055	9903 NW 41 ST	1,213
3501	MIAMI GARDENS BUSINESS, LLC DBA SUBWAY #27829	GDO	6056	4897 NW 183 ST	308
3502	CORAL GRAND, LLC DBA CORAL GABLES COUNTRY CLUB	GDO	6059	997 N GREENWAY DR	16,875
3503	PRAMANIK CORPORATION DBA CORNER FOOD STORE STORE	GDO	6061	16701 NE 19 AVE	0
3504	PLEASANT WAYS, INC. DBA OLIVER'S RESTAURANT	GDO	6064	959 WEST AVE #15	584
3505	PAL-MED PIZZA PASTA & GRILL	GDO	6069	7160 W 20 AVE M131	140
3506	CANTINA @ THE RITZ CARLTON	GDO	6072	455 GRAND BAY DR	3,725
3507	JURGENSON TRADING CORP. DBA SUBWAY #23939	GDO	6075	1905 W 35 ST	560
3508	PORTOFINO GOURMET DELI MARKET CORP.	GDO	6078	500 S POINTE DR 130	252
3509	LUVISO, LLC DBA CUATRO LECHES	GDO	6079	4752 SW 74 AVE	0
3510	SUBWAY 51926, INC.	GDO	6080	13955 NW 67 AVE	390
3511	ALBIE'S SUB FACTORY, LLP	GDO	6082	16775 N MIAMI AVE	188
3512	SUSHI SAKE HIALEAH, INC. DBA SUSHI SAKE	GDO	6083	1165 W 49 ST #106	315
3513	SHADDAI FINE LEBANESE CUISINE, LLC	GDO	6087	9519 S DIXIE HWY	470
3514	ST. MONICA CATHOLIC CHURCH	GDO	6088	3490 NW 191 ST	2,000
3515	CATERING CONNECTION, INC. DBA SUSHI JOE	GDO	6089	9557 NW 41 ST	750
3516	CHANG & CHENG, INC. DBA HOUSE OF CHANG RESTAURANT	GDO	6091	1913 NE 168 ST	0
3517	BRASSERIE CENTRAL, LLC	GDO	6095	320 SAN LORENZO AVE #1205	884
3518	VILLAGIO RESTAURANT @ MERRICK PARK	GDO	6097	360 SAN LORENZO AVE #1430	6,050
3519	STEVE'S PIZZA	GDO	6101	16285 SW 88 ST	896
3520	SSAIBA #1, LLC DBA SUBWAY #26212	GDO	6103	9630 SW 24 ST	336

No.	FACILITY_NAME	PERMIT	PERMIT_NUMBER	ADDRESS	TOTAL_GPD
3521	TWO G'S SUBS, INC. DBA SUBWAY	GDO	6106	401 BISCAYNE BLVD S-101	92
3522	PONCE PLAZA REHABILITATION CENTER	GDO	6107	335 SW 12 AVE	0
3523	LA PLAZA LOPEZ, LLC	GDO	6108	2775 E 10 AVE #D	575
3524	MOJO DONUTS & FRIED CHICKEN, LLC	GDO	6109	8870 SW 40 ST 13	375
3525	TDH CAPITAL, LLC DBA WING STOP	GDO	6114	21317 NW 2 AVE A7	700
3526	ONE-TWO-THREE BBQ	GDO	6117	7751 W 28 ST 1	0
3527	FRAPPE GREEK COMPANY	GDO	6119	16850 COLLINS AVE #111	325
3528	ROXMYL CORP. DBA VELA RESTAURANT	GDO	6124	701 W 27 ST	193
3529	NOVECENTO GROUP, LLC	GDO	6125	1414 BRICKELL AVE	100,000
3530	SE FOOD MARKET, INC. DBA PK ORIENTAL MART	GDO	6127	255 NE 167 ST	0
3531	THE SUBWAY GROUP, INC. DBA SUBWAY	GDO	6130	7415 COLLINS AVE	308
3532	VICKY BAKERY, INC.	GDO	6131	2885 W 68 ST #5-6	510
3533	GLOBAL MIAMI J.V. DBA CAFE VERSAILLES	GDO	6134	E30-35/3FL CC-E	119
3534	PANERA, LLC DBA PANERA BREAD #1114	GDO	6135	5701 SW 72 ST	4,250
3535	FAMILY CUISINE OF FL. INC. DBA VINCENT SAINT	GDO	6142	1572 NE 165 ST	3
3536	AVILA BISTRO, LLC	GDO	6143	17951 BISCAYNE BLVD	191
3537	IVES DAIRY MARATHON, LLC	GDO	6146	19760 NW 2 AVE SUITE 1	625
3538	KB IMPERIO CORP. DBA EL GRAN MAR DE PLATA RESTAURANT & LOUNGE	GDO	6147	10325 HAMMOCKS BLVD	1,750
3539	ANDINA FOODS, LLC	GDO	6148	1660 W 31 PL	1,000
3540	JO ANN'S MARKET PLACE	GDO	6149	8247 S DIXIE HWY	1,143
3541	WEST DADE MOOSE LODGE #1825	GDO	6151	9900 SW 77 AVE	360
3542	LA NUEVA HONDURAS RESTAURANT CORP.	GDO	6155	1000 E 8 AVE A	300
3543	BAPTIST HEALTH SOUTH FLORIDA DOCTOR'S HOSPITAL	GDO	6156	5000 UNIVERSITY DR	0
3544	LA CHIQUITICA CAFE CORP.	GDO	6159	1091 E 47 ST	23,750
3545	MILANNI'S, LLC DBA IL PONTE VECCHIO	GDO	6165	18660 COLLINS AVE #102	406
3546	ALEMAR I CORP.	GDO	6166	1701 W FLAGLER ST #101	200
3547	EL DORAL, LLC DBA LAS VEGAS CUBAN CUISINE	GDO	6167	11500 NW 41 ST	5,000
3548	KERED CATERING CORP. DBA WATERS EDGE/SNEAKERS	GDO	6168	5000 TOWERSIDE TER	0
3549	LFP LORENZO RESTAURANT, LLC DBA LORENZO	GDO	6169	1776 COLLINS AVE	1,926
3550	MAHARAB CORP. DBA CHURROMANIA	GDO	6172	1455 NW 107 AVE 674	0
3551	MONDONGO'S, INC.	GDO	6173	3500 NW 87 AVE	5,475
3552	HIALEAH DRIVE DONUTS, LLC DBA DUNKIN DONUTS	GDO	6174	535 HIALEAH DR	418
3553	M & J DELIGHT, LLC	GDO	6176	2010 OPA LOCKA BLVD	188
3554	NO. 1 WOK OF MIAMI, INC.	GDO	6178	2617 SW 147 AVE	2
3555	CHEKO ENTERPRISES, INC. DBA HOLY GUACAMOLE	GDO	6179	1251 WASHINGTON AVE	146
3556	SALVADORENO RESTAURANT, LLC DBA RINCONCITO SALVADORENO	GDO	6181	15924 SW 137 AVE	457
3557	MOTORINO, LLC DBA PIOLA	GDO	6182	11421 S DIXIE HWY	633
3558	BODY CAFE II, INC.	GDO	6183	10055 NW 41 ST	40
3559	PARRILLADA FAMILIAR DA SILVA, LLC	GDO	6184	10720 NW 58 ST	99,975
3560	DONNOLI CATERING CORP. DBA NONNA BISTRO	GDO	6185	2615 SW 147 AVE	300
3561	DEMA FOOD STORES, INC. DBA STOP N SHOP	GDO	6187	201 NE 183 ST	0
3562	JOE'S OLD SCHOOL PIZZA 2, INC.	GDO	6188	1232 S DIXIE HWY	390
3563	BURGER AND BEER JOINT, LLC	GDO	6189	1766 BAY RD 2	1,347
3564	WESTMINSTER CHRISTIAN SCHOOL	GDO	6192	6855 SW 152 ST	100
3565	BOCASA GOURMET, LLC	GDO	6193	919 SW 122 AVE	0
3566	WAN ENTERPRISE CATERING SERVICES, INC.	GDO	6200	4635 SW 75 AVE #E	375
3567	CILOTTE BAKERY AND CATERING, INC.	GDO	6201	15364 W DIXIE HWY	0
3568	MASI ORION INVESTMENTS, LLC DBA DOWNSTAIRS	GDO	6202	10700 SW 186 ST	625
3569	9472 HARDING, LLC DBA VILLA CASTELLI	GDO	6205	9472 HARDING AVE	898
3570	LA FORTUNA RESTAURANT, INC.	GDO	6206	1925 W 76 ST A	750
3571	EL MACHETICO DELI CORP.	GDO	6207	9674 NW 25 ST	125
3572	RESTAURANT VENTURES 1.0, LLC DBA DICED	GDO	6211	10840 SW 104 ST	608
3573	RINCON ESPANOL INVESTMENTS, INC. DBA RINCON ESPANOL	GDO	6213	9511 S DIXIE HWY	900
3574	SUBWAY 41 & TURNPIKE, INC. DBA SUBWAY	GDO	6215	11402 NW 41 ST 103	406
3575	CREACAFE AT THE ICON, LLC	GDO	6217	450 ALTON RD 6TH FLOOR	750
3576	THE FALLS CREPES MIAMI, INC. DBA CREPE MAKER	GDO	6220	8888 SW 136 ST 500	150
3577	AGABE SUPERMARKET CORP.	GDO	6221	19770 SW 177 AVE	0
3578	PIZZA HUT/BURGER KING/BUDWEISER BREWHOUSE	GDO	6222	GATE G-10 CC-G	336
3579	ALLAN COMPANY, LLC DBA NEW HONG KONG	GDO	6224	3116 W 76 ST 108-D	250
3580	7-ELEVEN, INC. DBA 7-ELEVEN STORE #37548A	GDO	6225	20361 OLD CUTLER RD	945
3581	RICE BRICKELL, LLC DBA RICE HOUSE OF KABOB	GDO	6226	50 SW 10 ST #46	1,077
3582	MIAMI MORENO FOOD, INC. DBA CERVICHE & GRILL	GDO	6228	13818 SW 8 ST	1,250
3583	LISA'S SUNSET CAFE	GDO	6229	9260 SW 72 ST 101	100
3584	SOUTH SHORE TRADING, INC. DBA CARVEL ICE CREAM	GDO	6230	725 NE 167 ST	200
3585	KFC US PROPERTIES, INC. DBA KFC #Y309161	GDO	6231	720 NW 37 AVE	560
3586	BOMBAY BISTRO, INC.	GDO	6232	232 12 ST	245
3587	AGHA SUBS CORP. DBA QUIZNOS #3672	GDO	6235	16733 NW 67 AVE	616
3588	MDCAD - FIRE RESCUE STATION #12 MID-FIELD	GDO	6236	AST 600	489
3589	YOYITOS CAFE CORP. DBA YOYITO CAFETERIA RESTAURANT	GDO	6238	495 E 49 ST	1,225
3590	SIMON CAFETERIA, INC.	GDO	6239	1001 E 52 ST	275
3591	FINKA TABLE & TAP, INC.	GDO	6240	14690 SW 26 ST	856
3592	CALLE 6 FOOD MART	GDO	6241	630 6 ST	0
3593	LOS LAURELES DEL RIO, INC.	GDO	6243	3109 NW 24 ST	750
3594	CHINA WOK MIAMI, INC.	GDO	6244	3305 W 80 ST D3	225
3595	FOODS OF SOUTH FLORIDA, INC. DBA MR. MIKE'S GROCERY	GDO	6245	4701 NW 32 AVE	0
3596	TIKAL BAKERY	GDO	6248	1255 NW 1 ST	0
3597	TINTA Y CAFE, INC.	GDO	6249	268 SW 8 ST	375
3598	PICCOLO NI.DO., INC. DBA SAPORE DI MARE ITALIAN	GDO	6250	3111 GRAND AVE	213
3599	BLESSING RESTAURANT	GDO	6251	8427 NE 2 AVE	250
3600	NAGUA RESTAURANT	GDO	6252	3801 NW 17 AVE A	498
3601	R & A BAKERY CORP. DBA EL CAPUCHINO BAKERY & CAFE	GDO	6254	700 PALM AVE	718
3602	PATAGON DISTRIBUTION, INC.	GDO	6255	1780 NW 96 AVE	1,450
3603	POWER SMOOTHIE, INC.	GDO	6257	10419 NW 41 ST	235
3604	BBQ RANCH EDNAMAR CORP.	GDO	6258	3690 NW 54 ST	425
3605	PITA PLUS, INC. AVENTURA	GDO	6260	18833 BISCAYNE BLVD	840
3606	HB MIAMI CORP. DBA HAPPY BUFFET	GDO	6261	1533 W 49 ST	1,500
3607	AMERICAN VAL USA, INC. DBA J & R STOP N GO	GDO	6262	10595 SW 109 CT	500
3608	FISH-N-THINGS SOUTH, INC.	GDO	6263	18901 S DIXIE HWY #109	0

No.	FACILITY_NAME	PERMIT	PERMIT_NUMBER	ADDRESS	TOTAL_GPD
3609	TEQUENOSABOR, INC.	GDO	6265	13880 SW 139 CT	331
3610	FOOD & SUBS CAFETERIA, INC.	GDO	6268	18901 S DIXIE HWY #106	70
3611	MDCAD - FIRE RESCUE STATION #25 OPA-LOCKA	GDO	6270	4600 NW 148 ST 107	0
3612	LITTLE LOUIE'S ITALIAN KITCHEN, INC.	GDO	6271	4254 SW 152 AVE	140
3613	PIZZARIUM MIAMI BEACH, LLC	GDO	6272	540 WASHINGTON AVE	166
3614	LA RUTA 75, LLC	GDO	6273	8200 W 33 AVE 3	363
3615	OCEAN ZONE RESTAURANTS, LLC DBA WING SPOT	GDO	6276	729 WASHINGTON AVE #B	225
3616	STARBUCKS COFFEE COMPANY, INC. DBA STARBUCKS #8520	GDO	6278	7575 SW 88 ST	98
3617	SUBWAY #28842 (MIAMI CHILDREN'S MUSEUM)	GDO	6279	980 MAC ARTHUR CSWY	560
3618	RASPAO	GDO	6281	18640 NW 67 AVE	0
3619	GREEN STEP, LLC	GDO	6284	1321 WASHINGTON AVE	250
3620	PEKING TOKYO BUFFET, INC. DBA HONG KONG GARDEN	GDO	6286	8583 NW 186 ST	0
3621	MDFR - FIRE RESCUE STATION #57	GDO	6287	8501 SW 127 AVE	0
3622	PARADISE SUBWAY CORP. DBA SUBWAY #25234	GDO	6288	12840 SW 120 ST	182
3623	CHIVAS EXPRESS, INC.	GDO	6289	16781 NW 67 AVE	600
3624	INGRIDS ICE CREAM SANDWICH, INC. DBA TIO COLO BOCADITOS DE HELADO	GDO	6290	8051 W 24 AVE #1	300
3625	EL SALVADOR E. HIALEAH BAPTIST CHURCH (KITCHEN)	GDO	6291	3805 W 8 AVE	800
3626	GARDEN RESTAURANTS GROUP, LLC	GDO	6293	19780 NW 27 AVE	4,000
3627	CARNICERIA ARGENTINA LA ESTANCIA, INC.	GDO	6294	10371-75 NW 41 ST	1,500
3628	MOTHER OF OUR REDEEMER SCHOOL	GDO	6295	8445 NW 186 ST	305
3629	CARMITA, LLC DBA THE KNIFE	GDO	6296	1455 NW 107 AVE 428	0
3630	SUNNY SUBS FLAGLER, LLC DBA SUBWAY #29579	GDO	6297	11317 W FLAGLER ST	420
3631	MIAMI GRILL CATERING, LLC	GDO	6300	2350 W 84 ST # 8	300
3632	LA PATRONA BAKERY CORP.	GDO	6301	110 W MOWRY DR	0
3633	GRACE KENNEDY FOODS (USA), LLC DBA LA FE	GDO	6303	6601 NW 37 AVE	5,000
3634	O CAFE, LLC DBA CORAL CAFE	GDO	6304	959 WEST AVE #3	300
3635	HOT PANDEYUCA & COMPANY, INC. DBA PA'YA EXPRESS	GDO	6306	6043 NW 167 ST A22	0
3636	RAVELO TROPICAL BAKERY CORP.	GDO	6310	6741 NW 37 CT	1,000
3637	CASA JUAN RESTAURANT	GDO	6311	5755 NW 7 ST	2,225
3638	OPTIM, LLC DBA LUL GRILL CAFE	GDO	6313	18288 COLLINS AVE #2	661
3639	AUGUSTA LR, LLC DBA PINCH ME	GDO	6315	216 PALERMO AVE	375
3640	CARE WITH LOVE CORP. DBA LA HABANERA CAFE	GDO	6319	4700 NW 7 ST 12-13	375
3641	EL GUEGUENSE BAKERY, INC.	GDO	6320	4700 NW 7 ST #17-18	297
3642	PRESIDENTE SUPERMARKET #23, INC.	GDO	6321	2199 NW 36 ST	0
3643	MAKKO, LLC DBA YOKO'S JAPANESE AND SUSHI BAR	GDO	6322	9837 SW 184 ST	250
3644	JIN JIN FOOD CORP.	GDO	6323	7900 NW 27 AVE #234	1,475
3645	IFV, INC. DBA NEW LATIN AMERICAN FOOD & BAKERY	GDO	6324	3580 W 18 AVE 110	245
3646	PUBLIX SUPERMARKETS, INC. DBA PUBLIX STORE #1017	GDO	6325	14641 BISCAYNE BLVD	0
3647	LA CUBANITA PIZZERIA Y HELADERIA CORP.	GDO	6327	4800 W FLAGLER ST #101	375
3648	PASEO CATRACHO, INC.	GDO	6328	4750 NW 7 ST #7	163
3649	EL MEGA CHUZO, LLC	GDO	6329	17632 COLLINS AVE	750
3650	MINISTERIO CRISTO FIEL Y VERDADERO, INC.	GDO	6330	10680 SW 113 PL	0
3651	LA CREMA PIZZA CAFETERIA	GDO	6332	2263 NW 28 ST	84
3652	HANSON, INC. DBA MAAM'S JAMAICAN RESTAURANT	GDO	6333	1518 NE 205 ST	0
3653	ANITA'S CARIBBEAN CUISINE, LLC	GDO	6334	7900 NW 27 AVE #601	244
3654	BULLA, LLC	GDO	6335	2500 PONCE DE LEON BLVD	1,531
3655	LATIN AMERICA HOUSE OF MIAMI CORP.	GDO	6337	7250 W 24 AVE #7-8	339
3656	CD MAN, LLC DBA ENERJUICER	GDO	6341	1455 NW 107 AVE K-102	36
3657	THE DAILY WEST AVE CORP. DBA THE DAILY RESTAURANT	GDO	6343	959 WEST AVE #8-10	1,077
3658	4 D MIAMI, LLC DBA 4 D GELATO	GDO	6344	500 S POINTE DR 190	0
3659	THE CORNER MUSE, INC. DBA HEARTS OF PALM CATERING	GDO	6345	99 NW 54 ST	500
3660	JIN JIN TAKEOUT RESTAURANT	GDO	6346	15705 SW 56 ST	0
3661	1051 COLLINS HOTEL, LLC DBA WYNWOOD SOUTH BEACH HOTEL	GDO	6347	1051 COLLINS AVE	155
3662	EURO TABLE, INC. DBA EURO TABLE CATERING	GDO	6352	119 MADEIRA AVE	300
3663	PASTA IL CUOCO, INC.	GDO	6353	3528 W FLAGLER ST	175
3664	FRITANGA SUYEN	GDO	6354	1515 NW 17 AVE	500
3665	HUI FOOD SERVICE CORP. DBA BENTO BOX CAFE	GDO	6355	8051 W 24 AVE #17-18	600
3666	SUBWAY #31108, INC.	GDO	6356	279 CORAL WAY	532
3667	YAIRE CORPORATION DBA LOS VERDES COLOMBIAN FAST FOOD	GDO	6357	7590 NW 186 ST #101-102	600
3668	SYSCO FOODS OF SOUTH FLORIDA	GDO	6359	12500 SYSCO WAY	0
3669	LATIN GRILL OF DADELAND, INC.	GDO	6362	7535 SW 88 ST #1460	145
3670	EL DIAMANTE GRILL CORP.	GDO	6365	1245 NE 8 ST	625
3671	JKR BENTLEY MANAGEMENT, LLC DBA PICCILO	GDO	6367	510 OCEAN DR CU-1	1,750
3672	WAL-MART STORES EAST, LP DBA SAM'S CLUB #6217	GDO	6368	1480 NW 84 AVE	532
3673	BOLIVAR SUBWAY CORP. DBA SUBWAY #36750	GDO	6370	1 NW 54 ST	375
3674	ENCHANTED ISLAND, LLC DBA ISLA DEL ENCANTO	GDO	6371	12850 SW 120 ST	200
3675	KONGO'S PIZZA CORP.	GDO	6372	7250 W 24 AVE BAY 11	140
3676	ALBUIN CORP. DBA CORAL RESTAURANT CAFETERIA	GDO	6374	7390 NW 35 TER	2,225
3677	RDP GROUP, CORP. DBA SAMMI'S CAFE	GDO	6375	5201 BLUE LAGOON DR 150	250
3678	V3 FOODS AND SERVICES, LLC DBA ORIGINAL GRANDMA'S STYLE SNACKS	GDO	6378	4847 E 10 CT	1,250
3679	VE RESTAURANT GROUP, LLC DBA SEGAFREDO ZANETTI ESPRESSO	GDO	6380	1421 S MIAMI AVE #5B	1,250
3680	LILAHK, INC. DBA PEKADITOS PERUVIAN RESTAURANT	GDO	6384	11980 SW 8 ST 4-5	443
3681	TAKESHE ENTERTAINMENT, LLC DBA THE PLACE OF MIAMI	GDO	6386	833 SW 29 AVE #1-4	1,000
3682	LAKES SEAFOOD RESTAURANT	GDO	6387	15480 NW 77 CT	1,700
3683	TACITAS CAFE, INC.	GDO	6389	3800 SHIPPING AVE	111
3684	BRINKER FLORIDA, INC. DBA CHILI'S GRILL & BAR	GDO	6390	401 BISCAYNE BLVD N212	965
3685	SARA SHARPE CATERING, INC.	GDO	6392	3324-28 SW 23 TER	0
3686	SWEETNESS BAKE SHOP & CAFE, INC.	GDO	6394	9549 SW 72 ST	280
3687	WENDY'S INTERNATIONAL, INC. DBA WENDY'S #9765	GDO	6395	2000 NW 107 AVE	1,176
3688	SWEET LIBERTY BROTHERS, LLC DBA SWEET LIBERTY	GDO	6397	237 20 ST B	900
3689	LA SIEMBRA RESTAURANT, INC.	GDO	6399	15512 SW 72 ST	250
3690	TEXAS DE BRAZIL CORP. (MIAMI)	GDO	6400	11401 NW 12 ST 514	0
3691	TURNBERRY OCEAN COLONY MASTER ASSOCIATION, INC.	GDO	6401	16049 COLLINS AVE	550
3692	SUMO SUSHI BAR & GRILL	GDO	6402	17630 COLLINS AVE	1,675
3693	GASTON HOLDINGS, LLC DBA DOWNTOWN BISTRO	GDO	6404	114-116 SE 1 ST	606
3694	DOHERTY APPLE SOUTH FLORIDA, LLC DBA APPEL BEE'S NEIGHBORHOOD	GDO	6406	33009 S DIXIE HWY	4,500
3695	STARBUCKS COFFEE COMPANY, INC. DBA STARBUCKS #8647	GDO	6407	8012 NW 154 ST	532
3696	CK AT CORAL REEF, LLC DBA CHICKEN KITCHEN	GDO	6409	15053 S DIXIE HWY	644

No.	FACILITY_NAME	PERMIT	PERMIT_NUMBER	ADDRESS	TOTAL_GPD
3697	FRITANGA MONIMBO-MILLER SQUARE, INC.	GDO	6410	13710 SW 56 ST I	750
3698	JAE MIAMI DADE, LLC DBA WENDY'S #9764	GDO	6411	8540 NW 58 ST	772
3699	MILES FISH AND CHICKEN, INC. DBA TWO BROTHERS FISH & CHICKEN	GDO	6414	13565 NW 27 AVE	375
3700	DC HOTELS, LLC DBA DADELAND COURTYARD BY MARRIOTT	GDO	6418	9075 S DADELAND BLVD	1,000
3701	SWEET FOR YOU, INC. DBA HAAGEN DAZS	GDO	6419	1455 NW 107 AVE K103	0
3702	26 SUSHI K GROUP, LLC DBA 26	GDO	6420	9487-89 HARDING AVE	375
3703	BAYFRONT CAFE 104, INC.	GDO	6424	104 SE 1 ST	150
3704	RACETRAC PETROLEUM	GDO	6425	20696 NW 27 AVE	0
3705	MCDONALD'S RESTAURANT	GDO	6426	466 HIALEAH DR	1,694
3706	FRITANGA MONIMBO EL DORAL, INC.	GDO	6427	10471 NW 41 ST	600
3707	STARBUCKS COFFEE COMPANY, INC. DBA STARBUCKS #2751	GDO	6429	10690 NW 19 ST #1A	392
3708	EL RINCONCITO LATINO RESTAURANT CAFETERIA, INC.	GDO	6430	15500 SW 72 ST	512
3709	THE PINCHO FACTORY, INC.	GDO	6431	9860 SW 40 ST	334
3710	MTB, LLC DBA MARIO THE BAKER	GDO	6432	43 W FLAGLER ST	256
3711	FLB MIAMI LLC DBA FRATELLI LA BUFALA	GDO	6433	437 WASHINGTON AVE	250
3712	R & M FRUIT CORP. DBA SORIANO BROTHERS	GDO	6434	2393 W 78 ST	946
3713	BOTTEGA GRILL, LLC	GDO	6435	2411 SW 147 AVE	1,304
3714	JP PIZZA, INC. DBA JERSEY BOARDWALK PIZZA	GDO	6436	33497 S DIXIE HWY #105	347
3715	PUBLIX SUPERMARKETS, INC. DBA PUBLIX STORE #1090	GDO	6437	5715 NW 7 ST	0
3716	CHINA STAR RESTAURANT	GDO	6440	48 E FLAGLER ST M-37	0
3717	SEA TOWN OF NORTH MIAMI, INC. DBA SNAPPER'S FISH & CHICKEN	GDO	6442	18312 NW 7 AVE #100	425
3718	DINMAR, LLC DBA VIA VENETO BAKERY & ITALIAN	GDO	6443	10740 NW 58 ST	582
3719	DU KANG, LLC DBA JING QUAN DU	GDO	6444	9899 SW 40 ST A	1,750
3720	DORAL SUBWAY, LLC DBA SUBWAY #24035	GDO	6445	2050 NW 107 AVE	0
3721	MIAMI DONNA, LLC DBA BARDO	GDO	6446	1500 BAY RD S.TOWER	300
3722	FLORIDA MEAT PACKAGING, INC.	GDO	6447	2480 W 80 ST #1	375
3723	CHEF NUNEZ CATERING, INC.	GDO	6448	2313 NW 27 AVE	175
3724	ALEX'S BAKERY, LLC	GDO	6450	15584-88 SW 72 ST	510
3725	MEXIPIZZA, LLC DBA L'INCONTRO PIZZERIA	GDO	6451	12388 SW 127 AVE	450
3726	ECUMAT, LLC DBA FLAMINGO'S LAUNDROMAT	GDO	6452	2900 W 2 AVE	88
3727	CK AT MIAMI LAKES, LLC DBA CHICKEN KITCHEN	GDO	6453	15221 NW 67 AVE	728
3728	AVENTURA CREAMERY, LLC DBA COLD STONE CREAMERY	GDO	6454	18225 BISCAYNE BLVD	140
3729	SOUTHERNMOST WINE CO., LLC DBA VINOS IN THE GROVE	GDO	6455	3409 MAIN HWY	450
3730	MESA MEAT PROCESSORS CORP.	GDO	6457	190 W 24 ST A	0
3731	TAITAS GROUP CORPORATION DBA TAITAS PERUVIAN RESTAURANT	GDO	6458	145 E FLAGLER ST A-27	271
3732	1427 WEST, LLC DBA BARTON G THE RESTAURANT	GDO	6459	1427 WEST AVE	1,664
3733	CIBE LINCOLN ROAD, LLC DBA SIBILLA CAFE	GDO	6460	833 LINCOLN RD	834
3734	2 DOLLAR HOUSE GROCERY, INC. DBA BAR-B-GROCERY	GDO	6461	6290 NW 15 AVE	0
3735	MIRACLES FRIED CONCH FRITTERS	GDO	6462	7070 NW 15 AVE	0
3736	B & W BAHAMIAN RESTAURANT	GDO	6463	5931 NW 17 AVE	393
3737	JOANKALE ICE CREAM & COFFEE SHOP, INC.	GDO	6464	1058 SW 1 ST	200
3738	DELICIAS HONDURENAS, INC.	GDO	6465	955 W FLAGLER ST	154
3739	MONTOYA HOLDINGS, INC. DBA HEALTHY CHILDREN CATERING	GDO	6467	2620-30 W 2 AVE	0
3740	GUO TIE KING, LLC DBA DUMPLING KING	GDO	6469	237 NE 167 ST	425
3741	GLOBAL MIAMI J.V. DBA ISLANDER BAR & GRILL	GDO	6470	D-49 N.TERM	264
3742	RIWO, INC. DBA SCHNITZEL HAUS RESTAURANT	GDO	6471	1085 NE 79 ST	1,000
3743	MANGU CAFE RESTAURANT, INC.	GDO	6472	2007 W 62 ST	325
3744	GOGO FRESH HOLDINGS, LLC DBA GOGO FRESH FOODS	GDO	6474	926 ALTON RD	375
3745	CRP/TWG WASHINGTON AVE, LLC DBA EMPLOYEES ONLY	GDO	6478	1030 WASHINGTON AVE	710
3746	LOS AZTECAS RESTAURANT	GDO	6479	501 W PALM DR #116	1,300
3747	JK CHINA KING, LLC DBA CHINA KING	GDO	6480	4225 NW 107 AVE #24	250
3748	LBC GOURMET BREAD, LLC.	GDO	6481	1108 E 13 ST	0
3749	COTRINA USA, INC. DBA LA VILLA DE DON POLLO	GDO	6482	12372 QUAIL ROOST DR	504
3750	VITAFOODS ENTERPRISES, INC. DBA FUDDRUCKERS	GDO	6483	10680 NW 19 ST	2,548
3751	PRECIOUS TIME CHILD CARE & LEARNING CENTER	GDO	6484	17601 NW 78 AVE	800
3752	AMERICAN SUSHI, LLC DBA OBBA SUSHI & MORE	GDO	6485	200 SE 15 RD 1	414
3753	SANTA MARIA BISTRO CORP.	GDO	6486	1643 BRICKELL AVE LOBBY	90
3754	LINSARO CO. DBA LUCY'S CAFE	GDO	6487	2451 BRICKELL AVE C-1	210
3755	PEGA GRILL, INC.	GDO	6491	15 E FLAGLER ST	275
3756	ADEL & ADAM ENTERPRISES, INC. DBA FRIENDS MEAT MARKET	GDO	6493	6101 NW 17 AVE	750
3757	JEME ENTERPRISE CORP. DBA SUBWAY	GDO	6494	10737 NW 58 ST	280
3758	DECO SANDWICHES AND BURGER, LLC	GDO	6495	1361 WASHINGTON AVE	465
3759	SUAREZ BBQ, INC.	GDO	6496	12963 W OKEECHOBEE RD #6	313
3760	SHIRIN GLATT, INC.	GDO	6498	48 E FLAGLER ST M-43	135
3761	AGUSTINIX, LLC DBA 5411 EMPANADAS	GDO	6503	98 MIRACLE MILE	254
3762	LOLITA RESTAURANT CORP.	GDO	6504	316 SW 8 AVE	173
3763	ZAGA BRICKELL, LLC DBA 7 PECADOS BRICKELL	GDO	6505	1441 BRICKELL AVE #310	1,150
3764	CHIKA'S LATIN BAKERY CORP.	GDO	6506	3553 W 76 ST #6-7	428
3765	LEHRMAN COMMUNITY DAY SCHOOL, INC.	GDO	6509	727 77 ST	0
3766	LANTIGUA KITCHEN CORPORATION DBA NUEVO AMANECER RESTAURANT	GDO	6510	2912 NW 17 AVE	375
3767	MINI HEALTHY DELI, INC.	GDO	6511	48 E FLAGLER ST M-23	750
3768	FOREX FOREIGN TRADE CORPORATION DBA MEGA PIZZA	GDO	6514	865 COLLINS AVE C	285
3769	COCOLAKE, INC.	GDO	6515	14321 SW 139 CT 7	0
3770	TAQUERIA MORELIA	GDO	6519	961 W PALM DR 1	375
3771	CHIKA'S LATIN BAKERY CORP. DBA CHIKA'S BAKERY	GDO	6521	7250 W 24 AVE 3	350
3772	CAKE LOUNGE MIAMI, LLC	GDO	6527	1245 SW 22 ST	160
3773	4D LINCOLN, LLC DBA 4D GELATO	GDO	6530	670 LINCOLN RD	668
3774	819 FIFTH STREET CORP. DBA TAP TAP	GDO	6531	819 5 ST	1,500
3775	MOM'S PIZZA, INC.	GDO	6533	1059 COLLINS AVE 106	113
3776	SUSHI HOUSE CO.	GDO	6536	15911 BISCAYNE BLVD	5,225
3777	CAFE D'CREST, INC.	GDO	6538	1666 JAMES AVE	1,500
3778	HIGH TIDE RESTAURANT GROUP, INC. OLA RESTAURANT	GDO	6540	1745 JAMES AVE	1,950
3779	A & F SUBWAY 32229, INC. DBA SUBWAY #32229	GDO	6541	1395 BRICKELL AVE	616
3780	BELLA CUBA, INC.	GDO	6542	1659 WASHINGTON AVE	1,400
3781	M & M FOODS OF MIAMI, INC. DBA QUIZNO'S SUBS	GDO	6546	9700 NW 115 WAY	532
3782	OLD PADUA, INC. DBA CAFFE DI MAURO	GDO	6547	1464 WASHINGTON AVE	520
3783	EL MESON DEL PARAISO, INC.	GDO	6548	12820 SW 120 ST	900
3784	PASHA'S RESTAURANTS, INC.	GDO	6550	1414 BRICKELL AVE	910

No.	FACILITY_NAME	PERMIT	PERMIT_NUMBER	ADDRESS	TOTAL_GPD
3785	MADISON CONVENIENCE STORE, INC. DBA SEACOAST CAFE	GDO	6551	5151 COLLINS AVE	75
3786	JESSI ENTERPRISES, INC. DBA DECO PIZZA	GDO	6553	1249 WASHINGTON AVE	182
3787	CAFE & OCEAN, LLC	GDO	6555	600 OCEAN DR	0
3788	LA CUISINE AT CORAL GABLES, LLC.	GDO	6556	50 ARAGON AVE	0
3789	PINCHO FACTORY #2, INC. DBA PINCHO FACTORY	GDO	6558	30 GIRALDA AVE	429
3790	CAFE DELIGHTS, LLC DBA PANNA CAFE	GDO	6559	11402 NW 41 ST #112	699
3791	SSC339889, LLC DBA DUNKIN DONUTS #339889	GDO	6560	5130 BISCAYNE BLVD	252
3792	BETSY ROSS OWNER, LLC	GDO	6561	1440 OCEAN DR	5,600
3793	PARTIES BY PAT, INC.	GDO	6562	6700 CRANDON BLVD	875
3794	GINERAL #3 CORP. DBA HIALEAH DRIVE CHEVRON	GDO	6564	800 HIALEAH DR	0
3795	WING TEAM, LLC DBA WINGSTOP	GDO	6565	16650 NW 27 AVE #400	0
3796	YUGAS, INC. (CITGO)	GDO	6566	2290 W 84 ST	0
3797	ZALCAB INVESTMENT, LLC DBA DELICATESSEN PATAGONIA	GDO	6568	244 CORAL WAY	669
3798	CBOCS, INC. DBA CRACKER BARREL OLD COUNTRY STORE #545	GDO	6571	155 N KROME AVE	5,100
3799	SAMMICH TOTAL SERVICES CORP. DBA MR. AND MRS. BUN	GDO	6572	15572 SW 72 ST	250
3800	STARBUCKS COFFEE COMPANY, INC. DBA STARBUCKS #19899	GDO	6573	199 NE 167 ST	159
3801	BIG SPLASH KENDALL CORP. DBA BENIHANA	GDO	6574	242 CORAL WAY	5,050
3802	A.B.C. CATERING SERVICE, INC.	GDO	6575	15920 SW 137 AVE	214
3803	ELI-MAR CORP. DBA ELI-MAR MARKET & CAFETERIA	GDO	6577	1217 71 ST	0
3804	ES LO QUE HAY, LLC	GDO	6578	6987 COLLINS AVE	768
3805	MR. PASTA CORP.	GDO	6579	7311 COLLINS AVE	0
3806	PINOLANDIA 3 CORPORATION	GDO	6580	10948 SW 184 ST	850
3807	ESPECIALIDADES ORIENTALES CORP. DBA SALON CANTON RESTAURANT	GDO	6583	916 71 ST	347
3808	FERRADO LIDO, LLC DBA THE STANDARD MIAMI	GDO	6587	40 ISLAND AVE	450
3809	LA PERLA FOOD, LLC DBA BAMBOO RESTAURANT	GDO	6590	9342 SW 56 ST	600
3810	WAL-MART STORES EAST, LP DBA WAL-MART STORE #1590	GDO	6591	5851 NW 177 ST	0
3811	PARRILLADA LAS VACAS GORDAS, INC.	GDO	6592	933 NORMANDY DR	500
3812	RANDOLPH & MORTIMER, LLLP DBA IZZY'S FISH & OYSTER BAR	GDO	6595	423 WASHINGTON AVE	504
3813	BODEGON 71, LLC	GDO	6598	1014 71 ST	533
3814	GOLDEN RULE GROCERY, INC.	GDO	6599	17505 S DIXIE HWY	1,446
3815	TARPON BEND RAW BAR & GRILL, LLC	GDO	6600	65 MIRACLE MILE	1,554
3816	THE UNION CRAFT BEER, LLC	GDO	6602	1547 SW 8 ST	385
3817	ESPITIA INTERNATIONAL, INC. DBA PANDEBONO BAKERY	GDO	6605	615 71 ST	200
3818	THE PALEO CRAVE, INC.	GDO	6607	2114 W 62 ST	375
3819	JEME ENTERPRISE CORP. DBA SUBWAY	GDO	6609	9326 SW 56 ST	112
3820	KILLER MELTS, LLC	GDO	6612	12310 SW 127 AVE	275
3821	TAKEE OUTEE RESTAURANT, INC.	GDO	6613	20234 OLD CUTLER RD	2
3822	STARBUCKS COFFEE COMPANY, INC. DBA STARBUCKS COFFEE #8566	GDO	6615	18215 BISCAYNE BLVD	525
3823	IRON SUSHI	GDO	6617	6940 COLLINS AVE	140
3824	CAFETERIA EL BANI CORP.	GDO	6619	650 PALM AVE #2	420
3825	SKYCOB, LLC DBA MONTEFIERO CAFE AND RESTAURANT	GDO	6620	4017 PRAIRIE AVE	441
3826	JJ BAY HARBOR, LLC DBA JIMMY JOHN'S GOURMET SANDW	GDO	6621	21213 BISCAYNE BLVD	232
3827	THE ORIGINAL CAFETIN CORP. DBA FIFI'S PLACE	GDO	6624	6932-34 COLLINS AVE	56,250
3828	OFF THE GRILL II CORP. DBA OFF THE GRILL II	GDO	6625	300 NE 2 AVE	0
3829	ORLANDO'S PIZZA	GDO	6628	1067 95 ST	313
3830	SAJ BROS ENTERPRISES, LLC DBA NATURAL CHICKEN GRILL	GDO	6629	2070 NW 107 AVE 8	490
3831	SJ SMOKER SHOP, INC.	GDO	6630	19401 S DIXIE HWY	875
3832	BONEFISH GRILL, LLC DBA BONEFISH GRILL #7019	GDO	6631	12520 SW 120 ST	5,000
3833	CKC FOOD STORES, INC. DBA CKC EXXON RIVER	GDO	6636	5 NE 79 ST	24
3834	DOMINO'S PIZZA, LLC	GDO	6638	8100 BISCAYNE BLVD	468
3835	OSI/FLEMING'S, LLC DBA FLEMING'S PRIME STEAKHOUSE & WINE BAR #2005	GDO	6639	2525 PONCE DE LEON BLVD	5,450
3836	TACO BELL OF AMERICA, LLC DBA TACO BELL	GDO	6640	4870 NW 183 ST	1,176
3837	KFC CORPORATION DBA KFC #Y309136	GDO	6641	12566 SW 120 ST	853
3838	GOLDEN OWL ENTERTAINMENT, LLC DBA KOI NIGHT CLUB	GDO	6643	50 NE 11 ST	2,814
3839	CHINA CAFE	GDO	6646	6810 NE 2 AVE	1
3840	BUAIZ TRADING CORP.	GDO	6647	3553 W 76 ST #11-12	520
3841	ERNESLI CORPORATION DBA ZUBI SUPERMARKET	GDO	6651	5700 NW 2 AVE	0
3842	THE BAKERY BOYS, LLC DBA AU-BON BAKERY	GDO	6652	145 NW 71 ST	525
3843	SUDAKA'S, LLC DBA FIORITO	GDO	6653	5555 NE 2 AVE #1	297
3844	G & C RESTAURANT	GDO	6654	7100 NW 2 AVE	168
3845	SUBWAY #32898, INC.	GDO	6659	1838 NE MIAMI GARDENS DR	308
3846	EL TAQUITO CORP.	GDO	6660	3410 MAIN HWY	0
3847	ACADEMY OF ARTS AND MINDS CAFE	GDO	6661	3138 COMMODORE PLZ 318	0
3848	MOSHI MOSHI PALM GROVE, LLC DBA MOSHI MOSHI	GDO	6663	7232 BISCAYNE BLVD	1,125
3849	FRANCISCO'S CAFE AND SERVICES, INC.	GDO	6665	2711 SW 137 AVE R2	125
3850	M & M SUPERMARKET	GDO	6666	17585 HOMESTEAD AVE	0
3851	BRYAN PETROLEUM 102, LLC	GDO	6667	7907 NW 6 AVE	375
3852	J. TOKYO, LLC DBA J. TOKYO SUSHI & BEYOND	GDO	6668	12374 SW 127 AVE	463
3853	SABOR TROPICAL #4, INC.	GDO	6671	8000 NE 5 AVE	6,007
3854	NASER FOOD MARKET, INC.	GDO	6674	5845 NE 2 AVE	0
3855	OISHI THAI RESTAURANT, INC.	GDO	6677	14841 BISCAYNE BLVD	2,150
3856	GRILL HOUSE, INC.	GDO	6678	976 ARTHUR GODFREY RD	325
3857	ALEIDA'S CAFETERIA, INC.	GDO	6680	186 NE 29 ST	1,500
3858	MERCEDES COFFEE SHOP	GDO	6681	3595 NW 54 ST	750
3859	ST. PETERSBURG MARKET, LLC DBA EUROPEAN DELIGHTS	GDO	6682	17080 COLLINS AVE	140
3860	CAROLINA IM CORP. DBA RING THE BELL RESTAURANT	GDO	6683	4030 NW 2 AVE	625
3861	SUBWAY #29366, INC.	GDO	6684	8304 S DIXIE HWY	294
3862	BILAL TRADING, INC. DBA SUBWAY #29896	GDO	6686	1000 PARK CENTRE BLVD 110	476
3863	N & G SERVICE STATION	GDO	6688	3195 NW 54 ST FAC. A	400
3864	VICTORIA RESTAURANT	GDO	6691	2209 NW 7 AVE	650
3865	CM W 2814 HIALEAH GARDENS, LLC DBA CHURROMANIA	GDO	6693	9300 NW 77 AVE	98
3866	83 BROOKLYN BAGEL COMPANY LLC DBA TOASTED BAGELRY DELI	GDO	6696	83 SW 8 ST	418
3867	AREPAS MACITAS, INC.	GDO	6697	9825 SW 184 ST	0
3868	FWF ENTERPRISES, LLC	GDO	6698	6075 BISCAYNE BLVD	50
3869	CHE SOPRANOS, INC. DBA THE TERRACE AT DEVITA	GDO	6699	7251 BISCAYNE BLVD	900
3870	HONDURAS NICA CAFE, LLC	GDO	6701	280 NW 79 ST	225
3871	RICKY BAKERY II, INC.	GDO	6704	3115 SW 22 ST	0
3872	MOE'S DORAL, LLC DBA MOE'S SOUTHWEST GRILL	GDO	6706	10660 NW 19 ST	1,036

No.	FACILITY_NAME	PERMIT	PERMIT_NUMBER	ADDRESS	TOTAL_GPD
3873	PITA GRILL MARKET	GDO	6708	12776 SW 88 ST	0
3874	KUSH WYNWOOD, LLC	GDO	6709	2003 N MIAMI AVE	250
3875	E.A.S. BROTHERS, INC. DBA LITTLE HAITI SUPERMARKET	GDO	6710	5600 NE 2 AVE	1,125
3876	I J SUPERMARKET, LLC DBA GUINES MARKET	GDO	6711	2300 NW 28 ST	0
3877	STARBUCKS COFFEE COMPANY, INC. DBA STARBUCKS #8446	GDO	6714	14795 S DIXIE HWY	630
3878	SUBWAY 28444, LLC	GDO	6715	913 NORMANDY DR	375
3879	CAFETERIA LESLEY	GDO	6718	2258 NW 28 ST	121
3880	GABYSA DOLLAR DISCOUNT CORP. DBA LA NUEVA ESTRELLA	GDO	6719	2521 NW 27 AVE	0
3881	LA FAMA #2 GROCERY/MEAT DEPT.	GDO	6732	2288 NW 28 ST	0
3882	LA YALLI OF MIAMI	GDO	6733	11402 NW 41 ST 115	1,150
3883	CORPORATE CATERERS, INC.	GDO	6735	12105 SW 130 ST 205	1,169
3884	LOLA AND SAM, INC. DBA MACAU SPECIALTIES MISICAL REST.	GDO	6736	7632 NW 186 ST	1,105
3885	KARLA M. CAFETERIA, INC.	GDO	6737	2150 NW 36 ST	250
3886	DAILY DISH CATERING, INC.	GDO	6740	12783 SW 280 ST	800
3887	GLOBAL MIAMI JOINT VENTURE DBA CAFE VERSAILLES	GDO	6741	D-45 FAC.B N.TERM	0
3888	LORENZA CAFETERIA, INC.	GDO	6742	4850 NW 2 AVE	244
3889	NOA CATERING, INC.	GDO	6743	2711 NE 2 AVE	650
3890	CARY BAKERY, INC.	GDO	6744	1849 NW 21 ST	0
3891	DON TOSTON, INC.	GDO	6745	2234 NW 17 AVE	700
3892	FOOD AT ALL NATIONS, INC. DBA SARAH'S TENT	GDO	6749	3565 NE 207 ST A1	183
3893	MISHA'S CUPCAKES, INC.	GDO	6750	1548 S DIXIE HWY	249
3894	AMARO FOODS ENTERPRISES, INC.	GDO	6752	2180 NW 19 AVE	0
3895	MOLINAS RANCH RESTAURANT & BANQUET HALL	GDO	6753	4090 E 8 AVE	3,850
3896	YUGA RESTAURANT, INC.	GDO	6754	355-357 ALCAZAR AVE	1,225
3897	LUNA ASIA ENTERPRISES, LLC DBA ASIA BAY RESTAURANT	GDO	6755	1007 KANE CONCOURSE	1,350
3898	POLO NORTE PSN, INC. DBA POLO NORTE PIZZA	GDO	6756	8531 NW 186 ST	263
3899	CHOCOLATE FASHION, INC.	GDO	6757	2606-08 NW 21 TER	375
3900	NEW STAR FISH DEPOT, LLC	GDO	6759	47 NW 79 ST	825
3901	SUBWAY 26209, INC.	GDO	6761	6815 BISCAYNE BLVD 104	350
3902	MOZART CAFE SUNNY ISLES, INC. DBA MOZART CAFE & CONVENIENCE	GDO	6762	18110 COLLINS AVE	875
3903	KITCHEN GRILL CORP.	GDO	6764	8444 SW 8 ST	280
3904	G & L CREAMERY, INC. DBA COLD STONE CREAMERY	GDO	6765	14226 SW 8 ST	0
3905	PALM FOOD STORE, INC.	GDO	6766	17851 NW 78 AVE	0
3906	MACY'S FLORIDA STORES, LLC DBA MACY'S TASTE BAR	GDO	6769	9100 SW 136 ST	1,150
3907	PAN GOLD, LLC DBA DON PAN INTERNATIONAL BAKERY	GDO	6771	4179 NW 107 AVE	420
3908	EL FRIJOLITO, INC. DBA LAGUNA STADIUM RESTAURANT	GDO	6774	2500 NW 10 AVE	500
3909	KIDDIE CORNER ACADEMY	GDO	6775	7640 NW 186 ST	13
3910	PALMAR CAFETERIA	GDO	6776	6927 NW 77 AVE	675
3911	INARI SUSHI FUSION, LLC	GDO	6777	15672 SW 72 ST	252
3912	JARAGUA RESTAURANT, INC. DBA JARAGUA RESTAURANT LIQUORS LOUNGE	GDO	6778	1298 NW 29 ST	500
3913	LATIN FLAVORS ENTERPRISE, INC. DBA LATIN FLAVORS	GDO	6779	4801 NW 128 ST	0
3914	OMAR SEAFOOD MARKET & CAFETERIA	GDO	6781	2111 NW 10 AVE	600
3915	DORAL ISLES STATION - CHICK N GRILL/EL AREPAZO	GDO	6783	10191 NW 58 ST	560
3916	DELICIAS EXPRESS, INC.	GDO	6784	1031 NW 23 ST	263
3917	HIGH TOP PRODUCTS CORP.	GDO	6785	1034 NW 23 ST	1,875
3918	BONEFISH GRILL, LLC DBA BONEFISH GRILL #7022	GDO	6786	14218 SW 8 ST	5,000
3919	POLLO OPERATIONS, INC. DBA POLLO TROPICAL #72	GDO	6787	14150 SW 8 ST	800
3920	VERY TASTY, LLC	GDO	6791	2177 NW 24 CT	503
3921	SOUTHLAND SUBWAY, LLC DBA SOUTHLAND SUBWAY	GDO	6792	21627 S DIXIE HWY	112
3922	SOUTHERN SNACK, INC.	GDO	6793	20320-22 NE 16 PL	1,495
3923	DAVID'S FOOD & FUN, INC. DBA DIXIE CATERING	GDO	6795	12222 SW 132 CT 19	0
3924	EL CORTIJO CAFE	GDO	6800	714 NW 22 ST	75
3925	FRIENDS OF LUBAVITCH OF FLORIDA	GDO	6802	1140 ALTON RD	50
3926	PRODUCTOS DE NICARAGUA, INC. DBA DELICIAS DE NICARAGUA	GDO	6803	6900 W 32 AVE #5	216
3927	JELUJO, INC. DBA QUIZNO'S SUBS	GDO	6804	7100 SW 40 ST	275
3928	VIGOA ENTERPRISES, LLC DBA SUBWAY #32900	GDO	6805	15707 SW 56 ST	140
3929	WHITE STAR, LLC DBA WHITE STAR CAFE	GDO	6806	7188 SW 47 ST	450
3930	CG RYC, LLC	GDO	6807	401 SW 3 AVE	2,718
3931	SALMA INTERNATIONAL, INC. DBA SUBWAY #32286	GDO	6808	18731 BISCAYNE BLVD #A	0
3932	PRIMO PIZZA, INC.	GDO	6809	100 COLLINS AVE #1	425
3933	SUBRAGEOUS BIRD RD, INC. DBA SUBRAGEOUS	GDO	6810	8752 SW 40 ST	425
3934	NOSNAWS CORP. DBA IHOP #36-158	GDO	6811	5175 NW 36 ST	3,150
3935	F & G THAI RESTAURANT HOLDINGS, LLC DBA THAI RAMA SUSHI	GDO	6815	61 CURTISS PKY	500
3936	LACOF CORPORATION DBA RANCHUELO COFFEE SHOP	GDO	6816	12948 SW 87 AVE	210
3937	STOP AND SHOP FOOD STORE (HOT STUFF PIZZA/BOAR'S HEAD)	GDO	6817	5665 NW 36 ST	0
3938	BARNARD NUT COMPANY DBA NUTS ABOUT FLORIDA	GDO	6819	2801 NW 125 ST	0
3939	STRIKE MIAMI, LLC	GDO	6820	11401 NW 12 ST E-624	5,375
3940	RUENGVIRESH, INC. DBA THAI CAFE	GDO	6821	6845 MAIN ST	1,625
3941	SELEH, INC. DBA 207 QUICK STOP	GDO	6822	3175 NW 207 ST	0
3942	LA CASA DEL PAN CON PAN, LLC	GDO	6824	4960 NW 165 ST BAY 7	925
3943	Z CAPITAL FLORIDA RESORT, LLC DBA CARILLON HOTEL & SPA	GDO	6825	6801 COLLINS AVE	0
3944	GRAND AVE ENTERPRISES, LLC	GDO	6828	3135 GRAND AVE FAC. A	550
3945	PING HOUSE CHINESE RESTAURANT	GDO	6829	5315 NW 36 ST	1,500
3946	NORDSTROM, INC. DBA NORDSTROM-CAFE BISTRO	GDO	6831	7239 SW 88 ST	1,850
3947	AJC PROJECTS, LLC DBA THE COFFEE PLACE	GDO	6832	7535 SW 88 ST K-118	49
3948	CORAL REEF OPERATING, LLC DBA CORAL REEF NURSING	GDO	6835	9869 SW 152 ST	2,400
3949	FRITANGA MONIMBO, INC. DBA FRITANGA MONIMBO AIRPORT	GDO	6837	4441 NW 36 ST	620
3950	BELKIS @ FAMILY CORP. DBA MAMA DOLORES CAFETERIA	GDO	6840	1100 ALI BABA AVE	250
3951	PIREAS, INC. DBA AIRPORT DINER	GDO	6841	4545 NW 36 ST	2,475
3952	AIRPORT CAFE & LIQUORS	GDO	6842	4427 NW 36 ST	750
3953	HARVEST MOON GOURMET FOOD EMPORIUM	GDO	6843	102 CURTISS PKY	750
3954	RUBY TUESDAY, INC. DBA RUBY TUESDAY #7734	GDO	6844	15281 NW 67 AVE	6,400
3955	DIVERSE VENTURE OF MIAMI, INC. DBA COLD STONE CREAMERY #1450	GDO	6846	8448 SW 8 ST	0
3956	MENENDEZ MANAGEMENT CORP. DBA MCDONALD'S #2740	GDO	6847	4999 NW 36 ST	670
3957	CHECKERS DRIVE-IN RESTAURANTS, INC. DBA CHECKERS #C-312	GDO	6848	2645 NW 183 ST	476
3958	WORLDWIDE CONCESSIONS AIR, LLC DBA BURGER KING PIZZA HUT	GDO	6850	GATE F-9 CC-F	90
3959	GREAT BEGINNINGS SERVICES CORP. DBA LA CORIANA	GDO	6853	3655 NW 107 AVE 105	300
3960	JAE MIAMI DADE, LLC DBA WENDY'S #9823	GDO	6854	14180 SW 8 ST	788

No.	FACILITY_NAME	PERMIT	PERMIT_NUMBER	ADDRESS	TOTAL_GPD
3961	LA TINAJITA CAFE	GDO	6855	13690 SW 142 AVE 29	725
3962	ELBA INTERNATIONAL AVENTURA, INC. DBA CHARLEY'S GRILLED SUBS	GDO	6856	19501 BISCAYNE BLVD 1397	0
3963	KATTOURA, INC. DBA VALERO OF MIAMI	GDO	6858	3201 NW 36 ST	0
3964	THE FRESH MARKET, INC.	GDO	6860	2640 S BAYSHORE DR	0
3965	KR BROTHERHOOD LLC DBA MUNCHY'S PIZZA AND WINGS	GDO	6864	1608 NE 183 ST	55,875
3966	HEARTLAND-MIAMI LAKES OF HIALEAH FL, LLC	GDO	6866	5725 NW 186 ST	0
3967	YGLASIAS CUBAN CAFE CORP.	GDO	6868	10641 SW 88 ST 7A	1
3968	CARMELA DESSERTS, LLC	GDO	6869	735 E 10 ST	250
3969	HEARA, INC.	GDO	6871	19595 NE 10 AVE G	1,600
3970	STARBUCKS COFFEE COMPANY, INC. DBA STARBUCKS #8866	GDO	6872	17760 NW 57 AVE BLDG A	364
3971	ST. HUGH CATHOLIC SCHOOL	GDO	6873	3460 ROYAL RD	0
3972	CIBO WINE BAR, LLC	GDO	6874	45 MIRACLE MILE	1,782
3973	KEY LARGO FISH MARKET, INC.	GDO	6876	564 HIALEAH DR	350
3974	TROPICAL BAKERY DISTRIBUTOR CORP.	GDO	6877	524 HIALEAH DR	420
3975	FAROFA NORTH MIAMI CORP.	GDO	6878	14691 BISCAYNE BLVD	897
3976	KMH PIRATES/JIMMY JOHNS #971	GDO	6881	45 W FLAGLER ST	280
3977	JAE MIAMI DADE, LLC DBA WENDY'S #9248	GDO	6884	14715 SW 42 ST	763
3978	RAW REPUBLIC BISCAYNE COMMONS, LLC DBA RAW REPUBLIC	GDO	6885	14871 BISCAYNE BLVD #412	215
3979	HIALEAH DRIVE CITGO	GDO	6886	50 SE 8 AVE	28
3980	RANSOM EVERGLADES SCHOOL	GDO	6887	3575 MAIN HWY	0
3981	RANSOM EVERGLADES SCHOOL FOR GIRLS	GDO	6888	2045 S BAYSHORE DR	0
3982	MNDM CORP. DBA BRYSON'S	GDO	6889	3790 CURTISS PKY	1,250
3983	ASIAN FUSION, INC.	GDO	6890	17043 S DIXIE HWY	875
3984	ST JOHN THE APOSTLE SCHOOL	GDO	6891	479 E 4 ST	250
3985	ARTEAGA CORP. DBA PIZZA CAPRESA	GDO	6893	12150 SW 131 AVE 1	0
3986	JAGUAR CEVICHE SPOON BAR & LATAM GRILL	GDO	6894	3067 GRAND AVE	1,250
3987	CALVANO FOODS, INC. DBA BURRITOVILLE	GDO	6896	1 CURTISS PKY BAY 4	750
3988	SSC340018, LLC DBA DUNKIN DONUTS #340018	GDO	6898	12930 SW 120 ST	528
3989	BUENAVISTA INVESTMENT HOLDING, LLC DBA GAVANNA MIAMI	GDO	6901	10-28 NE 40 ST	913
3990	SOUTH BEACH ASSOCIATES, LLC DBA ATLANTIC BAR & GRILL	GDO	6902	1024 OCEAN DR	2,475
3991	FORTUNE INN CORP. DBA FORTUNE COOKIES RESTAURANT	GDO	6905	640 6 ST	0
3992	GOCELI, INC. DBA HAAGEN-DAZS ICE CREAM SHOPPE	GDO	6912	424 LINCOLN RD	0
3993	17 & DIXIE UNION 76, INC.	GDO	6914	2465 SW 17 AVE	0
3994	WARD TOWERS ASSISTED LIVING FACILITY	GDO	6916	5301 NW 23 AVE	3,980
3995	BLUE LAMB CUISINE, INC.	GDO	6917	3138 SW 22 ST	1,575
3996	WILLIAM A KIRLEW JR. ACADEMY	GDO	6918	18900 NW 32 AVE	0
3997	HOST TINSLEY JOINT VENTURE, INC. DBA STARBUCK FOOD COURT	GDO	6920	FOOD CT. CC-E	184
3998	ARLINE'S SEAFOOD REST. #1, INC. DBA ARLINE'S BBQ AND CRAB SHACK	GDO	6921	16650 NW 27 AVE #300	376
3999	EL RANCHO GRANDE MEXICAN RESTAURANT KENDALL, INC.	GDO	6925	12881 SW 88 ST	900
4000	RYDER SYSTEM, INC. - RYDER SYSTEM HEADQUARTERS CAFE	GDO	6926	11690 NW 105 ST	6,250
4001	MEI CHANG & CLASSIC CHICKEN	GDO	6927	546 HIALEAH DR	0
4002	PRIME 112, LLC DBA PRIME 112 RESTAURANT/BROWNS HOTEL	GDO	6928	112 OCEAN DR	2,200
4003	GIANELLA'S CORP. DBA EL TAMBO GRILL	GDO	6931	12861 SW 88 ST	250
4004	STARBUCKS COFFEE COMPANY, INC. DBA STARBUCKS #10550	GDO	6932	7840 NW 25 ST	616
4005	SUBWAY 52528, INC. DBA SUBWAY #52528	GDO	6933	10201 HAMMOCKS BLVD #135	400
4006	ARA FOOD CORPORATION	GDO	6934	8029-31 NW 60 ST	0
4007	THE SUSHI SPOT, LLC DBA OBBA SUSHI AND MORE	GDO	6936	2525 PONCE DE LEON BLVD #110	766
4008	LA GUELAGETZA MEAT MARKET	GDO	6938	501 W PALM DR 101-102	0
4009	UNIQUE CUISINES, INC.	GDO	6939	13350 NW 27 AVE	278
4010	TANIA RESTAURANT, INC.	GDO	6941	944 HIALEAH DR	1,075
4011	REGAL CINEMAS, INC.	GDO	6942	8595 SW 124 AVE	47,082
4012	EUREKA SUBWAY #26355, INC.	GDO	6943	11100 SW 184 ST	336
4013	WEN-SOUTH HOLDINGS, INC. DBA WENDY'S #9325	GDO	6947	7555 NW 12 ST	1,008
4014	LISBER CATERING, INC.	GDO	6949	12949 N OKEECHOBEE RD C-2	0
4015	JIM & PETER, INC. DBA MIAMI SUBS EXPRESS	GDO	6950	4320 NW 167 ST	504
4016	PANERA, LLC DBA PANERA BREAD #983	GDO	6954	13617 S DIXIE HWY #127	3,350
4017	VENAMEM CORP. DBA ALHAMBRA STATION CAFE	GDO	6957	255 ALHAMBRA CIR	1,250
4018	WELLNESS & HEALTHY COMPANY, LLC DBA LE TARTINE DI TERESA	GDO	6962	94 MIRACLE MILE	198
4019	TALAVERA CORAL GABLES, LLC	GDO	6966	2271-99 PONCE DE LEON BLVD	1,350
4020	BUGATTI THE ART OF PASTA, INC.	GDO	6967	2504 PONCE DE LEON BLVD	1,625
4021	SHANNON COOKS, INC. DBA FRENCHIES AMERICAN FOOD	GDO	6968	2618 GALIANO ST	450
4022	THE PATTY PLACE, INC.	GDO	6969	19547 NW 2 AVE	0
4023	STATE OF FLORIDA DEPT OF TRANSPORTATION-DISTRICT 6	GDO	6970	1000 NW 111 AVE	13
4024	AYINTOVE ASSOCIATES, LLC DBA HARMONY HEALTH CENTER	GDO	6971	9820 N KENDALL DR	4,060
4025	IGLESIA BAUTISTA GETSEMANI, INC.	GDO	6972	5298 NW 7 ST	750
4026	FORTH OF JULY, LLC DBA HEALTHY ROUTE 66 CORAL GABLES	GDO	6973	1831 PONCE DE LEON BLVD	475
4027	DORAL STATION CORP. DBA CITGO	GDO	6977	9690 NW 25 ST	700
4028	MYLOS RESTAURANT @ BEST WESTERN CHATEAUBLEAU HOTEL	GDO	6978	1111 E PONCE DE LEON BLVD	2,750
4029	MADLYN'S CAKES	GDO	6979	40 W 49 ST	0
4030	TINI & MIMO CORPORATION DBA CARIBBEAN CAFE	GDO	6980	1421 NE 163 ST #1442	205
4031	MARVEL BANQUET HALL, INC.	GDO	6981	2717 SW 142 AVE	1,155
4032	CLINIC SUPPLY CORP.	GDO	6982	12254 SW 131 AVE 2	0
4033	EDEN IN EDEN, LLC	GDO	6983	1248 SW 22 ST #4	211
4034	SU SHIN IZAKAYA	GDO	6984	159 ARAGON AVE	3,250
4035	CAFETERIA TONITA	GDO	6985	1625 PALM AVE	238
4036	MS. CHEEZIOUS, INC.	GDO	6986	1915 PONCE DE LEON BLVD	450
4037	HIRO'S SUSHI EXPRESS	GDO	6989	1518 WASHINGTON AVE	750
4038	LAS TAPAS DE ROSA	GDO	6990	449 SW 8 ST	250
4039	VIOLINES BANQUET HALL CORP.	GDO	6991	10550 NW 77 CT #415	2,250
4040	THE GRIND HOSPITALITY GROUP, LLC DBA BATCH GASTROPUB	GDO	6993	30 SW 12 ST	1,215
4041	WAL-MART STORES EAST, LP DBA WAL-MART SUPERCENTER #1680	GDO	6997	15885 SW 88 ST	4,084
4042	POMODORO PIZZA SUBS AND MORE II CORP. DBA POMODORO PIZZA	GDO	7000	2413 GALIANO ST	150
4043	AR VISIONS, LLC DBA EUROPA DELICATESSE DELI & GOURMET MARKET	GDO	7001	425 WASHINGTON AVE	390
4044	COLD STORAGE ASSOCIATES	GDO	7003	500 NE 185 ST	0
4045	BENCHMARK HOSPITALITY DBA MANERAS RESORT	GDO	7005	18683 COLLINS AVE	4,000
4046	AMERICANA RESTAURANT @ RITZ CARLTON HOTEL	GDO	7007	1 LINCOLN RD	2,000
4047	LITTLE BEACH RESTAURANT @ RITZ CARLTON HOTEL	GDO	7008	1 LINCOLN RD	3,000
4048	PHYSICAL NATURAL AND HEALTHY, LLC DBA NATURAL CHICKEN GRILL	GDO	7009	5628 NW 167 ST	450

No.	FACILITY_NAME	PERMIT	PERMIT_NUMBER	ADDRESS	TOTAL_GPD
4049	FLORIDA CHRISTIAN SCHOOL	GDO	7011	4200 SW 89 AVE	136
4050	BAIRES GRILL, LLC DBA BAIRES GRILL SIDEWALK CAFE	GDO	7013	1116 LINCOLN RD	574
4051	BJ'S WHOLESale CLUB, INC. DBA BJ'S WHOLESale CLUB #170	GDO	7014	650 SE 8 ST	350
4052	LA MARGARITA CORPORATION DBA MARGARITA'S RESTAURANT	GDO	7015	1385 PALM AVE	425
4053	JAMAICA HOUSE RESTAURANT, INC.	GDO	7020	19555 NW 2 AVE	1,250
4054	AKM 5425, LLC DBA LA MAS BARATA SUPERMARKET DISCOUNT	GDO	7021	5425 W 20 AVE	738
4055	RICE HOUSE OF KABOB, LLC	GDO	7022	1318 ALTON RD	600
4056	GOLD KOSHER CATERING, INC.	GDO	7024	19593 NE 10 AVE BAY C&D 4	0
4057	GSIVE, LLC	GDO	7026	337 NW 170 ST	2,500
4058	FLOWERS BAKING COMPANY OF MIAMI, LLC	GDO	7028	17800 NW MIAMI CT	0
4059	UNITED WAY MIAMI DADE, INC. DBA THE CENTER FOR EXCELLENCE, LLC.	GDO	7029	3250 SW 3 AVE	144
4060	CARINO'S DORAL, LLC DBA JOHNNY CARINO'S	GDO	7030	8240 NW 36 ST	6,000
4061	SENA, INC. DBA ICHIBAN JAPANESE BUFFET	GDO	7032	10832 NW 58 ST	814
4062	INNER FUELED, LLC	GDO	7034	7415 NW 54 ST	800
4063	ROCA MIR, INC. DBA BAHIA HONDA FISH MARKET & GROCERY	GDO	7037	10670 SW 24 ST	438
4064	DAVIDSON HOTEL COMPANY, LLC DBA HOTEL COLONNADE CORAL GABLES	GDO	7038	180 ARAGON AVE	375
4065	ALIF FOOD, INC. DBA DHAKA BAZAR	GDO	7039	16762 NE 5 AVE	425
4066	CARIBBEAN KITCHEN 305, LLC	GDO	7048	762 NW 183 ST	339
4067	LITTLE CAESAR'S ENTERPRISES, INC. DBA LITTLE CAESAR'S PIZZA #2288	GDO	7051	3715 W FLAGLER ST	350
4068	MIAMI SHORES NURSING & REHABILITATION CENTER	GDO	7052	9380 NW 7 AVE	1,900
4069	LEEVERS SUPERMARKETS, INC. DBA SAVE-A-LOT	GDO	7053	8890 NW 7 AVE	0
4070	NUEVA SAN SALVADOR RESTAURANT CAFE CORP.	GDO	7054	2500 NW 20 ST	350
4071	DIEGOOS, INC. DBA BOCAITO CAFE AND DELI	GDO	7055	1801 SW 22 ST #110	384
4072	KEMP CAPITAL CORP. DBA SCORE	GDO	7060	1437-39 WASHINGTON AVE	3,375
4073	CATARSIS, INC.	GDO	7065	3717 SW 8 ST	1,250
4074	PUBLIX SUPERMARKETS, INC. DBA PUBLIX STORE #1108	GDO	7066	20201 SW 127 AVE	0
4075	MERCEDES OF MIAMI, LLC DBA LAS MERCEDES RESTAURANT	GDO	7067	10505 NW 112 AVE #4	700
4076	COCINA LATINA, LLC	GDO	7069	2298 W 78 ST	0
4077	GREAT WALL ZHENG, LLC DBA GREAT WALL	GDO	7071	20111 SW 127 AVE	338
4078	ECOLOGIC ENTERPRISES, INC.	GDO	7073	6795 W 4 AVE	0
4079	FRAIOLI & ASSOCIATED, LLC DBA LA CREMA DE LA EMPANADAS	GDO	7075	7800 NW 25 ST 16	140
4080	DREAM LIGHT, LLC DBA JASMINE SUSHI & THAI CUISINE	GDO	7079	1429 SW 107 AVE	600
4081	NEIGHBORHOOD GAS & CONVENIENCE INC. DBA OPA-LOCKA CHEVRON	GDO	7085	13715 NW 22 AVE	950
4082	DEVALAI, LLC DBA SILVER SPOON THAI & SUSHI	GDO	7086	15352 NW 79 CT	1,050
4083	FRITANGA MONIMBO FONTAINEBLEAU, INC.	GDO	7087	9622 FONTAINEBLEAU BLVD	336
4084	KINGSTON DELIGHT RESTAURANT & GROCERY/MEAT	GDO	7088	1340-1342 NE 163 ST	250
4085	NEW RIVIERA NURSING & REHABILITATION CENTER, LLC.	GDO	7089	6901 YUMURI ST	58
4086	LE POULET CHIC, LLC	GDO	7090	1362 NE 163 ST	188
4087	MIAMI-DADE PARKS & RECREATION DBA COUNTRY VILLAGE PARK	GDO	7091	6550 NW 188 TER	0
4088	LEFAB MANUFACTURE, LLC DBA MORELIA GOURMET PALETAS	GDO	7094	76 MIRACLE MILE	234
4089	CLASSIC CLUB BANQUET HALL	GDO	7095	3838 W 16 AVE	0
4090	RED BASE, INC. DBA SHEILA'S CARIBBEAN BAKERY & REST.	GDO	7096	20725-27 NW 2 AVE	230
4091	POLLO OPERATIONS, INC. DBA POLLO TROPICAL #66	GDO	7097	3094 NE 41 TER	1,064
4092	PIMIENTO RESTAURANT, INC.	GDO	7099	16403 NW 67 AVE	112
4093	ATLANTA RESTAURANT PARTNERS, LLC DBA TGI FRIDAY'S #0427	GDO	7104	14891 BISCAYNE BLVD	1,701
4094	INVECAM, LLC DBA FRESH PASTA	GDO	7105	27 N MIAMI AVE #106	188
4095	NUNO DOLPHIN MALL, INC. DBA ROTELLI PIZZA AND PASTA	GDO	7107	11401 NW 12 ST E-500	2,142
4096	E.C. MANAGEMENT CORPORATION DBA MCDONALD'S #7135	GDO	7110	8050 NW 27 AVE	1,428
4097	CHI SEAFOOD, LLC DBA 1826 RESTAURANT & LOUNGE	GDO	7111	1826 COLLINS AVE	2,162
4098	DJ TUNA EXPRESS, INC.	GDO	7112	2265 W 9 AVE #3-4	0
4099	YOUR CAKE BOUTIQUE, INC.	GDO	7115	13307 SW 42 ST	230
4100	BUTTERCREAM CUPCAKES & COFFEE, INC.	GDO	7119	1411 SW 72 ST	99
4101	SMOOTHIE KING CO. INC. DBA SMOOTHIE KING #962	GDO	7120	2001 BISCAYNE BLVD #107	380
4102	SUSHI CAFE II, INC.	GDO	7123	3301 NE 1 AVE #107	374
4103	BIG TIME EQUIPMENT, INC. DBA ICE PALACE	GDO	7125	71 NW 14 ST	3,000
4104	LLAM GROUP, LLC DBA SEMILLA EATRY & BAR	GDO	7126	1330 ALTON RD	449
4105	NEW GENERATION FOOD MARKET	GDO	7127	7910 NW 22 AVE	0
4106	CEDARS OIL BLUE LAGOON, LLC	GDO	7128	5100 NW 7 ST	625
4107	FOOD BY CHEF LARS, INC.	GDO	7129	7056 SW 44 ST	350
4108	JOHNSON RESTAURANT	GDO	7130	5930 NW 17 AVE	750
4109	LINCOLN TOBACCO, INC. DBA LINCOLN RD TOBACCO	GDO	7131	414 LINCOLN RD	420
4110	LOS MARTIN CAFETERIA RESTAURANT	GDO	7133	1636 W 33 PL	750
4111	MAYSA, INC. DBA JUGGLER'S SUPERMARKET	GDO	7137	1949 NW 62 ST	0
4112	STARBUCKS COFFEE COMPANY, INC. DBA STARBUCKS #13007	GDO	7140	601 LINCOLN RD	600
4113	EVENTS BY BEA CORP.	GDO	7146	2753 SW 142 AVE	325
4114	LA MINA RESTAURANT CORP.	GDO	7148	8302 NW 103 ST 101	200
4115	WZ TRADING GROUP CORP. DBA WILLIAM'S FOOD MARKET	GDO	7150	1298 NW 62 ST	700
4116	MI BUEN GUSTO BAKERY AND CAFETERIA, LLC	GDO	7153	5667 NW 195 DR	213
4117	LATIN HIALEAH GARDENS RESTAURANT CORP.	GDO	7155	9160 NW 122 ST 1-5	2,100
4118	MCDONALD'S @ WALMART SUPERCENTER #3235	GDO	7156	1425 NE 163 ST FAC. B	616
4119	WAL-MART STORES EAST, LP DBA WAL-MART SUPERCENTER #3235	GDO	7157	1425 NE 163 ST	0
4120	MI SABOR LATINO, INC.	GDO	7162	4275 SW 73 AVE	700
4121	SUBRAGEOUS CUTLER RIDGE, INC.	GDO	7163	19100 SW 106 AVE 1	625
4122	ROBERT & RICK, INC. DBA VINCENT'S BAKERY	GDO	7164	10906 SW 184 ST	293
4123	BEST BROTHERS FOOD, INC. DBA TOTAL FOODS	GDO	7165	7777 NW 17 AVE	0
4124	GAMMA SEAFOOD CORPORATION	GDO	7167	7850 NW SOUTH RIVER DR	0
4125	IRON SUSHI, LLC	GDO	7168	16350 W DIXIE HWY	375
4126	SAND Q CORPORATION DBA SANDWICH QBANO	GDO	7169	110 WASHINGTON AVE CU-9	580
4127	HOST TINSLEY JOINT VENTURE DBA QUIZNO'S CC H	GDO	7170	H-12\14 CC-H	184
4128	ANL KANAAN, LLC DBA KABOBI	GDO	7177	3055-61 NE 163 ST	1,000
4129	NQC MIAMI, LLC	GDO	7179	6189 MIAMI LAKES DR	145
4130	JOE'S MARKET, INC.	GDO	7181	2190 NW 46 ST	0
4131	POP'S PIZZA	GDO	7182	3623 NW 36 ST	0
4132	NOVIO'S CAFE CORP.	GDO	7183	2692 PALM AVE	388
4133	SUBWAY 30976 OF DADE COUNTY, INC. DBA SUBWAY #30976	GDO	7184	2350 W 84 ST A	112
4134	MCDONALD'S CORP. DBA MCDONALD'S #7768	GDO	7186	330 W 29 ST	1,456
4135	LA GRAN PARADA DOMINICANA RESTAURANT, INC.	GDO	7187	7503 NW 32 AVE	500
4136	LP HOMESTEAD, LLC DBA BROOKWOOD GARDENS CONVALESCENT CENTER	GDO	7188	1990 S CANAL DR	2,400

No.	FACILITY_NAME	PERMIT	PERMIT_NUMBER	ADDRESS	TOTAL_GPD
4137	TOWN & COUNTRY SUBWAY, INC. DBA SUBWAY #30975, INC./DBA SUBWAY	GDO	7191	8352 MILLS DR	280
4138	CHARANGA CATERING, LLC DBA LOS VINALEROS II	GDO	7192	233 W 28 ST	35,000
4139	KIDDIE CORNER PRESCHOOL, INC. DBA EARLY YEARS ACADEMY	GDO	7194	17790 NW 78 AVE	134
4140	UTOPIA BANQUET HALL, LLC	GDO	7196	7911 NW 72 AVE 222-A	1,250
4141	UMG RESTAURANT GROUP, LLC DBA MIAMI GRILL SOUTH BEACH	GDO	7201	1541 WASHINGTON AVE	350
4142	LC'S FAST FOOD JOINT, INC.	GDO	7202	19505 NW 2 AVE	280
4143	FIVE SONS CAFE CORP.	GDO	7206	5828 NW 22 AVE	116
4144	MULTI NATIONAL BUSINESS LINK, INC. DBA SUBWAY	GDO	7208	4100 NW 27 AVE	140
4145	TACO BELL OF AMERICA, LLC DBA TACO BELL #028507	GDO	7209	11890 HIALEAH GARDENS BLVD	639
4146	FINETRA, LLC DBA PIOLA	GDO	7210	1250 S MIAMI AVE 2 & 3	788
4147	WAL-MART STORES EAST, LP DBA WAL-MART SUPERCENTER #3397	GDO	7212	17650 NW 2 AVE	0
4148	POLLO OPERATIONS, INC. DBA POLLO TROPICAL #89	GDO	7214	19700 NW 27 AVE	1,316
4149	ANGEL'S CAFETERIA, INC.	GDO	7218	3677 NW 50 ST	1,075
4150	BULLDOG BBQ, LLC	GDO	7219	15400 BISCAYNE BLVD 106 & 107	325
4151	OPEN RICE, INC. DBA RICE BUCKET	GDO	7220	15364 NW 79 CT	300
4152	MARWA, INC. DBA DOLPHINE SUPERMARKET	GDO	7221	2352 NW 46 ST	500
4153	BC 210, LLC	GDO	7224	13725 SW 152 ST	404
4154	TAIKI, LLC DBA SAKE ROOM EXPRESS DORAL	GDO	7225	3655 NW 107 AVE 104	300
4155	SUCULENTOS MIAMI CORP. DBA SUCULENTOS	GDO	7226	14256 SW 8 ST #27	365
4156	ARLENE'S SEAFOOD RESTAURANT, INC.	GDO	7227	2770 NW 167 ST	875
4157	CAFFE CAPPUCCINO, INC.	GDO	7231	6335 NW 99 AVE # 36	75
4158	MIAMI GARDENS SQUARE ONE, INC. DBA TOOTSIES CABARET	GDO	7235	150 NW 183 ST #100	2,226
4159	CHINA FUN J OF NARANJA, INC.	GDO	7237	27423 S DIXIE HWY	300
4160	BJ'S WHOLESALE CLUB, INC. DBA BJ'S WHOLESALE CLUB #179	GDO	7244	16200 SW 88 ST	0
4161	LA ESQUINA DEL LECHON, LLC	GDO	7245	8601 NW 58 ST #101	175,250
4162	J & I CAFE CORP. DBA LATIN CAFE ON THE BEACH	GDO	7246	7445 COLLINS AVE	2,075
4163	CHIPOTLE MEXICAN GRILLE OF COLORADO, LLC DBA CHIPOTLE #1203	GDO	7248	8000 NW 154 ST	2,300
4164	COLLINS & 74 STREET CORP. DBA M & L FOOD MARKET	GDO	7249	7446 COLLINS AVE	1,250
4165	MGDT, LLC DBA LAGNIAPPE	GDO	7250	3425 NE 2 AVE	288
4166	EL AHORRO SUPERMARKET CORP.	GDO	7253	1880-90 PALM AVE	1,375
4167	NIDO CAFFE 2015, LLC DBA NIDO MOZZARELLA BAR	GDO	7254	7295 BISCAYNE BLVD	313
4168	STARBUCKS COFFEE COMPANY, INC. DBA STARBUCKS #9699	GDO	7259	12512 SW 120 ST	0
4169	TERRYMAX SNACK BAR	GDO	7261	141 NE 1 ST	650
4170	TRATORIA DI PIU CORPORATION	GDO	7262	2475 NW 95 AVE #9	309
4171	TAMARINA RESTAURANTS, LLC	GDO	7263	600 BRICKELL AVE #125	1,804
4172	VICKY BAKERY KENDALL, INC.	GDO	7264	12300 SW 127 AVE #1	600
4173	ZATE-OU-ZATAR, INC. DBA AL'S COFFEE SHOP	GDO	7265	2121 PONCE DE LEON BLVD #120	325
4174	SABORES CAFE, INC.	GDO	7266	9136 NW 25 ST	750
4175	F & M CAFETERIA, INC.	GDO	7267	12085 W OKEECHOBEE RD	672
4176	K'CHAPAS, INC.	GDO	7268	5209 NW 79 AVE	150
4177	MILANO PIZZA CAFE, LLC	GDO	7270	2195 NE 163 ST #6	359
4178	GLOBAL WING CORP. DBA WING STOP RESTAURANT	GDO	7273	12528 SW 120 ST	392
4179	SHALIMAR CORPORATION DBA SUBWAY SANDWICH SHOP	GDO	7274	9536 HARDING AVE	252
4180	SUN & SEAFOOD SERVICE INC. PLUS DBA HOUSE CAFE & DELI	GDO	7276	9 ISLAND AVE MEZZ	1,575
4181	ESPECIALIDADES ORIENTALES CORP. DBA SALON CANTON RESTAURANT	GDO	7277	9668-70 NW 25 ST	335
4182	RESTAURANTS & BEVERAGE OPERATOR LOS CEDROS, LLC DBA OGGI CAFFE	GDO	7278	1666 79 ST #102	750
4183	EL VALLE BBQ, INC.	GDO	7279	8108 NW 103 ST #122	630
4184	SHANNA, INC. DBA CHINA DELIGHT	GDO	7280	13911 SW 42 ST #111	365
4185	KMH MING RULERS, LLC DBA JIMMY JOHN'S # 971	GDO	7281	125 MIRACLE MILE	850
4186	DUKE OF RUSSELL, LLC DBA THE SEVEN DIALS	GDO	7282	2030 SW 37 AVE #102	291
4187	ZKJ BUSINESS, INC. DBA JERRY'S SUBS & PIZZA	GDO	7283	9160 NW 122 ST #20	170
4188	SUBGIRL CORP. DBA SUBWAY #25213	GDO	7285	7800 NW 25 ST #14	280
4189	CHEEN-HUAYE, INC. DBA SOUTHERN MEXICAN CUISINE	GDO	7286	15400 BISCAYNE BLVD #118	850
4190	ONE STOP FOOD PLUS, LLC	GDO	7292	1274 NW 62 ST	450
4191	CONCH TOWN USA, INC.	GDO	7293	3637 NW 17 AVE	0
4192	ORLINDA'S RESTAURANT	GDO	7294	1047 E 28 ST	750
4193	LAS DELICIAS CAFE, INC.	GDO	7297	8725 NW 117 ST #12-13	280
4194	MEATS SUPERMARKET AND MORE, LLC	GDO	7300	9160 NW 122 ST #35-42	850
4195	JPJE CORP. DBA BOLIVAR RESTAURANT	GDO	7301	841 WASHINGTON AVE	225
4196	FREEDOM OIL STATION, INC. (TAKE-OUT DELI)	GDO	7302	22295 S DIXIE HWY	0
4197	LA AMERICA FOOD DELIVERY, INC.	GDO	7303	468 E 25 ST	2
4198	MEAT PLACE PLUS, INC.	GDO	7304	11108 SW 184 ST	0
4199	AN RESTAURANT, INC.	GDO	7307	14240 SW 8 ST	438
4200	STRATEGIC SUBS CORP. DBA SUBWAY GALLOWAY	GDO	7308	8686 NW 13 TER	280
4201	HEALTHY & TASTY VENTURES, LLC DBA GRILLIT	GDO	7309	5799 NW 7 ST	560
4202	LATIN MIX RESTAURANT & CAFETERIA, INC.	GDO	7311	11368 SW 184 ST	803
4203	FLORIDA, INC. DBA SHELL	GDO	7313	1025 HIALEAH DR	350
4204	HALF MOON EMPANADAS, LLC	GDO	7315	860 NE 79 ST #C	250
4205	PIZZERIAS, LLC DBA PAPA JOHN'S PIZZA #428	GDO	7317	8849 BISCAYNE BLVD	480
4206	KGD LI, INC. DBA CHINA CASA	GDO	7318	3300 W 84 ST 5	0
4207	YOA'S CAFE, INC.	GDO	7320	2350 NW 7 ST	325
4208	PRINCESS BALLROOMS CORP.	GDO	7323	27407 S DIXIE HWY	1,554
4209	PRESTO FOODS CORP.	GDO	7329	1790 NW 96 AVE	0
4210	IMAGES & BEYOND, INC. DBA CHICKS-N-WINGS	GDO	7330	10918 SW 184 ST	0
4211	KNR LINCOLN, LLC DBA QUATTRO	GDO	7332	1014 LINCOLN RD	6,175
4212	CALIFORNIA PIZZA KITCHEN, INC.	GDO	7333	300 MIRACLE MILE	5,000
4213	LOS AMIGOS DEL SOL CAFE, INC.	GDO	7335	1001 E 28 ST	750
4214	PINECREST ACADEMY AT KENDALL GREENS	GDO	7336	15130 SW 80 ST	0
4215	RIGUTH GOURMET, LLC DBA RIGUTH GOURMET	GDO	7345	1800 SW 27 AVE #101	248
4216	LOST AND FOUND SALOON	GDO	7346	185 NW 36 ST	500
4217	VARADERO SUPERMARKET, INC.	GDO	7347	8074 NW 103 ST #14	0
4218	CREATIVE KITCHENS NAOMI'S, LLC	GDO	7352	650 NW 71 ST	0
4219	THE NEWS LOUNGE, INC.	GDO	7353	5580 NE 4 CT #4E & 5A	2,325
4220	CLIVE CAFE, LLC	GDO	7354	5890 NW 2 AVE	740
4221	PASTRY BY RUDY, INC. DBA LUNA PASTA	GDO	7357	6815 BISCAYNE BLVD #101	275
4222	LIBERTY ACADEMY DAYCARE & PRESCHOOL, INC.	GDO	7363	7750 NW 12 AVE	600
4223	AVENTURA MINIMART, INC. DBA MARATHON 166	GDO	7365	21005 BISCAYNE BLVD	875
4224	ENGY & INC. DBA CENTRAL PARK FOOD STATION	GDO	7366	10771 NW 58 ST	600

No.	FACILITY_NAME	PERMIT	PERMIT_NUMBER	ADDRESS	TOTAL_GPD
4225	EUMAC, LLC DBA QUIZNO'S SUBS - HIALEAH	GDO	7367	3520 W 18 AVE 100	378
4226	RICO PAN PIZZERIA & GRILL, INC.	GDO	7368	18400 NW 75 PL #107	311
4227	CK CORAL GABLES, LLC DBA CHICKEN KITCHEN	GDO	7369	111 MIRACLE MILE	938
4228	EL RANCHO GRANDE 2, INC.	GDO	7372	314 72 ST	1,500
4229	QUICK MARKET, INC.	GDO	7373	2100 LINCOLN AVE	0
4230	FJ AVENTURA LTD DBA FUJI HANA	GDO	7375	2775 NE 187 ST #1	1,650
4231	LA MIA PIZZA & WINGS CORP.	GDO	7376	4195 NW 183 ST	166
4232	ENIS SEAFOOD, INC.	GDO	7377	11322 SW 184 ST	1,000
4233	SUBWAY 29350, INC.	GDO	7378	18541 S DIXIE HWY	313
4234	SPIZZIGO ENTERPRISES, LLC DBA LA GRIGLIA	GDO	7379	11402 NW 41 ST 106	500
4235	FOOD PROCESSING USA 1826, LLC DBA DELICIAS TROPICALES	GDO	7380	1375 NW 97 AVE #13	453
4236	GRINDER MAESTROS, INC. DBA SUBWAY #6774	GDO	7381	14713 SW 42 ST 102	375
4237	MACITAS RESTAURANT, INC.	GDO	7382	18533 S DIXIE HWY	800
4238	SPICY BAKERY ARTEZANAL CORP.	GDO	7384	18400 NW 75 PL #113	308
4239	EL POBLADO, INC. DBA DON PATACON RESTAURANT COLOMBIA CUISINE	GDO	7387	14709 SW 42 ST #307	284
4240	PANDA RESTAURANT GROUP DBA PANDA EXPRESS #1174	GDO	7388	1405 NE 163 ST	868
4241	OLD CUTLER CREAMERY, INC. DBA COLD STONE CREAMERY	GDO	7391	20587 OLD CUTLER RD	392
4242	JOURNEY MANAGEMENT GROUP, LLC DBA SALAD OZ	GDO	7392	215 N MIAMI AVE	200
4243	CHEZ LINE RESTAURANT, INC.	GDO	7397	5616 NW 2 AVE	200
4244	GIARDINO RESTAURANT GROUP, LLC DBA GIARDINO GOURMET SALADS	GDO	7400	11402 NW 41 ST #110	240
4245	ZHRCO ENTERPRISES, INC. DBA SAWA	GDO	7401	360 SAN LORENZO AVE #1500	537
4246	GOTO, LLC DBA GO TO SUSHI	GDO	7402	5140 BISCAYNE BLVD	200
4247	A & R FOOD CHAIN, INC.	GDO	7404	5299 NE 2 AVE MARKET	0
4248	AMALIA'S BAKERY, INC.	GDO	7405	11610 QUAIL ROOST DR	700
4249	SUSHI MAKI	GDO	7406	8025 NW 90 ST	0
4250	INVERSIONES DONA LUCIA, INC.	GDO	7407	11300 NW 87 CT #120-B	113
4251	DORAL MIAMI DONUTS, LLC DBA DUNKIN DONUTS # 342960	GDO	7408	11402 NW 41 ST #104	500
4252	VARELA ENTERPRISES CORP. DBA CRUZ BAKERY	GDO	7409	4330 E 10 LN	550
4253	HANAN'S CHILDCARE AND ACADEMIC DEVELOPMENT CENTER	GDO	7413	13250 NW 28 AVE	0
4254	TARGET CORPORATION DBA TARGET STORE #2188	GDO	7414	3401 N MIAMI AVE	504
4255	CAS ENTERPRISES OF MIAMI, LLC DBA CHARLIE'S ICE CREAM	GDO	7416	510 HIALEAH DR	200
4256	TRUST & COMPANY BAR & RESTAURANT, LLC	GDO	7417	2 ARAGON AVE #120-126	2,188
4257	DORAL BILLIARDS, LLC	GDO	7424	7800 NW 25 ST #1	560
4258	MULTISUMINISTROS JAMA, INC. DBA PASTEL GOURMET	GDO	7426	2600 NW 87 AVE #13	428
4259	HONG KONG HOUSE, LLC	GDO	7428	2784 NW 167 ST	300
4260	SUBWAY #32899, INC.	GDO	7429	1437 NE 163 ST	344
4261	U SHOP MEDLEY, INC. DBA VALERO	GDO	7430	10201 NW 116 WAY	625
4262	SMOOTHIE KING CO, INC. DBA SMOOTHIE KING # 1230	GDO	7433	681 W 49 ST	291
4263	VENEMEX GROUP, LLC DBA CHURRASCO'S RESTAURANT	GDO	7435	2777 NW 79 AVE	500
4264	DELIRIO INVESTMENT GROUP, LLC DBA DELIRIO FRESHCO	GDO	7437	2475 NW 95 AVE #8	296
4265	BISTROLICIOUS CORP. DBA BON PICAT	GDO	7441	3655 NW 107 AVE #102	140
4266	JEB BUSINESS FLORIDA, LLC DBA CANE A SUCRE	GDO	7442	21 NW MIAMI CT	502
4267	CAFFE LINGO, INC.	GDO	7445	777 NW 72 AVE #100	368
4268	MIAMI CHICKEN GRILL USA CORP. DBA CHICKEN GRILL	GDO	7446	16776 SW 88 ST	336
4269	SUGAR FACTORY OCEAN DRIVE, LLC	GDO	7447	1144 OCEAN DR 106-A	794
4270	LA TERRAZZA, LLC	GDO	7448	400 ALTON RD	150
4271	MVJ, INC. DBA LA TROCHA SUPERMARKET	GDO	7450	12073 W OKEECHOBEE RD	0
4272	A B C ATHENS, INC. DBA GREEK AMERICAN DELI	GDO	7452	195 WESTWARD DR	750
4273	COSE NOSTRE, LLC	GDO	7453	367 ALHAMBRA CIR	409
4274	WAL-MART STORES EAST, LP DBA WAL-MART SUPERCENTER #3311	GDO	7456	19501 NW 27 AVE	0
4275	FIT 2 GO, LLC	GDO	7458	7342 NW 35 ST	275
4276	THE CHURCH OF THE INCARNATION	GDO	7459	1835 NW 54 ST	0
4277	BRINKER FLORIDA, INC. DBA CHILI'S GRILL & BAR #1235	GDO	7461	2220 NE 8 ST	1,516
4278	F & F GAS STATION, INC. DBA CARAF OIL	GDO	7463	6151 NW 32 AVE	648
4279	SHANGHAI & TOKYO	GDO	7465	3088 NE 41 TER #2	300
4280	ARTISTAS RESTAURANT, INC.	GDO	7466	9550 NW 79 AVE BAY 3	625
4281	1910 REAL ESTATE HOLDINGS, LLC DBA ORION	GDO	7467	1910 NW 7 ST	99
4282	FAST FOOD SERVICES BY SERGIO'S, INC. DBA SERGIO'S	GDO	7468	9300 NW 77 AVE	250
4283	POLO NORTE KENDALL, INC.	GDO	7471	13901 SW 42 ST	700
4284	LA ESTRELLA II, INC. DBA LA ESTRELLA II CAFETERIA RESTAURANT	GDO	7472	8074 NW 103 ST 5,6,7	1,175
4285	SSC343805, LLC DBA DUNKIN DONUTS #343805	GDO	7476	3467 NE 163 ST	400
4286	MOTO PIZZERIA CAFFE & GRILL, INC.	GDO	7477	8434 S DIXIE HWY	350
4287	STARBUCKS COFFEE COMPANY, INC. DBA STARBUCK'S #8868	GDO	7478	583 W 49 ST	700
4288	WAN HEN CORP.	GDO	7482	9160 NW 122 ST 31-32	600
4289	TANUKI, LLC	GDO	7483	1080 ALTON RD	877
4290	CAFE LAGOON, INC.	GDO	7485	10450 NW SOUTH RIVER DR	750
4291	KROME EXPRESS, LLC	GDO	7486	1460 N KROME AVE	1,100
4292	HAVANA'S BAKERY CAFE, LLC	GDO	7487	13390 SW 288 ST	357
4293	WOONWON GROUP FLORIDA, LLC DBA KOBE JAPANESE STEAK & SEAFOOD	GDO	7489	11401 NW 12 ST E-504	1,500
4294	PERFORMANCE FOOD GROUP, INC.	GDO	7491	3595 NW 125 ST	25,000
4295	TUCAN & BARU BRICKELL, LLC	GDO	7495	901 S MIAMI AVE 101-103	2,704
4296	TACO RICO RESTAURANT OF FL, INC.	GDO	7497	8688 NW 13 TER	370
4297	L'ARTE BIANCO BAKERY, LLC	GDO	7499	12572 SW 88 ST	750
4298	EL FARO BAKERY, INC.	GDO	7502	8030 NW 103 ST #7	0
4299	RA99 OPERATING, INC. DBA DUNKIN DONUTS	GDO	7503	8595 NW 186 ST	400
4300	RODRIGUEZ III, LLC DBA MCDONALDS #31059	GDO	7504	19501 NW 27 AVE	538
4301	AN EVERLASTING EVENT, INC. DBA ROYAL PALACE BANQUET HALL	GDO	7508	1825-35 NE 8 ST	0
4302	MCBAIN RESTAURANT CORP. DBA MCDONALD'S RESTAURANT	GDO	7509	14670 SW 8 ST	925
4303	KHALO, INC. DBA RED RESTAURANT	GDO	7511	13911 SW 42 ST #115	358
4304	ELBARDI GK SM, LLC DBA GYU-KAKO JAPANESE BBQ	GDO	7512	11327 S DIXIE HWY	723
4305	TRES AMIGOS ENTERPRISE, INC. DBA ROYAL FOOD MARKET	GDO	7513	4998 E 4 AVE	0
4306	CANTON FOOD ENTERPRISES, INC.	GDO	7514	8005 NW 90 ST	0
4307	VICKY BAKERY CORAL GABLES, INC.	GDO	7516	243 UNIVERSITY DR	413
4308	SWING MIAMI ENTERTAINMENT, LLC DBA BIN #18	GDO	7517	275 NE 18 ST # 107	343
4309	GULL-TREE INVESTMENT HOLDINGS, LLC DBA MCDONALD'S	GDO	7519	2880 NE 8 ST	1,260
4310	SAPORI DELLA SICILIA, LLC	GDO	7520	15516 SW 72 ST	252
4311	PA'COMER BAKERY, INC.	GDO	7521	455 W 23 ST #1-2	101
4312	T 5 MANAGEMENT, LLC DBA BUFFALO WILD WINGS GRILL & BAR	GDO	7522	11401 NW 12 ST E-526	162,500

No.	FACILITY_NAME	PERMIT	PERMIT_NUMBER	ADDRESS	TOTAL_GPD
4313	FOOD SOCIETY, LLC DBA SIAM DRAGON RESTAURANT	GDO	7523	7748 SW 88 ST E-02	571
4314	VILLA SOTA PROMENADE, LLC DBA BOULANGERIE BOUL MICH	GDO	7525	20475 BISCAYNE BLVD G 7-8	438
4315	DIBRI, INC. DBA CREPE CONNECTION CAFE	GDO	7527	14264 SW 8 ST	315
4316	SPEEDWAY, LLC DBA SPEEDWAY #6894	GDO	7528	11401 BISCAYNE BLVD	224
4317	TENTACIONES GOURMET, INC.	GDO	7531	2500 NW 79 AVE #100	325
4318	EMPEROR FOOD, LLC	GDO	7532	2297 W 76 ST	0
4319	GEO'S ICE CREAM	GDO	7533	204 SW 107 AVE	0
4320	MY LITTLE CAPTAIN GOURMET, LLC	GDO	7535	18400 NW 75 PL #129	0
4321	KONING RESTAURANTS INTERNATIONAL, LC PIZZA HUT #23167	GDO	7536	1665 W 68 ST #104	0
4322	HOMESTEAD HOSPITAL, INC.	GDO	7539	975 BAPTIST WAY	5,350
4323	VMSB, LLC DBA IL SOLE MIAMI	GDO	7540	1116 OCEAN DR	850
4324	MKCH INVESTMENTS, INC. DBA ACQUA NEL MARE	GDO	7542	11401 NW 12 ST E-515	952
4325	NANCY'S CAFE CORP.	GDO	7544	2324 NW 7 CT	250
4326	T.M. MIAMI FRANCHISE CORP. DBA TACO MAKER MEXICAN GRILL	GDO	7548	1665 SW 107 AVE	495
4327	FRITANGA NICA EL CASTILLO, INC.	GDO	7551	18710 SW 107 AVE #33	251
4328	WHITELAW HOTEL	GDO	7555	808 COLLINS AVE	280
4329	RINCONCITO PERUANO	GDO	7557	4644 PALM AVE	750
4330	WOODS STATION, INC. DBA BP SERVICE STATION	GDO	7558	13190 SW 120 ST	0
4331	STERLING FOODS, INC.	GDO	7559	13100 NW 38 AVE	4,350
4332	DD REALTY VENTURE, LLC DBA KRISPY KREME #1048	GDO	7561	32999 S DIXIE HWY	800
4333	BEST TIME EVER, LLC	GDO	7562	9851 NW 58 ST 101-102	1,124
4334	GC HOMESTEAD, INC. DBA DAIRY QUEEN OF HOMESTEAD	GDO	7563	3330 NE 8 ST	654
4335	VENTURA CAPITAL ONE, LLC DBA CAVALIER HOTEL & RESTAURANT	GDO	7564	1320 OCEAN DR	277
4336	TARPUN BAY USA, INC. DBA BAHAMIAN CONNECTION BAR & GRILL	GDO	7566	4400 NW 2 AVE	625
4337	RAGAZZO'S CAFE, INC. DBA EMILIO'S TRATTORIA	GDO	7568	1088 KANE CONCOURSE	552
4338	SUBWAY #28925, INC. DBA SUBWAY #28925	GDO	7569	20131 SW 127 AVE	238
4339	LA GAMBIA RESTAURANT, LLC	GDO	7571	3437 MAIN HWY	288
4340	P.H. XU, LLC DBA ICHIMI	GDO	7573	2330 SALZEDO ST	325
4341	CNG OPERATIONS USA, LLC DBA CHICK-N-GRILL	GDO	7575	15356 NW 79 CT	623
4342	SABOR A PERU EN MIAMI, INC.	GDO	7576	2923 BISCAYNE BLVD	140
4343	KINGS CREEK HOLE IN THE WALL, LLC	GDO	7577	8100 SW 81 DR #8002	1,375
4344	DOMENICOS ITALIAN DELI, INC.	GDO	7578	13975 NW 67 AVE	504
4345	OSI/CARRABBA'S ITALIAN GRILL, LLC	GDO	7580	3921 COLLINS AVE	5,625
4346	EF INTERNATIONAL LANGUAGE SCHOOLS, INC.	GDO	7581	2469 COLLINS AVE	223
4347	NEWS CAFE, INC.	GDO	7582	804 OCEAN DR	1,500
4348	DRAGON FIRE 28 CORP. DBA QIANLONG	GDO	7583	8726 NW 26 ST 15	538
4349	WANG'S BROTHER, INC. DBA CHINA TOWN	GDO	7584	18344 NW 7 AVE	140
4350	GALJO ENTERPRISES CORP. DBA BAJITO RESTAURANT & LOUNGE	GDO	7585	9851 NW 58 ST #110	427
4351	YESICA ENTERPRISES, INC. DBA LA PERLA SANTIAGUERA	GDO	7586	9410 NW 109 ST	339
4352	SO-BEE, INC. DBA FOOD MART	GDO	7587	1359 WASHINGTON AVE	0
4353	DOLLAR BONANZA, INC. DBA ROBEKS JUICE	GDO	7589	12510 SW 120 ST	3
4354	3010 COLLINS, LLC DBA HABANA LIBRE	GDO	7590	3010 COLLINS AVE	400
4355	NERGUIZ GROUP DBA BROS ON THE BEACH	GDO	7592	2603 COLLINS AVE	0
4356	SSP156, LLC	GDO	7595	130 MIRACLE MILE #101	387
4357	JIMMY'Z KITCHEN BRICKELL, LLC	GDO	7596	60 SW 10 ST	250
4358	WHOLE FOODS MARKET, INC.	GDO	7597	1554 VENERA AVE	1,932
4359	ARA INTERNATIONAL GROUP, LLC	GDO	7598	959 WEST AVE 2	242
4360	BP JJ ENTERPRISES, LLC DBA JIMMY JOHN'S GOURMET	GDO	7599	1295 W 49 ST	464
4361	DEAUVILLE HOTEL MANAGEMENT, LLC DBA DEAUVILLE BEACH RESORT	GDO	7600	6701 COLLINS AVE	3,500
4362	BIBARD INVESTMENTS, LLC DBA L'EDITO RESTAURANT	GDO	7602	5700 COLLINS AVE	200
4363	SOUTHLAND RESTAURANT, INC. DBA SAL'S ITALIAN RISTORANTE	GDO	7604	20505 S DIXIE HWY 1245	1,950
4364	GREEN APPLE KENDALL, LLC	GDO	7605	15160 SW 136 ST #1	250
4365	ELYPO CORPORATION DBA LA ESQUINA DEL SABOR	GDO	7609	3695 NW 46 ST	238
4366	70 ARAGON, INC. DBA IRON SUSHI	GDO	7610	70 ARAGON AVE	266
4367	WE ARE DIFERENT COMPANY, INC. DORAL RECEPTIONS	GDO	7611	10395 NW 41 ST 215-235	2,200
4368	PORCINI CAFE, INC.	GDO	7613	6565 COLLINS AVE	750
4369	WENDY'S INTERNATIONAL, INC. DBA WENDYS #11355	GDO	7614	12415 BISCAYNE BLVD	919
4370	MI COLOMBIA BAKERY, INC. DBA LOS PERROS	GDO	7615	1427 ALTON RD F	288
4371	COURTYARD BY MARRIOTT-SOUTH BEACH	GDO	7617	1530 WASHINGTON AVE	500
4372	EVERGLADES OVERSEAS, LLC	GDO	7618	10190 NW 116 WAY	650
4373	SURI SOUTH BEACH, INC. DBA D'VINE HOOKAH LOUNGE	GDO	7619	445 LINCOLN RD	1,500
4374	MDFR - MIAMI FIRE RESCUE STATION #39	GDO	7622	641 EUROPE WAY	0
4375	BRAZA FIESTA ITALIAN BUFFET, INC. DBA VICTORIANO'S PIZZA & GRILL	GDO	7624	10548 SW 8 ST	306
4376	MARAKA'S PIZZA RESTAURANT CORP.	GDO	7625	14707 SW 42 ST #406	236
4377	EL FLORIDITA FISH RESTAURANT, INC.	GDO	7626	13501 SW 136 ST 101	600
4378	EXITO PLUS CORP. DBA N'CHILL-ADA	GDO	7627	48 E FLAGLER ST M34-36	200
4379	YAC & F CORP. DBA EL OASIS RESTAURANT	GDO	7628	30 NE 3 AVE	290
4380	ATLANTIS CAFE, INC.	GDO	7630	12 NW 1 ST	255
4381	CREPE PALACE, LLC DBA VERY CREPE	GDO	7631	17026 COLLINS AVE	275
4382	DFM RESTAURANTS GROUP, INC.	GDO	7635	2093 SW 22 ST	1,200
4383	BONE ISLAND FISH MARKET, INC.	GDO	7637	19200 SW 106 AVE 10	300
4384	SPARKY'S ROADSIDE BARBQUE, LLC DBA SPARKY'S BBQ	GDO	7638	204 NE 1 ST	343
4385	STARBUCKS COFFEE COMPANY, INC. DBA STARBUCKS #19033	GDO	7640	19151 S DIXIE HWY	598
4386	COFFEE HOUSE HOLDINGS, INC. DBA STARBUCKS #19877	GDO	7641	2550 S BAYSHORE DR #101	488
4387	KAORI SUSHI EXPRESS	GDO	7642	100 S BISCAYNE BLVD 116	875
4388	HCH ENTERPRISES, LLC DBA RUBI LOUNGE	GDO	7643	690 SW 1 CT E	1,150
4389	BURRITO SAN RESTAURANT GROUP, LLC	GDO	7644	119 SE 1 AVE	570
4390	SUBWAY 5382, INC.	GDO	7645	165 SE 3 AVE	375
4391	FGS ENTERPRISES CORP. DBA PASSION DEL CIELO COFFEE CO.	GDO	7646	100 GIRALDA AVE	238
4392	PUBLIX SUPERMARKETS, INC. DBA PUBLIX STORE #1062	GDO	7647	15771 SW 152 ST	0
4393	POWER 4, INC. DBA POWER PIZZA	GDO	7649	8237 SW 124 ST	188
4394	LAS PALETAS USA, INC.	GDO	7650	6915-21 NW 51 ST	575
4395	ALI'S SWEET TREATS, INC.	GDO	7651	7094 SW 117 AVE	372
4396	BUZZ, LLC DBA IRON SUSHI	GDO	7653	150 SE 3 AVE A	168
4397	BISCAYNE 100 S, LLC DBA CLOS	GDO	7654	100 S BISCAYNE BLVD 118	875
4398	RINCON NICA RESTAURANT, INC.	GDO	7655	4395 W 16 AVE	840
4399	ROMA BALLROOM, INC.	GDO	7657	1570 W 43 PL 37	510
4400	SUBWAY 39077, INC. DBA SUBWAY #39077	GDO	7658	19870 NW 27 AVE	317

No.	FACILITY_NAME	PERMIT	PERMIT_NUMBER	ADDRESS	TOTAL_GPD
4401	LINGENFELSER ENTERPRISE, INC. DBA CJ'S CRAB SHACK	GDO	7661	600 OCEAN DR FACILITY B	5,000
4402	CAMILAS, INC. DBA CAMILAS RESTAURANT	GDO	7662	129 SE 1 AVE	1,625
4403	PIZZERIAS, LLC DBA PAPA JOHN'S PIZZA #1806	GDO	7664	400 SW 8 ST	375
4404	CASABLANCA FISH MARKET, INC.	GDO	7665	404 NW NORTH RIVER DR	0
4405	SON OF A PIZZA PUB, INC.	GDO	7673	30390 OLD DIXIE HWY	805
4406	DERVIV ENTERPRISE, INC. DBA TOP TASTE JAMAICAN RESTAURANT	GDO	7674	27411 S DIXIE HWY #17	288
4407	SAMACO, INC. DBA TEXACO GAS STATION	GDO	7676	15450 SW 136 ST	375
4408	BRAVO SUPERMARKET	GDO	7677	10400 NW 7 AVE	0
4409	DIA RESTAURANT GROUP, INC. DBA BARRIO LATINO REST.	GDO	7680	3585 NE 207 ST C-1	3,750
4410	JEFF'S ORIGINAL SOUL SHACK, INC. DBA DBA JEFF'S FISH TACO & BURGERS	GDO	7682	12581 BISCAYNE BLVD	250
4411	BEIRUT DORAL 73, LLC	GDO	7684	2475 NW 95 AVE #10	655
4412	BOSS WINGS III, LLC DBA WINGSTOP	GDO	7685	20565 OLD CUTLER RD	1,696
4413	KINGDOM ACADEMY, INC.	GDO	7686	9010 SW 157 AVE	400
4414	STARBUCKS COFFEE COMPANY, INC. DBA STARBUCKS #11905	GDO	7687	7290 SW 168 ST	588
4415	TEXAS DE BRAZIL (SOUTH BEACH) CORP.	GDO	7691	300 ALTON RD 200	7,803
4416	GIARDINO, LLC DBA GIARDINO GOURMET SALADS	GDO	7692	2346 PONCE DE LEON BLVD	304
4417	MHGC HOLDINGS, LLC	GDO	7695	1190 W FLAGLER ST	36
4418	PURA VIDA MIAMI, LLC DBA PURA VIDA CAFETERIA	GDO	7696	110 WASHINGTON AVE CU-2	314
4419	COOKIES AND CAKES, LLC	GDO	7697	2248 W 77 ST	0
4420	MDFR - FIRE RESCUE STATION #61	GDO	7698	15155 SW 10 ST	0
4421	HETERY HOME FOR THE ELDERLY	GDO	7699	825 SE 7 AVE	0
4422	EASY FOODS, INC.	GDO	7700	5900 NW 97 AVE C-14	0
4423	R.O. OKEECHOBEE CORP.	GDO	7701	13899 W OKEECHOBEE RD	0
4424	RAI OPERATING, INC. DBA DUNKIN DONUTS & BASKIN ROBBINS	GDO	7702	4880 NW 183 ST	331
4425	COMUNAL ALIMENTS, LLC DBA CACHITO COFFEE BAKERY	GDO	7703	251 71 ST	246
4426	THE PALACE AT KENDALL DBA KENDALL HEALTHCARE PROPERTIES	GDO	7705	11377 SW 84 ST	3,600
4427	SAKE THAI, LLC DBA SAKE THAI & SUSHI BAR HOMESTEAD	GDO	7708	650 NE 22 TER # 102-04	476
4428	LIFE'S FLAVOR CAFE SWEET, INC.	GDO	7709	1840 W 49 ST #104	224
4429	C.R. HOMESTEAD, LLC DBA CASAVANA CUBAN CUISINE	GDO	7710	2814 NE 8 ST	3,150
4430	TINTAMAR, LLC	GDO	7712	1601 SW 22 ST	0
4431	HOLY BAGELS AND PIZZERIA OF DOWNTOWN CORP.	GDO	7714	93 NW 1 ST	350
4432	SUPER AREPA, LLC	GDO	7715	14417 SW 42 ST	500
4433	BRINKER FLORIDA, INC. DBA CHILI'S GRILL & BARSTAUANT	GDO	7716	19801 NW 2 AVE	1,443
4434	STARBUCKS COFFEE COMPANY, INC. DBA STARBUCKS #10901	GDO	7719	14401 SW 42 ST	500
4435	JIM LEZAMA, INC. DBA SUBWAY #29352	GDO	7720	9803 SW 40 ST	375
4436	MATER EAST HIGH SCHOOL & EAST CHARTER MIDDLE	GDO	7722	998 SW 1 ST	0
4437	LA PROVENCE PROPERTIES, INC. DBA LA PROVENCE WHOLESAL	GDO	7723	2106 NW 13 AVE	1,500
4438	PROVIDENT DORAL RESORTS, LLC DBA PROVIDENT DORAL AT THE BLUE	GDO	7725	5300 NW 87 AVE	629
4439	SUBWAY #40457, INC.	GDO	7726	8005 NW 95 ST	0
4440	ASHOKA INDIAN CUISINE, INC.	GDO	7727	295 NW 82 AVE	1,125
4441	INTERVAL INTERNATIONAL, INC.	GDO	7728	6262 SW 72 ST	625
4442	STACY MC CORPORATION DBA MIAMI RIVER CAFE	GDO	7731	350 NW 8 AVE	500
4443	LE PETIT BISTRO, INC. DBA LE PROVENCAL RESTAURANT	GDO	7733	266 MIRACLE MILE	3,250
4444	KAAM ENTERPRISES, INC. DBA SUBWAY #33823	GDO	7734	2336 BISCAYNE BLVD	350
4445	TAQUERIA MORELIA, INC.	GDO	7735	1871-81 NE 8 ST	565
4446	KONING RESTAURANTS INTERNATIONAL, LLC DBA PIZZA HUT RESTAURANTS	GDO	7736	14607 SW 104 ST	339
4447	BULGOGI CORPORATION DBA BISTRO BUL GO GI	GDO	7738	1450 NW 87 AVE #108	415
4448	IXAR ENTERPRISES, INC. DBA LA GRINGA TACO SHOP	GDO	7739	1223 W FLAGLER ST	175
4449	CAKE DESIGNS BY EDDA, INC.	GDO	7741	4408 SW 73 AVE	0
4450	MI LINDO ECUADOR, INC.	GDO	7742	8726 NW 26 ST #18	1,400
4451	WESTLAND DESSERTS, INC. DBA HAAGEN DAZS	GDO	7743	1675 W 49 ST #1460	175
4452	PEI WEI ASIAN DINER, LLC.	GDO	7744	15519 NW 67 AVE	789
4453	SUBWAY #40458, INC.	GDO	7745	3463 NE 163 ST	224
4454	JAE MIAMI DADE, LLC DBA WENDY'S #10954	GDO	7747	13485 SW 288 ST	788
4455	STIR MOON SOUTHLAND, INC.	GDO	7748	20505 S DIXIE HWY #563	1,385
4456	ROSYER, INC. DBA ARROYITO CAFE	GDO	7749	2307 W FLAGLER ST	950
4457	MIAMI LIVE, LLC	GDO	7750	912 71 ST	729
4458	TUTTO PASTA DELI CORP. DBA TUTTO PIZZA	GDO	7751	1763 SW 3 AVE	650
4459	ANGLER'S RESORT, LLC DBA THE ANGLERS HOTEL	GDO	7752	660 WASHINGTON AVE	1,700
4460	SUBWAY IVES CORNER 37207, LLC DBA SUBWAY #37207	GDO	7755	19801 NW 2 AVE #7	392
4461	WANG'S PANDA KITCHEN, INC. DBA CHINA GARDEN	GDO	7756	17207 NW 27 AVE	200
4462	PANERA, LLC DBA PANERA BREAD BAKERY-CAFE #1177	GDO	7757	8870 SW 72 CT A-105	1,988
4463	PANNA CAFE EXPRESS TOGO, LLC	GDO	7759	18330 NE 2 AVE	3,250
4464	OSI/CARRABBA'S ITALIAN GRILL, LLC DBA CARRABA'S ITALIAN GRILL #6057	GDO	7760	5829 SW 73 ST #102	1,458
4465	CHIPOTLE MEXICAN GRILL OF COLORADO, LLC DBA CHIPOTLE #0952	GDO	7764	14770 BISCAYNE BLVD	742
4466	OSEO THIRTY-EIGHT, LLC	GDO	7765	1625 MICHIGAN AVE	600
4467	OSI/CARRABBA'S ITALIAN GRILL, LLC DBA CARRABAS ITALIAN GRILL #6049	GDO	7766	18600 NW 87 AVE #101	5,625
4468	NAIVIN LLC DBA LIZ CAFE	GDO	7767	2600 W FLAGLER ST	63
4469	THE PALACE FOOD BAR, LLC	GDO	7768	1200 OCEAN DR FACILITY B	3,100
4470	SILVER CINEMAS ACQUISITION CO. DBA LANDMARK THEATRES, INC.	GDO	7769	358 SAN LORENZO AVE	445
4471	BRINKER FLORIDA, INC. DBA CHILI'S GRILL & BAR	GDO	7770	8815 SW 72 PL	4,775
4472	RICE DORAL, LLC	GDO	7772	1450 NW 87 AVE #110	1,775
4473	HOMESTEAD DONUTS, LLC DBA DUNKIN DONUTS #344168	GDO	7776	1485 NE 1 AVE #108	550
4474	STARBUCKS COFFEE COMPANY, INC. DBA STARBUCKS #11749	GDO	7777	8805 SW 107 AVE	448
4475	ELITE REALSTATE INVESTMENT DBA TANTALIZE MIAMI	GDO	7778	330 LINCOLN RD	1,600
4476	SUBWAY SOUTH BEACH, INC. DBA SUBWAY #1575	GDO	7779	1614 WASHINGTON AVE	388
4477	THE SUBWAY RESTAURANT OF BOLIVAR, INC. DBA SUBWAY #4211	GDO	7780	6265 NW 7 AVE	489
4478	PACHITO'S ICE CREAM CORP. DBA YUMMY FROZEN DESSERTS	GDO	7781	14025 SW 143 CT 31	471
4479	DANNY'S BAKERY, INC.	GDO	7782	8901 SW 157 AVE #15	360
4480	MARIN'S CATERING CORPORATION	GDO	7786	3420 W 84 ST A 108	285
4481	BETSY ROSS OWNER, LLC DBA THE BETSY SOUTH BEACH	GDO	7787	1433 COLLINS AVE	920
4482	PUBLIX SUPERMARKETS, INC. DBA PUBLIX STORE #1136	GDO	7790	2950 NE 8 ST	0
4483	EDUARDO LATIN AMERICAN, LLC DBA LATIN AMERICAN RESTAURAN	GDO	7791	18400 NW 75 PL 101-103	1,300
4484	SUNSHINE GASOLINE DISTRIBUTOR, INC. DBA CHEVRON	GDO	7794	15698 SW 88 ST	250
4485	SOUTH DADE SNAPPERS, INC. DBA SNAPPERS FISH & CHICKEN	GDO	7796	9610 SW 160 ST	252
4486	SOMERSET ACADEMY - ACADEMICA CORP.	GDO	7797	23255 SW 115 AVE	0
4487	LITTLE CAESAR'S ENTERPRISES, INC. LITTLE CAESAR'S #2290	GDO	7798	3335 W 80 ST	338
4488	ZHU & CHEN, INC. DBA HONG KONG RESTAURANT	GDO	7801	15741 SW 152 ST B-3	250

No.	FACILITY_NAME	PERMIT	PERMIT_NUMBER	ADDRESS	TOTAL_GPD
4489	RINCONCITO SUPERLATINO II, LLC	GDO	7803	8901 SW 157 AVE #1-2	609
4490	RUIZ EQUITY, INC. DBA BOSS PIZZA	GDO	7805	16451 NE 15 AVE	162
4491	VITA FOODS ENTERPRISES III DBA FUDDRUCKER'S	GDO	7806	1675 W 49 ST #1304	2,380
4492	PHG HOMESTEAD, LLC DBA PORTOFINO COAL FIRED PIZZA	GDO	7807	650 NE 22 TER # 112-116	930
4493	DOMINO'S PIZZA, LLC DBA DOMINO'S PIZZA #3196	GDO	7808	1485 NE 1 AVE #102	0
4494	SEDANO'S SUPERMARKET #36	GDO	7809	18600 NW 87 AVE BAY 113	231
4495	EL TORO MEAT PACKING, INC. DBA MORRISON MEAT PACKERS	GDO	7814	738 NW 72 ST	0
4496	PUBLIX SUPERMARKETS, INC. DBA PUBLIX STORE #1009	GDO	7815	911 SW 1 AVE	0
4497	PURA VIDA DAIRY, INC.	GDO	7816	3130 W 84 ST #1	265
4498	NEW CHINA RESTAURANT	GDO	7818	11459 SW 40 ST	288
4499	OTB ACQUISITION, LLC DBA ON THE BORDER MEXICAN GRILL & CANTINA	GDO	7819	15301 NW 67 AVE	171,000
4500	CALABRONE CAFE RESTAURANT, INC.	GDO	7820	1515 NW 167 ST #130	1,675
4501	ST. CATHERINE'S REHABILITATION HOSPITAL WEST	GDO	7821	8850 NW 122 ST	1,600
4502	JADA ASSOCIATES, LLC DBA KIDDIE ACADEMY OF MIAMI LAKES	GDO	7822	18600 NW 87 AVE #111	181
4503	SPECIAL AMERICA'S BBQ, INC.	GDO	7823	3600 NW 41 ST	603
4504	MORTON'S OF CHICAGO CG, LLC DBA MORTON'S STEAKHOUSE	GDO	7824	2333 PONCE DE LEON BLVD	5,025
4505	HAVANA OCEAN, LLC DBA HAVANA 1957	GDO	7828	1410 OCEAN DR CU-01	1,256
4506	CHANDLER'S PLACE, INC. DBA CHANDLER'S PLACE	GDO	7835	166 ALHAMBRA CIR #1	194
4507	2300 PITTI'S CAFE CORP.	GDO	7836	2300 W 84 ST 110	88
4508	STARBUCKS COFFEE COMPANY, INC. DBA STARBUCKS #9394	GDO	7837	14200 SW 8 ST #101	0
4509	SSC351521, LLC DBA DUNKIN DONUT #351521	GDO	7839	116 W FLAGLER ST	210
4510	WONDER GAMES, INC.	GDO	7840	1541 SE 12 AVE 35-36	900
4511	FERRARI'S PIZZA, INC.	GDO	7841	15761 SW 152 ST	477
4512	STARPIKE, LLC DBA LIME TREE LOUNGE	GDO	7842	1131 COLLINS AVE	862
4513	LAS TRES HUASTECAS CORP.	GDO	7846	312 NE 8 ST	535
4514	LA PASADITA RESTAURANT CORP.	GDO	7847	624 ENGLISH AVE	238
4515	DIAZ SUPERMARKET, INC.	GDO	7848	212 W MOWRY DR	0
4516	THE PROSPERITY PROJECT, LLC DBA NCUENTRO RESTAURANT	GDO	7851	10779 NW 41 ST #3	377
4517	SKY 9, LLC DBA NIKKO BY SUNSHINE	GDO	7855	186 SE 12 TER CU-2	265
4518	BRUSCHETTA E VINO USMIA, LLC	GDO	7857	1331 BRICKELL BAY DR CU 1	782
4519	BALCHAN CORPORATION	GDO	7860	436 N KROME AVE	450
4520	LITTLE CAESAR'S ENTERPRISES, INC. DBA LITTLE CAESAR'S PIZZA #2292	GDO	7863	2854 NE 8 ST	0
4521	SUBWAY 40731, INC.	GDO	7864	3401 N MIAMI AVE #112	387
4522	STARBUCKS COFFEE COMPANY, INC. DBA STARBUCKS #16954	GDO	7866	2501 SW 87 AVE	538
4523	AL-RIAZ, INC. DBA CARVEL STORE #2618	GDO	7867	8349 W FLAGLER ST	125
4524	TINA'S ORIGINAL CAKE, INC.	GDO	7868	8601 NW 58 ST UNIT-103	274
4525	SHAMAI, LLC DBA ASIS GRILL	GDO	7869	4020 ROYAL PALM AVE	475
4526	PASHA'S AVENTURA, LLC	GDO	7871	19501 BISCAYNE BLVD #1433	148
4527	ALPHA & OMEGA RESIDENTIAL, INC.	GDO	7874	410 E 24 ST	0
4528	NORLAND FOODS CORP. DBA MCDONALD'S RESTAURANT # 31060	GDO	7875	17650 NW 2 AVE FACILITY B	560
4529	REDZ RESTAURANT GROUP, INC.	GDO	7876	18600 NW 87 AVE #117	538
4530	POWER-5 INC. DBA POWER PIZZA	GDO	7880	4261 NW 107 AVE	224
4531	AK "N" ELL, LLC DBA KING OF DIAMONDS	GDO	7881	17800 E STATE RD 9	10,611
4532	BROTHERS VENTURES, INC. DBA SUBWAY #40690	GDO	7883	14608 SW 8 ST #15	313
4533	PARTY CAKE BAKERY VIII, INC. DBA PARTY CAKE BAKERY	GDO	7885	14600 SW 8 ST	551
4534	STARBUCKS COFFEE COMPANY, INC. DBA STARBUCKS #13736	GDO	7886	2645 SW 22 ST	591
4535	CAKE DELIGHT BAKERY, INC.	GDO	7888	14655 SW 56 ST FAC-B	225
4536	PDKS, LLC DBA PIEDUCKS	GDO	7889	1451 S MIAMI AVE C-2	348
4537	LAS PIEDRAS CAFE, LLC	GDO	7893	330 E 9 ST #106	27
4538	EL TAQUITO III CORP.	GDO	7894	14429 SW 42 ST	600
4539	DIVINITUS, LLC DBA VANIGLIA & CIOCCOLATO	GDO	7895	3725 NE 163 ST	257
4540	GABLES EXPRESS, LLC DBA PUMMAROLA	GDO	7897	141 ARAGON AVE	225
4541	LA VINOTECA EATERY, INC. DBA CHIPA'S	GDO	7898	221 NAVARRE AVE	205
4542	LA PARRILLA LATINA CORP.	GDO	7899	28864 S DIXIE HWY	225
4543	APETY 450 LINCOLN, LLC DBA PAUL	GDO	7903	450 LINCOLN RD	852
4544	ARC HOSPITALITY PORFOLIO I TRS, LLC HYATT PLACE MIAMI AIRPORT -	GDO	7904	3655 NW 82 AVE	165
4545	STYLE 10, LLC DBA KEBO RESTAURANT	GDO	7905	200 CRANDON BLVD #104-106	603
4546	KELLY'S BAKERY CORP. DBA ATLANTIC COASTAL BAKERIES	GDO	7907	3990 NW 132 ST A	0
4547	PANERA, LLC DBA PANERA BREAD #1058	GDO	7908	13672 SW 88 ST	1,100
4548	MI TIERRA LATINA RESTAURANT, LLC	GDO	7910	8457 NW 61 ST	188
4549	ADVANCE BUSINESS ASSOCIATES, INC.	GDO	7913	1500 NW 167 ST	70
4550	MIAMI BRIDGE YOUTH AND FAMILY SERVICES, INC.	GDO	7915	326 NW 4 ST	400
4551	EL AREPAZO 2 KENDALL, LLC	GDO	7916	12161 SW 152 ST	387
4552	CHINA GARDEN	GDO	7917	12165 SW 152 ST	381
4553	DON PAN KENDALL 137, INC. DBA DON PAN	GDO	7920	13758 SW 88 ST	500
4554	DORAL TRADING SOLUTIONS, INC. DBA VIA 41	GDO	7921	10437 NW 41 ST #12	254
4555	MERCANTIL COMMERCEBANK CAFETERIA	GDO	7922	12496 NW 25 ST	980
4556	KILLIAN GREENS, LLC DBA KILLIAN GREEN GOLF CLUB	GDO	7923	9980 SW 104 ST	488
4557	STARBUCKS COFFEE COMPANY, INC. DBA STARBUCKS #9702	GDO	7925	1029 N HOMESTEAD BLVD	357
4558	RA SUSHI SOUTH MIAMI CORP.	GDO	7929	5829 SW 73 ST 1	1,125
4559	ROSANA COOK & ART CORP. DBA LA COSECHA ARGENTINIAN STEAK HOUSE	GDO	7930	6981 NW 74 ST	400
4560	MIAMI BEACH FOOD STORES, INC. DBA STOP & SHOP	GDO	7931	1300 LINCOLN RD C-1A	875
4561	CASA BAKERY INC.	GDO	7932	8100 SW 8 ST 2	320
4562	A & D SMOOTHIE SPOT, LLC DBA SMOOTHIE SPOT	GDO	7933	20714 S DIXIE HWY	300
4563	CHOICES CAFE, INC.	GDO	7934	646 NE 79 ST	459
4564	SOYKA, INC.	GDO	7937	5556 NE 4 CT	5,225
4565	VENTURA 77, LLC DBA MOTEL BLU	GDO	7939	7700 BISCAYNE BLVD	800
4566	LEO AND MARY'S CAFE	GDO	7941	8200 NW 27 ST #106	369
4567	CEZAR, LLC DBA CHOCK FULL-O-NUTS	GDO	7943	1395 BRICKELL AVE #140	47
4568	PEI WEI ASIAN DINER, LLC	GDO	7944	13616 SW 88 ST	1,950
4569	LIN CHEN, INC. DBA CHINESE FOOD TO GO RESTAURANT	GDO	7945	1520 NE 205 TER	325
4570	STARBUCKS COFFEE COMPANY, INC. DBA STARBUCKS #13642	GDO	7947	7735 W 33 AVE	476
4571	PANDA EXPRESS, INC.	GDO	7948	10821 SW 72 ST	980
4572	CHIPOTLE MEXICAN GRILL OF COLORADO, LLC DBA CHIPOTLE #0914	GDO	7950	13612 SW 88 ST	2,050
4573	SAMBA MIDTOWN, LLC DBA SUGARCANE RAW BAR GRILL	GDO	7951	3250 NE 1 AVE #115	746
4574	HOME OF THE NAZARENE REHABILITAION CENTER	GDO	7952	2199 ALI BABA AVE	260
4575	BENGAL CUISINE, INC. DBA BENGAL MODERN INDIAN CUISINE	GDO	7958	2010 BISCAYNE BLVD 1	650
4576	NORDSTROM, INC. DBA CAFE BISTRO NORDSTROM	GDO	7962	19507 BISCAYNE BLVD 15	2,700

No.	FACILITY_NAME	PERMIT	PERMIT_NUMBER	ADDRESS	TOTAL_GPD
4577	KAN OF MIAMI CORP. DBA CAFE CHUNG KING	GDO	7963	1250 NW 54 ST	100
4578	367 INC. DBA HURRICANE BAR AND GRILL	GDO	7964	365 N ROYAL POINCIANA BLVD	2,725
4579	INDUSTRIAL BAKERY, INC.	GDO	7965	1010 E 33 ST	213
4580	TOWNSEND & G CATERING & EVENTS, INC.	GDO	7966	5701 COLLINS AVE	350
4581	OCEAN'S END, LLC DBA TEQUILA CHICAS	GDO	7967	1501 COLLINS AVE #112	500
4582	CAMPOS CLEANING ENTERPRISE, INC.	GDO	7970	1800 W 68 ST 120-21	26
4583	FEJEME ENTERPRISES CORP. DBA SUBWAY #38715	GDO	7971	10728 NW 74 ST	280
4584	J.D. SUBS, INC. DBA SUBWAY #41051	GDO	7972	1485 NE 1 AVE #101	375
4585	STARBUCKS COFFEE COMPANY, INC. DBA STARBUCKS #10358	GDO	7973	13604 SW 88 ST	672
4586	TARGET CORPORATION DBA TARGET STORE T-2196	GDO	7975	5601 NW 183 ST	490
4587	SUBWAY #42040, INC.	GDO	7976	1 WESTWARD DR 2	18,200
4588	CHUNG HENG, INC.	GDO	7980	2542 SW 27 AVE FAC. B	225
4589	MORALES ENTERPRISES DBA MARY'S COIN LAUNDRY AND CAFETERIA	GDO	7982	2542 SW 27 AVE FAC. B	25
4590	VCVS ENTERPRISES, LLC DBA KOKAI SUSHI & LOUNGE	GDO	7983	9036-40 NW 25 ST	498
4591	DRE HOLDINGS, LLC DBA HOLE IN THE WALL PUB	GDO	7985	14421 S DIXIE HWY	500
4592	DORAL MIAMI DONUTS, LLC DBA DUNKIN DONUTS #344453	GDO	7986	14632 SW 8 ST	97
4593	CONCESSIONS MIAMI, LLC DBA NATHAN'S FAMOUS	GDO	7988	H-9 CC-H	336
4594	HIALEAH REY PIZZA, INC. DBA REY'S PIZZA	GDO	7989	8790 NW 122 ST	1,850
4595	920 LINCOLN ROAD, LLC DBA TOCAYA ORGANICA	GDO	7990	920 LINCOLN RD	569
4596	MIAMI CHOCOLATES, LLC DBA PETERBROOKE CHOCOLATIER	GDO	7991	227 ARAGON AVE	0
4597	PIZZA PIZZA, INC.	GDO	7997	401 BISCAYNE BLVD 1118	116
4598	TRINITY PRUF CREATIONS, INC. DBA APIZZA BROOKLYN	GDO	7999	9513-15 S DIXIE HWY	438
4599	SUBWAY 39771 JM, INC. DBA SUBWAY #39771	GDO	8001	13652 SW 88 ST	315
4600	CORRECT CARE, LLC-SOUTH FLORIDA EVALUATION AND TREATMENT CENTER	GDO	8002	18680 SW 376 ST BLDG-B	25,000
4601	ELORE ENTERPRISES, LLC	GDO	8005	1055 NW 159 DR	6,000
4602	CHEFS 4 YOU, LLC	GDO	8006	275 NW 82 AVE 11	210
4603	NORWEGIAN CRUISE LINE DBA ARAMARK @ NCL	GDO	8007	7650 CORPORATE CENTER DR	3,350
4604	JAMBA JUICE/ILLYS/BONGOS	GDO	8008	FOOD CT. S.TERM.	75
4605	AREAS USA, INC. DBA CHICKEN GRILL/FAMOUS FAMIGLIA	GDO	8009	FOOD CT. S.TERM.	3,750
4606	AREAS USA, INC. DBA CORONA BAR & GRILL	GDO	8010	J 11/12 CC-J	1,650
4607	FOGO DE CHAO CHURRASCARIA, LLC	GDO	8013	834-836 1 ST	2,925
4608	WING GROUP, LLC DBA WING STOP	GDO	8017	651 NW 62 ST	288
4609	2AC, LLC DBA HAAGEN DAZS	GDO	8019	40 S POINTE DR #100-101	216
4610	SSC351116, LLC DBA DUNKIN DONUTS #351116	GDO	8020	13746 SW 56 ST	444
4611	CUISINE & CULTURE, LLC	GDO	8022	17560 NW 27 AVE #113	218
4612	TSP BAR, LLC	GDO	8023	15901 COLLINS AVE	849
4613	AM 2427 GALIANO, INC. DBA FRESCOS CAFE	GDO	8027	2427 GALIANO ST	163
4614	PIZZERIAS, LLC DBA PAPA JOHN'S PIZZA #1354	GDO	8028	13300 NW 27 AVE #1	37,240
4615	SUBWAY 5142, INC. DBA SUBWAY #5142	GDO	8030	13300 NW 27 AVE #3	252
4616	MIGNONETTE MIAMI, LLC	GDO	8033	210 NE 18 ST	350
4617	AREAS USA MIA, LLC DBA LA PAUSA	GDO	8034	FOOD CT. S.TERM.	1,975
4618	MONUMENT RESTAURANTS VI (KD), LLC DBA FIVE GUYS BURGERS & FRIES	GDO	8035	10471 SW 88 ST B-103	509
4619	PC OF FLORIDA STORE 5, LLC. DBA POLLO CAMPERO	GDO	8036	2800 SW 8 ST	1,550
4620	TACO RICO REST OF FLA V, INC. DBA TACO RICO	GDO	8037	12275 S DIXIE HWY	378
4621	MIAMI DISTRICT HOTEL PARTNER, LLC DBA SPRING HILL	GDO	8038	1311 NW 10 AVE	1,200
4622	RSJ INVESTMENTS, INC. DBA RSJ CHEVRON	GDO	8041	2545 NW 42 AVE	0
4623	SUBPREME GRILL, INC.	GDO	8042	15260 SW 280 ST #111	250
4624	KING CHEZ, INC.	GDO	8050	1 WESTWARD DR #3	300
4625	EL OSO BLANCO CAFETERIA, INC.	GDO	8052	3301 NW 28 ST FACILITY B	500
4626	GDC FOODS, LLC DBA BIG TOMATO	GDO	8053	1 WESTWARD DR #1	700
4627	BELIJI, INC. DBA JUBEL CHEVRON	GDO	8054	4097 PALM AVE BAY B	425
4628	LITTLE CAESAR'S ENTERPRISES, INC. DBA LITTLE CAESAR'S PIZZA # 2291	GDO	8055	20121 SW 127 AVE	338
4629	EL PARADITO, INC. DBA EL SANTO COYOTE	GDO	8056	26115 S DIXIE HWY	1,250
4630	DON IGNACIO CULINARY ARTS SCHOOL, INC. DBA DON IGNACIO	GDO	8058	10395 NW 41 ST 115-125	925
4631	MAWI GOURMET, LLC DBA MAWI PLAY CAFE	GDO	8059	8850 NW 13 TER #101	771
4632	CAPORAL CHICKEN, INC.	GDO	8062	14616 SW 8 ST	325
4633	TEAM 88, INC. DBA KANPEI	GDO	8064	7308 COLLINS AVE	300
4634	PINECREST BAKERY, LLC	GDO	8065	11375 SW 40 ST	499
4635	ORION CORALES, LLC DBA DOWNSTAIRS	GDO	8066	13960 SW 56 ST	455
4636	O'DEENY'S CARIBBEAN RESTAURANT, LLC	GDO	8068	1380 N KROME AVE #109	244
4637	660 OCEAN DRIVE, LLC DBA ON OCEAN 7 CAFE	GDO	8069	660 OCEAN DR	450
4638	FRITANGA CUTLER BAY, INC.	GDO	8070	20232 OLD CUTLER RD	243
4639	SAINT THOMAS UNIVERSITY, INC. @ FERNANDEZ FAMILY CENTER	GDO	8073	16401 NW 37 AVE	336
4640	JUICE & JAVA EXPRESS, INC.	GDO	8074	19501 BISCAYNE BLVD 3002	100
4641	SUSHI SIAM BRICKELL, LLC	GDO	8076	931 BRICKELL AVE	1,061
4642	MOISES BAKERY OF MIAMI, INC.	GDO	8079	7310 COLLINS AVE	3
4643	SUSHI NOW, LLC	GDO	8081	20808 BISCAYNE BLVD	188
4644	BJ'S WHOLESALE CLUB, INC. DBA BJ'S WHOLESALE CLUB #174	GDO	8084	17250 NW 57 AVE	700
4645	MIAMI COUNTRY DAY SCHOOL, INC.	GDO	8085	601 NE 107 ST	18,680
4646	LOPETEGUI CORPORATION	GDO	8086	400 NW 2 AVE	354
4647	DPC BUSINESS ASSOCIATION, LLC DBA CAPELLI D'ANGELO	GDO	8087	4001 SW 152 AVE 1	391
4648	CITY HALL THE RESTAURANT, LLC	GDO	8089	2004 BISCAYNE BLVD	1,450
4649	CAVIAR RUSSE MIAMI, LLC	GDO	8092	1441 BRICKELL AVE #110	22
4650	MELIMAR INVESTMENT, INC. DBA MEDLEY U-GAS	GDO	8093	10100 NW 89 AVE	250
4651	SHIRAZ FL., INC.	GDO	8094	515 SW 17 AVE BAY 100	325
4652	APPLE REIT COMPANIES DBA COURTYARD BY MARRIOTT	GDO	8095	11275 NW 12 ST	1,200
4653	FOOTBALL SANDWICH SHOP 72, LLC	GDO	8096	8484 NE 2 AVE	616
4654	1100 WEST INVESTMENTS, LLC DBA MONDRIAN SOUTH BEACH	GDO	8098	1100 WEST AVE	1,375
4655	PANDA EXPRESS, INC. PANDA EXPRESS #1514	GDO	8099	13440 SW 120 ST #600	826
4656	PUBBELLY, LLC	GDO	8103	1418 20 ST	308
4657	MAS POR MENOS SUPERMARKET CAFETERIA, INC.	GDO	8104	15260 SW 280 ST 106-108	1,150
4658	DOHERTY APPLE SOUTH FLORIDA, LLC DBA APPELBEES NEIGHBORHOOD	GDO	8108	3690 W 16 AVE	1,698
4659	COSTCO WHOLESALE CORP. DBA COSTCO WHOLESALE #1023	GDO	8109	13450 SW 120 ST	672
4660	PUBLIX SUPERMARKETS, INC. DBA PUBLIX STORE #1209	GDO	8110	1100 6 ST	0
4661	EL SANDUCHON, INC.	GDO	8112	10740 NW 74 ST #11	350
4662	CHERRY BLOSSOM LEARNING CENTER, INC.	GDO	8113	2933 SW 3 AVE	77
4663	LOCURA MARINA, INC.	GDO	8114	7118 COLLINS AVE	590
4664	PANDA EXPRESS, INC.	GDO	8117	33550 S DIXIE HWY	1,400

No.	FACILITY_NAME	PERMIT	PERMIT_NUMBER	ADDRESS	TOTAL_GPD
4665	LA MEXICANA MARKET, INC.	GDO	8118	27859-61 S DIXIE HWY	175
4666	GLOBAL MIAMI J.V. DBA CAFE LA CARRETA	GDO	8119	1ST FLOOR CC-E	119
4667	12425, INC. DBA STIR CRAZY LOUNGE	GDO	8123	12425 S DIXIE HWY	12,000
4668	COMPANIONI & COMPANIONI HOLDINGS, LLC	GDO	8127	18600 NW 87 AVE 103-104	740
4669	BURGER KING CORPORATION DBA BURGER KING #0044	GDO	8128	13201 S DIXIE HWY	1,050
4670	147 AVE & 8 ST SUPERMARKET, INC. DBA SEDANO'S SUPERMARKET #37	GDO	8129	14524 SW 8 ST	112
4671	BACARDI U.S.A., INC.	GDO	8130	2701 LE JEUNE RD	681
4672	BEACH BEAUTY, INC.	GDO	8131	6685 COLLINS AVE	0
4673	T 4 MANAGEMENT, LLC DBA BUFFALO WILD WINGS GRILL & BAR	GDO	8132	20505 S DIXIE HWY # 555-A	1,299
4674	SERGIO'S RESTAURANT NO. 3	GDO	8133	13550 SW 120 ST 400-400-A B	1,000
4675	GODIVA CHOCOLATIER, INC.	GDO	8134	19501 BISCAYNE BLVD #1085	0
4676	CUBAN GUYS 101, LLC DBA CUBAN GUYS SANDWICH & MORE	GDO	8135	3174 W 76 ST	386
4677	DEERWOOD SUBWAY CORP. DBA SUBWAY #29353	GDO	8137	12089 SW 152 ST	378
4678	MADE IN BRAZIL CORP. DBA BOVINOS STEAKHOUSE	GDO	8139	3073 NE 163 ST	641
4679	TEQUENOMANIA, INC.	GDO	8140	6720 SW 117 AVE	396
4680	DORAL STATION III CORP.	GDO	8141	9290 NW 25 ST	746
4681	SUSHI SAKE BRICKELL	GDO	8142	261 SW 8 ST	658
4682	CITY OF HIALEAH EDUCATIONAL ACADEMY, INC.	GDO	8143	2590 W 76 ST	6,380
4683	SUBWAY 60232, INC.	GDO	8145	11401 NW 12 ST # 112	104
4684	WAKIM ENTERPRISES, INC. DBA SUBWAY #3762	GDO	8146	4130 COLLINS AVE	175
4685	DBK CENTER CORP. DBA 163 PONTE ITALIAN RESTAURANT & RAW BAR	GDO	8147	3933 NE 163 ST	885
4686	DE LEON FOOD SERVICE, INC. DBA EL NUEVO AMANECER CAFE	GDO	8148	3553 W 76 ST #13-14	300
4687	STARBUCKS COFFEE COMPANY, INC. DBA STARBUCKS #13238	GDO	8149	16305 SW 88 ST	428
4688	RUNWAY GRILL II, INC.	GDO	8150	790 NW 107 AVE #100	688
4689	SAKAYA KITCHEN, LLC	GDO	8151	3401 N MIAMI AVE #125	672
4690	MORGAN'S 2829, INC. DBA MORGAN'S RESTAURANT	GDO	8152	28 NE 29 ST	338
4691	GRAZIANO AT BRICKELL, LLC	GDO	8154	177 SW 7 ST	5,000
4692	ZORRO VENTURES, LLC DBA CRABSTER RESTAURANT	GDO	8156	433 LINCOLN RD	775
4693	AMPY ENTERPRISES, INC. DBA MCDONALD'S #22125	GDO	8157	1635 W 49 ST #1252	0
4694	RICE MILLER, LLC DBA RICE HOUSE OF KABOB	GDO	8158	13742 SW 56 ST UNIT 3	800
4695	CLUB JAMON IBERICO "PATA NEGRA" CORP.	GDO	8160	10 SW SOUTH RIVER DR C-1	375
4696	GLOBAL MIAMI JOINT VENTURE DBA MANCHU WOK	GDO	8163	D-45 FAC.C N.TERM	0
4697	EL CHAMAN HOLDINGS, LLC DBA EL CHAMAN RESTAURANT	GDO	8165	14239 SW 42 ST	725
4698	BURGER KING CORPORATION DBA BURGER KING #17700	GDO	8166	50 W FLAGLER ST	300
4699	SHONDORFHAUS SPECIALTIES, LLC DBA BABE FROMAN FINE SAUSAGES	GDO	8167	19151 SW 108 AVE 27	465
4700	P & T ENTERPRISES, LLC DBA THE PITA PIT	GDO	8169	16323 SW 88 ST	350
4701	HOST TINSLEY JOINT VENTURE DBA STARBUCK H	GDO	8170	H5 \ H7 CC-H	185
4702	HOST TINSLEY JOINT VENTURE DBA COMMISSARY	GDO	8171	UNIT 38 3074	0
4703	PANE PAN 2, INC.	GDO	8172	7191 N WATERWAY DR	360
4704	THE PCKOCK BROTHER'S, LLC DBA DAAZKEN	GDO	8173	219 W 27 ST	420
4705	B & R SUPERMARKET, INC. DBA MILAM'S MARKET	GDO	8174	80 CURTISS PKY	0
4706	LOVE IS BLIND, LLC	GDO	8175	225 ALTARA AVE	1,606
4707	SABOR VENEZOLANO, INC.	GDO	8179	10722 NW 74 ST	363
4708	COCOLIMON, LLC	GDO	8181	126 MIRACLE MILE	354
4709	TANGERINE SOLUTIONS, LLC DBA SPICE 'N' CURRY	GDO	8182	121-123 SW 107 AVE	394
4710	MANHATTAN BIG APPLE, INC. DBA MANHATTAN PIZZA PLACE	GDO	8184	5201 W 24 AVE	130
4711	SOUTH MIAMI SUBS, INC. DBA FIREHOUSE SUBS	GDO	8190	16010 NW 57 AVE #118	383
4712	DORAL MIAMI DONUTS, LLC DBA DUNKIN DONUTS # 346499	GDO	8192	2060 NW 107 AVE	341
4713	Y & O PERUVIAN FOOD, LLC DBA PUNTO PERU	GDO	8197	20500 S DIXIE HWY	490
4714	HAARIS & JUNAI, INC. DBA SUBWAY #31664	GDO	8199	2109 SW 22 ST	223
4715	CORAL GABLES CULINARY INSTITUTE, LLC	GDO	8200	2135 SW 22 ST	1,156
4716	CESS, LLC DBA CAFE BASTILLE	GDO	8202	248 SE 1 ST	250
4717	PIZZA BAR, LLC	GDO	8206	1627 COLLINS AVE CU-4	412
4718	MB FLORIDA LIMITED, LLC DBA GRAND BEACH HOTEL	GDO	8207	4835 COLLINS AVE	972
4719	THE BACK OF THE ROAD SPORTS GRILL, INC.	GDO	8208	15420 SW 136 ST #4	350
4720	SIGNATURE HEALTHCARE OF WATERFORD, LLC	GDO	8209	8333 W OKEECHOBEE RD	2,400
4721	SHEPHERD COFFEE AT DOUBLE TREE BY HILTON	GDO	8212	711 NW 72 AVE 1ST FLOOR	121
4722	LONDON SUBWAY CORP. DBA SUBWAY #29354	GDO	8213	13630 SW 120 ST #226	0
4723	AMICI'S TRATTORIA ITALIANA, INC.	GDO	8214	10201 HAMMOCKS BLVD 137-138	1,048
4724	CHOCOLATE FASHION, INC.	GDO	8217	396 ALHAMBRA CIR #155	523
4725	FORC, LLC DBA JAR & FORK	GDO	8218	270 E FLAGLER ST	776
4726	J & J NATURE EXOTIC, LLC DBA TAQUERIA HERENCIA MEXICANA	GDO	8221	1550 W 84 ST #18	240
4727	FOOD LINE SERVICE, INC. DBA THE VILLAGE CAFE	GDO	8224	701 NW 1 CT G-107	1,500
4728	SUSHI MAKI BRICKELL, LLC	GDO	8225	1036 S MIAMI AVE	255
4729	CHICK-FIL-A, INC.	GDO	8226	16100 NW 57 AVE	980
4730	RARE HOSPITALITY MANAGEMENT, INC. DBA LONGHORN STEAKHOUSE	GDO	8227	2531 NE 8 ST	1,470
4731	FLORIDA SE, LLC DBA THE OLIVE GARDEN ITALIAN RESTAURANT #1802	GDO	8228	2575 NE 8 ST	6,150
4732	KINDRED HOSPITALS EAST, LLC DBA KINDRED HOSPITAL SOUTH FLORIDA	GDO	8229	5190 SW 8 ST	0
4733	CARRIE MANAGEMENT, LLC. DBA DUNKIN DONUTS	GDO	8231	TERMINAL CC-G	161
4734	MANGOE'S CARIBBEAN BISTRO	GDO	8232	11030 SW 184 ST	250
4735	DP PROPERTY HOLDING, LLC DBA AREA 31	GDO	8233	270 BISCAYNE BLVD	5,200
4736	KERO CREP HOUSE, LLC	GDO	8234	401 BISCAYNE BLVD #5204	156
4737	LATIN CORNER, INC.	GDO	8235	2980 NW 7 ST	838
4738	VIRGEN DE LA CARIDAD SUPERMARKET, INC.	GDO	8236	1405 SW 17 AVE	0
4739	OLGA EXPRESS SUB & PASTA	GDO	8238	10000 SW 56 ST #16	135
4740	AGAVE DORAL, LLC DBA AGAVE TACO BAR	GDO	8240	9739 NW 41 ST	388
4741	TAMIAMI SUBS, INC.	GDO	8241	14261 SW 120 ST #105	280
4742	CARNICERIA LA NEVADA CORP.	GDO	8243	14279 SW 42 ST	400
4743	G AND S EVENTS, LLC	GDO	8246	16205 SW 117 AVE #5	259
4744	KROLLS FOODS, LLC DBA POWER PIZZERIA	GDO	8247	12305 SW 137 AVE #306-A C	508
4745	IMPERIAL BAKERY, INC.	GDO	8249	1640 W 33 PL	1,000
4746	WANG'S CHINA TOWN, INC. DBA CHINA TOWN II	GDO	8256	19658 NW 27 AVE	2
4747	VALENTINI, INC. DBA CAPRICCIO SALAD BAR & PANINI	GDO	8258	9551 NW 41 ST	300
4748	FX FUEL, LLC	GDO	8259	11500 NW SOUTH RIVER DR # 1	232
4749	36 STREET TWO, LLC DBA HILTON GARDEN INN MIAMI AIRPORT WEST	GDO	8264	3550 NW 74 AVE	1,500
4750	CHINA WOK, INC.	GDO	8265	9340 SW 56 ST	0
4751	TSUKI SUSHI & BAR, LLC	GDO	8266	10726 NW 74 ST	1,150
4752	MACA CORPORATION OF MIAMI #2	GDO	8267	1400 SW 6 ST	625

No.	FACILITY_NAME	PERMIT	PERMIT_NUMBER	ADDRESS	TOTAL_GPD
4753	ON GOLDEN POND DEVELOPMENT, LLC DBA BELLE BAKING	GDO	8268	2480 W 82 ST #3-4	1,000
4754	CHINO CHANG EMPIRE CORP.	GDO	8269	11951 W OKEECHOBEE RD	125
4755	FDG BRICKELL II, LLC DBA BURGER & BEER JOINT	GDO	8272	900 S MIAMI AVE #130-132	1,369
4756	MOE OF MIAMI, INC. DBA SUBWAY #31622	GDO	8273	900 S MIAMI AVE #141	140
4757	ROSA MEXICANO MIAMI, LLC	GDO	8274	900 S MIAMI AVE #161	1,990
4758	BLUE MARTINI MIAMI HOLDINGS, LLC	GDO	8275	900 S MIAMI AVE #250	1,550
4759	S.P.E. PARTNERS, LLC DBA AMORE GELATO	GDO	8276	901 S MIAMI AVE #105	125
4760	BUBBA GUMP SHRIMP CO. RESTAURANT, INC.	GDO	8279	401 BISCAYNE BLVD #100-R	188,050
4761	TRADE WINDS DELI, LLC	GDO	8283	401 BISCAYNE BLVD N-1057	1,650
4762	LOS RANCHOS OF BAYSIDE, INC.	GDO	8284	401 BISCAYNE BLVD N-200	1,169
4763	HOOTER'S OF BAYSIDE, INC.	GDO	8285	401 BISCAYNE BLVD #225-N	1,185
4764	LATIN AMERICAN CAFETERIA BAYSIDE, INC.	GDO	8286	401 BISCAYNE BLVD # S-102	2,050
4765	GELATERIA 4 D MIAMI, LLC DBA 4 D GELATO	GDO	8287	401 BISCAYNE BLVD #S-106	125
4766	CROCODILE CANTINA, INC. DBA MAMBO CAFE	GDO	8288	401 BISCAYNE BLVD # S-119	3,750
4767	RE & FA, LLC DBA LOMBARDI'S RISTORANTE	GDO	8289	401 BISCAYNE BLVD #S-125	1,219
4768	CARMA CINCO, LLC DBA THE KNIFE	GDO	8292	401 BISCAYNE BLVD # S-212	149,000
4769	BREAD PARTNERS #11, INC. DBA AU BON PAIN	GDO	8296	100 SE 2 ST #110	375
4770	GHANTOUS BROTHERS, INC. DBA PREMIOS DELI	GDO	8297	1 SE 3 AVE UNIT-160	434
4771	SANDEL BEACH CORP. DBA MANOLO CHURROS PIZZA AND MUCH MORE	GDO	8298	685 WASHINGTON AVE	1,800
4772	LAGO DEL SOL BISTRO, LLC DBA CHARLIES BISTRO & BAR	GDO	8299	100 COSTA DEL SOL BLVD	500
4773	PROMISE HOSPITAL OF DADE DBA PROMISE HOSPITAL OF MIAMI	GDO	8302	14001 NW 82 AVE	0
4774	BARCELONETA, LLC	GDO	8303	1400 20 ST	525
4775	LOS CATRACHOS RESTAURANT II, INC. DBA MERCADITO & RESTAURANT LOS	GDO	8304	18 SW 11 AVE	375
4776	INVESTMENT 41, LLC DBA EMBARCADERO 41	GDO	8307	168 SE 1 ST 1A	1,110
4777	MOON THAI KENDALL, INC. MOON THAI & JAPANESE	GDO	8309	16311 SW 88 ST	1,129
4778	TUTTO PASTA DELI CORP. DBA TUTTO PIZZA	GDO	8311	1753 SW 3 AVE	500
4779	PERICO FOOD, INC.	GDO	8312	8944 NW 24 TER	0
4780	GFII DVI CARDEL FLAGLER COURTYARD, LLC DBA FLAGLER STATION	GDO	8313	11580 NW 105 ST	583
4781	STARBUCKS COFFEE COMPANY, INC. DBA STARBUCKS #11485	GDO	8314	12305 SW 137 AVE #310	406
4782	RDG II ENTERPRISES, INC. DBA WESTAR	GDO	8315	790 E 25 ST	250
4783	4D DOLPHIN, LLC	GDO	8317	11401 NW 12 ST K-103	59
4784	ADP TOTAL SOURCE GROUP, INC.	GDO	8321	10200 SW 72 ST	0
4785	LA PROVENCE FRENCH BAKERY	GDO	8323	1064 BRICKELL AVE	450
4786	TENET HEALTHCARE SYSTEM DBA HIALEAH HOSPITAL	GDO	8324	651 E 25 ST	2,750
4787	GLOBAL DISTRIBUTORS, INC.	GDO	8325	2167 NW 25 AVE	1,250
4788	STARBUCKS COFFEE COMPANY, INC. DBA STARBUCKS #9334	GDO	8327	200 CRANDON BLVD #111	350
4789	ORIGIN ASIAN BISTRO & SUSHI, INC.	GDO	8328	200 CRANDON BLVD #112	413
4790	GOURMET BY J & D DBA GOURMET GOURMET	GDO	8330	4249 W FLAGLER ST	200
4791	MONDO PASTA GROUP, LLC	GDO	8331	1200 BRICKELL BAY DR #107	626
4792	MARIO RESTAURANT	GDO	8332	290 NW 71 ST	250
4793	Y F LONDON, LLC DBA YOGEN FRUZ	GDO	8333	13520 SW 120 ST #106	300
4794	POPPING WEST, LLC DBA DOC POPCORN/DIPPIN' DOTS	GDO	8334	1675 W 49 ST #9115	38
4795	FETES & EVENTS, INC.	GDO	8335	270 CATALONIA AVE	0
4796	TRADITIONAL SNACK, INC.	GDO	8336	12905 W OKEECHOBEE RD #5	279
4797	MENENDEZ MANAGEMENT CORP. DBA MCDONALD'S OF MIA #32589	GDO	8337	FOOD CT. S.TERM.	425
4798	RICKY BAKERY IV, INC.	GDO	8339	13440 SW 120 ST #602	525
4799	MANNY'S CAFE, INC. DBA EL AGUILA CENTRO AMERICANO RESTAURANT	GDO	8340	2291 NW 36 ST	500
4800	NB2J INVESTMENTS, LLC DBA FRESKO	GDO	8341	19048 NE 29 AVE	341
4801	CHARRALITA CORP. DBA EL RINKON CAFETERIA	GDO	8342	3105 NW 27 AVE	60
4802	MONUMENT RESTAURANTS VI (LS), LLC DBA FIVE GUYS BURGERS & FRIES	GDO	8343	13440 SW 120 ST #610	588
4803	ELOISE & EARNESTINE SOUL FOOD, INC.	GDO	8345	6781 NW 27 AVE	269
4804	BARU GROUP DORAL, LLC DBA BARU URBANO	GDO	8346	11402 NW 41 ST 100-102	1,858
4805	LA ESTANCIA KENDALL, LLC DBA SIMPLY CAKES	GDO	8350	9355 SW 56 ST	425
4806	STEVE'S RESTAURANT CORP. DBA STEVE'S PIZZA	GDO	8351	12101 BISCAYNE BLVD	500
4807	RRF 7455, LLC DBA DENNY'S #7455	GDO	8352	12105 BISCAYNE BLVD	2,750
4808	CHECKERS DRIVE-IN RESTAURANTS, INC. DBA CHECKERS #6335	GDO	8354	2695 NW 54 ST	187
4809	LITTLE MOMENTS PRESCHOOL	GDO	8355	12975 W OKEECHOBEE RD UNIT 9	0
4810	PLANTATION GENERAL HOSPITAL LP DBA MERCY HOSPITAL	GDO	8358	3663 S MIAMI AVE	1,431
4811	CANTINA GRILL AT PALM SPRINGS MILE, INC.	GDO	8359	691 W 49 ST	375
4812	ANYTIME GAS, INC. DBA ANYTIME CAFE	GDO	8360	2691 E 11 AVE	0
4813	SUBWAY 46435, INC.	GDO	8362	11093 NW 138 ST A-127	303
4814	MILLER WEST, INC. DBA MCDONALD'S #35786	GDO	8363	15710 SW 56 ST	972
4815	LITTLE CAESAR ENTERPRISES, INC. DBA LITTLE CAESAR'S PIZZA STORE # 2299	GDO	8365	13280 BISCAYNE BLVD	19,740
4816	BLESSED CATERING SOMETHING DIFFERENT, INC.	GDO	8366	5711 NW 7 AVE	1,384
4817	GYROVILLE SEVEN LLC DBA GYROVILLE REALLY FRESH REALLY GREEK	GDO	8367	2801 NW 87 AVE #2	367
4818	FLODELEX, LLC DBA COLD STONE CREAMERY	GDO	8368	1631 ALTON RD	267
4819	MEATOS, LLC DBA ART CAFE	GDO	8370	3507 NE 163 ST	350
4820	FLAGLER 4100 PROPERTY, LLC DBA BEST WESTERN PREMIER	GDO	8371	4100 W FLAGLER ST	350
4821	RODE, LLC DBA HABIBI DINER	GDO	8372	751 WASHINGTON AVE	275
4822	BLUE LAGOON HOSPITALITY, LLC DBA HOTEL URBANO	GDO	8373	2500 BRICKELL AVE	750
4823	DOBARGANES MIAMI, INC.	GDO	8375	6799 W FLAGLER ST	413
4824	PANAREA MIDTOWN STORE, LLC DBA THE CHEESE COURSE	GDO	8377	3451 NE 1 AVE #102-A	650
4825	MARINE HARVEST USA, LLC DBA MARINE HARVEST	GDO	8378	8550 NW 17 ST #100	9,926
4826	GOURMET CHEF ON TOUR CORP. DBA CHEF ROSE'S CAFE	GDO	8382	1320 S DIXIE HWY #171	346
4827	MIAMI FOOD COURT DBA MAMA'S ON WHEELS	GDO	8383	645 NW 20 ST	225
4828	CONCH IT UP SOUL FOOD, LLC	GDO	8384	4507 NW 17 AVE	127
4829	BLUEBONE INVESTMENT, LLC	GDO	8387	18090 COLLINS AVE #T-18	200
4830	SUB-MAC ENTERPRISES, INC. DBA SUBWAY #46217	GDO	8390	234 NE 3 ST # 100	224
4831	36TH STREET ONE, LLC DBA HOMEWOOD SUITES BY HILTON MIAMI AIRPORT	GDO	8391	3590 NW 74 AVE	100
4832	GRINDER MAESTROS, INC. DBA SUBWAY #45141	GDO	8393	12853 SW 42 ST	575
4833	ROK SOUTH, LLC DBA ROK BRGR BURGER BAR & GASTRO PUB	GDO	8396	5800 SW 73 ST	475
4834	FRESH FISH DELIVERY, INC.	GDO	8397	10750 NW 138 ST #6	0
4835	PANSCOMPANY CORP.	GDO	8398	4325 SW 75 AVE	500
4836	FDOC-EVERGLADES CORRECTIONAL INSTITUTION	GDO	8400	1601 SW 187 AVE	35,000
4837	BPM BAKERY, INC. DBA VICKY BAKERY	GDO	8402	14441-47 SW 42 ST	0
4838	FDOC-MIAMI NORTH CORRECTIONAL CENTER	GDO	8406	7090 NW 41 ST	3,700
4839	FDOC-SOUTH FLA. RECEPTION CENTER	GDO	8407	14000 NW 41 ST	32,000
4840	ALEXANDER FOOD SERVICE, LLC DBA HARVEY'S SMOKE HOUSE BBQ	GDO	8409	20218 OLD CUTLER RD #5	500

No.	FACILITY_NAME	PERMIT	PERMIT_NUMBER	ADDRESS	TOTAL_GPD
4841	PANDA EXPRESS, INC.	GDO	8410	8750 W FLAGLER ST	1,200
4842	FREEDOM WINGS ENTERPRISES, INC.	GDO	8412	7900 NW 27 AVE #604-A	63
4843	MILMAN CAFE CORP. DBA MESON MILMAN CAFE	GDO	8414	353 SE 2 ST	325
4844	OKEECHOBEE FUEL SERVICES CORP.	GDO	8415	398 W 9 ST	0
4845	CJ MIAMI INVESTMENTS INC. DBA BRASAS Y VINOS RESTAURANT	GDO	8416	231-235 PARK BLVD	450
4846	EMPANADA HARRY'S, INC.	GDO	8417	4009 SW 152 AVE #3	353
4847	SPECIALTEA LOUNGE, LLC	GDO	8420	10766 SW 24 ST	23,700
4848	777 BRICKELL PARTNERS LLC DBA TRULUCK'S SEAFOOD STEAK & CRAB	GDO	8422	777 BRICKELL AVE	2,022
4849	HANNYA, LLC DBA HANNYA	GDO	8427	1063 SE 1 AVE	574
4850	649 CHINA TOWN, INC.	GDO	8429	649 NW 62 ST	288
4851	SW 125 - US1, INC. DBA SUBWAY #46469	GDO	8430	12525 S DIXIE HWY	266
4852	ANTHONY'S COAL FIRED PIZZA OF DORAL, LLC	GDO	8431	2801 NW 87 AVE #1	2,400
4853	FDOC-OPA-LOCKA COMMUNITY CORRECTION	GDO	8434	5400 NW 135 ST	2,960
4854	TEMPASIO CORPORATION DBA CHINA BUFFET	GDO	8437	3800 W 18 AVE SUITE 100	175,000
4855	JVL FRANCO 2, LLC DBA JUAN VALDEZ CAFE	GDO	8438	364 SE 1 ST	325
4856	ANTHONY'S COAL FIRED PIZZA OF MIAMI LAKES, LLC.	GDO	8440	15492 NW 77 CT	790
4857	ACFP HOLDINGS, INC. DBA ANTHONY'S COAL FIRED PIZZA	GDO	8441	10205 S DIXIE HWY #104	765
4858	FROM SCRATCH GROUP, LLC DBA SALSA FIESTA URBAN MEXICAN	GDO	8444	2929 BISCAYNE BLVD	300
4859	PANDORA BOX ENTERTAINMENT CORP.	GDO	8445	5101 NW 79 AVE 1	460
4860	PURE SIMPLE COOKING, LLC DBA OPEN KITCHEN BY PURE SIMPLE COOKING	GDO	8446	1071 95 ST	143
4861	SOUTHERN PROPERTY INVESTMENTS CORP. DBA CADET HOTEL	GDO	8447	1701 JAMES AVE	500
4862	LIBAR INTERNATIONAL USA, LLC	GDO	8448	900 BISCAYNE BLVD 102-103	599
4863	CARNE AND COMPANIA, LLC DBA BOTECO	GDO	8449	916 NE 79 ST	907
4864	LA FIESTA CAFETERIA, INC.	GDO	8450	2570 W 12 AVE	275
4865	BON FROMAGE, INC.	GDO	8452	500 BRICKELL AVE #106	238
4866	KONEXPRESS JAPANESE FOOD CORP.	GDO	8453	445 ESPANOLA WAY	209
4867	I LOVE PIZZA MIDTOWN, LLC	GDO	8454	3451 NE 1 AVE #105	275
4868	TWIN 918, LLC DBA VENUE SOUTH BEACH	GDO	8455	1330 OCEAN DR C-6	817
4869	BURGER KING CORPORATION DBA BURGER KING #16847	GDO	8457	28644 SW 137 AVE	559
4870	XICA MARIA REPOSTERIA, LLC	GDO	8459	4237 NW 107 AVE #26	337
4871	LATIN AMERICAN FOOD & PIZZA, LLC.	GDO	8461	11093 NW 138 ST #124	281
4872	BRUNO'S BAKERY AND RESTAURANT, LLC	GDO	8462	21315 NW 2 AVE	225
4873	94TH SPIRIT GRILL, LLC DBA 94TH AERO SQUADRON	GDO	8464	1395 NW 57 AVE	3,750
4874	AC & AL TEJEDA ENTERPRISES CORP. DBA DI ANGELO PIZZA	GDO	8465	4882 NW 183 ST	350
4875	DI-POW CORP. DBA CREPEMAKER OF KENDALL	GDO	8466	12305 SW 137 AVE #304	250
4876	ATCHANA'S, INC. DBA ATCHANA EAST/WEST KITCHEN	GDO	8468	2951 S BAYSHORE DR	100
4877	LIGHTHOUSE CAFE, INC. DBA BOATER'S GRILL	GDO	8470	1200 CRANDON BLVD FACILITY B	2,700
4878	CANTINA GRILL, LLC	GDO	8471	14713 SW 42 ST #104-105	428
4879	SI-RIN, LLC DBA SEA SIAM CONNECTION	GDO	8473	13440 SW 120 ST #604	777
4880	DELMAR C & G, LLC DBA LA CEBI	GDO	8475	13668 SW 88 ST	320
4881	TINY DELIGHTS, INC.	GDO	8478	12847 SW 42 ST	210
4882	PIPOBREAD, INC.	GDO	8479	11735 SW 147 AVE UNIT-3	220
4883	VITORI PRODUCTIONS, INC. DBA CHEESEBURGER BABY	GDO	8480	212 NE 79 ST	75
4884	GLOBAL MIAMI J.V. DBA NATHAN'S	GDO	8481	D-37 N.TERM	139
4885	CONCESSIONS MIAMI, LLC DBA GILBERT'S BAKERY	GDO	8482	FOOD CT. S.TERM.	399
4886	GLOBAL MIAMI J.V. DBA LA CARRETA RESTAURANT	GDO	8483	D-39 N TERM	2,125
4887	MELTZER MANAGEMENT CORP. THE DAILY CREATIVE FOOD CO.	GDO	8485	2001 BISCAYNE BLVD #109	750
4888	AMANDINE AND PRALINE, INC. DBA ATELIER MONNIER	GDO	8486	848 BRICKELL AVE #120	325
4889	DE REGLA, LLC DBA ANGELIQUE EURO CAFE	GDO	8489	117 MIRACLE MILE	820
4890	SALUMI 104, INC. DBA SALUMERIA	GDO	8490	3451 NE 1 AVE #104	380
4891	RED LOBSTER HOSPITALITY, LLC DBA RED LOBSTER #6359	GDO	8491	2301 NE 8 ST	1,757
4892	SVNP CORP. DBA SUVI THAI & SUSHI RESTAURANT	GDO	8492	250 N HOMESTEAD BLVD	825
4893	CAFEINA CAFE LOUNGE, LLC DBA CAFEINA CAFE LOUNGE/BANQUET HALL	GDO	8493	297 NW 23 ST	543
4894	CHEF BELON, LLC	GDO	8495	350 NE 24 ST #109	337
4895	TROPICAL PERK CORP.	GDO	8498	2000 S DIXIE HWY #101-B	93
4896	DESIGN PLACE COFFEE AND SHOP, LLC	GDO	8500	5205 NE 2 CT	119
4897	ISLAND COFFEE, INC.	GDO	8501	330 SW 27 AVE #103	221
4898	NORMANDY SHORES GOLF CLUB (RESTAURANT)	GDO	8503	2401 BIARRITZ DR	170,000
4899	AMERICAN AIRLINES, INC. DBA AMERICAN AIRLINES PREMIUM LOUNGE	GDO	8504	D-30 N.TERM	2,172
4900	SUNSET FLORIDA ENTERPRISE, INC. DBA KENDALL RECEPTION HALL	GDO	8506	15544 SW 72 ST	1,800
4901	LITTLE CAESAR'S ENTERPRISE, INC. DBA LITTLE CAESAR'S PIZZA #224	GDO	8508	13710 SW 56 ST #G	438
4902	AMERICANA BURGER CLUB, INC. DBA HAMBURGUESA	GDO	8509	401 BISCAYNE BLVD 116-B	225
4903	RCRESCENTE CORPORATION DBA CHEZ NOUS	GDO	8510	16772 SW 88 ST #C-10	350
4904	I LOVE NY PIZZA CITY, INC.	GDO	8511	15725 SW 72 ST #158	200
4905	MIAMI CEREBRAL PALSY	GDO	8513	7100 SW 122 AVE UNIT-A-B-C	480
4906	Y.S. CATERING SERVICES	GDO	8517	3321 NW 7 AVE	539
4907	LA CANASTA LATINA CORP.	GDO	8518	27 NW 13 AVE	264
4908	PUCCI'S PIZZA 2, LLC	GDO	8519	888 BISCAYNE BLVD # 102	409
4909	RIKA BAKERIES, INC.	GDO	8521	1025 E 24 ST	1,750
4910	MDFR - FIRE RESCUE STATION #16	GDO	8522	255 NW 4 AVE	0
4911	LA VIE EN RAW, LLC	GDO	8523	3808 SW 8 ST	225
4912	TEAM WARE, LLC DBA COREY'S KITCHEN STORE #2	GDO	8524	3809 GRAND AVE	188
4913	MARAYA GAS STATION, LLC DBA WESTAR 27 AVENUE	GDO	8527	1600 SW 27 AVE	0
4914	AMERICAN SOCIAL BRICKELL, LLC	GDO	8528	690 SW 1 CT F	1,470
4915	EL CASTILLO DE LAS FRUTAS LATIN PROUD, LLC	GDO	8530	1101 W FLAGLER ST	422
4916	SING BO CORP. DBA LING NAM RESTAURANT	GDO	8531	2261 SW 67 AVE	900
4917	MIMI RESTAURANT CORP. DBA EL CUBANITO RESTAURANT	GDO	8534	10651 NW 132 ST #8-9	1,200
4918	FPS HOSPITALITY GROUP, LLC DBA MAZZI CUCINA	GDO	8536	17010 W DIXIE HWY F	175
4919	CLY MINIMARKET CORP.	GDO	8537	600 NE 36 ST C11-12	266
4920	SAMIRA CORP. DBA KWIK STOP	GDO	8539	2581 E 8 AVE	625
4921	HOST TINSLEY JOINT VENTURE STARBUCKS (D15)	GDO	8540	D-10 N. TERM	184
4922	HOST TINSLEY JOINT VENTURE STARBUCKS CONCOURSE B	GDO	8541	TERMINAL 2 N.TERM	123
4923	BAY EASY SHOP CORP.	GDO	8543	1925 BRICKELL AVE #D-200	108
4924	L'ENTRECOTE DE PARIS #1, LLC	GDO	8544	1053 SE 1 AVE #L5	1,158
4925	LA FOURCHETTE RESTAURANT, LLC	GDO	8545	8267 N MIAMI AVE	163
4926	TIERRA NUEVA FINE COCOA, LLC	GDO	8553	1130 NW 159 DR	10,500
4927	OUR LADY OF LOURDES SCHOOL	GDO	8554	14000 SW 112 ST	5,400
4928	TALITA KUM, LLC DBA MAMMA CARUSO'S PIZZERIA	GDO	8555	2905 NE 2 AVE	275

No.	FACILITY_NAME	PERMIT	PERMIT_NUMBER	ADDRESS	TOTAL_GPD
4929	FAMAR, INC. DBA LA VICTORIA DISTRIBUTOR	GDO	8557	3310 NW 30 ST	5,048
4930	KENDALL CREAMERY, INC. DBA COLD STONE CREAMERY	GDO	8560	13624 SW 88 ST	400
4931	BARDOT MIAMI, LLC	GDO	8561	3456 N MIAMI AVE #102	825
4932	SIAM SQUARE NORTH MIAMI INC. DBA SIAM SQUARE RESTAURANT	GDO	8563	54 NW 167 ST	750
4933	SEBASTIAN'S BAKERY, INC.	GDO	8564	425 SW 22 AVE	550
4934	WOLF MIAMI, LLC DBA WOLFGAN'S STEAKHOUSE BY WOLFGANG ZWIENER	GDO	8567	315 S BISCAYNE BLVD	1,959
4935	NEW CHINA TOWN EXPRESS, INC. DBA NEW CHINA TOWN	GDO	8568	2549 NW 54 ST	200
4936	SUBWAY 465847, INC.	GDO	8569	2528 NE 10 CT	300
4937	CAMILLUS HOUSE, INC. DBA CAMILLUS HOUSE CENTER	GDO	8570	1603 NW 7 AVE	2,375
4938	GOOD BREAD BAKERY, INC. DBA GYROS & SALADS	GDO	8574	2207 PONCE DE LEON BLVD	202
4939	SUBWAY 46574, INC.	GDO	8578	15789 SW 72 ST #114	280
4940	GROWN 8211 S. DIXIE HWY 33143, LLC DBA GROWN	GDO	8580	8211 S DIXIE HWY	821
4941	NEW YORK BAGEL AND DELI, INC.	GDO	8584	41 SE 5 ST CU-3	345
4942	THE SALVATION ARMY MIAMI ARC	GDO	8586	2236 NW MIAMI CT	983
4943	PHILLIPS-CI, LLC DBA EINSTEINS BAGEL BROS	GDO	8589	D-26 N.TERM	162
4944	THE SALVATION ARMY, A GEORGIA CORP.	GDO	8590	361 NW 67 ST	3,522
4945	LOS ROQUES GOURMET & GRILL, INC.	GDO	8591	10728 NW 58 ST	281
4946	BIRD & 87 AVE SUPERMARKET, INC. DBA SEDANOS #38	GDO	8593	8601 SW 40 ST #38	10,000
4947	ADAMS CATERING, INC. DBA HAVE IT YOUR WAY	GDO	8595	14080 NW 22 AVE	0
4948	LA CEIBA CORPORATION DBA ADELITA'S DAUGHTER CAFE	GDO	8596	2795 NW 17 AVE	225
4949	U.S. DEPT. OF JUSTICE-FEDERAL CORRECTIONAL INSTITUTION	GDO	8599	15801 SW 137 AVE	144,000
4950	EL PASAPOGA, LLC	GDO	8600	15725 SW 72 ST #184	1,000
4951	QUETZAL BAKERY, INC.	GDO	8601	269 NW 82 AVE	200
4952	CRAIZE CORN, INC.	GDO	8602	6903 NE 3 AVE	325
4953	BUENA VISTA DELI, LLC	GDO	8603	4590 NE 2 AVE	391
4954	CIPURA CORP. DBA MANDOLIN	GDO	8604	4312 NE 2 AVE	150
4955	BAL BAY REALTY, LTD DBA HIALEAH PARK	GDO	8605	2200 E 4 AVE	3,418
4956	AKB, LLC DBA BALANS	GDO	8606	6789 BISCAYNE BLVD	5,000
4957	HESTIA FOOD SERVICES, LLC	GDO	8607	1250 S MIAMI AVE #6	351
4958	CHAYITO'S MINI-MARKET & FRITANGA, INC.	GDO	8608	6153 SW 8 ST	225
4959	SHMC, INC. DBA SUBWAY #46477	GDO	8609	1302 W 49 ST	408
4960	THE FRESH MARKET, INC. DBA THE FRESH MARKET #105	GDO	8614	1800 WEST AVE	7,085
4961	232 COLLINS WASHINGTON HOLDINGS, LLC DBA DIRT RESTAURANT	GDO	8615	232 5 ST	378
4962	THREE GRAND INTL, LLC DBA AQUA RECEPTION HALL	GDO	8617	14060 SW 8 ST	1,370
4963	ZUMA JAPANESE, LLC	GDO	8619	270 BISCAYNE BLVD	1,875
4964	URBIETA STORE OPERATIONS, LLC DBA 7-ELEVEN	GDO	8620	3401 BISCAYNE BLVD	2,720
4965	JD IMEX, INC. DBA YOGURBERRY	GDO	8621	11401 NW 12 ST A-244	250
4966	100 M WEST KENDALL, LLC DBA 100 MONTADITOS	GDO	8622	13440 SW 120 ST #608	573
4967	CAPRI RISTORANTE, LLC	GDO	8624	726 ARTHUR GODFREY RD	796
4968	SV PINCHO BRICKELL, LLC	GDO	8630	1250 S MIAMI AVE CU-4	469
4969	PRETTY HEALTHY, LLC	GDO	8632	17560 NW 27 AVE #1	199
4970	AJI CARBON SUNNY ISLES CORP.	GDO	8633	150 SUNNY ISLES BLVD #13	976
4971	SUVICHE, LLC	GDO	8635	49 SW 11 ST	125
4972	JUICY SMASHED BURGERS, LLC	GDO	8639	117 SE 3 AVE	298
4973	CVZ CORPORATION DBA LOL RESTO BAR	GDO	8640	801 BRICKELL BAY DR #13	275
4974	CREATIVE EDGE PARTIES SOUTH FLORIDA, LLC.	GDO	8646	4029 N MIAMI AVE	1,331
4975	MONUMENT RESTAURANTS VI (PC), LLC DBA FIVE GUYS BURGERS AND FRIES	GDO	8651	9457 S DIXIE HWY #54	746
4976	CHIPOTLE MEXICAN GRILL OF COLORADO, LLC DBA CHIPOTTE #1404	GDO	8652	18461 NW 67 AVE	1,500
4977	ZENG & JIA, INC. DBA ASIAN GARDEN CHINESE FOOD & SUSHI BAR	GDO	8655	2451 W 68 ST #4	500
4978	SANCHEZ COIN LAUNDRY CORP. DBA SANCHEZ COIN LAUNDRY	GDO	8660	1663 SW 67 AVE	0
4979	COLORADO PREMIUM DELI, LLC	GDO	8662	1630 NW 70 AVE	9,500
4980	TUOFIC & RIMA, INC. DBA DAILY BREAD	GDO	8663	12133-37 S DIXIE HWY	525
4981	PEPPERS BURRITO GRILL, LLC	GDO	8664	1238 WASHINGTON AVE	450
4982	MIXTURA PERUVIAN RESTAURANT, LLC	GDO	8666	10921 SW 186 ST	570
4983	JACALITO TAQUERIA, INC.	GDO	8669	3622 W FLAGLER ST	150
4984	LAFFA MEDITERRANEAN GRILL BRICKELL, LLC	GDO	8670	1250 S MIAMI AVE #CU-05	315
4985	JR SIXTEEN, INC. DBA JOHNNY ROCKETS #16	GDO	8671	20505 S DIXIE HWY #1303	3,575
4986	DFO ENTERPRISES, INC. DBA FOOQ'S	GDO	8672	1035 N MIAMI AVE #103	231
4987	ALMA MEXICANA, LLC	GDO	8677	1344 WASHINGTON AVE	234
4988	CORONAS MIA, LLC DBA CORONAS BEACH HOUSE	GDO	8678	D-23 N.TERM	514
4989	BEIJING CAFE 6950, LLC	GDO	8681	6950 COLLINS AVE	288
4990	RARE EXTREME HOLDINGS, LLC DBA RARE STEAKHOUSE	GDO	8682	4101 PINE TREE DR	1,978
4991	4 JJJJ OF MIAMI CORP. DBA 4 JJJJ PIZZERIA ICE CREAM & RESTAURANT	GDO	8683	1801-05 NE 8 ST	1,150
4992	1941 MARKET, LLC DBA OCEAN DELI	GDO	8684	1941 LIBERTY AVE	550
4993	ARAMARK CORP.	GDO	8685	4200 W FLAGLER ST	3,725
4994	DIVINE DELIVERIES, INC. DBA OLD FASHION DIVINE	GDO	8686	6825 NW 7 AVE	429
4995	TEJAS DE HONDURAS CORP.	GDO	8688	19200 SW 106 AVE #8	279
4996	FISHER ISLAND CLUB, INC. DBA PASTA TRATTORIA	GDO	8691	42101 FISHER ISLAND DR	502
4997	LA ORQUIDIA RESTAURANT CORP.	GDO	8692	10827 SW 40 ST	275
4998	1701 NW FOOD CORP. DBA BRAVO SUPERMARKET #360	GDO	8693	1701 NW 119 ST	5,043
4999	HONEST FOOD MIAMI, LLC	GDO	8696	134 NE 2 AVE	213
5000	GRK F&B, LLC	GDO	8697	1601 WASHINGTON AVE #120	476
5001	SHAKE SHACK 1111 LINCOLN ROAD, LLC DBA SHAKE SHACK	GDO	8698	1111 LINCOLN RD #14	696
5002	IGBY, INC. DBA QUANTUM MARKET	GDO	8701	1900 N BAYSHORE DR #208	174
5003	GUSTOS PIZZERIA AT BAYSIDE, INC. DBA GUSTOS PIZZA & SUBS	GDO	8702	401 BISCAYNE BLVD 2145	3
5004	PUBLIX SUPERMARKETS, INC. DBA PUBLIX STORE #1273	GDO	8703	18280 SW 147 AVE	11,293
5005	PUBLIX SUPERMARKETS, INC. DBA PUBLIX STORE #1247	GDO	8704	23300 SW 112 AVE	11,400
5006	NEW STAR CAFETERIA, LLC	GDO	8707	47 NW 79 ST REAR	150
5007	VIVIAN CAFETERIA, INC.	GDO	8713	1801 NW 7 ST #7	57
5008	LA NUEVA VECINA CAFETERIA, INC.	GDO	8714	735 NW 20 ST	175
5009	LOVE OF LEARNING ACADEMY, LLC	GDO	8715	19350 BELVIEW DR	44
5010	GARI MARIA RESTAURANT, INC.	GDO	8716	229 NW 22 AVE	500
5011	MR. RICE AND FRIENDS, INC.	GDO	8717	205 W 27 ST	250
5012	THE FRESH MARKET, INC.	GDO	8720	18299 BISCAYNE BLVD	4,900
5013	SILVER EARTH, INC. DBA RITMO SNACKS	GDO	8721	1365 NW 98 CT #6	250
5014	REDLAND MARKET VILLAGE, INC.	GDO	8722	24420 PACKING HOUSE RD	1,078
5015	L & M OF SOUTH MIAMI, LLC DBA SPLITSVILLE	GDO	8724	5701 SW 72 ST #202	10,750
5016	EL CIELO RESTAURANT, LLC	GDO	8728	31 SE 5 ST	598

No.	FACILITY_NAME	PERMIT	PERMIT_NUMBER	ADDRESS	TOTAL_GPD
5017	COMO TRAYMORE, LLC DBA TRAYMORE HOTEL	GDO	8730	2445 COLLINS AVE	1,516
5018	VII MP MIAMI HOTEL OWNER, LLC [#601]	GDO	8731	1441 BRICKELL AVE #601	40,825
5019	VII MP MIAMI HOTEL OWNER, LLC [#701] - YDGE RESTAURANT	GDO	8732	1441 BRICKELL AVE #701	1,214
5020	VII MP MIAMI HOTEL OWNER, LLC [#702]	GDO	8733	1441 BRICKELL AVE #702	658
5021	VII MP MIAMI HOTEL OWNER, LLC [#703]	GDO	8734	1441 BRICKELL AVE #703	417
5022	A LITTLE BIT A PHILLY, INC.	GDO	8735	3940 CURTISS PKY	0
5023	PAINS ET GATEAUX, LLC	GDO	8737	1380 N KROME AVE #13	313
5024	THEA'S PIZZERIA, INC.	GDO	8739	1951 NW 7 AVE #190	365
5025	MONUMENT RESTAURANTS VI (DL), LLC DBA FIVE GUYS BURGERS & FRIES	GDO	8742	9725 NW 41 ST	875
5026	NESPRESSO USA, INC.	GDO	8744	1111 LINCOLN RD #9	750
5027	MY CEVERICE-BRICKELL	GDO	8746	1250 S MIAMI AVE # 107	180
5028	DIAMOND FUEL, LLC DBA WESTAR	GDO	8750	14290 W DIXIE HWY	56
5029	EASTER SEALS SOUTH FLORIDA, INC.	GDO	8753	1475 NW 14 AVE	223
5030	YF LINCOLN ROAD, LLC DBA YOGEN FRUZ	GDO	8754	521 LINCOLN RD	225
5031	TERRAZA CASTELLANA MIAMI CORP. DBA OCEAN DELIGHT'S CAFE	GDO	8755	782 NW 42 AVE #14	540
5032	TASTE BAKERY CAFE LLC	GDO	8756	1686 JEFFERSON AVE	450
5033	NORMAN BROTHERS PRODUCE, INC.	GDO	8758	7621 SW 87 AVE	763
5034	FERMANTON, LLC DBA JARDIM DE PORTUGAL	GDO	8762	2960 SW 22 ST CU-1	409
5035	GAS PETRO, LLC DBA LEJEUNE AMOCO	GDO	8763	1250 SE 8 AVE	500
5036	BOOKS & BOOKS OF MIAMI BEACH INC. DBA BOOKS & BOOKS CAFE	GDO	8764	927 LINCOLN RD	625
5037	CAFE AMBASSADOR'S, INC.	GDO	8765	825 BRICKELL BAY DR LOBBY	500
5038	AMERICAN BANKERS LIFE ASSURANCE (ASSURANT CHILD'S PLACE)	GDO	8770	11222 QUAIL ROOST DR	1,880
5039	THE SNACK PLACE, INC.	GDO	8771	217 W 27 ST	313
5040	GIGI NMA, LLC	GDO	8772	3470 N MIAMI AVE	573
5041	PRESIDENTE SUPERMARKET #25, INC.	GDO	8773	621 NW 62 ST	8,000
5042	R.C. COBB II, LLC DBA REGAL SOUTH BEACH 18	GDO	8774	1120 LINCOLN RD	12,500
5043	LITTLE CAESAR'S ENTERPRISES, INC. DBA LITTLE CAESARS	GDO	8775	24655 SW 112 AVE #101	341
5044	ANGELITA TORTILLERIA, INC. DBA FRITANGA PONELOYA	GDO	8776	10170 W FLAGLER ST 2ND USER	0
5045	SPAGHETTINO, LLC	GDO	8778	947 BRICKELL AVE	720
5046	COURTYARD MANAGEMENT CORP. DBA COURTYARD BY MARRIOTT (LOBBY)	GDO	8779	2649 S BAYSHORE DR LOBBY BAR	1,150
5047	COURTYARD MANAGEMENT CORP. DBA COURTYARD BY MARRIOTT	GDO	8780	2649 S BAYSHORE DR BALLROOM	260
5048	DION'S QUIK MARTS, LLC DBA DION'S QUIK MART #12	GDO	8782	16 N KROME AVE	2,799
5049	P.F. CHANG'S CHINA BISTRO, INC. DBA PFCB #9872	GDO	8784	11361 NW 12 ST E-541	1,903
5050	PUBLIX SUPERMARKETS, INC. DBA PUBLIX STORE #1264	GDO	8785	3250 E 2 AVE	9,801
5051	WOW SPECIALTY CUTS CORP.	GDO	8786	10840 NW 138 ST 3-A	387
5052	KOCOYEH, LLC DBA KOCOYEH CUISINE	GDO	8787	11900 BISCAYNE BLVD # 103	236
5053	RESTAURANT INVESTMENT AT DORAL, LLC DBA DIVIETO ITALIAN AMERICAN	GDO	8789	10650 NW 41 ST	1,625
5054	BASIL THAI OF DADELAND, INC. DBA BASIL THAI	GDO	8790	7535 SW 88 ST FC-1360	104
5055	DGS RESTAURANT, LLC DBA RED PIZZA	GDO	8793	1260 WASHINGTON AVE	300
5056	RESTAURANTE EL TINAJON, INC.	GDO	8795	6355 NW 36 ST	400
5057	HARVEST PITA DBA THE HARBOUR GRILL	GDO	8796	9427 HARDING AVE	218
5058	REASONS, LLC DBA NUTREAT	GDO	8797	100 S BISCAYNE BLVD #108	175
5059	JR INVESTMENTS ENTERPRISES INC. DBA EL CARMELO CAFETERIA	GDO	8798	1915 W 60 ST	174
5060	SALVADORAN CUISINE, INC.	GDO	8799	15260 SW 280 ST #120-122	806
5061	SUBWAY ALTON CORP. DBA SUBWAY #48253	GDO	8801	1107 5 ST	362
5062	LE DONG CORP. DBA GINZA JAPANESE BUFFET	GDO	8803	16153 BISCAYNE BLVD #6	1,350
5063	BLUE OWL VENTURES, LLC	GDO	8804	3250 NE 1 AVE #107	800
5064	CITY OF HIALEAH - MILANDER CENTER (CONCESSIONS)	GDO	8806	4800 PALM AVE	250
5065	MGD56, INC. DBA LA ESQUINA SUPERMARKET	GDO	8808	1385 NW 27 AVE	1,000
5066	CHEZ SOLANGE RESTAURANT, LLC	GDO	8809	13030 NW 7 AVE	175
5067	MANAGUA CORPORATION DBA FRITANGA COSAS NUEVAS	GDO	8812	11735 SW 147 AVE #25	293
5068	SUBWAY 47338, INC.	GDO	8813	23268 SW 112 AVE	325
5069	G & F BRIDGE, LLC DBA MIAMI SUBS & CAFE	GDO	8814	4905 NW 72 AVE #1	400
5070	JAAN HOSPITALITY, LLC DBA BEACH PLAZA HOTEL	GDO	8817	1401 COLLINS AVE	1,000
5071	A & Y RESTAURANT, LLC DBA DON CRIOLLITO	GDO	8818	20505 S DIXIE HWY KIOSK 1926	50
5072	ORGULLO CATRACHO CORP.	GDO	8820	2300 SW 8 ST	2,500
5073	GOLDSTEIN'S KOSHER MEATS, INC. DBA GOLDSTEIN'S PRIME	GDO	8821	7419 COLLINS AVE	750
5074	FRITANGA MORALIMPIA #2, INC.	GDO	8822	4353 NW 7 ST	20,000
5075	DON HECTOR GOURMET, LLC DBA FRITANGA EL TORITO	GDO	8824	12891 SW 42 ST	206
5076	THE CHICKEN LITTLE WING OF THE SOUTH, INC.	GDO	8825	1133 W 68 ST	315
5077	DADELAND SUBWAYS, LLC DBA SUBWAY #46991	GDO	8826	9300 S DADELAND BLVD #110	6
5078	PITA LOCA OF SOUTH BEACH DBA PITA LOCA RESTAURANT	GDO	8828	601 COLLINS AVE UNIT 5	126
5079	LA MORA ITALIANA, INC.	GDO	8829	17225 S DIXIE HWY #100	371
5080	ROOTS JUICE BAR, LLC DBA ROOTS JUICE BAR	GDO	8830	8530 SW 124 AVE #101	250
5081	HEARTLAND OF KENDALL FL., LLC	GDO	8832	9400 SW 137 AVE	2,400
5082	ILY'S PIES, INC.	GDO	8833	13091 PORT SAID RD #1	375
5083	GIACC ENTERPRISES, LLC DBA PALATINO JAMAICAN RESTAURANT	GDO	8834	3004 NW 2 AVE	225
5084	MARIE KITCHEN, LLC DBA CHARLIES CARIBBEAN KITCHEN	GDO	8835	1550 NE 164 ST	389
5085	GLOBAL INVESTMENTS OF SOUTH FL., LLC DBA CAFE QUE RICO	GDO	8839	1822 NE MIAMI GARDENS DR	258
5086	SOUTH FLORIDA BAKERY, INC.	GDO	8840	14305-09 SW 142 AVE	1,525
5087	PIZZA NAPOLITANO, LLC	GDO	8841	8481 NW SOUTH RIVER DR	125
5088	OLD LISBON SUNNY ISLES, LLC	GDO	8845	17100 COLLINS AVE OP-1	1,046
5089	GARCIA-AMAYA, LLC DBA GARCIA RESTAURANT	GDO	8846	404 SW 22 AVE	1,250
5090	BLUE MARTINI KENDALL HOLDINGS, LLC DBA BLUE MARTINI	GDO	8847	8405 MILLS DR #205	234,100
5091	ZAPO ENAMORADO, INC. DBA EL ZAPO ENAMORADO	GDO	8848	2280 NW 20 ST	750
5092	YARDIE SPICE, LLC DBA YARDIE SPICE JAMAICAN & HAITIAN RESTAURANT	GDO	8850	225 S KROME AVE	163
5093	BAILIE CHEN, LLC DBA PETE'S KITCHEN	GDO	8851	14775 SW 184 ST	225
5094	AROMA COLOMBIANO, LLC	GDO	8852	3935-37 NW 7 ST	163
5095	THE KELLY GROUP OF CORAL GABLES, LLC	GDO	8853	9805 NW 80 AVE BAY 13-I	150
5096	ALL TRADING MIAMI, LLC DBA FROZEN BUBBLES	GDO	8854	1 CURTISS PKY #3	250
5097	MACILLON GRIO FISH & CHICKEN, INC.	GDO	8855	1026 NE 163 ST	275
5098	WELFARE RESTAURANT CORP.	GDO	8857	1444 SW 8 ST	500
5099	CHINA PAN, INC.	GDO	8859	23250 SW 112 AVE	263
5100	NUEVO PATIO RESTAURANT & LONGE CORP.	GDO	8864	1861-63 NW 22 ST	550
5101	FLORIDA EDUCATION INSTITUTE, INC. DBA PASION	GDO	8865	5915 SW 8 ST	1,000
5102	CAFE SABROSO RESTAURANT CORP.	GDO	8866	1881 NW 7 ST	205
5103	ABITBOL MIDDOWN WINGS, LLC DBA HURRICANE GRILL & WINGS	GDO	8867	3201 N MIAMI AVE #100-C	648
5104	DSEFERE RESTAURANTS, INC. DBA BLUE COLLAR RESTAURANT	GDO	8868	6730 BISCAYNE BLVD #130	288

No.	FACILITY_NAME	PERMIT	PERMIT_NUMBER	ADDRESS	TOTAL_GPD
5105	MLK ENTERPRISES, INC. DBA 62ND ST MARKET PEP LA	GDO	8869	1 NW 62 ST	800
5106	HIRO'S YAKKO-SAN, INC. DBA HIRO'S SUSHI EXPRESS	GDO	8870	17040-46 W DIXIE HWY	625
5107	LPFC, INC. DBA LUTONG PINOY FILIPINO CUISINE	GDO	8871	17048-50 W DIXIE HWY	313
5108	LA ABUELA CAKES CORPORATION	GDO	8876	6047 SW 8 ST	200
5109	CAFE CON LECHE AT WESTLAND, INC. DBA CAFE CON LECHE	GDO	8880	1675 W 49 ST #1180	45
5110	LA PRIMA CASA, INC.	GDO	8881	2733 SW 3 AVE	925
5111	BAMBOO COLOMBIAN CUISINE, INC.	GDO	8883	13327 SW 42 ST	300
5112	SUNNY 88, LLC. DBA 3 CHEFS CHINESE RESTAURANT	GDO	8884	275 NE 18 ST CU-5	361
5113	GS BISCAYNE, LLC DBA SUBWAY #17085	GDO	8885	10701 BISCAYNE BLVD	500
5114	STARBUCKS CORP. DBA STARBUCKS COFFEE COMPANY #11715	GDO	8886	52 CURTISS PKY	526
5115	BCX GROUP CORP. DBA BRAZUCA'S GRILL	GDO	8887	10808 NW 58 ST	276
5116	SPRIS MIDTOWN, LLC DBA SPRIS ARTISAN PIZZA-MIDTOWN	GDO	8888	3201 N MIAMI AVE #102	480
5117	ABITBOL ITALIAN, LLC DBA BIG LOUIE'S	GDO	8890	61 NW 37 AVE	1,189
5118	REVO SOCCER DORAL, LLC	GDO	8891	10395 NW 41 ST #101	10
5119	BEALLBERRY, LLC DBA PINKBERRY	GDO	8892	3401 N MIAMI AVE #122	311
5120	SUBWAY 49157, INC.	GDO	8893	2899 COLLINS AVE	455
5121	THE B GUIDAS, INC. DBA OKINAWA SUSHI EXPRESS	GDO	8894	119 SE 2 AVE	200
5122	NATY'S BAKERY CORP.	GDO	8895	12150 SW 132 CT 214-B	262
5123	LITTLE BY LITTLE, INC. DBA TROPICAL SMOOTHIE CAFE	GDO	8896	13550 SW 120 ST #452	574
5124	DON CRIOLLITO CORP.	GDO	8897	12039 SW 132 CT #1-2	400
5125	LA FLACA CAFETERIA AND PRODUCE	GDO	8899	2186 NW 13 AVE #1	75
5126	LENIET CORP. DBA LEISURE CITY SERVICE CENTER (BP)	GDO	8901	29421 SW 152 AVE	926
5127	FROZEN YOGURT WESTFIELD, LLC	GDO	8902	1675 W 49 ST #1190	56
5128	LEEMBURG-CRUZ, INC. DBA DEL CAMPO LATIN FOOD & CAFE	GDO	8903	24655 SW 112 AVE 108-109	410
5129	SUBWAY 49157, INC.	GDO	8904	9457 W FLAGLER ST A	364
5130	SUBWAY 46981, INC.	GDO	8905	8298 SW 40 ST	402
5131	J.L.S., INC. DBA SOTO ENTERPRISES	GDO	8906	1580 W 38 PL #2	230
5132	ANS EXPRESS, INC. DBA CUISINE CREOLE RESTAURANT	GDO	8907	15034 NE 6 AVE	275
5133	THE TOWER HOUSE CONDOMINIUM, INC. DBA LA BRASSERIE RESTA	GDO	8908	5500 COLLINS AVE	319
5134	YAKKO-SAN, LLC	GDO	8911	3881 NE 163 ST	1,064
5135	LETTUCE & TOMATO RESTAURANT, LLC	GDO	8912	17070 W DIXIE HWY	310
5136	HGR, LLC DBA PIZZA SCENE	GDO	8913	2360 W 68 ST #130	400
5137	FUFI, LLC	GDO	8915	4600 NE 2 AVE #10	161
5138	ICEBOX CAFE AT MIA, LLC DBA ICEBOX CAFE	GDO	8916	D-8 N.TERM.	288
5139	CUZCO BRICKELL COCINA PERUANA, INC.	GDO	8917	900 S MIAMI AVE #180	476
5140	WYNWOOD KITCHEN & BAR, LLC	GDO	8921	2550 NW 2 AVE	1,029
5141	MBV IRISH PUB, LLC DBA FADO IRISH PUB	GDO	8922	900 S MIAMI AVE #220	1,848
5142	CATRACHOLANDIA LATINO, INC. DBA CAFETERIA Y ASADOS "EL TORO	GDO	8924	1640 W FLAGLER ST	175
5143	INTERMEZZO @ JM MARRIOTT MARQUIS, MIAMI	GDO	8926	255 SE 4 ST FACILITY A	500
5144	THE PALACE MANAGEMENT GROUP, LLC DBA THE PALACE AT CORAL GABLES	GDO	8930	1 ANDALUSIA AVE	2,289
5145	SUCRE CAFE, INC.	GDO	8931	475 BILTMORE WAY #104-B	128
5146	DAIRY BITES DBA LENNY'S PIZZA	GDO	8934	544 ARTHUR GODFREY RD	350
5147	BEST BEACH PIZZA, LLC DBA I LOVE PIZZA	GDO	8935	7105 COLLINS AVE	200
5148	LARGO SEAFOOD GRILL, INC.	GDO	8936	401 BISCAYNE BLVD #1030	495
5149	THE ROCK INVESTMENT, LLC DBA PATACON PISA'O RESTAURANT	GDO	8937	13630 SW 120 ST #216	328
5150	7-ELEVEN, INC. DBA 7-ELEVEN #34577H	GDO	8938	18421 NW 67 AVE	651
5151	MIMAR, INC. DBA THE GREEK PLACE	GDO	8940	9561 HARDING AVE	348
5152	SH FOOD SERVICES, LLC DBA LA MARGARITA WONDER FOOD	GDO	8943	9851 NW 58 ST # 105	370
5153	MIA - NYC DOWNTOWN, LLC DBA JALEO OCHO RESTAURANT	GDO	8944	1644 SW 8 ST	50,000
5154	NOVE KITCHEN AND BAR, LLC	GDO	8945	1750 N BAYSHORE DR 102-103	475
5155	DON DOMINGO CARNICERIA ARGENTINA	GDO	8948	2752-56 SW 137 AVE	513
5156	FRANZO ENTERPRISES, INC. DBA TAMAMIAMI 99	GDO	8949	9980 SW 8 ST	225
5157	RICE NORTH MIAMI, LLC DBA RICE HOUSE OF KABOB	GDO	8951	14480 BISCAYNE BLVD	388
5158	MIDTOWN BLACK BRICK, LLC DBA BLACK BRICK	GDO	8952	3451 NE 1 AVE #103	418
5159	INTERNATIONAL SWEET SPOT, INC.	GDO	8954	1455 NW 107 AVE K-101	50
5160	THE CAFE AT BOOKS & BOOKS/ARSHT CENTER, LLC. DBA CAFE AT BOOKS &	GDO	8955	1300 BISCAYNE BLVD FACILITY B	60,225
5161	MET CAFE & BAR @ JM MARRIOTT MARQUIS, MIAMI	GDO	8956	255 SE 4 ST FACILITY B	350
5162	THREE FORTY-FIVE @ JM MARRIOTT MARQUIS, MIAMI	GDO	8957	255 SE 4 ST FACILITY C	871
5163	BISTRO MODERNE @ JM MARRIOTT MARQUIS, MIAMI	GDO	8958	255 SE 4 ST FACILITY D	2,775
5164	LA GRACIA CORP. DBA LA CASA DE LOS BALEADOS	GDO	8960	100 SW 17 AVE	250
5165	CRAB STOP OF MIAMI, INC.	GDO	8961	4801 NW 27 AVE	191
5166	SEASONS 52 HOLDINGS, LLC DBA SEASONS 52 #4509	GDO	8962	321 MIRACLE MILE	2,658
5167	QUEEN GROCERY TRADER, INC. DBA GIANT MARKETPLACE	GDO	8963	15006 NE 6 AVE	2,500
5168	TOWN KITCHEN, LLC. DBA TOWN KITCHEN & BAR	GDO	8967	7301 SW 57 CT #100	1,100
5169	FLORIDA JUICES, LLC DBA LA ESTRELLA DE LOS JUGOS	GDO	8968	2200 PALM AVE	800
5170	RINCON PROGRESENO MARKET PLACE CORP.	GDO	8970	2148 NW 17 AVE #5-7	438
5171	GLOBAL MIAMI JOINT VENTURE/CLUBHOUSE ONE	GDO	8972	D-24 N. TERM.	778
5172	GLOBAL MIAMI JOINT VENTURE DBA SUSHI MAKI	GDO	8973	D-29 N. TERM.	456
5173	GLOBAL MIAMI JOINT VENTURE DBA ISLANDER BAR & GRIL	GDO	8974	D-4 N. TERM.	313
5174	CRISP CREATIONS, LLC DBA GIARDINO GOURMET SALADS	GDO	8977	6653 S DIXIE HWY	241
5175	RYMC ENTERPRISES, LLC DBA GAR SING RESTAURANT	GDO	8980	14515 SW 42 ST	350
5176	ANDY'S SON, INC. DBA TOP TASTE	GDO	8981	955 NW 3 AVE #1	413
5177	OFF THE GRILLE II @ MIAMI-DADE COLLEGE INTERAMERICAN CAMPUS	GDO	8983	627 SW 27 AVE #1133	174
5178	IBC FOOD CORP. DBA LA BODEGUITA MEAT MARKET	GDO	8984	16010 NW 57 AVE 122 & 124	559
5179	PERUVIAN GOURMET, INC. DBA DELIZIA	GDO	8985	4868 NW 7 ST	125
5180	FLORIDA INTERNATIONAL UNIVERSITY - THE WOLFSONIAN	GDO	8986	1001 WASHINGTON AVE	531
5181	JACKSON HEIGHTS NH, LLC DBA UNITY HEALTH AND REHAB	GDO	8987	1404 NW 22 ST	1,335
5182	RICO'S HOT DOG & BURGERS CORP.	GDO	8990	2400 NW 7 AVE	25
5183	FAST GRILL ENTERPRISES OF HAMMOCKS, LLC	GDO	8992	11735 SW 147 AVE #1-2	650
5184	HOST INTERNATIONAL, INC. DBA BEAUDEVIN	GDO	8993	D-24 B N.TERM.	225
5185	BETTER DAYZ, INC. DBA HAAGEN DAZ	GDO	8996	8405 MILLS DR #201	240
5186	STK MANAGEMENT, INC. DBA PIZZA RUSTICA BRICKELL	GDO	8997	75 SE 6 ST #102	450
5187	7-ELEVEN, INC. DBA 7-ELEVEN #34651H	GDO	8998	792 S HOMESTEAD BLVD	510
5188	CATHOLIC CHARITIES, INC. DBA NEW LIFE FAMILY SHELTER	GDO	9000	3620 NW 1 AVE	600
5189	NITAL TRADING COMPANY, INC.	GDO	9002	7277 NW 78 TER	250
5190	HOOTERS OF MIAMI, INC. DBA HOOTERS RESTAURANT	GDO	9003	3301 SW 22 ST #104	1,300
5191	ANGELINA'S COFFEE & YOGURT, LLC	GDO	9004	3451 NE 1 AVE #102-B	228
5192	BELLA BAKERY, LLC	GDO	9005	357 N ROYAL POINCIANA BLVD 106	163

No.	FACILITY_NAME	PERMIT	PERMIT_NUMBER	ADDRESS	TOTAL_GPD
5193	LA NUEVA BONAFIDE CORP.	GDO	9007	1617-19 NE 163 ST	625
5194	MOE'S KENDALL, LLC DBA MOE'S SOUTHWEST GRILL	GDO	9009	8746 MILLS DR	691
5195	JIMMY'Z KITCHEN WYNWOOD, LLC	GDO	9010	2700 N MIAMI AVE #106	714
5196	JENNIFER'S CAFETERIA, INC.	GDO	9012	16462 NE 16 AVE	313
5197	PRESIDENTE SUPERMARKET #24, INC.	GDO	9013	14870 SW 88 ST	4,927
5198	168 FENG WU CORP. DBA CHINA EXPRESS	GDO	9015	5748 W FLAGLER ST	171
5199	FRITANGA EL SABOR NICA, INC.	GDO	9016	858 N KROME AVE	140
5200	NURYS ENTERPRISES OF SOUTH FLORIDA, INC.	GDO	9017	3333 NW 17 AVE	375
5201	SERGIO'S RESTAURANT #6, LLC	GDO	9019	1640 NW 87 AVE	1,728
5202	RINCON CRIOLLO RESTAURANT CAFETERIA, INC.	GDO	9023	2601 NW 39 AVE	375
5203	MARJOUILA, INC. DBA LILE'S AIRPORT CAFE	GDO	9024	2555 NW 39 AVE	150
5204	JTYMIA CC, LLC DBA JIMMY JOHN'S GOURMET SANDWICH #2895	GDO	9027	1516 WASHINGTON AVE	288
5205	7-ELEVEN, INC. DBA 7-ELEVEN STORE #39355A	GDO	9028	6348 COLLINS AVE	575
5206	MARINA PARK INN, LLC DBA HOLIDAY INN PORT OF MIAMI	GDO	9029	340 BISCAYNE BLVD	666
5207	BARRACUDAS RESTAURANT & CAFETERIA, INC.	GDO	9033	10949 SW 186 ST	255
5208	7 ATE 9, INC. DBA HUAHUA'S TAQUERIA	GDO	9034	1209-11 LINCOLN RD	296
5209	Y F DORAL, LLC DBA YOGEN FRUZ	GDO	9035	10741 NW 58 ST	375
5210	PEACE A CAKE, INC.	GDO	9038	1325 NW 98 CT #4	453
5211	GREEN APPLE VENTURE, LLC DBA YOGURT LAND	GDO	9039	9715 NW 41 ST #28	311
5212	LA NUEVA PASTELERIA BAKERY, INC. DBA PASTELMANIA BAKERY	GDO	9041	2015 W FLAGLER ST	350
5213	BLUE RIVIERE, LLC DBA YUZU FROZEN YOGURT & CREPES	GDO	9042	235 SW 8 ST	342
5214	J.R. BAY, INC. DBA TONY CHAN'S WATER CLUB	GDO	9043	1717 N BAYSHORE DR #131	1,554
5215	THE WINE VAULT OF MIAMI, INC.	GDO	9044	3201 N MIAMI AVE #100-E	304
5216	ACG INVESTMENT V, LLC DBA ORION	GDO	9046	1055 NW 27 AVE	125
5217	MILOP, LLC DBA LATTE NEWS AND EXPRESSO	GDO	9047	3320 BUENA VISTA AVE	596
5218	YEPARA, INC.	GDO	9049	1884 79 ST	225
5219	GALILEO ENTERPRISE, LLC DBA MARE MIO RESTAURANT	GDO	9050	447 ESPANOLA WAY	555
5220	ABEL & BAKER (MIAMI), LLC	GDO	9051	920 ALTON RD	953
5221	PIRIPU UMP, LLC DBA PIRIPU BAR AND RESTAURANT	GDO	9053	320 SAN LORENZO AVE #1315	1,269
5222	ROOC SUNILAND, LLC DBA THE CHEESE COURSE	GDO	9057	11355 S DIXIE HWY	525
5223	FOOD SPOT OF KENDALL, INC. DBA FOOD SPOT	GDO	9058	11559 SW 88 ST	338
5224	SIR PIZZA OF OLD CUTLER ROAD, INC.	GDO	9060	7290 SW 168 ST E	361
5225	FRESH BREAK, LLC	GDO	9061	1110 BRICKELL AVE 102	175
5226	MACUTANI, LLC	GDO	9063	2697 BISCAYNE BLVD	112
5227	LOS VERDES PALMETTO BAY, LLC DBA LOS VERDES RESTAURANT	GDO	9065	4243 NW 107 AVE	343
5228	ANMA RESTAURANT, LLC DBA SBARRO FRESH ITALIAN COOKING	GDO	9068	1668 COLLINS AVE	534
5229	POLLOS Y JARRAS, LLC	GDO	9069	115 NE 3 AVE	1,941
5230	HOLY BAGEL & PIZZERIA CORP.	GDO	9070	15903 BISCAYNE BLVD	437
5231	TAKEE OUTEE OF BRIAR BAY, LLC	GDO	9072	13015 SW 89 PL	330
5232	AZTLAN FOODS CORP.	GDO	9076	13117 NW 107 AVE #2	450
5233	CHICKEN KITCHEN @ WEST FLAGLER, LLC DBA CHICKEN KITCHEN	GDO	9077	8754 W FLAGLER ST	375
5234	MONTI INTERNATIONAL, LLC DBA 100 MONTADITOS	GDO	9078	3252 NE 1 AVE # 104	533
5235	WORLDWIDE CONCESSION, INC. DBA BACARDI MOJITO BAR	GDO	9079	D-55 N.TERM	504
5236	MIAMI RESTAURANT CUBAN CAFE CORP.	GDO	9082	5635 SW 8 ST	250
5237	PLAYCHEF K, LLC	GDO	9083	21008 W DIXIE HWY	173
5238	CALIMAS CORP. DBA ERNESTO'S TACO SHOP	GDO	9085	13729 SW 152 ST	280
5239	SEVEN STARS DADES CORNER DBA SUBWAYS	GDO	9087	17696 SW 8 ST	100
5240	JAVIER CAFETERIA CORP.	GDO	9088	13001 PORT SAID RD #4	0
5241	LA 49, LLC DBA EL PALACIO DE LOS JUGOS	GDO	9089	1275 W 49 ST	1,300
5242	CENTRO VENEZOLANO DE CAPACITACION GASTRONOMICA, LLC.	GDO	9090	12803 SW 42 ST	214
5243	HNI, LLC DBA MENCHIES	GDO	9091	18451 NW 67 AVE	278
5244	NEW YORK ROMA PIZZA & CATERING #3, INC.	GDO	9092	1444 BISCAYNE BLVD #103	258
5245	ROSA MEXICANO SOUTH BEACH, LLC	GDO	9093	1119 LINCOLN RD #103	1,619
5246	MIAMI BEACH GOLF CLUB RESTAURANT	GDO	9095	2301 ALTON RD	1,641
5247	HOST TINSLEY JOINT VENTURE, INC. DBA THE COUNTER	GDO	9096	D-33 N.TERM	538
5248	SUNRISE DADELAND, LLC DBA VILLA FRESH ITALIAN KITCHEN	GDO	9097	7501 SW 88 ST #4	309
5249	DOLPHIN FUN, LLC DBA COOL DE SAC	GDO	9098	11401 NW 12 ST #E-610	2,047
5250	PINOLANDIA NO.4 CORP.	GDO	9099	1100 NW 119 ST	375
5251	PANTHER COFFEE, LLC DBA PANTHER COFFEE	GDO	9104	2390 NW 2 AVE	297
5252	LUNA BY THE GANG, LLC DBA THE GANG RESTAURANT	GDO	9105	3500 N MIAMI AVE B	666
5253	AT THE REN, LLC	GDO	9106	10855 SW 72 ST 1-5	1,800
5254	PANTHER & CO., INC.	GDO	9108	8321 NW 90 ST	219
5255	SETTGO, LLC DBA LA SANDWICHERRIE RESTAURANT	GDO	9109	34 SW 8 ST	471
5256	SDR 1 FOOD CORP. DBA SABOR TROPICAL SUPERMARKET	GDO	9110	8700 SW 137 AVE	388
5257	CHARCOALS GRILL, INC. DBA CHARCOALS STEAK & GRILL	GDO	9115	13550 SW 120 ST #408	583
5258	MISHA'S CUPCAKES, INC.	GDO	9117	13440 SW 120 ST #606	163
5259	SYLVANO, INC. DBA SYLVANO'S RESTAURANT	GDO	9118	1925 LIBERTY AVE	837
5260	MAESY COFFEE SHOP CORP. DBA MAESY RESTAURANT CAFETERIA	GDO	9119	1466-68 SW 6 ST	308
5261	PUBLIX SUPERMARKETS, INC. DBA PUBLIX STORE #1397	GDO	9121	1776 BISCAYNE BLVD	12,301
5262	TEMPLE BETH SHOLOM, INC.	GDO	9123	4144 CHASE AVE	250
5263	DESSERT FLORIDA, LLC	GDO	9125	2451 NW 109 AVE 7	279
5264	MI RANCHO MEXICAN GRILL, INC.	GDO	9126	2157 W FLAGLER ST	375
5265	GREEN EGGS CAFE MANAGEMENT AND RESTAURANT DESIGN	GDO	9129	18729 BISCAYNE BLVD	1,713
5266	SUMAX INVESTMENTS, LLC DBA MENCHIE'S OF MIAMI LAKES	GDO	9131	7309 MIAMI LAKES DR	506
5267	BERN BROS, LLC DBA SAVORY BAKERY & CAFE	GDO	9132	1701 PURDY AVE #101	194
5268	PANERA, LLC DBA PANERA BREAD BAKERY CAFE #1525	GDO	9137	1428 ALTON RD	1,188
5269	TONGUE & CHEEK, LLC	GDO	9138	431 WASHINGTON AVE	1,245
5270	SIAMO, INC.	GDO	9140	307 N ROYAL POINCIANA BLVD	188
5271	MORRISON MANAGEMENT SPECIALIST, INC.	GDO	9141	1475 NW 12 AVE	430
5272	YOGURT FUSION CORP.	GDO	9143	15785 SW 152 ST C3	385
5273	MABEL'S PLACE CORP.	GDO	9144	1923 NW 22 ST	350
5274	LIQUID ASSETS, LLC DBA PROOF PIZZA & PASTA	GDO	9145	3328 N MIAMI AVE	393
5275	BEST FRIENDS SINCE 1880, LLC DBA BEST FRIENDS	GDO	9147	7201 SW 59 AVE	500
5276	RIVIERA FOOD USA, INC. DBA RESTAURANT RIVIERA FOCACCERIA ITALIANA	GDO	9149	3250 NE 1 AVE #110	516
5277	SABOR A PERU CORPORATION	GDO	9151	2927 BISCAYNE BLVD	336
5278	AFF CATERING, INC.	GDO	9153	22069 S DIXIE HWY	270
5279	ETERNITY COFFEE ROASTERS, LLC	GDO	9154	117 SE 2 AVE	273
5280	SACHA'S AT BRICKELL DBA SACHA'S CAFE	GDO	9155	1450 BRICKELL AVE # 170	445

No.	FACILITY_NAME	PERMIT	PERMIT_NUMBER	ADDRESS	TOTAL_GPD
5281	FUJI TERIYAKI, INC.	GDO	9156	1604 WASHINGTON AVE A	278
5282	17315 COLLINS AVE, LLC DBA ALBA	GDO	9158	17315 COLLINS AVE	975
5283	URBIETA STORE OPERATIONS LLC DBA 7-ELEVEN #39489	GDO	9160	11603 W OKEECHOBEE RD #1	892
5284	DUFFY'S OF NORTH MIAMI BEACH, INC. DBA INTRACOASTAL MALL	GDO	9161	3969 NE 163 ST	3,306
5285	MMMM CUISINE, LLC	GDO	9162	2519 NW 2 AVE	318
5286	BURGERS & SHAKES, INC.	GDO	9164	7401 COLLINS AVE A	159
5287	SPIT FIRE, LLC	GDO	9166	405-07 15 ST	458
5288	MASH POTATOES, INC.	GDO	9167	1535 MADRUGA AVE #200	238
5289	WEST KENDALL BAPTIST HOSPITAL, INC.	GDO	9168	9555 SW 162 AVE	52
5290	MEDITERRANEAN CUISINE, INC.	GDO	9169	209 11 ST	145
5291	OCEANIA CLUB, INC.	GDO	9172	16421 COLLINS AVE	750
5292	GLOBAL MIAMI JV DBA VERSAILLES MANCHU WOK VILA PIZ	GDO	9173	D 20-21 N.TERM	1,486
5293	AREAS USA MIA, LLC DBA ISLAND CHICKEN GRILL	GDO	9174	D-22 N.TERM	441
5294	109 BURGER JOINT CORP.	GDO	9175	646 SW 109 AVE	313
5295	TACO RICO RESTAURANTS OF KENDALL, LLC	GDO	9177	12305 SW 137 AVE #300	375
5296	SWEET CONNECTION INVESTMENTS, LLC DBA BERRY BERRY FROZEN YOGURT	GDO	9179	7436 SW 117 AVE	243
5297	VU FOOD SERVICES, INC. DBA BASILIC VIETNAMESE GRILL	GDO	9180	14734 BISCAYNE BLVD	698
5298	EBM 1, LLC DBA ELEVATION BURGER	GDO	9183	16010 NW 57 AVE #138	532
5299	PIZZA BUFFET KENDALL, LLC DBA CICI'S PIZZA #846	GDO	9185	7580 SW 117 AVE	1,025
5300	SUBWAY AIRPORT H, LLC DBA SUBWAY #59573	GDO	9187	H5/H7 CC-H	138
5301	FULL BLOOM VEGAN, LLC DBA FULL BLOOM	GDO	9191	11 ISLAND AVE	373
5302	LURE SB, LLC DBA LURE FISHBAR	GDO	9192	1601 COLLINS AVE FAC.B	950
5303	JAC-ZAY, LLC DBA WHITE STAR CAFE	GDO	9194	8755-75 SW 72 ST	604
5304	DALE PIZZA, LLC DBA PIZZA RUSTICA FIU	GDO	9196	1671 SW 107 AVE	325
5305	LA SIERRA CONCESSIONS, LLC DBA KUVA RESTAURNAT & B	GDO	9197	D-20 N.TERM	1,410
5306	MOFONGO CAFETERIA, INC.	GDO	9198	2228 NW 28 ST	250
5307	ARGUS FOOD PROCESSING CORP.	GDO	9199	9202 NW 106 ST	5,000
5308	CALIFORNIA CLUB SUBWAY, LLC DBA SUBWAY #58274	GDO	9200	800 NE IVES DAIRY RD	350
5309	BELA CAFE, LLC	GDO	9204	3155 NW 77 AVE	88
5310	CENTRAL PALACE SERVICES, INC.	GDO	9205	4491 SW 8 ST	1,625
5311	TACO VIDA MIAMI, INC.	GDO	9206	11401 NW 12 ST E-532	500
5312	GRANITE CITY RESTAURANT OPERATIONS, INC.	GDO	9207	11735 SHERRY LN	1,963
5313	LEFT FIELD HOLDINGS, LLC DBA LIME FRESH MEXICAN GRILL	GDO	9208	9005 SW 72 PL	675
5314	3919 FOOD SERVICE, INC. DBA CHINA BEACH RESTAURANT	GDO	9209	3919 ALTON RD	225
5315	FLORIDA CINEMA INVESTMENTS, LLC DBA CINEPOLIS	GDO	9210	3015 GRAND AVE 322	482
5316	PUBBELLY SUSHI, LLC	GDO	9211	1422 20 ST	429
5317	1800 FLAGLER VALERO, INC.	GDO	9213	1800 W FLAGLER ST	73
5318	NUTRI D, LLC DBA WOODY'S BAR B Q	GDO	9214	16367 SW 88 ST	750
5319	NOVELTYGIFTS CORPORATION DBA COMMERCIAL KITCHEN ART 29	GDO	9215	14260 SW 136 ST #18	621
5320	FLAVOR OF BRASIL, INC.	GDO	9216	17010 W DIXIE HWY C	188
5321	INTERGLOBAL BROKERS, INC. DBA THE BUZZER BEATER	GDO	9222	8347 NW 36 ST A	656
5322	DELICIAS DE ESPANA 3, INC.	GDO	9223	8950 SW 74 CT 101	333
5323	FRESH F&B, LLC DBA FRESHKO	GDO	9224	228 SE 1 ST	297
5324	FLAMINGO THEATER, LLC DBA FLAMINGO THEATER BAR/LA SCALA DE MIAMI	GDO	9225	801 BRICKELL BAY DR 5-100	7,000
5325	LA CUEVA BAR BRICKELL, LLC	GDO	9226	1111 SW 1 AVE #107	383
5326	FLORIDA SE, LLC DBA THE OLIVE GARDEN ITALIAN RESTAURANT #1884	GDO	9227	1350 W 49 ST	2,133
5327	CHERRY BLOSSOM, LLC	GDO	9230	2731 NE 2 AVE	675
5328	PUBLIX SUPERMARKETS, INC. DBA PUBLIX STORE #1386	GDO	9232	1290 W 68 ST	9,900
5329	GIGI NMA, LLC	GDO	9233	3452 N MIAMI AVE 102-B	571
5330	HOMESTEAD VPE HOTEL, LLC DBA COURTYARD MARRIOTT HOTEL	GDO	9234	2905 NE 9 ST	1,125
5331	MIAMI DOWNTOWN CORP. DBA LA GRANJA	GDO	9236	127 SE 2 AVE	650
5332	SSC349618, LLC DBA DUNKIN DONUTS	GDO	9238	8099 S DIXIE HWY	609
5333	DELI PUPUSERIA SALVADORENA, INC.	GDO	9239	10929 SW 186 ST #3	245
5334	MILOS BY COSTAS SPILIADIS, INC. DBA ESTIATORIO MILOS	GDO	9240	730 1 ST	2,793
5335	LA PROVENCE DOWNTOWN, LLC	GDO	9241	247-249 E FLAGLER ST	675
5336	EATING HOUSE, LLC	GDO	9244	804 PONCE DE LEON BLVD	434
5337	LA LATINA, LLC	GDO	9245	3509 NE 2 AVE	183
5338	CARVALHO GROUP, LLC DBA FRITANGA ANGONICA	GDO	9249	2794 W 68 ST #101	248
5339	BARU MIDTOWN, LLC DBA BARU URBANO MIDTOWN	GDO	9250	3250 NE 1 AVE #122	853
5340	CUBAN GUYS 104, LLC DBA CUBAN GUYS SANDWICHES & MORE	GDO	9251	1675 W 49 ST 1574	547
5341	1111 ROOF TOP, LLC DBA JUVIA MIAMI BEACH	GDO	9252	1654 LENOX AVE	2,233
5342	ZENATI CORP. DBA LA DOLCE VIDA PIZZA	GDO	9254	2 W FLAGLER ST	619
5343	THE ORIGINAL PITA HUT, INC.	GDO	9255	530 W 41 ST	738
5344	CASABE, INC.	GDO	9256	1762 SW 22 ST	325
5345	BGM COLLINS, LLC DBA BURGERFI	GDO	9257	6812 COLLINS AVE	741
5346	PRODUCTION WAREHOUSE, LLC	GDO	9259	240 NE 72 ST	2,500
5347	M G PRODUCTS, LLC	GDO	9260	2642-90 NW 112 AVE	1,096
5348	GENUINE HOSPITALITY GROUP, LLC DBA CYPRESS ROOM	GDO	9261	3620 NE 2 AVE	377
5349	ME SABE A PERU, INC.	GDO	9265	3715 W 16 AVE #14	149
5350	BRAIN FREEZE, LLC DBA BRAIN FREEZE NITROGEN ICE CREAM	GDO	9266	8711 SW 124 AVE	393
5351	AZUCAR ICE CREAM, LLC	GDO	9267	1503 SW 8 ST	213
5352	BELUGA BAR, INC.	GDO	9268	19501 BISCAYNE BLVD K-2000	65
5353	7-ELEVEN, INC. DBA 7-ELEVEN #34689H	GDO	9269	1 W FLAGLER ST	821
5354	FRIEND FOOD SERVICE, INC. DBA FRIEND COFFEE	GDO	9271	7434 SW 48 ST	250
5355	OZZY'S CAFE, INC.	GDO	9275	13055 NW 42 AVE	375
5356	DMC GROUP, LLC DBA SEVENTEEN	GDO	9276	1205 17 ST	226
5357	BLU GIN, INC.	GDO	9278	5445 COLLINS AVE #CU-2A	596
5358	LA MAISON CHEVALIER, INC.	GDO	9280	2486 NW 20 ST	392
5359	THE FLAMINGO AT BAY RD, INC. DBA FLAMINGO MARKET	GDO	9281	1508 BAY RD	225
5360	T 6 MANAGEMENT, LLC DBA BUFFALO WILD WINGS BAR & GRILL	GDO	9285	5701 SW 72 ST #162	1,629
5361	FARE TO REMEMBER CATERING, INC.	GDO	9286	17225 S DIXIE HWY 104	550
5362	7-ELEVEN, INC. DBA 7-ELEVEN #35002C	GDO	9287	133 NE 2 AVE	983
5363	LFMG MANAGEMENT, INC. DBA YARDBIRD SOUTHERN TABLE & BAR	GDO	9288	1600 LENOX AVE	1,020
5364	RMAN, LLC DBA PLANET KIDS INDOOR PLAYGROUND	GDO	9290	2403 NE 2 AVE #108	320
5365	BEURRE, LLC DBA CLASICA VICTORIA	GDO	9291	638 CRANDON BLVD 13	231
5366	JABA 2426, LLC	GDO	9292	10738 NW 74 ST #10	329
5367	NMJ REST & MARKET PLACE, INC. DBA HARVEST DELIGHTS	GDO	9294	3470 NW 82 AVE #150	1,000
5368	226, LLC	GDO	9296	123 SE 2 AVE	260

No.	FACILITY_NAME	PERMIT	PERMIT_NUMBER	ADDRESS	TOTAL_GPD
5369	ALAMAAN, INC. DBA SUBWAY #50856	GDO	9298	203 UNIVERSITY DR	119
5370	RINCONCITO CUBANO RESTAURANT OF DADELAND, INC.	GDO	9300	7360 SW 90 ST	540
5371	CARIFLEX, INC.	GDO	9303	14291 SW 120 ST #113	350
5372	ELLEE'S CO.	GDO	9304	8601 NW 54 ST	350
5373	ANTONIO DIAZ RT, LLC DBA RICKY TIKI BAR & GRILL	GDO	9305	5445 COLLINS AVE CU-19	273
5374	PESTANA MIAMI, LLC DBA PESTANA SOUTH BEACH HOTEL	GDO	9306	1817 JAMES AVE	602
5375	SCANDINAVIAN BC, INC.	GDO	9308	6801 SW 8 ST #101	759
5376	UNIVERSITY PLAZA REHABILITATION & NURSING CENTER	GDO	9311	724 NW 19 ST	2,960
5377	EL PALACIO DE LOS CAKES, INC. DBA CHURRO MAGICO, INC.	GDO	9312	4254 E 4 AVE #2	188
5378	888 SUBWAY, INC.	GDO	9314	888 BISCAYNE BLVD #105	244
5379	7450 OCEAN TERRACE, LLC DBA DAYS INN & SUITES	GDO	9315	7450 OCEAN TER	500
5380	NOBIYAM INVESTMENT, LLC DBA FIORI BRUHA PASTA	GDO	9321	5340 NW 163 ST	3,065
5381	YOGURTBLAST, LLC DBA MENCHIE'S FROZEN YOGURT	GDO	9322	2512 NE 10 CT	398
5382	CLM1, LLC DBA CHEF LEON	GDO	9323	3250 NE 1 AVE #118	526
5383	LOBA HOLDINGS, INC. DBA LOBA	GDO	9324	7420 BISCAYNE BLVD	260
5384	PIZZARIUM, INC.	GDO	9325	69 E FLAGLER ST	537
5385	MIAMI SPA MANAGEMENT, LLC (JUICE BAR)	GDO	9326	18201 COLLINS AVE	28
5386	MINA BISTRO CORP.	GDO	9328	63 NW 9 ST	305
5387	MONUMENT RESTAURANTS VI, LLC DBA FIVE GUYS BURGERS & FRIES	GDO	9329	13286-92 BISCAYNE BLVD	703
5388	CAFE MAYI CORP.	GDO	9331	2475 BRICKELL AVE 6 FL	75
5389	ATLANTA RESTAURANT PARTNERS LLC DBA T.G.I. FRIDAY'S	GDO	9333	D-36 N.TERM	846
5390	ROMO'S PIZZA, INC.	GDO	9336	13300 NW 42 AVE BAY 1	345
5391	NIITAYA, LLC DBA EAST THAI & NOODLE	GDO	9337	8384 SW 40 ST	268
5392	NORTH TRADING CORP. DBA VALERO	GDO	9339	7229 N MIAMI AVE	695
5393	DELIGURT ENTERPRISES CORP.	GDO	9340	2254 W 77 ST	925
5394	MIMI FROZEN YOGURT, INC.	GDO	9352	7122 COLLINS AVE	634
5395	USA HAM, LLC	GDO	9353	463 W 28 ST	500
5396	HST DOWMTOWN MIAMI, LLC DBA BISCAYNE TAVERN	GDO	9355	146 BISCAYNE BLVD	766
5397	FENG MEI, INC. DBA BAYING LEE CHINESE RESTAURANT	GDO	9357	1297 NW 103 ST	225
5398	GRAZIE DIO, LLC DBA GRAZIE DIO MARKEPLACE	GDO	9359	9340 NW 25 ST	229
5399	CANTINA GRILL AT CORAL REEF VILLAGE, INC.	GDO	9360	15463-65 SW 137 AVE	284
5400	4 AMIGOS MIAMI, LLC DBA LA LUPITA	GDO	9362	1057 SE 1 AVE	523
5401	LINCOLN MARTI COMMUNITY AGENCY, INC.	GDO	9363	904 SW 23 AVE	6,679
5402	THE GREAT AMERICAN BATTER COMPANY	GDO	9364	2408 NW 72 AVE	1,200
5403	TTOTAL BUSINESS, LLC DBA MARGARITA PIZZA BEER AND WINE	GDO	9365	234 NE 3 ST CU-1	168
5404	LINCOLN-MARTI COMMUNITY AGENCY, INC. DBA LINCOLN-MARTI SCHOOL	GDO	9367	2700 SW 8 ST	2,475
5405	MONUMENT RESTAURANTS VI (FIU), LLC DBA FIVE GUYS	GDO	9368	1433 SW 107 AVE	554
5406	URBIETA STORE OPERATIONS LLC DBA 7-ELEVEN STORE 39810A	GDO	9369	14970 NE 6 AVE	675
5407	FFC - COMMONS, LLC DBA MAOZ VEGETARIAN	GDO	9371	1657 WASHINGTON AVE	216
5408	MMMM CUPCAKES	GDO	9374	17 E FLAGLER ST #109	79
5409	BIKINI HOSTEL	GDO	9375	1255 WEST AVE	354
5410	MUNCHY'S PIZZA REMY CORP.	GDO	9376	2795 W 78 ST	438
5411	CHARCOALS STEAK & GRILL, INC.	GDO	9381	9019 SW 107 AVE #340	546
5412	7-ELEVEN, INC. DBA 7-ELEVEN STORE #37013A	GDO	9385	35 SE 9 ST	625
5413	TOSCANA DIVINO, LLC	GDO	9386	900 S MIAMI AVE #185	1,275
5414	PITA & SHAWARMA, LLC	GDO	9387	90 MIRACLE MILE	273
5415	SUNSHINE RESTAURANT MERGER SUB, LLC DBA IHOP RESTAURANT # 36-215	GDO	9389	3315 W 80 ST	1,200
5416	MIKA'S RESTAURANT, LLC	GDO	9391	2426 NE 2 AVE	550
5417	KILLIAN PALMS COUNTRY CLUB & SPORT COMPLEX	GDO	9397	9950 SW 104 ST	2,388
5418	PUBLIX SUPERMARKETS, INC. DBA PUBLIX STORE #1389	GDO	9398	11750 SW 104 ST	7,200
5419	ROCOCOA CAFE, INC. DBA ROCOCHA CAFE @ AVENTURA MALL	GDO	9401	19501 BISCAYNE BLVD K-1959	59
5420	MIRACLE M. LLC DBA LOUI	GDO	9403	271 MIRACLE MILE	385
5421	GIRAFFAS MIDTOWN, LLC	GDO	9404	3250 NE 1 AVE #106-C	539
5422	BEACHBAR@NEWPORTPIER, LLC	GDO	9405	16501 COLLINS AVE	750
5423	BREAD PARTNERS 34, INC. DBA AU BON PAIN	GDO	9407	1500 NW 12 AVE #101-102	475
5424	JV RESTAURANTS, LLC DBA TUTTO PIZZA & PASTA	GDO	9408	328 CRANDON BLVD #111	351
5425	SU HOGAR MINI MARKET, LLC	GDO	9409	241 NW 8 AVE	47
5426	JUGOFRESH CORAL GABLES, LLC	GDO	9410	2516 PONCE DE LEON BLVD	244
5427	1111 SW 1 AVE, LLC DBA EL TUCAN/MARION	GDO	9412	1111 SW 1 AVE CU #1-2	4,576
5428	BATTING CAGE BAR & LOUNGE CORP.	GDO	9413	1704 NW 7 ST	1,761
5429	DORAL CAROLINA ALE HOUSE LLC	GDO	9415	8669 NW 36 ST #120	1,800
5430	WOOD TAVERN, INC.	GDO	9416	2531 NW 2 AVE	303
5431	MCDONALD'S CORP. DBA MCDONALD'S #6103	GDO	9418	26601 S DIXIE HWY	754
5432	SUVICHE WYNWOOD, LLC	GDO	9419	2751 N MIAMI AVE	724
5433	DOWNTOWN PIZZA PARADISE, LLC	GDO	9421	50 BISCAYNE BLVD CU-9	163
5434	RANCHO CACAUAL FRUTERIA, INC. DBA EL PALACIO DE LOS JUGOS	GDO	9423	14300 SW 8 ST	860
5435	GABRIELA ADVENTURE CORP. DBA EL CAPITAN RESTAURANT CAFETERIA	GDO	9424	3061-65 NW SOUTH RIVER DR	600
5436	OCEAN ISLAND PIZZA, INC. DBA DOMINO'S PIZZA	GDO	9425	17028 COLLINS AVE	296
5437	DELI BRICKELL, LLC DBA BRICKELL DELI & MARKET	GDO	9432	1451 S MIAMI AVE C-1A	364
5438	ALL IN ONE ENTERPRISES, LLC DBA LA VANILLA	GDO	9433	413 ESPANOLA WAY	112
5439	ED DEVELOPERS, LLC	GDO	9434	3250 NE 1 AVE #114	423
5440	DORAKU BRICKELL, LLC	GDO	9435	900 S MIAMI AVE #133	745
5441	OMEGA EMPIRE, LLC DBA EAT GREEK # PIZZA	GDO	9436	2917 BISCAYNE BLVD	531
5442	VALENTIA GLOBAL, LLC	GDO	9437	1450 BRICKELL AVE #110	993
5443	SOUTHWEST REY'S PIZZA #2, INC.	GDO	9441	13732 SW 152 ST	1,015
5444	WAL-MART STORES EAST, LP DBA WAL-MART SUPERCENTER # 5945	GDO	9443	400 W 49 ST	7,721
5445	BONITO GOURMET SUSHI, LLC DBA KAPPA ROLLS+BOWLS	GDO	9444	14730 BISCAYNE BLVD	625
5446	LOS PINOS J.M. CAFETERIA CORP.	GDO	9445	6741 SW 8 ST	375
5447	DORAL'S BEST, INC. DBA BURGER KING #18297	GDO	9446	11400 NW 41 ST	859
5448	FNB IMEX, INC. DBA YOGURBERRY	GDO	9447	320 SAN LORENZO AVE #1250	119
5449	RINCON PROGRESENO II CORP.	GDO	9449	1717 NW 17 AVE #2	350
5450	PUBLIX SUPERMARKETS, INC. DBA PUBLIX STORE #1029	GDO	9450	3060 NE 41 TER	11,400
5451	WATERSTONE SUBWAY CORP. DBA SUBWAY #34657	GDO	9451	3090 NE 41 TER	313
5452	SUBWAY 49159, INC.	GDO	9452	1741 NW 20 ST	300
5453	ISLAS DEL CARIBE RESTAURANT, INC.	GDO	9453	4239-41 W FLAGLER ST	341
5454	VITA FOODS ENTERPRISES V, INC. DBA FUDDRUCKERS	GDO	9454	14875 S DIXIE HWY	1,911
5455	PANERA, LLC DBA PANERA BREAD BAKERY CAFE #1619	GDO	9455	2493 NE 9 CT	1,222
5456	LA PLANCHA FAST FOOD CORP.	GDO	9457	1981 SW 8 ST B	263

No.	FACILITY_NAME	PERMIT	PERMIT_NUMBER	ADDRESS	TOTAL_GPD
5457	TAVERNA OPA BRICKELL, LLC	GDO	9459	900 S MIAMI AVE #260	1,600
5458	CARMINE'S LA TRATTORIA, LLC DBA NOCHE KITCHEN & BAR	GDO	9461	11745 SHERRI LN	1,936
5459	HUNZA ENTERPRISES, INC. DBA KWIK STOP	GDO	9462	7695 SW 98 ST	800
5460	GYROVILLE FIVE, LLC	GDO	9463	18441 NW 67 AVE #2	210
5461	JOMARA WHOLESALE, INC.	GDO	9464	2250 W 9 AVE	230
5462	VAP BRICKELL, LLC DBA VAPIANO	GDO	9465	1221 BRICKELL AVE L-120	1,357
5463	DRB - 501, INC.	GDO	9468	501 NE 1 AVE #103	372
5464	ALAGUS, LLC	GDO	9470	7290 SW 168 ST D	354
5465	CAROLINA BBQ BRICKELL, LLC DBA BROTHER JIMMY'S BB	GDO	9473	900 S MIAMI AVE #135/137	2,075
5466	PANERA, LLC DBA PANERA BREAD #1625	GDO	9474	18111 BISCAYNE BLVD	1,044
5467	JC FROZEN YOGURT COMPANY DBA MENCHIE'S FROZEN YOGURT	GDO	9476	1553 W 49 ST	300
5468	AR ESPANOLA, LLC DBA NUMERO 28 PIZZERIA	GDO	9477	432 ESPANOLA WAY	237
5469	PUBLIX SUPERMARKETS, INC. DBA PUBLIX STORE #1288	GDO	9478	106 PONCE DE LEON BLVD	11,850
5470	PUBLIX SUPERMARKETS, INC. DBA PUBLIX STORE #1003	GDO	9479	12855 NE 6 AVE	9,749
5471	PUBLIX SUPERMARKETS, INC. DBA PUBLIX STORE #238	GDO	9480	14630 SW 26 ST	11,068
5472	SOCCER TOWN MIDTOWM MIAMI, LLC	GDO	9481	2728 NE 2 AVE	52
5473	LOS DOS CHEF, INC.	GDO	9484	5301 NW 7 ST	375
5474	TIJUANA FLATS #173, LLC DBA TIJUANA FLATS BURRITOYCO. #173	GDO	9485	13256-58 BISCAYNE BLVD	599
5475	PUERTO MADERO INT. CORP. DBA P.M. FISH & STEAK HOUSE	GDO	9487	1453 S MIAMI AVE	1,300
5476	DRINKS, INC.	GDO	9490	1402 NW 23 ST FAC. A	517
5477	AMISO9, LLC DBA LIQUE	GDO	9494	3957 NE 163 ST	800
5478	CAFE COLLINS 5, LLC	GDO	9495	540 COLLINS AVE	411
5479	KB FROYO, LLC DBA YOGURT BY YOU	GDO	9496	600 CRANDON BLVD #120	195
5480	LA MONTANARA MIAMI, LLC DBA LA MONTANARA	GDO	9497	18851 NE 29 AVE #102	1,205
5481	KAMAKURA, INC. DBA NAOE	GDO	9499	661 BRICKELL KEY DR	500
5482	TACO BELL OF AMERICA, LLC DBA TACO BELL #28066	GDO	9500	501 E 49 ST	625
5483	OCEANA CAFE, LLC DBA PALMAS CAFE	GDO	9501	919 BRICKELL AVE D-2	243
5484	SHOKUDO, LLC	GDO	9502	4740 NE 2 AVE	583
5485	TENDA, LLC DBA D'ORO CAFFE	GDO	9503	50 BISCAYNE BLVD #104-105	422
5486	YES NAKED TACO TWO, INC.	GDO	9504	1951 NW 7 AVE #150	1,253
5487	MEDITERRANEAN COFFEE SHOP, LLC	GDO	9505	58 E 5 ST	130
5488	MDFR - FIRE RESCUE STATION #24	GDO	9507	14150 SW 127 ST 122	584,780
5489	YOGURT LANDIA'S CORP.	GDO	9508	2794 W 68 ST #107	247
5490	KANAGI CORP.	GDO	9509	801 NW 37 AVE #803	350
5491	7-ELEVEN, INC. DBA 7-ELEVEN #35022A	GDO	9510	1099 SW 1 AVE	550
5492	DOLPHINS FAMILY CORPORATION #3 DBA EXXON GAS	GDO	9511	1490 NE 1 AVE	427
5493	RARE HOSPITALITY MANAGEMENT, LLC DBA LONGHORN STEAKHOUSE #5415	GDO	9512	1360 W 49 ST	1,606
5494	INFINITE LEEWAY, LLC DBA BARRACUDA BAR & GRILL	GDO	9514	3035 FULLER ST	525
5495	DELIVERANCE SOUL FOOD RESTAURANTS	GDO	9516	4020 NW 17 AVE	200
5496	PASION DEL CIELO DADELAND, LLC	GDO	9519	8915 SW 72 PL C-102	618
5497	LL HOSPITALITY COMPANY, LLC	GDO	9520	541 SW 12 AVE	200
5498	MESAGIOS, LLC	GDO	9523	3433 MAIN HWY	310
5499	AIRPORT CONCESSIONS GROUP, INC. DBA NATHAN'S FAMOUS	GDO	9525	TERMINAL 1 N.TERM	151
5500	GAULT'S, INC. DBA GUALT'S GOURMET & GIFTS	GDO	9529	201 S BISCAYNE BLVD #101	161
5501	CASTLE NOVO PIZZA CORP. DBA CASTLE NOVO PIZZA #2	GDO	9530	5950 W 16 AVE	194
5502	DOA MIAMI BEACH, LLC DBA DOA MIAMI BEACH	GDO	9531	2000 COLLINS AVE	1,194
5503	ORION SUNSET, LLC DBA DOWNSTAIRS	GDO	9532	8781 SW 72 ST	500
5504	ARAMARK CORPORATION DBA ARAMARK CAFE	GDO	9533	5110 NW 159 ST	100
5505	NUTRISPA, INC.	GDO	9534	5406 NW 72 AVE	319
5506	LA JOLLA RESTAURANT	GDO	9535	301 ALCAZAR AVE	900
5507	LATINO CONCEPTS, LLC	GDO	9536	1111 SW 1 AVE #4	1,087
5508	PANUBA HOLDINGS, LLC DBA PLATE	GDO	9539	2105 SW 22 ST A	100
5509	VIVA MEXICO Y ALGO MAS, INC.	GDO	9540	502 SW 12 AVE	125
5510	J B PRETZEL COMPANY	GDO	9542	1675 W 49 ST #9130	63
5511	FIRITO CORP.	GDO	9543	1071 NE 79 ST #103	128
5512	2K CLEVELANDER LLC DBA CLEVELANDER MARLINS PARK	GDO	9544	501 MARLIN WAY	1,543
5513	PATRIA SHORECREST, INC. DBA BYBLOS MIAMI	GDO	9545	1545 COLLINS AVE	2,502
5514	MILANO HOUSE, LLC DBA GYROS HOUSE	GDO	9546	401 BISCAYNE BLVD S-252	71
5515	OLD WORLD PIZZA, LLC	GDO	9548	15794 SW 56 ST	325
5516	LATIN AMERICAN SUBS, LLC DBA SUBWAY #50023	GDO	9549	3301 SW 22 ST #105	305
5517	FARARTIS LLC DBA PAGNIFIQUE	GDO	9554	12050 NW 28 AVE	10,300
5518	SUVICHE SOBE, LLC	GDO	9555	1119 16 ST	300
5519	SPAZIO HEALTHY, LLC	GDO	9557	13027 SW 112 ST	295
5520	FLORIDA FROZEN YOGURT, LLC DBA MENCHIES	GDO	9558	15798 SW 56 ST	304
5521	PIONONOS HOLDINGS, INC.	GDO	9559	328 CRANDON BLVD #217	208
5522	LEVY PREMIUM FOODSERVICE LTD PARTNERSHIP - MARLINS STADIUM	GDO	9560	501 MARLIN WAY	13,161
5523	WING PARTNERS 6408, LLC DBA WING STOP	GDO	9562	6408 NW 186 ST	348
5524	PAPA NOSE PIZZA, LLC	GDO	9563	14044 NW 82 AVE #2	700
5525	MOMI RAMEN, LLC	GDO	9564	5 SW 11 ST	238
5526	WEST END RESTAURANTS, LLC DBA BRICKTOP'S RESTAURANT	GDO	9565	2418 PONCE DE LEON BLVD	2,014
5527	POWER 6, INC. DBA POWER PIZZA #6	GDO	9567	50 SW 10 ST #130	333
5528	KIDDOO BRICKELL, LLC DBA KIDDOO KIDS CLUB AND CAFE	GDO	9568	625 SW 1 AVE	1,593
5529	SING SING KARAOKE, INC.	GDO	9570	717 WASHINGTON AVE	1,428
5530	TEQUIZTLAN MEXICAN RESTAURANT AND TEQUILA BAR, LLC	GDO	9571	1884 BAY RD	675
5531	HR CORPORATION & ASSOCIATES, INC.	GDO	9574	1221 BRICKELL AVE #200	324
5532	AVENUE D CAFE, INC. DBA GRAFFE	GDO	9575	2400 N MIAMI AVE	213
5533	PUBLIX SUPERMARKETS, INC. DBA PUBLIX STORE #1230	GDO	9576	121 SW 22 AVE	7,200
5534	7-ELEVEN, INC. DBA 7-ELEVEN #35707B	GDO	9577	100 BISCAYNE BLVD #104	760
5535	LAGO EXPRESS, INC. DBA BP	GDO	9579	4701 NW 7 ST	187
5536	PALOMA SUPER DOLLAR CAFE, INC.	GDO	9581	4073 NW 135 ST	350
5537	SPEEDWAY, LLC DBA SPEEDWAY #6913	GDO	9582	24435 SW 112 AVE	225
5538	STANZIONE 87, LLC	GDO	9583	87 SW 8 ST	327
5539	JVC FRANCO, LLC DBA JUAN VALDEZ CAFE	GDO	9584	101 NE 2 AVE	328
5540	SUMI 777 CORP.	GDO	9585	21 SW 11 ST	227
5541	HIBACHI GRILL, INC.	GDO	9586	50 BISCAYNE BLVD CU7	124
5542	THUMBELINA LEARNING CENTER CORP. DBA MASTERS PREPARATORY	GDO	9587	1395 E 4 AVE	5,637
5543	BURGER GUYS OF AVENTURA, LLC DBA BURGER FI	GDO	9588	18139-43 BISCAYNE BLVD	804
5544	TIRA.D.TOSS, LLC	GDO	9589	2475 NW 95 AVE #7	300

No.	FACILITY_NAME	PERMIT	PERMIT_NUMBER	ADDRESS	TOTAL_GPD
5545	CHESTNUT LAND COMPANY DBA AUNTIE ANNE'S SOFT PRETZELS #FL187	GDO	9590	1455 NW 107 AVE K-115	50
5546	RD AND RD CORP. DBA HOME 2 SUITES BY HILTON	GDO	9591	77 NE 3 ST	136
5547	INFOCOM, LLC DBA MATRYOSHKA - DELI MARKET	GDO	9592	18220 COLLINS AVE	827
5548	SUBWAY 54404, INC. DBA SUBWAY #54404	GDO	9593	10645 NW 7 AVE #109	252
5549	COFFEEZONE CORP.	GDO	9594	1101 BRICKELL AVE G-O	268
5550	OCEAN DRIVE RESTAURANT LB, LLC DBA LA BAGUETTE	GDO	9596	1052 OCEAN DR B	596
5551	KB ORIENTAL SERVICES, LLC DBA KAZUMI	GDO	9599	260 CRANDON BLVD C16	266
5552	FLORIDA HEALTH AND BEAUTY CORP. DBA RAMIREZ CAFETERIA	GDO	9600	9800 NW 77 AVE	725
5553	HAMMOCK MARINE CORP. DBA RED FISH GRILL RESTAURANT	GDO	9601	9610 OLD CUTLER RD	774
5554	LA BAGUETTE AT MARLINS, LLC DBA LA BAGUETTE SANDWICHIERIE	GDO	9602	501 MARLIN WAY	225
5555	L'INCONTRO COFFEE + SUPERMARKET	GDO	9604	350 S MIAMI AVE CU B	590
5556	STARBUCKS COFFEE CO., INC. DBA STARBUCKS COFFEE #17086	GDO	9605	1690 MIAMI GARDENS DR	381
5557	JO'S ISLAND CUISINE, LLC DBA GOLDEN KRUST BAKERY & GRILL	GDO	9606	19664 NW 27 AVE	350
5558	BONLINE, INC. DBA TOP THAT YOGURT	GDO	9607	10069 SW 72 ST	375
5559	VILLAS AT DORAL CONDOMINIUM ASSN DBA MARRIOTT'S VILLAS AT DORAL	GDO	9608	4101 NW 87 AVE	250
5560	GREEN APPLE VENTURES, LLC DBA YOGURTLAND	GDO	9610	12500 SW 88 ST	429
5561	S & S FIVE STAR FOODS, INC. DBA MUNDO CAFE	GDO	9611	390 NW 2 ST #100	604
5562	LGP 1930, LLC DBA LOCALI	GDO	9614	1930 BAY RD	858
5563	AMERICAN DOLLAR SERVICES, INC.	GDO	9615	454 NW 22 AVE #99-100	200
5564	MIAMI SPORTS PROPERTY, LLC DBA SPORTS LEADERSHIP MGMT CHARTER	GDO	9616	604 NW 12 AVE	2,940
5565	SWEET AND TASTY CORP.	GDO	9617	8471 NW SOUTH RIVER DR	245
5566	PAULA COAST, LLC DBA BUNBURY	GDO	9618	2200 NE 2 AVE	109
5567	MIDTOWN OYSTER BAR, LLC	GDO	9619	3301 NE 1 AVE CU-10N	274
5568	NORTH MIAMI CARAF, INC.	GDO	9622	13705 NW 7 AVE	200
5569	BHM UNITS, LLC DBA THE SENSE HOTEL	GDO	9623	400 OCEAN DR	0
5570	SICRE ENTERPRISES, LLC DBA NOTHING BUNDT CAKES	GDO	9624	12030 SW 88 ST	500
5571	MADRUGA'S CAFE CORP.	GDO	9626	6895 SW 40 ST	0
5572	EXPRESS CAFETERIA, LLC	GDO	9627	8670 SW 137 AVE	270
5573	KMH NINJAS, LLC DBA JIMMY JOHNS ON BRICKELL	GDO	9629	1221 BRICKELL AVE R-101	338
5574	LOLA'S SPANISH PRODUCTS	GDO	9630	5597 SW 8 ST	200
5575	HAPPY PLANNERS, INC.	GDO	9632	15746 SW 56 ST	975
5576	COLOMBIA'S GRILL, INC.	GDO	9633	1360 NE 163 ST	290
5577	CIPRIANI MIAMI RESTAURANT, LLC	GDO	9634	465 BRICKELL AVE #CU-1	2,697
5578	CITY OF MIAMI-PARKS & RECREATION DBA MOORE PARK COMMUNITY	GDO	9635	765 NW 36 ST	644
5579	LA CAPITAL DE LOS JUGOS, LLC	GDO	9636	2401 SW 122 AVE	759
5580	TASTE BUDS OF INDIA IV, INC.	GDO	9638	2624 PONCE DE LEON BLVD	496
5581	AREAS USA MIA, LLC DBA WENDY'S	GDO	9639	D-19 N.TERM	341
5582	PINECREST BAKERY	GDO	9641	12101 S DIXIE HWY	0
5583	SABOR VENEZOLANO, INC.	GDO	9646	10712 NW 74 ST	340
5584	VERTICAL VENTURES, INC. DBA SKY ZONE MIAMI	GDO	9653	5450 NW 82 AVE	602
5585	HOST INTERNATIONAL, INC. DBA SHULA'S BAR & GRILL	GDO	9655	D-17 N.TERM	476
5586	SARA'S BAKERY & COFFEE CORP.	GDO	9656	15420 SW 136 ST 5	75
5587	CHILL-N, LLC DBA CHILL-N NITROGEN ICE CREAM	GDO	9657	8271 SW 124 ST	141
5588	FOOD 305 CORP. DBA VISA-01 EXTRAORDINARY PIZZA	GDO	9658	1680 MICHIGAN AVE 101	146
5589	CHIPOTLE MEXICAN GRILL OF COLORADO, LLC DBA CHIPOTLE #1918	GDO	9660	2235 SW 37 AVE	742
5590	TAP 79 CORP.	GDO	9662	1071 NE 79 ST #101	279
5591	BONSAI HOLDINGS GROUP, LLC DBA BONSAI THAI & SUSHI RESTAURANT	GDO	9663	15734 SW 56 ST	1,000
5592	THE CONCRETE LAB, LLC DBA ARTISAN KITCHEN AND BAR	GDO	9664	658 CRANDON BLVD #120	474
5593	LEFT FIELD HOLDINGS II, LLC DBA LIME FRESH MEXICAN GRILL	GDO	9666	12516 SW 88 ST	604
5594	LITTLE CAESAR'S ENTERPRISES, INC. DBA LITTLE CAESAR'S PIZZA #2304	GDO	9668	11728 SW 104 ST	302
5595	3720 CROYDON LLC DBA CROYDON HOTEL/RESTAURANT	GDO	9669	3720 COLLINS AVE	596
5596	TERZO, INC. DBA DUE BACI RESTAURANT	GDO	9671	1920 ALTON RD #101	160
5597	PROHIBITION GOURMET BAR, LLC DBA PROHIBITION RESTAURANT AND	GDO	9673	3404 N MIAMI AVE	1,238
5598	BL RESTAURANT OPERATIONS, LLC DBA BAR LOUIE	GDO	9676	3201 N MIAMI AVE #2	1,504
5599	GRUPO ALDU, LLC DBA ROCK THAT BURGER	GDO	9677	7138 SW 117 AVE	240
5600	STOPH, LLC DBA MENCHIE'S	GDO	9678	18839-B BISCAYNE BLVD	441
5601	PUBLIX SUPERMARKETS, INC. DBA PUBLIX DISTRIBUTION CENTER	GDO	9680	100 NE 183 ST	875
5602	AJN INVESTMENTS, LLC DBA YOBLENDZ	GDO	9681	501 MARLIN WAY	125
5603	FLORIDA SE, INC. DBA THE OLIVE GARDEN ITALIAN RESTAURANT #4429	GDO	9682	20345 S DIXIE HWY	1,860
5604	K & K FORTUNE GROUP, INC. DBA OASIS RESTAURANT	GDO	9683	250 SUNNY ISLES BLVD #4-5	700
5605	F & P SUSHI ENTERPRISES CORP. DBA SUSHI XPRESS	GDO	9684	7299 NW 36 ST	214
5606	MOORE'S GROCERY	GDO	9685	122 NW 14 ST	300
5607	VICKY BAKERY FLAGLER, INC.	GDO	9687	10134-38 W FLAGLER ST	600
5608	THE FRESH MARKET, INC.	GDO	9688	8760 SW 136 ST	5,649
5609	BELL GAS STATION, INC.	GDO	9690	2698 NW 36 ST	500
5610	AIRPORT HOTEL GROUP, LTD. DBA HAMPTON INN	GDO	9694	777 NW 57 AVE	163
5611	FRANCOS PIZZA, INC.	GDO	9696	2556 NW 7 ST	244
5612	BJ'S RESTAURANTS, INC. DBA BJ'S RESTAURANT & BREWHOUSE	GDO	9697	1401 NW 107 AVE	2,455
5613	COMMERCIAL KITCHEN 305, LLC	GDO	9698	860 NE 79 ST B	500
5614	GLOBAL CONCESSIONS, INC. DBA CAFE VERSALLES A	GDO	9700	D 5/7 N.TERM	214
5615	CARRIE CONCESSIONS, INC. DBA HAAGEN DAZS	GDO	9701	D 10/11 N.TERM	97
5616	AIRPORT CAFES, LLC DBA JUAN VALDEZ CAFE	GDO	9702	D-23 N.TERM	174
5617	MCDONALD'S CORPORATION DBA MCDONALD'S #009-2422	GDO	9703	23351 SW 112 AVE	978
5618	TEQUENOMANIA OF DORAL, INC.	GDO	9704	10201 NW 58 ST #103	319
5619	DAMO U.S.A. CORPORATION	GDO	9705	3130 W 15 AVE #1	2,859
5620	CK AT 41 ST, LLC DBA CHICKEN KITCHEN	GDO	9708	524 ARTHUR GODFREY RD #102	448
5621	BACK ALLEY HOSPITALITY, INC. DBA LOST WEEKEND	GDO	9709	218 ESPANOLA WAY	1,254
5622	BERTONI GELATO BRICKELL, LLC	GDO	9710	1300 BRICKELL BAY DR	376
5623	YMK HOSPITALITIES CO., INC. DBA MINA'S MEDITERRANEO	GDO	9711	749 NE 79 ST	1,000
5624	PEI WEI ASIAN DINER, LLC	GDO	9712	2283 SW 37 AVE	1,088
5625	COUNTRY MEAT MARKET, INC.	GDO	9714	6419 NW 7 AVE	113
5626	SUSHI RUNNER MIAMI LAKES CORP.	GDO	9715	16010 NW 57 AVE #126	560
5627	HIALEAH GAS STATION CORP. DBA PALM SPRINGS MILE VALERO	GDO	9717	5090 W 4 AVE	175
5628	SICRE ENTERPRISES II, INC. DBA NOTHING BUNDT CAKES	GDO	9719	9487 S DIXIE HWY	375
5629	ROS & TOM, LLC DBA CAFE MISTRAL	GDO	9720	110 WASHINGTON AVE CU-6	206
5630	MDFR - FIRE RESCUE STATION #69	GDO	9721	11151 NW 74 ST	950
5631	HEMMINGWAY WAREHOUSE, LLC DBA SEASALT & PEPPER	GDO	9722	412 NW NORTH RIVER DR	1,577
5632	MONUMENT RESTAURANTS VI, LLC DBA FIVE GUYS BURGERS & FRIES #214	GDO	9724	3250 NE 1 AVE #116	679

No.	FACILITY_NAME	PERMIT	PERMIT_NUMBER	ADDRESS	TOTAL_GPD
5633	CHOICES CAFE CORAL GABLES, LLC	GDO	9726	2626 PONCE DE LEON BLVD B	426
5634	BUNNIE CAKES, LLC	GDO	9727	2322 NE 2 AVE	300
5635	TEN FRUITS EXPRESS, LLC	GDO	9728	143 NE 3 AVE	383
5636	MICOCOS, INC.	GDO	9730	1 ALHAMBRA PLZ #2150	206
5637	MADERO RESTAURANT, LLC	GDO	9731	1412 OCEAN DR	1,091
5638	JUANA M. BRICKELL, LLC DBA JUANA M RESTAURANT	GDO	9733	923 BRICKELL AVE	1,485
5639	TEXAS TACO FACTORY EXPRESS, INC.	GDO	9734	409-411 15 ST	293
5640	WHOLE FOODS MARKET GROUP, INC. DBA WHOLE FOODS MARKET	GDO	9735	299 SE 3 ST	11,128
5641	BAY SUBWAY CORP. DBA SUBWAY #52930	GDO	9738	1570 KENNEDY CSWY	338
5642	BREAD PARTNERS 35, INC. DBA AU BON PAIN #35	GDO	9739	15955 SW 96 ST #104	66
5643	STARBUCKS COFFEE COMPANY, INC. DBA STARBUCKS	GDO	9740	12225 S DIXIE HWY	327
5644	YOBEY INDUSTRIES, INC. DBA YOBEY YOGURT	GDO	9741	6125 W 21 CT	2,578
5645	QI MING, INC. DBA CHINA GOURMET	GDO	9742	14767 S DIXIE HWY #5-A	390
5646	HAKU, LLC DBA EMECK A BOLIO'S	GDO	9744	1915 PURDY AVE	134
5647	HOST INTERNATIONAL, INC. DBA STARBUCKS RETAIL PARTNERS JV	GDO	9750	J-7 CC-J	314
5648	SUBWAY 54291, INC. DBA SUBWAY #54291	GDO	9751	8262 NW 103 ST	375
5649	M & S ENTERPRISES USA, INC. DBA SUBWAY #54635	GDO	9752	11850 HIALEAH GARDENS BLVD #121	281
5650	TAKEE OUTTEE OF HIALEAH GARDENS, LLC	GDO	9753	11850 HIALEAH GARDENS BLVD #124	375
5651	LA VICTORIA DISTRIBUTOR, INC. DBA GILBERT'S FOOD BAR	GDO	9754	TERMINAL CC-J	569
5652	CARRIE CONCESSIONS, INC. DBA SUBWAY/HAAGEN DAZS	GDO	9755	TERMINAL CC-E	467
5653	SUBWAY #43633, INC.	GDO	9756	11780 SW 104 ST #B-105	300
5654	OUTBACK STEAKHOUSE OF FLORIDA, LLC DBA OUTBACK STEAKHOUSE #1079	GDO	9757	8405 MILLS DR B-209	1,895
5655	WALMART STORES EAST, LP DBA WAL-MART STORE #5615	GDO	9758	11800 HIALEAH GARDENS BLVD	9,850
5656	B SWEET, LLC	GDO	9760	20 NE 41 ST	150
5657	PFR SERVICES DBA PIAMONTE RESTAURANT	GDO	9761	8040 NW 95 ST #101-102	350
5658	BJ'S RESTAURANT, INC. DBA BJ'S RESTAURANT & BREWHOUSE	GDO	9762	8888 SW 136 ST #350	2,017
5659	CAROL FIRST STREET, LLC DBA KONE SUSHI	GDO	9775	247 SE 1 ST	372
5660	GIRAFFAS DORAL, LLC	GDO	9776	9690 NW 41 ST #6	625
5661	DON NOVO & SON, INC.	GDO	9777	6707 NW 37 AVE	1,011
5662	NEWMART CORP. DBA TWO PIZZA GUYS	GDO	9778	15420 SW 136 ST 2	289
5663	PRIDE & JOY MIAMI, LLC	GDO	9779	2800-08 N MIAMI AVE	1,692
5664	SB TWO ENTERPRISES, LLC DBA SHULA BURGER, LLC.	GDO	9780	11790 SW 104 ST	597
5665	3 QUEENS RESTAURANT, LLC	GDO	9782	7625 NE 2 AVE	238
5666	JC & JC CAFETERIA RESTAURANT CORP.	GDO	9783	26073 S DIXIE HWY	182
5667	REAL RESTAURANT GROUP, INC.	GDO	9784	9600 SW 8 ST #11	397
5668	R & G ESPANOLA WAY, LLC DBA PICCOLA CUCINA	GDO	9785	440 ESPANOLA WAY	366
5669	CITY SLICKERS SUBS & SALADS NORTH MIAMI, LLC.	GDO	9789	1807 NE 123 ST #3	518
5670	AROMAS HOLDING, LLC	GDO	9791	13960-76 SW 8 ST	1,043
5671	FROZEN TREATS OF SOUTH FLORIDA, LLC DBA FROZEN YOGURTS - TCBY	GDO	9792	8888 SW 136 ST #250-B	119
5672	SYDELL INDIAN CREEK, LLC DBA FREE HAND "27" RESTAURANT	GDO	9793	2727 INDIAN CREEK DR	1,190
5673	SSC349476, LLC DBA DUNKIN DONUTS #349476	GDO	9794	6790 SW 8 ST	458
5674	KTERING DESSERTS, LLC	GDO	9796	21014 W DIXIE HWY	157
5675	HOULIHAN'S RESTAURANTS, LLC DBA DEVON SEAFOOD & STEAK	GDO	9797	11715 SHERRI LN	2,224
5676	SERGIO'S RESTAURANT #5, INC.	GDO	9798	8807 SW 107 AVE	1,228
5677	B & B CAPPUCINO CORP.	GDO	9799	801 BRICKELL AVE CART	13
5678	KONING RESTAURANTS INTERNATIONAL, LC DBA PIZZA HUT 028450	GDO	9800	23244 SW 112 AVE A-14	263
5679	GLOBAL CONCESSIONS, INC. DBA AU BON PAIN	GDO	9801	D-45 FAC.D N.TERM	0
5680	FABULOUS ICE CREAM & CAFE CORP.	GDO	9802	7106 SW 117 AVE	240
5681	AMERICAN GIRL RETAIL, INC.	GDO	9803	8888 SW 136 ST #395-A	669
5682	THE BUTCHERY SHOP, INC.	GDO	9806	165 NW 23 ST	1,126
5683	4D THEATER, LLC DBA 4D GELATERIA	GDO	9807	551 LINCOLN RD #5	98
5684	7-ELEVEN, INC. DBA 7-ELEVEN #36662A	GDO	9808	1200 BRICKELL BAY DR #109	674
5685	INEDIT GOURMET, LLC	GDO	9810	12100 SW 132 CT #A-116	262
5686	RED LOBSTER HOSPITALITY, LLC DBA RED LOBSTER #464	GDO	9811	13300 BISCAYNE BLVD	2,363
5687	HORACE MEAT & FISH, INC.	GDO	9812	16722-26 NE 6 AVE	557
5688	KENNEDY CROSSING CORP. DBA POWER SMOOTHIE	GDO	9815	20475 BISCAYNE BLVD G-14	323
5689	27 ENTREPRENEURS, LLC DBA MY CECICHE	GDO	9816	235 WASHINGTON AVE A	60
5690	RANCHITO MI PERU II, INC.	GDO	9817	2102 NW 22 CT	250
5691	UNIQUE DESIGNER'S CAKE, INC.	GDO	9818	915 NW 1 AVE #4A	302
5692	HOME SWEET HOME BAR & GRILL, INC.	GDO	9820	3039 NW 54 ST	373
5693	SUBWAY 53841, LLC	GDO	9821	1951 NW 7 AVE #170	350
5694	SOUTH POINT ASSET PARTNERS, LLC DBA SOUTH POINTE TAVERN	GDO	9822	40 S POINTE DR #109	423
5695	NICHI'S SWEET CONFECTIONS, INC.	GDO	9823	1017 KANE CONCOURSE	300
5696	BENJAMIN MEAT STORE CORP. DBA BENJAMIN GROCERY	GDO	9829	3750 W 16 AVE #101	163
5697	SUNSET HARBOR PIZZA, LLC DBA LA MODERNA	GDO	9834	1900 BAY RD #113-C	660
5698	JCY FRUIT STAND INC. DBA SORIANO BROTHERS CUBAN CUISINE	GDO	9835	3435 NW 7 ST	1,053
5699	MARIO THE BAKER MIDTOWN, INC.	GDO	9836	2508 NE 2 AVE	310
5700	ICEBOX CAFE, LC	GDO	9838	1900 BAY RD #109-F	581
5701	CHIPOTLE MEXICAN GRILL OF COLORADO, LLC DBA CHIPOTLE MEXICAN	GDO	9842	12227 S DIXIE HWY	637
5702	FAHO, INC. DBA MERCADO LATINO	GDO	9843	3250 NE 1 AVE #120	487
5703	LEUNG'S INC. DBA EL FARO SUPERMARKET	GDO	9844	4338 NW 7 ST	500
5704	BUCEFALO MX, LLC DBA SMOOTHIE KING	GDO	9845	9690 NW 41 ST #5A	285
5705	PALPIRAMYDE, LLC DBA YOGURT4YOU HIALEAH GARDENS	GDO	9849	11850 HIALEAH GARDENS BLVD #126	352
5706	B & JCM HOSPITALITY GROUP, LLC	GDO	9850	3895 NW 107 AVE	250
5707	OKS STADIUM, LLC DBA SONIC BEACH	GDO	9851	2660 NW 199 ST	928
5708	PIZZA DUDE RESTAURANTS, LLC	GDO	9852	451 W 41 ST	375
5709	YOGURT SPOT II, LLC	GDO	9853	9519 HARDING AVE	235
5710	STARBUCKS COFFEE COMPANY, INC. DBA STARBUCKS COFFEE #10869	GDO	9854	1201 WASHINGTON AVE	449
5711	LA GUARDIA GROUP III, INC.	GDO	9856	645 NW 27 AVE	683
5712	EL TORO LOCO CHURRASCARIA 8 ST. LLC	GDO	9858	13800-02 SW 8 ST	450
5713	GOLDEN STATION NORTH MIAMI GAS, LLC DBA GOLDEN STATION NORTH	GDO	9859	98 NE 167 ST	550
5714	BGA ENTERPRISES OF HAMMOCKS, LLC	GDO	9860	11735 SW 147 AVE #38	421
5715	CORVATSCH CORP. DBA TRUE LOAF BAKERY	GDO	9863	1894 BAY RD	399
5716	SUNSHINE KITCHENS, LLC DBA 251 WYNWOOD	GDO	9864	251 NW 25 ST	669
5717	AKI JAPANESE BUFFET CORP.	GDO	9865	9605 NW 41 ST	1,125
5718	MORRISON MANAGEMENT SPECIALISTS, INC. DBA UMH-STARBUCKS #19197	GDO	9866	1400 NW 12 AVE	282
5719	KABOB SHACK, INC.	GDO	9867	7400 SW 57 AVE #4	146
5720	AREAS USA MIAMI, LLC DBA EARL OF SANDWICH	GDO	9869	J-8 CC-J	323

No.	FACILITY_NAME	PERMIT	PERMIT_NUMBER	ADDRESS	TOTAL_GPD
5721	SEVEN SEAS RESTAURANT & FISH MARKET CORPORATION	GDO	9870	5205 NE 2 AVE	225
5722	MCJARS CORP. DBA FLY BUY	GDO	9873	2859 BIRD AVE #1	550
5723	M AND N RESTAURANT, INC. DBA PAULO LUIGI TO GO	GDO	9874	2859 BIRD AVE #3	280
5724	TRADER JOE'S EAST, INC. DBA TRADER JOE'S #770	GDO	9878	9205 S DIXIE HWY	3,367
5725	LA NUEVA ERA CAFE, LLC	GDO	9879	3517 NW 17 AVE	275
5726	EL TAQUITO II CORP. (FOOD SERVICE)	GDO	9880	1380 SW 8 ST FAC.B	305
5727	TASTE BUDS OF INDIA II, INC.	GDO	9881	5850 SW 72 ST B	536
5728	FESTIVE FOOD BRANDS, LLC	GDO	9886	10112 NW 87 CT	2,640
5729	KONING RESTAURANTS INTERNATIONAL, LC DBA PIZZA HUT #028172	GDO	9887	18510 NW 67 AVE #1024	497
5730	NEWSLINK MAV, LLC DBA BOOKLINK & CAFE	GDO	9888	D-20 N.TERM	915
5731	GLOBAL CONCESSIONS, INC. DBA NATHAN'S TERM D22	GDO	9889	D-21 N.TERM	60
5732	SODEXO AMERICA, LLC @ JACKSON PERDUE MEDICAL CENTER	GDO	9892	19590 OLD CUTLER RD	430
5733	RDG IV ENTERPRISES, INC.	GDO	9895	2190 SW 22 ST	958
5734	FEDERAL DETENTION CENTER-FDC MIAMI	GDO	9896	33 NE 4 ST	1,750
5735	PEPITOLANDIA CORP.	GDO	9897	10201 NW 58 ST #105	431
5736	HIJOLE TAQUERIA, INC.	GDO	9898	2164 NW 7 ST	120
5737	KILLIAN CAFE & GRILL, LLC	GDO	9901	11740 SW 104 ST	434
5738	7-ELEVEN, INC. DBA 7-ELEVEN #39492A	GDO	9904	1650 NW 20 ST	697
5739	BEALLBERRY, LLC DBA PINKBERRY	GDO	9906	21211 BISCAYNE BLVD	180
5740	PANTHER COFFEE BEACH, LLC DBA PANTHER COFFEE	GDO	9911	1875 PURDY AVE	407
5741	SUSHI 2 MEE, INC. DBA SUSHI CAFE & MORE	GDO	9912	11865 SW 26 ST C-26	185
5742	BRIZA ON THE BAY, LLC	GDO	9913	1717 N BAYSHORE DR #115	1,456
5743	CLAMATO HOLDINGS CORP. DBA LA MEXICANA CANTINA AND GRILL	GDO	9914	1451 S MIAMI AVE C-5	691
5744	WYNWOOD ENTERTAINMENT, LLC DBA BRICK HOUSE	GDO	9915	187 NW 28 ST	474
5745	SMOOTHIE KING CO., INC. DBA SMOOTHIE KING #1120	GDO	9916	2315 PONCE DE LEON BLVD	170
5746	CHATEAU BEACH, LLC DBA CHATEAU BEACH CONDO	GDO	9917	17475 COLLINS AVE	110
5747	BAM FOOD SERVICE, LLC DBA WINGSTOP	GDO	9918	1452 NE 163 ST	348
5748	SOFIA SUBWAY CORP. DBA SUBWAY #52931	GDO	9920	2962 SW 8 ST	518
5749	COYA RESTAURANTS, LLC	GDO	9921	999 BRICKELL AVE #103	2,499
5750	VIVI1317, LLC DBA 345 CAFE ITALIANO	GDO	9925	259 MIRACLE MILE	382
5751	DGN NORTH BEACH, INC. DBA DENNY'S #8850	GDO	9926	7140 COLLINS AVE	766
5752	GREEN APPLE VENTURES, LLC DBA YOGURTLAND	GDO	9927	13274 BISCAYNE BLVD	276
5753	PINECREST BAKERY, LLC	GDO	9928	2540 NE 10 CT	412
5754	MEENA CREATIONS, INC. DBA KFC EXPRESS	GDO	9931	20505 S DIXIE HWY #1869	110
5755	850 COMMERCE RESTAURANT, LLC DBA PORFIRIO'S RESTAURANT	GDO	9935	850 COMMERCE ST	1,890
5756	MEL YOUNG, LLC DBA GREEN PLATE BUFFET	GDO	9936	9901 NW 41 ST A	1,000
5757	BARBARITO'S FRESH FISH & MEAT MARKET, LLC	GDO	9937	1067 SW 27 AVE	250
5758	DON PAN HIALEAH, INC.	GDO	9938	585-A W 49 ST	600
5759	EINSTEIN AND NOAH CORP. DBA EINSTEIN BROS BAGELS	GDO	9940	9690 NW 41 ST #7	602
5760	ITALIAN ICE BY DENISE, LLC	GDO	9942	1019 NW 3 AVE	127
5761	COFFEE HOUSE HOLDINGS, INC. DBA STARBUCKS #19090	GDO	9944	9560 HARDING AVE	593
5762	MIDTOWN SOHO RESTAURANT, LLC DBA NOVECENTO	GDO	9946	3201 N MIAMI AVE #116	1,837
5763	METROMOLE, LLC DBA SALSA OLIVO	GDO	9947	8405 MILLS DR #208	673
5764	OUNZE CORPORATE, LLC DBA TAPELIA	GDO	9949	551 LINCOLN RD	954
5765	G.M. ISLAND DELIGHT, INC. DBA JAMROCK KITCHEN	GDO	9950	22117 S DIXIE HWY 15-A	210
5766	QUICK PICK MARKET, INC.	GDO	9951	5830 NW 12 AVE	475
5767	BAKERS SERVICE OF SOUTH FL. INC. DBA TRACY BAKERY	GDO	9953	17501 SW 99 RD	4,571
5768	SUSHI SAKE DADELAND, LLC DBA SUSHI SAKE	GDO	9955	9059 SW 73 CT	373
5769	TASTE OF STYLE CATERING & EVENT PLANNING, INC.	GDO	9956	4747 NW 79 AVE 2ND FLOOR	1,100
5770	HOST TINSLEY JOINT VENTURE DBA STARBUCKS DLL	GDO	9957	D-30 GR N.TERM	285
5771	PASTAZZI, LLC	GDO	9960	28715 SW 132 AVE #128	400
5772	RABAGO FY CORP. DBA FELIX CAFE	GDO	9963	223 S KROME AVE	150
5773	BELLMONT COMPANY, LLC DBA BELLMONT BAKERY & RESTAURANT	GDO	9966	339 MIRACLE MILE	575
5774	NATH PETROLEUM, INC. DBA MOBIL FOOD MART	GDO	9967	26929 S DIXIE HWY	400
5775	LITTLE CAESAR'S ENTERPRISES, INC. DBA LITTLE CAESAR'S PIZZA #2305	GDO	9969	15457 SW 137 AVE	300
5776	GEODINAMICA, LLC DBA HEALTHY XPRESS	GDO	9970	6404 NW 82 AVE	250
5777	MM & JJ GROUP, LLC DBA MAMA YOGURT	GDO	9972	14649 SW 42 ST	350
5778	URBW FOOD CONCEPTS, LLC DBA PLANET TASTI	GDO	9974	5723 NW 7 ST	240
5779	SUNO 24, LLC DBA SUNOCO	GDO	9975	2395 NW 119 ST	550
5780	INTERNATIONAL CHILDREN'S ACADEMY, INC.	GDO	9976	585 E 49 ST #5	28,000
5781	INTERNATIONAL GRAPHICS, INC. DBA DON NICOLA PIZZERIA	GDO	9978	3585 NE 191 ST	157
5782	BUTTERFLY BALL, LLC	GDO	9983	22 NE 3 AVE	267
5783	NOROCO GROUP CORP. DBA MR. FOOD MART	GDO	9984	14801 BETHUNE DR	878
5784	VELEZ GROUP, INC. DBA BARISTA COFFEE BY VELEZ	GDO	9986	2351 SALZEDO ST	146
5785	EL RINCONCITO LATIN CAFE, LLC	GDO	9989	62-B NE 1 ST	163
5786	PARAISO CAFE CORP.	GDO	9991	2156 NW 7 AVE	500
5787	MAS HOSPITALITY MIAMI, LLC	GDO	9992	195 SE 3 AVE	537
5788	U-RAWK ENERGY, INC.	GDO	9993	1402 NW 23 ST FAC. C	125
5789	JUGOFRESH WYNWOOD WALLS, LLC	GDO	9996	222 NW 26 ST	594
5790	CHIPOTLE MEXICAN GRILL OF COLORADO, LLC DBA CHIPOTLE #2085	GDO	9997	19151 S DIXIE HWY FAC. B	735
5791	ENCOTEL, LLC DBA VINTRO HOTEL	GDO	10001	2216 PARK AVE	543
5792	YARDHOUSE USA, INC.	GDO	10003	1681 LENOX AVE	3,089
5793	T 7 MANAGEMENT, LLC DBA BUFFALO WILD WINGS BAR & GRILL	GDO	10005	18721 BISCAYNE BLVD #320	1,480
5794	PIZZA PAZZA, INC.	GDO	10007	275 NE 18 ST CU-9	391
5795	JJ ASSASSINS, LLC DBA JIMMY JOHN'S	GDO	10008	2770 SW 27 AVE #2	413
5796	TWM 2, LLC DBA CREAM #2	GDO	10011	18719 BISCAYNE BLVD #310	387
5797	WAL-MART STORE EAST, LP DBA WAL-MART STORE # 5912	GDO	10013	21151 S DIXIE HWY	23,050
5798	LEFT FIELD HOLDINGS III, LLC DBA LIME FRESH MEXICAN GRILL	GDO	10014	8484 NW 36 ST #400	852
5799	MARIMAR SEAFOOD CORP.	GDO	10017	24420 PACKING HOUSE RD C-7 & C-8	0
5800	CAFE MIJITA, LLC DBA CAFE CURUBA	GDO	10019	2626 PONCE DE LEON BLVD #3	209
5801	RP/WG CABANA OWNER, LP DBA HILTON CABANA MIAMI BEACH	GDO	10022	6261 COLLINS AVE	3,116
5802	BGM SOUTH BEACH, LLC DBA BURGERFI	GDO	10024	1242 WASHINGTON AVE	781
5803	ELITE FOLIAGE, INC. DBA ALTON ROAD NURSERY	GDO	10025	1239 ALTON RD #2	109
5804	3 CHEFS AT BRICKELL	GDO	10026	48 SW 12 ST	289
5805	DUFFY'S MANAGEMENT, INC. DBA DUFFY'S SPORTS GRILL	GDO	10027	3015 GRAND AVE #250	1,677
5806	LITTLE HAVANA RESTAURANT, INC.	GDO	10030	12727 BISCAYNE BLVD	2,200
5807	MIA LEJEUNE LLC DBA HYATT PLACE MIAMI AIRPORT	GDO	10031	3549 LE JEUNE RD	0
5808	MILLELIRE CORPORATION DBA VIA VERDI	GDO	10033	6900 BISCAYNE BLVD #7	375

No.	FACILITY_NAME	PERMIT	PERMIT_NUMBER	ADDRESS	TOTAL_GPD
5809	BOSTON MARKET CORPORATION DBA BOSTON MARKET #3301	GDO	10034	1001 W 49 ST	741
5810	ENTERPRISES AGC, INC. DBA SUBWAY	GDO	10035	21151 S DIXIE HWY FAC. B	225
5811	18200 PARTNERS, INC. DBA BELLINI ITALIAN BISTRO	GDO	10037	18200 SW 147 AVE A9-A12	1,226
5812	JUSSI GROUP, LLC DBA BARYTONO CAFE	GDO	10039	7800 NW 25 ST #10	300
5813	CMTG, INC. DBA MCDONALD'S	GDO	10040	33501 S DIXIE HWY FAC. B	300
5814	ROROCK FITNESS, INC.	GDO	10041	12039 SW 132 CT #6	247
5815	OKS CAMPBELL, LLC DBA SONIC BEACH #6222	GDO	10042	2425 NE 8 ST	535
5816	BRONCO NORTE, LLC	GDO	10043	24625 S DIXIE HWY	422
5817	R & M MINI MARKET, INC.	GDO	10046	815 NW 5 AVE	0
5818	ARANGO CAFETERIA, INC.	GDO	10047	5945 W 25 CT FAC. B	150
5819	GAUCHOS ARGENTINEAN GOURMET, LLC	GDO	10052	14291 SW 42 ST 32-A	850
5820	BRANCHES, INC. DBA BRANCHES FLORIDA CITY	GDO	10054	129 SW 5 AVE	998
5821	STARR RESTAURANTS CATERING GROUP NYAF, LLC. DBA TEDS AT	GDO	10055	2100 BISCAYNE BLVD	624
5822	1600 COLLINS AVENUE LLC DBA HYATT CENTRIC SOUTH BEACH	GDO	10056	1600 COLLINS AVE	1,125
5823	BAGATELLE MIAMI, LLC	GDO	10057	2000 COLLINS AVE #1	1,091
5824	MORRISON MANAGEMENT SPECIALISTS, INC. DBA STARBUCKS #17010	GDO	10060	1601 NW 10 AVE	385
5825	CURE CAFE, LLC	GDO	10070	1800 SW 1 AVE #104	210
5826	SUBWAY 55714, INC.	GDO	10072	6500 W 4 AVE #41-42	300
5827	LATAM AIRLINES GROUP, S.A. DBA VIP LOUNGE	GDO	10074	S. TERMINAL 3 FLOOR	2,566
5828	PORTO ALEGRE BRAZILIAN GRILL & MEAT MARKET CORP.	GDO	10075	795 E 8 AVE 2ND USER	121
5829	UNITED STATES POSTAL SERVICE - MIAMI PROCESSING &	GDO	10076	2200 NW 72 AVE	0
5830	ARAVITA COFFEE, LLC	GDO	10077	18400 NW 75 PL #134	215
5831	WINGMANIA, LLC	GDO	10080	28600 SW 137 AVE A-2	350
5832	7-ELEVEN, INC. DBA 7-ELEVEN STORE #39711A	GDO	10084	9691 SW 72 ST	301
5833	R HOUSE, INC.	GDO	10087	2727 NW 2 AVE	1,021
5834	BRASAS KB, LLC	GDO	10088	328 CRANDON BLVD #107	201
5835	CLOUT INVESTMENTS DBA SHOTS MIAMI	GDO	10089	356 NW 24 ST	1,678
5836	MIAMI HOTEL ENTERPRISE, LLC DBA ELEMENT MIAMI DORAL	GDO	10090	3285 NW 107 AVE	188
5837	STARBUCKS COFFEE COMPANY, INC. DBA STARBUCKS #21315	GDO	10091	11429 NW 41 ST	433
5838	NDM HOSPITALITY SERVICES, LLC DBA BURGER FI	GDO	10096	136 CORAL WAY	577
5839	FACE TO FACE COOKING CLUB CORP.	GDO	10098	8181 NW 36 ST 16-A	100
5840	THE SALTY DONUT OPERATIONS, LLC	GDO	10099	303 NE 61 ST #100	392
5841	CAFE 1000, LLC DBA CAFE 1000	GDO	10102	1000 BRICKELL AVE #139	71
5842	ELBARDI GK BRICKELL LLC DBA GYU KAKU JAPANESE BBQ	GDO	10103	34 SW 13 ST #R-7	1,100
5843	ACQUALINA MANAGEMENT LLC DBA PIAZZETA AT ACQUALIN	GDO	10106	17875 COLLINS AVE 2ND FL	565
5844	CUBAN GUYS 102, LLC DBA CUBAN GUYS SANDWICHES & M	GDO	10107	10801 SW 72 ST	570
5845	BBP DADELAND, LLC DBA BOBBY'S BURGER PALACE	GDO	10108	7535 SW 88 ST #2520	875
5846	SUBWAY 899, INC.	GDO	10109	561 NE 81 ST	363
5847	SUNFLOWER HOSPITALITY, LLC DBA CAMBRIA SUITES MIAMI AIRPORT	GDO	10110	6750 NW 7 ST	575
5848	CITY SLICKERS SUBS & SALADS BRICKELL, LLC	GDO	10111	40 SW 12 ST	639
5849	CASTEL FREDDO, LLC DBA TUTTI FRUTTI FROZEN YOGURT	GDO	10112	10201 HAMMOCKS BLVD #139	298
5850	EMPANADAS 305, LLC	GDO	10113	221 W 27 ST	500
5851	WAL-MART STORES EAST, LP DBA WAL-MART #3183	GDO	10114	1499 N HOMESTEAD BLVD	10,680
5852	CAFE MIAMI GARDENS, LLC	GDO	10116	2491 NE 186 ST	518
5853	LA BODEGUITA Y MAS II CORP.	GDO	10118	140 SW 57 AVE	514
5854	NIKRD INVESTMENTS, LLC DBA CEVICHIRO RESTAURANT	GDO	10119	2419 BISCAYNE BLVD	195
5855	TECLO GELATERIA, INC.	GDO	10123	1241 WASHINGTON AVE	171
5856	BRIKA INVESTMENTS, LLC DBA 5INCO INDOOR	GDO	10124	8081 W 28 AVE #4	469
5857	COAST TO COAST SEAFOOD, INC.	GDO	10125	4350 NW 17 AVE	325
5858	FIB ENTERPRISE CORP.	GDO	10127	4635 SW 75 AVE #E 2ND USE	375
5859	WYNWOOD CLUB, LLC	GDO	10129	2136 NW 1 AVE	1,636
5860	2912 COLLINS AVENUE, LLC DBA AC HOTEL MIAMI BEACH	GDO	10130	2912 COLLINS AVE	814
5861	HDP-TLD PARTNERS, LLC DBA RESIDENCE INN MIAMI BEACH	GDO	10131	9200 COLLINS AVE	231
5862	TOWN SQUARE SUBWAY, INC. DBA SUBWAY #53076	GDO	10135	897 N HOMESTEAD BLVD	0
5863	HOMESTEAD AIR RESERVE BASE TROOP FEEDING FACILITY	GDO	10138	400	4,350
5864	CHILL-N AVENTURA, LLC DBA CHILL-N ICE CREAM	GDO	10139	17831 BISCAYNE BLVD	205
5865	ELEVATED EATERIES OF MIAMI, LLC DBA TOUCHE	GDO	10140	15 NE 11 ST	1,738
5866	HATEM BROTHERS, INC. DBA HURRICANE GRILL & WINGS OF KENDALL	GDO	10143	15500 SW 88 ST	1,100
5867	HN3, LLC DBA MENCHIES UNIVERSITY CENTER NORTH	GDO	10145	1309 SW 107 AVE #B	408
5868	NIPOTE'S DESSERT WORLD BAKERY, INC.	GDO	10146	6741 NE 3 AVE	675
5869	PAPA PIZZA CUBANA CORP.	GDO	10147	4625 NW 199 ST	147
5870	SRIRACHA HOUSE, LLC	GDO	10149	1502-04 WASHINGTON AVE	404
5871	QUADRUM MIAMI BEACH, LLC DBA NAUTILUS	GDO	10150	1825 COLLINS AVE 1	2,396
5872	SIDE TO SIDE INVESTMENT CORP. DBA JANETTE & CO. MACARON	GDO	10153	208 MIRACLE MILE	374
5873	TEALOGY, INC. DBA SMALL TEA CO	GDO	10154	205 ARAGON AVE	472
5874	SUBWAY #57734, INC.	GDO	10156	1612 E 4 AVE #2	400
5875	BRICKELL LODAINA, LLC DBA HOMEWOOD SUITES	GDO	10157	1750 SW 1 AVE	68
5876	SUBWAY NUMBER 28843, INC.	GDO	10160	1501 BISCAYNE BLVD #102	282
5877	JJ BULLDOGS, LLC DBA JIMMY JOHN'S	GDO	10162	3423 MAIN HWY	317
5878	BURGERLOVE, LLC	GDO	10163	645 BRICKELL KEY DR	161
5879	FUNDACION HISPANOS UNIDOS CORP.	GDO	10164	2957 NW 17 AVE	837
5880	OCEAN 13 INVESTMENTS, INC. DBA HUNGRY HOWIE'S PIZZA	GDO	10165	3206 GRAND AVE	375
5881	PROFESSIONAL CHEF FOODS, LLC DBA SAVOR MIAMI	GDO	10166	1851 DELAWARE PKY E	599
5882	EAT GREEN, LLC DBA EAT GREEN	GDO	10168	14881 BISCAYNE BLVD #20	343
5883	HEREDEROS, INC.	GDO	10170	4165 NW 132 ST #12	94
5884	PIZZERIA REAL PASTA, LLC	GDO	10172	4040 W 12 AVE	488
5885	JJ OF DORAL, LLC DBA JIMMY JOHN'S GOURMET SANDWICHES	GDO	10175	10678 NW 19 ST	340
5886	THIRTYNINE COLLINS, LLC DBA CIRCA 39	GDO	10176	3900 COLLINS AVE	397
5887	MANGIA LEGGERO, INC.	GDO	10177	197 NW 62 ST	250
5888	EARL'S RESTAURANT (DADELAND), INC.	GDO	10180	7535 SW 88 ST #2510	2,732
5889	BAKED OCEAN PARALLEL, LLC DBA INSOMNIA COOKIES	GDO	10181	1227 WASHINGTON AVE	143
5890	SWEET DOLPHIN, LLC DBA CHURROMANIA	GDO	10182	11401 NW 12 ST E309	196
5891	MIAMI SMOKERS, LLC	GDO	10184	306 NW 27 AVE	625
5892	CORAL GATE CAFE & DELI CORP.	GDO	10185	1645 SW 32 AVE	467
5893	THE ARC OF SOUTH FLORIDA INC.DBA ACE/ARC ACADEMY SCHOOL	GDO	10186	303 W PALM DR	94,000
5894	LILA'S DESSERTS, INC.	GDO	10189	12309-15 SW 130 ST	1,238
5895	EMILY ENTERTAINMENT, INC. DBA KEY HOLE	GDO	10192	200 CRANDON BLVD #100	236
5896	BALANS DADELAND, LLC	GDO	10194	7535 SW 88 ST #2570	886

No.	FACILITY_NAME	PERMIT	PERMIT_NUMBER	ADDRESS	TOTAL_GPD
5897	I PUB, LLC DBA HAVANA 1957	GDO	10198	1451 S MIAMI AVE #C-3	1,275
5898	ESSA GROUP, INC. DBA LA PREP	GDO	10199	777 BRICKELL AVE #190-B	549
5899	NADER STATION CORP.	GDO	10200	2075 NW 7 ST	209
5900	FAITH HOSPITALITY GROUP, LLC DBA FAITH & PIZZA	GDO	10201	8975 SW 72 PL C-150	525
5901	JJ DRAGON SLAYERS, LLC DBA JIMMY JOHNS	GDO	10202	2921 BISCAYNE BLVD	356
5902	CARAF VIII, INC. DBA GRATIGNY CARAF	GDO	10204	1695 NW 119 ST	375
5903	WENDY'S CHOCOLATES & GIFT BASKETS, INC.	GDO	10206	17856 S DIXIE HWY	200
5904	SUBWAY 55712, INC.	GDO	10207	6792 SW 40 ST	308
5905	BENVERN 1 CORP. DBA KING JERK GRILL & RESTAURANT	GDO	10208	161 NE 183 ST	1,222
5906	ELLE TACO, LLC DBA ELLE TACO	GDO	10209	7535 SW 88 ST #1420	159
5907	AOKI KENDALL, LLC DBA AOKI TEPPANYAKI	GDO	10210	7535 SW 88 ST #2530	1,491
5908	POLLO OPERATIONS, INC. DBA POLLO TROPICAL	GDO	10211	7090 SW 24 ST	875
5909	THE EMPANADA LADY CO.	GDO	10212	6732 NE 4 AVE	650
5910	BLUE MINI MARKET CORP.	GDO	10215	7050 NW 15 AVE	625
5911	PANSCOMPANY CORP.	GDO	10216	4313 SW 75 AVE	500
5912	LILIKOI SOUTH POINTE, LLC DBA LILIKOI ORGANIC LIVING	GDO	10218	500 S POINTE DR #180	465
5913	STARR RESTAURANT CATERING GROUP MAM, LLC	GDO	10219	1103 BISCAYNE BLVD	625
5914	NEW YORK ROMA PIZZA, INC.	GDO	10221	1755 NW 7 ST	125
5915	EL PORTAL, INC. DBA EL MESON DEL PARAISO	GDO	10222	13921 SW 143 CT #1	609
5916	JACALITO TAQUERIA 2, INC.	GDO	10223	33 NW 27 AVE	206
5917	SEVENTY7, LLC DBA WONDERLAND	GDO	10224	7778 BISCAYNE BLVD	3,625
5918	VITAFOODS ENTERPRISES IV, LLC DBA FUDDRUCKERS	GDO	10225	15400 SW 88 ST	1,495
5919	WESTCHESTER GENERAL HOSPITAL, INC.	GDO	10226	2500 SW 75 AVE	17,961
5920	LAS PALMERAS RESTAURANT, INC.	GDO	10229	2500 SW 107 AVE #1	525
5921	BARNES AND NOBLE, INC. DBA BARNES AND NOBLE #2739	GDO	10230	152 MIRACLE MILE	338
5922	TORTILLERIA MINI MARKET DEL CAMPO	GDO	10233	820 N KROME AVE	525
5923	REY CHAVEZ DISTRIBUTOR CORP.	GDO	10236	3400 NW 62 ST FAC A	18,250
5924	CHURCHILL'S PUB, LLC	GDO	10237	5501 NE 2 AVE	1,000
5925	SONESTA COCONUT GROVE, INC. DBA SONESTA BAYFRONT HOTEL COCONUT	GDO	10238	2889 MCFARLANE RD	642
5926	AM 11247 FOOD CORP. DBA BRAVO SUPERMARKET	GDO	10239	11247 SW 152 ST	3,267
5927	PINECREST BAKERY, LLC	GDO	10240	6655 S DIXIE HWY	363
5928	BJ'S WHOLESALE CLUB, INC. DBA BJ'S WHOLESALE CLUB #367	GDO	10241	7050 SW 24 ST	23,900
5929	ZAK THE BAKER, LLC	GDO	10242	405 NW 26 ST	544
5930	POLLO OPERATIONS, INC. DBA POLLO TROPICAL #128	GDO	10246	7845 HIALEAH GARDENS BLVD	855
5931	THE OM CENTER, LLC	GDO	10249	7580 NE 4 CT #118	125
5932	PEI WEI ASIAN DINER, LLC	GDO	10251	12175 S DIXIE HWY BLDG 3	731
5933	1111 BRICKELL, LLC DBA EL TUCAN/MARION	GDO	10253	1111 SW 1 AVE #106	538
5934	ROYAL POLO HOTEL, LLC DBA HILTON GARDEN INN	GDO	10254	2940 COLLINS AVE	1,121
5935	MONUMENT RESTAURANTS VI (BM) LLC DBA FIVE GUYS BURGERS AND FRIES	GDO	10256	401 BISCAYNE BLVD N-226	602
5936	MASTERBRAND GROUP, LLC DBA MISTER BLOCK	GDO	10258	2621 NW 2 AVE #22	172
5937	AMAIZE DORAL PARK CENTER, LLC DBA AMAIZE	GDO	10261	3887 NW 107 AVE #101	692
5938	CIBO WINE BAR MIAMI, LLC DBA CIBO WINE BAR & RESTAURANT	GDO	10263	200 S POINTE DR	2,983
5939	STARBUCKS COFFEE COMPANY, INC. STARBUCKS # 21216	GDO	10264	827 W 41 ST	492
5940	MASAYITA MINI-MARKET CORPORATION	GDO	10265	10930 W FLAGLER ST #304	188
5941	CHEDIAK, LLC	GDO	10266	169 SW 7 ST CU-A	633
5942	CRISP CREATION, LLC DBA GIARDINO GOURMET SALADS	GDO	10267	8008 NW 154 ST	232
5943	WAL-MART STORES EAST, LP DBA WALMART MARKET # 2907	GDO	10270	3791 NW 167 ST	10,750
5944	GUSTOFINO, LLC DBA GUSTOFINO ITALIAN DELI	GDO	10271	299 ALHAMBRA CIR #271	503
5945	LCB US1, LLC	GDO	10273	7350 BISCAYNE BLVD	945
5946	BIANCO FINE FOODS, LLC	GDO	10275	3137 COMMODORE PLZ	319
5947	AMNZ SUBWAY 57843, INC.	GDO	10280	701 NW 183 ST #4	315
5948	UNA DELICIA ARGENTINA, LLC	GDO	10281	2800 PONCE DE LEON BLVD #175	125
5949	SHEPHERD ARTISAN COFFEE, LLC	GDO	10285	919 COLLINS AVE	191
5950	PLYMOUTH HOTEL, LLC	GDO	10289	336 21 ST	1,023
5951	PHOMI2GO, LLC	GDO	10290	17010 W DIXIE HWY UNIT-G	138
5952	GAM FHS, LLC DBA FIREHOUSE SUBS	GDO	10293	13581 BISCAYNE BLVD	475
5953	SOHO BAY RESTAURANT, LLC	GDO	10294	520 WEST AVE #C-1	1,564
5954	IRMG OF BAYSIDE, INC. DBA KELLY'S CAJUN GRILL/YEUNG'S LOTUS	GDO	10296	401 BISCAYNE BLVD #2130	286
5955	TANGO GRILL OF BAYSIDE, INC.	GDO	10297	401 BISCAYNE BLVD #2140	175
5956	CAFE BABBO, LLC DBA BACCANO	GDO	10299	97 NW 25 ST #103	254
5957	LA FORTANA D'ORAZIO, LLC DBA LA FONTANA RESTAURANT	GDO	10301	10702 NW 74 ST #5-6	620
5958	3420 COLLINS AVENUE, LLC DBA FAENA FORUM	GDO	10302	3301 INDIAN CREEK DR	2,445
5959	USEMARIT, LLC DBA TIRAMESU RESTAURANT	GDO	10304	101 WASHINGTON AVE	696
5960	SOBE 17 OWNER, LLC DBA RESIDENCE INN MIAMI SOUTH BEACH	GDO	10305	1231 17 ST	0
5961	HADDON HALL HOTEL OPERATOR, LLC DBA THE HALL SOUTH BEACH	GDO	10306	1500 COLLINS AVE	1,458
5962	FAMILY DOUGHNUT OPERATIONS, LLC DBA KRISPY KREME	GDO	10307	1597 W 49 ST	471
5963	KAPALLAQ, LLC DBA KAPALLAQ PERUVIAN CUISINE	GDO	10309	9559 S DIXIE HWY	1,180
5964	HRM OFFICE SOLUTIONS, LLC DBA 101 SNACKS	GDO	10313	2100 PONCE DE LEON BLVD 101	107
5965	PIZZERIAS, LLC DBA PAPA JOHN'S PIZZA #580	GDO	10315	1315 W 49 ST	404
5966	BAVARIA HAUS, LLC DBA BAVARIA HAUS RESTAURANT	GDO	10316	401 BISCAYNE BLVD #N 215-19	1,343
5967	CAFAGU, LLC DBA HAAGEN DAZS #1129	GDO	10323	1670 COLLINS AVE	200
5968	DESSERT CHIC, LLC DBA ECCOLOPOPS	GDO	10328	150 NE 1 AVE	195
5969	WAL-MART STORES EAST, LP DBA WAL-MART STORE #5671	GDO	10330	13600 SW 288 ST	3,750
5970	MART SUBWAY CORP. DBA SUBWAY #62263	GDO	10331	13600 SW 288 ST FAC. B	288
5971	SUKHO THAI EXPRESS, LLC	GDO	10333	11735 SW 147 AVE #36	293
5972	GREEN VALLEY CONVENIENCE STORE, LLC DBA WESTAR	GDO	10335	21627 S DIXIE HWY FAC. A	625
5973	COMIDA, LLC DBA E CAFE & DELI	GDO	10336	5001 NW 72 AVE	61
5974	SUBWAY #57575, INC.	GDO	10337	172 W FLAGLER ST #A	325
5975	CHASO ENTERPRISE, LLC DBA CAFE KAFFE	GDO	10338	40 SW 13 ST R-2	173
5976	CANDULE, LLC DBA SAGAFREDO ZANETTI ESPRESSO	GDO	10340	401 BISCAYNE BLVD R-106	242
5977	BONEFISH GRILL, LLC DBA BONEFISH GRILL #7601	GDO	10341	18713 BISCAYNE BLVD #300	2,016
5978	PINECREST BAKERY, LLC DBA PINECREST BAKERY #8	GDO	10342	18751-53 S DIXIE HWY	921
5979	HONEY HOUSE CATERING, INC.	GDO	10346	8234 NW SOUTH RIVER DR	250
5980	SUBWAY 57574, INC.	GDO	10347	4819 SW 8 ST	350
5981	SELEBRITY SOUL FOOD, INC.	GDO	10348	3610 NW 183 ST	213
5982	T.A.M. SUNRISE CORP. DBA TIRAMISU ACADEMY MILANO	GDO	10349	1455 NW 107 AVE K-46	40
5983	GIOVANNI SANDRI CORP. DBA GIOVANNI SANDRI FINE LUXURY CATERING	GDO	10350	34 NE 54 ST	285
5984	ALFA ACQUISITIONS, LLC DBA VIXI GELATERIA	GDO	10351	374 MIRACLE MILE	329

No.	FACILITY_NAME	PERMIT	PERMIT_NUMBER	ADDRESS	TOTAL_GPD
5985	VICTORIA BAKERY AND RESTAURANT CORP.	GDO	10353	1130 W FLAGLER ST	758
5986	TUTTO FOODS DORAL CORP.	GDO	10354	3905 NW 107 AVE #105	200
5987	GREENLIFE MIAMI, INC.	GDO	10355	104 GIRALDA AVE	186
5988	FORNERIA DISTRICT, LLC DBA FORNERIA RESTAURANT	GDO	10356	2750 SW 26 AVE C	629
5989	C.F.R. HEALTHY FOOD, LLC DBA FRESHII	GDO	10357	2300 NW 2 AVE #5	575
5990	ISLAND QUEEN CAFE, CRUISES & TOURS, INC.	GDO	10358	401 BISCAYNE BLVD K-5590	149
5991	SUSHI GARAGE, LLC	GDO	10360	1784 WEST AVE #1	817
5992	EL TROPICO EXPRESS, INC.	GDO	10361	323 SUNNY ISLES BLVD #102	135
5993	1220 MANAGEMENT GROUP, LLC DBA BODEGA	GDO	10362	1220 16 ST	800
5994	GRAZIANOS GOURMET AT DORAL, LLC DBA GRAZIANO'S GOURMET	GDO	10364	11415-21 NW 41 ST	1,320
5995	ATTON HOTELS MIAMI LLC DBA ATTON BRICKELL MIAMI HOTEL	GDO	10365	1500 SW 1 AVE	1,368
5996	WAL-MART STORES EAST, LP DBA WAL-MART STORES #2091	GDO	10367	8651 NW 13 TER	4,075
5997	HOPE COMMUNITY DEVELOPMENT CORP. DBA YVONNE LEARNING CENTER	GDO	10368	7561 NE 1 AVE	7,561
5998	HISPANIC AMERICAN GLOBAL MERCHANDISE, LLC.	GDO	10369	425 NE 22 ST #203	162
5999	DLC DOUGH, LLC	GDO	10371	12235 SW 128 ST #201	463
6000	PUBLIX SUPERMARKETS, INC. DBA PUBLIX PHARMACY AND PUBLIX CAFE	GDO	10373	120 SW 13 ST	282
6001	IKEA US EAST, LLC DBA IKEA #327	GDO	10375	1801 NW 117 AVE	2,890
6002	MIAMI CAFE & BOUTIQUE, LLC	GDO	10376	2750 NW 3 AVE #21	381
6003	CK AT ALTON RD, LLC DBA CHICKEN KITCHEN	GDO	10379	1509 ALTON RD	353
6004	AIYARA, LLC DBA NAI YA RA THAI RESTAURANT	GDO	10381	1900 BAY RD FAC. B	0
6005	TOWN & COCOA, LLC	GDO	10383	4565 SW 71 AVE	250
6006	SYLFORT BAKERY	GDO	10384	5301 NW 2 AVE #2	609
6007	GLOBAL CONCESSIONS, INC. DBA IRISH PUB BAR & GRILL	GDO	10385	D.308 N.TERM	298
6008	BCC HOTEL, LLC (5TH FLOOR RESTAURANT)	GDO	10387	788 BRICKELL AVE 5TH FLOOR	1,773
6009	BLOOMIN BRANDS, INC. DBA CARRABA'S ITALIAN GRILL	GDO	10389	9231 W FLAGLER ST C-101	1,571
6010	FAST GRILL OF HIALEAH GARDENS, INC. DBA LA GRANJA POLLOS A LA BRASA	GDO	10390	11870 HIALEAH GARDENS BLVD #130	575
6011	STARBUCKS COFFEE COMPANY, INC. DBA STARBUCK'S COFFEE #8507	GDO	10396	6320 BISCAYNE BLVD	462
6012	GREENLIFE MIAMI, INC. DBA GREENLIFE ORGANIC BISTRO	GDO	10398	909 BRICKELL AVE	125
6013	LANGFORD PARTNERS, LLC DBA THE LANGFORD HOTEL	GDO	10399	121 SE 1 ST	1,889
6014	7-ELEVEN, INC. DBA 7-ELEVEN STORE #37121A	GDO	10400	735 NW 12 AVE	745
6015	CAKE WYNWOOD, LLC DBA CAKE THAI CAFE	GDO	10404	180 NW 29 ST	276
6016	ELITE CATERING SERVICES OF MIAMI, LLC	GDO	10405	7700 NW 37 AVE	1,430
6017	WAL-MART STORES EAST, LP DBA WAL-MART STORE #4161	GDO	10406	9191 W FLAGLER ST	25,000
6018	PARTY CAKE BAKERY VII, INC.	GDO	10407	15726-30 SW 56 ST	650
6019	SUPER FUZION, LLC	GDO	10408	7056 SW 44 ST FAC. B	350
6020	LAS VILLAS PHARMACY DISCOUNT AND MEDICAL SUPPLIES, INC. DBA LAS	GDO	10410	716 W 29 ST	45
6021	SALAD CREATIONS AT BISCAYNE, LLC	GDO	10411	2001 BISCAYNE BLVD #105	319
6022	SUNSHINE HOSPITALITY, LLC	GDO	10412	3450 NW 91 AVE	332
6023	ASIAN THAI KITCHEN, INC.	GDO	10414	3135 GRAND AVE FAC. B	125
6024	MARINA HOT DOGS	GDO	10416	1810 NW 21 TER	899
6025	ORGANICALLY RAW, LLC	GDO	10417	4556 SW 71 AVE	225
6026	SUBWAY 49156, INC.	GDO	10418	3200 SW 60 CT	219
6027	HNS PARTNERS LLC 58064 DBA SUBWAY #58064	GDO	10422	847 WASHINGTON AVE	0
6028	CM THE FALLS, LLC DBA CHURROMANIA	GDO	10423	8888 SW 136 ST K-101	70
6029	THREEFOLD CAFE KEY BISCAYNE, LLC	GDO	10424	10 VILLAGE GREEN WAY	64
6030	EINSTEIN & NOAH CORP. DBA EINSTEIN BROS BAGELS	GDO	10425	12180 SW 88 ST	617
6031	CASABLANCA ON THE BAY, INC.	GDO	10426	1717 N BAYSHORE DR #200	1,350
6032	FIREMAN DEREK'S KEY LIME PIE, LLC DBA FIREMAN DEREK'S BAKE SHOP &	GDO	10427	2818 N MIAMI AVE	150
6033	GHA ENTERPRISES, INC. DBA EXXON	GDO	10429	2801 NW 42 AVE	300
6034	WAL-MART STORES EAST, LP DBA WAL-MART MARKET # 4140	GDO	10430	6991 SW 8 ST	13,750
6035	JOFA, INC. DBA BISTRO CASSIS	GDO	10431	3242 NE 1 AVE #118	575
6036	BROOKLYN HOSPITALITY, LLC DBA THE BROOKLYN	GDO	10432	928 71 ST	696
6037	EL CHALET RESTAURANT CAFETERIA, INC.	GDO	10433	11500 NW SOUTH RIVER DR #2	375
6038	GOURMEZZA INVESTMENTS, LLC DBA GOURMEZZA CATERING	GDO	10435	2059 W 62 ST	402
6039	MIKE'S CAFE & DELI, INC.	GDO	10436	8300 NW 53 ST #109	425
6040	BLANCA RETAIL, LLC DBA LATTERIA ITALIANA	GDO	10438	3301 NE 1 AVE #101	334
6041	UNDERGROUND CAFE, LLC	GDO	10439	331 NW 26 ST	389
6042	TACO BELL OF AMERICA, INC. DBA TACO BELL #030358	GDO	10443	390 W 29 ST	507
6043	PALM BEACH RESTAURANT PARTNERS, LLC	GDO	10444	10121 W FLAGLER ST	1,075
6044	GMAC CORP. DBA MCDONALDS	GDO	10445	13690 BISCAYNE DR	902
6045	BIKINI SPORT BAR AND LOUNGE, LLC	GDO	10447	7309 COLLINS AVE	225
6046	ADVANTAGE ACADEMY OF MIAMI, INC.	GDO	10448	6700 NW 104 AVE	13,750
6047	BIRD BOWL INVESTMENTS, LLP	GDO	10449	9275 SW 40 ST	625
6048	PARTY CAKE BAKERY VI, INC.	GDO	10450	15448-52 SW 88 ST	557
6049	RACETRAC PETROLEUM, INC.	GDO	10451	14201 NW 57 AVE	1,453
6050	PANERA, LLC DBA PANERA BREAD #1704	GDO	10454	10061 W FLAGLER ST	1,148
6051	CRAVECLEAN, LLC	GDO	10455	3822 SW 8 ST	225
6052	CYBR - CAFFE SOBE CORP.	GDO	10456	1574 WASHINGTON AVE	500
6053	KAWAYAN GRILL DBA KAWAYAN CREW EXPRESS	GDO	10457	252 NE 1 ST	242
6054	PUBLIX SUPERMARKETS INC. DBA PUBLIX STORE #1467	GDO	10459	9951 W FLAGLER ST	11,400
6055	PSYCHO SOCIAL REHABILITATION CENTER, INC.	GDO	10460	9823-27 E HIBISCUS ST	11,560
6056	SMOOTHIE KING CO., INC. DBA SMOOTHIE KING #1125	GDO	10462	1050 NW 14 ST #4-A	301
6057	HIBACHI GRILL, INC.	GDO	10463	35 SE 6 ST #105	257
6058	ABOTI, LLC DBA HAAGEN DAZS #1130	GDO	10465	286 CORAL WAY	200
6059	DI TUTTO TAKEOUT RESTAURANT, LLC	GDO	10468	9588 NW 41 ST	165
6060	SHRIHAN ENTERPRISES, INC. DBA OVERTOWN FOOD MARKET	GDO	10470	295 NW 20 ST	740
6061	DECIZIE, INC. DBA ALMOTTI	GDO	10471	14395 SW 139 CT #102	348
6062	NOOR ENTERPRISES, INC. DBA CARVEL STORE NO. 6621	GDO	10472	12224 SW 8 ST	325
6063	PRH 1300 HOTEL, LLC DBA SLS BRICKELL	GDO	10474	1300 S MIAMI AVE REST. #1	1,236
6064	ADRIAN FISH MARKET & RESTAURANT CORP.	GDO	10476	13115 W OKEECHOBEE RD #114-116	1,003
6065	ROBINSON SPORTS, INC. DBA FIT2RUN JUICE BAR	GDO	10477	401 BISCAYNE BLVD #1180	52
6066	THE PRIMITIVE NUTRITION GROUP CORP.	GDO	10481	642 W 84 ST	396
6067	IVAN AND MYKOLA, LLC DBA BEN & JERRY'S SCOOP SHOP	GDO	10482	15484 NW 77 CT #300	340
6068	MAKI'S PLACE BAYSIDE MARKETPLACE, LLC	GDO	10484	401 BISCAYNE BLVD #2260	152
6069	CAFE PAPILLON, INC.	GDO	10486	244 BISCAYNE BLVD N-2	264
6070	FLORIDA QUALITY GROUP, LLC DBA LITTLE CAESARS	GDO	10487	6792 COLLINS AVE	325
6071	ITALUSA FOOD & SERVICES, INC. DBA FIREHOUSE SUBS	GDO	10488	12528 SW 88 ST	541
6072	SUSHI SIAM OCEAN DRIVE, LLC	GDO	10489	804 OCEAN DR 2ND USER	377

No.	FACILITY_NAME	PERMIT	PERMIT_NUMBER	ADDRESS	TOTAL_GPD
6073	SSC352021, LLC DBA DUNKIN DONUTS	GDO	10491	1050 NW 14 ST #106	325
6074	NIGHT OWL COOKIE CO. LLC	GDO	10493	10742 SW 24 ST	160
6075	PANTHER COFFEE COCONUT GROVE, LLC DBA PANTHER COFFEE	GDO	10494	3407 MAIN HWY	281
6076	LUNCHBOX AT WYNWOOD, LLC	GDO	10497	78 NW 25 ST	333
6077	MEATS ON THE BEACH, LLC DBA QUALITY MEATS	GDO	10499	1501 COLLINS AVE	2,650
6078	SIBELLA HOLDINGS, LLC DBA GROOVY'S PIZZA & GRILL	GDO	10501	2770 SW 27 AVE #1	0
6079	CASA VENEZIA, INC.	GDO	10502	1200 BRICKELL BAY DR #108	375
6080	MIA BREWING CO., INC.	GDO	10503	10400 NW 33 ST #150	2,738
6081	TACO BELL OF AMERICA, LLC DBA TACO BELL	GDO	10504	12001 SW 129 CT	507
6082	SHORTY'S IV, INC. DBA SHORTY'S BBQ #4	GDO	10506	2255 NW 87 AVE #205	1,800
6083	SHORTY'S, INC. DBA SHORTY'S BBQ #1	GDO	10507	9200 S DIXIE HWY	1,000
6084	PBE-JACKSON MEMORIAL, LLC DBA MOE'S SOUTHWEST GRILL	GDO	10509	901 NW 17 ST SUITE L SPACE A	766
6085	PBE-JACKSON MEMORIAL, LLC DBA AUNTIE ANNE'S	GDO	10510	901 NW 17 ST SUITE L SPACE C	202
6086	PUBLIX SUPERMARKETS, INC. DBA PUBLIX STORE #1492	GDO	10512	7550 NW 104 AVE FAC. A	12,396
6087	BEST HOSPITALITY GROUP, INC. DBA BAGEL TIME CAFE	GDO	10513	3915 ALTON RD	450
6088	TEXAS ROADHOUSE HOLDINGS, LLC	GDO	10514	9161 W FLAGLER ST	1,792
6089	MANY FACES ACADEMY, INC.	GDO	10515	13350 SW 288 ST	140,000
6090	LOS SOIRELLES, LLC DBA TRU-TRU CAKES AND MORE	GDO	10517	1523 NW 165 ST UNIT A	878
6091	WAL-MART STORES EAST, LP DBA WALMART STORE #4303	GDO	10518	3200 NW 79 ST	25,000
6092	BOBA WORLD, INC.	GDO	10519	9658 SW 72 ST	275
6093	PRIMO SERVICES, LLC	GDO	10520	10 NE 27 ST #103	887
6094	START FROM SCRATCH BAKERY, LLC	GDO	10521	9543 S DIXIE HWY #13	251
6095	7-ELEVEN, INC. DBA 7-ELEVEN #10497A	GDO	10525	51 HARBOR DR	0
6096	BEALLSANDWICH, LLC DBA JIMMY JOHN'S #2959	GDO	10526	10524 SW 8 ST	256
6097	LULU'S MIAMI BEACH, LLC DBA LULU'S NITROGEN ICE CREAM	GDO	10527	1439 ALTON RD	105
6098	811 ENTERPRISES, INC. DBA CARVEL STORE # 2455	GDO	10528	14740 SW 56 ST	275
6099	M & D INTERNATIONAL INVESTMENTS, LLC	GDO	10529	999 BRICKELL AVE #102	133
6100	MISKICHA, INC. DBA CHICK-FIL-A STORE #3238	GDO	10531	9301 W FLAGLER ST	1,050
6101	OFF CENTER RESTAURANT GROUP, LLC DBA ALTER	GDO	10532	219 NW 23 ST	0
6102	ARGENTINA BBQ MEATS & CAFETERIA, INC. DBA GRAZIANOS RESTAURANT	GDO	10533	9227 SW 40 ST	900
6103	ARGENTINA MEAT MARKET, INC. DBA GRAZIANO'S MARKET	GDO	10535	3922 SW 92 AVE	0
6104	MACONDO DORAL, INC.	GDO	10536	2494 NW 89 PL	575
6105	DECO TRE, LLC DBA ROSETTA BAKERY	GDO	10537	1666 COLLINS AVE	549
6106	305 CONCEPTS WYNWOOD, LLC DBA COYO TACO	GDO	10538	2300 NW 2 AVE	775
6107	PARADIGM KITCHEN, LLC	GDO	10539	1834 BAY RD	506
6108	MS. CHEEZIOUS, INC.	GDO	10541	7418 BISCAYNE BLVD	395
6109	FAMK GROUP, INC. DBA SALT AND PEPPER	GDO	10542	2315 NW 107 AVE 1M31	475
6110	ALI MOLINA CORP. DBA LA ESTACION CAFE	GDO	10544	1390 BRICKELL AVE #100	455
6111	EDITION MANAGEMENT, LLC DBA THE MIAMI BEACH EDITION BASEMENT	GDO	10545	2901 COLLINS AVE FAC.B	433
6112	EDITION MANAGEMENT, LLC THE MIAMI BEACH EDITION MATADOR/OCEAN	GDO	10546	2901 COLLINS AVE FAC.C	1,080
6113	EDITION MANAGEMENT, LLC DBA THE MIAMI BEACH EDITION - MARKET	GDO	10547	2901 COLLINS AVE FAC.D	635
6114	PAC PARTNERS, INC.	GDO	10548	275 NE 18 ST #108	375
6115	MIAMI ARTS, INC. DBA MIAMI ARTS CHARTER SCHOOL	GDO	10551	95 NW 23 ST	0
6116	STARBUCKS COFFEE COMPANY, INC. DBA STARBUCKS #22267	GDO	10553	6702 SW 40 ST #3	532
6117	THE ART & FREEDOM DBA LA ESQUINA DE LA FAMA	GDO	10558	1388 SW 8 ST	568
6118	CABO FLATS DORAL, LLC	GDO	10561	11401 NW 12 ST R100, R101	2,966
6119	BOUN PANE ITALIANO, LLC	GDO	10563	729 5 ST CU-7	248
6120	TEXAS DE BRAZIL (DADELAND) CORP DBA TEXAS DE BRAZI	GDO	10565	7535 SW 88 ST #2534	1,456
6121	VICKY ENTERPRISES, INC.	GDO	10566	7230 NW 77 ST	2,875
6122	CA CAO ART, LLC	GDO	10570	7165 SW 47 ST 316	279
6123	CHITO'S, INC. DBA CHITO'S TAKE-OUT	GDO	10571	16435 NE 15 AVE	313
6124	IMCMV MIA AIRPORT, LLC. DBA MARGARITAVILLE	GDO	10572	2 FL CC-E	647
6125	HAVANA ASSOCIATES SERVICES, INC. DBA HANS & BROTHERS PIZZERIA	GDO	10574	14751 SW 184 ST	0
6126	OH MY GOSH BRIGADEIROS, INC.	GDO	10578	2771 SW 22 ST	226
6127	GREENTAG INTERNATIONAL, INC.	GDO	10579	2621 NW 2 AVE #8	90
6128	YAMOR, LLC DBA YA-FIT	GDO	10580	1500 BAY RD #4	200
6129	ONYX SIGNATURE GYM, LLC	GDO	10587	2600 NW 87 AVE #25	400
6130	US DAIRY UNLIMITED, LLC	GDO	10588	1066 NW 21 ST	751
6131	7-ELEVEN, INC. DBA 7-ELEVEN STORE #37159H	GDO	10592	1050 NW 14 ST 9A	501
6132	WINNERS MACARONS, LLC DBA LE MACARON FRENCH PASTRIES MIAMI	GDO	10595	1630 PENNSYLVANIA AVE	210
6133	BLITZ DEVELOPMENT INT'L, LLC DBA GK BISTRONOMIE	GDO	10596	218 NW 25 ST	1,088
6134	GLASSHOUSE COCONUT GROVE, LLC	GDO	10597	2820 MCFARLANE RD	1,245
6135	S LOT PARTNERS, LLC DBA UPLAND	GDO	10598	49 COLLINS AVE	1,981
6136	THE MEDITERRANEAN KITCHEN, LLC (SPACE-DC25168)	GDO	10600	D-28 N.TERM	88
6137	NATURAL HARVESTER, INC. DBA APPLE A DAY	GDO	10601	1534 ALTON RD	375
6138	DRINKHOUSE FIRE & ICE, LLC	GDO	10604	1672 COLLINS AVE	1,050
6139	ONLY ORGANIC CORP. DBA ORGANIC BITES	GDO	10608	7010 BISCAYNE BLVD	250
6140	OHANA RVR, LLC DBA OHANA SUSHI	GDO	10609	3887 NW 107 AVE #103	350
6141	LA ESQUINA AT 11TH, LLC	GDO	10613	1040 BISCAYNE BLVD #30	347
6142	305 PIZZA AT MIA, LLC	GDO	10618	3514 NW 36 ST FAC. A	112
6143	WINE & TIGELLA, LLC	GDO	10619	12 NE 1 AVE R-1A	265
6144	LOS SUIZOS CORP. DBA LA SUIZA BAKERY	GDO	10622	14016 SW 8 ST	325
6145	HEALTHY LIFESTYLE CLUB, INC. DBA HEALTHY LIFESTYLE CUISINE	GDO	10623	1806 NW 183 ST	69
6146	WINGMANIA, LLC	GDO	10624	20141 SW 127 AVE	338
6147	GOCHON GOURMET FAST FOOD, INC.	GDO	10627	12805 SW 42 ST	214
6148	LULU'S ICE CREAM, LLC	GDO	10628	2001 BISCAYNE BLVD #CU-8	225
6149	HARRY'S PIZZERIA II, LLC	GDO	10632	3401 MAIN HWY	455
6150	GABLES HOTEL GROUP LLC DBA FOUR POINT BY SHERATON	GDO	10634	3861 BIRD RD	200
6151	LES ALPILLES, LLC DBA L'EPICERIE WYNWOOD	GDO	10635	195-197 NW 36 ST	434
6152	BR FOODS INTERNATIONAL, LLC DBA BAHAMA BUCK OF MIAMI	GDO	10637	14601 SW 104 ST #1	359
6153	RED SHALLOT CORP.	GDO	10639	9032 NW 25 ST	218
6154	2 SWEET OF FLORIDA, INC. DBA AUNTIE ANNE'S	GDO	10640	401 BISCAYNE BLVD #6510	38
6155	SCM COFFEE, INC. DBA PASION DEL CIELO COFFEE - THE FALLS	GDO	10647	8888 SW 136 ST #585	297
6156	LADUREE MIAMI, LLC	GDO	10648	1100 LINCOLN RD #1118-B	158
6157	TANG CHAO, LLC	GDO	10652	10720 W FLAGLER ST #14	0
6158	DELI 26, LLC DBA MEATOAST	GDO	10654	222 71 ST	105
6159	3755 PROPERTY HOLDINGS, LLC DBA WYNDHAM MIAMI AIRPORT	GDO	10655	3755 NW 78 AVE	12
6160	BACHOUR HOSPITALITY, LLC	GDO	10656	600 BRICKELL AVE #175	513

No.	FACILITY_NAME	PERMIT	PERMIT_NUMBER	ADDRESS	TOTAL_GPD
6161	BRAIN FREEZE, LLC	GDO	10657	3905 NW 107 AVE #106	357
6162	KONA MACADAMIA, INC. DBA KONA GRILL	GDO	10662	11401 NW 12 ST R-104	2,242
6163	CHIPOTLE MEXICAN GRILL OF COLORADO, LLC. DBA CHIPOTLE MEXICAN	GDO	10665	2000 NW 87 AVE #1	653
6164	BRAVO BRIO RESTAURANT GROUP, INC.	GDO	10670	11401 NW 12 ST R-105	2,245
6165	PC 136, LLC DBA ELLA POP	GDO	10671	140 NE 39 ST #136	135
6166	CU COPPER, LLC DBA COPPER 29	GDO	10673	206 MIRACLE MILE	0
6167	AMERICAN EXPRESS COMPANY, INC. DBA AMERICAN EXPRESS CENTURION	GDO	10678	D-12 N.TERM	2,250
6168	HYPERFIT NUTRITION, INC.	GDO	10680	3826 SW 8 ST	0
6169	BULLA DORAL, LLC	GDO	10681	5335 NW 87 AVE C-102	1,805
6170	PISCO Y NAZCA DORAL, LLC	GDO	10683	8551 NW 53 ST A-101	1,780
6171	305 PIZZA @ MIA, LLC	GDO	10685	D27 N.TERM	128
6172	XPRESSO MARKET, LLC	GDO	10686	400 KINGS POINT DR #3	450
6173	SAKURA GROUP OF USA, INC.	GDO	10687	3000 SW 22 ST #CU-4	527
6174	CHIPOTLE MEXICAN GRILL OF COLORADO, LLC DBA CHIPOTLE #2306	GDO	10688	10141 W FLAGLER ST #D-100	567
6175	HARMONIE, LLC DBA HARMONIE FINE RESTAURANT	GDO	10689	110 GIRALDA AVE	1,009
6176	CARRFOUR SUPPORTIVE HOUSING, INC. DBA VERDE COMMUNITY FARM &	GDO	10695	12690 SW 280 ST	1,250
6177	EMBUTIOS FANGUITO, INC. DBA DISTRIBUIDORA EL FANGUITO	GDO	10697	1423 NW 23 ST	500
6178	SMOOTHIE CORP. DBA SMOOTHIE KING KENDALL	GDO	10698	12520 SW 88 ST	169
6179	WYNWOOD DINER, LLC	GDO	10700	2601 NW 2 AVE	1,433
6180	PINECREST BAKERY, LLC	GDO	10702	1511 ALTON RD	693
6181	PIZZA TONDA AMERICA, LLC	GDO	10706	28 SW 11 ST	208
6182	DRAGONFLY OF DORAL, LLC DBA DRAGONFLY	GDO	10714	5241 NW 87 AVE D101-03	0
6183	FDG DOLPHIN MIAMI, LLC DBA BURGER & BEER JOINT	GDO	10715	11401 NW 12 ST R-102	1,499
6184	DOWNTOWN CHICKEN, INC.	GDO	10717	140 NE 2 AVE #148	328
6185	ANNY'S PIZZERIA, LLC DBA ANNY'S PIZZA	GDO	10719	2997 W 12 AVE	173
6186	FRESH HORIZONS OF BRICKELL, LLC	GDO	10722	1102 S MIAMI AVE	219
6187	MARTINEZ DISTRIBUTORS CORP.	GDO	10723	3081 NW 74 AVE	480
6188	GREENG LIFESTYLE, LLC	GDO	10725	222 NE 25 ST #106	359
6189	POLLO OPERATIONS, INC. DBA POLLO TROPICAL #10167	GDO	10726	23200 SW 112 AVE	913
6190	MOM'S CAFE, INC.	GDO	10737	1209 NW 9 AVE	375
6191	JERSEY MIKE'S FRANCHISE SYSTEMS, INC.	GDO	10738	10141 W FLAGLER ST #110	358
6192	MIAMI WEISS, LLC DBA CONTINENTAL MIAMI	GDO	10740	2360 COLLINS AVE 2ND USE	2,376
6193	SWEET BAKERY, INC.	GDO	10741	1467 N KROME AVE #7	300
6194	NPJ GROUP CORPORATION DBA MY BRICKELL GOURMET RESTAURANT-	GDO	10744	31 SE 6 ST CU	675
6195	GT BAKERY, LLC	GDO	10745	3100 NW 17 AVE	375
6196	DOWNTOWN DORAL STELLINOS TRATTORIA, LLC	GDO	10747	8550 NW 53 ST B-107	1,165
6197	LITTLE CEASER ENTERPRISES, INC.	GDO	10748	1712 NW 36 ST	0
6198	DIZIO, LLC DBA FARINELLI 1937	GDO	10749	3197 COMMODORE PLZ	525
6199	CAKES BY CARY CORP.	GDO	10752	18505 NW 75 PL #111	248
6200	COO DEL ANGEL CORP. DBA DEL ANGEL ICE	GDO	10755	16225 SW 117 AVE #24D	26
6201	MIDTOWN GELATO, LLC DBA 4 D GELATO AND ITALIAN GOURMET	GDO	10758	3201 N MIAMI AVE #101	287
6202	DOS CROQUETAS, LLC	GDO	10760	7342 NW 35 ST 2ND USER	0
6203	LIDER GRILL, LLC DBA LIDER GRILL RESTAURANT	GDO	10762	10917 SW 40 ST	200
6204	PBE-JACKSON MEMORIAL, LLC DBA JAMBA JUICE	GDO	10763	901 NW 17 ST SUITE L SPACE B	240
6205	PBE-JACKSON MEMORIAL, LLC DBA CARVEL'S	GDO	10764	901 NW 17 ST SUITE L SPACE D	131
6206	HANGAR ONE INFLIGHT CATERING, LLC	GDO	10766	14950 NW 44 CT	214
6207	PARINTO GLOBAL ENTERPRISES, LLC	GDO	10768	5213 NW 79 AVE	225
6208	FRESH PARRAS BARBER SHOP CORP. (RESTAURANT)	GDO	10772	70 W 49 ST	500
6209	2180 KITCHEN, LLC	GDO	10773	2180 NW 24 CT	730
6210	KNEED A PIZZA, LLC	GDO	10775	13471 SW 288 ST	300
6211	LOS RANCHO OF THE FALLS, INC.	GDO	10778	8888 SW 136 ST #373	1,123
6212	HOST TINSLEY JOINT VENTURE DBA STARBUCKS D-30	GDO	10782	D-31-32 N. TERM	285
6213	WOW LOOK FEEL GOOD, LLC	GDO	10785	701 E OKEECHOBEE RD	62
6214	BRU'S ROOM BIRD ROAD, LLC DBA BRUS ROOM	GDO	10786	8318 SW 40 ST	2,450
6215	BAR BISTRO & BEYOND, LLC	GDO	10787	703 NE 63 ST	95
6216	ORIENTE, LLC DBA LAS VEGAS	GDO	10788	8550 NW 53 ST #B-101	1,068
6217	BHOLA SUB'S, LLC DBA FIRE HOUSE SUB'S	GDO	10789	9251 W FLAGLER ST	350
6218	ESEVAGONTE, INC.	GDO	10793	6801 SW 8 ST #101	759
6219	SEMOFE USA, LLC DBA FROOTS	GDO	10795	13909 SW 88 ST	281
6220	BEACON HILL CHOCOLATES	GDO	10798	6318 BISCAYNE BLVD #100	185
6221	LE MARCHE CAFE AT HABITAT, LLC	GDO	10801	1700 SW 2 AVE	216
6222	AMERICAN RESTAURANT GROUP #4, INC. DBA DENNY'S	GDO	10805	18600 NW 67 AVE	1,132
6223	TAP 42 GABLES, LLC	GDO	10809	301 GIRALDA AVE	1,502
6224	KAZUKI SUSHI BAR, LLC	GDO	10810	10141 W FLAGLER ST D130\D140	648
6225	MH RICKY'S, LLC DBA RICKY'S	GDO	10811	1224 16 ST	527
6226	IPIC GOLD CLASS ENTERTAINMENT, LLC	GDO	10814	3701 NE 163 ST	50
6227	PIZZERIAS, LLC DBA PAPA JOHN'S #539	GDO	10817	2877 BISCAYNE BLVD	360
6228	MANNA ENTERPRISES, LLC DBA MANNA LIFE FOOD	GDO	10819	80 NE 2 AVE	300
6229	FORTUNE INVESTMENT GROUP, LLC DBA WHICH WICH SUPERIOR	GDO	10822	8880 SW 72 PL	373
6230	SPORA CAFE & SMOOTHIE BAR, INC.	GDO	10825	6778 COLLINS AVE	160
6231	AMERICAN AIRLINES, INC. - ADMIRAL'S CLUB	GDO	10826	D-15 3-FL	3,526
6232	DORAL CREAMERY, LLC DBA COLD STONE CREAMERY # 21143	GDO	10828	2000 NW 87 AVE #4	303
6233	MACRA, LLC	GDO	10833	1035 N MIAMI AVE #102	155
6234	GASDORAL MANAGEMENT, LLC DBA MOBIL AT DORAL	GDO	10834	10895 NW 41 ST 2ND USE	0
6235	PIEOLOGY FOUNTAIN SQUARE, LLC DBA PIEOLOGY PIZZERIA	GDO	10837	10141 W FLAGLER ST D-150	663
6236	PASTICERIA BELLUCCI CORP.	GDO	10838	526 HIALEAH DR	275
6237	WYNWOOD LEARNING CENTER II, LLC	GDO	10839	5580 NW 7 AVE	2,342
6238	LOWHAA, INC. DBA LOWHAA	GDO	10842	1557 NE 167 ST	0
6239	LODINO VENEZUELAN FOODS, INC.	GDO	10845	13800 SW 142 AVE #10	466
6240	THE RITZ CARLTON HOTEL COMPANY, LLC DBA LIGHTKEEPERS	GDO	10850	455 GRAND BAY DR	3,248
6241	26 LUGLIO, LLC DBA A MODO MIO	GDO	10851	16850 COLLINS AVE #113-A	429
6242	AGUSTIN GIANZA FINE CUBAN & LATIN AMERICAN, INC. DBA GIANZA ART &	GDO	10856	1652 SW 8 ST	206
6243	BITES HOSPITALITY, LLC DBA ROASTERS N' TOASTERS	GDO	10857	18515 NE 18 AVE	1,000
6244	1306 LOUNGE, LLC	GDO	10860	1306 N MIAMI AVE	500
6245	SPICYTOWN, LLC DBA SALSA FIESTA	GDO	10861	1050 NW 14 ST #108	450
6246	THE WYNWOOD YARD, LLC	GDO	10862	56 NW 29 ST	2,500
6247	T & R PLAZA, LLC	GDO	10863	19202 W DIXIE HWY	175
6248	AF1 INTERNATIONAL, LLC DBA PARIS 6	GDO	10867	2216 COLLINS AVE	910

No.	FACILITY_NAME	PERMIT	PERMIT_NUMBER	ADDRESS	TOTAL_GPD
6249	DVI CARDEL FLAGLER RESIDENCE, LLC DBA FLAGLER RESIDENCE INN	GDO	10869	11500 NW 105 ST	225
6250	JOSHUA A. INVESTMENTS, INC. DBA PINCHO FACTORY	GDO	10870	12519 S DIXIE HWY	335
6251	INGENIUM ESPRESSO COFFEE	GDO	10872	7791 NW 46 ST L1	182
6252	ADOLPHE TAKEOUT RESTAURANT & SUPERMARKET, INC.	GDO	10874	215 NE 82 TER	188
6253	MSG PINECREST, LLC DBA MOE'S SOUTHWEST GRILL	GDO	10882	9079 S DIXIE HWY	433
6254	BETA ROOM, LLC DBA BEAKER AND GRAY	GDO	10883	2637 N MIAMI AVE #102	1,035
6255	CHURRO MAGICO, INC.	GDO	10884	3300 W 84 ST #1	211
6256	SSC355073, LLC DBA DUNKIN DONUTS	GDO	10885	19801 NW 27 AVE FAC. A	432
6257	AZ GLOBAL ENTERPRISES, LLC DBA ROBEKS JUICE	GDO	10886	5335 NW 87 AVE	271
6258	PISCO Y NAZCA KENDALL, LLC	GDO	10887	8405 MILLS DR #206	1,387
6259	119 CHINA TOWN, INC.	GDO	10888	715 NW 119 ST	225
6260	SWEETS FLOWERS & BOOKS, LLC	GDO	10890	3301 NE 1 AVE 110	213
6261	CAFE COLLINS 16, LLC DBA AROMA CAFE	GDO	10891	1601 COLLINS AVE FAC. C	962
6262	27 ENTREPRENEUR MIAMI INTL. DBA GEORGE STONE CRAB	GDO	10895	D-29A N. TERM.	60
6263	KENDAL KS, LLC DBA KWIK STOP #106	GDO	10896	12700 SW 122 AVE #106	300
6264	EAST RIDGE RETIREMENT VILLAGE, INC.	GDO	10897	19225 SW 87 AVE	2,446
6265	YONG TAI ENTERPRISE, INC.	GDO	10898	18812 S DIXIE HWY	1,300
6266	7-ELEVEN, INC. DBA 7-ELEVEN STORE #37165A	GDO	10899	13690 SW 268 ST	766
6267	DR. SMOOD WYNWOOD, LLC	GDO	10901	2230 NW 2 AVE	1,125
6268	FOOD PROVISIONS, LLC DBA THE GOLDEN HOG	GDO	10902	235 CRANDON BLVD #4	277
6269	ALTAS CAFE CORP.	GDO	10903	3203 NW 17 AVE	238
6270	SANATOS, LLC DBA WELLNESS CHOICE EXPRESS MARKET	GDO	10920	190 MINORCA AVE	238
6271	RONNY RAMIREZ RX CORP.	GDO	10927	3105 NW 107 AVE #102	600
6272	DORAL NORTH, INC. DBA MCDONALD'S RESTAURANT	GDO	10929	7570 NW 104 AVE	1,080
6273	ABUELO'S ADULT CARE, LLC	GDO	10930	3383 NW 7 ST #101	341
6274	7-ELEVEN, INC. DBA 7-ELEVEN STORE #37089A	GDO	10931	12720 SW 200 ST	748
6275	YAZU SOUTH MIAMI, LLC DBA YAZU	GDO	10932	6635 S DIXIE HWY	204
6276	LAR 2016, LLC DBA ARENA'S MARKET BISTRO	GDO	10933	900 BISCAYNE BLVD #101-B	741
6277	MARCO SIMEON CORP. DBA MAMMA ANTONIA	GDO	10935	1100 COLLINS AVE CU-5	162
6278	IMC HOSPITALITY, LLC DBA POLLO TROPICAL/VIENA	GDO	10937	1611 NW 12 AVE	1,413
6279	NANNDI, INC. DBA NANNDI	GDO	10939	8845 SW 72 PL A-103	365
6280	ELIA GROUP, LLC DBA ELIA GOURMET	GDO	10940	900 BISCAYNE BLVD #105	0
6281	LA FONTANA CORP.	GDO	10943	512 ESPANOLA WAY	415
6282	VARGAS FAMILY, INC.	GDO	10944	2361 NW 7 ST	250
6283	MIAMI PRO CATERERS, LLC	GDO	10945	7500 NW 25 ST 103	237
6284	F27, INC.	GDO	10946	7610 NE 4 CT	70
6285	CHOQUETTES, LLC DBA CAFE CREME	GDO	10947	750 NE 125 ST	1,053
6286	COSECHAS FLORIDA OP, LLC DBA PURPLE ORCHID	GDO	10949	100 S BISCAYNE BLVD 101	262
6287	SPLURGE JUICE BAR & CAFE, LLC	GDO	10950	18505 NW 75 PL #119	264
6288	TEA GALLERY CORP.	GDO	10952	1455 NW 107 AVE K-51	0
6289	EL MIO, INC.	GDO	10956	12362 QUAIL ROOST DR	268
6290	ARAMARK SERVICES, INC. DBA JAVA CAFE	GDO	10957	2911 GRAND AVE 100-B	167
6291	CINEMEX USA REAL ESTATE HOLDINGS, INC. DBA CMX BRICKELL	GDO	10958	701 S MIAMI AVE #401	8,938
6292	PLAYPEN ACQUISITIONS, LLC DBA QT'S CABARET	GDO	10959	23101 S DIXIE HWY	1,050
6293	MI COLOMBIA CAFETERIA, INC.	GDO	10960	702 71 ST	172
6294	CANTINA GRILL AT THE PALMETTO PLAZA, LLC DBA XOCHIMEX CANTINA	GDO	10961	16171 NW 57 AVE	625
6295	MUNA MIAMI, LLC DBA O'MUNACIELLO RISTORANTE-PIZZERIA	GDO	10967	6405 BISCAYNE BLVD #105	572
6296	THE HABIT RESTAURANTS, LLC	GDO	10968	9971 W FLAGLER ST #180	847
6297	HOME TOWN MARKET, INC.	GDO	10970	5351 NW 27 AVE	540
6298	TRAMEZZO FL., LLC	GDO	10975	1099 NE 79 ST	475
6299	MAHALO 9, LLC	GDO	10977	9250 NW 36 ST 2ND FLOOR	338
6300	VARIAN GROUP, INC.	GDO	10978	14275 SW 139 CT	450
6301	7-ELEVEN, INC. DBA 7-ELEVEN STORE #37248H	GDO	10983	9500 NW 7 AVE	722
6302	ANTICA MARE, LLC	GDO	10985	7999 NE BAYSHORE CT	0
6303	GO FISH CARGO, INC.	GDO	10989	2605 NW 75 AVE	1,050
6304	THREEFOLD CAFE SOUTH MIAMI, LLC	GDO	10990	6907 RED RD	500
6305	GRANDPARENTS ADULT DAY CARE CORP.	GDO	10995	1131 NW 22 AVE	474
6306	SSC355278, LLC DBA DUNKIN DONUTS	GDO	10997	4123 NW 132 ST	257
6307	TRIPS WINGS, LLC	GDO	10998	9570 SW 160 ST	450
6308	P & Y FOOD SERVICE, LLC	GDO	11002	1679 SW 107 AVE	0
6309	1701 MIAMI OPERATOR, LLC DBA THE BAZAAR	GDO	11003	1701 COLLINS AVE FAC. B	459
6310	1701 MIAMI OPERATOR, LLC DBA KATSUYA	GDO	11004	1701 COLLINS AVE FAC. C	916
6311	RISE PIES, LLC DBA RISE PIES	GDO	11011	1455 NW 107 AVE #444-B	544
6312	ACQUA TRATTORIA, LLC DBA ACQUA	GDO	11012	3565 NE 207 ST #A-11	450
6313	HOLI PETIT RESTAURANT, LLC DBA HOLI PETIT CAFE	GDO	11014	3099 NE 163 ST	311
6314	URBIETA STORE OPERATIONS, LLC DBA AIRPORT CIRCLE K	GDO	11018	4801 NW 36 ST	500
6315	PLANT-BASED RESTAURANT MIAMI, LLC	GDO	11020	100 NE 25 ST #A	1,247
6316	BANYAN COMMUNITY HEALTH CENTER, INC.	GDO	11023	3800 W FLAGLER ST	2,694
6317	LAS MERCEDES ADULT DAY CARE I, INC.	GDO	11025	1619 NW 27 AVE	864
6318	MURPHY OIL USA, INC. DBA MURPHY USA #7596	GDO	11031	17680 NW 2 AVE	300
6319	BC 249, LLC DBA MOOYAH BURGER, FRIES AND SHAKES	GDO	11032	2000 NW 87 AVE #3	455
6320	HALLEY ENTERPRISE GROUPS, INC. DBA LOS AMIGOS CAFE	GDO	11036	7105 SW 47 ST	275
6321	BONJOUR, LLC DBA BONJOUR FRENCH BAKERY & CAFE	GDO	11041	16650 SW 88 ST #104	503
6322	P49, LLC DBA PIOLA	GDO	11042	1950 NW 87 AVE	734
6323	CHESTNUT LAND COMPANY DBA AUNTIE ANNE'S SOFT PRETZELS	GDO	11044	11401 NW 12 ST #131	293
6324	JMR FOODS II, INC.	GDO	11045	155 NW 3 ST	464
6325	MADRUGA, LLC	GDO	11048	1430 S DIXIE HWY #117	574
6326	CHEFS OF THE CARIBBEAN, LLC	GDO	11054	D-29 N. TERM.	72
6327	LE PETITE MAISON RESTAURANTS, LLC	GDO	11057	1300 BRICKELL BAY DR CU-1	1,938
6328	SALAD MAKER 1, LLC DBA GIARDINO GOURMET SALADS	GDO	11059	5241 NW 87 AVE D-104	346
6329	TACO BELL OF AMERICA, LLC DBA TACO BELL #031588	GDO	11062	15725 SW 72 ST	507
6330	7-ELEVEN, INC. DBA 7-ELEVEN #37530	GDO	11064	11901 NW 7 AVE	100
6331	A MI MANERA ADULT CARE, INC.	GDO	11069	7397 SW 8 ST	1,262
6332	SOARING WINGS DORAL, LLC	GDO	11072	2000 NW 87 AVE	1,324
6333	JADED ENTERPRISES CORP.	GDO	11073	5623 SW 107 AVE	350
6334	PREMIER BEVERAGE CATERING, INC.	GDO	11077	860 NE 79 ST B (USER 2)	500
6335	VICE CITY BEAN, LLC	GDO	11078	1657 N MIAMI AVE #C	269
6336	AMMORE GROUP, INC.	GDO	11079	6740 NE 4 AVE	713

No.	FACILITY_NAME	PERMIT	PERMIT_NUMBER	ADDRESS	TOTAL_GPD
6337	FLORENCE CAZENAIVE, LLC	GDO	11080	860 NE 79 ST #B (USER3)	500
6338	RINCONCITO RESTAURANT & CAFE, LLC	GDO	11082	17630 SW 137 AVE	425
6339	ARIS DELI, INC.	GDO	11083	1390 S DIXIE HWY #2122	100
6340	GASTRONOMICOM, LLC	GDO	11085	2151 SW 42 AVE #110	868
6341	PROSPERITY MANAGEMENT, LLC	GDO	11087	1564 S DIXIE HWY	148
6342	CHESTNUT LAND COMPANY DBA AUNTIE ANNE'S SOFT PRETZELS	GDO	11090	11401 NW 12 ST K-109B	68
6343	GRAMPS BAR, LLC	GDO	11092	176 NW 24 ST	400
6344	GABLES AH, LLC DBA CAROLINA ALE HOUSE	GDO	11094	6810 SW 40 ST	1,956
6345	ORION HIALEAH, LLC	GDO	11099	2390 W 76 ST #2	25
6346	BCC HOTEL, LLC - 40TH FLOOR RESTAURANT & BAR	GDO	11100	788 BRICKELL AVE 40TH FLOOR	1,060
6347	BCC HOTEL, LLC - LOBBY BAR	GDO	11101	788 BRICKELL AVE BAR LOBBY	270
6348	FRESH HORIZONS OF DORAL, LLC DBA FREDDO	GDO	11102	8550 NW 53 ST B-105	475
6349	THE JUICERY BAR NMB, LLC DBA THE JUICERY BAR	GDO	11106	17082 W DIXIE HWY	200
6350	RAW JUICE OF WEST AVE, LLC	GDO	11109	959 WEST AVE #13	223
6351	DORAL SWEETS, LLC DBA MENCHIE'S FROZEN YOGURT	GDO	11113	7450 NW 104 AVE C-104	348
6352	RANK TRADE SERVICES, INC.	GDO	11114	8800 NW 79 AVE	10,000
6353	JUICENSE, LLC DBA JUICENSE JUICE BAR	GDO	11121	2992 MCFARLANE RD	289
6354	LEMON CITY CORAL GARDENS, LLC	GDO	11126	5808 NE 4 CT	588
6355	F & F HEALTHY FOODS, LLC	GDO	11127	7341 COLLINS AVE	242
6356	BONGOS CUBAN CAFE DBA ESTEFAN KITCHEN	GDO	11128	D-27 N.TERM	133
6357	PURA VIDA FIT, LLC	GDO	11130	1756 N BAYSHORE DR #119	48
6358	PRIME CIGAR BRICKELL, LLC	GDO	11137	1106 S MIAMI AVE #202	1,086
6359	JEN'S BAKE SHOP, INC.	GDO	11139	15192 SW 137 ST #1	213
6360	THE BRIGHT DAYS PRESCHOOL #5, INC.	GDO	11141	5202 W FLAGLER ST	500
6361	HALF MOON EMPANADAS AT MIA, LLC	GDO	11142	D-29B N.TERM.	48
6362	NEWSLINK OF MIAMI AIR VENTURES, LLC DBA NEWSLINK	GDO	11143	D-34 N.TERM	407
6363	IC - MIAMI DADELAND, LLC DBA MIAMI DADELAND HOTEL	GDO	11145	7600 SW 88 ST	0
6364	KEEPSAKE DORAL, LLC DBA TROPICAL SMOOTHIE CAFE	GDO	11146	2000 NW 87 AVE #2	347
6365	KEN'S HEALTHY DELIGHTS, LLC	GDO	11150	8422 MILLS DR	216
6366	DELICIAS BAKERY, LLC	GDO	11152	12700 SW 122 AVE #119	395
6367	THE ART PLACE WYNWOOD DBA WYNWOOD CAFE	GDO	11153	450 NW 27 ST B	255
6368	MORRISON MANAGEMENT SPECIALISTS, INC.	GDO	11159	1120 NW 14 ST 9TH FLOOR	184
6369	TRIVENETI, INC. DBA VENETA GELATERIA	GDO	11162	13115 W OKEECHOBEE RD #113	420
6370	GOURMET TEMPTATIONS, LLC	GDO	11164	9573 HARDING AVE	234
6371	KINGS BOWL OF CITYPLACE, LLC	GDO	11171	3450 NW 83 AVE #152	5,189
6372	801 STORE, LLC	GDO	11173	3270 NW 7 ST	216
6373	GURU SHOTS, LLC DBA SHAMANNA TONIC	GDO	11176	18301 S DIXIE HWY 2ND USER	99
6374	PRALINE PASTIES, LLC	GDO	11178	2691 NE 203 ST	400
6375	AMERICA MIAMI GASOLINE, LLC	GDO	11179	9 N ROYAL POINCIANA BLVD	595
6376	RAIL 71 CAFE, LLC	GDO	11180	7255 NE 4 AVE #111	308
6377	SANDWICH WHERE, LLC	GDO	11189	36 NE 54 ST	313
6378	SHORE TO DOOR FISH MARKET, LLC	GDO	11195	3380 SW 37 AVE	188
6379	SSC355482, LLC DBA DUNKIN DONUTS #355482	GDO	11197	940 SW 1 AVE #102	345
6380	ONO POKE SHOP, LLC	GDO	11205	2320 N MIAMI AVE	216
6381	POLLO OPERATIONS, INC. DBA POLLO TROPICAL #0236	GDO	11220	7401 W 4 AVE	340
6382	PALACIO DE LA 8, LLC	GDO	11222	8700 SW 8 ST	1,290
6383	STARBUCKS COFFEE COMPANY, INC. DBA STARBUCKS #28862	GDO	11223	11401 NW 12 ST K-117	72
6384	ST. LAZARUS CHURCH, INC.	GDO	11227	1778 NW 3 ST	250
6385	GAUCHOS DE LAS PAMPAS, LLC	GDO	11229	9648 SW 24 ST	300
6386	OCEANSIDE CATERING, INC.	GDO	11233	345 E 49 ST 2ND USER	700
6387	CITY OF HIALEAH DBA HIALEAH FIRE STATION # 8	GDO	11234	5405 W 18 AVE	51
6388	MIKONOS INVESTMENTS OF FLORIDA, LLC DBA VENETIAN BANQUET HALL	GDO	11235	8300 W FLAGLER ST #124-125	588
6389	ST. MICHAEL THE ARCHANGEL CATHOLIC SCHOOL	GDO	11236	300 NW 28 AVE	1,797
6390	K & K BILLARD & SPORT BAR, INC.	GDO	11248	1090 NE 79 ST	1,350
6391	THE COFFEE EXPERIENCE, LLC DBA STARBUCKS	GDO	11249	1080 BRICKELL AVE	278
6392	ALVECA CATERING CORP. DBA EL CORRALITO CAFE	GDO	11251	436 S KROME AVE	0
6393	PAO BROS, INC.	GDO	11252	9848 SW 40 ST	475
6394	DABDOUB TRADE CORPORATION	GDO	11256	240 E 1 AVE #102	0
6395	MAIA SPIRITS & WINES LLC DBA AZUL SPIRITS & WINE, INC	GDO	11260	1412-14 20 ST	329
6396	S & S FIVE STAR FOODS, INC.	GDO	11261	3150 SW 38 AVE #105	65
6397	VSMA FOOD CORP. DBA TOP VALUE SUPERMARKET	GDO	11262	1490 NW 3 AVE	4,425
6398	SSC351452, LLC DBA DUNKIN DONUTS #351452	GDO	11291	9732 SW 88 ST	0
6399	CHIPOTLE MEXICAN GRILL OF COLORADO, LLC	GDO	11298	2200 SW 87 AVE	513
6400	OVERTOWN PERFORMING ARTS CENTER	GDO	11306	1074 NW 3 AVE	540
6401	CLOUD 9 BAKERY, LLC	GDO	11307	12723 S DIXIE HWY	337
6402	ALADDIN MARKET & FOOD, INC.	GDO	11308	20 NE 167 ST	463
6403	LES MOULINS LA FAYETTE USA, LLC	GDO	11310	211 LINCOLN RD	400
6404	BE BRICKELL, LLC DBA BIG EASY WINEBAR & GRILL	GDO	11313	701 S MIAMI AVE #339-B	1,398
6405	PH BRICKELL, LLC DBA AMERICAN HARVEST	GDO	11314	701 S MIAMI AVE #340-B	417
6406	DAVIDSTEA (USA), INC. DBA DAVIDSTEA	GDO	11315	701 S MIAMI AVE #352	152
6407	PBS BRICKELL, LLC DBA PUBBELLY SUSHI	GDO	11316	701 S MIAMI AVE #421	692
6408	TACO CHIC, LLC DBA TACOLOGY	GDO	11317	701 S MIAMI AVE #423	1,531
6409	INVESTMENTS PH, LLC	GDO	11318	7450 NW 104 AVE C-101	674
6410	BAREFOOT BAKER, INC. DBA MEL'S CAKES & WHATNOTS	GDO	11319	13911 SW 42 ST #105	173
6411	TRADER PLUS, LLC	GDO	11320	10505 NW 112 AVE #8	600
6412	NEWSLINK MAV, LLC DBA NEWSLINK	GDO	11324	D-17 N.TERM	407
6413	LILY PATISSERIE, LLC	GDO	11388	13375 SW 128 ST #101-A	500
6414	PIZZERIAS, LLC DBA PAPA JOHN'S #513	GDO	11389	12509 S DIXIE HWY	367
6415	SSC343978, LLC DBA DUNKIN DONUTS #343978	GDO	11390	12561 BISCAYNE BLVD	335
6416	MATER ACADEMY, INC.	GDO	11391	8003 NW 103 ST BLDG A-B	625
6417	TACO BELL OF AMERICA, LLC DBA TACO BELL #31630	GDO	11399	4185 SW 147 AVE	512
6418	GUARAPO JUICE BAR, INC.	GDO	11408	553 NE 81 ST	351
6419	GOLDEN TRUST GROUP, LLC DBA LE ROY RENE	GDO	11412	701 S MIAMI AVE #335-B	127
6420	DISHES FOR DOGS, LLC	GDO	11416	2561 N MIAMI AVE	318
6421	GOURMET EXPRESS FOODS, INC.	GDO	11419	860 NE 79 ST #B (USER4)	250
6422	PRH 1300 HOTEL, LLC DBA SLS BRICKELL	GDO	11420	1300 S MIAMI AVE REST. #2	2,040
6423	PRH 1300 HOTEL, LLC DBA SLS BRICKELL	GDO	11421	1300 S MIAMI AVE REST. #3	439
6424	EL FARO BAKERY, INC.	GDO	11422	4020 E 10 CT	3,675

No.	FACILITY_NAME	PERMIT	PERMIT_NUMBER	ADDRESS	TOTAL_GPD
6425	OTL ASSOCIATES, LLC	GDO	11424	160 NE 40 ST	688
6426	HOJEIJ TOBACCO, INC. DBA HOOKAH PALACE	GDO	11427	11865 SW 26 ST G-9	595
6427	DR SMOOD BRICKELL, LLC	GDO	11428	701 S MIAMI AVE #345-B	362
6428	CITY JUICE BRICKELL, LLC	GDO	11436	18 SW 8 ST	225
6429	GREEN PLUS HOLDING COMPANY, LLC DBA WYNWOOD 5TH AVE.COM	GDO	11437	2451 NW 5 AVE	376
6430	MONTEBANA FUELS, LLC DBA PALM AVENUE MARATHON	GDO	11452	2090 PALM AVE	75
6431	FINAMAC, LLC	GDO	11455	11231 NW 20 ST #130-31	1,541
6432	NATUREL JUICE BAR CORP. DBA RAW ENERGY	GDO	11457	1675 W 49 ST FW-1	60
6433	CHANG-CHONG CORP.	GDO	11462	140 NE 39 ST PC-133	0
6434	MSG CUTLERBAY, LLC	GDO	11472	19270 S DIXIE HWY SUITE F	699
6435	CHIVITOTECA ART, LLC DBA CHIVITOTECA	GDO	11473	2621 NW 2 AVE #28	359
6436	LA GAUCHITA BAKERY, INC.	GDO	11478	180 CRANDON BLVD #111	174
6437	BREWVILLE DOLPHIN MALL, LLC DBA BREWVILLE BAR & TASTE	GDO	11479	11401 NW 12 ST E-511	118
6438	7-ELEVEN, INC. DBA 7-ELEVEN STORE #37613	GDO	11480	25 S HOMESTEAD BLVD	110
6439	AMC FLORIDA, INC.	GDO	11481	20505 S DIXIE HWY K-3008	50
6440	LUKES LOBSTER XX, LLC	GDO	11482	701 S MIAMI AVE #353	171
6441	CBSW HOSPITALITY, INC. DBA THE BRICK	GDO	11490	8955 SW 72 PL	668
6442	PICAMEAL, INC. DBA PICAMEAL	GDO	11491	14395 SW 139 CT #106	346
6443	HD BRICKELL, INC. DBA HAAGEN-DAZS ICE CREAM	GDO	11494	701 S MIAMI AVE #354-B	153
6444	H&TFF RESTAURANTS FLORIDA, LLC DBA FRESHEALTHY	GDO	11510	1573 SUNSET DR	375
6445	LA GRANJA MIAMI CORP.	GDO	11532	2885 NW 36 ST	763
6446	LOPEZ RESTAURANTS, INC. DBA MCDONALDS	GDO	11539	11115 SW 132 AVE	1,097
6447	27 ENTREPRENEURS MIDTOWN, LLC	GDO	11540	3250 NE 1 AVE #117	547
6448	URRA INVESTMENT CORP. DBA MAGIC CITY CROSS TRAININ	GDO	11553	12338 SW 127 AVE	125
6449	3TEAM INVESTMENT CORP. DBA MR BEE'S SPECIALTY CAKE	GDO	11557	13591 SW 135 AVE #101	337
6450	GARDENS FOOD STORE, INC. DBA 216 CHEVRON	GDO	11558	11195 SW 216 ST	700
6451	CABO DORAL CITY PLACE, LLC DBA CABO FLATS	GDO	11567	3450 NW 83 AVE #200	1,758
6452	JVC FRANCO 3, LLC DBA JUAN VALDEZ CAFE	GDO	11570	1455 NW 107 AVE #7	36
6453	BOTTLENEIX DORAL, LLC DBA CITY WORKS	GDO	11579	3450 NW 83 AVE #140	2,163
6454	COBB THEATRES IV, LLC DBA CINE BRISTO @ CITY PLACE DORAL	GDO	11603	3450 NW 83 AVE #212	657
6455	NEW HOTEL BBG, LLC DBA B.B.G.	GDO	11606	7337 HARDING AVE	325
6456	SWEET SENSATIONS OF DORAL, LLC	GDO	11612	3450 NW 83 AVE #132	575

A. Total Number of Facilities	6,456
B. Total Number of Active GDO Facilities with Flow Data	5,643
% Active GDO Facilities with Flow Data	87%
C. Average Annual Daily Flow Rate (GDOs with data) in GPD	12,250,021
D. Average Annual Daily Flow Rate (GDOs with data)	2,171
Q _{GDO} extrapolated to 6500 facilities in GPD	14,014,910
Q _{GDO} extrapolated to 6500 facilities in MGPD	14
C _{GDO} (mg/L)	768
M _{GDO} (lbs/day)= Q _{GDO} x C _{GDO} x 8.34	89,672

Attachment 8

Waste Water Treatment Plants Data

FOG Influent to Plants

North Dade Plant (listed values are in mg/L)				
Year	Influent Low	Influent Medium	Influent High	Average
2016	15.9	19.1	22.2	19.1
2015	38.2	36.1	21.2	31.8
2014	30.4	38.4	15.8	28.2

Central Dade Plant (listed values are in mg/L)			
Year	Influent #1	Influent #2	Average
2016	25.9	20.4	23.15
2015	31.3	28.5	29.9
2014	26.1	26.9	26.5

South Dade Plant (listed values are in mg/L)			
Year	Influent #1	Influent #2	Average
2016	24.8	103	63.9
2015	27.6	17	22.3
2014	41.8	8.4	25.1

2014-North Dade Plant

Month	Total Annual Influent (MGD)
JAN	88.03
FEB	88.39
MAR	85.10
APR	86.57
MAY	86.29
JUN	91.17
JUL	99.84
AUG	101.61
SEP	99.67
OCT	95.13
NOV	91.00
DEC	89.52
AVE	91.86

2015-North Dade Plant

Month	Total Annual Influent (MGD)
JAN	92.16
FEB	89.89
MAR	91.19
APR	87.47
MAY	88.81
JUN	82.97
JUL	85.84
AUG	90.42
SEP	92.00
OCT	103.35
NOV	85.80
DEC	81.23
AVE	89.26

2016-North Dade Plant

Month	Total Annual Influent (MGD)
JAN	72.99
FEB	72.55
MAR	67.61
APR	68.10
MAY	86.35
JUN	87.73
JUL	87.52
AUG	98.71
SEP	95.97
OCT	96.10
NOV	91.43
DEC	95.26
AVE	85.03

2014-Central Dade Plant

Month	Annual Influent (MGD)		
	#1	#2	TOTAL
JAN	55.70	32.36	88.06
FEB	53.78	33.88	87.66
MAR	38.74	42.77	81.51
APR	41.37	36.76	78.13
MAY	48.52	41.64	90.16
JUN	54.38	41.38	95.77
JUL	59.36	60.20	119.56
AUG	53.02	54.83	107.85
SEP	49.70	52.81	102.51
OCT	51.18	53.79	104.97
NOV	42.05	54.45	96.50
DEC	34.16	84.47	118.63
AVE	48.50	49.11	97.61

2015-Central Dade Plant

Month	Annual Influent (MGD)		
	#1	#2	TOTAL
JAN	46.89	55.73	102.62
FEB	47.65	60.88	108.52
MAR	43.43	64.46	107.88
APR	40.80	64.90	105.71
MAY	48.38	53.56	101.94
JUN	41.65	54.24	95.90
JUL	37.82	60.67	98.49
AUG	44.16	67.54	111.70
SEP	63.42	98.86	162.28
OCT	64.63	101.82	166.45
NOV	61.43	99.12	160.55
DEC	105.28	113.65	218.93
AVE	53.80	74.62	128.41

2016-Central Dade Plant

Month	Annual Influent (MGD)		
	#1	#2	TOTAL
JAN	60.33	96.61	156.94
FEB	57.81	95.46	153.27
MAR	45.73	73.85	119.58
APR	45.38	67.64	113.02
MAY	42.19	79.10	121.29
JUN	35.25	73.73	108.98
JUL	39.06	69.75	108.81
AUG	50.04	79.66	129.69
SEP	36.33	85.71	122.04
OCT	47.37	102.41	149.77
NOV	38.92	82.58	121.50
DEC	30.18	72.28	102.47
AVE	44.05	81.57	125.61

2014 South Dade Plant

Month	Annual Influent (MGD)		
	#1	#2	TOTAL
JAN	55.70	32.36	88.06
FEB	53.78	33.88	87.66
MAR	38.74	42.77	81.51
APR	41.37	36.76	78.13
MAY	48.52	41.64	90.16
JUN	54.38	41.38	95.77
JUL	59.36	60.20	119.56
AUG	53.02	54.83	107.85
SEP	49.70	52.81	102.51
OCT	51.18	53.79	104.97
NOV	42.05	54.45	96.50
DEC	34.16	84.47	118.63
AVE	48.50	49.11	97.61

2015 South Dade Plant

Month	Annual Influent (MGD)		
	#1	#2	TOTAL
JAN	39.09	70.06	109.16
FEB	42.46	43.05	85.51
MAR	38.35	43.02	81.38
APR	33.96	39.62	73.59
MAY	33.02	53.23	86.25
JUN	29.11	44.08	73.19
JUL	32.51	52.32	84.82
AUG	43.55	53.52	97.07
SEP	73.46	63.21	136.68
OCT	58.53	53.79	112.32
NOV	45.25	49.68	94.93
DEC	75.70	67.02	142.72
AVE	45.42	52.72	98.13

2016 South Dade Plant

Month	Annual Influent (MGD)		
	#1	#2	TOTAL
JAN	57.35	48.28	105.63
FEB	54.84	44.15	98.99
MAR	53.97	34.99	88.96
APR	49.69	43.66	93.35
MAY	54.72	47.26	101.99
JUN	49.32	43.26	92.58
JUL	51.71	43.29	95.00
AUG	66.43	53.30	119.74
SEP	56.99	47.11	104.10
OCT	55.21	48.82	104.03
NOV	51.20	43.60	94.80
DEC	49.86	43.66	93.52
AVE	54.28	45.12	99.39

38 effect and remain unchanged.

39 >>Accelerated FOG maintenance shall mean cleaning performed by utilities
40 to prevent sanitary sewer overflows caused by FOG blockages in sanitary sewer
41 systems, including but not limited to laterals, gravity mains, pump stations, and
42 air release valves.<<

43 * * *

44
45
46 >>Back of the House shall mean all areas where food is stored, processed,
47 cooked, prepared, and assembled, and cleanup areas. It does not include offices,
48 dry storage or front of the house areas.<<

49 * * *

50
51
52 >>Best Management Practices shall mean a schedule of activities,
53 prohibitions of practices, maintenance procedures, and other management
54 practices to prevent or minimize pollution.<<

55 * * *

56
57
58 >>Black Grease shall mean any FOG commingled with septic wastes
59 (bathroom wastes).<<

60 * * *

61
62
63 >>Brown Grease shall mean FOG waste collected in, or removed from, a
64 FOG control device.<<

65 * * *

66
67
68 >>Building Sewer shall mean the part of the building drainage system that
69 extends from the end of the building drain and conveys the discharge to utility or
70 non-utility owned or operated sanitary sewer system.

71
72 Building Sanitary Drains shall mean the pipes intended to receive sanitary
73 wastewater and effluent from FOG control devices where FOG control devices
74 are installed or required. FOG or food waste shall not be discharged into the
75 building sanitary drains.<<

76 * * *

77
78
79 >>Dishmachine shall mean equipment used to sanitize and does not actually
80 wash the items put inside.

81
82 Dishwasher shall mean equipment that washes and sanitizes.<<

83

* * *

>>Fats, Oils and Grease (FOG) shall mean any substance such as vegetable or animal product used in, or a byproduct of, the cooking, ~~or~~ food preparation, or cleaning process, that can cause or lead to corrosion, blockages, reduced flow, or interference with the sanitary sewer system when discharged alone or combined with other materials or waste which turns or may turn viscous or solidifies with a change in temperature or other conditions.<<

* * *

>>FOG Capacity Limit shall mean the combined FOG and solids depth equal to twenty-five (25) percent of the design hydraulic depth in any location of a FOG control device ~~designed pursuant to Chapter 64E-6, Florida Administrative Code,~~ or seventy-five (75) percent of the rated FOG and solids capacity established by third party certification.

FOG Control Device shall mean equipment designed to remove, hold and prevent the passage of FOG to onsite sewage treatment and disposal systems and sanitary sewer systems ~~FOG control devices include grease traps and grease interceptors.~~

FOG Control Device Operator shall mean a person or entity which has management control for FOG control devices which serve other FOG generators.

FOG Generator shall mean any nonresidential facility, including, but not limited to, restaurants, bakeries, hotel and cafeteria kitchens, commercial kitchens, kitchens serving hospitals, nursing homes, daycares, assisted living facilities and other healthcare facilities, food processing plants or such other nonresidential facilities that can introduce food waste or FOG into building sanitary drains, building sewers, onsite sewage treatment and disposal systems, or non-utility or utility sanitary sewer systems. A FOG generator also includes those nonresidential facilities that produce yellow grease. ~~An industrial user subject to industrial pretreatment requirements under section 24-42.4 is not included herein.~~

FOG Generator Certified Staff shall mean a FOG generator employee which has attended training prescribed by the Director or Director's designee, and has received certification for training.

FOG Liquid Waste Transporter Certified Staff shall mean a FOG Liquid Waste Transporter employee which has attended training prescribed by the Director or Director's designee, and has received certification for training.

FOG Operating Permit shall mean an operating permit issued to FOG generators or FOG control device operators pursuant to Sections 24-18 and 24-42.6.

130 FOG Sampling Point shall mean a reasonably accessible location for sampling
131 the effluent of a FOG control device.<<

132 * * *

133
134
135 >>Front of the House shall mean office space, dry storage, but shall not
136 include areas defined as all areas not included in the back of the house.<<

137 * * *

138
139
140 >>Gravity Grease Interceptor shall mean a FOG control device that primarily
141 relies on the difference in specific gravity between wastewater and FOG to affect
142 separation of FOG from wastewater.<<

143 * * *

144
145
146 >>Grease Interceptor shall mean a FOG control device,
147 connected to a building grease waste drain.

148 Grease Trap shall mean a FOG control device located between one or more
149 fixtures (e.g., three compartment sink) and a building sanitary drain or grease
150 waste drain. A grease trap does not receive waste from a building grease waste
151 drain and can be located above or below ground.

152
153 Grease Waste Drains shall mean the pipes intended to receive FOG and food
154 waste. They convey the discharge to solids separators, when installed, and FOG
155 control devices.<<

156 * * *

157
158
159 >>Hydromechanical Grease Interceptor shall mean a FOG control device that
160 is third party tested and certified, and relies on the difference in specific gravity
161 between wastewater and FOG to affect separation of FOG from wastewater, and
162 may incorporate a flow control device, air entrainment, and other means or
163 principles to improve the efficacy of separation as demonstrated by third-party
164 testing, validation and certification.<<

165 * * *

166
167
168 >>Interceptor Monitoring Alarm shall mean a system and its components
169 capable of monitoring floating and settled solids levels in a FOG control device
170 on a regular interval. The system shall trigger a visual and audible alarm at the
171 FOG Capacity Limit.

172
173 Interceptor Monitoring Device shall mean a system and its components
174 capable of monitoring floating and settled solids in a FOG control device on a
175 regular interval, triggering a visual and audible alarm at the FOG Capacity Limit,

176 and reporting data electronically to the Department at a frequency and format
177 approved by the Director or Director's designee.<<

178 * * *

181 >>Residential FOG Source shall mean a residential kitchen that can introduce
182 food waste or FOG into a building drain, building sewer, onsite sewage treatment
183 and disposal system, or non-utility or utility sanitary sewer system.<<

184 * * *

185 >>Solids Separator shall mean a separator intended to capture solids and
186 allow ~~grease~~ FOG to pass through. It is installed at the source or on the grease
187 waste drains prior to a FOG control device ~~grease trap or grease intercepter.~~<<

188 * * *

189 >>Third Party Certified shall mean a certification by an independent entity
190 that specific equipment or devices have been tested and meet or exceed standards
191 established by the certifying entity and which the certifying entity has reviewed or
192 audited the manufacturing process. The certifying entity shall be recognized by
193 the Director or Director's designee and can include, but is not limited to, the
194 National Sanitation Foundation (NSF), American Society of Mechanical
195 Engineers (ASME), Plumbing and Drainage Institute (PDI) or Canadian
196 Standards Association (CSA) or combination of these and other entities to include
197 the aforementioned requirements.<<

198 * * *

199 >>Wash-Down Area shall mean an area where FOG generators wash the back
200 of the house mats or equipment.<<

201 * * *

202 >>Yellow Grease shall mean FOG generated as a byproduct from cooking or
203 food preparation that is not mixed with water, wastewater or other waste.<<

204 * * *

205 Section 2. Section 24-8 of the Code of Miami-Dade County, Florida, is hereby

206 amended to read as follows:

207 **Sec. 24-8. Environmental Quality Control Board.**

208 A Miami-Dade County Environmental Quality Control Board is hereby
209

220 created and established, consisting of five (5) members appointed by the County
221 Commission.

222 * * *

223
224
225 (5) *Duties and powers of the Environmental Quality Control Board.* The
226 Environmental Quality Control Board shall have the following duties, functions,
227 powers and responsibilities:

228
229 (a) To hear appeals by any person aggrieved by any action or decision of
230 the Director as provided in Section 24-11.

231
232 (b) To hear and pass upon all applications for variances and extensions of
233 time in the manner provided by Sections 24-13 and 24-14, except for
234 compliance with >>the regulations set forth in Section 24-25,
235 Adoption of rules and regulations of the State of Florida Department
236 of Environmental Protection, Florida Department of Health, or the
237 United States Environmental Protection Agency, or applicable federal
238 or state binding agreement<< ~~[[Federal Pretreatment Regulations set~~
239 ~~forth in 40 CFR 403 as incorporated in this chapter]].~~

240
241 (c) To hear and pass upon all applications for extension of time for
242 compliance with the provisions of this chapter. All such applications
243 shall be filed in accordance with the provisions of this chapter and
244 shall be heard and considered by the Environmental Quality Control
245 Board at a public hearing pursuant to notice. In considering such
246 applications, the Board shall take into account such factors as
247 practicability, availability of equipment, and relative benefits to the
248 community. The Board shall not have the power and authority to grant
249 any application for extension of time to comply with the prohibitions
250 against open burning (Section 24-41.4), or the prohibitions against
251 reduction of animal matter (Section 24-41.8), or the prohibitions
252 against a nuisance (Section 24-27), or the prohibitions against the
253 discharge of cyanides or other toxic chemicals into the waters in
254 excess of the standards set forth in Section 24-42(3). Applications for
255 extension of time for compliance shall be considered on the basis of
256 public interest and not merely on economic benefit to the applicant;
257 applications shall be granted only when it is established that the
258 requested extension of time for compliance will not be detrimental to
259 the public health, welfare and safety, and will not create or permit the
260 continuation of a nuisance, or that no technically feasible,
261 economically reasonable means of compliance are readily available to
262 the applicant. The Board shall not have the power and authority to
263 grant extensions of time for compliance with the >>regulations set
264 forth in Section 24-25, Adoption of rules and regulations of the State
265 of Florida Department of Environmental Protection, Florida

266
267
268
269
270
271
272
273
274
275

276

277
278
279
280
281
282
283
284
285
286
287
288
289
290
291
292
293
294
295
296
297
298
299
300
301
302
303
304
305
306
307
308
309

Department of Health, or the United States Environmental Protection Agency, or applicable federal or state binding agreement<<[[~~Federal Pretreatment Regulations set forth in 40 CFR 403 as incorporated in this chapter~~]]. Any person aggrieved by any decision of the Environmental Quality Control Board shall be entitled to judicial review in accordance with the Florida Rules of Appellate Procedure.

* * *

Section 3. Section 24-11 of the Code of Miami-Dade County, Florida, is hereby

amended to read as follows:

Sec. 24-11. Appeals from actions or decision of the Director of the Miami-Dade County Department of Environmental Resources Management.

Any person aggrieved by any action or decision of the Director, may appeal to the Environmental Quality Control Board by filing within fifteen (15) days after the date of the action or decision complained of, a written notice of appeal which shall set forth concisely the action or decision appealed from and the reasons or grounds for the appeal. The Environmental Quality Control Board shall set such appeal for hearing at the earliest possible date, and cause notice thereof to be served upon the appellant and the Director. The Environmental Quality Control Board shall hear and consider all facts material to the appeal, and render a decision promptly. The Environmental Quality Control Board may affirm, reverse or modify the action or decision appealed from provided that the Environmental Quality Control Board shall not take any action which conflicts with or nullifies any of the provisions of this chapter >>, or applicable federal or state law, or binding agreement between the County and any Federal or State Agency governing any applicable law<<. The decision of the Environmental Quality Control Board shall constitute final administrative review and no hearing or reconsideration shall be considered. Any person aggrieved by any decision of the Environmental Quality Control Board on an appeal shall be entitled to judicial review in accordance with the Florida Rules of Appellate Procedure. The words "action" and "decision" as used herein shall not include the filing of any action by the Director, in any court. The Board shall not have jurisdiction to reconsider the subject matter of any appeal after its final administrative determination for a period of six (6) months from the date of the Board's final action, unless the Board determines that there has been a material and substantial change in the circumstances; provided, however, any action taken or decision made by the Director at any time may be reconsidered by the Director and the Director may therefore modify any such action or decision.

* * *

310 Section 4. Section 24-15 of the Code of Miami-Dade County, Florida, is hereby
311 amended to read as follows:

312 **Sec. 24-15. Plan approval required.**

313 (1) *Intent.* It is the intent and purpose of this section to require that all new
314 facilities, equipment and processes constructed or operated after the effective date
315 of this chapter shall comply with the requirements herein contained, and that any
316 ~~[[major or substantial]]~~ enlargement, expansion or addition to existing facilities
317 also shall comply with the requirements herein contained. Any building permit
318 issued by the County or a municipality in violation of the provisions of this
319 chapter is hereby determined to be void.

320
321 (2) *Waste water facilities.* It shall be unlawful for any person to ~~[[enter~~
322 ~~into or let a contract for or to]]~~ commence the installation, extension, or operation
323 of any sewerage system ~~>>including collection, conveyance, transmission or~~
324 ~~treatment<<~~ or waste treatment facility or any industrial waste disposal facility
325 without first obtaining the prior written approval of the Director or the Director's
326 designee. It shall be unlawful for any person to make any enlargement, alteration
327 or addition to any ~~>>sewerage system including collection, conveyance,~~
328 ~~transmission or treatment or waste treatment facility or any industrial waste~~
329 ~~disposal<<~~ facility, or commence the construction of any ~~>>such systems or~~
330 ~~facilities<<[[facility]]~~, that will reasonably be expected to be a source of water
331 pollution without first obtaining the prior written approval of the Director or the
332 Director's designee. No building permit involving the generation or discharge of
333 effluents shall be issued by the County or any municipality unless the application
334 for a building permit has been approved by the Director or the Director's
335 designee.

336
337 The provisions of this section shall not apply to facilities discharging only
338 domestic wastes to a ~~>>utility or non-utility<<[[public sewer system]]~~ ~~>>through~~
339 ~~a single lateral<<~~ approved by the Director or the Director's designee.
340 Notwithstanding the foregoing, the provisions of this section shall apply to
341 facilities discharging only domestic wastes to a ~~>>utility or non-utility<<[[public~~
342 ~~sewer system]]~~ ~~>>through a single lateral<<~~ approved by the Director or the
343 Director's designee if the facilities ~~<<have or require a FOG control device in~~
344 ~~accordance with Section 24-42.6>>[[provide any form of pretreatment in~~
345 ~~conjunction with a grease trap]].~~

346 * * *

347
348
349 Section 5. Section 24-15.3 of the Code of Miami-Dade County, Florida, is hereby
350 amended to read as follows:

351 **Sec. 24-15.3 Standards for preparation of plans.**

352
353 (1) Waste treatment works shall be designed in accordance with the
354 sewerage guide promulgated by the Florida State Board of Health, or similar
355 professional publication, recommended standards for sewage works and water
356 pollution control federation manuals of practice numbered eight (8) and nine (9),
357 as applicable to conditions prevailing within Miami-Dade County, and in
358 accordance with good engineering practices.

359
360 (2) Outfalls shall be extended or carried to the channel of a stream or to
361 deep water where outlet is submerged at all times. The extent and length of the
362 outfall shall conform to the requirements of the Director or the Director's
363 designee. No outfall shall be approved unless satisfactory evidence is presented to
364 establish that solids or other objectionable pollutants will not be deposited on the
365 shore, and that other forms of pollution will not be caused.

366
367 (3) ~~>>FOG control devices<< [[Grease traps]] shall be provided and~~
368 ~~installed in accordance with >>Section 24-42.6<<[[the rules and regulations~~
369 ~~promulgated under the provisions]] of this chapter. [[At a minimum, all grease~~
370 ~~traps discharging to publicly or privately owned or operated sanitary sewer~~
371 ~~collection systems shall be provided with a sampling point on the effluent~~
372 ~~discharge side of the grease trap. Wastes containing sizable quantities of grease~~
373 ~~such as those produced by restaurants shall not be deemed suitable for disposal~~
374 ~~into tile drainfields]].~~

375
376 (4) Drainage or disposal wells shall not be used for disposal of treated or
377 untreated wastes except as approved by the Director or the Director's designee.

378 * * *

379
380 Section 6. Section 24-18 of the Code of Miami-Dade County, Florida, is hereby

381 amended to read as follows:

382
383 **Sec. 24-18. Operating permits.**

384
385 (A) *Permit Required*>>.<< No person shall operate, maintain or permit,
386 cause, allow, let or suffer the operation or maintenance of a public water system,
387 public sewerage system, a location where a site rehabilitation action has been
388 completed in accordance with the provisions set forth in Section 24-44(2)(k)(ii)
389 >>.<< or any of the following facilities, all of which will reasonably be expected
390 to be a source of air pollution, ground pollution or water pollution, without a valid
391 operating permit issued by the Director or the Director's designee or in violation
392 of any condition, limitation or restriction which is part of an operating permit:

393
394 (1) Interim package sewage treatment plants;

395
396
397
398
399
400
401
402
403
404
405
406
407
408
409
410
411
412
413
414
415
416
417
418
419
420
421
422
423
424
425
426
427
428
429
430
431
432
433
434
435
436
437
438

* * *

(18) ~~[[Any nonresidential facility, including, but not limited to, restaurants, bakeries, hotel and cafeteria kitchens, processing plants or such other nonresidential facilities discharging into a publicly or privately owned or operated sanitary sewer collection system, if oil and grease can be introduced into a sewer by such nonresidential facility in quantities which have the potential to affect or hinder the operation of sewage collecting, transmission or treatment facilities.]]~~ >>FOG generator discharging to a utility or non-utility owned or operated sanitary sewer collection system or onsite sewage treatment and disposal system located in ~~the basic~~ a wellfield protection area of any utility or non-utility potable water supply wells. Refer to Section 24-42.6(9) for FOG generator operating permit requirements;<<

* * *

- (20) >>FOG Liquid Waste Transporter;
- (21) Liquid Waste Transporter;
- (22) FOG, Yellow Grease, Brown Grease, or other Grease Storage, Transfer or Treatment facility;
- (23) FOG Control Device Operator.<<

* * *

Section 7. Section 24-25 of the Code of Miami-Dade County, Florida, is hereby amended to read as follows:

Sec. 24-25. Violations of rules and regulations of the State of Florida Department of Environmental Protection, Florida Department of Health, and the United States Environmental Protection Agency.

- (1) **All of the following rules and regulations are hereby adopted and are incorporated herein by reference hereto as same may be amended from time to time:**
 - (a) Chapter 62-160 of the Florida Administrative Code
 - (b) Chapter 62-550 of the Florida Administrative Code

- 439 (c) Chapter 62-713 of the Florida Administrative Code
- 440
- 441 (d) Chapter 62-761 of the Florida Administrative Code
- 442
- 443 ~~[(e) Chapter 64E-8 of the Florida Administrative Code]~~
- 444
- 445 >>(e)<<[[(+)] Chapter 62-770 of the Florida Administrative Code
- 446
- 447 >>(f)<<[[(+)] Chapter 62-777 of the Florida Administrative Code
- 448
- 449 >>(g)<<[[(+)] Chapter 62-782 of the Florida Administrative Code
- 450
- 451 >>(h)<<[[(+)] Chapter 62-785 of the Florida Administrative Code
- 452
- 453 >>(i) Chapter 64E-6 of the Florida Administrative Code
- 454
- 455 (j) Chapter 64E-8 of the Florida Administrative Code<<
- 456

* * *

461 Section 8. Section 24-42.3 of the Code of Miami-Dade County, Florida, is hereby
 462 amended to read as follows:

**Sec. 24-42.3. Certification of sanitary sewer system collection, transmission
 and treatment capacity.**

(1) Notwithstanding any provision of this Code, no county or municipal officer, agent, employee or board shall approve, grant or issue any building permit, certificate of occupancy, >>certificate of completion,<< certificate of use (except for changes in ownership) or municipal occupational license (except for changes in ownership) for any land use served or to be served by a utility or non-utility owned or operated wastewater collection and transmission system until the county or municipal officer, agent, employee or board has obtained the prior written unconditional approval or prior written conditional approval of the Director or the Director's designee. Notwithstanding any provision of this Code, no person shall construct, utilize, operate, occupy or cause, allow, let, permit or suffer to be constructed, utilized, operated or occupied any land use served or to be served by a utility or non-utility owned or operated wastewater collection and transmission system until the person has obtained the prior written unconditional approval or the prior written conditional approval of the Director or the Director's designee.

* * *

483
484 (3) No new additional sewage flows shall be authorized for any sanitary
485 sewer basin, sewage pump station, or system pursuant to Section 24-42.3 unless
486 and until:

487
488 >>(a)<<[[†]] >>T<<[[‡]]he official responsible for issuing certificates of
489 occupancy, certificates of use or equivalent municipal occupational
490 licenses provides a monthly report that identifies projects that have
491 been issued a certificate of occupancy, >>certificate of completion,<<
492 certificate of use or an equivalent municipal occupational license that
493 have also received a conditional or unconditional written approval, and
494

495 >>(b)<<[[‡]] >>A<<[[a]]ll actions or reports required by Section 24-42.2
496 >>and Section 24-42.6(11)<< for the basin, pump station, or system
497 have been completed according to the schedules required therein.
498

499 * * *

500 Section 9. Section 24-42.4 of the Code of Miami-Dade County, Florida, is hereby

501 amended to read as follows:

502
503 **Sec. 24-42.4. Sanitary sewer discharge limitations and pretreatment**
504 **standards**

505 (1) *Definitions.* The following definitions shall be applicable only to the
506 provisions of Section 24-42.4:

507
508 (a) *Pollutant* shall mean dredged spoil, solid waste, incinerator residue,
509 filter backwash, sewage, garbage, sewage sludge, munitions, chemical
510 wastes, biological materials, radioactive materials, heat, wrecked or
511 discarded equipment, rock, sand, cellar dirt, and industrial, municipal,
512 and agricultural wastes discharged into water.

513 * * *

514
515 (2) *General Pretreatment Standards and Local Limits.*

516 * * *

517
518 (d) It shall be unlawful for any person to throw, drain, run or otherwise
519 discharge into a sanitary sewer, or to cause, permit, allow or suffer
520 to >>seep, to<< be thrown, run, drained, ~~[[allowed to seep,]]~~ or
521 otherwise discharged into such sewer any of the following
522 substances:
523
524
525

- 526 (i) Any gasoline, naphtha, fuel oil or other flammable or
 527 explosive liquid, solid or gas; any pollutants which may
 528 create a fire or explosion hazard in the POTW, including
 529 waste streams with a closed cup flash point of less than one
 530 hundred forty (140) degrees Fahrenheit or sixty (60)
 531 degrees Centigrade using the test methods in 40 CFR
 532 261.21.
- 533
- 534 (ii) Any waters or wastes containing any pollutant, a toxic or
 535 poisonous substance in sufficient quantity or flow rate to
 536 injure or interfere with any sewage treatment process,
 537 constitute a hazard to humans or animals, or create any hazard
 538 in the receiving waters of the sewage treatment plant or
 539 deteriorate quality of the sewage sludge to prevent sludge use
 540 or disposal.
- 541
- 542 (iii) Any pollutant in amounts which alone or in combination
 543 with other discharges will cause obstruction to the flow in
 544 the POTW.
- 545
- 546 (iv) Any substance that will pass through the sewage treatment
 547 plant and exceed State or Federal requirements for the
 548 receiving water.
- 549
- 550 (v) Any water or waste which contains substances which may
 551 solidify and become viscous at temperatures between
 552 thirty-three (33) degrees Fahrenheit and one hundred fifty
 553 (150) degrees Fahrenheit (10—65 degrees Centigrade).
- 554
- 555 (vi) Any effluents in excess of the following local limits:
- 556

<i>Chemical, Physical or Biological Characteristic</i>	<i>Standards</i>
Biochemical oxygen demand	145 lbs/day at a concentration not to exceed 200 mg/l unless allowed by the POTW
Total suspended solids	145 lbs/day at a concentration level not to exceed 200 mg/l unless allowed by the POTW
Oil and grease EPA Method 1664 (Hexane Extractable Materials)	100.0 mg/l

>> Fats, Oils and Grease (FOG) EPA Method 1664 (Hexane Extractable Materials) for facilities strictly subject to Section 24-42.6 <<	>> 150.0 mg/l <<
Total Recoverable Petroleum Hydrocarbons EPA Method 1664 (Silica Gel Treated Hexane Extractable Materials)	50.0 mg/l
Ammonia (un-ionized)	100.0 mg/l
Temperature	150°F and shall not cause the plant influent to exceed 104°F (40°C) or inhibit biological activity
pH	5.5—11.5, and shall not cause damage to or create a hazard to structures, equipment, or personnel of the POTW
Arsenic	0.325 mg/l
Cadmium	0.187 mg/l
Chromium (Total)	7.6 mg/l
Copper	0.5 mg/l
Lead	0.7 mg/l
Mercury	0.01 mg/l
Molybdenum	0.4 mg/l
Manganese	1.9 mg/l
Nickel	0.39 mg/l
Selenium	0.65 mg/l
Silver	0.6 mg/l
Thallium	0.0005 mg/l
Zinc	6.8 mg/l
Cyanides, total	0.5 mg/l
Poly chlorinated biphenyls	0.008 mg/l
Benzene	0.2 mg/l

Carbon Tetrachloride	0.22 mg/l
1,2-c-Dichloroethylene	3.75 mg/l
Tetrachloroethylene	0.125 mg/l
Trichloroethylene	0.16 mg/l
Vinyl Chloride	0.08 mg/l

557
558
559
560
561
562
563
564
565
566
567
568
569
570
571
572
573
574
575
576
577
578
579
580
581
582
583
584
585
586
587
588
589
590

* * *

Section 10. Section 24-42.6 of the Code of Miami-Dade County, Florida, is hereby added to read as follows:

>>**Sec. 24-42.6. Fats, Oils and Grease Control Program**

The intent and purpose of this Section is to safeguard public health, safety and welfare, and protect the sanitary sewer collection, transmission and treatment systems by setting minimum requirements and standards for the design and operation of FOG generating facilities not classified by the Director or Director's designee as a Significant Industrial User pursuant to Section 24-42.4.

(1) No person shall dispose of any FOG or food waste, or cause, let, permit, suffer or allow disposal or discharge of any FOG or food waste to be disposed or discharged into any stormwater drainage system, ground or groundwater, surface water, private street, public right of way, or any other location not approved by the Director or Director's designee.

(2) When a breached FOG control device is the source of FOG or wastewater discharge as prohibited above to ground or groundwater, the FOG generator or FOG control device operator shall:

(a) Make temporary repairs within seven (7) days of the date the Director or the Director's designee determines that the FOG control device is breached.

(b) Within thirty (30) days of the date the Director or the Director's designee determines that the FOG control device is breached discharged FOG or wastewater to ground or groundwater, the FOG generator or FOG control device operator shall submit plans to the Department for review and approval for the installation of a new FOG control device that complies with design requirements in Section 24-42.6(8).

591 (c) Within ninety (90) days of the date the Director or the Director's
592 designee determines that the FOG control device is breached, the FOG
593 generator or FOG control device operator shall obtain all required
594 approvals and permits and install the Department approved FOG
595 control device.

596
597 (d) Cease the discharge of FOG and wastewater as prohibited above.
598 Failure to stop the discharge of FOG and wastewater as prohibited
599 above shall result in the Director or the Director's designee directing
600 the FOG generator or FOG control device operator to cease operating
601 or ordering the utility providing water service to the facility to cease
602 providing such service.

603
604 (3) No person shall dispose of any FOG, or cause, let, permit, suffer or
605 allow disposal or discharge of any FOG into any onsite sewage treatment and
606 disposal system, non-utility or utility sanitary sewer system in quantities ~~or~~
607 concentrations which affects negatively or hinders the operation of any onsite
608 sewage treatment and disposal system, sewage collection, transmission or
609 treatment system, exceeds the FOG sanitary sewer discharge limitation and
610 pretreatment standards in Section 24-42.4, or causes a sanitary nuisance.

611
612 (a) When a FOG generator or a FOG control device operator is found to
613 have violated Section 24-42.6(2), the FOG generator or FOG control
614 device operator shall immediately cease and desist from discharging
615 FOG in such quantities or concentrations. The FOG generator or FOG
616 control device operator shall submit a corrective action plan to the
617 Department within thirty (30) days of the date the Director or the
618 Director's designee determines that the FOG generator or FOG control
619 device operator discharged FOG in such quantities or concentrations.
620 The corrective action plan shall include equipment, process or
621 procedure modifications proposed to prevent discharging FOG in such
622 quantities or concentrations. The corrective action plan shall be
623 implemented within the timeframe provided in the Department's
624 approval of the corrective action plan. Until the corrective action plan
625 is approved by the Director or Director's designee and implemented in
626 accordance with the Director or Director designee's approval, the FOG
627 generator or FOG control device operator shall take all necessary
628 actions to prevent the discharge of FOG in such quantities or
629 concentrations and to prevent causation of a sanitary nuisance.

630
631 (b) When a Residential FOG Source is found to have violated Section 24-
632 42.6(2), the Residential FOG Source shall immediately cease and
633 desist from discharging FOG in such quantities or concentrations.

634
635 (i) When a Residential FOG Source is located in an apartment
636 building or condominium, the building manager, association,

637 property owner, or other responsible party shall submit a
638 corrective action plan to the Department within thirty (30) days
639 of the date the Director or the Director's designee determines
640 that the FOG residential source has violated Section 24-
641 42.6(2). The corrective action plan shall be implemented within
642 the timeframe provided in the Department's approval of the
643 corrective action plan.

644
645 (ii) The corrective action plan shall include equipment, process or
646 procedure modifications proposed to correct the FOG
647 discharge.

648
649 (iii) Until the corrective action plan is approved by the Director or
650 Director's designee and implemented in accordance with the
651 Director or Director designee's approval, the building manager,
652 association, property owner, or other responsible party shall
653 take all necessary actions to prevent violation of Section 24-
654 42.6(2) and to prevent causation of a sanitary nuisance.

655
656 (4) Existing FOG generators with a current FOG operating permit issued
657 prior to (CLERK TO INSERT EFFECTIVE DATE), not proposing to increase
658 seating capacity, dining area or drive-thru capacity, nor proposing to make any
659 other modification, any of which will increase the discharge of FOG, shall comply
660 with the following:

661
662 (a) Where there is an existing FOG control device and sampling point, the
663 sampling point shall be located after the point of no further treatment
664 and shall be directly accessible for visual inspection and sampling.

665
666 (b) Where there is no FOG control device, plans shall be submitted to the
667 Department for the installation of a FOG control device which shall
668 be installed in accordance with plans approved by the Director or
669 Director's designee, within ninety (90) days of the date the Director or
670 the Director's designee determines that there is no FOG control device.
671 The FOG generator shall take all necessary actions to prevent the
672 discharge of FOG to the building sanitary drains and to prevent
673 causing a sanitary nuisance until a FOG control device is properly
674 installed.

675
676 (c) Where the discharge from a FOG control device exceeds the FOG
677 sanitary sewer discharge limitation and pretreatment standards in
678 Section 24-42.4, or causes the accumulation of FOG in building
679 sanitary drains or building sewer, the FOG control device shall be
680 repaired, upgraded or replaced within ninety (90) days of the date the
681 Director or the Director's designee determines that Section 24-42.4
682 FOG sanitary sewer discharge limitation and pretreatment effluent

683 standards have been exceeded, or from the date the Director or the
684 Director's designee determines that FOG has accumulated in building
685 sanitary drains or building sewer. Repairs or upgrades shall not render
686 third party certifications or approvals null and void.

687
688 (d) Where the Director or Director's designee determines that there is no
689 sampling point or the existing sampling point is not reasonably
690 accessible or adequate for sampling, a new reasonably accessible
691 sampling point shall be installed within sixty (60) ~~thirty (30)~~ days of
692 the determination of the Director or Director's designee.

693
694 (e) Where a FOG control device or sampling point are required to be
695 repaired, replaced or installed, plans shall be submitted to the
696 Department for review and approval and all required permits shall be
697 obtained prior to repair, replacement or installation. Replacement or
698 new FOG control devices shall be designed pursuant to Section 24-
699 42.6(8). Repairs or upgrades shall not render third party certifications
700 or approvals null and void.

701
702 (f) FOG generators shall comply with their current FOG generator
703 operating permit conditions until the permit expires. Thereafter, FOG
704 generators shall comply with permit conditions based on Section 24-
705 42.6(9) requirements.

706
707 (5) Existing FOG generators and FOG control device operators that do not
708 hold a valid FOG operating permit issued prior to (CLERK TO INSERT
709 EFFECTIVE DATE), that discharge to a utility or non-utility owned or operated
710 sanitary sewer system, shall comply with the following:

711
712 (a) Submit as-built plans prepared by a ~~licensed plumber or Florida~~
713 Professional Engineer and condition assessment prepared by a licensed
714 plumber or Florida Professional Engineer within sixty (60) days from
715 the Director or the Director designee's determination that the FOG
716 generator or FOG control device operator does not have a valid FOG
717 operating permit. As-built plans and condition assessment shall
718 demonstrate the following, where applicable:

719
720 (i) That all existing back of the house fixtures discharge to
721 existing FOG control devices and not directly to the building
722 sanitary drains or building sewers.

723
724 (ii) That existing FOG control devices comply with Section 24-
725 42.6(8).

726

727 (iii) That the FOG control device is functioning in accordance with
728 the manufacture's specifications and instructions and that the
729 sampling point complies with Section 24-42.6(7).

730
731 (iv) That a sampling point is located after the point of no further
732 treatment and is reasonably accessible for visual inspection and
733 sampling.

734
735 (v) That existing yellow and brown grease storage areas prevent
736 the release of FOG to ground, groundwater, surface waters or
737 storm sewers.

738
739 (vi) That existing mat and equipment wash-down areas prevent the
740 release of FOG to ground, groundwater, surface waters or
741 storm sewers and prevent inflow of stormwater.

742
743 (b) FOG generators or FOG control device operators that cannot comply
744 with Sections 24-42.6(4)(a) shall submit plans to upgrade the facility
745 pursuant to Section 24-42.6(6)(a)(i), (ii) and (iii) within ninety (90)
746 days of the date the Director or the Director's designee determines that
747 the FOG generator or FOG control device operator does not have a
748 valid FOG operating permit. The facility upgrade shall be completed
749 within 180 ~~ninety (90)~~ days of the date the Director or the Director's
750 designee ~~determines that the FOG generator or FOG control device~~
751 ~~operator does not hold a valid FOG operating permit~~ approves the
752 plans.

753
754 (c) Within five (5) days of the Director or the Director designee's
755 approval of the as-built plans ~~or plans to upgrade the facility pursuant~~
756 to Section 24-42.6(4)(b), a FOG operating permit application shall be
757 submitted to the Department pursuant to Sections 24-18(A)(18) and
758 24-42.6(9).

759
760 (6) Existing FOG generators and FOG control device operators that do not
761 hold a valid FOG operating permit issued prior to (CLERK TO INSERT
762 EFFECTIVE DATE), that discharge to an onsite sewage treatment and disposal
763 system located in a wellfield protection area of any utility potable water supply
764 wells, shall comply with the following within one (1) year ~~180 days~~ of
765 Department notification:

766
767 (a) Submit as-built plans prepared by a ~~licensed plumber or Florida~~
768 Professional Engineer and condition assessment prepared by a licensed
769 plumber or Florida Professional Engineer. As-built plans and condition
770 assessment shall demonstrate the following, where applicable:

771

- 772 (i) That all existing back of the house fixtures discharge to
773 existing FOG control devices and not directly to the building
774 sanitary drains or building sewers.
- 775
- 776 (ii) That existing FOG control devices comply with Chapter 64E-6,
777 FAC.
- 778
- 779 (iii) That the FOG control device is functioning in accordance with
780 the manufacture's specifications and instructions and that the
781 sampling point complies with Section 24-42.6(7).
- 782
- 783 (iv) That the outlet tee of the last grease interceptor is reasonably
784 accessible for visual inspection and sampling.
- 785
- 786 (iv) That existing yellow and brown grease storage areas prevent
787 the release of FOG to ground, groundwater, surface waters or
788 storm sewers.
- 789
- 790 (vi) That existing mat and equipment wash-down areas prevent the
791 release of FOG to ground, groundwater, surface waters or
792 storm sewers and prevent inflow of stormwater.
- 793
- 794 (b) FOG generators or FOG control device operators that cannot comply
795 with Sections 24-42.6(5)(a) shall submit plans to upgrade the facility
796 pursuant to Section 24-42.6(6)(a)(i), (ii) and (iii) and implement
797 upgrades within one (1) year of Department notification (~~CLERK TO~~
798 ~~INSERT EFFECTIVE DATE~~).
- 799
- 800 (c) Within five (5) days of the Director or the Director designee's
801 approval of the as-built plans or plans to upgrade the facility pursuant
802 to Section 24-42.6(5)(b), a FOG operating permit application shall be
803 submitted to the Department pursuant to Sections 24-18(A)(18) and
804 24-42.6(9).
- 805
- 806 (7) Notwithstanding any provision of this Code, no county or municipal
807 officer, agent, employee or board shall approve, grant or issue any building
808 permit, certificate of occupancy, certificate of completion, certificate of use or
809 municipal occupational license for a FOG generator or FOG control device
810 operator until prior written approval of the Director or the Director's designee has
811 been obtained. Furthermore, no person shall construct, utilize, operate, occupy or
812 cause, allow, let, permit or suffer to be constructed, utilized, operated or occupied
813 any FOG generator or FOG control device until prior written approval of the
814 Director or the Director's designee has been obtained.
- 815
- 816 (a) For new FOG generators or FOG control operators discharging to a
817 utility or non-utility owned or operated sanitary sewer collection

818 system or to an onsite sewage treatment and disposal system located in
819 a the basic wellfield protection area of any utility potable water supply
820 wells, the Director or the Director's designee shall not issue a written
821 approval until the Director or the Director's designee finds that:

822
823 (i) Construction plans comply with Section 24-42.6(7).

824
825 (ii) FOG control devices have been inspected by the Department
826 and found to be in compliance with Section 24-42.6(8) and
827 with Department approved construction plans pursuant to 24-
828 42.6(6)(a)(i). Compliance with approved plans shall be
829 determined by construction inspection. Persons performing
830 construction inspections for FOG control devices shall be
831 trained to perform such inspections. Training shall be
832 prescribed by the Director or the Director's designee. No
833 building/plumbing permit final inspection, certificate of
834 occupancy or certificate of completion shall be issued prior to
835 the Department's inspection finding that the FOG control
836 devices have been installed in compliance with Department
837 approved construction plans.

838
839 (iii) FOG operating permit applications shall be submitted pursuant
840 to Sections 24-18 (A)(18) and 24-42.6(9).

841
842 (b) For existing FOG generators discharging to a utility or non-utility
843 owned or operated sanitary sewer system or discharging to an onsite
844 sewage treatment and disposal system located in a the basic
845 wellfield protection area of any utility potable water supply wells, proposing to
846 increase seating capacity, dining area or drive-thru capacity, or other
847 modification any of which will increase the discharge of FOG, the
848 Director or the Director's designee shall not issue a written approval
849 until the Director or the Director's designee finds that the proposed
850 increased seating capacity, dining area or drive-thru capacity, or other
851 modification any of which will increase the discharge of FOG,
852 complies with Section 24-42.6 (6)(a)(i), (ii) and (iii).

853
854 (c) For changes in ownership or other changes that require the issuance of
855 a certificate of use, municipal occupational license, or equivalent
856 municipal approval to operate or use a business, the Director or the
857 Director's designee shall not issue a written approval until the Director
858 or the Director's designee finds that:

859
860 (i) The prior use had a valid FOG operating permit within the last
861 twelve (12) months.

862
863 (ii) There is no construction proposed or required.

864
865
866
867
868
869
870
871
872
873
874
875
876
877
878
879
880
881
882
883
884
885
886
887

888
889
890
891
892
893
894
895
896
897
898
899
900
901
902
903
904
905
906
907

(iii) There are no changes to the back of house.

(iv) No changes have been made, or are proposed, to the plumbing system, use, or facility operations that will impact the FOG control device.

(v) A FOG control device condition assessment is performed by a licensed plumber or Florida Professional Engineer and the findings, submitted to the Department in a form prescribed by the Director or the Director's designee, show that the FOG control device is functioning in accordance with the manufacturer's specifications and instructions and that the sampling point complies with Section 24-42.6(7).

(d) For changes in ownership or other changes that require the issuance of a certificate of use, municipal occupational license, or equivalent municipal approval to operate or use a business, that do not comply with 24-42.6(6)(c) shall be required to comply with Section 24-42.6(6)(a)(i), (ii) and (iii) prior to the Department approval of the change in ownership or other changes that require the issuance of a certificate of use, municipal occupational license, or equivalent municipal approval to operate or use a business.

~~On or before January 1, 2018, FOG generators discharging to a utility or non-utility owned or operated sanitary sewer system or onsite sewage treatment and disposal system located in the basic wellfield protection area of any utility potable water supply wells that are not subject to 24-42.6(5)(a) or (b), shall comply with the following requirements:~~

~~(i) All back of the house fixtures and other fixtures, including wash down areas, which can discharge food waste or FOG, shall be connected to a FOG control device that complies with Section 24-42.6(7).~~

~~(ii) A sampling point shall be located after the point of no further treatment. The sampling point shall be directly accessible for visual inspection and sampling.~~

~~(iii) Yellow and brown grease storage areas and wash down areas shall be designed to prevent the release of FOG or wash water to ground, groundwater, surface waters or storm sewers.~~

908 ~~(iv) Solids separation shall be provided prior to FOG control~~
909 ~~devices that require a flow control device or are not certified to~~
910 ~~handle solids.~~

911
912 ~~(vi) Sanitary wastes from bathrooms and stormwater shall not~~
913 ~~discharge to grease waste drains, solids separators or FOG~~
914 ~~control devices.~~

915
916 ~~(vii) Submit Certification to the Department in a form prescribed by~~
917 ~~the Director or the Director's designee and prepared by a~~
918 ~~Florida Professional Engineer or master plumber, attesting to~~
919 ~~compliance with Sections 24 42.6(5)(c)(i) through (vi) above.~~
920 ~~Furthermore, confirmation of compliance with Section 24~~
921 ~~42.6(7) shall be signed and sealed by a Florida Professional~~
922 ~~Engineer.~~

923
924 ~~(viii) Where the existing FOG control device was approved pursuant~~
925 ~~to Section 24 42.6(7), certification of Section 24 42.6(5)(c)(i)~~
926 ~~shall not be required.~~

927
928 (8) Plans. Where required in Section 24-42.6, plans shall include the
929 following minimum information:

930
931 (a) Florida Professional Engineer signature, seal and date. ~~Signature and~~
932 ~~seal of a Florida Professional Engineer.~~

933
934 (b) All existing and proposed back of the house and front of the house
935 areas and drive-thru lanes are shown and labeled.

936
937 (c) Plan and isometric drawings showing and labeling all existing and
938 proposed drainage pipes, fixtures, sumps, pumps, ejectors, solids
939 separators, FOG control devices and sampling points are shown and
940 labeled. All drainage pipes that receive or can receive waste from back
941 of the house fixtures, and other fixtures that can discharge food waste
942 or FOG, shall be labeled grease waste drains or GW and shall include
943 slope, diameter and drainage fixture units. Back of the house fixtures
944 include floor drains, floor sinks, trough drains, mop sinks, three-
945 compartment sinks, hand sinks, pre-rinse station/sink, preparation sink,
946 pot sink, wok sink, self-cleaning kitchen exhaust hoods, and any and
947 all fixtures, appurtenances and equipment that have the potential to
948 introduce food waste or FOG into drainage pipes. Screens shall be
949 shown and labeled in all sinks and drains. Where multiple users/tenant
950 spaces connect to a common FOG control device, the plans shall
951 include all users/tenant spaces.
952

- 953 (d) Where multiple users/tenant spaces connect to a common FOG control
954 device, the plans shall include all users/tenant spaces.
955
- 956 (e) Plan and isometric drawings showing grease waste drains and sanitary
957 drains from bathrooms and other non-FOG drains connecting to
958 building drain and include slope, diameter and drainage fixture units.
959
- 960 ~~(e) Isometric diagrams showing and labeling all existing and proposed~~
961 ~~plumbing pipes, fixtures, pipe diameter and drainage fixture units,~~
962 ~~solids separators, FOG control devices and sampling points. Grease~~
963 ~~waste drains shall be labeled grease waste drain or GW.~~
964
- 965 ~~(f) Screens are shown and labeled in all sinks and drains.~~
966
- 967 (f) All grease waste drains are connected to a FOG control device that
968 complies with Section 24-42.6(8). FOG control devices shall not
969 receive flow under pressure. No pump, ejector or any equipment that
970 can mechanically emulsify FOG, or reduce the efficiency of a FOG
971 control device, shall connect directly or indirectly to a FOG control
972 device.
973
- 974 (g) FOG control devices installed below ground/grade to intersect the
975 building grease waste drain. When installation below grade is not
976 physically possible, the Director or Director's designee may approve a
977 single above grade installation if the FOG control device required
978 pursuant to Section 24-42.6(8) is rated at twenty-five (25) gallons per
979 minute or less and includes an air gap or air break.
980
- 981 (h) At least one (1) sampling point, located after the point of no further
982 treatment, shown and labeled. The sampling point shall be directly
983 accessible for visual inspection and sampling.
984
- 985 (i) Profiles, sections and details of FOG control device and sampling
986 point drawn to scale. FOG control devices and sampling points shall
987 be accessible for cleaning pursuant to Section 24-42.6(9). At a
988 minimum, four (4) feet of vertical clearance and three (3) feet of
989 horizontal clearance shall be provided for each.
990
- 991 (j) Where FOG control device access risers are required, the riser height
992 shall not exceed thirty (30) inches. A greater riser height may be
993 approved by the Director or Director's designee where access for
994 inspection and cleaning can be achieved and demonstrated.
995
- 996 (k) Construction material for FOG control devices shall be labeled and
997 shall be compatible with all waste, including waste with a pH of 3 or
998 less.

999
1000
1001
1002
1003
1004
1005
1006
1007
1008
1009
1010
1011
1012
1013
1014
1015
1016
1017
1018
1019
1020
1021
1022
1023
1024
1025
1026
1027
1028
1029
1030
1031
1032
1033
1034
1035
1036
1037
1038
1039
1040
1041
1042
1043
1044

- (l) The point and method of wastewater discharge for kiosk and booths using holding tanks shall be ~~are~~ shown and labeled. The point of discharge shall be a grease waste drain or FOG control device sized for the quantity of waste generated. All waste containers shall be shown on plans.

- (m) FOG control device sizing calculations and assumptions, including peak flow rate, temperature, FOG and solids loading rates, and frequency of FOG and solids removal shall be ~~are~~ shown and labeled. Where the FOG control device will serve multiple users/tenants, each user/tenant shall be identified and their flows and loading rates shall also be included on the plans. Loading rates shall include waste from food preparation and cleaning associated with eat-in, take-out and drive-thru meals. FOG loading shall include all FOG sources, including kitchen exhaust hoods. For self-cleaning kitchen exhaust hoods, the manufacturer’s specifications for peak discharge shall be included.

- (n) Manufacturer’s and third party certification installation requirements.

- (o) FOG control device model numbers and third party certifications ~~are~~ shall be shown and labeled. Plan profiles and sections shall demonstrate how all labels and markings on FOG control devices remain visible during and after installation.

- (p) State Health Office’s designated approval/tank numbers for grease interceptors designed in accordance with 64E-6, Florida Administrative Code, shall be ~~are~~ shown and labeled. All labels and markings on FOG control devices shall be visible before and after installation.

- (q) For concrete precast FOG control devices, the precast concrete plant name and precast concrete plant certifying agency accepted by the Florida Department of Transportation shall be ~~are~~ shown and labeled accordingly. Site cast FOG control devices are not permitted.

- (r) ~~Dishmachines are not required to be connected to a FOG control device where washing and rinsing are performed in a two (2) or three (3) compartment sink and the dishmachine connects to grease waste drain prior to a sampling point. Dishwashers with dedicated soiled-dish table or pre-rinse station, where all food solids and liquids are removed, are not required to be connected to a FOG control device when connected to a grease waste drain prior to a sampling point. All other and~~ dishwashers shall be connected to a FOG control device sized to account for emulsified grease FOG.

1045
1046
1047
1048
1049
1050
1051
1052
1053
1054
1055
1056
1057
1058
1059
1060
1061
1062
1063
1064
1065
1066
1067
1068
1069
1070
1071
1072
1073
1074
1075
1076
1077
1078
1079
1080
1081
1082
1083
1084
1085
1086
1087
1088
1089
1090

~~(q) At least one (1) sampling point located after the point of no further treatment shown and labeled. The sampling point shall be directly accessible for visual inspection and sampling. At a minimum, four (4) feet of vertical clearance and three (3) of horizontal clearance shall be provided.~~

(s) Locations and details for all stored waste, including yellow and brown grease, shall be are shown and labeled. Storage areas shall be designed to prevent the release of FOG to ground, groundwater, surface waters or storm sewers. Storage containers shall be identified by waste type and capacity in gallons and sized to prevent overfilling. All storage containers shall have a lid that prevents rainwater inflow and that can be locked to prevent vandalism.

(t) Locations and details for all wash-down areas shall be are shown and labeled. All wash-down areas shall be designed to prevent the release of wash-water and FOG to ground, groundwater, surface waters, storm sewer or any other location not approved by the Director or Director's designee. Where mat and equipment wash-down is to be performed in a mop sink, the mop sink shall be sized and labeled.

(u) Solids separation is provided prior to existing or proposed FOG control devices that require a flow control device or that are not certified to handle solids.

(v) Access is provided for cleaning of ~~food solids and congealed grease~~ FOG in grease waste drains where the horizontal run from the source of food waste and FOG is greater than ~~twenty-five (25)~~ fifty (50) feet from the solids separator or FOG control device. Access points shall not be spaced greater than ~~twenty-five (25)~~ fifty (50) feet, measured center-to-center. Location of access points and details for access point shall be provided in drawings. Where the horizontal run from the source of food waste and FOG is greater than one hundred (100) feet, plans shall include provisions for preventing clogging by ~~congealed FOG and other waste~~. Where the FOG control device is located at a remote location, it shall be equipped with a functional Interceptor Monitoring Alarm or Device. Remote locations include a different floor, or any horizontal distance exceeding one hundred (100) feet from the back of the house area.

(w) Sanitary wastes from bathrooms and stormwater are not discharged into grease waste drains, solids separators, ~~or~~ FOG control devices or ~~sampling point~~. Only grease waste lines and drains shall connect to a FOG control device.

1091 (9) FOG Control Device Sizing. Where required in Section 24-42.6, FOG
1092 control devices shall be sized for all intended users, facilities and tenants using
1093 one of the following criteria and approved by the Director or Director's designee:
1094

1095 (a) Gravity Grease Interceptors: The minimum volume for gravity grease
1096 interceptors shall be the largest of the following:
1097

1098 (i) Calculations or selection based on the Florida Building Code,
1099 latest edition; or
1100

1101 ~~(ii) Calculations prepared by a Florida Professional Engineer~~
1102 ~~demonstrate that the FOG effluent concentration is equal to or~~
1103 ~~less than the FOG sanitary sewer discharge limitation and~~
1104 ~~pretreatment standard referenced in Section 24-42.4.~~
1105 ~~Calculations shall include peak flow rate; temperature and~~
1106 ~~temperature driven flow patterns; rising and settling velocities;~~
1107 ~~short circuiting induced by inlet, baffle and outlet effects and~~
1108 ~~velocity distribution; FOG and solids loading rate; and~~
1109 ~~frequency of FOG and solids removal; or~~
1110

1111 (ii) Alternative calculations:
1112

1113 1. Calculations prepared by a Florida Professional
1114 Engineer that include projected peak flow rate, thirty
1115 (30)-minute hydraulic detention time calculated using
1116 net wet volume, temperature, FOG and solids loading
1117 rates, and proposed frequency of FOG and solids
1118 removal. Net wet volume shall be total wet volume
1119 minus the maximum volume of waste stored between
1120 cleaning cycles, and third party certification of FOG
1121 removal efficiency and containment capacity; or
1122

1123 2. Calculations prepared by a Florida Professional
1124 Engineer that include projected peak flow rate;
1125 temperature; FOG and solids loading rates; proposed
1126 frequency of FOG and solids removal; and third party
1127 certification of the maximum FOG containment
1128 capacity; and third party certification of the effluent
1129 concentration or of the FOG removal efficiency. The
1130 certified effluent concentration shall be equal to or less
1131 than the FOG sanitary sewer discharge limitation and
1132 pretreatment standards referenced in Section 24-42.4.
1133 The minimum FOG removal efficiency shall be 99% at
1134 the third party certified flow rate and minimum required
1135 FOG containment capacity.
1136

1137
1138
1139
1140
1141
1142
1143
1144
1145
1146
1147
1148
1149
1150
1151
1152
1153
1154
1155
1156
1157
1158
1159
1160
1161
1162
1163
1164
1165
1166
1167
1168
1169
1170
1171
1172
1173
1174
1175
1176
1177
1178
1179
1180
1181
1182

(iii) Where Chapter 64E-6, Florida Administrative Code, applies, as determined by the Director or Director’s designee, total volume shall be calculated using seats and meals, where meals are used to calculate the volume associated with take out, drive through and other FOG loads not accounted for in seats, and the total volume is increased to account for the maximum volume of waste stored between cleaning cycles. ~~total wet volume, minus the maximum volume of waste stored between cleaning cycles, is the greater of the following:~~ As an alternative to calculating the maximum volume of waste stored between cleaning cycles, the following multiplication factors can be used to increase the volume calculated by seats and meals:

<u>Cleaning Cycle</u>	<u>Multiplication Factor</u>
<u>Every 30 days</u>	<u>1.0</u>
<u>Every 60 days</u>	<u>1.15</u>
<u>Every 90 days</u>	<u>1.25</u>

(b) Where more than one (1) gravity grease interceptor is required to provide the largest volume calculated in Section 24-42.6(8)(a), they shall be installed in series with consideration given to minimize disturbance between tanks by utilizing appropriately sized pipes and influent and effluent appurtenances that maximize FOG separation.

~~(i) Seven hundred and fifty (750) gallons; or~~

~~(ii) Volume calculated based on Chapter 64E-6; or~~

(c) Hydromechanical Grease Interceptors: The minimum size and number of hydromechanical grease interceptors shall be the greatest of the following:

(i) Twenty gallons per minute.

(ii) Calculations or selection based on the Florida Building Code, latest edition.; or

~~(ii) Calculations prepared by a Florida Professional Engineer demonstrate that the FOG effluent concentration is equal to or less than the FOG sanitary sewer discharge limitation and pretreatment standard referenced in Section 24-42.4. Calculations shall include peak flow rate; temperature and temperature driven flow patterns; rising and settling velocities; short-circuiting induced by inlet, baffle and outlet effects and velocity distribution; FOG and solids loading rate; and frequency of FOG and solids removal; or~~

1183
1184
1185
1186
1187
1188
1189
1190
1191
1192
1193
1194
1195
1196
1197
1198
1199
1200
1201
1202
1203
1204
1205
1206
1207
1208
1209
1210
1211
1212
1213
1214
1215
1216
1217
1218
1219
1220
1221
1222
1223
1224
1225
1226
1227
1228

(iii) Calculations prepared by a Florida Professional Engineer that include projected peak flow rate; temperature; FOG and solids loading rates; proposed frequency of FOG and solids removal; third party certification of the maximum FOG containment capacity; and third party certification of the effluent concentration or of the FOG removal efficiency. The certified effluent concentration shall be equal to or less than the FOG sanitary sewer discharge limitation and pretreatment standards referenced in Section 24-42.4. The minimum FOG removal efficiency shall be 99% at the third party certified flow rate and minimum required FOG containment capacity;~~or~~

~~Calculations prepared by a Florida Professional Engineer that include projected peak flow rate, temperature, FOG and solids loading rates, proposed frequency of FOG and solids removal, and third party certification of FOG removal efficiency and containment capacity. The minimum FOG removal efficiency shall be 99% at the third party certified flow rate and minimum required FOG containment capacity.~~

(d) Where more than one (1) hydromechanical grease interceptor is required to provide the required removal efficiency, they shall be installed in series and the removal efficiency shall be based on the third party testing of the proposed configuration and number of grease interceptors proposed. The test configuration, including flow control, air entrainment and other appurtenances, shall match the proposed field installation.

(e) FOG Control Devices not classified by the Director or Director's designee as hydromechanical or gravity grease interceptors: The minimum size and number of FOG control devices shall be the greatest of the following:

(i) Calculations or selection based on the Florida Building Code, latest edition;~~or~~

(ii) Calculations prepared by a Florida Professional Engineer that include ~~projected~~ peak flow rate; temperature; FOG and solids loading rates; FOG and solids biological and chemical removal rates; frequency of FOG and solids removal; and third party certification of maximum FOG containment capacity and effluent concentration. The certified effluent concentration shall be equal to or less than the FOG sanitary sewer discharge limitation and pretreatment standards referenced in Section 24-42.4.

1229
1230
1231
1232
1233
1234
1235
1236
1237
1238
1239
1240
1241
1242
1243
1244
1245
1246
1247
1248
1249
1250
1251
1252
1253
1254
1255
1256
1257

- (f) Where more than one (1) FOG control device, not classified by the Director or Director’s designee as hydromechanical or gravity grease interceptors, is required to provide the required effluent concentration, it shall be based on third party testing of the proposed configuration and number of grease interceptors proposed. The test configuration, including flow control, air entrainment and other appurtenances, shall match the proposed field installation.

- (g) Peak Flow Rate. Where peak flow rate is required in Section 24-42.6, it shall be estimated as follows:
 - (i) Shell buildings. Peak flow shall be calculated using Manning’s Formula for full pipe flow for the grease waste drain nominal diameter and slope and a roughness coefficient of 0.0113.

 - (ii) Plans with complete plumbing design. Peak flow shall be estimated as provided above for shell building, total fixture flow rate using one (1) or two minute (2) drain time, or drainage fixture units (DFUs). For DFUs, the peak flow rate shall be calculated by multiplying the proposed DFUs by the flow rate calculated using Manning’s Formula for full pipe flow and a roughness coefficient of 0.0113 and divided by the maximum number of DFUs allowed under the Florida Building Code, latest edition, for the grease waste drain diameter and slope.

 - (iii) Minimum Peaks flows.

<u>Nominal pipe size in inches</u>	<u>Minimum Total Flow Rate at Grease Interceptor Influent</u>
<u>1.25 – 2.5</u>	<u>20 gpm</u>
<u>3</u>	<u>23 gpm</u>
<u>4</u>	<u>50 gpm</u>
<u>5</u>	<u>91 gpm</u>
<u>6</u>	<u>147 gpm</u>
<u>8</u>	<u>317 gpm</u>
<u>10</u>	<u>576 gpm</u>
<u>12</u>	<u>936 gpm</u>
<u>15</u>	<u>1,697 gpm</u>

1258
1259

1260 (10) Operating Permits for FOG Generators and FOG Control Device
1261 Operators. No person shall operate, cause, let, permit, suffer or allow the
1262 operation of a FOG generating facility or FOG control devices serving FOG
1263 generators ~~discharging to a utility or non-utility owned or operated sanitary sewer~~
1264 system or an onsite sewage treatment and disposal system located in a wellfield
1265 protection area of any utility potable water supply wells without a valid FOG
1266 operating permit issued by the Director or the Director's designee or in violation
1267 of any condition, limitation or restriction which is part of a FOG operating permit.
1268 ~~FOG operating permits are valid for up to one year, expire December 31 of each~~
1269 ~~year, and shall be renewed annually by January 1 of each calendar year.~~
1270

1271 (a) Existing FOG generators and FOG control device operators that do not
1272 hold a valid FOG operating permit issued prior to (CLERK TO
1273 INSERT EFFECTIVE DATE), that discharge to an onsite sewage
1274 treatment and disposal system located in a wellfield protection area of
1275 any utility potable water supply wells, shall apply for a FOG operating
1276 permit within 180 days of (CLERK TO INSERT EFFECTIVE DATE)
1277 using a form prescribed by the Director or Director's designee in
1278 accordance with Section 24-42.6(5).
1279

1280 (b) Applications for new FOG generators and new FOG control device
1281 operators and renewals of same shall be in a form prescribed by the
1282 Director or Director's designee. When the FOG operating permit
1283 applicant is a tenant, the application shall be completed and signed by
1284 the tenant(s) and property owner(s) as co-applicants. The owner's
1285 section of the application shall include a statement acknowledging that
1286 the property owner(s) is responsible for the proper closure of a FOG
1287 generator pursuant to Section 24-42.6(8)(c)(vi).
1288

1289 (c) Renewal applications shall include a certification form, which is
1290 prescribed by the Director or the Director's designee. ~~Where made~~
1291 available by the Department, certification shall be completed using a
1292 secure online system or by an equivalent system developed by the
1293 Department. Said form shall be prepared by a Florida Professional
1294 Engineer or licensed plumber or liquid waste transporter, attesting that
1295 the existing FOG control devices are functioning as designed and are
1296 in good working order. Where required in this Section, the renewal
1297 shall also include training certificates for staff trained pursuant to
1298 Section 24-42.6(8)(c)(iv).
1299

1300 (d) Operating permits for new FOG generators and new FOG control
1301 device operators, and renewal of same, discharging to a utility or non-
1302 utility owned or operated sanitary sewer system or an onsite sewage
1303 treatment and disposal system located in a wellfield protection area of
1304 any utility potable water supply wells shall include the following:
1305

1306
1307
1308
1309
1310
1311
1312
1313
1314
1315
1316
1317
1318
1319
1320
1321
1322
1323
1324
1325
1326
1327
1328
1329
1330
1331
1332
1333
1334
1335
1336
1337
1338
1339
1340
1341
1342
1343
1344
1345
1346
1347
1348
1349
1350
1351

(i) Best management practices. The Director or Director's designee shall maintain a list of approved best management practices and update the list ~~annually or as required-necessary.~~

(ii) Maintenance. All FOG control devices and equipment shall be serviced to function properly and continuously to prevent the discharge of FOG into building sanitary drains, building sewers, utility or non-utility owned or operated sanitary sewer systems, ~~or and~~ onsite sewage treatment and disposal systems. Where cleaning of FOG control devices is required in Section 24-42.6, cleaning shall include the complete removal of the full contents of the FOG control device, including settled solids, wastewater and floating materials. Side walls, baffle walls, cross-pipes, and inlet and outlet pipes shall be pressure washed or scraped to remove all attached materials. Decanting, skimming, or backflushing is prohibited. Emulsifiers, grease cutters or other chemicals or detergents which could cause FOG to pass through the system to the building sanitary drains or building sewers are prohibited and shall not be used. At a minimum, the following maintenance shall be performed:

1. Grease Waste Drains, Building Sanitary Drains and Building Sewers. When jetting, rodding or other cleaning activities are required, FOG shall not be flushed, discharged, conveyed or allowed to pass through to utility or non-utility owned or operated sanitary sewer systems or onsite sewage treatment and disposal systems. All FOG shall be collected and transported by a liquid waste transporter, permitted by the Department, to an approved disposal facility.

2. Kitchen Exhaust Hoods. All waste generated by manual hood cleaning shall not be flushed, discharged, conveyed or allowed to pass through to utility or non-utility owned or operated sanitary sewer systems or onsite sewage treatment and disposal systems. All wastes shall be collected and transported by a liquid waste transporter permitted by the Department to an approved disposal facility. Where a hood is designed to be self-cleaning, the FOG control device shall be designed for the maximum cold water and hot water flow rates. Where a surfactant/detergent is used, the FOG control device shall be sized to provide sufficient detention time to allow FOG waste separation so that the effluent does not exceed the standards set forth in Section 24-42.4.

1352
1353
1354
1355
1356
1357
1358
1359
1360
1361
1362
1363
1364
1365
1366
1367
1368
1369
1370
1371
1372
1373
1374
1375
1376
1377
1378
1379
1380
1381
1382
1383
1384
1385
1386
1387
1388
1389
1390
1391
1392
1393
1394
1395
1396
1397

3. Yellow and Brown Grease Storage Areas. Yellow and brown grease storage areas shall be maintained free of debris and storage containers shall not be overfilled. Storage containers shall be visually inspected daily and emptied before they reach ninety (90) percent capacity. Spills shall be contained and cleaned using absorbent materials. Wet cleanup methods shall not be used. Storage container lids shall be maintained to prevent rainwater inflow and locked to prevent vandalism.

4. Mat and Equipment Wash-Down Areas. Mat and equipment wash-down areas shall be maintained free of debris and wash-water shall not be released to ground, groundwater, surface waters, storm sewer or any other location not approved by the Director or Director's designee. Wash-down areas shall not allow stormwater or rainwater to enter the building sanitary drains, building sewers, utility or non-utility owned or operated sanitary sewer systems, or onsite sewage treatment and disposal systems.

5. Solids Separators. Where installation of a solids separator is required or approved pursuant to Section 24-42.6(7), solids separators shall be serviced to function as designed and shall not be missing or have defective elements or components that reduce its ability to separate solids. All solids separators shall be visually inspected daily to prevent excessive accumulation and discharge of food solids to FOG control devices, building sanitary drains, building sewers, utility or non-utility owned or operated sanitary sewer systems, or onsite sewage treatment and disposal systems. Solids shall be properly discarded as solid waste or removed by a liquid waste transporter permitted by the Department.

6. Hydromechanical Grease Interceptors Traps. Cleaning of grease traps interceptors shall be performed as follows:

a. Automatic grease interceptors traps shall be cleaned by a liquid waste transporter, permitted by the Department, ~~Automatic grease traps shall be cleaned monthly or more frequently so that the FOG capacity limit or FOG sanitary~~

1398
1399
1400
1401
1402
1403
1404
1405
1406
1407
1408
1409
1410
1411
1412
1413
1414
1415
1416
1417
1418
1419
1420
1421
1422
1423
1424
1425
1426
1427
1428
1429
1430
1431
1432
1433
1434
1435
1436
1437
1438
1439
1440
1441
1442

sewer discharge limitation and pretreatment effluent standards in Section 24-42.4 are not exceeded. The contents of the strainer/screen and automatic storage receptacles shall be emptied by the FOG generator or FOG control device operator on a daily basis and transferred to waste containers intended and approved for such use to prevent overflowing or spills. If at any time the automatic elements or components do not function as intended and designed, the malfunctioning automatic grease interceptor trap shall be operated and reported as a manual grease interceptor trap and cleaned by a liquid waste transporter, permitted by the Department, on a daily basis until the system is repaired. In no instance shall the automatic grease interceptor trap operate as a manual grease interceptor trap for more than thirty (30) days or be allowed to cause a sanitary nuisance at any time. In the event of a sanitary nuisance, such conditions shall be abated within twenty-four (24) hours pursuant to Section 24-28. The automatic grease interceptor trap shall be repaired within thirty (30) days of malfunctioning. If the automatic grease interceptor trap is not capable of repair, it shall be replaced within ninety (90) days of malfunctioning. Plans for replacement shall be reviewed and approved by the Director or Director's designee pursuant to Section 24-42.6(7).

- b. Manual grease interceptor traps shall be cleaned monthly by a liquid waste transporter permitted by the Department or more frequently when necessary to avoid exceeding the FOG capacity limit or effluent standards in Section 24-42.4. The FOG generator or FOG control device operator shall may remove floating materials and settled solids on a regular daily basis, between cleaning intervals performed by a liquid waste transporter, and may transfer the waste to containers intended and approved for such use to prevent overflowing or spills.

1443 c. Alternative cleaning frequencies, not to exceed
1444 90 days, may be approved by the Director or
1445 Director's designee based on a complete
1446 engineering analysis, pursuant to Section 24-
1447 42.6(8), or the results of a field study approved
1448 by the Director or Director's designee that
1449 demonstrates that less frequent cleaning is
1450 appropriate and will not result in an exceedance
1451 of the FOG sanitary sewer discharge limitation
1452 and pretreatment standards referenced in
1453 Section 24-42.4.

1454
1455 d. Exception: A FOG generator that does not have
1456 fryers; is not required by the Florida Building
1457 Code Mechanical (latest addition) to have a
1458 Type I kitchen exhaust hood; the ~~peak flow rate~~
1459 ~~to the grease interceptor-trap~~ is rated ~~at does~~
1460 ~~not exceed~~ twenty (20) gallons per minute ~~or~~
1461 ~~less~~, and cleans the grease ~~interceptor-trap~~ daily
1462 is not required to have a liquid waste transporter
1463 clean the grease ~~interceptor as required above in~~
1464 ~~Section 24-42.6(10)(d)(ii)(6)-trap~~ monthly if the
1465 FOG generator does not discharge FOG or food
1466 waste in quantities ~~or concentrations~~ which
1467 affects negatively or hinders the operation of
1468 any onsite sewage treatment and disposal
1469 system, sewage collection, transmission or
1470 treatment system, ~~or exceeds FOG sanitary~~
1471 ~~sewer discharge limitation and pretreatment~~
1472 ~~standards in Section 24-42.4, or causes a~~
1473 sanitary nuisance.

1474
1475 7. Gravity Grease Interceptors. Cleaning of gravity grease
1476 interceptors shall be performed as follows:

1477
1478 a. Gravity grease interceptors ~~shall be~~ shall be
1479 cleaned every sixty (60) days by a liquid waste
1480 transporter permitted by the Department or more
1481 frequently when necessary to avoid exceeding
1482 the FOG capacity limit or FOG sanitary sewer
1483 discharge limitation and pretreatment effluent
1484 standards in Section 24-42.4.

1485
1486 b. Single and grouped gravity grease interceptors
1487 equipped with a functional Interceptor
1488 Monitoring Device shall ~~all~~ be cleaned by a

1489
1490
1491
1492
1493
1494
1495
1496
1497
1498
1499
1500
1501
1502
1503
1504
1505
1506
1507
1508
1509
1510
1511
1512
1513
1514
1515
1516
1517
1518
1519
1520
1521
1522
1523
1524
1525
1526
1527
1528
1529
1530
1531
1532

liquid waste transporter permitted by the Department at an interval not to exceed every one hundred eighty (180) days, by a liquid waste transporter permitted by the Department or more frequently when necessary to avoid exceeding the FOG capacity limit, or FOG sanitary sewer discharge limitation and pretreatment effluent standards in Section 24-42.4.

e. Grouped grease interceptors, in parallel or series, shall all be cleaned every sixty (60) days by a liquid waste transporter permitted by the Department or more frequently when necessary to avoid exceeding the FOG capacity limit or effluent standards in Section 24-42.4. Where functional Interceptor Monitoring Devices are used, all grease interceptors shall be cleaned every one hundred eighty (180) days by a liquid waste transporter permitted by the Department or more frequently when necessary to avoid exceeding the FOG capacity limit or effluent standards in Section 24-42.4

c. Alternative cleaning frequencies may be approved pursuant to Section 24-42.6(9)(d)(ii)6.c.

8. FOG Control Devices not classified by the Director or Director's designee as hydromechanical or gravity grease interceptors: FOG control devices shall be cleaned pursuant Section 24-42.6(9)(d)(ii)6.

(iii) Record Keeping. Each FOG generator and FOG control device operator shall maintain records of maintenance and repair activities, service calls and staff training. All records shall be retained onsite for a period of not less than three years and made available onsite to Department staff upon request. Offsite records shall not be an acceptable substitute for onsite records required herein. At a minimum, each FOG generator and FOG control device operator shall maintain the following records using forms prescribed by the Director or Director's designee.

1533
1534
1535
1536
1537
1538
1539
1540
1541
1542
1543
1544
1545
1546
1547
1548
1549
1550
1551
1552
1553
1554
1555
1556
1557
1558
1559
1560
1561
1562
1563
1564
1565
1566
1567
1568
1569
1570
1571
1572
1573
1574
1575
1576
1577
1578

1. Scheduled and unscheduled service calls to clean grease waste drains, building sanitary drains, or building sewers.
2. Repairs required resulting from food or FOG accumulation or blockages.
3. Kitchen exhaust hood cleaning.
4. FOG control device cleaning, maintenance and repair.
5. Waste manifest forms pursuant to Sections 24-42.6(9)(c)(v) and 24-46.
6. Staff training records pursuant to Section 24-42.6(9)(c)(iv).

(iv) Training Requirements. Each FOG generator and FOG control device operator~~s~~ shall maintain trained staff to ensure compliance with the requirements of Section 24-42.6(9). The content and form of training shall be prescribed by the Director or Director's designee. Training shall include orientation of new employees and quarterly training of existing employees. On or before January 1, 2019, each FOG generator and FOG control device operator shall have one (1) trained person on staff which has working knowledge of the following where applicable:

1. Kitchen exhaust hoods,
2. Solids separators.
3. FOG control devices.
4. Best management practices.
5. Yellow and brown grease storage.
6. Mat and equipment wash-down areas.
7. Record keeping and reporting.

(v) Reporting. Each FOG generator and FOG control device operator shall submit ~~monthly~~ reports to the Department using forms prescribed by the Director or Director's designee pursuant to maintenance schedules in Section 24-

1579 42.6(10)(d)(ii). Where made available by the Department,
1580 reporting shall be completed using a secure online system or by
1581 an equivalent system developed by the Department. Monthly
1582 Reports shall include ~~total volume of each waste stream~~
1583 ~~disposed, transported or collected,~~ the date and the name of
1584 liquid waste transporter.

1585
1586 (vi) Closure Requirements. No more than thirty (30) days after a
1587 FOG generator closes, the property owner shall notify the
1588 Department to perform a closure inspection. On or before the
1589 closure inspection, the property owner shall have all yellow
1590 and brown grease containers and bins emptied, storage areas
1591 cleaned and FOG control devices cleaned. Decanting,
1592 skimming, or backflushing is prohibited. Emulsifiers, grease
1593 cutters or other chemicals and detergents which could cause
1594 FOG to pass through the system to the drain lines are
1595 prohibited and shall not be used. All waste shall be disposed at
1596 a permitted facility, using an approved liquid waste transporter
1597 with manifests submitted to ~~the~~ Department.

1598
1599 (e) Existing FOG generators with a current FOG operating permit, issued
1600 prior to (CLERK TO INSERT EFFECTIVE DATE), proposing to
1601 increase seating capacity, dining area or drive-thru capacity, or other
1602 modification, any of which will increase the discharge of FOG, shall
1603 comply with Sections 24-42.6(6)(a)(i), (ii) and (iii), and 24-42.6(9)(c).

1604
1605 (f) FOG generators discharging to an onsite sewage treatment and
1606 disposal system located in ~~the basic~~ a wellfield protection area of any
1607 utility potable water supply wells, proposing to increase seating
1608 capacity, dining area or drive-thru capacity, or other modification, any
1609 of which will increase the discharge of FOG, shall comply with
1610 Sections 24-42.6(6)(b), and 24-42.6(9)(c).

1611
1612 (g) FOG generators discharging to an onsite sewage treatment and
1613 disposal system located in ~~the basic~~ a wellfield protection area of any
1614 utility potable water supply wells, not proposing to increase seating
1615 capacity, dining area or drive-thru capacity, or other modification, any
1616 of which will increase the discharge of FOG, shall apply for an
1617 operating permit ~~by January 1, 2018~~ pursuant to Section 24-42.6(5).

1618
1619 (h) Any FOG operating permit approved and issued by the Department
1620 may be revoked for failure to comply with permit conditions or
1621 conditions established in Section 24-42.6. Cause for revoking an
1622 operating permit may include, but not be limited to, the following:
1623

- 1624 (i) Falsifying information on any record or document required by
1625 the county; or
1626
- 1627 (ii) Failure to have a FOG control device cleaned properly or in a
1628 timely manner as described in Section 24-42.6(9); or
1629
- 1630 (iii) Having a FOG control device cleaned by a person not
1631 permitted by the Department to perform such cleaning; or
1632
- 1633 (iv) Utilizing a liquid waste transporter not permitted by the
1634 Department; or
1635
- 1636 (v) Failure to comply with any permit condition; or
1637
- 1638 (vi) Violation of any federal, state, or local regulation governing
1639 the handling of FOG wastes; or
1640
- 1641 (vii) Failure to pay invoices, fees, fines, judgments or liens owed to
1642 the county.
1643
- 1644 (viii) The revocation of an operating permit shall be in addition to
1645 any penalties assessed for violation of this Chapter, or provided
1646 elsewhere in the Code of Miami-Dade County.
1647

1648 (11) FOG Liquid Waste Transporters. Notwithstanding any provision of
1649 this Code, no person shall collect, pump, transport, or cause, let, permit, suffer or
1650 allow any FOG, yellow grease, brown grease or black grease to be collected,
1651 pumped or transported without a valid operating permit issued by the Department
1652 pursuant to Sections 24-18, ~~24-42.6(8)~~ and 24-46. In addition to the requirements
1653 enumerated in Section 24-46, FOG liquid waste transporters shall comply with the
1654 following:
1655

- 1656 (a) All waste transported and FOG control device condition assessments
1657 shall be manifested using forms prescribed by the Director or
1658 Director's designee and ~~Where made available by the Department,~~
1659 ~~reporting shall be completed using a secure online system or by an~~
1660 ~~equivalent system developed by the Department. Reporting shall be~~
1661 ~~completed no later than 20 days after the end of the month during~~
1662 ~~which cleaning was performed.~~
1663
- 1664 (b) FOG, yellow grease, black grease and brown grease shall only be
1665 stored or disposed at private or public facilities approved by the
1666 Department.
1667
- 1668 (c) FOG control device cleaning shall include completely removing the
1669 full contents of the FOG control device, including settled solids,

1670 wastewater and floating materials, pressure washing or scraping side
1671 walls, baffle walls, cross-pipes, and inlet and outlet pipes to remove all
1672 attached materials. Decanting, skimming, or backflushing is
1673 prohibited. Emulsifiers, grease cutters or other chemicals and
1674 detergents which could cause FOG to pass through the system to the
1675 building sanitary drains or building sewers are prohibited and shall not
1676 be used.

1677
1678 (d) Effective January 12, 2017~~9~~, liquid waste transporter staff shall be
1679 trained to ensure compliance with the requirements of Section 24-
1680 42.6(9)(c)(ii) and 24-42.6(10)(c). The content and form of training
1681 shall be prescribed by the Director or Director's designee. At a
1682 minimum, one trained staff member shall be present while ~~grease traps~~
1683 ~~or grease interceptors~~ FOG control devices are being cleaned. Staff
1684 performing assessments of the condition of any system or part thereof
1685 (condition assessments) stipulated in Section 24-42.6(10) shall be
1686 trained in accordance with this Section.

1687
1688 (e) ~~Effective January 2, 2017, s~~ Septage or other waste shall not be
1689 commingled with yellow or brown grease.

1690
1691 ~~(f) Effective January 2, 2017, where made available by the~~
1692 ~~Department, waste manifesting shall be completed using a secure~~
1693 ~~online system or by equivalent system developed by the Department.~~

1694
1695 (f) ~~Effective January 2, 2017, l~~ Liquid waste transporters shall perform
1696 FOG control device condition assessments when cleaning is required
1697 pursuant to Section 24-42.6(9)(c)(ii). The condition assessment shall
1698 be performed and reported ~~using forms prescribed by the Director or~~
1699 ~~Director's designee, including the online forms pursuant to Section 24-~~
1700 ~~42.6(10)(a) where made available by the Department.~~ At a minimum,
1701 the condition assessment shall document the following:

1702
1703 (i) The water level and thickness of floating FOG and settled
1704 solids prior to cleaning.

1705
1706 1. Where FOG control devices are installed below ground
1707 and the water level prior to cleaning is below the invert
1708 of the outlet pipe, or groundwater infiltration is
1709 observed during or after cleaning, the condition
1710 assessment shall document leaks.

1711
1712 2. Where FOG control devices are installed above ground
1713 and leaks are observed, the condition assessment shall
1714 document leaks.

1715

1716
1717
1718
1719
1720
1721
1722
1723
1724
1725
1726
1727
1728
1729
1730
1731
1732
1733
1734
1735
1736
1737
1738
1739
1740
1741
1742
1743
1744
1745
1746
1747
1748

1749
1750
1751
1752
1753
1754
1755
1756
1757
1758
1759
1760
1761

~~3. All leaks shall be reported to the Department within twenty four (24) hours of being detected or observed and the FOG control device repaired within forty eight (48) hours. Until the FOG control device is repaired, the FOG control device shall not receive any flow or be bypassed.~~

3. Should a leak cause a sanitary nuisance, the sanitary nuisance shall be removed, abated or corrected within twenty-four (24) hours or such other reasonable time as the Director or the Director's designee may determine.

(ii) Integrity of solids separators and FOG control devices, including the inlet and outlet appurtenances; interior, bottom, top, side walls, baffle walls, and cross-pipes; manhole rings, extenders and covers; sampling points and cleanouts; interceptor monitoring alarms and devices; and other elements and equipment approved by the Department.

~~Where a solids separator or FOG control device is observed to be malfunctioning so that solids or FOG are being discharged to the building sanitary drains or building sewers, the Department shall be notified.~~

~~In no instance shall the unpermitted discharge be permitted to continue or result in a building sanitary drain or building sanitary drain back up or a sanitary nuisance.~~

~~(iii) All repairs performed by the liquid waste transporter.~~

(iii*) The condition of yellow and brown grease containers and bins.

(12) FOG Disposal Facilities. All facilities accepting, storing, transferring or treating FOG, yellow grease or brown grease shall obtain an operating permit pursuant to Section 24-18(A)(23) and comply with the following:

(a) Maintain trained staff to assure compliance with the requirements of Section 24-42.6. The content and form of training shall be prescribed by the Director or Director's designee. Training shall be completed prior to permit renewal starting January 1, 2019. At a minimum, one (1) trained staff member shall be present during maintenance and repair of the system and/or system components.

(b) Submit monthly reports to the Department using forms prescribed by the Director or Director's designee. Where made available by the

1762 Department, reporting shall be completed using a secure online system
1763 or by an equivalent system developed by the Department. Monthly
1764 reports shall include total volume of each waste stream accepted,
1765 collected, stored, treated, disposed, or transported and include waste
1766 manifests for all waste transported. Waste manifests shall track waste
1767 from the point of origin to the final disposal facility.

1768
1769 (13) Utilities. Utilities shall submit a monthly report to the Department that
1770 includes the following minimum information:

1771
1772 (a) A list with dates and locations where accelerated FOG maintenance
1773 was performed to prevent a sanitary sewer overflow. Locations shall
1774 also be identified in a geographical information system (GIS) format
1775 based on the utilities atlas pursuant to Section 24-42.2.

1776
1777 (b) A description of accelerated FOG maintenance performed, including
1778 quantities of waste FOG removed, recovered, collected or treated to
1779 prevent a sanitary sewer overflow. The information shall be provided
1780 in test and GIS form.

1781
1782 (c) Cost of accelerated FOG maintenance, including labor, equipment and
1783 materials. Labor shall include field and office staff.<<

Attachment 5
FDEP and EPA letter of approval of the FOG Control
Program and FOG Ordinance dated September 7,
2017



UNITED STATES ENVIRONMENTAL PROTECTION AGENCY

REGION 4
ATLANTA FEDERAL CENTER
61 FORSYTH STREET
ATLANTA, GEORGIA 30303-8960

SEP 07 2017

RECEIVED
DERM
SEP 19 2017
POLLUTION REGULATION
DIVISION

CERTIFIED MAIL 7016 0600 0000 3846 7497
RETURN RECEIPT REQUESTED

Mr. Lee N. Hefty
Assistant Director
Division of Environmental Resources Management
Miami-Dade Regulatory and Economic Resources Department
Miami-Dade County
701 NW 1st Court, 4th Floor
Miami, Florida 33136

Re: Consent Decree (Case: No.: 1:12-cv-24400-FAM)
Reference DOJ Case No.: 90-5-1-1-4022
Section VI – Fats, Oils and Grease Control Program, Paragraph 19(a)

Dear Mr. Hefty:

The United States Environmental Protection Agency Region 4 and the Florida Department of Environmental Protection (FDEP) are in receipt of Miami-Dade County's (Miami-Dade) May 1, 2017 submittal of the responses to comments on the Fats, Oils and Grease (FOG) Control Program and draft FOG ordinance set forth in Paragraph 19.(a). of the above-referenced Consent Decree (CD). The EPA has consulted with FDEP and we hereby approve the FOG Control Program and FOG ordinance.

Miami-Dade should provide the EPA and FDEP with a copy of the updated and approved FOG Control Program within 30 days of receipt of this letter. If you should have any questions regarding this matter, please contact Mr. Brad Ammons of the EPA at (404) 562-9769 or via email at ammons.brad@epa.gov.

Sincerely,

Maurice L. Horsey, IV, Chief
Municipal and Industrial Enforcement Section
NPDES Permitting and Enforcement Branch

cc: See Attached Mailing List

Mailing List:

Mr. Jonathan A. Glogau
Office of the Attorney General

Mr. Kirk White
Florida Department of Environmental Protection

Ms. Lisa Self
Florida Department of Environmental Protection

Mayor Carlos A. Gimenez
Miami-Dade County

Mr. Lester Sola
Miami-Dade Water and Sewer Department

Mr. Jack Osterholt
Miami-Dade Regulatory and Economic Resources

Ms. Abigail Price-Williams
Miami-Dade County Attorney

Mr. William A. Weinischke
U.S. Department of Justice

Ms. Rachael Amy Kamons
U.S. Department of Justice

USPS Tracking® Results

[FAQs >](http://faq.usps.com/?articleId=220900) (<http://faq.usps.com/?articleId=220900>)

Track Another Package +

Remove ✕

Tracking Number: 70160600000038467497



Delivered

Product & Tracking Information

[See Available Actions](#)

Postal Product:

Features:
Certified Mail™

DATE & TIME	STATUS OF ITEM	LOCATION
September 18, 2017, 1:14 pm	Delivered, Left with Individual ▲	MIAMI, FL 33136
Your item was delivered to an individual at the address at 1:14 pm on September 18, 2017 in MIAMI, FL 33136.		
September 18, 2017, 9:05 am	In Transit to Destination	ON ITS WAY TO MIAMI, FL 33136
September 17, 2017, 9:05 am	In Transit to Destination	ON ITS WAY TO MIAMI, FL 33136
September 16, 2017, 9:05 am	In Transit to Destination	ON ITS WAY TO MIAMI, FL 33136

[See More](#) ▼

Available Actions

Text & Email Updates



[See Less](#) ^

Can't find what you're looking for?

Go to our [FAQs](#) section to find answers to your tracking questions.

[FAQs](http://faq.usps.com/?articleId=220900) (<http://faq.usps.com/?articleId=220900>)

Attachment 6
Outreach Meetings

FOG Control Program Outreach Summary

MEETING	Intended Audience	Notification Method	DATE	LOCATION
FBPE Course New Consent Decree and Certification of Sanitary Sewer system Collection, Transmission, and Treatment Capacity	<ul style="list-style-type: none"> PE Engineers 	<ul style="list-style-type: none"> Emails 	November 13, 2013	Miami Dade Water and Sewer Dept 3071 SW 38 Ave.
The New Consent Decree, What Engineers Need to Know	<ul style="list-style-type: none"> Design Professionals 	<ul style="list-style-type: none"> Florida Engineering Society 	January 28, 2014	94 th Aero Squadron Restaurant 1395 NW 57th Ave
South Florida Building Officials Association (SFBOA): How To Control FOG Costs & Compliance In A Consent Decree Environment	<ul style="list-style-type: none"> Building Officials Plumbing Chiefs Plumbing Plans Examiners Plumbing Inspectors Plumbing Contractors 	<ul style="list-style-type: none"> SFBOA 	February 5, 2014	94 th Aero Squadron Restaurant 1395 NW 57th Avenue
Building a Better FOG Control Program	<ul style="list-style-type: none"> Food Service Establishments with GDO Permit (e.g., Restaurants, Cafeterias, etc.) Liquid Waste Transporters with LWT Permit. Design Professionals Building Departments Municipal Officials Public Works/Utilities Equipment Manufactures Brown grease recyclers 	<ul style="list-style-type: none"> Mailings to ALL permitted facilities (e.g., Restaurants, Cafeterias, etc.). RER-Web Site Emails 	September 10, 2014	Main Library Auditorium 101 W Flagler
South Florida Plumbing Chiefs and Code Standards Committee	<ul style="list-style-type: none"> Plumbing Chiefs Plumbing Plans Examiners Plumbing Inspectors Plumbing Contractors 	<ul style="list-style-type: none"> South Florida Plumbing Chiefs and Code Standards Committee 	October 30, 2014	South Florida Plumbing Chiefs and Code Offices

FOG Control Program Outreach Summary

MEETING	Intended Audience	Notification Method	DATE	LOCATION
Sustainable Buildings Lecture Series: Overview of the proposed Fats, Oils and Grease Control Program - FOG ^{2.0}	<ul style="list-style-type: none"> Sustainability community 	<ul style="list-style-type: none"> Sustainable Buildings Lecture Series, Office of Sustainability 	November 21, 2014	Overtown Transit Village 7 th Floor Conf Room – North Side
Building a Better FOG Control Program FOG^{2.0}	<ul style="list-style-type: none"> Liquid Waste Transporters 	<ul style="list-style-type: none"> Mailings to ALL permitted facilities (e.g., Restaurants, Cafeterias, etc.). RER-Web Site Emails 	November 19, 2014	OTV Building 2 nd Floor Training Room 701 NW 1 st Court
Building a Better FOG Control Program FOG^{2.0}	<ul style="list-style-type: none"> Design Professionals Equipment Manufactures Utilities Municipalities 	<ul style="list-style-type: none"> RER-Web Site Emails 	November 21, 2014	Miami Dade Water and Sewer Dept 3071 SW 38 Ave.
American Society of Plumbing Engineers (ASPE): FOG Control Design Requirements Effective December 1st	<ul style="list-style-type: none"> Design Professionals Plumbing Contractors 	<ul style="list-style-type: none"> ASPE 	December 9, 2014	La Carreta Restaurant 8650 Bird Road Miami, Florida 33155
FOG 2.0 Design Session	<ul style="list-style-type: none"> Food Service Establishments with GDO Permit (e.g., Restaurants, Cafeterias, etc.) Liquid Waste Transporters with LWT Permit. Design Professionals Building Departments Municipal Officials Public Works/Utilities Equipment Manufactures Brown grease recyclers 	<ul style="list-style-type: none"> Emails 	January 6, 2015	MCAD/AIA 100 NE 1 st Ave.

FOG Control Program Outreach Summary

MEETING	Intended Audience	Notification Method	DATE	LOCATION
<p>FOG 2.0 Certification Class</p> <p>Co-Sponsored by City of Miami Beach Public Works Department (Mike Alvarez)</p>	<ul style="list-style-type: none"> • Food Service Establishments with GDO Permit (e.g., Restaurants, Cafeterias, etc.) • Liquid Waste Transporters with LWT Permit. • Design Professionals • Building Departments • Municipal Officials • Public Works/Utilities • Equipment Manufactures • Brown grease recyclers 	<ul style="list-style-type: none"> • Emails 	<p>January 7, 2015</p>	<p>Miami Beach Convention Center</p>
<p>Utility Round Tables</p>	<ul style="list-style-type: none"> • FOG update for Utility Directors 	<ul style="list-style-type: none"> • Emails 	<p>October 10, 2013 January 15, 2014 April 15, 2014 July 15, 2014 October 15, 2014 January 15, 2015</p>	<p>OTV Building 2nd Floor Training Room 701 NW 1st Court</p>
<p>Liquid Waste Transporters</p>	<ul style="list-style-type: none"> • Liquid Waste Transporters with LWT Permit. 	<ul style="list-style-type: none"> • Mailings • Posting at South District Plant • Posting at Broward/Power line Plant 	<p>February 18, 2015</p>	<p>Black Point Wastewater Treatment Plant</p>
<p>Compliance Assistance for FSEs</p>	<ul style="list-style-type: none"> • Food Service Establishments with GDO Permit (e.g., Restaurants, Cafeterias, etc.) 	<ul style="list-style-type: none"> • Mailings to ALL permitted facilities (e.g., Restaurants, Cafeterias, etc.). • RER-Web Site • Door-to-Door Flyers • Emails • Municipalities 	<p>February 19, 2015</p>	<ul style="list-style-type: none"> • City of Miami Beach Library

FOG Control Program Outreach Summary

MEETING	Intended Audience	Notification Method	DATE	LOCATION
South Florida Building Officials Association (SFBOA): FOG1.0 to FOG2.0 A Parallel Course to Reducing FOG	<ul style="list-style-type: none"> • Building Officials • Plumbing Chiefs • Plumbing Plans Examiners • Plumbing Inspectors • Plumbing Contractors 	<ul style="list-style-type: none"> • SFBOA 	March 4, 2015	94 th Aero Squadron Restaurant 1395 NW 57th Avenue
City of Coral Gables	<ul style="list-style-type: none"> • Food Service Establishments 	<ul style="list-style-type: none"> • Mailings to ALL permitted facilities (e.g., Restaurants, Cafeterias, etc.). • RER-Web Site • Door-to-Door Flyers 	March 17, 2015	Fire/Police Facility
City of Miami Food Service Establishments	Food Service Establishments	<ul style="list-style-type: none"> • Mailings to ALL permitted facilities (e.g., Restaurants, Cafeterias, etc.). • RER-Web Site 	March 18, 2015	Main Library Auditorium 101 W Flagler
MIA	MIA Staff	Interdepartmental Coordination	April 2, 2015	Miami International Airport
Deputy Mayor RER Director's Office			April 10, 2015	
Georgia FOG Alliance			April 21, 2015	

FOG Control Program Outreach Summary

MEETING	Intended Audience	Notification Method	DATE	LOCATION
April 2015	<ul style="list-style-type: none"> • All Stakeholders 	<ul style="list-style-type: none"> • Mailings to ALL permitted facilities (e.g., Restaurants, Cafeterias, etc.). • RER-Web Site • Door-to-Door Flyers • Emails • Municipalities 	TBD	<ul style="list-style-type: none"> • Multiple
City of Hialeah - Compliance Assistance for FSEs	<ul style="list-style-type: none"> • Food Service Establishments with GDO Permit (e.g., Restaurants, Cafeterias, etc.)and no grease trap 	<ul style="list-style-type: none"> • Mailings to ALL GDO permitted facilities with status NGT (e.g., Restaurants, Cafeterias, etc.). • Outreach to 33 sites 	May 6, 2015	Hialeah's City Hall 501 Palm Avenue
MIA Tenants	<ul style="list-style-type: none"> • MIA Food Service Establishments 	<ul style="list-style-type: none"> • MIA Leasing 	May 8, 2015	MIA
FOG Control Program Update	<ul style="list-style-type: none"> • Food Service Establishments with GDO Permit (e.g., Restaurants, Cafeterias, etc.)and no grease trap 	<ul style="list-style-type: none"> • Mailings to ALL permitted facilities (e.g., Restaurants, Cafeterias, etc.). • RER-Web Site 	May 18, 2015	Miami-Dade Public Library 101 West Flagler St.

FOG Control Program Outreach Summary

MEETING	Intended Audience	Notification Method	DATE	LOCATION
FOG Control Program Update – SFACE	<ul style="list-style-type: none"> • South Florida Association of Code Enforcement (SFACE) • Professionals involved in enforcement of health, safety and environmental regulations. 	<ul style="list-style-type: none"> • Emails from SFACE 	May 27, 2015	10720 Caribbean Blvd., Suite #220 Cutler Bay, FL 33189
Southwest Inspections	<ul style="list-style-type: none"> • Inspectors • FOG Control Equipment Manufactures • Engineers • Utilities 	<ul style="list-style-type: none"> • Members meeting - email 	August 14, 2015	Tampa, FL
ASSE	<ul style="list-style-type: none"> • Sanitary Engineers and Plumbers 	<ul style="list-style-type: none"> • Members meeting - email 	August 17, 2015	Pompano Beach
City of Miami FOG Inspections	<ul style="list-style-type: none"> • 	<ul style="list-style-type: none"> • Email 	August 24, 2015	1101 NW 7 St., Miami Station No. 3 Troy Sutton
Public Meeting	<ul style="list-style-type: none"> • 	<ul style="list-style-type: none"> • Mail, email 	December 11, 2015	Overtown Transit Village – 2 nd Floor
FOG Control Device Design Criteria and Requirements	<ul style="list-style-type: none"> • FOG Design Professionals (Engineers and Architects) 	<ul style="list-style-type: none"> • Email 	March 9, 2016	Overtown Transit Village – 2 nd Floor
FOG Control Program Update - Electronic FOG Manifesting	<ul style="list-style-type: none"> • LWT 	<ul style="list-style-type: none"> • Email and Mailings to all LWT. 	May 3, 2016	South District Wastewater Treatment Plant

FOG Control Program Outreach Summary

MEETING	Intended Audience	Notification Method	DATE	LOCATION
FOG Control Program Update - Plan review	<ul style="list-style-type: none"> RER - Plumbing inspectors 	<ul style="list-style-type: none"> Email 	May 17, 2016	West Dade -PIC
South Florida Plumbing and Mechanical Chief Inspectors and Code Standards Committee	<ul style="list-style-type: none"> Plumbing inspectors 	<ul style="list-style-type: none"> Email 	May 18, 2016	Plumbing Contractors Association 7204 SW 48 street, Miami
IPMP MDWSD Pilot	<ul style="list-style-type: none"> Liquid waste Transporters 	<ul style="list-style-type: none"> Email 	May 20, 2016	MDWSD
Life Demo of FOG applications	<ul style="list-style-type: none"> 	<ul style="list-style-type: none"> Email 	June 2, 2016	OTV Building/RER 3rd Floor Computer Services Training Room
Grease Trap monitoring pilot test	<ul style="list-style-type: none"> 	<ul style="list-style-type: none"> Email 	June 24, 2016	Facilities Building
Utility Round Table	<ul style="list-style-type: none"> 	<ul style="list-style-type: none"> Email 	June 29, 2016	Overtown Transit Village – 2 nd Floor
Adopt a Tree	<ul style="list-style-type: none"> Residential community 	<ul style="list-style-type: none"> Mailings sent by the Adopt a Tree campaign 	August 27, 2016	West Kendall Baptist Hospital. 15755 SW 96 Street, Kendall

FOG Control Program Outreach Summary

MEETING	Intended Audience	Notification Method	DATE	LOCATION
1st FOG Round Table	<ul style="list-style-type: none"> FOG Stakeholders 	<ul style="list-style-type: none"> Email and mailings to FSEs, LWTs, manufacturers, contractors, engineers, architects, regulators, plumbing associations, building departments. 	September 14, 2016	Miami-Dade Public Library - Main Branch 101 W. Flagler St.
WASD FOG treatment facilities	<ul style="list-style-type: none"> WASD 	<ul style="list-style-type: none"> Email 	September 16, 2016	MDWSD
Adopt a Tree	<ul style="list-style-type: none"> Residential community 	<ul style="list-style-type: none"> Mailings sent by the Adopt a Tree campaign 	September 17, 2016	Doral Central Park 3000 NW 87th Avenue, Doral
South Florida Plumbing and Mechanical Chief Inspectors and Code Standards Committee	<ul style="list-style-type: none"> Plumbing inspectors 	<ul style="list-style-type: none"> Email 	September 21, 2016	Plumbing Contractors Association 7204 SW 48 street, Miami
Utility Round Table – FOG update	<ul style="list-style-type: none"> Utilities 	<ul style="list-style-type: none"> Email 	October 12, 2016	OTV Building/RER 2 nd Floor Training Room
eManifest Training for LWTs	<ul style="list-style-type: none"> LWT 	<ul style="list-style-type: none"> Email 	October 13, 2016	OTV Building/RER 3rd Floor Computer Services Training Room

FOG Control Program Outreach Summary

MEETING	Intended Audience	Notification Method	DATE	LOCATION
eManifest Training for LWTs	<ul style="list-style-type: none"> LWT 	<ul style="list-style-type: none"> Email 	October 20, 2016	OTV Building/RER 3rd Floor Computer Services Training Room
Plumbing Contractors Association General Membership Meeting	<ul style="list-style-type: none"> Plumbing inspectors 	<ul style="list-style-type: none"> Email 	October 25, 2016	Plumbing Contractors Association 7204 SW 48 street, Miami
Plumbing and Mechanical Trade Show and Expo	<ul style="list-style-type: none"> Plumbing contractors 	<ul style="list-style-type: none"> Email 	November 17, 2016	711 NW 72 nd Ave., Miami
Utility Round Table	<ul style="list-style-type: none"> FOG Ordinance Update Hot Spots 	<ul style="list-style-type: none"> Email to utilities and contractors 	January 11, 2017	Overtown Transit Village – 2 nd Floor
NSF International FOG Prevention Conference 2017	<ul style="list-style-type: none"> FOG Control Equipment Manufactures Engineers Utilities Grease Interceptors Certifying Agencies (PDI) Testing Facilities 	<ul style="list-style-type: none"> Email 	February 7-8, 2017	NSF International 789 North Dixboro Road Ann Arbor, MI 48105

FOG Control Program Outreach Summary

FOG Training for Liquid Waste Transporters	<ul style="list-style-type: none"> Liquid Waste Transporters 	<ul style="list-style-type: none"> Email 	March 28, 2017	Overtown Transit Village – 2 nd Floor
2nd FOG Round Table	<ul style="list-style-type: none"> FOG Stakeholders 	<ul style="list-style-type: none"> Email to FSEs, LWTs, manufacturers, contractors, engineers, architects, regulators, plumbing associations, building departments. 	March 15, 2017	Overtown Transit Village – 2 nd Floor
Utility Round Table	<ul style="list-style-type: none"> FOG Ordinance Update Hot Spots 	<ul style="list-style-type: none"> Email to utilities and contractors 	April 28, 2017	Overtown Transit Village – 2 nd Floor
FOG Training for Liquid Waste Transporters	<ul style="list-style-type: none"> Liquid Waste Transporters 	<ul style="list-style-type: none"> Email 	May 8, 2017	Overtown Transit Village – 2 nd Floor
3rd FOG Round Table	<ul style="list-style-type: none"> FOG Stakeholders 	<ul style="list-style-type: none"> Email to FSEs, LWTs, manufacturers, contractors, engineers, architects, regulators, plumbing associations, building departments. 	June 7, 2017	Overtown Transit Village – 2 nd Floor
Utility Round Table	<ul style="list-style-type: none"> FOG Ordinance Update Hot Spots 	<ul style="list-style-type: none"> Email to utilities and contractors 	July 12, 2017	Overtown Transit Village – 2 nd Floor

FOG Control Program Outreach Summary

MEETING	Intended Audience	Notification Method	DATE	LOCATION
West Coast FOG Inspectors Meeting	<ul style="list-style-type: none"> • Inspectors • FOG Control Equipment Manufactures • Engineers • Utilities • Grease Interceptors Certifying Agencies (PDI) 	<ul style="list-style-type: none"> • Email 	August 10-11, 2017	Manatee County Fairgrounds 1303 17th St W Palmetto, Fl. 34221
Compliance Assistance for FSEs	<ul style="list-style-type: none"> • Food Service Establishments with GDO Permit (e.g., Restaurants, Cafeterias, etc.) 	<ul style="list-style-type: none"> • Compliance Assistance Visits to inform on new electronic reporting requirements. 	October 2017	Miami-Dade County
Utility Round Table	<ul style="list-style-type: none"> • FOG Ordinance Update • Hot Spots 	<ul style="list-style-type: none"> • Email to utilities and contractors 	October 11, 2017	Overtown Transit Village – 2 nd Floor
FOG Round Table	<ul style="list-style-type: none"> • FOG Stakeholders 	<ul style="list-style-type: none"> • Email to FSEs, LWTs, manufacturers, contractors, engineers, architects, regulators, plumbing associations, building departments. 	October 20, 2017	Overtown Transit Village – 2 nd Floor

Attachment 6
Outreach Meetings

FOG Control Program Outreach Summary

MEETING	Intended Audience	Notification Method	DATE	LOCATION
FBPE Course New Consent Decree and Certification of Sanitary Sewer system Collection, Transmission, and Treatment Capacity	<ul style="list-style-type: none"> PE Engineers 	<ul style="list-style-type: none"> Emails 	November 13, 2013	Miami Dade Water and Sewer Dept 3071 SW 38 Ave.
The New Consent Decree, What Engineers Need to Know	<ul style="list-style-type: none"> Design Professionals 	<ul style="list-style-type: none"> Florida Engineering Society 	January 28, 2014	94 th Aero Squadron Restaurant 1395 NW 57th Ave
South Florida Building Officials Association (SFBOA): How To Control FOG Costs & Compliance In A Consent Decree Environment	<ul style="list-style-type: none"> Building Officials Plumbing Chiefs Plumbing Plans Examiners Plumbing Inspectors Plumbing Contractors 	<ul style="list-style-type: none"> SFBOA 	February 5, 2014	94 th Aero Squadron Restaurant 1395 NW 57th Avenue
Building a Better FOG Control Program	<ul style="list-style-type: none"> Food Service Establishments with GDO Permit (e.g., Restaurants, Cafeterias, etc.) Liquid Waste Transporters with LWT Permit. Design Professionals Building Departments Municipal Officials Public Works/Utilities Equipment Manufactures Brown grease recyclers 	<ul style="list-style-type: none"> Mailings to ALL permitted facilities (e.g., Restaurants, Cafeterias, etc.). RER-Web Site Emails 	September 10, 2014	Main Library Auditorium 101 W Flagler
South Florida Plumbing Chiefs and Code Standards Committee	<ul style="list-style-type: none"> Plumbing Chiefs Plumbing Plans Examiners Plumbing Inspectors Plumbing Contractors 	<ul style="list-style-type: none"> South Florida Plumbing Chiefs and Code Standards Committee 	October 30, 2014	South Florida Plumbing Chiefs and Code Offices

FOG Control Program Outreach Summary

MEETING	Intended Audience	Notification Method	DATE	LOCATION
Sustainable Buildings Lecture Series: Overview of the proposed Fats, Oils and Grease Control Program - FOG ^{2.0}	<ul style="list-style-type: none"> Sustainability community 	<ul style="list-style-type: none"> Sustainable Buildings Lecture Series, Office of Sustainability 	November 21, 2014	Overtown Transit Village 7 th Floor Conf Room – North Side
Building a Better FOG Control Program FOG^{2.0}	<ul style="list-style-type: none"> Liquid Waste Transporters 	<ul style="list-style-type: none"> Mailings to ALL permitted facilities (e.g., Restaurants, Cafeterias, etc.). RER-Web Site Emails 	November 19, 2014	OTV Building 2 nd Floor Training Room 701 NW 1 st Court
Building a Better FOG Control Program FOG^{2.0}	<ul style="list-style-type: none"> Design Professionals Equipment Manufactures Utilities Municipalities 	<ul style="list-style-type: none"> RER-Web Site Emails 	November 21, 2014	Miami Dade Water and Sewer Dept 3071 SW 38 Ave.
American Society of Plumbing Engineers (ASPE): FOG Control Design Requirements Effective December 1st	<ul style="list-style-type: none"> Design Professionals Plumbing Contractors 	<ul style="list-style-type: none"> ASPE 	December 9, 2014	La Carreta Restaurant 8650 Bird Road Miami, Florida 33155
FOG 2.0 Design Session	<ul style="list-style-type: none"> Food Service Establishments with GDO Permit (e.g., Restaurants, Cafeterias, etc.) Liquid Waste Transporters with LWT Permit. Design Professionals Building Departments Municipal Officials Public Works/Utilities Equipment Manufactures Brown grease recyclers 	<ul style="list-style-type: none"> Emails 	January 6, 2015	MCAD/AIA 100 NE 1 st Ave.

FOG Control Program Outreach Summary

MEETING	Intended Audience	Notification Method	DATE	LOCATION
<p>FOG 2.0 Certification Class</p> <p>Co-Sponsored by City of Miami Beach Public Works Department (Mike Alvarez)</p>	<ul style="list-style-type: none"> • Food Service Establishments with GDO Permit (e.g., Restaurants, Cafeterias, etc.) • Liquid Waste Transporters with LWT Permit. • Design Professionals • Building Departments • Municipal Officials • Public Works/Utilities • Equipment Manufactures • Brown grease recyclers 	<ul style="list-style-type: none"> • Emails 	<p>January 7, 2015</p>	<p>Miami Beach Convention Center</p>
<p>Utility Round Tables</p>	<ul style="list-style-type: none"> • FOG update for Utility Directors 	<ul style="list-style-type: none"> • Emails 	<p>October 10, 2013 January 15, 2014 April 15, 2014 July 15, 2014 October 15, 2014 January 15, 2015</p>	<p>OTV Building 2nd Floor Training Room 701 NW 1st Court</p>
<p>Liquid Waste Transporters</p>	<ul style="list-style-type: none"> • Liquid Waste Transporters with LWT Permit. 	<ul style="list-style-type: none"> • Mailings • Posting at South District Plant • Posting at Broward/Power line Plant 	<p>February 18, 2015</p>	<p>Black Point Wastewater Treatment Plant</p>
<p>Compliance Assistance for FSEs</p>	<ul style="list-style-type: none"> • Food Service Establishments with GDO Permit (e.g., Restaurants, Cafeterias, etc.) 	<ul style="list-style-type: none"> • Mailings to ALL permitted facilities (e.g., Restaurants, Cafeterias, etc.). • RER-Web Site • Door-to-Door Flyers • Emails • Municipalities 	<p>February 19, 2015</p>	<ul style="list-style-type: none"> • City of Miami Beach Library

FOG Control Program Outreach Summary

MEETING	Intended Audience	Notification Method	DATE	LOCATION
South Florida Building Officials Association (SFBOA): FOG1.0 to FOG2.0 A Parallel Course to Reducing FOG	<ul style="list-style-type: none"> • Building Officials • Plumbing Chiefs • Plumbing Plans Examiners • Plumbing Inspectors • Plumbing Contractors 	<ul style="list-style-type: none"> • SFBOA 	March 4, 2015	94 th Aero Squadron Restaurant 1395 NW 57th Avenue
City of Coral Gables	<ul style="list-style-type: none"> • Food Service Establishments 	<ul style="list-style-type: none"> • Mailings to ALL permitted facilities (e.g., Restaurants, Cafeterias, etc.). • RER-Web Site • Door-to-Door Flyers 	March 17, 2015	Fire/Police Facility
City of Miami Food Service Establishments	Food Service Establishments	<ul style="list-style-type: none"> • Mailings to ALL permitted facilities (e.g., Restaurants, Cafeterias, etc.). • RER-Web Site 	March 18, 2015	Main Library Auditorium 101 W Flagler
MIA	MIA Staff	Interdepartmental Coordination	April 2, 2015	Miami International Airport
Deputy Mayor RER Director's Office			April 10, 2015	
Georgia FOG Alliance			April 21, 2015	

FOG Control Program Outreach Summary

MEETING	Intended Audience	Notification Method	DATE	LOCATION
April 2015	<ul style="list-style-type: none"> • All Stakeholders 	<ul style="list-style-type: none"> • Mailings to ALL permitted facilities (e.g., Restaurants, Cafeterias, etc.). • RER-Web Site • Door-to-Door Flyers • Emails • Municipalities 	TBD	<ul style="list-style-type: none"> • Multiple
City of Hialeah - Compliance Assistance for FSEs	<ul style="list-style-type: none"> • Food Service Establishments with GDO Permit (e.g., Restaurants, Cafeterias, etc.)and no grease trap 	<ul style="list-style-type: none"> • Mailings to ALL GDO permitted facilities with status NGT (e.g., Restaurants, Cafeterias, etc.). • Outreach to 33 sites 	May 6, 2015	Hialeah's City Hall 501 Palm Avenue
MIA Tenants	<ul style="list-style-type: none"> • MIA Food Service Establishments 	<ul style="list-style-type: none"> • MIA Leasing 	May 8, 2015	MIA
FOG Control Program Update	<ul style="list-style-type: none"> • Food Service Establishments with GDO Permit (e.g., Restaurants, Cafeterias, etc.)and no grease trap 	<ul style="list-style-type: none"> • Mailings to ALL permitted facilities (e.g., Restaurants, Cafeterias, etc.). • RER-Web Site 	May 18, 2015	Miami-Dade Public Library 101 West Flagler St.

FOG Control Program Outreach Summary

MEETING	Intended Audience	Notification Method	DATE	LOCATION
FOG Control Program Update – SFACE	<ul style="list-style-type: none"> • South Florida Association of Code Enforcement (SFACE) • Professionals involved in enforcement of health, safety and environmental regulations. 	<ul style="list-style-type: none"> • Emails from SFACE 	May 27, 2015	10720 Caribbean Blvd., Suite #220 Cutler Bay, FL 33189
Southwest Inspections	<ul style="list-style-type: none"> • Inspectors • FOG Control Equipment Manufactures • Engineers • Utilities 	<ul style="list-style-type: none"> • Members meeting - email 	August 14, 2015	Tampa, FL
ASSE	<ul style="list-style-type: none"> • Sanitary Engineers and Plumbers 	<ul style="list-style-type: none"> • Members meeting - email 	August 17, 2015	Pompano Beach
City of Miami FOG Inspections	<ul style="list-style-type: none"> • 	<ul style="list-style-type: none"> • Email 	August 24, 2015	1101 NW 7 St., Miami Station No. 3 Troy Sutton
Public Meeting	<ul style="list-style-type: none"> • 	<ul style="list-style-type: none"> • Mail, email 	December 11, 2015	Overtown Transit Village – 2 nd Floor
FOG Control Device Design Criteria and Requirements	<ul style="list-style-type: none"> • FOG Design Professionals (Engineers and Architects) 	<ul style="list-style-type: none"> • Email 	March 9, 2016	Overtown Transit Village – 2 nd Floor
FOG Control Program Update - Electronic FOG Manifesting	<ul style="list-style-type: none"> • LWT 	<ul style="list-style-type: none"> • Email and Mailings to all LWT. 	May 3, 2016	South District Wastewater Treatment Plant

FOG Control Program Outreach Summary

MEETING	Intended Audience	Notification Method	DATE	LOCATION
FOG Control Program Update - Plan review	<ul style="list-style-type: none"> RER - Plumbing inspectors 	<ul style="list-style-type: none"> Email 	May 17, 2016	West Dade -PIC
South Florida Plumbing and Mechanical Chief Inspectors and Code Standards Committee	<ul style="list-style-type: none"> Plumbing inspectors 	<ul style="list-style-type: none"> Email 	May 18, 2016	Plumbing Contractors Association 7204 SW 48 street, Miami
IPMP MDWSD Pilot	<ul style="list-style-type: none"> Liquid waste Transporters 	<ul style="list-style-type: none"> Email 	May 20, 2016	MDWSD
Life Demo of FOG applications	<ul style="list-style-type: none"> 	<ul style="list-style-type: none"> Email 	June 2, 2016	OTV Building/RER 3rd Floor Computer Services Training Room
Grease Trap monitoring pilot test	<ul style="list-style-type: none"> 	<ul style="list-style-type: none"> Email 	June 24, 2016	Facilities Building
Utility Round Table	<ul style="list-style-type: none"> 	<ul style="list-style-type: none"> Email 	June 29, 2016	Overtown Transit Village – 2 nd Floor
Adopt a Tree	<ul style="list-style-type: none"> Residential community 	<ul style="list-style-type: none"> Mailings sent by the Adopt a Tree campaign 	August 27, 2016	West Kendall Baptist Hospital. 15755 SW 96 Street, Kendall

FOG Control Program Outreach Summary

MEETING	Intended Audience	Notification Method	DATE	LOCATION
1st FOG Round Table	<ul style="list-style-type: none"> • FOG Stakeholders 	<ul style="list-style-type: none"> • Email and mailings to FSEs, LWTs, manufacturers, contractors, engineers, architects, regulators, plumbing associations, building departments. 	September 14, 2016	Miami-Dade Public Library - Main Branch 101 W. Flagler St.
WASD FOG treatment facilities	<ul style="list-style-type: none"> • WASD 	<ul style="list-style-type: none"> • Email 	September 16, 2016	MDWSD
Adopt a Tree	<ul style="list-style-type: none"> • Residential community 	<ul style="list-style-type: none"> • Mailings sent by the Adopt a Tree campaign 	September 17, 2016	Doral Central Park 3000 NW 87th Avenue, Doral
South Florida Plumbing and Mechanical Chief Inspectors and Code Standards Committee	<ul style="list-style-type: none"> • Plumbing inspectors 	<ul style="list-style-type: none"> • Email 	September 21, 2016	Plumbing Contractors Association 7204 SW 48 street, Miami
Utility Round Table – FOG update	<ul style="list-style-type: none"> • Utilities 	<ul style="list-style-type: none"> • Email 	October 12, 2016	OTV Building/RER 2 nd Floor Training Room
eManifest Training for LWTs	<ul style="list-style-type: none"> • LWT 	<ul style="list-style-type: none"> • Email 	October 13, 2016	OTV Building/RER 3rd Floor Computer Services Training Room

FOG Control Program Outreach Summary

MEETING	Intended Audience	Notification Method	DATE	LOCATION
eManifest Training for LWTs	<ul style="list-style-type: none"> • LWT 	<ul style="list-style-type: none"> • Email 	October 20, 2016	OTV Building/RER 3rd Floor Computer Services Training Room
Plumbing Contractors Association General Membership Meeting	<ul style="list-style-type: none"> • Plumbing inspectors 	<ul style="list-style-type: none"> • Email 	October 25, 2016	Plumbing Contractors Association 7204 SW 48 street, Miami
Plumbing and Mechanical Trade Show and Expo	<ul style="list-style-type: none"> • Plumbing contractors 	<ul style="list-style-type: none"> • Email 	November 17, 2016	711 NW 72 nd Ave., Miami
Utility Round Table	<ul style="list-style-type: none"> • FOG Ordinance Update • Hot Spots 	<ul style="list-style-type: none"> • Email to utilities and contractors 	January 11, 2017	Overtown Transit Village – 2 nd Floor
NSF International FOG Prevention Conference 2017	<ul style="list-style-type: none"> • FOG Control Equipment Manufactures • Engineers • Utilities • Grease Interceptors Certifying Agencies (PDI) • Testing Facilities 	<ul style="list-style-type: none"> • Email 	February 7-8, 2017	NSF International 789 North Dixboro Road Ann Arbor, MI 48105

FOG Control Program Outreach Summary

FOG Training for Liquid Waste Transporters	<ul style="list-style-type: none"> Liquid Waste Transporters 	<ul style="list-style-type: none"> Email 	March 28, 2017	Overtown Transit Village – 2 nd Floor
2nd FOG Round Table	<ul style="list-style-type: none"> FOG Stakeholders 	<ul style="list-style-type: none"> Email to FSEs, LWTs, manufacturers, contractors, engineers, architects, regulators, plumbing associations, building departments. 	March 15, 2017	Overtown Transit Village – 2 nd Floor
Utility Round Table	<ul style="list-style-type: none"> FOG Ordinance Update Hot Spots 	<ul style="list-style-type: none"> Email to utilities and contractors 	April 28, 2017	Overtown Transit Village – 2 nd Floor
FOG Training for Liquid Waste Transporters	<ul style="list-style-type: none"> Liquid Waste Transporters 	<ul style="list-style-type: none"> Email 	May 8, 2017	Overtown Transit Village – 2 nd Floor
3rd FOG Round Table	<ul style="list-style-type: none"> FOG Stakeholders 	<ul style="list-style-type: none"> Email to FSEs, LWTs, manufacturers, contractors, engineers, architects, regulators, plumbing associations, building departments. 	June 7, 2017	Overtown Transit Village – 2 nd Floor
Utility Round Table	<ul style="list-style-type: none"> FOG Ordinance Update Hot Spots 	<ul style="list-style-type: none"> Email to utilities and contractors 	July 12, 2017	Overtown Transit Village – 2 nd Floor

FOG Control Program Outreach Summary

MEETING	Intended Audience	Notification Method	DATE	LOCATION
West Coast FOG Inspectors Meeting	<ul style="list-style-type: none"> • Inspectors • FOG Control Equipment Manufactures • Engineers • Utilities • Grease Interceptors Certifying Agencies (PDI) 	<ul style="list-style-type: none"> • Email 	August 10-11, 2017	Manatee County Fairgrounds 1303 17th St W Palmetto, Fl. 34221
Compliance Assistance for FSEs	<ul style="list-style-type: none"> • Food Service Establishments with GDO Permit (e.g., Restaurants, Cafeterias, etc.) 	<ul style="list-style-type: none"> • Compliance Assistance Visits to inform on new electronic reporting requirements. 	October 2017	Miami-Dade County
Utility Round Table	<ul style="list-style-type: none"> • FOG Ordinance Update • Hot Spots 	<ul style="list-style-type: none"> • Email to utilities and contractors 	October 11, 2017	Overtown Transit Village – 2 nd Floor
FOG Round Table	<ul style="list-style-type: none"> • FOG Stakeholders 	<ul style="list-style-type: none"> • Email to FSEs, LWTs, manufacturers, contractors, engineers, architects, regulators, plumbing associations, building departments. 	October 20, 2017	Overtown Transit Village – 2 nd Floor

Attachment 7
FOG Control Device Guidance Manual

FOG^{2.0} Control Device Guidance Manual

FOG Control Program Miami Dade County

Carlos L. Hernandez, PE, CFM, CEHP, LEED AP

Wastewater Permitting Section Chief

October, 2017

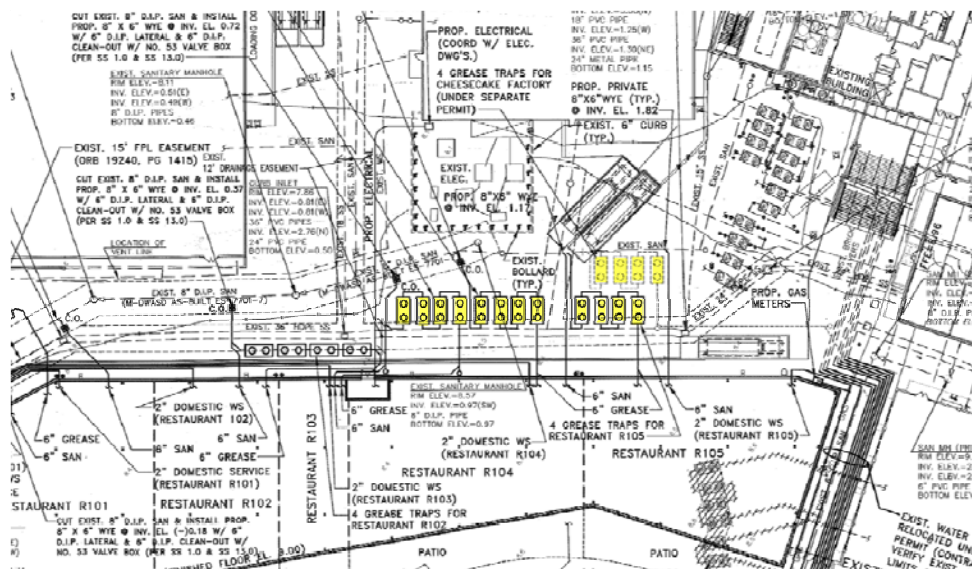

This manual was developed in collaboration with Wastewater Permitting Section Staff.

Table of Contents

List of Attachments	3
FOG^{2.0} Control Device Guidance Manual	4
1.0 Introduction	4
2.0 FOG Terms & Definitions	4
3.0 Rules & Regulations	7
4.0 FCD Permitting Process	9
4.1 Where to submit	9
4.2 When is a FOG Review Required.....	9
4.2.1 Plan Review Process.....	10
4.2.2 Certificate of Use / Occupational License Application Review	10
4.3. Atypical cases.....	11
4.3.1 Facilities that serve of Handle Food but not Prepare it	11
The local DOH offices issue a Food Permit or a Sanitation Certificate to the establishments under its jurisdiction, which outlines the limitations and prohibitions. Food permits are available upon request from the local office.	11
4.3.2 Facilities on Septic.....	13
4.3.3 Beer House/ Wine	13
4.3.4 Second user	13
5.0 FOG Design Requirements	14
5.1 Fixtures to be connected to Grease Interceptor.....	15
5.2 Wastewater Flow Rate and FOG Mass Rate	16
5.2.1 Wastewater Flow Rate [MDC-Section 24-4.6(9)(g)]	16
5.2.2 FOG Loading	16
5.3 Hydromechanical FCD Selection & Configuration.....	17
5.4 Gravity FCD Selection & Configuration	18
5.5 Shared FCDs Sizing Considerations	19
5.6 FCDs Sizing for Shell Spaces	20
5.7 FCD Sampling Point	20
5.8 FCD Accessibility.....	26
5.9 Other Design Considerations	27
5.9.1 Existing FOG Control Devices	27

- 5.9.2 Facilities adding Seating Capacity 27
- 5.9.2 Stormwater/Rainwater 28
- 5.9.3 Solids Separators..... 28
- 5.9.4 Yellow Grease Storage Areas 29
- 5.9.5 Wash-Down Areas..... 29
- 5.9.6 FOG Alarms & Sensors 29
- 5.9.8. No Direct Connection for 3-Compartment Sinks 29
- LIST OF ACCRONYMS..... 30
- LIST OF FIGURES 31

List of Attachments

Attachment 1	General Plan Review Process Diagram
Attachment 2	FOG Engineering Plan Review Process (Wastewater Permitting Section-WPS)
Attachment 3	FOG Plan Review Tracking Form
Attachment 4	Fixture and Fixture Symbols

FOG^{2.0} Control Device Guidance Manual

1.0 Introduction

The Fats, Oil, and Grease (FOG) Control Device Guidance Manual is intended to serve as a design guide for Professional Engineers designing FOG Control Devices for Food Service Establishments in Miami-Dade County. It is NOT intended to replace engineering judgement or replace the engineering design process. It is NOT a “recipe” book; instead, it provides “minimum” requirements. The Professional Engineer shall use sound engineering judgement and consider (Section 61G15, Florida Administrative Code):

1. The selection of engineering alternatives to be investigated and the comparison of alternatives for engineering works.
2. The selection or development of design standards or methods, and materials to be used.
3. The selection or development of techniques or methods of testing to be used in evaluating materials or completed works, either new or existing.
4. The development and control of operating and maintenance procedures.”

2.0 FOG Terms & Definitions

To establish a consistent basis for reviewing and approving plans and confirming compliance, the following terms are to be used.

- Back of the House - All areas where food is stored, processed, cooked, prepared, and assembled and cleanup areas. It does not include offices, dry storage or front of the house areas.
- Best Management Practices - Activities, prohibitions of practices, maintenance procedures, and other management practices to prevent or minimize pollution.
- Black Grease - Any FOG commingled with septic wastes (bathroom wastes).
- Brown Grease - FOG waste collected in, or removed from, a FOG control device.
- Building Sewer- The part of the building drainage system that extends from the end of the building drain and conveys the discharge to utility or non-utility owned or operated sanitary sewer system.

- Building Sanitary Drains** - The pipes intended to receive sanitary wastewater and effluent from FOG control devices where FOG control devices are installed or required. FOG or food waste shall not be discharged into the building sanitary drains.
- Dish machine** - Equipment used to sanitize only not to wash.
- Dishwasher** - Equipment that washes and sanitizes.
- Equipment**— All stoves, ranges, hoods, meat blocks, tables, counters, cabinets, refrigerators, freezers, sinks, dishwashing machines, steam tables and similar items, other than utensils, used in the operation of a food service establishment.
- Fats, Oil and Grease (FOG)** - Any substance such as vegetable or animal product used in, or a byproduct of, the cooking or food preparation process, that can cause or lead to corrosion, blockages, reduced flow, or interference with the sanitary sewer system when discharged alone or combined with other materials or waste.
- FOG Capacity Limit** - The combined FOG and solids depth equal to twenty-five (25) percent of the design hydraulic depth in any location of a FOG control device, or seventy-five (75) percent of the rated FOG and solids capacity established by third party certification.
- FOG Control Device** - Equipment designed to remove, hold and prevent the passage of FOG to onsite sewage treatment and disposal systems and sanitary sewer systems.
- FOG Control Device Operator** - Person or entity which has management control for FOG control devices which serve other FOG generators.
- FOG Generator** - Any nonresidential facility, including, but not limited to, restaurants, bakeries, hotel and cafeteria kitchens, commercial kitchens, kitchens serving hospitals, nursing homes, daycares, assisted living facilities and other healthcare facilities, food processing plants or such other nonresidential facilities that can introduce food waste or FOG into building sanitary drains, building sewers, onsite sewage treatment and disposal systems, or non-utility or utility sanitary sewer systems. A FOG generator also includes those nonresidential facilities that produce yellow grease.
- FOG Operating Permit** - Operating permit issued to FOG generators or FOG control device operators pursuant to Sections 24-18 and 24-42.6.
- FOG Sampling Point** - A reasonably accessible location for sampling the effluent of a FOG control device.
- Front of the House** - Office space, dry storage, and in general all areas not included in the back of the house.

Gravity Grease Interceptor- FOG control device that primarily relies on the difference in specific gravity between wastewater and FOG to affect separation of FOG from wastewater.

Grease Interceptor - FOG control device connected to a building grease waste drain or located between one or more fixtures (e.g., three-compartment sink, mop sink, dishwasher, etc) and a building sanitary drain or grease waste (GW) drain line, above or below ground. The term “grease interceptor” is also commonly used to describe the same device. For the intents and purposes of this document the term grease interceptor would be used instead of grease interceptor. Grease interceptors shall not receive sanitary sewage waste (bathrooms).

Grease Waste Drains - The pipes intended to receive FOG and food waste. They convey the discharge to solids separators and FOG control devices.

Hydromechanical Grease Interceptor- FOG control device that is third party tested and certified, and relies on the difference in specific gravity between wastewater and FOG to affect separation of FOG from wastewater, and may incorporate a flow control device, air entrainment, and other means or principles to improve the efficacy of separation as demonstrated by third-party testing, validation and certification.

Interceptor Monitoring Alarm- System and its components capable of monitoring a FOG control device on a regular interval. The system shall trigger a visual and audible alarm at the FOG Capacity Limit.

Interceptor Monitoring Device- System and its components capable of monitoring floating and settled solids in a FOG control device on a regular interval, triggering a visual and audible alarm at the FOG Capacity Limit, and reporting data electronically to the Department at a frequency and format approved by the Director or Director’s designee

Kitchenware – All multi-use utensils other than tableware.

Ordinary Restaurant - Food service establishment with reusable plates and silverware.

Residential FOG Source- Residential kitchen that can introduce food waste or FOG into a building drain, building sewer, onsite sewage treatment and disposal system, or non-utility or utility sanitary sewer system.

Single-service article – Any cups, containers, closures, plates, straws, place mats, napkins, doilies, spoons, stirrers, paddles, knives, forks, wrapping materials and all similar articles which are constructed wholly or in part from paper, paperboard, molded pulp, foil, wood,

plastic, synthetic or other readily destructible materials, and which are intended by the manufacturers to be for one-time, one-person use, then to be discarded.

Single Service Article Restaurant - Food service establishment with throw away utensils, plates, etc.

Solids Separator (SS) - Separator intended to capture solids and allow grease to pass through. It is installed at the source or on the grease waste drains prior to a grease interceptor or a grease interceptor. SS are recommended to improve the operation of grease interceptors. However, SS are always required after a food/solids grinder.

Tableware- Multi-use eating and drinking utensils.

Third Party Certified- A certification by an independent entity that specific equipment or devices have been tested and meet or exceed standards established by the certifying entity and which the certifying entity has reviewed or audited the manufacturing process. The certifying entity shall be recognized by the Director or Director's designee and can include, but is not limited to, the National Sanitation Foundation (NSF), American Society of Mechanical Engineers (ASME), Plumbing and Drainage Institute (PDI) or Canadian Standards Association (CSA) or combination of these and other entities to include the aforementioned requirements.

Utensils- Implements such as pots, pans, ladles or food containers used in the preparation, storage, transportation or serving of food.

Warewashing - Cleaning and sanitizing of utensils and food-contact surfaces or equipment.

Wash-Down Area - Area where FOG generators wash the back of the house mats or equipment.

Yellow Grease - FOG generated as a byproduct from cooking or food preparation that is not mixed with water, wastewater or other waste.

3.0 Rules & Regulations

What facilities or uses can introduce FOG to a utility or non-utility sanitary sewer system? Restaurants, bakeries, cafeterias, hotels, coffee shops, banquet halls (with Kitchen), ice cream parlor, and catering establishments are just a few obvious examples of facilities or uses that can introduce FOG to a utility or non-utility sanitary sewer system. Others are less obvious; e.g., Bank with full kitchen, day care, fish market, tea shop.

Chapter 24, Environmental Code of Miami-Dade County (Section 24-18), requires that FOG Control Devices (FCDs) be installed, and that a sampling point be provided on the effluent/discharge side (i.e., beyond point of no further treatment) of the FCD, for all nonresidential food service establishments/facilities discharging into a

publicly or privately operated sanitary sewer collection system if oil and grease can be introduced into the sewer in quantities which have the potential to affect or hinder the operation of sewage collection, transmission or treatment facilities. Concentrations as low as 150 mg/L of FOG can impact the collection, transmission and treatment facilities.

Chapter 24 also provides that the discharge of grease to a drainfield (onsite sewage treatment and disposal systems, OSTDS) shall not be deemed suitable. Therefore, the requirements and recommendations for the installation of FCDs for publicly or privately operated sanitary sewer collection systems also apply to onsite sewage treatment and disposal systems, except that:

- i) An operating permit is only required for facilities located in a wellfield protection area of any utility or non-utility potable water supply wells, and that
- ii) Hydromechanical systems shall not be used as the primary FCD (refer to section 4.3.2 Facilities).
Note: This may change if future versions of the Florida Building Code remove the requirements of Chapter 64E-6, FAC for gravity systems.

Consequently, FCDs and sampling points shall be provided for all nonresidential food service establishments/facilities discharging to OSTDS.

Applicable Chapter 24 code sections are provided below.

- 24-5 Definitions
- 24-18 Operating Permit required
- 24-15 Plan Approval Required
 - 24-15.1 Procedures for approval of plans
 - 24-15.2 Registered engineer required
 - 24-15.3 Standards for preparation of plans
 - 24-15.3(3) FOG control device required
- 24-42.4 Sanitary sewer discharge limitations and pretreatment standards
- 24-42.6 Fats, Oils and Grease Control Program

Other applicable codes and regulations:

- Florida Building Code – Chapter 10 – Plumbing

Section 1003 Interceptors and Separators

1003.1 Where required

1003.2 Approval

1003.3 Grease interceptors and grease interceptors for publicly owned or investor-owned sewage systems

1003.5 Grease interceptors for onsite sewage treatment and disposal systems.

- Florida Administrative Code

Rule 64E-6 Standards for onsite sewage treatment and disposal

64E-6.013 Construction Materials and Standards for Treatment Receptacles

Rule 64E-11 Food hygiene

4.0 FCD Permitting Process

4.1 Where to submit

Note that the first step for any construction project subject to this guide manual is to “submit” construction drawings to the Building Department having jurisdiction over the establishment/site under construction. Once the a process number is provided by the Building Department, and prior to obtaining a Building (or plumbing) permit, plans must be submitted for DERM’s approval.

If the establishment is located within Unincorporated Miami Dade County (folio 30-) drawings should be taken to the Permitting and Inspection Center (11805 SW 26 Street, Miami FL, 33175) for DERM review.

If the establishment is located within a Municipality (incorporated Miami-Dade County), drawings should be submitted for review at Overtown Transit Village (OTV) – Environmental Plan Review Section (701 NW 1st Court, 2nd Floor, Miami, FL 33136).

4.2 When is a FOG Review Required

Plans for non-residential facilities that can introduce FOG to a utility or non-utility sanitary sewer system or OSTDS require a FOG Review. There are two main entry points for review, Plan Review and Certificate of Use (CU) / Occupational License (OL) Application Review. Plan Review is required for all new development, additions or enlargements, renovations, and changes in use. CU/OL Application Reviews are required for all new uses, changes in use, and changes in name or ownership.

4.2.1 Plan Review Process

A general plan review process diagram for a stand-alone set of plans submitted for one of the following processes is included as **Attachment 1**:

- New construction
- Interior remodeling
- Change in seating capacity, and/or change in area
- Changes in ownership, or type of use
- FCD update to comply with discharge limitations
- Revisions to master permit

A general plan review process diagram and the FOG engineering review process performed by the Wastewater Permitting Section (WPS)/Specialty Review Group is included as **Attachment 2**.

4.2.2 Certificate of Use / Occupational License Application Review

Certificate of Use (CU)/ Occupational License (OL) Application Reviews are required for all new uses, changes in use, and changes in name or ownership. The application entry point is the plan review section, at the Overtown Transit Village for establishments located within Incorporated Miami Dade County, and at the Permitting and Inspection Center for establishments located within Unincorporated Miami Dade County.

Facilities with active FOG Discharge Control operating permit proposing only change in ownership, are required to bring along with the FOG Discharge Control operating permit application¹ a FOG Control Device (FCD) condition assessment², to assure that the FCD is in operating conditions.

Facilities with active FOG Discharge Control operating permit proposing change in food service establishment (FSE) type, or change in seating capacity, or change in area, are required to submit plans for review to include new FCD sizing calculations, proposed pump out frequency, FCD condition assessment using the Department's template².

Facilities with FOG Discharge Control operating permit inactive/closed for a period not to exceed three (3) years, without change of FSE type, or area, or seating capacity, and without enforcement case open; are required to provide FOG Control Device (FCD) condition assessment², to assure that the FCD is in operating conditions. If the FCD is not in working conditions plan review is required to propose a new system.

¹ FOG Discharge Control - Operating permit Application available at <http://www.miamidade.gov/permits/library/grease-discharge.pdf>

² FCD condition assessment template available at <http://www.miamidade.gov/environment/fats-oils-grease.asp>. Form must be completed by a professional engineer, licensed plumber, or a septic tank contractor registered pursuant to Part III of Chapter 489 of Florida Statute, and Part III of Rule 64E-6, FAC

Facilities with FOG Discharge Control operating permit inactive/closed for a period not to exceed three (3) years, and proposing change of FSE type, or area, or seating capacity, or with open enforcement; are required to submit plans for review at the plan review section, to show compliance with the FOG Control Program requirements. Plans submitted shall include a FCD condition assessment² completely filled out to assure that the FCD is in operating conditions. If plans have been approved under FOG 1.5, or FOG 2.0, and the information in the CU/OL application is consistent with the approved plans, new plans submittal is not required.

Facilities with FOG Discharge Control operating permit inactive/closed for more than three (3) years, facilities that never had a permit, facilities marked as NGT, AND with no record of plans approved under FOG1.5 or FOG 2.0, shall submit plans for review at the plan review section, to show compliance with the FOG Control Program requirements. Plans submitted shall include a FCD condition assessment² completely filled out to assure that the FCD is in operating conditions.

4.3. Atypical FSEs

4.3.1 Facilities that serve or Handle Food but don't Prepare it

This category includes facilities like Day Cares, Adult Cares and other regulated by the Department of Health (DOH). Food service establishments under DOH authority are regulated by the Chapter 64E-11, Florida Administrative Code, which clearly outlines when the operation requires to have washing equipment and when it does not. This distinction is used to determine the requirement of a grease interceptor; when washing equipment is required then a grease interceptor is required.

Basically, if the establishment uses or intends to use multiuse equipment and utensils then washing equipment is required. Washing equipment can be comprised of three compartment sink, or/and a two compartment sink and dishwashing machines. DOH rules do not require dishwashing equipment if the FSE will ONLY use single service articles, or if the establishment caters food AND the catering contract/agreement indicates that all multiuse utensils/equipment will be returned to the caterer³.

The local DOH offices issue a Food Permit or a Sanitation Certificate to the establishments under its jurisdiction, which outlines the limitations and prohibitions. Food permits are available upon request from the local DOH office.

³ Email communication with Mr. Ric Mathis, EHPC, Food Safety and Sanitation Program, FL Department of Health, Division of Disease Control and Health Protection

For DERM, with regards to FOG, the requirements for a grease interceptor are summarized in Table 1.

Any facility that:	Any facility that:	Any facility that:
(1) Prepares/Cooks food, or (2) Serves/Handles food prepared on site, catered, or delivered with multi-use utensils (kitchenware)	(1) Prepares/Cooks food, or (2) Requires “Equipment” for washing utensils and/or kitchenware, or (3) Has or Proposes “Equipment” for washing utensils and/or kitchenware	(1) Only uses/requires single-service articles, AND (2) Does not Prepare/Cook food, AND (3) Does not Require “Equipment” for washing Utensils, AND (4) Does not have or propose “Equipment” for washing utensils and/or kitchenware
Must provide washing equipment, and therefore must provide a grease interceptor	Must provide a Grease Interceptor.	Is NOT required (BY DERM) to have a Grease Interceptor (they are NOT prohibited from having a Grease Interceptor)

Table 1. FSEs under DOH Authority Required to have Grease Interceptor

The Department of Health is responsible for working with food service establishments as listed in Table 2, that includes County Health Departments’ inspections and the issuance of food certificates to these facilities. Unless exempted, these food operations need to comply with food manager certification requirements.

Department of Agriculture and Consumer Services (DACS)	Department of Business and Professional Regulations (DBPR)	Department of Health (DOH)
<ul style="list-style-type: none"> • Grocery stores • Food processing plants • Food storage • Food distribution points 	<ul style="list-style-type: none"> • Restaurants • Mobile food vehicles • Caterers 	<ul style="list-style-type: none"> • Institutions • Schools • Civic or fraternal organizations • Bars and lounges • Theaters that serve traditional Theater foods (such as soft drinks, popcorn, hot dogs, etc.) • Locations that participate in the USDA Afterschool Meal Program. • Temporary food events, mobile food units, and vending machines that operate at or through any of these facilities.

Source: <http://www.floridahealth.gov/environmental-health/food-safety-and-sanitation/food-manager-code->

[standards.html](#)

Table 2. FSEs under DOH Authority

4.3.2 Facilities utilizing OSTDS

Pursuant Section 24-42.6(3) of the Miami-Dade County (MDC) Code, FOG shall not be disposed or discharged into any onsite sewage treatment and disposal system (OSTDS), in quantities that may hinder the operation of the OSTDS, exceeds the FOG sanitary sewer discharge limitation and pretreatment standards in Section 24-42.4 (150 mg/l), or causes a sanitary nuisance; therefore a grease interceptor is required for FSEs located in properties served by septic tanks.

Onsite sewage treatment and disposal systems are regulated by Rule 64E-6 of the Florida Administrative Code (FAC), which provides that, in addition to other criteria, the minimum volume for grease interceptor (GI) shall be 750 gallons, and the maximum volume of a single GI chamber shall be 1,250 gallons, and requires the GI to be listed as approved by DOH's.

Facilities served by OSTDS, are therefore regulated by the Department of Health (DOH), and the type of grease interceptor must comply with DOH regulations per Rule 64E-6 (gravity interceptors) and Section 24-42.6.

Onsite sewage treatment and disposal system, located in a wellfield protection area⁴ requires a FOG Operating Permit.

4.3.3 Beer House/ Wine

In general, facilities operating only as Beer House or a Wine bar are not required to install a grease interceptor if NO open food is served at the establishment, and if there is no ware washing equipment onsite (cleaning AND sanitizing-Refer to section 4.3.1 Facilities that serve or Handle Food but don't Prepare it). The FOG reviewer will carefully analyze each case.

4.3.4 Second user

Facilities applying as second user, shall submit plans for review at the plan review section, with updated FOG control device sizing calculations. Plans submitted shall include the FCD condition assessment⁵ completely filled out to assure that the FCD is in operating conditions.

Sizing calculations included with plans shall reflect flow and grease load from all users connected to the grease interceptor. A FOG Discharge Control Operating permit will be issued to each user.

⁴ <http://www.miamidade.gov/environment/library/maps/wellfield-protection-areas.pdf>

⁵ FCD condition assessment template available at <http://www.miamidade.gov/environment/fats-oils-grease.asp>. Form must be completed by a professional engineer, licensed plumber, or a septic tank contractor registered pursuant to Part III of Chapter 489 of Florida Status, and Part III of Rule 64E-6, FAC.

5.0 FOG Design Requirements

Several factors must be considered when deciding the type of system, available space to install the FCD, volume of the waste generated by the FSE, influent concentration, temperature, flow rate, and number of fixtures to be connected to the interceptor, among others. All designs shall be prepared by a Florida Professional Engineer (MDC Code Chapter 24, Section 24.15.2).

Even though all FOG control devices operate on the principle that water and FOG have different specific gravity, for design there are two major types of system, hydromechanical and gravity. Hydromechanical systems are commonly available up to 100 gpm of rated flow capacity, and are generally but not always, located indoors close to the fixture source of FOG. Gravity systems must be located outdoors, the capacity of is measured in gallons, and are most commonly made of concrete, but are also found in fiberglass, plastic, and protected steel.

For the separation of the FOG from the waste stream, hydromechanical FCDs utilize the difference in specific gravity, air entrainment, baffles, and hydraulic flow action; whereas for the gravity FCDs the separation of FOG relies on gravity flow, stokes law and retention time⁶.

Hydromechanical interceptors must be third party certified to one of the following standards ASME A112.14.3 Appendix A, ASME A112.14.4, CSA B481.3 or PDI G101. The certification is for certain flow-through rate (gallons per minute/gpm) and certain pounds of FOG retention capacity. Hydromechanical systems are included in Section 24-42.6 of the MDC Code, and in the Florida Building Code Plumbing (FBC-P), Chapter 10. Where a conflict exists between Section 24-42.6 and FBC-P, the stricter requirement shall apply. When proposing hydromechanical interceptors the engineer should indicate in plans FCD's third party certifier, capacity in gpm, and capacity in pounds of grease retention at 99% removal efficiency. Testing results from the certification of the interceptor must be obtained from the manufacturer.

Gravity Systems are included in Section 24-42.6 of the MDC Code and Florida Administrative Code (FAC) Rule 64E-6. Per FAC Rule 64E-6.013(7) the minimum volume of any gravity grease interceptor shall be 750-gallons and the maximum volume of an individual single grease interceptor chamber shall be 1250 gallons. When the required effective capacity of the grease interceptor is greater than 1250 gallons, installation of multi-chambered grease interceptors or grease interceptors in SERIES is required. Where a conflict exists between Section 24-42.6 and FAC Rule 64E6, the stricter requirement shall apply.

When proposing gravity systems the engineer is required to show in plans the State Health Office's designated approval number that demonstrates that the proposed interceptor was approved as grease interceptor (FAC 64E-6.013(3)). DOH website provides an updated list of approved grease interceptors⁷.

⁶ Source: Grease Interceptors, Continuing Education from the American Society of Plumbing Engineers, CEU 199, May 2013.

⁷ http://www.floridahealth.gov/environmental-health/onsite-sewage/products/_documents/septic-tanks.pdf

For concrete precast interceptors, the engineer is also required to obtain from the manufacturer and include in plans the name of the concrete precast plant and name of the plant's certifying agent approved by the Department of Transportation (MDC Code Section 24-42.6(8)(q)). The tank shall also be designed to withstand a pH of 3.

5.1 Fixtures to be connected to Grease Interceptor

All plumbing fixtures with potential to discharge grease-laden waste located in food and beverage preparation areas must be routed through a grease interceptor (GI). The obvious fixtures include:

- Preparation (Prep) sinks,
- Pre-rinse sinks,
- Pot sinks,
- Three-compartment sinks,
- Mop sinks,
- Dishwashers (ware washers), and
- Floor and trench drains

There are other fixtures that can contribute FOG (e.g., wok stations, pasta stations, etc.). All fixtures that can contribute FOG shall connect to the building grease waste (GW) drain line. The GW drain line shall be clearly marked with GW to distinguish it from the sanitary line serving bathrooms and other sources that should not be plumbed to the grease interceptor.

The location of the fixture is also important, for example, a floor drain located behind the service counter shall be connected to the GW drain line even if there is no direct FOG discharge connected to it (refer to **Error! Reference source not found.**). Some judgment should be exercised for existing facilities as it applies to floor sinks or floor drains. In some applications, floor drains can't be used to discharge greasy water and only serve to provide a point of discharge for an indirect discharge (e.g., ice maker).



5.2 Wastewater Flow Rate and FOG Mass Rate

Wastewater flow rate and mass rate are determining factors in the design of a grease waste pretreatment system. Calculations and considerations will differ for hydromechanical and gravity systems.

5.2.1 Wastewater Flow Rate [MDC-Section 24-4.6(9)(g)]

Peak flow must be calculated to properly size a grease interceptor to a particular use. When the total number of fixtures is unknown (shell building), peak flow can be calculated using Manning’s Formula for full pipe flow for the grease waste drain nominal diameter and slope and a roughness coefficient of 0.0113.

For plans for a build out, or renovation, where the number of fixtures is a known factor, peak flow can be estimated as provided above for shell building, total fixture flow rate using one (1) or two minute (2) drain time, or using drainage fixture units (DFUs). For DFUs, the peak flow rate shall be calculated by multiplying the proposed DFUs by the flow rate calculated using Manning’s Formula for full pipe flow and a roughness coefficient of 0.0113 and divided by the maximum number of DFUs allowed under the Florida Building Code, latest edition, for the grease waste drain diameter and slope. In any case, the calculated flow shall not be less than the flow rates listed below.

Nominal pipe size in inches	Minimum Total Flow Rate at Grease Interceptor Influent
1.25 – 2.5	20 gpm
3	23 gpm
4	50 gpm
5	91 gpm
6	147 gpm
8	317 gpm

Table 3. Minimum Peak Flows (MDC Code Section 24-42.6(9)(iii))

Note that the listed flows are NOT default peak flows, but instead shall be used if the calculated flow is less than the minimum listed above. For example, if the calculated flow for a 4-inch GW drain is 35 gpm, the minimum peak design flow shall be 50 gpm. Likewise, if the calculated flow is 95 gpm, the design flow shall be 95 gpm.

5.2.2 FOG Loading

Fats Oils and Grease loading to the interceptor is used to calculate cleaning frequencies, and as a factor to properly calculate the size of the grease interceptor. The production of FOG per meal changes according to the type of food service establishment, the following values might be used to estimate the FOG loading to the grease interceptor per meal.

Grease Production ⁸	(lbs/meal)	FSE TYPE
Very Low	.01	<ul style="list-style-type: none"> • Bar • Tea Place
Low	.02	<ul style="list-style-type: none"> • Convenience store • Delicatessen • Juice bar • Sandwich shop no cooking • Snack Bar • Sushi bar
Medium	.03	<ul style="list-style-type: none"> • Coffee house • Fast food, Greek, Indian • Fish market • Frozen yogurt/smoothies • Grocery store (no fryer) • Ice cream parlor • Pizza
High	.04	<ul style="list-style-type: none"> • Bakery • Buffet • Cafeteria • Full Service restaurant • Steak house
Very High	.05	<ul style="list-style-type: none"> • FSE with Fryer • FSE with rotisserie • Full fare Mexican, BBQ, Asian Cuisine, American

Table 4. FOG Loadings

5.3 Hydromechanical FCD Selection & Configuration

Sizing requirements are included in Section 24-42.6(9)(c) of the code. When sizing for a hydromechanical grease interceptor the engineer should consider flow rating capacity (gpm) as well as the grease retention capacity at 99% removal efficiency of the interceptor. Where more than one (1) hydromechanical grease interceptor is required to provide the required removal efficiency, they shall be installed in series and the removal efficiency shall be based on the third party testing of the proposed configuration (MDC Code Section 24-42.6(9)(d)). The engineer designing the system shall obtain from the manufacturer testing information, and include it with plans.

The minimum size and number of grease interceptors shall be the greatest of the following:

- i) 20 gallons per minute

⁸ Refer to ASPE Plumbing Engineer Design Handbook Volume 4., Chapter 8

- ii) Calculations based on the Florida Building Code, latest edition.
- iii) Calculations based on peak flow rate

AND

Grease Interceptor FOG Storage Capacity at 99% efficiency > M (meals/day) x FOG MEAL (lbs/meal) X T (Cleaning Frequency)

Where,

M = maximum number of meals served per day

FOGMEAL = average pounds of Fats, Oils and Grease contained per meal (Table 4)

5.4 Gravity FCD Selection & Configuration

FCD sizing requirements are included in Section 24-42.6 (9)(a) of the Code. Grease Interceptor(s) proposed shall comply with minimum and maximum size (effective volume) requirements of 64E6, FAC.

The minimum size and number of grease interceptors shall be the greatest of the following:

- i) Grease interceptor volume based on the Florida Building Code, latest edition.
- ii) Alternative calculations:
 - a. Third party certification of the effluent concentration showing that complies with discharge standards per Section 24-42.4 (150 mg/L), or of the FOG removal efficiency at 99%.
 - b. Grease interceptor volume based on peak flow rate (Q_{PEAK}) and thirty (30)-minute hydraulic detention time. Total calculated volume shall be increased to account for the maximum volume of waste stored between cleaning cycles (V_{FOG}).

$$V = Q_{PEAK} \times 30 \text{ min} + V_{FOG}$$

Q_{PEAK} = peak flow rate, gpm (full pipe flow based on pipe diameter, slope & DFUs)

V_{FOG} = volume of waste stored between cleaning cycles

- iii) Grease Interceptor Volume (V) calculated based on Chapter 64E-6, Florida Administrative Code.

$$V = [S \times HR/12 \times GS \times RF] + [M \times GM \times LF] + V_{FOG}$$

Where,

S = Number of seats (indoor and outdoor)

HR = Hours of Operation, including prep time and closing

GS = Gallons per seat (25 gallons for ordinary restaurants and 10 gallons for single service article restaurant)

RF = Road factor: use 2.0 interstate highways, 1.5 other freeways, 1.25 recreational areas, 1.0 main highway, and 0.75 other roads.

LF = No ware washer 0.75, with ware washer 1 (additional hydraulic detention time for surfactants and heat)

M = Number of meals served per day, excluding sit-down restaurant meals (take out, drive-thru, banquet, room service, etc.).

If no take-out meals, specify NO Take-Out Meals. If no drive-thru, specify NO Drive-Thru.

GM = 5 gallons per meal

LF = Ware washer 1, without use 0.75

V_{FOG} = Volume of waste stored between cleaning cycles (Table 5)

Cleaning Cycle	Multiplying Factor
Every 30 days	1.0
Every 60 days	1.15
Every 90 days	1.25

Table 5. Gravity Cleaning Cycle Factors

5.5 Shared FCDs Sizing Considerations

Some facilities share FCDs, more common cases are observed in malls, and multiuse buildings. When a FCD serves more than one site, the administrator of the system shall keep track of the capacity allocated to each site, as follows:

Gravity systems

- For restaurants: number of seats, hours of operation, type of establishment (ordinary restaurant or single service article restaurant)
- Commercial kitchens: number of meals per day and whether the site is equipped with dishwasher or not.

Hydromechanical systems

- Number of DFUs or GPM allocated per site.
- Grease production factor according to the type of FSE (Table 4)

Plans submitted for a FSE with a shared FOG control device shall incorporate sizing calculations for all the FSEs in the system to show available capacity for the project.

5.6 FCDs Sizing for Shell Spaces

When sizing FCDs for shell spaces, where the configuration of the system is unknown, the size of the FCD provided shall be adequate for the maximum capacity of the grease waste (GW) drain line, according to Table 710.1(1) of the FBC-Plumbing, shown below.

Engineering assumptions with sizing calculations are expected. For example, when proposing a gravity system the engineer may determine the seating area for the future FSE and based on occupation rates estimate the seating capacity. Table 1004.1.1 of the Florida Building Code, provides occupational loads for restaurants/dining room area as 1/15, i.e., for a dining area of 600 square feet, the estimated number of seats can be derived based on number of people allowed as 600/15, 40 people/seats. The engineer designing the system should exercise caution as the capacity of the FCD will limit future use.

DIAMETER OF PIPE (Inches)	MAXIMUM NUMBER OF DFU / Slope per Foot		
	1/8	1/4	½
2	--	21	26
3	36	42	50
4	180	216	250
5	390	480	575
6	700	840	1000

Table 6. DFUs per Pipe Size

5.7 FCD Sampling Point

Pursuant MDC Code Section 24-42.6(8), a reasonably accessible location to sample the effluent of the FOG control device shall be provided. The sampling point shall be located after the point of no further treatment. Sampling points located after an individual grease interceptor shall not be considered sufficient for the

purpose of demonstrating compliance if there are other fixtures that can introduce FOG beyond the sampling point. A sampling point located after an individual grease interceptor can be used to evaluate the performance of the individual interceptor, but not for overall compliance. Therefore when the system consists of more than one FCD, it is required to provide one compliance sampling point after the flow from all FCDs after is combined.

Referring to **Error! Reference source not found.**, note that the existing grease interceptor is inadequate because there are fixtures (e.g., dishwasher) that can introduce FOG into the private or public sewer connected to the building (kitchen) drain after the grease interceptor. Also note that the sampling point is inadequate for the same reason.

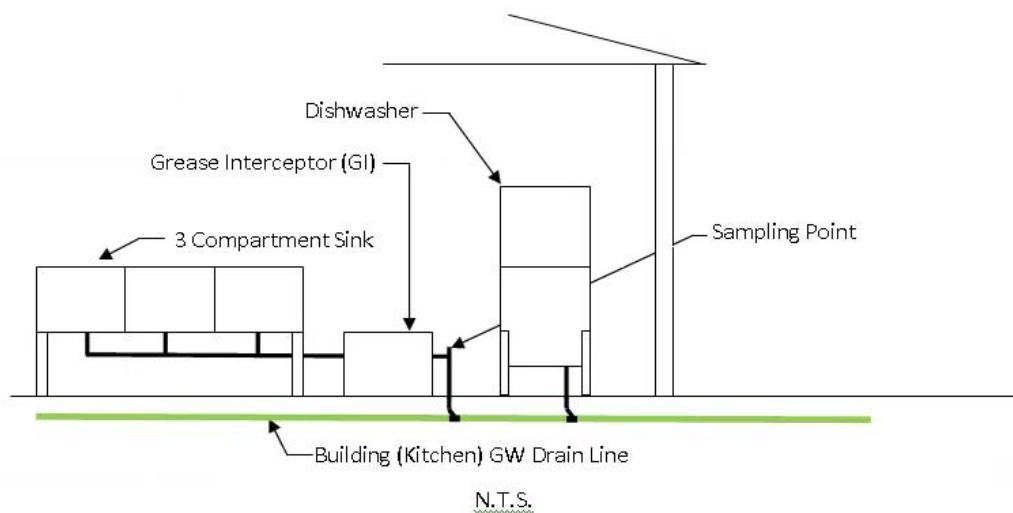

Figure 1. Grease Interceptor Location Inadequate

In Figure 2 and Figure 3 below, note that the existing grease interceptor is adequate because it is located beyond all fixtures that can introduce FOG into the private or public sewer. Also note that the sampling point is adequate for the same reason.

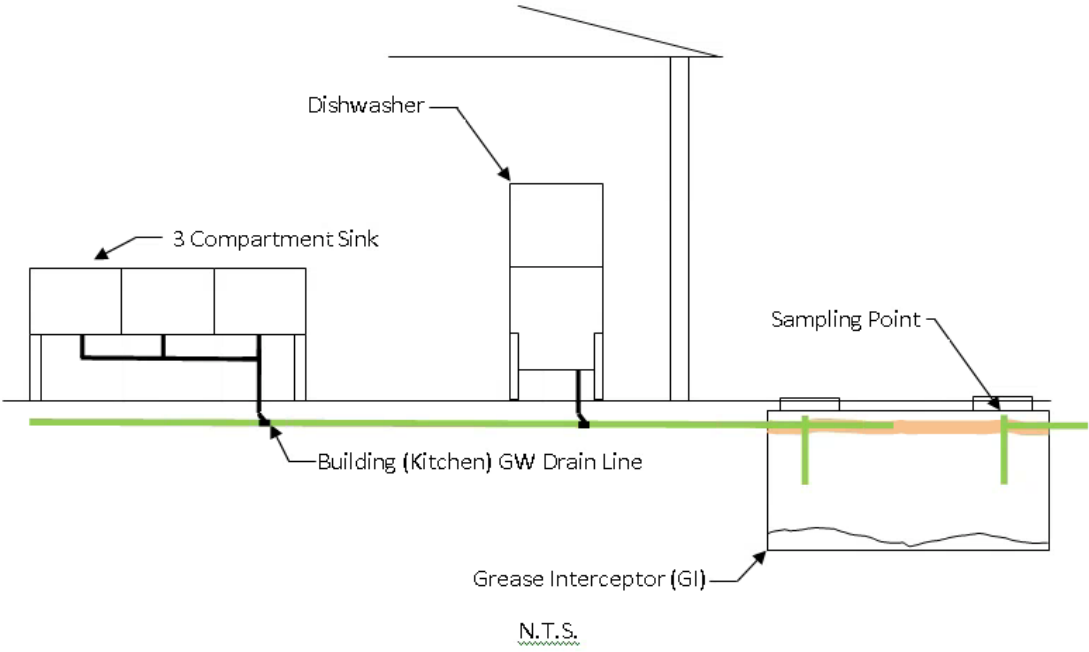

Figure 2. Grease Interceptor and Sampling Point Adequate Location

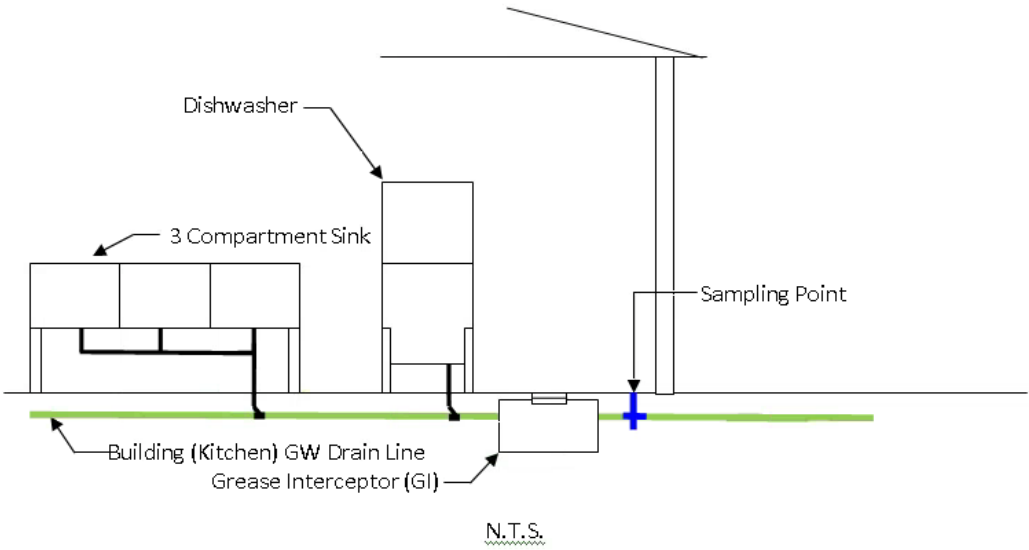

Figure 3. Grease Interceptor adequate Location

Some grease interceptors have a built-in sampling port (point) while others have “viewing ports” not suitable for sampling. To be suitable for sampling, the opening shall be easily accessible and allow the introduction of a sample bottle (min 3” diameter and min 6” long). For grease interceptors that do not have an accessible

sampling point, a manufactured sampling point (device/bucket) can be installed. Several grease interceptor manufacturers have sampling point (devices/buckets) that can be used to collect a compliance sample, some samples are included in Figure 4.



Figure 4. Sampling Port Configurations

Manufactured sampling points (devices) shall have sufficient depth and access to allow sample collection using a 3-inch diameter x 6-inch long sample bottle.

An alternative to a manufactured sampling point (device) is a plumbing fitting configured to allow sample collection. Sampling point design shall at least comply with:

- A double sanitary tee installed on the building (kitchen) GW Drain Line and located hydraulically beyond all fixtures that can contribute FOG (e.g., 3-compartment sink, mop sink, dish washer, prep-sink, etc.).
- The double sanitary tee sampling point includes a PVC-CAP on the bottom of the vertical axis to create the sampling sump.
- Minimum diameter vertical axis is 4-inch, and minimum depth of the sump 6-inch.

The configuration is provided below (Figure 6), shows drawings of double sanitary tees on 4-inch, 3-inch and 2-inch GW lines are shown. Note that utilizing DERM's retrofit sampling point detail is not mandatory. **The engineer of record shall design/select the most appropriate sampling point design to assure consistent and representative sampling results based on site-specific facility and operation conditions.** The sampling point

shall be directly accessible for visual inspection and sampling. Minimum diameter for the vertical axis is 4-inches. Minimum clearance for sampling port is 3 ft horizontal and 4 ft vertical, shall be shown in plans.

Sampling is performed during flowing conditions with sampling bottle tilting in the direction of flow which causes the bottle to quickly sink into sump, resulting in a full sample bottle. Sampling shall commence 15 seconds after flowing conditions are established.

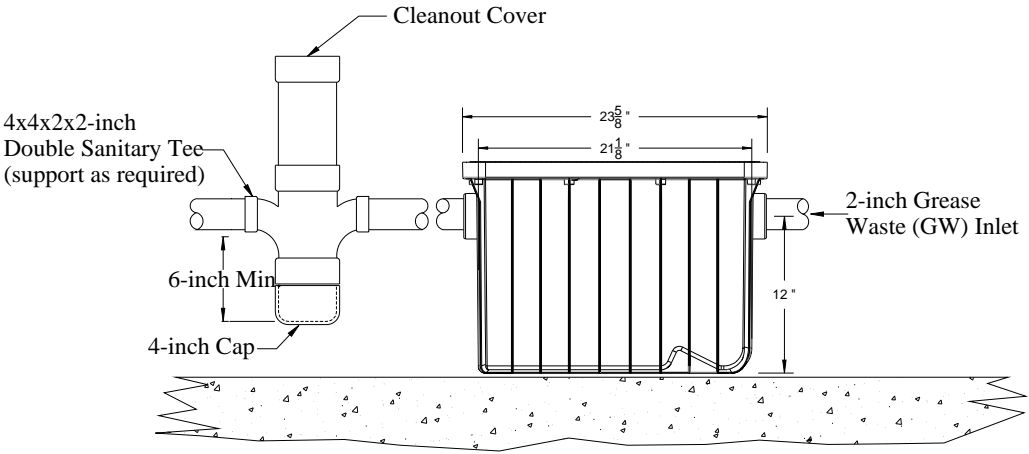

Figure 5. Sampling point above ground

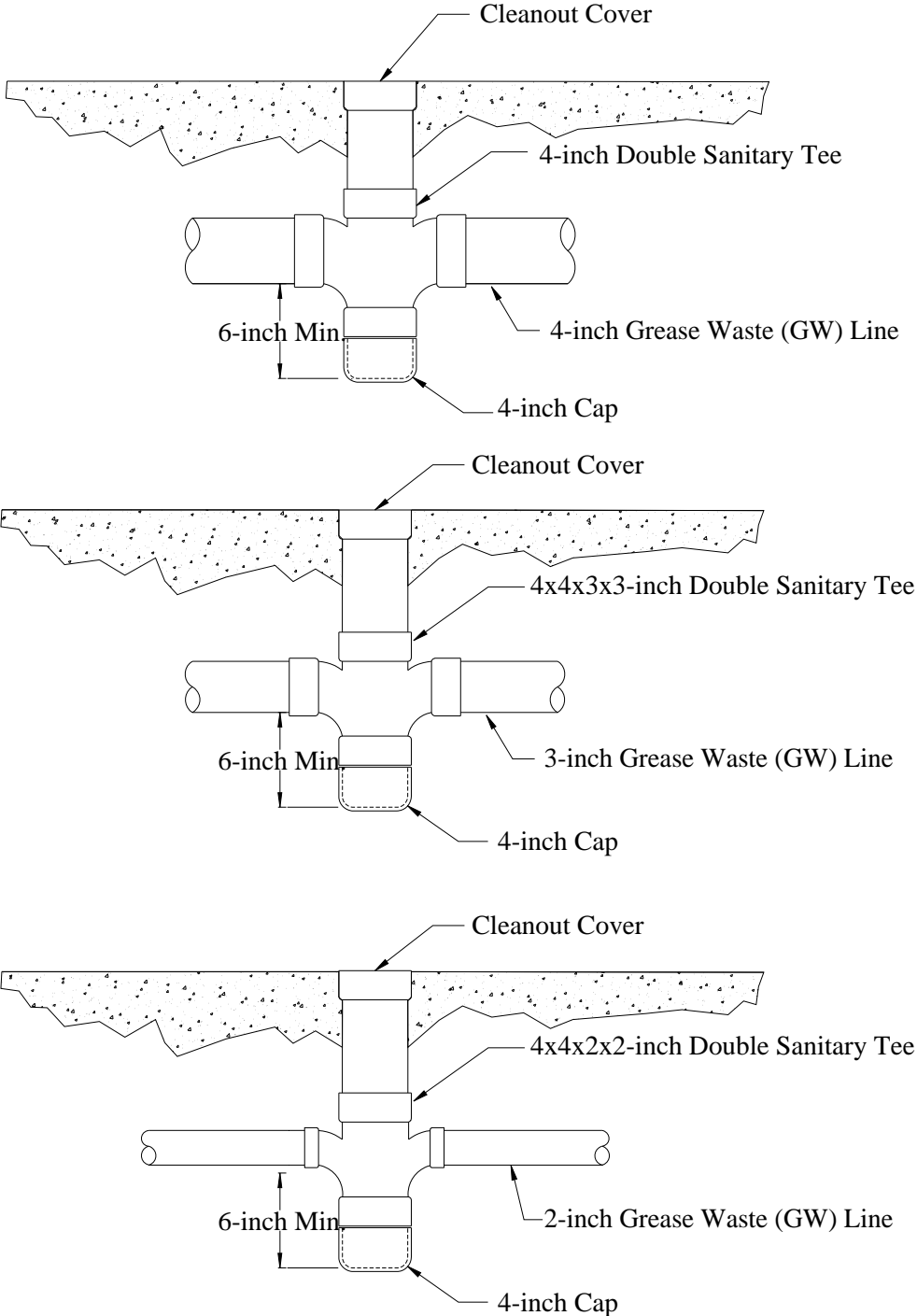

Figure 6: Sampling Point Schematics (NTS)

The sampling point shall not be confused with a cleanout, which are part of most systems and are there to provide access to the line, but are not configured to allow sample collection. Section 708 of the FBC-Plumbing indicates that cleanouts when required must be accessible and shall not be covered with cement or plaster. See below for example of cleanout located before and after an In Ground interceptor.

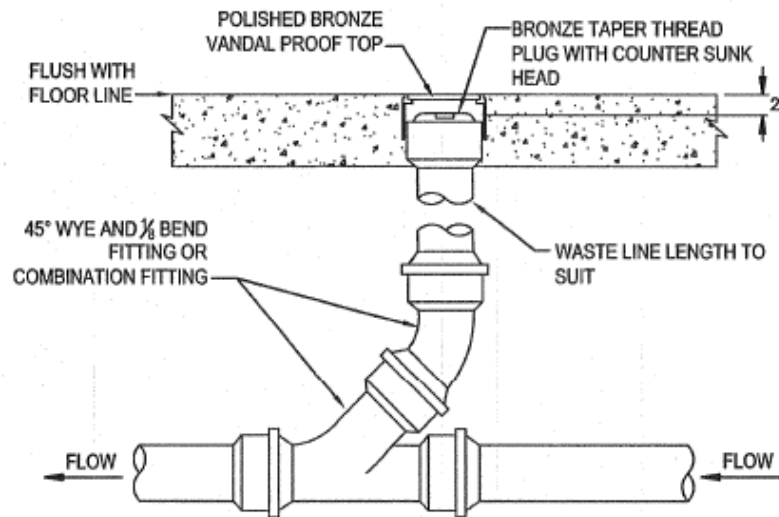

Figure 7. Cleanout Schematic

5.8 FCD Accessibility

Accessibility is also a very important consideration when deciding location of the FCD. In the case of hydromechanical systems located inside the establishment, installations under the 3-compartment sinks or under counters are not accepted. The design shall give enough clearance for maintenance and inspection purposes. Usually four (4) feet of vertical clearance will be enough, depending on the size of the FCD. Ultimately the dimensions of the FCD shall determine the required clearance. A minimum clearance of 4-ft vertical and 3-ft horizontal shall be shown on plans for interceptor and sampling point. The FOG Ordinance, provides that FCDs shall be installed below grade (MDC Code, Section 24-42.6(8)(g)).

Systems with manholes as access point shall not be located in areas with high traffic like drive thru lines or parking lot spaces. Design phase shall also consider access route to the FCD for pump out, and location of the FCD in areas where the public/customers or the operation of the establishment is not disturbed during the maintenance.

Horizontal run is another aspect of the design sometimes overlooked by the engineer designing the system, to avoid clogging of pipes with congealed grease location of the grease interceptor more than 25-feet from the source is not advised (PDI-G101-installation).

Section 24-42.6(8)(v) of the MDC code provides that when the location of the interceptor is at a distance greater than 50-ft from the source of FOG, access points must be provided at least every 50-ft. When the distance is greater than 100-ft, the engineer must include in plans strategies to avoid clogging of lines by FOG. If the FCD is located at a different floor from the source of FOG, or at more than 100-ft horizontal distance, an Interceptor Monitoring Alarm or Device will be required.

Drawings shall include an elevation of the FCD and sampling port to show that the proposed location of the interceptor and sampling port, allows the inspection of contents of the interceptor and the collection of samples while standing on the ground/floor.

5.9 Other Design Considerations

5.9.1 Existing FOG Control Devices

When a new facility is connecting to an existing FCD, or when an expansion or renovation is proposed where the existing FCD will remain, a certification that the grease interceptor is in optimal conditions is required. The FCD will need to be inspected by a licensed plumber or a Liquid Waste Transporter with a valid DERM operating permit. Said inspection shall be performed with tank dry (all contents pumped out) to inspect for tank integrity (no cracks, exposed rebar, waffling, etc.). The inspection results shall be included in the Department's FCD condition assessment template format available at:

<http://www.miamidade.gov/environment/fats-oils-grease.asp>.

5.9.2 Facilities adding Seating Capacity

Adding seating capacity is directly correlated with the FOG control device capacity. In the case of gravity systems regulated by Rule 64E-6, sized based on number of seats the relation between number of seats and capacity is clear. For Hydromechanical systems where the sizing criterion is in gallons per minute (GPM) the grease capacity of the system might limit the number of seats. In both cases the design professional shall show new Sizing calculations and new pump out cycle calculations.

5.9.2 Stormwater/Rainwater

The installation of a FCD shall not allow the infiltration of rain water in the sewer system. See figure below, where an outdoor grease interceptor was provided with a pump to evacuate rain water through the sewer line. Outdoor mop sinks are also not allowed, to avoid rainwater infiltration in the system.

5.9.3 Solids Separators

Grease waste systems receive solids and food solids from grinders and mainly as a result of lack of best management practices during cleaning activities (untrained staff). The accumulation of solids reduces the effectiveness of the FCD by reducing hydraulic detention time, and is problematic for the flow control mechanisms as solids can block the flow control, which effectively reduces pipe size; most if not all hydromechanical units, require a flow control.

Solids separation is a critical component to preventing plumbing backups, and to reduce the frequency of pump/maintenance for the FOG control device; therefore the importance of installing adequate Solids Separators.



Figure 8. Rain water vs. GI Installation

Per FBC-Plumbing Section 1003.3.2 where discharge of food waste grinders is to be connected to the grease interceptor, a solids separator shall be used to separate the solids before connecting to the FCD. Per MDC Code, Section 24-42(8)(v) solid separation is required for all FCDs that are equipped with a flow control device or that are not certified to handle solids. Solid separators shall at a minimum meet intended flow rate of the fixture they are installed on.

5.9.4 Yellow Grease Storage Areas

Yellow and brown grease storage areas shall be designed to prevent the release of FOG to ground, groundwater, surface waters or storm sewers. Storage containers shall be sized so they do not exceed ninety percent capacity prior to being emptied. All storage containers shall have a lid that prevents rainwater inflow and can be locked to prevent vandalism (MDC Code Section 24-42.6(5)(v), (6)(v), (8)(s)).

5.9.5 Wash-Down Areas

All wash-down areas shall be designed to prevent the release of wash-water and FOG to ground, groundwater, surface waters, storm sewer ((MDC Code Section 24-42.6 (8)(t)).

5.9.6 FOG Alarms & Sensors

The use of monitoring devices, with alarms and sensors is a recommended practice as a means to properly manage the levels of floating and settled solids. Regular monitoring will ensure that the total solids are being kept at twenty-five (25) percent or less, and therefore managing the pump out frequency of the interceptor more efficiently. The MDC Code provides that for FCDs located at a remote location, an Interceptor Monitoring Alarm or Device is required (Section 24-42.6(8)(v)).

Remote locations include a different floor, or any horizontal distance exceeding one hundred (100) feet from the back of the house area.

5.9.8. No Direct Connection for 3-Compartment Sinks

Per FBC-802.1.8 Sinks used for the washing, rinsing or sanitizing of utensils, dishes, pots, pans or service ware used in the preparation, serving or eating of food shall discharge indirectly through an air gap or an air break to the drainage system.

LIST OF ACCRONYMS

ASME	American Society of Mechanical Engineers
BMPs	Best management Practices
FBC-P	Florida Building Code, Plumbing
FCD	FOG Control Device
FOG	Fats, Oil, and Grease
FU	Fixture Units
GI	Grease Interceptor
GW	Grease Waste
OSTDS	Onsite Sewage Treatment and Disposal Systems
PDI	Plumbing and Drainage Institute
PIC	Permitting and Inspection Center
SS	Solid Separator
WPS	Wastewater Permitting Section

LIST OF FIGURES

Figure 1. Grease Interceptor Location Inadequate 21

Figure 2. Grease Interceptor and Sampling Point Adequate Location 22

Figure 3. Grease Interceptor adequate Location 22

Figure 4. Sampling Port Configurations 23

Figure 5. Sampling point above ground 24

Figure 6: Sampling Point Schematics (NTS)..... 25

Figure 7. Cleanout Schematic 26

Figure 8. Rain water vs. GI Installation 28

Attachment 8
URT Meeting Presentation 10-11-2017

**Department of Regulatory and Economic Resources (RER)
Division of Environmental Resources Management (DERM)
is Hosting the**

17th Utility Round Table

Meeting

Date: Wednesday, October 11th, 2017

Time: 10:00 am to 12 noon

Location: Overtown Transit Village-North
Training Room – 2nd Floor
701 NW 1st Court,
Miami, FL 33136



Topics of Discussion:

- Stakeholders Presentations
- Consent Decree Requirements - Update
- Water Atlas in GIS Format Due 1/30/2018
- COI Televising Report: Due 12/31/2018
- PS Moratorium Status - Update
- ~~“Low Pressure Systems”~~ Force Main Systems
- ETs Readings for Month of SEP-2017
- New “Regular” Agenda Items for URT Meetings
- SEWER EXTENSION REVIEWS:
 - Review Actions - Refresher
 - “What Not to do” - Sample Cases
 - “No Permit Required” (NPR) Permits
 - Who is required to Connect?
- Under Development

*For more information please contact us at:
PSO@miamidade.gov*

New URT Meeting Format Stakeholder Report / DERM Report (Starting 10/11/2017)

• Part A: Utilities

1. Presentation/Report

- Miami Beach
- Coral Gables
- Hialeah
- North Miami

2. Suggested Topics:

- Achievements
- System Improvements
- Any other significant topic

• Part B: RER-DERM

1. Presentation/Report

- Over all Compliance Status Summary

2. Additional Suggested Topics:

- New/Improved Forms
- Sewer Extension Updates
- Efforts to improve Reviews
- Any Other

Part A: Stakeholders Presentation

Miami Beach / Coral Gables / Hialeah / North Miami

Part A: Stakeholders Presentation

Miami Beach / Coral Gables / Hialeah / North Miami

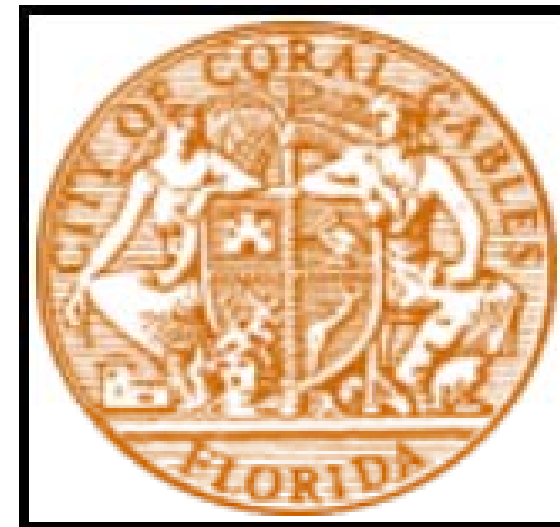

Important dates

Reminder

Due Dates:

1. **1/01/2018:** 2018-JAN1 Illicit Stormwater Discharges Rpt
2. **1/06/2018:** GIS As-Builts Submittal – UPDATE
3. **1/30/2018:** [Water Atlas in GIS Format](#)
4. **1/31/2018:** 2017-CMOM Annual Status Rpt
5. **3/01/2018:** 2017/2018-SSES Annual Report (New Format)
6. **7/01/2018:** 2018-JUL1 Illicit Stormwater Discharges Rpt
7. **11/12/2022:** SSES 3rd Cycle – All PS Basins *



Part B: RER - DERM Presentation

Status - Updates

CMOM / POC / ILLICIT CONNECTIONS / SSES / GIS

Update



CMOM Annual Rpt / SSES-Ph-3 / Illicit Connections

Update

Utility/VSC	SSES Phase 3 Rpt (Due 11/12/2016)	GIS As-Builts (Due 1/06/2017)	POC (Due 3/11/2016)	2016 CMOM Annual Rpt (Due 1/31/2017)	2017-JUL1-ILLICIT CONN. (Due 7/01/2017)
02-CITY OF MIAMI BEACH	SUBMITTED	SUBMITTED	SUBMITTED	SUBMITTED	SUBMITTED
03-CITY OF CORAL GABLES	SUBMITTED	SUBMITTED	SUBMITTED	SUBMITTED	SUBMITTED
04-CITY OF HIALEAH	SUBMITTED	SUBMITTED	SUBMITTED	SUBMITTED	SUBMITTED*
06-CITY OF NORTH MIAMI	SUBMITTED	SUBMITTED	SUBMITTED	SUBMITTED	SUBMITTED
07-CITY OF NORTH MIAMI BEACH	SUBMITTED	SUBMITTED	SUBMITTED	SUBMITTED	SUBMITTED
08-CITY OF OPA LOCKA	SUBMITTED	SUBMITTED	SUBMITTED	SUBMITTED	SUBMITTED
10-CITY OF HOMESTEAD	SUBMITTED	SUBMITTED	SUBMITTED	SUBMITTED	SUBMITTED
12-BAL HARBOR VILLAGE	SUBMITTED	SUBMITTED	SUBMITTED	SUBMITTED	SUBMITTED
13-RAY HARBOR ISLANDS	SUBMITTED	SUBMITTED	SUBMITTED	SUBMITTED	SUBMITTED
14-TOWN OF SURFSIDE	SUBMITTED	SUBMITTED	SUBMITTED	SUBMITTED	SUBMITTED
15-CITY OF WEST MIAMI	SUBMITTED	SUBMITTED	SUBMITTED	SUBMITTED	SUBMITTED
16-CITY OF FLORIDA CITY	SUBMITTED	SUBMITTED	SUBMITTED	SUBMITTED	SUBMITTED
22-TOWN OF MEDLEY	SUBMITTED	SUBMITTED	SUBMITTED	SUBMITTED	SUBMITTED
23-CITY OF NORTH BAY VILLAGE	SUBMITTED	SUBMITTED	SUBMITTED	SUBMITTED	SUBMITTED
27-CITY OF HIALEAH GARDENS	SUBMITTED	SUBMITTED	SUBMITTED	SUBMITTED	SUBMITTED
30-MIAMI-DADE WATER & SEWER DEPARTMENT	SUBMITTED	SUBMITTED	SUBMITTED	SUBMITTED to EPA	On-Going
00-MIAMI INTERNATIONAL AIRPORT (Miami-Dade CO.)	SUBMITTED	SUBMITTED	SUBMITTED	SUBMITTED	SUBMITTED
	REVIEW COMPLETED	UNDER REVIEW	UNDER REVIEW	REVIEW COMPLETED	* Pending Repairs

Water GIS Atlas w/ Customer Layer Importance & Use



Water GIS Atlas w/ Customer Layer

Basics - Requirements

- Pursuant to Potable Water Operating (PWO) Permit - Specific Condition No. 3:

Regulation Division, 701 NW 1st Court, 7th Floor, Miami, FL, 33136.

3. The permittee shall submit, by January 30th of each year, a map (valve and water line atlas) to the Director or his designee which includes a list of all water service areas including the total length (in feet) of water lines according to pipe diameter and type of material. It is recommended that the submittal be in Arc View electronic shape files, including: (1) Distribution Lines, (2) Transmission Lines, (3) Valves and (4) Fire Hydrants. The files shall be in State Plane Coordinates NAD 83, with the units in feet. The following parameters for each of the above shape files shall also be included in the submittal: (a) Distribution Lines and Transmission Lines: pipe diameter, length, material, (b) Valves: size, type, x-y coordinates, (c) Fire Hydrants: x-y coordinates.

GENERAL CONDITIONS

Water GIS Atlas w/ Customer Layer

Importance & Use

- **GIS Atlas to be used in Plan Reviews**
- **Improve Customer Service Efficiency**
- **Connections Required under Chapter 24**
- **Some Utilities already have a Water GIS Atlas**

Water GIS Atlas w/ Customer Layer

Basics - Requirements

- **Water Atlas due by January 30th, 2018**
 - **It is recommended that All utilities submit the Water Atlas in GIS format**
 - **Shape Files to be compatible with WASD GIS System**
- **Including :**
 - **1) Distribution Lines**
 - **2) Transmission Lines**
 - **3) Valves**
 - **4) Fire Hydrants**
 - **5) Customer Water Account Layer (to improve customer service)**
- **Yearly Updates**

Cone of Influence (COI) Televising & *Repair Completion* Report

Due 12/31/2018

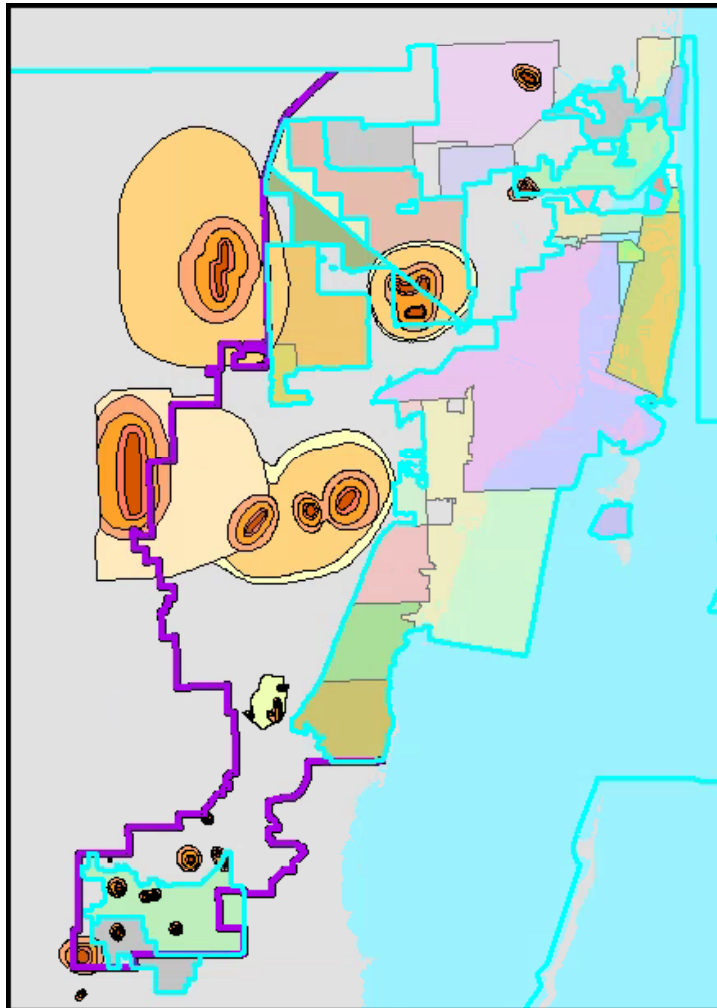

- **Utilities with collection systems within a COI:**

- Hialeah,
- North Miami,
- North Miami Beach,
- Homestead,
- Florida City,
- Medley*,
- WASD, and
- MIA.

* Completed

COI Televising & Repair Completion Reports Criteria

- **DERM Reminder Letters**
 - Sent to Utilities December 7, 2016

a Miami-Dade County wellfield protection area. Section 24-43 (4)(b)(v) of Chapter 24 of the Code of Miami-Dade County, requires that:

"Existing gravity sanitary sewers with pipe diameters of eight (8) inches or more shall be visually inspected by television every five (5) years by the responsible utility or property owner to ensure both structural and pipe joint integrity. Existing manholes shall be visually inspected for both structural and incoming pipe connection integrity every five (5) years.

A report documenting the certified test and inspection results and repair logs shall be submitted to the Department for review and approval within thirty (30) days after completion of the particular test, inspections, and repairs, but no later than twelve (12) months from the end date of the five (5) year cycle."

Be advised that December 31, 2017, marks the end of a five (5) years cycle. Therefore, the required report certifying the inspection results and repair logs pertaining to the above requirement shall be submitted to DERM, for all portions of your system within the wellfield protection area, by **no later than December 31, 2018**.

The report(s) shall be submitted in **electronic format, Certified (signed and sealed) by a Professional Engineer in the State of Florida**, as part of the documentation of the work done. Any televising records shall be transferred into DVD/CD format and the field records shall be scanned and submitted in PDF format.

If you have any questions about the above, please contact Mr. Carlos Hernandez, PE, HernaC@miamidade.gov or Mr. Oscar Aguirre, EI, (AguirO@miamidade.gov), at (305) 372-6486.

Sincerely,

- **Current 5 Year Cycle ends:**
 - December 31, 2017
- **COI Televising & Repair Completion Report Due to DERM by:**
 - On, or before, December 31, 2018

COI Televising & Repair Completion Reports Code Requirement

- (b) Sanitary sewers. For any land use served or to be served by sanitary sewer which require a building permit for new construction, enlargement, or alteration that increases gross square area, the sewage loading into sanitary sewers will not exceed the number of gallons per day for each unsubmerged acre of land as set forth in Table B-1, or that the property is residential, uses a public water supply, has not been the subject of any zoning action (district boundary change, unusual use, use variance, or equivalent municipal zoning action) or any platting action (final plat, waiver of plat, or equivalent municipal platting action) after March 13, 1981. All sanitary sewers, or portion thereof, installed within a wellfield protection area of any utility potable water supply well, after June 13, 1986, shall comply with the following standards:

24-43 (4)(b)(v)

approval within thirty (30) days after completion of the particular test, inspections and repairs.

Existing gravity sanitary sewers with pipe diameters of eight (8) inches or more shall be evaluated by closed circuit television or other method as approved by the Director every five (5) years by the responsible utility or non-utility to determine structural and pipe joint integrity. Existing manholes shall be visually inspected for both structural and incoming pipe connection integrity every five (5) years.

A report documenting the certified test and inspection results and repair logs shall be submitted to the Department for review and approval within thirty (30) days after completion of the particular test, inspections, and repairs, but no later than twelve (12) months from the end date of the five (5) year cycle.

- (c) Storm water disposal methods. For any land use required to install or modify a storm water disposal method the storm water disposal methods utilized or to be utilized will be limited as set forth in Table C-1.

Pump Stations Status

10/01/2017



Pump Station Basins - Status

10/01/2017

PS Basins - Moratorium Status (OCT-01-2017)													
Utility/VSC	TOTAL	AC	AH	AM	CH	CM	CN	FH	IM	IN*	OH	OK	
02-CITY OF MIAMI BEACH	25	2	1	1						1	2	18	72%
03-CITY OF CORAL GABLES	35	1							1		3	30	86%
04-CITY OF HIALEAH	94			1	4	4	3		1	27	2	52	55%
06-CITY OF NORTH MIAMI	44			1	3	4			3	7	4	22	50%
07-CITY OF NORTH MIAMI BEACH	94											94	100%
08-CITY OF OPA LOCKA	19			1	1				1	14		2	11%
10-CITY OF HOMESTEAD	79	1		1		2	4		9	8	1	53	67%
12-BAL HARBOUR VILLAGE	2	1								1			0%
13-BAY HARBOR ISLANDS	1									1			0%
14-TOWN OF SURFSIDE	2											2	100%
15-CITY OF WEST MIAMI	4											4	100%
16-CITY OF FLORIDA CITY	28		1		2	1	1		1	14	1	7	25%
22-TOWN OF MEDLEY	21	1				1				1		18	86%
23-CITY OF NORTH BAY VILLAGE	4					1				1		2	50%
27-CITY OF HIALEAH GARDENS	19					1	1			3	1	13	68%
30-WASD	1042	19	3	12	50	54	10	2	1	16	35	840	81%
77 - UNIVERSITY OF MIAMI	17	1					1			12		3	18%
88 - MIAMI INTERNATIONAL AIRPORT (Miami-Dade CO.)	39						1		1	9	1	27	69%
	1569	26	5	17	60	68	21	2	18	115	50	1187	
		1.7%	0.3%	1.1%	3.8%	4.3%	1.3%	0.1%	1.1%	7.3%	3.2%	75.7%	

All Utilities may view PS Status at any time with **PS Capacity Estimator** WEB Application. <https://www.miamidade.gov/rer/PumpStationCapacityEstimator/default.aspx>



Pump Station Basins - Moratorium Status

PS Capacity Estimator - Sample

Pump Station Capacity Estimator

This Is Not An Official Document
 10/1/2017 8:22 PM - Version 12.20

Calculations are based on the criteria stipulated in Section 24-42.3, Miami-Dade Code, and Federal Consent Decree (Case: No. 1:12-cv-24400-FAM)
 For more information about the Consent Decree, please visit the [South Florida Building Officials Association](#) website.

Please be aware that the information obtained with this Application is for general information only, and it is only correct as of the time and date in which the search was executed. Consequently, the information obtained with this application DOES NOT CONSTITUTE AN OFFICIAL DEPARTMENTAL DETERMINATION or APPROVAL for your project. For any additional information about the **Pump Station Capacity Estimator** application, please refer to the [Application Guidelines](#) or contact the **RER-DEEM Wastewater Permitting Section** at 305-372-6600 or via email at PSO@miamidade.gov

* Required fields

Search Criteria	
Sanitary Sewer Utility *	06 - CITY OF NORTH MIAMI
Pump Station Number *	ARCH-C1
Proposed Projected Flow (GPD) *	10900 GPD <i>(Only numbers are allowed)</i>
Project will require, or is part of, a Sewer Extension *	No
<input type="button" value="Submit"/> <input type="button" value="Clear"/>	

Pump Station Capacity Estimator Result
 → UNCONDITIONAL ALLOCATION ALLOWED ←

Search Criteria Detailed Result	
Sanitary Sewer Utility	06 - CITY OF NORTH MIAMI
Pump Station Number	ARCH-C1
Proposed Projected Flow (GPD)	10,900 GPD
Project will require, or is part of, a Sewer Extension	No

Pump Station Downstream	Pump Station Owner	Pump Station Number	Moratorium Code	Projected NAPOT	Proposed Hrs (Δt)	Proposed Projected Hrs
Receiving PS	06	ARCH-C1	OK	2.63	0.81	3.44
↓	30	0347	OK	2.05	0.02	2.07
↓↓	30	ND	--	--	--	--

PS Capacity Estimator WEB Application Link:

<https://www.miamidade.gov/rer/PumpStationCapacityEstimator/default.aspx>



~~“Low Pressure System”~~ Force Main System Basics

~~“Low Pressure System”~~ Force Main System Basics

What is a Low Pressure sewer system?

- A System that conveys wastewater from a ***Single Family Residence*** using a simplex grinder pump station to connect to a public sanitary sewer system.
- Low pressure sewers are installed where gravity sewers are not cost effective or feasible.

"~~Low Pressure System~~" Force Main System Basics

Sample of a Force Main System Design: Miami Shores Village - Forcemain

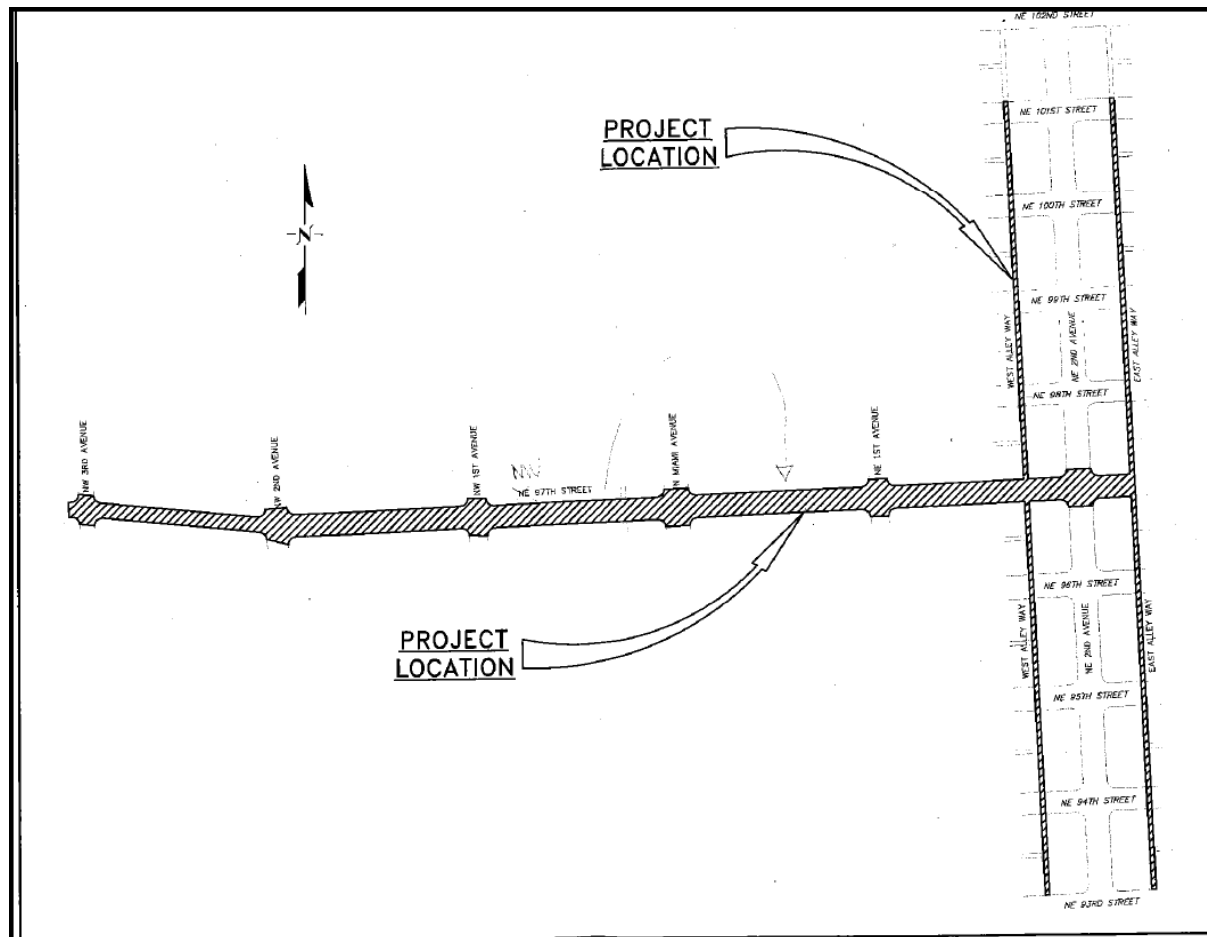

"Low Pressure System" Force Main System Basics

Sample Design: Miami Shores Village Force Main Project – Grinder Pump Stations

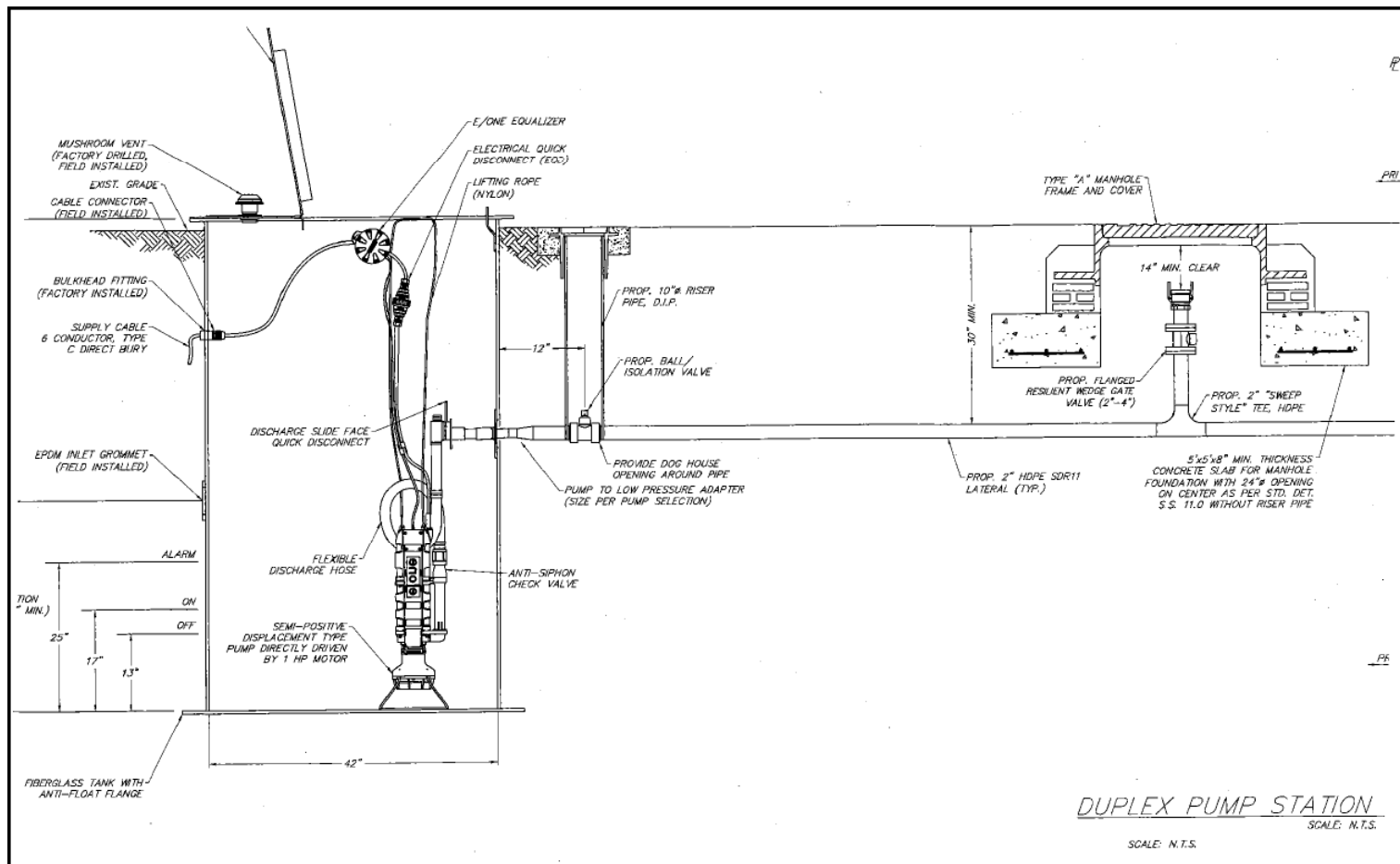

~~“Low Pressure System”~~ Force Main System Basics

Permitting Requirements

- State Construction Permit (Sewer Extension) for:
 - ✓ Forcemain (Primary & Secondary)
 - ✓ Pump Stations (Regional* and Grinders)

- SE Applicant**
 - ✓ Utility
 - ✓ Property owners

* When applicable

** Depending on system ownership

Elapsed Time (ET) Readings

September 2017

September 10, 2017 5:00am

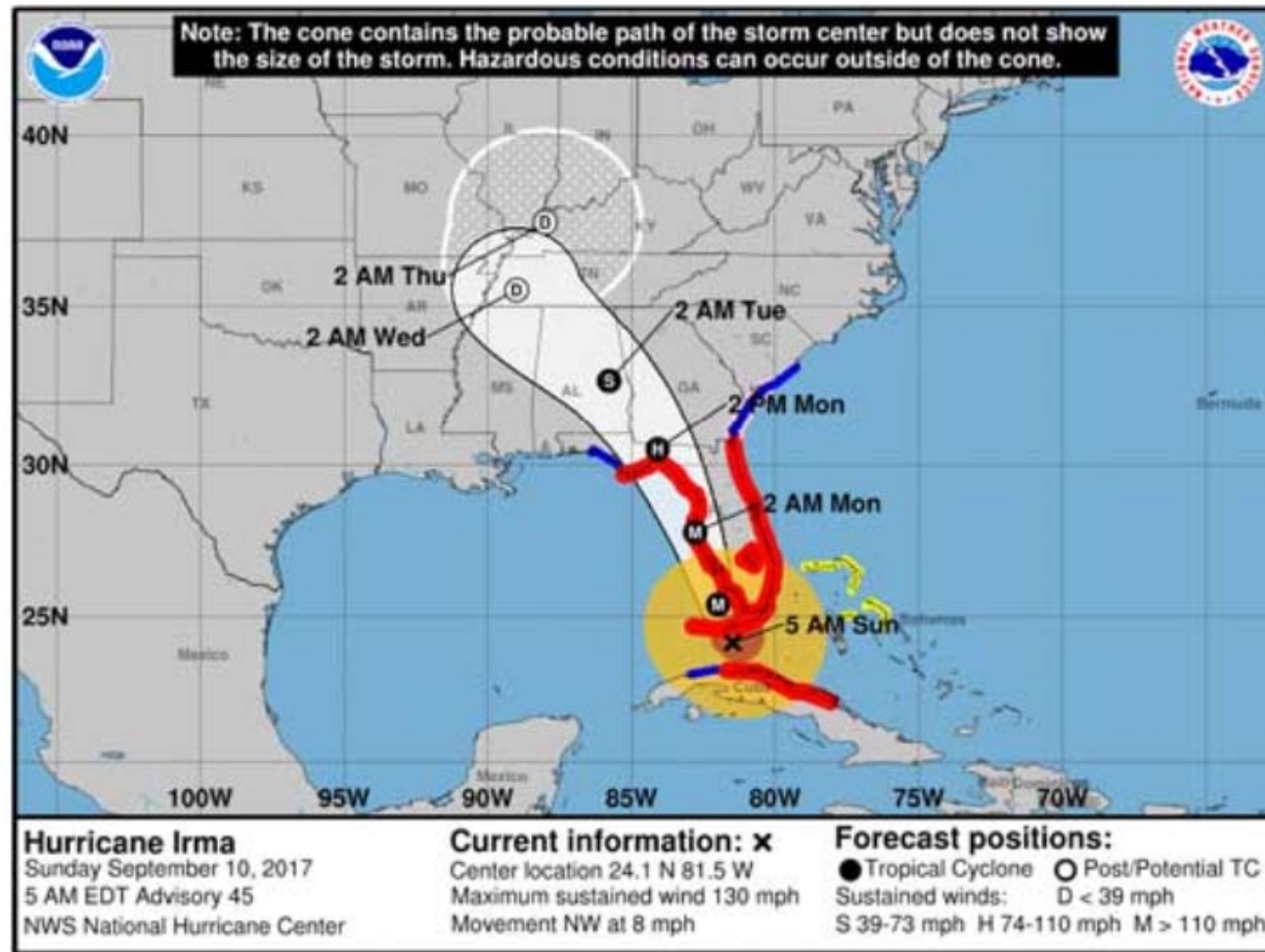

Elapsed Time (ET) Readings

September 2017

Section 24-42.2 (3) (c)(i)

- (c) Each utility or non-utility owned or operated sanitary sewer system shall provide the following reports to the Director or the Director's designee:
- (i) The daily average pump station operating time and the multiple and variable speed daily average pump station power consumption, as applicable, for each pump station in the sanitary sewer system shall be reported to the Director or the Director's designee on a monthly basis no later than fourteen (14) calendar days after the end of the preceding monthly reporting period. The report shall be in such form as prescribed by the Director or the Director's designee. The report shall include an explanation for any single event, Act of God, or other documentable reason which leads to excessive pump station operating time or power consumption. The Director or Director's designee may exclude such data from the nominal average pump operating time calculations.
 - (ii) The existence of stormwater discharge into any utility or non-utility owned or operated

DERM will apply Data Exemption for Applicable Month (September or October 2017?)

FATS OILS and GREASE



FOG 2.0 Update

FOG 2.0 Update

FOG Control Program (FCP) & Ordinance

- Proposed Ordinance submitted to EPA 6/5/2015
- Comments from FDEP/EPA received 12/2016
- Response to comments and revised proposed Ordinance submitted to EPA 5/1/2017
 - Find copy of the Proposed Ordinance in the Consent Decree Public Document Repository at:
<https://spext.miamidade.gov/wasddecree2/SitePages/Home.aspx>

Force Majeure Notification for CD CIP 2.02	5/11/2017 5:36 PM	5/11/2017 5:36 PM
Response to the EPA and FDEP Comments in the FOG Control Program	5/1/2017 5:57 PM	5/1/2017 5:57 PM
2017 Quarterly Report No. 1	5/1/2017 4:53 PM	5/1/2017 4:53 PM

• FCP & Ordinance APPROVED BY EPA September 2017

- MORE on this later!

New "Regular" Agenda Item for URT Meetings

Description



"FOG" Hot Spots

New FOG Ordinance Requirements

Section 24-42.6 (13)

(13) Utilities shall submit [a monthly](#) report to the Department that includes the following minimum information:

(a) A list with dates and locations where accelerated FOG maintenance was performed to prevent a sanitary sewer overflow. Locations shall also be identified in a geographical information system (GIS) format based on the utilities atlas pursuant to Section 24-42.2.

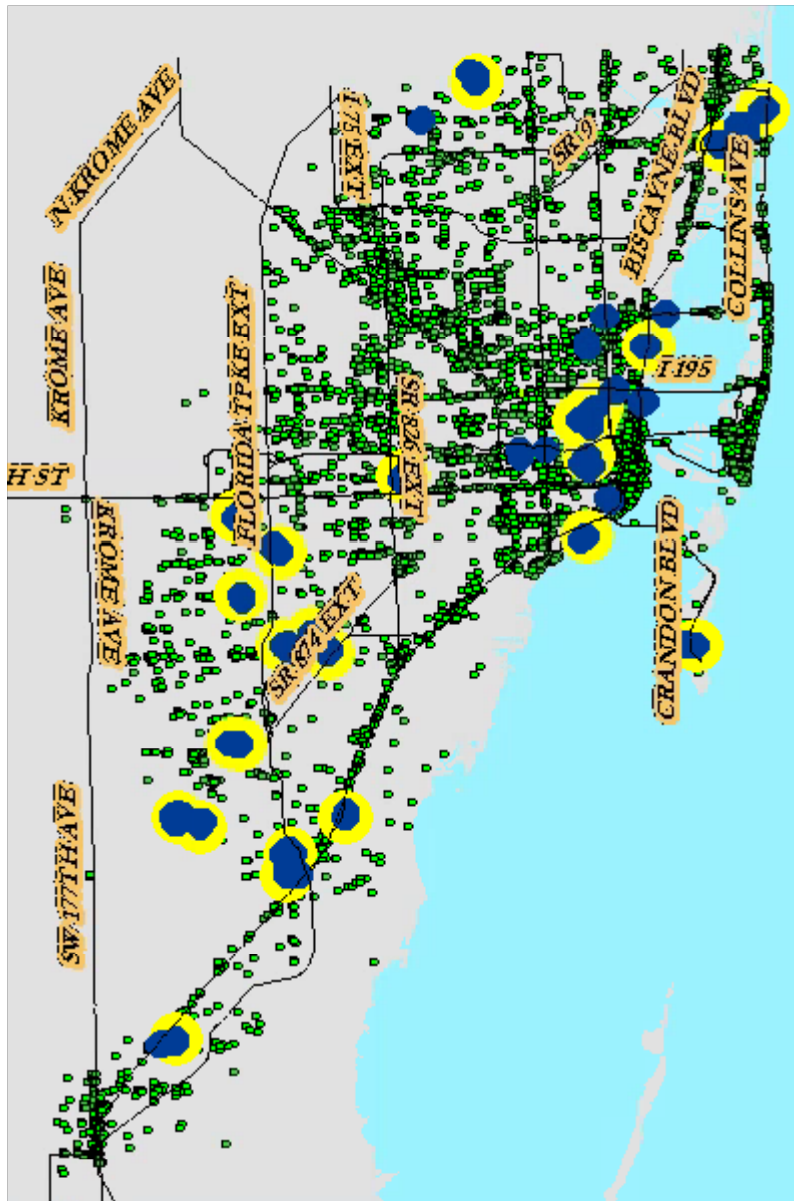

“FOG Hot Spots”



“FOG” Hot Spots

New FOG Ordinance Requirements

Section 24-42.6 (13)

- (b) A description of accelerated FOG maintenance performed, including quantities of waste removed, recovered, collected or treated to prevent a sanitary sewer overflow. The information shall be provided in text and GIS form.
- (c) Cost of accelerated FOG maintenance, including labor, equipment and materials. Labor shall include field and office staff.

Accelerated FOG maintenance is defined under Section 24-5

"FOG" Hot Spots

New FOG Ordinance Requirements

Section 24-5:

Accelerated FOG maintenance shall mean cleaning performed by utilities to prevent sanitary sewer overflows caused by FOG blockages in sanitary sewer systems, including but not limited to laterals, gravity mains, pump stations, and air release valves.

“FOG” Hot Spots

New FOG Ordinance Requirements

First Report Due: April 2018

First “FOG” Hot Spots Agenda Item @ URT:

1. October 11, 2017 (17th URT Meeting) Kick Off Discussion
2. January 17, 2018 (18th URT Meeting) Guidelines Discussion
3. April 11, 2018 (19th URT Meeting) Data Discussion/Analysis

Sewer Extension Reviews Scenarios and Sample Cases



Sewer Extension Requirements Review Actions - Refresher

RER-DERM: SEWER EXTENSION PROGRAM

- Latest DERM Forms:
 - Intermediate Downstream Collection and Transmission System (IDC&TS) Certification of Adequate Reserve Capacity (UT Form)
 - Version (7/12/2017)
 - RER-DERM Water-Sewer General Notes (4/27/2017)
- Use Web Page to download forms – Every Project!
WEB link:
<http://www.miamidade.gov/permits/home.asp>
 - Handout Today

Sewer Extension Requirements

Review Actions - Refresher

New / Revised RER-DERM Forms

Available in the County's WEB Page

Steps to get to the Forms:

1. <http://www.miamidade.gov/permits/home.asp>
2. Select "Environment" in the first box, then
3. Select "One-Time Permits", in the second box, and then scroll down to "Sewer Extension Permit".
The Forms are on the right hand side. See pictures below.

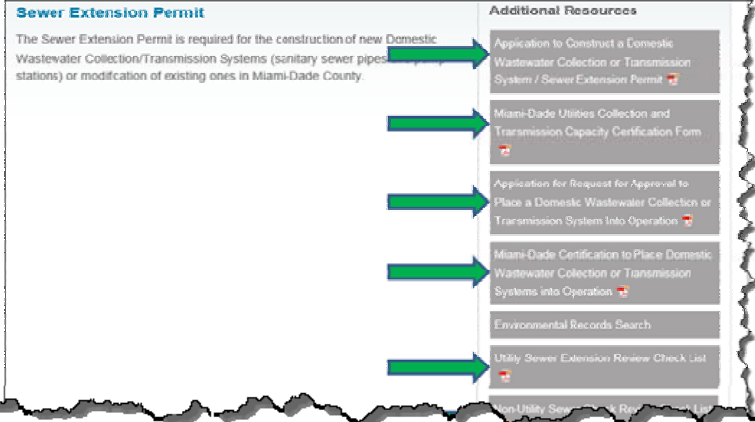
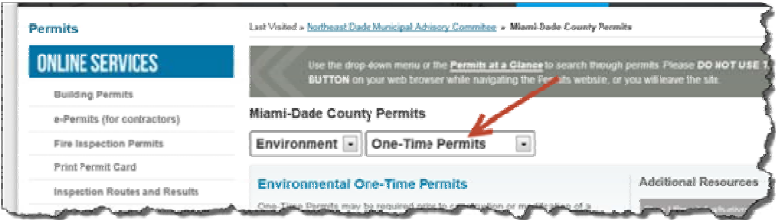

• [Try it!!](#)

Sewer Extension Requirements

RFI Meeting Requirement

RFI Timeline *

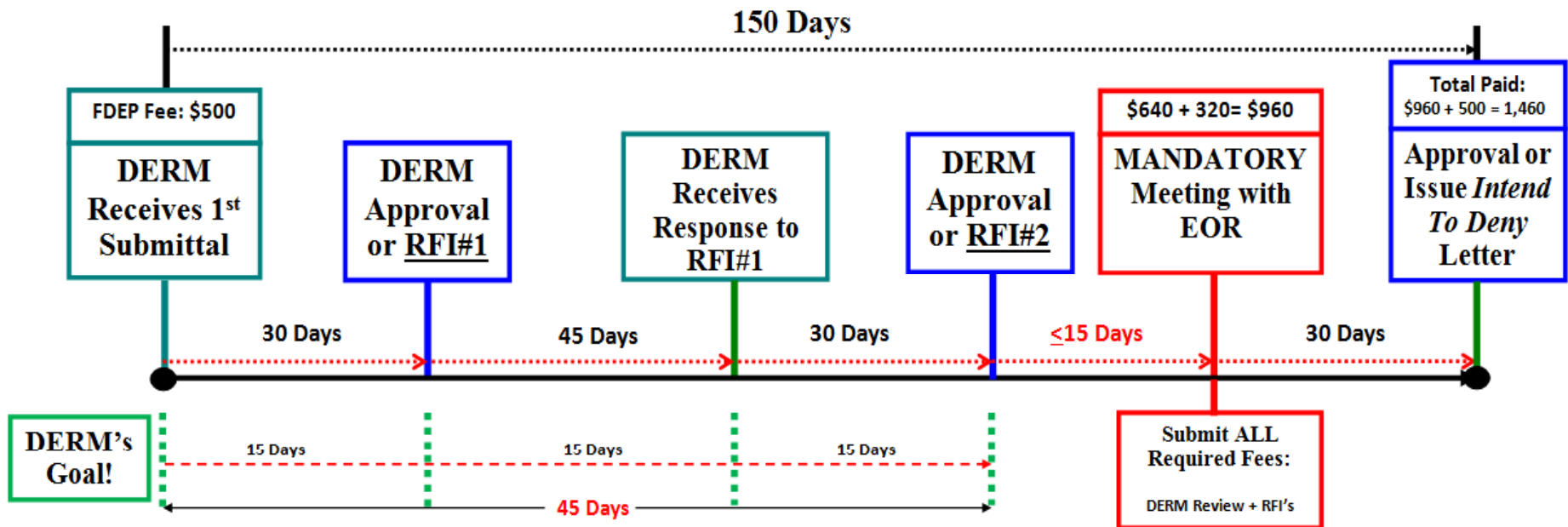

* To Provide BEST SERVICE Possible to ALL!

Sewer Extension Requirements

Roles of the Utility, Engineer of Record and DERM

Sewer Extension Requirements

SE Expired

- **Sewer Extension Expired within last 10 years**

- Utilities

- Miami Beach (9)
- Coral Gables (3)
- Hialeah (15)
- North Miami (10)
- North Miami Beach (9)
- Opa-Locka (3)
- Homestead (20)
- Surfside (1)
- West Miami (2)
- Florida City (9)
- Medley (2)
- Hialeah Gardens (4)
- Airport – MDAD (4)
- WASD (130)

Sewer Extension Requirements

Roles of the Utility, Engineer of Record and DERM

- **Signing of Documents / Forms**

- **FDEP Application:** Property Owner (applicant), Utility and EOR
- **UT:** Utility Director, or authorized representative
- **SE Certification-FDEP Application:** Property Owner (applicant), Utility and EOR
- **Start UP Test:** Manufacturer's Representative / EOR
- **Exfiltration / Press Test:**
 - Public: Utility Representative / EOR
 - Private: Professional Engineer

Sewer Extension Requirements

Roles of the Utility, Engineer of Record and DERM

MAIN ROLES, among others:

UTILITY

- Assure compliance with Utility Standards
- Tracking / Monitoring of new Projects
- Make sure NO flows until DERM Certified!

ENGINEER OF RECORD (EOR)

- Assure design projects meet or exceed Federal, State, County regulations and/or standards
- Assure that engineering principles are kept throughout project, from design to certification of completion
- **Design the “Right” System (NOT simply minimum code requirement)!**

DERM

- Issue construction permits for projects that meet or exceed minimum design standards
- Assure compliance with Federal, State, and County regulations and/or standards

Sewer Extension Requirements

Roles of the Utility, Engineer of Record and DERM

CONSTRUCTION DRAWINGS - Requirements

- All sheets pertinent to the Utility shall be **Stamped Approved by the Utility**

MIAMI-DADE

WATER

WATER PER N/A

APPROVED: Asif Bawaney, REVIEWER'S

THIS ACCEPTANCE VALIDATES THE ENGINEER AND COUNTY AND STATE

City of Miami Beach
Public Works Department
Approved Not Approved
By: ENB Date: _____
Comments: _____

IN.
IN.
IN.
IN.
IN.
IN.
IN.
IN.

City of Hialeah
Department of Water & Sewers
Water Project No.: 1167
Sewer Project No.: 1168
City No.: _____
Approval For Construction
Approval Date: 5/20/15 By: _____

411402-19 - Allis @ BohneggDrawings/Construction Plans

Sewer Extension Requirements

Roles of the Utility, Engineer of Record and DERM

CONSTRUCTION DRAWINGS - Requirements

- Include/provide a profile view for **each Lateral connection** being proposed (except for SFR).

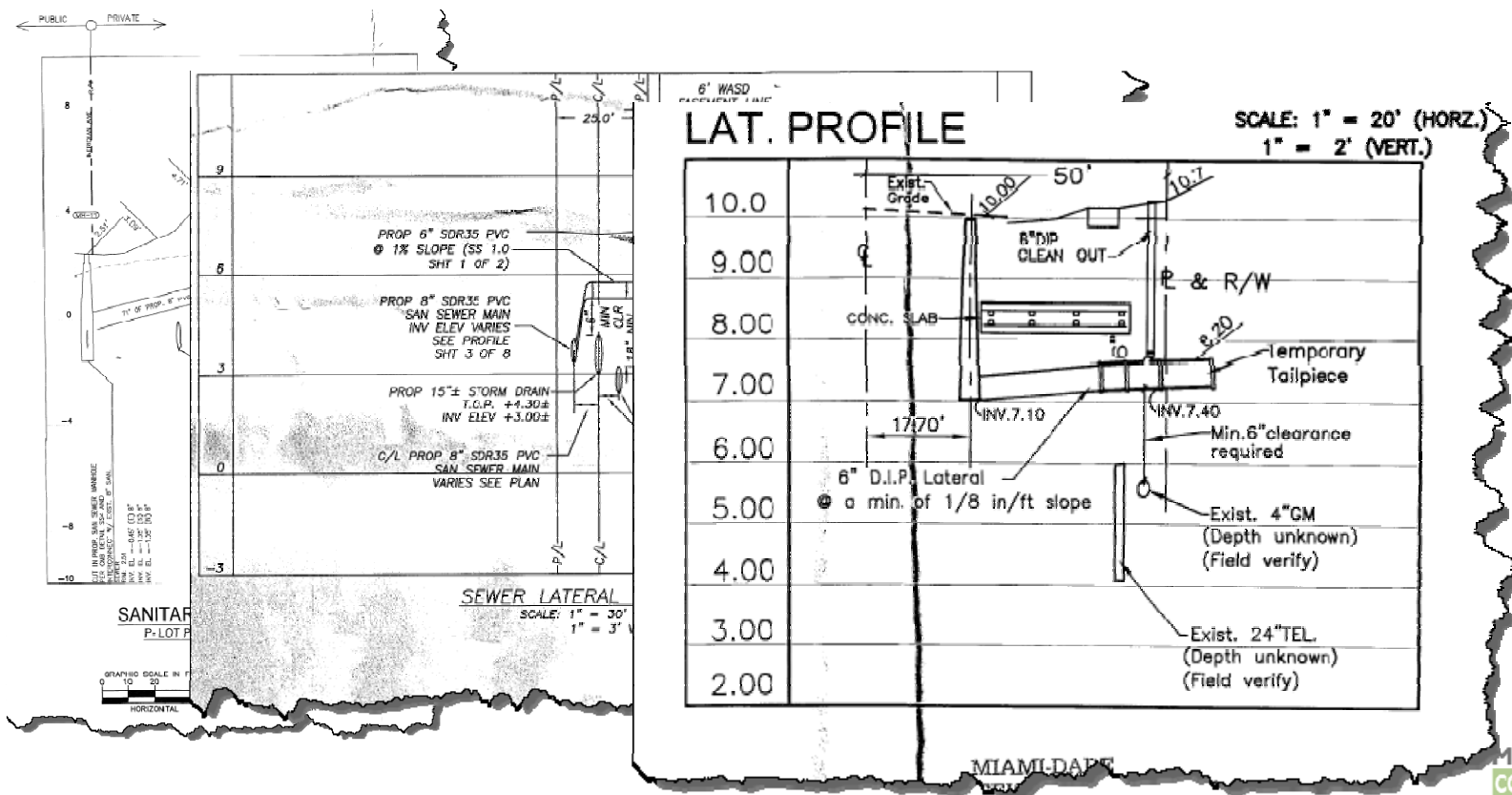

Sewer Extension Requirements

Roles of the Utility, Engineer of Record and DERM

CONSTRUCTION DRAWINGS - Requirements

- “In-kind” Pipe Replacement (GM/FM) Requires DERM Review/Approval
 - Some may also need an SE!
 - To assure proper design & construction requirements (COI, Contaminated soils, etc)
 - To assure compliance with pressure/exfiltration tests

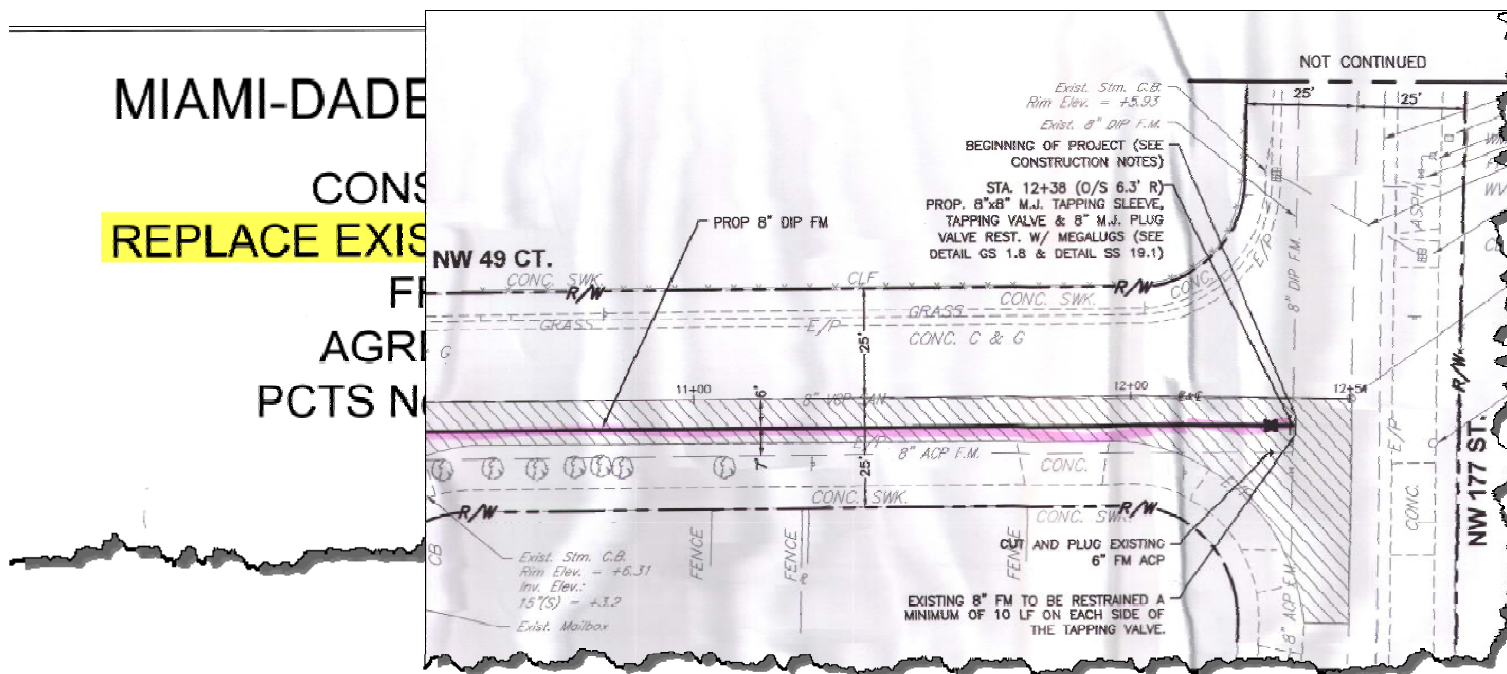

Sewer Extension Requirements

“What Not to do” - Sample Cases

Sewer Extension Requirements

“What Not to do” - Sample Cases

Proposed Gravity Main Case

- What DERM Approved

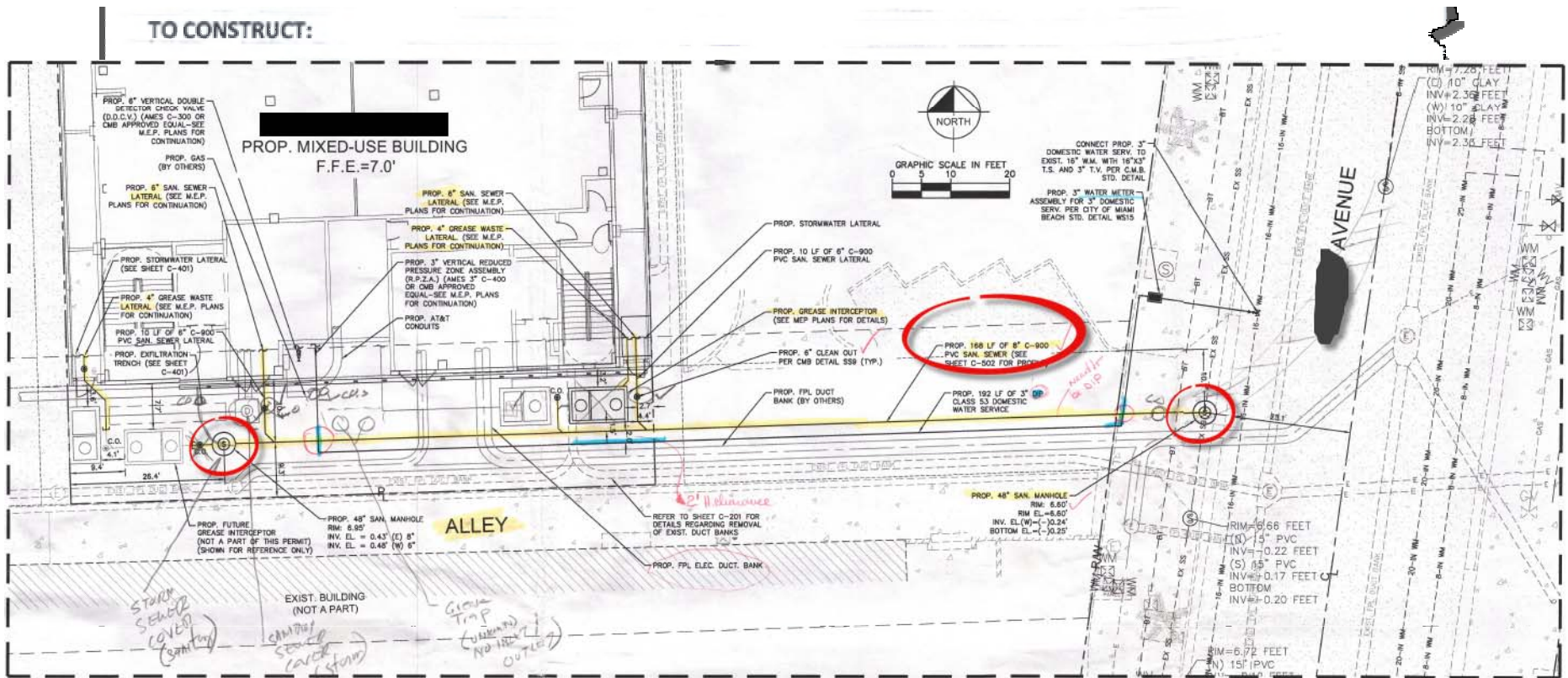

Sewer Extension Requirements

“What Not to do” - Sample Cases

Proposed Gravity Main Case

- What Owner built

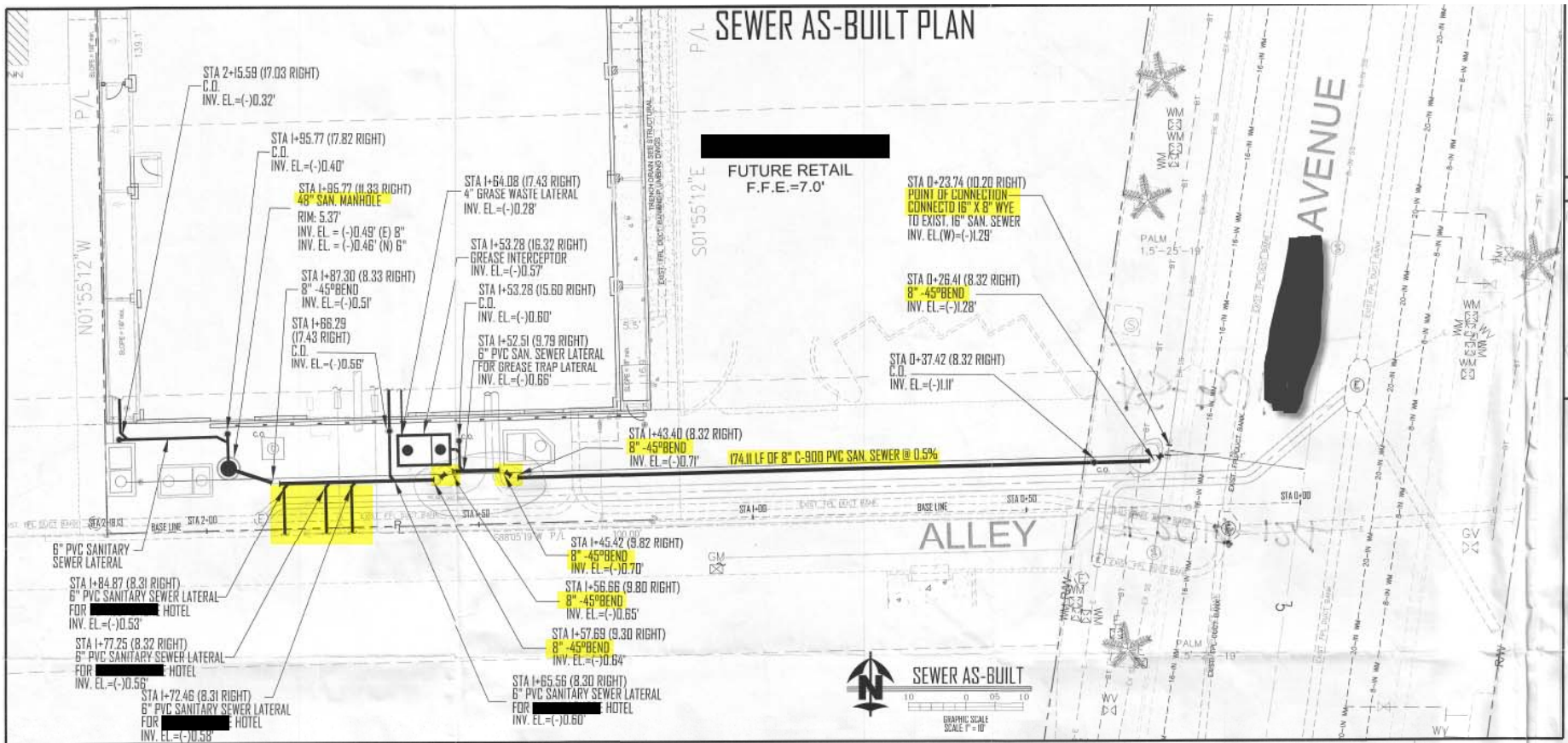

Sewer Extension Requirements

“What Not to do” - Sample Cases

Proposed Gravity Main Case

- Certification Request

Is the entire project included under the collection/transmission system permit substantially complete? Yes No (If approval is being requested to place a portion of the project into operation, attach a copy of the site plan or sketch that was submitted with the application showing the portion of the project which is substantially complete and for which approval is being requested.)

Description of Portion of Project for Which Approval is Being Requested (including pipe length, total number of manholes and total number of pump stations): 174 LF of 8" PVC pipe and 4 manholes

The following is a description and explanation of substantial deviations** from the construction permit and engineering plans and specifications for the substantially completed portion of this project. (Attach additional sheets if necessary.)

The total length of pipe changed from approximately 168 LF to 174 LF. The slope of the pipe change from 0.4% to 0.5%. Due to conflicts with un-anticipated existing utilities encountered during construction, five (5) 45-degree horizontal bends were installed to deviate the alignment and avoid conflicts with said existing utilities. The proposed manhole at [redacted] Avenue was removed due to conflicts with existing utilities making it unfeasible to construct per plans and was replaced with a wye connection to the existing sanitary sewer. Three sanitary sewer laterals 6" were additionally connected to the 8" main.

Sewer Extension Requirements

“What Not to do” - Sample Cases

Proposed Pump Station Case

- What DERM Approved

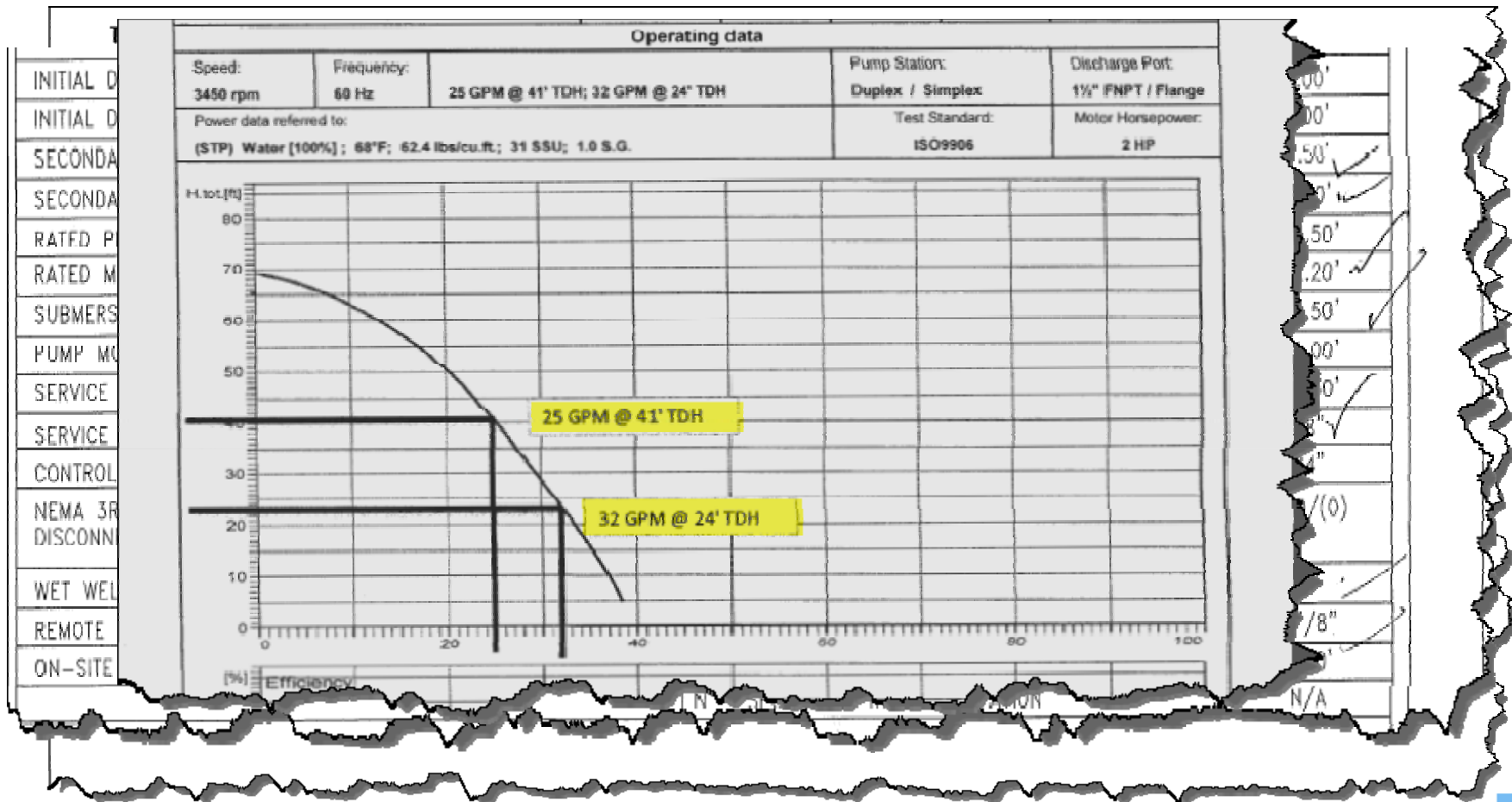

Sewer Extension Requirements

“What Not to do” - Sample Cases

Proposed Pump Station Case

- What Owner built
- Included in the Certification Application

The application “Request for Approval to place a Domestic Wastewater Collection/Transmission System into Operation” received included the following:

- A. A private pump station constructed to serve:
- Phase 1: 24 apartments.
 - Phase 2: 14,000 SF of medical office, 120 Rooms Hotel, 30,000 SF of retail and 20,000 SF of restaurant.
 - Total Flow for phase 1 and Phase 2: 41,400 GPD.
- B. Private pump station designed with operating point of 120 GPM @ 46 TDH.

This certification is only warranted for the original proposed scope of work including items 1 through 5 above and only.

Sewer Extension Requirements

“What Not to do” - Sample Cases

Proposed Pump Station Case

- DERM Certification

This certification is hereby granted for the original proposed scope of work, including items 1 through 5 above and only serving 24 apartments, with the exception that the pump station operating point is 120 GPM @ 46 TDH. This certification ***does not*** include the private sanitary sewer system/pump station serving the following: 14,000 SF of medical office, 120 Rooms Hotel, 30,000 SF of retail, 20,000 SF of restaurant or any other development outside of Folio No. 3411330030110.

Be reminded that any connection to the private sanitary sewer system/pump station requires WPS approval. Be further reminded that the only development that can be approved to connect to the private sanitary sewer system/pump station is development located entirely within the Folio of the private pump station. Additionally, subdivision of the

Sewer Extension Requirements

“What Not to do” - Sample Cases

Lessons learned:

- Significant Deviations from the original SE Permit **SHALL BE** addressed with DERM before built on site.
 - Applicant may obtain a **SE Permit Revision**, or
 - DERM confirmation that deviation is approvable!
 - What if DERM Can't Approve/Certify?
 - Significant deviations may require a New SE Permit.
- Utilities do not have the final Approval of the SE Construction permit.
 - The SE permit is State delegated to DERM.
- **Do not wait for the Certification Process to address permit changes!**

Sewer Extension Requirements “No-Permit-Required (NPR)”

Sewer Extension Requirements

“No-Permit-Required (NPR)”

“No Permit Required (NPR)” Permits

Projects that do not require a FDEP Construction Permit

62-604.600 Procedure to Obtain Construction Permits.

(1) Except as noted in (2) below, either a general or individual construction permit is required for the construction or modification of any collection/transmission system in accordance with (6) and (7) below.

(2) The following activities do not require a collection system permit.

(a) Replacement of any facilities with new facilities of the same capacity at the same location as the facilities being replaced;

(b) Construction of any single gravity or non-gravity individual service connection from a single building to a gravity collection system; however, construction of a non-gravity connection from other than a single family residence to an existing force main system requires a permit;

(c) Construction of a low pressure (grinder pump or STEP) or vacuum sewer individual service connection where the system serving the area has been previously permitted by the Department;

(d) Installatino of odor control facilities;

(e) Modifications associated with routine maintenance; or

(f) Modifications associated with ancillary and electrical equipment and structures.

Sewer Extension Requirements

“No-Permit-Required (NPR)”

No-Permit-Required (NPR) Permits

- Minimum Information required
 - Signed Sealed Plans
 - Utility Approval

HEALTH DEPARTMENT NOTES
 (SEE LIST OF DEPARTMENTS FOR APPROVALS)
 1. ALL WORK SHALL BE DONE IN ACCORDANCE WITH THE CITY OF MIAMI-DADE CODES AND ORDINANCES.
 2. ALL WORK SHALL BE DONE IN ACCORDANCE WITH THE CITY OF MIAMI-DADE DEPARTMENT OF PUBLIC WORKS AND ENGINEERING SPECIFICATIONS.
 3. ALL WORK SHALL BE DONE IN ACCORDANCE WITH THE CITY OF MIAMI-DADE DEPARTMENT OF PUBLIC WORKS AND ENGINEERING STANDARD SPECIFICATIONS.
 4. ALL WORK SHALL BE DONE IN ACCORDANCE WITH THE CITY OF MIAMI-DADE DEPARTMENT OF PUBLIC WORKS AND ENGINEERING STANDARD DRAWINGS.
 5. ALL WORK SHALL BE DONE IN ACCORDANCE WITH THE CITY OF MIAMI-DADE DEPARTMENT OF PUBLIC WORKS AND ENGINEERING STANDARD CONTRACTS.
 6. ALL WORK SHALL BE DONE IN ACCORDANCE WITH THE CITY OF MIAMI-DADE DEPARTMENT OF PUBLIC WORKS AND ENGINEERING STANDARD AGREEMENTS.
 7. ALL WORK SHALL BE DONE IN ACCORDANCE WITH THE CITY OF MIAMI-DADE DEPARTMENT OF PUBLIC WORKS AND ENGINEERING STANDARD CONDITIONS.
 8. ALL WORK SHALL BE DONE IN ACCORDANCE WITH THE CITY OF MIAMI-DADE DEPARTMENT OF PUBLIC WORKS AND ENGINEERING STANDARD TERMS AND CONDITIONS.
 9. ALL WORK SHALL BE DONE IN ACCORDANCE WITH THE CITY OF MIAMI-DADE DEPARTMENT OF PUBLIC WORKS AND ENGINEERING STANDARD PROVISIONS.
 10. ALL WORK SHALL BE DONE IN ACCORDANCE WITH THE CITY OF MIAMI-DADE DEPARTMENT OF PUBLIC WORKS AND ENGINEERING STANDARD CLAUSES.

MIAMI-DADE WATER & SEWER DEPARTMENT
 WATER PERMIT
 APPROVED AS SHOWN
 REVIEWER'S NAME: [Signature]
 DATE: [Date]

REVISIONS

NO.	DATE	DESCRIPTION
1	07/24/15	ISSUED FOR PERMIT

CONSULTING ENGINEER
 CONSULTING ENGINEER, P.E.
 LIC. NO. 80051
 6423 NW 73 LANE, MIAMI, FL 33151
 305-527-4672

PROPOSED SEWER LATERAL
 MAECDONIA MISSIONARY BAPTIST CHURCH
 3515 DOUGLAS ROAD, 306-9073
 MIAMI, FL 33133, (305) 306-9073

RECEIVED
 JUL 23 2015
 PERMITTING SECTION
 P&ED

AGREEMENT NO.: 15118
SHEET 1 OF 1



Sewer Extension Requirements

“No-Permit-Required (NPR)”

No-Permit-Required (NPR) Permits

- Outcome of the review
 - DERM Determination Letter: “...a wastewater collection/transmission permit is not required for the subject project.”

Environmental Resources Management (DERM) under delegation by the Florida Department of Environmental Protection (hereby jointly referred to as the Department) has reviewed a permit application to construct a wastewater collection/transmission system for the above referenced project.

Upon review of the information provided with the application, the Department hereby approves the proposed work, and hereby determines that a Florida Department of Environmental Protection (FDEP) wastewater collection/transmission construction permit is not required for the subject project.

Please note any modification to the plans of the subject project should be submitted for review, as changes may void this determination resulting in a permit being required. Furthermore, be advised that this letter does not relieve the applicant from the need to obtain any other applicable local, state, or federal permit(s) or approval(s). This determination has been conducted on the basis of the following information presented by the applicant:

Construction drawings C-1 dated 8/2/2017, duly dated, signed and sealed by Albert R Dettbarn, a Licensed Professional Engineer registered in the State of Florida, PE No. PE18966, on 8/7/2017, showing that the construction consists of the installation of a 4-inch PVC Sewer Lateral to serve a duplex residence.

Sewer Extension Requirements

Sewer Connections

Sewer Extension Requirements

Sewer Connections

Who is required to Connect?

Abutting Properties: Upon completion of construction of SE (NORC)

Sewers Available: Determined by DERM and Utility (Sewer Agreement)

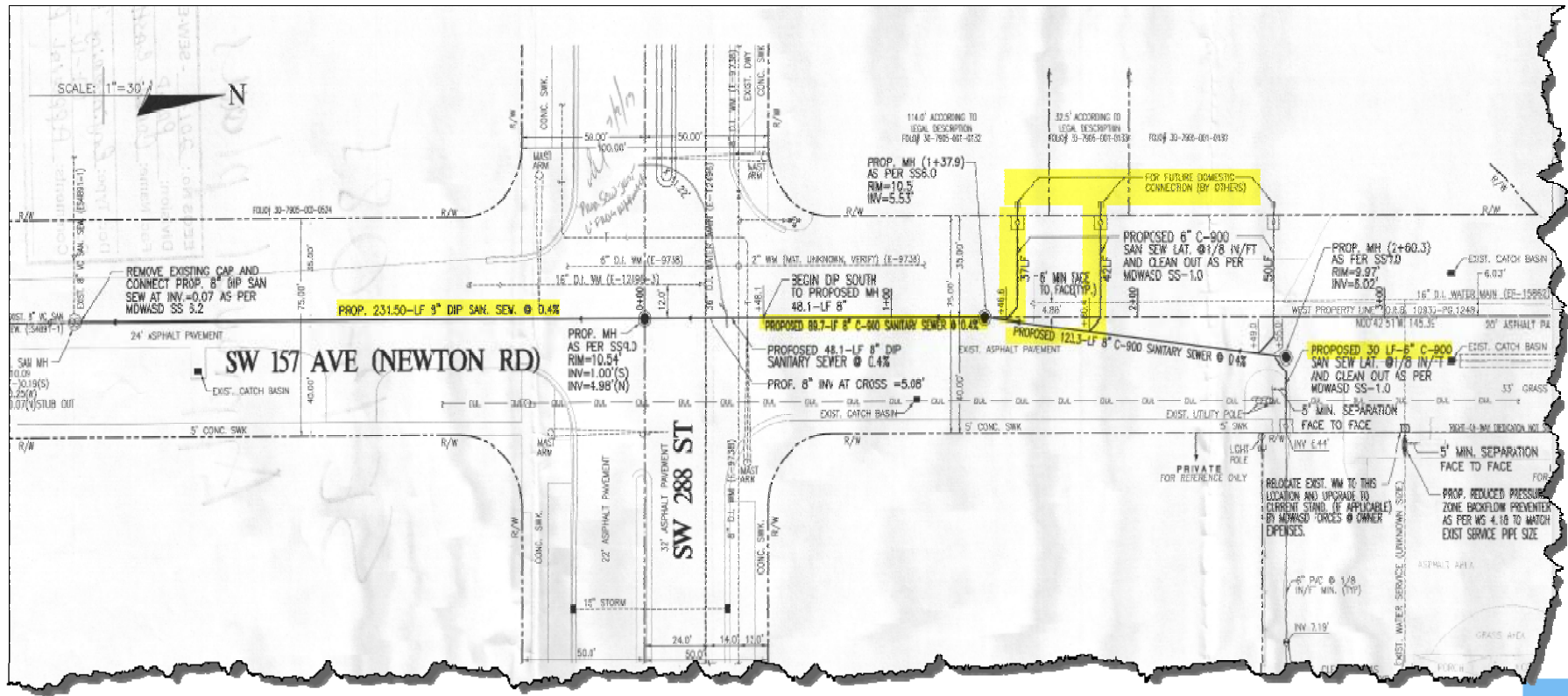

Additional Topic

Cooling Towers Discharge

1. Where shall Cooling Towers Discharge?

- Storm Water?
- Sanitary Sewers?

2. Who reviews the construction plans?

- Building Department
- Utility
- DERM

What we are working on!!



What we are working on!!

Under Development

- ❑ **Improving the Sewer Extension Check List**

- ❑ **Simplifying the Re-Occurring Required Utility Reports**
 - SSES Annual Rpt (New Excel Format to be available in Web
 - Group all three (3) Required Reports
 - ✓ Illicit Stormwater (Semi Annual)
 - ✓ SSES Annual Report (Annual)
 - ✓ CMOM Annual Report (annual)

- ❑ **Improving the RER-DERM Water-Sewer General Notes**
 - ✓ Include Asbestos requirements

Sewer System Flow Paths

Sanitary Sewer Pump Station System Schematic

Due 1/06/2018



Department of Regulatory and Economic Resources (RER)
*Division of **Environmental Resources Management (DERM)***



Questions?

New URT Meeting Format Stakeholder Report / DERM Report (Starting 10/11/2017)

• Part A: Utilities

1. Presentation/Report

- Miami Beach
- Coral Gables
- Hialeah
- North Miami

2. Suggested Topics:

- Achievements
- System Improvements
- Any other significant topic

• Part B: RER-DERM

1. Presentation/Report

- Over all Compliance Status Summary

2. Additional Suggested Topics:

- New/Improved Forms
- Sewer Extension Updates
- Efforts to improve Reviews
- Any Other

Next Meetings

2018 URT Schedule

 URT Meeting																															
2018 Calendar																															
January 2018							February 2018							March 2018							April 2018										
Nº	S	M	T	W	T	F	S	Nº	S	M	T	W	T	F	S	Nº	S	M	T	W	T	F	S	Nº	S	M	T	W	T	F	S
1		1	2	3	4	5	6	5					1	2	3	9					1	2	3	14	1	2	3	4	5	6	7
2	7	8	9	10	11	12	13	6	4	5	6	7	8	9	10	10	4	5	6	7	8	9	10	15	8	9	10	11	12	13	14
3	14	15	16	17	18	19	20	7	11	12	13	14	15	16	17	11	11	12	13	14	15	16	17	16	15	16	17	18	19	20	21
4	21	22	23	24	25	26	27	8	18	19	20	21	22	23	24	12	18	19	20	21	22	23	24	17	22	23	24	25	26	27	28
5	28	29	30	31				9	25	26	27	28				13	25	26	27	28	29	30	31	18	29	30					
May 2018							June 2018							July 2018							August 2018										
Nº	S	M	T	W	T	F	S	Nº	S	M	T	W	T	F	S	Nº	S	M	T	W	T	F	S	Nº	S	M	T	W	T	F	S
18				1	2	3	4	5	22					1	2	27	1	2	3	4	5	6	7	31				1	2	3	4
19	6	7	8	9	10	11	12	23	3	4	5	6	7	8	9	28	8	9	10	11	12	13	14	32	5	6	7	8	9	10	11
20	13	14	15	16	17	18	19	24	10	11	12	13	14	15	16	29	15	16	17	18	19	20	21	33	12	13	14	15	16	17	18
21	20	21	22	23	24	25	26	25	17	18	19	20	21	22	23	30	22	23	24	25	26	27	28	34	19	20	21	22	23	24	25
22	27	28	29	30	31			26	24	25	26	27	28	29	30	31	29	30	31					35	26	27	28	29	30	31	
September 2018							October 2018							November 2018							December 2018										
Nº	S	M	T	W	T	F	S	Nº	S	M	T	W	T	F	S	Nº	S	M	T	W	T	F	S	Nº	S	M	T	W	T	F	S
35							1	40		1	2	3	4	5	6	44					1	2	3	48							1
36	2	3	4	5	6	7	8	41	7	8	9	10	11	12	13	45	4	5	6	7	8	9	10	49	2	3	4	5	6	7	8
37	9	10	11	12	13	14	15	42	14	15	16	17	18	19	20	46	11	12	13	14	15	16	17	50	9	10	11	12	13	14	15
38	16	17	18	19	20	21	22	43	21	22	23	24	25	26	27	47	18	19	20	21	22	23	24	51	16	17	18	19	20	21	22
39	23	24	25	26	27	28	29	44	28	29	30	31				48	25	26	27	28	29	30		52	23	24	25	26	27	28	29
40	30																							1	30	31					
2018 Holidays							Notes:																								
January 1: New Year's Day January 15: Martin Luther King Day February 19: Presidents Day May 28: Memorial Day July 4: Independence Day September 3: Labor Day							October 8: Columbus Day November 11: Veterans' Day November 22: Thanksgiving December 25: Christmas Day																								

1. January 17th
2. April 11th
3. July 11th
4. October 17th

Important dates

Reminder

Due Dates:

1. **1/01/2018:** 2018-JAN1 Illicit Stormwater Discharges Rpt
2. **1/06/2018:** GIS As-Builts Submittal – UPDATE
3. **1/30/2018:** [Water Atlas in GIS Format](#)
4. **1/31/2018:** 2017-CMOM Annual Status Rpt
5. **3/01/2018:** 2017/2018-SSES Annual Report (New Format)
6. **7/01/2018:** 2018-JUL1 Illicit Stormwater Discharges Rpt
7. **11/12/2022:** SSES 3rd Cycle – All PS Basins *



Attachment 9
Best Management Practices

Miami-Dade County FOG Control Program Best Management Practices (BMPs)

This guidance document provides the established Best Management Practices (BMPs) for fats, oil, and grease (FOG) encountered in Food Service establishments operating in Miami-Dade County.

The implementation of Best Management Practices listed below will result in an overall improvement in the performance and operation of the grease interceptor, and will help in reducing maintenance costs, by reducing the discharges of solids (food scraps) into the grease interceptor.

- Train kitchen personnel in the importance of the implementation of BMPs.
- Dry-wipe dishware, pots and pans prior to washing.
- Remove food waste from preparation and service items prior to washing.
- Dispose food waste in a special recycling container or in the trash.
- Install screens in all sinks, floor sinks, and floor drains.
- Clean screens frequently into the trash or the food waste recycling container.
- Have a schedule for maintenance of exhaust hood.
- Maintain regularly exhaust hood removable filters.
- Dispose used oil/grease in a designated receptacle that is kept free of spills, and closed with a lid.
- Never pour grease or cooking oil into a sink, floor drain, dumpster, or storm drain.
- Inspect the used (yellow grease) oil/grease receptacles daily to avoid overfilling and/or spills.
- Inspect solid separators daily to prevent excessive accumulation of food solids.
- Use dry methods like rags, absorbent material, sweeping, to clean up spills, prior to mop and bucket.
- Discharge Mop water through the grease interceptor.
- Discharge cleaning waters from floor mats, exhaust hoods, large kitchen equipment through the grease interceptor.
- Be present during the grease interceptor's pump out/cleaning, to assure the complete removal of the contents of the device.

Attachment 10
MDWASD Hot Spots Maps



WWCTLD

Smart Cover Location Maps



MIAMI - DADE WATER AND SEWER DEPARTMENT WWCTLD - HotSpot Smart Cover Location



North

MWASD NOTICE

The materials contained herein are provided "AS IS" and may contain inaccuracies. User is warned to utilize the materials herein at User's own risk and to verify the material's accuracy independently and ASSUMES THE RISK OF ANY AND ALL LOSS.
MISGIS Modified 07-10-06

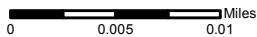

Smart covers list

EAMID	EAMDESC	NEW MH#	OLD MH#	PS#	S	ADDRESS	ZIPCODE
445042	Sewer Manhole 0301-A-117	119	117	0301	A	Collins Ave & in front of Trump	33160
417169	Sewer Manhole 0301-A-109	111	109	0301	A	N. Bay Rd & NE 183rd St	
423613	Sewer Manhole 0349-A-039	39	39	0349	A	NW 8th Pl & 210th St	33169
430231	Sewer Manhole 0364-A-047	47	47	0364	A	NW 47th Ave & 207th Dr	33055
437884	Sewer Manhole 0415-A-170	170	195	0415	A	NW 193rd St & 36th Ave	33056
401495	Sewer Manhole 0467-A-053	67	53	0467	A	at NE 171st St end of street	33160
387601	Sewer Manhole 0467-A-010	13	10	0467	A	at NE 167th St end of street	33160
397353	Sewer Manhole 0467-A-009	12	9	0467	A	at NE 168th St end of street	33160
442913	Sewer Manhole 0467-A-062	77	62	0467	A	at NE 169th St end of street	33160
427145	Sewer Manhole 0467-A-052	66	52	0467	A	at NE 170th St end of street	33160
446024	Sewer Manhole 0467-A-46	46	34	0467	A	3922-3923 NE 166th St	33160
410698	Sewer Manhole 0476-A-011	10	11	0476	A	NW 179th St & 70th Ave	33015
435228	Sewer Manhole 0476-A-063	62	63	0476	A	6855 NW 179th St	33015
438106	Sewer Manhole 0476-A-051	50	51	0476	A	7050 NW 177th St	33015

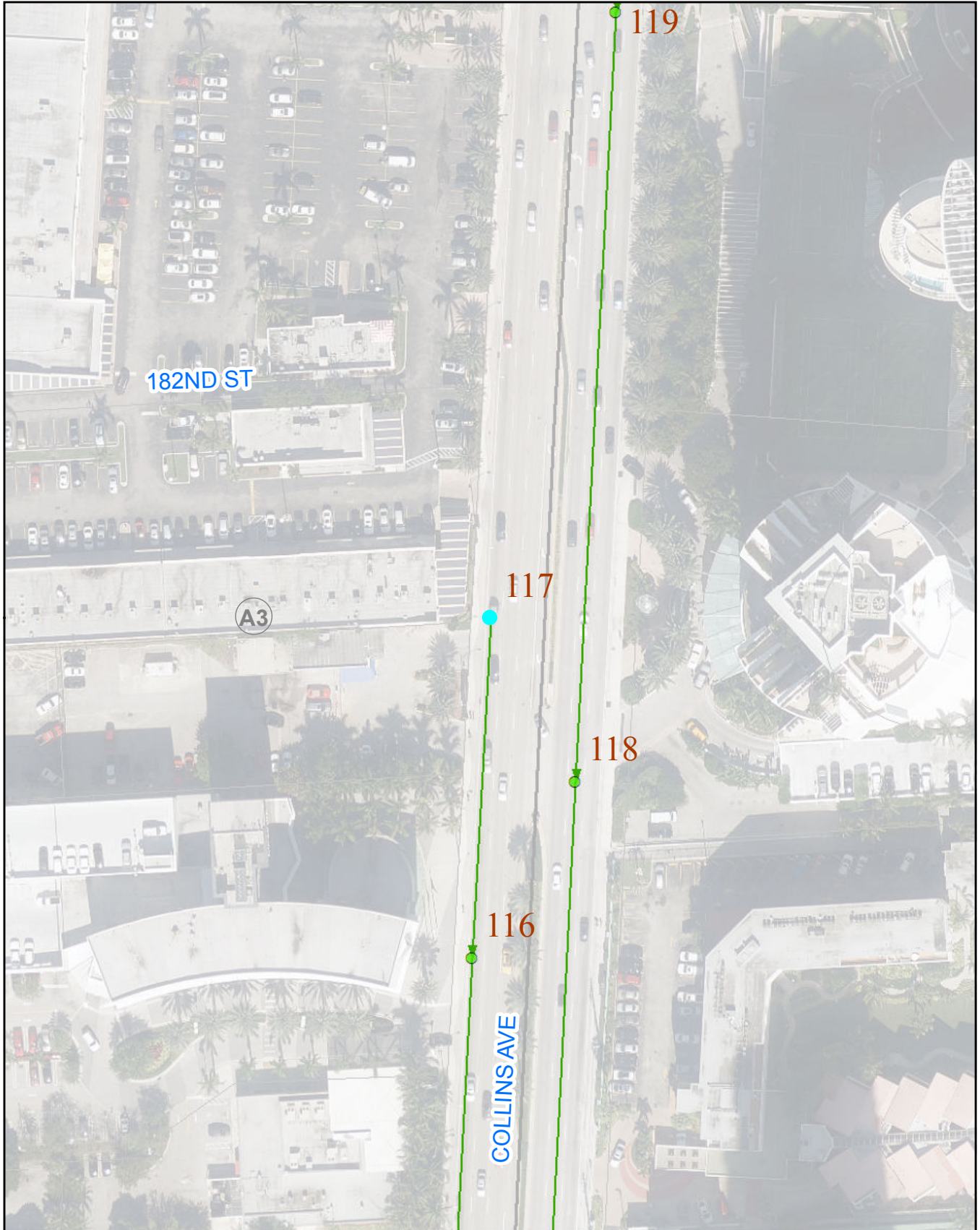

MDWASD NOTICE

The materials contained herein are provided "AS IS" and may contain inaccuracies. User is wanted to utilize the materials herein at User's own risk and to verify the material's accuracy independently and ASSUMES THE RISK OF ANY AND ALL LOSS.
MIS/GIS Modified 07-10-06

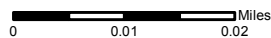



MDWASD NOTICE

The materials contained herein are provided "AS IS" and may contain inaccuracies. User is wanted to utilize the materials herein at User's own risk and to verify the material's accuracy independently and ASSUMES THE RISK OF ANY AND ALL LOSS.
MS/GIS Modified 07-10-06

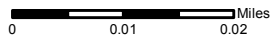

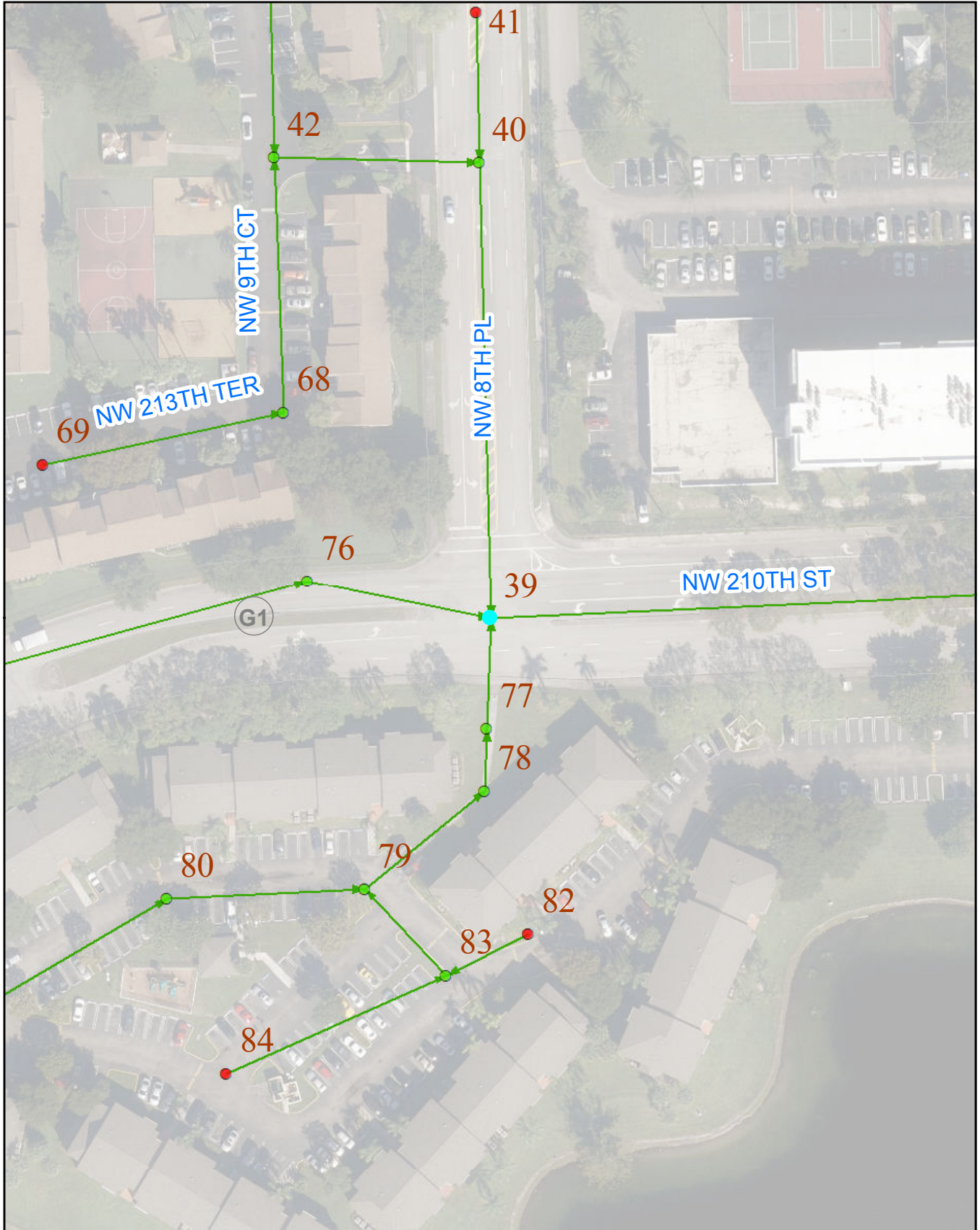

MDWASD NOTICE

The materials contained herein are provided "AS IS" and may contain inaccuracies. User is wanted to utilize the materials herein at User's own risk and to verify the material's accuracy independently and ASSUMES THE RISK OF ANY AND ALL LOSS.
MIS/GIS Modified 07-10-06

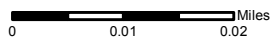

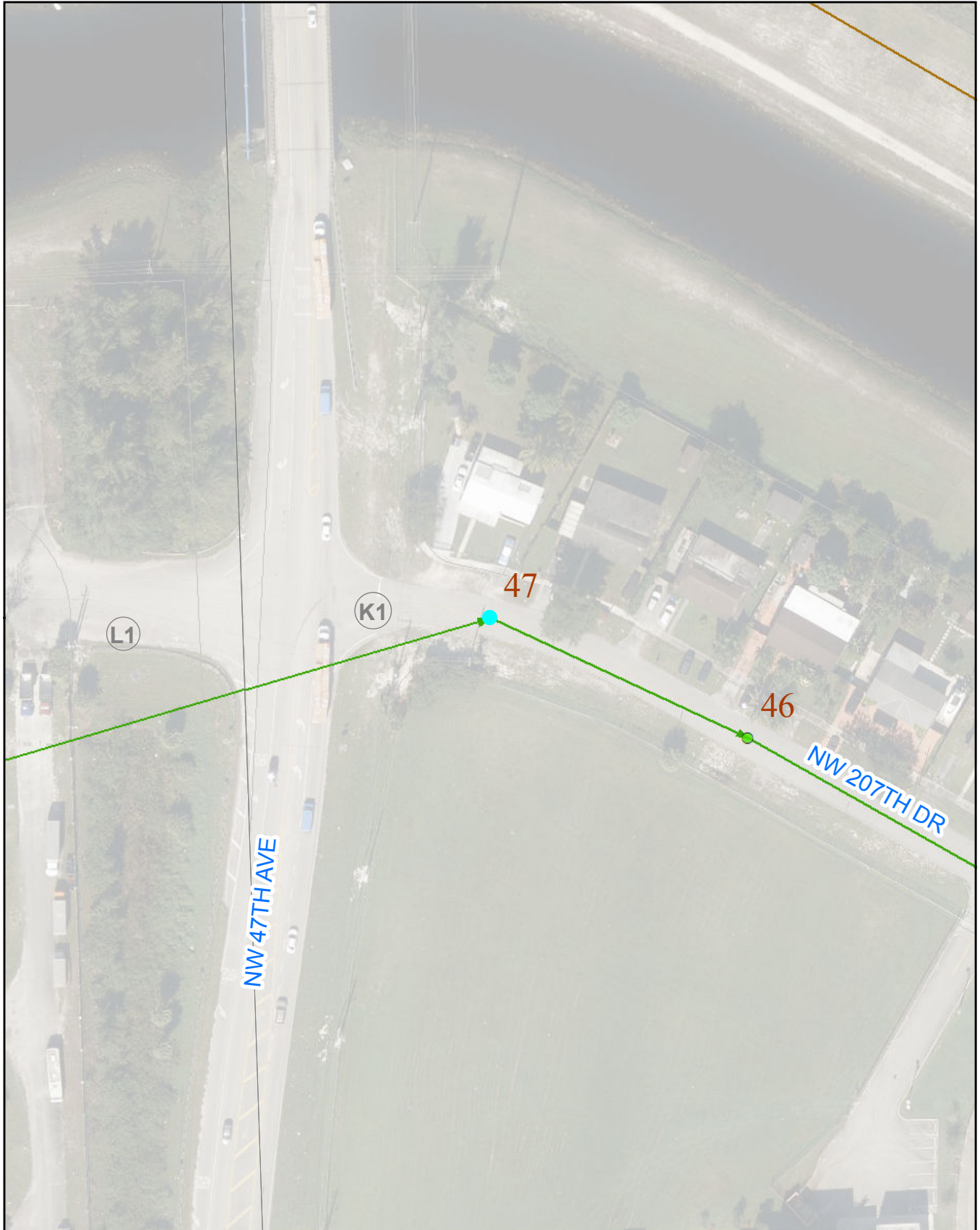

MDWASD NOTICE

The materials contained herein are provided "AS IS" and may contain inaccuracies. User is wanted to utilize the materials herein at User's own risk and to verify the material's accuracy independently and ASSUMES THE RISK OF ANY AND ALL LOSS.
MS/GIS Modified 07-10-06

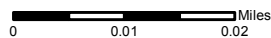

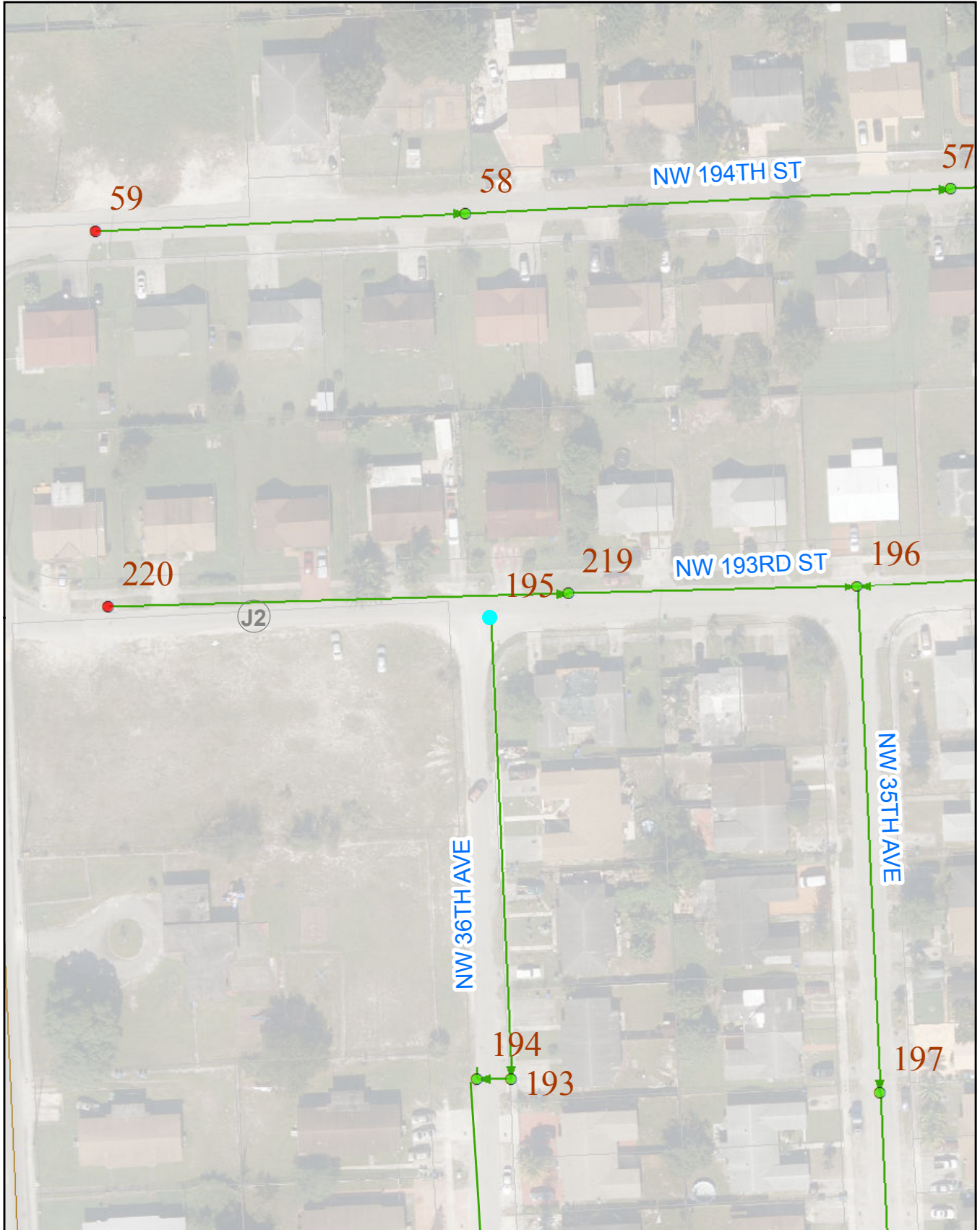

MDWASD NOTICE

The materials contained herein are provided "AS IS" and may contain inaccuracies. User is wanted to utilize the materials herein at User's own risk and to verify the material's accuracy independently and ASSUMES THE RISK OF ANY AND ALL LOSS.
MIS/GIS Modified 07-10-06

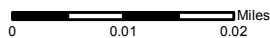

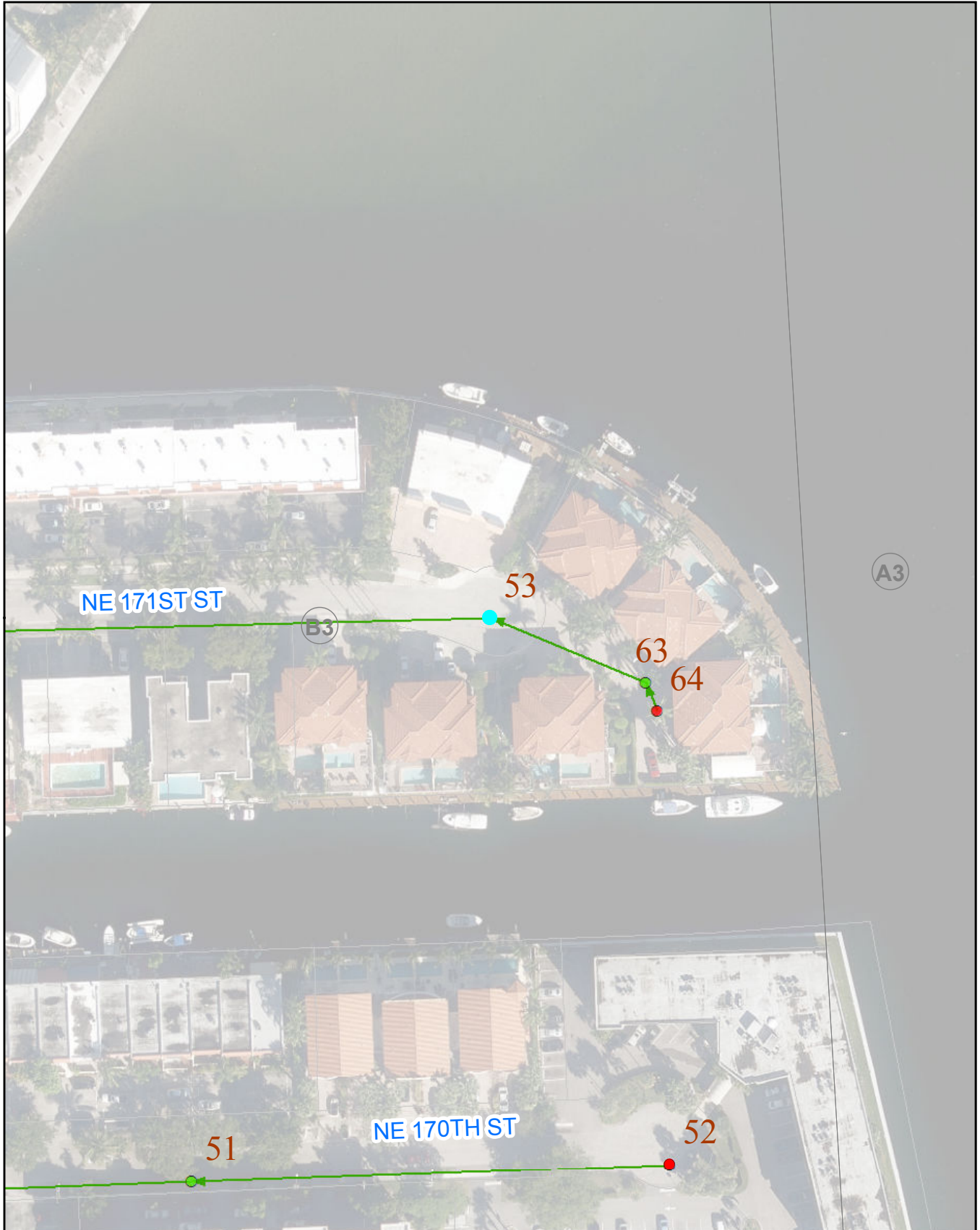

MDWASD NOTICE

The materials contained herein are provided "AS IS" and may contain inaccuracies. User is wanted to utilize the materials herein at User's own risk and to verify the material's accuracy independently and ASSUMES THE RISK OF ANY AND ALL LOSS.
MIS/GIS Modified 07-10-06

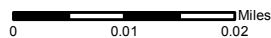



MDWASD NOTICE

The materials contained herein are provided "AS IS" and may contain inaccuracies. User is wanted to utilize the materials herein at User's own risk and to verify the material's accuracy independently and ASSUMES THE RISK OF ANY AND ALL LOSS.
MS/GIS Modified 07-10-06

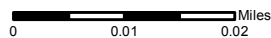



MDWASD NOTICE

The materials contained herein are provided "AS IS" and may contain inaccuracies. User is wanted to utilize the materials herein at User's own risk and to verify the material's accuracy independently and ASSUMES THE RISK OF ANY AND ALL LOSS.
MIS/GIS Modified 07-10-06

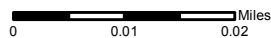



MDWASD NOTICE

The materials contained herein are provided "AS IS" and may contain inaccuracies. User is wanted to utilize the materials herein at User's own risk and to verify the material's accuracy independently and ASSUMES THE RISK OF ANY AND ALL LOSS.
MS/GIS Modified 07-10-06

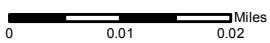

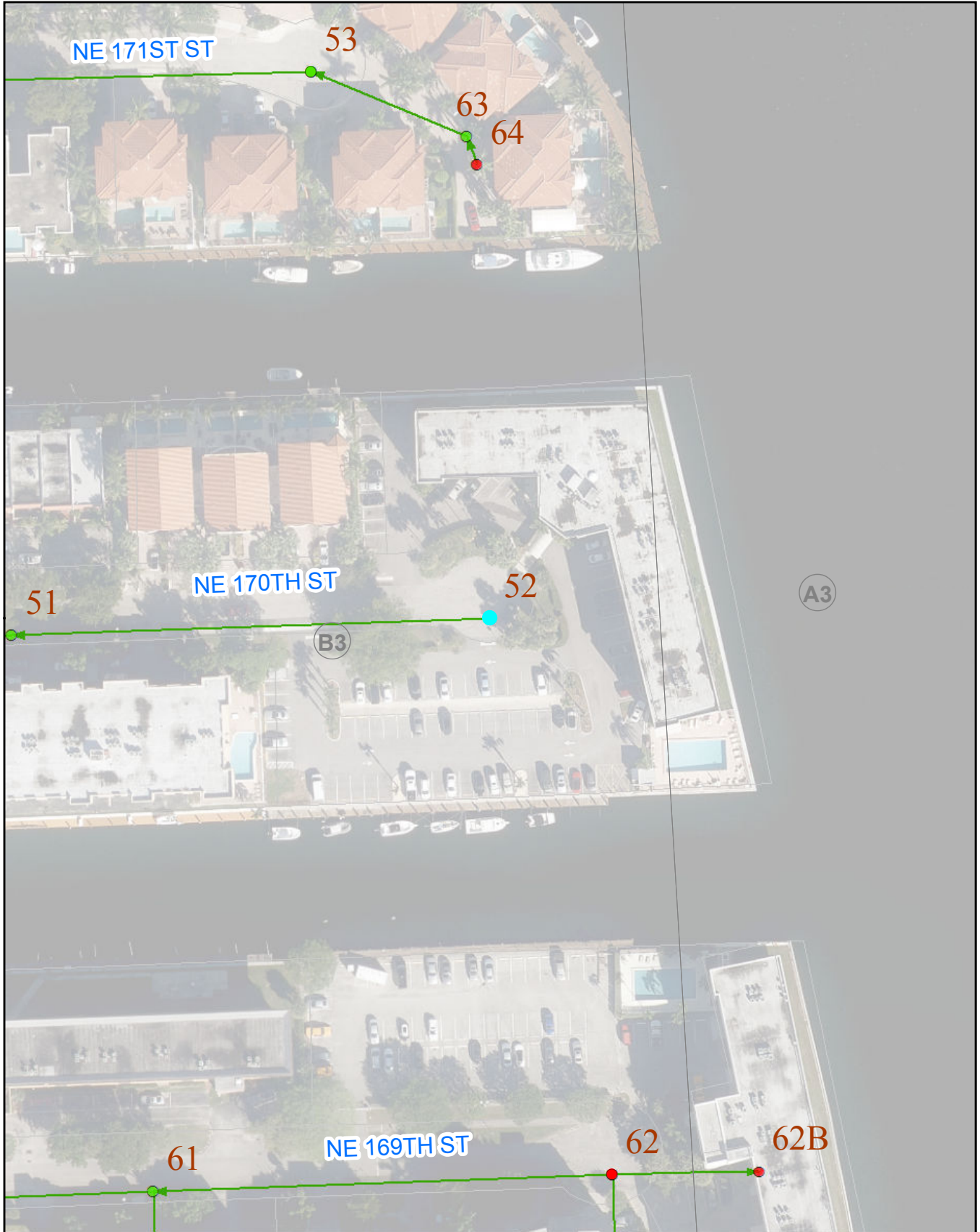

MDWASD NOTICE
The materials contained herein are provided "AS IS" and may contain inaccuracies. User is wanted to utilize the materials herein at User's own risk and to verify the material's accuracy independently and ASSUMES THE RISK OF ANY AND ALL LOSS.
MIS/GIS Modified 07-10-06

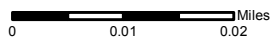

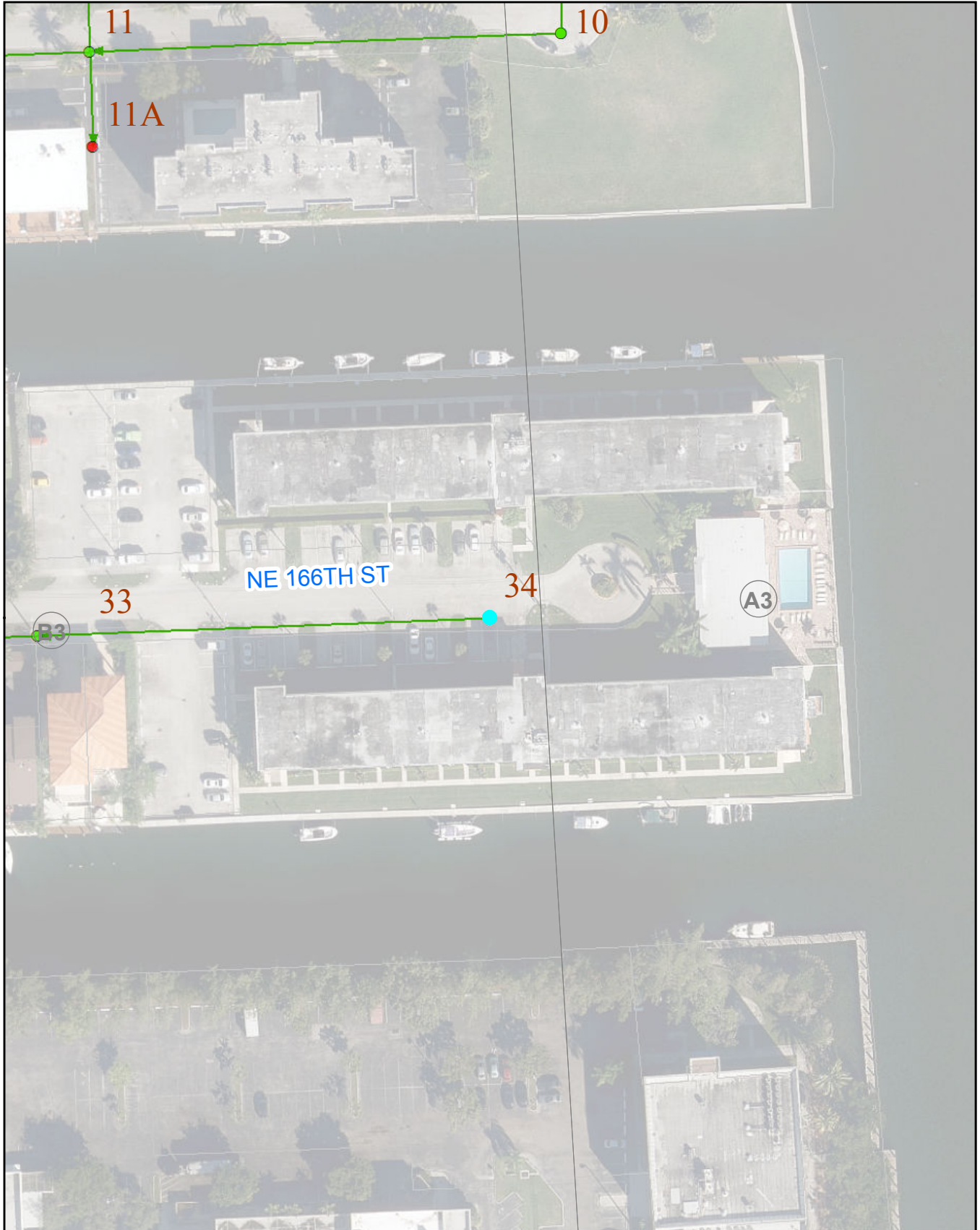

MDWASD NOTICE

The materials contained herein are provided "AS IS" and may contain inaccuracies. User is wanted to utilize the materials herein at User's own risk and to verify the material's accuracy independently and ASSUMES THE RISK OF ANY AND ALL LOSS.
MIS/GIS Modified 07-10-06

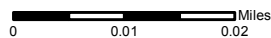

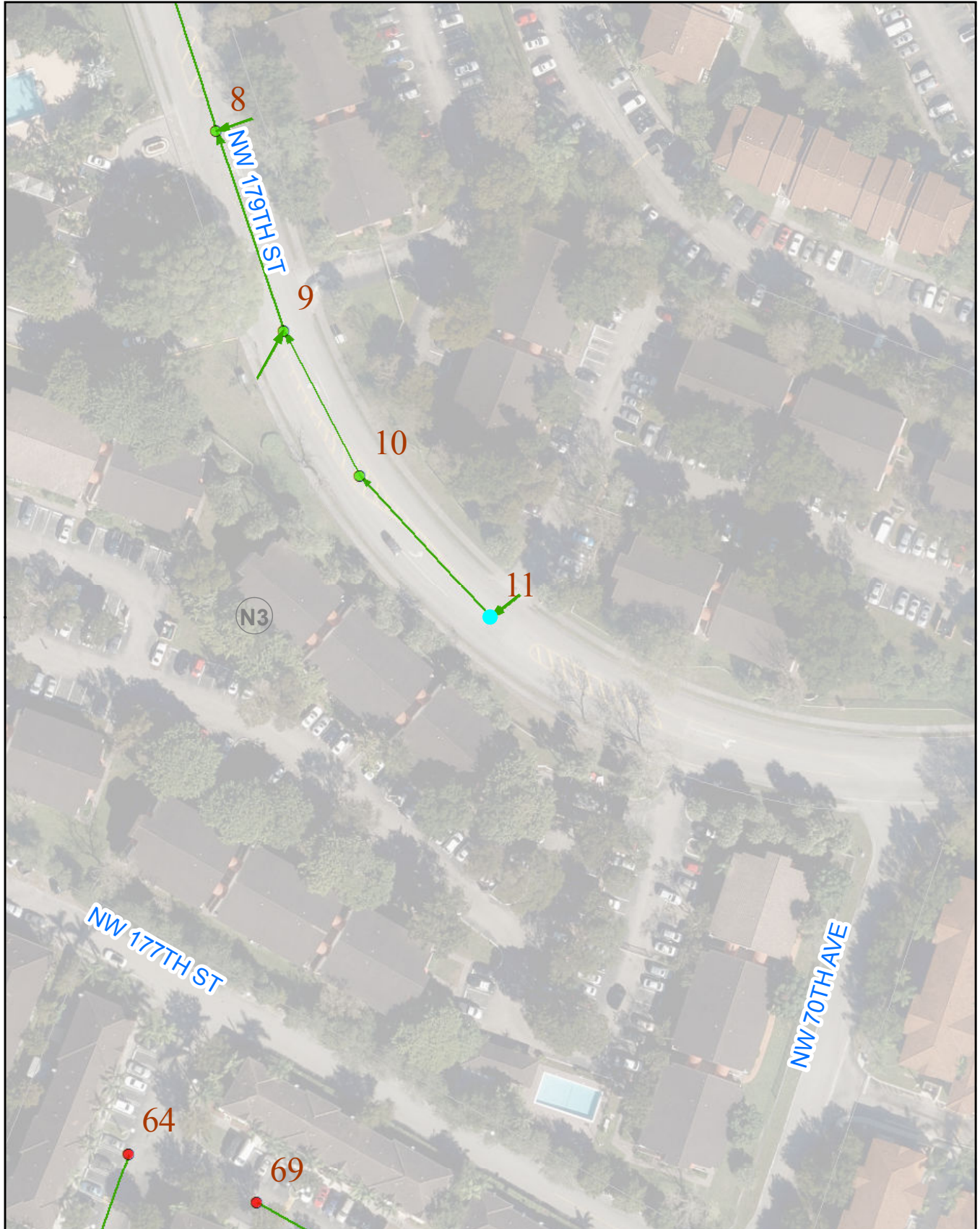

MDWASD NOTICE

The materials contained herein are provided "AS IS" and may contain inaccuracies. User is wanted to utilize the materials herein at User's own risk and to verify the material's accuracy independently and ASSUMES THE RISK OF ANY AND ALL LOSS.
MIS/GIS Modified 07-10-08

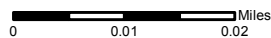

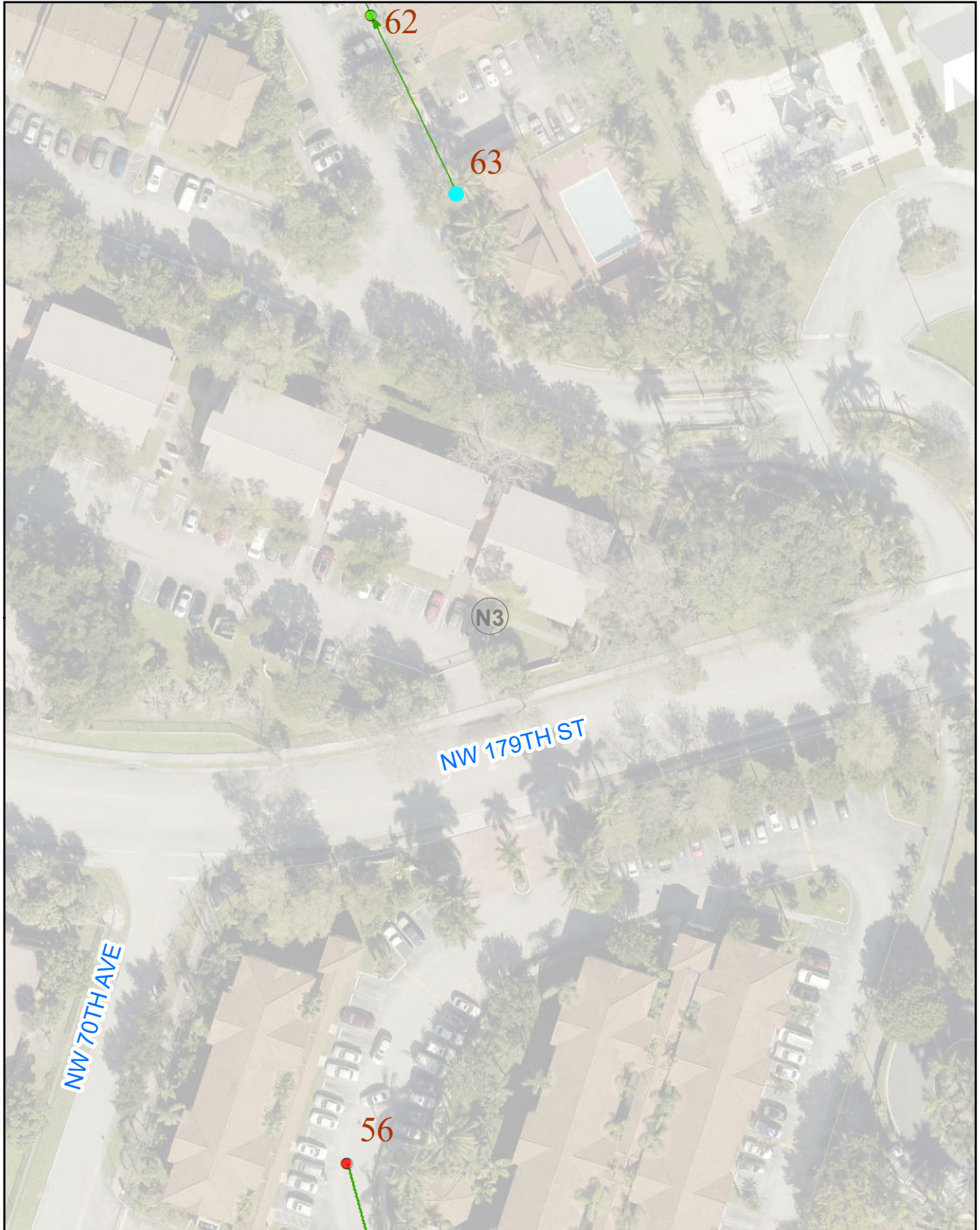

MDWASD NOTICE

The materials contained herein are provided "AS IS" and may contain inaccuracies. User is wanted to utilize the materials herein at User's own risk and to verify the material's accuracy independently and ASSUMES THE RISK OF ANY AND ALL LOSS.
MIS/GIS Modified 07-10-06

0 0.0075 0.015 Miles



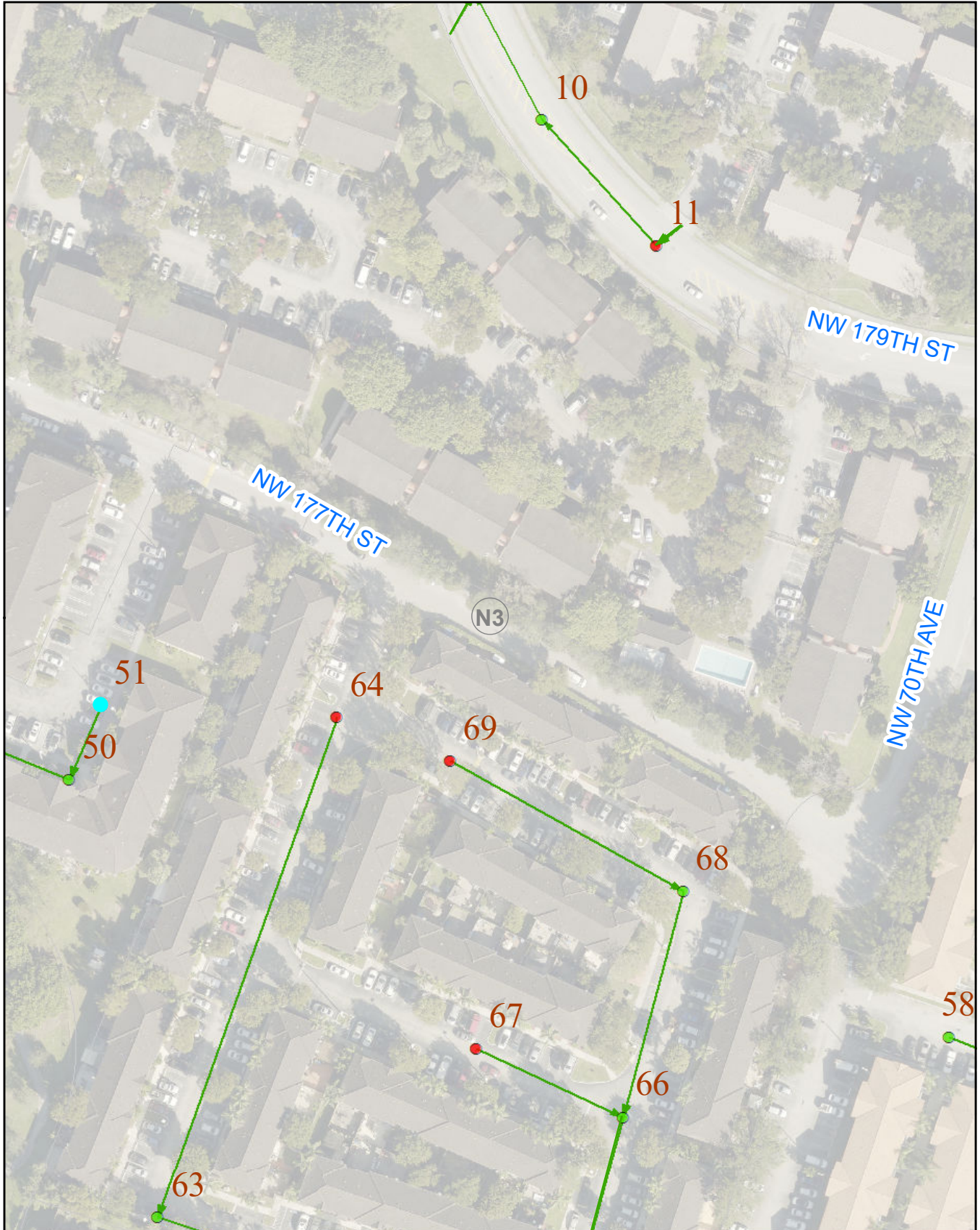

MDWASD NOTICE

The materials contained herein are provided "AS IS" and may contain inaccuracies. User is wanted to utilize the materials herein at User's own risk and to verify the material's accuracy independently and ASSUMES THE RISK OF ANY AND ALL LOSS.
MIS/GIS Modified 07-10-06

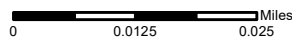



MIAMI - DADE WATER AND SEWER DEPARTMENT WWCTLD - HotSpot Smart Cover Location



Central

MOWASD NOTICE

The materials contained herein are provided "AS IS" and may contain inaccuracies. User is warned to utilize the materials herein at User's own risk and to verify the material's accuracy independently and ASSUMES THE RISK OF ANY AND ALL LOSS.
MISGIS Modified 07-10-06

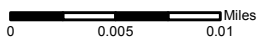

Legend



Smart covers list

EAMID	EAMDESC	NEW MH#	OLD MH#	PS#	S	ADDRESS	ZIPCODE
383074	Sewer Manhole 0001-A-196	790	196	0001	A	196 NW 1st St / W. Flagler	33128
373418	Sewer Manhole 0001-B-2477	2477	361	0001	B	NW 3rd St & 13th Ave	33125
347385	Sewer Manhole 0001-B-401	1453	401	0001	B	988 NW 2nd St	33128
377106	Sewer Manhole 0001-C-133	530	133	0001	C	SW 22nd Rd & 3rd Ave	33129
352090	Sewer Manhole 0001-D-080	322	80	0001	D	NW 20th St & 12th Ave	33136
367018	Sewer Manhole 0002-B-214	1081	214	0002	B	NE 30th Ter & 7th Ave	33137
378463	Sewer Manhole 0002-C-133	751	133	0002	C	NW 36th St close to 36th yard	33127
346843	Sewer Manhole 0010-A-093	93	94	0010	A	NW 11th St & 26th Ave	33125
384785	Sewer Manhole 0014-A-049	50	49	0014	A	8130 NW 58th St	33166
384511	Sewer Manhole 0042-A-198	194	198	0042	A	2900 NW 10th Ave	33127
378932	Sewer Manhole 0054-A-255	255	130	0054	A	1251 NW 20th St	33142
379767	Sewer Manhole 0055-A-34	34	33	0055	A	NW 3rd St & 13th Ave	33125
359529	Sewer Manhole 0055-A-28	28	27	0055	A	NW 3rd St & 15th Ave	33125
366411	Sewer Manhole 0062-A-189	186	189	0062	A	NW 7th Ave & 79th St	33150
351089	Sewer Manhole 0064-A-006	6	6	0064	A	S. Bayshore Dr & W. Fairviews	33133
378890	Sewer Manhole 0072-A-448	449	448	0072	A	NW 12th Ct & 67th St	33147
373636	Sewer Manhole 0105-A-009	9	9	0105	A	7707 NW 7th St	33126
369924	Sewer Manhole 0135-A-033	29	33	0135	A	Fernwood & Enid Dr (KB)	33149
354284	Sewer Manhole 0136-A-050	51	50	0136	A	30 W Mashta Dr	33149
368960	Sewer Manhole 0190-A-114	115	114	0190	A	454 NW 57th Ave	33126
370338	Sewer Manhole 0190-A-058	61	58	0190	A	NW 53rd Ave & 4th Ter	33126



MDWASD NOTICE

The materials contained herein are provided "AS IS" and may contain inaccuracies. User is wanted to utilize the materials herein at User's own risk and to verify the material's accuracy independently and ASSUMES THE RISK OF ANY AND ALL LOSS.
MS/GIS Modified 07-10-06

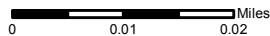



MDWASD NOTICE

The materials contained herein are provided "AS IS" and may contain inaccuracies. User is wanted to utilize the materials herein at User's own risk and to verify the material's accuracy independently and ASSUMES THE RISK OF ANY AND ALL LOSS.
MIS/GIS Modified 07-10-06

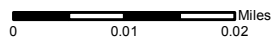



MDWASD NOTICE

The materials contained herein are provided "AS IS" and may contain inaccuracies. User is wanted to utilize the materials herein at User's own risk and to verify the material's accuracy independently and ASSUMES THE RISK OF ANY AND ALL LOSS.
MIS/GIS Modified 07-10-08

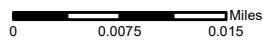

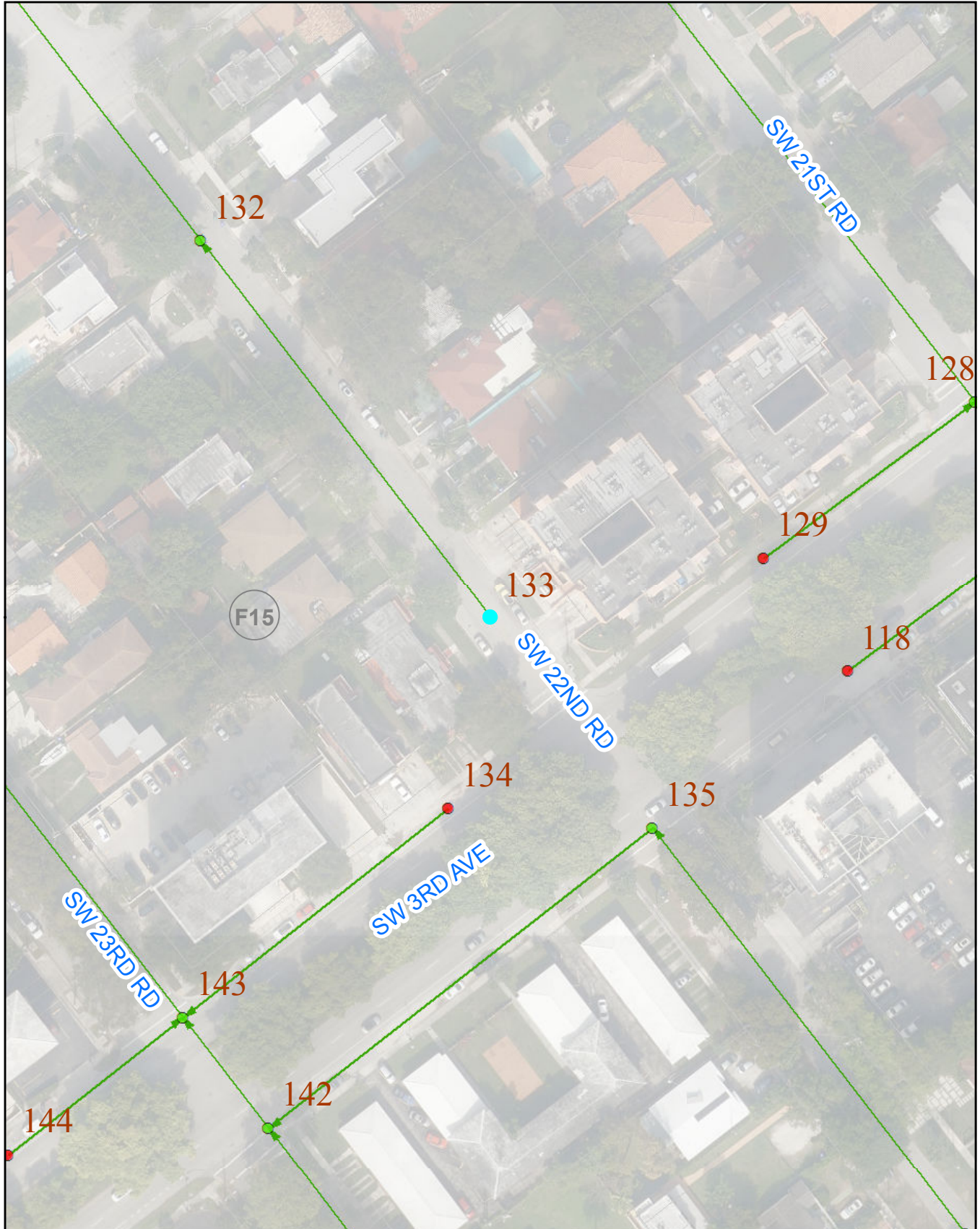

MDWASD NOTICE

The materials contained herein are provided "AS IS" and may contain inaccuracies. User is wanted to utilize the materials herein at User's own risk and to verify the material's accuracy independently and ASSUMES THE RISK OF ANY AND ALL LOSS.
MIS/GIS Modified 07-10-06

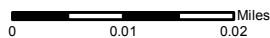

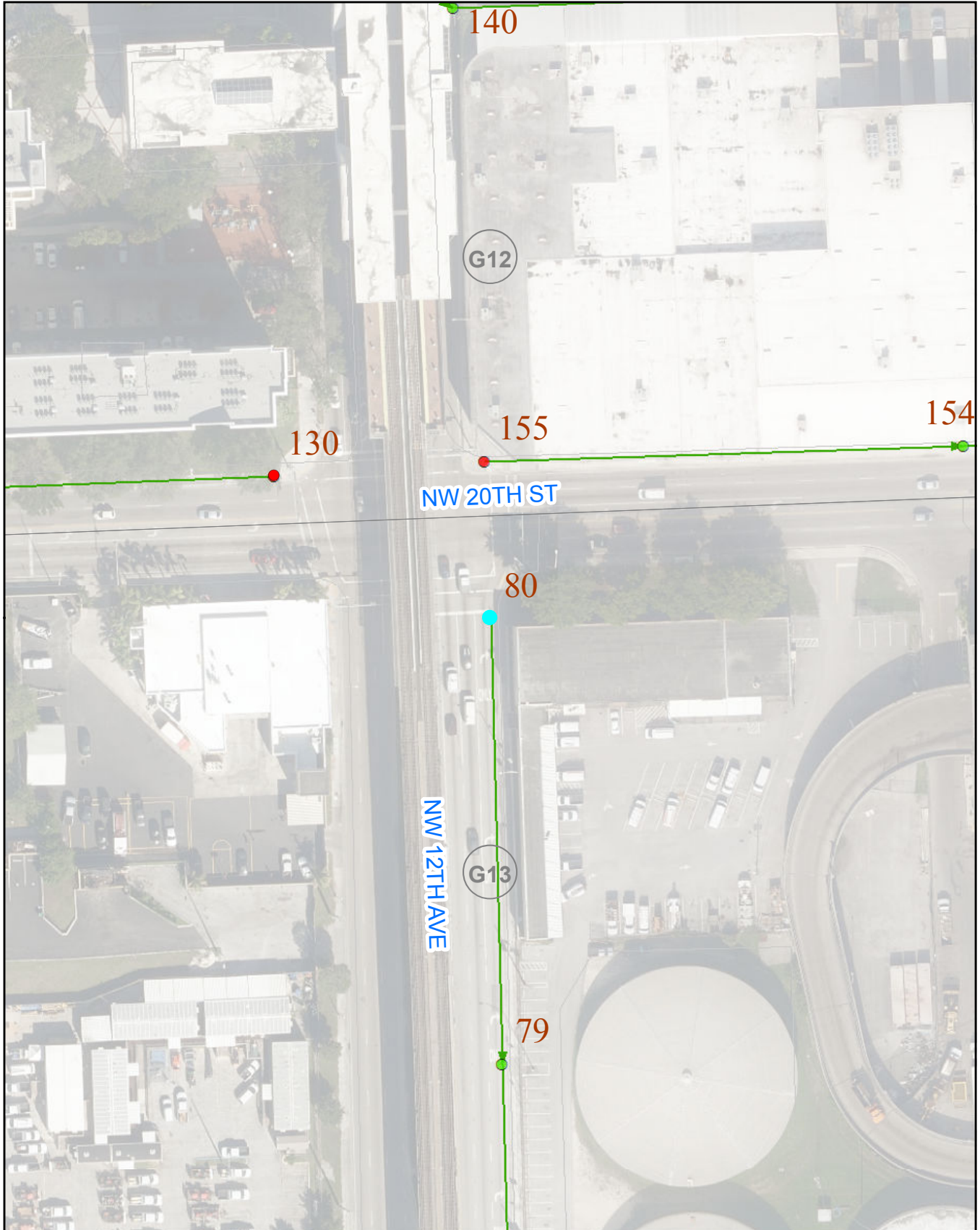

MDWASD NOTICE

The materials contained herein are provided "AS IS" and may contain inaccuracies. User is wanted to utilize the materials herein at User's own risk and to verify the material's accuracy independently and ASSUMES THE RISK OF ANY AND ALL LOSS.
MDS/GIS Modified 07-10-06

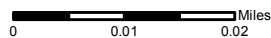



MDWASD NOTICE

The materials contained herein are provided "AS IS" and may contain inaccuracies. User is wanted to utilize the materials herein at User's own risk and to verify the material's accuracy independently and ASSUMES THE RISK OF ANY AND ALL LOSS.
MIS/GIS Modified 07-10-06

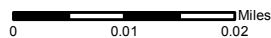

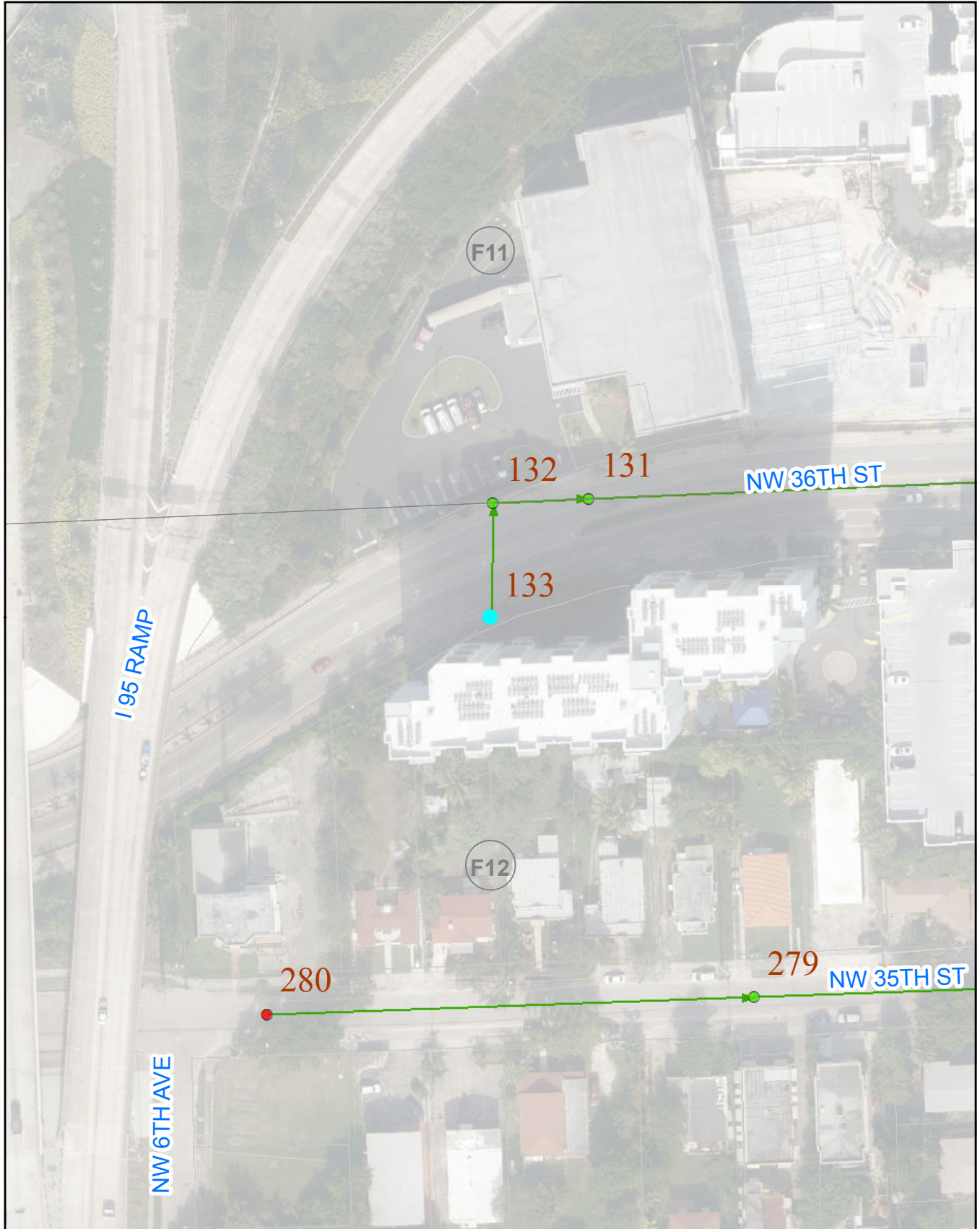

MDWASD NOTICE

The materials contained herein are provided "AS IS" and may contain inaccuracies. User is wanted to utilize the materials herein at User's own risk and to verify the material's accuracy independently and ASSUMES THE RISK OF ANY AND ALL LOSS.
MIS/GIS Modified 07-10-06

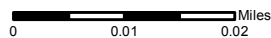



MDWASD NOTICE

The materials contained herein are provided "AS IS" and may contain inaccuracies. User is wanted to utilize the materials herein at User's own risk and to verify the material's accuracy independently and ASSUMES THE RISK OF ANY AND ALL LOSS.
MIS/GIS Modified 07-10-06

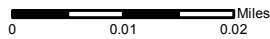

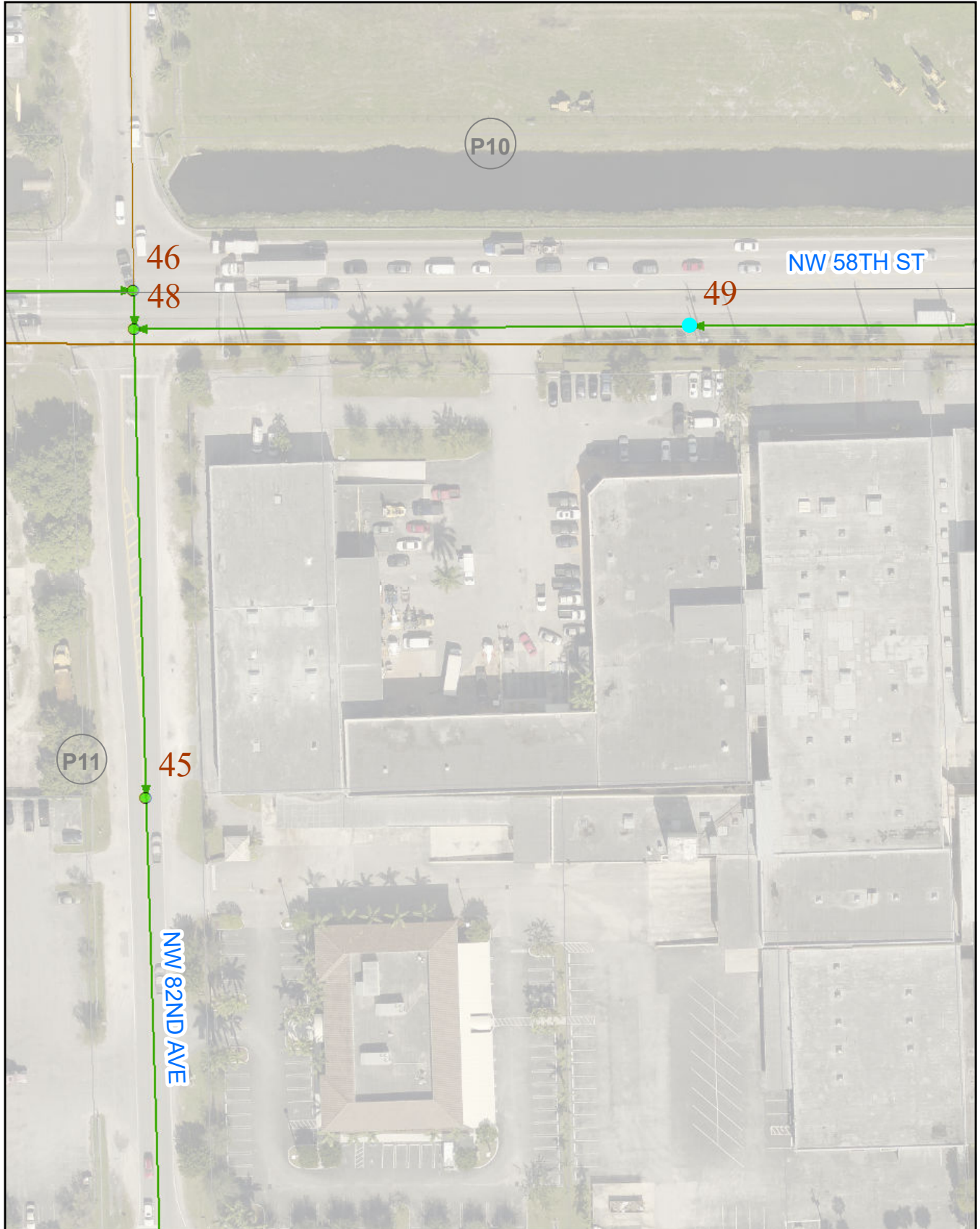

MDWASD NOTICE

The materials contained herein are provided "AS IS" and may contain inaccuracies. User is wanted to utilize the materials herein at User's own risk and to verify the material's accuracy independently and ASSUMES THE RISK OF ANY AND ALL LOSS.
MIS/GIS Modified 07-10-06

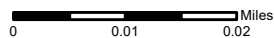

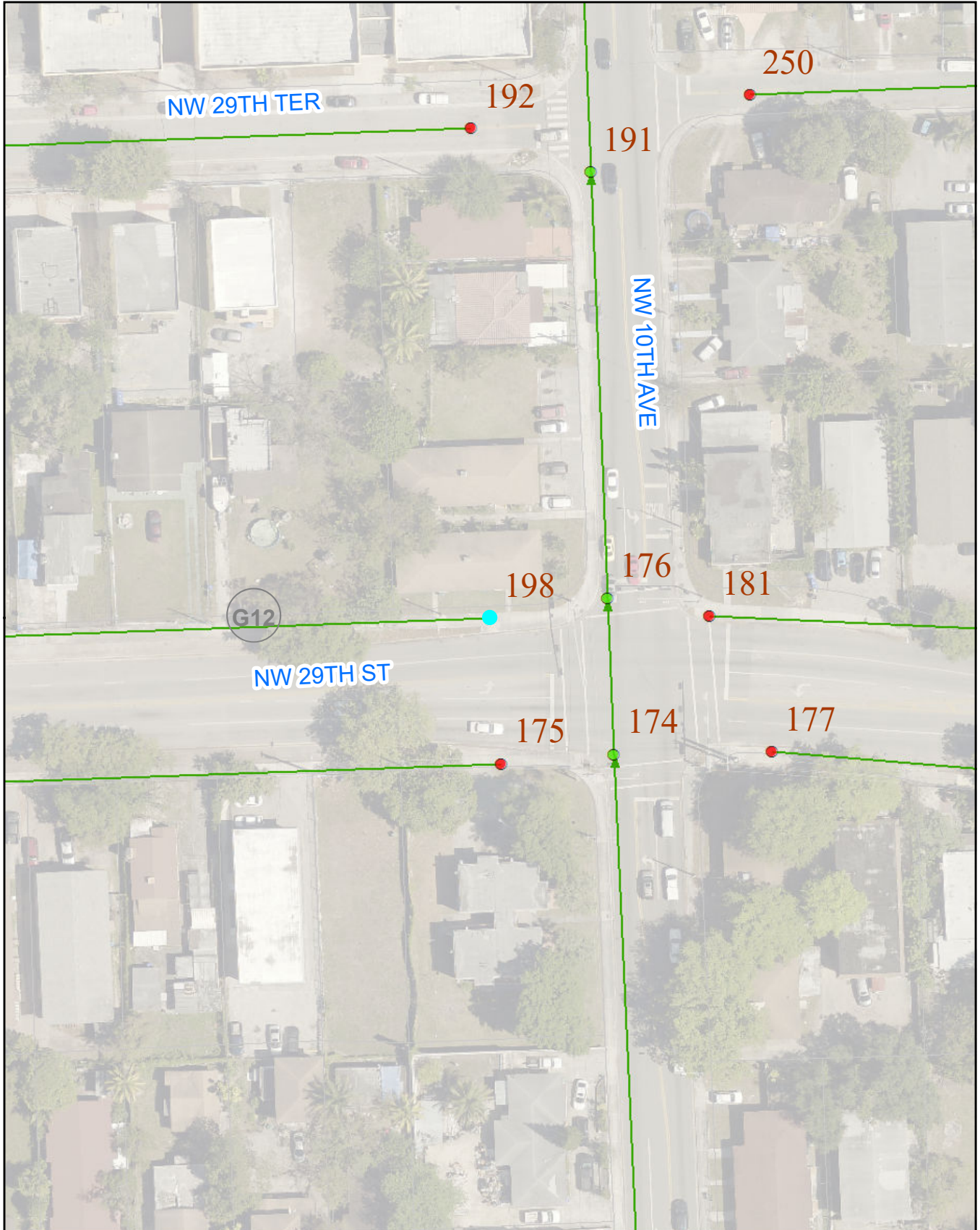

MDWASD NOTICE

The materials contained herein are provided "AS IS" and may contain inaccuracies. User is wanted to utilize the materials herein at User's own risk and to verify the material's accuracy independently and ASSUMES THE RISK OF ANY AND ALL LOSS.
MIS/GIS Modified 07-10-06

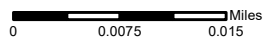

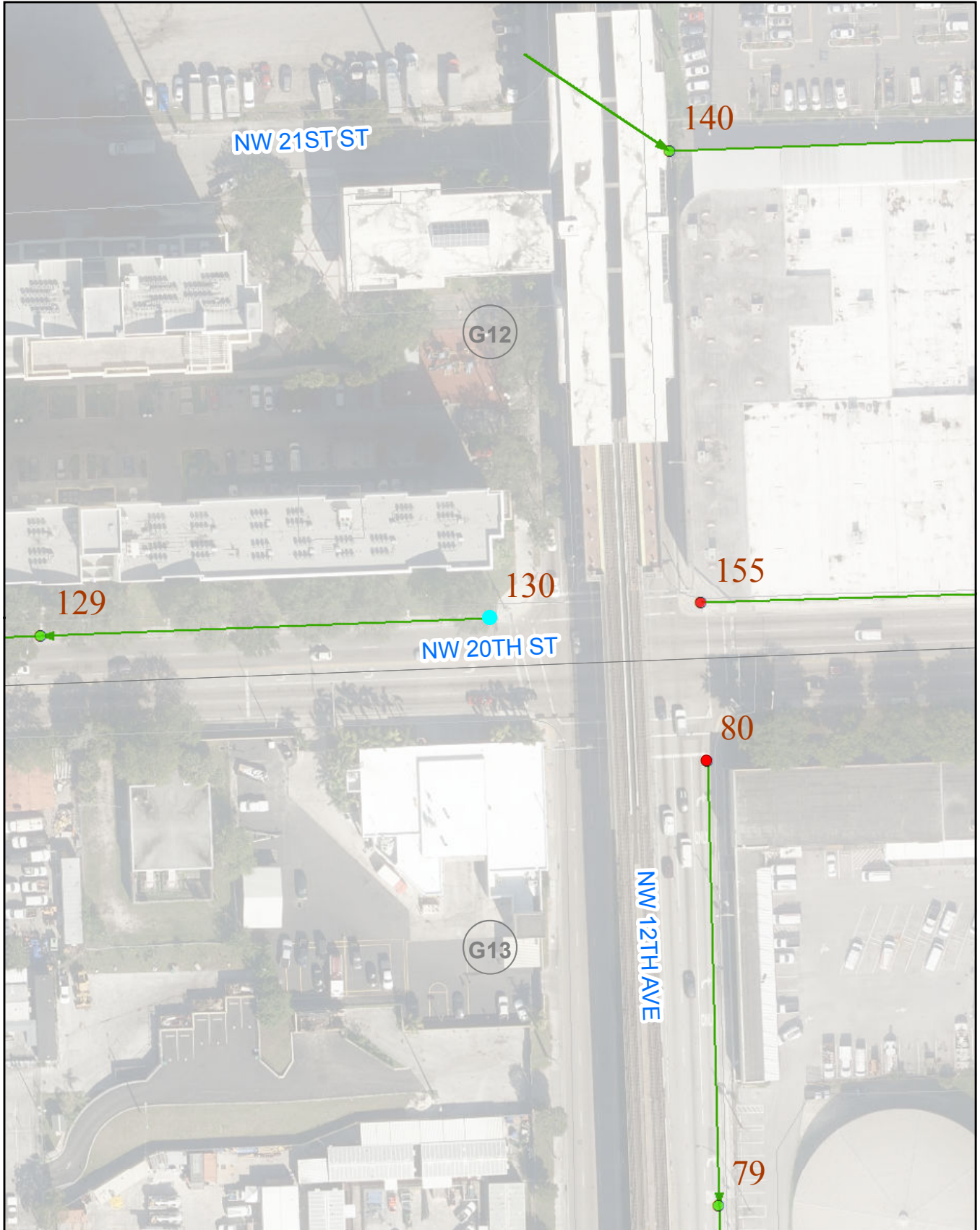

MDWASD NOTICE

The materials contained herein are provided "AS IS" and may contain inaccuracies. User is wanted to utilize the materials herein at User's own risk and to verify the material's accuracy independently and ASSUMES THE RISK OF ANY AND ALL LOSS.
MIS/GIS Modified 07-10-06

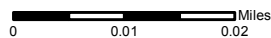

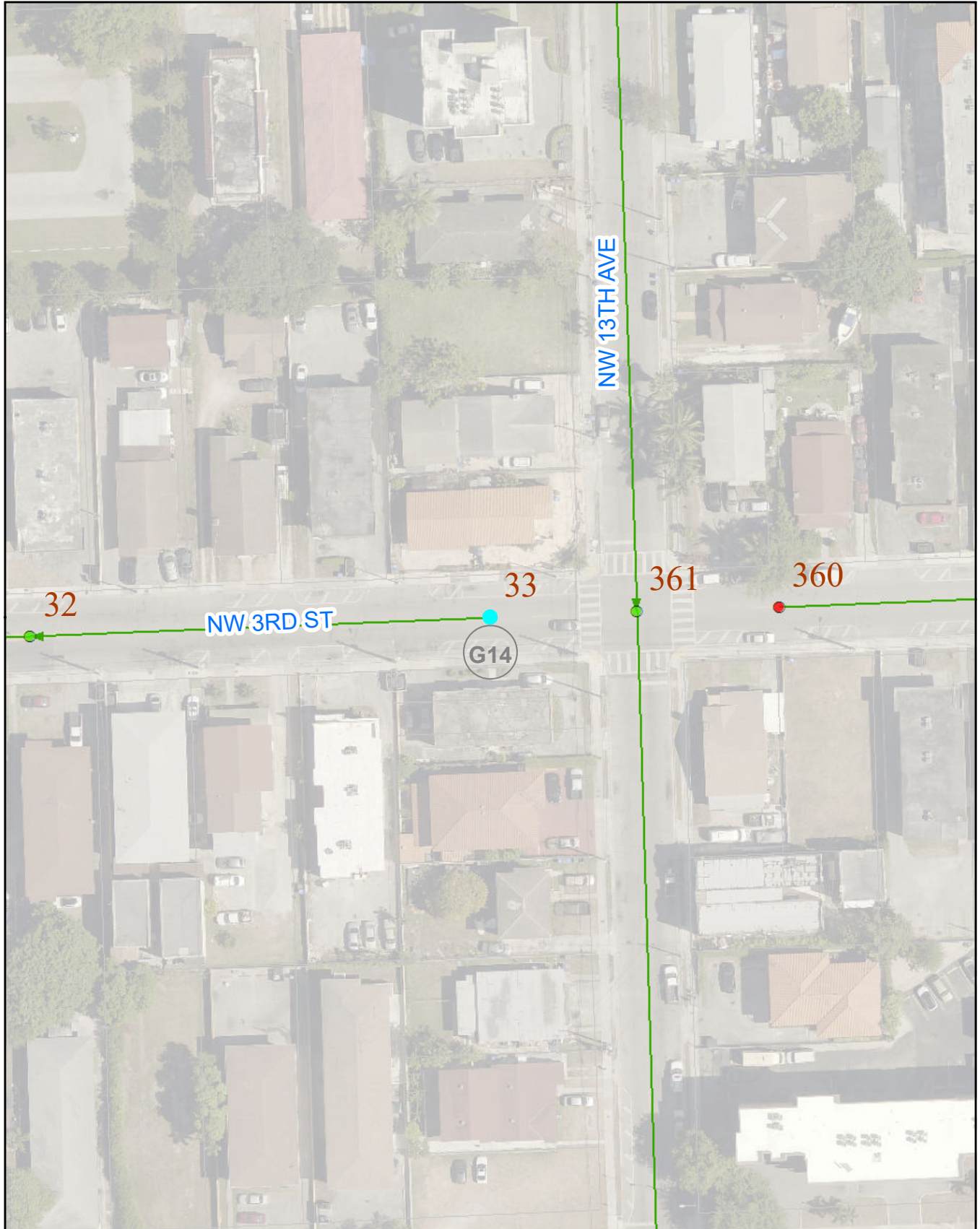

MDWASD NOTICE

The materials contained herein are provided "AS IS" and may contain inaccuracies. User is wanted to utilize the materials herein at User's own risk and to verify the material's accuracy independently and ASSUMES THE RISK OF ANY AND ALL LOSS.
MDS/GIS Modified 07-10-06

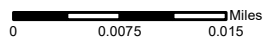

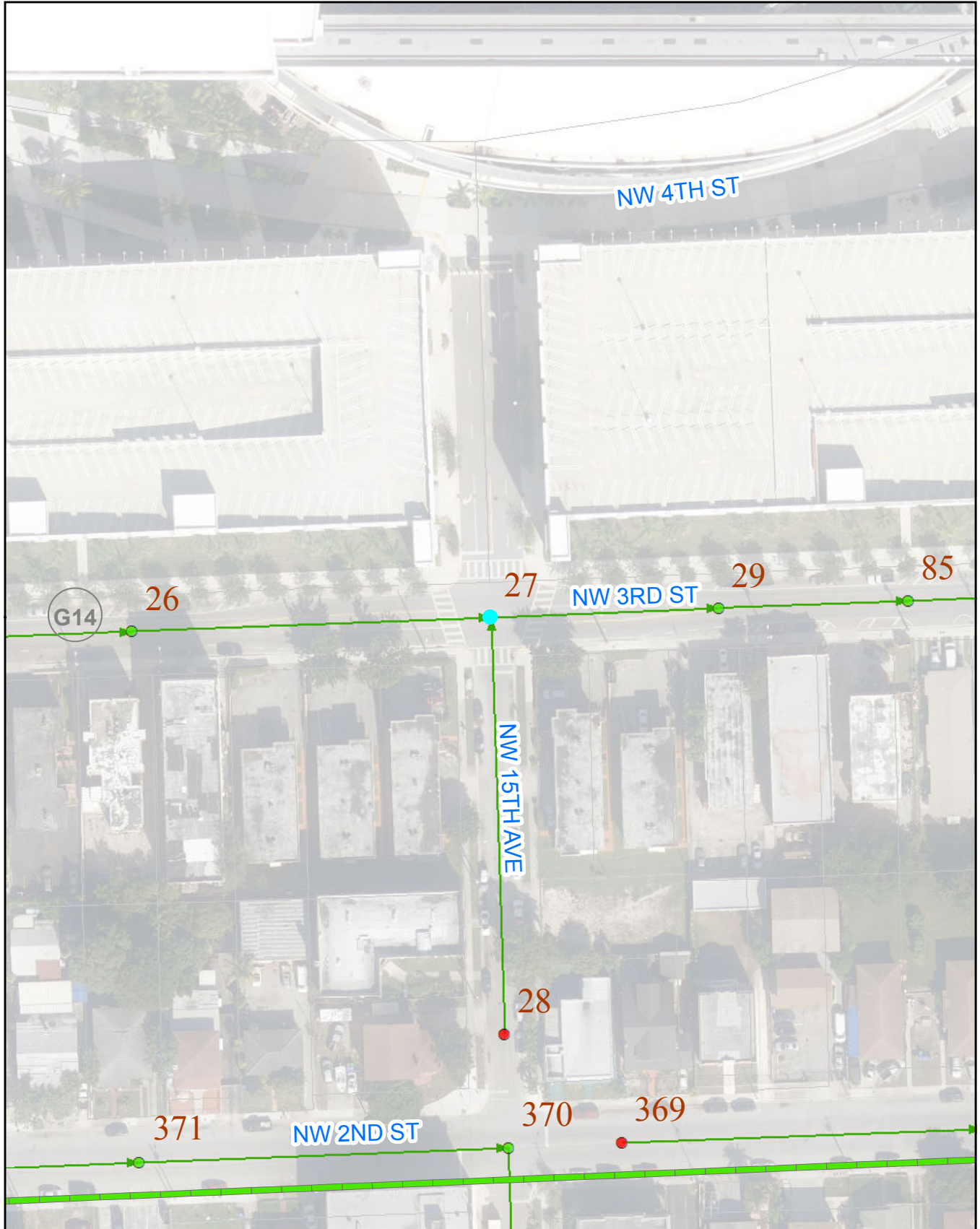

MDWASD NOTICE

The materials contained herein are provided "AS IS" and may contain inaccuracies. User is wanted to utilize the materials herein at User's own risk and to verify the material's accuracy independently and ASSUMES THE RISK OF ANY AND ALL LOSS.
MIS/GIS Modified 07-10-06

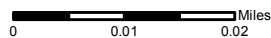

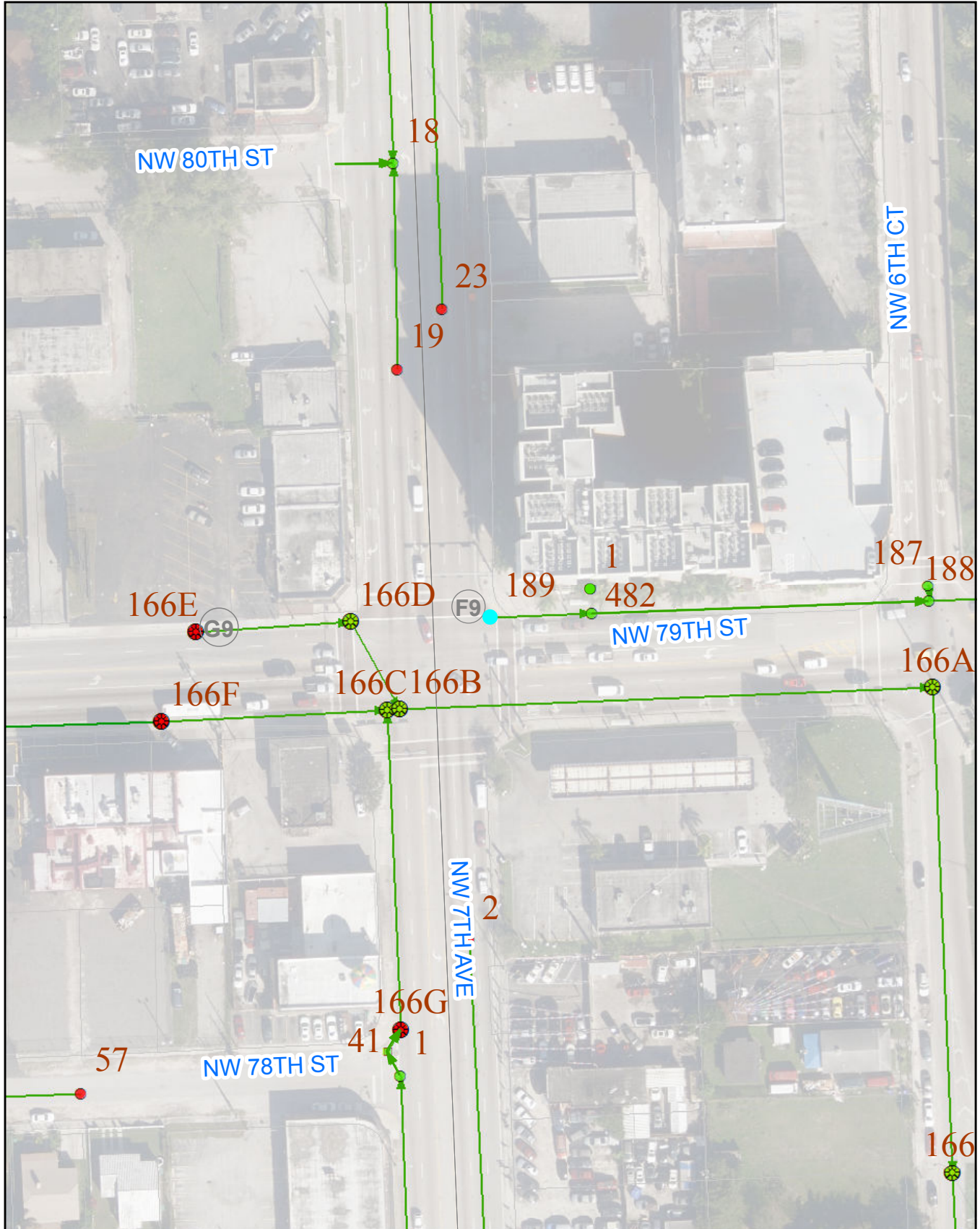

MDWASD NOTICE

The materials contained herein are provided "AS IS" and may contain inaccuracies. User is wanted to utilize the materials herein at User's own risk and to verify the material's accuracy independently and ASSUMES THE RISK OF ANY AND ALL LOSS.
 MDC/GIS Modified 07-10-06

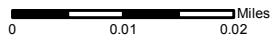



MDWASD NOTICE

The materials contained herein are provided "AS IS" and may contain inaccuracies. User is wanted to utilize the materials herein at User's own risk and to verify the material's accuracy independently and ASSUMES THE RISK OF ANY AND ALL LOSS.
MS/GIS Modified 07-10-06

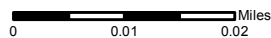



MDWASD NOTICE

The materials contained herein are provided "AS IS" and may contain inaccuracies. User is wanted to utilize the materials herein at User's own risk and to verify the material's accuracy independently and ASSUMES THE RISK OF ANY AND ALL LOSS.
MIS/GIS Modified 07-10-06

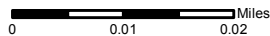

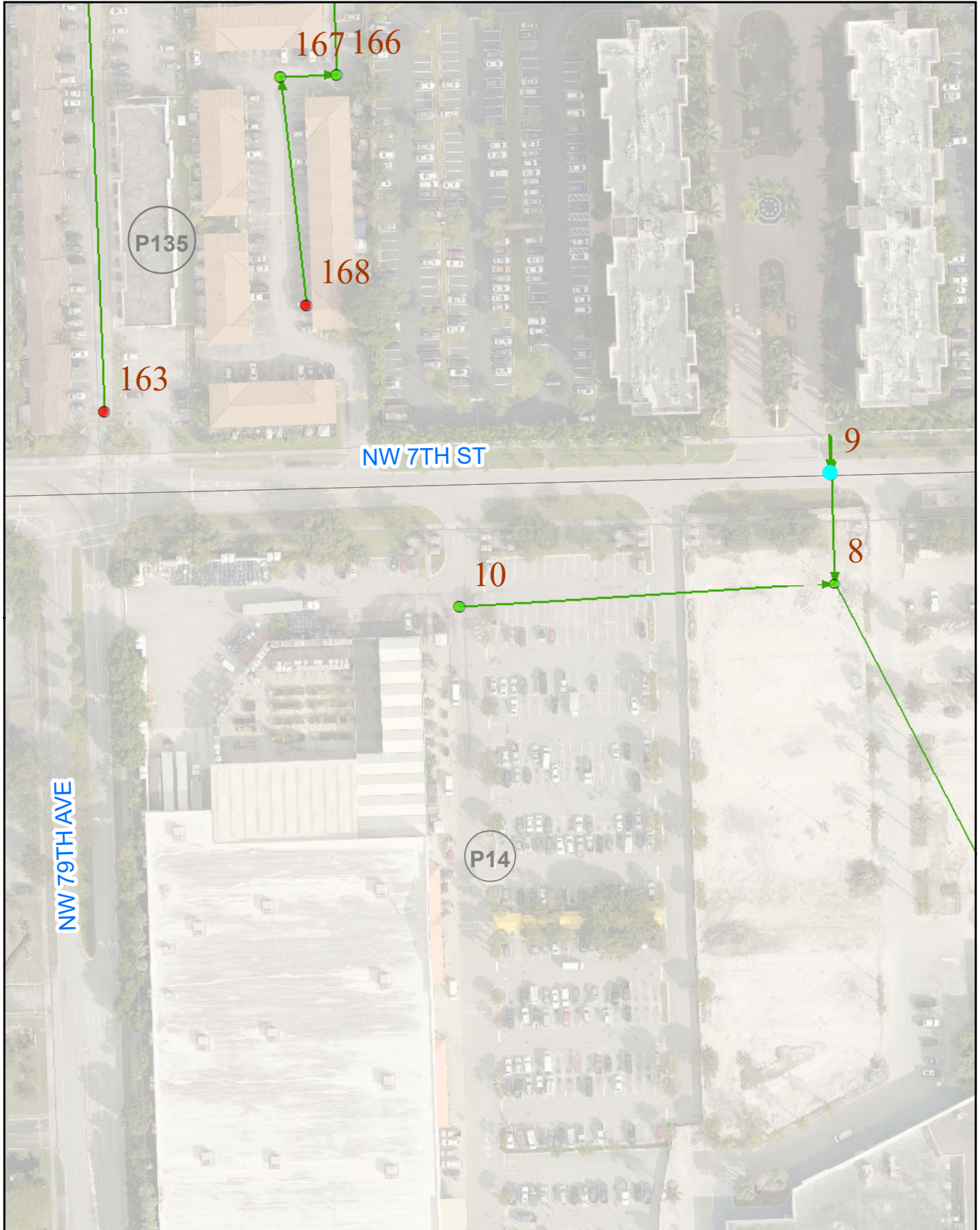

MDWASD NOTICE

The materials contained herein are provided "AS IS" and may contain inaccuracies. User is wanted to utilize the materials herein at User's own risk and to verify the material's accuracy independently and ASSUMES THE RISK OF ANY AND ALL LOSS.
MIS/GIS Modified 07-10-06

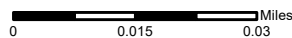

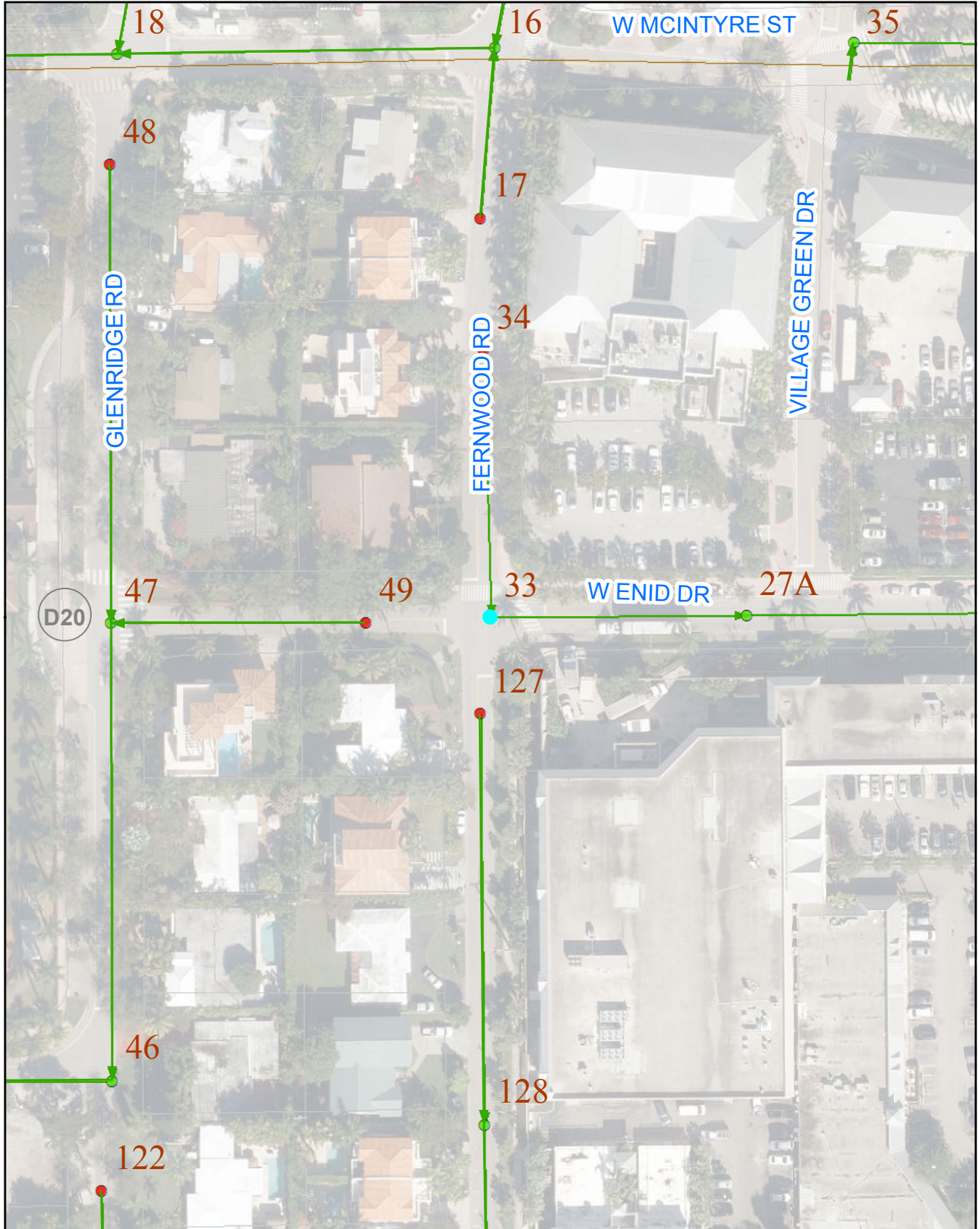

MDWASD NOTICE

The materials contained herein are provided "AS IS" and may contain inaccuracies. User is wanted to utilize the materials herein at User's own risk and to verify the material's accuracy independently and ASSUMES THE RISK OF ANY AND ALL LOSS.
MS/GIS Modified 07-10-06

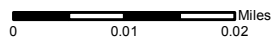

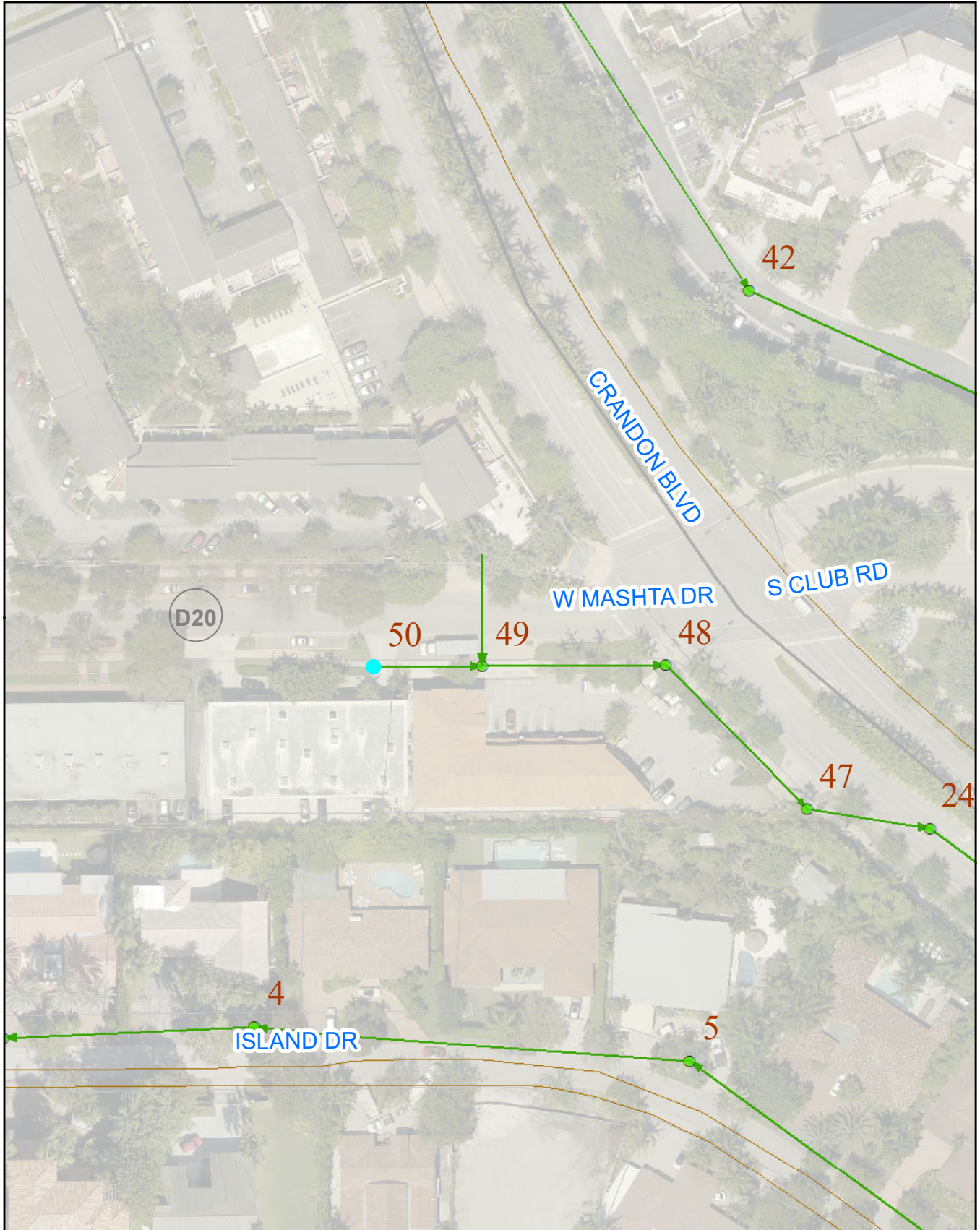

MDWASD NOTICE

The materials contained herein are provided "AS IS" and may contain inaccuracies. User is wanted to utilize the materials herein at User's own risk and to verify the material's accuracy independently and ASSUMES THE RISK OF ANY AND ALL LOSS.
MIS/GIS Modified 07-10-06

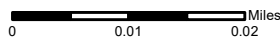



MDWASD NOTICE

The materials contained herein are provided "AS IS" and may contain inaccuracies. User is wanted to utilize the materials herein at User's own risk and to verify the material's accuracy independently and ASSUMES THE RISK OF ANY AND ALL LOSS.
MIS/GIS Modified 07-10-06

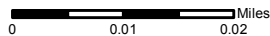

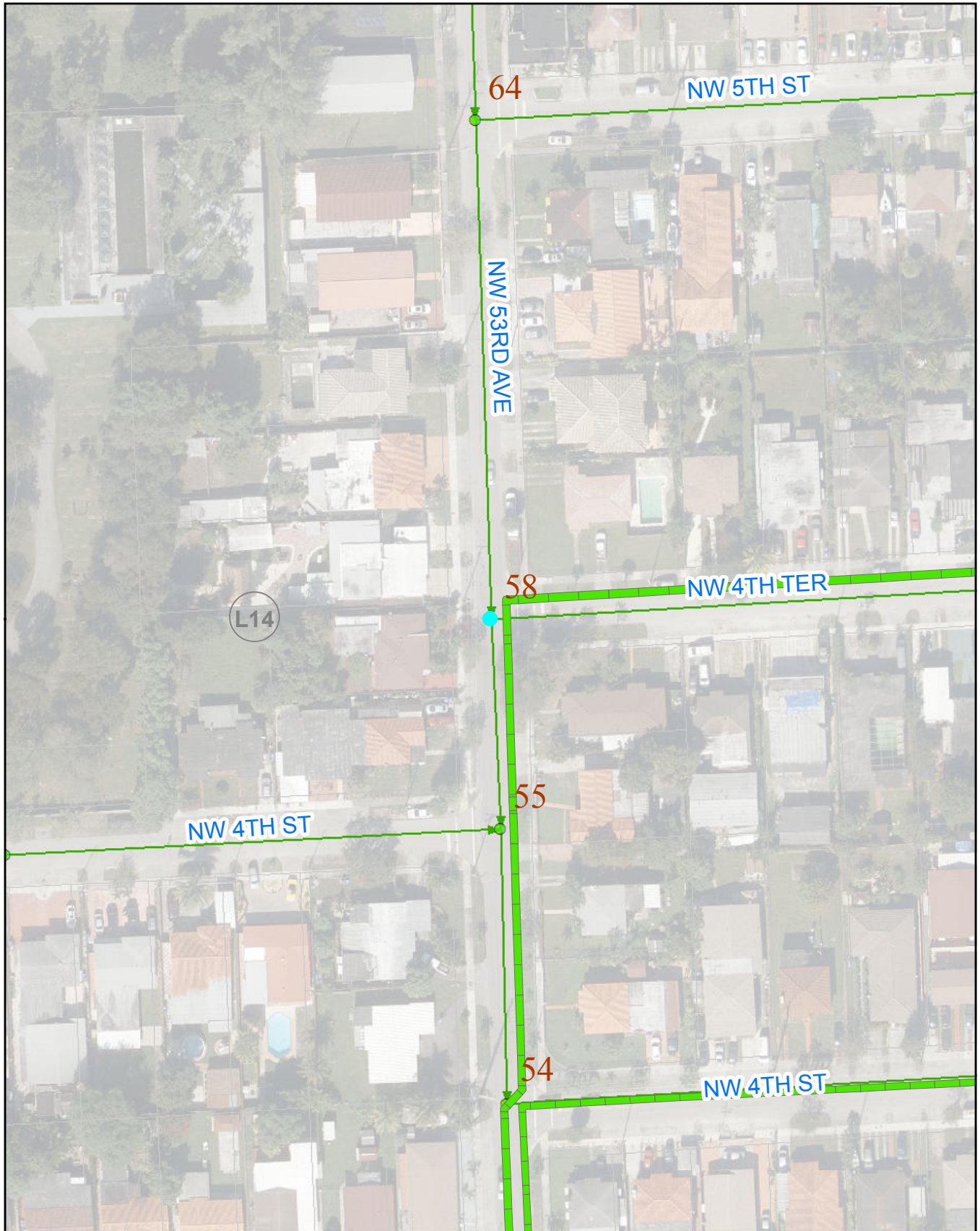

MDWASD NOTICE

The materials contained herein are provided "AS IS" and may contain inaccuracies. User is wanted to utilize the materials herein at User's own risk and to verify the material's accuracy independently and ASSUMES THE RISK OF ANY AND ALL LOSS.
MS/GIS Modified 07-10-06

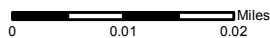



MIAMI - DADE WATER AND SEWER DEPARTMENT WWCTLD - HotSpot Smart Cover Location



South

MDWASD NOTICE

The materials contained herein are provided "AS IS" and may contain inaccuracies. User is warranted to utilize the materials herein at User's own risk and to verify the material's accuracy independently and ASSUMES THE RISK OF ANY AND ALL LOSS.
MISGIS Modified 07-10-06

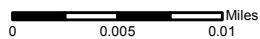

Legend



Smart covers list

EAMID	EAMDESC	NEW MH#	OLD MH#	PS#	S	ADDRESS	ZIPCODE
398487	Sewer Manhole 0501-A-073	73	73	0501	A	SW 147th Ave & 110th St	33196
405046	Sewer Manhole 0513-A-051	46	51	0513	A	SW 130th St & 123rd Ave	33186
434229	Sewer Manhole 0571-A-121	121	120	0571	A	SW 88th St & 99th Ct	33176
435432	Sewer Manhole 0639-A-058	58	58	0639	A	SW 114th Ave & 189th St	33157
426564	Sewer Manhole 0639-A-026	26	26	0639	A	SW 110th Ct & Caribbean Blvd	33157
405887	Sewer Manhole 0642-A-061	61	61	0642	A	SW 152nd Ave & 81st St	33193
394241	Sewer Manhole 0645-A-012	12	12	0645	A	SW 149th Ave & 80th St	33193
420979	Sewer Manhole 0649-A-023	23	23	0649	A	SW 127th Ct& 17th Ter	33175
397402	Sewer Manhole 0650-A-041	41	41	0650	A	SW 127th Ave & 12th St	33184
419093	Sewer Manhole 0662-A-014	14	14	0662	A	SW 113th Ct & 188th Ter	33157
428648	Sewer Manhole 0666-A-048	47	48	0666	A	SW 116th Pl & 34th Ln	33165
412288	Sewer Manhole 0732-A-013	12	13	0732	A	SW 94th Ave & 170th Ln	33157
392946	Sewer Manhole 0786-A-012	12	12	0786	A	SW 24th St & 103rd Ct	33165
427935	Sewer Manhole 0806-A-010	7	10	0806	A	SW 136th St at The Falls	33176
387192	Sewer Manhole 0806-A-19	19	21	0806	A	8778 SW 136th St (Fresh	33176
387326	Sewer Manhole 0808-A-013	14	13	0808	A	11105-11199 SW 88th St	33176
394475	Sewer Manhole 0808-A-010	11	10	0808	A	SW 112th Ave & 84th St	33176
397080	Sewer Manhole 0809-A-081	81	81	0809	A	The Palace- Hospital (Kendall)	33173
429575	Sewer Manhole 0880-A-072	72	72	0880	A	SW 112th St & 131st Ave	33186
387558	Sewer Manhole 1007-A-224A	167	224A	1007	A	15485-15625 Biscayne Dr	33033
435665	Sewer Manhole 1028-A-044	44	44	1028	A	SW 270th St & 136th Ave	33032
445279	Sewer Manhole 1037-A-013	13	13	1037	A	10469-10487 SW 216th St	33190
436418	Sewer Manhole 1044-A-007	7	7	1044	A	SW 140th Ct & 172nd St	33177
418703	Sewer Manhole 1065-A-010	10	10	1065	A	SW 186th St & US1	33157
442007	Sewer Manhole 1079-A-082	82	82	1079	A	SW 149th Pl & 173rd Ter	33187



MDWASD NOTICE

The materials contained herein are provided "AS IS" and may contain inaccuracies. User is wanted to utilize the materials herein at User's own risk and to verify the material's accuracy independently and ASSUMES THE RISK OF ANY AND ALL LOSS.
MIS/GIS Modified 07-10-06

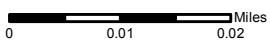



MDWASD NOTICE

The materials contained herein are provided "AS IS" and may contain inaccuracies. User is wanted to utilize the materials herein at User's own risk and to verify the material's accuracy independently and ASSUMES THE RISK OF ANY AND ALL LOSS.
MIS/GIS Modified 07-10-06

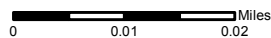

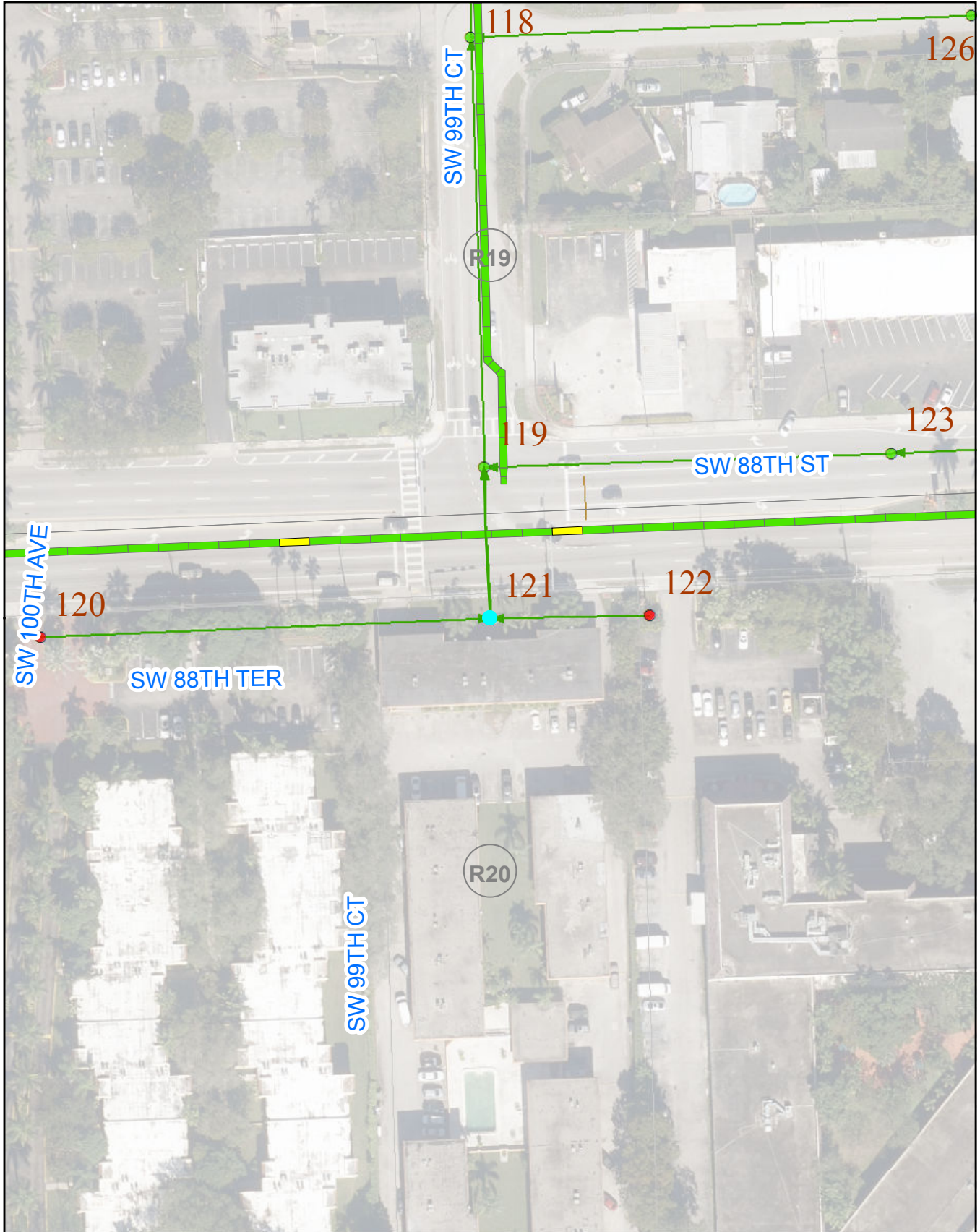

MDWASD NOTICE

The materials contained herein are provided "AS IS" and may contain inaccuracies. User is wanted to utilize the materials herein at User's own risk and to verify the material's accuracy independently and ASSUMES THE RISK OF ANY AND ALL LOSS.
MIS/GIS Modified 07-10-06

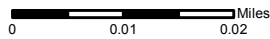

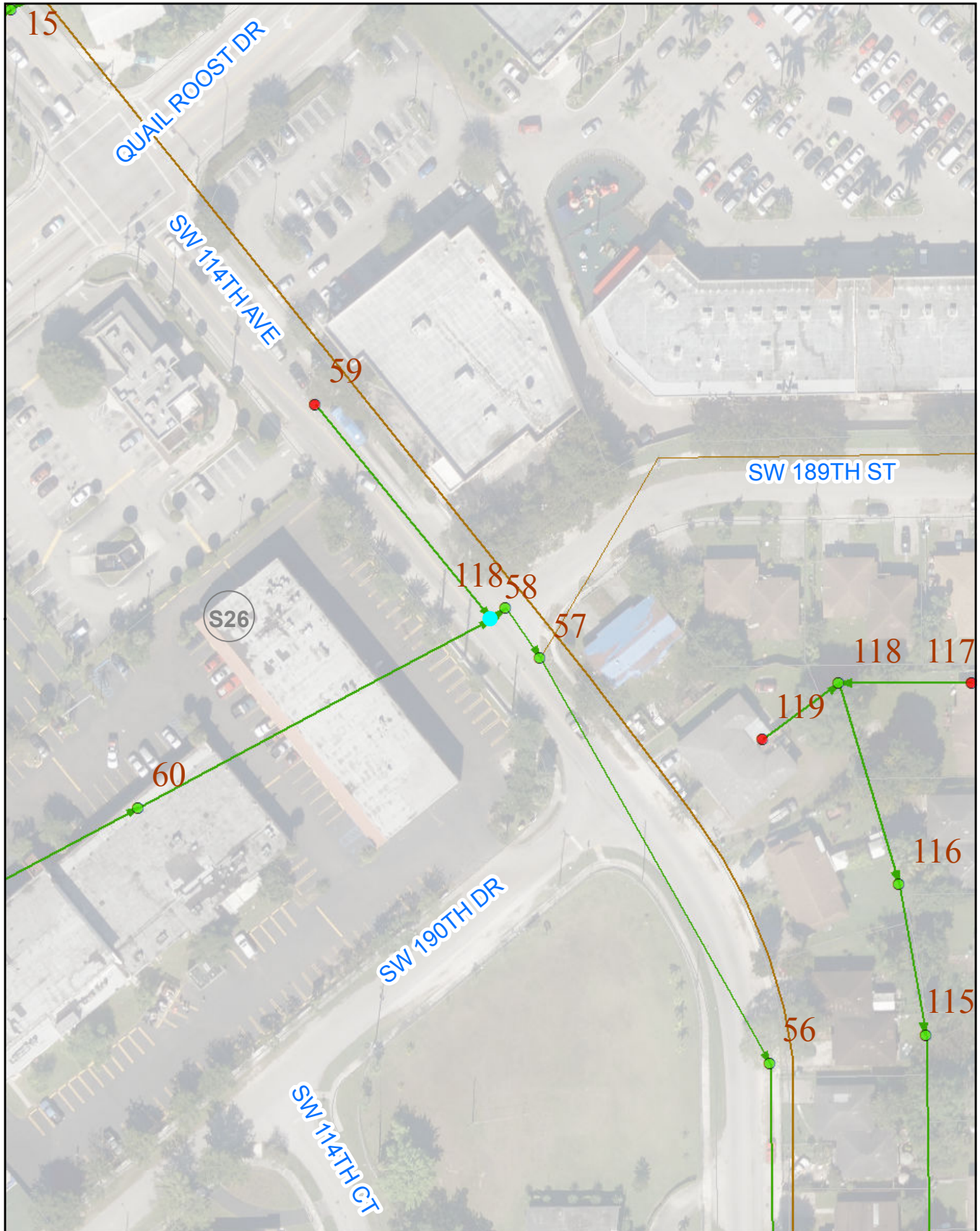

MDWASD NOTICE

The materials contained herein are provided "AS IS" and may contain inaccuracies. User is wanted to utilize the materials herein at User's own risk and to verify the material's accuracy independently and ASSUMES THE RISK OF ANY AND ALL LOSS.
MS/GIS Modified 07-10-06

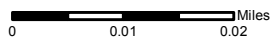

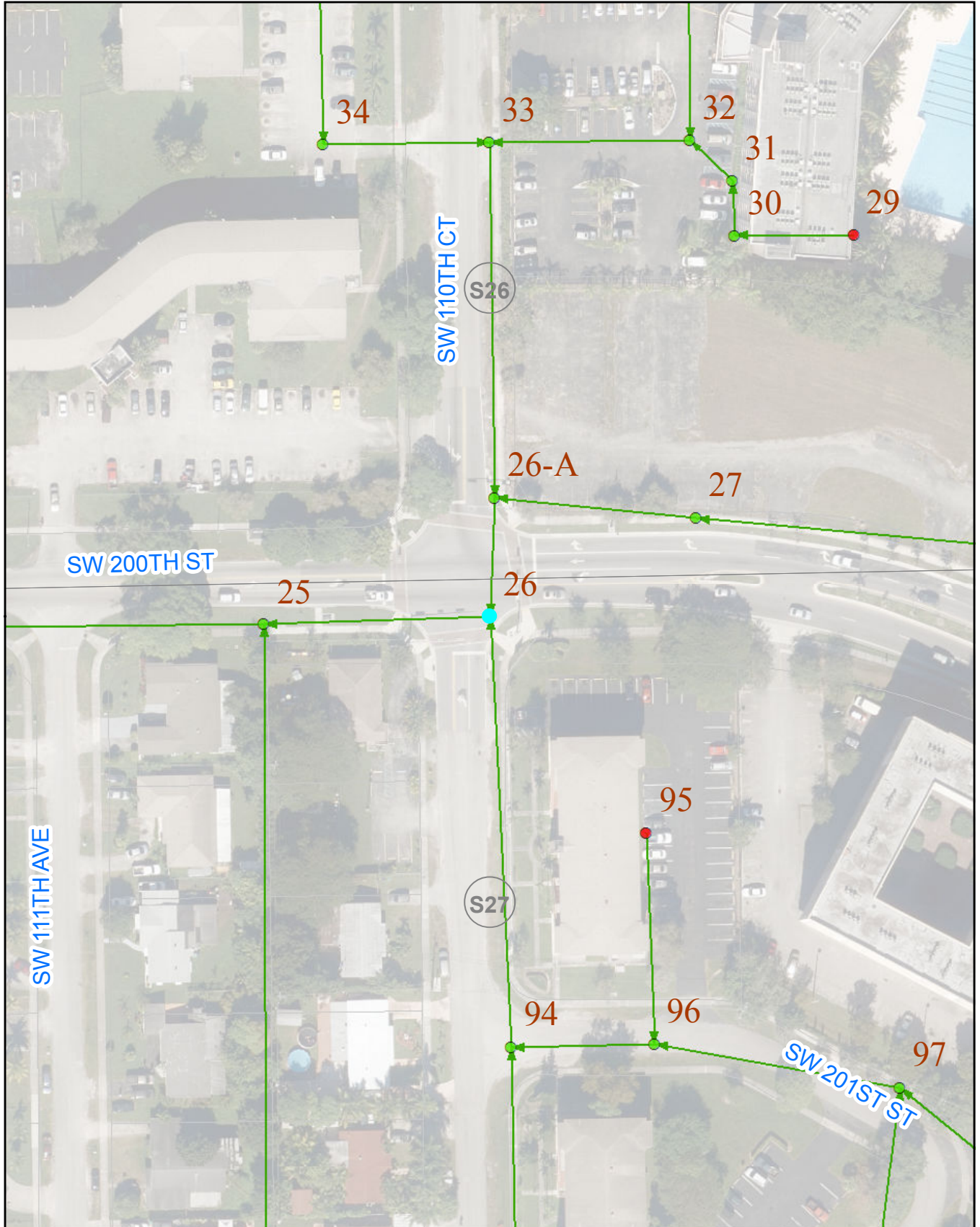

MDWASD NOTICE

The materials contained herein are provided "AS IS" and may contain inaccuracies. User is wanted to utilize the materials herein at User's own risk and to verify the material's accuracy independently and ASSUMES THE RISK OF ANY AND ALL LOSS.
MIS/GIS Modified 07-10-06

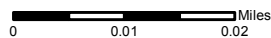



MDWASD NOTICE

The materials contained herein are provided "AS IS" and may contain inaccuracies. User is wanted to utilize the materials herein at User's own risk and to verify the material's accuracy independently and ASSUMES THE RISK OF ANY AND ALL LOSS.
MIS/GIS Modified 07-10-08

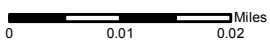

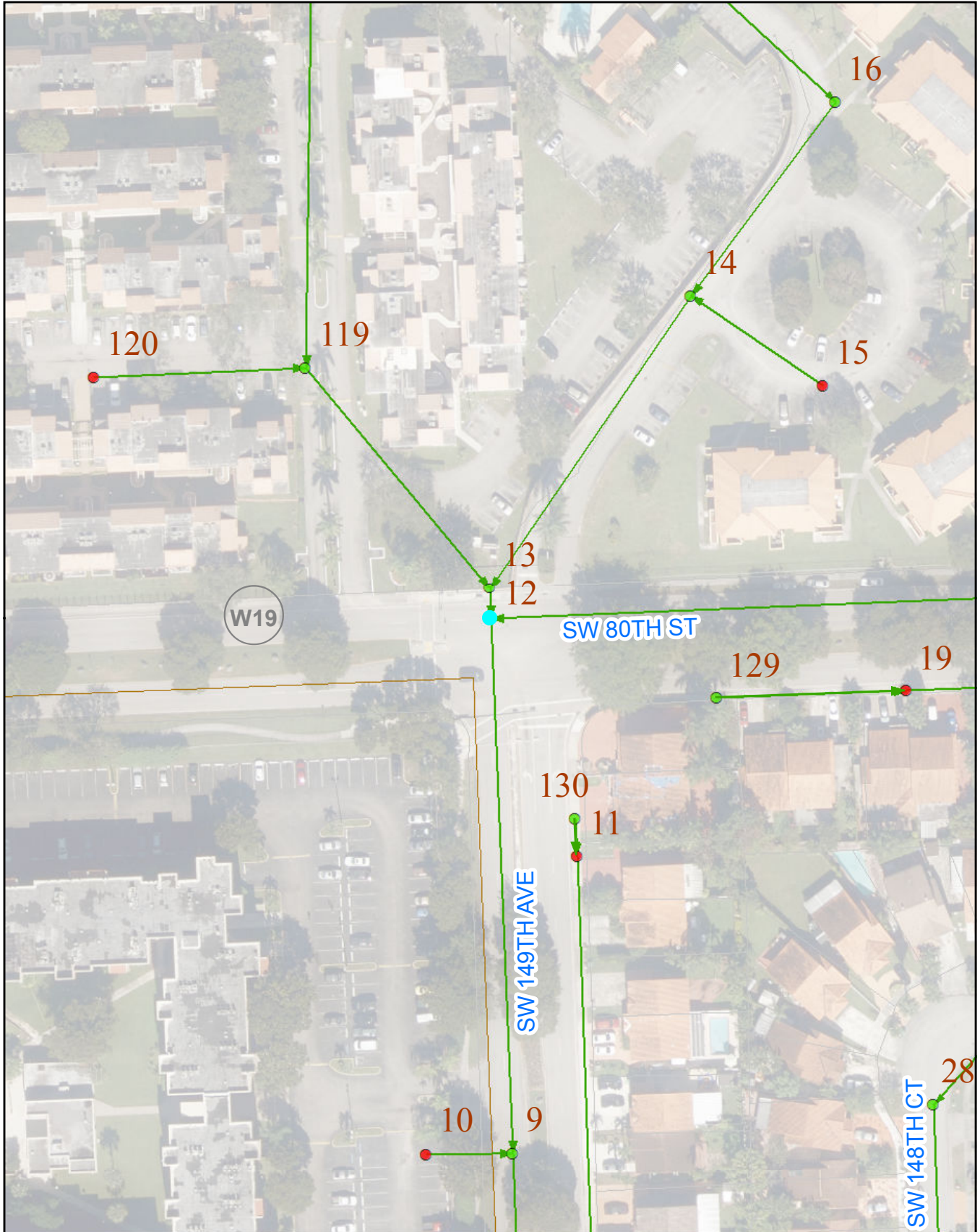

MDWASD NOTICE

The materials contained herein are provided "AS IS" and may contain inaccuracies. User is wanted to utilize the materials herein at User's own risk and to verify the material's accuracy independently and ASSUMES THE RISK OF ANY AND ALL LOSS.
MS/GIS Modified 07-10-06

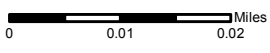



MDWASD NOTICE

The materials contained herein are provided "AS IS" and may contain inaccuracies. User is wanted to utilize the materials herein at User's own risk and to verify the material's accuracy independently and ASSUMES THE RISK OF ANY AND ALL LOSS.
MIS/GIS Modified 07-10-06

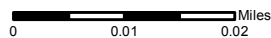



MDWASD NOTICE

The materials contained herein are provided "AS IS" and may contain inaccuracies. User is wanted to utilize the materials herein at User's own risk and to verify the material's accuracy independently and ASSUMES THE RISK OF ANY AND ALL LOSS.
MS/GIS Modified 07-10-06

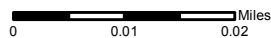

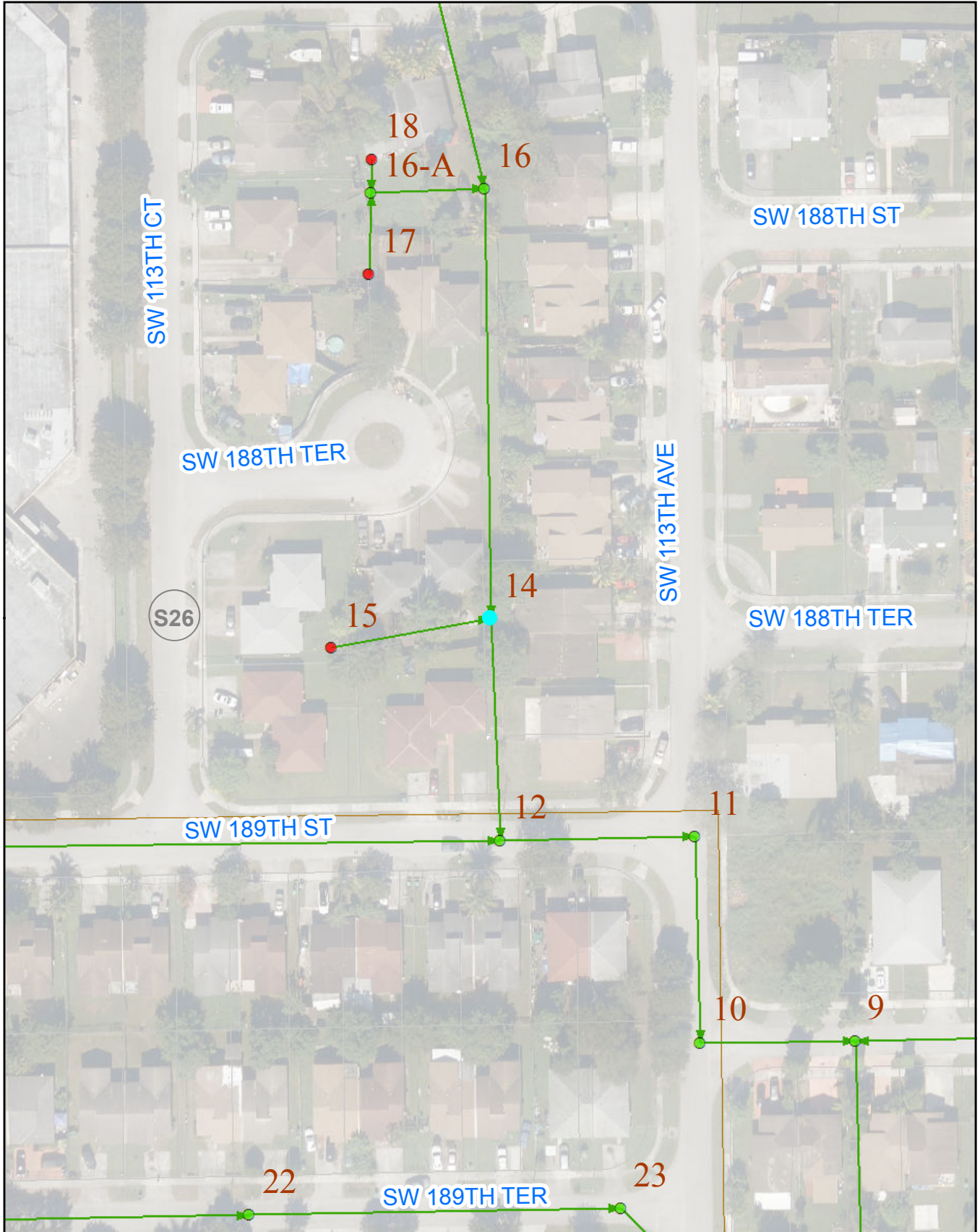

MDWASD NOTICE

The materials contained herein are provided "AS IS" and may contain inaccuracies. User is wanted to utilize the materials herein at User's own risk and to verify the material's accuracy independently and ASSUMES THE RISK OF ANY AND ALL LOSS.
MIS/GIS Modified 07-10-06

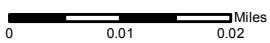

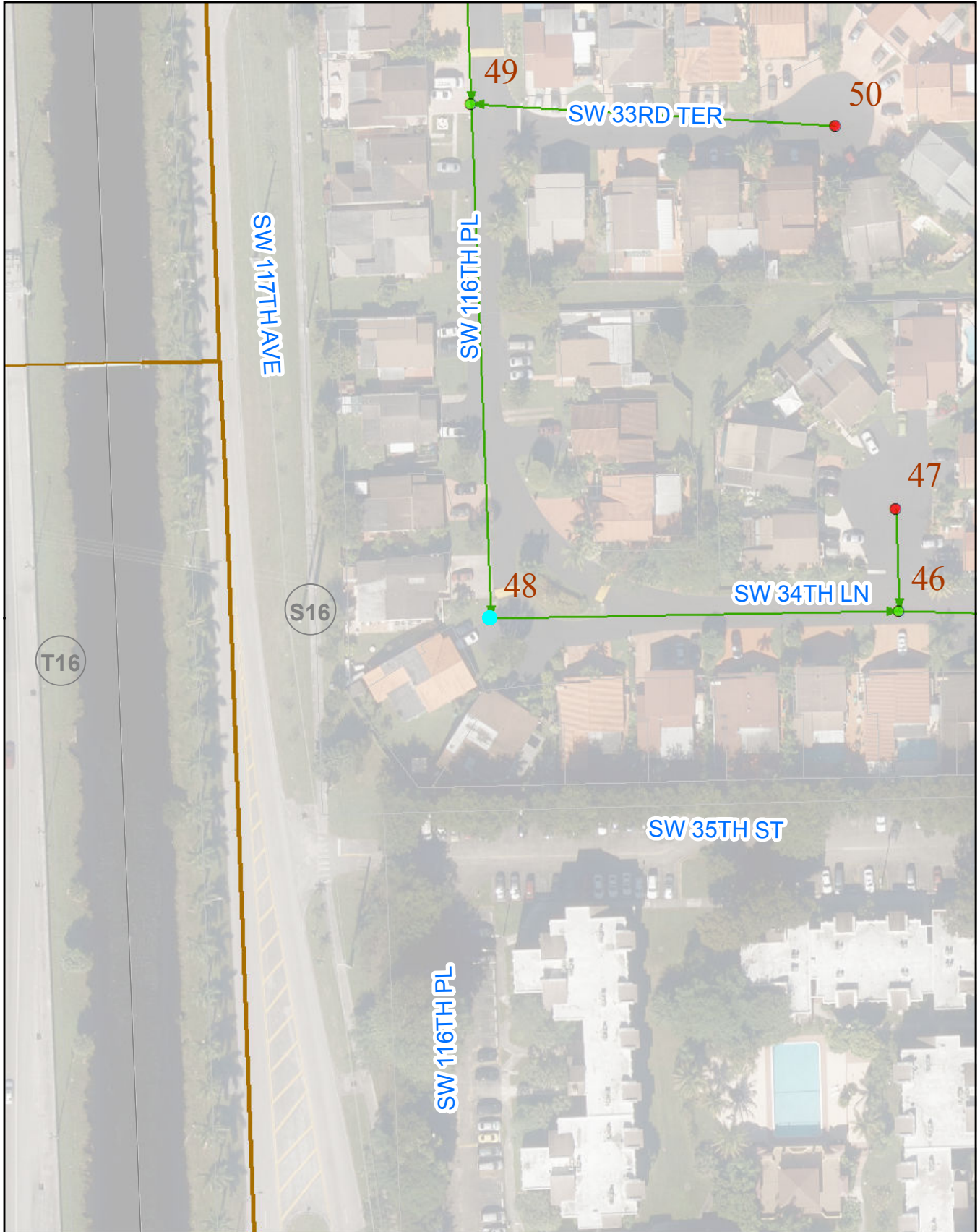

MDWASD NOTICE

The materials contained herein are provided "AS IS" and may contain inaccuracies. User is wanted to utilize the materials herein at User's own risk and to verify the material's accuracy independently and ASSUMES THE RISK OF ANY AND ALL LOSS.
MIS/GIS Modified 07-10-06

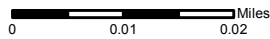



MDWASD NOTICE

The materials contained herein are provided "AS IS" and may contain inaccuracies. User is wanted to utilize the materials herein at User's own risk and to verify the material's accuracy independently and ASSUMES THE RISK OF ANY AND ALL LOSS.
MIS/GIS Modified 07-10-06

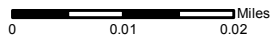

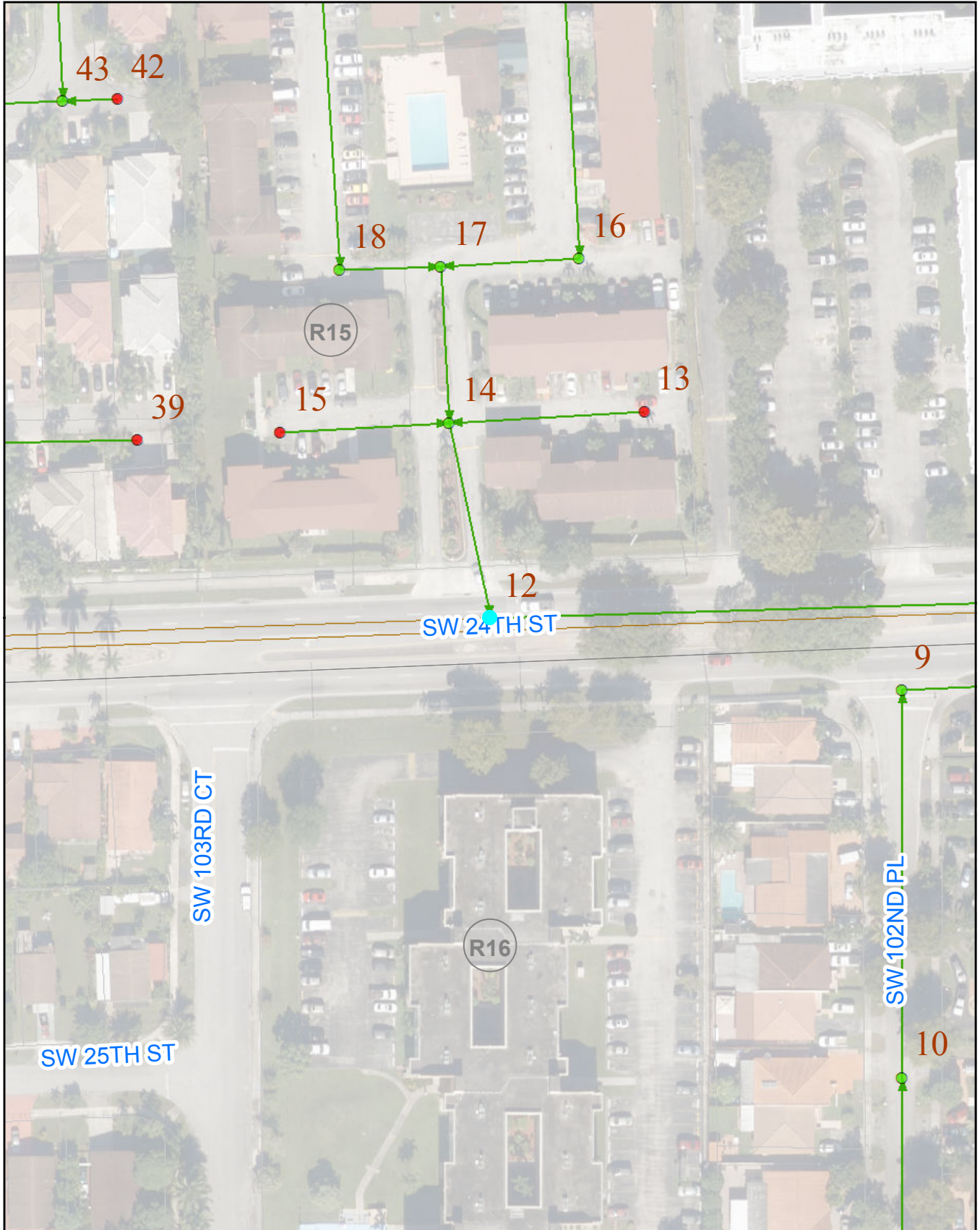

MDWASD NOTICE

The materials contained herein are provided "AS IS" and may contain inaccuracies. User is wanted to utilize the materials herein at User's own risk and to verify the material's accuracy independently and ASSUMES THE RISK OF ANY AND ALL LOSS.
MIS/GIS Modified 07-10-06

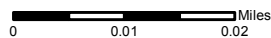

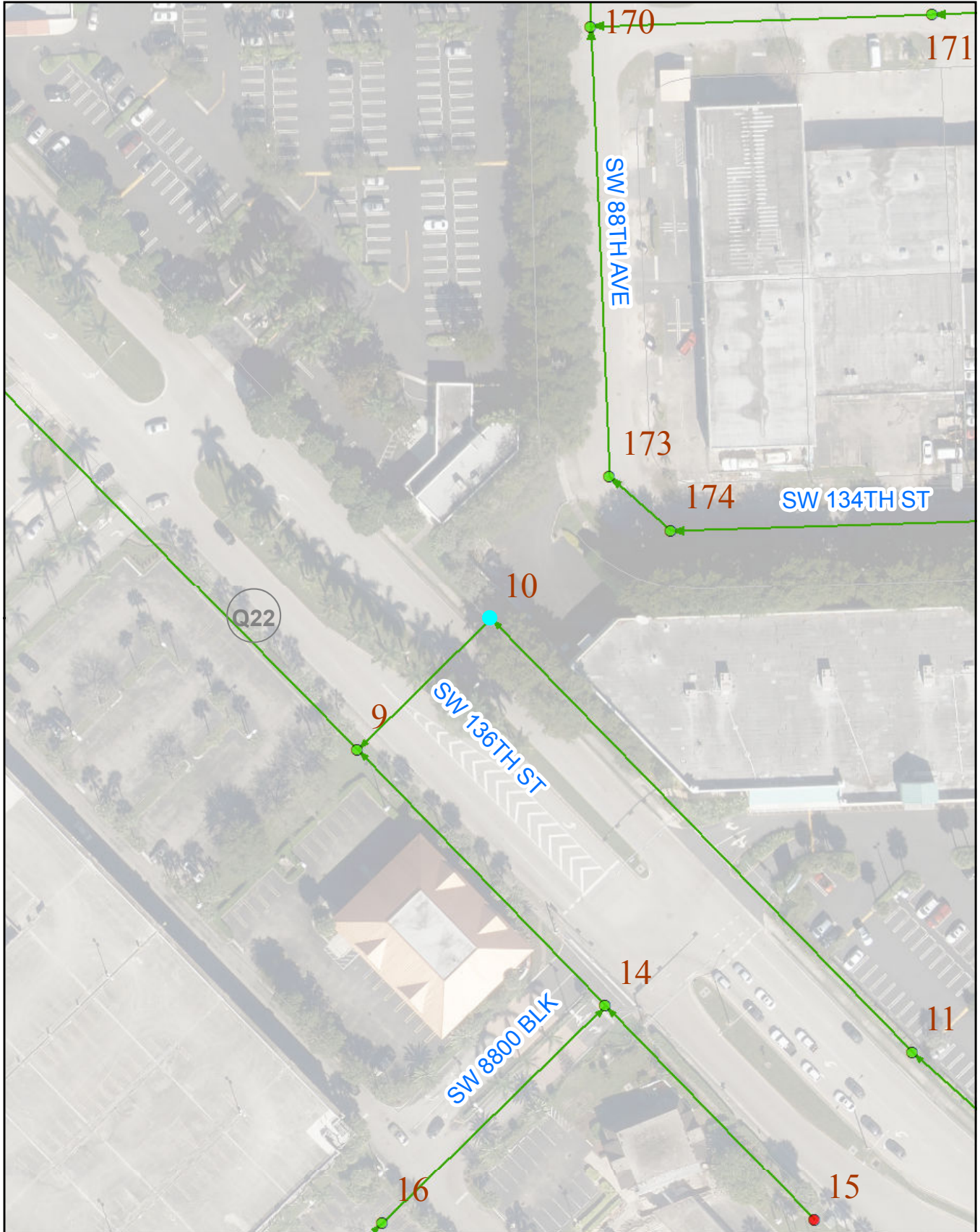

MDWASD NOTICE

The materials contained herein are provided "AS IS" and may contain inaccuracies. User is wanted to utilize the materials herein at User's own risk and to verify the material's accuracy independently and ASSUMES THE RISK OF ANY AND ALL LOSS.
MIS/GIS Modified 07-10-06

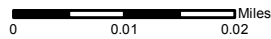

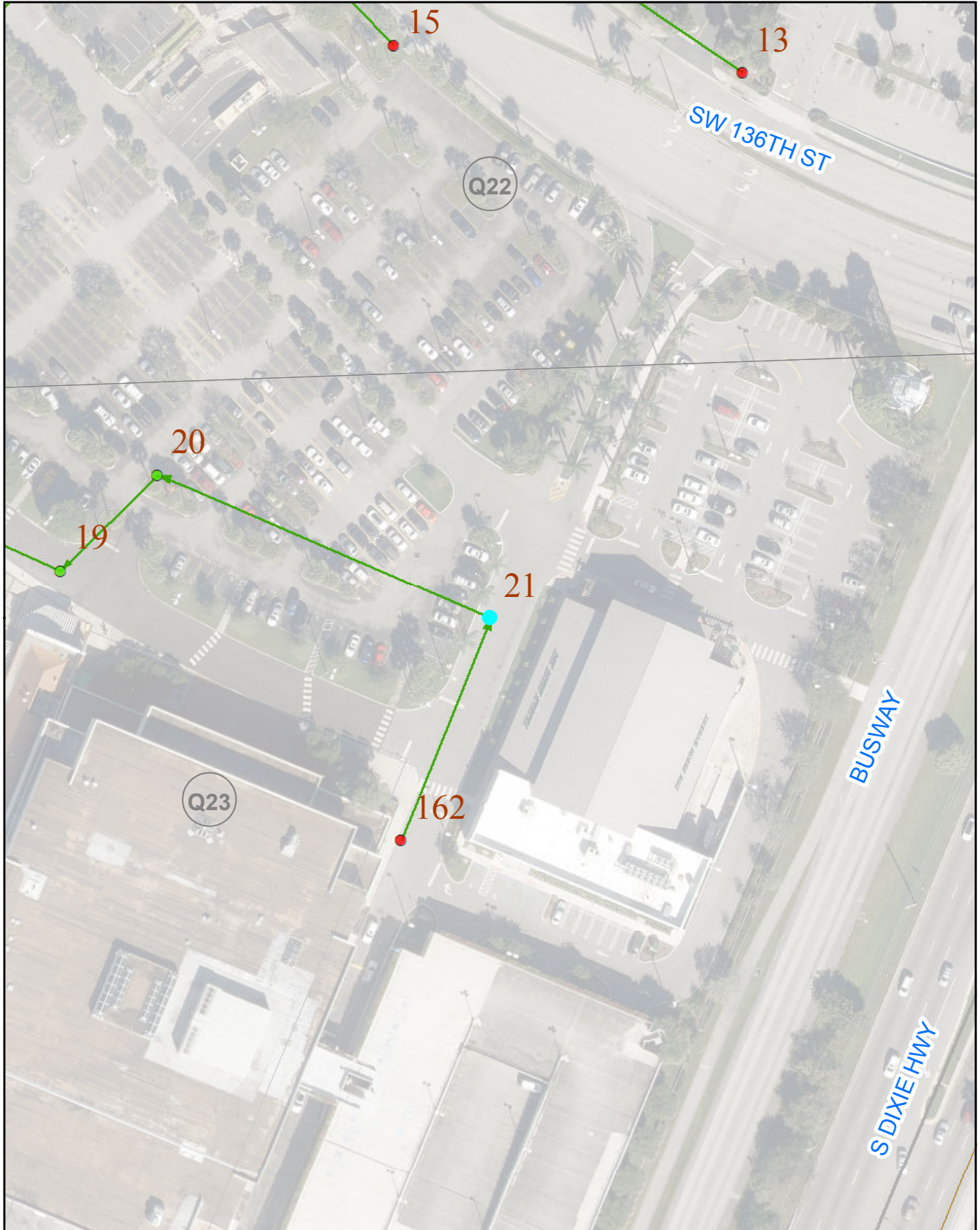

MDWASD NOTICE

The materials contained herein are provided "AS IS" and may contain inaccuracies. User is wanted to utilize the materials herein at User's own risk and to verify the material's accuracy independently and ASSUMES THE RISK OF ANY AND ALL LOSS.
MIS/GIS Modified 07-10-06

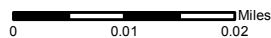

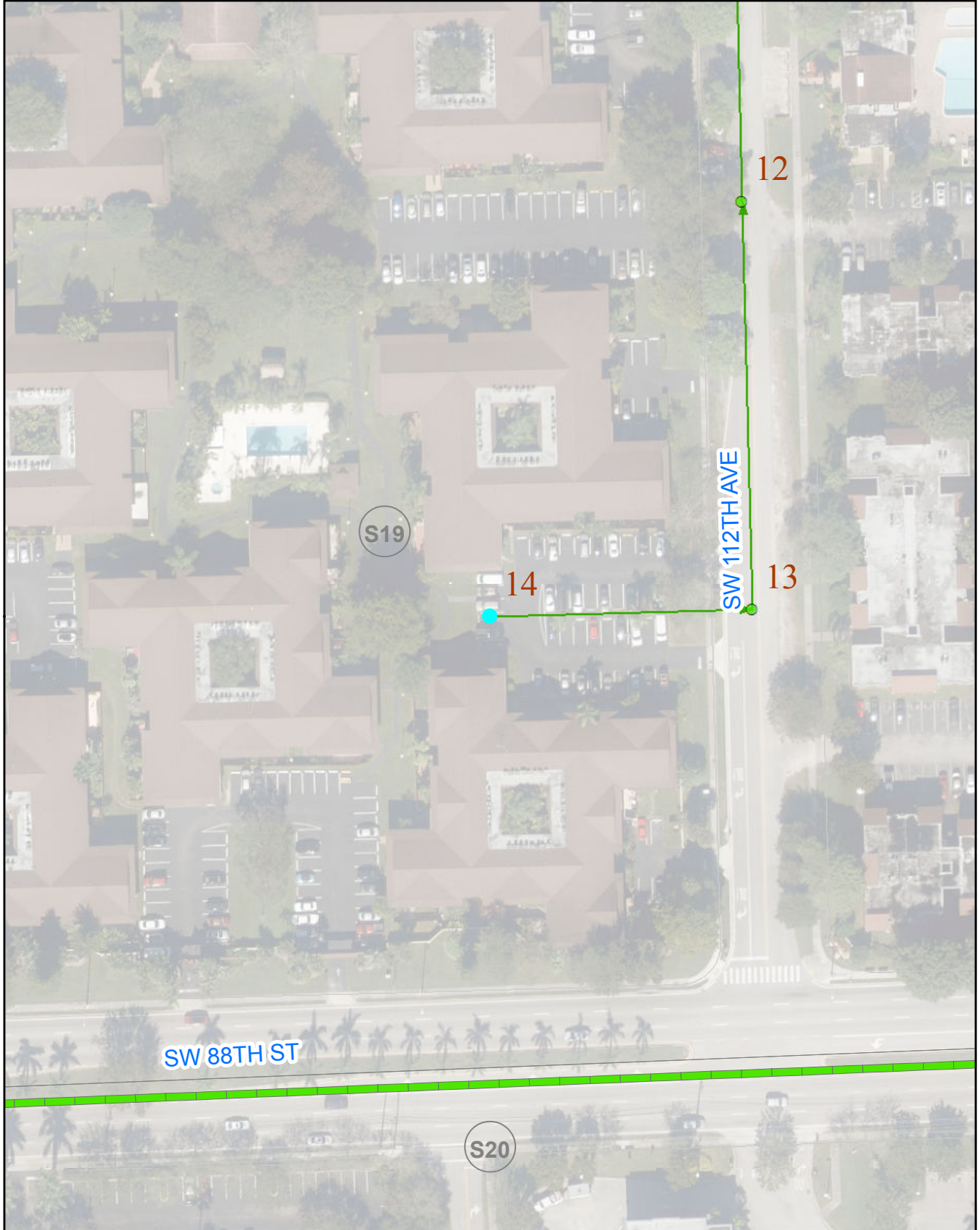

MDWASD NOTICE

The materials contained herein are provided "AS IS" and may contain inaccuracies. User is wanted to utilize the materials herein at User's own risk and to verify the material's accuracy independently and ASSUMES THE RISK OF ANY AND ALL LOSS.
MIS/GIS Modified 07-10-06

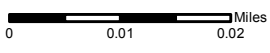

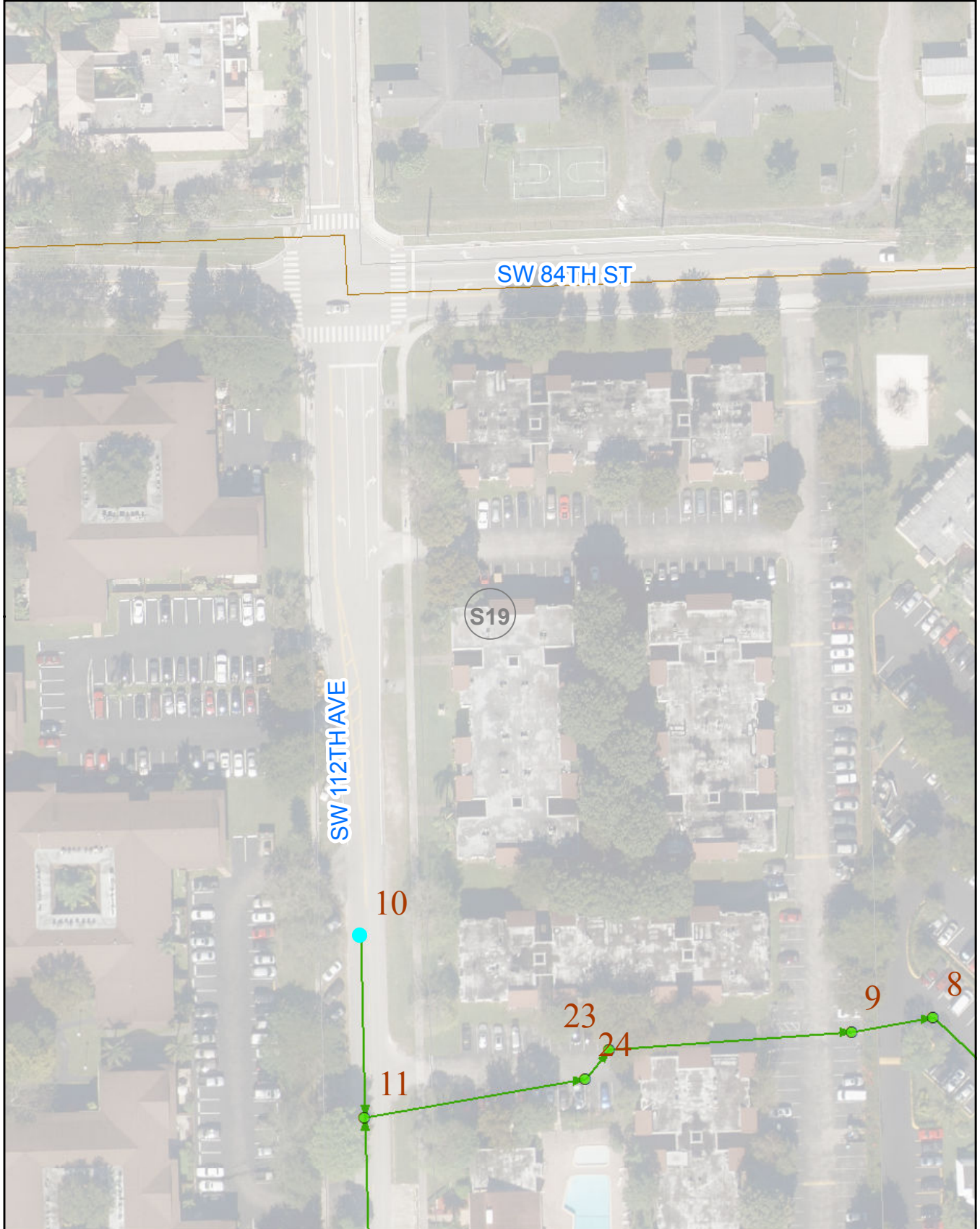

MDWASD NOTICE

The materials contained herein are provided "AS IS" and may contain inaccuracies. User is wanted to utilize the materials herein at User's own risk and to verify the material's accuracy independently and ASSUMES THE RISK OF ANY AND ALL LOSS.
MIS/GIS Modified 07-10-06

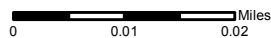

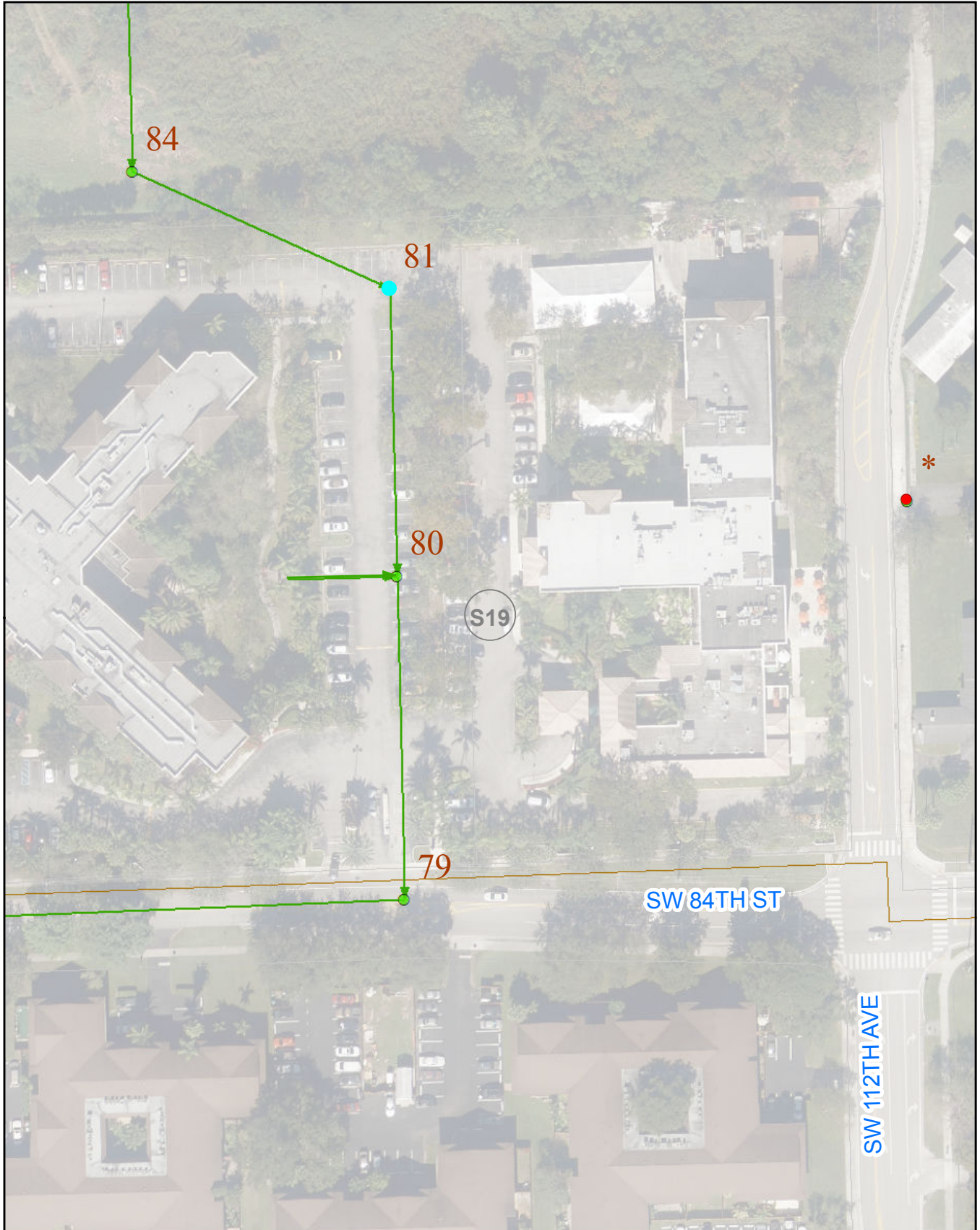

MDWASD NOTICE

The materials contained herein are provided "AS IS" and may contain inaccuracies. User is wanted to utilize the materials herein at User's own risk and to verify the material's accuracy independently and ASSUMES THE RISK OF ANY AND ALL LOSS.
MIS/GIS Modified 07-10-08

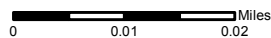

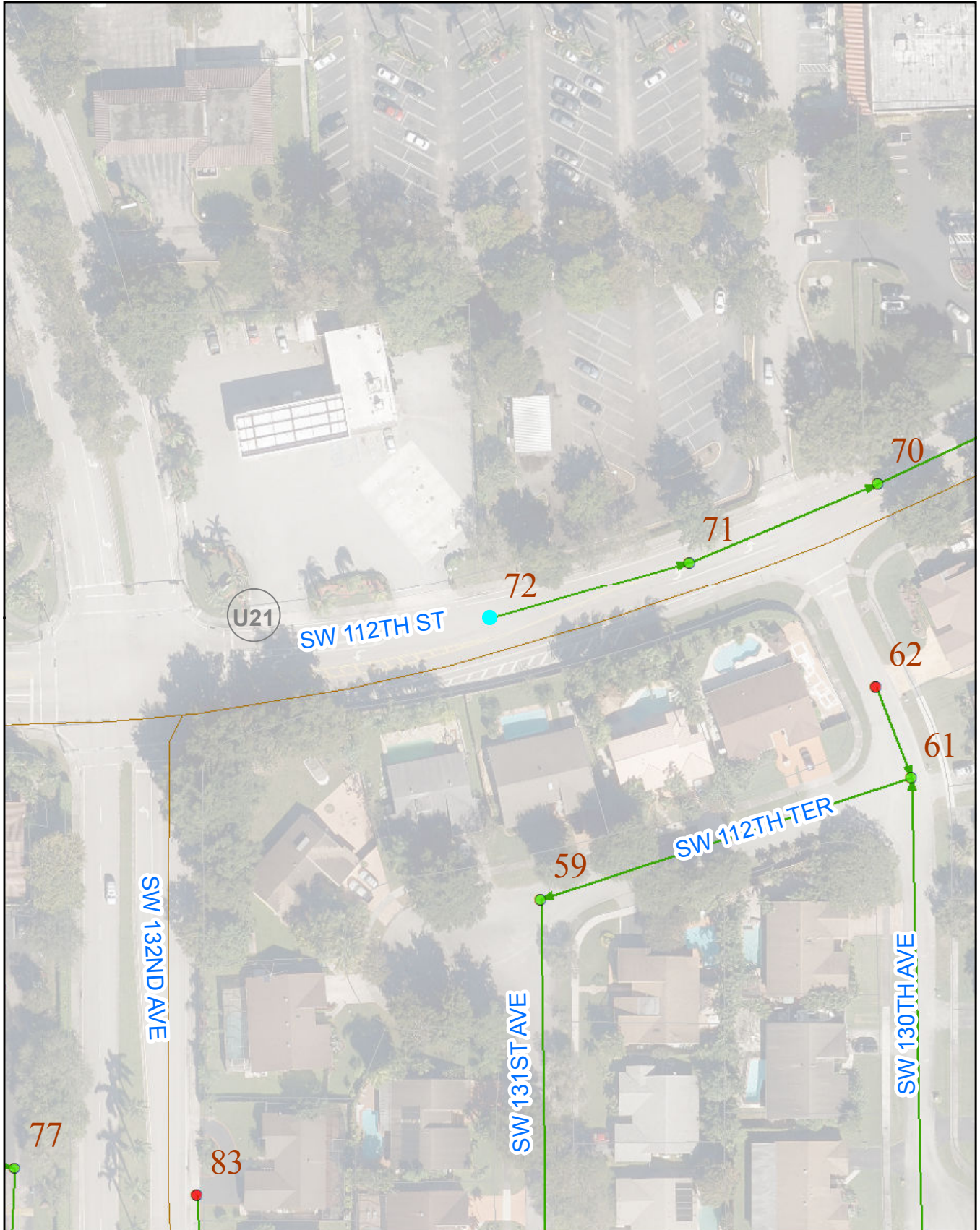

MDWASD NOTICE

The materials contained herein are provided "AS IS" and may contain inaccuracies. User is wanted to utilize the materials herein at User's own risk and to verify the material's accuracy independently and ASSUMES THE RISK OF ANY AND ALL LOSS.
MIS/GIS Modified 07-10-06

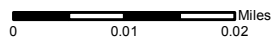

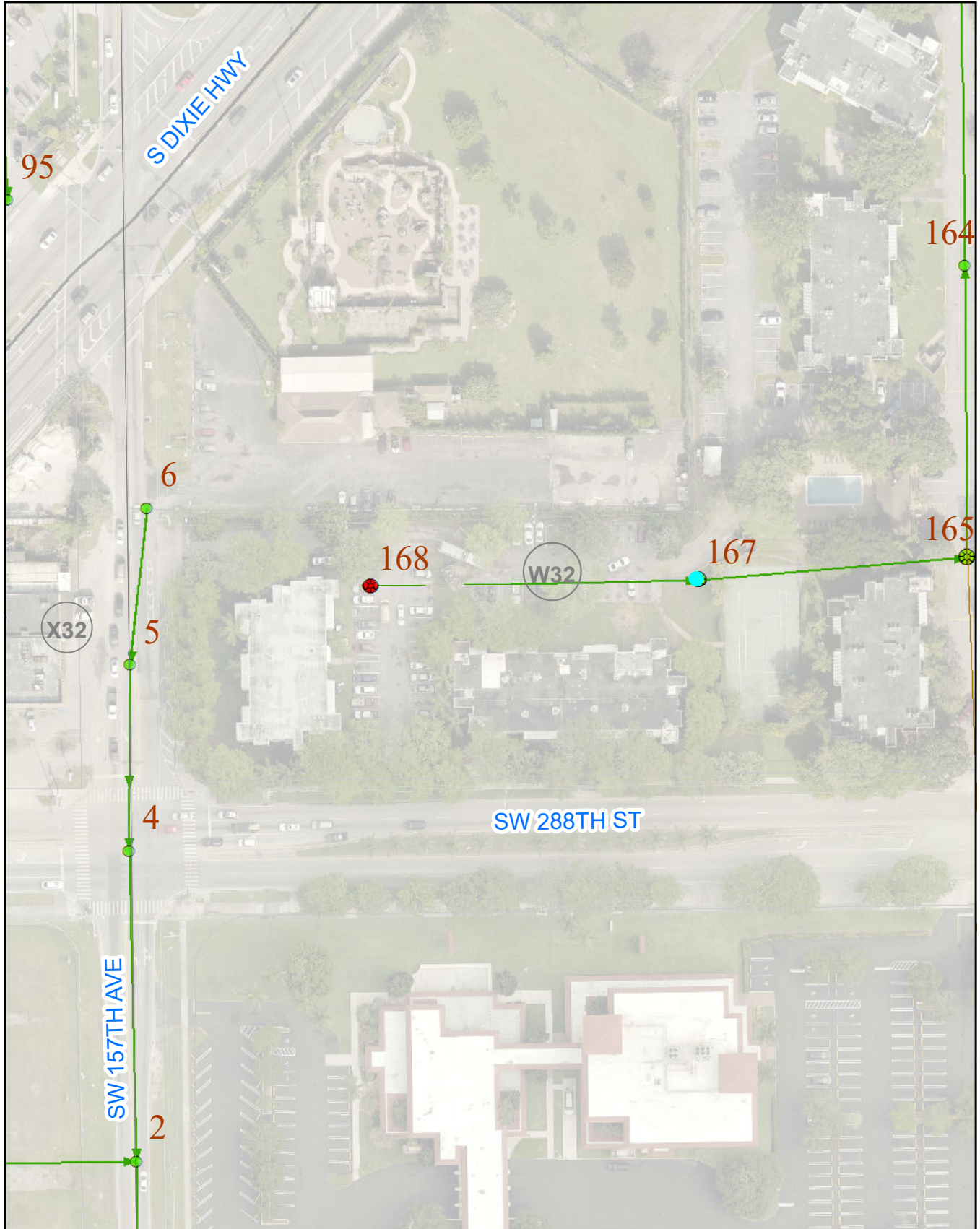

MDWASD NOTICE

The materials contained herein are provided "AS IS" and may contain inaccuracies. User is wanted to utilize the materials herein at User's own risk and to verify the material's accuracy independently and ASSUMES THE RISK OF ANY AND ALL LOSS.
MIS/GIS Modified 07-10-06

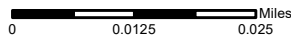

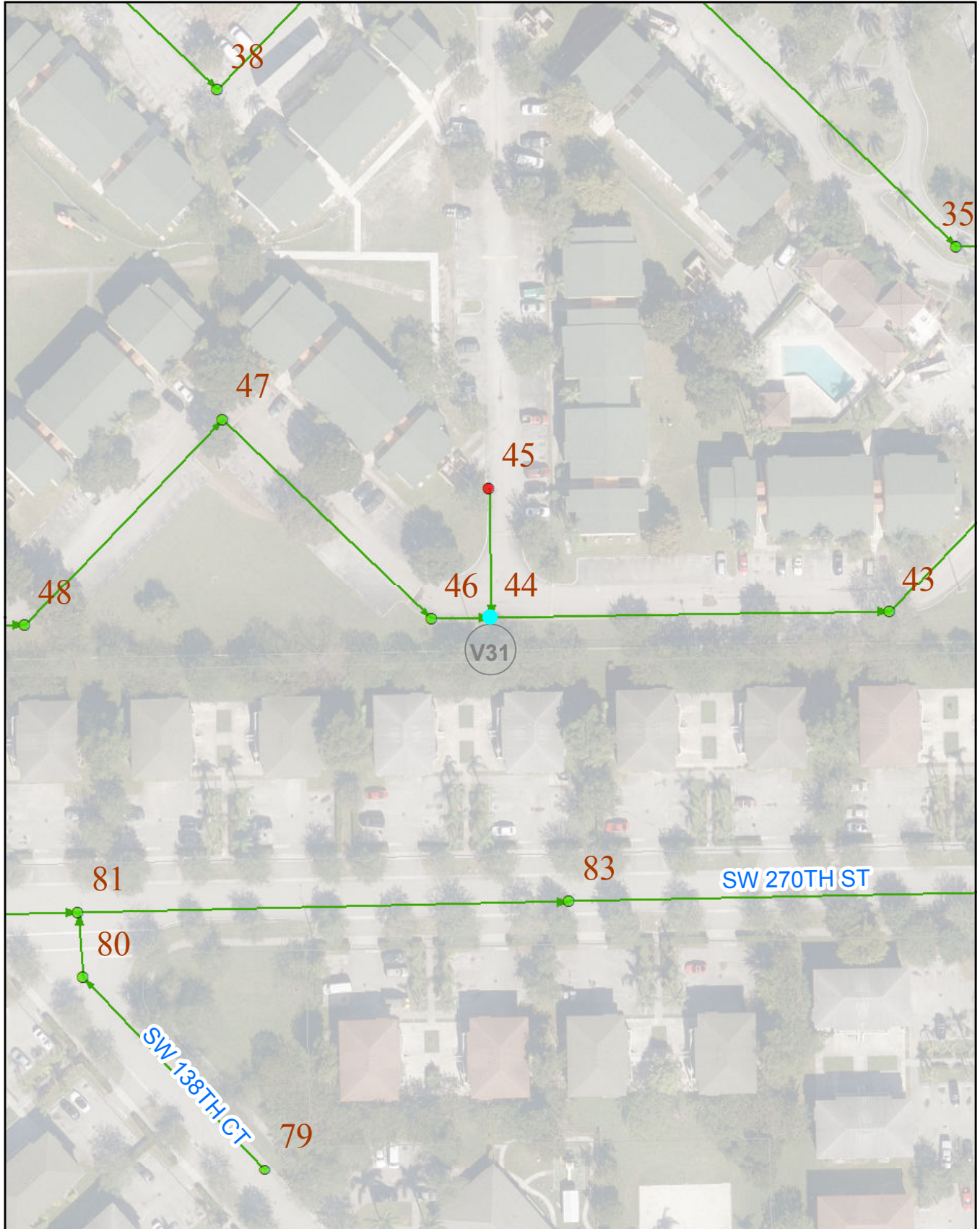

MDWASD NOTICE

The materials contained herein are provided "AS IS" and may contain inaccuracies. User is wanted to utilize the materials herein at User's own risk and to verify the material's accuracy independently and ASSUMES THE RISK OF ANY AND ALL LOSS.
MIS/GIS Modified 07-10-06

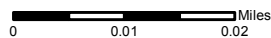

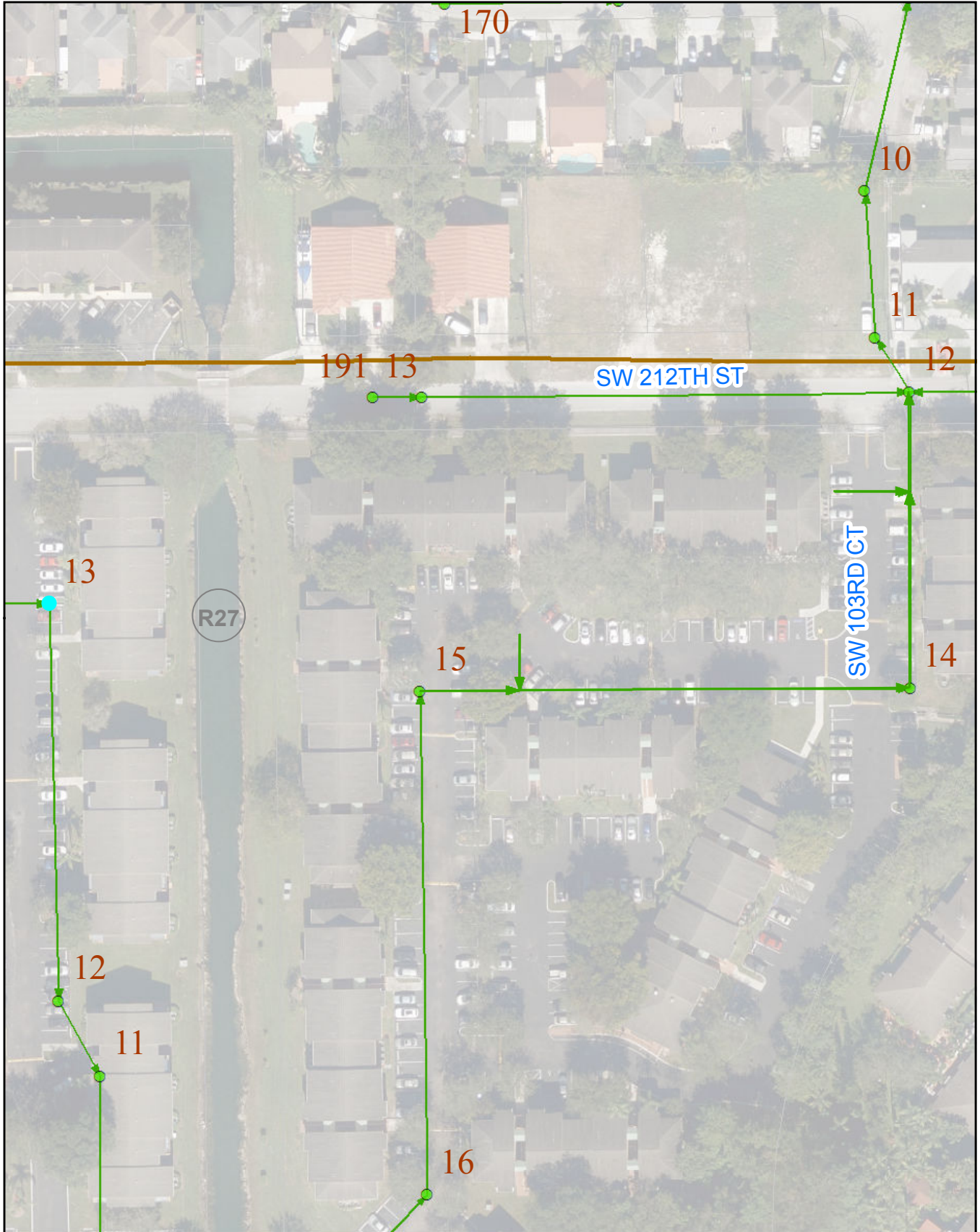

MDWASD NOTICE

The materials contained herein are provided "AS IS" and may contain inaccuracies. User is wanted to utilize the materials herein at User's own risk and to verify the material's accuracy independently and ASSUMES THE RISK OF ANY AND ALL LOSS.
MIS/GIS Modified 07-10-06

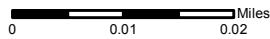

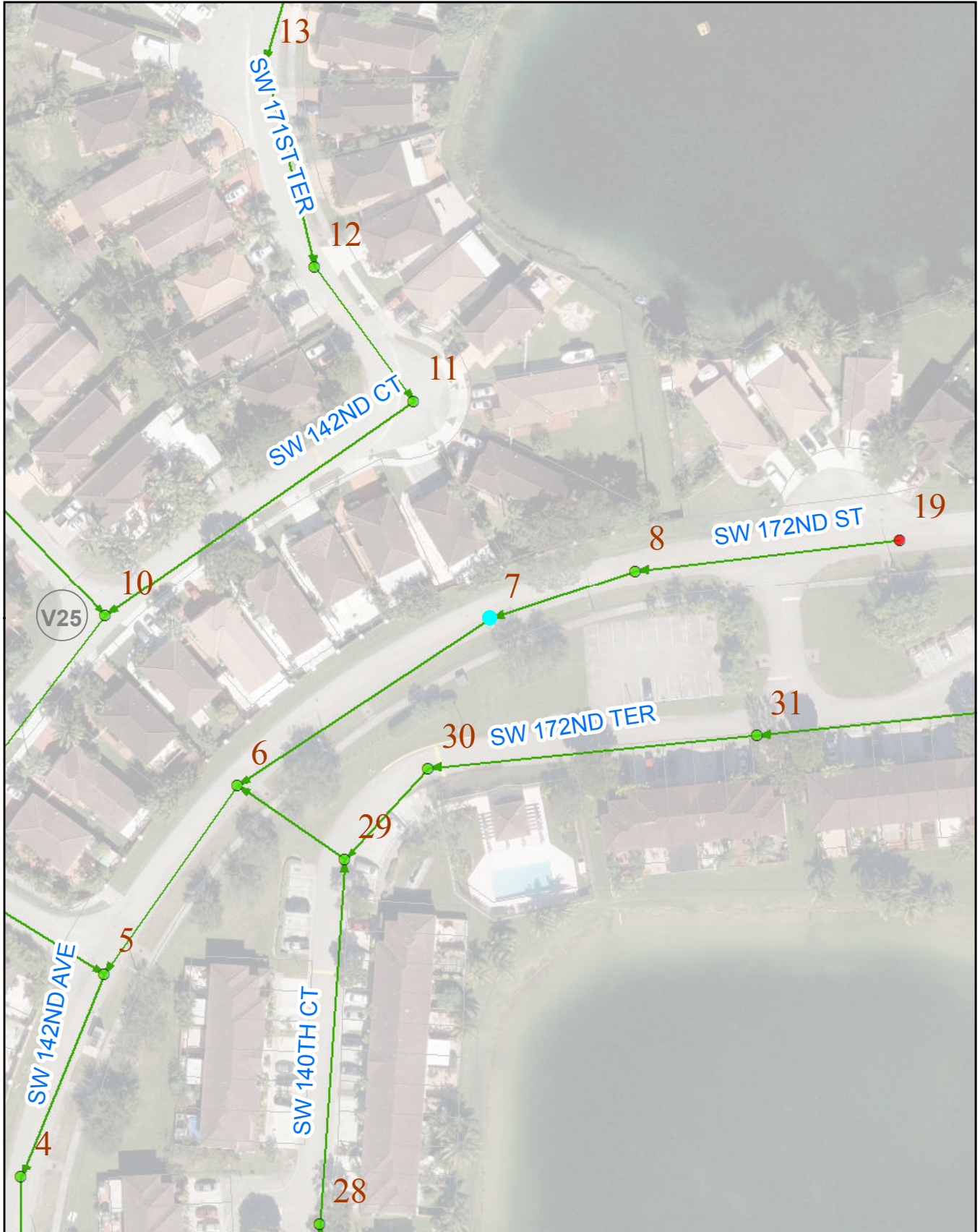

MDWASD NOTICE

The materials contained herein are provided "AS IS" and may contain inaccuracies. User is wanted to utilize the materials herein at User's own risk and to verify the material's accuracy independently and ASSUMES THE RISK OF ANY AND ALL LOSS.
MIS/GIS Modified 07-10-06

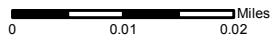



MDWASD NOTICE

The materials contained herein are provided "AS IS" and may contain inaccuracies. User is wanted to utilize the materials herein at User's own risk and to verify the material's accuracy independently and ASSUMES THE RISK OF ANY AND ALL LOSS.
MIS/GIS Modified 07-10-06

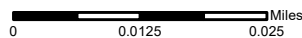

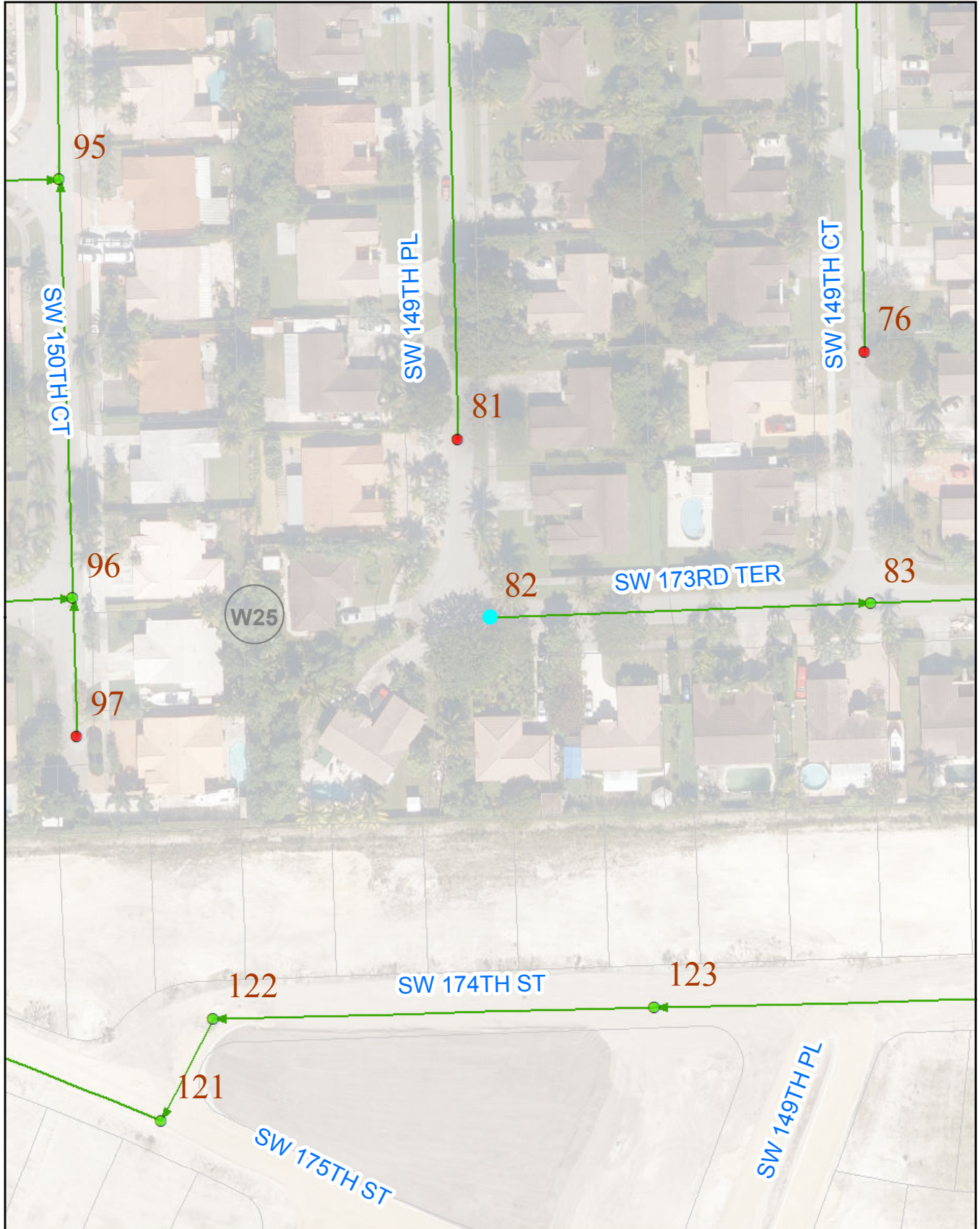

MDWASD NOTICE

The materials contained herein are provided "AS IS" and may contain inaccuracies. User is wanted to utilize the materials herein at User's own risk and to verify the material's accuracy independently and ASSUMES THE RISK OF ANY AND ALL LOSS.
MIS/GIS Modified 07-10-06

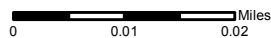

Attachment 11
FOG Inspection Manual

FOG 2.0
Inspection
Manual

October 9

2017

Miami-Dade County.
RER/DERM. Waste
Water Permitting
Section. FOG Control
Program

TABLE OF CONTENTS

- I. Background
- II. Legal Authority
- III. Definitions
- IV. Permitting
- V. Types of Grease Interceptors
- VI. Inspection
- VII. Violations
- VIII. Enforcement

I. Background:

The need for a GDO Program originated from the combined effect of unpermitted and uncontrolled discharges of oil and grease into the sanitary sewer systems and the corrosion of the force main sewer lines in Miami-Dade County during the 1980s and 1990s. The resulting sewage overflows in the Miami River and in Biscayne Bay prompted enforcement actions by the South Florida Water Management District, as these incidents violated several National Pollutant Discharge Elimination System (NPDES) requirements. The Environmental Protection Agency (EPA) subsequently issued a “First Partial Consent Decree” (Case No. 93-1109 CIV-MORENO) ordering Miami-Dade County to undertake all steps necessary to eliminate or otherwise control the discharge of Oil and Grease from non-residential facilities into the sanitary sewer systems. The Miami-Dade County Manager’s Office submitted a relevant “Grease Trap Permitting Program” Ordinance to the Board of County Commissioners on May 17, 1994. The proposed Grease Discharge Ordinance (GDO), No. 94-132, was ratified on June 21, 1994.

The Program was specifically created to identify, permit, and monitor commercial, industrial, or other non-residential facilities discharging FOG into available sewer collection systems.

In 2013, Miami-Dade County entered a new Consent Decree with EPA, designed to implement measures to reduce the number of Sanitary Sewer Overflows, (SSOs). EPA’s Report to Congress indicates that: “Grease from restaurants, homes and industrial sources are the most common cause (47%) of reported blockages.” In addition, grease blockages cause Utilities, and Taxpayers, elevated costs in cleaning, and maintenance of sewer lines, pump stations, and publicly owned sewer treatment plants. Sanitary Sewer Overflows affect the quality of life of Residents and Tourists, recreation opportunities, property damage, (public and private), development and the economy.

In response to the Consent Decree, DERM initiated efforts to reduce the amount of FOG entering the sanitary sewer system, by improving the FOG Control Program, enhancing the Plan Review process regarding design, approval and installation of grease interceptors, (GIs, adequately designed for the specific operations). A new FOG Control Ordinance has been drafted and is awaiting approval from the Board of County Commissioners of Miami-Dade County.

The FOG Inspection Program incorporated new operating procedures, in which facilities are fully evaluated during each inspection, and samples are collected from grease interceptors to determine if the GI is properly sized for the operation.



II. Legal Authority

1. Miami-Dade County Environmental Ordinance, (Chapter 24)

1.1. Section 24-18 (A)(18): Operating Permits

Any nonresidential facility, including, but not limited to, restaurants, bakeries, hotel and cafeteria kitchens, processing plants or such other nonresidential facilities discharging into a publicly or privately-owned or operated sanitary sewer collection system, if oil and grease can be introduced into a sewer by such nonresidential facility in quantities which have the potential to affect or hinder the operation of sewage collecting, transmission or treatment facilities.

1.2. Section 24.15.3: Standards for Preparations of Plans

FOG control devices shall be provided and installed in accordance with Section 24-42.6 of this chapter.

1.3. Section 24-42.6. Fats, Oils and Grease Control Program

1.4. Section 24-42.4(2)(d)(vi): Effluent Discharge Limitations. General Pretreatment Standards and Local Limits.

(d) It shall be unlawful for any person to throw, drain, run or otherwise discharge into a sanitary sewer, or to cause, permit, allow or suffer to be thrown, run, drained, allowed to seep, or otherwise discharged into such sewer any of the following substances:

(vi) Any effluents in excess of the following local limits:

<i>Chemical, Physical or Biological Characteristic</i>	<i>Standards</i>
Biochemical oxygen demand	145 lbs/day at a concentration not to exceed 200 mg/l unless allowed by the POTW
Total suspended solids	145 lbs/day at a concentration level not to exceed 200 mg/l unless allowed by the POTW
Oil and grease EPA Method 1664 (Hexane Extractable Materials)	100.0 mg/l
Fats, Oils and Grease (FOG) EPA Method 1664 (Hexane Extractable Materials) for facilities strictly subject to Section 24-42.6	150.0 mg/l
Total Recoverable Petroleum Hydrocarbons EPA Method 1664 (Silica Gel Treated Hexane Extractable Materials)	50.0 mg/l
Ammonia (un-ionized)	100.0 mg/l
Temperature	150°F and shall not cause the plant influent to exceed 104°F (40°C) or inhibit biological activity

2. Miami-Dade County Chapter 14B: Food and Food Service Establishments

2.1. Section 14-B15: Approval of Plans

No construction, extension or alteration of a public food service establishment shall take place before the owner and operator have submitted complete plans for said establishment showing existing and proposed layout and said plans have received written approval by the Dade County Department of Public Health.

3. Florida Building Code Chapter 10: Plumbing

3.1. Traps, Interceptors and Separators. (Design, sizing, types, materials).

4. Florida Administrative Code (FAC)

4.1. Rule 64E-6.013(7): Requirements for Grease Interceptors (GGIs).

III. Definitions:

1. Fats, Oils and Grease (FOG):

Any substance such as vegetable or animal product used in, or a byproduct of, the cooking, food preparation, or cleaning process, that can cause or lead to corrosion,

blockages, reduce flow, or interference with the sanitary sewer system when discharged alone or combined with other materials or waste.

2. FOG Capacity Limit:

Combined FOG and Solids depth equal to twenty-five (25) percent of the design hydraulic depth in any location of a FOG control device or seventy-five (75) percent of the rated FOG and solids capacity established by third party certification.

3. FOG Control Device:

Equipment designed to remove, hold, and prevent passage of FOG to onsite sewage treatment and disposal systems and sanitary sewer systems.

4. FOG Control Device Operator:

A person or entity which has management control for FOG control devices which serve other FOG generators.

5. FOG Generator:

Any nonresidential facility, including, but not limited to, restaurants, bakeries, hotel and cafeteria kitchens, commercial kitchens, kitchens serving hospitals, nursing homes, daycares, assisted living facilities and other healthcare facilities, food processing plants or such other nonresidential facilities that can introduce food waste or FOG into building sanitary drains, building sewers, onsite sewage treatment and disposal systems, or non-utility or utility sanitary sewer systems. A FOG generator also includes those nonresidential facilities that produce yellow grease. An industrial user subject to industrial pretreatment requirements under section 24-42.4 is not included herein.

6. FOG Generator Certified Staff:

A FOG generator employee which has attended training prescribed by the Director or Director's designee, and has received certification for training.

7. FOG Liquid Waste Transporter Certified Staff:

A FOG Liquid Waste Transporter employee which has attended training prescribed by the Director or Director's designee, and has received certification for training.

8. FOG Operating Permit:

An operating permit issued to FOG generators or FOG control device operators pursuant to Sections 24-18 and 24-42.6.

9. FOG Sampling Point:

A reasonably accessible location for sampling the effluent of a FOG control device.

10. Front of the House:

Office space, dry storage, but shall not include areas defined as back of the house.

11. Back of the House:

Back of the House shall mean all areas where food is stored, processed, cooked, prepared, and assembled, and cleanup areas. It does not include offices, dry storage or front of the house areas.

12. Best Management Practices:

A schedule of activities, prohibitions of practices, maintenance procedures, and other management practices to prevent or minimize pollution.

13. Black Grease:

Any FOG commingled with septic wastes (bathroom wastes).

14. Brown Grease:

FOG waste collected in, or removed from, a FOG control device.

15. Yellow Grease:

FOG generated as a byproduct from cooking or food preparation that is not mixed with water, wastewater or other waste.

16. Wash-Down Area:

An area where FOG generators wash the back of the house mats or equipment.

17. Solids Separator:

A separator intended to capture solids and allow FOG to pass through. It is installed at the source or on the grease waste drains prior to a FOG control device.

18. Gravity Grease Interceptor:

A FOG control device that primarily relies on the difference in specific gravity between wastewater and FOG to affect separation of FOG from wastewater.

19. Grease Interceptor:

A FOG control device.

20. Grease Waste Drains:

The pipes intended to receive FOG and food waste. They convey the discharge to solids separators, when installed, and FOG control devices.

21. Hydromechanical Grease Interceptor:

A FOG control device that is third party tested and certified, and relies on the difference in specific gravity between wastewater and FOG to affect separation of FOG from wastewater, and may incorporate a flow control device, air entrainment, and other means or principles to improve the efficacy of separation as demonstrated by third-party testing, validation and certification.

22. Building Sewer:

The part of the building drainage system that extends from the end of the building drain and conveys the discharge to utility or non-utility owned or operated sanitary sewer system.

23. Building Sanitary Drains:

The pipes intended to receive sanitary wastewater and effluent from FOG control devices where FOG control devices are installed or required. FOG or food waste shall not be discharged into the building sanitary drains.

24. Dishmachine:

Equipment used to sanitize and does not actually wash the items put inside.

25. Dishwasher:

Equipment that washes and sanitizes

26. Interceptor Monitoring Alarm:

A system and its components capable of monitoring s levels in a FOG control device on a regular interval. The system shall trigger a visual and audible alarm at the FOG Capacity Limit.

27. Interceptor Monitoring Device:

A system and its components capable of monitoring floating and settled solids in a FOG control device on a regular interval, triggering a visual and audible alarm at the FOG Capacity Limit, and reporting data electronically to the Department at a frequency and format approved by the Director or Director's designee.

28. Residential FOG Source:

A residential kitchen that can introduce food waste or FOG into a building drain, building sewer, onsite sewage treatment and disposal system, or non-utility or utility sanitary sewer system.

IV. Permitting

Any non-residential facility that handles, prepares or processes food (hot or cold), discharges or has the potential to discharge FOG to the public sanitary sewer system requires a FOG Discharge Control (FOG) operating permit. These facilities are categorized as FOG generators. Typical examples of FOG generators include restaurants, cafeterias, supermarkets, schools, banquet halls and food courts at malls or shopping centers.

FOG Discharge Control operating permits are renewed annually and are non-transferable. Notification shall be provided to the department upon sale, relocation, or legal transfer of the permitted facility. New business owners are required to secure a new FOG operating permit.

Permits are tracked in the Permitting and Enforcement System (aka PEN). PEN integrates the following functions:

- **Tracking** of facilities, Permits, inspections, enforcement cases, remediation efforts, fee scheduling and accounting, and complaints
- **Issuance** of permits, both new and renewals
- **Management** of permit and event enforcement files
- **Scheduling** of routine inspections
- **Monitoring** of public complaints
- **Referral** of a possible facility violations between DERM sections

1. Tracking of facilities start in two ways:

- a. A facility has been identified during an inspection and it has been determined that the operation requires an Operating Permit from DERM. In this case a FOG Control Discharge Operating Permit. Inspectors issue a Notice of Permit Requirement, with the basic information of the location and business.
- b. A facility is planning to open for business at a location and start obtaining Certificate of Use and or Occupational License. As part of this process they are required to obtain an Operating Permit from DERM.

```

MIAMI-DADE DEPARTMENT OF ENVIRONMENTAL RESOURCES MANAGEMENT
Permits And Enforcement System - Permits

Permit ID 1999-0309-1015-4695 Session Number AA PER
Permit: Type GDO Number 00000001 Class IGT Status 5 Area 1
Permit Frq 12 FOC 0 Year 2017 Fee Code GDO_FEE Permit Fee 300.00
Fee Required Y [Y/N] Title Code AOP Permit Title FATS, OILS AND GREASE DISC
Facility ID 1991-0731-1448-3049 Name MIAMI BEACH RESORT OWNER, LLC
Location ID 2000-0630-1436-1948 4833 COLLINS AVE
Contact ID 1993-0131-0754-2272 Dates: Open 01/01/2013 Close / /
Inspector MARTINE Area GD-2 Dates: Valid From 01/01/2017 Valid To 12/31/2017
EQCB Count Renewal 11/01/2017 Print 08/15/2017 Issue / /
Shell IGT/AGT Insp F 12 MSP N Last NOV Date 02/12/2015 NOV CMail 700006000
Ticket {Date 09/07/2001 Number 781704} FNPTC {Date / / CMail / / }
Last Date {Ren 11/05/2016 Pay 11/23/2016 Schedule Insp 06/22/2015}
Insp{Init / / Last Routine 02/05/2014 Last 06/22/2015 Next 02/05/2015}
Building Process # Fee Dates {From 01/01/2017 To 12/31/2017}
LN Doc Type PT P No Par(ID Type No) Par Description Username Date Time
◆◆◆
User DIAZA J-File EDMS K-Coordinates FWG DT 08/15/2017-16:26:41.08
No Such Details
    
```

2. Operating Permits are required for:
 - a. Non-residential facilities that generate and discharge FOG into the sanitary sewer system.
 - b. Facilities engaged in food preparation, processing, or handling.
 - c. Facilities served by sanitary sewers system.

3. Types of Facilities that require Operating Permits:
 - a. Bakeries
 - b. Restaurants / Eating establishment
 - c. Kitchens (Schools, Churches, Fire Stations)
 - d. Convenience Stores / Supermarkets
 - e. Packing / Distributors
 - f. Processing Plants
 - g. Specialty (Coffee, Ice Cream)
 - h. Bars

4. Permit Classes
 - a. IGT In-ground Gravity Interceptor
 - b. AGT Above ground Gravity Interceptor
 - c. MGRU Hydromechanical Unit
 - d. AGRU Hydromechanical Unit (Automatic)

5. Permit Status:

STATUS	DEFINITION
1	Notified of Permit Requirement
2	NOV issued (Permit Expired)
3	Final Notice for not complying with Permit (UCVN /Ticket issued)
4	Payment Processed (Permit will be printed and mailed)
5	Permit issued
7	Facility no longer requires a permit
8	Permit cannot be issued
9	Construction completed
10	New facility, never had a permit. Has been notified.
13	Permit deactivated
16	Plans approved
17	Inspection requested by Plan Review to determine if Permit is required

6. Permitting Facts:

- a. Permits are not transferrable: If business is sold, new owner must apply for a new permit.
- b. Permit cycle runs from January 1st to December 31st.
- c. Multiple facilities may share a location, and each require a Permit. In this cases, the Permitting Section will identify them by adding after the address: Fac. A, Fac. B, Fac. C.
- d. The address in a permit must include all bays, suites occupied by the facility :
 - 2905-2907 SW 8 St
 - 3800 SW 8 ST, Bay 1-2

7. Unpermitted Facilities:

If a facility is found operating without a FOG Control Discharge Operating Permit:

- Perform initial inspection
- Request to see Occupational License and Certificate of Use
- Document if there is grease interceptor on site, including type and capacity

- Request last three pump-out receipts for grease interceptor
- Issue a Notice of Permit Requirement. Facility must initiate the process within 5 days and obtain a permit

V. Types of Grease Interceptors

1. Gravity Systems:

FOG control device that primarily relies on the difference in specific gravity between wastewater and FOG to affect separation of FOG from wastewater.

- Can be installed single or in series
- May be shared with multiple facilities
- Two manholes per tanks
- Must have outlet tee on effluent side
- Installation requires DERM Plan approval
- Capacity measured in gallons

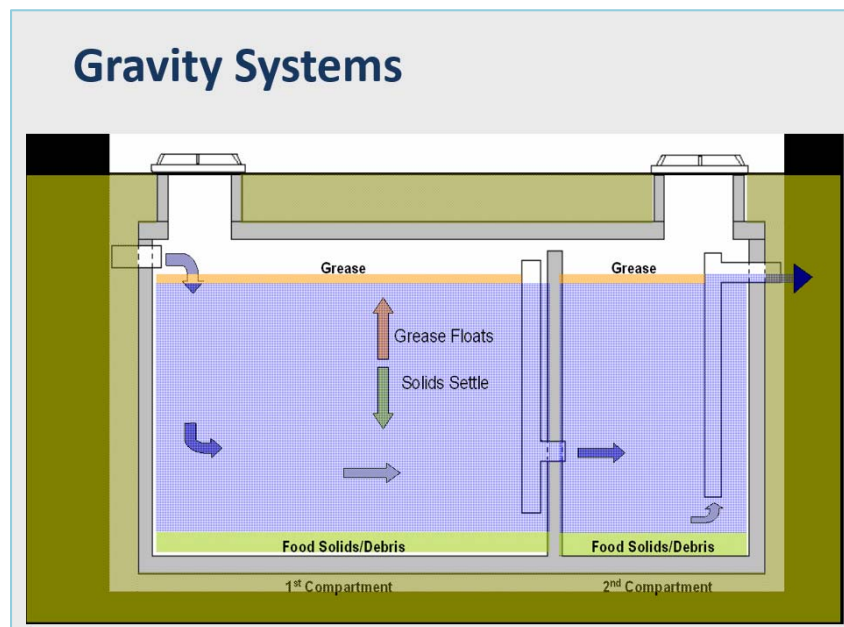

Big Foot™

gravity grease interceptors

GGI-750 Listing to IAPMO/ANSI Z1001-2014 is pending

installation: outdoor
liquid capacity: 750 gal (2,839.1 L)
grease capacity: 810 lbs. (367.4 kg)
weight: 1,200 lbs. (544.3 kg)

[download center](#)



Gravity Systems connected in series

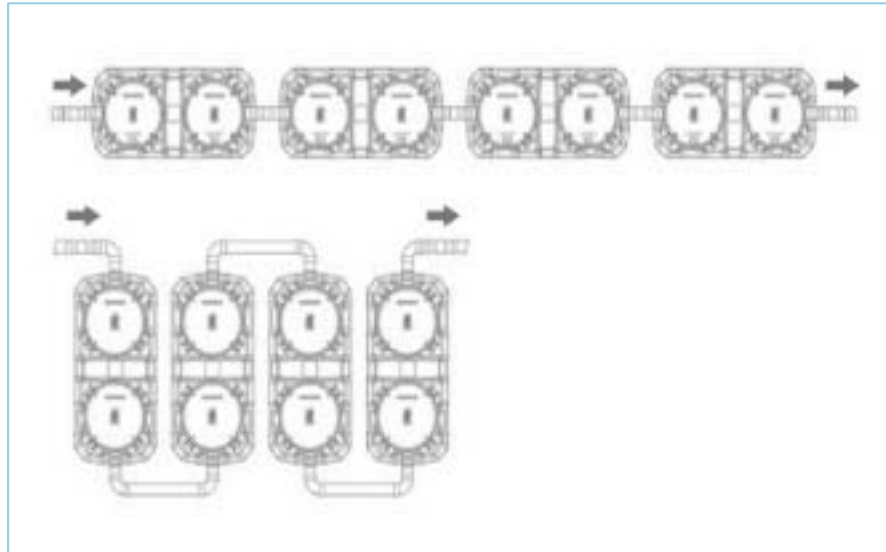

2. Hydromechanical Systems:

FOG control device that is third party tested and certified, and relies on the difference in specific gravity between wastewater and FOG to affect separation of FOG from wastewater. It may incorporate a flow control device, air entrainment, and other means or principles to improve the efficacy of separation as demonstrated by third-party testing, validation and certification.

- May be automatic or manual
- Installation requires DERM Plan approval
- Capacity measured in Gallons per minute (GPM)
- Required to have a sampling point

Illustrations below show different types of Hydromechanical grease interceptors:

Automatic Grease Interceptors

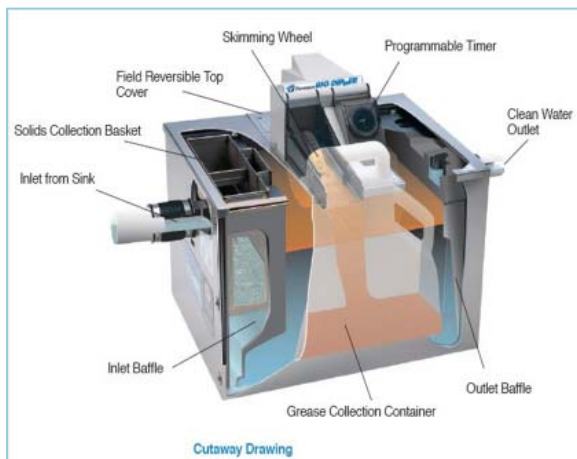

Big Dipper FS-1 Flat Strainer

Manual Grease interceptors

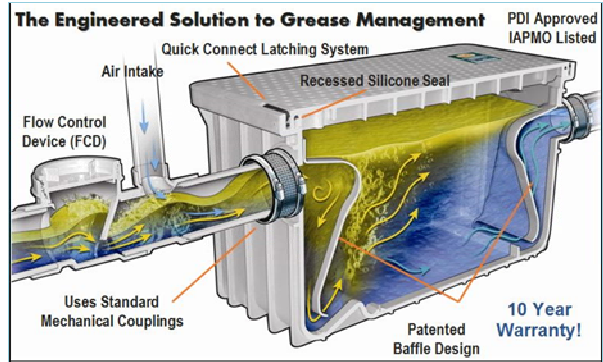

Great Basin with Diffusion Flow

Efficient Flow Design

Great Basin grease interceptors incorporate Schier's patented Diffusion Flow™ design for maximum grease separation performance. Grease or FOG (fats, oils and grease) is lighter than water – it naturally separates under the right conditions and usually within the first few minutes of retention. Diffusion Flow simply generates the most effective flow pattern, enabling maximum separation and storage. In fact, WERF's independent flow study indicates that a "distributed no baffle configuration", much like Schier's Diffusion Flow design, provides the possible best grease interceptor performance.*

- 1 Influent passes through pre-calibrated built-in flow control
- 2 Flow moves downward to center of unit minimizing disruption of the grease/solids layers
- 3 Flow is diffused upward through wet volume to begin separation
- 4 Grease rises and collects to surface while heavier food waste falls out
- 5 Free of grease and food waste, effluent flows through outlet



Schier Products
Great Basin™ Indoor/Outdoor Polyethylene Grease Interceptors



Sampling point:

- A reasonably accessible location for sampling the effluent of a FOG control device.
- Installation requires DERM Plan approval

Picture 4

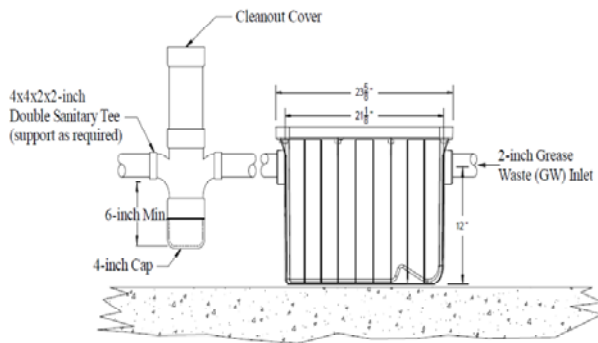

VI. Inspection:

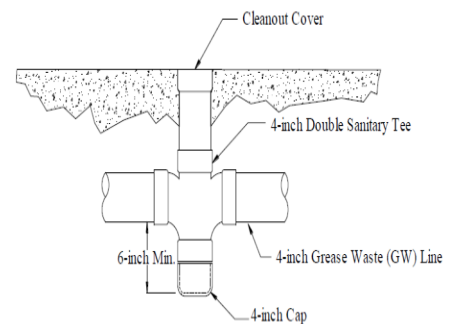

Field inspections are conducted to verify compliance with permit conditions and the FOG Control Ordinance. Inspectors assist facility operators in keeping facilities in compliance and bring no-compliant facilities into compliance with requirements. This is accomplished by the initiation and implementation of enforcement procedures along with an educational component. The inspection provides an opportunity for staff to explain and discuss environmental and regulatory concerns with facility representatives and assist them to resolve such concerns and violations.

Inspections should be conducted in a manner that furthers DERM's mission to "Balance today's needs through responsive governance, education, and conservation, to protect our environment for tomorrow." In order to accomplish this mission, field staff should note the following operational standards:

- Follow all inspection related safety procedures and carry all necessary safety equipment. Never conduct an activity in a manner that would jeopardize his or her personal safety or the safety of others.
- Conduct inspections in an efficient, effective and professional manner.
- Provide educational materials to facility operators, and owners.
- Conduct inspections during normal business hours, unless other arrangements are necessary.
- Conduct unannounced inspections, unless special arrangements are necessary.
- Conduct yourself in an ethical manner. Show a high level of respect to facilities and their employees.

1. Planning for inspections:

- a. Review any existing records for the facilities you plan to inspect. This review must include: Permit status, type of grease interceptor, check for open enforcement or pending items from previous inspections, (PEN and ECM).
- b. For facilities for which we have no records, we must check sewer availability, property information (PTXA), and if we have a name, Corporate information (Florida Corporations).
- c. Before leaving the office, make sure you have all necessary equipment to conduct your inspections.

EQUIPMENT LIST	
Manhole Puller	Sampling Bottles
Traffic Cones	Lab Cards & Labels
Dye Tablets	Log Book
Screw Drivers	Computer
Mallet	Printer
Gloves	Camera
Cooler & Ice	Field Notices
Sludge Judge	Flyers
Soap	Maintenance Logs
pH Meter / pH Paper	Thermometer
Hydrogen Sulfide Test kit	Measuring tape
Flash light	Safety Boots

2. Inspection of Food Service Establishments (FSEs):

- a. Introduce yourself to the facility management. Show your credentials and explain why you are onsite and what must be done. Ask the owner, manager or person in charge to assist you at the grease interceptor(s).
- b. Request to see their FOG Control Operating Permit, and verify information:
 - Address,
 - Facility Name and Ownership
 - Permit status
 - Issue Notices for any change in existing information, expired permits or unpermitted operations
 - Issue Notices on site and explain Correction Action expected
- c. Identify equipment and drainage fixtures: Inspect the Grease Interceptor: Content (level and quantity), quality of effluent, location
- d. Dye test fixtures with potential to receive FOG discharges (sinks, floor drains, mop sinks)
- e. Check if grease interceptor is provided with a Sampling port and outlet tee
- f. Check if level of contents is adequate. If level is below the effluent pipe, and the unit has not been pumped out recently, the tank is breached and it must be replaced. A temporary repair must be conducted within 7 days to avoid waste water to infiltrate in the groundwater.
- g. Request most recent copies of pump-out receipts and Maintenance Logs.
- h. If unit has not been cleaned within last 90 days, issue a FN to Pump-out the unit
- i. Issue Educational FN to keep maintenance Logs and pump-out receipts on site for future inspections
- j. Document area designated to wash mops & rugs. Must be connected to interceptor and covered from rain

- k. Verify that yellow grease is properly collected and that no spills are occurring in the adjacent areas. Check storm drains to verify if they have been impacted by FOG
- l. Address any issues pending from previous inspections
- m. Use the sludge judge to measure the percentage of FOG and sediments in the grease interceptor.
- n. Collect samples if needed and take them to the Lab to be analyzed for Oil & Grease, (EPA 1664). If results are above sanitary sewer standards for Oil & Grease, request that the Grease Interceptor is pumped out and schedule a second sampling event in 30 days. If the result of the second sample is above the sanitary sewer standard, case is referred to the Enforcement Section to send a Notice of Violation instructing the facility to upgrade the Grease Interceptor with Plans Approved by DERM. New Grease Interceptor must be properly sized for the operation.
- o. Issue Field Notices for any observed violations with recommended days to comply. Refer to Enforcement Matrix for compliance times.

Wrap-up

- 1. Perfect opportunity to provide recommendations on Best Management practices, interceptor maintenance, and record keeping. Education is a crucial component of this program
- 2. Explain that the Operating permits, include cleaning frequency for each facility
- 3. Explain that starting on January 2018, operators are required to report online every time that the grease interceptor is cleaned. Account has to be set up. Information includes date of service and name of provider
- 4. Explain the nature of violations and what is required to resolve them
- 5. Issue Notices on site and explain Correction Action expected

VII. Violations:

The most common violations observed in Food Service Establishments are described below:

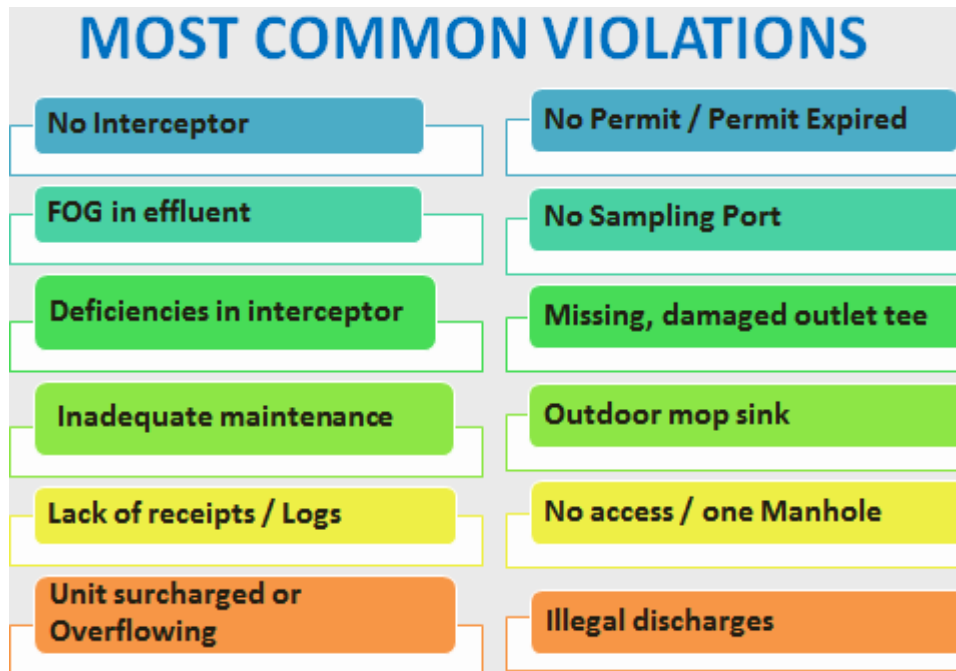

Correction of some violations, require that the facility obtain approval of Plans by DERM. The Enforcement Matrix for the FOG Control Program is included in Attachments Section of this document. The matrix illustrates progressive Enforcement Actions, time frames, and other requirements to bring facilities into compliance.

VIII. Enforcement:

1. Violations of Permit Conditions, of Chapter 24 of the Miami-Dade County Code must be addressed by issuing the appropriate Enforcement Notices. Inspectors and Environmental Technicians must explain the nature of the violations, the way to correct them and the time frame for compliance. The operator must be clear of what is expected to avoid confusion and assist in compliance. Enforcement notices may be issued in the field or sent from the office:

a. Issued in the field:

- Field Notice of Violation FOG Control Program
- Warning Notice FOG Control Program
- Field Notice of Violation
- Notice of Permit Requirement
- Notice to correct a Sanitary Nuisance
- Uniform Civil Field Notice of Violation (UCVN)

b. Issued from the Office:

- Notice of Violation , (Formal NOV)
- Consent Agreement
- Final Notice Prior to Court Action
- Demand Letter
- Refer to County Attorney's Office to file Civil Case

I

2. Follow-up:

To achieve the goals of the FOG Control Program is important to follow up in a timely manner, and to manage time in a more efficient way. If too much time lapses between violation and follow-up, operators will forget. Inspectors must keep control of the open enforcement cases until compliance is achieved or the violation is corrected.

- a. When the compliance time on an enforcement notice has expired, the Inspector or Technician must call the operator to ask if the violation has been corrected. If there is no compliance, explain that further enforcement actions may be taken for no compliance. Document the call in a Telephone communication form. If facility does not comply after that call, discuss the case with your supervisor to escalate enforcement.
- b. If violation was to send pump-out receipts, no follow-up inspection is required. Request the receipts again by phone, and document the call. If records are not received in 5 days, discuss the case with your supervisor to escalate enforcement.
- c. If the violation requires installation with plan approval from DERM, check EEOS to verify if they have been submitted.
 - If they were submitted and were approved, conduct inspection to verify installation as per approved plans.
 - If installation was completed, close the task in PEN
 - If installation has not been completed, issue a FN to finish installation in 30 days
 - If plans were disapproved, issue a FN to re-submit and install in 60 days

- Follow up shortly after the 60 days. A UCVN must be issued if there is no compliance
- If installation was completed as per approved Plans, close task in PEN.
- d. If facility complies, close the correspondent enforcement Task & Event in PEN.
- e. When a UCVN is issued, case is referred to the Enforcement Section. The Code Enforcement officer will follow up with the case until compliance is achieved.

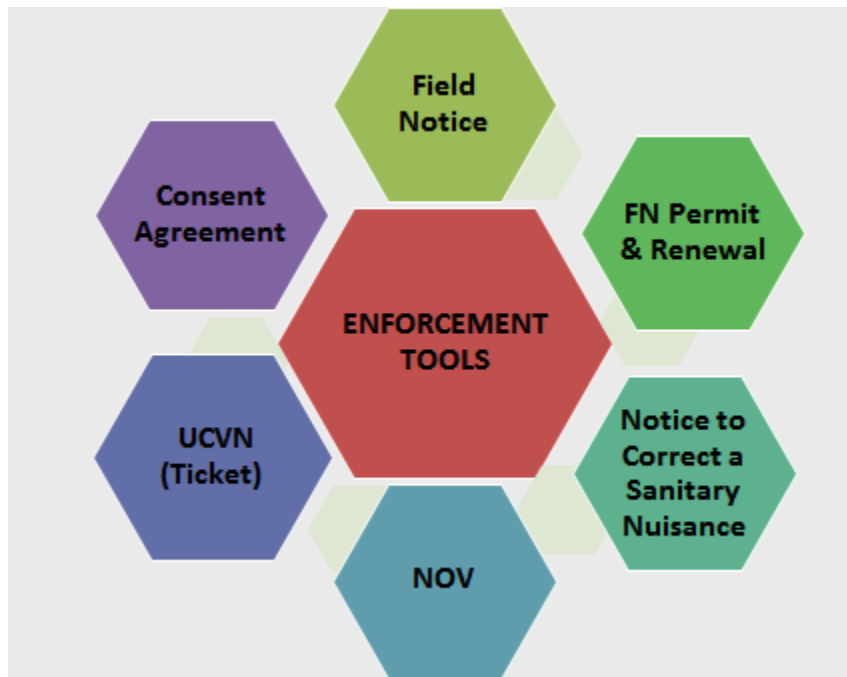

Inspection, Enforcement, Follow-up & Compliance:

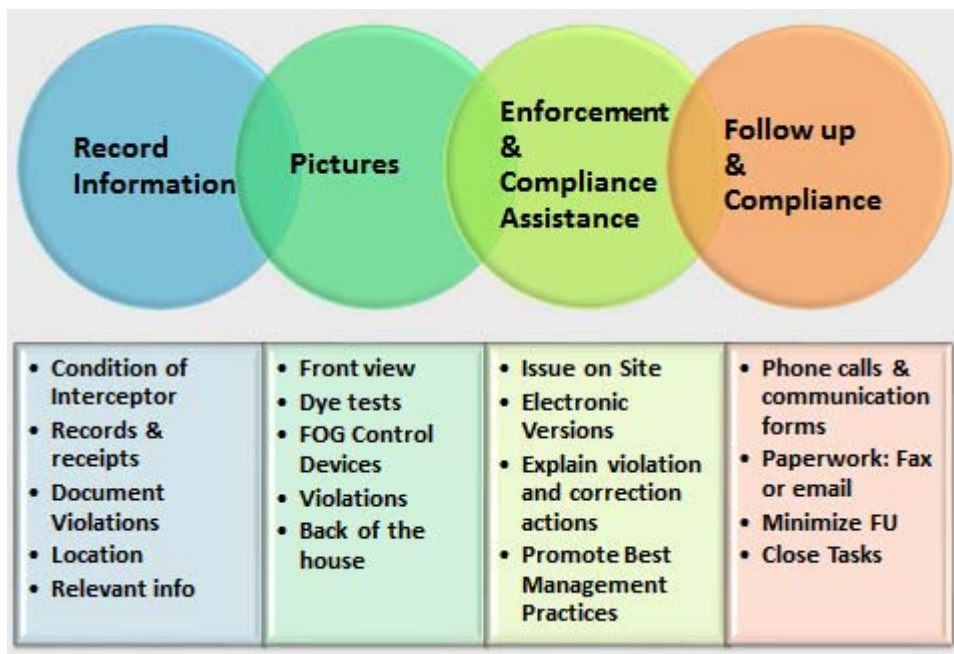

Attachment 12
LWT Guidance Manual

RER – DERM 2015

FOG^{1.5} Control Program

Liquid Waste Transporter Septage & FOG Waste Manifest Guidance Manual

Carlos L. Hernandez, PE, CFM, CEHP, LEED AP

Wastewater Permitting Section Chief

February 25, 2015



FOG^{1.5} Septage and FOG Waste Manifest

Background: Chapter 24, Miami-Dade County Environmental Protection Ordinance (Code) provides that all liquid waste transported within Miami-Dade County shall be transported by transporters with valid liquid waste transporter operating permits (a.k.a. LWT). Requirements for liquid waste transporters are included in Section 24-46 of the Code. A copy of the Code is provided below.

Sec. 24-46. Regulation of liquid waste transporters.

- (1) It shall be unlawful for any person to permit, cause, allow, let or suffer the transportation within Miami-Dade County of any liquid waste without having a valid liquid waste transporter operating permit issued by the Director or the Director's designee pursuant to [Section 24-18](#).
- (2) The Director or the Director's designee shall approve, deny, or approve with conditions, limitations or restrictions any application for a liquid waste transporter operating permit. Violations of any permit condition, limitation or restriction shall constitute a violation of the provisions of this chapter. The Director or the Director's designee may suspend or revoke a liquid waste transporter operating permit for failure to comply with any of the provisions of this chapter. The criterion for issuance of the operating permit pursuant to this section is compliance with [Chapter 24](#) of the Code of Miami-Dade County. In addition to the liquid waste transporter operating permit, the Director, or the Director's designee, shall issue numbered stickers which shall be visibly posted on each vehicle permitted to transport liquid waste.
- (3) All applications for permits issued pursuant to this section shall be on a form prescribed by the Director or the Director's designee and accompanied by a fee which shall be established by administrative order of the County Manager and approved by the Board of County Commissioners.
The permit fee payable hereunder shall be deposited in a separate county fund and shall be used exclusively by the Department to pay for the costs of environmental services to and environmental regulation of liquid waste transportation in Miami-Dade County, Florida.
- (4) All operating permits required by this chapter shall be in addition to any other permits, registrations or occupational licenses which may be required by federal, State or local law. The Director, or the Director's designee, in his or her discretion, may require conditions, limitations or restrictions as part of the operating permit if said conditions, limitations and restrictions are consistent with the requirements of this chapter.
- (5) Monthly reporting required. All liquid waste transporters shall submit on a monthly basis to the Director or the Director's designee, on a form prescribed by the Department all information required by any conditions, limitations or restrictions which are part of the liquid waste transporter's operating permit.
- (6) Immediate reporting required. Any liquid waste transporter who causes, permits, lets, allows, or suffers any liquid waste accident, liquid waste spill, or other liquid waste discharge anywhere within the boundaries of Miami-Dade County, shall immediately report the same to the Department.
- (7) It shall be unlawful for any liquid waste transporter to dump, dispose, throw, drain, run, leak or otherwise discharge, or to allow, cause, permit, let, or suffer to be dumped, disposed, thrown, drained, run, leaked or otherwise discharged any liquid waste or solid waste into a sanitary sewer, any type of manhole, storm sewer, catch basin, french drain, disposal well, soakage pit, solid waste transfer or disposal facility, recycling facility, waste oil facility or similar structure or on to or into the ground, or into any of the waters of this county, or at any other place in Miami-Dade County unless said place is a sewage treatment plant or industrial waste treatment plant or a resource recovery and management facility approved by the Director or the Director's designee to receive said liquid or solid wastes and unless the liquid waste transporter's operating permit authorizes said place for disposal.
- (8) No person shall utilize a liquid waste transporter unless the liquid waste transporter has a valid operating permit issued by the Director or the Director's designee.
- (9) The following activities shall be exempt from the provisions of this ordinance:
 - (a) The on site transportation of liquid waste to a place within the boundaries of a particular facility, location, property or site.
 - (b) The transportation of fully containerized and hermetically-sealed receptacles approved by the State of Florida Department of Transportation, provided said transportation does not commence or end in Miami-Dade County.

(Ord. No. 04-214, §§ 1, 5, 12-2-04; Ord. No. 08-55, § 2, 5-6-08)

Monthly Reporting: The Code requires that all liquid waste transporters that transport liquid waste “within” Miami-Dade County, regardless of the point of origination or final disposition, submit a monthly report to the Department, “*on a form prescribed by the Department.*” To facilitate the reporting process, the Department developed a simple one-page Septage and Fats, Oil and Grease (FOG) waste manifest form (**Attached**). Each permittee shall make copies of the manifest form in triplicate: Transporter (Permittee), Disposal Facility, and DERM Copy. This form is mandatory and shall be used by all Septage and FOG transporters starting April 1, 2015. Failure to utilize this form after April 1, 2015 **will result in a Warning Notice and escalated enforcement action as needed for continued and additional violations to include possible revocation of your transporters operating permit as provided in the Code.**

On or before the 20th of each month, all liquid waste transporters shall submit to the Department the following items/forms for all liquid waste transported within Miami-Dade County the previous month; e.g., submit reports for waste transported during April by May 15, 2015.

1. ***Septage and FOG Single Load LWT Manifest Form (Attached)***. Each manifest form can document up to five facilities. If more than five facilities are pumped, then additional manifests are required to document the single load/truck. For example, if a truck fully evacuates grease interceptors from six (6) different locations, then two manifests are required to document the single (truck) load. Note that the disposal ticket number will be the same on both manifest forms.
2. ***Disposal Tickets***. Each manifest form shall have a corresponding disposal ticket. Using the prior example, if a truck fully evacuates grease interceptors from six different locations, then two manifests and one disposal ticket are required to document the single (truck) load. The single ticket number will appear in Section 5 of the two manifest forms.
3. ***Monthly Summary Form (Attached)***. The monthly summary form simply totals all loads and links manifest and disposal tickets in one form. This form is also used to calculate the monthly fee.
4. ***Monthly Fee***. Include check made payable to Miami-Dade County.

All reports and checks shall be submitted to:

PO Box 01-2378

Miami, FL 33101-2378

Sample Monthly Reporting: Two samples of a typical monthly submittal are provided below.

Sample No.1

Permittee: CL Liquid Waste Transporters

Permit Number: LW-000999-2015/2016 ST

Number of Trucks: One

DERM Capacity (Decal): Truck No. 1: 3,000 gallons (ST999)

Monthly Report: June 2015 Report submitted to RER-DERM on July 13th.

For June 2015, the permittee hauled grease trap waste from Islamorada Krab House to South District Wastewater Treatment Plant (Black Point). Krab House has two 1,250 gallon grease interceptors. The manifests, disposal tickets and monthly form are included below.

Septage and FOG Single Load Liquid Waste Transporter Manifest

Section 1: Liquid Waste Transporter Information

Company Name: CL Liquid Waste
 DERM Decal No.: ST999
 Vehicle License Plate: OHM911
 Vehicle Full Load Capacity: 3000 Gallons

Section 2: Origination of Waste

Facility Name: Krab House
 Facility Address: Mile Marker 52, Islamorada
 Facility Name: _____
 Facility Address: _____
 Facility Name: _____
 Facility Address: _____
 Facility Name: _____
 Facility Address: _____
 Facility Name: _____
 Facility Address: _____

Section 3: Waste Type, Gallons & Date Pumped

Grease Trap/Grease Interceptor (Gallons)	Residential Septic Tank	Portable Toilet/Chemical Toilet	Other:	Other:	Sub-Total Waste (Gallons)	Date Pumped
Fats, Oil & Grease GDO: <u>N/A</u>					<u>2,500</u>	<u>6/15/15</u>
GDO: _____						
GDO: _____						
GDO: _____						
GDO: _____						
GDO: _____						
					Total Waste this Load: <u>2,500</u>	Gallons

Section 4: Transporter Certification

Print Driver Name: Bill Trap Driver Signature: Bill trap
 Total Waste Unloaded: 2,500 Gallons Date Waste Unloaded: 6/15/15 Time Waste Unloaded: 10:21 AM or PM
 By signing Section 4, I certify that the information in Section 1, 2 & 3 above is true and accurate, and that only the facilities listed in the "Origination of Waste" section is contained in this service vehicle/hauler truck tank. I also certify that the attached disposal ticket corresponds with this manifest. I understand that the discharge of any waste other than grease waste, septic tank waste, or portable toilet waste from customers in the Miami Dade County jurisdiction must be approved before the waste is transported to the South District Wastewater Treatment Facility. I am aware that falsification of this manifest may result in prosecution.

Section 5: Disposal Facility Certification

Disposal Location: South District WWTP Ticket No.: 190951 Date Waste Unloaded: 6/15/15
 DERM Decal No.: ST999 Vehicle Full Load Capacity: 3000 Gallons Total Waste Unloaded: 3000 Gallons
 Operator Name: Tom Study Operator Signature: Tom Study

By signing Section 5, I certify that the information in Section 5 is true and accurate.

>>>>>Attach Disposal Facility Ticket<<<<<<

SOUTH DISTRICT WASTE WATER TREATMENT PLANT
MIAMI-DADE WATER & SEWER DEPARTMENT

No. 190951

DATE: June 15, 2015

one load of septic tank

Received from CL Liquid Waste
(Name of Customer)

residue containing approximately 2,500 gallons for which there is a charge of \$ WASD dollars.

Residential Septage

Combination

Greasetrap

I certify the above information is correct.

WATER AND SEWER DEPARTMENT

Delivered by: Carlos L. Hernandez

(Driver Print Name)

[Signature]

(Driver Signature)

Identifier No. A 999 Sep. No. 999

Received by:

Bill Trap

(WWTP Employee Print Name)

[Signature]

(Signature)

Time: 10:01 pm

110-SP-9 7/05

CUSTOMER

F:\mms\schltt.wk4

RER-Division of Environmental Resources Management
Monthly Septage and FOG Liquid Waste Transporter Reporting Form

Permit No.: LW-000999 2014/2015 ST
 Month/Year: June 2015
 Company Name: CL Liquid Waste
 Report Contact: Bill Trap
 Mailing Address: 123 SW 321 Rd, Palmetto Village
 Phone No.: 305-372-6714
 Email Address: CLLW@CLLW.COM

Manifest Ticket Number	Sub-Total Waste (gallons)
190951	2,500
	↓

Total Liquid Waste: 2,500 gallons
 Total Liquid Waste x 3.9/1000 gallons: \$ 9.75

Sample No.2

Permittee: 4 Liquid Waste Transporters

Permit Number: LW-000999-2015/2016 ST

Number of Trucks: One

DERM Capacity (Decal): Truck No. 1: 4,000 gallons (ST999)

Month: March 2015 Report submitted to RER-DERM on April 13th.

For March 2015, the permittee hauled grease trap waste from Bayside Krab House to Broward County (Powerline). Krab House has four (4) 1,000 gallon grease interceptors. The manifests, disposal tickets and monthly form are included below.

Waste Tracking Form

TP12

for EPGMD Decal Number [REDACTED]
to the Broward County, Septage Receiving Facility

Hauler: 4 Liquid Waste Transporters

Account Number [REDACTED]

Permit Number [REDACTED]

Pick up Date	Waste Pick up Location Name/ Address/Phone Number	Waste Class Type of Waste	Estimated Volume (Gal.)
1. 3/2/15	Bayside Krab House, 111 Biscayne Blvd, Miami, FL	<input checked="" type="checkbox"/> Business <input type="checkbox"/> Residence <i>OPERATE</i> <i>3316</i>	<i>4000</i>
2.		<input type="checkbox"/> Business <input type="checkbox"/> Residence	
3.		<input type="checkbox"/> Business <input type="checkbox"/> Residence	
4.		<input type="checkbox"/> Business <input type="checkbox"/> Residence	

Waste origin: Dade Broward Palm Beach Other _____

Vehicle cleaning needed? Yes No

Transporting liquid waste? Yes No

I certify that the information listed here is true, accurate and complete.

Driver Name (Print Name) [REDACTED] Signature [REDACTED]

To be completed by Septage Receiving Facility Operator:

Date 3/2/15 Time 11:02 Ticket Number 89205 Initials J



**Broward County Water and Wastewater Services
SEPTAGE RECEIVING FACILITY
3100 N. Powerline Road, Pompano Beach, FL - 33069
SEPTAGE RECEIVING RECEIPT**

Ticket Number



Ticket Date

3/2/2015 11:02:17 AM

EPD Decal



Customer



Energy Customer # 3210749

Service Area Broward County

Miscellaneous Truck Wash

After Hours Dump

Waste Volume 4000 gals

Waste Types

Grease Trap

Comments

Truck Driver Signature

Utilities Clerk Initials

Attachments

Septage and FOG Liquid Waste Transporter Manifest Form

Monthly Summary Report

Attachment 12

Liquid Waste Transporter Septage & FOG Waste Manifest Guide

CURRENTLY BEING FINALIZED TO BE SUBMITTED TO THE EPA & FDEP
BY OCTOBER 31, 2017 FOR APPROVAL

Attachment 14
FOG Enforcement Response Plan



Delivering Excellence Every Day

Fats, Oils & Grease (FOG) ENFORCEMENT RESPONSE PLAN

The Department of Regulatory and Economic Resources, Division of Environmental Resources Management (DERM) has a current Enforcement Policy that is used by all Program areas within DERM, including DERM's current Fats, Oil & Grease (FOG) Control Program. This FOG Enforcement Response Plan will be a supplement to the existing DERM Enforcement Policy, and it defines investigative and enforcement procedures specific to the FOG Control Program. It provides a framework for timely, consistent and equitable enforcement actions for facilities regulated under the FOG Control Program and consistent with the provisions of 19(a)(ix) of the Consent Decree. This FOG Enforcement Response Plan also ensures a consistent response to all FOG generators that cause, or have the potential to cause, interference, obstruction, sanitary sewer overflows, bypasses, or storm water inflow to a wastewater collection and transmission system and wastewater treatment plant. DERM is responsible for administering the FOG Control Program as a means of monitoring FOG generators. DERM's regulatory authority lies in Chapter 24 (and as amended) and Chapter 8CC, Miami-Dade County Codes.

This document will be reviewed by DERM from time to time and amended as necessary to incorporate new policies and/or updates as appropriate. Any changes made will be reported in the Annual FOG Control Program Review report submitted annually to EPA and FDEP.

I. METHODS TO INVESTIGATE NON-COMPLIANCE

Non-compliance investigations will involve FOG Control Program staff (e.g., technicians, inspectors, supervisors, and engineers), other DERM program staff. Information from utilities and municipalities (public works, code compliance and others) will be leveraged to identify non-compliance occurrences/events. Methods to investigate non-compliance will include field observations made during routine inspections or complaint response, dye-testing, manhole-to-manhole evaluations, sample collection and analysis, close-circuit televising (by utility), and root cause analysis.

II. DERM STAFF RESPONSIBILITIES

Field and Support Personnel- Field and support personnel include Pollution Control Inspectors, Environmental Technicians, and permitting engineers in charge of inspecting/monitoring FOG generators to evaluate compliance with FOG Control Program regulations. Field personnel are responsible for conducting site inspections according to an established work plan and the information collected is compiled in the form of an inspection report which is incorporated into the Department's electronic data management system (EDMS). Staff review submittals and self-monitoring reports as required to identify potential violations, and prepares Warning Notices and other field notices. Records such as operating permits, copies of facility records, plan submittals, and monitoring reports are sent to the file.

FOG Control Program Supervisor (FCPS) - Reports to the Section Manager and is responsible for supervising field personnel and reviewing all work product generated by them including inspection reports, field notices and Warning Notices. The FCPS will establish the annual work plan and ensure that inspections are being conducted in a timely manner and that violations are being addressed according to established policies. The FCPS prepares annual reports, refers cases for further enforcement, evaluates violations, and manages the day-to-day activities of the program.

Code Enforcement Section Manager- Supervises the DERM's Code Enforcement Officers, reviews and assigns cases referred for enforcement action and oversees the management of all formal enforcement cases

Environmental Code Enforcement Officers Is (CEO Is) - CEO 1s will be responsible for follow-up of Uniform Civil Violation Notices (UCVNs; i.e., tickets), issuance of Notices of Liens and placement of Liens, as applicable. Approximately three (3) CEO 1s can be assigned to FOG enforcement cases.

Environmental Code Enforcement Officers IIs (CEO IIs) - CEO 2s are responsible for issuance of formal administrative notices, Consent Agreements and civil court case referrals. Approximately three (3) to four (4) CEO 2s can be assigned to the FOG enforcement cases.

Department Assistant Director- Approves and implements all permitting, inspections, enforcement and other regulatory actions pursuant to his authority set forth in Chapter 24, through his designee(s).

County Attorney's Office (CAO)- The CAO plays a significant role in bringing major, non-compliant FSE's into compliance. They are in charge of filing the appropriate court action against these individuals/corporation on behalf of DERM/County.

III. ENFORCEMENT REMEDIES AVAILABLE TO DERM

Depending upon the nature of evidence obtained documenting a violation and determining the severity of the violation, the following enforcement remedies or combination of remedies are available to obtain compliance:

A. **Administrative Enforcement Remedies**

1. **Written field notice (various types)** – A written field notice or written warning may be issued in the field or mailed from the office. A field notice contains an order to cease and desist any unauthorized discharges or to cease any other activities that violate the requirements of Chapter 24 of the Code.
2. **Warning Notice** –A written warning issued from the Office. Provides for specific corrective measures to be implemented within specific timeframes.
3. **Notice of Violation and Orders for Corrective Action (NOV)** – A formal, comprehensive NOV summarizing the violation(s) and Code sections cited and requiring specific corrective measures to be implemented within specific timeframes. The first order of any NOV for pretreatment cases is to cease and desist from any unauthorized discharges.
4. **Final Notice Prior to Court Action (FNPTCA)** – Notice issued advising violator of impending civil case preparation due to non-compliance with NOV. This notice may include the offer of a Consent Agreement as a means of resolving violations and avoiding court action.
5. **Demand Letter** –One of the latter enforcement actions which offers an administrative consent agreement as a means of case settlement, prior to any court action. Failure to comply with requirements of above-referenced progressive enforcement notices or voluntarily enter into a consent agreement at this point to implement the necessary corrective actions, may lead to referral to the Office of the County Attorney for civil litigation. Failure to comply at this point may also lead to revocation of operating permit and cessation of operations.
6. **Cessation of Operations/Permit Revocation-** Failure by a facility to comply with requirement to cease & desist violations may result in the facility being issued an order to restrict, cease or suspend operations causing the violation until the violation is corrected. In addition, the facility's operating permit may be suspended or revoked.
7. Other enforcement notices may be issued in an effort to continue towards administratively achieving compliance.
8. **Consent Agreement** – A consent agreement pursuant to Section 24-7(15) (c) of the Code is a written agreement between DERM and the person subject to an action or investigation. The agreement constitutes a lawful order of the Director and provides written assurance of voluntary compliance with applicable provisions of Chapter 24 of

the Code. The agreement may also include a compliance schedule, provisions for environmental restoration, damages, civil penalties and administrative costs. The consent agreement is an administrative remedy which allows DERM to settle violations prior to or to avoid court action, if possible.

9. **Annual Publication of Significant Noncompliance (SNC)** - Annual public notification of users in SNC in a newspaper of general circulation that provides meaningful public notice within the jurisdiction of Miami-Dade County, of pretreatment facilities with chronic violations.

B. Formalized Enforcement Remedies

1. **Uniform Civil Violation Notice or "ticket"** – A Uniform Civil Violation Notice (UCVN) requires correction of a violation and mandatory payment of a civil penalty specified in Chapter 8CC of the Code. A violator may appeal the issuance of a UCVN and request a formal administrative hearing. If no corrective action or payment of accrued penalties is made, an affidavit of non-compliance is issued by the environmental code inspector. Generally, DERM fully supports a procedure whereby an alleged violator is given a minimum of one (1) written warning or field notice prior to the issuance of a UCVN or "ticket". This procedure will accomplish three things:
 - a. Provide the violator with proper notice and allow a reasonable period for voluntary compliance.
 - b. Provide a timetable for quick correction of minor or readily correctable violations.
 - c. In the event of non-compliance, clearly establish that the violator was given an opportunity to comply without risk of being penalized.

The procedure of issuing a warning notice prior to the ticket does not apply to repeat violators for the same offense.

When possible, the environmental code inspectors should review the circumstances and evidence of each case with their supervisor or one of the DERM's Code Enforcement Officers prior to issuing the UCVN. This provides consistency in application and use of ticketing authority. When circumstances arise which prevent prior review, the environmental code inspector is to use his/her best judgment in achieving timely compliance.

2. **Liens** – A Code Enforcement lien, pursuant to the provisions of Chapter 8CC may be placed on property where there has been no compliance with the UCVN issued (and an Affidavit of Non-compliance has been filed by the environmental code inspector), which has resulted in an accrual of penalties. Said lien in the amount of the accrued penalty, is recorded in the public records against the property on which the violation exists or upon any other real or personal property owned by the violator. Such liens may be enforced in the same manner as a court judgment by the sheriff's Office.

3. **Civil legal action** – Civil cases filed by DERM are processed and litigated by the Office of the County Attorney. These cases, or lawsuits, are generally in the form of requests for injunctive relief whereby the court can require compliance with Chapter 24 of the Code, recover DERM administrative costs, and impose civil penalties of up to \$25,000 per offense per day. The majority of cases which DERM pursues in this manner are the more complex cases or those requiring substantial corrective measures, including but not limited to pretreatment violations. The circuit court judges who hear these cases can issue orders requiring the defendant to perform specific acts or issue orders prohibiting the defendant from performing specific acts.
4. **County court misdemeanor complaints** – Violations of Chapter 24 of the Code may be prosecuted by the State Attorney's Office in County Court as a violation of a local ordinance. These cases are processed through the general intake office of the Miami-Dade County State Attorney. Although they are classified by the state as ordinance violations, they are prosecuted in the same manner as criminal misdemeanors. The penalties are equivalent to second degree misdemeanors (up to \$500 and/or up to 60 days in jail). The majority of cases which DERM pursues in this manner includes but is not limited to continuing violations such as a facility or business operating without a valid DERM permit. Formal complaints are only filed when prior warnings and the issuance of a UCVN have not brought the facility into compliance. Using this procedure, the DERM may receive after-the fact permitting fees and administrative costs. Note that these violations are not defined by the state as crimes.
5. **Criminal legal action** – These cases involve criminal offenses that are classified as felonies or misdemeanors and can result in sanctions such as maximum imprisonment not to exceed 30 years (state 1st degree felony) or maximum fines not to exceed \$1,000,000.00 (Federal Clean Water Act felony). The documented criminal offense must include a requisite state of mind (such as intentionally, knowingly, recklessly, or grossly negligent) as well as an act classified as a crime under the Florida Statutes or federal regulations. Accidents and acts that are coerced would not be considered crimes. Criminal cases may involve deliberate violations such as hazardous or toxic waste discharge or dumping.

Many of these cases involve corporations or individuals with a prior history of environmental violations or a criminal record. Criminal cases must be proven "beyond and to the exclusion of a reasonable doubt", and proper, comprehensive documentation and procedures must be followed to meet the evidentiary requirement necessary to file such cases. Judges hearing these cases are limited to determining the defendant's guilt or innocence and imposing appropriate fines or jail time. Remediation of contaminated sites associated with these cases can be addressed through parallel proceedings in Civil Court.

IV. SCHEDULE OF CIVIL PENALTIES (Sec. 8CC-10)

<i>Code Section</i>	<i>Description of Violation</i>	<i>Civil Penalty</i>
24-18	Failure to properly secure required operating permit or comply with the conditions of an operating permit	250.00
24-21	Failure to maintain and keep operating records	200.00
24-42(2)	Exceeding effluent standards for discharges	200.00
24-42(3)	Unlawful discharge affecting water quality	200.00
24-42.1	Breach of effluent standards by new sewage treatment plants and industrial waste treatment facilities	100.00
24-42.2	Noncompliance with provisions regulating sanitary sewer collection and transmission systems	250.00
24-42.4	Discharging prohibited wastes or substances into sewers	300.00
24-42.6	Non-Compliance with FOG Control Program requirements	Refer to Applicable Violation (e.g., \$250.00 for Operating without GDO or violation permit condition)
24-28	Sanitary nuisance	500.00

V. SENFORCEMENT RESPONSE GUIDE)

<i>DERM FOG Control Program ENFORCEMENT RESPONSE GUIDE</i>			
Type of Violation	Initial Enforcement Action	Timeframe for Enforcement Response	Follow-up for Non-Compliance
FOG Discharge to Sewer			
FOG Found in Sampling Port	Field or Warning Notice	Upon documentation of violation	Uniform Civil Violation Notice
FOG in Building Sewer	Warning Notice; or Notice of Violation (NOV).	Within fifteen (15) days of documentation of violation	Progressive enforcement leading to UCVN, possible Consent Agreement, civil litigation, or criminal prosecution
FOG in Sanitary Sewer or Cause SSO	Notice of Violation & Emergency Orders for Corrective Action (as applicable)	Upon documentation of violation	Final Notice Prior to Court Action; Consent Agreement; Referral for court action
<i>FOG Control Device Components & Maintenance violations</i>			
Grease Interceptor (GI) Structural Failure	Warning Notice/NOV	Upon documentation of violation	Uniform Civil Violation Notice
Failure to install FOG control device	WN, /Notice of Violation. Corrective actions may be required	Within 90 days of documentation of violation	Progressive enforcement leading to possible Consent Agreement, civil litigation, or criminal prosecution Possible cessation of operations causing violations
Failure to complete & submit GI certification; failure to correct failed GI	WN/Notice of Violation	Within thirty (30) days of documentation of violation	UCVN or other Progressive enforcement leading to possible Consent Agreement, civil litigation, or criminal prosecution Possible cessation of operations causing violations

FOG Control Device Components & Maintenance violations (Cont'd)

Type of Violation	Initial Enforcement Action	Timeframe for Enforcement Response	Follow-up for Non-Compliance
Failure to maintain FOG Control Device	Field Notice/Warning Notice	Within 7 days of receipt of Notice	Uniform Civil Violation Notice
Recordkeeping & Reporting Violations No Record	Field Notice/Warning Notice	Within 7 days of Notice	Uniform Civil Violation Notice
Falsification of Records	NOV	Within 7 days of due date	Refer for criminal prosecution Possible cessation of operations causing violations
Failure to implement FOG facility upgrades	WN/ Notice of Violation	Within 30 days of documentation of violation	Progressive enforcement leading to possible Consent Agreement, civil litigation, or criminal prosecution. Possible cessation of operations causing violations
Reporting Violation Falsification	Notice of Violation	Within 30 days of documentation of violation	Refer for criminal prosecution Possible cessation of operations causing violations

Other Violations			
Denial of Entry/Allow access	Field Notice/WN	Within 24 hours	Seek inspection warrant
Violation of Permit Conditions	Warning Notice	Within 30 days of documentation of violation	UCVN or other Progressive enforcement leading to possible Consent Agreement, civil litigation, or criminal prosecution. Possible cessation of operations causing violations
Improper Waste Disposal	NOV and Orders for Corrective Action	Immediate Cease & Desist; process/equipment changes	Progressive enforcement leading to possible Consent Agreement, civil litigation, or criminal prosecution. Possible cessation of operations causing violations
<p>Below is a flow chart (Levels of Enforcement) representing the progressive enforcement process referred to in the Enforcement Response Guide above.</p>			

Levels of Enforcement

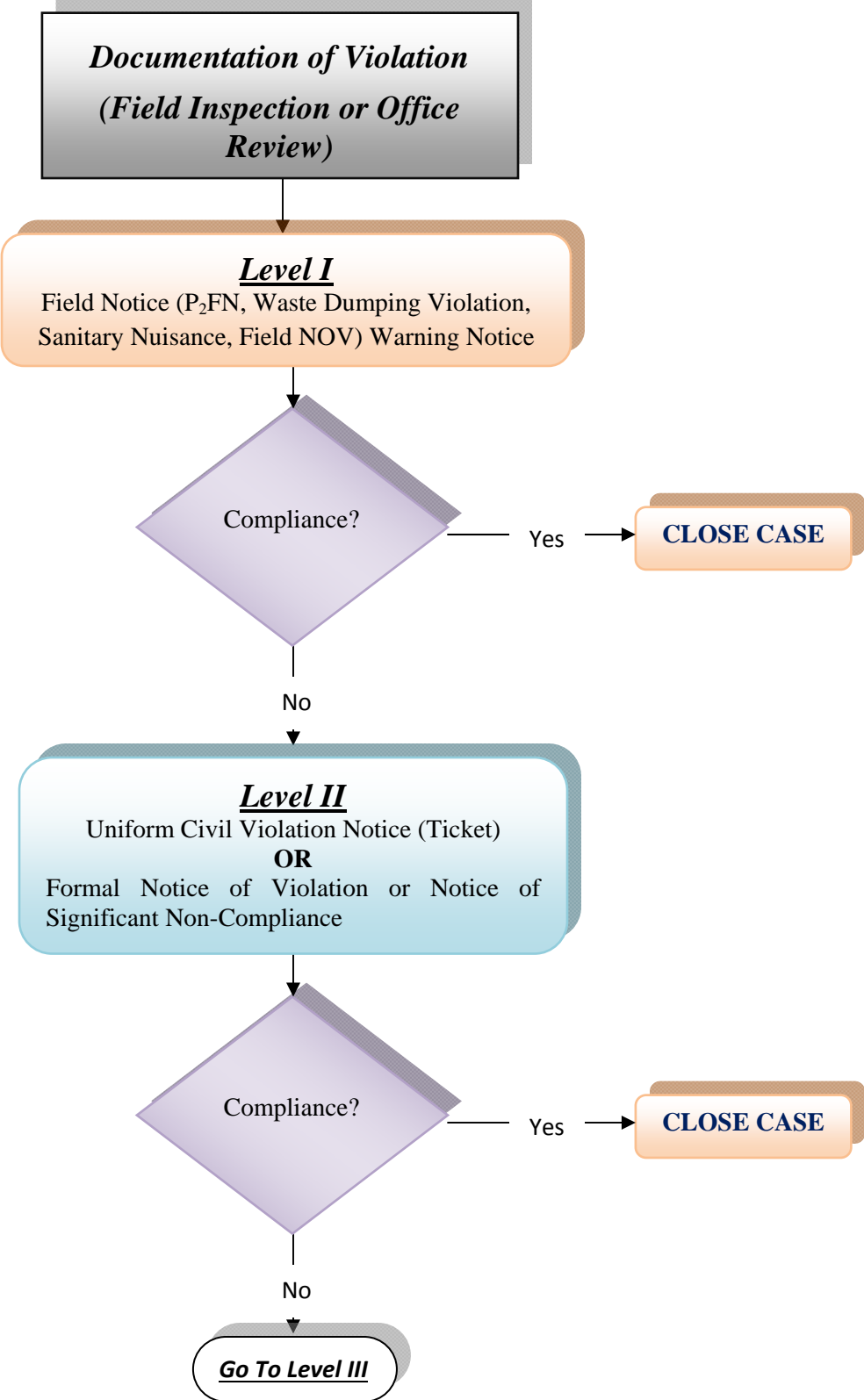

Levels of Enforcement (Cont'd)

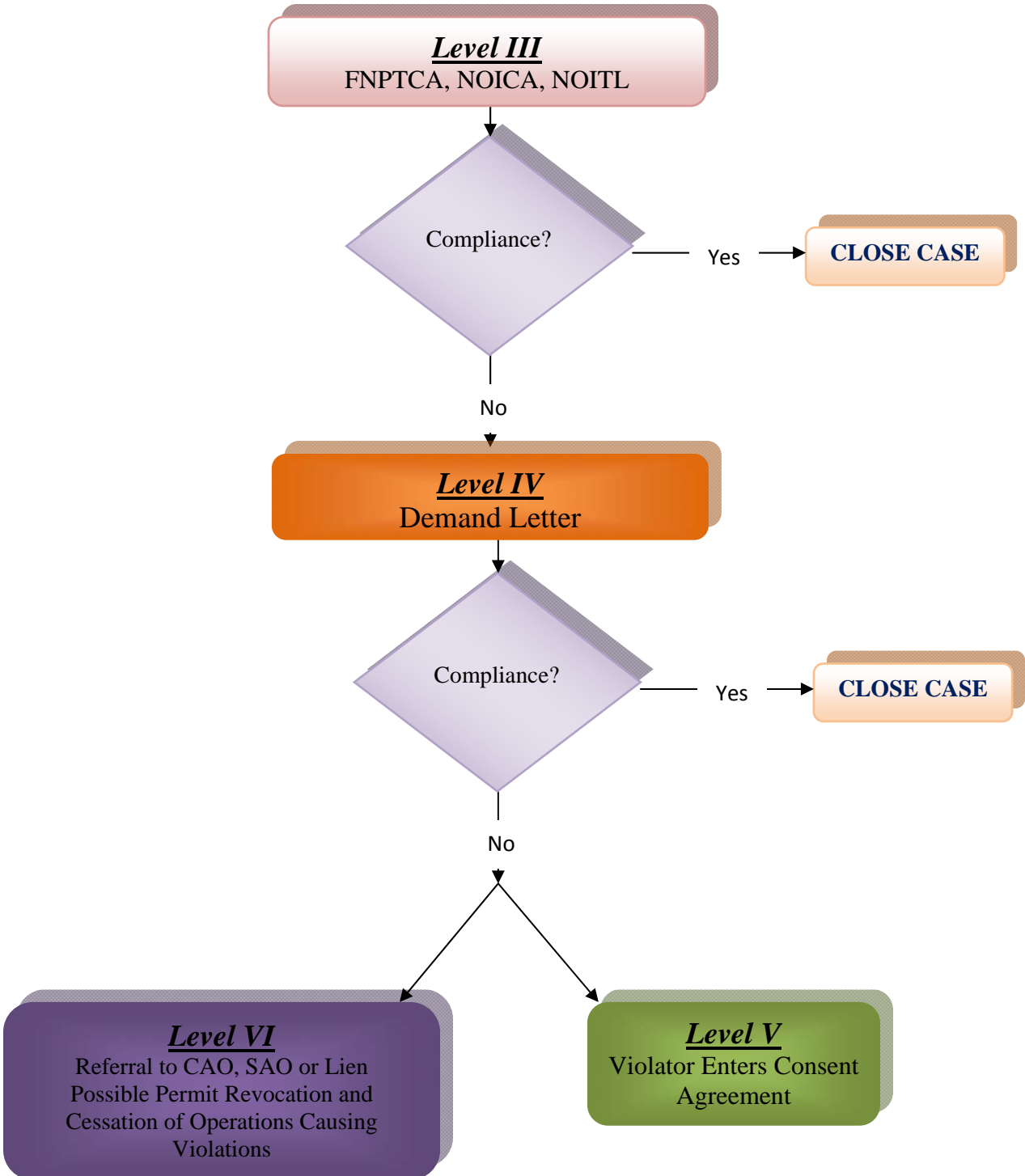

Attachment 15
Summary of Inspection Task Actions (Enforcement)

FOG^{1.0} DERM INSPECTIONS

Routine FOG Inspection			
Task	Task Result	Task Action	Task Outcome
Verify ALL FSEs have GDO			
Check Posting of GDO Permit		NOT APPLICABLE (NA)	
Request 3 Last Pump-Out Receipts	Not Available At Facility	• WN	
• Review Receipts	Provided & Insufficient	• WN	
• Check LWT Approved by DERM	Provided & Sufficient	• NA	
Inspect FCD: • Visual Condition Assessment of System (+System Outlet/Sampling Port)	System NOT Maintained but no FOG Discharge		NA
	System NOT Maintained & FOG Discharge	• FN to clean system & Fax disposal receipt	
	System Maintained	• NA	

MDC-FOG Control Program 2016/2017: Improvements Implemented

FOG^{1.5} DERM INSPECTIONS

Routine FOG Inspection

Task	Task Result	Task Action	Task Outcome
Verify ALL FSEs have GDO	Identify FSEs w/out GDO Permit Identify FSEs w/GDO Permit	<ul style="list-style-type: none"> Inspect & Issue Field Notice (FN) Inspect 	All FSEs permitted
Check Posting of GDO Permit	Not Posted Posted	<ul style="list-style-type: none"> 1st-time = Warning Notice (WN) 2nd + = Ticket Review with GDO 	Awareness & Comply w/Permit Conditions Awareness of Requirements
Request 3 Last Pump-Out Receipts	Not Available At Facility Provided & Insufficient Provided & Sufficient	<ul style="list-style-type: none"> 1st-time = WN 2nd + = Ticket 1st-time = WN 2nd + = Ticket Review Receipts Check Liquid Waste Transporter (LWT) Approved by DERM 	Maintain System
Inspect FCD: <ul style="list-style-type: none"> Visual Condition Assessment of System (+System Outlet/Sampling Port) Effluent Sampling Dye Test Fixtures FOG & Solids Levels (dipstick pro or equal) Downstream Manhole(s) Assessment 	System NOT Maintained but no FOG Discharge System NOT Maintained & FOG Discharge	<ul style="list-style-type: none"> 1st-time = FN to clean system and provide disposal receipt w/in 48 hrs. 2nd + = Ticket Follow-Up Inspection to Confirm Compliance Samples collected 1st-time = FN to clean system and provide disposal receipt w/in 48 hrs. 2nd + = Ticket System Upgrade Follow-Up Inspection to Confirm Compliance 	Maintain System & Protect WCTS
	System Maintained	Review with GDO	

Thank You for Protecting your Public Infrastructure Card if ALL PASS to encourage Ongoing Compliance!

MDC-FOG Control Program 2016/2017: Improvements Implemented

Attachment 16
List of FOG Generators as of 10/10/2017

WORK GROUP	PERMIT NUMBER	PERMIT CLASS	PERMIT	PERMIT FEE	BUSINESS_TYPE	RECORDED SEATS	OBSERVED SEATS	FACILITY AREA	UTILITY	SYSTEM FORMAT	TOTAL CAPACITY	TANK_CAPACITY	PUMP OUT	TOTAL GPD
GDO	283	MGRU	5	150	Bakery	2	2	0			0	one 25 gpm	30	1
GDO	336	MGRU	5	150	Bakery	9	0	2500	MIAMI DADE WATER & SEWER DEPARTMENT		0	one 25 gpm	30	625
GDO	388	MGRU	5	150	Bakery	0	0	0	MIAMI DADE WATER & SEWER DEPARTMENT		0	one 25 gpm	30	0
GDO	401	IGT	5	150	Bakery	0	0	0	CITY OF HIALEAH	Single	1200	one 1200 gallon	90	0
GDO	414	IGT	5	150	Bakery	0	0	0		Single	750	one 750 gallon	90	0
GDO	473	IGT	5	150	Bakery	10	10	1660	MIAMI DADE WATER & SEWER DEPARTMENT	Single	950	one 950 gallon	90	415
GDO	478	IGT	5	150	Bakery	0	0	1200	CITY OF HIALEAH	Single	950	one 950 gallon	90	300
GDO	492	IGT	5	150	Bakery	5	5	0		Single	1050	one 1050 gallon	90	1
GDO	498	IGT	5	150	Bakery	4	4	0		Single	750	one 750 gallon	90	1
GDO	513	MGRU	5	150	Bakery	0	0	900	MIAMI DADE WATER & SEWER DEPARTMENT		0	one 25 gpm	30	225
GDO	564	MGRU	5	150	Bakery	0	0	2000	MIAMI DADE WATER & SEWER DEPARTMENT		0	one 25 gpm	30	500
GDO	669	MGRU	5	150	Bakery	3	3	0			0	one 25 gpm	30	1
GDO	680	IGT	5	150	Bakery	0	0	0	CITY OF HIALEAH	Single	950	one 950 gallon	90	0
GDO	732	IGT	5	300	Bakery	30	30	0		Single	1050	one 1050 gallon	90	8
GDO	744	IGT	5	150	Bakery	0	0	1000	MIAMI DADE WATER & SEWER DEPARTMENT	Single	750	one 750 gallon	90	250
GDO	786	IGT	5	150	Bakery	0	0	0		Single	1050	one 1050 gallon	90	0
GDO	799	IGT	5	300	Bakery	0	0	4064	CITY OF HIALEAH	Single	1200	one 1200 gallon	90	1016
GDO	808	IGT	5	150	Bakery	1	1	0		Single	950	one 950 gallon	90	0
GDO	811	IGT	5	150	Bakery	0	0	0		Single	950	one 950 gallon	90	0
GDO	817	IGT	5	150	Bakery	0	0	0	CITY OF HIALEAH	Single	1050	one 1050 gallon	90	0
GDO	834	IGT	5	150	Bakery	47	47	1950	MIAMI DADE WATER & SEWER DEPARTMENT	Single	900	one 900 gallon	90	488
GDO	836	IGT	5	150	Bakery	18	18	0		Single	1200	one 1200 gallon	90	5
GDO	849	IGT	5	150	Bakery	0	0	1710	MIAMI DADE WATER & SEWER DEPARTMENT	Single	750	one 750-gallon	90	428
GDO	885	IGT	5	150	Bakery	0	0	0	CITY OF NORTH MIAMI BEACH	Single	1200	one 1200 gallon	90	0
GDO	895	IGT	5	150	Bakery	10	10	0	VIRGINIA GARDENS	Single	1200	one 1200 gallon	90	3
GDO	915	IGT	5	150	Bakery	20	20	0		Single	1200	one 1200 gallon	90	5
GDO	917	IGT	5	150	Bakery	3	3	0	MIAMI DADE WATER & SEWER DEPARTMENT	Single	1050	one 1050 gallon	90	1
GDO	925	IGT	5	150	Bakery	0	0	910	CITY OF HIALEAH	Single	1200	one 1200 gallon	90	228
GDO	941	MGRU	5	150	Bakery	6	6	0	MIAMI DADE WATER & SEWER DEPARTMENT		0	one 25 gpm	30	0
GDO	943	IGT	5	150	Bakery	8	8	2160	CITY OF HIALEAH	Single	1200	one 1200 gallon	90	540
GDO	958	IGT	5	150	Bakery	16	16	1795	CITY OF HIALEAH	Single	750	one 750 gallon	90	449
GDO	973	IGT	5	150	Bakery	2	2	0	CITY OF NORTH MIAMI BEACH	Single	750	one 750 gallon	90	1
GDO	1013	MGRU	5	150	Bakery	2	2	0			0	one 25 gpm	30	1
GDO	1017	IGT	5	150	Bakery	0	0	1800	MIAMI DADE WATER & SEWER DEPARTMENT	Single	750	one 750 gallon	90	450
GDO	1066	IGT	5	150	Bakery	0	0	2323	CITY OF HIALEAH	Single	750	one 750 gallon	90	581
GDO	1122	IGT	5	150	Bakery	3	3	0		Single	1050	one 1050 gallon	90	1
GDO	1143	MGRU	5	150	Bakery	22	0	800	MIAMI DADE WATER & SEWER DEPARTMENT		0	one 50 gpm	30	200
GDO	1149	MGRU	5	150	Bakery	6	6	0			0	one 25 gpm	30	2
GDO	1166	IGT	5	150	Bakery	0	0	0	MIAMI DADE WATER & SEWER DEPARTMENT	Series	1500	one 1500 gallon	90	0
GDO	1173	IGT	5	150	Bakery	1	1	0		Single	1200	one 1200 gallon	90	0
GDO	1204	MGRU	5	150	Bakery	2	2	0	MIAMI DADE WATER & SEWER DEPARTMENT		0	one 25 gpm	30	1
GDO	1212	IGT	5	150	Bakery	5	5	0		Single	750	one 750 gallon	90	1
GDO	1269	IGT	5	150	Bakery	0	0	1600	MIAMI DADE WATER & SEWER DEPARTMENT	Single	1200	one 1200 gallon	90	400
GDO	1289	IGT	5	150	Bakery	50	50	1500	CITY OF HIALEAH	Single	950	one 950 gallon	90	375
GDO	1301	IGT	5	150	Bakery	1	1	0	CITY OF HIALEAH GARDENS	Single	1200	one 1200 gallon	90	0
GDO	1308	IGT	5	150	Bakery	0	0	780	CITY OF HIALEAH	Single	750	one 750 gallon	90	195
GDO	1319	IGT	5	150	Bakery	30	30	1691	MIAMI DADE WATER & SEWER DEPARTMENT	Single	950	one 950 gallon	90	423
GDO	1321	IGT	5	150	Bakery	5	5	0		Single	900	one 950 gallon	90	1
GDO	1327	IGT	5	150	Bakery	5	5	0		Single	1050	one 1050 gallon	90	1
GDO	1409	IGT	5	300	Bakery	0	0	4054	MIAMI DADE WATER & SEWER DEPARTMENT	Single	750	one 750 gallon	90	1014
GDO	1429	IGT	5	150	Bakery	8	8	0		Single	750	one 750 gallon	90	2
GDO	1432	IGT	5	150	Bakery	5	5	0		Single	1200	one 1200 gallon	90	1
GDO	1439	IGT	5	150	Bakery	0	0	0	CITY OF HIALEAH	Single	1200	one 1200-gallon	90	0
GDO	1466	IGT	5	150	Bakery	1	0	0	CITY OF HIALEAH	Single	750	one 750 gallon	90	0
GDO	1467	IGT	5	150	Bakery	35	35	0	CITY OF HIALEAH	Single	750	one 750 gallon	90	0
GDO	1506	IGT	5	150	Bakery	2	2	0		Single	1050	one 1050 gallon	90	1
GDO	1533	IGT	5	150	Bakery	10	10	3500	CITY OF HIALEAH	Single	950	one 950 gallon	90	875
GDO	1567	MGRU	5	150	Bakery	4	4	0	CITY OF HIALEAH		0	one 25 gpm	30	1
GDO	1623	IGT	5	150	Bakery	16	16	0	CITY OF HIALEAH	Single	1200	one 1200 gallon	90	224
GDO	1628	IGT	5	150	Bakery	3	3	1050	CITY OF HIALEAH	Single	1050	one 1050 gallon	90	263
GDO	1631	IGT	5	150	Bakery	3	3	0		Single	900	one 900 gallon	90	1

WORK GROUP	PERMIT NUMBER	PERMIT CLASS	PERMIT	PERMIT FEE	BUSINESS_TYPE	RECORDED SEATS	OBSERVED SEATS	FACILITY AREA	UTILITY	SYSTEM FORMAT	TOTAL CAPACITY	TANK_CAPACITY	PUMP OUT	TOTAL GPD
GDO	1638	IGT	5	150	Bakery	10	10	0	MIAMI DADE WATER & SEWER DEPARTMENT	Single	1200	one 1200 gallon	90	875
GDO	1639	IGT	5	150	Bakery	0	0	0		Single	950	one 950 gallon	90	0
GDO	1680	IGT	1	150	Bakery	0	0	1760	CITY OF HIALEAH	Single	750	one 750 gallon	90	440
GDO	1699	IGT	5	150	Bakery	10	10	0		Single	1200	one 1200 gallon	90	3
GDO	1722	IGT	5	150	Bakery	4	4	2100	MIAMI DADE WATER & SEWER DEPARTMENT	Single	950	one 950 gallon	90	525
GDO	1735	IGT	5	150	Bakery	2	2	0	MIAMI DADE WATER & SEWER DEPARTMENT	Single	1050	one 1050 gallon	90	1
GDO	1740	IGT	5	150	Bakery	0	0	0		Single	1200	one 1200 gallon	90	0
GDO	1777	IGT	5	150	Bakery	15	15	0		Single	750	one 750 gallon	90	4
GDO	1840	IGT	5	150	Bakery	0	0	0	CITY OF HIALEAH	Single	950	one 950 gallon	90	0
GDO	1842	IGT	5	150	Bakery	10	10	0	MIAMI DADE WATER & SEWER DEPARTMENT	Series	750	one 750 gallon	90	3
GDO	1852	IGT	5	150	Bakery	3	3	0	CITY OF HIALEAH	Single	750	one 750 gallon	90	1
GDO	1864	IGT	5	150	Bakery	12	12	0		Single	750	one 750 gallon	90	3
GDO	1940	IGT	5	150	Bakery	10	10	0		Single	1050	one 1050 gallon	90	3
GDO	1948	MGRU	5	150	Bakery	1	1	0			0	one 25 gpm	30	0
GDO	1974	MGRU	5	150	Bakery	0	0	1000	CITY OF HIALEAH		0	one 25 gpm	30	250
GDO	1988	IGT	5	150	Bakery	8	8	0	MIAMI DADE WATER & SEWER DEPARTMENT	Single	1050	one 1050 gallon	90	0
GDO	2016	IGT	5	150	Bakery	35	35	0	MIAMI DADE WATER & SEWER DEPARTMENT	Single	1200	one 1200 gallon	90	875
GDO	2027	IGT	5	150	Bakery	0	0	0		Single	750	one 750 gallon	90	0
GDO	2055	IGT	5	150	Bakery	0	0	950	MIAMI DADE WATER & SEWER DEPARTMENT	Single	750	one 750 gallon	90	238
GDO	2071	IGT	5	150	Bakery	1	1	0		Single	1050	one 1050 gallon	90	0
GDO	2079	IGT	5	150	Bakery	100	100	3500	CITY OF NORTH MIAMI BEACH	Single	950	one 950 gallon	90	875
GDO	2088	IGT	5	150	Bakery	0	0	0		Single	1000	one 1000 gallon	90	0
GDO	2095	IGT	5	150	Bakery	4	4	1200	MIAMI DADE WATER & SEWER DEPARTMENT	Single	1200	one 1200-gallon	90	300
GDO	2100	IGT	5	150	Bakery	3	3	0		Single	1200	one 1200 gallon	90	1
GDO	2108	IGT	5	150	Bakery	30	30	0	MIAMI DADE WATER & SEWER DEPARTMENT	Single	1200	one 1200 gallon	90	8
GDO	2147	IGT	5	150	Bakery	4	4	0	CITY OF HIALEAH	Single	950	one 950 gallon	90	1
GDO	2166	IGT	5	150	Bakery	1	1	0	MIAMI DADE WATER & SEWER DEPARTMENT	Single	1200	one 1200 gallon	90	0
GDO	2172	IGT	5	150	Bakery	5	5	1860	CITY OF NORTH MIAMI BEACH	Single	950	one 950 gallon	90	465
GDO	2225	IGT	5	150	Bakery	0	0	0		Single	1200	one 1200 gallon	90	0
GDO	2236	IGT	5	150	Bakery	32	32	2250	MIAMI DADE WATER & SEWER DEPARTMENT	Single	950	one 950 gallon	90	563
GDO	2245	IGT	5	150	Bakery	0	0	0	MIAMI DADE WATER & SEWER DEPARTMENT	Single	1050	one 1050 gallon	90	0
GDO	2322	IGT	5	150	Bakery	0	0	0		Single	750	one 750 gallon	90	0
GDO	2323	IGT	5	150	Bakery	0	0	0		Single	750	one 750 gallon	90	0
GDO	2408	AGRU	5	150	Bakery	0	0	0	MIAMI DADE WATER & SEWER DEPARTMENT		0	one 35 gpm	30	0
GDO	2432	IGT	5	150	Bakery	0	0	1625	MIAMI DADE WATER & SEWER DEPARTMENT	Single	950	one 950 gallon	90	406
GDO	2435	IGT	5	150	Bakery	6	6	0	MIAMI DADE WATER & SEWER DEPARTMENT	Single	950	one 950 gallon	90	84
GDO	2445	IGT	5	150	Bakery	10	10	1800	MIAMI DADE WATER & SEWER DEPARTMENT	Single	1200	one 1200 gallon	90	450
GDO	2452	IGT	5	150	Bakery	10	10	0		Single	1050	one 1050 gallon	90	3
GDO	2572	AGRU	5	150	Bakery	7	7	1981	MIAMI DADE WATER & SEWER DEPARTMENT		0	one 25 gpm	30	495
GDO	2574	IGT	5	150	Bakery	2	2	2201	MIAMI DADE WATER & SEWER DEPARTMENT	Single	750	one 750 gallon	90	550
GDO	2586	IGT	5	150	Bakery	6	6	3000	CITY OF HIALEAH		0	one 750 gallon	90	2
GDO	2592	IGT	5	150	Bakery	0	0	0		Single	750	one 750 gallon	90	0
GDO	2609	IGT	5	150	Bakery	0	0	0		Single	950	one 950 gallon	90	0
GDO	2624	IGT	5	150	Bakery	0	0	1400	CITY OF HIALEAH	Series	2400	two 1200 gallon	90	350
GDO	2632	IGT	5	150	Bakery	50	50	1665	MIAMI DADE WATER & SEWER DEPARTMENT	Single	750	one 750 gallon	90	416
GDO	2638	IGT	5	150	Bakery	6	6	2500	MIAMI DADE WATER & SEWER DEPARTMENT	Single	950	one 950 gallon	90	625
GDO	2711	IGT	5	150	Bakery	6	6	0		Single	750	one 750 gallon	90	2
GDO	2727	IGT	5	150	Bakery	3	3	1250	MIAMI DADE WATER & SEWER DEPARTMENT	Single	750	one 750 gallon	90	313
GDO	2734	IGT	5	150	Bakery	0	0	0	MIAMI DADE WATER & SEWER DEPARTMENT	Single	750	one 750 gallon	90	0
GDO	2761	IGT	5	150	Bakery	20	20	1950	MIAMI DADE WATER & SEWER DEPARTMENT	Single	750	one 750 gallon	90	488
GDO	2775	IGT	1	150	Bakery	0	0	2619	CITY OF HIALEAH		1050	one 1050 gallon	90	655
GDO	2778	IGT	5	150	Bakery	8	8	0	MIAMI DADE WATER & SEWER DEPARTMENT	Single	750	one 750 gallon	90	2
GDO	2797	MGRU	5	150	Bakery	5	5	0	MIAMI DADE WATER & SEWER DEPARTMENT		0	one 25 gpm	30	1
GDO	2826	IGT	5	150	Bakery	0	0	1800	MIAMI DADE WATER & SEWER DEPARTMENT	Single	750	one 750 gallon	90	450
GDO	2840	IGT	5	150	Bakery	2	2	0		Single	0	one 950 gallon	90	1
GDO	2842	IGT	5	150	Bakery	20	0	2400	MIAMI DADE WATER & SEWER DEPARTMENT	Single	750	one 750 gallon	60	600
GDO	2854	IGT	5	150	Bakery	5	5	0	MIAMI DADE WATER & SEWER DEPARTMENT	Single	750	one 750 gallon	90	1
GDO	2874	IGT	5	150	Bakery	0	0	0		Single	1050	one 1050 gallon	90	0
GDO	2881	MGRU	5	150	Bakery	0	0	1000	MIAMI DADE WATER & SEWER DEPARTMENT		0	one 25 gpm	30	250
GDO	2883	IGT	5	150	Bakery	4	4	0	MIAMI DADE WATER & SEWER DEPARTMENT	Series	3600	three 1200 gallon	90	1
GDO	2896	IGT	5	150	Bakery	0	0	2800	MIAMI DADE WATER & SEWER DEPARTMENT	Single	1200	one 1200 gallon	90	0

WORK GROUP	PERMIT NUMBER	PERMIT CLASS	PERMIT	PERMIT FEE	BUSINESS_TYPE	RECORDED SEATS	OBSERVED SEATS	FACILITY AREA	UTILITY	SYSTEM FORMAT	TOTAL CAPACITY	TANK_CAPACITY	PUMP OUT	TOTAL GPD
GDO	2914	IGT	5	150	Bakery	0	0	0	MIAMI DADE WATER & SEWER DEPARTMENT	Single	900	one 900 gallon	90	0
GDO	2928	IGT	5	150	Bakery	3	3	0		Single	750	one 750 gallon	90	1
GDO	2941	IGT	5	150	Bakery	14	14	3300	MIAMI DADE WATER & SEWER DEPARTMENT	Single	1050	one 1050 gallon	90	825
GDO	3002	IGT	5	150	Bakery	4	4	0	MIAMI DADE WATER & SEWER DEPARTMENT	Single	750	one 750 gallon	90	1
GDO	3007	MGRU	5	150	Bakery	0	0	900	CITY OF FLORIDA CITY		0	one 15 gpm	30	225
GDO	3024	IGT	5	150	Bakery	0	0	1400	MIAMI DADE WATER & SEWER DEPARTMENT	Single	750	one 750 gallon	90	350
GDO	3055	IGT	5	150	Bakery	0	0	1200	CITY OF HIALEAH	Single	1050	one 1050 gallon	90	300
GDO	3106	IGT	5	150	Bakery	9	9	2000		Single	950	one 950-gallon	90	500
GDO	3132	IGT	5	150	Bakery	30	30	1927	MIAMI DADE WATER & SEWER DEPARTMENT	Single	1200	one 1200 gallon	90	482
GDO	3147	IGT	5	150	Bakery	0	0	2789	MIAMI DADE WATER & SEWER DEPARTMENT	Single	750	one 750 gallon	90	697
GDO	3193	IGT	5	150	Bakery	0	0	1400	MIAMI DADE WATER & SEWER DEPARTMENT	Single	750	one 750 gallon	90	350
GDO	3235	IGT	5	150	Bakery	0	0	0		Single	750	one 750 gallon	90	0
GDO	3304	IGT	5	150	Bakery	0	0	0		Single	1200	one 1200 gallon	90	0
GDO	3322	IGT	5	150	Bakery	0	0	980	MIAMI DADE WATER & SEWER DEPARTMENT	Single	750	one 750 gallon	90	0
GDO	3332	IGT	5	150	Bakery	4	4	0		Single	750	one 750 gallon	90	1
GDO	3346	IGT	5	300	Bakery	0	0	0	MIAMI DADE WATER & SEWER DEPARTMENT	Single	950	one 950 gallon	90	0
GDO	3378	AGRU	5	150	Bakery	0	0	0			0	one 25 gpm	30	0
GDO	3393	IGT	5	150	Bakery	0	0	908	MIAMI DADE WATER & SEWER DEPARTMENT	Single	750	one 750 gallon	90	227
GDO	3428	IGT	5	150	Bakery	3	3	0	MIAMI DADE WATER & SEWER DEPARTMENT	Single	950	one 950 gallon	90	1
GDO	3508	IGT	5	150	Bakery	0	0	0		Single	1050	one 1050 gallon	90	0
GDO	3537	IGT	5	150	Bakery	16	16	0	MIAMI DADE WATER & SEWER DEPARTMENT	Single	1050	one 1050-gallon	90	4
GDO	3726	IGT	5	150	Bakery	5	5	0		Single	750	one 750 gallon	90	1
GDO	3789	IGT	5	150	Bakery	0	0	0		Single	750	one 750 gallon	90	0
GDO	3871	IGT	5	150	Bakery	0	0	0	CITY OF HIALEAH	Single	750	one 750 gallon	90	0
GDO	3933	IGT	5	150	Bakery	0	0	1850	CITY OF HIALEAH	Single	950	one 950 gallon	90	463
GDO	3934	IGT	5	150	Bakery	30	30	850	CITY OF HIALEAH	Single	750	one 750 gallon	90	213
GDO	3937	IGT	5	150	Bakery	0	0	618	MIAMI DADE WATER & SEWER DEPARTMENT	Single	750	one 750 gallon	90	155
GDO	4072	IGT	5	150	Bakery	0	0	0	MIAMI DADE WATER & SEWER DEPARTMENT	Single	1050	one 1050 gallon	90	0
GDO	4094	IGT	5	150	Bakery	10	0	1438	MIAMI DADE WATER & SEWER DEPARTMENT	Single	1200	one 1200 gallon	60	360
GDO	4102	IGT	5	150	Bakery	7	7	1780	MIAMI DADE WATER & SEWER DEPARTMENT	Single	1200	one 1200-gallon	90	445
GDO	4155	IGT	5	150	Bakery	0	0	0	MIAMI DADE WATER & SEWER DEPARTMENT	Single	750	one 750 gallon	90	0
GDO	4192	IGT	5	150	Bakery	0	0	0		Single	950	one 950 gallon	90	0
GDO	4291	MGRU	5	150	Bakery	0	0	800	MIAMI DADE WATER & SEWER DEPARTMENT		0	one 25 gpm	30	200
GDO	4358	IGT	5	300	Bakery	20	20	4000	MIAMI DADE WATER & SEWER DEPARTMENT	Single	1200	one 1200 gallon	90	1000
GDO	4389	IGT	5	150	Bakery	0	0	3000	MIAMI DADE WATER & SEWER DEPARTMENT	Single	1200	one 1200 gallon	90	750
GDO	4434	IGT	5	150	Bakery	5	5	0		Single	750	one 750 gallon	90	1
GDO	4446	IGT	5	150	Bakery	0	0	0	MIAMI DADE WATER & SEWER DEPARTMENT	Single	950	one 950 gallon	90	0
GDO	4518	IGT	5	150	Bakery	30	30	2585	MIAMI DADE WATER & SEWER DEPARTMENT	Single	750	one 750-gallon	90	646
GDO	4526	IGT	5	150	Bakery	5	5	0		Single	750	one 750 gallon	90	1
GDO	4535	IGT	5	300	Bakery	0	0	5700	CITY OF HIALEAH	Single	1200	one 1200 gallon	90	1425
GDO	4585	IGT	5	150	Bakery	0	0	1400	CITY OF HIALEAH	Single	750	one 750 gallon	90	350
GDO	4648	IGT	5	150	Bakery	0	0	996	CITY OF HIALEAH	Single	950	one 950 gallon	90	249
GDO	4682	IGT	5	150	Bakery	10	10	1428	MIAMI DADE WATER & SEWER DEPARTMENT	Single	950	one 950 gallon	90	357
GDO	4770	MGRU	5	150	Bakery	0	0	0	MIAMI DADE WATER & SEWER DEPARTMENT		0	one 50 gpm	30	0
GDO	4771	MGRU	5	150	Bakery	4	4	0			0	one 25 gpm	30	1
GDO	4824	AGRU	5	150	Bakery	0	0	0	CITY OF HIALEAH		0	one 25 gpm	30	0
GDO	4851	IGT	5	300	Bakery	14	14	0		Single	750	one 750 gallon	90	4
GDO	4904	IGT	5	150	Bakery	0	0	2000	MIAMI DADE WATER & SEWER DEPARTMENT	Single	1600	one 1600 gallon	90	500
GDO	4953	IGT	5	150	Bakery	0	0	0		Single	1050	one 1050 gallon	90	0
GDO	4972	AGRU	5	150	Bakery	0	0	0	MIAMI DADE WATER & SEWER DEPARTMENT		0	one 25 gpm	30	0
GDO	4991	IGT	5	150	Bakery	10	0	1200	MIAMI DADE WATER & SEWER DEPARTMENT	Single	1200	one 1200 gallon	60	300
GDO	5030	IGT	5	300	Bakery	38	38	0	CITY OF MIAMI BEACH	Single	1050	one 1050 gallon	90	950
GDO	5033	IGT	5	150	Bakery	5	5	1900	MIAMI DADE WATER & SEWER DEPARTMENT	Single	1050	one 1050 gallon	90	475
GDO	5040	IGT	5	150	Bakery	5	5	2550	MIAMI DADE WATER & SEWER DEPARTMENT	Single	950	one 950 gallon	90	638
GDO	5061	MGRU	5	150	Bakery	0	0	0	CITY OF HIALEAH		0	one 25 gpm	30	0
GDO	5089	IGT	5	150	Bakery	22	22	1000	MIAMI DADE WATER & SEWER DEPARTMENT	Single	1200	one 1200 gallon	90	250
GDO	5129	IGT	5	150	Bakery	2	2	0	CITY OF HIALEAH	Single	1500	one 1500 gallon	90	1
GDO	5157	MGRU	5	150	Bakery	0	0	667	MIAMI DADE WATER & SEWER DEPARTMENT		0	not applicable	0	167
GDO	5165	AGRU	5	300	Bakery	0	0	3500	CITY OF NORTH MIAMI BEACH		0	one 25 gpm	30	875
GDO	5175	MGRU	5	150	Bakery	0	0	156	MIAMI DADE WATER & SEWER DEPARTMENT		0	one 15 gpm	30	39
GDO	5188	IGT	5	150	Bakery	0	0	0		Single	750	one 750 gallon	90	0

WORK GROUP	PERMIT NUMBER	PERMIT CLASS	PERMIT	PERMIT FEE	BUSINESS_TYPE	RECORDED SEATS	OBSERVED SEATS	FACILITY AREA	UTILITY	SYSTEM FORMAT	TOTAL CAPACITY	TANK_CAPACITY	PUMP OUT	TOTAL GPD
GDO	5212	IGT	5	150	Bakery	0	0	0	CITY OF HIALEAH	Single	950	one 950 gallon	90	0
GDO	5248	IGT	5	150	Bakery	0	0	0	MIAMI DADE WATER & SEWER DEPARTMENT	Single	950	one 950 gallon	90	0
GDO	5272	MGRU	5	150	Bakery	0	0	1200	MIAMI DADE WATER & SEWER DEPARTMENT		0	one 25-gpm	30	300
GDO	5278	IGT	5	150	Bakery	18	18	2000	CITY OF MIAMI BEACH	Single	750	one 750 gallon	90	500
GDO	5318	IGT	5	300	Bakery	36	36	0	MIAMI DADE WATER & SEWER DEPARTMENT	Single	750	one 750 gallon	90	504
GDO	5323	AGRU	5	150	Bakery	2	2	0	MIAMI DADE WATER & SEWER DEPARTMENT		0	one 25 gpm	30	1
GDO	5366	IGT	5	150	Bakery	0	0	0		Single	750	one 750 gallon	90	0
GDO	5390	MGRU	5	150	Bakery	10	0	998	MIAMI DADE WATER & SEWER DEPARTMENT		0	one 75 gpm	30	250
GDO	5445	IGT	5	150	Bakery	0	0	0		Single	950	one 950 gallon	90	0
GDO	5460	AGRU	5	150	Bakery	0	0	0	MIAMI DADE WATER & SEWER DEPARTMENT		0	one 25 gpm	30	0
GDO	5466	IGT	5	150	Bakery	5	5	1550	CITY OF MIAMI BEACH	Single	950	one 950 gallon	90	388
GDO	5476	IGT	5	150	Bakery	10	10	918	MIAMI DADE WATER & SEWER DEPARTMENT	Single	750	one 750 gallon	90	230
GDO	5691	IGT	5	150	Bakery	3	3	0	MIAMI DADE WATER & SEWER DEPARTMENT	Single	750	one 750 gallon	90	1
GDO	5737	AGRU	5	150	Bakery	0	0	1700	MIAMI DADE WATER & SEWER DEPARTMENT		0	one 50 gpm	30	425
GDO	5739	MGRU	5	150	Bakery	2	2	0			0	one 25 gpm	30	1
GDO	5748	IGT	5	150	Bakery	96	96	3995	MIAMI DADE WATER & SEWER DEPARTMENT	Single	750	one 750 gallon	90	999
GDO	5758	IGT	5	150	Bakery	0	0	1000	MIAMI DADE WATER & SEWER DEPARTMENT	Single	950	one 950 gallon	90	250
GDO	5801	AGRU	5	150	Bakery	2	2	0	CITY OF HOMESTEAD		0	one 35 gpm	30	1
GDO	5813	IGT	5	150	Bakery	0	0	0	MIAMI DADE WATER & SEWER DEPARTMENT	Single	1200	one 1200 gallon	90	0
GDO	5846	IGT	5	150	Bakery	0	0	0	CITY OF HIALEAH	Single	1050	one 1050 gallon	90	0
GDO	5892	IGT	5	150	Bakery	8	8	0	CITY OF HIALEAH	Single	750	one 750 gallon	90	2
GDO	5943	IGT	5	150	Bakery	0	0	600	MIAMI DADE WATER & SEWER DEPARTMENT	Single	750	one 750 gallon	90	150
GDO	5950	IGT	5	150	Bakery	24	24	1500	MIAMI DADE WATER & SEWER DEPARTMENT	Single	750	one 750 gallon	90	375
GDO	6013	MGRU	5	150	Bakery	8	8	1770	CITY OF NORTH MIAMI BEACH		0	one 35 gpm	30	293
GDO	6033	IGT	5	150	Bakery	0	0	2800	MIAMI DADE WATER & SEWER DEPARTMENT	Single	1050	one 1050 gallon	90	700
GDO	6079	AGRU	5	150	Bakery	0	0	0	MIAMI DADE WATER & SEWER DEPARTMENT		0	one 25 gpm	30	0
GDO	6131	IGT	5	150	Bakery	0	0	2040	CITY OF HIALEAH	Single	1500	one 1500 gallon	90	510
GDO	6142	IGT	5	150	Bakery	10	10	0	CITY OF NORTH MIAMI BEACH	Single	750	one 750 gallon	90	3
GDO	6148	IGT	5	150	Bakery	0	0	4000	CITY OF HIALEAH	Single	1200	one 1200 gallon	90	1000
GDO	6174	IGT	5	150	Bakery	18	18	1673	CITY OF HIALEAH	Single	950	one 950 gallon	90	418
GDO	6201	MGRU	5	150	Bakery	0	0	0	MIAMI DADE WATER & SEWER DEPARTMENT		0	one 25 gpm	30	0
GDO	6248	MGRU	5	150	Bakery	0	0	0	MIAMI DADE WATER & SEWER DEPARTMENT		0	not applicable	30	0
GDO	6254	MGRU	5	150	Bakery	0	0	2870	CITY OF HIALEAH		0	one 25 gpm	30	718
GDO	6289	IGT	5	150	Bakery	24	24	1742	MIAMI DADE WATER & SEWER DEPARTMENT	Single	1050	one 1050 galon	90	600
GDO	6301	IGT	5	150	Bakery	0	0	0	CITY OF HOMESTEAD	Single	950	one 950 gallon	90	0
GDO	6306	AGRU	5	150	Bakery	0	0	0	MIAMI DADE WATER & SEWER DEPARTMENT		0	one 25 gpm	30	0
GDO	6310	MGRU	5	300	Bakery	0	0	4000	CITY OF HIALEAH		0	one 20 gpm	30	1000
GDO	6320	MGRU	5	150	Bakery	8	8	1188	MIAMI DADE WATER & SEWER DEPARTMENT		0	one 10-gpm	30	297
GDO	6324	MGRU	5	150	Bakery	0	0	980	CITY OF HIALEAH		0	one 25 gpm	30	245
GDO	6353	MGRU	5	150	Bakery	12	12	700	MIAMI DADE WATER & SEWER DEPARTMENT		0	one 25 gpm	30	175
GDO	6450	IGT	5	150	Bakery	12	12	2040	MIAMI DADE WATER & SEWER DEPARTMENT	Single	750	one 750 gallon	90	510
GDO	6481	AGRU	5	150	Bakery	0	0	0	CITY OF HIALEAH		0	one 25 gpm	30	0
GDO	6506	IGT	5	150	Bakery	0	0	1710	CITY OF HIALEAH	Single	750	one 750 gallon	90	428
GDO	6527	MGRU	5	150	Bakery	7	7	638	MIAMI DADE WATER & SEWER DEPARTMENT		0	one 25 gpm	30	160
GDO	6575	AGRU	5	150	Bakery	0	0	856	MIAMI DADE WATER & SEWER DEPARTMENT		0	one 35 gpm	30	214
GDO	6605	IGT	5	150	Bakery	0	0	800	CITY OF MIAMI BEACH	Single	750	one 750 gallon	90	200
GDO	6652	MGRU	5	150	Bakery	0	0	2100	MIAMI DADE WATER & SEWER DEPARTMENT		0	one 25 gpm	30	525
GDO	6704	IGT	5	150	Bakery	0	0	0	MIAMI DADE WATER & SEWER DEPARTMENT	Single	950	one 950 gallon	90	0
GDO	6744	IGT	5	150	Bakery	0	0	0	MIAMI DADE WATER & SEWER DEPARTMENT	Single	950	one 950 gallon	90	0
GDO	6750	MGRU	5	150	Bakery	0	0	995	MIAMI DADE WATER & SEWER DEPARTMENT		0	one 20 gpm	30	249
GDO	6757	IGT	5	150	Bakery	0	0	1500	MIAMI DADE WATER & SEWER DEPARTMENT		1200	one 1200 gallon	90	375
GDO	6771	IGT	5	300	Bakery	30	30	0	MIAMI DADE WATER & SEWER DEPARTMENT	Single	1050	one 1050 gallon	90	420
GDO	6779	MGRU	5	150	Bakery	0	0	0	CITY OF OPA LOCKA		0	not applicable	30	0
GDO	6869	MGRU	5	150	Bakery	8	8	1000	CITY OF HIALEAH		0	one 25 gpm	30	250
GDO	6871	IGT	5	300	Bakery	0	0	6400	MIAMI DADE WATER & SEWER DEPARTMENT	Single	1050	one 1050 gallon	90	1600
GDO	6979	MGRU	5	150	Bakery	0	0	0	CITY OF HIALEAH		0	one 25 gpm	30	0
GDO	7028	IGT	5	300	Bakery	0	0	0	CITY OF NORTH MIAMI BEACH	Single	3200	two 1600 gallon	90	0
GDO	7096	MGRU	5	150	Bakery	0	0	920	MIAMI DADE WATER & SEWER DEPARTMENT		0	one 25 gpm	30	230
GDO	7115	MGRU	5	150	Bakery	0	0	920	MIAMI DADE WATER & SEWER DEPARTMENT		0	one 25 gpm	30	230
GDO	7153	MGRU	5	150	Bakery	0	0	850	MIAMI DADE WATER & SEWER DEPARTMENT		0	one 25 gpm	30	213
GDO	7164	IGT	5	150	Bakery	0	0	1170	MIAMI DADE WATER & SEWER DEPARTMENT	Single	950	one 950 gallon	60	293

WORK GROUP	PERMIT NUMBER	PERMIT CLASS	PERMIT	PERMIT FEE	BUSINESS_TYPE	RECORDED SEATS	OBSERVED SEATS	FACILITY AREA	UTILITY	SYSTEM FORMAT	TOTAL CAPACITY	TANK_CAPACITY	PUMP OUT	TOTAL GPD
GDO	7226	MGRU	5	150	Bakery	0	0	1460	MIAMI DADE WATER & SEWER DEPARTMENT		0	one 25 gpm	30	365
GDO	7231	IGT	5	150	Bakery	0	0	300	MIAMI DADE WATER & SEWER DEPARTMENT	Single	950	one 950 gallon	90	75
GDO	7264	IGT	5	150	Bakery	0	0	2400	MIAMI DADE WATER & SEWER DEPARTMENT	Single	1050	one 1050 gallon	90	600
GDO	7405	IGT	5	150	Bakery	0	0	2800	MIAMI DADE WATER & SEWER DEPARTMENT	Single	950	one 950 gallon	90	700
GDO	7408	IGT	5	150	Bakery	20	20	0	MIAMI DADE WATER & SEWER DEPARTMENT	Single	1050	one 1050 gallon	90	500
GDO	7409	IGT	5	150	Bakery	0	0	2200	CITY OF HIALEAH	Single	950	one 950 gallon	90	550
GDO	7440	IGT	5	150	Bakery	2	0	1360	CITY OF HIALEAH	Single	1500	one 1500 gallon	60	340
GDO	7487	IGT	5	150	Bakery	12	12	1428	MIAMI DADE WATER & SEWER DEPARTMENT	Single	750	one 750-gallon	90	357
GDO	7499	IGT	5	150	Bakery	20	20	3000	MIAMI DADE WATER & SEWER DEPARTMENT	Single	950	one 950 gallon	90	750
GDO	7502	MGRU	5	150	Bakery	8	8	0	CITY OF HIALEAH GARDENS		0	one 25 gpm	30	0
GDO	7516	MGRU	2	150	Bakery	10	10	1650	MIAMI DADE WATER & SEWER DEPARTMENT		0	one 25 gpm	30	413
GDO	7561	IGT	5	150	Bakery	48	48	3200	CITY OF FLORIDA CITY	Series	5000	two 2500 gallon	90	800
GDO	7615	IGT	5	150	Bakery	4	4	1150	MIAMI DADE WATER & SEWER DEPARTMENT	Single	750	one 750 gallon	90	288
GDO	7651	IGT	5	150	Bakery	13	13	1487	MIAMI DADE WATER & SEWER DEPARTMENT	Single	950	one 950 gallon	90	372
GDO	7697	MGRU	5	150	Bakery	0	0	0	CITY OF HIALEAH		0	one 25 gpm	30	0
GDO	7702	IGT	5	150	Bakery	20	20	1323	MIAMI DADE WATER & SEWER DEPARTMENT	Single	950	one 950 gallon	90	331
GDO	7723	MGRU	5	300	Bakery	0	0	6000	MIAMI DADE WATER & SEWER DEPARTMENT		0	one 25 gpm	30	1500
GDO	7741	MGRU	5	150	Bakery	0	0	0	MIAMI DADE WATER & SEWER DEPARTMENT		0	one 25 gpm	30	0
GDO	7757	IGT	5	300	Bakery	142	142	0	MIAMI DADE WATER & SEWER DEPARTMENT	Single	1600	one 1600 gallon	90	1988
GDO	7776	IGT	5	150	Bakery	20	20	2200	CITY OF FLORIDA CITY	Single	1050	one 1050-gallon	90	550
GDO	7782	IGT	5	150	Bakery	0	0	1440	MIAMI DADE WATER & SEWER DEPARTMENT	Single	1200	one 1200 gallon	90	360
GDO	7839	MGRU	5	150	Bakery	7	7	840	MIAMI DADE WATER & SEWER DEPARTMENT		0	one 50 gpm	30	210
GDO	7868	MGRU	5	150	Bakery	0	0	1095	MIAMI DADE WATER & SEWER DEPARTMENT		0	one 25 gpm	30	274
GDO	7885	IGT	5	150	Bakery	48	0	2205	MIAMI DADE WATER & SEWER DEPARTMENT	Single	1050	one 1050 gallon	90	551
GDO	7888	IGT	5	150	Bakery	0	0	900	MIAMI DADE WATER & SEWER DEPARTMENT	Single	1200	one 1200 gallon	90	225
GDO	7907	AGRU	5	150	Bakery	0	0	5000	CITY OF OPA LOCKA		0	one 25 gallon	30	0
GDO	7920	MGRU	5	150	Bakery	0	0	2000	MIAMI DADE WATER & SEWER DEPARTMENT		0	one 25 gpm	30	500
GDO	7932	MGRU	5	150	Bakery	0	0	1279	CITY OF MIAMI		0	one 75 gpm	30	450
GDO	7986	MGRU	5	150	Bakery	10	10	389	MIAMI DADE WATER & SEWER DEPARTMENT		0	one 25 gpm	30	97
GDO	8068	MGRU	5	150	Bakery	14	0	974	CITY OF FLORIDA CITY		0	one 20 gpm	30	244
GDO	8079	IGT	5	150	Bakery	12	12	0	CITY OF MIAMI BEACH	Single	950	one 950 gallon	90	3
GDO	8112	IGT	5	150	Bakery	6	23	1400	MIAMI DADE WATER & SEWER DEPARTMENT	Single	1200	one 1200 gallon	90	350
GDO	8127	IGT	5	150	Bakery	0	0	2960	MIAMI DADE WATER & SEWER DEPARTMENT	Single	950	one 950 gallon	90	740
GDO	8140	IGT	5	150	Bakery	0	0	1583	MIAMI DADE WATER & SEWER DEPARTMENT	Single	1050	one 1050 gallon	90	396
GDO	8172	IGT	2	150	Bakery	0	0	1440	MIAMI DADE WATER & SEWER DEPARTMENT	Single	1050	one 1050 gallon	90	360
GDO	8231	AGRU	5	150	Bakery	0	0	645	MIAMI DADE WATER & SEWER DEPARTMENT		0	not available	30	161
GDO	8249	MGRU	5	150	Bakery	0	0	4000	CITY OF HIALEAH		0	one 25 gpm	30	1000
GDO	8268	MGRU	5	300	Bakery	0	0	4000	CITY OF HIALEAH		0	one 25 gpm	30	1000
GDO	8402	IGT	5	150	Bakery	0	0	0	MIAMI DADE WATER & SEWER DEPARTMENT	Single	1050	one 1050-gallon	90	0
GDO	8478	MGRU	5	150	Bakery	0	0	840	MIAMI DADE WATER & SEWER DEPARTMENT		0	one 50 gpm	30	210
GDO	8479	IGT	5	150	Bakery	0	0	881	MIAMI DADE WATER & SEWER DEPARTMENT	Single	1050	one 1050 gallon	90	220
GDO	8521	MGRU	5	300	Bakery	0	0	7000	CITY OF HIALEAH		0	two 25-gpm	30	1750
GDO	8557	IGT	5	300	Bakery	0	0	20192	MIAMI DADE WATER & SEWER DEPARTMENT	Single	1050	one 1050 gallon	90	5048
GDO	8564	IGT	5	150	Bakery	0	0	2200	MIAMI DADE WATER & SEWER DEPARTMENT	Single	1200	one 1200 gallon	60	550
GDO	8601	MGRU	5	150	Bakery	0	0	800	MIAMI DADE WATER & SEWER DEPARTMENT		0	one 25-gpm	30	200
GDO	8602	MGRU	5	150	Bakery	0	0	1300	MIAMI DADE WATER & SEWER DEPARTMENT		0	one 25 gpm	30	325
GDO	8663	IGT	5	150	Bakery	0	0	2100	MIAMI DADE WATER & SEWER DEPARTMENT	Single	1050	one 1050 gallon	90	525
GDO	8717	MGRU	5	150	Bakery	0	0	1000	CITY OF HIALEAH		0	one 25 gpm	30	250
GDO	8737	IGT	5	150	Bakery	10	10	1252	CITY OF FLORIDA CITY	Single	1050	one 1050 gallon	90	313
GDO	8833	IGT	5	150	Bakery	0	0	1500	CITY OF OPA LOCKA	Single	950	one 950 gallon	90	375
GDO	8840	IGT	5	300	Bakery	0	0	6100	MIAMI DADE WATER & SEWER DEPARTMENT	Single	950	one 950 gallon	90	1525
GDO	8853	MGRU	5	150	Bakery	0	0	600	CITY OF HIALEAH GARDENS		0	one 25 gpm	30	150
GDO	8876	MGRU	5	150	Bakery	0	0	800	MIAMI DADE WATER & SEWER DEPARTMENT		0	one 10 gpm	30	200
GDO	8895	MGRU	5	150	Bakery	0	0	1048	MIAMI DADE WATER & SEWER DEPARTMENT		0	one 25 gpm	30	262
GDO	8947	MGRU	5	150	Bakery	0	0	120	MIAMI DADE WATER & SEWER DEPARTMENT		0	one 15 gpm	30	30
GDO	8991	IGT	5	150	Bakery	0	0	625	CITY OF FLORIDA CITY	Single	1500	one 1500 gallon	90	156
GDO	9005	MGRU	5	150	Bakery	0	0	650	CITY OF MIAMI SPRINGS		0	one 25 gpm	30	163
GDO	9007	MGRU	5	150	Bakery	0	0	2500	CITY OF NORTH MIAMI BEACH		0	one 25-gpm	30	625
GDO	9038	MGRU	5	150	Bakery	0	0	1810	MIAMI DADE WATER & SEWER DEPARTMENT		0	one 25 gpm	30	453
GDO	9041	MGRU	5	150	Bakery	0	0	1400	MIAMI DADE WATER & SEWER DEPARTMENT		0	one 25 gpm	30	350
GDO	9049	MGRU	5	150	Bakery	15	0	900	CITY OF NORTH BAY VILLAGE		0	one 50 gpm	30	225

WORK GROUP	PERMIT NUMBER	PERMIT CLASS	PERMIT	PERMIT FEE	BUSINESS_TYPE	RECORDED SEATS	OBSERVED SEATS	FACILITY AREA	UTILITY	SYSTEM FORMAT	TOTAL CAPACITY	TANK_CAPACITY	PUMP OUT	TOTAL GPD
GDO	9117	IGT	5	150	Bakery	0	0	650	MIAMI DADE WATER & SEWER DEPARTMENT	Single	1050	one 1050 gallon	90	163
GDO	9187	IGT	5	150	Bakery	0	0	550	MIAMI DADE WATER & SEWER DEPARTMENT	Single	2000	one 2000 gallon	90	138
GDO	9222	IGT	5	150	Bakery	126	126	2623	MIAMI DADE WATER & SEWER DEPARTMENT	Single	1050	one 1050-gallon	90	656
GDO	9291	MGRU	5	150	Bakery	0	0	925	MIAMI DADE WATER & SEWER DEPARTMENT		0	one 25 gpm	30	231
GDO	9304	MGRU	5	150	Bakery	10	10	1400	MIAMI DADE WATER & SEWER DEPARTMENT		0	one 25-gpm	30	350
GDO	9308	IGT	5	150	Bakery	50	50	2317	MIAMI DADE WATER & SEWER DEPARTMENT	Single	950	one 950-gallon	90	759
GDO	9312	MGRU	5	150	Bakery	0	0	750	CITY OF HIALEAH		0	one 25-gpm	30	188
GDO	9374	MGRU	5	150	Bakery	12	12	315	MIAMI DADE WATER & SEWER DEPARTMENT		0	one 25 gpm	30	79
GDO	9407	MGRU	5	150	Bakery	30	0	1752	MIAMI DADE WATER & SEWER DEPARTMENT		0	one 25 gpm	30	438
GDO	9542	AGRU	5	150	Bakery	0	0	250	CITY OF HIALEAH		0	one 25 gpm	30	63
GDO	9559	MGRU	5	150	Bakery	0	0	833	MIAMI DADE WATER & SEWER DEPARTMENT		0	one 25 gpm	30	208
GDO	9606	IGT	5	150	Bakery	0	0	1400	MIAMI DADE WATER & SEWER DEPARTMENT	Single	1050	one 1050 gallon	90	350
GDO	9624	MGRU	5	150	Bakery	0	0	2000	MIAMI DADE WATER & SEWER DEPARTMENT		0	one 25 gpm	30	500
GDO	9641	MGRU	5	150	Bakery	0	0	0	MIAMI DADE WATER & SEWER DEPARTMENT		0	one 25 gpm	30	0
GDO	9656	MGRU	5	150	Bakery	0	0	300	MIAMI DADE WATER & SEWER DEPARTMENT		0	one 25-gpm	30	75
GDO	9687	IGT	5	150	Bakery	0	0	2400	MIAMI DADE WATER & SEWER DEPARTMENT	Single	1050	one 1050-gallon	90	600
GDO	9719	IGT	5	150	Bakery	0	0	1500	MIAMI DADE WATER & SEWER DEPARTMENT	Single	1050	one 1050-gallon	90	375
GDO	9727	IGT	5	150	Bakery	0	0	1200	MIAMI DADE WATER & SEWER DEPARTMENT	Single	750	one 750 gallon	90	300
GDO	9794	IGT	5	150	Bakery	0	0	1832	MIAMI DADE WATER & SEWER DEPARTMENT	Single	1050	one 1050-gallon	90	458
GDO	9796	MGRU	5	150	Bakery	0	0	627	MIAMI DADE WATER & SEWER DEPARTMENT		0	one 25-gpm	30	157
GDO	9801	IGT	5	150	Bakery	0	0	0	MIAMI DADE WATER & SEWER DEPARTMENT	Single	2000	one 2000 gallon	90	0
GDO	9818	MGRU	5	150	Bakery	0	0	1209	MIAMI DADE WATER & SEWER DEPARTMENT		0	one 25 gpm	30	302
GDO	9863	IGT	5	150	Bakery	2	2	1595	CITY OF MIAMI BEACH	Single	1050	one 1050 gallon	90	399
GDO	9928	MGRU	5	150	Bakery	8	8	1646	CITY OF HOMESTEAD		0	one 25 gpm	30	412
GDO	9938	MGRU	5	150	Bakery	0	0	2400	CITY OF HIALEAH		0	one 25 gpm	30	600
GDO	9966	MGRU	5	150	Bakery	0	0	2300	MIAMI DADE WATER & SEWER DEPARTMENT		0	one 25 gpm	30	575
GDO	10099	IGT	5	150	Bakery	0	0	1569	MIAMI DADE WATER & SEWER DEPARTMENT	Series	3750	three 1250 gallon	90	392
GDO	10146	MGRU	5	150	Bakery	0	0	2700	MIAMI DADE WATER & SEWER DEPARTMENT		0	one 25 gpm	30	675
GDO	10153	MGRU	5	150	Bakery	10	0	1497	MIAMI DADE WATER & SEWER DEPARTMENT		0	one 25 gpm	30	374
GDO	10181	MGRU	5	150	Bakery	0	0	572	CITY OF MIAMI BEACH		0	one 25 gpm	30	143
GDO	10240	MGRU	5	150	Bakery	0	0	1450	MIAMI DADE WATER & SEWER DEPARTMENT		0	one 25 gpm	30	363
GDO	10242	MGRU	5	150	Bakery	10	0	2175	MIAMI DADE WATER & SEWER DEPARTMENT		0	one 100 gpm	60	544
GDO	10307	IGT	5	150	Bakery	0	0	1882	CITY OF HIALEAH	Single	1050	one 1050 gallon	90	471
GDO	10342	MGRU	5	150	Bakery	10	10	3684	MIAMI DADE WATER & SEWER DEPARTMENT		0	one 25 gpm	30	921
GDO	10353	MGRU	5	150	Bakery	32	0	3030	MIAMI DADE WATER & SEWER DEPARTMENT		0	one 50 gpm	30	758
GDO	10371	MGRU	5	150	Bakery	0	0	1852	MIAMI DADE WATER & SEWER DEPARTMENT		0	one 25 gpm	30	463
GDO	10384	MGRU	5	150	Bakery	0	0	2434	MIAMI DADE WATER & SEWER DEPARTMENT		0	one 25 gpm	30	609
GDO	10404	IGT	5	150	Bakery	60	0	1104	MIAMI DADE WATER & SEWER DEPARTMENT	Single	1250	one 1250 gallon	60	276
GDO	10407	IGT	5	150	Bakery	10	10	2600	MIAMI DADE WATER & SEWER DEPARTMENT	Single	1050	one 1050 gallon	90	650
GDO	10423	MGRU	5	150	Bakery	0	0	280	MIAMI DADE WATER & SEWER DEPARTMENT		0	one 25 gpm	30	70
GDO	10427	MGRU	5	150	Bakery	12	12	600	MIAMI DADE WATER & SEWER DEPARTMENT		0	one 25 gpm	30	150
GDO	10455	IGT	5	150	Bakery	0	0	898	CITY OF CORAL GABLES	Single	1050	one 1050 gallon	90	225
GDO	10491	MGRU	5	150	Bakery	26	0	1300	MIAMI DADE WATER & SEWER DEPARTMENT		0	twenty-four 100 gpm	60	325
GDO	10517	MGRU	2	150	Bakery	0	0	3510	MIAMI DADE WATER & SEWER DEPARTMENT		0	one 25 gpm	30	878
GDO	10537	MGRU	5	150	Bakery	21	0	2147	CITY OF MIAMI BEACH		0	one 75 gpm	30	549
GDO	10563	MGRU	5	150	Bakery	0	0	992	CITY OF MIAMI BEACH		0	one 40 gpm	30	248
GDO	10566	MGRU	5	300	Bakery	0	0	11500	MIAMI DADE WATER & SEWER DEPARTMENT		0	one 35 gpm	30	2875
GDO	10648	MGRU	5	150	Bakery	0	0	338	CITY OF MIAMI BEACH		0	one 25 gpm	30	158
GDO	10702	MGRU	5	150	Bakery	34	34	2770	CITY OF MIAMI BEACH		0	one 35 gpm	30	693
GDO	10745	MGRU	5	150	Bakery	6	6	1500	MIAMI DADE WATER & SEWER DEPARTMENT		0	one 15 gpm	30	375
GDO	10793	IGT	5	150	Bakery	50	50	3036	MIAMI DADE WATER & SEWER DEPARTMENT	Single	900	one 900-gallon	90	759
GDO	10801	MGRU	5	150	Bakery	8	8	862	MIAMI DADE WATER & SEWER DEPARTMENT		0	one 35 gpm	30	216
GDO	10838	MGRU	5	150	Bakery	0	0	1100	CITY OF HIALEAH		0	one 20 gpm	30	275
GDO	10939	MGRU	5	150	Bakery	23	0	1461	MIAMI DADE WATER & SEWER DEPARTMENT		0	one 20 gpm	30	365
GDO	11044	MGRU	5	150	Bakery	0	0	1170	MIAMI DADE WATER & SEWER DEPARTMENT		0	one 50 gpm	30	293
GDO	11048	MGRU	5	150	Bakery	32	0	2295	CITY OF CORAL GABLES		0	one 15 gpm and one 35 gpm	30	574
GDO	11079	IGT	5	150	Bakery	0	0	2851	MIAMI DADE WATER & SEWER DEPARTMENT	Single	900	one 900 gallon	60	713
GDO	11083	MGRU	5	150	Bakery	0	0	400	CITY OF CORAL GABLES		0	one 50 gpm	30	100
GDO	11090	MGRU	5	150	Bakery	0	0	270	MIAMI DADE WATER & SEWER DEPARTMENT		0	one 20 gpm	30	68

WORK GROUP	PERMIT NUMBER	PERMIT CLASS	PERMIT	PERMIT FEE	BUSINESS_TYPE	RECORDED SEATS	OBSERVED SEATS	FACILITY AREA	UTILITY	SYSTEM FORMAT	TOTAL CAPACITY	TANK_CAPACITY	PUMP OUT	TOTAL GPD
GDO	11139	MGRU	5	150	Bakery	0	0	851	MIAMI DADE WATER & SEWER DEPARTMENT		0	one 75 gpm	30	213
GDO	11152	MGRU	5	150	Bakery	0	0	1580	MIAMI DADE WATER & SEWER DEPARTMENT		0	one 50 gpm	60	395
GDO	11164	MGRU	5	150	Bakery	0	0	937	MIAMI DADE WATER & SEWER DEPARTMENT		0	one 50 gpm	30	234
GDO	11178	IGT	5	150	Bakery	0	0	1600	MIAMI DADE WATER & SEWER DEPARTMENT	Single	1200	one 1200 gallon	60	400
GDO	11291	IGT	5	150	Bakery	0	0	0	MIAMI DADE WATER & SEWER DEPARTMENT	Single	1050	one 1050 gallon	60	0
GDO	11310	MGRU	5	150	Bakery	24	0	1600	CITY OF MIAMI BEACH		0	one 75 gpm	30	400
GDO	11319	MGRU	5	150	Bakery	0	0	691	MIAMI DADE WATER & SEWER DEPARTMENT		0	one 35 gpm	60	173
GDO	11422	MGRU	5	300	Bakery	0	0	14700	CITY OF HIALEAH		0	one 20 gpm	30	3675
GDO	11478	MGRU	5	150	Bakery	0	0	694	MIAMI DADE WATER & SEWER DEPARTMENT		0	one 35 gpm	60	174
GDO	11557	IGT	5	150	Bakery	0	0	1348	MIAMI DADE WATER & SEWER DEPARTMENT	Single	750	one 750 gallon	60	337
GDO	11571	IGT	5	150	Bakery	0	0	1275	CITY OF HOMESTEAD	Single	1050	one 1050 gallon	60	319
GDO	11611	MGRU	5	150	Bakery	0	0	1000	MIAMI DADE WATER & SEWER DEPARTMENT		0	one 50 gpm	30	250
GDO	11840	IGT	5	150	Bakery	140	0	3700	CITY OF NORTH MIAMI	Series	1750	one 750 and one 1000 gallon	90	925
GDO	341	MGRU	5	150	Concession	2786	2786	0	MIAMI DADE WATER & SEWER DEPARTMENT		0	one 75 gpm	30	697
GDO	3319	IGT	5	750	Concession	290	290	0		Single	1050	one 1050 gallon	90	4060
GDO	3441	IGT	5	150	Concession	0	0	0		Single	1050	one 1050 gallon	90	0
GDO	3943	MGRU	5	150	Concession	0	0	734	MIAMI DADE WATER & SEWER DEPARTMENT		0	one 50 gpm	30	184
GDO	4176	IGT	5	150	Concession	0	0	0	MIAMI DADE WATER & SEWER DEPARTMENT	Multiple	17500	five 3500 gallon	90	0
GDO	4186	IGT	5	150	Concession	0	0	0	MIAMI DADE WATER & SEWER DEPARTMENT	Multiple	6150	five 750 & two 1200 gallon	90	0
GDO	4368	IGT	5	150	Concession	0	0	65562	MIAMI DADE WATER & SEWER DEPARTMENT	Single	1600	one 1600 gallon	90	0
GDO	5150	IGT	5	150	Concession	0	0	0	MIAMI DADE WATER & SEWER DEPARTMENT	Single	750	one 750 gallon	90	0
GDO	5425	IGT	5	150	Concession	0	0	0	MIAMI DADE WATER & SEWER DEPARTMENT	Series	3200	two 1600 gallon	90	0
GDO	5643	AGRU	5	150	Concession	0	0	734	MIAMI DADE WATER & SEWER DEPARTMENT		0	one 50 gpm	30	184
GDO	6282	MGRU	5	150	Concession	36	0	320	MIAMI DADE WATER & SEWER DEPARTMENT		0	one 20 gpm	30	80
GDO	6920	AGRU	5	150	Concession	0	0	734	MIAMI DADE WATER & SEWER DEPARTMENT		0	one 75-gpm	30	184
GDO	6942	IGT	5	150	Concession	3363	3363	0	MIAMI DADE WATER & SEWER DEPARTMENT		0	not available	90	47082
GDO	7091	IGT	2	150	Concession	0	0	0	MIAMI DADE WATER & SEWER DEPARTMENT	Single	1200	one 1200 gallon	90	0
GDO	7244	IGT	5	300	Concession	0	0	0	MIAMI DADE WATER & SEWER DEPARTMENT	Single	1050	one 1050 gallon	90	0
GDO	8774	IGT	5	150	Concession	2000	0	50000	CITY OF MIAMI BEACH	Series	6000	three 2000 gallon	90	12500
GDO	8806	IGT	5	150	Concession	0	0	1000	CITY OF HIALEAH	Single	1050	one 1050 gallon	90	250
GDO	8891	MGRU	5	150	Concession	0	0	40	MIAMI DADE WATER & SEWER DEPARTMENT		0	one 25 gpm	30	10
GDO	9560	IGT	5	750	Concession	0	0	52645	MIAMI DADE WATER & SEWER DEPARTMENT	Single	2000	one 2000-gallon	90	13161
GDO	10958	IGT	5	750	Concession	622	0	35753	MIAMI DADE WATER & SEWER DEPARTMENT	Series	7000	two 3500 gallon	90	8938
GDO	11143	IGT	5	150	Concession	0	0	1627	MIAMI DADE WATER & SEWER DEPARTMENT	Series	3600	three 1200 gallon	90	407
GDO	11324	IGT	5	150	Concession	0	0	1627	MIAMI DADE WATER & SEWER DEPARTMENT	Series	3600	three 1200 gallon	90	407
GDO	11603	MGRU	5	150	Concession	0	0	2627	MIAMI DADE WATER & SEWER DEPARTMENT		0	fifteen 100 gpm	60	657
GDO	765	IGT	5	150	Convenience	0	0	2000	MIAMI DADE WATER & SEWER DEPARTMENT	Single	750	one 750-gallon	90	500
GDO	1293	IGT	5	150	Convenience	0	0	2627	CITY OF HIALEAH	Single	1200	one 1200 gallon	90	657
GDO	1731	IGT	5	150	Convenience	0	0	5507	MIAMI DADE WATER & SEWER DEPARTMENT	Single	950	one 950 gallon	90	1377
GDO	2167	IGT	5	150	Convenience	0	0	2000	MIAMI DADE WATER & SEWER DEPARTMENT	Single	750	one 750 gallon	90	500
GDO	2168	IGT	5	150	Convenience	0	0	1200	MIAMI DADE WATER & SEWER DEPARTMENT	Single	950	one 950 gallon	90	300
GDO	2169	IGT	5	150	Convenience	16	16	3055	MIAMI DADE WATER & SEWER DEPARTMENT	Single	750	one 750 gallon	90	764
GDO	2170	IGT	5	150	Convenience	0	0	0	MIAMI DADE WATER & SEWER DEPARTMENT	Single	1200	one 1200 gallon	90	0
GDO	2434	IGT	5	150	Convenience	6	6	1607	MIAMI DADE WATER & SEWER DEPARTMENT	Single	1200	one 1200 gallon	90	402
GDO	2531	IGT	5	150	Convenience	0	0	0	MIAMI DADE WATER & SEWER DEPARTMENT	Single	750	one 750 gallon	90	0
GDO	2639	IGT	5	150	Convenience	0	0	1000	CITY OF HIALEAH	Single	750	one 750 gallon	30	250
GDO	2820	IGT	5	150	Convenience	0	0	500	MIAMI DADE WATER & SEWER DEPARTMENT	Single	950	one 950 gallon	60	125
GDO	3039	IGT	5	150	Convenience	0	0	0	MIAMI DADE WATER & SEWER DEPARTMENT	Single	950	one 950 gallon	90	0
GDO	3168	IGT	5	150	Convenience	0	0	0	MIAMI DADE WATER & SEWER DEPARTMENT	Single	750	one 750 gallon	90	0
GDO	3221	IGT	5	150	Convenience	10	10	200	CITY OF NORTH MIAMI BEACH	Single	750	one 750 gallon	90	50
GDO	3353	IGT	5	150	Convenience	0	0	2691	MIAMI DADE WATER & SEWER DEPARTMENT	Single	1200	one 1200 gallon	90	673
GDO	3443	IGT	5	150	Convenience	0	0	0			0	one 750 gallon	90	0
GDO	3681	IGT	5	150	Convenience	6	6	2937	MIAMI DADE WATER & SEWER DEPARTMENT	Single	750	one 750 gallon	90	0
GDO	3829	IGT	5	150	Convenience	0	0	0	MIAMI DADE WATER & SEWER DEPARTMENT	Single	950	one 950 gallon	90	0
GDO	3960	IGT	5	150	Convenience	0	0	0		Single	750	one 750 gallon	90	0
GDO	3971	IGT	5	150	Convenience	0	0	4000	CITY OF HOMESTEAD	Single	1500	one 1500 gallon	90	1000
GDO	4039	IGT	5	150	Convenience	0	0	2800	CITY OF NORTH MIAMI BEACH	Single	750	one 750 gallon	90	700
GDO	4126	IGT	5	150	Convenience	0	0	0		Single	950	one 950 gallon	90	0
GDO	4338	IGT	5	150	Convenience	20	20	0	CITY OF HIALEAH	Single	750	one 750 gallon	90	280

WORK GROUP	PERMIT NUMBER	PERMIT CLASS	PERMIT	PERMIT FEE	BUSINESS_TYPE	RECORDED SEATS	OBSERVED SEATS	FACILITY AREA	UTILITY	SYSTEM FORMAT	TOTAL CAPACITY	TANK_CAPACITY	PUMP OUT	TOTAL GPD
GDO	4437	IGT	5	150	Convenience	0	0	0		Single	750	one 750 gallon	90	0
GDO	4476	IGT	5	150	Convenience	0	0	0	CITY OF HIALEAH	Single	750	one 750 gallon	90	0
GDO	4537	IGT	5	150	Convenience	0	0	3000	CITY OF HIALEAH	Single	1050	one 1050 gallon	90	750
GDO	4565	IGT	5	150	Convenience	0	0	1500	CITY OF MIAMI BEACH	Single	1050	one 1050 gallon	90	375
GDO	4570	IGT	5	150	Convenience	0	0	0		Single	750	not applicable	90	0
GDO	4647	IGT	5	150	Convenience	0	0	1900	MIAMI DADE WATER & SEWER DEPARTMENT	Single	750	one 750 gallon	90	475
GDO	4680	IGT	5	150	Convenience	0	0	0		Single	750	one 750 gallon	90	0
GDO	4712	IGT	5	150	Convenience	0	0	0	MIAMI DADE WATER & SEWER DEPARTMENT	Single	950	one 950 gallon	90	0
GDO	4893	IGT	5	150	Convenience	0	0	0	CITY OF NORTH MIAMI BEACH	Single	1050	one 1050 gallon	60	0
GDO	4916	IGT	5	150	Convenience	0	0	1000	CITY OF OPA LOCKA	Single	1050	one 1050 gallon	90	250
GDO	5151	IGT	5	150	Convenience	0	0	3082	MIAMI DADE WATER & SEWER DEPARTMENT	Single	750	one 750 gallon	90	771
GDO	5236	IGT	5	150	Convenience	0	0	1000	CITY OF HIALEAH	Single	750	one 750 gallon	90	250
GDO	5246	IGT	5	150	Convenience	0	0	1400	CITY OF HIALEAH	Single	750	one 750 gallon	90	350
GDO	5351	IGT	5	150	Convenience	0	0	3198	MIAMI DADE WATER & SEWER DEPARTMENT	Single	750	one 750 gallon	90	800
GDO	5378	IGT	5	150	Convenience	0	0	0	MIAMI DADE WATER & SEWER DEPARTMENT	Single	950	one 950 gallon	90	0
GDO	5392	IGT	5	150	Convenience	0	0	2880	MIAMI DADE WATER & SEWER DEPARTMENT	Single	750	one 750 gallon	90	720
GDO	5399	MGRU	5	150	Convenience	0	0	0	MIAMI DADE WATER & SEWER DEPARTMENT		0	one 25 gpm	30	0
GDO	5482	IGT	5	150	Convenience	0	0	2300	MIAMI DADE WATER & SEWER DEPARTMENT	Single	950	one 950 gallon	90	575
GDO	5532	IGT	5	150	Convenience	0	0	0	CITY OF HOMESTEAD	Single	1050	one 1050 gallon	90	0
GDO	5764	IGT	5	150	Convenience	0	0	0	CITY OF HIALEAH	Single	750	one 750 gallon	90	0
GDO	5766	IGT	5	150	Convenience	8	8	0	CITY OF NORTH MIAMI BEACH	Single	750	one 750 gallon	90	0
GDO	5768	IGT	5	150	Convenience	0	0	0	MIAMI DADE WATER & SEWER DEPARTMENT	Single	750	one 750 gallon	90	0
GDO	5770	IGT	5	150	Convenience	0	0	0	MIAMI DADE WATER & SEWER DEPARTMENT		0	not applicable	90	0
GDO	5933	IGT	5	150	Convenience	8	8	0	MIAMI DADE WATER & SEWER DEPARTMENT	Single	750	one 750 gallon	90	0
GDO	5941	IGT	5	150	Convenience	16	0	0	MIAMI DADE WATER & SEWER DEPARTMENT	Single	1200	one 1200 gallon	90	0
GDO	5985	MGRU	5	150	Convenience	0	0	2263	CITY OF HIALEAH		0	one 15 gpm	30	566
GDO	6202	IGT	5	150	Convenience	16	16	2500	MIAMI DADE WATER & SEWER DEPARTMENT	Single	750	one 750 gallon	90	625
GDO	6262	MGRU	5	150	Convenience	0	0	2000	MIAMI DADE WATER & SEWER DEPARTMENT		0	one 25 gpm	30	500
GDO	6425	IGT	2	150	Convenience	0	0	0	MIAMI DADE WATER & SEWER DEPARTMENT	Single	950	one 950 gallon	90	0
GDO	6564	IGT	5	150	Convenience	4	4	2984	CITY OF HIALEAH	Single	950	one 950 gallon	90	0
GDO	6566	IGT	5	150	Convenience	0	0	0	CITY OF HIALEAH	Single	950	one 950 gallon	90	0
GDO	7085	IGT	5	150	Convenience	0	0	3800	CITY OF OPA LOCKA	Single	750	one 750 gallon	90	950
GDO	7128	IGT	5	150	Convenience	0	0	2500	MIAMI DADE WATER & SEWER DEPARTMENT	Single	1050	one 1050 gallon	90	625
GDO	7430	IGT	5	150	Convenience	30	30	2500	MIAMI DADE WATER & SEWER DEPARTMENT	Single	950	one 950 gallon	90	625
GDO	7558	IGT	5	150	Convenience	0	0	0	MIAMI DADE WATER & SEWER DEPARTMENT		0	not available	90	0
GDO	7579	MGRU	5	150	Convenience	0	0	0	CITY OF MIAMI BEACH		0	not available	0	0
GDO	7592	MGRU	5	150	Convenience	0	0	0	CITY OF MIAMI BEACH		0	not available	30	0
GDO	7676	IGT	5	150	Convenience	0	0	1550	MIAMI DADE WATER & SEWER DEPARTMENT	Single	950	one 950 gallon	90	375
GDO	7712	IGT	5	150	Convenience	0	0	0	MIAMI DADE WATER & SEWER DEPARTMENT	Single	1050	one 1050 gallon	90	0
GDO	7794	IGT	5	150	Convenience	0	0	1000	MIAMI DADE WATER & SEWER DEPARTMENT	Single	1050	one 1050 gallon	90	250
GDO	8041	IGT	5	150	Convenience	0	0	0	MIAMI DADE WATER & SEWER DEPARTMENT	Single	750	one 750 gallon	90	0
GDO	8054	IGT	2	150	Convenience	0	0	11700	CITY OF HIALEAH	Single	1050	one 1050 gallon	90	425
GDO	8066	MGRU	5	150	Convenience	0	0	1820	MIAMI DADE WATER & SEWER DEPARTMENT		0	one 25 gpm	30	455
GDO	8527	MGRU	5	150	Convenience	0	0	0	MIAMI DADE WATER & SEWER DEPARTMENT		0	one 25 gpm	30	0
GDO	8620	IGT	5	150	Convenience	0	0	10881	MIAMI DADE WATER & SEWER DEPARTMENT		0	none	0	2720
GDO	8782	IGT	5	150	Convenience	0	0	11195	CITY OF FLORIDA CITY	Single	950	one 950 gallon	90	2799
GDO	8901	IGT	5	150	Convenience	0	0	3704	CITY OF HOMESTEAD	Single	1050	one 1050 gallon	90	926
GDO	8938	MGRU	5	150	Convenience	0	0	2604	MIAMI DADE WATER & SEWER DEPARTMENT		0	one 25 gpm	30	651
GDO	8942	MGRU	3	0	Convenience	0	0	3739	MIAMI DADE WATER & SEWER DEPARTMENT		0	one 75 gpm	90	935
GDO	8949	IGT	5	150	Convenience	0	0	900	MIAMI DADE WATER & SEWER DEPARTMENT	Single	750	one 750 gallon	90	225
GDO	8998	MGRU	5	150	Convenience	0	0	2040	CITY OF HOMESTEAD		0	one 25 gpm	30	510
GDO	9067	MGRU	5	150	Convenience	0	0	100	MIAMI DADE WATER & SEWER DEPARTMENT		0	one 100 gpm	90	25
GDO	9160	IGT	5	150	Convenience	0	0	3568	CITY OF HIALEAH	Single	1050	one 1050 gallon	90	892
GDO	9213	IGT	5	150	Convenience	0	0	290	MIAMI DADE WATER & SEWER DEPARTMENT	Single	1050	one 1050-gallon	90	73
GDO	9269	MGRU	5	150	Convenience	0	0	3285	MIAMI DADE WATER & SEWER DEPARTMENT		0	unknown	30	821
GDO	9339	MGRU	5	150	Convenience	0	0	2780	MIAMI DADE WATER & SEWER DEPARTMENT		0	one 25 gpm	30	695
GDO	9462	MGRU	5	150	Convenience	0	0	3200	MIAMI DADE WATER & SEWER DEPARTMENT		0	one 25 gpm	30	800
GDO	9510	AGRU	5	150	Convenience	0	0	2200	MIAMI DADE WATER & SEWER DEPARTMENT		0	one 35 gpm	30	550
GDO	9511	IGT	5	150	Convenience	0	0	1708	CITY OF FLORIDA CITY	Single	1050	one 1050 gallon	90	427
GDO	9622	IGT	5	150	Convenience	0	0	800	CITY OF NORTH MIAMI	Single	1050	one 1050-gallon	90	200
GDO	9690	MGRU	5	150	Convenience	0	0	2000	MIAMI DADE WATER & SEWER DEPARTMENT		0	one 25 gpm	30	500

WORK GROUP	PERMIT NUMBER	PERMIT CLASS	PERMIT	PERMIT FEE	BUSINESS_TYPE	RECORDED SEATS	OBSERVED SEATS	FACILITY AREA	UTILITY	SYSTEM FORMAT	TOTAL CAPACITY	TANK_CAPACITY	PUMP OUT	TOTAL GPD
GDO	9808	MGRU	5	150	Convenience	0	0	2697	MIAMI DADE WATER & SEWER DEPARTMENT		0	one 25 gpm	30	674
GDO	9827	MGRU	5	150	Convenience	0	0	80	CITY OF HIALEAH		0	one 25 gpm	30	20
GDO	9856	MGRU	5	150	Convenience	0	0	2732	MIAMI DADE WATER & SEWER DEPARTMENT		0	one 25 gpm	30	683
GDO	9859	IGT	5	150	Convenience	0	0	2200	CITY OF NORTH MIAMI BEACH	Single	1050	one 1050-gallon	90	550
GDO	9873	MGRU	5	150	Convenience	6	0	2200	MIAMI DADE WATER & SEWER DEPARTMENT		0	one 10 gpm	30	550
GDO	9895	IGT	5	150	Convenience	8	8	3832	MIAMI DADE WATER & SEWER DEPARTMENT	Single	1050	one 1050 gallon	90	958
GDO	9904	IGT	5	150	Convenience	0	0	2789	MIAMI DADE WATER & SEWER DEPARTMENT		0	one 750 gallon	90	697
GDO	9975	IGT	5	150	Convenience	0	0	2200	CITY OF NORTH MIAMI	Single	750	one 750 gallon	90	550
GDO	9984	MGRU	5	150	Convenience	0	0	3510	MIAMI DADE WATER & SEWER DEPARTMENT		0	one 25 gpm	30	878
GDO	10084	IGT	5	150	Convenience	0	0	1202	MIAMI DADE WATER & SEWER DEPARTMENT	Single	1050	one 1050 gallon	90	301
GDO	10200	MGRU	5	150	Convenience	0	0	836	MIAMI DADE WATER & SEWER DEPARTMENT		0	one 25 gpm	30	209
GDO	10204	IGT	5	150	Convenience	0	0	1500	CITY OF NORTH MIAMI	Single	1050	one 1050 gallon	90	375
GDO	10335	IGT	5	150	Convenience	0	0	2500	MIAMI DADE WATER & SEWER DEPARTMENT	Single	1050	one 1050 gallon	90	625
GDO	10400	MGRU	5	150	Convenience	0	0	2979	MIAMI DADE WATER & SEWER DEPARTMENT		0	one 50 gpm	30	745
GDO	10429	MGRU	5	150	Convenience	12	12	1200	MIAMI DADE WATER & SEWER DEPARTMENT		0	two 25 gpm	30	300
GDO	10451	IGT	2	300	Convenience	0	0	5811	MIAMI DADE WATER & SEWER DEPARTMENT	Single	1050	one 1050 gallon	90	1453
GDO	10525	MGRU	5	150	Convenience	0	0	0	CITY OF MIAMI BEACH		0	one 20 gpm	30	0
GDO	10592	IGT	5	150	Convenience	0	0	2002	MIAMI DADE WATER & SEWER DEPARTMENT	Multiple	6000	twenty-four 250-gallon	90	501
GDO	10686	MGRU	5	150	Convenience	18	18	1800	CITY OF NORTH MIAMI BEACH		0	one 15 gpm	30	450
GDO	10834	IGT	5	150	Convenience	0	0	0	MIAMI DADE WATER & SEWER DEPARTMENT	Single	750	one 750 gallon	90	0
GDO	10892	IGT	5	150	Convenience	4	0	2880	MIAMI DADE WATER & SEWER DEPARTMENT	Single	1250	one 1250 gallon	90	720
GDO	10899	MGRU	5	150	Convenience	0	0	3062	CITY OF HOMESTEAD		0	one 25 gpm	30	766
GDO	10931	MGRU	5	150	Convenience	0	0	2993	MIAMI DADE WATER & SEWER DEPARTMENT		0	one 50 gpm	60	748
GDO	10983	MGRU	5	150	Convenience	0	0	2886	MIAMI DADE WATER & SEWER DEPARTMENT		0	one 35 gpm	60	722
GDO	11015	IGT	5	150	Convenience	0	0	100	CITY OF NORTH MIAMI	Single	750	one 750 gallon	60	25
GDO	11018	IGT	5	150	Convenience	0	0	2000	MIAMI DADE WATER & SEWER DEPARTMENT	Single	750	one 750 gallon	30	500
GDO	11031	IGT	5	150	Convenience	0	0	1200	MIAMI DADE WATER & SEWER DEPARTMENT	Single	1000	one 1000 gallon	60	300
GDO	11064	MGRU	5	150	Convenience	0	0	400	CITY OF NORTH MIAMI		0	one 50 gpm	60	100
GDO	11179	MGRU	5	150	Convenience	0	0	2380	CITY OF MIAMI SPRINGS		0	one 20 gpm	60	595
GDO	11382	MGRU	5	150	Convenience	0	0	9030	MIAMI DADE WATER & SEWER DEPARTMENT		0	one 35 gpm	30	100
GDO	11452	MGRU	5	150	Convenience	0	0	300	CITY OF HIALEAH		0	one 100 gpm	60	75
GDO	11480	IGT	5	150	Convenience	0	0	440	CITY OF HOMESTEAD	Single	750	one 750 gallon	90	110
GDO	11629	IGT	5	150	Convenience	0	0	3000	MIAMI DADE WATER & SEWER DEPARTMENT	Single	750	one 750 gallon	90	750
GDO	6255	IGT	5	150	Distribution	0	0	5800	MIAMI DADE WATER & SEWER DEPARTMENT	Single	1050	one 1050 gallon	90	1450
GDO	6359	IGT	5	150	Distribution	0	0	0	MIAMI DADE WATER & SEWER DEPARTMENT	Single	1200	one 1200 gallon	90	0
GDO	6752	IGT	5	150	Distribution	0	0	0	MIAMI DADE WATER & SEWER DEPARTMENT	Series	2100	two 1050 gallon	90	0
GDO	7003	IGT	5	150	Distribution	0	0	0	CITY OF NORTH MIAMI BEACH	Single	1200	one 1200 gallon	90	0
GDO	7491	IGT	5	150	Distribution	0	0	165000	CITY OF OPA LOCKA	Single	750	one 750 gallon	90	25000
GDO	7514	IGT	5	150	Distribution	0	0	0	MIAMI DADE WATER & SEWER DEPARTMENT	Single	750	one 750 gallon	90	0
GDO	10236	IGT	5	300	Distribution	0	0	73000	MIAMI DADE WATER & SEWER DEPARTMENT	Series	2100	two 1050 gallon	90	18250
GDO	10416	MGRU	5	150	Distribution	0	0	3597	MIAMI DADE WATER & SEWER DEPARTMENT		0	one 25 gpm	30	899
GDO	10723	IGT	5	150	Distribution	0	0	1920	MIAMI DADE WATER & SEWER DEPARTMENT	Single	750	one 750-gallon	90	480
GDO	11114	MGRU	5	300	Distribution	0	0	40000	MIAMI DADE WATER & SEWER DEPARTMENT		0	one 100 gpm	30	10000
GDO	11221	IGT	5	150	Distribution	0	0	0		Single	1050	one 1050 gallon	60	0
GDO	11299	MGRU	5	300	Distribution	0	0	177253	MIAMI DADE WATER & SEWER DEPARTMENT		0	one 100 gpm	60	25000
GDO	5210	IGT	5	150	Dumpster/trash	0	0	0	MIAMI DADE WATER & SEWER DEPARTMENT	Single	2000	one 2000 gallon	90	0
GDO	1	IGT	5	300	Eating establishment	110	110	0	CITY OF MIAMI BEACH	Parallel	1800	one 750 & one 1050 gallon	90	2750
GDO	2	IGT	5	750	Eating establishment	300	300	0	CITY OF MIAMI BEACH	Series	2400	two 1200 gallon	90	0
GDO	3	IGT	5	150	Eating establishment	165	165	1200	MIAMI DADE WATER & SEWER DEPARTMENT	Series	2400	two 1200 gallon	90	300
GDO	4	IGT	5	750	Eating establishment	211	211	0	MIAMI DADE WATER & SEWER DEPARTMENT	Single	1050	one 1050 gallon	90	0
GDO	5	IGT	5	150	Eating establishment	60	60	2009	MIAMI DADE WATER & SEWER DEPARTMENT	Single	2000	one 2000 gallon	90	502
GDO	6	IGT	5	150	Eating establishment	52	52	0	MIAMI DADE WATER & SEWER DEPARTMENT	Single	1050	one 1050 gallon	90	1300
GDO	7	IGT	5	150	Eating establishment	32	32	1208	MIAMI DADE WATER & SEWER DEPARTMENT	Single	1050	one 1050 gallon	90	30200
GDO	9	IGT	5	150	Eating establishment	60	60	3950	MIAMI DADE WATER & SEWER DEPARTMENT	Single	1200	one 1200 gallon	90	988
GDO	10	IGT	5	300	Eating establishment	96	98	4140	MIAMI DADE WATER & SEWER DEPARTMENT	Single	1500	one 1500 gallon	90	1035
GDO	11	IGT	5	300	Eating establishment	150	150	0	MIAMI DADE WATER & SEWER DEPARTMENT	Single	2000	one 2000 gallon	90	3750
GDO	15	IGT	5	300	Eating establishment	180	180	0	MIAMI DADE WATER & SEWER DEPARTMENT	Single	6000	one 6000 gallon	90	4500
GDO	16	IGT	5	300	Eating establishment	109	0	3000	MIAMI DADE WATER & SEWER DEPARTMENT	Series	4000	two 2000 gallon	30	750
GDO	17	IGT	5	150	Eating establishment	159	0	2950	MIAMI DADE WATER & SEWER DEPARTMENT	Series	4000	two 2000 gallon	60	738

WORK GROUP	PERMIT NUMBER	PERMIT CLASS	PERMIT	PERMIT FEE	BUSINESS_TYPE	RECORDED SEATS	OBSERVED SEATS	FACILITY AREA	UTILITY	SYSTEM FORMAT	TOTAL CAPACITY	TANK_CAPACITY	PUMP OUT	TOTAL GPD
GDO	18	IGT	5	750	Eating establishment	205	217	0		Single	1200	one 1200 gallon	90	5125
GDO	20	IGT	5	750	Eating establishment	426	426	0	MIAMI DADE WATER & SEWER DEPARTMENT	Series	1900	two 950 gallon	90	10650
GDO	21	IGT	5	300	Eating establishment	170	170	0	MIAMI DADE WATER & SEWER DEPARTMENT	Single	1050	one 1050 gallon	90	4250
GDO	24	IGT	5	750	Eating establishment	225	225	0	CITY OF HIALEAH	Single	1050	one 1050 gallon	90	5625
GDO	25	IGT	3	300	Eating establishment	150	150	0	MIAMI DADE WATER & SEWER DEPARTMENT	Series	1900	two 950 gallon	90	3750
GDO	26	IGT	5	300	Eating establishment	200	150	0	MIAMI DADE WATER & SEWER DEPARTMENT	Single	1200	one 1200 gallon	90	5000
GDO	28	IGT	5	300	Eating establishment	200	259	0	MIAMI DADE WATER & SEWER DEPARTMENT	Series	2650	one 750 & two 950 gallon	90	5000
GDO	29	IGT	5	750	Eating establishment	230	230	0		Single	1200	one 1200 gallon	90	5750
GDO	32	IGT	5	150	Eating establishment	150	0	3750	MIAMI DADE WATER & SEWER DEPARTMENT	Single	1200	one 1200 gallon	60	938
GDO	33	IGT	5	150	Eating establishment	111	0	3858	MIAMI DADE WATER & SEWER DEPARTMENT	Single	1200	one 1200 gallon	30	965
GDO	34	IGT	5	300	Eating establishment	217	217	4003	MIAMI DADE WATER & SEWER DEPARTMENT	Series	1900	two 950 gallon	60	1001
GDO	35	IGT	5	300	Eating establishment	150	150	0		Series	2400	two 1200 gallon	90	3750
GDO	37	IGT	5	150	Eating establishment	78	78	3693	CITY OF MIAMI SPRINGS	Single	1650	one 1650 gallon	90	923
GDO	38	IGT	5	150	Eating establishment	200	200	2020	MIAMI DADE WATER & SEWER DEPARTMENT	Multiple	6400	two 2000 & two 1200 gallon	90	505
GDO	40	IGT	5	750	Eating establishment	515	515	0	CITY OF MIAMI BEACH	Series	2400	two 1200 gallon	90	12875
GDO	41	IGT	5	300	Eating establishment	201	201	5278	MIAMI DADE WATER & SEWER DEPARTMENT	Single	1250	one 1250 gallon	60	1320
GDO	42	IGT	5	300	Eating establishment	299	299	5000	CITY OF MIAMI BEACH	Single	1200	one 1200 gallon	90	1250
GDO	43	IGT	5	750	Eating establishment	293	293	0	MIAMI DADE WATER & SEWER DEPARTMENT	Series	2550	one 950 & one 1600 gallon	30	7325
GDO	44	IGT	5	150	Eating establishment	0	0	0	CITY OF NORTH MIAMI BEACH	Single	1050	one 1050 gallon	90	0
GDO	45	IGT	5	150	Eating establishment	48	48	0		Single	750	one 750 gallon	90	12
GDO	46	IGT	5	300	Eating establishment	206	0	6514	MIAMI DADE WATER & SEWER DEPARTMENT	Single	1050	one 1050 gallon	90	1629
GDO	47	IGT	5	300	Eating establishment	180	180	0	CITY OF HIALEAH	Single	2100	two 1050 gallon	90	4500
GDO	51	IGT	5	300	Eating establishment	85	80	0	CITY OF NORTH BAY VILLAGE	Single	1050	one 1050 gallon	90	2000
GDO	52	IGT	5	150	Eating establishment	60	60	1298	MIAMI DADE WATER & SEWER DEPARTMENT	Single	1500	one 1500 gallon	90	325
GDO	53	IGT	5	300	Eating establishment	150	150	6071	CITY OF NORTH MIAMI BEACH	Series	2400	two 1200 gallon	90	1518
GDO	54	IGT	5	150	Eating establishment	200	200	3899	MIAMI DADE WATER & SEWER DEPARTMENT	Series	1500	two 750 gallon	90	97475
GDO	55	IGT	5	300	Eating establishment	550	550	20851	CITY OF MIAMI BEACH	Series	5000	four 1250 gallon	90	5213
GDO	58	IGT	5	300	Eating establishment	158	230	0	MIAMI DADE WATER & SEWER DEPARTMENT	Single	1500	one 1500 gallon	90	3950
GDO	60	IGT	5	750	Eating establishment	217	217	0		Single	1200	one 1200 gallon	90	5425
GDO	63	IGT	5	300	Eating establishment	90	90	0	CITY OF MIAMI BEACH	Single	1200	one 1200 gallon	90	2250
GDO	66	IGT	5	750	Eating establishment	500	500	0	CITY OF MIAMI BEACH	Single	1050	one 1050 gallon	90	12500
GDO	67	IGT	5	150	Eating establishment	30	30	1200	CITY OF HIALEAH	Single	1200	one 1200 gallon	90	300
GDO	68	IGT	5	300	Eating establishment	260	260	12105	MIAMI DADE WATER & SEWER DEPARTMENT	Series	2400	two 1200-gallon	90	3420
GDO	73	MGRU	5	150	Eating establishment	0	0	0			0	one 25 gpm	30	0
GDO	74	IGT	5	750	Eating establishment	230	230	0	MIAMI DADE WATER & SEWER DEPARTMENT	Single	1200	one 1200 gallon	90	5750
GDO	75	IGT	5	300	Eating establishment	330	0	9100	MIAMI DADE WATER & SEWER DEPARTMENT	Single	1200	one 1200 gallon	60	2275
GDO	76	IGT	5	300	Eating establishment	138	138	4050	MIAMI DADE WATER & SEWER DEPARTMENT	Single	1200	one 1200 gallon	90	1013
GDO	77	AGT	5	150	Eating establishment	8	8	6769	MIAMI DADE WATER & SEWER DEPARTMENT	Series	1300	two 650 gallon	90	1692
GDO	79	IGT	5	150	Eating establishment	15	15	1500	MIAMI DADE WATER & SEWER DEPARTMENT	Single	1050	one 1050 gallon	90	375
GDO	80	IGT	5	300	Eating establishment	208	208	0	MIAMI DADE WATER & SEWER DEPARTMENT	Single	750	one 750 gallon	90	1040
GDO	81	IGT	5	300	Eating establishment	200	200	5476	MIAMI DADE WATER & SEWER DEPARTMENT	Single	1200	one 1200 gallon	90	1369
GDO	85	IGT	5	300	Eating establishment	186	186	6428	MIAMI DADE WATER & SEWER DEPARTMENT	Single	1200	one 1200 gallon	90	1607
GDO	90	IGT	5	300	Eating establishment	160	160	0	MIAMI DADE WATER & SEWER DEPARTMENT	Single	5000	one 5000 gallon	90	4000
GDO	91	IGT	5	300	Eating establishment	230	0	7400	MIAMI DADE WATER & SEWER DEPARTMENT	Single	1050	one 1050 gallon	60	1850
GDO	93	IGT	5	300	Eating establishment	200	200	0		Single	2000	one 2000 gallon	90	5000
GDO	94	IGT	5	750	Eating establishment	275	275	0	MIAMI DADE WATER & SEWER DEPARTMENT	Series	3200	two 1600 gallon	90	6875
GDO	97	IGT	5	300	Eating establishment	228	228	8564	MIAMI DADE WATER & SEWER DEPARTMENT	Single	1500	one 1500-gallon	90	2141
GDO	98	IGT	5	150	Eating establishment	156	0	3260	MIAMI DADE WATER & SEWER DEPARTMENT	Single	1500	one 1500 gallon	60	1136
GDO	100	IGT	5	300	Eating establishment	228	228	7930	MIAMI DADE WATER & SEWER DEPARTMENT	Series	2400	two 1200 gallon	90	1983
GDO	102	IGT	5	300	Eating establishment	150	150	0		Series	2400	two 1200 gallon	90	3750
GDO	103	IGT	5	300	Eating establishment	200	200	0	CITY OF MIAMI BEACH	Single	750	one 750 gallon	90	5000
GDO	104	IGT	5	300	Eating establishment	250	250	8938	MIAMI DADE WATER & SEWER DEPARTMENT	Single	1500	one 1500 gallon	90	2235
GDO	107	IGT	5	300	Eating establishment	150	150	0	MIAMI DADE WATER & SEWER DEPARTMENT	Single	2000	one 2000 gallon	90	2100
GDO	108	IGT	5	300	Eating establishment	64	64	0	MIAMI DADE WATER & SEWER DEPARTMENT	Single	1200	one 1200 gallon	90	896
GDO	109	IGT	5	150	Eating establishment	46	100	1625	MIAMI DADE WATER & SEWER DEPARTMENT	Series	3600	three 1200 gallon	60	468
GDO	110	IGT	5	750	Eating establishment	225	225	0	MIAMI DADE WATER & SEWER DEPARTMENT	Series	4000	two 2000 gallon	90	1125
GDO	111	IGT	5	300	Eating establishment	132	132	0	MIAMI DADE WATER & SEWER DEPARTMENT	Series	2100	two 1050 gallon	90	3300
GDO	112	IGT	5	300	Eating establishment	195	195	0	MIAMI DADE WATER & SEWER DEPARTMENT	Series	3600	three 1200 gallon	90	4875

WORK GROUP	PERMIT NUMBER	PERMIT CLASS	PERMIT	PERMIT FEE	BUSINESS_TYPE	RECORDED SEATS	OBSERVED SEATS	FACILITY AREA	UTILITY	SYSTEM FORMAT	TOTAL CAPACITY	TANK_CAPACITY	PUMP OUT	TOTAL GPD
GDO	113	IGT	5	150	Eating establishment	42	42	2100	MIAMI DADE WATER & SEWER DEPARTMENT	Single	1500	one 1500-gallon	90	525
GDO	114	IGT	5	150	Eating establishment	86	86	3400	MIAMI DADE WATER & SEWER DEPARTMENT	Single	1500	one 1500 gallon	90	850
GDO	119	IGT	5	750	Eating establishment	202	202	0	MIAMI DADE WATER & SEWER DEPARTMENT	Single	1200	one 1200 gallon	90	5050
GDO	120	IGT	5	750	Eating establishment	220	220	0	MIAMI DADE WATER & SEWER DEPARTMENT	Single	750	one 750 gallon	90	5500
GDO	122	IGT	5	750	Eating establishment	204	204	0	MIAMI DADE WATER & SEWER DEPARTMENT	Series	3600	three 1200 gallon	60	5100
GDO	123	IGT	5	300	Eating establishment	125	125	0		Single	1500	one 1500 gallon	90	3125
GDO	124	IGT	5	150	Eating establishment	46	0	2800	MIAMI DADE WATER & SEWER DEPARTMENT	Single	950	one 950 gallon	90	700
GDO	125	IGT	5	300	Eating establishment	150	150	7520	CITY OF HIALEAH	Series	3000	two 1500-gallon	90	1880
GDO	126	IGT	5	300	Eating establishment	60	60	0	MIAMI DADE WATER & SEWER DEPARTMENT	Single	1200	one 1200 gallon	90	840
GDO	127	IGT	5	150	Eating establishment	50	50	0	MIAMI DADE WATER & SEWER DEPARTMENT	Single	1050	one 1050 gallon	90	700
GDO	132	IGT	5	300	Eating establishment	150	150	0	MIAMI DADE WATER & SEWER DEPARTMENT	Series	1200	two 1200 gallon	90	0
GDO	133	IGT	5	150	Eating establishment	40	40	850	MIAMI DADE WATER & SEWER DEPARTMENT	Single	750	one 750 gallon	90	213
GDO	134	IGT	5	300	Eating establishment	149	149	0	CITY OF HIALEAH	Single	1600	one 1600 gallon	90	3725
GDO	135	IGT	5	300	Eating establishment	128	128	0		Single	1600	one 1600 gallon	90	1792
GDO	136	IGT	5	300	Eating establishment	150	150	0	MIAMI DADE WATER & SEWER DEPARTMENT	Single	750	one 750 gallon	90	2100
GDO	137	IGT	5	150	Eating establishment	101	101	3409		Single	1250	one 1250-gallon	90	47726
GDO	138	IGT	5	300	Eating establishment	180	180	0	MIAMI DADE WATER & SEWER DEPARTMENT	Single	4000	one 4000 gallon	90	0
GDO	139	IGT	5	150	Eating establishment	0	0	1440	MIAMI DADE WATER & SEWER DEPARTMENT	Single	1200	one 1200 gallon	90	360
GDO	141	IGT	5	300	Eating establishment	163	163	0	MIAMI DADE WATER & SEWER DEPARTMENT	Series	2400	two 1200 gallon	90	4075
GDO	147	IGT	5	300	Eating establishment	84	84	0	MIAMI DADE WATER & SEWER DEPARTMENT	Single	1500	one 1500 gallon	90	1176
GDO	148	IGT	5	150	Eating establishment	120	0	3601	MIAMI DADE WATER & SEWER DEPARTMENT	Single	1500	one 1500 gallon	60	900
GDO	150	IGT	5	150	Eating establishment	89	0	3152	MIAMI DADE WATER & SEWER DEPARTMENT	Single	1500	one 1500 gallon	60	788
GDO	151	IGT	5	150	Eating establishment	80	0	3150	CITY OF FLORIDA CITY	Single	1250	one 1250 gallon	60	788
GDO	152	IGT	5	300	Eating establishment	70	70	0		Single	1500	one 1500 gallon	90	980
GDO	153	IGT	5	300	Eating establishment	86	86	0		Single	1200	one 1200 gallon	90	1204
GDO	155	IGT	5	150	Eating establishment	149	149	0			1600	one 1600 gallon	90	2086
GDO	157	MGRU	5	300	Eating establishment	122	0	4124	MIAMI DADE WATER & SEWER DEPARTMENT		0	one 100 gpm	60	1031
GDO	158	IGT	5	150	Eating establishment	90	0	3120	MIAMI DADE WATER & SEWER DEPARTMENT	Single	1250	one 1250 gallon	60	780
GDO	160	IGT	5	150	Eating establishment	97	0	3445	CITY OF HIALEAH	Single	1250	one 1250 gallon	60	861
GDO	161	IGT	5	150	Eating establishment	82	82	3468	CITY OF MIAMI BEACH	Single	1200	one 1200 gallon	90	86700
GDO	162	IGT	5	300	Eating establishment	60	60	0	MIAMI DADE WATER & SEWER DEPARTMENT	Single	1050	one 1050 gallon	90	840
GDO	163	IGT	5	300	Eating establishment	62	62	0	MIAMI DADE WATER & SEWER DEPARTMENT	Single	950	one 950 gallon	90	868
GDO	165	IGT	5	150	Eating establishment	120	0	2500	MIAMI DADE WATER & SEWER DEPARTMENT	Single	2000	one 2000 gallon	60	625
GDO	168	IGT	5	150	Eating establishment	140	140	1810	CITY OF MIAMI BEACH	Single	1200	one 1200 gallon	90	453
GDO	170	IGT	5	150	Eating establishment	36	36	0		Single	950	one 950 gallon	90	900
GDO	172	IGT	5	150	Eating establishment	88	0	3177	MIAMI DADE WATER & SEWER DEPARTMENT	Single	1500	one 1500 gallon	60	794
GDO	173	IGT	5	150	Eating establishment	106	106	3076	CITY OF HIALEAH	Single	1500	one 1500 gallon	90	769
GDO	176	IGT	5	300	Eating establishment	375	375	0		Series	6400	four 1600 gallon	90	375
GDO	177	IGT	5	300	Eating establishment	150	150	0		Series	2100	two 1050 gallon	90	3750
GDO	178	IGT	5	300	Eating establishment	70	70	0	CITY OF HOMESTEAD	Single	1050	one 1050 gallon	90	980
GDO	179	IGT	5	150	Eating establishment	46	46	0	MIAMI DADE WATER & SEWER DEPARTMENT	Single	750	one 750 gallon	90	644
GDO	189	IGT	5	300	Eating establishment	200	200	0	MIAMI DADE WATER & SEWER DEPARTMENT	Single	1050	one 1050 gallon	90	5000
GDO	190	IGT	5	150	Eating establishment	75	75	0	MIAMI DADE WATER & SEWER DEPARTMENT	Single	1050	one 1050 gallon	90	1050
GDO	193	IGT	5	150	Eating establishment	48	48	2300	CITY OF NORTH MIAMI BEACH	Single	1050	one 1050 gallon	90	575
GDO	194	IGT	5	300	Eating establishment	155	155	0	MIAMI DADE WATER & SEWER DEPARTMENT	Multiple	12500	one 1500, two 2500 and two 3000 gallon	90	3875
GDO	195	IGT	5	150	Eating establishment	40	40	1800	MIAMI DADE WATER & SEWER DEPARTMENT	Single	1050	one 1050 gallon	90	1000
GDO	200	IGT	5	300	Eating establishment	149	149	0	MIAMI DADE WATER & SEWER DEPARTMENT	Series	2400	two 1200 gallon	90	3725
GDO	201	IGT	5	150	Eating establishment	62	62	2116	MIAMI DADE WATER & SEWER DEPARTMENT	Single	1200	one 1200 gallon	90	529
GDO	203	IGT	5	300	Eating establishment	200	200	7301	MIAMI DADE WATER & SEWER DEPARTMENT	Single	1200	one 1200 gallon	90	1825
GDO	205	IGT	5	300	Eating establishment	104	104	0	MIAMI DADE WATER & SEWER DEPARTMENT	Single	1600	one 1600 gallon	90	1456
GDO	207	IGT	5	150	Eating establishment	96	96	1475	MIAMI DADE WATER & SEWER DEPARTMENT	Single	1500	one 1500 gallon	90	369
GDO	208	IGT	5	150	Eating establishment	88	0	3092	MIAMI DADE WATER & SEWER DEPARTMENT	Single	1250	one 1250 gallon	60	773
GDO	209	IGT	5	300	Eating establishment	120	120	6500	MIAMI DADE WATER & SEWER DEPARTMENT	Single	1200	one 1200 gallon	90	1625
GDO	210	IGT	5	150	Eating establishment	0	0	1725	MIAMI DADE WATER & SEWER DEPARTMENT	Single	750	one 750 gallon	90	431
GDO	213	IGT	5	150	Eating establishment	80	0	3453	MIAMI DADE WATER & SEWER DEPARTMENT	Single	1600	one 1600 gallon	90	863
GDO	216	IGT	5	300	Eating establishment	110	110	4255	CITY OF NORTH MIAMI BEACH	Series	3200	two 1600 gallon	90	1540
GDO	218	MGRU	5	300	Eating establishment	120	0	4290	MIAMI DADE WATER & SEWER DEPARTMENT		0	two 100 gpm	30	1073
GDO	219	IGT	5	150	Eating establishment	48	0	3400	MIAMI DADE WATER & SEWER DEPARTMENT	Single	1200	one 1200 gallon	60	850
GDO	220	MGRU	5	150	Eating establishment	16	0	1700	MIAMI DADE WATER & SEWER DEPARTMENT		0	one 50 gpm	30	425

WORK GROUP	PERMIT NUMBER	PERMIT CLASS	PERMIT	PERMIT FEE	BUSINESS_TYPE	RECORDED SEATS	OBSERVED SEATS	FACILITY AREA	UTILITY	SYSTEM FORMAT	TOTAL CAPACITY	TANK_CAPACITY	PUMP OUT	TOTAL GPD
GDO	221	IGT	5	150	Eating establishment	30	30	0	MIAMI DADE WATER & SEWER DEPARTMENT	Single	1200	one 1200 gallon	90	420
GDO	222	IGT	5	300	Eating establishment	74	74	0	MIAMI DADE WATER & SEWER DEPARTMENT	Single	1200	one 1200 gallon	90	1036
GDO	223	IGT	5	150	Eating establishment	74	74	2760	CITY OF HIALEAH	Single	1050	one 1050 gallon	90	690
GDO	225	IGT	5	300	Eating establishment	70	70	0	MIAMI DADE WATER & SEWER DEPARTMENT	Single	1200	one 1200 gallon	90	980
GDO	226	IGT	5	300	Eating establishment	62	62	0	MIAMI DADE WATER & SEWER DEPARTMENT	Single	1200	one 1200 gallon	90	868
GDO	227	IGT	5	300	Eating establishment	150	150	0	MIAMI DADE WATER & SEWER DEPARTMENT	Single	1200	one 1200 gallon	90	2100
GDO	228	IGT	5	300	Eating establishment	130	130	0	MIAMI DADE WATER & SEWER DEPARTMENT	Single	1650	one 1650 gallon	90	1820
GDO	229	IGT	5	300	Eating establishment	76	76	0	CITY OF MIAMI BEACH	Single	1600	one 1600 gallon	90	1064
GDO	230	IGT	5	300	Eating establishment	121	121	0	MIAMI DADE WATER & SEWER DEPARTMENT	Single	22050	one 1050 gallon	90	1694
GDO	231	IGT	5	300	Eating establishment	120	120	0	MIAMI DADE WATER & SEWER DEPARTMENT	Single	1600	one 1600 gallon	90	1680
GDO	233	IGT	5	150	Eating establishment	30	30	0	CITY OF HIALEAH	Single	1200	one 1200 gallon	90	420
GDO	234	IGT	5	150	Eating establishment	74	74	0	CITY OF HIALEAH	Single	1050	one 1050 gallon	90	711
GDO	235	IGT	5	300	Eating establishment	150	150	0	MIAMI DADE WATER & SEWER DEPARTMENT	Series	2400	two 1200 gallon	90	3750
GDO	236	IGT	5	300	Eating establishment	220	0	6000	MIAMI DADE WATER & SEWER DEPARTMENT	Series	2400	two 1200 gallon	60	1500
GDO	238	IGT	5	150	Eating establishment	80	80	3017	MIAMI DADE WATER & SEWER DEPARTMENT	Single	1200	one 1200 gallon	90	754
GDO	239	IGT	5	300	Eating establishment	74	74	0	MIAMI DADE WATER & SEWER DEPARTMENT	Single	1200	one 1200 gallon	90	1036
GDO	245	IGT	5	150	Eating establishment	20	20	0	MIAMI DADE WATER & SEWER DEPARTMENT	Single	1200	one 1200 gallon	90	280
GDO	246	IGT	5	150	Eating establishment	0	0	0		Single	1200	one 1200 gallon	90	0
GDO	247	IGT	5	750	Eating establishment	252	252	0	MIAMI DADE WATER & SEWER DEPARTMENT	Series	2400	two 1200 gallon	90	0
GDO	248	IGT	5	750	Eating establishment	215	215	0	CITY OF NORTH MIAMI BEACH	Single	1050	one 1050 gallon	90	5375
GDO	249	IGT	5	300	Eating establishment	103	103	0	MIAMI DADE WATER & SEWER DEPARTMENT	Single	1500	one 1500 gallon	90	1442
GDO	250	IGT	5	300	Eating establishment	108	108	0	CITY OF HOMESTEAD	Single	1200	one 1200 gallon	90	1512
GDO	251	IGT	5	300	Eating establishment	101	101	0	CITY OF NORTH MIAMI BEACH	Single	1650	one 1650 gallon	90	1414
GDO	252	IGT	5	300	Eating establishment	62	62	0	CITY OF HIALEAH	Single	1600	one 1600 gallon	90	868
GDO	253	IGT	5	300	Eating establishment	107	107	0	MIAMI DADE WATER & SEWER DEPARTMENT	Single	1500	one 1500 gallon	90	1498
GDO	254	IGT	5	300	Eating establishment	85	85	0	MIAMI DADE WATER & SEWER DEPARTMENT	Single	1500	one 1500 gallon	90	1190
GDO	256	IGT	5	300	Eating establishment	242	242	7441	MIAMI DADE WATER & SEWER DEPARTMENT	Series	4500	one 750 and three 1250 gallon	90	1860
GDO	257	IGT	5	150	Eating establishment	65	65	2260	MIAMI DADE WATER & SEWER DEPARTMENT	Single	750	one 750 gallon	90	565
GDO	260	IGT	5	150	Eating establishment	14	14	0	MIAMI DADE WATER & SEWER DEPARTMENT	Single	750	one 750 gallon	90	196
GDO	267	AGRU	5	300	Eating establishment	80	80	0	MIAMI DADE WATER & SEWER DEPARTMENT		0	one 35 gpm	30	2000
GDO	268	IGT	5	150	Eating establishment	25	0	2800	MIAMI DADE WATER & SEWER DEPARTMENT	Single	750	one 750 gallon	60	700
GDO	269	IGT	5	150	Eating establishment	27	27	1500	MIAMI DADE WATER & SEWER DEPARTMENT	Single	750	one 750-gallon	90	375
GDO	270	MGRU	5	150	Eating establishment	50	50	0	MIAMI DADE WATER & SEWER DEPARTMENT		0	one 25 gpm	30	1250
GDO	275	MGRU	5	150	Eating establishment	30	0	2210	MIAMI DADE WATER & SEWER DEPARTMENT		0	one 100 gpm	30	553
GDO	278	IGT	5	150	Eating establishment	20	20	720	MIAMI DADE WATER & SEWER DEPARTMENT	Single	750	one 750 gallon	90	180
GDO	279	MGRU	5	150	Eating establishment	20	20	1000	MIAMI DADE WATER & SEWER DEPARTMENT		0	one 30 gpm	30	250
GDO	280	MGRU	5	150	Eating establishment	10	10	1300	MIAMI DADE WATER & SEWER DEPARTMENT		0	one 25 gpm	30	325
GDO	281	IGT	5	150	Eating establishment	27	27	0	MIAMI DADE WATER & SEWER DEPARTMENT	Single	1200	one 1200 gallon	90	675
GDO	282	IGT	5	150	Eating establishment	74	74	2000	MIAMI DADE WATER & SEWER DEPARTMENT	Single	1200	one 1200 gallon	90	500
GDO	285	IGT	5	150	Eating establishment	30	30	0		Single	900	one 900 gallon	90	750
GDO	287	MGRU	5	150	Eating establishment	18	18	606	MIAMI DADE WATER & SEWER DEPARTMENT		0	one 25 gpm	30	152
GDO	288	IGT	5	300	Eating establishment	118	90	0	MIAMI DADE WATER & SEWER DEPARTMENT	Single	1200	one 1200 gallon	90	2250
GDO	289	IGT	5	300	Eating establishment	63	63	0	MIAMI DADE WATER & SEWER DEPARTMENT	Single	1200	one 1200 gallon	90	882
GDO	290	IGT	5	300	Eating establishment	65	65	0	MIAMI DADE WATER & SEWER DEPARTMENT	Single	1500	one 1500 gallon	90	910
GDO	291	IGT	5	150	Eating establishment	64	64	2259	CITY OF NORTH MIAMI BEACH	Single	1200	one 1200 gallon	90	565
GDO	292	IGT	5	300	Eating establishment	90	90	0	MIAMI DADE WATER & SEWER DEPARTMENT	Single	1200	one 1200 gallon	90	1260
GDO	294	IGT	5	300	Eating establishment	260	260	8756	MIAMI DADE WATER & SEWER DEPARTMENT	Single	3150	three 1050 gallon	90	2189
GDO	299	IGT	5	300	Eating establishment	80	80	0	MIAMI DADE WATER & SEWER DEPARTMENT	Single	1500	one 1500 gallon	90	1120
GDO	300	IGT	5	300	Eating establishment	134	134	0	MIAMI DADE WATER & SEWER DEPARTMENT	Single	1600	one 1600-gallon	90	1876
GDO	301	IGT	5	300	Eating establishment	149	149	0		Single	1200	one 1200 gallon	90	2086
GDO	302	MGRU	5	150	Eating establishment	36	36	2480	MIAMI DADE WATER & SEWER DEPARTMENT		0	two 100 gpm	90	620
GDO	303	IGT	5	300	Eating establishment	148	148	0	MIAMI DADE WATER & SEWER DEPARTMENT	Single	1050	one 1050 gallon	90	3700
GDO	304	IGT	5	300	Eating establishment	60	60	0	MIAMI DADE WATER & SEWER DEPARTMENT	Single	1200	one 1200 gallon	90	1500
GDO	305	IGT	5	300	Eating establishment	149	149	0	MIAMI DADE WATER & SEWER DEPARTMENT	Single	950	one 950 gallon	90	3725
GDO	309	IGT	5	300	Eating establishment	149	149	0		Series	2100	two 1050 gallon	90	2086
GDO	310	IGT	2	300	Eating establishment	220	220	5000	MIAMI DADE WATER & SEWER DEPARTMENT	Single	750	one 750 gallon	90	125000
GDO	311	IGT	5	150	Eating establishment	20	20	0		Single	1050	one 1050 gallon	90	280
GDO	312	MGRU	5	300	Eating establishment	149	149	0	MIAMI DADE WATER & SEWER DEPARTMENT		0	one 75 gpm	30	3725
GDO	313	IGT	5	150	Eating establishment	125	125	2000	CITY OF MIAMI BEACH	Single	1200	one 1200 gallon	90	500
GDO	315	IGT	5	300	Eating establishment	102	102	0	MIAMI DADE WATER & SEWER DEPARTMENT	Single	1200	one 1200 gallon	90	1428

WORK GROUP	PERMIT NUMBER	PERMIT CLASS	PERMIT	PERMIT FEE	BUSINESS_TYPE	RECORDED SEATS	OBSERVED SEATS	FACILITY AREA	UTILITY	SYSTEM FORMAT	TOTAL CAPACITY	TANK_CAPACITY	PUMP OUT	TOTAL GPD
GDO	316	IGT	5	300	Eating establishment	99	99	0	MIAMI DADE WATER & SEWER DEPARTMENT	Single	1600	one 1600 gallon	90	1386
GDO	318	IGT	5	150	Eating establishment	68	68	3300	MIAMI DADE WATER & SEWER DEPARTMENT	Single	1200	one 1200 gallon	90	46200
GDO	319	IGT	5	300	Eating establishment	200	200	0	MIAMI DADE WATER & SEWER DEPARTMENT	Single	950	one 950 gallon	90	5000
GDO	320	IGT	5	300	Eating establishment	85	85	0		Series	2100	two 1050 gallon	90	2125
GDO	321	IGT	5	300	Eating establishment	84	84	0	MIAMI DADE WATER & SEWER DEPARTMENT	Series	2100	two 1050 gallon	90	2100
GDO	322	IGT	5	150	Eating establishment	0	0	0	MIAMI DADE WATER & SEWER DEPARTMENT	Single	950	one 950 gallon	90	0
GDO	324	IGT	5	150	Eating establishment	18	18	3400	MIAMI DADE WATER & SEWER DEPARTMENT	Single	750	one 750 gallon	90	850
GDO	326	IGT	5	300	Eating establishment	92	92	4349	MIAMI DADE WATER & SEWER DEPARTMENT	Single	2100	two 1050 gallon	90	1087
GDO	327	IGT	5	150	Eating establishment	53	53	0	MIAMI DADE WATER & SEWER DEPARTMENT	Single	750	one 750 gallon	90	1325
GDO	329	MGRU	5	150	Eating establishment	16	16	0			0	one 25 gpm	30	224
GDO	331	IGT	5	150	Eating establishment	30	30	0		Single	750	one 750 gallon	90	750
GDO	333	IGT	5	150	Eating establishment	0	0	1380	MIAMI DADE WATER & SEWER DEPARTMENT	Single	1050	one 1050 gallon	60	345
GDO	337	IGT	5	300	Eating establishment	70	70	0	MIAMI DADE WATER & SEWER DEPARTMENT	Single	750	one 750 gallon	90	1750
GDO	338	MGRU	5	150	Eating establishment	24	24	1200	MIAMI DADE WATER & SEWER DEPARTMENT		0	one 25 gpm	30	300
GDO	340	IGT	5	300	Eating establishment	200	200	4300	MIAMI DADE WATER & SEWER DEPARTMENT	Single	1200	one 1200 gallon	90	1075
GDO	342	IGT	5	150	Eating establishment	72	72	2556	CITY OF NORTH MIAMI BEACH	Single	1200	one 1200 gallon	90	639
GDO	343	IGT	5	150	Eating establishment	54	54	2000	MIAMI DADE WATER & SEWER DEPARTMENT	Single	1050	one 1050 gallon	90	500
GDO	345	IGT	5	300	Eating establishment	48	48	0	MIAMI DADE WATER & SEWER DEPARTMENT	Series	3000	two 1500 gallon	90	672
GDO	346	IGT	5	300	Eating establishment	211	0	4050	MIAMI DADE WATER & SEWER DEPARTMENT	Series	2400	two 1200 gallon	60	1200
GDO	348	IGT	5	150	Eating establishment	40	0	3100	MIAMI DADE WATER & SEWER DEPARTMENT	Single	0	one 1500 gallon	60	775
GDO	351	IGT	5	150	Eating establishment	42	42	0	MIAMI DADE WATER & SEWER DEPARTMENT	Single	1600	one 1600 gallon	90	1050
GDO	354	MGRU	5	300	Eating establishment	90	90	0	MIAMI DADE WATER & SEWER DEPARTMENT		0	one 25 gpm	30	2250
GDO	355	IGT	5	150	Eating establishment	72	0	2986	CITY OF MIAMI BEACH	Single	900	one 900 gallon	30	747
GDO	358	IGT	5	300	Eating establishment	94	94	0	CITY OF HIALEAH	Single	1500	one 1500 gallon	90	1316
GDO	359	IGT	5	300	Eating establishment	74	74	0	MIAMI DADE WATER & SEWER DEPARTMENT	Single	1200	one 1200 gallon	90	1036
GDO	360	IGT	5	150	Eating establishment	30	30	0	MIAMI DADE WATER & SEWER DEPARTMENT	Single	1050	one 1050 gallon	90	420
GDO	362	IGT	5	300	Eating establishment	60	60	0	MIAMI DADE WATER & SEWER DEPARTMENT	Series	1500	two 750 gallon	90	840
GDO	364	MGRU	5	150	Eating establishment	0	0	750	MIAMI DADE WATER & SEWER DEPARTMENT		0	one 25 gpm	30	188
GDO	365	IGT	5	300	Eating establishment	89	89	5308	MIAMI DADE WATER & SEWER DEPARTMENT	Series	1250	two 1250 gallon	30	1327
GDO	366	IGT	5	300	Eating establishment	72	72	0	MIAMI DADE WATER & SEWER DEPARTMENT	Single	1500	one 1500 gallon	90	1008
GDO	367	IGT	5	150	Eating establishment	0	0	0	MIAMI DADE WATER & SEWER DEPARTMENT	Single	950	one 950 gallon	90	0
GDO	371	IGT	5	150	Eating establishment	0	0	4000	MIAMI DADE WATER & SEWER DEPARTMENT	Single	1500	one 1500 gallon	90	1000
GDO	372	IGT	5	300	Eating establishment	60	60	0	MIAMI DADE WATER & SEWER DEPARTMENT	Single	1200	one 1200 gallon	90	840
GDO	376	IGT	5	300	Eating establishment	109	109	0		Series	3000	two 1500 gallon	90	1526
GDO	378	MGRU	5	150	Eating establishment	52	52	1764	MIAMI DADE WATER & SEWER DEPARTMENT		0	one 25 gpm	30	441
GDO	379	MGRU	5	150	Eating establishment	20	20	1000	MIAMI DADE WATER & SEWER DEPARTMENT		0	one 25 gpm	30	250
GDO	380	MGRU	5	150	Eating establishment	0	0	530	MIAMI DADE WATER & SEWER DEPARTMENT		0	one 50 gpm	30	133
GDO	384	IGT	5	300	Eating establishment	116	186	0	CITY OF NORTH MIAMI BEACH	Single	1600	one 1600 gallon	90	4650
GDO	387	IGT	5	300	Eating establishment	74	74	0	CITY OF HIALEAH	Single	750	one 750 gallon	90	1850
GDO	389	IGT	5	150	Eating establishment	19	19	500	MIAMI DADE WATER & SEWER DEPARTMENT	Single	1200	one 1200 gallon	90	125
GDO	392	IGT	5	300	Eating establishment	50	50	3500	MIAMI DADE WATER & SEWER DEPARTMENT	Single	1200	one 1200 gallon	90	875
GDO	393	IGT	5	150	Eating establishment	19	19	1200	MIAMI DADE WATER & SEWER DEPARTMENT	Single	1200	one 1200 gallon	90	266
GDO	397	IGT	5	150	Eating establishment	99	0	3819		Single	1250	one 1250 gallon	60	955
GDO	398	IGT	5	300	Eating establishment	149	149	0	CITY OF OPA LOCKA	Single	1200	one 1200 gallon	90	2086
GDO	400	IGT	5	300	Eating establishment	74	74	0	MIAMI DADE WATER & SEWER DEPARTMENT	Series	2400	two 1200 gallon	90	1036
GDO	402	IGT	5	300	Eating establishment	80	80	0		Single	1500	one 1500 gallon	90	1120
GDO	404	IGT	5	300	Eating establishment	247	247	7081	CITY OF NORTH MIAMI BEACH	Series	3200	two 1600 gallon	90	1770
GDO	406	IGT	5	150	Eating establishment	125	125	3500	MIAMI DADE WATER & SEWER DEPARTMENT	Single	1200	one 1200 gallon	90	875
GDO	407	IGT	5	300	Eating establishment	80	80	0	MIAMI DADE WATER & SEWER DEPARTMENT	Single	750	one 750 gallon	90	2000
GDO	411	IGT	5	150	Eating establishment	50	50	0	MIAMI DADE WATER & SEWER DEPARTMENT	Single	950	one 950 gallon	90	700
GDO	412	MGRU	5	150	Eating establishment	10	10	750			0	one 25 gpm	30	188
GDO	415	IGT	5	300	Eating establishment	149	149	0		Single	2000	one 2000 gallon	90	3725
GDO	417	IGT	5	150	Eating establishment	90	90	3494	CITY OF HIALEAH	Single	750	one 750 gallon	90	874
GDO	421	IGT	5	300	Eating establishment	150	150	8000		Series	4000	two 4000 gallon	90	2000
GDO	422	IGT	5	150	Eating establishment	49	49	2751	MIAMI DADE WATER & SEWER DEPARTMENT	Single	1050	one 1050 gallon	90	688
GDO	423	IGT	5	300	Eating establishment	180	180	0	MIAMI DADE WATER & SEWER DEPARTMENT	Series	3000	two 1500 gallon	90	4500
GDO	427	IGT	5	150	Eating establishment	88	0	2300	CITY OF HIALEAH	Single	1050	one 1050 gallon	60	575
GDO	432	MGRU	5	150	Eating establishment	0	0	450	CITY OF HIALEAH		0	one 25 gpm	30	113
GDO	433	IGT	5	300	Eating establishment	74	74	0	CITY OF HIALEAH	Single	1500	one 1500 gallon	90	1036
GDO	436	IGT	5	750	Eating establishment	203	203	0		Single	1600	two 1600 gallon	90	5075
GDO	437	IGT	5	300	Eating establishment	100	100	0	MIAMI DADE WATER & SEWER DEPARTMENT	Series	2400	two 1200 gallon	90	1400

WORK GROUP	PERMIT NUMBER	PERMIT CLASS	PERMIT	PERMIT FEE	BUSINESS_TYPE	RECORDED SEATS	OBSERVED SEATS	FACILITY AREA	UTILITY	SYSTEM FORMAT	TOTAL CAPACITY	TANK_CAPACITY	PUMP OUT	TOTAL GPD
GDO	440	IGT	5	300	Eating establishment	90	90	0		Single	1200	one 1200 gallon	90	1260
GDO	441	IGT	5	300	Eating establishment	80	80	0		Single	1500	one 1500 gallon	90	1120
GDO	442	IGT	5	150	Eating establishment	50	50	0		Single	1200	one 1200 gallon	90	700
GDO	443	IGT	5	300	Eating establishment	96	96	0	MIAMI DADE WATER & SEWER DEPARTMENT	Single	1600	one 1600 gallon	90	2400
GDO	444	AGRU	2	150	Eating establishment	20	20	900	MIAMI DADE WATER & SEWER DEPARTMENT		0	one 25 gpm	30	225
GDO	446	IGT	5	150	Eating establishment	52	52	2500	MIAMI DADE WATER & SEWER DEPARTMENT	Single	750	one 750-gallon	90	625
GDO	447	IGT	5	300	Eating establishment	76	76	0	MIAMI DADE WATER & SEWER DEPARTMENT	Single	950	one 950 gallon	90	1900
GDO	449	IGT	5	300	Eating establishment	100	100	454	CITY OF MIAMI BEACH	Single	1050	one 1050 gallon	90	2500
GDO	454	MGRU	5	150	Eating establishment	30	30	0	MIAMI DADE WATER & SEWER DEPARTMENT		0	one 25 gpm	30	750
GDO	456	IGT	5	150	Eating establishment	0	0	0	MIAMI DADE WATER & SEWER DEPARTMENT	Single	750	one 750 gallon	90	0
GDO	458	IGT	5	300	Eating establishment	150	150	0	MIAMI DADE WATER & SEWER DEPARTMENT	Single	1200	one 1200 gallon	90	3750
GDO	463	IGT	5	300	Eating establishment	74	74	0	MIAMI DADE WATER & SEWER DEPARTMENT	Series	3000	two 1500 gallon	90	1036
GDO	464	IGT	5	300	Eating establishment	86	86	0	MIAMI DADE WATER & SEWER DEPARTMENT	Single	750	one 750 gallon	90	2150
GDO	467	IGT	5	150	Eating establishment	6	6	900	MIAMI DADE WATER & SEWER DEPARTMENT	Single	750	one 750 gallon	90	225
GDO	468	IGT	5	150	Eating establishment	74	74	3540	MIAMI DADE WATER & SEWER DEPARTMENT	Single	1050	one 1050 gallon	90	885
GDO	469	IGT	5	150	Eating establishment	30	30	0	MIAMI DADE WATER & SEWER DEPARTMENT	Single	1050	one 1050 gallon	90	750
GDO	474	MGRU	5	150	Eating establishment	0	0	1060	MIAMI DADE WATER & SEWER DEPARTMENT		0	one 50 gpm	30	265
GDO	481	IGT	5	300	Eating establishment	74	74	0	MIAMI DADE WATER & SEWER DEPARTMENT	Series	1900	two 950 gallon	90	1850
GDO	482	IGT	5	300	Eating establishment	149	149	0	MIAMI DADE WATER & SEWER DEPARTMENT	Series	2400	two 1200 gallon	90	2086
GDO	485	IGT	5	300	Eating establishment	420	420	3957	MIAMI DADE WATER & SEWER DEPARTMENT	Series	4500	three 1500-gallon	90	79140
GDO	486	IGT	5	150	Eating establishment	34	34	1050	CITY OF HIALEAH	Series	1500	two 750 gallon	90	850
GDO	489	IGT	5	150	Eating establishment	39	0	1000	MIAMI DADE WATER & SEWER DEPARTMENT	Single	750	one 750 gallon	60	300
GDO	491	IGT	5	150	Eating establishment	0	0	0		Single	750	one 750 gallon	90	0
GDO	494	IGT	5	150	Eating establishment	32	32	1900	MIAMI DADE WATER & SEWER DEPARTMENT	Single	1050	one 1050 gallon	90	800
GDO	499	IGT	5	300	Eating establishment	78	78	0	MIAMI DADE WATER & SEWER DEPARTMENT	Series	2400	two 1200 gallon	90	1092
GDO	500	IGT	5	300	Eating establishment	149	149	0		Single	1050	one 1050 gallon	90	2086
GDO	501	IGT	5	150	Eating establishment	24	24	750	MIAMI DADE WATER & SEWER DEPARTMENT	Single	750	one 750 gallon	90	188
GDO	502	IGT	5	300	Eating establishment	68	68	0	MIAMI DADE WATER & SEWER DEPARTMENT	Single	1200	one 1200 gallon	90	952
GDO	504	IGT	5	150	Eating establishment	40	40	1800	CITY OF HIALEAH	Single	1200	one 1200 gallon	90	450
GDO	508	IGT	5	300	Eating establishment	86	86	0	MIAMI DADE WATER & SEWER DEPARTMENT	Single	1500	one 1500 gallon	90	2150
GDO	509	IGT	5	150	Eating establishment	40	40	0		Single	750	one 750 gallon	90	560
GDO	510	IGT	5	300	Eating establishment	64	64	0	MIAMI DADE WATER & SEWER DEPARTMENT	Single	1200	one 1200 gallon	90	896
GDO	511	IGT	5	150	Eating establishment	40	40	0	MIAMI DADE WATER & SEWER DEPARTMENT	Single	1200	one 1200 gallon	90	560
GDO	512	IGT	5	300	Eating establishment	100	100	0	MIAMI DADE WATER & SEWER DEPARTMENT	Series	2400	two 1200 gallon	90	1400
GDO	518	IGT	5	150	Eating establishment	29	29	0		Single	1200	one 1200 gallon	90	406
GDO	519	IGT	5	300	Eating establishment	82	82	0	MIAMI DADE WATER & SEWER DEPARTMENT	Single	1200	one 1200 gallon	90	2050
GDO	520	IGT	5	300	Eating establishment	85	85	0	MIAMI DADE WATER & SEWER DEPARTMENT	Series	2400	two 1200 gallon	90	1190
GDO	521	IGT	5	300	Eating establishment	92	92	0	MIAMI DADE WATER & SEWER DEPARTMENT	Single	750	one 750 gallon	90	2300
GDO	522	IGT	5	150	Eating establishment	71	71	3020	MIAMI DADE WATER & SEWER DEPARTMENT	Series	2100	two 1050 gallon	90	755
GDO	524	IGT	5	150	Eating establishment	32	19	0	MIAMI DADE WATER & SEWER DEPARTMENT	Single	1050	one 1050 gallon	90	5
GDO	525	IGT	5	300	Eating establishment	149	149	0	MIAMI DADE WATER & SEWER DEPARTMENT	Series	2400	two 1200 gallon	90	2086
GDO	528	IGT	5	150	Eating establishment	20	0	1200	MIAMI DADE WATER & SEWER DEPARTMENT	Single	750	one 750 gallon	60	300
GDO	529	IGT	5	300	Eating establishment	99	99	0		Single	750	one 750 gallon	90	1386
GDO	531	IGT	5	150	Eating establishment	65	65	3084	MIAMI DADE WATER & SEWER DEPARTMENT	Series	2400	two 1200 gallon	90	771
GDO	532	IGT	5	300	Eating establishment	78	78	0		Single	1200	one 1200 gallon	90	1092
GDO	533	IGT	5	150	Eating establishment	0	0	0	CITY OF MIAMI BEACH	Single	1200	one 1200 gallon	90	0
GDO	534	IGT	5	300	Eating establishment	80	80	0	MIAMI DADE WATER & SEWER DEPARTMENT	Single	950	one 950 gallon	90	1120
GDO	536	MGRU	5	150	Eating establishment	12	12	0	MIAMI DADE WATER & SEWER DEPARTMENT		0	one 25 gpm	30	300
GDO	538	IGT	5	300	Eating establishment	147	147	0	MIAMI DADE WATER & SEWER DEPARTMENT	Single	1200	one 1200 gallon	90	2058
GDO	539	IGT	5	150	Eating establishment	48	48	1648	MIAMI DADE WATER & SEWER DEPARTMENT	Single	950	one 950 gallon	90	412
GDO	541	IGT	5	300	Eating establishment	150	150	0	MIAMI DADE WATER & SEWER DEPARTMENT	Single	2000	one 2000 gallon	90	3750
GDO	542	IGT	5	150	Eating establishment	50	0	2250	MIAMI DADE WATER & SEWER DEPARTMENT	Single	1050	one 1050 gallon	60	563
GDO	543	IGT	5	300	Eating establishment	90	0	5858	MIAMI DADE WATER & SEWER DEPARTMENT	Series	2400	two 1200 gallon	60	1465
GDO	545	IGT	5	150	Eating establishment	70	0	2665	MIAMI DADE WATER & SEWER DEPARTMENT	Single	1200	one 1200 gallon	60	666
GDO	549	IGT	5	150	Eating establishment	65	0	2933	MIAMI DADE WATER & SEWER DEPARTMENT	Single	950	one 950 gallon	60	733
GDO	550	IGT	5	150	Eating establishment	40	40	2750	MIAMI DADE WATER & SEWER DEPARTMENT	Single	1250	one 1250 gallon	90	688
GDO	551	IGT	5	300	Eating establishment	149	149	0		Single	750	one 750 gallon	90	3725
GDO	552	IGT	5	300	Eating establishment	74	74	0		Series	3000	two 1500 gallon	90	1036
GDO	553	IGT	5	150	Eating establishment	92	92	3135	MIAMI DADE WATER & SEWER DEPARTMENT	Single	1200	one 1200-gallon	90	784
GDO	554	IGT	5	150	Eating establishment	32	32	1200	MIAMI DADE WATER & SEWER DEPARTMENT	Single	1200	one 1200 gallon	90	300
GDO	555	IGT	5	150	Eating establishment	40	40	0	MIAMI DADE WATER & SEWER DEPARTMENT	Single	1200	one 1200 gallon	90	560

WORK GROUP	PERMIT NUMBER	PERMIT CLASS	PERMIT	PERMIT FEE	BUSINESS_TYPE	RECORDED SEATS	OBSERVED SEATS	FACILITY AREA	UTILITY	SYSTEM FORMAT	TOTAL CAPACITY	TANK_CAPACITY	PUMP OUT	TOTAL GPD
GDO	556	IGT	5	300	Eating establishment	149	149	0		Single	1200	one 1200 gallon	90	2086
GDO	557	IGT	5	150	Eating establishment	60	0	3471	CITY OF HIALEAH	Series	5500	two 1250 and two 1500 gallon	90	868
GDO	559	IGT	5	300	Eating establishment	112	112	4237	MIAMI DADE WATER & SEWER DEPARTMENT	Series	2400	two 1200 gallon	90	1059
GDO	560	IGT	5	150	Eating establishment	15	0	1293	MIAMI DADE WATER & SEWER DEPARTMENT	Single	1200	one 1200 gallon	60	323
GDO	561	IGT	5	150	Eating establishment	40	40	3172	MIAMI DADE WATER & SEWER DEPARTMENT	Single	1200	one 1200 gallon	90	793
GDO	562	IGT	5	150	Eating establishment	124	0	3000		Single	750	one 750 gallon	60	750
GDO	563	IGT	5	150	Eating establishment	0	0	0		Single	950	one 950 gallon	90	0
GDO	565	IGT	5	300	Eating establishment	80	80	0	MIAMI DADE WATER & SEWER DEPARTMENT	Single	950	one 950 gallon	90	1120
GDO	566	IGT	5	150	Eating establishment	36	36	0	MIAMI DADE WATER & SEWER DEPARTMENT	Single	950	one 950 gallon	90	0
GDO	567	IGT	5	150	Eating establishment	40	40	0	MIAMI DADE WATER & SEWER DEPARTMENT	Single	1050	one 1050 gallon	90	1000
GDO	568	MGRU	5	300	Eating establishment	202	202	5970	CITY OF MIAMI BEACH	Single	950	one 950 gallon	30	149250
GDO	570	MGRU	5	150	Eating establishment	26	0	2100	MIAMI DADE WATER & SEWER DEPARTMENT		0	one 25 gpm	30	525
GDO	571	IGT	5	300	Eating establishment	149	149	0		Single	1200	one 1200 gallon	90	2086
GDO	574	IGT	5	300	Eating establishment	46	46	0		Single	1050	one 1050 gallon	90	1150
GDO	575	IGT	5	150	Eating establishment	65	65	3816	MIAMI DADE WATER & SEWER DEPARTMENT	Single	1200	one 1200 gallon	90	954
GDO	576	IGT	5	150	Eating establishment	30	30	0		Single	750	one 750 gallon	90	750
GDO	577	IGT	5	150	Eating establishment	20	20	0	MIAMI DADE WATER & SEWER DEPARTMENT	Single	1050	one 1050 gallon	90	5
GDO	578	IGT	5	150	Eating establishment	0	0	0	MIAMI DADE WATER & SEWER DEPARTMENT	Single	950	one 950 gallon	90	0
GDO	579	IGT	5	150	Eating establishment	0	0	0	MIAMI DADE WATER & SEWER DEPARTMENT	Single	750	one 750 gallon	90	0
GDO	580	IGT	5	300	Eating establishment	115	0	4318	MIAMI DADE WATER & SEWER DEPARTMENT	Series	4800	four 1200 gallon	90	1080
GDO	581	IGT	5	300	Eating establishment	117	117	0	MIAMI DADE WATER & SEWER DEPARTMENT	Series	3000	two 1500 gallon	90	1638
GDO	582	IGT	5	150	Eating establishment	56	0	2430	MIAMI DADE WATER & SEWER DEPARTMENT	Series	2400	two 1200 gallon	60	34020
GDO	584	IGT	5	300	Eating establishment	200	200	0	MIAMI DADE WATER & SEWER DEPARTMENT	Single	1200	one 1200 gallon	90	2800
GDO	587	IGT	5	150	Eating establishment	0	0	0	MIAMI DADE WATER & SEWER DEPARTMENT	Single	1200	one 1200 gallon	90	0
GDO	588	IGT	5	300	Eating establishment	74	74	0		Single	1200	one 1200 gallon	90	1036
GDO	589	IGT	5	150	Eating establishment	30	30	0	MIAMI DADE WATER & SEWER DEPARTMENT	Single	1500	one 1500 gallon	90	750
GDO	590	IGT	5	150	Eating establishment	60	60	2300	MIAMI DADE WATER & SEWER DEPARTMENT	Single	750	one 750 gallon	90	575
GDO	593	IGT	5	150	Eating establishment	30	30	0	MIAMI DADE WATER & SEWER DEPARTMENT		0	one 1200 gallon	90	420
GDO	595	IGT	5	150	Eating establishment	0	0	1720	MIAMI DADE WATER & SEWER DEPARTMENT	Single	1050	one 1050-gallon	90	430
GDO	598	IGT	5	150	Eating establishment	30	30	0		Single	1200	one 1200 gallon	90	420
GDO	599	IGT	5	300	Eating establishment	149	149	0		Single	1200	one 1200 gallon	90	3725
GDO	601	IGT	5	300	Eating establishment	149	149	0	MIAMI DADE WATER & SEWER DEPARTMENT	Series	2400	two 1200 gallon	90	2086
GDO	602	IGT	5	300	Eating establishment	72	72	0	MIAMI DADE WATER & SEWER DEPARTMENT	Single	1050	one 1050 gallon	90	1008
GDO	606	MGRU	5	150	Eating establishment	90	0	2839	CITY OF MIAMI BEACH		0	one 50 and one 15 gpm	30	710
GDO	608	IGT	5	150	Eating establishment	74	74	2658	MIAMI DADE WATER & SEWER DEPARTMENT	Series	2100	two 1050 gallon	90	665
GDO	609	IGT	5	300	Eating establishment	117	117	4320	MIAMI DADE WATER & SEWER DEPARTMENT	Series	2100	two 1050 gallon	90	1080
GDO	610	IGT	5	300	Eating establishment	85	85	0	AVENTURA	Series	2400	two 1200 gallon	90	2125
GDO	611	IGT	5	150	Eating establishment	0	0	0		Series	2100	two 1050 gallon	90	0
GDO	614	MGRU	5	150	Eating establishment	0	0	1328	MIAMI DADE WATER & SEWER DEPARTMENT		0	one 100 gpm	30	332
GDO	615	IGT	5	300	Eating establishment	5	5	0	MIAMI DADE WATER & SEWER DEPARTMENT	Single	750	one 750 gallon	90	1
GDO	621	IGT	5	150	Eating establishment	10	10	0	MIAMI DADE WATER & SEWER DEPARTMENT	Single	1600	one 1600 gallon	90	140
GDO	622	IGT	5	150	Eating establishment	0	0	0	MIAMI DADE WATER & SEWER DEPARTMENT	Single	750	one 750 gallon	90	0
GDO	623	IGT	5	300	Eating establishment	100	100	0	MIAMI DADE WATER & SEWER DEPARTMENT	Single	1050	one 1050 gallon	90	2500
GDO	624	IGT	5	150	Eating establishment	0	0	0	MIAMI DADE WATER & SEWER DEPARTMENT	Single	1200	one 1200 gallon	90	0
GDO	625	IGT	5	150	Eating establishment	25	25	0		Single	750	one 750 gallon	90	350
GDO	626	IGT	5	150	Eating establishment	0	0	0		Single	1200	one 1200 gallon	90	0
GDO	627	IGT	5	150	Eating establishment	0	0	1280		Single	1050	one 1050-gallon	90	320
GDO	628	IGT	5	150	Eating establishment	600	600	0		Single	1500	one 1500 gallon	90	600
GDO	632	IGT	5	150	Eating establishment	42	42	0		Single	1500	one 1500 gallon	90	1050
GDO	633	IGT	5	150	Eating establishment	13	13	697	CITY OF MIAMI BEACH	Single	750	one 750-gallon	90	174
GDO	634	IGT	5	300	Eating establishment	52	56	0	CITY OF MIAMI BEACH	Single	1050	one 1050 gallon	90	728
GDO	635	MGRU	5	150	Eating establishment	30	30	0	CITY OF MIAMI BEACH		0	one 25 gpm	30	750
GDO	640	AGRU	5	150	Eating establishment	8	8	1000	MIAMI DADE WATER & SEWER DEPARTMENT		0	one 35 gpm	30	2
GDO	641	IGT	5	150	Eating establishment	6	6	3200	MIAMI DADE WATER & SEWER DEPARTMENT	Single	750	one 750 gallon	90	800
GDO	644	IGT	5	150	Eating establishment	0	0	800	MIAMI DADE WATER & SEWER DEPARTMENT	Single	750	one 750-gallon	90	200
GDO	649	IGT	5	300	Eating establishment	149	149	0	MIAMI DADE WATER & SEWER DEPARTMENT	Series	2400	two 1200 gallon	90	2086
GDO	650	IGT	5	150	Eating establishment	25	25	0	MIAMI DADE WATER & SEWER DEPARTMENT	Single	1050	one 1050 gallon	90	6
GDO	651	IGT	5	300	Eating establishment	110	110	0	MIAMI DADE WATER & SEWER DEPARTMENT	Single	1200	one 1200 gallon	90	2750
GDO	652	IGT	5	300	Eating establishment	65	65	0	MIAMI DADE WATER & SEWER DEPARTMENT	Single	750	one 750 gallon	90	1625

WORK GROUP	PERMIT NUMBER	PERMIT CLASS	PERMIT	PERMIT FEE	BUSINESS_TYPE	RECORDED SEATS	OBSERVED SEATS	FACILITY AREA	UTILITY	SYSTEM FORMAT	TOTAL CAPACITY	TANK_CAPACITY	PUMP OUT	TOTAL GPD
GDO	653	IGT	5	300	Eating establishment	40	40	0	CITY OF HOMESTEAD	Single	750	one 750 gallon	90	1000
GDO	654	IGT	5	150	Eating establishment	0	0	0	CITY OF HOMESTEAD	Single	1200	one 1200 gallon	90	0
GDO	655	IGT	5	300	Eating establishment	161	161	0	MIAMI DADE WATER & SEWER DEPARTMENT	Single	1200	one 1200 gallon	90	4025
GDO	656	IGT	5	150	Eating establishment	9	9	600	CITY OF HIALEAH	Single	750	one 750 gallon	90	150
GDO	657	IGT	5	300	Eating establishment	149	149	0	MIAMI DADE WATER & SEWER DEPARTMENT	Single	2000	one 2000 gallon	90	2086
GDO	658	MGRU	5	150	Eating establishment	0	0	0	MIAMI DADE WATER & SEWER DEPARTMENT	Single	750	one 750-gallon	30	0
GDO	659	IGT	5	150	Eating establishment	0	0	0		Single	1200	one 1200 gallon	90	0
GDO	660	IGT	5	300	Eating establishment	149	149	0	MIAMI DADE WATER & SEWER DEPARTMENT	Single	2400	two 1200 gallon	90	3725
GDO	661	IGT	5	300	Eating establishment	56	0	0	CITY OF HIALEAH	Series	1500	two 750 gallon	60	784
GDO	662	IGT	5	300	Eating establishment	50	50	0	MIAMI DADE WATER & SEWER DEPARTMENT	Single	1200	one 1200 gallon	90	1250
GDO	664	AGRU	5	150	Eating establishment	12	12	0	MIAMI DADE WATER & SEWER DEPARTMENT		0	one 25 gpm	30	168
GDO	665	IGT	5	300	Eating establishment	54	54	0		Single	1200	one 1200 gallon	90	756
GDO	666	IGT	5	300	Eating establishment	100	100	0	CITY OF HOMESTEAD	Series	3000	two 1500 gallon	90	1400
GDO	668	IGT	5	150	Eating establishment	44	44	1765	MIAMI DADE WATER & SEWER DEPARTMENT	Single	1200	one 1200-gallon	90	441
GDO	670	IGT	5	150	Eating establishment	27	27	1200	CITY OF HIALEAH	Single	1050	one 1050 gallon	60	300
GDO	671	IGT	5	150	Eating establishment	0	0	0	MIAMI DADE WATER & SEWER DEPARTMENT	Single	950	one 950 gallon	90	0
GDO	672	IGT	5	150	Eating establishment	62	62	1200	MIAMI DADE WATER & SEWER DEPARTMENT	Single	1200	one 1200 gallon	90	1550
GDO	674	IGT	5	150	Eating establishment	48	48	1675	MIAMI DADE WATER & SEWER DEPARTMENT	Single	1050	one 1050-gallon	90	419
GDO	675	MGRU	5	150	Eating establishment	34	34	800	CITY OF HIALEAH		0	one 25 gpm	30	200
GDO	679	IGT	5	300	Eating establishment	74	74	0		Single	1200	one 1200 gallon	90	1036
GDO	682	IGT	5	300	Eating establishment	149	149	0	MIAMI DADE WATER & SEWER DEPARTMENT	Series	2400	two 1200 gallon	90	2086
GDO	683	IGT	5	300	Eating establishment	229	229	4529	CITY OF HIALEAH	Single	1250	one 1250 gallon	90	1132
GDO	687	IGT	5	300	Eating establishment	52	52	0	CITY OF HIALEAH	Single	1050	one 1050 gallon	90	1300
GDO	689	IGT	5	150	Eating establishment	16	16	1000	MIAMI DADE WATER & SEWER DEPARTMENT	Single	950	one 950-gallon	90	250
GDO	690	IGT	5	300	Eating establishment	86	86	0	CITY OF HIALEAH	Single	1500	one 1500 gallon	90	1204
GDO	691	IGT	5	300	Eating establishment	74	74	0		Single	1200	one 1200 gallon	90	1850
GDO	692	IGT	5	150	Eating establishment	3	3	900	MIAMI DADE WATER & SEWER DEPARTMENT	Single	750	one 750-gallon	90	225
GDO	693	MGRU	5	150	Eating establishment	50	0	2876	CITY OF FLORIDA CITY	Single	1200	one 1200 gallon and one 100 gpm	90	719
GDO	695	IGT	5	150	Eating establishment	96	0	3000	MIAMI DADE WATER & SEWER DEPARTMENT	Single	750	one 750 gallon	30	750
GDO	697	IGT	5	300	Eating establishment	74	74	0	MIAMI DADE WATER & SEWER DEPARTMENT	Single	950	one 950 gallon	90	1850
GDO	698	IGT	5	300	Eating establishment	78	78	0		Single	1200	one 1200 gallon	90	1950
GDO	700	MGRU	5	150	Eating establishment	0	0	900	MIAMI DADE WATER & SEWER DEPARTMENT		0	one 35 gpm	30	225
GDO	701	IGT	5	300	Eating establishment	74	74	0	MIAMI DADE WATER & SEWER DEPARTMENT	Single	1200	one 1200 gallon	90	1850
GDO	703	IGT	5	300	Eating establishment	70	70	0		Series	2100	two 1050 gallon	90	980
GDO	705	IGT	5	150	Eating establishment	66	66	2613	MIAMI DADE WATER & SEWER DEPARTMENT	Single	1050	one 1050 gallon	90	653
GDO	706	IGT	5	300	Eating establishment	76	76	0		Single	1050	one 1050 gallon	90	1064
GDO	707	IGT	5	150	Eating establishment	18	91	2078	MIAMI DADE WATER & SEWER DEPARTMENT	Single	750	one 750 gallon	90	520
GDO	709	IGT	5	150	Eating establishment	0	0	1175	MIAMI DADE WATER & SEWER DEPARTMENT	Single	1050	one 1050 gallon	90	294
GDO	711	IGT	5	300	Eating establishment	79	79	0	MIAMI DADE WATER & SEWER DEPARTMENT	Single	950	one 950 gallon	90	1975
GDO	716	IGT	5	150	Eating establishment	45	45	0	MIAMI DADE WATER & SEWER DEPARTMENT	Single	1500	one 1500 gallon	90	630
GDO	717	IGT	5	150	Eating establishment	80	0	2900	MIAMI DADE WATER & SEWER DEPARTMENT	Single	1250	one 1250 gallon	60	725
GDO	718	IGT	5	300	Eating establishment	200	200	0	MIAMI DADE WATER & SEWER DEPARTMENT	Series	2100	two 1050 gallon	90	5000
GDO	719	IGT	5	300	Eating establishment	149	149	0	MIAMI DADE WATER & SEWER DEPARTMENT	Series	2400	two 1200 gallon	90	2086
GDO	720	IGT	5	300	Eating establishment	149	149	0	MIAMI DADE WATER & SEWER DEPARTMENT	Series	2400	two 1200 gallon	90	2086
GDO	721	IGT	5	150	Eating establishment	84	84	1500		Single	1200	one 1200 gallon	90	375
GDO	722	IGT	5	300	Eating establishment	74	74	0		Single	950	one 950 gallon	90	1036
GDO	724	IGT	5	300	Eating establishment	59	59	0		Single	1050	one 1050 gallon	90	826
GDO	727	IGT	5	300	Eating establishment	75	75	0	CITY OF HIALEAH	Series	2400	two 1200 gallon	90	1050
GDO	730	IGT	5	150	Eating establishment	74	74	2300	CITY OF HOMESTEAD	Single	1050	one 1050 gallon	90	575
GDO	731	IGT	5	150	Eating establishment	30	30	800	MIAMI DADE WATER & SEWER DEPARTMENT	Single	1050	one 1050-gallon	90	200
GDO	734	IGT	5	300	Eating establishment	85	85	0	MIAMI DADE WATER & SEWER DEPARTMENT	Single	750	one 750 gallon	90	2125
GDO	735	IGT	5	150	Eating establishment	40	40	2700	MIAMI DADE WATER & SEWER DEPARTMENT	Single	750	one 750 gallon	90	675
GDO	736	AGRU	5	150	Eating establishment	0	0	0	CITY OF MIAMI BEACH		0	one 20 gpm	30	0
GDO	737	IGT	5	150	Eating establishment	128	0	3600	MIAMI DADE WATER & SEWER DEPARTMENT	Series	2400	two 1200 gallon	90	900
GDO	738	IGT	5	150	Eating establishment	20	20	1508	MIAMI DADE WATER & SEWER DEPARTMENT	Single	750	one 750 gallon	90	5
GDO	739	IGT	5	300	Eating establishment	95	95	0	MIAMI DADE WATER & SEWER DEPARTMENT	Single	1500	one 1500 gallon	90	1330
GDO	741	IGT	5	300	Eating establishment	149	149	0	CITY OF HOMESTEAD	Single	1200	one 1200 gallon	90	3725
GDO	742	IGT	5	150	Eating establishment	60	60	0		Single	1200	one 1200 gallon	90	575
GDO	743	IGT	5	150	Eating establishment	46	46	0	CITY OF FLORIDA CITY	Single	1200	one 1200 gallon	90	644
GDO	745	IGT	5	150	Eating establishment	47	47	1400	MIAMI DADE WATER & SEWER DEPARTMENT	Single	950	one 950 gallon	90	350

WORK GROUP	PERMIT NUMBER	PERMIT CLASS	PERMIT	PERMIT FEE	BUSINESS_TYPE	RECORDED SEATS	OBSERVED SEATS	FACILITY AREA	UTILITY	SYSTEM FORMAT	TOTAL CAPACITY	TANK_CAPACITY	PUMP OUT	TOTAL GPD
GDO	747	IGT	5	150	Eating establishment	49	49	2300	MIAMI DADE WATER & SEWER DEPARTMENT	Single	1500	one 1500 gallon	90	575
GDO	749	IGT	5	300	Eating establishment	190	190	10175	CITY OF MIAMI BEACH	Single	750	one 750 gallon	90	2544
GDO	752	IGT	5	150	Eating establishment	24	0	1000	CITY OF HIALEAH	Single	1200	one 1200 gallon	60	250
GDO	753	IGT	5	150	Eating establishment	42	42	1320	MIAMI DADE WATER & SEWER DEPARTMENT	Single	1500	one 1500 gallon	90	330
GDO	756	IGT	5	150	Eating establishment	44	44	4587	MIAMI DADE WATER & SEWER DEPARTMENT	Series	2500	two 1250 gallon	90	616
GDO	762	IGT	5	300	Eating establishment	149	149	0	MIAMI DADE WATER & SEWER DEPARTMENT	Single	950	one 950 gallon	90	3725
GDO	763	IGT	5	150	Eating establishment	300	300	0	CITY OF MIAMI SPRINGS	Single	1200	one 1200 gallon	90	75
GDO	764	IGT	5	150	Eating establishment	72	72	2500	MIAMI DADE WATER & SEWER DEPARTMENT	Single	1200	one 1200 gallon	90	625
GDO	766	IGT	5	300	Eating establishment	149	149	0		Single	1050	one 1050 gallon	90	2086
GDO	769	IGT	5	150	Eating establishment	0	0	910	MIAMI DADE WATER & SEWER DEPARTMENT	Single	1050	one 1050 gallon	90	228
GDO	771	IGT	5	150	Eating establishment	20	20	0	MIAMI DADE WATER & SEWER DEPARTMENT	Single	750	one 750 gallon	90	280
GDO	772	IGT	5	150	Eating establishment	50	50	0		Single	1050	one 1050 gallon	90	700
GDO	773	AGRU	5	150	Eating establishment	26	26	1400	MIAMI DADE WATER & SEWER DEPARTMENT		0	one 35 gpm	30	350
GDO	774	IGT	5	150	Eating establishment	0	0	0		Single	1200	one 1200 gallon	90	0
GDO	775	IGT	5	150	Eating establishment	0	0	940	MIAMI DADE WATER & SEWER DEPARTMENT		750	one 750 gallon	90	235
GDO	776	IGT	5	300	Eating establishment	105	105	0	MIAMI DADE WATER & SEWER DEPARTMENT	Series	5000	four 1250 gallon	90	1470
GDO	777	IGT	5	150	Eating establishment	32	32	0	MIAMI DADE WATER & SEWER DEPARTMENT	Single	1500	one 1500 gallon	90	448
GDO	778	IGT	5	150	Eating establishment	10	10	2500	MIAMI DADE WATER & SEWER DEPARTMENT	Single	950	one 950 gallon	90	625
GDO	779	IGT	5	150	Eating establishment	100	100	0	CITY OF NORTH MIAMI BEACH	Single	1050	one 1050 gallon	90	2000
GDO	780	IGT	5	150	Eating establishment	50	50	0	MIAMI DADE WATER & SEWER DEPARTMENT	Single	1050	one 1050 gallon	90	1250
GDO	781	IGT	5	150	Eating establishment	12	12	800	CITY OF HOMESTEAD	Single	1500	one 1500 gallon	90	200
GDO	782	IGT	5	150	Eating establishment	18	18	0	CITY OF NORTH MIAMI BEACH	Single	750	one 750 gallon	90	252
GDO	783	IGT	5	150	Eating establishment	0	0	0		Single	950	one 950 gallon	90	0
GDO	784	IGT	5	300	Eating establishment	88	88	0	CITY OF NORTH MIAMI BEACH	Single	950	one 950 gallon	90	2200
GDO	785	IGT	5	150	Eating establishment	30	0	1608	CITY OF NORTH MIAMI BEACH	Single	1200	one 1200 gallon	60	473
GDO	787	MGRU	5	150	Eating establishment	25	25	0	MIAMI DADE WATER & SEWER DEPARTMENT		0	one 25 gpm	30	350
GDO	789	IGT	5	150	Eating establishment	25	25	0		Single	900	one 900 gallon	90	625
GDO	790	IGT	5	150	Eating establishment	24	24	830	MIAMI DADE WATER & SEWER DEPARTMENT	Single	750	one 750 gallon	60	208
GDO	794	IGT	5	300	Eating establishment	103	103	0	CITY OF FLORIDA CITY	Single	3200	two 1200 gallon	90	1442
GDO	795	IGT	5	150	Eating establishment	49	0	2794	CITY OF NORTH MIAMI BEACH	Single	1050	one 1050 gallon	60	699
GDO	796	IGT	5	300	Eating establishment	210	195	0	MIAMI DADE WATER & SEWER DEPARTMENT	Single	2450	one 950 & one 1500 gallon	90	4875
GDO	798	IGT	5	300	Eating establishment	150	150	0	MIAMI DADE WATER & SEWER DEPARTMENT	Parallel	3300	two 1650 gallon	90	3750
GDO	802	IGT	5	150	Eating establishment	0	0	0		Single	1200	one 1200 gallon	90	0
GDO	804	IGT	5	150	Eating establishment	20	20	1945	CITY OF NORTH MIAMI BEACH	Single	1200	one 1200 gallon	90	280
GDO	805	IGT	5	150	Eating establishment	74	74	2000	MIAMI DADE WATER & SEWER DEPARTMENT	Single	1200	one 1200 gallon	90	500
GDO	812	IGT	5	300	Eating establishment	108	108	0	MIAMI DADE WATER & SEWER DEPARTMENT	Series	2400	two 1200 gallon	90	1512
GDO	813	IGT	5	750	Eating establishment	295	295	0	MIAMI DADE WATER & SEWER DEPARTMENT	Series	3000	two 1500 gallon	90	7375
GDO	815	MGRU	5	150	Eating establishment	31	31	565	MIAMI DADE WATER & SEWER DEPARTMENT		0	one 25 gpm	30	141
GDO	818	IGT	5	150	Eating establishment	9	9	0		Single	1050	one 1050 gallon	90	2
GDO	819	MGRU	5	150	Eating establishment	30	30	1200	MIAMI DADE WATER & SEWER DEPARTMENT		0	one 20 gpm	30	300
GDO	820	IGT	5	300	Eating establishment	54	54	0	MIAMI DADE WATER & SEWER DEPARTMENT	Single	1200	one 1200 gallon	90	1350
GDO	823	IGT	5	750	Eating establishment	436	436	0	MIAMI DADE WATER & SEWER DEPARTMENT	Series	3200	two 1600 gallon	90	10900
GDO	824	IGT	5	150	Eating establishment	0	0	0		Single	2100	two 1050 gallon	90	0
GDO	829	IGT	5	150	Eating establishment	68	68	1500	CITY OF HIALEAH	Single	750	one 750 gallon	90	1700
GDO	832	IGT	5	150	Eating establishment	30	30	850	CITY OF HIALEAH	Single	750	one 750-gallon	90	213
GDO	833	IGT	5	150	Eating establishment	120	120	3360	MIAMI DADE WATER & SEWER DEPARTMENT	Single	950	one 950 gallon	90	840
GDO	837	IGT	5	150	Eating establishment	32	32	0		Single	1200	one 1200 gallon	90	800
GDO	839	IGT	5	150	Eating establishment	12	12	1500	MIAMI DADE WATER & SEWER DEPARTMENT	Single	1200	one 1200 gallon	90	375
GDO	843	IGT	5	750	Eating establishment	250	250	0	MIAMI DADE WATER & SEWER DEPARTMENT	Single	1900	two 950 gallon	90	6250
GDO	844	IGT	5	300	Eating establishment	200	200	0	MIAMI DADE WATER & SEWER DEPARTMENT	Single	1200	one 1200 gallon	90	5000
GDO	848	IGT	5	150	Eating establishment	5	5	0		Single	1500	one 1500 gallon	90	1
GDO	850	IGT	5	300	Eating establishment	70	70	0		Single	1500	one 1500 gallon	90	980
GDO	853	IGT	5	150	Eating establishment	51	51	1393	CITY OF MIAMI BEACH	Series	900	two 450-gallon	90	423
GDO	854	AGRU	5	150	Eating establishment	32	32	0	CITY OF MIAMI BEACH		0	one 25 gallon	30	800
GDO	856	IGT	5	300	Eating establishment	74	74	4053	MIAMI DADE WATER & SEWER DEPARTMENT	Series	2400	two 1200 gallon	90	1013
GDO	857	IGT	5	300	Eating establishment	250	0	7443	MIAMI DADE WATER & SEWER DEPARTMENT	Series	1200	two 1200 gallon	90	1861
GDO	860	IGT	5	300	Eating establishment	109	109	0	MIAMI DADE WATER & SEWER DEPARTMENT	Single	750	one 750 gallon	90	2725
GDO	862	IGT	5	150	Eating establishment	30	30	0	CITY OF HIALEAH	Single	750	one 750 gallon	90	750
GDO	863	IGT	5	150	Eating establishment	16	16	990	MIAMI DADE WATER & SEWER DEPARTMENT	Single	750	one 750 gallon	90	248
GDO	864	IGT	5	150	Eating establishment	72	72	3076	CITY OF HIALEAH	Single	1200	one 1200 gallon	90	769

WORK GROUP	PERMIT NUMBER	PERMIT CLASS	PERMIT	PERMIT FEE	BUSINESS_TYPE	RECORDED SEATS	OBSERVED SEATS	FACILITY AREA	UTILITY	SYSTEM FORMAT	TOTAL CAPACITY	TANK_CAPACITY	PUMP OUT	TOTAL GPD
GDO	865	IGT	5	300	Eating establishment	87	87	0	CITY OF HIALEAH	Series	2400	two 1200 gallon	90	1218
GDO	867	IGT	5	150	Eating establishment	0	0	1372	MIAMI DADE WATER & SEWER DEPARTMENT	Single	750	one 750 gallon	90	343
GDO	870	IGT	5	150	Eating establishment	40	40	0	CITY OF HIALEAH	Single	1050	one 1050 gallon	90	1000
GDO	871	IGT	5	150	Eating establishment	40	40	0	MIAMI DADE WATER & SEWER DEPARTMENT		1050	one 1050 gallon	90	1000
GDO	872	MGRU	2	150	Eating establishment	25	25	1605	MIAMI DADE WATER & SEWER DEPARTMENT		0	one 25 gpm	30	401
GDO	874	IGT	5	150	Eating establishment	48	48	1500	MIAMI DADE WATER & SEWER DEPARTMENT	Single	750	one 750 gallon	90	375
GDO	875	MGRU	5	150	Eating establishment	0	0	525	MIAMI DADE WATER & SEWER DEPARTMENT		0	one 35 gpm	30	131
GDO	877	AGRU	5	300	Eating establishment	118	118	0	MIAMI DADE WATER & SEWER DEPARTMENT		0	one 75 gpm	30	1652
GDO	879	IGT	5	300	Eating establishment	74	74	0		Single	1050	one 1050 gallon	90	1850
GDO	880	MGRU	5	150	Eating establishment	12	0	620	MIAMI DADE WATER & SEWER DEPARTMENT		0	one 50 and one 25 gpm	30	155
GDO	881	MGRU	5	150	Eating establishment	26	26	1000	MIAMI DADE WATER & SEWER DEPARTMENT		0	one 25 gpm	30	250
GDO	884	IGT	5	300	Eating establishment	74	64	0	MIAMI DADE WATER & SEWER DEPARTMENT	Single	1050	one 1050 gallon	90	0
GDO	892	IGT	5	300	Eating establishment	70	70	8477	MIAMI DADE WATER & SEWER DEPARTMENT	Single	1050	one 1050 gallon	90	2119
GDO	893	IGT	5	150	Eating establishment	30	30	0		Single	1050	one 1050 gallon	90	750
GDO	894	IGT	5	300	Eating establishment	149	149	0	MIAMI DADE WATER & SEWER DEPARTMENT	Single	750	one 750 gallon	90	2086
GDO	897	IGT	5	150	Eating establishment	74	40	0	MIAMI DADE WATER & SEWER DEPARTMENT	Single	1050	one 1050 gallon	90	560
GDO	899	IGT	5	150	Eating establishment	36	36	1200	CITY OF HIALEAH	Single	1200	one 1200 gallon	90	900
GDO	901	MGRU	5	150	Eating establishment	90	90	833	CITY OF HIALEAH		0	one 25 gpm	30	208
GDO	902	IGT	5	150	Eating establishment	20	20	1795	MIAMI DADE WATER & SEWER DEPARTMENT	Single	750	one 750 gallon	90	449
GDO	903	IGT	5	150	Eating establishment	0	0	875	CITY OF HIALEAH	Single	1050	one 1050 gallon	90	219
GDO	905	IGT	5	150	Eating establishment	0	0	0		Single	750	one 750 gallon	90	0
GDO	906	IGT	5	150	Eating establishment	80	0	2510	MIAMI DADE WATER & SEWER DEPARTMENT	Single	1000	one 1000 gallon	90	628
GDO	907	IGT	5	300	Eating establishment	90	90	0	MIAMI DADE WATER & SEWER DEPARTMENT	Single	750	one 750 gallon	90	2250
GDO	909	AGRU	5	150	Eating establishment	49	49	1100	MIAMI DADE WATER & SEWER DEPARTMENT		0	one 20 gpm	30	275
GDO	914	IGT	5	150	Eating establishment	50	50	2000	MIAMI DADE WATER & SEWER DEPARTMENT	Single	1050	one 1050 gallon	90	500
GDO	916	IGT	5	150	Eating establishment	39	0	2600	MIAMI DADE WATER & SEWER DEPARTMENT	Single	900	one 900 gallon	90	650
GDO	919	MGRU	5	150	Eating establishment	40	40	850	MIAMI DADE WATER & SEWER DEPARTMENT		0	one 25 gpm	30	213
GDO	920	MGRU	5	150	Eating establishment	60	60	2670	MIAMI DADE WATER & SEWER DEPARTMENT		0	two 100 gpm	30	668
GDO	921	IGT	5	300	Eating establishment	84	84	0	MIAMI DADE WATER & SEWER DEPARTMENT	Single	2000	one 2000 gallon	90	1176
GDO	927	IGT	5	300	Eating establishment	149	149	0		Single	1200	one 1200 gallon	90	3725
GDO	930	IGT	5	150	Eating establishment	0	0	0	MIAMI DADE WATER & SEWER DEPARTMENT	Single	1200	one 1200 gallon	90	0
GDO	933	IGT	5	150	Eating establishment	0	0	3000	MIAMI DADE WATER & SEWER DEPARTMENT	Single	750	one 750 gallon	90	750
GDO	935	IGT	5	300	Eating establishment	80	80	0	MIAMI DADE WATER & SEWER DEPARTMENT	Single	1200	one 1200 gallon	90	2000
GDO	937	IGT	5	150	Eating establishment	28	28	0	MIAMI DADE WATER & SEWER DEPARTMENT	Single	1050	one 1050 gallon	90	700
GDO	938	IGT	5	300	Eating establishment	74	74	0	MIAMI DADE WATER & SEWER DEPARTMENT	Single	1600	1	90	1036
GDO	940	IGT	5	150	Eating establishment	36	36	0	MIAMI DADE WATER & SEWER DEPARTMENT	Single	750	one 750 gallon	90	504
GDO	942	IGT	5	150	Eating establishment	0	0	2135	CITY OF HIALEAH GARDENS	Single	1250	one 1250 gallon	90	534
GDO	944	IGT	5	150	Eating establishment	36	36	1094	CITY OF MIAMI BEACH	Single	950	one 950 gallon	90	274
GDO	945	IGT	5	150	Eating establishment	40	0	1400	MIAMI DADE WATER & SEWER DEPARTMENT	Single	750	one 750 gallon	60	350
GDO	950	IGT	5	150	Eating establishment	30	30	1857	CITY OF MIAMI BEACH	Single	1200	one 1200 gallon	90	464
GDO	951	AGRU	5	150	Eating establishment	60	60	3593	CITY OF MIAMI BEACH		0	one 25-gpm	30	898
GDO	952	MGRU	5	150	Eating establishment	0	0	1100	CITY OF MIAMI BEACH		0	one 25-gpm	30	275
GDO	953	IGT	5	300	Eating establishment	98	0	3150	MIAMI DADE WATER & SEWER DEPARTMENT	Single	1250	one 1250 gallon	60	788
GDO	954	MGRU	5	300	Eating establishment	70	70	0	CITY OF MIAMI BEACH		0	one 50 gpm	30	1750
GDO	961	IGT	5	150	Eating establishment	24	24	0	CITY OF HIALEAH	Single	1200	one 1200 gallon	90	336
GDO	962	IGT	5	300	Eating establishment	90	0	3117		Single	1500	one 1500 gallon	60	779
GDO	964	IGT	5	300	Eating establishment	90	90	3423	CITY OF HIALEAH	Single	1250	one 1250-gallon	90	47922
GDO	965	IGT	5	150	Eating establishment	10	10	1215	MIAMI DADE WATER & SEWER DEPARTMENT	Single	750	one 750 gallon	90	304
GDO	966	IGT	5	150	Eating establishment	5	5	0		Single	1050	one 1050 gallon	90	1
GDO	968	IGT	5	150	Eating establishment	80	80	1800	MIAMI DADE WATER & SEWER DEPARTMENT	Single	1200	one 1200 gallon	90	450
GDO	969	IGT	5	150	Eating establishment	0	0	0	CITY OF HIALEAH	Single	1200	one 1200 gallon	90	0
GDO	970	MGRU	5	150	Eating establishment	22	22	0	CITY OF NORTH MIAMI BEACH		0	Not applicable	0	308
GDO	971	IGT	5	150	Eating establishment	24	39	0	CITY OF HIALEAH	Single	950	one 950 gallon	90	600
GDO	972	IGT	5	300	Eating establishment	78	78	0	CITY OF NORTH MIAMI BEACH	Single	950	one 950 gallon	90	1950
GDO	974	IGT	5	150	Eating establishment	80	80	2900	CITY OF HOMESTEAD	Single	1200	one 1200 gallon	90	725
GDO	976	IGT	5	300	Eating establishment	90	90	0	MIAMI DADE WATER & SEWER DEPARTMENT	Single	1500	one 1500 gallon	90	2250
GDO	977	IGT	5	150	Eating establishment	104	104	3228	MIAMI DADE WATER & SEWER DEPARTMENT	Single	1050	one 1050-gallon	90	807
GDO	980	AGRU	5	300	Eating establishment	60	60	4500	CITY OF MIAMI BEACH		0	one 25 gpm	30	1125
GDO	981	IGT	5	150	Eating establishment	75	75	2980	MIAMI DADE WATER & SEWER DEPARTMENT	Single	1050	one 1050 gallon	90	745

WORK GROUP	PERMIT NUMBER	PERMIT CLASS	PERMIT	PERMIT FEE	BUSINESS_TYPE	RECORDED SEATS	OBSERVED SEATS	FACILITY AREA	UTILITY	SYSTEM FORMAT	TOTAL CAPACITY	TANK_CAPACITY	PUMP OUT	TOTAL GPD
GDO	983	MGRU	5	150	Eating establishment	20	0	1200	CITY OF NORTH MIAMI BEACH		0	one 20 gpm	30	300
GDO	984	IGT	5	300	Eating establishment	74	74	0		Single	950	one 950 gallon	90	1850
GDO	989	IGT	5	750	Eating establishment	300	300	0	MIAMI DADE WATER & SEWER DEPARTMENT	Series	3300	one 1200 & two 1050 gallon	90	4200
GDO	992	MGRU	5	150	Eating establishment	19	19	600	MIAMI DADE WATER & SEWER DEPARTMENT		0	one 100 gpm	30	266
GDO	994	MGRU	5	150	Eating establishment	24	24	0	MIAMI DADE WATER & SEWER DEPARTMENT		0	one 25 gpm	30	600
GDO	995	MGRU	5	150	Eating establishment	15	15	800	MIAMI DADE WATER & SEWER DEPARTMENT		0	one 50 gpm	30	375
GDO	996	IGT	5	750	Eating establishment	327	327	0	MIAMI DADE WATER & SEWER DEPARTMENT	Single	1500	one 1500 gallon	90	4578
GDO	1000	MGRU	5	150	Eating establishment	36	0	750	CITY OF HIALEAH		0	one 25 gpm	30	188
GDO	1003	IGT	5	150	Eating establishment	110	110	2500	MIAMI DADE WATER & SEWER DEPARTMENT	Single	1200	one 1200 gallon	90	625
GDO	1006	IGT	5	300	Eating establishment	200	200	0		Single	1200	one 1200 gallon	90	5000
GDO	1007	IGT	5	300	Eating establishment	113	113	0	MIAMI DADE WATER & SEWER DEPARTMENT	Series	2400	two 1200 gallon	90	1582
GDO	1009	IGT	5	150	Eating establishment	0	0	0	CITY OF HIALEAH	Single	1200	one 1200 gallon	90	0
GDO	1010	IGT	5	300	Eating establishment	118	118	4700	CITY OF HIALEAH	Series	3600	two 1800 gallon	90	1175
GDO	1012	IGT	5	150	Eating establishment	0	0	0	CITY OF HIALEAH	Single	750	one 750 gallon	90	0
GDO	1015	MGRU	5	150	Eating establishment	30	30	0	MIAMI DADE WATER & SEWER DEPARTMENT		0	one 25 gpm	30	750
GDO	1020	AGRU	5	300	Eating establishment	22	22	4400	MIAMI DADE WATER & SEWER DEPARTMENT		0	one 25 gpm	30	1100
GDO	1024	IGT	5	300	Eating establishment	60	60	0	CITY OF HOMESTEAD	Single	1200	one 750 gallon	90	1500
GDO	1026	IGT	5	300	Eating establishment	200	200	10000	CITY OF HIALEAH	Single	1200	one 1200 gallon	90	1200
GDO	1027	IGT	5	150	Eating establishment	111	111	800	MIAMI DADE WATER & SEWER DEPARTMENT	Series	2400	two 1200 gallon	90	20000
GDO	1029	IGT	5	150	Eating establishment	68	68	1500	MIAMI DADE WATER & SEWER DEPARTMENT	Single	1500	one 1500 gallon	90	375
GDO	1031	AGRU	5	150	Eating establishment	60	60	1000	CITY OF MIAMI BEACH		0	one 25 gpm	30	250
GDO	1033	MGRU	5	150	Eating establishment	48	0	3265	CITY OF MIAMI BEACH	Single	1200	one 1200-gallon	30	816
GDO	1034	IGT	5	150	Eating establishment	52	52	0	MIAMI DADE WATER & SEWER DEPARTMENT	Single	1200	one 1200 gallon	90	728
GDO	1035	IGT	5	150	Eating establishment	52	0	2199	MIAMI DADE WATER & SEWER DEPARTMENT	Single	1200	one 1200 gallon	60	550
GDO	1036	MGRU	5	150	Eating establishment	34	34	0	MIAMI DADE WATER & SEWER DEPARTMENT		0	one 25 gpm	30	476
GDO	1037	MGRU	5	150	Eating establishment	10	10	750	CITY OF HIALEAH		0	one 25-gpm	30	188
GDO	1039	IGT	5	300	Eating establishment	136	136	0		Single	1200	one 1200 gallon	90	3400
GDO	1040	MGRU	5	150	Eating establishment	40	40	1200	CITY OF HOMESTEAD		0	one 25 gpm	30	300
GDO	1041	AGRU	5	150	Eating establishment	50	50	0			0	one 25 gpm	30	1250
GDO	1043	MGRU	5	150	Eating establishment	40	0	1350	MIAMI DADE WATER & SEWER DEPARTMENT		0	one 35 gpm	60	338
GDO	1044	IGT	5	150	Eating establishment	18	0	1750	MIAMI DADE WATER & SEWER DEPARTMENT	Single	900	one 900 gallon	60	438
GDO	1050	IGT	5	300	Eating establishment	75	75	0	MIAMI DADE WATER & SEWER DEPARTMENT	Single	750	one 750 gallon	90	1875
GDO	1051	IGT	5	150	Eating establishment	5	5	0	MIAMI DADE WATER & SEWER DEPARTMENT	Single	750	one 750 gallon	90	1
GDO	1053	IGT	5	150	Eating establishment	49	49	3061	MIAMI DADE WATER & SEWER DEPARTMENT	Single	750	one 750 gallon	90	765
GDO	1054	IGT	5	150	Eating establishment	30	30	0		Single	750	one 750 gallon	90	8
GDO	1055	IGT	5	150	Eating establishment	26	26	1150	MIAMI DADE WATER & SEWER DEPARTMENT	Single	750	one 750 gallon	90	28750
GDO	1057	IGT	5	150	Eating establishment	15	15	500	MIAMI DADE WATER & SEWER DEPARTMENT	Single	1050	one 1050 gallon	90	125
GDO	1058	IGT	5	150	Eating establishment	44	44	1200	MIAMI DADE WATER & SEWER DEPARTMENT	Single	950	one 950 gallon	90	300
GDO	1059	IGT	5	150	Eating establishment	49	0	1890	MIAMI DADE WATER & SEWER DEPARTMENT	Single	2500	one 2500 gallon	90	473
GDO	1062	IGT	5	150	Eating establishment	50	50	0	MIAMI DADE WATER & SEWER DEPARTMENT	Single	750	one 750 gallon	90	1250
GDO	1064	IGT	5	150	Eating establishment	25	25	0		Single	950	one 950 gallon	90	350
GDO	1070	IGT	5	300	Eating establishment	149	149	0		Single	1050	one 1050 gallon	90	2086
GDO	1071	MGRU	5	300	Eating establishment	207	207	2730	MIAMI DADE WATER & SEWER DEPARTMENT		0	one 25 gpm	30	683
GDO	1072	MGRU	5	150	Eating establishment	30	30	0			0	one 25 gpm	30	420
GDO	1076	MGRU	5	150	Eating establishment	24	24	750	MIAMI DADE WATER & SEWER DEPARTMENT		0	one 25 gpm	30	188
GDO	1079	MGRU	5	150	Eating establishment	29	29	0			0	one 25 gpm	30	406
GDO	1085	IGT	5	150	Eating establishment	77	0	2781	CITY OF HIALEAH	Single	950	one 950 gallon	90	695
GDO	1086	IGT	5	150	Eating establishment	128	128	2871	CITY OF HIALEAH	Single	1200	one 1200 gallon	90	468
GDO	1087	IGT	5	150	Eating establishment	0	0	750	CITY OF OPA LOCKA	Single	750	one 750-gallon	90	188
GDO	1089	IGT	5	300	Eating establishment	60	60	0		Series	2400	two 1200 gallon	90	840
GDO	1092	IGT	5	300	Eating establishment	75	75	0	CITY OF HIALEAH	Single	1050	one 1050 gallon	90	1050
GDO	1094	MGRU	5	150	Eating establishment	40	40	2000	MIAMI DADE WATER & SEWER DEPARTMENT		0	one 25 gpm	30	500
GDO	1095	IGT	5	150	Eating establishment	0	0	4000	MIAMI DADE WATER & SEWER DEPARTMENT	Single	950	one 950 gallon	90	1000
GDO	1097	MGRU	5	300	Eating establishment	70	0	6000	CITY OF MIAMI BEACH		0	one 75 gpm	60	1500
GDO	1099	IGT	5	750	Eating establishment	330	330	60005	MIAMI DADE WATER & SEWER DEPARTMENT	Series	9600	eight 1200 gallon	90	15001
GDO	1100	MGRU	5	150	Eating establishment	30	30	0	MIAMI DADE WATER & SEWER DEPARTMENT		0	one 25 gpm	30	420
GDO	1101	IGT	5	300	Eating establishment	150	150	0	MIAMI DADE WATER & SEWER DEPARTMENT	Series	4000	two 2000 gallon	90	3750
GDO	1103	IGT	5	300	Eating establishment	74	74	0	MIAMI DADE WATER & SEWER DEPARTMENT	Single	750	one 750 gallon	90	1036
GDO	1104	IGT	5	300	Eating establishment	74	74	0	CITY OF NORTH MIAMI BEACH	Single	1200	one 1200 gallon	90	1036
GDO	1108	IGT	5	300	Eating establishment	74	74	0	CITY OF HOMESTEAD	Single	950	one 950 gallon	90	1850

WORK GROUP	PERMIT NUMBER	PERMIT CLASS	PERMIT	PERMIT FEE	BUSINESS_TYPE	RECORDED SEATS	OBSERVED SEATS	FACILITY AREA	UTILITY	SYSTEM FORMAT	TOTAL CAPACITY	TANK_CAPACITY	PUMP OUT	TOTAL GPD
GDO	1110	IGT	5	300	Eating establishment	120	120	4000	MIAMI DADE WATER & SEWER DEPARTMENT	Single	1500	one 1500-gallon	90	100000
GDO	1111	IGT	2	300	Eating establishment	150	146	0	MIAMI DADE WATER & SEWER DEPARTMENT	Single	1500	one 1500 gallon	90	3650
GDO	1112	IGT	5	150	Eating establishment	34	34	1200	MIAMI DADE WATER & SEWER DEPARTMENT	Single	750	one 750 gallon	90	300
GDO	1117	MGRU	5	150	Eating establishment	20	20	1400	MIAMI DADE WATER & SEWER DEPARTMENT		0	one 25-gpm	30	350
GDO	1119	IGT	5	300	Eating establishment	80	80	0	MIAMI DADE WATER & SEWER DEPARTMENT	Single	750	one 750 gallon	90	2000
GDO	1120	MGRU	5	150	Eating establishment	30	30	600	MIAMI DADE WATER & SEWER DEPARTMENT		0	one 25 gpm	30	150
GDO	1127	IGT	5	150	Eating establishment	0	0	0	MIAMI DADE WATER & SEWER DEPARTMENT	Single	1050	one 1050 gallon	90	0
GDO	1128	IGT	5	150	Eating establishment	149	149	0	VIRGINIA GARDENS	Series	2400	two 1200 gallon	90	3725
GDO	1129	MGRU	5	150	Eating establishment	32	32	0	CITY OF HIALEAH		0	one 25 gpm	30	800
GDO	1132	IGT	5	150	Eating establishment	12	0	1400	MIAMI DADE WATER & SEWER DEPARTMENT	Single	1050	one 1050 gallon	60	350
GDO	1133	MGRU	5	150	Eating establishment	18	18	1200	MIAMI DADE WATER & SEWER DEPARTMENT		0	one 25 gpm	30	300
GDO	1134	MGRU	5	150	Eating establishment	12	0	260	MIAMI DADE WATER & SEWER DEPARTMENT		0	one 20 gpm	30	65
GDO	1135	IGT	5	300	Eating establishment	200	200	0		Series	3000	two 1500 gallon	90	5000
GDO	1137	AGRU	5	150	Eating establishment	44	44	0			0	one 25 gpm	30	616
GDO	1141	IGT	5	150	Eating establishment	0	0	0	MIAMI DADE WATER & SEWER DEPARTMENT	Single	1050	one 1050 gallon	90	0
GDO	1145	MGRU	5	150	Eating establishment	4	4	0	CITY OF HIALEAH		0	one 25 gpm	30	1
GDO	1146	IGT	5	150	Eating establishment	42	42	1000	CITY OF NORTH MIAMI BEACH	Series	1500	two 750 gallon	90	250
GDO	1148	IGT	5	300	Eating establishment	148	148	4016	MIAMI DADE WATER & SEWER DEPARTMENT	Single	1050	one 1050-gallon	90	1004
GDO	1150	IGT	5	300	Eating establishment	200	200	0		Single	1050	one 1050 gallon	90	5000
GDO	1152	IGT	5	150	Eating establishment	0	0	0	CITY OF NORTH BAY VILLAGE	Single	750	one 750 gallon	90	0
GDO	1153	IGT	5	300	Eating establishment	74	74	0		Single	1500	one 1500 gallon	90	1036
GDO	1156	AGRU	5	150	Eating establishment	30	30	1155	MIAMI DADE WATER & SEWER DEPARTMENT		0	one 25 gpm	30	289
GDO	1158	IGT	5	150	Eating establishment	38	38	0	MIAMI DADE WATER & SEWER DEPARTMENT	Single	750	one 750 gallon	90	532
GDO	1162	IGT	5	150	Eating establishment	0	0	990	MIAMI DADE WATER & SEWER DEPARTMENT	Single	900	one 900 gallon	60	248
GDO	1164	IGT	5	150	Eating establishment	49	0	1000	CITY OF MIAMI BEACH	Single	1050	one 1050 gallon	90	250
GDO	1168	IGT	5	150	Eating establishment	20	20	750	CITY OF NORTH MIAMI BEACH	Single	750	one 750 gallon	90	188
GDO	1169	MGRU	5	150	Eating establishment	8	8	650	CITY OF HIALEAH		0	one 10 gpm	30	163
GDO	1170	MGRU	5	150	Eating establishment	20	0	1571	MIAMI DADE WATER & SEWER DEPARTMENT		0	one 20 gpm	60	393
GDO	1171	IGT	5	150	Eating establishment	11	11	450	MIAMI DADE WATER & SEWER DEPARTMENT	Single	750	one 750-gallon	90	113
GDO	1175	IGT	5	150	Eating establishment	30	30	1800	CITY OF HIALEAH	Single	1200	one 1200 gallon	90	450
GDO	1176	IGT	5	150	Eating establishment	42	42	1300	CITY OF HIALEAH	Single	1500	one 1500 gallon	90	325
GDO	1178	MGRU	5	150	Eating establishment	7	7	0	CITY OF HIALEAH		0	one 25 gpm	30	2
GDO	1181	IGT	5	300	Eating establishment	88	88	0	CITY OF NORTH MIAMI BEACH	Series	2400	two 1200 gallon	90	1232
GDO	1182	IGT	5	150	Eating establishment	31	31	0	MIAMI DADE WATER & SEWER DEPARTMENT	Single	1200	one 1200 gallon	90	775
GDO	1183	IGT	5	150	Eating establishment	84	84	0	MIAMI DADE WATER & SEWER DEPARTMENT	Single	1050	one 1050 gallon	90	500
GDO	1186	IGT	5	300	Eating establishment	168	168	0		Single	950	one 950 gallon	90	4200
GDO	1188	AGRU	5	300	Eating establishment	149	149	0	MIAMI DADE WATER & SEWER DEPARTMENT		0	two 20 gpm	30	2086
GDO	1190	IGT	5	300	Eating establishment	62	62	0	MIAMI DADE WATER & SEWER DEPARTMENT	Series	2400	two 1200 gallon	90	868
GDO	1191	IGT	5	300	Eating establishment	290	290	5200	MIAMI DADE WATER & SEWER DEPARTMENT	Single	1200	one 1200 gallon	90	1300
GDO	1192	IGT	5	300	Eating establishment	100	100	0	MIAMI DADE WATER & SEWER DEPARTMENT	Single	1200	one 1200 gallon	90	2500
GDO	1195	MGRU	5	150	Eating establishment	34	34	1000	CITY OF HIALEAH		0	one 25 gpm	30	250
GDO	1196	IGT	5	300	Eating establishment	82	82	0	CITY OF HIALEAH	Single	950	one 950 gallon	90	2050
GDO	1202	IGT	5	150	Eating establishment	35	35	1261	MIAMI DADE WATER & SEWER DEPARTMENT	Single	750	one 750 gallon	90	315
GDO	1203	MGRU	5	150	Eating establishment	25	0	900	MIAMI DADE WATER & SEWER DEPARTMENT		0	one 10 gpm	30	225
GDO	1209	IGT	5	150	Eating establishment	68	68	2050	MIAMI DADE WATER & SEWER DEPARTMENT	Single	950	one 950 gallon	90	51250
GDO	1210	IGT	5	150	Eating establishment	20	20	0	MIAMI DADE WATER & SEWER DEPARTMENT	Single	750	one 750 gallon	90	280
GDO	1221	IGT	5	150	Eating establishment	30	30	2000	MIAMI DADE WATER & SEWER DEPARTMENT	Single	1200	one 1200 gallon	90	750
GDO	1222	IGT	5	150	Eating establishment	24	0	621	MIAMI DADE WATER & SEWER DEPARTMENT	Single	900	one 900 gallon	90	15525
GDO	1223	AGRU	5	150	Eating establishment	10	10	0	CITY OF NORTH MIAMI BEACH		0	one 35 gpm	30	3
GDO	1227	IGT	5	150	Eating establishment	20	20	0		Single	750	one 750 gallon	90	280
GDO	1228	MGRU	5	150	Eating establishment	27	27	800	MIAMI DADE WATER & SEWER DEPARTMENT		0	one 25 gpm	30	675
GDO	1230	MGRU	5	150	Eating establishment	19	19	500	MIAMI DADE WATER & SEWER DEPARTMENT		0	one 25 gpm	30	125
GDO	1233	MGRU	2	150	Eating establishment	90	90	1721	MIAMI DADE WATER & SEWER DEPARTMENT		0	one 25 gpm	30	430
GDO	1235	IGT	5	150	Eating establishment	30	30	1300	CITY OF HIALEAH	Single	1200	one 1200 gallon	90	12825
GDO	1236	IGT	5	150	Eating establishment	210	210	0	MIAMI DADE WATER & SEWER DEPARTMENT	Single	1200	one 1200 gallon	90	5250
GDO	1238	IGT	5	150	Eating establishment	0	0	1440	MIAMI DADE WATER & SEWER DEPARTMENT	Single	1200	one 1200 gallon	60	360
GDO	1239	IGT	5	150	Eating establishment	50	50	2858	MIAMI DADE WATER & SEWER DEPARTMENT	Single	1050	one 1050 gallon	90	715
GDO	1240	IGT	5	150	Eating establishment	10	10	0	CITY OF HOMESTEAD	Single	1050	one 1050 gallon	90	140
GDO	1242	IGT	5	150	Eating establishment	48	48	0	CITY OF HIALEAH		0	not applicable	90	1200
GDO	1243	IGT	5	150	Eating establishment	42	0	2120	MIAMI DADE WATER & SEWER DEPARTMENT	Single	1250	one 1250 gallon	60	530
GDO	1246	MGRU	5	150	Eating establishment	25	25	0	MIAMI DADE WATER & SEWER DEPARTMENT		0	one 25 gpm	30	625

WORK GROUP	PERMIT NUMBER	PERMIT CLASS	PERMIT	PERMIT FEE	BUSINESS_TYPE	RECORDED SEATS	OBSERVED SEATS	FACILITY AREA	UTILITY	SYSTEM FORMAT	TOTAL CAPACITY	TANK_CAPACITY	PUMP OUT	TOTAL GPD
GDO	1248	AGRU	5	150	Eating establishment	8	8	0			0	one 25 gpm	30	2
GDO	1249	IGT	5	150	Eating establishment	47	0	2000	MIAMI DADE WATER & SEWER DEPARTMENT	Single	1050	one 1050-gallon	60	500
GDO	1251	IGT	5	300	Eating establishment	80	80	3300	MIAMI DADE WATER & SEWER DEPARTMENT	Single	750	one 750 gallon	90	2000
GDO	1254	IGT	5	150	Eating establishment	22	22	0	CITY OF OPA LOCKA	Single	1200	one 1200 gallon	90	308
GDO	1255	IGT	5	300	Eating establishment	74	74	0	MIAMI DADE WATER & SEWER DEPARTMENT	Series	1900	two 950 gallon	90	1036
GDO	1256	IGT	5	150	Eating establishment	58	0	1600	MIAMI DADE WATER & SEWER DEPARTMENT	Single	1200	one 1200 gallon	60	400
GDO	1258	IGT	5	150	Eating establishment	35	35	0	MIAMI DADE WATER & SEWER DEPARTMENT	Single	750	one 750 gallon	90	875
GDO	1264	IGT	5	750	Eating establishment	243	243	0		Single	1200	one 1200 gallon	90	6075
GDO	1265	AGRU	5	150	Eating establishment	0	0	300	CITY OF NORTH MIAMI BEACH		0	one 25 gpm	30	75
GDO	1266	IGT	5	300	Eating establishment	60	60	0		Single	1200	one 1200 gallon	90	1500
GDO	1267	IGT	5	150	Eating establishment	45	45	0	CITY OF HIALEAH	Single	1200	one 1200 gallon	90	1125
GDO	1270	IGT	5	300	Eating establishment	159	159	0	MIAMI DADE WATER & SEWER DEPARTMENT	Single	950	one 950 gallon	90	3975
GDO	1271	IGT	5	150	Eating establishment	100	0	3500	MIAMI DADE WATER & SEWER DEPARTMENT	Single	1200	one 1200 gallon	90	875
GDO	1273	MGRU	5	300	Eating establishment	51	51	0			0	one 25 gpm	30	1275
GDO	1276	IGT	5	300	Eating establishment	75	0	2600	CITY OF NORTH MIAMI BEACH	Single	1050	one 1050 gallon	30	650
GDO	1280	AGRU	5	150	Eating establishment	12	0	1300	MIAMI DADE WATER & SEWER DEPARTMENT		0	one 35 gpm	30	325
GDO	1281	IGT	5	300	Eating establishment	74	74	0	CITY OF HIALEAH	Single	1200	one 1200 gallon	90	1850
GDO	1286	IGT	5	150	Eating establishment	38	38	1825	CITY OF NORTH MIAMI BEACH	Series	1050	one 1050 gallon	90	456
GDO	1287	IGT	5	150	Eating establishment	38	38	1800	CITY OF NORTH MIAMI BEACH	Single	1200	one 1200 gallon	90	450
GDO	1288	IGT	5	150	Eating establishment	18	18	725	MIAMI DADE WATER & SEWER DEPARTMENT	Single	750	one 750 gallon	90	181
GDO	1290	MGRU	5	150	Eating establishment	30	30	0	CITY OF HIALEAH		0	one 25 gpm	30	750
GDO	1291	IGT	5	150	Eating establishment	72	0	3000	CITY OF HIALEAH	Single	950	one 950 gallon	60	750
GDO	1292	AGRU	5	150	Eating establishment	25	25	600	MIAMI DADE WATER & SEWER DEPARTMENT		0	one 35 gpm	30	150
GDO	1294	AGRU	5	150	Eating establishment	73	73	2332	CITY OF NORTH MIAMI BEACH		0	three 25 gpm	30	583
GDO	1295	MGRU	5	150	Eating establishment	8	0	900	CITY OF MIAMI BEACH		0	one 50 gpm	30	225
GDO	1296	IGT	5	150	Eating establishment	0	0	895	MIAMI DADE WATER & SEWER DEPARTMENT	Single	1050	one 1050 gallon	90	0
GDO	1297	IGT	5	150	Eating establishment	0	0	0	MIAMI DADE WATER & SEWER DEPARTMENT	Single	1200	one 1200 gallon	90	0
GDO	1299	IGT	5	300	Eating establishment	74	74	4000	MIAMI DADE WATER & SEWER DEPARTMENT	Single	1050	one 1050 gallon	90	1000
GDO	1304	IGT	5	300	Eating establishment	74	0	2159	CITY OF HIALEAH	Single	1200	one 1200 gallon	60	540
GDO	1305	IGT	5	150	Eating establishment	170	170	1500	CITY OF HIALEAH	Single	1200	one 1200-gallon	90	375
GDO	1306	IGT	5	150	Eating establishment	18	18	0	CITY OF HIALEAH	Single	1500	one 1500 gallon	90	450
GDO	1307	IGT	5	150	Eating establishment	26	26	0	CITY OF HIALEAH	Single	1200	one 1200 gallon	90	650
GDO	1309	IGT	5	150	Eating establishment	6	6	1100	MIAMI DADE WATER & SEWER DEPARTMENT	Single	750	one 750 gallon	90	275
GDO	1310	IGT	5	750	Eating establishment	70000	70000	0	MIAMI DADE WATER & SEWER DEPARTMENT	Multiple	8400	seven 1200 gallon	90	42000
GDO	1311	IGT	5	300	Eating establishment	70	70	0	MIAMI DADE WATER & SEWER DEPARTMENT	Single	750	one 750 gallon	90	1750
GDO	1317	IGT	5	150	Eating establishment	48	48	0	CITY OF HIALEAH	Single	1050	one 1050 gallon	90	672
GDO	1320	IGT	5	150	Eating establishment	64	64	1200	MIAMI DADE WATER & SEWER DEPARTMENT	Single	750	one 750-gallon	90	300
GDO	1322	AGRU	5	150	Eating establishment	40	40	0	MIAMI DADE WATER & SEWER DEPARTMENT		0	two 35 gpm	30	1000
GDO	1323	IGT	5	300	Eating establishment	68	68	0	CITY OF NORTH MIAMI BEACH	Series	3000	two 1500 gallon	90	952
GDO	1326	IGT	5	150	Eating establishment	20	20	900	MIAMI DADE WATER & SEWER DEPARTMENT	Single	1050	one 1050 gallon	90	225
GDO	1330	IGT	5	300	Eating establishment	58	58	4320	CITY OF HIALEAH	Single	1500	one 1500 gallon	90	1080
GDO	1331	IGT	5	150	Eating establishment	35	35	2000		Single	1050	one 1050 gallon	90	500
GDO	1332	IGT	5	300	Eating establishment	238	0	6844	MIAMI DADE WATER & SEWER DEPARTMENT	Series	7000	two 3500 gallon	30	1711
GDO	1333	MGRU	5	300	Eating establishment	58	58	0	MIAMI DADE WATER & SEWER DEPARTMENT		0	one 25 gpm	30	1450
GDO	1334	IGT	5	150	Eating establishment	45	45	0	MIAMI DADE WATER & SEWER DEPARTMENT	Single	1200	one 1200 gallon	90	1125
GDO	1336	IGT	5	150	Eating establishment	0	0	0	MIAMI DADE WATER & SEWER DEPARTMENT	Single	1050	one 1050 gallon	90	0
GDO	1337	IGT	5	150	Eating establishment	74	74	2000	MIAMI DADE WATER & SEWER DEPARTMENT	Single	1050	one 1050 gallon	90	500
GDO	1339	IGT	5	300	Eating establishment	120	120	0	CITY OF HIALEAH	Single	1500	one 1500 gallon	90	3000
GDO	1343	MGRU	5	150	Eating establishment	49	49	1000	MIAMI DADE WATER & SEWER DEPARTMENT		0	one 25 gpm	30	250
GDO	1344	IGT	5	150	Eating establishment	100	100	2000	MIAMI DADE WATER & SEWER DEPARTMENT	Single	950	one 950 gallon	90	500
GDO	1346	MGRU	5	150	Eating establishment	110	0	3145	MIAMI DADE WATER & SEWER DEPARTMENT		0	one 50 gpm	30	786
GDO	1347	AGRU	5	300	Eating establishment	120	120	0	MIAMI DADE WATER & SEWER DEPARTMENT		0	one 25 gpm	30	3000
GDO	1350	IGT	5	300	Eating establishment	79	79	0	MIAMI DADE WATER & SEWER DEPARTMENT	Multiple	1800	one 750 & one 1050 gallon	90	1975
GDO	1352	IGT	5	150	Eating establishment	28	28	1400	CITY OF HIALEAH	Single	950	one 950-gallon	90	350
GDO	1358	IGT	5	750	Eating establishment	350	350	0	MIAMI DADE WATER & SEWER DEPARTMENT	Single	8000	one 8000 gallon	90	4900
GDO	1361	IGT	5	300	Eating establishment	207	207	6730	CITY OF MIAMI BEACH	Series	2500	two 1250-gallon	90	1683
GDO	1365	IGT	5	300	Eating establishment	74	74	0	MIAMI DADE WATER & SEWER DEPARTMENT	Single	1200	one 1200 gallon	90	1850
GDO	1368	AGRU	5	150	Eating establishment	55	55	2250	MIAMI DADE WATER & SEWER DEPARTMENT		0	one 25 gpm	30	56250
GDO	1370	IGT	5	300	Eating establishment	72	72	0	MIAMI DADE WATER & SEWER DEPARTMENT	Series	2400	two 1200 gallon	90	1800
GDO	1373	IGT	5	300	Eating establishment	74	74	0	MIAMI DADE WATER & SEWER DEPARTMENT	Single	1050	one 1050 gallon	90	1850

WORK GROUP	PERMIT NUMBER	PERMIT CLASS	PERMIT	PERMIT FEE	BUSINESS_TYPE	RECORDED SEATS	OBSERVED SEATS	FACILITY AREA	UTILITY	SYSTEM FORMAT	TOTAL CAPACITY	TANK_CAPACITY	PUMP OUT	TOTAL GPD
GDO	1374	IGT	5	300	Eating establishment	130	130	0	CITY OF HIALEAH	Single	1200	one 1200 gallon	90	3250
GDO	1375	IGT	5	150	Eating establishment	38	38	0		Single	750	one 750 gallon	90	532
GDO	1378	IGT	5	150	Eating establishment	132	132	2838	MIAMI DADE WATER & SEWER DEPARTMENT	Single	2000	one 2000-gallon	90	710
GDO	1383	IGT	5	150	Eating establishment	42	0	2200	CITY OF HIALEAH	Single	1050	one 1050 gallon	60	550
GDO	1390	IGT	5	300	Eating establishment	100	100	0	MIAMI DADE WATER & SEWER DEPARTMENT	Series	4000	two 2000 gallon	90	0
GDO	1391	IGT	5	150	Eating establishment	100	0	2000	CITY OF HIALEAH	Single	1050	one 1050 gallon	90	500
GDO	1392	IGT	5	150	Eating establishment	35	35	2025		Single	1050	one 1050-gallon	90	506
GDO	1393	IGT	5	150	Eating establishment	36	36	1408	MIAMI DADE WATER & SEWER DEPARTMENT	Single	950	one 950 gallon	90	900
GDO	1396	IGT	5	150	Eating establishment	48	48	0	MIAMI DADE WATER & SEWER DEPARTMENT	Single	1050	one 1050 gallon	90	672
GDO	1397	IGT	5	150	Eating establishment	98	98	3766	MIAMI DADE WATER & SEWER DEPARTMENT	Single	950	one 950 gallon	90	942
GDO	1399	IGT	5	150	Eating establishment	73	73	3965	CITY OF NORTH MIAMI BEACH	Single	750	one 750 gallon	90	991
GDO	1402	IGT	5	150	Eating establishment	20	20	0		Single	950	one 950 gallon	90	280
GDO	1405	IGT	5	150	Eating establishment	81	81	0	CITY OF HIALEAH	Series	2400	two 1200 gallon	90	1134
GDO	1406	IGT	5	300	Eating establishment	150	150	0	MIAMI DADE WATER & SEWER DEPARTMENT	Single	1200	one 1200 gallon	90	2100
GDO	1407	IGT	5	300	Eating establishment	131	131	0	MIAMI DADE WATER & SEWER DEPARTMENT	Single	2100	two 1050 gallon	90	3275
GDO	1408	IGT	5	150	Eating establishment	0	0	0	MIAMI DADE WATER & SEWER DEPARTMENT	Single	1050	one 1050 gallon	90	0
GDO	1410	MGRU	5	150	Eating establishment	12	12	1085	CITY OF MIAMI BEACH		0	one 15 gpm	30	271
GDO	1416	IGT	5	150	Eating establishment	40	40	0		Single	950	one 950 gallon	90	1000
GDO	1418	IGT	5	150	Eating establishment	35	35	2000	MIAMI DADE WATER & SEWER DEPARTMENT	Single	1200	one 1200 gallon	90	500
GDO	1421	IGT	5	150	Eating establishment	38	38	2000	MIAMI DADE WATER & SEWER DEPARTMENT	Single	1050	one 1050-gallon	90	500
GDO	1423	IGT	5	300	Eating establishment	70	70	0		Single	1200	one 1200 gallon	90	1750
GDO	1426	IGT	5	150	Eating establishment	139	139	0	CITY OF MIAMI BEACH	Single	1200	one 1200 gallon	90	139
GDO	1427	IGT	5	300	Eating establishment	200	200	12537	CITY OF MIAMI BEACH	Single	1200	one 1200 gallon	90	3134
GDO	1430	IGT	5	150	Eating establishment	100	0	2637	CITY OF HIALEAH	Single	750	one 750 gallon	60	659
GDO	1431	IGT	5	150	Eating establishment	38	38	0	CITY OF HIALEAH	Single	1200	one 1200 gallon	90	10
GDO	1433	IGT	5	300	Eating establishment	83	83	0	MIAMI DADE WATER & SEWER DEPARTMENT	Single	1200	one 1200 gallon	90	2075
GDO	1435	IGT	5	150	Eating establishment	36	36	0		Single	1050	one 1050 gallon	90	900
GDO	1438	IGT	5	300	Eating establishment	160	160	0	CITY OF HIALEAH	Single	1200	one 1200 gallon	90	4000
GDO	1440	IGT	5	300	Eating establishment	200	200	4300	CITY OF HIALEAH	Single	950	one 950 gallon	90	1075
GDO	1441	IGT	5	150	Eating establishment	30	30	1400	CITY OF HIALEAH	Single	1200	one 1200 gallon	90	350
GDO	1443	IGT	5	150	Eating establishment	78	78	2116	MIAMI DADE WATER & SEWER DEPARTMENT	Single	1050	one 1050 gallon	90	529
GDO	1446	IGT	5	150	Eating establishment	24	24	0	CITY OF HOMESTEAD	Single	1200	one 1050 gallon	90	600
GDO	1449	MGRU	5	150	Eating establishment	0	0	0	CITY OF NORTH MIAMI BEACH		0	one 25 gpm	30	0
GDO	1451	IGT	5	300	Eating establishment	64	64	0	MIAMI DADE WATER & SEWER DEPARTMENT	Single	1200	one 1200 gallon	90	896
GDO	1453	IGT	5	150	Eating establishment	88	88	3500	MIAMI DADE WATER & SEWER DEPARTMENT	Single	1500	one 1500 gallon	90	875
GDO	1454	IGT	5	150	Eating establishment	30	30	900	CITY OF HIALEAH	Single	1050	one 1050 gallon	90	225
GDO	1456	IGT	5	150	Eating establishment	5	5	0	CITY OF HIALEAH	Single	1200	one 1200 gallon	90	1
GDO	1457	IGT	5	150	Eating establishment	28	28	2300	MIAMI DADE WATER & SEWER DEPARTMENT	Single	750	one 750 gallon	90	575
GDO	1459	AGRU	5	150	Eating establishment	50	50	0	MIAMI DADE WATER & SEWER DEPARTMENT		0	one 25 gpm	30	1250
GDO	1460	IGT	5	150	Eating establishment	150	150	0		Multiple	9350	two 950, one 1050 and four 1600 gallon	90	3750
GDO	1461	MGRU	5	150	Eating establishment	30	0	850	CITY OF HIALEAH		0	one 25 gpm	30	213
GDO	1463	IGT	5	150	Eating establishment	40	40	0	MIAMI DADE WATER & SEWER DEPARTMENT	Single	1200	one 1200 gallon	90	560
GDO	1464	IGT	5	150	Eating establishment	64	64	2200	MIAMI DADE WATER & SEWER DEPARTMENT	Single	1200	one 1200 gallon	90	550
GDO	1465	IGT	5	300	Eating establishment	54	54	0	CITY OF HIALEAH	Single	1200	one 1200 gallon	90	1350
GDO	1472	IGT	5	300	Eating establishment	137	137	0	MIAMI DADE WATER & SEWER DEPARTMENT	Single	1050	one 1050 gallon	90	3425
GDO	1474	IGT	5	300	Eating establishment	109	109	0	MIAMI DADE WATER & SEWER DEPARTMENT	Single	1200	one 1200 gallon	90	2725
GDO	1476	MGRU	5	150	Eating establishment	5	5	0	CITY OF HIALEAH		0	one 25 gpm	30	125
GDO	1478	IGT	5	150	Eating establishment	9	9	0	CITY OF HIALEAH	Single	750	one 750 gallon	90	2
GDO	1482	IGT	5	150	Eating establishment	10	10	850	MIAMI DADE WATER & SEWER DEPARTMENT	Single	750	one 750 gallon	90	250
GDO	1483	IGT	5	300	Eating establishment	74	74	0	MIAMI DADE WATER & SEWER DEPARTMENT	Single	750	one 750 gallon	90	1850
GDO	1485	IGT	5	150	Eating establishment	22	22	0	MIAMI DADE WATER & SEWER DEPARTMENT	Single	750	one 750 gallon	90	550
GDO	1486	IGT	5	150	Eating establishment	0	0	0	MIAMI DADE WATER & SEWER DEPARTMENT	Single	1200	one 1200 gallon	90	0
GDO	1488	IGT	5	150	Eating establishment	30	30	0		Single	1200	one 1200 gallon	90	750
GDO	1489	IGT	5	150	Eating establishment	100	100	3000	MIAMI DADE WATER & SEWER DEPARTMENT	Single	950	one 950 gallon	90	750
GDO	1491	IGT	5	150	Eating establishment	60	60	1800	MIAMI DADE WATER & SEWER DEPARTMENT	Single	750	one 750 gallon	90	450
GDO	1492	IGT	5	300	Eating establishment	95	95	0	MIAMI DADE WATER & SEWER DEPARTMENT	Single	1050	one 1050 gallon	90	2375
GDO	1493	IGT	5	150	Eating establishment	24	0	2000	MIAMI DADE WATER & SEWER DEPARTMENT	Single	750	one 750 gallon	60	500
GDO	1495	IGT	5	300	Eating establishment	76	76	0	CITY OF NORTH MIAMI BEACH	Single	1200	one 1200 gallon	90	1064
GDO	1497	IGT	5	300	Eating establishment	225	0	10757	MIAMI DADE WATER & SEWER DEPARTMENT	Single	3000	one 3000 gallon	90	2689

WORK GROUP	PERMIT NUMBER	PERMIT CLASS	PERMIT	PERMIT FEE	BUSINESS_TYPE	RECORDED SEATS	OBSERVED SEATS	FACILITY AREA	UTILITY	SYSTEM FORMAT	TOTAL CAPACITY	TANK_CAPACITY	PUMP OUT	TOTAL GPD
GDO	1499	IGT	5	150	Eating establishment	0	0	0	MIAMI DADE WATER & SEWER DEPARTMENT	Single	750	one 750 gallon	90	0
GDO	1500	IGT	5	150	Eating establishment	25	25	750	MIAMI DADE WATER & SEWER DEPARTMENT	Single	750	one 750 gallon	90	188
GDO	1501	IGT	5	150	Eating establishment	0	0	624	CITY OF NORTH MIAMI BEACH	Single	1200	one 1200 gallon	90	156
GDO	1502	IGT	5	150	Eating establishment	49	0	2298	MIAMI DADE WATER & SEWER DEPARTMENT	Single	750	one 750 gallon	90	57450
GDO	1503	IGT	5	300	Eating establishment	74	74	0	CITY OF HIALEAH	Single	1200	one 1200 gallon	90	1850
GDO	1504	IGT	5	300	Eating establishment	56	56	0	CITY OF HIALEAH	Single	950	one 950 gallon	90	784
GDO	1507	IGT	5	300	Eating establishment	88	0	2800	MIAMI DADE WATER & SEWER DEPARTMENT	Single	1050	one 1050 gallon	60	700
GDO	1508	IGT	5	300	Eating establishment	150	150	0	MIAMI DADE WATER & SEWER DEPARTMENT	Single	1200	one 1200 gallon	90	3750
GDO	1509	IGT	5	750	Eating establishment	207	207	0	CITY OF NORTH MIAMI BEACH	Series	2100	two 1050 gallon	90	5175
GDO	1514	IGT	5	750	Eating establishment	278	278	0	CITY OF NORTH MIAMI BEACH	Series	4000	two 2000 gallon	90	6950
GDO	1515	IGT	5	300	Eating establishment	75	75	0	CITY OF NORTH MIAMI BEACH	Single	750	one 750 gallon	90	1875
GDO	1516	IGT	5	750	Eating establishment	300	300	0	MIAMI DADE WATER & SEWER DEPARTMENT	Single	1050	one 1050 gallon	90	4200
GDO	1517	IGT	5	300	Eating establishment	0	0	12000	MIAMI DADE WATER & SEWER DEPARTMENT	Single	900	one 900 gallon	90	3000
GDO	1518	IGT	5	300	Eating establishment	84	84	0	MIAMI DADE WATER & SEWER DEPARTMENT	Single	950	one 950 gallon	90	1176
GDO	1520	IGT	5	150	Eating establishment	0	0	0		Single	750	one 750 gallon	90	0
GDO	1521	IGT	5	150	Eating establishment	30	30	0		Single	1050	one 1050 gallon	90	420
GDO	1522	IGT	5	300	Eating establishment	163	163	0	CITY OF HIALEAH	Single	1200	one 1200 gallon	90	4075
GDO	1524	IGT	5	300	Eating establishment	115	115	4250	CITY OF NORTH BAY VILLAGE	Series	2400	two 1200 gallon	90	1063
GDO	1525	MGRU	5	150	Eating establishment	30	30	0			0	one 25 gpm	30	420
GDO	1526	IGT	5	300	Eating establishment	52	52	4800	MIAMI DADE WATER & SEWER DEPARTMENT	Single	1200	one 1200 gallon	90	1200
GDO	1529	IGT	5	150	Eating establishment	4	4	2246		Single	1050	one 1050-gallon	90	562
GDO	1539	IGT	5	150	Eating establishment	30	30	0	CITY OF HIALEAH	Single	950	one 950 gallon	90	750
GDO	1542	IGT	5	150	Eating establishment	0	0	3241	MIAMI DADE WATER & SEWER DEPARTMENT	Single	1200	one 1200 gallon	90	810
GDO	1545	IGT	5	150	Eating establishment	55	0	2596	CITY OF NORTH MIAMI BEACH	Single	1250	one 1250 gallon	60	649
GDO	1554	IGT	5	300	Eating establishment	90	90	0	CITY OF NORTH MIAMI BEACH	Series	2100	two 1050 gallon	90	2250
GDO	1559	IGT	5	150	Eating establishment	18	18	530	CITY OF HIALEAH	Single	950	one 950 gallon	90	133
GDO	1561	MGRU	5	150	Eating establishment	25	0	1200	MIAMI DADE WATER & SEWER DEPARTMENT		0	one 25 gpm	30	300
GDO	1562	MGRU	5	150	Eating establishment	48	48	2500	MIAMI DADE WATER & SEWER DEPARTMENT		0	one 25 gpm	30	625
GDO	1566	IGT	5	300	Eating establishment	78	78	0	MIAMI DADE WATER & SEWER DEPARTMENT	Single	1050	one 1050 gallon	90	1950
GDO	1569	IGT	5	150	Eating establishment	0	0	150	MIAMI DADE WATER & SEWER DEPARTMENT	Single	1200	one 1200 gallon	90	38
GDO	1570	IGT	5	150	Eating establishment	30	30	0	MIAMI DADE WATER & SEWER DEPARTMENT	Single	1050	one 1050 gallon	90	420
GDO	1571	IGT	5	150	Eating establishment	36	0	1200	MIAMI DADE WATER & SEWER DEPARTMENT	Single	1050	one 1050 gallon	90	300
GDO	1575	IGT	5	150	Eating establishment	40	40	3500	MIAMI DADE WATER & SEWER DEPARTMENT	Single	2000	one 2000 gallon	90	875
GDO	1579	AGRU	5	150	Eating establishment	0	0	1200	MIAMI DADE WATER & SEWER DEPARTMENT		0	one 25 gpm	30	300
GDO	1580	IGT	5	300	Eating establishment	74	74	0	MIAMI DADE WATER & SEWER DEPARTMENT	Single	750	one 750 gallon	90	1850
GDO	1581	IGT	5	150	Eating establishment	30	30	500	MIAMI DADE WATER & SEWER DEPARTMENT	Single	750	one 750 gallon	90	750
GDO	1582	IGT	5	150	Eating establishment	17	17	1238	MIAMI DADE WATER & SEWER DEPARTMENT	Single	1050	one 1050 gallon	90	310
GDO	1583	IGT	5	300	Eating establishment	65	65	0	MIAMI DADE WATER & SEWER DEPARTMENT	Single	950	one 950 gallon	90	1625
GDO	1584	IGT	5	300	Eating establishment	125	125	0	MIAMI DADE WATER & SEWER DEPARTMENT	Series	2400	two 1200 gallon	90	0
GDO	1585	IGT	5	150	Eating establishment	0	0	3302	MIAMI DADE WATER & SEWER DEPARTMENT	Single	950	one 950-gallon	90	826
GDO	1586	IGT	5	300	Eating establishment	75	75	0	CITY OF MIAMI SPRINGS	Single	1050	one 1050 gallon	90	1050
GDO	1589	IGT	5	150	Eating establishment	0	0	0	MIAMI DADE WATER & SEWER DEPARTMENT	Single	1050	one 1050 gallon	90	0
GDO	1590	IGT	5	150	Eating establishment	54	0	1500	MIAMI DADE WATER & SEWER DEPARTMENT	Single	1200	one 1200 gallon	30	375
GDO	1592	IGT	5	300	Eating establishment	0	0	8000	MIAMI DADE WATER & SEWER DEPARTMENT	Single	950	one 950 gallon	90	2000
GDO	1593	IGT	5	300	Eating establishment	120	120	0		Single	1200	one 1200 gallon	90	1680
GDO	1594	IGT	5	150	Eating establishment	30	30	0	CITY OF HIALEAH	Single	950	one 950 gallon	90	750
GDO	1595	IGT	5	300	Eating establishment	92	92	0		Single	1200	one 1200 gallon	90	1288
GDO	1596	IGT	5	150	Eating establishment	40	0	750	CITY OF HIALEAH	Single	900	one 900 gallon	60	188
GDO	1597	IGT	5	150	Eating establishment	42	0	1152	CITY OF HIALEAH	Single	1250	one 1250 gallon	30	288
GDO	1600	IGT	5	300	Eating establishment	99	99	0		Single	1200	one 1200 gallon	90	1386
GDO	1601	MGRU	5	150	Eating establishment	80	80	2125	MIAMI DADE WATER & SEWER DEPARTMENT		0	one 25 gpm	30	531
GDO	1602	IGT	5	150	Eating establishment	0	0	0	MIAMI DADE WATER & SEWER DEPARTMENT	Series	2250	three 750-gallon	90	0
GDO	1604	IGT	5	150	Eating establishment	200	200	0		Single	750	one 750 gallon	90	200
GDO	1605	IGT	5	150	Eating establishment	20	20	0	CITY OF HOMESTEAD	Single	1200	one 1200 gallon	90	500
GDO	1606	IGT	2	150	Eating establishment	200	200	2810	MIAMI DADE WATER & SEWER DEPARTMENT	Single	1200	one 1200 gallon	90	703
GDO	1607	IGT	5	300	Eating establishment	115	115	0	MIAMI DADE WATER & SEWER DEPARTMENT	Single	950	one 950 gallon	90	2875
GDO	1608	IGT	5	750	Eating establishment	300	300	0	CITY OF FLORIDA CITY	Single	2400	two 1200 gallon	90	7500
GDO	1610	IGT	5	150	Eating establishment	0	0	850	CITY OF HIALEAH	Single	950	one 950 gallon	90	213
GDO	1612	AGRU	5	150	Eating establishment	52	52	1985	CITY OF MIAMI BEACH		0	one 25 gpm	30	496
GDO	1615	IGT	5	150	Eating establishment	30	30	1405	CITY OF HIALEAH	Single	1200	one 1200-gallon	90	351
GDO	1616	IGT	5	150	Eating establishment	0	0	2560	MIAMI DADE WATER & SEWER DEPARTMENT	Single	1050	one 1050 gallon	90	640

WORK GROUP	PERMIT NUMBER	PERMIT CLASS	PERMIT	PERMIT FEE	BUSINESS_TYPE	RECORDED SEATS	OBSERVED SEATS	FACILITY AREA	UTILITY	SYSTEM FORMAT	TOTAL CAPACITY	TANK_CAPACITY	PUMP OUT	TOTAL GPD
GDO	1617	IGT	5	300	Eating establishment	150	150	0	MIAMI DADE WATER & SEWER DEPARTMENT	Single	1050	one 1050 gallon	90	3750
GDO	1618	IGT	5	150	Eating establishment	33	33	0	CITY OF HIALEAH	Single	750	one 750 gallon	90	825
GDO	1621	IGT	5	150	Eating establishment	40	40	0		Single	1050	one 1050 gallon	90	1000
GDO	1622	IGT	5	150	Eating establishment	75	75	0		Single	1050	one 1050 gallon	90	1875
GDO	1624	IGT	5	150	Eating establishment	26	26	1942	MIAMI DADE WATER & SEWER DEPARTMENT	Single	1050	one 1050-gallon	90	486
GDO	1625	IGT	5	150	Eating establishment	33	33	2400	CITY OF HIALEAH	Single	1050	one 1050 gallon	90	462
GDO	1626	IGT	5	150	Eating establishment	20	20	0		Single	1050	one 1050 gallon	90	5
GDO	1629	IGT	5	150	Eating establishment	80	80	2508	CITY OF MIAMI BEACH	Single	750	one 750 gallon	90	627
GDO	1630	IGT	5	750	Eating establishment	505	505	0	MIAMI DADE WATER & SEWER DEPARTMENT	Series	3150	three 1050 gallon	90	0
GDO	1635	MGRU	5	150	Eating establishment	18	18	0	MIAMI DADE WATER & SEWER DEPARTMENT		0	one 35 gpm	90	5
GDO	1637	IGT	5	150	Eating establishment	114	114	3200	CITY OF HIALEAH	Single	1200	one 1200 gallon	90	800
GDO	1642	IGT	5	150	Eating establishment	30	30	0		Single	750	one 750 gallon	90	420
GDO	1643	IGT	5	150	Eating establishment	0	0	2500	MIAMI DADE WATER & SEWER DEPARTMENT	Single	1050	one 1050 gallon	90	625
GDO	1644	IGT	5	300	Eating establishment	200	200	4100	MIAMI DADE WATER & SEWER DEPARTMENT	Single	1200	one 1200-gallon	90	1025
GDO	1645	IGT	5	300	Eating establishment	60	60	0		Single	750	one 750 gallon	90	840
GDO	1647	IGT	5	150	Eating establishment	27	27	850	MIAMI DADE WATER & SEWER DEPARTMENT	Single	1500	one 1500 gallon	90	213
GDO	1650	IGT	5	300	Eating establishment	74	74	0		Single	750	one 750 gallon	90	1036
GDO	1651	IGT	5	750	Eating establishment	225	225	0	CITY OF MIAMI BEACH	Single	950	one 950 gallon	90	5625
GDO	1655	MGRU	5	150	Eating establishment	30	30	0	MIAMI DADE WATER & SEWER DEPARTMENT		0	one 25 gpm	30	420
GDO	1657	IGT	5	150	Eating establishment	10	10	0	TOWN OF MEDLEY	Single	1050	one 1050 gallon	90	140
GDO	1660	MGRU	5	150	Eating establishment	0	0	0	MIAMI DADE WATER & SEWER DEPARTMENT		0	one 35 gpm	30	0
GDO	1671	MGRU	5	150	Eating establishment	49	49	920	MIAMI DADE WATER & SEWER DEPARTMENT		0	one 25 gpm	30	230
GDO	1673	IGT	5	150	Eating establishment	72	30	0	CITY OF MIAMI BEACH	Single	2000	one 2000 gallon	90	750
GDO	1675	MGRU	5	150	Eating establishment	18	0	2303	MIAMI DADE WATER & SEWER DEPARTMENT		0	one 50 gpm	30	576
GDO	1676	MGRU	5	150	Eating establishment	30	30	0			0	one 25 gpm	30	420
GDO	1678	IGT	5	150	Eating establishment	49	49	2500	CITY OF HIALEAH	Single	950	one 950-gallon	90	625
GDO	1679	IGT	5	150	Eating establishment	30	30	0		Single	2000	one 2000 gallon	90	750
GDO	1681	IGT	5	300	Eating establishment	125	125	0	CITY OF HIALEAH	Single	1200	one 1200 gallon	90	3125
GDO	1682	IGT	5	150	Eating establishment	30	30	2500	CITY OF HIALEAH	Single	750	one 750 gallon	90	625
GDO	1683	IGT	5	150	Eating establishment	30	39	0	MIAMI DADE WATER & SEWER DEPARTMENT	Single	750	one 750 gallon	90	975
GDO	1687	IGT	5	150	Eating establishment	12	12	1325	CITY OF HIALEAH	Single	750	one 750 gallon	90	331
GDO	1688	IGT	5	300	Eating establishment	52	52	0	MIAMI DADE WATER & SEWER DEPARTMENT		750	one 750 gallon	90	728
GDO	1690	MGRU	5	150	Eating establishment	50	50	0			0	one 25 gpm	30	700
GDO	1694	IGT	5	150	Eating establishment	150	0	3685	MIAMI DADE WATER & SEWER DEPARTMENT	Series	2100	two 1050 gallon	90	921
GDO	1697	IGT	5	300	Eating establishment	70	70	0	MIAMI DADE WATER & SEWER DEPARTMENT	Single	1200	one 1200 gallon	90	1750
GDO	1698	IGT	5	150	Eating establishment	10	10	1500	MIAMI DADE WATER & SEWER DEPARTMENT	Single	750	one 750 gallon	90	375
GDO	1703	IGT	5	150	Eating establishment	93	0	2900	CITY OF NORTH MIAMI BEACH	Series	2400	two 1200 gallon	60	725
GDO	1704	IGT	5	150	Eating establishment	90	0	2746	CITY OF NORTH MIAMI BEACH	Series	2400	two 1200 gallon	60	687
GDO	1707	IGT	5	300	Eating establishment	88	88	0	MIAMI DADE WATER & SEWER DEPARTMENT	Single	1050	one 1050 gallon	90	2200
GDO	1710	MGRU	5	150	Eating establishment	9	9	0	CITY OF MIAMI BEACH		0	Not applicable	30	126
GDO	1712	MGRU	4	150	Eating establishment	24	24	1539	CITY OF HIALEAH		0	one 50 gpm	30	385
GDO	1714	IGT	5	150	Eating establishment	12	12	0	CITY OF HIALEAH	Series	1900	two 950 gallon	90	168
GDO	1718	IGT	5	300	Eating establishment	159	0	4200	MIAMI DADE WATER & SEWER DEPARTMENT	Single	1200	one 1200 gallon	60	105000
GDO	1719	MGRU	5	300	Eating establishment	130	130	4033	MIAMI DADE WATER & SEWER DEPARTMENT	Single	0	one 100 gpm	30	1008
GDO	1720	IGT	5	150	Eating establishment	30	30	1513	MIAMI DADE WATER & SEWER DEPARTMENT	Single	750	one 750 gallon	90	378
GDO	1723	IGT	5	150	Eating establishment	0	0	2000	MIAMI DADE WATER & SEWER DEPARTMENT	Single	950	one 950 gallon	90	500
GDO	1724	IGT	5	150	Eating establishment	89	89	2500	MIAMI DADE WATER & SEWER DEPARTMENT	Single	750	one 750 gallon	90	2225
GDO	1727	IGT	5	150	Eating establishment	0	0	850	MIAMI DADE WATER & SEWER DEPARTMENT	Single	950	one 950 gallon	90	213
GDO	1732	IGT	5	150	Eating establishment	30	30	1300	MIAMI DADE WATER & SEWER DEPARTMENT	Single	750	one 750 gallon	90	325
GDO	1734	MGRU	5	150	Eating establishment	36	36	850	CITY OF HIALEAH		0	one 25 gpm	30	213
GDO	1739	IGT	5	150	Eating establishment	0	0	140	CITY OF MIAMI BEACH	Single	750	one 750 gallon	90	35
GDO	1744	IGT	5	150	Eating establishment	100	100	0		Single	1200	one 1200 gallon	90	100
GDO	1746	IGT	5	150	Eating establishment	48	48	1726	MIAMI DADE WATER & SEWER DEPARTMENT	Single	1200	one 1200 gallon	90	432
GDO	1747	IGT	5	300	Eating establishment	60	60	0	MIAMI DADE WATER & SEWER DEPARTMENT	Single	750	one 750 gallon	90	1500
GDO	1748	IGT	5	300	Eating establishment	200	200	0	MIAMI DADE WATER & SEWER DEPARTMENT	Series	1500	two 750 gallon	90	5000
GDO	1750	IGT	5	150	Eating establishment	100	100	3000	CITY OF HOMESTEAD	Single	1200	one 1200 gallon	90	750
GDO	1751	IGT	5	150	Eating establishment	0	0	0	MIAMI DADE WATER & SEWER DEPARTMENT	Single	1200	one 1200 gallon	90	0
GDO	1752	IGT	5	150	Eating establishment	0	0	0	MIAMI DADE WATER & SEWER DEPARTMENT	Single	1050	one 1050 gallon	90	0
GDO	1755	IGT	5	300	Eating establishment	109	0	4140	MIAMI DADE WATER & SEWER DEPARTMENT	Series	2100	two 1050 gallon	90	1035
GDO	1756	IGT	5	150	Eating establishment	20	20	800	MIAMI DADE WATER & SEWER DEPARTMENT	Single	1050	one 1050 gallon	90	200
GDO	1757	IGT	5	300	Eating establishment	180	180	4285	MIAMI DADE WATER & SEWER DEPARTMENT	Single	950	one 950 gallon	60	1071

WORK GROUP	PERMIT NUMBER	PERMIT CLASS	PERMIT	PERMIT FEE	BUSINESS_TYPE	RECORDED SEATS	OBSERVED SEATS	FACILITY AREA	UTILITY	SYSTEM FORMAT	TOTAL CAPACITY	TANK_CAPACITY	PUMP OUT	TOTAL GPD
GDO	1758	IGT	5	150	Eating establishment	40	40	1280	MIAMI DADE WATER & SEWER DEPARTMENT	Single	750	one 750-gallon	90	320
GDO	1759	IGT	5	150	Eating establishment	0	0	1200	MIAMI DADE WATER & SEWER DEPARTMENT	Single	1200	one 1200 gallon	90	300
GDO	1760	IGT	5	300	Eating establishment	60	60	0		Single	750	one 750 gallon	90	1500
GDO	1762	IGT	5	150	Eating establishment	20	0	2529	MIAMI DADE WATER & SEWER DEPARTMENT	Single	2000	one 2000 gallon	60	382
GDO	1764	IGT	5	150	Eating establishment	0	0	0	MIAMI DADE WATER & SEWER DEPARTMENT	Single	750	one 750 gallon	90	0
GDO	1765	IGT	5	150	Eating establishment	60	60	2097	MIAMI DADE WATER & SEWER DEPARTMENT	Single	1050	one 1050 gallon	90	524
GDO	1767	IGT	5	150	Eating establishment	28	28	1500	MIAMI DADE WATER & SEWER DEPARTMENT	Single	1200	one 1200 gallon	90	375
GDO	1771	IGT	5	300	Eating establishment	65	65	0	MIAMI DADE WATER & SEWER DEPARTMENT	Series	2400	two 1200 gallon	90	910
GDO	1772	IGT	5	300	Eating establishment	104	104	0	MIAMI DADE WATER & SEWER DEPARTMENT	Series	2100	two 1050 gallon	90	1456
GDO	1773	IGT	5	150	Eating establishment	128	128	3908	MIAMI DADE WATER & SEWER DEPARTMENT	Series	2500	two 1250-gallon	90	977
GDO	1775	IGT	5	300	Eating establishment	139	139	0	CITY OF MIAMI BEACH	Single	1050	one 1050 gallon	90	3475
GDO	1778	IGT	5	150	Eating establishment	80	80	2000	CITY OF MIAMI BEACH	Single	1200	one 1200 gallon	90	500
GDO	1781	IGT	5	750	Eating establishment	214	214	0	MIAMI DADE WATER & SEWER DEPARTMENT	Single	750	one 750 gallon	90	54
GDO	1782	IGT	5	300	Eating establishment	84	84	2233	MIAMI DADE WATER & SEWER DEPARTMENT	Single	2400	two 1200 gallon	90	558
GDO	1788	IGT	5	150	Eating establishment	31	43	0	MIAMI DADE WATER & SEWER DEPARTMENT	Single	750	one 750 gallon	90	775
GDO	1791	IGT	5	150	Eating establishment	30	30	875	MIAMI DADE WATER & SEWER DEPARTMENT	Single	950	one 950 gallon	90	420
GDO	1792	IGT	5	150	Eating establishment	20	20	2621	CITY OF NORTH MIAMI BEACH	Single	1200	one 1200 gallon	90	655
GDO	1793	IGT	5	300	Eating establishment	220	220	6175	MIAMI DADE WATER & SEWER DEPARTMENT	Series	1900	two 950 gallon	90	1544
GDO	1796	IGT	5	150	Eating establishment	22	0	1185	CITY OF HIALEAH	Single	1050	one 1050 gallon	60	296
GDO	1798	IGT	5	150	Eating establishment	39	39	1000	MIAMI DADE WATER & SEWER DEPARTMENT	Single	750	one 750-gallon	60	250
												three 2000 & one		
GDO	1799	IGT	5	150	Eating establishment	140	140	3350	CITY OF NORTH MIAMI BEACH	Multiple	8000	2000 gallon	90	838
GDO	1801	IGT	5	150	Eating establishment	65	65	3420	MIAMI DADE WATER & SEWER DEPARTMENT	Single	1050	one 1050 gallon	90	855
GDO	1802	IGT	5	150	Eating establishment	18	0	1200	MIAMI DADE WATER & SEWER DEPARTMENT	Single	1200	one 1200 gallon	60	300
GDO	1806	IGT	5	150	Eating establishment	30	30	0		Single	1200	one 1200 gallon	90	8
GDO	1808	IGT	5	150	Eating establishment	8	8	0		Single	1200	one 1200 gallon	90	2
GDO	1811	IGT	5	300	Eating establishment	50	50	0	CITY OF FLORIDA CITY	Single	1200	one 1200 gallon	90	1250
GDO	1812	IGT	5	150	Eating establishment	0	0	2000	MIAMI DADE WATER & SEWER DEPARTMENT	Single	1050	one 1050 gallon	90	500
GDO	1813	IGT	5	150	Eating establishment	70	0	2038	CITY OF MIAMI BEACH	Single	0	one 1500 gallon	60	510
GDO	1814	MGRU	5	150	Eating establishment	49	49	0	CITY OF MIAMI BEACH		0	one 25 gpm	30	1225
GDO	1817	IGT	5	150	Eating establishment	200	200	3082	MIAMI DADE WATER & SEWER DEPARTMENT	Single	1200	one 1200-gallon	90	771
GDO	1818	IGT	5	150	Eating establishment	80	80	2100	MIAMI DADE WATER & SEWER DEPARTMENT	Single	1900	two 950 gallon	90	525
GDO	1819	MGRU	5	150	Eating establishment	49	49	2200	MIAMI DADE WATER & SEWER DEPARTMENT		0	one 25 gpm	30	550
GDO	1821	IGT	5	150	Eating establishment	22	22	0		Single	1050	one 1050 gallon	90	308
GDO	1824	IGT	5	150	Eating establishment	30	0	1500	CITY OF HIALEAH	Single	750	one 750 gallon	60	375
GDO	1828	IGT	1	150	Eating establishment	30	30	650	MIAMI DADE WATER & SEWER DEPARTMENT	Single	1050	one 1050 gallon	90	750
GDO	1830	IGT	5	150	Eating establishment	30	30	0	MIAMI DADE WATER & SEWER DEPARTMENT	Single	1050	one 1050 gallon	90	750
GDO	1835	IGT	5	150	Eating establishment	50	50	0	MIAMI DADE WATER & SEWER DEPARTMENT	Single	1050	one 1050 gallon	90	1250
GDO	1837	IGT	5	150	Eating establishment	0	0	0	MIAMI DADE WATER & SEWER DEPARTMENT	Single	1050	one 1050 gallon	90	0
GDO	1843	IGT	5	300	Eating establishment	52	52	0	MIAMI DADE WATER & SEWER DEPARTMENT	Single	1200	one 1200 gallon	90	728
GDO	1844	IGT	5	300	Eating establishment	80	80	0		Single	1200	one 1200 gallon	90	1120
GDO	1848	AGRU	5	150	Eating establishment	48	48	0	MIAMI DADE WATER & SEWER DEPARTMENT		0	one 25 gpm	30	672
GDO	1850	IGT	5	150	Eating establishment	0	0	2000	MIAMI DADE WATER & SEWER DEPARTMENT	Single	1200	one 1200 gallon	90	500
GDO	1851	IGT	5	150	Eating establishment	20	20	0	MIAMI DADE WATER & SEWER DEPARTMENT	Single	1200	one 1200 gallon	90	280
GDO	1853	IGT	5	150	Eating establishment	60	0	940	MIAMI DADE WATER & SEWER DEPARTMENT	Single	2000	one 2000 gallon	90	235
GDO	1854	IGT	5	150	Eating establishment	100	100	0	MIAMI DADE WATER & SEWER DEPARTMENT	Single	1500	one 1500 gallon	90	0
GDO	1855	IGT	5	300	Eating establishment	112	0	3683	MIAMI DADE WATER & SEWER DEPARTMENT	Single	1200	one 1200 gallon	90	921
GDO	1856	IGT	5	150	Eating establishment	56	0	2800	MIAMI DADE WATER & SEWER DEPARTMENT	Single	750	one 750 gallon	60	700
GDO	1857	MGRU	5	150	Eating establishment	30	17	0	CITY OF HIALEAH		0	one 25 gpm	30	420
GDO	1858	IGT	5	150	Eating establishment	0	0	0	MIAMI DADE WATER & SEWER DEPARTMENT	Single	1050	one 1050 gallon	90	0
GDO	1859	IGT	5	150	Eating establishment	45	45	0	CITY OF HIALEAH	Single	1050	one 1050 gallon	90	630
GDO	1860	IGT	5	300	Eating establishment	150	150	0		Single	950	one 950 gallon	90	3750
GDO	1865	IGT	5	150	Eating establishment	35	35	0	CITY OF HOMESTEAD	Single	900	one 900 gallon	90	9
GDO	1870	IGT	5	150	Eating establishment	16	16	2500	CITY OF HIALEAH	Single	950	one 950-gallon	90	625
GDO	1872	MGRU	5	150	Eating establishment	29	29	0			0	one 25 gpm	30	406
GDO	1873	IGT	5	150	Eating establishment	88	0	2400	CITY OF HIALEAH	Single	750	one 750 gallon	60	600
GDO	1874	IGT	5	150	Eating establishment	30	30	0		Single	750	one 750 gallon	90	8
GDO	1876	IGT	5	150	Eating establishment	50	50	0	CITY OF HOMESTEAD	Single	1050	one 1050 gallon	90	1250
GDO	1877	MGRU	5	150	Eating establishment	20	20	0	MIAMI DADE WATER & SEWER DEPARTMENT		0	one 25 gpm	30	280
GDO	1878	IGT	5	300	Eating establishment	149	149	0	CITY OF HIALEAH	Single	950	one 950 gallon	90	3725
GDO	1879	IGT	5	150	Eating establishment	42	42	0	MIAMI DADE WATER & SEWER DEPARTMENT	Single	1050	one 1050 gallon	90	588

WORK GROUP	PERMIT NUMBER	PERMIT CLASS	PERMIT	PERMIT FEE	BUSINESS_TYPE	RECORDED SEATS	OBSERVED SEATS	FACILITY AREA	UTILITY	SYSTEM FORMAT	TOTAL CAPACITY	TANK_CAPACITY	PUMP OUT	TOTAL GPD
GDO	1883	IGT	5	150	Eating establishment	0	0	0	MIAMI DADE WATER & SEWER DEPARTMENT	Single	750	one 750 gallon	90	0
GDO	1885	IGT	5	150	Eating establishment	48	48	0	MIAMI DADE WATER & SEWER DEPARTMENT	Single	1200	one 1200 gallon	90	1200
GDO	1886	IGT	5	150	Eating establishment	38	38	0	MIAMI DADE WATER & SEWER DEPARTMENT	Single	750	one 750 gallon	90	532
GDO	1891	IGT	5	300	Eating establishment	215	215	6500	MIAMI DADE WATER & SEWER DEPARTMENT	Single	2000	one 2000 gallon	90	1625
GDO	1892	IGT	5	150	Eating establishment	40	40	0	MIAMI DADE WATER & SEWER DEPARTMENT	Single	750	one 750 gallon	90	1000
GDO	1893	IGT	5	150	Eating establishment	0	0	1400	MIAMI DADE WATER & SEWER DEPARTMENT	Single	950	one 950-gallon	90	350
GDO	1894	IGT	5	150	Eating establishment	25	25	1600	CITY OF HIALEAH	Single	750	one 750 gallon	90	400
GDO	1895	IGT	5	150	Eating establishment	48	48	0	MIAMI DADE WATER & SEWER DEPARTMENT	Single	950	one 950 gallon	90	1200
GDO	1896	IGT	5	150	Eating establishment	42	42	1750		Single	900	one 900 gallon	90	438
GDO	1897	IGT	2	150	Eating establishment	72	72	2000	MIAMI DADE WATER & SEWER DEPARTMENT	Single	750	one 750 gallon	90	500
GDO	1898	IGT	5	300	Eating establishment	75	75	0	MIAMI DADE WATER & SEWER DEPARTMENT	Single	950	one 950 gallon	90	1875
GDO	1901	IGT	5	150	Eating establishment	16	16	1100	CITY OF MIAMI BEACH	Single	1200	one 1200 gallon	90	275
GDO	1903	AGRU	5	150	Eating establishment	15	15	0			0	one 25 gpm	30	4
GDO	1904	AGRU	5	150	Eating establishment	0	0	1020	CITY OF MIAMI BEACH		0	one 25 gpm	30	467
GDO	1905	MGRU	5	150	Eating establishment	15	0	700	MIAMI DADE WATER & SEWER DEPARTMENT		0	one 35 gpm	30	175
GDO	1906	MGRU	5	150	Eating establishment	0	0	1080	CITY OF MIAMI BEACH		0	one 25 gpm	30	270
GDO	1907	IGT	5	150	Eating establishment	6	0	781	MIAMI DADE WATER & SEWER DEPARTMENT	Single	1050	one 1050-gallon	90	195
GDO	1909	IGT	5	150	Eating establishment	149	40	0	MIAMI DADE WATER & SEWER DEPARTMENT	Single	950	one 950 gallon	90	1000
GDO	1911	IGT	5	300	Eating establishment	70	70	0	CITY OF HIALEAH	Single	1200	one 1200 gallon	90	980
GDO	1912	IGT	5	150	Eating establishment	76	76	2600	MIAMI DADE WATER & SEWER DEPARTMENT	Single	750	one 750 gallon	90	650
GDO	1913	IGT	5	150	Eating establishment	40	40	1200	MIAMI DADE WATER & SEWER DEPARTMENT	Single	750	one 750 gallon	90	300
GDO	1915	IGT	5	150	Eating establishment	80	80	2300	MIAMI DADE WATER & SEWER DEPARTMENT	Single	1200	one 1200 gallon	90	575
GDO	1917	IGT	5	150	Eating establishment	45	45	0		Single	750	one 750 gallon	90	1125
GDO	1918	IGT	5	150	Eating establishment	36	36	0	CITY OF HIALEAH	Single	750	one 750 gallon	90	900
GDO	1919	IGT	5	150	Eating establishment	1600	1600	0	MIAMI DADE WATER & SEWER DEPARTMENT	Multiple	2000	one 950 and one 1050 gallon	90	1600
GDO	1921	IGT	5	150	Eating establishment	16	16	0	MIAMI DADE WATER & SEWER DEPARTMENT	Single	1200	one 1200 gallon	90	224
GDO	1922	IGT	5	150	Eating establishment	52	52	3966	MIAMI DADE WATER & SEWER DEPARTMENT	Single	1200	one 1200 gallon	90	992
GDO	1923	IGT	5	150	Eating establishment	0	0	0	MIAMI DADE WATER & SEWER DEPARTMENT	Single	1200	one 1200 gallon	90	0
GDO	1925	IGT	5	300	Eating establishment	0	0	0	MIAMI DADE WATER & SEWER DEPARTMENT	Single	1050	one 1050 gallon	90	0
GDO	1926	IGT	5	300	Eating establishment	76	76	0	TOWN OF MEDLEY	Single	1200	one 1200 gallon	90	1064
GDO	1928	MGRU	5	150	Eating establishment	0	0	0			0	one 25 gpm	30	0
GDO	1930	IGT	5	150	Eating establishment	30	30	0		Single	1200	one 1200 gallon	90	750
GDO	1931	IGT	5	150	Eating establishment	60	0	1920	MIAMI DADE WATER & SEWER DEPARTMENT	Single	900	one 900 gallon	60	480
GDO	1934	IGT	5	150	Eating establishment	56	56	4000	CITY OF HIALEAH	Single	750	one 750 gallon	90	1000
GDO	1935	IGT	5	150	Eating establishment	49	49	0	CITY OF HIALEAH	Single	750	one 750 gallon	90	1225
GDO	1937	AGRU	5	150	Eating establishment	9	0	492	CITY OF MIAMI BEACH		0	one 35 gpm	30	123
GDO	1939	IGT	5	150	Eating establishment	0	0	0	CITY OF HOMESTEAD	Single	1200	one 1200 gallon	90	0
GDO	1941	IGT	5	300	Eating establishment	74	74	0	CITY OF HOMESTEAD	Single	1050	one 1050 gallon	90	1850
GDO	1950	MGRU	5	150	Eating establishment	30	30	1475	CITY OF HIALEAH		0	one 25 gpm	30	369
GDO	1954	IGT	5	300	Eating establishment	143	0	6981	CITY OF MIAMI BEACH	Series	8000	four 2000 gallon	60	1745
GDO	1956	IGT	5	300	Eating establishment	88	88	0	MIAMI DADE WATER & SEWER DEPARTMENT	Single	2000	one 2000 gallon	90	2200
GDO	1958	MGRU	5	150	Eating establishment	0	0	0	MIAMI DADE WATER & SEWER DEPARTMENT		0	one 25 gpm	30	0
GDO	1960	IGT	5	150	Eating establishment	0	0	0	MIAMI DADE WATER & SEWER DEPARTMENT	Single	1200	one 1200 gallon	90	0
GDO	1963	IGT	5	150	Eating establishment	18	18	0	CITY OF HIALEAH	Single	950	one 950 gallon	90	252
GDO	1966	IGT	5	150	Eating establishment	8	8	0		Single	750	one 750 gallon	90	112
GDO	1968	IGT	5	300	Eating establishment	100	100	0	MIAMI DADE WATER & SEWER DEPARTMENT	Single	1050	one 1050 gallon	90	2500
GDO	1970	IGT	5	150	Eating establishment	40	40	0		Single	750	one 750 gallon	90	1000
GDO	1972	IGT	5	150	Eating establishment	74	74	1622	CITY OF NORTH MIAMI BEACH	Single	750	one 750 gallon	90	406
GDO	1975	IGT	5	150	Eating establishment	24	24	0		Single	950	one 950 gallon	90	336
GDO	1976	IGT	5	150	Eating establishment	0	0	1408	MIAMI DADE WATER & SEWER DEPARTMENT	Single	1050	one 1050 gallon	90	352
GDO	1978	IGT	5	150	Eating establishment	0	0	1500	MIAMI DADE WATER & SEWER DEPARTMENT	Series	3200	two 1600 gallon	90	375
GDO	1979	IGT	5	150	Eating establishment	49	49	0		Single	1200	one 1200 gallon	90	686
GDO	1980	AGRU	5	150	Eating establishment	1	1	0			0	one 25 gpm	30	0
GDO	1982	IGT	5	150	Eating establishment	15	0	700	MIAMI DADE WATER & SEWER DEPARTMENT	Single	1500	one 1500 gallon	60	175
GDO	1984	IGT	5	150	Eating establishment	14	14	750	MIAMI DADE WATER & SEWER DEPARTMENT	Single	950	one 950 gallon	90	188
GDO	1993	IGT	5	150	Eating establishment	0	0	0	MIAMI DADE WATER & SEWER DEPARTMENT	Single	1200	one 1200 gallon	90	0
GDO	1994	IGT	5	150	Eating establishment	74	74	2865	CITY OF HIALEAH	Single	950	one 950-gallon	90	716
GDO	1995	IGT	5	300	Eating establishment	70	70	0	MIAMI DADE WATER & SEWER DEPARTMENT	Single	1500	one 1500 gallon	90	1750
GDO	1997	IGT	5	300	Eating establishment	125	125	0		Series	2100	two 1050 gallon	90	1750
GDO	1998	IGT	5	150	Eating establishment	0	0	0	MIAMI DADE WATER & SEWER DEPARTMENT	Single	1200	one 1200 gallon	90	0

WORK GROUP	PERMIT NUMBER	PERMIT CLASS	PERMIT	PERMIT FEE	BUSINESS_TYPE	RECORDED SEATS	OBSERVED SEATS	FACILITY AREA	UTILITY	SYSTEM FORMAT	TOTAL CAPACITY	TANK_CAPACITY	PUMP OUT	TOTAL GPD
GDO	1999	MGRU	5	150	Eating establishment	63	63	1778	CITY OF MIAMI BEACH		0	one 25 gpm	30	493
GDO	2000	MGRU	5	150	Eating establishment	20	20	640	MIAMI DADE WATER & SEWER DEPARTMENT		0	one 25 gpm	30	500
GDO	2002	IGT	5	300	Eating establishment	75	75	0		Single	1050	one 1050 gallon	90	1875
GDO	2003	IGT	5	150	Eating establishment	20	20	0		Single	950	one 950 gallon	90	5
GDO	2005	IGT	5	300	Eating establishment	150	150	0	MIAMI DADE WATER & SEWER DEPARTMENT	Single	2400	two 1200 gallon	90	3750
GDO	2006	IGT	5	300	Eating establishment	220	220	4890	CITY OF MIAMI BEACH	Single	1600	one 1600-gallon	90	1223
GDO	2007	IGT	5	150	Eating establishment	344	344	0	MIAMI DADE WATER & SEWER DEPARTMENT	Single	750	one 750 gallon	90	344
GDO	2010	IGT	5	150	Eating establishment	0	0	0	MIAMI DADE WATER & SEWER DEPARTMENT	Single	1200	one 1200 gallon	90	0
GDO	2012	IGT	5	150	Eating establishment	36	0	1582	MIAMI DADE WATER & SEWER DEPARTMENT	Single	950	one 950 gallon	90	396
GDO	2014	IGT	4	150	Eating establishment	0	0	0	MIAMI DADE WATER & SEWER DEPARTMENT	Single	1050	one 1050 gallon	90	0
GDO	2018	IGT	5	150	Eating establishment	30	30	1530	CITY OF HIALEAH	Single	950	one 950 gallon	90	433
GDO	2019	IGT	5	150	Eating establishment	30	30	0		Single	750	one 750 gallon	90	420
GDO	2020	IGT	5	300	Eating establishment	245	0	6800	CITY OF MIAMI BEACH	Single	750	one 750-gallon	90	1825
GDO	2021	MGRU	5	300	Eating establishment	137	137	6160	CITY OF MIAMI BEACH	Multiple	0	three 100 gpm	90	1540
GDO	2023	AGRU	5	300	Eating establishment	140	140	0	CITY OF MIAMI BEACH		0	one 25 gpm	30	3500
GDO	2024	AGRU	5	150	Eating establishment	5	5	0	CITY OF MIAMI BEACH		0	one 25 gpm	30	1
GDO	2026	IGT	5	150	Eating establishment	129	129	2986	MIAMI DADE WATER & SEWER DEPARTMENT	Single	1200	one 1200 gallon	90	747
GDO	2029	AGRU	5	300	Eating establishment	111	111	0	CITY OF MIAMI BEACH		0	one 35 gpm	30	2775
GDO	2031	IGT	5	150	Eating establishment	50	50	1250	CITY OF HIALEAH	Single	950	one 950 gallon	90	313
GDO	2032	IGT	5	150	Eating establishment	30	30	2200	MIAMI DADE WATER & SEWER DEPARTMENT	Single	1050	one 1050-gallon	90	550
GDO	2037	IGT	5	300	Eating establishment	242	0	6474	MIAMI DADE WATER & SEWER DEPARTMENT	Series	3200	two 1600 gallon	60	1619
GDO	2039	IGT	5	150	Eating establishment	56	56	2250	MIAMI DADE WATER & SEWER DEPARTMENT	Single	750	one 750 gallon	90	563
GDO	2045	IGT	5	150	Eating establishment	41	41	0	CITY OF HIALEAH	Single	950	one 950 gallon	90	1025
GDO	2046	IGT	5	300	Eating establishment	200	200	0		Single	2000	one 2000 gallon	90	5000
GDO	2047	IGT	5	150	Eating establishment	24	24	0	MIAMI DADE WATER & SEWER DEPARTMENT	Single	1200	one 1200 gallon	90	600
GDO	2053	IGT	5	300	Eating establishment	70	70	0	MIAMI DADE WATER & SEWER DEPARTMENT	Single	1200	one 1200 gallon	90	1750
GDO	2059	MGRU	5	150	Eating establishment	30	30	0			0	one 25 gpm	30	750
GDO	2063	IGT	5	300	Eating establishment	0	0	4700	MIAMI DADE WATER & SEWER DEPARTMENT	Single	1200	one 1200 gallon	90	117500
GDO	2064	IGT	5	150	Eating establishment	200	0	3600	CITY OF HIALEAH	Series	1900	two 950 gallon	90	900
GDO	2065	IGT	5	150	Eating establishment	42	0	2200	CITY OF HIALEAH	Single	900	one 900 gallon	60	550
GDO	2070	IGT	5	300	Eating establishment	150	150	5800		Multiple	3900	two 750 and two 1200 gallon	90	1538
GDO	2073	IGT	5	150	Eating establishment	32	32	1720	CITY OF NORTH MIAMI BEACH	Single	1200	one 1200-gallon	90	430
GDO	2074	IGT	5	150	Eating establishment	30	0	2338	MIAMI DADE WATER & SEWER DEPARTMENT	Single	2000	one 2000 gallon	60	585
GDO	2075	IGT	5	750	Eating establishment	231	231	0	CITY OF MIAMI BEACH	Single	1200	one 1200 gallon	90	5775
GDO	2076	IGT	5	150	Eating establishment	100	100	0	MIAMI DADE WATER & SEWER DEPARTMENT	Series	4000	two 2000 gallon	90	0
GDO	2077	IGT	5	150	Eating establishment	100	100	0	MIAMI DADE WATER & SEWER DEPARTMENT	Multiple	3000	four 750 gallon	90	0
GDO	2080	MGRU	5	150	Eating establishment	42	0	1700	CITY OF NORTH MIAMI BEACH		0	one 50 gpm	30	425
GDO	2081	IGT	5	300	Eating establishment	104	104	0	CITY OF NORTH MIAMI BEACH	Single	950	one 950 gallon	90	1456
GDO	2082	IGT	5	300	Eating establishment	85	85	0	MIAMI DADE WATER & SEWER DEPARTMENT	Single	900	one 900 gallon	90	2125
GDO	2085	IGT	5	150	Eating establishment	0	0	0	MIAMI DADE WATER & SEWER DEPARTMENT	Single	1050	one 1050 gallon	90	0
GDO	2086	IGT	5	150	Eating establishment	48	0	1900	MIAMI DADE WATER & SEWER DEPARTMENT	Single	750	one 750 gallon	60	475
GDO	2087	IGT	5	150	Eating establishment	30	30	1969	MIAMI DADE WATER & SEWER DEPARTMENT	Single	1050	one 1050 gallon	90	420
GDO	2090	IGT	5	150	Eating establishment	0	0	0	MIAMI DADE WATER & SEWER DEPARTMENT	Single	1050	one 1050 gallon	90	0
GDO	2092	IGT	5	150	Eating establishment	64	64	2150	MIAMI DADE WATER & SEWER DEPARTMENT	Single	1200	one 1200 gallon	90	538
GDO	2093	IGT	5	150	Eating establishment	3460	3460	0	MIAMI DADE WATER & SEWER DEPARTMENT	Multiple	5600	two 1200 & two 1600 gallon	90	0
GDO	2097	IGT	5	300	Eating establishment	54	54	0		Single	750	one 750 gallon	90	1350
GDO	2098	IGT	5	300	Eating establishment	72	72	0	MIAMI DADE WATER & SEWER DEPARTMENT	Single	1050	one 1050 gallon	90	1800
GDO	2101	IGT	5	150	Eating establishment	74	74	3600	MIAMI DADE WATER & SEWER DEPARTMENT	Single	1200	one 1200 gallon	90	900
GDO	2103	MGRU	5	150	Eating establishment	60	0	420	MIAMI DADE WATER & SEWER DEPARTMENT		0	one 50 gpm	90	105
GDO	2105	IGT	5	300	Eating establishment	118	0	7518	MIAMI DADE WATER & SEWER DEPARTMENT	Single	3230	one 3230 gallon	30	1880
GDO	2107	IGT	5	300	Eating establishment	207	207	5500	CITY OF NORTH MIAMI BEACH	Series	2400	two 1200-gallon	90	1375
GDO	2110	IGT	5	300	Eating establishment	70	70	0	CITY OF MIAMI BEACH	Single	1200	one 1200 gallon	90	980
GDO	2116	IGT	5	750	Eating establishment	238	238	0	MIAMI DADE WATER & SEWER DEPARTMENT	Series	2100	two 1050 gallon	90	5950
GDO	2118	IGT	5	150	Eating establishment	30	30	0	CITY OF HIALEAH	Single	950	one 950 gallon	90	750
GDO	2120	IGT	5	300	Eating establishment	184	184	0	CITY OF HIALEAH	Single	1050	one 1050 gallon	90	4600
GDO	2121	MGRU	5	150	Eating establishment	0	0	0	MIAMI DADE WATER & SEWER DEPARTMENT		0	one 50 gpm	90	0
GDO	2125	MGRU	5	150	Eating establishment	20	0	1200	CITY OF NORTH MIAMI BEACH		0	one 35 gpm	90	300
GDO	2127	IGT	5	150	Eating establishment	0	0	0	MIAMI DADE WATER & SEWER DEPARTMENT	Single	900	one 900 gallon	90	0
GDO	2130	IGT	5	150	Eating establishment	62	62	2490	CITY OF HIALEAH	Single	1200	one 1200 gallon	90	623

WORK GROUP	PERMIT NUMBER	PERMIT CLASS	PERMIT	PERMIT FEE	BUSINESS_TYPE	RECORDED SEATS	OBSERVED SEATS	FACILITY AREA	UTILITY	SYSTEM FORMAT	TOTAL CAPACITY	TANK_CAPACITY	PUMP OUT	TOTAL GPD
GDO	2131	IGT	5	300	Eating establishment	60	60	0	CITY OF HIALEAH		750	one 750 gallon	90	1500
GDO	2133	AGRU	5	150	Eating establishment	32	32	0	MIAMI DADE WATER & SEWER DEPARTMENT		0	one 35-gpm	30	448
GDO	2134	IGT	5	150	Eating establishment	50	50	3100	MIAMI DADE WATER & SEWER DEPARTMENT	Single	1500	one 1500 gallon	90	775
GDO	2137	IGT	5	150	Eating establishment	50	50	0	CITY OF NORTH MIAMI BEACH	Single	1050	one 1050 gallon	90	700
GDO	2139	IGT	5	150	Eating establishment	39	39	0	MIAMI DADE WATER & SEWER DEPARTMENT	Single	750	one 750 gallon	90	975
GDO	2140	IGT	5	150	Eating establishment	18	18	1000	MIAMI DADE WATER & SEWER DEPARTMENT	Single	1050	one 1050-gallon	90	250
GDO	2142	IGT	5	150	Eating establishment	26	26	1600	MIAMI DADE WATER & SEWER DEPARTMENT	Single	1200	one 1200 gallon	90	400
GDO	2143	IGT	5	150	Eating establishment	40	0	864	MIAMI DADE WATER & SEWER DEPARTMENT	Single	1200	one 1200 gallon	90	216
GDO	2144	IGT	5	150	Eating establishment	30	30	2000	CITY OF NORTH MIAMI BEACH	Single	950	one 950 gallon	90	500
GDO	2145	MGRU	5	150	Eating establishment	84	84	2000	CITY OF NORTH MIAMI BEACH		0	one 25 gpm	30	500
GDO	2148	IGT	5	150	Eating establishment	40	40	2063	CITY OF HIALEAH	Single	1200	one 1200-gallon	90	516
GDO	2150	IGT	5	300	Eating establishment	0	0	0		Single	2000	one 2000 gallon	90	0
GDO	2153	MGRU	5	150	Eating establishment	0	0	900	MIAMI DADE WATER & SEWER DEPARTMENT		0	one 35 gpm	30	225
GDO	2154	AGRU	5	150	Eating establishment	85	85	1000	MIAMI DADE WATER & SEWER DEPARTMENT		0	one 35 gpm	30	250
GDO	2157	IGT	5	150	Eating establishment	34	34	0	MIAMI DADE WATER & SEWER DEPARTMENT	Single	1200	one 1200 gallon	90	850
GDO	2158	IGT	5	150	Eating establishment	30	20	0	MIAMI DADE WATER & SEWER DEPARTMENT	Single	1600	one 1600 gallon	90	420
GDO	2159	IGT	5	300	Eating establishment	74	74	0		Single	1200	one 1200 gallon	90	1850
GDO	2160	IGT	5	150	Eating establishment	67	67	2159	MIAMI DADE WATER & SEWER DEPARTMENT		0	one 750 gallon	90	540
GDO	2161	IGT	5	150	Eating establishment	6	6	660	MIAMI DADE WATER & SEWER DEPARTMENT	Single	750	one 750 gallon	90	165
GDO	2162	IGT	5	150	Eating establishment	35	35	855	MIAMI DADE WATER & SEWER DEPARTMENT	Single	750	one 750 gallon	90	214
GDO	2165	IGT	5	150	Eating establishment	44	44	2400	MIAMI DADE WATER & SEWER DEPARTMENT	Single	1500	one 1500-gallon	90	600
GDO	2173	AGRU	5	150	Eating establishment	42	42	1656	MIAMI DADE WATER & SEWER DEPARTMENT		0	one 25 gpm	30	414
GDO	2175	MGRU	5	150	Eating establishment	20	0	393	MIAMI DADE WATER & SEWER DEPARTMENT		0	one 50 gpm	39	98
GDO	2177	IGT	5	150	Eating establishment	22	0	0		Single	1600	one 1600 gallon	90	0
GDO	2178	IGT	5	150	Eating establishment	70	0	1000	MIAMI DADE WATER & SEWER DEPARTMENT	Single	950	one 950 gallon	60	250
GDO	2181	AGRU	5	150	Eating establishment	42	42	2480	MIAMI DADE WATER & SEWER DEPARTMENT		0	one 25 gpm	30	1050
GDO	2182	IGT	5	150	Eating establishment	33	33	2590	MIAMI DADE WATER & SEWER DEPARTMENT	Single	1050	one 1050 gallon	90	648
GDO	2184	IGT	5	150	Eating establishment	50	50	0	MIAMI DADE WATER & SEWER DEPARTMENT	Single	1200	one 1200 gallon	30	1250
GDO	2189	MGRU	5	150	Eating establishment	1	1	1500	CITY OF NORTH MIAMI BEACH		0	one 25 gpm	30	375
GDO	2193	IGT	5	150	Eating establishment	48	48	0	CITY OF HIALEAH	Single	900	one 900 gallon	90	672
GDO	2195	MGRU	5	150	Eating establishment	24	24	934	MIAMI DADE WATER & SEWER DEPARTMENT		0	one 25 gpm	30	234
GDO	2196	IGT	5	150	Eating establishment	0	0	0	MIAMI DADE WATER & SEWER DEPARTMENT	Single	1050	one 1050 gallon	90	0
GDO	2201	IGT	5	150	Eating establishment	50	0	2000	MIAMI DADE WATER & SEWER DEPARTMENT	Single	950	one 950 gallon	30	575
GDO	2202	IGT	5	300	Eating establishment	180	180	0		Single	2000	one 2000 gallon	90	4500
GDO	2203	IGT	5	300	Eating establishment	130	130	6769		Single	1200	one 1200 gallon	90	1692
GDO	2204	IGT	5	150	Eating establishment	68	68	2166	MIAMI DADE WATER & SEWER DEPARTMENT	Series	4000	two 2000 gallon	90	542
GDO	2205	IGT	5	150	Eating establishment	25	25	1640	MIAMI DADE WATER & SEWER DEPARTMENT	Single	1200	one 1200-gallon	90	410
GDO	2207	IGT	5	150	Eating establishment	45	0	0			0	one 950 gallon	90	0
GDO	2208	IGT	5	150	Eating establishment	20	20	0	MIAMI DADE WATER & SEWER DEPARTMENT	Single	950	one 950 gallon	90	5
GDO	2209	IGT	5	150	Eating establishment	36	36	0	MIAMI DADE WATER & SEWER DEPARTMENT	Single	950	one 950 gallon	90	504
GDO	2210	IGT	5	300	Eating establishment	60	60	0	CITY OF HIALEAH	Single	900	one 900 gallon	90	1500
GDO	2211	IGT	5	300	Eating establishment	74	74	0		Single	1200	one 1200 gallon	90	1036
GDO	2212	MGRU	5	150	Eating establishment	0	0	1400	CITY OF HIALEAH		0	one 25-gpm	30	350
GDO	2220	IGT	5	300	Eating establishment	75	75	0	MIAMI DADE WATER & SEWER DEPARTMENT	Single	1200	one 1200 gallon	90	1875
GDO	2221	IGT	5	150	Eating establishment	38	38	0	CITY OF OPA LOCKA	Single	950	one 950 gallon	90	532
GDO	2224	IGT	5	150	Eating establishment	44	44	0		Single	750	one 750 gallon	90	1100
GDO	2226	IGT	5	300	Eating establishment	90	90	0	MIAMI DADE WATER & SEWER DEPARTMENT	Single	950	one 950 gallon	90	1260
GDO	2228	IGT	5	300	Eating establishment	100	100	0	MIAMI DADE WATER & SEWER DEPARTMENT	Series	2100	two 2000 gallon	90	2500
GDO	2230	IGT	5	300	Eating establishment	150	150	0	MIAMI DADE WATER & SEWER DEPARTMENT	Single	950	one 950 gallon	90	3750
GDO	2231	IGT	5	150	Eating establishment	28	0	675	MIAMI DADE WATER & SEWER DEPARTMENT	Single	750	one 750 gallon	60	16875
GDO	2235	IGT	5	300	Eating establishment	92	92	0	MIAMI DADE WATER & SEWER DEPARTMENT	Single	950	one 950 gallon	90	2300
GDO	2237	IGT	5	750	Eating establishment	350	350	0	MIAMI DADE WATER & SEWER DEPARTMENT	Series	3200	two 1600 gallon	90	8750
GDO	2238	IGT	5	300	Eating establishment	74	74	0	MIAMI DADE WATER & SEWER DEPARTMENT	Single	1200	one 1200 gallon	90	1850
GDO	2240	IGT	5	750	Eating establishment	250	250	0	MIAMI DADE WATER & SEWER DEPARTMENT	Single	1200	one 1200 gallon	90	6250
GDO	2241	IGT	5	300	Eating establishment	149	149	0	MIAMI DADE WATER & SEWER DEPARTMENT	Single	1050	one 1050-gallon	90	3725
GDO	2243	IGT	5	150	Eating establishment	28	28	0		Single	1200	one 1200 gallon	90	7
GDO	2244	IGT	5	300	Eating establishment	149	149	0	MIAMI DADE WATER & SEWER DEPARTMENT	Single	1200	one 1200 gallon	90	3725
GDO	2246	IGT	5	300	Eating establishment	38	38	0		Single	750	one 750 gallon	90	950
GDO	2250	IGT	5	300	Eating establishment	49	49	0	MIAMI DADE WATER & SEWER DEPARTMENT	Single	750	one 750 gallon	90	1225
GDO	2251	IGT	5	150	Eating establishment	40	40	0		Single	1050	one 1050 gallon	90	560
GDO	2252	IGT	5	150	Eating establishment	38	0	1580	MIAMI DADE WATER & SEWER DEPARTMENT	Single	1000	one 1000 gallon	60	395

WORK GROUP	PERMIT NUMBER	PERMIT CLASS	PERMIT	PERMIT FEE	BUSINESS_TYPE	RECORDED SEATS	OBSERVED SEATS	FACILITY AREA	UTILITY	SYSTEM FORMAT	TOTAL CAPACITY	TANK_CAPACITY	PUMP OUT	TOTAL GPD
GDO	2257	IGT	5	150	Eating establishment	0	0	0	CITY OF HIALEAH	Single	750	one 750 gallon	90	0
GDO	2259	MGRU	5	150	Eating establishment	49	0	2270	MIAMI DADE WATER & SEWER DEPARTMENT		0	one 25 gpm	30	568
GDO	2260	MGRU	5	750	Eating establishment	313	313	0	CITY OF MIAMI BEACH		0	one 25 gpm	30	7825
GDO	2261	IGT	5	300	Eating establishment	200	200	0	MIAMI DADE WATER & SEWER DEPARTMENT	Single	950	one 950 gallon	90	5000
GDO	2262	MGRU	5	150	Eating establishment	140	0	1200	MIAMI DADE WATER & SEWER DEPARTMENT	Single	750	two 25 gpm	30	300
GDO	2264	IGT	5	150	Eating establishment	51	0	1502	CITY OF MIAMI BEACH	Single	750	one 750 gallon	60	376
GDO	2265	IGT	5	300	Eating establishment	66	66	0	MIAMI DADE WATER & SEWER DEPARTMENT	Single	2000	one 2000 gallon	90	1650
GDO	2269	IGT	5	300	Eating establishment	96	96	0		Series	2100	two 1050 gallon	90	1344
GDO	2270	IGT	5	150	Eating establishment	0	0	932	CITY OF FLORIDA CITY	Single	2000	one 1500 gallon	90	233
GDO	2271	IGT	5	300	Eating establishment	68	68	0	MIAMI DADE WATER & SEWER DEPARTMENT	Series	2100	two 1050 gallon	90	1700
GDO	2272	IGT	5	300	Eating establishment	200	200	0	CITY OF CORAL GABLES	Single	950	one 950 gallon	90	5000
GDO	2273	IGT	5	300	Eating establishment	76	76	0	MIAMI DADE WATER & SEWER DEPARTMENT	Single	1200	one 1200 gallon	90	1064
GDO	2276	IGT	5	150	Eating establishment	60	60	900	MIAMI DADE WATER & SEWER DEPARTMENT	Single	1050	one 1050 gallon	90	225
GDO	2277	IGT	5	150	Eating establishment	30	30	1562	MIAMI DADE WATER & SEWER DEPARTMENT		0	one 25 gpm	90	391
GDO	2278	IGT	5	150	Eating establishment	0	0	0		Single	1050	one 1050 gallon	90	0
GDO	2280	IGT	5	150	Eating establishment	30	30	0	MIAMI DADE WATER & SEWER DEPARTMENT	Single	950	one 950 gallon	90	420
GDO	2281	IGT	5	150	Eating establishment	5	0	1500	CITY OF HIALEAH	Single	1050	one 1050 gallon	90	375
GDO	2287	IGT	5	150	Eating establishment	30	30	1840	CITY OF HIALEAH	Single	750	one 750 gallon	90	460
GDO	2289	IGT	5	300	Eating establishment	70	70	0		Single	1050	one 1050 gallon	90	980
GDO	2290	IGT	5	150	Eating establishment	0	0	960	MIAMI DADE WATER & SEWER DEPARTMENT	Single	750	one 750 gallon	90	240
GDO	2292	MGRU	5	150	Eating establishment	0	0	1400	MIAMI DADE WATER & SEWER DEPARTMENT		0	one 35 gpm	30	350
GDO	2293	IGT	5	300	Eating establishment	70	70	0	MIAMI DADE WATER & SEWER DEPARTMENT	Single	950	one 950 gallon	90	980
GDO	2294	IGT	5	150	Eating establishment	0	0	600	MIAMI DADE WATER & SEWER DEPARTMENT	Single	750	one 750-gallon	90	150
GDO	2295	IGT	5	150	Eating establishment	0	0	800	MIAMI DADE WATER & SEWER DEPARTMENT	Single	750	one 750 gallon	90	200
GDO	2297	IGT	5	150	Eating establishment	0	0	1245	MIAMI DADE WATER & SEWER DEPARTMENT	Single	950	one 950 gallon	90	311
GDO	2301	IGT	5	150	Eating establishment	0	0	0	CITY OF NORTH MIAMI BEACH	Single	950	one 950 gallon	90	0
GDO	2302	IGT	5	300	Eating establishment	150	150	0	MIAMI DADE WATER & SEWER DEPARTMENT	Series	3000	one 1500 gallon	90	38
GDO	2303	MGRU	5	150	Eating establishment	0	0	1600	MIAMI DADE WATER & SEWER DEPARTMENT		0	one 35 gpm	30	400
GDO	2307	IGT	5	150	Eating establishment	0	0	2500	MIAMI DADE WATER & SEWER DEPARTMENT	Single	750	one 750 gallon	90	625
GDO	2308	IGT	5	150	Eating establishment	0	0	0			0	one 750 gallon	90	0
GDO	2311	IGT	5	300	Eating establishment	66	66	0	MIAMI DADE WATER & SEWER DEPARTMENT	Single	2000	one 2000 gallon	90	1650
GDO	2313	IGT	5	300	Eating establishment	160	160	0	CITY OF NORTH MIAMI BEACH	Single	750	one 750 gallon	90	4000
GDO	2314	MGRU	5	150	Eating establishment	30	30	0	CITY OF MIAMI BEACH		0	one 25 gpm	30	750
GDO	2315	IGT	5	150	Eating establishment	226	226	3095	CITY OF MIAMI BEACH	Series	2100	two 1050 gallon	90	774
GDO	2317	MGRU	5	150	Eating establishment	32	32	950	CITY OF MIAMI BEACH		0	one 25 gpm	30	238
GDO	2319	IGT	5	300	Eating establishment	95	95	0		Single	950	one 950 gallon	90	2375
GDO	2320	IGT	5	150	Eating establishment	38	38	0	MIAMI DADE WATER & SEWER DEPARTMENT	Single	950	one 950 gallon	90	950
GDO	2324	IGT	5	300	Eating establishment	58	58	0		Series	2100	two 1050 gallon	90	812
GDO	2326	IGT	5	300	Eating establishment	149	149	0	CITY OF HIALEAH	Series	1500	two 750 gallon	90	3725
GDO	2327	MGRU	5	150	Eating establishment	6	6	2200	CITY OF HIALEAH		0	one 25 gpm	30	550
GDO	2328	IGT	5	300	Eating establishment	58	0	8207	CITY OF HIALEAH	Single	950	one 950 gallon	60	2052
GDO	2329	IGT	5	300	Eating establishment	149	149	0	MIAMI DADE WATER & SEWER DEPARTMENT	Single	3200	two 1600 gallon	90	3725
GDO	2330	IGT	5	150	Eating establishment	30	30	0	CITY OF HIALEAH	Single	1050	one 1050 gallon	90	750
GDO	2331	IGT	5	150	Eating establishment	0	0	775	MIAMI DADE WATER & SEWER DEPARTMENT	Single	750	one 750 gallon	90	194
GDO	2332	IGT	5	300	Eating establishment	99	99	0	MIAMI DADE WATER & SEWER DEPARTMENT	Single	2000	one 2000 gallon	90	1386
GDO	2333	IGT	5	150	Eating establishment	0	0	0		Single	1050	one 1050 gallon	90	0
GDO	2334	IGT	5	150	Eating establishment	50	50	0	MIAMI DADE WATER & SEWER DEPARTMENT	Single	1050	one 1050 gallon	90	700
GDO	2335	IGT	5	150	Eating establishment	90	90	2500	MIAMI DADE WATER & SEWER DEPARTMENT	Single	750	one 750 gallon	90	625
GDO	2336	IGT	5	150	Eating establishment	30	30	0	MIAMI DADE WATER & SEWER DEPARTMENT	Single	950	one 950 gallon	90	750
GDO	2337	IGT	5	300	Eating establishment	200	200	4500	MIAMI DADE WATER & SEWER DEPARTMENT	Single	750	one 750 gallon	90	1125
GDO	2339	IGT	5	300	Eating establishment	48	48	0	MIAMI DADE WATER & SEWER DEPARTMENT	Single	1050	one 1050 gallon	90	1200
GDO	2341	IGT	5	300	Eating establishment	74	74	0		Single	2200	one 2200 gallon	90	1850
GDO	2345	IGT	5	300	Eating establishment	89	0	4092	CITY OF NORTH MIAMI BEACH	Single	950	one 950 gallon	90	1023
GDO	2346	IGT	5	300	Eating establishment	101	0	5028	MIAMI DADE WATER & SEWER DEPARTMENT	Single	1500	one 1500 gallon	60	125700
GDO	2347	IGT	5	150	Eating establishment	0	0	1300	MIAMI DADE WATER & SEWER DEPARTMENT	Single	950	one 950 gallon	90	325
GDO	2348	IGT	5	150	Eating establishment	0	0	1483	MIAMI DADE WATER & SEWER DEPARTMENT	Single	950	one 950 gallon	90	371
GDO	2349	IGT	5	300	Eating establishment	200	200	5400	MIAMI DADE WATER & SEWER DEPARTMENT	Series	1900	two 950-gallon	90	1350
GDO	2350	IGT	5	300	Eating establishment	74	74	0	MIAMI DADE WATER & SEWER DEPARTMENT	Single	1200	one 1200 gallon	90	1036
GDO	2353	IGT	5	300	Eating establishment	70	70	0	MIAMI DADE WATER & SEWER DEPARTMENT	Single	1200	one 1200 gallon	90	1750
GDO	2357	AGRU	5	150	Eating establishment	30	30	1400	CITY OF MIAMI BEACH		0	one 25 gpm	30	350
GDO	2358	IGT	5	150	Eating establishment	50	50	2558	MIAMI DADE WATER & SEWER DEPARTMENT	Single	750	one 750 gallon	90	640

WORK GROUP	PERMIT NUMBER	PERMIT CLASS	PERMIT	PERMIT FEE	BUSINESS_TYPE	RECORDED SEATS	OBSERVED SEATS	FACILITY AREA	UTILITY	SYSTEM FORMAT	TOTAL CAPACITY	TANK_CAPACITY	PUMP OUT	TOTAL GPD
GDO	2360	IGT	5	150	Eating establishment	0	0	890	MIAMI DADE WATER & SEWER DEPARTMENT	Single	1050	one 1050 gallon	90	223
GDO	2362	IGT	5	150	Eating establishment	5	5	1500	MIAMI DADE WATER & SEWER DEPARTMENT	Single	1200	one 1200 gallon	90	375
GDO	2363	IGT	5	150	Eating establishment	18	18	1126	MIAMI DADE WATER & SEWER DEPARTMENT	Single	1200	one 1200 gallon	30	282
GDO	2365	IGT	5	300	Eating establishment	130	130	6125	CITY OF MIAMI BEACH	Single	950	one 950 gallon	90	1531
GDO	2367	IGT	5	150	Eating establishment	20	25	1200	MIAMI DADE WATER & SEWER DEPARTMENT	Single	900	one 900 gallon	90	300
GDO	2368	IGT	5	300	Eating establishment	230	230	5079	MIAMI DADE WATER & SEWER DEPARTMENT	Series	3200	two 1600 gallon	90	1270
GDO	2370	IGT	5	150	Eating establishment	34	30	0	MIAMI DADE WATER & SEWER DEPARTMENT	Single	1050	one 1050 gallon	90	476
GDO	2373	IGT	5	300	Eating establishment	149	149	0		Single	1050	one 1050 gallon	90	2086
GDO	2375	IGT	5	300	Eating establishment	127	127	0	MIAMI DADE WATER & SEWER DEPARTMENT	Single	2500	one 2500 gallon	90	3175
GDO	2376	IGT	5	150	Eating establishment	44	44	980	MIAMI DADE WATER & SEWER DEPARTMENT	Single	1500	one 1500-gallon	90	245
GDO	2378	IGT	5	300	Eating establishment	80	80	0	MIAMI DADE WATER & SEWER DEPARTMENT	Series	2100	two 1050 gallon	90	2000
GDO	2379	IGT	5	150	Eating establishment	0	0	0	CITY OF HIALEAH	Single	900	one 900 gallon	90	0
GDO	2381	AGRU	5	150	Eating establishment	15	0	900	MIAMI DADE WATER & SEWER DEPARTMENT		0	one 35 gpm	60	225
GDO	2382	IGT	5	150	Eating establishment	0	0	4000	MIAMI DADE WATER & SEWER DEPARTMENT	Single	1200	one 1200 gallon	60	1000
GDO	2383	IGT	5	150	Eating establishment	9	9	1250	CITY OF OPA LOCKA	Single	750	one 750 gallon	90	313
GDO	2386	MGRU	5	150	Eating establishment	0	0	1500	MIAMI DADE WATER & SEWER DEPARTMENT		0	one 25-gpm	30	375
GDO	2389	IGT	5	300	Eating establishment	175	175	6300	MIAMI DADE WATER & SEWER DEPARTMENT	Single	1200	one 1200 gallon	90	1575
GDO	2390	AGRU	5	150	Eating establishment	20	20	1100	MIAMI DADE WATER & SEWER DEPARTMENT		0	one 25 gpm	30	275
GDO	2391	IGT	5	150	Eating establishment	200	0	3760	CITY OF NORTH MIAMI BEACH	Single	750	one 750 gallon	90	565
GDO	2392	IGT	5	300	Eating establishment	56	56	0	CITY OF NORTH MIAMI BEACH	Single	1500	one 1500 gallon	90	1400
GDO	2395	IGT	5	150	Eating establishment	93	93	3500	CITY OF NORTH MIAMI BEACH	Single	950	one 950-gallon	60	979
GDO	2397	IGT	5	150	Eating establishment	10	10	0	CITY OF HIALEAH	Single	950	one 950 gallon	90	0
GDO	2400	MGRU	5	150	Eating establishment	16	0	2114	CITY OF MIAMI BEACH		0	one 100 gpm	30	529
GDO	2401	IGT	5	300	Eating establishment	200	200	4000	CITY OF NORTH MIAMI BEACH	Single	1050	one 1050 gallon	90	1000
GDO	2402	IGT	5	750	Eating establishment	260	260	0	CITY OF NORTH MIAMI BEACH	Series	1900	two 950 gallon	90	6500
GDO	2403	IGT	5	150	Eating establishment	96	96	2800	CITY OF NORTH MIAMI BEACH	Single	950	one 950 gallon	90	700
GDO	2409	IGT	5	150	Eating establishment	50	50	0	CITY OF NORTH MIAMI BEACH		750	one 750 gallon	90	1250
GDO	2410	IGT	5	150	Eating establishment	30	30	1848	MIAMI DADE WATER & SEWER DEPARTMENT	Single	950	one 950-gallon	90	462
GDO	2411	IGT	5	150	Eating establishment	9	9	0	MIAMI DADE WATER & SEWER DEPARTMENT	Single	750	one 750 gallon	90	126
GDO	2412	IGT	5	150	Eating establishment	149	149	2800	MIAMI DADE WATER & SEWER DEPARTMENT	Series	1500	two 750 gallon	90	700
GDO	2417	IGT	5	300	Eating establishment	64	64	0	CITY OF HIALEAH	Single	1050	one 1050 gallon	90	896
GDO	2423	IGT	5	150	Eating establishment	40	40	0	MIAMI DADE WATER & SEWER DEPARTMENT	Single	950	one 950 gallon	90	1000
GDO	2424	IGT	5	300	Eating establishment	65	65	0	CITY OF NORTH MIAMI BEACH	Single	950	one 950 gallon	90	1625
GDO	2425	IGT	5	300	Eating establishment	200	0	2963	CITY OF NORTH MIAMI BEACH	Single	2000	one 2000 gallon	60	1028
GDO	2426	MGRU	5	150	Eating establishment	6	6	854	CITY OF NORTH MIAMI BEACH		0	one 25 gpm	30	214
GDO	2428	IGT	5	150	Eating establishment	61	0	2835	MIAMI DADE WATER & SEWER DEPARTMENT	Series	2400	two 1200 gallon	60	709
GDO	2430	IGT	5	150	Eating establishment	105	105	1000	CITY OF NORTH MIAMI BEACH	Single	750	one 750 gallon	90	250
GDO	2431	IGT	5	300	Eating establishment	150	150	0	MIAMI DADE WATER & SEWER DEPARTMENT	Single	750	one 750 gallon	90	3750
GDO	2433	IGT	5	150	Eating establishment	38	38	1500	MIAMI DADE WATER & SEWER DEPARTMENT	Single	1200	one 1200 gallon	90	375
GDO	2436	IGT	5	150	Eating establishment	30	30	0		Single	1200	one 1200 gallon	90	420
GDO	2437	IGT	5	150	Eating establishment	20	20	800	MIAMI DADE WATER & SEWER DEPARTMENT	Single	750	one 750 gallon	90	200
GDO	2438	IGT	5	300	Eating establishment	71	71	0	MIAMI DADE WATER & SEWER DEPARTMENT	Single	950	one 950 gallon	90	1775
GDO	2439	IGT	5	150	Eating establishment	30	30	1530	MIAMI DADE WATER & SEWER DEPARTMENT	Single	950	one 950 gallon	90	383
GDO	2440	IGT	5	150	Eating establishment	55	55	2800	MIAMI DADE WATER & SEWER DEPARTMENT	Single	750	one 750 gallon	90	700
GDO	2441	AGRU	5	300	Eating establishment	116	116	0	CITY OF MIAMI BEACH		0	one 25 gpm	30	2900
GDO	2442	AGRU	5	150	Eating establishment	32	32	1900	CITY OF MIAMI BEACH		0	one 10 gpm	30	475
GDO	2443	IGT	5	150	Eating establishment	41	41	1200	MIAMI DADE WATER & SEWER DEPARTMENT	Single	1050	one 1050 gallon	90	300
GDO	2444	IGT	5	150	Eating establishment	0	0	0		Single	750	one 750 gallon	90	0
GDO	2446	IGT	5	300	Eating establishment	66	66	0	MIAMI DADE WATER & SEWER DEPARTMENT	Single	950	one 950 gallon	90	1650
GDO	2448	IGT	5	150	Eating establishment	15	15	1100	CITY OF NORTH MIAMI BEACH	Single	950	one 950 gallon	90	275
GDO	2449	MGRU	5	150	Eating establishment	0	0	0	MIAMI DADE WATER & SEWER DEPARTMENT		0	Not applicable	0	0
GDO	2451	IGT	5	150	Eating establishment	25	25	0	CITY OF HIALEAH	Single	1050	one 1050 gallon	90	625
GDO	2453	IGT	5	300	Eating establishment	195	195	0	MIAMI DADE WATER & SEWER DEPARTMENT	Single	1050	one 1050 gallon	90	4875
GDO	2455	MGRU	5	300	Eating establishment	30	30	3800	CITY OF HIALEAH		0	two 25 gpm	30	950
GDO	2456	IGT	5	150	Eating establishment	32	32	3000	MIAMI DADE WATER & SEWER DEPARTMENT	Single	1050	one 1050 gallon	90	750
GDO	2457	IGT	5	150	Eating establishment	110	0	2500	MIAMI DADE WATER & SEWER DEPARTMENT	Single	1050	one 1050 gallon	60	625
GDO	2458	IGT	5	150	Eating establishment	60	60	2817	MIAMI DADE WATER & SEWER DEPARTMENT	Single	1500	one 1500-gallon	90	704
GDO	2466	MGRU	5	150	Eating establishment	28	28	0	MIAMI DADE WATER & SEWER DEPARTMENT		0	one 25 gpm	30	700
GDO	2468	IGT	5	300	Eating establishment	200	200	0	MIAMI DADE WATER & SEWER DEPARTMENT	Single	900	one 900 gallon	90	5000
GDO	2473	AGRU	5	150	Eating establishment	60	60	1200	MIAMI DADE WATER & SEWER DEPARTMENT		0	one 25 gpm	30	300
GDO	2475	IGT	2	150	Eating establishment	0	0	1100	MIAMI DADE WATER & SEWER DEPARTMENT	Single	2000	one 2000 gallon	90	275

WORK GROUP	PERMIT NUMBER	PERMIT CLASS	PERMIT	PERMIT FEE	BUSINESS_TYPE	RECORDED SEATS	OBSERVED SEATS	FACILITY AREA	UTILITY	SYSTEM FORMAT	TOTAL CAPACITY	TANK_CAPACITY	PUMP OUT	TOTAL GPD
GDO	2476	MGRU	5	150	Eating establishment	34	34	1100	MIAMI DADE WATER & SEWER DEPARTMENT		0	one 25 gpm	30	275
GDO	2477	IGT	5	150	Eating establishment	120	120	3500	MIAMI DADE WATER & SEWER DEPARTMENT	Series	1900	two 950 gallon	90	875
GDO	2478	IGT	5	150	Eating establishment	16	16	0	CITY OF FLORIDA CITY	Single	1200	one 1200 gallon	90	224
GDO	2479	IGT	5	150	Eating establishment	149	149	2500		Single	750	one 750 gallon	90	625
GDO	2480	IGT	5	300	Eating establishment	139	0	4000	CITY OF FLORIDA CITY	Single	1600	one 1600 gallon	90	100000
GDO	2485	IGT	5	150	Eating establishment	45	45	0	MIAMI DADE WATER & SEWER DEPARTMENT	Single	1500	one 1500 gallon	90	1125
GDO	2487	IGT	5	150	Eating establishment	114	0	3560	MIAMI DADE WATER & SEWER DEPARTMENT	Single	900	one 900 gallon	30	890
GDO	2490	IGT	5	150	Eating establishment	40	40	0		Single	1050	one 1050 gallon	90	560
GDO	2493	IGT	5	150	Eating establishment	10	10	0	MIAMI DADE WATER & SEWER DEPARTMENT	Single	1050	one 1050 gallon	90	140
GDO	2494	IGT	5	150	Eating establishment	18	18	0	MIAMI DADE WATER & SEWER DEPARTMENT	Single	750	one 750 gallon	90	252
GDO	2497	IGT	5	150	Eating establishment	10	10	0		Single	1200	one 1200 gallon	90	140
GDO	2500	IGT	5	150	Eating establishment	6	6	1292	CITY OF NORTH MIAMI BEACH	Single	950	one 950 gallon	90	323
GDO	2502	IGT	5	150	Eating establishment	30	30	0	MIAMI DADE WATER & SEWER DEPARTMENT	Single	1050	one 1050 gallon	90	750
GDO	2510	IGT	5	150	Eating establishment	120	120	1625	CITY OF NORTH MIAMI BEACH	Series	4000	two 2000 gallon	90	406
GDO	2512	AGRU	5	150	Eating establishment	44	44	1480	CITY OF MIAMI BEACH		0	one 25 gpm	30	370
GDO	2515	MGRU	5	150	Eating establishment	10	10	0	MIAMI DADE WATER & SEWER DEPARTMENT		0	one 20 gpm	30	3
GDO	2516	IGT	5	150	Eating establishment	40	40	0	CITY OF NORTH MIAMI BEACH	Series	2400	two 1200 gallon	90	560
GDO	2517	IGT	5	150	Eating establishment	140	140	3000	CITY OF NORTH MIAMI BEACH	Single	1250	one 1250 gallon	60	858
GDO	2518	IGT	5	150	Eating establishment	54	0	1800	MIAMI DADE WATER & SEWER DEPARTMENT	Single	950	one 950 gallon	60	450
GDO	2520	IGT	5	300	Eating establishment	55	55	2750	MIAMI DADE WATER & SEWER DEPARTMENT	Single	900	one 900 gallon	90	1375
GDO	2521	IGT	5	300	Eating establishment	149	72	0	MIAMI DADE WATER & SEWER DEPARTMENT	Single	2500	Not applicable	90	1800
GDO	2522	IGT	5	150	Eating establishment	25	25	1800	MIAMI DADE WATER & SEWER DEPARTMENT	Single	1200	one 1200 gallon	90	450
GDO	2523	MGRU	5	150	Eating establishment	8	0	800	MIAMI DADE WATER & SEWER DEPARTMENT		0	one 50 gpm	30	200
GDO	2524	IGT	5	150	Eating establishment	45	45	1500	CITY OF OPA LOCKA	Single	750	one 750 gallon	90	37500
GDO	2525	IGT	5	150	Eating establishment	39	39	0	MIAMI DADE WATER & SEWER DEPARTMENT	Single	1050	one 1050 gallon	90	546
GDO	2529	IGT	5	150	Eating establishment	30	30	0	MIAMI DADE WATER & SEWER DEPARTMENT	Single	900	one 900 gallon	90	750
GDO	2533	MGRU	5	150	Eating establishment	27	27	0	CITY OF OPA LOCKA		0	one 25 gpm	30	378
GDO	2534	IGT	5	150	Eating establishment	34	34	0	CITY OF OPA LOCKA	Single	750	one 750 gallon	90	476
GDO	2538	IGT	5	300	Eating establishment	168	168	5388	MIAMI DADE WATER & SEWER DEPARTMENT	Single	1200	one 1200 gallon	90	1347
GDO	2540	IGT	5	300	Eating establishment	236	236	5858	MIAMI DADE WATER & SEWER DEPARTMENT	Single	1200	one 1200 gallon	90	1465
GDO	2542	IGT	5	150	Eating establishment	0	0	1800	MIAMI DADE WATER & SEWER DEPARTMENT	Single	750	one 750 gallon	90	450
GDO	2544	AGRU	5	150	Eating establishment	0	0	1700	MIAMI DADE WATER & SEWER DEPARTMENT		0	Thermaco W-350-IS	30	425
GDO	2546	IGT	5	150	Eating establishment	30	30	0		Single	900	one 900 gallon	90	750
GDO	2547	IGT	5	300	Eating establishment	76	76	0		Single	1050	one 1050 gallon	90	1900
GDO	2550	IGT	5	300	Eating establishment	125	125	0	MIAMI DADE WATER & SEWER DEPARTMENT	Single	1600	one 1600 gallon	90	3125
GDO	2551	IGT	5	150	Eating establishment	49	49	0	CITY OF NORTH MIAMI BEACH	Single	1050	one 1050 gallon	90	1225
GDO	2555	IGT	5	300	Eating establishment	74	74	0		Single	900	one 900 gallon	90	1036
GDO	2557	IGT	5	300	Eating establishment	278	278	7506	MIAMI DADE WATER & SEWER DEPARTMENT	Single	950	one 950 gallon	90	1877
GDO	2558	IGT	5	300	Eating establishment	150	150	0		Single	950	one 950 gallon	90	3750
GDO	2559	IGT	5	150	Eating establishment	250	250	17600	MIAMI DADE WATER & SEWER DEPARTMENT	Single	750	one 750 gallon	90	5000
GDO	2560	IGT	5	300	Eating establishment	75	70	0	MIAMI DADE WATER & SEWER DEPARTMENT	Single	900	one 900 gallon	90	980
GDO	2561	IGT	5	300	Eating establishment	0	0	0	MIAMI DADE WATER & SEWER DEPARTMENT	Single	950	one 950 gallon	30	0
GDO	2563	IGT	5	300	Eating establishment	30	30	6000		Single	750	one 750 gallon	90	1500
GDO	2564	IGT	5	150	Eating establishment	27	27	0	CITY OF NORTH MIAMI BEACH	Single	1050	one 1050 gallon	90	7
GDO	2565	MGRU	5	150	Eating establishment	40	0	1100	CITY OF HIALEAH		0	one 6 gpm	30	275
GDO	2567	IGT	5	150	Eating establishment	32	0	1894	MIAMI DADE WATER & SEWER DEPARTMENT	Single	1250	one 1250 gallon	90	474
GDO	2570	IGT	5	150	Eating establishment	37	37	0		Single	1500	one 1500 gallon	90	925
GDO	2571	IGT	5	150	Eating establishment	48	48	2850	MIAMI DADE WATER & SEWER DEPARTMENT	Single	750	one 750-gallon	90	71250
GDO	2575	IGT	5	300	Eating establishment	131	131	0	MIAMI DADE WATER & SEWER DEPARTMENT	Single	750	one 750 gallon	90	3275
GDO	2577	IGT	5	150	Eating establishment	35	35	0	CITY OF HIALEAH	Single	950	one 950 gallon	90	875
GDO	2579	IGT	5	150	Eating establishment	38	38	0	CITY OF HIALEAH	Single	750	one 750 gallon	90	532
GDO	2580	IGT	5	150	Eating establishment	38	38	1200	CITY OF HIALEAH	Single	1050	one 1050 gallon	30	300
GDO	2581	IGT	5	150	Eating establishment	25	25	0		Single	750	one 750 gallon	90	6
GDO	2582	IGT	5	150	Eating establishment	0	0	0	MIAMI DADE WATER & SEWER DEPARTMENT	Single	950	one 950 gallon	90	0
GDO	2583	IGT	5	150	Eating establishment	69	69	1500	MIAMI DADE WATER & SEWER DEPARTMENT		0	one 10 gallon	90	375
GDO	2584	IGT	5	150	Eating establishment	0	0	300	MIAMI DADE WATER & SEWER DEPARTMENT	Single	1200	one 1200 gallon	60	75
GDO	2588	IGT	5	150	Eating establishment	40	40	1388	MIAMI DADE WATER & SEWER DEPARTMENT	Single	750	one 750-gallon	90	347
GDO	2590	IGT	5	150	Eating establishment	16	16	0	MIAMI DADE WATER & SEWER DEPARTMENT	Single	1050	one 1050 gallon	90	224
GDO	2593	IGT	5	150	Eating establishment	42	42	1500	SWEETWATER	Single	750	one 750 gallon	90	375
GDO	2594	IGT	5	300	Eating establishment	52	52	0	MIAMI DADE WATER & SEWER DEPARTMENT	Single	750	one 750 gallon	90	1300

WORK GROUP	PERMIT NUMBER	PERMIT CLASS	PERMIT	PERMIT FEE	BUSINESS_TYPE	RECORDED SEATS	OBSERVED SEATS	FACILITY AREA	UTILITY	SYSTEM FORMAT	TOTAL CAPACITY	TANK_CAPACITY	PUMP OUT	TOTAL GPD
GDO	2596	IGT	5	150	Eating establishment	45	45	0	MIAMI DADE WATER & SEWER DEPARTMENT	Single	750	one 750 gallon	90	1125
GDO	2597	IGT	5	300	Eating establishment	72	72	3500		Single	1200	one 1200 gallon	90	875
GDO	2599	AGRU	5	150	Eating establishment	0	0	0	MIAMI DADE WATER & SEWER DEPARTMENT		0	one 25 gpm	30	0
GDO	2600	IGT	5	150	Eating establishment	47	47	0	CITY OF HIALEAH	Single	1050	one 1050 gallon	90	1175
GDO	2601	IGT	5	150	Eating establishment	80	0	3200	MIAMI DADE WATER & SEWER DEPARTMENT	Single	1200	one 1200 gallon	90	800
GDO	2603	MGRU	5	150	Eating establishment	19	0	2440	MIAMI DADE WATER & SEWER DEPARTMENT		0	one 35 gpm	30	610
GDO	2606	IGT	5	300	Eating establishment	74	74	0	MIAMI DADE WATER & SEWER DEPARTMENT	Single	1200	one 1200 gallon	90	1850
GDO	2608	IGT	5	300	Eating establishment	52	52	2580	MIAMI DADE WATER & SEWER DEPARTMENT	Single	750	one 750 gallon	90	1300
GDO	2610	IGT	5	300	Eating establishment	128	128	0	CITY OF HIALEAH	Single	2000	one 2000 gallon	90	1792
GDO	2614	IGT	5	750	Eating establishment	299	299	0	MIAMI DADE WATER & SEWER DEPARTMENT	Single	1600	one 1600 gallon	90	7475
GDO	2615	IGT	5	750	Eating establishment	220	220	0	CITY OF NORTH MIAMI BEACH	Series	4000	two 2000 gallon	90	5500
GDO	2617	IGT	5	150	Eating establishment	7	7	1500	MIAMI DADE WATER & SEWER DEPARTMENT	Single	1050	one 1050 gallon	90	375
GDO	2618	IGT	5	150	Eating establishment	0	0	0	CITY OF OPA LOCKA	Single	950	one 950 gallon	90	0
GDO	2620	IGT	5	150	Eating establishment	30	30	1400	CITY OF HIALEAH	Single	1050	one 1050 gallon	60	350
GDO	2621	MGRU	5	150	Eating establishment	30	30	1584	MIAMI DADE WATER & SEWER DEPARTMENT	Single	0	one 50 gpm	90	396
GDO	2623	AGRU	5	150	Eating establishment	30	30	0			0	one 35 gpm	30	420
GDO	2626	IGT	5	150	Eating establishment	64	64	2160	MIAMI DADE WATER & SEWER DEPARTMENT	Single	1050	one 1050 gallon	90	540
GDO	2633	IGT	5	300	Eating establishment	149	149	4000	CITY OF NORTH MIAMI BEACH	Single	1200	one 1200 gallon	90	3725
GDO	2636	IGT	5	150	Eating establishment	47	47	1777	TOWN OF MEDLEY	Single	1050	one 1050-gallon	90	444
GDO	2640	IGT	5	300	Eating establishment	58	58	0		Single	900	one 900 gallon	90	1450
GDO	2641	IGT	5	150	Eating establishment	24	24	1500	MIAMI DADE WATER & SEWER DEPARTMENT	Single	1050	one 1050 gallon	90	375
GDO	2642	IGT	2	150	Eating establishment	81	0	1090	MIAMI DADE WATER & SEWER DEPARTMENT	Single	950	one 950 gallon	60	395
GDO	2643	IGT	5	150	Eating establishment	50	50	0	MIAMI DADE WATER & SEWER DEPARTMENT	Single	1200	one 1200 gallon	90	1250
GDO	2644	IGT	5	150	Eating establishment	30	30	1500	MIAMI DADE WATER & SEWER DEPARTMENT	Single	950	one 950 gallon	90	375
GDO	2645	IGT	5	150	Eating establishment	30	30	0		Single	950	one 950 gallon	90	8
GDO	2646	IGT	5	150	Eating establishment	70	70	1800	MIAMI DADE WATER & SEWER DEPARTMENT	Single	950	one 950 gallon	90	450
GDO	2647	IGT	5	150	Eating establishment	30	0	950	CITY OF OPA LOCKA	Single	750	one 750 gallon	60	238
GDO	2649	IGT	5	150	Eating establishment	35	35	0	MIAMI DADE WATER & SEWER DEPARTMENT	Single	750	one 750 gallon	90	875
GDO	2658	IGT	5	150	Eating establishment	0	0	0	MIAMI DADE WATER & SEWER DEPARTMENT	Single	1050	one 1050 gallon	90	0
GDO	2659	IGT	5	300	Eating establishment	85	85	0	MIAMI DADE WATER & SEWER DEPARTMENT	Single	1050	one 1050 gallon	90	2125
GDO	2660	IGT	5	150	Eating establishment	300	300	0		Series	6000	two 3000 gallon	90	4200
GDO	2662	MGRU	5	150	Eating establishment	70	0	0	MIAMI DADE WATER & SEWER DEPARTMENT		0	two 100 gpm	90	1225
GDO	2663	IGT	5	300	Eating establishment	0	0	4750	MIAMI DADE WATER & SEWER DEPARTMENT	Single	950	one 950 gallon	90	1188
GDO	2665	IGT	5	300	Eating establishment	96	96	0	MIAMI DADE WATER & SEWER DEPARTMENT	Single	1050	one 1050 gallon	90	2400
GDO	2666	IGT	5	150	Eating establishment	30	30	0	CITY OF HIALEAH	Single	1200	one 1200 gallon	90	750
GDO	2668	MGRU	5	300	Eating establishment	140	0	4420	CITY OF MIAMI BEACH	Single	950	one 950 gallon	30	1630
GDO	2669	IGT	5	150	Eating establishment	20	20	200	MIAMI DADE WATER & SEWER DEPARTMENT	Single	1200	one 1200 gallon	90	50
GDO	2673	IGT	5	150	Eating establishment	0	0	0	MIAMI DADE WATER & SEWER DEPARTMENT	Series	4000	two 2000 gallon	90	0
GDO	2677	IGT	2	150	Eating establishment	0	0	0	MIAMI DADE WATER & SEWER DEPARTMENT		0	one 950 gallon	90	0
GDO	2678	IGT	2	150	Eating establishment	0	0	0			0	one 950 gallon	90	0
GDO	2679	IGT	2	150	Eating establishment	0	0	0			0	one 950 gallon	90	0
GDO	2680	IGT	2	150	Eating establishment	0	0	0			0	one 950 gallon	90	0
GDO	2681	IGT	5	300	Eating establishment	149	149	0	MIAMI DADE WATER & SEWER DEPARTMENT	Single	1050	one 1050 gallon	90	3725
GDO	2683	IGT	5	300	Eating establishment	150	150	4300	MIAMI DADE WATER & SEWER DEPARTMENT	Series	2100	two 1050 gallon	90	1075
GDO	2685	IGT	5	150	Eating establishment	35	35	0	CITY OF NORTH MIAMI	Single	750	one 750 gallon	90	490
GDO	2687	MGRU	5	150	Eating establishment	21	21	960	CITY OF OPA LOCKA		0	one 25 gpm	30	525
GDO	2691	IGT	5	150	Eating establishment	54	0	1478	CITY OF OPA LOCKA	Single	750	one 750 gallon	60	370
GDO	2693	MGRU	5	150	Eating establishment	38	38	0	CITY OF OPA LOCKA		0	one 25 gpm	30	532
GDO	2695	IGT	5	300	Eating establishment	70	70	0	MIAMI DADE WATER & SEWER DEPARTMENT	Single	1050	one 1050 gallon	90	1750
GDO	2698	IGT	5	150	Eating establishment	20	20	1340	MIAMI DADE WATER & SEWER DEPARTMENT	Single	950	one 950 gallon	90	335
GDO	2699	IGT	5	150	Eating establishment	0	0	9300	MIAMI DADE WATER & SEWER DEPARTMENT	Single	950	one 950-gallon	90	2325
GDO	2700	IGT	5	750	Eating establishment	292	292	0	CITY OF MIAMI BEACH	Series	1500	two 750 gallon	90	7300
GDO	2703	IGT	5	150	Eating establishment	48	48	0	MIAMI DADE WATER & SEWER DEPARTMENT	Single	750	one 750 gallon	90	672
GDO	2704	IGT	5	300	Eating establishment	150	150	0	MIAMI DADE WATER & SEWER DEPARTMENT	Series	2400	two 1200 gallon	90	3750
GDO	2706	IGT	5	150	Eating establishment	50	50	0	MIAMI DADE WATER & SEWER DEPARTMENT	Series	2100	two 1050 gallon	90	1250
GDO	2707	AGRU	5	150	Eating establishment	0	0	0	MIAMI DADE WATER & SEWER DEPARTMENT		0	one 35 gpm	30	0
GDO	2708	IGT	5	300	Eating establishment	150	150	0	MIAMI DADE WATER & SEWER DEPARTMENT	Single	1000	one 1000 gallon	90	3750
GDO	2709	AGRU	5	150	Eating establishment	18	18	0	MIAMI DADE WATER & SEWER DEPARTMENT		0	one 25 gpm	30	252
GDO	2710	IGT	5	300	Eating establishment	150	150	0	MIAMI DADE WATER & SEWER DEPARTMENT	Single	2000	one 2000 gallon	90	3750
GDO	2714	IGT	5	150	Eating establishment	24	24	0		Single	750	one 750 gallon	90	336
GDO	2716	IGT	5	150	Eating establishment	0	0	0		Single	750	one 750 gallon	90	0

WORK GROUP	PERMIT NUMBER	PERMIT CLASS	PERMIT T	PERMIT FEE	BUSINESS_TYPE	RECORDED SEATS	OBSERVED SEATS	FACILITY AREA	UTILITY	SYSTEM FORMAT	TOTAL CAPACITY	TANK_CAPACITY	PUMP OUT	TOTAL GPD
GDO	2717	IGT	5	750	Eating establishment	220	220	0	MIAMI DADE WATER & SEWER DEPARTMENT	Series	1500	two 750 gallon each	90	5500
GDO	2719	IGT	5	150	Eating establishment	20	20	1642	MIAMI DADE WATER & SEWER DEPARTMENT	Single	750	one 750-gallon	90	411
GDO	2721	IGT	5	150	Eating establishment	50	50	0		Single	1050	one 1050 gallon	90	700
GDO	2722	AGRU	5	150	Eating establishment	28	28	680	CITY OF MIAMI BEACH		0	one 25 gpm	30	170
GDO	2724	IGT	5	150	Eating establishment	0	0	764	MIAMI DADE WATER & SEWER DEPARTMENT	Series	3200	two 1600 gallon	90	191
GDO	2729	IGT	5	150	Eating establishment	18	18	1000	CITY OF MIAMI BEACH	Single	950	one 950-gallon	90	250
GDO	2731	AGRU	5	150	Eating establishment	30	30	800	CITY OF MIAMI BEACH		0	one 25 gpm	30	200
GDO	2732	IGT	5	150	Eating establishment	32	32	0		Single	1050	one 1050 gallon	90	448
GDO	2737	IGT	5	150	Eating establishment	30	30	801	MIAMI DADE WATER & SEWER DEPARTMENT	Single	750	one 750 gallon	90	200
GDO	2738	IGT	5	300	Eating establishment	85	85	3000	MIAMI DADE WATER & SEWER DEPARTMENT	Single	950	one 950 gallon	90	75000
GDO	2740	IGT	5	150	Eating establishment	19	19	0	MIAMI DADE WATER & SEWER DEPARTMENT	Single	1200	one 1200 gallon	90	475
GDO	2743	IGT	5	150	Eating establishment	0	0	0		Single	750	one 750 gallon	90	0
GDO	2747	IGT	5	150	Eating establishment	20	20	0	MIAMI DADE WATER & SEWER DEPARTMENT	Single	750	one 750 gallon	90	500
GDO	2749	AGRU	5	150	Eating establishment	20	0	800	MIAMI DADE WATER & SEWER DEPARTMENT		0	one 20 gpm	30	200
GDO	2750	IGT	5	300	Eating establishment	49	49	3500	MIAMI DADE WATER & SEWER DEPARTMENT	Single	1200	one 1200 gallon	60	87500
GDO	2751	IGT	5	150	Eating establishment	0	0	1200	MIAMI DADE WATER & SEWER DEPARTMENT	Single	750	one 750-gallon	90	300
GDO	2756	IGT	5	300	Eating establishment	150	150	0		Single	1500	one 1500 gallon	90	3750
GDO	2760	IGT	5	300	Eating establishment	94	94	0	MIAMI DADE WATER & SEWER DEPARTMENT	Series	2000	two 1000 gallon	90	2350
GDO	2762	IGT	5	300	Eating establishment	200	200	0	MIAMI DADE WATER & SEWER DEPARTMENT	Single	1200	one 1200 gallon	90	5000
GDO	2764	IGT	5	150	Eating establishment	0	0	0	MIAMI DADE WATER & SEWER DEPARTMENT	Single	750	one 750 gallon	90	0
GDO	2766	AGT	5	300	Eating establishment	132	132	0	CITY OF MIAMI BEACH	Single	1200	one 1200 gallon	90	3300
GDO	2769	AGRU	5	150	Eating establishment	14	14	900	CITY OF MIAMI BEACH		0	one 25 gpm	30	225
GDO	2772	IGT	5	150	Eating establishment	10	10	0		Single	1200	one 1200 gallon	90	3
GDO	2774	IGT	5	150	Eating establishment	50	50	2509	MIAMI DADE WATER & SEWER DEPARTMENT	Single	950	one 950-gallon	90	627
GDO	2777	MGRU	5	150	Eating establishment	54	54	0	CITY OF HIALEAH		0	one 25-gpm	30	756
GDO	2779	IGT	5	150	Eating establishment	2150	2150	0	MIAMI DADE WATER & SEWER DEPARTMENT	Series	10000	two 5000 gallon	90	0
GDO	2780	IGT	5	300	Eating establishment	100	100	0	MIAMI DADE WATER & SEWER DEPARTMENT	Single	1500	one 1500 gallon	90	0
GDO	2781	IGT	5	150	Eating establishment	28	28	1068	MIAMI DADE WATER & SEWER DEPARTMENT	Single	750	one 750-gallon	90	267
GDO	2786	IGT	5	150	Eating establishment	72	0	1950	CITY OF MIAMI SPRINGS	Single	1250	one 1250 gallon	60	488
GDO	2787	IGT	5	150	Eating establishment	30	0	3000	CITY OF HIALEAH	Single	750	one 750 gallon	60	750
GDO	2788	IGT	5	300	Eating establishment	80	80	0		Single	1500	one 1500 gallon	90	2000
GDO	2790	IGT	5	300	Eating establishment	138	138	0	MIAMI DADE WATER & SEWER DEPARTMENT	Single	1200	one 1200 gallon	90	3450
GDO	2793	IGT	5	750	Eating establishment	260	260	0	MIAMI DADE WATER & SEWER DEPARTMENT	Multiple	2100	two 1050 gallon	90	1560
GDO	2794	IGT	5	150	Eating establishment	21	0	1200	MIAMI DADE WATER & SEWER DEPARTMENT	Single	750	one 750 gallon	60	300
GDO	2795	IGT	5	150	Eating establishment	0	0	0	CITY OF HIALEAH	Single	750	one 750 gallon	90	0
GDO	2796	IGT	5	300	Eating establishment	51	51	2200	MIAMI DADE WATER & SEWER DEPARTMENT	Single	1200	one 1200 gallon	90	714
GDO	2799	IGT	5	150	Eating establishment	0	0	2400	MIAMI DADE WATER & SEWER DEPARTMENT	Single	950	one 950 gallon	90	600
GDO	2800	IGT	5	150	Eating establishment	36	36	1600	MIAMI DADE WATER & SEWER DEPARTMENT	Single	750	one 750 gallon	90	400
GDO	2805	IGT	5	150	Eating establishment	24	24	0	MIAMI DADE WATER & SEWER DEPARTMENT	Single	1500	one 1500 gallon	90	600
GDO	2808	MGRU	5	150	Eating establishment	24	24	1511	MIAMI DADE WATER & SEWER DEPARTMENT		0	one 25 gpm	30	378
GDO	2811	IGT	5	300	Eating establishment	125	125	0	MIAMI DADE WATER & SEWER DEPARTMENT	Series	2400	two 1200 gallon	90	3125
GDO	2814	IGT	5	150	Eating establishment	56	56	2528	MIAMI DADE WATER & SEWER DEPARTMENT	Single	1050	one 1050 gallon	90	632
GDO	2815	IGT	5	300	Eating establishment	100	100	8000	MIAMI DADE WATER & SEWER DEPARTMENT	Single	2000	one 2000 gallon	90	2000
GDO	2816	IGT	5	150	Eating establishment	20	20	0	CITY OF HIALEAH	Single	1500	one 1500 gallon	90	280
GDO	2817	IGT	5	150	Eating establishment	50	50	0	CITY OF HIALEAH	Single	1200	one 1200 gallon	90	1250
GDO	2822	IGT	5	150	Eating establishment	32	32	2000	CITY OF HIALEAH	Single	950	one 950 gallon	90	28000
GDO	2827	MGRU	5	150	Eating establishment	20	0	1650	MIAMI DADE WATER & SEWER DEPARTMENT		0	one 25 gpm	30	413
GDO	2828	IGT	5	150	Eating establishment	15	15	0	MIAMI DADE WATER & SEWER DEPARTMENT	Single	750	one 750 gallon	90	375
GDO	2833	IGT	5	150	Eating establishment	30	30	0	CITY OF OPA LOCKA	Single	750	one 750 gallon	90	750
GDO	2834	IGT	5	150	Eating establishment	56	56	2600	MIAMI DADE WATER & SEWER DEPARTMENT	Single	1200	one 1200 gallon	90	650
GDO	2835	IGT	5	150	Eating establishment	75	75	1200	CITY OF HIALEAH	Single	1050	one 1050 gallon	90	300
GDO	2837	MGRU	5	150	Eating establishment	45	45	2550	CITY OF HIALEAH		0	one 25 gallon	30	638
GDO	2841	IGT	5	150	Eating establishment	18	18	1440		Single	1050	one 1050-gallon	90	360
GDO	2843	IGT	5	150	Eating establishment	30	30	2322	MIAMI DADE WATER & SEWER DEPARTMENT	Single	1500	one 1500 gallon	90	581
GDO	2844	MGRU	5	150	Eating establishment	20	0	950	MIAMI DADE WATER & SEWER DEPARTMENT		0	one 25 gpm	30	238
GDO	2845	IGT	5	150	Eating establishment	28	28	750	MIAMI DADE WATER & SEWER DEPARTMENT	Single	750	one 750 gallon	90	700
GDO	2851	IGT	5	150	Eating establishment	48	48	0		Single	1050	one 1050 gallon	90	672
GDO	2852	IGT	5	150	Eating establishment	18	18	0		Single	750	one 750 gallon	90	5
GDO	2853	IGT	5	300	Eating establishment	180	0	4572	CITY OF CORAL GABLES	Single	750	one 750 gallon	60	1643
GDO	2858	MGRU	5	150	Eating establishment	49	49	1697	CITY OF MIAMI BEACH		0	one 25 gpm	30	424

WORK GROUP	PERMIT NUMBER	PERMIT CLASS	PERMIT	PERMIT FEE	BUSINESS_TYPE	RECORDED SEATS	OBSERVED SEATS	FACILITY AREA	UTILITY	SYSTEM FORMAT	TOTAL CAPACITY	TANK_CAPACITY	PUMP OUT	TOTAL GPD
GDO	2859	IGT	5	300	Eating establishment	74	74	0	CITY OF NORTH MIAMI BEACH	Single	950	one 950 gallon	90	1850
GDO	2860	IGT	2	150	Eating establishment	450	450	0	MIAMI DADE WATER & SEWER DEPARTMENT	Single	950	one 950 gallon	90	0
GDO	2861	IGT	5	150	Eating establishment	0	0	0		Single	950	one 950 gallon	90	0
GDO	2864	IGT	5	150	Eating establishment	42	42	1800	MIAMI DADE WATER & SEWER DEPARTMENT	Single	750	one 750 gallon	90	450
GDO	2868	IGT	5	300	Eating establishment	120	120	0	CITY OF HIALEAH	Single	750	one 750 gallon	90	3000
GDO	2869	IGT	5	150	Eating establishment	40	40	2000	MIAMI DADE WATER & SEWER DEPARTMENT	Single	950	one 950 gallon	90	500
GDO	2873	IGT	5	150	Eating establishment	30	30	2000	MIAMI DADE WATER & SEWER DEPARTMENT	Single	950	one 950 gallon	90	750
GDO	2876	IGT	5	750	Eating establishment	262	262	0	MIAMI DADE WATER & SEWER DEPARTMENT	Series	2400	two 1200 gallon	90	6550
GDO	2877	IGT	5	150	Eating establishment	0	0	0	MIAMI DADE WATER & SEWER DEPARTMENT	Single	750	one 750 gallon	90	0
GDO	2878	IGT	5	150	Eating establishment	0	0	300	MIAMI DADE WATER & SEWER DEPARTMENT	Single	950	one 950 gallon	90	75
GDO	2879	IGT	5	150	Eating establishment	30	30	1700	MIAMI DADE WATER & SEWER DEPARTMENT	Single	900	one 900 gallon	90	750
GDO	2882	IGT	5	150	Eating establishment	0	0	0		Single	750	one 750 gallon	90	0
GDO	2884	IGT	5	150	Eating establishment	42	42	0	MIAMI DADE WATER & SEWER DEPARTMENT	Single	750	one 750 gallon	90	1050
GDO	2885	IGT	5	150	Eating establishment	40	40	0	MIAMI DADE WATER & SEWER DEPARTMENT	Single	750	one 750 gallon	30	1000
GDO	2890	IGT	5	300	Eating establishment	56	56	1700	MIAMI DADE WATER & SEWER DEPARTMENT	Single	750	one 750 gallon	90	1400
GDO	2891	IGT	5	150	Eating establishment	28	28	0		Single	900	one 900 gallon	90	392
GDO	2892	IGT	5	150	Eating establishment	0	0	0	MIAMI DADE WATER & SEWER DEPARTMENT	Single	950	one 950 gallon	90	0
GDO	2893	IGT	5	150	Eating establishment	0	0	685	MIAMI DADE WATER & SEWER DEPARTMENT	Single	1050	one 1050 gallon	90	171
GDO	2894	IGT	5	150	Eating establishment	24	24	0		Single	1200	one 1200 gallon	90	6
GDO	2895	IGT	5	150	Eating establishment	30	30	0	MIAMI DADE WATER & SEWER DEPARTMENT	Single	1050	one 1050 gallon	90	420
GDO	2897	IGT	5	300	Eating establishment	160	160	6900	MIAMI DADE WATER & SEWER DEPARTMENT	Series	2400	two 1200 gallon	90	1725
GDO	2898	IGT	5	150	Eating establishment	50	50	2503	MIAMI DADE WATER & SEWER DEPARTMENT	Single	1500	One 1500-gallon	90	626
GDO	2906	IGT	5	300	Eating establishment	149	149	0		Single	1200	one 1200 gallon	90	3725
GDO	2907	IGT	5	150	Eating establishment	30	30	0	MIAMI DADE WATER & SEWER DEPARTMENT	Single	2000	one 2000 gallon	90	420
GDO	2908	IGT	5	150	Eating establishment	100	100	0		Series	4000	two 2000 gallon	90	1400
GDO	2909	IGT	5	300	Eating establishment	123	123	0		Single	750	one 750 gallon	90	3075
GDO	2910	IGT	5	150	Eating establishment	50	50	0		Series	4000	two 2000 gallon	90	700
GDO	2912	IGT	5	300	Eating establishment	149	149	0	MIAMI DADE WATER & SEWER DEPARTMENT	Single	1050	one 1050 gallon	90	3725
GDO	2913	IGT	5	300	Eating establishment	210	210	5001	MIAMI DADE WATER & SEWER DEPARTMENT	Single	950	one 950 gallon	90	1250
GDO	2915	IGT	5	150	Eating establishment	0	0	0	MIAMI DADE WATER & SEWER DEPARTMENT	Single	1050	one 1050 gallon	90	0
GDO	2916	IGT	5	300	Eating establishment	74	74	0	MIAMI DADE WATER & SEWER DEPARTMENT	Single	1050	one 1050 gallon	90	1850
GDO	2917	IGT	5	150	Eating establishment	0	0	0		Single	950	one 950 gallon	90	0
GDO	2918	IGT	5	150	Eating establishment	40	40	2040	MIAMI DADE WATER & SEWER DEPARTMENT	Single	1050	one 1050 gallon	90	510
GDO	2919	MGRU	5	150	Eating establishment	30	30	0	MIAMI DADE WATER & SEWER DEPARTMENT		0	one 25 gpm	30	750
GDO	2921	IGT	5	150	Eating establishment	0	0	0	MIAMI DADE WATER & SEWER DEPARTMENT	Single	950	one 950 gallon	90	0
GDO	2922	IGT	5	300	Eating establishment	66	66	2363	MIAMI DADE WATER & SEWER DEPARTMENT	Single	950	one 950 gallon	90	1650
GDO	2923	IGT	5	150	Eating establishment	23	23	0	MIAMI DADE WATER & SEWER DEPARTMENT	Single	750	one 750 gallon	90	575
GDO	2924	IGT	5	300	Eating establishment	65	65	0	MIAMI DADE WATER & SEWER DEPARTMENT	Single	950	one 950 gallon	90	1625
GDO	2925	IGT	5	300	Eating establishment	92	92	0	MIAMI DADE WATER & SEWER DEPARTMENT	Single	1050	one 1050 gallon	90	2300
GDO	2926	IGT	5	300	Eating establishment	74	74	2200	MIAMI DADE WATER & SEWER DEPARTMENT	Series	2100	two 1050 gallon	90	1850
GDO	2929	IGT	5	300	Eating establishment	200	200	0		Series	4000	two 2000 gallon	90	5000
GDO	2930	MGRU	5	300	Eating establishment	31	0	6000	CITY OF NORTH MIAMI BEACH		0	three 25 gpm	30	1500
GDO	2931	MGRU	5	150	Eating establishment	7	7	1300	CITY OF HIALEAH		0	one 20 gpm	30	325
GDO	2933	IGT	5	300	Eating establishment	149	149	0	MIAMI DADE WATER & SEWER DEPARTMENT	Single	1050	one 1050 gallon	90	3725
GDO	2934	IGT	5	300	Eating establishment	200	200	4200	MIAMI DADE WATER & SEWER DEPARTMENT	Single	750	one 750 gallon	90	105000
GDO	2935	IGT	5	150	Eating establishment	0	0	0	MIAMI DADE WATER & SEWER DEPARTMENT	Single	750	one 750 gallon	90	0
GDO	2938	IGT	5	150	Eating establishment	25	25	0		Single	950	one 950 gallon	90	625
GDO	2939	IGT	5	150	Eating establishment	0	0	0	MIAMI DADE WATER & SEWER DEPARTMENT	Single	950	one 950 gallon	90	0
GDO	2940	IGT	5	150	Eating establishment	0	0	0		Single	1050	one 1050 gallon	90	0
GDO	2942	MGRU	5	150	Eating establishment	24	0	967	MIAMI DADE WATER & SEWER DEPARTMENT		0	one 25 gpm	30	242
GDO	2944	IGT	5	150	Eating establishment	22	22	0		Single	750	one 750 gallon	90	440
GDO	2946	IGT	5	300	Eating establishment	78	78	0	MIAMI DADE WATER & SEWER DEPARTMENT	Single	1900	two 950 gallon	90	1950
GDO	2950	AGRU	5	150	Eating establishment	10	10	1534	MIAMI DADE WATER & SEWER DEPARTMENT		0	one 25 gpm	30	384
GDO	2951	IGT	5	150	Eating establishment	0	0	1400	MIAMI DADE WATER & SEWER DEPARTMENT	Single	750	one 750 gallon	90	350
GDO	2952	MGRU	5	150	Eating establishment	45	45	0	MIAMI DADE WATER & SEWER DEPARTMENT		0	one 25 gpm	30	1125
GDO	2954	IGT	5	150	Eating establishment	0	0	0	CITY OF NORTH MIAMI	Single	950	one 950 gallon	90	0
GDO	2956	IGT	5	300	Eating establishment	76	76	0		Single	750	one 750 gallon	90	1900
GDO	2957	IGT	5	300	Eating establishment	80	80	5260	MIAMI DADE WATER & SEWER DEPARTMENT	Single	750	one 750 gallon	90	1315
GDO	2961	IGT	5	150	Eating establishment	0	0	920	MIAMI DADE WATER & SEWER DEPARTMENT	Single	1050	one 1050 gallon	90	230
GDO	2962	IGT	5	300	Eating establishment	85	85	0	MIAMI DADE WATER & SEWER DEPARTMENT	Series	2400	two 1200 gallon	90	1190
GDO	2963	MGRU	5	150	Eating establishment	5	5	700	MIAMI DADE WATER & SEWER DEPARTMENT		0	one 25 gpm	30	175

WORK GROUP	PERMIT NUMBER	PERMIT CLASS	PERMIT	PERMIT FEE	BUSINESS_TYPE	RECORDED SEATS	OBSERVED SEATS	FACILITY AREA	UTILITY	SYSTEM FORMAT	TOTAL CAPACITY	TANK_CAPACITY	PUMP OUT	TOTAL GPD
GDO	2965	IGT	5	300	Eating establishment	100	100	0	CITY OF MIAMI BEACH	Series	1500	two 750 gallon	90	2500
GDO	2967	IGT	5	150	Eating establishment	75	0	3100	MIAMI DADE WATER & SEWER DEPARTMENT	Single	750	one 750 gallon	60	775
GDO	2968	IGT	5	150	Eating establishment	6	6	1000	MIAMI DADE WATER & SEWER DEPARTMENT	Single	750	one 750 gallon	90	84
GDO	2970	IGT	5	150	Eating establishment	30	30	1178	MIAMI DADE WATER & SEWER DEPARTMENT	Single	750	one 750-gallon	90	295
GDO	2974	IGT	5	150	Eating establishment	0	0	0	MIAMI DADE WATER & SEWER DEPARTMENT	Single	950	one 950 gallon	90	0
GDO	2975	IGT	5	150	Eating establishment	30	30	1485	CITY OF HIALEAH	Single	1200	one 1200 gallon	90	371
GDO	2978	IGT	5	150	Eating establishment	0	0	0	CITY OF HIALEAH	Single	900	one 900 gallon	90	0
GDO	2979	IGT	5	300	Eating establishment	75	75	0	MIAMI DADE WATER & SEWER DEPARTMENT	Single	750	one 750 gallon	90	1875
GDO	2980	IGT	5	150	Eating establishment	48	48	0		Single	1050	one 1050 gallon	90	672
GDO	2981	IGT	5	150	Eating establishment	22	0	960	MIAMI DADE WATER & SEWER DEPARTMENT	Single	950	one 950 gallon	90	240
GDO	2982	IGT	5	150	Eating establishment	28	28	900	MIAMI DADE WATER & SEWER DEPARTMENT	Single	750	one 750 gallon	90	225
GDO	2983	IGT	5	300	Eating establishment	200	200	0		Single	2000	one 2000 gallon	90	5000
GDO	2985	IGT	5	750	Eating establishment	550	550	0	CITY OF MIAMI BEACH	Series	6800	four 1200 & one 2000 gallon	90	0
GDO	2986	IGT	5	150	Eating establishment	214	214	3900	CITY OF NORTH MIAMI BEACH	Single	1600	one 1600 gallon	90	975
GDO	2987	MGRU	5	150	Eating establishment	42	42	0		Multiple	1050	one 25 gpm mgru and one 1050 gallon	30	840
GDO	2993	IGT	5	150	Eating establishment	0	0	0			0	one 950 gallon	90	0
GDO	2998	IGT	5	150	Eating establishment	10	10	1019	MIAMI DADE WATER & SEWER DEPARTMENT	Single	950	one 950 gallon	90	255
GDO	3003	IGT	5	150	Eating establishment	0	0	400	MIAMI DADE WATER & SEWER DEPARTMENT	Single	750	one 750 gallon	90	100
GDO	3005	AGRU	5	150	Eating establishment	14	14	750	MIAMI DADE WATER & SEWER DEPARTMENT		0	one 25 gpm	30	188
GDO	3006	MGRU	5	150	Eating establishment	80	80	1698	CITY OF MIAMI BEACH		0	one 35 gpm	30	425
GDO	3010	IGT	5	300	Eating establishment	202	202	5350	MIAMI DADE WATER & SEWER DEPARTMENT	Single	2000	one 2000 gallon	90	1338
GDO	3011	IGT	5	150	Eating establishment	40	40	1900	CITY OF OPA LOCKA	Single	950	one 950 gallon	90	475
GDO	3013	IGT	5	150	Eating establishment	30	30	1800	CITY OF HIALEAH	Single	750	one 750 gallon	90	450
GDO	3014	IGT	5	150	Eating establishment	75	75	2800	MIAMI DADE WATER & SEWER DEPARTMENT	Single	750	one 750-gallon	90	700
GDO	3015	IGT	1	750	Eating establishment	272	272	0	MIAMI DADE WATER & SEWER DEPARTMENT	Single	1500	one 1500 gallon	90	6800
GDO	3016	IGT	5	150	Eating establishment	28	28	0		Single	750	one 750 gallon	90	392
GDO	3018	IGT	5	750	Eating establishment	306	306	0	MIAMI DADE WATER & SEWER DEPARTMENT	Series	5050	one 5050 gallon	90	7650
GDO	3019	IGT	5	150	Eating establishment	48	48	1500	MIAMI DADE WATER & SEWER DEPARTMENT	Single	950	one 950 gallon	90	375
GDO	3025	IGT	5	150	Eating establishment	10	10	1019	MIAMI DADE WATER & SEWER DEPARTMENT	Single	1500	one 1500 gallon	90	255
GDO	3026	IGT	5	150	Eating establishment	2	2	0			0	one 1050 gallon	90	1
GDO	3027	IGT	5	300	Eating establishment	60	60	0	MIAMI DADE WATER & SEWER DEPARTMENT	Single	1200	one 1200 gallon	90	1500
GDO	3035	IGT	5	150	Eating establishment	20	20	0		Single	750	one 750 gallon	90	500
GDO	3038	IGT	5	300	Eating establishment	110	110	0	CITY OF SURFSIDE	Single	1200	one 1200 gallon	90	2750
GDO	3040	IGT	5	300	Eating establishment	300	0	8440	MIAMI DADE WATER & SEWER DEPARTMENT	Single	1500	one 1500 gallon	60	2110
GDO	3043	IGT	5	150	Eating establishment	10	10	0	MIAMI DADE WATER & SEWER DEPARTMENT	Single	950	one 950 gallon	90	140
GDO	3044	IGT	5	750	Eating establishment	233	233	0		Series	1500	two 750 gallon	90	5825
GDO	3048	IGT	5	150	Eating establishment	100	100	0	MIAMI DADE WATER & SEWER DEPARTMENT	Single	950	one 950 gallon	90	100
GDO	3049	IGT	5	300	Eating establishment	25	25	3538	CITY OF OPA LOCKA	Single	1200	one 1200 gallon	90	49532
GDO	3052	AGRU	5	150	Eating establishment	0	0	0	MIAMI DADE WATER & SEWER DEPARTMENT		0	one 25 gpm	30	0
GDO	3053	IGT	5	150	Eating establishment	20	20	1300	MIAMI DADE WATER & SEWER DEPARTMENT	Single	750	one 750 gallon	90	325
GDO	3054	MGRU	5	150	Eating establishment	0	0	3000	CITY OF MIAMI BEACH		0	one 25-gpm	30	750
GDO	3056	IGT	5	150	Eating establishment	10	10	950	MIAMI DADE WATER & SEWER DEPARTMENT	Single	1600	one 1600 gallon	90	3
GDO	3057	IGT	5	300	Eating establishment	100	100	3271	MIAMI DADE WATER & SEWER DEPARTMENT	Single	1200	one 1200 gallon	90	818
GDO	3059	IGT	5	150	Eating establishment	0	0	636	CITY OF MIAMI BEACH	Single	950	one 950 gallon	90	159
GDO	3060	IGT	5	300	Eating establishment	240	240	2097	CITY OF MIAMI BEACH	Single	1200	one 1200 gallon	90	524
GDO	3062	IGT	5	150	Eating establishment	49	49	0	CITY OF MIAMI BEACH	Single	950	one 950 gallon	90	1225
GDO	3067	IGT	5	300	Eating establishment	64	69	0	CITY OF NORTH MIAMI BEACH	Single	950	one 950 gallon	90	1600
GDO	3068	IGT	5	300	Eating establishment	200	200	4500	MIAMI SHORES	Multiple	4700	one 1500 and two 1600 gallon	90	1125
GDO	3069	IGT	5	300	Eating establishment	150	150	0	MIAMI SHORES	Single	2000	one 2000 gallon	90	0
GDO	3072	MGRU	5	150	Eating establishment	37	100	0	MIAMI DADE WATER & SEWER DEPARTMENT		0	one 25 gpm	30	518
GDO	3074	IGT	5	300	Eating establishment	200	200	0	CITY OF NORTH MIAMI BEACH	Single	750	one 750 gallon	90	5000
GDO	3075	MGRU	5	150	Eating establishment	30	30	1797	MIAMI DADE WATER & SEWER DEPARTMENT		0	one 25 gpm	30	449
GDO	3076	IGT	5	150	Eating establishment	0	0	1200	MIAMI DADE WATER & SEWER DEPARTMENT	Single	950	one 950 gallon	90	300
GDO	3078	IGT	5	150	Eating establishment	30	30	1200	MIAMI DADE WATER & SEWER DEPARTMENT	Single	750	one 750-gallon	90	300
GDO	3083	IGT	5	150	Eating establishment	45	45	0		Single	750	one 750 gallon	90	1125
GDO	3084	IGT	5	150	Eating establishment	99	0	3264	MIAMI DADE WATER & SEWER DEPARTMENT	Single	1250	one 1250 gallon	60	979
GDO	3096	IGT	5	150	Eating establishment	0	0	0		Single	750	one 750 gallon	90	0

WORK GROUP	PERMIT NUMBER	PERMIT CLASS	PERMIT	PERMIT FEE	BUSINESS_TYPE	RECORDED SEATS	OBSERVED SEATS	FACILITY AREA	UTILITY	SYSTEM FORMAT	TOTAL CAPACITY	TANK_CAPACITY	PUMP OUT	TOTAL GPD
GDO	3098	IGT	5	150	Eating establishment	40	40	0	MIAMI DADE WATER & SEWER DEPARTMENT	Single	1050	one 1050 gallon	90	560
GDO	3102	IGT	5	300	Eating establishment	92	92	0	CITY OF HIALEAH	Single	1959	one 1050 gallon	90	1288
GDO	3103	IGT	5	150	Eating establishment	20	20	0	CITY OF HIALEAH		0	one 750 gallon	90	280
GDO	3104	IGT	5	150	Eating establishment	0	0	0	MIAMI DADE WATER & SEWER DEPARTMENT	Single	750	one 750 gallon	90	0
GDO	3105	MGRU	5	150	Eating establishment	25	25	0			0	one 25 gpm	30	350
GDO	3107	IGT	5	150	Eating establishment	56	56	2900	MIAMI DADE WATER & SEWER DEPARTMENT	Single	1500	one 1500-gallon	90	725
GDO	3109	IGT	5	150	Eating establishment	30	30	1900	CITY OF HIALEAH	Single	750	one 750 gallon	90	475
GDO	3110	IGT	5	300	Eating establishment	88	88	0		Single	1050	one 1050 gallon	90	2200
GDO	3111	IGT	5	150	Eating establishment	10	10	0	MIAMI DADE WATER & SEWER DEPARTMENT	Single	1200	one 1200 gallon	90	3
GDO	3113	IGT	5	150	Eating establishment	0	0	1700	MIAMI DADE WATER & SEWER DEPARTMENT	Single	1200	one 1200 gallon	60	425
GDO	3114	MGRU	5	150	Eating establishment	0	0	521	MIAMI DADE WATER & SEWER DEPARTMENT		0	one 25 gpm	30	130
GDO	3115	IGT	5	300	Eating establishment	60	60	0	MIAMI DADE WATER & SEWER DEPARTMENT	Single	950	one 950 gallon	90	1500
GDO	3117	IGT	5	750	Eating establishment	250	250	0	MIAMI DADE WATER & SEWER DEPARTMENT	Single	1050	one 1050 gallon	90	1250
GDO	3119	IGT	5	300	Eating establishment	74	74	0	MIAMI DADE WATER & SEWER DEPARTMENT	Single	750	one 750 gallon	90	1850
GDO	3121	IGT	5	150	Eating establishment	0	0	300	MIAMI DADE WATER & SEWER DEPARTMENT	Single	750	one 750 gallon	90	75
GDO	3123	IGT	5	150	Eating establishment	30	30	0	MIAMI DADE WATER & SEWER DEPARTMENT	Single	750	one 750 gallon	90	750
GDO	3124	MGRU	5	150	Eating establishment	0	0	0	MIAMI DADE WATER & SEWER DEPARTMENT		0	one 35 gpm	30	0
GDO	3125	MGRU	5	150	Eating establishment	0	0	200	MIAMI DADE WATER & SEWER DEPARTMENT		0	one 25 gpm	30	50
GDO	3128	IGT	5	150	Eating establishment	50	50	1012	CITY OF NORTH MIAMI BEACH	Single	750	one 750 gallon	90	253
GDO	3129	IGT	5	150	Eating establishment	15	0	702	MIAMI DADE WATER & SEWER DEPARTMENT	Single	1050	one 1050 gallon	60	550
GDO	3133	MGRU	5	150	Eating establishment	10	10	200	MIAMI DADE WATER & SEWER DEPARTMENT		0	one 25 gpm	30	50
GDO	3141	MGRU	5	150	Eating establishment	12	12	0			0	one 25 gpm	30	168
GDO	3144	IGT	2	150	Eating establishment	200	200	4000	MIAMI DADE WATER & SEWER DEPARTMENT	Single	1500	one 1500 gallon	30	1000
GDO	3146	MGRU	5	150	Eating establishment	7	7	900	MIAMI DADE WATER & SEWER DEPARTMENT		0	one 20 gpm	30	225
GDO	3148	IGT	5	150	Eating establishment	41	41	0	MIAMI DADE WATER & SEWER DEPARTMENT	Single	1200	one 1200 gallon	90	1025
GDO	3149	IGT	5	300	Eating establishment	202	202	5156	MIAMI DADE WATER & SEWER DEPARTMENT	Series	3000	two 1500 gallon	90	1289
GDO	3151	IGT	5	150	Eating establishment	0	0	0	CITY OF HIALEAH	Single	750	one 750 gallon	90	0
GDO	3155	IGT	5	150	Eating establishment	20	20	1200	MIAMI DADE WATER & SEWER DEPARTMENT	Single	750	one 750 gallon	90	300
GDO	3156	IGT	5	150	Eating establishment	16	16	0	MIAMI DADE WATER & SEWER DEPARTMENT	Single	750	one 750 gallon	90	224
GDO	3157	IGT	5	150	Eating establishment	50	50	0	MIAMI DADE WATER & SEWER DEPARTMENT	Single	950	one 950 gallon	90	1250
GDO	3161	IGT	5	150	Eating establishment	0	0	1281	MIAMI DADE WATER & SEWER DEPARTMENT	Single	1500	one 1500 gallon	90	0
GDO	3162	IGT	5	150	Eating establishment	68	68	5700	CITY OF HIALEAH	Single	950	one 950 gallon	90	68
GDO	3164	IGT	5	150	Eating establishment	0	0	1000	MIAMI DADE WATER & SEWER DEPARTMENT	Single	950	one 950 gallon	90	250
GDO	3165	MGRU	5	150	Eating establishment	50	50	0	MIAMI DADE WATER & SEWER DEPARTMENT		0	one 25 gpm	30	700
GDO	3167	IGT	5	300	Eating establishment	286	286	16911	MIAMI DADE WATER & SEWER DEPARTMENT	Series	2100	two 1050 gallon	90	4228
GDO	3173	MGRU	5	150	Eating establishment	30	30	0	MIAMI DADE WATER & SEWER DEPARTMENT		0	one 25 gpm	30	750
GDO	3176	IGT	5	150	Eating establishment	25	25	0	MIAMI DADE WATER & SEWER DEPARTMENT	Single	1200	one 1200 gallon	90	625
GDO	3177	MGRU	5	150	Eating establishment	4	4	990	MIAMI DADE WATER & SEWER DEPARTMENT		0	one 25 gpm	30	248
GDO	3178	IGT	5	150	Eating establishment	30	30	0	MIAMI DADE WATER & SEWER DEPARTMENT	Single	1500	one 1500 gallon	90	420
GDO	3179	IGT	5	300	Eating establishment	80	80	0	CITY OF MIAMI BEACH	Single	750	one 750 gallon	90	2000
GDO	3189	IGT	5	150	Eating establishment	32	32	1325	MIAMI DADE WATER & SEWER DEPARTMENT	Single	750	one 750 gallon	90	800
GDO	3191	IGT	5	150	Eating establishment	2	2	0		Single	900	one 900 gallon	90	1
GDO	3192	IGT	5	300	Eating establishment	75	75	4002	MIAMI DADE WATER & SEWER DEPARTMENT	Single	1050	one 1050 gallon	90	1001
GDO	3194	IGT	5	300	Eating establishment	70	70	0	MIAMI DADE WATER & SEWER DEPARTMENT	Single	950	one 950 gallon	90	980
GDO	3195	IGT	5	150	Eating establishment	16	16	0		Single	750	one 750 gallon	90	4
GDO	3196	IGT	5	150	Eating establishment	49	49	2000	MIAMI DADE WATER & SEWER DEPARTMENT	Single	1050	one 1050 gallon	90	500
GDO	3197	IGT	5	150	Eating establishment	30	30	1600	MIAMI DADE WATER & SEWER DEPARTMENT	Single	1050	one 1050 gallon	90	400
GDO	3200	IGT	5	150	Eating establishment	50	50	1620	MIAMI DADE WATER & SEWER DEPARTMENT		1200	one 1200 gallon	90	405
GDO	3202	IGT	5	150	Eating establishment	15	15	2823	MIAMI DADE WATER & SEWER DEPARTMENT	Single	750	one 750 gallon	90	706
GDO	3204	IGT	5	150	Eating establishment	22	22	0		Multiple	1900	two 950 gallon	90	308
GDO	3207	IGT	5	300	Eating establishment	299	299	10000	MIAMI DADE WATER & SEWER DEPARTMENT	Single	2000	one 2000 gallon	90	2500
GDO	3208	IGT	5	150	Eating establishment	45	45	2000	MIAMI DADE WATER & SEWER DEPARTMENT	Single	750	one 750 gallon	90	500
GDO	3209	MGRU	5	150	Eating establishment	30	30	750	CITY OF HIALEAH		0	one 25 gpm	30	188
GDO	3210	AGRU	5	150	Eating establishment	60	60	1180	MIAMI DADE WATER & SEWER DEPARTMENT		0	one 25 gpm	30	295
GDO	3211	IGT	2	300	Eating establishment	249	249	9500	CITY OF NORTH BAY VILLAGE	Single	1500	one 1500 gallon	90	2375
GDO	3214	IGT	5	300	Eating establishment	115	115	0	MIAMI DADE WATER & SEWER DEPARTMENT	Single	1600	one 1600 gallon	90	2875
GDO	3215	MGRU	5	150	Eating establishment	0	0	630	MIAMI DADE WATER & SEWER DEPARTMENT		0	one 25 gpm	30	158
GDO	3217	IGT	5	300	Eating establishment	200	200	0	MIAMI DADE WATER & SEWER DEPARTMENT	Series	1500	two 750 gallon	90	5000
GDO	3218	IGT	5	300	Eating establishment	138	138	3234	MIAMI DADE WATER & SEWER DEPARTMENT	Single	750	one 750-gallon	90	895
GDO	3219	IGT	5	300	Eating establishment	73	0	3000	MIAMI DADE WATER & SEWER DEPARTMENT	Single	1200	one 1200 gallon	90	750
GDO	3222	MGRU	5	150	Eating establishment	20	0	1500	CITY OF MIAMI BEACH		0	one 20 gpm	30	375

WORK GROUP	PERMIT NUMBER	PERMIT CLASS	PERMIT	PERMIT FEE	BUSINESS_TYPE	RECORDED SEATS	OBSERVED SEATS	FACILITY AREA	UTILITY	SYSTEM FORMAT	TOTAL CAPACITY	TANK_CAPACITY	PUMP OUT	TOTAL GPD
GDO	3223	MGRU	5	150	Eating establishment	30	30	1200	MIAMI DADE WATER & SEWER DEPARTMENT		0	one 25 gpm	30	300
GDO	3224	MGRU	5	150	Eating establishment	28	28	990	MIAMI DADE WATER & SEWER DEPARTMENT		0	one 25-gpm	30	248
GDO	3225	IGT	5	150	Eating establishment	0	0	1075	CITY OF NORTH MIAMI BEACH	Single	1050	one 1050-gallon	90	269
GDO	3226	IGT	5	300	Eating establishment	68	68	0		Single	1500	one 1500 gallon	90	952
GDO	3227	IGT	5	150	Eating establishment	37	37	0	CITY OF HIALEAH	Single	750	one 750 gallon	90	925
GDO	3228	IGT	5	150	Eating establishment	25	25	950	MIAMI DADE WATER & SEWER DEPARTMENT		750	one 750-gallon	90	238
GDO	3229	MGRU	5	150	Eating establishment	30	30	0	MIAMI DADE WATER & SEWER DEPARTMENT	Single	0	one 25 gpm	30	420
GDO	3230	IGT	5	300	Eating establishment	270	270	12000	CITY OF NORTH MIAMI BEACH	Series	2400	two 1200 gallon	90	3052
GDO	3233	IGT	5	150	Eating establishment	8	8	0	CITY OF HIALEAH	Single	1050	one 1050 gallon	90	112
GDO	3234	IGT	5	150	Eating establishment	0	0	850	CITY OF HIALEAH	Single	1050	one 1050 gallon	90	213
GDO	3237	IGT	5	150	Eating establishment	110	110	2500	MIAMI DADE WATER & SEWER DEPARTMENT	Single	1200	one 1200 gallon	90	625
GDO	3238	IGT	5	300	Eating establishment	75	75	0	MIAMI DADE WATER & SEWER DEPARTMENT	Single	1050	one 1050 gallon	90	1875
GDO	3239	IGT	5	150	Eating establishment	85	85	4000	MIAMI DADE WATER & SEWER DEPARTMENT	Single	1500	one 1500 gallon	90	1000
GDO	3242	AGRU	5	150	Eating establishment	4	4	0			0	one 20 gpm	30	1
GDO	3245	IGT	5	150	Eating establishment	20	20	0	CITY OF HIALEAH	Single	950	one 950 gallon	90	500
GDO	3246	MGRU	5	150	Eating establishment	7	7	0	CITY OF MIAMI BEACH		0	one 25 gpm	30	98
GDO	3254	IGT	5	150	Eating establishment	30	30	0	MIAMI DADE WATER & SEWER DEPARTMENT	Single	1200	one 1200 gallon	90	420
GDO	3257	IGT	5	150	Eating establishment	32	32	1600	MIAMI DADE WATER & SEWER DEPARTMENT	Single	750	one 750 gallon	90	400
GDO	3258	IGT	5	150	Eating establishment	40	40	1200	MIAMI DADE WATER & SEWER DEPARTMENT	Single	750	one 750 gallon	90	300
GDO	3260	IGT	5	150	Eating establishment	0	0	0	MIAMI DADE WATER & SEWER DEPARTMENT	Single	750	one 750 gallon	90	0
GDO	3270	IGT	5	150	Eating establishment	0	0	0	MIAMI DADE WATER & SEWER DEPARTMENT	Single	750	one 750 gallon	90	0
GDO	3271	IGT	5	150	Eating establishment	30	30	0	MIAMI DADE WATER & SEWER DEPARTMENT	Single	1050	one 1050 gallon	90	750
GDO	3272	IGT	5	150	Eating establishment	28	28	1100	MIAMI DADE WATER & SEWER DEPARTMENT	Single	1500	one 1500 gallon	90	275
GDO	3273	IGT	5	150	Eating establishment	30	30	0		Series	3200	two 1600 gallon	90	420
GDO	3274	IGT	5	150	Eating establishment	24	24	1200	MIAMI DADE WATER & SEWER DEPARTMENT	Single	750	one 750 gallon	90	300
GDO	3278	IGT	5	300	Eating establishment	150	150	0	CITY OF MIAMI BEACH	Single	750	one 750 gallon	90	3750
GDO	3286	MGRU	5	150	Eating establishment	30	30	0	MIAMI DADE WATER & SEWER DEPARTMENT		0	one 25 gpm	30	750
GDO	3289	IGT	5	300	Eating establishment	74	74	0	MIAMI DADE WATER & SEWER DEPARTMENT		750	one 750 gallon	90	1850
GDO	3290	IGT	5	150	Eating establishment	0	0	0	MIAMI DADE WATER & SEWER DEPARTMENT	Single	950	one 950 gallon	90	0
GDO	3291	IGT	5	300	Eating establishment	120	120	0	MIAMI DADE WATER & SEWER DEPARTMENT	Single	950	one 950 gallon	90	3000
GDO	3292	IGT	5	150	Eating establishment	7	7	0	MIAMI DADE WATER & SEWER DEPARTMENT	Single	1050	one 1050 gallon	90	98
GDO	3293	IGT	5	150	Eating establishment	52	52	3000	MIAMI DADE WATER & SEWER DEPARTMENT	Single	1050	one 1050 gallon	90	750
GDO	3298	IGT	5	150	Eating establishment	0	0	0	MIAMI DADE WATER & SEWER DEPARTMENT	Single	1050	one 1050 gallon	90	0
GDO	3300	IGT	5	150	Eating establishment	0	0	0	MIAMI DADE WATER & SEWER DEPARTMENT	Single	1050	one 1050 gallon	90	0
GDO	3301	IGT	5	150	Eating establishment	3	3	0	CITY OF HIALEAH	Single	750	one 750 gallon	90	42
GDO	3302	IGT	5	300	Eating establishment	100	100	0	MIAMI DADE WATER & SEWER DEPARTMENT	Single	1200	one 1200 gallon	90	2500
GDO	3306	IGT	5	150	Eating establishment	54	54	2430	MIAMI DADE WATER & SEWER DEPARTMENT	Single	1500	one 1500-gallon	90	608
GDO	3307	IGT	5	150	Eating establishment	24	24	1206	MIAMI DADE WATER & SEWER DEPARTMENT	Single	1200	one 1200-gallon	90	302
GDO	3308	IGT	5	150	Eating establishment	53	0	1217	MIAMI DADE WATER & SEWER DEPARTMENT	Single	1500	one 1500 gallon	90	304
GDO	3309	IGT	5	150	Eating establishment	0	0	1100	MIAMI DADE WATER & SEWER DEPARTMENT	Single	950	one 950 gallon	90	275
GDO	3310	IGT	5	300	Eating establishment	50	50	4700	CITY OF NORTH MIAMI BEACH	Single	1500	one 1500 gallon	90	1175
GDO	3311	IGT	5	150	Eating establishment	30	30	0	CITY OF HIALEAH	Single	750	one 750 gallon	90	750
GDO	3312	IGT	5	150	Eating establishment	18	18	0	CITY OF HIALEAH	Single	1200	one 1200 gallon	90	5
GDO	3313	IGT	5	150	Eating establishment	0	0	0	CITY OF MIAMI BEACH	Series	3600	three 1200 gallon	90	0
GDO	3314	IGT	5	150	Eating establishment	30	30	0	MIAMI DADE WATER & SEWER DEPARTMENT	Single	750	one 750 gallon	90	750
GDO	3315	IGT	5	150	Eating establishment	49	49	0	MIAMI DADE WATER & SEWER DEPARTMENT	Single	950	one 950 gallon	90	1225
GDO	3317	IGT	5	150	Eating establishment	74	74	0	MIAMI DADE WATER & SEWER DEPARTMENT	Single	1050	one 1050 gallon	90	483
GDO	3318	IGT	5	150	Eating establishment	50	50	2800	MIAMI DADE WATER & SEWER DEPARTMENT	Single	1050	one 1050 gallon	90	1250
GDO	3320	MGRU	5	150	Eating establishment	10	0	800	CITY OF NORTH MIAMI BEACH		0	one 20 gpm	60	200
GDO	3321	IGT	5	300	Eating establishment	70	70	0	MIAMI DADE WATER & SEWER DEPARTMENT	Single	1500	one 1500 gallon	90	1750
GDO	3325	IGT	5	150	Eating establishment	81	81	2400	MIAMI DADE WATER & SEWER DEPARTMENT	Series	4000	two 2000 gallon	90	600
GDO	3328	IGT	5	150	Eating establishment	0	0	0	MIAMI DADE WATER & SEWER DEPARTMENT	Single	1050	one 1050 gallon	90	0
GDO	3330	IGT	5	150	Eating establishment	42	0	1450	CITY OF HIALEAH	Single	1200	one 1200 gallon	60	363
GDO	3334	AGRU	5	150	Eating establishment	30	30	0			0	one 25 gpm	30	750
GDO	3336	IGT	5	150	Eating establishment	30	0	1100	CITY OF MIAMI BEACH	Single	1200	one 1200 gallon	60	275
GDO	3337	IGT	5	150	Eating establishment	8	8	1150	CITY OF MIAMI BEACH	Single	750	one 750 gallon	90	288
GDO	3338	IGT	5	150	Eating establishment	20	20	0	CITY OF MIAMI BEACH	Single	750	one 750 gallon	90	280
GDO	3339	AGRU	5	150	Eating establishment	38	38	0	MIAMI DADE WATER & SEWER DEPARTMENT		0	one 25 gpm Thermaco	30	532
GDO	3341	IGT	5	150	Eating establishment	20	0	1200	CITY OF HIALEAH	Single	1200	one 1200 gallon	60	300
GDO	3342	IGT	5	150	Eating establishment	43	43	0	MIAMI DADE WATER & SEWER DEPARTMENT	Single	750	one 750 gallon	90	1075

WORK GROUP	PERMIT NUMBER	PERMIT CLASS	PERMIT	PERMIT FEE	BUSINESS_TYPE	RECORDED SEATS	OBSERVED SEATS	FACILITY AREA	UTILITY	SYSTEM FORMAT	TOTAL CAPACITY	TANK_CAPACITY	PUMP OUT	TOTAL GPD
GDO	3345	IGT	5	150	Eating establishment	20	20	0	MIAMI DADE WATER & SEWER DEPARTMENT	Single	750	one 750 gallon	90	500
GDO	3347	IGT	5	750	Eating establishment	222	222	0		Single	3200	two 1600 gallon	90	5550
GDO	3348	IGT	2	150	Eating establishment	0	0	1115	MIAMI DADE WATER & SEWER DEPARTMENT	Single	1200	one 1200 gallon	60	279
GDO	3349	IGT	5	150	Eating establishment	30	30	0		Single	750	one 750 gallon	90	420
GDO	3350	MGRU	5	150	Eating establishment	0	0	0			0	one 25 gpm	30	0
GDO	3351	IGT	5	300	Eating establishment	26	26	130220	MIAMI DADE WATER & SEWER DEPARTMENT	Series	2400	two 1200 gallon	90	3256
GDO	3354	IGT	5	300	Eating establishment	112	112	0	MIAMI DADE WATER & SEWER DEPARTMENT	Single	1250	one 1250 gallon	90	1568
GDO	3358	MGRU	5	150	Eating establishment	0	0	269	MIAMI DADE WATER & SEWER DEPARTMENT		0	one 75-gpm	30	67
												one 1500 and one		
GDO	3361	IGT	5	300	Eating establishment	180	180	0		Single	4500	3000 gallon	90	4500
GDO	3363	MGRU	5	300	Eating establishment	150	150	0	MIAMI DADE WATER & SEWER DEPARTMENT		0	five 100 gpm	90	3750
GDO	3364	AGT	5	300	Eating establishment	116	0	7675	MIAMI DADE WATER & SEWER DEPARTMENT	Single	1250	one 1250 gallon	90	1919
GDO	3365	IGT	5	750	Eating establishment	317	317	10754	MIAMI DADE WATER & SEWER DEPARTMENT	Series	6000	two 3000 gallon	90	2836
GDO	3370	IGT	5	300	Eating establishment	200	200	4500	MIAMI DADE WATER & SEWER DEPARTMENT	Single	950	one 950 gallon	90	1125
GDO	3373	IGT	5	300	Eating establishment	90	90	0	CITY OF NORTH MIAMI BEACH	Single	1050	one 1050 gallon	90	2250
GDO	3374	IGT	5	150	Eating establishment	30	30	0	CITY OF MIAMI BEACH	Single	950	one 950 gallon	90	750
GDO	3375	IGT	5	150	Eating establishment	21	21	1200		Single	950	one 950 gallon	90	300
GDO	3376	IGT	5	300	Eating establishment	172	172	6300	MIAMI DADE WATER & SEWER DEPARTMENT	Series	3600	three 1200 gallon	90	1575
GDO	3380	MGRU	5	150	Eating establishment	16	16	1175	MIAMI DADE WATER & SEWER DEPARTMENT		0	one 25 gpm	30	294
GDO	3382	IGT	5	150	Eating establishment	0	0	2800	MIAMI DADE WATER & SEWER DEPARTMENT	Single	1050	one 1050 gallon	90	700
GDO	3383	IGT	5	300	Eating establishment	60	60	0		Single	750	one 750 gallon	90	1500
GDO	3385	IGT	5	150	Eating establishment	60	60	1800	MIAMI DADE WATER & SEWER DEPARTMENT	Single	900	one 900 gallon	90	55000
GDO	3391	IGT	5	300	Eating establishment	130	130	0	MIAMI DADE WATER & SEWER DEPARTMENT	Single	1050	one 1050 gallon	90	3250
GDO	3394	IGT	5	150	Eating establishment	72	72	2250	CITY OF NORTH MIAMI BEACH	Single	1200	one 1200 gallon	90	563
GDO	3395	IGT	5	150	Eating establishment	0	0	0	MIAMI DADE WATER & SEWER DEPARTMENT	Single	750	one 750 gallon	90	0
GDO	3397	MGRU	5	150	Eating establishment	24	0	0	MIAMI DADE WATER & SEWER DEPARTMENT		0	one 50 gpm	90	0
GDO	3401	IGT	5	150	Eating establishment	20	0	1387	CITY OF HIALEAH GARDENS	Series	2100	two 1050 gallon	90	347
GDO	3403	IGT	5	150	Eating establishment	0	0	0	MIAMI DADE WATER & SEWER DEPARTMENT	Single	1050	one 1050 gallon	90	0
GDO	3404	AGRU	5	150	Eating establishment	0	0	0			0	one 25 gpm	30	0
GDO	3406	IGT	5	150	Eating establishment	57	57	1500	MIAMI DADE WATER & SEWER DEPARTMENT	Single	750	one 750 gallon	90	375
GDO	3407	IGT	5	150	Eating establishment	0	0	0	MIAMI DADE WATER & SEWER DEPARTMENT	Single	750	one 750 gallon	90	0
GDO	3408	MGRU	5	150	Eating establishment	45	45	0	MIAMI DADE WATER & SEWER DEPARTMENT	Single	0	one 25 gpm	30	1125
GDO	3411	MGRU	5	150	Eating establishment	0	0	0	MIAMI DADE WATER & SEWER DEPARTMENT		0	one 25 gpm	30	0
GDO	3412	IGT	5	150	Eating establishment	0	0	0	MIAMI DADE WATER & SEWER DEPARTMENT	Single	750	one 750 gallon	90	0
GDO	3414	IGT	5	300	Eating establishment	210	210	12262	MIAMI DADE WATER & SEWER DEPARTMENT	Single	2000	one 2000 gallon	90	3066
GDO	3419	IGT	5	150	Eating establishment	0	0	0	MIAMI DADE WATER & SEWER DEPARTMENT	Single	750	one 750 gallon	90	0
GDO	3425	IGT	5	300	Eating establishment	80	80	0	MIAMI DADE WATER & SEWER DEPARTMENT	Single	950	one 950 gallon	90	1600
GDO	3426	IGT	5	150	Eating establishment	72	0	1958	CITY OF NORTH MIAMI BEACH	Single	950	one 950 gallon	90	490
GDO	3427	IGT	5	150	Eating establishment	28	28	1260	MIAMI DADE WATER & SEWER DEPARTMENT	Single	1050	one 1050 gallon	90	700
GDO	3433	MGRU	5	150	Eating establishment	20	0	866	MIAMI DADE WATER & SEWER DEPARTMENT		0	one 50 gpm	30	217
GDO	3435	IGT	5	300	Eating establishment	90	90	0	CITY OF MIAMI BEACH	Single	950	one 950 gallon	90	2250
GDO	3436	AGRU	5	150	Eating establishment	40	40	0			0	one 35 gpm	30	1000
GDO	3437	MGRU	5	150	Eating establishment	10	10	700	CITY OF MIAMI BEACH		0	one 25 gpm	30	175
GDO	3440	IGT	5	150	Eating establishment	56	56	1810		Single	1050	one 1050 gallon	90	453
GDO	3442	IGT	5	150	Eating establishment	50	50	0		Single	1050	one 1050 gallon	90	700
GDO	3445	IGT	5	150	Eating establishment	42	42	0		Single	1200	one 1200 gallon	90	588
GDO	3450	IGT	5	150	Eating establishment	1000	1000	0	MIAMI DADE WATER & SEWER DEPARTMENT	Single	750	one 750 gallon	90	1000
GDO	3451	IGT	5	150	Eating establishment	255	255	0	MIAMI DADE WATER & SEWER DEPARTMENT	Single	1050	one 1050 gallon	90	255
GDO	3452	IGT	5	150	Eating establishment	173	173	0	CITY OF NORTH MIAMI BEACH	Single	750	one 750 gallon	90	173
GDO	3453	IGT	5	150	Eating establishment	465	465	0	MIAMI DADE WATER & SEWER DEPARTMENT	Series	4200	four 1050 gallon	90	465
GDO	3454	IGT	5	150	Eating establishment	217	217	0	MIAMI DADE WATER & SEWER DEPARTMENT	Series	2100	two 1050 gallon	90	217
GDO	3459	IGT	5	150	Eating establishment	549	549	0	CITY OF NORTH MIAMI	Single	1000	one 1000 gallon	90	549
GDO	3461	IGT	5	150	Eating establishment	406	406	0	MIAMI DADE WATER & SEWER DEPARTMENT	Series	2000	two 1000 gallon	90	406
GDO	3462	IGT	5	150	Eating establishment	129	129	0	CITY OF OPA LOCKA	Series	1000	one 1000 gallon	90	129
GDO	3464	IGT	5	150	Eating establishment	104	105	0		Single	2000	one 2000 gallon	90	105
GDO	3465	IGT	5	150	Eating establishment	163	163	0		Series	2100	two 1050 gallon	90	163
GDO	3466	IGT	5	150	Eating establishment	695	695	0		Series	7350	seven 1050 gallon	90	695
GDO	3467	IGT	5	150	Eating establishment	403	403	0	MIAMI DADE WATER & SEWER DEPARTMENT	Series	4200	four 1050 gallon	90	403
GDO	3468	IGT	5	150	Eating establishment	30	30	900	CITY OF HIALEAH	Single	750	one 750 gallon	90	750
GDO	3470	IGT	5	150	Eating establishment	171	171	0		Single	1050	one 1050 gallon	90	171
GDO	3471	IGT	5	150	Eating establishment	147	147	0	MIAMI DADE WATER & SEWER DEPARTMENT	Single	1050	one 1050 gallon	90	147

WORK GROUP	PERMIT NUMBER	PERMIT CLASS	PERMIT T	PERMIT FEE	BUSINESS_TYPE	RECORDED SEATS	OBSERVED SEATS	FACILITY AREA	UTILITY	SYSTEM FORMAT	TOTAL CAPACITY	TANK_CAPACITY	PUMP OUT	TOTAL GPD
GDO	3472	IGT	5	300	Eating establishment	96	96	688	MIAMI DADE WATER & SEWER DEPARTMENT	Parallel	1500	two 750 gallon	90	172
GDO	3473	IGT	5	150	Eating establishment	125	125	0		Series	3000	three 1000 gallon	90	0
GDO	3474	IGT	5	150	Eating establishment	48	48	0	MIAMI DADE WATER & SEWER DEPARTMENT	Single	1050	one 1050 gallon	90	48
GDO	3475	IGT	5	150	Eating establishment	125	125	0		Single	1500	one 1500 gallon	90	0
GDO	3476	IGT	5	150	Eating establishment	638	638	0	MIAMI DADE WATER & SEWER DEPARTMENT	Single	1200	one 1200 gallon	90	638
GDO	3477	IGT	5	150	Eating establishment	717	717	0	MIAMI DADE WATER & SEWER DEPARTMENT	Series	4100	three 1050 & one 950+ gallon	90	717
GDO	3484	IGT	5	150	Eating establishment	100	100	4096	MIAMI DADE WATER & SEWER DEPARTMENT	Single	3000	one 3000 gallon	90	600
GDO	3486	IGT	5	150	Eating establishment	176	176	0		Single	1050	one 1050 gallon	90	176
GDO	3487	IGT	5	150	Eating establishment	141	141	0	MIAMI DADE WATER & SEWER DEPARTMENT	Single	1050	one 1050 gallon	90	141
GDO	3488	IGT	5	150	Eating establishment	713	713	0	MIAMI DADE WATER & SEWER DEPARTMENT	Single	950	one 950 gallon	90	713
GDO	3489	IGT	5	150	Eating establishment	303	303	0		Series	2100	two 1050 gallon	90	303
GDO	3490	IGT	5	150	Eating establishment	390	390	0		Single	3700	one 3700 gallon	90	390
GDO	3491	IGT	5	150	Eating establishment	599	599	0	MIAMI DADE WATER & SEWER DEPARTMENT	Series	2100	two 1050 gallon	90	599
GDO	3493	IGT	5	150	Eating establishment	30	30	700	CITY OF HIALEAH	Single	750	one 750 gallon	90	175
GDO	3494	IGT	5	150	Eating establishment	14	14	0	CITY OF NORTH MIAMI BEACH	Single	750	one 750 gallon	90	196
GDO	3497	IGT	5	150	Eating establishment	235	235	1715	CITY OF MIAMI BEACH	Series	3750	three 1250-gallon	90	429
GDO	3500	IGT	5	150	Eating establishment	400	400	0		Series	3150	three 1050 gallon	90	400
GDO	3501	IGT	5	150	Eating establishment	40	40	0		Single	750	one 750 gallon	90	1000
GDO	3502	IGT	5	150	Eating establishment	877	877	0	MIAMI DADE WATER & SEWER DEPARTMENT	Series	3800	four 950 gallon	90	877
GDO	3509	MGRU	5	300	Eating establishment	96	96	3000	CITY OF MIAMI BEACH		0	one 25 gpm	30	750
GDO	3510	IGT	5	150	Eating establishment	40	40	0		Series	3600	three 1200 gallon	90	560
GDO	3513	IGT	5	150	Eating establishment	461	461	0		Series	3150	three 1050 gallon	90	461
GDO	3514	IGT	5	150	Eating establishment	390	390	0		Series	2100	two 1050 gallon	90	390
GDO	3516	IGT	5	150	Eating establishment	607	607	0	CITY OF HIALEAH GARDENS	Series	4200	four 1050 gallon	90	607
GDO	3517	IGT	5	150	Eating establishment	881	881	0		Single	1050	one 1050 gallon	90	881
GDO	3518	IGT	5	150	Eating establishment	467	467	0		Single	1050	one 1050 gallon	90	467
GDO	3519	IGT	5	150	Eating establishment	685	685	0		Single	1500	one 1500 gallon	90	685
GDO	3521	IGT	5	150	Eating establishment	859	859	0		Single	1050	one 1050 gallon	90	859
GDO	3522	IGT	5	150	Eating establishment	279	279	0		Series	2100	two 1050 gallon	90	279
GDO	3523	IGT	5	300	Eating establishment	40	40	3800	CITY OF HIALEAH	Single	950	one 950-gallon	90	950
GDO	3526	IGT	5	750	Eating establishment	253	253	0	CITY OF NORTH MIAMI BEACH	Single	1050	one 1050 gallon	90	6325
GDO	3530	IGT	5	150	Eating establishment	20	20	600	MIAMI DADE WATER & SEWER DEPARTMENT	Single	750	one 750 gallon	90	150
GDO	3531	MGRU	5	150	Eating establishment	12	12	1087	MIAMI DADE WATER & SEWER DEPARTMENT		0	one 100 gpm	30	272
GDO	3532	IGT	5	150	Eating establishment	30	30	2200	MIAMI DADE WATER & SEWER DEPARTMENT	Single	750	one 750 gallon	90	750
GDO	3533	IGT	5	150	Eating establishment	43	43	0	MIAMI DADE WATER & SEWER DEPARTMENT	Single	750	one 750 gallon	90	1075
GDO	3534	MGRU	5	150	Eating establishment	24	0	1100	CITY OF HIALEAH		0	one 20 gpm	30	275
GDO	3536	IGT	5	150	Eating establishment	30	30	0	MIAMI DADE WATER & SEWER DEPARTMENT	Single	1200	one 1200 gallon	90	750
GDO	3540	IGT	5	150	Eating establishment	37	37	0	MIAMI DADE WATER & SEWER DEPARTMENT	Single	1050	one 1050 gallon	90	518
GDO	3541	IGT	5	300	Eating establishment	150	150	0		Series	2400	two 1200 gallon	90	3750
GDO	3542	IGT	5	150	Eating establishment	0	0	0		Single	950	one 950 gallon	90	0
GDO	3543	IGT	5	300	Eating establishment	150	150	0	MIAMI DADE WATER & SEWER DEPARTMENT	Single	3000	one 3000 gallon	90	3750
GDO	3544	IGT	5	150	Eating establishment	16	16	1500	CITY OF HIALEAH	Single	1050	one 1050 gallon	90	375
GDO	3549	IGT	5	150	Eating establishment	0	0	1200	MIAMI DADE WATER & SEWER DEPARTMENT	Single	1050	one 1050 gallon	60	300
GDO	3550	IGT	2	150	Eating establishment	0	0	1927	MIAMI DADE WATER & SEWER DEPARTMENT	Series	4500	one 1500 & one 3000 gallon	90	482
GDO	3552	IGT	5	150	Eating establishment	10	10	960	MIAMI DADE WATER & SEWER DEPARTMENT	Single	950	one 950 gallon	90	240
GDO	3555	AGRU	5	150	Eating establishment	32	32	0	MIAMI DADE WATER & SEWER DEPARTMENT		0	one 25 gpm	30	448
GDO	3556	IGT	5	300	Eating establishment	92	92	4557	MIAMI DADE WATER & SEWER DEPARTMENT	Single	2400	one 2400-gallon	90	113925
GDO	3560	IGT	5	300	Eating establishment	140	140	0	MIAMI DADE WATER & SEWER DEPARTMENT	Single	1200	one 1200 gallon	90	3500
GDO	3561	IGT	5	150	Eating establishment	26	0	1990	MIAMI DADE WATER & SEWER DEPARTMENT	Single	750	one 750 gallon	60	498
GDO	3562	IGT	5	150	Eating establishment	892	892	0		Series	6000	eight 750 gallon	90	892
GDO	3563	IGT	5	150	Eating establishment	50	50	2600	CITY OF HIALEAH	Single	950	one 950 gallon	90	650
GDO	3564	IGT	5	150	Eating establishment	381	381	0	MIAMI DADE WATER & SEWER DEPARTMENT	Single	1050	one 1050 gallon	90	381
GDO	3567	IGT	5	150	Eating establishment	503	503	0	CITY OF NORTH MIAMI BEACH	Single	2000	one 2000 gallon	90	503
GDO	3573	IGT	5	150	Eating establishment	311	311	0		Series	3000	three 1000 gallon	90	311
GDO	3574	IGT	5	150	Eating establishment	901	901	0		Single	1000	one 1000 gallon	90	901
GDO	3575	IGT	5	150	Eating establishment	722	722	0	CITY OF NORTH MIAMI BEACH	Series	4000	two 2000 gallon	90	722
GDO	3576	IGT	5	150	Eating establishment	321	321	0		Single	1500	one 1500 gallon	90	321
GDO	3577	IGT	5	150	Eating establishment	500	0	0		Single	2000	one 2000 gallon	90	0
GDO	3580	IGT	5	150	Eating establishment	200	200	0	MIAMI DADE WATER & SEWER DEPARTMENT	Single	2000	one 2000 gallon	90	5000

WORK GROUP	PERMIT NUMBER	PERMIT CLASS	PERMIT	PERMIT FEE	BUSINESS_TYPE	RECORDED SEATS	OBSERVED SEATS	FACILITY AREA	UTILITY	SYSTEM FORMAT	TOTAL CAPACITY	TANK_CAPACITY	PUMP OUT	TOTAL GPD
GDO	3581	IGT	5	150	Eating establishment	595	595	0		Single	1000	one 1000 gallon	90	595
GDO	3583	IGT	5	150	Eating establishment	741	741	0		Single	1500	one 1500 gallon	90	741
GDO	3584	IGT	5	150	Eating establishment	518	518	0	MIAMI DADE WATER & SEWER DEPARTMENT	Single	2000	one 2000 gallon	90	518
GDO	3585	IGT	5	150	Eating establishment	523	523	0	MIAMI DADE WATER & SEWER DEPARTMENT	Single	750	one 750 gallon	90	523
GDO	3586	IGT	5	150	Eating establishment	702	702	0	MIAMI DADE WATER & SEWER DEPARTMENT	Series	2000	two 1000 gallon	90	702
GDO	3587	IGT	5	150	Eating establishment	594	594	0	MIAMI DADE WATER & SEWER DEPARTMENT	Single	750	one 750 gallon	90	594
GDO	3588	IGT	5	150	Eating establishment	490	490	0		Series	2000	two 1000 gallon	90	490
GDO	3589	IGT	5	150	Eating establishment	560	560	0		Single	2000	one 2000 gallon	90	560
GDO	3590	IGT	5	150	Eating establishment	283	283	0		Single	1500	one 1500 gallon	90	283
GDO	3591	IGT	5	150	Eating establishment	840	840	0		Single	1500	one 1500 gallon	90	840
GDO	3592	IGT	5	150	Eating establishment	502	502	0		Series	2000	two 1000 gallon	90	502
GDO	3594	IGT	5	150	Eating establishment	929	929	0		Single	1500	one 1500 gallon	90	929
GDO	3595	IGT	5	150	Eating establishment	294	294	0	MIAMI DADE WATER & SEWER DEPARTMENT	Series	8000	four 2000 gallon	90	294
GDO	3596	IGT	5	150	Eating establishment	705	705	0		Single	2000	one 2000 gallon	90	705
GDO	3597	IGT	5	150	Eating establishment	449	449	0		Single	1000	one 1000 gallon	90	449
GDO	3598	IGT	5	150	Eating establishment	438	438	0		Series	2000	two 1000 gallon	90	438
GDO	3599	IGT	5	150	Eating establishment	264	264	0		Series	3000	three 1000 gallon	90	264
GDO	3600	IGT	5	150	Eating establishment	664	664	0		Single	2000	one 2000 gallon	90	664
GDO	3601	IGT	5	150	Eating establishment	257	257	0		Series	3000	one 1000 & one 2000 gallon	90	257
GDO	3602	IGT	5	150	Eating establishment	444	444	0		Series	5250	five 1050 gallon	90	444
GDO	3603	IGT	5	150	Eating establishment	500	0	0		Single	900	one 900 gallon	90	0
GDO	3604	IGT	5	150	Eating establishment	508	508	0		Single	1000	one 1000 gallon	90	508
GDO	3605	IGT	5	150	Eating establishment	150	150	0		Series	6000	tree 2000 gallon	90	150
GDO	3606	IGT	5	150	Eating establishment	615	615	0		Single	1000	one 1000 gallon	90	615
GDO	3607	IGT	5	150	Eating establishment	196	196	0	MIAMI DADE WATER & SEWER DEPARTMENT	Series	3000	three 1000 gallon	90	196
GDO	3608	IGT	5	150	Eating establishment	210	210	0	CITY OF HIALEAH	Single	1000	one 1000 gallon	90	210
GDO	3609	IGT	5	150	Eating establishment	419	419	0	CITY OF OPA LOCKA	Single	750	one 750 gallon	90	419
GDO	3612	IGT	5	150	Eating establishment	149	149	0	MIAMI DADE WATER & SEWER DEPARTMENT	Series	2000	two 1000 gallon	90	149
GDO	3613	IGT	5	150	Eating establishment	286	286	0		Single	1000	one 1000 gallon	90	286
GDO	3614	IGT	5	150	Eating establishment	260	260	0		Series	4500	three 1500 gallon	90	260
GDO	3615	IGT	5	150	Eating establishment	125	125	0	MIAMI DADE WATER & SEWER DEPARTMENT	Single	1500	one 1500 gallon	90	0
GDO	3616	IGT	5	150	Eating establishment	171	171	0	MIAMI DADE WATER & SEWER DEPARTMENT	Single	2000	two 1000 gallon	90	171
GDO	3617	IGT	5	150	Eating establishment	1161	1161	0	MIAMI DADE WATER & SEWER DEPARTMENT	Series	6000	six 1000 gallon	90	1000
GDO	3618	IGT	5	150	Eating establishment	330	330	0	MIAMI DADE WATER & SEWER DEPARTMENT	Series	3000	three 1000 gallon	90	330
GDO	3619	IGT	5	150	Eating establishment	108	108	0	MIAMI DADE WATER & SEWER DEPARTMENT	Series	1650	one 900 & one 750 gallon	90	108
GDO	3620	IGT	5	150	Eating establishment	327	327	0	MIAMI DADE WATER & SEWER DEPARTMENT	Series	2000	two 1000 gallon	90	327
GDO	3621	IGT	5	150	Eating establishment	154	154	0		Single	1050	one 1050 gallon	90	154
GDO	3622	IGT	5	150	Eating establishment	254	254	0	MIAMI DADE WATER & SEWER DEPARTMENT	Series	8000	four 2000 gallon	90	254
GDO	3623	IGT	5	150	Eating establishment	126	126	0	MIAMI DADE WATER & SEWER DEPARTMENT	Single	1600	one 1600 gallon	90	126
GDO	3624	IGT	5	150	Eating establishment	170	170	0		Single	1600	one 1600 gallon	90	170
GDO	3625	IGT	5	150	Eating establishment	790	790	0	MIAMI DADE WATER & SEWER DEPARTMENT	Series	8000	eight 1000 gallon	90	790
GDO	3626	IGT	5	150	Eating establishment	157	157	0	MIAMI DADE WATER & SEWER DEPARTMENT	Single	2000	two 1000 gallon	90	157
GDO	3628	IGT	5	150	Eating establishment	968	968	0		Single	5000	one 5000 gallon	90	968
GDO	3629	IGT	5	150	Eating establishment	531	531	0	CITY OF MIAMI SPRINGS	Single	2000	one 2000 gallon	90	531
GDO	3630	IGT	5	150	Eating establishment	0	0	1130	MIAMI DADE WATER & SEWER DEPARTMENT	Single	750	one 750-gallon	90	283
GDO	3631	IGT	5	150	Eating establishment	406	406	0		Single	900	one 900 gallon	90	406
GDO	3632	IGT	5	150	Eating establishment	322	322	0	MIAMI DADE WATER & SEWER DEPARTMENT	Single	2000	one 2000 gallon	90	322
GDO	3633	IGT	5	150	Eating establishment	439	439	0	MIAMI DADE WATER & SEWER DEPARTMENT	Single	1500	one 1500 gallon	90	439
GDO	3634	IGT	5	150	Eating establishment	221	221	0	MIAMI DADE WATER & SEWER DEPARTMENT	Series	4000	four 1000 gallon	90	221
GDO	3635	IGT	5	150	Eating establishment	145	145	0		Single	4000	one 4000 gallon	90	145
GDO	3637	IGT	5	150	Eating establishment	168	168	0		Single	750	one 750 gallon	90	168
GDO	3638	IGT	5	150	Eating establishment	140	140	0	CITY OF HIALEAH	Series	3000	three 1000 gallon	90	140
GDO	3639	IGT	5	150	Eating establishment	211	211	0	CITY OF HIALEAH	Series	2000	two 1000 gallon	90	211
GDO	3640	IGT	5	150	Eating establishment	189	189	0	CITY OF MIAMI SPRINGS	Single	750	one 750 gallon	90	189
GDO	3641	IGT	5	150	Eating establishment	267	267	0	MIAMI DADE WATER & SEWER DEPARTMENT	Series	2000	two 1000 gallon	90	267
GDO	3643	IGT	5	150	Eating establishment	308	308	0	MIAMI DADE WATER & SEWER DEPARTMENT	Series	2000	two 1000 gallon	90	308
GDO	3644	IGT	5	150	Eating establishment	339	339	0	MIAMI DADE WATER & SEWER DEPARTMENT	Series	5000	one 1000 & two 2000 gallon	90	339
GDO	3645	IGT	5	150	Eating establishment	686	686	0	MIAMI DADE WATER & SEWER DEPARTMENT	Single	1000	one 1000 gallon	90	686

WORK GROUP	PERMIT NUMBER	PERMIT CLASS	PERMIT	PERMIT FEE	BUSINESS_TYPE	RECORDED SEATS	OBSERVED SEATS	FACILITY AREA	UTILITY	SYSTEM FORMAT	TOTAL CAPACITY	TANK_CAPACITY	PUMP OUT	TOTAL GPD
GDO	3646	IGT	5	150	Eating establishment	217	217	0		Series	3000	three 1000 gallon	90	217
GDO	3647	IGT	5	150	Eating establishment	500	0	0		Single	1000	one 1000 gallon	90	0
GDO	3648	IGT	5	150	Eating establishment	489	489	0		Single	1500	one 1500 gallon	90	489
GDO	3649	IGT	5	150	Eating establishment	322	322	0		Single	750	one 750 gallon	90	322
GDO	3650	IGT	5	150	Eating establishment	681	681	0		Series	750	one 750 gallon	90	681
GDO	3651	IGT	5	150	Eating establishment	436	436	0		Single	2000	one 2000 gallon	90	436
GDO	3652	IGT	5	150	Eating establishment	311	311	0		Series	3000	three 1000 gallon	90	311
GDO	3653	IGT	5	150	Eating establishment	500	0	0		Series	5000	five 1000 gallon	90	0
GDO	3654	IGT	5	150	Eating establishment	567	567	0	MIAMI DADE WATER & SEWER DEPARTMENT	Series	3200	two 1600 gallon	90	567
GDO	3655	IGT	5	300	Eating establishment	214	214	0	MIAMI DADE WATER & SEWER DEPARTMENT	Single	750	one 750 gallon	90	2996
GDO	3656	IGT	5	150	Eating establishment	294	294	0	MIAMI DADE WATER & SEWER DEPARTMENT	Single	1000	one 1000 gallon	90	294
GDO	3657	IGT	5	150	Eating establishment	566	566	0		Single	2000	one 2000 gallon	90	566
GDO	3658	IGT	5	150	Eating establishment	440	440	0		Series	3000	three 1000 gallon	90	440
GDO	3659	IGT	5	150	Eating establishment	551	551	0		Single	4000	one 4000 gallon	90	551
GDO	3660	IGT	5	150	Eating establishment	477	477	0	MIAMI DADE WATER & SEWER DEPARTMENT	Single	750	one 750 gallon	90	477
GDO	3661	IGT	5	150	Eating establishment	10	10	750	MIAMI DADE WATER & SEWER DEPARTMENT	Single	1200	one 1200 gallon	90	250
GDO	3664	IGT	5	150	Eating establishment	266	266	0	CITY OF NORTH BAY VILLAGE	Series	3000	three 1000 gallon	90	266
GDO	3665	IGT	5	150	Eating establishment	297	297	0		Series	2750	one 750 & two 1000 gallon	90	297
GDO	3666	IGT	5	150	Eating establishment	268	268	0	CITY OF MIAMI BEACH	Single	1000	one 1000 gallon	90	268
GDO	3667	IGT	5	150	Eating establishment	786	786	0	CITY OF MIAMI BEACH	Multiple	3150	three 1050 gallon	90	786
GDO	3668	IGT	5	150	Eating establishment	353	353	0		Series	4000	four 1000 gallon	90	353
GDO	3671	IGT	5	150	Eating establishment	624	624	0	CITY OF MIAMI BEACH	Single	1000	one 1000 gallon	90	624
GDO	3672	IGT	5	150	Eating establishment	332	332	0	CITY OF HIALEAH	Series	3000	three 1000 gallon	90	332
GDO	3674	IGT	5	150	Eating establishment	0	0	8300	MIAMI DADE WATER & SEWER DEPARTMENT	Series	1500	two 750-gallon	90	2075
GDO	3678	IGT	5	150	Eating establishment	0	0	0		Single	1200	one 1200 gallon	90	0
GDO	3679	MGRU	5	150	Eating establishment	20	20	0	MIAMI DADE WATER & SEWER DEPARTMENT		0	Not applicable	0	280
GDO	3682	IGT	5	150	Eating establishment	36	36	2500	MIAMI DADE WATER & SEWER DEPARTMENT	Series	2550	one 1050 & one 1500 gallon	90	625
GDO	3683	IGT	5	150	Eating establishment	944	944	0	CITY OF HIALEAH	Single	750	one 750 gallon	90	944
GDO	3684	IGT	5	150	Eating establishment	1016	1016	0	CITY OF HIALEAH	Single	4000	one 4000 gallon	90	1016
GDO	3686	IGT	5	150	Eating establishment	340	340	0		Single	2000	one 2000 gallon	90	340
GDO	3687	IGT	5	150	Eating establishment	780	780	0		Series	2000	two 1000 gallon	90	780
GDO	3688	IGT	5	150	Eating establishment	851	851	0		Series	2500	one 1000 & one 1500 gallon	90	851
GDO	3689	IGT	5	150	Eating establishment	409	409	0		Series	5000	one 1000 & one 4000 gallon	90	409
GDO	3690	IGT	5	150	Eating establishment	291	291	0	CITY OF HIALEAH	Series	3150	three 1050 gallon	90	291
GDO	3692	IGT	5	150	Eating establishment	18	18	1200	CITY OF HIALEAH	Single	950	one 950 gallon	90	300
GDO	3694	MGRU	5	150	Eating establishment	30	30	0	CITY OF HIALEAH		0	one 25 gpm	30	750
GDO	3695	IGT	5	150	Eating establishment	30	30	850	CITY OF HIALEAH	Single	950	one 950 gallon	90	213
GDO	3696	IGT	5	150	Eating establishment	24	24	0	MIAMI DADE WATER & SEWER DEPARTMENT	Single	1200	one 1200 gallon	90	336
GDO	3699	IGT	5	150	Eating establishment	983	983	0		Series	3150	three 1050 gallon	90	983
GDO	3701	IGT	5	150	Eating establishment	427	427	0		Series	3000	three 1000 gallon	90	427
GDO	3703	IGT	5	150	Eating establishment	266	266	0		Single	1000	one 1000 gallon	90	266
GDO	3704	IGT	5	150	Eating establishment	607	607	0		Single	2000	one 2000 gallon	90	607
GDO	3705	IGT	5	150	Eating establishment	653	653	0		Series	2000	two 1000 gallon	90	653
GDO	3706	IGT	5	150	Eating establishment	328	328	0		Single	4000	one 4000 gallon	90	328
GDO	3707	IGT	5	150	Eating establishment	604	604	0		Series	2000	two 1000 gallon	90	604
GDO	3708	IGT	5	150	Eating establishment	963	963	0		Series	1700	two 750 & two 1000 gallon	90	963
GDO	3710	MGRU	5	150	Eating establishment	0	0	0	MIAMI DADE WATER & SEWER DEPARTMENT		0	one 25 gpm	30	0
GDO	3712	IGT	5	300	Eating establishment	120	120	0		Series	10500	three 3500 gallon	90	3000
GDO	3713	IGT	5	150	Eating establishment	326	326	0		Series	3150	three 1050 gallon	90	326
GDO	3714	IGT	5	150	Eating establishment	369	369	0		Series	2100	two 1050 gallon	90	369
GDO	3715	IGT	5	150	Eating establishment	301	301	0		Single	1500	one 1500 gallon	90	301
GDO	3716	IGT	5	150	Eating establishment	315	315	0	MIAMI DADE WATER & SEWER DEPARTMENT	Series	2000	two 1000 gallon	90	0
GDO	3717	IGT	5	150	Eating establishment	560	560	0		Single	1000	one 1000 gallon	90	560
GDO	3718	IGT	5	150	Eating establishment	252	252	0		Single	1000	one 1000 gallon	90	252
GDO	3719	IGT	5	150	Eating establishment	873	873	0		Single	950	one 950 gallon	90	873
GDO	3720	IGT	5	150	Eating establishment	331	331	0		Single	1000	one 1000 gallon	90	331

WORK GROUP	PERMIT NUMBER	PERMIT CLASS	PERMIT	PERMIT FEE	BUSINESS_TYPE	RECORDED SEATS	OBSERVED SEATS	FACILITY AREA	UTILITY	SYSTEM FORMAT	TOTAL CAPACITY	TANK_CAPACITY	PUMP OUT	TOTAL GPD
GDO	3721	IGT	5	150	Eating establishment	447	447	0		Single	2000	one 2000 gallon	90	447
GDO	3722	IGT	5	150	Eating establishment	514	514	0		Single	1000	one 1000 gallon	90	514
GDO	3723	IGT	5	150	Eating establishment	620	620	0		Single	950	one 950 gallon	90	620
GDO	3729	IGT	5	150	Eating establishment	538	538	0		Series	950	one 950 gallon	90	538
GDO	3730	IGT	5	150	Eating establishment	781	781	0		Single	3000	one 3000 gallon	90	781
GDO	3731	IGT	5	150	Eating establishment	901	901	0		Series	2100	two 1050 gallon	90	901
GDO	3732	IGT	5	150	Eating establishment	359	359	0		Single	1000	one 1000 gallon	90	359
GDO	3733	IGT	5	150	Eating establishment	705	705	0		Single	1500	one 750 gallon	90	705
GDO	3734	IGT	5	150	Eating establishment	1104	1104	0		Series	2000	two 1000 gallon	90	1104
GDO	3736	IGT	5	150	Eating establishment	805	805	0		Series	1500	two 750 gallon	90	805
GDO	3738	IGT	5	150	Eating establishment	594	594	0		Series	2000	two 1000 gallon	90	594
GDO	3739	IGT	5	150	Eating establishment	673	673	0		Single	1000	one 1000 gallon	90	673
GDO	3741	IGT	5	150	Eating establishment	270	270	0		Single	1050	one 1050 gallon	90	270
GDO	3743	IGT	5	150	Eating establishment	27	27	0		Single	1050	one 1050 gallon	90	378
GDO	3744	MGRU	5	150	Eating establishment	40	0	1479	MIAMI DADE WATER & SEWER DEPARTMENT		0	one 20 gpm	30	370
GDO	3745	IGT	5	150	Eating establishment	500	500	0		Single	1000	one 1000 gallon	90	0
GDO	3747	IGT	5	150	Eating establishment	691	691	0		Single	350	one 350 gallon	90	691
GDO	3748	IGT	5	150	Eating establishment	500	0	0		Single	1000	one 1000 gallon	90	0
GDO	3749	IGT	5	150	Eating establishment	500	500	0		Single	750	one 750 gallon	90	0
GDO	3750	IGT	5	150	Eating establishment	747	747	0		Single	1000	one 1000 gallon	90	747
GDO	3751	IGT	5	150	Eating establishment	336	336	0		Single	300	one 300 gallon	90	336
GDO	3752	IGT	5	150	Eating establishment	444	444	0		Single	1000	one 1000 gallon	90	444
GDO	3753	IGT	5	150	Eating establishment	262	262	0		Multiple	2600	one 500 and two 1050 gallon	90	262
GDO	3754	IGT	5	150	Eating establishment	868	868	0	CITY OF CORAL GABLES	Single	3800	four 950 gallon	90	868
GDO	3755	IGT	5	150	Eating establishment	425	425	0	MIAMI DADE WATER & SEWER DEPARTMENT	Multiple	3150	three 1050 gallon	90	425
GDO	3756	IGT	5	150	Eating establishment	286	286	0		Single	1000	one 1000 gallon	90	286
GDO	3757	IGT	5	150	Eating establishment	326	326	0		Single	750	one 750 gallon	90	326
GDO	3758	IGT	5	150	Eating establishment	411	411	0		Series	1500	two 750 gallon	90	411
GDO	3759	IGT	5	150	Eating establishment	368	368	0	CITY OF CORAL GABLES	Series	2500	two 1250 gallon	90	368
GDO	3760	IGT	5	150	Eating establishment	388	388	0		Single	1000	one 1000 gallon	90	388
GDO	3761	IGT	5	150	Eating establishment	500	0	0		Single	750	one 750 gallon	90	0
GDO	3762	IGT	5	150	Eating establishment	372	372	0		Single	4000	one 4000 gallon	90	372
GDO	3763	IGT	5	150	Eating establishment	289	289	0		Series	3000	three 1000 gallon	90	289
GDO	3765	IGT	5	150	Eating establishment	500	0	0		Series	4000	two 2000 gallon	90	0
GDO	3766	IGT	5	150	Eating establishment	253	253	0		Series	750	one 750 gallon	90	253
GDO	3767	IGT	5	150	Eating establishment	500	500	0	MIAMI DADE WATER & SEWER DEPARTMENT	Series	2000	two 1000 gallon	90	500
GDO	3768	IGT	5	150	Eating establishment	657	657	0	MIAMI DADE WATER & SEWER DEPARTMENT	Series	3000	four 750 gallon	90	657
GDO	3769	IGT	5	150	Eating establishment	435	435	0	MIAMI DADE WATER & SEWER DEPARTMENT	Series	2000	two 1000 gallon	90	435
GDO	3770	IGT	5	300	Eating establishment	74	74	3900	MIAMI DADE WATER & SEWER DEPARTMENT	Single	1200	one 1200 gallon	90	975
GDO	3771	IGT	5	150	Eating establishment	401	401	0	MIAMI DADE WATER & SEWER DEPARTMENT	Series	2000	two 1000 gallon	90	401
GDO	3772	MGRU	5	150	Eating establishment	36	36	0			0	one 25 gpm	30	504
GDO	3773	IGT	5	150	Eating establishment	432	432	0		Single	1000	one 1000 gallon	90	432
GDO	3774	IGT	5	150	Eating establishment	639	639	0		Single	1000	one 1000 gallon	90	639
GDO	3775	IGT	5	150	Eating establishment	500	0	0		Series	4000	two 2000 gallon	90	0
GDO	3776	IGT	5	150	Eating establishment	667	667	0		Series	2000	two 1000 gallon	90	667
GDO	3777	IGT	5	150	Eating establishment	926	926	0		Series	2000	two 1000 gallon	90	926
GDO	3778	IGT	5	150	Eating establishment	270	270	0		Single	1500	one 1500 gallon	90	270
GDO	3779	IGT	5	150	Eating establishment	755	755	0		Series	2000	two 1000 gallon	90	755
GDO	3780	IGT	5	150	Eating establishment	500	0	0		Single	1050	one 1050 gallon	90	0
GDO	3781	IGT	5	150	Eating establishment	269	269	0	MIAMI DADE WATER & SEWER DEPARTMENT	Series	2100	two 1050 gallon	90	0
GDO	3782	IGT	5	150	Eating establishment	986	986	0		Single	750	one 750 gallon	90	986
GDO	3790	AGRU	2	300	Eating establishment	15	15	0	CITY OF MIAMI BEACH		0	one 25 gpm	30	375
GDO	3796	IGT	5	300	Eating establishment	158	158	3845	CITY OF MIAMI BEACH	Single	750	one 750 gallon	90	3950
GDO	3797	IGT	5	300	Eating establishment	166	166	4000	MIAMI DADE WATER & SEWER DEPARTMENT	Single	1050	one 1050 gallon	90	4150
GDO	3798	IGT	5	300	Eating establishment	10	10	4838	CITY OF HIALEAH	Single	65	one 65 gallon	90	1210
GDO	3801	IGT	5	300	Eating establishment	150	150	0	MIAMI DADE WATER & SEWER DEPARTMENT	Series	1500	two 750 gallon	90	3750
GDO	3802	IGT	5	300	Eating establishment	0	0	4303	MIAMI DADE WATER & SEWER DEPARTMENT	Single	950	one 950 gallon	90	1076
GDO	3804	IGT	5	150	Eating establishment	9	9	0	MIAMI DADE WATER & SEWER DEPARTMENT	Single	750	one 750 gallon	90	126
GDO	3805	IGT	5	150	Eating establishment	10	10	716	MIAMI DADE WATER & SEWER DEPARTMENT	Single	750	one 750 gallon	90	250
GDO	3807	IGT	5	150	Eating establishment	30	30	0		Single	950	one 950 gallon	90	420

WORK GROUP	PERMIT NUMBER	PERMIT CLASS	PERMIT	PERMIT FEE	BUSINESS_TYPE	RECORDED SEATS	OBSERVED SEATS	FACILITY AREA	UTILITY	SYSTEM FORMAT	TOTAL CAPACITY	TANK_CAPACITY	PUMP OUT	TOTAL GPD
GDO	3808	AGRU	5	300	Eating establishment	132	132	4164	MIAMI DADE WATER & SEWER DEPARTMENT		0	one 25 gpm	30	1041
GDO	3809	IGT	5	300	Eating establishment	98	98	0		Series	2400	two 1200 gallon	90	1372
GDO	3810	IGT	5	300	Eating establishment	150	0	5100	MIAMI DADE WATER & SEWER DEPARTMENT	Series	2400	two 1200 gallon	60	1275
GDO	3812	IGT	5	150	Eating establishment	1148	900	0		Single	1500	one 1500 gallon	90	1148
GDO	3813	IGT	5	150	Eating establishment	442	442	0	MIAMI DADE WATER & SEWER DEPARTMENT	Series	3000	three 1000 gallon	90	442
GDO	3814	IGT	5	150	Eating establishment	431	431	0		Single	3000	three 1000 gallon	90	431
GDO	3815	IGT	5	150	Eating establishment	583	583	0		Series	3000	three 1000 gallon	90	583
GDO	3818	IGT	5	150	Eating establishment	46	46	1600	MIAMI DADE WATER & SEWER DEPARTMENT	Single	750	one 750 gallon	90	400
GDO	3821	IGT	5	150	Eating establishment	566	566	0		Single	1200	one 1200 gallon	90	566
GDO	3822	IGT	5	150	Eating establishment	500	500	0		Single	4000	one 4000 gallon	90	0
GDO	3823	IGT	5	150	Eating establishment	500	500	0		Single	1000	one 1000 gallon	90	0
GDO	3824	IGT	5	300	Eating establishment	74	74	0		Single	950	one 950 gallon	90	1850
GDO	3825	IGT	5	150	Eating establishment	591	591	0		Single	1200	one 1200 gallon	90	591
GDO	3826	IGT	5	150	Eating establishment	847	847	0		Single	2000	one 2000 gallon	90	847
GDO	3827	IGT	5	150	Eating establishment	318	318	0		Single	2100	two 1050-gallon	90	318
GDO	3828	IGT	5	150	Eating establishment	468	468	0		Single	4000	one 4000 gallon	90	468
GDO	3830	IGT	5	150	Eating establishment	70	0	1981	MIAMI DADE WATER & SEWER DEPARTMENT	Single	750	one 750 gallon	90	495
GDO	3831	MGRU	5	150	Eating establishment	30	30	0	CITY OF HIALEAH		0	one 50 gpm	25	750
GDO	3832	IGT	5	150	Eating establishment	294	294	0		Single	1000	one 1000 gallon	90	294
GDO	3833	IGT	5	150	Eating establishment	30	30	0	CITY OF HIALEAH	Single	750	one 750 gallon	90	420
GDO	3834	IGT	5	300	Eating establishment	210	210	7320	MIAMI DADE WATER & SEWER DEPARTMENT	Series	1900	two 950 gallon	90	1830
GDO	3835	IGT	5	300	Eating establishment	208	208	7330	MIAMI DADE WATER & SEWER DEPARTMENT	Single	2000	one 2000 gallon	90	1833
GDO	3836	IGT	5	300	Eating establishment	199	199	3500	MIAMI DADE WATER & SEWER DEPARTMENT	Single	1200	one 1200 gallon	90	4975
GDO	3838	MGRU	5	150	Eating establishment	28	28	0	MIAMI DADE WATER & SEWER DEPARTMENT		0	two 15 gpm	30	7
GDO	3839	IGT	5	150	Eating establishment	71	71	3500	MIAMI DADE WATER & SEWER DEPARTMENT	Single	750	one 750 gallon	60	875
GDO	3840	IGT	5	300	Eating establishment	80	80	0	CITY OF NORTH MIAMI BEACH	Single	1200	one 1200 gallon	90	1120
GDO	3841	IGT	5	150	Eating establishment	475	475	0		Single	4000	one 4000 gallon	90	475
GDO	3842	IGT	5	150	Eating establishment	994	994	0		Single	1000	one 1000 gallon	90	994
GDO	3843	IGT	5	150	Eating establishment	270	270	0		Series	3000	three 1000 gallon	90	270
GDO	3844	IGT	5	150	Eating establishment	471	471	0		Single	1500	one 1500 gallon	90	471
GDO	3845	IGT	5	150	Eating establishment	302	302	0		Series	2000	two 1000 gallon	90	302
GDO	3846	IGT	5	150	Eating establishment	500	500	0		Single	1000	one 1000 gallon	90	0
GDO	3847	IGT	5	150	Eating establishment	200	200	0		Series	3150	three 1050 gallon	90	200
GDO	3848	IGT	5	150	Eating establishment	339	339	0		Series	2000	two 1000 gallon	90	339
GDO	3849	IGT	5	150	Eating establishment	406	406	0		Single	1000	one 1000 gallon	90	406
GDO	3850	IGT	5	150	Eating establishment	468	468	0		Single	2000	one 2000 gallon	90	468
GDO	3851	IGT	5	150	Eating establishment	710	710	0		Series	2400	two 1200 gallon	90	710
GDO	3852	IGT	5	150	Eating establishment	609	609	0		Single	1000	one 1000 gallon	90	609
GDO	3853	IGT	5	150	Eating establishment	619	619	0		Single	2000	one 2000 gallon	90	619
GDO	3854	IGT	5	150	Eating establishment	500	500	0		Single	1000	one 1000 gallon	90	0
GDO	3855	IGT	5	150	Eating establishment	307	307	0		Single	1000	one 1000 gallon	90	307
GDO	3856	IGT	5	150	Eating establishment	499	499	0		Series	3750	four 1000 gallon	90	499
GDO	3857	IGT	5	150	Eating establishment	365	365	0		Series	3000	three 1000 gallon	90	365
GDO	3858	IGT	5	150	Eating establishment	717	717	0		Series	7500	three 2500 gallon	90	717
GDO	3859	IGT	5	150	Eating establishment	815	815	0		Series	3000	three 1000 gallon	90	815
GDO	3860	IGT	5	150	Eating establishment	828	828	0		Series	2100	two 1050 gallon	90	828
GDO	3861	IGT	5	150	Eating establishment	944	944	0	MIAMI DADE WATER & SEWER DEPARTMENT	Multiple	6000	four 1500 gallon	90	944
GDO	3862	IGT	5	150	Eating establishment	808	808	0		Single	1200	one 1200 gallon	90	808
GDO	3863	IGT	5	150	Eating establishment	594	594	0		Series	4000	one 4000 gallon	90	594
GDO	3867	IGT	5	150	Eating establishment	44	44	0		Single	1250	one 1250 gallon	90	1100
GDO	3872	IGT	5	150	Eating establishment	930	930	0		Series	2000	two 1000 gallon	90	930
GDO	3873	IGT	5	150	Eating establishment	672	672	0		Single	1000	one 1000 gallon	90	672
GDO	3874	IGT	5	150	Eating establishment	0	0	0	CITY OF MIAMI BEACH	Series	2100	two 1050 gallon	90	0
GDO	3875	IGT	5	150	Eating establishment	647	647	0		Single	1000	one 1000 gallon	90	647
GDO	3878	IGT	5	150	Eating establishment	500	0	0		Single	1000	one 1000 gallon	90	0
GDO	3879	IGT	5	150	Eating establishment	433	433	0		Single	2000	one 2000 gallon	90	433
GDO	3880	IGT	5	150	Eating establishment	269	269	0		Series	2000	two 1000 gallon	90	269
GDO	3881	IGT	5	150	Eating establishment	996	996	0	MIAMI DADE WATER & SEWER DEPARTMENT	Multiple	2100	two 1050 gallon	90	996
GDO	3882	IGT	5	150	Eating establishment	655	655	0		Single	2000	one 2000 gallon	90	655
GDO	3883	IGT	5	150	Eating establishment	896	896	0		Series	2400	two 1200 gallon	90	896
GDO	3884	IGT	5	150	Eating establishment	751	751	0		Series	3000	two 1500 gallon	90	751

WORK GROUP	PERMIT NUMBER	PERMIT CLASS	PERMIT	PERMIT FEE	BUSINESS_TYPE	RECORDED SEATS	OBSERVED SEATS	FACILITY AREA	UTILITY	SYSTEM FORMAT	TOTAL CAPACITY	TANK_CAPACITY	PUMP OUT	TOTAL GPD
GDO	3885	IGT	5	150	Eating establishment	983	983	0		Single	1500	one 1500 gallon	90	983
GDO	3886	IGT	5	150	Eating establishment	336	336	0	CITY OF HOMESTEAD	Single	2000	one 2000 gallon	90	336
GDO	3887	IGT	5	150	Eating establishment	500	0	0		Series	3150	three 1050 gallon	90	0
GDO	3888	IGT	5	150	Eating establishment	500	0	0		Single	1000	one 1000 gallon	90	0
GDO	3889	IGT	5	150	Eating establishment	804	804	0		Single	1000	one 1000 gallon	90	804
GDO	3890	IGT	5	150	Eating establishment	647	647	0		Series	1750	one 1000 & one 750 gallon	90	647
GDO	3891	IGT	5	150	Eating establishment	500	0	0		Series	3000	three 1000 gallon	90	0
GDO	3892	IGT	5	150	Eating establishment	964	964	0		Series	3000	three 1000 gallon	90	964
GDO	3893	IGT	5	150	Eating establishment	500	0	0		Series	3000	three 1000 gallon	90	0
GDO	3894	IGT	5	150	Eating establishment	299	299	0		Single	4000	one 4000 gallon	90	299
GDO	3895	IGT	5	150	Eating establishment	275	275	0		Single	1000	one 1000 gallon	90	275
GDO	3896	IGT	5	150	Eating establishment	361	361	0	MIAMI DADE WATER & SEWER DEPARTMENT	Series	3000	three 1000 gallon	90	361
GDO	3897	IGT	5	150	Eating establishment	807	807	0	CITY OF FLORIDA CITY	Series	2000	two 1000 gallon	90	807
GDO	3898	IGT	5	150	Eating establishment	677	677	0		Series	2000	two 1000 gallon	90	677
GDO	3899	IGT	5	150	Eating establishment	345	345	0	CITY OF HOMESTEAD	Series	2000	two 1000 gallon	90	345
GDO	3900	IGT	5	150	Eating establishment	829	829	0		Multiple	3000	three 1000 gallon	90	829
GDO	3901	IGT	5	150	Eating establishment	279	279	0	CITY OF HOMESTEAD	Series	3150	three 1050 gallon	90	279
GDO	3902	IGT	5	150	Eating establishment	273	273	0		Series	2000	two 1000 gallon	90	273
GDO	3903	IGT	5	150	Eating establishment	451	451	0		Series	3000	three 1000 gallon	90	451
GDO	3904	IGT	5	150	Eating establishment	274	274	0		Series	3750	three 1000 & one 750 gallon	90	274
GDO	3905	AGRU	5	150	Eating establishment	0	0	950	MIAMI DADE WATER & SEWER DEPARTMENT		0	one 25 gpm	30	238
GDO	3907	IGT	5	150	Eating establishment	0	0	0		Single	950	one 950 gallon	90	0
GDO	3913	IGT	5	300	Eating establishment	200	200	0	MIAMI DADE WATER & SEWER DEPARTMENT	Single	1500	one 1500 gallon	90	5000
GDO	3914	IGT	5	150	Eating establishment	1053	1053	0		Series	2000	two 1000 gallon	90	1053
GDO	3915	MGRU	5	150	Eating establishment	25	25	2568	CITY OF MIAMI BEACH		0	one 35 gpm	30	642
GDO	3916	IGT	5	300	Eating establishment	149	149	3616	MIAMI DADE WATER & SEWER DEPARTMENT	Single	1200	one 1200 gallon	30	904
GDO	3917	MGRU	5	150	Eating establishment	60	60	2040	CITY OF MIAMI BEACH		0	one 25 gpm	30	650
GDO	3919	IGT	5	150	Eating establishment	117	117	0		Single	1000	one 1000 gallon	90	117
GDO	3920	IGT	5	150	Eating establishment	500	0	0		Single	1600	one 1600 gallon	90	0
GDO	3921	IGT	5	150	Eating establishment	711	711	0		Series	2000	two 1000 gallon	90	711
GDO	3922	IGT	5	150	Eating establishment	701	701	0		Single	2500	one 2500 gallon	90	701
GDO	3923	IGT	5	150	Eating establishment	251	251	0		Single	1000	one 1000 gallon	90	251
GDO	3924	IGT	5	150	Eating establishment	500	0	0		Single	1000	one 1000 gallon	90	0
GDO	3926	IGT	5	150	Eating establishment	676	676	0		Series	3000	three 1000 gallon	90	676
GDO	3927	IGT	5	150	Eating establishment	832	832	0	CITY OF HOMESTEAD	Parallel	4200	four 1050 gallon	90	832
GDO	3928	IGT	5	150	Eating establishment	820	820	0		Series	2000	two 1000 gallon	90	820
GDO	3929	IGT	5	150	Eating establishment	853	853	0		Series	2000	two 1000 gallon	90	853
GDO	3930	IGT	5	150	Eating establishment	236	236	0	MIAMI DADE WATER & SEWER DEPARTMENT	Series	3000	three 1000 gallon	90	236
GDO	3931	IGT	5	150	Eating establishment	125	125	0	MIAMI DADE WATER & SEWER DEPARTMENT	Single	1050	one 1050 gallon	90	0
GDO	3935	IGT	5	150	Eating establishment	0	0	0	MIAMI DADE WATER & SEWER DEPARTMENT	Single	750	one 750 gallon	90	0
GDO	3936	IGT	5	150	Eating establishment	0	0	1800	MIAMI DADE WATER & SEWER DEPARTMENT	Single	750	one 750 gallon	60	450
GDO	3942	AGRU	5	150	Eating establishment	0	0	2439	MIAMI DADE WATER & SEWER DEPARTMENT		0	one 25 gpm	30	610
GDO	3944	IGT	5	150	Eating establishment	44	44	0	MIAMI DADE WATER & SEWER DEPARTMENT	Single	1200	one 1200 gallon	90	1100
GDO	3945	AGRU	5	150	Eating establishment	40	40	0	MIAMI DADE WATER & SEWER DEPARTMENT		0	one 25 gpm	30	560
GDO	3946	IGT	5	150	Eating establishment	42	42	2040	MIAMI DADE WATER & SEWER DEPARTMENT	Single	750	one 750 gallon	90	510
GDO	3947	IGT	5	300	Eating establishment	98	98	0	MIAMI DADE WATER & SEWER DEPARTMENT	Series	2400	two 1200 gallon	90	1372
GDO	3948	IGT	5	150	Eating establishment	85	0	3217	MIAMI DADE WATER & SEWER DEPARTMENT	Series	3600	three 1200 gallon	90	804
GDO	3949	IGT	5	150	Eating establishment	7	7	0		Series	2400	two 1200 gallon	90	2
GDO	3952	IGT	5	150	Eating establishment	0	0	2600	MIAMI DADE WATER & SEWER DEPARTMENT	Single	1050	one 1050 gallon	90	650
GDO	3953	MGRU	5	150	Eating establishment	16	16	0	CITY OF MIAMI BEACH		0	one 25 gpm	30	224
GDO	3954	MGRU	5	150	Eating establishment	29	0	980	MIAMI DADE WATER & SEWER DEPARTMENT		0	one 20 gpm	30	245
GDO	3956	AGRU	5	150	Eating establishment	0	0	1500	CITY OF MIAMI BEACH		0	one 25 gpm	30	375
GDO	3957	IGT	5	150	Eating establishment	36	36	0	MIAMI DADE WATER & SEWER DEPARTMENT	Single	1200	one 1200 gallon	90	900
GDO	3958	IGT	5	150	Eating establishment	0	0	800	MIAMI DADE WATER & SEWER DEPARTMENT	Single	1200	one 1200-gallon	90	200
GDO	3961	AGRU	5	300	Eating establishment	137	140	0	CITY OF MIAMI BEACH		0	one 35 gpm	30	3425
GDO	3962	IGT	5	150	Eating establishment	40	40	0	CITY OF HIALEAH	Single	750	one 750 gallon	90	560
GDO	3966	IGT	5	750	Eating establishment	210	210	0	MIAMI DADE WATER & SEWER DEPARTMENT	Series	2400	two 1200 gallon	90	5250
GDO	3967	IGT	5	150	Eating establishment	30	30	0	CITY OF HIALEAH	Single	750	one 750 gallon	90	0
GDO	3968	IGT	5	750	Eating establishment	500	500	0	CITY OF MIAMI BEACH	Multiple	9600	six 1600 gallon	90	0

WORK GROUP	PERMIT NUMBER	PERMIT CLASS	PERMIT T	PERMIT FEE	BUSINESS_TYPE	RECORDED SEATS	OBSERVED SEATS	FACILITY AREA	UTILITY	SYSTEM FORMAT	TOTAL CAPACITY	TANK_CAPACITY	PUMP OUT	TOTAL GPD
GDO	3970	IGT	5	150	Eating establishment	20	20	0	CITY OF HIALEAH	Single	950	one 950 gallon	90	500
GDO	3973	IGT	5	150	Eating establishment	34	34	1064	MIAMI DADE WATER & SEWER DEPARTMENT	Single	1050	one 1050 gallon	90	266
GDO	3978	IGT	5	150	Eating establishment	0	0	348	CITY OF HIALEAH	Single	750	one 750 gallon	90	87
GDO	3979	IGT	5	150	Eating establishment	48	48	1514	MIAMI DADE WATER & SEWER DEPARTMENT	Single	950	one 950 gallon	90	37850
GDO	3981	IGT	5	150	Eating establishment	74	74	0	MIAMI DADE WATER & SEWER DEPARTMENT	Single	1050	one 1050 gallon	90	1850
GDO	3985	IGT	5	300	Eating establishment	121	121	0	MIAMI DADE WATER & SEWER DEPARTMENT	Series	3200	two 1600 gallon	90	3025
GDO	3990	IGT	5	150	Eating establishment	86	86	2400	MIAMI DADE WATER & SEWER DEPARTMENT	Single	1050	one 1050 gallon	90	600
GDO	3992	IGT	5	300	Eating establishment	62	62	4474	CITY OF MIAMI BEACH	Single	950	one 950-gallon	90	1119
GDO	4000	IGT	5	150	Eating establishment	25	25	2325	MIAMI DADE WATER & SEWER DEPARTMENT	Single	750	one 750-gallon	90	581
GDO	4002	IGT	5	150	Eating establishment	0	0	2125	MIAMI DADE WATER & SEWER DEPARTMENT	Single	750	one 750 gallon	90	531
GDO	4003	IGT	5	150	Eating establishment	26	26	1567	MIAMI DADE WATER & SEWER DEPARTMENT	Single	750	one 750 gallon	90	650
GDO	4004	MGRU	5	750	Eating establishment	30	313	0	MIAMI DADE WATER & SEWER DEPARTMENT		0	one 25 gpm	30	1878
GDO	4005	IGT	5	150	Eating establishment	22	22	1100	MIAMI DADE WATER & SEWER DEPARTMENT	Single	750	one 750 gallon	90	275
GDO	4006	MGRU	5	150	Eating establishment	66	66	0	MIAMI DADE WATER & SEWER DEPARTMENT		0	one 25 gpm	30	1650
GDO	4007	IGT	5	150	Eating establishment	16	16	0	MIAMI DADE WATER & SEWER DEPARTMENT	Single	750	one 750 gallon	90	400
GDO	4008	MGRU	5	150	Eating establishment	72	0	2350	MIAMI DADE WATER & SEWER DEPARTMENT		0	one 20 gpm	30	588
GDO	4009	MGRU	5	150	Eating establishment	72	72	1709	MIAMI DADE WATER & SEWER DEPARTMENT		0	one 25 gpm	30	427
GDO	4010	MGRU	2	150	Eating establishment	40	40	2000	MIAMI DADE WATER & SEWER DEPARTMENT		0	one 25 gpm	30	500
GDO	4012	IGT	5	300	Eating establishment	70	0	2500	MIAMI DADE WATER & SEWER DEPARTMENT	Single	1200	one 1200 gallon	60	625
GDO	4016	MGRU	5	150	Eating establishment	10	10	0	MIAMI DADE WATER & SEWER DEPARTMENT		0	one 25 gpm	30	250
GDO	4017	IGT	5	150	Eating establishment	32	32	0	MIAMI DADE WATER & SEWER DEPARTMENT	Single	750	one 750 gallon	90	800
GDO	4018	IGT	5	150	Eating establishment	30	30	0		Single	750	one 750 gallon	90	420
GDO	4022	IGT	5	150	Eating establishment	40	40	0	MIAMI DADE WATER & SEWER DEPARTMENT	Single	750	one 750 gallon	90	1000
GDO	4030	IGT	5	150	Eating establishment	9	0	331	CITY OF HIALEAH	Single	1050	one 1050 gallon	90	83
GDO	4031	IGT	5	300	Eating establishment	150	150	0	MIAMI DADE WATER & SEWER DEPARTMENT	Single	950	one 950 gallon	90	3750
GDO	4032	IGT	5	300	Eating establishment	550	550	0	MIAMI DADE WATER & SEWER DEPARTMENT	Series	8500	two 2000 & three 1500 gallon	90	0
GDO	4033	IGT	5	300	Eating establishment	236	236	6400	MIAMI DADE WATER & SEWER DEPARTMENT	Series	2500	two 1250 gallon	90	1600
GDO	4036	IGT	5	150	Eating establishment	62	62	2730	MIAMI DADE WATER & SEWER DEPARTMENT	Single	1200	one 1200 gallon	90	683
GDO	4037	IGT	5	300	Eating establishment	200	0	6528	MIAMI DADE WATER & SEWER DEPARTMENT	Single	1200	one 1200 gallon	90	1632
GDO	4040	IGT	5	150	Eating establishment	14	14	1400	MIAMI DADE WATER & SEWER DEPARTMENT	Single	950	one 950 gallon	90	35000
GDO	4041	IGT	5	150	Eating establishment	26	26	1800	MIAMI DADE WATER & SEWER DEPARTMENT	Single	750	one 750-gallon	90	450
GDO	4042	IGT	5	150	Eating establishment	0	0	0	MIAMI DADE WATER & SEWER DEPARTMENT	Single	950	one 950 gallon	90	0
GDO	4044	IGT	5	300	Eating establishment	150	150	0		Single	950	one 950 gallon	90	3750
GDO	4049	IGT	5	150	Eating establishment	8	8	2065	MIAMI DADE WATER & SEWER DEPARTMENT	Single	750	one 750 gallon	90	516
GDO	4050	MGRU	5	150	Eating establishment	0	0	550	MIAMI DADE WATER & SEWER DEPARTMENT		0	one 35 gpm	30	138
GDO	4052	IGT	2	300	Eating establishment	149	149	6157	MIAMI DADE WATER & SEWER DEPARTMENT	Single	950	one 950 gallon	90	3725
GDO	4056	MGRU	5	150	Eating establishment	0	0	800	CITY OF NORTH MIAMI		0	one 25 gpm	30	200
GDO	4058	IGT	5	150	Eating establishment	0	0	900	MIAMI DADE WATER & SEWER DEPARTMENT	Single	750	one 750 gallon	90	225
GDO	4059	IGT	5	300	Eating establishment	75	75	0		Single	1200	one 1200 gallon	90	1875
GDO	4060	IGT	5	300	Eating establishment	0	0	4200	CITY OF MIAMI BEACH	Single	1050	one 1050 gallon	90	1050
GDO	4062	IGT	5	150	Eating establishment	3	3	0		Single	750	one 750 gallon	90	1
GDO	4065	MGRU	5	300	Eating establishment	410	410	10640	CITY OF NORTH MIAMI BEACH		0	two 100 gpm	90	2660
GDO	4066	IGT	5	150	Eating establishment	26	26	0	MIAMI DADE WATER & SEWER DEPARTMENT	Single	950	one 950 gallon	90	650
GDO	4069	AGT	5	150	Eating establishment	52	52	2350	MIAMI DADE WATER & SEWER DEPARTMENT	Single	1650	one 1650 gallon	60	588
GDO	4070	IGT	5	300	Eating establishment	149	149	4653	MIAMI DADE WATER & SEWER DEPARTMENT	Single	750	one 750 gallon	90	1163
GDO	4073	IGT	5	150	Eating establishment	0	0	0	MIAMI DADE WATER & SEWER DEPARTMENT	Single	750	one 750 gallon	90	0
GDO	4074	MGRU	5	150	Eating establishment	49	0	2000	MIAMI DADE WATER & SEWER DEPARTMENT		0	one 10 gpm	30	500
GDO	4075	IGT	5	300	Eating establishment	133	133	0	CITY OF HIALEAH	Single	1200	one 1200 gallon	90	3325
GDO	4076	MGRU	5	150	Eating establishment	20	0	1077	MIAMI DADE WATER & SEWER DEPARTMENT		0	one 20 gpm	90	269
GDO	4079	IGT	5	300	Eating establishment	110	110	0		Single	950	one 950 gallon	90	2750
GDO	4080	IGT	5	300	Eating establishment	80	80	2700	MIAMI DADE WATER & SEWER DEPARTMENT	Single	1200	one 1200 gallon	90	675
GDO	4084	IGT	5	150	Eating establishment	0	0	0	MIAMI DADE WATER & SEWER DEPARTMENT	Single	1050	one 1050 gallon	90	0
GDO	4085	IGT	5	300	Eating establishment	200	200	4100	MIAMI DADE WATER & SEWER DEPARTMENT	Single	750	one 750-gallon	90	1025
GDO	4086	IGT	5	150	Eating establishment	48	0	2736	MIAMI DADE WATER & SEWER DEPARTMENT	Single	1200	one 1200 gallon	90	684
GDO	4087	IGT	5	150	Eating establishment	0	0	2400	MIAMI DADE WATER & SEWER DEPARTMENT	Single	750	one 750 gallon	90	600
GDO	4088	IGT	5	150	Eating establishment	30	30	0	MIAMI DADE WATER & SEWER DEPARTMENT	Single	1050	one 1050 gallon	90	750
GDO	4089	IGT	5	150	Eating establishment	80	80	1897	MIAMI DADE WATER & SEWER DEPARTMENT	Single	1200	one 1200 gallon	60	474
GDO	4090	IGT	5	150	Eating establishment	0	0	0	MIAMI DADE WATER & SEWER DEPARTMENT	Single	750	one 750 gallon	90	0
GDO	4093	IGT	5	300	Eating establishment	192	0	7400	MIAMI DADE WATER & SEWER DEPARTMENT	Series	3600	three 1200 gallon	60	1850
GDO	4095	IGT	5	300	Eating establishment	54	54	0	MIAMI DADE WATER & SEWER DEPARTMENT	Single	1200	one 1200 gallon	90	1350

WORK GROUP	PERMIT NUMBER	PERMIT CLASS	PERMIT	PERMIT FEE	BUSINESS_TYPE	RECORDED SEATS	OBSERVED SEATS	FACILITY AREA	UTILITY	SYSTEM FORMAT	TOTAL CAPACITY	TANK_CAPACITY	PUMP OUT	TOTAL GPD
GDO	4097	MGRU	5	150	Eating establishment	10	10	500	MIAMI DADE WATER & SEWER DEPARTMENT		0	one 25 gpm	30	125
GDO	4098	IGT	5	150	Eating establishment	48	48	0	MIAMI DADE WATER & SEWER DEPARTMENT	Single	1500	two 750 gallon	90	672
GDO	4099	IGT	5	150	Eating establishment	0	0	0	MIAMI DADE WATER & SEWER DEPARTMENT	Single	750	one 750 gallon	90	0
GDO	4101	IGT	5	150	Eating establishment	12	12	650	MIAMI DADE WATER & SEWER DEPARTMENT		750	one 750 gallon	90	163
GDO	4104	IGT	5	150	Eating establishment	0	0	946	MIAMI DADE WATER & SEWER DEPARTMENT	Single	750	one 750 gallon	90	237
GDO	4105	MGRU	5	150	Eating establishment	12	12	1500	MIAMI DADE WATER & SEWER DEPARTMENT		0	one 25 gpm	30	375
GDO	4107	MGRU	5	150	Eating establishment	8	0	2200	MIAMI DADE WATER & SEWER DEPARTMENT		0	one 25 gpm	30	550
GDO	4108	IGT	5	150	Eating establishment	47	47	0	MIAMI DADE WATER & SEWER DEPARTMENT	Single	1200	one 1200 gallon	90	1175
GDO	4111	IGT	5	150	Eating establishment	8	8	200	MIAMI DADE WATER & SEWER DEPARTMENT	Single	950	one 950 gallon	90	50
GDO	4115	AGRU	5	150	Eating establishment	90	90	2288	CITY OF MIAMI BEACH		0	one 25 gpm	30	572
GDO	4116	IGT	5	300	Eating establishment	200	200	0	MIAMI DADE WATER & SEWER DEPARTMENT	Series	1500	two 750 gallon	90	5000
GDO	4117	IGT	5	150	Eating establishment	40	40	0		Single	1200	one 1200 gallon	90	560
GDO	4120	MGRU	5	150	Eating establishment	0	0	900	CITY OF HIALEAH		0	one 25 gpm	60	225
GDO	4121	MGRU	5	750	Eating establishment	237	237	0	CITY OF MIAMI BEACH		0	one 25 gpm	30	5925
GDO	4123	IGT	5	300	Eating establishment	60	60	0		Series	2400	two 1200 gallon	90	15
GDO	4124	IGT	5	150	Eating establishment	0	0	0			0	one 1050 gallon	90	0
GDO	4127	IGT	5	300	Eating establishment	123	123	0		Single	2200	one 2200 gallon	90	3075
GDO	4129	IGT	5	300	Eating establishment	86	86	0		Series	2400	two 1200 gallon	90	1204
GDO	4131	IGT	5	150	Eating establishment	30	30	0		Series	2100	two 1050 gallon	90	420
GDO	4133	IGT	5	300	Eating establishment	126	126	0		Single	1600	one 1600 gallon	90	3150
GDO	4134	IGT	5	300	Eating establishment	230	230	10000	MIAMI DADE WATER & SEWER DEPARTMENT	Single	1200	one 1200 gallon	90	2500
GDO	4141	IGT	5	150	Eating establishment	16	16	0		Single	750	one 750 gallon	90	224
GDO	4144	IGT	5	300	Eating establishment	80	80	4503	MIAMI DADE WATER & SEWER DEPARTMENT	Single	1050	one 1050 gallon	90	1126
GDO	4146	MGRU	5	150	Eating establishment	0	0	900	MIAMI DADE WATER & SEWER DEPARTMENT		0	one 25 gpm	30	225
GDO	4149	IGT	5	300	Eating establishment	74	74	0	CITY OF HIALEAH	Single	1050	one 1050 gallon	90	1036
GDO	4150	IGT	5	150	Eating establishment	30	30	0	MIAMI DADE WATER & SEWER DEPARTMENT	Single	1050	one 1050 gallon	90	750
GDO	4156	IGT	5	150	Eating establishment	0	0	3430	CITY OF MIAMI BEACH	Single	950	one 950 gallon	90	858
GDO	4157	IGT	5	300	Eating establishment	114	114	0	CITY OF MIAMI BEACH	Single	750	one 750 gallon	90	2850
GDO	4160	IGT	5	150	Eating establishment	0	0	240	MIAMI DADE WATER & SEWER DEPARTMENT	Single	750	one 750 gallon	90	60
GDO	4161	IGT	5	150	Eating establishment	0	0	242	MIAMI DADE WATER & SEWER DEPARTMENT	Single	950	one 950 gallon	90	61
GDO	4163	IGT	5	300	Eating establishment	97	97	0	MIAMI DADE WATER & SEWER DEPARTMENT	Single	1050	one 1050 gallon	90	2425
GDO	4164	MGRU	5	150	Eating establishment	18	18	0			0	one 25 gpm	90	252
GDO	4165	IGT	5	150	Eating establishment	0	0	1200	MIAMI DADE WATER & SEWER DEPARTMENT	Single	750	one 750 gallon	90	300
GDO	4166	MGRU	5	150	Eating establishment	40	40	0	MIAMI DADE WATER & SEWER DEPARTMENT		0	one 25 gpm	30	560
GDO	4168	IGT	5	150	Eating establishment	0	0	0	MIAMI DADE WATER & SEWER DEPARTMENT	Series	3200	two 1600 gallon	90	0
GDO	4169	IGT	5	300	Eating establishment	0	0	35000	MIAMI DADE WATER & SEWER DEPARTMENT	Series	7000	two 3500 gallon	90	1000
GDO	4171	IGT	5	150	Eating establishment	19	19	0	MIAMI DADE WATER & SEWER DEPARTMENT	Single	950	one 950 gallon	90	475
GDO	4178	IGT	5	150	Eating establishment	0	0	0	MIAMI DADE WATER & SEWER DEPARTMENT	Single	950	one 950 gallon	90	0
GDO	4179	IGT	5	150	Eating establishment	30	30	0	MIAMI DADE WATER & SEWER DEPARTMENT	Series	10500	three 3500 gallon	90	420
GDO	4181	IGT	5	150	Eating establishment	54	54	2303	MIAMI DADE WATER & SEWER DEPARTMENT	Single	750	one 750 gallon	90	576
GDO	4182	IGT	5	150	Eating establishment	0	0	0	MIAMI DADE WATER & SEWER DEPARTMENT	Single	1200	one 1200 gallon	90	0
GDO	4183	IGT	5	150	Eating establishment	70	0	1539	MIAMI DADE WATER & SEWER DEPARTMENT	Single	950	one 950 gallon	60	510
GDO	4184	IGT	5	150	Eating establishment	51	0	3026	MIAMI DADE WATER & SEWER DEPARTMENT	Single	1200	one 1200 gallon	60	757
GDO	4185	IGT	5	150	Eating establishment	21	0	2084	MIAMI DADE WATER & SEWER DEPARTMENT	Single	1200	one 1200 gallon	90	521
GDO	4188	IGT	5	150	Eating establishment	30	30	950	MIAMI DADE WATER & SEWER DEPARTMENT	Single	950	one 950 gallon	90	238
GDO	4190	AGRU	5	300	Eating establishment	199	199	0	CITY OF MIAMI BEACH		0	one 25 gpm	30	4975
GDO	4191	IGT	5	300	Eating establishment	98	98	4037	MIAMI DADE WATER & SEWER DEPARTMENT	Single	1600	one 1600 gallon	90	1009
GDO	4194	MGRU	5	150	Eating establishment	8	0	350	MIAMI DADE WATER & SEWER DEPARTMENT		0	one 25 gpm	30	88
GDO	4195	IGT	5	150	Eating establishment	0	0	1000	MIAMI DADE WATER & SEWER DEPARTMENT	Single	1600	one 1600 gallon	90	250
GDO	4196	MGRU	5	150	Eating establishment	30	30	850	CITY OF HIALEAH		0	one 25 gpm	30	213
GDO	4198	IGT	5	150	Eating establishment	30	30	1300	MIAMI DADE WATER & SEWER DEPARTMENT	Single	750	one 750 gallon	90	325
GDO	4199	MGRU	5	150	Eating establishment	200	200	3793	MIAMI DADE WATER & SEWER DEPARTMENT		0	one 25 gpm	30	948
GDO	4200	IGT	5	300	Eating establishment	293	293	6011	CITY OF MIAMI BEACH	Single	750	one 750 gallon	90	1503
GDO	4201	MGRU	5	150	Eating establishment	0	0	0	MIAMI DADE WATER & SEWER DEPARTMENT		0	one 25 gpm	30	0
GDO	4203	IGT	5	150	Eating establishment	0	0	1000	MIAMI DADE WATER & SEWER DEPARTMENT	Single	750	one 750 gallon	90	250
GDO	4204	IGT	5	300	Eating establishment	78	78	0	MIAMI DADE WATER & SEWER DEPARTMENT	Single	950	one 950 gallon	90	1950
GDO	4205	MGRU	5	150	Eating establishment	140	0	1958	CITY OF MIAMI BEACH		0	one 100 gpm	30	692
GDO	4206	MGRU	5	150	Eating establishment	36	0	800	CITY OF HIALEAH		0	one 25 gpm	30	200
GDO	4209	IGT	5	150	Eating establishment	30	30	0	CITY OF NORTH MIAMI BEACH	Single	1200	one 1200 gallon	90	420
GDO	4211	MGRU	5	150	Eating establishment	36	36	1994	MIAMI DADE WATER & SEWER DEPARTMENT		0	one 25 gpm	30	499
GDO	4213	IGT	5	300	Eating establishment	60	60	0	MIAMI DADE WATER & SEWER DEPARTMENT	Single	2400	two 1200 gallon	90	840

WORK GROUP	PERMIT NUMBER	PERMIT CLASS	PERMIT	PERMIT FEE	BUSINESS_TYPE	RECORDED SEATS	OBSERVED SEATS	FACILITY AREA	UTILITY	SYSTEM FORMAT	TOTAL CAPACITY	TANK_CAPACITY	PUMP OUT	TOTAL GPD
GDO	4214	MGRU	5	150	Eating establishment	40	40	0	MIAMI DADE WATER & SEWER DEPARTMENT		0	one 25 gpm	30	1000
GDO	4217	IGT	5	150	Eating establishment	21	21	0		Single	1200	one 1200 gallon	90	294
GDO	4218	IGT	5	300	Eating establishment	80	80	0	MIAMI DADE WATER & SEWER DEPARTMENT	Single	1200	one 1200 gallon	90	1120
GDO	4221	IGT	5	750	Eating establishment	226	226	0	CITY OF HIALEAH	Single	2100	two 1050 gallon	90	5650
GDO	4222	IGT	5	300	Eating establishment	100	100	0	CITY OF MIAMI BEACH	Single	1050	one 1050-gallon	90	2500
GDO	4224	AGRU	5	150	Eating establishment	36	36	0			0	one 25 gpm	30	900
GDO	4226	IGT	5	150	Eating establishment	21	21	768	PRIVATE	Single	950	one 950-gallon	90	192
GDO	4228	IGT	5	300	Eating establishment	74	74	3525	CITY OF HIALEAH	Single	1050	one 1050 gallon	90	881
GDO	4230	IGT	5	300	Eating establishment	192	192	1715	CITY OF MIAMI BEACH	Single	1200	one 1200 gallon	90	4800
GDO	4233	MGRU	5	150	Eating establishment	25	25	850	CITY OF HIALEAH		0	one 25 gpm	30	213
GDO	4236	IGT	5	300	Eating establishment	56	56	4900	CITY OF NORTH MIAMI BEACH	Single	1600	one 1600 gallon	90	1225
GDO	4237	MGRU	5	150	Eating establishment	30	30	1200	CITY OF HIALEAH		0	one 25 gpm	30	300
GDO	4238	IGT	5	150	Eating establishment	20	20	1050	CITY OF HIALEAH	Single	950	one 950-gallon	90	263
GDO	4239	IGT	5	150	Eating establishment	72	0	1800	MIAMI DADE WATER & SEWER DEPARTMENT	Single	2000	one 2000 gallon	90	450
GDO	4240	MGRU	5	150	Eating establishment	30	30	1322	MIAMI DADE WATER & SEWER DEPARTMENT		0	one 20 gpm	30	331
GDO	4244	IGT	5	300	Eating establishment	200	200	0		Single	750	one 750 gallon	90	5000
GDO	4247	IGT	5	150	Eating establishment	20	0	1100	MIAMI DADE WATER & SEWER DEPARTMENT	Single	750	one 750 gallon	60	275
GDO	4249	IGT	5	150	Eating establishment	6	6	1368	MIAMI DADE WATER & SEWER DEPARTMENT	Single	1050	one 1050 gallon	90	342
GDO	4254	IGT	5	150	Eating establishment	0	0	0	CITY OF HIALEAH	Single	750	one 750 gallon	90	0
GDO	4256	IGT	5	750	Eating establishment	212	212	0	CITY OF NORTH MIAMI BEACH	Series	1600	two 1600 gallon	90	5300
GDO	4257	MGRU	5	150	Eating establishment	100	0	2060	CITY OF HIALEAH		0	one 25 gpm	30	515
GDO	4262	MGRU	2	150	Eating establishment	15	0	0	MIAMI DADE WATER & SEWER DEPARTMENT		0	one 25 gpm	30	0
GDO	4268	IGT	5	150	Eating establishment	50	50	0		Single	1050	one 1050 gallon	90	700
GDO	4269	IGT	5	150	Eating establishment	10	10	1600	CITY OF HIALEAH	Single	1050	one 1050 gallon	90	400
GDO	4272	IGT	5	150	Eating establishment	20	20	160	MIAMI DADE WATER & SEWER DEPARTMENT	Single	750	one 750 gallon	90	40
GDO	4274	IGT	5	300	Eating establishment	208	208	9000	MIAMI DADE WATER & SEWER DEPARTMENT	Series	2400	two 1200 gallon	90	2250
GDO	4278	MGRU	5	150	Eating establishment	18	18	1100	MIAMI DADE WATER & SEWER DEPARTMENT		0	none	30	275
GDO	4279	MGRU	5	150	Eating establishment	20	20	0	MIAMI DADE WATER & SEWER DEPARTMENT		0	one 25 gpm	30	500
GDO	4280	MGRU	5	150	Eating establishment	30	30	960	CITY OF HIALEAH		0	one 25 gpm	30	240
GDO	4281	MGRU	5	150	Eating establishment	60	60	2468	CITY OF MIAMI BEACH		0	one 25 gpm	30	617
GDO	4286	IGT	5	150	Eating establishment	10	10	1350	MIAMI DADE WATER & SEWER DEPARTMENT	Single	750	one 750-gallon	90	338
GDO	4288	IGT	5	150	Eating establishment	48	46	0	MIAMI DADE WATER & SEWER DEPARTMENT	Single	750	one 750 gallon	90	1150
GDO	4289	MGRU	5	150	Eating establishment	25	25	0	MIAMI DADE WATER & SEWER DEPARTMENT		0	one 25 gpm	30	625
GDO	4292	IGT	5	150	Eating establishment	0	0	5000	MIAMI DADE WATER & SEWER DEPARTMENT	Single	750	one 750 gallon	60	1000
GDO	4293	IGT	5	150	Eating establishment	0	0	0	MIAMI DADE WATER & SEWER DEPARTMENT	Single	950	one 950 gallon	90	0
GDO	4295	IGT	5	150	Eating establishment	30	30	1700	MIAMI DADE WATER & SEWER DEPARTMENT	Single	950	one 950 gallon	90	425
GDO	4296	MGRU	5	150	Eating establishment	18	0	2531	MIAMI DADE WATER & SEWER DEPARTMENT		0	one 50 gpm	30	633
GDO	4298	IGT	5	150	Eating establishment	0	0	800	MIAMI DADE WATER & SEWER DEPARTMENT	Single	1050	one 1050 gallon	90	200
GDO	4299	IGT	5	150	Eating establishment	303	303	0		Series	3000	two 1500 gallon	90	0
GDO	4302	AGRU	5	150	Eating establishment	0	0	0			0	one 35 gpm	30	0
GDO	4305	IGT	5	150	Eating establishment	40	40	1350	MIAMI DADE WATER & SEWER DEPARTMENT	Single	750	one 750 gallon	90	1000
GDO	4306	AGRU	5	300	Eating establishment	130	130	0	CITY OF MIAMI BEACH		0	one 25 gpm	30	3250
GDO	4307	IGT	5	150	Eating establishment	49	49	1819	MIAMI DADE WATER & SEWER DEPARTMENT	Single	750	one 750 gallon	90	455
GDO	4308	IGT	5	300	Eating establishment	250	250	5500	MIAMI DADE WATER & SEWER DEPARTMENT	Single	950	one 950 gallon	90	1375
GDO	4309	IGT	5	300	Eating establishment	60	60	0	MIAMI DADE WATER & SEWER DEPARTMENT	Single	750	one 750 gallon	90	1500
GDO	4310	MGRU	5	150	Eating establishment	0	0	100	CITY OF HIALEAH		0	10 gpm	45	25
GDO	4312	IGT	5	150	Eating establishment	315	315	0	MIAMI DADE WATER & SEWER DEPARTMENT	Single	750	one 750 gallon	90	315
GDO	4313	IGT	5	150	Eating establishment	56	56	2110	MIAMI DADE WATER & SEWER DEPARTMENT	Single	1200	one 1200 gallon	90	528
GDO	4314	IGT	5	150	Eating establishment	40	40	0		Single	750	one 750 gallon	90	560
GDO	4318	IGT	5	150	Eating establishment	250	250	0	MIAMI DADE WATER & SEWER DEPARTMENT	Series	3000	two 1500 gallon	90	1250
GDO	4319	IGT	5	150	Eating establishment	0	0	0	MIAMI DADE WATER & SEWER DEPARTMENT	Series	1200	one 1200 gallon	90	0
GDO	4320	IGT	5	150	Eating establishment	41	41	0		Single	750	one 750 gallon	90	1025
GDO	4321	IGT	5	150	Eating establishment	12	0	625	MIAMI DADE WATER & SEWER DEPARTMENT	Single	750	one 750 gallon	60	242
GDO	4322	IGT	5	150	Eating establishment	38	38	2083	CITY OF MIAMI BEACH	Single	900	one 900 gallon	90	550
GDO	4324	IGT	5	150	Eating establishment	0	0	600	MIAMI DADE WATER & SEWER DEPARTMENT	Single	750	one 750 gallon	90	150
GDO	4326	IGT	5	150	Eating establishment	30	30	0		Single	750	one 750 gallon	90	750
GDO	4328	IGT	5	150	Eating establishment	45	45	1386	MIAMI DADE WATER & SEWER DEPARTMENT	Single	750	one 750-gallon	90	347
GDO	4329	IGT	5	150	Eating establishment	39	39	0		Single	1200	one 1200 gallon	90	546
GDO	4332	AGRU	5	150	Eating establishment	25	25	0			0	one 25 gpm	30	625
GDO	4334	AGRU	5	150	Eating establishment	0	0	180	MIAMI DADE WATER & SEWER DEPARTMENT		0	one 25 gpm	30	45
GDO	4336	IGT	5	750	Eating establishment	229	229	0	MIAMI DADE WATER & SEWER DEPARTMENT	Single	1200	one 1200 gallon	90	5725

WORK GROUP	PERMIT NUMBER	PERMIT CLASS	PERMIT T	PERMIT FEE	BUSINESS_TYPE	RECORDED SEATS	OBSERVED SEATS	FACILITY AREA	UTILITY	SYSTEM FORMAT	TOTAL CAPACITY	TANK_CAPACITY	PUMP OUT	TOTAL GPD
GDO	4337	IGT	5	750	Eating establishment	1000	1000	0	CITY OF MIAMI BEACH	Multiple	8850	one 950, two 1200, one 1500, & two 2000 gallon	90	14000
GDO	4342	IGT	5	300	Eating establishment	129	129	0	CITY OF MIAMI BEACH	Single	950	one 950 gallon	90	3225
GDO	4344	AGRU	5	150	Eating establishment	12	12	0	CITY OF MIAMI BEACH		0	one 25 gpm	30	168
GDO	4345	IGT	5	150	Eating establishment	50	50	0	MIAMI DADE WATER & SEWER DEPARTMENT	Single	750	one 750 gallon	90	1250
GDO	4348	IGT	5	150	Eating establishment	10	10	0	MIAMI DADE WATER & SEWER DEPARTMENT	Single	750	one 750 gallon	90	140
GDO	4350	MGRU	5	150	Eating establishment	32	32	850	MIAMI DADE WATER & SEWER DEPARTMENT		0	one 25 gpm	30	213
GDO	4351	IGT	5	150	Eating establishment	38	38	1500	CITY OF HIALEAH	Single	750	one 750 gallon	90	375
GDO	4352	IGT	5	150	Eating establishment	40	40	0	MIAMI DADE WATER & SEWER DEPARTMENT	Single	1050	one 1050 gallon & two 1050 gallon &	90	560
GDO	4355	IGT	5	750	Eating establishment	120	200	0	MIAMI DADE WATER & SEWER DEPARTMENT	Series	5300	two 1600 gallon	90	5000
GDO	4359	IGT	5	300	Eating establishment	195	195	3993	CITY OF MIAMI BEACH	Series	2850	three 950-gallon	90	998
GDO	4361	AGRU	5	150	Eating establishment	40	40	0	MIAMI DADE WATER & SEWER DEPARTMENT		0	one 25 gpm	30	560
GDO	4366	IGT	5	750	Eating establishment	208	208	0	MIAMI DADE WATER & SEWER DEPARTMENT	Single	950	one 950 gallon	90	5200
GDO	4367	IGT	5	150	Eating establishment	30	30	0	MIAMI DADE WATER & SEWER DEPARTMENT	Single	950	one 950 gallon	90	420
GDO	4369	MGRU	5	150	Eating establishment	34	34	935	MIAMI DADE WATER & SEWER DEPARTMENT		0	one 25 gpm	30	234
GDO	4370	IGT	5	150	Eating establishment	38	38	1300	CITY OF NORTH MIAMI BEACH	Single	1200	one 1200 gallon	90	325
GDO	4371	IGT	5	300	Eating establishment	89	89	5670	CITY OF MIAMI BEACH	Single	750	one 750 gallon	90	1418
GDO	4372	MGRU	5	300	Eating establishment	114	114	0			0	one 25 gpm	30	2850
GDO	4373	IGT	5	300	Eating establishment	149	149	0	MIAMI DADE WATER & SEWER DEPARTMENT	Single	1600	one 1600 gallon	90	37
GDO	4381	AGRU	5	150	Eating establishment	37	37	1600	MIAMI DADE WATER & SEWER DEPARTMENT		0	one 50 gpm	30	400
GDO	4382	MGRU	5	300	Eating establishment	60	60	0	CITY OF MIAMI BEACH		0	one 25 gpm	30	1500
GDO	4383	IGT	5	300	Eating establishment	40	40	4386	CITY OF MIAMI BEACH	Single	1200	one 1200 gallon	90	1097
GDO	4384	IGT	5	150	Eating establishment	333	333	2635	CITY OF MIAMI BEACH	Single	950	one 950 gallon	90	842
GDO	4386	IGT	5	750	Eating establishment	229	229	0	CITY OF MIAMI BEACH	Single	750	one 750 gallon	90	5725
GDO	4390	IGT	5	300	Eating establishment	72	72	0		Single	1200	one 1200 gallon	90	1008
GDO	4393	IGT	5	300	Eating establishment	121	121	422		Series	4500	three 1500 gallon	90	3025
GDO	4397	MGRU	5	150	Eating establishment	70	70	2000	MIAMI DADE WATER & SEWER DEPARTMENT		0	one 25-gpm	30	500
GDO	4400	IGT	5	150	Eating establishment	0	0	1080	CITY OF MIAMI BEACH	Single	950	one 950 gallon	90	270
GDO	4401	IGT	5	300	Eating establishment	102	102	0	MIAMI DADE WATER & SEWER DEPARTMENT	Single	1500	one 1500 gallon	90	2550
GDO	4402	IGT	5	150	Eating establishment	30	0	900	CITY OF HIALEAH	Single	750	one 750 gallon	60	225
GDO	4405	IGT	5	300	Eating establishment	160	160	0	CITY OF MIAMI BEACH	Single	950	one 950 gallon	90	4000
GDO	4406	IGT	5	300	Eating establishment	128	128	0	CITY OF MIAMI BEACH	Single	950	one 950 gallon	90	3200
GDO	4407	IGT	5	750	Eating establishment	447	447	0	CITY OF MIAMI BEACH	Multiple	2500	two 1250 gallon	90	11175
GDO	4408	MGRU	5	300	Eating establishment	24	0	3438	CITY OF MIAMI BEACH		0	one 100 gpm	30	860
GDO	4409	AGRU	5	150	Eating establishment	58	48	900	CITY OF MIAMI BEACH		0	one 25 gpm	30	225
GDO	4410	IGT	5	300	Eating establishment	197	197	7669	CITY OF MIAMI BEACH	Single	1500	one 1500-gallon	90	1917
GDO	4411	IGT	5	150	Eating establishment	74	0	3035	MIAMI DADE WATER & SEWER DEPARTMENT	Single	1250	one 1250 gallon	60	759
GDO	4412	IGT	5	150	Eating establishment	40	40	0	MIAMI DADE WATER & SEWER DEPARTMENT	Single	750	one 750 gallon	90	1000
GDO	4413	IGT	5	300	Eating establishment	160	160	0	MIAMI DADE WATER & SEWER DEPARTMENT	Single	1200	one 1200 gallon	90	2240
GDO	4415	IGT	5	150	Eating establishment	40	40	0	CITY OF NORTH MIAMI BEACH	Single	950	one 950 gallon	90	1000
GDO	4416	IGT	5	150	Eating establishment	30	30	0		Single	750	one 750 gallon	90	420
GDO	4417	IGT	5	150	Eating establishment	16	16	1200	CITY OF HIALEAH	Single	1200	one 1200 gallon	90	400
GDO	4419	MGRU	5	150	Eating establishment	80	0	2721	MIAMI DADE WATER & SEWER DEPARTMENT		0	one 100 gpm	30	68025
GDO	4421	IGT	5	300	Eating establishment	328	328	7080	CITY OF MIAMI BEACH	Single	2000	one 2000 gallon	90	1770
GDO	4422	IGT	5	300	Eating establishment	201	201	4200	MIAMI DADE WATER & SEWER DEPARTMENT	Series	2400	two 1200 gallon	90	1050
GDO	4424	IGT	5	150	Eating establishment	94	0	3246	MIAMI DADE WATER & SEWER DEPARTMENT	Single	1250	one 1250 gallon	60	812
GDO	4425	IGT	5	150	Eating establishment	80	0	3500	MIAMI DADE WATER & SEWER DEPARTMENT	Single	1250	one 1250 gallon	60	875
GDO	4426	IGT	5	150	Eating establishment	38	38	0	CITY OF HIALEAH GARDENS	Single	1200	one 1200 gallon	90	532
GDO	4428	IGT	5	300	Eating establishment	160	160	5000	CITY OF MIAMI SPRINGS	Single	750	one 750 gallon	90	4000
GDO	4429	MGRU	5	150	Eating establishment	53	53	1375	MIAMI DADE WATER & SEWER DEPARTMENT		0	one 25-gpm	30	344
GDO	4430	IGT	5	300	Eating establishment	80	80	0		Single	1250	one 1250 gallon	90	1120
GDO	4433	IGT	5	150	Eating establishment	43	43	2720	MIAMI DADE WATER & SEWER DEPARTMENT	Single	1500	one 1500-gallon	90	680
GDO	4436	IGT	5	300	Eating establishment	94	94	0	MIAMI DADE WATER & SEWER DEPARTMENT	Single	1200	one 1200 gallon	90	1316
GDO	4438	MGRU	5	300	Eating establishment	28	0	1140	MIAMI DADE WATER & SEWER DEPARTMENT	Multiple	0	six 100 gpm	60	382
GDO	4440	IGT	5	150	Eating establishment	100	100	1900	CITY OF MIAMI BEACH	Single	450	one 450 gallon	90	475
GDO	4441	AGRU	5	300	Eating establishment	250	250	3939	CITY OF MIAMI BEACH		0	one 35 gpm	30	1173
GDO	4442	IGT	5	150	Eating establishment	80	80	3200	MIAMI DADE WATER & SEWER DEPARTMENT	Single	750	one 750 gallon	90	800
GDO	4445	IGT	5	300	Eating establishment	135	135	0		Series	6400	four 1600 gallon	90	1890
GDO	4447	IGT	5	150	Eating establishment	0	0	0	MIAMI DADE WATER & SEWER DEPARTMENT	Single	1500	one 1500 gallon	90	0

WORK GROUP	PERMIT NUMBER	PERMIT CLASS	PERMIT	PERMIT FEE	BUSINESS_TYPE	RECORDED SEATS	OBSERVED SEATS	FACILITY AREA	UTILITY	SYSTEM FORMAT	TOTAL CAPACITY	TANK_CAPACITY	PUMP OUT	TOTAL GPD
GDO	4448	IGT	5	150	Eating establishment	43	43	0	MIAMI DADE WATER & SEWER DEPARTMENT	Single	1200	one 1200 gallon	90	1075
GDO	4449	IGT	5	150	Eating establishment	76	76	2200	MIAMI DADE WATER & SEWER DEPARTMENT	Single	1200	one 1200-gallon	90	550
GDO	4450	IGT	5	150	Eating establishment	0	0	2680	CITY OF MIAMI BEACH	Single	750	one 750 gallon	90	670
GDO	4458	AGRU	5	300	Eating establishment	198	198	5020	CITY OF MIAMI BEACH	Single	0	one 75-gpm	30	1322
GDO	4459	AGRU	5	150	Eating establishment	15	15	1020	MIAMI DADE WATER & SEWER DEPARTMENT		0	one 25 gpm	30	255
GDO	4460	IGT	5	150	Eating establishment	40	40	0		Single	1200	one 1200 gallon	90	1000
GDO	4461	IGT	5	300	Eating establishment	340	186	9960	MIAMI DADE WATER & SEWER DEPARTMENT	Single	1200	one 1200-gallon	90	2881
GDO	4462	MGRU	5	150	Eating establishment	246	0	2613	CITY OF MIAMI BEACH		0	four 100 gpm	90	653
GDO	4463	IGT	5	300	Eating establishment	200	200	4619	CITY OF MIAMI BEACH	Single	1200	one 1200 gallon	90	1155
GDO	4464	IGT	5	150	Eating establishment	30	30	2750	MIAMI DADE WATER & SEWER DEPARTMENT	Single	950	one 950 gallon	90	688
GDO	4465	IGT	5	150	Eating establishment	12	12	1200	MIAMI DADE WATER & SEWER DEPARTMENT	Single	1200	one 1200 gallon	90	300
GDO	4470	IGT	5	150	Eating establishment	50	50	0	MIAMI DADE WATER & SEWER DEPARTMENT	Single	1050	one 1050 gallon	90	700
GDO	4471	IGT	5	300	Eating establishment	100	100	3800	MIAMI DADE WATER & SEWER DEPARTMENT	Single	1050	one 1050 gallon	90	950
GDO	4472	IGT	5	150	Eating establishment	38	38	0		Single	950	one 950 gallon	90	532
GDO	4479	IGT	5	300	Eating establishment	200	200	0		Single	2000	one 2000 gallon	90	2800
GDO	4482	IGT	5	750	Eating establishment	453	453	0	MIAMI DADE WATER & SEWER DEPARTMENT	Series	3000	two 1500 gallon	90	6342
GDO	4483	IGT	5	150	Eating establishment	0	0	650	CITY OF FLORIDA CITY	Single	1200	one 1200 gallon	60	163
GDO	4485	IGT	5	300	Eating establishment	473	473	10450	CITY OF MIAMI BEACH	Series	7000	two 3500 gallon	90	2613
GDO	4487	IGT	5	150	Eating establishment	10	10	0		Single	1050	one 1050-gallon	90	140
GDO	4489	IGT	5	150	Eating establishment	25	25	0	CITY OF HIALEAH	Single	750	one 750 gallon	90	625
GDO	4492	IGT	5	300	Eating establishment	80	80	0		Single	950	one 950 gallon	90	2000
GDO	4495	IGT	5	300	Eating establishment	80	80	0	MIAMI DADE WATER & SEWER DEPARTMENT	Single	750	one 750 gallon	90	2000
GDO	4497	MGRU	5	150	Eating establishment	0	0	602	MIAMI DADE WATER & SEWER DEPARTMENT		0	one 25 gpm	30	151
GDO	4499	IGT	5	150	Eating establishment	4	0	3000	CITY OF HIALEAH	Single	950	one 950 gallon	90	750
GDO	4501	IGT	5	150	Eating establishment	50	0	35086	CITY OF HIALEAH	Single	1200	one 1200 gallon	90	1000
GDO	4502	IGT	5	150	Eating establishment	35	35	3200	CITY OF HIALEAH	Single	750	one 750-gallon	90	800
GDO	4503	MGRU	5	150	Eating establishment	45	45	0	MIAMI DADE WATER & SEWER DEPARTMENT		0	one 25 gpm	30	630
GDO	4504	IGT	5	150	Eating establishment	40	40	850	CITY OF HIALEAH	Single	950	one 950-gallon	90	213
GDO	4505	IGT	5	300	Eating establishment	100	100	0	MIAMI DADE WATER & SEWER DEPARTMENT	Single	2000	one 2000 gallon	90	2500
GDO	4506	IGT	5	150	Eating establishment	64	0	3570	MIAMI DADE WATER & SEWER DEPARTMENT	Single	1250	one 1250 gallon	30	893
GDO	4509	IGT	2	150	Eating establishment	8	8	710	MIAMI DADE WATER & SEWER DEPARTMENT	Single	750	one 750-gallon	90	178
GDO	4512	IGT	5	300	Eating establishment	15	15	3200	CITY OF HIALEAH	Single	750	one 750-gallon	90	800
GDO	4514	AGRU	5	300	Eating establishment	112	110	3000	CITY OF MIAMI BEACH		0	one 35 gpm	30	750
GDO	4516	AGRU	5	300	Eating establishment	190	0	1840	CITY OF MIAMI BEACH		0	one 75 gpm	30	460
GDO	4517	IGT	5	300	Eating establishment	76	76	0	MIAMI DADE WATER & SEWER DEPARTMENT	Single	1200	one 1200 gallon	90	1064
GDO	4519	IGT	5	150	Eating establishment	74	74	2500	MIAMI DADE WATER & SEWER DEPARTMENT	Single	750	one 750 gallon	90	625
GDO	4527	IGT	5	150	Eating establishment	25	25	1428	CITY OF HIALEAH	Single	1050	one 1050 gallon	90	357
GDO	4530	IGT	5	150	Eating establishment	0	0	3378	MIAMI DADE WATER & SEWER DEPARTMENT	Single	900	one 900 gallon	90	845
GDO	4532	IGT	5	150	Eating establishment	8	8	1100	CITY OF FLORIDA CITY	Single	1200	one 1200 gallon	90	275
GDO	4539	IGT	5	300	Eating establishment	69	69	0		Single	1050	one 1050 gallon	90	1725
GDO	4540	IGT	5	150	Eating establishment	0	0	0	CITY OF HIALEAH	Single	1200	one 1200 gallon	90	0
GDO	4541	AGRU	5	150	Eating establishment	0	0	1392	MIAMI DADE WATER & SEWER DEPARTMENT		0	one 25-gpm	30	348
GDO	4544	MGRU	5	150	Eating establishment	48	48	2076	MIAMI DADE WATER & SEWER DEPARTMENT		0	one 25 gpm	30	51900
GDO	4546	IGT	5	150	Eating establishment	30	30	2400	CITY OF MIAMI BEACH	Single	950	one 950 gallon	90	600
GDO	4548	IGT	5	150	Eating establishment	55	0	850	CITY OF MIAMI BEACH	Single	1200	one 1200 gallon	60	213
GDO	4550	IGT	5	300	Eating establishment	60	60	0		Single	1200	one 1200 gallon	90	840
GDO	4552	IGT	5	300	Eating establishment	64	64	0		Single	1600	one 1600 gallon	90	1600
GDO	4554	IGT	5	300	Eating establishment	322	322	7100	MIAMI DADE WATER & SEWER DEPARTMENT	Series	3200	two 1600 gallon	90	1775
GDO	4555	IGT	5	150	Eating establishment	0	0	802	MIAMI DADE WATER & SEWER DEPARTMENT	Series	14400	two 1200 gallon	90	201
GDO	4557	IGT	5	150	Eating establishment	12	12	0		Single	1200	one 1200 gallon	90	1080
GDO	4561	MGRU	5	300	Eating establishment	56	56	0			0	one 25 gpm	30	1400
GDO	4562	MGRU	5	300	Eating establishment	125	125	5590	CITY OF MIAMI BEACH		0	one 25 gpm	30	1398
GDO	4563	IGT	5	300	Eating establishment	200	0	4536	CITY OF HOMESTEAD	Single	1500	one 1500 gallon	60	1134
GDO	4571	IGT	5	750	Eating establishment	236	236	0	CITY OF CORAL GABLES	Single	750	one 750 gallon	90	5900
GDO	4573	IGT	5	150	Eating establishment	0	0	300	CITY OF HIALEAH	Single	2500	one 2500 gallon	90	75
GDO	4574	IGT	5	300	Eating establishment	58	58	0	MIAMI DADE WATER & SEWER DEPARTMENT	Single	1600	one 1600 gallon	90	0
GDO	4580	IGT	5	150	Eating establishment	48	48	2145	MIAMI DADE WATER & SEWER DEPARTMENT	Single	1200	one 1200-gallon	90	536
GDO	4582	IGT	5	300	Eating establishment	0	0	5000	CITY OF NORTH MIAMI BEACH	Single	1200	one 1200 gallon	90	1250
GDO	4583	MGRU	5	150	Eating establishment	48	48	0			0	one 25 gpm	30	672
GDO	4586	IGT	5	150	Eating establishment	0	0	0	MIAMI DADE WATER & SEWER DEPARTMENT	Series	4000	two 2000 gallon	90	0
GDO	4588	IGT	5	150	Eating establishment	22	22	1300	MIAMI DADE WATER & SEWER DEPARTMENT	Single	750	one 750 gallon	90	325

WORK GROUP	PERMIT NUMBER	PERMIT CLASS	PERMIT	PERMIT FEE	BUSINESS_TYPE	RECORDED SEATS	OBSERVED SEATS	FACILITY AREA	UTILITY	SYSTEM FORMAT	TOTAL CAPACITY	TANK_CAPACITY	PUMP OUT	TOTAL GPD
GDO	4591	IGT	5	150	Eating establishment	0	0	0		Single	2000	one 2000 gallon	90	0
GDO	4593	IGT	5	150	Eating establishment	0	0	0		Single	1200	one 1200 gallon	90	0
GDO	4598	MGRU	5	300	Eating establishment	201	201	6000	MIAMI DADE WATER & SEWER DEPARTMENT		0	one 25 gpm	30	1500
GDO	4599	AGRU	5	150	Eating establishment	30	30	1275	CITY OF MIAMI BEACH		0	one 25 gpm	30	319
GDO	4600	IGT	5	150	Eating establishment	42	42	0	MIAMI DADE WATER & SEWER DEPARTMENT	Single	2000	one 2000 gallon	90	1050
GDO	4601	MGRU	5	150	Eating establishment	60	0	0	CITY OF CORAL GABLES		0	one 50 gpm	30	0
GDO	4602	MGRU	5	150	Eating establishment	49	50	640	CITY OF MIAMI BEACH		0	one 25 gpm	30	254
GDO	4603	IGT	5	150	Eating establishment	2300	2300	0	CITY OF HOMESTEAD	Multiple	4800	four 1200 gallon	90	1380
GDO	4606	IGT	5	150	Eating establishment	35	0	1400		Single	750	one 750 gallon	90	350
GDO	4607	IGT	5	150	Eating establishment	0	0	0	MIAMI DADE WATER & SEWER DEPARTMENT	Single	1600	one 1600 gallon	90	0
GDO	4608	IGT	5	300	Eating establishment	114	114	0	MIAMI DADE WATER & SEWER DEPARTMENT	Single	3600	three 1200 gallon	90	2850
GDO	4609	IGT	5	150	Eating establishment	32	32	0	MIAMI DADE WATER & SEWER DEPARTMENT	Single	1600	one 1600 gallon	90	448
GDO	4610	IGT	5	150	Eating establishment	0	0	780	MIAMI DADE WATER & SEWER DEPARTMENT	Single	1600	one 1600 gallon	90	195
GDO	4611	IGT	5	150	Eating establishment	1	1	0	MIAMI DADE WATER & SEWER DEPARTMENT	Single	1600	one 1600 gallon	90	0
GDO	4612	MGRU	5	150	Eating establishment	40	0	900	MIAMI DADE WATER & SEWER DEPARTMENT		0	one 4 gpm	90	225
GDO	4613	IGT	5	300	Eating establishment	450	450	7000	CITY OF HIALEAH	Single	1600	one 1600-gallon	90	1750
GDO	4614	MGRU	5	150	Eating establishment	30	0	440	CITY OF MIAMI BEACH		0	one 50 gpm	30	110
GDO	4618	IGT	5	150	Eating establishment	0	0	0		Single	1050	one 1050 gallon	90	0
GDO	4620	IGT	5	150	Eating establishment	30	30	2200	CITY OF HIALEAH	Single	750	one 750-gallon	90	550
GDO	4625	IGT	5	150	Eating establishment	40	0	2179	MIAMI DADE WATER & SEWER DEPARTMENT	Series	3200	two 1600-gallon	60	545
GDO	4626	IGT	5	150	Eating establishment	42	42	2750	MIAMI DADE WATER & SEWER DEPARTMENT	Single	1500	one 1500-gallon	90	688
GDO	4627	IGT	5	150	Eating establishment	80	80	2800	CITY OF NORTH MIAMI BEACH	Single	750	one 750 gallon	90	825
GDO	4630	AGRU	5	150	Eating establishment	0	0	0			0	one 25 gpm	30	0
GDO	4631	MGRU	5	150	Eating establishment	42	42	2430	CITY OF MIAMI BEACH		0	two 50 gpm	30	1050
GDO	4633	IGT	5	150	Eating establishment	12	12	2900	CITY OF HIALEAH GARDENS	Single	750	one 750 gallon	90	168
GDO	4636	AGRU	5	150	Eating establishment	40	40	1800	CITY OF MIAMI BEACH		0	one 35 gpm	30	450
GDO	4638	IGT	5	150	Eating establishment	97	0	3050	MIAMI DADE WATER & SEWER DEPARTMENT	Single	1250	one 1250	60	763
GDO	4639	IGT	5	300	Eating establishment	74	74	0	MIAMI DADE WATER & SEWER DEPARTMENT	Single	1050	one 1050 gallon	90	1036
GDO	4640	IGT	5	300	Eating establishment	80	80	0	MIAMI DADE WATER & SEWER DEPARTMENT	Single	2000	one 2000 gallon	90	1120
GDO	4644	MGRU	5	150	Eating establishment	18	18	0			0	one 25 gpm	30	252
GDO	4646	IGT	5	150	Eating establishment	0	0	0	MIAMI DADE WATER & SEWER DEPARTMENT	Single	750	one 750 gallon	90	0
GDO	4649	IGT	5	150	Eating establishment	30	30	2500	CITY OF HIALEAH	Single	750	one 750 gallon	90	625
GDO	4650	IGT	5	150	Eating establishment	0	0	0		Single	1200	one 1200 gallon	90	0
GDO	4653	IGT	5	300	Eating establishment	96	96	0	MIAMI DADE WATER & SEWER DEPARTMENT	Single	900	one 900 gallon	90	1344
GDO	4654	IGT	5	150	Eating establishment	150	150	0		Single	1050	one 1050-gallon	90	3750
GDO	4660	IGT	5	150	Eating establishment	72	0	1166	MIAMI DADE WATER & SEWER DEPARTMENT	Single	3000	one 3000 gallon	90	292
GDO	4661	IGT	5	150	Eating establishment	42	42	0	CITY OF HIALEAH	Single	750	one 750 gallon	90	1050
GDO	4662	IGT	5	300	Eating establishment	98	98	3879	CITY OF MIAMI BEACH	Single	750	one 750 gallon	90	1157
GDO	4669	IGT	5	150	Eating establishment	16	16	0	MIAMI DADE WATER & SEWER DEPARTMENT	Single	750	one 750 gallon	90	400
GDO	4670	AGRU	5	150	Eating establishment	18	18	1803	MIAMI DADE WATER & SEWER DEPARTMENT		0	one 35 gpm	30	451
GDO	4673	IGT	5	300	Eating establishment	55	55	0		Single	750	one 750 gallon	90	1375
GDO	4674	IGT	5	150	Eating establishment	47	47	0		Single	2000	one 2000 gallon	90	658
GDO	4675	IGT	5	150	Eating establishment	47	47	620	CITY OF HIALEAH	Single	2000	one 2000 gallon	90	155
GDO	4676	IGT	5	150	Eating establishment	47	47	628	CITY OF HIALEAH	Single	2000	one 2000 gallon	90	157
GDO	4677	IGT	5	150	Eating establishment	0	0	608	CITY OF HIALEAH	Single	2000	one 2000 gallon	90	152
GDO	4683	MGRU	5	150	Eating establishment	60	60	0	CITY OF MIAMI BEACH		0	one 25 gpm	30	1500
GDO	4684	IGT	5	150	Eating establishment	89	89	2600	CITY OF HOMESTEAD	Single	1050	one 1050-gallon	90	650
GDO	4685	IGT	5	300	Eating establishment	56	56	2781	CITY OF MIAMI BEACH	Single	1200	one 1200 gallon	90	1400
GDO	4690	IGT	5	300	Eating establishment	85	85	0	MIAMI DADE WATER & SEWER DEPARTMENT	Single	950	one 950 gallon	90	2125
GDO	4691	IGT	5	150	Eating establishment	86	86	2040	CITY OF MIAMI BEACH	Single	2000	one 2000 gallon	90	510
GDO	4692	MGRU	5	150	Eating establishment	50	50	0	MIAMI DADE WATER & SEWER DEPARTMENT		0	one 25 gpm	30	1250
GDO	4698	IGT	5	300	Eating establishment	120	120	0	CITY OF MIAMI BEACH	Single	950	one 950 gallon	90	3000
GDO	4702	IGT	5	300	Eating establishment	30	30	0	CITY OF MIAMI BEACH	Single	950	one 950 gallon	90	750
GDO	4704	IGT	5	300	Eating establishment	85	85	0	MIAMI DADE WATER & SEWER DEPARTMENT	Single	750	one 750 gallon	90	2125
GDO	4705	MGRU	5	150	Eating establishment	60	0	1553	CITY OF MIAMI BEACH	Series	5000	four 1250 gallon	30	474
GDO	4706	MGRU	5	150	Eating establishment	0	0	0			0	one 25 gpm	30	0
GDO	4708	IGT	5	150	Eating establishment	30	30	0		Single	750	one 750 gallon	90	420
GDO	4709	IGT	5	150	Eating establishment	45	45	0	CITY OF HOMESTEAD	Single	950	one 950 gallon	90	630
GDO	4710	IGT	5	300	Eating establishment	120	120	0	CITY OF HOMESTEAD	Single	1050	one 1050 gallon	90	3000
GDO	4719	MGRU	5	150	Eating establishment	36	36	1140	CITY OF HIALEAH		0	one 25 gpm	30	285
GDO	4720	IGT	5	150	Eating establishment	0	0	1200	MIAMI DADE WATER & SEWER DEPARTMENT	Single	1200	one 1200 gallon	90	300

WORK GROUP	PERMIT NUMBER	PERMIT CLASS	PERMIT	PERMIT FEE	BUSINESS_TYPE	RECORDED SEATS	OBSERVED SEATS	FACILITY AREA	UTILITY	SYSTEM FORMAT	TOTAL CAPACITY	TANK_CAPACITY	PUMP OUT	TOTAL GPD
GDO	4728	IGT	5	750	Eating establishment	341	341	0	MIAMI DADE WATER & SEWER DEPARTMENT	Series	10000	five 2000 gallon	90	4774
GDO	4730	IGT	5	750	Eating establishment	326	326	0	MIAMI DADE WATER & SEWER DEPARTMENT	Series	2100	two 1050 gallon	90	8150
GDO	4731	IGT	5	150	Eating establishment	62	0	2287	MIAMI DADE WATER & SEWER DEPARTMENT	Single	750	one 750 gallon	90	572
GDO	4734	IGT	5	300	Eating establishment	98	98	0	MIAMI DADE WATER & SEWER DEPARTMENT	Single	1200	one 1200 gallon	90	1372
GDO	4740	IGT	5	150	Eating establishment	50	50	0		Series	2400	two 1200 gallon	90	700
GDO	4743	IGT	5	300	Eating establishment	340	340	7000	CITY OF NORTH MIAMI BEACH	Single	3000	one 3000 gallon	90	1750
GDO	4746	IGT	5	750	Eating establishment	224	224	0		Single	1600	one 1600 gallon	90	5600
GDO	4750	IGT	5	300	Eating establishment	55	55	0	MIAMI DADE WATER & SEWER DEPARTMENT	Single	1200	one 1200 gallon	90	1375
GDO	4754	IGT	5	150	Eating establishment	40	40	0		Single	2000	one 2000 gallon	90	1000
GDO	4756	IGT	5	300	Eating establishment	93	93	0	CITY OF NORTH MIAMI BEACH	Single	1500	one 1500 gallon	90	2325
GDO	4757	MGRU	5	150	Eating establishment	70	0	0	CITY OF MIAMI BEACH		0	one 100 gpm	60	0
GDO	4760	IGT	5	150	Eating establishment	0	0	0	MIAMI DADE WATER & SEWER DEPARTMENT	Single	750	One 750 gallon	60	0
GDO	4761	IGT	5	300	Eating establishment	58	58	0	MIAMI DADE WATER & SEWER DEPARTMENT	Single	1050	one 1050 gallon	90	812
GDO	4765	IGT	5	150	Eating establishment	116	0	1462	CITY OF NORTH MIAMI BEACH	Series	2100	two 1050 gallon	4	425
GDO	4767	IGT	5	300	Eating establishment	92	92	0	MIAMI DADE WATER & SEWER DEPARTMENT	Single	950	one 950 gallon	90	1288
GDO	4768	MGRU	5	150	Eating establishment	38	38	1300	CITY OF MIAMI BEACH		0	one 25 gpm	30	325
GDO	4772	IGT	5	300	Eating establishment	140	140	0	MIAMI DADE WATER & SEWER DEPARTMENT	Single	1050	one 1050 gallon	90	3500
GDO	4773	MGRU	5	150	Eating establishment	156	156	1104	CITY OF MIAMI BEACH		0	two 100 gpm	60	522
GDO	4781	IGT	5	300	Eating establishment	56	56	0	CITY OF NORTH MIAMI BEACH	Single	1050	one 1050 gallon	90	784
GDO	4782	IGT	5	150	Eating establishment	12	12	1600	MIAMI DADE WATER & SEWER DEPARTMENT	Single	750	one 750 gallon	90	40000
GDO	4785	MGRU	5	150	Eating establishment	34	34	0	CITY OF HIALEAH		0	one 25 gpm	30	850
GDO	4790	IGT	5	300	Eating establishment	212	212	4700	CITY OF HIALEAH	Series	3600	three 1200 gallon	90	1175
GDO	4792	IGT	5	300	Eating establishment	0	0	7260	MIAMI DADE WATER & SEWER DEPARTMENT	Series	2100	two 1050 gallon	90	1815
GDO	4796	IGT	5	150	Eating establishment	20	20	1440		Series	7500	three 2500 gallon	90	362
GDO	4797	IGT	2	150	Eating establishment	426	426	0		Single	950	one 950 gallon	90	426
GDO	4799	IGT	5	300	Eating establishment	72	72	0	MIAMI DADE WATER & SEWER DEPARTMENT	Single	1200	one 1200 gallon	90	1800
GDO	4802	IGT	5	300	Eating establishment	150	150	0	CITY OF MIAMI BEACH	Single	750	one 750 gallon	90	3750
GDO	4806	MGRU	5	150	Eating establishment	20	20	0	CITY OF MIAMI BEACH		0	one 25 gpm	30	280
GDO	4807	IGT	5	150	Eating establishment	149	149	3851	CITY OF MIAMI BEACH	Single	1250	one 1250-gallon	90	963
GDO	4810	IGT	5	150	Eating establishment	10	0	1000	MIAMI DADE WATER & SEWER DEPARTMENT	Single	950	one 950 gallon	60	250
GDO	4811	MGRU	5	150	Eating establishment	18	18	0			0	one 35 gpm	30	252
GDO	4812	IGT	5	150	Eating establishment	40	40	0	MIAMI DADE WATER & SEWER DEPARTMENT	Single	750	one 750 gallon	90	1000
GDO	4813	AGRU	5	150	Eating establishment	38	0	1000	MIAMI DADE WATER & SEWER DEPARTMENT		0	one 25 gpm	30	250
GDO	4815	IGT	5	150	Eating establishment	78	78	1400	CITY OF HOMESTEAD	Single	1050	one 1050-gallon	90	350
GDO	4817	IGT	5	300	Eating establishment	87	87	3505	MIAMI DADE WATER & SEWER DEPARTMENT	Series	3600	three 1200 gallon	90	876
GDO	4819	IGT	5	150	Eating establishment	30	30	0	CITY OF HIALEAH	Single	950	one 950 gallon	90	750
GDO	4822	IGT	5	300	Eating establishment	163	163	0	MIAMI DADE WATER & SEWER DEPARTMENT	Single	750	one 750 gallon	90	4075
GDO	4825	IGT	5	150	Eating establishment	0	0	350	CITY OF NORTH MIAMI BEACH	Single	950	one 950 gallon	90	88
GDO	4826	IGT	5	300	Eating establishment	200	200	9527	MIAMI DADE WATER & SEWER DEPARTMENT	Single	1050	one 1050 gallon	90	2382
GDO	4829	IGT	5	300	Eating establishment	70	70	0		Single	1000	one 1000 gallon	90	980
GDO	4831	MGRU	5	150	Eating establishment	32	32	919	CITY OF MIAMI BEACH		0	one 25 gpm	30	230
GDO	4838	AGRU	5	150	Eating establishment	30	30	1189	MIAMI DADE WATER & SEWER DEPARTMENT		0	one 25 gpm	30	297
GDO	4840	IGT	5	300	Eating establishment	206	206	0	CITY OF MIAMI BEACH	Series	2400	two 1200 gallon	90	5150
GDO	4843	IGT	5	150	Eating establishment	36	36	1315	MIAMI DADE WATER & SEWER DEPARTMENT	Single	950	one 950 gallon	90	329
GDO	4846	MGRU	5	300	Eating establishment	164	164	5000	CITY OF MIAMI BEACH	Single	1050	one 1050 gallon	30	4100
GDO	4849	MGRU	5	150	Eating establishment	36	36	1400	MIAMI DADE WATER & SEWER DEPARTMENT		0	one 25 gpm	30	350
GDO	4850	IGT	5	150	Eating establishment	0	0	0	CITY OF OPA LOCKA	Single	2000	one 2000 gallon	90	0
GDO	4852	AGRU	5	150	Eating establishment	30	0	350	CITY OF MIAMI BEACH		0	one 20 gpm	30	88
GDO	4853	IGT	5	750	Eating establishment	250	250	0	MIAMI DADE WATER & SEWER DEPARTMENT	Series	6000	three 2000 gallon	90	6250
GDO	4857	IGT	3	300	Eating establishment	238	238	9155	CITY OF MIAMI BEACH	Series	2400	two 1200 gallon	90	2289
GDO	4858	MGRU	5	150	Eating establishment	46	46	1500	MIAMI DADE WATER & SEWER DEPARTMENT		0	one 25 gpm	30	375
GDO	4860	IGT	5	300	Eating establishment	60	0	4172		Single	1200	one 1200 gallon	60	1043
GDO	4861	IGT	5	150	Eating establishment	601	601	0	MIAMI DADE WATER & SEWER DEPARTMENT	Multiple	4000	two 2000 gallon	90	601
GDO	4864	IGT	5	150	Eating establishment	16	16	0	MIAMI DADE WATER & SEWER DEPARTMENT	Single	750	one 750 gallon	90	400
GDO	4865	IGT	5	300	Eating establishment	200	200	0	MIAMI DADE WATER & SEWER DEPARTMENT	Series	2400	two 1200 gallon	90	5000
GDO	4868	IGT	5	300	Eating establishment	124	124	0		Single	1200	one 1200 gallon	90	3100
GDO	4870	IGT	5	300	Eating establishment	1263	1263	18909	CITY OF MIAMI BEACH	Series	2500	two 1250 gallon	90	4727
GDO	4876	IGT	5	150	Eating establishment	50	50	0	CITY OF MIAMI BEACH	Single	750	one 750 gallon	90	1250
GDO	4877	IGT	5	150	Eating establishment	49	49	0	MIAMI DADE WATER & SEWER DEPARTMENT	Single	1200	one 1200 gallon	90	1225
GDO	4878	IGT	5	150	Eating establishment	30	30	1344	MIAMI DADE WATER & SEWER DEPARTMENT	Single	1200	one 1200-gallon	90	336
GDO	4879	IGT	5	150	Eating establishment	47	47	1800	MIAMI DADE WATER & SEWER DEPARTMENT	Single	750	one 750-gallon	90	450

WORK GROUP	PERMIT NUMBER	PERMIT CLASS	PERMIT	PERMIT FEE	BUSINESS_TYPE	RECORDED SEATS	OBSERVED SEATS	FACILITY AREA	UTILITY	SYSTEM FORMAT	TOTAL CAPACITY	TANK_CAPACITY	PUMP OUT	TOTAL GPD
GDO	4880	MGRU	5	150	Eating establishment	60	0	1720	MIAMI DADE WATER & SEWER DEPARTMENT		0	one 35 gpm	30	480
GDO	4884	IGT	5	300	Eating establishment	60	60	0	CITY OF MIAMI BEACH	Single	1050	one 1050 gallon	90	1500
GDO	4885	IGT	5	150	Eating establishment	30	30	0		Single	1200	one 1200 gallon	90	750
GDO	4886	IGT	5	150	Eating establishment	36	36	2000	CITY OF MIAMI BEACH	Single	950	one 950 gallon	90	500
GDO	4891	IGT	5	150	Eating establishment	48	48	1700	MIAMI DADE WATER & SEWER DEPARTMENT	Single	1200	one 1200 gallon	90	425
GDO	4894	IGT	5	300	Eating establishment	132	132	0	CITY OF HIALEAH	Single	2000	one 200 gallon	90	3300
GDO	4896	IGT	5	150	Eating establishment	35	35	0	MIAMI DADE WATER & SEWER DEPARTMENT	Single	750	one 750 gallon	90	875
GDO	4897	IGT	5	150	Eating establishment	60	0	2541	CITY OF MIAMI BEACH	Series	6000	three 2000 gallon	90	635
GDO	4900	IGT	5	300	Eating establishment	80	80	0	MIAMI DADE WATER & SEWER DEPARTMENT	Single	1200	one 1200 gallon	90	1120
GDO	4902	IGT	5	150	Eating establishment	19	19	0	CITY OF MIAMI SPRINGS	Single	750	one 750 gallon	90	475
GDO	4906	IGT	5	150	Eating establishment	150	150	0	MIAMI DADE WATER & SEWER DEPARTMENT	Single	1200	one 1200 gallon	90	150
GDO	4912	MGRU	5	150	Eating establishment	22	22	900	MIAMI DADE WATER & SEWER DEPARTMENT		0	one 25 gpm	30	225
GDO	4913	IGT	5	150	Eating establishment	4	4	0	CITY OF NORTH BAY VILLAGE	Single	1050	one 1050 gallon	90	1
GDO	4914	IGT	5	300	Eating establishment	275	275	6875	CITY OF MIAMI BEACH	Single	950	one 950 gallon	90	1719
GDO	4917	AGRU	5	300	Eating establishment	90	90	0	CITY OF MIAMI BEACH		0	one 25 gpm	30	2250
GDO	4919	IGT	5	150	Eating establishment	50	50	0	CITY OF MIAMI BEACH	Single	950	one 950 gallon	90	700
GDO	4921	IGT	5	150	Eating establishment	40	40	0	CITY OF MIAMI BEACH	Single	950	one 950 gallon	90	1000
GDO	4923	AGRU	5	150	Eating establishment	2	2	0	MIAMI DADE WATER & SEWER DEPARTMENT		0	one 35 gpm	30	1
GDO	4925	IGT	5	300	Eating establishment	74	74	0	CITY OF HIALEAH	Single	750	one 750 gallon	90	1036
GDO	4926	IGT	5	300	Eating establishment	76	76	0		Single	950	one 950 gallon	90	1900
GDO	4928	IGT	5	150	Eating establishment	16	16	0	MIAMI DADE WATER & SEWER DEPARTMENT	Single	1200	one 1200 gallon	90	400
GDO	4929	MGRU	5	150	Eating establishment	49	49	0			0	one 25 gpm	30	1225
GDO	4933	IGT	5	150	Eating establishment	62	62	0	MIAMI DADE WATER & SEWER DEPARTMENT	Single	1200	one 1200 gallon	90	868
GDO	4935	IGT	5	150	Eating establishment	15	15	2000	MIAMI DADE WATER & SEWER DEPARTMENT	Single	750	one 750 gallon	90	210
GDO	4939	MGRU	5	150	Eating establishment	0	0	0			0	one 25 gpm	30	0
GDO	4942	IGT	5	300	Eating establishment	80	80	0		Single	750	one 750 gallon	90	1120
GDO	4943	IGT	2	150	Eating establishment	85	85	2500	CITY OF MIAMI BEACH	Single	750	one 750 gallon	90	625
GDO	4944	IGT	5	150	Eating establishment	68	0	3000	MIAMI DADE WATER & SEWER DEPARTMENT	Single	1050	one 1050 gallon	90	750
GDO	4947	AGRU	5	150	Eating establishment	40	40	1780	MIAMI DADE WATER & SEWER DEPARTMENT		0	one 25 gpm	30	1000
GDO	4949	IGT	5	150	Eating establishment	50	50	0	MIAMI DADE WATER & SEWER DEPARTMENT	Single	950	one 950 gallon	90	700
GDO	4951	IGT	5	750	Eating establishment	217	217	0		Series	2400	two 1200 gallon	90	5425
GDO	4952	MGRU	5	150	Eating establishment	0	0	550	MIAMI DADE WATER & SEWER DEPARTMENT		0	one 25 gpm	30	138
GDO	4954	IGT	5	150	Eating establishment	0	0	800	CITY OF HOMESTEAD	Single	1200	one 1200 gallon	90	200
GDO	4955	IGT	5	150	Eating establishment	0	0	0	MIAMI DADE WATER & SEWER DEPARTMENT	Single	1050	one 1050 gallon	90	0
GDO	4956	IGT	5	150	Eating establishment	60	60	0	MIAMI DADE WATER & SEWER DEPARTMENT	Single	1200	one 1200 gallon	90	840
GDO	4957	IGT	5	750	Eating establishment	518	518	0	MIAMI DADE WATER & SEWER DEPARTMENT	Series	2400	two 1200 gallon	90	12950
GDO	4958	MGRU	5	150	Eating establishment	25	0	1500	CITY OF HIALEAH		0	one 25 gpm	30	375
GDO	4959	MGRU	5	150	Eating establishment	30	30	0			0	not applicable	0	750
GDO	4960	IGT	5	150	Eating establishment	50	50	0	MIAMI DADE WATER & SEWER DEPARTMENT	Single	750	one 750 gallon	90	700
GDO	4962	IGT	5	300	Eating establishment	80	80	3975		Single	950	one 950 gallon	90	994
GDO	4963	IGT	5	300	Eating establishment	74	74	0		Single	1200	one 1200 gallon	90	1036
GDO	4965	IGT	5	300	Eating establishment	74	74	0	CITY OF MIAMI BEACH	Single	1200	one 1200 gallon	90	1850
GDO	4966	IGT	5	150	Eating establishment	74	74	2000	MIAMI DADE WATER & SEWER DEPARTMENT	Single	950	one 950 gallon	90	500
GDO	4968	AGRU	5	150	Eating establishment	32	32	1545	CITY OF NORTH MIAMI BEACH		0	one 25 gpm	30	386
GDO	4969	IGT	5	150	Eating establishment	30	30	0	CITY OF HIALEAH	Single	1050	one 1050 gallon	90	420
GDO	4970	IGT	5	150	Eating establishment	37	37	1600	MIAMI DADE WATER & SEWER DEPARTMENT	Single	750	one 750 gallon	90	400
GDO	4973	MGRU	5	150	Eating establishment	0	0	400	CITY OF CORAL GABLES		0	one 35 gpm	30	100
GDO	4974	IGT	5	300	Eating establishment	84	84	3250	CITY OF CORAL GABLES	Single	750	one 750 gallon	90	813
GDO	4975	IGT	5	150	Eating establishment	2	2	0		Single	1050	one 1050 gallon	90	1
GDO	4977	IGT	5	300	Eating establishment	91	91	0	MIAMI DADE WATER & SEWER DEPARTMENT	Series	1900	two 950 gallon	90	2275
GDO	4978	IGT	5	150	Eating establishment	0	0	814	MIAMI DADE WATER & SEWER DEPARTMENT	Series	3200	two 1600 gallon	90	204
GDO	4979	IGT	5	150	Eating establishment	0	0	0		Series	3200	two 1600 gallon	90	0
GDO	4981	MGRU	5	150	Eating establishment	0	0	0	MIAMI DADE WATER & SEWER DEPARTMENT		0	one 25 gpm	30	0
GDO	4982	IGT	5	150	Eating establishment	0	0	0	MIAMI DADE WATER & SEWER DEPARTMENT	Series	3200	two 1600 gallon	90	0
GDO	4983	IGT	5	150	Eating establishment	0	0	754	MIAMI DADE WATER & SEWER DEPARTMENT	Series	3200	two 1600 gallon	90	189
GDO	4984	IGT	5	150	Eating establishment	0	0	960	MIAMI DADE WATER & SEWER DEPARTMENT	Series	3200	two 1600-gallon	90	240
GDO	4994	IGT	5	150	Eating establishment	15	15	0		Single	1050	one 1050 gallon	90	210
GDO	4995	IGT	5	300	Eating establishment	74	74	0	MIAMI DADE WATER & SEWER DEPARTMENT	Single	1050	one 1050 gallon	90	1036
GDO	4996	IGT	5	150	Eating establishment	0	0	1120	MIAMI DADE WATER & SEWER DEPARTMENT	Single	750	one 750-gallon	90	280
GDO	4997	IGT	5	150	Eating establishment	112	112	0		Single	750	one 750 gallon	90	112
GDO	4998	IGT	5	150	Eating establishment	0	0	3165	MIAMI DADE WATER & SEWER DEPARTMENT	Single	750	one 750 gallon	90	791

WORK GROUP	PERMIT NUMBER	PERMIT CLASS	PERMIT	PERMIT FEE	BUSINESS_TYPE	RECORDED SEATS	OBSERVED SEATS	FACILITY AREA	UTILITY	SYSTEM FORMAT	TOTAL CAPACITY	TANK_CAPACITY	PUMP OUT	TOTAL GPD
GDO	4999	IGT	5	150	Eating establishment	120	120	2700	CITY OF HOMESTEAD	Single	1050	one 1050 gallon	90	990
GDO	5003	IGT	5	150	Eating establishment	0	0	0		Single	1050	one 1050 gallon	90	0
GDO	5005	IGT	5	150	Eating establishment	145	145	0	CITY OF HIALEAH GARDENS	Single	1200	one 1200 gallon	90	145
GDO	5009	AGRU	5	150	Eating establishment	13	13	0			0	one 25 gpm	30	182
GDO	5010	IGT	5	150	Eating establishment	0	0	0	MIAMI DADE WATER & SEWER DEPARTMENT	Single	750	one 750 gallon	90	0
GDO	5012	IGT	5	300	Eating establishment	100	100	0	MIAMI DADE WATER & SEWER DEPARTMENT	Single	650	one 650 gallon	90	2500
GDO	5013	MGRU	5	150	Eating establishment	24	0	1500			0	one 25 gpm	30	375
GDO	5020	IGT	5	150	Eating establishment	50	50	0	MIAMI DADE WATER & SEWER DEPARTMENT	Single	950	one 950 gallon	90	1250
GDO	5023	IGT	5	150	Eating establishment	40	40	1408	MIAMI DADE WATER & SEWER DEPARTMENT	Single	950	one 950 gallon	90	352
GDO	5024	IGT	5	150	Eating establishment	34	34	1485	MIAMI DADE WATER & SEWER DEPARTMENT	Single	950	one 950 gallon	90	371
GDO	5025	IGT	5	300	Eating establishment	250	250	4169	CITY OF MIAMI BEACH	Series	3950	two 1500 and one 950 gallon	90	1042
GDO	5026	AGRU	5	150	Eating establishment	8	8	936	CITY OF MIAMI BEACH		0	one 25 gpm	30	234
GDO	5027	IGT	5	150	Eating establishment	40	40	2235	CITY OF MIAMI BEACH	Single	950	one 950 gallon	90	560
GDO	5028	MGRU	5	150	Eating establishment	12	12	450	CITY OF NORTH MIAMI BEACH		0	one 25 gpm	30	113
GDO	5029	MGRU	5	150	Eating establishment	6	6	0	CITY OF HIALEAH		0	one 25 gpm	30	84
GDO	5034	MGRU	5	150	Eating establishment	70	0	1600	MIAMI DADE WATER & SEWER DEPARTMENT		0	one 35 gpm	30	400
GDO	5035	IGT	5	150	Eating establishment	58	58	2000	MIAMI DADE WATER & SEWER DEPARTMENT	Single	750	one 750 gallon	90	500
GDO	5037	IGT	5	150	Eating establishment	95	95	2900	MIAMI DADE WATER & SEWER DEPARTMENT	Single	7050	one 750 gallon	90	725
GDO	5042	IGT	5	300	Eating establishment	292	292	0	MIAMI DADE WATER & SEWER DEPARTMENT	Series	8400	seven 1200 gallon	90	7300
GDO	5043	IGT	5	150	Eating establishment	56	56	2470	MIAMI DADE WATER & SEWER DEPARTMENT	Single	950	one 950 gallon	90	618
GDO	5044	IGT	5	150	Eating establishment	76	76	2400		Single	750	one 750 gallon	90	600
GDO	5047	MGRU	5	150	Eating establishment	4	4	850	CITY OF HIALEAH		0	one 25 gpm	30	213
GDO	5048	IGT	5	150	Eating establishment	44	44	0	MIAMI DADE WATER & SEWER DEPARTMENT	Single	950	one 950 gallon	90	1100
GDO	5049	IGT	5	150	Eating establishment	6	6	920	MIAMI DADE WATER & SEWER DEPARTMENT	Series	2100	two 1050 gallon	90	274
GDO	5053	AGRU	5	150	Eating establishment	25	25	0	MIAMI DADE WATER & SEWER DEPARTMENT		0	one 25 gpm	30	350
GDO	5057	MGRU	5	150	Eating establishment	92	92	3401	CITY OF MIAMI BEACH		0	one 25 gpm	30	850
GDO	5058	IGT	5	150	Eating establishment	12	12	120	MIAMI DADE WATER & SEWER DEPARTMENT	Single	750	one 750-gallon	90	30
GDO	5059	IGT	5	300	Eating establishment	60	60	0	MIAMI DADE WATER & SEWER DEPARTMENT	Single	750	one 750 gallon	90	840
GDO	5060	MGRU	2	150	Eating establishment	12	12	600	MIAMI DADE WATER & SEWER DEPARTMENT		0	one 25 gpm	30	150
GDO	5062	IGT	5	150	Eating establishment	0	0	775	MIAMI DADE WATER & SEWER DEPARTMENT	Series	4000	two 2000 gallon	90	194
GDO	5063	IGT	5	150	Eating establishment	0	0	775	MIAMI DADE WATER & SEWER DEPARTMENT	Series	4000	two 2000 gallon	90	194
GDO	5064	IGT	5	150	Eating establishment	0	0	1042	MIAMI DADE WATER & SEWER DEPARTMENT	Series	4000	two 2000 gallon	90	261
GDO	5065	IGT	5	150	Eating establishment	0	0	906	MIAMI DADE WATER & SEWER DEPARTMENT	Series	4000	one 2000 gallon	90	227
GDO	5067	AGRU	5	150	Eating establishment	0	0	734	MIAMI DADE WATER & SEWER DEPARTMENT		0	one 75 gpm	30	184
GDO	5069	IGT	5	150	Eating establishment	0	0	220	MIAMI DADE WATER & SEWER DEPARTMENT	Single	750	one 750 gallon	90	0
GDO	5070	MGRU	5	150	Eating establishment	29	29	600	MIAMI DADE WATER & SEWER DEPARTMENT		0	one 25 gpm	30	150
GDO	5071	IGT	5	150	Eating establishment	20	0	1200	MIAMI DADE WATER & SEWER DEPARTMENT	Series	3750	three 1250 gallon	60	300
GDO	5072	IGT	5	150	Eating establishment	60	60	2000	MIAMI DADE WATER & SEWER DEPARTMENT	Single	1250	one 1250 gallon	90	500
GDO	5075	IGT	5	150	Eating establishment	40	0	1400	MIAMI DADE WATER & SEWER DEPARTMENT	Single	1050	one 1050 gallon	60	350
GDO	5076	IGT	5	150	Eating establishment	36	0	900	MIAMI DADE WATER & SEWER DEPARTMENT	Single	1050	one 1050 gallon	60	225
GDO	5077	IGT	5	300	Eating establishment	88	88	0		Single	1200	one 1200 gallon	90	1232
GDO	5080	IGT	5	300	Eating establishment	254	254	4000	MIAMI DADE WATER & SEWER DEPARTMENT	Single	1050	one 1050 gallon	90	1000
GDO	5081	IGT	5	150	Eating establishment	16	16	500	MIAMI DADE WATER & SEWER DEPARTMENT	Single	1050	one 1050 gallon	90	125
GDO	5082	IGT	5	150	Eating establishment	48	48	1740	MIAMI DADE WATER & SEWER DEPARTMENT	Single	750	one 750 gallon	90	1200
GDO	5083	IGT	5	150	Eating establishment	40	40	0	CITY OF HIALEAH	Single	750	one 750 gallon	90	1000
GDO	5084	IGT	5	150	Eating establishment	26	26	1711	MIAMI DADE WATER & SEWER DEPARTMENT	Single	750	one 750 gallon	90	428
GDO	5085	IGT	5	150	Eating establishment	0	0	0	MIAMI DADE WATER & SEWER DEPARTMENT	Series	750	one 25 gpm agru and one 750 gallon	90	0
GDO	5091	IGT	5	300	Eating establishment	318	0	11700	MIAMI DADE WATER & SEWER DEPARTMENT	Series	6000	three 2000 gallon	30	2925
GDO	5092	IGT	3	300	Eating establishment	150	150	4400	MIAMI DADE WATER & SEWER DEPARTMENT	Single	1050	one 1050 gallon	90	1100
GDO	5093	IGT	5	150	Eating establishment	27	27	0	CITY OF NORTH MIAMI BEACH	Single	1050	one 1050 gallon	90	378
GDO	5094	IGT	5	150	Eating establishment	20	20	1200	MIAMI DADE WATER & SEWER DEPARTMENT	Single	750	one 750 gallon	90	300
GDO	5101	MGRU	5	150	Eating establishment	30	30	1486	CITY OF MIAMI BEACH		0	one 25 gpm	30	372
GDO	5107	IGT	5	300	Eating establishment	74	74	0	MIAMI DADE WATER & SEWER DEPARTMENT	Single	1050	one 1050 gallon	90	1850
GDO	5108	IGT	5	300	Eating establishment	180	0	5613	CITY OF FLORIDA CITY	Multiple	4500	two 1200 and two 1050 gallon	90	78582
GDO	5109	MGRU	5	150	Eating establishment	0	0	840	MIAMI DADE WATER & SEWER DEPARTMENT		0	one 25 gpm	30	210
GDO	5111	MGRU	5	150	Eating establishment	0	0	2410	CITY OF MIAMI BEACH		0	one 35 gpm	30	603
GDO	5112	MGRU	5	150	Eating establishment	22	22	0	MIAMI DADE WATER & SEWER DEPARTMENT		0	one 25 gpm	30	308
GDO	5114	IGT	5	150	Eating establishment	200	200	4100	MIAMI DADE WATER & SEWER DEPARTMENT	Single	950	one 950 gallon	90	1000

WORK GROUP	PERMIT NUMBER	PERMIT CLASS	PERMIT	PERMIT FEE	BUSINESS_TYPE	RECORDED SEATS	OBSERVED SEATS	FACILITY AREA	UTILITY	SYSTEM FORMAT	TOTAL CAPACITY	TANK_CAPACITY	PUMP OUT	TOTAL GPD
GDO	5115	IGT	5	150	Eating establishment	0	0	0	MIAMI DADE WATER & SEWER DEPARTMENT	Single	750	one 750 gallon	90	0
GDO	5118	IGT	5	150	Eating establishment	30	30	1711	MIAMI DADE WATER & SEWER DEPARTMENT	Single	1600	one 1600 gallon	90	428
GDO	5121	IGT	2	150	Eating establishment	30	30	1700	CITY OF HIALEAH	Single	750	one 750 gallon	90	425
GDO	5122	MGRU	5	150	Eating establishment	30	30	1100	CITY OF HIALEAH		0	one 25 gpm	30	275
GDO	5126	MGRU	5	150	Eating establishment	0	0	2920	CITY OF NORTH MIAMI BEACH		0	one 25 gpm	30	730
GDO	5130	IGT	5	150	Eating establishment	0	0	0		Single	1050	one 1050 gallon	90	0
GDO	5132	IGT	5	300	Eating establishment	55	55	0	MIAMI DADE WATER & SEWER DEPARTMENT	Single	2000	one 2000 gallon	90	770
GDO	5136	IGT	5	150	Eating establishment	15	15	0	MIAMI DADE WATER & SEWER DEPARTMENT	Single	750	one 750 gallon	90	210
GDO	5137	IGT	5	150	Eating establishment	26	26	2520	CITY OF NORTH MIAMI BEACH	Single	1800	one 1800 gallon	90	630
GDO	5138	MGRU	5	300	Eating establishment	96	96	0	CITY OF MIAMI BEACH		0	one 25 gpm	30	2400
GDO	5141	MGRU	5	300	Eating establishment	175	0	10600	CITY OF MIAMI BEACH		0	two 100 gpm	90	2718
GDO	5149	IGT	5	150	Eating establishment	0	0	600	MIAMI DADE WATER & SEWER DEPARTMENT	Single	2400	two 1200 gallon	90	150
GDO	5155	IGT	5	150	Eating establishment	75	0	3391	MIAMI DADE WATER & SEWER DEPARTMENT	Single	1250	one 1250 gallon	60	848
GDO	5156	IGT	5	150	Eating establishment	30	0	1200	CITY OF HIALEAH	Single	1050	one 1050 gallon	60	300
GDO	5163	MGRU	5	150	Eating establishment	20	20	0	MIAMI DADE WATER & SEWER DEPARTMENT		0	one 25 gpm	30	500
GDO	5173	IGT	5	150	Eating establishment	45	0	400	MIAMI DADE WATER & SEWER DEPARTMENT	Single	1250	one 1250 gallon	90	100
GDO	5174	IGT	5	150	Eating establishment	80	80	0	MIAMI DADE WATER & SEWER DEPARTMENT	Single	1600	one 1600 gallon	90	2000
GDO	5176	IGT	5	150	Eating establishment	0	0	0	MIAMI DADE WATER & SEWER DEPARTMENT	Single	1600	one 1600 gallon	90	0
GDO	5179	MGRU	5	150	Eating establishment	100	100	2136	MIAMI DADE WATER & SEWER DEPARTMENT		0	one 25 gpm	30	534
GDO	5181	IGT	5	150	Eating establishment	28	28	0	MIAMI DADE WATER & SEWER DEPARTMENT	Single	750	one 750 gallon	90	392
GDO	5183	IGT	5	150	Eating establishment	44	44	0	MIAMI DADE WATER & SEWER DEPARTMENT	Single	750	one 750 gallon	90	1100
GDO	5189	IGT	5	150	Eating establishment	20	20	0		Single	750	one 750 gallon	90	280
GDO	5190	IGT	5	150	Eating establishment	25	25	0	MIAMI DADE WATER & SEWER DEPARTMENT	Single	750	one 750 gallon	90	625
GDO	5191	AGRU	5	150	Eating establishment	0	0	0	MIAMI DADE WATER & SEWER DEPARTMENT		0	one 25 gpm	30	0
GDO	5192	IGT	5	150	Eating establishment	0	0	1600	CITY OF CORAL GABLES	Single	750	one 750 gallon	90	400
GDO	5194	MGRU	5	150	Eating establishment	24	24	0	MIAMI DADE WATER & SEWER DEPARTMENT		0	one 25 gpm	30	600
GDO	5195	IGT	5	150	Eating establishment	0	0	1106	MIAMI DADE WATER & SEWER DEPARTMENT	Single	1600	one 1600 gallon	90	0
GDO	5196	IGT	5	300	Eating establishment	80	80	0	MIAMI DADE WATER & SEWER DEPARTMENT	Single	1600	one 1600 gallon	90	1120
GDO	5204	IGT	5	300	Eating establishment	144	144	4200	MIAMI DADE WATER & SEWER DEPARTMENT	Single	1600	one 1600-gallon	90	1050
GDO	5208	IGT	5	150	Eating establishment	26	26	2000	MIAMI DADE WATER & SEWER DEPARTMENT	Single	1200	one 1200 gallon	90	500
GDO	5215	IGT	5	150	Eating establishment	50	50	1200	MIAMI DADE WATER & SEWER DEPARTMENT	Single	1050	one 1050 gallon	90	300
GDO	5217	IGT	5	150	Eating establishment	23	23	0	MIAMI DADE WATER & SEWER DEPARTMENT	Single	950	one 950 gallon	90	575
GDO	5219	IGT	5	150	Eating establishment	70	70	2900	MIAMI DADE WATER & SEWER DEPARTMENT	Single	750	one 750-gallon	90	725
GDO	5220	MGRU	5	300	Eating establishment	115	115	0	MIAMI DADE WATER & SEWER DEPARTMENT		0	one 20 gpm	30	2875
GDO	5221	IGT	5	300	Eating establishment	80	80	0	CITY OF CORAL GABLES	Single	750	one 750 gallon	90	2000
GDO	5227	AGRU	5	150	Eating establishment	0	0	750	MIAMI DADE WATER & SEWER DEPARTMENT		0	one 25 gpm	30	188
GDO	5229	AGRU	5	300	Eating establishment	55	55	1978	MIAMI DADE WATER & SEWER DEPARTMENT		0	one 25 gpm	30	495
GDO	5231	MGRU	5	150	Eating establishment	7	7	0	CITY OF HIALEAH		0	one 25 gpm	30	2
GDO	5233	IGT	5	150	Eating establishment	30	30	0	CITY OF HIALEAH	Single	750	one 750 gallon	90	750
GDO	5237	IGT	5	300	Eating establishment	195	195	0	MIAMI DADE WATER & SEWER DEPARTMENT	Single	950	one 950 gallon	90	4875
GDO	5239	IGT	5	150	Eating establishment	48	0	1866	CITY OF MIAMI SPRINGS	Single	1000	one 1000 gallon	60	467
GDO	5240	IGT	5	150	Eating establishment	50	50	0	MIAMI DADE WATER & SEWER DEPARTMENT	Single	750	one 750 gallon	90	1250
GDO	5241	IGT	5	300	Eating establishment	64	64	0	MIAMI DADE WATER & SEWER DEPARTMENT	Single	750	one 750 gallon	90	1600
GDO	5244	IGT	5	300	Eating establishment	200	200	0	MIAMI DADE WATER & SEWER DEPARTMENT	Single	750	one 750 gallon	90	5000
GDO	5245	IGT	5	300	Eating establishment	149	149	0		Single	1050	one 1050 gallon	90	3725
GDO	5250	IGT	5	300	Eating establishment	200	200	4000	MIAMI DADE WATER & SEWER DEPARTMENT	Single	750	one 750-gallon	90	1000
GDO	5251	IGT	5	750	Eating establishment	350	350	0	MIAMI DADE WATER & SEWER DEPARTMENT	Series	3150	two 1200 gallon and one 750 gallon	90	4900
GDO	5253	IGT	5	150	Eating establishment	0	0	0	MIAMI DADE WATER & SEWER DEPARTMENT	Single	750	one 750 gallon	90	0
GDO	5256	IGT	5	300	Eating establishment	65	65	0	CITY OF MIAMI SPRINGS	Single	750	one 750 gallon	90	1625
GDO	5257	MGRU	5	300	Eating establishment	73	73	4065	CITY OF MIAMI BEACH		0	one 35 gpm	30	1093
GDO	5259	IGT	5	150	Eating establishment	60	60	1512	CITY OF MIAMI BEACH	Single	1600	one 1600 gallon	90	378
GDO	5261	AGRU	5	150	Eating establishment	11	11	960	MIAMI DADE WATER & SEWER DEPARTMENT		0	one 25 gpm	30	154
GDO	5262	IGT	5	150	Eating establishment	20	20	350	MIAMI DADE WATER & SEWER DEPARTMENT	Single	1250	one 1250 gallon	60	88
GDO	5263	IGT	5	150	Eating establishment	30	0	1600	CITY OF HIALEAH	Single	750	one 750 gallon	60	400
GDO	5264	IGT	5	150	Eating establishment	38	38	2000	MIAMI DADE WATER & SEWER DEPARTMENT	Single	950	one 950 gallon	90	950
GDO	5265	MGRU	5	150	Eating establishment	0	0	0			0	one 25 gpm	30	0
GDO	5266	AGRU	5	150	Eating establishment	0	0	0	MIAMI DADE WATER & SEWER DEPARTMENT		0	one 25 gpm	30	0
GDO	5270	AGRU	5	150	Eating establishment	16	16	0	MIAMI DADE WATER & SEWER DEPARTMENT		0	one 25 gpm	30	224
GDO	5273	IGT	5	150	Eating establishment	40	40	0	CITY OF MIAMI BEACH	Single	950	one 950 gallon	90	1000
GDO	5275	MGRU	5	150	Eating establishment	60	60	2000	MIAMI DADE WATER & SEWER DEPARTMENT		0	one 25 gpm	30	500

WORK GROUP	PERMIT NUMBER	PERMIT CLASS	PERMIT	PERMIT FEE	BUSINESS_TYPE	RECORDED SEATS	OBSERVED SEATS	FACILITY AREA	UTILITY	SYSTEM FORMAT	TOTAL CAPACITY	TANK_CAPACITY	PUMP OUT	TOTAL GPD
GDO	5277	IGT	5	150	Eating establishment	44	44	1750	MIAMI DADE WATER & SEWER DEPARTMENT	Single	750	one 750 gallon	90	438
GDO	5280	IGT	5	300	Eating establishment	220	0	5462	CITY OF NORTH MIAMI BEACH	Single	1250	one 1250 gallon	30	1366
GDO	5284	MGRU	5	300	Eating establishment	74	74	0	CITY OF MIAMI BEACH		0	one 25 gpm	30	1850
GDO	5285	IGT	5	150	Eating establishment	0	0	0	CITY OF HIALEAH	Single	750	one 750 gallon	90	0
GDO	5289	IGT	5	150	Eating establishment	0	0	1023	CITY OF HIALEAH	Single	950	one 950 gallon	90	256
GDO	5291	IGT	5	150	Eating establishment	49	49	2200	CITY OF MIAMI BEACH	Single	950	one 950 gallon	90	550
GDO	5293	IGT	5	150	Eating establishment	0	0	4220	MIAMI DADE WATER & SEWER DEPARTMENT	Single	750	one 750 gallon	90	1055
GDO	5294	IGT	5	150	Eating establishment	60	0	1800	MIAMI DADE WATER & SEWER DEPARTMENT	Single	750	one 750 gallon	90	450
GDO	5295	IGT	5	150	Eating establishment	192	0	3909	MIAMI DADE WATER & SEWER DEPARTMENT	Single	1200	one 1200 gallon	90	977
GDO	5297	IGT	5	150	Eating establishment	56	56	2360	MIAMI DADE WATER & SEWER DEPARTMENT		950	one 950 gallon	90	590
GDO	5298	IGT	5	150	Eating establishment	37	37	0	MIAMI DADE WATER & SEWER DEPARTMENT	Single	1050	one 1050 gallon	90	925
GDO	5299	MGRU	5	150	Eating establishment	20	0	946	CITY OF MIAMI BEACH		0	one 50 gpm	90	237
GDO	5300	MGRU	5	300	Eating establishment	200	0	5440	MIAMI DADE WATER & SEWER DEPARTMENT		0	one 100 gpm	30	1360
GDO	5303	IGT	5	300	Eating establishment	198	198	5989	MIAMI DADE WATER & SEWER DEPARTMENT	Single	1050	one 1050-gallon	90	1497
GDO	5305	MGRU	5	300	Eating establishment	130	130	0	CITY OF MIAMI BEACH		0	one 25 gpm	30	3250
GDO	5306	AGRU	5	150	Eating establishment	26	22	0	CITY OF MIAMI BEACH		0	one 25 gpm	30	308
GDO	5315	IGT	5	150	Eating establishment	30	30	1200	CITY OF HIALEAH	Single	750	one 750 gallon	90	300
GDO	5317	MGRU	5	150	Eating establishment	20	20	0			0	one 25 gpm	30	500
GDO	5322	MGRU	5	150	Eating establishment	32	32	1262	CITY OF MIAMI BEACH		0	one 25 gpm	30	367
GDO	5325	IGT	5	300	Eating establishment	150	150	5695	MIAMI DADE WATER & SEWER DEPARTMENT	Series	2400	two 1200 gallon	90	1424
GDO	5329	IGT	5	150	Eating establishment	30	30	2000	MIAMI DADE WATER & SEWER DEPARTMENT	Single	950	one 950 gallon	90	500
GDO	5330	IGT	5	300	Eating establishment	74	74	0	MIAMI DADE WATER & SEWER DEPARTMENT	Series	2400	two 1200 gallon	90	1036
GDO	5332	MGRU	5	150	Eating establishment	43	43	0	CITY OF MIAMI BEACH		0	one 25-gpm	30	1075
GDO	5333	IGT	5	150	Eating establishment	30	30	0	MIAMI DADE WATER & SEWER DEPARTMENT	Single	750	one 750 gallon	90	750
GDO	5339	IGT	5	150	Eating establishment	0	0	0	MIAMI DADE WATER & SEWER DEPARTMENT	Single	1200	one 1200 gallon	90	0
GDO	5341	MGRU	5	150	Eating establishment	30	30	800	CITY OF HIALEAH		0	one 25-gpm	30	200
GDO	5342	MGRU	5	150	Eating establishment	20	20	1335	CITY OF MIAMI BEACH		0	one 20 gpm	30	334
GDO	5343	IGT	5	300	Eating establishment	172	172	4941	MIAMI DADE WATER & SEWER DEPARTMENT	Single	950	one 950 gallon	90	1235
GDO	5344	IGT	2	300	Eating establishment	0	0	3000	MIAMI DADE WATER & SEWER DEPARTMENT	Single	1200	one 1200 gallon	60	750
GDO	5346	IGT	5	300	Eating establishment	294	294	5000	CITY OF MIAMI BEACH	Single	4500	one 4500-gallon	90	1321
GDO	5348	IGT	5	150	Eating establishment	46	0	2400	MIAMI DADE WATER & SEWER DEPARTMENT	Single	750	one 750 gallon	60	600
GDO	5352	IGT	5	150	Eating establishment	49	49	0		Single	1050	one 1050 gallon	90	686
GDO	5355	IGT	5	150	Eating establishment	14	14	0		Single	750	one 750 gallon	90	350
GDO	5356	MGRU	5	150	Eating establishment	16	16	640	CITY OF HIALEAH		0	one 25 gpm	30	160
GDO	5357	IGT	5	300	Eating establishment	80	80	2000	MIAMI DADE WATER & SEWER DEPARTMENT	Single	1200	one 1200 gallon	90	2000
GDO	5359	IGT	5	150	Eating establishment	0	0	0	MIAMI DADE WATER & SEWER DEPARTMENT	Single	750	one 750 gallon	90	0
GDO	5361	AGRU	5	150	Eating establishment	0	0	1286	MIAMI DADE WATER & SEWER DEPARTMENT		0	one 25 gpm	30	322
GDO	5362	IGT	5	300	Eating establishment	74	74	0	CITY OF HIALEAH GARDENS	Single	1200	one 1200 gallon	90	1036
GDO	5363	IGT	5	150	Eating establishment	40	40	0		Single	1500	one 1500 gallon	90	1000
GDO	5364	IGT	5	300	Eating establishment	130	130	0		Single	1600	one 1600 gallon	90	0
GDO	5367	MGRU	5	150	Eating establishment	126	126	1273	CITY OF MIAMI BEACH		0	one 25 gpm	30	658
GDO	5368	IGT	5	150	Eating establishment	8	8	1100	MIAMI DADE WATER & SEWER DEPARTMENT	Single	1050	one 1050 gallon	90	275
GDO	5371	IGT	5	300	Eating establishment	200	200	3750	MIAMI DADE WATER & SEWER DEPARTMENT	Series	1900	two 950-gallon	90	938
GDO	5372	IGT	5	300	Eating establishment	129	129	0	MIAMI DADE WATER & SEWER DEPARTMENT	Single	950	one 950 gallon	90	3225
GDO	5377	MGRU	5	150	Eating establishment	100	0	3552	MIAMI DADE WATER & SEWER DEPARTMENT		0	one 100 gpm	30	888
GDO	5379	IGT	5	300	Eating establishment	200	200	0	MIAMI DADE WATER & SEWER DEPARTMENT	Single	1050	one 1050 gallon	90	5000
GDO	5380	IGT	5	300	Eating establishment	80	80	0	MIAMI DADE WATER & SEWER DEPARTMENT	Single	950	one 950 gallon	90	2000
GDO	5381	IGT	5	150	Eating establishment	40	40	0	MIAMI DADE WATER & SEWER DEPARTMENT	Single	1200	one 1200 gallon	90	1000
GDO	5383	IGT	5	300	Eating establishment	60	60	0	MIAMI DADE WATER & SEWER DEPARTMENT	Single	950	one 950 gallon	90	1500
GDO	5384	IGT	5	300	Eating establishment	54	54	0	MIAMI DADE WATER & SEWER DEPARTMENT	Single	750	one 750 gallon	90	1350
GDO	5388	IGT	5	300	Eating establishment	108	108	0		Series	1900	two 950 gallon	90	1512
GDO	5395	IGT	5	300	Eating establishment	200	200	0	MIAMI DADE WATER & SEWER DEPARTMENT	Series	8000	five 1600 gallon	90	5000
GDO	5397	MGRU	5	150	Eating establishment	0	0	1000	MIAMI DADE WATER & SEWER DEPARTMENT		0	one 25 gpm	30	250
GDO	5402	IGT	5	150	Eating establishment	180	180	1500	CITY OF NORTH MIAMI BEACH	Series	2100	two 1050 gallon	90	375
GDO	5403	IGT	5	150	Eating establishment	0	0	0	MIAMI DADE WATER & SEWER DEPARTMENT	Single	1200	one 1200 gallon	90	0
GDO	5404	MGRU	5	150	Eating establishment	12	12	966	MIAMI DADE WATER & SEWER DEPARTMENT		0	one 25 gpm	30	242
GDO	5406	IGT	5	150	Eating establishment	31	0	1300	MIAMI DADE WATER & SEWER DEPARTMENT	Single	400	one 400 gallon	90	413
GDO	5407	MGRU	5	150	Eating establishment	24	24	0	MIAMI DADE WATER & SEWER DEPARTMENT		0	not applicable	30	336
GDO	5411	AGRU	5	300	Eating establishment	172	172	0	MIAMI DADE WATER & SEWER DEPARTMENT		0	one 50 gpm	30	2408
GDO	5412	AGRU	5	300	Eating establishment	132	132	0			0	one 50 gpm	30	3300
GDO	5413	IGT	5	150	Eating establishment	24	24	825	MIAMI DADE WATER & SEWER DEPARTMENT	Single	1000	one 1000 gallon	30	206

WORK GROUP	PERMIT NUMBER	PERMIT CLASS	PERMIT	PERMIT FEE	BUSINESS_TYPE	RECORDED SEATS	OBSERVED SEATS	FACILITY AREA	UTILITY	SYSTEM FORMAT	TOTAL CAPACITY	TANK_CAPACITY	PUMP OUT	TOTAL GPD
GDO	5415	IGT	5	150	Eating establishment	48	48	0	CITY OF HIALEAH	Single	750	one 750 gallon	90	700
GDO	5419	IGT	5	150	Eating establishment	20	20	0	MIAMI DADE WATER & SEWER DEPARTMENT	Single	750	one 750 gallon	90	280
GDO	5421	MGRU	5	300	Eating establishment	90	0	4670	MIAMI DADE WATER & SEWER DEPARTMENT		0	one 75 gpm	30	1168
GDO	5422	IGT	5	150	Eating establishment	0	0	1000	MIAMI DADE WATER & SEWER DEPARTMENT	Single	750	one 750 gallon	90	250
GDO	5424	IGT	5	300	Eating establishment	149	149	0	MIAMI DADE WATER & SEWER DEPARTMENT	Single	2000	one 2000 gallon	90	2086
GDO	5426	AGRU	5	150	Eating establishment	0	0	455	MIAMI DADE WATER & SEWER DEPARTMENT		0	one 25 gpm	30	114
GDO	5427	MGRU	5	150	Eating establishment	40	0	1400			0	one 20 gpm	30	350
GDO	5429	MGRU	5	150	Eating establishment	35	0	1070	MIAMI DADE WATER & SEWER DEPARTMENT		0	one 25 gpm	30	268
GDO	5431	IGT	5	150	Eating establishment	0	0	0		Single	950	one 950 gallon	90	0
GDO	5432	MGRU	5	150	Eating establishment	0	0	0	MIAMI DADE WATER & SEWER DEPARTMENT		0	one 25 gpm	30	0
GDO	5436	IGT	5	300	Eating establishment	200	200	0	MIAMI DADE WATER & SEWER DEPARTMENT	Single	1200	one 1200 gallon	90	5000
GDO	5444	IGT	5	300	Eating establishment	149	149	0	MIAMI DADE WATER & SEWER DEPARTMENT	Single	1200	one 1200 gallon	90	3725
GDO	5448	IGT	5	150	Eating establishment	50	50	0	MIAMI DADE WATER & SEWER DEPARTMENT	Single	750	one 750 gallon	90	700
GDO	5452	IGT	5	150	Eating establishment	22	22	0	MIAMI DADE WATER & SEWER DEPARTMENT	Single	950	one 950 gallon	60	6
GDO	5454	IGT	5	150	Eating establishment	54	54	1742	MIAMI DADE WATER & SEWER DEPARTMENT	Single	750	one 750 gallon	90	436
GDO	5455	IGT	5	150	Eating establishment	20	0	900	MIAMI DADE WATER & SEWER DEPARTMENT	Single	950	one 950 gallon	60	225
GDO	5456	IGT	5	150	Eating establishment	30	30	1200	MIAMI DADE WATER & SEWER DEPARTMENT	Single	950	one 950 gallon	90	300
GDO	5457	AGRU	5	300	Eating establishment	112	112	0	CITY OF MIAMI BEACH		0	one 35 gpm	30	2800
GDO	5461	MGRU	5	150	Eating establishment	34	34	0			0	one 25 gpm	30	850
GDO	5465	IGT	5	150	Eating establishment	0	0	0		Parallel	1900	two 950-gallon	90	0
GDO	5468	IGT	5	150	Eating establishment	0	0	0	MIAMI DADE WATER & SEWER DEPARTMENT	Single	750	one 750 gallon	90	0
GDO	5470	IGT	5	150	Eating establishment	48	48	0		Single	1050	one 1050 gallon	90	672
GDO	5478	IGT	5	150	Eating establishment	20	20	1300	MIAMI DADE WATER & SEWER DEPARTMENT	Single	1200	one 1200 gallon	90	500
GDO	5479	IGT	5	150	Eating establishment	0	0	600	MIAMI DADE WATER & SEWER DEPARTMENT	Series	3600	three 1200 gallon	90	150
GDO	5480	IGT	5	150	Eating establishment	30	30	0	MIAMI DADE WATER & SEWER DEPARTMENT	Multiple	3600	three 1200 gallon	90	420
GDO	5486	IGT	5	150	Eating establishment	28	28	1320	MIAMI DADE WATER & SEWER DEPARTMENT	Single	950	one 950 gallon	90	330
GDO	5487	MGRU	5	150	Eating establishment	0	0	2958	MIAMI DADE WATER & SEWER DEPARTMENT		0	one 10 and one 50 gpm	30	740
GDO	5488	MGRU	5	300	Eating establishment	74	74	0	MIAMI DADE WATER & SEWER DEPARTMENT		0	one 25 gpm	30	1850
GDO	5492	MGRU	5	150	Eating establishment	0	0	892	CITY OF MIAMI BEACH		0	one 25-gpm	30	223
GDO	5493	IGT	5	150	Eating establishment	0	0	463	MIAMI DADE WATER & SEWER DEPARTMENT	Single	750	one 750 gallon	90	116
GDO	5497	MGRU	5	300	Eating establishment	90	0	2450	MIAMI DADE WATER & SEWER DEPARTMENT		0	one 100 gpm	60	613
GDO	5500	IGT	5	150	Eating establishment	0	0	0	MIAMI DADE WATER & SEWER DEPARTMENT	Single	750	one 750 gallon	90	0
GDO	5501	IGT	5	150	Eating establishment	0	0	593		Multiple	3600	three 1200 gallon	90	148
GDO	5504	IGT	5	150	Eating establishment	0	0	758	MIAMI DADE WATER & SEWER DEPARTMENT	Multiple	2400	two 1200-gallon	90	190
GDO	5505	IGT	5	150	Eating establishment	20	20	554	MIAMI DADE WATER & SEWER DEPARTMENT	Multiple	3600	three 1200 gallon	90	139
GDO	5506	MGRU	5	150	Eating establishment	3	3	850	CITY OF HIALEAH		0	one 25 gpm	30	213
GDO	5507	IGT	5	150	Eating establishment	18	18	0		Single	950	one 950 gallon	90	5
GDO	5510	AGRU	5	150	Eating establishment	14	14	0	MIAMI DADE WATER & SEWER DEPARTMENT		0	one 25 gpm	30	196
GDO	5515	IGT	5	150	Eating establishment	65	0	1500	MIAMI DADE WATER & SEWER DEPARTMENT	Single	750	one 750 gallon	90	375
GDO	5516	IGT	5	300	Eating establishment	204	204	5797	MIAMI DADE WATER & SEWER DEPARTMENT	Single	1200	one 1200 gallon	90	1449
GDO	5519	IGT	5	150	Eating establishment	45	0	3000	MIAMI DADE WATER & SEWER DEPARTMENT	Single	950	one 950 gallon	60	750
GDO	5520	IGT	5	300	Eating establishment	54	54	0		Single	1500	one 1500 gallon	90	756
GDO	5522	IGT	5	150	Eating establishment	25	25	900	MIAMI DADE WATER & SEWER DEPARTMENT	Single	750	one 750 gallon	90	225
GDO	5525	IGT	5	150	Eating establishment	36	36	2090	CITY OF HIALEAH	Single	950	one 950-gallon	90	523
GDO	5526	IGT	5	150	Eating establishment	0	0	0		Single	750	one 750 gallon	90	0
GDO	5536	MGRU	5	150	Eating establishment	24	0	1200	MIAMI DADE WATER & SEWER DEPARTMENT		0	one 10 gpm	30	417
GDO	5537	IGT	5	150	Eating establishment	45	45	1410	MIAMI DADE WATER & SEWER DEPARTMENT	Single	750	one 750-gallon	90	353
GDO	5538	MGRU	5	150	Eating establishment	30	0	1500	MIAMI DADE WATER & SEWER DEPARTMENT		0	one 25 gpm	30	375
GDO	5539	MGRU	5	300	Eating establishment	70	70	4000	MIAMI DADE WATER & SEWER DEPARTMENT		0	one 25-gpm	30	1000
GDO	5541	IGT	5	150	Eating establishment	36	36	0	CITY OF NORTH MIAMI BEACH	Single	750	one 750 gallon	90	504
GDO	5542	IGT	5	150	Eating establishment	0	0	0		Series	3600	three 1200 gallon	90	0
GDO	5545	IGT	5	150	Eating establishment	0	0	0	MIAMI DADE WATER & SEWER DEPARTMENT	Single	750	one 750 gallon	90	0
GDO	5546	AGRU	5	150	Eating establishment	42	42	0			0	one 25 gpm	30	588
GDO	5548	MGRU	5	150	Eating establishment	2	2	0	CITY OF MIAMI BEACH		0	one 25 gpm	30	28
GDO	5549	MGRU	5	150	Eating establishment	15	0	969	MIAMI DADE WATER & SEWER DEPARTMENT		0	one 35 gpm	30	242
GDO	5554	IGT	5	150	Eating establishment	10	0	1500	CITY OF NORTH MIAMI BEACH	Single	750	one 750-gallon	30	375
GDO	5555	IGT	5	300	Eating establishment	150	150	10722	MIAMI DADE WATER & SEWER DEPARTMENT	Series	2400	two 1200 gallon	90	2681
GDO	5563	AGRU	5	300	Eating establishment	0	0	0			0	one 35 gpm	30	0
GDO	5564	AGRU	5	150	Eating establishment	30	30	1829	CITY OF MIAMI BEACH		0	one 25 gpm	30	457
GDO	5565	IGT	5	150	Eating establishment	0	0	463	MIAMI DADE WATER & SEWER DEPARTMENT	Series	2400	two 1200 gallon	90	116

WORK GROUP	PERMIT NUMBER	PERMIT CLASS	PERMIT	PERMIT FEE	BUSINESS_TYPE	RECORDED SEATS	OBSERVED SEATS	FACILITY AREA	UTILITY	SYSTEM FORMAT	TOTAL CAPACITY	TANK_CAPACITY	PUMP OUT	TOTAL GPD
GDO	5566	AGRU	5	150	Eating establishment	0	0	1700	MIAMI DADE WATER & SEWER DEPARTMENT		0	one 25 gpm	30	425
GDO	5567	IGT	5	750	Eating establishment	205	205	0	MIAMI DADE WATER & SEWER DEPARTMENT	Series	2400	two 1200 gallon	90	5125
GDO	5568	IGT	5	150	Eating establishment	0	0	1579	MIAMI DADE WATER & SEWER DEPARTMENT	Single	750	one 750 gallon	90	395
GDO	5572	MGRU	5	150	Eating establishment	20	0	1752	CITY OF MIAMI BEACH		0	one 100 gpm	30	454
GDO	5574	IGT	5	300	Eating establishment	60	60	4516	MIAMI DADE WATER & SEWER DEPARTMENT	Single	1200	one 1200 gallon	90	1129
GDO	5575	AGRU	5	150	Eating establishment	0	0	734	MIAMI DADE WATER & SEWER DEPARTMENT		0	one 75 gpm	30	184
GDO	5577	IGT	5	150	Eating establishment	18	22	0	VIRGINIA GARDENS	Single	950	one 950 gallon	90	308
GDO	5578	IGT	5	300	Eating establishment	130	136	0	MIAMI DADE WATER & SEWER DEPARTMENT	Single	1500	one 1500 gallon	90	3400
GDO	5579	IGT	5	150	Eating establishment	95	95	3900	CITY OF MIAMI BEACH	Single	950	one 950 gallon	90	975
GDO	5581	IGT	5	150	Eating establishment	75	75	3822	MIAMI DADE WATER & SEWER DEPARTMENT	Single	950	one 950 gallon	90	95550
GDO	5587	IGT	5	300	Eating establishment	68	68	0	MIAMI DADE WATER & SEWER DEPARTMENT	Series	2400	two 1200 gallon	90	952
GDO	5589	IGT	5	150	Eating establishment	95	95	2625	MIAMI DADE WATER & SEWER DEPARTMENT	Series	2400	two 1200 gallon	90	656
GDO	5592	IGT	5	300	Eating establishment	60	60	0		Single	1200	one 1200 gallon	90	840
GDO	5593	IGT	5	150	Eating establishment	30	30	1200	MIAMI DADE WATER & SEWER DEPARTMENT	Single	950	one 950 gallon	90	750
GDO	5594	IGT	5	150	Eating establishment	0	0	0		Single	950	one 950 gallon	30	0
GDO	5596	IGT	5	300	Eating establishment	74	74	0	MIAMI DADE WATER & SEWER DEPARTMENT	Single	1050	one 1050 gallon	90	1036
GDO	5598	MGRU	5	150	Eating establishment	69	0	2621	MIAMI DADE WATER & SEWER DEPARTMENT		0	one 75 gpm	30	655
GDO	5600	IGT	5	150	Eating establishment	34	34	0		Single	750	one 750 gallon	90	476
GDO	5601	IGT	5	150	Eating establishment	30	30	1986	MIAMI DADE WATER & SEWER DEPARTMENT	Single	1200	one 1200 gallon	90	497
GDO	5602	IGT	5	150	Eating establishment	0	0	0	MIAMI DADE WATER & SEWER DEPARTMENT	Single	1050	one 1050 gallon	90	0
GDO	5603	IGT	5	150	Eating establishment	58	58	1200	MIAMI DADE WATER & SEWER DEPARTMENT	Single	1050	one 1050 gallon	90	300
GDO	5604	MGRU	5	150	Eating establishment	65	0	1784	VIRGINIA GARDENS		0	one 15 gpm	30	446
GDO	5605	MGRU	5	150	Eating establishment	48	48	0			0	one 25 gpm	30	1200
GDO	5608	IGT	5	150	Eating establishment	50	50	0	MIAMI DADE WATER & SEWER DEPARTMENT	Single	750	one 750 gallon	90	700
GDO	5609	IGT	5	150	Eating establishment	38	38	2640	MIAMI DADE WATER & SEWER DEPARTMENT	Single	1500	one 1500-gallon	90	660
GDO	5610	IGT	5	150	Eating establishment	60	60	2474	CITY OF MIAMI SPRINGS	Single	1050	one 1050 gallon	90	619
GDO	5612	IGT	5	150	Eating establishment	40	40	0		Single	750	one 750 gallon	90	560
GDO	5614	IGT	5	150	Eating establishment	0	0	682	MIAMI DADE WATER & SEWER DEPARTMENT	Series	4000	two 2000 gallon	90	171
GDO	5615	IGT	5	150	Eating establishment	22	22	0	MIAMI DADE WATER & SEWER DEPARTMENT	Series	950	one 950 gallon	90	550
GDO	5616	IGT	5	150	Eating establishment	0	0	1980	CITY OF HIALEAH	Single	750	one 750 gallon	90	495
GDO	5617	IGT	5	300	Eating establishment	126	126	0	MIAMI DADE WATER & SEWER DEPARTMENT	Series	2100	two 1050 gallon	90	3150
GDO	5618	IGT	5	150	Eating establishment	66	66	0	MIAMI DADE WATER & SEWER DEPARTMENT	Single	1200	one 1300 gallon	90	1650
GDO	5619	IGT	5	300	Eating establishment	190	190	0		Single	1600	one 1600 gallon	90	4750
GDO	5621	MGRU	5	300	Eating establishment	200	0	8820	MIAMI DADE WATER & SEWER DEPARTMENT		0	one 25 gpm	30	2205
GDO	5622	IGT	5	300	Eating establishment	60	60	0	MIAMI DADE WATER & SEWER DEPARTMENT	Single	1050	one 1050 gallon	90	1500
GDO	5625	IGT	5	300	Eating establishment	89	89	0	MIAMI DADE WATER & SEWER DEPARTMENT	Single	1200	one 1200 gallon	90	2225
GDO	5626	IGT	5	300	Eating establishment	98	98	0	MIAMI DADE WATER & SEWER DEPARTMENT	Series	2400	two 1200 gallon	90	1372
GDO	5630	IGT	5	150	Eating establishment	10	10	0	MIAMI DADE WATER & SEWER DEPARTMENT	Single	750	one 750 gallon	90	250
GDO	5631	IGT	5	150	Eating establishment	0	0	785	MIAMI DADE WATER & SEWER DEPARTMENT	Single	1600	one 1600 gallon	90	196
GDO	5632	IGT	5	150	Eating establishment	0	0	888	MIAMI DADE WATER & SEWER DEPARTMENT	Single	1050	one 1050 gallon	90	222
GDO	5637	IGT	5	300	Eating establishment	210	210	3000	MIAMI DADE WATER & SEWER DEPARTMENT	Single	3500	one 3500 gallon	90	750
GDO	5639	AGRU	5	150	Eating establishment	0	0	0	MIAMI DADE WATER & SEWER DEPARTMENT		0	one 75 gpm	30	0
GDO	5640	MGRU	5	150	Eating establishment	0	0	1948	MIAMI DADE WATER & SEWER DEPARTMENT		0	one 50 gpm	30	487
GDO	5644	IGT	5	150	Eating establishment	28	0	1300	CITY OF HOMESTEAD	Single	1050	one 1050-gallon	90	325
GDO	5647	IGT	5	150	Eating establishment	0	0	0		Single	1200	one 1200 gallon	90	0
GDO	5648	IGT	5	150	Eating establishment	0	0	0	MIAMI DADE WATER & SEWER DEPARTMENT	Single	1200	one 1200 gallon	90	0
GDO	5653	MGRU	5	150	Eating establishment	50	50	0	MIAMI DADE WATER & SEWER DEPARTMENT		0	one 25 gpm	30	1250
GDO	5655	IGT	5	150	Eating establishment	0	0	0	MIAMI DADE WATER & SEWER DEPARTMENT	Series	3600	three 1200 gallon	90	0
GDO	5660	IGT	5	150	Eating establishment	160	0	5400		Series	8000	four 2000 gallon	90	5400
GDO	5662	IGT	5	150	Eating establishment	0	0	1092	MIAMI DADE WATER & SEWER DEPARTMENT	Single	1200	one 1200 gallon	60	273
GDO	5665	IGT	5	150	Eating establishment	80	80	2700	MIAMI DADE WATER & SEWER DEPARTMENT	Single	1050	one 1050 gallon	90	675
GDO	5669	IGT	5	300	Eating establishment	150	0	3725	CITY OF NORTH MIAMI BEACH	Series	3500	one 1500 and one 2000 gallon	30	931
GDO	5672	IGT	5	300	Eating establishment	212	212	0	MIAMI DADE WATER & SEWER DEPARTMENT	Series	2800	one 1600 & one 1200 gallon	90	5300
GDO	5674	IGT	5	150	Eating establishment	30	30	0	MIAMI DADE WATER & SEWER DEPARTMENT	Series	3600	three 1200 gallon	90	420
GDO	5677	MGRU	5	150	Eating establishment	30	30	801	CITY OF MIAMI BEACH		0	not applicable	30	200
GDO	5678	MGRU	5	150	Eating establishment	12	12	0	MIAMI DADE WATER & SEWER DEPARTMENT		0	one 25 gpm	30	300
GDO	5679	IGT	5	300	Eating establishment	118	118	0	MIAMI DADE WATER & SEWER DEPARTMENT	Single	950	one 950 gallon	90	2950
GDO	5681	IGT	5	300	Eating establishment	72	72	0		Single	1200	one 1200 gallon	90	1008
GDO	5685	MGRU	5	150	Eating establishment	4	4	0	CITY OF HIALEAH		0	one 25 gpm	30	56

WORK GROUP	PERMIT NUMBER	PERMIT CLASS	PERMIT	PERMIT FEE	BUSINESS_TYPE	RECORDED SEATS	OBSERVED SEATS	FACILITY AREA	UTILITY	SYSTEM FORMAT	TOTAL CAPACITY	TANK_CAPACITY	PUMP OUT	TOTAL GPD
GDO	5688	IGT	5	300	Eating establishment	150	150	8102	CITY OF NORTH MIAMI BEACH	Single	2000	one 2000 gallon	90	2026
GDO	5689	IGT	5	300	Eating establishment	200	0	4000		Series	2400	two 1200 gallon	90	1000
GDO	5692	MGRU	5	150	Eating establishment	20	20	875	MIAMI DADE WATER & SEWER DEPARTMENT		0	one 25 gpm	30	219
GDO	5695	IGT	5	300	Eating establishment	202	202	6194	MIAMI DADE WATER & SEWER DEPARTMENT	Single	3000	two 1600 gallon	90	1549
GDO	5696	IGT	5	150	Eating establishment	25	25	3000	CITY OF HIALEAH	Single	750	one 750 gallon	90	750
GDO	5698	MGRU	5	300	Eating establishment	64	64	0	MIAMI DADE WATER & SEWER DEPARTMENT		0	one 25 gpm	30	1600
GDO	5705	IGT	5	150	Eating establishment	40	0	1400	CITY OF HIALEAH	Single	950	one 950 gallon	60	425
GDO	5707	MGRU	5	150	Eating establishment	6	6	0	MIAMI DADE WATER & SEWER DEPARTMENT		0	one 25 gpm	30	84
GDO	5709	IGT	5	150	Eating establishment	60	60	560	CITY OF HIALEAH	Single	1200	one 1200 gallon	60	140
GDO	5710	IGT	5	150	Eating establishment	28	28	1400	MIAMI DADE WATER & SEWER DEPARTMENT	Single	950	one 950 gallon	90	350
GDO	5712	MGRU	5	150	Eating establishment	76	76	1000	CITY OF MIAMI BEACH		0	one 25-gpm	30	250
GDO	5715	AGRU	5	300	Eating establishment	119	119	0	MIAMI DADE WATER & SEWER DEPARTMENT		0	one 50 gpm	30	2975
GDO	5716	IGT	5	300	Eating establishment	149	149	0	MIAMI DADE WATER & SEWER DEPARTMENT	Single	1050	one 1050 gallon	90	3725
GDO	5718	IGT	5	300	Eating establishment	90	90	5427	CITY OF MIAMI BEACH	Single	750	one 750 gallon	90	1357
GDO	5721	IGT	5	300	Eating establishment	74	74	0	MIAMI DADE WATER & SEWER DEPARTMENT	Single	1200	one 1200 gallon	90	1036
GDO	5726	IGT	5	150	Eating establishment	133	133	1521	CITY OF MIAMI BEACH	Single	1050	one 1050 gallon	90	380
GDO	5730	IGT	5	150	Eating establishment	50	50	1713	MIAMI DADE WATER & SEWER DEPARTMENT	Single	600	one 600 gallon	90	428
GDO	5732	IGT	4	150	Eating establishment	0	0	1817	MIAMI DADE WATER & SEWER DEPARTMENT	Single	750	one 750 gallon	90	454
GDO	5742	IGT	5	150	Eating establishment	8	8	0	MIAMI DADE WATER & SEWER DEPARTMENT	Single	750	one 750 gallon	90	112
GDO	5744	MGRU	5	300	Eating establishment	70	70	0	MIAMI DADE WATER & SEWER DEPARTMENT		0	one 25 gpm	30	1750
GDO	5747	AGRU	5	300	Eating establishment	200	200	0	MIAMI DADE WATER & SEWER DEPARTMENT		0	one 50 gpm	30	5000
GDO	5752	IGT	5	150	Eating establishment	44	44	1860	MIAMI DADE WATER & SEWER DEPARTMENT	Single	1050	one 1050 gallon	90	465
GDO	5755	IGT	5	150	Eating establishment	0	0	0		Single	750	one 750 gallon	90	0
GDO	5756	MGRU	5	300	Eating establishment	214	214	4500	MIAMI DADE WATER & SEWER DEPARTMENT		0	one 25 gpm	30	1125
GDO	5765	IGT	5	150	Eating establishment	0	0	200	CITY OF HIALEAH		750	one 750 gallon	60	50
GDO	5767	IGT	5	150	Eating establishment	10	10	400	MIAMI DADE WATER & SEWER DEPARTMENT	Single	750	one 750 gallon	90	100
GDO	5771	IGT	5	300	Eating establishment	74	74	0	CITY OF NORTH MIAMI BEACH	Single	750	one 750 gallon	90	1850
GDO	5773	IGT	5	150	Eating establishment	0	0	1099	MIAMI DADE WATER & SEWER DEPARTMENT	Series	4000	two 2000 gallon	90	275
GDO	5774	IGT	5	150	Eating establishment	0	0	0	MIAMI DADE WATER & SEWER DEPARTMENT	Series	4000	two 2000 gallon	90	0
GDO	5777	IGT	5	150	Eating establishment	46	46	0	MIAMI DADE WATER & SEWER DEPARTMENT	Single	950	one 1200 gallon	90	644
GDO	5779	IGT	5	150	Eating establishment	40	0	2176	MIAMI DADE WATER & SEWER DEPARTMENT	Single	950	one 950 gallon	90	544
GDO	5780	MGRU	5	150	Eating establishment	28	24	0	MIAMI DADE WATER & SEWER DEPARTMENT		0	one 25 gpm	30	336
GDO	5781	MGRU	5	150	Eating establishment	40	40	0	MIAMI DADE WATER & SEWER DEPARTMENT		0	one 25 gpm	30	560
GDO	5783	IGT	5	150	Eating establishment	42	0	1834	MIAMI DADE WATER & SEWER DEPARTMENT	Single	1250	one 1250 gallon	60	459
GDO	5784	IGT	5	150	Eating establishment	125	125	2940	MIAMI DADE WATER & SEWER DEPARTMENT	Single	950	one 950 gallon	90	735
GDO	5786	IGT	5	300	Eating establishment	116	116	2060	MIAMI DADE WATER & SEWER DEPARTMENT	Single	1050	one 1050 gallon	90	2900
GDO	5791	IGT	5	300	Eating establishment	124	124	0	MIAMI DADE WATER & SEWER DEPARTMENT	Single	1600	one 1600 gallon	90	3100
GDO	5792	IGT	5	150	Eating establishment	0	0	630	MIAMI DADE WATER & SEWER DEPARTMENT	Series	4000	two 2000 gallon	90	158
GDO	5803	MGRU	5	150	Eating establishment	50	50	2380	MIAMI DADE WATER & SEWER DEPARTMENT		0	one 25 gpm	30	595
GDO	5807	IGT	5	150	Eating establishment	472	472	0	MIAMI DADE WATER & SEWER DEPARTMENT	Series	4500	three 1500 gallon	90	472
GDO	5808	MGRU	5	150	Eating establishment	10	10	1000	MIAMI DADE WATER & SEWER DEPARTMENT		0	one 25 gpm	30	250
GDO	5810	IGT	5	300	Eating establishment	160	160	0	CITY OF MIAMI BEACH	Series	1900	two 950 gallon	90	4000
GDO	5812	IGT	5	300	Eating establishment	188	188	7500	CITY OF HOMESTEAD	Series	2400	two 1200 gallon	90	1875
GDO	5815	IGT	5	150	Eating establishment	50	50	2700	MIAMI DADE WATER & SEWER DEPARTMENT	Single	1200	one 1200 gallon	90	675
GDO	5819	IGT	5	300	Eating establishment	152	0	6440	CITY OF NORTH MIAMI BEACH	Series	3000	two 1500 gallon	60	1610
GDO	5822	IGT	5	300	Eating establishment	145	145	8000	MIAMI DADE WATER & SEWER DEPARTMENT	Single	950	one 950 gallon	90	2000
GDO	5823	IGT	5	150	Eating establishment	91	91	3665	CITY OF MIAMI BEACH	Single	950	one 950 gallon	90	916
GDO	5826	IGT	5	150	Eating establishment	52	52	2500	CITY OF HIALEAH	Single	950	one 950-gallon	90	625
GDO	5829	IGT	5	150	Eating establishment	30	30	0		Single	1050	one 1050 gallon	90	420
GDO	5830	IGT	5	300	Eating establishment	205	205	5125	CITY OF MIAMI BEACH	Single	2000	one 2000 gallon	90	128125
GDO	5831	IGT	5	300	Eating establishment	298	0	10916	CITY OF MIAMI BEACH	Single	1200	one 1200 gallon	90	2729
GDO	5833	IGT	5	300	Eating establishment	84	84	0	MIAMI DADE WATER & SEWER DEPARTMENT	Single	950	one 950 gallon	90	2100
GDO	5834	IGT	5	300	Eating establishment	30	30	0	CITY OF MIAMI SPRINGS	Single	900	one 900 gallon	90	750
GDO	5835	IGT	5	150	Eating establishment	0	0	758	CITY OF HIALEAH	Single	950	one 950 gallon	90	190
GDO	5837	IGT	5	300	Eating establishment	203	203	10039	CITY OF MIAMI BEACH	Single	1050	one 1050 gallon	90	2510
GDO	5841	IGT	5	150	Eating establishment	15	0	1100	CITY OF CORAL GABLES	Single	750	one 750 gallon	60	275
GDO	5843	IGT	5	300	Eating establishment	102	102	0	MIAMI DADE WATER & SEWER DEPARTMENT	Single	950	one 950 gallon	90	2550
GDO	5848	MGRU	5	150	Eating establishment	60	0	2133	CITY OF MIAMI BEACH		0	one 50 gpm	30	533
GDO	5849	IGT	5	150	Eating establishment	46	0	2000	MIAMI DADE WATER & SEWER DEPARTMENT	Single	750	one 750 gallon	90	50000
GDO	5850	IGT	5	300	Eating establishment	62	62	0	MIAMI DADE WATER & SEWER DEPARTMENT	Single	1200	one 1200 gallon	90	868
GDO	5851	AGRU	5	150	Eating establishment	70	70	2300	CITY OF MIAMI BEACH		0	one 35 gpm	30	575

WORK GROUP	PERMIT NUMBER	PERMIT CLASS	PERMIT	PERMIT FEE	BUSINESS_TYPE	RECORDED SEATS	OBSERVED SEATS	FACILITY AREA	UTILITY	SYSTEM FORMAT	TOTAL CAPACITY	TANK_CAPACITY	PUMP OUT	TOTAL GPD
GDO	5852	AGRU	5	150	Eating establishment	47	0	1850	CITY OF HIALEAH		0	one 25 gpm	30	463
GDO	5853	AGRU	5	150	Eating establishment	34	34	0	CITY OF MIAMI BEACH		0	one 25 gpm	30	476
GDO	5854	IGT	5	750	Eating establishment	300	300	0	CITY OF FLORIDA CITY	Single	2000	one 2000 gallon	90	7500
GDO	5856	IGT	5	150	Eating establishment	28	28	0	MIAMI DADE WATER & SEWER DEPARTMENT	Single	1200	one 1200 gallon	90	700
GDO	5858	MGRU	5	300	Eating establishment	80	80	0	CITY OF MIAMI BEACH		0	one 25 gpm	30	2000
GDO	5859	IGT	5	300	Eating establishment	64	64	0	MIAMI DADE WATER & SEWER DEPARTMENT	Single	750	one 750 gallon	90	1600
GDO	5860	AGRU	5	150	Eating establishment	18	18	0	CITY OF MIAMI BEACH		0	one 25 gpm	30	252
GDO	5864	IGT	5	300	Eating establishment	110	110	0		Single	1050	one 1050 gallon	90	2750
GDO	5867	IGT	5	150	Eating establishment	60	60	0		Single	1050	one 1050 gallon	90	1500
GDO	5868	IGT	5	150	Eating establishment	36	36	1508	MIAMI DADE WATER & SEWER DEPARTMENT	Single	1200	one 1200 gallon	90	377
GDO	5869	IGT	5	150	Eating establishment	29	29	0	MIAMI DADE WATER & SEWER DEPARTMENT	Series	1900	two 950 gallon	90	406
GDO	5874	IGT	5	300	Eating establishment	70	70	0		Series	1500	two 750 gallon	90	1750
GDO	5879	MGRU	5	150	Eating establishment	65	65	1359	CITY OF MIAMI BEACH		0	one 50 gpm	30	340
GDO	5888	IGT	5	150	Eating establishment	18	18	0	MIAMI DADE WATER & SEWER DEPARTMENT	Single	750	one 750 gallon	90	252
GDO	5889	AGRU	5	150	Eating establishment	10	10	0	CITY OF MIAMI BEACH		0	one 35 gpm	30	140
GDO	5890	IGT	5	150	Eating establishment	200	200	2800	CITY OF MIAMI BEACH	Single	1050	one 1050 gallon	90	700
GDO	5893	IGT	5	150	Eating establishment	20	20	1500	MIAMI DADE WATER & SEWER DEPARTMENT	Single	750	one 750 gallon	90	375
GDO	5901	MGRU	5	150	Eating establishment	30	30	0	CITY OF MIAMI BEACH		0	one 25 gpm	30	750
GDO	5902	IGT	5	150	Eating establishment	0	0	1412	MIAMI DADE WATER & SEWER DEPARTMENT	Single	750	one 750-gallon	90	353
GDO	5903	AGRU	5	150	Eating establishment	0	0	1304	CITY OF NORTH MIAMI BEACH		0	one 20 gpm	30	326
GDO	5904	IGT	5	150	Eating establishment	36	36	0	MIAMI DADE WATER & SEWER DEPARTMENT	Single	950	one 950 gallon	90	900
GDO	5908	IGT	5	300	Eating establishment	100	100	0	MIAMI DADE WATER & SEWER DEPARTMENT	Single	900	one 900 gallon	90	2500
GDO	5909	IGT	5	300	Eating establishment	349	349	8828	MIAMI DADE WATER & SEWER DEPARTMENT	Single	3200	two 1600 gallon	90	2207
GDO	5910	MGRU	5	150	Eating establishment	0	0	200	CITY OF HIALEAH		0	one 35 gpm	60	50
GDO	5911	MGRU	5	150	Eating establishment	30	30	1159	CITY OF NORTH MIAMI BEACH		0	one 20 gpm	30	290
GDO	5912	IGT	5	300	Eating establishment	125	125	0	MIAMI DADE WATER & SEWER DEPARTMENT	Single	750	one 750 gallon	90	1750
GDO	5914	IGT	5	150	Eating establishment	8	8	0	MIAMI DADE WATER & SEWER DEPARTMENT	Single	750	one 750 gallon	90	2
GDO	5917	MGRU	5	150	Eating establishment	0	0	0			0	one 25 gpm	30	0
GDO	5920	IGT	5	150	Eating establishment	200	200	2700	MIAMI DADE WATER & SEWER DEPARTMENT	Series	4100	two 1250 and one 1600 gallon	90	675
GDO	5926	IGT	5	150	Eating establishment	12	12	0	MIAMI DADE WATER & SEWER DEPARTMENT	Single	750	one 750 gallon	90	168
GDO	5930	IGT	5	300	Eating establishment	150	150	0	CITY OF MIAMI BEACH	Single	950	one 950 gallon	90	3750
GDO	5934	IGT	5	150	Eating establishment	0	0	2590	MIAMI DADE WATER & SEWER DEPARTMENT		750	one 750 gallon	90	648
GDO	5936	IGT	5	150	Eating establishment	24	24	0	MIAMI DADE WATER & SEWER DEPARTMENT	Single	950	one 950 gallon	90	600
GDO	5937	IGT	5	150	Eating establishment	5	5	0	MIAMI DADE WATER & SEWER DEPARTMENT	Single	750	one 750 gallon	90	125
GDO	5942	MGRU	5	150	Eating establishment	15	15	500	MIAMI DADE WATER & SEWER DEPARTMENT		0	one 25 gpm	30	125
GDO	5944	IGT	5	150	Eating establishment	65	65	3114	MIAMI DADE WATER & SEWER DEPARTMENT	Single	2400	two 1200-gallon	90	779
GDO	5946	AGRU	5	150	Eating establishment	40	40	1890	MIAMI DADE WATER & SEWER DEPARTMENT		0	one 25 gpm	30	473
GDO	5956	MGRU	5	150	Eating establishment	0	0	750	CITY OF MIAMI BEACH		0	one 25 gpm	30	188
GDO	5957	IGT	5	300	Eating establishment	326	326	13153	MIAMI DADE WATER & SEWER DEPARTMENT	Series	6400	four 1600-gallon	90	3288
GDO	5960	IGT	5	300	Eating establishment	200	200	5000	CITY OF MIAMI SPRINGS	Single	950	one 950-gallon	90	1250
GDO	5965	AGRU	5	150	Eating establishment	50	50	1322	MIAMI DADE WATER & SEWER DEPARTMENT		0	one 25 gpm	30	331
GDO	5967	IGT	5	300	Eating establishment	75	75	0	CITY OF MIAMI SPRINGS	Single	1050	one 1050 gallon	90	1875
GDO	5968	MGRU	5	150	Eating establishment	28	28	0	MIAMI DADE WATER & SEWER DEPARTMENT		0	one 25 gpm	30	7
GDO	5969	MGRU	5	300	Eating establishment	96	96	12910	MIAMI DADE WATER & SEWER DEPARTMENT		0	three 100 gpm	90	3228
GDO	5977	AGRU	5	300	Eating establishment	54	54	0	MIAMI DADE WATER & SEWER DEPARTMENT		0	one 25 gpm	30	1350
GDO	5978	IGT	5	150	Eating establishment	38	38	855	MIAMI DADE WATER & SEWER DEPARTMENT	Single	1500	one 1500 gallon	90	214
GDO	5981	IGT	5	150	Eating establishment	0	0	1250	MIAMI DADE WATER & SEWER DEPARTMENT	Single	750	one 750-gallon	90	313
GDO	5987	IGT	5	150	Eating establishment	189	189	0	MIAMI DADE WATER & SEWER DEPARTMENT	Single	950	one 950 gallon	90	0
GDO	5995	IGT	5	150	Eating establishment	58	58	3337	MIAMI DADE WATER & SEWER DEPARTMENT	Series	2500	two 1250 gallon	90	834
GDO	5998	IGT	5	150	Eating establishment	28	28	1574	MIAMI DADE WATER & SEWER DEPARTMENT	Single	750	one 750 gallon	90	394
GDO	6001	MGRU	5	150	Eating establishment	32	32	0	MIAMI DADE WATER & SEWER DEPARTMENT		0	one 25 gpm	30	448
GDO	6002	MGRU	5	150	Eating establishment	30	30	0	CITY OF MIAMI BEACH		0	one 25 gpm	30	750
GDO	6005	IGT	5	150	Eating establishment	68	68	2605	MIAMI DADE WATER & SEWER DEPARTMENT	Single	1200	one 1200 gallon	90	651
GDO	6006	IGT	5	150	Eating establishment	40	40	2225	MIAMI DADE WATER & SEWER DEPARTMENT	Single	1600	one 1600-gallon	90	556
GDO	6007	IGT	5	150	Eating establishment	12	12	0	MIAMI DADE WATER & SEWER DEPARTMENT	Single	1050	one 1050 gallon	90	168
GDO	6010	IGT	5	150	Eating establishment	0	0	3950	MIAMI DADE WATER & SEWER DEPARTMENT	Single	750	one 750-gallon	90	50
GDO	6015	MGRU	5	150	Eating establishment	25	25	600	MIAMI DADE WATER & SEWER DEPARTMENT		0	one 25 gpm	30	150
GDO	6022	IGT	5	150	Eating establishment	10	10	1200	MIAMI DADE WATER & SEWER DEPARTMENT	Single	750	one 750 gallon	90	300
GDO	6025	MGRU	5	150	Eating establishment	0	0	1820	MIAMI DADE WATER & SEWER DEPARTMENT		0	one 25 gpm	30	455
GDO	6030	IGT	5	300	Eating establishment	280	280	8993	MIAMI DADE WATER & SEWER DEPARTMENT	Series	3600	three 1200 gallon	90	2248

WORK GROUP	PERMIT NUMBER	PERMIT CLASS	PERMIT	PERMIT FEE	BUSINESS_TYPE	RECORDED SEATS	OBSERVED SEATS	FACILITY AREA	UTILITY	SYSTEM FORMAT	TOTAL CAPACITY	TANK_CAPACITY	PUMP OUT	TOTAL GPD
GDO	6034	AGRU	5	150	Eating establishment	0	0	751	MIAMI DADE WATER & SEWER DEPARTMENT		0	one 25 gpm	30	188
GDO	6035	IGT	5	150	Eating establishment	0	0	1881	MIAMI DADE WATER & SEWER DEPARTMENT	Single	950	one 950 gallon	90	470
GDO	6036	IGT	5	150	Eating establishment	15	15	0	MIAMI DADE WATER & SEWER DEPARTMENT	Single	1500	one 1500 gallon	90	375
GDO	6040	MGRU	5	150	Eating establishment	25	25	0	MIAMI DADE WATER & SEWER DEPARTMENT		0	one 25 gpmc	30	625
GDO	6044	IGT	5	150	Eating establishment	0	0	3750	MIAMI DADE WATER & SEWER DEPARTMENT	Single	2000	one 2000 gallon	90	938
GDO	6052	IGT	5	300	Eating establishment	200	0	4100	MIAMI DADE WATER & SEWER DEPARTMENT	Multiple	3350	one 1200 and two 1050 gallon	60	1025
GDO	6054	IGT	5	300	Eating establishment	80	0	0	MIAMI DADE WATER & SEWER DEPARTMENT	Series	5550	one 1050, two 1250 and one 2000 gallon	90	1400
GDO	6055	IGT	5	300	Eating establishment	150	150	4850	MIAMI DADE WATER & SEWER DEPARTMENT	Series	2100	two 1050-gallon	90	1213
GDO	6056	IGT	5	150	Eating establishment	22	22	0	MIAMI DADE WATER & SEWER DEPARTMENT	Single	750	one 750 gallon	90	308
GDO	6059	IGT	5	750	Eating establishment	675	675	35746	MIAMI DADE WATER & SEWER DEPARTMENT	Single	1050	one 1050 gallon	90	16875
GDO	6064	AGRU	5	150	Eating establishment	83	83	1916	CITY OF MIAMI BEACH		0	one 25 gpm	30	584
GDO	6069	IGT	5	150	Eating establishment	10	10	0	CITY OF HIALEAH	Single	1050	one 1050 gallon	90	140
GDO	6072	IGT	5	300	Eating establishment	149	149	0	MIAMI DADE WATER & SEWER DEPARTMENT	Single	2100	two 1050 gallon	90	3725
GDO	6075	IGT	5	150	Eating establishment	40	40	0	CITY OF HIALEAH	Single	1050	one 1050 gallon	90	560
GDO	6080	MGRU	5	150	Eating establishment	24	24	1560	MIAMI DADE WATER & SEWER DEPARTMENT		0	one 25 gpm	30	390
GDO	6082	MGRU	5	150	Eating establishment	0	0	750	MIAMI DADE WATER & SEWER DEPARTMENT		0	one 25 gpm	30	188
GDO	6083	MGRU	5	150	Eating establishment	23	23	1260	CITY OF HIALEAH		0	one 50 gpm	30	315
GDO	6087	IGT	5	150	Eating establishment	65	65	1880	MIAMI DADE WATER & SEWER DEPARTMENT	Single	950	one 950-gallon	90	470
GDO	6089	IGT	5	150	Eating establishment	30	30	0	MIAMI DADE WATER & SEWER DEPARTMENT	Series	1900	two 950 gallon	90	750
GDO	6091	IGT	5	150	Eating establishment	0	0	0	CITY OF NORTH MIAMI BEACH	Single	1200	one 1200 gallon	90	0
GDO	6095	IGT	5	150	Eating establishment	80	80	3280	MIAMI DADE WATER & SEWER DEPARTMENT	Single	1600	one 1600-gallon	90	884
GDO	6097	IGT	5	300	Eating establishment	242	242	6500	MIAMI DADE WATER & SEWER DEPARTMENT	Single	1600	one 1600 gallon	90	6050
GDO	6101	IGT	5	300	Eating establishment	64	64	0	MIAMI DADE WATER & SEWER DEPARTMENT	Single	750	one 750 gallon	90	896
GDO	6103	IGT	5	150	Eating establishment	24	24	0	MIAMI DADE WATER & SEWER DEPARTMENT	Single	950	one 950 gallon	90	336
GDO	6106	IGT	5	150	Eating establishment	0	0	369	MIAMI DADE WATER & SEWER DEPARTMENT		0	unknown	90	92
GDO	6109	IGT	5	150	Eating establishment	32	0	1500	MIAMI DADE WATER & SEWER DEPARTMENT	Single	900	one 900 gallon	90	375
GDO	6114	IGT	5	150	Eating establishment	28	28	1500	MIAMI DADE WATER & SEWER DEPARTMENT	Single	950	one 950 gallon	90	700
GDO	6117	IGT	5	150	Eating establishment	6	6	0	CITY OF HIALEAH	Single	750	one 750 gallon	90	0
GDO	6119	MGRU	5	150	Eating establishment	8	0	1300	CITY OF NORTH MIAMI BEACH		0	one 20 gpm	30	325
GDO	6124	IGT	5	150	Eating establishment	49	49	771	CITY OF HIALEAH	Single	1050	one 1050-gallon	90	193
GDO	6125	IGT	5	300	Eating establishment	258	258	4000	MIAMI DADE WATER & SEWER DEPARTMENT	Series	1500	two 750 gallon	90	100000
GDO	6130	MGRU	5	150	Eating establishment	22	22	0	CITY OF MIAMI BEACH		0	one 25 gpm	30	308
GDO	6134	AGRU	5	150	Eating establishment	0	0	475	MIAMI DADE WATER & SEWER DEPARTMENT		0	one 75 gpm	30	119
GDO	6135	IGT	5	300	Eating establishment	170	170	0	MIAMI DADE WATER & SEWER DEPARTMENT	Series	10500	three 3500 gallon	90	4250
GDO	6143	MGRU	5	150	Eating establishment	0	0	763	MIAMI DADE WATER & SEWER DEPARTMENT		0	one 25 gpm	30	191
GDO	6144	AGRU	5	150	Eating establishment	8	8	700	CITY OF NORTH MIAMI BEACH		0	one 25 gpm	30	175
GDO	6146	IGT	5	150	Eating establishment	0	0	2500	MIAMI DADE WATER & SEWER DEPARTMENT	Single	750	one 750 gallon	90	625
GDO	6147	IGT	5	300	Eating establishment	152	152	7000	MIAMI DADE WATER & SEWER DEPARTMENT	Parallel	950	one 950-gallon	90	1750
GDO	6151	MGRU	5	150	Eating establishment	60	60	0	MIAMI DADE WATER & SEWER DEPARTMENT		0	one 25 gpm	30	360
GDO	6155	IGT	5	150	Eating establishment	25	25	1200	CITY OF HIALEAH	Single	950	one 950 gallon	90	300
GDO	6159	IGT	5	150	Eating establishment	30	30	950	CITY OF HIALEAH	Single	750	one 750 gallon	90	23750
GDO	6165	AGRU	5	150	Eating establishment	29	29	1000	CITY OF NORTH MIAMI BEACH		0	one 25 gpm	30	406
GDO	6166	AGRU	5	150	Eating establishment	60	0	1200	MIAMI DADE WATER & SEWER DEPARTMENT		0	one 20 gpm	30	300
GDO	6167	IGT	5	300	Eating establishment	200	200	0	MIAMI DADE WATER & SEWER DEPARTMENT	Single	950	one 1050 gallon	90	5000
GDO	6168	IGT	5	300	Eating establishment	0	0	0		Single	1050	one 1050 gallon	90	0
GDO	6169	IGT	5	750	Eating establishment	0	0	7702	CITY OF MIAMI BEACH	Series	2250	three 750-gallon	90	1926
GDO	6172	AGRU	5	150	Eating establishment	0	0	0	MIAMI DADE WATER & SEWER DEPARTMENT		0	one 25 gpm	30	0
GDO	6173	IGT	5	750	Eating establishment	219	219	0	MIAMI DADE WATER & SEWER DEPARTMENT	Series	2400	two 1200 gallon	90	5475
GDO	6176	IGT	5	150	Eating establishment	12	12	750	CITY OF OPA LOCKA	Single	1050	one 1050 gallon	90	188
GDO	6178	IGT	5	150	Eating establishment	6	6	0	MIAMI DADE WATER & SEWER DEPARTMENT	Single	1200	one 1200 gallon	90	2
GDO	6179	MGRU	5	150	Eating establishment	9	9	582	CITY OF MIAMI BEACH		0	one 25 gpm	30	146
GDO	6181	AGRU	5	150	Eating establishment	20	20	1829	MIAMI DADE WATER & SEWER DEPARTMENT		0	one 35 gpm	30	457
GDO	6182	IGT	5	150	Eating establishment	51	51	2531	MIAMI DADE WATER & SEWER DEPARTMENT	Single	950	one 950 gallon	60	633
GDO	6183	IGT	5	150	Eating establishment	16	16	160	MIAMI DADE WATER & SEWER DEPARTMENT	Single	750	one 750 gallon	90	40
GDO	6184	IGT	5	150	Eating establishment	84	84	2509	MIAMI DADE WATER & SEWER DEPARTMENT	Single	1200	one 1200-gallon	90	99975
GDO	6185	IGT	5	150	Eating establishment	19	19	1200		Single	1200	one 1200 gallon	90	300
GDO	6187	MGRU	5	150	Eating establishment	0	0	0	CITY OF NORTH MIAMI BEACH		0	not available	30	0
GDO	6188	IGT	5	150	Eating establishment	32	32	1560	MIAMI DADE WATER & SEWER DEPARTMENT	Single	750	one 750-gallon	90	390

WORK GROUP	PERMIT NUMBER	PERMIT CLASS	PERMIT	PERMIT FEE	BUSINESS_TYPE	RECORDED SEATS	OBSERVED SEATS	FACILITY AREA	UTILITY	SYSTEM FORMAT	TOTAL CAPACITY	TANK_CAPACITY	PUMP OUT	TOTAL GPD
GDO	6189	IGT	5	300	Eating establishment	60	60	5387	CITY OF MIAMI BEACH	Single	1600	one 1600 gallon	90	1347
GDO	6192	IGT	5	150	Eating establishment	100	100	0	MIAMI DADE WATER & SEWER DEPARTMENT	Series	2100	two 1050 gallon	90	100
GDO	6193	IGT	5	150	Eating establishment	0	0	0	MIAMI DADE WATER & SEWER DEPARTMENT	Single	750	one 750 gallon	90	0
GDO	6205	IGT	5	150	Eating establishment	100	100	3591	CITY OF SURFSIDE	Single	1200	one 1200 gallon	90	898
GDO	6206	IGT	5	150	Eating establishment	30	30	0	CITY OF HIALEAH	Single	1050	one 1050 gallon	90	750
GDO	6207	MGRU	5	150	Eating establishment	5	5	0	MIAMI DADE WATER & SEWER DEPARTMENT		0	one 25 gpm	30	125
GDO	6211	IGT	5	150	Eating establishment	40	0	2430	MIAMI DADE WATER & SEWER DEPARTMENT	Single	950	one 950 gallon	60	608
GDO	6213	IGT	5	150	Eating establishment	36	36	0	MIAMI DADE WATER & SEWER DEPARTMENT	Single	950	one 950 gallon	90	900
GDO	6215	IGT	5	150	Eating establishment	29	29	1266	MIAMI DADE WATER & SEWER DEPARTMENT	Single	1200	one 1200 gallon	90	406
GDO	6217	IGT	5	150	Eating establishment	30	30	2323	CITY OF MIAMI BEACH	Single	1500	one 1500 gallon	90	750
GDO	6220	MGRU	5	150	Eating establishment	6	6	600	MIAMI DADE WATER & SEWER DEPARTMENT		0	one 25 gpm	30	150
GDO	6222	IGT	5	300	Eating establishment	24	24	0	MIAMI DADE WATER & SEWER DEPARTMENT	Single	1200	one 1200 gallon	90	336
GDO	6224	IGT	5	150	Eating establishment	0	0	998	CITY OF HIALEAH	Single	950	one 950 gallon	90	250
GDO	6225	IGT	5	150	Eating establishment	0	0	3778	MIAMI DADE WATER & SEWER DEPARTMENT	Single	750	one 750 gallon	90	945
GDO	6226	IGT	5	300	Eating establishment	0	0	4307	MIAMI DADE WATER & SEWER DEPARTMENT	Single	1200	one 1200 gallon	90	1077
GDO	6228	IGT	5	150	Eating establishment	50	50	1500	MIAMI DADE WATER & SEWER DEPARTMENT	Single	950	one 950 gallon	90	1250
GDO	6229	MGRU	5	150	Eating establishment	4	4	0	MIAMI DADE WATER & SEWER DEPARTMENT		0	one 25 gpm	30	100
GDO	6231	IGT	5	150	Eating establishment	40	40	0	MIAMI DADE WATER & SEWER DEPARTMENT	Single	1200	one 1200 gallon	90	560
GDO	6232	MGRU	5	150	Eating establishment	30	0	980	CITY OF MIAMI BEACH		0	one 25 gpm	30	245
GDO	6234	MGRU	5	150	Eating establishment	16	0	933	CITY OF NORTH MIAMI BEACH		0	one 100 gpm	30	233
GDO	6235	IGT	5	150	Eating establishment	44	44	0	MIAMI DADE WATER & SEWER DEPARTMENT	Single	1050	one 1050 gallon	90	616
GDO	6238	IGT	5	150	Eating establishment	49	49	0	CITY OF HIALEAH	Single	750	one 750 gallon	90	1225
GDO	6239	MGRU	5	150	Eating establishment	0	0	1100	CITY OF HIALEAH		0	one 25 gpm	30	275
GDO	6240	IGT	5	150	Eating establishment	223	223	3422	MIAMI DADE WATER & SEWER DEPARTMENT	Single	950	one 950-gallon	90	856
GDO	6243	IGT	5	150	Eating establishment	30	30	0	MIAMI DADE WATER & SEWER DEPARTMENT	Single	750	one 750 gallon	90	750
GDO	6244	IGT	5	150	Eating establishment	8	8	900	CITY OF HIALEAH	Single	950	one 950 gallon	90	225
GDO	6250	MGRU	5	150	Eating establishment	33	33	850	MIAMI DADE WATER & SEWER DEPARTMENT		0	one 25 gpm	30	213
GDO	6251	IGT	5	150	Eating establishment	10	10	774	MIAMI DADE WATER & SEWER DEPARTMENT	Single	750	one 750 gallon	90	250
GDO	6252	IGT	5	150	Eating establishment	28	0	1440	MIAMI DADE WATER & SEWER DEPARTMENT		950	one 950 gallon	60	498
GDO	6258	MGRU	5	150	Eating establishment	30	30	1700	MIAMI DADE WATER & SEWER DEPARTMENT		0	one 25 gpm	30	425
GDO	6260	IGT	5	300	Eating establishment	60	60	0	MIAMI DADE WATER & SEWER DEPARTMENT	Single	1050	one 1050 gallon	90	840
GDO	6261	IGT	5	300	Eating establishment	120	120	6000	CITY OF HIALEAH	Series	4000	two 2000 gallon	90	1500
GDO	6263	IGT	5	150	Eating establishment	0	0	0	MIAMI DADE WATER & SEWER DEPARTMENT	Single	950	one 950 gallon	90	0
GDO	6265	IGT	5	150	Eating establishment	0	0	1323	MIAMI DADE WATER & SEWER DEPARTMENT	Single	750	one 750 gallon	90	331
GDO	6271	IGT	5	150	Eating establishment	10	10	1200	MIAMI DADE WATER & SEWER DEPARTMENT	Single	750	one 750 gallon	90	140
GDO	6272	MGRU	5	150	Eating establishment	6	0	664	CITY OF MIAMI BEACH		0	one 75 gpm	30	166
GDO	6273	AGRU	5	150	Eating establishment	0	0	1450	CITY OF HIALEAH		0	one 35 gpm	30	363
GDO	6279	AGRU	5	150	Eating establishment	40	40	0	MIAMI DADE WATER & SEWER DEPARTMENT		0	one 25 gpm	30	560
GDO	6284	MGRU	5	150	Eating establishment	30	30	1000	CITY OF MIAMI BEACH		0	one 35 gpm	30	250
GDO	6286	IGT	5	150	Eating establishment	0	0	0	MIAMI DADE WATER & SEWER DEPARTMENT	Single	750	one 750 gallon	90	0
GDO	6288	IGT	5	150	Eating establishment	13	13	1200	MIAMI DADE WATER & SEWER DEPARTMENT	Single	1050	one 1050 gallon	90	182
GDO	6290	IGT	5	150	Eating establishment	0	0	1200	CITY OF HIALEAH	Single	950	one 950 gallon	90	300
GDO	6293	IGT	5	300	Eating establishment	160	160	0	MIAMI DADE WATER & SEWER DEPARTMENT	Single	1200	one 1200 gallon	90	4000
GDO	6294	IGT	5	300	Eating establishment	33	60	0	MIAMI DADE WATER & SEWER DEPARTMENT	Single	1050	one 1050 gallon	90	1500
GDO	6296	IGT	5	150	Eating establishment	0	0	0	MIAMI DADE WATER & SEWER DEPARTMENT	Series	2100	two 1050 gallon	90	0
GDO	6297	AGRU	5	150	Eating establishment	30	30	0	MIAMI DADE WATER & SEWER DEPARTMENT		0	one 25 gpm	30	420
GDO	6300	IGT	5	150	Eating establishment	29	29	1200	CITY OF HIALEAH	Single	750	one 750 gallon	90	300
GDO	6311	IGT	5	300	Eating establishment	89	89	0	MIAMI DADE WATER & SEWER DEPARTMENT	Series	1900	two 950 gallon	90	2225
GDO	6313	MGRU	5	150	Eating establishment	70	0	2420	CITY OF NORTH MIAMI BEACH		0	one 75 gpm	30	661
GDO	6315	IGT	5	150	Eating establishment	70	70	1501	MIAMI DADE WATER & SEWER DEPARTMENT	Single	1050	one 1050 gallon	90	375
GDO	6318	MGRU	5	150	Eating establishment	39	0	1324	MIAMI DADE WATER & SEWER DEPARTMENT		0	one 75 gpm	30	331
GDO	6319	IGT	5	150	Eating establishment	25	0	1500	MIAMI DADE WATER & SEWER DEPARTMENT	Single	1050	one 1050-gallon	60	375
GDO	6322	MGRU	5	150	Eating establishment	0	0	1000	MIAMI DADE WATER & SEWER DEPARTMENT		0	one 25 gpm	30	250
GDO	6323	IGT	5	300	Eating establishment	248	248	5900	MIAMI DADE WATER & SEWER DEPARTMENT	Series	2100	two 1050 gallon	90	1475
GDO	6327	IGT	5	150	Eating establishment	39	39	1500	MIAMI DADE WATER & SEWER DEPARTMENT	Single	1050	one 1050 gallon	90	375
GDO	6328	MGRU	5	150	Eating establishment	0	0	650	MIAMI DADE WATER & SEWER DEPARTMENT		0	one 25 gpm	30	163
GDO	6329	IGT	5	150	Eating establishment	40	40	3000	CITY OF NORTH MIAMI BEACH	Series	1900	two 950 gallon	90	750
GDO	6332	MGRU	5	150	Eating establishment	6	6	0	MIAMI DADE WATER & SEWER DEPARTMENT		0	one 25 gpm	30	84
GDO	6333	IGT	5	150	Eating establishment	0	0	0	MIAMI DADE WATER & SEWER DEPARTMENT	Single	1500	one 1500 gallon	90	0
GDO	6334	IGT	5	150	Eating establishment	0	0	975	MIAMI DADE WATER & SEWER DEPARTMENT	Single	750	one 750 gallon	90	244
GDO	6335	IGT	5	300	Eating establishment	213	213	6123	MIAMI DADE WATER & SEWER DEPARTMENT	Single	1050	one 1050-gallon	90	1531

WORK GROUP	PERMIT NUMBER	PERMIT CLASS	PERMIT T	PERMIT FEE	BUSINESS_TYPE	RECORDED SEATS	OBSERVED SEATS	FACILITY AREA	UTILITY	SYSTEM FORMAT	TOTAL CAPACITY	TANK_CAPACITY	PUMP OUT	TOTAL GPD
GDO	6336	MGRU	1	150	Eating establishment	10	10	0	CITY OF HIALEAH		0	one 50 gpm	30	3
GDO	6337	IGT	5	150	Eating establishment	55	0	1357	CITY OF HIALEAH	Single	750	one 750 gallon	60	339
GDO	6342	MGRU	5	150	Eating establishment	152	0	2436	CITY OF MIAMI BEACH	Single	950	one 950 gallon	90	104125
GDO	6343	IGT	5	300	Eating establishment	30	30	3656	CITY OF MIAMI BEACH	Single	1600	one 1600-gallon	90	1077
GDO	6345	MGRU	5	150	Eating establishment	20	20	0	MIAMI DADE WATER & SEWER DEPARTMENT		0	one 25 gpm	30	500
GDO	6346	IGT	5	150	Eating establishment	0	0	0	MIAMI DADE WATER & SEWER DEPARTMENT	Single	750	one 750 gallon	90	0
GDO	6352	MGRU	5	150	Eating establishment	10	10	1200	MIAMI DADE WATER & SEWER DEPARTMENT		0	one 25 gpm	30	300
GDO	6354	MGRU	5	150	Eating establishment	20	20	0	MIAMI DADE WATER & SEWER DEPARTMENT		0	one 25 gpm	30	500
GDO	6355	IGT	5	150	Eating establishment	26	0	2500	CITY OF HIALEAH	Single	750	one 750 gallon	60	625
GDO	6357	IGT	5	150	Eating establishment	24	24	1716	MIAMI DADE WATER & SEWER DEPARTMENT	Single	750	one 750 gallon	90	600
GDO	6362	IGT	5	150	Eating establishment	0	0	580	MIAMI DADE WATER & SEWER DEPARTMENT	Series	5600	one 2000 and two 1800 gallon	90	145
GDO	6363	MGRU	5	150	Eating establishment	49	0	1104	MIAMI DADE WATER & SEWER DEPARTMENT		0	one 75 gpm	30	299
GDO	6364	MGRU	1	150	Eating establishment	16	16	0	CITY OF HOMESTEAD		0	one 25 gpm	30	400
GDO	6365	IGT	5	150	Eating establishment	149	149	2500	CITY OF HOMESTEAD	Single	750	one 750 gallon	90	625
GDO	6367	IGT	5	300	Eating establishment	70	70	0	CITY OF MIAMI BEACH	Single	750	one 750 gallon	90	1750
GDO	6368	IGT	5	150	Eating establishment	38	38	0	MIAMI DADE WATER & SEWER DEPARTMENT	Multiple	2400	two 1200 gallon	90	532
GDO	6370	MGRU	5	150	Eating establishment	15	15	1500	MIAMI DADE WATER & SEWER DEPARTMENT		0	one 25 gpm	30	375
GDO	6371	IGT	5	150	Eating establishment	52	52	800	MIAMI DADE WATER & SEWER DEPARTMENT	Single	950	one 950 gallon	90	200
GDO	6372	IGT	5	150	Eating establishment	10	10	0	CITY OF HIALEAH	Single	750	one 750 gallon	90	140
GDO	6374	IGT	5	300	Eating establishment	89	89	0	MIAMI DADE WATER & SEWER DEPARTMENT	Single	750	one 750 gallon	90	2225
GDO	6375	AGRU	5	150	Eating establishment	10	10	1052	MIAMI DADE WATER & SEWER DEPARTMENT		0	one 25 gpm	30	250
GDO	6376	MGRU	5	150	Eating establishment	50	0	1400	MIAMI DADE WATER & SEWER DEPARTMENT		0	one 50 gpm	30	350
GDO	6378	MGRU	5	300	Eating establishment	0	0	5000	CITY OF HIALEAH		0	one 25-gpm	30	1250
GDO	6380	IGT	5	300	Eating establishment	250	0	5000	MIAMI DADE WATER & SEWER DEPARTMENT	Series	4400	two 2200 gallon	90	1250
GDO	6382	MGRU	5	150	Eating establishment	10	0	900	CITY OF MIAMI BEACH		0	one 35 gpm	30	255
GDO	6386	MGRU	5	300	Eating establishment	200	0	4000	MIAMI DADE WATER & SEWER DEPARTMENT		0	one 35 gpm	30	1000
GDO	6387	IGT	5	150	Eating establishment	50	0	2125	MIAMI DADE WATER & SEWER DEPARTMENT	Single	950	one 950 gallon	60	531
GDO	6389	MGRU	5	150	Eating establishment	0	0	442	MIAMI DADE WATER & SEWER DEPARTMENT		0	one 50 gpm	30	111
GDO	6390	IGT	5	150	Eating establishment	226	226	3860	MIAMI DADE WATER & SEWER DEPARTMENT	Single	950	one 950 gallon	90	965
GDO	6392	IGT	5	750	Eating establishment	0	0	0	MIAMI DADE WATER & SEWER DEPARTMENT	Single	750	one 750 gallon	90	0
GDO	6393	AGRU	5	150	Eating establishment	8	0	953	MIAMI DADE WATER & SEWER DEPARTMENT		0	one 35 gpm	30	238
GDO	6394	MGRU	5	150	Eating establishment	20	20	1326	MIAMI DADE WATER & SEWER DEPARTMENT		0	one 25 gpm	30	280
GDO	6395	IGT	5	150	Eating establishment	55	0	3745	MIAMI DADE WATER & SEWER DEPARTMENT	Single	950	one 950 gallon	60	936
GDO	6397	IGT	5	150	Eating establishment	62	62	3600	CITY OF MIAMI BEACH	Single	1200	one 1200 gallon	90	900
GDO	6399	IGT	5	150	Eating establishment	12	0	1200	MIAMI DADE WATER & SEWER DEPARTMENT	Single	750	one 750-gallon	30	300
GDO	6400	IGT	5	150	Eating establishment	0	0	0	MIAMI DADE WATER & SEWER DEPARTMENT	Series	3200	two 1600 gallon	90	0
GDO	6401	IGT	5	150	Eating establishment	0	0	2200	MIAMI DADE WATER & SEWER DEPARTMENT	Single	1050	one 1050 gallon	90	550
GDO	6402	IGT	5	300	Eating establishment	67	67	0	CITY OF NORTH MIAMI BEACH	Series	1900	two 950 gallon	90	1675
GDO	6404	IGT	5	150	Eating establishment	0	0	2422	MIAMI DADE WATER & SEWER DEPARTMENT	Single	1050	one 1050 gallon	90	606
GDO	6406	IGT	5	300	Eating establishment	238	180	0	CITY OF HOMESTEAD	Series	2100	two 1050 gallon	90	4500
GDO	6409	IGT	5	150	Eating establishment	46	46	0	MIAMI DADE WATER & SEWER DEPARTMENT	Single	1050	one 1050 gallon	90	644
GDO	6410	IGT	5	150	Eating establishment	30	30	0	MIAMI DADE WATER & SEWER DEPARTMENT	Single	750	one 750 gallon	90	750
GDO	6411	IGT	5	150	Eating establishment	72	72	3088	MIAMI DADE WATER & SEWER DEPARTMENT	Single	1200	one 1200 gallon	90	772
GDO	6414	IGT	5	150	Eating establishment	44	44	1500	CITY OF OPA LOCKA	Single	750	one 750 gallon	90	375
GDO	6418	IGT	5	150	Eating establishment	40	40	0	MIAMI DADE WATER & SEWER DEPARTMENT	Single	1200	one 1200 gallon	90	1000
GDO	6420	AGRU	5	150	Eating establishment	45	45	1500	MIAMI DADE WATER & SEWER DEPARTMENT		0	one 35 gpm	30	375
GDO	6424	IGT	5	150	Eating establishment	0	0	600	MIAMI DADE WATER & SEWER DEPARTMENT	Single	1050	one 1050 gallon	90	150
GDO	6426	IGT	5	300	Eating establishment	121	121	0	CITY OF HIALEAH	Series	2400	two 1200 gallon	90	1694
GDO	6427	AGRU	5	150	Eating establishment	24	24	0	MIAMI DADE WATER & SEWER DEPARTMENT		0	one 25 gpm	30	600
GDO	6430	IGT	5	150	Eating establishment	26	26	2047	MIAMI DADE WATER & SEWER DEPARTMENT	Single	750	one 750 gallon	90	512
GDO	6431	AGRU	5	150	Eating establishment	22	22	1334	MIAMI DADE WATER & SEWER DEPARTMENT		0	one 25 gpm	30	334
GDO	6432	MGRU	5	150	Eating establishment	16	16	1024	MIAMI DADE WATER & SEWER DEPARTMENT		0	one 25 gpm	30	256
GDO	6433	MGRU	5	150	Eating establishment	50	50	1000	CITY OF MIAMI BEACH		0	one 25 gpm	30	250
GDO	6434	IGT	5	150	Eating establishment	30	30	2913	CITY OF HIALEAH	Single	950	one 950 gallon	90	946
GDO	6435	IGT	5	300	Eating establishment	200	200	5214	MIAMI DADE WATER & SEWER DEPARTMENT	Series	2400	two 1200 gallon	90	1304
GDO	6436	MGRU	5	150	Eating establishment	38	38	1388	CITY OF FLORIDA CITY		0	one 25 gpm	30	347
GDO	6439	IGT	5	150	Eating establishment	0	0	359	MIAMI DADE WATER & SEWER DEPARTMENT	Single	5000	one 5000 gallon	90	90
GDO	6441	IGT	5	150	Eating establishment	0	0	270	MIAMI DADE WATER & SEWER DEPARTMENT	Single	5000	one 5000 gallon	30	68
GDO	6442	IGT	5	150	Eating establishment	0	0	1700	CITY OF NORTH MIAMI BEACH	Single	750	one 750 gallon	90	425
GDO	6443	IGT	5	150	Eating establishment	32	0	2326	MIAMI DADE WATER & SEWER DEPARTMENT	Single	1200	one 1200 gallon	90	582

WORK GROUP	PERMIT NUMBER	PERMIT CLASS	PERMIT	PERMIT FEE	BUSINESS_TYPE	RECORDED SEATS	OBSERVED SEATS	FACILITY AREA	UTILITY	SYSTEM FORMAT	TOTAL CAPACITY	TANK_CAPACITY	PUMP OUT	TOTAL GPD
GDO	6444	IGT	5	300	Eating establishment	70	70	0	MIAMI DADE WATER & SEWER DEPARTMENT	Single	950	one 950 gallon	90	1750
GDO	6445	IGT	5	150	Eating establishment	26	26	0	MIAMI DADE WATER & SEWER DEPARTMENT	Single	750	one 750 gallon	90	0
GDO	6446	AGRU	5	150	Eating establishment	0	0	1200	CITY OF MIAMI BEACH		0	one 25 gpm	30	300
GDO	6451	AGRU	5	150	Eating establishment	55	55	1800	MIAMI DADE WATER & SEWER DEPARTMENT		0	one 75-gpm	30	450
GDO	6452	MGRU	5	150	Eating establishment	0	0	350	CITY OF HIALEAH		0	one 7 gpm	30	88
GDO	6453	IGT	5	300	Eating establishment	52	52	0	MIAMI DADE WATER & SEWER DEPARTMENT	Single	1200	one 1200 gallon	90	728
GDO	6455	IGT	5	150	Eating establishment	20	20	1800	MIAMI DADE WATER & SEWER DEPARTMENT	Single	1600	one 1600 gallon	90	450
GDO	6458	IGT	5	150	Eating establishment	0	0	1084	MIAMI DADE WATER & SEWER DEPARTMENT	Single	950	one 950 gallon	90	271
GDO	6459	IGT	5	300	Eating establishment	386	386	6654	CITY OF MIAMI BEACH	Single	950	one 950 gallon	90	1664
GDO	6460	MGRU	5	150	Eating establishment	154	154	3336	CITY OF MIAMI BEACH		0	one 25 gpm	30	834
GDO	6461	IGT	2	150	Eating establishment	0	0	0	MIAMI DADE WATER & SEWER DEPARTMENT	Single	950	one 950 gallon	60	0
GDO	6462	IGT	5	150	Eating establishment	0	0	0	MIAMI DADE WATER & SEWER DEPARTMENT	Single	750	one 750 gallon	90	0
GDO	6463	IGT	5	150	Eating establishment	29	29	1571	MIAMI DADE WATER & SEWER DEPARTMENT	Single	950	one 950 gallon	90	393
GDO	6464	MGRU	5	150	Eating establishment	10	10	800	MIAMI DADE WATER & SEWER DEPARTMENT		0	one 25-gpm	30	200
GDO	6465	MGRU	5	150	Eating establishment	11	11	0	MIAMI DADE WATER & SEWER DEPARTMENT		0	one 25 gpm	30	154
GDO	6469	IGT	5	150	Eating establishment	30	30	1700	CITY OF NORTH MIAMI BEACH	Single	750	one 750-gallon	90	425
GDO	6470	IGT	5	150	Eating establishment	0	0	1057	MIAMI DADE WATER & SEWER DEPARTMENT	Single	2000	one 2000 gallon	90	264
GDO	6471	IGT	5	150	Eating establishment	40	40	0	MIAMI DADE WATER & SEWER DEPARTMENT	Single	1050	one 1050 gallon	90	1000
GDO	6472	IGT	5	150	Eating establishment	48	48	1300	CITY OF HIALEAH	Single	950	one 950-gallon	90	325
GDO	6474	IGT	5	150	Eating establishment	30	30	1500	CITY OF MIAMI BEACH	Single	750	one 750 gallon	90	375
												one 25 and one 75		
GDO	6478	MGRU	5	150	Eating establishment	92	0	2841	CITY OF MIAMI BEACH		0	gpm	30	710
GDO	6479	IGT	5	300	Eating establishment	52	52	0	CITY OF HOMESTEAD	Single	950	one 950 gallon	90	1300
GDO	6480	IGT	5	150	Eating establishment	8	8	1000	MIAMI DADE WATER & SEWER DEPARTMENT	Single	1050	one 1050 gallon	90	250
GDO	6482	IGT	5	150	Eating establishment	36	36	0	MIAMI DADE WATER & SEWER DEPARTMENT	Single	750	one 750 gallon	90	504
GDO	6483	IGT	5	300	Eating establishment	182	182	0	MIAMI DADE WATER & SEWER DEPARTMENT	Single	950	one 950 gallon	90	2548
GDO	6485	MGRU	5	150	Eating establishment	15	15	1654	MIAMI DADE WATER & SEWER DEPARTMENT		0	one 25 gpm	30	414
GDO	6486	MGRU	5	150	Eating establishment	0	0	360	MIAMI DADE WATER & SEWER DEPARTMENT		0	one 25 gpm	30	90
GDO	6487	MGRU	5	150	Eating establishment	4	4	841	MIAMI DADE WATER & SEWER DEPARTMENT		0	one 20 gpm	30	210
GDO	6491	MGRU	5	150	Eating establishment	0	0	1100	MIAMI DADE WATER & SEWER DEPARTMENT		0	one 25 gpm	30	275
GDO	6494	IGT	5	150	Eating establishment	20	20	0	MIAMI DADE WATER & SEWER DEPARTMENT	Single	1050	one 1050 gallon	90	280
GDO	6495	AGRU	5	150	Eating establishment	30	0	1680	CITY OF MIAMI BEACH		0	one 25 gpm	30	420
GDO	6496	MGRU	5	150	Eating establishment	20	20	1250	CITY OF HIALEAH GARDENS		0	one 25 gpm	30	313
GDO	6497	MGRU	5	150	Eating establishment	22	0	1250	MIAMI DADE WATER & SEWER DEPARTMENT		0	one 25 gpm	30	313
GDO	6498	IGT	5	150	Eating establishment	0	0	540	MIAMI DADE WATER & SEWER DEPARTMENT	Single	950	one 5000 gallon	90	135
GDO	6503	MGRU	5	150	Eating establishment	30	30	3000	MIAMI DADE WATER & SEWER DEPARTMENT		0	one 25 gpm	30	254
GDO	6504	MGRU	5	150	Eating establishment	20	0	540	MIAMI DADE WATER & SEWER DEPARTMENT		0	one 25 gpm	30	173
GDO	6505	AGRU	5	150	Eating establishment	46	46	2200	MIAMI DADE WATER & SEWER DEPARTMENT		0	one 25 gpm	30	1150
GDO	6510	MGRU	5	150	Eating establishment	30	0	1500	MIAMI DADE WATER & SEWER DEPARTMENT		0	one 35 gpm	30	375
GDO	6511	MGRU	5	150	Eating establishment	30	0	400	MIAMI DADE WATER & SEWER DEPARTMENT	Single	5000	one 5000 gallon	90	100
GDO	6514	MGRU	5	150	Eating establishment	8	8	1140	CITY OF MIAMI BEACH		0	one 25 gpm	30	285
GDO	6515	MGRU	5	150	Eating establishment	0	0	0	MIAMI DADE WATER & SEWER DEPARTMENT		0	one 25 gpm	30	0
GDO	6519	IGT	5	150	Eating establishment	15	15	1340	CITY OF FLORIDA CITY	Single	950	one 950 gallon	90	375
GDO	6521	IGT	5	150	Eating establishment	0	0	1400	CITY OF HIALEAH	Single	750	one 750 gallon	90	350
GDO	6531	IGT	5	300	Eating establishment	60	60	0	CITY OF MIAMI BEACH	Single	1600	one 1600 gallon	90	1500
GDO	6533	MGRU	5	150	Eating establishment	0	0	450	CITY OF MIAMI BEACH		0	one 25 gpm	30	113
GDO	6536	IGT	5	750	Eating establishment	209	209	0	CITY OF NORTH MIAMI BEACH	Single	1050	one 1050 gallon	90	5225
GDO	6538	IGT	2	300	Eating establishment	60	60	300	CITY OF MIAMI BEACH	Single	950	one 950 gallon	90	1500
GDO	6540	AGRU	5	300	Eating establishment	78	78	0	CITY OF MIAMI BEACH		0	one 25 gpm	30	1950
GDO	6541	MGRU	5	150	Eating establishment	44	44	0	MIAMI DADE WATER & SEWER DEPARTMENT		0	one 25 gpm	30	616
GDO	6542	AGRU	5	300	Eating establishment	56	56	0	CITY OF MIAMI BEACH		0	one 25 gpm	30	1400
GDO	6546	MGRU	5	150	Eating establishment	38	38	0	MIAMI DADE WATER & SEWER DEPARTMENT		0	one 25 gpm	30	532
GDO	6547	MGRU	5	150	Eating establishment	6	6	1802	CITY OF MIAMI BEACH		0	one 25 gpm	30	520
GDO	6548	IGT	5	150	Eating establishment	36	36	0	MIAMI DADE WATER & SEWER DEPARTMENT	Single	1200	one 1200 gallon	90	900
GDO	6550	IGT	5	150	Eating establishment	40	0	2000	MIAMI DADE WATER & SEWER DEPARTMENT	Series	4000	two 2000 gallon	30	500
GDO	6551	MGRU	5	150	Eating establishment	3	3	0	CITY OF MIAMI BEACH		0	one 25 gpm	30	75
GDO	6553	MGRU	5	150	Eating establishment	13	13	0	CITY OF MIAMI BEACH		0	one 25 gpm	30	182
GDO	6558	MGRU	5	150	Eating establishment	6	6	1715	MIAMI DADE WATER & SEWER DEPARTMENT		0	one 25 gpm	30	429
GDO	6559	IGT	5	150	Eating establishment	70	70	2794	MIAMI DADE WATER & SEWER DEPARTMENT	Single	950	one 950-gallon	90	699
GDO	6560	IGT	5	150	Eating establishment	18	18	1700	MIAMI DADE WATER & SEWER DEPARTMENT	Single	750	one 750 gallon	90	252
GDO	6561	AGRU	5	750	Eating establishment	224	224	0	CITY OF MIAMI BEACH		0	one 25 gpm	30	5600

WORK GROUP	PERMIT NUMBER	PERMIT CLASS	PERMIT	PERMIT FEE	BUSINESS_TYPE	RECORDED SEATS	OBSERVED SEATS	FACILITY AREA	UTILITY	SYSTEM FORMAT	TOTAL CAPACITY	TANK_CAPACITY	PUMP OUT	TOTAL GPD
GDO	6562	IGT	5	150	Eating establishment	220	220	3500	MIAMI DADE WATER & SEWER DEPARTMENT	Series	2100	two 1050-gallon	90	875
GDO	6563	MGRU	5	150	Eating establishment	30	0	1400	CITY OF MIAMI BEACH		0	one 25 gpm	30	350
GDO	6565	IGT	5	150	Eating establishment	0	0	0	MIAMI DADE WATER & SEWER DEPARTMENT	Single	1050	one 1050 gallon	90	0
GDO	6568	MGRU	5	150	Eating establishment	50	50	2675	MIAMI DADE WATER & SEWER DEPARTMENT		0	one 25-gpm	30	669
GDO	6571	IGT	5	750	Eating establishment	204	204	0	MIAMI DADE WATER & SEWER DEPARTMENT	Series	7500	five 1500 gallon	90	5100
GDO	6572	IGT	5	150	Eating establishment	0	0	1000	MIAMI DADE WATER & SEWER DEPARTMENT	Single	950	one 950 gallon	90	250
GDO	6574	IGT	5	750	Eating establishment	202	202	0	MIAMI DADE WATER & SEWER DEPARTMENT	Single	1050	one 1050 gallon	90	5050
GDO	6577	IGT	5	300	Eating establishment	6	6	0	CITY OF MIAMI BEACH	Single	750	one 750 gallon	90	0
GDO	6578	AGRU	5	150	Eating establishment	60	0	2970	CITY OF MIAMI BEACH		0	one 25 gpm	30	768
GDO	6579	MGRU	5	150	Eating establishment	0	0	0	CITY OF MIAMI BEACH		0	one 25 gpm	30	0
GDO	6580	IGT	5	150	Eating establishment	34	34	1500	MIAMI DADE WATER & SEWER DEPARTMENT	Single	1050	one 1050 gallon	90	850
GDO	6583	MGRU	5	150	Eating establishment	32	32	1389	CITY OF MIAMI BEACH		0	one 25 gpm	30	347
GDO	6587	IGT	5	150	Eating establishment	209	209	1801	CITY OF MIAMI BEACH	Single	1500	one 1500 gallon	90	450
GDO	6590	IGT	5	150	Eating establishment	24	24	1200	MIAMI DADE WATER & SEWER DEPARTMENT	Single	950	one 950 gallon	90	600
GDO	6592	IGT	5	150	Eating establishment	60	60	2000	CITY OF MIAMI BEACH	Single	1500	one 1500 gallon	90	500
GDO	6595	AGRU	5	150	Eating establishment	64	64	1725	CITY OF MIAMI BEACH		0	one 35 gpm	30	504
GDO	6599	IGT	5	300	Eating establishment	24	24	5783	MIAMI DADE WATER & SEWER DEPARTMENT	Series	2100	two 1050 gallon	90	1446
GDO	6600	IGT	5	300	Eating establishment	225	225	6215	MIAMI DADE WATER & SEWER DEPARTMENT	Single	1600	one 1600 gallon	90	1554
GDO	6602	MGRU	5	150	Eating establishment	15	0	1540	MIAMI DADE WATER & SEWER DEPARTMENT		0	one 50 gpm	30	385
GDO	6607	MGRU	5	150	Eating establishment	0	0	1500	CITY OF HIALEAH		0	one 25 gpm	30	375
GDO	6609	MGRU	5	150	Eating establishment	8	8	1210	MIAMI DADE WATER & SEWER DEPARTMENT		0	one 25 gpm	30	112
GDO	6612	MGRU	5	150	Eating establishment	0	0	1100	MIAMI DADE WATER & SEWER DEPARTMENT		0	one 25 gpm	30	275
GDO	6613	IGT	5	150	Eating establishment	8	8	0	MIAMI DADE WATER & SEWER DEPARTMENT	Single	1050	one 1050 gallon	90	2
GDO	6614	MGRU	1	0	Eating establishment	32	0	0	CITY OF MIAMI BEACH		0	one 35 gpm	30	0
GDO	6617	AGRU	5	150	Eating establishment	10	10	0	CITY OF MIAMI BEACH		0	one 25 gpm	30	140
GDO	6619	MGRU	5	150	Eating establishment	30	30	0	CITY OF HIALEAH	Single	2000	one 2000 gallon	90	420
GDO	6620	MGRU	5	150	Eating establishment	12	12	1632	CITY OF MIAMI BEACH		0	one 25-gpm	30	441
GDO	6621	MGRU	5	150	Eating establishment	8	8	928	MIAMI DADE WATER & SEWER DEPARTMENT		0	one 25 gpm	30	232
GDO	6624	MGRU	5	150	Eating establishment	55	0	2250	CITY OF MIAMI BEACH		0	one 35 gpm	30	56250
GDO	6625	IGT	5	150	Eating establishment	0	0	0	MIAMI DADE WATER & SEWER DEPARTMENT	Single	1200	one 1200 gallon	90	0
GDO	6628	IGT	5	150	Eating establishment	55	55	1250	CITY OF MIAMI BEACH	Single	1050	one 1050 gallon	90	313
GDO	6629	IGT	5	150	Eating establishment	35	35	0	MIAMI DADE WATER & SEWER DEPARTMENT	Single	1050	one 1050 gallon	90	490
GDO	6630	IGT	5	150	Eating establishment	49	49	3500	MIAMI DADE WATER & SEWER DEPARTMENT	Single	750	one 750-gallon	90	875
GDO	6631	IGT	5	300	Eating establishment	200	200	0	MIAMI DADE WATER & SEWER DEPARTMENT	Series	1500	two 750 gallon	90	5000
GDO	6636	IGT	2	150	Eating establishment	0	0	96	MIAMI DADE WATER & SEWER DEPARTMENT	Single	1050	one 1050 gallon	60	24
GDO	6638	IGT	5	150	Eating establishment	20	20	1872	MIAMI DADE WATER & SEWER DEPARTMENT	Single	950	one 950 gallon	90	468
GDO	6639	IGT	5	750	Eating establishment	218	218	0	MIAMI DADE WATER & SEWER DEPARTMENT	Series	2400	two 1200 gallon	90	5450
GDO	6640	IGT	5	300	Eating establishment	84	84	0	MIAMI DADE WATER & SEWER DEPARTMENT	Single	1200	one 1200 gallon	90	1176
GDO	6641	IGT	5	150	Eating establishment	65	65	3413	MIAMI DADE WATER & SEWER DEPARTMENT	Single	1500	one 1500-gallon	90	853
GDO	6643	AGRU	5	750	Eating establishment	0	0	11257	MIAMI DADE WATER & SEWER DEPARTMENT		0	two 20-gpm	30	2814
GDO	6646	MGRU	5	150	Eating establishment	4	4	0	MIAMI DADE WATER & SEWER DEPARTMENT		0	one 25 gpm	30	1
GDO	6650	IGT	5	150	Eating establishment	30	0	2297	MIAMI DADE WATER & SEWER DEPARTMENT	Single	750	one 750 gallon	30	574
GDO	6653	MGRU	5	150	Eating establishment	109	0	1187	MIAMI DADE WATER & SEWER DEPARTMENT		0	one 75 gpm	30	297
GDO	6659	MGRU	5	150	Eating establishment	22	46	0	CITY OF NORTH MIAMI BEACH		0	one 25 gpm	30	308
GDO	6660	MGRU	5	150	Eating establishment	6	6	0	MIAMI DADE WATER & SEWER DEPARTMENT		0	one 25 gpm	30	0
GDO	6663	IGT	5	150	Eating establishment	45	45	1000	MIAMI DADE WATER & SEWER DEPARTMENT	Single	950	one 950 gallon	90	1125
GDO	6665	IGT	5	150	Eating establishment	0	0	400	MIAMI DADE WATER & SEWER DEPARTMENT	Single	950	one 950 gallon	90	125
GDO	6667	MGRU	5	150	Eating establishment	0	0	1500	MIAMI DADE WATER & SEWER DEPARTMENT		0	one 25 gpm	30	375
GDO	6668	IGT	5	150	Eating establishment	60	60	1850	MIAMI DADE WATER & SEWER DEPARTMENT	Single	1200	one 1200 gallon	90	463
GDO	6677	IGT	5	300	Eating establishment	86	86	0	CITY OF NORTH MIAMI BEACH	Single	950	one 950 gallon	90	2150
GDO	6678	MGRU	5	150	Eating establishment	44	44	1300	CITY OF HIALEAH		0	one 25 gpm	30	325
GDO	6680	IGT	5	300	Eating establishment	60	60	0	MIAMI DADE WATER & SEWER DEPARTMENT	Single	750	one 750 gallon	90	1500
GDO	6681	IGT	5	150	Eating establishment	30	30	0	MIAMI DADE WATER & SEWER DEPARTMENT	Single	950	one 950 gallon	90	750
GDO	6682	MGRU	5	150	Eating establishment	10	10	0	CITY OF NORTH MIAMI BEACH		0	one 25 gpm	30	140
GDO	6683	MGRU	5	150	Eating establishment	25	25	0	MIAMI DADE WATER & SEWER DEPARTMENT		0	one 25 gpm	30	625
GDO	6684	IGT	5	150	Eating establishment	21	21	0	MIAMI DADE WATER & SEWER DEPARTMENT	Single	750	one 750 gallon	90	294
GDO	6686	AGRU	5	150	Eating establishment	34	34	0	CITY OF NORTH MIAMI BEACH		0	one 35 gpm	30	476
GDO	6688	IGT	5	150	Eating establishment	0	0	1600	MIAMI DADE WATER & SEWER DEPARTMENT	Single	750	one 750 gallon	90	400
GDO	6691	IGT	5	150	Eating establishment	50	50	2600	MIAMI DADE WATER & SEWER DEPARTMENT	Single	950	one 950-gallon	90	650
GDO	6693	IGT	5	150	Eating establishment	0	0	390	CITY OF HIALEAH	Single	1050	one 1050-gallon	90	98
GDO	6696	MGRU	5	150	Eating establishment	20	0	1671	MIAMI DADE WATER & SEWER DEPARTMENT		0	one 25 gpm	30	418

WORK GROUP	PERMIT NUMBER	PERMIT CLASS	PERMIT	PERMIT FEE	BUSINESS_TYPE	RECORDED SEATS	OBSERVED SEATS	FACILITY AREA	UTILITY	SYSTEM FORMAT	TOTAL CAPACITY	TANK_CAPACITY	PUMP OUT	TOTAL GPD
GDO	6698	IGT	5	150	Eating establishment	10	10	4189	MIAMI DADE WATER & SEWER DEPARTMENT	Single	1050	one 1050 gallon	90	50
GDO	6699	IGT	2	150	Eating establishment	36	36	0	MIAMI DADE WATER & SEWER DEPARTMENT	Single	950	one 950 gallon	90	900
GDO	6701	MGRU	5	150	Eating establishment	0	0	900	MIAMI DADE WATER & SEWER DEPARTMENT		0	one 25 gpm	30	225
GDO	6706	IGT	5	300	Eating establishment	74	74	0	MIAMI DADE WATER & SEWER DEPARTMENT	Single	950	one 950 gallon	90	1036
GDO	6709	MGRU	5	150	Eating establishment	15	15	1000	MIAMI DADE WATER & SEWER DEPARTMENT		0	one 25-gpm	30	250
GDO	6715	AGRU	5	150	Eating establishment	10	10	1500	CITY OF MIAMI BEACH		0	one 35 gpm	30	375
GDO	6718	IGT	5	150	Eating establishment	10	10	482	MIAMI DADE WATER & SEWER DEPARTMENT	Single	1200	one 1200 gallon	90	121
GDO	6733	IGT	5	150	Eating establishment	46	46	2000	MIAMI DADE WATER & SEWER DEPARTMENT	Single	1050	one 1050 gallon	90	1150
GDO	6736	IGT	5	300	Eating establishment	0	0	4421	MIAMI DADE WATER & SEWER DEPARTMENT	Single	1050	one 1050 gallon	90	1105
GDO	6740	IGT	5	150	Eating establishment	32	32	0	MIAMI DADE WATER & SEWER DEPARTMENT	Single	750	one 750 gallon	90	800
GDO	6741	IGT	5	150	Eating establishment	0	0	0	MIAMI DADE WATER & SEWER DEPARTMENT	Single	1600	one 1600 gallon	90	0
GDO	6742	MGRU	5	150	Eating establishment	5	5	976	MIAMI DADE WATER & SEWER DEPARTMENT		0	one 25 gpm	30	244
GDO	6743	MGRU	5	150	Eating establishment	26	26	0	MIAMI DADE WATER & SEWER DEPARTMENT		0	one 25 gpm	30	650
GDO	6745	MGRU	5	150	Eating establishment	28	28	440	MIAMI DADE WATER & SEWER DEPARTMENT		0	not available	30	700
GDO	6749	IGT	5	150	Eating establishment	0	0	730	CITY OF NORTH MIAMI BEACH	Single	950	one 950 gallon	90	183
GDO	6753	IGT	5	300	Eating establishment	154	154	0	CITY OF HIALEAH	Series	1900	two 950 gallon	90	3850
GDO	6754	MGRU	5	150	Eating establishment	49	49	0	MIAMI DADE WATER & SEWER DEPARTMENT		0	one 25 gpm	30	1225
GDO	6755	MGRU	5	300	Eating establishment	54	54	0	MIAMI DADE WATER & SEWER DEPARTMENT		0	one 25 gpm	30	1350
GDO	6756	MGRU	5	150	Eating establishment	10	10	1050	MIAMI DADE WATER & SEWER DEPARTMENT		0	one 25 gpm	30	263
GDO	6761	IGT	5	150	Eating establishment	20	20	1400	MIAMI DADE WATER & SEWER DEPARTMENT	Single	1050	one 1050-gallon	90	350
GDO	6762	MGRU	5	150	Eating establishment	41	41	3500	CITY OF NORTH MIAMI BEACH		0	one 25 gpm	30	875
GDO	6764	IGT	5	150	Eating establishment	20	20	0	MIAMI DADE WATER & SEWER DEPARTMENT	Single	750	one 750 gallon	90	280
GDO	6769	MGRU	5	150	Eating establishment	46	46	0	MIAMI DADE WATER & SEWER DEPARTMENT		0	one 25 gpm	30	1150
GDO	6774	IGT	5	150	Eating establishment	40	40	2000	MIAMI DADE WATER & SEWER DEPARTMENT	Single	750	one 750-gallon	90	500
GDO	6776	IGT	5	150	Eating establishment	27	27	0	MIAMI DADE WATER & SEWER DEPARTMENT	Single	1050	one 1050 gallon	90	675
GDO	6777	IGT	5	150	Eating establishment	8	8	1008	MIAMI DADE WATER & SEWER DEPARTMENT	Single	950	one 950-gallon	90	252
GDO	6778	MGRU	5	150	Eating establishment	60	60	2000	MIAMI DADE WATER & SEWER DEPARTMENT		0	one 25 gpm	30	500
GDO	6781	IGT	5	150	Eating establishment	24	24	0	MIAMI DADE WATER & SEWER DEPARTMENT	Single	1050	one 1050 gallon	90	600
GDO	6783	IGT	5	150	Eating establishment	40	40	0	MIAMI DADE WATER & SEWER DEPARTMENT	Single	950	one 950 gallon	90	560
GDO	6784	MGRU	5	150	Eating establishment	16	16	1050	MIAMI DADE WATER & SEWER DEPARTMENT		0	one 25 gpm	30	263
GDO	6786	IGT	5	300	Eating establishment	200	200	0	MIAMI DADE WATER & SEWER DEPARTMENT	Series	1900	two 950 gallon	90	5000
GDO	6787	IGT	5	150	Eating establishment	78	78	3200	MIAMI DADE WATER & SEWER DEPARTMENT	Single	1200	one 1200 gallon	90	800
GDO	6792	IGT	5	150	Eating establishment	8	8	0	MIAMI DADE WATER & SEWER DEPARTMENT	Single	950	one 950 gallon	90	112
GDO	6800	MGRU	5	150	Eating establishment	0	0	300	MIAMI DADE WATER & SEWER DEPARTMENT		0	one 25 gpm	30	75
GDO	6803	IGT	5	150	Eating establishment	10	10	865	CITY OF HIALEAH	Single	950	one 950 gallon	90	216
GDO	6804	IGT	5	150	Eating establishment	25	25	1100	MIAMI DADE WATER & SEWER DEPARTMENT	Single	1050	one 1050 gallon	90	275
GDO	6805	IGT	5	150	Eating establishment	10	10	0	MIAMI DADE WATER & SEWER DEPARTMENT	Single	950	one 950 gallon	90	140
GDO	6806	AGRU	5	150	Eating establishment	10	10	1800	MIAMI DADE WATER & SEWER DEPARTMENT		0	one 25 gpm	30	450
GDO	6807	IGT	5	300	Eating establishment	260	260	10871	MIAMI DADE WATER & SEWER DEPARTMENT	Single	950	one 950 gallon	90	2718
GDO	6808	MGRU	5	150	Eating establishment	0	0	0	CITY OF NORTH MIAMI BEACH		0	one 25 gpm	30	0
GDO	6809	MGRU	5	150	Eating establishment	30	30	1700	CITY OF MIAMI BEACH		0	one 25 gpm	30	425
GDO	6810	IGT	5	150	Eating establishment	40	40	1700	MIAMI DADE WATER & SEWER DEPARTMENT	Single	1050	one 1050 gallon	90	425
GDO	6811	IGT	5	300	Eating establishment	126	126	0	CITY OF MIAMI SPRINGS	Series	1900	two 950 gallon	90	3150
GDO	6812	MGRU	5	150	Eating establishment	48	0	2580	MIAMI DADE WATER & SEWER DEPARTMENT		0	one 20 gpm	30	645
GDO	6815	IGT	5	150	Eating establishment	40	40	2000	CITY OF MIAMI SPRINGS	Single	1050	one 1050 gallon	90	500
GDO	6816	MGRU	5	150	Eating establishment	15	15	0	MIAMI DADE WATER & SEWER DEPARTMENT		0	one 25 gpm	30	210
GDO	6820	IGT	5	750	Eating establishment	215	215	0	MIAMI DADE WATER & SEWER DEPARTMENT	Series	4200	four 1050 gallon	90	5375
GDO	6821	IGT	5	300	Eating establishment	65	65	0	MIAMI DADE WATER & SEWER DEPARTMENT	Single	750	one 750 gallon	90	1625
GDO	6824	IGT	5	150	Eating establishment	37	37	0	MIAMI DADE WATER & SEWER DEPARTMENT	Single	950	one 950 gallon	90	925
GDO	6829	IGT	5	300	Eating establishment	60	0	1553	MIAMI DADE WATER & SEWER DEPARTMENT	Single	1050	one 1050 gallon	90	388
GDO	6831	IGT	5	300	Eating establishment	74	74	0	MIAMI DADE WATER & SEWER DEPARTMENT	Single	1050	one 1050 gallon	90	1850
GDO	6832	AGRU	5	150	Eating establishment	0	0	196	MIAMI DADE WATER & SEWER DEPARTMENT		0	one 25-gpm	30	49
GDO	6837	IGT	5	150	Eating establishment	82	82	2480	CITY OF MIAMI SPRINGS	Single	1200	one 1200 gallon	90	620
GDO	6840	MGRU	5	150	Eating establishment	10	10	0	CITY OF OPA LOCKA		0	one 25-gpm	30	250
GDO	6842	IGT	5	150	Eating establishment	30	30	0	CITY OF MIAMI SPRINGS	Single	750	one 750 gallon	90	750
GDO	6843	IGT	5	150	Eating establishment	30	30	0	CITY OF MIAMI SPRINGS	Single	750	one 750 gallon	60	750
GDO	6844	IGT	5	750	Eating establishment	256	256	0	MIAMI DADE WATER & SEWER DEPARTMENT	Series	2250	three 750 gallon	90	6400
GDO	6847	IGT	5	150	Eating establishment	67	67	2678	MIAMI DADE WATER & SEWER DEPARTMENT	Series	2400	two 1200 gallon	90	670
GDO	6848	IGT	5	150	Eating establishment	34	34	0	MIAMI DADE WATER & SEWER DEPARTMENT	Single	1050	one 1050 gallon	90	476
GDO	6850	AGRU	5	150	Eating establishment	0	0	360	MIAMI DADE WATER & SEWER DEPARTMENT		0	one 75-gpm	30	90
GDO	6853	MGRU	5	150	Eating establishment	20	20	1200	MIAMI DADE WATER & SEWER DEPARTMENT		0	one 25 gpm	30	300

WORK GROUP	PERMIT NUMBER	PERMIT CLASS	PERMIT	PERMIT FEE	BUSINESS_TYPE	RECORDED SEATS	OBSERVED SEATS	FACILITY AREA	UTILITY	SYSTEM FORMAT	TOTAL CAPACITY	TANK_CAPACITY	PUMP OUT	TOTAL GPD
GDO	6854	IGT	5	150	Eating establishment	80	0	3150	MIAMI DADE WATER & SEWER DEPARTMENT	Single	1250	one 1250 gallon	60	788
GDO	6855	MGRU	5	150	Eating establishment	29	29	0	MIAMI DADE WATER & SEWER DEPARTMENT		0	one 50 gpm	30	725
GDO	6859	IGT	5	150	Eating establishment	95	0	2000	MIAMI DADE WATER & SEWER DEPARTMENT	Series	2400	two 1200 gallon	60	500
GDO	6864	IGT	5	150	Eating establishment	105	0	2235	CITY OF NORTH MIAMI BEACH	Single	1250	one 1250 gallon	60	55875
GDO	6868	IGT	5	150	Eating establishment	4	4	0	MIAMI DADE WATER & SEWER DEPARTMENT	Single	950	one 950 gallon	90	1
GDO	6874	IGT	5	300	Eating establishment	261	261	7126	MIAMI DADE WATER & SEWER DEPARTMENT	Single	950	one 950 gallon	90	1782
GDO	6876	MGRU	5	150	Eating establishment	30	30	1400	CITY OF HIALEAH		0	one 25 gpm	30	350
GDO	6877	IGT	5	150	Eating establishment	30	0	1100	CITY OF HIALEAH	Single	950	one 950 gallon	60	275
GDO	6878	IGT	5	150	Eating establishment	0	0	3588	CITY OF NORTH MIAMI BEACH	Single	950	one 950 gallon	90	897
GDO	6881	MGRU	5	150	Eating establishment	20	20	1200	MIAMI DADE WATER & SEWER DEPARTMENT		0	one 25 gpm	30	280
GDO	6884	IGT	5	150	Eating establishment	76	0	3050	MIAMI DADE WATER & SEWER DEPARTMENT	Single	1250	one 1250 gallon	60	763
GDO	6885	IGT	5	150	Eating establishment	49	49	859	CITY OF NORTH MIAMI BEACH	Series	2100	two 1050 gallon	90	215
GDO	6886	IGT	5	150	Eating establishment	2	2	0	CITY OF HIALEAH	Single	950	one 950 gallon	90	28
GDO	6889	IGT	5	150	Eating establishment	50	50	0	VIRGINIA GARDENS	Single	1600	one 1600 gallon	90	1250
GDO	6890	AGRU	5	150	Eating establishment	35	35	0	MIAMI DADE WATER & SEWER DEPARTMENT		0	one 25 gpm	30	875
GDO	6893	MGRU	5	150	Eating establishment	0	0	0	MIAMI DADE WATER & SEWER DEPARTMENT		0	one 25 gpm	30	0
GDO	6894	MGRU	5	300	Eating establishment	200	200	5000	MIAMI DADE WATER & SEWER DEPARTMENT		0	one 25 gpm	30	1250
GDO	6896	MGRU	5	150	Eating establishment	30	30	0	CITY OF MIAMI SPRINGS		0	one 25 gpm	30	750
GDO	6898	IGT	5	150	Eating establishment	35	0	2110	MIAMI DADE WATER & SEWER DEPARTMENT	Single	1200	one 1200 gallon	60	528
GDO	6901	AGRU	5	150	Eating establishment	150	150	3650	MIAMI DADE WATER & SEWER DEPARTMENT		0	one 25 gpm	30	913
GDO	6902	AGRU	5	300	Eating establishment	99	99	0	CITY OF MIAMI BEACH		0	one 25 gpm	30	2475
GDO	6905	AGRU	5	150	Eating establishment	9	9	0	CITY OF MIAMI BEACH		0	one 25 gpm	30	0
GDO	6914	MGRU	5	150	Eating establishment	0	0	0	MIAMI DADE WATER & SEWER DEPARTMENT		0	not applicable	30	0
GDO	6915	AGRU	5	150	Eating establishment	10	0	980	MIAMI DADE WATER & SEWER DEPARTMENT		0	one 25 gpm	30	245
GDO	6917	IGT	5	300	Eating establishment	217	0	6300	MIAMI DADE WATER & SEWER DEPARTMENT	Single	1200	one 1200 gallon	90	1575
GDO	6921	IGT	5	150	Eating establishment	24	24	1503	MIAMI DADE WATER & SEWER DEPARTMENT	Single	1050	one 1050 gallon	90	376
GDO	6925	IGT	5	150	Eating establishment	36	36	1826	MIAMI DADE WATER & SEWER DEPARTMENT	Single	950	one 950 gallon	90	900
GDO	6926	IGT	5	750	Eating establishment	250	250	0	MIAMI DADE WATER & SEWER DEPARTMENT	Single	1050	one 1050-gallon	90	6250
GDO	6927	IGT	5	150	Eating establishment	0	0	0	CITY OF HIALEAH	Single	1050	one 1050 gallon	90	0
GDO	6928	AGRU	5	300	Eating establishment	88	88	0	CITY OF MIAMI BEACH		0	one 25 gpm	30	2200
GDO	6931	IGT	5	150	Eating establishment	10	10	0	MIAMI DADE WATER & SEWER DEPARTMENT	Single	750	one 750 gallon	90	250
GDO	6932	IGT	5	150	Eating establishment	44	44	0	MIAMI DADE WATER & SEWER DEPARTMENT	Single	1200	one 1200 gallon	90	616
GDO	6933	MGRU	5	150	Eating establishment	26	26	1600	MIAMI DADE WATER & SEWER DEPARTMENT		0	one 25 gpm	30	400
GDO	6936	IGT	5	150	Eating establishment	108	108	2658	MIAMI DADE WATER & SEWER DEPARTMENT	Single	1050	one 1050 gallon	90	766
GDO	6939	MGRU	5	150	Eating establishment	16	16	1113	CITY OF OPA LOCKA		0	one 20 gpm	30	278
GDO	6944	MGRU	5	150	Eating establishment	24	0	1385	MIAMI DADE WATER & SEWER DEPARTMENT		0	one 75 gpm	30	346
GDO	6947	IGT	5	300	Eating establishment	72	72	0	MIAMI DADE WATER & SEWER DEPARTMENT	Single	750	one 750 gallon	90	1008
GDO	6950	IGT	5	150	Eating establishment	36	36	0	CITY OF OPA LOCKA	Single	1650	one 1650 gallon	90	504
GDO	6954	IGT	5	300	Eating establishment	134	134	0	MIAMI DADE WATER & SEWER DEPARTMENT		0	not available	90	3350
GDO	6957	MGRU	5	150	Eating establishment	50	50	1700	MIAMI DADE WATER & SEWER DEPARTMENT		0	one 25 gpm	30	1250
GDO	6960	AGRU	5	150	Eating establishment	103	0	2557	MIAMI DADE WATER & SEWER DEPARTMENT		0	one 75 gpm	30	710
GDO	6966	IGT	5	300	Eating establishment	54	54	0	MIAMI DADE WATER & SEWER DEPARTMENT	Single	950	one 950 gallon	90	1350
GDO	6967	IGT	5	300	Eating establishment	65	65	0	MIAMI DADE WATER & SEWER DEPARTMENT	Single	1050	one 1050 gallon	90	1625
GDO	6968	IGT	5	150	Eating establishment	49	49	1800	MIAMI DADE WATER & SEWER DEPARTMENT	Single	750	one 750 gallon	90	450
GDO	6969	IGT	5	150	Eating establishment	0	0	0	MIAMI DADE WATER & SEWER DEPARTMENT	Single	750	one 750 gallon	90	0
GDO	6970	IGT	5	150	Eating establishment	52	52	0	MIAMI DADE WATER & SEWER DEPARTMENT	Single	1600	one 1600 gallon	90	13
GDO	6973	IGT	5	150	Eating establishment	49	0	1900	MIAMI DADE WATER & SEWER DEPARTMENT	Single	1200	one 1200 gallon	60	475
GDO	6977	IGT	5	150	Eating establishment	28	28	0	MIAMI DADE WATER & SEWER DEPARTMENT	Single	750	one 750 gallon	90	700
GDO	6978	IGT	5	300	Eating establishment	110	110	0	MIAMI DADE WATER & SEWER DEPARTMENT	Single	950	one 950 gallon	90	2750
GDO	6980	IGT	5	150	Eating establishment	24	24	820	CITY OF NORTH MIAMI BEACH	Series	4200	four 1050 gallon	90	205
GDO	6983	MGRU	5	150	Eating establishment	0	0	843	MIAMI DADE WATER & SEWER DEPARTMENT		0	one 25 gpm	30	211
GDO	6984	IGT	5	300	Eating establishment	130	130	0	MIAMI DADE WATER & SEWER DEPARTMENT	Single	1200	one 1200 gallon	90	3250
GDO	6985	MGRU	5	150	Eating establishment	17	17	0	CITY OF HIALEAH		0	one 25 gpm	30	238
GDO	6986	IGT	5	150	Eating establishment	60	60	1800	MIAMI DADE WATER & SEWER DEPARTMENT	Single	950	one 950-gallon	90	450
GDO	6989	MGRU	5	150	Eating establishment	30	30	0	CITY OF MIAMI BEACH		0	one 25 gpm	30	750
GDO	6990	IGT	5	150	Eating establishment	10	10	0	MIAMI DADE WATER & SEWER DEPARTMENT	Single	950	one 950 gallon	90	250
GDO	6993	MGRU	5	300	Eating establishment	0	0	4861	MIAMI DADE WATER & SEWER DEPARTMENT		0	one 35 gpm	30	1215
GDO	6997	IGT	5	300	Eating establishment	0	0	163342	MIAMI DADE WATER & SEWER DEPARTMENT	Series	2500	two 1250 gallon	90	4084
GDO	7000	MGRU	5	150	Eating establishment	6	6	600	MIAMI DADE WATER & SEWER DEPARTMENT		0	one 25 gpm	30	150
GDO	7001	IGT	3	150	Eating establishment	0	0	0	CITY OF MIAMI BEACH	Single	1050	one 1050 gallon	90	390
GDO	7005	IGT	5	300	Eating establishment	160	160	10500	CITY OF NORTH MIAMI BEACH	Series	2500	two 1250 gallon	90	4000

WORK GROUP	PERMIT NUMBER	PERMIT CLASS	PERMIT	PERMIT FEE	BUSINESS_TYPE	RECORDED SEATS	OBSERVED SEATS	FACILITY AREA	UTILITY	SYSTEM FORMAT	TOTAL CAPACITY	TANK_CAPACITY	PUMP OUT	TOTAL GPD
GDO	7007	IGT	5	300	Eating establishment	80	80	0	CITY OF MIAMI BEACH	Single	1200	one 1200 gallon	90	2000
GDO	7008	IGT	5	300	Eating establishment	120	120	0	CITY OF MIAMI BEACH	Single	1200	one 1200 gallon	90	3000
GDO	7009	IGT	5	150	Eating establishment	22	22	1800	MIAMI DADE WATER & SEWER DEPARTMENT	Single	950	one 950-gallon	90	450
GDO	7013	IGT	5	150	Eating establishment	108	108	2295	CITY OF MIAMI BEACH	Series	2400	two 1200 gallon one 750 and one	90	574
GDO	7014	IGT	5	150	Eating establishment	25	25	0	CITY OF HOMESTEAD	Multiple	1800	1050 gallon	90	350
GDO	7015	IGT	5	150	Eating establishment	0	0	1700	CITY OF HIALEAH	Single	1050	one 1050 gallon	90	425
GDO	7020	IGT	5	150	Eating establishment	50	50	0	MIAMI DADE WATER & SEWER DEPARTMENT	Single	950	one 950 gallon	90	1250
GDO	7022	IGT	5	150	Eating establishment	24	24	0	CITY OF MIAMI BEACH	Single	1200	one 1200 gallon	90	600
GDO	7026	IGT	5	300	Eating establishment	178	178	10000	CITY OF NORTH MIAMI BEACH	Single	950	one 950 gallon	90	2500
GDO	7030	IGT	5	750	Eating establishment	240	240	0	MIAMI DADE WATER & SEWER DEPARTMENT	Single	950	one 950 gallon	90	6000
GDO	7032	IGT	5	150	Eating establishment	141	141	3255	MIAMI DADE WATER & SEWER DEPARTMENT	Series	2400	two 1200 gallon	90	814
GDO	7034	MGRU	5	150	Eating establishment	0	0	3200	MIAMI DADE WATER & SEWER DEPARTMENT		0	one 25 gpm	30	800
GDO	7035	AGRU	5	150	Eating establishment	34	0	1553	MIAMI DADE WATER & SEWER DEPARTMENT		0	one 25 gpm	30	388
GDO	7048	MGRU	5	150	Eating establishment	0	0	1355	CITY OF NORTH MIAMI BEACH		0	one 35 gpm	30	339
GDO	7051	MGRU	5	150	Eating establishment	0	0	1400	MIAMI DADE WATER & SEWER DEPARTMENT		0	one 25-gpm	30	350
GDO	7054	MGRU	5	150	Eating establishment	40	40	1400	MIAMI DADE WATER & SEWER DEPARTMENT		0	one 25 gpm	30	350
GDO	7055	MGRU	5	150	Eating establishment	45	0	1534	MIAMI DADE WATER & SEWER DEPARTMENT		0	one 50 gpm	30	384
GDO	7060	MGRU	5	300	Eating establishment	120	120	13500	CITY OF MIAMI BEACH		0	one 25 gpm	30	3375
GDO	7065	MGRU	5	150	Eating establishment	50	50	0	MIAMI DADE WATER & SEWER DEPARTMENT		0	one 25 gpm	30	1250
GDO	7067	IGT	5	150	Eating establishment	28	28	0	MIAMI DADE WATER & SEWER DEPARTMENT	Single	1200	one 1200 gallon	90	700
GDO	7071	IGT	5	150	Eating establishment	0	0	1350	MIAMI DADE WATER & SEWER DEPARTMENT	Single	1050	one 1050-gallon	90	338
GDO	7073	MGRU	5	150	Eating establishment	0	0	0	CITY OF HIALEAH		0	one 75 gpm	90	0
GDO	7075	IGT	5	150	Eating establishment	10	10	0	MIAMI DADE WATER & SEWER DEPARTMENT	Single	950	one 950 gallon	90	140
GDO	7077	MGRU	5	150	Eating establishment	16	0	1200	MIAMI DADE WATER & SEWER DEPARTMENT		0	one 25 gpm	30	300
GDO	7079	IGT	5	150	Eating establishment	65	65	2400	MIAMI DADE WATER & SEWER DEPARTMENT	Single	950	one 950 gallon	90	600
GDO	7086	IGT	5	300	Eating establishment	179	179	4200	MIAMI DADE WATER & SEWER DEPARTMENT	Single	950	one 950 gallon	90	1050
GDO	7087	AGRU	5	150	Eating establishment	24	24	1500	MIAMI DADE WATER & SEWER DEPARTMENT		0	one 25 gpm	30	336
GDO	7088	IGT	5	150	Eating establishment	10	10	0	CITY OF NORTH MIAMI BEACH	Single	1050	one 1050 gallon	90	250
GDO	7090	IGT	5	150	Eating establishment	5	5	750	CITY OF NORTH MIAMI BEACH	Single	1050	one 1050 gallon	90	188
GDO	7094	AGRU	5	150	Eating establishment	16	0	935	MIAMI DADE WATER & SEWER DEPARTMENT		0	one 25 gpm	30	234
GDO	7097	IGT	5	300	Eating establishment	76	76	0	CITY OF HOMESTEAD	Series	2100	two 1050 gallon	90	1064
GDO	7099	MGRU	5	150	Eating establishment	8	8	0	MIAMI DADE WATER & SEWER DEPARTMENT		0	one 25 gpm	30	112
GDO	7100	IGT	5	150	Eating establishment	10	0	2076	CITY OF NORTH MIAMI BEACH	Series	2150	one 950 and one 1200 gallon	90	519
GDO	7104	IGT	5	300	Eating establishment	311	311	6803	MIAMI DADE WATER & SEWER DEPARTMENT	Series	4500	three 1500 gallon	90	1701
GDO	7105	MGRU	5	150	Eating establishment	32	0	750	MIAMI DADE WATER & SEWER DEPARTMENT		0	one 10 gpm	30	188
GDO	7107	IGT	5	300	Eating establishment	153	153	0	MIAMI DADE WATER & SEWER DEPARTMENT	Series	2400	two 1200 gallon	90	2142
GDO	7110	IGT	5	300	Eating establishment	102	102	0	MIAMI DADE WATER & SEWER DEPARTMENT	Series	2400	two 1200 gallon	90	1428
GDO	7111	IGT	5	750	Eating establishment	202	202	8648	CITY OF MIAMI BEACH	Series	2100	two 1050 gallon	90	2162
GDO	7119	IGT	5	150	Eating establishment	10	10	396	MIAMI DADE WATER & SEWER DEPARTMENT	Single	1050	one 1050-gallon	90	99
GDO	7123	IGT	5	150	Eating establishment	27	27	1494	MIAMI DADE WATER & SEWER DEPARTMENT	Series	3150	three 1050 gallon	90	374
GDO	7125	IGT	5	300	Eating establishment	120	120	0	MIAMI DADE WATER & SEWER DEPARTMENT	Single	950	one 950 gallon	90	3000
GDO	7126	IGT	5	150	Eating establishment	66	66	1794	CITY OF MIAMI BEACH	Single	1200	one 1200 gallon	90	449
GDO	7130	IGT	5	150	Eating establishment	30	30	0	MIAMI DADE WATER & SEWER DEPARTMENT	Single	750	one 750 gallon	90	750
GDO	7133	IGT	5	150	Eating establishment	30	30	0	CITY OF HIALEAH	Single	950	one 950 gallon	90	750
GDO	7146	AGRU	5	150	Eating establishment	5	5	1300	MIAMI DADE WATER & SEWER DEPARTMENT		0	one 25 gpm	30	325
GDO	7148	MGRU	5	150	Eating establishment	14	14	800	CITY OF HIALEAH		0	one 25 gpm	30	200
GDO	7155	IGT	5	300	Eating establishment	84	84	0	CITY OF HIALEAH GARDENS		950	one 950 gallon	90	2100
GDO	7156	IGT	5	150	Eating establishment	44	44	0	CITY OF NORTH MIAMI BEACH	Series	1900	two 950 gallon	90	616
GDO	7160	IGT	5	150	Eating establishment	37	37	1918	MIAMI DADE WATER & SEWER DEPARTMENT	Single	950	one 950 gallon	90	480
GDO	7162	MGRU	5	150	Eating establishment	28	28	0	MIAMI DADE WATER & SEWER DEPARTMENT		0	one 25 gpm	30	700
GDO	7163	IGT	5	150	Eating establishment	0	0	2500	MIAMI DADE WATER & SEWER DEPARTMENT	Single	950	one 750 gallon	90	625
GDO	7168	IGT	5	150	Eating establishment	15	15	0	CITY OF NORTH MIAMI BEACH	Series	2100	two 1050 gallon	90	375
GDO	7169	MGRU	5	150	Eating establishment	0	0	2318	CITY OF MIAMI BEACH		0	one 25 gpm	30	580
GDO	7170	MGRU	5	150	Eating establishment	0	0	734	MIAMI DADE WATER & SEWER DEPARTMENT		0	one 50 gpm	30	184
GDO	7177	IGT	5	150	Eating establishment	40	40	1400	CITY OF NORTH MIAMI BEACH	Single	950	one 950 gallon	90	1000
GDO	7182	MGRU	5	150	Eating establishment	0	0	0	MIAMI DADE WATER & SEWER DEPARTMENT		0	one 25 gpm	30	0
GDO	7183	MGRU	5	150	Eating establishment	36	36	1550	CITY OF HIALEAH		0	one 25 gpm	30	388
GDO	7184	MGRU	5	150	Eating establishment	8	8	0	CITY OF HIALEAH		0	one 25 gpm	30	112
GDO	7185	MGRU	5	150	Eating establishment	0	0	70	MIAMI DADE WATER & SEWER DEPARTMENT		0	unknown	0	18

WORK GROUP	PERMIT NUMBER	PERMIT CLASS	PERMIT	PERMIT FEE	BUSINESS_TYPE	RECORDED SEATS	OBSERVED SEATS	FACILITY AREA	UTILITY	SYSTEM FORMAT	TOTAL CAPACITY	TANK_CAPACITY	PUMP OUT	TOTAL GPD
GDO	7186	IGT	5	300	Eating establishment	104	104	0	CITY OF HIALEAH	Series	2400	two 1200 gallon	90	1456
GDO	7187	AGRU	5	150	Eating establishment	20	20	0	MIAMI DADE WATER & SEWER DEPARTMENT		0	one 25 gpm	30	500
GDO	7191	AGRU	5	150	Eating establishment	20	20	1200	MIAMI DADE WATER & SEWER DEPARTMENT		0	one 25 gpm	30	2800
GDO	7192	IGT	5	150	Eating establishment	0	0	1400	CITY OF HIALEAH	Single	1200	one 1200 gallon	60	35000
GDO	7198	MGRU	5	150	Eating establishment	0	0	0	CITY OF NORTH BAY VILLAGE		0	not available	0	0
GDO	7201	MGRU	5	150	Eating establishment	30	0	1400	CITY OF MIAMI BEACH		0	one 100 gpm	30	350
GDO	7202	IGT	5	150	Eating establishment	20	20	0	CITY OF NORTH MIAMI BEACH	Single	1200	one 1200 gallon	90	280
GDO	7206	IGT	5	150	Eating establishment	0	0	462	MIAMI DADE WATER & SEWER DEPARTMENT	Single	950	one 950 gallon	90	116
GDO	7208	IGT	5	150	Eating establishment	10	10	0	MIAMI DADE WATER & SEWER DEPARTMENT	Single	950	one 950 gallon	90	140
GDO	7209	IGT	5	150	Eating establishment	50	50	2556	CITY OF HIALEAH	Single	1050	one 1050 gallon	90	639
GDO	7210	IGT	5	150	Eating establishment	84	84	3150	MIAMI DADE WATER & SEWER DEPARTMENT	Single	1050	one 1050 gallon	90	788
GDO	7214	IGT	5	300	Eating establishment	94	94	0	MIAMI DADE WATER & SEWER DEPARTMENT	Single	750	one 750 gallon	90	1316
GDO	7218	MGRU	5	150	Eating establishment	43	43	0	MIAMI DADE WATER & SEWER DEPARTMENT		0	one 25 gpm	30	1075
GDO	7219	AGRU	5	150	Eating establishment	46	46	1300	CITY OF NORTH MIAMI		0	one 25 gpm	30	325
GDO	7220	IGT	5	150	Eating establishment	30	30	1200	MIAMI DADE WATER & SEWER DEPARTMENT	Single	1050	one 1050 gallon	90	300
GDO	7224	MGRU	5	150	Eating establishment	100	100	1616	MIAMI DADE WATER & SEWER DEPARTMENT		0	one 35 gpm	30	404
GDO	7225	MGRU	5	150	Eating establishment	10	10	1200	MIAMI DADE WATER & SEWER DEPARTMENT		0	one 50 gpm	30	300
GDO	7227	IGT	5	150	Eating establishment	35	35	0	MIAMI DADE WATER & SEWER DEPARTMENT	Single	750	one 750 gallon	90	875
GDO	7235	MGRU	5	300	Eating establishment	371	371	0	CITY OF NORTH MIAMI BEACH		0	four 25-gpm	30	2226
GDO	7237	AGRU	5	150	Eating establishment	0	0	1200	MIAMI DADE WATER & SEWER DEPARTMENT		0	one 25 gpm	30	300
GDO	7245	IGT	5	300	Eating establishment	109	109	7010	MIAMI DADE WATER & SEWER DEPARTMENT	Series	2400	two 1200 gallon	90	175250
GDO	7246	MGRU	5	300	Eating establishment	83	83	0	CITY OF MIAMI BEACH		0	one 25 gpm	30	2075
GDO	7248	IGT	5	300	Eating establishment	92	92	0	MIAMI DADE WATER & SEWER DEPARTMENT	Single	1050	one 1050 gallon	90	2300
GDO	7250	MGRU	5	150	Eating establishment	0	0	1152	MIAMI DADE WATER & SEWER DEPARTMENT		0	one 25 gpm	30	288
GDO	7254	AGRU	5	150	Eating establishment	25	25	1250	MIAMI DADE WATER & SEWER DEPARTMENT		0	one 25 gpm	30	313
GDO	7261	MGRU	5	150	Eating establishment	26	26	0	MIAMI DADE WATER & SEWER DEPARTMENT		0	one 25 gpm	30	650
GDO	7262	IGT	5	150	Eating establishment	22	0	1235	MIAMI DADE WATER & SEWER DEPARTMENT		1600	one 1600 gallon	60	309
GDO	7263	MGRU	5	300	Eating establishment	210	210	7217	MIAMI DADE WATER & SEWER DEPARTMENT		0	one 75 gpm	30	1804
GDO	7265	IGT	5	150	Eating establishment	13	13	0	MIAMI DADE WATER & SEWER DEPARTMENT	Single	1200	one 1200 gallon	90	325
GDO	7266	IGT	5	150	Eating establishment	30	30	1634	MIAMI DADE WATER & SEWER DEPARTMENT	Single	750	one 750 gallon	90	750
GDO	7267	IGT	5	150	Eating establishment	48	48	0	CITY OF HIALEAH	Single	1050	one 1050 gallon	90	672
GDO	7270	IGT	5	150	Eating establishment	48	48	1437	CITY OF NORTH MIAMI BEACH	Series	2500	two 1250 gallon	90	359
GDO	7273	IGT	5	150	Eating establishment	28	34	0	MIAMI DADE WATER & SEWER DEPARTMENT	Single	950	one 950 gallon	90	392
GDO	7274	MGRU	5	150	Eating establishment	18	18	0	CITY OF MIAMI BEACH		0	one 25 gpm	30	252
GDO	7276	IGT	5	300	Eating establishment	63	63	0	CITY OF MIAMI BEACH	Single	1200	one 1200 gallon	90	1575
GDO	7277	AGRU	5	150	Eating establishment	20	20	1338	MIAMI DADE WATER & SEWER DEPARTMENT		0	one 25 gpm	30	335
GDO	7278	IGT	5	150	Eating establishment	72	72	3000	CITY OF NORTH BAY VILLAGE	Series	2100	two 1050 gallon	90	750
GDO	7279	IGT	5	150	Eating establishment	45	45	0	CITY OF HIALEAH	Single	1200	one 1200 gallon	90	630
GDO	7280	IGT	5	150	Eating establishment	40	40	1460	MIAMI DADE WATER & SEWER DEPARTMENT	Single	950	one 950 gallon	90	365
GDO	7281	MGRU	5	150	Eating establishment	34	34	0	MIAMI DADE WATER & SEWER DEPARTMENT		0	one 25 gpm	30	850
GDO	7282	IGT	5	150	Eating establishment	50	50	1162	MIAMI DADE WATER & SEWER DEPARTMENT	Single	1050	one 1050-gallon	90	291
GDO	7283	IGT	5	150	Eating establishment	6	6	680	CITY OF HIALEAH	Single	750	one 750 gallon	90	170
GDO	7285	IGT	5	150	Eating establishment	20	20	0	MIAMI DADE WATER & SEWER DEPARTMENT	Single	950	one 950 gallon	90	280
GDO	7286	IGT	5	150	Eating establishment	34	34	400	CITY OF NORTH MIAMI	Single	1200	one 1200 gallon	90	850
GDO	7293	MGRU	5	150	Eating establishment	0	0	0	MIAMI DADE WATER & SEWER DEPARTMENT		0	one 25 gpm	30	0
GDO	7294	MGRU	5	150	Eating establishment	30	30	0	CITY OF HIALEAH		0	one 25 gpm	30	750
GDO	7297	MGRU	5	150	Eating establishment	26	26	1120	MIAMI DADE WATER & SEWER DEPARTMENT		0	one 25 gpm	30	280
GDO	7301	MGRU	5	150	Eating establishment	60	60	900	CITY OF MIAMI BEACH		0	one 25 gpm	30	225
GDO	7302	IGT	5	150	Eating establishment	0	0	0	MIAMI DADE WATER & SEWER DEPARTMENT	Single	750	one 750 gallon	90	0
GDO	7303	IGT	5	150	Eating establishment	7	7	0	CITY OF HIALEAH	Single	1200	one 1200 gallon	90	2
GDO	7307	MGRU	5	150	Eating establishment	88	88	1750	MIAMI DADE WATER & SEWER DEPARTMENT		0	one 25 gpm	30	438
GDO	7308	IGT	5	150	Eating establishment	20	20	0	MIAMI DADE WATER & SEWER DEPARTMENT	Single	750	one 750 gallon	90	280
GDO	7311	IGT	5	150	Eating establishment	61	61	3210	MIAMI DADE WATER & SEWER DEPARTMENT	Single	1050	one 1050 gallon	90	803
GDO	7313	IGT	5	150	Eating establishment	0	0	1400	CITY OF HIALEAH		950	one 950 gallon	90	350
GDO	7315	IGT	5	150	Eating establishment	0	0	1000	MIAMI DADE WATER & SEWER DEPARTMENT	Single	950	one 950-gallon	90	250
GDO	7317	MGRU	5	150	Eating establishment	0	0	1919	MIAMI DADE WATER & SEWER DEPARTMENT		0	one 25 gpm	30	480
GDO	7318	AGRU	5	150	Eating establishment	0	0	0	CITY OF HIALEAH		0	one 35 gpm	30	0
GDO	7320	IGT	5	150	Eating establishment	38	38	1300	MIAMI DADE WATER & SEWER DEPARTMENT	Single	750	one 750 gallon	90	325
GDO	7324	MGRU	5	300	Eating establishment	0	0	5194	CITY OF MIAMI BEACH		0	one 15 and two 100 gpm	60	1299
GDO	7330	MGRU	5	150	Eating establishment	8	8	0	MIAMI DADE WATER & SEWER DEPARTMENT		0	two 25 gpm	30	0

WORK GROUP	PERMIT NUMBER	PERMIT CLASS	PERMIT	PERMIT FEE	BUSINESS_TYPE	RECORDED SEATS	OBSERVED SEATS	FACILITY AREA	UTILITY	SYSTEM FORMAT	TOTAL CAPACITY	TANK_CAPACITY	PUMP OUT	TOTAL GPD
GDO	7332	IGT	5	750	Eating establishment	247	247	0	CITY OF MIAMI BEACH	Series	1500	two 750 gallon	90	6175
GDO	7333	IGT	5	300	Eating establishment	200	200	0	MIAMI DADE WATER & SEWER DEPARTMENT	Single	950	one 950 gallon	90	5000
GDO	7335	IGT	5	150	Eating establishment	30	30	982	CITY OF HIALEAH	Single	950	one 950 gallon	90	750
GDO	7336	IGT	5	150	Eating establishment	600	600	0	MIAMI DADE WATER & SEWER DEPARTMENT	Single	950	one 950 gallon	90	0
GDO	7346	IGT	5	150	Eating establishment	20	20	0	MIAMI DADE WATER & SEWER DEPARTMENT	Single	1050	one 1050 gallon	90	500
GDO	7352	IGT	5	150	Eating establishment	0	0	0	MIAMI DADE WATER & SEWER DEPARTMENT	Single	950	one 950 gallon	90	0
GDO	7353	MGRU	2	300	Eating establishment	93	93	0	MIAMI DADE WATER & SEWER DEPARTMENT		0	one 25 gpm	30	2325
GDO	7354	MGRU	5	150	Eating establishment	49	49	2960	MIAMI DADE WATER & SEWER DEPARTMENT		0	one 25 gpm	30	740
GDO	7357	IGT	5	150	Eating establishment	0	0	1100	MIAMI DADE WATER & SEWER DEPARTMENT	Single	950	one 950 gallon	90	275
GDO	7365	IGT	5	150	Eating establishment	16	0	3500	MIAMI DADE WATER & SEWER DEPARTMENT	Single	750	one 750 gallon	90	875
GDO	7366	IGT	5	150	Eating establishment	24	24	0	MIAMI DADE WATER & SEWER DEPARTMENT	Single	1050	one 1050 gallon	90	600
GDO	7367	MGRU	5	150	Eating establishment	27	27	0	CITY OF HIALEAH		0	one 25 gallon	30	378
GDO	7368	AGRU	5	150	Eating establishment	24	24	1245	MIAMI DADE WATER & SEWER DEPARTMENT		0	one 50 gpm	30	311
GDO	7369	AGRU	5	300	Eating establishment	67	67	0	MIAMI DADE WATER & SEWER DEPARTMENT		0	one 25 gpm	30	938
GDO	7372	MGRU	5	300	Eating establishment	60	60	0	MIAMI DADE WATER & SEWER DEPARTMENT		0	one 25 gpm	30	1500
GDO	7373	IGT	2	150	Eating establishment	0	0	0	CITY OF OPA LOCKA	Single	1050	one 1050 gallon	90	0
GDO	7375	IGT	5	300	Eating establishment	66	66	0	MIAMI DADE WATER & SEWER DEPARTMENT	Series	2500	two 1250 gallon	90	1650
GDO	7376	IGT	5	150	Eating establishment	0	0	663	MIAMI DADE WATER & SEWER DEPARTMENT	Single	1050	one 1050 gallon	60	166
GDO	7377	AGRU	5	150	Eating establishment	40	40	0	MIAMI DADE WATER & SEWER DEPARTMENT		0	one 25 gpm	30	1000
GDO	7378	AGRU	5	150	Eating establishment	26	26	1250	MIAMI DADE WATER & SEWER DEPARTMENT		0	one 25 gpm	30	313
GDO	7379	IGT	5	150	Eating establishment	71	71	2000	MIAMI DADE WATER & SEWER DEPARTMENT	Single	1050	one 1050 gallon	90	500
GDO	7381	IGT	5	150	Eating establishment	15	15	1386	MIAMI DADE WATER & SEWER DEPARTMENT	Single	950	one 950 gallon	90	375
GDO	7382	IGT	5	150	Eating establishment	84	84	3200	MIAMI DADE WATER & SEWER DEPARTMENT	Single	1500	one 1500 gallon	90	800
GDO	7384	MGRU	5	150	Eating establishment	4	4	1230	MIAMI DADE WATER & SEWER DEPARTMENT		0	one 35 gpm	30	308
GDO	7387	IGT	5	150	Eating establishment	16	16	1135	MIAMI DADE WATER & SEWER DEPARTMENT	Single	750	one 750 gallon	90	284
GDO	7388	IGT	5	300	Eating establishment	62	62	0	CITY OF NORTH MIAMI BEACH	Multiple	2100	two 1050 gallon	90	868
GDO	7391	MGRU	5	150	Eating establishment	17	17	1567	MIAMI DADE WATER & SEWER DEPARTMENT		0	one 25 gpm	30	392
GDO	7392	MGRU	5	150	Eating establishment	22	0	800	MIAMI DADE WATER & SEWER DEPARTMENT		0	one 25 gpm	30	200
GDO	7397	MGRU	5	150	Eating establishment	10	10	800	MIAMI DADE WATER & SEWER DEPARTMENT		0	one 25 gpm	30	200
GDO	7400	AGRU	5	150	Eating establishment	29	0	961	MIAMI DADE WATER & SEWER DEPARTMENT		0	one 20 gpm	30	240
GDO	7401	IGT	5	150	Eating establishment	110	110	2149	MIAMI DADE WATER & SEWER DEPARTMENT	Single	1600	one 1600 gallon	90	537
GDO	7402	MGRU	5	150	Eating establishment	8	8	1700	MIAMI DADE WATER & SEWER DEPARTMENT		0	one 25 gpm	30	200
GDO	7414	IGT	5	150	Eating establishment	36	36	0	MIAMI DADE WATER & SEWER DEPARTMENT	Single	1500	one 1500 gallon	90	504
GDO	7417	IGT	5	300	Eating establishment	275	275	8751	MIAMI DADE WATER & SEWER DEPARTMENT	Single	1500	one 1500 gallon	90	2188
GDO	7423	IGT	5	300	Eating establishment	163	0	4500	CITY OF HIALEAH	Single	1050	one 1050 gallon	60	1125
GDO	7424	AGRU	5	150	Eating establishment	40	40	0	MIAMI DADE WATER & SEWER DEPARTMENT		0	one 25 gpm	30	560
GDO	7426	MGRU	2	150	Eating establishment	31	31	1711	MIAMI DADE WATER & SEWER DEPARTMENT		0	one 35 gpm	30	428
GDO	7428	IGT	5	150	Eating establishment	4	4	1200	MIAMI DADE WATER & SEWER DEPARTMENT	Single	950	one 950 gallon	90	300
GDO	7429	MGRU	5	150	Eating establishment	20	20	1375	CITY OF NORTH MIAMI BEACH		0	one 25 gpm	30	344
GDO	7435	IGT	5	150	Eating establishment	64	64	1999	MIAMI DADE WATER & SEWER DEPARTMENT	Series	2850	three 950 gallon	90	500
GDO	7437	IGT	5	150	Eating establishment	36	36	1184	MIAMI DADE WATER & SEWER DEPARTMENT	Single	750	one 750 gallon	90	296
GDO	7439	MGRU	5	150	Eating establishment	10	0	400	MIAMI DADE WATER & SEWER DEPARTMENT		0	one 75 gpm	30	100
GDO	7441	MGRU	5	150	Eating establishment	10	10	0	MIAMI DADE WATER & SEWER DEPARTMENT		0	one 25 gpm	30	140
GDO	7442	MGRU	5	150	Eating establishment	23	23	2006	MIAMI DADE WATER & SEWER DEPARTMENT		0	one 25 gpm	30	502
GDO	7446	IGT	5	150	Eating establishment	24	24	1300	MIAMI DADE WATER & SEWER DEPARTMENT	Single	750	one 750 gallon	90	336
GDO	7448	AGRU	5	150	Eating establishment	0	0	600	CITY OF MIAMI BEACH		0	one 25 gpm	30	150
GDO	7452	MGRU	5	150	Eating establishment	30	30	0	CITY OF MIAMI SPRINGS		0	one 25 gpm	30	750
GDO	7453	IGT	5	150	Eating establishment	30	0	1635	MIAMI DADE WATER & SEWER DEPARTMENT	Single	1250	one 1250 gallon	60	409
GDO	7461	IGT	5	300	Eating establishment	219	219	6062	CITY OF HOMESTEAD	Series	3750	three 1250 gallon	90	1516
GDO	7463	IGT	5	150	Eating establishment	0	0	2590	MIAMI DADE WATER & SEWER DEPARTMENT	Single	750	one 750 gallon	90	648
GDO	7465	IGT	5	150	Eating establishment	10	10	1200	CITY OF HOMESTEAD		0	no available	90	300
GDO	7466	MGRU	5	150	Eating establishment	25	25	0	MIAMI DADE WATER & SEWER DEPARTMENT		0	one 25 gpm	30	625
GDO	7467	MGRU	4	150	Eating establishment	0	0	397	MIAMI DADE WATER & SEWER DEPARTMENT		0	one 25 gpm	30	99
GDO	7468	IGT	5	150	Eating establishment	72	72	1000	MIAMI DADE WATER & SEWER DEPARTMENT	Single	1050	one 1050-gallon	90	250
GDO	7471	IGT	5	150	Eating establishment	61	61	2800	MIAMI DADE WATER & SEWER DEPARTMENT	Single	950	one 950 gallon	90	700
GDO	7472	IGT	5	150	Eating establishment	44	0	980	CITY OF HIALEAH	Single	750	one 750 gallon	60	245
GDO	7476	MGRU	5	150	Eating establishment	16	16	1900	CITY OF NORTH MIAMI BEACH		0	one 25 gpm	30	400
GDO	7477	IGT	5	150	Eating establishment	15	15	1400	MIAMI DADE WATER & SEWER DEPARTMENT	Single	750	one 750-gallon	90	350
GDO	7478	IGT	5	150	Eating establishment	50	50	0	CITY OF HIALEAH	Single	1250	one 1250 gallon	90	700
GDO	7482	IGT	5	150	Eating establishment	24	24	1360	MIAMI DADE WATER & SEWER DEPARTMENT	Single	750	one 750 gallon	90	600
GDO	7483	MGRU	5	150	Eating establishment	65	0	3508	CITY OF MIAMI BEACH		0	one 75 gpm	30	877

WORK GROUP	PERMIT NUMBER	PERMIT CLASS	PERMIT	PERMIT FEE	BUSINESS_TYPE	RECORDED SEATS	OBSERVED SEATS	FACILITY AREA	UTILITY	SYSTEM FORMAT	TOTAL CAPACITY	TANK_CAPACITY	PUMP OUT	TOTAL GPD
GDO	7485	IGT	5	150	Eating establishment	30	30	0	CITY OF HIALEAH	Single	1050	one 1050 gallon	90	750
GDO	7486	IGT	5	150	Eating establishment	44	44	13685	CITY OF FLORIDA CITY	Series	2100	two 1050-gallon	90	1100
GDO	7489	IGT	5	300	Eating establishment	216	216	6000	MIAMI DADE WATER & SEWER DEPARTMENT	Series	2400	two 1200 gallon	90	1500
GDO	7495	IGT	5	300	Eating establishment	280	280	10816	MIAMI DADE WATER & SEWER DEPARTMENT	Series	3150	three 1050 gallon	90	2704
GDO	7497	IGT	5	150	Eating establishment	10	10	1480	MIAMI DADE WATER & SEWER DEPARTMENT	Single	750	one 750 gallon	90	370
GDO	7503	IGT	5	150	Eating establishment	19	19	1600	MIAMI DADE WATER & SEWER DEPARTMENT	Single	950	one 950 gallon	90	400
GDO	7504	IGT	5	150	Eating establishment	48	48	2153	MIAMI DADE WATER & SEWER DEPARTMENT	Series	2400	two 1200-gallon	90	538
GDO	7509	IGT	5	150	Eating establishment	60	60	3698	MIAMI DADE WATER & SEWER DEPARTMENT	Series	2400	two 1200 gallon	90	925
GDO	7511	IGT	5	150	Eating establishment	0	0	1430	MIAMI DADE WATER & SEWER DEPARTMENT	Single	950	one 950 gallon	90	358
GDO	7512	IGT	5	150	Eating establishment	112	112	2433	MIAMI DADE WATER & SEWER DEPARTMENT	Single	950	one 950 gallon	60	723
GDO	7517	MGRU	5	150	Eating establishment	10	10	1370	MIAMI DADE WATER & SEWER DEPARTMENT		0	one 25 gpm	30	343
GDO	7519	IGT	5	300	Eating establishment	90	90	0	CITY OF HOMESTEAD	Single	1050	one 1050-gallon	90	1260
GDO	7520	MGRU	5	150	Eating establishment	15	15	1007	MIAMI DADE WATER & SEWER DEPARTMENT		0	one 25 gpm	30	252
GDO	7522	IGT	5	300	Eating establishment	311	311	6500	MIAMI DADE WATER & SEWER DEPARTMENT	Series	8400	seven 1200-gallon	90	162500
GDO	7523	IGT	5	150	Eating establishment	79	79	2282	MIAMI DADE WATER & SEWER DEPARTMENT	Single	950	one 950 gallon	90	571
GDO	7525	MGRU	5	150	Eating establishment	43	43	1750	CITY OF NORTH MIAMI BEACH		0	one 25 gpm	30	438
GDO	7527	IGT	5	150	Eating establishment	8	8	1260	MIAMI DADE WATER & SEWER DEPARTMENT	Single	1200	one 1200 gallon	90	315
GDO	7528	IGT	5	150	Eating establishment	16	16	0	MIAMI DADE WATER & SEWER DEPARTMENT	Single	750	one 750 gallon	90	224
GDO	7531	MGRU	5	150	Eating establishment	30	30	1300	MIAMI DADE WATER & SEWER DEPARTMENT		0	one 15 gpm	30	325
GDO	7536	MGRU	5	150	Eating establishment	0	0	0	MIAMI DADE WATER & SEWER DEPARTMENT		0	one 25 gpm	30	0
GDO	7540	MGRU	5	150	Eating establishment	60	60	3401	CITY OF MIAMI BEACH		0	one 25 gpm	30	850
GDO	7542	IGT	5	150	Eating establishment	144	144	3807	MIAMI DADE WATER & SEWER DEPARTMENT	Series	2400	two 1200 gallon	90	952
GDO	7544	IGT	5	150	Eating establishment	35	35	1000	MIAMI DADE WATER & SEWER DEPARTMENT	Single	950	one 950 gallon	90	250
GDO	7548	MGRU	2	150	Eating establishment	8	8	1980	MIAMI DADE WATER & SEWER DEPARTMENT		0	one 25 gpm	30	495
GDO	7549	MGRU	5	300	Eating establishment	159	0	1375	CITY OF MIAMI BEACH	Single	950	one 50 gpm, one 100 gpm and one 950 gallon	60	1316
GDO	7551	AGRU	5	150	Eating establishment	10	10	1004	MIAMI DADE WATER & SEWER DEPARTMENT		0	one 25 gpm	30	251
GDO	7555	MGRU	5	150	Eating establishment	20	20	0	MIAMI DADE WATER & SEWER DEPARTMENT		0	one 25 gpm	30	280
GDO	7557	IGT	5	150	Eating establishment	30	30	1200	CITY OF HIALEAH	Single	750	one 750 gallon	90	750
GDO	7562	MGRU	5	150	Eating establishment	40	40	4497	MIAMI DADE WATER & SEWER DEPARTMENT		0	one 25 gpm	30	1124
GDO	7563	IGT	5	150	Eating establishment	51	51	2614	CITY OF HOMESTEAD	Single	950	one 950 gallon	90	654
GDO	7564	MGRU	5	150	Eating establishment	113	0	1106	CITY OF MIAMI BEACH		0	one 100 gpm	30	277
GDO	7566	MGRU	5	150	Eating establishment	100	100	2500	MIAMI DADE WATER & SEWER DEPARTMENT		0	one 25 gpm	30	625
GDO	7569	IGT	5	150	Eating establishment	17	17	1332	MIAMI DADE WATER & SEWER DEPARTMENT	Single	750	one 750 gallon	90	238
GDO	7571	AGRU	5	150	Eating establishment	40	40	1152	MIAMI DADE WATER & SEWER DEPARTMENT		0	one 25 gpm	30	288
GDO	7573	IGT	5	150	Eating establishment	38	0	1950	MIAMI DADE WATER & SEWER DEPARTMENT	Single	1050	one 1050 gallon	60	488
GDO	7575	IGT	5	150	Eating establishment	67	67	2493	MIAMI DADE WATER & SEWER DEPARTMENT	Single	1200	one 1200 gallon	90	623
GDO	7576	MGRU	5	150	Eating establishment	24	24	560	MIAMI DADE WATER & SEWER DEPARTMENT		0	one 75 gpm	30	140
GDO	7577	IGT	5	300	Eating establishment	63	63	5500	MIAMI DADE WATER & SEWER DEPARTMENT	Single	750	one 750 gallon	90	1375
GDO	7578	MGRU	5	150	Eating establishment	36	36	0	MIAMI DADE WATER & SEWER DEPARTMENT		0	one 25 gpm	30	504
GDO	7580	IGT	5	750	Eating establishment	241	0	6300	MIAMI DADE WATER & SEWER DEPARTMENT	Series	3150	three 1050 gallon	60	1575
GDO	7581	MGRU	5	150	Eating establishment	100	0	890	CITY OF MIAMI BEACH		0	one 100 gpm	60	223
GDO	7582	IGT	5	300	Eating establishment	60	60	0	CITY OF MIAMI BEACH	Single	750	one 750 gallon	90	1500
GDO	7583	AGRU	5	150	Eating establishment	44	44	2153	MIAMI DADE WATER & SEWER DEPARTMENT		0	one 25 gpm	30	538
GDO	7584	IGT	5	150	Eating establishment	10	10	1050	CITY OF NORTH MIAMI BEACH	Single	750	one 750 gallon	90	140
GDO	7585	IGT	2	150	Eating establishment	10	10	1706	MIAMI DADE WATER & SEWER DEPARTMENT	Single	950	one 950 gallon	90	427
GDO	7586	IGT	5	150	Eating establishment	32	32	1357	MIAMI DADE WATER & SEWER DEPARTMENT	Single	750	one 750 gallon	90	339
GDO	7590	MGRU	5	150	Eating establishment	40	40	1600	CITY OF MIAMI BEACH		0	two 35 gpm	30	400
GDO	7595	IGT	5	150	Eating establishment	42	0	1549	MIAMI DADE WATER & SEWER DEPARTMENT	Single	1250	one 1250 gallon	60	387
GDO	7596	AGRU	5	150	Eating establishment	10	10	1000	MIAMI DADE WATER & SEWER DEPARTMENT		0	one 25 gpm	30	250
GDO	7598	IGT	5	150	Eating establishment	30	0	967	CITY OF MIAMI BEACH	Single	1600	one 1600 gallon	90	242
GDO	7599	MGRU	5	150	Eating establishment	70	70	1854	CITY OF HIALEAH		0	one 25 gpm	30	464
GDO	7602	AGRU	5	150	Eating establishment	35	35	800	CITY OF MIAMI BEACH		0	one 25 gpm	30	200
GDO	7604	IGT	5	300	Eating establishment	78	78	0	MIAMI DADE WATER & SEWER DEPARTMENT	Series	2400	two 1200 gallon	90	1950
GDO	7605	IGT	5	150	Eating establishment	0	0	1000	MIAMI DADE WATER & SEWER DEPARTMENT	Single	750	one 750 gallon	90	250
GDO	7609	IGT	5	150	Eating establishment	17	17	250	CITY OF HIALEAH	Single	750	one 750 gallon	90	238
GDO	7610	AGRU	5	150	Eating establishment	19	19	914	MIAMI DADE WATER & SEWER DEPARTMENT		0	one 25 gpm	30	266
GDO	7613	IGT	5	150	Eating establishment	60	60	3000	MIAMI DADE WATER & SEWER DEPARTMENT	Single	950	one 950 gallon	90	750
GDO	7614	IGT	5	150	Eating establishment	91	91	3675	CITY OF NORTH MIAMI	Single	1250	one 1250 gallon	90	919
GDO	7618	IGT	5	150	Eating establishment	26	26	0	MIAMI DADE WATER & SEWER DEPARTMENT		0	not available	90	650

WORK GROUP	PERMIT NUMBER	PERMIT CLASS	PERMIT	PERMIT FEE	BUSINESS_TYPE	RECORDED SEATS	OBSERVED SEATS	FACILITY AREA	UTILITY	SYSTEM FORMAT	TOTAL CAPACITY	TANK_CAPACITY	PUMP OUT	TOTAL GPD
GDO	7619	AGRU	5	300	Eating establishment	60	60	0	CITY OF MIAMI BEACH		0	one 25 gpm	30	1500
GDO	7623	MGRU	5	150	Eating establishment	30	0	1300	MIAMI DADE WATER & SEWER DEPARTMENT		0	one 20 gpm	30	325
GDO	7624	MGRU	5	150	Eating establishment	30	30	1224	MIAMI DADE WATER & SEWER DEPARTMENT		0	one 25 gpm	30	306
GDO	7625	IGT	5	150	Eating establishment	10	10	945	MIAMI DADE WATER & SEWER DEPARTMENT	Single	750	one 750-gallon	90	236
GDO	7626	IGT	5	150	Eating establishment	58	98	2400	MIAMI DADE WATER & SEWER DEPARTMENT	Single	1200	one 1200 gallon	90	600
GDO	7628	MGRU	5	150	Eating establishment	36	36	1160	MIAMI DADE WATER & SEWER DEPARTMENT		0	one 10 gpm	30	290
GDO	7630	MGRU	5	150	Eating establishment	25	0	1020	MIAMI DADE WATER & SEWER DEPARTMENT		0	one 15 gpm	30	255
GDO	7631	MGRU	5	150	Eating establishment	18	18	950	CITY OF NORTH MIAMI BEACH		0	one 25 gpm	30	275
GDO	7635	IGT	5	300	Eating establishment	204	204	4800	MIAMI DADE WATER & SEWER DEPARTMENT	Series	2400	two 1200 gallon	60	1200
GDO	7638	MGRU	5	150	Eating establishment	50	50	1370	MIAMI DADE WATER & SEWER DEPARTMENT		0	one 25 gpm	30	343
GDO	7642	MGRU	5	150	Eating establishment	35	35	0	MIAMI DADE WATER & SEWER DEPARTMENT		0	one 25 gallon	30	875
GDO	7643	IGT	5	300	Eating establishment	88	88	4600	MIAMI DADE WATER & SEWER DEPARTMENT	Single	950	one 950 gallon	90	1150
GDO	7644	IGT	5	150	Eating establishment	48	48	2279	MIAMI DADE WATER & SEWER DEPARTMENT	Single	1050	one 1050 gallon	90	570
GDO	7645	AGRU	5	150	Eating establishment	36	36	1500	MIAMI DADE WATER & SEWER DEPARTMENT		0	one 25 gpm	30	375
GDO	7649	MGRU	5	150	Eating establishment	0	0	750	MIAMI DADE WATER & SEWER DEPARTMENT		0	one 25 gpm	30	188
GDO	7653	MGRU	5	150	Eating establishment	10	10	670	MIAMI DADE WATER & SEWER DEPARTMENT		0	one 25 gpm	30	168
GDO	7654	AGRU	5	150	Eating establishment	35	35	0	MIAMI DADE WATER & SEWER DEPARTMENT		0	one 25 gpm	30	875
GDO	7655	IGT	5	300	Eating establishment	60	60	0	CITY OF HIALEAH	Series	2100	two 1050 gallon	90	840
GDO	7658	MGRU	5	150	Eating establishment	19	19	1268	MIAMI DADE WATER & SEWER DEPARTMENT		0	one 25 gpm	30	317
GDO	7661	IGT	5	300	Eating establishment	200	200	0	CITY OF MIAMI BEACH	Series	2500	two 1250 gallon	60	5000
GDO	7662	IGT	5	300	Eating establishment	65	65	0	MIAMI DADE WATER & SEWER DEPARTMENT	Single	1050	one 1050 gallon	90	1625
GDO	7664	MGRU	5	150	Eating establishment	0	0	1500	MIAMI DADE WATER & SEWER DEPARTMENT		0	one 35 gpm	30	375
GDO	7673	IGT	5	150	Eating establishment	0	0	3220	CITY OF HOMESTEAD	Single	1050	one 1050 gallon	90	805
GDO	7674	MGRU	5	150	Eating establishment	0	0	1150	CITY OF HOMESTEAD		0	one 25 gpm	30	288
GDO	7684	IGT	5	150	Eating establishment	44	0	2618	MIAMI DADE WATER & SEWER DEPARTMENT	Single	1050	one 1050 gallon	60	655
GDO	7685	IGT	5	300	Eating establishment	26	26	6785	MIAMI DADE WATER & SEWER DEPARTMENT	Single	750	one 750 gallon	90	1696
GDO	7691	IGT	5	750	Eating establishment	0	0	31211	CITY OF MIAMI BEACH	Single	1200	one 1200 gallon	90	7803
GDO	7692	IGT	5	150	Eating establishment	14	14	1214	MIAMI DADE WATER & SEWER DEPARTMENT	Single	1050	one 1050-gallon	90	304
GDO	7695	MGRU	5	150	Eating establishment	0	0	143	MIAMI DADE WATER & SEWER DEPARTMENT		0	one 75 gpm	30	36
GDO	7696	MGRU	5	150	Eating establishment	10	10	1256	CITY OF MIAMI BEACH		0	one 50 gpm	60	314
GDO	7701	IGT	5	150	Eating establishment	0	0	0	CITY OF HIALEAH		0	unknown	90	0
GDO	7703	MGRU	5	150	Eating establishment	6	6	983	CITY OF MIAMI BEACH		0	one 25 gpm	30	246
GDO	7708	IGT	5	150	Eating establishment	74	74	1902	CITY OF HOMESTEAD	Single	1250	one 1250 gallon	90	476
GDO	7709	MGRU	5	150	Eating establishment	16	16	0	CITY OF HIALEAH		0	one 25 gpm	30	224
GDO	7710	IGT	5	300	Eating establishment	126	126	0	CITY OF HOMESTEAD	Series	2500	two 1250 gallon	90	3150
GDO	7714	MGRU	5	150	Eating establishment	35	0	1400	MIAMI DADE WATER & SEWER DEPARTMENT		0	one 75 gpm	30	350
GDO	7715	IGT	5	150	Eating establishment	20	20	0	MIAMI DADE WATER & SEWER DEPARTMENT	Single	1050	one 1050 gallon	90	500
GDO	7716	IGT	5	300	Eating establishment	203	203	5770	MIAMI DADE WATER & SEWER DEPARTMENT	Single	750	one 750 gallon	90	1443
GDO	7717	IGT	5	150	Eating establishment	180	180	2500	MIAMI DADE WATER & SEWER DEPARTMENT	Series	2100	two 1050 gallon	90	625
GDO	7720	IGT	5	150	Eating establishment	27	27	1500	MIAMI DADE WATER & SEWER DEPARTMENT	Series	1900	two 950 gallon	90	375
GDO	7725	IGT	5	150	Eating establishment	270	270	2515	MIAMI DADE WATER & SEWER DEPARTMENT	Single	1050	one 1050 gallon	90	629
GDO	7726	IGT	5	150	Eating establishment	0	0	0	MIAMI DADE WATER & SEWER DEPARTMENT	Single	1200	one 1200 gallon	90	0
GDO	7727	IGT	5	300	Eating establishment	32	0	4500	MIAMI DADE WATER & SEWER DEPARTMENT	Single	1500	one 1500 gallon	60	1125
GDO	7731	IGT	5	150	Eating establishment	20	20	0	MIAMI DADE WATER & SEWER DEPARTMENT	Single	1050	one 1050 gallon	90	500
GDO	7733	MGRU	5	300	Eating establishment	130	130	0	MIAMI DADE WATER & SEWER DEPARTMENT		0	one 25 gpm	30	3250
GDO	7734	MGRU	5	150	Eating establishment	25	25	0	MIAMI DADE WATER & SEWER DEPARTMENT		0	one 25 gpm	30	350
GDO	7735	IGT	5	150	Eating establishment	72	72	2260	CITY OF HOMESTEAD	Single	1050	one 1050 gallon	90	565
GDO	7736	MGRU	5	150	Eating establishment	17	0	1357	MIAMI DADE WATER & SEWER DEPARTMENT		0	one 50 gpm	30	339
GDO	7738	IGT	5	150	Eating establishment	49	49	1658	MIAMI DADE WATER & SEWER DEPARTMENT	Single	1600	one 1600-gallon	90	415
GDO	7739	IGT	5	150	Eating establishment	0	0	700	MIAMI DADE WATER & SEWER DEPARTMENT	Single	1050	one 1050 gallon	90	175
GDO	7742	MGRU	5	300	Eating establishment	56	56	0	MIAMI DADE WATER & SEWER DEPARTMENT		0	one 25 gpm	30	1400
GDO	7744	IGT	5	150	Eating establishment	70	70	3154	MIAMI DADE WATER & SEWER DEPARTMENT	Series	1500	two 750 gallon	90	789
GDO	7745	MGRU	5	150	Eating establishment	16	16	0	CITY OF NORTH MIAMI BEACH		0	one 25 gpm	30	224
GDO	7747	IGT	5	150	Eating establishment	92	0	3153	CITY OF HOMESTEAD	Single	1250	one 1250 gallon	60	788
GDO	7748	IGT	5	300	Eating establishment	200	200	5540	MIAMI DADE WATER & SEWER DEPARTMENT	Series	4200	four 1050 gallon	90	1385
GDO	7749	MGRU	5	150	Eating establishment	38	38	0	MIAMI DADE WATER & SEWER DEPARTMENT		0	one 25 gpm	30	950
GDO	7750	MGRU	5	150	Eating establishment	0	0	2917	CITY OF MIAMI BEACH		0	one 15 gpm	30	729
GDO	7751	MGRU	5	150	Eating establishment	26	26	0	MIAMI DADE WATER & SEWER DEPARTMENT		0	one 25-gpm	30	650
GDO	7752	MGRU	5	300	Eating establishment	68	68	0	CITY OF MIAMI BEACH		0	one 25 gpm	30	1700
GDO	7755	IGT	5	150	Eating establishment	28	28	0	CITY OF NORTH MIAMI BEACH	Single	1200	one 1200 gallon	90	392
GDO	7756	IGT	5	150	Eating establishment	8	8	1500	MIAMI DADE WATER & SEWER DEPARTMENT		1050	one 1050 gallon	90	200

WORK GROUP	PERMIT NUMBER	PERMIT CLASS	PERMIT	PERMIT FEE	BUSINESS_TYPE	RECORDED SEATS	OBSERVED SEATS	FACILITY AREA	UTILITY	SYSTEM FORMAT	TOTAL CAPACITY	TANK_CAPACITY	PUMP OUT	TOTAL GPD
GDO	7759	IGT	5	300	Eating establishment	0	0	13000	CITY OF NORTH MIAMI BEACH	Single	1050	one 1050 gallon	90	3250
GDO	7760	IGT	5	300	Eating establishment	232	232	5831	MIAMI DADE WATER & SEWER DEPARTMENT	Series	2400	two 1200 gallon	90	1458
GDO	7764	IGT	5	300	Eating establishment	53	53	0	CITY OF NORTH MIAMI BEACH	Single	1250	one 1250 gallon	90	742
GDO	7765	MGRU	5	150	Eating establishment	85	0	2400	CITY OF MIAMI BEACH		0	one 25 gpm	30	600
GDO	7766	IGT	5	750	Eating establishment	225	225	0	MIAMI DADE WATER & SEWER DEPARTMENT		0	no applicable	90	5625
GDO	7768	MGRU	5	300	Eating establishment	124	124	0	CITY OF MIAMI BEACH		0	one 25 gpm	30	3100
GDO	7769	IGT	5	150	Eating establishment	49	0	1780	MIAMI DADE WATER & SEWER DEPARTMENT	Series	3500	one 3500 gallon	90	445
GDO	7770	IGT	5	300	Eating establishment	191	191	0	MIAMI DADE WATER & SEWER DEPARTMENT	Single	1200	one 1200 gallon	90	4775
GDO	7772	IGT	5	300	Eating establishment	71	71	0	MIAMI DADE WATER & SEWER DEPARTMENT	Single	1250	one 1250 gallon	90	1775
GDO	7777	IGT	5	150	Eating establishment	32	32	1491	MIAMI DADE WATER & SEWER DEPARTMENT	Single	1250	one 1250 gallon	90	448
GDO	7779	MGRU	5	150	Eating establishment	0	0	1552	CITY OF MIAMI BEACH		0	one 25 gpm	30	388
GDO	7780	MGRU	5	150	Eating establishment	0	0	1955	MIAMI DADE WATER & SEWER DEPARTMENT		0	one 25 gpm	30	489
GDO	7786	IGT	5	150	Eating establishment	25	0	1140	CITY OF HIALEAH	Single	950	one 950 gallon	90	285
GDO	7787	MGRU	5	150	Eating establishment	40	40	3680	CITY OF MIAMI BEACH		0	one 100 gpm	60	920
GDO	7791	IGT	5	300	Eating establishment	92	0	5200	MIAMI DADE WATER & SEWER DEPARTMENT	Single	1200	one 1200 gallon	60	1300
GDO	7796	IGT	5	150	Eating establishment	18	18	1884	CITY OF MIAMI BEACH	Single	750	one 750 gallon	90	252
GDO	7798	MGRU	5	150	Eating establishment	0	0	1350	CITY OF HIALEAH		0	one 25 gpm	30	338
GDO	7799	MGRU	5	150	Eating establishment	0	0	822	MIAMI DADE WATER & SEWER DEPARTMENT		1200	one 1200 gallon	90	206
GDO	7801	AGRU	5	150	Eating establishment	8	8	1000	MIAMI DADE WATER & SEWER DEPARTMENT		0	one 35 gpm	30	250
GDO	7803	IGT	5	150	Eating establishment	88	0	2436	MIAMI DADE WATER & SEWER DEPARTMENT	Single	900	one 900 gallon	60	609
GDO	7805	MGRU	2	150	Eating establishment	0	0	648	MIAMI DADE WATER & SEWER DEPARTMENT		0	one 25 gpm	30	162
GDO	7806	IGT	5	300	Eating establishment	170	170	0	CITY OF HIALEAH	Single	1050	one 1050 gallon	90	2380
GDO	7807	IGT	5	150	Eating establishment	111	111	3718	CITY OF HOMESTEAD	Single	1050	one 1050 gallon	90	930
GDO	7808	IGT	5	150	Eating establishment	0	0	0	CITY OF FLORIDA CITY		1050	one 1050 gallon	90	0
GDO	7818	IGT	5	150	Eating establishment	0	0	1151	MIAMI DADE WATER & SEWER DEPARTMENT	Single	950	one 950 gallon	90	288
GDO	7819	IGT	5	300	Eating establishment	238	238	6840	MIAMI DADE WATER & SEWER DEPARTMENT	Series	3150	three 1050 gallon	90	171000
GDO	7820	MGRU	5	300	Eating establishment	67	67	0	CITY OF NORTH MIAMI BEACH		0	one 25 gpm	30	1675
GDO	7824	MGRU	5	750	Eating establishment	201	201	0	MIAMI DADE WATER & SEWER DEPARTMENT		0	three 25-gpm	30	5025
GDO	7828	MGRU	5	300	Eating establishment	176	0	4451	CITY OF MIAMI BEACH		0	one 100 gpm	30	1256
GDO	7835	MGRU	2	150	Eating establishment	0	0	775	MIAMI DADE WATER & SEWER DEPARTMENT		0	one 25 gpm	30	194
GDO	7836	MGRU	5	150	Eating establishment	64	64	351	CITY OF HIALEAH		0	one 25 gpm	30	88
GDO	7840	IGT	5	150	Eating establishment	52	52	3600	CITY OF HOMESTEAD	Single	1050	one 1050 gallon	60	900
GDO	7841	IGT	5	150	Eating establishment	44	44	1907	MIAMI DADE WATER & SEWER DEPARTMENT	Single	1050	one 1050 gallon	90	477
GDO	7842	AGRU	5	150	Eating establishment	100	100	3448	CITY OF MIAMI BEACH		0	one 25 gpm	30	862
GDO	7846	MGRU	5	150	Eating establishment	70	70	2139	CITY OF HOMESTEAD		0	one 25 gpm	30	535
GDO	7847	IGT	5	150	Eating establishment	9	9	950	CITY OF HOMESTEAD	Single	950	one 950 gallon	90	238
GDO	7851	MGRU	5	150	Eating establishment	66	0	2107	MIAMI DADE WATER & SEWER DEPARTMENT		0	one 20 gpm	30	527
GDO	7855	MGRU	5	150	Eating establishment	23	23	1060	MIAMI DADE WATER & SEWER DEPARTMENT		0	one 25 gpm	30	265
GDO	7860	MGRU	5	150	Eating establishment	24	24	1800	CITY OF HOMESTEAD		0	one 20 gpm	30	450
GDO	7863	MGRU	5	150	Eating establishment	0	0	0	CITY OF HOMESTEAD		0	one 25 gpm	30	0
GDO	7864	MGRU	5	150	Eating establishment	20	20	1547	MIAMI DADE WATER & SEWER DEPARTMENT		0	one 25-gpm	30	387
GDO	7866	IGT	5	150	Eating establishment	81	81	2153	MIAMI DADE WATER & SEWER DEPARTMENT	Single	950	one 950 gallon	90	538
GDO	7867	MGRU	5	150	Eating establishment	18	18	500	MIAMI DADE WATER & SEWER DEPARTMENT		0	one 25 gpm	30	125
GDO	7869	MGRU	2	150	Eating establishment	0	0	1900	CITY OF MIAMI BEACH		0	one 25 gpm	30	475
GDO	7875	IGT	5	150	Eating establishment	40	40	0	CITY OF NORTH MIAMI BEACH	Series	3150	three 1050 gallon	90	560
GDO	7876	IGT	5	150	Eating establishment	64	64	2150	MIAMI DADE WATER & SEWER DEPARTMENT	Single	1500	one 1500 gallon	90	538
GDO	7880	MGRU	5	150	Eating establishment	16	16	1240	MIAMI DADE WATER & SEWER DEPARTMENT		0	one 25 gpm	30	310
GDO	7881	IGT	5	300	Eating establishment	562	562	42444	CITY OF NORTH MIAMI BEACH	Single	1050	one 1050-gallon	90	10611
GDO	7883	MGRU	5	150	Eating establishment	14	14	1250	MIAMI DADE WATER & SEWER DEPARTMENT		0	one 25 gpm	30	313
GDO	7889	MGRU	5	150	Eating establishment	16	16	1390	MIAMI DADE WATER & SEWER DEPARTMENT		0	onw 25-gpm	30	348
GDO	7890	MGRU	5	150	Eating establishment	40	0	1272	CITY OF NORTH MIAMI BEACH		0	one 4 and one 7 gpm	30	318
GDO	7893	IGT	5	150	Eating establishment	5	5	106	CITY OF HIALEAH	Single	950	one 950 gallon	90	27
GDO	7895	MGRU	5	150	Eating establishment	10	10	1026	CITY OF NORTH MIAMI BEACH		0	one 25 gpm	30	257
GDO	7897	MGRU	5	150	Eating establishment	0	0	900	MIAMI DADE WATER & SEWER DEPARTMENT		0	one 25-gpm	30	225
GDO	7898	IGT	5	150	Eating establishment	50	50	820	MIAMI DADE WATER & SEWER DEPARTMENT	Single	1050	one 1050 gallon	90	205
GDO	7899	MGRU	5	150	Eating establishment	0	0	900	MIAMI DADE WATER & SEWER DEPARTMENT		0	one 25-gpm	30	225
GDO	7903	IGT	5	150	Eating establishment	150	150	2304	CITY OF MIAMI BEACH	Single	1050	one 1050 gallon	90	852
GDO	7904	MGRU	5	150	Eating establishment	36	36	659	MIAMI DADE WATER & SEWER DEPARTMENT		0	one 25 gpm	30	165
GDO	7905	IGT	5	150	Eating establishment	60	60	2413	MIAMI DADE WATER & SEWER DEPARTMENT	Series	2100	two 1050-gallon	90	603
GDO	7908	IGT	5	300	Eating establishment	130	130	4400	MIAMI DADE WATER & SEWER DEPARTMENT	Single	950	one 950 gallon	90	1100

WORK GROUP	PERMIT NUMBER	PERMIT CLASS	PERMIT	PERMIT FEE	BUSINESS_TYPE	RECORDED SEATS	OBSERVED SEATS	FACILITY AREA	UTILITY	SYSTEM FORMAT	TOTAL CAPACITY	TANK_CAPACITY	PUMP OUT	TOTAL GPD
GDO	7910	IGT	5	150	Eating establishment	0	0	750	MIAMI DADE WATER & SEWER DEPARTMENT	Single	950	one 950 gallon	90	188
GDO	7913	MGRU	5	150	Eating establishment	0	0	280	MIAMI DADE WATER & SEWER DEPARTMENT		0	one 25 gpm	30	70
GDO	7916	AGRU	5	150	Eating establishment	43	43	1547	MIAMI DADE WATER & SEWER DEPARTMENT		0	one 25 gpm	30	387
GDO	7917	IGT	5	150	Eating establishment	8	8	1524	MIAMI DADE WATER & SEWER DEPARTMENT	Single	1050	one 1050 gallon	90	381
GDO	7921	IGT	5	150	Eating establishment	28	28	1015	MIAMI DADE WATER & SEWER DEPARTMENT	Single	1050	one 1050 gallon	90	254
GDO	7922	IGT	5	150	Eating establishment	204	204	3920	MIAMI DADE WATER & SEWER DEPARTMENT	Single	1050	one 1050 gallon	90	980
GDO	7923	IGT	5	150	Eating establishment	44	0	1950	MIAMI DADE WATER & SEWER DEPARTMENT	Single	1050	one 1050 gallon	60	488
GDO	7929	MGRU	5	300	Eating establishment	170	170	4498	MIAMI DADE WATER & SEWER DEPARTMENT		0	one 75 gpm	60	1125
GDO	7930	MGRU	5	150	Eating establishment	16	16	0	MIAMI DADE WATER & SEWER DEPARTMENT		0	one 25 gpm	30	400
GDO	7933	IGT	5	150	Eating establishment	30	0	1200	MIAMI DADE WATER & SEWER DEPARTMENT	Single	950	one 950 gallon	90	300
GDO	7934	MGRU	5	150	Eating establishment	10	10	1836	MIAMI DADE WATER & SEWER DEPARTMENT		0	one 25-gpm	30	459
GDO	7935	MGRU	5	150	Eating establishment	20	0	792	MIAMI DADE WATER & SEWER DEPARTMENT		0	one 25 gpm	30	198
GDO	7937	IGT	5	750	Eating establishment	209	251	0	MIAMI DADE WATER & SEWER DEPARTMENT	Single	1200	one 1200 gallon	90	5225
GDO	7939	IGT	5	150	Eating establishment	32	32	0	MIAMI DADE WATER & SEWER DEPARTMENT	Single	1050	one 1050 gallon	90	800
GDO	7941	AGRU	5	150	Eating establishment	38	0	1475	MIAMI DADE WATER & SEWER DEPARTMENT		0	one 25 gpm	30	369
GDO	7943	MGRU	5	150	Eating establishment	0	0	187	MIAMI DADE WATER & SEWER DEPARTMENT		0	one 25 gpm	30	47
GDO	7944	IGT	5	300	Eating establishment	78	78	0	MIAMI DADE WATER & SEWER DEPARTMENT	Series	2100	two 1050-gallon	90	1950
GDO	7945	IGT	5	150	Eating establishment	0	0	1300	CITY OF NORTH MIAMI BEACH	Single	1050	one 1050 gallon	90	325
GDO	7948	IGT	5	300	Eating establishment	70	70	0	MIAMI DADE WATER & SEWER DEPARTMENT	Single	1050	one 1050-gallon	90	980
GDO	7949	IGT	4	300	Eating establishment	80	80	4000	MIAMI DADE WATER & SEWER DEPARTMENT	Single	1200	one 1200-gallon	90	1000
GDO	7950	IGT	5	300	Eating establishment	82	82	0	MIAMI DADE WATER & SEWER DEPARTMENT	Single	1050	one 1050 gallon	90	2050
GDO	7951	MGRU	5	150	Eating establishment	197	197	2985	MIAMI DADE WATER & SEWER DEPARTMENT		0	six 100 gpm	90	746
GDO	7962	IGT	5	150	Eating establishment	108	108	0	CITY OF NORTH MIAMI BEACH	Series	2400	two 1200 gallon	90	2700
GDO	7963	IGT	5	150	Eating establishment	0	0	400	MIAMI DADE WATER & SEWER DEPARTMENT	Single	1050	one 1050 gallon	90	100
GDO	7964	IGT	2	300	Eating establishment	109	109	0		Single	1050	one 1050-gallon	90	2725
GDO	7965	MGRU	5	150	Eating establishment	0	0	850	CITY OF HIALEAH		0	one 25 gpm	30	213
GDO	7966	IGT	5	150	Eating establishment	48	0	1400	CITY OF MIAMI BEACH	Single	2000	one 2000 gallon	60	350
GDO	7967	IGT	5	150	Eating establishment	92	92	2000	CITY OF MIAMI BEACH	Single	950	one 950 gallon	90	500
GDO	7970	MGRU	2	150	Eating establishment	0	0	102	CITY OF HIALEAH		0	one 25 gpm	30	26
GDO	7971	IGT	5	150	Eating establishment	20	20	1292	MIAMI DADE WATER & SEWER DEPARTMENT	Single	1050	one 1050 gallon	90	280
GDO	7972	IGT	5	150	Eating establishment	24	24	1500	CITY OF FLORIDA CITY	Single	1050	one 1050 gallon	90	375
GDO	7975	IGT	5	150	Eating establishment	35	35	0	MIAMI DADE WATER & SEWER DEPARTMENT	Single	950	one 950 gallon	90	490
GDO	7976	IGT	5	150	Eating establishment	25	25	1300	CITY OF MIAMI SPRINGS	Single	1050	one 1050 gallon	90	18200
GDO	7982	IGT	5	150	Eating establishment	4	4	100	MIAMI DADE WATER & SEWER DEPARTMENT	Single	1050	one 1050 gallon	90	25
GDO	7983	MGRU	5	150	Eating establishment	0	0	1992	MIAMI DADE WATER & SEWER DEPARTMENT		0	one 25 gpm	30	498
GDO	7984	IGT	5	150	Eating establishment	300	0	914	MIAMI DADE WATER & SEWER DEPARTMENT	Series	2700	two 1350 gallon	60	779
GDO	7985	MGRU	5	150	Eating establishment	20	20	0	MIAMI DADE WATER & SEWER DEPARTMENT		0	one 25-gpm	30	500
GDO	7988	IGT	5	150	Eating establishment	24	24	0	MIAMI DADE WATER & SEWER DEPARTMENT	Single	5000	one 5000 gallon	90	336
GDO	7989	IGT	5	300	Eating establishment	74	0	2793	CITY OF HIALEAH	Single	1200	one 1200 gallon	30	69825
GDO	7990	MGRU	5	150	Eating establishment	0	0	1513	CITY OF MIAMI BEACH		0	one 25-gpm	30	569
GDO	7995	IGT	5	150	Eating establishment	52	52	1800	CITY OF FLORIDA CITY	Single	1050	one 1050 gallon	90	450
GDO	7996	MGRU	5	150	Eating establishment	10	10	800	CITY OF MIAMI SPRINGS	Single	1050	one 1050 gallon	30	200
GDO	7997	IGT	5	150	Eating establishment	0	0	464	MIAMI DADE WATER & SEWER DEPARTMENT	Series	1900	two 950 gallon	90	116
GDO	7999	IGT	5	150	Eating establishment	0	0	1750	MIAMI DADE WATER & SEWER DEPARTMENT		1050	one 1050 gallon	90	438
GDO	8001	IGT	5	150	Eating establishment	14	14	1260	MIAMI DADE WATER & SEWER DEPARTMENT	Single	1050	one 1050 gallon	90	315
GDO	8006	MGRU	5	150	Eating establishment	0	0	840	MIAMI DADE WATER & SEWER DEPARTMENT		0	one 25-gpm	30	210
GDO	8007	IGT	5	300	Eating establishment	134	134	0	MIAMI DADE WATER & SEWER DEPARTMENT	Single	1200	one 1200 gallon	90	3350
GDO	8008	IGT	5	150	Eating establishment	0	0	300	MIAMI DADE WATER & SEWER DEPARTMENT	Series	4000	two 2000 gallon	90	75
GDO	8009	IGT	5	300	Eating establishment	150	150	0	MIAMI DADE WATER & SEWER DEPARTMENT	Series	5000	two 2500 gallon	90	3750
GDO	8010	IGT	5	300	Eating establishment	66	66	0	MIAMI DADE WATER & SEWER DEPARTMENT	Single	2500	one 2500 gallon	90	1650
GDO	8011	MGRU	5	150	Eating establishment	60	0	2100	CITY OF MIAMI BEACH		0	one 1 and one 75 gpm	30	525
GDO	8013	IGT	5	300	Eating establishment	288	288	11700	CITY OF MIAMI BEACH	Single	950	one 950 gallon	90	2925
GDO	8016	MGRU	5	150	Eating establishment	27	0	850	MIAMI DADE WATER & SEWER DEPARTMENT		0	one 25 gpm	30	213
GDO	8017	IGT	5	150	Eating establishment	0	0	1150	MIAMI DADE WATER & SEWER DEPARTMENT	Single	750	one 750 gallon	90	288
GDO	8019	MGRU	5	150	Eating establishment	0	0	865	CITY OF MIAMI BEACH		0	one 25 gpm	30	216
GDO	8020	IGT	5	150	Eating establishment	23	23	1776	MIAMI DADE WATER & SEWER DEPARTMENT	Single	950	one 950 gallon	60	444
GDO	8022	MGRU	5	150	Eating establishment	0	0	870	MIAMI DADE WATER & SEWER DEPARTMENT		0	one 25 gpm	30	218
GDO	8023	MGRU	5	150	Eating establishment	74	0	2667	CITY OF NORTH MIAMI BEACH		0	one 100 gpm	30	849
GDO	8027	IGT	5	150	Eating establishment	11	0	650	MIAMI DADE WATER & SEWER DEPARTMENT	Single	750	one 750 gallon	90	163
GDO	8028	IGT	5	150	Eating establishment	0	0	2660	CITY OF OPA LOCKA	Single	950	one 950 gallon	90	37240

WORK GROUP	PERMIT NUMBER	PERMIT CLASS	PERMIT	PERMIT FEE	BUSINESS_TYPE	RECORDED SEATS	OBSERVED SEATS	FACILITY AREA	UTILITY	SYSTEM FORMAT	TOTAL CAPACITY	TANK_CAPACITY	PUMP OUT	TOTAL GPD
GDO	8030	IGT	5	150	Eating establishment	18	18	1300	CITY OF OPA LOCKA	Single	950	one 950 gallon	90	252
GDO	8033	MGRU	5	150	Eating establishment	30	30	1400	MIAMI DADE WATER & SEWER DEPARTMENT		0	one 25 gpm	30	350
GDO	8034	IGT	5	300	Eating establishment	79	79	0	MIAMI DADE WATER & SEWER DEPARTMENT	Series	5000	two 2500 gallon	90	1975
GDO	8035	IGT	5	150	Eating establishment	44	44	2034	MIAMI DADE WATER & SEWER DEPARTMENT	Single	750	one 750 gallon	90	509
GDO	8036	IGT	5	300	Eating establishment	62	62	0	MIAMI DADE WATER & SEWER DEPARTMENT	Single	950	one 950 gallon	90	1550
GDO	8037	IGT	5	150	Eating establishment	27	27	0	MIAMI DADE WATER & SEWER DEPARTMENT	Single	950	one 950 gallon	90	378
GDO	8038	IGT	5	150	Eating establishment	48	48	0	MIAMI DADE WATER & SEWER DEPARTMENT	Single	1250	one 1250 gallon	90	1200
GDO	8042	MGRU	5	150	Eating establishment	10	10	0	CITY OF HOMESTEAD		0	one 25 gpm	30	250
GDO	8050	IGT	5	150	Eating establishment	30	30	1200	CITY OF MIAMI SPRINGS	Single	1050	one 1050 gallon	90	300
GDO	8052	IGT	2	150	Eating establishment	20	20	0	MIAMI DADE WATER & SEWER DEPARTMENT	Single	750	one 750 gallon	90	500
GDO	8053	IGT	5	150	Eating establishment	50	50	0		Single	1050	one 1050 gallon	90	700
GDO	8055	MGRU	5	150	Eating establishment	0	0	1350	MIAMI DADE WATER & SEWER DEPARTMENT		0	one 25-gpm	30	338
GDO	8056	IGT	5	150	Eating establishment	50	50	680	CITY OF HOMESTEAD	Single	950	one 950 gallon	90	1250
GDO	8058	IGT	5	150	Eating establishment	37	37	0	MIAMI DADE WATER & SEWER DEPARTMENT		0	not applicable	90	925
GDO	8059	MGRU	5	150	Eating establishment	44	44	3085	MIAMI DADE WATER & SEWER DEPARTMENT		0	one 25 gpm	30	771
GDO	8062	MGRU	5	150	Eating establishment	0	0	1300	MIAMI DADE WATER & SEWER DEPARTMENT		0	one 25-gpm	30	325
GDO	8064	MGRU	5	150	Eating establishment	0	0	1200	CITY OF MIAMI BEACH		0	one 25 gpm	30	300
GDO	8065	IGT	5	150	Eating establishment	25	25	1995	MIAMI DADE WATER & SEWER DEPARTMENT	Single	1050	one 1050 gallon	90	499
GDO	8069	MGRU	5	150	Eating establishment	76	76	1800	CITY OF MIAMI BEACH		0	one 25 gpm	30	450
GDO	8070	IGT	5	150	Eating establishment	0	0	970	MIAMI DADE WATER & SEWER DEPARTMENT	Single	1050	one 1050 gallon	90	243
GDO	8073	IGT	5	150	Eating establishment	24	0	2600	MIAMI DADE WATER & SEWER DEPARTMENT	Single	750	one 750 gallon	90	36400
GDO	8074	MGRU	5	150	Eating establishment	0	0	400	CITY OF NORTH MIAMI BEACH		0	one 25 gpm	30	100
GDO	8076	IGT	5	300	Eating establishment	200	200	4245	MIAMI DADE WATER & SEWER DEPARTMENT	Series	3600	three 1200 gallon	60	1061
GDO	8078	MGRU	5	150	Eating establishment	0	0	1500	CITY OF MIAMI BEACH		0	one 25-gpm	30	375
GDO	8081	MGRU	5	150	Eating establishment	3	3	750	CITY OF NORTH MIAMI BEACH		0	one 25 gpm	30	188
GDO	8084	IGT	5	150	Eating establishment	50	50	0	MIAMI DADE WATER & SEWER DEPARTMENT	Single	950	one 950 gallon	90	700
GDO	8086	IGT	5	150	Eating establishment	0	0	1416	MIAMI DADE WATER & SEWER DEPARTMENT	Series	2400	two 1200 gallon	90	354
GDO	8087	MGRU	5	150	Eating establishment	32	32	1563	MIAMI DADE WATER & SEWER DEPARTMENT		0	one 25 gpm	30	391
GDO	8091	IGT	5	150	Eating establishment	0	0	965	MIAMI DADE WATER & SEWER DEPARTMENT	Single	1200	one 1200 gallon	90	241
GDO	8092	MGRU	5	150	Eating establishment	86	86	0	MIAMI DADE WATER & SEWER DEPARTMENT		0	on 75 gpm	30	22
GDO	8093	IGT	5	150	Eating establishment	0	0	1000	MIAMI DADE WATER & SEWER DEPARTMENT	Single	950	one 950-gallon	90	250
GDO	8094	MGRU	5	150	Eating establishment	0	0	1300	MIAMI DADE WATER & SEWER DEPARTMENT		0	one 25 gpm	30	325
GDO	8095	IGT	5	150	Eating establishment	48	48	0	MIAMI DADE WATER & SEWER DEPARTMENT	Single	1050	one 1050 gallon	90	1200
GDO	8096	MGRU	5	150	Eating establishment	30	63	2465	MIAMI DADE WATER & SEWER DEPARTMENT		0	one 30 gpm	30	616
GDO	8098	MGRU	5	300	Eating establishment	265	0	5500	MIAMI DADE WATER & SEWER DEPARTMENT		0	two 100 gpm	60	1375
GDO	8099	IGT	5	300	Eating establishment	59	59	0	MIAMI DADE WATER & SEWER DEPARTMENT	Single	1050	one 1050 gallon	90	826
GDO	8103	MGRU	5	150	Eating establishment	30	30	1230	CITY OF MIAMI BEACH		0	one 25 gpm	30	308
GDO	8108	IGT	5	300	Eating establishment	238	238	6791	CITY OF HIALEAH	Series	4200	four 1050 gallon	90	1698
GDO	8114	MGRU	5	150	Eating establishment	68	68	2200	CITY OF MIAMI BEACH		0	one 25 gpm	30	590
GDO	8117	IGT	5	300	Eating establishment	56	56	0	CITY OF FLORIDA CITY		0	not available	90	1400
GDO	8119	MGRU	5	150	Eating establishment	0	0	475	MIAMI DADE WATER & SEWER DEPARTMENT		0	one 75 gpm	30	119
GDO	8128	IGT	5	300	Eating establishment	68	68	4200	MIAMI DADE WATER & SEWER DEPARTMENT	Single	1200	one 1200 gallon	90	1050
GDO	8130	IGT	5	150	Eating establishment	302	302	2722	MIAMI DADE WATER & SEWER DEPARTMENT	Single	750	one 750-gallon	90	681
GDO	8132	IGT	5	300	Eating establishment	296	296	5196	MIAMI DADE WATER & SEWER DEPARTMENT	Series	2400	two 1200 gallon	90	1299
GDO	8133	IGT	5	300	Eating establishment	200	0	4700	MIAMI DADE WATER & SEWER DEPARTMENT	Series	4800	four 1200 gallon	60	1175
GDO	8135	IGT	5	150	Eating establishment	26	26	1544	CITY OF HIALEAH	Single	950	one 950 gallon	90	386
GDO	8136	IGT	5	150	Eating establishment	10	10	1200	MIAMI DADE WATER & SEWER DEPARTMENT	Single	1050	one 1050 gallon	90	300
GDO	8137	IGT	5	150	Eating establishment	27	27	0	MIAMI DADE WATER & SEWER DEPARTMENT	Single	1050	one 1050 gallon	90	378
GDO	8139	IGT	5	150	Eating establishment	50	0	2364	CITY OF NORTH MIAMI BEACH	Single	950	one 950 gallon	90	641
GDO	8141	MGRU	5	150	Eating establishment	9	9	2984	MIAMI DADE WATER & SEWER DEPARTMENT		0	one 25 gpm	30	746
GDO	8142	MGRU	5	150	Eating establishment	70	70	2630	MIAMI DADE WATER & SEWER DEPARTMENT		0	one 25 gpm	30	658
GDO	8143	IGT	5	150	Eating establishment	319	319	0	CITY OF HIALEAH	Single	1200	one 1200 gallon	90	6380
GDO	8145	IGT	5	150	Eating establishment	0	0	416	MIAMI DADE WATER & SEWER DEPARTMENT	Series	4000	two 2000-gallon	90	104
GDO	8146	MGRU	5	150	Eating establishment	0	0	700	CITY OF MIAMI BEACH		0	one 25 gpm	30	175
GDO	8147	IGT	5	150	Eating establishment	200	200	3541	CITY OF NORTH MIAMI BEACH	Single	1050	one 1050 gallon	90	885
GDO	8148	IGT	5	150	Eating establishment	21	21	1200	CITY OF HIALEAH	Single	950	one 950 gallon	90	300
GDO	8150	IGT	5	150	Eating establishment	30	30	2750	MIAMI DADE WATER & SEWER DEPARTMENT	Single	1050	one 1050-gallon	90	688
GDO	8151	IGT	5	150	Eating establishment	48	48	0	MIAMI DADE WATER & SEWER DEPARTMENT	Single	950	one 950 gallon	90	672
GDO	8152	IGT	5	150	Eating establishment	50	50	1350	MIAMI DADE WATER & SEWER DEPARTMENT	Single	1050	one 1050-gallon	90	338
GDO	8154	IGT	5	300	Eating establishment	200	200	0	MIAMI DADE WATER & SEWER DEPARTMENT	Single	1050	one 1050 gallon	90	5000
GDO	8156	MGRU	5	150	Eating establishment	173	173	3100	CITY OF MIAMI BEACH		0	one 25-gpm	30	775

WORK GROUP	PERMIT NUMBER	PERMIT CLASS	PERMIT	PERMIT FEE	BUSINESS_TYPE	RECORDED SEATS	OBSERVED SEATS	FACILITY AREA	UTILITY	SYSTEM FORMAT	TOTAL CAPACITY	TANK_CAPACITY	PUMP OUT	TOTAL GPD
GDO	8157	IGT	5	150	Eating establishment	0	0	0	CITY OF HIALEAH	Single	4000	one 4000 gallon	90	0
GDO	8158	IGT	5	150	Eating establishment	32	32	0	MIAMI DADE WATER & SEWER DEPARTMENT	Single	1050	one 1050 gallon	90	800
GDO	8160	IGT	5	150	Eating establishment	10	10	1500	MIAMI DADE WATER & SEWER DEPARTMENT	Single	950	one 950 gallon	90	375
GDO	8163	IGT	5	150	Eating establishment	0	0	0	MIAMI DADE WATER & SEWER DEPARTMENT	Single	2000	one 2000 gallon	90	0
GDO	8165	IGT	5	150	Eating establishment	80	80	2900	MIAMI DADE WATER & SEWER DEPARTMENT	Single	1050	one 1050 gallon	90	725
GDO	8166	MGRU	5	150	Eating establishment	78	78	1200	MIAMI DADE WATER & SEWER DEPARTMENT		0	one 25 gpm	30	300
GDO	8170	IGT	5	150	Eating establishment	0	0	738	MIAMI DADE WATER & SEWER DEPARTMENT	Single	2000	one 2000 gallon	90	185
GDO	8171	IGT	5	150	Eating establishment	0	0	0	MIAMI DADE WATER & SEWER DEPARTMENT	Series	8000	four 2000 gallon	90	0
GDO	8175	IGT	5	300	Eating establishment	230	230	6422	MIAMI DADE WATER & SEWER DEPARTMENT	Single	1050	one 1050 gallon	90	1606
GDO	8177	MGRU	5	150	Eating establishment	30	0	1189	CITY OF MIAMI BEACH		0	two 20 gpm and one 50 gpm	30	297
GDO	8179	IGT	5	150	Eating establishment	20	20	1450	MIAMI DADE WATER & SEWER DEPARTMENT	Single	1200	one 1200 gallon	90	363
GDO	8182	IGT	5	150	Eating establishment	0	0	1575	MIAMI DADE WATER & SEWER DEPARTMENT	Single	1050	one 1050-gallon	90	394
GDO	8184	MGRU	5	150	Eating establishment	0	0	520	CITY OF HIALEAH		0	one 25 gpm	30	130
GDO	8190	MGRU	5	150	Eating establishment	43	43	1533	MIAMI DADE WATER & SEWER DEPARTMENT		0	one 35 gpm	30	383
GDO	8192	IGT	5	150	Eating establishment	10	10	1364	MIAMI DADE WATER & SEWER DEPARTMENT	Single	1050	one 1050 gallon	90	341
GDO	8194	UNKN	3	150	Eating establishment	0	0	256	MIAMI DADE WATER & SEWER DEPARTMENT		0	not available	0	64
GDO	8197	IGT	5	150	Eating establishment	36	36	1960	MIAMI DADE WATER & SEWER DEPARTMENT	Single	1050	one 1050-gallon	90	490
GDO	8199	AGRU	5	150	Eating establishment	8	8	890	MIAMI DADE WATER & SEWER DEPARTMENT		0	one 25 gpm	30	223
GDO	8200	IGT	5	300	Eating establishment	0	0	4625	MIAMI DADE WATER & SEWER DEPARTMENT	Single	1050	one 1050 gallon	90	1156
GDO	8202	AGRU	5	150	Eating establishment	10	10	1200	MIAMI DADE WATER & SEWER DEPARTMENT		0	one 25 gpm	30	250
GDO	8206	IGT	5	150	Eating establishment	0	0	1648	CITY OF MIAMI BEACH	Single	1050	one 1050-gallon	90	412
GDO	8207	IGT	5	150	Eating establishment	182	182	3887	CITY OF MIAMI BEACH	Series	2100	two 1050 gallon	90	972
GDO	8208	MGRU	5	150	Eating establishment	24	24	1400	MIAMI DADE WATER & SEWER DEPARTMENT		0	one 25-gpm	30	350
GDO	8212	MGRU	5	150	Eating establishment	30	0	484	MIAMI DADE WATER & SEWER DEPARTMENT	Series	2400	two 1200 gallon	60	121
GDO	8213	IGT	5	150	Eating establishment	0	0	0	MIAMI DADE WATER & SEWER DEPARTMENT	Single	1050	one 1050 gallon	90	0
GDO	8214	IGT	5	300	Eating establishment	201	201	4191	MIAMI DADE WATER & SEWER DEPARTMENT	Single	1600	one 1600 gallon	90	1048
GDO	8218	MGRU	5	300	Eating establishment	40	40	1380	MIAMI DADE WATER & SEWER DEPARTMENT		0	three 50 gpm	30	776
GDO	8221	IGT	5	150	Eating establishment	20	20	960	CITY OF HIALEAH	Single	950	one 950 gallon	90	240
GDO	8224	IGT	5	300	Eating establishment	60	60	0	MIAMI DADE WATER & SEWER DEPARTMENT	Single	950	one 950 gallon	90	1500
GDO	8225	IGT	5	150	Eating establishment	45	0	1000	MIAMI DADE WATER & SEWER DEPARTMENT	Single	1250	one 1250 gallon	60	255
GDO	8226	IGT	5	150	Eating establishment	118	118	3921	MIAMI DADE WATER & SEWER DEPARTMENT	Single	1200	one 1200 gallon	90	980
GDO	8227	IGT	5	300	Eating establishment	204	204	5880	CITY OF HOMESTEAD	Series	1900	two 950 gallon	90	1470
GDO	8228	IGT	5	750	Eating establishment	246	246	0	CITY OF HOMESTEAD	Series	5000	four 1250 gallon	90	6150
GDO	8232	IGT	5	150	Eating establishment	10	10	0	MIAMI DADE WATER & SEWER DEPARTMENT	Single	950	one 950 gallon	90	250
GDO	8233	IGT	5	750	Eating establishment	208	208	0	MIAMI DADE WATER & SEWER DEPARTMENT	Series	2100	two 1050 gallon	90	5200
GDO	8234	IGT	5	150	Eating establishment	10	10	625	MIAMI DADE WATER & SEWER DEPARTMENT	Single	1050	one 1050 gallon	90	156
GDO	8235	IGT	5	150	Eating establishment	24	0	3351	MIAMI DADE WATER & SEWER DEPARTMENT	Single	750	one 750 gallon	90	838
GDO	8238	MGRU	5	150	Eating establishment	0	0	540	MIAMI DADE WATER & SEWER DEPARTMENT		0	one 25 gpm	30	135
GDO	8240	IGT	5	150	Eating establishment	52	52	1550	MIAMI DADE WATER & SEWER DEPARTMENT	Single	950	one 950 gallon	90	388
GDO	8241	IGT	5	150	Eating establishment	20	20	0	MIAMI DADE WATER & SEWER DEPARTMENT	Single	1050	one 1050 gallon	90	280
GDO	8246	MGRU	5	150	Eating establishment	32	32	1035	MIAMI DADE WATER & SEWER DEPARTMENT		0	one 25-gpm	30	259
GDO	8250	MGRU	5	150	Eating establishment	0	0	495	MIAMI DADE WATER & SEWER DEPARTMENT		0	one 20 gpm	30	124
GDO	8256	IGT	5	150	Eating establishment	8	8	0	MIAMI DADE WATER & SEWER DEPARTMENT	Single	1050	one 1050 gallon	90	2
GDO	8258	IGT	5	150	Eating establishment	12	12	0	MIAMI DADE WATER & SEWER DEPARTMENT	Series	1900	two 950 gallon	90	300
GDO	8259	IGT	5	150	Eating establishment	4	4	928	MIAMI DADE WATER & SEWER DEPARTMENT	Single	950	one 950 gallon	90	232
GDO	8264	IGT	5	300	Eating establishment	60	60	111551	MIAMI DADE WATER & SEWER DEPARTMENT	Single	1050	one 1050 gallon	90	1500
GDO	8265	IGT	5	150	Eating establishment	0	0	0	MIAMI DADE WATER & SEWER DEPARTMENT	Single	750	one 750-gallon	90	0
GDO	8266	IGT	5	150	Eating establishment	46	46	0	MIAMI DADE WATER & SEWER DEPARTMENT	Single	1050	one 1050 gallon	90	1150
GDO	8267	MGRU	5	150	Eating establishment	25	25	0	MIAMI DADE WATER & SEWER DEPARTMENT		0	one 25 gpm	30	625
GDO	8269	IGT	5	150	Eating establishment	0	0	500	CITY OF HIALEAH		1050	one 1050 gallon	90	125
GDO	8272	IGT	5	300	Eating establishment	276	276	5477	MIAMI DADE WATER & SEWER DEPARTMENT	Single	2500	one 2500-gallon	90	1369
GDO	8273	MGRU	5	150	Eating establishment	10	10	0	MIAMI DADE WATER & SEWER DEPARTMENT		0	one 25 gpm	30	140
GDO	8274	IGT	5	300	Eating establishment	304	304	7961	MIAMI DADE WATER & SEWER DEPARTMENT	Series	5000	two 2500 gallon	90	1990
GDO	8275	IGT	5	300	Eating establishment	220	220	6200	MIAMI DADE WATER & SEWER DEPARTMENT	Series	4800	four 1200 gallon	90	1550
GDO	8276	MGRU	5	150	Eating establishment	10	10	500	MIAMI DADE WATER & SEWER DEPARTMENT		0	one 25 gpm	30	125
GDO	8279	IGT	5	750	Eating establishment	318	318	7522	MIAMI DADE WATER & SEWER DEPARTMENT	Single	1650	one 1650 gallon	90	188050
GDO	8283	AGRU	5	300	Eating establishment	66	66	0	MIAMI DADE WATER & SEWER DEPARTMENT		0	one 35 gpm	30	1650
GDO	8284	IGT	5	300	Eating establishment	204	204	4677	MIAMI DADE WATER & SEWER DEPARTMENT	Single	2000	one 2000 gallon	90	1169
GDO	8285	IGT	5	300	Eating establishment	255	255	4739	MIAMI DADE WATER & SEWER DEPARTMENT	Single	2000	one 2000 gallon	90	1185
GDO	8286	IGT	5	300	Eating establishment	82	82	0	MIAMI DADE WATER & SEWER DEPARTMENT	Single	1500	one 1500 gallon	90	2050

WORK GROUP	PERMIT NUMBER	PERMIT CLASS	PERMIT	PERMIT FEE	BUSINESS_TYPE	RECORDED SEATS	OBSERVED SEATS	FACILITY AREA	UTILITY	SYSTEM FORMAT	TOTAL CAPACITY	TANK_CAPACITY	PUMP OUT	TOTAL GPD
GDO	8287	IGT	5	150	Eating establishment	0	0	500	MIAMI DADE WATER & SEWER DEPARTMENT		1050	one 1050 gallon	90	125
GDO	8288	IGT	5	300	Eating establishment	150	150	0	MIAMI DADE WATER & SEWER DEPARTMENT	Single	950	one 950 gallon	90	3750
GDO	8289	IGT	5	300	Eating establishment	246	246	4877	MIAMI DADE WATER & SEWER DEPARTMENT	Single	950	one 950-gallon	90	1219
GDO	8292	IGT	5	300	Eating establishment	188	188	5960	MIAMI DADE WATER & SEWER DEPARTMENT	Single	1050	one 1050 gallon	90	149000
GDO	8295	IGT	5	150	Eating establishment	20	0	500	MIAMI DADE WATER & SEWER DEPARTMENT	Single	2000	one 2000 gallon	60	125
GDO	8296	AGRU	5	150	Eating establishment	30	30	1500	MIAMI DADE WATER & SEWER DEPARTMENT		0	one 35 gpm	30	375
GDO	8297	IGT	5	150	Eating establishment	31	31	1500	MIAMI DADE WATER & SEWER DEPARTMENT	Single	950	one 950 gallon	90	434
GDO	8298	IGT	5	300	Eating establishment	72	72	0	CITY OF MIAMI BEACH	Single	1050	one 1050 gallon	90	1800
GDO	8299	IGT	5	150	Eating establishment	99	99	2000	MIAMI DADE WATER & SEWER DEPARTMENT	Single	1050	one 1050 gallon	90	500
GDO	8303	MGRU	5	150	Eating establishment	60	60	2100	CITY OF MIAMI BEACH		0	one 25 gpm	30	525
GDO	8304	MGRU	5	150	Eating establishment	0	0	1500	MIAMI DADE WATER & SEWER DEPARTMENT		0	one 25 gpm	30	375
GDO	8307	IGT	5	300	Eating establishment	204	204	4438	MIAMI DADE WATER & SEWER DEPARTMENT	Single	1050	one 1050 gallon	90	1110
GDO	8309	IGT	5	300	Eating establishment	200	200	4514	MIAMI DADE WATER & SEWER DEPARTMENT	Series	3300	two 1650 gallon	90	1129
GDO	8311	MGRU	5	150	Eating establishment	20	20	0	MIAMI DADE WATER & SEWER DEPARTMENT		0	one 25-gpm	30	500
GDO	8313	IGT	5	150	Eating establishment	85	85	2333	MIAMI DADE WATER & SEWER DEPARTMENT	Single	1200	one 1200 gallon	90	583
GDO	8314	IGT	5	150	Eating establishment	29	29	0	MIAMI DADE WATER & SEWER DEPARTMENT	Single	1200	one 1200 gallon	90	406
GDO	8315	MGRU	5	150	Eating establishment	0	0	1000	CITY OF HIALEAH		0	one 7 gpm	30	250
GDO	8317	MGRU	5	150	Eating establishment	0	0	234	MIAMI DADE WATER & SEWER DEPARTMENT		0	one 25 gpm	30	59
GDO	8323	MGRU	5	150	Eating establishment	38	38	1800	MIAMI DADE WATER & SEWER DEPARTMENT		0	one 25 gpm	30	450
GDO	8324	IGT	5	300	Eating establishment	440	440	11000	CITY OF HIALEAH	Single	1500	one 1500 gallon	90	2750
GDO	8328	IGT	5	150	Eating establishment	60	60	1650	MIAMI DADE WATER & SEWER DEPARTMENT	Single	1050	one 1050 gallon	90	413
GDO	8330	IGT	5	150	Eating establishment	10	10	800	MIAMI DADE WATER & SEWER DEPARTMENT	Single	1050	one 1050 gallon	90	200
GDO	8331	MGRU	5	150	Eating establishment	30	0	2505	MIAMI DADE WATER & SEWER DEPARTMENT		0	one 100 gpm	30	626
GDO	8332	MGRU	5	150	Eating establishment	20	20	1000	MIAMI DADE WATER & SEWER DEPARTMENT		0	one 25 gpm	30	250
GDO	8334	MGRU	5	150	Eating establishment	0	0	150	CITY OF HIALEAH		0	one 25 gpm	30	38
GDO	8337	IGT	5	150	Eating establishment	0	0	1700	MIAMI DADE WATER & SEWER DEPARTMENT	Series	2100	two 1050 gallon	90	425
GDO	8339	IGT	5	150	Eating establishment	36	36	2098	MIAMI DADE WATER & SEWER DEPARTMENT	Single	1050	one 1050 gallon	90	525
GDO	8340	IGT	5	150	Eating establishment	50	50	2000	MIAMI DADE WATER & SEWER DEPARTMENT	Single	1050	one 1050-gallon	90	500
GDO	8341	MGRU	5	150	Eating establishment	26	26	1365	CITY OF NORTH MIAMI BEACH		0	one 25 gpm	30	341
GDO	8342	MGRU	5	150	Eating establishment	12	12	249	MIAMI DADE WATER & SEWER DEPARTMENT		0	one 25 gpm	30	60
GDO	8343	IGT	5	150	Eating establishment	53	53	2352	MIAMI DADE WATER & SEWER DEPARTMENT	Single	1050	one 1050 gallon	90	588
GDO	8345	AGRU	5	150	Eating establishment	40	40	1075	MIAMI DADE WATER & SEWER DEPARTMENT		0	one 20 gpm	30	269
GDO	8346	IGT	5	300	Eating establishment	208	208	7430	MIAMI DADE WATER & SEWER DEPARTMENT		2400	two 1,200 gallon	90	1858
GDO	8351	IGT	5	150	Eating establishment	20	20	0	CITY OF NORTH MIAMI	Single	1050	one 1050 gallon	90	500
GDO	8352	IGT	5	300	Eating establishment	110	110	0	CITY OF NORTH MIAMI	Single	1050	one 1050 gallon	90	2750
GDO	8354	IGT	5	150	Eating establishment	24	24	748	MIAMI DADE WATER & SEWER DEPARTMENT	Single	1050	one 1050 gallon	90	187
GDO	8358	IGT	5	300	Eating establishment	195	195	5722	MIAMI DADE WATER & SEWER DEPARTMENT	Series	10000	two 5000 gallon	90	1431
GDO	8359	IGT	5	150	Eating establishment	47	47	1500	CITY OF HIALEAH	Single	1250	one 1250-gallon	90	375
GDO	8360	IGT	5	150	Eating establishment	0	0	0	CITY OF HIALEAH	Single	1200	one 1200 gallon	90	0
GDO	8362	AGRU	5	150	Eating establishment	20	20	1210	CITY OF HIALEAH		0	one 25 gpm	30	303
GDO	8363	IGT	5	150	Eating establishment	70	70	3889	MIAMI DADE WATER & SEWER DEPARTMENT		2400	two 1200 gallon	90	972
GDO	8365	AGRU	5	150	Eating establishment	0	0	1410	CITY OF NORTH MIAMI		0	one 50 gpm	30	19740
GDO	8367	MGRU	5	150	Eating establishment	34	34	1466	MIAMI DADE WATER & SEWER DEPARTMENT		0	one 25 gpm	30	367
GDO	8370	MGRU	5	150	Eating establishment	28	28	1400	CITY OF NORTH MIAMI BEACH		0	one 25-gpm	30	350
GDO	8371	IGT	5	150	Eating establishment	66	66	1400	MIAMI DADE WATER & SEWER DEPARTMENT	Single	750	one 750 gallon	90	350
GDO	8372	MGRU	5	150	Eating establishment	10	0	1100	CITY OF MIAMI BEACH		0	one 25 gpm	30	275
GDO	8373	IGT	5	150	Eating establishment	75	0	3000	MIAMI DADE WATER & SEWER DEPARTMENT	Single	950	one 950 gallon	90	750
GDO	8375	MGRU	5	150	Eating establishment	50	0	1650	MIAMI DADE WATER & SEWER DEPARTMENT		0	one 75 gpm	30	413
GDO	8377	IGT	5	150	Eating establishment	26	26	0	MIAMI DADE WATER & SEWER DEPARTMENT	Single	1050	one 1050 gallon	90	650
GDO	8382	MGRU	2	150	Eating establishment	42	42	1385	MIAMI DADE WATER & SEWER DEPARTMENT		0	one 25 gpm	30	346
GDO	8383	IGT	5	150	Eating establishment	0	0	900	MIAMI DADE WATER & SEWER DEPARTMENT	Single	1050	one 1050 gallon	90	225
GDO	8384	MGRU	5	150	Eating establishment	0	0	506	MIAMI DADE WATER & SEWER DEPARTMENT		0	one 75 gpm	30	127
GDO	8387	MGRU	5	150	Eating establishment	10	10	800	CITY OF NORTH MIAMI BEACH		0	one 10 gpm	30	200
GDO	8390	IGT	5	150	Eating establishment	16	16	1367	MIAMI DADE WATER & SEWER DEPARTMENT	Single	750	one 750 gallon	90	224
GDO	8392	MGRU	5	150	Eating establishment	20	0	1550	MIAMI DADE WATER & SEWER DEPARTMENT		0	one 35 gpm	30	388
GDO	8393	IGT	5	150	Eating establishment	23	23	1650	MIAMI DADE WATER & SEWER DEPARTMENT		0	not available	90	575
GDO	8396	IGT	5	150	Eating establishment	144	144	1900	MIAMI DADE WATER & SEWER DEPARTMENT	Series	2100	two 1050-gallon	90	475
GDO	8409	IGT	5	150	Eating establishment	20	20	0	MIAMI DADE WATER & SEWER DEPARTMENT	Single	1050	one 1050-gallon	90	500
GDO	8410	IGT	5	150	Eating establishment	48	48	2100	MIAMI DADE WATER & SEWER DEPARTMENT		0	not available	90	1200
GDO	8412	IGT	5	150	Eating establishment	0	0	250	MIAMI DADE WATER & SEWER DEPARTMENT	Single	1050	one 1050 gallon	60	63
GDO	8414	MGRU	5	150	Eating establishment	60	0	1300	MIAMI DADE WATER & SEWER DEPARTMENT		0	one 25 gpm	30	325

WORK GROUP	PERMIT NUMBER	PERMIT CLASS	PERMIT	PERMIT FEE	BUSINESS_TYPE	RECORDED SEATS	OBSERVED SEATS	FACILITY AREA	UTILITY	SYSTEM FORMAT	TOTAL CAPACITY	TANK_CAPACITY	PUMP OUT	TOTAL GPD
GDO	8415	IGT	5	150	Eating establishment	0	0	0	CITY OF HIALEAH		0	not available	90	0
GDO	8416	IGT	5	150	Eating establishment	60	60	1800	MIAMI DADE WATER & SEWER DEPARTMENT	Single	1200	one 1200 gallon	90	450
GDO	8417	MGRU	5	150	Eating establishment	0	0	1410	MIAMI DADE WATER & SEWER DEPARTMENT		0	one 35 gpm	30	353
GDO	8420	MGRU	5	150	Eating establishment	70	70	948	MIAMI DADE WATER & SEWER DEPARTMENT		0	one 25 gpm	30	23700
												two 75 and two 15		
GDO	8422	MGRU	5	300	Eating establishment	221	221	8086	MIAMI DADE WATER & SEWER DEPARTMENT		0	gpm	30	2022
GDO	8427	IGT	5	150	Eating establishment	55	55	2297	MIAMI DADE WATER & SEWER DEPARTMENT	Single	1050	one 1050 gallon	90	574
GDO	8429	MGRU	5	150	Eating establishment	8	8	1150	MIAMI DADE WATER & SEWER DEPARTMENT		0	one 25 gpm	30	288
GDO	8430	MGRU	5	150	Eating establishment	19	19	0	MIAMI DADE WATER & SEWER DEPARTMENT		0	one 25 gpm	30	266
GDO	8431	IGT	5	300	Eating establishment	96	96	0	MIAMI DADE WATER & SEWER DEPARTMENT	Series	2100	two 1050 gallon	90	2400
GDO	8437	IGT	5	300	Eating establishment	246	246	7000	CITY OF HIALEAH	Series	4200	four 1050 gallon	90	175000
GDO	8438	AGRU	5	150	Eating establishment	34	34	1300	MIAMI DADE WATER & SEWER DEPARTMENT		0	one 50 gpm	30	325
GDO	8440	IGT	5	150	Eating establishment	82	82	3160	MIAMI DADE WATER & SEWER DEPARTMENT	Single	1050	one 1050 gallon	90	790
GDO	8441	IGT	5	150	Eating establishment	95	95	3058	MIAMI DADE WATER & SEWER DEPARTMENT	Single	1200	one 1200 gallon	90	765
GDO	8444	IGT	5	150	Eating establishment	85	85	1200	MIAMI DADE WATER & SEWER DEPARTMENT	Single	1200	one 1200 gallon	60	300
GDO	8446	MGRU	5	150	Eating establishment	10	10	571	CITY OF MIAMI BEACH		0	one 25 gpm	30	143
GDO	8447	IGT	5	150	Eating establishment	20	20	0	CITY OF MIAMI BEACH		0	not available	90	500
GDO	8448	MGRU	2	150	Eating establishment	0	0	2394	MIAMI DADE WATER & SEWER DEPARTMENT		0	one 25 gpm	30	599
GDO	8449	IGT	5	150	Eating establishment	67	67	3629	MIAMI DADE WATER & SEWER DEPARTMENT	Single	1050	one 1050 gallon	90	907
GDO	8450	IGT	5	150	Eating establishment	0	0	1100	CITY OF HIALEAH	Single	750	one 750-gallon	90	275
GDO	8452	IGT	2	150	Eating establishment	0	0	950	MIAMI DADE WATER & SEWER DEPARTMENT	Single	1050	one 1050 gallon	90	238
GDO	8453	MGRU	5	150	Eating establishment	30	30	837	CITY OF MIAMI BEACH		0	one 25 gpm	30	209
GDO	8454	IGT	5	150	Eating establishment	6	6	1099	MIAMI DADE WATER & SEWER DEPARTMENT	Single	1200	one 1200 gallon	90	275
GDO	8455	IGT	5	150	Eating establishment	107	107	3268	CITY OF MIAMI BEACH	Single	1600	one 1600 gallon	60	817
GDO	8457	IGT	5	150	Eating establishment	60	60	2236	MIAMI DADE WATER & SEWER DEPARTMENT		1050	one 1050 gallon	90	559
GDO	8459	MGRU	5	150	Eating establishment	32	32	1346	MIAMI DADE WATER & SEWER DEPARTMENT		0	one 25 gpm	30	337
GDO	8461	MGRU	5	150	Eating establishment	33	33	1125	CITY OF HIALEAH		0	one 75-gpm	30	281
GDO	8462	IGT	5	150	Eating establishment	18	18	900	CITY OF NORTH MIAMI BEACH	Single	1050	one 1050 gallon	90	225
GDO	8464	IGT	5	300	Eating establishment	150	150	0	MIAMI DADE WATER & SEWER DEPARTMENT	Series	2500	two 1250 gallon	90	3750
GDO	8465	IGT	5	150	Eating establishment	30	0	1400	MIAMI DADE WATER & SEWER DEPARTMENT	Single	1050	one 1050 gallon	90	350
GDO	8466	MGRU	5	150	Eating establishment	10	10	0	MIAMI DADE WATER & SEWER DEPARTMENT		0	one 25 gpm	30	250
GDO	8468	IGT	5	150	Eating establishment	24	24	400	MIAMI DADE WATER & SEWER DEPARTMENT	Single	1050	one 1050 gallon	90	100
GDO	8470	MGRU	5	300	Eating establishment	108	108	0	MIAMI DADE WATER & SEWER DEPARTMENT		0	one 50 gpm	30	2700
GDO	8471	IGT	5	150	Eating establishment	8	8	1712	MIAMI DADE WATER & SEWER DEPARTMENT	Single	1050	one 1050-gallon	90	428
GDO	8473	IGT	5	150	Eating establishment	56	56	3108	MIAMI DADE WATER & SEWER DEPARTMENT	Single	1050	one 1050 gallon	90	777
GDO	8475	IGT	5	150	Eating establishment	0	0	1280	MIAMI DADE WATER & SEWER DEPARTMENT	Single	950	one 950-gallon	90	320
GDO	8480	MGRU	5	150	Eating establishment	0	0	300	MIAMI DADE WATER & SEWER DEPARTMENT		0	one 25 gpm	30	75
GDO	8481	IGT	5	150	Eating establishment	0	0	557	MIAMI DADE WATER & SEWER DEPARTMENT	Series	1200	three 1200 gallon	90	139
GDO	8482	IGT	5	150	Eating establishment	0	0	1595	MIAMI DADE WATER & SEWER DEPARTMENT	Single	1200	one 1200 gallon	90	399
GDO	8483	IGT	5	300	Eating establishment	197	197	8500	MIAMI DADE WATER & SEWER DEPARTMENT	Single	2000	one 2000 gallon	90	2125
GDO	8485	IGT	5	150	Eating establishment	82	82	3000	MIAMI DADE WATER & SEWER DEPARTMENT	Single	1050	one 1050 gallon	90	750
GDO	8486	MGRU	5	150	Eating establishment	10	10	1301	MIAMI DADE WATER & SEWER DEPARTMENT		0	one 25 gpm	30	325
GDO	8489	MGRU	5	150	Eating establishment	79	79	3100	MIAMI DADE WATER & SEWER DEPARTMENT		0	one 50 gpm	30	820
GDO	8490	IGT	5	150	Eating establishment	31	31	1520	MIAMI DADE WATER & SEWER DEPARTMENT	Single	1050	one 1050 gallon	90	380
GDO	8491	IGT	5	300	Eating establishment	250	250	7028	CITY OF HOMESTEAD	Series	5000	four 1250 gallon	90	1757
GDO	8492	IGT	5	150	Eating establishment	84	84	3300	CITY OF HOMESTEAD	Single	1050	one 1050-gallon	90	825
GDO	8493	MGRU	5	150	Eating establishment	65	0	2170	MIAMI DADE WATER & SEWER DEPARTMENT		0	one 35 gpm	30	543
GDO	8494	IGT	3	150	Eating establishment	0	0	1110	MIAMI DADE WATER & SEWER DEPARTMENT	Single	1050	one 1050 gallon	90	278
GDO	8495	MGRU	5	150	Eating establishment	0	0	1346	MIAMI DADE WATER & SEWER DEPARTMENT		0	one 25 gpm	30	337
GDO	8498	MGRU	5	150	Eating establishment	9	9	370	MIAMI DADE WATER & SEWER DEPARTMENT		0	one 25 gpm	30	93
GDO	8501	MGRU	5	150	Eating establishment	13	13	884	MIAMI DADE WATER & SEWER DEPARTMENT	Single	750	one 750 gallon	30	221
GDO	8503	IGT	5	300	Eating establishment	113	113	6800	CITY OF MIAMI BEACH	Single	1050	one 1050 gallon	90	170000
GDO	8506	AGRU	5	150	Eating establishment	72	72	0	MIAMI DADE WATER & SEWER DEPARTMENT		0	one 25 gpm	30	1800
GDO	8508	IGT	5	150	Eating establishment	0	0	1750	MIAMI DADE WATER & SEWER DEPARTMENT	Single	750	one 750 gallon	90	438
GDO	8509	MGRU	5	150	Eating establishment	0	0	900	MIAMI DADE WATER & SEWER DEPARTMENT		0	one 25 gpm	30	225
GDO	8510	IGT	5	150	Eating establishment	25	25	1400	MIAMI DADE WATER & SEWER DEPARTMENT	Single	1050	one 1050 gallon	90	350
GDO	8511	MGRU	5	150	Eating establishment	0	0	800	MIAMI DADE WATER & SEWER DEPARTMENT		0	one 25 gpm	30	200
GDO	8518	MGRU	5	150	Eating establishment	0	0	1056	MIAMI DADE WATER & SEWER DEPARTMENT		0	one 25 gpm	30	264
GDO	8519	MGRU	5	150	Eating establishment	0	0	1634	MIAMI DADE WATER & SEWER DEPARTMENT		0	one 25-gpm	30	409
GDO	8523	MGRU	5	150	Eating establishment	14	14	900	MIAMI DADE WATER & SEWER DEPARTMENT		0	one 25-gpm	30	225
GDO	8528	AGRU	5	300	Eating establishment	134	134	5878	MIAMI DADE WATER & SEWER DEPARTMENT		0	one 25 gpm	30	1470

WORK GROUP	PERMIT NUMBER	PERMIT CLASS	PERMIT	PERMIT FEE	BUSINESS_TYPE	RECORDED SEATS	OBSERVED SEATS	FACILITY AREA	UTILITY	SYSTEM FORMAT	TOTAL CAPACITY	TANK_CAPACITY	PUMP OUT	TOTAL GPD
GDO	8530	IGT	2	150	Eating establishment	35	35	1689	MIAMI DADE WATER & SEWER DEPARTMENT	Single	750	one 750 gallon	90	422
GDO	8531	MGRU	5	150	Eating establishment	36	36	0	MIAMI DADE WATER & SEWER DEPARTMENT		0	one 25 gpm	30	900
GDO	8534	IGT	5	150	Eating establishment	48	48	0	CITY OF HIALEAH	Single	1050	one 1050-gallon	90	1200
GDO	8535	IGT	5	300	Eating establishment	0	0	7000	MIAMI DADE WATER & SEWER DEPARTMENT	Series	4000	two 2000 gallon	60	1750
GDO	8536	MGRU	5	150	Eating establishment	15	0	700	CITY OF NORTH MIAMI BEACH		0	one 25 gpm	30	175
GDO	8539	MGRU	5	150	Eating establishment	0	0	2500	CITY OF HIALEAH		0	not available	0	625
GDO	8540	IGT	5	150	Eating establishment	0	0	736	MIAMI DADE WATER & SEWER DEPARTMENT	Single	2000	one 2000 gallon	90	184
GDO	8541	IGT	5	150	Eating establishment	0	0	491	MIAMI DADE WATER & SEWER DEPARTMENT	Single	2000	one 2000 gallon	90	123
GDO	8543	MGRU	5	150	Eating establishment	0	0	432	MIAMI DADE WATER & SEWER DEPARTMENT		0	one 25 gpm	30	108
GDO	8545	IGT	5	150	Eating establishment	0	0	650	MIAMI DADE WATER & SEWER DEPARTMENT	Single	1200	one 1200 gallon	90	163
GDO	8555	MGRU	5	150	Eating establishment	0	0	1100	MIAMI DADE WATER & SEWER DEPARTMENT		0	one 25-gpm	30	275
GDO	8561	MGRU	5	150	Eating establishment	29	29	3300	MIAMI DADE WATER & SEWER DEPARTMENT		0	one 25 gpm	30	825
GDO	8563	IGT	5	150	Eating establishment	59	59	3000	CITY OF NORTH MIAMI BEACH	Single	1050	one 1050 gallon	90	750
GDO	8567	IGT	5	300	Eating establishment	292	292	7834	MIAMI DADE WATER & SEWER DEPARTMENT	Series	2400	two 1200-gallon	90	1959
GDO	8568	IGT	5	150	Eating establishment	8	8	0	MIAMI DADE WATER & SEWER DEPARTMENT	Single	1050	one 1050 gallon	90	200
GDO	8569	IGT	5	150	Eating establishment	20	20	1200	CITY OF HOMESTEAD	Single	750	one 750 gallon	90	300
GDO	8570	IGT	5	300	Eating establishment	252	252	9500	MIAMI DADE WATER & SEWER DEPARTMENT	Multiple	5750	one 750 and four 1250 gallon	90	2375
GDO	8572	IGT	5	150	Eating establishment	75	75	2175	MIAMI DADE WATER & SEWER DEPARTMENT	Single	1050	one 1050 gallon	90	544
GDO	8574	MGRU	5	150	Eating establishment	18	18	809	MIAMI DADE WATER & SEWER DEPARTMENT		0	one 25-gpm	30	202
GDO	8576	IGT	5	150	Eating establishment	760	0	0			7500		90	760
GDO	8578	IGT	5	150	Eating establishment	20	20	1280	MIAMI DADE WATER & SEWER DEPARTMENT	Single	1050	one 1050 gallon	90	280
GDO	8580	IGT	5	150	Eating establishment	65	0	1860	MIAMI DADE WATER & SEWER DEPARTMENT	Single	1250	one 1250 gallon	90	821
GDO	8584	MGRU	5	150	Eating establishment	10	10	1380	MIAMI DADE WATER & SEWER DEPARTMENT		0	unknown	30	345
GDO	8586	MGRU	5	150	Eating establishment	167	167	3931	MIAMI DADE WATER & SEWER DEPARTMENT		0	one 100 gpm	60	983
GDO	8589	IGT	5	150	Eating establishment	0	0	647	MIAMI DADE WATER & SEWER DEPARTMENT	Series	4000	two 2000 gallon	30	162
GDO	8590	IGT	5	150	Eating establishment	0	0	14086	MIAMI DADE WATER & SEWER DEPARTMENT	Single	750	one 750 gallon	90	3522
GDO	8591	MGRU	5	150	Eating establishment	14	14	1125	MIAMI DADE WATER & SEWER DEPARTMENT		0	one 25 gpm	30	281
GDO	8596	MGRU	5	150	Eating establishment	0	0	900	MIAMI DADE WATER & SEWER DEPARTMENT		0	one 25 gpm	30	225
GDO	8600	IGT	5	150	Eating establishment	40	40	0	MIAMI DADE WATER & SEWER DEPARTMENT	Series	3150	three 1050 gallon	90	1000
GDO	8603	MGRU	5	150	Eating establishment	10	10	1565	MIAMI DADE WATER & SEWER DEPARTMENT		0	one 25 gpm	30	391
GDO	8604	MGRU	5	150	Eating establishment	20	20	600	MIAMI DADE WATER & SEWER DEPARTMENT		0	one 25 gpm	30	150
GDO	8605	IGT	5	300	Eating establishment	378	378	13670	CITY OF HIALEAH	Multiple	3150	three 1050 gallon	90	3418
GDO	8606	IGT	5	300	Eating establishment	200	200	0	CITY OF MIAMI BEACH	Single	1250	one 1250	90	5000
GDO	8607	MGRU	5	150	Eating establishment	44	44	1405	MIAMI DADE WATER & SEWER DEPARTMENT		0	one 25 gpm	30	351
GDO	8608	MGRU	5	150	Eating establishment	9	9	900	MIAMI DADE WATER & SEWER DEPARTMENT		0	one 25 gpm	30	225
GDO	8609	IGT	5	150	Eating establishment	27	27	1630	CITY OF HIALEAH	Single	0	one 25 gpm	90	408
GDO	8615	AGRU	5	150	Eating establishment	68	68	1511	CITY OF MIAMI BEACH		0	one 125 gpm	30	378
GDO	8617	IGT	5	150	Eating establishment	200	200	5480	MIAMI DADE WATER & SEWER DEPARTMENT	Series	2850	three 950 gallon	90	1370
GDO	8619	IGT	5	300	Eating establishment	291	291	7500	MIAMI DADE WATER & SEWER DEPARTMENT	Series	2100	two 1050 gallon	90	1875
GDO	8621	MGRU	5	150	Eating establishment	6	6	1000	MIAMI DADE WATER & SEWER DEPARTMENT		0	one 25 gpm	30	250
GDO	8622	IGT	5	150	Eating establishment	97	97	2291	MIAMI DADE WATER & SEWER DEPARTMENT	Single	1050	one 1050 gallon	90	573
GDO	8624	MGRU	5	150	Eating establishment	50	50	3185	CITY OF MIAMI BEACH		0	one 25 gpm	30	796
GDO	8629	MGRU	5	150	Eating establishment	15	0	2000	MIAMI DADE WATER & SEWER DEPARTMENT		0	one 75 gpm	30	500
GDO	8630	IGT	5	150	Eating establishment	54	0	1492	MIAMI DADE WATER & SEWER DEPARTMENT	Single	1050	one 1050 gallon	60	469
GDO	8632	MGRU	5	150	Eating establishment	8	0	794	CITY OF NORTH MIAMI BEACH		0	one 20 gpm	30	199
GDO	8633	IGT	5	150	Eating establishment	49	0	2832	CITY OF NORTH MIAMI BEACH	Single	1050	one 1050 gallon	90	976
GDO	8635	MGRU	5	150	Eating establishment	10	10	500	CITY OF MIAMI		0	one 25 gpm	30	125
GDO	8639	MGRU	5	150	Eating establishment	24	24	1192	MIAMI DADE WATER & SEWER DEPARTMENT		0	one 35 gpm	30	298
GDO	8640	IGT	5	150	Eating establishment	0	0	1100	MIAMI DADE WATER & SEWER DEPARTMENT	Single	1050	one 1050 gallon	90	275
GDO	8646	MGRU	5	300	Eating establishment	202	0	4325	MIAMI DADE WATER & SEWER DEPARTMENT		0	one 25 gpm	30	1331
GDO	8651	IGT	5	150	Eating establishment	80	80	2982	MIAMI DADE WATER & SEWER DEPARTMENT	Single	1200	one 1200 gallon	90	746
GDO	8652	MGRU	5	300	Eating establishment	60	60	0	MIAMI DADE WATER & SEWER DEPARTMENT		0	one 100 gpm	90	1500
GDO	8655	MGRU	5	150	Eating establishment	16	16	2000	CITY OF HIALEAH		0	one 25-gpm	30	500
GDO	8659	MGRU	5	150	Eating establishment	0	0	500	MIAMI DADE WATER & SEWER DEPARTMENT		0	one 15 gpm	30	125
GDO	8660	MGRU	5	150	Eating establishment	0	0	0	MIAMI DADE WATER & SEWER DEPARTMENT		0	one 25 gpm	30	0
GDO	8664	MGRU	5	150	Eating establishment	40	40	1800	MIAMI DADE WATER & SEWER DEPARTMENT		0	one 25-gpm	30	450
GDO	8669	MGRU	5	150	Eating establishment	22	22	600	MIAMI DADE WATER & SEWER DEPARTMENT		0	one 25 gpm	30	150
GDO	8670	IGT	5	150	Eating establishment	30	30	1260	MIAMI DADE WATER & SEWER DEPARTMENT	Single	1500	one 1500 gallon	90	315
GDO	8671	IGT	5	300	Eating establishment	143	143	0	MIAMI DADE WATER & SEWER DEPARTMENT	Single	950	one 950 gallon	90	3575
GDO	8672	MGRU	5	150	Eating establishment	130	130	923	MIAMI DADE WATER & SEWER DEPARTMENT		0	one 25 gpm	30	231

WORK GROUP	PERMIT NUMBER	PERMIT CLASS	PERMIT	PERMIT FEE	BUSINESS_TYPE	RECORDED SEATS	OBSERVED SEATS	FACILITY AREA	UTILITY	SYSTEM FORMAT	TOTAL CAPACITY	TANK_CAPACITY	PUMP OUT	TOTAL GPD
GDO	8677	IGT	5	150	Eating establishment	0	0	936	CITY OF MIAMI BEACH	Single	2000	one 2000 gallon	90	234
GDO	8678	IGT	5	150	Eating establishment	136	136	2055	MIAMI DADE WATER & SEWER DEPARTMENT	Single	5000	one 5000 gallon	90	514
GDO	8681	IGT	5	150	Eating establishment	4	0	1150	CITY OF MIAMI BEACH	Single	1200	one 1200 gallon	60	288
GDO	8682	IGT	5	300	Eating establishment	158	0	4600	CITY OF MIAMI BEACH	Series	4600	two 2300 gallon	30	1150
GDO	8683	IGT	5	150	Eating establishment	46	46	2195	CITY OF HOMESTEAD	Single	1200	one 1200 gallon	90	1150
GDO	8685	IGT	5	300	Eating establishment	149	149	0	MIAMI DADE WATER & SEWER DEPARTMENT		0	not available	90	3725
GDO	8686	MGRU	5	150	Eating establishment	20	20	1715	MIAMI DADE WATER & SEWER DEPARTMENT		0	one 50 gpm	30	429
GDO	8688	MGRU	5	150	Eating establishment	0	0	1115	MIAMI DADE WATER & SEWER DEPARTMENT		0	one 25 gpm	30	279
GDO	8691	IGT	5	150	Eating establishment	36	36	2008	MIAMI DADE WATER & SEWER DEPARTMENT	Single	1050	one 1050 gallon	90	502
GDO	8692	IGT	5	150	Eating establishment	26	26	1100	MIAMI DADE WATER & SEWER DEPARTMENT	Single	1050	one 1050 gallon	90	275
GDO	8696	MGRU	5	150	Eating establishment	10	10	850	MIAMI DADE WATER & SEWER DEPARTMENT		0	one 25 gpm	30	213
GDO	8697	IGT	5	150	Eating establishment	24	24	1905	CITY OF MIAMI BEACH	Single	1050	one 1050 gallon	90	476
GDO	8698	MGRU	5	150	Eating establishment	50	50	2785	CITY OF MIAMI BEACH		0	one 75 gpm	30	696
GDO	8702	IGT	5	150	Eating establishment	10	10	0	MIAMI DADE WATER & SEWER DEPARTMENT	Single	2500	one 2500 gallon	90	3
GDO	8707	IGT	5	150	Eating establishment	0	0	600	MIAMI DADE WATER & SEWER DEPARTMENT	Single	950	one 950 gallon	90	150
GDO	8713	MGRU	5	150	Eating establishment	0	0	229	MIAMI DADE WATER & SEWER DEPARTMENT		0	one 25 gpm	30	57
GDO	8714	MGRU	5	150	Eating establishment	20	20	700	MIAMI DADE WATER & SEWER DEPARTMENT		0	one 25 gpm	30	175
GDO	8716	AGRU	2	150	Eating establishment	20	20	2000	MIAMI DADE WATER & SEWER DEPARTMENT		0	one 25 gpm	30	500
GDO	8721	MGRU	5	150	Eating establishment	0	0	1000	MIAMI DADE WATER & SEWER DEPARTMENT		0	one 50 gpm	30	250
GDO	8724	IGT	5	750	Eating establishment	430	430	25000	MIAMI DADE WATER & SEWER DEPARTMENT	Series	4000	two 2000 gallon	90	10750
GDO	8728	MGRU	5	150	Eating establishment	63	63	2390	MIAMI DADE WATER & SEWER DEPARTMENT		0	one 25 gpm	30	598
GDO	8730	IGT	5	300	Eating establishment	126	126	6065	CITY OF MIAMI BEACH	Single	1250	one 1250-gallon	90	1516
GDO	8731	IGT	5	150	Eating establishment	108	108	1633	MIAMI DADE WATER & SEWER DEPARTMENT	Series	2800	one 1200 & one 1600 gallon	90	40825
GDO	8732	IGT	5	300	Eating establishment	252	252	4856	MIAMI DADE WATER & SEWER DEPARTMENT	Series	2800	one 1200 & one 1600 gallon	90	1214
GDO	8733	IGT	5	150	Eating establishment	90	0	2630	MIAMI DADE WATER & SEWER DEPARTMENT	Series	2800	one 1200 & one 1600 gallon	60	658
GDO	8734	IGT	5	150	Eating establishment	54	0	1668	MIAMI DADE WATER & SEWER DEPARTMENT	Series	2800	one 1200 & one 1600 gallon	60	417
GDO	8735	IGT	5	150	Eating establishment	0	0	0	MIAMI DADE WATER & SEWER DEPARTMENT		0	not available	90	0
GDO	8738	IGT	5	300	Eating establishment	46	0	4200	CITY OF HIALEAH	Single	1200	one 1200 gallon	60	1050
GDO	8739	IGT	5	150	Eating establishment	35	35	1460	MIAMI DADE WATER & SEWER DEPARTMENT	Series	2500	two 1250 gallon	90	365
GDO	8741	IGT	5	150	Eating establishment	0	0	1090	MIAMI DADE WATER & SEWER DEPARTMENT	Single	750	one 750 gallon	60	273
GDO	8742	IGT	5	150	Eating establishment	93	93	3500	MIAMI DADE WATER & SEWER DEPARTMENT	Single	1250	one 1250 gallon	90	875
GDO	8744	MGRU	5	150	Eating establishment	0	0	3000	CITY OF MIAMI BEACH		0	one 25 gpm	30	750
GDO	8746	AGRU	5	150	Eating establishment	10	10	720	MIAMI DADE WATER & SEWER DEPARTMENT		0	one 25 gpm	30	180
GDO	8750	IGT	5	150	Eating establishment	0	0	225	CITY OF NORTH MIAMI	Single	750	one 750 gallon	90	56
GDO	8755	IGT	5	150	Eating establishment	38	38	2160	MIAMI DADE WATER & SEWER DEPARTMENT	Single	1050	one 1050 gallon	90	540
GDO	8762	AGRU	5	150	Eating establishment	30	30	1636	MIAMI DADE WATER & SEWER DEPARTMENT		0	one 25-gpm	30	409
GDO	8763	IGT	5	150	Eating establishment	0	0	2000	CITY OF HIALEAH	Single	750	one 750 gallon	90	500
GDO	8764	MGRU	5	150	Eating establishment	128	128	2500	CITY OF MIAMI BEACH		0	not available	30	625
GDO	8765	IGT	5	150	Eating establishment	10	10	1998	CITY OF MIAMI	Single	1050	one 1050 gallon	90	500
GDO	8770	IGT	5	150	Eating establishment	313	313	7518	MIAMI DADE WATER & SEWER DEPARTMENT	Multiple	3150	three 1050-gallon	60	7518
GDO	8775	IGT	5	150	Eating establishment	0	0	1365	MIAMI DADE WATER & SEWER DEPARTMENT	Single	1050	one 1050-gallon	90	341
GDO	8776	IGT	5	150	Eating establishment	0	0	0	MIAMI DADE WATER & SEWER DEPARTMENT	Single	1050	one 1050 gallon	90	0
GDO	8778	IGT	5	150	Eating establishment	50	50	2880	CITY OF MIAMI	Series	2100	two 1050 gallon	90	720
GDO	8779	IGT	5	150	Eating establishment	46	46	0	MIAMI DADE WATER & SEWER DEPARTMENT	Single	1050	one 1050 gallon	90	1150
GDO	8780	IGT	5	150	Eating establishment	52	52	3000	MIAMI DADE WATER & SEWER DEPARTMENT	Single	1050	one 1050-gallon	90	15000
GDO	8784	IGT	5	300	Eating establishment	220	220	7612	MIAMI DADE WATER & SEWER DEPARTMENT	Multiple	6250	five 1250 gallon	90	1903
GDO	8787	IGT	5	150	Eating establishment	20	20	942	CITY OF NORTH MIAMI	Single	1050	one 1050-gallon	90	236
GDO	8789	IGT	5	300	Eating establishment	204	204	6500	MIAMI DADE WATER & SEWER DEPARTMENT	Series	3200	two 1600 gallon	90	1625
GDO	8790	IGT	5	150	Eating establishment	0	0	414	MIAMI DADE WATER & SEWER DEPARTMENT	Series	3600	two 1800-gallon	90	104
GDO	8793	MGRU	5	150	Eating establishment	30	30	1200	MIAMI DADE WATER & SEWER DEPARTMENT		0	one 25-gpm	30	300
GDO	8795	MGRU	5	150	Eating establishment	0	0	1600	MIAMI DADE WATER & SEWER DEPARTMENT		0	one 25 gpm	30	400
GDO	8796	MGRU	5	150	Eating establishment	30	30	870	CITY OF MIAMI BEACH		0	one 25-gpm	30	218
GDO	8797	MGRU	5	150	Eating establishment	20	20	700	MIAMI DADE WATER & SEWER DEPARTMENT		0	one 25 gpm	30	175
GDO	8799	IGT	5	150	Eating establishment	68	68	3224	MIAMI DADE WATER & SEWER DEPARTMENT	Single	950	one 950 gallon	90	806
GDO	8801	IGT	5	150	Eating establishment	24	24	1446	CITY OF MIAMI BEACH	Single	1050	one 1050 gallon	90	362
GDO	8803	IGT	5	300	Eating establishment	0	0	5400	CITY OF NORTH MIAMI BEACH	Series	2100	two 1050 gallon	90	1350
GDO	8804	IGT	5	150	Eating establishment	104	104	3201	MIAMI DADE WATER & SEWER DEPARTMENT	Series	2400	two 1200 gallon	90	800

WORK GROUP	PERMIT NUMBER	PERMIT CLASS	PERMIT	PERMIT FEE	BUSINESS_TYPE	RECORDED SEATS	OBSERVED SEATS	FACILITY AREA	UTILITY	SYSTEM FORMAT	TOTAL CAPACITY	TANK_CAPACITY	PUMP OUT	TOTAL GPD
GDO	8809	IGT	5	150	Eating establishment	0	0	701	CITY OF NORTH MIAMI	Single	1050	one 1050 gallon	60	175
GDO	8812	IGT	5	150	Eating establishment	10	10	1170	MIAMI DADE WATER & SEWER DEPARTMENT	Single	1200	one 1200 gallon	90	293
GDO	8813	MGRU	5	150	Eating establishment	22	22	1300	MIAMI DADE WATER & SEWER DEPARTMENT		0	one 25 gpm	30	325
GDO	8814	MGRU	5	150	Eating establishment	22	22	1600	MIAMI DADE WATER & SEWER DEPARTMENT		0	one 25 gpm	30	400
GDO	8817	MGRU	5	150	Eating establishment	40	40	0	CITY OF MIAMI BEACH		0	one 25 gpm	30	1000
GDO	8818	MGRU	5	150	Eating establishment	0	0	200	MIAMI DADE WATER & SEWER DEPARTMENT		0	one 7 gpm	30	50
GDO	8820	IGT	5	300	Eating establishment	100	100	0	MIAMI DADE WATER & SEWER DEPARTMENT	Single	1050	one 1050-gallon	90	2500
GDO	8822	IGT	5	150	Eating establishment	0	0	800	MIAMI DADE WATER & SEWER DEPARTMENT	Single	950	one 950 gallon	90	20000
GDO	8824	MGRU	5	150	Eating establishment	0	0	825	MIAMI DADE WATER & SEWER DEPARTMENT		0	one 25 gpm	30	206
GDO	8825	IGT	5	150	Eating establishment	32	32	1258	CITY OF HIALEAH	Single	950	one 950 gallon	90	315
GDO	8826	MGRU	5	150	Eating establishment	22	22	1156	MIAMI DADE WATER & SEWER DEPARTMENT		0	not available	30	6
GDO	8828	MGRU	5	150	Eating establishment	9	9	0	CITY OF MIAMI BEACH		0	one 25 gpm	30	126
GDO	8829	IGT	5	150	Eating establishment	0	0	1482	MIAMI DADE WATER & SEWER DEPARTMENT	Single	1050	one 1050 gallon	90	371
GDO	8834	MGRU	2	150	Eating establishment	20	20	900	MIAMI DADE WATER & SEWER DEPARTMENT		0	one 25 gpm	30	225
GDO	8835	IGT	5	150	Eating establishment	78	78	1556	CITY OF NORTH MIAMI BEACH	Single	950	one 950 gallon	90	389
GDO	8837	IGT	5	150	Eating establishment	32	0	1250	MIAMI DADE WATER & SEWER DEPARTMENT	Single	750	one 750 gallon	60	313
GDO	8839	MGRU	5	150	Eating establishment	7	7	1030	MIAMI DADE WATER & SEWER DEPARTMENT		0	one 25 gpm	30	258
GDO	8841	IGT	5	150	Eating establishment	0	0	500	MIAMI DADE WATER & SEWER DEPARTMENT	Single	950	one 950 gallon	90	125
GDO	8845	IGT	5	300	Eating establishment	120	0	3500	CITY OF NORTH MIAMI BEACH	Single	1050	one 1050 gallon	60	1046
GDO	8846	MGRU	5	150	Eating establishment	40	0	2325	MIAMI DADE WATER & SEWER DEPARTMENT		0	one 25 gpm	30	581
GDO	8847	IGT	5	300	Eating establishment	294	294	9364	MIAMI DADE WATER & SEWER DEPARTMENT	Series	5000	four 1250 gallon	90	234100
GDO	8848	MGRU	5	150	Eating establishment	30	30	0	MIAMI DADE WATER & SEWER DEPARTMENT		0	not available	30	750
GDO	8850	AGRU	5	150	Eating establishment	0	0	650	CITY OF HOMESTEAD		0	one 25 gpm	30	163
GDO	8851	IGT	5	150	Eating establishment	0	0	900	MIAMI DADE WATER & SEWER DEPARTMENT	Single	1050	one 1050-gallon	90	225
GDO	8852	IGT	5	150	Eating establishment	42	42	650	MIAMI DADE WATER & SEWER DEPARTMENT	Single	1200	one 1200 gallon	90	163
GDO	8854	MGRU	5	150	Eating establishment	30	30	1000	CITY OF MIAMI SPRINGS		0	one 25 gpm	30	250
GDO	8855	IGT	5	150	Eating establishment	0	0	1100	CITY OF NORTH MIAMI BEACH	Single	950	one 750 gallon	90	275
GDO	8859	IGT	5	150	Eating establishment	0	0	1050	MIAMI DADE WATER & SEWER DEPARTMENT	Single	1050	one 1050 gallon	90	263
GDO	8865	IGT	5	150	Eating establishment	40	40	1360	MIAMI DADE WATER & SEWER DEPARTMENT	Single	1050	one 1050 gallon	90	1000
GDO	8866	IGT	5	150	Eating establishment	28	28	820	MIAMI DADE WATER & SEWER DEPARTMENT	Single	1050	one 1050-gallon	90	205
GDO	8867	IGT	5	150	Eating establishment	91	91	2590	MIAMI DADE WATER & SEWER DEPARTMENT	Single	1050	one 1050 gallon	90	648
GDO	8868	MGRU	5	150	Eating establishment	0	0	851	MIAMI DADE WATER & SEWER DEPARTMENT		0	one 25 gpm	30	288
GDO	8870	IGT	5	150	Eating establishment	48	48	2500	CITY OF NORTH MIAMI BEACH	Single	1050	one 1050-gallon	90	625
GDO	8871	IGT	5	150	Eating establishment	10	10	1250	CITY OF NORTH MIAMI BEACH	Single	1050	one 1050-gallon	90	313
GDO	8880	AGRU	5	150	Eating establishment	0	0	180	CITY OF HIALEAH		0	one 25 gpm	30	45
GDO	8883	IGT	5	150	Eating establishment	45	0	1200	MIAMI DADE WATER & SEWER DEPARTMENT	Single	1200	one 1200 gallon	60	300
GDO	8884	MGRU	5	150	Eating establishment	15	15	1443	MIAMI DADE WATER & SEWER DEPARTMENT		0	one 25-gpm	30	361
GDO	8885	MGRU	5	150	Eating establishment	0	0	2000	MIAMI DADE WATER & SEWER DEPARTMENT		0	one 75 gpm	60	500
GDO	8888	IGT	5	150	Eating establishment	38	28	1920	MIAMI DADE WATER & SEWER DEPARTMENT	Single	1250	one 1250-gallon	90	480
GDO	8890	IGT	2	300	Eating establishment	200	200	4757	MIAMI DADE WATER & SEWER DEPARTMENT	Single	1050	one 1050 gallon	90	1189
GDO	8893	MGRU	5	150	Eating establishment	26	26	1820	CITY OF MIAMI BEACH		0	one 25 gpm	30	455
GDO	8894	MGRU	5	150	Eating establishment	0	0	800	MIAMI DADE WATER & SEWER DEPARTMENT		0	one 25 gpm	30	200
GDO	8896	MGRU	5	150	Eating establishment	41	41	1800	MIAMI DADE WATER & SEWER DEPARTMENT		0	one 25-gpm	30	574
GDO	8897	IGT	5	150	Eating establishment	23	0	1100	MIAMI DADE WATER & SEWER DEPARTMENT	Single	1050	one 1050 gallon	60	275
GDO	8899	MGRU	5	150	Eating establishment	10	10	300	MIAMI DADE WATER & SEWER DEPARTMENT		0	one 25-gpm	30	75
GDO	8902	MGRU	5	150	Eating establishment	0	0	224	MIAMI DADE WATER & SEWER DEPARTMENT		0	one 25 gpm	30	56
GDO	8903	IGT	5	150	Eating establishment	20	20	1640	MIAMI DADE WATER & SEWER DEPARTMENT	Single	1050	one 1050-gallon	90	410
GDO	8904	MGRU	5	150	Eating establishment	26	26	1426	MIAMI DADE WATER & SEWER DEPARTMENT		0	not available	30	364
GDO	8905	IGT	5	150	Eating establishment	34	34	1609	MIAMI DADE WATER & SEWER DEPARTMENT	Single	750	one 750 gallon	90	402
GDO	8907	IGT	5	150	Eating establishment	4	4	1100	MIAMI DADE WATER & SEWER DEPARTMENT	Single	950	one 950 gallon	90	275
GDO	8908	MGRU	5	150	Eating establishment	28	28	1276	CITY OF MIAMI BEACH		0	one 25 gpm	30	319
GDO	8911	IGT	5	300	Eating establishment	121	121	4254	CITY OF NORTH MIAMI BEACH	Series	2500	two 1250 gallon	90	1064
GDO	8912	IGT	5	150	Eating establishment	35	0	1240	CITY OF NORTH MIAMI BEACH	Single	900	one 900 gallon	60	310
GDO	8913	MGRU	5	150	Eating establishment	0	0	1600	CITY OF HIALEAH		0	one 25 gpm	30	400
GDO	8915	MGRU	5	150	Eating establishment	0	0	643	MIAMI DADE WATER & SEWER DEPARTMENT		0	one 25-gpm	30	161
GDO	8916	IGT	5	150	Eating establishment	52	52	1152	MIAMI DADE WATER & SEWER DEPARTMENT	Single	2000	one 2000 gallon	90	288
GDO	8917	MGRU	5	150	Eating establishment	73	73	1903	MIAMI DADE WATER & SEWER DEPARTMENT		0	one 25 gpm	30	476
GDO	8921	IGT	5	300	Eating establishment	204	204	4115	MIAMI DADE WATER & SEWER DEPARTMENT	Series	2100	two 1050 gallon	90	1029
GDO	8922	IGT	5	300	Eating establishment	0	0	7390	MIAMI DADE WATER & SEWER DEPARTMENT	Series	3150	three 1050 gallon	90	1848
GDO	8924	MGRU	5	150	Eating establishment	0	0	700	MIAMI DADE WATER & SEWER DEPARTMENT		0	one 25 gpm	30	175
GDO	8926	IGT	5	150	Eating establishment	20	20	1017	MIAMI DADE WATER & SEWER DEPARTMENT	Multiple	7500	six 1250 gallon	90	500

WORK GROUP	PERMIT NUMBER	PERMIT CLASS	PERMIT	PERMIT FEE	BUSINESS_TYPE	RECORDED SEATS	OBSERVED SEATS	FACILITY AREA	UTILITY	SYSTEM FORMAT	TOTAL CAPACITY	TANK_CAPACITY	PUMP OUT	TOTAL GPD
GDO	8930	IGT	5	150	Eating establishment	0	0	9154	MIAMI DADE WATER & SEWER DEPARTMENT	Series	5000	four 1250-gallon	90	2289
GDO	8931	MGRU	5	150	Eating establishment	22	22	400	MIAMI DADE WATER & SEWER DEPARTMENT		0	one 4 gpm	30	128
GDO	8934	MGRU	2	150	Eating establishment	22	22	1400	CITY OF MIAMI BEACH		0	one 25 gpm	30	350
GDO	8935	MGRU	5	150	Eating establishment	0	0	800	CITY OF MIAMI BEACH		0	unknown	30	200
GDO	8936	IGT	5	150	Eating establishment	222	222	1978	MIAMI DADE WATER & SEWER DEPARTMENT		0	not available	90	495
GDO	8937	IGT	5	150	Eating establishment	58	58	1312	MIAMI DADE WATER & SEWER DEPARTMENT	Single	1050	one 1050 gallon	90	328
GDO	8940	MGRU	5	150	Eating establishment	19	19	1392	CITY OF SURFSIDE		0	one 25-gpm	30	348
GDO	8944	MGRU	5	150	Eating establishment	84	84	2000	MIAMI DADE WATER & SEWER DEPARTMENT		0	one 25 gpm	30	50000
GDO	8945	MGRU	5	150	Eating establishment	0	0	1900	MIAMI DADE WATER & SEWER DEPARTMENT		0	one 25 gpm	30	475
GDO	8948	IGT	5	150	Eating establishment	0	0	2050	MIAMI DADE WATER & SEWER DEPARTMENT	Single	1050	one 1050 gallon	90	513
GDO	8951	MGRU	5	150	Eating establishment	27	27	1550	CITY OF NORTH MIAMI BEACH		0	one 25 gpm	30	388
GDO	8952	IGT	5	150	Eating establishment	18	18	1670	MIAMI DADE WATER & SEWER DEPARTMENT	Single	1050	one 1050-gallon	90	418
GDO	8954	MGRU	5	150	Eating establishment	0	0	200	MIAMI DADE WATER & SEWER DEPARTMENT		0	one 7 gpm	60	50
GDO	8955	IGT	5	150	Eating establishment	134	134	2409	MIAMI DADE WATER & SEWER DEPARTMENT	Single	1500	one 1500 gallon	90	60225
GDO	8956	IGT	5	150	Eating establishment	57	57	1400	MIAMI DADE WATER & SEWER DEPARTMENT	Multiple	7500	six 1250 gallon	90	350
GDO	8957	IGT	5	150	Eating establishment	128	128	3484	MIAMI DADE WATER & SEWER DEPARTMENT	Multiple	7500	six 1250 gallon	90	871
GDO	8958	IGT	5	300	Eating establishment	253	253	11100	MIAMI DADE WATER & SEWER DEPARTMENT	Multiple	7500	six 1250 gallon	90	2775
GDO	8960	MGRU	5	150	Eating establishment	60	60	1000	MIAMI DADE WATER & SEWER DEPARTMENT		0	one 25-gpm	30	250
GDO	8961	MGRU	2	150	Eating establishment	0	0	762	MIAMI DADE WATER & SEWER DEPARTMENT		0	one 25 gpm	30	191
GDO	8962	IGT	5	300	Eating establishment	323	0	10630	MIAMI DADE WATER & SEWER DEPARTMENT	Series	2500	two 1250 gallon	60	2658
GDO	8967	IGT	5	300	Eating establishment	200	200	4400	MIAMI DADE WATER & SEWER DEPARTMENT	Single	950	one 950 gallon	90	1100
GDO	8968	AGRU	5	150	Eating establishment	48	48	3200	MIAMI DADE WATER & SEWER DEPARTMENT		0	one 50 gpm	30	800
GDO	8970	IGT	5	150	Eating establishment	49	0	1592	MIAMI DADE WATER & SEWER DEPARTMENT	Single	1050	one 1050-gallon	60	398
GDO	8972	IGT	5	150	Eating establishment	147	147	3111	MIAMI DADE WATER & SEWER DEPARTMENT	Single	2000	one 2000 gallon	90	778
GDO	8973	IGT	5	150	Eating establishment	69	69	1822	MIAMI DADE WATER & SEWER DEPARTMENT	Single	2000	one 2000 gallon	90	456
GDO	8974	IGT	5	150	Eating establishment	77	77	1252	MIAMI DADE WATER & SEWER DEPARTMENT	Single	2000	one 2000 gallon	90	313
GDO	8977	MGRU	5	150	Eating establishment	13	13	965	MIAMI DADE WATER & SEWER DEPARTMENT		0	one 25 gpm	30	241
GDO	8980	IGT	5	150	Eating establishment	17	17	1400	MIAMI DADE WATER & SEWER DEPARTMENT	Single	1050	one 1050 gallon	90	350
GDO	8981	IGT	5	150	Eating establishment	0	0	1650	CITY OF FLORIDA CITY		0	not available	90	413
GDO	8983	IGT	5	150	Eating establishment	0	0	695	MIAMI DADE WATER & SEWER DEPARTMENT	Single	1050	one 1050 gallon	90	174
GDO	8985	IGT	5	150	Eating establishment	6	6	500	MIAMI DADE WATER & SEWER DEPARTMENT	Single	1050	one 1050-gallon	90	125
GDO	8986	IGT	5	150	Eating establishment	35	35	2125	CITY OF MIAMI BEACH	Single	1050	one 1050 gallon	90	531
GDO	8989	MGRU	5	150	Eating establishment	10	10	900	MIAMI DADE WATER & SEWER DEPARTMENT		0	one 50 gpm	30	225
GDO	8990	MGRU	5	150	Eating establishment	0	0	100	MIAMI DADE WATER & SEWER DEPARTMENT		0	one 15 gpm	90	25
GDO	8992	IGT	5	150	Eating establishment	73	0	2600	MIAMI DADE WATER & SEWER DEPARTMENT	Single	2000	one 2000 gallon	90	650
GDO	8993	MGRU	5	150	Eating establishment	0	0	900	MIAMI DADE WATER & SEWER DEPARTMENT		0	one 75 gpm	30	225
GDO	8997	MGRU	5	150	Eating establishment	65	65	1500	MIAMI DADE WATER & SEWER DEPARTMENT		0	one 25 gpm	30	450
GDO	8999	MGRU	5	150	Eating establishment	0	0	300	MIAMI DADE WATER & SEWER DEPARTMENT		0	one 20 gpm	30	75
GDO	9003	IGT	5	300	Eating establishment	229	229	5201	MIAMI DADE WATER & SEWER DEPARTMENT	Single	950	one 950-gallon	90	1300
GDO	9004	MGRU	5	150	Eating establishment	14	0	911	MIAMI DADE WATER & SEWER DEPARTMENT		0	one 20 gpm	30	290
GDO	9009	IGT	5	150	Eating establishment	114	114	2762	MIAMI DADE WATER & SEWER DEPARTMENT	Single	1500	one 1500 gallon	90	691
GDO	9010	MGRU	5	150	Eating establishment	0	0	2857	MIAMI DADE WATER & SEWER DEPARTMENT		0	one 25 gpm	30	714
GDO	9012	IGT	5	150	Eating establishment	0	0	1250	CITY OF NORTH MIAMI BEACH	Single	1050	one 1050-gallon	90	313
GDO	9015	IGT	5	150	Eating establishment	0	0	685	MIAMI DADE WATER & SEWER DEPARTMENT	Single	1050	one 1050 gallon	90	171
GDO	9016	MGRU	5	150	Eating establishment	2	0	559	CITY OF HOMESTEAD		0	one 25 gpm	30	140
GDO	9019	IGT	5	300	Eating establishment	0	0	6913	MIAMI DADE WATER & SEWER DEPARTMENT	Single	1500	one 1500 gallon	90	1728
GDO	9023	IGT	5	150	Eating establishment	0	0	1500	MIAMI DADE WATER & SEWER DEPARTMENT	Single	750	one 750 gallon	90	375
GDO	9024	IGT	2	150	Eating establishment	0	0	600	MIAMI DADE WATER & SEWER DEPARTMENT	Single	1050	one 1050 gallon	90	150
GDO	9027	MGRU	5	150	Eating establishment	25	0	1090	CITY OF MIAMI BEACH		0	one 50-gpm	30	288
GDO	9028	MGRU	5	150	Eating establishment	0	0	2300	CITY OF MIAMI BEACH		0	unknown	30	575
GDO	9029	IGT	5	150	Eating establishment	170	170	2665	MIAMI DADE WATER & SEWER DEPARTMENT	Single	1050	one 1050-gallon	90	666
GDO	9033	MGRU	5	150	Eating establishment	0	0	1018	MIAMI DADE WATER & SEWER DEPARTMENT		0	one 25 gpm	30	255
GDO	9034	MGRU	5	150	Eating establishment	0	0	1185	CITY OF MIAMI BEACH		0	one 25 gpm	30	296
GDO	9043	IGT	5	300	Eating establishment	0	0	6217	MIAMI DADE WATER & SEWER DEPARTMENT	Series	2400	two 1200-gallon	90	1554
GDO	9044	IGT	5	150	Eating establishment	0	0	1215	MIAMI DADE WATER & SEWER DEPARTMENT	Series	2500	two 1250-gallon	90	304
GDO	9046	MGRU	5	150	Eating establishment	0	0	500	MIAMI DADE WATER & SEWER DEPARTMENT		0	one 25 gpm	30	125
GDO	9047	IGT	5	150	Eating establishment	35	0	1950	MIAMI DADE WATER & SEWER DEPARTMENT	Single	2500	two 1250 gallon	30	488
GDO	9050	MGRU	5	150	Eating establishment	93	93	2221	CITY OF MIAMI BEACH		0	one 25 gpm	30	555
GDO	9051	IGT	5	150	Eating establishment	66	0	3813	CITY OF MIAMI BEACH	Single	950	one 950 gallon	60	953
GDO	9053	IGT	5	300	Eating establishment	190	190	5074	MIAMI DADE WATER & SEWER DEPARTMENT	Single	1050	one 1050-gallon	90	1269
GDO	9057	MGRU	5	150	Eating establishment	42	42	2099	MIAMI DADE WATER & SEWER DEPARTMENT		0	one 25 gpm	30	525

WORK GROUP	PERMIT NUMBER	PERMIT CLASS	PERMIT	PERMIT FEE	BUSINESS_TYPE	RECORDED SEATS	OBSERVED SEATS	FACILITY AREA	UTILITY	SYSTEM FORMAT	TOTAL CAPACITY	TANK_CAPACITY	PUMP OUT	TOTAL GPD
GDO	9059	MGRU	5	150	Eating establishment	0	0	1600	CITY OF NORTH MIAMI BEACH		0	one 35 gpm	30	400
GDO	9060	IGT	5	150	Eating establishment	10	10	1442	MIAMI DADE WATER & SEWER DEPARTMENT	Single	750	one 750 gallon	90	361
GDO	9063	MGRU	5	150	Eating establishment	0	0	448	MIAMI DADE WATER & SEWER DEPARTMENT		0	one 25 gpm	30	112
GDO	9065	IGT	5	150	Eating establishment	0	0	1370	MIAMI DADE WATER & SEWER DEPARTMENT	Single	1050	one 1050 gallon	90	343
GDO	9068	MGRU	5	150	Eating establishment	34	34	2137	CITY OF MIAMI BEACH		0	one 25 gpm	30	534
GDO	9069	MGRU	5	300	Eating establishment	240	0	7764	MIAMI DADE WATER & SEWER DEPARTMENT		0	one 100 gpm	30	1941
GDO	9070	IGT	5	150	Eating establishment	0	0	1748	CITY OF NORTH MIAMI BEACH	Single	950	one 950 gallon	90	437
GDO	9072	IGT	5	150	Eating establishment	0	0	1320	MIAMI DADE WATER & SEWER DEPARTMENT	Single	450	one 450 gallon	90	330
GDO	9074	IGT	5	150	Eating establishment	204	204	5890	MIAMI DADE WATER & SEWER DEPARTMENT		0	unknown	0	1473
GDO	9077	IGT	5	150	Eating establishment	0	0	1500	MIAMI DADE WATER & SEWER DEPARTMENT	Single	1050	one 1050 gallon	90	375
GDO	9078	IGT	5	150	Eating establishment	0	0	2131	MIAMI DADE WATER & SEWER DEPARTMENT	Single	1050	one 1050-gallon	90	533
GDO	9079	IGT	5	150	Eating establishment	81	81	2016	MIAMI DADE WATER & SEWER DEPARTMENT	Single	2000	one 2000 gallon	90	504
GDO	9082	IGT	2	150	Eating establishment	0	0	1000	MIAMI DADE WATER & SEWER DEPARTMENT	Single	950	one 950 gallon	90	250
GDO	9083	MGRU	5	150	Eating establishment	0	0	690	MIAMI DADE WATER & SEWER DEPARTMENT		0	one 50 gpm	30	173
GDO	9085	MGRU	5	150	Eating establishment	0	0	1120	MIAMI DADE WATER & SEWER DEPARTMENT		0	one 25 gpm	30	280
GDO	9087	MGRU	5	150	Eating establishment	0	0	400	MIAMI DADE WATER & SEWER DEPARTMENT		0	one 25 gpm	30	100
GDO	9088	IGT	5	150	Eating establishment	0	0	0	CITY OF OPA LOCKA	Single	1050	one 1050-gallon	90	0
GDO	9089	IGT	5	300	Eating establishment	0	0	5200	MIAMI DADE WATER & SEWER DEPARTMENT	Single	1050	one 1050-gallon	90	1300
GDO	9091	MGRU	2	150	Eating establishment	0	0	1110	MIAMI DADE WATER & SEWER DEPARTMENT		0	one 25 gpm	30	278
GDO	9092	IGT	5	150	Eating establishment	0	0	1030	MIAMI DADE WATER & SEWER DEPARTMENT	Single	750	one 750 gallon	90	258
GDO	9093	IGT	5	300	Eating establishment	64	64	5392	CITY OF MIAMI BEACH	Series	1500	two 750 gallon	60	1619
GDO	9095	IGT	5	300	Eating establishment	0	0	6563	CITY OF MIAMI BEACH	Single	1050	one 1050 gallon	90	1641
GDO	9096	IGT	5	150	Eating establishment	0	0	2150	MIAMI DADE WATER & SEWER DEPARTMENT	Series	4000	two 2000 gallon	90	538
GDO	9097	IGT	5	150	Eating establishment	0	0	1236	MIAMI DADE WATER & SEWER DEPARTMENT	Series	2400	two 1200 gallon	90	309
GDO	9098	IGT	5	300	Eating establishment	0	0	8188	MIAMI DADE WATER & SEWER DEPARTMENT	Single	1050	one 1050 gallon	90	2047
GDO	9099	IGT	5	150	Eating establishment	0	0	1500	MIAMI DADE WATER & SEWER DEPARTMENT	Single	950	one 950 gallon	90	375
GDO	9100	MGRU	5	150	Eating establishment	0	0	225	MIAMI DADE WATER & SEWER DEPARTMENT		0	one 35 gpm	30	56
GDO	9104	MGRU	5	150	Eating establishment	0	0	1188	MIAMI DADE WATER & SEWER DEPARTMENT		0	one 25 gpm	30	297
GDO	9105	AGRU	5	150	Eating establishment	0	0	2664	MIAMI DADE WATER & SEWER DEPARTMENT		0	one 25 gpm	30	666
GDO	9106	AGRU	4	300	Eating establishment	0	0	7200	MIAMI DADE WATER & SEWER DEPARTMENT		0	unknown	30	1800
GDO	9109	MGRU	5	150	Eating establishment	0	0	1882	MIAMI DADE WATER & SEWER DEPARTMENT		0	one 25 gpm	30	471
GDO	9110	IGT	5	150	Eating establishment	0	0	1550	MIAMI DADE WATER & SEWER DEPARTMENT	Single	1050	one 1050 gallon	90	388
GDO	9115	IGT	5	150	Eating establishment	0	0	2331	MIAMI DADE WATER & SEWER DEPARTMENT	Single	1050	one 1050-gallon	90	583
GDO	9118	IGT	5	150	Eating establishment	0	0	3346	CITY OF MIAMI BEACH	Single	1050	one 1050 gallon	90	837
GDO	9119	MGRU	5	150	Eating establishment	30	30	1231	MIAMI DADE WATER & SEWER DEPARTMENT		0	one 25 gpm	30	308
GDO	9126	MGRU	5	150	Eating establishment	30	0	1500	MIAMI DADE WATER & SEWER DEPARTMENT		0	one 25 gpm	30	375
GDO	9129	IGT	5	300	Eating establishment	121	121	6850	MIAMI DADE WATER & SEWER DEPARTMENT	Series	1900	two 950 gallon	90	1713
GDO	9132	MGRU	5	150	Eating establishment	10	10	775	MIAMI DADE WATER & SEWER DEPARTMENT		0	one 25 gpm	30	194
GDO	9136	MGRU	3	150	Eating establishment	0	0	1542	MIAMI DADE WATER & SEWER DEPARTMENT		0	one 25 gpm	30	386
GDO	9137	IGT	5	300	Eating establishment	128	128	4751	CITY OF MIAMI BEACH	Series	3000	two 1500 gallon	90	1188
GDO	9139	IGT	5	150	Eating establishment	0	0	1534	MIAMI DADE WATER & SEWER DEPARTMENT		0	unknown	90	384
GDO	9140	MGRU	5	150	Eating establishment	0	0	750	CITY OF MIAMI SPRINGS		0	one 25-gpm	30	188
GDO	9141	IGT	5	150	Eating establishment	0	0	1718	MIAMI DADE WATER & SEWER DEPARTMENT	Single	1050	one 1050 gallon	90	430
GDO	9144	MGRU	5	150	Eating establishment	0	0	1400	MIAMI DADE WATER & SEWER DEPARTMENT		0	unknown	30	350
GDO	9145	IGT	5	150	Eating establishment	0	0	1572	MIAMI DADE WATER & SEWER DEPARTMENT	Single	1050	one 1050-gallon	90	393
GDO	9146	MGRU	5	150	Eating establishment	10	0	1489	MIAMI DADE WATER & SEWER DEPARTMENT		0	one 50 gpm	30	372
GDO	9147	MGRU	5	150	Eating establishment	100	100	2000	MIAMI DADE WATER & SEWER DEPARTMENT		0	one 25 gpm	30	500
GDO	9149	IGT	5	150	Eating establishment	0	0	2065	MIAMI DADE WATER & SEWER DEPARTMENT	Series	2500	two 1250-gallon	90	516
GDO	9151	IGT	5	150	Eating establishment	0	0	1342	MIAMI DADE WATER & SEWER DEPARTMENT	Single	1050	one 1050 gallon	90	336
GDO	9153	IGT	5	150	Eating establishment	0	0	1080	MIAMI DADE WATER & SEWER DEPARTMENT	Single	1200	one 1200 gallon	90	270
GDO	9154	MGRU	5	150	Eating establishment	0	0	1091	MIAMI DADE WATER & SEWER DEPARTMENT		0	unknown	30	273
GDO	9155	AGRU	5	150	Eating establishment	0	0	1780	MIAMI DADE WATER & SEWER DEPARTMENT		0	one 25 gpm	30	445
GDO	9156	MGRU	5	150	Eating establishment	0	0	1110	CITY OF MIAMI BEACH		0	one 25 gpm	30	278
GDO	9158	IGT	5	150	Eating establishment	145	145	3900	CITY OF NORTH MIAMI BEACH	Single	1200	one 1200-gallon	90	975
GDO	9161	IGT	5	300	Eating establishment	426	426	13222	CITY OF NORTH MIAMI BEACH	Series	2400	two 1200 gallon	90	3306
GDO	9162	MGRU	5	150	Eating establishment	0	0	1270	MIAMI DADE WATER & SEWER DEPARTMENT		0	one 25 gpm	30	318
GDO	9164	MGRU	5	150	Eating establishment	30	30	635	CITY OF MIAMI BEACH		0	one 25 gpm	30	159
GDO	9166	MGRU	5	150	Eating establishment	38	38	1710	CITY OF MIAMI BEACH		0	one 25-gpm	30	458
GDO	9167	MGRU	5	150	Eating establishment	10	10	950	MIAMI DADE WATER & SEWER DEPARTMENT		0	one 25 gpm	30	238
GDO	9169	AGRU	5	150	Eating establishment	0	0	580	MIAMI DADE WATER & SEWER DEPARTMENT		0	one 25 gpm	30	145
GDO	9172	IGT	5	300	Eating establishment	250	250	30000	CITY OF NORTH MIAMI BEACH	Series	3200	two 1600 gallon	90	750

WORK GROUP	PERMIT NUMBER	PERMIT CLASS	PERMIT	PERMIT FEE	BUSINESS_TYPE	RECORDED SEATS	OBSERVED SEATS	FACILITY AREA	UTILITY	SYSTEM FORMAT	TOTAL CAPACITY	TANK_CAPACITY	PUMP OUT	TOTAL GPD
GDO	9173	IGT	5	300	Eating establishment	160	160	5945	MIAMI DADE WATER & SEWER DEPARTMENT	Single	2000	one 2000 gallon	90	1486
GDO	9174	IGT	5	150	Eating establishment	0	0	1762	MIAMI DADE WATER & SEWER DEPARTMENT	Series	4000	two 2000 gallon	90	441
GDO	9175	IGT	2	150	Eating establishment	26	26	1250	MIAMI DADE WATER & SEWER DEPARTMENT	Single	1050	one 1050-gallon	90	313
GDO	9177	IGT	5	150	Eating establishment	0	0	1500	MIAMI DADE WATER & SEWER DEPARTMENT	Single	950	one 950 gallon	90	375
GDO	9179	MGRU	5	150	Eating establishment	21	0	972	MIAMI DADE WATER & SEWER DEPARTMENT		0	one 25 gpm	30	243
GDO	9180	IGT	5	150	Eating establishment	0	0	2793	CITY OF NORTH MIAMI BEACH	Single	1050	one 1050 gallon	90	698
GDO	9183	IGT	5	150	Eating establishment	0	0	2127	MIAMI DADE WATER & SEWER DEPARTMENT	Single	1050	one 1050 gallon	90	532
GDO	9185	IGT	5	300	Eating establishment	98	98	4100	MIAMI DADE WATER & SEWER DEPARTMENT	Series	2400	two 1200 gallon	90	1025
GDO	9188	MGRU	5	150	Eating establishment	49	0	800	MIAMI DADE WATER & SEWER DEPARTMENT		0	one 50 gpm	30	200
GDO	9191	IGT	5	150	Eating establishment	105	105	1490	MIAMI DADE WATER & SEWER DEPARTMENT	Single	950	one 950-gallon	90	373
GDO	9192	IGT	5	150	Eating establishment	325	325	3798	MIAMI DADE WATER & SEWER DEPARTMENT	Series	3200	two 1600 gallon	90	950
GDO	9193	MGRU	5	150	Eating establishment	0	0	283	MIAMI DADE WATER & SEWER DEPARTMENT	Series	10500	one 35 gpm	90	71
GDO	9194	MGRU	5	150	Eating establishment	54	0	2416	MIAMI DADE WATER & SEWER DEPARTMENT		0	one 100 gpm	80	604
GDO	9196	MGRU	5	150	Eating establishment	30	30	1300	MIAMI DADE WATER & SEWER DEPARTMENT		0	one 25-gpm	30	325
GDO	9197	IGT	5	300	Eating establishment	0	0	5639	MIAMI DADE WATER & SEWER DEPARTMENT	Series	3600	three 1200 gallon	90	1410
GDO	9198	MGRU	5	150	Eating establishment	0	0	1000	MIAMI DADE WATER & SEWER DEPARTMENT		0	one 25 gpm	30	250
GDO	9200	IGT	5	150	Eating establishment	0	0	1400	MIAMI DADE WATER & SEWER DEPARTMENT	Single	1050	one 1050-gallon	90	350
GDO	9204	MGRU	5	150	Eating establishment	0	0	350	MIAMI DADE WATER & SEWER DEPARTMENT		0	one 25 gpm	30	88
GDO	9205	IGT	5	150	Eating establishment	0	0	6500	MIAMI DADE WATER & SEWER DEPARTMENT	Single	1050	one 1050 gallon	90	1625
GDO	9206	IGT	5	150	Eating establishment	20	20	2000	MIAMI DADE WATER & SEWER DEPARTMENT	Single	1050	one 1050 gallon	90	500
GDO	9207	IGT	5	300	Eating establishment	0	0	7850	MIAMI DADE WATER & SEWER DEPARTMENT	Series	4200	four 1050-gallon	90	1963
GDO	9208	IGT	5	150	Eating establishment	74	74	2700	MIAMI DADE WATER & SEWER DEPARTMENT	Single	1050	one 1050 gallon	90	675
GDO	9209	MGRU	5	150	Eating establishment	10	10	900	CITY OF MIAMI BEACH		0	one 25 gpm	30	225
GDO	9210	IGT	5	150	Eating establishment	74	74	1927	MIAMI DADE WATER & SEWER DEPARTMENT	Single	1200	one 1200-gallon	90	482
GDO	9211	MGRU	5	150	Eating establishment	0	0	1715	CITY OF MIAMI BEACH		0	one 25-gpm	30	429
GDO	9212	IGT	5	150	Eating establishment	48	0	2182	MIAMI DADE WATER & SEWER DEPARTMENT	Single	1200	one 1200 gallon	90	546
GDO	9214	IGT	5	150	Eating establishment	84	0	3000	MIAMI DADE WATER & SEWER DEPARTMENT	Single	1600	one 1600 gallon	60	750
GDO	9216	MGRU	5	150	Eating establishment	0	0	750	CITY OF NORTH MIAMI BEACH		0	one 25 gpm	30	188
GDO	9223	MGRU	5	150	Eating establishment	80	80	1332	MIAMI DADE WATER & SEWER DEPARTMENT		0	one 25-gpm	30	333
GDO	9224	MGRU	5	150	Eating establishment	16	0	1186	MIAMI DADE WATER & SEWER DEPARTMENT		0	one 50 gpm	30	297
GDO	9225	IGT	5	150	Eating establishment	935	935	28000	MIAMI DADE WATER & SEWER DEPARTMENT	Series	3200	two 1600-gallon	90	7000
GDO	9226	MGRU	5	150	Eating establishment	42	0	1530	MIAMI DADE WATER & SEWER DEPARTMENT		0	one 50 gpm	90	383
GDO	9227	IGT	5	300	Eating establishment	258	258	8530	CITY OF HIALEAH	Series	3000	four 750-gallon	90	2133
GDO	9229	MGRU	5	150	Eating establishment	20	0	950	MIAMI DADE WATER & SEWER DEPARTMENT		0	one 50 gpm	30	238
GDO	9233	IGT	2	150	Eating establishment	0	0	2283	MIAMI DADE WATER & SEWER DEPARTMENT	Single	750	one 750 gallon	90	571
GDO	9234	IGT	5	300	Eating establishment	0	0	4500	CITY OF HOMESTEAD	Single	750	one 750 gallon	90	1125
GDO	9236	AGRU	5	150	Eating establishment	0	0	2600	MIAMI DADE WATER & SEWER DEPARTMENT		0	one 25 gpm	30	650
GDO	9238	IGT	5	150	Eating establishment	0	0	2436	MIAMI DADE WATER & SEWER DEPARTMENT	Single	1050	one 1050 gallon	90	609
GDO	9239	MGRU	5	150	Eating establishment	0	0	980	MIAMI DADE WATER & SEWER DEPARTMENT		0	one 25 gpm	30	245
GDO	9240	IGT	5	300	Eating establishment	0	0	11170	CITY OF MIAMI BEACH	Series	750	three 250 gallon	90	2793
GDO	9244	IGT	5	150	Eating establishment	51	51	1737	MIAMI DADE WATER & SEWER DEPARTMENT	Single	1050	one 1050-gallon	90	434
GDO	9245	MGRU	5	150	Eating establishment	10	10	732	MIAMI DADE WATER & SEWER DEPARTMENT		0	one 25 gpm	30	183
GDO	9249	IGT	5	150	Eating establishment	24	24	992	CITY OF HIALEAH	Single	1050	one 1050-gallon	90	248
GDO	9250	MGRU	5	150	Eating establishment	0	0	3412	MIAMI DADE WATER & SEWER DEPARTMENT		0	six 100 gpm	90	853
GDO	9251	IGT	5	150	Eating establishment	63	63	2188	CITY OF HIALEAH	Single	1200	one 1200 gallon	90	547
GDO	9252	IGT	5	300	Eating establishment	210	210	8933	CITY OF MIAMI BEACH	Series	4200	four 1050 gallon	90	2233
GDO	9254	MGRU	5	150	Eating establishment	49	49	2476	MIAMI DADE WATER & SEWER DEPARTMENT		0	one 25 gpm	30	619
GDO	9255	IGT	5	150	Eating establishment	78	78	2953	CITY OF MIAMI BEACH	Single	1050	one 1050 gallon	90	738
GDO	9256	IGT	5	150	Eating establishment	16	16	1300	MIAMI DADE WATER & SEWER DEPARTMENT	Single	750	one 750 gallon	90	325
GDO	9257	IGT	5	150	Eating establishment	0	0	2962	MIAMI DADE WATER & SEWER DEPARTMENT	Single	1050	one 1050-gallon	90	741
GDO	9261	MGRU	5	150	Eating establishment	70	0	1650	MIAMI DADE WATER & SEWER DEPARTMENT		0	one 35 gpm	30	413
GDO	9265	MGRU	5	150	Eating establishment	8	0	594	CITY OF HIALEAH		0	one 15 gpm	30	149
GDO	9268	MGRU	5	150	Eating establishment	0	0	260	CITY OF NORTH MIAMI BEACH		0	one 25-gpm	30	65
GDO	9271	IGT	5	150	Eating establishment	0	0	1000	MIAMI DADE WATER & SEWER DEPARTMENT	Single	1200	one 1200 gallon	90	250
GDO	9273	MGRU	5	150	Eating establishment	0	0	500	MIAMI DADE WATER & SEWER DEPARTMENT		0	one 35 gpm	30	125
GDO	9275	MGRU	5	150	Eating establishment	0	0	1500	MIAMI DADE WATER & SEWER DEPARTMENT		0	one 25-gpm	30	375
GDO	9276	MGRU	2	150	Eating establishment	24	24	905	CITY OF MIAMI BEACH		0	one 25 gpm	30	226
GDO	9278	IGT	5	150	Eating establishment	0	0	2384	CITY OF MIAMI BEACH	Series	2100	two 1050-gallon	90	596
GDO	9280	MGRU	5	150	Eating establishment	0	0	1567	MIAMI DADE WATER & SEWER DEPARTMENT		0	one 25 gpm	30	392
GDO	9285	IGT	5	300	Eating establishment	288	288	6516	MIAMI DADE WATER & SEWER DEPARTMENT	Single	1050	one 1050 gallon	90	1629
GDO	9287	IGT	5	150	Eating establishment	0	0	3933	MIAMI DADE WATER & SEWER DEPARTMENT	Single	1050	one 1050 gallon	90	983

WORK GROUP	PERMIT NUMBER	PERMIT CLASS	PERMIT	PERMIT FEE	BUSINESS_TYPE	RECORDED SEATS	OBSERVED SEATS	FACILITY AREA	UTILITY	SYSTEM FORMAT	TOTAL CAPACITY	TANK_CAPACITY	PUMP OUT	TOTAL GPD
GDO	9288	IGT	5	300	Eating establishment	202	202	4079	CITY OF MIAMI BEACH	Series	3600	three 1200 gallon	90	1020
GDO	9290	MGRU	5	150	Eating establishment	20	20	1280	MIAMI DADE WATER & SEWER DEPARTMENT		0	one 25 gpm	30	320
GDO	9292	MGRU	5	150	Eating establishment	36	36	1317	MIAMI DADE WATER & SEWER DEPARTMENT		0	one 40 gpm	30	329
GDO	9294	IGT	5	300	Eating establishment	0	0	4000	MIAMI DADE WATER & SEWER DEPARTMENT	Series	3000	two 1500 gallon	90	1000
GDO	9296	MGRU	1	150	Eating establishment	15	15	1040	MIAMI DADE WATER & SEWER DEPARTMENT		0	one 20 gpm	30	260
GDO	9298	MGRU	2	150	Eating establishment	0	0	475	MIAMI DADE WATER & SEWER DEPARTMENT		0	one 25 gpm	30	119
GDO	9300	MGRU	5	150	Eating establishment	87	87	2160	MIAMI DADE WATER & SEWER DEPARTMENT		0	one 25-gpm	30	540
GDO	9301	MGRU	5	150	Eating establishment	17	0	1800	CITY OF MIAMI BEACH		0	one 35 gpm	30	450
GDO	9303	MGRU	5	150	Eating establishment	0	0	1400	MIAMI DADE WATER & SEWER DEPARTMENT		0	one 25 gpm	30	350
GDO	9305	IGT	5	150	Eating establishment	36	36	1092	CITY OF MIAMI BEACH	Single	1050	one 1050 gallon	90	273
GDO	9306	IGT	5	150	Eating establishment	0	0	2408	CITY OF MIAMI BEACH	Single	1050	one 1050 gallon	90	602
GDO	9314	MGRU	5	150	Eating establishment	0	0	977	MIAMI DADE WATER & SEWER DEPARTMENT		0	one 25-gpm	30	244
GDO	9315	IGT	5	150	Eating establishment	0	0	2000	CITY OF MIAMI BEACH	Single	1050	one 1050-gallon	90	500
GDO	9323	MGRU	5	150	Eating establishment	55	0	2104	MIAMI DADE WATER & SEWER DEPARTMENT		0	six 100 gpm	60	526
GDO	9324	MGRU	5	150	Eating establishment	35	0	1040	MIAMI DADE WATER & SEWER DEPARTMENT		0	one 25 gpm	30	260
GDO	9325	AGT	5	150	Eating establishment	50	50	2147	MIAMI DADE WATER & SEWER DEPARTMENT	Single	750	one 750 gallon	90	537
GDO	9326	MGRU	5	150	Eating establishment	0	0	110	CITY OF NORTH MIAMI BEACH		0	one 10 gpm	30	28
GDO	9328	MGRU	5	150	Eating establishment	0	0	1220	MIAMI DADE WATER & SEWER DEPARTMENT		0	one 25 gpm	30	305
GDO	9329	IGT	5	150	Eating establishment	94	94	2812	MIAMI DADE WATER & SEWER DEPARTMENT	Single	1050	one 1050-gallon	90	703
GDO	9331	MGRU	5	150	Eating establishment	0	0	299	MIAMI DADE WATER & SEWER DEPARTMENT		0	one 25 gpm	30	75
GDO	9333	IGT	5	150	Eating establishment	154	154	3385	MIAMI DADE WATER & SEWER DEPARTMENT	Series	4000	two 2000 gallon	90	846
GDO	9335	IGT	5	150	Eating establishment	95	0	3240	MIAMI DADE WATER & SEWER DEPARTMENT	Single	1050	one 1050 gallon	60	810
GDO	9336	MGRU	5	150	Eating establishment	200	200	1379	CITY OF OPA LOCKA		0	unknown	30	345
GDO	9337	IGT	5	150	Eating establishment	0	0	1070	MIAMI DADE WATER & SEWER DEPARTMENT	Single	1050	one 1050-gallon	90	268
GDO	9355	IGT	5	150	Eating establishment	95	95	3062	MIAMI DADE WATER & SEWER DEPARTMENT	Single	750	one 750 gallon	90	766
GDO	9357	MGRU	5	150	Eating establishment	0	0	900	MIAMI DADE WATER & SEWER DEPARTMENT		0	one 25 gpm	30	225
GDO	9359	MGRU	5	150	Eating establishment	0	0	914	MIAMI DADE WATER & SEWER DEPARTMENT		0	one 25 gpm	30	229
GDO	9360	IGT	5	150	Eating establishment	32	0	1136	MIAMI DADE WATER & SEWER DEPARTMENT	Single	950	one 950 gallon	60	284
GDO	9362	IGT	5	150	Eating establishment	40	40	2090	MIAMI DADE WATER & SEWER DEPARTMENT	Single	1050	one 1050-gallon	90	523
GDO	9365	IGT	5	150	Eating establishment	9	9	673	MIAMI DADE WATER & SEWER DEPARTMENT	Single	750	one 750 gallon	90	168
GDO	9368	MGRU	5	150	Eating establishment	0	0	2216	MIAMI DADE WATER & SEWER DEPARTMENT		0	one 25 gpm	30	554
GDO	9369	IGT	5	150	Eating establishment	0	0	2700	CITY OF NORTH MIAMI	Single	1500	one 1500 gallon	90	675
GDO	9371	MGRU	2	150	Eating establishment	10	10	863	CITY OF MIAMI BEACH		0	one 25 gpm	30	216
GDO	9375	MGRU	2	150	Eating establishment	0	0	1415	CITY OF MIAMI BEACH		0	one 25 gpm	30	354
GDO	9376	MGRU	5	150	Eating establishment	49	0	2500	CITY OF HIALEAH		0	one 10 gpm	30	650
GDO	9381	IGT	5	150	Eating establishment	72	72	2182	MIAMI DADE WATER & SEWER DEPARTMENT	Single	1050	one 1050 gallon	90	546
GDO	9386	IGT	5	300	Eating establishment	0	0	5100	MIAMI DADE WATER & SEWER DEPARTMENT	Single	1050	one 1050 gallon	90	1275
GDO	9387	MGRU	5	150	Eating establishment	22	22	1092	MIAMI DADE WATER & SEWER DEPARTMENT		0	one 25 gpm	30	273
GDO	9389	IGT	5	300	Eating establishment	0	0	4800	CITY OF HIALEAH	Single	1050	one 1050-gallon	90	1200
GDO	9391	MGRU	5	150	Eating establishment	50	0	2200	MIAMI DADE WATER & SEWER DEPARTMENT		0	one 75 gpm	30	550
GDO	9401	MGRU	5	150	Eating establishment	0	0	236	MIAMI DADE WATER & SEWER DEPARTMENT		0	unknown	0	59
GDO	9403	IGT	5	150	Eating establishment	58	58	1400	MIAMI DADE WATER & SEWER DEPARTMENT	Single	1050	one 1050-gallon	90	385
GDO	9404	IGT	5	150	Eating establishment	0	0	2155	MIAMI DADE WATER & SEWER DEPARTMENT	Series	2100	two 1050 gallon	90	539
GDO	9405	MGRU	5	150	Eating establishment	220	220	3000	CITY OF NORTH MIAMI BEACH		0	one 25 gpm	30	750
GDO	9408	MGRU	5	150	Eating establishment	56	56	1405	MIAMI DADE WATER & SEWER DEPARTMENT		0	one 25 gpm	30	351
GDO	9409	MGRU	5	150	Eating establishment	0	0	186	MIAMI DADE WATER & SEWER DEPARTMENT		0	one 15 gpm	30	47
GDO	9412	MGRU	5	300	Eating establishment	561	561	18303	MIAMI DADE WATER & SEWER DEPARTMENT		0	four 75 gpm	30	4576
GDO	9413	IGT	5	300	Eating establishment	200	200	7044	MIAMI DADE WATER & SEWER DEPARTMENT	Single	1050	one 1050 gallon	90	1761
GDO	9415	IGT	5	300	Eating establishment	374	374	7200	MIAMI DADE WATER & SEWER DEPARTMENT	Series	2100	two 1050 gallon	90	1800
GDO	9416	IGT	5	150	Eating establishment	0	0	1213	MIAMI DADE WATER & SEWER DEPARTMENT	Single	950	one 950 gallon	90	303
GDO	9418	IGT	5	150	Eating establishment	0	0	3014	MIAMI DADE WATER & SEWER DEPARTMENT	Series	2400	two 1200 gallon	90	754
GDO	9419	IGT	5	150	Eating establishment	110	110	2894	MIAMI DADE WATER & SEWER DEPARTMENT	Series	2500	two 1250 gallon	90	724
GDO	9421	MGRU	5	150	Eating establishment	20	0	458	MIAMI DADE WATER & SEWER DEPARTMENT		0	one 50 gpm	30	163
GDO	9422	IGT	5	150	Eating establishment	30	0	1500	MIAMI DADE WATER & SEWER DEPARTMENT	Single	900	one 900 gallon	60	375
GDO	9423	IGT	5	150	Eating establishment	0	0	3440	MIAMI DADE WATER & SEWER DEPARTMENT	Single	1050	one 1050-gallon	90	860
GDO	9424	IGT	5	150	Eating establishment	56	0	2400	MIAMI DADE WATER & SEWER DEPARTMENT	Single	1050	one 1050 gallon	60	600
GDO	9425	MGRU	5	150	Eating establishment	0	0	1182	CITY OF NORTH MIAMI BEACH		0	one 25 gpm	30	296
GDO	9432	IGT	5	150	Eating establishment	5	5	1455	MIAMI DADE WATER & SEWER DEPARTMENT	Series	2100	two 1050-gallon	90	364
GDO	9433	MGRU	5	150	Eating establishment	13	13	350	CITY OF MIAMI BEACH		0	one 35 gpm	30	112
GDO	9435	IGT	5	150	Eating establishment	176	176	2980	MIAMI DADE WATER & SEWER DEPARTMENT	Single	1050	one 1050-gallon	90	745
GDO	9436	MGRU	5	150	Eating establishment	56	56	2123	MIAMI DADE WATER & SEWER DEPARTMENT		0	one 25 gpm	30	531

WORK GROUP	PERMIT NUMBER	PERMIT CLASS	PERMIT	PERMIT FEE	BUSINESS_TYPE	RECORDED SEATS	OBSERVED SEATS	FACILITY AREA	UTILITY	SYSTEM FORMAT	TOTAL CAPACITY	TANK_CAPACITY	PUMP OUT	TOTAL GPD
GDO	9437	IGT	5	150	Eating establishment	96	96	3973	MIAMI DADE WATER & SEWER DEPARTMENT	Single	1050	one 1050 gallon	90	993
GDO	9441	IGT	5	300	Eating establishment	0	0	4058	MIAMI DADE WATER & SEWER DEPARTMENT	Series	2100	two 1050 gallon	90	1015
GDO	9444	IGT	5	150	Eating establishment	110	110	2500	CITY OF NORTH MIAMI BEACH	Series	3750	three 1250 gallon	90	625
GDO	9446	IGT	5	150	Eating establishment	54	54	3437	MIAMI DADE WATER & SEWER DEPARTMENT	Single	750	one 750-gallon	90	859
GDO	9447	MGRU	5	150	Eating establishment	0	0	475	MIAMI DADE WATER & SEWER DEPARTMENT		0	one 25 gpm	30	119
GDO	9449	MGRU	5	150	Eating establishment	56	56	1400	MIAMI DADE WATER & SEWER DEPARTMENT		0	one 25-gpm	30	350
GDO	9451	IGT	5	150	Eating establishment	0	0	1250	CITY OF HOMESTEAD	Single	1050	one 1050 gallon	90	313
GDO	9452	MGRU	5	150	Eating establishment	21	21	1200	MIAMI DADE WATER & SEWER DEPARTMENT		0	one 25 gpm	30	300
GDO	9453	MGRU	5	150	Eating establishment	46	46	1364	MIAMI DADE WATER & SEWER DEPARTMENT		0	one 7 gpm	30	341
GDO	9454	IGT	5	300	Eating establishment	312	312	7643	MIAMI DADE WATER & SEWER DEPARTMENT	Series	2400	two 1200-gallon	90	1911
GDO	9455	IGT	5	300	Eating establishment	90	90	4889	CITY OF HOMESTEAD	Series	1900	two 950 gallon	90	1222
GDO	9457	MGRU	5	150	Eating establishment	0	0	1050	MIAMI DADE WATER & SEWER DEPARTMENT		0	one 15 gpm	30	263
GDO	9459	IGT	5	300	Eating establishment	344	344	6401	MIAMI DADE WATER & SEWER DEPARTMENT		1250	one 1250 gallon	90	1600
GDO	9463	MGRU	5	150	Eating establishment	0	0	840	MIAMI DADE WATER & SEWER DEPARTMENT		0	one 25 gpm	30	210
GDO	9465	AGT	5	300	Eating establishment	259	259	5426	MIAMI DADE WATER & SEWER DEPARTMENT	Series	2400	two 1200 gallon	90	1357
GDO	9468	IGT	5	150	Eating establishment	0	0	1488	MIAMI DADE WATER & SEWER DEPARTMENT	Single	1050	one 1050 gallon	90	372
GDO	9470	IGT	5	150	Eating establishment	30	0	1414	MIAMI DADE WATER & SEWER DEPARTMENT	Single	750	one 750 gallon	90	354
GDO	9473	IGT	5	300	Eating establishment	201	0	6780	MIAMI DADE WATER & SEWER DEPARTMENT	Series	3200	two 1600 gallon	90	2075
GDO	9474	IGT	5	150	Eating establishment	92	92	4175	MIAMI DADE WATER & SEWER DEPARTMENT	Series	2400	two 1200 gallon	90	1044
GDO	9475	IGT	5	150	Eating establishment	0	0	1020	CITY OF HOMESTEAD	Series	2100	two 1050 gallon	60	255
GDO	9476	MGRU	5	150	Eating establishment	12	12	1200	CITY OF HIALEAH		0	one 25-gpm	30	300
GDO	9477	MGRU	5	150	Eating establishment	46	0	695	CITY OF MIAMI BEACH		0	one 75 gpm	30	237
GDO	9481	MGRU	2	150	Eating establishment	10	10	206	MIAMI DADE WATER & SEWER DEPARTMENT		0	one 25 gpm	30	52
GDO	9484	IGT	5	150	Eating establishment	48	48	1500	MIAMI DADE WATER & SEWER DEPARTMENT	Single	1200	one 1200 gallon	90	375
GDO	9485	IGT	5	150	Eating establishment	126	126	2396	CITY OF NORTH MIAMI	Single	250	one 250 gallon	90	599
GDO	9487	MGRU	5	300	Eating establishment	202	202	5200	MIAMI DADE WATER & SEWER DEPARTMENT		0	one 35 gpm	30	1300
GDO	9490	MGRU	5	150	Eating establishment	0	0	2069	MIAMI DADE WATER & SEWER DEPARTMENT		0	one 25 gpm	30	517
GDO	9491	MGRU	5	150	Eating establishment	145	0	2474	MIAMI DADE WATER & SEWER DEPARTMENT		0	one 100 gpm	30	619
GDO	9493	IGT	5	150	Eating establishment	81	0	2240	MIAMI DADE WATER & SEWER DEPARTMENT	Series	3600	one 1500 and two 1050 gallon	60	560
GDO	9494	IGT	5	150	Eating establishment	200	200	3200	CITY OF NORTH MIAMI BEACH	Single	1050	one 1050 gallon	90	800
GDO	9495	IGT	5	150	Eating establishment	38	38	1642	CITY OF MIAMI BEACH	Single	1050	one 1050 gallon	90	411
GDO	9497	IGT	5	300	Eating establishment	206	0	5795	MIAMI DADE WATER & SEWER DEPARTMENT	Single	1500	one 1500 gallon	90	1449
GDO	9499	AGT	5	150	Eating establishment	13	13	2000	MIAMI DADE WATER & SEWER DEPARTMENT	Single	1050	one 1050 gallon	90	500
GDO	9500	IGT	5	150	Eating establishment	0	0	2498	CITY OF HIALEAH	Single	1050	one 1050 gallon	90	625
GDO	9501	IGT	5	150	Eating establishment	20	20	972	MIAMI DADE WATER & SEWER DEPARTMENT	Single	1500	one 1500-gallon	90	243
GDO	9502	IGT	5	150	Eating establishment	20	20	2331	MIAMI DADE WATER & SEWER DEPARTMENT	Single	750	one 750 gallon	90	583
GDO	9503	MGRU	4	150	Eating establishment	21	21	1687	MIAMI DADE WATER & SEWER DEPARTMENT		0	one 25 gpm	30	422
GDO	9504	IGT	5	300	Eating establishment	200	200	5012	MIAMI DADE WATER & SEWER DEPARTMENT	Single	1050	one 1050 gallon	90	1253
GDO	9505	MGRU	5	150	Eating establishment	0	0	520	CITY OF HIALEAH		0	one 25-gpm	30	130
GDO	9509	IGT	5	150	Eating establishment	26	0	1400	MIAMI DADE WATER & SEWER DEPARTMENT	Single	750	one 750 gallon	90	350
GDO	9512	IGT	5	300	Eating establishment	0	0	6423	CITY OF HIALEAH	Series	3000	four 750-gallon	90	1606
GDO	9514	MGRU	5	150	Eating establishment	0	0	2100	MIAMI DADE WATER & SEWER DEPARTMENT		0	one 25-gpm	30	525
GDO	9519	IGT	5	150	Eating establishment	0	0	2471	MIAMI DADE WATER & SEWER DEPARTMENT	Series	3000	two 1500 gallon	90	618
GDO	9520	MGRU	5	150	Eating establishment	0	0	800	MIAMI DADE WATER & SEWER DEPARTMENT		0	one 25 gpm	30	200
GDO	9523	MGRU	5	150	Eating establishment	30	0	1241	MIAMI DADE WATER & SEWER DEPARTMENT		0	one 50 gpm	30	310
GDO	9525	IGT	5	150	Eating establishment	18	18	603	MIAMI DADE WATER & SEWER DEPARTMENT	Series	2400	two 1200 gallon	90	151
GDO	9529	MGRU	5	150	Eating establishment	0	0	644	MIAMI DADE WATER & SEWER DEPARTMENT		0	one 25 gpm	30	161
GDO	9530	MGRU	5	150	Eating establishment	3	3	774	CITY OF HIALEAH		0	one 25 gpm	30	194
GDO	9531	IGT	5	300	Eating establishment	230	230	4775	MIAMI DADE WATER & SEWER DEPARTMENT	Series	5000	four 1250 gallon	90	1194
GDO	9533	IGT	5	150	Eating establishment	0	0	400	MIAMI DADE WATER & SEWER DEPARTMENT	Single	1050	one 1050 gallon	90	100
GDO	9534	IGT	5	150	Eating establishment	0	0	1274	MIAMI DADE WATER & SEWER DEPARTMENT	Single	950	one 950 gallon	90	319
GDO	9535	IGT	5	150	Eating establishment	0	0	3600	MIAMI DADE WATER & SEWER DEPARTMENT	Series	1900	two 950 gallon	90	900
GDO	9536	MGRU	5	300	Eating establishment	74	74	2648	MIAMI DADE WATER & SEWER DEPARTMENT		0	one 75 gpm	30	1087
GDO	9539	MGRU	5	150	Eating establishment	0	0	400	MIAMI DADE WATER & SEWER DEPARTMENT		0	one 25 gpm	30	100
GDO	9540	MGRU	4	150	Eating establishment	0	0	500	MIAMI DADE WATER & SEWER DEPARTMENT		0	one 25-gpm	30	125
GDO	9543	MGRU	5	150	Eating establishment	0	0	512	MIAMI DADE WATER & SEWER DEPARTMENT		0	one 25 gpm	30	128
GDO	9544	MGRU	5	300	Eating establishment	210	210	6171	MIAMI DADE WATER & SEWER DEPARTMENT		0	one 25 gpm	30	1543
GDO	9545	IGT	5	300	Eating establishment	245	245	9745	CITY OF MIAMI BEACH	Series	84	two 42-gallon	90	2502
GDO	9546	IGT	2	150	Eating establishment	0	0	285	MIAMI DADE WATER & SEWER DEPARTMENT	Series	2100	two 1050-gallon	90	71
GDO	9548	IGT	5	150	Eating establishment	0	0	1300	MIAMI DADE WATER & SEWER DEPARTMENT	Single	1050	one 1050 gallon	90	325

WORK GROUP	PERMIT NUMBER	PERMIT CLASS	PERMIT	PERMIT FEE	BUSINESS_TYPE	RECORDED SEATS	OBSERVED SEATS	FACILITY AREA	UTILITY	SYSTEM FORMAT	TOTAL CAPACITY	TANK_CAPACITY	PUMP OUT	TOTAL GPD
GDO	9549	IGT	5	150	Eating establishment	20	20	1220	MIAMI DADE WATER & SEWER DEPARTMENT	Series	2400	two 1200 gallon	60	305
GDO	9553	IGT	5	150	Eating establishment	36	0	2056	CITY OF NORTH MIAMI BEACH	Single	1050	one 1050 gallon	60	514
GDO	9555	MGRU	5	150	Eating establishment	38	38	1150	CITY OF MIAMI BEACH		0	one 25 gpm	30	300
GDO	9562	MGRU	5	150	Eating establishment	27	27	1390	MIAMI DADE WATER & SEWER DEPARTMENT		0	one 25 gpm	30	348
GDO	9563	MGRU	5	150	Eating establishment	0	0	2800	MIAMI DADE WATER & SEWER DEPARTMENT		0	one 75 gpm	30	700
GDO	9564	IGT	5	150	Eating establishment	0	0	952	MIAMI DADE WATER & SEWER DEPARTMENT	Single	1050	one 1050 gallon	90	238
GDO	9565	IGT	5	300	Eating establishment	252	252	8054	MIAMI DADE WATER & SEWER DEPARTMENT	Single	4000	one 4000 gallon	90	2014
GDO	9567	IGT	2	150	Eating establishment	18	18	1332	MIAMI DADE WATER & SEWER DEPARTMENT	Series	2100	two 1050-gallon	90	333
GDO	9568	IGT	5	150	Eating establishment	0	0	6373	MIAMI DADE WATER & SEWER DEPARTMENT	Single	1050	one 1050 gallon	90	1593
GDO	9570	MGRU	5	300	Eating establishment	103	103	5713	CITY OF MIAMI BEACH		0	one 25 gpm	30	1428
GDO	9571	IGT	5	150	Eating establishment	106	106	2698	CITY OF MIAMI BEACH	Series	3150	three 1050 gallon	90	675
GDO	9574	IGT	5	150	Eating establishment	32	32	1296	MIAMI DADE WATER & SEWER DEPARTMENT	Single	1050	one 1050 gallon	90	324
GDO	9575	MGRU	2	150	Eating establishment	0	0	850	MIAMI DADE WATER & SEWER DEPARTMENT		0	one 25 gpm	30	213
GDO	9579	MGRU	5	150	Eating establishment	8	8	3606	MIAMI DADE WATER & SEWER DEPARTMENT		0	one 25 gpm	30	187
GDO	9581	MGRU	5	150	Eating establishment	39	39	1400	CITY OF OPA LOCKA		0	one 25-gpm	30	350
GDO	9582	IGT	5	150	Eating establishment	16	16	900	MIAMI DADE WATER & SEWER DEPARTMENT	Single	750	one 750 gallon	90	225
GDO	9583	MGRU	5	150	Eating establishment	0	0	1309	MIAMI DADE WATER & SEWER DEPARTMENT		0	one 25 gpm	30	327
GDO	9584	AGRU	5	150	Eating establishment	25	25	1312	MIAMI DADE WATER & SEWER DEPARTMENT		0	one 25 gpm	30	328
GDO	9585	MGRU	5	150	Eating establishment	29	29	907	MIAMI DADE WATER & SEWER DEPARTMENT		0	two 25 gpm	30	227
GDO	9586	MGRU	5	150	Eating establishment	12	0	494	MIAMI DADE WATER & SEWER DEPARTMENT		0	one 15 gpm	30	124
GDO	9588	IGT	5	150	Eating establishment	0	0	3216	MIAMI DADE WATER & SEWER DEPARTMENT	Series	2100	two 1050 gallon	90	804
GDO	9589	MGRU	5	150	Eating establishment	29	29	1200	MIAMI DADE WATER & SEWER DEPARTMENT		0	one 25 gpm	30	300
GDO	9591	MGRU	5	150	Eating establishment	0	0	544	CITY OF FLORIDA CITY		0	one 25 gpm	30	136
GDO	9593	IGT	5	150	Eating establishment	16	16	1007	MIAMI DADE WATER & SEWER DEPARTMENT	Single	1050	one 1050 gallon	90	252
GDO	9594	IGT	5	150	Eating establishment	0	0	1071	MIAMI DADE WATER & SEWER DEPARTMENT	Single	1250	one 1250 gallon	90	268
GDO	9596	MGRU	5	150	Eating establishment	56	56	2385	MIAMI DADE WATER & SEWER DEPARTMENT		0	one 25 gpm	30	596
GDO	9599	IGT	5	150	Eating establishment	36	36	1063	MIAMI DADE WATER & SEWER DEPARTMENT	Single	1050	one 1050 gallon	90	266
GDO	9600	IGT	5	150	Eating establishment	0	0	2900	MIAMI DADE WATER & SEWER DEPARTMENT	Single	1050	one 1050-gallon	90	725
GDO	9601	IGT	5	150	Eating establishment	100	100	3096	MIAMI DADE WATER & SEWER DEPARTMENT	Single	950	one 950-gallon	90	774
GDO	9604	IGT	5	150	Eating establishment	65	0	2359	MIAMI DADE WATER & SEWER DEPARTMENT	Single	2000	one 2000 gallon	60	590
GDO	9608	MGRU	5	150	Eating establishment	24	24	1000	MIAMI DADE WATER & SEWER DEPARTMENT		0	one 25 gpm	30	250
GDO	9611	MGRU	5	150	Eating establishment	0	0	2417	MIAMI DADE WATER & SEWER DEPARTMENT		0	one 20 gpm	30	604
GDO	9614	MGRU	5	300	Eating establishment	80	80	3430	CITY OF MIAMI BEACH		0	one 25 gpm	30	858
GDO	9615	MGRU	5	150	Eating establishment	0	0	800	MIAMI DADE WATER & SEWER DEPARTMENT		0	one 25 gpm	30	200
GDO	9617	IGT	5	150	Eating establishment	0	0	980	MIAMI DADE WATER & SEWER DEPARTMENT	Single	950	one 950-gallon	90	245
GDO	9618	MGRU	5	150	Eating establishment	3	3	437	MIAMI DADE WATER & SEWER DEPARTMENT		0	one 25 gpm	30	109
GDO	9619	IGT	5	150	Eating establishment	25	25	1096	MIAMI DADE WATER & SEWER DEPARTMENT	Series	3150	three 1050 gallon	90	274
GDO	9623	IGT	5	150	Eating establishment	0	0	0	CITY OF MIAMI BEACH	Single	1050	one 1050 gallon	90	0
GDO	9626	IGT	5	150	Eating establishment	14	14	0	MIAMI DADE WATER & SEWER DEPARTMENT	Single	1050	one 1050-gallon	90	0
GDO	9627	MGRU	5	150	Eating establishment	0	0	1080	MIAMI DADE WATER & SEWER DEPARTMENT		0	one 25 gpm	30	270
GDO	9629	MGRU	5	150	Eating establishment	26	26	1350	MIAMI DADE WATER & SEWER DEPARTMENT		0	one 25 gpm	30	338
GDO	9632	IGT	5	150	Eating establishment	48	48	3900	MIAMI DADE WATER & SEWER DEPARTMENT	Single	1050	one 1050 gallon	90	975
GDO	9633	IGT	5	150	Eating establishment	35	35	1158	CITY OF NORTH MIAMI BEACH	Single	1050	one 1050 gallon	90	290
GDO	9634	IGT	5	300	Eating establishment	0	0	10786	MIAMI DADE WATER & SEWER DEPARTMENT	Single	1050	one 1050 gallon	90	2697
GDO	9636	IGT	5	150	Eating establishment	34	34	3035	MIAMI DADE WATER & SEWER DEPARTMENT	Single	1050	one 1050 gallon	90	759
GDO	9638	IGT	5	150	Eating establishment	49	0	1985	MIAMI DADE WATER & SEWER DEPARTMENT	Single	1250	one 1250 gallon	60	496
GDO	9639	AGRU	5	150	Eating establishment	0	0	1362	MIAMI DADE WATER & SEWER DEPARTMENT		0	one 75 gpm	30	341
GDO	9646	IGT	5	150	Eating establishment	10	0	1359	MIAMI DADE WATER & SEWER DEPARTMENT	Single	1200	one 1200 gallon	30	340
GDO	9653	IGT	5	150	Eating establishment	0	0	2407	MIAMI DADE WATER & SEWER DEPARTMENT	Single	750	one 750-gallon	90	602
GDO	9655	IGT	5	150	Eating establishment	0	0	1905	MIAMI DADE WATER & SEWER DEPARTMENT	Single	750	one 750 gallon	90	476
GDO	9658	MGRU	5	150	Eating establishment	13	13	584	CITY OF MIAMI BEACH		0	one 25 gpm	30	146
GDO	9660	IGT	5	150	Eating establishment	80	80	2967	MIAMI DADE WATER & SEWER DEPARTMENT	Series	1500	two 750 gallon	90	742
GDO	9662	MGRU	5	150	Eating establishment	56	56	1117	MIAMI DADE WATER & SEWER DEPARTMENT		0	one 25 gpm	30	279
GDO	9663	IGT	5	300	Eating establishment	0	0	4000	MIAMI DADE WATER & SEWER DEPARTMENT	Single	1050	one 1050 gallon	90	1000
GDO	9664	IGT	5	150	Eating establishment	55	55	1896	MIAMI DADE WATER & SEWER DEPARTMENT		0	one 100 gpm	60	474
GDO	9666	IGT	5	150	Eating establishment	0	0	2415	MIAMI DADE WATER & SEWER DEPARTMENT	Single	1050	one 1050-gallon	90	604
GDO	9668	IGT	5	150	Eating establishment	0	0	1209	MIAMI DADE WATER & SEWER DEPARTMENT	Single	1050	one 1050 gallon	90	302
GDO	9669	MGRU	5	150	Eating establishment	73	73	2385	CITY OF MIAMI BEACH		0	one 25 gpm	30	596
GDO	9671	MGRU	5	300	Eating establishment	79	0	638	CITY OF MIAMI BEACH		0	one 100 gpm	60	160
GDO	9673	IGT	5	300	Eating establishment	237	237	4950	MIAMI DADE WATER & SEWER DEPARTMENT	Series	2100	two 1050 gallon	90	1238
GDO	9676	IGT	5	300	Eating establishment	213	213	6014	MIAMI DADE WATER & SEWER DEPARTMENT	Single	1050	one 1050 gallon	90	1504

WORK GROUP	PERMIT NUMBER	PERMIT CLASS	PERMIT	PERMIT FEE	BUSINESS_TYPE	RECORDED SEATS	OBSERVED SEATS	FACILITY AREA	UTILITY	SYSTEM FORMAT	TOTAL CAPACITY	TANK_CAPACITY	PUMP OUT	TOTAL GPD
GDO	9677	IGT	5	150	Eating establishment	0	0	960	MIAMI DADE WATER & SEWER DEPARTMENT		1050	one 1050-gallon	90	240
GDO	9678	MGRU	5	150	Eating establishment	42	42	1763	MIAMI DADE WATER & SEWER DEPARTMENT		0	one 25 gpm	30	441
GDO	9680	IGT	5	300	Eating establishment	0	0	3500	MIAMI DADE WATER & SEWER DEPARTMENT	Single	1200	one 1200 gallon	90	875
GDO	9682	IGT	5	300	Eating establishment	242	0	7441	MIAMI DADE WATER & SEWER DEPARTMENT	Series	5000	four 1250 gallon	90	1860
GDO	9683	IGT	5	150	Eating establishment	60	60	2800	CITY OF NORTH MIAMI BEACH	Single	1600	one 1600 gallon	60	780
GDO	9684	MGRU	5	150	Eating establishment	0	0	855	MIAMI DADE WATER & SEWER DEPARTMENT		0	one 25 gpm	30	214
GDO	9685	MGRU	5	150	Eating establishment	0	0	1200	MIAMI DADE WATER & SEWER DEPARTMENT		0	one 25 gpm	30	300
GDO	9689	MGRU	5	150	Eating establishment	0	0	437	CITY OF HIALEAH		0	one 25 gpm	30	109
GDO	9694	MGRU	5	150	Eating establishment	0	0	650	MIAMI DADE WATER & SEWER DEPARTMENT		0	one 35 gpm	30	163
GDO	9696	MGRU	5	150	Eating establishment	0	0	976	MIAMI DADE WATER & SEWER DEPARTMENT		0	one 20 gpm	30	244
GDO	9697	IGT	5	300	Eating establishment	348	348	9821	MIAMI DADE WATER & SEWER DEPARTMENT	Single	1050	one 1050 gallon	90	2455
GDO	9700	IGT	5	150	Eating establishment	0	0	856	MIAMI DADE WATER & SEWER DEPARTMENT	Single	2000	one 2000 gallon	90	214
GDO	9702	IGT	5	150	Eating establishment	0	0	697	MIAMI DADE WATER & SEWER DEPARTMENT	Single	2000	one 2000 gallon	90	174
GDO	9703	IGT	5	150	Eating establishment	74	74	3911	MIAMI DADE WATER & SEWER DEPARTMENT	Series	2500	two 1250 gallon	90	978
GDO	9704	IGT	5	150	Eating establishment	8	8	1274	MIAMI DADE WATER & SEWER DEPARTMENT	Series	1900	two 950 gallon	90	319
GDO	9708	IGT	5	150	Eating establishment	28	28	1790	CITY OF MIAMI BEACH	Single	1050	one 1050 gallon	90	448
GDO	9709	MGRU	5	300	Eating establishment	0	0	5014	CITY OF MIAMI BEACH		0	one 25 gpm	30	1254
GDO	9710	MGRU	5	150	Eating establishment	0	0	1503	MIAMI DADE WATER & SEWER DEPARTMENT		0	one 75 gpm	60	376
GDO	9711	IGT	5	300	Eating establishment	200	200	2900	MIAMI DADE WATER & SEWER DEPARTMENT	Series	2100	two 1050 gallon	90	1000
GDO	9712	IGT	5	300	Eating establishment	120	120	4351	MIAMI DADE WATER & SEWER DEPARTMENT	Series	2500	two 1250 gallon	90	1088
GDO	9715	IGT	5	150	Eating establishment	60	0	2021	MIAMI DADE WATER & SEWER DEPARTMENT	Single	750	one 750-gallon	90	560
GDO	9716	IGT	5	150	Eating establishment	39	0	1050	MIAMI DADE WATER & SEWER DEPARTMENT	Series	2500	two 1250 gallon	60	263
GDO	9717	IGT	5	150	Eating establishment	0	0	700	CITY OF HIALEAH	Single	1050	one 1050 gallon	90	175
GDO	9720	MGRU	5	150	Eating establishment	42	42	825	CITY OF MIAMI BEACH		0	one 35 gpm	30	206
GDO	9722	MGRU	5	300	Eating establishment	300	300	6307	MIAMI DADE WATER & SEWER DEPARTMENT		0	one 25 gpm	30	1577
GDO	9723	MGRU	1	150	Eating establishment	13	0	1200	MIAMI DADE WATER & SEWER DEPARTMENT		0	one 35 gpm	30	300
GDO	9724	MGRU	5	150	Eating establishment	180	180	2416	MIAMI DADE WATER & SEWER DEPARTMENT		0	six 100 gpm	90	679
GDO	9726	IGT	5	150	Eating establishment	50	0	1988	MIAMI DADE WATER & SEWER DEPARTMENT	Single	1200	one 1200 gallon	30	497
GDO	9728	MGRU	5	150	Eating establishment	0	0	1530	MIAMI DADE WATER & SEWER DEPARTMENT		0	one 35 gpm	30	383
GDO	9730	MGRU	5	150	Eating establishment	0	0	825	MIAMI DADE WATER & SEWER DEPARTMENT		0	one 25 gpm	30	206
GDO	9731	AGRU	5	300	Eating establishment	73	73	3380	CITY OF MIAMI BEACH		0	one 50 gpm	30	1091
GDO	9734	MGRU	5	150	Eating establishment	19	0	1172	CITY OF MIAMI BEACH		0	one 35 gpm	30	293
GDO	9738	MGRU	5	150	Eating establishment	20	20	1350	CITY OF NORTH BAY VILLAGE		0	one 25 gpm	30	338
GDO	9739	IGT	5	150	Eating establishment	0	0	262	MIAMI DADE WATER & SEWER DEPARTMENT	Single	1050	one 1050 gallon	90	66
GDO	9742	IGT	5	150	Eating establishment	0	0	1558	MIAMI DADE WATER & SEWER DEPARTMENT	Single	1050	one 1050 gallon	90	390
GDO	9751	IGT	5	150	Eating establishment	0	0	1500	MIAMI DADE WATER & SEWER DEPARTMENT	Single	750	one 750 gallon	90	375
GDO	9752	MGRU	5	150	Eating establishment	0	0	1125	CITY OF HIALEAH		0	one 25 gpm	30	281
GDO	9753	IGT	5	150	Eating establishment	0	0	1500	CITY OF HIALEAH	Single	1050	one 1050 gallon	90	375
GDO	9754	MGRU	5	150	Eating establishment	20	20	2275	MIAMI DADE WATER & SEWER DEPARTMENT		0	one 25 gpm	30	569
GDO	9755	MGRU	5	150	Eating establishment	16	16	1869	MIAMI DADE WATER & SEWER DEPARTMENT		0	one 25 gpm	30	467
GDO	9756	MGRU	5	150	Eating establishment	18	18	1200	MIAMI DADE WATER & SEWER DEPARTMENT		0	one 25 gpm	30	300
GDO	9757	IGT	5	300	Eating establishment	254	254	7580	MIAMI DADE WATER & SEWER DEPARTMENT	Series	4200	four 1050 gallon	90	1895
GDO	9760	MGRU	2	150	Eating establishment	10	10	600	MIAMI DADE WATER & SEWER DEPARTMENT		0	unknown	30	150
GDO	9761	IGT	5	150	Eating establishment	0	0	1400	MIAMI DADE WATER & SEWER DEPARTMENT	Single	1050	one 1050 gallon	90	350
GDO	9762	IGT	5	300	Eating establishment	322	322	8068	MIAMI DADE WATER & SEWER DEPARTMENT	Series	9000	six 1500 gallon	90	2017
GDO	9775	MGRU	5	150	Eating establishment	38	38	1489	MIAMI DADE WATER & SEWER DEPARTMENT		0	one 25 gpm	30	372
GDO	9776	IGT	5	150	Eating establishment	0	0	2500	MIAMI DADE WATER & SEWER DEPARTMENT	Series	3600	three 1200-gallon	90	625
GDO	9778	MGRU	5	150	Eating establishment	24	0	1156	MIAMI DADE WATER & SEWER DEPARTMENT		0	one 25-gpm	30	289
GDO	9779	IGT	2	300	Eating establishment	200	200	6769	MIAMI DADE WATER & SEWER DEPARTMENT	Single	1050	one 1050 gallon	90	1692
GDO	9780	IGT	5	150	Eating establishment	98	98	2386	MIAMI DADE WATER & SEWER DEPARTMENT	Single	1050	one 1050 gallon	90	597
GDO	9782	MGRU	5	150	Eating establishment	0	0	950	MIAMI DADE WATER & SEWER DEPARTMENT		0	one 25 gpm	30	238
GDO	9783	IGT	5	150	Eating establishment	8	8	726	MIAMI DADE WATER & SEWER DEPARTMENT	Single	1050	one 1050 gallon	90	182
GDO	9784	MGRU	2	150	Eating establishment	40	40	1587	MIAMI DADE WATER & SEWER DEPARTMENT		0	one 25-gpm	30	397
GDO	9785	MGRU	5	150	Eating establishment	60	60	1462	CITY OF MIAMI BEACH		0	one 25 gpm	30	366
GDO	9789	IGT	2	150	Eating establishment	0	0	2070	CITY OF NORTH MIAMI	Single	1050	one 1050-gallon	90	518
GDO	9791	IGT	5	300	Eating establishment	200	0	4171	MIAMI DADE WATER & SEWER DEPARTMENT	Single	1050	one 1050	60	1043
GDO	9793	IGT	5	300	Eating establishment	0	0	4759	CITY OF MIAMI BEACH	Single	1050	one 1050 gallon	90	1190
GDO	9797	IGT	5	300	Eating establishment	279	279	8879	MIAMI DADE WATER & SEWER DEPARTMENT	Multiple	5000	four 1250-gallon	90	2224
GDO	9798	IGT	5	300	Eating establishment	0	0	4910	MIAMI DADE WATER & SEWER DEPARTMENT	Series	2100	two 1050 gallon	90	1228
GDO	9799	MGRU	5	150	Eating establishment	0	0	50	MIAMI DADE WATER & SEWER DEPARTMENT		0	one 7 gpm	30	13
GDO	9800	MGRU	5	150	Eating establishment	0	0	1053	MIAMI DADE WATER & SEWER DEPARTMENT		0	one 25 gpm	30	263

WORK GROUP	PERMIT NUMBER	PERMIT CLASS	PERMIT	PERMIT FEE	BUSINESS_TYPE	RECORDED SEATS	OBSERVED SEATS	FACILITY AREA	UTILITY	SYSTEM FORMAT	TOTAL CAPACITY	TANK_CAPACITY	PUMP OUT	TOTAL GPD
GDO	9803	MGRU	5	150	Eating establishment	60	60	2674	MIAMI DADE WATER & SEWER DEPARTMENT		0	one 25 gpm	30	669
GDO	9806	IGT	5	300	Eating establishment	211	211	4505	MIAMI DADE WATER & SEWER DEPARTMENT	Single	1200	one 1200 gallon	90	1126
GDO	9810	MGRU	5	150	Eating establishment	0	0	1049	MIAMI DADE WATER & SEWER DEPARTMENT		0	one 25 gpm	30	262
GDO	9811	IGT	5	300	Eating establishment	281	281	9450	CITY OF NORTH MIAMI	Single	1050	one 1050-gallon	90	2363
GDO	9816	MGRU	5	150	Eating establishment	0	0	240	CITY OF MIAMI BEACH		0	one 25-gpm	30	60
GDO	9817	IGT	5	150	Eating establishment	40	40	1000	MIAMI DADE WATER & SEWER DEPARTMENT	Single	1050	one 1050 gallon	90	250
GDO	9820	IGT	2	150	Eating establishment	0	0	1490	MIAMI DADE WATER & SEWER DEPARTMENT	Single	1050	one 1050 gallon	90	373
GDO	9821	MGRU	5	150	Eating establishment	0	0	1400	MIAMI DADE WATER & SEWER DEPARTMENT		0	one 25 gpm	30	350
GDO	9822	MGRU	5	150	Eating establishment	12	0	1691	CITY OF MIAMI BEACH		0	one 35 gpm	30	423
GDO	9823	MGRU	5	150	Eating establishment	10	0	1200	CITY OF MIAMI BEACH		0	one 50 gpm	30	300
GDO	9834	IGT	5	150	Eating establishment	0	0	2640	CITY OF MIAMI BEACH	Series	3750	three 1250 gallon	90	660
GDO	9835	IGT	5	300	Eating establishment	50	50	4210	MIAMI DADE WATER & SEWER DEPARTMENT	Single	750	one 750 gallon	90	1053
GDO	9836	MGRU	2	150	Eating establishment	0	0	1240	MIAMI DADE WATER & SEWER DEPARTMENT		0	one 35 gpm	30	310
GDO	9838	IGT	5	150	Eating establishment	99	99	2325	CITY OF MIAMI BEACH	Series	3150	three 1050 gallon	90	581
GDO	9842	IGT	5	150	Eating establishment	57	57	2548	MIAMI DADE WATER & SEWER DEPARTMENT	Single	1250	one 1250 gallon	90	637
GDO	9843	MGRU	5	150	Eating establishment	22	22	1946	MIAMI DADE WATER & SEWER DEPARTMENT		0	six 100 gpm	90	487
GDO	9847	MGRU	5	150	Eating establishment	109	0	3749	CITY OF MIAMI BEACH		0	two 100 gpm	60	937
GDO	9850	IGT	5	150	Eating establishment	55	0	1000		Series	1900	two 950 gallon	90	250
GDO	9851	IGT	5	150	Eating establishment	168	168	3710	CITY OF NORTH MIAMI BEACH	Single	1050	one 1050 gallon	90	928
GDO	9852	MGRU	5	150	Eating establishment	30	30	1500	CITY OF MIAMI BEACH		0	one 25 gpm	30	375
GDO	9853	MGRU	5	150	Eating establishment	17	0	846	CITY OF MIAMI BEACH		0	one 25 gpm	30	212
GDO	9854	MGRU	5	150	Eating establishment	38	38	1797	CITY OF MIAMI BEACH		0	one 25 gpm	30	449
GDO	9855	MGRU	3	0	Eating establishment	38	38	1290	MIAMI DADE WATER & SEWER DEPARTMENT		0	unknown	30	323
GDO	9858	IGT	5	150	Eating establishment	0	0	1800	MIAMI DADE WATER & SEWER DEPARTMENT	Series	1050	one 1050 gallon	90	450
GDO	9860	IGT	5	150	Eating establishment	0	0	1684	MIAMI DADE WATER & SEWER DEPARTMENT	Single	1050	one 1050 gallon	90	421
GDO	9864	MGRU	5	150	Eating establishment	130	130	2676	MIAMI DADE WATER & SEWER DEPARTMENT		0	one 25 gpm	30	669
GDO	9865	IGT	5	300	Eating establishment	120	120	4500	MIAMI DADE WATER & SEWER DEPARTMENT	Single	1050	one 1050 gallon	90	1125
GDO	9866	MGRU	5	150	Eating establishment	0	0	1129	MIAMI DADE WATER & SEWER DEPARTMENT		0	one 25 gpm	30	282
GDO	9867	MGRU	5	150	Eating establishment	0	0	585	MIAMI DADE WATER & SEWER DEPARTMENT		0	one 25 gpm	30	146
GDO	9869	MGRU	5	150	Eating establishment	0	0	1293	MIAMI DADE WATER & SEWER DEPARTMENT		0	one 35 gpm	30	323
GDO	9874	IGT	2	150	Eating establishment	0	0	1120	MIAMI DADE WATER & SEWER DEPARTMENT	Single	1050	one 1050 gallon	90	280
GDO	9879	MGRU	5	150	Eating establishment	20	20	1100	MIAMI DADE WATER & SEWER DEPARTMENT		0	one 25 gpm	30	275
GDO	9880	IGT	5	150	Eating establishment	8	8	1220	MIAMI DADE WATER & SEWER DEPARTMENT	Single	750	one 750 gallon	90	305
GDO	9881	IGT	5	150	Eating establishment	78	78	2145	MIAMI DADE WATER & SEWER DEPARTMENT	Single	1050	one 1050 gallon	90	536
GDO	9885	MGRU	5	150	Eating establishment	0	0	1400	MIAMI DADE WATER & SEWER DEPARTMENT		0	one 50 gpm	60	350
GDO	9887	IGT	5	150	Eating establishment	0	0	1988	MIAMI DADE WATER & SEWER DEPARTMENT	Single	1050	one 1050-gallon	90	497
GDO	9888	IGT	5	300	Eating establishment	0	0	3661	MIAMI DADE WATER & SEWER DEPARTMENT	Single	2000	one 2000 gallon	90	915
GDO	9889	IGT	5	150	Eating establishment	0	0	239	MIAMI DADE WATER & SEWER DEPARTMENT	Series	3600	three 1200 gallon	90	60
GDO	9892	IGT	5	150	Eating establishment	125	125	1720	MIAMI DADE WATER & SEWER DEPARTMENT	Single	1050	one 1050 gallon	90	430
GDO	9897	IGT	5	150	Eating establishment	30	30	1725	MIAMI DADE WATER & SEWER DEPARTMENT	Series	2100	two 1050-gallon	90	431
GDO	9898	MGRU	5	150	Eating establishment	4	0	480	MIAMI DADE WATER & SEWER DEPARTMENT		0	one 35 gpm	30	120
GDO	9901	IGT	5	150	Eating establishment	30	30	1734	MIAMI DADE WATER & SEWER DEPARTMENT	Single	1200	one 1200 gallon	60	434
GDO	9902	MGRU	5	150	Eating establishment	0	0	833	MIAMI DADE WATER & SEWER DEPARTMENT		0	one 25 gpm	60	208
GDO	9911	IGT	5	150	Eating establishment	23	23	1628	CITY OF MIAMI BEACH	Single	950	one 950 gallon	90	407
GDO	9912	MGRU	5	150	Eating establishment	12	12	740	MIAMI DADE WATER & SEWER DEPARTMENT		0	one 25 gpm	30	185
GDO	9913	IGT	5	300	Eating establishment	300	300	5825	MIAMI DADE WATER & SEWER DEPARTMENT	Series	3400	two 950 and one 1500 gallon	90	1456
GDO	9914	IGT	5	150	Eating establishment	0	0	2765	MIAMI DADE WATER & SEWER DEPARTMENT	Series	2400	two 1200 gallon	90	691
GDO	9915	MGRU	5	150	Eating establishment	0	0	1897	MIAMI DADE WATER & SEWER DEPARTMENT		0	one 25 gpm	30	474
GDO	9917	MGRU	5	150	Eating establishment	14	0	440	CITY OF NORTH MIAMI BEACH		0	two 50 gpm	30	110
GDO	9918	IGT	5	150	Eating establishment	24	24	1392	CITY OF NORTH MIAMI BEACH	Single	1050	one 1050 gallon	90	348
GDO	9920	IGT	5	150	Eating establishment	0	0	2070	MIAMI DADE WATER & SEWER DEPARTMENT	Single	1050	one 1050 gallon	90	518
GDO	9921	IGT	5	750	Eating establishment	200	0	8748	MIAMI DADE WATER & SEWER DEPARTMENT	Series	7500	six 1250 gallon	60	2499
GDO	9926	IGT	5	150	Eating establishment	108	108	3065	CITY OF MIAMI BEACH	Single	1050	one 1050 gallon	90	766
GDO	9931	MGRU	5	150	Eating establishment	0	0	438	MIAMI DADE WATER & SEWER DEPARTMENT		0	one 25-gpm	30	110
GDO	9933	MGRU	5	150	Eating establishment	67	0	1973	CITY OF MIAMI BEACH	Single	1050	one 1050 gallon	60	701
GDO	9935	MGRU	5	300	Eating establishment	200	0	7560	CITY OF MIAMI BEACH		0	one 100 gpm	90	1890
GDO	9936	IGT	5	300	Eating establishment	150	150	4000	MIAMI DADE WATER & SEWER DEPARTMENT	Series	1900	two 950 gallon	90	1000
GDO	9940	IGT	5	150	Eating establishment	47	47	2408	MIAMI DADE WATER & SEWER DEPARTMENT	Series	3600	three 1200-gallon	90	602
GDO	9946	IGT	5	300	Eating establishment	201	0	7346	MIAMI DADE WATER & SEWER DEPARTMENT	Series	1250	two 625 gallon	60	1837
GDO	9947	IGT	5	150	Eating establishment	82	82	2692	MIAMI DADE WATER & SEWER DEPARTMENT	Single	1200	one 1200 gallon	90	673

WORK GROUP	PERMIT NUMBER	PERMIT CLASS	PERMIT	PERMIT FEE	BUSINESS_TYPE	RECORDED SEATS	OBSERVED SEATS	FACILITY AREA	UTILITY	SYSTEM FORMAT	TOTAL CAPACITY	TANK_CAPACITY	PUMP OUT	TOTAL GPD
GDO	9949	MGRU	5	150	Eating establishment	50	50	2534	CITY OF MIAMI BEACH	Series	2100	two 1050 gallon	90	954
GDO	9950	IGT	5	150	Eating establishment	0	0	840	MIAMI DADE WATER & SEWER DEPARTMENT	Single	1050	one 1050 gallon	90	210
GDO	9955	MGRU	5	150	Eating establishment	60	60	1490	MIAMI DADE WATER & SEWER DEPARTMENT		0	one 50 gpm	30	373
GDO	9960	IGT	5	150	Eating establishment	5	5	1600	CITY OF HOMESTEAD	Single	45	one 45 gallon	90	400
GDO	9963	MGRU	5	150	Eating establishment	10	10	600	CITY OF HOMESTEAD		0	one 25 gpm	30	150
GDO	9967	IGT	5	150	Eating establishment	0	0	1600	MIAMI DADE WATER & SEWER DEPARTMENT	Single	1050	one 1050 gallon	90	400
GDO	9969	IGT	5	150	Eating establishment	0	0	1200	MIAMI DADE WATER & SEWER DEPARTMENT	Single	1050	one 1050 gallon	90	300
GDO	9970	MGRU	5	150	Eating establishment	0	0	1000	MIAMI DADE WATER & SEWER DEPARTMENT		0	one 25-gpm	30	250
GDO	9972	MGRU	5	150	Eating establishment	0	0	1400	MIAMI DADE WATER & SEWER DEPARTMENT		0	one 25 gpm	30	350
GDO	9978	MGRU	5	150	Eating establishment	10	10	629	MIAMI DADE WATER & SEWER DEPARTMENT		0	one 25 gpm	30	157
GDO	9983	MGRU	5	150	Eating establishment	0	0	1068	CITY OF MIAMI BEACH		0	one 25 gpm	30	267
GDO	9986	MGRU	5	150	Eating establishment	0	0	583	MIAMI DADE WATER & SEWER DEPARTMENT		0	one 25 gpm	30	146
GDO	9989	MGRU	5	150	Eating establishment	0	0	650	MIAMI DADE WATER & SEWER DEPARTMENT		0	one 25 gpm	30	163
GDO	9991	MGRU	5	150	Eating establishment	30	30	2000	MIAMI DADE WATER & SEWER DEPARTMENT		0	one 25 gpm	30	500
GDO	9992	MGRU	5	150	Eating establishment	58	58	2147	MIAMI DADE WATER & SEWER DEPARTMENT		0	one 25 gpm	30	537
GDO	9997	IGT	5	150	Eating establishment	0	0	2939	MIAMI DADE WATER & SEWER DEPARTMENT	Single	1050	one 1050 gallon	90	735
GDO	10001	IGT	5	150	Eating establishment	0	0	2171	CITY OF MIAMI BEACH	Single	1050	one 1050 gallon	90	543
GDO	10003	IGT	5	750	Eating establishment	397	397	12356	CITY OF MIAMI BEACH	Series	5250	five 1050 gallon	90	3089
GDO	10004	MGRU	5	150	Eating establishment	73	0	2152	MIAMI DADE WATER & SEWER DEPARTMENT		0	one 35 gpm	30	538
GDO	10005	IGT	5	300	Eating establishment	298	298	5919	MIAMI DADE WATER & SEWER DEPARTMENT	Series	2400	two 1200 gallon	90	1480
GDO	10007	MGRU	2	150	Eating establishment	40	40	1563	MIAMI DADE WATER & SEWER DEPARTMENT		0	one 25 gpm	30	391
GDO	10011	IGT	5	150	Eating establishment	60	60	1547	MIAMI DADE WATER & SEWER DEPARTMENT	Series	2500	two 1250 gallon	90	387
GDO	10014	IGT	5	150	Eating establishment	136	136	2550	CITY OF MIAMI BEACH	Single	1250	one 1250-gallon	90	852
GDO	10019	IGT	5	150	Eating establishment	12	12	836	MIAMI DADE WATER & SEWER DEPARTMENT	Single	1050	one 1050 gallon	90	209
GDO	10022	MGRU	5	750	Eating establishment	134	0	13993	CITY OF MIAMI BEACH		0	one 100 gpm	30	3116
GDO	10024	MGRU	5	150	Eating establishment	0	0	3123	CITY OF MIAMI BEACH		0	one 25 gpm	30	781
GDO	10025	MGRU	5	150	Eating establishment	0	0	2238	CITY OF MIAMI BEACH		0	one 50 gpm	30	109
GDO	10026	IGT	5	150	Eating establishment	48	48	1157	MIAMI DADE WATER & SEWER DEPARTMENT	Single	1050	one 1050 gallon	90	289
GDO	10027	IGT	5	300	Eating establishment	274	274	6708	MIAMI DADE WATER & SEWER DEPARTMENT	Single	1050	one 1050 gallon	90	1677
GDO	10030	IGT	5	750	Eating establishment	210	210	8800	CITY OF NORTH MIAMI	Single	1050	one 1050-gallon	90	2200
GDO	10033	MGRU	5	150	Eating establishment	0	0	1500	MIAMI DADE WATER & SEWER DEPARTMENT		0	one 25 gpm	30	375
GDO	10034	IGT	5	150	Eating establishment	68	68	2965	CITY OF HIALEAH	Single	1250	one 1250 gallon	90	741
GDO	10035	IGT	5	150	Eating establishment	20	20	900	MIAMI DADE WATER & SEWER DEPARTMENT	Series	2100	two 1050 gallon	90	225
GDO	10037	MGRU	5	300	Eating establishment	230	230	4330	MIAMI DADE WATER & SEWER DEPARTMENT		0	one 25 gpm	30	1226
GDO	10039	IGT	2	150	Eating establishment	20	20	1200	MIAMI DADE WATER & SEWER DEPARTMENT	Single	1200	one 1200-gallon	90	300
GDO	10040	IGT	5	150	Eating establishment	0	0	1200	CITY OF FLORIDA CITY	Single	1200	one 1200 gallon	90	300
GDO	10041	MGRU	5	150	Eating establishment	0	0	986	MIAMI DADE WATER & SEWER DEPARTMENT		0	one 25 gpm	30	247
GDO	10042	IGT	2	150	Eating establishment	0	0	2140	CITY OF HOMESTEAD	Single	1200	one 1200 gallon	90	535
GDO	10043	IGT	5	150	Eating establishment	0	0	1688	MIAMI DADE WATER & SEWER DEPARTMENT	Single	1050	one 1050 gallon	90	422
GDO	10046	IGT	5	150	Eating establishment	0	0	0	CITY OF FLORIDA CITY	Single	1050	one 1050 gallon	90	0
GDO	10047	IGT	5	150	Eating establishment	0	0	600	CITY OF HIALEAH	Single	750	one 750 gallon	90	150
GDO	10052	IGT	5	150	Eating establishment	55	55	3400	MIAMI DADE WATER & SEWER DEPARTMENT	Single	1050	one 1050 gallon	90	850
GDO	10056	IGT	5	300	Eating establishment	110	110	4500	CITY OF MIAMI BEACH	Series	5000	four 1250-gallon	90	1125
GDO	10057	IGT	5	300	Eating establishment	0	0	4362	CITY OF MIAMI BEACH	Series	2500	two 1250 gallon	90	1091
GDO	10070	MGRU	5	150	Eating establishment	0	0	840	MIAMI DADE WATER & SEWER DEPARTMENT		0	one 75 gpm	30	210
GDO	10072	IGT	5	150	Eating establishment	18	18	1200	CITY OF HIALEAH	Single	1050	one 1050 gallon	90	300
GDO	10074	MGRU	2	300	Eating establishment	206	206	10264	MIAMI DADE WATER & SEWER DEPARTMENT		0	one 50 gpm	60	2566
GDO	10077	MGRU	5	150	Eating establishment	10	10	859	MIAMI DADE WATER & SEWER DEPARTMENT		0	one 25 gpm	30	215
GDO	10080	IGT	5	150	Eating establishment	39	39	1400	MIAMI DADE WATER & SEWER DEPARTMENT	Single	750	one 750-gallon	90	350
GDO	10087	MGRU	5	300	Eating establishment	168	168	4083	MIAMI DADE WATER & SEWER DEPARTMENT		0	one 25 gpm	30	1021
GDO	10088	MGRU	5	150	Eating establishment	10	10	802	MIAMI DADE WATER & SEWER DEPARTMENT		0	one 20 gpm	30	201
GDO	10089	MGRU	5	300	Eating establishment	80	80	6711	MIAMI DADE WATER & SEWER DEPARTMENT		0	one 35 gpm	30	1678
GDO	10090	IGT	5	150	Eating establishment	0	0	750	MIAMI DADE WATER & SEWER DEPARTMENT	Single	1250	one 1250 gallon	90	188
GDO	10096	IGT	5	150	Eating establishment	64	64	2306	MIAMI DADE WATER & SEWER DEPARTMENT	Single	1050	one 1050 gallon	90	577
GDO	10102	MGRU	5	150	Eating establishment	4	0	282	MIAMI DADE WATER & SEWER DEPARTMENT		0	one 15 gpm	90	71
GDO	10103	IGT	5	300	Eating establishment	0	0	4400	MIAMI DADE WATER & SEWER DEPARTMENT	Series	2100	two 1050 gallon	90	1100
GDO	10106	IGT	5	150	Eating establishment	0	0	2261	CITY OF NORTH MIAMI BEACH	Single	1050	one 1050 gallon	90	565
GDO	10107	MGRU	5	150	Eating establishment	0	0	2278	MIAMI DADE WATER & SEWER DEPARTMENT		0	one 25 gpm	30	570
GDO	10108	IGT	5	150	Eating establishment	123	123	3500	MIAMI DADE WATER & SEWER DEPARTMENT	Series	8400	eight 1050 gallon	90	875
GDO	10109	MGRU	5	150	Eating establishment	44	44	1450	MIAMI DADE WATER & SEWER DEPARTMENT		0	one 35 gpm	30	363
GDO	10110	MGRU	5	150	Eating establishment	0	0	2300	MIAMI DADE WATER & SEWER DEPARTMENT		0	one 25 gpm	30	575

WORK GROUP	PERMIT NUMBER	PERMIT CLASS	PERMIT	PERMIT FEE	BUSINESS_TYPE	RECORDED SEATS	OBSERVED SEATS	FACILITY AREA	UTILITY	SYSTEM FORMAT	TOTAL CAPACITY	TANK_CAPACITY	PUMP OUT	TOTAL GPD
GDO	10111	MGRU	5	150	Eating establishment	0	0	2554	MIAMI DADE WATER & SEWER DEPARTMENT		0	one 35 gpm	30	639
GDO	10116	IGT	5	150	Eating establishment	127	127	2071	CITY OF NORTH MIAMI BEACH	Single	1050	one 1050 gallon	90	518
GDO	10117	IGT	5	150	Eating establishment	9	9	895	MIAMI DADE WATER & SEWER DEPARTMENT	Single	1050	one 1050 gallon	90	224
GDO	10119	MGRU	5	150	Eating establishment	20	20	781	MIAMI DADE WATER & SEWER DEPARTMENT		0	one 25 gpm	30	195
GDO	10124	IGT	5	150	Eating establishment	0	0	1876	CITY OF HIALEAH	Single	1050	one 1050 gallon	90	469
GDO	10130	MGRU	5	150	Eating establishment	0	0	3254	CITY OF MIAMI BEACH		0	three 100 gpm	60	814
GDO	10131	MGRU	5	150	Eating establishment	43	43	925	CITY OF MIAMI BEACH		0	two 35 gpm	30	231
GDO	10134	MGRU	5	150	Eating establishment	16	0	572	MIAMI DADE WATER & SEWER DEPARTMENT		0	two 20 gpm	90	143
GDO	10135	MGRU	5	150	Eating establishment	0	0	0			0	one 25 gpm	30	0
GDO	10140	MGRU	5	300	Eating establishment	268	268	6950	MIAMI DADE WATER & SEWER DEPARTMENT		0	two 25 gpm	30	1738
GDO	10143	IGT	5	300	Eating establishment	0	0	4400	MIAMI DADE WATER & SEWER DEPARTMENT	Series	4200	four 1050 gallon	90	1100
GDO	10147	IGT	5	150	Eating establishment	0	0	588	MIAMI DADE WATER & SEWER DEPARTMENT	Single	1050	one 1050 gallon	90	147
GDO	10149	MGRU	5	150	Eating establishment	40	40	1617	CITY OF MIAMI BEACH		0	one 25 gpm	30	404
GDO	10150	IGT	5	300	Eating establishment	393	0	9585	CITY OF MIAMI BEACH	Series	2500	two 1250 gallon	60	2396
GDO	10154	MGRU	5	150	Eating establishment	0	0	1886	CITY OF CORAL GABLES		0	one 25 gpm	30	472
GDO	10156	MGRU	5	150	Eating establishment	0	0	1600	CITY OF HIALEAH		0	one 20 gpm	30	400
GDO	10157	MGRU	5	150	Eating establishment	0	0	270	MIAMI DADE WATER & SEWER DEPARTMENT		0	one 20 gpm	30	68
GDO	10160	MGRU	5	150	Eating establishment	24	24	1128	MIAMI DADE WATER & SEWER DEPARTMENT		0	one 25 gpm	30	282
GDO	10162	MGRU	5	150	Eating establishment	0	0	1269	MIAMI DADE WATER & SEWER DEPARTMENT		0	one 25 gpm	30	317
GDO	10163	MGRU	5	150	Eating establishment	20	20	644	MIAMI DADE WATER & SEWER DEPARTMENT		0	one 25 gpm	30	161
GDO	10168	IGT	5	150	Eating establishment	40	0	1370	CITY OF NORTH MIAMI BEACH	Series	2500	two 1250 gallon	90	343
GDO	10172	IGT	5	150	Eating establishment	64	0	1950	CITY OF HIALEAH	Single	750	one 750 gallon	90	488
GDO	10175	MGRU	5	150	Eating establishment	44	44	1360	MIAMI DADE WATER & SEWER DEPARTMENT		0	one 25 gpm	30	340
GDO	10176	MGRU	5	150	Eating establishment	36	0	1586	CITY OF MIAMI BEACH		0	one 7 and one 50 gpm	30	397
GDO	10180	IGT	5	750	Eating establishment	340	340	10929	MIAMI DADE WATER & SEWER DEPARTMENT	Series	8400	eight 1050 gallon	90	2732
GDO	10182	MGRU	2	150	Eating establishment	19	0	785	MIAMI DADE WATER & SEWER DEPARTMENT		0	one 35 gpm	90	196
GDO	10185	MGRU	5	150	Eating establishment	33	0	1867	MIAMI DADE WATER & SEWER DEPARTMENT		0	one 24 gpm	30	467
GDO	10187	MGRU	5	150	Eating establishment	22	22	1370	MIAMI DADE WATER & SEWER DEPARTMENT		0	one 35 gpm	60	343
GDO	10192	MGRU	5	150	Eating establishment	0	0	945	MIAMI DADE WATER & SEWER DEPARTMENT		0	one 25 gpm	30	236
GDO	10194	IGT	5	150	Eating establishment	0	0	3543	MIAMI DADE WATER & SEWER DEPARTMENT	Series	8400	eight 1050 gallon	90	886
GDO	10198	IGT	5	300	Eating establishment	130	130	5100	MIAMI DADE WATER & SEWER DEPARTMENT	Single	1200	one 1200-gallon	90	1275
GDO	10199	MGRU	5	150	Eating establishment	60	60	2197	MIAMI DADE WATER & SEWER DEPARTMENT		0	one 25 gpm	30	549
GDO	10201	IGT	5	150	Eating establishment	70	0	1972	MIAMI DADE WATER & SEWER DEPARTMENT	Series	9000	two 4500 gallon	90	525
GDO	10202	MGRU	5	150	Eating establishment	0	0	1422	MIAMI DADE WATER & SEWER DEPARTMENT		0	one 25 gpm	30	356
GDO	10207	MGRU	5	150	Eating establishment	22	22	1233	MIAMI DADE WATER & SEWER DEPARTMENT		0	one 25 gpm	30	308
GDO	10208	MGRU	5	300	Eating establishment	0	0	4886	MIAMI DADE WATER & SEWER DEPARTMENT		0	one 25 gpm	30	1222
GDO	10209	IGT	5	150	Eating establishment	0	0	634	MIAMI DADE WATER & SEWER DEPARTMENT	Single	2000	one 2000 gallon	60	159
GDO	10210	IGT	5	300	Eating establishment	0	0	5962	MIAMI DADE WATER & SEWER DEPARTMENT	Series	8400	eight 1050 gallon	90	1491
GDO	10211	IGT	5	150	Eating establishment	73	73	3500	MIAMI DADE WATER & SEWER DEPARTMENT	Single	1250	one 1250-gallon	90	875
GDO	10218	IGT	5	150	Eating establishment	60	60	1858	CITY OF MIAMI BEACH	Single	1500	one 1500 gallon	90	465
GDO	10219	IGT	5	150	Eating establishment	104	104	2500	MIAMI DADE WATER & SEWER DEPARTMENT	Single	1050	one 1050 gallon	90	625
GDO	10220	MGRU	5	150	Eating establishment	3	0	260	MIAMI DADE WATER & SEWER DEPARTMENT		0	one 15 gpm	30	65
GDO	10221	IGT	5	150	Eating establishment	0	0	500	MIAMI DADE WATER & SEWER DEPARTMENT	Single	1050	one 1050 gallon	90	125
GDO	10222	IGT	5	150	Eating establishment	61	61	2435	MIAMI DADE WATER & SEWER DEPARTMENT	Single	1200	one 1200 gallon	90	609
GDO	10223	MGRU	5	150	Eating establishment	20	0	825	MIAMI DADE WATER & SEWER DEPARTMENT		0	one 15 gpm	30	206
GDO	10224	MGRU	5	300	Eating establishment	220	220	14500	MIAMI DADE WATER & SEWER DEPARTMENT		0	one 25 gpm	30	3625
GDO	10225	IGT	5	300	Eating establishment	0	0	5980	MIAMI DADE WATER & SEWER DEPARTMENT	Series	3150	three 1050 gallon	90	1495
GDO	10229	IGT	5	150	Eating establishment	0	0	2100	MIAMI DADE WATER & SEWER DEPARTMENT	Single	1050	one 1050 gallon	90	525
GDO	10230	IGT	5	150	Eating establishment	60	60	1350	MIAMI DADE WATER & SEWER DEPARTMENT	Single	750	one 750-gallon	90	338
GDO	10237	MGRU	5	300	Eating establishment	149	149	4000	MIAMI DADE WATER & SEWER DEPARTMENT		0	one 35 gpm	30	1000
GDO	10238	IGT	5	150	Eating establishment	0	0	2569	MIAMI DADE WATER & SEWER DEPARTMENT	Series	2500	two 1250-gallon	90	642
GDO	10246	IGT	5	150	Eating establishment	0	0	3420	CITY OF HIALEAH	Single	1050	one 1050 gallon	90	855
GDO	10249	MGRU	5	150	Eating establishment	30	30	500	MIAMI DADE WATER & SEWER DEPARTMENT		0	one 25 gpm	30	125
GDO	10251	IGT	5	150	Eating establishment	60	60	2925	MIAMI DADE WATER & SEWER DEPARTMENT	Single	1600	one 1600-gallon	90	731
GDO	10253	MGRU	5	150	Eating establishment	93	93	1830	MIAMI DADE WATER & SEWER DEPARTMENT		0	one 20 gpm	30	538
GDO	10254	MGRU	5	300	Eating establishment	73	0	3357	CITY OF MIAMI BEACH		0	one 7 and one 75 gpm	30	1121
GDO	10256	IGT	5	150	Eating establishment	46	46	2408	MIAMI DADE WATER & SEWER DEPARTMENT	Single	1050	one 1050 gallon	90	602
GDO	10257	IGT	5	150	Eating establishment	0	0	0	MIAMI DADE WATER & SEWER DEPARTMENT	Single	1050	one 1050 gallon	90	0
GDO	10258	IGT	5	150	Eating establishment	0	0	687	MIAMI DADE WATER & SEWER DEPARTMENT	Series	760	two 380 gallon	90	172

WORK GROUP	PERMIT NUMBER	PERMIT CLASS	PERMIT	PERMIT FEE	BUSINESS_TYPE	RECORDED SEATS	OBSERVED SEATS	FACILITY AREA	UTILITY	SYSTEM FORMAT	TOTAL CAPACITY	TANK_CAPACITY	PUMP OUT	TOTAL GPD
GDO	10260	MGRU	5	150	Eating establishment	0	0	758	MIAMI DADE WATER & SEWER DEPARTMENT		0	one 200 gpm	90	190
GDO	10261	IGT	5	150	Eating establishment	75	75	2767	MIAMI DADE WATER & SEWER DEPARTMENT	Parallel	2100	two 1050 gallon	90	692
GDO	10262	MGRU	5	150	Eating establishment	0	0	300	MIAMI DADE WATER & SEWER DEPARTMENT		0	one 25 gpm	30	75
GDO	10263	IGT	5	750	Eating establishment	0	0	11933	CITY OF MIAMI BEACH	Series	5250	five 1050 gallon	90	2983
GDO	10266	MGRU	5	150	Eating establishment	24	24	2530	MIAMI DADE WATER & SEWER DEPARTMENT		0	one 25 gpm	30	633
GDO	10267	MGRU	5	150	Eating establishment	10	10	927	MIAMI DADE WATER & SEWER DEPARTMENT		0	one 25-gpm	30	232
GDO	10269	IGT	5	150	Eating establishment	60	0	1650	CITY OF HIALEAH	Single	4000	one 4000 gallon	60	413
GDO	10271	MGRU	5	150	Eating establishment	53	53	2012	MIAMI DADE WATER & SEWER DEPARTMENT		0	one 25 gpm	30	503
GDO	10273	IGT	5	150	Eating establishment	90	0	3780	MIAMI DADE WATER & SEWER DEPARTMENT	Single	1200	one 1200 gallon	90	945
GDO	10277	MGRU	5	300	Eating establishment	84	0	1014	MIAMI DADE WATER & SEWER DEPARTMENT	Single	1050	one 1050 gallon	30	1528
GDO	10280	IGT	5	150	Eating establishment	0	0	1260	MIAMI DADE WATER & SEWER DEPARTMENT	Single	750	one 750-gallon	90	315
GDO	10281	MGRU	5	150	Eating establishment	0	0	500	CITY OF CORAL GABLES		0	one 25 gpm	30	125
GDO	10285	MGRU	5	150	Eating establishment	0	0	763	CITY OF MIAMI BEACH		0	one 25 gpm	30	191
GDO	10289	MGRU	5	300	Eating establishment	90	0	3537	CITY OF MIAMI BEACH		0	two 100 gpm	30	1023
GDO	10290	MGRU	5	150	Eating establishment	12	0	550	CITY OF NORTH MIAMI BEACH		0	one 15 gpm	30	138
GDO	10293	MGRU	5	150	Eating establishment	49	0	1900	CITY OF NORTH MIAMI		0	one 50 gpm	30	475
GDO	10294	IGT	2	300	Eating establishment	200	200	6255	CITY OF MIAMI BEACH	Series	3000	two 1500-gallon	90	1564
GDO	10296	IGT	5	150	Eating establishment	0	0	1145	MIAMI DADE WATER & SEWER DEPARTMENT	Single	2500	one 2500 gallon	90	286
GDO	10297	IGT	5	150	Eating establishment	0	0	700	MIAMI DADE WATER & SEWER DEPARTMENT	Single	1050	one 1050-gallon	90	175
GDO	10299	MGRU	5	150	Eating establishment	33	33	1017	MIAMI DADE WATER & SEWER DEPARTMENT		0	one 50 gpm	30	254
GDO	10301	IGT	5	150	Eating establishment	95	95	2480	MIAMI DADE WATER & SEWER DEPARTMENT	Single	1050	one 1050 gallon	90	620
GDO	10302	MGRU	5	300	Eating establishment	200	0	9760	CITY OF MIAMI BEACH		0	two 100 gpm	60	2445
GDO	10304	MGRU	5	150	Eating establishment	62	0	2784	CITY OF MIAMI BEACH		0	one 20 gpm and one 50 gpm	30	696
GDO	10305	MGRU	5	150	Eating establishment	58	0	0	CITY OF MIAMI BEACH		0	one 100 gpm	60	0
GDO	10306	IGT	5	300	Eating establishment	0	0	3122	CITY OF MIAMI BEACH	Single	1250	one 1250 gallon	90	1458
GDO	10309	IGT	5	300	Eating establishment	202	0	4720	MIAMI DADE WATER & SEWER DEPARTMENT	Single	1250	one 1250 gallon	90	1180
GDO	10313	MGRU	5	150	Eating establishment	0	0	426	MIAMI DADE WATER & SEWER DEPARTMENT		0	one 25 gpm	30	107
GDO	10315	MGRU	5	150	Eating establishment	0	0	1617	CITY OF HIALEAH		0	one 25 gpm	30	404
GDO	10316	IGT	5	300	Eating establishment	205	205	3304	MIAMI DADE WATER & SEWER DEPARTMENT	Series	2500	two 1250-gallon	90	1343
GDO	10320	MGRU	5	150	Eating establishment	62	0	2420	MIAMI DADE WATER & SEWER DEPARTMENT		0	two 100 gpm	60	605
GDO	10331	IGT	5	150	Eating establishment	0	0	1150	MIAMI DADE WATER & SEWER DEPARTMENT	Series	2100	two 1050 gallon	90	288
GDO	10333	IGT	5	150	Eating establishment	0	0	1170	MIAMI DADE WATER & SEWER DEPARTMENT	Single	1050	one 1050 gallon	90	293
GDO	10336	MGRU	5	150	Eating establishment	0	0	242	MIAMI DADE WATER & SEWER DEPARTMENT		0	one 25 gpm	30	61
GDO	10337	IGT	5	150	Eating establishment	42	42	1300	MIAMI DADE WATER & SEWER DEPARTMENT	Single	1050	one 1050 gallon	90	325
GDO	10338	MGRU	5	150	Eating establishment	12	12	692	MIAMI DADE WATER & SEWER DEPARTMENT		0	one 25 gpm	30	173
GDO	10340	MGRU	5	150	Eating establishment	70	70	966	MIAMI DADE WATER & SEWER DEPARTMENT		0	one 25 gpm	30	242
GDO	10341	IGT	5	750	Eating establishment	309	309	8062	CITY OF NORTH MIAMI BEACH	Series	5100	two 1050 and two 1500 gallon	90	2016
GDO	10347	MGRU	5	150	Eating establishment	40	40	1400	MIAMI DADE WATER & SEWER DEPARTMENT		0	one 25 gpm	30	350
GDO	10348	IGT	5	150	Eating establishment	0	0	850	MIAMI DADE WATER & SEWER DEPARTMENT	Single	1050	one 1050 gallon	90	213
GDO	10350	IGT	5	150	Eating establishment	0	0	1138	MIAMI DADE WATER & SEWER DEPARTMENT	Single	750	one 750-gallon	90	285
GDO	10354	MGRU	5	150	Eating establishment	30	0	800	MIAMI DADE WATER & SEWER DEPARTMENT		0	one 50 gpm	30	200
GDO	10355	MGRU	5	150	Eating establishment	22	22	744	MIAMI DADE WATER & SEWER DEPARTMENT		0	one 25 gpm	30	186
GDO	10356	MGRU	5	150	Eating establishment	89	89	2517	MIAMI DADE WATER & SEWER DEPARTMENT		0	one 75 gpm	30	629
GDO	10357	MGRU	5	150	Eating establishment	50	50	2300	MIAMI DADE WATER & SEWER DEPARTMENT		0	one 35 gpm	30	575
GDO	10358	MGRU	5	150	Eating establishment	0	0	596	MIAMI DADE WATER & SEWER DEPARTMENT		0	one 25 gpm	30	149
GDO	10360	MGRU	5	150	Eating establishment	97	0	3268	CITY OF MIAMI BEACH		0	one 100 gpm	90	817
GDO	10361	MGRU	5	150	Eating establishment	8	0	540	CITY OF NORTH MIAMI BEACH		0	one 50 gpm	30	135
GDO	10362	IGT	5	150	Eating establishment	0	0	3200	CITY OF MIAMI BEACH	Single	1050	one 1050 gallon	90	800
GDO	10364	IGT	5	300	Eating establishment	0	0	5280	MIAMI DADE WATER & SEWER DEPARTMENT	Single	1250	one 1250 gallon	90	1320
GDO	10365	IGT	5	150	Eating establishment	265	0	4461	MIAMI DADE WATER & SEWER DEPARTMENT	Series	5000	four 1250 gallon	60	1368
GDO	10366	IGT	5	150	Eating establishment	42	0	1300	MIAMI DADE WATER & SEWER DEPARTMENT	Series	2300	one 1050 and one 1250 gallon	60	325
GDO	10369	MGRU	5	150	Eating establishment	12	0	648	MIAMI DADE WATER & SEWER DEPARTMENT		0	one 15 gpm	30	162
GDO	10373	MGRU	5	150	Eating establishment	18	18	1128	MIAMI DADE WATER & SEWER DEPARTMENT		0	one 25-gpm	30	282
GDO	10375	IGT	5	300	Eating establishment	720	720	11558	MIAMI DADE WATER & SEWER DEPARTMENT	Series	5000	four 1250-gallon	90	2890
GDO	10376	IGT	5	150	Eating establishment	0	0	1522	MIAMI DADE WATER & SEWER DEPARTMENT	Single	1050	one 1050 gallon	90	381
GDO	10379	MGRU	5	150	Eating establishment	38	0	1410	CITY OF MIAMI BEACH	Single	1050	one 1050 gallon	60	353
GDO	10381	IGT	5	150	Eating establishment	0	0	0	CITY OF MIAMI BEACH	Single	1250	one 1250 gallon	90	0
GDO	10385	IGT	5	150	Eating establishment	50	50	1190	MIAMI DADE WATER & SEWER DEPARTMENT	Series	4000	two 2000 gallon	90	298

WORK GROUP	PERMIT NUMBER	PERMIT CLASS	PERMIT	PERMIT FEE	BUSINESS_TYPE	RECORDED SEATS	OBSERVED SEATS	FACILITY AREA	UTILITY	SYSTEM FORMAT	TOTAL CAPACITY	TANK_CAPACITY	PUMP OUT	TOTAL GPD
GDO	10387	IGT	5	300	Eating establishment	225	0	7093	MIAMI DADE WATER & SEWER DEPARTMENT	Series	72362	six +10,000 gallon	90	1773
GDO	10389	IGT	5	300	Eating establishment	231	231	6284	MIAMI DADE WATER & SEWER DEPARTMENT	Series	3150	three 1050 gallon	90	1571
GDO	10390	IGT	5	150	Eating establishment	0	0	2300	CITY OF HIALEAH	Single	1050	one 1050 gallon	90	575
GDO	10398	MGRU	5	150	Eating establishment	0	0	501	MIAMI DADE WATER & SEWER DEPARTMENT		0	one 25 gpm	30	125
GDO	10399	AGRU	5	300	Eating establishment	82	0	7555	MIAMI DADE WATER & SEWER DEPARTMENT		0	two 75 gpm	60	1889
GDO	10402	IGT	5	150	Eating establishment	0	0	1455	MIAMI DADE WATER & SEWER DEPARTMENT	Single	3000	one 3000 gallon	60	364
GDO	10410	MGRU	5	150	Eating establishment	8	8	180	CITY OF HIALEAH		0	one 50 gpm	30	45
GDO	10411	MGRU	5	150	Eating establishment	0	0	1277	MIAMI DADE WATER & SEWER DEPARTMENT		0	one 25 gpm	30	319
GDO	10412	IGT	5	150	Eating establishment	40	0	1327	MIAMI DADE WATER & SEWER DEPARTMENT	Series	2500	two 1250 gallon	60	332
GDO	10414	MGRU	5	150	Eating establishment	0	0	500	MIAMI DADE WATER & SEWER DEPARTMENT		0	one 25 gpm	30	125
GDO	10418	MGRU	5	150	Eating establishment	7	7	875	MIAMI DADE WATER & SEWER DEPARTMENT		0	one 25 gpm	30	219
GDO	10422	MGRU	5	150	Eating establishment	0	0	0	CITY OF MIAMI BEACH		0	one 25 gpm	30	0
GDO	10424	MGRU	5	150	Eating establishment	0	0	254	MIAMI DADE WATER & SEWER DEPARTMENT		0	one 15 gpm	30	64
GDO	10425	IGT	5	150	Eating establishment	0	0	2466	MIAMI DADE WATER & SEWER DEPARTMENT	Single	750	one 750-gallon	90	617
GDO	10426	IGT	5	300	Eating establishment	210	210	5400	MIAMI DADE WATER & SEWER DEPARTMENT	Series	3400	two 950 and one 1500 gallon	90	1350
GDO	10432	MGRU	2	150	Eating establishment	62	62	2784	CITY OF MIAMI BEACH		0	one 25 gpm	30	696
GDO	10433	IGT	5	150	Eating establishment	0	0	1500	MIAMI DADE WATER & SEWER DEPARTMENT	Single	1050	one 1050 gallon	90	375
GDO	10435	MGRU	5	150	Eating establishment	0	0	1607	CITY OF HIALEAH		0	one 100-gpm	30	402
GDO	10436	MGRU	5	150	Eating establishment	22	0	1700	MIAMI DADE WATER & SEWER DEPARTMENT		0	one 50 gpm	30	425
GDO	10438	MGRU	5	150	Eating establishment	10	10	1335	MIAMI DADE WATER & SEWER DEPARTMENT		0	one 25 gpm	30	334
GDO	10439	IGT	5	150	Eating establishment	68	68	1557	CITY OF MIAMI BEACH	Single	1050	one 1050-gallon	90	389
GDO	10443	IGT	5	150	Eating establishment	40	40	2029	CITY OF HIALEAH	Single	1200	one 1200-gallon	90	507
GDO	10444	IGT	5	300	Eating establishment	0	0	4300	MIAMI DADE WATER & SEWER DEPARTMENT	Single	1050	one 1050 gallon	90	1075
GDO	10445	IGT	5	150	Eating establishment	0	0	3606	CITY OF NORTH MIAMI	Series	2500	two 1250-gallon	90	902
GDO	10447	MGRU	5	150	Eating establishment	0	0	900	CITY OF MIAMI BEACH		0	one 7 gpm	30	225
GDO	10449	IGT	5	150	Eating establishment	0	0	2500	MIAMI DADE WATER & SEWER DEPARTMENT	Single	1050	one 1050 gallon	90	625
GDO	10450	IGT	5	150	Eating establishment	0	0	2227	MIAMI DADE WATER & SEWER DEPARTMENT	Single	1050	one 1050 gallon	90	557
GDO	10454	IGT	5	300	Eating establishment	0	0	4593	MIAMI DADE WATER & SEWER DEPARTMENT	Series	2500	two 1250 gallon	90	1148
GDO	10456	AGRU	5	150	Eating establishment	0	0	2000	CITY OF MIAMI BEACH		0	one 25 gpm	30	500
GDO	10463	IGT	5	150	Eating establishment	20	20	944	MIAMI DADE WATER & SEWER DEPARTMENT	Single	1200	one 1200-gallon	90	257
GDO	10468	MGRU	5	150	Eating establishment	0	0	660	MIAMI DADE WATER & SEWER DEPARTMENT		0	one 25 gpm	30	165
GDO	10470	IGT	5	150	Eating establishment	0	0	2959	MIAMI DADE WATER & SEWER DEPARTMENT	Single	1050	one 1050 gallon	90	740
GDO	10474	IGT	5	300	Eating establishment	0	0	4944	MIAMI DADE WATER & SEWER DEPARTMENT	Series	2500	two 1250 gallon	60	1236
GDO	10486	MGRU	5	150	Eating establishment	49	49	1056	MIAMI DADE WATER & SEWER DEPARTMENT		0	one 35 gpm	30	264
GDO	10487	MGRU	5	150	Eating establishment	0	0	1300	CITY OF MIAMI BEACH		0	one 25 gpm	30	325
GDO	10488	MGRU	5	150	Eating establishment	0	0	2163	MIAMI DADE WATER & SEWER DEPARTMENT		0	one 25 gpm	30	541
GDO	10489	MGRU	5	150	Eating establishment	48	48	1401	CITY OF MIAMI BEACH		0	one 35 gpm	30	377
GDO	10493	MGRU	5	150	Eating establishment	0	0	640	MIAMI DADE WATER & SEWER DEPARTMENT		0	one 35 gpm	60	160
GDO	10494	MGRU	5	150	Eating establishment	0	0	1122	MIAMI DADE WATER & SEWER DEPARTMENT		0	one 15 gpm	30	281
GDO	10497	IGT	5	150	Eating establishment	48	0	1331	MIAMI DADE WATER & SEWER DEPARTMENT	Single	750	one 750-gallon	90	333
GDO	10499	IGT	5	750	Eating establishment	322	322	10600	CITY OF MIAMI BEACH	Series	3000	two 1500 gallon	90	2650
GDO	10501	IGT	5	150	Eating establishment	0	0	0	MIAMI DADE WATER & SEWER DEPARTMENT	Single	380	one 380 gallon	90	0
GDO	10502	IGT	5	150	Eating establishment	0	0	1499	MIAMI DADE WATER & SEWER DEPARTMENT	Series	2400	two 1200 gallon	60	375
GDO	10504	IGT	5	150	Eating establishment	40	40	2029	MIAMI DADE WATER & SEWER DEPARTMENT	Single	1250	one 1250 gallon	90	507
GDO	10506	IGT	5	750	Eating establishment	0	0	7200	MIAMI DADE WATER & SEWER DEPARTMENT	Series	2100	two 1050 gallon	90	1800
GDO	10507	IGT	5	300	Eating establishment	0	0	4000	MIAMI DADE WATER & SEWER DEPARTMENT	Series	2250	three 750 gallon	90	1000
GDO	10508	IGT	5	150	Eating establishment	26	0	1495	MIAMI DADE WATER & SEWER DEPARTMENT	Single	1200	one 1200 gallon	60	374
GDO	10509	IGT	5	150	Eating establishment	0	0	3064	MIAMI DADE WATER & SEWER DEPARTMENT	Single	1500	one 1500 gallon	90	766
GDO	10510	IGT	5	150	Eating establishment	0	0	807	MIAMI DADE WATER & SEWER DEPARTMENT	Single	1500	one 1500 gallon	90	202
GDO	10513	MGRU	5	150	Eating establishment	54	54	1800	CITY OF MIAMI BEACH		0		30	450
GDO	10514	IGT	5	750	Eating establishment	0	0	7169	MIAMI DADE WATER & SEWER DEPARTMENT	Series	3750	three 1250 gallon	60	1792
GDO	10516	IGT	5	150	Eating establishment	86	0	2350	MIAMI DADE WATER & SEWER DEPARTMENT	Series	3150	three 1050 gallon	60	647
GDO	10520	MGRU	2	150	Eating establishment	42	0	3546	MIAMI DADE WATER & SEWER DEPARTMENT		0	one 10 gpm	30	887
GDO	10521	MGRU	4	150	Eating establishment	12	0	1004	MIAMI DADE WATER & SEWER DEPARTMENT		0	one 50 gpm	30	251
GDO	10526	MGRU	5	150	Eating establishment	0	0	1022	MIAMI DADE WATER & SEWER DEPARTMENT		0	one 50 gpm	30	256
GDO	10529	MGRU	5	150	Eating establishment	14	0	530	MIAMI DADE WATER & SEWER DEPARTMENT		0	one 35 gpm	30	133
GDO	10531	IGT	5	300	Eating establishment	0	0	4200	MIAMI DADE WATER & SEWER DEPARTMENT		0	unknown	90	1050
GDO	10532	MGRU	5	150	Eating establishment	0	0	0	MIAMI DADE WATER & SEWER DEPARTMENT		0	one 25 gpm	30	0
GDO	10533	IGT	5	150	Eating establishment	0	0	3600	MIAMI DADE WATER & SEWER DEPARTMENT	Single	1050	one 1050 gallon	60	900
GDO	10534	MGRU	5	150	Eating establishment	0	0	819	MIAMI DADE WATER & SEWER DEPARTMENT		0	one 75 gpm	30	205

WORK GROUP	PERMIT NUMBER	PERMIT CLASS	PERMIT	PERMIT FEE	BUSINESS_TYPE	RECORDED SEATS	OBSERVED SEATS	FACILITY AREA	UTILITY	SYSTEM FORMAT	TOTAL CAPACITY	TANK_CAPACITY	PUMP OUT	TOTAL GPD
GDO	10536	MGRU	5	150	Eating establishment	0	0	2300	MIAMI DADE WATER & SEWER DEPARTMENT		0	one 25 gpm	30	575
GDO	10538	MGRU	5	150	Eating establishment	0	0	3099	MIAMI DADE WATER & SEWER DEPARTMENT		0	one 20 gpm	30	775
GDO	10539	IGT	5	150	Eating establishment	22	0	2025	CITY OF MIAMI BEACH	Series	3750	three 1250 gallon	30	506
GDO	10541	MGRU	5	150	Eating establishment	0	0	1580	MIAMI DADE WATER & SEWER DEPARTMENT		0	one 50 gpm	30	395
GDO	10542	MGRU	5	150	Eating establishment	30	30	1900	MIAMI DADE WATER & SEWER DEPARTMENT		0	one 25 gpm	30	475
GDO	10544	MGRU	5	150	Eating establishment	30	30	1821	MIAMI DADE WATER & SEWER DEPARTMENT		0	one 25 gpm	30	455
GDO	10545	IGT	5	150	Eating establishment	65	65	1730	CITY OF MIAMI BEACH	Series	2400	two 1200 gallon	90	433
GDO	10546	IGT	5	300	Eating establishment	252	252	4320	CITY OF MIAMI BEACH	Series	4800	four 1200 gallon	90	1080
GDO	10547	IGT	5	150	Eating establishment	217	217	2540	CITY OF MIAMI BEACH	Series	2400	two 1200 gallon	90	635
GDO	10548	MGRU	5	150	Eating establishment	24	0	1501	MIAMI DADE WATER & SEWER DEPARTMENT		0	five 25 gpm	30	375
GDO	10558	MGRU	5	150	Eating establishment	100	0	2271	MIAMI DADE WATER & SEWER DEPARTMENT		0	one 50 gpm	30	568
GDO	10560	MGRU	5	150	Eating establishment	0	0	240	CITY OF HIALEAH		0	one 10 gpm	30	60
GDO	10561	IGT	5	300	Eating establishment	333	0	9785	MIAMI DADE WATER & SEWER DEPARTMENT	Multiple	6250	five 1250-gallon	90	2966
GDO	10565	IGT	5	300	Eating establishment	0	0	5824	MIAMI DADE WATER & SEWER DEPARTMENT	Series	20000	two 10,000-gallon	90	1456
GDO	10570	MGRU	5	150	Eating establishment	0	0	1115	MIAMI DADE WATER & SEWER DEPARTMENT		0	one 25 gpm	30	279
GDO	10571	IGT	5	150	Eating establishment	0	0	1250	CITY OF NORTH MIAMI BEACH	Single	900	one 900-gallon	90	313
GDO	10572	AGRU	5	150	Eating establishment	96	96	2588	MIAMI DADE WATER & SEWER DEPARTMENT		0	one 75 gpm	30	647
GDO	10574	MGRU	5	150	Eating establishment	0	0	0	MIAMI DADE WATER & SEWER DEPARTMENT		0	one 25 gpm	30	0
GDO	10577	IGT	5	150	Eating establishment	15	0	896	MIAMI DADE WATER & SEWER DEPARTMENT	Single	1000	one 1000 gallon	60	224
GDO	10578	MGRU	5	150	Eating establishment	0	0	905	MIAMI DADE WATER & SEWER DEPARTMENT		0	one 25 gpm	30	226
GDO	10579	MGRU	5	150	Eating establishment	7	7	361	MIAMI DADE WATER & SEWER DEPARTMENT		0	one 10 gpm	30	90
GDO	10580	MGRU	5	150	Eating establishment	0	0	800	CITY OF MIAMI BEACH		0	one 20 gpm	30	200
GDO	10587	MGRU	5	150	Eating establishment	0	0	1600	MIAMI DADE WATER & SEWER DEPARTMENT		0	one 25 gpm	30	400
GDO	10595	MGRU	4	150	Eating establishment	0	0	839	CITY OF MIAMI BEACH		0	one 35 gpm	30	210
GDO	10596	IGT	5	300	Eating establishment	0	0	3600	MIAMI DADE WATER & SEWER DEPARTMENT		380	one 380-gallon	90	1088
GDO	10597	IGT	5	300	Eating establishment	240	240	1605	MIAMI DADE WATER & SEWER DEPARTMENT		760	two 380-gallon	90	1245
GDO	10598	MGRU	5	300	Eating establishment	167	0	7924	CITY OF MIAMI BEACH		0	three 100 gpm	90	1981
GDO	10600	MGRU	5	150	Eating establishment	0	0	350	MIAMI DADE WATER & SEWER DEPARTMENT		0	one 75 gpm	30	88
GDO	10601	MGRU	5	150	Eating establishment	20	20	1499	CITY OF MIAMI BEACH		0	one 20 gpm	30	375
GDO	10604	MGRU	5	300	Eating establishment	66	66	4200	CITY OF MIAMI BEACH		0	one 30 and one 20 gpm	30	1050
GDO	10608	IGT	5	150	Eating establishment	20	20	1000	MIAMI DADE WATER & SEWER DEPARTMENT	Single	1200	one 1200 gallon	90	250
GDO	10609	IGT	5	150	Eating establishment	0	0	1400	MIAMI DADE WATER & SEWER DEPARTMENT	Single	900	one 900 gallon	90	350
GDO	10615	AGRU	5	150	Eating establishment	27	0	0	MIAMI DADE WATER & SEWER DEPARTMENT		0	one 20 gpm	30	0
GDO	10619	MGRU	5	150	Eating establishment	0	0	1061	MIAMI DADE WATER & SEWER DEPARTMENT		0	one 20 and one 50 gpm	30	265
GDO	10622	MGRU	5	150	Eating establishment	16	0	1300	MIAMI DADE WATER & SEWER DEPARTMENT		0	one 25 gpm	90	325
GDO	10623	MGRU	5	150	Eating establishment	0	0	275	MIAMI DADE WATER & SEWER DEPARTMENT		0	one 20 gpm	30	69
GDO	10624	IGT	5	150	Eating establishment	0	0	1350	CITY OF NORTH MIAMI BEACH	Single	750	one 750-gallon	90	338
GDO	10627	MGRU	5	150	Eating establishment	0	0	855	MIAMI DADE WATER & SEWER DEPARTMENT		0	one 25 gpm	30	214
GDO	10632	IGT	5	150	Eating establishment	55	0	1818	MIAMI DADE WATER & SEWER DEPARTMENT		1600	one 1600-gallon	90	455
GDO	10634	IGT	5	150	Eating establishment	46	46	800	MIAMI DADE WATER & SEWER DEPARTMENT	Single	1200	one 1200 gallon	90	200
GDO	10635	IGT	5	150	Eating establishment	20	20	1736	MIAMI DADE WATER & SEWER DEPARTMENT	Single	900	one 900-gallon	90	434
GDO	10637	MGRU	5	150	Eating establishment	0	0	1435	MIAMI DADE WATER & SEWER DEPARTMENT		0	one 20 gpm and one 50 gpm	30	359
GDO	10639	MGRU	5	150	Eating establishment	0	0	870	MIAMI DADE WATER & SEWER DEPARTMENT		0	one 25 gpm	30	218
GDO	10640	IGT	5	150	Eating establishment	0	0	150	MIAMI DADE WATER & SEWER DEPARTMENT	Single	2000	one 2000-gallon	90	38
GDO	10647	MGRU	5	150	Eating establishment	24	24	1188	MIAMI DADE WATER & SEWER DEPARTMENT		0	one 20 gpm	30	297
GDO	10652	MGRU	5	150	Eating establishment	0	0	0	MIAMI DADE WATER & SEWER DEPARTMENT		0	one 20 gpm	30	0
GDO	10654	MGRU	5	150	Eating establishment	14	0	420	CITY OF MIAMI BEACH		0	one 20 gpm	30	105
GDO	10655	MGRU	5	150	Eating establishment	0	0	0	MIAMI DADE WATER & SEWER DEPARTMENT		0	two 100 gpm	60	12
GDO	10656	MGRU	5	150	Eating establishment	62	0	1600	MIAMI DADE WATER & SEWER DEPARTMENT		0	one 75 gpm	30	513
GDO	10662	IGT	5	300	Eating establishment	289	0	7001	MIAMI DADE WATER & SEWER DEPARTMENT	Series	6250	five 1250-gallon	90	2242
GDO	10665	IGT	5	150	Eating establishment	82	82	2610	MIAMI DADE WATER & SEWER DEPARTMENT	Series	2500	two 1250-gallon	90	653
GDO	10670	IGT	5	300	Eating establishment	316	0	7500	MIAMI DADE WATER & SEWER DEPARTMENT	Series	5000	four 1250-gallon	90	2245
GDO	10671	MGRU	5	150	Eating establishment	20	20	540	MIAMI DADE WATER & SEWER DEPARTMENT		0	one 20 gpm	30	135
GDO	10673	MGRU	5	150	Eating establishment	0	0	0			0	two 25 gpm	30	0
GDO	10678	IGT	5	750	Eating establishment	0	0	9000	MIAMI DADE WATER & SEWER DEPARTMENT	Single	3000	one 3000 gallon	90	2250
GDO	10680	IGT	5	150	Eating establishment	0	0	0	MIAMI DADE WATER & SEWER DEPARTMENT	Single	380	one 380 gallon	90	0
GDO	10681	MGRU	5	300	Eating establishment	240	0	6175	MIAMI DADE WATER & SEWER DEPARTMENT		0	three 100 gpm	30	1805
GDO	10683	MGRU	5	300	Eating establishment	270	0	6432	MIAMI DADE WATER & SEWER DEPARTMENT	Series	1140	three 380 gallon	90	1780

WORK GROUP	PERMIT NUMBER	PERMIT CLASS	PERMIT T	PERMIT FEE	BUSINESS_TYPE	RECORDED SEATS	OBSERVED SEATS	FACILITY AREA	UTILITY	SYSTEM FORMAT	TOTAL CAPACITY	TANK_CAPACITY	PUMP OUT	TOTAL GPD
GDO	10685	AGRU	5	150	Eating establishment	8	0	512	MIAMI DADE WATER & SEWER DEPARTMENT		0	one 25 gpm	30	128
GDO	10687	IGT	5	150	Eating establishment	40	0	2106	MIAMI DADE WATER & SEWER DEPARTMENT	Single	1500	one 1500-gallon	60	527
GDO	10688	IGT	5	150	Eating establishment	54	54	2269	MIAMI DADE WATER & SEWER DEPARTMENT	Single	1500	one 1500-gallon	90	567
GDO	10700	IGT	5	300	Eating establishment	0	0	5732	MIAMI DADE WATER & SEWER DEPARTMENT	Series	760	two 380-gallon	90	1433
GDO	10706	MGRU	5	150	Eating establishment	0	0	830	MIAMI DADE WATER & SEWER DEPARTMENT		0	one 75 gpm	90	208
GDO	10709	IGT	5	150	Eating establishment	14	0	828	MIAMI DADE WATER & SEWER DEPARTMENT	Series	3750	three 1250-gallon	90	207
GDO	10714	MGRU	5	300	Eating establishment	0	0	0	MIAMI DADE WATER & SEWER DEPARTMENT		0	three 100 gpm	60	0
GDO	10715	IGT	5	300	Eating establishment	230	230	5995	MIAMI DADE WATER & SEWER DEPARTMENT	Series	5000	four 1250 gallon	90	1499
GDO	10717	MGRU	5	150	Eating establishment	48	0	1310	MIAMI DADE WATER & SEWER DEPARTMENT		0	one 100 gpm	60	328
GDO	10719	MGRU	5	150	Eating establishment	0	0	691	CITY OF HIALEAH		0	one 7 gpm	30	173
GDO	10722	MGRU	5	150	Eating establishment	11	11	874	MIAMI DADE WATER & SEWER DEPARTMENT	Series	0	two 100 gpm	90	219
GDO	10726	IGT	5	150	Eating establishment	73	73	3652	MIAMI DADE WATER & SEWER DEPARTMENT	Single	1250	one 1250-gallon	90	913
GDO	10736	IGT	5	150	Eating establishment	18	0	2338	CITY OF MIAMI BEACH	Single	750	one 750 gallon	60	585
GDO	10737	MGRU	5	150	Eating establishment	10	0	1500	MIAMI DADE WATER & SEWER DEPARTMENT		0	one 35 gpm	30	375
GDO	10738	IGT	5	150	Eating establishment	38	38	1430	MIAMI DADE WATER & SEWER DEPARTMENT	Single	1500	one 1500 gallon	90	358
GDO	10740	IGT	5	300	Eating establishment	0	0	5334	CITY OF MIAMI BEACH	Series	2500	two 1250 gallon	60	2376
GDO	10741	IGT	5	150	Eating establishment	0	0	1200	CITY OF HOMESTEAD	Single	1050	one 1050 gallon	90	300
GDO	10744	MGRU	5	150	Eating establishment	63	63	2700	MIAMI DADE WATER & SEWER DEPARTMENT		0	one 100 gpm	90	675
GDO	10748	MGRU	5	150	Eating establishment	0	0	0			0	one 35 gpm	30	0
GDO	10749	MGRU	5	150	Eating establishment	41	41	2100	MIAMI DADE WATER & SEWER DEPARTMENT		0	one 75 gpm	30	525
GDO	10752	MGRU	5	150	Eating establishment	0	0	990	MIAMI DADE WATER & SEWER DEPARTMENT		0	one 35 gpm	30	248
GDO	10755	MGRU	5	150	Eating establishment	0	0	104	MIAMI DADE WATER & SEWER DEPARTMENT		0	one 7 gpm	30	26
GDO	10756	MGRU	5	150	Eating establishment	25	0	3106	MIAMI DADE WATER & SEWER DEPARTMENT		0	one 75 gpm	30	527
GDO	10760	IGT	5	150	Eating establishment	0	0	0	MIAMI DADE WATER & SEWER DEPARTMENT	Single	750	one 750 gallon	90	0
GDO	10762	MGRU	5	150	Eating establishment	10	10	800	MIAMI DADE WATER & SEWER DEPARTMENT		0	one 25 gpm	30	200
GDO	10763	IGT	5	150	Eating establishment	0	0	960	MIAMI DADE WATER & SEWER DEPARTMENT	Single	1500	one 1500 gallon	90	240
GDO	10766	IGT	5	150	Eating establishment	0	0	855	CITY OF OPA LOCKA	Single	1250	one 1250-gallon	60	214
GDO	10768	MGRU	5	150	Eating establishment	0	0	900	MIAMI DADE WATER & SEWER DEPARTMENT		0	one 35 gpm	30	225
GDO	10772	MGRU	5	150	Eating establishment	15	15	2000	CITY OF HIALEAH		0	one 25 gpm	30	500
												one 10 and one 25 gpm		
GDO	10775	MGRU	5	150	Eating establishment	0	0	1200	MIAMI DADE WATER & SEWER DEPARTMENT		0	one 10 and one 25 gpm	30	300
GDO	10778	IGT	5	300	Eating establishment	216	216	4490	MIAMI DADE WATER & SEWER DEPARTMENT	Series	2500	two 1250-gallon	90	1123
GDO	10779	MGRU	5	150	Eating establishment	49	0	1255	MIAMI DADE WATER & SEWER DEPARTMENT		0	one 20 gpm	30	314
GDO	10785	MGRU	5	150	Eating establishment	0	0	248	CITY OF HIALEAH		0	one 25 gpm	30	62
GDO	10786	IGT	5	300	Eating establishment	0	0	9800	MIAMI DADE WATER & SEWER DEPARTMENT	Parallel	2100	two 1050 gallon	90	2450
GDO	10787	MGRU	5	150	Eating establishment	0	0	380	MIAMI DADE WATER & SEWER DEPARTMENT		0	one 4 gpm	30	95
GDO	10788	MGRU	5	300	Eating establishment	298	0	3415	MIAMI DADE WATER & SEWER DEPARTMENT		0	one 20 gpm	30	1068
GDO	10789	IGT	5	150	Eating establishment	43	0	1400	MIAMI DADE WATER & SEWER DEPARTMENT	Single	750	one 750 gallon	60	350
GDO	10791	MGRU	5	150	Eating establishment	0	0	3267	MIAMI DADE WATER & SEWER DEPARTMENT		0	one 75 gpm	30	817
GDO	10805	IGT	5	300	Eating establishment	130	0	4528	MIAMI DADE WATER & SEWER DEPARTMENT	Single	1200	one 1200 gallon	60	1132
GDO	10809	IGT	5	300	Eating establishment	220	0	5423	CITY OF CORAL GABLES	Series	2500	two 1250-gallon	90	1502
GDO	10810	IGT	5	150	Eating establishment	116	0	2590	MIAMI DADE WATER & SEWER DEPARTMENT	Single	1500	one 1500-gallon	90	648
GDO	10811	IGT	5	150	Eating establishment	0	0	2109	CITY OF MIAMI BEACH	Single	1250	one 1250 gallon	60	527
GDO	10814	IGT	5	150	Eating establishment	177	0	38593	CITY OF NORTH MIAMI BEACH	Series	2500	two 1250 gallon	90	50
GDO	10817	MGRU	5	150	Eating establishment	0	0	1440	MIAMI DADE WATER & SEWER DEPARTMENT		0	one 50 gpm	30	360
GDO	10819	MGRU	5	150	Eating establishment	0	0	1200	MIAMI DADE WATER & SEWER DEPARTMENT		0	one 25 gpm	30	300
GDO	10825	MGRU	5	150	Eating establishment	0	0	640			0	one 50 gpm	30	160
GDO	10832	MGRU	5	150	Eating establishment	0	0	415	MIAMI DADE WATER & SEWER DEPARTMENT		0	two 25 gpm	30	354
GDO	10833	MGRU	5	150	Eating establishment	22	0	620	MIAMI DADE WATER & SEWER DEPARTMENT		0	one 50 gpm	30	155
GDO	10836	MGRU	5	150	Eating establishment	80	0	0	MIAMI DADE WATER & SEWER DEPARTMENT		0	one 75 gpm	30	0
GDO	10837	IGT	5	150	Eating establishment	64	0	2650	MIAMI DADE WATER & SEWER DEPARTMENT	Single	1500	one 1500 gallon	90	663
GDO	10842	MGRU	5	150	Eating establishment	20	0	750	CITY OF NORTH MIAMI BEACH		0	one 35 gpm	30	188
GDO	10850	MGRU	5	300	Eating establishment	344	0	12990	MIAMI DADE WATER & SEWER DEPARTMENT		0	six 100 gpm	30	3248
GDO	10851	MGRU	5	150	Eating establishment	37	0	1551	CITY OF NORTH MIAMI BEACH		0	one 25 gpm	30	429
GDO	10856	MGRU	5	150	Eating establishment	0	0	825	MIAMI DADE WATER & SEWER DEPARTMENT		0	one 25 gpm	30	206
GDO	10857	IGT	5	150	Eating establishment	120	0	4000	CITY OF NORTH MIAMI BEACH	Single	1000	one 1000 gallon	30	1000
GDO	10861	MGRU	5	150	Eating establishment	42	0	1500	MIAMI DADE WATER & SEWER DEPARTMENT		0	twenty-four 100 gpm	30	450
GDO	10862	MGRU	5	150	Eating establishment	200	0	10000	MIAMI DADE WATER & SEWER DEPARTMENT		0	one 100 gpm	60	2500
GDO	10863	IGT	5	150	Eating establishment	22	0	700	MIAMI DADE WATER & SEWER DEPARTMENT	Single	1500	one 1500 gallon	90	175

WORK GROUP	PERMIT NUMBER	PERMIT CLASS	PERMIT	PERMIT FEE	BUSINESS_TYPE	RECORDED SEATS	OBSERVED SEATS	FACILITY AREA	UTILITY	SYSTEM FORMAT	TOTAL CAPACITY	TANK_CAPACITY	PUMP OUT	TOTAL GPD
GDO	10867	MGRU	5	150	Eating establishment	0	0	3638	CITY OF MIAMI BEACH		0	one 35 and one 75 gpm	60	910
GDO	10870	MGRU	5	150	Eating establishment	40	0	1340	MIAMI DADE WATER & SEWER DEPARTMENT		0	one 75 gpm	90	335
GDO	10872	MGRU	5	150	Eating establishment	0	0	727	MIAMI DADE WATER & SEWER DEPARTMENT		0	one 7 gpm	30	182
GDO	10874	MGRU	5	150	Eating establishment	0	0	750	MIAMI DADE WATER & SEWER DEPARTMENT		0	one 25 gpm	30	188
GDO	10882	MGRU	5	150	Eating establishment	61	0	1730	MIAMI DADE WATER & SEWER DEPARTMENT		0	one 100 gpm	60	433
GDO	10883	MGRU	5	300	Eating establishment	101	0	3400	MIAMI DADE WATER & SEWER DEPARTMENT		0	one 35 and one 75 gpm	30	1035
GDO	10884	MGRU	5	150	Eating establishment	0	0	845	MIAMI DADE WATER & SEWER DEPARTMENT		0	one 100 gpm	60	211
GDO	10885	IGT	5	150	Eating establishment	20	0	1727	MIAMI DADE WATER & SEWER DEPARTMENT	Single	950	one 950 gallon	90	432
GDO	10886	MGRU	5	150	Eating establishment	4	0	1083	MIAMI DADE WATER & SEWER DEPARTMENT		0	one 50 gpm	60	271
GDO	10887	IGT	5	300	Eating establishment	210	0	5244	MIAMI DADE WATER & SEWER DEPARTMENT	Series	3750	three 1250 gallon	90	1387
GDO	10888	IGT	5	150	Eating establishment	6	0	900	CITY OF NORTH MIAMI	Single	750	one 750 gallon	90	225
GDO	10890	MGRU	2	150	Eating establishment	10	0	700	MIAMI DADE WATER & SEWER DEPARTMENT		0	one 35 gpm	30	213
GDO	10891	IGT	5	150	Eating establishment	30	0	2285	CITY OF MIAMI BEACH	Series	4800	three 1600-gallon	90	962
GDO	10895	AGRU	5	150	Eating establishment	0	0	240	MIAMI DADE WATER & SEWER DEPARTMENT		0	two 20 gpm	30	60
GDO	10896	MGRU	5	150	Eating establishment	0	0	1200	MIAMI DADE WATER & SEWER DEPARTMENT		0	one 50 gpm	30	300
GDO	10898	IGT	5	300	Eating establishment	126	0	5200	MIAMI DADE WATER & SEWER DEPARTMENT	Series	2000	one 750 and one 1250 gallon	90	1300
GDO	10901	MGRU	5	300	Eating establishment	50	0	4500	MIAMI DADE WATER & SEWER DEPARTMENT		0	one 100 gpm	60	1125
GDO	10902	MGRU	5	150	Eating establishment	0	0	1109	MIAMI DADE WATER & SEWER DEPARTMENT		0	one 50 gpm	30	277
GDO	10903	MGRU	5	150	Eating establishment	17	0	950	MIAMI DADE WATER & SEWER DEPARTMENT		0	one 50 gpm	30	238
GDO	10929	IGT	5	300	Eating establishment	0	0	4319	MIAMI DADE WATER & SEWER DEPARTMENT	Series	2700	two 1350 gallon	90	1080
GDO	10932	MGRU	5	150	Eating establishment	8	0	817	MIAMI DADE WATER & SEWER DEPARTMENT		0	one 35 gpm	30	204
GDO	10933	IGT	5	150	Eating establishment	50	0	2964	MIAMI DADE WATER & SEWER DEPARTMENT	Series	2500	two 1250 gallon	90	741
GDO	10937	MGRU	5	300	Eating establishment	153	0	5651	MIAMI DADE WATER & SEWER DEPARTMENT		0	two 100 gpm	60	1413
GDO	10940	IGT	5	150	Eating establishment	0	0	0	MIAMI DADE WATER & SEWER DEPARTMENT	Series	6250	five 1250 gallon	60	0
GDO	10942	IGT	5	150	Eating establishment	130	0	1730	MIAMI DADE WATER & SEWER DEPARTMENT	Single	750	one 750 gallon	60	433
GDO	10943	MGRU	5	150	Eating establishment	0	0	1660	CITY OF MIAMI BEACH		0	one 20 gpm	30	415
GDO	10944	IGT	5	150	Eating establishment	20	0	1000	MIAMI DADE WATER & SEWER DEPARTMENT	Single	750	one 750 gallon	60	250
GDO	10945	MGRU	5	150	Eating establishment	40	0	949	MIAMI DADE WATER & SEWER DEPARTMENT		0	one 100 gpm	30	237
GDO	10947	MGRU	5	300	Eating establishment	0	0	2435	CITY OF NORTH MIAMI		0	one 50 gpm	60	1053
GDO	10956	MGRU	5	150	Eating establishment	12	0	1073	MIAMI DADE WATER & SEWER DEPARTMENT		0	one 25 gpm	30	268
GDO	10957	MGRU	5	150	Eating establishment	0	0	667	MIAMI DADE WATER & SEWER DEPARTMENT		0	one 35 gpm	30	167
GDO	10959	IGT	5	300	Eating establishment	60	0	4200	MIAMI DADE WATER & SEWER DEPARTMENT	Single	750	one 750 gallon	90	1050
GDO	10960	MGRU	5	150	Eating establishment	22	0	688	MIAMI DADE WATER & SEWER DEPARTMENT		0	one 25 gpm	30	172
GDO	10961	MGRU	5	150	Eating establishment	26	0	2500	MIAMI DADE WATER & SEWER DEPARTMENT		0	one 75 gpm	60	625
GDO	10967	MGRU	5	150	Eating establishment	48	0	2289	MIAMI DADE WATER & SEWER DEPARTMENT		0	one 100 gpm	60	572
GDO	10968	IGT	5	150	Eating establishment	108	0	3389	MIAMI DADE WATER & SEWER DEPARTMENT	Single	1500	one 1500 gallon	90	847
GDO	10976	IGT	5	150	Eating establishment	67	0	2100	MIAMI DADE WATER & SEWER DEPARTMENT	Single	1500	one 1500 gallon	30	525
GDO	10978	IGT	5	150	Eating establishment	40	0	1100	MIAMI DADE WATER & SEWER DEPARTMENT	Single	1050	one 1050 gallon	90	450
GDO	10982	MGRU	5	150	Eating establishment	0	0	625	CITY OF MIAMI BEACH		0	one 75 gpm	30	156
GDO	10984	IGT	1	0	Eating establishment	0	0	0	MIAMI DADE WATER & SEWER DEPARTMENT	Single	1250	one 1250 gallon	90	0
GDO	10985	IGT	5	300	Eating establishment	0	0	0	MIAMI DADE WATER & SEWER DEPARTMENT	Series	3600	three 1200 gallon	30	0
GDO	10990	AGRU	5	150	Eating establishment	32	0	1500	CITY OF CORAL GABLES		0	one 25 gpm	30	500
GDO	10992	MGRU	5	300	Eating establishment	0	0	5887	MIAMI DADE WATER & SEWER DEPARTMENT		0	three 100 gpm	60	1752
GDO	10997	MGRU	5	150	Eating establishment	7	0	1028	MIAMI DADE WATER & SEWER DEPARTMENT		0	one 75 gpm	30	257
GDO	10998	MGRU	5	150	Eating establishment	40	0	1800	MIAMI DADE WATER & SEWER DEPARTMENT		0	one 100 gpm	60	450
GDO	11002	IGT	5	150	Eating establishment	0	0	0	MIAMI DADE WATER & SEWER DEPARTMENT	Single	1050	one 1050 gallon	90	0
GDO	11003	IGT	5	150	Eating establishment	0	0	1435	CITY OF MIAMI BEACH	Single	750	one 750 gallon	90	459
GDO	11004	IGT	5	150	Eating establishment	164	0	3000	CITY OF MIAMI BEACH	Single	750	one 750 gallon	90	916
GDO	11011	MGRU	5	150	Eating establishment	0	0	2176	MIAMI DADE WATER & SEWER DEPARTMENT		0	one 20 gpm	60	544
GDO	11012	IGT	5	150	Eating establishment	85	0	1800	MIAMI DADE WATER & SEWER DEPARTMENT	Single	0	one 1200 gallon	90	450
GDO	11014	MGRU	5	150	Eating establishment	19	0	1245	CITY OF NORTH MIAMI BEACH		0	two 7 and one 10 gpm	30	311
GDO	11020	MGRU	5	300	Eating establishment	113	0	3465	MIAMI DADE WATER & SEWER DEPARTMENT		0	one 100 gpm	60	1247
GDO	11032	IGT	5	150	Eating establishment	44	0	1818	MIAMI DADE WATER & SEWER DEPARTMENT	Series	2500	two 1250 gallon	90	455
GDO	11036	MGRU	5	150	Eating establishment	30	0	1099	MIAMI DADE WATER & SEWER DEPARTMENT		0	one 15 gpm	30	275
GDO	11039	IGT	5	300	Eating establishment	230	0	5485	MIAMI DADE WATER & SEWER DEPARTMENT	Series	3750	three 1250 gallon	60	1611
GDO	11041	IGT	5	150	Eating establishment	24	0	2013	MIAMI DADE WATER & SEWER DEPARTMENT	Single	750	one 750 gallon	90	503
GDO	11042	IGT	5	150	Eating establishment	149	0	2937	MIAMI DADE WATER & SEWER DEPARTMENT	Single	1250	one 1250 gallon	62	734

WORK GROUP	PERMIT NUMBER	PERMIT CLASS	PERMIT T	PERMIT FEE	BUSINESS_TYPE	RECORDED SEATS	OBSERVED SEATS	FACILITY AREA	UTILITY	SYSTEM FORMAT	TOTAL CAPACITY	TANK_CAPACITY	PUMP OUT	TOTAL GPD
GDO	11045	MGRU	5	150	Eating establishment	52	0	1854	MIAMI DADE WATER & SEWER DEPARTMENT		0	one 35 gpm and two 25 gpm	30	464
GDO	11054	IGT	5	150	Eating establishment	0	0	289	MIAMI DADE WATER & SEWER DEPARTMENT	Single	1500	one 1500 gallon	60	72
GDO	11057	IGT	5	300	Eating establishment	153	0	7750	MIAMI DADE WATER & SEWER DEPARTMENT	Series	2400	two 1200 gallon	60	1938
GDO	11059	IGT	5	150	Eating establishment	34	0	1385	MIAMI DADE WATER & SEWER DEPARTMENT	Single	1250	one 1250 gallon	60	346
GDO	11062	IGT	5	150	Eating establishment	40	0	2086	MIAMI DADE WATER & SEWER DEPARTMENT	Single	1250	one 1250 gallon	60	522
GDO	11072	MGRU	5	300	Eating establishment	209	0	4455	MIAMI DADE WATER & SEWER DEPARTMENT		0	one 100 gpm	30	1324
GDO	11073	MGRU	5	150	Eating establishment	20	0	1400	MIAMI DADE WATER & SEWER DEPARTMENT		0	one 10 gpm	30	350
GDO	11081	IGT	5	150	Eating establishment	50	0	2638	MIAMI DADE WATER & SEWER DEPARTMENT	Single	1250	one 1250 gallon	60	660
GDO	11082	IGT	5	150	Eating establishment	24	0	1700	MIAMI DADE WATER & SEWER DEPARTMENT	Single	900	one 900 gallon	90	425
GDO	11088	MGRU	5	300	Eating establishment	24	0	4572	MIAMI DADE WATER & SEWER DEPARTMENT		0	one 100 gpm	90	1143
GDO	11092	MGRU	5	150	Eating establishment	30	0	1600	MIAMI DADE WATER & SEWER DEPARTMENT		0	one 75 gpm	60	400
GDO	11093	MGRU	5	150	Eating establishment	0	0	1250	MIAMI DADE WATER & SEWER DEPARTMENT		0	one 125 gpm	90	313
GDO	11094	MGRU	5	300	Eating establishment	224	0	6200	MIAMI DADE WATER & SEWER DEPARTMENT		0	two 100 gpm	60	1956
GDO	11099	IGT	5	150	Eating establishment	0	0	100	CITY OF HIALEAH	Single	750	one 750 gallon	90	25
GDO	11100	IGT	5	300	Eating establishment	166	0	4238	MIAMI DADE WATER & SEWER DEPARTMENT	Series	72362	six +10,000 gallon	90	1060
GDO	11101	IGT	5	150	Eating establishment	27	0	1080	MIAMI DADE WATER & SEWER DEPARTMENT	Series	72362	six +10,000 gallon	90	270
GDO	11102	MGRU	5	150	Eating establishment	60	0	1500	MIAMI DADE WATER & SEWER DEPARTMENT		0	one 100 gpm	60	475
GDO	11118	MGRU	5	150	Eating establishment	10	0	738	CITY OF MIAMI BEACH		0	one 50 gpm	30	185
GDO	11121	MGRU	5	150	Eating establishment	12	0	1157	MIAMI DADE WATER & SEWER DEPARTMENT		0	one 100 gpm	90	289
GDO	11124	IGT	5	150	Eating establishment	20	0	1623	MIAMI DADE WATER & SEWER DEPARTMENT	Single	1250	one 1250 gallon	90	406
GDO	11126	MGRU	5	150	Eating establishment	45	0	2037	MIAMI DADE WATER & SEWER DEPARTMENT		0	one 100 gpm	60	588
GDO	11127	MGRU	5	150	Eating establishment	30	0	967	MIAMI DADE WATER & SEWER DEPARTMENT		0	one 50 gpm	60	242
GDO	11128	MGRU	5	150	Eating establishment	0	0	532	MIAMI DADE WATER & SEWER DEPARTMENT		0	one 7 and one 20 gpm	30	133
GDO	11137	MGRU	5	300	Eating establishment	146	0	4345	MIAMI DADE WATER & SEWER DEPARTMENT		0	one 100 gpm	30	1086
GDO	11142	MGRU	5	150	Eating establishment	0	0	190	MIAMI DADE WATER & SEWER DEPARTMENT		0	one 20 gpm	30	48
GDO	11145	IGT	5	150	Eating establishment	0	0	0	MIAMI DADE WATER & SEWER DEPARTMENT	Series	5000	four 1250 gallon	60	0
GDO	11146	IGT	5	150	Eating establishment	28	0	1387	MIAMI DADE WATER & SEWER DEPARTMENT	Single	1250	one 1250 gallon	60	347
GDO	11150	MGRU	5	150	Eating establishment	20	0	863	MIAMI DADE WATER & SEWER DEPARTMENT		0	one 75 gpm	60	216
GDO	11153	MGRU	5	150	Eating establishment	19	0	1020	MIAMI DADE WATER & SEWER DEPARTMENT		0	one 15 gpm	30	255
GDO	11159	MGRU	5	150	Eating establishment	0	0	735	MIAMI DADE WATER & SEWER DEPARTMENT		0	two 15 gpm and one 50 gpm	60	184
GDO	11170	MGRU	5	150	Eating establishment	90	0	2000	MIAMI DADE WATER & SEWER DEPARTMENT		0	sixteen 100 gpm	90	590
GDO	11171	MGRU	5	750	Eating establishment	385	0	20756	MIAMI DADE WATER & SEWER DEPARTMENT		0	sixteen 100 gpm	90	5189
GDO	11172	MGRU	5	300	Eating establishment	212	0	4692	MIAMI DADE WATER & SEWER DEPARTMENT		0	two 100 gpm	60	1313
GDO	11180	IGT	5	150	Eating establishment	30	0	1230	MIAMI DADE WATER & SEWER DEPARTMENT	Single	1250	one 1250 gallon	60	308
GDO	11181	MGRU	5	150	Eating establishment	0	0	0	MIAMI DADE WATER & SEWER DEPARTMENT		0	three 100 gpm	90	0
GDO	11182	IGT	5	150	Eating establishment	15	0	0	CITY OF MIAMI BEACH	Series	3200	two 1600 gallon	90	0
GDO	11189	MGRU	5	150	Eating establishment	5	0	1250	MIAMI DADE WATER & SEWER DEPARTMENT		0	one 50 gpm	60	313
GDO	11193	IGT	5	150	Eating establishment	58	0	1805	MIAMI DADE WATER & SEWER DEPARTMENT	Series	3150	three 1050 gallon	60	451
GDO	11197	MGRU	5	150	Eating establishment	14	0	1378	MIAMI DADE WATER & SEWER DEPARTMENT		0	one 75 gpm	30	345
GDO	11200	MGRU	5	150	Eating establishment	0	0	960	MIAMI DADE WATER & SEWER DEPARTMENT		0	one 100 gpm	60	240
GDO	11205	MGRU	5	150	Eating establishment	14	0	862	CITY OF MIAMI BEACH		0	one 50 gpm	30	216
GDO	11220	IGT	5	150	Eating establishment	0	0	1358	CITY OF HIALEAH	Single	1250	one 1250 gallon	60	340
GDO	11222	IGT	5	300	Eating establishment	172	0	4620	MIAMI DADE WATER & SEWER DEPARTMENT	Single	1200	one 1200 gallon	60	1290
GDO	11228	MGRU	5	150	Eating establishment	50	0	0	MIAMI DADE WATER & SEWER DEPARTMENT		0	one 100 gpm	60	0
GDO	11229	IGT	5	150	Eating establishment	10	0	1200	MIAMI DADE WATER & SEWER DEPARTMENT	Single	1200	one 1200 gallon	90	300
GDO	11230	MGRU	5	150	Eating establishment	50	0	2700	CITY OF MIAMI BEACH		0	one 100 gpm	90	969
GDO	11232	MGRU	5	300	Eating establishment	200	0	4898	MIAMI DADE WATER & SEWER DEPARTMENT		0	one 100 gpm	60	1763
GDO	11238	IGT	5	150	Eating establishment	30	0	2100	MIAMI DADE WATER & SEWER DEPARTMENT	Series	0	two 1200 gallon	30	525
GDO	11246	MGRU	5	150	Eating establishment	0	0	234	MIAMI DADE WATER & SEWER DEPARTMENT		0	one 35 gpm	60	59
GDO	11248	MGRU	5	300	Eating establishment	0	0	5400	MIAMI DADE WATER & SEWER DEPARTMENT		0	one 50 gpm	30	1350
GDO	11251	MGRU	5	150	Eating establishment	0	0	0	CITY OF HOMESTEAD		0	one 25 gpm	30	0
GDO	11253	IGT	5	150	Eating establishment	99	0	3089	MIAMI DADE WATER & SEWER DEPARTMENT	Series	2500	two 1250 gallon	60	772
GDO	11256	AGRU	5	150	Eating establishment	0	0	0			0	one 35 gpm	30	0
GDO	11261	MGRU	5	150	Eating establishment	0	0	259	MIAMI DADE WATER & SEWER DEPARTMENT		0	one 20 gpm	30	65
GDO	11264	MGRU	5	150	Eating establishment	8	0	797	CITY OF MIAMI BEACH		0	one 75 gpm	90	199
GDO	11265	IGT	3	0	Eating establishment	0	0	0	CITY OF NORTH MIAMI	Series	2100	two 1050 gallon	90	0
GDO	11297	IGT	5	150	Eating establishment	74	0	2800	MIAMI DADE WATER & SEWER DEPARTMENT	Single	1250	one 1250 gallon	90	849
GDO	11298	IGT	5	150	Eating establishment	60	0	2053	MIAMI DADE WATER & SEWER DEPARTMENT	Single	1050	one 1050 gallon	60	513

WORK GROUP	PERMIT NUMBER	PERMIT CLASS	PERMIT	PERMIT FEE	BUSINESS_TYPE	RECORDED SEATS	OBSERVED SEATS	FACILITY AREA	UTILITY	SYSTEM FORMAT	TOTAL CAPACITY	TANK_CAPACITY	PUMP OUT	TOTAL GPD
GDO	11301	IGT	5	150	Eating establishment	0	0	1346	MIAMI DADE WATER & SEWER DEPARTMENT		1250	one 1250 gallon	90	337
GDO	11307	MGRU	5	150	Eating establishment	0	0	1346	MIAMI DADE WATER & SEWER DEPARTMENT		0	one 100 gpm	60	337
GDO	11313	IGT	5	300	Eating establishment	189	0	5592	MIAMI DADE WATER & SEWER DEPARTMENT	Single	11119	one 11,119 gallon	90	1398
GDO	11314	IGT	5	150	Eating establishment	44	0	1666	MIAMI DADE WATER & SEWER DEPARTMENT	Single	9244	one 9,244 gallon	90	417
GDO	11315	IGT	5	150	Eating establishment	0	0	609	MIAMI DADE WATER & SEWER DEPARTMENT	Single	14709	one 14,709 gallon	90	152
GDO	11316	IGT	5	150	Eating establishment	94	0	2767	MIAMI DADE WATER & SEWER DEPARTMENT	Single	12369	one 12,369 gallon	90	692
GDO	11317	IGT	5	300	Eating establishment	211	0	4266	MIAMI DADE WATER & SEWER DEPARTMENT	Single	16088	one 16,088 gallon	90	1531
GDO	11318	IGT	5	150	Eating establishment	83	0	2600	MIAMI DADE WATER & SEWER DEPARTMENT	Single	1250	one 1250 gallon	60	674
GDO	11320	IGT	5	150	Eating establishment	60	0	2400	MIAMI DADE WATER & SEWER DEPARTMENT	Single	1250	one 1250 gallon	60	600
GDO	11321	IGT	5	150	Eating establishment	97	0	2503	MIAMI DADE WATER & SEWER DEPARTMENT	Single	14709	one 14,709 gallon	90	626
GDO	11360	MGRU	5	150	Eating establishment	49	0	1670	MIAMI DADE WATER & SEWER DEPARTMENT		0	one 100 gpm	60	418
GDO	11362	IGT	5	150	Eating establishment	48	0	1000	MIAMI DADE WATER & SEWER DEPARTMENT	Single	1050	one 1050 gallon	60	250
GDO	11367	MGRU	5	150	Eating establishment	85	0	2814	MIAMI DADE WATER & SEWER DEPARTMENT		0	one 100 gpm	60	854
GDO	11378	MGRU	5	150	Eating establishment	32	0	1930	MIAMI DADE WATER & SEWER DEPARTMENT		0	one 50 gpm	30	483
GDO	11388	MGRU	5	150	Eating establishment	0	0	2000	MIAMI DADE WATER & SEWER DEPARTMENT		0	one 15 gpm	60	500
GDO	11389	MGRU	5	150	Eating establishment	0	0	1466	MIAMI DADE WATER & SEWER DEPARTMENT		0	one 50 gpm	30	367
GDO	11390	MGRU	5	150	Eating establishment	0	0	1340	CITY OF NORTH MIAMI		0	one 50 gpm	60	335
GDO	11391	IGT	5	150	Eating establishment	0	0	2500	CITY OF HIALEAH GARDENS	Single	1250	one 1250 gallon	60	625
GDO	11399	IGT	5	150	Eating establishment	40	0	2046	MIAMI DADE WATER & SEWER DEPARTMENT	Single	1250	one 1250 gallon	60	512
GDO	11408	MGRU	5	150	Eating establishment	49	0	1402	MIAMI DADE WATER & SEWER DEPARTMENT		0	one 7 and one 25 gpm	30	351
GDO	11415	MGRU	5	150	Eating establishment	20	0	745	MIAMI DADE WATER & SEWER DEPARTMENT		0	one 100 gpm	90	186
GDO	11416	IGT	5	150	Eating establishment	0	0	1272	MIAMI DADE WATER & SEWER DEPARTMENT	Single	950	one 950 gallon	60	318
GDO	11419	IGT	5	150	Eating establishment	0	0	1000	MIAMI DADE WATER & SEWER DEPARTMENT	Single	950	one 950 gallon	60	250
GDO	11420	IGT	5	300	Eating establishment	0	0	6624	CITY OF MIAMI BEACH	Series	2500	two 1250 gallon	60	2040
GDO	11421	IGT	5	150	Eating establishment	0	0	1755	CITY OF MIAMI BEACH	Series	2500	two 1250 gallon	60	439
GDO	11423	MGRU	5	150	Eating establishment	0	0	2055	MIAMI DADE WATER & SEWER DEPARTMENT		0	one 50 gpm	60	514
GDO	11424	MGRU	5	150	Eating establishment	42	0	2750	MIAMI DADE WATER & SEWER DEPARTMENT		0	one 50 gpm	30	688
GDO	11427	MGRU	5	150	Eating establishment	28	0	2380	MIAMI DADE WATER & SEWER DEPARTMENT		0	one 75 gpm	30	595
GDO	11428	IGT	5	150	Eating establishment	24	0	1447	MIAMI DADE WATER & SEWER DEPARTMENT	Single	4915	one 4915 gallon	90	362
GDO	11430	IGT	5	150	Eating establishment	68	0	2600	MIAMI DADE WATER & SEWER DEPARTMENT	Series	1950	one 900 and one 1050 gallon	60	650
GDO	11433	MGRU	5	150	Eating establishment	32	0	1235	MIAMI DADE WATER & SEWER DEPARTMENT		0	one 75 gpm	90	309
GDO	11436	MGRU	5	150	Eating establishment	15	0	900	MIAMI DADE WATER & SEWER DEPARTMENT		0	one 50 gpm	30	225
GDO	11437	MGRU	5	150	Eating establishment	50	0	1504	MIAMI DADE WATER & SEWER DEPARTMENT		0	two 4 and one 50 gpm	30	376
GDO	11441	IGT	5	150	Eating establishment	110	0	2917	MIAMI DADE WATER & SEWER DEPARTMENT	Series	2500	two 1250 gallon	90	729
GDO	11457	IGT	5	150	Eating establishment	0	0	240	CITY OF HIALEAH	Single	4000	one 4000 gallon	60	60
GDO	11462	AGRU	5	300	Eating establishment	0	0	0	MIAMI DADE WATER & SEWER DEPARTMENT		0	two 100 gpm and one 20 gpm	30	0
GDO	11463	MGRU	5	300	Eating establishment	84	0	4303	MIAMI DADE WATER & SEWER DEPARTMENT		0	one 50 gpm and one 100 gpm	30	1076
GDO	11472	MGRU	5	150	Eating establishment	85	0	2797	MIAMI DADE WATER & SEWER DEPARTMENT		0	two 100 gpm	60	699
GDO	11473	MGRU	5	150	Eating establishment	0	0	1435	MIAMI DADE WATER & SEWER DEPARTMENT		0	one 75 gpm	60	359
GDO	11476	MGRU	5	150	Eating establishment	0	0	600	MIAMI DADE WATER & SEWER DEPARTMENT		0	one 15 gpm	30	150
GDO	11477	MGRU	5	150	Eating establishment	20	0	1700	MIAMI DADE WATER & SEWER DEPARTMENT		0	one 75 gpm	30	425
GDO	11479	MGRU	5	150	Eating establishment	20	0	473	MIAMI DADE WATER & SEWER DEPARTMENT		0	one 25 gpm	30	118
GDO	11481	IGT	5	150	Eating establishment	12	0	200	MIAMI DADE WATER & SEWER DEPARTMENT	Single	1250	one 1250 gallon	60	50
GDO	11482	IGT	5	150	Eating establishment	12	0	683	MIAMI DADE WATER & SEWER DEPARTMENT	Single	14709	one 14,709 gallon	90	171
GDO	11486	IGT	5	150	Eating establishment	87	0	2385	MIAMI DADE WATER & SEWER DEPARTMENT	Series	9000	two 4500 gallon	30	596
GDO	11490	IGT	5	150	Eating establishment	229	0	2670	MIAMI DADE WATER & SEWER DEPARTMENT	Series	9000	two 4500 gallon	60	668
GDO	11503	MGRU	5	150	Eating establishment	0	0	683	CITY OF MIAMI BEACH		0	one 75 gpm	30	171
GDO	11505	IGT	5	150	Eating establishment	0	0	15	MIAMI DADE WATER & SEWER DEPARTMENT	Single	5000	one 5000 gallon	60	4
GDO	11506	MGRU	5	150	Eating establishment	9	0	1043	MIAMI DADE WATER & SEWER DEPARTMENT		0	one 35 gpm	90	261
GDO	11510	MGRU	5	150	Eating establishment	26	0	1500	MIAMI DADE WATER & SEWER DEPARTMENT		0	one 50 gpm	30	375
GDO	11513	MGRU	5	150	Eating establishment	0	0	450	CITY OF HIALEAH		0	one 25 gpm	30	113
GDO	11524	MGRU	5	150	Eating establishment	0	0	1728	CITY OF CORAL GABLES		0	three 7 gpm, one 10 gpm, and one 25 gpm	30	432
GDO	11528	MGRU	5	150	Eating establishment	85	0	2462	CITY OF MIAMI SPRINGS		0	one 100 gpm	60	740
GDO	11529	MGRU	5	150	Eating establishment	45	0	2322	MIAMI DADE WATER & SEWER DEPARTMENT		0	one 75 gpm	90	581

WORK GROUP	PERMIT NUMBER	PERMIT CLASS	PERMIT	PERMIT FEE	BUSINESS_TYPE	RECORDED SEATS	OBSERVED SEATS	FACILITY AREA	UTILITY	SYSTEM FORMAT	TOTAL CAPACITY	TANK_CAPACITY	PUMP OUT	TOTAL GPD
GDO	11532	MGRU	5	150	Eating establishment	40	0	3051	MIAMI DADE WATER & SEWER DEPARTMENT		0	one 50 gpm	30	763
GDO	11535	IGT	5	150	Eating establishment	46	0	1542	MIAMI DADE WATER & SEWER DEPARTMENT	Series	3000	two 1500 gallon	60	386
GDO	11539	IGT	5	300	Eating establishment	64	0	4388	MIAMI DADE WATER & SEWER DEPARTMENT	Series	5000	four 1250 gallon	90	1097
GDO	11540	IGT	5	150	Eating establishment	39	0	1856	MIAMI DADE WATER & SEWER DEPARTMENT	Single	1000	one 1000 gallon	60	547
GDO	11553	MGRU	5	150	Eating establishment	0	0	500	MIAMI DADE WATER & SEWER DEPARTMENT		0	one 75 gpm	30	125
GDO	11559	MGRU	5	150	Eating establishment	27	0	985	CITY OF NORTH MIAMI		0	one 75 gpm	60	246
GDO	11562	MGRU	5	150	Eating establishment	56	0	2100	MIAMI DADE WATER & SEWER DEPARTMENT		0	one 100 gpm	90	525
GDO	11567	MGRU	5	300	Eating establishment	261	0	7032	MIAMI DADE WATER & SEWER DEPARTMENT		0	fifteen 100 gpm	30	1758
GDO	11579	MGRU	5	750	Eating establishment	290	0	8653	MIAMI DADE WATER & SEWER DEPARTMENT		0	two 100 gpm	60	2163
GDO	11585	MGRU	5	150	Eating establishment	38	0	1926	CITY OF MIAMI BEACH		0	one 50 gpm	30	512
GDO	11597	MGRU	5	150	Eating establishment	8	0	396	MIAMI DADE WATER & SEWER DEPARTMENT		0	one 100 gpm	60	99
GDO	11598	MGRU	5	300	Eating establishment	100	0	5128	MIAMI DADE WATER & SEWER DEPARTMENT		0	one 100 gpm	60	1282
GDO	11606	MGRU	5	150	Eating establishment	45	0	1300	CITY OF MIAMI BEACH		0	one 50 gpm	60	325
GDO	11613	IGT	5	150	Eating establishment	70	0	1400	CITY OF HOMESTEAD	Single	1200	one 1200 gallon	60	504
GDO	11615	MGRU	5	150	Eating establishment	0	0	990	MIAMI DADE WATER & SEWER DEPARTMENT		0	one 35 gpm	30	248
GDO	11617	MGRU	5	150	Eating establishment	29	0	912	CITY OF MIAMI BEACH		0	one 35 gpm	30	228
GDO	11618	MGRU	5	300	Eating establishment	200	0	3572	MIAMI DADE WATER & SEWER DEPARTMENT		0	one 100 gpm	30	1048
GDO	11619	IGT	4	150	Eating establishment	68	0	1895	MIAMI DADE WATER & SEWER DEPARTMENT	Single	1250	one 1250 gallon	60	474
GDO	11634	MGRU	5	300	Eating establishment	294	0	10887	MIAMI DADE WATER & SEWER DEPARTMENT		0	five 100 gpm	60	2987
GDO	11636	IGT	5	300	Eating establishment	78	0	4300	MIAMI DADE WATER & SEWER DEPARTMENT	Single	1050	one 50 gpm hydromechanical and one 1050 gallon	30	1075
GDO	11646	IGT	5	150	Eating establishment	72	0	3515	MIAMI DADE WATER & SEWER DEPARTMENT	Single	1250	one 1250 gallon	60	879
GDO	11650	MGRU	5	150	Eating establishment	0	0	628	MIAMI DADE WATER & SEWER DEPARTMENT		0	one 20 gpm	30	157
GDO	11657	MGRU	5	150	Eating establishment	48	0	1962	CITY OF MIAMI BEACH		0	three 100 gpm	90	656
GDO	11660	IGT	5	150	Eating establishment	80	0	2600	CITY OF NORTH MIAMI BEACH	Single	2700	one 2700 gallon	90	650
GDO	11661	IGT	5	150	Eating establishment	72	0	1350	MIAMI DADE WATER & SEWER DEPARTMENT	Single	750	one 750 gallon	60	338
GDO	11671	IGT	5	150	Eating establishment	12	0	625	MIAMI DADE WATER & SEWER DEPARTMENT	Single	750	one 750 gallon	60	242
GDO	11673	IGT	5	150	Eating establishment	0	0	250	MIAMI DADE WATER & SEWER DEPARTMENT	Single	750	one 750 gallon	60	63
GDO	11674	MGRU	5	300	Eating establishment	185	0	5511	MIAMI DADE WATER & SEWER DEPARTMENT		0	ten 100 gpm	60	1705
GDO	11684	MGRU	5	150	Eating establishment	0	0	600	MIAMI DADE WATER & SEWER DEPARTMENT		0	one 15 gpm	30	150
GDO	11686	MGRU	5	150	Eating establishment	0	0	3150	MIAMI DADE WATER & SEWER DEPARTMENT		0	one 100 gpm	60	788
GDO	11698	MGRU	5	150	Eating establishment	6	0	1140	MIAMI DADE WATER & SEWER DEPARTMENT		0	one 75 gpm	90	285
GDO	11701	IGT	5	150	Eating establishment	48	0	1278	CITY OF NORTH MIAMI BEACH	Single	1250	one 1250 gallon	60	320
GDO	11706	MGRU	5	150	Eating establishment	4	0	1800	CITY OF MIAMI BEACH		0	one 20 gpm	30	450
GDO	11708	IGT	5	150	Eating establishment	30	0	1581	CITY OF NORTH MIAMI BEACH	Single	1350	one 1350 gallon	60	395
GDO	11712	MGRU	5	150	Eating establishment	0	0	524	MIAMI DADE WATER & SEWER DEPARTMENT		0	one 35 gpm	90	131
GDO	11714	MGRU	5	150	Eating establishment	0	0	0	MIAMI DADE WATER & SEWER DEPARTMENT		0	one 20 gpm	30	0
GDO	11720	IGT	5	150	Eating establishment	16	0	3362	MIAMI DADE WATER & SEWER DEPARTMENT	Single	0	one 9791 gallon	90	841
GDO	11731	MGRU	5	150	Eating establishment	0	0	1150	CITY OF MIAMI BEACH		0	one 25 gpm	30	288
GDO	11734	IGT	5	150	Eating establishment	70	0	0	CITY OF NORTH MIAMI BEACH	Series	2100	two 1050 gallon	60	704
GDO	11736	MGRU	5	150	Eating establishment	19	0	719	MIAMI DADE WATER & SEWER DEPARTMENT		0	one 50 gpm	30	230
GDO	11738	MGRU	5	150	Eating establishment	7	0	0	MIAMI DADE WATER & SEWER DEPARTMENT		0	one 50 gpm	30	75
GDO	11741	IGT	5	150	Eating establishment	48	0	1800	MIAMI DADE WATER & SEWER DEPARTMENT	Single	1050	one 1050 gallon	60	450
GDO	11743	MGRU	5	150	Eating establishment	10	0	705	MIAMI DADE WATER & SEWER DEPARTMENT		0	two 100 gpm	60	201
GDO	11751	MGRU	5	150	Eating establishment	0	0	3398	CITY OF MIAMI SPRINGS		0	one 50 gpm	30	950
GDO	11754	MGRU	5	150	Eating establishment	49	0	1000	MIAMI DADE WATER & SEWER DEPARTMENT		0	one 35 gpm	30	250
GDO	11755	MGRU	5	150	Eating establishment	37	0	1500	SUNNY ISLES BEACH		0	one 20 gpm	30	375
GDO	11756	IGT	5	300	Eating establishment	190	0	3560	MIAMI DADE WATER & SEWER DEPARTMENT	Series	2500	two 1250 gallon	60	1340
GDO	11757	MGRU	5	150	Eating establishment	0	0	700	MIAMI DADE WATER & SEWER DEPARTMENT		0	one 15 gpm	30	175
GDO	11758	IGT	5	150	Eating establishment	219	0	800	MIAMI DADE WATER & SEWER DEPARTMENT	Series	2400	two 1200 gallon	60	200
GDO	11777	MGRU	5	150	Eating establishment	0	0	96	MIAMI DADE WATER & SEWER DEPARTMENT		0	one 10 gpm	30	24
GDO	11807	MGRU	5	150	Eating establishment	3	0	455	CITY OF MIAMI BEACH		0	one 35 gpm	30	114
GDO	11808	MGRU	5	150	Eating establishment	0	0	1200	MIAMI DADE WATER & SEWER DEPARTMENT		0	one 75 gpm	30	300
GDO	11813	MGRU	5	150	Eating establishment	0	0	855	MIAMI DADE WATER & SEWER DEPARTMENT		0	one 50 gpm	30	214
GDO	11818	MGRU	5	150	Eating establishment	55	0	1300	CITY OF CORAL GABLES		0	one 75 gpm	30	325
GDO	11821	MGRU	5	150	Eating establishment	10	0	600	CITY OF CORAL GABLES		0	one 50 gpm	30	150
GDO	11831	MGRU	5	150	Eating establishment	20	0	848	MIAMI DADE WATER & SEWER DEPARTMENT		0	one 50 gpm	60	212
GDO	11832	MGRU	5	150	Eating establishment	93	0	3958	CITY OF MIAMI BEACH		0	one 4 gpm and two 7 gpm	60	990

WORK GROUP	PERMIT NUMBER	PERMIT CLASS	PERMIT T	PERMIT FEE	BUSINESS_TYPE	RECORDED SEATS	OBSERVED SEATS	FACILITY AREA	UTILITY	SYSTEM FORMAT	TOTAL CAPACITY	TANK_CAPACITY	PUMP OUT	TOTAL GPD
GDO	11837	MGRU	5	150	Eating establishment	0	0	1250	MIAMI DADE WATER & SEWER DEPARTMENT		0	one 75 gpm	60	313
GDO	11849	IGT	5	150	Eating establishment	40	0	2000	MIAMI DADE WATER & SEWER DEPARTMENT	Single	750	one 750 gallon	60	500
GDO	11850	IGT	5	150	Eating establishment	63	0	1800	MIAMI DADE WATER & SEWER DEPARTMENT	Single	750	one 750 gallon	60	450
GDO	11854	MGRU	5	300	Eating establishment	200	0	5000	MIAMI DADE WATER & SEWER DEPARTMENT		0	one 100 gpm	60	1250
GDO	11856	IGT	5	150	Eating establishment	49	0	2025	CITY OF NORTH MIAMI	Single	1050	one 1050 gallon	60	506
GDO	11857	IGT	5	150	Eating establishment	0	0	700	MIAMI DADE WATER & SEWER DEPARTMENT	Single	1500	one 1500 gallon	60	175
GDO	11860	MGRU	5	300	Eating establishment	20	0	780	CITY OF MIAMI BEACH		0	one 20 gpm	30	1087
GDO	11861	MGRU	5	150	Eating establishment	30	0	813	CITY OF MIAMI BEACH		0	one 100 gpm	30	442
GDO	11862	IGT	5	150	Eating establishment	0	0	725	CITY OF MIAMI BEACH	Series	6000	five 1200 gallon	30	181
GDO	11864	IGT	5	300	Eating establishment	266	0	11038	CITY OF MIAMI BEACH	Series	6000	five 1200 gallon	30	2760
GDO	11865	IGT	5	150	Eating establishment	8	0	722	CITY OF MIAMI BEACH	Series	6000	five 1200 gallon	30	181
GDO	11866	MGRU	5	150	Eating establishment	0	0	1271	MIAMI DADE WATER & SEWER DEPARTMENT		0	one 20 gpm	60	318
GDO	11867	MGRU	5	300	Eating establishment	422	0	16375	CITY OF MIAMI BEACH		0	six 100 gpm	90	4297
GDO	11892	IGT	5	150	Eating establishment	20	0	1600	MIAMI DADE WATER & SEWER DEPARTMENT	Single	750	one 750 gallon	60	400
GDO	11895	MGRU	5	150	Eating establishment	8	0	360	CITY OF MIAMI BEACH		0	one 35 gpm	30	90
GDO	11898	IGT	5	150	Eating establishment	32	0	1039	MIAMI DADE WATER & SEWER DEPARTMENT	Single	1200	one 1200 gallon	60	260
GDO	8	IGT	5	300	Kitchen	300	0	9185	MIAMI DADE WATER & SEWER DEPARTMENT	Single	1200	one 1200 gallon	60	2296
GDO	183	IGT	5	300	Kitchen	100	100	0		Single	1200	one 1200 gallon	90	25
GDO	255	IGT	5	300	Kitchen	74	74	0	MIAMI DADE WATER & SEWER DEPARTMENT	Single	1050	one 1050 gallon	90	1036
GDO	295	MGRU	5	150	Kitchen	80	80	0	MIAMI DADE WATER & SEWER DEPARTMENT		0	one 25 gpm	30	1600
GDO	483	IGT	5	150	Kitchen	190	0	3000		Single	1200	one 1200 gallon	60	750
GDO	629	IGT	5	300	Kitchen	100	100	0		Series	2400	two 1200-gallon	90	0
GDO	714	IGT	5	750	Kitchen	550	550	0	MIAMI DADE WATER & SEWER DEPARTMENT	Single	1200	one 1200 gallon	90	11000
GDO	1116	IGT	5	150	Kitchen	160	160	0	CITY OF HOMESTEAD	Single	2500	one 2500 gallon	90	3200
GDO	1253	IGT	5	150	Kitchen	100	100	0		Multiple	2400	two 1200 gallon	90	100
GDO	1882	IGT	5	150	Kitchen	508	0	0		Series	4800	four 1200 gallon	90	0
GDO	1929	IGT	5	150	Kitchen	1200	1200	0	MIAMI DADE WATER & SEWER DEPARTMENT	Series	2400	two 1200 gallon	90	24000
GDO	1977	IGT	5	150	Kitchen	150	150	0		Single	750	one 750 gallon	90	38
GDO	2011	IGT	5	150	Kitchen	16	16	0	MIAMI DADE WATER & SEWER DEPARTMENT	Single	1200	one 1200 gallon	90	0
GDO	2041	IGT	5	150	Kitchen	400	400	0	CITY OF HIALEAH	Single	1200	one 1200 gallon	90	2000
GDO	2171	IGT	5	150	Kitchen	200	200	0	MIAMI DADE WATER & SEWER DEPARTMENT	Single	950	one 950 gallon	90	0
GDO	2406	IGT	2	150	Kitchen	10	0	0		Single	1050	one 1050 gallon	90	0
GDO	2474	AGRU	5	300	Kitchen	200	200	5948	MIAMI DADE WATER & SEWER DEPARTMENT		0	one 35 gpm	30	1487
GDO	2568	IGT	5	150	Kitchen	16	0	850	CITY OF NORTH MIAMI	Single	1500	one 1500 gallon	60	213
GDO	2604	IGT	5	150	Kitchen	49	49	0	MIAMI DADE WATER & SEWER DEPARTMENT	Single	1200	one 1200 gallon	90	980
GDO	2670	IGT	5	150	Kitchen	6	6	0	CITY OF HOMESTEAD	Single	1050	one 1050 gallon	90	120
GDO	2671	IGT	5	150	Kitchen	0	0	0	MIAMI DADE WATER & SEWER DEPARTMENT	Series	2100	two 1050 gallon	90	0
GDO	2672	IGT	5	150	Kitchen	0	0	6431	MIAMI DADE WATER & SEWER DEPARTMENT	Single	750	one 750-gallon	90	128620
GDO	2674	IGT	5	150	Kitchen	0	0	0	MIAMI DADE WATER & SEWER DEPARTMENT	Single	950	one 950 gallon	90	0
GDO	2713	IGT	5	150	Kitchen	45	45	0		Single	750	one 750 gallon	90	900
GDO	2758	IGT	5	150	Kitchen	80	80	0	MIAMI DADE WATER & SEWER DEPARTMENT	Single	2000	one 2000 gallon	90	0
GDO	2889	IGT	5	150	Kitchen	50	50	0	CITY OF HIALEAH	Single	1050	one 1050 gallon	90	700
GDO	2936	IGT	5	150	Kitchen	200	200	0		Series	1900	two 950 gallon	90	0
GDO	2991	IGT	5	150	Kitchen	0	0	0		Single	1050	one 1050 gallon	90	0
GDO	2994	IGT	5	150	Kitchen	0	0	0		Single	1050	one 1050 gallon	90	0
GDO	3064	IGT	5	150	Kitchen	25	25	6854	MIAMI DADE WATER & SEWER DEPARTMENT	Single	750	one 750-gallon	90	137080
GDO	3169	IGT	5	300	Kitchen	123	123	0	MIAMI DADE WATER & SEWER DEPARTMENT	Series	2000	one 2000 gallon	90	0
GDO	3170	IGT	5	750	Kitchen	210	210	0	MIAMI DADE WATER & SEWER DEPARTMENT	Single	5000	one 5000 gallon	90	0
GDO	3241	IGT	5	150	Kitchen	186	186	0	MIAMI DADE WATER & SEWER DEPARTMENT	Single	750	one 750 gallon	90	0
GDO	3250	MGRU	5	150	Kitchen	80	0	0	MIAMI DADE WATER & SEWER DEPARTMENT		0	one 35 gpm	30	25
GDO	3269	IGT	5	300	Kitchen	0	0	0	MIAMI DADE WATER & SEWER DEPARTMENT	Single	750	one 750 gallon	90	0
GDO	3335	IGT	5	150	Kitchen	120	120	0	CITY OF MIAMI BEACH		0	one 1050 gallon	90	0
GDO	3402	IGT	5	300	Kitchen	120	120	0	CITY OF NORTH MIAMI BEACH	Series	2100	two 1050 gallon	90	0
GDO	3455	IGT	5	150	Kitchen	384	384	0	MIAMI DADE WATER & SEWER DEPARTMENT	Multiple	2850	one 750 & two 1050 gallon	90	384
GDO	3548	MGRU	5	750	Kitchen	122	0	4710	MIAMI DADE WATER & SEWER DEPARTMENT	Single	3000	one 3000 gallon and two 100 gpm	60	1178
GDO	3554	IGT	5	150	Kitchen	500	500	0	CITY OF HOMESTEAD	Single	1600	one 1600 gallon	90	0
GDO	3570	IGT	5	150	Kitchen	3234	3234	0	CITY OF NORTH MIAMI	Multiple	10000	eight 1250 gallon	90	3234
GDO	3662	IGT	5	150	Kitchen	364	364	0		Series	2100	two 1050 gallon	90	364
GDO	3702	IGT	5	150	Kitchen	500	0	0		Series	3000	three 1000 gallon	90	0

WORK GROUP	PERMIT NUMBER	PERMIT CLASS	PERMIT	PERMIT FEE	BUSINESS_TYPE	RECORDED SEATS	OBSERVED SEATS	FACILITY AREA	UTILITY	SYSTEM FORMAT	TOTAL CAPACITY	TANK_CAPACITY	PUMP OUT	TOTAL GPD
GDO	3711	IGT	5	150	Kitchen	0	0	0	MIAMI DADE WATER & SEWER DEPARTMENT	Single	750	one 750 gallon	90	0
GDO	3868	IGT	5	150	Kitchen	20	20	0		Single	750	one 750 gallon	90	400
GDO	3877	IGT	5	150	Kitchen	791	791	0	MIAMI DADE WATER & SEWER DEPARTMENT	Series	3000	two 1500 gallon	90	791
GDO	3940	IGT	5	300	Kitchen	165	165	0		Single	2000	one 2000 gallon	90	2310
GDO	3941	IGT	5	300	Kitchen	127	127	0	MIAMI DADE WATER & SEWER DEPARTMENT	Single	1200	one 1200 gallon	90	0
GDO	3959	IGT	2	150	Kitchen	10	0	0		Single	750	one 750 gallon	90	0
GDO	3972	IGT	5	150	Kitchen	48	48	1427	MIAMI DADE WATER & SEWER DEPARTMENT	Single	950	one 950 gallon	90	357
GDO	3980	IGT	5	150	Kitchen	7	7	0	CITY OF HIALEAH	Single	750	one 750 gallon	90	2
GDO	3989	IGT	5	150	Kitchen	200	200	0	MIAMI DADE WATER & SEWER DEPARTMENT	Single	750	one 750 gallon	90	200
GDO	3993	IGT	5	300	Kitchen	180	180	180	MIAMI DADE WATER & SEWER DEPARTMENT	Series	4000	two 2000 gallon	90	45
GDO	4029	IGT	5	150	Kitchen	0	0	0	CITY OF HIALEAH	Single	750	one 750 gallon	90	0
GDO	4043	IGT	5	150	Kitchen	14	14	2908	MIAMI DADE WATER & SEWER DEPARTMENT	Single	750	one 750 gallon	90	280
GDO	4114	IGT	5	150	Kitchen	200	200	0	MIAMI DADE WATER & SEWER DEPARTMENT	Single	750	one 750 gallon	90	0
GDO	4128	IGT	5	150	Kitchen	100	100	0	MIAMI DADE WATER & SEWER DEPARTMENT	Single	1200	one 1200 gallon	90	2000
GDO	4173	IGT	5	150	Kitchen	100	100	0	MIAMI DADE WATER & SEWER DEPARTMENT	Single	1500	one 1500 gallon	90	25
GDO	4225	IGT	5	150	Kitchen	100	100	0		Series	3200	two 1600 gallon	90	0
GDO	4248	IGT	5	300	Kitchen	382	382	0	CITY OF NORTH MIAMI BEACH	Single	2000	one 2000 gallon	90	7640
GDO	4259	IGT	2	150	Kitchen	11	11	200	MIAMI DADE WATER & SEWER DEPARTMENT	Single	750	one 750 gallon	90	50
GDO	4261	IGT	2	150	Kitchen	11	0	0		Single	1050	one 1050 gallon	90	0
GDO	4263	MGRU	2	150	Kitchen	11	0	0	MIAMI DADE WATER & SEWER DEPARTMENT		0	one 25 gpm	30	0
GDO	4264	IGT	2	150	Kitchen	0	0	200	MIAMI DADE WATER & SEWER DEPARTMENT	Single	750	one 750 gallon	90	50
GDO	4265	AGRU	2	150	Kitchen	7	7	0	MIAMI DADE WATER & SEWER DEPARTMENT		0	one 25 gpm	30	140
GDO	4270	IGT	5	150	Kitchen	50	50	0		Single	750	one 750 gallon	90	50
GDO	4277	IGT	5	150	Kitchen	100	100	0		Single	750	one 750 gallon	90	0
GDO	4346	IGT	5	300	Kitchen	150	150	0	MIAMI DADE WATER & SEWER DEPARTMENT	Series	1200	two 1200 gallon	90	0
GDO	4354	IGT	5	300	Kitchen	120	120	0	CITY OF HIALEAH	Single	1200	one 1200 gallon	90	0
GDO	4394	IGT	5	300	Kitchen	0	0	12000	MIAMI DADE WATER & SEWER DEPARTMENT	Single	950	one 950 gallon	90	3000
GDO	4418	IGT	5	150	Kitchen	25	0	0		Single	1200	one 1200 gallon	90	0
GDO	4455	MGRU	5	300	Kitchen	0	0	6250	MIAMI DADE WATER & SEWER DEPARTMENT		0	one 25 gpm	60	1563
GDO	4477	IGT	5	150	Kitchen	400	400	0	MIAMI DADE WATER & SEWER DEPARTMENT	Single	950	one 950 gallon	90	8000
GDO	4510	IGT	5	150	Kitchen	75	75	0	CITY OF HIALEAH	Single	750	one 750 gallon	90	0
GDO	4524	IGT	5	150	Kitchen	0	0	0	MIAMI DADE WATER & SEWER DEPARTMENT	Single	1050	one 1050 gallon	90	0
GDO	4525	IGT	5	300	Kitchen	86	86	0	MIAMI DADE WATER & SEWER DEPARTMENT	Single	1200	one 1200 gallon	90	86
GDO	4533	IGT	5	150	Kitchen	0	0	2400	CITY OF HIALEAH	Single	1050	one 1050 gallon	90	600
GDO	4547	MGRU	5	150	Kitchen	0	0	2500	CITY OF HOMESTEAD		0	one 25 gpm	30	625
GDO	4577	IGT	5	150	Kitchen	0	0	0	MIAMI DADE WATER & SEWER DEPARTMENT	Single	1600	one 1600 gallon	90	0
GDO	4584	IGT	5	150	Kitchen	50	50	0	MIAMI DADE WATER & SEWER DEPARTMENT	Single	750	one 750 gallon	90	0
GDO	4587	IGT	5	150	Kitchen	50	50	0	MIAMI DADE WATER & SEWER DEPARTMENT	Single	1200	one 1200 gallon	90	50
GDO	4643	IGT	5	150	Kitchen	7	0	261	CITY OF HIALEAH	Single	750	one 750 gallon	90	65
GDO	4645	IGT	5	150	Kitchen	0	0	22989	CITY OF CORAL GABLES	Single	950	one 950-gallon	90	5747
GDO	4686	IGT	5	300	Kitchen	352	0	0	CITY OF MIAMI BEACH	Series	6250	five 1250 gallon	90	58
GDO	4751	IGT	5	300	Kitchen	0	0	0	MIAMI DADE WATER & SEWER DEPARTMENT	Series	3200	two 1600 gallon	90	0
GDO	4753	IGT	5	300	Kitchen	60	60	0	MIAMI DADE WATER & SEWER DEPARTMENT	Series	4000	two 2000 gallon	90	1500
GDO	4786	IGT	5	150	Kitchen	0	0	1450	MIAMI DADE WATER & SEWER DEPARTMENT	Series	10000	four 2500 gallon	90	363
GDO	4787	IGT	5	150	Kitchen	1267	1267	0	MIAMI DADE WATER & SEWER DEPARTMENT	Single	2000	one 2000 gallon	90	25340
GDO	4821	IGT	5	300	Kitchen	125	125	0		Single	1200	one 1200 gallon	90	0
GDO	4832	IGT	5	150	Kitchen	50	50	0		Single	1500	one 1500 gallon	90	50
GDO	4862	IGT	5	150	Kitchen	0	0	0	MIAMI DADE WATER & SEWER DEPARTMENT	Single	1050	one 1050 gallon	90	0
GDO	4899	IGT	5	150	Kitchen	0	0	6387	MIAMI DADE WATER & SEWER DEPARTMENT	Single	1050	one 1050 gallon	90	1597
GDO	4936	IGT	5	150	Kitchen	250	250	0	MIAMI DADE WATER & SEWER DEPARTMENT	Series	1900	two 950 gallon	90	0
GDO	5045	IGT	5	150	Kitchen	200	0	0	MIAMI DADE WATER & SEWER DEPARTMENT	Single	750	one 750 gallon	90	0
GDO	5117	IGT	5	150	Kitchen	8	8	5373	MIAMI DADE WATER & SEWER DEPARTMENT	Single	750	one 750-gallon	90	107460
GDO	5178	IGT	5	150	Kitchen	225	225	0	MIAMI DADE WATER & SEWER DEPARTMENT	Series	2400	two 1200 gallon	90	1125
GDO	5180	IGT	5	150	Kitchen	200	200	0	MIAMI DADE WATER & SEWER DEPARTMENT	Series	2100	two 1050 gallon	90	0
GDO	5224	IGT	5	150	Kitchen	0	0	0	MIAMI DADE WATER & SEWER DEPARTMENT	Single	1200	one 1200 gallon	90	0
GDO	5225	AGRU	5	150	Kitchen	650	650	0	MIAMI DADE WATER & SEWER DEPARTMENT		0	one 50 gpm	30	650
GDO	5243	IGT	5	150	Kitchen	84	84	0	MIAMI DADE WATER & SEWER DEPARTMENT	Single	1050	one 1050 gallon	90	504
GDO	5288	MGRU	5	150	Kitchen	680	680	34000	MIAMI DADE WATER & SEWER DEPARTMENT	Single	1050	two 100 gpm and one 1050 gallon	90	680
GDO	5304	IGT	5	150	Kitchen	15	15	0		Single	1050	one 1050 gallon	90	300
GDO	5396	IGT	5	150	Kitchen	0	0	0		Single	1050	one 1050 gallon	90	0

WORK GROUP	PERMIT NUMBER	PERMIT CLASS	PERMIT	PERMIT FEE	BUSINESS_TYPE	RECORDED SEATS	OBSERVED SEATS	FACILITY AREA	UTILITY	SYSTEM FORMAT	TOTAL CAPACITY	TANK_CAPACITY	PUMP OUT	TOTAL GPD
GDO	5409	IGT	5	150	Kitchen	50	50	0	MIAMI DADE WATER & SEWER DEPARTMENT	Single	950	one 950 gallon	90	0
GDO	5410	IGT	5	300	Kitchen	100	100	0	CITY OF NORTH MIAMI BEACH	Single	1050	one 1050 gallon	90	0
GDO	5446	IGT	5	150	Kitchen	100	100	0	MIAMI DADE WATER & SEWER DEPARTMENT	Single	1200	one 35 gpm mgru and one 1200 gallon	90	0
GDO	5450	IGT	5	150	Kitchen	0	0	0		Single	750	one 750 gallon	90	0
GDO	5502	IGT	5	150	Kitchen	0	0	0		Single	750	one 750 gallon	90	0
GDO	5524	IGT	5	150	Kitchen	64	64	0	MIAMI DADE WATER & SEWER DEPARTMENT	Single	950	one 950 gallon	90	64
GDO	5656	IGT	5	150	Kitchen	15	15	0		Single	1200	one 1200 gallon	90	300
GDO	5694	IGT	5	150	Kitchen	150	150	5170	MIAMI DADE WATER & SEWER DEPARTMENT	Single	1600	one 1600 gallon	90	1293
GDO	5725	IGT	5	150	Kitchen	436	436	0		Single	2000	one 2000 gallon	90	436
GDO	5728	IGT	5	150	Kitchen	0	0	14720	MIAMI DADE WATER & SEWER DEPARTMENT	Single	950	one 950 gallon	90	0
GDO	5820	IGT	5	150	Kitchen	200	200	0		Single	1200	one 1200 gallon	90	200
GDO	5840	IGT	5	150	Kitchen	0	0	16500	MIAMI DADE WATER & SEWER DEPARTMENT	Single	1200	one 1200 gallon	90	4125
GDO	5906	IGT	5	300	Kitchen	0	0	4015	MIAMI DADE WATER & SEWER DEPARTMENT	Single	750	one 750 gallon	90	1004
GDO	5927	IGT	5	150	Kitchen	180	180	0	MIAMI DADE WATER & SEWER DEPARTMENT	Single	950	one 950 gallon	90	3600
GDO	5939	IGT	5	300	Kitchen	0	0	0	MIAMI DADE WATER & SEWER DEPARTMENT	Series	2100	two 1050 gallon	90	0
GDO	5947	IGT	5	150	Kitchen	50	50	0	MIAMI DADE WATER & SEWER DEPARTMENT	Single	950	one 950 gallon	90	1000
GDO	5954	MGRU	5	150	Kitchen	0	0	5400	MIAMI DADE WATER & SEWER DEPARTMENT		0	one 25 gpm	30	1350
GDO	5989	IGT	5	150	Kitchen	35	35	1200	CITY OF HIALEAH	Single	950	one 950 gallon	90	300
GDO	5990	AGRU	5	150	Kitchen	16	16	0	MIAMI DADE WATER & SEWER DEPARTMENT		0	two 50 gpm	30	320
GDO	6019	IGT	5	150	Kitchen	0	0	0	MIAMI DADE WATER & SEWER DEPARTMENT	Single	950	one 950 gallon	90	0
GDO	6039	AGRU	5	150	Kitchen	0	0	0	MIAMI DADE WATER & SEWER DEPARTMENT		0	one 35 gpm	30	0
GDO	6088	MGRU	5	150	Kitchen	100	100	0	MIAMI DADE WATER & SEWER DEPARTMENT		0	one 25 gpm	30	2000
GDO	6107	IGT	5	150	Kitchen	0	0	0	MIAMI DADE WATER & SEWER DEPARTMENT	Single	1050	one 1050 gallon	90	0
GDO	6156	IGT	5	150	Kitchen	0	0	0	MIAMI DADE WATER & SEWER DEPARTMENT	Single	1500	one 1500 gallon	90	0
GDO	6200	IGT	5	150	Kitchen	0	0	1500	MIAMI DADE WATER & SEWER DEPARTMENT	Single	950	one 950 gallon	90	375
GDO	6236	IGT	5	150	Kitchen	0	0	1954	MIAMI DADE WATER & SEWER DEPARTMENT	Single	950	one 950 gallon	90	489
GDO	6270	IGT	5	150	Kitchen	0	0	0	MIAMI DADE WATER & SEWER DEPARTMENT	Single	1050	one 1050-gallon	90	0
GDO	6287	IGT	5	150	Kitchen	0	0	0	MIAMI DADE WATER & SEWER DEPARTMENT	Single	1050	one 1050 gallon	90	0
GDO	6291	IGT	5	150	Kitchen	40	40	0	CITY OF HIALEAH	Single	1050	one 1050 gallon	90	800
GDO	6295	IGT	5	150	Kitchen	305	305	0	MIAMI DADE WATER & SEWER DEPARTMENT	Single	750	one 750 gallon	90	305
GDO	6330	IGT	5	150	Kitchen	0	0	0	MIAMI DADE WATER & SEWER DEPARTMENT	Single	950	one 950 gallon	90	0
GDO	6448	IGT	5	150	Kitchen	0	0	700	MIAMI DADE WATER & SEWER DEPARTMENT	Single	1050	one 1050 gallon	90	175
GDO	6467	IGT	5	150	Kitchen	0	0	0	MIAMI DADE WATER & SEWER DEPARTMENT	Single	950	one 950 gallon	90	0
GDO	6484	IGT	5	150	Kitchen	40	40	0	MIAMI DADE WATER & SEWER DEPARTMENT	Single	950	one 950 gallon	90	800
GDO	6509	IGT	5	150	Kitchen	60	60	0	CITY OF MIAMI BEACH	Single	1050	one 1050 gallon	90	0
GDO	6556	IGT	5	150	Kitchen	0	0	0	MIAMI DADE WATER & SEWER DEPARTMENT	Single	3000	two 1500 gallon	90	0
GDO	6661	IGT	5	150	Kitchen	46	46	0	MIAMI DADE WATER & SEWER DEPARTMENT	Single	1050	one 1050 gallon	90	0
GDO	6735	IGT	5	150	Kitchen	0	0	4674	MIAMI DADE WATER & SEWER DEPARTMENT	Single	750	one 750 gallon	90	1169
GDO	6775	MGRU	5	150	Kitchen	50	50	0	MIAMI DADE WATER & SEWER DEPARTMENT		0	one 25 gpm	30	13
GDO	6795	IGT	5	150	Kitchen	0	0	0	MIAMI DADE WATER & SEWER DEPARTMENT	Single	1050	one 1050 gallon	90	0
GDO	6802	IGT	5	150	Kitchen	50	50	0	CITY OF MIAMI BEACH	Single	1200	one 1200 gallon	90	50
GDO	6825	IGT	5	300	Kitchen	258	258	0	CITY OF MIAMI BEACH	Series	3200	two 1600 gallon	90	0
GDO	6835	IGT	5	300	Kitchen	120	120	41400	MIAMI DADE WATER & SEWER DEPARTMENT	Single	1050	one 1050 gallon	90	2400
GDO	6866	IGT	5	150	Kitchen	0	0	0	MIAMI DADE WATER & SEWER DEPARTMENT	Single	1050	one 1050 gallon	90	0
GDO	6873	MGRU	5	150	Kitchen	200	200	0	MIAMI DADE WATER & SEWER DEPARTMENT		0	one 25 gpm	30	0
GDO	6887	IGT	5	150	Kitchen	140	140	0	MIAMI DADE WATER & SEWER DEPARTMENT	Single	950	one 950 gallon	90	0
GDO	6888	IGT	5	150	Kitchen	150	150	0	MIAMI DADE WATER & SEWER DEPARTMENT	Single	750	one 750 gallon	90	0
GDO	6891	IGT	5	150	Kitchen	250	250	0	CITY OF HIALEAH	Single	750	one 750 gallon	90	250
GDO	6916	IGT	5	150	Kitchen	199	199	0	MIAMI DADE WATER & SEWER DEPARTMENT	Single	1050	one 1050 gallon	90	3980
GDO	6918	IGT	5	150	Kitchen	50	50	0	MIAMI DADE WATER & SEWER DEPARTMENT	Single	750	one 750 gallon	90	0
GDO	6949	MGRU	5	150	Kitchen	0	0	0	CITY OF HIALEAH		0	one 25 gpm	30	0
GDO	6971	IGT	5	300	Kitchen	203	203	0	MIAMI DADE WATER & SEWER DEPARTMENT	Single	1200	one 1200 gallon	90	4060
GDO	6972	IGT	5	150	Kitchen	180	180	3000	MIAMI DADE WATER & SEWER DEPARTMENT	Single	1050	one 1050 gallon	90	750
GDO	6981	MGRU	5	150	Kitchen	200	200	4620	MIAMI DADE WATER & SEWER DEPARTMENT		0	one 25 gpm	30	1155
GDO	6982	IGT	5	150	Kitchen	0	0	0	MIAMI DADE WATER & SEWER DEPARTMENT	Single	950	one 950 gallon	90	0
GDO	6991	MGRU	2	150	Kitchen	450	450	0	CITY OF HIALEAH		0	one 25 gpm	30	2250
GDO	7011	IGT	5	150	Kitchen	136	136	0	MIAMI DADE WATER & SEWER DEPARTMENT	Single	950	one 950 gallon	90	136
GDO	7024	IGT	5	150	Kitchen	0	0	0	CITY OF NORTH MIAMI BEACH	Single	950	one 950 gallon	90	0
GDO	7029	IGT	5	150	Kitchen	144	144	0	MIAMI DADE WATER & SEWER DEPARTMENT	Single	1050	one 1050 gallon	90	144

WORK GROUP	PERMIT NUMBER	PERMIT CLASS	PERMIT	PERMIT FEE	BUSINESS_TYPE	RECORDED SEATS	OBSERVED SEATS	FACILITY AREA	UTILITY	SYSTEM FORMAT	TOTAL CAPACITY	TANK_CAPACITY	PUMP OUT	TOTAL GPD
GDO	7038	IGT	5	150	Kitchen	0	0	1500	CITY OF CORAL GABLES	Series	2400	two 1200 gallon	60	375
GDO	7052	IGT	5	300	Kitchen	95	95	0	CITY OF NORTH MIAMI	Single	950	one 950 gallon	90	1900
GDO	7089	MGRU	5	150	Kitchen	223	223	0	CITY OF CORAL GABLES		0	one 25 gpm	30	58
GDO	7095	IGT	2	150	Kitchen	500	500	0	CITY OF HIALEAH	Single	950	one 950 gallon	90	0
GDO	7129	MGRU	5	150	Kitchen	0	0	1400	MIAMI DADE WATER & SEWER DEPARTMENT		0	one 25 gpm	30	350
GDO	7188	IGT	5	150	Kitchen	120	120	0	CITY OF HOMESTEAD	Single	950	one 950 gallon	90	2400
GDO	7189	MGRU	5	150	Kitchen	20	0	3000	CITY OF HIALEAH		0	one 15 gpm	60	3000
GDO	7194	MGRU	5	150	Kitchen	134	134	0	MIAMI DADE WATER & SEWER DEPARTMENT		0	one 25 gpm	30	134
GDO	7319	IGT	5	150	Kitchen	500	500	0	MIAMI DADE WATER & SEWER DEPARTMENT	Series	6300	six 1050 gallon	90	0
GDO	7323	IGT	5	150	Kitchen	0	0	6215	MIAMI DADE WATER & SEWER DEPARTMENT	Single	1050	one 1050 gallon	90	1554
GDO	7363	IGT	5	150	Kitchen	30	30	0	MIAMI DADE WATER & SEWER DEPARTMENT	Single	1200	one 1200 gallon	60	600
GDO	7413	IGT	5	150	Kitchen	17	17	0	CITY OF OPA LOCKA	Single	950	one 950 gallon	90	0
GDO	7459	IGT	5	150	Kitchen	100	100	0	MIAMI DADE WATER & SEWER DEPARTMENT	Single	950	one 950 gallon	90	0
GDO	7479	IGT	5	150	Kitchen	200	200	0	MIAMI DADE WATER & SEWER DEPARTMENT	Single	1200	one 1200 gallon	90	4000
GDO	7508	IGT	5	150	Kitchen	0	0	0	CITY OF HOMESTEAD	Single	950	one 950 gallon	90	0
GDO	7535	AGRU	5	150	Kitchen	0	0	0	MIAMI DADE WATER & SEWER DEPARTMENT		0	one 25 gpm	30	0
GDO	7539	IGT	5	750	Kitchen	214	214	0	CITY OF HOMESTEAD	Series	950	four 950 gallon	90	5350
GDO	7600	IGT	5	300	Kitchen	140	140	0	MIAMI DADE WATER & SEWER DEPARTMENT	Single	750	one 750 gallon	90	3500
GDO	7611	MGRU	5	150	Kitchen	88	88	0	MIAMI DADE WATER & SEWER DEPARTMENT		0	one 25 gpm	30	2200
GDO	7617	AGRU	5	150	Kitchen	20	20	0	CITY OF MIAMI BEACH		0	one 35 gpm	30	500
GDO	7622	IGT	5	150	Kitchen	0	0	0	MIAMI DADE WATER & SEWER DEPARTMENT	Single	1050	one 1050 gallon	90	0
GDO	7657	MGRU	5	150	Kitchen	102	102	0			0	one 25 gpm	30	510
GDO	7686	IGT	5	150	Kitchen	20	20	664	MIAMI DADE WATER & SEWER DEPARTMENT	Single	950	one 950 gallon	90	400
GDO	7698	IGT	5	150	Kitchen	0	0	0	MIAMI DADE WATER & SEWER DEPARTMENT	Single	950	one 950-gallon	90	0
GDO	7699	MGRU	5	150	Kitchen	0	0	0	CITY OF HIALEAH		0	one 25 gpm	30	0
GDO	7705	IGT	5	300	Kitchen	180	180	0	MIAMI DADE WATER & SEWER DEPARTMENT	Series	3150	three 1050 gallon	90	3600
GDO	7722	IGT	5	150	Kitchen	625	625	0	MIAMI DADE WATER & SEWER DEPARTMENT	Single	950	one 950 gallon	90	0
GDO	7728	IGT	5	150	Kitchen	68	68	2500	MIAMI DADE WATER & SEWER DEPARTMENT	Single	750	one 750 gallon	90	625
GDO	7774	IGT	5	150	Kitchen	0	0	1275	CITY OF HOMESTEAD	Single	1050	one 1050 gallon	90	319
GDO	7797	IGT	5	150	Kitchen	232	232	0	MIAMI DADE WATER & SEWER DEPARTMENT	Single	1350	one 1350 gallon	90	0
GDO	7821	IGT	5	300	Kitchen	80	80	0	MIAMI DADE WATER & SEWER DEPARTMENT	Series	2100	two 1050-gallon	90	1600
GDO	7822	MGRU	5	150	Kitchen	181	181	0	MIAMI DADE WATER & SEWER DEPARTMENT		0	one 25 gpm	30	181
GDO	7874	MGRU	5	150	Kitchen	48	48	0	CITY OF HIALEAH		0	one 15 gpm	30	0
GDO	7915	IGT	5	150	Kitchen	20	20	0	CITY OF HOMESTEAD	Single	950	one 950 gallon	90	400
GDO	7936	IGT	5	150	Kitchen	500	500	0	MIAMI DADE WATER & SEWER DEPARTMENT	Series	2850	three 950 gallon	90	500
GDO	7952	IGT	5	150	Kitchen	13	13	0	CITY OF OPA LOCKA	Single	1050	one 1050-gallon	90	260
GDO	8002	IGT	5	300	Kitchen	220	220	154345	CITY OF FLORIDA CITY	Series	2850	three 950 gallon	90	25000
GDO	8085	IGT	5	150	Kitchen	934	934	0	MIAMI DADE WATER & SEWER DEPARTMENT	Series	1900	two 950 gallon	90	18680
GDO	8113	MGRU	5	150	Kitchen	77	77	0	MIAMI DADE WATER & SEWER DEPARTMENT		0	one 25 gpm	30	77
GDO	8123	MGRU	5	150	Kitchen	150	150	2000	MIAMI DADE WATER & SEWER DEPARTMENT		0	one 25 gpm	30	12000
GDO	8167	MGRU	5	150	Kitchen	0	0	1850	MIAMI DADE WATER & SEWER DEPARTMENT		0	one 25 gpm	30	465
GDO	8209	IGT	5	300	Kitchen	120	120	0	CITY OF HIALEAH		1050	one 1050 gallon	90	2400
GDO	8229	IGT	5	150	Kitchen	60	60	43027	CITY OF CORAL GABLES	Single	2000	one 2000 gallon	90	0
GDO	8302	IGT	5	300	Kitchen	100	0	0	MIAMI DADE WATER & SEWER DEPARTMENT	Series	2500	two 1250 gallon	90	0
GDO	8321	IGT	5	150	Kitchen	42	42	0	MIAMI DADE WATER & SEWER DEPARTMENT	Single	1050	one 1050 gallon	90	0
GDO	8335	IGT	5	150	Kitchen	0	0	0	MIAMI DADE WATER & SEWER DEPARTMENT	Single	1050	one 1050 gallon	90	0
GDO	8355	MGRU	5	150	Kitchen	0	0	0	CITY OF HIALEAH		0	not available	0	0
GDO	8391	IGT	5	150	Kitchen	4	4	84745	MIAMI DADE WATER & SEWER DEPARTMENT	Single	950	one 950 gallon	90	100
GDO	8400	IGT	5	750	Kitchen	1750	1750	0	MIAMI DADE WATER & SEWER DEPARTMENT	Series	4000	two 2000 gallon	90	35000
GDO	8406	IGT	5	300	Kitchen	185	185	0	MIAMI DADE WATER & SEWER DEPARTMENT	Single	1500	one 1500 gallon	90	3700
GDO	8407	IGT	5	750	Kitchen	1600	1600	0	MIAMI DADE WATER & SEWER DEPARTMENT	Series	6000	two 3000 gallon	90	32000
GDO	8413	IGT	5	150	Kitchen	600	500	0	MIAMI DADE WATER & SEWER DEPARTMENT	Series	4200	four 1050 gallon	90	600
GDO	8434	IGT	5	300	Kitchen	148	148	0	CITY OF OPA LOCKA	Single	2000	one 2000 gallon	90	2960
GDO	8445	MGRU	5	150	Kitchen	0	0	1841	MIAMI DADE WATER & SEWER DEPARTMENT		0	one 25-gpm	30	460
GDO	8504	IGT	5	150	Kitchen	362	362	0	MIAMI DADE WATER & SEWER DEPARTMENT	Series	3600	three 1200 gallon	90	2172
GDO	8513	IGT	5	150	Kitchen	24	24	4700	MIAMI DADE WATER & SEWER DEPARTMENT	Multiple	2250	three 750 gallon	90	480
GDO	8522	IGT	5	150	Kitchen	0	0	0	MIAMI DADE WATER & SEWER DEPARTMENT	Single	950	one 950 gallon	90	0
GDO	8554	IGT	5	150	Kitchen	270	270	3892	MIAMI DADE WATER & SEWER DEPARTMENT	Single	1050	one 1050 gallon	90	5400
GDO	8565	IGT	5	150	Kitchen	406	406	2500	MIAMI DADE WATER & SEWER DEPARTMENT	Multiple	7500	six 1250 gallon	90	406
GDO	8588	IGT	5	150	Kitchen	2428	2428	0	MIAMI DADE WATER & SEWER DEPARTMENT	Multiple	9600	eight 1200 gallon	90	2428
GDO	8595	IGT	5	150	Kitchen	0	0	0	CITY OF OPA LOCKA	Single	750	one 750 gallon	90	0

WORK GROUP	PERMIT NUMBER	PERMIT CLASS	PERMIT T	PERMIT FEE	BUSINESS_TYPE	RECORDED SEATS	OBSERVED SEATS	FACILITY AREA	UTILITY	SYSTEM FORMAT	TOTAL CAPACITY	TANK_CAPACITY	PUMP OUT	TOTAL GPD
GDO	8599	IGT	5	300	Kitchen	950	950	7200	MIAMI DADE WATER & SEWER DEPARTMENT	Multiple	9500	two 2000, one 2500 and 3000 gallon	90	144000
GDO	8715	IGT	5	150	Kitchen	44	44	0	MIAMI DADE WATER & SEWER DEPARTMENT	Single	1050	one 1050 gallon	90	44
GDO	8751	IGT	5	150	Kitchen	744	744	0	MIAMI DADE WATER & SEWER DEPARTMENT	Multiple	5000	four 1250 gallon	90	744
GDO	8753	IGT	5	150	Kitchen	223	223	0	MIAMI DADE WATER & SEWER DEPARTMENT	Single	1050	one 1050 gallon	90	223
GDO	8832	IGT	5	150	Kitchen	120	120	0	MIAMI DADE WATER & SEWER DEPARTMENT	Single	1050	one 1050 gallon	90	2400
GDO	8881	MGRU	5	150	Kitchen	88	88	3700	MIAMI DADE WATER & SEWER DEPARTMENT		0	one 25 gpm	30	925
GDO	8900	IGT	5	150	Kitchen	569	569	0	MIAMI DADE WATER & SEWER DEPARTMENT		3750	three 1250 gallon	90	569
GDO	8976	IGT	5	150	Kitchen	744	744	0	MIAMI DADE WATER & SEWER DEPARTMENT	Multiple	5000	four 1250 gallon	90	0
GDO	8987	IGT	5	300	Kitchen	0	0	5340	MIAMI DADE WATER & SEWER DEPARTMENT	Single	1050	one 1050 gallon	90	1335
GDO	9000	IGT	5	150	Kitchen	0	0	2400	MIAMI DADE WATER & SEWER DEPARTMENT	Single	1050	one 1050-gallon	90	600
GDO	9094	MGRU	5	150	Kitchen	0	0	2564	MIAMI DADE WATER & SEWER DEPARTMENT		0	one 25 gpm	30	641
GDO	9123	IGT	5	150	Kitchen	0	0	1000	CITY OF MIAMI BEACH	Single	1050	one 1050 gallon	90	250
GDO	9168	IGT	5	300	Kitchen	208	208	288086	MIAMI DADE WATER & SEWER DEPARTMENT	Series	6250	five 1250 gallon	90	52
GDO	9215	IGT	5	150	Kitchen	0	0	2484	MIAMI DADE WATER & SEWER DEPARTMENT	Single	1050	one 1050-gallon	90	621
GDO	9230	MGRU	5	150	Kitchen	0	0	2700	MIAMI DADE WATER & SEWER DEPARTMENT		0	one 25 gpm	30	675
GDO	9259	IGT	5	150	Kitchen	0	0	10000	MIAMI DADE WATER & SEWER DEPARTMENT	Single	1050	one 1050-gallon	90	2500
GDO	9286	IGT	5	150	Kitchen	0	0	2200	MIAMI DADE WATER & SEWER DEPARTMENT	Single	950	one 950 gallon	90	550
GDO	9307	IGT	5	150	Kitchen	0	0	0	MIAMI DADE WATER & SEWER DEPARTMENT	Multiple	5910	one 1200 and three 1570 gallon	90	0
GDO	9311	IGT	5	150	Kitchen	148	148	91046	MIAMI DADE WATER & SEWER DEPARTMENT	Series	2500	two 1250 gallon	90	2960
GDO	9341	IGT	5	150	Kitchen	91	91	0	MIAMI DADE WATER & SEWER DEPARTMENT	Multiple	5000	four 1250 gallon	90	91
GDO	9342	IGT	5	150	Kitchen	744	744	0	MIAMI DADE WATER & SEWER DEPARTMENT	Multiple	6250	five 1250 gallon	90	744
GDO	9343	IGT	5	150	Kitchen	295	295	0	MIAMI DADE WATER & SEWER DEPARTMENT	Single	1050	one 1050 gallon	90	295
GDO	9344	IGT	5	150	Kitchen	1072	1072	0	MIAMI DADE WATER & SEWER DEPARTMENT	Multiple	5000	four 1250 gallon	90	268
GDO	9345	IGT	5	150	Kitchen	48	48	0	MIAMI DADE WATER & SEWER DEPARTMENT	Single	750	one 750 gallon	90	48
GDO	9346	IGT	5	150	Kitchen	89	89	0	MIAMI DADE WATER & SEWER DEPARTMENT	Series	2500	two 1250 gallon	90	89
GDO	9347	IGT	5	150	Kitchen	569	569	0	CITY OF HIALEAH	Multiple	2850	one 750 and two 1050 gallon	90	569
GDO	9348	IGT	5	150	Kitchen	871	871	0	MIAMI DADE WATER & SEWER DEPARTMENT	Series	5000	four 1250 gallon	90	871
GDO	9349	IGT	5	150	Kitchen	502	502	0	MIAMI DADE WATER & SEWER DEPARTMENT	Series	5000	four 1250 gallon	90	502
GDO	9350	IGT	5	150	Kitchen	436	436	0	MIAMI DADE WATER & SEWER DEPARTMENT	Multiple	4600	two 1050 and two 1250 gallon	90	436
GDO	9351	IGT	5	150	Kitchen	407	407	0	MIAMI DADE WATER & SEWER DEPARTMENT	Series	3150	three 1050 gallon	90	407
GDO	9363	IGT	5	150	Kitchen	0	0	6679	MIAMI DADE WATER & SEWER DEPARTMENT	Single	1050	one 1050 gallon	90	6679
GDO	9367	IGT	5	150	Kitchen	0	0	2475	MIAMI DADE WATER & SEWER DEPARTMENT	Single	750	one 750 gallon	90	2475
GDO	9397	IGT	5	300	Kitchen	100	100	9550	MIAMI DADE WATER & SEWER DEPARTMENT	Single	1050	one 1050-gallon	90	2388
GDO	9507	IGT	5	150	Kitchen	0	0	29239	MIAMI DADE WATER & SEWER DEPARTMENT	Single	950	one 950 gallon	90	584780
GDO	9587	IGT	5	150	Kitchen	0	0	22548	MIAMI DADE WATER & SEWER DEPARTMENT	Single	1050	one 1050 gallon	90	5637
GDO	9616	IGT	4	150	Kitchen	196	196	2940	MIAMI DADE WATER & SEWER DEPARTMENT	Single	1200	one 1200 gallon	90	2940
GDO	9635	IGT	5	150	Kitchen	140	140	2576	MIAMI DADE WATER & SEWER DEPARTMENT		1250	one 1250-gallon	90	644
GDO	9698	IGT	5	150	Kitchen	0	0	2000	MIAMI DADE WATER & SEWER DEPARTMENT	Single	1050	one 1050 gallon	90	500
GDO	9721	IGT	5	150	Kitchen	0	0	3800	MIAMI DADE WATER & SEWER DEPARTMENT	Single	750	one 750 gallon	90	950
GDO	9872	IGT	4	300	Kitchen	150	0	19227	MIAMI DADE WATER & SEWER DEPARTMENT	Single	1250	one 1250 gallon	90	4807
GDO	9896	IGT	5	150	Kitchen	0	0	7000	MIAMI DADE WATER & SEWER DEPARTMENT	Series	2100	two 1050-gallon	90	1750
GDO	9956	IGT	5	150	Kitchen	0	0	4400	MIAMI DADE WATER & SEWER DEPARTMENT	Single	1050	one 1050-gallon	90	1100
GDO	9976	MGRU	5	150	Kitchen	0	0	1400	CITY OF HIALEAH		0	one 7 gpm	30	28000
GDO	10031	MGRU	5	300	Kitchen	0	0	0	CITY OF MIAMI SPRINGS		0	three 100 gpm	90	0
GDO	10054	IGT	5	150	Kitchen	0	0	3990	CITY OF FLORIDA CITY	Single	1250	one 1250-gallon	90	998
GDO	10076	IGT	5	150	Kitchen	0	0	0	MIAMI DADE WATER & SEWER DEPARTMENT	Series	1050	one 1050 gallon	90	0
GDO	10086	IGT	5	150	Kitchen	0	0	0	CITY OF HIALEAH	Multiple	6250	five 1250-gallon	90	20000
GDO	10098	MGRU	5	150	Kitchen	0	0	400	MIAMI DADE WATER & SEWER DEPARTMENT		0	one 25-gpm	30	100
GDO	10127	IGT	5	150	Kitchen	0	0	1500	MIAMI DADE WATER & SEWER DEPARTMENT	Single	950	one 950	90	375
GDO	10129	IGT	5	300	Kitchen	0	0	6545	MIAMI DADE WATER & SEWER DEPARTMENT	Single	1620	one 1620 gallon	90	1636
GDO	10138	IGT	5	300	Kitchen	0	0	17400	MIAMI DADE WATER & SEWER DEPARTMENT	Single	0	one 2000-gallon	90	4350
GDO	10164	MGRU	5	150	Kitchen	0	0	3347	MIAMI DADE WATER & SEWER DEPARTMENT		0	one 15 gpm	30	837
GDO	10177	MGRU	2	150	Kitchen	0	0	1000	MIAMI DADE WATER & SEWER DEPARTMENT		0	one 25 gpm	30	250
GDO	10186	IGT	5	150	Kitchen	0	0	4700	CITY OF FLORIDA CITY	Series	2100	two 1050 gallon	90	94000
GDO	10226	IGT	5	150	Kitchen	26	26	71843	MIAMI DADE WATER & SEWER DEPARTMENT	Single	1050	one 1050-gallon	90	17961
GDO	10346	MGRU	5	150	Kitchen	0	0	1000	MIAMI DADE WATER & SEWER DEPARTMENT		0	one 25 gpm	30	250
GDO	10368	IGT	5	150	Kitchen	0	0	7561	MIAMI DADE WATER & SEWER DEPARTMENT	Single	1050	one 1050 gallon	90	7561

WORK GROUP	PERMIT NUMBER	PERMIT CLASS	PERMIT T	PERMIT FEE	BUSINESS_TYPE	RECORDED SEATS	OBSERVED SEATS	FACILITY AREA	UTILITY	SYSTEM FORMAT	TOTAL CAPACITY	TANK_CAPACITY	PUMP OUT	TOTAL GPD
GDO	10388	IGT	5	150	Kitchen	208	0	7878	CITY OF HOMESTEAD	Series	3750	three 1250 gallon	90	1970
GDO	10405	MGRU	5	300	Kitchen	0	0	5720	MIAMI DADE WATER & SEWER DEPARTMENT		0	one 75 gpm	60	1430
GDO	10408	MGRU	5	150	Kitchen	0	0	1400	MIAMI DADE WATER & SEWER DEPARTMENT		0	one 25 gpm	30	350
GDO	10448	MGRU	5	150	Kitchen	0	0	55000	MIAMI DADE WATER & SEWER DEPARTMENT		0	one 35 gpm	30	13750
GDO	10460	MGRU	5	150	Kitchen	36	36	578	MIAMI DADE WATER & SEWER DEPARTMENT		0	one 25 gpm	30	11560
GDO	10481	MGRU	5	150	Kitchen	0	0	1584	CITY OF HIALEAH		0	one 50 gpm	60	396
GDO	10515	IGT	5	150	Kitchen	0	0	7000	MIAMI DADE WATER & SEWER DEPARTMENT	Single	1050	one 1050 gallon	90	140000
GDO	10551	IGT	5	150	Kitchen	0	0	192081	MIAMI DADE WATER & SEWER DEPARTMENT	Single	1250	one 1250 gallon	30	0
GDO	10773	IGT	5	150	Kitchen	0	0	2920	MIAMI DADE WATER & SEWER DEPARTMENT	Single	2000	one 2000-gallon	90	730
GDO	10826	IGT	5	150	Kitchen	313	0	14105	MIAMI DADE WATER & SEWER DEPARTMENT	Single	2000	one 2000 gallon	90	3526
GDO	10839	IGT	5	150	Kitchen	0	0	2342	MIAMI DADE WATER & SEWER DEPARTMENT	Single	750	one 750 gallon	90	2342
GDO	10860	MGRU	5	150	Kitchen	0	0	2000	MIAMI DADE WATER & SEWER DEPARTMENT		0	one 15 gpm	30	500
GDO	10869	MGRU	5	150	Kitchen	35	0	650	MIAMI DADE WATER & SEWER DEPARTMENT		0	one 100 gpm	30	225
GDO	10897	MGRU	5	300	Kitchen	122	0	9782	MIAMI DADE WATER & SEWER DEPARTMENT		0	one 100 gpm	60	2446
GDO	10930	MGRU	5	150	Kitchen	0	0	1364	MIAMI DADE WATER & SEWER DEPARTMENT		0	one 25 gpm	30	341
GDO	10975	MGRU	5	150	Kitchen	48	0	1900	MIAMI DADE WATER & SEWER DEPARTMENT		0	one 100 gpm	90	475
GDO	10995	MGRU	5	150	Kitchen	0	0	1897	MIAMI DADE WATER & SEWER DEPARTMENT		0	one 10 gpm	30	474
GDO	11023	IGT	5	150	Kitchen	0	0	10777	MIAMI DADE WATER & SEWER DEPARTMENT	Single	750	one 750 gallon	90	2694
GDO	11025	MGRU	5	150	Kitchen	0	0	3456	MIAMI DADE WATER & SEWER DEPARTMENT		0	one 35 gpm	30	864
GDO	11038	MGRU	5	150	Kitchen	401	0	2807	MIAMI DADE WATER & SEWER DEPARTMENT		0	three 100 gpm	60	702
GDO	11069	AGRU	5	150	Kitchen	99	0	5048	MIAMI DADE WATER & SEWER DEPARTMENT		0	one 20 gpm	30	1262
GDO	11077	IGT	5	150	Kitchen	0	0	2000	MIAMI DADE WATER & SEWER DEPARTMENT	Single	900	one 900 gallon	90	500
GDO	11080	IGT	5	150	Kitchen	0	0	2000	MIAMI DADE WATER & SEWER DEPARTMENT	Single	950	one 950 gallon	90	500
GDO	11085	MGRU	5	150	Kitchen	0	0	3473	CITY OF CORAL GABLES		0	three 35 gpm	30	868
GDO	11141	MGRU	5	150	Kitchen	0	0	2000	MIAMI DADE WATER & SEWER DEPARTMENT		0	one 10 gpm	30	500
GDO	11176	IGT	5	150	Kitchen	0	0	394	MIAMI DADE WATER & SEWER DEPARTMENT	Series	3600	two 1800 gallon	60	99
GDO	11187	MGRU	5	150	Kitchen	0	0	4359	MIAMI DADE WATER & SEWER DEPARTMENT		0	one 15 gpm	30	1090
GDO	11227	MGRU	5	150	Kitchen	92	0	1000	MIAMI DADE WATER & SEWER DEPARTMENT		0	one 15 gpm	30	250
GDO	11234	IGT	5	150	Kitchen	6	0	283	CITY OF HIALEAH	Single	750	one 750 gallon	90	71
GDO	11235	MGRU	5	150	Kitchen	0	0	2350	MIAMI DADE WATER & SEWER DEPARTMENT		0	one 20 gpm	60	588
GDO	11236	MGRU	5	150	Kitchen	200	0	7188	MIAMI DADE WATER & SEWER DEPARTMENT		0	one 100 gpm	60	1797
GDO	11239	IGT	5	300	Kitchen	30	0	5520	MIAMI DADE WATER & SEWER DEPARTMENT	Series	2400	two 1200 gallon	30	1380
GDO	11306	MGRU	5	150	Kitchen	147	0	2160	MIAMI DADE WATER & SEWER DEPARTMENT		0	one 100 gpm	30	540
GDO	11333	IGT	5	150	Kitchen	450	0	0	MIAMI DADE WATER & SEWER DEPARTMENT	Multiple	4500	one 750 and three 1250 gallon	90	0
GDO	11413	MGRU	5	150	Kitchen	0	0	860	MIAMI DADE WATER & SEWER DEPARTMENT		0	one 75 gpm	90	215
GDO	11466	MGRU	5	150	Kitchen	74	0	0	MIAMI DADE WATER & SEWER DEPARTMENT		0	one 50 gpm	30	0
GDO	11491	MGRU	5	150	Kitchen	0	0	1384	MIAMI DADE WATER & SEWER DEPARTMENT		0	one 50 gpm	30	346
GDO	11516	MGRU	4	150	Kitchen	115	0	0	CITY OF MIAMI BEACH		0	one 35 gpm	60	0
GDO	11625	IGT	5	150	Kitchen	0	0	6050	MIAMI DADE WATER & SEWER DEPARTMENT	Single	2000	one 2000 gallon	90	1513
GDO	11637	IGT	5	150	Kitchen	500	0	0	MIAMI DADE WATER & SEWER DEPARTMENT	Series	3000	two 1500 gallon	60	10000
GDO	11748	MGRU	5	150	Kitchen	40	0	768	CITY OF MIAMI BEACH		0	one 75 gpm	60	284
GDO	11749	IGT	5	150	Kitchen	0	0	1000	MIAMI DADE WATER & SEWER DEPARTMENT	Single	1200	one 1200 gallon	60	250
GDO	11753	MGRU	5	150	Kitchen	0	0	600	MIAMI DADE WATER & SEWER DEPARTMENT		0	one 75 gpm	30	150
GDO	11828	IGT	5	150	Kitchen	0	0	500	MIAMI DADE WATER & SEWER DEPARTMENT	Single	1050	one 1050 gallon	60	125
GDO	11863	IGT	5	300	Kitchen	891	0	18700	CITY OF MIAMI BEACH	Series	6000	five 1200 gallon	30	4675
GDO	11899	IGT	5	150	Kitchen	0	0	2210	MIAMI DADE WATER & SEWER DEPARTMENT	Single	750	one 750 gallon	60	553
GDO	121	IGT	5	150	Market	0	0	2400	CITY OF MIAMI BEACH	Series	2400	two 1200 gallon	90	600
GDO	262	MGRU	5	150	Market	0	0	0	MIAMI DADE WATER & SEWER DEPARTMENT		0	one 25 gpm	30	0
GDO	284	IGT	5	300	Market	0	0	0	MIAMI DADE WATER & SEWER DEPARTMENT	Single	950	one 950 gallon	90	0
GDO	352	IGT	5	150	Market	0	0	0	MIAMI DADE WATER & SEWER DEPARTMENT	Single	1200	one 1200 gallon	90	0
GDO	466	IGT	5	150	Market	20	0	600	MIAMI DADE WATER & SEWER DEPARTMENT	Single	1200	one 1200 gallon	90	150
GDO	479	IGT	5	300	Market	10	10	0			0	one 1050 & one 750 gallon	90	3
GDO	526	IGT	5	300	Market	0	0	0	MIAMI DADE WATER & SEWER DEPARTMENT	Single	750	one 750 gallon	90	0
GDO	723	AGRU	5	150	Market	30	30	850	CITY OF HIALEAH		0	one 25 gpm	30	213
GDO	746	IGT	5	300	Market	0	0	0	CITY OF HOMESTEAD	Single	1500	one 1500 gallon	90	0
GDO	1088	IGT	5	150	Market	1	1	0	CITY OF NORTH MIAMI BEACH	Single	1200	one 1200 gallon	90	0
GDO	1272	IGT	5	150	Market	0	0	1908	MIAMI DADE WATER & SEWER DEPARTMENT	Single	1200	one 1200 gallon	90	477
GDO	1357	IGT	5	300	Market	32	0	7555	MIAMI DADE WATER & SEWER DEPARTMENT	Single	1250	one 1250 gallon	90	188875
GDO	1377	IGT	5	150	Market	0	0	0	CITY OF OPA LOCKA	Single	1050	one 1050 gallon	90	0

WORK GROUP	PERMIT NUMBER	PERMIT CLASS	PERMIT	PERMIT FEE	BUSINESS_TYPE	RECORDED SEATS	OBSERVED SEATS	FACILITY AREA	UTILITY	SYSTEM FORMAT	TOTAL CAPACITY	TANK_CAPACITY	PUMP OUT	TOTAL GPD
GDO	1385	IGT	5	150	Market	0	0	0		Single	1000	one 1000 gallon	90	0
GDO	1450	IGT	5	150	Market	0	0	0	CITY OF HOMESTEAD	Single	750	one 750 gallon	90	0
GDO	1528	IGT	5	150	Market	0	0	0		Single	1200	one 1200 gallon	90	0
GDO	1534	IGT	5	150	Market	0	0	0	CITY OF HIALEAH	Single	1050	two 1050 gallon	90	0
GDO	1538	IGT	5	150	Market	30	30	0	MIAMI DADE WATER & SEWER DEPARTMENT	Parallel	1500	two 750 gallon	90	420
GDO	1670	MGRU	5	150	Market	0	0	0	CITY OF HIALEAH		0	one 7 gpm	30	0
GDO	1833	MGRU	5	150	Market	0	0	3859	MIAMI DADE WATER & SEWER DEPARTMENT		0	one 25 gpm	30	965
GDO	1839	IGT	5	300	Market	0	0	0	CITY OF MIAMI BEACH	Single	1050	one 1050 gallon	90	0
GDO	1868	IGT	5	300	Market	16	16	0	CITY OF HIALEAH	Single	950	one 950 gallon	90	4
GDO	2004	MGRU	5	300	Market	0	0	0			0	one 25 gpm	30	0
GDO	2191	IGT	5	150	Market	0	0	0	MIAMI DADE WATER & SEWER DEPARTMENT	Single	750	one 750 gallon	90	0
GDO	2242	IGT	5	300	Market	0	0	0	MIAMI DADE WATER & SEWER DEPARTMENT	Single	1200	one 1200 gallon	90	0
GDO	2275	IGT	5	150	Market	0	0	0	MIAMI DADE WATER & SEWER DEPARTMENT	Single	1050	one 1050 gallon	90	0
GDO	2279	IGT	5	150	Market	0	0	0		Single	950	one 950 gallon	90	0
GDO	2407	IGT	5	150	Market	0	0	0	CITY OF NORTH MIAMI BEACH	Single	750	one 750 gallon	90	0
GDO	2496	IGT	5	150	Market	0	0	5941	MIAMI DADE WATER & SEWER DEPARTMENT	Single	750	one 750 gallon	90	1485
GDO	2537	IGT	5	150	Market	0	0	0	CITY OF OPA LOCKA	Single	750	one 750 gallon	90	0
GDO	2656	IGT	5	150	Market	0	0	2400	MIAMI DADE WATER & SEWER DEPARTMENT	Single	950	one 950 gallon	90	600
GDO	2682	IGT	5	150	Market	0	0	0	CITY OF OPA LOCKA	Single	1050	one 1050 gallon	90	0
GDO	2694	IGT	5	150	Market	0	0	0		Series	2100	two 1050 gallon	90	0
GDO	2728	MGRU	5	150	Market	9	0	3154	CITY OF MIAMI BEACH		0	one 25 gpm	30	789
GDO	2745	IGT	5	150	Market	24	24	0	MIAMI DADE WATER & SEWER DEPARTMENT	Single	1200	one 1200 gallon	90	336
GDO	2829	IGT	5	300	Market	0	0	0	MIAMI DADE WATER & SEWER DEPARTMENT	Single	950	one 950 gallon	90	0
GDO	2863	IGT	5	150	Market	0	0	0			0	one 1050 gallon	90	0
GDO	2867	IGT	5	150	Market	0	0	0	CITY OF HIALEAH	Single	750	one 750 gallon	90	0
GDO	2960	IGT	5	150	Market	18	18	6600	MIAMI DADE WATER & SEWER DEPARTMENT		0	one 750 gallon	90	50
GDO	2971	IGT	5	150	Market	21	21	0		Single	1200	one 1200 gallon	90	5
GDO	3030	IGT	5	150	Market	0	0	0	CITY OF NORTH MIAMI BEACH	Single	1050	one 1050 gallon	90	0
GDO	3032	IGT	5	300	Market	50	50	0		Single	1050	one 1050 gallon	90	13
GDO	3036	IGT	5	150	Market	0	0	0		Multiple	4500	three 1500 gallon	90	0
GDO	3050	IGT	5	150	Market	5	5	0		Single	950	one 950 gallon	90	1
GDO	3153	IGT	5	150	Market	0	0	1200	MIAMI DADE WATER & SEWER DEPARTMENT	Single	750	one 750 gallon	90	0
GDO	3276	IGT	5	150	Market	0	0	0	MIAMI DADE WATER & SEWER DEPARTMENT	Single	750	one 750 gallon	90	0
GDO	3294	IGT	5	150	Market	0	0	0		Single	950	one 950 gallon	90	0
GDO	3371	IGT	5	150	Market	9	9	0	MIAMI DADE WATER & SEWER DEPARTMENT	Single	1050	one 1050 gallon	90	2
GDO	3498	MGRU	5	150	Market	4	4	1850	MIAMI DADE WATER & SEWER DEPARTMENT		0	one 10 gpm	30	463
GDO	3799	IGT	5	150	Market	0	0	0	CITY OF HOMESTEAD	Single	1050	one 1050 gallon	90	0
GDO	3951	IGT	5	150	Market	0	0	0	MIAMI DADE WATER & SEWER DEPARTMENT	Single	750	one 750 gallon	90	0
GDO	4047	IGT	5	300	Market	20	20	0		Single	950	one 950 gallon	90	280
GDO	4112	MGRU	5	150	Market	0	0	0	CITY OF NORTH MIAMI BEACH		0	one 35 gpm	30	0
GDO	4137	IGT	5	150	Market	0	0	1000	CITY OF MIAMI BEACH	Single	1200	one 1200 gallon	90	250
GDO	4152	IGT	5	150	Market	0	0	0		Single	950	one 950 gallon	90	0
GDO	4193	IGT	5	300	Market	0	0	0		Single	750	one 750 gallon	90	0
GDO	4232	IGT	5	150	Market	0	0	1800	MIAMI DADE WATER & SEWER DEPARTMENT	Single	750	one 750 gallon	90	450
GDO	4271	MGRU	5	150	Market	0	0	4686	MIAMI DADE WATER & SEWER DEPARTMENT		0	one 50 gpm	60	1172
GDO	4297	MGRU	5	150	Market	0	0	0			0	one 25 gpm	30	0
GDO	4443	IGT	5	150	Market	0	0	2450	MIAMI DADE WATER & SEWER DEPARTMENT	Single	1250	one 1250 gallon	60	216
GDO	4480	IGT	5	150	Market	6	6	0	CITY OF HIALEAH	Single	1050	one 1050 gallon	90	2
GDO	4718	IGT	5	150	Market	0	0	0		Single	1050	one 1050 gallon	90	0
GDO	5001	IGT	5	150	Market	0	0	0	MIAMI DADE WATER & SEWER DEPARTMENT	Single	750	one 750 gallon	90	0
GDO	5127	IGT	5	150	Market	0	0	0		Single	1050	one 1050 gallon	90	0
GDO	5286	IGT	5	150	Market	0	0	0		Single	950	one 950 gallon	90	0
GDO	5375	AGRU	5	150	Market	0	0	0			0	one 25 gpm	30	0
GDO	5420	IGT	5	150	Market	0	0	0		Single	750	one 750 gallon	90	0
GDO	5442	IGT	5	150	Market	0	0	0	CITY OF HIALEAH	Single	1200	one 1200 gallon	90	0
GDO	5517	IGT	5	150	Market	0	0	0	MIAMI DADE WATER & SEWER DEPARTMENT	Single	950	one 950 gallon	90	0
GDO	5809	IGT	5	300	Market	76	76	0	CITY OF NORTH MIAMI BEACH	Multiple	2000	one 1050 and one 950 gallon	90	1064
GDO	5836	MGRU	5	150	Market	25	25	0	MIAMI DADE WATER & SEWER DEPARTMENT		0	one 25 gpm	30	625
GDO	5876	IGT	5	150	Market	6	6	0	CITY OF HIALEAH	Single	750	one 750 gallon	90	0
GDO	5884	MGRU	5	300	Market	0	0	0			0	one 25 gpm	30	0

WORK GROUP	PERMIT NUMBER	PERMIT CLASS	PERMIT T	PERMIT FEE	BUSINESS_TYPE	RECORDED SEATS	OBSERVED SEATS	FACILITY AREA	UTILITY	SYSTEM FORMAT	TOTAL CAPACITY	TANK_CAPACITY	PUMP OUT	TOTAL GPD
GDO	5885	MGRU	5	150	Market	0	0	0			0	not applicable	30	0
GDO	6008	IGT	5	150	Market	0	0	0	CITY OF FLORIDA CITY	Single	950	one 950 gallon	90	0
GDO	6061	MGRU	5	150	Market	0	0	0	CITY OF NORTH MIAMI BEACH		0	one 25 gpm	30	0
GDO	6108	MGRU	5	150	Market	10	10	2300	CITY OF HIALEAH		0	one 25 gpm	30	575
GDO	6127	IGT	5	150	Market	0	0	0	CITY OF NORTH MIAMI BEACH	Single	950	one 950 gallon	90	0
GDO	6149	IGT	5	300	Market	32	32	4570	MIAMI DADE WATER & SEWER DEPARTMENT	Single	1200	one 1200 gallon	90	1143
GDO	6241	MGRU	5	150	Market	0	0	0	CITY OF MIAMI BEACH		0	one 25 gpm	30	0
GDO	6384	IGT	5	150	Market	10	10	1772	MIAMI DADE WATER & SEWER DEPARTMENT	Single	950	one 950-gallon	90	443
GDO	6447	AGRU	5	150	Market	0	0	1500	CITY OF HIALEAH		0	one 25 gpm	30	375
GDO	6493	IGT	5	150	Market	0	0	3000	MIAMI DADE WATER & SEWER DEPARTMENT	Single	950	one 950 gallon	90	750
GDO	6647	IGT	5	150	Market	34	34	2080	CITY OF HIALEAH	Single	950	one 950-gallon	90	520
GDO	6666	IGT	5	150	Market	0	0	1400	MIAMI DADE WATER & SEWER DEPARTMENT	Single	1050	one 1050 gallon	60	350
GDO	6674	IGT	5	150	Market	0	0	2000	MIAMI DADE WATER & SEWER DEPARTMENT	Single	750	one 750 gallon	60	500
GDO	6708	MGRU	5	150	Market	0	0	0	MIAMI DADE WATER & SEWER DEPARTMENT		0	one 25 gpm	30	0
GDO	6710	AGRU	5	150	Market	0	0	4500	MIAMI DADE WATER & SEWER DEPARTMENT		0	one 25 gpm	30	1125
GDO	6711	IGT	5	150	Market	0	0	0	MIAMI DADE WATER & SEWER DEPARTMENT	Single	950	one 950 gallon	90	0
GDO	6719	MGRU	5	150	Market	0	0	0	MIAMI DADE WATER & SEWER DEPARTMENT		0	one 25 gpm	30	0
GDO	6732	IGT	5	150	Market	0	0	0	MIAMI DADE WATER & SEWER DEPARTMENT	Single	950	one 950 gallon	90	0
GDO	6759	IGT	5	150	Market	0	0	3300	MIAMI DADE WATER & SEWER DEPARTMENT	Single	950	one 950 gallon	90	825
GDO	6766	AGRU	5	150	Market	0	0	0	MIAMI DADE WATER & SEWER DEPARTMENT		0	one 25 gpm	30	0
GDO	6817	IGT	5	150	Market	0	0	0	CITY OF MIAMI SPRINGS	Single	1050	one 1050 gallon	90	0
GDO	6822	IGT	5	150	Market	0	0	0	MIAMI DADE WATER & SEWER DEPARTMENT	Single	750	one 750 gallon	90	0
GDO	6828	MGRU	5	150	Market	0	0	2200	MIAMI DADE WATER & SEWER DEPARTMENT		0	one 25 gpm	30	550
GDO	6860	IGT	5	150	Market	0	0	0	MIAMI DADE WATER & SEWER DEPARTMENT	Single	950	one 950 gallon	90	0
GDO	6938	IGT	5	150	Market	0	0	0	CITY OF FLORIDA CITY	Single	1050	one 1050 gallon	90	0
GDO	7021	IGT	5	150	Market	0	0	2950	CITY OF HIALEAH	Single	1050	one 1050 gallon	90	738
GDO	7037	IGT	5	150	Market	0	0	1750	MIAMI DADE WATER & SEWER DEPARTMENT	Single	950	one 950 gallon	90	438
GDO	7039	MGRU	5	150	Market	0	0	1700	CITY OF NORTH MIAMI BEACH		0	one 25 gpm	30	425
GDO	7053	MGRU	5	150	Market	0	0	0	MIAMI DADE WATER & SEWER DEPARTMENT		0	one 25 gpm	30	0
GDO	7112	IGT	5	150	Market	0	0	4400	CITY OF HIALEAH	Single	950	one 950 gallon	90	0
GDO	7150	IGT	5	150	Market	0	0	2800	MIAMI DADE WATER & SEWER DEPARTMENT	Single	1050	one 1050-gallon	90	700
GDO	7157	IGT	5	300	Market	0	0	0	CITY OF NORTH MIAMI BEACH	Series	1900	two 950 gallon	90	0
GDO	7179	MGRU	5	150	Market	0	0	580	MIAMI DADE WATER & SEWER DEPARTMENT		0	one 25 gpm	60	145
GDO	7181	IGT	5	150	Market	0	0	0	MIAMI DADE WATER & SEWER DEPARTMENT	Single	950	one 950 gallon	90	0
GDO	7221	MGRU	5	150	Market	0	0	2000	MIAMI DADE WATER & SEWER DEPARTMENT		0	one 25 gpm	30	500
GDO	7249	MGRU	5	300	Market	0	0	5000	CITY OF MIAMI BEACH		0	one 25 gpm	30	1250
GDO	7292	MGRU	5	150	Market	0	0	1800	MIAMI DADE WATER & SEWER DEPARTMENT		0	one 25 gpm	90	450
GDO	7300	IGT	5	150	Market	0	0	3400	MIAMI DADE WATER & SEWER DEPARTMENT	Single	1200	one 1200 gallon	60	850
GDO	7304	IGT	5	150	Market	0	0	0	MIAMI DADE WATER & SEWER DEPARTMENT	Single	1200	one 1200 gallon	90	0
GDO	7513	MGRU	5	150	Market	0	0	0	CITY OF HIALEAH		0	one 25 gpm	30	0
GDO	7637	IGT	5	150	Market	0	0	1200	MIAMI DADE WATER & SEWER DEPARTMENT	Single	950	one 950 gallon	90	300
GDO	7665	IGT	5	150	Market	0	0	0	MIAMI DADE WATER & SEWER DEPARTMENT	Single	950	one 950 gallon	90	0
GDO	7894	MGRU	5	150	Market	49	49	2400	MIAMI DADE WATER & SEWER DEPARTMENT		0	one 25 gpm	30	600
GDO	7931	MGRU	5	150	Market	0	0	3500	CITY OF MIAMI BEACH		0	one 25 gpm	30	875
GDO	8109	IGT	5	300	Market	48	48	0	MIAMI DADE WATER & SEWER DEPARTMENT	Multiple	3150	three 1050 gallon	90	672
GDO	8118	MGRU	5	150	Market	0	0	700	MIAMI DADE WATER & SEWER DEPARTMENT		0	one 25 gpm	30	175
GDO	8242	IGT	5	150	Market	0	0	1420	CITY OF HOMESTEAD	Single	1050	one 1050 gallon	90	355
GDO	8243	MGRU	5	150	Market	0	0	1598	MIAMI DADE WATER & SEWER DEPARTMENT		0	one 25 gpm	30	400
GDO	8537	MGRU	5	150	Market	0	0	1064	MIAMI DADE WATER & SEWER DEPARTMENT		0	one 7 gpm	30	266
GDO	8684	IGT	5	150	Market	0	0	2200	CITY OF MIAMI BEACH	Single	750	one 750 gallon	90	550
GDO	8701	MGRU	5	150	Market	0	0	694	MIAMI DADE WATER & SEWER DEPARTMENT		0	one 25 gpm	30	174
GDO	8722	IGT	5	300	Market	0	0	4310	MIAMI DADE WATER & SEWER DEPARTMENT		0	unknown	90	1078
GDO	8758	IGT	5	150	Market	32	32	3051	MIAMI DADE WATER & SEWER DEPARTMENT	Single	1050	one 1050 gallon	90	763
GDO	8777	MGRU	5	150	Market	0	0	0	MIAMI DADE WATER & SEWER DEPARTMENT		0	two 7 gpm	30	0
GDO	8869	IGT	5	150	Market	0	0	3200	MIAMI DADE WATER & SEWER DEPARTMENT	Single	1050	one 1050 gallon	90	800
GDO	8984	MGRU	5	150	Market	0	0	2235	MIAMI DADE WATER & SEWER DEPARTMENT		0	one 25 gpm	30	559
GDO	9090	MGRU	5	150	Market	0	0	855	MIAMI DADE WATER & SEWER DEPARTMENT		0	one 15 gpm	30	214
GDO	9263	IGT	5	150	Market	0	0	3000	CITY OF FLORIDA CITY	Single	1050	one 1050 gallon	30	750
GDO	9281	MGRU	5	150	Market	0	0	900	CITY OF MIAMI BEACH		0	one 25-gpm	30	225
GDO	9385	IGT	5	150	Market	0	0	2500	MIAMI DADE WATER & SEWER DEPARTMENT	Series	2500	two 1250-gallon	90	625
GDO	9464	IGT	5	150	Market	0	0	920	CITY OF HIALEAH	Single	1200	one 1200-gallon	90	230

WORK GROUP	PERMIT NUMBER	PERMIT CLASS	PERMIT	PERMIT FEE	BUSINESS_TYPE	RECORDED SEATS	OBSERVED SEATS	FACILITY AREA	UTILITY	SYSTEM FORMAT	TOTAL CAPACITY	TANK_CAPACITY	PUMP OUT	TOTAL GPD
GDO	9672	MGRU	5	150	Market	39	0	1706	CITY OF MIAMI BEACH		0	one 100 gpm	60	485
GDO	9688	IGT	5	300	Market	0	0	22596	MIAMI DADE WATER & SEWER DEPARTMENT	Series	2100	two 1050-gallon	90	5649
GDO	9812	IGT	5	150	Market	0	0	2229	CITY OF NORTH MIAMI BEACH	Single	1050	one 1050 gallon	90	557
GDO	9829	MGRU	5	150	Market	0	0	650	CITY OF HIALEAH		0	one 25 gpm	30	163
GDO	9870	IGT	5	150	Market	20	20	900	MIAMI DADE WATER & SEWER DEPARTMENT	Single	1050	one 1050 gallon	90	225
GDO	9937	MGRU	5	150	Market	20	0	1000	MIAMI DADE WATER & SEWER DEPARTMENT		0	one 15 gpm	30	250
GDO	9951	MGRU	5	150	Market	0	0	1900	MIAMI DADE WATER & SEWER DEPARTMENT		0	one 25 gpm	30	475
GDO	10075	MGRU	5	150	Market	0	0	483	CITY OF HIALEAH		0	one 25 gpm	30	121
GDO	10184	AGRU	5	150	Market	0	0	2500	MIAMI DADE WATER & SEWER DEPARTMENT		0	one 35 gpm	30	625
GDO	10215	MGRU	2	150	Market	0	0	2500	MIAMI DADE WATER & SEWER DEPARTMENT		0	one 25 gpm	30	625
GDO	10233	MGRU	5	150	Market	0	0	2100	CITY OF HOMESTEAD		0	one 25 gpm	30	525
GDO	10241	IGT	5	300	Market	0	0	95598	MIAMI DADE WATER & SEWER DEPARTMENT	Single	1050	one 1050 gallon	90	23900
GDO	10265	MGRU	5	150	Market	0	0	750	MIAMI DADE WATER & SEWER DEPARTMENT		0	one 25 gpm	30	188
GDO	10457	MGRU	2	150	Market	10	10	966	MIAMI DADE WATER & SEWER DEPARTMENT		0	one 25 gpm	30	242
GDO	10476	IGT	5	300	Market	0	0	2463	CITY OF HIALEAH	Single	1200	one 1200 gallon	90	1003
GDO	10535	IGT	5	150	Market	0	0	0		Single	1050	one 1050 gallon	90	0
GDO	10610	MGRU	5	150	Market	0	0	1729	MIAMI DADE WATER & SEWER DEPARTMENT		0	one 25 gpm	30	432
GDO	10695	IGT	5	300	Market	94	0	5000	MIAMI DADE WATER & SEWER DEPARTMENT	Single	1250	one 1250 gallon	60	1250
GDO	10875	IGT	5	150	Market	0	0	800	MIAMI DADE WATER & SEWER DEPARTMENT	Single	1250	one 1250 gallon	60	200
GDO	11173	MGRU	5	150	Market	0	0	864	MIAMI DADE WATER & SEWER DEPARTMENT		0	one 10 gpm	30	216
GDO	11195	MGRU	5	150	Market	0	0	750	MIAMI DADE WATER & SEWER DEPARTMENT		0	one 50 gpm	30	188
GDO	11308	IGT	5	150	Market	30	0	1850	CITY OF NORTH MIAMI BEACH	Single	1200	one 1200 gallon	60	463
GDO	11558	IGT	5	150	Market	0	0	2800	MIAMI DADE WATER & SEWER DEPARTMENT	Single	750	one 750 gallon	60	700
GDO	11596	MGRU	5	150	Market	0	0	1461	MIAMI DADE WATER & SEWER DEPARTMENT		0	one 25 gpm	30	365
GDO	11656	MGRU	5	150	Market	0	0	1178	MIAMI DADE WATER & SEWER DEPARTMENT		0	one 25 gpm	90	295
GDO	11679	IGT	5	300	Market	48	0	149752	MIAMI DADE WATER & SEWER DEPARTMENT	Multiple	2500	one 1000 and one 1500 gallon	60	3744
GDO	5499	IGT	5	150	Packing	0	0	0		Single	1200	one 1200 gallon	90	0
GDO	5606	IGT	5	150	Packing	0	0	0	MIAMI DADE WATER & SEWER DEPARTMENT	Single	1050	one 1050 gallon	90	0
GDO	6819	IGT	5	150	Packing	0	0	0	MIAMI DADE WATER & SEWER DEPARTMENT	Single	1050	one 1050 gallon	90	0
GDO	7814	IGT	5	300	Packing	0	0	13281	MIAMI DADE WATER & SEWER DEPARTMENT	Single	950	one 950 gallon	90	0
GDO	10697	MGRU	5	150	Packing	0	0	2000	MIAMI DADE WATER & SEWER DEPARTMENT		0	one 50 gpm	30	500
GDO	11769	MGRU	5	150	Packing	0	0	30534	MIAMI DADE WATER & SEWER DEPARTMENT		0	one 100 gpm	90	7634
GDO	1313	IGT	5	300	Processing	0	0	4000	CITY OF NORTH MIAMI BEACH	Series	1900	two 950 gallon	90	1000
GDO	1565	MGRU	5	150	Processing	0	0	1302	MIAMI DADE WATER & SEWER DEPARTMENT		0	one 25 gpm	30	326
GDO	1951	IGT	5	300	Processing	0	0	4000	MIAMI DADE WATER & SEWER DEPARTMENT	Single	750	one 750-gallon	90	1000
GDO	1986	IGT	5	150	Processing	0	0	0	MIAMI DADE WATER & SEWER DEPARTMENT	Single	1200	one 2000 gallon	90	0
GDO	2114	IGT	5	150	Processing	4	4	0		Single	900	one 900 gallon	90	1
GDO	2374	IGT	5	150	Processing	0	0	1400	CITY OF HIALEAH	Single	950	one 950 gallon	90	350
GDO	2377	IGT	5	150	Processing	0	0	3360	MIAMI DADE WATER & SEWER DEPARTMENT	Single	750	one 750 gallon	90	840
GDO	3423	IGT	5	150	Processing	0	0	0	MIAMI DADE WATER & SEWER DEPARTMENT	Single	750	one 750 gallon	90	0
GDO	3727	MGRU	5	150	Processing	0	0	0			0	one 25 gpm	30	0
GDO	4061	IGT	5	150	Processing	0	0	0	MIAMI DADE WATER & SEWER DEPARTMENT	Single	950	one 950 gallon	90	0
GDO	4481	IGT	5	150	Processing	0	0	0		Single	1050	one 1050 gallon	90	0
GDO	4564	IGT	5	300	Processing	0	0	4896	CITY OF NORTH MIAMI BEACH	Single	1200	one 1200 gallon	90	1216
GDO	5055	IGT	5	150	Processing	0	0	0	CITY OF HIALEAH	Single	750	one 750 gallon	90	0
GDO	5056	IGT	5	150	Processing	0	0	2000	CITY OF HIALEAH	Single	750	one 750 gallon	90	500
GDO	5283	IGT	5	150	Processing	0	0	0	MIAMI DADE WATER & SEWER DEPARTMENT	Single	1050	one 1050 gallon	90	0
GDO	5508	AGRU	5	150	Processing	0	0	1000	MIAMI DADE WATER & SEWER DEPARTMENT		0	one 25 gpm	30	250
GDO	5686	IGT	5	300	Processing	0	0	5013	CITY OF HIALEAH	Single	950	one 950 gallon	90	1253
GDO	5839	AGRU	5	150	Processing	0	0	1500	CITY OF HIALEAH		0	one 25 gpm	30	375
GDO	5918	IGT	5	150	Processing	0	0	2900	MIAMI DADE WATER & SEWER DEPARTMENT	Single	750	one 100 gpm hydromechanical and one 750 gallon	90	725
GDO	5994	IGT	5	300	Processing	0	0	9767	CITY OF HIALEAH	Single	1200	one 1200 gallon	60	2442
GDO	6031	IGT	5	150	Processing	0	0	0	CITY OF HIALEAH	Single	950	one 950 gallon	90	0
GDO	6303	IGT	5	300	Processing	0	0	20000	MIAMI DADE WATER & SEWER DEPARTMENT	Series	2400	two 1200 gallon	90	5000
GDO	6349	MGRU	1	150	Processing	0	0	0	CITY OF HIALEAH		0	one 50 gpm	90	0
GDO	6457	IGT	5	150	Processing	0	0	0	CITY OF HIALEAH	Single	950	one 950 gallon	90	0
GDO	6697	IGT	5	150	Processing	0	0	0	MIAMI DADE WATER & SEWER DEPARTMENT	Single	950	one 950 gallon	90	0
GDO	6785	IGT	5	150	Processing	0	0	7500	MIAMI DADE WATER & SEWER DEPARTMENT	Single	1200	one 1200 gallon	90	1875

WORK GROUP	PERMIT NUMBER	PERMIT CLASS	PERMIT	PERMIT FEE	BUSINESS_TYPE	RECORDED SEATS	OBSERVED SEATS	FACILITY AREA	UTILITY	SYSTEM FORMAT	TOTAL CAPACITY	TANK_CAPACITY	PUMP OUT	TOTAL GPD
GDO	6791	IGT	5	150	Processing	0	0	2013	MIAMI DADE WATER & SEWER DEPARTMENT	Single	950	one 950 gallon	90	503
GDO	6793	MGRU	5	300	Processing	0	0	5980	MIAMI DADE WATER & SEWER DEPARTMENT		0	one 25 gpm	30	1495
GDO	6934	IGT	5	150	Processing	0	0	0	MIAMI DADE WATER & SEWER DEPARTMENT	Series	2500	two 1250 gallon	90	0
GDO	7069	MGRU	5	150	Processing	0	0	0	CITY OF HIALEAH		0	one 25 gpm	30	0
GDO	7167	IGT	5	150	Processing	0	0	0	MIAMI DADE WATER & SEWER DEPARTMENT	Single	1050	one 1050 gallon	90	0
GDO	7329	IGT	5	150	Processing	0	0	0	MIAMI DADE WATER & SEWER DEPARTMENT	Single	750	one 750 gallon	90	0
GDO	7380	MGRU	5	150	Processing	0	0	1811	MIAMI DADE WATER & SEWER DEPARTMENT		0	one 35 gpm	30	453
GDO	7406	IGT	5	150	Processing	0	0	5600	MIAMI DADE WATER & SEWER DEPARTMENT	Single	1800	one 1800 gallon	90	0
GDO	7458	IGT	5	150	Processing	0	0	1100	MIAMI DADE WATER & SEWER DEPARTMENT	Single	750	one 750 gallon	90	275
GDO	7532	MGRU	5	150	Processing	0	0	0	CITY OF HIALEAH		0	one 25 gpm	30	0
GDO	7559	IGT	5	300	Processing	0	0	17400	CITY OF OPA LOCKA	Single	1200	one 1200 gallon	90	4350
GDO	7574	MGRU	5	150	Processing	0	0	1046	MIAMI DADE WATER & SEWER DEPARTMENT		0	one 35 gpm	90	262
GDO	7650	IGT	5	150	Processing	0	0	2300	MIAMI DADE WATER & SEWER DEPARTMENT	Single	1200	one 1200 gallon	90	575
GDO	7700	IGT	5	150	Processing	0	0	0	MIAMI DADE WATER & SEWER DEPARTMENT	Series	1050	two 1050 gallon	90	0
GDO	7781	MGRU	5	150	Processing	0	0	1884	MIAMI DADE WATER & SEWER DEPARTMENT		0	one 25 gpm	30	471
GDO	7816	IGT	5	150	Processing	0	0	1060	CITY OF HIALEAH	Single	1050	one 1050 gallon	90	265
GDO	7823	IGT	5	150	Processing	0	0	2411	MIAMI DADE WATER & SEWER DEPARTMENT	Single	750	one 750 gallon	90	603
GDO	8005	IGT	5	300	Processing	0	0	24000	MIAMI DADE WATER & SEWER DEPARTMENT	Multiple	3150	three 1050 gallon	90	6000
GDO	8173	IGT	5	150	Processing	0	0	1680	CITY OF HIALEAH	Single	1600	one 1600 gallon	60	420
GDO	8312	IGT	5	300	Processing	0	0	0	MIAMI DADE WATER & SEWER DEPARTMENT	Single	1050	one 1050 gallon	90	0
GDO	8325	IGT	5	300	Processing	0	0	5000	MIAMI DADE WATER & SEWER DEPARTMENT	Single	1200	one 1200 gallon	90	1250
GDO	8336	MGRU	5	150	Processing	0	0	1117	CITY OF HIALEAH		0	one 25 gallon	30	279
GDO	8350	IGT	5	150	Processing	0	0	1700	MIAMI DADE WATER & SEWER DEPARTMENT	Single	1500	one 1500 gallon	90	425
GDO	8378	IGT	5	750	Processing	58	58	39704	MIAMI DADE WATER & SEWER DEPARTMENT	Single	1050	one 1050 gallon	90	9926
GDO	8398	MGRU	5	150	Processing	0	0	2000	MIAMI DADE WATER & SEWER DEPARTMENT		0	one 25 gpm	30	500
GDO	8553	MGRU	5	300	Processing	0	0	42000	MIAMI DADE WATER & SEWER DEPARTMENT		0	one 25 gpm	30	10500
GDO	8662	IGT	5	300	Processing	0	0	38000	MIAMI DADE WATER & SEWER DEPARTMENT	Parallel	6000	four 1500 gallon	90	9500
GDO	8771	MGRU	5	150	Processing	0	0	1250	CITY OF HIALEAH		0	one 25 gpm	30	313
GDO	8786	AGRU	5	150	Processing	0	0	1549	CITY OF HIALEAH		0	not available	30	387
GDO	8906	MGRU	5	150	Processing	0	0	920	CITY OF HIALEAH		0	one 25 gpm	30	230
GDO	8943	MGRU	5	150	Processing	0	0	1480	MIAMI DADE WATER & SEWER DEPARTMENT		0	one 25 gpm	30	370
GDO	9002	IGT	5	150	Processing	0	0	1000	MIAMI DADE WATER & SEWER DEPARTMENT	Single	1200	one 1200 gallon	90	250
GDO	9076	MGRU	2	150	Processing	0	0	1800	CITY OF HIALEAH GARDENS		0	one 25-gpm	30	450
GDO	9108	IGT	5	150	Processing	0	0	875	MIAMI DADE WATER & SEWER DEPARTMENT	Single	750	one 750 gallon	90	219
GDO	9125	MGRU	5	150	Processing	0	0	1116	MIAMI DADE WATER & SEWER DEPARTMENT		0	one 50 gpm	30	279
GDO	9199	IGT	5	750	Processing	0	0	20000	MIAMI DADE WATER & SEWER DEPARTMENT	Single	1050	one 1050-gallon	90	5000
GDO	9260	IGT	5	300	Processing	0	0	4385	MIAMI DADE WATER & SEWER DEPARTMENT	Single	1500	one 1500 gallon	90	1096
GDO	9321	IGT	5	300	Processing	0	0	12259	MIAMI DADE WATER & SEWER DEPARTMENT	Single	1200	one 1200-gallon	90	3065
GDO	9340	MGRU	5	150	Processing	0	0	3700	CITY OF HIALEAH		0	one 35 gpm	30	925
GDO	9353	IGT	5	150	Processing	0	0	2000	CITY OF HIALEAH	Single	1050	one 1050 gallon	90	500
GDO	9364	IGT	5	300	Processing	0	0	4800	MIAMI DADE WATER & SEWER DEPARTMENT	Single	1050	one 1050 gallon	90	1200
GDO	9554	IGT	5	750	Processing	0	0	41200	MIAMI DADE WATER & SEWER DEPARTMENT	Series	2100	two 1050 gallon	90	10300
GDO	9705	IGT	5	300	Processing	0	0	11434	CITY OF HIALEAH	Single	950	one 950 gallon	90	2859
GDO	9741	IGT	5	300	Processing	0	0	10312	CITY OF HIALEAH	Single	1050	one 1050-gallon	90	2578
GDO	9777	IGT	5	300	Processing	0	0	4045	MIAMI DADE WATER & SEWER DEPARTMENT	Series	2850	three 950 gallon	90	1011
GDO	9886	MGRU	5	300	Processing	0	0	10560	MIAMI DADE WATER & SEWER DEPARTMENT		0	one 25 gpm	30	2640
GDO	9953	IGT	5	300	Processing	0	0	18284	MIAMI DADE WATER & SEWER DEPARTMENT	Single	1050	one 1050 gallon	90	4571
GDO	10113	IGT	5	150	Processing	0	0	2000	CITY OF HIALEAH	Single	1050	one 1050 gallon	90	500
GDO	10170	MGRU	5	150	Processing	0	0	375	CITY OF OPA LOCKA		0	one 25 gpm	30	94
GDO	10173	IGT	5	300	Processing	0	0	5050	MIAMI DADE WATER & SEWER DEPARTMENT	Single	950	one 950 gallon	60	1263
GDO	10189	IGT	5	300	Processing	0	0	4951	MIAMI DADE WATER & SEWER DEPARTMENT	Single	1050	one 1050 gallon	90	1238
GDO	10212	MGRU	5	150	Processing	0	0	2600	MIAMI DADE WATER & SEWER DEPARTMENT		0	one 25 gpm	30	650
GDO	10216	MGRU	5	150	Processing	0	0	2000	MIAMI DADE WATER & SEWER DEPARTMENT		0	one 25 gpm	30	500
GDO	10417	MGRU	5	150	Processing	0	0	900	MIAMI DADE WATER & SEWER DEPARTMENT		0	one 25 gpm	30	225
GDO	10461	MGRU	5	300	Processing	0	0	10879	MIAMI DADE WATER & SEWER DEPARTMENT		0	one 20 gpm	90	2720
GDO	10471	MGRU	5	150	Processing	0	0	1390	MIAMI DADE WATER & SEWER DEPARTMENT		0	one 25 gpm	30	348
GDO	10503	MGRU	5	150	Processing	40	40	10950	MIAMI DADE WATER & SEWER DEPARTMENT		0	two 25 gpm	30	2738
GDO	10588	IGT	5	150	Processing	0	0	3003	MIAMI DADE WATER & SEWER DEPARTMENT	Single	600	one 600-gallon	90	751
GDO	10618	AGRU	5	150	Processing	0	0	447	MIAMI DADE WATER & SEWER DEPARTMENT		0	one 25 gpm	30	112
GDO	10845	MGRU	5	150	Processing	0	0	1863	MIAMI DADE WATER & SEWER DEPARTMENT		0	one 100 gpm	60	466
GDO	10868	IGT	5	300	Processing	0	0	11014	MIAMI DADE WATER & SEWER DEPARTMENT	Single	1250	one 1250 gallon	30	2754

WORK GROUP	PERMIT NUMBER	PERMIT CLASS	PERMIT	PERMIT FEE	BUSINESS_TYPE	RECORDED SEATS	OBSERVED SEATS	FACILITY AREA	UTILITY	SYSTEM FORMAT	TOTAL CAPACITY	TANK_CAPACITY	PUMP OUT	TOTAL GPD
GDO	10989	MGRU	5	750	Processing	0	0	4200	MIAMI DADE WATER & SEWER DEPARTMENT		0	one 100 gpm	30	1050
GDO	11252	MGRU	5	150	Processing	0	0	1900	MIAMI DADE WATER & SEWER DEPARTMENT		0	one 25 gpm	30	475
GDO	11309	MGRU	5	150	Processing	0	0	916	MIAMI DADE WATER & SEWER DEPARTMENT		0	one 25 gpm	30	229
GDO	11334	MGRU	5	300	Processing	0	0	9704	MIAMI DADE WATER & SEWER DEPARTMENT		0	four 100 gpm	90	2426
GDO	11455	MGRU	5	150	Processing	0	0	6162	MIAMI DADE WATER & SEWER DEPARTMENT		0	one 15 gpm	30	1541
GDO	11599	MGRU	5	150	Processing	0	0	6000	MIAMI DADE WATER & SEWER DEPARTMENT		0	one 35 gpm	30	1500
GDO	11717	MGRU	5	150	Processing	0	0	3000	MIAMI DADE WATER & SEWER DEPARTMENT		0	one 50 gpm	60	750
GDO	11752	MGRU	5	150	Processing	0	0	2130	MIAMI DADE WATER & SEWER DEPARTMENT		0	one 35 gpm	30	533
GDO	11802	IGT	5	300	Processing	0	0	4200	MIAMI DADE WATER & SEWER DEPARTMENT	Single	1200	one 1200 gallon	60	1050
GDO	982	MGRU	5	150	Specialty	19	19	1250	MIAMI DADE WATER & SEWER DEPARTMENT		0	one 150 gpm	60	313
GDO	1160	MGRU	5	150	Specialty	15	15	0	MIAMI DADE WATER & SEWER DEPARTMENT		0	one 25 gpm	30	4
GDO	1300	MGRU	5	150	Specialty	20	20	0	MIAMI DADE WATER & SEWER DEPARTMENT		0	one 75 gpm	90	0
GDO	1487	MGRU	5	150	Specialty	0	0	0	MIAMI DADE WATER & SEWER DEPARTMENT		0	Not applicable	0	0
GDO	1548	MGRU	5	150	Specialty	58	58	0	MIAMI DADE WATER & SEWER DEPARTMENT		0	one 25 gpm	30	15
GDO	1841	IGT	5	150	Specialty	24	0	1952	CITY OF MIAMI BEACH	Single	1050	one 1050 gallon	60	488
GDO	1884	IGT	5	150	Specialty	0	0	0	CITY OF HIALEAH	Single	900	one 900 gallon	90	0
GDO	2051	MGRU	5	150	Specialty	0	0	0	MIAMI DADE WATER & SEWER DEPARTMENT		0	one 50 gpm	30	0
GDO	2192	IGT	5	150	Specialty	30	30	0	MIAMI DADE WATER & SEWER DEPARTMENT	Single	1200	one 1200 gallon	90	420
GDO	2419	MGRU	5	150	Specialty	0	0	0			0	no applicable	0	0
GDO	2420	AGRU	5	150	Specialty	25	25	0			0	one 35 gpm	30	6
GDO	2753	IGT	5	150	Specialty	0	0	440	MIAMI DADE WATER & SEWER DEPARTMENT	Single	1600	one 1600 gallon	60	110
GDO	2767	MGRU	5	150	Specialty	9	9	0			0	one 25 gpm	30	2
GDO	2997	IGT	5	150	Specialty	20	20	0	MIAMI DADE WATER & SEWER DEPARTMENT	Single	1200	one 1200 gallon	90	280
GDO	2999	MGRU	5	150	Specialty	10	10	0			0	one 25 gpm	30	3
GDO	3248	IGT	5	150	Specialty	10	0	1300	MIAMI DADE WATER & SEWER DEPARTMENT	Single	750	one 750 gallon	90	325
GDO	3390	MGRU	5	150	Specialty	8	8	943	MIAMI DADE WATER & SEWER DEPARTMENT		0	one 25 gpm	30	236
GDO	3503	IGT	5	150	Specialty	0	0	900	MIAMI DADE WATER & SEWER DEPARTMENT	Single	1200	one 1200 gallon	90	225
GDO	3538	IGT	5	150	Specialty	4	4	0	MIAMI DADE WATER & SEWER DEPARTMENT	Single	1200	one 1200 gallon	90	0
GDO	3697	AGRU	5	150	Specialty	0	0	0			0	one 25 gpm	30	0
GDO	3911	MGRU	5	150	Specialty	24	20	0	MIAMI DADE WATER & SEWER DEPARTMENT		0	one 25 gpm	30	6
GDO	4053	IGT	5	150	Specialty	0	0	0			0	Not applicable	90	0
GDO	4140	MGRU	5	150	Specialty	18	18	0	MIAMI DADE WATER & SEWER DEPARTMENT		0	Not applicable	0	5
GDO	4207	MGRU	5	150	Specialty	43	43	0	MIAMI DADE WATER & SEWER DEPARTMENT		0	one 25 gpm	30	602
GDO	4212	MGRU	5	150	Specialty	15	15	0			0	one 35 gpm	7	4
GDO	4252	MGRU	5	150	Specialty	22	0	0	MIAMI DADE WATER & SEWER DEPARTMENT		0	one 25 gpm	30	6
GDO	4275	MGRU	5	150	Specialty	17	17	0	MIAMI DADE WATER & SEWER DEPARTMENT		0	one 20 gpm	30	4
GDO	4290	MGRU	5	150	Specialty	0	0	336	MIAMI DADE WATER & SEWER DEPARTMENT		0	one 10 gpm	30	84
GDO	4456	MGRU	5	150	Specialty	45	45	0			0	one 25 gpm	30	11
GDO	4468	AGRU	5	150	Specialty	0	0	0	BAL HARBOUR VILLAGE		0	one 25 gpm	30	0
GDO	4493	IGT	5	150	Specialty	0	0	0	CITY OF MIAMI BEACH	Series	3600	three 1200 gallon	90	0
GDO	4617	IGT	5	150	Specialty	12	12	0	MIAMI DADE WATER & SEWER DEPARTMENT	Parallel	1500	two 750-gallon	90	168
GDO	4632	IGT	5	150	Specialty	34	34	0		Single	750	one 750 gallon	90	9
GDO	4678	IGT	5	150	Specialty	0	0	608	CITY OF HIALEAH	Single	4000	one 4000 gallon	90	152
GDO	4694	MGRU	5	150	Specialty	0	0	1400	CITY OF MIAMI BEACH		0	one 25 gpm	30	350
GDO	4696	IGT	5	300	Specialty	83	83	3216	CITY OF MIAMI BEACH	Single	950	one 950 gallon	90	804
GDO	4834	MGRU	5	150	Specialty	20	20	0	CITY OF HIALEAH		0	one 50 gpm	30	280
GDO	4980	IGT	5	150	Specialty	0	0	0	MIAMI DADE WATER & SEWER DEPARTMENT	Series	3200	two 1600 gallon	90	0
GDO	4989	MGRU	5	150	Specialty	25	25	0	MIAMI DADE WATER & SEWER DEPARTMENT		0	one 35 gpm	30	350
GDO	5066	MGRU	5	150	Specialty	6	6	0	MIAMI DADE WATER & SEWER DEPARTMENT		0	one 35 gpm	30	0
GDO	5074	AGRU	5	150	Specialty	6	0	800	MIAMI DADE WATER & SEWER DEPARTMENT		0	one 50 gpm	30	200
GDO	5090	IGT	5	150	Specialty	10	10	0		Single	1600	one 1600 gallon	90	3
GDO	5103	AGRU	5	150	Specialty	0	0	0			0	one 25 gpm	30	0
GDO	5185	MGRU	5	150	Specialty	0	0	0	MIAMI DADE WATER & SEWER DEPARTMENT		0	one 25 gpm	30	0
GDO	5186	IGT	5	150	Specialty	0	0	0		Single	1600	one 1600 gallon	90	0
GDO	5401	AGRU	5	150	Specialty	21	21	0	MIAMI DADE WATER & SEWER DEPARTMENT		0	one 25 gpm	30	5
GDO	5416	MGRU	5	150	Specialty	23	23	1260	MIAMI DADE WATER & SEWER DEPARTMENT		0	one 25 gpm	30	315
GDO	5657	MGRU	5	150	Specialty	0	0	1400			0	one 50 gpm	30	350
GDO	5727	IGT	5	150	Specialty	20	20	0		Single	950	one 950 gallon	90	5
GDO	5729	MGRU	5	150	Specialty	48	0	0	MIAMI DADE WATER & SEWER DEPARTMENT		0	one 100 gpm	90	13
GDO	5740	IGT	5	150	Specialty	30	30	0		Single	950	one 950 gallon	90	8
GDO	5799	IGT	5	150	Specialty	0	0	0	MIAMI DADE WATER & SEWER DEPARTMENT	Series	4000	two 2000 gallon	90	0

WORK GROUP	PERMIT NUMBER	PERMIT CLASS	PERMIT T	PERMIT FEE	BUSINESS_TYPE	RECORDED SEATS	OBSERVED SEATS	FACILITY AREA	UTILITY	SYSTEM FORMAT	TOTAL CAPACITY	TANK_CAPACITY	PUMP OUT	TOTAL GPD
GDO	5984	MGRU	5	150	Specialty	13	34	0	CITY OF MIAMI BEACH		0	one 25 gpm	30	476
GDO	6011	MGRU	5	150	Specialty	23	0	1600	CITY OF MIAMI BEACH		0	one 75 gpm	60	400
GDO	6012	MGRU	5	150	Specialty	52	52	2083	MIAMI DADE WATER & SEWER DEPARTMENT		0	one 25 gpm	30	521
GDO	6078	MGRU	5	150	Specialty	18	18	0	CITY OF MIAMI BEACH		0	one 25 gpm	30	252
GDO	6230	MGRU	5	150	Specialty	0	0	800	CITY OF NORTH MIAMI BEACH		0	one 20 gpm	30	200
GDO	6257	MGRU	5	150	Specialty	0	0	940	MIAMI DADE WATER & SEWER DEPARTMENT		0	one 25 gpm	30	235
GDO	6278	MGRU	5	150	Specialty	20	20	390	MIAMI DADE WATER & SEWER DEPARTMENT		0	one 25 gpm	30	98
GDO	6281	IGT	5	150	Specialty	16	16	0	MIAMI DADE WATER & SEWER DEPARTMENT	Single	1050	one 1050 gallon	90	0
GDO	6341	IGT	5	150	Specialty	0	0	144	MIAMI DADE WATER & SEWER DEPARTMENT	Single	1050	one 1050-gallon	90	36
GDO	6344	MGRU	5	150	Specialty	6	6	0	CITY OF MIAMI BEACH		0	one 25 gpm	30	0
GDO	6347	MGRU	5	150	Specialty	8	0	618	CITY OF MIAMI BEACH		0	one 75 gpm	30	155
GDO	6407	MGRU	5	150	Specialty	18	38	0	MIAMI DADE WATER & SEWER DEPARTMENT		0	not applicable	0	532
GDO	6419	MGRU	5	150	Specialty	0	0	0	MIAMI DADE WATER & SEWER DEPARTMENT		0	one 25 gpm	30	0
GDO	6429	MGRU	5	150	Specialty	28	28	0	MIAMI DADE WATER & SEWER DEPARTMENT		0	one 25 gpm	30	392
GDO	6454	MGRU	5	150	Specialty	10	10	1550	MIAMI DADE WATER & SEWER DEPARTMENT		0	one 25 gpm	30	140
GDO	6530	MGRU	5	150	Specialty	30	0	2670	CITY OF MIAMI BEACH		0	one 10 gpm	30	668
GDO	6555	IGT	5	150	Specialty	0	0	0	CITY OF MIAMI BEACH	Series	2500	two 1250 gallon	60	0
GDO	6573	IGT	5	150	Specialty	0	0	634	CITY OF NORTH MIAMI BEACH	Single	1050	one 1050-gallon	90	159
GDO	6598	AGRU	5	150	Specialty	17	17	2130	CITY OF MIAMI BEACH		0	one 35 gpm	30	533
GDO	6615	MGRU	5	150	Specialty	47	47	2100	MIAMI DADE WATER & SEWER DEPARTMENT		0	one 25 gpm	30	525
GDO	6714	MGRU	5	150	Specialty	45	45	0	MIAMI DADE WATER & SEWER DEPARTMENT		0	one 25 gpm	30	630
GDO	6765	MGRU	5	150	Specialty	0	0	0	MIAMI DADE WATER & SEWER DEPARTMENT		0	one 25 gpm	30	0
GDO	6846	IGT	5	150	Specialty	0	0	0	MIAMI DADE WATER & SEWER DEPARTMENT	Single	950	one 950 gallon	90	0
GDO	6872	IGT	5	150	Specialty	39	26	0	MIAMI DADE WATER & SEWER DEPARTMENT	Single	1050	one 1050 gallon	90	364
GDO	6912	MGRU	5	150	Specialty	4	4	0	CITY OF MIAMI BEACH		0	one 25 gpm	30	0
GDO	6946	MGRU	5	150	Specialty	0	0	1391	MIAMI DADE WATER & SEWER DEPARTMENT		0	one 25 gpm	90	348
GDO	7120	MGRU	5	150	Specialty	8	8	1519	MIAMI DADE WATER & SEWER DEPARTMENT		0	one 30 gpm	30	380
GDO	7131	MGRU	5	150	Specialty	30	30	0	CITY OF MIAMI BEACH		0	one 25 gpm	30	420
GDO	7140	MGRU	5	150	Specialty	24	24	0	CITY OF MIAMI BEACH		0	one 25 gpm	30	600
GDO	7259	IGT	5	150	Specialty	24	0	0	MIAMI DADE WATER & SEWER DEPARTMENT	Single	1200	one 1200 gallon	90	0
GDO	7268	MGRU	5	150	Specialty	6	6	600	MIAMI DADE WATER & SEWER DEPARTMENT		0	one 25-gpm	30	150
GDO	7416	MGRU	5	150	Specialty	0	0	800	CITY OF HIALEAH		0	one 25 gpm	30	200
GDO	7433	MGRU	5	150	Specialty	18	18	1163	CITY OF HIALEAH		0	one 25 gpm	30	291
GDO	7445	AGRU	5	150	Specialty	23	23	1470	MIAMI DADE WATER & SEWER DEPARTMENT		0	one 35 gpm	30	368
GDO	7447	MGRU	5	150	Specialty	145	145	2586	CITY OF MIAMI BEACH		0	one 25 gpm	30	794
GDO	7533	IGT	5	150	Specialty	7	7	0	MIAMI DADE WATER & SEWER DEPARTMENT	Single	1050	one 1050 gallon	90	0
GDO	7568	MGRU	5	150	Specialty	24	24	2208	CITY OF MIAMI BEACH		0	one 25 gpm	30	552
GDO	7589	MGRU	5	150	Specialty	10	10	1440	MIAMI DADE WATER & SEWER DEPARTMENT		0	one 25 gpm	30	3
GDO	7640	IGT	5	150	Specialty	64	64	2392	MIAMI DADE WATER & SEWER DEPARTMENT	Single	1050	one 1050 gallon	90	598
GDO	7641	IGT	5	150	Specialty	65	65	1952	MIAMI DADE WATER & SEWER DEPARTMENT	Single	1050	one 1050 gallon	90	488
GDO	7646	MGRU	5	150	Specialty	32	32	950	MIAMI DADE WATER & SEWER DEPARTMENT		0	one 25 gpm	30	238
GDO	7687	IGT	5	150	Specialty	42	42	2006	MIAMI DADE WATER & SEWER DEPARTMENT	Single	1200	one 1200 gallon	90	588
GDO	7719	IGT	5	150	Specialty	51	51	2000	MIAMI DADE WATER & SEWER DEPARTMENT	Single	1200	one 1200 gallon	90	500
GDO	7743	MGRU	5	150	Specialty	0	0	700	CITY OF HIALEAH		0	one 25 gpm	30	175
GDO	7837	IGT	5	150	Specialty	77	77	0	MIAMI DADE WATER & SEWER DEPARTMENT	Single	1050	one 1050 gallon	90	0
GDO	7849	MGRU	5	150	Specialty	10	0	1200	CITY OF HOMESTEAD		0	two 25 gpm	30	300
GDO	7886	IGT	5	150	Specialty	33	33	2363	MIAMI DADE WATER & SEWER DEPARTMENT	Single	750	one 750 gallon	90	591
GDO	7925	IGT	5	150	Specialty	43	43	1428	CITY OF HOMESTEAD	Single	1200	one 1200 gallon	60	357
GDO	7947	IGT	5	150	Specialty	34	34	1550	CITY OF HIALEAH	Single	950	one 950 gallon	90	476
GDO	7973	IGT	5	150	Specialty	48	48	0	MIAMI DADE WATER & SEWER DEPARTMENT	Single	1200	one 1200 gallon	60	672
GDO	7991	MGRU	5	150	Specialty	15	15	0	MIAMI DADE WATER & SEWER DEPARTMENT		0	one 25 gpm	30	0
GDO	8131	MGRU	5	150	Specialty	0	0	0	MIAMI DADE WATER & SEWER DEPARTMENT		0	not available	30	0
GDO	8149	IGT	5	150	Specialty	39	39	1712	MIAMI DADE WATER & SEWER DEPARTMENT	Single	950	one 950 gallon	90	428
GDO	8217	MGRU	5	150	Specialty	0	0	2093	MIAMI DADE WATER & SEWER DEPARTMENT		0	one 35 gpm	30	523
GDO	8327	MGRU	5	150	Specialty	40	0	1400	MIAMI DADE WATER & SEWER DEPARTMENT	Single	1250	one 1250 gallon	30	350
GDO	8333	IGT	5	150	Specialty	8	8	1200	MIAMI DADE WATER & SEWER DEPARTMENT	Single	1050	one 1050 gallon	90	300
GDO	8368	IGT	5	150	Specialty	6	0	1068	CITY OF MIAMI BEACH	Series	6000	three 2000 gallon	60	267
GDO	8560	IGT	5	150	Specialty	6	6	1600	MIAMI DADE WATER & SEWER DEPARTMENT	Single	1200	one 1200 gallon	90	400
GDO	8754	MGRU	5	150	Specialty	0	0	900	CITY OF MIAMI BEACH		0	one 25 gpm	30	225
GDO	8798	MGRU	2	150	Specialty	9	9	696	CITY OF HIALEAH		0	one 25 gpm	30	174
GDO	8830	MGRU	5	150	Specialty	0	0	1000	MIAMI DADE WATER & SEWER DEPARTMENT		0	three 15 gpm	30	250

WORK GROUP	PERMIT NUMBER	PERMIT CLASS	PERMIT	PERMIT FEE	BUSINESS_TYPE	RECORDED SEATS	OBSERVED SEATS	FACILITY AREA	UTILITY	SYSTEM FORMAT	TOTAL CAPACITY	TANK_CAPACITY	PUMP OUT	TOTAL GPD
GDO	8886	IGT	5	150	Specialty	30	30	2104	CITY OF MIAMI SPRINGS	Single	750	one 750 gallon	90	526
GDO	8892	MGRU	5	150	Specialty	8	8	1244	MIAMI DADE WATER & SEWER DEPARTMENT		0	one 25 gpm	30	311
GDO	8996	IGT	5	150	Specialty	9	9	960	MIAMI DADE WATER & SEWER DEPARTMENT	Series	4200	four 1050 gallon	90	240
GDO	9035	MGRU	5	150	Specialty	0	0	1500	MIAMI DADE WATER & SEWER DEPARTMENT		0	one 25 gpm	30	375
GDO	9039	MGRU	5	150	Specialty	0	0	1243	MIAMI DADE WATER & SEWER DEPARTMENT		0	one 25 gpm	30	311
GDO	9042	MGRU	5	150	Specialty	0	0	1366	MIAMI DADE WATER & SEWER DEPARTMENT		0	one 25 gpm	30	342
GDO	9113	IGT	5	150	Specialty	74	0	1188	MIAMI DADE WATER & SEWER DEPARTMENT	Single	750	one 750 gallon	90	297
GDO	9131	AGRU	5	150	Specialty	33	33	2025	MIAMI DADE WATER & SEWER DEPARTMENT		0	one 25 gpm	30	506
GDO	9143	IGT	5	150	Specialty	28	28	1540	MIAMI DADE WATER & SEWER DEPARTMENT	Series	2100	two 1050 gallon	90	385
GDO	9266	MGRU	5	150	Specialty	23	23	1571	MIAMI DADE WATER & SEWER DEPARTMENT		0	one 35-gpm	30	393
GDO	9267	MGRU	5	150	Specialty	0	0	853	MIAMI DADE WATER & SEWER DEPARTMENT		0	one 25 gpm	30	213
GDO	9322	MGRU	5	150	Specialty	0	0	1590	CITY OF HOMESTEAD		0	one 25 gpm	30	398
GDO	9352	MGRU	5	150	Specialty	0	0	2536	CITY OF MIAMI BEACH		0	unknown	30	634
GDO	9496	MGRU	5	150	Specialty	4	4	780	MIAMI DADE WATER & SEWER DEPARTMENT		0	one 25 gpm	30	195
GDO	9508	IGT	5	150	Specialty	0	0	986	CITY OF HIALEAH	Single	1050	one 1050-gallon	90	247
GDO	9558	IGT	5	150	Specialty	0	0	1215	MIAMI DADE WATER & SEWER DEPARTMENT	Single	1050	one 1050-gallon	90	304
GDO	9590	MGRU	5	150	Specialty	0	0	198	MIAMI DADE WATER & SEWER DEPARTMENT		0	one 25 gpm	30	50
GDO	9605	IGT	5	150	Specialty	55	55	1525	MIAMI DADE WATER & SEWER DEPARTMENT	Single	750	one 750 gallon	90	381
GDO	9607	MGRU	5	150	Specialty	0	0	1500	MIAMI DADE WATER & SEWER DEPARTMENT		0	one 25-gpm	30	375
GDO	9657	IGT	5	150	Specialty	12	12	562	MIAMI DADE WATER & SEWER DEPARTMENT	Single	1050	one 1050 gallon	90	141
GDO	9667	MGRU	5	150	Specialty	0	0	1164	MIAMI DADE WATER & SEWER DEPARTMENT		0	one 50 gpm	30	291
GDO	9701	IGT	5	150	Specialty	0	0	386	MIAMI DADE WATER & SEWER DEPARTMENT	Single	2000	one 2000 gallon	90	97
GDO	9740	IGT	5	150	Specialty	0	0	1308	MIAMI DADE WATER & SEWER DEPARTMENT	Single	1050	one 1050 gallon	90	327
GDO	9744	MGRU	5	150	Specialty	0	0	535	CITY OF MIAMI BEACH		0	one 15 gpm	30	134
GDO	9750	IGT	5	150	Specialty	0	0	1257	MIAMI DADE WATER & SEWER DEPARTMENT	Single	2000	one 2000 gallon	90	314
GDO	9792	MGRU	5	150	Specialty	0	0	475	MIAMI DADE WATER & SEWER DEPARTMENT		0	one 25 gpm	30	119
GDO	9802	MGRU	5	150	Specialty	0	0	960	MIAMI DADE WATER & SEWER DEPARTMENT		0	one 25 gpm	30	240
GDO	9807	MGRU	5	150	Specialty	0	0	390	CITY OF MIAMI BEACH		0	one 25 gpm	30	98
GDO	9815	IGT	5	150	Specialty	0	0	1290	MIAMI DADE WATER & SEWER DEPARTMENT	Single	1050	one 1050-gallon	90	323
GDO	9845	IGT	5	150	Specialty	0	0	1140	MIAMI DADE WATER & SEWER DEPARTMENT	Series	3600	three 1200-gallon	90	285
GDO	9906	MGRU	5	150	Specialty	0	0	719	MIAMI DADE WATER & SEWER DEPARTMENT		0	one 25 gpm	30	180
GDO	9916	MGRU	5	150	Specialty	4	4	680	MIAMI DADE WATER & SEWER DEPARTMENT		0	one 20 gpm	30	170
GDO	9942	MGRU	5	150	Specialty	0	0	508	MIAMI DADE WATER & SEWER DEPARTMENT		0	one 25 gpm	30	127
GDO	9944	MGRU	5	150	Specialty	52	53	2370	CITY OF MIAMI BEACH		0	one 25 gpm	30	593
GDO	9957	AGRU	5	150	Specialty	34	34	1138	MIAMI DADE WATER & SEWER DEPARTMENT		0	one 75 gpm	30	285
GDO	9974	MGRU	5	150	Specialty	8	8	960	MIAMI DADE WATER & SEWER DEPARTMENT		0	one 35 gpm	30	240
GDO	9996	IGT	5	150	Specialty	0	0	2376	MIAMI DADE WATER & SEWER DEPARTMENT	Single	1050	one 1050 gallon	90	594
GDO	10060	MGRU	5	150	Specialty	0	0	1540	MIAMI DADE WATER & SEWER DEPARTMENT		0	one 25 gpm	30	385
GDO	10091	IGT	5	150	Specialty	37	37	1730	MIAMI DADE WATER & SEWER DEPARTMENT	Single	950	one 950 gallon	90	433
GDO	10112	IGT	5	150	Specialty	0	0	1191	MIAMI DADE WATER & SEWER DEPARTMENT	Series	3150	three 1050 gallon	90	298
GDO	10123	MGRU	5	150	Specialty	0	0	640	CITY OF MIAMI BEACH		0	one turn 7 gpm hydromechanical	30	171
GDO	10139	MGRU	5	150	Specialty	0	0	819	MIAMI DADE WATER & SEWER DEPARTMENT		0	one 25 gpm	30	205
GDO	10145	IGT	2	150	Specialty	0	0	1632	MIAMI DADE WATER & SEWER DEPARTMENT	Single	1050	one 1050 gallon	90	408
GDO	10206	MGRU	5	150	Specialty	0	0	800	MIAMI DADE WATER & SEWER DEPARTMENT		0	one 75 gpm	30	200
GDO	10264	MGRU	5	150	Specialty	0	0	1967	CITY OF MIAMI BEACH		0	one 100 gpm	30	492
GDO	10275	MGRU	5	150	Specialty	25	25	1275	MIAMI DADE WATER & SEWER DEPARTMENT		0	one 25 gpm	30	319
GDO	10323	MGRU	5	150	Specialty	2	2	800	CITY OF MIAMI BEACH		0	one 25 gpm	30	200
GDO	10328	MGRU	5	150	Specialty	4	0	780	MIAMI DADE WATER & SEWER DEPARTMENT		0	one 20 gpm	30	195
GDO	10351	MGRU	5	150	Specialty	10	10	1316	CITY OF CORAL GABLES		0	one 25 and one 10 gpm	30	329
GDO	10396	MGRU	5	150	Specialty	56	56	1848	MIAMI DADE WATER & SEWER DEPARTMENT		0	one 100 gpm	60	462
GDO	10462	MGRU	5	150	Specialty	0	0	1203	MIAMI DADE WATER & SEWER DEPARTMENT		0	twenty-four 100 gpm	60	301
GDO	10465	IGT	5	150	Specialty	0	0	800	CITY OF CORAL GABLES	Single	65	one 65-gallon	90	200
GDO	10472	MGRU	5	150	Specialty	0	0	1300	MIAMI DADE WATER & SEWER DEPARTMENT		0	one 25 gpm	30	325
GDO	10477	MGRU	2	150	Specialty	0	0	208	MIAMI DADE WATER & SEWER DEPARTMENT		0	one 20 gpm	30	52
GDO	10482	MGRU	5	150	Specialty	0	0	1360	MIAMI DADE WATER & SEWER DEPARTMENT		0	one 25 gpm	30	340
GDO	10519	MGRU	5	150	Specialty	0	0	1100	MIAMI DADE WATER & SEWER DEPARTMENT		0	one 25 gpm	30	275
GDO	10527	MGRU	2	150	Specialty	0	0	421	CITY OF MIAMI BEACH		0	one 35 gpm	30	105
GDO	10528	MGRU	5	150	Specialty	0	0	0	MIAMI DADE WATER & SEWER DEPARTMENT		0	one 25 gpm	30	275

WORK GROUP	PERMIT NUMBER	PERMIT CLASS	PERMIT	PERMIT FEE	BUSINESS_TYPE	RECORDED SEATS	OBSERVED SEATS	FACILITY AREA	UTILITY	SYSTEM FORMAT	TOTAL CAPACITY	TANK_CAPACITY	PUMP OUT	TOTAL GPD
GDO	10553	IGT	5	150	Specialty	54	54	2128	MIAMI DADE WATER & SEWER DEPARTMENT	Single	1050	one 1050 gallon	90	532
GDO	10628	MGRU	5	150	Specialty	6	6	899	MIAMI DADE WATER & SEWER DEPARTMENT		0	one 50 gpm	30	225
GDO	10657	MGRU	5	150	Specialty	23	23	1427	MIAMI DADE WATER & SEWER DEPARTMENT		0	one 100 gpm	30	357
GDO	10698	IGT	5	150	Specialty	0	0	675	MIAMI DADE WATER & SEWER DEPARTMENT	Single	65	one 65 gallon	90	169
GDO	10725	MGRU	5	150	Specialty	0	0	1436	MIAMI DADE WATER & SEWER DEPARTMENT		0	one 50-gpm	30	359
GDO	10758	IGT	5	150	Specialty	0	0	1146	MIAMI DADE WATER & SEWER DEPARTMENT	Single	1250	one 1250 gallon	90	287
GDO	10764	IGT	5	150	Specialty	0	0	523	MIAMI DADE WATER & SEWER DEPARTMENT	Single	1500	one 1500 gallon	90	131
GDO	10782	MGRU	5	150	Specialty	34	34	1138	MIAMI DADE WATER & SEWER DEPARTMENT		0	one 75 gpm	30	285
GDO	10795	MGRU	5	150	Specialty	0	0	1125	MIAMI DADE WATER & SEWER DEPARTMENT		0	one 35 gpm	30	281
GDO	10798	MGRU	5	150	Specialty	0	0	741	MIAMI DADE WATER & SEWER DEPARTMENT		0	one 20 gpm	30	185
GDO	10828	IGT	5	150	Specialty	10	0	1211	MIAMI DADE WATER & SEWER DEPARTMENT	Single	1250	one 1250 gallon	90	303
GDO	10920	MGRU	5	150	Specialty	0	0	950	CITY OF CORAL GABLES		0	one 35 gpm	30	238
GDO	10927	MGRU	5	150	Specialty	24	0	2400	MIAMI DADE WATER & SEWER DEPARTMENT		0	one 100 gpm	60	600
GDO	10935	MGRU	5	150	Specialty	0	0	647	CITY OF MIAMI BEACH		0	one 15 and one 30 gpm	30	162
GDO	10949	MGRU	5	150	Specialty	12	0	1048	MIAMI DADE WATER & SEWER DEPARTMENT		0	one 25 gpm	30	262
GDO	10950	MGRU	5	150	Specialty	0	0	1056	MIAMI DADE WATER & SEWER DEPARTMENT		0	one 35 gpm	30	264
GDO	11078	MGRU	5	150	Specialty	14	0	1076	MIAMI DADE WATER & SEWER DEPARTMENT		0	one 50 gpm	30	269
GDO	11087	MGRU	5	150	Specialty	4	0	540	CITY OF CORAL GABLES		0	one 25 gpm	30	148
GDO	11106	IGT	5	150	Specialty	10	0	800	CITY OF NORTH MIAMI BEACH	Single	750	one 750 gallon	60	200
GDO	11109	MGRU	5	150	Specialty	0	0	890	MIAMI DADE WATER & SEWER DEPARTMENT		0	one 50 gpm	60	223
GDO	11113	MGRU	5	150	Specialty	20	0	1253	MIAMI DADE WATER & SEWER DEPARTMENT		0	one 35 gpm	30	348
GDO	11130	MGRU	5	150	Specialty	4	0	192	MIAMI DADE WATER & SEWER DEPARTMENT		0	one 20 gpm	30	48
GDO	11151	IGT	5	150	Specialty	71	0	2497	MIAMI DADE WATER & SEWER DEPARTMENT	Single	1250	one 1250 gallon	30	624
GDO	11162	MGRU	5	150	Specialty	8	0	1680	CITY OF HIALEAH		0	one 25 gpm	90	420
GDO	11223	MGRU	5	150	Specialty	0	0	288	MIAMI DADE WATER & SEWER DEPARTMENT		0	one 75 gpm	30	72
GDO	11249	IGT	5	150	Specialty	37	0	1112	MIAMI DADE WATER & SEWER DEPARTMENT	Single	750	one 750 gallon	30	278
GDO	11260	MGRU	5	150	Specialty	9	0	1236	CITY OF MIAMI BEACH		0	one 25 gpm	30	329
GDO	11402	MGRU	5	150	Specialty	49	0	1566	MIAMI DADE WATER & SEWER DEPARTMENT		0	three 100 gpm	60	431
GDO	11412	IGT	5	150	Specialty	0	0	506	MIAMI DADE WATER & SEWER DEPARTMENT	Single	11119	one 11,119 gallon	90	127
GDO	11429	MGRU	5	150	Specialty	66	0	2055	CITY OF MIAMI BEACH		0	two 100 gpm	90	514
GDO	11448	MGRU	5	150	Specialty	8	0	817	MIAMI DADE WATER & SEWER DEPARTMENT		0	one 15 gpm	90	204
GDO	11467	MGRU	5	150	Specialty	50	0	2154	MIAMI DADE WATER & SEWER DEPARTMENT		0	one 100 gpm	30	539
GDO	11485	MGRU	5	150	Specialty	0	0	845	MIAMI DADE WATER & SEWER DEPARTMENT		0	one 35 gpm	30	211
GDO	11494	IGT	5	150	Specialty	0	0	610	MIAMI DADE WATER & SEWER DEPARTMENT	Single	14709	one 14,709 gallon	90	153
GDO	11551	MGRU	5	150	Specialty	0	0	800	CITY OF CORAL GABLES		0	one 25 gpm	60	200
GDO	11570	MGRU	5	150	Specialty	6	0	144	MIAMI DADE WATER & SEWER DEPARTMENT		0	one 75 gpm	30	36
GDO	11610	MGRU	5	150	Specialty	0	0	1050	MIAMI DADE WATER & SEWER DEPARTMENT		0	one 75 gpm	60	263
GDO	11612	MGRU	5	150	Specialty	10	0	2300	MIAMI DADE WATER & SEWER DEPARTMENT		0	four 100 gpm	60	575
GDO	11632	MGRU	5	150	Specialty	30	0	501	CITY OF MIAMI BEACH		0	one 25 gpm	30	125
GDO	11633	IGT	5	150	Specialty	44	0	1782	MIAMI DADE WATER & SEWER DEPARTMENT	Single	1250	one 1250 gallon	60	446
GDO	11664	MGRU	5	150	Specialty	0	0	1540	MIAMI DADE WATER & SEWER DEPARTMENT		0	one 50 gpm	30	385
GDO	11675	MGRU	5	150	Specialty	16	0	975	CITY OF HOMESTEAD		0	one 20 gpm	30	244
GDO	11677	MGRU	5	150	Specialty	15	0	767	CITY OF MIAMI BEACH		0	one 15 gpm	30	192
GDO	11691	IGT	5	150	Specialty	110	0	3222	MIAMI DADE WATER & SEWER DEPARTMENT	Single	1250	one 1250 gallon	60	860
GDO	11699	MGRU	5	150	Specialty	0	0	478	MIAMI DADE WATER & SEWER DEPARTMENT		0	one 75 gpm	90	120
GDO	11707	MGRU	5	150	Specialty	13	0	1000	MIAMI DADE WATER & SEWER DEPARTMENT		0	one 35 gpm	30	250
GDO	11760	MGRU	5	150	Specialty	0	0	486	CITY OF NORTH MIAMI		0	one 10 gpm	30	122
GDO	11814	IGT	5	150	Specialty	0	0	736	MIAMI DADE WATER & SEWER DEPARTMENT	Single	3000	one 3000 gallon	60	184
GDO	11848	MGRU	5	150	Specialty	5	0	748	MIAMI DADE WATER & SEWER DEPARTMENT		0	one 50 gpm	30	187
GDO	50	IGT	5	300	Supermarket	0	0	0		Single	500	one 500 gallon	90	0
GDO	78	IGT	5	150	Supermarket	0	0	7400	MIAMI DADE WATER & SEWER DEPARTMENT	Single	1050	one 1050 gallon	90	1850
GDO	87	IGT	5	300	Supermarket	6	6	0		Single	950	one 950 gallon	90	2
GDO	130	IGT	5	300	Supermarket	47	47	0		Single	2000	one 2000 gallon	90	12
GDO	263	IGT	5	300	Supermarket	0	0	28500	MIAMI DADE WATER & SEWER DEPARTMENT	Single	1500	one 1500-gallon	90	7125
GDO	277	IGT	5	150	Supermarket	0	0	0			0	Not applicable	90	0
GDO	307	IGT	5	300	Supermarket	0	0	0		Single	1500	one 1500 gallon	90	0
GDO	323	IGT	5	300	Supermarket	10	10	0		Series	2100	two 1050 gallon	90	3
GDO	339	IGT	5	300	Supermarket	10	10	0		Single	2000	one 2000 gallon	90	3
GDO	381	IGT	5	300	Supermarket	10	10	0	MIAMI DADE WATER & SEWER DEPARTMENT	Single	1050	one 1050 gallon	90	140
GDO	394	IGT	5	300	Supermarket	5	5	0		Single	2400	two 1200 gallon	90	1

WORK GROUP	PERMIT NUMBER	PERMIT CLASS	PERMIT	PERMIT FEE	BUSINESS_TYPE	RECORDED SEATS	OBSERVED SEATS	FACILITY AREA	UTILITY	SYSTEM FORMAT	TOTAL CAPACITY	TANK_CAPACITY	PUMP OUT	TOTAL GPD
GDO	395	IGT	5	300	Supermarket	0	0	0		Series	2400	two 1200 gallon	90	0
GDO	396	IGT	5	300	Supermarket	10	10	0		Series	3000	two 1500 gallon	90	3
GDO	409	IGT	5	300	Supermarket	0	0	0		Single	1500	one 1500 gallon	90	0
GDO	426	IGT	5	300	Supermarket	0	0	0		Series	1200	one 1200 gallon	90	0
GDO	428	IGT	5	300	Supermarket	0	0	0		Series	2700	two 1350 gallon	90	0
GDO	429	IGT	5	300	Supermarket	0	0	0		Series	1500	two 750 gallon	90	0
GDO	434	IGT	5	300	Supermarket	0	0	0		Series	2400	two 1200 gallon	90	0
GDO	438	IGT	5	150	Supermarket	14	32	2000	MIAMI DADE WATER & SEWER DEPARTMENT	Single	750	one 750 gallon	90	500
GDO	459	IGT	5	300	Supermarket	0	0	0		Single	1200	one 1200 gallon	90	0
GDO	460	IGT	5	300	Supermarket	5	5	0		Single	1050	one 1050 gallon	90	1
GDO	461	IGT	5	300	Supermarket	0	0	0		Series	2400	two 1200 gallon	90	0
GDO	465	IGT	5	300	Supermarket	0	0	0	CITY OF CORAL GABLES	Series	1600	two 800 gallon	90	0
GDO	475	IGT	5	300	Supermarket	0	0	0		Single	1200	one 1200 gallon	60	0
GDO	477	IGT	5	300	Supermarket	10	10	0		Parallel	3200	two 1600 gallon	90	3
GDO	484	IGT	5	300	Supermarket	5	5	0		Series	2100	two 1050 gallon	90	1
GDO	497	IGT	5	300	Supermarket	0	0	0		Single	1200	one 1200 gallon	90	0
GDO	530	IGT	5	300	Supermarket	8	8	0	MIAMI DADE WATER & SEWER DEPARTMENT	Single	900	one 900 gallon	90	2
GDO	537	IGT	5	300	Supermarket	0	0	4705	MIAMI DADE WATER & SEWER DEPARTMENT	Series	2700	one 1200 and one 1500 gallon	60	10176
GDO	569	IGT	2	300	Supermarket	30	30	0		Single	1050	one 1050-gallon	90	8
GDO	607	IGT	5	300	Supermarket	0	0	0		Single	1200	one 1200 gallon	90	0
GDO	616	IGT	5	300	Supermarket	0	0	0	MIAMI DADE WATER & SEWER DEPARTMENT	Single	2400	two 1200 gallon	90	0
GDO	618	IGT	5	300	Supermarket	0	0	0		Single	1500	one 1500 gallon	90	0
GDO	630	IGT	5	300	Supermarket	0	0	0		Series	2400	two 1200 gallon	90	0
GDO	639	IGT	5	300	Supermarket	0	0	0		Multiple	2400	two 1200 gallon	90	0
GDO	643	IGT	5	300	Supermarket	0	0	0	MIAMI DADE WATER & SEWER DEPARTMENT	Single	1600	one 1600 gallon	90	0
GDO	678	IGT	5	300	Supermarket	0	0	0		Single	1200	one 1200 gallon	90	0
GDO	686	IGT	5	300	Supermarket	0	0	0		Series	2400	two 1200-gallon	90	0
GDO	694	IGT	5	300	Supermarket	30	30	0		Single	1500	one 1500 gallon	90	8
GDO	702	IGT	5	300	Supermarket	0	0	0		Series	2100	two 1050 gallon	90	0
GDO	704	IGT	5	300	Supermarket	0	0	0		Single	1800	one 1800 gallon	90	0
GDO	713	IGT	5	300	Supermarket	0	0	0	MIAMI DADE WATER & SEWER DEPARTMENT	Multiple	2400	two 1200 gallon	90	0
GDO	715	IGT	5	300	Supermarket	0	0	0		Single	1500	one 1500 gallon	90	0
GDO	750	IGT	5	300	Supermarket	0	0	0		Series	2000	two 1000 gallon	90	0
GDO	758	IGT	5	300	Supermarket	0	0	0		Series	2000	two 1000 gallon	90	0
GDO	792	MGRU	5	150	Supermarket	0	0	2000	MIAMI DADE WATER & SEWER DEPARTMENT		0	one 25 gpm	30	500
GDO	800	IGT	5	300	Supermarket	0	0	0	MIAMI DADE WATER & SEWER DEPARTMENT	Single	1200	one 1200 gallon	90	0
GDO	821	IGT	5	300	Supermarket	0	0	0	MIAMI DADE WATER & SEWER DEPARTMENT	Single	950	one 950 gallon	90	0
GDO	828	IGT	5	300	Supermarket	0	0	0	CITY OF HIALEAH	Series	2100	two 1050 gallon	90	0
GDO	883	IGT	5	300	Supermarket	0	0	45600	CITY OF MIAMI BEACH	Series	2500	two 1250 gallon	90	11400
GDO	886	IGT	5	150	Supermarket	0	0	0		Single	1200	one 1200 gallon	90	0
GDO	912	IGT	5	300	Supermarket	10	10	0		Series	2700	one 1200 & one 1500 gallon	90	3
GDO	913	IGT	5	150	Supermarket	0	0	0			750	one 750 gallon	90	0
GDO	924	IGT	5	150	Supermarket	0	0	0		Single	1050	one 1050 gallon	90	0
GDO	967	IGT	5	300	Supermarket	0	0	0		Multiple	3150	three 1050 gallon	90	0
GDO	979	IGT	5	300	Supermarket	0	0	0		Multiple	3000	two 1500 gallon	90	0
GDO	991	IGT	5	300	Supermarket	1	1	0		Single	1050	one 1050 gallon	90	0
GDO	1005	IGT	5	150	Supermarket	0	0	0		Single	1200	one 1200 gallon	90	0
GDO	1018	IGT	5	150	Supermarket	0	0	2896	MIAMI DADE WATER & SEWER DEPARTMENT	Single	1050	one 1050 gallon	90	724
GDO	1030	IGT	5	300	Supermarket	0	0	0		Single	4000	one 4000 gallon	90	0
GDO	1083	IGT	5	150	Supermarket	0	0	0	MIAMI DADE WATER & SEWER DEPARTMENT	Single	1200	one 1200 gallon	90	0
GDO	1084	IGT	5	300	Supermarket	0	0	0	MIAMI DADE WATER & SEWER DEPARTMENT	Single	1200	one 1200 gallon	90	0
GDO	1124	IGT	5	300	Supermarket	30	30	0		Multiple	1500	two 750 gallon	90	420
GDO	1167	IGT	5	300	Supermarket	0	0	7200	CITY OF HIALEAH	Single	1200	one 1200 gallon	90	1800
GDO	1172	IGT	5	300	Supermarket	0	0	25766	CITY OF HIALEAH	Single	1500	one 1500 gallon	90	6442
GDO	1205	MGRU	5	150	Supermarket	0	0	3800	MIAMI DADE WATER & SEWER DEPARTMENT		0	one 25 gpm	30	950
GDO	1216	IGT	5	300	Supermarket	0	0	0		Single	950	one 950 gallon	90	0
GDO	1302	IGT	5	150	Supermarket	0	0	0		Single	1200	one 1200 gallon	90	0
GDO	1315	IGT	5	300	Supermarket	0	0	0	CITY OF HIALEAH	Single	1200	one 1200 gallon	90	0
GDO	1316	IGT	5	300	Supermarket	14	14	0	CITY OF HIALEAH	Single	1200	one 1200 gallon	90	196

WORK GROUP	PERMIT NUMBER	PERMIT CLASS	PERMIT	PERMIT FEE	BUSINESS_TYPE	RECORDED SEATS	OBSERVED SEATS	FACILITY AREA	UTILITY	SYSTEM FORMAT	TOTAL CAPACITY	TANK_CAPACITY	PUMP OUT	TOTAL GPD
GDO	1362	IGT	5	300	Supermarket	0	0	0		Single	1200	one 1200 gallon	90	0
GDO	1363	IGT	5	300	Supermarket	14	14	0	MIAMI DADE WATER & SEWER DEPARTMENT	Series	2500	two 1250 gallon	90	4
GDO	1364	IGT	5	300	Supermarket	5	5	0		Series	2400	two 1200 gallon	90	1
GDO	1366	IGT	5	300	Supermarket	0	0	0		Single	1500	one 1500 gallon	90	0
GDO	1369	IGT	5	300	Supermarket	22	22	0		Single	1200	one 1200 gallon	90	6
GDO	1400	IGT	5	300	Supermarket	0	0	0		Multiple	3300	two 900 and one 1500 gallon	90	0
GDO	1411	IGT	5	300	Supermarket	0	0	0		Single	1050	one 1050 gallon	90	0
GDO	1412	IGT	5	300	Supermarket	55	55	0	MIAMI DADE WATER & SEWER DEPARTMENT	Multiple	3150	three 1050 gallon	90	14
GDO	1413	IGT	5	300	Supermarket	0	0	0	MIAMI DADE WATER & SEWER DEPARTMENT	Multiple	1200	one 1200-gallon	90	0
GDO	1414	IGT	5	300	Supermarket	0	0	0	MIAMI DADE WATER & SEWER DEPARTMENT	Series	2500	two 1250 gallon	90	0
GDO	1415	IGT	5	300	Supermarket	0	0	0	MIAMI DADE WATER & SEWER DEPARTMENT	Series	2100	two 1050 gallon	90	0
GDO	1434	IGT	5	300	Supermarket	0	0	4254	MIAMI DADE WATER & SEWER DEPARTMENT	Single	750	one 750 gallon	90	1064
GDO	1442	IGT	5	300	Supermarket	14	14	0		Series	2250	three 750 gallon	60	4
GDO	1445	IGT	5	300	Supermarket	0	0	0	MIAMI DADE WATER & SEWER DEPARTMENT	Single	1000	one 1000 gallon	90	0
GDO	1452	IGT	5	150	Supermarket	0	0	0		Single	750	one 750 gallon	90	0
GDO	1473	IGT	5	300	Supermarket	16	16	0		Single	1200	one 1200 gallon	90	4
GDO	1475	IGT	5	300	Supermarket	0	0	0		Series	2400	two 1200 gallon	90	0
GDO	1480	IGT	5	300	Supermarket	0	0	0		Single	1200	one 1200 gallon	90	0
GDO	1510	IGT	5	150	Supermarket	0	0	0		Single	1050	one 1050 gallon	90	0
GDO	1541	IGT	5	150	Supermarket	20	0	686	MIAMI DADE WATER & SEWER DEPARTMENT	Single	750	one 750 gallon	90	172
GDO	1611	IGT	5	300	Supermarket	3	3	0	CITY OF HIALEAH		0	one 1050 gallon	90	1
GDO	1656	IGT	5	300	Supermarket	7	7	0	MIAMI DADE WATER & SEWER DEPARTMENT	Single	1050	one 1050 gallon	90	2
GDO	1677	IGT	5	150	Supermarket	16	16	2000	MIAMI DADE WATER & SEWER DEPARTMENT	Single	380	one 380-gallon	90	500
GDO	1684	IGT	5	300	Supermarket	42	42	0		Series	2000	two 1000 gallon	90	11
GDO	1695	MGRU	5	150	Supermarket	0	0	0	MIAMI DADE WATER & SEWER DEPARTMENT		0	one 25-gpm	30	0
GDO	1705	IGT	5	300	Supermarket	0	0	0	CITY OF HIALEAH	Series	2400	two 1200 gallon	90	0
GDO	1713	IGT	5	300	Supermarket	0	0	0		Single	1050	one 1050 gallon	90	0
GDO	1717	IGT	5	300	Supermarket	0	0	0	MIAMI DADE WATER & SEWER DEPARTMENT	Single	1200	one 1200 gallon	90	0
GDO	1721	IGT	5	300	Supermarket	0	0	0	MIAMI DADE WATER & SEWER DEPARTMENT	Single	1200	one 1200 gallon	90	0
GDO	1730	IGT	5	300	Supermarket	1	1	0		Series	2400	two 1200 gallon	90	0
GDO	1745	IGT	5	300	Supermarket	0	0	4500	MIAMI DADE WATER & SEWER DEPARTMENT	Single	1250	one 1250-gallon	90	1125
GDO	1786	IGT	5	300	Supermarket	0	0	0		Series	2400	two 1200 gallon	90	0
GDO	1787	IGT	5	300	Supermarket	0	0	0	CITY OF HIALEAH	Single	900	one 900 gallon	90	0
GDO	1789	IGT	5	300	Supermarket	22	22	0		Series	2400	two 1200 gallon	90	6
GDO	1794	IGT	5	300	Supermarket	0	0	0		Single	1200	one 1200 gallon	90	0
GDO	1800	IGT	5	300	Supermarket	4	4	12000		Single	950	one 950 gallon	90	3000
GDO	1804	MGRU	5	300	Supermarket	0	0	0	CITY OF MIAMI BEACH		0	one 25 gpm	30	0
GDO	1836	IGT	5	300	Supermarket	0	0	0	MIAMI DADE WATER & SEWER DEPARTMENT	Single	1200	one 1200 gallon	90	0
GDO	1838	IGT	5	300	Supermarket	0	0	0	CITY OF MIAMI BEACH	Single	1500	one 1500 gallon	90	0
GDO	1869	IGT	5	300	Supermarket	0	0	0	CITY OF HIALEAH	Single	1050	one 1050 gallon	90	0
GDO	1902	IGT	5	300	Supermarket	12	12	0		Single	950	one 950 gallon	90	3
GDO	1914	IGT	5	300	Supermarket	14	14	0		Multiple	3150	three 1050 gallon	90	4
GDO	1920	IGT	5	150	Supermarket	0	0	0	CITY OF HIALEAH	Single	1200	one 1200 gallon	90	0
GDO	1945	IGT	5	300	Supermarket	10	10	27562	MIAMI DADE WATER & SEWER DEPARTMENT	Series	2500	two 1250 gallon	90	6891
GDO	1947	IGT	5	300	Supermarket	0	0	9300	CITY OF MIAMI BEACH	Single	1050	one 1050-gallon	90	2325
GDO	1969	IGT	5	300	Supermarket	10	10	0		Series	1900	two 950 gallon	90	3
GDO	2025	MGRU	5	150	Supermarket	0	0	676	MIAMI DADE WATER & SEWER DEPARTMENT		0	one 50 gpm	30	169
GDO	2049	IGT	5	300	Supermarket	5	5	12500	MIAMI DADE WATER & SEWER DEPARTMENT	Single	950	one 950 gallon	90	3125
GDO	2057	IGT	5	300	Supermarket	0	0	0	CITY OF NORTH MIAMI BEACH	Series	2500	two 1250 gallon	90	0
GDO	2094	IGT	5	300	Supermarket	1	1	0		Single	1200	one 1200 gallon	90	0
GDO	2099	IGT	5	300	Supermarket	0	0	0		Single	1200	one 1200 gallon	90	0
GDO	2126	IGT	5	150	Supermarket	0	0	0	CITY OF NORTH MIAMI BEACH	Single	750	one 750 gallon	90	0
GDO	2229	IGT	5	300	Supermarket	0	0	0	MIAMI DADE WATER & SEWER DEPARTMENT	Single	1050	one 1050 gallon	90	0
GDO	2234	IGT	5	300	Supermarket	0	0	23896	MIAMI DADE WATER & SEWER DEPARTMENT	Single	950	one 950 gallon	90	5974
GDO	2454	IGT	5	150	Supermarket	0	0	0	CITY OF HIALEAH	Single	950	one 950 gallon	90	0
GDO	2460	IGT	5	150	Supermarket	0	0	500	MIAMI DADE WATER & SEWER DEPARTMENT	Single	750	one 750-gallon	90	125
GDO	2465	IGT	5	150	Supermarket	0	0	12000	CITY OF OPA LOCKA	Single	750	one 750 gallon	90	3000
GDO	2483	IGT	5	150	Supermarket	0	0	2678	MIAMI DADE WATER & SEWER DEPARTMENT		950	one 950 gallon	90	670
GDO	2486	IGT	5	300	Supermarket	0	0	0	MIAMI DADE WATER & SEWER DEPARTMENT	Single	1200	one 1200 gallon	90	0
GDO	2491	IGT	5	300	Supermarket	0	0	0	MIAMI DADE WATER & SEWER DEPARTMENT	Single	1500	one 1500 gallon	90	0

WORK GROUP	PERMIT NUMBER	PERMIT CLASS	PERMIT	PERMIT FEE	BUSINESS_TYPE	RECORDED SEATS	OBSERVED SEATS	FACILITY AREA	UTILITY	SYSTEM FORMAT	TOTAL CAPACITY	TANK_CAPACITY	PUMP OUT	TOTAL GPD
GDO	2501	IGT	5	300	Supermarket	0	0	0	MIAMI DADE WATER & SEWER DEPARTMENT	Single	1200	one 1200 gallon	90	0
GDO	2509	IGT	5	300	Supermarket	0	0	0		Series	1500	two 750 gallon	90	0
GDO	2545	MGRU	5	150	Supermarket	0	0	2200	CITY OF MIAMI BEACH		0	one 25 gpm	30	550
GDO	2591	IGT	5	150	Supermarket	0	0	0		Single	950	one 950 gallon	90	0
GDO	2612	IGT	5	300	Supermarket	0	0	0		Series	2500	two 1250 gallon	90	0
GDO	2686	IGT	5	300	Supermarket	0	0	0		Single	1200	one 1200 gallon	90	0
GDO	2720	IGT	5	300	Supermarket	72	72	0	CITY OF HIALEAH	Single	950	one 950 gallon	90	1008
GDO	2746	IGT	5	150	Supermarket	0	0	4500	MIAMI DADE WATER & SEWER DEPARTMENT	Single	750	one 750 gallon	90	0
GDO	2782	IGT	5	150	Supermarket	0	0	24000	MIAMI DADE WATER & SEWER DEPARTMENT	Series	2100	two 1050 gallon	60	6000
GDO	2825	IGT	5	300	Supermarket	0	0	0	MIAMI DADE WATER & SEWER DEPARTMENT	Single	950	one 950 gallon	90	0
GDO	2846	IGT	5	300	Supermarket	0	0	0		Single	750	one 750 gallon	90	0
GDO	2865	IGT	5	300	Supermarket	0	0	0		Single	1200	one 1200 gallon	90	0
GDO	2875	IGT	5	300	Supermarket	0	0	0		Series	2400	two 1200 gallon	90	0
GDO	2900	MGRU	5	150	Supermarket	0	0	2000	MIAMI DADE WATER & SEWER DEPARTMENT		0	one 10 gpm	30	500
GDO	2911	MGRU	5	150	Supermarket	20	0	4223	MIAMI DADE WATER & SEWER DEPARTMENT		0	one 100 gpm	30	225
GDO	2937	MGRU	5	150	Supermarket	0	0	3000	MIAMI DADE WATER & SEWER DEPARTMENT		0	one 75 gpm	60	750
GDO	2977	IGT	5	150	Supermarket	0	0	900	CITY OF HIALEAH	Single	750	one 750 gallon	90	225
GDO	3071	IGT	5	150	Supermarket	0	0	4568	MIAMI DADE WATER & SEWER DEPARTMENT	Single	750	one 750 gallon	90	1142
GDO	3138	IGT	5	150	Supermarket	0	0	5000	MIAMI DADE WATER & SEWER DEPARTMENT	Single	750	one 750 gallon	90	1250
GDO	3198	MGRU	2	150	Supermarket	0	0	0			0	one 25 gpm	30	0
GDO	3201	AGRU	5	300	Supermarket	0	0	5000	MIAMI DADE WATER & SEWER DEPARTMENT		0	one 25 gpm	30	1250
GDO	3206	MGRU	5	150	Supermarket	0	0	0			0	one 25 gpm	30	0
GDO	3247	IGT	5	300	Supermarket	0	0	0	CITY OF HIALEAH	Single	750	one 750 gallon	90	0
GDO	3253	IGT	5	300	Supermarket	14	14	0		Multiple	1800	one 750 & one 1050 gallon	90	4
GDO	3324	IGT	5	300	Supermarket	0	0	0		Single	1050	one 1050 gallon	90	0
GDO	3368	IGT	5	300	Supermarket	0	0	0		Series	2000	two 1000 gallon	90	0
GDO	3416	IGT	5	300	Supermarket	0	0	0	MIAMI DADE WATER & SEWER DEPARTMENT	Single	1050	one 1050 gallon	90	0
GDO	3429	IGT	5	300	Supermarket	0	0	4000	MIAMI DADE WATER & SEWER DEPARTMENT	Single	1050	one 1050 gallon	90	1000
GDO	3439	IGT	5	300	Supermarket	0	0	0		Series	3000	two 1500 gallon	90	0
GDO	3495	IGT	5	300	Supermarket	0	0	0	CITY OF SURFSIDE	Series	2400	two 1200 gallon	90	0
GDO	3559	IGT	5	150	Supermarket	0	0	0		Single	950	one 950 gallon	90	0
GDO	3582	IGT	5	300	Supermarket	30	30	0	MIAMI DADE WATER & SEWER DEPARTMENT	Single	1050	one 1050 gallon	90	0
GDO	3675	IGT	5	300	Supermarket	0	0	0		Series	2500	two 1250 gallon	90	0
GDO	3676	IGT	5	300	Supermarket	0	0	0		Series	2500	two 1250 gallon	90	0
GDO	3677	IGT	5	300	Supermarket	0	0	0		Series	2400	two 1200 gallon	90	0
GDO	3724	MGRU	5	150	Supermarket	8	8	2500	MIAMI DADE WATER & SEWER DEPARTMENT		0	one 25 gpm	30	625
GDO	3793	MGRU	5	150	Supermarket	0	0	0	MIAMI DADE WATER & SEWER DEPARTMENT		0	one 25 gpm	30	0
GDO	3794	IGT	5	150	Supermarket	10	10	11888	MIAMI DADE WATER & SEWER DEPARTMENT	Single	1050	one 1050 gallon	90	2972
GDO	3969	IGT	5	300	Supermarket	0	0	0		Series	2400	two 1200 gallon	90	0
GDO	4001	MGRU	5	150	Supermarket	0	0	2400	MIAMI DADE WATER & SEWER DEPARTMENT		0	one 10 gpm	30	600
GDO	4020	IGT	5	300	Supermarket	16	0	7736	MIAMI DADE WATER & SEWER DEPARTMENT	Single	750	one 750 gallon	60	1934
GDO	4046	IGT	5	300	Supermarket	0	0	0		Series	2500	two 1250 gallon	90	0
GDO	4051	IGT	5	300	Supermarket	0	0	0		Single	950	one 950 gallon	90	0
GDO	4103	IGT	5	150	Supermarket	0	0	0		Single	1050	one 1050 gallon	90	0
GDO	4303	IGT	5	300	Supermarket	0	0	0	MIAMI DADE WATER & SEWER DEPARTMENT	Series	3250	one 1250 and one 2000 gallon	90	0
GDO	4581	IGT	5	300	Supermarket	9	9	0		Single	1200	one 1200 gallon	90	2
GDO	4659	IGT	5	300	Supermarket	0	0	0	CITY OF HOMESTEAD	Single	1200	one 1200 gallon	90	0
GDO	4758	IGT	5	300	Supermarket	0	0	0		Single	1500	one 1500 gallon	90	0
GDO	4776	IGT	5	300	Supermarket	12	12	0	CITY OF HIALEAH	Series	2500	two 1250 gallon	90	3
GDO	4795	IGT	5	300	Supermarket	0	0	0		Multiple	2400	two 1200 gallon	90	0
GDO	4920	MGRU	5	150	Supermarket	0	0	0			0	one 25 gpm	30	0
GDO	5041	IGT	5	300	Supermarket	0	0	0		Single	1200	one 1200 gallon	90	0
GDO	5120	IGT	5	300	Supermarket	6	6	2100		Single	1500	one 1500 gallon	90	525
GDO	5143	IGT	5	300	Supermarket	0	0	500	CITY OF HIALEAH	Single	750	one 750 gallon	90	125
GDO	5222	IGT	5	300	Supermarket	0	0	0	MIAMI DADE WATER & SEWER DEPARTMENT	Parallel	2100	two 1050 gallon	90	0
GDO	5337	IGT	5	150	Supermarket	0	0	0		Single	1050	one 1050 gallon	90	0
GDO	5369	IGT	5	300	Supermarket	0	0	0	MIAMI DADE WATER & SEWER DEPARTMENT	Single	750	one 750 gallon	90	0
GDO	5533	IGT	5	300	Supermarket	0	0	0	MIAMI DADE WATER & SEWER DEPARTMENT	Single	1600	one 1600 gallon	90	0
GDO	5562	IGT	5	300	Supermarket	0	0	0		Single	1600	one 1600 gallon	90	0

WORK GROUP	PERMIT NUMBER	PERMIT CLASS	PERMIT	PERMIT FEE	BUSINESS_TYPE	RECORDED SEATS	OBSERVED SEATS	FACILITY AREA	UTILITY	SYSTEM FORMAT	TOTAL CAPACITY	TANK_CAPACITY	PUMP OUT	TOTAL GPD
GDO	5576	IGT	5	300	Supermarket	0	0	0	MIAMI DADE WATER & SEWER DEPARTMENT	Series	2500	two 1250 gallon	90	0
GDO	5757	IGT	5	300	Supermarket	0	0	0	CITY OF HIALEAH	Series	4000	two 2000 gallon	90	0
GDO	5776	IGT	5	300	Supermarket	0	0	0	MIAMI DADE WATER & SEWER DEPARTMENT	Series	2500	two 1250 gallon	90	0
GDO	5814	IGT	5	300	Supermarket	24	24	0		Single	1200	one 1200 gallon	90	336
GDO	5877	IGT	5	150	Supermarket	0	0	0		Single	1200	one 1200 gallon	90	0
GDO	6046	IGT	5	300	Supermarket	0	0	0	MIAMI DADE WATER & SEWER DEPARTMENT	Series	3200	two 1600 gallon	90	0
GDO	6221	IGT	5	150	Supermarket	0	0	0	MIAMI DADE WATER & SEWER DEPARTMENT	Single	750	one 750 gallon	90	0
GDO	6245	MGRU	5	150	Supermarket	0	0	0	MIAMI DADE WATER & SEWER DEPARTMENT		0	one 25 gpm	30	0
GDO	6321	IGT	5	150	Supermarket	0	0	0	MIAMI DADE WATER & SEWER DEPARTMENT	Single	1050	one 1050 gallon	90	0
GDO	6325	IGT	5	300	Supermarket	0	0	0	CITY OF NORTH MIAMI BEACH	Series	2400	two 1200 gallon	90	0
GDO	6437	IGT	5	300	Supermarket	0	0	0	MIAMI DADE WATER & SEWER DEPARTMENT	Series	2500	two 1250 gallon	90	0
GDO	6591	IGT	5	300	Supermarket	0	0	0	MIAMI DADE WATER & SEWER DEPARTMENT	Series	2100	two 1050 gallon	90	0
GDO	6651	IGT	5	150	Supermarket	0	0	0	MIAMI DADE WATER & SEWER DEPARTMENT	Single	1050	one 1050 gallon	90	0
GDO	6671	IGT	5	300	Supermarket	0	0	24026	MIAMI DADE WATER & SEWER DEPARTMENT	Single	1050	one 1050 gallon	90	6007
GDO	7066	IGT	5	300	Supermarket	0	0	0	MIAMI DADE WATER & SEWER DEPARTMENT	Series	2500	two 1250 gallon	90	0
GDO	7127	IGT	5	150	Supermarket	0	0	0	MIAMI DADE WATER & SEWER DEPARTMENT	Single	950	one 950 gallon	90	0
GDO	7165	IGT	5	150	Supermarket	0	0	0	MIAMI DADE WATER & SEWER DEPARTMENT	Single	950	one 950 gallon	90	0
GDO	7212	IGT	5	300	Supermarket	0	0	0	CITY OF NORTH MIAMI BEACH	Multiple	3150	three 1050 gallon	90	0
GDO	7253	IGT	2	300	Supermarket	0	0	5500	CITY OF HIALEAH	Single	1200	one 1200 gallon	90	1375
GDO	7347	IGT	5	150	Supermarket	0	0	0	CITY OF HIALEAH	Single	750	one 750 gallon	90	0
GDO	7404	IGT	5	150	Supermarket	0	0	0	MIAMI DADE WATER & SEWER DEPARTMENT	Single	950	one 950 gallon	90	0
GDO	7450	IGT	5	150	Supermarket	0	0	0	CITY OF HIALEAH	Single	950	one 950 gallon	90	0
GDO	7456	IGT	5	300	Supermarket	79	79	0	MIAMI DADE WATER & SEWER DEPARTMENT	Series	2100	two 1050 gallon	90	0
GDO	7587	MGRU	5	150	Supermarket	0	0	0	CITY OF MIAMI BEACH		0	one 25 gpm	30	0
GDO	7597	IGT	5	300	Supermarket	138	138	0	MIAMI DADE WATER & SEWER DEPARTMENT	Series	2400	two 1200 gallon	90	1932
GDO	7647	IGT	5	300	Supermarket	0	0	6031	MIAMI DADE WATER & SEWER DEPARTMENT	Series	1900	two 950 gallon	90	0
GDO	7677	IGT	5	300	Supermarket	0	0	0	MIAMI DADE WATER & SEWER DEPARTMENT	Single	950	one 950 gallon	90	0
GDO	7790	IGT	5	300	Supermarket	0	0	0	CITY OF HOMESTEAD	Series	2500	two 1250 gallon	90	0
GDO	7809	IGT	5	300	Supermarket	12	12	924	MIAMI DADE WATER & SEWER DEPARTMENT	Single	1200	one 1200 gallon	90	231
GDO	7815	IGT	5	300	Supermarket	0	0	0	MIAMI DADE WATER & SEWER DEPARTMENT	Single	1200	one 1200 gallon	90	0
GDO	7848	IGT	5	150	Supermarket	0	0	0	CITY OF HOMESTEAD	Single	1050	one 1050 gallon	90	0
GDO	8104	IGT	5	150	Supermarket	0	0	4600	MIAMI DADE WATER & SEWER DEPARTMENT	Single	1050	one 1050 gallon	90	1150
GDO	8110	IGT	5	300	Supermarket	0	0	44146	CITY OF MIAMI BEACH	Series	1250	two 1250 gallon	90	0
GDO	8129	IGT	5	300	Supermarket	8	8	37000	MIAMI DADE WATER & SEWER DEPARTMENT	Single	950	one 950 gallon	90	112
GDO	8174	IGT	5	150	Supermarket	0	0	0	CITY OF MIAMI SPRINGS	Single	1050	one 1050 gallon	90	0
GDO	8236	IGT	5	150	Supermarket	0	0	0	MIAMI DADE WATER & SEWER DEPARTMENT	Single	1050	one 1050 gallon	90	0
GDO	8593	IGT	5	300	Supermarket	4	4	40000	MIAMI DADE WATER & SEWER DEPARTMENT	Single	950	one 950 gallon	90	10000
GDO	8614	IGT	5	300	Supermarket	0	0	28338	CITY OF MIAMI BEACH	Single	1250	one 1250 gallon	90	7085
GDO	8693	IGT	5	300	Supermarket	0	0	20171	CITY OF NORTH MIAMI	Single	750	one 750-gallon	90	5043
GDO	8703	IGT	5	300	Supermarket	0	0	45171	MIAMI DADE WATER & SEWER DEPARTMENT		0	not available	90	11293
GDO	8704	IGT	5	300	Supermarket	0	0	45600	MIAMI DADE WATER & SEWER DEPARTMENT	Series	2400	two 1200 gallon	90	11400
GDO	8720	IGT	5	300	Supermarket	0	0	19600	CITY OF NORTH MIAMI BEACH	Single	1050	one 1050 gallon	90	4900
GDO	8773	IGT	5	150	Supermarket	0	0	32000	MIAMI DADE WATER & SEWER DEPARTMENT	Single	1050	one 1050 gallon	90	8000
GDO	8785	IGT	5	300	Supermarket	0	0	39203	CITY OF HIALEAH	Series	2500	two 1250-gallon	90	9801
GDO	8808	IGT	5	150	Supermarket	0	0	4000	MIAMI DADE WATER & SEWER DEPARTMENT	Single	950	one 950 gallon	60	1000
GDO	8821	MGRU	5	150	Supermarket	0	0	3000	CITY OF MIAMI BEACH		0	one 25 gpm	30	750
GDO	8963	IGT	5	300	Supermarket	0	0	10000	CITY OF NORTH MIAMI	Single	750	one 750 gallon	90	2500
GDO	9013	IGT	5	300	Supermarket	0	0	19709	MIAMI DADE WATER & SEWER DEPARTMENT		0	unknown	90	4927
GDO	9121	IGT	5	300	Supermarket	0	0	49204	MIAMI DADE WATER & SEWER DEPARTMENT	Series	2500	two 1250 gallon	90	12301
GDO	9232	IGT	5	300	Supermarket	0	0	39600	CITY OF HIALEAH	Series	2500	two 1250 gallon	90	9900
GDO	9398	IGT	5	300	Supermarket	0	0	28800	MIAMI DADE WATER & SEWER DEPARTMENT	Series	2500	two 1250 gallon	90	7200
GDO	9443	IGT	5	300	Supermarket	0	0	30885	CITY OF HIALEAH	Single	1250	one 1250-gallon	90	7721
GDO	9450	IGT	5	300	Supermarket	0	0	45600	CITY OF HOMESTEAD	Series	2500	two 1250 gallon	90	11400
GDO	9478	IGT	5	300	Supermarket	0	0	47400	MIAMI DADE WATER & SEWER DEPARTMENT	Series	2500	two 1250 gallon	90	11850
GDO	9479	IGT	5	300	Supermarket	0	0	38997	CITY OF NORTH MIAMI	Series	2500	two 1250 gallon	90	9749
GDO	9480	IGT	5	300	Supermarket	0	0	44271	MIAMI DADE WATER & SEWER DEPARTMENT	Series	2500	two 1250 gallon	90	11068
GDO	9576	IGT	5	300	Supermarket	0	0	28800	MIAMI DADE WATER & SEWER DEPARTMENT	Series	2100	two 1050 gallon	90	7200
GDO	9592	IGT	5	150	Supermarket	20	20	3308	CITY OF NORTH MIAMI BEACH	Single	1050	one 1050 gallon	90	827
GDO	9735	IGT	5	300	Supermarket	58	58	44510	MIAMI DADE WATER & SEWER DEPARTMENT	Series	2100	two 1050 gallon	90	11128
GDO	9758	IGT	5	300	Supermarket	0	0	39400	CITY OF HIALEAH	Series	2400	two 1200-gallon	90	9850
GDO	9844	MGRU	5	150	Supermarket	0	0	2000	MIAMI DADE WATER & SEWER DEPARTMENT		0	one 25 gpm	30	500

WORK GROUP	PERMIT NUMBER	PERMIT CLASS	PERMIT	PERMIT FEE	BUSINESS_TYPE	RECORDED SEATS	OBSERVED SEATS	FACILITY AREA	UTILITY	SYSTEM FORMAT	TOTAL CAPACITY	TANK_CAPACITY	PUMP OUT	TOTAL GPD
GDO	9878	MGRU	5	300	Supermarket	0	0	13466	MIAMI DADE WATER & SEWER DEPARTMENT		0	one 25 gpm	30	3367
GDO	10013	IGT	5	300	Supermarket	0	0	92200	MIAMI DADE WATER & SEWER DEPARTMENT	Series	2100	two 1050 gallon	90	23050
GDO	10114	IGT	5	300	Supermarket	0	0	42718	CITY OF HOMESTEAD	Series	2100	two 1050 gallon	90	10680
GDO	10118	MGRU	5	150	Supermarket	8	8	2055	MIAMI DADE WATER & SEWER DEPARTMENT		0	one 25 gpm	30	514
GDO	10239	IGT	5	300	Supermarket	0	0	13069	MIAMI DADE WATER & SEWER DEPARTMENT	Series	2500	two 1250 gallon	90	3267
GDO	10270	IGT	5	300	Supermarket	0	0	43000	MIAMI DADE WATER & SEWER DEPARTMENT	Series	2500	two 1250 gallon	90	10750
GDO	10330	IGT	5	300	Supermarket	0	0	150000	MIAMI DADE WATER & SEWER DEPARTMENT	Series	2100	two 1050 gallon	90	3750
GDO	10367	IGT	5	300	Supermarket	0	0	16300	MIAMI DADE WATER & SEWER DEPARTMENT	Multiple	2500	two 1250-gallon	90	4075
GDO	10406	IGT	5	300	Supermarket	0	9	110000	MIAMI DADE WATER & SEWER DEPARTMENT	Single	1200	one 1200-gallon	90	25000
GDO	10430	IGT	5	300	Supermarket	0	0	55000	MIAMI DADE WATER & SEWER DEPARTMENT	Series	2400	two 1200 gallon	90	13750
GDO	10459	IGT	5	300	Supermarket	0	0	45600	MIAMI DADE WATER & SEWER DEPARTMENT	Series	2500	two 1250 gallon	90	11400
GDO	10512	IGT	5	300	Supermarket	0	0	49582	MIAMI DADE WATER & SEWER DEPARTMENT	Series	3000	two 1500 gallon	90	12396
GDO	10518	IGT	5	300	Supermarket	0	0	182070	MIAMI DADE WATER & SEWER DEPARTMENT	Series	2400	two 1200 gallon	90	25000
GDO	10613	MGRU	5	150	Supermarket	32	0	1386	MIAMI DADE WATER & SEWER DEPARTMENT		0	one 30 gpm	30	347
GDO	10970	IGT	5	150	Supermarket	0	0	2158	MIAMI DADE WATER & SEWER DEPARTMENT	Single	1200	one 1200 gallon	60	540
GDO	11000	MGRU	5	150	Supermarket	0	0	1500	MIAMI DADE WATER & SEWER DEPARTMENT		0	one 50 gpm	30	375
GDO	11237	IGT	5	150	Supermarket	47	0	25724	MIAMI DADE WATER & SEWER DEPARTMENT	Single	1250	one 1250 gallon	90	6431
GDO	11262	IGT	5	300	Supermarket	0	0	17700	MIAMI DADE WATER & SEWER DEPARTMENT	Single	750	one 750 gallon	60	4425
GDO	11649	MGRU	5	150	Supermarket	0	0	1450	MIAMI DADE WATER & SEWER DEPARTMENT		0	one 50 gpm	90	363

Attachment 17
Maps Showing Location of FOG Generators

MIAMI-DADE COUNTY GDO FACILITIES

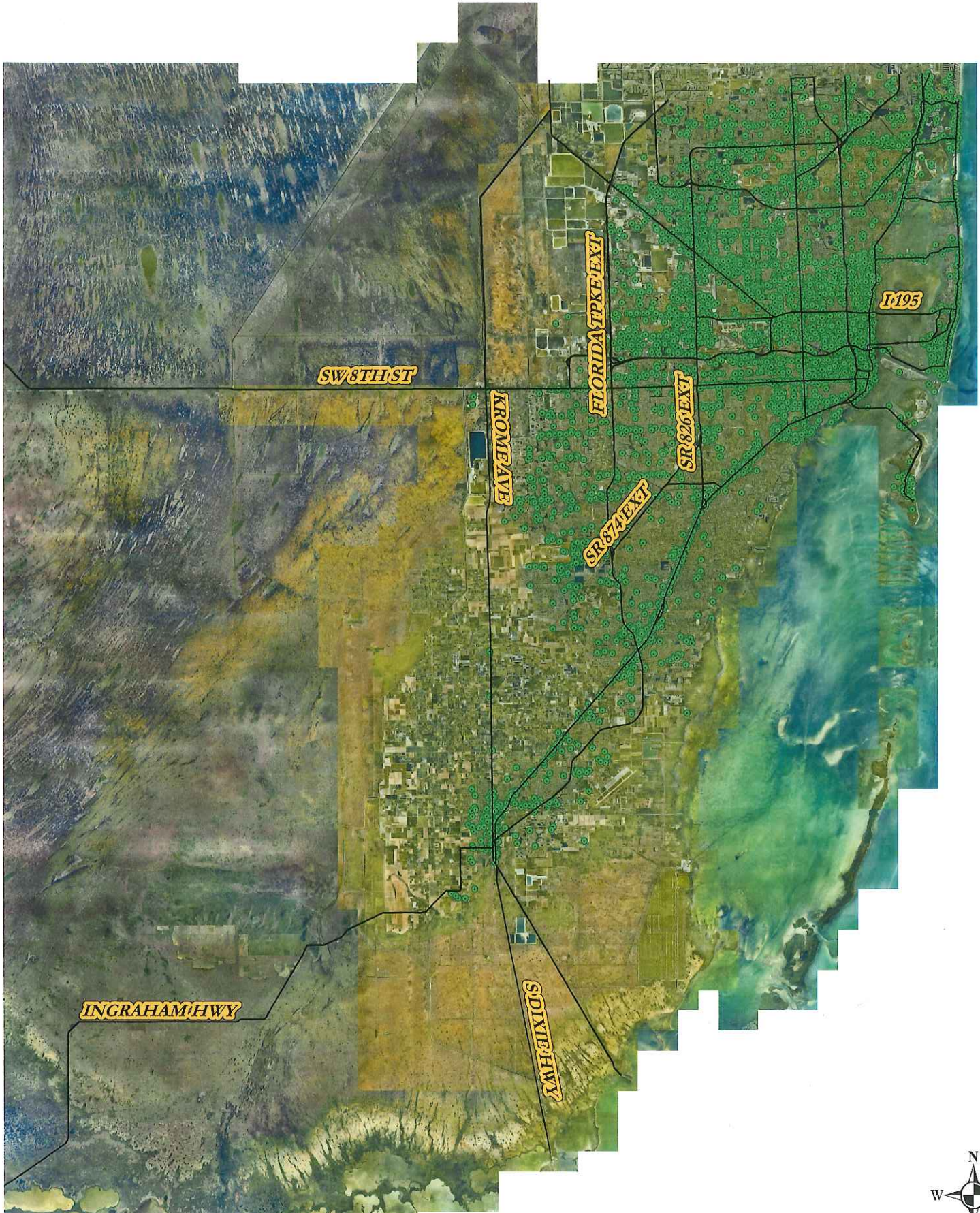

SCALE: 1 inch = 32,418 feet



MIAMI-DADE COUNTY GDO FACILITIES NORTH OF SW 8TH STREET

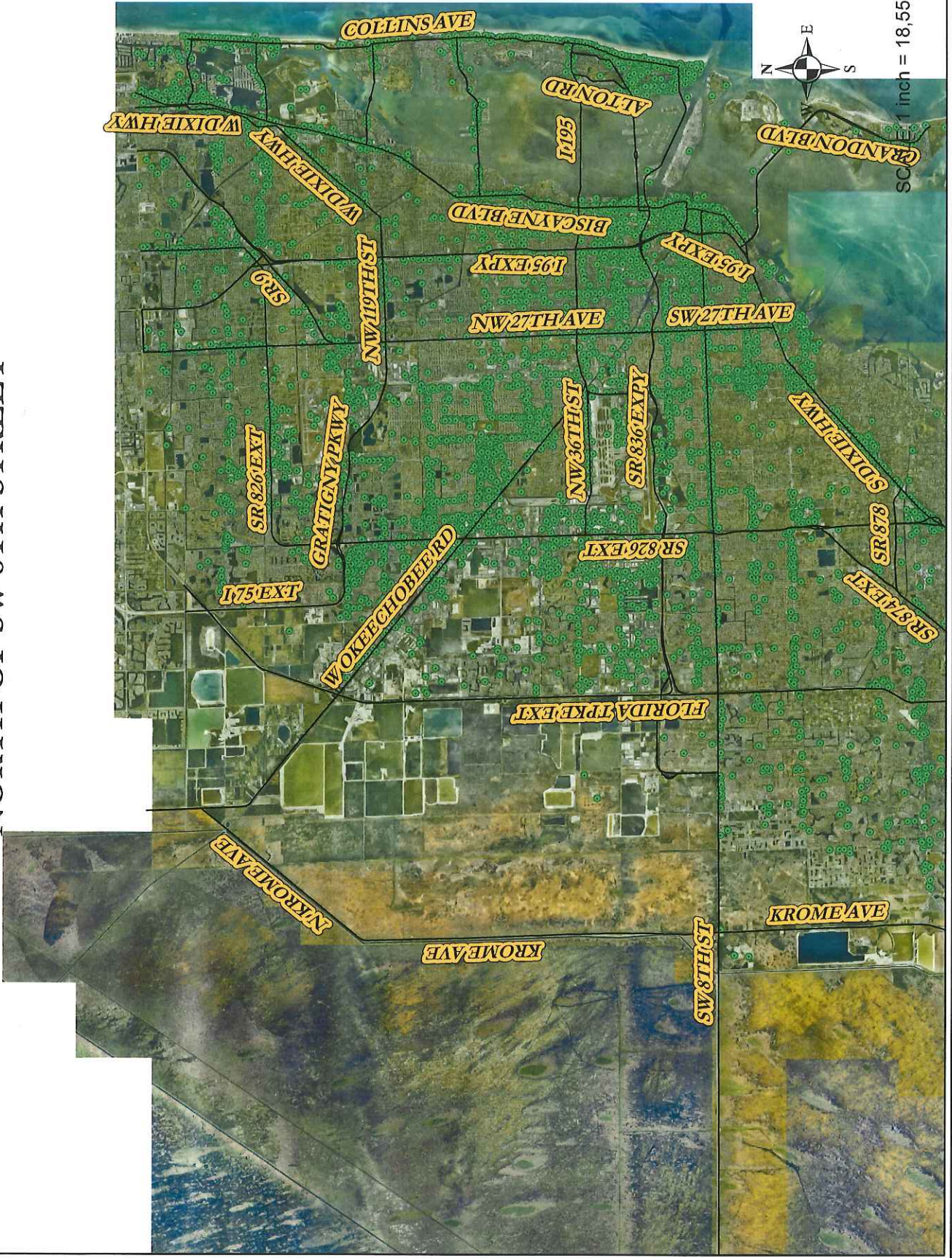

SOUTH OF 8TH STREET



SCALE: 1 inch = 28,323 feet

