

Integrated Controllers **MICREX-SX** Series
Programmable Controllers

**PROGRAMMABLE
CONTROLLER
SPH**



Control, operation and Supervisory Integrated Controllers

MICREX-SX Series



PROGRAMMABLE CONTROLLER SPH



Realizes High-Speed Advanced Machine Control

I/O control with a program capacity of up to 117K steps and up to 8192 points enables suitable system configuration ranging from small through to large scale.

1ms program scan and I/O refresh are possible. Function and performance distribution are possible in multi-CPU system configuration with up to 8 CPUs.

Meets Increasing Demand for Higher Reliability

Compatible with CPU redundancy and power supply redundancy as standard functions. 1:1 warm standby or N:1 cold standby can be selected as required.

Open Network Oriented

Both the hardware and software conform to the IEC 61131 international standard for programmable controllers. Compatible with Ethernet, LonWorks, FL-net, DeviceNet, PROFIBUS-DP, AS-i, and other diverse open networks.

Realizes Integrated Programming Support

Loaders for functional modules and POD, mainly loaders for programmable controllers realized on a personal computer, can be used in an integrated environment.

Sharing of variable names (labels) required for each loader, and mutual data reference at the time of programming and debugging, can be performed easily.

Applicable to Software Control

Operates on a personal computer and panel controller, and the functions provide software equivalent to each hardware.

Software programmable controller SPS: Equivalent to programmable controller SPH
 Software POD SUS: Equivalent to the POD UG30/20 series

The OPC-coordinated library enables coordination with commercial SCADA software.

Note: This software accommodates system business talks. For details, contact our sales section.

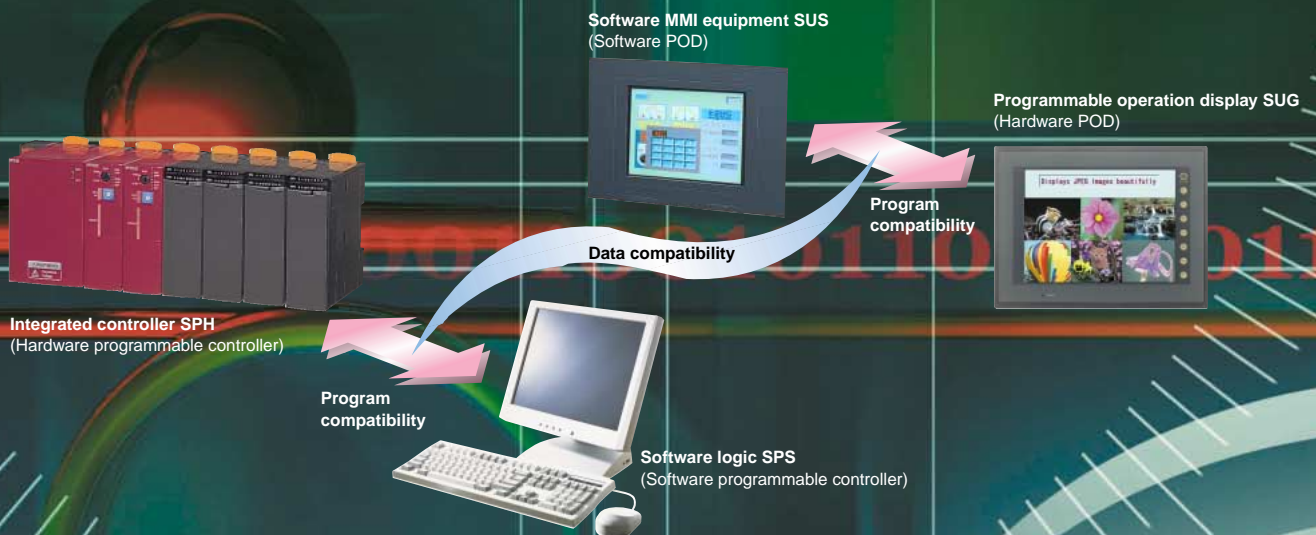

I N D E X

- Overview of MICREX-SX series2
- Network configuration of SPH4
- Features of SPH series6
- Integrated programmable support8
- Basic configuration of SX bus10

- <Contents>
- General specifications12
 - CPU module.....13
 - Power supply module.....15
 - Base board 16
 - Standard I/O module 17
 - Communication module 28
 - Function and positioning module ... 47
 - Programming support tool 57

- Related devices 65
- Dimensions 67
- Ordering informations..... 70

SX Bus and Diverse Network Systems Enabling Seamless Access

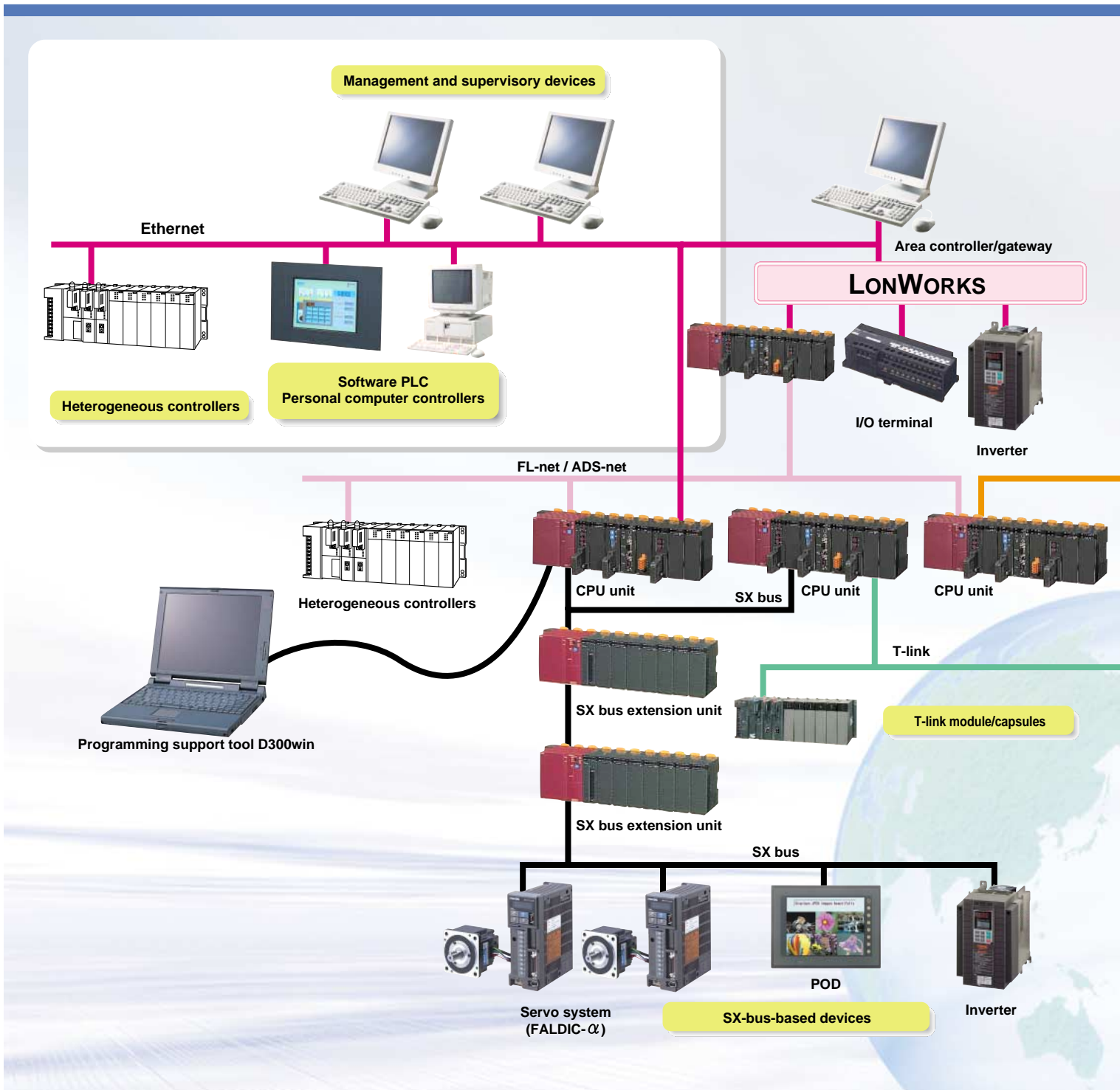

LonWorks

Internationally noticeable open network for building management. System configuration as a device with distributed autonomous functions is enabled by the control functions incorporated in site devices. Replacement, update, addition, and removal of site devices can easily be performed.

FL-net (OPCN-2)

Open network at the FA application-type controller level established by the Manufacturing Science and Technology Center and the Japan FA Open Systems Promotion Group. Allows inter-connection with PC, CNC, and robots beyond the frame of a single manufacturer. The communication physical layer employs Ethernet.

PROFIBUS-DP

Device level open network established by the EN 50170 European standard, which best suits time-critical applications between an automation system and distributed devices (remote I/Os, inverters, etc.)

**Fast, Distributed, Densely Linked SX bus Enables Seamless Connection of Operation Display Units and Servo Inverter.
Network System Variety Strongly Backs Up Optimum System Configuration from A Small System with Embedded Machine to A Large-scale Hierarchical Distributed System.**

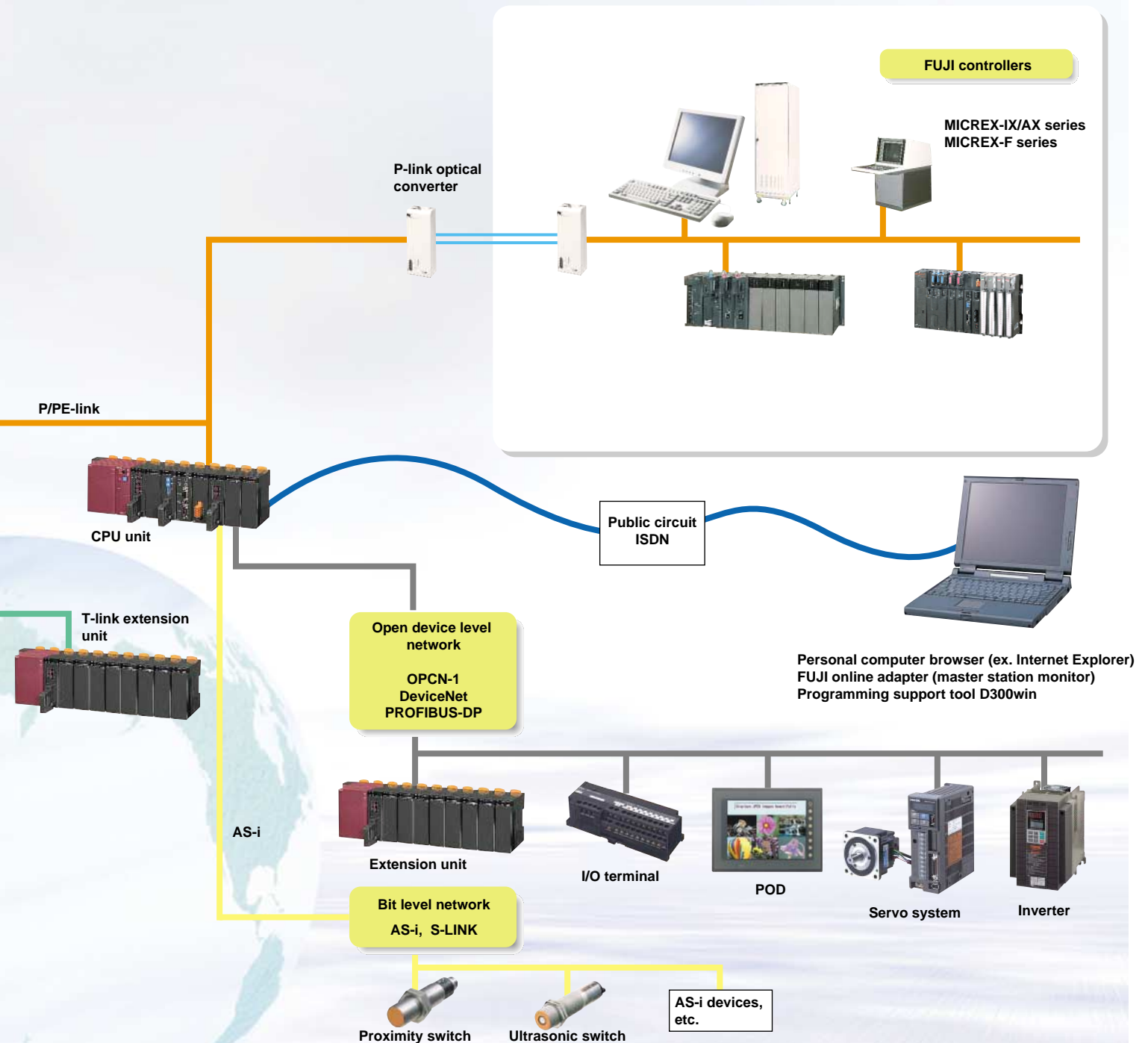

OPCN-1

Device-level open network established by Japan Electrical Manufacturers Association. Allows connection with PC and robots using the same signal line beyond the frame of a single manufacturer, very effective in open system improvement and optimization.

DeviceNet

Open device-level network which facilitates inter-connection of control equipment such as PCs, personal computers, sensors, and actuators. Wiring cost reduction by minimizing wiring, and multi-vendor equipment connection simplify an economical system configuration.

AS-i

Bit-level network optimum to distribution of the I/O equipment including proximity switches, photoelectric switches, pushbuttons, and intelligent equipment such as ultrasonic sensors.

Realizes High-Speed Advanced Machine Control

Ultra High-Speed 1ms Controller

1ms scan

- Program scan time of 1ms is implemented by increased instruction processing speed.
- Real number operation and high-precision positioning control have been put to practical use by dramatically improved floating-point operation speed.

	SPH300	SPH200
Basic instruction LD	20ns	70ns
MOV	40ns	140ns
Floating-point operation instruction	80ns	56000 to 85000ns

* For details on each instruction word's processing speed and takt cycle, see the User's Manual (FEH200).

1ms I/O refreshing

- 1024-point input/output is refreshed in 1ms
- Tact control assures a fixed I/O refresh interval. The I/O refresh cycle can be set to 1ms, 2ms, or up to 10ms, which is suitable for processing requiring strict tact time.
- The SPH300 allows tact time setting in 0.5ms units with a minimum setting of 0.5ms.

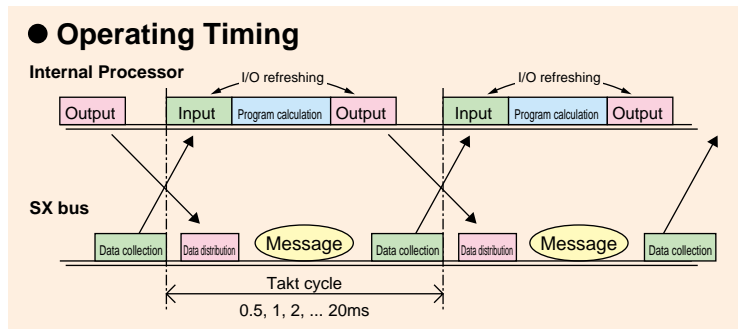

Controller Conforms to International Standard

Conforms to IEC 61131 international standard

- Both the hardware and software conform to the IEC 61131 international standard for programmable controllers.
- The programming language conforms to the IEC 61131-3 international standard.

Conforming to international standard

- Conforms to the CE marking and UL standards as well as IEC standard.
- Conforms to the LR ship standard (England).

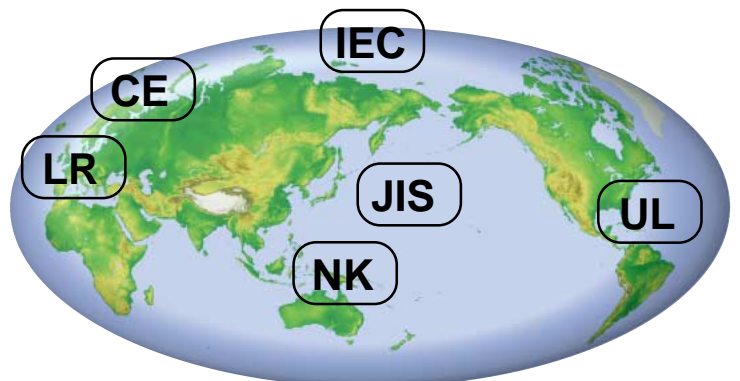

Multi-CPU System Applicable to Up to 8 CPUs (SPH300)

Parallel processing with up to 8 CPUs

Alleviates the load for each CPU allowing high speed processing of a large application program.

For example, the load can be distributed for advanced processing and sequence control processing with additional CPUs. I/O refresh control is performed automatically even if parallel processing by multiple CPUs is performed.

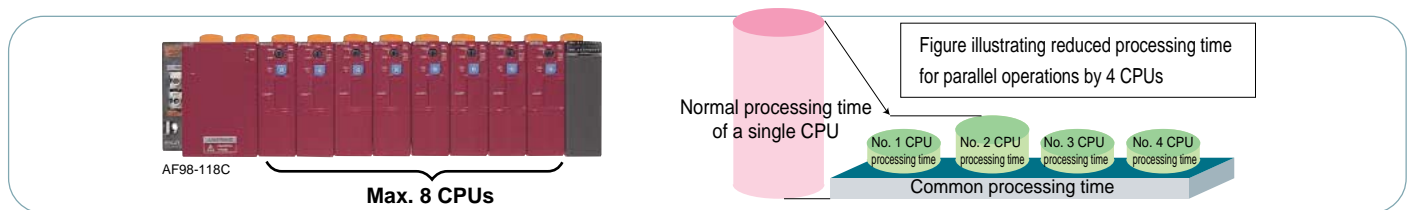

Redundant System Assuring System Safety and Reliability (SPH300)

1-to-1 warm-standby feature

This redundancy configuration enables continued operation without system downtime if a CPU fails.

(Control may temporarily stop due to fault detection and CPU changeover.)

- The same program is stored in CPUs for the active and backup systems, allowing constant data value equalization.



N-to-1 backup feature

This redundancy configuration accepts a system down and minimizes the time for operation restart when a CPU is faulty.

- Data retained by the active system is not taken over. The backup system CPU performs initial start.

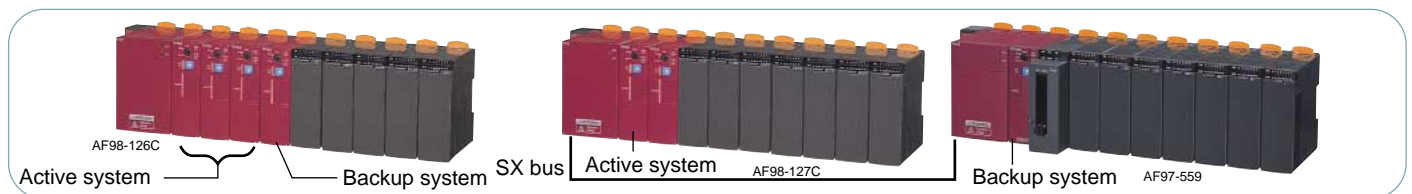

- Programs can be intensively controlled by a memory card.

Programs for N units of systems can be stored on a memory card, which is installed in the memory card interface module for centralized control of the programs. The same processing programs as on the down CPU are downloaded to the backup system CPU.

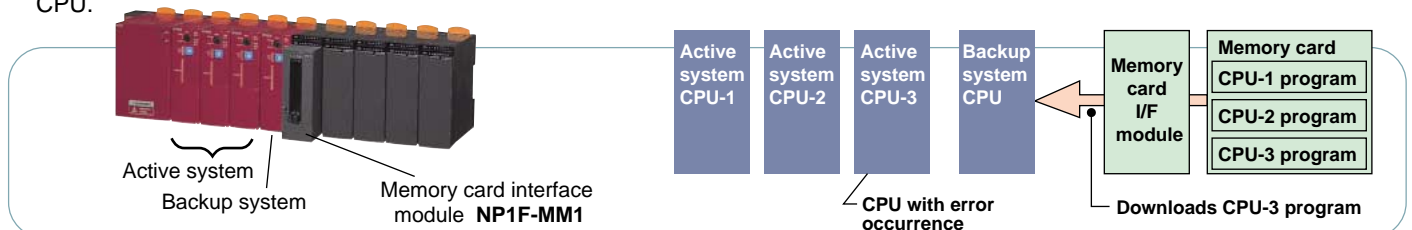

Note: For the redundancy configuration buildup with the DC power supply, contact our sales section.

Improves Programming Development Efficiency

Realizes Integrated Programming Support

Provision of Integrated Support Environment

The SPH can be used in an integrated environment consisting mainly of a programmable controller loader implemented on a personal computer, as well as a function module loader and POD loader.

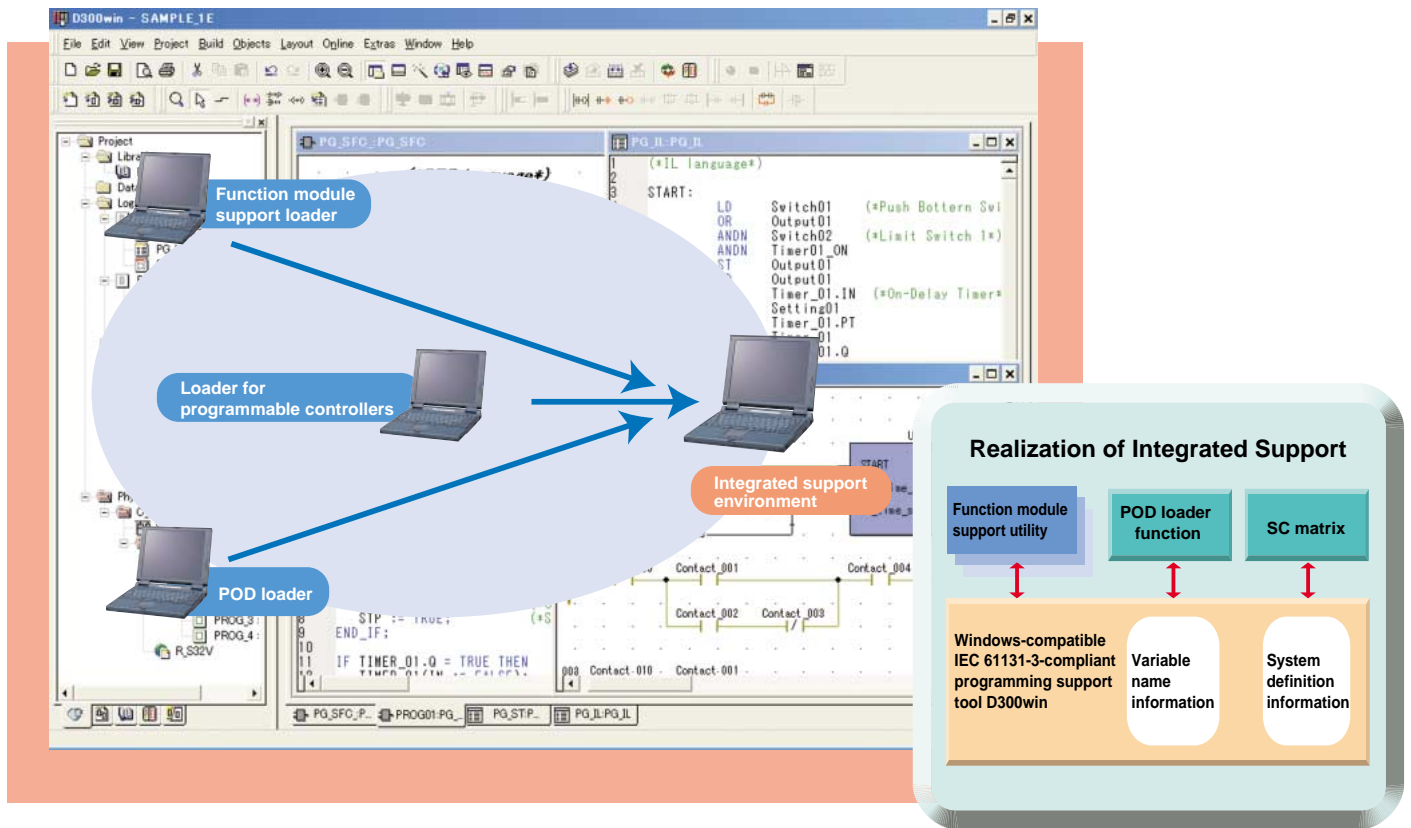

Realizes Software-based Scalable System

External failure diagnosis, PID, and other regulation system operations and general-purpose protocol control and positioning control operations have been realized by software (extended FB) using the advanced processing functions of the CPU module. The use of the extended FB allows efficient system configuration based not on each function module but on the standard I/O module, general-purpose communication module, and positioning module.

Application model

- The application model is a control model that incorporates diverse function software in addition to the extended FB above.
- A high-quality system can be configured in a short time simply by incorporating customer functions in the application model.
- For engineering support costs, please contact our sales section.

Programming Support Tool SED (D300win) Conforming to Windows-compatible IEC 61131-3

The D300win is a programming support tool that conforms to the IEC 61131-3 international standard and that runs under Windows NT/2000/XP. It is a next-generation support tool with an abundance of features such as programming by variable names (labels), mixed-language programming, excellent documentation function, and basic ease of operation. The D300win incorporates a number of features that simplify the programming environment. Such features include the function to implement user-designed circuits on an FB, error & jump function, instruction entry guidance, and multi-window function.

Compatible with the IEC 61131-3 international standard

The use of a programming language system in compliance with international standards allows the user to produce programs that are understandable worldwide.

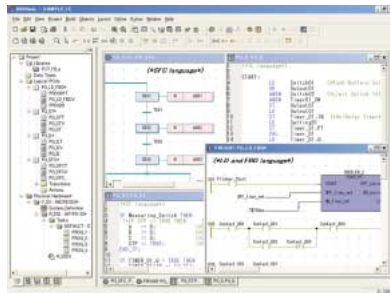

Simulation function

The simulation function allows the user to conduct test runs of programs using the D300win built-in PLC function in place of a real machine. This function simulates the operation of programs that are written in the IEC-compliant SX Series programming language. The function can force any given signal to on or off and monitor its state. It greatly enhances the efficiency of programming and debugging.

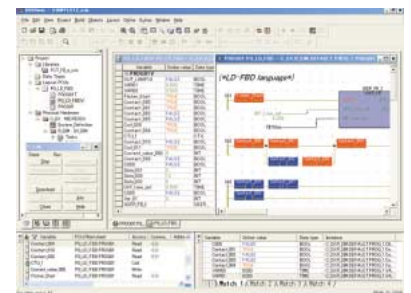

Accommodates a mixture of code written in two or more programming languages.

The D300win completely supports five types of program representations specified by the standards. It allows the programmer to code the combination of representations best suited for the control target.

Supported representations

- IL (Instruction List)
- LD (Ladder Diagram)
- FBD (Function Block Diagram)
- ST (Structured Text)
- SFC (Sequential Function Chart)

Programmable Operation Display (POD) cooperation function

The D300win has implemented POD cooperation support functions as common support tools.



Excellent documentation function

The documentation preparation function of the D300win has been substantially improved. Not only can it print drawing numbers, dates, page, and borders, but also company logos and comments. It also augments the print preview function, which allows the user to verify the print state on the screen before beginning printing, and its scaled printing function which

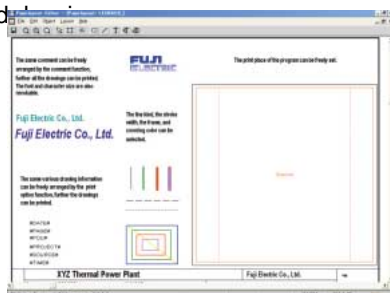

SX Bus Meets Diverse Demands for System Extension

Basic SX Bus Configuration

Ultra Fast SX Bus Preserves Distributed Installation and Expandability Up To 254-module Direct Bus Connection.

SX bus implements distributed installation of equipment.

The total length of the SX bus is 25m. Up to 25 extension base boards, PODs, and other SX-bus-based devices can be connected within 25m.

Free topology is implemented by T branches.

Use of T branches allows detailed, distributed installation of the SX bus. Expansion units and diverse equipment arranged in tree structure can be connected in the optimum way.

SX bus implements connecting maximum 254 modules (within 512 words).

The number of modules that can be connected to the SX bus is a maximum 254 units. The connectable units include CPU modules, communications modules, positioning modules, function modules, standard I/O modules, and SX-bus compatible equipment such as servo systems and PODs. The SX bus can also be easily connected to a large-scale system without being conscious of the module quantity limit.

Classification of System Configuration

Limit of modules connected in single configuration

Module Type	Max. Connected Units
Power module	Not limited in the number of power modules to be connected.
CPU module	8 units (1 unit for the SPH200)
P/PE-link module	Total 2 units of FL-net modules, P-link modules, and PE-link modules
Type A module	8 units (remote I/O master module)
Type B module	A total of 16 units including the SX bus communication unit of POD.
Type C module	238 units including Type A and B connected modules (excluding FL-net modules, P-link modules, and PE-link modules)

* Note: For details informations, refer to the each manuals.

Module classification

Type A	Type B	Type C
<ul style="list-style-type: none"> • OPCN-1 master module (NP1L-JP1) • OPCN-1 slave module (NP1L-JS1) • DeviceNet master module (NP1L-DN1) • PROFIBUS-DP master module (NP1L-PD1) • T-link master module (NP1L-TL1) • T-link slave module (NP1L-TS1) 	<ul style="list-style-type: none"> • Web module (NP1L-WE1) • Ethernet module (NP1L-ET1) • FL-net module (NP1L-FL2) • ADS-net module (NP1L-AD1) • P-link module (NP1L-PL1) • PE-link module (NP1L-PE1) • General-purpose communication module (NP1L-RS1/RS2/RS4) • Memory card I/F module (NP1L-MM1) 	<ul style="list-style-type: none"> • All modules other than those of Type A and B * The AS-i master module is also included in category C.

No. of connectable base boards/units

Unit for supplying SX bus transmission power	Unit for receiving SX bus transmission power
<ul style="list-style-type: none"> • Base board (power ON) • SX bus optical converter (external 24V connected) 	<ul style="list-style-type: none"> • I/O terminal • SX bus optical converter (external 24V not connected) • UG30/20 series (POD) • PCI-bus-based high performance CPU board (built in personal computer) • AC servo FALDIC-α series • Base board (power OFF) equivalent to 3 units above

* Up to 10 units for receiving SX bus transmission power can be continuously connected to each of the IN and OUT connectors of the unit for supplying SX bus transmission power.

Other connection notes

- Be sure to install the power supply module and at least one module other than the power supply module to the left of each base board.
- Up to 25 base boards including the T branch unit can be connected.
- Basically, base boards (power supply) in one configuration should be turned ON at one time. However, if it is necessary to turn OFF some base boards (power supply) for application convenience, up to 3 continuous base boards can be turned OFF in one configuration.

General Specifications	12	Bit-level Communication Module	44
CPU Module	13	AS-i Master Module	44
Features	13	S-LINK Master Module	45
Performance specifications	13	SX Bus Optical Link Module	46
Outer view	14	SX Bus Optical Converter Unit	46
Power Supply Module	15	Function Module/Positioning Control Module/ Positioning Extension FB Software Package	
Features	15	Memory Card Interface Module	47
Power supply specifications	15	Dummy Module	48
Base Board	16	High-speed Counter Module	49
Dimensions	16	Two-axis Pulse Train Output Positioning Control Module ..	50
Standard I/O Module		Two-axis Pulse Train Multiple Positioning Control Module ..	51
Digital Input Module	17	Two-axis Analog Multiple Positioning Control Module	52
Digital Output Module	18	MC Module	53
Digital Input/Output Module	19	Positioning Module Function List	54
High-speed Digital Input Module	19	Positioning Extension FB Software Package	
Pulse Train Output Built-in Digital Output Module	20	[Japanese Version]	55
Analog Input Module	21	Functional Extension FB Software Package	
Analog Output Module	22	[Japanese Version]	56
Resistance Bulb Input Module	23	Programming Support Tool (D300win)	
Thermo-couple Input Module	23	Programming Support Tool Conforming to International	
Terminal Relay	25	Standard IEC 61131-3 (D300win)	57
Communication Module		Programming Support Tool (SC Matrix)	61
Computer-level Communication Module	28	MC Module Programming Support Tool	63
Web Module	28	OPC-Coordinated Library SX Communication	
Ethernet Interface Module	29	Middleware	64
Online Adapter	30	Related Devices	
Controller-level Communication Module	31	PCI-Bus-Based SPH300 CPU Board	65
FL-net (OPCN-2) Ver. 2.0 Module	31	PCI-Bus-Based FL-net (OPCN-2) Ver. 2.0 Board	66
ADS-net Module	32	Dimensions	67
LonWorks Network Interface Module	33	Odering Information	70
LonWorks Network Interface Module Support Tool	33		
P-link/PE-link Module	34		
General Purpose Communication Module	35		
General Purpose Communication Package for			
Factory Automation Machine	36		
Device-level Communication Module	37		
OPCN-1 Master / Slave / Interface Module	37		
DeviceNet Master / Interface Module	38		
T-link Master / Slave / Interface Module	39		
PROFIBUS-DP Master Module	40		
I/O Terminal	41		



AF98-126

Programmable Controllers
MICREX-SX series SPH
General Specifications



■ **General specifications**

Item		Specification	
Physical environmental condition	Operating ambient temperature	0 to 55°C	IEC 61131-2
	Storage temperature	-25 to +70°C	
	Relative humidity	20 to 95%RH no condensation	
	Pollution degree	2 (Free from conductive dust)	
	Corrosion immunity	Free from corrosive gases. Not stained with organic solvents	
	Operating altitude	2000m or less above sea level (Transport condition: 70kpa or more)	
Mechanical service condition	Vibration	Half amplitude: 0.15mm, Constant acceleration: 19.6m/s ² two hours for each of three axes, total six hours.	
	Shock	Acceleration peak: 147m/s ² three times for each of three axes	
Electrical service condition	Electrostatic discharge	Contact discharge: ± 6kV Aerial discharge: ± 8kV	IEC 61000-4-2
	Radiated, radio-frequency, electromagnetic field	80 to 1000MHz (10V/m)	IEC 61000-4-3
	EFT/B (Electrical fast transient/burst)	± 2kV (excluding the communication line)	IEC 61000-4-4
	Lightning impulse surge	± 4kV common mode, ± 2kV normal mode	IEC 61000-4-5
	Conducted radio frequency	150kHz to 80MHz, 10V	IEC 61000-4-6
	Power frequency magnetic field	50Hz, 30A/m	IEC 61000-4-8
	Damped oscillatory wave	± 2kV, 1MHz ring waves	IEC 61000-4-12
	Square wave	± 1.5kV rise time 1ns, pulse width 1μs 50Hz	
Construction	Panel-mounting type IP30		
Cooling	Self-cooling		

CPU Module: NP1P □ - □ □

■ **Features**

- Ultra high-speed processing
SPH300 processes basic instructions in 20ns and application instructions in 40ns, the SPH200 carries out basic instructions in 70ns and application instructions in 140ns.
- Multi-CPU configuration (SPH300)
Up to 8 CPUs can be configured, effective for high-speed control by load distribution.
- Redundancy (SPH300)
1-to-1 hot standby feature and N-to-1 backup feature improves the system safety and reliability.
- IEC 61131-3
Complete compliance with the IEC 61131-3 international standard languages enables programming understood worldwide.
- Compatible with USB and user ROM
The SPH300 of the USB and user ROM versions with separate formats are offered (NP1PS-32R/74R/117R).

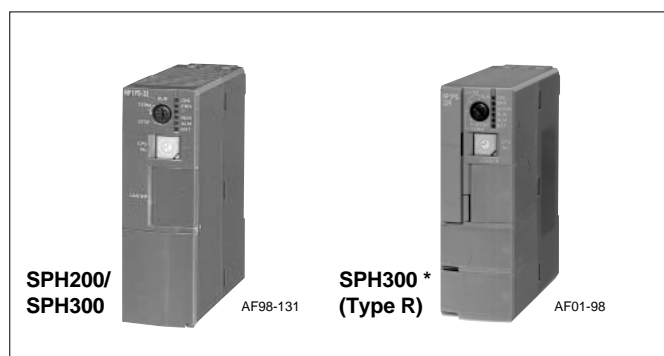

* CPU modules of the type with trailing "R" (NP1PS-□□R) and the NP1PS-117 have the same shape.

Enables USB-based high-speed communication, source program storage and user's data with user ROM, and user ROM operation. The SPH200 allows only user ROM operation but does not correspond to USB-based communication functions.

■ **Performance specifications**

		SPH200		SPH300			
Type		NP1PH-08	NP1PH-16	NP1PS-32/NP1PS32R	NP1PS-74/NP1PS74R	NP1PS-117/NP1PS-117R	
Control system		Stored program, Cyclic scanning system (default task), periodic task, event task					
Input / Output connection method		Direct connection I/O (SX bus), remote I/O (DeviceNet, OPCN-1, and other remote I/O links)					
I/O control system		SX bus: Tact synchronization refresh Remote I/O link: Refresh at 10-ms fixed intervals (not synchronized with scan)					
CPU		16-bit OS processor, 16-bit execution processor		32-bit OS processor, 32-bit execution processor			
Memory types		Program memory, Data memory, Temporary					
Programming language		IL language (Instruction List) ST language (Structured Text) LD language (Ladder Diagram) FBD language (Function Block Diagram) FSC elements (Sequential Function Chart) To IEC 61131-3					
Length of instructions		Variable length (depending on language)					
Instruction execution speed	Sequence instruction	70ns or more/instruction		20ns or more/instruction			
	Applied instruction	140ns or more/instruction		40ns or more/instruction			
Program memory capacity		8192 steps	16384 steps	32768 steps	75776 steps	119808 steps	
Program steps in a POU		4096 steps		4096 steps			
memory (Note 1)	I/O memory (I/Q)	512 words (Max. 8192 points)		512 words (Max. 8192 points)			
	General memory (M)	4096 words	8192 words	8192 words	32768 words	131072 words	
	Retain memory (M)	2048 words	4096 words	4096 words	16384 words	32768 words	
	Instance memory for User FB (M)	2048 words	4096 words	4096 words	16384 words	32768 words	
	Instance memory for system FB (M)		4096 words	8192 words	16384 words	65536 words	65536 words
		Timer	128 points	256 points	512 points	2048 points	2048 points
		Integrating timer	32 points	64 points	128 points	512 points	512 points
		Counter	64 points	128 points	256 points	1024 points	1024 points
	Edge detection	256 points	512 points	1024 points	4096 points	4096 points	
	Others	2048 points	4096 points	8192 points	32768 points	32768 points	
	System memory (M)	512 words		512 words			
Temporary area		4096 words		8192 words			
Available basic data type (Note 2)		BOOL, INT, DINT, UINT, UDINT, REAL, TIME, DATE, TOD, DT, STRING, WORD, DWORD					
Data type nesting		One level (array of arrays, structure of arrays, array of structures, structure of structures)					
No. of structure data type members		200					
No. of array data type elements		Limited by the size of the memory area used. With "Standard memory" with 8192 words, up to 8192 words can be used.		16-bit data format: 4096, 32-bit data format: 2048			
No. of tasks		Default tasks (Cyclic scanning): 1 Periodic tasks: 4 Event tasks: 4 (Total of 4 tasks when Periodic task is used)					
Program instance (No. of POU's/resource)		64 (Max. number of registrations in one task: 64)		256 (Max. no. of instances allowed in one task=128)			
No. of POU's in program		2000 (including POU's in the library)					

Note: 1) The area sizes of standard memory, retain memory, the instance memory for user FBs, and the instance memory for system FBs can freely be increased or decreased. Default values are shown in the above table.
2) This depends on each instruction.

Programmable Controllers

MICREX-SX series SPH

CPU Module

● Performance specifications

		SPH200		SPH300		
Item		NP1PH-08	NP1PH-16	NP1PS-32/NP1PS-32R	NP1PS-74/NP1PS-74R	NP1PS-117/NP1PS-117R
No. of user function blocks		256		512		
Nesting depth of user function blocks		64 levels		127 levels		
No. of user functions		256		512		
Nesting depth of user functions		64 levels				
FB instance		620/POU (Up to 620 FBs allowed in one POU)				
Variable	Global variable	8000		Earlier than D300win version V1.2: 8000 D300win version 2.0 or later: 15000		
	Local variable	8000		Earlier than D300win version V1.2: 8000 (Total for all POU) D300win version 2.0 or later: 15000/POU		
No. of user FB terminals		VAR_INPUT : Up to 128 VAR_OUTPUT: Up to 128 } 128 in total				
Library	No. of registered libraries	16/project				
	Nesting depth	8 levels				
Diagnostic function		Self-diagnosis (memory check, ROM sum check), System configuration supervising, Module fault monitoring				
Security function		Password				
Calendar		Up to 31 Dec. 2069 23:59:59 ± 27sec/month (when active)		Up to 31 Dec. 2069 23:59:59 ±27sec/month (when active) When multi-CPU system is used, time is synchronized.		
Battery backup		Backup range: Application programs, system definitions, ZIP files, data memory, calendar IC memory Battery used: Lithium primary battery Backup time: 5 years (25° C) Replacement time: Within 5 minutes (25° C)		Data memory, calendar IC memory Primary lithium battery Switching time: within 5 min. (at 25° C) Durability (at 25° C): NP1PS-32 5 years NP1PS-74 1.3 years NP1PS-117R 1.3 years		
Memory backup by flash ROM (contained in CPU module)		Application programs, system definitions, and ZIP files can be saved in the user ROM card.		Application programs, system definitions, and ZIP files can be saved in the flash memory built in the CPU.		
Memory backup by user ROM card (removable) (only for NP1PS-117R)		Application programs, system definitions, and ZIP files can be saved in the user ROM card.		Application programs, system definitions, zip files and compressed projects can be saved in user ROM card (compact flash card).		
Internal current consumption		24V DC 70mA or less		24V DC 200mA or less		
Mass		Approx. 170g		Approx. 200g (NP1PS32/NP1PS74/NP1PS117) Approx. 220g (NP1PS32R/NP1PS74R/NP1PS117R)		

■ Outer view

• SPH200 (NP1PH-08/NP1PH-16)

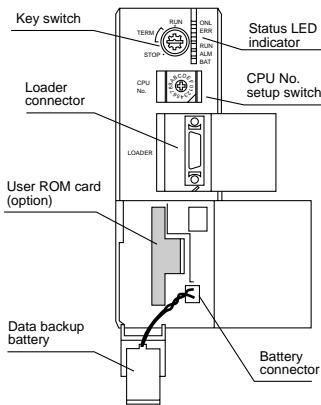

• SPH300 (NP1PS-32/NP1PS-74)

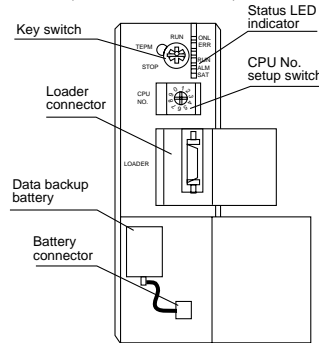

• SPH300 (NP1PS-117)

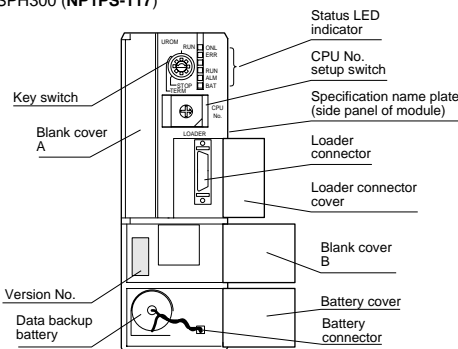

• SPH300 (NP1PS-32R/NP1PS-74R/NP1PS-117R)

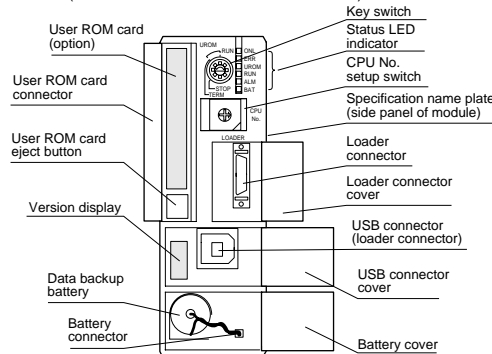

Power Supply Module: NP1S-□□

■ **Features**

- Redundant power supply module (**NP1S-22/NP1S-42**)
Redundancy of the power supply has been realized by supplying the power from multiple (up to 3) power supply modules. The redundant configuration of the power supply section with the highest failure rate can improve the system reliability.
- Small capacity power supply module (**NP1S-91**)
The use of the 100VAC small capacity power supply module (single slot) on a 6-slot basis allows effective use of one slot.

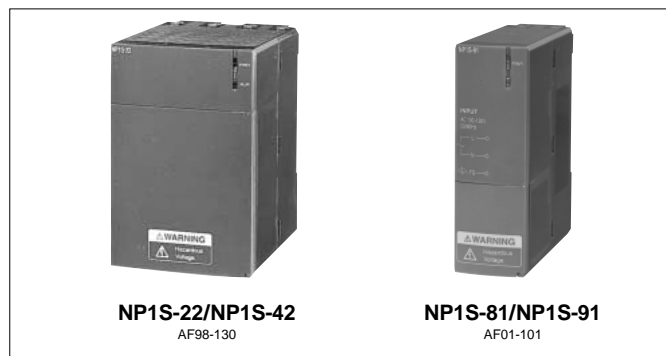

■ **Power supply specifications**

Item	Specification			
Type	NP1S-22	NP1S-42	NP1S-81	NP1S-91
Rated input voltage	100 to 120V AC / 200 to 240V AC	24V DC	200 to 240V AC	100 to 120V AC
Voltage tolerance	85 to 132V AC / 170 to 264V AC	19.2 to 30V DC	170 to 264V AC	85 to 132V AC
Rated frequency	50/60Hz	—	50/60Hz	—
Dropout tolerance	1 cycle or less (Rated voltage, rated load)	10ms or less (Rated voltage, rated load)	1 cycle or less (Rated voltage, rated load)	—
AC waveform distortion factor	5% or less	—	5% or less	—
Ripple factor tolerance	—	Three-phase full-wave rectification can be used 5% or less	—	—
Leakage current	0.25mA or less			
Inrush current	22.5Ao-p or less (Ta=25° C not repeated)	150Ao-p or less 2ms or less	25Ao-p or less (Ta=25° C not repeated)	22.5Ao-p or less (Ta=25° C not repeated)
Power consumption	110VA or less	45W or less	50VA or less	40VA or less
Rated output voltage	24V DC (22.8 to 26.4V DC)			
Output current	0 to 1.46A		0 to 0.625A	
Isolation method	Transducer			
Dielectric strength	2900Vrms AC, 1 second, between power input terminals and ground	560Vrms AC, 1 second, between power input terminals and ground	1800Vrms AC, 1 second, between power input terminals and ground	
Insulation resistance	10MΩ or more (500V DC megger)			
No. of occupied slots	2 slots		1 slot (specialized for a 6-slot basis)	
Alarm output	Relay NC contact output (Monitoring of output voltage: 24V DC, 0.3A or less)		None	
Multiple power supply	Compatible		None	
Mass	Approx. 330g	Approx. 360g	Approx. 180g	

Programmable Controllers

MICREX-SX series SPH

Base Board

Base Board: NP1B □ - □ □

Name	Type	No. of slots	Maximum no. of modules	Internal current consumption	Mass	Remarks
Standard base board	NP1BS-06	6 slots	5 (Not contain the power supply)	45mA or less	Approx. 420g	SX bus 6 slots, processor bus 4 slots
	NP1BS-08	8 slots	6 (Not contain the power supply)	50mA or less	Approx. 540g	SX bus 8 slots, processor bus 3 slots
	NP1BS-11	11 slots	9 (not contain the power supply)	60mA or less	Approx. 720g	SX bus 11 slots, processor bus 3 slots
	NP1BS-13	13 slots	11 (Not contain the power supply)	70mA or less	Approx. 840g	SX bus 13 slots, processor bus 3 slots
High-performance base board	NP1BP-13	13 slots	11 (Not contain the power supply)	70mA or less	Approx. 840g	SX bus 13 slots, processor bus 10 slots

Note: * High performance base board is used for the P/PE-link high-speed handling of large amounts of data or for the multi-CPU configuration with the system processing speed increased. The standard base board is sufficient for a system operating at the normal processing speed.

■ Dimensions, mm

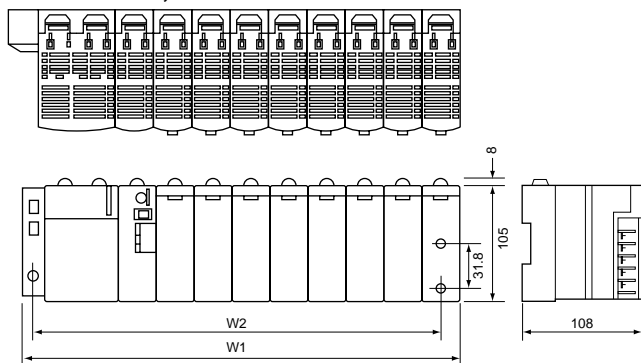

No. of slots	W1	W2
6	238	220
8	308	290
11	413	395
13	483	465

When the connector is mounted, depth is max. 195.3 mm.
The bracket is already mounted on the base.

Digital Input Module: NP1X □

■ Performance specifications

Type	Input	No. of input points	Rated voltage	Rated current	Operating voltage		Input delay time		Isolation method	Status indication	No. of points /common	External wire connection	Internal current consumption (24V DC)	Mass
					OFF to ON	ON to OFF	OFF to ON	ON to OFF						
NP1X1606-W	DC input, sink/ source	16	24V DC	7mA	15 to 30V	0 to 5V	1 to 100ms Variable by parameter setting		Photocoupler	LED indication	8 (x 2)	Terminal block	35mA or less	Approx. 150g
NP1X3206-W		32		4mA							32 (x 1)		Connector	
NP1X3202-W			5 to 12V DC	3 to 9mA	3.5 to 13.2V	0 to 1V								50mA or less
NP1X6406-W		64	24V DC	4mA	15 to 30V	0 to 5V					32 (x 2)		85mA or less	Approx. 180g
NP1X0810	AC input	8	100 to 120V AC	10mA	80 to 132V	0 to 20V	Approx.	Approx.	Photocoupler	LED indication	8 (x 1)	Terminal block	35mA or less	Approx. 130g
NP1X1610		16					10ms	10ms			16 (x 1)			
NP1X0811		8	200 to 240V AC			160 to 264V	0 to 40V				8 (x 1)		35mA or less	Approx. 130g

■ Internal circuit diagram

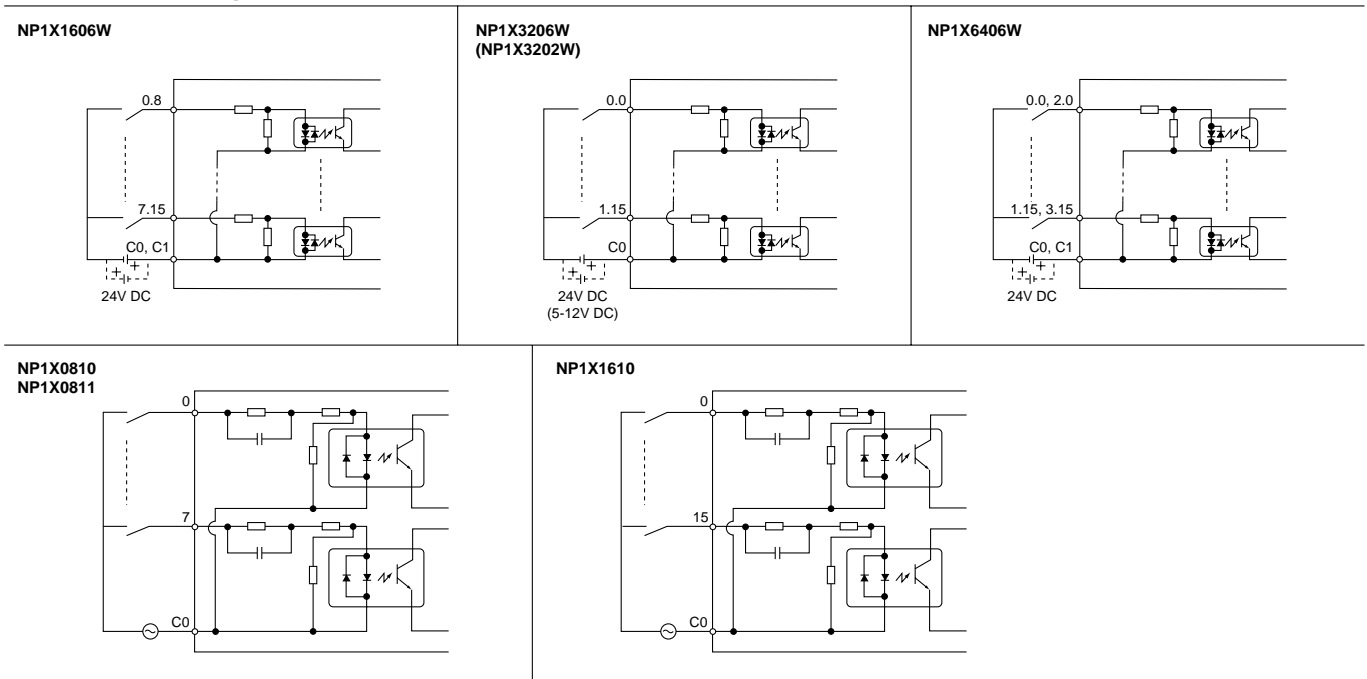

Programmable Controllers

MICREX-SX series SPH

Standard I/O Module

Digital Output Module: NP1Y □

Performance specifications

Type	Output	No. of output points	Rated voltage	Max. load current		Response time		Isolation method	Status indication	No. of points / common	Surge protection	External wire connection	Internal current consumption (24V DC)	Mass			
				Per point	Common	OFF to ON	ON to OFF										
NP1Y08T0902	Transistor output sink	8	12 to 24V DC	2.4A	8A	1ms or less	1ms or less	Photocoupler	LED indication	8 (x 1)	Varistor	Terminal block	33mA or less	Approx. 150g			
NP1Y16T09P6		16		0.6A	4A					8 (x 2)			42mA or less		Approx. 160g		
NP1Y32T09P1		32		0.12A	3.2A					32 (x 1)			Zener diode			Connector	52mA or less
NP1Y64T09P1		64								32 (x 2)					90mA or less	Approx. 180g	
NP1Y08U0902	Transistor output source	8	12 to 24V DC	2.4A	8A	1ms or less	1ms or less	Photocoupler	LED indication	8 (x 1)	Varistor	Terminal block	33mA or less	Approx. 150g			
NP1Y16U09P6		16		0.6A	4A					8 (x 2)			43mA or less		Approx. 160g		
NP1Y32U09P1		32		0.12A	3.2A					32 (x 1)			Zener diode			Connector	45mA or less
NP1Y64U09P1		64								32 (x 2)					90mA or less	Approx. 180g	
NP1Y06S	SSR output	6	100 to 240V AC	2.2A	4.4A	10ms or less	10ms or less	Relay	LED indication	2 (x 3)	CR absorber and varistor	Terminal block	60mA or less	Approx. 190g			
NP1Y08S		8		2.2A	2.2A					All points are independent			80mA or less		Approx. 200g		
NP1Y08R-04	Relay output	8	110V DC/ 240V AC	30V DC/ 264V AC: 2.2A	30V DC/ 264V AC: 4A	Approx. 10ms	Approx. 10ms	Relay	LED indication	4 (x 2)	Varistor	Terminal block	80mA or less	Approx. 150g			
NP1Y16R-08		16		30V DC/ 264V AC: 2.2A	30V DC/ 264V AC: 8A					8 (x 2)			176mA or less		Approx. 190g		

Internal circuit diagram

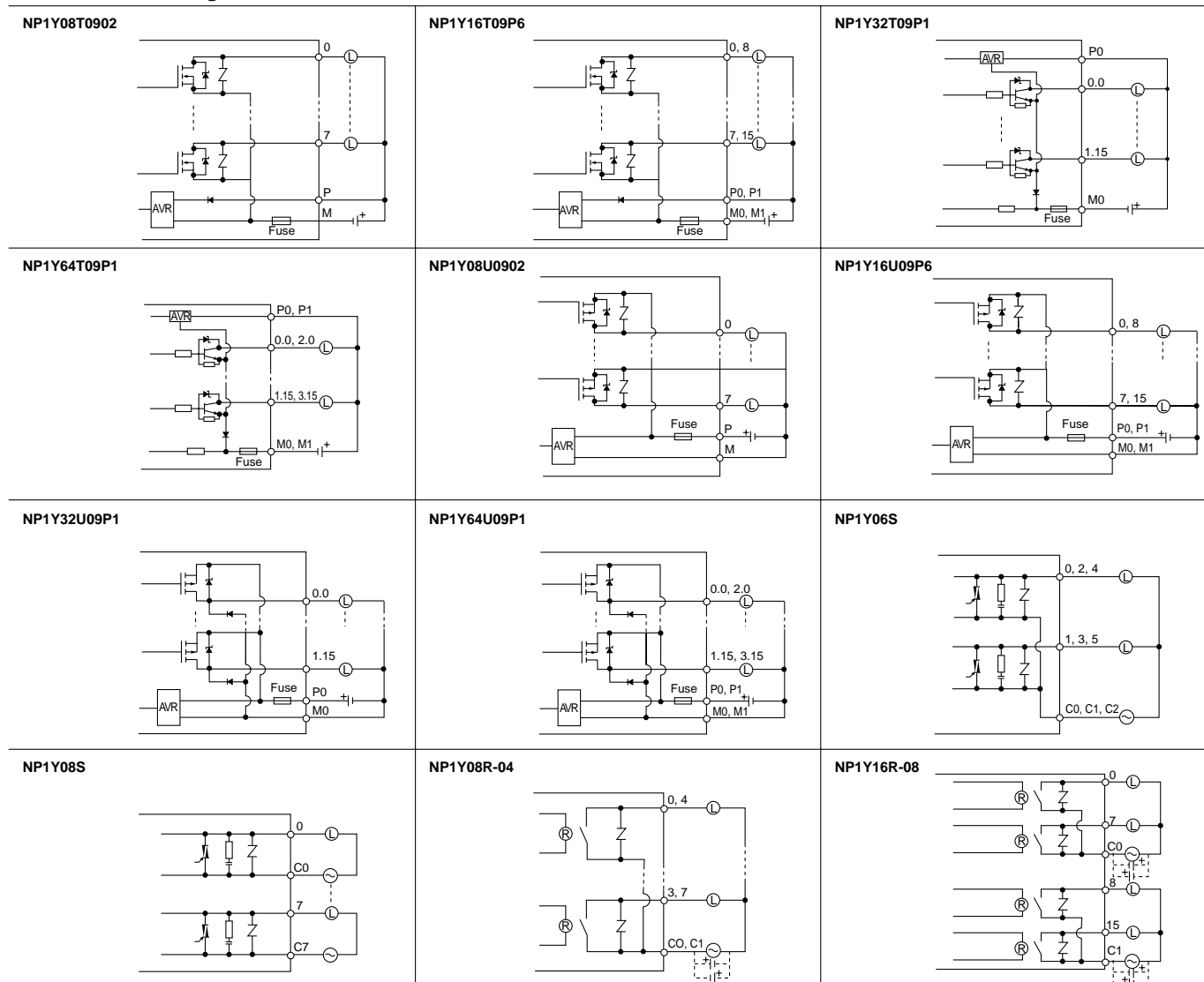

Digital Input/Output Module: NP1W □

■ Performance specifications

Type	Input					Output						Common				
	Input	No. of input points	Rated voltage	Rated current	No. of points / common	Output	No. of output points	Rated voltage	Max. load current	No. of points/ common	Isolation method	Status indication	External wire connection	Internal current consumption (24V DC)	Mass	
NP1W1606T	DC input, source	8	24V DC	7mA	8 (x 1)	Transistor output, sink	8	12 to 24V DC	0.6A	4A	8 (x 1)	Photocoupler	LED indication	Terminal block	35mA or less	Approx. 150g
NP1W3206T		16		4mA	16 (x 1)		16		0.12A	1.6A				16 (x 1)	Connector	50mA or less
NP1W1606U	DC input, sink	8	24V DC	7mA	8 (x 1)	Transistor output, source	8	12 to 24V DC	0.6A	4A	8 (x 1)	Photocoupler	LED indication	Terminal block	35mA or less	Approx. 150g
NP1W3206U		16		4mA	16 (x 1)		16		0.12A	1.6A				16 (x 1)	Connector	50mA or less

■ Internal circuit diagram

NP1W1606T

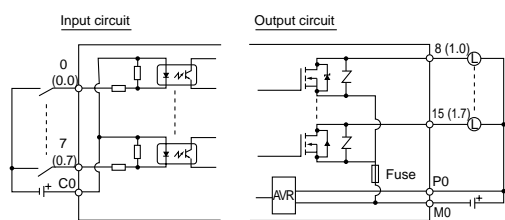

NP1W1606U

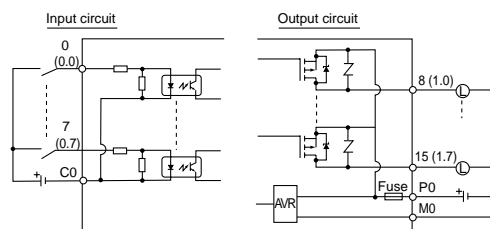

NP1W3206T

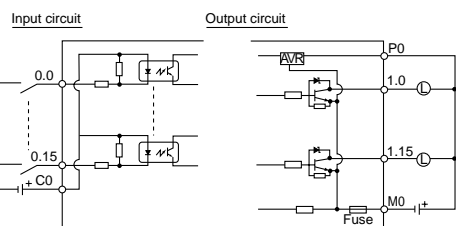

NP1W3206U

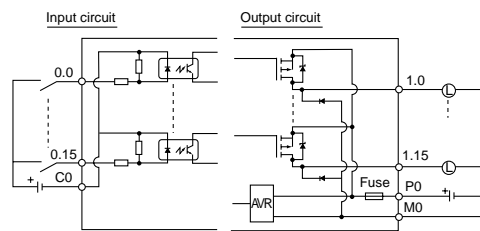

High-speed Digital Input Module: NP1X3206-A

- Digital input module with pulse catch input
- Pulse catch input of minimum 20µs or normal input
- Pulse counter input function of maximum 20kHz, 4 ch. (two-phase)

■ Specifications

Type	Input	No. of input points	Rated voltage	Rated current	Operating voltage		Input delay time		Isolation method	Status indication	No. of points /common	External wire connection	Internal current consumption (24V DC)	Mass
					OFF to ON	ON to OFF	OFF to ON	ON to OFF						
NP1X3206-A	24V DC, source	32	24V DC	4mA	15 to 30V	0 to 5V	0.1 to 100ms	Variable by parameter setting	Photocoupler	LED indication	24 (x 1) 2 (x 4)	Connector	50mA or less	Approx. 130g

■ Internal circuit diagram

NP1X3206-A

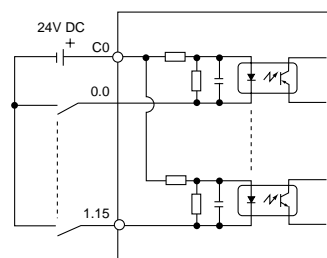

Pulse Train Output Built-in Digital Output Module: NP1Y32T09P1-A

- Module with transistor output and pulse train output built-in
- Pulse train output (20kHz) can be selected up to maximum 4 ch. x 2 phases

■ Specifications

Type	Output	No. of output points	Rated voltage	Max. load current		Respose time		Isolation method	Status indication	No. of points /common	Surge protection	External wire connection	Internal current consumption (24V DC)	Mass
				Per point	Common	OFF to ON	ON to OFF							
NP1Y32T09P1-A	Transistor output, sink	32	12 to 24V DC	0.12A	3.2A	20μs or less, 1μs or less at port sections	20μs or less, 1μs or less at port sections	Photocoupler	LED indication	32 (x 1)	Zener diode	Connector	50mA or less	Approx. 200g

■ Built-in pulse train output specifications

Item	Specification
No. of pulse train output channels	Max. 4 ch. x 2 phases (only when pulse train output mode is selected)
Max. output frequency	20kHz
Pulse output mode	(1) Forward pulse, reverse pulse (2) Pulse train + Sign
Output pulse counting method	Built-in 16-bit up-down counter
Operation mode	Start, stop, and clear operations, Ring operation Frequency/rotation direction/output mode settings
No. of general-purpose output points	32 points (min. 24 points in pulse train output mode)

■ Internal circuit diagram

NP1Y32T09P1-A

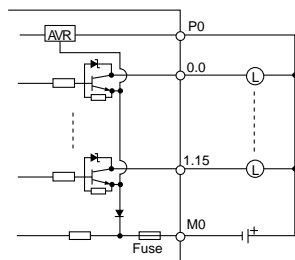

Analog Input Module: NP1AX □

■ Performance specifications

Type	Input	No. of channels	Signal range	Digital output value	Digital resolution	Total accuracy	Converting speed	Occupied word	External wire connection	Internal current consumption (24V DC)	Mass
NP1AXH8V-MR	Multi-range input	8-ch	0 to 5V DC	-8000 to +8000 or 0 to 16000	14 bits	±0.1% or less (at 18 to 28°C) ±0.2% or less (at 0 to 55°C) ±0.3% or less (at 0 to 55°C, 1-5V range)	2.5ms or less /8ch	8 words + 4 words	Terminal block	200mA or less	Approx. 240g
NP1AXH8I-MR			0 to 20mA DC 4 to 20mA DC -20 to +20mA DC								
NP1AXH4-MR		4-ch	0 to 5V DC	-8000 to +8000 or 0 to 16000	14 bits	±0.1% or less (at 25°C) ±1.0% or less (at 0 to 50°C)	1ms/4ch	8 words + 2 words		120mA or less	Approx. 200g
NP1AX04-MR			0 to 10V DC								
NP1AX08-MR		1 to 5V DC	8-ch	-10 to +10V DC	±0.5% or less (at 25°C) ±1.0% or less (at 0 to 50°C)	5ms/8ch	16 words + 2 words				

■ Characteristic diagram

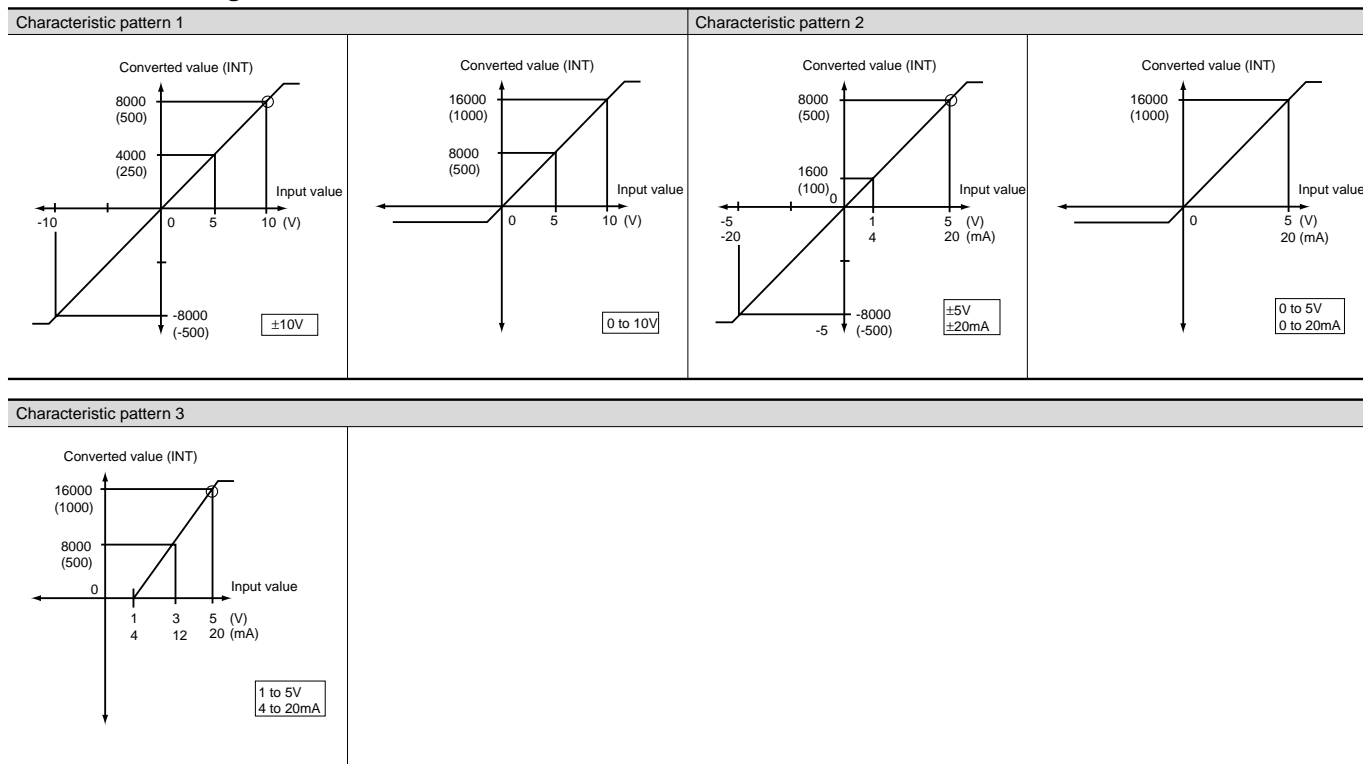

■ Input value and converted value

Characteristic pattern	1	2	3
Range of input			
± 5V		± 8000 (± 500)	
0 to 5V		16000 (1000)	
1 to 5V			16000 (1000)
0 to 10V	16000 (1000)		
± 10V	± 8000 (± 500)		
0 to 20mA		16000 (1000)	
4 to 20mA			16000 (1000)
± 20mA		± 8000 (± 500)	

Analog Output Module: NP1AY □

■ Performance specifications

Type	Input	No. of channels	Signal range	Digital output value	Digital resolution	Total accuracy	Converting speed	Occupied word	External wire connection	Internal current consumption (24V DC)	Mass
NP1AYH8V-MR	Multi-range output	8 ch	0 to 5V DC 0 to 10V DC 1 to 5V DC, -10 to +10V DC	-8000 to +8000 or 0 to 16000	14 bits	±0.1% or less (at 18 to 28°C) ±0.2% or less (at 0 to 55°C) ±0.3% or less (at 0 to 55°C, 1 to 5V range)	2ms/8ch	4 words + 8 words	Terminal block	240mA or less	Approx. 240g
NP1AYH8I-MR			0 to 20mA DC 4 to 20mA DC	0 to 16000		±0.1% or less (at 18 to 28°C) ±0.4% or less (at 0 to 55°C)					
NP1AYH4V-MR		4 ch	0 to 5V DC 0 to 10V DC 1 to 5V DC, -10 to +10V DC	-8000 to +8000 or 0 to 16000		±0.1% or less (at 18 to 28°C) ±0.2% or less (at 0 to 55°C) ±0.3% or less (at 0 to 55°C, 1 to 5V range)	1ms/4ch	4 words + 4 words		200mA or less	
NP1AYH4I-MR			0 to 20mA DC 4 to 20mA DC	0 to 16000		±0.1% or less (at 18 to 28°C) ±0.4% or less (at 0 to 55°C)					
NP1AYH2-MR		2 ch	0 to 5V DC 0 to 10V DC 1 to 5V DC, -10 to +10V DC	-8000 to +8000 or 0 to 16000		±0.1% or less (at 25°C) ±1.0% or less (at 0 to 50°C)	1ms/2ch	2 words + 4 words		120mA or less	Approx. 200g
NP1AY02-MR			-5 to +5V DC 0 to 20mA DC 4 to 20mA DC	-500 to +500 or 0 to 1000		10 bits					

■ Characteristic diagram

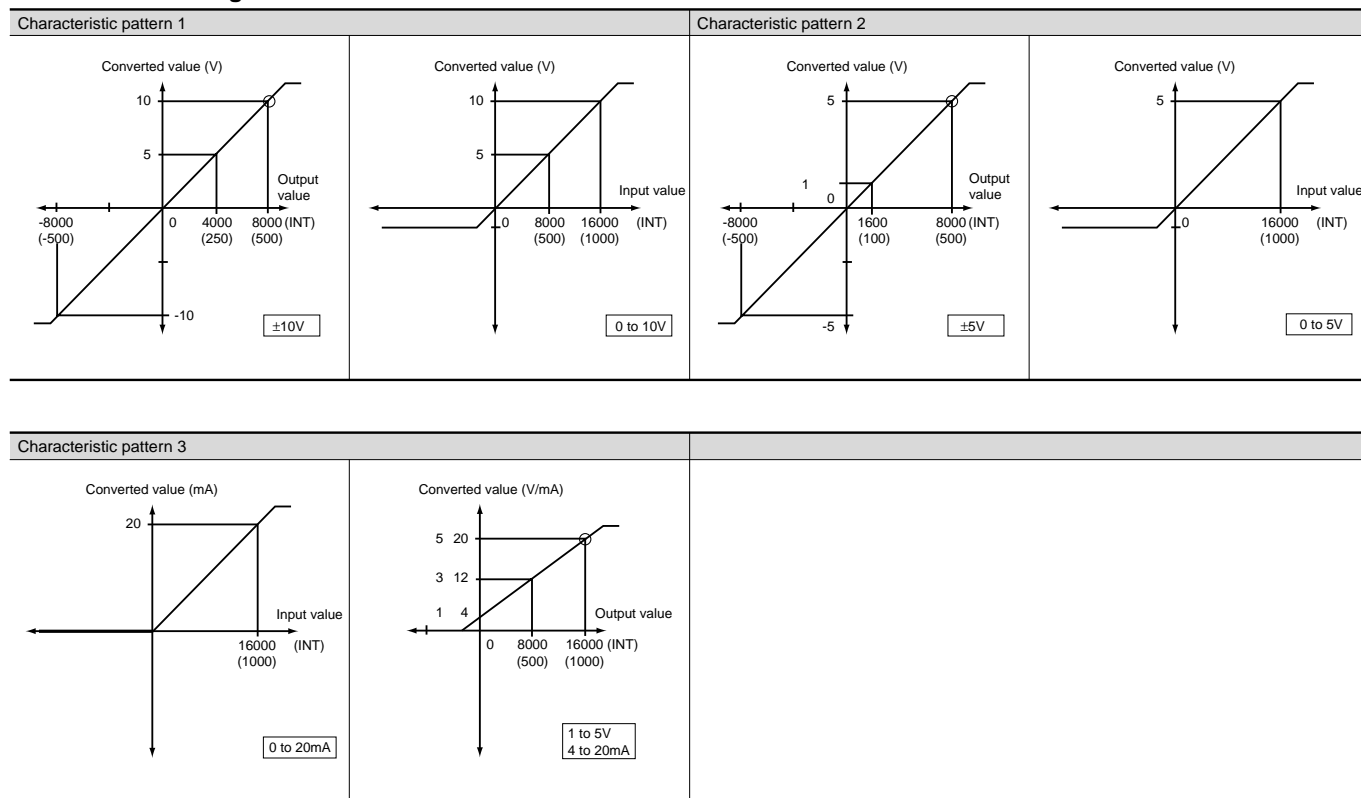

■ Input value and converted value

Characteristic pattern	1	2	3
Range of input			
± 5V		±8000 (± 500)	
0 to 5V		16000 (1000)	
1 to 5V			16000 (1000)
0 to 10V	16000 (1000)		
± 10V	± 8000 (± 500)		
0 to 20mA		16000 (1000)	
4 to 20mA			16000 (1000)

Resistance Bulb Input Module: NP1AXH4-PT

- IEC Standards conformed sensors (platinum resistance thermometer bulb) can be connected. Batch setting is possible for all channels.
- Error detection (the detection of sensor wire breakage or short-circuit) is possible.
- Temperature scale is selectable between Celsius and Fahrenheit.

■ Specifications

Item	Specification
Measurement accuracy	± 0.3% (ambient temperature 18 to 28°C) ± 0.7% (ambient temperature 0 to 55°C) With the 0.0 to 100.0°C and -20.0 to 80.0°C ranges ± 0.4% (ambient temperature 18 to 28°C) ± 0.8% (ambient temperature 0 to 55°C)
Allowable input wiring resistance	10Ω or less
Sampling interval	500ms/4ch
Input filtering time	Hardware (time constant): 50ms Software filter: 1s (variable from 1 to 100s by program)
No. of input channels	4 ch (insulation between channels)
No. of occupied I/O points	Input 8 words, output 8 words
Internal current consumption	150mA or less
External connection	Removable terminal block M3, 20 pins
Mass	Approx. 240g

■ Type of resistance thermometer element and Resolutions

Type of resistance thermometer element	Celsius (°C)		Fahrenheit (°F)		Resolution of data
	Measuring temperature range		Measuring temperature range		
Pt	0 to 200		32 to 392		1
	-20 to 80		-4 to 176		
	0 to 100		32 to 212		
	0 to 400		32 to 752		
	-200 to 200		-328 to 392		0.1
	-200 to 600		-328 to 1112		
	0.0 to 200.0		32.0 to 392.0		
	-20.0 to 80.0		-4.0 to 176.0		
	0.0 to 100.0		32.0 to 212.0		
	0.0 to 400.0		32.0 to 752.0		
	-200.0 to 200.0		-328.0 to 392.0		
	-200.0 to 400.0		-328.0 to 1112.0		
JPt	0 to 200		32 to 392		1
	-20 to 80		-4 to 176		
	0 to 100		32 to 212		
	0 to 400		32 to 752		
	-200 to 200		-328 to 392		0.1
	-200 to 500		328 to 932		
	0.0 to 200.0		32.0 to 392.0		
	-20.0 to 80.0		-4.0 to 176.0		
	0.0 to 100.0		32.0 to 212.0		
	0.0 to 400.0		32.0 to 752.0		
	-200.0 to 200.0		-328.0 to 392.0		
	-200.0 to 500.0		-328.0 to 932.0		

■ Characteristic diagram

In case of PT0.0 to 400.0°C

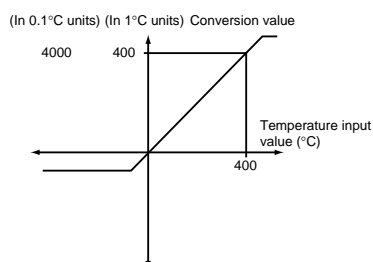

Thermo-couple Input Module: NP1AXH4-TC

- The following thermocouples that conform to IEC, ASTN and DIN Standards can be connected. Batch setting is possible for all channels.
IEC: R, K, J, S, B, E, T, N ASTN: W5Re, W26Re, PLII
DIN: U, L
- Error detection (the detection of sensor wire breakage or short-circuit) is possible.
- Temperature scale is selectable between Celsius and Fahrenheit.

■ Specifications

Item	Specification
Measurement accuracy	± 0.3% (ambient temperature 18 to 28°C) ± 0.7% (ambient temperature 0 to 55°C) With K (0.0 to 400.0°C, 0.0 to 500.0°C, 0.0 to 800.0°C) and T (0.0 to 400.0°C) ranges ± 0.4% (ambient temperature 18 to 28°C), ± 0.8% (ambient temperature 0 to 55°C)
Cold contact compensation accuracy	± 1°C (ambient temperature 18 to 28°C)
Allowable input wiring resistance	100Ω or less
Sampling interval	500ms/4ch
Input filtering time	Hardware (time constant): 50ms Software filter: 1s (variable from 1 to 100s by program)
No. of input channels	4ch
No. of occupied words	Input 8 words, output 8 words
Internal current consumption	150mA or less
External connection	Removable terminal block M3, 20 pins
Mass	Approx. 240g

■ Thermocouple Types and Resolutions

Thermocouple type	Celsius (°C)		Fahrenheit (°F)		Resolution of data
	Measuring temperature range		Measuring temperature range		
K	0 to 1300		32 to 2372		1
	0 to 500		32 to 932		
	0 to 800		32 to 1472		
	0.0 to 400.0		32.0 to 752.0		0.1
	0.0 to 500.0		32.0 to 932.0		
	0.0 to 800.0		32.0 to 1472.0		
B	0 to 1800		32 to 3272		1
R	0 to 1700		32 to 3092		1
S	0 to 1700		32 to 3092		1
E	0 to 400		32 to 752		1
	0 to 700		32 to 1292		
	0.0 to 700.0		32.0 to 1292.0		
J	0 to 500		32 to 932		1
	0 to 800		32 to 1472		
	0.0 to 400.0		32.0 to 752.0		
	0.0 to 500.0		32.0 to 932.0		
T	0 to 800.0		32.0 to 1472.0		0.1
	0 to 400		32 to 752		
	0.0 to 400.0		32.0 to 752.0		
N	0 to 1300		32 to 2372		1
U	0 to 400		32 to 752		1
	0 to 600		32 to 1112		
	0.0 to 600.0		32.0 to 1112.0		
	0.0 to 600.0		32.0 to 1112.0		
L	0 to 400		32 to 752		1
	0 to 900		32 to 1652		
	0.0 to 400.0		32.0 to 752.0		
	0.0 to 900.0		32.0 to 1652.0		
PL II	0 to 1200		32 to 2372		1
W5Re, W26Re	0 to 2300		32 to 4172		1

■ Characteristic diagram

In case of K0.0 to 800.0°C

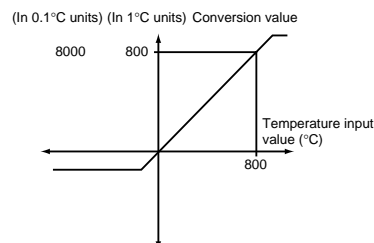

Programmable Controllers

MICREX-SX series SPH

Standard I/O Module

I/O Connection of Connector-type Modules

The following types of modules are connected using connectors and recommended for the I/O connection use.

Connector type module list

Item	Type	Specification
Digital input module	NP1X3206-A	24V DC, 32 points, 4mA 0ms to 100ms variable, with 20kHz x 4 ch. built-in pulse counter
	NP1X3206-W	24V DC, 32 points, 4mA 1ms to 100ms variable
	NP1X3202-W	5/12V DC, 32 points, 3/9mA 1ms to 100ms variable
	NP1X6406-W	24V DC, 64 points, 4mA 1ms to 100ms variable
Digital output module	NP1Y32T09P1-A	Tr. Sink, 24V DC, 32 points, 0.12A/point, 3.2A/common, with 20kHz x 4 ch. built-in pulse train output
	NP1Y32T09P1	Transistor sink, 12 to 24V DC, 32 points, 0.12A/point, 3.2A/common
	NP1Y64T09P1	Transistor sink, 12 to 24V DC, 64 points, 0.12A/point, 3.2A/common
	NP1Y32U09P1	Transistor source, 12 to 24V DC, 32 points, 0.12A/point, 3.2A/common
	NP1Y64U09P1	Transistor source, 12 to 24V DC, 64 points, 0.12A/point, 3.2A/common
Digital input/output module	NP1W3206T	24V DC, 16 points, Source input, 12 to 24V DC, Tr sink 16-point output
	NP1W3206U	24V DC, 16 points, Sink input, 12 to 24V DC, Tr source 16-point output
High-speed counter module	NP1F-HC2	500kHz x 2 ch, 90-degree phase difference 2-phase signal, pulse + directional signal, others
Multi-channel high-speed counter module	NP1F-HC8	50kHz x 8 ch, 90-degree phase difference 2-phase signal, pulse + directional signal, others
Pulse train output positioning control module	NP1F-HP2	Pulse train command 250kHz x 2 ch.
Pulse train positioning control combined module	NP1F-MP2	2-axis pulse train command positioning control combined module output pulse: 250kHz, Feedback pulse: 500kHz
Analog command positioning control combined module	NP1F-MA2	2-axis analog command positioning control combined module feedback pulse: 500kHz

Recommended connector

Description	Type (Fujitsu)	
Solder type *	Socket: FCN-361J040-AU	Cover: FCN-360C040-B
Crimp-style type	Housing: FCN-363J040	Cover: FCN-360C040-B
	Contact: FCN-363J-AU	
Pressure-welding type	FCN-367J040-AU/F (no cover needed)	

Note: * For the solder-type, the Fuji Electric connector (NP8V-CN) is available.
For details information of Fujitsu made connector, contact our sales section.

Recommended relay terminal blocks and connection cables

- Type, model, and product code
- Unit

Model	No. of terminal block pins	No. of connector pins	Rating (connector)	Performance	Product code
AU-CW41B1-11	41	40	Insulation resistance: 100MΩ or more Withstand voltage: 60V (AC,DC) Conductive current: 500V, 1 minute Allowable ambient temperature: -5 to +40°C Allowable ambient humidity: 45 to 85%RH Flame resistance: UL94-V1	Insulation resistance: 100MΩ or more Withstand voltage: 500V, 1 minute Allowable ambient temperature: -5 to +40°C Allowable ambient humidity: 45 to 85%RH Flame resistance: UL94-V1	LP1W-41BA5

Connection cable

Applicable terminal block model	No. of pins	Cable type	Connection cable model	Product code
AU-CW41B1-11	40	Multi-core cable	AUX011-40 □	LP911-40 □
		Flat cable	AUX021-40 □	LP921-40 □

* □ indicates the length of the multi-core cable and flat cable.
1:1m (standard), 2:2m, 3:3m

- Recommended cables
- Cable with connectors

AUX011-40 □ type (Fujitsu)

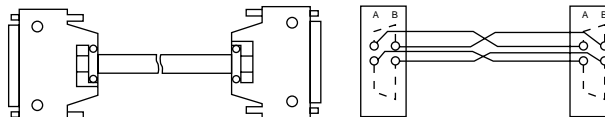

- Flat cable with connectors
- AUX021-40 □ type (Fujitsu)

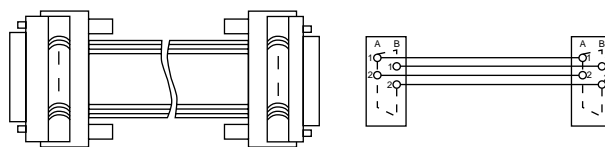

Dimensions, mm (AU-CW41B1-11 type)

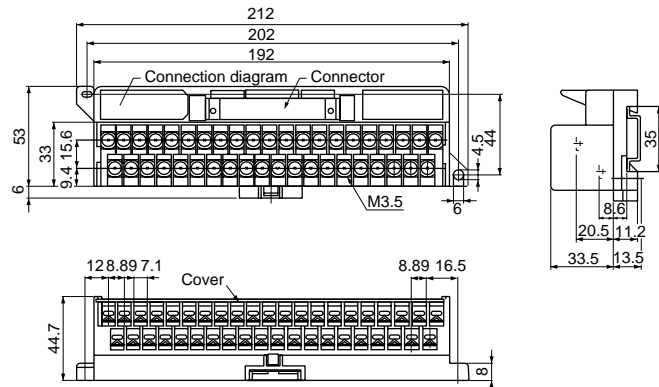

Connection diagram

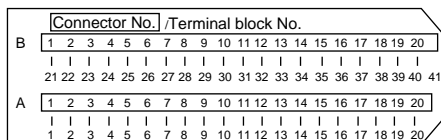

AU-CW41B1-11
connector mounting
direction (viewed from
the fitting side)

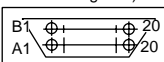

Terminal Relay

■ Features

- Minimum width of 110mm has been achieved.
The external dimension is as compact as 110mm (W) x 52mm (D) x 37mm (H). In particular, the minimum width in this field has been implemented. (As of Sept. '97)
- Push-set terminal facilitates tightening screws.
Push-set terminal is used in the terminal section, eliminating the screw tightening time and preventing screws from being lost.
- LED operation indication facilitates I/O ON/OFF operation check.
Operation indication LED is arranged in 1:1 correspondence with the relay. This makes the ON/OFF relay operation status clear at a glance.

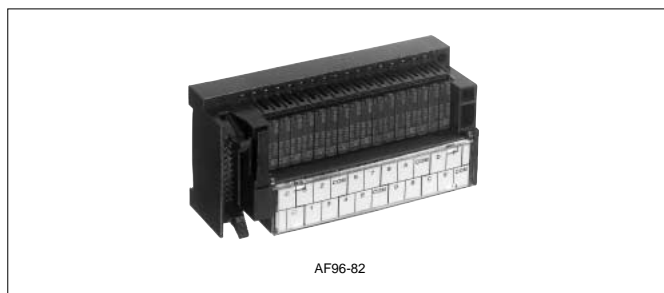

AF96-82

- Two types of relays available for output and input.
- With surge protection diode provided.
- Terminal cover is installed as standard allowing device No. indication.
- With the built-in relay remover.
- Used for both DIN rail installation and rear-side screw mounting.

■ Performance specifications

Item	Performance
Operating duration	10ms or less
Recovery duration	10ms or less
Vibration resistance	Malfunction
	Durability
Impact resistance	Malfunction
	Durability
Operation ambient temperature	-25 to +55 °C (no condensation)
Operation ambient humidity	35 to 85% RH
Terminal screw size	M3
External connection tightening torque	0.5 to 0.7 N·m
Mounting method	Rail mounting (screw mounting also possible)
Applicable round-type crimp-style terminal	R1.25 to 3 (max.6mm wide)
Connection wire	max. ø1.4
LED indication color	Operation indication: Red, Power indication: Green
Coil surge protection element	Diode
Relay removal count	50 times
Insulation resistance (initial)	100 MΩ or more (with 500V DC megger)
Voltage resistance	Between contact coils
	Between contacts with same polarity
	Between contacts with different polarity
Mass	200g

■ Type/Model/Ordering code

Model (Ordering code)	I/O type	No. of points	Rated voltage	Common line handling on Connector side
RS16-□04	Output	16 points	5V DC [DY]	NPN compatible (+ common)
RS16-□04P		(1a x 16)	24V DC [DE]	PNP compatible (- common)
RS16E-□04	Input	16 points		NPN compatible (+ common)

■ Rating

Opening section, connector side (per RB105 1 point)

Item	Load	RS16 (output)		RS16E (input)	
		Resistance load (cosφ =1, L/R=0ms)	Inductive load (cosφ =0.4, L/R=7ms)	Resistance load (cosφ =1, L/R=0ms)	Inductive load (cosφ =0.4, L/R=7ms)
Rated load, rated voltage/current		220V AC 2A	220V AC 2A	24V DC 1A	24V DC 1A
Rated conducting current		2A * (1)		1A * (2)	
Contact resistance		30mΩ or less		30mΩ or less	
Voltage/current applicable to min. applicable load (P standard reference value)		0.1V 0.1mA		0.1V 0.1mA	
Mechanical lifetime		20 mil. times		-	
Electrical lifetime		0.2 mil. times	0.3 mil. times	0.1 mil. times	0.06 mil. times

- (1) The relay (RB105) is a 5A rated conducting current product. However, the main unit rated conducting current is restricted to 2A due to the structural characteristics of the terminal relay.
(2) The relay (RB105) is a 5A rated conducting current product. However, the main unit rated conducting current is restricted to 1A due to the structural characteristics of the terminal relay.

Operating coil I/O specification (per RB105 1 point)

(at 20°C)

Rated voltage	Rated current	Coil resistance ±10%	Operating voltage	Recovery voltage	Max. allowable voltage	Power consumption	
						Per 1 point	Per 16 points
5V DC	40mA	125Ω	70% or less of rated voltage	10% or more of rated voltage	110% of rated voltage	0.2W	3.2W
24V DC	8.3mA	2,880Ω	70% or less of rated voltage	10% or more of rated voltage	110% of rated voltage	0.2W	3.2W

Note: Current supplied to LED is approximately 1mA. To calculate the power supply capacity, add the current value.

Programmable Controllers

MICREX-SX series SPH

Terminal Relay

Internal connection diagram

● RS16-DE04 (output, applicable to NPN)

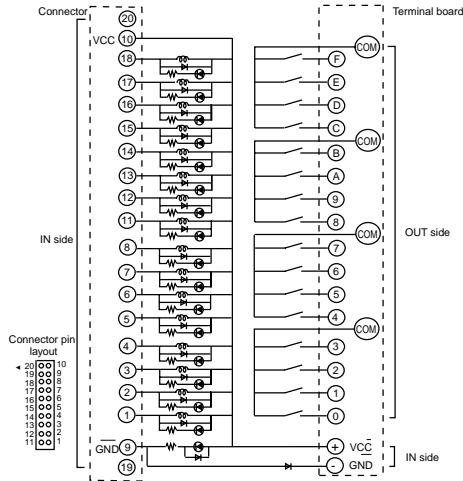

● RS16-DE04P (output, applicable to PNP)

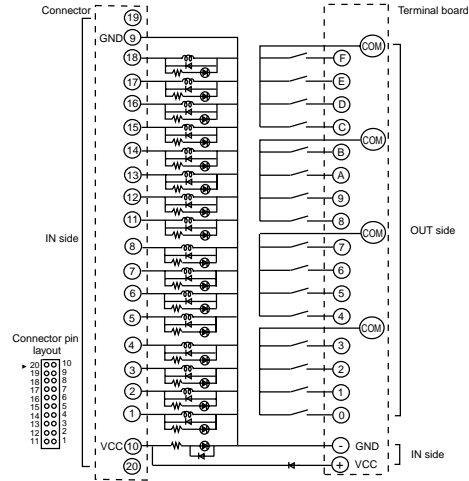

● RS16E-DE04 (input, applicable to NPN)

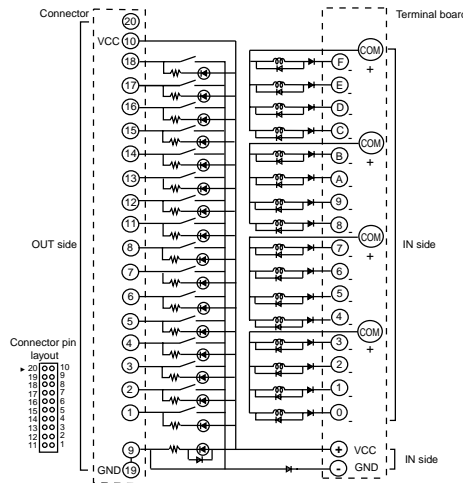

Using the push-set terminal

(1) Push up the terminal screw with a screwdriver, etc.



AF95-388

(3) When the solderless terminal is inserted, push down the terminal screw with a screwdriver and then fasten screws.



AF95-390

(2) When the terminal screw is pushed up, insert the solderless terminal.



AF95-389

(Note) Fasten the screw of unused terminals.

Dimensions

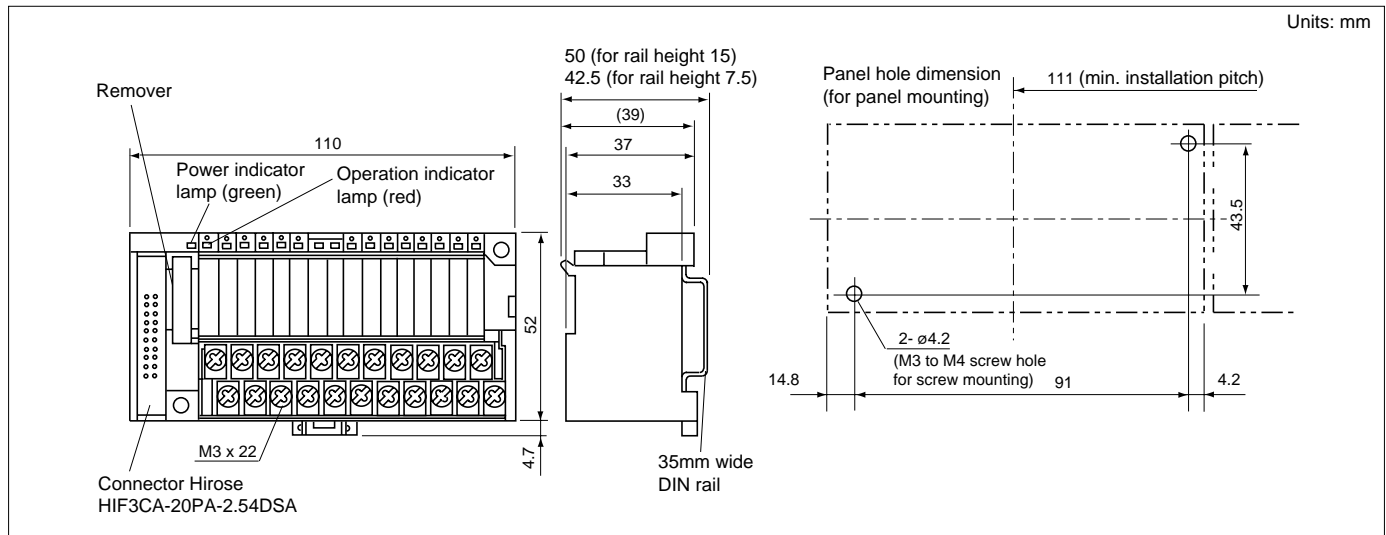

■ Terminal relay cable

● Type/Model/Ordering code

Type	Cable Length	Model (ordering code)
Cable with connectors (1:2) For MICREX-SX (for input, output)	1,000mm	RS910M2-0104
	2,000mm	RS910M2-0204
	3,000mm	RS910M2-0304

● Dimension specification

Model (ordering code)	I/O type	Compatible PLC
RS910M2-□□04	Output	MICREX-SX series Tr output module NP1Y32□ *1 NP1Y64□
	Input	MICREX-SX series Input module NP1X32□ NP1X64□ NP1W3206T□

Numeric in □□ indicates a cable length.
01: 1m
02: 2m
03: 3m

*1 NP1Y32T09P1-A (with the pulse train output function) is not applicable.

External specification	
Controller side	Terminal relay side

⚠ Notes on use

(1) Attachment direction

Although there is especially no limitation on the attachment direction, when the relay can be attached horizontally with respect to the floor surface, the direction where the connector comes to the lower side, as shown at right, is recommended. This direction makes the moving section of the relay come to the lower side, thus improving the resistance to vibration. In this case, use retainer fitting TS-XT to prevent the section from dropping downward.

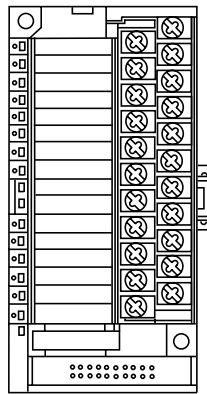

(Connector side)

(2) Attach the relay to or remove it from the socket so that it be perpendicular to the surface of the socket. Attaching or removing the relay slantly may cause bend of the relay terminal or damage to the socket. Use the provided pull-out tool when attaching or removing the relay.

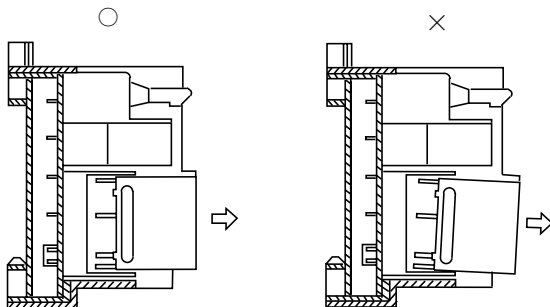

(3) The type of the relay corresponding to the card relay terminal relay applicable to the terminal relay is RB105. As the replacement relay, use a relay of the same type and with the same voltage specification as the one supplied at the time of delivery.

(4) When attaching the PC terminal to the control panel, etc., leave a space between the adjacent equipment or duct and the PC terminal to secure a space for connector removal handle operation, as shown at right.

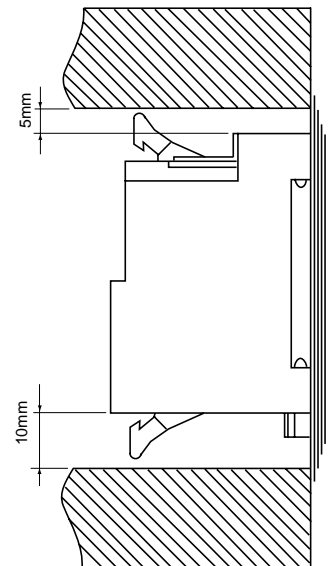

(5) As for connector selection, use connectors prepared as an option. When using commercial products, use products from Hirose Electric. Using a connector from other manufacturers may cause inferior connection or other failures.

Programmable Controllers

MICREX-SX series SPH

Communication Module

Computer-level Communication Module

Web Module: NP1L-WE1

■ Features

Through the Internet and Intranet, this module realizes equipment supervision by Web browser, E-mail sending at failure occurrence, and remote control and remote maintenance (monitoring/program modification) by the programming support tool.



■ Functional specifications

Item	Specification
Web server functions	Controller data can be monitored and set using a browser (Internet Explorer) on a remote personal computer. Mounts the tabular form data display and trend graph display functions as standard. Initial setup items for the Web modules are all set in the browser screen.
E-mail send function	Sends E-mail (failure alarm notification, etc.) to the specified destination address at occurrence of a set event.
FTP function	Saves trend data and CPU data (binary file) in external FTP server at occurrence of a set event. Saved data can be processed to generate a daily/monthly report or trend graph.
Security function	Limits users and setup operations by user name and password.
Remote loader function	Remote operation of SX support tool (D300win), such as monitoring of SPH sequence, from a personal computer
PPP function (option)	Realizes the above functions through telephone circuit connection service, PPP connection, etc.
User contents creation function	Incorporates user-created contents in the Web module.

■ Functional specifications

Item	Specification
Ethernet interface	10BASE-T/100BASE-TX, RJ45 modular jack x1 Auto negotiation
RS-232C interface (Option for PPP connection)	115.2kbps max. Dsub 9-pin (male) connector x1 Character format Data length: 7/8 bits Parity: Even/odd parity Stop bits: 1/2 bits Hardware flow control: Provided
No. of units mounted	4 or less recommended (in the same configuration)
Internal current consumption	24V DC, 140mA or less
Mass	Approx. 140g

■ System configuration

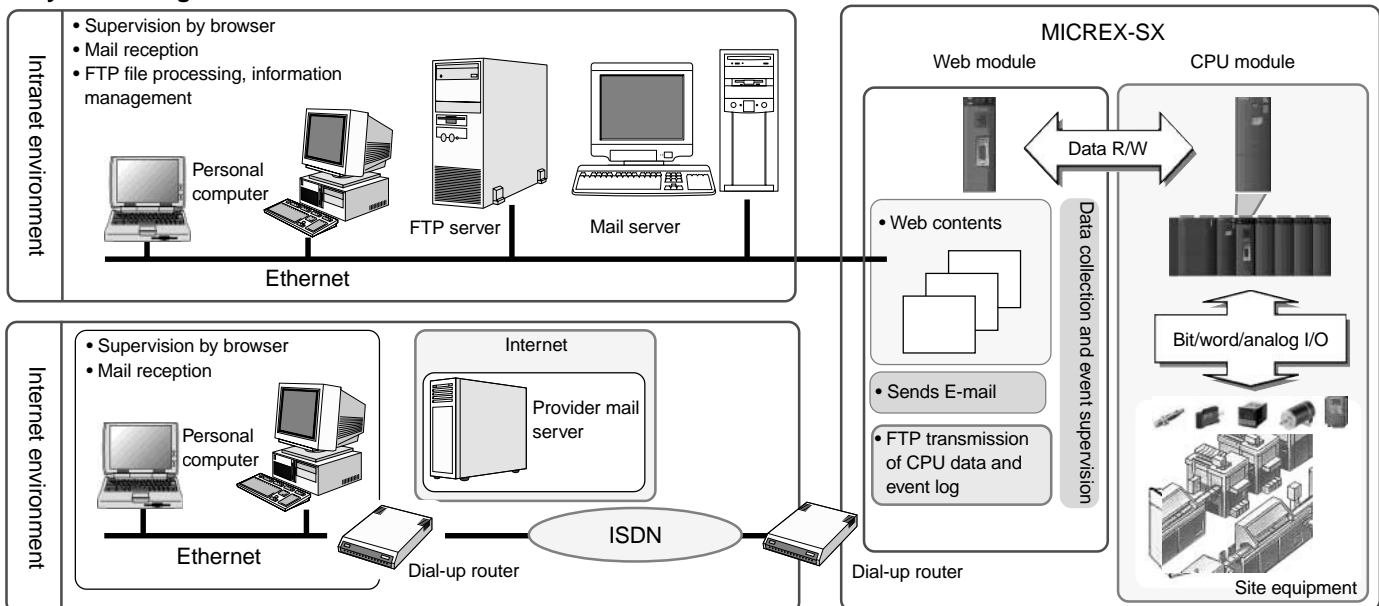

Ethernet Interface Module: NP1L-ET1

■ **Features**

- Supports the 100BASE-TX interface as well as 10BASE-T. (Automatic selection by the auto negotiation function)
- Supports three different communication modes.
- General-purpose communication mode (TCP/IP or UDP/IP protocol communication)
- Fixed buffer communication mode (Handshake communication between PC and specific node)
- Loader command communication mode (MICREX-SX loader command function)



■ **Performance specifications**

Item		NP1L-ET1
Communication function	Application communication mode	General-purpose communication
	Loader command automatic reception mode	Fixed buffer communication
		Automatic transmission communication
Interface		10BASE-T/100BASE-TX Automatic selection by the auto negotiation function
Media control		IEEE 802.3/IEEE 802.3u
Transmission rate		10Mbps/100Mbps
Transmission medium		Twist pair cable (UTP)
Protocol		TCP/IP, UDP/IP
Max. number of nodes for simultaneous communication		16 stations (ports)
Max. number of transmit words		1017 words
Max. number of loader connections simultaneously		8 units
No. of units mounted		4 or less recommended (in the same configuration)
Internal current consumption		24V DC, 140mA or less
Mass		Approx. 140g

■ **System configuration**

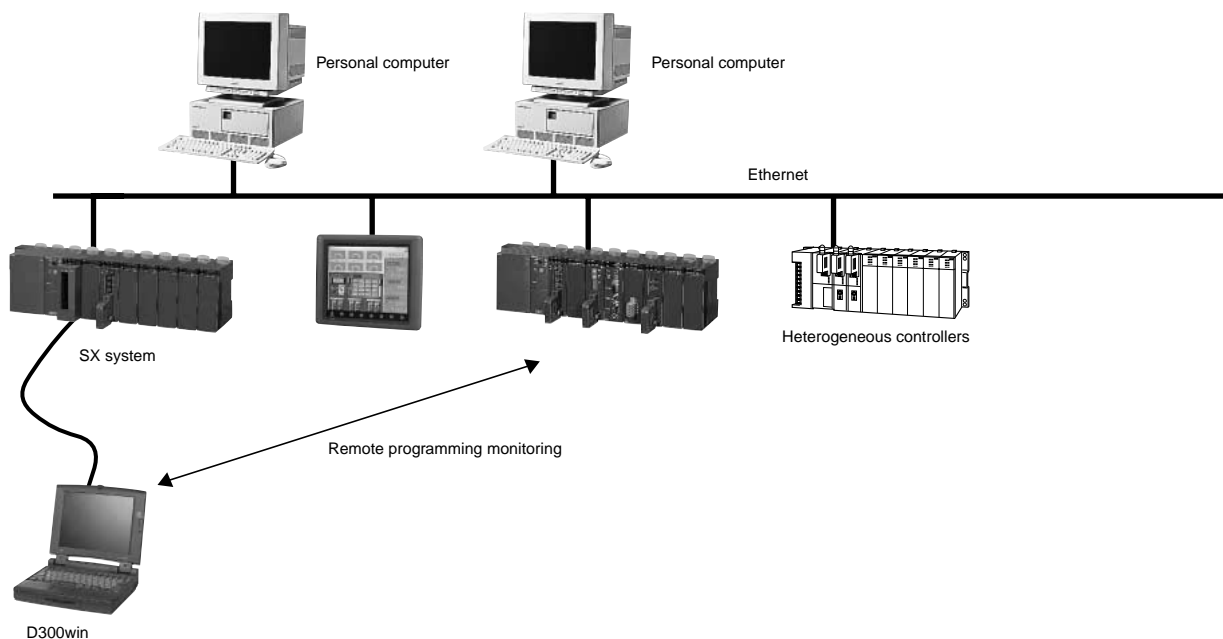

Programmable Controllers

MICREX-SX series SPH

Communication Module

Online Adapter: FOA-ALFA2

■ Features

This module allows easy remote maintenance system configuration simply by connecting the online adapter to the loader port without changing any program on the PC (MICREX-SX SPH) side.

- Bi-directional communication between the master station (personal computer) and slave station (SPH)
- Diverse functions
 - Failure monitor function
 - Data accumulation function
 - Integrated time monitor function
- Calendar function (year, month, day, hour, minute, second)
- Data backup function (data memory, calendar IC memory)
- Communication status display by LED indicators

■ Specifications

● General specifications

Item	Specification	
Physical environment	Operating ambient temperature	0 to ± 55°C (without condensation)
	Storage temperature	-20 to ± 70°C (without condensation)
	Relative humidity	20 to -90%RH (without condensation)
	Contamination	Contamination level 2
	Corrosion resistance	No corrosive gas is present, no organic solvent adhesion
	Operating altitude/air pressure	Altitude of 2000m or less (air pressure of 70kPa or higher during transportation)
Mechanical operating condition	Resistance to vibration	One amplitude: 0.15mm, constant acceleration: 9.8m/s ² , 2 hours for each direction, 6 hours total
	Resistance to shock	Peak acceleration: 294m/s ² , 3 times for each direction
Electrical operating condition	Resistance to noise	Noise simulator method, rise time of 1ns, pulse width of 1us, 1kV
	Resistance to electrostatic discharge	Contact discharge method: ± 6kV, air discharge method: ± 8kV
	Resistance to radiation electromagnetic field	10V/m (80 to 1000MHz)
Cooling system	Natural cooling	
Insulation characteristic	Insulation resistance	10MΩ or more (between connectors and ground) with a 500V DC megger
	Power supply method	Supplies 24V DC from PC or 12V DC from AC adapter.
Current consumption	24V: 60mA or less 12V: 120mA or less	
Mass	Approx. 320g	
Calendar accuracy	± 90 seconds/month (25°C, conduction)	
Battery type/operating life	Lithium primary battery 3.6V NP8P-BT (FUJI ELECTRIC)/ 5 years (ambient temperature of 25°C)	

Note: For operating environment, take into consideration the specifications of the communication devices used.
* Use the AC adapter only at the time of initial setup data transmission. Do not use it for connection with SPH.

■ System configuration



Specialized connection cable (option)
NP4H-CB2

■ Initial setup loader (Model: FOA-LOADER2-CD) <Japanese version>

The initial setup loader is provided with the following functions:

- Creates initial setup data (each function setup).
Sets the failure monitor, data accumulation, integrated time monitor functions and registers AT commands for communication.
- Writes the initial setup data to the online adapter.
After creating setup data (each function setup) using the initial setup loader, writes the data to the online adapter.
- Reads the initial setup data from the online adapter.
Loads the initial setup file of the online adapter in the initial setup loader screen.
- Reads the version information in the online adapter.
Loads the version information of the online adapter in the initial setup loader screen.



FOA-ALFA2
KD02-024B

● Functional specifications

Mode	Contents
Online adapter mode	Execution mode of various monitor functions
Loader mode	Monitors SPH programming monitor locally.
Remote mode	Monitors SPH programming monitor from a remote site.
Initial setup mode	Writes setup data necessary for various monitor functions using the initial setup loader.
Memory clear mode	Backup memory initialization (clear) mode

■ Outside dimensional drawing

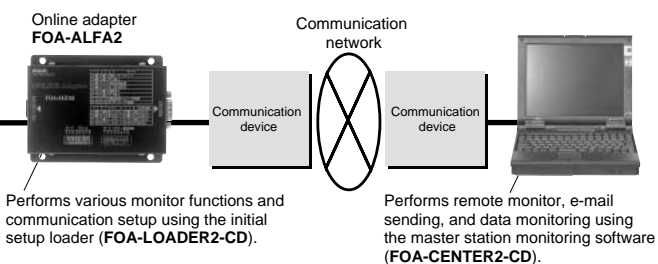
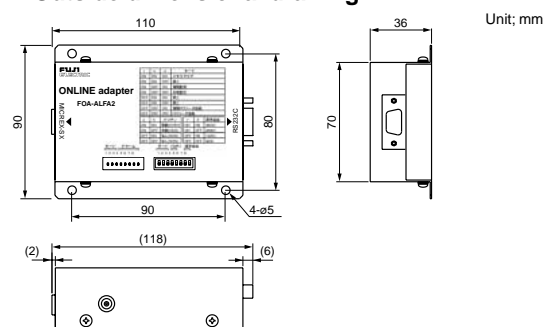

■ Master station monitoring software (Model: FOA-CENTER2-CD) <Japanese version>

The master station monitoring software is provided with the following functions:

- Slave station monitor function (reception of notification from slave station)
 - Failure monitor function
 - Data accumulation function
 - Integrated time monitor function
- Access from the master monitor software (personal computer) to slave station.
- Reads data accumulated in the online adapter.
- Automatically collects data by time specification (with circuit connection each time).
- Updates the initial setup data from a remote site. (Remote update function)
- Uses the personal computer loader software from a remote site.
- Other functions
 - Saves receive data as CSV files.
 - Monitors accumulated data in bar graph form.
 - Upon reception of failure information, automatically transfers the failure information to E-mail-based mobile tool through the internet using the online adapter.

Controller-level Communication Module
FL-net (OPCN-2) Ver. 2.0 Module: NP1L-FL2

■ **Features**

- Up to 2 communication modules including P/PE-link can be installed on the base board equipped with CPU.
- Data exchange between processors
Cyclic data communication, message communication
- FL-net loader commands supported
- SX system loader functions via network are supported.



■ **Performance specifications**

Item	Specification	
Transmission specification	10BASE 5	10BASE T
No. of SX bus connectable modules	Max.2 /configuration (including P/PE-link)	
Max. number of system nodes	254 units (100 units/segment)	254 units (2 units/segment)
Transmission line format	Bus configuraiton (multi-drop)	
Transmission line	Ethernet coaxial cable	UTP (unshilded twisted pair cable)
Framing method	Ethernet II	
Access control	CSMA/CD	
Transmission method (code)	Base band (Manchester coding)	
Transmission speed	10Mbps	
Max. segment length	500m (2500m max. with repeater)	100m (between node and hub) (max. 200m with repeater)
Max. nodes	254 (However, it is necessary to increase the segment by using the repeater.)	
Min. node interval	2.5m (multiplying integer of 2.5m)	-
Protocol	FA link protocol, UDP/IP, ICMP, ARP	
IP address	Class C	
Data exchange method	<ul style="list-style-type: none"> • Cyclic broadcast transmission method Data size: Max. 8.5kW • Message transmission method Data size: Max. 512W 	
Host interface	Common memory cyclic refresh method, block data read/write	
Internal current consumption	24V DC, 105mA or less	
Mass	Approx. 220g	

■ **System configuration**

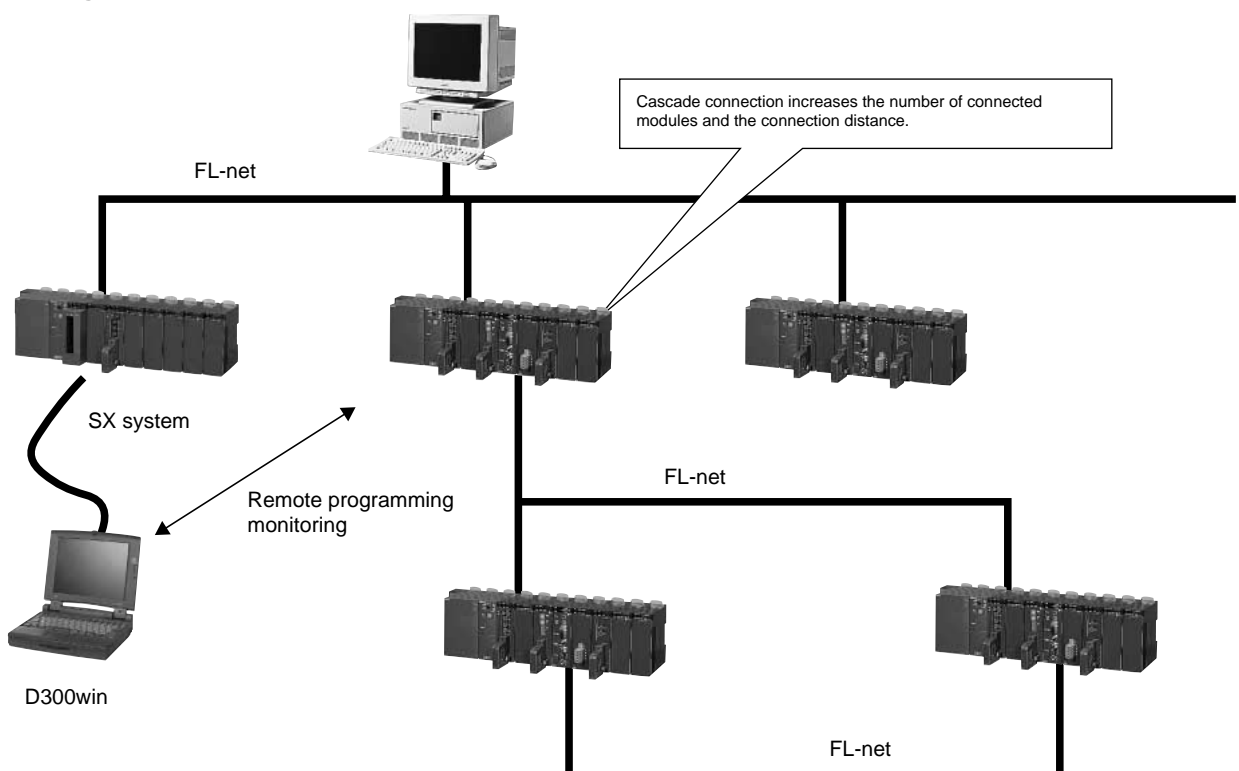

Programmable Controllers

MICREX-SX series SPH

Communication Module

ADS-net Module: NP1L-AD1

■ Features

- Supports the Autonomous Decentralized Protocol (R3.0) * and is provided with the following functions:
 - Multicast communication function
 - Existence signal transmit function
 - Trouble information transmit function
- Supports the test support function.
- Supports input and output of I/O transactions and up to 16 TCDs.
- Supports the 10BASE-T (TPI) and 10BASE5 (AUI) interfaces.

* The Autonomous Decentralized Protocol is a protocol decided by FA Open Systems Promotion Forum (FAOP) of Manufacturing Science and Technology Center (MSTC, Japan), and the protocol is being discussed in ISO.



■ Performance specifications

Item	Specification (overview)
Communication function	<ul style="list-style-type: none"> • Multicast communication (function class: Base-1) ^{Note 1} • Existence signal transmission (function class: Base-2) ^{Note 2} • Trouble information transmission (function class: Base-3) ^{Note 3}
Message size	Up to 1024 bytes (user data section)
Message buffer size	Selected from 256/512/1024 bytes.
No. of data fields registered	1 data field
No. of multicast groups registered	Up to 8 groups
No. of output transaction codes	Up to 16 TCD
No. of input transaction codes	Up to 16 TCD
Test node setup	Possible
Interface selector switch	Selected by the switch on the front panel of the module.
Interface	10BASE-T or 10BASE5
Media control	IEEE 802.3
Transmission rate	10Mbps
Max. segment length	10BASE-T: 100m, 10BASE5: 500m (2500m max. with repeaters)
Max. number of nodes	10BASE-T: 1 unit/segment, 10BASE5: 100 units/segment
Protocol	UDP/IP, autonomous distribution protocol (R3.0)
External power supply	12V DC, 500mA ^{Note 2}
Internal current consumption	24V DC, 140mA or less
Mass	Approx. 220g

Note 1: 10BASE-T and 10BASE5 cannot be used at the same time.

Note 2: When 10BASE5 is used, an external power supply (12V DC) is required. Use an external power supply (12V DC) which satisfies the specifications of the transceiver and transceiver cable (AUI cable).

[Reference]

IEEE 802.3 defines the following specifications of the transceiver and transceiver cable (AUI cable):

- Transceiver I/O terminal voltage: 12V DC-6% to 15V DC+5%
- Transceiver cable DC resistance: 40 Ω/km or less, maximum total length 50m
- Transceiver maximum current consumption: 500mA

■ System configuration

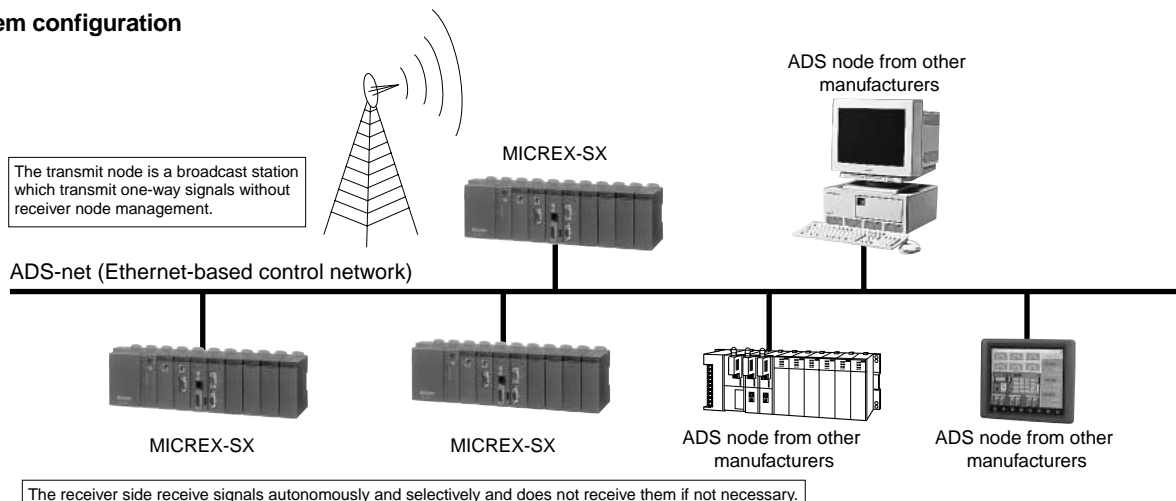

LonWorks Network Interface Module: NP1L-LW1

■ **Features**

- Uses the communication extension FB compatible with the LonWorks network, making it easier to transfer and receive MICREX-SX application data to/from other LonWorks nodes.
- Max. number of NVs: 300, Number of CPs: Up to 200 intelligent nodes can be configured.
- Up to two units can be mounted in one system (configuration).



■ **Specifications**

Item	Specification	Remarks
Applicable standards	LonTalk (EIA-709.1), LonMark	
Transmission rate	78k bit/sec	
Transmission distance	2200m	Uses 16AWG for communication with the bus type.
	500m	Uses 16AWG for with free topology.
No. of node connections	64 units	No. of node connections in the same segment
Transceiver	FTT-10A	
Control LSI	TMPN3120	Application programs operate on SPH.
No. of LonWorks modules mounted	Up to 2 modules	Can be used through connection to two LonWorks networks.
Max. number of NVs	300	Depends on the definition.
Max. number of CPs	200	Depends on the definition.
Total data size of NV+CP	8K words + 128 words	
Pio area size	128 words	Used for NV and CP.
Memory area size	Size x 4 blocks, a total of 8K words or less	Used for NV and CP.
No. of address entries	Fixed to 15	No. of nodes for NVo variable binding
No. of domain table entries	Fixed to 2	
Internal current consumption	24V DC, 140mA or less	
Mass	Approx. 200g	

■ **System configuration**

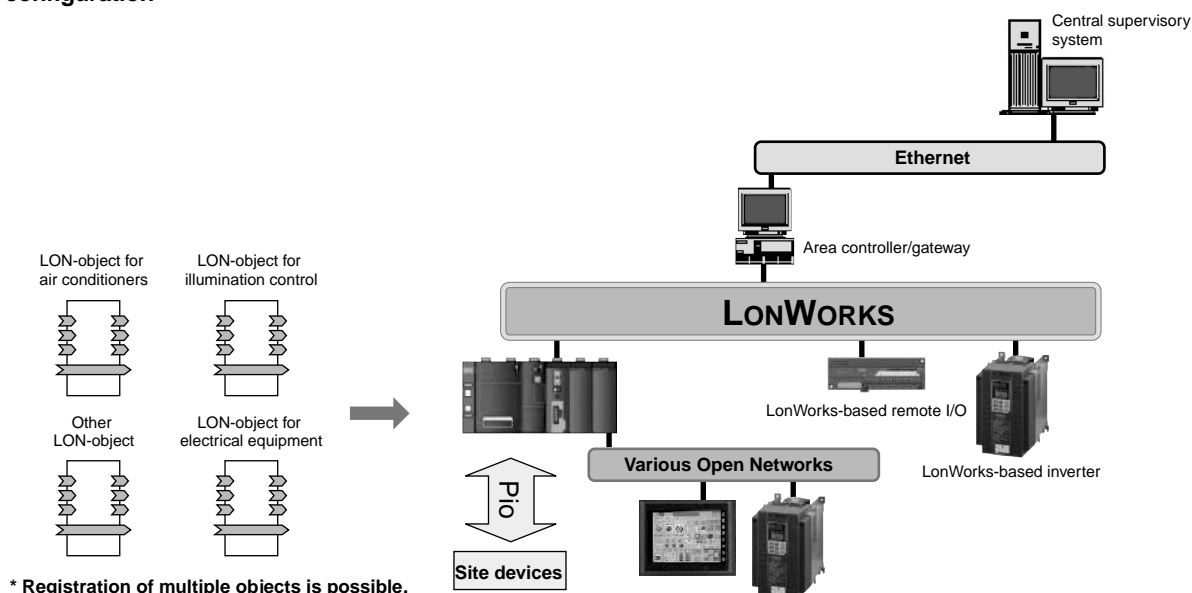

LonWorks Network Interface Module Support Tool: NP4N-LNDF [Japanese Version]

■ **SLDEF (Model: NP4N-LNDF)**

- To perform communication with the LonWorks network, it is necessary to define network variables using the specialized tool compatible with the LonWorks network (neuron C language programming).
- SLDEF makes it possible to define these variables with an ACCESS file without knowledge of the neuron C language.
- The information (SXD files) defined by SLDEF are downloaded from programming support tool D300win to the LonWorks module.
- Since the node object definition specified by LonMark is offered as FB, LonWorks control can be defined by PLC programming.

Programmable Controllers

MICREX-SX series SPH

Communication Module

P-link/PE-link Module: NP1L-PL1 (P-link) NP1L-PE1 (PE-link)

■ Features

- Up to 2 P/PE-link modules can be installed in a single system configuration.
- N-to-N communications in the token passing method
- Data exchange between processors
Broadcast communication, message communication
- User program upload/download and processor start/stop are possible from the host computer.
- Remote programming for other processor is possible via the P/PE-link.

■ Performance specifications

Item	Specification	
Type	NP1L-PL1 (P-link)	NP1L-PE1 (PE-link)
No. of SX bus connectable modules	Max.2 /configuration	
No. of P/PE links	Max. 16	Max. 64
Transmission line format	Bus configuration (multi-drop)	
Transmission line	Coaxial cable Total length: Max.250m	Coaxial cable Total length: Max.500m
Transmission method	Half-duplex, serial transmission	
Data exchange method	N: N (token passing) method, memory refresh method	
Transmission speed	5Mbps	
Data transfer	Broadcast communication, message transmission	
Cable	Coaxial cable /5C-2V (conforming to JIS C 3501)	
Internal current consumption	24V DC, 160mA or less	
Mass	Approx. 235g (module), approx. 40g (P/PE-link connector)	



■ P/PE-link connection equipment

Classification	Series	Type	Link	Remarks
PC	MICREX-F70S	NC1H-PL1	P-link	
	MICREX-F120S to 150S	FPC220P FPC420P	P-link PE-link	
FA personal computer	FMV5233FA or later	CNVAD120-01	P-link	
		CNVAD190-01	PE-link	
Optional	MICREX-F (Optical converter)	FNC200B-□	P-link	
		FNC302A-□	PE-link	
	(Electrical repeater)	FNC320A-□	PE-link	Long-distance type
		FRP200A-C10	P-link	

□ indicates the power supply type.
C10: 100 to 110V AC, 110V DC
A20: 200 to 240V AC

■ System configuration

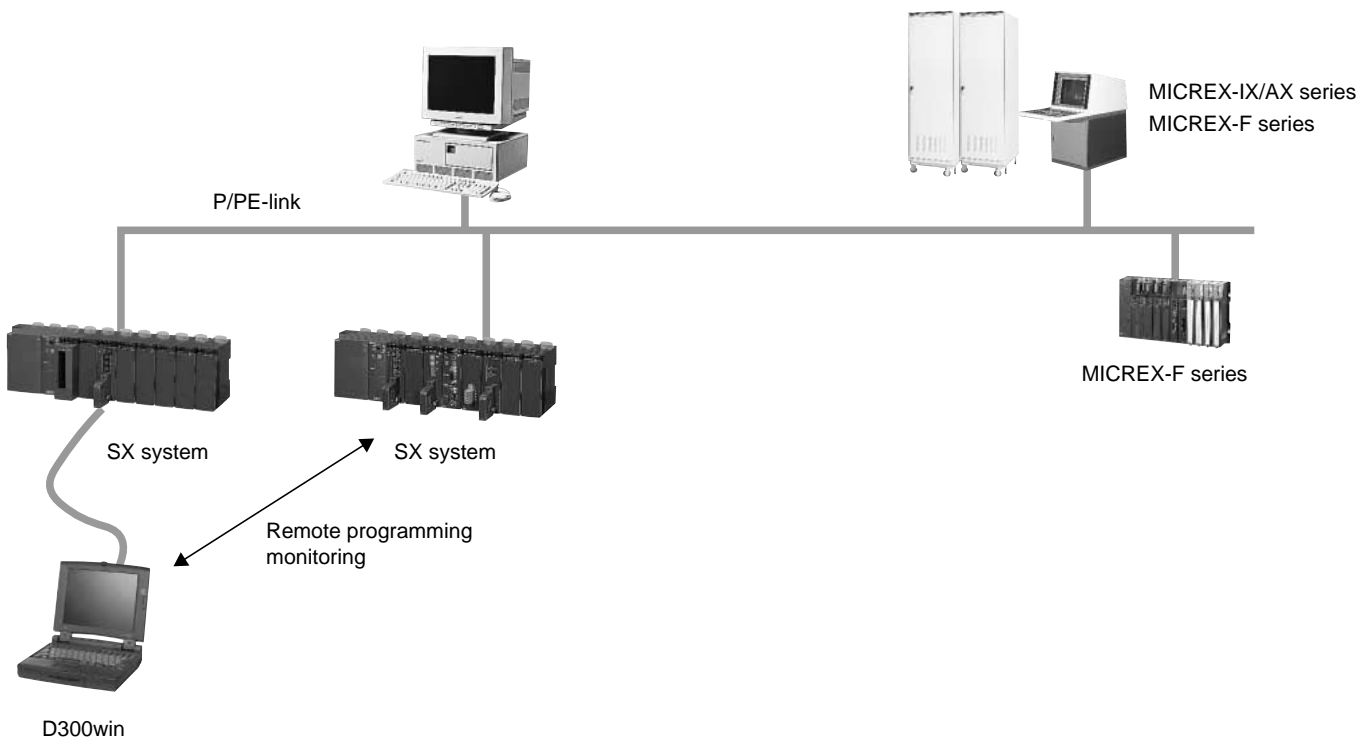

General Purpose Communication Module: NP1L-RS

Features

- Can be combined with an expansion FB (Function Block) for communications with diverse equipment without creating any communication control program.
- Communication port can be used as the loader connection port, which is effective in debugging from the SX bus expansion side installed at a distance.

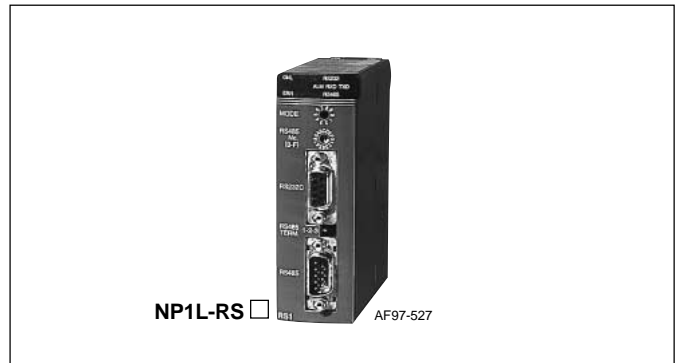

Performance specifications

Item	Specification	
Type	NP1L-RS1 (RS-232C), NP1L-RS2	NP1L-RS1 (RS-485), NP1L-RS4
No. of SX bus connectable modules	Max. 16 /configuration	
Port	RS-232C x 1 channel	RS-485 x 1 channel
Communication method	Full-duplex or half-duplex communication ^{Note 1}	
Synchronization method	Start-stop synchronous transmission	
Transmission speed	1200/2400/4800/9600/19200/38400/57600/76800/115200bps (115200bps or less in total of 2-ch.) ^{Note 2}	
Transmission distance	15m or less	1km or less (transmission speed : 19200bps or less)
No. of connectable modules	1:1 (One external device)	1:N (Max. 31)
Connection method	D-sub, 9-pin connector (female)	D-sub, 9-pin connector (male)
Transmission protocol	Depends on the application program(Expansion FB) in the CPU module	
Internal current consumption	NP1L-RS1 : 24V DC, 110mA or less / NP1L-RS2 : 24V DC, 90mA or less / NP1L-RS4 : 24V DC, 80mA or less	
Mass	NP1L-RS1 : Approx. 170g, NP1L-RS2 : Approx. 160g, NP1L-RS4 : Approx. 160g	

Note 1: The use of the non-procedure FB allows full-duplex communication on applications.

Note 2: For transmission rates 300, 600, 76800, and 115200 bps, use FBs corresponding to the transmission rate.

System configuration

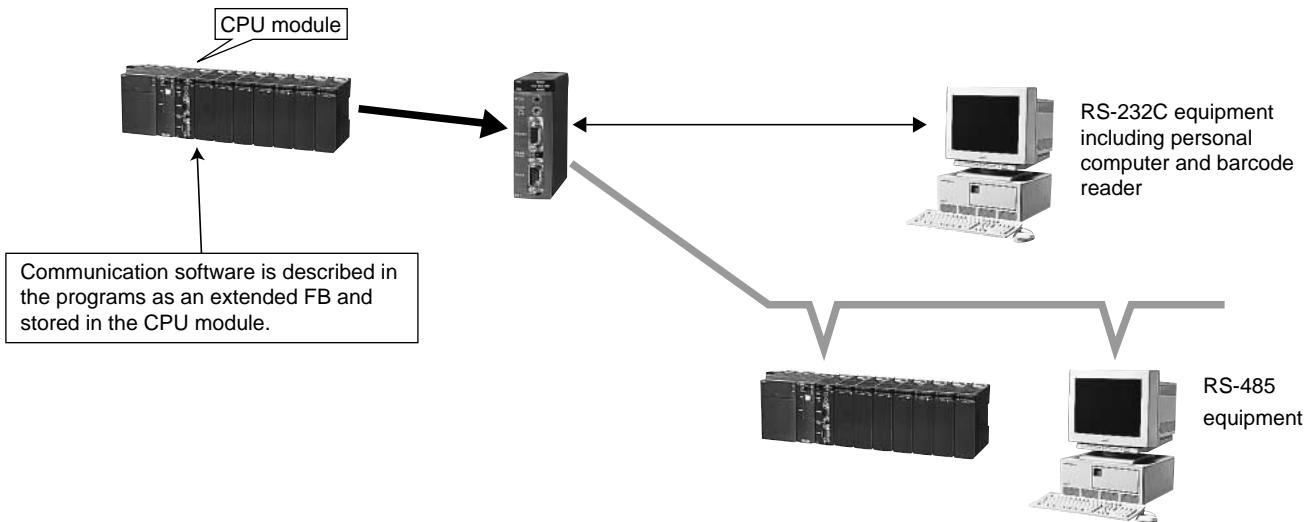

Support tool network function

Use of general-purpose communication modules enables supporting multiple systems with one unit of personal computer loader or remotely supporting the system via modem.

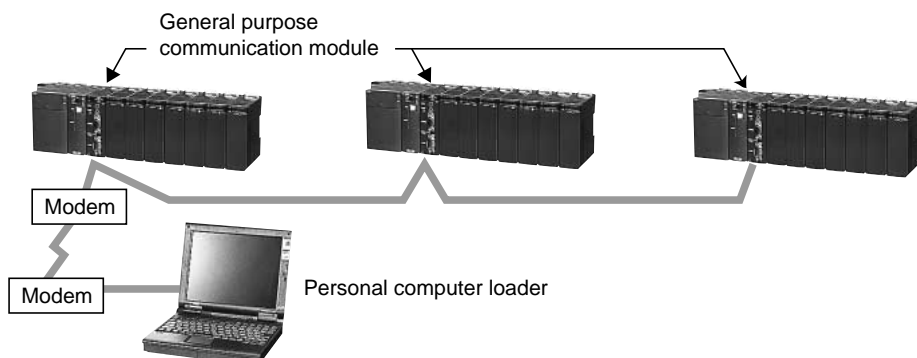

**General Purpose Communication Package for Factory Automation Machine:
NP4N-COMFV3 [Japanese Version]**

NP4N-COMF is an expansion FB software package that is used in combination with general-purpose communication modules to implement the target communication functions. The expansion FB is stored in the CPU module to implement various communication protocols.

■ **Communication expansion FB list**

Package classification	Extended FB type	Applicable equipment	Extended FB name
Standard general-purpose communication FB (D300win included as standard)	Start-stop protocol	FB for implementing the start-stop communication protocol using application programs	_C_free
			_Cfr252
			_Cfr128
			_Cfr64
			_Cfr32
			_Cfrpr (Built-in protocol)
			_Cfrp2 (Built-in protocol)
	Temperature controller communication protocol	Fuji Electric: PYX	_CfdPYX
	BCR communication protocol	Fuji Electric: PK2	_CfdPK
	Inverter communication protocol	FUJI ELECTRIC: FRENIC5000 For FVR-C11 (FGI-BUS) For FVR-C11 (FGI-BUS) (Reduces the capacity of communication programs.)	_CfdFRN _CfdFVR _Cfvrpr
FA equipment general-purpose communication package NP4N-COMFV3 [Japanese Version]	MODBUS	The MICREX-SX functions as a master station to communicate with MODBUS slave stations.	_C_modm
	Temperature controller protocol	RKC INSTRUMENT INC.: REX-F, REX-D, FAREX-SR series	_CrkREX
		OMRON: Digital temperature controller E5AX, E5XJ series	_Com AX
		OMRON: Digital temperature controller E5CK series	_ComCK
		Yamatake: Digitronics temperature controller SDC40A/40G series	_CymSDC
	ID system protocol	OMRON: V600 series	_ComV6
		SHARP MANUFACTURING SYSTEM: Microwave ID plate system DS series	_CshDS
		Yamatake: Code recognition ID system WAM120 series	_CymWAM
		IDEAL IZUMI: Data carrier system FP1A series	_CizFP
	Barcode reader protocol	Token: TCD8200/8500, TLMS-3200RV series	_Ctk TCD
		NIPPON ELECTRIC INDUSTRY: BCC2600 series	_CndBCC
		KEYENCE: BL180, BL500, BL700 series	_CkyBL
		IZUMI DATA LOGIC: Barcode reader DS series	_CizDS
SECS protocol	SECS procedure semiconductor manufacturing system (only SECS-I supported)	_C_SECS	
NC protocol	FANUC: FANUC series 18i	_CDNC2	
Serial printer protocol	NEC: PC-PR201 series	_C_print	

Device-level Communication Module

OPCN-1 Master Module: NP1L-JP1

OPCN-1 Slave Module: NP1L-JS1

OPCN-1 Interface Module: NP1L-RJ1

■ **Features**

NP1L-JP1

- Up to 8 units can be connected in a single system configuration.
- Up to 31 units of slave equipment can be connected to a single master unit.
- Number of I/O points is maximum 8192 points (512 words).
- Line speed can be changed to 1Mbps, 500kbps, 250kbps, or 125kbps.

NP1L-JS1

- I/O data link through the OPCN-1 is possible between CPUs.
- Number of I/O points is maximum 2048 points (128 words)



NP1L-RJ1

- Slave station configuration, conforming to the OPCN-1 Standard, implements compact, economical, centralized remote I/O as a multi-vendor network.
- Input filtering time of the input module can be set with DIP switch on the front.

■ **Communication specifications**

Item	Specification		
Type	NP1L-JP1	NP1L-JS1	NP1L-RJ1
Applicable class	TYPE-M51 I		TYPE-S51 I
No. of SX bus connectable modules	Max. 8 /configuration		-
No. of connectable slaves	31/master module	-	-
Station No. setting range	00 fixed	01 to 7F	-
Transmission line format	Bus configuration (multi-drop)		
Transmission line	Shielded twisted pair cable		
Transmission method	Half-duplex, serial transmission, based on EIA RS-485		
Transmission speed (Max. total length)*	125kbps (1000m), 250kbps (800m), 500kbps (480m), 1Mbps (240m)		
Encoding method	NRZI (Non Return to Zero Inverted)		
Error check	ECS (X ¹⁶ +X ¹² +X ⁵ +1) and retry		
Communication function	<ul style="list-style-type: none"> • Initial setting service • I/O service • Reset service • JEM-TR192 service (data read/write service) 	<ul style="list-style-type: none"> • Initial setting service • I/O service • Reset service • Simultaneous broadcast service 	
No. of I/O points	Max. 8192 points (512 words) /1 master	Max. 2048 points (128 words) /1 slave	
No. of message points	Max. length of single transmission: 250 bytes (data section for the data read/write service)	-	
Internal current consumption	24V DC, 130mA or less		
Mass	Approx. 230g (module), Approx. 40g (OPCN-1 connector)		

Note: * The transmission distance applies to T-KPEV-SB 1.25mm² from Furukawa Electric Co. Note that the distance may vary with the cable characteristics.

■ **System configuration**

● **OPCN-1 remote I/O system**

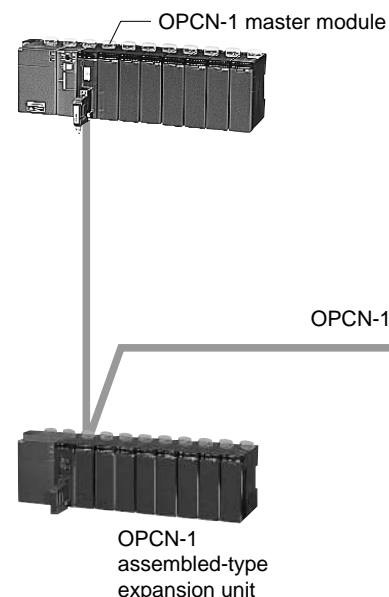

● **OPCN-1 slave system**

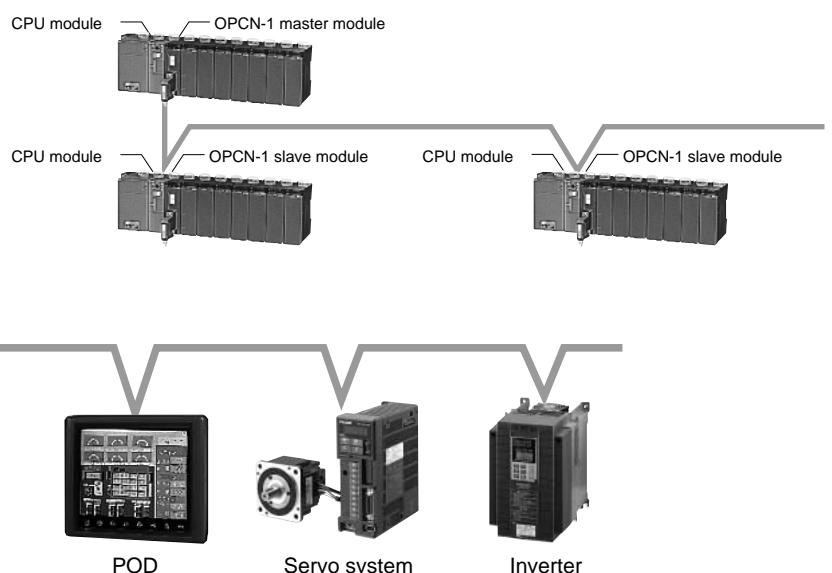

Programmable Controllers

MICREX-SX series SPH

Communication Module

DeviceNet Master Module: NP1L-DN1
DeviceNet Interface Module: NP1L-RD1

■ Features

NP1L-DN1

- Up to 8 units can be connected in a single system configuration.
- Up to 63 units of remote I/O equipment can be connected to a single master unit.
- Number of I/O points is maximum 2032 points (127 words).
- Line speed can be changed to 125kbps (500m), 250kbps (250m), or 500kbps (100m).

NP1L-RD1

- Realizes small economic collective remote I/O as a DeviceNet slave station.



■ Communication specifications

Item	Specification	
Type	NP1L-DN1	NP1L-RD1
No. of SX bus connectable modules	Max. 8/configuration	—
No. of remote I/O stations	63 units/master module	—
MAC ID setting range	00 to 63	
Transmission line format	Bus configuration (multi-drop), tree-structure, branch-structure	
Transmission line	Trunk (thick cable), drop (thin cable)	
Transmission method	Half duplex serial communication method	
Data rate (distance)	125kbps (500m), 250kbps (250m), 500kbps (100m)	
Media access control	CSMA/NBA	
Modulation	Base band	
Media linking	DC coupling-type differential Tx/Rx	
Encoding method	Non-zero recovery using the bit stuff function NRZ (Non Return to Zero)	
Error check	FCS (Frame Check Sequence CRC-16)	
Communication function	I/O message Poll command/response Bit-Strobe command/response Change of state/Cyclic ACK not provided Change of state/Cyclic ACK provided Explicit message (implements the client/server function to set and diagnose the remote I/O stations Low priority communication traffic)	Poll command/response Explicit message
Vendor ID	319 (Fuji Electric)	
Device type	Communication Adapter (Code: 0x0C)	
No. of I/O points	Max. 2032 points (127 words)/master	
No. of message points	Max. length 492 bytes per transmission (Explicit message)	
Network current consumption	24V DC, 45mA or less (supplied from DeviceNet power supply)	
Internal current consumption	24V DC, 90mA or less	
Mass	Approx. 170g	

■ System configuration

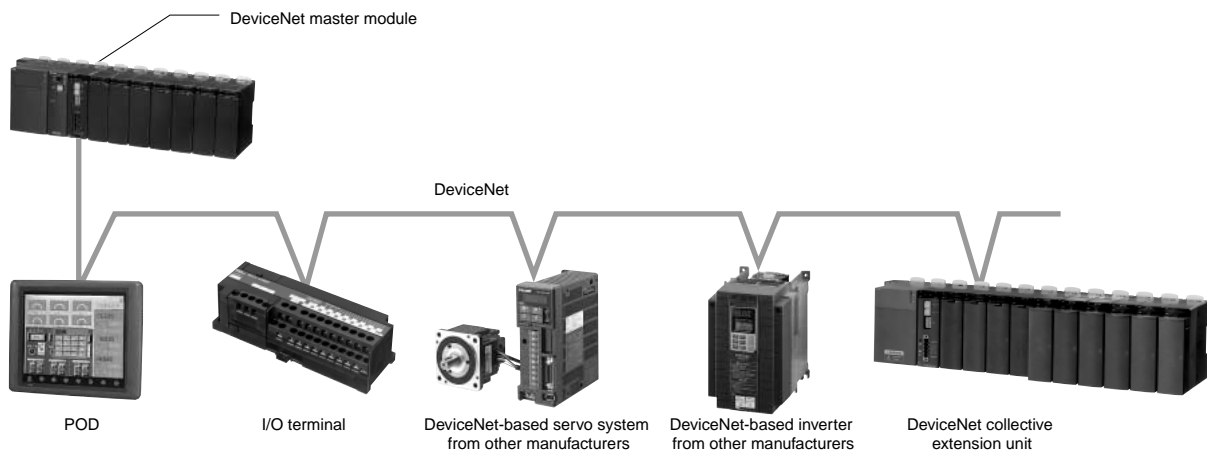

T-link Master Module: NP1L-TL1
T-link Slave Module: NP1L-TS1
T-link Interface Module: NP1L-RT1

■ **Features**

NP1L-TL1

- Up to 8 units can be connected in a single system configuration.
- Up to 32 units of slave equipment can be connected to a single master unit.
- Number of I/O points is maximum 8192 points (512 words).
- T-link equipment for such as MICREX-F and FLEX-PC can be used. (Some types excluded.)

■ **Communication specifications**

Item	Specification		
Type	NP1L-TL1	NP1L-TS1	NP1L-RT1
No. of SX bus connectable modules	Max. 8 /configuration		
No. of connectable T-link slaves	32 /master module		
Transmission line format	Bus configuration (multi-drop)		
Transmission line (Max. total length)*	Bus transmission line: Shielded twisted pair cable Total length: Max. 1000m Optical transmission line: SI/GI quarts cable, multicomponent cable (Optical connector FNC120/130 is needed for the optical transmission line)		
Transmission method	Half-duplex, serial transmission		
Data exchange method	1:N (polling / selecting) method		
Transmission speed	500kbps		
Error check	FCS (X ¹⁶ +X ¹² +X ⁵ +1)		
No. of I/O points	2048 points (128 words)		
No. of message points	Max. length per transmission: 220 bytes		
Internal current consumption	24V DC, 140mA or less		
Weight	About 200g (module), about 40g (T-link connector)		

Note: * Transmission distance is the length when using the T-KPEV-SB 1.25mm² cable manufactured by Furukawa Electric Co. However, note that the distance may occasionally vary due to the cable characteristics.

■ **System configuration**

● **T-link slave system**

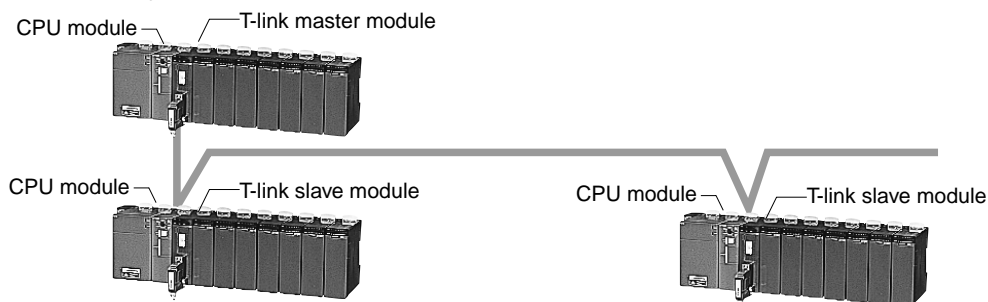

● **T-link remote I/O system**

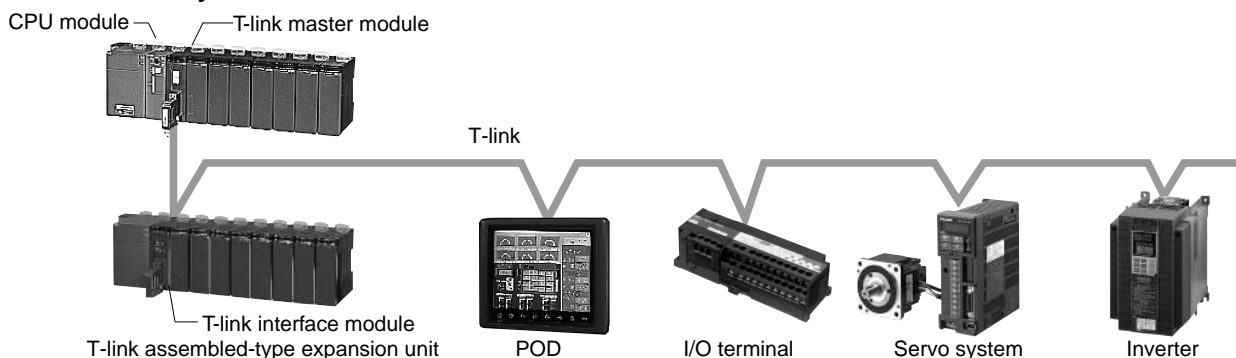

NP1L-TS1

- Data link by I/O data between CPUs through T-link is possible.
- Five different number of I/O points (1 word/1 word, 2 words/2 words, 4 words/4 words, 8 words/8 words, 32 words/32 words) can be selected according to application.

NP1L-RT1

- Realizes small economic collective remote I/O as a T-link slave station.

■ **Option**

Category	Series name		Remarks
Option	MICREX-F	Optical converter	FNC100C-C10
			FNC100C-A20
			FNC110A-C10
			FNC110A-C10
			FNC120A-A10
			FNC120A-G10
		Electrical repeater	FRC200A-C10

A10, A20, C10, and G10 indicate electrical types.

- A10: 100-240V AC
- A20: 200-240V AC
- C10: 100-110V AC, 110V DC
- G10: 110V DC

PROFIBUS-DP Master Module: NP1L-PD1

■ **Features**

- **Open system**
Diverse slave products of PROFIBUS-DP can be connected (from more than 300 vendors). As for the DP slave, the compatibility authenticated by the PROFIBUS association has been confirmed.
- **Flexible system configuration**
In addition to the basic configuration consisting of one DP master and multiple DP slaves, combination with multiple DP masters and multiple DP slaves are possible, making it easier to distribute master functions.
The maximum number of unit connections (including master stations) is 126. With 33 units or more, repeaters are required.
- **Transmission rate**
Can be selected from seven options: 9.6/19.2/93.75/187.5/500/1500/12000kbps. (The upper limit depends on the type of the DP slave.)



■ **Performance specifications**

Item	Specification																
Applicable standards	IEC 66158, EN 50170, DIN 19245																
Communication function	PROFIBUS-DP master (DPM1) function																
No. of slave station connections	Up to 32 units (up to 126 units with repeaters)																
Station No. (station address) setup range	0 to 125																
Transmission line form	Bus configuration (multi-drop)																
Communication standard	Applicable to EN 50170 and DIN 19245.																
Data exchange system	1:N (polling/selecting)																
Transmission rate	Seven options (set by configuration) 9.6/19.2/93.75/187.5/500/1500/12000 kbps																
Transmission distance	1200m with a transmission rate of 9.6kbps, 100m with a transmission rate of 12Mbps (Refer to the table below.)																
	<table border="1" style="width: 100%; text-align: center;"> <thead> <tr> <th>Baud rate (kbps)</th> <th>9.6</th> <th>19.2</th> <th>93.75</th> <th>187.5</th> <th>500</th> <th>1500</th> <th>12000</th> </tr> </thead> <tbody> <tr> <td>Distance/segment</td> <td>1200m</td> <td>1200m</td> <td>1200m</td> <td>1000m</td> <td>400m</td> <td>200m</td> <td>100m</td> </tr> </tbody> </table>	Baud rate (kbps)	9.6	19.2	93.75	187.5	500	1500	12000	Distance/segment	1200m	1200m	1200m	1000m	400m	200m	100m
Baud rate (kbps)	9.6	19.2	93.75	187.5	500	1500	12000										
Distance/segment	1200m	1200m	1200m	1000m	400m	200m	100m										
Cable	PROFIBUS-DP cable (Shielded twist pair cable)																
No. of I/O points	Max. total number of I/O points: 510 words (Max. number of input or output points: 255 words)																
Internal current consumption	24V DC, 200mA or less																
Mass	Approx. 250g																

■ **System configuration**

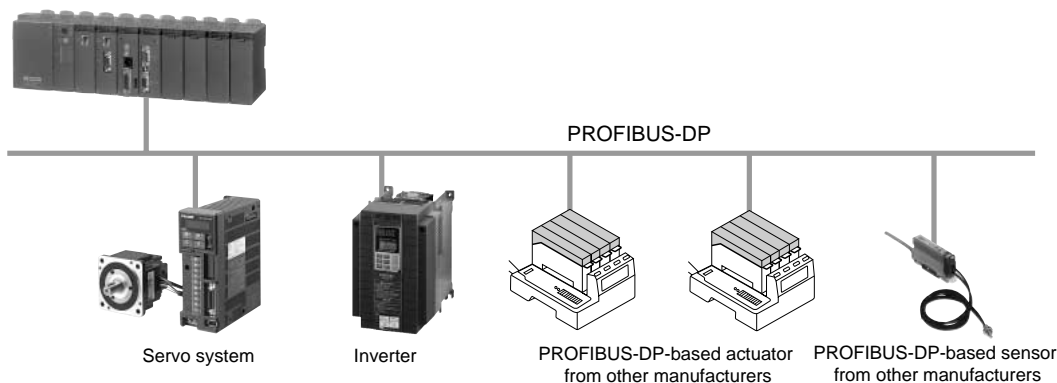

■ **Configurator Software: KONF-PDP**

Used to download the system configuration information to the PROFIBUS-DP master module. Required to update the initial setup or system configuration.

■ **Please purchase from**

HMS INDUSTRIAL NETWORKS

I/O Terminal: NR1 □

Compact type I/O terminal applicable to diverse field networks with a common frame size.

Wiring can be made directly to the main unit using the optional common extension terminal block without using the relay terminal block, allowing 25% reduction of the total installation space in comparison with the conventional wiring method.

■ **Features**

- **Compatible with diverse device level networks**
Device level network which performs high-speed communication of I/O information and messages between a programmable controller, a personal computer, and other controllers and an inverter, a servo, an MMI device, and other FA devices, among diverse networks consisting of an FA system, ranging from the computer level to the bit level. The I/O terminal corresponds to open device level networks: OPCN-1, DeviceNet, T-link, LonWorks, and SX bus.
- **Easy maintenance**
Since removable terminal blocks are used as the terminal blocks for the communication section, power supply, and I/O, the main unit can be attached and removed easily.

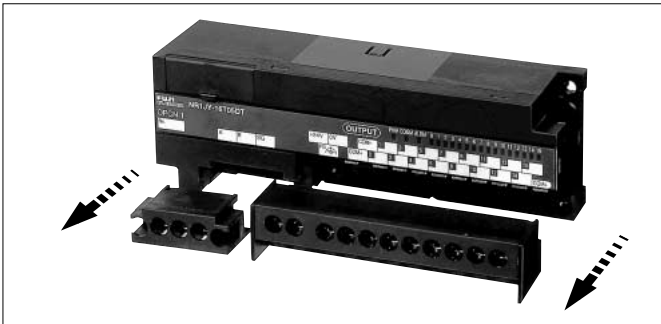

- **Efficient safe terminal block structure**
This terminal block has terminal screws which are self-lifting by themselves after loosening, thus preventing screws from being lost at the time of wiring to the round amplifier terminal, increasing the wiring work efficiency. The use of power supply and I/O terminal blocks with the finger protection fitting (IP20) contributes to the safety of machines and equipment.

(Self-lifting screw terminals/Finger protection fitting)

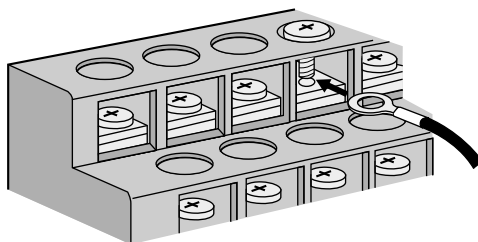

- **Preventing mis-wiring**
Uses different colors for the surface sheets of the main unit: input (white), output (black), and I/O mixture (zebra). Applicable networks are also displayed, enabling determination of the unit type at a glance.



AF00-187,188

Input unit (white)

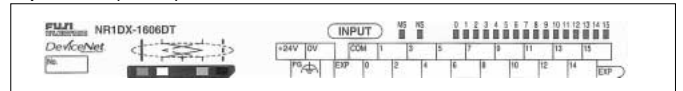

Output unit (black)

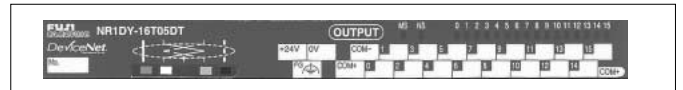

I/O mixture unit (zebra)

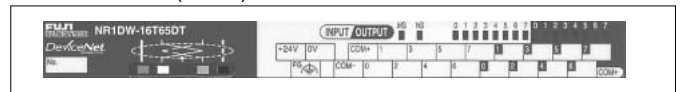

- **25% reduction of total installation space**
“Common extension terminal block” which extends the number of common terminals with one-touch operation is optionally available. The use of “common extension terminal block” eliminates the necessity of the separate relay terminal block for common extension, reducing the total installation space by 25%.

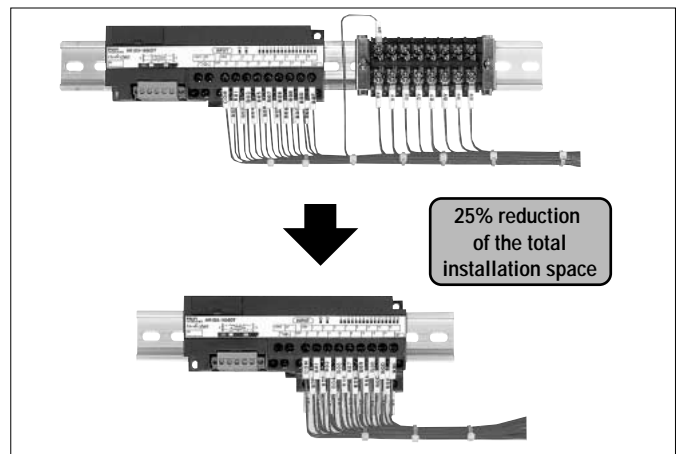

- **Contributing to panel design standardization**
The unit frame is unified to a compact size of 148x50x40 (WxHxD: mm), allowing design standardization without worrying about external view modifications by I/O specifications and network specifications. Network modifications can be dealt only with unit replacement.
- **Enabling DIN rail attachment**
Not only usual screw attachment but also DIN rail attachment is possible.

Programmable Controllers

MICREX-SX series SPH

Communication Module

■ Models

Product name		Model (= Product code)	Specification
OPCN-1 SX bus	16-point input	NR1□X-1606DT	24V DC, 16-point bi-directional input, removable terminal block
	8-point Ry output	NR1□Y-08R07DT	240V AC/110V DC, 8-point Ry output, removable terminal block
T-link	16-point Tr output *2	NR1□Y-16T05DT	24V DC, 16-point Tr sink output, removable terminal block
DeviceNet *1	8/8-point mixture	NR1□W-16T65DT	24V DC, 8-point source input, 12-24V DC, 8-point Tr sink output, removable terminal block
LonWorks	16-point input	NR1LX-1606DT	24V DC, 16-point bi-directional input (4 points can be used as pulse inputs), removable terminal block
	8-point Ry output	NR1LY-08R07DT	240V AC/110V DC, 8-point Ry output, removable terminal block
	9-point input/2-point output	NR1LW-11R80DT	24V DC, 9-point source input (4 points can be used as pulse inputs), 2-point Ry output, removable terminal block
Option		NR1XV-CB1	Common extension terminal block (9 pins)

*1: □ specification (applicable network specification): J=OPCN-1, S=SX bus, T=T-link, D=DeviceNet

*2: Tr output products without a fly-wheel diode are also offered. (Model: NR1□Y-16T05DTZ701)

■ Specifications

● General specifications

Item	Specification	
Applicable standards	IEC 61131-2, UL508	
Physical environment	Operating ambient temperature	0 to ± 55°C (Lon Works-based product: -10 to +55°C)
	Storage temperature	-20 to +70°C
	Relative humidity	20 to 95%RH (without condensation)
	Dust	No dust present
	Contamination	Contamination level 2
	Corrosion resistance	No corrosive gas is present, no organic solvent adhesion
	Operating altitude/air pressure	Altitude of 2000m or less (air pressure of 70kPa or higher during transportation)
Mechanical operating condition	Resistance to vibration	One amplitude: 0.15mm, constant acceleration: 19.6m/s ² , 2 hours for each direction, 6 hours total
	Resistance to shock	Peak acceleration: 147m/s ² , 3 times for each direction
Electrical operating condition	Electrostatic discharge	Contact discharge: ± 6kV, air discharge: ± 8kV
	Radiative radio frequency electromagnetic field	80 to 1,000MHz: 10V/m
	Fast transient burst wave	2kV
	Conductive radio frequency interference	0.15 to 80MHz, 10Vrms
	Lightning surge	Common mode 2kV, normal mode: 1kV
	Square wave noise	Noise power supply 1.5kV, pulse width 1us, Rising time 1ns
Installation and wiring conditions	Structure	IP20 Panel-mount type
	Screw fastening torque	Terminal screw, terminal block mounting screw: 0.5-0.6N·m Unit mounting screw: 1 to 1.5N·m
	Cooling system	Natural cooling

● Power supply specifications

Item	Specification	
Rated input voltage	24V DC	
Input voltage range	21.6 to 26.4V DC (LonWorks-based product: 20.4 to 27.6V DC)	
Dropout tolerance	1ms	
Inrush current	5A, 1ms or less (LonWorks-based product: 3A, 5ms or less 25A, 5ms or less for the NR1LY-08R07DT)	
Dielectric strength	1500V AC, 1 minute (Between input terminal and ground)	
Insulation resistance	10MΩ or more (500V DC megger) (Between input terminal and ground)	
Power consumption	OPCN-1	NR1□X-1606DT (16-point input): 1.4W or less
	SX bus	NR1□Y-08R07DT (8-point Ry output): 3W or less
	T-link	NR1□X-16T05DT (16-point Tr output): 1.4W or less
	DeviceNet	NR1□X-16T65DT (8/8-point mixture): 1.4W or less
	LonWorks	NR1LX-1606DT (16-point input): 1.6W or less NR1LY-08R07DT (8-point Ry output): 3W or less NR1LW-11R80DT (9-point input/2-point Ry output): 1.6W or less NR1LW-11R67DT (9-point input/2-point Ry output): 1.6W or less

● I/O specifications

(1) I/O specifications of OPCN-1/SX bus/T-link/DeviceNet-based products

● Input specifications

Item	Specification
Type	NR1□X-1606DT, NR1□W-16T65DT *
Rated input voltage	24V DC
Max. input voltage	26.4V DC
Ripple percentage	5% or less
Rated input current	7mA
Input type	No polarity
Input impedance	3.3kΩ
Operating voltage	ON voltage range: 15 to 26.4V OFF voltage range: 0 to 5V
Input delay time	OPCN-1, DeviceNet: 3ms/3ms
ON/OFF filtering time	SX bus: Can be changed collectively through parameter setup. T-link: 5ms/5ms
No. of points per common	16 points/common (Mixture model: 8 points/common)
Isolation	Photocoupler
Dielectric strength	1500V AC, 1 minute (Between input terminals and ground)
Insulation resistance	10MΩ or more (500V DC megger) (Between input terminals and ground)
Internal current consumption	24V DC, 70mA or less (When all points are turned ON)

* [OFF to ON] - [ON to OFF]: 1-1, 3-3 (default), 3-10, 10-10, 30-30, 100-100ms

● Transistor output specifications

Item	Specification
Rated output voltage	24V DC
Allowable output voltage range	19.2-30V DC
Output format	Sink
Rated load current	0.5A/point (30V DC), 4A/common
Max. load current	0.6A/point (30V DC), 4.8A/common
Output voltage drop	1.5V or less (0.5A)
Output delay time	OFF to ON: 1ms or less ON to OFF: 1ms or less
Leakage current when OFF	0.1mA max.
Surge current	2A, 10ms
Surge suppresser circuit	Clamp diode
Common configuration	16 points/common (8 points/common only for mixture products)
Insulation method	Photocoupler insulation
Dielectric strength	1500V AC, one minute, between input terminals and FG
Insulation resistance	10MΩ or more with a 500V DC megger Between input terminals and FG
Internal current consumption	24V DC, 70mA or less (all points ON)

● Relay output specifications

Item	Specification
Rated output voltage	240V AC, 110V DC
Max. allowable output voltage	264V AC or less, 110V DC or less
Max. load current	30/250V DC: 2A/point, 110V DC: 0.2A/point
Output delay time	OFF to ON: 10ms or less ON to OFF: 10ms or less
Leakage current when OFF	None
Surge suppresser circuit	None
Min. load voltage, current	5V DC, 1mA
Max. open/close frequency	1800 times/hour
Common configuration	1 point/common
Insulation method	Relay insulation + photocoupler insulation
Dielectric strength	1500V AC, one minute, between input terminals and FG
Insulation resistance	10MΩ or more with a 500V DC megger Between input terminals and FG
Internal current consumption	24V DC, 140mA or less (all points ON)

(2) I/O specification of LonWorks-based product

• Input specification

Item	Specification	
	NR1LX-1606DT	NR1LW-11R80DT
No. of input points	DI: 12 points, PI (Pulse input) : 4 points*1	DI: 5 points, PI (Pulse input) : 4 points*1
Input common composition	16 points/common	9 points/common
Input type	None polarity	Source input
Rated voltage	24V DC	
Max. voltage	26.4V DC	
Rated current	7mA	
Input impedance	3.3kΩ	
Max. pulse input frequency	20Hz	
Pulse input measurement range	0-2147483648 (31 bits, incremental method)	
Standard operation range	OFF to ON 15 to 26.4V, ON to OFF 0 to 5V	
Input delay time	OFF to ON 10ms or less, ON to OFF 10ms or less	
Input type	DC (EN 61131 Type 2)	
Insulation	Photo coupler	
Delating condition	None	

* 1 PI can be used also as DI.

• Communication specifications

Item	Specification				
	DeviceNet	OPCN-1(Former JPCN-1)	SX bus	T-link	LonWorks
Transmission line format	Bus configuration (multi-drop, T-branching)	Bus configuration (multi-drop)	Bus configuration (ring)	Bus configuration (multi-drop)	Free topology (bus-structure/star-structure)
Max. signal point	128 words (2048 points)/master (When configurator is not used)	127 words (2032 /master)	512 words (8192 points)	100 words (8192 points)	228 bytes
Transmission speed/distance	125kbps/500m 250kbps/250m 500kbps/100m (Changes with the switch)	125kbps/1km 250kbps/800m 500kbps/480m 1Mbps/240m (Changes with the switch)	25Mbps/25m	500kbps/1km	78kbps/500 to 2700m
No. of connected stations	64 node	31 stations	254 stations (including CPU module)*2	32 stations	64 units/segment
Electric characteristics	-	EIA RS-485	EIA RS-422	Pulse transfer method	-
Transmission line	DeviceNet cable	Shielded twist pair cable	SX bus expansion cable	Shielded twist pair cable	Twist pair (1P-S)
No. of occupied words*1	8 points: 1 word 16 points: 1 word	8/8 (Mixture): 2 words			

*1 When the master module of MICREX-SX series is used

*2 The maximum number of I/O terminal connections is 10 per base. Up to 22 units can be connected by extending the number of base boards between I/O terminals.

■ System configuration

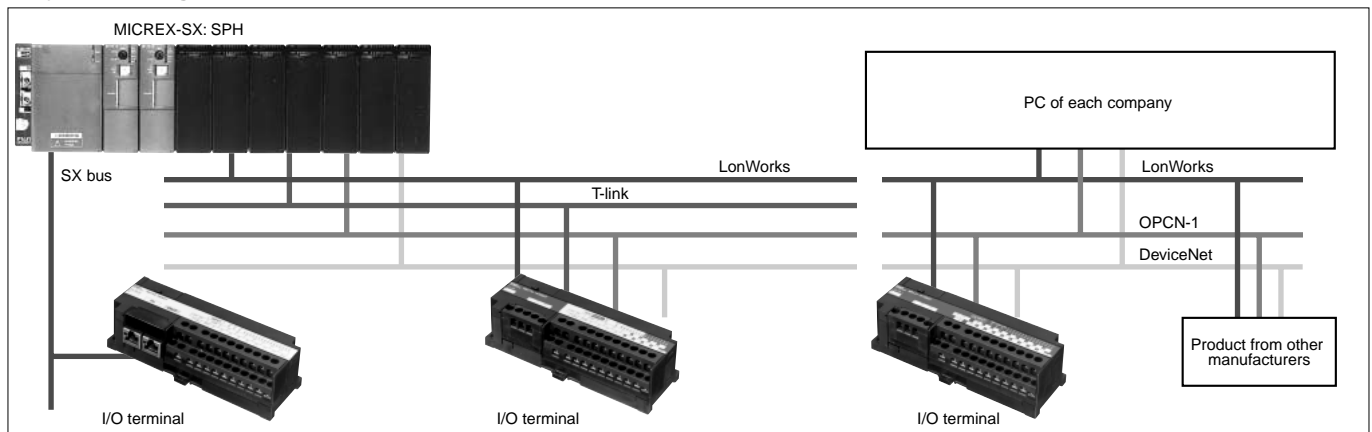

■ Dimensions, mm

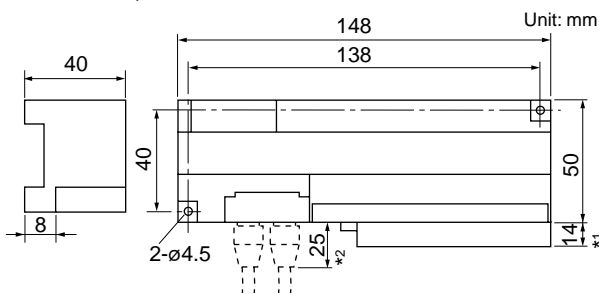

Notes: *1 When the extension terminal block is mounted.
*2 When the SX bus-adapted unit is connected.

• Output specification

Item	Specification	
	NR1LY-08R07DT	NR1LW-11R80DT
No. of output points	DO: 8 points	DO: 2 points
Output common composition	1 point/common	
Rated voltage	240V AC 110V DC	
Max. load current	Relay output 30V DC/240V AC: 2A, 110V DC: 0.2A	
	Voltage output 24V DC: 50mA/point	
Min. load current	5V DC: 1mA	
Output delay time * 1	OFF to ON 10ms or less ON to OFF 10ms or less	
Leakage current at the time of OFF	0.1mA or less (200V AC 60Hz)	
Surge protection	None	Varistor
Output protection	None	
Max. operating frequency	1800 times/hour	
Insulation	Photo coupler+Relay	Relay
Output type * 1	Relay output	Relay output or 24V DC voltage output
Delating condition	None	

■ Extension terminal block

Used to extend the common terminal block that is mounted on the lower side of the main unit.

Type: NR1XB-CB1

The terminals are divided into two groups for electrical connection: □ and ■ as shown below.

To COM/EXP of the main unit

To mounting screw of terminal block (right side)



Bit-level Communication Module
AS-i Master Module: NP1L-AS2

■ **Features**

- The **NP1L-AS2** is based on the AS-i communication protocol Version 2.1.
- Up to 12 units can be connected in a single system configuration.
- Can be connected to diverse types of actuators and sensors conforming to the AS-i Standards.
- Line length: Total 100m
- Up to 62 slave stations can be connected to a single master station.
- Up to 336 I/O points can be controlled.
- The AS-i master module is communicate to between the analog slave station automatically.



■ **Communication specifications**

Item	Specification
No. of SX bus connectable modules	Max. 12 /configuration
No. of connectable slaves	Max. 62 /master module
Transmission line format	Tree-structure, line-structure, star-structure, ring-structure
Transmission distance	100m (Max.300m at using a repeater)
Transmission method	Half-duplex, serial transmission
Transmission speed	167kbps
Applicable cable	AS-i cable
Refresh time	Approx. 10ms (when 62 units connected) Approx. 5ms (when 31 units connected)
No. of I/O points	Input points: Max. 168 Output points: Max. 168 (Input / Output: 21 words / 21 words)
Current consumption of AS-i master section	30V DC, 100mA or less (supplied from the AS-i power supply, and insulated from the SX bus.)
Internal current consumption	Inside of module (supplied from the SX bus): 24V DC, 100mA or less
Mass	Approx. 180g

■ **System configuration**

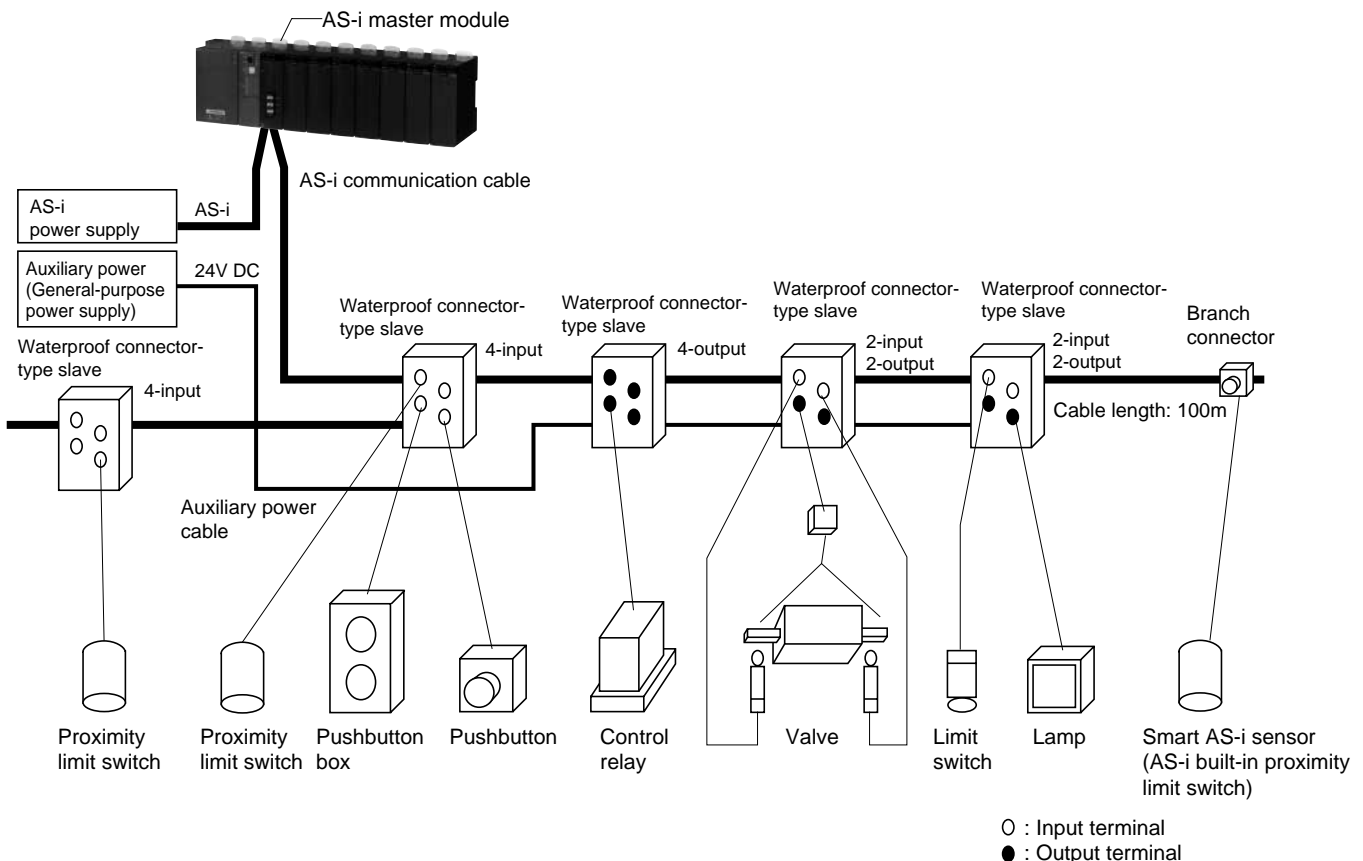

S-LINK Master Module: NP1L-SL1

■ **Features**

- Connected to the S-LINK (bit) level serial transmission provided by SUNX.
- 128-point I/O control can be performed for each master station. There is no limitation on the number of master connections.



■ **Communication specifications**

Item	Specification
No. of SX bus connections	No limitation (within the limit of the maximum number of SX bus connections of 8192 points)
No. of slave connections	No limitation
Transmission system	Bi-directional time-division multiplex transmission system
Synchronization system	Bit synchronization, frame synchronization
Protocol	2-wire protocol
Transmission rate	28.5kbps
	Signal trunk line: Total length 200m
Connection method	Multi-drop connection
No. of I/O points	Up to 128 points
Cable	Cable from SUNX: 4-wire flat cable
Refresh time	32 points: 1.4 to 2.9ms 64 points: 2.5 to 5.2ms 96 points: 3.6 to 7.4ms 128 points: 4.7 to 9.6ms
S-LINK master section current consumption	24V DC, 1.6mA or less (supplied from an external power supply, and insulated from the SX bus.)
Internal current consumption	Inside of module (supplied from the SX bus): 24V DC, 80mA or less, S-LINK communication section (supplied from an external power supply): 24V DC, 1.6A or less
Mass	Approx. 200g

■ **System configuration**

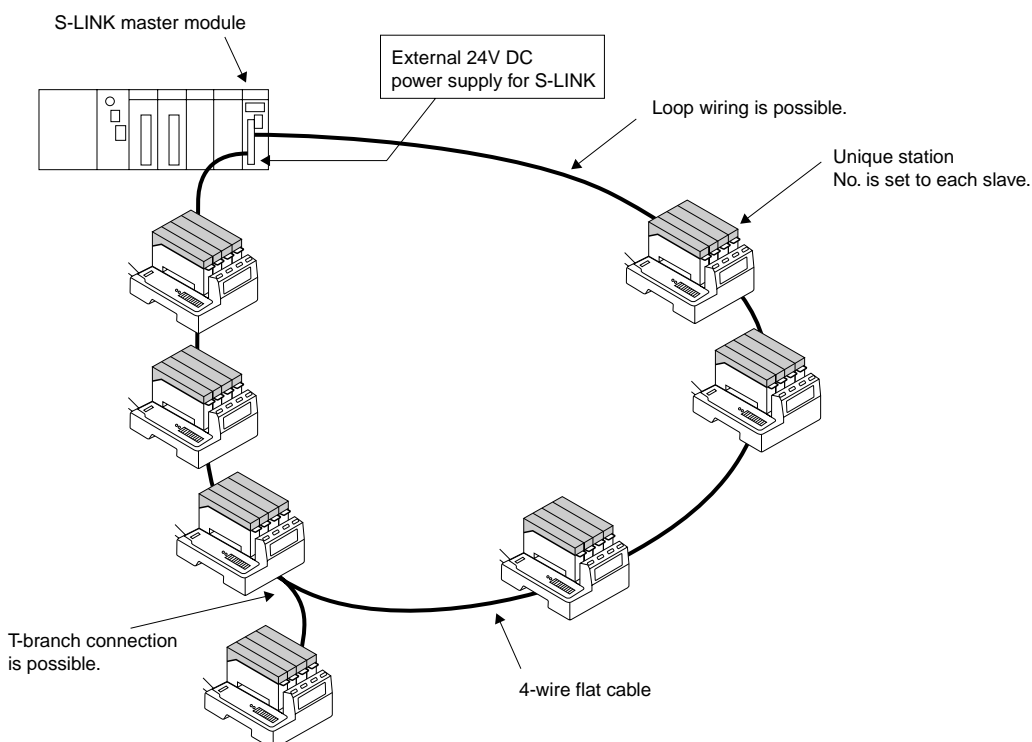

Programmable Controllers

MICREX-SX series SPH

Communication Module



SX Bus Optical Link Module: NP1L-OL1
SX Bus Optical Converter Unit: NP2L-OE1

■ Features

NP1L-OL1

- Mounted on the base board to transmit the SX bus signal as an optical signal.
- Maximum transmission distance is 25.6km (25°C).

NP2L-OE1

- This unit connects between the SX bus cable and optical fiber cable to transmit the SX bus signal as an optical signal.
- Maximum transmission distance is 25.6km (25°C).



■ Transmission specifications

Item		Specification	
Type		NP1L-OL1	NP2L-OE1
No. of connectable modules		Max. 64 /configuration (Total No. of NP1L-OL1 and NP2L-OE1)	
Optical fiber	Type	PCF (Polymer clad fiber)	
	Core/Clad diameter	Core: 200μm Clad: 230μm	
	Min. bending radius (Note 1)	50mm	
	Optical connector	Type: F07	
Transmission distance (Note 1)		Between stations: Max. 800m (Total extension distance 25.6km)	
Internal current consumption		24V DC 54mA or less	
Power supply terminal (External power supply) (Note 2)	Rated input voltage	–	24V DC, 70mA or less
	Rush current	–	165mA or less: When a switching power supply is used (Note 3) 50Ao-p-70μs: When 24V DC is directly turned ON
Mass		Approx. 135g	Approx. 155g

- Notes: 1 Minimum bending radius depends on what type of optical-fiber cable is used. Above table shows the values when the HG-20/08 from Sumitomo Electric Industries, Ltd. is used.
 2 As an external power supply, use a switching power supply (conforming to the UL standard) with "reinforced insulation" of 24V DC 1A or more for each unit.
 3 When 24V DC is directly turned ON, the rush current is 50Ao-p, 70μs (reference value). This value depends on power conditions.

● Recommended cables

- Optical fiber cable: HG-20/08 (type H-PCF) from Sumitomo Electric Industries, Ltd.
- Optical fiber cable connector: CF-2071 from Sumitomo Electric Industries, Ltd.
- Crimping tool: CAK-0057 from Sumitomo Electric Industries, Ltd.

■ System configuration

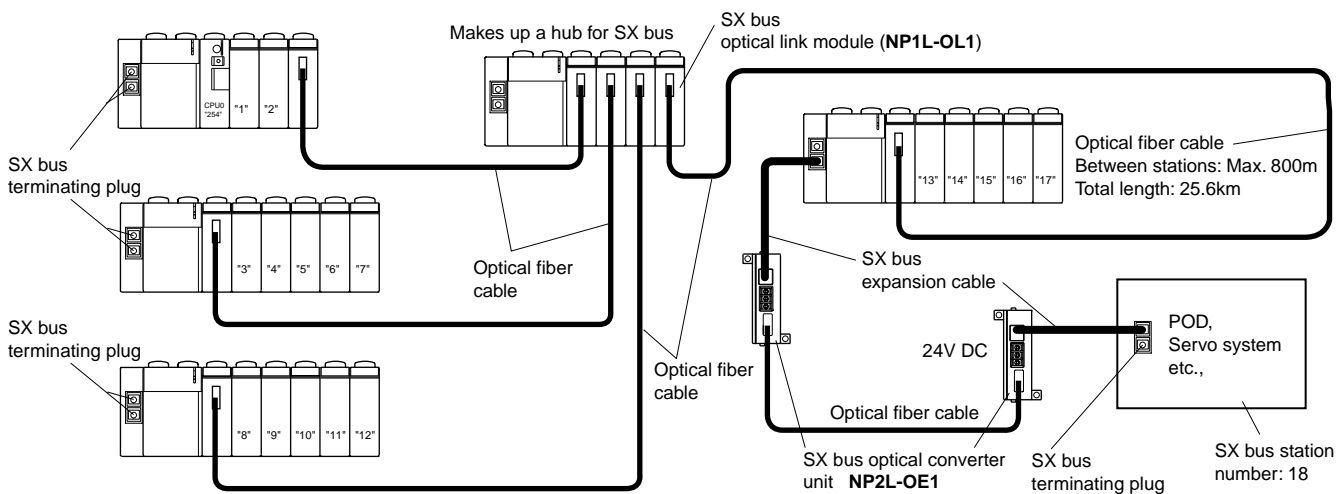

Memory Card Interface Module: NP1F-MM1

■ Features

- Equipped with 1 slot for PC card interface (PCMCIA) as standard.
- Use of commercially available memory card enables storing data from the CPU modules or reading control and/or management information from the memory card.
- Programs can be uploaded/downloaded from/to CPU module.
- Files can be read/written from the personal computer via the PC card slot.
- Used to back up programs when configuring a redundant (N:1) system for CPU modules.



■ Performance specifications

Item	Specification
No. of SX bus connectable modules	Max. 16 /configuration
Memory card interface	Based on JEIDA Ver. 4.1 /PCMCIA Rel.2.01 Type I, II x 1 slot, 5V
Card type	SRAM card
Internal current consumption	24V DC, 90mA or less
Mass	Approx. 210g (excluding the memory card)

■ Functional specifications

Item	Specification
Data read/write from CPU module	Data read/write between CPU module and memory card by application programs
Program read/write from memory card interface module	Program read/write between CPU module and memory card by the front SW operation of the memory card interface module. Program write to the memory card by the D300win operation after memory card installation in the PC card slot of the personal computer.
Self-diagnosis/RAS function	Supervise the current status of the local station for error detection, and notify the error to the CPU module.

■ Memory card selection reference

Item	Specification (Example)	Application restrictions and conditions	Remarks
Power supply voltage	5 ± 0.25V DC	Available if the product is specified for 5V	
Current consumption	90mA or less at 5V DC	NP1F-MM1 : Available if the total is 300mA or less.	
Operating temperature range	0 to 60 °C	When a memory card is mounted in the module, heat generation in the module increases the temperature by 10°C. Thus, the max. operating temperature with this memory card used is 50°C.	Give priority to the memory card specification range rather than the operating range of this module.
Operating humidity range	10 to 90% RH, no condensation	No problem because wider than the environment range of this module.	
Storage temperature range	-20 to 70°C	No problem due to the same conditions as the common specification of this module.	
Card removal count	5,000 times or more (outdoor) 10,000 times or more (indoor)	Make sufficient consideration for the removal count.	
Vibration/shock	Vibration: 147m/s ² -p (max.) in operation Shock: 490m/s ² (max.) in operation	Module's vibration/shock resistance performance can be met by securing the memory card with the metal bracket, included in this module.	

Note: Be sure to purchase the memory card for which "electrostatic countermeasure" has been taken as well as having the items specified above.

■ System configuration

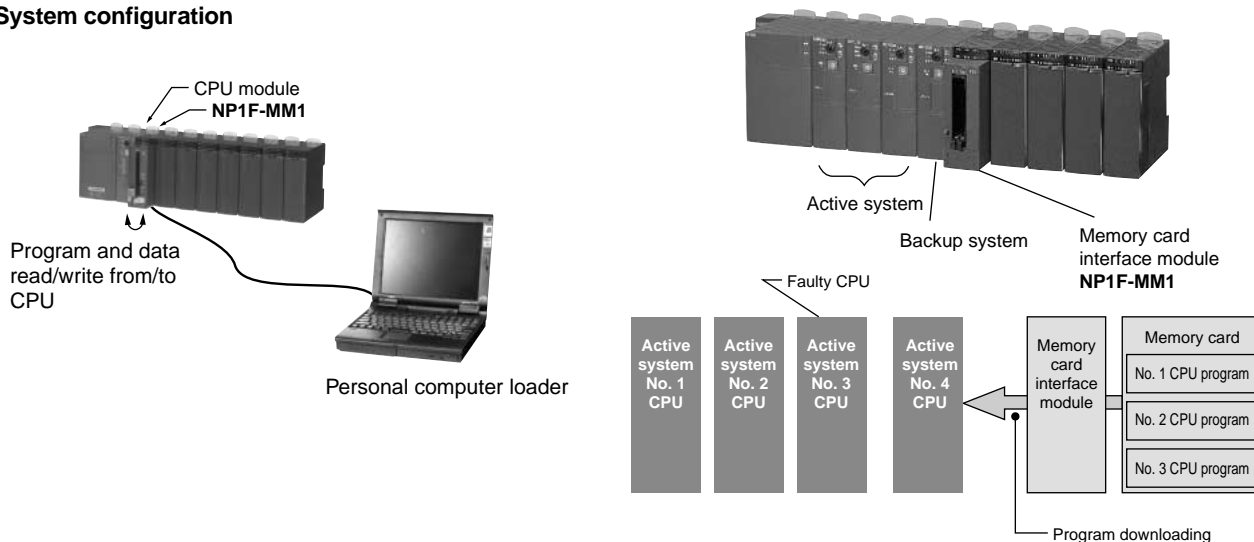

Dummy Module: NP1F-DMY

■ **Features**

- When your system will be expanded in the future, the dummy module can be used as a substitute for the extension module.
- If an active module has failed during operation of the system, the system can be restarted when you replace the failed module with the dummy module (which, however, cannot perform the functions of the failed module).



■ **Specifications**

Item	Specification
Type	NP1F-DMY
Substituted module	All modules except power module and CPU module
Mounting place	On a base board directly connected to SX bus Cannot be mounted on a T-link base board or other remote I/O module.
Occupied words	0 word
Internal current consumption	24V DC, 26mA or less
Mass	Approx. 120g

Programmable Controllers

MICREX-SX series SPH

Positioning Control Module

Two-axis Pulse Train Output Positioning Control Module: NP1F-HP2

■ Features

- Combined with the servo amplifier motor of the pulse train command input type or the stepping motor driver allows high-precision positioning.
- Use of an expansion FB facilitates embedding necessary functions including axis-independent single-function positioning to multi-axis simultaneous start positioning (pseudo linear interpolation).
- Use of the signal converter (NP2F-LEV) enables connecting the differential input type equipment.

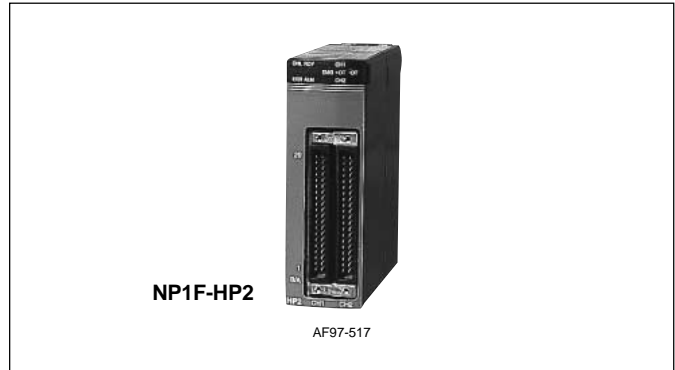

■ Performance specifications

Item	Specification	
No. of control axes	2 axes	
Positioning control	Open loop	
Acceleration /deceleration characteristics	Trapezoidal (at pulse generation mode)	
Position data	Max. 2 ³² -1 pulse /command	
Command pulse	Command frequency	250kHz
	Frequency resolution	16 bits /20 bits
	Output type	Open collector output (forward pulse + reverse pulse)
Control function	Pulse generation mode	
Combination actuator	Servo system prepared pulse train command input or stepping motor	
Occupied word	Input: 8 words/Output: 8 words (total: 16 words)	
Internal current consumption	24V DC 95mA or less	
External power supply	24V DC 35mA or less	
Mass	Approx. 180g	

■ System configuration

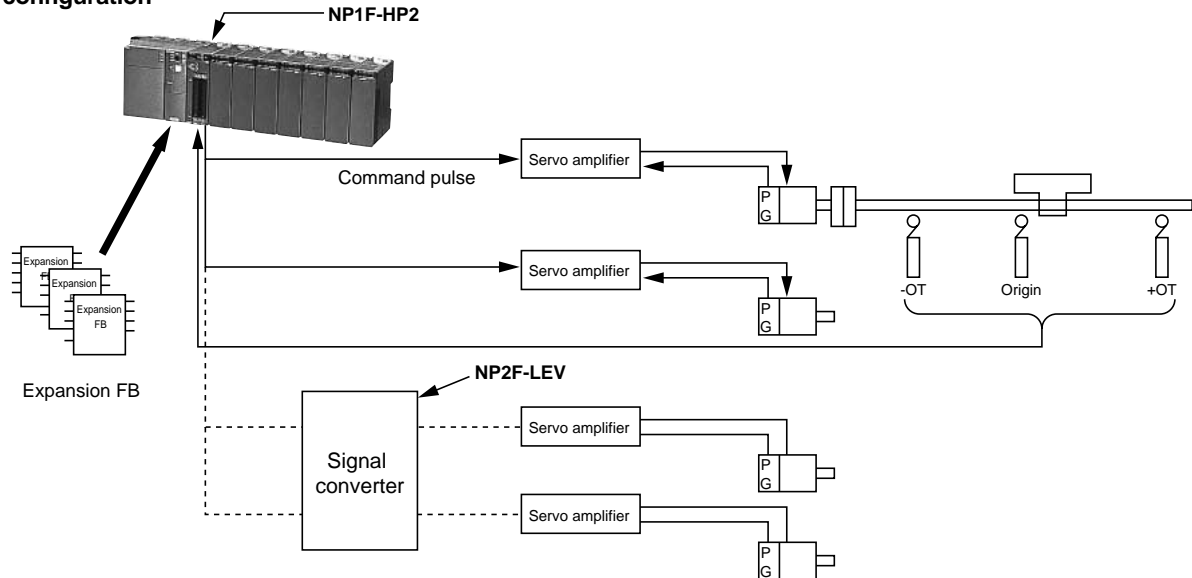

■ Signal converter (NP2F-LEV) specifications

Item	Specification	
No. of control axes	2 axes (4 channels)	
Input signal	Input frequency	Max. 1MHz
	Input type	Open collector input
Output signal	Output frequency	Max. 1MHz
	Output type	Differential signal
External power supply	24V DC, 35mA	
Mass	Approx. 130g	

■ Dimensions, mm

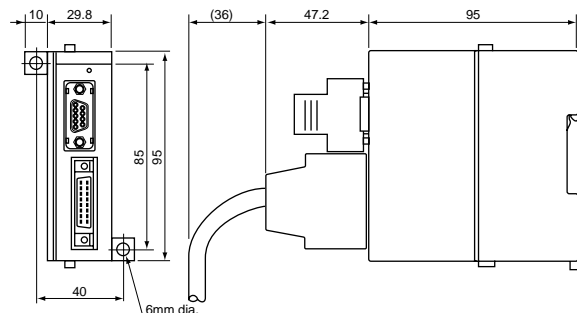

Two-axis Pulse Train Multiple Positioning Control Module: NP1F-MP2

■ **Features**

- Combined with the servo amplifier motor of the pulse train command input type or the stepping motor driver allows high-precision positioning.
- Use of an expansion FB facilitates embedding necessary functions including axis-independent single-function positioning to multi-axis simultaneous start positioning (pseudo linear interpolation), interpolation, and cam/running cut.
- Current position (current feedback value) can be detected with the feedback pulse. 2 types of operation modes are available: pulse generation mode and position command mode.
- Use of the signal converter (**NP2F-LEV**) enables connecting differential input type equipment.

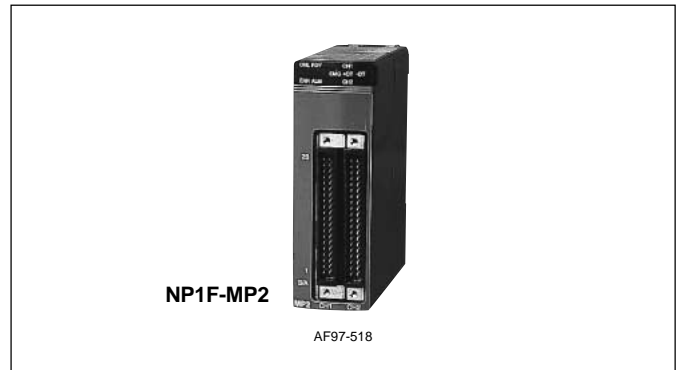

■ **Performance specifications**

Item	Specification	
No. of control axes	2 axes	
Positioning control	Open loop	
Acceleration /decelerations characteristics	Trapezoidal (at pulse generation mode)	
Position data	Max. $2^{32}-1$ pulse /command	
Command pulse	Command frequency	250kHz
	Frequency resolution	16 bits /20 bits
	Output type	Open collector output (forward pulse + reverse pulse)
Feedback pulse	Input frequency	500kHz
	Input type	Open collector input or differential signal (90° phase difference, phase A, B and phase Z)
Manual pulse unit	Input frequency	500kHz
	Input type	Open collector input or differential signal (90° phase difference, phase A, B or forward pulse + reverse pulse)
Control function	Pulse generation mode, positioning command mode	
Combination actuator	Servo system prepared pulse train command input or stepping mode	
Occupied word	Input: 14 words / Output: 8 words (total: 22 words)	
Internal current consumption	24V DC 95mA or less	
External power supply	24V DC 35mA or less	
Mass	Approx. 200g	

■ **System configuration**

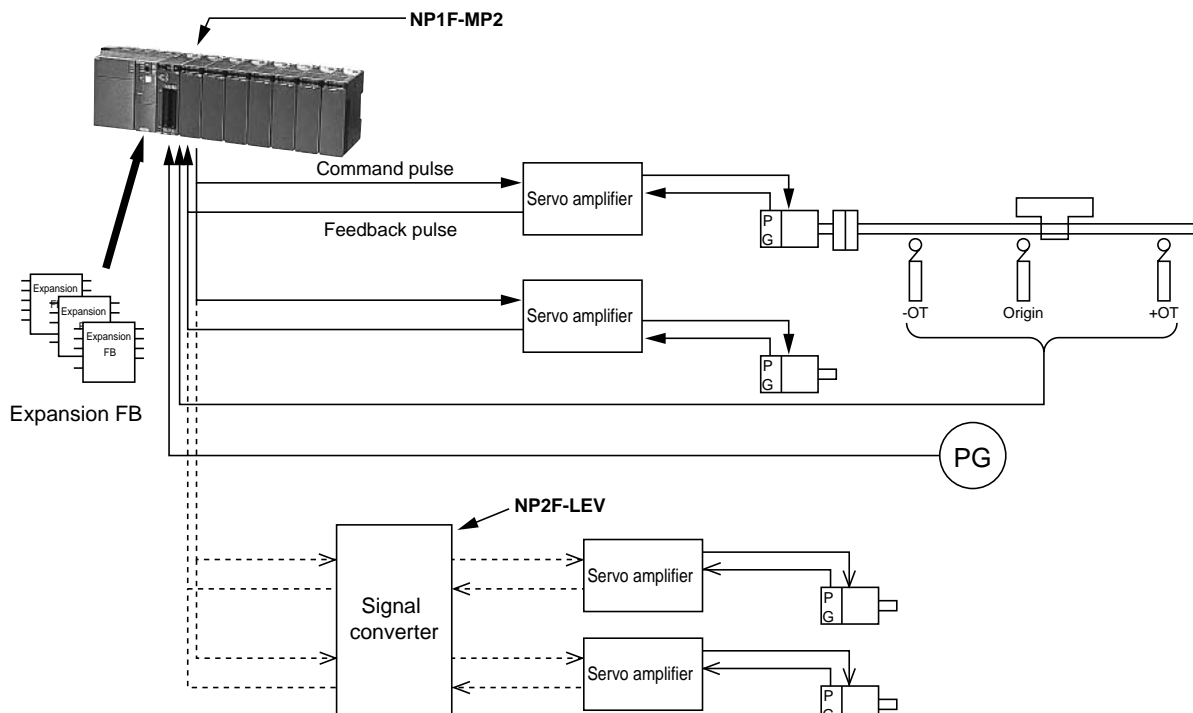

Programmable Controllers

MICREX-SX series SPH

Positioning Control Module

Two-axis Analog Multiple Positioning Control Module: NP1F-MA2

■ Features

- Combined with the servo amplifier motor of the pulse train command input type or the stepping motor driver allows high-precision positioning.
- Use of an expansion FB facilitates embedding necessary functions including axis-independent single-function positioning to multi-axis simultaneous start positioning (pseudo linear interpolation), interpolation, and cam/running cut.
- 3 types of operation modes are available: pulse generation mode, position control mode, and position command mode.

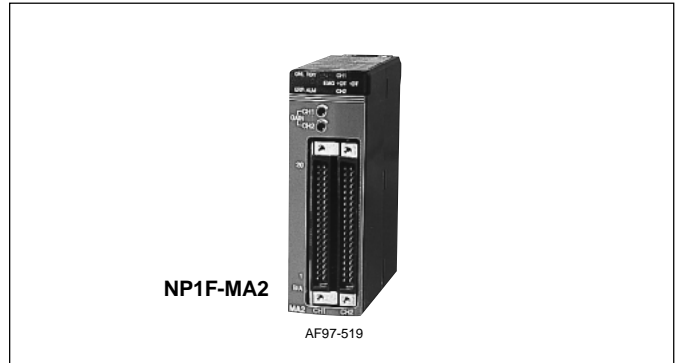

■ Performance specifications

Item	Specification	
No. of control axes	2 axes	
Positioning control	Semi-closed loop	
Acceleration /deceleration characteristics	Trapezoidal (at pulse generation mode)	
Position data	Max. $2^{32}-1$ pulse /command (at pulse generation mode)	
Speed command	Command voltage	Analog speed command (0 to $\pm 10.24V$)
	Signal type	Analog voltage command
Feedback pulse	Input frequency	500kHz
	Input type	Open collector input or differential signal (90° phase difference, phase A, phase B and phase Z)
Manual pulse unit	Input frequency	500kHz
	Input type	Open collector input or differential signal (90° phase difference, phase A, phase B, or forward pulse + reverse pulse)
Control functions	Pulse occurrence mode, positioning command mode, positioning control mode	
Combination actuator	Servo system prepared analog speed command input	
Occupied words	Input: 14 words / Output: 8 words (total: 22 words)	
Internal current consumption	24V DC 150mA or less	
Mass	Approx. 200g	

■ System configuration

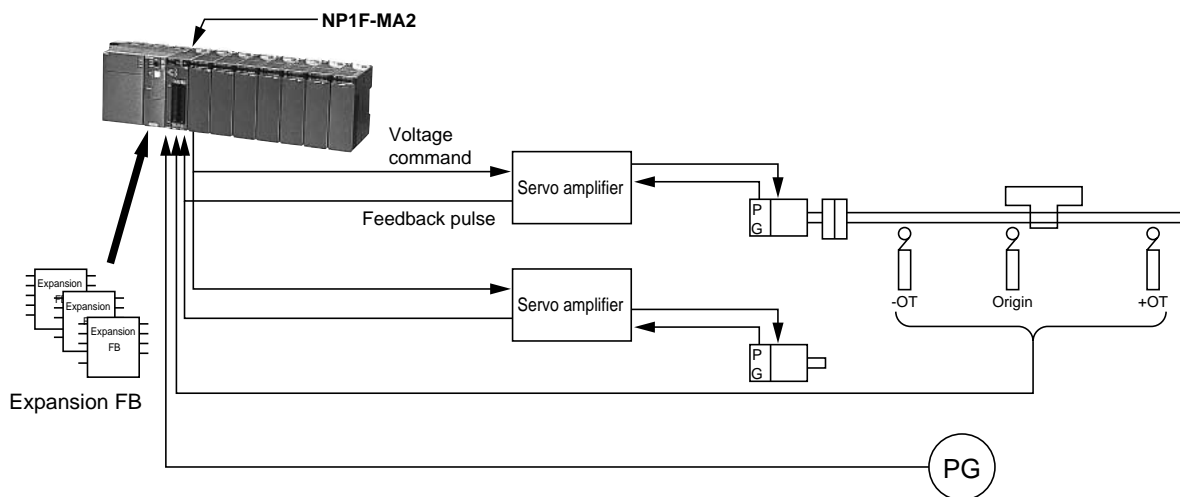

MC Module: NP1F-MC8P1

■ **Features**

- 8-axis 8-task motion control can be performed with a single module. Axis control can be interpolated with any combination.
- A tabular form programming language is used, allowing conversion the spreadsheet (Excel).
- Sequence control is performed by the CPU and motion control by this module, realizing multi-axis control without loading the CPU.
- Motion control programs are created with the optional MC module programming support tool.



■ **Performance specifications**

Item	Specification
No. of control axes	8-axis/module
Max. position data	-2147483647 to 2147483647 pulses (in 1-pulse steps)
Control operation interval	2ms (4-axis control) or more
Control function	PTP, interpolation
Interpolation function	Straight line interpolation for up to 4 axes, 2-axis arc interpolation
Program form	Tabular form
Simultaneous execution program	Up to 8 tasks
No. of program stored	Up to 500
Program size	Up to 2500 steps/program, total number of steps: 12500 steps
Combination actuator	Servo system model RYS □□□ S3-VSS (FUJI ELECTRIC)
Actuator interface	SX-MC bus (25MHz)
No. of occupied words	Input 28 words/output 28 words
External power supply current consumption	Input power supply (for external interrupt signal): 24V DC ± 5%, 5mA or less SX-MC bus drive power supply: 24V DC ± 5%, 500mA or less
Internal current consumption	24V DC ± 5%, 150mA or less
Mass	Approx. 186g

■ **System configuration**

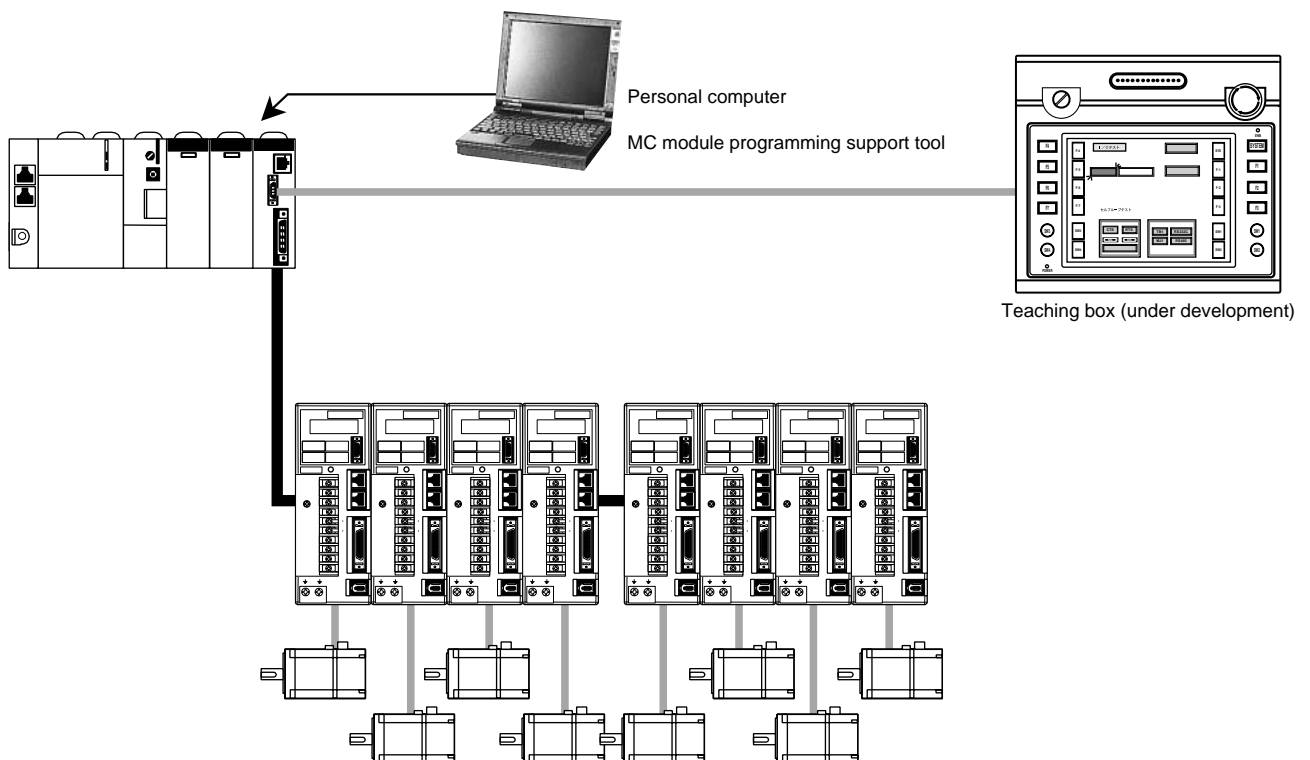

■ Positioning Module Function List

No.	Function	Description	NP1L-HP2		NP1L-MP2		NP1L-MA2	
			Pulse generation	Position command	Pulse generation	Position command	Position control	Position command
1	Pulse train command	Outputs the pulse train command signal for forward and reverse pulses.	○	○				
2	Pulse generation mode positioning	References the pulse count and frequency data in the CPU module and carries out positioning by generating the command pulse using the built-in pulse generator.	○	○			○	
3	Position control mode positioning	Directly references position and speed data in the CPU module and carries out positioning.						○
4	Position command mode positioning	References position data in the CPU module and carries out positioning by generating the command pulse using the built-in pulse generator.			○			○
5	Current value count	Counts the command pulse and detects the current command value (multiplied by 4).	○	○	○	○	○	○
		Counts the feedback pulse and detects the current feedback value (multiplied by 4).			○	○	○	○
6	Phase-Z position detect (Origin return operation)	Detects the command position at the phase-Z rising edge (or falling edge).	○	○	○			
		Detects the deviation amount at the phase-Z rising edge (or falling edge).			○	○	○	○
		Detects the current feedback position at the phase-Z rising edge (or falling edge).			○	○	○	○
7	Interrupt position detect (Interrupt positioning operation)	Detects the command position at the rising edge (or falling edge) of the external interrupt signal.	○	○	○			
		Detects the deviation value at the rising edge (or falling edge) of the external interrupt signal.			○	○	○	○
		Detects the current feedback position at the rising edge (or falling edge) of the external interrupt signal.			○	○	○	○
8	Automatic-start frequency setting	Allows the user to set the automatic-start frequency.	○	○		○		
9	Trapezoidal acceleration/ deceleration computation	Computes trapezoidal acceleration/deceleration.	○	○		○		
10	Deceleration point automatic computation	Automatically computes the deceleration point.	○	○		○		
11	Continuous frequency change	Continuously updates the command frequency of the pulse generator.	○	○		○		
12	Command pulse count additional setting	Sets the additional command pulse count during pulse generator output.	○	○		○		
13	Pulse output stop processing	Two types of acceleration can be selected for trapezoidal deceleration when the pulse output is interrupted.	○	○		○		
14	Emergency stop processing	Carries out quick stop when an emergency stop error is detected.	○	○				
		Immediately stops the pulse output.			○			
		Immediately clears the speed command voltage to 0V.				○	○	
15	Over travel (Plus or minus error detection)	Carries out deceleration and stop when a +/-OT error is detected.	○	○		○		
		Immediately stops the pulse output.			○			
		Performs exponential deceleration and stop.					○	
16	Transmission error monitoring	Monitors a module control program error on the CPU module side, and carries out quick stop when a transmission error is detected.	○	○		○		
		Immediately stops the pulse output.			○			
		Performs exponential deceleration and stop.					○	
17	External pulse count	Counts the external input pulse for manual pulse unit operation or synchronous operation.		○	○	○	○	
18	Positioning data first read	Up to four items of positioning data per axis can be registered in the FIFO buffer. The registered positioning data is executed sequentially. It is also possible to make additional settings in the FIFO buffer during operation.		○		○		
19	Positioning data write	Sets additional positioning data during continuous frequency change processing.		○		○		
20	External input signal detect	Detects the input status of all DI signals.	○	○	○	○	○	
21	External output signal setting	All DO signals can be switched with the CPU module.	○	○	○	○	○	

**Positioning Extension FB Software Package
[Japanese Version]**

Product name	Model	Description
Positioning FB package	NP4N-PTPFV3	1-axis PTP positioning FB (pseudo linear interpolating function included), highly-functional 1-axis positioning FB, compact 1-axis positioning FB
Electronic cam FB package	NP4N-CAMFV3	Cam operation FB (running cut function included), variable cam FB

High-speed counter extended FB, high-speed input counter FB, and simplified positioning expansion FB are included with the programming support tool D300win as standard.

■ **High-speed counter extended FB**

This FB is installed to use the high-speed counter. Multi-functional and simple-functional FBs are available.

■ **High-speed input counter FB**

This FB is installed to use the pulse counter input function of the high-speed digital input module (NP1X3206-A).

■ **Simplified positioning expansion FB**

This is a simplified positioning FB for the digital output module (NP1Y32T09P1-A) with pulse train output built-in. It carries out positioning of 1-axis PTP using the pulse train command.

■ **Positioning FB package**

- 1-axis PTP positioning FB (pseudo linear interpolating function included) (SPH300)

This FB is used to accelerate to the set speed, decelerate-and-stop at the specified position, and perform position management. Thus, the specified positioning can be implemented by only setting the target position and speed from the sequence program side. This FB allows speed changeover using a function such as the override function during operation so that the user can easily reduce the conveyance time by fast travel and make high-precision positioning by low-speed travel. The position command and speed command can be set in units of mm or mm/s. The pulse count for the position data is converted by this FB to facilitate the operation. This FB is the most suitable for equipment conveying or assembling basic loaders and unloaders.

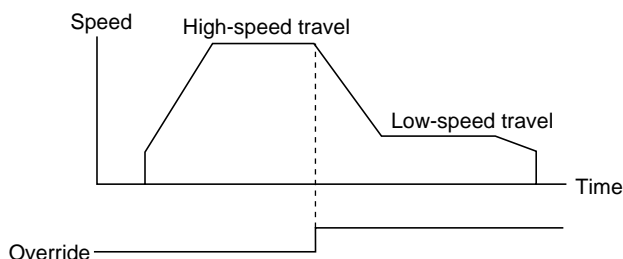

In addition, pseudo linear interpolating operation is implemented by 2-axis, 3-axis, or 4-axis simultaneous start. This operation can be applied to control of most types of multi-layer warehouses and assembling equipment, and is also available for conveyor line control. This FB can be applied to the pulse train positioning control combined module, analog positioning control combined module, and pulse train output positioning module.

- Highly-functional 1-axis positioning FB (SPH300)
This FB has the 1-axis PTP positioning function with S-shape acceleration/deceleration and manual pulse unit operating functions added. This FB is required for electronic cam or running cut operation. It can be applied to the pulse train positioning control combined module and analog positioning control combined module.
- Compact 1-axis FB
This FB has a compact program size and a reduced memory data count for applying the pulse train positioning control combined module or analog positioning control combined module. It performs 1-axis PTP positioning and is best suited for application to SPH200.

■ **Electronic cam FB package (SPH300)**

Positioning implemented by cam control operation is very frequently applied in diverse types of machines such as packaging. Use of this FB package allows accommodating various types of cam mechanism operation (cam patterns), eliminating complicated gear changes of the mechanical cam. It also enables implementing operations impossible with the mechanical cam.

- Cam operation FB
This FB executes 1-axis cam operation positioning. It can implement operations impossible with the mechanical cam as well as operations superseding the conventional mechanical cams. This FB can be applied to the pulse train positioning control combined module and analog positioning control combined module.

The extended FB with functions necessary for control of a running cut machine is also available. Operation synchronous with the conveyer speed does not need conveyer stop and restart, greatly contributing to machine speed increase. This extended FB is used for various types of machine control as well as for the running cut machine. Use of this FB allows easily implementing synchronous control. This extended FB can be applied to the pulse train positioning control combined module and analog positioning control combined module.

- Rotary shear control
Rotary shear control refers to control of the roll-shaped cutting section (cutter or press) to cut continuously fed material (film, paper, and so on) by feeding at the same speed as the original feed speed. It can be used for such diverse machines as packaging and film manufacture.

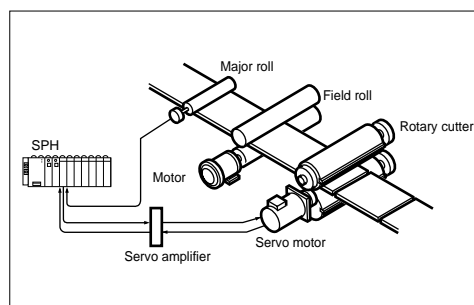

Positioning Extension FB Software Package

- Flying shear control

Flying shear control means controlling so that the cutting section (cutter or press), consisting of ball screw, rack-and-pinion, or equivalent, will cut the continuously fed material (iron plate, external wall material, clay, and so on) by feeding at the same speed as the original feed speed. It can be used for such diverse machines as metal processing, tile manufacturing, and coating.

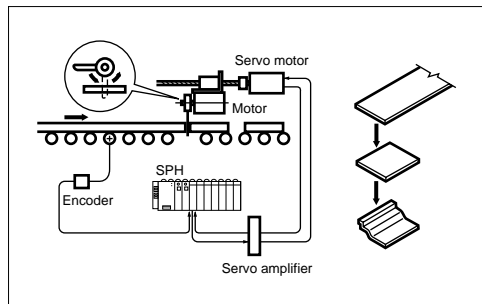

- Flying cutter control

Flying cutter control is to control so that the cutting section (cutter or water jet), consisting of the ball screw, rack and pinion, chain, and so on, will cut the continuously fed material (film, paper, plastic, etc.) by feeding at a constant ratio to the material's feed speed and at a certain angle to the material. It can be used for such diverse machines as board manufacturing.

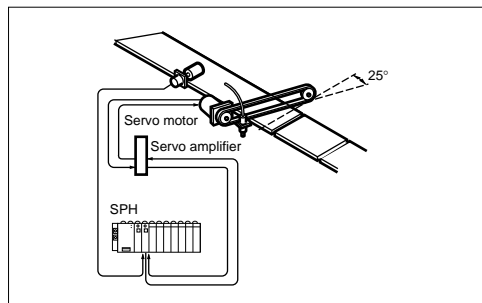

- Variable cam FB

This FB realizes the variable cam function. It detects the machine's main shaft angle (current work value), and turns ON/OFF the output signal of the set main shaft angle (work position). This FB can be applied to the pulse train positioning control combined module, analog positioning control combined module, and pulse train output positioning module.

Functional Extension FB Software Package [Japanese Version]

- Easily realizes functional extension by software

External fault diagnostic and adjustment system functions can also be implemented with software (an expansion FB) by using the enhanced processing functions of the CPU module. The software processing section is placed in the CPU section as an expansion FB and only the external equipment interface processing is separately performed in the I/O section. Thus, an optimum system can be configured according to the function and performance requirements.

- Diagnostic FB package: NP4N-TRBFV3

Necessary diagnosis can be conducted only by selecting an extended FB for each diagnostic function. If this software is stored in the CPU module for control programs, it is not necessary to add any other special function module. When it is used in the multi-CPU configuration, independence of the control CPU can also be preserved.

For notification of the diagnostic results to the external equipment, Ethernet or a network of general-purpose communication modules or equivalent can also be used.

- Expansion FB packages which implement the fault diagnostic functions

The following diagnostic and data sampling FBs are available:

- Sequence/time diagnostic FB
- Time diagnostic FB
- Upper/lower limit diagnostic FB
- Data sampling FB

- PID FB package: NP4N-PIDFV3

Instrumentation control and sequence control were conventionally separated with respect to both hardware and software. When packaged as an extended FB, this adjustment system computing function is a true linkage between instrumentation control and sequence control.

In addition, the restriction on the control loop count has sufficient expandability in a multi-CPU configuration. (The number of FBs that can be stored in a CPU module is limited by the number of program steps and the sampling rate.)

- Extension FB package realizing the temperature regulation system operation function

- ON/OFF control FB
- PID FB with auto-tuning

- Extension FB package set: NP4N-FSETV3

This set includes the following five different extension FB packages:

- FA Device General-Purpose Communication Package: **NP4N-COMFV3**
- Positioning FB Package: **NP4N-PTPFV3**
- Electronic Cam FB Package: **NP4N-CAMFV3**
- Failure Diagnosis FB Package: **NP4N-TRBFV3**
- PID FB Package: **NP4N-PIDFV3**

Programming Support Tool
Programming Support Tool Conforming to International Standard IEC 61131-3 (D300win): NP4H-SEDBV3

■ **Features**

● **Complete conformity to IEC 61131-3 International Standard**
D300win supports five types of program representations completely conforming to the IEC 61131-3 International Standard. It allows the programmer to code the combination of program representations best suited for the control target.

● **Supported representations**

- IL (Instruction List)
- FBD (Function Block Diagram)
- SFC (Sequential Function Chart)
- LD (Ladder Diagram)
- ST (Structured Text)

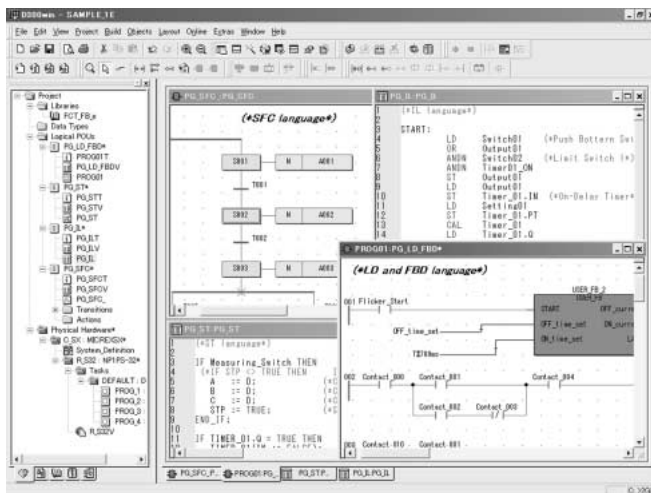

● **Structured programming**

Programmability in units of POU or worksheets allows separate program creation for each function or process so that the programmer can easily generate programs with a structured design and good readability. In addition, this structured programming enables multiple designers to divide the design work to effectively reduce the program creation time.

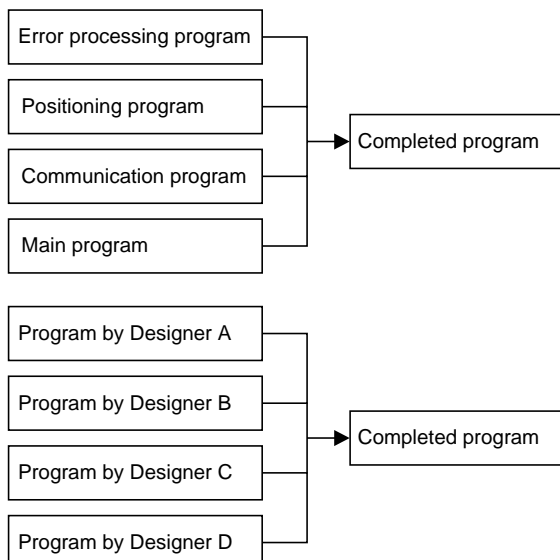

● **Free description of programs and comments**

Programs can be described in any location on a worksheet to facilitate understanding of the processing relationships such as in linkage between the interlock condition and the sequence processing section/computing section, allowing efficient programming.

In addition, when a comment is described on a worksheet, the programmer can put a local comment for each circuit block as well as a comment in units of contacts, coils, or circuits, greatly contributing to ease of reading and understanding.

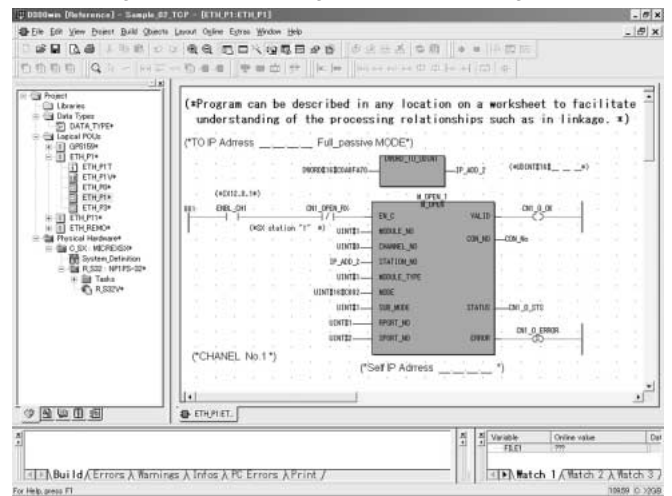

● **Programming with variables (labels)**

Differing from conventional programming, the D300win Programming Support Tool uses label programming (addresses are automatically assigned) in which the address section is described like conventional comments, enabling program coding without being conscious of memory addressing. After the programming, any changes in address assignment can be accommodated by merely changing the corresponding label definition to update the program.

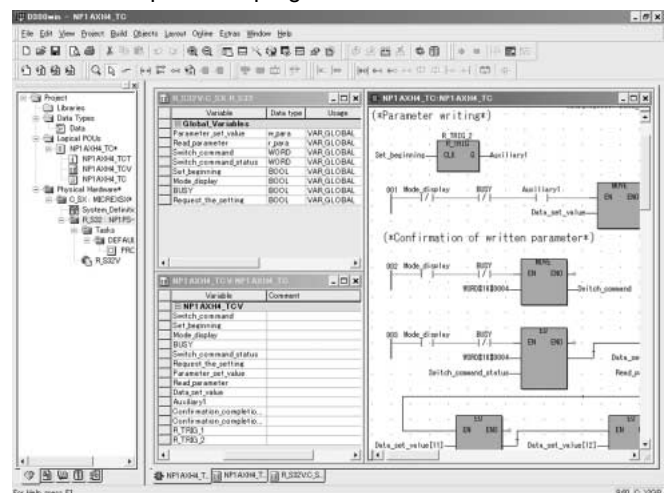

Programmable Controllers MICREX-SX series SPH Programming Support Tool (D300win)



- **Integrates user-original circuits into an FB**

Frequently used routine programs or circuits can be integrated into an FB so that the programmer can easily reuse them. For FB generation, the user can select a language compatible with IEC 61131-3 supported by D300win instead of a special language. If the programs or circuits are stored in library form, the target function can be effectively used without being conscious of debugging. This is also effective for circuit standardization or structuring if a single control block is integrated into an FB.

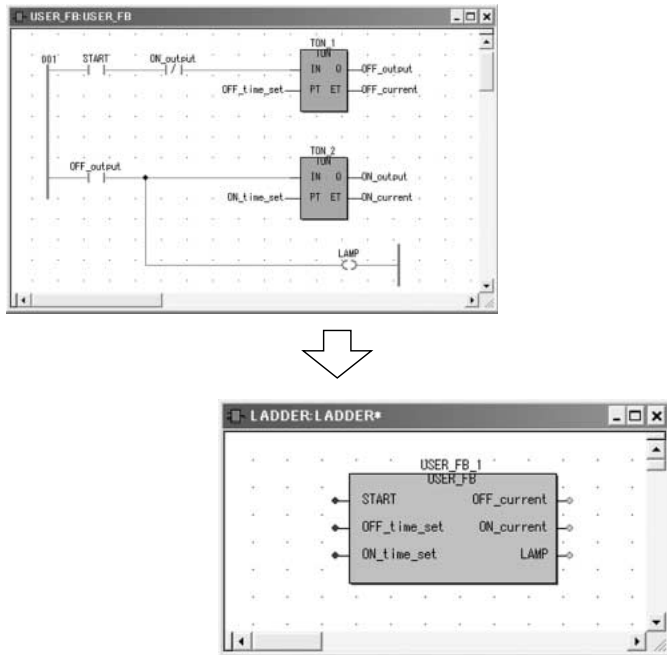

- **Enlarge/reduction display, multi-window display**

Frequent demands at the time of programming include legibility, with large characters and display of many circuits to facilitate understanding of the entire process. The tab-key screen selection function, overview function, and quadruple display function make it easier to grasp the program structure and improve program editing efficiency.

- **Error & jump check function**

The tool performs program syntax check at the time of program compilation to detect syntax errors. It is possible to jump to an error position by double-clicking an error detection section. This function, together with the cross-reference function and data watch window function, exhibits its power in program correction and testing.

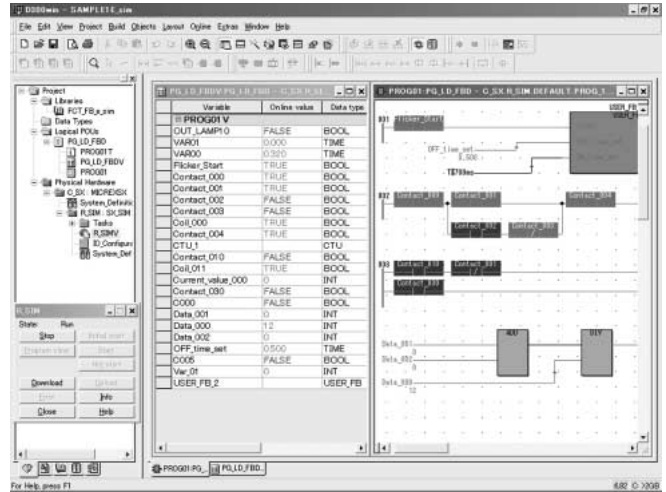

- **Simulation function**

This tool enables program logic test using the software PLC function for simulation built in D300win, without using the actual unit.

It performs operating simulation of a program written with a programming language conforming to IEC 61131-3. It enables forced ON/OFF and monitoring of any signal, possibly resulting in remarkable improvement of the programming and debugging efficiency for the SX series.

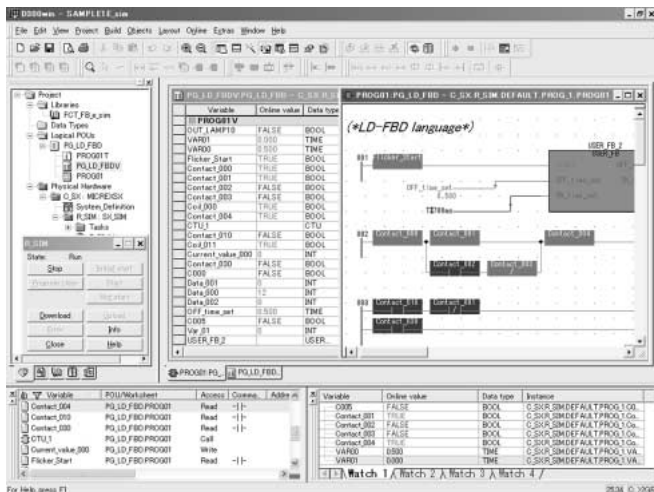

● **Documentation function**

The documentation preparation function has been substantially improved. Not only can it print drawing numbers, dates, page, and drawing borders, but also company logos and comments. It also augments the print preview function, which allows the user to verify the print state on the screen before beginning printing, and the scaled printing function which eliminates the need to select the paper size.

Layout function

The layout function allows the user to print a program list in a free, user-original format. The created layout can be stored as a layout library, which can be used when necessary.

- Frame creation: Program list can be printed with frames. The frames can be freely designed facilitating reproduction of a conventionally used drawing sheet.
- Company logo: Company logo can be attached to a document. It is created as BMP data and pasted to the frames.
- Drawing number: Drawing number can be placed in a specified position within the frame.
- Page: Page number can be placed in a specified position within the frame.
- Comment: Comments can be placed in a specified position within the frame.

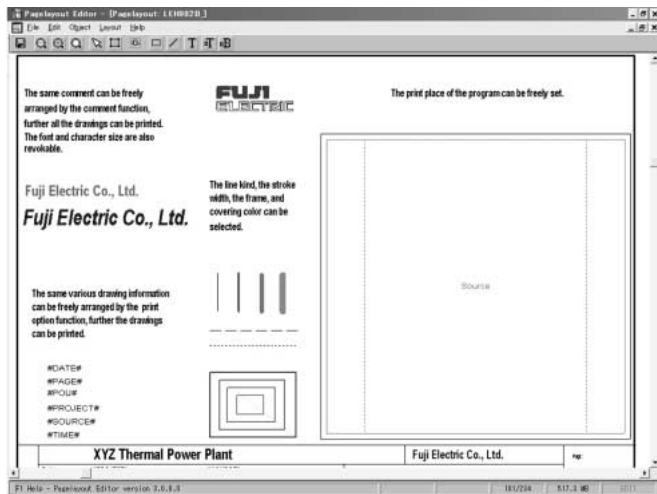

Preview function

Use of the preview function before printing allows the user to verify the print image.

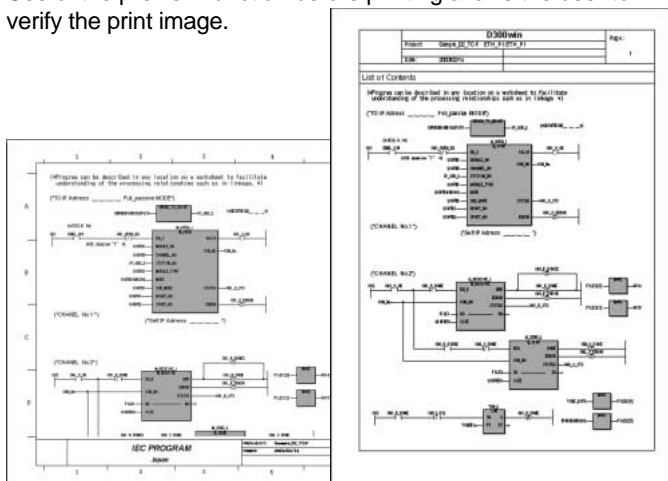

Scaled printing

Documents can be printed in enlarged or reduced size. The paper size can be freely selected according to the purpose. The number of programs printed on a single sheet can be freely adjusted to provide united documentation.

● **Function module support**

The function module support (built-in each extended FB software package) has been realized as a common support tool. Thus, a dedicated loader is not required.

Sharing program definitions including variable names

Labels and files defined/created with the D300win programming support tool can be used as is from the function module support tool. This allows not only reducing the programming workload, but also unifying management of programs.

Sharing the support tool connection port

The function module support tool can be used even when the IEC programming support tool remains connected to the CPU module. The support function can be used only by starting the function module support tool, thus, it is not necessary to change the connection by replacing the CPU module with the function module. Parameter transmission between the CPU module and the function module is carried out by the extended FB.

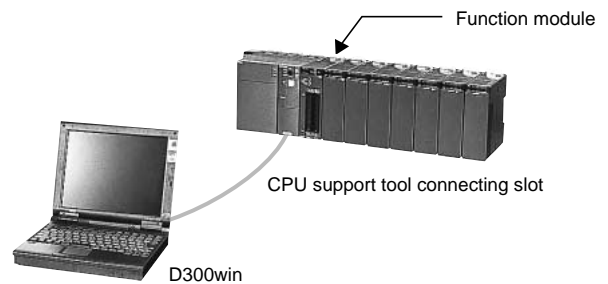
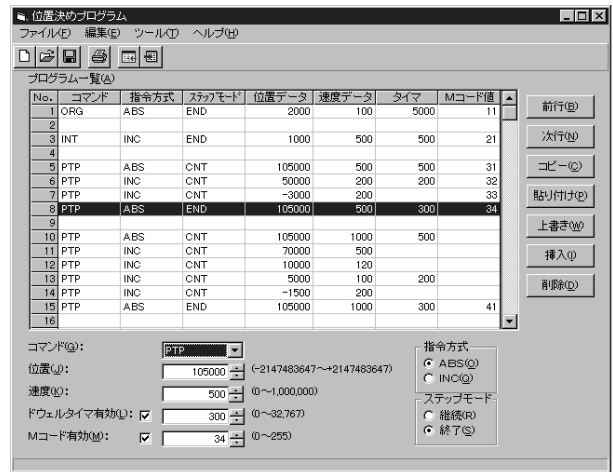

Programmable Controllers

MICREX-SX series SPH

Programming Support Tool (D300win)

● POD cooperated support

Screen creation for the Programmable Operation Display (POD) can be performed using variable names set with D300win.

POD screen creation software

POD screen creation software and D300win run on a personal computer, which is the common platform.



● USB interface

The connection method using the full-speed USB (Universal Serial Bus) 1.1 has been added as a loader connection method. Communication with the advanced CPU module (NP1PS-□□R) can be performed at high speed using a commercial USB cable.

● Uploading and downloading a project

This tool makes it possible to download a project to the user ROM card (compact flash card) attached to the advanced CPU module (NP1PS-□□R), upload it from the user ROM card, and perform project collation.

■ Operating environment

Item	Specification	
D300win system software	NP4H-SEDBV3	
Hardware	IBM-PC/AT compatible	
CPU	Intel Pentium 233MHz or higher (350MHz or higher recommended when WindowsXP is used)	
Hard disk	Free space of 220M bytes or more (D300win system software: 100MB or more Standard extension FB software package: 120MB or more)	
CD-ROM unit	1 unit (x 4 speed or faster), media: ISO 9660 format	
Memory capacity	64M bytes or more (128M bytes or more recommended when WindowsXP is used)	
Keyboard	101 keyboard	
Mouse	USB mouse, serial mouse, bus mouse, or PS2 mouse	
Indicator	800 x 600-dots resolution or higher (1024 x 768-dots resolution or higher recommended)	
Communication interface	RS-232C	
	Ethernet	Possible
	ISDN	Possible (analog port is used)
	USB	Possible with V1.1 (Target CPU: NP1PS-□□R)
	P/PE-link	Possible
	SX bus	Possible
	FL-net	Possible
OS	WindowsNT4.0 (SP6 or later)/2000/XP	
Other software	Internet Explorer 5.0 or later	
Portability	Depends on commercial mobile personal computer.	
Environmental durability	Depends on environmental conditions of commercial personal computer.	

■ System configuration

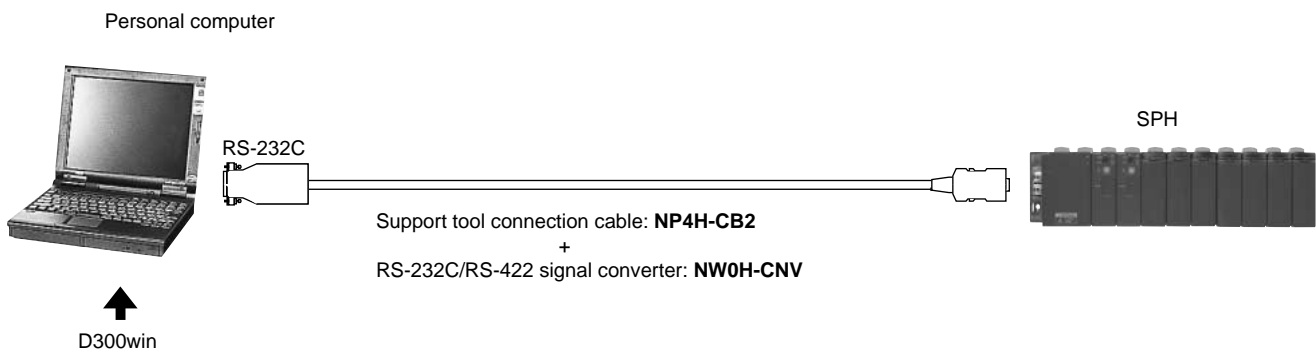

**Programming Automatic Generation Tool SC Matrix:
NP4H-SESV2 [Japanese Version]**

■ Features

● Suitable for process step control

This programming tool is intended to create process step control programs necessary for machine control and line control.

● Matrix programming using Excel

The SC matrix operates on Microsoft Excel. Process step programming is made simply by setting I/O conditions on a matrix basis using Excel worksheets. Program downloading to the PC is performed by means of D300win.

SC matrix table

This table is used to set the process step condition and output conditions for each process. Up to 98 processes and up to 100 transitional conditions can be described in one table. Up to 64 Excel worksheets can be registered, allowing creation of up to 64 tables.

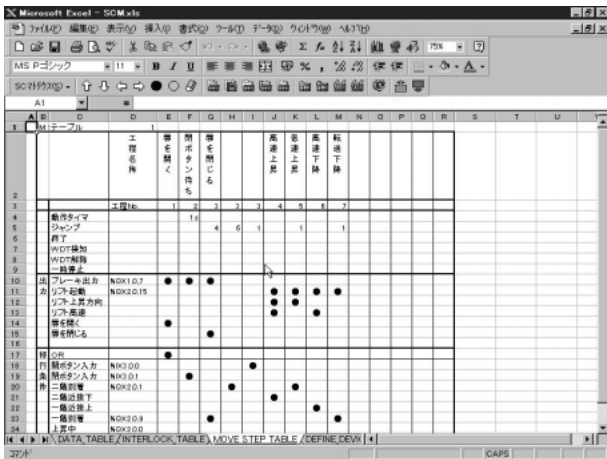

Output condition table

This table defines the devices to be output to a specific input. It corresponds to the SC matrix table and allows setting of interlock condition for each output. The condition is monitored regardless of the process step and, if a condition is met, the specified device is turned ON.

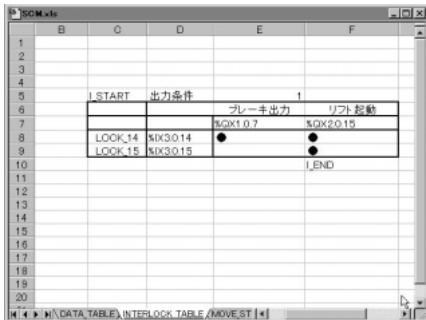

Data table

This table defines the data trains to be transferred to the PC using the SC matrix table. It relates the definition number starting with "DT" to the setting and target device. Data trains of up to 4000 points can be set as integers or double-precision integers. Multiple data tables can be registered which can be selected during each operation.

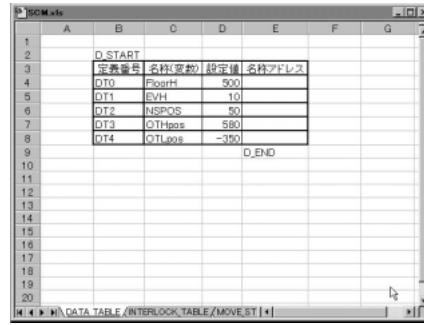

● Programming by variable (label)

Like D300win, since variables can be used for the PC address, programming can be made without being aware of the memory address.

● Automatic generation programming

PC programs are generated automatically by compiling programs created on Excel. PC programs can be created without the knowledge of programming languages specific to the PC, allowing PC novices to make programs easily.

● Monitoring

The PC monitor can also be displayed in the same screen as the Excel worksheet. This makes it easier to grasp the machine process step and perform adjustment and maintenance of machines.

Overall monitor

This screen monitors the entire SC matrix table. It is suitable for overlooking the entire process operation. Other tables can be monitored easily by switching between worksheets.



Programmable Controllers

MICREX-SX series SPH

Programming Support Tool (SC Matrix)

Partial monitor

This screen monitors only the current process being executed. It displays the relationship between the operating output signal and the transitional conditions.



Operating environment

Item	Specification	
Hardware	IBM-PC/AT compatible	
CPU	Intel Pentium 233MHz or higher	
Hard disk	Free space of 10M bytes or more (with additional disk space for D300win and Excel)	
CD-ROM unit	1 unit (x 4 speed or faster), media: ISO 9660 format	
Memory capacity	32M bytes or more (64M bytes or more recommended)	
Keyboard	101 keyboard	
Mouse	USB mouse, bus mouse, or PS2 mouse	
Indicator	800 x 600-dots resolution or higher (1024 x 768-dots resolution or higher recommended)	
Communication interface	RS-232C	9600bps to 57600kbps
	Ethernet	Possible
	ISDN	Possible (analog port is used)
	USB	Possible with V1.1 (Target CPU: NP1PS-□□R)
OS	Windows95/98/NT4.0/2000	
Excel version	Excel97/2000	
Portability	Depends on commercial mobile personal computer.	
Environmental durability	Depends on environmental conditions of commercial personal computer.	

System configuration

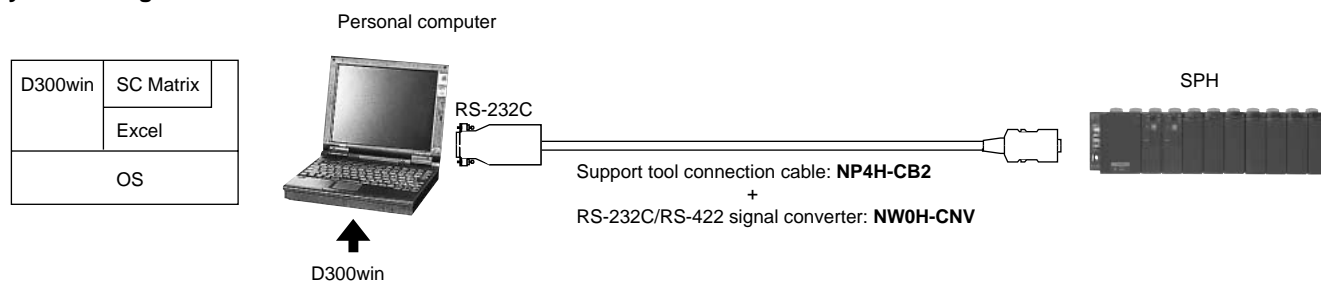

OPC-Coordinated Library SX Communication Middleware: NP4N-MDLW [Japanese Version]

■ **Features**

● **OPC-coordinated library**

Among various specifications established by OPC Foundation, this library is compatible with the OPC common specification and data access specification. The OPC automation interface and OPC custom interface are prepared as programming interfaces.

- In combination with a commercial SCADA software (RSView32 from ROCKWELL AUTOMATION, Intouch from SUMITOMO METAL SYSTEM SOLUTION, etc.), this library makes it possible to display the SPH-controlled data to the supervisory screen and utilize the data for the SPH setup data from the operation screen.

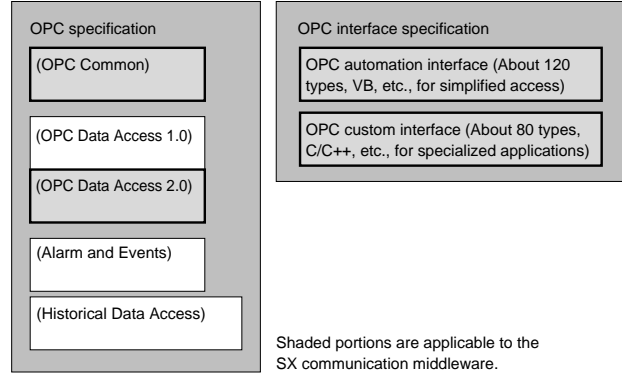

■ **Operating environment**

Item	Specification	
Hardware	IBM-PC/AT compatible	
CPU	Intel Pentium 233MHz or higher	
Hard disk	At least 1 unit, free space of 10M bytes or more (with additional disk space for D300win)	
CD-ROM unit	1 unit (x 4 speed or faster), media: ISO 9660 format	
Memory capacity	128M bytes or more	
Keyboard	101 keyboard	
Mouse	USB mouse, bus mouse, or PS2 mouse	
Indicator	1024 x 768-dots resolution or higher	
Communication interface	Ethernet	Commercial Ethernet board
	RS-232C	Commercial personal computer
	Modem	Commercial personal computer
	FL-net	Commercial Ethernet board
	SX bus	NP3L-SX1SASS
Software (OS)	Windows NT4.0/2000	
Environmental durability	Depends on environmental condition of a commercial personal computer.	
Models to be connected	MICREX-SX SPH series	
Language for user application software development	Microsoft Visual Basic	
	Microsoft Visual C++	

■ **Sample application system**

The example at right is a centralized monitor system for line equipment configured using SPH as a controller.

- The monitor screen makes status display and data collection of each I/O device.
- The operation screen sets production command data for each line.

■ **Sample application monitor screen**

The following is a sample application monitor screen using the SCADA software.

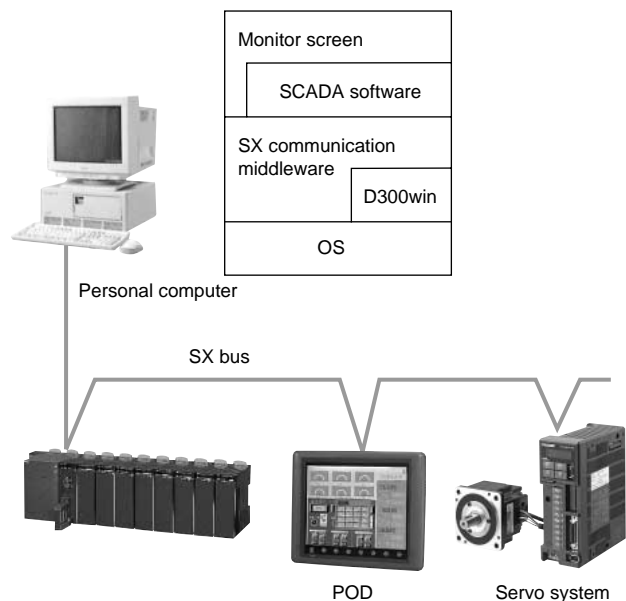
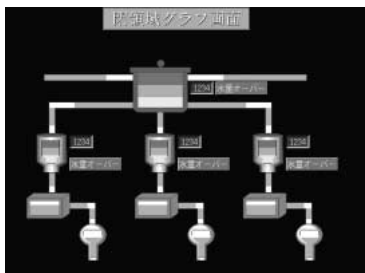

The SX communication middleware accommodates system business talks. For details, please contact our sales section.

PCI-Bus-Based SPH300 CPU Board: NP3PS-SX1PCS □

■ **Features**

- The board is provided with an extension connector of the SX bus, FUJI ELECTRIC original high-speed bus, allowing connection to diverse SX-based devices (indicators, remote I/Os, servo units, etc.) as well as standalone operation on a personal computer.
- When programming supporting tool D300win conforming to IEC is installed in a personal computer with this board mounted, programming and maintenance can be performed from the personal computer. Like the SPH300, this board is provided with a loader connector as standard. This makes it possible to perform programming and maintenance also from other personal computers with D300win using a specialized loader cable (**NP4H-CB2**) and a signal converter (**NW0H-CNV**).
- This board is connected to the PCI bus through 8K-word dual port memory, allowing high-speed data transmission. It can interface to applications for personal computers.

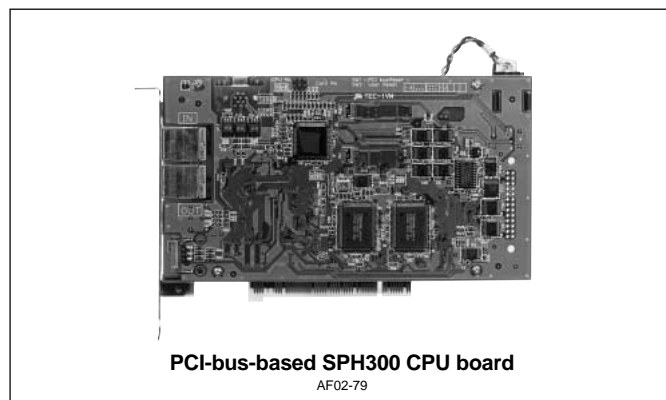

PCI-bus-based SPH300 CPU board
AF02-79

- A communication driver for data access with this board has been prepared.

■ **Performance specifications**

Performance and specifications of the built-in board type CPU board **NP3PS-SXPCS32/NP3PS-SXPCS74** are equivalent to those of the module type **NP1PS-32/NP1PS-74**.

Built-in board type	Module type	Program memory capacity
NP3PS-SXPCS32	NP1PS-32	32768 steps
NP3PS-SXPCS74	NP1PS-74	75776 steps

For details on performance and specifications, refer to “CPU Module: **NP1P□-□□**” on pages 13 and 14 of this catalog.

■ **Operating environment**

Item	Specification	
Hardware	IBM-PC/AT compatible (DOS/V PC)*	
CPU	Intel Pentium 133MHz or higher	
Hard disk	At least 1 unit, free space of 5M bytes or more	
External storage unit/interface	Floppy disk unit	At least 1 unit, media: 2HD1.25M/1.44M-byte 3.5-inch floppy disk
	CD-ROM unit	At least 1 unit, (x 4 speed or faster recommended), media: ISO 9660 format
Memory capacity	32M bytes or more (64M bytes or more for D300win operation)	
Keyboard	101 English keyboard	
Mouse	USB mouse, bus mouse, or PS2 mouse	
Indicator (resolution)	800 x 600-dots resolution or higher	
Current consumption	Personal computer with a power capacity capable of supplying 1.5A or more to this board	
Operating system	WindowsNT4.0 Workstation Service Pack3 or later, Windows2000 Professional Service Pack1 or later	
Others	TCP/IP protocol	

* This board is not applicable to the multi-CPU configuration. Use a personal computer with the single-CPU configuration.

**PCI-Bus-Based FL-net (OPCN-2) Ver. 2.0 Board:
 NP3L-FL2PCS**

■ **Features**

- Two different communication functions by application
 With cyclic communication, this board supports both the common memory function, which allows each node to share the same data, and the message communication function, which exchanges only necessary information when required.
- Large capacity common memory
 The capacity of the common memory is 8K bits and 8K words.
- High-reliability by the master-less method
 Since no master exists, participation and removal of each node can freely be performed without affecting communication of other nodes. The power of any node can be turned ON or OFF, allowing easy maintenance.

■ **Performance specifications**

Performance and specifications of the built-in board type FL-net board **NP3L-FL2PCS** are equivalent to those of the module type **NP1L-FL2**.

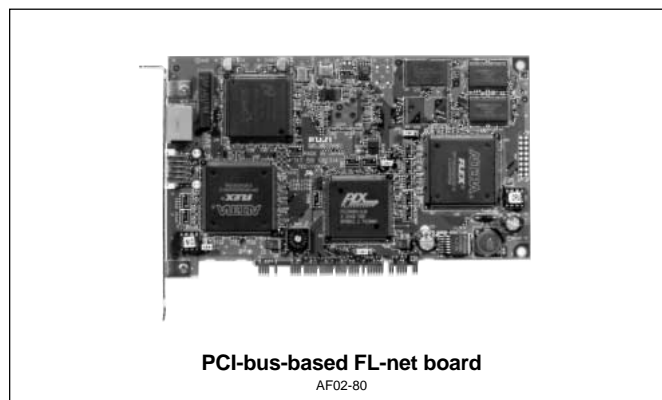

For details on performance and specifications, refer to “FL-net (OPCN-2) Ver. 2.0 Module: **NP1L-FL2**” on page 31 of this catalog.

■ **Operating environment**

Item	Specification
Hardware	IBM-PC/AT compatible (DOS/V PC)*
CPU	Intel Pentium 133MHz or higher
Hard disk	At least 1 unit, free space of 5M bytes or more
External storage unit/interface	Floppy disk unit
	CD-ROM unit
	At least 1 unit, media: 2HD1.25M/1.44M-byte 3.5-inch floppy disk
	At least 1 unit, (x 4 speed or faster recommended), media: ISO 9660 format
Memory capacity	32M bytes or more (64M bytes or more for D300win operation)
Keyboard	101 English keyboard
Mouse	USB mouse, bus mouse, or PS2 mouse
Indicator (resolution)	800 x 600-dots resolution or higher
Current consumption	Personal computer with a power capacity capable of supplying 1A or more to this board
Operating system	WindowsNT4.0 Workstation Service Pack3 or later, Windows2000 Professional Service Pack1 or later

* This board is not applicable to the multi-CPU configuration. Use a personal computer with the single-CPU configuration.

■ Dimensions

(1) Power supply module

1) NP1S-22, NP1S-42

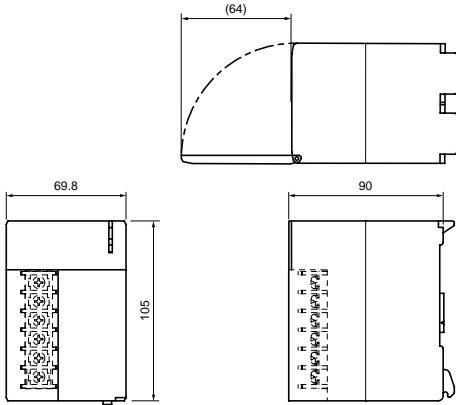

2) NP1S-91, NP1S-81

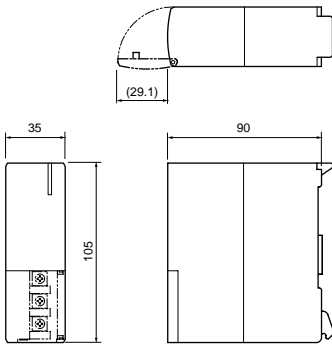

(2) CPU module

1) High-Performance CPU **NP1PS-32, NP1PS-74, NP1PS-117**
Standard CPU **NP1PH-16, NP1PH-38**

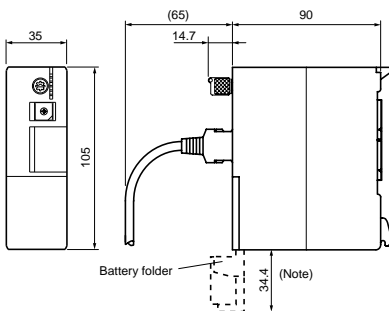

Note: For the standard CPU, open the battery folder at an angle of 180° when user ROM card is removed.

2) High-Performance CPU (User ROM card adapted CPU)
NP1PS-32R, NP1PS-74R, NP1PS-117R

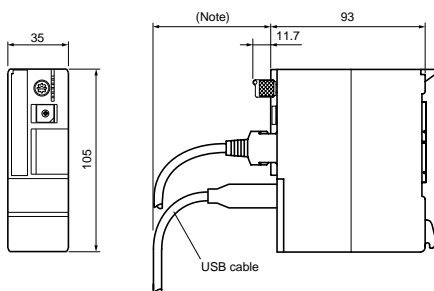

Note: For bend radius, check the specification for the loader cable you use.

(3) Base board

1) NP1BP-13, NP1BS-13

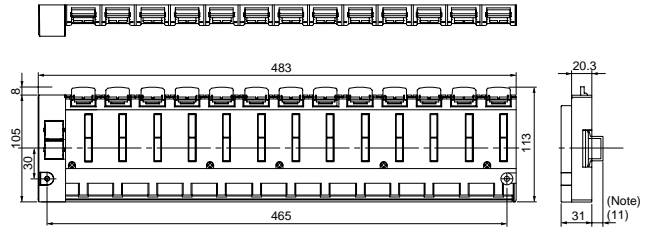

Note: () means to use the rail (TH35-15AL) made by FUJII.

2) NP1BS-11

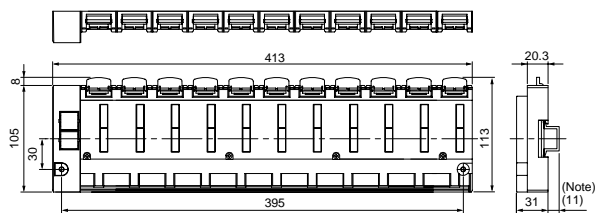

Note: () means to use the rail (TH35-15AL) made by FUJII.

3) NP1BS-08

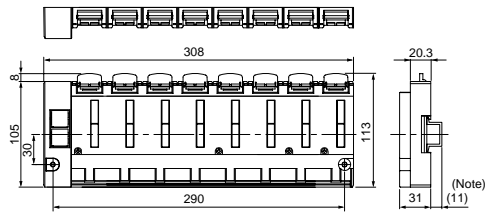

Note: () means to use the rail (TH35-15AL) made by FUJII.

4) NP1BS-06

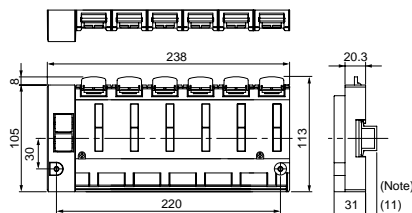

Note: () means to use the rail (TH35-15AL) made by FUJII.

(4) Base board mounting bracket (accessories for base board)

Type	L (mm)
For NP1BP-13/NP1BS-13	476.5
For NP1BS-11	406.5
For NP1BS-08	301.5
For NP1BS-06	231.5

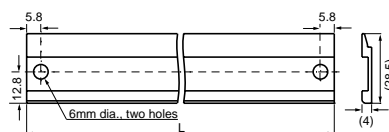

(5) Base board mounting stud **NP8B-ST**

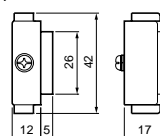

Programmable Controllers
MICREX-SX series SPH
Dimensions

(6) I/O module

1) 6-point/8-point module (digital)

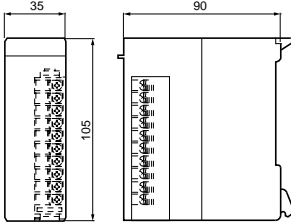

Note: Transistor sink 8-point output type (NP1Y08T0902) and SSR 8-point output type (NP1Y08S) are equivalent to the 16-point module below.

2) 16-point module (digital) / Analog input module / Analog output module
(NP1AY□2-MR, NP1AX□4-MR, NP1AX08-MR)

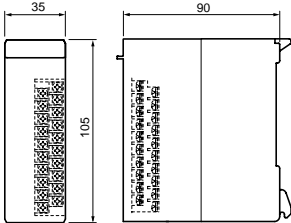

3) 32-point module

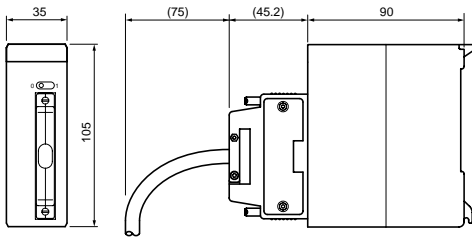

4) 64-point module

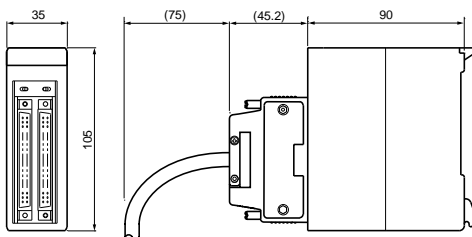

5) Terminal block protrusion module
(Resistance temperature sensor input module **NP1AXH4-PT**,
Thermocouple input module **NP1AXH4-TC**,
Analog I/O module
NP1AXH8□-MR, NP1AYH8□-MR, NP1AYH4□-MR)

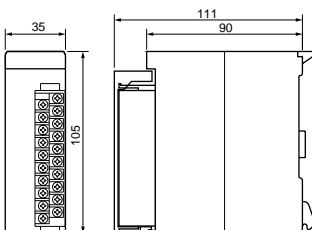

(7) Communication module

1) Web module **NP1L-WE1, NP1L-ET1**

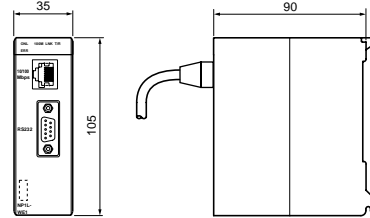

2) General purpose communication module **NP1L-RS1/2/4**,
PROFIBUS-DP master module **NP1L-PD1**

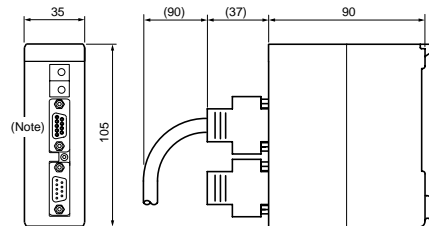

3) T-link master module **NP1L-TL1**,
T-link slave module **NP1L-TS1**,
T-link interface module **NP1L-RT1**,
P-link module **NP1L-PL1**,
PE-link module **NP1L-PE1**,
OPCN-1 master module **NP1L-JP1**,
OPCN-1 slave module **NP1L-JS1**,
OPCN-1 interface module **NP1L-RJ1**

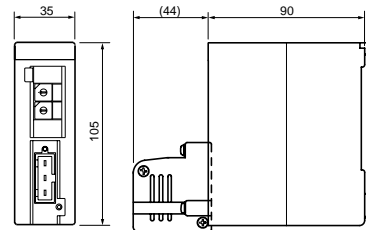

Note: This differs by type, whether or not connectors and switches exist, but outside dimensions are the same for all types.

4) AS-i master module **NP1L-AS2**

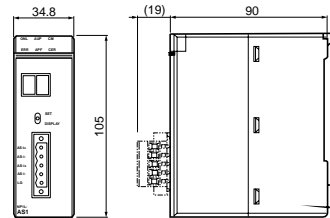

5) FL-net module **NP1L-FL2**,
ADS-net module **NP1L-AD1**

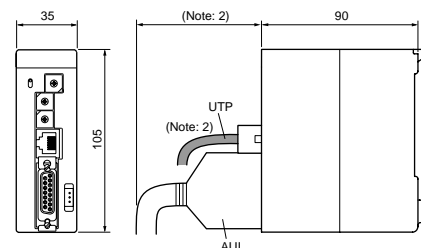

Note: 1) This differs by type, whether or not switches exist, but outside dimensions are the same for all types.

Note: 2) For AUI and UTP cables, you need to take connector dimensions and cable bend into consideration. (For bend radius, check the specification for the cable you use.)

6) DeviceNet master module **NP1L-DN1**,
DeviceNet interface module **NP1L-RD1**

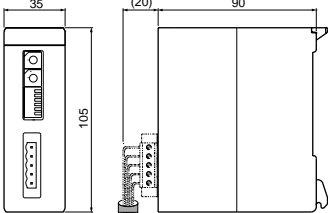

7) LonWorks interface module **NP1L-LW1**

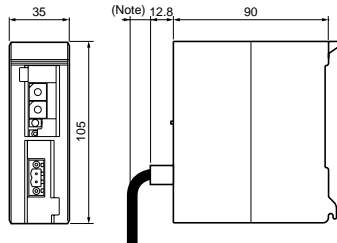

Note: For bend radius, check the specification for the loader cable you use.

8) S-LINK master module **NP1L-SJ1**

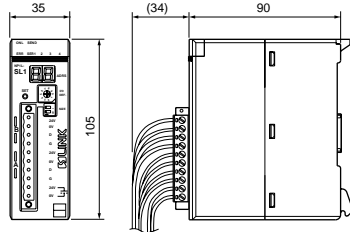

9) SX bus optical link module **NP1L-OL1**

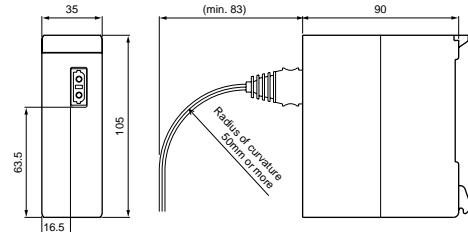

10) SX bus optical link converter **NP2L-OE1**

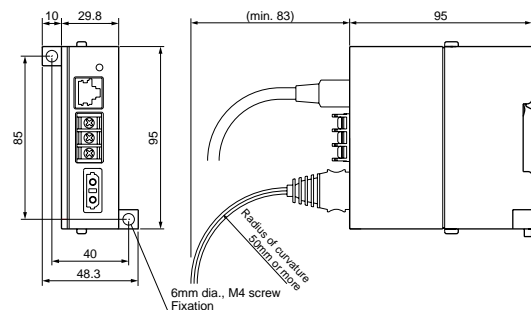

(8) Positioning control module / Unit

1) High-speed counter module **NP1F-HC2**,
Multi channel high-speed counter module **NP1F-HC8**

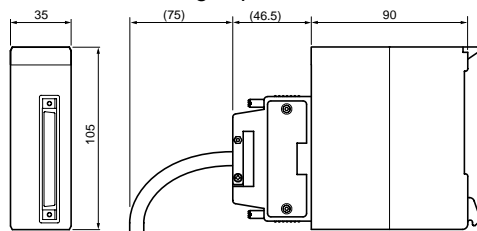

2) Signal converter **NP2F-LEV**

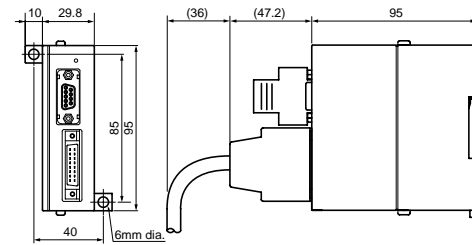

3) Positioning control module **NP1F-MA2**, **NP1F-MP2**,
NP1F-HP2

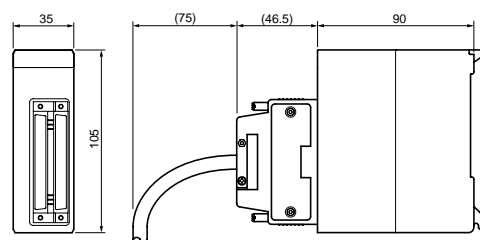

4) Motion control module **NP1F-MC8P1**

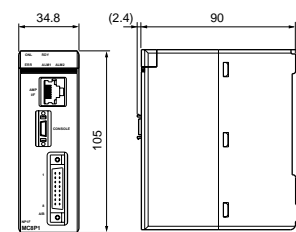

(9) Function module / Unit

1) Memory card interface module **NP1F-MM1**

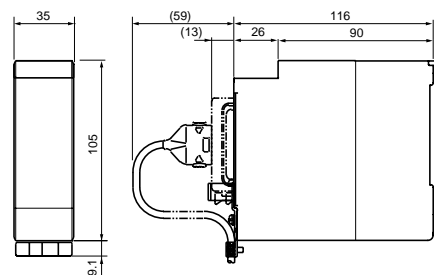

2) Dummy module **NP1F-DMY**

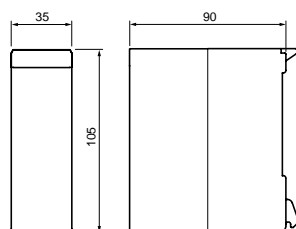

3) SX bus T-branch unit **NP8B-TB**

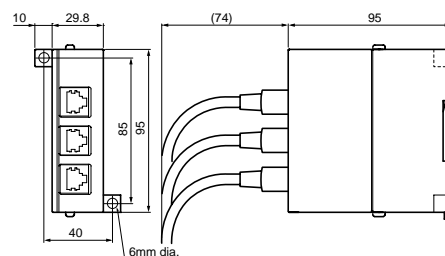

Programmable Controllers

MICREX-SX series SPH

Ordering Information



Types/Ordering codes

Names	Types (Ordering codes)	Specifications, Names	Standards					
			CE	UL	LR	NK		
CPU module SPH200/300	NP1PS-32	SPH300 Program memory capacity 32K steps Max. No. of I/O points 8192 points	Accessories: Data backup battery (Built-in) SX bus terminating plug 2 pieces CPU mode selection key switch Screwdriver (for the CPU setting)	Basic instruction execution speeds 20ns or more	○	○	○	○
	NP1PS-74	SPH300 Program memory capacity 74K steps Max. No. of I/O points 8192 points			○	○	○	○
	NP1PS-117	SPH300 program memory capacity 117K steps Max. No. of I/O points 8192 points			○	○	△	△
	NP1PS-32R	SPH300 Program memory capacity 32K steps User ROM/USB adapted, Max. No. of I/O points 8192 points			○	○	△	△
	NP1PS-74R	SPH300 Program memory capacity 74K steps User ROM/USB adapted, Max. No. of I/O points 8192 points			○	○	△	△
	NP1PS-117R	SPH300 Program memory capacity 117K steps User ROM/USB adapted, Max. No. of I/O points 8192 points			○	○	△	△
	NP1PH-08	SPH200 Program memory capacity 8K steps Max. No. of I/O points 8192 points			○	○	○	○
	NP1PH-16	SPH200 Program memory capacity 16K steps Max. No. of I/O points 8192 points			○	○	○	○
Power supply module	NP1S-22	100/240V AC Input power supply, output capacity 35W, Accessories: Connector for ALM contact, Voltage selection jumper plate	○	○	○	○		
	NP1S-81	200V AC Input power supply 15W (1 slot)						
	NP1S-91	100V AC Input power supply 15W (1 slot)	○	○				
	NP1S-42	24V DC Input power supply, output capacity 35W, Accessories: Connector for ALM contact	○	○	○	○		
Base board	NP1BS-06	For 6 slots Processor buses 3 slots	Accessories: Base board mounting bracket	○	○	○	○	
	NP1BS-08	For 8 slots Processor buses 3 slots		○	○	○	○	
	NP1BS-11	For 11 slots Processor buses 3 slots		○	○	○	○	
	NP1BS-13	For 13 slots Processor buses 3 slots		○	○	○	○	
	NP1BP-13	For 13 slots Processor buses 10 slots (High speed type)		○	○	○	○	
SX bus expansion cable	NP1C-P3	300mm cable	—	○	○	○		
	NP1C-P6	600mm cable	—	○	○	○		
	NP1C-P8	800mm cable	—	○	○	○		
	NP1C-02	2000mm cable	—	○	○	○		
	NP1C-05	5000mm cable	—	○	○	○		
	NP1C-10	10000mm cable	—	○	○	○		
	NP1C-25	25000mm cable	—	○	○	○		
SX bus T-branch unit	NP8B-TB	SX bus T-branch connecting unit, Accessories: SX bus terminating plug 1 piece	○	○	○	○		
Digital input module *1	NP1X1606-W	24V DC, 16 points, 7mA 1 to 100ms variable	Screw terminal	○	○	○	○	
	NP1X3206-W	24V DC, 32 points, 4mA 1 to 100ms variable, Optional Connector	Connector	○	○	○	○	
	NP1X3202-W	5V/12V DC, 32 points, 3mA/9mA 1 to 100ms variable, Optional Connector	Connector	○	○	○	○	
	NP1X3206-A	24V DC, 32 points, 4mA 0 to 100ms variable, Pulse catch 20kHz, Optional Connector	Connector	○	○			
	NP1X6406-W	24V DC, 64 points, 4mA 1 to 100ms variable, Optional Connector	Connector	○	○	○	○	
	NP1X0810	100/120V AC, 8 points, 10mA 10ms	Screw terminal	○	○	○	○	
	NP1X1610	100/120V AC, 16 points, 10mA 10ms	Screw terminal			○	○	
	NP1X0811	200/240V AC, 8 points, 10mA 10ms	Screw terminal	○	○	○	○	
	NP1Y08T0902	Tr sink, 12 to 24V DC, 8 points, 2.4A/point, 4A/common	Screw terminal	○	○	○	○	
	NP1Y16T09P6	Tr sink, 12 to 24V DC, 16 points, 0.6A/point, 4A/common	Screw terminal	○	○	○	○	
Digital output module *1	NP1Y32T09P1-A	Tr sink, 24V DC, 32 points, 0.12A/point, 3.2A/common, Pulse train output 20kHz x 4ch (Built-in), Optional Connector	Connector	○	○			
	NP1Y32T09P1	Tr sink, 12 to 24V DC, 32 points, 0.12A/point, 3.2A/common, Optional Connector	Connector	○	○	○	○	
	NP1Y64T09P1	Tr sink, 12 to 24V DC, 64 points, 0.12A/point, 3.2A/common, Optional Connector	Connector	○	○	○	○	
	NP1Y08U0902	Tr source, 12 to 24V DC, 8 points, 2.4A/point, 4A/common	Screw terminal	○	○	○	○	
	NP1Y16U09P6	Tr source, 12 to 24V DC, 16 points, 0.6A/point, 4A/common	Screw terminal	○	○	○	○	
	NP1Y32U09P1	Tr source, 12 to 24V DC, 32 points, 0.12A/point, 3.2A/common, Optional Connector	Connector	○	○	○	○	
	NP1Y64U09P1	Tr source, 12 to 24V DC, 64 points, 0.12A/point, 3.2A/common, Optional Connector	Connector	○	○	○	○	
	NP1Y06S	SSR, 100 to 240V AC, 6 points, 2.2A/point, 4.4A/common	Screw terminal	○	○	○	○	
	NP1Y08S	SSR, 100 to 240V AC, 8 points: all points are independent, 2.2A/points	Screw terminal			○	○	
	NP1Y08R-04	Ry, 110V DC, 240V AC, 8 points, 30V DC/ 264V AC: 2.2A/point, 4A/common	Screw terminal	○	○	○	○	
	NP1Y16R-08	Ry, 110V DC, 240V AC, 16 points, 30V DC/ 264V AC: 2.2A/point, 8A/common	Screw terminal			○	○	
	Digital I/O mixed module *1	NP1W1606T	24V DC 8 points source input, 12 to 24V DC 8 points Tr sink output	Screw terminal	○	○	○	○
		NP1W1606U	24V DC 8 points sink input, 12 to 24V DC 8 points Tr source output	Screw terminal	○	○	○	○
		NP1W3206T	24V DC 16 points source input, 12 to 24V DC Tr sink 16 points output, Optional Connector	Connector	○	○	○	○
NP1W3206U		24V DC 16 points sink input, 12 to 24V DC Tr source 16 points output, Optional Connector	Connector	○	○	○	○	
Terminal Relay	RS16E-DE04	24V DC source input						
	RS16-DE04	24V DC sink output	○	○				
	RS16-DE04P	24V DC source output			○			
	RS910M2-0104	Terminal cable for MICREX-SX: 1m						
	RS910M2-0204	Terminal cable for MICREX-SX: 2m						
	RS910M2-0304	Terminal cable for MICREX-SX: 3m						

Standards | ○ | Certified | △ | Under planing | — | Exceptions

*1 Connectors (solder type) for digital input, output, I/O-mixed, and positioning modules are separately available.

Applicable connector type: Fujitsu FCN-361J040 (connector), FCN-360C040-B (cover), Our Fuji's type: **NP8V-CN**.

*2 Conformance to CE marking is confirmed on individual SX Series models. When exporting the final product with the SX Series built in to the EU, be sure to verify the standard conformance corresponding to the final product.

*3 For vibration countermeasures, the modules must be fixed in units of base board. For further information, contact your Fuji sales representative.

Names	Types (Ordering codes)	Specifications, Names	Standards					
			CE	UL	LR	NK		
Analog I/O module	NP1AXH4-MR	High speed type multi-range input 4ch, resolution: 14 bits	○	○	○	○	○	
	NP1AXH8V-MR	High speed type multi-range input 8ch, resolution: 14 bits (voltage type)	○	○				
	NP1AXH8I-MR	High speed type multi-range input 8ch, resolution: 14 bits (current type)	○	○				
	NP1AXH4-PT	Resistance thermometer element input (Pt100Ω/JPt100Ω) 8ch, resolution: 14 bits	○	○				
	NP1AXH4-TC	Thermo-couple input module 4ch, resolution: 14 bits	○	○				
	NP1AYH2-MR	High speed type multi-range output 2ch, resolution: 14 bits	○	○	○	○		
	NP1AYH4V-MR	High speed type multi-range output 4ch, resolution: 14 bits (voltage type)	○	○				
	NP1AYH4I-MR	High speed type multi-range output 4ch, resolution: 14 bits (current type)	○	○				
	NP1AYH8V-MR	High speed type multi-range output 8ch, resolution: 14 bits (voltage type)	○	○				
	NP1AYH8I-MR	High speed type multi-range output 8ch, resolution: 14 bits (current type)	○	○				
	NP1AX04-MR	Standard type multi-range input 4ch, resolution: 10 bits	○	○	○	○		
	NP1AX08-MR	Standard type multi-range input 8ch, resolution: 10 bits	○	○				
	NP1AY02-MR	Standard type multi-range output 2ch, resolution: 10 bits	○	○	○	○		
	Communication module	NP1L-WE1	Web module 10BASE-T/100BASE-TX Web server function	○	○			
NP1L-ET1		Ethernet interface module 10BASE-T/100BASE-TX	○	○				
NP1L-FL1		FL-net module Ver. 1.0 Accessories: Power supply cable for the 10BASE5	○	○				
NP1L-FL2		FL-net module Ver. 2.0 Accessories: Power supply cable for the 10BASE5	○	○				
NP1L-AD1		ADS-net module Self-directed distributed protocol (R3.0) support Accessories: Power supply cable for the 10BASE5	○	○				
NP1L-LW1		LonWorks interface module 1ch (78kbps) Accessories: Connector for cable connected		○				
NP1L-PL1		P-link module Accessories: P/PE-link connector			○	○	○	
NP1L-PE1		PE-link module Accessories: P/PE-link connector			○	○	○	
NP1L-RS1		General purpose communication module RS-232C (connector), RS-485 (connector) each 1ch	○	○	○	○		
NP1L-RS2		General purpose communication module RS-232C (connector) 1ch	○	○	○	○		
NP1L-RS4		General purpose communication module RS-485 (connector) 1ch	○	○	○	○		
NP1L-JP1		OPCN-1 master module Accessories: OPCN-1 connector, Terminating resistor 2 pieces	○	○	○	○		
NP1L-JS1		OPCN-1 slave module Accessories: OPCN-1 connector	○	○				
NP1L-RJ1		OPCN-1 interface module Accessories: OPCN-1 connector, SX bus terminating plug 2 pieces	○	○	○	○		
NP1L-DN1		DeviceNet master module Accessories: Screw connector (for cable splicing)	○	○				
NP1L-RD1		DeviceNet interface module Accessories: Screw connector (for cable splicing), SX bus terminating plug 2 pieces	○	○				
NP1L-TL1		T-link master module Accessories: T-link connector, T-link terminating resistor 2 pieces	○	○	○	○		
NP1L-RT1		T-link interface module Accessories: T-link connector, SX bus terminating plug 2 pieces	○	○	○	○		
NP1L-TS1		T-link slave module Accessories: T-link connector	○	○				
NP1L-PD1		PROFIBUS-DP master module Communication standard (IEC 66158, EN 50171, DIN 19245)	○	○				
NP1L-AS2		AS-i master module Accessories: Screw connector (for cable splicing)						
NP1L-AS1		AS-i master module Accessories: Screw connector (for cable splicing)	○	○				
NP1L-SL1		S-LINK master module 1ch Accessories: Screw connector (for cable splicing)						
NP1L-OL1		SX bus optical link module Accessories: SX bus terminating plug	△	○				
NP2L-OE1		SX bus optical converter Accessories: SX bus terminating plug	△	○				
Positioning module * 1		NP1F-HC2	High speed counter module 500kHz x 2ch Accessories: Optional Connector		○			
		NP1F-HC8	Multi-channel high speed counter module 50kHz x 8ch Accessories: Optional Connector	○	○			
		NP1F-HP2	Pulse train output positioning control module Pulse train command 250kHz x 2ch Accessories: Optional Connector	○	○			
	NP1F-MP2	Pulse train positioning control combined module Output pulse: 250kHz x 2ch, Feedback pulse: 500kHz, Accessories: Optional Connector	○	○				
	NP1F-MA2	Analog command positioning control combined module Feedback pulse: 500kHz x 2ch, Accessories: Optional Connector	○	○				
	NP2F-LEV	Signal converter Converts signal level: 4ch, open collector to differential signal, Accessories: I/O connector each 1 piece	○	○				
	NP1F-MC8P1	MC (Motion control) module Table format PTP, Accessories: SX bus terminating plug 1 piece						
	NP1F-MM1	Memory card interface module Memory card interface 1ch, Accessories: Memory card mounting bracket, Dummy card	○	○				
Function module	NP1F-DMY	Dummy module		○				
Extended FB software package (Japanese version)	NP4N-TRBFV3	Fault diagnosis FB software package Version 3	—	—	—	—	—	
	NP4N-PIDFV3	PID FB software package Version 3	—	—	—	—	—	
	NP4N-PTPFV3	Positioning control FB software package Version 3	—	—	—	—	—	
	NP4N-CAMFV3	Electronic cam FB software package Version 3	—	—	—	—	—	
	NP4N-COMFV3	General purpose communication software package for Factory Automation machine Version 3	—	—	—	—	—	
	NP4N-FSEFV3	Extension FB software package set Version 3	—	—	—	—	—	
	NP4N-MDLW	SX communication middleware	—	—	—	—	—	
	NP4N-LNDF	LonWorks module definition tool (ACSESS format)	—	—	—	—	—	
Personal computer loader * 4	NP4H-SEDBV3	Programming support tool based on IEC 61131-3 D300win software package Version 3	—	—	—	—	—	
	NP4H-SEDBV2	Programming support tool based on IEC 61131-3 D300win software package Version 2	—	—	—	—	—	
	NP4H-SESV2	Automatic programming generation tool for process step control, SC matrix (Japanese version) * 5	—	—	—	—	—	
	NP4H-MC1	MC module programming support tool (Japanese version)	—	—	—	—	—	

Standards | ○ | Certified | △ | Under planing | — | Exceptions

*1 Connectors (solder type) for digital input, output, I/O-mixed, and positioning modules are separately available.

Applicable connector type: Fujitsu FCN-361J040 (connector), FCN-360C040-B (cover), Our Fuji's type: **NP8V-CN**.

*2 Conformance to CE marking is confirmed on individual SX Series models. When exporting the final product with the SX Series built in to the EU, be sure to verify the standard conformance corresponding to the final product.

*3 For vibration countermeasures, the modules must be fixed in units of base board. For further information, contact your Fuji sales representative.

*4 The OS is not included.

*5 Can be used regardless of the D300win system version 2.

Programmable Controllers

MICREX-SX series SPH

Ordering Information



Names	Types (Ordering codes)	Specifications, Names	Standards				
			CE	UL	LR	NK	cUL
Loader connecting cable	NP4H-CB2	Programming support tool connection cable for AT compatible personal computer (Necessary to the signal converter: NW0H-CNV)					
	NW0H-CNV	Programming support tool for AT compatible personal computer. Signal converter for CPU module connecting (It used to with combined the loader connecting cable (NP4H-CB2 , Optional).	○				
Simulative-input switch	NP8X-SW	Simulative-input switch for DC input module (16 points)					
ROM cassette	NP8PMF-16	User ROM cassette for the SPH200					
	NP8PCF-16	User ROM card compact flash memory for the SPH300, Capacity: 16MB					
Online adapter and	FOA-ALFA2	Online adapter (Necessary for the NP4H-CB2 on connection to personal computer)					
Relational software (Japanese version)	FOA-LOADER2-CD	Initial setting loader software for the online adapter					
	FOA-CENTER2-CD	Master station monitoring software for the online adapter					
Auxiliaries	NP8P-BT	Data backup battery (Battery type: Lithium primary battery)					
	NP8B-BP	SX bus terminating plug					
	NP8B-ST	Base board mounting stud (DIN rail type)					
	NP8V-CN	I/O, positioning control module connector (solder type)					
	NP8P-KY	CPU mode selection key switch					
	FTC120T	T link / OPCN-1 connector					
	FTC120P	P/PE link connector					
	FRT120A100	T link / OPCN-1 terminating resistor					
	FRT220A75	P/PE link terminating resistor					
	I/O terminals	OPCN-1	NR1JX-1606DT	No polarity, input 24V DC, 16 points, detachable terminals		○	○
NR1JY-08R07DT			Ry output 240V AC / 110V DC, 8 points, detachable terminals		○	○	
NR1JY-16T05DT			Tr sink output 24V DC, 16 points, detachable terminals		○	○	
NR1JW-16T65DT			Source input 24V DC, 8 points, Tr sink output 24V DC, 8 points, detachable terminals		○	○	
DeviceNet		NR1DX-1606DT	No polarity, input 24V DC, 16 points, detachable terminals		○	○	
		NR1DY-08R07DT	Ry output 240V AC / 110V DC, 8 points, detachable terminals		○	○	
		NR1DY-16T05DT	Tr sink output 24V DC, 16 points, detachable terminals		○	○	
		NR1DW-16T65DT	Source input 24V DC, 8 points, Tr sink output 24V DC, 8 points, detachable terminals		○	○	
T-LINK		NR1TX-1606DT	No polarity, input 24V DC, 16 points, detachable terminals		○	○	
		NR1TY-08R07DT	Ry output 240V AC / 110V DC, 8 points, detachable terminals		○	○	
		NR1TY-16T05DT	Tr sink output 24V DC, 16 points, detachable terminals		○	○	
		NR1TW-16T65DT	Source input 24V DC, 8 points, Tr sink output 24V DC, 8 points, detachable terminals		○	○	
SX bus	NR1SX-1606DT	No polarity, input 24V DC, 16 points, detachable terminals		○	○		
	NR1SY-08R07DT	Ry output 240V AC / 110V DC, 8 points, detachable terminals		○	○		
	NR1SY-16T05DT	Tr sink output 24V DC, 16 points, detachable terminals		○	○		
	NR1SW-16T65DT	Source input 24V DC, 8 points, Tr sink output 24V DC, 8 points, detachable terminals		○	○		
LonWorks	NR1LX-1606DT	No polarity, input 24V DC, 16 points (included the 4 pulse input points), detachable terminals	Accessories: Neuron ID seal				
	NR1LY-08R07DT	Ry output 240V AC / 110V DC, 8 points, detachable terminals					
	NR1LW-11R80DT	Source input 24V DC, 9 points (included the 4 pulse input points), Ry output 240V AC / 110V DC, 2 points, detachable terminals					
Optional	NR1XV-CB1	Common extension bar (9 pins)					

Standards Certified Under planning Exceptions

Names	Types (Ordering codes)	Standards				
		CE	UL	LR	NK	cUL
PCI bus based SPH300 CPU board Program memory capacity: 32K steps	Accessories: Driver (CD version), Data backup battery, SX bus terminating plug 2 pieces CPU mode selection key switch Name and use seal	NP3PS-SX1PCS32				
PCI bus based SPH300 CPU board Program memory capacity: 74K steps		NP3PS-SX1PCS74				
PCI bus based FL-net board Ver. 1.0	Accessories: Driver (CD version), Name and use seal	NP3L-FL1PCS				
PCI bus based FL-net board Ver. 2.0		NP3L-FL2PCS				

Standards Certified Under planning Exceptions

* Microsoft, MS-DOS, Windows, Windows NT, Word, Excel, Visual Basic, Visual C++ are trademarks of Microsoft Corporation in the USA and other countries.
 * Intel486 and Pentium are trademarks or registered trademarks of Intel Corp.
 * LON and LONWORKS are trademarks of Echelon Corporation in the USA and other countries.
 And other companies name, products name in this catalog, are trademarks or registered trademarks of the each companies.

Safety Considerations

- For safe operation, before using the product read the instruction manual or user manual that comes with the product carefully or consult the Fuji sales representative from which you purchased the product.
- Products introduced in this catalog have not been designed or manufactured for such applications in a system or equipment that will affect human bodies or lives.
- Customers, who want to use the products introduced in this catalog for special system or device such as for atomic-energy control, aerospace use, medical use, passenger vehicle, and traffic control, are requested to consult the Fuji sales division.
- Customers are requested to prepare safety measures when they apply the products introduced in this catalog to such system or facilities that will affect human lives or cause severe damage to property if the products become faulty.
- For safe operation, wiring should be conducted only by qualified engineers who have sufficient technical knowledge about electrical work or wiring.

●Appearance and specifications are subject to change without prior notice for the purpose of product improvement.

Fuji Electric Co., Ltd.

ED & C • Drive Systems Company

Gate City Ohsaki, East Tower

11-2, Osaki 1-chome, Shinagawa-ku, Tokyo, 141-0032, Japan

Phone: +81-3-5435-7135~8

Fax: +81-3-5435-7456~9