

R&S® FSVA/FSV

Signal and Spectrum Analyzer

Operating Manual



This manual describes the following R&S FSVA/FSV models with firmware version 3.30 and higher:

- R&S®FSVA4 (1321.3008K05)
- R&S®FSVA7 (1321.3008K08)
- R&S®FSVA13 (1321.3008K14)
- R&S®FSVA30 (1321.3008K31)
- R&S®FSVA40 (1321.3008K41)
- R&S®FSV4 (1321.3008K04)
- R&S®FSV7 (1321.3008K07)
- R&S®FSV13 (1321.3008K13)
- R&S®FSV30 (1321.3008K30)
- R&S®FSV40 (1321.3008K39/1321.3008K40)

It also applies to the following R&S®FSV models. However, note the differences described in [Chapter 1.1, "Notes for Users of R&S FSV 1307.9002Kxx Models"](#), on page 5.

- R&S®FSV3 (1307.9002K03)
- R&S®FSV7 (1307.9002K07)
- R&S®FSV13 (1307.9002K13)
- R&S®FSV30 (1307.9002K30)
- R&S®FSV40 (1307.9002K39/1307.9002K40)

In addition to the base unit, the following options are described:

- R&S FSV-B9/10 (1310.9545.02/1310.9551.02)
- R&S FSVA-B11 (1321.3714.xx)
- R&S FSV-B17 (1310.9568.02)
- R&S FSV-B21 (1310.9597.02)
- R&S FSV-B22 (1310.9600.02)
- R&S FSV-B24 (1310.9616.13)
- R&S®FSVA-B40 (1329.0214.02) / R&S®FSV-B70 (1310.9645.02)
- R&S FSV-B160 (1311.2015.02/1311.2015.13/1311.2015.40)
- R&S FSV-K9 (1310.8203.02)
- R&S FSV-K14 (1310.8255.02)

© 2019 Rohde & Schwarz GmbH & Co. KG

Mühldorfstr. 15, 81671 München, Germany

Phone: +49 89 41 29 - 0

Fax: +49 89 41 29 12 164

Email: info@rohde-schwarz.com

Internet: www.rohde-schwarz.com

Subject to change – Data without tolerance limits is not binding.

R&S® is a registered trademark of Rohde & Schwarz GmbH & Co. KG.

Trade names are trademarks of the owners.

1176.7510.02 | Version 13 | R&S® FSVA/FSV

Throughout this manual, products from Rohde & Schwarz are indicated without the ® symbol, e.g. R&S®FSV is indicated as R&S FSV.

Contents

1	Preface	5
1.1	Notes for Users of R&S FSV 1307.9002Kxx Models.....	5
1.2	Conventions Used in the Documentation.....	5
1.3	How to Use the Help System.....	6
2	Safety Information	8
3	Documentation Overview	9
3.1	Quick Start Guide.....	9
3.2	Operating Manuals and Help.....	9
3.3	Service Manual.....	9
3.4	Instrument Security Procedures.....	10
3.5	Basic Safety Instructions.....	10
3.6	Data Sheets and Brochures.....	10
3.7	Release Notes and Open Source Acknowledgment (OSA).....	10
3.8	Application Notes, Application Cards, White Papers, etc.....	10
4	Quick Start	11
4.1	Front and Rear Panel View.....	11
4.2	Preparing for Use.....	23
4.3	Firmware Update and Installation of Firmware Options.....	47
4.4	Basic Operations.....	50
4.5	Basic Measurement Examples.....	77
4.6	Advanced Measurement Examples.....	105
5	Instrument Functions	135
5.1	General Settings, Printout and Instrument Settings.....	138
5.2	Measurement Parameters.....	182
5.3	Measurement Functions.....	248
5.4	Measurement Modes.....	406
5.5	Instrument Functions - I/Q Analyzer.....	411
5.6	Instrument Functions – Tracking Generator (Options R&S FSV-B9/ R&S FSV-B10)	445
5.7	Instrument Functions - R&S Digital I/Q Interface (Option R&S FSV-B17).....	470

5.8	Instrument Functions – External Mixer (Option R&S FSV-B21).....	488
5.9	Instrument Functions - Power Sensor (R&S FSV-K9).....	509
5.10	Instrument Functions - Spectrogram Measurements.....	522
6	Remote Control.....	535
6.1	Remote Control - Basics.....	537
6.2	Controlling the R&S FSVA/FSV Remotely.....	567
6.3	Remote Control – Commands.....	607
6.4	Remote Control – Programming Examples.....	1011
7	Maintenance.....	1055
7.1	Cleaning.....	1055
7.2	Storing and Packing.....	1056
7.3	List of Available Power Cables.....	1056
8	Error Messages.....	1057
	List of Commands.....	1059
	Index.....	1076

1 Preface

This chapter provides safety-related information, an overview of the user documentation and the conventions used in the documentation.

1.1 Notes for Users of R&S FSV 1307.9002Kxx Models

Users of R&S FSV 1307.9002Kxx models should consider the following differences to the description of the newer R&S FSVA/FSV 1321.3008Kxx models:

- Functions that are based on the Windows 10 operating system (e.g. printing or setting up networks) may have a slightly different appearance or require different settings on the Windows XP based models. For such functions, refer to the Windows documentation or the documentation originally provided with the R&S FSV instrument.
- The R&S FSV 1307.9002K03 model is restricted to a maximum frequency of 3 GHz, whereas the R&S FSVA/FSV1321.3008K04 model has a maximum frequency of 4 GHz.
- The bandwidth extension option R&S FSV-B160 (1311.2015.xx) is not available for the R&S FSV 1307.9002Kxx models. The maximum usable I/Q analysis bandwidth for these models is 28 MHz, or with option R&S FSV-B70, 40 MHz.

1.2 Conventions Used in the Documentation

1.2.1 Typographical Conventions

The following text markers are used throughout this documentation:

Convention	Description
"Graphical user interface elements"	All names of graphical user interface elements on the screen, such as dialog boxes, menus, options, buttons, and softkeys are enclosed by quotation marks.
[Keys]	Key and knob names are enclosed by square brackets.
Filenames, commands, program code	Filenames, commands, coding samples and screen output are distinguished by their font.
<i>Input</i>	Input to be entered by the user is displayed in italics.
Links	Links that you can click are displayed in blue font.
"References"	References to other parts of the documentation are enclosed by quotation marks.

1.2.2 Conventions for Procedure Descriptions

When operating the instrument, several alternative methods may be available to perform the same task. In this case, the procedure using the touchscreen is described. Any elements that can be activated by touching can also be clicked using an additionally connected mouse. The alternative procedure using the keys on the instrument or the on-screen keyboard is only described if it deviates from the standard operating procedures.

The term "select" may refer to any of the described methods, i.e. using a finger on the touchscreen, a mouse pointer in the display, or a key on the instrument or on a keyboard.

1.2.3 Notes on Screenshots

When describing the functions of the product, we use sample screenshots. These screenshots are meant to illustrate as many as possible of the provided functions and possible interdependencies between parameters. The shown values may not represent realistic usage scenarios.

The screenshots usually show a fully equipped product, that is: with all options installed. Thus, some functions shown in the screenshots may not be available in your particular product configuration.

1.3 How to Use the Help System

Calling context-sensitive and general help

- ▶ To display the general help dialog box, press the [HELP] key on the front panel. The help dialog box "View" tab is displayed. A topic containing information about the current menu or the currently opened dialog box and its function is displayed.



For standard Windows dialog boxes (e.g. File Properties, Print dialog etc.), no context-sensitive help is available.

- ▶ If the help is already displayed, press the softkey for which you want to display help. A topic containing information about the softkey and its function is displayed.



If a softkey opens a submenu and you press the softkey a second time, the submenu of the softkey is displayed.

Contents of the help dialog box

The help dialog box contains four tabs:

- "Contents" - contains a table of help contents
- "View" - contains a specific help topic
- "Index" - contains index entries to search for help topics
- "Zoom" - contains zoom functions for the help display

To change between these tabs, press the tab on the touchscreen.

Navigating in the table of contents

- To move through the displayed contents entries, use the [UP ARROW] and [DOWN ARROW] keys. Entries that contain further entries are marked with a plus sign.
- To display a help topic, press the [ENTER] key. The "View" tab with the corresponding help topic is displayed.
- To change to the next tab, press the tab on the touchscreen.

Navigating in the help topics

- To scroll through a page, use the rotary knob or the [UP ARROW] and [DOWN ARROW] keys.
- To jump to the linked topic, press the link text on the touchscreen.

Searching for a topic

1. Change to the "Index" tab.
2. Enter the first characters of the topic you are interested in. The entries starting with these characters are displayed.
3. Change the focus by pressing the [ENTER] key.
4. Select the suitable keyword by using the [UP ARROW] or [DOWN ARROW] keys or the rotary knob.
5. Press the [ENTER] key to display the help topic.

The "View" tab with the corresponding help topic is displayed.

Changing the zoom

1. Change to the "Zoom" tab.
2. Set the zoom using the rotary knob. Four settings are available: 1-4. The smallest size is selected by number 1, the largest size is selected by number 4.

Closing the help window

- ▶ Press the [ESC] key or a function key on the front panel.

2 Safety Information

The product documentation helps you use the R&S FSVA/FSV safely and efficiently. Follow the instructions provided here and in the printed "Basic Safety Instructions". Keep the product documentation nearby and offer it to other users.

Intended use

The R&S FSVA/FSV is intended for the development, production and verification of electronic components and devices in industrial, administrative, and laboratory environments. Use the R&S FSVA/FSV only for its designated purpose. Observe the operating conditions and performance limits stated in the data sheet.

Where do I find safety information?

Safety information is part of the product documentation. It warns you about the potential dangers and gives instructions how to prevent personal injuries or damage caused by dangerous situations. Safety information is provided as follows:

- The printed "Basic Safety Instructions" provide safety information in many languages and are delivered with the R&S FSVA/FSV.
- Throughout the documentation, safety instructions are provided when you need to take care during setup or operation.

3 Documentation Overview

This section provides an overview of the R&S FSVA/FSV user documentation. Unless specified otherwise, you find the documents on the R&S FSVA/FSV product page at:

www.rohde-schwarz.com/manual/FSVA

3.1 Quick Start Guide

Introduces the R&S FSVA/FSV and describes how to set up and start working with the product. Includes basic operations, typical measurement examples, and general information, e.g. safety instructions, etc. A printed version is delivered with the instrument. A PDF version is available for download on the Internet.

3.2 Operating Manuals and Help

Separate operating manuals are provided for the base unit and the firmware applications:

- Base unit manual
Contains the description of all instrument modes and functions. It also provides an introduction to remote control, a complete description of the remote control commands with programming examples, and information on maintenance, instrument interfaces and error messages. Includes the contents of the getting started manual.
- Firmware application manual
Contains the description of the specific functions of a firmware application. Basic information on operating the R&S FSVA/FSV is not included.

The contents of the operating manuals are available as help in the R&S FSVA/FSV. The help offers quick, context-sensitive access to the complete information for the base unit and the firmware applications.

All operating manuals are also available for download or for immediate display on the Internet.

3.3 Service Manual

Describes the performance test for checking the rated specifications, module replacement and repair, firmware update, troubleshooting and fault elimination, and contains mechanical drawings and spare part lists.

The service manual is available for registered users on the global Rohde & Schwarz information system (GLORIS, <https://gloris.rohde-schwarz.com>).

3.4 Instrument Security Procedures

Deals with security issues when working with the R&S FSVA/FSV in secure areas. It is available for download on the Internet.

3.5 Basic Safety Instructions

Contains safety instructions, operating conditions and further important information. The printed document is delivered with the instrument.

3.6 Data Sheets and Brochures

The data sheet contains the technical specifications of the R&S FSVA/FSV. It also lists the firmware applications and their order numbers, and optional accessories.

The brochure provides an overview of the instrument and deals with the specific characteristics.

See www.rohde-schwarz.com/brochure-datasheet/FSV

3.7 Release Notes and Open Source Acknowledgment (OSA)

The release notes list new features, improvements and known issues of the current firmware version, and describe the firmware installation.

The open source acknowledgment document provides verbatim license texts of the used open source software.

See www.rohde-schwarz.com/firmware/FSV

3.8 Application Notes, Application Cards, White Papers, etc.

These documents deal with special applications or background information on particular topics.

See www.rohde-schwarz.com/application/FSV

4 Quick Start

Note: the following chapters are identical to those in the printed R&S FSVA/FSV Quick Start Guide.

- [Front and Rear Panel View](#)..... 11
- [Preparing for Use](#).....23
- [Firmware Update and Installation of Firmware Options](#).....47
- [Basic Operations](#).....50
- [Basic Measurement Examples](#).....77
- [Advanced Measurement Examples](#)..... 105

4.1 Front and Rear Panel View

4.1.1 Front Panel View

This chapter describes the front panel, including all function keys and connectors.

[Figure 4-1](#) shows the front panel view of the R&S FSVA. (The R&S FSV is very similar.) The individual elements are described in more detail in the subsequent sections.

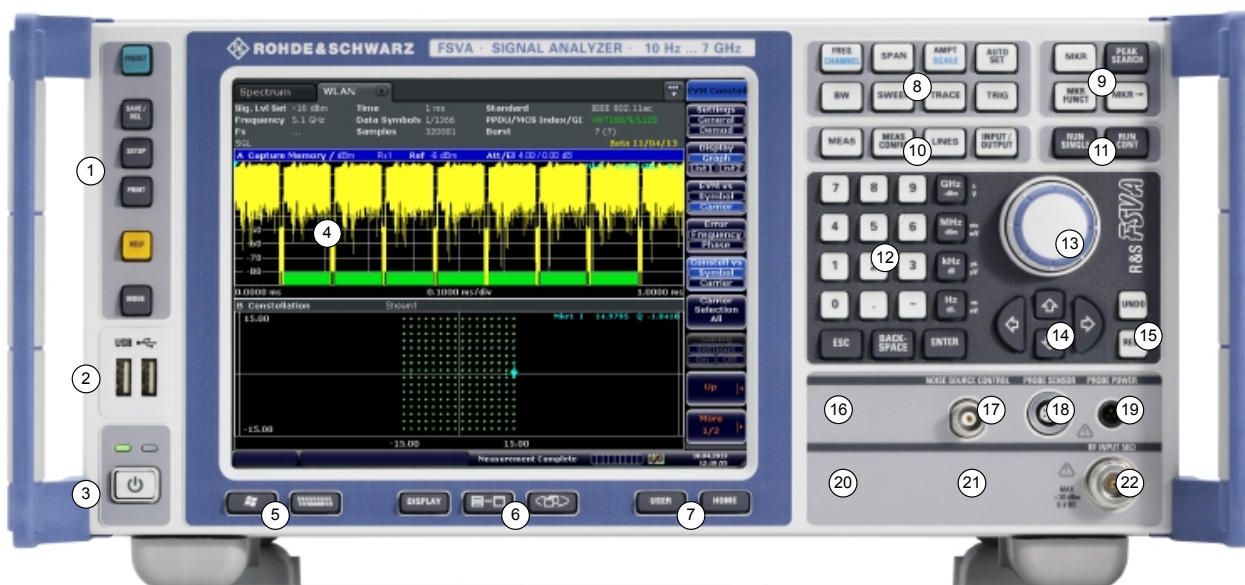

Figure 4-1: Front panel view of an R&S FSVA





No.	Description	See
1	General device functions e.g. Change mode, Setup, Default Settings, Help.	Chapter 4.1.1.1, "Function Keys on the Front Panel" , on page 12
2	USB connector for external devices, e.g. keyboard, mouse	Chapter 4.1.1.3, "Connectors on the Front Panel" , on page 16

No.	Description	See
3	ON/OFF switch	Chapter 4.2.1.8, "Switching the Instrument On and Off" , on page 32
4	Touchscreen; display area for measurement results	Chapter 4.1.1.2, "Touchscreen Display" , on page 15
5	Auxiliary functions to display Windows Start menu or on-screen keyboard	Chapter 4.1.1.1, "Function Keys on the Front Panel" , on page 12
6	Display options for screen	Chapter 4.4.4, "Changing the Display" , on page 70
7	Navigation options for screen menu	Chapter 4.4.2.6, "Arrow Keys, UNDO/REDO Keys" , on page 61
8	Measurement control settings, e.g. frequency, levels	Chapter 4.1.1.1, "Function Keys on the Front Panel" , on page 12
9	Marker functions	Chapter 4.1.1.1, "Function Keys on the Front Panel" , on page 12
10	Measurement configuration	Chapter 4.1.1.1, "Function Keys on the Front Panel" , on page 12
11	Measurement start	Chapter 4.1.1.1, "Function Keys on the Front Panel" , on page 12
12	Numeric keyboard, units and data entry keys	Chapter 4.4.2.4, "Keypad" , on page 60
13	Rotary knob	Chapter 4.4.2.5, "Rotary Knob" , on page 61
14	Arrow keys	Chapter 4.4.2.6, "Arrow Keys, UNDO/REDO Keys" , on page 61
15	Undo/redo functions	Chapter 4.4.2.6, "Arrow Keys, UNDO/REDO Keys" , on page 61
16	AF output with volume control, optional	Chapter 4.1.1.4, "Optional Front Panel Connectors" , on page 17
17	Noise source control	Chapter 4.1.1.3, "Connectors on the Front Panel" , on page 16
18	Power sensor, optional	Chapter 4.1.1.4, "Optional Front Panel Connectors" , on page 17
19	Probe power connector - supply voltage for measurement accessories	Chapter 4.1.1.3, "Connectors on the Front Panel" , on page 16
20	Tracking generator output, optional	Chapter 4.1.1.4, "Optional Front Panel Connectors" , on page 17
21	External mixer (LO output, IF input), optional	Chapter 4.1.1.4, "Optional Front Panel Connectors" , on page 17
22	RF input	Chapter 4.1.1.3, "Connectors on the Front Panel" , on page 16

4.1.1.1 Function Keys on the Front Panel

A detailed description of the corresponding menus and the other function keys is provided in chapter 6 "Instrument Functions" of the Operating Manual.

Table 4-1: Front panel function keys

Function key	Assigned functions
	Switches the instrument on and off.
General device functions	
PRESET	Resets the instrument to the default state.
SAVE/RCL	Provides the functions for saving/loading instrument settings and for managing stored files.
SETUP	Provides basic instrument configuration functions, e.g.: <ul style="list-style-type: none"> • Reference frequency (external/internal), noise source • Date, time, display configuration • LAN interface • Self-alignment • Firmware update and enabling of options • Information about instrument configuration incl. firmware version and system error messages • Service support functions (self test etc.)
PRINT	Customizes the printout, selects and configures the printer.
HELP	Displays the Online Help.
MODE	Provides the selection between firmware options.
External functions	
	Displays Windows Start menu.
	Toggles the on-screen keyboard display: <ul style="list-style-type: none"> • at the top of the screen • at the bottom of the screen • off
Display options	
DISPLAY	Opens a dialog box to switch screen elements on or off.
	Switches between maximized and split display of focus area.
	Switches focus area between table and diagram.
Navigation functions	
USER	Allows you to define and use softkeys to load user-specific settings files.
HOME	Jumps to the highest softkey menu level of the current firmware option.
Measurement settings	
FREQ (CHANNEL)	Sets the center frequency as well as the start and stop frequencies for the frequency range under consideration. This key is also used to set the frequency offset and the signal track function. (CHANNEL for special applications)
SPAN	Sets the frequency span to be analyzed.

Function key	Assigned functions
AMPT (SCALE)	<p>Sets the reference level, the displayed dynamic range, the RF attenuation and the unit for the level display.</p> <p>Sets the level offset and the input impedance.</p> <p>Activates the preamplifier (option RF Preamplifier, R&S FSV-B22). (SCALE for special applications)</p>
AUTO SET	Enables automatic settings for level, frequency or sweep type mode.
BW	Sets the resolution bandwidth and the video bandwidth.
SWEEP	<p>Sets the sweep time and the number of measurement points.</p> <p>Selects continuous measurement or single measurement.</p>
TRACE	Configures the measured data acquisition and the analysis of the measurement data.
TRIG	Sets the trigger mode, the trigger threshold, the trigger delay, and the gate configuration in the case of gated sweep.
Marker functions	
MKR	Sets and positions the absolute and relative measurement markers (markers and delta markers).
PEAK SEARCH	Performs a peak search for active marker. If no marker is active, normal marker 1 is activated and the peak search is performed for it.
MKR FUNC	<p>Provides additional analysis functions of the measurement markers:</p> <ul style="list-style-type: none"> • Frequency counter (Sig Count) • Fixed reference point for relative measurement markers (Ref Fixed) • Noise marker (Noise Meas) • Phase noise • n dB down function • AM/FM audio demodulation (with option R&S FSV-B3) • Peak list
MKR->	<p>Used for search functions of the measurement markers (maximum/minimum of the trace).</p> <p>Assigns the marker frequency to the center frequency, and the marker level to the reference level.</p> <p>Restricts the search area (Search Limits) and characterizes the maximum points and minimum points (Peak Excursion).</p>
Measurement functions	
MEAS	<p>Provides the measurement functions:</p> <ul style="list-style-type: none"> • Measurement of multicarrier adjacent channel power (Ch Power ACLR) • Carrier to noise spacing (C/N C/No) • Occupied bandwidth (OBW) • Spectrum emission mask measurement (Spectrum Emission Mask) • Spurious emissions (Spurious Emissions) • Measurement of time domain power (Time Domain Power) • Signal statistics: amplitude probability distribution (APD) and cumulative complementary distribution function (CCDF) • Third-order intercept point (TOI) • AM modulation depth (AM Mod Depth)
MEAS CONFIG	Used to define measurement configuration.
LINES	Configures display lines and limit lines.

Function key	Assigned functions
INPUT/OUTPUT	Displays softkeys for input/output functions.
Measurement start functions	
RUN SINGLE	Starts a single new measurement (Single Sweep Mode).
RUN CONT	Starts a continuous measurement (Continuous Sweep Mode).
Function execution	
UNDO	Reverts last operation.
REDO	Repeats previously reverted operation.

4.1.1.2 Touchscreen Display

All measurement results are displayed in the screen on the front panel. Additionally, the screen display provides status and setting information and allows you to switch between various measurement tasks. The screen is touch-sensitive, offering an alternative means of user interaction for quick and easy handling of the device.

The [Figure 4-2](#) shows the touchscreen display of the R&S FSVA/FSV. The individual elements are described in more detail in [Chapter 4.4, "Basic Operations"](#), on page 50.

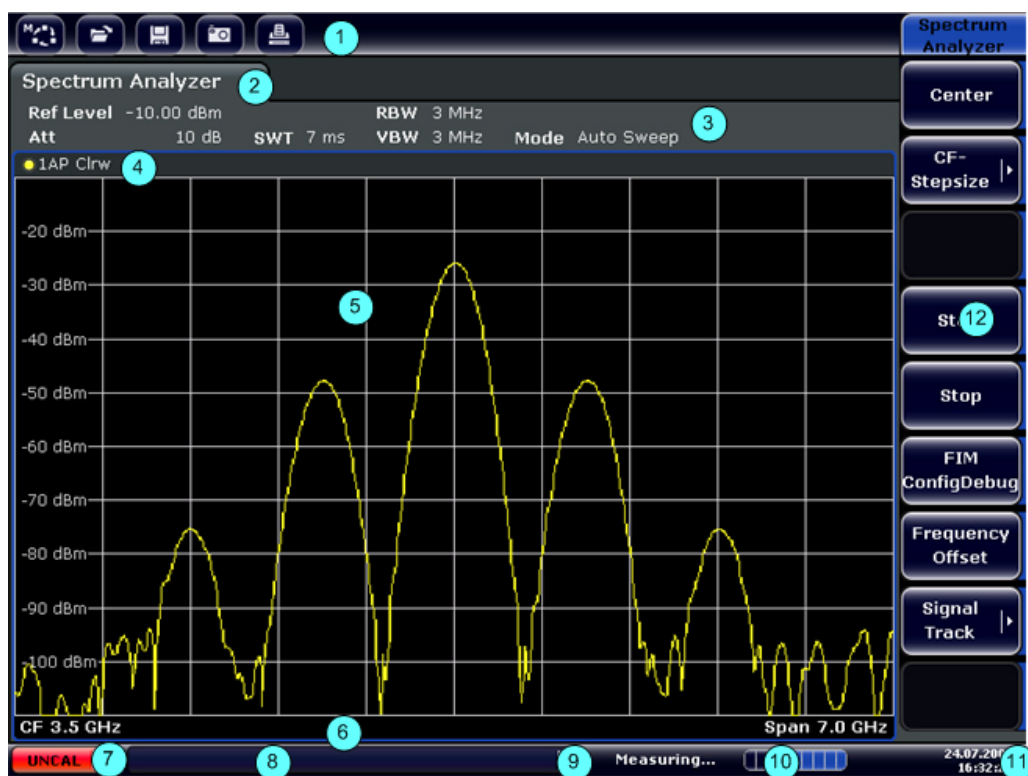

Figure 4-2: Touchscreen elements

- 1 = Toolbar with standard application functions, e.g. print, save/open file etc.
- 2 = Tabs for individual measurement tasks
- 3 = Channel information bar for current measurement settings
- 4 = Diagram header with diagram-specific (trace) information
- 5 = Measurement results area
- 6 = Diagram footer with diagram-specific information, depending on measurement mode
- 7 = Error indicator
- 8 = Error message, if available
- 9 = Device status
- 10 = Progress bar for measurement
- 11 = Date and time display
- 12 = Softkeys for menu access

4.1.1.3 Connectors on the Front Panel

This section describes the front connectors and interfaces of the R&S FSVA/FSV. Optional connectors and interfaces are indicated by the option name in brackets. Most connectors on the front panel (except for USB) are located at the bottom right-hand side.

USB

The front panel provides two female USB connectors to connect devices like a keyboard or mouse. Also a memory stick can be connected to store and reload instrument settings and measurement data.

NOISE SOURCE CONTROL

The noise source control female connector is used to provide the supply voltage for an external noise source, e.g., to measure the noise figure and gain of amplifiers and frequency converting DUTs.

Conventional noise sources require a voltage of +28 V in order to be switched on and 0 V to be switched off. The output supports a maximum load of 100 mA.

RF INPUT 50Ω

The RF input is to be connected to the DUT via a cable equipped with an appropriate connector.

NOTICE

Risk of instrument damage

Do not overload the input. For maximum allowed values, see the data sheet.

For AC-coupling, a DC input voltage of 50 V must never be exceeded. For DC-coupling, DC voltage must not be applied at the input. In both cases, noncompliance will destroy the input mixers.

PROBE POWER



The R&S FSVA/FSV provides a connector for supply voltages of +15 V to -12 V and ground for active probes and preamplifiers. A maximum current of 140 mA is available. This connector is suitable as power supply for high-impedance probes from Agilent.

POWER SENSOR

The LEMOSA female connector is used to connect power sensors of the R&S NRP family (requires option R&S FSV-K9). For details on supported power sensors see the data sheet.

4.1.1.4 Optional Front Panel Connectors

AF OUTPUT (Audio Demodulator option, R&S FSV-B3)

Headphones equipped with a miniature jack plug can be connected to the AF output female connector. The internal impedance is 10 Ω . The output voltage can be set by using the volume control to the right of the female connector. If a plug is connected, the internal loudspeaker is automatically switched off.

The female connector and volume control are available only with the audio demodulator option (R&S FSV-B3). To use the AF OUTPUT, in the "In-/Output" menu ([INPUT/OUTPUT] key), select "Video Output". The output voltage (volume) is 1V.

CAUTION

Risk of hearing damage

Before putting on the headphones, make sure that the volume setting is not too high to protect your hearing.

Tracking Generator Output (GEN OUTPUT 50 Ω , Option R&S FSV-B9)

The R&S FSVA/FSV is equipped with an optional tracking generator and therefore provides a tracking generator output connector.

The output of the tracking generator is to be connected to the DUT via a cable equipped with a male N connector. The female connector is available only with the tracking generator option (R&S FSV-B9).

If the output is active, the LED is green.

NOTICE

Risk of damaging the tracking generator

To avoid damaging the tracking generator, make sure that the reverse power (i.e. input power caused, for example, by reflections in the test setup) never exceeds 1 W RF power. Do not apply a DC voltage at the output.

For details, refer to the data sheet.



Sensitive DUTs concerning matching

For DUTs with sensitive RF characteristics with regard to matching (VSWR) at the input, insert a 10 dB attenuator between the DUT and the tracking generator.

Connections for External Mixers (EXT MIXER, Option R&S FSV-B21)

External mixers can be connected at the LO OUT/IF IN and IF IN female connectors (option R&S FSV-B21 for R&S FSVA/FSV 30 and R&S FSVA/FSV 40 instruments). Both two-port and three-port mixers can be used. Connect the mixer as follows:



Use the supplied coaxial cable to feed in the LO signal. If no external mixers are connected to the R&S FSVA/FSV, cover the two front connectors LO OUT / IF IN and IF IN with the SMA caps supplied.

Three-port mixer

Three-port mixer:

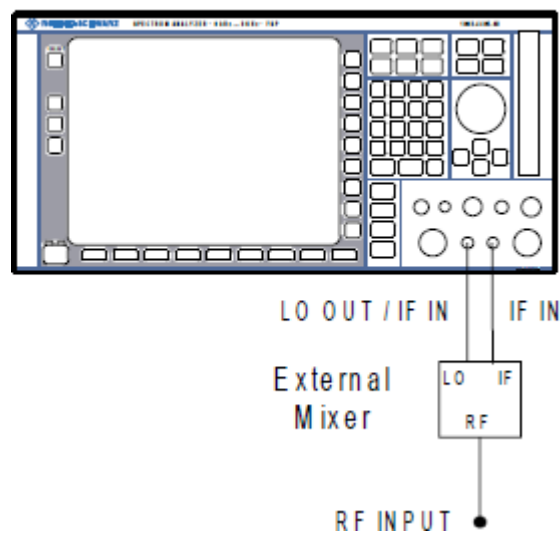

1. Connect the LO OUT / IF IN output of the R&S FSVA/FSV to the LO port of the external mixer.
2. Connect the IF IN input of the R&S FSVA/FSV to the IF port of the external mixer.
3. Feed the signal to be measured to the RF input of the external mixer.

Two-port mixer

Two-port mixer:

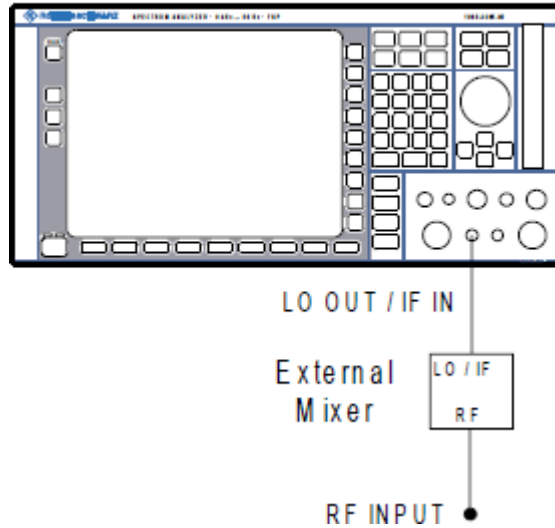

1. 1. Connect the LO OUT / IF IN output of the R&S FSVA/FSV to the LO/IF port of the external mixer. The nominal LO level is 15.5 dBm.
Because of the diplexer contained in the R&S FSVA/FSV, the IF signal can be tapped from the line which is used to feed the LO signal to the mixer.
2. Feed the signal to be measured to the RF input of the external mixer.

4.1.2 Rear Panel View

Figure 4-3 shows the rear panel view of the R&S FSVA/FSV. The individual elements are described in more detail in the subsequent sections. Optional connectors and interfaces are indicated by the option name in brackets.



Figure 4-3: Rear panel view

- 1 = LAN
- 2 = TRIGGER OUTPUT
- 3 = IF/VIDEO
- 4 = USB
- 5 = AUX PORT
- 6+7 = External generator control (option B10)
- 8 = EXT TRIGGER / GATE IN
- 9+10 = DIGITAL BASEBAND INPUT/OUTPUT connectors (option B17)
- 11 = MONITOR (VGA)
- 12 = REF IN
- 13 = REF OUT
- 14 = GPIB interface
- 15 = AC Power Supply Connection and Main Power Switch with fuse
- 16 = EXT REF with OCXO option (-B4)

4.1.2.1 Standard Rear Panel Connectors

AC Power Supply Connection and Main Power Switch

An AC power supply connector and main power switch are located in a unit on the rear panel of the instrument.

Main power switch function:

Position 1: The instrument is in operation.

Position O: The entire instrument is disconnected from the AC power supply.

For details refer to [Chapter 4.2.1.8, "Switching the Instrument On and Off"](#), on page 32.

**Warm-up time for OCXO**

When the instrument is switched on, the OCXO requires an extended warm-up time (see data sheet).

LAN

The LAN interface can be used to connect the R&S FSVA/FSV to a local network for remote control, printouts and data transfer. The assignment of the RJ-45 connector supports twisted-pair category 5 UTP/STP cables in a star configuration (UTP stands for *unshielded twisted pair*, and STP for *shielded twisted pair*).

MONITOR (VGA)

The female VGA connector is used to connect an external monitor. Step-by-step instructions how to connect an external monitor are provided in [Chapter 4.2.3, "Connecting an External Monitor"](#), on page 35.

EXT TRIGGER / GATE IN

The female connector for external trigger/gate input is used to control the measurement by means of an external signal. The voltage levels can range from 0.5 to 3.5 V. The default value is 1.4 V. The typical input impedance is 10 kΩ.

REF IN

As a reference signal, you can either use the internal reference, or connect an external one. The setup menu is used to switch between the internal and an external reference. The REF IN female connector is used as an input for a 1-20 MHz reference signal. The required input level is 0-10 dBm.

REF OUT

This connector can be used to provide an external reference signal (e.g. the OCXO or ultra high precision reference signal) to other devices that are connected to this instrument. The REF OUT female connector can output a 10 MHz reference signal with an output level of 0 dBm.

GPIB interface

The GPIB interface is in compliance with IEEE488 and SCPI. A computer for remote control can be connected via this interface. To set up the connection, a shielded cable is recommended. For more details refer to chapter 7 "Remote Control Basics" in the Operating Manual.

TRIGGER OUTPUT

The female BNC connector can be used to provide a signal to another device. The signal is TTL compatible (0 V / 5 V). The "Trigger out" softkey in the "In-/Output" menu ([INPUT/OUTPUT] key) is used to control the trigger output.

IF/VIDEO

The female BNC connector can be used for various outputs:

- Intermediate frequency (IF) output of approximately 20 MHz
- Video output (1V)

The "In-/Output" menu ([INPUT/OUTPUT] key) is used to select between the IF and video output.

USB

The rear panel provides two additional female USB connectors to connect devices like keyboard and mouse. Also, a memory stick can be connected to store and reload instrument settings and measurement data.



EMI impact on measurement results

Electromagnetic interference (EMI) can affect the measurement results. To avoid any impact, make sure that the following conditions are met:

- Use suitable double-shielded cables.
- Do not use USB connecting cables exceeding 1 m in length.
- Use only USB devices that remain within the permissible EMI limits.
- Always terminate any connected IEC-bus cables with an instrument or controller.

AUX PORT

The 9 pole SUB-D male connector provides control signals for controlling external devices. The voltage levels are of the TTL type (5 V).



Pin	Signal	Description
1	+5 V / max. 250 mA	Supply voltage for external circuits
2 to 7	I/O	Control lines for user ports (see User manual)
8	GND	Ground
9	READY FOR TRIGGER	Signal indicating that the instrument is ready to receive a trigger signal (Low active = 0 V)

NOTICE

Short-circuit hazard

Always observe the designated pin assignment. A short-circuit can damage the port.

4.1.2.2 Optional Rear Panel Connectors

OCXO option (R&S FSV-B4)

This option generates a very precise 10 MHz reference signal with an output level of ≥ 0 dBm. If installed, and if no external signal or ultra high precision reference is used (see "Ultra High Precision Reference Option (R&S FSV-B14)" on page 23), this sig-

nal is used as an internal reference. It can also be used to synchronize other connected devices via the REF OUT connector.



Warm-up time for OCXO

When the instrument is switched on, the OCXO requires an extended warm-up time (see data sheet).



Ultra High Precision Reference Option (R&S FSV-B14)

Alternatively to the OCXO reference, an ultra high precision reference (option R&S FSV-B14) is available. This option generates an even more precise 10 MHz reference signal with an output level of ≥ 0 dBm. If installed, and if no external signal is used, this signal is used as an internal reference (also if an OCXO reference is installed). It can also be used to synchronize other connected devices via the REF OUT connector.

External Generator Control Option (R&S FSV-B10)

The external generator control option provides an additional GPIB and an [AUX CONTROL] connector.

The GPIB connector can be used to connect the external generator to the R&S FSVA/FSV.

The female [AUX CONTROL] connector is required for TTL synchronization, if supported by the generator.

For details on connecting an external generator see the "External Generator Control" section of the R&S FSVA/FSV User Manual.

Digital Baseband Interface (R&S FSV-B17)

The R&S FSVA/FSV Digital Baseband Interface option (R&S FSV-B17) provides an online digital I/Q data interface on the rear panel of the instrument for input and output. The digital input and output can be enabled in the base unit or in one of the applications (where available).

4.2 Preparing for Use

4.2.1 Putting into Operation

This section describes the basic steps to be taken when setting up the R&S FSVA/FSV for the first time.

⚠ WARNING**Risk of injury due to disregarding safety information**

Observe the information on appropriate operating conditions provided in the data sheet to prevent personal injury or damage to the instrument. Read and observe the basic safety instructions provided with the instrument, in addition to the safety instructions in the following sections. In particular:

- Do not open the instrument casing.

NOTICE**Risk of instrument damage due to inappropriate operating conditions**

Specific operating conditions are required to ensure accurate measurements and to avoid damage to the instrument. Observe the information on appropriate operating conditions provided in the basic safety instructions and the instrument's data sheet.

NOTICE**Risk of instrument damage due to inappropriate operating conditions**

An unsuitable operating site or test setup can damage the instrument and connected devices. Before switching on the instrument, observe the information on appropriate operating conditions provided in the data sheet. In particular, ensure the following:

- All fan openings are unobstructed and the airflow perforations are unimpeded. A minimum distance of 10 cm to other objects is recommended.
- The instrument is dry and shows no sign of condensation.
- The instrument is positioned as described in the following sections.
- The ambient temperature does not exceed the range specified in the data sheet.
- Signal levels at the input connectors are all within the specified ranges.
- Signal outputs are connected correctly and are not overloaded.

NOTICE**Instrument damage caused by electrostatic discharge**

Electrostatic discharge (ESD) can damage the electronic components of the instrument and the device under test (DUT). Electrostatic discharge is most likely to occur when you connect or disconnect a DUT or test fixture to the instrument's test ports. To prevent electrostatic discharge, use a wrist strap and cord and connect yourself to the ground, or use a conductive floor mat and heel strap combination.



EMI impact on measurement results

Electromagnetic interference (EMI) may affect the measurement results.

To suppress generated electromagnetic interference (EMI):

- Use suitable shielded cables of high quality. For example, use double-shielded RF and LAN cables.
- Always terminate open cable ends.
- Note the EMC classification in the data sheet.

4.2.1.1 Unpacking and Checking the Instrument

To remove the instrument from its packaging and check the equipment for completeness, proceed as follows:

1. Pull off the polyethylene protection pads from the instrument's rear feet.
2. Carefully remove the pads from the instrument handles at the front.
3. Pull off the corrugated cardboard cover that protects the rear of the instrument.
4. Carefully unthread the corrugated cardboard cover at the front that protects the instrument handles and remove it.
5. Check the equipment for completeness using the delivery note and the accessory lists for the various items.
6. Check the instrument for any damage. If there is damage, immediately contact the carrier who delivered the instrument. Make sure not to discard the box and packing material.



Packing material

Retain the original packing material. If the instrument needs to be transported or shipped later, you can use the material to protect the control elements and connectors.

4.2.1.2 Accessory List

The instrument comes with the following accessories:

- Power cable
- Quick Start Guide

4.2.1.3 Placing or Mounting the Instrument

The R&S FSVA/FSV is designed for use under laboratory conditions, either on a bench top or in a rack.

Bench Top Operation

If the R&S FSVA/FSV is operated on a bench top, the surface should be flat. The instrument can be used in horizontal position, standing on its feet, or with the support feet on the bottom extended.

WARNING

Risk of injury if feet are folded out

The feet can fold in if they are not folded out completely or if the instrument is shifted. Collapsing feet can cause injury or damage the instrument.

- Fold the feet completely in or out to ensure stability of the instrument. Never shift the instrument when the feet are folded out.
- When the feet are folded out, do not work under the instrument or place anything underneath.
- The feet can break if they are overloaded. The overall load on the folded-out feet must not exceed 500 N.

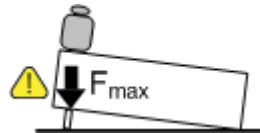

⚠ WARNING**Risk of injury when stacking instruments**

A stack of instruments can tilt over and cause injury if not stacked correctly. Furthermore, the instruments at the bottom of the stack can be damaged due to the load imposed by the instruments on top.

Observe the following instructions when stacking instruments:

- Never stack more than three instruments. If you need to stack more than three instruments, install them in a rack.
- The overall load imposed on the lowest instrument must not exceed 500 N.
- It is best if all instruments have the same dimensions (width and length). If you need to stack smaller instruments on the top, the overall load imposed on the lowest instrument must not exceed 250 N.
- If the instruments have foldable feet, fold them in completely.

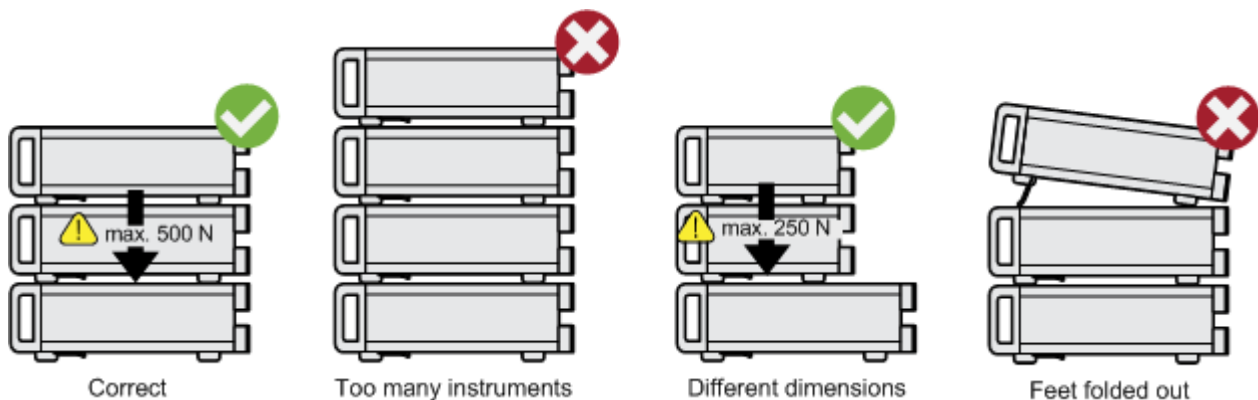
**Rackmounting**

The R&S FSVA/FSV can be installed in a rack using a rack adapter kit (for the order no., see data sheet). The installation instructions are part of the adapter kit.

NOTICE**Risk of instrument damage due to insufficient airflow in a rack**

If you mount several instruments in a rack, you need an efficient ventilation concept to ensure that the instruments do not overheat. Insufficient airflow for a longer period can disturb the operation and even cause damage.

4.2.1.4 Connecting the AC Power

The R&S FSVA/FSV is equipped with an AC power supply connector. The R&S FSVA/FSV can be used with different AC power voltages and adapts itself automatically to it. Refer to the datasheet for the requirements of voltage and frequency. The AC power connector is located on the rear panel of the instrument.



- ▶ Connect the R&S FSVA/FSV to the AC power supply using the supplied power cable.
Since the instrument is assembled in line with the specifications for safety class EN61010, it may only be connected to an outlet that has a ground contact.

4.2.1.5 Changing the AC Supply Fuse

Only fuses of the type IEC 60 127-T3.15H/250 V should be used. Those fuses are used for all of the specified nominal AC supply voltages.

To change the AC supply fuses

1. Disconnect the power cable.
2. Open the flap covering the fuse holder using a small screwdriver (or similar).
3. Remove the fuse holder.
4. Remove both fuses and install the new ones.
5. Reinsert the fuse holder.
6. Close the flap.

4.2.1.6 Using an Optional DC Power Supply

When only DC power is available, for example from a battery or in a vehicle, an optional DC power supply adapter (R&S FSV-B30) can be connected to the R&S FSVA/FSV to operate the instrument with a DC voltage of 10 V to 28 V.

For installation instructions see the option's installation guide.

⚠ WARNING

Shock hazard due to power supply

If you use external power supplies to supply the equipment with DC safety extra low voltage (SELV), make sure the requirements for reinforced or double insulation are met, according to DIN/EN/IEC 61010 (UL61010, CAN CSA C22.2 No. 61010) or DIN/EN/IEC 60950 (UL60950, CAN CSA C22.2 No. 60950). Otherwise you may be injured due to electrical shock.

Before switching on the R&S FSVA/FSV, switch on the DC power supply:

Switching the DC power supply on

1. Connect the R&S FSVA/FSV DC power supply device to the DC power source (e.g. battery pack or vehicle) as described in the option's installation guide.

2. Set the switch on the DC power supply to "I". A green LED indicates that the DC power supply is ready for operation.
3. In case of overvoltage or undervoltage, the DC power supply switches off automatically. This state is indicated by means of a red LED.
4. Set the power switch on the rear panel to "I".
5. Press the [ON/OFF] key on the front panel. A green LED above the [ON/OFF] key indicates that the instrument is ready for operation.

Switching the DC power supply off

1. Press the [ON/OFF] key on the front panel of the R&S FSVA/FSV and wait until the instrument has shut down.
2. Switch off the power switch on the rear panel of the R&S FSVA/FSV.
3. Switch off the DC power supply.

4.2.1.7 Using an Optional Battery Pack and Charger (Options R&S FSV-B32/-B34)

A lithium-ion battery pack with four rechargeable batteries is available for all R&S FSVA/FSV instruments (R&S FSV-B32). This battery pack also requires the DC power supply adapter (option R&S FSV-B30, see [Chapter 4.2.1.6, "Using an Optional DC Power Supply"](#), on page 28). To charge these batteries, an additional external battery charger is available (option R&S FSV-B34).

For installation instructions see the option's installation guide.

Switching on the battery pack

1. Connect the battery pack to the R&S FSVA/FSV as described in the installation guide.
Note: The batteries must be charged before initial use, see ["Charging the Battery Pack"](#) on page 30.
2. Set the switch on the battery pack to "I".
3. Set the switch on the DC power supply to "I". A green LED indicates that the DC power supply is ready for operation.
4. In case of undervoltage, the DC power supply switches off automatically. This state is indicated by means of a red LED.
5. Set the power switch on the rear panel to "I".
6. Press the [ON/OFF] key on the front panel. A green LED above the [ON/OFF] key indicates that the instrument is ready for operation.

Switching off the battery pack

1. Press the [ON/OFF] key on the front panel of the R&S FSVA/FSV and wait until the instrument has shut down.

2. Switch off the power switch on the rear panel of the R&S FSVA/FSV.
3. Switch off the DC power supply.
4. Switch off the battery pack.

Charging the Battery Pack

The battery pack is not charged in the factory. The rechargeable batteries must be charged before they are used for the first time.

The R&S FSV-B34 charger is a standalone charging device which can be used to charge all four rechargeable batteries of the R&S FSV-B32 battery pack simultaneously. The rechargeable batteries can be charged at ambient temperatures of 0 °C to +45 °C.

1. Undo the knurled screws (10) on the front of the battery pack and open the flap (11).
2. Pull the rechargeable batteries (12) by the tab out of the housing.

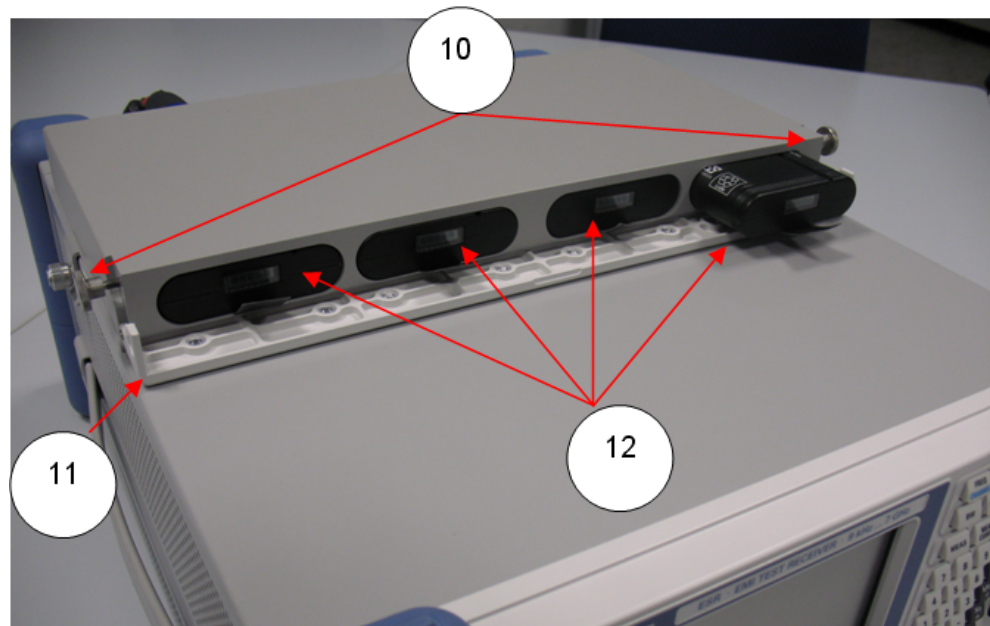

Figure 4-4: Battery compartment

3. Connect the power cable to the charger.
4. Insert the rechargeable batteries into the charging slots of the charger.



Figure 4-5: R&S FSV-B34 charger

LEDs indicate the operating state of each charging slot:

- Charging
Green LED flashes
 - Charging completed
Green LED remains lit
 - Fault
Red LED lights up
5. When charging has been completed, the rechargeable batteries can be removed from the charger. The LCD on the front of the rechargeable battery indicates the charge level in increments of 20 %.
 6. Insert the rechargeable batteries into the battery pack and close the flap on the front. Secure the flap using the two knurled screws.

4.2.1.8 Switching the Instrument On and Off

Switching the instrument on

If an optional DC power supply (R&S FSV-B30) or an optional battery pack (R&S FSV-B32) is used, you must switch on these devices first; see [Chapter 4.2.1.6, "Using an Optional DC Power Supply"](#), on page 28 or [Chapter 4.2.1.7, "Using an Optional Battery Pack and Charger \(Options R&S FSV-B32/-B34\)"](#), on page 29.

1. Press the AC power switch on the rear panel to position "I".

The instrument is supplied with AC power.

2. Press the [ON/OFF] key on the front panel.

After booting, the instrument is ready for operation. A green LED above the [ON/OFF] key indicates this.



Warm-up time for OCXO

When the instrument is switched on, the OCXO requires an extended warm-up time (see data sheet).

Switching the instrument off

1. Press the [ON/OFF] key on the front panel.

2. Change the AC power switch on the rear panel to position "O", or disconnect the instrument from the AC power supply.

The R&S FSV/FSV changes into off mode.

NOTICE

Risk of losing data

If you switch off the running instrument using the rear panel switch or by disconnecting the power cord, the instrument loses its current settings. Furthermore, program data can be lost.

Press the ON/STANDBY key first to shut down the application properly.

4.2.1.9 Performing a Self Alignment and a Self Test



Operating temperature

Before performing this functional test, make sure that the instrument has reached its operating temperature (for details, refer to the data sheet).

Performing a self alignment

1. Press the [SETUP] key.

2. Press the "Alignment" softkey.
3. Press the "Self Alignment" softkey.

Once the system correction values have been calculated successfully, a message is displayed.



To display the alignment results again later

- Press the [SETUP] key.
- Press the "Alignment" softkey.
- Press the "Show Align Results" softkey.

Performing a self test

The self test does not need to be repeated every time the instrument is switched on. It is only necessary when instrument malfunction is suspected.

1. Press the [SETUP] key.
2. Press the "More" softkey.
3. Press the "Service" softkey.
4. Press the "Selftest" softkey.

Once the instrument modules have been checked successfully, a message is displayed.

4.2.1.10 Checking the Supplied Options

The instrument may be equipped with both hardware and firmware options. In order to check whether the installed options correspond to the options indicated on the delivery note, proceed as follows.

1. Press the [SETUP] key.
2. Press the "System Info" softkey.
3. Press the "Versions + Options" softkey.

A list with hardware and firmware information is displayed.

4. Check the availability of the hardware options as indicated in the delivery note.
For an overview of the available options, refer to the datasheet.

4.2.2 Connecting USB Devices

The USB interfaces of the R&S FSVA/FSV allow you to connect USB devices directly to the instrument. Increase the number of possible connections using USB hubs. Due to the large number of available USB devices, there is almost no limit to the expansions that are possible with the R&S FSVA/FSV.

The following list shows various USB devices that can be useful:

- Memory stick for easy transfer of data to/from a computer (e.g. firmware updates)
- CD-ROM drives for easy installation of firmware applications
- Keyboard or mouse to simplify the entry of data, comments, filenames, etc.
- Printer for printing measurement results
- Power sensors, e.g. of the NRPxx family

Installing USB devices is easy under Windows, because all USB devices are plug&play. After a device is connected to the USB interface, the operating system automatically searches for a suitable device driver.

If Windows does not find a suitable driver, it prompts you to specify a directory that contains the driver software. If the driver software is on a CD, connect a USB CD-ROM drive to the instrument before proceeding.

When a USB device is then disconnected from the R&S FSVA/FSV, Windows immediately detects the change in hardware configuration and deactivates the corresponding driver.

All USB devices can be connected to or disconnected from the instrument during operation.

Connecting a memory stick or CD-ROM drive

If installation of a memory stick or CD-ROM drive is successful, Windows informs you that the device is ready to use. The device is made available as a new drive and is displayed in Windows Explorer. The name of the drive depends on the manufacturer.

Connecting a keyboard

The keyboard is detected automatically when it is connected. The default input language is English – US.

To configure the keyboard language

1. To access the Windows operating system, press the Windows key on the external keyboard.
2. Select "Start > Settings > Time & language > Region & language > Add a language" .

Connecting a mouse

The mouse is detected automatically when it is connected.

To configure the mouse properties

1. To access the Windows operating system, press the Windows key on the external keyboard.
2. Select "Start > Settings > Devices > Mouse & touchpad".

Connecting a printer

When printing a file, the instrument checks whether a printer is connected and turned on and whether the appropriate printer driver is installed. If necessary, printer driver installation is initiated. You only have to install a printer driver once.

To install a printer

1. To access the Windows operating system, press the Windows key on the external keyboard.
2. Select "Start > Settings > Devices > Add a printer or scanner".

You can load updated and improved driver versions or new drivers from an installation disk, USB memory stick or another external storage medium. If the instrument is integrated in a network, you can also install driver data stored in a network directory.

To install the driver

- ▶ Select "Start > Settings > Devices > Device Manager > Update Device drivers" .

4.2.3 Connecting an External Monitor

You can connect an external monitor to the "MONITOR" connector on the instrument's rear panel.

For details on the connector refer to "[MONITOR \(VGA\)](#)" on page 21.

1. Connect the external monitor to the R&S FSVA/FSV.
2. Press the [SETUP] key.
3. Press the "General Setup" softkey.
4. Press the "More" softkey.
5. Press the "Configure Monitor" softkey.

The configuration of the connected monitor is determined and displayed in the standard Windows configuration dialog box.

6. In the configuration dialog box, you can switch from the internal monitor (laptop icon) to the external monitor (monitor icon), or both (double monitor icon).

If the external monitor is selected, the R&S FSVA/FSV display is disabled. The screen content (measurement screen) formerly displayed on the R&S FSVA/FSV is displayed on the external screen. If you select both monitors, the R&S FSVA/FSV screen and the external screen are both active.

4.2.4 R&S FSVA/FSV Setup

This section describes how to setup the instrument.

• Changing the Language of the Instrument Interface	36
• Selecting the Frequency Reference Signal	36
• Setting the Date and Time	37
• Aligning the Touchscreen	38
• Setting the Screen Colors	38
• Setting the Display Power Save Function	41
• Selecting and Configuring Printers	42

4.2.4.1 Changing the Language of the Instrument Interface

You can change the language of the R&S FSVA/FSV graphical user interface (softkeys, dialog boxes, input settings etc.) to the any other installed language, if available.



If you do not understand the currently used interface language, this may be difficult. Thus, the position of the required elements in the menu is provided in the following procedure for convenience.

1. Select the [SETUP] hardkey.
2. Select the "General Settings" softkey (5th from the top).
3. Select the "Language" softkey (6th from the top).
4. Select an available interface language.

All softkeys, dialog boxes, input settings etc. are displayed in the selected language.



To change the default input language of an external keyboard, use the standard Windows operating system function (see "[Connecting a keyboard](#)" on page 34).

Remote command:

`SYSTem:DISPlay:LANGuage` on page 968

4.2.4.2 Selecting the Frequency Reference Signal

You can switch the reference signal for frequency processing of the R&S FSVA/FSV between the internal reference and an external reference signal at 10 MHz as follows:

1. Press the [SETUP] key.
2. Press the "Reference Int/Ext" softkey until it is in the desired state.



External reference signal

It is important that the external reference signal is deactivated when switching from external to internal reference to avoid interactions with the internal reference signal.

Remote commands:

```
ROSC:SOUR EXT
```

```
ROSC:EXT:FREQ 20
```

4.2.4.3 Setting the Date and Time

You can set the date and time for the internal real time clock as follows:

Opening the Date and Time Properties dialog box

1. Press the [SETUP] key.
2. Press the "General Setup" softkey.
3. Press the "Time + Date" softkey to open the "Date and Time Properties" dialog box.
The "Date & Time" tab is displayed.

Changing the date

1. Press the arrow on the "Month" field to display the list.
2. Select the month from the list.
3. Select the year by clicking on the up and down arrow buttons next to the "Year" field.
4. Select the day in the calendar display or enter the date via the keyboard.
5. Click "OK".

Remote command

```
SYST:DATE 2008,10,1
```

Changing the time

You can change hours, minutes and seconds independently of each other.

1. Select the hour, minute or seconds area of the "Time" field.
2. Enter the required setting via the keyboard or rotary knob.
3. Repeat these steps until the hour, minute and second settings are correct.
4. Click "OK".

Remote command

```
SYST:TIME 12,30,30
```

Changing the time zone

1. Select the "Time Zone" tab.
2. Press the arrow on the "Time Zone" field to display the list.
3. Select the required time zone from the list.

4. Optionally, select the "Automatically adjust clock for daylight saving changes" check box.
5. Click "OK".

4.2.4.4 Aligning the Touchscreen

When the device is delivered, the touchscreen is initially aligned. However, it may become necessary to adjust the alignment later, e.g. after an image update or after exchanging a hard disk. If you notice that touching a specific point on the screen does not achieve the correct response, try adjusting the alignment.



If the touchscreen is so out of order that you cannot navigate properly, connect an external mouse to the R&S FSVA/FSV and follow the steps described below to start re-alignment.

1. Press the [SETUP] key.
2. Press the "Alignment" softkey.
3. Press the "Touchscreen Alignment" softkey.
4. Using a finger or any other pointing device, press the 4 markers on the screen.

The touchscreen is aligned according to the executed pointing operations.

4.2.4.5 Setting the Screen Colors

To change the colors of the displayed objects, two default color settings are provided. Alternatively, you can change the color of objects individually using predefined colors or using colors of your own definition.



Some color settings are defined by the selected theme, see [Chapter 4.4.4.9, "Selecting a Theme"](#), on page 76, and cannot be changed individually.

Displaying the Screen Colors Submenu

1. Press the [SETUP] key.
2. Press the "Display Setup" softkey.
3. Press the "More" softkey.
4. Press the "Screen Colors" softkey.

The "Screen Colors" submenu is displayed.

Using the Default Color Settings

To select the default setting for brightness, tint and color saturation of all screen objects:

1. In the "Screen Colors" submenu (see ["Displaying the Screen Colors Submenu"](#) on page 38), press the "Set to Default" softkey.

The "Set User Colors to Default" dialog box is displayed.

2. Select one of the default color sets. The color schemes are selected in such a manner that all screen elements are visible optimally regardless whether viewed from above or below. In the instrument's default setting, "Default Colors 1" is active.

Remote commands:

```
DISP:CMAP:DEF1
```

```
DISP:CMAP:DEF2
```

Using the Predefined Color Set

1. In the screen colors submenu (see ["Displaying the Screen Colors Submenu"](#) on page 38), press the "Select Screen Color Set" softkey.

The "Select Screen Color Set" dialog box is displayed.

2. Select the "User Defined Colors" option.

3. In the screen colors submenu, press the "Select Object" softkey.

The "Screen Color Setup" dialog box is displayed.



4. Press the arrow on the "Selected Object" list and select the object for which you want to change the color setting.
5. Select the color you want to use for the object. The defined color is displayed in the "Preview" box.
6. Repeat the steps for all objects that you want to change in color.
7. To change to user-defined colors, press the "Userdefined Colors" softkey. For details refer to ["Defining and Using a User-Defined Color Set"](#) on page 40.
8. Click "OK" to accept the new settings and to close the dialog box.

Remote command:

```
DISP:CMAP1 ... 41:PDEF <color>
```

Defining and Using a User-Defined Color Set

1. In the screen colors submenu (see ["Displaying the Screen Colors Submenu"](#) on page 38), press the "Select Screen Color Set" softkey.
The "Select Screen Color Set" dialog box is displayed.
2. Select the "User Defined Colors" option.
3. In the "Screen Colors" submenu, press the "Select Object" softkey.
The "Screen Color Setup" dialog box is displayed.



4. Press the arrow on the "Selected Object" list and select the object for which you want to change the color setting.
5. In the color palette, select the color you want to use for the object, or enter values for tint, saturation and brightness.
The defined color is displayed in the "Preview" box.
Note: In the continuous color spectrum ("Tint") red is represented by 0% and blue by 100%.
6. Repeat the steps for all objects for which you want to change the color.
7. To change to predefined colors, press the "Predefined Colors" softkey. For details refer to ["Using the Predefined Color Set"](#) on page 39.
8. Click "OK" to accept the new settings and to close the dialog box.

Remote command:

```
DISP:CMAP1 ... 41:HSL <hue>,<sat>,<lum>
```

4.2.4.6 Setting the Display Power Save Function

The R&S FSVA/FSV provides a feature for automatically switching off its screen after a user-defined period of time. The background lighting is disabled if no entries are made from the front panel after the selected response time (key, softkey and rotary knob).

Activating display power save

1. Press the [SETUP] key.
2. Press the "Display Setup" softkey.
3. Press the "More" softkey.
4. Press the "Display Pwr Save On/Off" softkey.
The power save mode is activated ("On" is highlighted), and the dialog box to enter the response time is displayed.
5. Enter the desired response time in minutes and confirm the entry with the [ENTER] key.
The screen is disabled (turns dark) after the selected period of time.

Deactivating Display Power Save

- ▶ In the "Display Setup" submenu, press the "Display Pwr Save On/Off" softkey again.
"Off" is highlighted and the power save mode is switched off.

4.2.4.7 Selecting and Configuring Printers

You can printout your measurement results using a local printer or a network printer. The instrument supports two independent printout settings. This allows you to quickly switch between output to a file and a printer.

Configuring the Printer and the Printout

1. Press the [PRINT] key.
2. Press the "Device Setup" softkey.

The "Hardcopy Setup" dialog box is displayed.

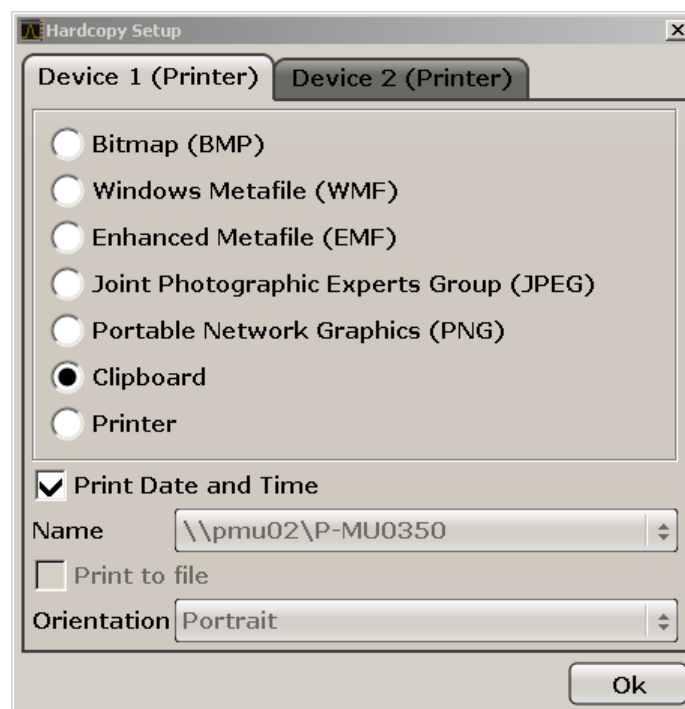

3. To change the tab in order to define the second print setting, press the tab on the screen.
4. Define the output by selecting the required options.
 - To save the hardcopy in an image file, select one of the image types. Depending on the image type, the color depth varies (e.g. 4-bit for BMP, 24-bit for PNG and JPEG).
 - To copy the image to the clipboard, select the "Clipboard" option.
 - To use a preconfigured network printer, select the "Printer" option.

Note: The "Name", "Print to File" and "Orientation" fields are only available if the "Printer" option is selected. You can perform the following steps only with the "Printer" option selected.
5. In the "Name" field, select the desired printer type.

6. To redirect the output to a postscript file rather than a printer, select the "Print to file" option.
7. In the "Orientation" field, select the desired orientation.
8. Optionally, activate the "Print Date and Time" option to add this information to the printout.
9. Click "OK" to accept the settings and to close the dialog box.

Selecting the Printout Colors

1. Press the [PRINT] key.
2. Press the "Colors" softkey.
3. To print in color, press the "Select Print Color Set" softkey to select the color set. The "Select Print Color Set" dialog box is displayed.
4. Select the color set by using the arrow keys and confirm your selection by pressing the [ENTER] key.
 - "Screen Colors (Print)" option: The current screen colors are used for the printout. Independently of the current screen colors, the background is printed in white and the grid in black.
Remote command: `HCOP : CMAP : DEF1`
 - "Optimized Colors" option: This setting improves the color clarity of the printout. Trace 1 is printed in blue, trace 2 in black, trace 3 in bright green, trace 4 in pink, trace 5 in sea green, trace 6 in dark red, and the markers in sky blue. The background is printed in white and the grid in black. The other colors correspond to the screen colors of the default color setting of the "Setup" menu.
Remote command: `HCOP : CMAP : DEF2`
 - "User Defined Colors" option: You define and use your own color set for the printout. For details how to proceed refer to ["Defining and Using a User-Defined Color Set"](#) on page 40.
Remote command: `HCOP : CMAP : DEF3`
 - "Screen Colors (Hardcopy)" option: The current screen colors without any changes for a hardcopy. For details on the output format see ["Configuring the Printer and the Printout"](#) on page 42 .
Remote command: `HCOP : CMAP : DEF4`
5. If you want a black-and-white printout, press the "Color On/Off" softkey to switch off the color. In the black-and-white printout, all background colors are printed out in white and all color lines in black. This allows you to improve contrast on the printout.
Remote command: `HCOP : DEV : COL ON`

4.2.5 Windows Operating System

The instrument contains the Windows 10 operating system which has been configured according to the instrument's features and needs. Changes in the system setup are only required when peripherals like keyboard or a printer are installed or if the network configuration does not comply with the default settings. After the R&S FSVA/FSV is started, the operating system boots and the instrument firmware is started automatically.

To ensure that the instrument software functions properly, certain rules must be adhered to concerning the operating system.

Tested software

The drivers and programs used on the instrument under Windows 10 are adapted to the instrument. Only install update software released by Rohde & Schwarz to modify existing instrument software.

You can install additional software on the instrument, however, additional software can impair instrument function. Thus, run only programs that Rohde & Schwarz has tested for compatibility with the instrument software.

The following program packages have been tested:

- Symantec Endpoint Security – virus-protection software
- FileShredder - for reliable deletion of files on the hard disk

4.2.5.1 Virus Protection

Take appropriate steps to protect your instruments from infection. Use strong firewall settings and scan any removable storage device used with a Rohde & Schwarz instrument regularly. It is also recommended that you install anti-virus software on the instrument. Rohde & Schwarz does NOT recommend running anti-virus software in the background ("on-access" mode) on Windows-based instruments, due to potentially degrading instrument performance. However, Rohde & Schwarz does recommend running it during non-critical hours.

For details and recommendations, see the following Rohde & Schwarz white paper:

- [1EF96: Malware Protection Windows 10](#)

4.2.5.2 Service Packs and Updates

Microsoft regularly creates security updates and other patches to protect Windows-based operating systems. These are released through the Microsoft Update website and associated update server. Instruments using Windows, especially those that connect to a network, should be updated regularly.

For details and recommendations, see the following Rohde & Schwarz white paper:

- [1EF96: Malware Protection Windows 10](#)

4.2.5.3 Login

Windows 10 requires that users identify themselves by entering a user name and password in a login window. By default, the R&S FSVA/FSV provides two user accounts:

- **"Instrument"**: an administrator account with unrestricted access to the computer/domain
- **"NormalUser"**: a standard user account with limited access

Some administrative tasks require administrator rights (e.g. the configuration of a LAN network). Refer to the description of the basic instrument setup ([SETUP] menu) to find out which functions are affected.

Automatic login

For the administrator account, an automatic login function is active by default. If activated, login is carried out automatically for the administrator (with full access) in the background when the R&S FSVA/FSV is started, without having to enter a password. This function is active until you explicitly deactivate it or change the password.

For information on how to deactivate or reactivate the automatic login, refer to ["Automatic Login Function"](#) on page 45.

Passwords

For all default user accounts, the initial password is *894129*. Note that this password is very weak, and it is recommended that you change the password for both users after initial login.

To change the password in Windows 10

1. From the Windows desktop, select "Start > Settings > Account > SignIn Options > Password > Change".
2. When you change the default passwords, the default auto-login function no longer works. Change the password for the auto-login function, as well, as described in ["Adapting the automatic login function to a new password"](#) on page 46.

Automatic Login Function

When shipped, the instrument automatically logs on the default "Instrument" user to Windows 10 using the default password.

Switching users when using the automatic login function

Which user account is used is defined during login. If automatic login is active, the login window is not displayed. However, you can also switch the user account to be used when the automatic login function is active.



1. Press the "Windows" key or the [CTRL + ESC] key combination on your keyboard to access the operating system of the R&S FSVA/FSV (see also [Chapter 4.2.5.4, "Accessing the Start Menu"](#), on page 47).
2. Press [CTRL + ALT + DEL], then select "Sign out".

The "Login" dialog box is displayed, in which you can enter the different user account name and password.

Deactivating the automatic login function

To deactivate the automatic login function, perform the following steps:



1. Press the "Windows" key or the [CTRL + ESC] key combination on your keyboard to access the operating system of the R&S FSVA/FSV (see also [Chapter 4.2.5.4, "Accessing the Start Menu"](#), on page 47).
2. In the "Start" menu, select "Run".
The "Run" dialog box is displayed.
3. Enter the command `C:\R_S\INSTR\USER\NO_AUTOLOGIN.REG`.
4. Press the [ENTER] key to confirm.
This command deactivates the automatic login function. The next time you switch on the instrument, the operating system prompts you to enter your user name and password before it starts the firmware.

Adapting the automatic login function to a new password

If you change the "Instrument" user's password, which is used during automatic login, this function no longer works. Adapt the settings for the command that activates the auto login function first.

1. Open the `C:\R_S\INSTR\USER\NO_AUTOLOGIN.REG` file in any text editor (e.g. Notepad).
2. In the line `"DefaultPassword"="894129"`, replace the default password (894129) by the new password for automatic login.
3. Save the changes to the file.

Reactivating the automatic login function



1. Press the "Windows" key or the [CTRL + ESC] key combination on your keyboard to access the operating system of the R&S FSVA/FSV (see also [Chapter 4.2.5.4, "Accessing the Start Menu"](#), on page 47).
2. In the "Start" menu, select "Run".
The "Run" dialog box is displayed.
3. Enter the command `C:\R_S\INSTR\USER\AUTOLOGIN.REG`.
4. Press the [ENTER] key to confirm.
This command reactivates automatic login function. It is active the next time the instrument reboots.

4.2.5.4 Accessing the Start Menu

The Windows "Start" menu provides access to the Windows 10 functionality and installed programs.

To open the "Start" menu:



- ▶ Select the "Windows" icon in the toolbar, or press the "Windows" key or the [CTRL + ESC] key combination on the (external) keyboard.

All necessary system settings can be defined in the "Start > Settings" menu.

(For required settings refer to the Windows 10 documentation and to the hardware description).

4.2.5.5 Accessing the Windows Taskbar

The Windows taskbar also provides quick access to commonly used programs, for example Paint or WordPad. IECWIN, the auxiliary remote control tool provided free of charge and installed by Rohde & Schwarz, is also available from the taskbar.



For details on the IECWIN tool, see the "Network and Remote Control" chapter of the R&S FSVA/FSV user manual.



To open the taskbar, press the "Windows" key or the [CTRL + ESC] key combination on your keyboard.

4.3 Firmware Update and Installation of Firmware Options

This chapter describes how to update the firmware and how to activate optional firmware packages.



Updating the firmware or installing optional firmware requires administrator rights (see [Chapter 4.2.5.3, "Login"](#), on page 45).

4.3.1 Firmware Update

You can install a new firmware version using one of the following methods:

- Copying the files to the instrument using USB devices (e.g. a memory stick), GPIB, or LAN
- Using the "Remote Installation" feature in a LAN network

Copying the files to the instrument

1. Press the [SETUP] key.
2. Press the "More" softkey.
3. Press the "Firmware Update" softkey.
The "Firmware Update" dialog box is displayed.
4. Enter the drive name and directory via the keypad.
Example: The installation files are stored on a memory stick in the `Update` directory. After you insert the memory stick, it will be detected as drive `D:`. Therefore, the required path specification is `D:\UPDATE`.
5. If you install via LAN using the Remote Desktop application, enter the drive name and directory or press the "Browse" button to locate the directory:
 - a) In the displayed dialog box, select the drive.
 - b) On the selected drive, select the folder that contains the installation file (*.exe).
 - c) Press the "Select" button to confirm your selection and go back to the "Firmware Update" dialog box.
6. Press "Execute"
The installation program will guide you through the installation.
7. After the firmware update, the "UNCAL" status display indicates the necessity of a self alignment. Perform a self alignment (for details refer to [Chapter 4.2.1.9, "Performing a Self Alignment and a Self Test"](#), on page 32).
Remote command: `SYST:FIRM:UPD 'D:\FW_UPDATE'`

Performing a remote installation from a Windows PC

This method requires a LAN connection from the instrument to a Windows PC (see [Chapter 6.2.5.1, "Connecting the Instrument to the Network"](#), on page 596).

1. Run the `Setup.exe` file on your PC.
2. Select "Remote Installation" and click the "Next" button.
3. Select the packages you want to install and click the "Next" button.
4. Your LAN subnet is scanned and all found instruments are listed.
Note: The setup procedure communicates with the instrument via LAN, which means the file must pass the firewall. Therefore, add the `Setup.exe` file to your firewall rules, then restart the scan by clicking "Rescan".
5. Select the instruments you want to update. You can select up to 5 instruments to update at the same time.
Note: All instruments in your LAN structure are included in the list. Make sure you select the correct instruments!
To display further options, click the "Options" button.
6. Start installation by clicking "Install".

7. Confirm that you want to reboot the instrument in order to activate the firmware update. The instrument restarts automatically.

4.3.2 Activating Firmware Options

Firmware options are enabled by entering license keys as described here.

To activate firmware options

1. Press the [SETUP] key.
2. Press the "More" softkey.
3. Press the "Option Licenses" softkey.
4. Press the "Install Option" softkey.
An edit dialog box is displayed.
5. Enter the option key number using the keypad.
6. Press the [ENTER] key.
If validation is successful, the message "option key valid" is displayed. If the validation fails, the option software is not installed.
7. Reboot the instrument.



With time-limited licenses, a message box appears if an option is about to expire. Press the "OK" button to resume using the R&S FSVA/FSV. If an option has already expired, a message box appears for you to confirm. In this case, all instrument functions are unavailable (including remote control) until the R&S FSVA/FSV is rebooted.

Alternatively, you can activate options using an XML file.

To activate firmware options using an XML file

1. Press the [SETUP] key.
2. Press the "More" softkey.
3. Press the "Option Licenses" softkey.
4. Press the "Install Option by XML" softkey.
An edit dialog box is displayed.
5. Enter or browse for the name of an XML file on the instrument that contains the option key.
6. Press "Select."
If validation is successful, the message "option key valid" is displayed. If the validation fails, the option software is not installed.
7. Reboot the instrument.

4.4 Basic Operations

This chapter gives an overview on how to work with the R&S FSVA/FSV. It describes what kind of information is displayed in the diagram area, how to operate the R&S FSVA/FSV via the front panel keys and other interaction methods, and how to use the Online Help.



Note the [Conventions Used in the Documentation](#) concerning procedure descriptions and terminology described at the beginning of this manual.

4.4.1 Information in the Diagram Area

The following figure shows a measurement diagram during analyzer operation. All different information areas are labeled. They are explained in more detail in the following sections.

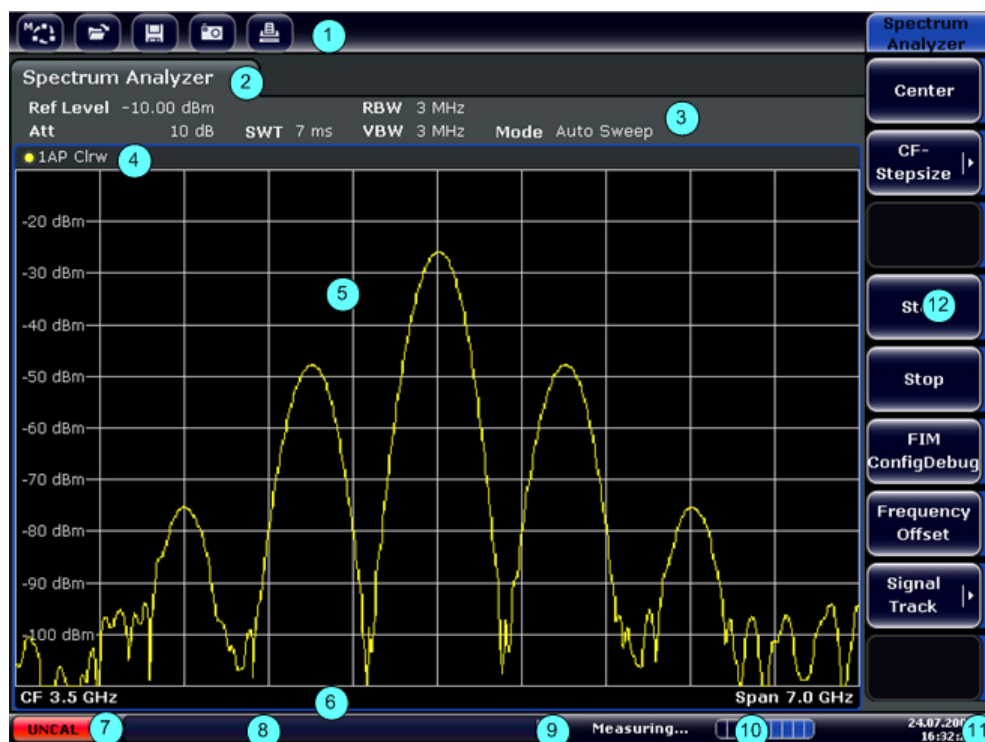



Figure 4-6: Screen layout of the R&S FSVA/FSV during analyzer operation

- 1 = Toolbar
- 2 = Channel information bar for firmware and measurement settings
- 3 = Toolbar toggle icon
- 4 = Diagram header with diagram-specific (trace) information
- 5 = Diagram area
- 6 = Diagram footer with diagram-specific information, depending on measurement mode
- 7 = Device status bar with error messages, progress bar and date/time display

4.4.1.1 Channel Display

Using the R&S FSVA/FSV you can handle several different measurement tasks (channels) at the same time (although they can only be performed asynchronously). For each channel, a separate tab is displayed on the screen. In order to switch from one channel display to another, simply press the corresponding tab.



The  icon on the tab label indicates that the displayed trace no longer matches the current instrument settings. This may be the case, for example, if a trace is frozen and the instrument settings are changed. As soon as a new measurement is performed, the icon disappears.

To start a new channel

1. Click the icon in the toolbar at the top of the screen (see also [Chapter 4.4.2.1, "Toolbar"](#), on page 57 on how to display the toolbar).
2. Select the softkey for the required measurement mode.
A new tab is displayed for the new channel.

4.4.1.2 Display of Hardware Settings

Information on hardware settings are displayed in the channel bar above the diagram.

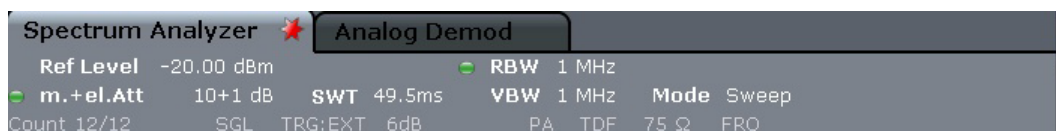

Invalid settings

A bullet next to the hardware setting indicates that user-defined settings are used, not automatic settings. A green bullet indicates this setting is valid and the measurement is correct. A red bullet indicates an invalid setting that does not provide useful results. It is the user's responsibility to remedy such a situation.



Editing settings in the channel bar

All settings that are displayed in the channel bar can easily be edited by touching the setting in the display (with a finger or mouse pointer). The corresponding (edit) dialog box is displayed where you can edit the setting.

In spectrum mode, the R&S FSVA/FSV shows the following settings:

Ref Level	Reference level
m.+el.Att	Mechanical and electronic RF attenuation that has been set.

Ref Offset	Reference level offset
SWT	Sweep time that has been set. If the sweep time does not correspond to the value for automatic coupling, a bullet is displayed in front of the field. The color of the bullet turns red if the sweep time is set below the value for automatic coupling. In addition, the UNCAL flag is shown. In this case, the sweep time must be increased.
RBW	Resolution bandwidth that has been set. If the bandwidth does not correspond to the value for automatic coupling, a green bullet appears in front of the field.
VBW	Video bandwidth that has been set. If the bandwidth does not correspond to the value for automatic coupling, a green bullet is displayed in front of the field.
Compatible	Compatible device mode (FSP, FSU, default; default not displayed)
Mode	Indicates which sweep mode type is selected: <ul style="list-style-type: none"> • "Auto FFT": automatically selected FFT sweep mode • "Auto sweep": automatically selected swept sweep mode • "FFT": manually selected FFT sweep mode • "Sweep": manually selected swept sweep mode
Mod	Analog demodulation mode (AM/FM/PM), option R&S FSV-K7 only
AQT	Acquisition time; for ACP/CCDF measurements, IQ analyzer and option R&S FSV-K7
DBW	Demodulation bandwidth option R&S FSV-K7 only
Dig Out	State of digital output, option R&S FSV-B17 only

4.4.1.3 Measurement Settings Information

In addition to the common hardware settings, the channel bar above the diagram also displays information on instrument settings that affect the measurement results even though this is not immediately apparent from the display of the measured values. This information is displayed in gray font and only when applicable for the current measurement, as opposed to the common hardware settings that are always displayed.

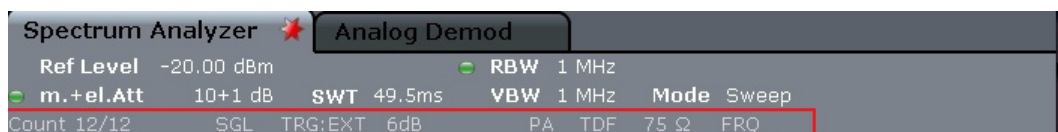

The following types of information may be displayed, if applicable.

Label	Description
SGL	The sweep is set to single sweep mode.
Sweep Count	The current signal count for measurement tasks that involve a specific number of subsequent sweeps (see "Sweep Count" setting in "Sweep" menu in the Operating manual)

Label	Description
TRG	Trigger source (for details see trigger settings in the "TRIG" menu in the Operating manual) <ul style="list-style-type: none"> • EXT: External • VID: Video • RFP: RF power • IFP: IF power • BBP: Baseband power • PSE: Power sensor • TIM: Time • SQL: Squelch
6dB/RRC/CHN	Filter type for sweep bandwidth (see BW menu in the Operating manual)
PA	The preamplifier is activated.
GAT	The frequency sweep is controlled via the [EXT TRIG/GATE IN] connector.
TDF	A transducer factor is activated.
75 Ω	The input impedance of the instrument is set to 75 Ω.
FRQ	A frequency offset ≠ 0 Hz is set.
DC/AC	An external DC or AC calibration signal is in use.
Inp	Input source: digital I/Q (option R&S FSV-B17 only)

4.4.1.4 Diagram-specific and Trace Information

Diagram-specific information, e.g. concerning traces, is indicated in the diagram header and footer.

Trace information in diagram header

The diagram header (above the diagram) contains the following trace information:



The header may contain a user-defined introductory title, see [Chapter 4.4.4.7, "Adding a Title to the Diagram Header"](#), on page 75.



Editing settings in the diagram header

All settings that are displayed in the diagram header can easily be edited by selecting the setting in the display (by tapping or clicking). The corresponding (edit) dialog box is displayed in which you can edit the setting.

Norm/NCor

Correction data is not used.

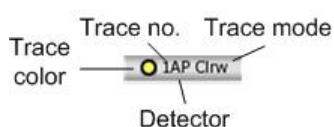

Trace color		Color of trace display in diagram
Trace no.		Trace number (1 to 6)
Detector		Selected detector:
	AP	AUTOPEAK detector
	Pk	MAX PEAK detector
	Mi	MIN PEAK detector
	Sa	SAMPLE detector
	Av	AVERAGE detector
	Rm	RMS detector
	QP	QUASIPeAK detector
	CA	CISPR Average detector
	RA	RMS Average detector
Trace Mode		Sweep mode:
	ClrW	CLEAR/WRITE
	Max	MAX HOLD
	Min	MIN HOLD
	Avg	AVERAGE (Lin/Log/Pwr)
	View	VIEW

Marker information in Diagram Grid

The x and y axis positions of the last 2 markers or delta markers that were set, as well as their index, are displayed within the diagram grid, if available. The value in the square brackets after the index indicates the trace to which the marker is assigned. (Example: M1[1] defines marker 1 on trace 1.) For more than 2 markers, a separate marker table is displayed beneath the diagram.

If applicable, the active measurement function for the marker and its main results are indicated, as well. The functions are indicated with the following abbreviations:

FXD	Reference fixed marker active
PHNoise	Phase noise measurement active
CNT	Frequency counter active
TRK	Signal track active
NOIse	Noise measurement active
MDepth	Measurement of the AM modulation depth active
TOI	TOI measurement active

Marker Information in Marker Table

In addition to the marker information displayed within the diagram grid, a separate marker table may be displayed beneath the diagram. This table provides the following information for all active markers:

Type	Marker type: N (normal), D (delta), T (temporary, internal), PWR (power sensor)
Dgr	Diagram number
Trc	Trace to which the marker is assigned
Stimulus	x-value of the marker
Response	y-value of the marker
Func	Activated marker or measurement function
Func .Result	Result of the active marker or measurement function

Mode-dependant Information in Diagram Footer

The diagram footer (beneath the diagram) contains the following information, depending on the current mode:

Mode	Label	Information
FREQ	CF	Center frequency (between start and stop)
	Span	Frequency span
SPAN	CF (1.0 ms/)	Zero span

For most modes, the number of sweep points shown in the display are indicated in the diagram footer. In zoom mode, the (rounded) number of currently displayed points are indicated.

The diagram footer can be removed from the display temporarily, see [Chapter 4.4.4.8, "Removing the Diagram Footer"](#), on page 76.

4.4.1.5 Instrument and Status Information

Global instrument settings, the instrument status and any irregularities are indicated in the status bar beneath the diagram.



Hiding the status bar

You can hide the status bar display, e.g. in order to enlarge the display area for the measurement results.

1. Press the [DISPLAY] key.
2. In the "Display Settings" dialog box, select "Status Bar State: Off".

The status bar is no longer displayed.



- To display the status bar again, select "Status Bar State: On".

SCPI command:

```
DISP:SBAR:STAT OFF
```

The following information is displayed:

Instrument status

	The instrument is configured for operation with an external reference.
	The optional Digital Baseband interface (B17) is being used for digital input (See Chapter 5.7.5, "Interface Status Information" , on page 484)
	The optional Digital Baseband interface (B17) is being used to provide digital output (See Chapter 5.7.5, "Interface Status Information" , on page 484)

Error information

If errors or irregularities are detected, a keyword and an error message, if available, are displayed in the status bar.



The following keywords are used:

UNCAL	One of the following conditions applies: <ul style="list-style-type: none"> • Correction data has been switched off. • No correction values are available. This occurs, for example, if a firmware update is performed followed by a cold start of the instrument. • Record the correction data by performing a self alignment (for details refer to Chapter 4.2.1.9, "Performing a Self Alignment and a Self Test", on page 32).
OVL	Overload of the input mixer. <ul style="list-style-type: none"> • Increase the RF attenuation (for RF input). • Reduce the input level (for digital input)
IFOVL	Overload of the IF signal path after the input mixer. <ul style="list-style-type: none"> • Increase the reference level.
LOUNL	Error in the instrument's frequency processing hardware was detected.
NO REF	Instrument was set to an external reference but no signal was detected on the reference input.
OVEN	OXCXO reference frequency (option R&S FSV-B4) has not yet reached its operating temperature. The message usually disappears a few minutes after power has been switched on.
FIFO OVL	for option R&S FSV-B17 only (See Chapter 5.7.5, "Interface Status Information" , on page 484)

Progress

The progress of the current operation is displayed in the status bar.



Date and time

The date and time settings of the instrument are displayed in the status bar.



4.4.2 Means of User Interaction

The instrument provides a user interface for operation that does not require an external keyboard, using the following means of interaction:

- [Chapter 4.4.2.1, "Toolbar"](#), on page 57
- [Chapter 4.4.2.2, "Touchscreen"](#), on page 58
- [Chapter 4.4.2.3, "On-screen Keyboard"](#), on page 59
- [Chapter 4.4.2.5, "Rotary Knob"](#), on page 61
- [Chapter 4.4.2.6, "Arrow Keys, UNDO/REDO Keys"](#), on page 61
- [Chapter 4.4.2.7, "Softkeys"](#), on page 62
- [Chapter 4.4.2.9, "Dialog Boxes"](#), on page 64

All tasks necessary to operate the instrument can be performed using this user interface. Apart from instrument specific keys, all other keys that correspond to an external keyboard (e.g. arrow keys, ENTER key) operate conform to Microsoft.

For most tasks, there are at least 2 alternative methods to perform them:

- Using the touchscreen
- Using other elements provided by the front panel, e.g. the keypad, rotary knob, or arrow and position keys

4.4.2.1 Toolbar

Standard functions can be performed via the icons in the toolbar at the top of the screen, if available (see [Chapter 4.4, "Basic Operations"](#), on page 50). By default, this toolbar is not displayed.

Displaying the toolbar

- ▶ Press the "Toolbar" icon to the right of the tabs in the display to toggle the toolbar on or off.



Alternatively:











1. Press the [SETUP] key.
2. Press the "Display Setup" softkey.
3. Press the "Tool Bar State On/Off" softkey.
Or:
4. Press the [DISPLAY] key.
5. In the "Display Settings" dialog box, select "Tool Bar State: On".
The toolbar is displayed at the top of the screen.

Remote:

DISP:TBAR:STAT ON

The following functions are available:

Table 4-2: Standard Application Functions in the Toolbar

Icon	Description
	Opens the "Select Mode" menu (see Chapter 4.4.1.1, "Channel Display" , on page 51)
	Opens an existing measurement (settings) file
	Stores the current measurement file
	Prints the current measurement screen
	Saves the current measurement screen as a file (screenshot)
	Reverts last operation.
	Repeats previously reverted operation.
	Selection mode: the cursor can be used to select (and move) markers in a zoomed display
	Zoom mode: displays a dotted rectangle in the diagram that can be expanded to define the zoom area. Can be repeated several times.
	Zoom off: the diagram is displayed in its original size

4.4.2.2 Touchscreen

A touchscreen is a screen that is touch-sensitive, i.e. it reacts in a specified way when a particular element on the screen is tapped by a finger or a pointing device, for example. Any user interface elements that can be clicked on by a mouse pointer can also be tapped on the screen to trigger the same behavior, and vice versa. Using the touchscreen, the following tasks (among others) can be performed by the tap of your finger:

- Changing a setting
- Changing the display
- Moving a marker
- Zooming into a diagram
- Saving or printing results and settings

To imitate a right-click by mouse using the touchscreen, for example to open a context-sensitive menu for a specific item, press the screen for about 1 second.

Deactivating and Activating the Touchscreen Function

The touchscreen function can be deactivated, e.g. when the instrument is being used for demonstration purposes and tapping the screen should not provoke an action.

1. Press the [DISPLAY] key.
2. In the dialog box, select one of the following options:
 - "Touchscreen ON": touchscreen function is active for the entire screen
 - "Touchscreen OFF": touchscreen is deactivated for the entire screen
 - "DIAGRAM TOUCH OFF": touchscreen is deactivated for the diagram area of the screen, but active for the surrounding softkeys, toolbars and menus.

SCPI command:

```
DISP:TOUCH:STAT OFF
```

4.4.2.3 On-screen Keyboard

The on-screen keyboard is an additional means of interacting with the instrument without having to connect an external keyboard.

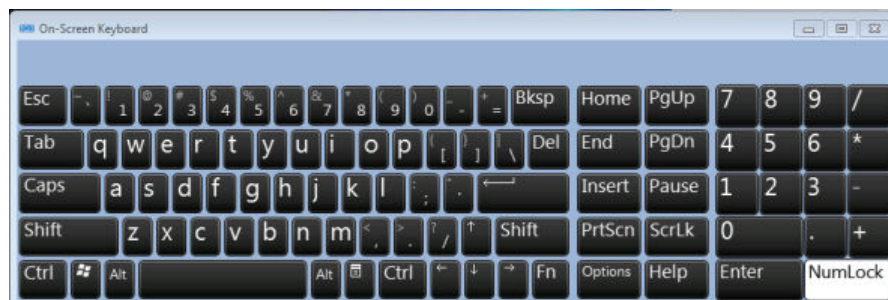

The on-screen keyboard display can be switched on and off as desired using the "On-Screen Keyboard" function key beneath the screen.



When you press this key, the display switches between the following options:

- Keyboard displayed at the top of the screen
- Keyboard displayed at the bottom of the screen
- No keyboard displayed



You can use the TAB key on the on-screen keyboard to move the focus from one field to another in dialog boxes.

4.4.2.4 Keypad



The keypad is used to enter alphanumeric parameters. It contains the following keys:

- Alphanumeric keys
 - Enters numbers and (special) characters in edit dialog boxes. For details refer to [Chapter 4.4.3.1, "Entering Numeric Parameters"](#), on page 65 and [Chapter 4.4.3.2, "Entering Alphanumeric Parameters"](#), on page 65.
- Decimal point
 - Inserts a decimal point "." at the cursor position.
- Sign key
 - Changes the sign of a numeric parameter. In the case of an alphanumeric parameter, inserts a "-" at the cursor position.
- Unit keys (GHz/dBm MHz/dBm, kHz/dB and Hz/dB)
 - These keys add the selected unit to the entered numeric value and complete the entry.
 - In the case of level entries (e.g. in dB) or dimensionless values, all units have the value "1" as multiplying factor. Thus, they have the same function as an ENTER key. The same is true for an alphanumeric entry.
- ESC key
 - Closes all kinds of dialog boxes, if the edit mode is not active. Quits the edit mode, if the edit mode is active. In dialog boxes that contain a "Cancel" button it activates that button.
 - For "Edit" dialog boxes the following mechanism is used:
 - If data entry has been started, it retains the original value and closes the dialog box.
 - If data entry has not been started or has been completed, it closes the dialog box.
- BACKSPACE key
 - If an alphanumeric entry has already been started, this key deletes the character to the left of the cursor.
 - If no input field is currently active, the most recently entered value is undone, i.e. the previous value is retrieved. Thus, you can toggle between two values (e.g. spans).
- ENTER key
 - Concludes the entry of dimensionless entries. The new value is accepted.
 - With other entries, this key can be used instead of the "Hz/dB" unit key.
 - In a dialog box, presses the default or focused button.
 - In a dialog box, activates the edit mode for the focused area, if available. For details on the edit mode refer to [Chapter 4.4.3.3, "Navigating in Dialog Boxes"](#), on page 67.

- In a dialog box, activates or deactivates the selected option of the focused area, if the edit mode is active.

4.4.2.5 Rotary Knob



The rotary knob has several functions:

- Increments (clockwise direction) or decrements (counter-clockwise direction) the instrument parameter at a defined step width in the case of a numeric entry.
- Shifts the selection bar within focused areas (e.g. lists), if the edit mode is activated.
- Shifts markers, limit lines, etc on the screen.
- Acts like the ENTER key, when it is pressed. For details refer to [Chapter 4.4.3.3, "Navigating in Dialog Boxes"](#), on page 67.
- Moves the scroll bar vertically, if the scroll bar is focused and the edit mode is activated.

For details on the edit mode refer to [Chapter 4.4.3.3, "Navigating in Dialog Boxes"](#), on page 67.

4.4.2.6 Arrow Keys, UNDO/REDO Keys

The arrow keys are used for navigation. The [UNDO]/[REDO] keys support you during input.



UPARROW/DNARROW keys

The [UPARROW] or [DNARROW] keys do the following:

- In a numeric edit dialog box, increase or decrease the instrument parameter.
- In a list, scroll forward and backward through the list entries.
- In a table, move the selection bar vertically.
- In windows or dialog boxes with vertical scroll bar, move the scroll bar.

LEFTARROW/RIGHTARROW keys

The [LEFTARROW] or [RIGHTARROW] keys do the following:

- In an alphanumeric edit dialog box, move the cursor.
- In a list, scroll forward and backward through the list entries.
- In a table, move the selection bar horizontally.
- In windows or dialog boxes with horizontal scroll bar, move the scroll bar.

UNDO/REDO keys

- The [UNDO] key reverts the previously performed action, i.e. the status before the previous action is retrieved.
The undo function is useful, for example, if you are performing a zero span measurement with several markers and a limit line defined and accidentally click the "ACP" softkey. In this case, very many settings would be lost. However, if you press [UNDO] immediately afterwards, the previous status is retrieved, i.e. the zero span measurement and all settings.
- The [REDO] key repeats the previously reverted action, i.e. the most recently performed action is repeated.



The [UNDO] function is not available after a [PRESET] or "RECALL" operation. When these functions are used, the history of previous actions is deleted.

4.4.2.7 Softkeys

Softkeys are virtual keys provided by the software. Thus, more functions can be provided than those that can be accessed directly via the function keys on the device. Softkeys are dynamic, i.e. depending on the selected function key, a different list of softkeys is displayed on the right side of the screen

A list of softkeys for a certain function key is also called a menu. Each softkey can either represent a specific function, or a submenu that in turn represents several softkeys.

Selecting softkeys

- ▶ A particular softkey is selected by pressing the key on the screen with a finger, mouse pointer or other pointing device.



Softkeys can only be operated via the screen, there are (usually) no corresponding function keys.

Navigating in softkey menus

- The "More" softkey indicates that the menu contains more softkeys than can be displayed at once on the screen. When pressed, it displays the next set of softkeys.
- If the softkey label contains a ">" symbol, it represents a submenu of further softkeys. When you press it, the submenu is displayed.
- The "Up" key switches to the next higher level of the menu.
- The start menu of the current measurement mode is accessed directly by pressing the [HOME] key on the front panel.

Softkey actions

A softkey performs one of the following actions when pressed:

- Opens a dialog box to enter data.
- Switches a function on or off.
- Opens a submenu (only softkeys with a ">" symbol).

Recognizing the softkey status by color

In the factory configuration, a softkey is highlighted orange when a corresponding dialog box is open. If it is a toggle softkey, the current state is highlighted blue. If an instrument function is not available temporarily due to a specific setting, the associated softkey is deactivated and its text is colored gray.

Some softkeys belong to a certain (firmware) option. If this option is not implemented in your device, the associated softkeys are not displayed.

Hiding softkeys

You can hide the softkey display, e.g. when using remote control, in order to enlarge the display area for the measurement results. When you press a function key on the front panel, the softkeys are displayed temporarily, enabling you to perform a certain task with the softkeys. They are then automatically hidden again when they have not been used for a specified time. Any edit dialog boxes required for entry remain in the display.

1. Press the [DISPLAY] key.
2. In the "Display Settings" dialog box, select "Softkey Bar State: Off".
The softkeys are no longer displayed.

► To display the softkeys again, select "Softkey Bar State: On".

Remote:

```
DISP:SKEY:STAT OFF
```

4.4.2.8 Context-sensitive Menus

Markers and traces in the display, as well as the information in the channel bar, have context-sensitive menus. If you right-click on a marker or trace in the display, or information in the channel bar (or touch it for about 1 second), a menu is displayed which contains the same functions as the corresponding softkey. This is useful, for example, when the softkey display is hidden (see [Chapter 4.4.2.7, "Softkeys"](#), on page 62).

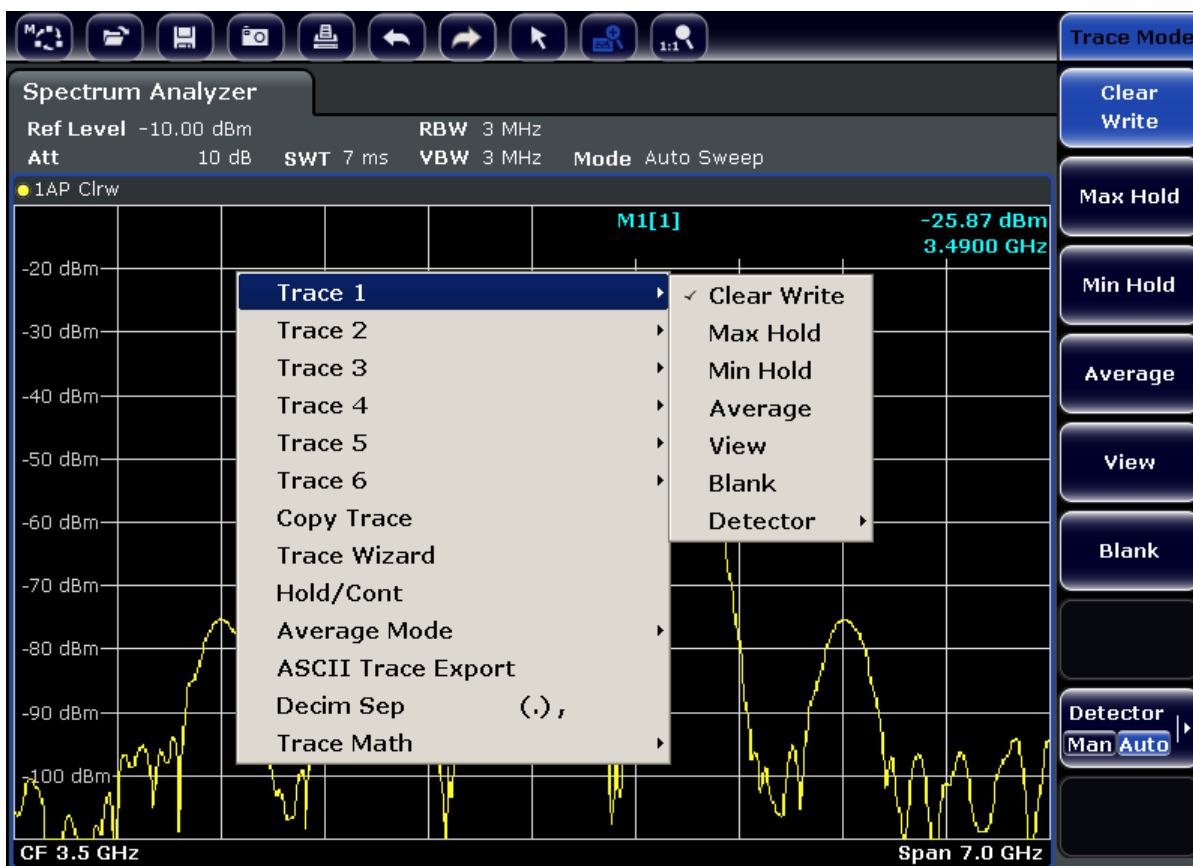

If a menu entry contains an arrow to the right of it, a submenu is available for that entry.

- ▶ To close the menu, press the ESC key or click in the display outside of the menu.

4.4.2.9 Dialog Boxes

In most cases, the R&S FSVA/FSV dialog boxes are designed to enter a numeric value. In the documentation, these dialog boxes are called "edit dialog boxes". Dialog boxes that are not only designed for parameter entry have a more complex structure and, in the documentation, are called "dialog boxes". The navigation in Windows dialog boxes differs in some aspects from the navigation in R&S FSVA/FSV dialog boxes. For details, see [Chapter 4.4.3.3, "Navigating in Dialog Boxes"](#), on page 67.

The following figure shows an example of a edit dialog box:

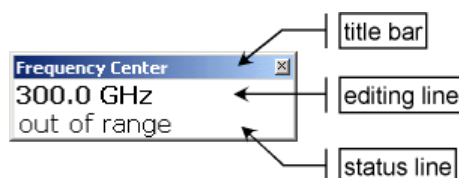

Figure 4-7: Edit dialog box for parameter entry

The title bar shows the name of the parameter that was selected. The entry is performed in the editing line. When the dialog box is displayed, the focus is on the editing line and it contains the currently used parameter value and its unit. The optional third line shows status and error messages which always refer to the current entry.

4.4.3 Setting Parameters

This section describes how to perform the following basic tasks in the R&S FSVA/FSV:

- [Chapter 4.4.3.1, "Entering Numeric Parameters"](#), on page 65
- [Chapter 4.4.3.2, "Entering Alphanumeric Parameters"](#), on page 65
- [Chapter 4.4.3.3, "Navigating in Dialog Boxes"](#), on page 67

4.4.3.1 Entering Numeric Parameters

If a field requires numeric input, the keypad provides only numbers.

1. Enter the parameter value using the keypad, or change the currently used parameter value by using the rotary knob (small steps) or the UPARROW or DNARROW keys (large steps).
2. After entering the numeric value via keypad, press the corresponding unit key. The unit is added to the entry.
3. If the parameter does not require a unit, confirm the entered value by pressing the ENTER key or one of the unit keys. The editing line is highlighted in order to confirm the entry.

4.4.3.2 Entering Alphanumeric Parameters

If a field requires alphanumeric input, you can use the on-screen keyboard to enter numbers and (special) characters (see also [Chapter 4.4.2.3, "On-screen Keyboard"](#), on page 59).

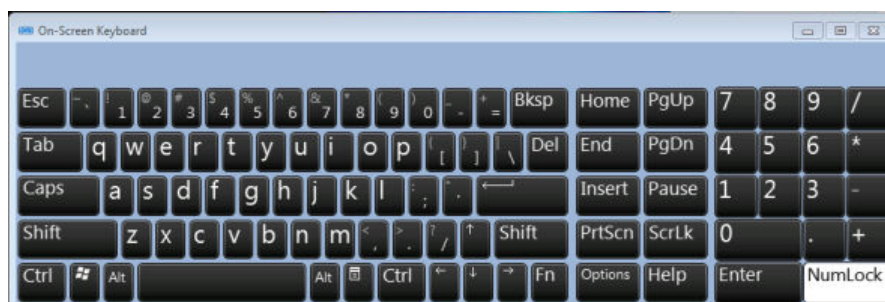

Figure 4-8: On-screen keyboard

Alternatively, you can use the keypad. Every alphanumeric key provides several characters and one number. The decimal point key (.) provides special characters, and the

sign key (-) toggles between capital and small letters. For the assignment refer to [Table 4-3](#).

Entering numbers and (special) characters via the keypad

1. Press the key once to enter the first possible value.
2. All characters available via this key are displayed.
3. To choose another value provided by this key, press the key again, until your desired value is displayed.
4. With every key stroke the next possible value of this key is displayed. If all possible values have been displayed, the series starts with the first value again. For information on the series refer to [Table 4-3](#).
5. To change from capital to small letters and vice versa, press the sign key (-).
6. When you have chosen the desired value, wait for 2 seconds (to use the same key again), or start the next entry by pressing another key.

Entering a blank

- ▶ Press the "Space" bar, or press the "0" key and wait 2 seconds.

Correcting an entry:

1. Using the arrow keys, move the cursor to the right of the entry you want to delete.
2. Press the [BACKSPACE] key.
3. The entry to the left of the cursor is deleted.
4. Enter your correction.

Completing the entry

- ▶ Press the [ENTER] key or the rotary knob.

Aborting the entry

- ▶ Press the [ESC] key.
The dialog box is closed without changing the settings.

Table 4-3: Keys for alphanumeric parameters

Key name (upper inscription)	Series of (special) characters and number provided
7	7 μ Ω ° € ¥ \$ ¢
8	A B C 8 Ä Æ Å Ç
9	D E F 9 É

Key name (upper inscription)	Series of (special) characters and number provided
4	G H I 4
5	J K L 5
6	M N O 6 Ñ Ö
1	P Q R S 1
2	T U V 2 Ü
3	W X Y Z 3
0	<blank> 0 – @ + / \ < > = % &
.	. * : _ , ; ' ' ? () #
–	<toggles between capital and small letters>

4.4.3.3 Navigating in Dialog Boxes

Some of the dialog boxes are not only for parameter entry, and therefore have a more complex structure. The following figure shows an example.

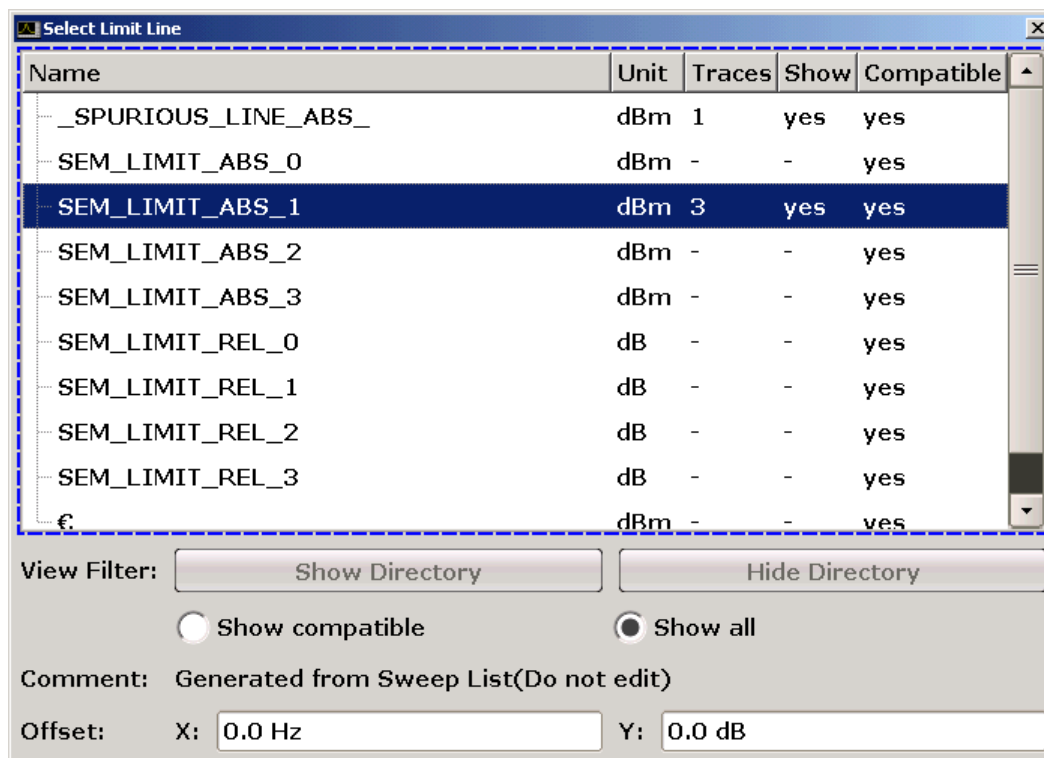

Changing the focus

The focus on the graphical user interface is moved by pressing an element on the screen, or via the rotary knob. The focused area is marked with a blue frame (see [Figure 4-9](#)). If this area consists of more than one element, e.g. lists of options or tables,

you must first switch to the edit mode in order to make changes. A focused area in the edit mode is marked with a dashed blue frame (see [Figure 4-10](#)).

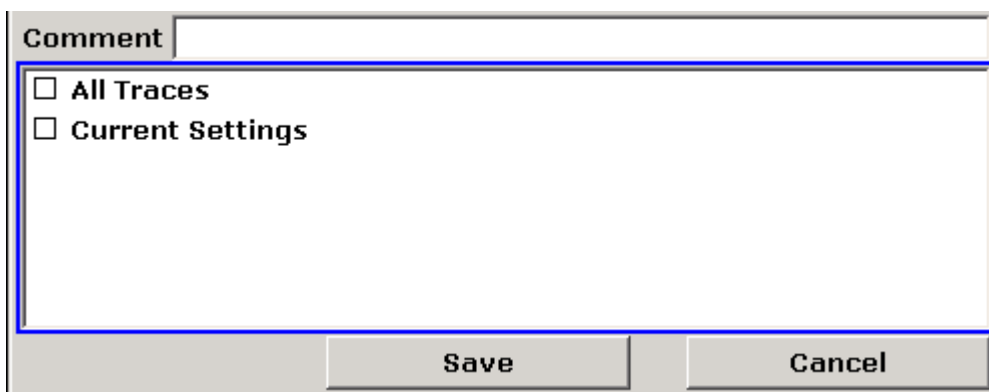

Figure 4-9: Focused area

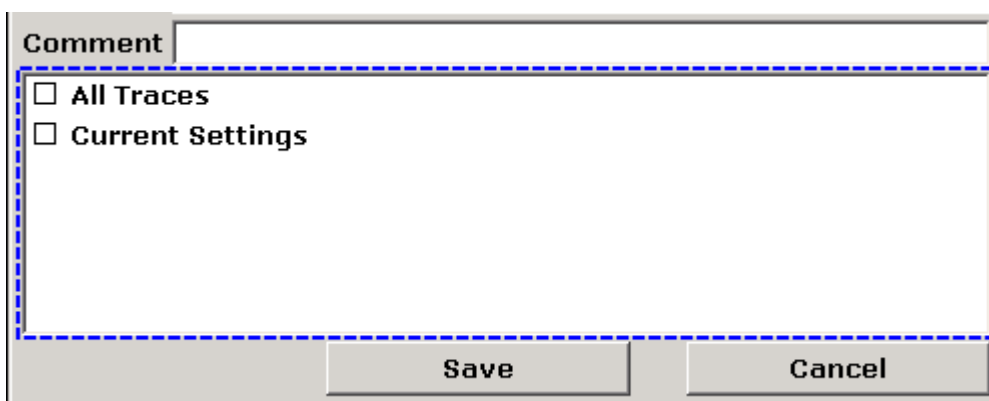

Figure 4-10: Focused area in edit mode



Edit mode

When using the touchscreen for focus changes, all focused areas are in the edit mode automatically, if available. Otherwise, you must switch to edit mode manually.

Switching to edit mode

1. Press the [ENTER] key.
2. To quit the edit mode, press the [ESC] key.

Working in dialog boxes

- To edit alphanumeric parameters, use the keypad or the on-screen keyboard. For details see [Chapter 4.4.3.1, "Entering Numeric Parameters"](#), on page 65 and [Chapter 4.4.3.2, "Entering Alphanumeric Parameters"](#), on page 65. If you edit fields, the edit mode is activated automatically when you start typing.
- To move the focus to the next interface element (e.g. field, option, list), press it on the screen, or turn the rotary knob.

- To select or deselect an option, press the option on the screen.
Alternatively:
 - If the focused area consists of more than one option and the edit mode is not active, change into the edit mode.
 - Scroll through the list of options using the arrow keys or the rotary knob (only for vertical direction) until the option you want to activate or deactivate is highlighted.
 - Press the rotary knob or the [ENTER] key to confirm your selection.
The option is activated or deactivated, depending on its previous setting.
 - To leave the edit mode, press the [ESC] key.
- To open a drop-down list, press the arrow next to the list. Alternatively, press the [ENTER] key or the rotary knob. When opened, the list is in edit mode.
- To select an entry without opening a drop-down list, use the arrow keys to browse through the list entries.
- To select a list entry, press the entry on the screen.
Alternatively:
 - If the edit mode is not active, change into the edit mode.
 - Scroll through the list using the arrow keys or the rotary knob until the list entry you want to select is highlighted.
 - Confirm your choice by pressing the rotary knob or the [ENTER] key.
If a drop-down list was opened, it is closed.
- To change from one tab to the next, press the tab on the screen.
- To press a button in a dialog box, press the button on the screen.
Alternatively:
 - Place the focus on the desired button using the rotary knob.
 - Confirm your choice by pressing the rotary knob or the [ENTER] key.
- To close the dialog box and accept the changes, press the "OK" button.
- To close the dialog box without accepting the changes, press the [ESC] key or the "Cancel" button.

Particularities in Windows dialog boxes

In some cases, e.g. if you want to install a printer, original Windows dialog boxes are used. In these dialog boxes, the navigation behavior is different to the one you are used to from R&S FSVA/FSV applications. In the following, the important differences and useful tips are listed:

- The rotary knob and function keys do not work. Do not use them. Use the touch-screen instead.

4.4.4 Changing the Display

4.4.4.1 Changing the Focus

Any selected function is always performed on the currently focussed element in the display, e.g. a dialog field, diagram, or table row. Which element is focussed is indicated by a blue frame (diagram, window, table) or is otherwise highlighted (softkey, marker etc.). Moving the focus is most easily done by tapping on the element on the touchscreen. Alternatively, use the "Tab" key on the on-screen keyboard or the rotary knob to move the focus from one element to the next on the display.



To move the focus on the screen between any displayed diagrams or tables, press the "Change focus" function key on the front panel. The focus moves from the diagram to the first table to the next table etc. and then back to the diagram.

4.4.4.2 Switching between Split and Maximized Display

	<p>In some measurement modes, a table with markers or measurement results is displayed beneath the diagram. In this case, you may wish to maximize the diagram or table display in order to see more details.</p>
--	---

Press the [SPLIT/MAXIMIZE] key on the front panel to switch between a split screen and a full screen (maximized display). In maximized display, the table or diagram currently focused is maximized. In split display, both the diagram and any available tables are displayed in one screen.

SCPI command:

`DISPlay[:WINDow<n>][:SUBWindow<m>]:SIZE` on page 749

4.4.4.3 Soft and Mini Soft Front Panel Display

When working with an external monitor or operating via remote control on a computer, it is useful to be able to interact with the R&S FSVA/FSV without requiring the keypad and keys located on the front panel of the instrument. Therefore, a "Soft Front Panel" display is available, which simulates the entire front panel of the instrument (except for the external connectors) on the screen. You can switch between "normal" screen display and extended display. In the extended display, the keys and other hardware controls of the instrument are simulated on the screen.

If you require a Soft Front Panel but do not want to lose too much space for results in the display area, a mini soft Front Panel is available. The mini version displays only the hardkeys in a separate window in the display area. This window can be closed automatically after pressing a key, or remain open, as desired. Using the Mini Front Panel, the R&S FSVA/FSV interface is fully operable from a monitor with a resolution of 1024x768 pixels.

Switching to soft Front Panel display

1. Press the SETUP key.
2. Press the "General Setup" softkey.
3. Press the "More" softkey.
4. Press the "Soft Front Panel" softkey.
Alternatively:
5. Press the [DISPLAY] key.
6. In the "Display Settings" dialog box, select "Front Panel State: On".
The extended display appears on the screen.

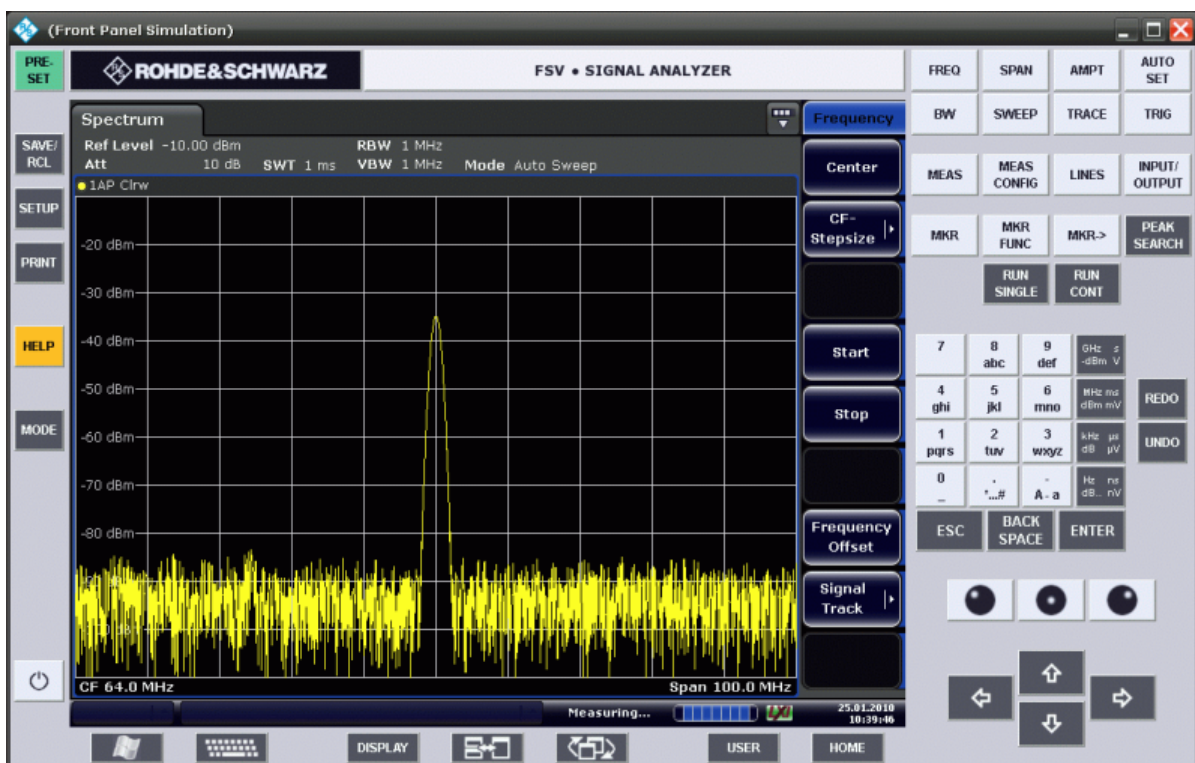



Using the F6 key you can toggle the Front Panel display on and off.

Remote: `SYST:DISP:FPAN:STAT ON`

Working with the Soft Front Panel

Basic operation with the soft Front Panel is identical to normal operation. To activate a key, either press the key on the touchscreen, or click on it with the mouse pointer. To simulate the use of the rotary knob, use the additional keys displayed between the keypad and the arrow keys:

Icon	Function
	Turn left
	Enter
	Turn right

Switching to Mini Front Panel display

1. Press the [DISPLAY] key.
2. In the "Display Settings" dialog box, select "Mini Front Panel State: On".
The "Mini Front Panel" window appears on the screen. It can be moved anywhere on the screen where it does not interfere with your current task.



Using the key combination [ALT + M] you can toggle the Mini Front Panel display on and off.

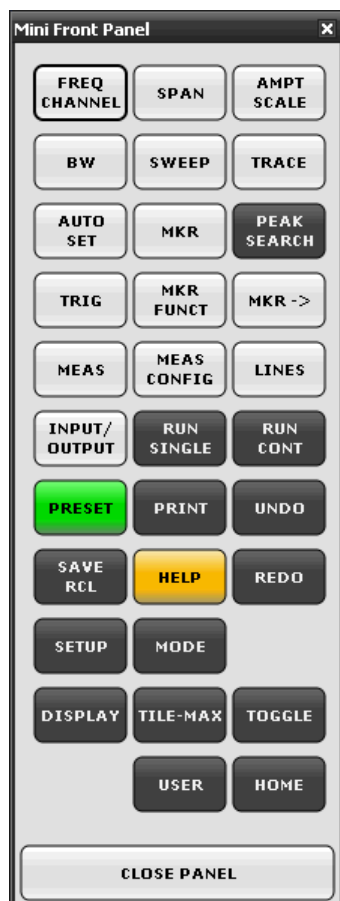

Auto close option

By default, the "Auto close" option is activated and the Mini Front Panel window closes automatically after you select a key. This is useful if you only require the Front Panel display to press a single function key.

If you want the window to remain open, deactivate the "Auto close" option. You can close the window manually by clicking "Close Panel" or the key combination [ALT + M].

4.4.4.4 Enlarging the Display Area



You can enlarge the screen display area if you are using an external monitor or the Soft and Mini Soft Frontpanel display (see [Chapter 4.4.4.3, "Soft and Mini Soft Front Panel Display"](#), on page 70). To do so, drag the lower right corner of the window to the required size. In standard display, a small icon is displayed in the lower right corner of the screen.

4.4.4.5 Displaying the Toolbar

Standard file functions can be performed via the icons in the toolbar at the top of the screen (see the [Chapter 4.4.2.1, "Toolbar"](#), on page 57). By default, this toolbar is not displayed.

To display the toolbar:

1. Press the DISPLAY key.
2. Under "Select Tool Bar State", select "On".

Alternatively:

1. Press the SETUP key.
2. Press the "Display Setup" softkey.
3. Press the "Tool Bar State On/Off" softkey.

The toolbar is displayed at the top of the screen.

4.4.4.6 Zooming into the Diagram

You can zoom into the diagram to visualize the measurement results in greater detail. Using the touchscreen or a mouse pointer you can easily define the area to be enlarged.



Zoom and the number of sweep points

Note that zooming is merely a visual tool, it does not change any measurement settings, such as the number of sweep points!

You should increase the number of sweep points before zooming, as otherwise the function has no real effect (see the "Sweep Points" softkey, described in the Operating Manual and online help).

To zoom into the diagram

1. Display the toolbar as described in [Chapter 4.4.4.5, "Displaying the Toolbar"](#), on page 73.
2.  Click on the "Zoom On" icon in the toolbar.
A dotted rectangle is displayed in the diagram.

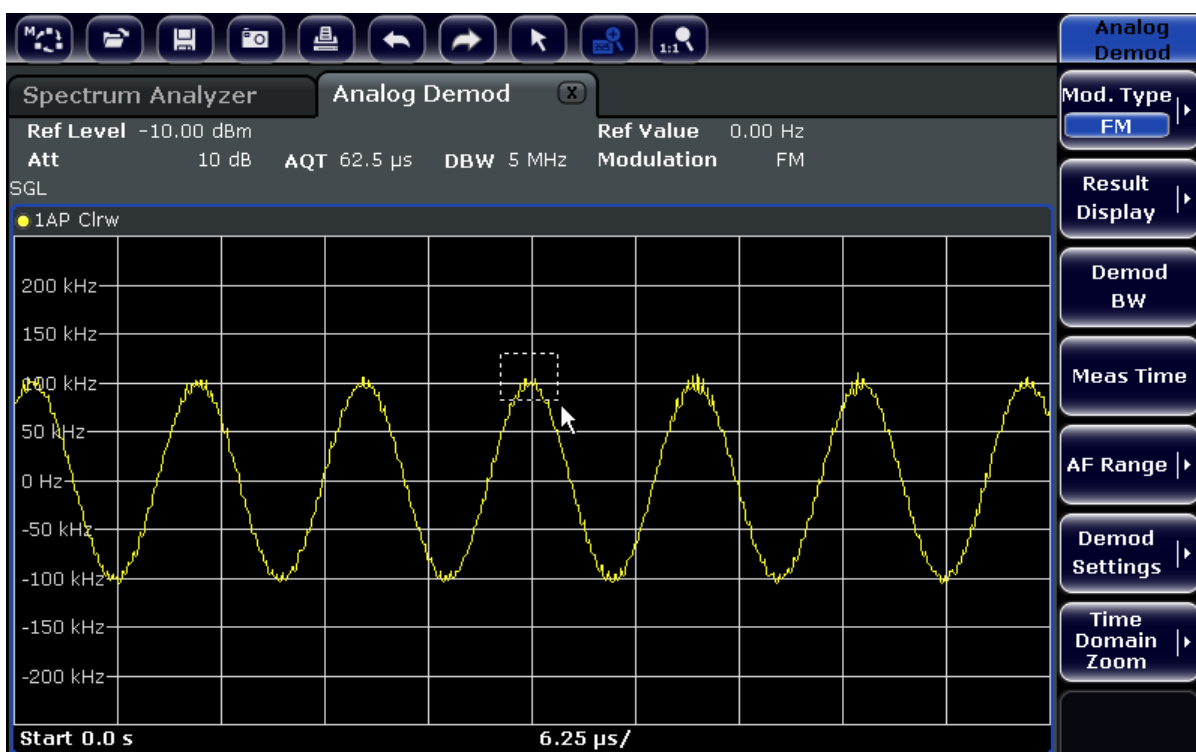

3. Drag the lower right corner of the rectangle (either via touchscreen or a mouse pointer) to define the area in the diagram to be enlarged.
4. Repeat these steps, if necessary, to enlarge the diagram further.



Scrolling in the zoomed display

You can scroll the diagram area to display the entire diagram using the scrollbars at the right and at the bottom of the diagram.



To return to selection mode in the diagram

While you are in zoom mode, touching the screen changes the zoom area. In order to select or move a trace or marker, you must switch back to selection mode:



- ▶ Click on the "Selection mode" icon in the toolbar.

To return to original display



- ▶ Click on the "Zoom Off" icon in the toolbar.
A dotted rectangle is displayed in the diagram.

Remote commands:

1. Activate the zoom mode:
`DISP:ZOOM ON`
2. Define the zoom area:
`DISP:ZOOM:AREA 5, 30, 20, 100`
3. Hide the overview window:
`DISP:ZOOM:OVER OFF`

4.4.4.7 Adding a Title to the Diagram Header

You can add an introductory title to the trace information in the diagram header.

1. Press the SETUP key.

2. Press the "Display Setup" softkey.
3. Press the "Screen Title On/Off" softkey.
An edit dialog box is displayed.
4. Enter the title and press "ENTER".
The title is displayed at the beginning of the diagram header.

4.4.4.8 Removing the Diagram Footer

Some additional diagram-specific information is displayed in the diagram footer (see [Chapter 4.4.1.4, "Diagram-specific and Trace Information"](#), on page 53). This footer can be removed from display if necessary.

1. Press the SETUP key.
2. Press the "Display Setup" softkey.
3. Press the "Annotation On/Off" softkey.
The footer is displayed beneath the diagram or removed from display.

4.4.4.9 Selecting a Theme

You can select a theme for the screen display. The theme defines the colors used for keys and screen elements, for example. The default theme is "BlueOcean".

Selecting a theme

1. Press the SETUP key.
2. Press the "Display Setup" softkey.
3. Press the "More" softkey.
4. Press the "Theme Selection" softkey. A list of available themes is displayed.
5. Select the desired theme from the list.
The screen display changes according to the selected theme.

SCPI command:

```
DISPlay:THEMe:SElect
```

4.4.4.10 Displaying and Setting the Date and Time

You can switch the date and time display in the diagram footer on or off. By default, it is displayed. You can also switch between German and US format.

Switching the date and time display off

1. Press the SETUP key.

2. Press the "Display Setup" softkey.
3. Press the "Time+Date" softkey to "Off".

Changing the format

1. Press the SETUP key.
2. Press the "Display Setup" softkey.
3. Press the "Time+Date Format" softkey until the required format is selected.

Setting the date and time

To set the date and time, click on the date and time display in the diagram footer. The standard Windows "Date and Time Properties" dialog is displayed and you can set the correct date and time.

4.4.4.11 Changing the Display Update Rate

When performance is poor due to slow data transfer (for example during remote control), it may be helpful to decrease the frequency with which the screen display is updated.

To decrease the display update rate

1. Press the [DISPLAY] key.
The "Display Settings" dialog box is opened.
2. Under "Display Update Rate", select "Slow".
The display is updated less frequently, and performance for measurements should improve. When data transfer is no longer a problem, you can set the update rate back to "Fast" in the same way.

4.5 Basic Measurement Examples

The following measurement examples are intended as an introduction to operating the R&S FSVA/FSV. The User Manual contains additional and more advanced examples. Refer to chapter "Advanced Measurement Examples" to find the following topics:

- High-Sensitivity Harmonics Measurements
- Separating Signals by Selecting an Appropriate Resolution Bandwidth
- Intermodulation Measurements
- Measuring Signals in the Vicinity of Noise
- Measuring Noise Power Density
- Measurement of Noise Power within a Transmission Channel
- Measuring Phase Noise
- Measuring Channel Power and Adjacent Channel Power

For a more detailed description of the basic operating steps, e.g. selecting menus and setting parameters, refer to [Chapter 4.4, "Basic Operations"](#), on page 50.

4.5.1 Measuring a Sinusoidal Signal

One of the most common measurement tasks that can be handled by using a signal analyzer is determining the level and frequency of a signal. When measuring an unknown signal, you can usually start with the presets.

WARNING

High input values

If levels higher than +30 dBm (=1 W) are expected or are possible, a power attenuator must be inserted before the RF input of the analyzer. If this is not done, signal levels exceeding 30 dBm can damage the RF attenuator or the input mixer. The total power of all occurring signals must be taken into account.

Test setup

- Connect the RF output of the signal generator to the RF input of R&S FSVA/FSV.

Table 4-4: Signal generator settings (e.g. R&S SMU)

Frequency	128 MHz
Level	-30 dBm

4.5.1.1 Measuring the Level and Frequency Using Markers

The level and frequency of a sinusoidal signal can be measured easily by using the marker function. The R&S FSVA/FSV always displays its amplitude and frequency at the marker position. The frequency measurement uncertainty is determined by the frequency reference of the R&S FSVA/FSV, the resolution of the marker frequency display and the number of sweep points.

1. Reset the instrument by pressing the [PRESET] key.
2. Connect the signal to be measured to the *RF INPUT* analyzer input on the instrument front panel.
3. Set the center frequency to *128 MHz*.
 - a) Press the [FREQ] key.
The dialog box for the center frequency is displayed.
 - b) In the dialog box, enter *128* using the numeric keypad and confirm the entry with the MHz key.
4. Reduce the frequency span to *1 MHz*.
 - a) Press the [SPAN] key.

- b) In the dialog box, enter *1* using the numeric keypad and confirm the entry by pressing the [MHz] key.

Note: Coupled settings. When the frequency span is defined, the resolution bandwidth, the video bandwidth and the sweep time are automatically adjusted, because these functions are defined as coupled functions in the presets.

5. Measure the level and frequency using the marker by pressing the [MKR] key. The marker is activated and automatically set on the maximum of the trace. The level and frequency values measured by the marker are displayed in the marker field at the top edge of the screen. They can be taken as the measurement result.

M1[1]	-30.00 dBm
	128.00000 MHz

The field header indicates the number of the marker (Marker 1) and the trace on which the marker is located ([1] = Trace 1).

Note: Performing a peak search. When a marker is initially activated, it automatically performs the peak search function (as shown in the example).

If a marker was already active, you have to press the [Peak Search] key on the front panel or the "Peak" softkey in the [MKR >] menu in order to set the currently active marker to the maximum of the displayed signal.

Increasing the Frequency Resolution

The frequency resolution of the marker is predefined by the pixel resolution of the trace. A trace uses 691 pixels, i.e. if the frequency span is 1 MHz, each pixel corresponds to a span of approx. 1.4 kHz. This corresponds to a maximum uncertainty of +/- 0.7 kHz.

You can increase the pixel resolution of the trace by reducing the frequency span.

Reducing the frequency span to 10 kHz

1. Press the [SPAN] key.
2. Using the numeric keypad, enter *10* in the dialog box and confirm the entry with the [kHz] key.

The generator signal is measured using a span of 10 kHz. The pixel resolution of the trace is now approx. 14 Hz (10 kHz span / 691 pixels), i.e. the precision of the marker frequency display increases to approx. ± 7 Hz.

Setting the Reference Level

With signal analyzers, the reference level is the level at the upper limit of the diagram. To achieve the widest dynamic range possible for a spectrum measurement, use the entire level span of the signal analyzer. In other words, the highest level that occurs in the signal should be located at the top edge of the diagram (=reference level) or immediately below it.



Low Reference Levels

If the selected reference level is lower than the highest signal that occurs in the spectrum, the signal path in the R&S FSVA/FSV is overloaded.

In this case, the message "IFOVL" is displayed in the error message field.

In the presets, the value of the reference level is -10 dBm. If the input signal is -30 dBm, the reference level can be reduced by 20 dB without causing the signal path to be overloaded.

Reducing the reference level by 20 dB

1. Press the [AMPT] key.
The amplitude menu is displayed. The "Ref Level" softkey is highlighted in red to indicate that it is activated for data entry. The dialog box for the reference level is also opened.
2. Using the numeric keypad, enter 30 and confirm the entry with the [- dBm] key.
The reference level is set to -30 dBm. The maximum of the trace is near the maximum of the measurement diagram. However, the increase in the displayed noise is not substantial. Thus, the distance between the signal maximum and the noise display (=dynamic range) has increased.

Setting the marker level equal to the reference level

The marker can also be used to shift the maximum value of the trace directly to the top edge of the diagram. If the marker is located at the maximum level of the trace (as in this example), the reference level can be moved to the marker level as follows:

1. Press the [MKR] key.
2. Press the "Ref Lvl = Mkr Lvl" softkey.

The reference level is set equal to the measured level where the marker is located.

Thus, setting the reference level is reduced to two keystrokes.

4.5.1.2 Measuring the Signal Frequency Using the Frequency Counter

The built-in frequency counter allows you to measure the frequency more accurately than measuring it with the marker. The frequency sweep is stopped at the marker, and the R&S FSVA/FSV measures the frequency of the signal at the marker position.

In the following example, the frequency of the generator at 128 MHz is shown by using the marker.

Prerequisite

In this example, a precise frequency measurement is to be performed. Therefore, connect the signal generator's "Ref OUT" connector to the analyzer's "Ref IN" connector.

1. Set the signal analyzer to the default state by pressing the [PRESET] key.

- The R&S FSVA/FSV is set to its default state.
2. Set the center frequency and the span.
 - a) Press the [FREQ] key and enter 128 MHz.
The center frequency of the R&S FSVA/FSV is set to 128 MHz.
 - b) Press the [SPAN] key and enter 1 MHz.
The frequency span of the R&S FSVA/FSV is set to 1 MHz.
 3. In the "Setup" menu, select "Reference Ext".
 4. Activate the marker by pressing the [MKR] key.
The marker is activated and set to the signal maximum. The level and the frequency of the marker are displayed in the marker field (diagram header or marker table).
 5. Activate the frequency counter by pressing the "Sig Count On/Off" softkey in the "MKR FUNC" menu.
The result of frequency counting is displayed in the selected resolution in the marker field.

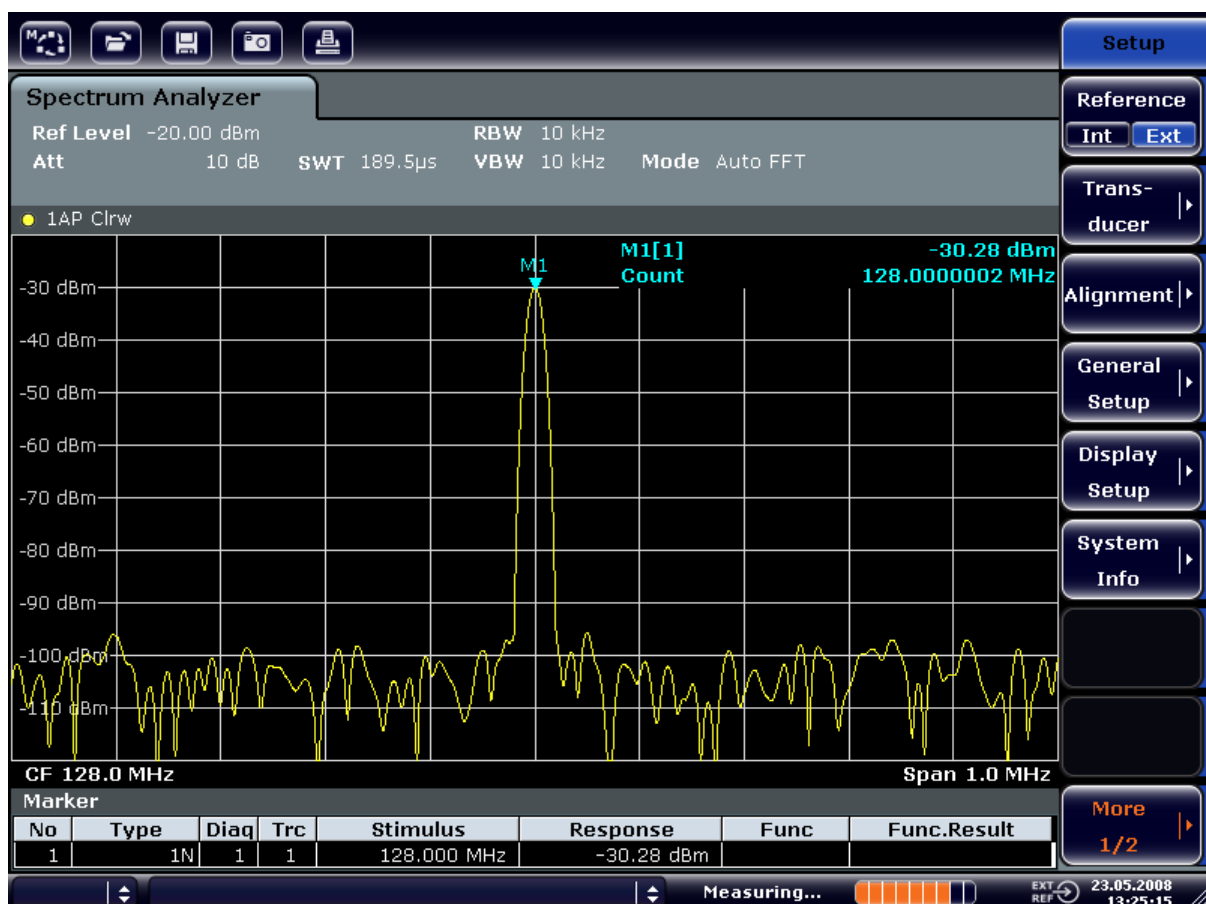

Figure 4-11: Measurement of the frequency with the frequency counter



Prerequisites for using the internal frequency counter

In order to obtain a correct result when measuring the frequency with the internal frequency counter, an RF sinusoidal signal or a spectral line must be available. The marker must be located more than 25 dB above the noise level to ensure that the specified measurement accuracy is adhered to.

4.5.2 Measuring Harmonics of Sinusoidal Signals

Measuring the harmonics of a signal is a very common task that can be performed optimally by using a Signal and Spectrum Analyzer.

In the following example, the generator signal with 128 MHz and -20 dBm is used again.

Measuring the Suppression of the First and Second Harmonic of an Input Signal

1. Set the signal analyzer to the default state by pressing the [PRESET] key.
The R&S FSVA/FSV is in the default state.
2. Set the start frequency to 100 MHz and the stop frequency to 400 MHz.
 - a) Press the [FREQ] key.
 - b) Press the "Start" softkey and enter *100 MHz*.
 - c) Press the "Stop" softkey and enter *400 MHz*.
The R&S FSVA/FSV displays the fundamental and the first and second harmonics of the input signal.
3. To average (smooth) the noise, reduce the video bandwidth.
 - a) Press the [BW] key.
 - b) Press the "Video BW Manual" softkey and enter *100 kHz*.
4. Set the attenuation to 0 dB.
 - a) Press the [AMPT] key.
 - b) Press the "RF Atten Manual" softkey.
 - c) Enter *0 dB* in the edit dialog box.
5. Activate the marker by pressing the [MKR] key.
"Marker 1" is activated and positioned to the signal maximum (fundamental at 128 MHz). The level and frequency of the marker is displayed in the marker field.
6. Activate the delta marker and measure the harmonic suppression.
 - a) In the "MKR" menu, press the "Marker 2" softkey.
"Marker 2" is activated as a delta marker ("D2 [1]"). It is automatically set on the largest harmonic of the signal. The frequency offset and level offset from marker 1 are displayed in the channel information bar.

- b) In the "MKR" menu, press the "Marker 3" softkey.
 "Marker 3" is activated as a delta marker ("D3 [1]"). It is automatically set on the next largest harmonic of the signal. The frequency offset and level offset from marker 1 on the fundamental are displayed in the channel information bar (see Figure 4-12).

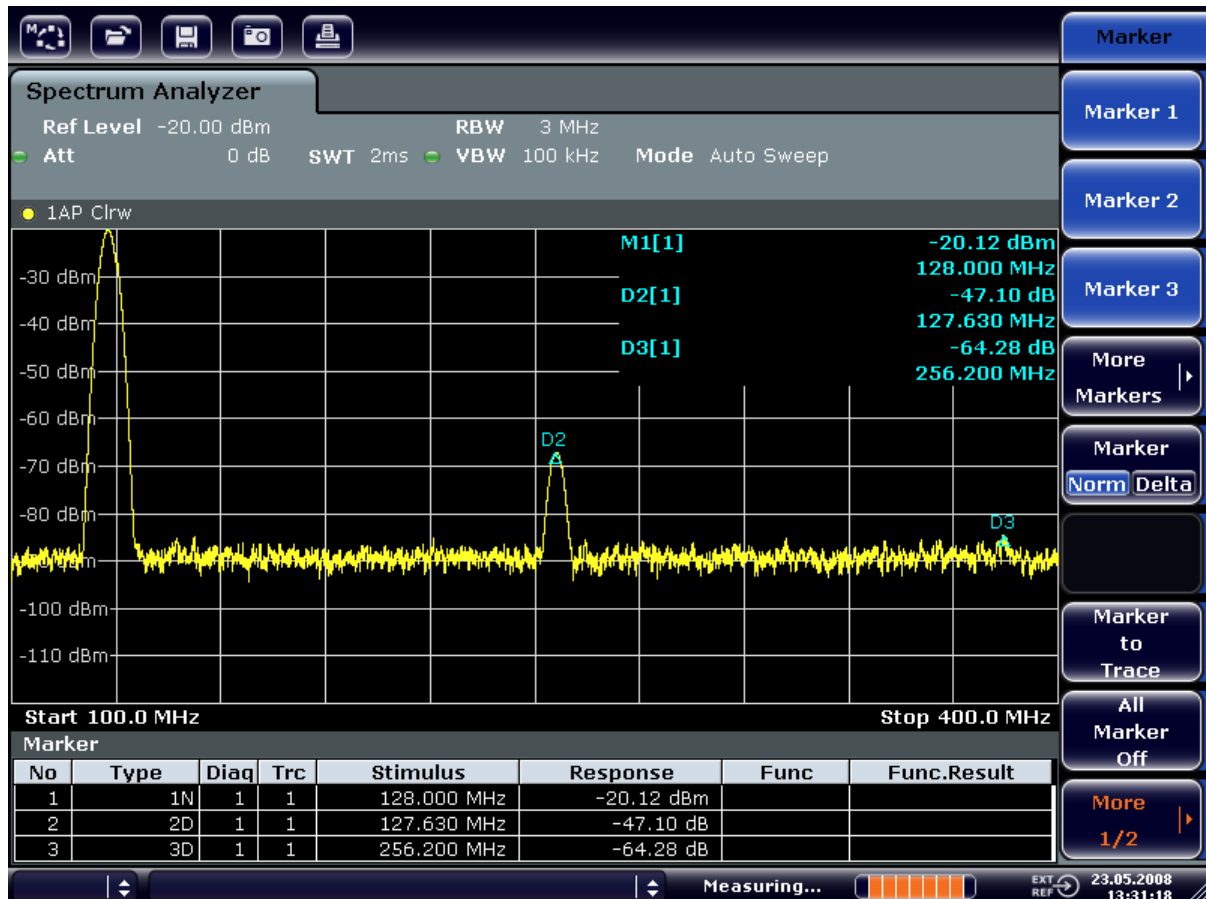

Figure 4-12: Measuring the harmonic suppression of the internal reference generator.

Delta markers D2 [1] and D3 [1] show the offset of the first and second harmonics from the fundamental.

Reducing Noise

The signal analyzer offers three methods to differentiate the harmonics of a signal from the noise effectively:

- Reducing the video bandwidth
- Averaging the trace
- Reducing the resolution bandwidth

Reducing the video bandwidth and averaging the traces cause the noise from the analyzer or the DUT to be reduced, depending on which component is larger. Both averaging methods reduce the measurement uncertainty, particularly in the case of small signal-to-noise ratios, because the measurement signal is also separated from the noise.

Reducing the noise by reducing the video bandwidth

1. Press the [BW] key.
2. Press the "Video BW Manual" softkey.
3. Reduce the video bandwidth to 1 kHz (for example), by entering *1 kHz*.
This smoothes the noise significantly, and the sweep time is increased to 200 ms. In other words, the measurement will take significantly more time. The video bandwidth that is displayed is marked with a bullet to indicate that it is no longer coupled to the resolution bandwidth (see [Figure 4-13](#)).



Figure 4-13: Suppression of noise during harmonics measurement by reducing video bandwidth

4. Recouple the video bandwidth to the resolution bandwidth.
 - a) Press the [BW] key.
 - b) Press the "Video BW Auto" softkey.

Reducing the noise by averaging the trace

1. Press the [TRACE] key.
2. Press the "Trace Wizard" softkey.

3. For "Trace 1", press the button in the "Trace Mode" column and select "Average" from the list.
The noise component of the trace is smoothed by averaging 10 successive traces.
4. Switch off trace averaging by pressing the button in the "Trace Mode" column and selecting "Clear Write" from the list.

Reducing the noise by reducing the measurement bandwidth

The noise is reduced in proportion to the bandwidth by reducing the resolution bandwidth, i.e. reducing the resolution bandwidth by a factor of 10 also reduces the noise by a factor of 10 (which corresponds to 10 dB). The amplitude of sinusoidal signals is not affected by reducing the resolution bandwidth.

1. Set the resolution bandwidth to 10 kHz.
 - a) Press the [BW] key.
 - b) Press the "Res BW Manual" softkey and enter *10 kHz*.
The noise decreases by approx. 25 dB compared to the previous setting. Since the video bandwidth is coupled to the resolution bandwidth, it is reduced to 30 kHz in proportion to the resolution bandwidth. This causes the sweep time to increase to 3.0 seconds.
2. Reset the resolution bandwidth (couple it to the span) by pressing the "Res BW Auto" softkey in the "BW" menu.

4.5.3 Measuring Signal Spectra with Multiple Signals

4.5.3.1 Separating Signals by Selecting the Resolution Bandwidth

A basic feature of a Signal and Spectrum Analyzer is the ability to separate the spectral components of a mixture of signals. The resolution at which the individual components can be separated is determined by the resolution bandwidth. Selecting a resolution bandwidth that is too large may make it impossible to distinguish between spectral components, i.e. they are displayed as a single component.

An RF sinusoidal signal is displayed using the passband characteristic of the defined resolution filter (RBW). Its specified bandwidth is the 3 dB bandwidth of the filter.

Two signals with the same amplitude can be resolved if the resolution bandwidth is smaller than or equal to the frequency spacing of the signal. If the resolution bandwidth is equal to the frequency spacing, the spectrum display shows a level drop of 3 dB precisely in the center of the two signals. Decreasing the resolution bandwidth makes the level drop larger, which thus makes the individual signals clearer.

Higher spectral resolution at a narrower bandwidth is accomplished through longer sweep times at the same span. Reducing the resolution bandwidth by a factor of 3 increases the sweep time by a factor of 9.

Example:

Separating Two Signals

The two signals have a level of -30 dBm each at a frequency spacing of 30 kHz

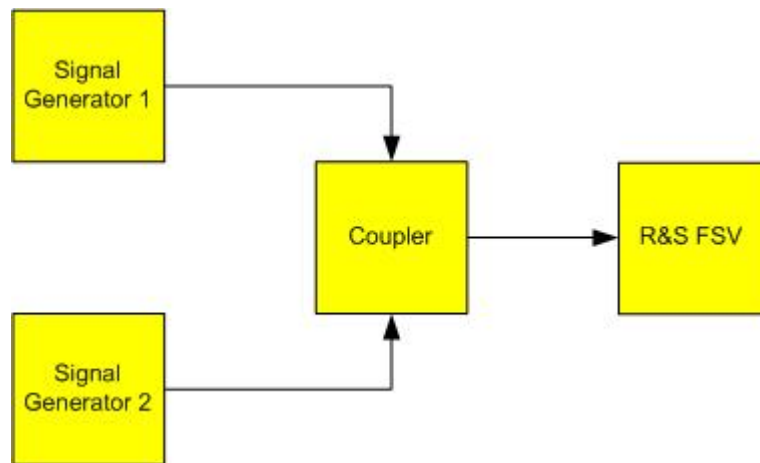

Table 4-5: Signal generator settings (e.g. R&S SMU)

	Level	Frequency
Signal generator 1	-30 dBm	128,00 MHz
Signal generator 2	-30 dBm	128,03 MHz

1. Set the signal analyzer to the default state by pressing the [PRESET] key.
The R&S FSVA/FSV is set to its default state.
2. Set the center frequency to 128.015 MHz and the frequency span to 300 kHz.
 - a) Press the [FREQ] key and enter 128.015 MHz.
 - b) Press the [SPAN] key and enter 300 kHz.
3. Set the resolution bandwidth to 30 kHz and the video bandwidth to 1 kHz.
 - a) Press the [BW] key
 - b) Press the "Res BW Manual" softkey and enter 30 kHz.
 - c) Press the "Video BW Manual" softkey and enter 1 kHz.

Note: Larger video bandwidths. The video bandwidth is set to 1 kHz in order to make the level drop in the center of the two signals clearly visible. At larger video bandwidths, the video voltage that results from envelope detection is not sufficiently suppressed. This produces additional voltages, which are visible in the trace, in the transition area between the two signals.

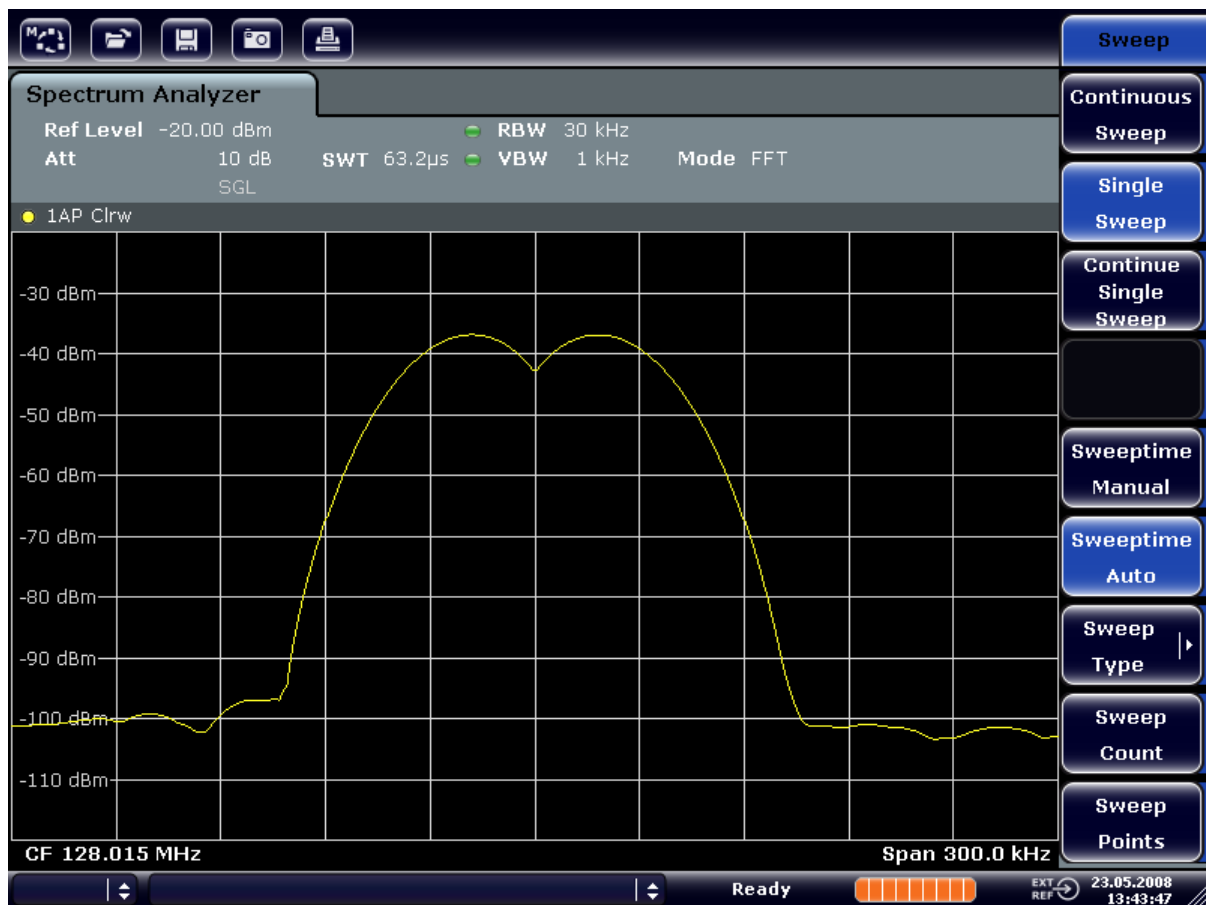

Figure 4-14: Measurement of two equally-leveled RF sinusoidal signals with the resolution bandwidth which corresponds to the frequency spacing of the signals

Matching generator and R&S FSVA/FSV frequencies

The level drop is located exactly in the center of the screen only if the generator frequencies match the frequency display of the R&S FSVA/FSV exactly. To achieve exact matching, the frequencies of the generators and the R&S FSVA/FSV must be synchronized.

4. Set the resolution bandwidth to 100 kHz. To do so, in the bandwidth menu, press the "Res BW Manual" softkey and enter 100 kHz.

It is no longer possible to clearly distinguish the two generator signals.

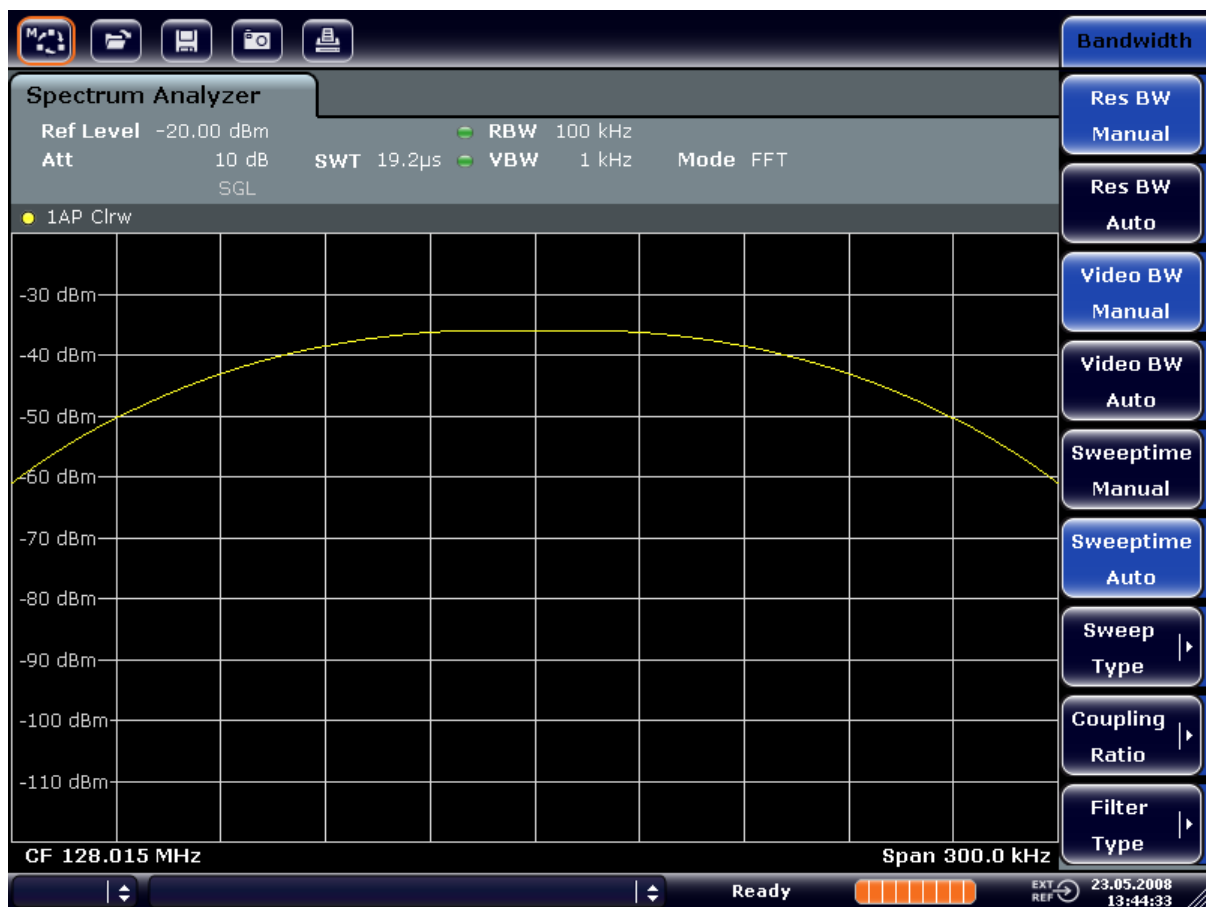

Figure 4-15: Measurement of two equally-leveled RF sinusoidal signals with a resolution bandwidth which is larger than their frequency spacing

Note: Reducing the resolution bandwidth. The resolution bandwidth (RBW) can be reduced again by turning the rotary knob counterclockwise, thus yielding a higher frequency resolution.

- Set the resolution bandwidth to 1 kHz. To do so, in the bandwidth menu, press the "Res BW Manual" softkey and enter 1 kHz.
The two generator signals are shown with high resolution. However, the sweep time becomes longer. At smaller bandwidths, the noise display decreases simultaneously (10 dB decrease in noise floor for a decrease in bandwidth by a factor of 10).

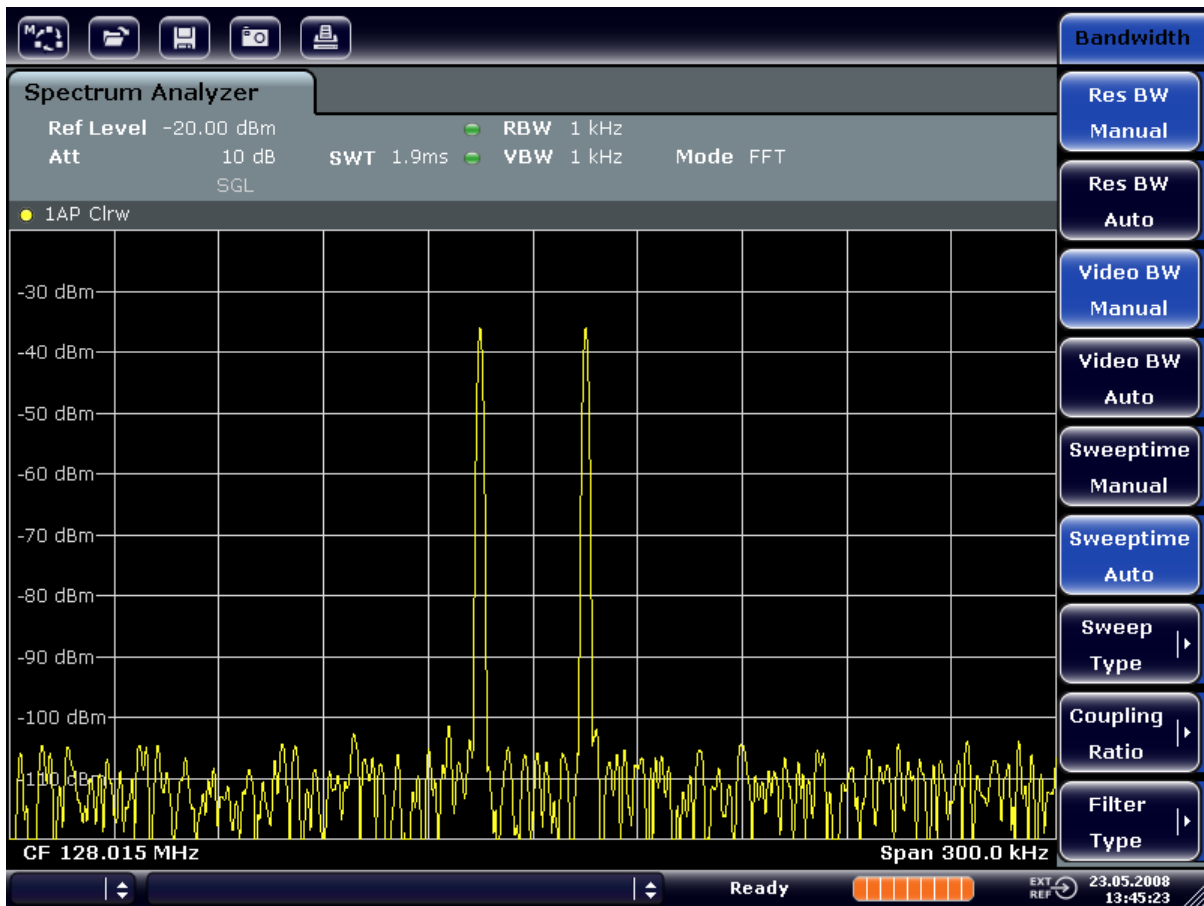

Figure 4-16: Measurement of two equally-levelled RF sinusoidal signals with a resolution bandwidth (1 kHz) which is significantly smaller than their frequency spacing

4.5.3.2 Measuring the Modulation Depth of an AM-Modulated Carrier (Span > 0)

In the frequency range display, the AM side bands can be resolved with a narrow bandwidth and measured separately. The modulation depth of a carrier modulated with a sinusoidal signal can then be measured. Since the dynamic range of a signal analyzer is very large, extremely small modulation depths can also be measured precisely. For this purpose, the R&S FSVA/FSV provides measurement routines that output the modulation depth numerically in % directly.

Test setup

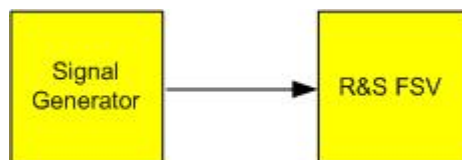

Table 4-6: Signal generator settings (e.g. R&S SMU)

Frequency	128 MHz
Level	-30 dBm
Modulation	50 % AM, 10 kHz AF

1. Set the signal analyzer to the default state by pressing the [PRESET] key. The R&S FSVA/FSV is set to its default state.
2. Set the center frequency to 128 MHz and span to 50 kHz.
 - a) Press the [FREQ] key and enter *128 MHz*.
 - b) Press the [SPAN] key and enter *50 kHz*.
3. Activate the marker function for measuring the AM modulation depth.
 - a) Press the [MEAS] key.
 - b) Press the "More" key.
 - c) Press the "AM Mod Depth" softkey.

The R&S FSVA/FSV automatically sets a marker to the carrier signal in the center of the diagram and one delta marker each to the upper and lower AM sidebands. The R&S FSVA/FSV calculates the AM modulation depth from the level differences of the delta markers to the main marker and outputs the numeric value in the marker field.

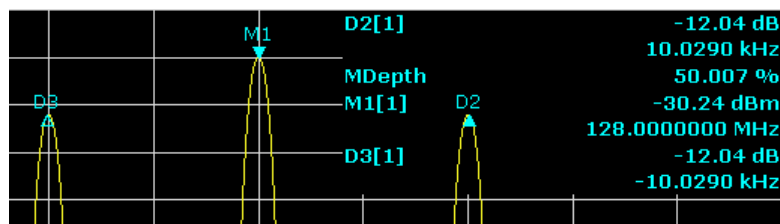

Figure 4-17: Measurement of the AM modulation depth

The modulation depth is displayed as "MDepth". The frequency of the AF signal can be obtained from the frequency display of the delta marker.

4.5.3.3 Measuring AM-Modulated Signals

The signal analyzer rectifies the RF input signal and displays it as a magnitude spectrum. The rectification also demodulates AM-modulated signals. The AF voltage can be displayed in zero span if the modulation sidebands fall within the resolution bandwidth.

Displaying the AF of an AM-modulated signal (Zero Span)

Test setup

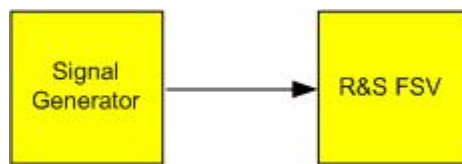

Table 4-7: Signal generator settings (e.g. R&S SMU)

Frequency	128 MHz
Level	-30 dBm
Modulation	50 % AM, 1 kHz AF

1. Set the signal analyzer to the default state by pressing the [PRESET] key. The R&S FSVA/FSV is set to its default state.
2. Set the center frequency to 128 MHz and the span to 0 Hz.
 - a) Press the [FREQ] key and enter *128 MHz*.
 - b) Press the [SPAN] key and enter *0 Hz* or press the "Zero Span" softkey.
3. Set the sweep time to 2.5 ms.
 - a) Press the [SWEEP] key.
 - b) Press the "Sweeptime Manual" softkey.
 - c) Enter *2.5 ms*.
4. Set the reference level to +6 dBm and the display range to linear.
 - a) Press the [AMPT] key and enter *6 dBm*.
 - b) Press the "Range" softkey.
 - c) Press the "Range Linear %" softkey.
5. Set triggering in response to the AF signal by using the video trigger to produce a static image.
 - a) Press the [TRIG] key.
 - b) Press the "Trg/Gate Source" softkey and select "Video" using the arrow keys.
 - c) Press the "Trg/Gate Level" softkey and enter *50%*.
The trigger level is displayed as a horizontal line across the entire measurement diagram. The R&S FSVA/FSV displays the 1 kHz AF signal as a static image in zero span. Use a headset to listen to the AF.
6. Activate the internal AM demodulator.
 - a) Press the [MKR FUNC] key.
 - b) Press the "Marker Demod" softkey.
The R&S FSVA/FSV automatically switches on the AM audio demodulator. A 1 kHz tone can be heard over headset. If necessary, use the volume control knob for AF OUTPUT on the front panel to turn up the volume.

4.5.4 Measurements in Zero Span

For radio transmission systems that use the TDMA method (e.g. GSM or IS136), transmission quality is determined not only by spectral characteristics but also by characteristics in zero span. A timeslot is assigned to each user since several users share the same frequency. Smooth operation is ensured only if all users adhere exactly to their assigned timeslots.

Both the power during the send phase as well as the timing and duration of the TDMA burst, and rise and fall times of the burst, are important.

4.5.4.1 Measuring the Power Characteristic of Burst Signals

To measure power in zero span, the R&S FSVA/FSV offers easy-to-use functions that measure the power over a predefined time.

Measuring the Power of a GSM Burst During the Activation Phase

Test setup

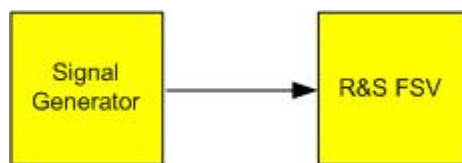

Table 4-8: Signal generator settings (e.g. R&S SMU)

Frequency	890 MHz
Level	0 dBm
Modulation	GSM, one timeslot activated

- Set the signal analyzer to the default state by pressing the [PRESET] key. The R&S FSVA/FSV is set to its default state.
- Set the center frequency to 890 MHz, the span to 0 Hz and the resolution bandwidth to 1 MHz.
 - Press the [FREQ] key and enter *890 MHz*.
 - Press the [SPAN] key and enter *0 Hz*, or press the "Zero Span" softkey.
- Set the reference level of the R&S FSVA/FSV to 10 dBm (= level of the signal generator +10 dB) and set the attenuation to 20 dB.
 - Press the [AMPT] key.
 - Enter *10 dBm*.
 - Press the "Rf Atten Manual" softkey.
 - Enter *20 dB*.
- Set the sweep time to 1 ms.
 - Press the [SWEEP] key.

- b) Press the "Sweptime Manual" softkey and enter *1 ms*.
The R&S FSVA/FSV shows the GSM burst continuously across the display.
5. By using the video trigger, set triggering on the rising edge of the burst.
 - a) Press the [TRIG] key.
 - b) Press the "Trg/Gate Source" softkey and select "Video" using the arrow keys.
 - c) Press the "Trg/Gate Level" softkey and enter *70%*.
The R&S FSVA/FSV shows a static image with the GSM burst at the start of the trace. The trigger level is displayed as a horizontal line labeled with the absolute level for the trigger threshold in the measurement diagram.
6. Configure power measurement in zero span.
 - a) Press the [MEAS] key.
 - b) Press the "Time Domain Power" softkey to open the submenu.
 - c) Switch the "Limits" softkey to "On."
 - d) Press the "Left Limit" softkey.
 - e) By turning the rotary knob clockwise, move the vertical line to the start of the burst.
 - f) Press the "Right Limit" softkey.
 - g) By turning the rotary knob counterclockwise, set the second vertical line to the end of the burst.

The R&S FSVA/FSV displays the average (mean) power during the activation phase of the burst.

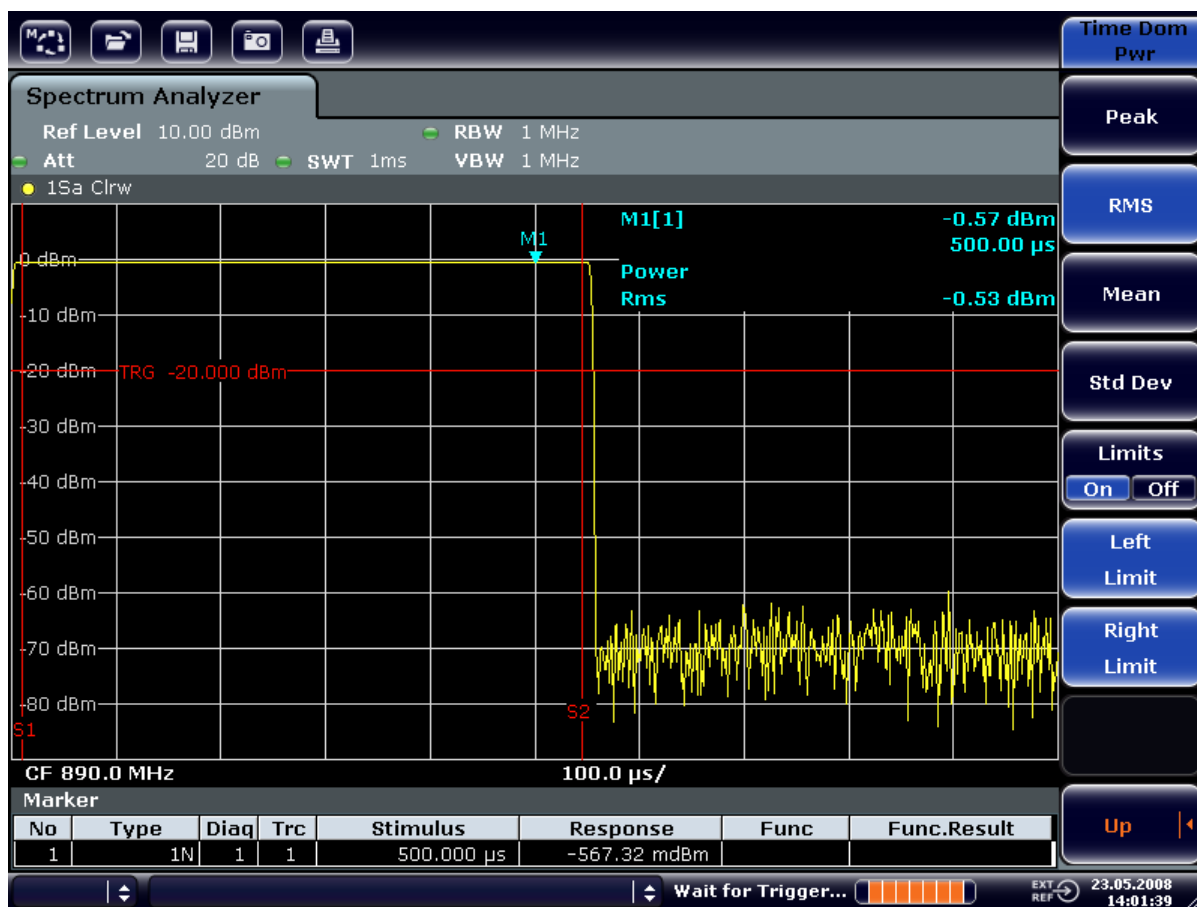

Figure 4-18: Measurement of the average power during the burst of a GSM signal

Measuring the Edges of a GSM Burst with High Time Resolution

Because of the high time resolution of the R&S FSVA/FSV at the 0 Hz display range, the edges of TDMA bursts can be measured precisely. The edges can be shifted to the screen area by using the trigger offset.

Test setup

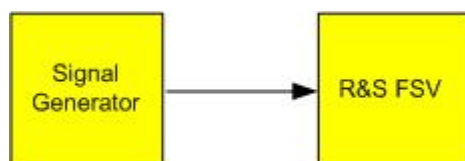

Table 4-9: Signal generator settings (e.g. R&S SMU)

Frequency	890 MHz
Level	0 dBm
Modulation	GSM, one timeslot activated

The measurement is based on the setting in the example above for measuring the power of the GSM during the activation phase.

1. Switch off the power measurement.
 - a) Press the [MEAS] key.
 - b) Press the "All Functions Off" softkey.
2. Increase the time resolution to 100 μ s.
 - a) Press the [SWEEP] key.
 - b) Press the "Sweeptime Manual" softkey and enter 100 μ s.
3. Using the trigger softkey, shift the rising edge of the GSM burst to the center of the screen.
 - a) Press the [TRIG] key.
 - b) Press the "Trigger Offset" softkey.
 - c) By turning the rotary knob counterclockwise, move the trigger offset until the burst edge can be seen in the center of the screen, or enter -50 μ s.
The R&S FSVA/FSV displays the rising edge of the GSM burst.

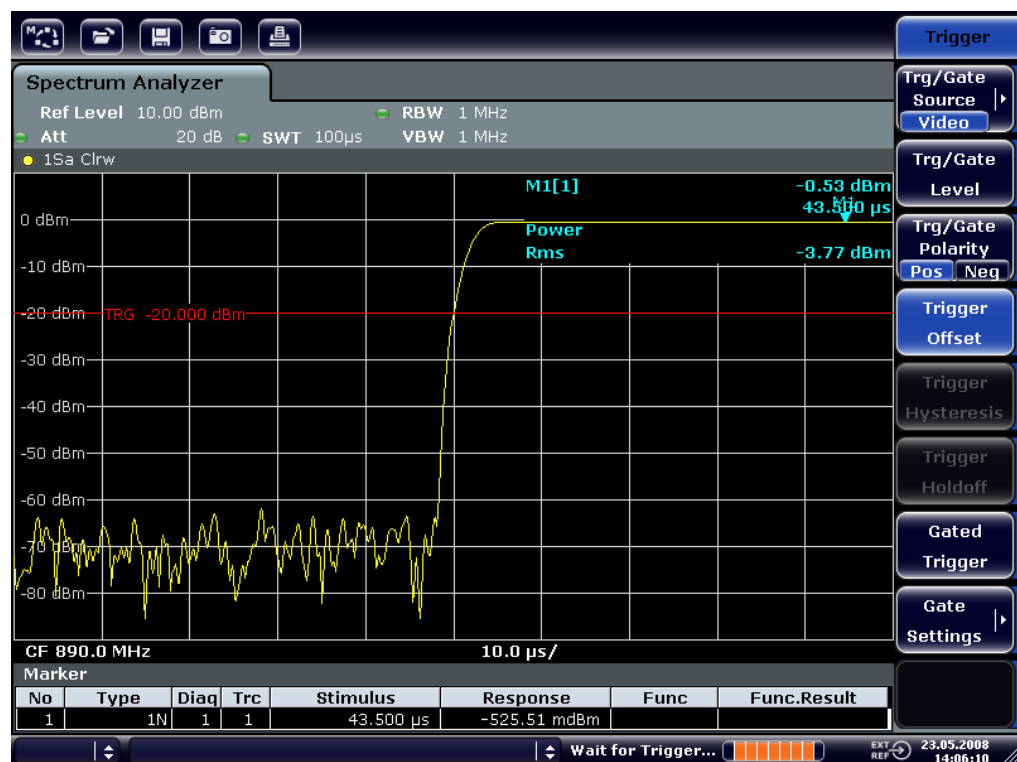

Figure 4-19: Rising edge of the GSM burst displayed with high time resolution

4. Using the trigger offset, move the falling edge of the burst to the center of the screen. To do so, switch the "Trg/Gate Polarity" softkey to "Neg".
The R&S FSVA/FSV displays the falling edge of the GSM burst.



Figure 4-20: Falling edge of the GSM burst displayed with high time resolution

4.5.4.2 Measuring the Signal-to-Noise Ratio of Burst Signals

When TDMA transmission methods are used, the signal-to-noise ratio or the deactivation dynamic range can be measured by comparing the power values during the activation phase and the deactivation phase of the transmission burst. For this purpose, the R&S FSVA/FSV provides the function for measuring absolute and relative power in zero span. In the following example, the measurement is performed using a GSM burst.

Signal-to-Noise Ratio of a GSM Signal

Test setup

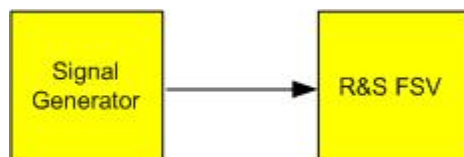

Table 4-10: Signal generator settings (e.g. R&S SMU)

Frequency	890 MHz
Level	0 dBm
Modulation	GSM, one time slot is switched on

1. Set the signal analyzer to the default state by pressing the [PRESET] key.
The R&S FSVA/FSV is set to its default state.
2. Set the center frequency to 890 MHz, the span to 0 Hz and the resolution bandwidth to 1 MHz.
 - a) Press the [FREQ] key and enter *890 MHz*.
 - b) Press the [SPAN] key and enter 0 Hz or press the "Zero Span" softkey.
 - c) Press the [BW] key.
 - d) Press the "Res BW Manual" softkey and enter *1 MHz*.
3. Set the reference level of the R&S FSVA/FSV to 0 dBm (= level of the signal generator) by pressing the [AMPT] key and entering *0 dBm*.
4. Set the sweep time to 2 ms.
 - a) Press the [SWEEP] key.
 - b) Press the "Sweeptime Manual" softkey and enter *2 ms*.
The R&S FSVA/FSV shows the GSM burst continuously across the display.
5. Use the trigger source "Video" and the trigger polarity "Pos" to trigger on the rising edge of the burst and shift the start of burst to the center of the screen.
 - a) Press the [TRIG] key.
 - b) Press the "Trg/Gate Source" softkey and select "Video" using the arrow keys.
 - c) Press the "Trg/Gate Level" softkey and enter *70%*.
The R&S FSVA/FSV shows a static image with the GSM burst at the start of the trace.
 - d) Press the "Trigger Offset" softkey and enter *-1 ms*.
The R&S FSVA/FSV shows the GSM burst in the right half of the measurement diagram.
6. Configure the power measurement in zero span.
 - a) Press the [MEAS] key.
 - b) Press the "Time Domain Power" softkey to open the submenu.
 - c) Switch the "Limits" softkey to "On."
 - d) Press the "Left Limit" softkey.
 - e) Using the rotary knob, move the vertical line to the start of the burst.
 - f) Press the "Right Limit" softkey.

- g) Using the rotary knob, move the second vertical line to the end of the burst. The R&S FSVA/FSV displays the power during the activation phase of the burst.

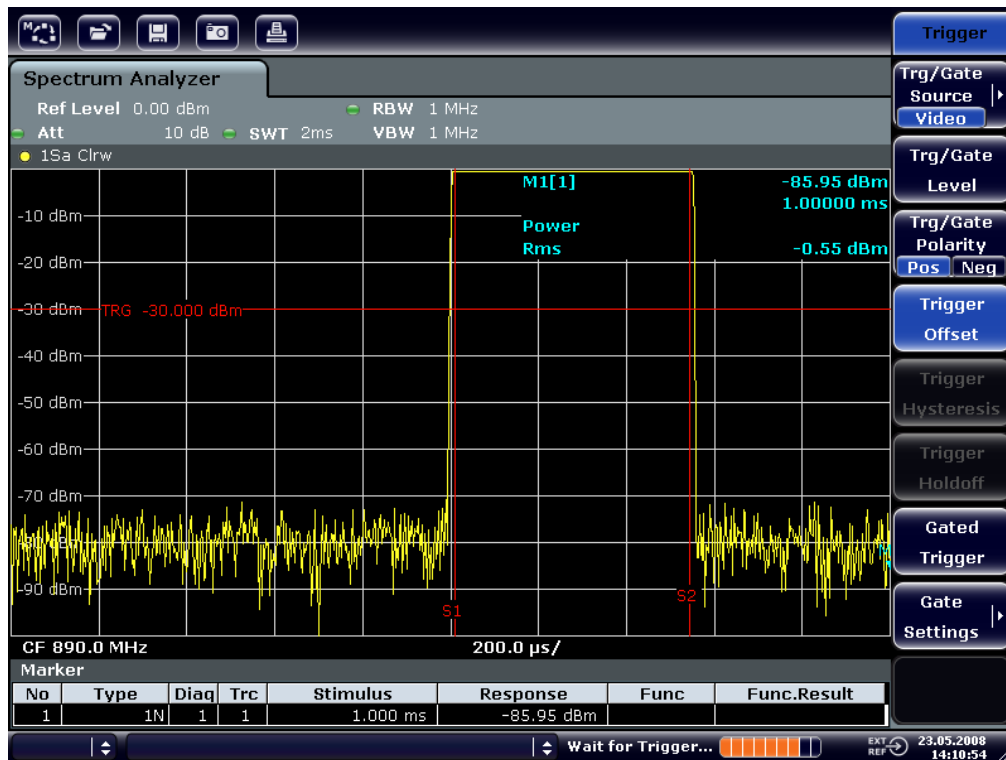

Figure 4-21: Power measurement during the activation phase of the burst

7. Measure the power during the deactivation phase of the burst.
- a) Press the [TRIG] key.

- b) Switch the "Trg/Gate Polarity" softkey to "Neg."
 The R&S FSVA/FSV initiates triggering in response to the falling edge of the burst. This shifts the burst to the left-hand half of the measurement diagram. The power is measured in the deactivation phase. The start of the burst is shifted to the center of the screen and the power during the deactivation phase is measured.

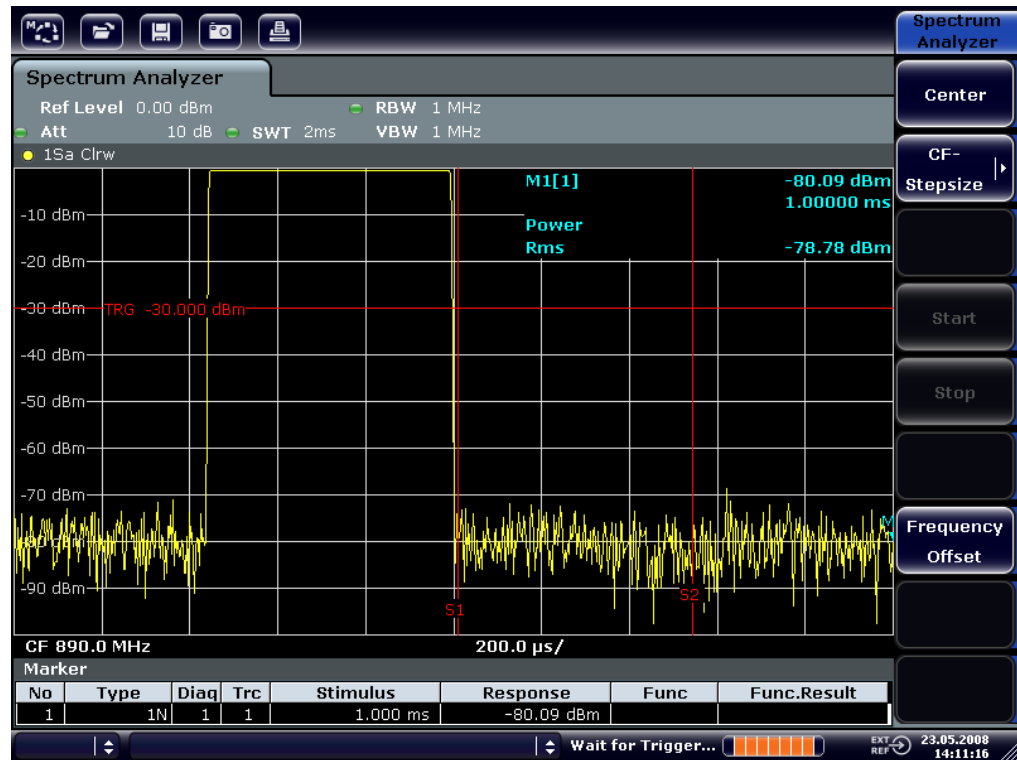

Figure 4-22: Measurement of the signal-to-noise ratio of a GSM burst signal in zero span.

4.5.4.3 Measuring FM-Modulated Signals

Since signal analyzers can display only the magnitude of the measurement signal by using the envelope detector, the modulation of FM-modulated signals cannot be measured directly as in the case of AM-modulated signals. The voltage at the output of the envelope detector remains constant for FM-modulated signals as long as the frequency deviation of the signal is located within the flat part of the passband characteristic of the employed resolution filter. Amplitude variation occurs only if the instantaneous frequency extends into a falling edge of the filter curve. This behavior can be used to demodulate FM-modulated signals. The center frequency of the analyzer is set in such a manner that the nominal frequency of the measurement signal is located on a filter edge (below or above the center frequency). The resolution bandwidth and the frequency offset must be selected in such a manner that the instantaneous frequency is located in the linear part of the filter edge. As a result, the frequency variation of the FM-modulated signal is transformed into an amplitude variation that can be displayed on screen in zero span.

Displaying the AF of an FM-Modulated Carrier

Test setup

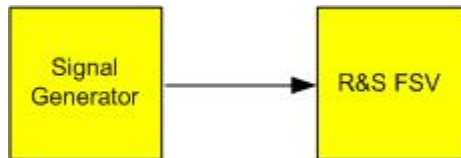

Table 4-11: Signal generator settings (e.g. R&S SMU)

Frequency	128 MHz
Level	-20 dBm
Modulation	FM 0 kHz deviation (i.e. FM modulation is deactivated), 1 kHz AF

1. Set the signal analyzer to the default state by pressing the [PRESET] key.
The R&S FSVA/FSV is set to its default state.
2. Set the center frequency to 127.50 MHz and the span to 300 kHz.
 - a) Press the [FREQ] key and enter *127.50 MHz*.
 - b) Press the [SPAN] key and enter *300 kHz*.
3. Set the resolution bandwidth to 300 kHz.
 - a) Press the [BW] key.
 - b) Press the "Res BW Manual" softkey and enter *300 kHz*.
 - c) Press the "Video BW Manual" softkey and enter *30 kHz*.
4. Set the display range to 20 dB and shift the filter trace to the center of the screen.
 - a) Press the [AMPT] key.
 - b) Press the "Range" softkey
 - c) Press the "Range Log Manual" softkey and enter *20 dB*.
 - d) Press the "Up ↑" softkey.
 - e) Press the "More" softkey.
 - f) Switch the "Grid" softkey to "Rel".
 - g) Press the "Up ↑" softkey.
 - h) Press the "Ref Level" softkey.

- i) Using the rotary knob, set the reference level such that the filter edge at the center frequency intersects the -10 dB level line.
The filter edge of the 300 kHz filter is displayed. This corresponds to the demodulator characteristic for FM signals with a steepness of approx. 18 dB/140 kHz. This can be verified using the marker and delta marker.

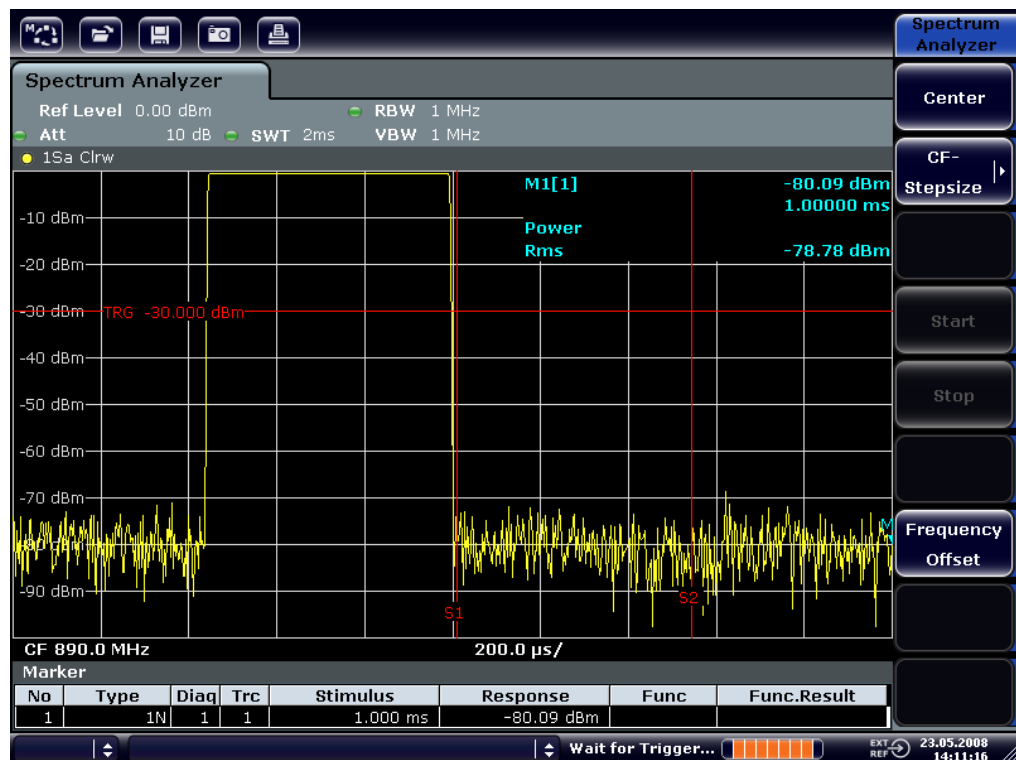

Figure 4-23: Display of the filter edge of the 300 kHz filter as an FM discriminator characteristic

5. Set the FM deviation to 50 kHz on the signal generator.
6. Set the span to 0 Hz on the R&S FSVA/FSV.
 - a) Press the [SPAN] key.
 - b) Press the "Zero Span" softkey.
The demodulated FM signal is displayed. The signal crosses the screen continuously.
7. Establish a stable display using video triggering.
 - a) Press the [TRIG] key.
 - b) Press the "Trg/Gate Source" softkey and select "Video" using the arrow keys.

- c) Press the "Trg/Gate Level" softkey and enter 50%.
 A static image for the FM AF signal is produced.
 Result: (-10 (5) dB; this yields a deviation of 100 kHz when the steepness of the demodulator characteristic is 5 dB/100 kHz.

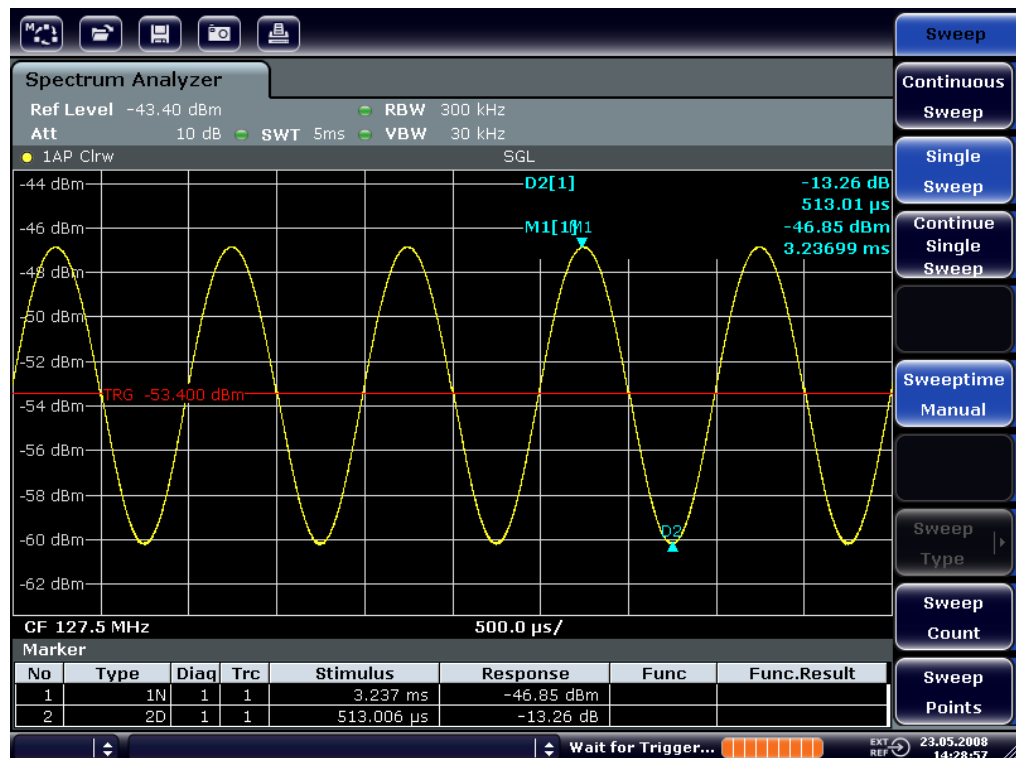

Figure 4-24: Demodulated FM signal

8. Determine the deviation.
- Press the [MKR] key.
Marker 1 is activated and placed on the peak of the curve.
 - Press the "Marker 2" softkey.
 - Press the [MKR] key.
 - Press the "More" softkey.
 - Press the "Min" softkey.
Marker 2 (delta marker) is placed on the minimum of the curve. The level difference is 13.3 dB, which corresponds to the peak-to-peak deviation. With the filter slope of 18 dB/140 kHz, the deviation can be calculated as follows:

$$\text{deviation} = \frac{1}{2} \times \frac{13.3 \times 140}{18} \text{ kHz} = \frac{1}{2} \times 103 \text{ kHz} = 51.7 \text{ kHz}$$

4.5.5 Storing and Loading Instrument Settings

The R&S FSVA/FSV can store complete instrument settings together with instrument configurations and measurement data in a settings file. The data is stored on the built-

in hard disk or - if selected - on a USB device (e.g. memory stick) or on a network drive. The hard disk has the drive letter C:.

In the default state, the current settings are stored. This includes the settings of the measurement functions, the activated limit lines and the active transducer factor.

4.5.5.1 Storing an Instrument Configuration (without Traces)

1. Press the [SAVE/RCL] key.
2. Press the "Save" softkey.
The dialog box for instrument configurations is displayed. The File Name field is in edit mode and contains a suggestion for a new name.

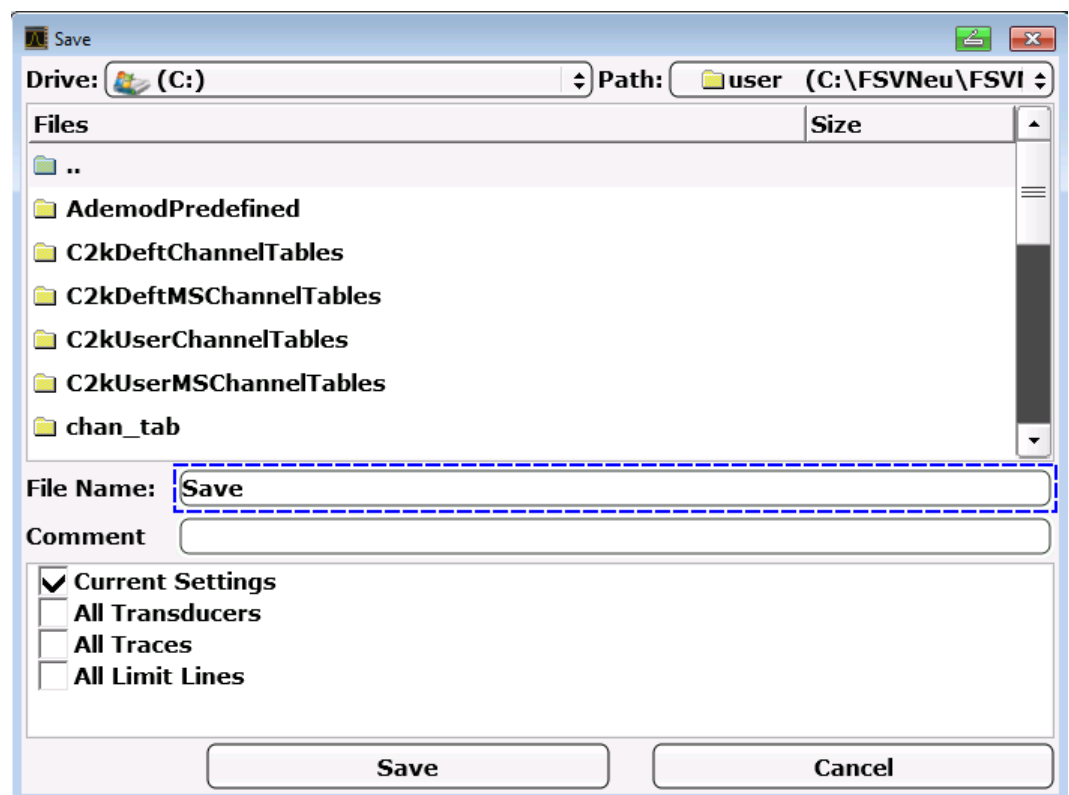

3. To change the suggested name, enter a name for the settings file to be stored. The name may contain letters and digits. For details on alphanumeric entries see [Chapter 4.4.3.2, "Entering Alphanumeric Parameters"](#), on page 65.
4. To store the file in a directory different to the default directory, select the required path in the Files area.
If the path is not changed, the default path for the instrument configurations (C:\R_S\Instr\user) is used.

Note: The selected directory is automatically used for any further save and recall operations.

5. Press the "Save File" softkey.
The settings file is stored and the dialog box is closed.

4.5.5.2 Storing Traces

Before you can store traces, you must first select the corresponding item entry. To do so, proceed as follows:

1. Press the [SAVE/RCL] key.
2. Press the "Save" softkey.
3. To change the suggested name, enter a file name.
4. Select the "All Traces" option.
5. Press the "SAVE" button.

4.5.5.3 Loading an Instrument Configuration (with Traces)

1. Press the [SAVE/RCL] key.
2. Press the "Recall" softkey.
3. If necessary, select the path under which the file to be loaded is stored.
4. Define the settings file to be loaded. One of the following ways is possible:
 - Click in the `File Name` field and enter the file name via the keyboard or keypad.
 - Select the file from the selection list using the touchscreen or mouse.Alternatively:
 - a) Press the "Select File" softkey.
The focus is set on the files list.
 - b) Using the rotary knob or arrow keys, focus the settings file to be loaded and confirm by pressing the rotary knob or the [ENTER] key.
5. To load traces, select the "All Traces" option.
Note: The "All Traces" option is only available if the selected file contains traces.
6. Press the "Recall" button in the dialog box, or the "Recall File" softkey.
The settings file is loaded. During loading, the R&S FSVA/FSV detects which items the selected settings file contains and, if applicable, ignores any items that were selected but are not available.

4.5.5.4 Configuring Automatic Loading

If the R&S FSVA/FSV is switched on in the factory default state, it loads the instrument settings that it had when switched off (provided that it was switched off using the [ON /

OFF] key on the front panel; see [Chapter 4.2.1.8, "Switching the Instrument On and Off"](#), on page 32. If the instrument is preset, it loads the presets.

You can alter these settings and define a settings file to be loaded. This requires performing the following procedure. Be aware that the chosen settings file is loaded both while booting and presetting.

1. Press the [SAVE/RCL] key.
2. Press the "Startup Recall" softkey.
3. Press the "Startup Recall (On/Off)" softkey to activate the recall function.
4. Press the "Select Dataset" softkey.
The "Startup Recall" dialog box is displayed.
5. If necessary, select the path under which the file to be loaded is stored.
6. Select the settings file to be loaded (DFL file).
7. Press the "Select" button in the dialog box.

4.6 Advanced Measurement Examples

This chapter explains how to operate the R&S FSVA/FSV using typical measurements as examples. Additional background information on the settings is given. For more detailed information on all available softkeys and the corresponding instrument functions, see [Chapter 5, "Instrument Functions"](#), on page 135.

Examples of more basic character are provided in the R&S FSVA/FSV Quick Start Guide, as an introduction. The following topics are included in the R&S FSVA/FSV Quick Start Guide:

- Measuring a Sinusoidal Signal
 - Measuring the Level and Frequency Using Markers
 - Measuring the Signal Frequency Using the Frequency Counter
- Measuring Harmonics of Sinusoidal Signals
 - Measuring the Suppression of the First and Second Harmonic of an Input Signal
 - Measuring the Modulation Depth of an AM-Modulated Carrier (Span > 0)
 - Measuring of AM-Modulated Signals
- Measuring Signal Spectra with Multiple Signals
 - Separating Signals by Selecting the Resolution Bandwidth
- Measurements with Zero Span
 - Measuring the Power Characteristic of Burst Signals
 - Measuring the Signal-to-Noise Ratio of Burst Signals
 - Measurement of FM-Modulated Signals
- Storing and Loading Instrument Settings

- Storing an Instrument Configuration (without Traces)
- Storing Traces
- Loading an Instrument Configuration (with Traces)
- Configuring Automatic Loading
- [Test Setup](#)..... 106
- [Measurement of Harmonics](#)..... 107
- [Measuring the Spectra of Complex Signals](#)..... 109
- [Measuring Signals in the Vicinity of Noise](#)..... 113
- [Noise Measurements](#)..... 118
- [Measurements on Modulated Signals](#)..... 125

4.6.1 Test Setup

All of the following examples are based on the standard settings of the R&S FSVA/FSV. These are set with the PRESET key. A complete listing of the standard settings can be found in chapter "Instrument Functions", section "Initializing the Configuration – PRESET Key".

In the following examples, a signal generator is used as a signal source. The RF output of the signal generator is connected to the RF input of R&S FSVA/FSV.

If a 64 MHz signal is required for the test setup, as an alternative to the signal generator, the internal 64 MHz reference generator can be used:

1. Switch on the internal reference generator.
 - a) Press the SETUP key.
 - b) Press the "More" key.
 - c) Press the "Service" softkey.
 - d) Press the "Input RF/Cal" softkey, until "Cal" is highlighted.
The internal 64 MHz reference generator is now on. The R&S FSVA/FSV's RF input is switched off.
2. Switch on the RF input again for normal operation of the R&S FSVA/FSV. Two ways are possible:
 - a) Press the PRESET key.
or:
 - b) Press the SETUP key.
 - c) Press the "Service" softkey.
 - d) Press the "Input RF/Cal" softkey, until "RF" is highlighted.

The internal signal path of the R&S FSVA/FSV is switched back to the RF input in order to resume normal operation.

4.6.2 Measurement of Harmonics

Signal generator settings (e.g. R&S SMW):

Frequency:	128 MHz
Level:	- 25 dBm

Procedure on the R&S FSVA/FSV:

1. Set the R&S FSVA/FSV to its default state by pressing the [PRESET] key.
2. Set the center frequency to *128 MHz* and the span to *100 kHz*.
3. Switch on the marker by pressing the [MKR] key.
The marker is positioned on the trace maximum.
4. Set the measured signal frequency and the measured level as reference values.
 - a) Press the [MKR FUNC] key
 - b) Press the "Ref Fixed" softkey.
The position of the marker becomes the reference point. The reference point level is indicated by a horizontal line, the reference point frequency with a vertical line. At the same time, the delta marker 2 is switched on.

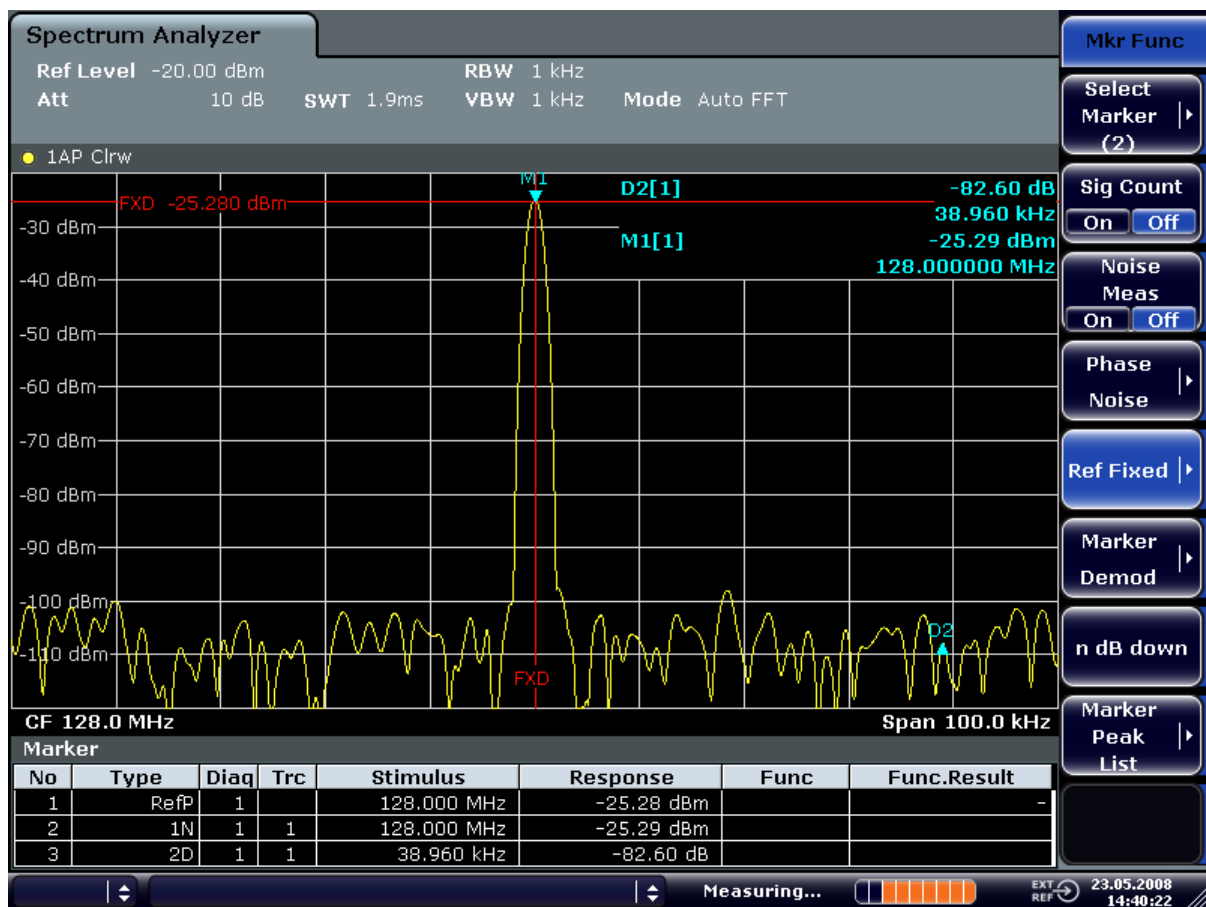

Figure 4-25: Fundamental wave and the frequency and level reference point

5. Make the step size for the center frequency equal to the signal frequency
 - a) Press the [FREQ] key.
 - b) Press the "CF-Stepsize" softkey and press the "= Marker" softkey in the sub-menu.

The step size for the center frequency is now equal to the marker frequency.

6. Set the center frequency to the second harmonic of the signal.
 - a) Press the [FREQ] key.
 - b) Press the [UPARROW] key once.

The center frequency is set to the second harmonic.

7. Place the delta marker on the second harmonic.

- a) Press the [MKR ->] key.
- b) Press the "Peak" softkey.

The delta marker moves to the maximum of the second harmonic. The displayed level result is relative to the reference point level (= fundamental wave level).

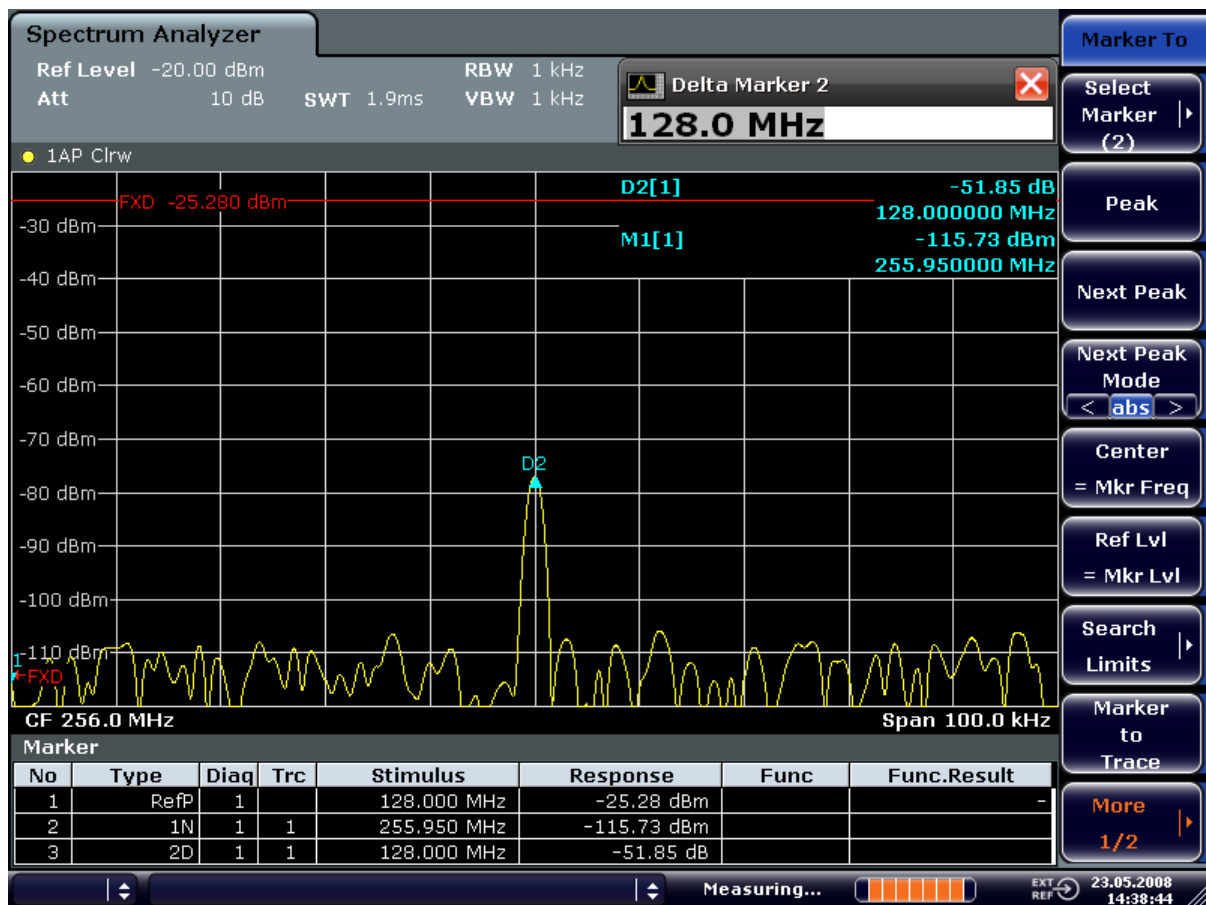

Figure 4-26: Measuring the level difference between the fundamental wave (= reference point level) and the 2nd harmonic

The other harmonics are measured with steps 5 and 6, the center frequency being incremented or decremented in steps of 128 MHz using the [UPARROW] or [DNARROW] key.

4.6.3 Measuring the Spectra of Complex Signals

4.6.3.1 Separating Signals by Selecting an Appropriate Resolution Bandwidth

A basic feature of a signal analyzer is being able to separate the spectral components of a mixture of signals. The resolution at which the individual components can be separated is determined by the resolution bandwidth. Selecting a resolution bandwidth that is too large may make it impossible to distinguish between spectral components, i.e. they are displayed as a single component.

An RF sinusoidal signal is displayed by means of the passband characteristic of the resolution filter (RBW) that has been set. Its specified bandwidth is the 3 dB bandwidth of the filter.

Two signals with the same amplitude can be resolved if the resolution bandwidth is smaller than or equal to the frequency spacing of the signal. If the resolution bandwidth is equal to the frequency spacing, the spectrum display screen shows a level drop of 3 dB precisely in the center of the two signals. Decreasing the resolution bandwidth makes the level drop larger, which thus makes the individual signals clearer.

If there are large level differences between signals, the resolution is determined by selectivity as well as by the resolution bandwidth that has been selected. The measure of selectivity used for signal analyzers is the ratio of the 60 dB bandwidth to the 3 dB bandwidth (= shape factor).

For the R&S FSVA/FSV, the shape factor for bandwidths is < 5 , i.e. the 60 dB bandwidth of the 30 kHz filter is < 150 kHz.

The higher spectral resolution with smaller bandwidths is won by longer sweep times for the same span. The sweep time has to allow the resolution filters to settle during a sweep at all signal levels and frequencies to be displayed.

4.6.3.2 Intermodulation Measurements

If several signals are applied to a transmission two-port device with nonlinear characteristic, intermodulation products appear at its output at the sums and differences of the signals. The nonlinear characteristic produces harmonics of the useful signals which intermodulate at the characteristic. The intermodulation products of lower order have a special effect since their level is largest and they are near the useful signals. The intermodulation product of third order causes the highest interference. It is the intermodulation product generated from one of the useful signals and the 2nd harmonic of the second useful signal in case of two-tone modulation.

For details see [Chapter 5.3.5.9, "Measuring the Third Order Intercept Point \(TOI\)"](#), on page 375.

Measurement Example – Measuring the R&S FSVA/FSV's Intrinsic Intermodulation

Test setup:

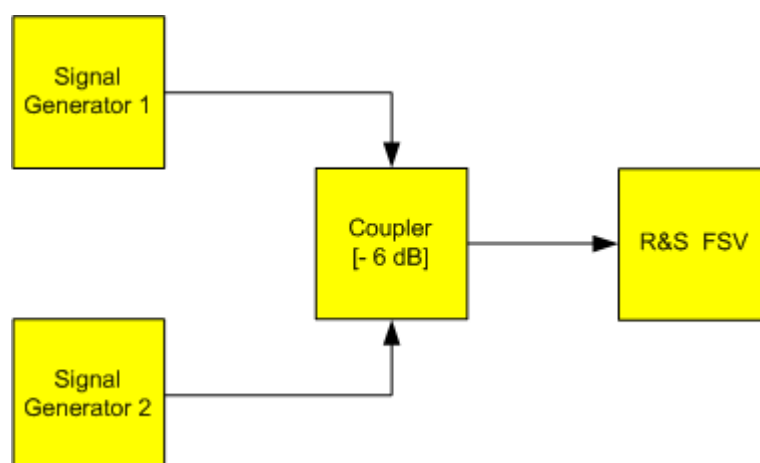

Signal generator settings (e.g. R&S SMW):

	Level	Frequency
Signal generator 1	-4 dBm	999.7 MHz
Signal generator 2	-4 dBm	1000.3 MHz

Setting up the measurement

1. Set the R&S FSVA/FSV to its default settings by pressing the [PRESET] key.
The R&S FSVA/FSV is in its default state.
2. Set center frequency to *1 GHz* and the frequency span to *3 MHz*.
3. Set the reference level to *-10 dBm* and RF attenuation to *0 dB*.
4. Set the resolution bandwidth to *10 kHz*.
The noise is reduced, the trace is smoothed further and the intermodulation products can be clearly seen.
5. Set the VBW to "1 kHz".

Measuring intermodulation using the 3rd order intercept (TOI) measurement function

1. Press the [MEAS] key and then the "TOI" softkey.
The R&S FSVA/FSV activates four markers to measure the intermodulation distance. Two markers are positioned on the useful signals and two on the intermodulation products. The 3rd order intercept is calculated from the level difference between the useful signals and the intermodulation products. It is then displayed on the screen:

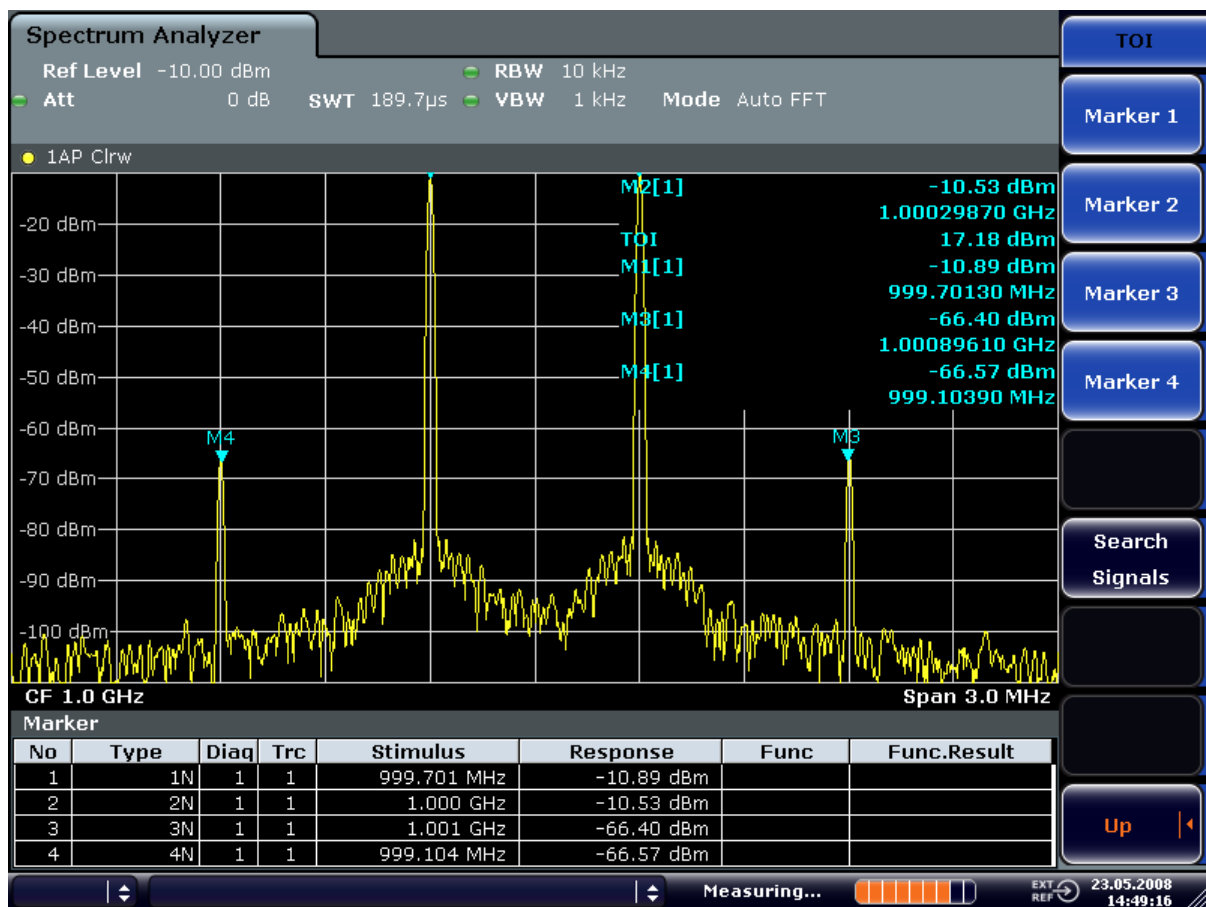
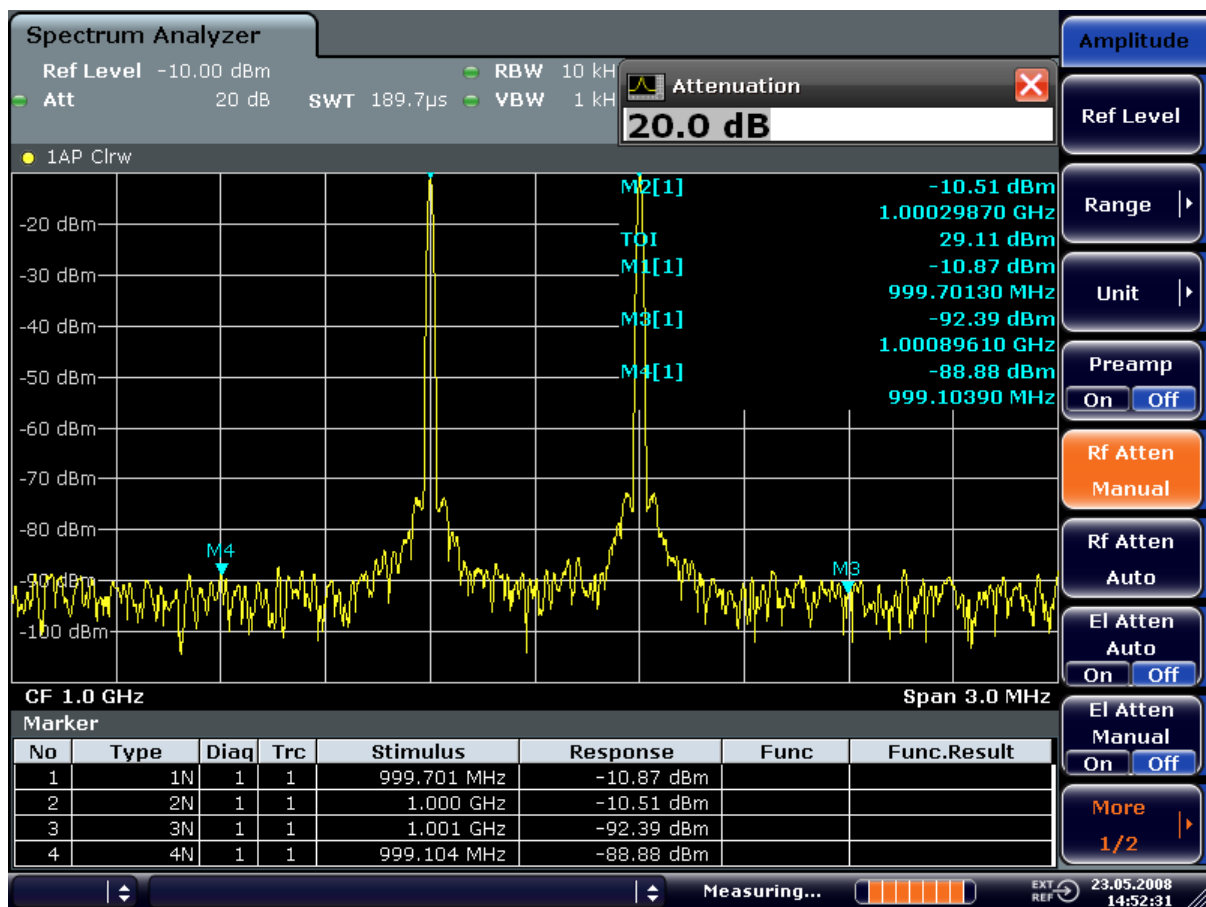

Figure 4-27: Result of intrinsic intermodulation measurement on the R&S FSVA/FSV.

The 3rd order intercept (TOI) is displayed at the top right corner of the grid.

- The level of a signal analyzer's intrinsic intermodulation products depends on the RF level of the useful signals at the input mixer. When the RF attenuation is added, the mixer level is reduced and the intermodulation distance is increased. With an additional RF attenuation of 10 dB, the levels of the intermodulation products are reduced by 20 dB. The noise level is, however, increased by 10 dB. Increase the RF attenuation to 20 dB to reduce intermodulation products.

The R&S FSVA/FSV's intrinsic intermodulation products disappear below the noise floor.



4.6.4 Measuring Signals in the Vicinity of Noise

The minimum signal level a signal analyzer can measure is limited by its intrinsic noise. Small signals can be swamped by noise and therefore cannot be measured. For signals that are just above the intrinsic noise, the accuracy of the level measurement is influenced by the intrinsic noise of the signal analyzer.

The displayed noise level of a signal analyzer depends on its noise figure, the selected RF attenuation, the selected reference level, the selected resolution and video bandwidth and the detector. The effect of the different parameters is explained in the following.

Impact of the RF attenuation setting

The sensitivity of a signal analyzer is directly influenced by the selected RF attenuation. The highest sensitivity is obtained at a RF attenuation of 0 dB. The attenuation can be set in 10 dB steps up to 70 dB. Each additional 10 dB step reduces the sensitivity by 10 dB, i.e. the displayed noise is increased by 10 dB.

Impact of the resolution bandwidth

The sensitivity of a signal analyzer also directly depends on the selected bandwidth. The highest sensitivity is obtained at the smallest bandwidth (1 Hz). If the bandwidth is increased, the reduction in sensitivity is proportional to the change in bandwidth. The R&S FSVA/FSV has bandwidth settings in 1, 2, 3, 5 sequence. Increasing the bandwidth by a factor of 3 increases the displayed noise by approx. 5 dB (4.77 dB precisely). If the bandwidth is increased by a factor of 10, the displayed noise increases by a factor of 10, i.e. 10 dB.

Impact of the video bandwidth

The displayed noise of a signal analyzer is also influenced by the selected video bandwidth. If the video bandwidth is considerably smaller than the resolution bandwidth, noise spikes are suppressed, i.e. the trace becomes much smoother. The level of a sine wave signal is not influenced by the video bandwidth. A sine wave signal can therefore be freed from noise by using a video bandwidth that is small compared with the resolution bandwidth, and thus be measured more accurately.

Impact of the detector

Noise is evaluated differently by the different detectors. The noise display is therefore influenced by the choice of detector. Sine wave signals are weighted in the same way by all detectors, i.e. the level display for a sine wave RF signal does not depend on the selected detector, provided that the signal-to-noise ratio is high enough. The measurement accuracy for signals in the vicinity of intrinsic signal analyzer noise is also influenced by the detector which has been selected. For details on the detectors of the R&S FSVA/FSV refer to chapter "Instrument Functions", section "Detector overview" or the Online Help.

4.6.4.1 Measurement Example – Measuring Level at Low S/N Ratios

The example shows the different factors influencing the S/N ratio.

Signal generator settings (e.g. R&S SMW):

Frequency:	128 MHz
Level:	- 90 dBm

Procedure:

1. Set the R&S FSVA/FSV to its default state by pressing the PRESET key.
The R&S FSVA/FSV is in its default state.
2. Set the center frequency to 128 MHz and the frequency span to 100 MHz:
 - a) Press the FREQ key and enter "128 MHz".

b) Press the SPAN key and enter "100 MHz".

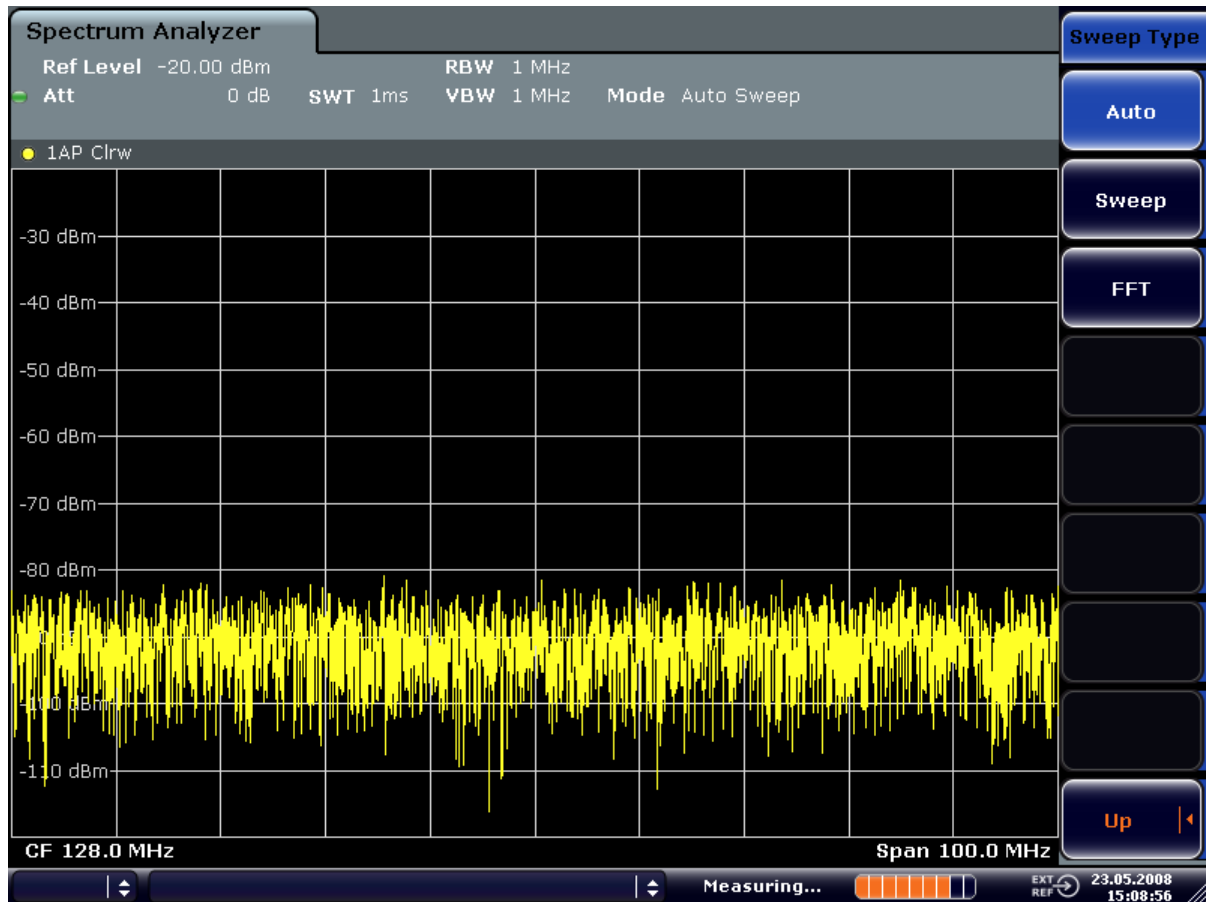

Figure 4-28: Sine wave signal with low S/N ratio. The signal is measured with the auto peak detector and is completely hidden in the intrinsic noise of the R&S FSVA/FSV.

3. To suppress noise spikes the trace can be averaged.
 - a) Press the TRACE key.
 - b) Press the "Trace Wizard" softkey.
The Trace Wizard dialog box opens.

- c) Select "Average" in the "Trace Mode" drop-down menu of the selected trace. The traces of consecutive sweeps are averaged. To perform averaging, the R&S FSVA/FSV automatically switches on the sample detector. The RF signal, therefore, can be more clearly distinguished from noise.

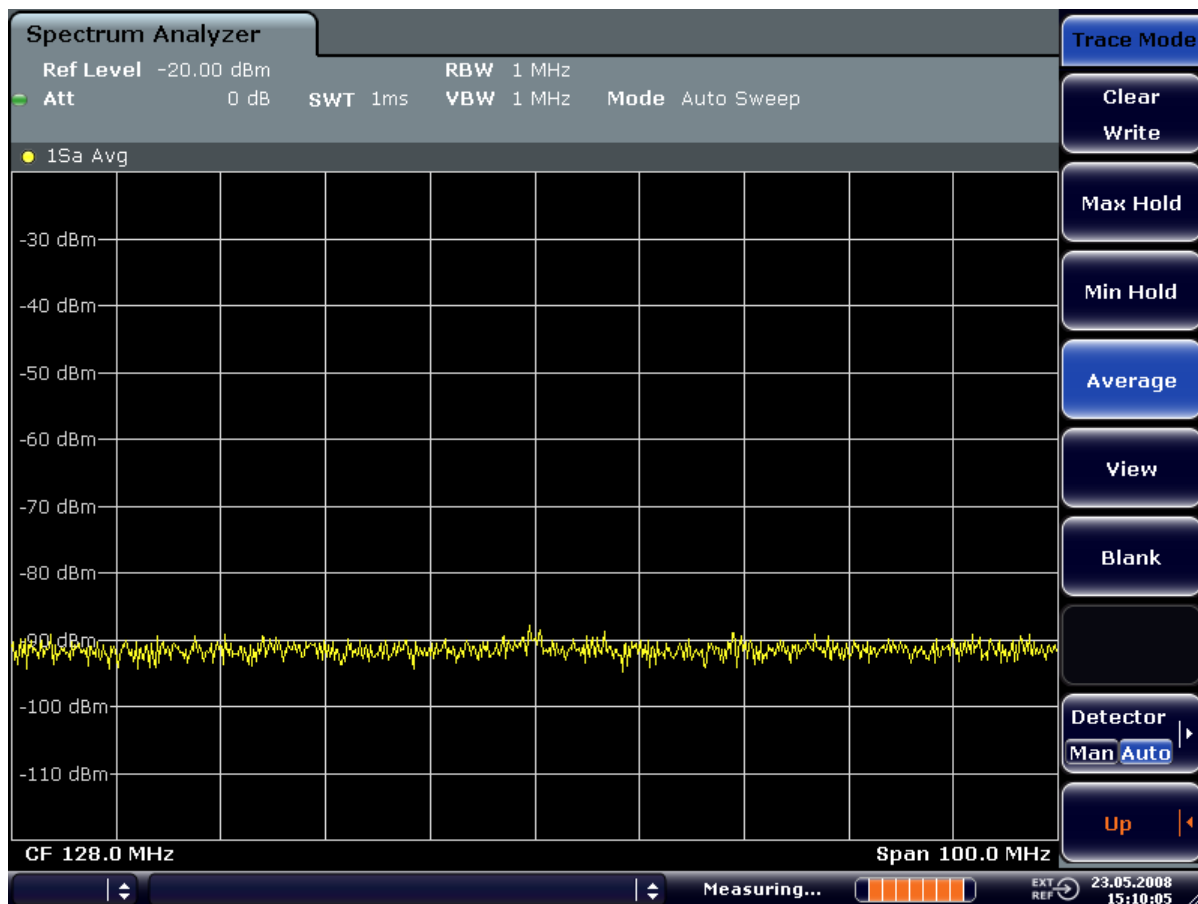

Figure 4-29: RF sine wave signal with low S/N ratio if the trace is averaged.

4. Instead of trace averaging, a video filter that is narrower than the resolution bandwidth can be selected:
 - a) Press the TRACE key.
 - b) Press the "Trace Wizard" softkey.
The Trace Wizard dialog box opens.
 - c) Select "Clear Write" in the "Trace Mode" drop-down menu of the selected trace.
 - d) Press the BW key.

- e) Press the "Video BW Manual" softkey and enter "10 kHz".
The RF signal can be more clearly distinguished from noise.

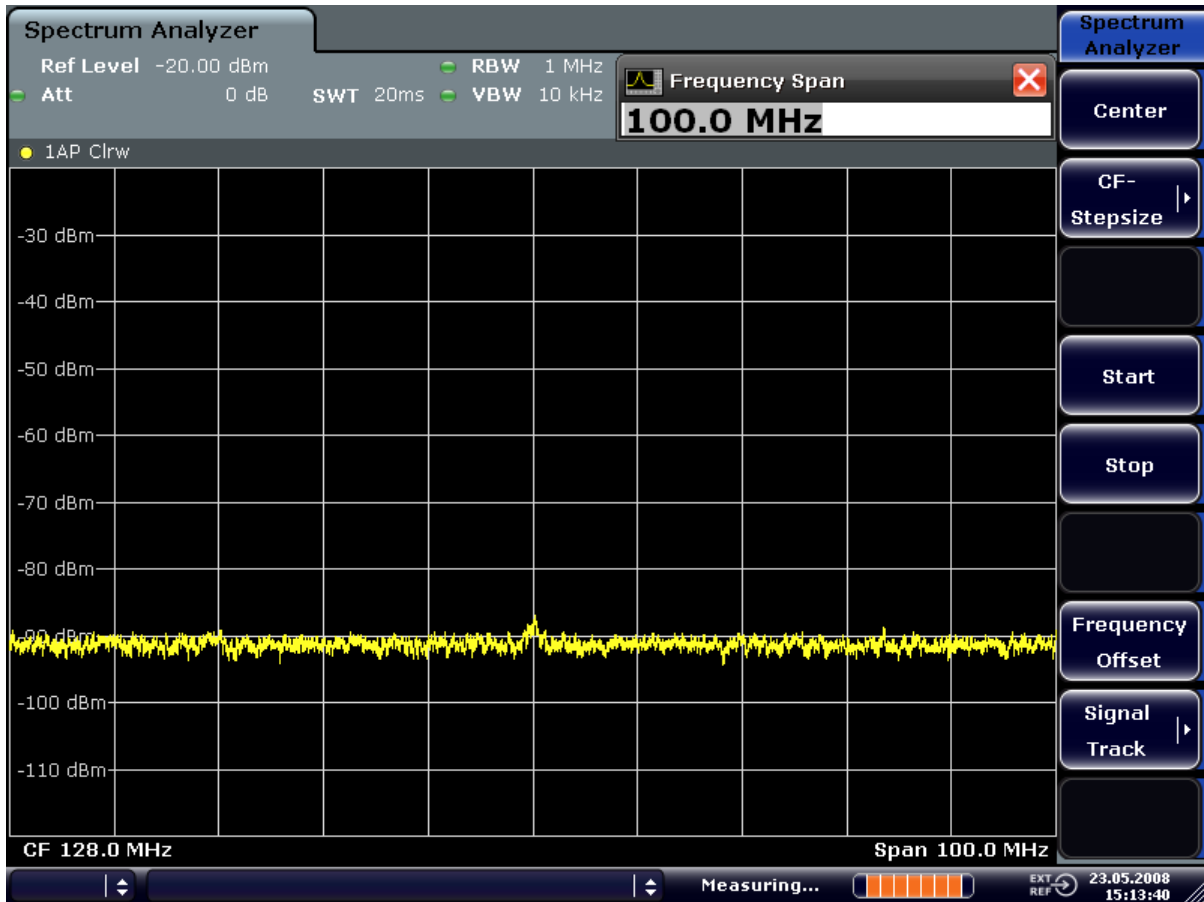

Figure 4-30: RF sine wave signal with low S/N ratio if a smaller video bandwidth is selected.

- By reducing the resolution bandwidth by a factor of 10, the noise is reduced by 10 dB:

- a) In the "Bandwidth" menu press the "Res BW Manual" softkey and enter "100 kHz".

The displayed noise is reduced by approx. 10 dB. The signal, therefore, emerges from noise by about 10 dB. Compared to the previous setting, the video bandwidth has remained the same, i.e. it has increased relative to the smaller resolution bandwidth. The averaging effect of the video bandwidth is therefore reduced. The trace will be noisier.

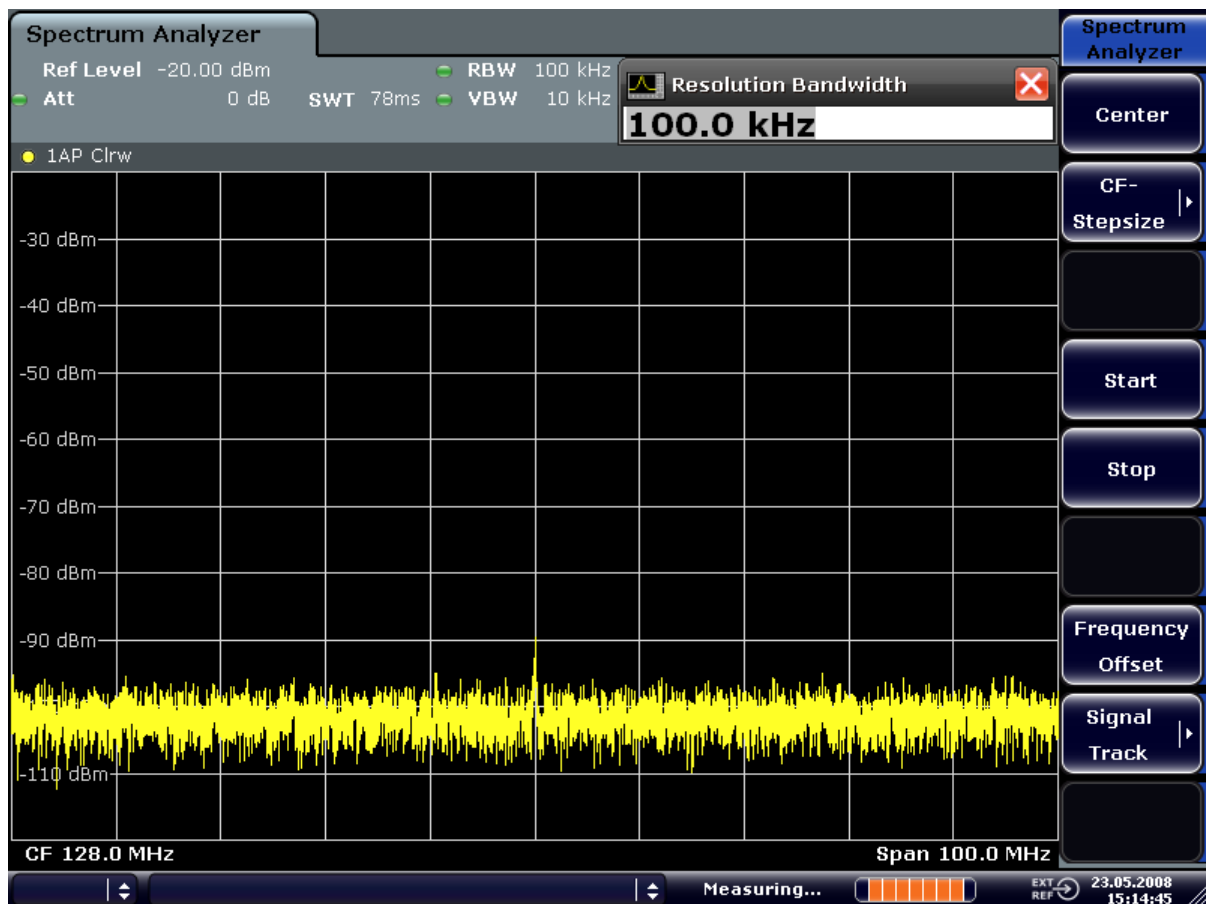

Figure 4-31: Reference signal at a smaller resolution bandwidth

4.6.5 Noise Measurements

Noise measurements play an important role in signal analysis. Noise e.g. affects the sensitivity of radio communication systems and their components.

Noise power is specified either as the total power in the transmission channel or as the power referred to a bandwidth of 1 Hz. The sources of noise are, for example, amplifier noise or noise generated by oscillators used for the frequency conversion of useful signals in receivers or transmitters. The noise at the output of an amplifier is determined by its noise figure and gain.

The noise of an oscillator is determined by phase noise near the oscillator frequency and by thermal noise of the active elements far from the oscillator frequency. Phase noise can mask weak signals near the oscillator frequency and make them impossible to detect.

4.6.5.1 Measuring Noise Power Density

To measure noise power referred to a bandwidth of 1 Hz at a certain frequency, the R&S FSVA/FSV provides marker function. This marker function calculates the noise power density from the measured marker level.

Measurement Example – Measuring the Intrinsic Noise Power Density of the R&S FSVA/FSV at 1 GHz and Calculating the R&S FSVA/FSV's Noise Figure

Test setup:

- ▶ Connect no signal to the RF input; terminate RF input with 50 Ω.

Procedure:

1. Set the R&S FSVA/FSV to its default state by pressing the PRESET key.
The R&S FSVA/FSV is in its default state.
2. Set the center frequency to 1.234 GHz and the span to 1 MHz.
 - a) Press the FREQ key and enter "1.234 GHz".
 - b) Press the SPAN key and enter "1 MHz".
3. Switch on the marker and set the marker frequency to 1.234 GHz by pressing the MKR key and entering "1.234 GHz".
4. Switch on the noise marker function by switching on the "Noise Meas" softkey.
 - a) Press the MKR FUNC key.
 - b) Switch the "Noise Meas" softkey to "On"
The R&S FSVA/FSV displays the noise power at 1.234 GHz in dBm (1Hz).

Note: Since noise is random, a sufficiently long measurement time has to be selected to obtain stable measurement results. This can be achieved by averaging the trace or by selecting a very small video bandwidth relative to the resolution bandwidth.

5. The measurement result is stabilized by averaging the trace.
 - a) Press the TRACE key.
 - b) Press the "Trace Wizard" softkey.
The Trace Wizard dialog box opens.
 - c) Select "Average" in the "Trace Mode" drop-down menu of the selected trace.
The R&S FSVA/FSV performs sliding averaging over 10 traces from consecutive sweeps. The measurement result becomes more stable.

Conversion to other reference bandwidths

The result of the noise measurement can be referred to other bandwidths by simple conversion. This is done by adding $10 \times \log(\text{BW})$ to the measurement result, BW being the new reference bandwidth.

Example:

A noise power of -150 dBm (1 Hz) is to be referred to a bandwidth of 1 kHz.

$$P_{[1\text{kHz}]} = -150 + 10 \times \log(1000) = -150 + 30 = -120 \text{ dBm (1 kHz)}$$

Calculation method for noise power

If the noise marker is switched on, the R&S FSVA/FSV automatically activates the sample detector. The video bandwidth is set to 1/10 of the selected resolution bandwidth (RBW).

To calculate the noise, the R&S FSVA/FSV takes an average over 17 adjacent pixels (the pixel on which the marker is positioned and 8 pixels to the left, 8 pixels to the right of the marker). The measurement result is stabilized by video filtering and averaging over 17 pixels.

Since both video filtering and averaging over 17 trace points is performed in the log display mode, the result would be 2.51 dB too low (difference between logarithmic noise average and noise power). The R&S FSVA/FSV, therefore, corrects the noise figure by 2.51 dB.

To standardize the measurement result to a bandwidth of 1 Hz, the result is also corrected by $-10 \times \log(\text{RBW}_{\text{noise}})$, with $\text{RBW}_{\text{noise}}$ being the power bandwidth of the selected resolution filter (RBW).

Detector selection

The noise power density is measured in the default setting with the sample detector and using averaging. Other detectors that can be used to perform a measurement giving true results are the average detector or the RMS detector. If the average detector is used, the linear video voltage is averaged and displayed as a pixel. If the RMS detector is used, the squared video voltage is averaged and displayed as a pixel. The averaging time depends on the selected sweep time ($=\text{SWT}/501$). An increase in the sweep time gives a longer averaging time per pixel and thus stabilizes the measurement result. The R&S FSVA/FSV automatically corrects the measurement result of the noise marker display depending on the selected detector (+1.05 dB for the average detector, 0 dB for the RMS detector). It is assumed that the video bandwidth is set to at least three times the resolution bandwidth. While the average or RMS detector is being switched on, the R&S FSVA/FSV sets the video bandwidth to a suitable value.

The Pos Peak, Neg Peak, Auto Peak and Quasi Peak detectors are not suitable for measuring noise power density.

Determining the noise figure

The noise figure of amplifiers or of the R&S FSVA/FSV alone can be obtained from the noise power display. Based on the known thermal noise power of a 50 Ω resistor at

room temperature (-174 dBm (1Hz)) and the measured noise power P_{noise} the noise figure (NF) is obtained as follows:

$$\text{NF} = P_{\text{noise}} + 174 - g,$$

where g = gain of DUT in dB

Example:

The measured internal noise power of the R&S FSVA/FSV at an attenuation of 0 dB is found to be -143 dBm/1 Hz. The noise figure of the R&S FSVA/FSV is obtained as follows

$$\text{NF} = -143 + 174 = 31 \text{ dB}$$



If noise power is measured at the output of an amplifier, for example, the sum of the internal noise power and the noise power at the output of the DUT is measured. The noise power of the DUT can be obtained by subtracting the internal noise power from the total power (subtraction of linear noise powers). By means of the following diagram, the noise level of the DUT can be estimated from the level difference between the total and the internal noise level.

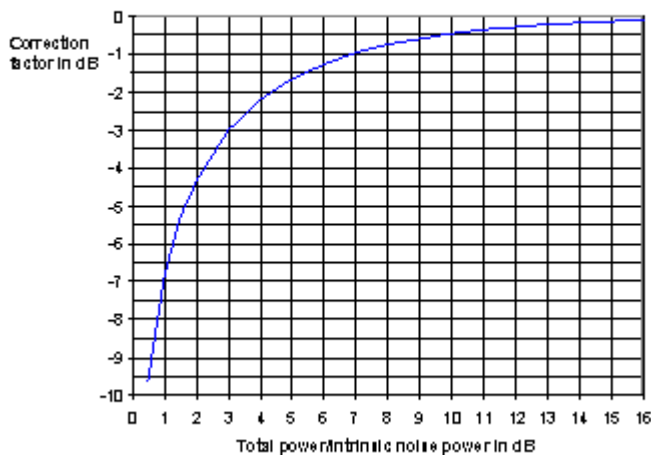

Figure 4-32: Correction factor for measured noise power as a function of the ratio of total power to the intrinsic noise power of the signal analyzer

4.6.5.2 Measurement of Noise Power within a Transmission Channel

Noise in any bandwidth can be measured with the channel power measurement functions. Thus the noise power in a communication channel can be determined, for example. If the noise spectrum within the channel bandwidth is flat, the noise marker from the previous example can be used to determine the noise power in the channel by considering the channel bandwidth. If, however, phase noise and noise that normally

increases towards the carrier is dominant in the channel to be measured, or if there are discrete spurious signals in the channel, the channel power measurement method must be used to obtain correct measurement results.

Measurement Example – Measuring the Intrinsic Noise of the R&S FSVA/FSV at 1 GHz in a 1.23 MHz Channel Bandwidth with the Channel Power Function

Test setup:

- ▶ Leave the RF input of the R&S FSVA/FSV open-circuited or terminate it with 50 Ω .

Procedure:

1. Set the R&S FSVA/FSV to its default state by pressing the [PRESET] key.
The R&S FSVA/FSV is in its default state.
2. Set the center frequency to 1 GHz and the span to 1 MHz.
3. To obtain maximum sensitivity, set RF attenuation on the R&S FSVA/FSV to 0 dB.
4. Set the "Sweep Type" to "Sweep".
5. Switch on and configure the channel power measurement.
 - a) Press the [MEAS] key.
 - b) Press the "Ch Power/ACLR" softkey.
The R&S FSVA/FSV activates the channel or adjacent channel power measurement according to the currently set configuration.
 - c) Press the "CP/ACLR Settings" softkey.
 - d) Press the "Channel Settings" softkey.
 - e) Press the "Channel Bandwidth" softkey and enter 1.23 MHz.
The R&S FSVA/FSV displays the 1.23 MHz channel as two vertical lines which are symmetrical to the center frequency.

- f) Press the "Adjust Settings" softkey.
The settings for the frequency span, the bandwidth (RBW and VBW) and the detector are automatically set to the optimum values required for the measurement.

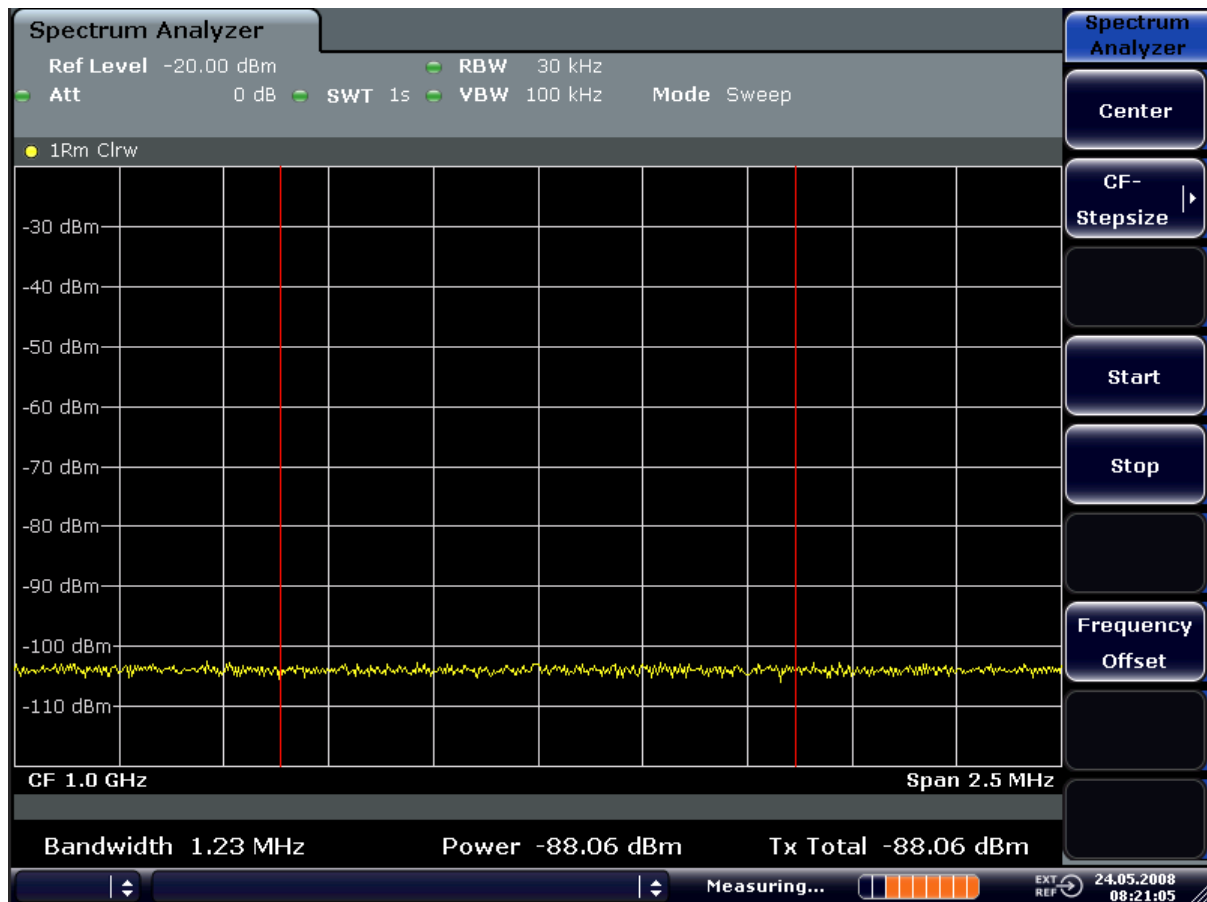

Figure 4-33: Measurement of the R&S FSVA/FSV's intrinsic noise power in a 1.23 MHz channel bandwidth.

6. Stabilize the measurement result by increasing the sweep time.
In the "Ch Power ACLR" menu, press the "Sweep Time" softkey and enter 1 s.
The trace becomes much smoother because of the RMS detector and the channel power measurement display is much more stable.

4.6.5.3 Measuring Phase Noise

The R&S FSVA/FSV has an easy-to-use marker function for phase noise measurements. This marker function indicates the phase noise of an RF oscillator at any carrier in dBc in a bandwidth of 1 Hz.

Measurement Example – Measuring the Phase Noise of a Signal Generator at a Carrier Offset of 10 kHz

Test setup:

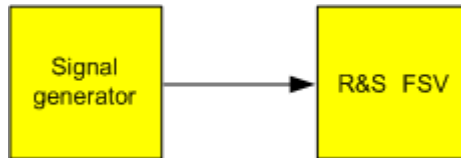

Signal generator settings (e.g. R&S SMW):

Frequency:	100 MHz
Level:	0 dBm

Procedure:

- Set the R&S FSVA/FSV to its default state by pressing the PRESET key. R&S FSVA/FSV is in its default state.
- Set the center frequency to 100 MHz and the span to 50 kHz.
 - Press the **FREQ** key and enter "100 MHz".
 - Press the **SPAN** key and enter "50 kHz".
- Set the R&S FSVA/FSV's reference level to 0 dBm (=signal generator level) by pressing the **AMPT** key and enter "0 dBm".
- Enable phase noise measurement.
 - Press the **MKR FUNC** key.
 - Press the "Phase Noise" softkey.
The R&S FSVA/FSV activates phase noise measurement. Marker 1 (=main marker) and marker 2 (= delta marker) are positioned on the signal maximum. The position of the marker is the reference (level and frequency) for the phase noise measurement. A horizontal line represents the level of the reference point and a vertical line the frequency of the reference point. The dialog box for the delta marker is displayed so that the frequency offset at which the phase noise is to be measured can be entered directly.
- Set the frequency offset to 10 kHz for determining phase noise by entering "10 kHz".
The R&S FSVA/FSV displays the phase noise at a frequency offset of 10 kHz. The magnitude of the phase noise in dBc/Hz is displayed in the delta marker output field at the top right of the screen (Phn2).
- Stabilize the measurement result by activating trace averaging.

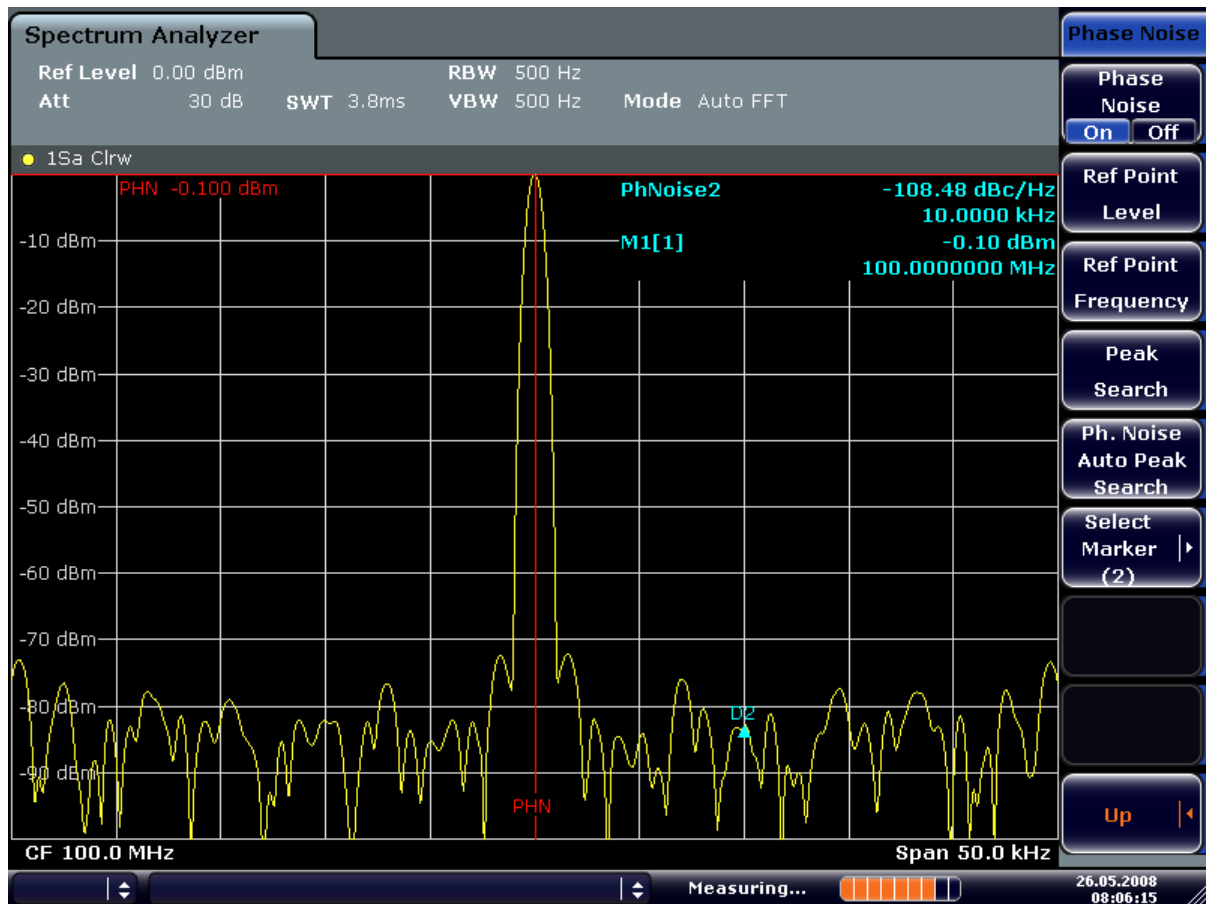

Figure 4-34: Measuring phase noise with the phase-noise marker function

The frequency offset can be varied by moving the marker with the rotary knob or by entering a new frequency offset as a number.

4.6.6 Measurements on Modulated Signals

For measurements on AM and FM signals refer to [Chapter 4.5, "Basic Measurement Examples"](#), on page 77.

4.6.6.1 Measuring Channel Power and Adjacent Channel Power

Measuring channel power and adjacent channel power is one of the most important tasks in the field of digital transmission for a signal analyzer with the necessary test routines. While, theoretically, channel power could be measured at highest accuracy with a power meter, its low selectivity means that it is not suitable for measuring adjacent channel power as an absolute value or relative to the transmit channel power. The power in the adjacent channels can only be measured with a selective power meter.

A signal analyzer cannot be classified as a true power meter, because it displays the IF envelope voltage. However, it is calibrated such as to correctly display the power of a pure sine wave signal irrespective of the selected detector. This calibration cannot be

applied for non-sinusoidal signals. Assuming that the digitally modulated signal has a Gaussian amplitude distribution, the signal power within the selected resolution bandwidth within the selected resolution bandwidth can be obtained using correction factors. These correction factors are normally used by the signal analyzer's internal power measurement routines in order to determine the signal power from IF envelope measurements. These factors apply if and only if the assumption of a Gaussian amplitude distribution is correct.

Apart from this common method, the R&S FSVA/FSV also has a true power detector, i.e. an RMS detector. It correctly displays the power of the test signal within the selected resolution bandwidth irrespective of the amplitude distribution, without additional correction factors being required. The absolute measurement uncertainty of the FSV is < 1.5 dB and a relative measurement uncertainty of < 0.5 dB (each with a confidence level of 95 %).

There are two possible methods for measuring channel and adjacent channel power with a signal analyzer:

1. IBW method (**I**ntegration **B**andwidth **M**ethod)

The signal analyzer measures with a resolution bandwidth that is less than the channel bandwidth and integrates the level values of the trace versus the channel bandwidth. This method is described in "[Measurement Example – Measuring the Intrinsic Noise of the R&S FSVA/FSV at 1 GHz in a 1.23 MHz Channel Bandwidth with the Channel Power Function](#)" on page 122.

2. Using a channel filter

For a detailed description, refer to the following section.

Measurements using a channel filter

In this case, the signal analyzer makes zero span measurements using an IF filter that corresponds to the channel bandwidth. The power is measured at the output of the IF filter. Until now, this method has not been used for signal analyzers, because channel filters were not available and the resolution bandwidths, optimized for the sweep, did not have a sufficient selectivity. The method was reserved for special receivers optimized for a particular transmission method.

The R&S FSVA/FSV has test routines for simple channel and adjacent channel power measurements. These routines give quick results without any complex or tedious setting procedures.

Measurement Example 1 – ACPR Measurement on an CDMA2000 Signal

Test setup:



Signal generator settings (e.g. R&S SMW):

Frequency:	850 MHz
Level:	0 dBm
Modulation:	CDMA2000

Procedure:

1. Set the R&S FSVA/FSV to its default state by pressing the [PRESET] key.
The R&S FSVA/FSV is in its default state.
2. Press the [FREQ] key and enter "850 MHz" as the center frequency.
3. Press the [SPAN] key and enter "4 MHz".
4. Set the reference level to +10 dBm by pressing the [AMPT] key and enter "10 dBm".
5. Configure the adjacent channel power for the CDMA2000 standard (more precisely: CDMA2000 1X).
 - a) Press the [MEAS] key.
 - b) Press the "Ch Power ACLR" softkey.
 - c) Press the "CP/ACLR Standard" softkey.
 - d) In the standards list, mark *CDMA2000*.

The R&S FSVA/FSV sets the channel configuration according to the 2000 standard with 2 adjacent channels above and 2 below the transmit channel. The spectrum is displayed in the upper part of the screen, the numeric values of the results and the channel configuration in the lower part of the screen. The various channels are represented by vertical lines on the graph.

The frequency span, resolution bandwidth, video bandwidth and detector are selected automatically to give correct results. To obtain stable results – especially in the adjacent channels (30 kHz bandwidth) which are narrow in comparison with the transmission channel bandwidth (1.23 MHz) – the RMS detector is used.

6. Set the optimal reference level and RF attenuation for the applied signal level by pressing the "Adjust Ref Level" softkey.
7. Activate "Fast ACP" mode to increase the repeatability of results by pressing the "Fast ACP" softkey (for details see below).

The R&S FSVA/FSV sets the optimal RF attenuation and the reference level based on the transmission channel power to obtain the maximum dynamic range. The [Figure 4-35](#) shows the result of the measurement.

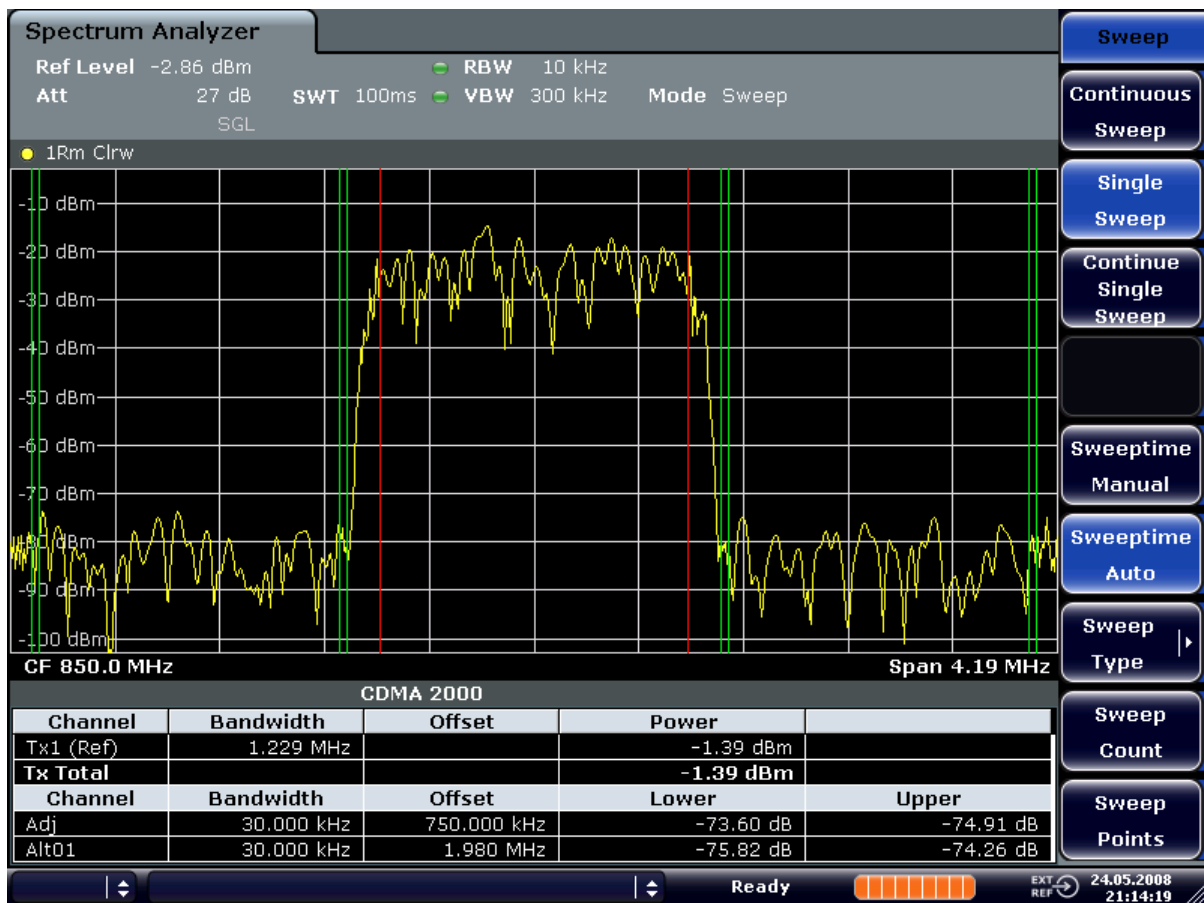
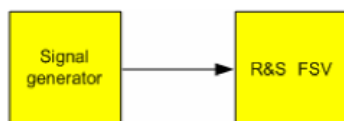

Figure 4-35: Adjacent channel power measurement on a CDMA2000 1x signal

Measurement Example 2 – Measuring Adjacent Channel Power of a W-CDMA Uplink Signal

Test setup:



Signal generator settings (e.g. R&S SMW):

Frequency:	1950 MHz
Level:	4 dBm
Modulation:	3 GPP W-CDMA Reverse Link

Procedure:

1. Set the R&S FSVA/FSV to its default state by pressing the [PRESET] key.

The R&S FSVA/FSV is in its default state.

2. Set the center frequency to 1950 MHz by pressing the [FREQ] key and entering "1950 MHz".
3. Switch on the ACLR measurement for W-CDMA.

- a) Press the [MEAS] key.
- b) Press the "Ch Power ACLR" softkey.
- c) Press the "CP/ACLR Standard" softkey.
- d) In the standards list, select *W-CDMA 3GPP REV*.

The R&S FSVA/FSV sets the channel configuration to the 3GPP W-CDMA standard for mobiles with two adjacent channels above and below the transmit channel. The frequency span, the resolution and video bandwidth and the detector are automatically set to the correct values. The spectrum is displayed in the upper part of the screen and the channel power, the level ratios of the adjacent channel powers and the channel configuration in the lower part of the screen. The individual channels are displayed as vertical lines on the graph.

4. Set the optimum reference level and the RF attenuation for the applied signal level.

- a) Press the "Adjust Ref Level" softkey.

The R&S FSVA/FSV sets the optimum RF attenuation and the reference level for the power in the transmission channel to obtain the maximum dynamic range. The following figure shows the result of the measurement.

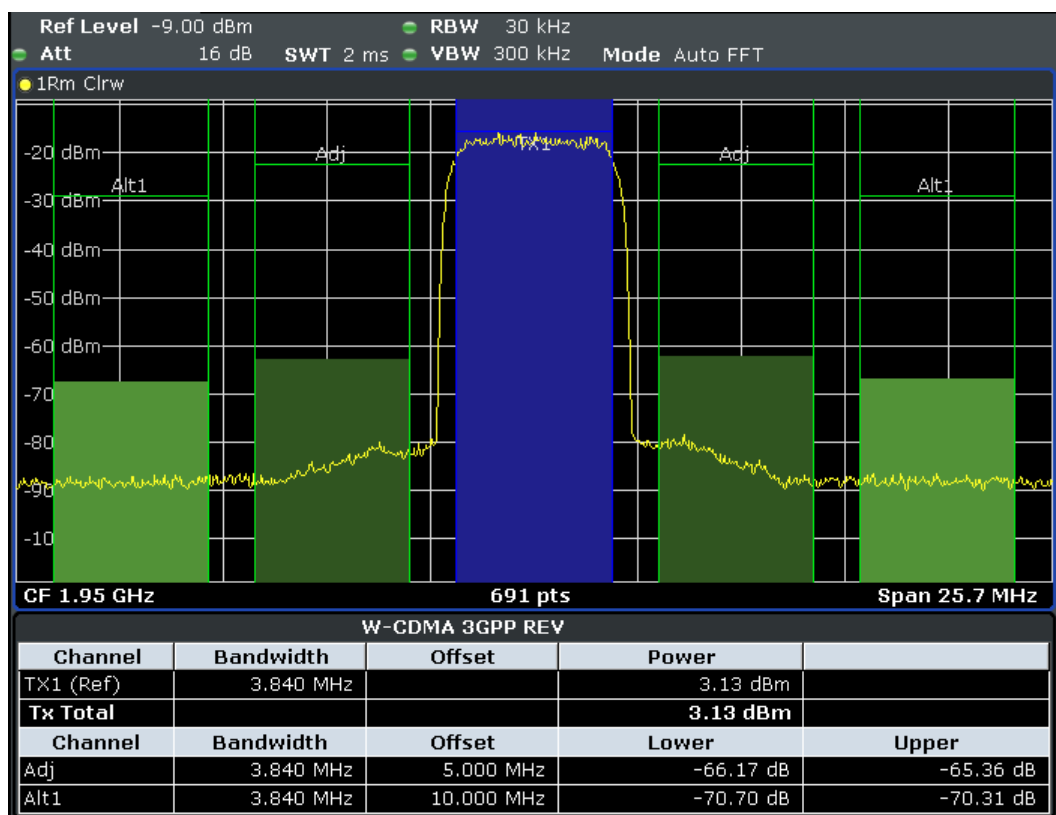

Figure 4-36: Measuring the relative adjacent channel power on a W-CDMA uplink signal

5. Set up the adjacent channel power measurement with the fast ACLR mode.

- a) Set "Fast ACLR" softkey to "On".
- b) Press the "Adjust Ref Level" softkey.

The R&S FSVA/FSV measures the power of the individual channels with zero span. A root raised cosine filter with the parameters $\alpha = 0.22$ and chip rate 3.84 Mcps (= receive filter for 3GPP W-CDMA) is used as channel filter.



Figure 4-37: Measuring the adjacent channel power of a W-CDMA signal with the fast ACLR mode

Optimum Level Setting for ACP Measurements on W-CDMA Signals

The dynamic range for ACPR measurements is limited by the thermal noise floor, the phase noise and the intermodulation (spectral regrowth) of the signal analyzer. The power values produced by the R&S FSVA/FSV due to these factors accumulate linearly. They depend on the applied level at the input mixer. The three factors are shown in the figure below for the adjacent channel (5 MHz carrier offset).

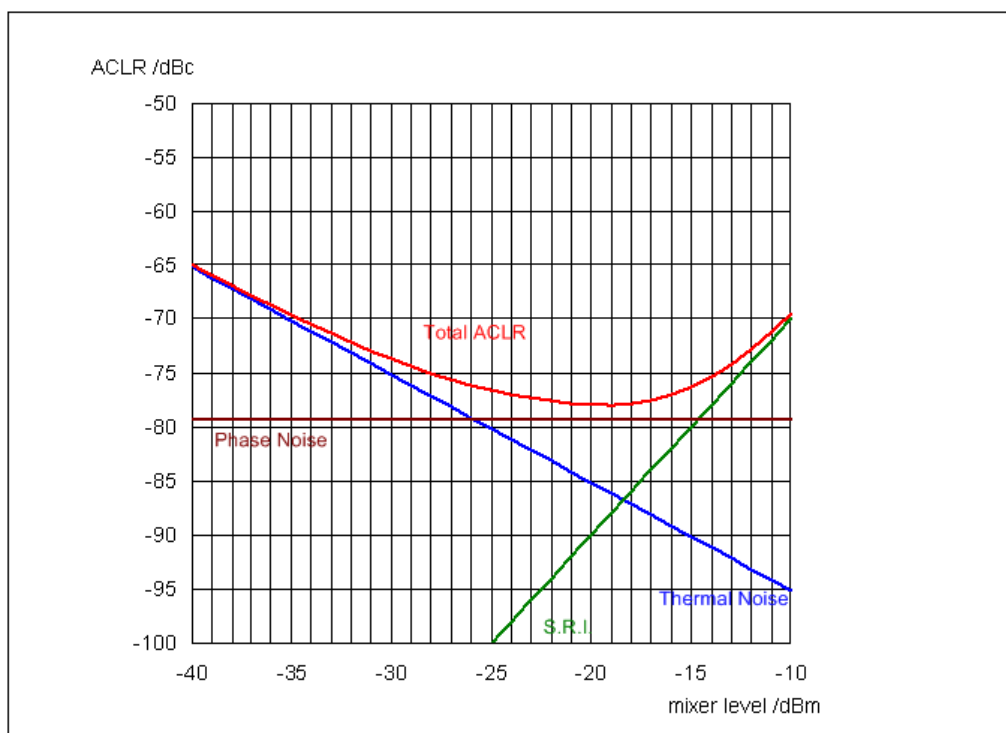

Figure 4-38: The R&S FSVA/FSV's dynamic range for adjacent channel power measurements on W-CDMA uplink signals is a function of the mixer level.

The level of the W-CDMA signal at the input mixer is shown on the horizontal axis, i.e. the measured signal level minus the selected RF attenuation. The individual components which contribute to the power in the adjacent channel and the resulting relative level (total ACPR) in the adjacent channel are displayed on the vertical axis. The optimum mixer level is -18 dBm. The relative adjacent channel power (ACPR) at an optimum mixer level is -77 dBc. Since, at a given signal level, the mixer level is set in 5 dB steps with the 5 dB RF attenuator, the optimum 10 dB range spreads from -17 dBm to -22 dBm. In this range, the obtainable dynamic range with noise correction is 77 dB.

To set the attenuation parameter manually, the following method is recommended:

- Set the RF attenuation so that the mixer level (= measured channel power – RF attenuation) is between -16 dBm and -22 dBm.

This method is automated with the "Adjust Ref Level" function. Especially in remote control mode, e.g. in production environments, it is best to correctly set the attenuation parameters prior to the measurement, as the time required for automatic setting can be saved.



To measure the R&S FSVA/FSV's intrinsic dynamic range for W-CDMA adjacent channel power measurements, a filter which suppresses the adjacent channel power is required at the output of the transmitter. A SAW filter with a bandwidth of 4 MHz, for example, can be used.

4.6.6.2 Amplitude Distribution Measurements

If modulation types are used that do not have a constant zero span envelope, the transmitter has to handle peak amplitudes that are greater than the average power. This includes all modulation types that involve amplitude modulation –QPSK for example. CDMA transmission modes in particular may have power peaks that are large compared to the average power.

For signals of this kind, the transmitter must provide large reserves for the peak power to prevent signal compression and thus an increase of the bit error rate at the receiver.

The peak power or the crest factor of a signal is therefore an important transmitter design criterion. The crest factor is defined as the peak power/mean power ratio or, logarithmically, as the peak level minus the average level of the signal.

To reduce power consumption and cut costs, transmitters are not designed for the largest power that could ever occur, but for a power that has a specified probability of being exceeded (e.g. 0.01 %).

To measure the amplitude distribution, the R&S FSVA/FSV has simple measurement functions to determine both the APD = Amplitude Probability Distribution and CCDF = Complementary Cumulative Distribution Function.

In the APD display mode, the probability of occurrence of a certain level is plotted against the level.

In the CCDF display mode, the probability that the mean signal power will be exceeded is shown in percent.

Measurement Example – Measuring the APD and CCDF of White Noise Generated by the R&S FSVA/FSV

1. Set the R&S FSVA/FSV to its default state by pressing the PRESET key.
The R&S FSVA/FSV is in its default state.
2. Configure the R&S FSVA/FSV for APD measurement
 - a) Press the AMPT key and enter "-60 dBm".
The R&S FSVA/FSV's intrinsic noise is displayed at the top of the screen.
 - b) Press the MEAS key.
 - c) Press the "More" softkey.
 - d) Press the "APD" softkey.
The R&S FSVA/FSV sets the frequency span to 0 Hz and measures the amplitude probability distribution (APD). The number of uncorrelated level measurements used for the measurement is 100000. The mean power and the peak power are displayed in dBm. The crest factor (peak power – mean power) is output as well.

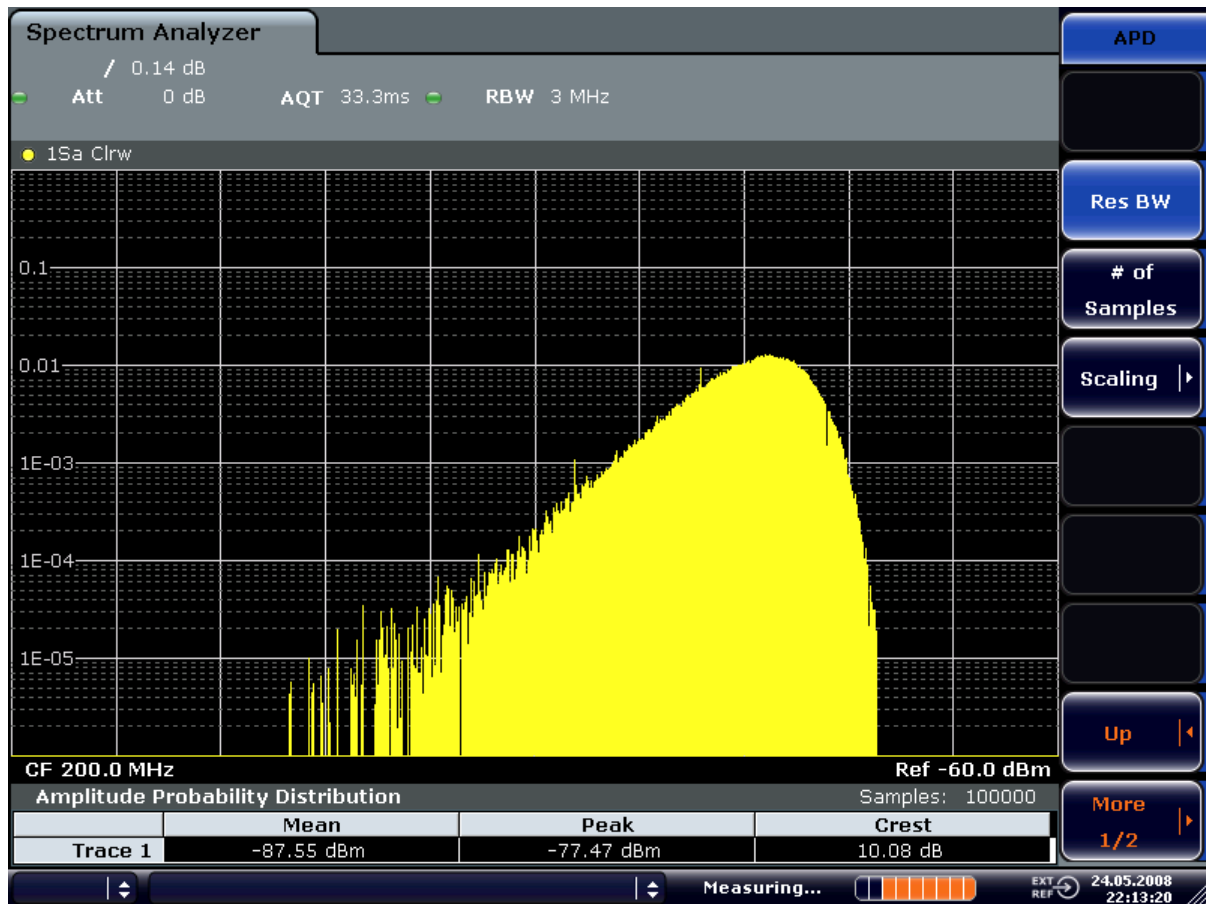

Figure 4-39: Amplitude probability distribution of white noise

3. Switch to the CCDF display mode.
 - a) Press the "UP" key.
 - b) Press the "CCDF" softkey.
The CCDF display mode is switched on.

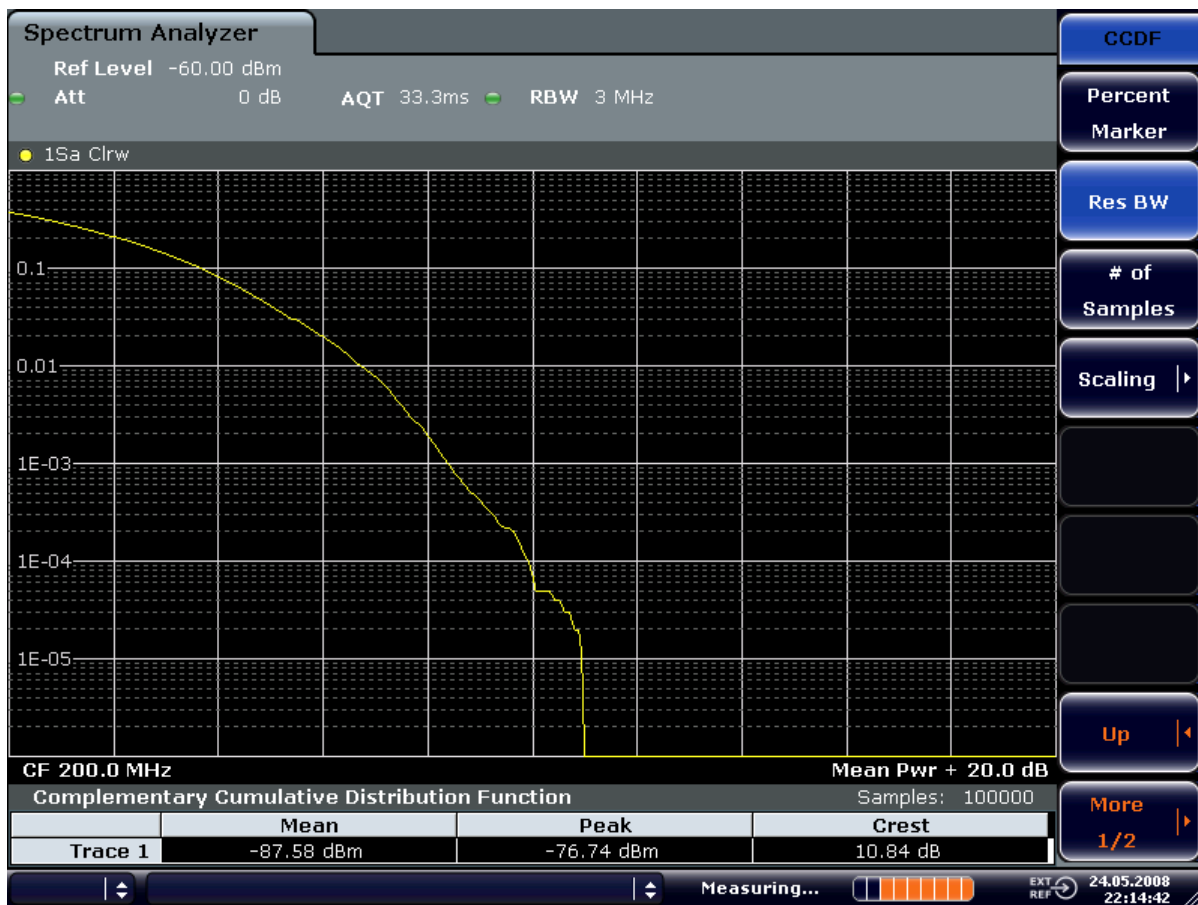

Figure 4-40: CCDF of white noise

The CCDF trace indicates the probability that a level will exceed the mean power. The level above the mean power is plotted along the x-axis of the graph. The origin of the axis corresponds to the mean power level. The probability that a level will be exceeded is plotted along the y-axis.

5 Instrument Functions

This chapter describes the analyzer functions and all basic settings functions of the R&S FSVA/FSV in detail.

For each key the available softkey menus and commands are described. The commands for the optional remote control (if any) are indicated for each softkey. The description is divided into the following topics:

- [Chapter 5.1, "General Settings, Printout and Instrument Settings"](#), on page 138
This section provides information on how to prepare measurements and process their results: setting the instrument, managing and retrieving data, returning to manual operation, and printout.
- [Chapter 5.2, "Measurement Parameters"](#), on page 182
This section describes how to reset the instrument, to set up specific measurements and to set the measurement parameters. Examples of basic operations are provided in the Quick Start Guide, chapter 5 "Basic Measurement Examples". Advanced examples are described in the Operating Manual, chapter "Advanced Measurement Examples".
- [Chapter 5.3, "Measurement Functions"](#), on page 248
This section informs about how to select and configure the measurement functions. Examples of basic operations are provided in the Quick Start Guide, chapter 5 "Basic Measurement Examples". Advanced examples are described in the Operating Manual, chapter "Advanced Measurement Examples".
- [Chapter 5.4, "Measurement Modes"](#), on page 406
This section describes the provided measurement modes, the change of measurement modes and the access to the menus of all active measurement modes.
- [Chapter 5.6, "Instrument Functions – Tracking Generator \(Options R&S FSV-B9/ R&S FSV-B10\)"](#), on page 445
This section provides information on how to configure and use optional tracking generators (R&S FSV-B9/B10).
- [Chapter 5.7, "Instrument Functions - R&S Digital I/Q Interface \(Option R&S FSV-B17\)"](#), on page 470
This section provides information on how to configure and use the optional R&S Digital I/Q Interface for digital input and output (R&S FSVB17).
- [Chapter 5.8, "Instrument Functions – External Mixer \(Option R&S FSV-B21\)"](#), on page 488
This section provides information on how to configure and use optional external mixers (R&S FSVB21).
- [Chapter 5.5, "Instrument Functions - I/Q Analyzer"](#), on page 411
This section provides information on using the IQ Analyzer.
- [Chapter 5.9, "Instrument Functions - Power Sensor \(R&S FSV-K9\)"](#), on page 509
This section describes how to configure and use an optional Power Sensor with an R&S FSVA/FSV (option R&S FSV-K9).
- [Chapter 5.10, "Instrument Functions - Spectrogram Measurements"](#), on page 522
This section describes how to perform Spectrogram measurements with an R&S FSVA/FSV (option R&S FSV-K14).

A brief introduction on handling the instrument is given in "Basic Operations" in the Quick Start Guide. This also includes the description of the keys for basic operations like switching the instrument on and off or starting a measurement.

The front and the rear view of the instrument together with a table of all available keys and a short description are provided in the R&S FSV/FSV Quick Start Guide. "Preparing for Use" informs how to start working with the instrument for the first time.

5.1	General Settings, Printout and Instrument Settings.....	138
5.1.1	Instrument Setup and Interface Configuration – SETUP Key.....	138
5.1.2	Saving and Recalling Settings Files – SAVE/RCL Key.....	163
5.1.3	Manual Operation – Local Menu.....	177
5.1.4	Measurement Documentation – PRINT Key.....	178
5.1.5	User-Defined Menu – USER key.....	181
5.2	Measurement Parameters.....	182
5.2.1	Initializing the Configuration – PRESET Key.....	183
5.2.2	Selecting the Frequency and Span – FREQ Key.....	185
5.2.3	Setting the Frequency Span – SPAN Key.....	191
5.2.4	Setting the Level Display and Configuring the RF Input – AMPT Key.....	192
5.2.5	Defining Automatic Settings – AUTO SET Key.....	201
5.2.6	Setting the Bandwidths and Sweep Time – BW Key.....	205
5.2.7	Configuring the Sweep Mode – SWEEP Key.....	214
5.2.8	Setting Traces – TRACE Key.....	219
5.2.9	Triggering the Sweep – TRIG Key.....	238
5.3	Measurement Functions.....	248
5.3.1	Using Markers and Delta Markers – MKR Key.....	249
5.3.2	Performing Peak Searches with Markers – PEAK SEARCH Key.....	256
5.3.3	Performing Marker Functions – MKR FUNC Key.....	256
5.3.4	Changing Settings via Markers – MKR-> Key.....	270
5.3.5	Power Measurements – MEAS Key.....	280
5.3.6	Measurement Configuration – MEAS CONFIG Key.....	386
5.3.7	Using Limit Lines and Display Lines – LINES Key.....	386
5.3.8	Input/Output Configuration – INPUT/OUTPUT Key.....	398
5.3.9	Performing Measurements – RUN SINGLE/RUN CONT Keys.....	406
5.4	Measurement Modes.....	406
5.4.1	Measurement Mode Selection – MODE Key.....	406
5.4.2	Measurement Mode Menus – HOME Key.....	411

5.5 Instrument Functions - I/Q Analyzer.....	411
5.5.1 Softkeys and Parameters of the I/Q Analyzer Menu.....	413
5.5.2 Softkeys of the Amplitude Menu in I/Q Analyzer Mode.....	422
5.5.3 Softkeys of the Trigger Menu in I/Q Analyzer Mode.....	429
5.5.4 Softkeys of the Marker To Menu in I/Q Analyzer Mode.....	434
5.5.5 Softkeys of the Marker Function Menu in I/Q Analyzer Mode.....	435
5.5.6 Working with I/Q Data.....	439
5.6 Instrument Functions – Tracking Generator (Options R&S FSV-B9/ R&S FSV-B10)	445
5.6.1 Softkeys of the Tracking Generator Menu.....	446
5.6.2 Connecting External Tracking Generators.....	450
5.6.3 Configuring Tracking Generators.....	454
5.6.4 Tracking Generator Functions.....	461
5.6.5 Displayed Information and Errors.....	469
5.7 Instrument Functions - R&S Digital I/Q Interface (Option R&S FSV-B17).....	470
5.7.1 Typical Applications for the R&S Digital I/Q Interface.....	471
5.7.2 Digital Input.....	473
5.7.3 Digital Output.....	479
5.7.4 Softkeys and Parameters of the R&S Digital I/Q Interface.....	480
5.7.5 Interface Status Information.....	484
5.7.6 Description of the LVDS Connector.....	487
5.8 Instrument Functions – External Mixer (Option R&S FSV-B21).....	488
5.8.1 General Information on External Mixers.....	489
5.8.2 Softkeys of the External Mixer (Option B21).....	495
5.8.3 Introductory Example of Operation.....	506
5.9 Instrument Functions - Power Sensor (R&S FSV-K9).....	509
5.9.1 Using Power Sensors.....	512
5.9.2 Zeroing the Power Sensor.....	513
5.9.3 Configuring an External Power Trigger.....	514
5.9.4 Softkeys of the Power Sensor Menu (R&S FSV-K9).....	516
5.9.5 Power Sensor Configuration Dialog.....	518
5.9.6 Error Messages.....	521
5.10 Instrument Functions - Spectrogram Measurements.....	522
5.10.1 General Information.....	523

5.10.2	Softkeys of the Spectrogram Menu.....	526
5.10.3	Configuring Color Settings for Spectrograms.....	527
5.10.4	ASCII File Export Format for Spectrograms.....	533

5.1 General Settings, Printout and Instrument Settings

After putting the instrument into operation and becoming familiar with the handling of the instrument (for details see Quick Start Guide) the preparations for measurements can start. In this section the general settings of the instrument, the data management and the processing of measurement results are described. This includes the following topics and keys:

5.1.1	Instrument Setup and Interface Configuration – SETUP Key.....	138
5.1.1.1	Softkeys of the Setup Menu.....	139
5.1.2	Saving and Recalling Settings Files – SAVE/RCL Key.....	163
5.1.2.1	Softkeys of the SAVE/RCL Menu.....	164
5.1.2.2	File Selection Dialog Boxes.....	170
5.1.2.3	Importing and Exporting I/Q Data.....	172
5.1.3	Manual Operation – Local Menu.....	177
5.1.4	Measurement Documentation – PRINT Key.....	178
5.1.5	User-Defined Menu – USER key.....	181

5.1.1 Instrument Setup and Interface Configuration – SETUP Key

The SETUP key is used to set or display the default settings of the instrument: reference frequency, noise source, level correction values, date, time, LAN interface, firmware update and enabling of options, information about instrument configuration and service support functions. For further details refer also to the Quick Start Guide, chapter 2 "Preparing for Use".

To open the Setup menu

- ▶ Press the SETUP key.
The "Setup" menu is displayed.

Menu and softkey description

- [Chapter 5.1.1.1, "Softkeys of the Setup Menu"](#), on page 139

5.1.1.1 Softkeys of the Setup Menu

The following table shows all softkeys available in the "Setup" menu. It is possible that your instrument configuration does not provide all softkeys. If a softkey is only available with a special option, model or (measurement) mode, this information is delivered in the corresponding softkey description.

Reference Int/Ext.....	141
Handle missing Ext. Ref.....	141
L Show Error Flag.....	142
L Auto select Reference.....	142
Transducer.....	142
L Active (On/Off).....	142
L Edit.....	143
L Edit Name.....	143
L Edit Unit.....	143
L Edit Value.....	143
L Insert Value.....	143
L Delete Value.....	144
L Interpolation Lin/Log.....	144
L Save Factor.....	144
L New.....	144
L Copy to.....	144
L Delete.....	144
L Ref Level Adjust (Man/Auto).....	145
L Show Directory.....	145
Alignment.....	145
L Self Alignment.....	145
L Show Align Results.....	145
L Touch Screen Alignment.....	146
General Setup.....	146
L Configure Network.....	146
L Network Address.....	146
L Computer Name.....	146
L IP Address.....	146
L Subnet Mask.....	147
L DHCP (On/Off).....	147
L LXI.....	147
L Info.....	147
L Password.....	147
L Description.....	147
L LAN Reset.....	148
L GPIB.....	148
L GPIB Address.....	148
L ID String Factory.....	148
L ID String User.....	148
L Compatibility Mode.....	148
L Mode Default.....	149
L Mode R&S FSP.....	149
L Mode R&S FSU.....	149

L GPIB Language.....	149
L IF Gain (Norm/Puls).....	150
L Sweep Repeat (On/Off).....	150
L Coupling (FSx/HP).....	150
L REV String Factory.....	151
L REV String User.....	151
L Tree Walking.....	151
L Wideband.....	151
L Display Update (On/Off).....	152
L GPIB Terminator LFEOL/EOI.....	152
L *IDN Format Leg./New.....	152
L I/O Logging (On/Off).....	152
L Time+Date.....	152
L Language.....	153
L Configure Monitor.....	153
L Soft Frontpanel.....	153
Display Setup.....	154
L Tool Bar State (On/Off).....	154
L Status Bar.....	155
L Screen Title (On/Off).....	155
L Time+Date (On/Off).....	155
L Time+Date Format (US/DE).....	155
L Print Logo (On/Off).....	155
L Annotation (On/Off).....	155
L Theme Selection.....	155
L Screen Colors.....	156
L Select Screen Color Set.....	156
L Color (On/Off).....	156
L Select Object.....	156
L Predefined Colors.....	156
L User Defined Colors.....	157
L Set to Default.....	157
L Print Colors.....	157
L Select Print Color Set.....	157
L Color (On/Off).....	158
L Display Pwr Save (On/Off).....	158
System Info.....	158
L Hardware Info.....	158
L Versions+Options.....	158
L System Messages.....	159
L Clear All Messages.....	159
Firmware Update.....	160
Option Licenses.....	160
L Install Option.....	160
L Install Option by XML.....	160
Application Setup Recovery.....	160
Service.....	161
L Input Source.....	161
L RF.....	161
L Calibration Frequency RF.....	161

L Calibration Frequency MW.....	161
L Calibration Frequency WB.....	161
L Calibration Frequency WB2.....	162
L Reset Password.....	162
L Selftest.....	162
L Selftest Results.....	162
L Password.....	162
L Service Function.....	162

Reference Int/Ext

Switches between the internal and external reference signal source. The default setting is internal reference. It is important that the external reference signal is deactivated when switching from external to internal reference to avoid interactions. When an external reference is used, "EXT REF" is displayed in the status bar.

If the reference signal is missing after switching to an external reference, the message "NO REF" is displayed to indicate that no synchronization is performed.

The R&S FSVA/FSV can use the internal reference source or an external reference source as frequency standard from which all internal oscillators are derived. A 10 MHz crystal oscillator is used as internal reference source. In the external reference setting, all internal oscillators of the R&S FSVA/FSV are synchronized to the external reference frequency. The external frequency can be set from 1 Hz to 20 MHz in 100 kHz steps.

For details on connectors, refer to [Chapter 4.1, "Front and Rear Panel View"](#), on page 11.

Note: Optional internal reference sources.

Alternatively to the standard internal reference source, an optional OCXO reference (option R&S FSV-B4), or an ultra high precision reference (option R&S FSV-B14) are available. These options generate a very precise 10 MHz reference signal with an output level of ≥ 0 dBm, which can also be used to synchronize other connected devices via the [REF OUT] connector.

If installed, and if no external signal is used, the OCXO signal is used as an internal reference. If an ultra high precision reference is installed, this reference signal is automatically used as the internal reference.

Remote command:

[\[SENSe:\]ROSCillator:SOURce](#) on page 958

[SOURce:EXTernal<1|2>:ROSCillator: EXTernal:FREQuency](#) on page 957

Handle missing Ext. Ref

If an external reference is selected but none is available, there are different ways the instrument can react. This command opens a submenu to select the preferred method of handling a missing external reference. By default, an error flag is displayed in the status bar of the display.

The submenu contains the following commands:

- ["Show Error Flag"](#) on page 142
- ["Auto select Reference"](#) on page 142

Show Error Flag ← Handle missing Ext. Ref

If this option is selected, an error flag is displayed in the status bar of the display when an external reference is selected but none is available.

Remote command:

[SENSe:]ROSCillator:SOURce on page 958

Auto select Reference ← Handle missing Ext. Ref

If this option is selected, the instrument automatically switches back to the internal reference if no external reference is available. Note that you must re-activate the external reference if it becomes available again later.

Remote command:

[SENSe:]ROSCillator:SOURce on page 958

Transducer

Opens the "Select Transducer" dialog box and a submenu to activate or deactivate defined transducer factors, to generate new transducer factors or to edit existing ones.

In the "Select Transducer" dialog box, a transducer factor can be edited, deleted or copied, if selected, using the corresponding softkeys. The default directory in which the transducer factors are saved is displayed (C:\R_S\INSTR\TRD; the extension of transducer factor files is *.TDF). Subdirectories can be added or deleted via the file manager. They are displayed or hidden using the arrow keys or the [Show Directory](#) softkey / "Hide Directory" button.

Two different directory views are possible: If the "Show all" option is activated, all transducer factors in the directory are displayed. If the "Show compatible" option is activated, only the compatible transducer factors in the directory are displayed.

The submenu contains the following commands:

- ["Active \(On/Off\)"](#) on page 142
- ["Edit"](#) on page 143 >
- ["New"](#) on page 144
- ["Copy to"](#) on page 144
- ["Delete"](#) on page 144
- ["Ref Level Adjust \(Man/Auto\)"](#) on page 145
- ["Show Directory"](#) on page 145

Remote command:

[SENSe:]CORRection:TRANsducer:SElect on page 956

Active (On/Off) ← Transducer

Activates or deactivates the selected transducer factor. A maximum of 8 transducer factors can be activated at the same time. Each time an additional transducer factor is activated, its unit compatibility is checked. If one factor has a different unit than dB, all the other activated factors must have the unit dB.

Remote command:

[SENSe:]CORRection:TRANsducer:SElect on page 956

[SENSe:]CORRection:TRANsducer[:STATe] on page 956

Edit ← Transducer

Opens the "Edit Transducer" dialog box with the data of the selected factor, as well as a submenu. During editing, a transducer factor remains stored in the background until the factor is saved using the [Save Factor](#) softkey.

A transducer factor can contain up to 625 values. By defining up to 8 adjacent factors, a transducer system with up to 5000 values can be implemented.

The submenu contains the following commands:

- ["Edit Name"](#) on page 143
- ["Edit Unit"](#) on page 143
- ["Edit Value"](#) on page 143
- ["Insert Value"](#) on page 143
- ["Delete Value"](#) on page 144
- ["Interpolation Lin/Log"](#) on page 144
- ["Save Factor"](#) on page 144

Remote command:

[\[SENSe:\]CORRection:TRANsducer:COMMeNt](#) on page 954

Edit Name ← Edit ← Transducer

Sets the focus on the "Name" field to enter a filename. The extension is added automatically.

Remote command:

[\[SENSe:\]CORRection:TRANsducer:SELeCt](#) on page 956

Edit Unit ← Edit ← Transducer

Sets the focus on the "Unit" field to select the unit.

Note: If one factor has a different unit than "dB", all the other activated factors must have the unit "dB".

Remote command:

[\[SENSe:\]CORRection:TRANsducer:UNIT](#) on page 956

Edit Value ← Edit ← Transducer

Sets the focus to enter positions and values as frequency/level pairs. The entered data is also displayed graphically. Using the "Shift x" or "Shift y" button, all entered values can be shifted in x or y direction.

The valid transducer value range is: $-200 \text{ dB} < \text{value} < 200 \text{ dB}$

Remote command:

[\[SENSe:\]CORRection:TRANsducer:DATA](#) on page 955

Insert Value ← Edit ← Transducer

Inserts an empty line above the selected reference value to enter a new reference value. When you enter a new reference value in the line, make sure that the frequencies are in ascending order.

Each transducer factor can contain a maximum of 625 values. The valid transducer value range is: $-200 \text{ dB} < \text{value} < 200 \text{ dB}$

Delete Value ← Edit ← Transducer

Deletes the selected reference value (complete line). The subsequent reference values move up one line.

Interpolation Lin/Log ← Edit ← Transducer

Sets the scaling of the x-axis to linear or logarithmic.

Remote command:

[SENSe:]CORRection:TRANsducer:SCALing on page 955

Save Factor ← Edit ← Transducer

Saves the changed factor to a file on the internal flash disk. If a transducer factor with the same name already exists, a confirmation query is displayed. If the new factor is active, the new values are immediately applied.

In remote control, the save operation is performed automatically after the definition of the reference values.

New ← Transducer

Opens the "Edit Transducer" dialog box to enter data for a new factor.

This dialog box contains the same contents as the [Edit](#) softkey.

The submenu contains the following commands:

- ["Edit Name"](#) on page 143
- ["Edit Unit"](#) on page 143
- ["Edit Value"](#) on page 143
- ["Insert Value"](#) on page 143
- ["Delete Value"](#) on page 144
- ["Interpolation Lin/Log"](#) on page 144
- ["Save Factor"](#) on page 144

Copy to ← Transducer

Opens the "Edit Transducer" dialog box to copy the selected factor.

This dialog box contains the same contents as the ["Edit"](#) on page 143 softkey.

The submenu contains the following commands:

- ["Edit Name"](#) on page 143
- ["Edit Unit"](#) on page 143
- ["Edit Value"](#) on page 143
- ["Insert Value"](#) on page 143
- ["Delete Value"](#) on page 144
- ["Interpolation Lin/Log"](#) on page 144
- ["Save Factor"](#) on page 144

Delete ← Transducer

Deletes the selected factor after confirmation.

Remote command:

[SENSe:]CORRection:TRANsducer:DELeTe on page 955

Ref Level Adjust (Man/Auto) ← Transducer

Activates or deactivates the automatic adjustment of the reference level to the selected transducer factor.

If a transducer factor is used (active), the trace is moved by a calculated shift. However, an upward shift reduces the dynamic range for the displayed values.

"Auto"	Activates the automatic adjustment. The original dynamic range is restored by also shifting the reference level by the maximum value of the transducer factor.
"Man"	Deactivates the automatic adjustment. Adjust the reference level via the "Amplitude" menu.

Remote command:

[\[SENSe:\]CORRection:TRANsducer:ADJust:RLEVel\[:STATe\]](#) on page 954

Show Directory ← Transducer

Displays the subdirectory of the selected directory.

Alignment

Opens a submenu with the available functions for recording, displaying and activating the data for self-alignment.

The R&S FSVA/FSV determines the correction data and characteristics required for the alignment automatically. It compares the results at different settings with the known characteristics of the high-precision calibration signal source at 65.83 MHz. The correction data is stored as a file on the instrument. You can display it using the ["Show Align Results"](#) on page 145 softkey.

The submenu contains the following commands:

- ["Self Alignment"](#) on page 145
- ["Show Align Results"](#) on page 145
- ["Touch Screen Alignment"](#) on page 146

Self Alignment ← Alignment

Starts the recording of correction data of the instrument. If the correction data acquisition has failed or if the correction values are deactivated, a corresponding message is displayed in the status field.

As long as the self-alignment data is being collected, you can cancel the procedure using the "Abort" button.

Remote command:

[*CAL?](#) on page 611

Show Align Results ← Alignment

Opens a dialog box that displays the correction data of the alignment:

- Date and time of last correction data record
- Overall results of correction data record
- List of found correction values according to function/module

The results are classified as follows:

PASSED	calibration successful without any restrictions
CHECK	deviation of correction value larger than expected, correction could however be performed
FAILED	deviations of correction value too large, no correction was possible. The found correction data are not applicable.

Remote command:

[CALibration:RESult?](#) on page 918

Touch Screen Alignment ← Alignment

Displays a touchscreen alignment dialog.

When the device is delivered, the touchscreen is initially aligned. However, it may become necessary to adjust the alignment later, e.g. after an image update or after exchanging a hard disk. If you notice that touching a specific point on the screen does not achieve the correct response, you may try adjusting the alignment, as well.

Using a finger or any other pointing device, press the 4 markers on the screen.

The touchscreen is aligned according to the executed pointing operations.

General Setup

Opens a submenu for all general settings such as IP address and LAN settings, date and time, remote control (optional) and measurement display.

Configure Network ← General Setup

Opens the "Network Connections" dialog box to change the LAN settings.

For details, refer to [Chapter 6.2.5, "Setting Up a Network \(LAN\) Connection"](#), on page 595.

Network Address ← General Setup

Opens a submenu to configure the Internet protocol properties and the computer name.

Computer Name ← Network Address ← General Setup

Opens an edit dialog box to enter the computer name via the keypad. The naming conventions of Windows apply. If too many characters and/or numbers are entered, a message is displayed in the status line. For step-by-step instructions, refer to [Chapter 6.2.5.3, "Using Computer Names"](#), on page 600.

IP Address ← Network Address ← General Setup

Opens an edit dialog box to enter the IP address via the keypad. The TCP/IP protocol is preinstalled with the IP address 10.0.0.10. If the DHCP server is available ("DHCP On"), the dialog box entry is read-only.

The IP address consists of four number blocks separated by dots. Each block contains 3 numbers in maximum (e.g. 100.100.100.100), but also one or two numbers are allowed in a block (as an example see the pre-installed address). For step-by-step instructions, refer to [Chapter 6.2.5.2, "Assigning the IP Address"](#), on page 597.

Subnet Mask ← Network Address ← General Setup

Opens an edit dialog box to enter the subnet mask via the keypad. The TCP/IP protocol is preinstalled with the subnet mask 255.255.255.0. If the DHCP server is available ("DHCP On"), the dialog box entry is read-only.

The subnet mask consists of four number blocks separated by dots. Each block contains 3 numbers in maximum (e.g. 100.100.100.100), but also one or two numbers are allowed in a block (as an example see the preinstalled address). For step-by-step instructions, refer to [Chapter 6.2.5, "Setting Up a Network \(LAN\) Connection"](#), on page 595.

DHCP (On/Off) ← Network Address ← General Setup

Switches between DHCP server available ("On") or not available ("Off"). If a DHCP server is available in the network, the IP address and subnet mask of the instrument are obtained automatically from the DHCP server. For further details, refer to [Chapter 6.2.5, "Setting Up a Network \(LAN\) Connection"](#), on page 595.

LXI ← General Setup

Opens the LXI submenu containing the following softkeys:

- "Info" on page 147
- "Password" on page 147
- "Description" on page 147
- "LAN Reset" on page 148

LXI functionality is available only for user accounts with administrator rights.

Info ← LXI ← General Setup

Shows the current LXI parameters, including the current version, class and various computer parameters like the computer name or IP address.

While active, the dialog is not updated.

LXI functionality is available only for user accounts with administrator rights.

Remote command:

`SYSTem:LXI:INFo?` on page 972

Password ← LXI ← General Setup

Shows the currently set password. You can also change the current password using this softkey.

The password is required to change settings via the web browser (e.g. IP parameter). An empty password is not valid, i.e. you must enter a password.

By default, the password is *LxiWebIfc*.

LXI functionality is available only for user accounts with administrator rights.

Remote command:

`SYSTem:LXI:PASSword` on page 973

Description ← LXI ← General Setup

Opens a dialog box to view or change the LXI instrument description. This description is used on some of the LXI web sites.

By default, the description is "Signal Analyzer".

LXI functionality is available only for user accounts with administrator rights.

Remote command:

[SYSTem:LXI:MDEscription](#) on page 972

LAN Reset ← LXI ← General Setup

Resets the LAN configuration to a state required by the LXI standard. For example, the TCP/IP mode is set to "DHCP" and "Dynamic DNS" and "ICMP Ping" are enabled. In addition, the R&S FSVA/FSV sets the password and the instrument description to their initial states (see ["Password"](#) on page 147 and ["Description"](#) on page 147 softkeys).

Only user accounts with administrator rights can reset the LAN configuration.

Remote command:

[SYSTem:LXI:LANReset](#) on page 972

GPIB ← General Setup

Opens a submenu to set the parameters of the remote control interface.

GPIB Address ← GPIB ← General Setup

Opens an edit dialog box to enter the GPIB address. Values from 0 to 30 are allowed. The default address is 20.

Remote command:

[SYSTem:COMMunicate:GPIB\[:SELF\]:ADDRESS](#) on page 964

ID String Factory ← GPIB ← General Setup

Selects the default response to the *IDN? query.

Remote command:

[SYSTem:IDENtify:FACTory](#) on page 970

ID String User ← GPIB ← General Setup

Opens an edit dialog box to enter a user-defined response to the *IDN? query. Max. 36 characters are allowed.

Remote command:

[SYSTem:IDENtify\[:STRing\]](#) on page 970

Compatibility Mode ← GPIB ← General Setup

Sets the R&S FSVA/FSV in a state compatible to previous R&S devices, enabling the usage of existing external control applications. In particular, the number of measurement points and available bandwidths are adjusted to the settings of other devices.

Furthermore, some special GPIB settings are available to emulate HP models (see [Chapter 6.3.5, "GPIB Commands of HP Models 856xE, 8566A/B, 8568A/B and 8594E"](#), on page 977):

- ["GPIB Language"](#) on page 149
- ["IF Gain \(Norm/Puls\)"](#) on page 150
- ["Sweep Repeat \(On/Off\)"](#) on page 150
- ["Coupling \(FSx/HP\)"](#) on page 150

"Default" Standard R&S FSVA/FSV operation, see ["Mode Default"](#) on page 149

"R&S FSP" Compatible to R&S FSP, see ["Mode R&S FSP"](#) on page 149

"R&S FSU" Compatible to R&S FSU, see ["Mode R&S FSU"](#) on page 149

Remote command:

[SYSTem:COMPAtible](#) on page 966

Mode Default ← Compatibility Mode ← GPIB ← General Setup

Resets the number of measurement points and available bandwidths to default R&S FSVA/FSV values.

Remote command:

SYST:COMP DEF, see [SYSTem:COMPAtible](#) on page 966

Mode R&S FSP ← Compatibility Mode ← GPIB ← General Setup

Sets the number of measurement points and available bandwidths as in R&S FSP devices.

Remote command:

SYST:COMP FSP, see [SYSTem:COMPAtible](#) on page 966

Mode R&S FSU ← Compatibility Mode ← GPIB ← General Setup

Sets the number of measurement points and available bandwidths as in R&S FSU devices.

Remote command:

SYST:COMP FSU, see [SYSTem:COMPAtible](#) on page 966

GPIB Language ← Compatibility Mode ← GPIB ← General Setup

Opens a list of selectable remote-control languages:

Language	Comment
SCPI	
71100C	Compatible to 8566A/B
71200C	Compatible to 8566A/B
71209A	Compatible to 8566A/B
8560E	
8561E	
8562E	
8563E	
8564E	
8565E	
8566A	Command sets A and B are available. Command sets A and B differ in the rules regarding the command structure.
8566B	
8568A	Command sets A and B are available. Command sets A and B differ in the rules regarding the command structure.

Language	Comment
8568A_DC	Uses DC input coupling by default if supported by the instrument
8568B	Command sets A and B are available. Command sets A and B differ in the rules regarding the command structure.
8568B_DC	Uses DC input coupling by default if supported by the instrument
8591E	Compatible to 8594E
8594E	Command sets A and B are available. Command sets A and B differ in the rules regarding the command structure.

For details on the GPIB languages, see [Chapter 6.3.5, "GPIB Commands of HP Models 856xE, 8566A/B, 8568A/B and 8594E"](#), on page 977.

Remote command:

[SYSTem:LANGuage](#) on page 971

IF Gain (Norm/Puls) ← Compatibility Mode ← GPIB ← General Setup

Configures the internal IF gain settings in HP emulation mode due to the application needs. This setting is only taken into account for resolution bandwidth < 300 kHz.

NORM	Optimized for high dynamic range, overload limit is close to reference level.
PULS	Optimized for pulsed signals, overload limit up to 10 dB above reference level.

This softkey is only available if an HP language is selected via the "GPIB Language" softkey (see ["GPIB Language"](#) on page 149).

Remote command:

[SYSTem:IFGain:MODE](#) on page 971

Sweep Repeat (On/Off) ← Compatibility Mode ← GPIB ← General Setup

Controls a repeated sweep of the E1 and MKPK HI/HL HP model commands (for details on the commands refer to ["GPIB Language"](#) on page 149). If the repeated sweep is "OFF", the marker is set without sweeping before.

Note: In single sweep mode, switch off this softkey before you set the marker via the E1 and MKPK HI/HL commands to avoid sweeping again.

This softkey is only available if an HP language is selected via the "GPIB Language" softkey (see ["GPIB Language"](#) on page 149).

Remote command:

[SYSTem:RSW](#) on page 975

Coupling (FSx/HP) ← Compatibility Mode ← GPIB ← General Setup

Controls the default coupling ratios in the HP emulation mode for:

- Span and resolution bandwidth (Span/RBW) and
- Resolution bandwidth and video bandwidth (RBW/VBW)

For FSP(=FSV), the standard parameter coupling of the instrument is used. As a result, usually a shorter sweep time is used than for HP.

This softkey is only available if an HP language is selected via the "GPIB Language" softkey (see ["GPIB Language"](#) on page 149).

Remote command:

[SYSTem:HPCoupling](#) on page 970

REV String Factory ← Compatibility Mode ← GPIB ← General Setup

Selects the default response to the `REV?` query for the revision number (HP emulation only, see [Chapter 6.3.5, "GPIB Commands of HP Models 856xE, 8566A/B, 8568A/B and 8594E"](#), on page 977).

Remote command:

[SYSTem:REVision:FACTory](#) on page 974

REV String User ← Compatibility Mode ← GPIB ← General Setup

Opens an edit dialog box to enter a user-defined revision number in response to the `REV?` query (HP emulation only, see [Chapter 6.3.5, "GPIB Commands of HP Models 856xE, 8566A/B, 8568A/B and 8594E"](#), on page 977). Max. 36 characters are allowed.

Remote command:

[SYSTem:REVision\[:STRing\]](#) on page 975

Tree Walking ← Compatibility Mode ← GPIB ← General Setup

Defines how remote control programs are evaluated, in particular multiple commands in one command line.

Note that this setting is retained after a [preset] or recall operation.

See the SCPI command for an example.

"Normal"	(Initial default:) SCPI-conform behavior The first command is always referenced to the root node. Subsequent commands, however, are referenced to the same tree level as the previous command in a message unit.
"Enhanced"	If subsequent commands are not found on the same tree level as the previous command, the SCPI parser searches "backwards up the tree" of defined SCPI commands. If the command is found at a higher node, that command is used. Only if the command is not found anywhere, an error message is returned.

Remote command:

[SYSTem:TWALking](#) on page 976

Wideband ← GPIB ← General Setup

This setting defines which option is returned when the `*OPT?` query is executed, depending on the state of the wideband option.

It is only available for PSA89600 emulation.

"Wideband Off"	No wideband is used. The option is indicated as "B7J".
"Wideband 40 MHz"	The 40 MHz wideband is used. The option is indicated as "B7J, 140".
"Wideband 80 MHz"	The 80 MHz wideband is used. The option is indicated as "B7J, 122".

Remote command:

[SYSTem:PSA:WIDeband](#) on page 974

Display Update (On/Off) ← GPIB ← General Setup

Defines whether the instrument display is switched off when changing from manual operation to remote control. In remote control mode, this softkey is displayed in the local menu.

Remote command:

`SYSTem:DISPlay:UPDate` on page 968

GPIB Terminator LFE0I/EOI ← GPIB ← General Setup

Changes the GPIB receive terminator.

According to the standard, the terminator in ASCII is <LF> and/or <EOI>. For binary data transfers (e.g. trace data) from the control computer to the instrument, the binary code used for <LF> might be included in the binary data block. Therefore, it should not be interpreted as a terminator in this particular case. This can be avoided by changing the receive terminator to EOI.

Remote command:

`SYSTem:COMMunicate:GPIB[:SELF]:RTERminator` on page 965

***IDN Format Leg./New ← GPIB ← General Setup**

Defines the response format to the `*IDN?` remote command (see `*IDN?` on page 612). This function is intended for re-use of existing control programs together with the R&S FSVA/FSV.

"Leg"	Legacy format, compatible to the R&S FSP/FSU/FSQ family e.g. Rohde&Schwarz, FSV-7, 100005/007, 1.61
"New"	R&S FSVA/FSV format e.g. Rohde&Schwarz, FSV-7, 1307.9002K07/100005, 1.61

Remote command:

`SYSTem:FORMat:IDENT` on page 969

I/O Logging (On/Off) ← GPIB ← General Setup

Activates or deactivates the SCPI log function. All remote control commands received by the R&S FSVA/FSV are recorded in the following log file:

`C:\R_S\Instr\scpi\logging\ScpiLog.txt`

Logging the commands can be extremely useful for debug purposes, e.g. to find misspelled keywords in control programs.

Remote command:

`SYSTem:CLOGging` on page 964

Time+Date ← General Setup

Opens an edit dialog box to enter time and date for the internal real-time clock.

For details, refer to [Chapter 4.2.4.3, "Setting the Date and Time"](#), on page 37.

Remote command:

`SYSTem:TIME` on page 975

`SYSTem:DATE` on page 967

Language ← General Setup

Changes the language of the graphical user interface (softkeys, dialog boxes, input settings etc.) to the selected language, if any other than the default language are installed.

Note: to change the default input language (English) of an external keyboard, use the standard Windows operating system function. To access the Windows operating system, press the Windows key on the external keyboard. Select "Start" > "Control Panel" > "Clock, Language, and Region" > "Change keyboards or other input methods" to configure the keyboard properties.

Remote command:

[SYSTem:DISPlay:LANGuage](#) on page 968

Configure Monitor ← General Setup

Determines and displays the configuration of a connected external monitor, if available. In the configuration dialog box, you can switch from the internal monitor (laptop icon) to the external monitor (monitor icon), or both (double monitor icon). For external, the R&S FSVA/FSV display is disabled (turns dark). The screen content formerly displayed on the R&S FSVA/FSV is displayed on the external screen.

For further details, refer to [Chapter 4.2.3, "Connecting an External Monitor"](#), on page 35.

Soft Frontpanel ← General Setup

Activates or deactivates the display of the instrument emulation.

deactivated	Only the measurement screen is displayed. This is the setting for working at the R&S FSVA/FSV.
activated	In addition to the measurement screen, the whole front panel is displayed, i.e. the hardkeys and other hardware controls of the device are simulated on the screen. This is the setting for working at a computer with Remote Desktop or at an external monitor.

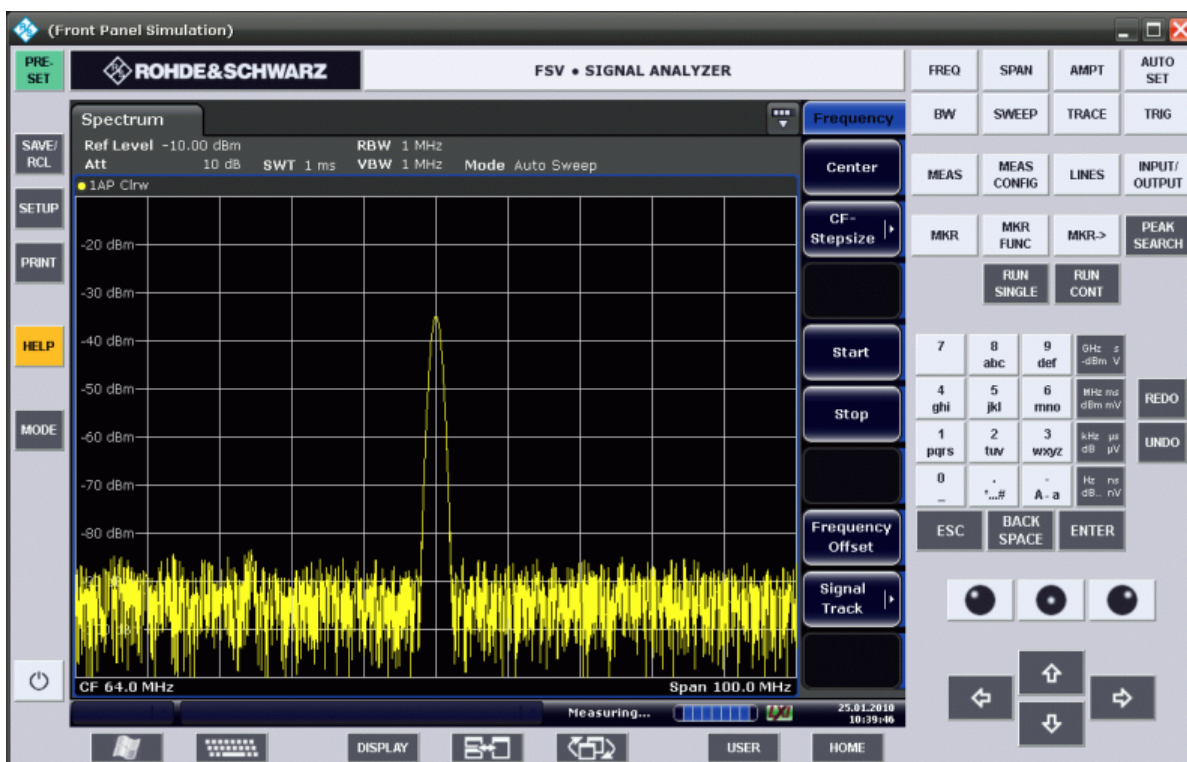

Figure 5-1: Soft frontpanel

Alternatively to this softkey, you can use the F6 key.

Remote command:

[SYSTem:DISPlay:FPANel](#) on page 967

Display Setup

Opens a submenu to define the display settings.

The following display settings are available:

- ["Tool Bar State \(On/Off\)"](#) on page 154
- ["Screen Title \(On/Off\)"](#) on page 155
- ["Time+Date \(On/Off\)"](#) on page 155
- ["Time+Date Format \(US/DE\)"](#) on page 155
- ["Print Logo \(On/Off\)"](#) on page 155
- ["Annotation \(On/Off\)"](#) on page 155
- ["Theme Selection"](#) on page 155
- ["Screen Colors"](#) on page 156
- ["Print Colors"](#) on page 157
- ["Display Pwr Save \(On/Off\)"](#) on page 158

Tool Bar State (On/Off) ← Display Setup

Displays or removes the toolbar above the diagram.

This setting is stored in instrument settings files.

Remote command:

[DISPlay:TBAR\[STATe\]](#) on page 929

Status Bar ← Display Setup

Displays or removes the status bar beneath the diagram.

The status bar indicates the global instrument settings, the instrument status and any irregularities during measurement or display.

This setting is stored in instrument settings files.

Remote command:

`DISPlay:SBAR[:STATe]` on page 928

Screen Title (On/Off) ← Display Setup

Activates/deactivates the display of a diagram title (if available) and opens an edit dialog box to enter a new title for the active diagram. Max. 20 characters are allowed.

Remote command:

`DISPlay[:WINDow<n>]:TEXT[:DATA]` on page 930

`DISPlay[:WINDow<n>]:TIME` on page 930

Time+Date (On/Off) ← Display Setup

Activates/deactivates the display of date and time beneath the diagram.

This setting is stored in instrument settings files.

Remote command:

`DISPlay[:WINDow<n>]:TIME` on page 930

Time+Date Format (US/DE) ← Display Setup

Switches the time and date display on the screen between US and German (DE).

This setting is stored in instrument settings files.

Remote command:

`DISPlay[:WINDow<n>]:TIME:FORMat` on page 931

Print Logo (On/Off) ← Display Setup

Activates/deactivates the display of the Rohde & Schwarz company logo in the upper left corner.

Remote command:

`DISPlay:LOGO` on page 928

Annotation (On/Off) ← Display Setup

Activates/deactivates the display of the frequency information in the diagram footer.

For example, to protect confidential data it can be useful to hide the frequency information.

Remote command:

`DISPlay:ANNOtation:FREQuency` on page 926

Theme Selection ← Display Setup

Opens a selection list of available themes for the screen display. The theme defines the colors used for keys and screen elements, for example. The default theme is "Blue-Ocean".

Remote command:

`DISPlay:THEMe:SELEct` on page 929

Screen Colors ← Display Setup

Opens a submenu to configure the screen colors.

For details on screen colors, refer to [Chapter 4.2.4.5, "Setting the Screen Colors"](#), on page 38.

The submenu contains the following commands:

- "Select Screen Color Set" on page 156
- "Color (On/Off)" on page 156
- "Select Object" on page 156
- "Predefined Colors" on page 156
- "User Defined Colors" on page 157
- "Set to Default" on page 157

Remote command:

`DISPlay:CMAP<item>:HSL` on page 927

Select Screen Color Set ← Screen Colors ← Display Setup

Opens the "Select Screen Color Set" dialog box to select default or user-defined color settings.

If one of the default settings is selected ("Default Colors 1"/"2"), the default settings for brightness, color tint and color saturation for all display screen elements are restored. The default color schemes provide optimum visibility of all picture elements at an angle of vision from above or below. Default setting is "Default Colors 1".

If "User Defined Colors" is selected, a user-defined color set can be defined.

For step-by-step instruction, refer to [Chapter 4.2.4.5, "Setting the Screen Colors"](#), on page 38.

Remote command:

`DISPlay:CMAP<item>:DEFault` on page 926

Color (On/Off) ← Screen Colors ← Display Setup

Switches from color display to black-and-white display and back. The default setting is color display.

Select Object ← Screen Colors ← Display Setup

Opens the "Color Setup" dialog box to select the color settings for a selected object.

The "Selected Object" list is displayed to select the object. To set the color, the predefined colors are displayed.

Remote command:

`DISPlay:CMAP<item>:HSL` on page 927

`HCOPY:CMAP<item>:HSL` on page 934

Predefined Colors ← Screen Colors ← Display Setup

In the "Color Setup" dialog box, displays the "Predefined Colors" (alternatively to the "Predefined Colors" button). This softkey is only available if, in the "Select Color Set" dialog box, the "User Defined Colors" option is selected or the "Color Setup" dialog box is displayed.

For further details, refer to [Chapter 4.2.4.5, "Setting the Screen Colors"](#), on page 38.

Remote command:

`DISPlay:CMAP<item>:PDEFined` on page 927

`HCOPY:CMAP<item>:PDEFined` on page 935

User Defined Colors ← Screen Colors ← Display Setup

In the "Color Setup" dialog box, displays the "User Defined Colors" (alternatively to the "User Defined Colors" button). This softkey is only available if, in the "Select Color Set" dialog box, the "User Defined Colors" option is selected or the "Color Setup" dialog box is displayed.

For further details, refer to [Chapter 4.2.4.5, "Setting the Screen Colors"](#), on page 38.

Remote command:

`DISPlay:CMAP<item>:HSL` on page 927

`HCOPY:CMAP<item>:HSL` on page 934

Set to Default ← Screen Colors ← Display Setup

Opens the "Set to Default" dialog box to select one of the factory default color settings.

Remote command:

`DISPlay:CMAP<item>:DEFault` on page 926

`HCOPY:CMAP<item>:DEFault` on page 934

Print Colors ← Display Setup

Opens a submenu to select the colors for the printout. To facilitate color selection, the selected color combination is displayed when the menu is entered. The previous colors are restored when the menu is exited.

For details on screen colors, refer to [Chapter 4.2.4.5, "Setting the Screen Colors"](#), on page 38.

The submenu contains the following commands:

- ["Select Print Color Set"](#) on page 157
- ["Color \(On/Off\)"](#) on page 158
- ["Select Object"](#) on page 180
- ["Predefined Colors"](#) on page 180
- ["User Defined Colors"](#) on page 180
- ["Set to Default"](#) on page 180

Remote command:

`HCOPY:CMAP<item>:HSL` on page 934

Select Print Color Set ← Print Colors ← Display Setup

Opens the "Select Print Color Set" dialog box to select the color settings for printout.

Screen colors (Print)	Selects the current screen colors for the printout. The background is always printed in white and the grid in black.
Screen colors (Hardcopy)	Selects the current screen colors without any changes for a hard-copy. The output format is set via the "Device Setup" on page 179 softkey in the "Print" menu.

Optimized colors	Selects an optimized color setting for the printout to improve the visibility of the colors (default setting). Trace 1 is blue, trace 2 black, trace 3 green, and the markers are turquoise. The background is always printed in white and the grid in black.
User-Defined colors	Enables the softkeys to define colors for the printout.

Remote command:

[HCOPY:CMAP<item>:DEFault](#) on page 934

Color (On/Off) ← Print Colors ← Display Setup

Switches from color printout to black-and-white printout and back. All colored areas are printed in white and all colored lines in black. This improves the contrast. The default setting is color printout, provided that the selected printer can produce color printouts.

Remote command:

[HCOPY:DEVICE:COLor](#) on page 936

Display Pwr Save (On/Off) ← Display Setup

Switches the power-save mode for the display (On/Off) and opens an edit dialog box to enter the time for the power-save function to respond. After this time, the display is switched off completely, i.e. including backlighting. This mode is recommended when the instrument is exclusively operated in remote control.

For details on the power-save mode for the display, refer to [Chapter 4.2.4.6, "Setting the Display Power Save Function"](#), on page 41.

Remote command:

[DISPlay:PSAVe\[:STATe\]](#) on page 928

[DISPlay:PSAVe:HOLDoff](#) on page 928

System Info

Opens a submenu to display detailed information on module data, device statistics and system messages.

The submenu contains the following commands:

- ["Hardware Info"](#) on page 158
- ["Versions+Options"](#) on page 158
- ["System Messages"](#) on page 159
- ["Clear All Messages"](#) on page 159

Hardware Info ← System Info

Opens a dialog box that displays hardware information, e.g. on the frontend and motherboard. Every listed component is described by its serial number, order number, model information, hardware code, and hardware revision.

Remote command:

[DIAGnostic<n>:SERVice:HWINfo?](#) on page 919

Versions+Options ← System Info

Opens a dialog box that displays a list of hardware and firmware information, including:

Label	Description
Device ID	Unique ID of the device
Instrument firmware	Installed firmware version
BIOS	Installed BIOS version
CPLD	CPLD version
MB-FPGA	Motherboard FPGA version
Data Sheet version	Data sheet version of the basic device
<option>	Installed hardware and firmware options Note that B99 indicates the R&S FSVA models (as opposed to the R&S FSV models).
"Open Source Acknowledgment: Open"	Displays a PDF file containing information on open source code used by the R&S FSVA/FSV firmware.

For details on options, refer to [Chapter 4.2.1.10, "Checking the Supplied Options"](#), on page 33.

Remote command:

*IDN? on page 612

*OPT? on page 612

SYSTem:DEVIce:ID? on page 967

SYSTem:DID? on page 967

System Messages ← System Info

Opens the "System Messages" dialog box that displays the generated system messages in the order of their occurrence. The most recent messages are placed at the top of the list. Messages that have occurred since the last display of system messages menu are marked with an asterisk '*'. The following information is available:

No	device-specific error code
Message	brief description of the message
Component	hardware messages: name of the affected module
	software messages: name of the affected software
Date/Time	date and time of the occurrence of the message

If the number of error messages exceeds the capacity of the error buffer, "Message buffer overflow" is displayed. To delete messages, see ["Clear All Messages"](#) on page 159 softkey.

Remote command:

SYSTem:ERRor:LIST? on page 968

Clear All Messages ← System Info

Deletes all system messages. The softkey is only available if the "System Messages" dialog box is displayed.

Remote command:

[SYSTem:ERRor:CLEar:ALL](#) on page 968

Firmware Update

Opens the "Firmware Update" dialog box.

Enter the name of or browse for the firmware installation file and press the "Execute" button. For details on installation, refer to [Chapter 4.3, "Firmware Update and Installation of Firmware Options"](#), on page 47.

Only user accounts with administrator rights can perform a firmware update.

Remote command:

[SYSTem:FIRMware:UPDate](#) on page 969

Option Licenses

Opens a submenu to install options. For details on options, refer to [Chapter 4.3, "Firmware Update and Installation of Firmware Options"](#), on page 47.

The submenu contains the following commands:

- ["Install Option"](#) on page 160
- ["Install Option by XML"](#) on page 160

Only user accounts with administrator rights are able to install options.

Install Option ← Option Licenses

Opens an edit dialog box to enter the license key for the option that you want to install.

If an option is about to expire, a message box is displayed to inform you. You can then use this softkey to enter a new license key.

If an option has already expired, a message box appears for you to confirm. In this case, all instrument functions are unavailable (including remote control) until you reboot the R&S FSVA/FSV. Then use the "Install Option" softkey to enter the new license key.

For more information about the option in question, refer to the [System Info](#) softkey in the "Setup" menu.

Only user accounts with administrator rights are able to install options.

Install Option by XML ← Option Licenses

Opens an edit dialog to install an additional option to the R&S FSVA/FSV using an XML file. Enter or browse for the name of an XML file on the instrument that contains the option key and press "Select".

Only user accounts with administrator rights are able to install options.

Application Setup Recovery

Controls instrument behavior when switching between measurement applications, e.g. from "Spectrum" to "Analog Demod" and back.

If this softkey is activated, the current instrument settings are stored when you switch to a different application. When you switch back to the previous application, the corresponding instrument settings are restored. Thus, the settings of the individual applications are independent of each other.

If the softkey is deactivated (default), only a few parameters of the current instrument setting are passed between applications (e.g. center frequency, level settings).

Note that this setting is not deactivated during a preset operation, i.e. you must deactivate it manually, if necessary.

Remote command:

`SYSTem:APPLication:SRECovery[:STATe]` on page 964

Service

Opens a submenu that contains additional functions for maintenance and/or troubleshooting.

NOTICE! Risk of incorrect operation due to service functions. The service functions are not necessary for normal measurement operation. However, incorrect use can affect correct operation and/or data integrity of the R&S FSVA/FSV.

Therefore, many of the functions can only be used after entering a password. They are described in the instrument service manual.

Only user accounts with administrator rights are able to use service functions.

Input Source ← Service

Opens a submenu to select the input source for measurement.

The submenu contains the following options:

- "RF" on page 161
- "Calibration Frequency RF" on page 161
- "Calibration Frequency MW" on page 161
- "Calibration Frequency MW" on page 161

RF ← Input Source ← Service

Switches the input of the R&S FSVA/FSV to the RF input connector (normal position). This is the default setting.

Remote command:

`DIAGnostic<n>:SERvice:INPut[:SElect]` on page 922

Calibration Frequency RF ← Input Source ← Service

Opens an edit dialog box to set the generator frequency for the internal calibration.

Remote command:

`DIAGnostic<n>:SERvice:INPut:PULSed:CFrequency` on page 920

Calibration Frequency MW ← Input Source ← Service

Opens an edit dialog box to set the calibration frequency for frequencies greater than 7 GHz.

(For R&S FSVA/FSV 13, 30, and 40 only).

Remote command:

`DIAGnostic<n>:SERvice:INPut:PULSed:MCFrequency` on page 920

Calibration Frequency WB ← Input Source ← Service

Defines the frequency of the internal broadband calibration signal to be used for IF filter calibration.

If you define a frequency that is not available, the R&S FSVA/FSV uses the next available frequency.

Tip: Use the arrow keys to step through the available frequencies.

This function is only available if the bandwidth extension option R&S FSV-B160 is installed and no other restrictions for its use apply (see "Restrictions" on page 441).

Remote command:

[DIAGnostic<n>:SERvice:INPut\[:SElect\]](#) on page 922

[DIAGnostic<n>:SERvice:INPut:PULSed:WBFrequency](#) on page 921

Calibration Frequency WB2 ← Input Source ← Service

Defines the frequency of the internal broadband calibration signal to be used for IF filter calibration (16 MHz or 32 MHz).

This function is only available for R&S FSVA instruments. It is independent of the bandwidth extension option R&S FSV-B160.

Remote command:

[DIAGnostic<n>:SERvice:INPut\[:SElect\]](#) on page 922

[DIAGnostic<n>:SERvice:INPut:PULSed:WB2Frequency](#) on page 921

Reset Password ← Service

Deactivates all set passwords.

Remote command:

[SYSTem:PASSword:RESet](#) on page 973

Selftest ← Service

Initiates the self-test of the instrument modules to identify a defective module if there was a failure. All modules are checked consecutively and the test result is displayed.

Remote command:

[*TST?](#) on page 615

Selftest Results ← Service

Opens the "Selftest Result" dialog box that contains the test results. In case of failure a short description of the failed test, the defective module, the associated value range and the corresponding test results are indicated.

Remote command:

[DIAGnostic<n>:SERvice:STEST:RESult?](#) on page 924

Password ← Service

Opens an edit dialog box to enter the password. This ensures that the service functions are only used by authorized personnel.

Remote command:

[SYSTem:PASSword\[:CENable\]](#) on page 973

Service Function ← Service

Opens the "Service Function" dialog box to start special service functions. For further information, refer to the service manual.

Remote command:

[DIAGnostic<n>:SERvice:SFUNction](#) on page 922

5.1.2 Saving and Recalling Settings Files – SAVE/RCL Key

The [SAVE/RCL] key is used to store and recall an instrument configuration.

The "Save/Recall" menu enables the user to save or recall the configuration file from the instrument's internal storage, a memory stick or a network drive. The file can also include various settings used by the options installed on the instrument. Measurement results can also be stored; however, it is strongly recommended that you use the "Print Screen" or "Trace Export" functions instead.



When recalling a saved configuration file, the following restrictions apply:

- Configuration files cannot be transferred from an R&S FSVA/FSV with a larger frequency range to one with a smaller frequency range
 - Configuration files created on a R&S FSVA/FSV with certain options in use will not work on an R&S FSVA/FSV without these options
 - Files created with newer firmware versions may not work with a previous version
-

Saving and recalling transducer and limit line settings

If a transducer file was in use when the save set was stored (with the save item "Current Settings" only) it is anticipated that these transducer values should remain valid after every recall of that save set. Thus, even if the transducer file is changed and the original save set file is recalled later, the *originally stored* transducer values are recalled and applied to the measurement. In the "Transducer" dialog box, however, the *changed* transducer file values are displayed as no updated transducer file was loaded.

The same applies to limit line settings.



If you want to apply the changed transducer values after recalling the save set you must force the application to reload the transducer file. To do so, simply open the "Edit Transducer" dialog box (see "[Transducer](#)" on page 142) and toggle the "X-Axis" option from "lin" to "log" and back. Due to that change, the transducer file is automatically reloaded, and the changed transducer values are applied to the current measurement. Now you can create a new save set with the updated transducer values.

Similarly, if you want to apply the changed limit values after recalling the save set you must force the application to reload the limit file. To do so, simply open the "Edit Limit Line" dialog box (see "[Edit](#)" on page 389) and toggle the "Y-Axis" unit. Due to that change, the limit line file is automatically reloaded, and the changed limit values are applied to the current measurement. Now a new save set with the updated limit values can be created.

To open the Save/Recall menu

- ▶ Press the [SAVE/RCL] key.
The "Save/Recall" menu is displayed.

Menu and softkey description

- [Chapter 5.1.2.1, "Softkeys of the SAVE/RCL Menu"](#), on page 164

Further information

- [Chapter 5.1.2.2, "File Selection Dialog Boxes"](#), on page 170
- [Chapter 5.1.2.3, "Importing and Exporting I/Q Data"](#), on page 172

5.1.2.1 Softkeys of the SAVE/RCL Menu

The following table shows all softkeys available in the "Save/Recall" menu.

Save.....	165
L Save File / Recall File.....	165
L Select Path.....	165
L Select File.....	165
L Edit File Name.....	165
L Edit Comment.....	165
L Select Items.....	165
L Select Items.....	165
L Enable all Items.....	166
L Disable all Items.....	166
L Delete File.....	166
Recall.....	166
Startup Recall.....	166
L Startup Recall (On/Off).....	167
L Select Dataset.....	167
ScreenShot.....	167
Export.....	167
L ASCII Trace Export.....	167
L Decim Sep.....	168
L IQ Export.....	168
Import.....	168
L IQ Import.....	168
File Manager.....	168
L Edit Path.....	168
L New Folder.....	168
L Copy.....	169
L Rename.....	169
L Cut.....	169
L Paste.....	169
L Delete.....	169
L Sort Mode.....	169
L Name.....	169

L Date.....	169
L Extension.....	169
L Size.....	169
L File Lists (1/2).....	169
L Current File List (1/2).....	169
L Network Drive.....	170
L Map Network Drive.....	170
L Disconnect Network Drive.....	170

Save

Opens the "Save" dialog box to define which measurement settings and results to store. To navigate in the dialog box and define/enter data, use the corresponding soft-keys.

For details see also [Chapter 5.1.2.2, "File Selection Dialog Boxes"](#), on page 170.

Save File / Recall File ← Save

Saves the settings file with the defined file name ("Save" dialog box), or recalls the selected settings file ("Recall" dialog box).

You can assign stored settings files to user-definable softkeys in the "User" menu for easy access, see [Chapter 5.1.5, "User-Defined Menu – USER key"](#), on page 181 .

Remote command:

[MMEMory:STORe<n>:STATe](#) on page 951

[MMEMory:STORe<n>:STATe:NEXT](#) on page 952

[MMEMory:LOAD:STATe](#) on page 945

Select Path ← Save

Opens the directory list to select the drive and folder for the settings file to be stored or loaded. The default path is C:\r_s\instr\user.

Select File ← Save

Sets the focus on the "Files" list.

Remote command:

[MMEMory:CATalog?](#) on page 940

Edit File Name ← Save

Sets the focus on the "File Name" field.

Edit Comment ← Save

Sets the focus on the "Comment" field to enter a comment for the settings file. Max. 60 characters are allowed.

Select Items ← Save

Displays the submenu for selecting the items to be stored or loaded.

Select Items ← Select Items ← Save

Sets the focus on the items list. Which items are available depends on the installed options.

In the "Save" dialog box, all items that can be saved are displayed.

In the "Recall" dialog box, the items saved in the selected file are displayed.

Remote command:

`MMEMory:SELEct[:ITEM]:HWSettings` on page 950

`MMEMory:SELEct[:ITEM]:LINes:ALL` on page 950

`MMEMory:SELEct[:ITEM]:TRACe[:ACTive]` on page 951

`MMEMory:SELEct[:ITEM]:TRANsducer:ALL` on page 951

Enable all Items ← Select Items ← Save

Selects all items for saving or loading.

Remote command:

`MMEMory:SELEct[:ITEM]:ALL` on page 949

Disable all Items ← Select Items ← Save

Selects none of the items for saving or loading.

Remote command:

`MMEMory:SELEct[:ITEM]:NONE` on page 950

Delete File ← Save

Deletes the selected settings file.

Remote command:

`MMEMory:CLEar:STATe 1`, on page 942

Recall

Opens the "Recall" dialog box to load a settings file. To navigate in the dialog box, use the corresponding softkeys.

For details see also [Chapter 5.1.2.2, "File Selection Dialog Boxes"](#), on page 170.

Path	Directory from which the settings file is loaded. The default path for user settings files is C:\r_s\instr\user
Files	List of stored settings files
File Name	Name of settings file
Comment	Comment of the settings file
[Items]	Items saved in the settings file

Note: After you use the "Recall" function, the history of previous actions is deleted, i.e. any actions performed previously cannot be undone or redone using the [UNDO/REDO] keys.

Remote command:

`MMEMory:LOAD:STATe` on page 945

Startup Recall

Opens a submenu to activate or deactivate and set up the startup recall function.

Startup Recall (On/Off) ← Startup Recall

Activates or deactivates the startup recall function. If activated, the settings stored in the file selected via the [Select Dataset](#) softkey are loaded when booting or for preset. If deactivated, the default settings are loaded.

Remote command:

[MMEMory:LOAD:AUTO](#) on page 945

Select Dataset ← Startup Recall

Opens the "Startup Recall" dialog box to select the settings file for the startup recall function.

ScreenShot

Saves the current measurement screen as a file (screenshot). This function can also be performed via the "Screenshot" icon in the toolbar, if available.

Remote command:

[HCOPY\[:IMMEDIATE<1|2>\]](#) on page 937

Export

Opens a submenu to configure data export.

ASCII Trace Export ← Export

Opens the "ASCII Trace Export Name" dialog box and saves the active trace in ASCII format to the specified file and directory.

Tip: You can export a single trace ("ASCII Trace Export Trace (x)" softkey) or all traces at the same time ("ASCII Trace Export All Traces"). When you use single trace export, the R&S FSVA/FSV exports the currently selected trace (indicated by the softkey label). Note that the exported ASCII file has a slightly different structure compared to a single trace export.

The file consists of the header containing important scaling parameters and a data section containing the trace data. For details on an ASCII file see [Chapter 5.2.8.7, "ASCII File Export Format"](#), on page 235.

This format can be processed by spreadsheet calculation programs, e.g. MS-Excel. It is necessary to define ';' as a separator for the data import. Different language versions of evaluation programs may require a different handling of the decimal point. It is therefore possible to select between separators '.' (decimal point) and ',' (comma) using the "Decim Sep" softkey (see ["Decim Sep"](#) on page 168).

If the spectrogram display is selected when you perform this function, the entire histogram buffer with all frames is exported to a file. The data corresponding to a particular frame begins with information about the frame number and the time that frame was recorded. For large history buffers the export operation may take some time.

For details see [Chapter 5.10.4, "ASCII File Export Format for Spectrograms"](#), on page 533.

Remote command:

[FORMat:DEXPort:TRACes](#) on page 760

[FORMat:DEXPort:DSEPARATOR](#) on page 759

[MMEMory:STORe<n>:TRACe](#) on page 775

[MMEMory:STORe:SGRam](#) on page 774

Decim Sep ← Export

Selects the decimal separator with floating-point numerals for the ASCII Trace export to support evaluation programs (e.g. MS-Excel) in different languages. The values '.' (decimal point) and ',' (comma) can be set.

Remote command:

`FORMat:DEXPort:DSEParator` on page 759

IQ Export ← Export

Opens a file selection dialog box to select an export file to which the IQ data will be stored. This function is only available in single sweep mode.

For details see [Chapter 5.1.2.3, "Importing and Exporting I/Q Data"](#), on page 172.

Remote command:

`MMEMory:STORe:IQ:STATe` on page 773

`MMEMory:STORe:IQ:COMM` on page 773

Import

Provides functions to import data.

IQ Import ← Import

Opens a file selection dialog box to select an import file that contains IQ data. This function is only available in single sweep mode.

For details see [Chapter 5.1.2.3, "Importing and Exporting I/Q Data"](#), on page 172.

Remote command:

`MMEMory:LOAD:IQ:STATe` on page 773

File Manager

Opens the "File Manager" dialog box and a submenu to manage mass storage media and files. In the upper left corner, the current drive is displayed. Below the folders and subfolders of the current directory are displayed.

For details on navigation see also [Chapter 5.1.2.2, "File Selection Dialog Boxes"](#), on page 170.

The following tasks can be performed:

- copying files from flash disk to other media
- copying files into another directory
- renaming and deleting files

Edit Path ← File Manager

Opens the directory list to select the drive and folder for the file to be stored or loaded. The default path is `C:\r_s\instr\user`.

Remote command:

`MMEMory:MSIS` on page 947

`MMEMory:CDIRectory` on page 942

New Folder ← File Manager

Creates a new folder and opens an edit dialog box to enter name and path (absolute or relative to the current directory) of the new folder.

Remote command:

[MMEMoRY:MDIRectory](#) on page 946

Copy ← File Manager

Copies the selected item to the clipboard. The item can be copied later using the [Paste](#) softkey.

Remote command:

[MMEMoRY:COPY](#) on page 943

Rename ← File Manager

Opens an edit dialog box to enter a new file or folder name.

Remote command:

[MMEMoRY:MOVE](#) on page 946

Cut ← File Manager

Copies the selected file to the clipboard. If the file is later copied to a different directory using the [Paste](#) softkey, it is deleted in the current directory.

Paste ← File Manager

Copies a file from the clipboard to the currently selected directory.

Delete ← File Manager

Deletes the selected item after confirmation.

Remote command:

[MMEMoRY:DELeTe](#) on page 944

[MMEMoRY:RDIRectory](#) on page 949

Sort Mode ← File Manager

Opens a submenu to select the sorting mode for the displayed files. The entry for the next higher directory level ("..") and the folders are always located at the top of the list.

Name ← Sort Mode ← File Manager

Sorts the displayed files in alphabetical order of the file names.

Date ← Sort Mode ← File Manager

Sorts the displayed files in respect to the date.

Extension ← Sort Mode ← File Manager

Sorts the displayed files in respect to the extension.

Size ← Sort Mode ← File Manager

Sorts the displayed files in respect to the size.

File Lists (1/2) ← File Manager

Splits the screen to copy files from one directory to the other. The focus between the two panes is switched using the [FIELD RIGHT] and [FIELD LEFT] keys.

Current File List (1/2) ← File Manager

Changes the focus to the selected file list.

Network Drive ← File Manager

Opens the "Map Network Drive" dialog box and submenu.

Map Network Drive ← Network Drive ← File Manager

Sets the focus on the "Drive" list.

Remote command:

[MMEemory:NETWork:MAP](#) on page 948

[MMEemory:NETWork:USEDdrives?](#) on page 949

[MMEemory:NETWork:UNUSeddrives?](#) on page 948

Disconnect Network Drive ← Network Drive ← File Manager

Opens the "Disconnect Network Drive" dialog box. In the "Drive" list, select the drive you want to disconnect and confirm with "OK".

Remote command:

[MMEemory:NETWork:DISConnect](#) on page 948

5.1.2.2 File Selection Dialog Boxes

The "Save" and "Recall" dialog boxes are used to save and recall settings and data files. The "File Manager" allows you to copy, delete or rename data files on the R&S FSVA/FSV. These and other file selection dialog boxes are very similar.

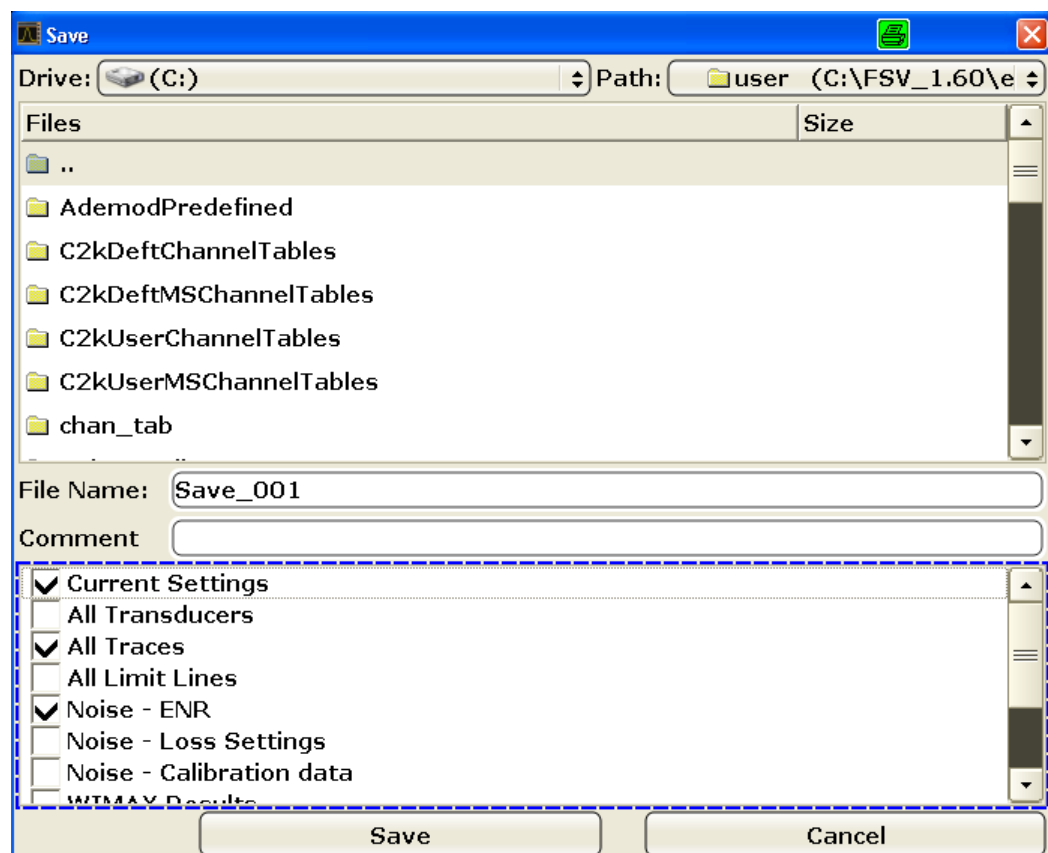

Drive

The data is stored on the internal flash disk or, if selected, on a memory stick or network drive. The mass media are assigned to the volume names as follows:

Drive	Designation	Comment
C	operating system, firmware and stored instrument settings	for customer data
A	USB floppy drive	if connected
D	USB memory stick or USB CD-ROM	if connected
E ...Z	additional USB mass storage devices or mounted LAN volumes	if connected

Path

The current path contains the drive and the complete file path to the currently selected folder.

To set the focus on the "Path" list, press the [Select Path/ Edit Path](#) softkey.

Files

This list contains the files and folders contained in the currently selected path.

To set the focus on the "Files" list, press the [Select File](#) softkey.

File Name

The "File Name" field contains the name of the data file without the path or extension.

To set the focus on "File Name" field, press the [Edit File Name](#) softkey.

In the "Save" dialog box, the field already contains a suggestion for a new name: the file name used in the last saving process is used, extended by an index. For example, if the name last used was `test_004`, the new name `test_005` is suggested, but only if this name is not in use. You can change the suggested name as you like.

By default, the name of a settings file consists of a base name followed by an underscore and three numbers, e.g. `limit_lines_005`. In the example, the base name is `limit_lines`. The base name can contain characters, numbers and underscores. The file extension `df1` is added automatically.

Comment

The comment is optional and may contain a description for the data file.

To set the focus on the "Comment" field, press the [Edit Comment](#) softkey.

Items

When saving data files you can select which data and settings are stored; when recalling such files, this field indicates which items were included during storage. In the "File Manager", this field is not available.

Which items are available depends on the installed options. The following items may be included:

Item	Description
Current Settings	Current measurement settings
All Transducers	All transducer factor <i>files</i> . (Note: Restoring a saveset overwrites transducer factor files on the hard disk that have the same name as those in the saveset. For more information, read "Saving and recalling transducer and limit line settings" on page 163.)
All Traces	All active traces; R&S FSV-K30 only: also calibration data
All Limit Lines	All limit line <i>files</i> (Note: information on which limit lines are active is stored with the "Current Settings")
Spectrograms	Spectrogram trace data (only available if spectrogram display is currently active, R&S FSV-K14 only)
Noise - ENR	Data in "ENR Settings" dialog box (R&S FSV-K30 only)
Noise - Loss Settings	Data in "Loss Settings" dialog box (R&S FSV-K30 only)
Noise - Calibration data	Results from calibration measurement (R&S FSV-K30 only)
K40 Results	All current phase noise trace results (R&S FSV-K40 only)
WLAN Results	Stores the trace and table results for WLAN measurements(R&S FSV-K91 only)
WLAN IQ Data	Stores the measured I/Q data (R&S FSV-K91 only)
WLAN User Limits	Stores any limit values modified in the table of results for WLAN measurements (R&S FSV-K91 only)
WiMAX Results	Stores the trace and table results for WiMAX measurements(R&S FSV-K93 only)

5.1.2.3 Importing and Exporting I/Q Data

In addition to instrument settings and displayed traces, also captured I/Q data can be exported to a file on the R&S FSVA/FSV. The stored data can then be imported again at a later time, also by different applications, for further processing. For example, you can capture I/Q data using the I/Q Analyzer (see [Chapter 5.5, "Instrument Functions - I/Q Analyzer"](#), on page 411) and then perform vector signal analysis on that data using the R&S FSV-K70 option, if available.

As opposed to storing trace data, which may be averaged or restricted to peak values, I/Q data is stored as it was captured, without further processing. The data is stored as complex values in 32-bit floating-point format. The I/Q data is stored in a packed format with the file extension `.iq.tar`.

The [IQ Import](#) and [IQ Export](#) functions are available from the "Save/Recall" menu, which is displayed when you press the [Save/Rcl] key on the front panel.

They can also be performed remotely using the following commands:

`MMEMory:STORe:IQ:STATe` on page 773

[MMEMory:LOAD:IQ:STATE](#) on page 773

iq-tar File Format Specification

I/Q data is stored in a compressed format with the file extension `.iq.tar`.

An `.iq.tar` file contains I/Q data in binary format together with meta information that describes the nature and the source of data, e.g. the sample rate. The objective of the `.iq.tar` file format is to separate I/Q data from the meta information while still having both inside one file. In addition, the file format allows you to preview the I/Q data in a web browser, and allows you to include user-specific data.

Contained files

An `iq-tar` file must contain the following files:

- **I/Q parameter XML file**, e.g. `xyz.xml`
Contains meta information about the I/Q data (e.g. sample rate). The filename can be defined freely, but there must be only one single I/Q parameter XML file inside an `iq-tar` file.
- **I/Q data binary file**, e.g. `xyz.complex.float32`
Contains the binary I/Q data of all channels. There must be only one single I/Q data binary file inside an `iq-tar` file.

Optionally, an `iq-tar` file can contain the following file:

- **I/Q preview XSLT file**, e.g. `open_IqTar_xml_file_in_web_browser.xslt`
Contains a stylesheet to display the I/Q parameter XML file and a preview of the I/Q data in a web browser.

I/Q Parameter XML File Specification



The content of the I/Q parameter XML file must comply with the XML schema `RsIqTar.xsd` available at: <http://www.rohde-schwarz.com/file/RsIqTar.xsd>.

In particular, the order of the XML elements must be respected, i.e. `iq-tar` uses an "ordered XML schema". For your own implementation of the `iq-tar` file format make sure to validate your XML file against the given schema.

The following example shows an I/Q parameter XML file. The XML elements and attributes are explained in the following sections.

Sample I/Q parameter XML file: `xyz.xml`

```
<?xml version="1.0" encoding="UTF-8"?>
<?xml-stylesheet type="text/xsl"
href="open_IqTar_xml_file_in_web_browser.xslt"?>
<RS_IQ_TAR_FileFormat fileFormatVersion="1"
xsi:noNamespaceSchemaLocation="RsIqTar.xsd"
xmlns:xsi="http://www.w3.org/2001/XMLSchema-instance">
  <Name>FSV-K10</Name>
  <Comment>Here is a comment</Comment>
  <DateTime>2011-01-24T14:02:49</DateTime>
```

```

<Samples>68751</Samples>
<Clock unit="Hz">6.5e+006</Clock>
<Format>complex</Format>
<DataType>float32</DataType>
<ScalingFactor unit="V">1</ScalingFactor>
<NumberOfChannels>1</NumberOfChannels>
<DataFilename>xyz.complex.float32</DataFilename>
<UserData>
  <UserDefinedElement>Example</UserDefinedElement>
</UserData>
  <PreviewData>...</PreviewData>
</RS_IQ_TAR_FileFormat>

```

Element	Description
RS_IQ_TAR_FileFormat	The root element of the XML file. It must contain the attribute <code>fileFormatVersion</code> that contains the number of the file format definition. Currently, <code>fileFormatVersion "2"</code> is used.
Name	Optional: describes the device or application that created the file.
Comment	Optional: contains text that further describes the contents of the file.
DateTime	Contains the date and time of the creation of the file. Its type is <code>xs:dateTime</code> (see <code>RsIqTar.xsd</code>).
Samples	Contains the number of samples of the I/Q data. For multi-channel signals all channels have the same number of samples. One sample can be: <ul style="list-style-type: none"> • A complex number represented as a pair of I and Q values • A complex number represented as a pair of magnitude and phase values • A real number represented as a single real value See also <code>Format</code> element.
Clock	Contains the clock frequency in Hz, i.e. the sample rate of the I/Q data. A signal generator typically outputs the I/Q data at a rate that equals the clock frequency. If the I/Q data was captured with a signal analyzer, the signal analyzer used the clock frequency as the sample rate. The attribute <code>unit</code> must be set to "Hz".
Format	Specifies how the binary data is saved in the I/Q data binary file (see <code>DataFilename</code> element). Every sample must be in the same format. The format can be one of the following: <ul style="list-style-type: none"> • Complex: Complex number in cartesian format, i.e. I and Q values interleaved. I and Q are unitless • Real: Real number (unitless) • Polar: Complex number in polar format, i.e. magnitude (unitless) and phase (rad) values interleaved. Requires <code>DataType = float32</code> or <code>float64</code>
DataType	Specifies the binary format used for samples in the I/Q data binary file (see <code>DataFilename</code> element and " I/Q Data Binary File " on page 176). The following data types are allowed: <ul style="list-style-type: none"> • <code>int8</code>: 8 bit signed integer data • <code>int16</code>: 16 bit signed integer data • <code>int32</code>: 32 bit signed integer data • <code>float32</code>: 32 bit floating point data (IEEE 754) • <code>float64</code>: 64 bit floating point data (IEEE 754)

Element	Description
ScalingFactor	Optional: describes how the binary data can be transformed into values in the unit Volt. The binary I/Q data itself has no unit. To get an I/Q sample in the unit Volt the saved samples have to be multiplied by the value of the <code>ScalingFactor</code> . For polar data only the magnitude value has to be multiplied. For multi-channel signals the <code>ScalingFactor</code> must be applied to all channels. The <code>ScalingFactor</code> must be > 0. If the <code>ScalingFactor</code> element is not defined, a value of 1 V is assumed.
NumberOfChannels	Optional: specifies the number of channels, e.g. of a MIMO signal, contained in the I/Q data binary file. For multi-channels, the I/Q samples of the channels are expected to be interleaved within the I/Q data file (see " I/Q Data Binary File " on page 176). If the <code>NumberOfChannels</code> element is not defined, one channel is assumed.
DataFilename	Contains the filename of the I/Q data binary file that is part of the <code>iq-tar</code> file. It is recommended that the filename uses the following convention: <code><xyz>.<Format>.<Channels>ch.<Type></code> <ul style="list-style-type: none"> • <code><xyz></code> = a valid Windows file name • <code><Format></code> = complex, polar or real (see <code>Format</code> element) • <code><Channels></code> = Number of channels (see <code>NumberOfChannels</code> element) • <code><Type></code> = float32, float64, int8, int16, int32 or int64 (see <code>DataType</code> element) Examples: <ul style="list-style-type: none"> • <code>xyz.complex.1ch.float32</code> • <code>xyz.polar.1ch.float64</code> • <code>xyz.real.1ch.int16</code> • <code>xyz.complex.16ch.int8</code>
UserData	Optional: contains user, application or device-specific XML data which is not part of the <code>iq-tar</code> specification. This element can be used to store additional information, e.g. the hardware configuration. It is recommended that you add user data as XML content.
PreviewData	Optional: contains further XML elements that provide a preview of the I/Q data. The preview data is determined by the routine that saves an <code>iq-tar</code> file (e.g. R&S FSVA/FSV). For the definition of this element refer to the <code>RsIqTar.xsd</code> schema. Note that the preview can be only displayed by current web browsers that have JavaScript enabled and if the XSLT stylesheet <code>open_IqTar_xml_file_in_web_browser.xslt</code> is available.

Example: ScalingFactor

Data stored as `int16` and a desired full scale voltage of 1 V

$$\text{ScalingFactor} = 1 \text{ V} / \text{maximum int16 value} = 1 \text{ V} / 2^{15} = 3.0517578125e-5 \text{ V}$$

	Numerical value	Numerical value x ScalingFactor
Minimum (negative) int16 value	$-2^{15} = -32768$	-1 V
Maximum (positive) int16 value	$2^{15}-1 = 32767$	0.999969482421875 V

Example: PreviewData in XML

```
<PreviewData>
  <ArrayOfChannel length="1">
    <Channel>
      <PowerVsTime>
```

```

    <Min>
      <ArrayOfFloat length="256">
        <float>-95</float>
        <float>-94</float>
        ...
        <float>-93</float>
      </ArrayOfFloat>
    </Min>
    <Max>
      <ArrayOfFloat length="256">
        <float>0</float>
        <float>-41</float>
        ...
        <float>0</float>
      </ArrayOfFloat>
    </Max>
  </PowerVsTime>
  <Spectrum>
    <Min>
      <ArrayOfFloat length="256">
        <float>-107</float>
        <float>-96</float>
        ...
        <float>-94</float>
      </ArrayOfFloat>
    </Min>
    <Max>
      <ArrayOfFloat length="256">
        <float>-25</float>
        <float>1</float>
        ...
        <float>1</float>
      </ArrayOfFloat>
    </Max>
  </Spectrum>
</Channel>
</ArrayOfChannel>
</PreviewData>

```

I/Q Data Binary File

The I/Q data is saved in binary format according to the format and data type specified in the XML file (see `Format` element and `DataType` element). To allow reading and writing of streamed I/Q data all data is interleaved, i.e. complex values are interleaved pairs of I and Q values and multi-channel signals contain interleaved (complex) samples for channel 1, channel 2, channel 3 etc.

Example: NumberOfChannels - Element ordering for complex cartesian data

Complex data: I[channel no][time index], Q[channel no][time index]

```

I[0][0], Q[0][0],          // Channel 0, Complex sample 0
I[1][0], Q[1][0],          // Channel 1, Complex sample 0
I[2][0], Q[2][0],          // Channel 2, Complex sample 0

I[0][1], Q[0][1],          // Channel 0, Complex sample 1
I[1][1], Q[1][1],          // Channel 1, Complex sample 1
I[2][1], Q[2][1],          // Channel 2, Complex sample 1

I[0][2], Q[0][2],          // Channel 0, Complex sample 2
I[1][2], Q[1][2],          // Channel 1, Complex sample 2
I[2][2], Q[2][2],          // Channel 2, Complex sample 2

I[0][3], Q[0][3],          // Channel 0, Complex sample 3
I[1][3], Q[1][3],          // Channel 1, Complex sample 3
I[2][3], Q[2][3],          // Channel 2, Complex sample 3

...

```

5.1.3 Manual Operation – Local Menu

When switched on, the instrument is always in the manual measurement mode and can be operated via the front panel. As soon as the instrument receives a remote command, it is switched to the remote control mode.

In remote control mode, all keys of the instrument except the PRESET key are disabled, see [Chapter 5.1.1, "Instrument Setup and Interface Configuration – SETUP Key"](#), on page 138. The "LOCAL" softkey and the [Display Update \(On/Off\)](#) softkey are displayed. Depending on the setting of the [Display Update \(On/Off\)](#) softkey, the diagrams, traces and display fields are displayed or hidden. For further details on the [Display Update \(On/Off\)](#) softkey refer to [Chapter 5.1.1, "Instrument Setup and Interface Configuration – SETUP Key"](#), on page 138.

For details on remote control refer to [Chapter 6.1, "Remote Control - Basics"](#), on page 537.



If you select the "Local" softkey while a self-alignment or a self-test is still running (which was started remotely), the instrument only returns to the manual operation state when the alignment or test is completed.

The change to manual operation consists of:

- Enabling the Front Panel Keys
Returning to manual mode enables all inactive keys. The main softkey menu of the current mode is displayed.
- Displaying the measurement diagrams again.
The diagrams, traces and display fields are displayed again.
- Generating the "OPERATION COMPLETE" message
If, at the time of pressing the "LOCAL" softkey, the synchronization mechanism via *OPC, *OPC? or *WAI is active, the currently running measurement procedure is

aborted and synchronization is achieved by setting the corresponding bits in the registers of the status reporting system.

- **Setting Bit 6 (User Request) of the Event Status Register**
With a corresponding configuration of the status reporting system, this bit immediately causes the generation of a service request (SRQ) to inform the control software that the user wishes to return to front panel control. For example this can be used to interrupt the control program and to correct instrument settings manually. This bit is set each time the "LOCAL" softkey is pressed.

To return to manual operation

- ▶ Press the "LOCAL" softkey.

The instrument switches from remote to manual operation, but only if the local lock-out function has not been activated in the remote control mode.

5.1.4 Measurement Documentation – PRINT Key

The PRINT key is used to select and configure the printer and to customize the screen printout.

For detailed information on printer selection and installation refer to [Chapter 4.2.4.7, "Selecting and Configuring Printers"](#), on page 42.

To open the Print menu

- ▶ Press the PRINT key.
The "Print" menu is displayed.

Softkeys of the Print Menu

The following table shows all softkeys available in the "Print" menu. It is possible that your instrument configuration does not provide all softkeys. If a softkey is only available with a special option, model or (measurement) mode, this information is delivered in the corresponding softkey description.

Print Screen.....	179
Device Setup.....	179
Device (1/2).....	179
Colors.....	179
L Select Print Color Set.....	180
L Color (On/Off).....	180
L Select Object.....	180
L Predefined Colors.....	180
L User Defined Colors.....	180
L Set to Default.....	180
Comment.....	180
Install Printer.....	180

Print Screen

Starts to printout all test results displayed on the screen: diagrams, traces, markers, marker lists, limit lines etc. Comments, title, date, and time are included at the bottom margin of the printout. All displayed items belonging to the instrument software (soft-keys, tables, dialog boxes) are not printed out.

The output is defined via the ["Device Setup"](#) on page 179 softkey. If the output is saved in a file, the file name used in the last saving process is counted up to the next unused name. If you use a file name that already exists, upon saving, a message is displayed. Selecting "Yes" overwrites the existing file, selecting "No" aborts the saving process. For further details on the file name and an example, refer to the ["Save/Recall"](#) menu, ["Edit File Name"](#) on page 165 softkey.

Path	Directory in which the file is stored. The default path is C:\r_s\instruser
Files	List of the existing files in the same format
File Name	Name of the file

Remote command:

[HCOPY\[:IMMEDIATE<1|2>\]](#) on page 937

[HCOPY\[:IMMEDIATE<1|2>\]:NEXT](#) on page 937

[HCOPY:ITEM:ALL](#) on page 938

Device Setup

Opens the "Hardcopy Setup" dialog box to define the output: image file, clipboard, or the printer. The dialog box consists of two tabs which are selected via the ["Device \(1/2\)"](#) on page 179 softkey.

For further information refer to [Chapter 4.2.4.7, "Selecting and Configuring Printers"](#), on page 42.

Remote command:

[HCOPY:DEVICE:LANGUAGE<1|2>](#) on page 936

[HCOPY:DESTINATION<1|2>](#) on page 935

[HCOPY:PAGE:ORIENTATION<1|2>](#) on page 939

[HCOPY:TDSTAMP:STATE<1|2>](#) on page 939

[SYSTEM:COMMUNICATE:PRINTER:ENUMERATE:FIRST?](#) on page 965

[SYSTEM:COMMUNICATE:PRINTER:ENUMERATE\[:NEXT\]?](#) on page 966

Device (1/2)

Selects the tab of the device in the "Device Setup" dialog box. The analyzer is able to manage two print settings independently of each other. For each device the print setting is displayed on the corresponding tab of the "Device Setup" dialog box (["Device Setup"](#) on page 179 softkey).

For further information refer to [Chapter 4.2.4.7, "Selecting and Configuring Printers"](#), on page 42.

Colors

Opens a submenu to define the colors to be used. For details see ["Print Colors"](#) on page 157 softkey of the "Setup" menu.

The submenu contains the following commands:

- ["Select Print Color Set"](#) on page 180
- ["Color \(On/Off\)"](#) on page 180
- ["Select Object"](#) on page 180
- ["Predefined Colors"](#) on page 180
- ["User Defined Colors"](#) on page 180
- ["Set to Default"](#) on page 180

Select Print Color Set ← Colors

For details see ["Select Print Color Set"](#) on page 157 softkey of the "Setup" menu.

Color (On/Off) ← Colors

For details see ["Color \(On/Off\)"](#) on page 156 softkey of the "Setup" menu.

Select Object ← Colors

For details see ["Select Object"](#) on page 156 softkey of the "Setup" menu.

Predefined Colors ← Colors

For details see ["Predefined Colors"](#) on page 156 softkey of the "Setup" menu.

User Defined Colors ← Colors

For details see ["User Defined Colors"](#) on page 157 softkey of the "Setup" menu.

Set to Default ← Colors

For details see ["Set to Default"](#) on page 157 softkey of the "Setup" menu.

Comment

Opens dialog box to enter a comment. Max. 120 characters are allowed. 60 characters fit in one line. In the first line, at any point a manual line-feed can be forced by entering "@".

Date and time are inserted automatically. The comment is printed below the diagram area, but not displayed on the screen. If a comment should not be printed, it must be deleted.

For details on the alphanumeric entries refer to [Chapter 4.4.3.2, "Entering Alphanumeric Parameters"](#), on page 65.

Remote command:

[HCOPY:ITEM:WINDOW:TEXT](#) on page 938

Install Printer

Opens the "Printers and Faxes" window to install a new printer. All printers that are already installed are displayed.

For further information refer to [Chapter 4.2.4.7, "Selecting and Configuring Printers"](#), on page 42.

Only user accounts with administrator rights can install a printer.

5.1.5 User-Defined Menu – USER key

The USER key displays a user-defined menu. The softkeys displayed here can be labelled and assigned to user-defined settings files as required.

To open the user-defined menu

- ▶ Press the USER key.
The "User" menu is displayed.

Softkeys of the "User" menu

The "User" menu contains 8 user-definable softkeys as well as a "[User Preference Setup](#)" softkey that allows you to define them. Pressing one of the user-definable softkeys has the same effect as the [Save File / Recall File](#) function for a pre-defined settings file. The definitions for these softkeys remain unchanged even after a reset function and after updating the firmware.



As opposed to recalling a settings file via the "Save/Recall" menu, when a saved settings file is loaded using one of the user-definable softkeys, the only item to be loaded is the current (measurement) settings - no trace settings, transducer or limit line configurations etc.

"User Preference Setup" softkey

Opens an "ApplicationManager" dialog to set up the user-defined softkeys.

	User key saveset	User key label
1		Empty
2	H:\etv\SW\user\Save2.dfl	Settings_2
3	H:\etv\SW\user\Save3.dfl	Settings_3
4	H:\etv\SW\user\Save4.dfl	Settings_4
5	H:\etv\SW\user\Save5.dfl	Settings_5
6		Empty
7	H:\etv\SW\user\Save7.dfl	Settings_7
8	H:\etv\SW\user\Save8.dfl	Settings_8

For each user-definable softkey (1–8), you can define a key label and assign a settings file that is to be loaded when the softkey is selected.

SCPI command:

[MMEMory:USER<Softkey>](#) on page 952

To define the key label

1. Click into the table entry for the corresponding softkey.
2. Enter a label for the softkey.
3. Press ENTER.

To assign a settings file

1. Click into the table entry for the corresponding softkey.
2. In the file selection dialog, select a stored settings file to be recalled when the softkey is selected.
3. Click "Select".
The selected file is displayed in the "ApplicationManager" dialog.

To store the softkey settings

- ▶ Click "Save" to store the user-defined softkey definitions.

5.2 Measurement Parameters

In this section all menus necessary for setting measurement parameters are described. For details on changing the mode refer to [Chapter 5.4.1, "Measurement Mode Selection – MODE Key"](#), on page 406.

**Editing measurement parameters in the information bar**

The currently defined main measurement parameters are displayed in the information bar of the display. They can easily be edited by touching the setting in the display (with a finger or mouse pointer). The corresponding (edit) dialog box is displayed where you can edit the setting.

If you touch the setting in the display longer than 1 second or right-click it, a context-sensitive menu is displayed. The entries correspond to the functions available in the softkey menu for that setting.

Table 5-1: Sweep range variables

Abbrev.	Definition	R&S FSVA/ FSV4 value	R&S FSVA/ FSV7 value	R&S FSVA/ FSV13 value	R&S FSVA/ FSV30 value	R&S FSVA/ FSV40 value
f_{\max}	max. frequency	4 GHz	7 GHz	13.6 GHz	30 GHz	40 GHz
f_{\min}	min. frequency available	0 Hz	0 Hz	0 Hz	0 Hz	0 Hz
span_{\min}	smallest selectable span > 0 Hz	10 Hz	10 Hz	10 Hz	10 Hz	10 Hz

- [Initializing the Configuration – PRESET Key](#)..... 183
- [Selecting the Frequency and Span – FREQ Key](#)..... 185
- [Setting the Frequency Span – SPAN Key](#)..... 191
- [Setting the Level Display and Configuring the RF Input – AMPT Key](#)..... 192
- [Defining Automatic Settings – AUTO SET Key](#)..... 201
- [Setting the Bandwidths and Sweep Time – BW Key](#)..... 205
- [Configuring the Sweep Mode – SWEEP Key](#)..... 214
- [Setting Traces – TRACE Key](#)..... 219
- [Triggering the Sweep – TRIG Key](#)..... 238

5.2.1 Initializing the Configuration – PRESET Key

The PRESET key resets the instrument to the default setting and therefore provides a defined initial state as a known starting point for measurements.



If the "local lockout" function is active in the remote control mode, the PRESET key is disabled.

Further information

- [Chapter 5.2.1.2, "Initial Configuration"](#), on page 184

Task

- [Chapter 5.2.1.1, "Presetting the Instrument"](#), on page 183

5.2.1.1 Presetting the Instrument

1. Define the data set for the presetting:
 - a) To retrieve the originally provided settings file (see [Chapter 5.2.1.2, "Initial Configuration"](#), on page 184), deactivate the "Startup Recall" softkey in the "SAVE/RCL" menu.

- b) To retrieve a customized settings file, in the "File" menu, activate the "Startup Recall" softkey, press the "Startup Recall Setup" softkey, and select the corresponding file.

For details refer to [Chapter 5.1.2, "Saving and Recalling Settings Files – SAVE/RCL Key"](#), on page 163.

2. Press the PRESET key to perform a preset.

Remote: *RST or SYSTem:PRESet



After you use the PRESET function, the history of previous actions is deleted, i.e. any actions performed previously cannot be undone or redone using the UNDO/REDO keys.

5.2.1.2 Initial Configuration

The initial configuration is selected such that the RF input is always protected against overload, provided that the applied signal levels are in the allowed range for the instrument.

The parameter set of the initial configuration can be customized using the "Startup Recall" softkey in the "Save/Rcl" menu. For further information refer to [Chapter 5.1.2, "Saving and Recalling Settings Files – SAVE/RCL Key"](#), on page 163.

Table 5-2: Initial configuration

Parameter	Setting
mode	Spectrum
sweep mode	auto
center frequency	$f_{max}/2$
center frequency step size	0.1 * span
span	maximum possible (depends on instrument model)
RF attenuation	0 dB
reference level	-10 dBm
level range	100 dB log
level unit	dBm
sweep time	auto
resolution bandwidth	auto (3 MHz)
video bandwidth	auto (3 MHz)
FFT filters	off
span/RBW	100
RBW/VBW	1
sweep	cont

Parameter	Setting
trigger	free run
trace 1	clr write
trace 2/3/4/5/6	blank
detector	auto peak
frequency offset	0 Hz
reference level offset	0 dB
reference level position	100 %
grid	abs
cal correction	on
noise source	off
input	RF

5.2.2 Selecting the Frequency and Span – FREQ Key

The FREQ key is used to configure the frequency axis, to set the frequency offset and the signal track function. You can configure the frequency axis either by the start and stop frequency or the center frequency and the span.

To open the Frequency menu

- Press the [FREQ] key.
The "Frequency" menu is displayed. The "Frequency Center" edit dialog box is displayed.

Menu and softkey description

- [Chapter 5.2.2.1, "Softkeys of the Frequency Menu"](#), on page 186

Tasks

- [Chapter 5.2.2.2, "Specifying the Frequency Axis by the Start and Stop Frequency"](#), on page 190
- [Chapter 5.2.2.3, "Specifying the Frequency Axis by the Center Frequency and the Span"](#), on page 190
- [Chapter 5.2.2.4, "Specifying the Step Size for the Arrow Keys and the Rotary Knob"](#), on page 190
- [Chapter 5.2.2.5, "Modifying the Frequency Axis by an Offset"](#), on page 191
- [Chapter 5.2.2.6, "Tracking Signals \(Span > 0\)"](#), on page 191

5.2.2.1 Softkeys of the Frequency Menu

The following chapter describes all softkeys available in the "Frequency" menu. It is possible that your instrument configuration does not provide all softkeys. If a softkey is only available with a special option, model or (measurement) mode, this information is provided in the corresponding softkey description.

Center.....	186
CF Stepsize.....	186
L 0.1*Span (span > 0).....	187
L 0.1*RBW (span > 0).....	187
L 0.5*Span (span > 0).....	187
L 0.5*RBW (span > 0).....	187
L x*Span (span > 0).....	187
L x*RBW (span > 0).....	187
L =Center.....	188
L =Marker.....	188
L Manual.....	188
Start.....	188
Stop.....	188
Frequency Offset.....	188
Signal Track (span > 0).....	189
L Track On/Off (span > 0).....	189
L Track BW (span > 0).....	189
L Track Threshold (span > 0).....	189
L Select Trace (span > 0).....	189
External Mixer.....	189

Center

Opens an edit dialog box to enter the center frequency. The allowed range of values for the center frequency depends on the frequency span.

$$\text{span} > 0: \text{span}_{\min}/2 \leq f_{\text{center}} \leq f_{\max} - \text{span}_{\min}/2$$

$$\text{span} = 0: 0 \text{ Hz} \leq f_{\text{center}} \leq f_{\max}$$

f_{\max} and span_{\min} are specified in the data sheet.

If the bandwidth extension option R&S FSV-B160 is active, center frequencies above 7 GHz are not available.

Remote command:

[SENSe:] FREQuency:CENTer on page 809

CF Stepsize

Opens a submenu to set the step size of the center frequency.

The step size defines the value by which the center frequency is increased or decreased when the arrow keys are pressed. When you use the rotary knob the center frequency changes in steps of 10% of the "Center Frequency Stepsize".

The step size can be set to a fraction of the span (span > 0) or a fraction of the resolution bandwidth (span = 0) or it can be set to a fixed value manually.

Apart from the =Center, =Marker and Manual softkeys, the other softkeys are displayed depending on the selected frequency span.

0.1*Span (span > 0) ← CF Stepsize

Sets the step size for the center frequency to 10 % of the span.

Remote command:

FREQ:CENT:STEP:LINK SPAN, see [SENSe:]FREQuency:CENTer:STEP:LINK on page 809

FREQ:CENT:STEP:LINK:FACT 10PCT, see [SENSe:]FREQuency:CENTer:STEP:LINK:FACTor on page 810

0.1*RBW (span > 0) ← CF Stepsize

Sets the step size for the center frequency to 10 % of the resolution bandwidth.

This is the default setting.

Remote command:

FREQ:CENT:STEP:LINK RBW, see [SENSe:]FREQuency:CENTer:STEP:LINK on page 809

FREQ:CENT:STEP:LINK:FACT 10PCT, see [SENSe:]FREQuency:CENTer:STEP:LINK:FACTor on page 810

0.5*Span (span > 0) ← CF Stepsize

Sets the step size for the center frequency to 50 % of the span.

Remote command:

FREQ:CENT:STEP:LINK SPAN, see [SENSe:]FREQuency:CENTer:STEP:LINK on page 809

FREQ:CENT:STEP:LINK:FACT 50PCT, see [SENSe:]FREQuency:CENTer:STEP:LINK:FACTor on page 810

0.5*RBW (span > 0) ← CF Stepsize

Sets the step size for the center frequency to 50 % of the resolution bandwidth.

Remote command:

FREQ:CENT:STEP:LINK RBW, see [SENSe:]FREQuency:CENTer:STEP:LINK on page 809

FREQ:CENT:STEP:LINK:FACT 50PCT, see [SENSe:]FREQuency:CENTer:STEP:LINK:FACTor on page 810

x*Span (span > 0) ← CF Stepsize

Opens an edit dialog box to set the step size for the center frequency as a percentage (%) of the span.

Remote command:

FREQ:CENT:STEP:LINK SPAN, see [SENSe:]FREQuency:CENTer:STEP:LINK on page 809

FREQ:CENT:STEP:LINK:FACT 20PCT, see [SENSe:]FREQuency:CENTer:STEP:LINK on page 809

x*RBW (span > 0) ← CF Stepsize

Opens an edit dialog box to set the step size for the center frequency as a percentage (%) of the resolution bandwidth. Values between 1 % and 100 % in steps of 1 % are allowed. The default setting is 10 %.

Remote command:

FREQ:CENT:STEP:LINK RBW, see [\[SENSe:\]FREQuency:CENTer:STEP:LINK](#) on page 809

FREQ:CENT:STEP:LINK:FACT 20PCT, see [\[SENSe:\]FREQuency:CENTer:STEP:LINK](#) on page 809

=Center ← CF Stepsize

Sets the step size to the value of the center frequency and removes the coupling of the step size to span or resolution bandwidth.

This function is especially useful for measurements of the signal harmonics. In this case, each stroke of the arrow key selects the center frequency of another harmonic.

=Marker ← CF Stepsize

Sets the step size to the value of the current marker and removes the coupling of the step size to span or resolution bandwidth.

This function is especially useful for measurements of the signal harmonics. In this case, each stroke of the arrow key selects the center frequency of another harmonic.

Manual ← CF Stepsize

Opens an edit dialog box to enter a fixed step size for the center frequency.

Remote command:

[\[SENSe:\]FREQuency:CENTer:STEP](#) on page 809

Start

Opens an edit dialog box to define the start frequency. The following range of values is allowed:

$$f_{\min} \leq f_{\text{start}} \leq f_{\max} - \text{span}_{\min}$$

f_{\min} , f_{\max} and span_{\min} are specified in the data sheet.

Remote command:

[\[SENSe:\]FREQuency:START](#) on page 812

Stop

Opens an edit dialog box to define the stop frequency. The following range of values for the stop frequency is allowed:

$$f_{\min} + \text{span}_{\min} \leq f_{\text{stop}} \leq f_{\max}$$

f_{\min} , f_{\max} and span_{\min} are specified in the data sheet.

Remote command:

[\[SENSe:\]FREQuency:STOP](#) on page 812

Frequency Offset

Opens an edit dialog box to enter a frequency offset that shifts the displayed frequency range by the specified offset.

The softkey indicates the current frequency offset. The allowed values range from -100 GHz to 100 GHz. The default setting is 0 Hz.

Remote command:

[\[SENSe:\]FREQuency:OFFSet](#) on page 811

Signal Track (span > 0)

Opens a submenu to define the signal tracking characteristics:

- search bandwidth
- threshold value
- trace

The search bandwidth and the threshold value are shown in the diagram by two vertical lines and one horizontal line, which are labeled as "TRK". After each sweep the center frequency is set to the maximum signal found within the searched bandwidth. If no maximum signal above the set threshold value is found in the searched bandwidth, the track mechanism stops.

The submenu contains the following softkeys:

- "Track On/Off (span > 0)" on page 189
- "Track BW (span > 0)" on page 189
- "Track Threshold (span > 0)" on page 189
- "Select Trace (span > 0)" on page 189

Track On/Off (span > 0) ← Signal Track (span > 0)

Switches the signal tracking on and off.

Remote command:

`CALCulate<n>:MARKer<m>:FUNCTION:STRack[:STATe]` on page 718

Track BW (span > 0) ← Signal Track (span > 0)

Opens an edit dialog box to set the search bandwidth for signal tracking. The frequency range is calculated as a function of the center frequency.

Remote command:

`CALCulate<n>:MARKer<m>:FUNCTION:STRack:BANDwidth|BWIDth`
on page 716

Track Threshold (span > 0) ← Signal Track (span > 0)

Opens an edit dialog box to set the threshold value for signal tracking.

Remote command:

`CALCulate<n>:MARKer<m>:FUNCTION:STRack:THReshold` on page 717

Select Trace (span > 0) ← Signal Track (span > 0)

Opens an edit dialog box to select the trace on which the signal is tracked.

Remote command:

`CALCulate<n>:MARKer<m>:FUNCTION:STRack:TRACe` on page 717

External Mixer

Opens the "Ext. Mixer" submenu to activate and configure an optional external mixer. This function is only available for R&S FSVA/FSV30 and 40 instruments with the B21 option installed.

For details on the external mixer functionality, see [Chapter 5.8, "Instrument Functions – External Mixer \(Option R&S FSV-B21\)"](#), on page 488.

5.2.2.2 Specifying the Frequency Axis by the Start and Stop Frequency

1. Press the **Start** softkey and enter a start frequency.
2. Press the **Stop** softkey and enter a stop frequency.

5.2.2.3 Specifying the Frequency Axis by the Center Frequency and the Span

1. Press the **FREQ** key and enter a center frequency in the "Frequency Center" edit dialog box.
2. Press the **SPAN** key and enter the bandwidth you want to analyze.



Entering a value of 0 Hz causes a change to the zero span analysis mode.

5.2.2.4 Specifying the Step Size for the Arrow Keys and the Rotary Knob

1. Press the **CF Stepsize** softkey.
The available softkeys depend on the selected frequency span (zero span or span > 0).
2. To define the step size of the center frequency:
 - a) If span > 0:
Press "0.1*Span", "0.5*Span" or "x*Span" to define the step size for the center frequency as percentage of the span (see **CF Stepsize**).
 - b) If span = 0:
Press "0.1*RBW", "0.5*RBW", or "x*RBW" to define the step size for the center frequency as percentage of the resolution bandwidth (see **CF Stepsize**).
 - c) Press the **=Center** softkey to set the step size to the value of the center frequency and remove the dependency of the step size to span or resolution bandwidth.
 - d) Press the **=Marker** softkey to set the step size to the value of the marker and remove the dependency of the step size to span or resolution bandwidth.
 - e) Press the **Manual** softkey and enter a fixed step size for the center frequency.



The step size assigned to arrow keys corresponds to the selected value.
The step size of the rotary knob is always 10 % of it.

5.2.2.5 Modifying the Frequency Axis by an Offset

- Press the [Frequency Offset](#) softkey and enter the offset to shift the displayed frequency span.

5.2.2.6 Tracking Signals (Span > 0)

Note that signal tracking is available for frequency spans > 0.

- Press the [Signal Track \(span > 0\)](#) softkey to open the submenu and start and stop signal tracking with specified parameters.
- Press the [Track On/Off \(span > 0\)](#) softkey to switch signal tracking on or off.
- Press the [Track BW \(span > 0\)](#) softkey and enter a bandwidth for signal tracking.
- Press the [Track Threshold \(span > 0\)](#) softkey and enter the threshold for signal tracking.
- Press the [Select Trace \(span > 0\)](#) softkey and select the trace for signal tracking.

5.2.3 Setting the Frequency Span – SPAN Key

The SPAN key is used to set the frequency span to be analyzed.

To open the Span menu

- Press the SPAN key.
The "Span" menu is displayed. For span > 0 an edit dialog box to enter the frequency is displayed. For zero span, an edit dialog box to enter the sweep time is displayed.

Menu and softkey description

- [Chapter 5.2.3.1, "Softkeys of the Span Menu"](#), on page 191

Task

- [Chapter 5.2.3.2, "Specifying the Span \(Alternatives\)"](#), on page 192

5.2.3.1 Softkeys of the Span Menu

The following chapter describes all softkeys available in the "Span" menu. It is possible that your instrument configuration does not provide all softkeys. If a softkey is only available with a special option, model or (measurement) mode, this information is provided in the corresponding softkey description.

Span Manual	192
Full Span	192
Zero Span	192
Last Span	192

Span Manual

Opens an edit dialog box to enter the frequency span. The center frequency remains the same when you change the span.

The following range is allowed:

span = 0: 0 Hz

span >0: $\text{span}_{\min} \leq f_{\text{span}} \leq f_{\max}$

f_{\max} and span_{\min} are specified in the data sheet.

Remote command:

[\[SENSe:\] FREQuency: SPAN](#) on page 811

Full Span

Sets the span to the full frequency range of the R&S FSVA/FSV specified in the data sheet. This setting is useful for overview measurements.

Remote command:

[\[SENSe:\] FREQuency: SPAN: FULL](#) on page 811

Zero Span

Sets the span to 0 Hz (zero span). The x-axis becomes the time axis with the grid lines corresponding to 1/10 of the current sweep time ("SWT").

Remote command:

`FREQ: SPAN 0Hz`, see [\[SENSe:\] FREQuency: SPAN](#) on page 811

Last Span

Sets the span to the previous value. With this function e.g. a fast change between overview measurement and detailed measurement is possible.

Remote command:

-

5.2.3.2 Specifying the Span (Alternatives)

1. To set the span, use the [Span Manual](#), [Full Span](#), [Zero Span](#) and [Last Span](#) softkeys.
2. To define a frequency range, use the [Start](#) and [Stop](#) softkeys of the "Frequency" menu.
3. In zero span, the span corresponds to the sweep time. In that case, press the [Sweptime Manual](#) softkey and enter a sweep time.

5.2.4 Setting the Level Display and Configuring the RF Input – AMPT Key

The AMPT key is used to set the reference level, the level range and unit, the scaling and the RF attenuation.

To open the amplitude menu

- Press the AMPT key.
The "Amplitude" menu is displayed. The "Reference Level" dialog box is displayed.

Menu and softkey description

- [Chapter 5.2.4.1, "Softkeys of the Amplitude Menu"](#), on page 193

Tasks

- [Chapter 5.2.4.2, "Specifying the Amplitude"](#), on page 200
- [Chapter 5.2.4.3, "Using Electronic Attenuation \(Option Electronic Attenuator, R&S FSV-B25\)"](#), on page 200

5.2.4.1 Softkeys of the Amplitude Menu

The following table shows all softkeys available in the "Amplitude" menu. It is possible that your instrument configuration does not provide all softkeys. If a softkey is only available with a special option, model or (measurement) mode, this information is provided in the corresponding softkey description.

Ref Level.....	193
Range.....	194
L Range Log 100 dB.....	194
L Range Log 50 dB.....	194
L Range Log 10 dB.....	194
L Range Log 5 dB.....	194
L Range Log 1 dB.....	195
L Range Log Manual.....	195
L Range Linear %.....	195
L Range Lin. Unit.....	195
Unit.....	195
Preamp On/Off.....	196
RF Atten Manual/Mech Att Manual.....	196
RF Atten Auto/Mech Att Auto.....	197
EI Atten On/Off.....	197
EI Atten Mode (Auto/Man).....	197
Ref Level Offset.....	198
Ref Level Position.....	198
Grid Abs/Rel.....	198
Noise Correction.....	198
Input (AC/DC).....	199
Input 50 Ω /75 Ω	199
(Bypassing the)YIG Filter.....	199

Ref Level

Opens an edit dialog box to enter the reference level in the current unit (dBm, dB μ V, etc).

The reference level is the maximum value the AD converter can handle without distortion of the measured value. Signal levels above this value will not be measured correctly, which is indicated by the "IFOVL" status display.

Remote command:

`DISPlay[:WINDow<n>]:TRACe<t>:Y[:SCALe]:RLEVEL` on page 754

Range

Opens a submenu to define the display range of the level axis.

Range Log 100 dB ← Range

Sets the level display range to 100 dB.

Remote command:

Logarithmic scaling:

`DISP:WIND:TRAC:Y:SPAC LOG`, see `DISPlay[:WINDow<n>]:TRACe<t>:Y:SPACing` on page 753

Display range:

`DISP:WIND:TRAC:Y 100DB`, see `DISPlay[:WINDow<n>]:TRACe<t>:Y[:SCALe]` on page 753

Range Log 50 dB ← Range

Sets the level display range to 50 dB.

Remote command:

Logarithmic scaling:

`DISP:WIND:TRAC:Y:SPAC LOG`, see `DISPlay[:WINDow<n>]:TRACe<t>:Y:SPACing` on page 753

Display range:

`DISP:WIND:TRAC:Y 50DB`, see `DISPlay[:WINDow<n>]:TRACe<t>:Y[:SCALe]` on page 753

Range Log 10 dB ← Range

Sets the level display range to 10 dB.

Remote command:

Logarithmic scaling:

`DISP:WIND:TRAC:Y:SPAC LOG`, see `DISPlay[:WINDow<n>]:TRACe<t>:Y:SPACing` on page 753

Display range:

`DISP:WIND:TRAC:Y 10DB`, see `DISPlay[:WINDow<n>]:TRACe<t>:Y[:SCALe]` on page 753

Range Log 5 dB ← Range

Sets the level display range to 5 dB.

Remote command:

Logarithmic scaling:

`DISP:WIND:TRAC:Y:SPAC LOG`, see `DISPlay[:WINDow<n>]:TRACe<t>:Y:SPACing` on page 753

Display range:

`DISP:WIND:TRAC:Y 5DB`, see `DISPlay[:WINDow<n>]:TRACe<t>:Y[:SCALe]` on page 753

Range Log 1 dB ← Range

Sets the level display range to 1 dB.

Remote command:

Logarithmic scaling:

DISP:WIND:TRAC:Y:SPAC LOG, see [DISPlay\[:WINDow<n>\]:TRACe<t>:Y:SPACing](#) on page 753

Display range:

DISP:WIND:TRAC:Y 1DB, see [DISPlay\[:WINDow<n>\]:TRACe<t>:Y\[:SCALe\]](#) on page 753

Range Log Manual ← Range

Opens an edit dialog box to define the display range of a logarithmic level axis manually.

Remote command:

Logarithmic scaling:

DISP:WIND:TRAC:Y:SPAC LOG, see [DISPlay\[:WINDow<n>\]:TRACe<t>:Y:SPACing](#) on page 753

Display range:

[DISPlay\[:WINDow<n>\]:TRACe<t>:Y\[:SCALe\]](#) on page 753

Range Linear % ← Range

Selects linear scaling for the level axis in %.

The grid is divided into decadal sections.

Markers are displayed in the selected unit ("Unit" softkey). Delta markers are displayed in % referenced to the voltage value at the position of marker 1. This is the default setting for linear scaling.

Remote command:

DISP:TRAC:Y:SPAC LIN, see [DISPlay\[:WINDow<n>\]:TRACe<t>:Y:SPACing](#) on page 753

Range Lin. Unit ← Range

Selects linear scaling in dB for the level display range, i.e. the horizontal lines are labeled in dB.

Markers are displayed in the selected unit ("Unit" softkey). Delta markers are displayed in dB referenced to the power value at the position of marker 1.

Remote command:

DISP:TRAC:Y:SPAC LDB, see [DISPlay\[:WINDow<n>\]:TRACe<t>:Y:SPACing](#) on page 753

Unit

Opens the "Unit" submenu to select the unit for the level axis.

The default setting is dBm.

If a transducer is switched on, the softkey is not available.

In general, the signal analyzer measures the signal voltage at the RF input. The level display is calibrated in RMS values of an unmodulated sine wave signal. In the default state, the level is displayed at a power of 1 mW (= dBm). Via the known input impedance (50 Ω or 75 Ω), conversion to other units is possible. The following units are available and directly convertible:

- dBm
- dBmV
- dBμV
- dBμA
- dBpW
- Volt
- Ampere
- Watt

Remote command:

`CALCulate<n>:UNIT:POWer` on page 747

Preamp On/Off

Switches the preamplifier on and off.

If option R&S FSV-B22 is installed, the preamplifier is only active below 7 GHz.

If option R&S FSV-B24 is installed, the preamplifier is active for all frequencies.

When measuring Spurious Emissions, using this softkey automatically opens the "Sweep List" dialog, see "[Sweep List dialog box](#)" on page 349.

This function is not available for input from the R&S Digital I/Q Interface (option R&S FSV-B17).

Remote command:

`INPut:GAIN:STATe` on page 769

RF Atten Manual/Mech Att Manual

Opens an edit dialog box to enter the attenuation, irrespective of the reference level. If electronic attenuation is activated (option R&S FSV-B25 only; "EI Atten Mode Auto" softkey), this setting defines the mechanical attenuation.

The mechanical attenuation can be set in 10 dB steps.

The RF attenuation can be set in 5 dB steps (R&S FSV with option R&S FSV-B25 or R&S FSVA: 1 dB steps). The range is specified in the data sheet. If the current reference level cannot be set for the set RF attenuation, the reference level is adjusted accordingly.

This function is not available for input from the R&S Digital I/Q Interface (option R&S FSV-B17).

The RF attenuation defines the level at the input mixer according to the formula:

$$\text{level}_{\text{mixer}} = \text{level}_{\text{input}} - \text{RF attenuation}$$

Note: As of firmware version 1.61, the maximum mixer level allowed is **0 dBm**. Mixer levels above this value may lead to incorrect measurement results, which are indicated by the "OVL" status display. The increased mixer level allows for an improved signal, but also increases the risk of overloading the instrument!

When measuring spurious emissions, using this softkey automatically opens the "Sweep List" dialog box, see ["Sweep List dialog box"](#) on page 349.

Remote command:

[INPut:ATTenuation](#) on page 763

RF Atten Auto/Mech Att Auto

Sets the RF attenuation automatically as a function of the selected reference level. This ensures that the optimum RF attenuation is always used. It is the default setting.

When measuring spurious emissions, using this softkey automatically opens the "Sweep List" dialog, see ["Sweep List dialog box"](#) on page 349.

This function is not available for input from the R&S Digital I/Q Interface (option R&S FSV-B17).

Remote command:

[INPut:ATTenuation:AUTO](#) on page 764

EI Atten On/Off

This softkey switches the electronic attenuator on or off. This softkey is only available with option R&S FSV-B25.

When the electronic attenuator is activated, the mechanical and electronic attenuation can be defined separately. Note however, that both parts must be defined in the same mode, i.e. either both manually, or both automatically.

This function is not available for input from the R&S Digital I/Q Interface (option R&S FSV-B17).

- To define the mechanical attenuation, use the [RF Atten Manual/Mech Att Manual](#) or [RF Atten Auto/Mech Att Auto](#) softkeys.
- To define the electronic attenuation, use the [EI Atten Mode \(Auto/Man\)](#) softkey.

Note: This function is not available for stop frequencies (or center frequencies in zero span) >7 GHz. In this case, the electronic and mechanical attenuation are summarized and the electronic attenuation can no longer be defined individually. As soon as the stop or center frequency is reduced below 7 GHz, this function is available again. When the electronic attenuator is switched off, the corresponding RF attenuation mode (auto/manual) is automatically activated.

Remote command:

[INPut:EATT:AUTO](#) on page 767

EI Atten Mode (Auto/Man)

This softkey defines whether the electronic attenuator value is to be set automatically or manually. If manual mode is selected, an edit dialog box is opened to enter the value. This softkey is only available with option R&S FSV-B25, and only if the electronic attenuator has been activated via the [EI Atten On/Off](#) softkey.

Note: This function is not available for stop frequencies (or center frequencies in zero span) >7 GHz. In this case, the electronic and mechanical attenuation are summarized and the electronic attenuation can no longer be defined individually. As soon as the stop or center frequency is reduced below 7 GHz, electronic attenuation is available again. If the electronic attenuation was defined manually, it must be re-defined.

The attenuation can be varied in 1 dB steps from 0 to 30 dB. Other entries are rounded to the next lower integer value.

To re-open the edit dialog box for manual value definition, select the "Man" mode again.

If the defined reference level cannot be set for the given RF attenuation, the reference level is adjusted accordingly and the warning "Limit reached" is output.

Remote command:

`INPut:EATT:AUTO` on page 767

`INPut:EATT` on page 767

Ref Level Offset

Opens an edit dialog box to enter the arithmetic level offset. This offset is added to the measured level irrespective of the selected unit. The scaling of the y-axis is changed accordingly. The setting range is ± 200 dB in 0.1 dB steps.

Remote command:

`DISPlay[:WINDow<n>]:TRACe<t>:Y[:SCALe]:RLEVel:OFFSet` on page 755

Ref Level Position

Opens an edit dialog box to enter the reference level position, i.e. the position of the maximum AD converter value on the level axis. The setting range is from -200 to +200 %, 0 % corresponding to the lower and 100 % to the upper limit of the diagram.

Remote command:

`DISPlay[:WINDow<n>]:TRACe<t>:Y[:SCALe]:RPOSition` on page 755

Grid Abs/Rel

Switches between absolute and relative scaling of the level axis (not available with "Linear" range).

"Abs" Absolute scaling: The labeling of the level lines refers to the absolute value of the reference level. Absolute scaling is the default setting.

"Rel" Relative scaling: The upper line of the grid is always at 0 dB. The scaling is in dB whereas the reference level is always in the set unit (for details on unit settings see the "Unit" softkey).

Remote command:

`DISPlay[:WINDow<n>]:TRACe<t>:Y[:SCALe]:MODE` on page 754

Noise Correction

If activated, the results are corrected by the instrument's inherent noise, which increases the dynamic range.

"ON" A reference measurement of the instrument's inherent noise is carried out. The noise power measured is then subtracted from the power in the channel that is being examined.

The inherent noise of the instrument depends on the selected center frequency, resolution bandwidth and level setting. Therefore, the correction function is disabled whenever one of these parameters is changed. A disable message is displayed on the screen. Noise correction must be switched on again manually after the change.

"OFF"	No noise correction is performed.
"AUTO"	Noise correction is performed. After a parameter change, noise correction is restarted automatically and a new correction measurement is performed.

Remote command:

[\[SENSe:\]POWER:NCORrection](#) on page 854

Input (AC/DC)

Toggles the RF input of the R&S FSVA/FSV between AC and DC coupling.

This function is not available for input from the R&S Digital I/Q Interface (option R&S FSV-B17).

Remote command:

[INPut:COUPling](#) on page 764

Input 50 Ω/75 Ω

Uses 50 Ω or 75 Ω as reference impedance for the measured levels. Default setting is 50 Ω.

The setting 75 Ω should be selected if the 50 Ω input impedance is transformed to a higher impedance using a 75 Ω adapter of the RAZ type (= 25 Ω in series to the input impedance of the instrument). The correction value in this case is 1.76 dB = 10 log (75 Ω/50 Ω).

All levels specified in this Operating Manual refer to the default setting of the instrument (50 Ω).

This function is not available for input from the R&S Digital I/Q Interface (option R&S FSV-B17).

Remote command:

[INPut:IMPedance](#) on page 769

(Bypassing the)YIG Filter

If the option R&S FSVA-B11 is installed, the YIG preselector can be bypassed.

This function is only available for R&S FSVA instruments.

If the YIG preselector at the input of the R&S FSVA is removed from the signal path, you can use the maximum bandwidth for signal analysis. However, image-frequency rejection is no longer ensured.

Note that the YIG preselector is active only on frequencies greater than 7 GHz. Therefore, switching the YIG preselector on and off has no effect if the frequency is below that value.

Note:

For the following measurements, the YIG preselector is off by default (if available).

- I/Q Analyzer
- GSM
- VSA

[INPut:FILTer:YIG\[:STATe\]](#) on page 768

5.2.4.2 Specifying the Amplitude

1. Set the reference level, offset and position using the "Ref Level", "Ref Level Offset" and "Ref Level Position" softkeys (see "Ref Level" on page 193, "Ref Level Offset" on page 198 and "Ref Level Position" on page 198).
2. Select the level range and the unit for the level axis using the "Range" and "Unit" softkeys (see "Range" on page 194 and "Unit" on page 195).
3. Set the scaling using the "Ref Level Position" and/or "Grid Abs/Rel" softkeys (see "Ref Level Position" on page 198 and "Grid Abs/Rel" on page 198).
4. Set the attenuation using the "RF Atten Manual/Mech Atten Manual" or "RF Atten Auto/Mech Att Auto", or (for option B25 only) "EI Atten Mode" softkeys (see "RF Atten Manual/Mech Att Manual" on page 196, "RF Atten Auto/Mech Att Auto" on page 197, "EI Atten Mode (Auto/Man)" on page 197).
5. Define the RF input coupling using the "Input (AC/DC)" softkey, or a reference impedance using the "Input (50Ω/75Ω)" softkey (see "Input (AC/DC)" on page 199, "Input 50 Ω/75 Ω" on page 199).
6. If available, activate or deactivate the RF Preamplifier (option R&S FSV-B22/B24) using the "Preamp" softkey (see "Preamp On/Off" on page 196).

5.2.4.3 Using Electronic Attenuation (Option Electronic Attenuator, R&S FSV-B25)

Besides the mechanical attenuator at the RF input, the R&S FSVA/FSV also offers an electronic attenuation setting (option Electronic Attenuator B25). The electronic attenuator can be set manually or automatically. The default attenuation is preset by the mechanical attenuator. The attenuation can be varied in 1 dB steps from 0 to 30 dB. Other entries are rounded to the next lower integer value.

In automatic mode, the electronic attenuator is set to 0 dB. If a reference level outside the allowed 30 dB range is set, the mechanical attenuator performs the setting. From this new reference level to over 30dB, the electronic attenuator performs the setting again.



For stop frequencies (or center frequencies in zero span) >7 GHz, electronic attenuation cannot be defined individually. In this case, the electronic and mechanical attenuation are summarized and the electronic attenuation can no longer be defined manually. As soon as the stop or center frequency is reduced below 7 GHz, electronic attenuation is available again. If the electronic attenuation was defined manually, it must be re-defined.

Setting electronic attenuation

1. Activate the electronic attenuation by pressing the **EI Atten On/Off** softkey.

2. Select the required attenuator mode by pressing the [EI Atten Mode \(Auto/Man\)](#) softkey until the required mode is highlighted.
Two new softkeys are displayed to set the mechanical attenuation. The same mode is activated for mechanical attenuation as was selected for electronic attenuation.
3. To define the attenuation manually:
 - a) Press the [EI Atten Mode \(Auto/Man\)](#) softkey again, if necessary, to display the edit dialog box.
 - b) Enter the value for the electronic attenuator in the edit dialog box.
 - c) If necessary, press the [RF Atten Manual/Mech Att Manual](#) softkey to open the edit dialog box for mechanical attenuation and enter the required value.

5.2.5 Defining Automatic Settings – AUTO SET Key

The "Auto Set" menu allows you define automatic settings for measurements quickly.

To open the Auto Set menu

- Press the [AUTO SET] key.
The "Auto Set" menu is displayed.

Menu and softkey description

- [Chapter 5.2.5.1, "Softkeys of the Auto Set Menu"](#), on page 201

5.2.5.1 Softkeys of the Auto Set Menu

The following table shows all softkeys available in the "Auto Set" menu. It is possible that your instrument configuration does not provide all softkeys. If a softkey is only available with a special option, model or (measurement) mode, this information is provided in the corresponding softkey description.



Adjusting settings automatically during triggered measurements

When you select an auto adjust function a measurement is performed to determine the optimal settings. If you select an auto adjust function for a triggered measurement, you can select how the R&S FSVA/FSV should behave:

- (default:) The measurement for adjustment waits for the next trigger
- The measurement for adjustment is performed without waiting for a trigger. The trigger source is temporarily set to "Free Run". After the measurement is completed, the original trigger source is restored. The trigger level is adjusted as follows:
 - For IF Power and RF Power triggers:
Trigger Level = Reference Level - 15 dB
 - For Video trigger:
Trigger Level = 85 %

SCPI command:

[SENSe:]ADJust:CONFigure:TRIG on page 783

Auto All.....	202
Auto Freq.....	202
Auto Level.....	203
Settings.....	203
L Meas Time Manual.....	203
L Meas Time Auto.....	203
L Upper Level Hysteresis.....	203
L Lower Level Hysteresis.....	203
Sweep Type.....	203
L Sweep.....	204
L FFT.....	204
L Auto.....	204
L FFT Filter Mode.....	204
L Auto.....	204
L Narrow.....	204

Auto All

Performs all automatic settings.

- "Auto Freq" on page 202
- "Auto Level" on page 203

Remote command:

[SENSe:]ADJust:ALL on page 781

Auto Freq

Defines the center frequency and the reference level automatically by determining the highest frequency level in the frequency span. This function uses the signal counter; thus it is intended for use with sinusoidal signals.

This function is not available for input from the R&S Digital I/Q Interface (option R&S FSV-B17).

This function is not available for 1xEV-DO MS Analysis mode (K85).

Remote command:

[SENSe:]ADJust:FREQuency on page 781

Auto Level

Defines the optimal reference level for the current measurement automatically.

The measurement time for automatic leveling can be defined using the [Settings](#) softkey.

You can define a threshold that the signal must exceed before the reference level is adjusted, see "[Upper Level Hysteresis](#)" on page 203 and "[Lower Level Hysteresis](#)" on page 203.

Remote command:

[SENSe:]ADJust:LEVel on page 781

Settings

Opens a submenu to define settings for automatic leveling.

Possible settings are:

- "[Meas Time Manual](#)" on page 203
- "[Meas Time Auto](#)" on page 203

Meas Time Manual ← Settings

Opens an edit dialog box to enter the duration of the level measurement in seconds. The level measurement is used to determine the optimal reference level automatically (see the "Auto Level" softkey, "[Auto Level](#)" on page 203). The default value is 1 ms.

Remote command:

[SENSe:]ADJust:CONFIgure:LEVel:DURation on page 782

Meas Time Auto ← Settings

The level measurement is used to determine the optimal reference level automatically (see the [Auto Level](#) softkey).

Upper Level Hysteresis ← Settings

Defines an upper threshold the signal must exceed before the reference level is automatically adjusted when the "Auto Level" function is performed.

Remote command:

[SENSe:]ADJust:CONFIguration:HYSTeresis:UPPer on page 783

Lower Level Hysteresis ← Settings

Defines a lower threshold the signal must exceed before the reference level is automatically adjusted when the "Auto Level" function is performed.

Remote command:

[SENSe:]ADJust:CONFIguration:HYSTeresis:LOWer on page 782

Sweep Type

Opens a submenu to define the sweep type.

This function is not available in IQ Analyzer mode or for input from the R&S Digital I/Q Interface (option R&S FSV-B17).

In frequency sweep mode, the analyzer provides several possible methods of sweeping:

- "Sweep" on page 204
- "FFT" on page 204 (not available with 5-Pole filters, channel filters or RRC filters, see [Chapter 5.2.6.3, "Selecting the Appropriate Filter Type"](#), on page 211)
- "Auto" on page 204

Sweep ← Sweep Type

Sets the [Sweep Type](#) to standard analog frequency sweep.

In the standard sweep mode, the local oscillator is set to provide the spectrum quasi analog from the start to the stop frequency.

Remote command:

SWE:TYPE SWE, see [\[SENSe:\]SWEep:TYPE](#) on page 863

FFT ← Sweep Type

Sets the [Sweep Type](#) to FFT mode.

The FFT sweep mode samples on a defined frequency value and transforms it to the spectrum by fast Fourier transformation (FFT).

FFT is not available when using 5-Pole filters, Channel filters or RRC filters. In this case, sweep mode is used.

Note: The same applies when a tracking generator (internal or external, options R&S FSV-B9/B10) is active.

Remote command:

SWE:TYPE FFT, see [\[SENSe:\]SWEep:TYPE](#) on page 863

Auto ← Sweep Type

Automatically sets the fastest available [Sweep Type](#) for the current measurement. Auto mode is set by default.

Remote command:

SWE:TYPE AUTO, see [\[SENSe:\]SWEep:TYPE](#) on page 863

FFT Filter Mode ← Sweep Type

Defines the filter mode to be used for FFT filters by defining the partial span size. The partial span is the span which is covered by one FFT analysis.

Auto ← FFT Filter Mode ← Sweep Type

The firmware determines whether to use wide or narrow filters to obtain the best measurement results.

Remote command:

[\[SENSe:\]BANDwidth|BWIDth\[:RESolution\]:FFT](#) on page 786

Narrow ← FFT Filter Mode ← Sweep Type

For an RBW \leq 10kHz, the FFT filters with the smaller partial span are used. This allows you to perform measurements near a carrier with a reduced reference level due to a narrower analog prefilter.

Remote command:

[SENSe:]BANDwidth|BWIDth[:RESolution]:FFT on page 786

5.2.6 Setting the Bandwidths and Sweep Time – BW Key

The BW key is used to set the resolution bandwidth, video bandwidth (VBW) and sweep time (SWT). The values available for resolution bandwidth and video bandwidth depend on the selected filter type. For details on channel filters see also [Chapter 5.2.6.4, "List of Available RRC and Channel Filters"](#), on page 212 .

To open the bandwidth menu

- Press the BW key.
The "Bandwidth" menu is displayed.

Menu and softkey description

- [Chapter 5.2.6.1, "Softkeys of the Bandwidth Menu"](#), on page 205

Further information

- [Chapter 5.2.6.4, "List of Available RRC and Channel Filters"](#), on page 212
- [Table 5-3](#)

Tasks

- [Chapter 5.2.6.2, "Specifying the Bandwidth"](#), on page 211
- [Chapter 5.2.6.3, "Selecting the Appropriate Filter Type"](#), on page 211

5.2.6.1 Softkeys of the Bandwidth Menu

The following table shows all softkeys available in the "Bandwidth" menu. It is possible that your instrument configuration does not provide all softkeys. If a softkey is only available with a special option, model or (measurement) mode, this information is provided in the corresponding softkey description.



For Spurious Emission Measurements, the settings are defined in the "Sweep List" dialog, see ["Sweep List dialog box"](#) on page 349.

Bandwidth settings are only available for RF measurements.

Res BW Manual.....	206
Res BW Auto.....	206
Video BW Manual.....	206
Video BW Auto.....	207
Sweeptime Manual.....	207
Sweeptime Auto.....	208
Sweep Type.....	208
L Sweep.....	208

L FFT.....	208
L Auto.....	208
L FFT Filter Mode.....	209
L Auto.....	209
L Narrow.....	209
Coupling Ratio.....	209
L RBW/VBW Sine [1/1].....	209
L RBW/VBW Pulse [.1].....	209
L RBW/VBW Noise [10].....	209
L RBW/VBW Manual.....	210
L Span/RBW Auto [100].....	210
L Span/RBW Manual.....	210
L Default Coupling.....	210
Filter Type.....	211

Res BW Manual

Opens an edit dialog box to enter a value for the resolution bandwidth. The available resolution bandwidths are specified in the data sheet.

For details on the correlation between resolution bandwidth and filter type refer to [Chapter 5.2.6.3, "Selecting the Appropriate Filter Type"](#), on page 211.

Numeric input is always rounded to the nearest possible bandwidth. For rotary knob or UP/DNARROW key inputs, the bandwidth is adjusted in steps either upwards or downwards.

The manual input mode of the resolution bandwidth is indicated by a green bullet next to the "RBW" display in the channel bar.

When measuring Spurious Emissions, using this softkey automatically opens the "Sweep List" dialog (see ["Sweep List dialog box"](#) on page 349).

Remote command:

`[SENSe:]BANDwidth|BWIDth[:RESolution]:AUTO` on page 786

`[SENSe:]BANDwidth|BWIDth[:RESolution]` on page 785

Res BW Auto

Couples the resolution bandwidth to the selected span (for span > 0). If you change the span, the resolution bandwidth is automatically adjusted.

This setting is recommended if you need the ideal resolution bandwidth in relation to a particular span.

Remote command:

`[SENSe:]BANDwidth|BWIDth[:RESolution]:AUTO` on page 786

Video BW Manual

Opens an edit dialog box to enter the video bandwidth. The available video bandwidths are specified in the data sheet.

Numeric input is always rounded to the nearest possible bandwidth. For rotary knob or UP/DOWN key inputs, the bandwidth is adjusted in steps either upwards or downwards.

The manual input mode of the video bandwidth is indicated by a green bullet next to the "VBW" display in the channel bar.

Note: RMS detector and VBW.

If an RMS detector is used, the video bandwidth in the hardware is bypassed. Thus, duplicate trace averaging with small VBWs and RMS detector no longer occurs. However, the VBW is still considered when calculating the sweep time. This leads to a longer sweep time for small VBW values. Thus, you can reduce the VBW value to achieve more stable trace curves even when using an RMS detector. Normally, if the RMS detector is used the sweep time should be increased to get more stable trace curves. For details on detectors see [Chapter 5.2.8.6, "Detector Overview"](#), on page 234.

When measuring Spurious Emissions, using this softkey automatically opens the "Sweep List" dialog (see ["Sweep List dialog box"](#) on page 349).

Remote command:

[\[SENSe:\]BANDwidth|BWIDth:VIDeo:AUTO](#) on page 788

[\[SENSe:\]BANDwidth|BWIDth:VIDeo](#) on page 788

Video BW Auto

Couples the video bandwidth to the resolution bandwidth. If you change the resolution bandwidth, the video bandwidth is automatically adjusted.

This setting is recommended if a minimum sweep time is required for a selected resolution bandwidth. Narrow video bandwidths result in longer sweep times due to the longer settling time. Wide bandwidths reduce the signal/noise ratio.

Remote command:

[\[SENSe:\]BANDwidth|BWIDth:VIDeo:AUTO](#) on page 788

Sweeptime Manual

Opens an edit dialog box to enter the sweep time.

Sweep time	
absolute max. sweep time value:	16000 s
absolute min. sweep time value:	zero span: 1 μ s
	span > 0: depends on device model (refer to data sheet)

Allowed values depend on the ratio of span to RBW and RBW to VBW. For details refer to the data sheet.

Numeric input is always rounded to the nearest possible sweep time. For rotary knob or UPARROW/DNARROW key inputs, the sweep time is adjusted in steps either downwards or upwards.

The manual input mode of the sweep time is indicated by a green bullet next to the "SWT" display in the channel bar. If the selected sweep time is too short for the selected bandwidth and span, level measurement errors will occur due to a too short settling time for the resolution or video filters. In this case, the R&S FSVA/FSV displays the error message "UNCAL" and marks the indicated sweep time with a red bullet.

When measuring Spurious Emissions, using this softkey automatically opens the "Sweep List" dialog, see ["Sweep List dialog box"](#) on page 349.

Remote command:

[SWE:TIME:AUTO OFF](#), see [\[SENSe:\]SWEep:TIME:AUTO](#) on page 862

[\[SENSe:\]SWEep:TIME](#) on page 862

Sweptime Auto

Couples the sweep time to the span, video bandwidth (VBW) and resolution bandwidth (RBW) (not available for zero span). If you change the span, resolution bandwidth or video bandwidth, the sweep time is automatically adjusted.

The R&S FSVA/FSV always selects the shortest sweep time that is possible without falsifying the signal. The maximum level error is < 0.1 dB, compared to using a longer sweep time.

When measuring Spurious Emissions, using this softkey automatically opens the "Sweep List" dialog, see "[Sweep List dialog box](#)" on page 349.

Remote command:

[SENSe:] SWEep:TIME:AUTO on page 862

Sweep Type

Opens a submenu to define the sweep type.

This function is not available in IQ Analyzer mode or for input from the R&S Digital I/Q Interface (option R&S FSV-B17).

In frequency sweep mode, the analyzer provides several possible methods of sweeping:

- "Sweep" on page 204
- "FFT" on page 204 (not available with 5-Pole filters, channel filters or RRC filters, see [Chapter 5.2.6.3, "Selecting the Appropriate Filter Type"](#), on page 211)
- "Auto" on page 204

Sweep ← Sweep Type

Sets the [Sweep Type](#) to standard analog frequency sweep.

In the standard sweep mode, the local oscillator is set to provide the spectrum quasi analog from the start to the stop frequency.

Remote command:

SWE:TYPE SWE, see [SENSe:] SWEep:TYPE on page 863

FFT ← Sweep Type

Sets the [Sweep Type](#) to FFT mode.

The FFT sweep mode samples on a defined frequency value and transforms it to the spectrum by fast Fourier transformation (FFT).

FFT is not available when using 5-Pole filters, Channel filters or RRC filters. In this case, sweep mode is used.

Note: The same applies when a tracking generator (internal or external, options R&S FSV-B9/B10) is active.

Remote command:

SWE:TYPE FFT, see [SENSe:] SWEep:TYPE on page 863

Auto ← Sweep Type

Automatically sets the fastest available [Sweep Type](#) for the current measurement. Auto mode is set by default.

Remote command:

SWE:TYPE AUTO, see [SENSe:] SWEep:TYPE on page 863

FFT Filter Mode ← Sweep Type

Defines the filter mode to be used for FFT filters by defining the partial span size. The partial span is the span which is covered by one FFT analysis.

Auto ← FFT Filter Mode ← Sweep Type

The firmware determines whether to use wide or narrow filters to obtain the best measurement results.

Remote command:

`[SENSe:]BANDwidth|BWIDth[:RESolution]:FFT` on page 786

Narrow ← FFT Filter Mode ← Sweep Type

For an $RBW \leq 10\text{kHz}$, the FFT filters with the smaller partial span are used. This allows you to perform measurements near a carrier with a reduced reference level due to a narrower analog prefilter.

Remote command:

`[SENSe:]BANDwidth|BWIDth[:RESolution]:FFT` on page 786

Coupling Ratio

Opens a submenu to select the coupling ratios for functions coupled to the bandwidth.

RBW/VBW Sine [1/1] ← Coupling Ratio

Sets the following coupling ratio:

"video bandwidth = resolution bandwidth"

This is the default setting for the coupling ratio resolution bandwidth/video bandwidth.

This is the coupling ratio recommended if sinusoidal signals are to be measured.

This setting takes effect if you define the video bandwidth automatically ([Video BW Auto](#)).

Remote command:

`BAND:VID:RAT 1`, see `[SENSe:]BANDwidth|BWIDth:VIDeo:RATio` on page 788

RBW/VBW Pulse [.1] ← Coupling Ratio

Sets the following coupling ratio:

"video bandwidth = $10 \times$ resolution bandwidth or"

"video bandwidth = 10 MHz (= max. VBW)."

This coupling ratio is recommended whenever the amplitudes of pulsed signals are to be measured correctly. The IF filter is exclusively responsible for pulse shaping. No additional evaluation is performed by the video filter.

This setting takes effect if you define the video bandwidth automatically ([Video BW Auto](#)).

Remote command:

`BAND:VID:RAT 10`, see `[SENSe:]BANDwidth|BWIDth:VIDeo:RATio` on page 788

RBW/VBW Noise [10] ← Coupling Ratio

Sets the following coupling ratio:

"video bandwidth = resolution bandwidth/10"

At this coupling ratio, noise and pulsed signals are suppressed in the video domain. For noise signals, the average value is displayed.

This setting takes effect if you define the video bandwidth automatically ([Video BW Auto](#)).

Remote command:

BAND:VID:RAT 0.1, see [\[SENSe:\]BANDwidth|BWIDth:VIDeo:RATio](#) on page 788

RBW/VBW Manual ← Coupling Ratio

Activates the manual input of the coupling ratio.

The resolution bandwidth/video bandwidth ratio can be set in the range 0.001 to 1000.

This setting takes effect if you define the video bandwidth automatically ([Video BW Auto](#)).

Remote command:

BAND:VID:RAT 10, see [\[SENSe:\]BANDwidth|BWIDth:VIDeo:RATio](#) on page 788

Span/RBW Auto [100] ← Coupling Ratio

Sets the following coupling ratio:

"resolution bandwidth = span/100"

This coupling ratio is the default setting of the R&S FSVA/FSV.

This setting takes effect if you define the resolution bandwidth automatically ([Res BW Auto](#)).

Remote command:

BAND:VID:RAT 0.001, see [\[SENSe:\]BANDwidth|BWIDth:VIDeo:RATio](#) on page 788

Span/RBW Manual ← Coupling Ratio

Activates the manual input of the coupling ratio.

This setting takes effect if you define the resolution bandwidth automatically ([Res BW Auto](#)).

The span/resolution bandwidth ratio can be set in the range 1 to 10000.

Remote command:

BAND:RAT 0.1, see [\[SENSe:\]BANDwidth|BWIDth\[:RESolution\]:RATio](#) on page 787

Default Coupling ← Coupling Ratio

Sets all coupled functions to the default state ("AUTO").

In addition, the ratio "RBW/VBW" is set to "SINE [1/1]" and the ratio "SPAN/RBW" to 100.

Remote command:

[\[SENSe:\]BANDwidth|BWIDth\[:RESolution\]:AUTO](#) on page 786

[\[SENSe:\]BANDwidth|BWIDth:VIDeo:AUTO](#) on page 788

[\[SENSe:\]SWEep:TIME:AUTO](#) on page 862

Filter Type

Opens a submenu to select the filter type.

When measuring Spurious Emissions, using this softkey automatically opens the "Sweep List" dialog (see ["Sweep List dialog box"](#) on page 349).

The submenu contains the following softkeys:

- Normal (3 dB)
- CISPR (6 dB)
- MIL Std (6 dB)
Note that the 6 dB bandwidths are available only with option R&S FSV-K54.
- Channel
- RRC
- 5-Pole (not available for sweep type "FFT")

For detailed information on filters see [Chapter 5.2.6.3, "Selecting the Appropriate Filter Type"](#), on page 211 and [Chapter 5.2.6.4, "List of Available RRC and Channel Filters"](#), on page 212.

Remote command:

`[SENSe:]BANDwidth|BWIDth[:RESolution]:TYPE` on page 787

5.2.6.2 Specifying the Bandwidth

1. Set the resolution bandwidth using the [Res BW Manual](#) or [Res BW Auto](#) softkey.
2. Set the video bandwidth using the [Video BW Manual](#) or [Video BW Auto](#) softkey.
3. Set the sweep time using the [Sweptime Manual](#) or [Sweptime Auto](#) softkey.
4. Press the [Filter Type](#) softkey and select the appropriate filters.

5.2.6.3 Selecting the Appropriate Filter Type

All resolution bandwidths are realized with digital filters.

The video filters are responsible for smoothing the displayed trace. Using video bandwidths that are small compared to the resolution bandwidth, only the signal average is displayed and noise peaks and pulsed signals are repressed. If pulsed signals are to be measured, it is advisable to use a video bandwidth that is large compared to the resolution bandwidth ($VBW * 10 \times RBW$) for the amplitudes of pulses to be measured correctly.

The following filter types are available:

- Normal (3dB) (Gaussian) filters
The Gaussian filters are set by default. The available bandwidths are specified in the data sheet.
- CISPR (6 dB) filters
- MIL Std (6 dB) filters
Note that the 6 dB bandwidths are available only with option R&S FSV-K54.
- Channel filters

For details see [Chapter 5.2.6.4, "List of Available RRC and Channel Filters"](#), on page 212 .

Channel filters do not support FFT mode.

- RRC filters
For details see [Chapter 5.2.6.4, "List of Available RRC and Channel Filters"](#), on page 212 .
RRC filters do not support FFT mode.
- 5-Pole filters
The available bandwidths are specified in the data sheet.
5-Pole filters do not support FFT mode.

5.2.6.4 List of Available RRC and Channel Filters

For power measurement a number of especially steep-edged channel filters are available (see the following table). The indicated filter bandwidth is the 3 dB bandwidth. For RRC filters, the fixed roll-off factor (α) is also indicated.

Table 5-3: Filter types

Filter Bandwidth	Filter Type	Application
100 Hz	CFILter	
200 Hz	CFILter	
300 Hz	CFILter	
500 Hz	CFILter	
1 kHz	CFILter	
1.5 kHz	CFILter	
2 kHz	CFILter	
2.4 kHz	CFILter	SSB
2.7 kHz	CFILter	
3 kHz	CFILter	
3.4 kHz	CFILter	
4 kHz	CFILter	DAB, Satellite
4.5 kHz	CFILter	
5 kHz	CFILter	
6 kHz	CFILter	
6 kHz, $\alpha=0.2$	RRC	APCO
7.5 kHz	CFILter	
8.5 kHz	CFILter	ETS300 113 (12.5 kHz channels)
9 kHz	CFILter	AM Radio

Filter Bandwidth	Filter Type	Application
10 kHz	CFILter	
12.5 kHz	CFILter	CDMAone
14 kHz	CFILter	ETS300 113 (20 kHz channels)
15 kHz	CFILter	
16 kHz	CFILter	ETS300 113 (25 kHz channels)
18 kHz, a=0.35	RRC	TETRA
20 kHz	CFILter	
21 kHz	CFILter	PDC
24.3 kHz, a=0.35	RRC	IS 136
25 kHz	CFILter	APCO 25-P2
30 kHz	CFILter	CDPD, CDMAone
50 kHz	CFILter	
100 kHz	CFILter	
150 kHz	CFILter	FM Radio
192 kHz	CFILter	PHS
200 kHz	CFILter	GSM
300 kHz	CFILter	
500 kHz	CFILter	J.83 (8-VSB DVB, USA); RF ID 14333
1 MHz	CFILter	CDMAone
1.228 MHz	CFILter	CDMAone
1.28 MHz, a=0.22	RRC	TD-SCDMA
1.5 MHz	CFILter	DAB
2 MHz	CFILter	
3 MHz	CFILter	
3.75 MHz	CFILter	
3.84 MHz, a=0.22	RRC	W-CDMA 3GPP
4.096 MHz, a=0.22	RRC	W-CDMA NTT DOCoMo
5 MHz	CFILter	
20 MHz	CFILter	
28 MHz	CFILter	
40 MHz	CFILter	

5.2.7 Configuring the Sweep Mode – SWEEP Key

The SWEEP key is used to configure the sweep mode. Continuous sweep or single sweep is possible. The sweep time and the number of measured values are set.

To open the Sweep menu

- Press the SWEEP key.
The "Sweep" menu is displayed.

Menu and softkey description

- [Chapter 5.2.7.1, "Softkeys of the Sweep Menu"](#), on page 214

Task

- [Chapter 5.2.7.2, "Specifying the Sweep Settings"](#), on page 219

5.2.7.1 Softkeys of the Sweep Menu

The following table shows all softkeys available in the "Sweep" menu. It is possible that your instrument configuration does not provide all softkeys. If a softkey is only available with a special option, model or (measurement) mode, this information is provided in the corresponding softkey description.

Continuous Sweep.....	214
Single Sweep.....	215
Continue Single Sweep.....	215
Sweeptime Manual.....	215
Sweeptime Auto.....	216
Sweep Type.....	216
L Sweep.....	216
L FFT.....	216
L Auto.....	216
L FFT Filter Mode.....	217
L Auto.....	217
L Narrow.....	217
Sweep Count.....	217
Sweep Points.....	217
Select Frame.....	218
Continue Frame (On Off).....	218
Frame Count.....	218
Spectrogram Clear.....	219

Continuous Sweep

Sets the continuous sweep mode: the sweep takes place continuously according to the trigger settings. This is the default setting.

The trace averaging is determined by the sweep count value (see the "Sweep Count" softkey, ["Sweep Count"](#) on page 217).

Remote command:

INIT:CONT ON, see [INITiate<n>:CONTinuous](#) on page 761

Single Sweep

Sets the single sweep mode: after triggering, starts the number of sweeps that are defined by using the [Sweep Count](#) softkey. The measurement stops after the defined number of sweeps has been performed.

Remote command:

INIT:CONT OFF, see [INITiate<n>:CONTinuous](#) on page 761

Continue Single Sweep

Repeats the number of sweeps set by using the [Sweep Count](#) softkey, without deleting the trace of the last measurement.

This is particularly of interest when using the trace configurations "Average" or "Max Hold" to take previously recorded measurements into account for averaging/maximum search.

For details on trace configuration refer to [Chapter 5.2.8, "Setting Traces – TRACE Key"](#), on page 219.

Remote command:

[INITiate<n>:CONMeas](#) on page 761

Sweeptime Manual

Opens an edit dialog box to enter the sweep time.

Sweep time	
absolute max. sweep time value:	16000 s
absolute min. sweep time value:	zero span: 1 μ s
	span > 0: depends on device model (refer to data sheet)

Allowed values depend on the ratio of span to RBW and RBW to VBW. For details refer to the data sheet.

Numeric input is always rounded to the nearest possible sweep time. For rotary knob or UPARROW/DNARROW key inputs, the sweep time is adjusted in steps either downwards or upwards.

The manual input mode of the sweep time is indicated by a green bullet next to the "SWT" display in the channel bar. If the selected sweep time is too short for the selected bandwidth and span, level measurement errors will occur due to a too short settling time for the resolution or video filters. In this case, the R&S FSV/FSV displays the error message "UNCAL" and marks the indicated sweep time with a red bullet.

When measuring Spurious Emissions, using this softkey automatically opens the "Sweep List" dialog, see ["Sweep List dialog box"](#) on page 349.

Remote command:

SWE:TIME:AUTO OFF, see [\[SENSe:\] SWEep:TIME:AUTO](#) on page 862
[\[SENSe:\] SWEep:TIME](#) on page 862

Sweptime Auto

Couples the sweep time to the span, video bandwidth (VBW) and resolution bandwidth (RBW) (not available for zero span). If you change the span, resolution bandwidth or video bandwidth, the sweep time is automatically adjusted.

The R&S FSVA/FSV always selects the shortest sweep time that is possible without falsifying the signal. The maximum level error is < 0.1 dB, compared to using a longer sweep time.

When measuring Spurious Emissions, using this softkey automatically opens the "Sweep List" dialog, see "[Sweep List dialog box](#)" on page 349.

Remote command:

[SENSe:] SWEep:TIME:AUTO on page 862

Sweep Type

Opens a submenu to define the sweep type.

This function is not available in IQ Analyzer mode or for input from the R&S Digital I/Q Interface (option R&S FSV-B17).

In frequency sweep mode, the analyzer provides several possible methods of sweeping:

- "Sweep" on page 204
- "FFT" on page 204 (not available with 5-Pole filters, channel filters or RRC filters, see [Chapter 5.2.6.3, "Selecting the Appropriate Filter Type"](#), on page 211)
- "Auto" on page 204

Sweep ← Sweep Type

Sets the [Sweep Type](#) to standard analog frequency sweep.

In the standard sweep mode, the local oscillator is set to provide the spectrum quasi analog from the start to the stop frequency.

Remote command:

SWE:TYPE SWE, see [SENSe:] SWEep:TYPE on page 863

FFT ← Sweep Type

Sets the [Sweep Type](#) to FFT mode.

The FFT sweep mode samples on a defined frequency value and transforms it to the spectrum by fast Fourier transformation (FFT).

FFT is not available when using 5-Pole filters, Channel filters or RRC filters. In this case, sweep mode is used.

Note: The same applies when a tracking generator (internal or external, options R&S FSV-B9/B10) is active.

Remote command:

SWE:TYPE FFT, see [SENSe:] SWEep:TYPE on page 863

Auto ← Sweep Type

Automatically sets the fastest available [Sweep Type](#) for the current measurement. Auto mode is set by default.

Remote command:

SWE:TYPE AUTO, see [SENSe:] SWEep:TYPE on page 863

FFT Filter Mode ← Sweep Type

Defines the filter mode to be used for FFT filters by defining the partial span size. The partial span is the span which is covered by one FFT analysis.

Auto ← FFT Filter Mode ← Sweep Type

The firmware determines whether to use wide or narrow filters to obtain the best measurement results.

Remote command:

`[SENSe:]BANDwidth|BWIDth[:RESolution]:FFT` on page 786

Narrow ← FFT Filter Mode ← Sweep Type

For an RBW \leq 10kHz, the FFT filters with the smaller partial span are used. This allows you to perform measurements near a carrier with a reduced reference level due to a narrower analog prefilter.

Remote command:

`[SENSe:]BANDwidth|BWIDth[:RESolution]:FFT` on page 786

Sweep Count

Opens an edit dialog box to enter the number of sweeps to be performed in the single sweep mode. Values from 0 to 32767 are allowed. If the values 0 or 1 are set, one sweep is performed. The sweep count is applied to all the traces in a diagram.

If the trace configurations "Average", "Max Hold" or "Min Hold" are set, the sweep count value also determines the number of averaging or maximum search procedures.

In continuous sweep mode, if sweep count = 0 (default), averaging is performed over 10 sweeps. For sweep count = 1, no averaging, maxhold or minhold operations are performed.

For details on trace configuration see [Chapter 5.2.8, "Setting Traces – TRACE Key"](#), on page 219.

Example:

- Press the [TRACE] key > [Trace 1/Trace 2/Trace 3/Trace 4/Trace 5/Trace 6](#) softkey > ["Max Hold"](#) on page 221 softkey.
- Press the [SWEEP] key > "Sweep Count" softkey.
- In the "Average Sweep Count" dialog box, enter 10.
- Press the ["Single Sweep"](#) on page 215 softkey:
R&S FSV/FSV performs the "Max Hold" function over 10 sweeps.

Remote command:

`[SENSe:]SWEep:COUNT` on page 856

Sweep Points

Opens an edit dialog box to enter the number of measured values to be collected during one sweep.

- Entry via rotary knob:
 - In the range from 101 to 1001, the sweep points are increased or decreased in steps of 100 points.
 - In the range from 1001 to 32001, the sweep points are increased or decreased in steps of 1000 points.
- Entry via keypad:

All values in the defined range can be set.

The default value is 691 sweep points.

When measuring spurious emissions, using this softkey automatically opens the "Sweep List" dialog, see "[Sweep List dialog box](#)" on page 349.

Remote command:

[\[SENSe:\] SWEep: POINts](#) on page 861

Select Frame

For spectrogram measurements only.

Opens a dialog box to select a specific frame and loads the corresponding trace from the memory.

Note that activating a marker or changing the position of the active marker automatically selects the frame that belongs to that marker.

This softkey is available in single sweep mode or if the sweep is stopped.

Remote command:

[CALCulate<n>:SGRam:FRAMe:SELeCt](#) on page 738

Continue Frame (On Off)

For spectrogram measurements only.

Determines whether the results of the last measurement are deleted before starting a new measurement.

- **On**
Repeats the single sweep measurement without deleting the spectrogram results of the last measurement. One of the following trace modes is to be used: Max Hold, Min Hold, Average.
- **Off**
Deletes the last measurement results before performing a single sweep measurement.

This softkey is available in single sweep mode.

Remote command:

[CALCulate<n>:SGRam:CONT](#) on page 737

Frame Count

For spectrogram measurements only.

Opens a dialog box to set the number of frames to be captured in a single sweep.

Therefore, the frame count defines the number of traces the R&S FSVA/FSV plots in the Spectrogram result display in a single sweep. The maximum number of possible frames depends on the history depth (see [CALCulate<n>:SGRam:HDEPth](#) on page 738).

The sweep count, on the other hand, determines how many sweeps are combined in one frame in the Spectrogram, i.e. how many sweeps the R&S FSVA/FSV performs to plot one trace in the Spectrogram result display (see "[Sweep Count](#)" on page 217).

This softkey is available in single sweep mode.

Remote command:

[CALCulate<n>:SGRam:FRAMe:COUNT](#) on page 737

Spectrogram Clear

For spectrogram measurements only.

Resets the Spectrogram result display and clears its history buffer.

Remote command:

[CALCulate<n>:SGRam:CLEar\[:IMMEDIATE\]](#) on page 736

5.2.7.2 Specifying the Sweep Settings

1. Press the [Sweep Count](#) softkey and enter the sweep count.
2. Press the [Sweeptime Manual](#) or [Sweeptime Auto](#) softkey to set the sweep time.
3. Press the [Sweep Type](#) softkey to select the sweep type.
4. Press the [Sweep Points](#) softkey and enter the number of sweep points.
5. Press the [Continuous Sweep](#) or [Single Sweep](#) softkey to select the sweep mode.
6. Press the [Continue Single Sweep](#) softkey to repeat the single sweep.

5.2.8 Setting Traces – TRACE Key

The TRACE key is used to configure the data acquisition for measurement and the analysis of the measurement data.

The R&S FSVA/FSV is capable of displaying up to six different traces at a time in a diagram. A trace consists of a maximum of 691 displayed measurement points on the horizontal axis (frequency or time). If more measured values than measurement points are available, several measured values are combined in one displayed measurement point.

The trace functions include the following:

- Display mode of the trace
For details on trace modes see [Chapter 5.2.8.4, "Trace Mode Overview"](#), on page 231.
- Evaluation of the trace as a whole
For details on averaging see [Chapter 5.2.8.5, "Description of the Averaging Method"](#), on page 232.
- Evaluation of individual measurement points of a trace. For details on detectors see [Chapter 5.2.8.6, "Detector Overview"](#), on page 234.

To open the Trace menu

- Press the TRACE key.
The "Trace" menu is displayed. The "Trace Configuration" dialog box is displayed.

Menu and softkey description

- [Chapter 5.2.8.1, "Softkeys of the Trace Menu"](#), on page 220

Further information

- Chapter 5.2.8.4, "Trace Mode Overview", on page 231
- Chapter 5.2.8.6, "Detector Overview", on page 234
- Chapter 5.2.8.7, "ASCII File Export Format", on page 235

Tasks

- Chapter 5.2.8.2, "Configuring Traces", on page 229
- Chapter 5.2.8.3, "Specifying the Trace Settings", on page 230

5.2.8.1 Softkeys of the Trace Menu

The following table shows all softkeys available in the "Trace" menu. It is possible that your instrument configuration does not provide all softkeys. If a softkey is only available with a special option, model or (measurement) mode, this information is provided in the corresponding softkey description.

Trace 1/Trace 2/Trace 3/Trace 4/Trace 5/Trace 6.....	221
L Clear Write.....	221
L Max Hold.....	221
L Min Hold.....	221
L Average.....	222
L View.....	222
L Blank.....	222
L Hold/Cont.....	222
L Detector.....	222
L Auto Select.....	223
L Auto Peak.....	223
L Positive Peak.....	223
L Negative Peak.....	224
L Sample.....	224
L RMS.....	224
L Average.....	224
L Quasipeak.....	224
L CISPR Average.....	224
L RMS Average.....	225
More Traces.....	225
Copy Trace.....	225
Trace Wizard.....	225
Spectrogram.....	225
Average Mode.....	225
L Lin.....	226
L Log.....	226
L Power.....	226
ASCII Trace Export.....	226
Decim Sep.....	227
Trace Math.....	227
Trace Math Mode.....	227
L Lin.....	228

L Log.....	228
L Power.....	228
Trace Math Position.....	228
Trace Math Off.....	228

Trace 1/Trace 2/Trace 3/Trace 4/Trace 5/Trace 6

Selects the active trace (1, 2, 3, 4, 5, 6) and opens the "Trace Mode" submenu for the selected trace.

The default setting is trace 1 in the overwrite mode (see "Clear Write" on page 221), the other traces are switched off (see "Blank" on page 222). For details see [Chapter 5.2.8.4, "Trace Mode Overview"](#), on page 231.

Tip: To configure several traces in one step, press the [Trace Wizard](#) softkey to open a trace configuration dialog. See also [Chapter 5.2.8.2, "Configuring Traces"](#), on page 229.

Remote command:

Selected via numeric suffix of:TRACe<1 . . . 6> commands

Clear Write ← Trace 1/Trace 2/Trace 3/Trace 4/Trace 5/Trace 6

Overwrite mode: the trace is overwritten by each sweep. This is the default setting.

All available detectors can be selected.

Remote command:

DISP:TRAC:MODE WRIT, see [DISPlay\[:WINDow<n>\]:TRACe<t>:MODE](#) on page 751

Max Hold ← Trace 1/Trace 2/Trace 3/Trace 4/Trace 5/Trace 6

The maximum value is determined over several sweeps and displayed. The R&S FSVA/FSV saves the sweep result in the trace memory only if the new value is greater than the previous one.

The detector is automatically set to "Positive Peak".

This mode is especially useful with modulated or pulsed signals. The signal spectrum is filled up upon each sweep until all signal components are detected in a kind of envelope.

This mode is not available for statistics measurements.

Remote command:

DISP:TRAC:MODE MAXH, see [DISPlay\[:WINDow<n>\]:TRACe<t>:MODE](#) on page 751

Min Hold ← Trace 1/Trace 2/Trace 3/Trace 4/Trace 5/Trace 6

The minimum value is determined from several measurements and displayed. The R&S FSVA/FSV saves the smallest of the previously stored/currently measured values in the trace memory.

The detector is automatically set to "Negative Peak".

This mode is useful e.g. for making an unmodulated carrier in a composite signal visible. Noise, interference signals or modulated signals are suppressed whereas a CW signal is recognized by its constant level.

This mode is not available for statistics measurements.

Remote command:

DISP:TRAC:MODE MINH, see [DISPlay\[:WINDow<n>\]:TRACe<t>:MODE](#) on page 751

Average ← Trace 1/Trace 2/Trace 3/Trace 4/Trace 5/Trace 6

The average is formed over several sweeps. The [Sweep Count](#) determines the number of averaging procedures.

All available detectors can be selected. If the detector is automatically selected, the sample detector is used (see [Chapter 5.2.8.6, "Detector Overview"](#), on page 234).

This mode is not available for statistics measurements.

Remote command:

DISP:TRAC:MODE AVER, see [DISPlay\[:WINDow<n>\]:TRACe<t>:MODE](#) on page 751

View ← Trace 1/Trace 2/Trace 3/Trace 4/Trace 5/Trace 6

The current contents of the trace memory are frozen and displayed.

Note: If a trace is frozen, the instrument settings, apart from level range and reference level (see below), can be changed without impact on the displayed trace. The fact that the displayed trace no longer matches the current instrument setting is indicated by the  icon on the tab label.

If the level range or reference level is changed, the R&S FSVA/FSV automatically adapts the measured data to the changed display range. This allows an amplitude zoom to be made after the measurement in order to show details of the trace.

Remote command:

DISP:TRAC:MODE VIEW, see [DISPlay\[:WINDow<n>\]:TRACe<t>:MODE](#) on page 751

Blank ← Trace 1/Trace 2/Trace 3/Trace 4/Trace 5/Trace 6

Hides the selected trace.

Remote command:

DISP:TRAC OFF, see [DISPlay\[:WINDow<n>\]:TRACe<t>\[:STATe\]](#) on page 750

Hold/Cont ← Trace 1/Trace 2/Trace 3/Trace 4/Trace 5/Trace 6

Switches the reset of the traces in Min Hold, Max Hold and Average mode after some specific parameter changes have been made on and off. The default setting is off.

Normally, the measurement is started anew after parameter changes, before the measurement results are evaluated (e.g. using a marker). In all cases that require a new measurement after parameter changes, the trace is reset automatically to avoid false results (e.g. with span changes). For applications that require no reset after parameter changes, the automatic reset can be switched off.

Remote command:

[DISPlay\[:WINDow<n>\]:TRACe<t>:MODE:HCONtinuous](#) on page 752

Detector ← Trace 1/Trace 2/Trace 3/Trace 4/Trace 5/Trace 6

Opens a submenu to select the detector manually, or activate automatic selection.

Note: When measuring spurious emissions, using this softkey automatically opens the Sweep List dialog, see ["Sweep List dialog box"](#) on page 349.

If a detector was selected manually, the "MAN" indicator is highlighted.

If "AUTO" is selected, the detector is defined automatically, depending on the selected trace mode:

Trace mode	Detector
Clear Write	Auto Peak
Max Hold	Positive Peak
Min Hold	Negative Peak
Average	Sample Peak
View	–
Blank	–

For details see [Chapter 5.2.8.6, "Detector Overview"](#), on page 234.

Auto Select ← Detector ← Trace 1/Trace 2/Trace 3/Trace 4/Trace 5/Trace 6

Selects the best detector for the selected trace and filter mode. This is the default setting.

For details see also [Chapter 5.2.8.6, "Detector Overview"](#), on page 234.

Trace mode	Detector
Clear/Write	Auto Peak
Average	Sample
Max Hold	Max Peak
Min Hold	Min Peak

Remote command:

`[SENSe:] [WINDow:] DETector<trace> [:FUNCTION]:AUTO` on page 864

Auto Peak ← Detector ← Trace 1/Trace 2/Trace 3/Trace 4/Trace 5/Trace 6

Selects the "Auto Peak" detector.

For details see [Chapter 5.2.8.6, "Detector Overview"](#), on page 234.

Remote command:

`DET APE, see [SENSe:] [WINDow:] DETector<trace> [:FUNCTION]`
on page 863

Positive Peak ← Detector ← Trace 1/Trace 2/Trace 3/Trace 4/Trace 5/Trace 6

Selects the "Positive Peak" detector.

For details see [Chapter 5.2.8.6, "Detector Overview"](#), on page 234.

Remote command:

`DET POS, see [SENSe:] [WINDow:] DETector<trace> [:FUNCTION]`
on page 863

Negative Peak ← Detector ← Trace 1/Trace 2/Trace 3/Trace 4/Trace 5/Trace 6

Selects the "Negative Peak" detector.

For details see [Chapter 5.2.8.6, "Detector Overview"](#), on page 234.

Remote command:

DET NEG, see [SENSe:] [WINDow:] DETector<trace>[:FUNCTION]
on page 863

Sample ← Detector ← Trace 1/Trace 2/Trace 3/Trace 4/Trace 5/Trace 6

Selects the "Sample" detector.

For details see [Chapter 5.2.8.6, "Detector Overview"](#), on page 234.

Remote command:

DET SAMP, see [SENSe:] [WINDow:] DETector<trace>[:FUNCTION]
on page 863

RMS ← Detector ← Trace 1/Trace 2/Trace 3/Trace 4/Trace 5/Trace 6

Selects the "RMS" detector.

For details see [Chapter 5.2.8.6, "Detector Overview"](#), on page 234.

Remote command:

DET RMS, see [SENSe:] [WINDow:] DETector<trace>[:FUNCTION]
on page 863

Average ← Detector ← Trace 1/Trace 2/Trace 3/Trace 4/Trace 5/Trace 6

Selects the "Average" detector.

For details see [Chapter 5.2.8.6, "Detector Overview"](#), on page 234.

Remote command:

DET AVER, see [SENSe:] [WINDow:] DETector<trace>[:FUNCTION]
on page 863

Quasipeak ← Detector ← Trace 1/Trace 2/Trace 3/Trace 4/Trace 5/Trace 6

Selects the "Quasipeak" detector.

The quasipeak detector is available with option R&S FSV-K54.

For details see [Chapter 5.2.8.6, "Detector Overview"](#), on page 234.

Remote command:

DET QPE, see [SENSe:] [WINDow:] DETector<trace>[:FUNCTION]
on page 863

CISPR Average ← Detector ← Trace 1/Trace 2/Trace 3/Trace 4/Trace 5/Trace 6

Selects the "CISPR Average" detector.

The CISPR Average detector is available with option R&S FSV-K54.

For details see [Chapter 5.2.8.6, "Detector Overview"](#), on page 234.

Remote command:

DET CAV, see [SENSe:] [WINDow:] DETector<trace>[:FUNCTION]
on page 863

RMS Average ← **Detector** ← **Trace 1/Trace 2/Trace 3/Trace 4/Trace 5/Trace 6**

Selects the "RMS Average" detector.

The quasipeak detector is available with option R&S FSV-K54.

For details see [Chapter 5.2.8.6, "Detector Overview"](#), on page 234.

Remote command:

DET CRMS, see [\[SENSe:\] \[WINDow:\] DETector<trace>\[:FUNCTION\]](#)
on page 863

More Traces

Opens a submenu to select one of the traces not currently displayed in the main menu.

Copy Trace

Opens an edit dialog box to enter the number of the trace memory in which the currently selected trace will be copied.

Remote command:

[TRACe<n>:COPY](#) on page 890

Trace Wizard

Opens the "Trace Wizard" dialog. See [Chapter 5.2.8.2, "Configuring Traces"](#), on page 229.

Spectrogram

Opens the submenu for the spectrogram view (firmware option R&S FSV-K14).

For details on this application refer to [Chapter 5.10, "Instrument Functions - Spectrogram Measurements"](#), on page 522.

Average Mode

Opens a submenu to select the averaging method for the average trace mode. The following methods are available:

- [Lin](#)
- [Log](#)
- [Power](#)

Logarithmic averaging is recommended to display signals with a low signal to noise ratio. While positive peak values are decreased in logarithmic averaging due to the characteristics involved, it is also true that negative peaks are increased relative to the average value. If the distorted amplitude distribution is averaged, a value is obtained that is smaller than the actual average value. The difference is -2.5 dB.

This low average value is usually corrected in noise power measurements by a 2.5 dB factor. Therefore the R&S FSVA/FSV offers the selection of linear averaging. The trace data is converted to linear values prior to averaging, then averaged and reconverted to logarithmic values. After these conversions the data is displayed on the screen. The average value is always correctly displayed irrespective of the signal characteristic.

In case of stationary sinusoidal signals both logarithmic and linear averaging has the same results.

Lin ← Average Mode

Activates linear averaging. Linear averaging means that the power level values are converted into linear units prior to averaging. After the averaging, the data is converted back into its original unit.

This softkey takes effect if the grid is set to a linear scale (see "Range Linear" softkey, "Range Linear %" on page 195). In this case, the averaging is done in two ways (depending on the set unit – see "Unit" softkey):

- The unit is set to either W or dBm: the data is converted into W prior to averaging, i.e. averaging is done in W.
- The unit is set to either V, A, dBmV, dBμV, dBμA or dBpW: the data is converted into V prior to averaging, i.e. averaging is done in V.

Remote command:

SENS: AVER1: TYPE LIN, see [SENSe:] AVERage<n>: TYPE on page 785

Log ← Average Mode

Activates logarithmic averaging.

This averaging method only takes effect if the grid is set to a logarithmic scale ("Range" softkey), i.e. the unit of the data is dBm. In this case the values are averaged in dBm. Otherwise (i.e. with linear scaling), the behavior is the same as with linear averaging (see Lin softkey). For further information on logarithmic scaling refer to the "Average Mode" softkey.

Remote command:

SENS: AVER1: TYPE VID, see [SENSe:] AVERage<n>: TYPE on page 785

Power ← Average Mode

Activates linear power averaging.

The power level values are converted into unit Watt prior to averaging. After the averaging, the data is converted back into its original unit.

Unlike the linear mode, the averaging is always done in W.

Remote command:

SENS: AVER1: TYPE POW, see [SENSe:] AVERage<n>: TYPE on page 785

ASCII Trace Export

Opens the "ASCII Trace Export Name" dialog box and saves the active trace in ASCII format to the specified file and directory.

Tip: You can export a single trace ("ASCII Trace Export Trace (x)" softkey) or all traces at the same time ("ASCII Trace Export All Traces"). When you use single trace export, the R&S FSVA/FSV exports the currently selected trace (indicated by the softkey label). Note that the exported ASCII file has a slightly different structure compared to a single trace export.

The file consists of the header containing important scaling parameters and a data section containing the trace data. For details on an ASCII file see [Chapter 5.2.8.7, "ASCII File Export Format"](#), on page 235.

This format can be processed by spreadsheet calculation programs, e.g. MS-Excel. It is necessary to define ';' as a separator for the data import. Different language versions of evaluation programs may require a different handling of the decimal point. It is therefore possible to select between separators '.' (decimal point) and ',' (comma) using the "Decim Sep" softkey (see ["Decim Sep"](#) on page 168).

If the spectrogram display is selected when you perform this function, the entire histogram buffer with all frames is exported to a file. The data corresponding to a particular frame begins with information about the frame number and the time that frame was recorded. For large history buffers the export operation may take some time.

For details see [Chapter 5.10.4, "ASCII File Export Format for Spectrograms"](#), on page 533.

Remote command:

[FORMat:DEXPort:TRACes](#) on page 760

[FORMat:DEXPort:DSEParator](#) on page 759

[MMEMory:STORe<n>:TRACe](#) on page 775

[MMEMory:STORe:SGRam](#) on page 774

Decim Sep

Selects the decimal separator with floating-point numerals for the ASCII Trace export to support evaluation programs (e.g. MS-Excel) in different languages. The values '.' (decimal point) and ',' (comma) can be set.

Remote command:

[FORMat:DEXPort:DSEParator](#) on page 759

Trace Math

Opens the "Trace Mathematics" dialog box to define which trace is subtracted from trace 1. The result is displayed in trace 1 and refers to the zero point defined with the [Trace Math Position](#) softkey. The following subtractions can be performed:

"T1"->"T1"-T2"	Subtracts trace 2 from trace 1.
"T1"->"T1"-T3"	Subtracts trace 3 from trace 1
"T1"->"T1"-T4"	Subtracts trace 4 from trace 1
"T1"->"T1"-T5"	Subtracts trace 5 from trace 1
"T1"->"T1"-T6"	Subtracts trace 6 from trace 1

To switch off the trace math, use the [Trace Math Off](#) softkey.

Remote command:

[CALCulate<n>:MATH\[:EXpression\] \[:DEFine\]](#) on page 731

[CALCulate<n>:MATH:STATe](#) on page 732

Trace Math Mode

Opens a submenu to select the mode for the trace math calculations.

Lin ← Trace Math Mode

Activates linear subtraction, which means that the power level values are converted into linear units prior to subtraction. After the subtraction, the data is converted back into its original unit.

This softkey takes effect if the grid is set to a linear scale (see [Range](#) softkey). In this case, subtraction is done in two ways (depending on the set unit – see [Unit](#) softkey):

- The unit is set to either W or dBm: the data is converted into W prior to subtraction, i.e. averaging is done in W.
- The unit is set to either V, A, dBmV, dB μ V, dB μ A or dBpW: the data is converted into V prior to subtraction, i.e. subtraction is done in V.

Remote command:

CALC:MATH:MODE LIN, see [CALCulate<n>:MATH:MODE](#) on page 732

Log ← Trace Math Mode

Activates logarithmic subtraction.

This subtraction method only takes effect if the grid is set to a logarithmic scale (see [Range](#) softkey), i.e. the unit of the data is dBm. In this case the values are subtracted in dBm. Otherwise (i.e. with linear scaling) the behavior is the same as with linear subtraction (see [Lin](#) softkey). For further information on logarithmic scaling refer to the [Average Mode](#) softkey.

Remote command:

CALC:MATH:MODE LOG, see [CALCulate<n>:MATH:MODE](#) on page 732

Power ← Trace Math Mode

Activates linear power subtraction.

The power level values are converted into unit Watt prior to subtraction. After the subtraction, the data is converted back into its original unit.

Unlike the linear mode, the subtraction is always done in W.

Remote command:

CALC:MATH:MODE POW, see [CALCulate<n>:MATH:MODE](#) on page 732

Trace Math Position

Opens an edit dialog box to define the zero point in % of the diagram height. The range of values extends from -100 % to +200 %.

Remote command:

[CALCulate<n>:MATH:POSition](#) on page 732

Trace Math Off

Deactivates any previously selected trace math functions.

Remote command:

CALC:MATH:STAT OFF, see [CALCulate<n>:MATH:STATe](#) on page 732

5.2.8.2 Configuring Traces

- To open the trace wizard, press the TRACE key and then the "Trace Wizard" softkey (see "Trace Wizard" on page 225).

Tip: Context-sensitive menus for traces. Traces have context-sensitive menus. If you right-click on a trace in the display or a trace setting in the information channel bar (or touch it for about 1 second), a menu is displayed which corresponds to the softkey functions available for traces. This is useful, for example, when the softkey display is hidden.

If a menu entry contains an arrow to the right of it, a submenu is available for that entry.

To close the menu, press the ESC key or click in the display outside of the menu.

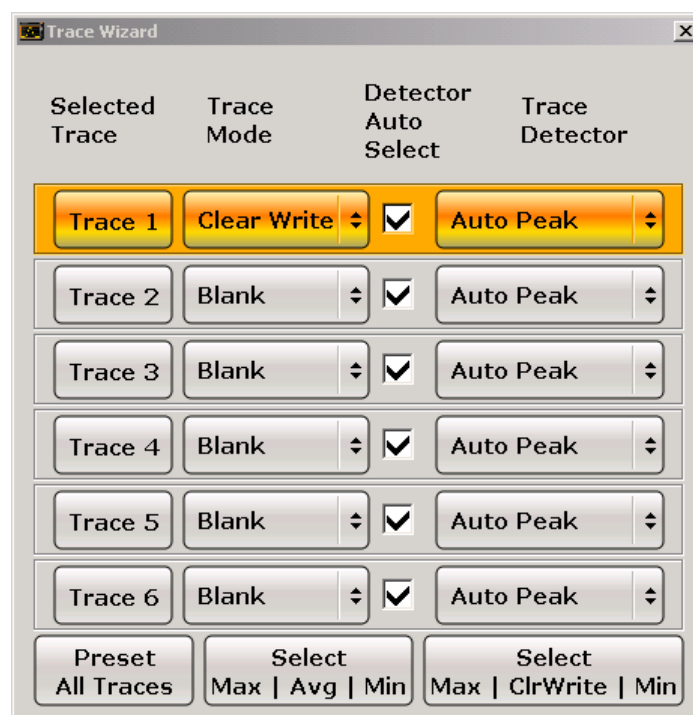

- For each trace you can define the following settings:

Display Mode	<ul style="list-style-type: none"> • Clear Write • Max Hold • Min Hold • Average • View • Blank <p>For details see Chapter 5.2.8.4, "Trace Mode Overview", on page 231.</p>
Detector Auto Select	Activates automatic detector selection (see Auto Select softkey). If activated, the "Trace Detector" setting is ignored.
Trace Detector	<p>Defines a specific trace detector. If one of the following settings is defined, the "Detector Auto Select" option is deactivated.</p> <ul style="list-style-type: none"> • "Auto Select" on page 223 • "Auto Peak" on page 223 • "Positive Peak" on page 223 • "Negative Peak" on page 224 • "Sample" on page 224 • "RMS" on page 224 • "Average" on page 224 • "Quasipeak" on page 224

3. To configure several traces to predefined display modes in one step, press the button for the required function:

Preset All Traces	Trace 1: Clear Write Trace 2-6: Blank
Select Max Avg Min	Trace 1: Max Hold Trace 2: Average Trace 3: Min Hold Trace 4-6: Blank
Select Max ClrWrite Min	Trace 1: Max Hold Trace 2: Clear Write Trace 3: Min Hold Trace 4-6: Blank

For details see [Chapter 5.2.8.4, "Trace Mode Overview"](#), on page 231.

5.2.8.3 Specifying the Trace Settings

1. To configure one or more traces, see [Chapter 5.2.8.2, "Configuring Traces"](#), on page 229.
2. To select the trace mode for the selected trace, press the softkey for the corresponding trace (for details see [Chapter 5.2.8.4, "Trace Mode Overview"](#), on page 231).
3. To select a detector, press the [Auto Select](#) softkey for automatic detector selection, or press the [Detector](#) softkey (for details see [Chapter 5.2.8.6, "Detector Overview"](#), on page 234).

4. To change the sweep count setting, which also determines trace averaging, press the [Sweep Count](#) softkey.
5. To deactivate the reset of the traces in "Min Hold" and "Max Hold" mode after some specific parameter changes, press the [Trace Math](#) softkey.
6. To copy a trace into another trace memory, press the [Copy Trace](#) softkey. Upon copying, the contents of the selected memory are overwritten and the new contents are displayed in the View mode.
7. To export the active trace in ASCII format:
 - a) Press the "More" softkey.
 - b) If necessary, press the [Decim Sep](#) softkey to change the decimal separator with floating-point numerals.
 - c) Press the [ASCII File Export](#) softkey to enter the ASCII file export name. The active trace is saved in ASCII format on the harddisk on or an external storage device.

5.2.8.4 Trace Mode Overview

The traces can be activated individually for a measurement or frozen after completion of a measurement. Traces that are not activate are hidden. Each time the trace mode is changed, the selected trace memory is cleared.

The R&S FSVA/FSV offers 6 different trace modes:

Clear Write

Overwrite mode: the trace is overwritten by each sweep. This is the default setting.

All available detectors can be selected.

Remote command:

`DISP:TRAC:MODE WRIT`, see [DISPlay\[:WINDow<n>\]:TRACe<t>:MODE](#) on page 751

Max Hold

The maximum value is determined over several sweeps and displayed. The R&S FSVA/FSV saves the sweep result in the trace memory only if the new value is greater than the previous one.

The detector is automatically set to "Positive Peak".

This mode is especially useful with modulated or pulsed signals. The signal spectrum is filled up upon each sweep until all signal components are detected in a kind of envelope.

This mode is not available for statistics measurements.

Remote command:

`DISP:TRAC:MODE MAXH`, see [DISPlay\[:WINDow<n>\]:TRACe<t>:MODE](#) on page 751

Min Hold

The minimum value is determined from several measurements and displayed. The R&S FSVA/FSV saves the smallest of the previously stored/currently measured values in the trace memory.

The detector is automatically set to "Negative Peak".

This mode is useful e.g. for making an unmodulated carrier in a composite signal visible. Noise, interference signals or modulated signals are suppressed whereas a CW signal is recognized by its constant level.

This mode is not available for statistics measurements.

Remote command:

DISP:TRAC:MODE MINH, see [DISPlay\[:WINDow<n>\]:TRACe<t>:MODE](#) on page 751

Average

The average is formed over several sweeps. The [Sweep Count](#) determines the number of averaging procedures.

All available detectors can be selected. If the detector is automatically selected, the sample detector is used (see [Chapter 5.2.8.6, "Detector Overview"](#), on page 234).

This mode is not available for statistics measurements.

Remote command:

DISP:TRAC:MODE AVER, see [DISPlay\[:WINDow<n>\]:TRACe<t>:MODE](#) on page 751

View

The current contents of the trace memory are frozen and displayed.

Note: If a trace is frozen, the instrument settings, apart from level range and reference level (see below), can be changed without impact on the displayed trace. The fact that the displayed trace no longer matches the current instrument setting is indicated by the  icon on the tab label.

If the level range or reference level is changed, the R&S FSVA/FSV automatically adapts the measured data to the changed display range. This allows an amplitude zoom to be made after the measurement in order to show details of the trace.

Remote command:

DISP:TRAC:MODE VIEW, see [DISPlay\[:WINDow<n>\]:TRACe<t>:MODE](#) on page 751

Blank

Hides the selected trace.

Remote command:

DISP:TRAC OFF, see [DISPlay\[:WINDow<n>\]:TRACe<t>\[:STATe\]](#) on page 750

5.2.8.5 Description of the Averaging Method

Averaging is carried out over the measurement points derived from the measurement samples. Several measured values may be combined in a measurement point. This means that with linear level display the average is formed over linear amplitude values.

The sweep mode (continuous or single sweep, for details see [Chapter 5.2.7, "Configuring the Sweep Mode – SWEEP Key"](#), on page 214) and running averaging apply to the average display analogously. In principle, two methods for calculating the average are used: continuous averaging and averaging over the selected number of sweeps.

- sweep count > 1
Depending on the relation of the following two parameters, two different situations exist:

n = number of sweeps performed since measurement start

c = sweep count (number of sweeps forming one statistics cycle)

- n ≤ c

In single sweep or continuous sweep mode during the first statistics cycle, averaging over the selected number of sweeps is performed. The average trace "n" is calculated at each measurement point according to:

$$Avg(n) = \frac{n-1}{n} Avg(n-1) + \frac{1}{n} Curr(n)$$

Figure 5-2: Equation 1

with Avg = average trace; Curr = current trace

Until the first statistics cycle is completed (n < c), a preliminary average is displayed which represents the arithmetic mean value over all measured sweeps. With n increasing, the displayed trace is increasingly smoothed since there are more single sweeps for averaging.

When the first statistics cycle is completed (n = c), the average trace is saved in the trace memory.

- n > c

In continuous sweep mode after the first statistics cycle, continuous averaging is performed. The average trace "n" is calculated at each measurement point according to:

$$Avg(n) = \frac{c-1}{c} Avg(n-1) + \frac{1}{c} Curr(n)$$

Figure 5-3: Equation 2

with Avg = average trace; Curr = current trace

In single sweep mode, the same formula is valid if the [Continue Single Sweep](#) softkey is pressed.

- sweep count = 0
In continuous sweep mode, a continuous average is calculated according to [Figure 5-3](#) with c = 10:

$$Avg(n) = \frac{9}{10} Avg(n-1) + \frac{1}{10} Curr(n)$$

Figure 5-4: Equation 3

with Avg = average trace; Curr = current trace

Due to the weighting between the current trace and the average trace, past values have practically no influence on the displayed trace after about ten sweeps. With this setting, signal noise is effectively reduced without need for restarting the averaging process after a change of the signal.

- sweep count = 1
The current trace is displayed. No averaging is performed. This is a special case of [Figure 5-2](#) with $n = 0$.

5.2.8.6 Detector Overview

The measurement detector for the individual display modes can be selected directly by the user or set automatically by the R&S FSVA/FSV. The detector activated for the specific trace is indicated in the corresponding trace display field by an abbreviation.

The detectors of the R&S FSVA/FSV are implemented as pure digital devices. They collect signal power data within each measured point during a sweep. The default number of sweep points is 691. The following detectors are available:

Table 5-4: Detector types

Detector	Indicator	Function
Auto Peak	Ap	Determines the maximum and the minimum value within a measurement point (not available for SEM)
Positive Peak	Pk	Determines the maximum value within a measurement point
Negative Peak (min peak)	Mi	Determines the minimum value within a measurement point
RMS	Rm	Determines the root mean square power within a measurement point
Average	Av	Determines the linear average power within a measurement point
Sample	Sa	Selects the last value within a measurement point

The result obtained from the selected detector within a measurement point is displayed as the power value at this measurement point.

All detectors work in parallel in the background, which means that the measurement speed is independent of the detector combination used for different traces.



Number of measured values

During a frequency sweep, the R&S FSVA/FSV increments the first local oscillator in steps that are smaller than approximately 1/10 of the bandwidth. This ensures that the oscillator step speed is conform to the hardware settling times and does not affect the precision of the measured power.

The number of measured values taken during a sweep is independent of the number of oscillator steps. It is always selected as a multiple or a fraction of 691 (= default number of trace points displayed on the screen). Choosing less than 691 measured values (e.g. 125 or 251) will lead to an interpolated measurement curve, choosing more than 691 points (e.g. 1001, 2001 ...) will result in several measured values being overlaid at the same frequency position.



RMS detector and VBW

If the RMS detector is selected, the video bandwidth in the hardware is bypassed. Thus, duplicate trace averaging with small VBWs and RMS detector no longer occurs. However, the VBW is still considered when calculating the sweep time. This leads to a longer sweep time for small VBW values. Thus, you can reduce the VBW value to achieve more stable trace curves even when using an RMS detector. Normally, if the RMS detector is used the sweep time should be increased to get more stable trace curves.

5.2.8.7 ASCII File Export Format

The data of the file header consist of three columns, each separated by a semicolon: parameter name; numeric value; basic unit. The data section starts with the keyword "Trace <n>" (<n> = number of stored trace), followed by the measured data in one or several columns (depending on measurement) which are also separated by a semicolon.



Exporting a single trace vs exporting all traces

Note that the file containing the trace data has a slightly different structure when you export all traces compared to exporting a single trace only. The differences are indicated in the tables below.

Blue font: Information provided when you export a single trace
Green font: Information provided when you export all traces
Black font: Information provided regardless of the export mode

Header	
Type; <instrument_model>;	Instrument model
Version;1.00;	Firmware version
Date;01. Jan 3000;	Date of data set storage
Mode;Receiver;	Application
Start;150000.000000;Hz	Start frequency of the scan
Stop;100000000.000000;Hz;	Stop frequency of the scan
X-Axis;LIN;	Scale of the x-axis
Detector;Average;	Detector type
X-Unit;Hz;	Unit of the x-axis
Y-Unit;dBµV;	Unit of the y-axis
Scan Count;1;	Scan count
Transducer;,,,,,;	Transducer information

Data section (scan ranges)	
Scan 1:	
Start;150000.000000;Hz;	Start frequency of the scan range
Stop;29998500.000000;Hz;	Stop frequency of the scan range
Step;4500.000000;Hz;	Frequency stepsize applied in the scan range
RBW;9000.000000;Hz;	Measurement bandwidth applied in the scan range
Meas Time;0.001000;s;	Measurement time in the scan range
Auto Ranging;OFF;	State of the auto ranging feature
RF Att;10.000000;dB;	Attenuation applied in the scan range
Auto Preamp;OFF; Preamp;0.000000;dB;	Preamplifier information for the scan range
RF Input;1;	RF input used in the scan range
Scan 2:	
(...)	

Data section (traces)	
Trace 1:	
Trace Mode;CLR/WRITE;	Trace mode
Detector;MAX PEAK;	Detector type
X-Unit;Hz;	Unit of the x-axis
Y-Unit;Hz;	Unit of the y-axis
Values;1343;	Number of measurement points
150000.000000;3.541122; 154500.000000;5.776306;[...]	String of results
Trace 2:	
(...)	

Blue font: Information provided when you export a single trace	
Green font: Information provided when you export all traces	
Black font: Information provided regardless of the export mode	
Header	
Type; <instrument_model>;	Instrument model
Version;1.00;	Firmware version
Date;01. Jan 3000;	Date of data set storage
Mode;Analyzer;	Application
Center Freq;100000000.000000;	Center frequency
Freq Offset;0.000000;Hz;	Frequency offset
Span;10000000000.000000;Hz;	Frequency span
X-Axis;LIN;	Scale of the x-axis
Start;150000.000000;Hz;	Start frequency
Stop;2500000.000000;Hz;	Stop frequency
Ref Level;97.000000;dB μ V;	Reference level
Level Offset;0.000000;Hz;	Reference level offset
Ref Position;100.000000;%;	Reference position
Y-Axis;LOG;	Scale of the y-axis
Level Range;100.000000;dB;	Range of the y-axis
Rf Att;10.000000;dB;	RF attenuation
RBW;3000000.000000;Hz;	Resolution bandwidth
VBW;300000.000000;Hz;	Video bandwidth
SWT;0.002000;s;	Sweep time
Trace mode;CLR/WRITE;	Trace mode
Detector;AUTOPEAK;	Detector type
X-Unit;Hz;	Unit of the x-axis
Y-Unit;Hz;	Unit of the y-axis
Preamplifier;OFF;	State of the preamplifier
Transducer;OFF;	Transducer information
Sweep Count;0;	Sweep / average count

Data section (traces)	
Trace 1:	
Trace Mode;CLR/WRITE;	Trace mode
Detector;MAX PEAK;	Detector type
X-Unit;Hz;	Unit of the x-axis
Y-Unit;Hz;	Unit of the y-axis
Preamplifier;OFF;	State of the preamplifier
Transducer;OFF;	Transducer information
Values;691;	Number of measurement points
150000.000000;3.541122; 154500.000000;5.776306;[...]	String of results
Trace 2:	
(...)	

5.2.9 Triggering the Sweep – TRIG Key

The [TRIG] key is used to select trigger mode, trigger threshold, trigger delay, trigger polarity and for gated sweep the gate configuration.

To open the Trigger menu

- Press the [TRIG] key.
The "Trigger" menu is displayed.

Menu and softkey description

- [Chapter 5.2.9.1, "Softkeys of the Trigger Menu"](#), on page 238

Tasks

- [Chapter 5.2.9.2, "Specifying the Trigger Settings"](#), on page 246
- [Chapter 5.2.9.3, "Using Gated Sweep Operation"](#), on page 246

5.2.9.1 Softkeys of the Trigger Menu

The following table shows all softkeys available in the "Trigger" menu. It is possible that your instrument configuration does not provide all softkeys. If a softkey is only available with a special option, model or (measurement) mode, this information is provided in the corresponding softkey description.

Trg/Gate Source.....	239
L Free Run.....	239
L External.....	239
L Video.....	239
L RF Power.....	239
L IF Power/BB Power.....	240
L Power Sensor.....	241
L Time.....	241
L Digital IQ.....	241
Trg/Gate Level.....	242
Trg/Gate Polarity.....	242
Trigger Offset.....	243
Repetition Interval.....	243
Trigger Hysteresis.....	243
Trigger Holdoff.....	243
Gated Trigger.....	244
Gate Settings.....	244
L Gate Mode (Lvl/Edge).....	244
L Gate Delay.....	244
L Gate Length (Gate Mode Edge).....	245
L Trg/Gate Source.....	245
L Trg/Gate Level.....	245
L Trg/Gate Polarity.....	245
L Sweep Time.....	245
L Res BW Manual.....	245

Trg/Gate Source

Opens the "Trigger/Gate Source" dialog box to select the trigger/gate mode.

As gate modes, all modes except "Power Sensor" are available. For details see also [Chapter 5.2.9.3, "Using Gated Sweep Operation"](#), on page 246.

The default setting is "Free Run". If a trigger mode other than "Free Run" has been set, the enhancement label "TRG" is displayed and the trigger source is indicated.

Note: When triggering or gating is activated, the squelch function is automatically disabled (see ["Squelch"](#) on page 261).

IF power and RF power triggers are not available together with the bandwidth extension option R&S FSV-B160.

Remote command:

[TRIGger<n>\[:SEQuence\]:SOURce](#) on page 912

[\[SENSe:\]SWEep:EGATe:SOURce](#) on page 858

Free Run ← Trg/Gate Source

The start of a sweep is not triggered. Once a measurement is completed, another is started immediately.

Remote command:

[TRIG:SOUR IMM](#), see [TRIGger<n>\[:SEQuence\]:SOURce](#) on page 912

External ← Trg/Gate Source

Defines triggering via a TTL signal at the "EXT TRIG/GATE IN" input connector on the rear panel.

Remote command:

[TRIG:SOUR EXT](#), see [TRIGger<n>\[:SEQuence\]:SOURce](#) on page 912

[SWE:EGAT:SOUR EXT](#) for gated triggering, see [\[SENSe:\]SWEep:EGATe:SOURce](#) on page 858

Video ← Trg/Gate Source

Defines triggering by the displayed voltage.

A horizontal trigger line is shown in the diagram. It is used to set the trigger threshold from 0 % to 100 % of the diagram height.

Video mode is only available in the time domain.

Remote command:

[TRIG:SOUR VID](#), see [TRIGger<n>\[:SEQuence\]:SOURce](#) on page 912

[SWE:EGAT:SOUR VID](#) for gated triggering, see [\[SENSe:\]SWEep:EGATe:SOURce](#) on page 858

RF Power ← Trg/Gate Source

Defines triggering of the measurement via signals which are outside the measurement channel.

This trigger mode is available with detector board 1307.9554.02 Rev 05.00 or higher. It is not available for input from the R&S Digital I/Q Interface (option R&S FSV-B17). If RF Power trigger mode is selected and digital baseband input is activated, the trigger mode is automatically switched to "Free Run".

RF power triggers are not available together with the bandwidth extension option R&S FSV-B160.

In RF Power trigger mode the instrument uses a level detector at the first intermediate frequency. The detector threshold can be selected in a range between - 50 dBm and -10 dBm at the input mixer. The resulting trigger level at the RF input lies within the following range:

$(-24\text{dBm} + \text{RF Att}) \leq \text{Triggerlevel} \leq (+5\text{dBm} + \text{RF Att})$, max. 30 dBm, for Preamp = OFF

$(-40\text{dBm} + \text{RF Att}) \leq \text{Triggerlevel} \leq (-11\text{dBm} + \text{RF Att})$, max. 30 dBm, for Preamp = ON with

$500 \text{ MHz} \leq \text{InputSignal} \leq 7 \text{ GHz}$

Note: If input values outside of this range occur (e.g. for fullspan measurements), the sweep may be aborted and a message indicating the allowed input values is displayed in the status bar.

A [Trigger Offset](#), [Trg/Gate Polarity](#) and [Trigger Holdoff](#) can be defined for the RF trigger to improve the trigger stability, but no hysteresis.

Remote command:

TRIG:SOUR RFP, see [TRIGger<n>\[:SEquence\]:SOURce](#) on page 912

SWE:EGAT:SOUR RFP for gated triggering, see [\[SENSe:\]SWEep:EGATe:SOURce](#) on page 858

IF Power/BB Power ← Trg/Gate Source

Defines triggering of the measurement using the second intermediate frequency.

For this purpose, the R&S FSVA/FSV uses a level detector at the second intermediate frequency.

The available trigger levels depend on the RF attenuation and preamplification. A reference level offset, if defined, is also considered.

For details on available trigger levels and trigger bandwidths see the data sheet.

The bandwidth at the intermediate frequency depends on the RBW and sweep type:

Sweep mode:

- RBW > 500 kHz: 40 MHz, nominal
- RBW ≤ 500 kHz: 6 MHz, nominal

FFT mode:

- RBW > 20 kHz: 40 MHz, nominal
- RBW ≤ 20 kHz: 6 MHz, nominal

Note: Be aware that in auto sweep type mode, due to a possible change in sweep types, the bandwidth may vary considerably for the same RBW setting.

The R&S FSVA/FSV is triggered as soon as the trigger level is exceeded around the selected frequency (= start frequency in the frequency sweep).

Thus, the measurement of spurious emissions, e.g. for pulsed carriers, is possible even if the carrier lies outside the selected frequency span.

For digital input via the R&S Digital I/Q Interface (R&S FSV-B17), the baseband power ("BB Power") is used as the trigger source.

IF power triggers are not available together with the bandwidth extension option R&S FSV-B160.

Remote command:

TRIG:SOUR IFP, see [TRIGger<n>\[:SEQuence\]:SOURce](#) on page 912

TRIG:SOUR BBP for digital input

SWE:EGAT:SOUR IFP for gated triggering, see [\[SENSe:\]SWEep:EGATe:SOURce](#) on page 858

Power Sensor ← Trg/Gate Source

Uses an external power sensor as a trigger function. This option is only available if the R&S FSV-K9 Power Sensor option is installed and a power sensor is connected and configured.

(See [Chapter 5.9, "Instrument Functions - Power Sensor \(R&S FSV-K9\)"](#), on page 509.)

Power sensors are configured in the "Input/Output" menu, see [Chapter 5.9.3, "Configuring an External Power Trigger"](#), on page 514.

If a power sensor is selected as the trigger mode, the following softkeys are not available; these settings are configured in the "Power Sensor Configuration" dialog box (see [Chapter 5.9.5, "Power Sensor Configuration Dialog"](#), on page 518).

- [Trg/Gate Level](#)
- [Trg/Gate Polarity](#)
- [Trigger Hysteresis](#)
- [Trigger Holdoff](#)

Note: For R&S power sensors, the "Gate Mode" *Lvl* is not supported. The signal sent by these sensors merely reflects the instant the level is first exceeded, rather than a time period. However, only time periods can be used for gating in level mode. Thus, the trigger impulse from the sensors is not long enough for a fully gated measurement; the measurement cannot be completed.

Remote command:

TRIG:SOUR PSE, see [TRIGger<n>\[:SEQuence\]:SOURce](#) on page 912

SWE:EGAT:SOUR PSE for gated triggering, see [\[SENSe:\]SWEep:EGATe:SOURce](#) on page 858

[TRACe<n>:IQ:SET](#) on page 904

Time ← Trg/Gate Source

Opens an edit dialog box to define a repetition interval in which the measurement is triggered. The shortest interval is 2 ms.

Remote command:

TRIG:SOUR TIMETRIGger<n>[:SEQuence]:SOURce on page 912

Digital IQ ← Trg/Gate Source

For I/Q Analyzer or AnalogDemod mode only:

Defines triggering of the measurement directly via the LVDS connector. In the sub-menu you must specify which general purpose bit (GP0 to GP5) will provide the trigger data.

This trigger mode is available for input from the R&S Digital I/Q Interface (option R&S FSV-B17) only.

A [Trigger Offset](#), and [Trg/Gate Polarity](#) can be defined for the Digital IQ trigger to improve the trigger stability, but no hysteresis or holdoff value.

The following table describes the assignment of the general purpose bits to the LVDS connector pins.

(See [Table 5-20](#))

Table 5-5: Assignment of general purpose bits to LVDS connector pins

Bit	LVDS pin
GP0	SDATA4_P - Trigger1
GP1	SDATA4_P - Trigger2
GP2	SDATA0_P - Reserve1
GP3	SDATA4_P - Reserve2
GP4	SDATA0_P - Marker1
GP5	SDATA4_P - Marker2

Remote command:

TRIG:SOUR GP0, see [TRIGger<n>\[:SEQuence\]:SOURce](#) on page 912

SWE:EGAT:SOUR RFP for gated triggering, see [\[SENSe:\]SWEep:EGATe:SOURce](#) on page 858

Trg/Gate Level

Opens an edit dialog box to enter the trigger/gate level.

For details see also [Chapter 5.2.9.3, "Using Gated Sweep Operation"](#), on page 246.

In the trigger modes "Time" and "Power Sensor", this softkey is not available.

Remote command:

[TRIGger<n>\[:SEQuence\]:LEVel:IFPower](#) on page 911

[TRIGger<n>\[:SEQuence\]:LEVel:VIDeo](#) on page 911

Trg/Gate Polarity

Sets the polarity of the trigger/gate source.

The sweep starts after a positive or negative edge of the trigger signal. The default setting is "Pos". The setting applies to all trigger modes with the exception of the "Free Run", "Power Sensor" and "Time" mode.

For details also see [Chapter 5.2.9.3, "Using Gated Sweep Operation"](#), on page 246.

"Pos" Level triggering: the sweep is stopped by the logic "0" signal and restarted by the logical "1" signal after the gate delay time has elapsed.

"Neg" Edge triggering: the sweep is continued on a "0" to "1" transition for the gate length duration after the gate delay time has elapsed.

Remote command:

[TRIGger<n>\[:SEQuence\]:SLOPe](#) on page 912

[\[SENSe:\]SWEep:EGATe:POLarity](#) on page 858

Trigger Offset

Opens an edit dialog box to enter the time offset between the trigger signal and the start of the sweep.

offset > 0:	Start of the sweep is delayed
offset < 0:	<p>Sweep starts earlier (pre-trigger)</p> <p>Only possible for span = 0 (e.g. I/Q Analyzer mode) and gated trigger switched off</p> <p>Maximum allowed range limited by the sweep time: $\text{pretrigger}_{\text{max}} = \text{sweep time}$</p> <p>When using the R&S Digital I/Q Interface (R&S FSV-B17) with I/Q Analyzer mode, the maximum range is limited by the number of pretrigger samples.</p> <p>See Table 5-14.</p>

In the "External" or "IF Power" trigger mode, a common input signal is used for both trigger and gate. Therefore, changes to the gate delay will affect the trigger delay (trigger offset) as well.

Tip: To determine the trigger point in the sample (for "External" or "IF Power" trigger mode), use the `TRACe<n>:IQ:TPISample?` command.

In the "Time" trigger mode, this softkey is not available.

Remote command:

`TRIGger<n>[:SEquence]:HOLDoff[:TIME]` on page 909

Repetition Interval

Opens an edit dialog box to define a repetition interval in which the measurement is triggered. The shortest interval is 2 ms. This softkey is only available if the trigger source "Time" is selected (see "Time" on page 241).

Remote command:

`TRIGger<n>[:SEquence]:TIME:RINTerval` on page 913

Trigger Hysteresis

Defines the value for the trigger hysteresis for "IF power" or "RF Power" trigger sources. The hysteresis in dB is the value the input signal must stay below the power trigger level in order to allow a trigger to start the measurement. The range of the value is between 3 dB and 50 dB with a step width of 1 dB.

Remote command:

`TRIGger<n>[:SEquence]:IFPower:HYSTeresis` on page 910

Trigger Holdoff

Defines the value for the trigger holdoff. The holdoff value in s is the time which must pass before triggering, in case another trigger event happens.

This softkey is only available if "IFPower", "RF Power" or "BBPower" is the selected trigger source.

Remote command:

[TRIGger<n>\[:SEquence\]:IFPower:HOLDoff](#) on page 909

For digital input via the R&S Digital I/Q Interface, R&S FSV-B17:

[TRIGger<n>\[:SEquence\]:BBPower:HOLDoff](#) on page 909

Gated Trigger

Switches the sweep mode with gate on or off.

This softkey requires the following "Trigger Mode" (see ["Trg/Gate Source"](#) on page 239):

span > 0	External or IF Power/BB PowerIF Power
span = 0	External or IF Power/BB PowerIF Power or Video

If a different mode is active, the [IF Power/BB Power](#) trigger mode is automatically selected.

Note: When triggering or gating is activated, the squelch function is automatically disabled (see ["Squelch"](#) on page 261).

If the gate is switched on, a gate signal applied to the rear panel connector "EXT TRIGGER/GATE" or the internal IF power detector controls the sweep of the analyzer.

In the trigger mode [Time](#), this softkey is not available.

For details also see [Chapter 5.2.9.3, "Using Gated Sweep Operation"](#), on page 246.

Remote command:

[\[SENSe:\]SWEep:EGATE](#) on page 857

[\[SENSe:\]SWEep:EGATE:SOURce](#) on page 858

Gate Settings

Opens a submenu to make all the settings required for gated sweep operation.

In the "Time" trigger mode, this softkey is not available.

For details also see [Chapter 5.2.9.3, "Using Gated Sweep Operation"](#), on page 246.

Gate Mode (Lvl/Edge) ← Gate Settings

Sets the gate mode. As settings level-triggered or edge-triggered gate mode can be selected.

For details also see [Chapter 5.2.9.3, "Using Gated Sweep Operation"](#), on page 246.

"Edge" Edge-triggered gate mode

"Lvl" Level-triggered gate mode

This mode is not supported when using R&S Power Sensors as power triggers ("Trg/Gate Source" = *Power Sensor* or *External*).

Remote command:

[\[SENSe:\]SWEep:EGATE:TYPE](#) on page 860

Gate Delay ← Gate Settings

Opens an edit dialog box to enter the gate delay time between the gate signal and the continuation of the sweep. The delay position on the time axis in relation to the sweep is indicated by a line labeled "GD".

This is useful for e.g. taking into account a delay between the gate signal and the stabilization of an RF carrier.

As a common input signal is used for both trigger and gate when selecting the "External" or "IF Power" trigger mode, changes to the gate delay will affect the trigger delay (trigger offset) as well.

For details also see [Chapter 5.2.9.3, "Using Gated Sweep Operation"](#), on page 246.

Remote command:

`[SENSe:] SWEEp:EGATe:HOLDoFF` on page 857

Gate Length (Gate Mode Edge) ← Gate Settings

Opens an edit dialog box to enter the gate length. The gate length in relation to the sweep is indicated by a line labeled "GL".

The length of the gate signal defines if the sweep is to be interrupted. Only in the edge-triggered mode the gate length can be set, while in the level-triggered the gate length depends on the length of the gate signal.

For details also see [Chapter 5.2.9.3, "Using Gated Sweep Operation"](#), on page 246.

Remote command:

`[SENSe:] SWEEp:EGATe:LENGth` on page 858

Trg/Gate Source ← Gate Settings

See ["Trg/Gate Source"](#) on page 239.

Trg/Gate Level ← Gate Settings

See ["Trg/Gate Level"](#) on page 242.

Trg/Gate Polarity ← Gate Settings

See ["Trg/Gate Polarity"](#) on page 242.

Sweep Time ← Gate Settings

Opens an edit dialog box to change the sweep time in order to obtain a higher resolution for positioning gate delay and gate length. When leaving the "Gate Settings" sub-menu, the original sweep time is retrieved.

For details also see [Chapter 5.2.9.3, "Using Gated Sweep Operation"](#), on page 246.

Res BW Manual ← Gate Settings

Opens an edit dialog box to enter a value for the resolution bandwidth. The available resolution bandwidths are specified in the data sheet.

For details on the correlation between resolution bandwidth and filter type refer to [Chapter 5.2.6.3, "Selecting the Appropriate Filter Type"](#), on page 211.

Numeric input is always rounded to the nearest possible bandwidth. For rotary knob or UP/DNARROW key inputs, the bandwidth is adjusted in steps either upwards or downwards.

The manual input mode of the resolution bandwidth is indicated by a green bullet next to the "RBW" display in the channel bar.

When measuring Spurious Emissions, using this softkey automatically opens the "Sweep List" dialog (see ["Sweep List dialog box"](#) on page 349).

Remote command:

[SENSe:]BANDwidth|BWIDth[:RESolution]:AUTO on page 786

[SENSe:]BANDwidth|BWIDth[:RESolution] on page 785

5.2.9.2 Specifying the Trigger Settings

1. Press the "Trg/Gate Source" softkey to select the trigger mode (for details see "Trg/Gate Source" on page 239).
2. Press the [Trg/Gate Level](#) softkey to set the trigger level.
3. Press the [Trigger Offset](#) softkey to set the trigger offset. In addition, a [Trigger Hysteresis](#) and [Trigger Holdoff](#) can be defined via the corresponding softkeys.

For details on gated sweep operation, see [Chapter 5.2.9.3, "Using Gated Sweep Operation"](#), on page 246.

5.2.9.3 Using Gated Sweep Operation

By using a gate in sweep mode and stopping the measurement while the gate signal is inactive, the spectrum for pulsed RF carriers can be displayed without the superposition of frequency components generated during switching. Similarly, the spectrum can also be examined for an inactive carrier. The sweep can be controlled by an external gate or by the internal power trigger.

Gated sweep operation is also possible for span = 0. This enables – e.g. in burst signals – level variations of individual slots to be displayed versus time.

1. Press the [Gate Settings](#) softkey to define the settings of the gate mode.
At the center frequency a transition to zero span is made and the time parameters gate delay and gate length are displayed as vertical lines to adjust them easily.
When quitting the [Gate Settings](#) submenu, the original span is retrieved so the desired measurement can be performed with the accurately set gate.
2. Setting the parameters gate delay and gate length highly accurate, press the [Sweep Time](#) softkey to alter the x-axis in a way that the signal range concerned (e.g. one full burst) is displayed.
3. Press the [Gate Delay](#) softkey to set the sampling time in a way that the desired portion of the signal is shown.
4. Press the [Gate Mode \(Lvl/Edge\)](#) softkey to set the gate mode.
5. If the "Edge" gate mode has been selected, press the [Gate Length \(Gate Mode Edge\)](#) softkey to set the sampling duration in a way that the desired portion of the signal is shown.
6. Press the [Trg/Gate Polarity](#) softkey to set the polarity of the trigger source.
7. Press the [Gated Trigger](#) softkey to activate the gated sweep mode.

To indicate that a gate is used for the sweep, the enhancement label "GAT" is displayed on the screen. This label appears to the right of the window for which the gate is configured.

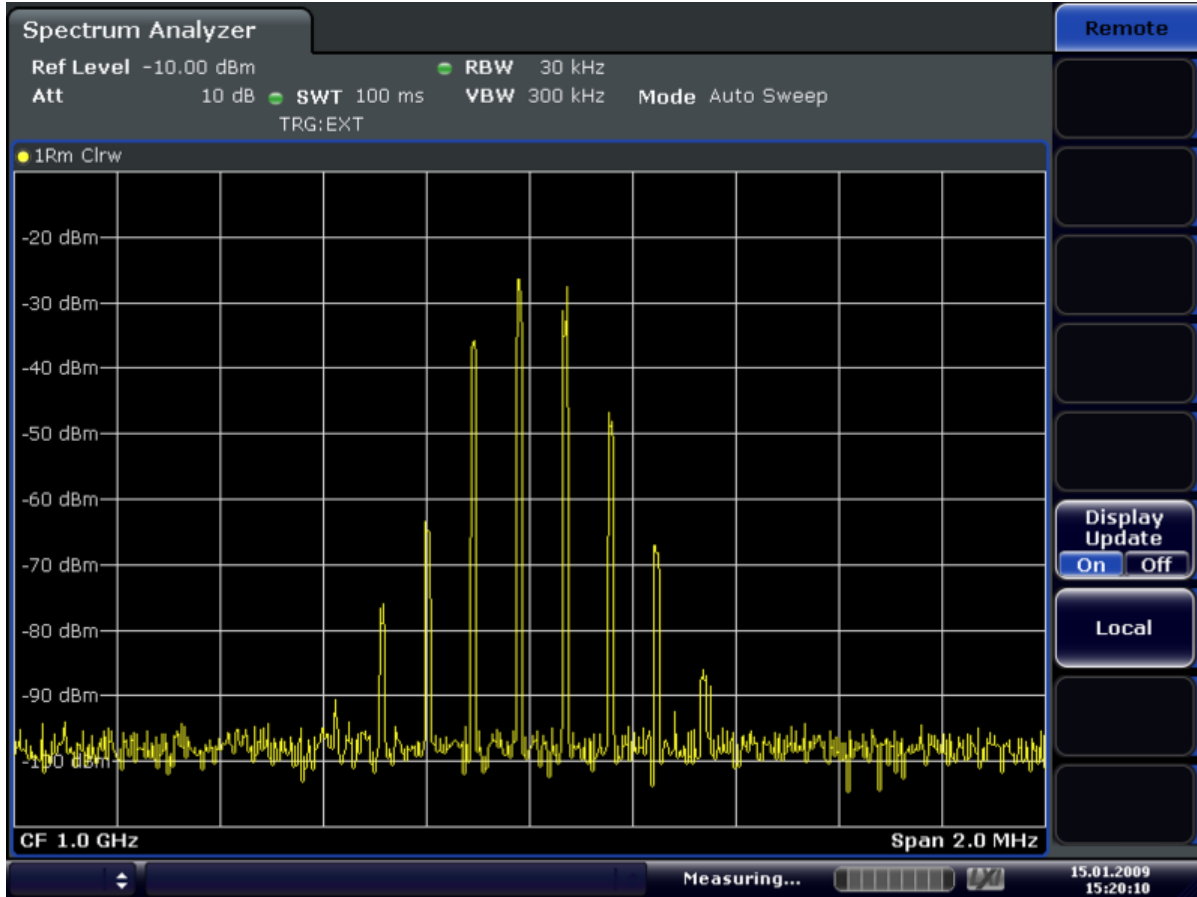

Figure 5-5: TDMA signal with GATE OFF

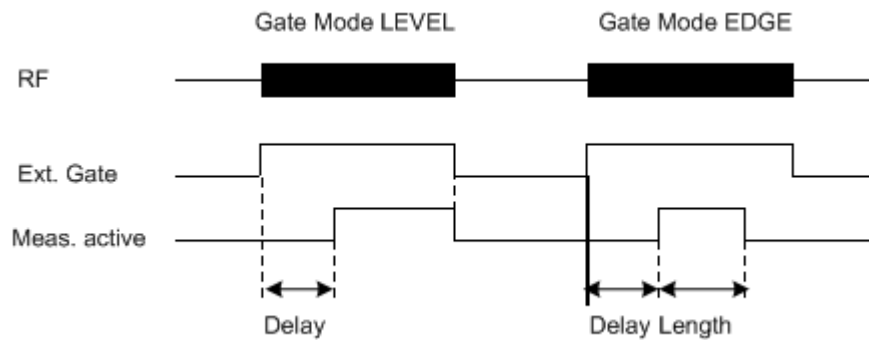

Figure 5-6: Timing diagram for GATE, GATE DELAY and GATE LENGTH

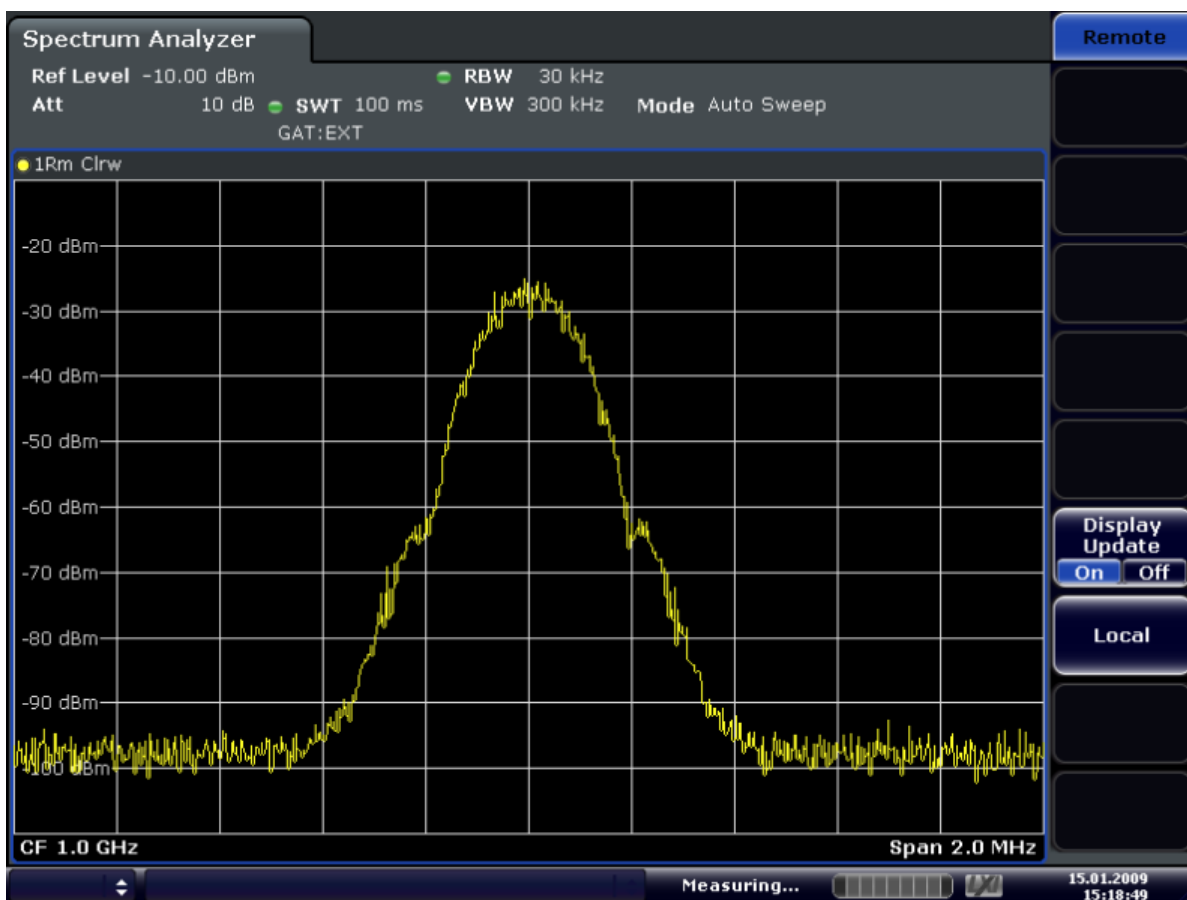

Figure 5-7: TDMA signal with GATE ON

5.3 Measurement Functions

In this section all menus necessary for setting measurement functions are described. This includes the following topics and keys:

- [Using Markers and Delta Markers – MKR Key](#)..... 249
- [Performing Peak Searches with Markers – PEAK SEARCH Key](#)..... 256
- [Performing Marker Functions – MKR FUNC Key](#)..... 256
- [Changing Settings via Markers – MKR-> Key](#)..... 270
- [Power Measurements – MEAS Key](#)..... 280
- [Measurement Configuration – MEAS CONFIG Key](#)..... 386
- [Using Limit Lines and Display Lines – LINES Key](#)..... 386
- [Input/Output Configuration – INPUT/OUTPUT Key](#)..... 398
- [Performing Measurements – RUN SINGLE/RUN CONT Keys](#)..... 406

5.3.1 Using Markers and Delta Markers – MKR Key

The markers are used for marking points on traces, reading out measurement results and for selecting a display section quickly. The R&S FSVA/FSV provides 16 markers per trace.

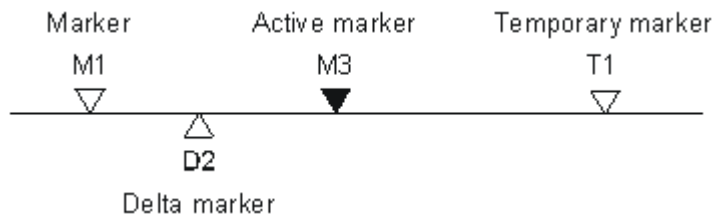

Figure 5-8: Marker types

All markers can be used either as markers or delta markers. The marker that can be moved by the user is defined in the following as the active marker. Temporary markers are used in addition to the markers and delta markers to evaluate the measurement results. They disappear when the associated function is deactivated.

The measurement results of the active marker (also called marker values) are displayed in the marker field, which is located at the upper right corner of the diagram, or in a separate table beneath the diagram. The marker information includes the following:

- marker type (M1 in the example)
- trace in square brackets ([1] in the example)
- level (-33.09 dBm in the example)
- marker location (3 GHz in the example)

```
M1[1]           -33.09 dBm
                3.000000000 GHz
```

Figure 5-9: Marker values

The MKR key is used to select and position the absolute and relative measurement markers (markers and delta markers). In addition, the functions for the frequency counter, a fixed reference point for relative measurement markers, and for enlargement of the measurement area are assigned to this key.

To open the Marker menu

- Press the MKR key.
The "Marker" menu is displayed. If no marker is active, marker 1 is activated and a peak search on the trace is carried out. Otherwise, the edit dialog box for the last activated marker is opened and the current frequency/time value is displayed.

Further information

- [Chapter 5.3.1.3, "Displayed Marker Information"](#), on page 255
- [Chapter 5.3.4, "Changing Settings via Markers – MKR-> Key"](#), on page 270.

Menu and softkey description

- [Chapter 5.3.1.1, "Softkeys of the Marker Menu"](#), on page 250

Tasks

- [Chapter 5.3.1.2, "Basic Marker Functions"](#), on page 253

5.3.1.1 Softkeys of the Marker Menu

The following table shows all softkeys available in the "Marker" menu. It is possible that your instrument configuration does not provide all softkeys. If a softkey is only available with a special option, model or (measurement) mode, this information is provided in the corresponding softkey description.

Marker 1 / Marker 2 / Marker 3 / ... Marker 16,/ Marker Norm/Delta	250
More Markers	251
Marker to Trace	251
Marker Wizard	251
L All Marker Off	252
All Marker Off	252
Marker Table	252
Marker Stepsize	252
L Stepsize Standard	252
L Stepsize Sweep Points	253
Marker Zoom (span > 0)	253
Link Mkr1 and Delta1	253

Marker 1 / Marker 2 / Marker 3 / ... Marker 16,/ Marker Norm/Delta

The "Marker X" softkey activates the corresponding marker and opens an edit dialog box to enter a value for the marker to be set to. Pressing the softkey again deactivates the selected marker.

If a marker value is changed using the rotary knob, the step size is defined via the [Stepsize Standard](#) or [Stepsize Sweep Points](#) softkeys.

Marker 1 is always the reference marker for relative measurements. If activated, markers 2 to 16 are delta markers that refer to marker 1. These markers can be converted into markers with absolute value display using the "Marker Norm/Delta" softkey. If marker 1 is the active marker, pressing the "Marker Norm/Delta" softkey switches on an additional delta marker.

Remote command:

[CALCulate<n>:MARKer<m>\[:STATe\]](#) on page 668

[CALCulate<n>:MARKer<m>:X](#) on page 677

[CALCulate<n>:MARKer<m>:Y?](#) on page 680

[CALCulate<n>:DELTamarker<m>\[:STATe\]](#) on page 618

[CALCulate<n>:DELTamarker<m>:X](#) on page 628

[CALCulate<n>:DELTamarker<m>:X:RELative?](#) on page 629

[CALCulate<n>:DELTamarker<m>:Y?](#) on page 629

More Markers

Opens a sub-menu to select one of up to 16 available markers. See "[Marker 1 / Marker 2 / Marker 3 / ... Marker 16, / Marker Norm/Delta](#)" on page 250.

Marker to Trace

Opens an edit dialog box to enter the number of the trace on which the marker is to be placed.

Remote command:

`CALCulate<n>:MARKer<m>:TRACe` on page 677

`CALCulate<n>:DELTaMarker<m>:TRACe` on page 628

Marker Wizard

Opens a configuration dialog for markers. The marker wizard allows you to configure and activate up to 16 different markers in one dialog. The first 8 markers are displayed on one tab, the last 8 markers on a second tab. For each marker, the following settings are available:

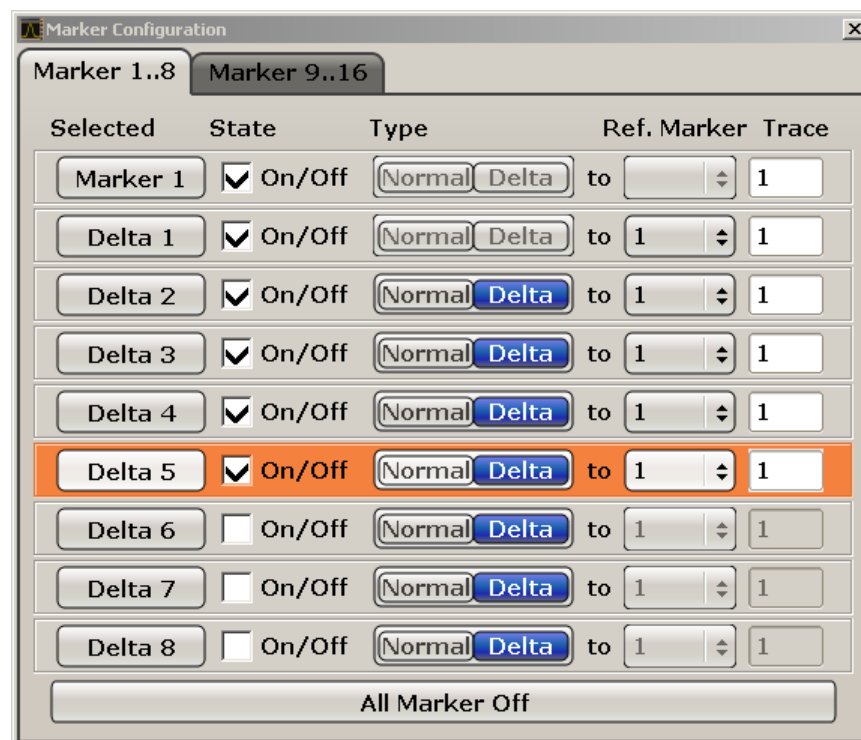

"Selected/
State"

When you press the "Selected" or "State" field the corresponding marker is activated and the marker row is highlighted.

"Normal/Delta"

Defines whether it is a normal marker or delta marker. For delta markers you can define a reference marker.

"Ref. Marker"

Reference marker for delta markers. The marker values for the delta marker are indicated relative to the specified reference marker. The reference marker can either be another active marker, or a fixed reference marker ("FXD", see "[Ref Fixed](#)" on page 260).

"Trace"

Trace for which the marker is to be set.

Remote command:

[CALCulate<n>:MARKer<m>\[:STATe\]](#) on page 668

[CALCulate<n>:DELTaMarker<m>\[:STATe\]](#) on page 618

[CALCulate<n>:MARKer<m>:TRACe](#) on page 677

[CALCulate<n>:DELTaMarker<m>:TRACe](#) on page 628

[CALCulate<n>:DELTaMarker<m>:MREF](#) on page 628

All Marker Off ← Marker Wizard

Switches all markers off. It also switches off all functions and displays that are associated with the markers/delta markers.

Remote command:

[CALCulate<n>:MARKer<m>:AOFF](#) on page 668

All Marker Off

Switches all markers off. It also switches off all functions and displays that are associated with the markers/delta markers.

Remote command:

[CALCulate<n>:MARKer<m>:AOFF](#) on page 668

Marker Table

Defines how the marker information is displayed.

For more information, see [Displayed Marker Information](#).

"On"	Displays the marker information in a table in a separate area beneath the diagram.
"Off"	Displays the marker information within the diagram area.
"Aut"	(Default) The marker table is displayed automatically if more than 2 markers are active, and removed if only 1 or 2 markers are active. This helps keep the information in the display clear.

Remote command:

[DISPlay:MTABLE](#) on page 749

Marker Step Size

Opens a submenu to set the step size of all markers and delta markers.

Default value for the marker step size is [Step Size Sweep Points](#).

Step Size Standard ← Marker Step Size

Moves the marker or delta marker from one measurement point to the next, if the marker or delta marker value is changed via the rotary knob ("Marker 1 / Marker 2 / Marker 3 / ... Marker 16, / Marker Norm/Delta" softkeys, see ["Marker 1 / Marker 2 / Marker 3 / ... Marker 16, / Marker Norm/Delta"](#) on page 250). If more measured values than measurement points exist, it is not possible to read out all measured values. In this case, use the [Step Size Sweep Points](#) softkey.

Remote command:

[CALC:MARK:X:SSIZ STAN](#) (see [CALCulate<n>:MARKer<m>:X:SSIZe](#) on page 680)

Stepsize Sweep Points ← Marker Stepsize

Moves the marker or delta marker from one measured value to the next, if the marker or delta marker value is changed via the rotary knob ("Marker 1 / Marker 2 / Marker 3 / ... Marker 16,/ Marker Norm/Delta" softkeys, see "[Marker 1 / Marker 2 / Marker 3 / ... Marker 16,/ Marker Norm/Delta](#)" on page 250). If more measured values than measurement points exist, every single measured value is accessible and its value is displayed in the marker field.

The number of measured values is defined in the ""Sweep"" menu via the [Sweep Points](#) softkey.

This functionality is available for all base unit measurements with the exception of statistics ("APD" and "CCDF" softkeys in the "Measurement" menu).

Remote command:

`CALC:MARK:X:SSIZ POIN` (see [CALCulate<n>:MARKer<m>:X:SSIZe](#) on page 680)

Marker Zoom (span > 0)

Opens an edit dialog box to enter a display range for the zoom. The area around marker 1 is expanded accordingly and more details of the result can be seen. If no marker is activated, marker 1 is switched on and set on the largest signal.

The following sweep is stopped at the position of the reference marker. The frequency of the signal is counted and the measured frequency becomes the new center frequency. The zoomed display range is then configured and the new settings are used by the R&S FSVA/FSV for further measurements.

If the display has not yet been switched to the new frequency display range and you press the softkey, the procedure is aborted. If an instrument setting is changed during this operation, the procedure is also aborted.

This function is not available in I/Q Analyzer mode.

Remote command:

`CALCulate<n>:MARKer<m>:FUNCTION:ZOOM` on page 698

Link Mkr1 and Delta1

The delta marker 1 is linked to marker 1, so if the x-axis value of the marker 1 is changed, the delta marker 1 will follow on the same x-position. The link is off by default.

You can set the two markers on different traces to measure the difference (e.g. between a max hold trace and a min hold trace or between a measurement and a reference trace).

Remote command:

`CALCulate<n>:DELTAmarker<m>:LINK` on page 623

5.3.1.2 Basic Marker Functions

- To open the "Marker" menu, press the [MKR] key. Marker 1 is activated and positioned on the maximum value of the trace as a normal marker. If several traces are displayed, the marker is set to the maximum value (peak) of the trace which has the lowest number (1 to 3) and is not frozen (View

mode). In case a marker is already located there, the new marker is set to the frequency of the next lowest level (next peak).

- To change marker settings quickly, right-click on the marker in the display (or touch it for about 1 second). A context-sensitive menu is displayed which corresponds to the softkey functions available for markers.
- To configure and activate several markers at once, select the "Marker Wizard" to open a configuration dialog for all markers.
- To change to another trace, press the "Marker to Trace" softkey ("[Marker to Trace](#)" on page 251) and enter the number of the trace on which the marker is to be placed.
The marker changes to the selected trace, but remains on the previous frequency or time. If a trace is turned off, the corresponding markers and marker functions are also deactivated.
- To switch to another marker, click on the marker label in the diagram. Alternatively, select the corresponding softkey. If necessary, select the [More Markers](#) softkey first to open a submenu that contains all marker numbers.
- To move the marker to a different position, click the marker label in the diagram and then drag it to the new position. When a marker label is selected, a vertical line indicates which indicates the marker's current x-value.

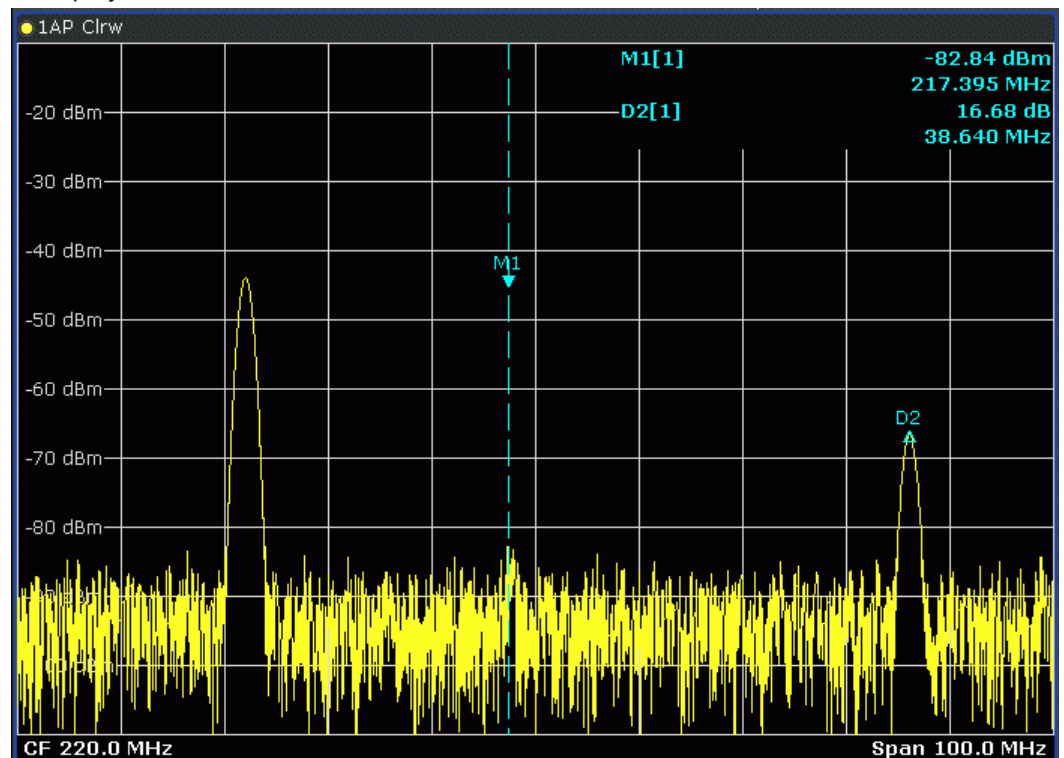

- To switch on a delta marker, select the softkey for the corresponding marker, then press the "Marker 1 / Marker 2 / Marker 3 / ... Marker 16, / Marker Norm/Delta" ("[Marker 1 / Marker 2 / Marker 3 / ... Marker 16, / Marker Norm/Delta](#)" on page 250) until "Delta" is highlighted.
The selected marker is switched on as a delta marker. The frequency and level of the marker are displayed in relation to marker 1 in the marker field.

- To change the marker type of a marker, select the softkey for the corresponding marker, then press the "Marker 1 / Marker 2 / Marker 3 / ... Marker 16, / Marker Norm/Delta" softkey ("[Marker 1 / Marker 2 / Marker 3 / ... Marker 16, / Marker Norm/Delta](#)" on page 250).
For a normal marker, the frequency and level are displayed as absolute values in the marker field. For a delta marker, the frequency and level of the marker are displayed in relation to marker 1 in the marker field.
- To switch off a marker, press the corresponding softkey again.
The marker is deactivated. Marker 1 becomes the active marker for entry. The frequency and level of marker 1 are displayed in the marker field.
- To switch off all markers, press the [All Marker Off](#) softkey.
- To change the stepsize between one measured value and the next when the marker or delta marker value is changed via the rotary knob, press either the [Stepsize Standard](#) softkey or the [Stepsize Sweep Points](#) softkey.
- To zoom into the display around a marker, press the "[Marker Zoom \(span > 0\)](#)" on page 253 softkey and enter a span.
- To link the delta marker1 to marker1, so if the x-axis value of the marker 1 is changed, the delta marker 1 follows on the same x-position, press the [Link Mkr1 and Delta1](#) softkey.

5.3.1.3 Displayed Marker Information

The following additional information is displayed within the diagram grid or in a marker table beneath the diagram. The marker table is displayed automatically if more than 2 markers are active. You can hide or show the table using the [Marker Table](#) softkey.

Marker information in Diagram Grid

The x and y axis positions of the last 2 markers or delta markers that were set, as well as their index, are displayed within the diagram grid, if available. The value in the square brackets after the index indicates the trace to which the marker is assigned. (Example: M1[1] defines marker 1 on trace 1.) For more than 2 markers, a separate marker table is displayed beneath the diagram.

If applicable, the active measurement function for the marker and its main results are indicated, as well. The functions are indicated with the following abbreviations:

FXD	Reference fixed marker active
PHNoise	Phase noise measurement active
CNT	Frequency counter active
TRK	Signal track active
NOIse	Noise measurement active
MDepth	Measurement of the AM modulation depth active
TOI	TOI measurement active
Occ BW	Occupied bandwidth

Marker Information in Marker Table

In addition to the marker information displayed within the diagram grid, a separate marker table may be displayed beneath the diagram. This table provides the following information for all active markers:



As of firmware version 1.50, the marker table also provides information from connected power sensors (requires option R&S FSV-K9).

See also [Chapter 5.9, "Instrument Functions - Power Sensor \(R&S FSV-K9\)"](#), on page 509.

No.	Serial number
Type	Marker type: N (normal), D (delta), T (temporary, internal)
Dgr	Diagram number
Trc	Trace to which the marker is assigned
Stimulus	x-value of the marker
Response	y-value of the marker
Func	Activated marker or measurement function
Func.Result	Result of the active marker or measurement function

5.3.2 Performing Peak Searches with Markers – PEAK SEARCH Key

The PEAK SEARCH key is used to perform a peak search with the currently active marker. If no marker is active, marker 1 is activated in normal mode and set as the peak.

If the selected diagram does not support markers, this key is ignored.

5.3.3 Performing Marker Functions – MKR FUNC Key

The [MKR FUNC] key provides various functions for markers, e.g.

- Phase Noise measurements
- Setting reference points
- Marker demodulation
- Defining Marker peak lists
- Signal counts
- Measuring the power for a band around the marker

To open the marker function menu

- Press the [MKR FUNC] key.
The "Mkr Func" (marker function) menu is displayed.

Menu and softkey description

- [Chapter 5.3.3.1, "Softkeys of the Marker Function Menu"](#), on page 257

Further information

- [Chapter 5.3.3.4, "AF Demodulation"](#), on page 266
- [Chapter 5.3.3.5, "Frequency Measurement with the Frequency Counter"](#), on page 267
- [Chapter 5.3.3.6, "Measurement of Noise Density"](#), on page 267
- [Chapter 5.3.3.7, "Measurement example for Phase Noise Auto Peak Search"](#), on page 268

Tasks

- [Chapter 5.3.3.2, "Setting a Fixed Reference Point \(Phase Noise Measurement\)"](#), on page 266
- [Chapter 5.3.3.3, "Setting the Demodulation Mode and Duration"](#), on page 266
- [Chapter 5.3.3.8, "Performing Band Power Measurements"](#), on page 269

5.3.3.1 Softkeys of the Marker Function Menu

The following table shows all softkeys available in the marker function menu. It is possible that your instrument configuration does not provide all softkeys. If a softkey is only available with a special option, model or (measurement) mode, this information is provided in the corresponding softkey description.

Select Marker (No).....	258
Signal Count.....	258
Noise Meas On/Off.....	258
Phase Noise.....	259
L Phase Noise On/Off.....	259
L Ref Point Level.....	259
L Ref Point Frequency (span > 0)/Ref Point Time (zero span).....	259
L Peak Search.....	259
L Ph. Noise Auto Peak Search.....	259
L Select Marker (No).....	260
Ref Fixed.....	260
L Ref. Fixed On/Off.....	260
L Ref Point Level.....	260
L Ref Point Frequency (span > 0)/Ref Point Time (zero span).....	260
L Peak Search.....	260
Marker Demod.....	260
L Mkr Demod On/Off.....	261
L AM.....	261
L FM.....	261
L Mkr Stop Time.....	261
L Continuous Demod (span > 0).....	261
L Squelch.....	261
L Squelch Level.....	262

n dB down.....	262
Marker Peak List.....	263
L Peak List On/Off.....	263
L Sort Mode Freq/Lvl.....	263
L Max Peak Count.....	263
L Peak Excursion.....	263
L Left Limit.....	263
L Right Limit.....	264
L Threshold.....	264
L ASCII File Export.....	264
L Decim Sep.....	264
L Marker Number.....	264
Band Power.....	265
L Select Marker (No).....	265
L Band Power On/Off.....	265
L Span.....	265
L Power.....	265
L Density.....	265

Select Marker (No)

Opens a submenu to select one of 16 markers and define whether the marker is a normal or a delta marker (see "[Marker 1 / Marker 2 / Marker 3 / ... Marker 16, / Marker Norm/Delta](#)" on page 250). "(No)" indicates the number of the currently active marker.

See "[Marker 1 / Marker 2 / Marker 3 / ... Marker 16, / Marker Norm/Delta](#)" on page 250.

Signal Count

Switches the frequency counter on or off, and opens an edit dialog box to define the resolution of the frequency counter, if enabled. The frequency is counted at the position of the reference marker (marker 1). If no marker is activate, marker 1 is switched on and positioned on the largest signal.

The sweep stops at the reference marker until the frequency counter has delivered a result. The result is displayed in the marker field (see [Figure 5-9](#)), labeled with [Tx CNT].

For more information see [Chapter 5.3.3.5, "Frequency Measurement with the Frequency Counter"](#), on page 267.

Remote command:

`CALCulate<n>:MARKer<m>:COUNT` on page 668

`CALCulate<n>:MARKer<m>:COUNT:FREQuency?` on page 669

Noise Meas On/Off

Switches the noise measurement for the active marker on or off. The corresponding marker becomes the normal marker.

For more information on noise measurement see [Chapter 5.3.3.6, "Measurement of Noise Density"](#), on page 267.

Remote command:

`CALCulate<n>:MARKer<m>:FUNction:NOISe[:STATe]` on page 695

`CALCulate<n>:MARKer<m>:FUNction:NOISe:RESult` on page 696

Phase Noise

This softkey opens a submenu that contains functionality to configure and perform phase noise measurements.

Phase Noise On/Off ← Phase Noise

Switches the phase noise measurement with all active delta markers on and off. The correction values for the bandwidth and the log amplifier are taken into account in the measurement.

Marker 1 is activated, if necessary, and a peak search is performed. If marker 1 is activated, its position becomes the reference point for the measurement.

Delta marker 2 is activated and can be used to read out the phase noise value at a given frequency offset.

Remote command:

`CALCulate<n>:DELTAmarker<m>:FUNCTION:PNOise[:STATe]` on page 622

`CALCulate<n>:DELTAmarker<m>:FUNCTION:PNOise:RESult?` on page 623

Ref Point Level ← Phase Noise

Opens an edit dialog box to enter a reference level value. All relative level values of the delta markers refer to this reference level.

Remote command:

`CALCulate<n>:DELTAmarker<m>:FUNCTION:FIXed:RPoint:Y` on page 621

Ref Point Frequency (span > 0)/Ref Point Time (zero span) ← Phase Noise

Opens an edit dialog box to enter a frequency reference or time value. All relative frequency or time values of the delta markers refer to this frequency reference. For phase noise measurement, input of reference time is not possible.

Remote command:

`CALCulate<n>:DELTAmarker<m>:FUNCTION:FIXed:RPoint:X` on page 621

Peak Search ← Phase Noise

Sets the maximum value of the selected trace as the reference point.

Remote command:

`CALCulate<n>:DELTAmarker<m>:FUNCTION:FIXed:RPoint:MAXimum[:PEAK]`
on page 620

Ph. Noise Auto Peak Search ← Phase Noise

Activates an automatic peak search for the reference fixed marker 1 at the end of each particular sweep.

This function can be used to track a drifting source during a phase noise measurement. The delta marker 2, which shows the phase noise measurement result, keeps the delta frequency value. Therefore the phase noise measurement leads to reliable results in a certain offset although the source is drifting. Only if the marker 2 reaches the border of the span, the delta marker value is adjusted to be within the span. In these cases, select a larger span.

Remote command:

`CALCulate<n>:DELTAmarker<m>:FUNCTION:PNOise:AUTO` on page 623

Select Marker (No) ← Phase Noise

Opens a submenu to select one of 16 markers and define whether the marker is a normal or a delta marker (see "[Marker 1 / Marker 2 / Marker 3 / ... Marker 16, / Marker Norm/Delta](#)" on page 250). "(No)" indicates the number of the currently active marker.

See "[Marker 1 / Marker 2 / Marker 3 / ... Marker 16, / Marker Norm/Delta](#)" on page 250.

Ref Fixed

Opens a submenu to set all values of a reference point. Instead of using the current values of the reference marker (marker 1) as reference point for the delta markers, level and frequency or time are set to fixed values and used as reference point.

Ref. Fixed On/Off ← Ref Fixed

Switches the relative measurement to a fixed reference value on or off. The level and frequency or time values of marker 1 immediately become the reference point, but can be altered using the corresponding softkeys ("[Ref Point Level](#)" on page 259, "[Ref Point Frequency \(span > 0\)/Ref Point Time \(zero span\)](#)" on page 259 and "[Peak Search](#)" on page 259).

When set to ON, all delta markers which previously referenced marker 1 are automatically set to reference the fixed marker.

The reference marker assignment can be changed using the "Marker Wizard" (see "[Marker Wizard](#)" on page 251).

Remote command:

`CALCulate<n>:DELTAmarker<m>:FUNCTION:FIXed[:STATe]` on page 620

Ref Point Level ← Ref Fixed

Opens an edit dialog box to enter a reference level value. All relative level values of the delta markers refer to this reference level.

Remote command:

`CALCulate<n>:DELTAmarker<m>:FUNCTION:FIXed:RPOINT:Y` on page 621

Ref Point Frequency (span > 0)/Ref Point Time (zero span) ← Ref Fixed

Opens an edit dialog box to enter a frequency reference or time value. All relative frequency or time values of the delta markers refer to this frequency reference. For phase noise measurement, input of reference time is not possible.

Remote command:

`CALCulate<n>:DELTAmarker<m>:FUNCTION:FIXed:RPOINT:X` on page 621

Peak Search ← Ref Fixed

Sets the maximum value of the selected trace as the reference point.

Remote command:

`CALCulate<n>:DELTAmarker<m>:FUNCTION:FIXed:RPOINT:MAXimum[:PEAK]` on page 620

Marker Demod

The marker demodulation function sends the AM data at the current marker frequency (in a bandwidth corresponding to the RBW) to the audio output. The "Marker Demod" softkey opens a submenu to set the demodulation output settings.

For more information see [Chapter 5.3.3.4, "AF Demodulation"](#), on page 266.

Marker demodulation is only available with option R&S FSV-B3 and is not available for Spectrum Emission Mask measurements.

Mkr Demod On/Off ← Marker Demod

Switches the demodulation output on or off.

For more information see [Chapter 5.3.3.4, "AF Demodulation"](#), on page 266.

Remote command:

`CALCulate<n>:MARKer<m>:FUNCTION:DEModulation[:STATe]` on page 686

AM ← Marker Demod

Sets AM as the output demodulation mode. This is the default setting.

For more information see [Chapter 5.3.3.4, "AF Demodulation"](#), on page 266.

Remote command:

`CALC:MARK1:FUNC:DEM:SEL AM`, see `CALCulate<n>:MARKer<m>:FUNCTION:DEModulation:SElect` on page 685

FM ← Marker Demod

Sets FM as the output demodulation mode. Default setting is AM.

For more information see [Chapter 5.3.3.4, "AF Demodulation"](#), on page 266.

Remote command:

`CALC:MARK1:FUNC:DEM:SEL FM`, see `CALCulate<n>:MARKer<m>:FUNCTION:DEModulation:SElect` on page 685

Mkr Stop Time ← Marker Demod

Opens an edit dialog box to define how long demodulation should be output for span > 0.

For more information see [Chapter 5.3.3.4, "AF Demodulation"](#), on page 266.

Remote command:

`CALCulate<n>:MARKer<m>:FUNCTION:DEModulation:HOLDoff` on page 685

Continuous Demod (span > 0) ← Marker Demod

Switches the continuous demodulation on or off. If the sweep time is long enough, the set frequency range can be monitored acoustically.

For more information see [Chapter 5.3.3.4, "AF Demodulation"](#), on page 266.

Remote command:

`CALCulate<n>:MARKer<m>:FUNCTION:DEModulation:CONTinuous` on page 684

Squelch ← Marker Demod

Activates the squelch function, i.e. the audible AF is cut off below a defined threshold level. Thus, you avoid hearing noise at the audio output when no signal is available.

The squelch function activates the video trigger function (see ["Video"](#) on page 239) and deactivates any other trigger or gating settings. The squelch level and trigger level are set to the same value.

The trigger source in the channel information bar is indicated as "SQL" for squelch. The squelch level is indicated by a red line in the diagram.

Remote command:

[\[SENSe:\]DEMod:SQUelch\[:STATe\]](#) on page 796

Squelch Level ← Marker Demod

Defines the level threshold below which the audible AF is cut off if squelching is enabled. The video trigger level is set to the same value.

The squelch level is indicated by a red line in the diagram.

Remote command:

[\[SENSe:\]DEMod:SQUelch:LEVel](#) on page 796

n dB down

Opens an edit dialog box to enter a value to define the level spacing of the two temporary markers to the right and left of marker 1 (default setting: 3 dB). Activates the temporary markers T1 and T2. The values of the temporary markers (T1, T2) and the entered value (ndB) are displayed in the marker field.

If a positive value is entered, the markers T1 and T2 are placed below the active reference marker. If a negative value (e.g. for notch filter measurements) is entered, the markers T1 and T2 are placed above the active reference marker. Marker T1 is placed to the left and marker T2 to the right of the reference marker.

In the marker table, the following results are displayed:

Span setting	Parameter name	Description
span > 0	Bw	frequency spacing of the two temporary markers
	Q factor	quality of the displayed bandwidth value (Bw)
span = 0	PWid	pulse width between the two temporary markers

If it is not possible to form the frequency spacing for the n dB value (e.g. because of noise display), dashes instead of a measured value are displayed.

Remote command:

[CALC:MARK1:FUNC:NDBD:STAT ON](#), see [CALCulate<n>:MARKer<m>:FUNCTION:NDBDown:STATe](#) on page 694

[CALC:MARK1:FUNC:NDBD 3dB](#), see [CALCulate<n>:MARKer<m>:FUNCTION:NDBDown](#) on page 692

[CALC:MARK1:FUNC:NDBD:RES?](#), see [CALCulate<n>:MARKer<m>:FUNCTION:NDBDown:RESult?](#) on page 694

[CALC:MARK:FUNC:NDBD:QFAC?](#), see [CALCulate<n>:MARKer<m>:FUNCTION:NDBDown:QFACTOR](#) on page 693

[CALC:MARK1:FUNC:NDBD:FREQ?](#) (span > 0), see [CALCulate<n>:MARKer<m>:FUNCTION:NDBDown:FREQuency?](#) on page 693

[CALC:MARK1:FUNC:NDBD:TIME?](#) (span = 0), see [CALCulate<n>:MARKer<m>:FUNCTION:NDBDown:TIME?](#) on page 695

Marker Peak List

Opens the "Peak List" submenu to define criteria for the sort order and the contents of the peak list. For each listed peak the frequency ("Stimulus") and level ("Response") values are given. In addition, the peaks are indicated in the trace display. A maximum of 50 entries are listed.

Remote command:

[CALCulate<n>:MARKer<m>:FUNction:FPEaks:COUNT?](#) on page 687

[CALCulate<n>:MARKer<m>:FUNction:FPEaks:X](#) on page 689

[CALCulate<n>:MARKer<m>:FUNction:FPEaks:Y?](#) on page 690

Peak List On/Off ← Marker Peak List

Activates/deactivates the marker peak list. If activated, the peak list is displayed and the peaks are indicated in the trace display.

Remote command:

[CALCulate<n>:MARKer<m>:FUNction:FPEaks:STAT](#) on page 689

Sort Mode Freq/Lvl ← Marker Peak List

Defines the criteria for sorting:

"Freq" sorting in ascending order of frequency values (span > 0) or time values (span = 0)

"Lvl" sorting in ascending order of the level

Remote command:

[CALCulate<n>:MARKer<m>:FUNction:FPEaks:SORT](#) on page 688

Max Peak Count ← Marker Peak List

Defines the maximum number of peaks to be determined and displayed.

Remote command:

[CALCulate<n>:MARKer<m>:FUNction:FPEaks:LIST:SIZE](#) on page 688

Peak Excursion ← Marker Peak List

Opens an edit dialog box for level measurements to enter the minimum level value by which a signal must rise or fall so that it will be identified as a maximum or a minimum by the search functions. Entries from 0 dB to 80 dB are allowed; the resolution is 0.1 dB. The default setting for the peak excursion is 6 dB.

For more information see "Specifying the suitable peak excursion" and "Effect of different peak excursion settings".

Remote command:

[CALCulate<n>:MARKer<m>:PEXCursion](#) on page 676

Left Limit ← Marker Peak List

Opens an edit dialog box to enter a value for the lower limit (left vertical line: S1 for span > 0; T1 for zero span). The search is performed between the lines of the left and right limit (see also [Right Limit](#) softkey).

Remote command:

[CALCulate<n>:MARKer<m>:X:SLIMits:LEFT](#) on page 678

Right Limit ← Marker Peak List

Opens an edit dialog box to enter a value for the upper limit (left vertical line: S2 for span > 0; T2 for zero span). The search is performed between the lines of the left and right limit (see also [Left Limit](#) softkey). If no value is set, the upper limit corresponds to the stop frequency.

Remote command:

[CALCulate<n>:MARKer<m>:X:SLIMits:RIGHT](#) on page 679

Threshold ← Marker Peak List

Opens an edit dialog box to define the threshold line. The threshold line represents the lower level limit for a "Peak" search and the upper level limit for a "Min" search.

Remote command:

[CALCulate<n>:THReshold:STATe](#) on page 746

[CALCulate<n>:THReshold](#) on page 745

ASCII File Export ← Marker Peak List

Opens the "ASCII File Export Name" dialog box and saves the active peak list in ASCII format to the specified file and directory.

The file consists of the header containing important scaling parameters and a data section containing the marker data. For details on an ASCII file see [Chapter 5.2.8.7, "ASCII File Export Format"](#), on page 235.

This format can be processed by spreadsheet calculation programs, e.g. MS-Excel. It is necessary to define ';' as a separator for the data import. Different language versions of evaluation programs may require a different handling of the decimal point. It is therefore possible to select between separators '.' (decimal point) and ',' (comma) using the "Decim Sep" softkey (see ["Decim Sep"](#) on page 168).

An example of an output file for Spectrum Emission Mask measurements is given in ["ASCII File Export Format \(Spectrum Emission Mask\)"](#) on page 340.

Remote command:

[FORMat:DEXPort:DSEParator](#) on page 759

[MMEMory:STORE<n>:LIST](#) on page 774

Decim Sep ← Marker Peak List

Selects the decimal separator with floating-point numerals for the ASCII Trace export to support evaluation programs (e.g. MS-Excel) in different languages. The values '.' (decimal point) and ',' (comma) can be set.

Remote command:

[FORMat:DEXPort:DSEParator](#) on page 759

Marker Number ← Marker Peak List

If enabled, the determined peaks are indicated by their corresponding marker number in the trace display.

Remote command:

[CALCulate<n>:MARKer<m>:FUNCTION:FPEaks:ANNotation:LABel:STATe](#) on page 687

Band Power

Opens a submenu to activate and configure a band power marker. Band power markers allow you to measure the integrated power for a defined span (band) around a marker. The result can be displayed either as a power (dBm) or density (dBm/Hz). The span is indicated by lines in the diagram.

Band power markers are only available for standard frequency measurements in Spectrum mode.

Note: As of firmware version 2.0, Band Power markers are also available in the I/Q Analyzer, but only for **Spectrum** displays (see "Display Config" on page 418).

For more information see [Chapter 5.3.3.8, "Performing Band Power Measurements"](#), on page 269.

Select Marker (No) ← Band Power

Opens a submenu to select one of 16 markers and define whether the marker is a normal or a delta marker (see "[Marker 1 / Marker 2 / Marker 3 / ... Marker 16, / Marker Norm/Delta](#)" on page 250). "(No)" indicates the number of the currently active marker.

See "[Marker 1 / Marker 2 / Marker 3 / ... Marker 16, / Marker Norm/Delta](#)" on page 250.

Band Power On/Off ← Band Power

Activates or deactivates the band power marker. When switched to on, if no marker is active yet, marker 1 is activated. Otherwise, the currently active marker is used as a band power marker (all other marker functions for this marker are deactivated). All markers can be defined as band power markers, each with a different span.

Remote command:

`CALCulate<n>:MARKer<m>:FUNCTION:BPOWER[:STATe]` on page 683

Span ← Band Power

Defines the span (band) around the marker for which the power is measured. The span is indicated by lines in the diagram.

Remote command:

`CALCulate<n>:MARKer<m>:FUNCTION:BPOWER:SPAN` on page 683

Power ← Band Power

Selects the power mode for the band power marker, i.e. the result is displayed in dBm.

Remote command:

`CALCulate<n>:MARKer<m>:FUNCTION:BPOWER:MODE` on page 682

`CALCulate<n>:MARKer<m>:FUNCTION:BPOWER:RESult?` on page 682

Density ← Band Power

Selects the density mode for the band power marker, i.e. the result is displayed in dBm/Hz.

Remote command:

`CALCulate<n>:MARKer<m>:FUNCTION:BPOWER:MODE` on page 682

`CALCulate<n>:MARKer<m>:FUNCTION:BPOWER:RESult?` on page 682

5.3.3.2 Setting a Fixed Reference Point (Phase Noise Measurement)

1. Press the **Phase Noise** softkey.
The submenu with the **Phase Noise On/Off** softkey switched on is displayed. The level and frequency or time values of marker 1 immediately become the reference point.
2. Setting the maximum of the selected trace as reference point, press the **Peak Search** softkey.
3. To define the values for the reference point, proceed as follows:
 - a) Press the **Ref Fixed** softkey.
 - b) Press the **Ref Point Level** softkey and enter a reference level value.
 - c) If span > 0, press the **Ref Point Frequency (span > 0)/Ref Point Time (zero span)** softkey and enter a frequency reference value.
 - d) If span = 0, press the "Ref Point Time" softkey and enter a reference time value (see "**Ref Point Frequency (span > 0)/Ref Point Time (zero span)**" on page 259).

5.3.3.3 Setting the Demodulation Mode and Duration

1. Press the **Marker Demod** softkey.
The submenu with the **Mkr Demod On/Off** softkey switched on is displayed.
2. To change the demodulation mode, press the **AM** or **FM** softkey.
3. For details see **Chapter 5.3.3.4, "AF Demodulation"**, on page 266.
4. To modify the demodulation time for span > 0, press the **Mkr Stop Time** softkey.
5. To change to continuous demodulation for span > 0, press the **Continuous Demod (span > 0)** softkey.

5.3.3.4 AF Demodulation

The R&S FSVA/FSV provides demodulators for AM and FM signals. With these demodulators, a displayed signal can be identified acoustically by using headphones.

⚠ CAUTION**Risk of hearing damage**

To protect your hearing, make sure that the volume setting is not too high before putting on the headphones.

The volume for the headphones is controlled using the rotary knob next to the "AF Output" interface on the front panel of the instrument.

For span > 0, the demodulation is not continuous. The frequency at which the demodulation takes place is determined by the active marker. The demodulation bandwidth corresponds to the RBW. If the level of the selected frequency is above the threshold line, the sweep stops for the selected time (stop time) and the RF signal is demodulated. For span = 0, the demodulation is continuously active irrespective of the stop time set.

5.3.3.5 Frequency Measurement with the Frequency Counter

In order to accurately determine the frequency of a signal, the R&S FSVA/FSV is equipped with a frequency counter which measures the frequency of the RF signal at the intermediate frequency. Using the measured IF, the R&S FSVA/FSV calculates the frequency of the RF input signal by applying the known frequency conversion factors.

The frequency measurement uncertainty depends only upon the accuracy of the frequency reference used (external or internal reference). Although the R&S FSVA/FSV always operates synchronously irrespective of the set span, the frequency counter delivers a more exact result than a measurement performed with a marker. This is due to the following:

- The marker measures only the position of the point on the trace and infers from this value the signal frequency. The trace, however, contains only a limited number of points. Depending upon the selected span, each point may contain many measurement values, which therefore limits the frequency resolution.
- The resolution with which the frequency can be measured with a marker is dependent on the selected resolution bandwidth, which in return affects the necessary measurement time. For this reason, the bandwidth is normally defined as wide as possible and the sweep time as short as possible. This results in a loss of frequency resolution. For the measurement with the frequency counter, the sweep is stopped at the reference marker, the frequency is counted with the desired resolution and then the sweep is allowed to continue.

In IQ Analyzer mode (see [Chapter 5.5, "Instrument Functions - I/Q Analyzer"](#), on page 411), the resolution with which the frequency can be measured with a marker is always the filter bandwidth, which is derived from the defined sample rate.

5.3.3.6 Measurement of Noise Density

During noise measurement, the noise power density is measured at the position of the marker. For span = 0, all points of the trace are used to determine the noise power density. For span > 0, two points to the right and left of the marker are used for the measurement to obtain a stable result.

The noise power density is indicated in the marker field. With logarithmic amplitude units (dBm, dBmV, dBm μ V, dB μ A), the noise power density is output in dBm/Hz, i.e. as level in 1 Hz bandwidth with reference to 1 mW. With linear amplitude units (V, A, W), the noise voltage density is evaluated in μ V/Hz, the noise current density in μ A/Hz or the noise power density in μ W/Hz.

In the default setting, the R&S FSVA/FSV uses the sample detector for the noise function.

With the sample detector, the trace can additionally be set to AVERAGE to stabilize the measured values. With RMS detector used, trace averaging must not be used since in this case it produces too low noise levels which cannot be corrected. Instead, the sweep time can be increased to obtain stable measurement results.

Prerequisite settings

The following settings have to be made to ensure that the power density measurement yields correct values:

- Detector: Sample or RMS
- Video bandwidth:
 - ≤ 0.1 resolution bandwidth with sample detector
 - ≥ 3 x resolution bandwidth with RMS detector
- Trace averaging:

With the sample detector, the trace can additionally be set to average to stabilize the measured values. With RMS detector used, trace averaging must not be used since in this case it produces too low noise levels which cannot be corrected. Instead, the sweep time can be increased to obtain stable measurement results.

Correction factors

The R&S FSVA/FSV uses the following correction factors to evaluate the noise density from the marker level:

- Since the noise power is indicated with reference to 1 Hz bandwidth, the bandwidth correction value is deducted from the marker level. It is $10 \times \lg(1 \text{ Hz}/\text{BW}_{\text{Noise}})$, where BW_{Noise} is the noise or power bandwidth of the set resolution filter (RBW).
- RMS detector: With the exception of bandwidth correction, no further corrections are required since this detector already indicates the power with every point of the trace.
- Sample detector: As a result of video filter averaging and trace averaging, 1.05 dB is added to the marker level. This is the difference between the average value and the RMS value of white noise. With a logarithmic level axis, 1.45 dB is added additionally. Logarithmic averaging is thus fully taken into account which yields a value that is 1.45 dB lower than that of linear averaging.
- To allow a more stable noise display the adjacent (symmetric to the measurement frequency) points of the trace are averaged.
- For span > 0, the measured values are averaged versus time (after a sweep).



The R&S FSVA/FSV noise figure can be calculated from the measured power density level. It is calculated by deducting the set RF attenuation (RF Att) from the displayed noise level and adding 174 to the result.

5.3.3.7 Measurement example for Phase Noise Auto Peak Search

The phase noise of a CW signal at 100 MHz with 0 dBm level is to be measured at 800 kHz from the carrier.

1. [PRESET]
The R&S FSP is set to the default setting.
2. [FREQ] > "CENTER": *100 MHz*
The center frequency is set to 100 MHz.
3. [SPAN]: *2 MHz*
The span is set to 2 MHz.
4. [AMPT]: *0 dBm*
The reference level is set to 0 dBm.
5. [MKR FCTN] > "MARKER 1"
Marker 1 is switched on and positioned at the maximum of the displayed trace.
6. "PHASE NOISE": *800 kHz*
The phase noise measurement is switched on. The delta marker is positioned on the main marker and the measured phase noise value is displayed in the marker info field. The sample detector is used and the video bandwidth is set to $3 \times \text{RBW}$. When the phase noise measurement function is enabled, the entry of the delta marker frequency is activated. It can be entered directly.

5.3.3.8 Performing Band Power Measurements

Band power markers allow you to measure the integrated power (similar to ACP measurements) for a defined span (band) around a marker. By default, 5 % of the current span is used. The span is indicated by colored lines in the diagram. The result can be displayed either as a power (dBm) or density (dBm/Hz).



Band power markers are only available for standard frequency measurements in Spectrum mode (not zero span, I/Q Analyzer etc.).

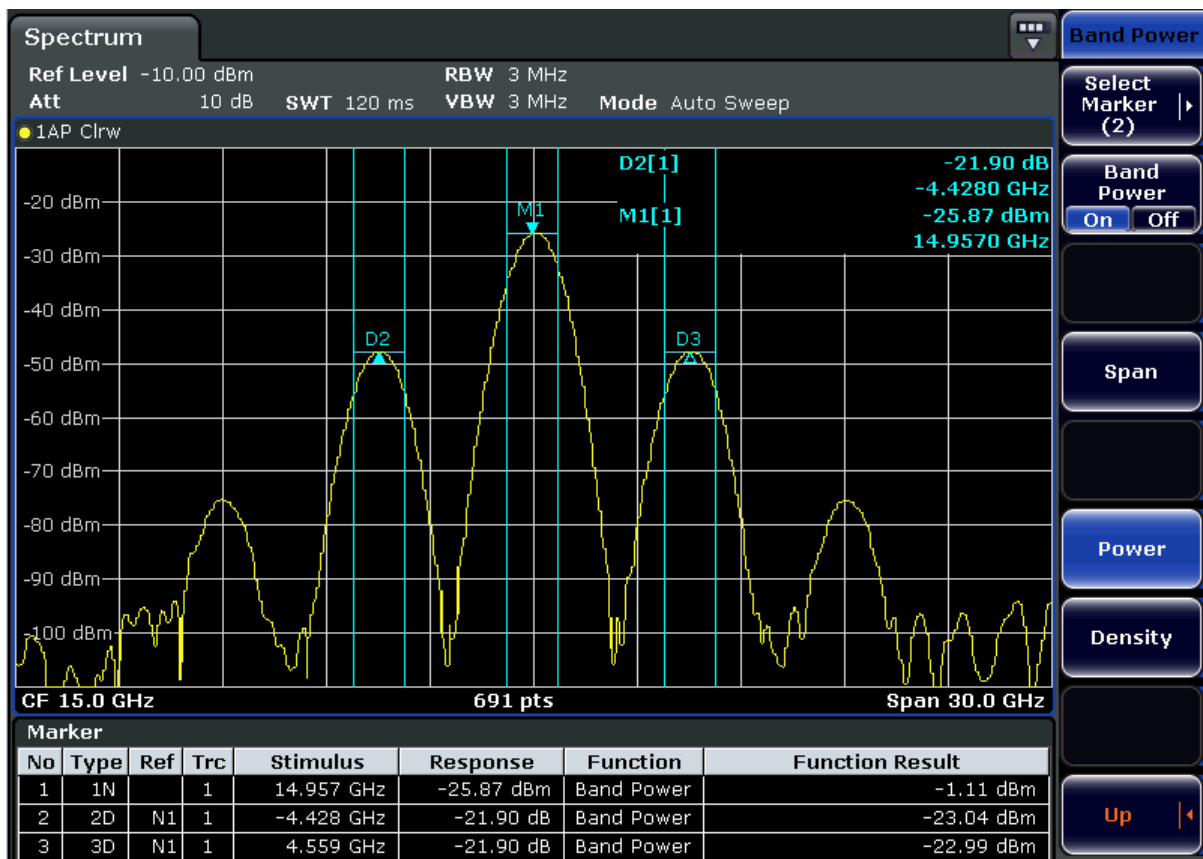

All markers can be defined as band power markers, each with a different span. When a band power marker is activated, if no marker is active yet, marker 1 is activated. Otherwise, the currently active marker is used as a band power marker (all other marker functions for this marker are deactivated).

If the detector mode for the marker trace is set to "AutoSelect", the RMS detector is used.

1. In the [MKR FUNC] menu, press "Band Power".
2. In the "Band Power" menu, press "Span" and enter the width of the band around the marker for which the power is to be measured.
3. To display the measurement result in dBm/Hz, press "Density". By default, the result is displayed as a power in dBm.
4. Press "Band Power On" to activate the band power marker.

The measurement results are displayed as usual in the marker table or in the diagram.

5.3.4 Changing Settings via Markers – MKR-> Key

The MKR -> key is used for search functions of measurement markers, assignment of the marker frequency as center frequency, restriction of the search area and character-

ization of maxima and minima. For details on markers in general, see [Chapter 5.3.1, "Using Markers and Delta Markers – MKR Key"](#), on page 249.

To open the Marker To menu

- Press the MKR -> key.
The "Marker To" menu is displayed. If no marker is active, marker 1 will be activated and a peak search on the trace carried out. Otherwise, the edit dialog box for the last activated marker is opened and the current frequency/time value is displayed.

Menu and softkey description

- [Chapter 5.3.4.1, "Softkeys of the Marker To Menu"](#), on page 271 Menu"

Further information

- [Chapter 5.3.4.8, "Effect of Different Peak Excursion Settings \(Example\)"](#), on page 278

Tasks

- [Chapter 5.3.4.2, "Searching for a Maximum"](#), on page 277
- [Chapter 5.3.4.3, "Searching for a Minimum"](#), on page 277
- [Chapter 5.3.4.4, "Specifying the Search Limits"](#), on page 277
- [Chapter 5.3.4.5, "Specifying the Search Range"](#), on page 277
- [Chapter 5.3.4.6, "Examining a Signal at the Center in Detail"](#), on page 277
- [Chapter 5.3.4.7, "Specifying the Suitable Peak Excursion"](#), on page 278

5.3.4.1 Softkeys of the Marker To Menu

The following table shows all softkeys available in the "Marker To" menu. It is possible that your instrument configuration does not provide all softkeys. If a softkey is only available with a special option, model or (measurement) mode, this information is provided in the corresponding softkey description.

Select Marker (No).....	272
Peak.....	272
Next Peak.....	272
Center =Mkr Freq (span > 0).....	272
Ref Lvl =Mkr Lvl.....	272
Marker to Trace.....	272
Min.....	272
Next Min.....	273
Auto Max Peak/Auto Min Peak.....	273
Search Limits.....	273
L Left Limit.....	273
L Right Limit.....	273
L Threshold.....	273
L Use Zoom Limits.....	274

L Search Lim Off.....	274
Next Mode.....	274
Exclude LO.....	274
Search Mode (Spectrograms).....	275
L Search Mode for Next Peak in X Direction.....	275
L Search Mode for Next Peak in Y Direction.....	275
L Marker Search Type.....	276
L Marker Search Area.....	276
Peak Excursion.....	276

Select Marker (No)

Opens a submenu to select one of 16 markers and define whether the marker is a normal or a delta marker (see "[Marker 1 / Marker 2 / Marker 3 / ... Marker 16 / Marker Norm/Delta](#)" on page 250). "(No)" indicates the number of the currently active marker.

Peak

Sets the active marker/delta marker to the highest maximum of the trace.

Remote command:

[CALCulate<n>:MARKer<m>:MAXimum\[:PEAK\]](#) on page 671

[CALCulate<n>:DELTAmarker<m>:MAXimum\[:PEAK\]](#) on page 624

Next Peak

Sets the active marker/delta marker to the next maximum of the selected trace.

Remote command:

[CALCulate<n>:MARKer<m>:MAXimum:NEXT](#) on page 672

[CALCulate<n>:DELTAmarker<m>:MAXimum:NEXT](#) on page 625

Center =Mkr Freq (span > 0)

Sets the center frequency to the current marker or delta marker frequency. A signal can thus be set to as center frequency, for example to examine it in detail with a smaller span.

Remote command:

[CALCulate<n>:MARKer<m>:FUNCTION:CENTer](#) on page 684

Ref Lvl =Mkr Lvl

Sets the reference level to the current marker level.

Remote command:

[CALCulate<n>:MARKer<m>:FUNCTION:REFerence](#) on page 696

Marker to Trace

Opens an edit dialog box to enter the number of the trace on which the marker is to be placed.

Remote command:

[CALCulate<n>:MARKer<m>:TRACe](#) on page 677

[CALCulate<n>:DELTAmarker<m>:TRACe](#) on page 628

Min

Sets the active marker/delta marker to the minimum of the selected trace.

Remote command:

[CALCulate<n>:MARKer<m>:MINimum\[:PEAK\]](#) on page 673

[CALCulate<n>:DELTamarker<m>:MINimum\[:PEAK\]](#) on page 626

Next Min

Sets the active marker/delta marker to the next minimum of the selected trace.

Remote command:

[CALCulate<n>:MARKer<m>:MINimum:NEXT](#) on page 675

[CALCulate<n>:DELTamarker<m>:MINimum:NEXT](#) on page 627

Auto Max Peak/Auto Min Peak

Adds an automatic peak search action for marker 1 at the end of each particular sweep. This function may be used during adjustments of a device under test to keep track of the current peak marker position and level.

The current marker search limit settings ([Left Limit](#), [Right Limit](#), [Threshold](#) softkeys) are taken into account.

Remote command:

[CALCulate<n>:MARKer<m>:MAXimum:AUTO](#) on page 671

[CALCulate<n>:MARKer<m>:MINimum:AUTO](#) on page 674

Search Limits

Opens a submenu to set the limits for maximum or minimum search in the x and y direction.

Remote command:

[CALCulate<n>:MARKer<m>:X:SLIMits\[:STATe\]](#) on page 678

Left Limit ← Search Limits

Opens an edit dialog box to enter a value for the lower limit (left vertical line: S1 for span > 0; T1 for zero span). The search is performed between the lines of the left and right limit (see also [Right Limit](#) softkey).

Remote command:

[CALCulate<n>:MARKer<m>:X:SLIMits:LEFT](#) on page 678

Right Limit ← Search Limits

Opens an edit dialog box to enter a value for the upper limit (left vertical line: S2 for span > 0; T2 for zero span). The search is performed between the lines of the left and right limit (see also [Left Limit](#) softkey). If no value is set, the upper limit corresponds to the stop frequency.

Remote command:

[CALCulate<n>:MARKer<m>:X:SLIMits:RIGHT](#) on page 679

Threshold ← Search Limits

Opens an edit dialog box to define the threshold line. The threshold line represents the lower level limit for a "Peak" search and the upper level limit for a "Min" search.

Remote command:

[CALCulate<n>:THReshold:STATe](#) on page 746

[CALCulate<n>:THReshold](#) on page 745

Use Zoom Limits ← Search Limits

Restricts the marker search to the zoomed area.

Remote command:

[CALCulate<n>:MARKer<m>:X:SLIMits:ZOOM](#) on page 679

Search Lim Off ← Search Limits

Deactivates all limits of the search range.

Remote command:

[CALCulate<n>:MARKer<m>:X:SLIMits\[:STATe\]](#) on page 678

[CALCulate<n>:THReshold:STATe](#) on page 746

Next Mode

Selects the mode of the [Next Peak](#) or [Next Min](#) softkey.

Three settings are available:

- "<" Sets the active marker/delta marker to the next maximum/minimum left to the marker of the selected trace.
- "abs" Sets the active marker/delta marker to the next lower maximum/higher minimum of the selected trace.
- ">" Sets the active marker/delta marker to the next maximum/minimum right to the marker of the selected trace.

Remote command:

Next Peak:

[CALC:MARK:MAX:LEFT \(<\):CALCulate<n>:MARKer<m>:MAXimum:LEFT](#)
on page 672

[CALCulate<n>:DELTamarker<m>:MAXimum:LEFT](#) on page 625

[CALC:MARK:MAX:RIGH \(>\):CALCulate<n>:MARKer<m>:MAXimum:RIGHT](#)
on page 673

[CALCulate<n>:DELTamarker<m>:MAXimum:RIGHT](#) on page 625

[CALC:DELT:MAX:NEXT \(abs\):CALCulate<n>:MARKer<m>:MAXimum:NEXT](#)
on page 672

[CALCulate<n>:DELTamarker<m>:MAXimum:NEXT](#) on page 625

Next Min:

[CALC:MARK:MIN:LEFT \(>\):CALCulate<n>:MARKer<m>:MINimum:LEFT](#)
on page 674

[CALCulate<n>:DELTamarker<m>:MINimum:LEFT](#) on page 626

[CALC:MARK:MIN:RIGH \(>\):CALCulate<n>:MARKer<m>:MINimum:RIGHT](#)
on page 675

[CALCulate<n>:DELTamarker<m>:MINimum:RIGHT](#) on page 627

[CALC:MARK:MIN:NEXT \(abs\):CALCulate<n>:MARKer<m>:MINimum:NEXT](#)
on page 675

[CALCulate<n>:DELTamarker<m>:MINimum:NEXT](#) on page 627

Exclude LO

Switches the frequency range limit for the marker search functions on or off.

- "ON" The minimum frequency included in the peak search range is $\geq 5 \times$ resolution bandwidth (RBW).
Due to the interference by the first local oscillator to the first intermediate frequency at the input mixer, the LO is represented as a signal at 0 Hz. To avoid the peak marker jumping to the LO signal at 0 Hz, this frequency is excluded from the peak search.
- "OFF" No restriction to the search range. The frequency 0 Hz is included in the marker search functions.

Remote command:

[CALCulate<n>:MARKer<m>:LOEXclude](#) on page 670

Search Mode (Spectrograms)

Spectrograms show not only the current sweep results, but also the sweep history. Thus, when searching for peaks, you must define the search settings within a single time frame (x-direction) and within several time frames (y-direction).

This setting is only available for spectrogram displays.

Search Mode for Next Peak in X Direction ← Search Mode (Spectrograms)

Selects the search mode for the next peak search within the currently selected frame.

- "Left" Determines the next maximum/minimum to the left of the current peak.
- "Absolute" Determines the next maximum/minimum to either side of the current peak.
- "Right" Determines the next maximum/minimum to the right of the current peak.

Remote command:

[CALCulate<n>:MARKer<m>:MAXimum:LEFT](#) on page 672

[CALCulate<n>:MARKer<m>:MAXimum:NEXT](#) on page 672

[CALCulate<n>:MARKer<m>:MAXimum:RIGHT](#) on page 673

[CALCulate<n>:MARKer<m>:MINimum:LEFT](#) on page 674

[CALCulate<n>:MARKer<m>:MINimum:NEXT](#) on page 675

[CALCulate<n>:MARKer<m>:MINimum:RIGHT](#) on page 675

Search Mode for Next Peak in Y Direction ← Search Mode (Spectrograms)

Selects the search mode for the next peak search within all frames at the current marker position.

- "Up" Determines the next maximum/minimum above the current peak (in more recent frames).
- "Absolute" Determines the next maximum/minimum above or below the current peak (in all frames).
- "Down" Determines the next maximum/minimum below the current peak (in older frames).

Remote command:

[CALCulate<n>:MARKer<m>:SGRam:Y:MAXimum:ABOVE](#) on page 712

[CALCulate<n>:DELTamarker<m>:SGRam:Y:MAXimum:ABOVE](#) on page 633

[CALCulate<n>:MARKer<m>:SGRam:Y:MAXimum:BELOW](#) on page 712

[CALCulate<n>:DELTamarker<m>:SGRam:Y:MAXimum:BELOW](#) on page 633
[CALCulate<n>:MARKer<m>:SGRam:Y:MAXimum:NEXT](#) on page 713
[CALCulate<n>:DELTamarker<m>:SGRam:Y:MAXimum:NEXT](#) on page 634
[CALCulate<n>:MARKer<m>:SGRam:Y:MINimum:ABOVE](#) on page 714
[CALCulate<n>:DELTamarker<m>:SGRam:Y:MINimum:ABOVE](#) on page 634
[CALCulate<n>:MARKer<m>:SGRam:Y:MINimum:BELOW](#) on page 714
[CALCulate<n>:DELTamarker<m>:SGRam:Y:MINimum:BELOW](#) on page 635
[CALCulate<n>:MARKer<m>:SGRam:Y:MINimum:NEXT](#) on page 715
[CALCulate<n>:DELTamarker<m>:SGRam:Y:MINimum:NEXT](#) on page 635

Marker Search Type ← Search Mode (Spectrograms)

Defines the type of search to be performed in the spectrogram.

"X-Search" Searches only within the currently selected frame.
 "Y-Search" Searches within all frames but only at the current marker position.
 "XY-Search" Searches in all frames at all positions.

Remote command:

[CALCulate<n>:MARKer<m>:SGRam:XY:MAXimum\[:PEAK\]](#) on page 711
[CALCulate<n>:DELTamarker<m>:SGRam:XY:MAXimum\[:PEAK\]](#) on page 632
[CALCulate<n>:MARKer<m>:SGRam:XY:MINimum\[:PEAK\]](#) on page 711
[CALCulate<n>:DELTamarker<m>:SGRam:XY:MINimum\[:PEAK\]](#) on page 632
[CALCulate<n>:MARKer<m>:SGRam:Y:MAXimum\[:PEAK\]](#) on page 713
[CALCulate<n>:DELTamarker<m>:SGRam:Y:MAXimum\[:PEAK\]](#) on page 634
[CALCulate<n>:MARKer<m>:SGRam:Y:MINimum\[:PEAK\]](#) on page 715
[CALCulate<n>:DELTamarker<m>:SGRam:Y:MINimum\[:PEAK\]](#) on page 636
[CALCulate<n>:MARKer<m>:MAXimum\[:PEAK\]](#) on page 671
[CALCulate<n>:DELTamarker<m>:MAXimum\[:PEAK\]](#) on page 624
[CALCulate<n>:MARKer<m>:MINimum\[:PEAK\]](#) on page 673
[CALCulate<n>:DELTamarker<m>:MINimum\[:PEAK\]](#) on page 626

Marker Search Area ← Search Mode (Spectrograms)

Defines which frames the search is performed in.

"Visible" Only the visible frames are searched.
 "Memory" All frames stored in the memory are searched.

Remote command:

[CALCulate<n>:MARKer<m>:SGRam:SARea](#) on page 710
[CALCulate<n>:DELTamarker<m>:SGRam:SARea](#) on page 631

Peak Excursion

Opens an edit dialog box for level measurements to enter the minimum level value by which a signal must rise or fall so that it will be identified as a maximum or a minimum by the search functions. Entries from 0 dB to 80 dB are allowed; the resolution is 0.1 dB. The default setting for the peak excursion is 6 dB.

For more information see "Specifying the suitable peak excursion" and "Effect of different peak excursion settings".

Remote command:

[CALCulate<n>:MARKer<m>:PEXCursion](#) on page 676

5.3.4.2 Searching for a Maximum

- To search for the highest maximum, press the **Peak** softkey.
- To define the search mode for the next maximum, use the **Next Mode** softkey.
- To start the search, press the **Next Peak** softkey.



You can define an automatic peak search action for marker 1 at the end of each particular sweep using the **Auto Max Peak/Auto Min Peak** softkey.

5.3.4.3 Searching for a Minimum

- To search for the minimum, press the **Min** softkey.
- To define the search mode for the next minimum, use the **Next Mode** softkey.
- To start the search, press the **Next Min** softkey.



You can define an automatic peak search action for marker 1 at the end of each particular sweep using the **Auto Max Peak/Auto Min Peak** softkey.

5.3.4.4 Specifying the Search Limits

- To define the lower limit, press the **Left Limit** softkey.
- To define the upper limit, press the **Right Limit** softkey.
- To define the threshold, press the **Threshold** softkey.
- To switch the search limits off, press the **Search Lim Off** softkey.

5.3.4.5 Specifying the Search Range

- Press the **Exclude LO** softkey to deactivate the "Exclude LO" mode in order to include the frequency down to 0 Hz in the marker search functions.

5.3.4.6 Examining a Signal at the Center in Detail

1. Press the [PRESET] key to set the R&S FSVA/FSV to the default setting.
2. Press the [MKR ->] key to open the "Marker To" menu.
3. Marker 1 is activated and set to the largest signal of the trace.
4. Press the **Center =Mkr Freq (span > 0)** softkey to set to the marker frequency.
5. The span is adapted in such a way that the minimum frequency (= 0 Hz) or the maximum frequency is not exceeded.
6. Press the **Ref Lvl =Mkr Lvl** softkey to set the reference level to the measured marker level.

7. Press the SPAN key.
8. The edit dialog box to enter a frequency span is displayed.
9. Reduce the span, e.g. using the rotary knob.

5.3.4.7 Specifying the Suitable Peak Excursion

1. If the **Peak Excursion** softkey is used, the default value is sufficient, since, in this mode, the next lower maximum or next higher minimum will always be detected.
2. If the < or > of the softkey **Next Mode** is used, the 6 dB level change set as a default value may already be attained by the inherent noise of the instrument. To avoid identifying noise peaks as maxima or minima, enter a peak excursion value that is higher than the difference between the highest and the lowest value measured for the displayed inherent noise.

5.3.4.8 Effect of Different Peak Excursion Settings (Example)

The following figure shows a trace to be examined.

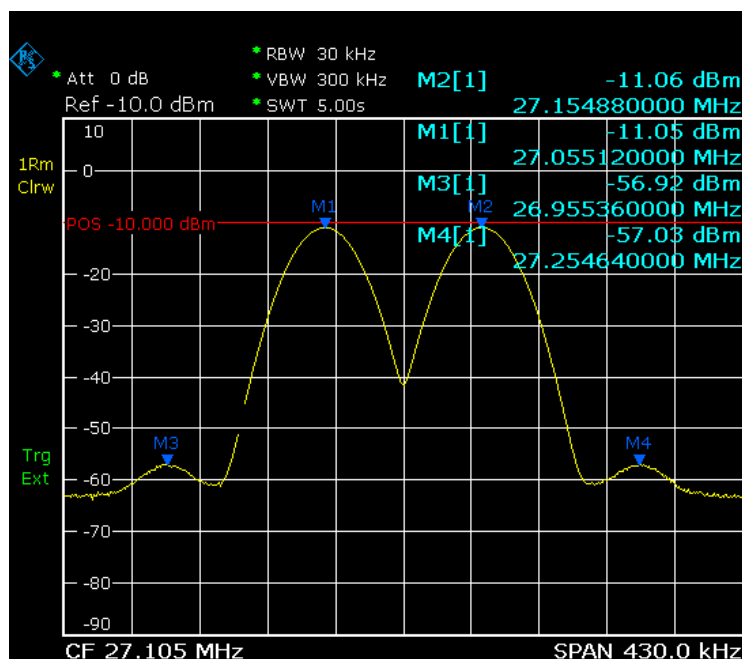

Figure 5-10: Trace example

The following table lists the signals as indicated by the marker numbers in the diagram above, as well as the minimum of the amplitude decrease to both sides of the signal:

Signal #	Min. amplitude decrease to both sides of the signal
1	30 dB
2	29.85 dB
3	7 dB
4	7 dB

The detected signals and their order are different depending on the peak excursion setting and the peak search method (whether the next lower maximum or the next relative maximum is searched). The following results are obtained. All tests start with the marker set to signal 1 by pressing the **Peak** softkey.

- 40 dB peak excursion
Result: With both methods apart from signal 1 no signal is detected, as the signal level does not decrease by more than 30 dB to either side of any signal.

Next lower maximum	Next relative maximum
Next Mode abs: signal 1 (no further signal detected)	Next Mode <: signal 1 (no further signal detected)
	Next Mode >: signal 1 (no further signal detected)

- 20 dB peak excursion
Result: With both methods apart from signal 1 signal 2 is detected, as the signal level decreases at least by 29.85 dB to either side of this signal, which is now greater than the peak excursion.

Next lower maximum	Next relative maximum
Next Mode abs: signal 2	Next Mode <: signal 1 (no further signal detected)
Next Mode abs: signal 2 (no further signal detected)	Next Mode >: signal 2
	Next Mode >: signal 2 (no further signal detected)

- 6 dB peak excursion
Result: With both methods all signals are detected.

Next lower maximum	Next relative maximum
Next Mode abs: signal 2	Next Mode <: signal 3
Next Mode abs: signal 3	Next Mode >: signal 1
Next Mode abs: signal 4	Next Mode >: signal 2
	Next Mode >: signal 4

5.3.5 Power Measurements – MEAS Key

With its power measurement functions, the R&S FSVA/FSV is able to measure all the necessary parameters with high accuracy in a wide dynamic range.

A modulated carrier is almost always used (except e.g. SSB-AM) for high-frequency transmission of information. Due to the information modulated upon the carrier, the latter covers a spectrum which is defined by the modulation, the transmission data rate and the signal filtering. Within a transmission band each carrier is assigned a channel taking into account these parameters. In order to ensure error-free transmission, each transmitter must be conforming to the specified parameters. These include among others:

- the output power
- the occupied bandwidth, i.e. the bandwidth which must contain a defined percentage of the power
- the power dissipation allowed in the adjacent channels

The MEAS key is used for complex measurement functions as power measurements, occupied bandwidth, signal statistic, carrier to noise spacing, AM modulation depth, third-order intercept point, harmonics and spurious emissions. For measurement examples refer to the Quick Start Guide, "Basic Measurement Examples".

Further examples are described in [Chapter 4.6, "Advanced Measurement Examples"](#), on page 105 and [Chapter 6.4, "Remote Control – Programming Examples"](#), on page 1011

The following measurements can be performed:

- Channel power and adjacent-channel power with span > 0 and with a single or several carriers ("CH Power ACLR" softkey, for details see [Chapter 5.3.5.2, "Measuring Channel Power and Adjacent-Channel Power"](#), on page 283)
- Carrier-to-noise ratio ("C/N C/NO" softkey, for details see [Chapter 5.3.5.3, "Measuring the Carrier-to-Noise Ratio"](#), on page 308)
- Occupied bandwidth ("OBW" softkey, for details see [Chapter 5.3.5.4, "Measuring the Occupied Bandwidth"](#), on page 311)
- Spectrum Emission Mask measurements ("Spectrum Emission Mask" softkey, for details see [Chapter 5.3.5.5, "Measuring with Spectrum Emission Masks"](#), on page 315)
- Spurious Emissions measurements ("Spurious Emissions" softkey, for details see [Chapter 5.3.5.6, "Measuring Spurious Emissions"](#), on page 343)
- Power in zero span ("Time Domain Power" softkey, for details see [Chapter 5.3.5.7, "Measuring the Power in Zero Span"](#), on page 354).
- Amplitude probability distribution ("APD" and "CCDF" softkeys, for details see [Chapter 5.3.5.8, "Calculating Signal Amplitude Statistics"](#), on page 357)
- 3rd order intercept ("TOI" softkey, for details see [Chapter 5.3.5.9, "Measuring the Third Order Intercept Point \(TOI\)"](#), on page 375)
- Modulation depth ("AM Mod Depth" softkey, for details see [Chapter 5.3.5.10, "Measuring the AM Modulation Depth"](#), on page 381)

- Harmonic Distortion measurements ("Harmonic Distortion" softkey, for details see [Chapter 5.3.5.11, "Measuring Harmonic Distortion"](#), on page 382)

To open the power measurement menu

- Press the [MEAS] key.
The measurement menu for spectrum analysis is displayed (see [Chapter 5.3.5.1, "Softkeys of the Power Measurement Menu"](#), on page 281).

5.3.5.1 Softkeys of the Power Measurement Menu

The following table shows all softkeys available in the power measurement menu. It is possible that your instrument configuration does not provide all softkeys. If a softkey is only available with a special option, model or (measurement) mode, this information is provided in the corresponding softkey description.

Ch Power ACLR.....	281
C/N, C/No (span > 0).....	281
OBW (span > 0).....	282
Spectrum Emission Mask.....	282
Spurious Emissions.....	282
Time Domain Power (zero span).....	282
All Functions Off.....	282
APD.....	282
CCDF.....	283
TOI.....	283
AM Mod Depth.....	283
Harmonic Distortion.....	283
All Functions Off.....	283

Ch Power ACLR

Activates the active channel or adjacent-channel power measurement either for a single carrier signal or for several carrier signals, depending on the current measurement configuration, and opens a submenu to configure the channel power measurement.

For details see [Chapter 5.3.5.2, "Measuring Channel Power and Adjacent-Channel Power"](#), on page 283.

Remote command:

`CALCulate<n>:MARKer<m>:FUNCTION:POWER:SElect` on page 707

`CALCulate<n>:MARKer<m>:FUNCTION:POWER:RESult?` on page 704

`CALCulate<n>:MARKer<m>:FUNCTION:POWER[:STATe]` on page 708

C/N, C/No (span > 0)

Opens a submenu to configure the carrier/noise ratio measurement. Measurements without (C/N) and measurements with reference to the bandwidth (C/No) are possible.

For details see [Chapter 5.3.5.3, "Measuring the Carrier-to-Noise Ratio"](#), on page 308.

OBW (span > 0)

Activates measurement of the occupied bandwidth according to the current configuration and opens a submenu to configure the measurement. For details see [Chapter 5.3.5.4, "Measuring the Occupied Bandwidth"](#), on page 311.

Remote command:

`CALCulate<n>:MARKer<m>:FUNCTION:POWER:SElect` on page 707

`CALCulate<n>:MARKer<m>:FUNCTION:POWER:RESult?` on page 704

`CALCulate<n>:MARKer<m>:FUNCTION:POWER[:STATe]` on page 708

Spectrum Emission Mask

Opens a submenu to configure the Spectrum Emission Mask measurement.

The Spectrum Emission Mask (SEM) measurement defines a measurement that monitors compliance with a spectral mask.

For details see [Chapter 5.3.5.5, "Measuring with Spectrum Emission Masks"](#), on page 315.

Remote command:

`SENS:SWE:MODE ESP`, see `[SENSe:]SWEep:MODE` on page 861

Spurious Emissions

Opens a submenu to configure the Spurious Emissions measurement.

The Spurious Emissions measurement defines a measurement that monitors unwanted RF products outside the assigned frequency band generated by an amplifier.

For details see [Chapter 5.3.5.6, "Measuring Spurious Emissions"](#), on page 343.

Remote command:

`SENS:SWE:MODE LIST`, see `[SENSe:]SWEep:MODE` on page 861

Time Domain Power (zero span)

Activates the power measurement in zero span and opens a submenu to configure the power measurement. For details see [Chapter 5.3.5.7, "Measuring the Power in Zero Span"](#), on page 354.

Remote command:

`CALCulate<n>:MARKer<m>:FUNCTION:SUMMary[:STATe]` on page 731

All Functions Off

Switches off all power measurement functions.

APD

Activates the function to measure the amplitude probability density (APD) and opens a submenu.

For details see [Chapter 5.3.5.8, "Calculating Signal Amplitude Statistics"](#), on page 357.

Remote command:

`CALCulate<n>:STATistics:APD[:STATe]` on page 741

CCDF

Activates the function to measure the complementary cumulative distribution function (CCDF) and opens a submenu.

For details see [Chapter 5.3.5.8, "Calculating Signal Amplitude Statistics"](#), on page 357.

Remote command:

`CALCulate<n>:STATistics:CCDF[:STATe]` on page 741

TOI

Opens a submenu and activates the measurement of the 3rd order intercept point.

For details see [Chapter 5.3.5.9, "Measuring the Third Order Intercept Point \(TOI\)"](#), on page 375.

Remote command:

`CALCulate<n>:MARKer<m>:FUNCTION:TOI[:STATe]` on page 697

`CALCulate<n>:MARKer<m>:FUNCTION:TOI:RESult?` on page 697

AM Mod Depth

Opens a submenu and activates the measurement of the AM modulation depth. An AM-modulated carrier is required on the screen to ensure correct operation.

For details see [Chapter 5.3.5.10, "Measuring the AM Modulation Depth"](#), on page 381.

Remote command:

`CALCulate<n>:MARKer<m>:FUNCTION:MDEPth[:STATe]` on page 691

`CALCulate<n>:MARKer<m>:FUNCTION:MDEPth:RESult?` on page 690

Harmonic Distortion

Opens a submenu to determine the settings for harmonics measurement and activates the harmonic distortion measurement.

For details see [Chapter 5.3.5.11, "Measuring Harmonic Distortion"](#), on page 382.

Remote command:

`CALCulate<n>:MARKer<m>:FUNCTION:HARMonics[:STATe]` on page 701

`CALCulate<n>:MARKer<m>:FUNCTION:HARMonics:DISToRtion?` on page 699

`CALCulate<n>:MARKer<m>:FUNCTION:HARMonics:LIST?` on page 700

All Functions Off

Switches off all power measurement functions.

5.3.5.2 Measuring Channel Power and Adjacent-Channel Power

Measuring the power in channels adjacent to the carrier or transmission channel is useful to detect interference. The results are displayed as a bar chart for the individual channels.

- [About Channel Power Measurements](#)..... 284
- [Channel Power Measurement Results](#).....288
- [Configuring and Performing Channel Power Measurements](#).....290

- [Softkeys for Channel and Adjacent-Channel Power Measurements](#)..... 294
- [Predefined CP/ACLR Standards](#).....305
- [Optimized Settings for CP/ACLR Test Parameters](#)..... 306

About Channel Power Measurements

Measuring channel power and adjacent channel power is one of the most important tasks in the field of digital transmission for a signal analyzer with the necessary test routines. While, theoretically, channel power could be measured at highest accuracy with a power meter, its low selectivity means that it is not suitable for measuring adjacent channel power as an absolute value or relative to the transmit channel power. The power in the adjacent channels can only be measured with a selective power meter.

A signal analyzer cannot be classified as a true power meter, because it displays the IF envelope voltage. However, it is calibrated such as to correctly display the power of a pure sine wave signal irrespective of the selected detector. This calibration cannot be applied for non-sinusoidal signals. Assuming that the digitally modulated signal has a Gaussian amplitude distribution, the signal power within the selected resolution bandwidth can be obtained using correction factors. These correction factors are normally used by the signal analyzer's internal power measurement routines in order to determine the signal power from IF envelope measurements. These factors apply if and only if the assumption of a Gaussian amplitude distribution is correct.

Apart from this common method, the R&S FSVA/FSV also has a true power detector, i.e. an RMS detector. It correctly displays the power of the test signal within the selected resolution bandwidth irrespective of the amplitude distribution, without additional correction factors being required. The absolute measurement uncertainty of the R&S FSVA/FSV is < 1.5 dB and a relative measurement uncertainty of < 0.5 dB (each with a confidence level of 95 %).



A detailed measurement example is described in [Chapter 4.6.6.1, "Measuring Channel Power and Adjacent Channel Power"](#), on page 125 and [Chapter 6.4, "Remote Control – Programming Examples"](#), on page 1011.

Measurement Methods

The channel power is defined as the integration of the power across the channel bandwidth.

The **Adjacent Channel Power Ratio (ACPR)**, also known as the **Adjacent Channel Leakage Power Ratio (ACLR)**, is defined as the ratio between the total power of the adjacent channel to the carrier channel's power. An ACLR measurement with several carrier (transmission) channels (TX channels) is also possible and is referred to as a "multi-carrier ACLR measurement".

There are two possible methods for measuring channel and adjacent channel power with a signal analyzer:

- IBW method (Integration **B**andwidth **M**ethod)
- Zero-span method (Fast ACLR), i.e. using a channel filter
- [IBW method](#)..... 285
- [Fast ACLR](#).....285

IBW method

When measuring the channel power, the R&S FSVA/FSV integrates the linear power which corresponds to the levels of the pixels within the selected channel. The signal analyzer uses a resolution bandwidth which is far smaller than the channel bandwidth. When sweeping over the channel, the channel filter is formed by the passband characteristics of the resolution bandwidth (see [Figure 5-11](#)).

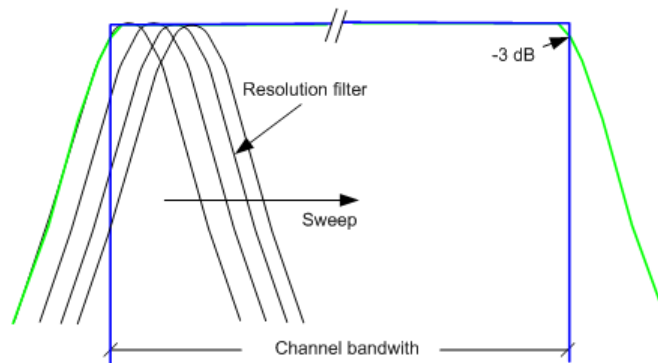

Figure 5-11: Approximating the channel filter by sweeping with a small resolution bandwidth

The following steps are performed:

1. The linear power of all the trace pixels within the channel is calculated.

$$P_i = 10^{(L_i/10)}$$
 where P_i = power of the trace pixel i
 L_i = displayed level of trace point i
2. The powers of all trace pixels within the channel are summed up and the sum is divided by the number of trace pixels in the channel.
3. The result is multiplied by the quotient of the selected channel bandwidth and the noise bandwidth of the resolution filter (RBW).

Since the power calculation is performed by integrating the trace within the channel bandwidth, this method is called the IBW method (**I**ntegration **B**andwidth method).

Fast ACLR

Using Fast ACLR, the R&S FSVA/FSV sets the center frequency to the different channel center frequencies consecutively and measures the power with the selected measurement time (= sweep time/number of channels).

The RBW filters suitable for the selected standard and frequency offset are automatically used (e.g. root raised cos with IS 136).

The RMS detector is used for obtaining correct power measurement results. Therefore no software correction factors are required.

Measurement Repeatability

The repeatability of the results, especially in the narrow adjacent channels, strongly depends on the measurement time for a given resolution bandwidth. A longer sweep time may increase the probability that the measured value converges to the true value of the adjacent channel power, but obviously increases measurement time.

The integrated bandwidth method (IBW) calculates channel power and ACLR from the trace data obtained during a continuous sweep over the selected span. Most parts of this sweep are neither part of the channel itself nor the defined adjacent channels. Therefore, most of the samples taken during the sweeptime cannot be used for channel power or ACLR calculation.

To obtain a high repeatability with short measurement times, the R&S FSVA/FSV offers a "Fast ACLR" mode. In the Fast ACLR mode, the R&S FSVA/FSV measures the power of each channel at the defined channel bandwidth, while being tuned to the center frequency of the channel in question. The digital implementation of the resolution bandwidths makes it possible to select filter characteristics that are precisely tailored to the signal. In case of CDMA2000, the power in the useful channel is measured with a bandwidth of 1.23 MHz and that of the adjacent channels with a bandwidth of 30 kHz. Therefore the R&S FSVA/FSV changes from one channel to the other and measures the power at a bandwidth of 1.23 MHz or 30 kHz using the RMS detector. The power of the frequency range between the channels of interest is not measured in Fast ACLR mode, because it is not required for channel power or ACLR calculation. The measurement time per channel is set with the sweep time. It is equal to the selected measurement time divided by the selected number of channels.

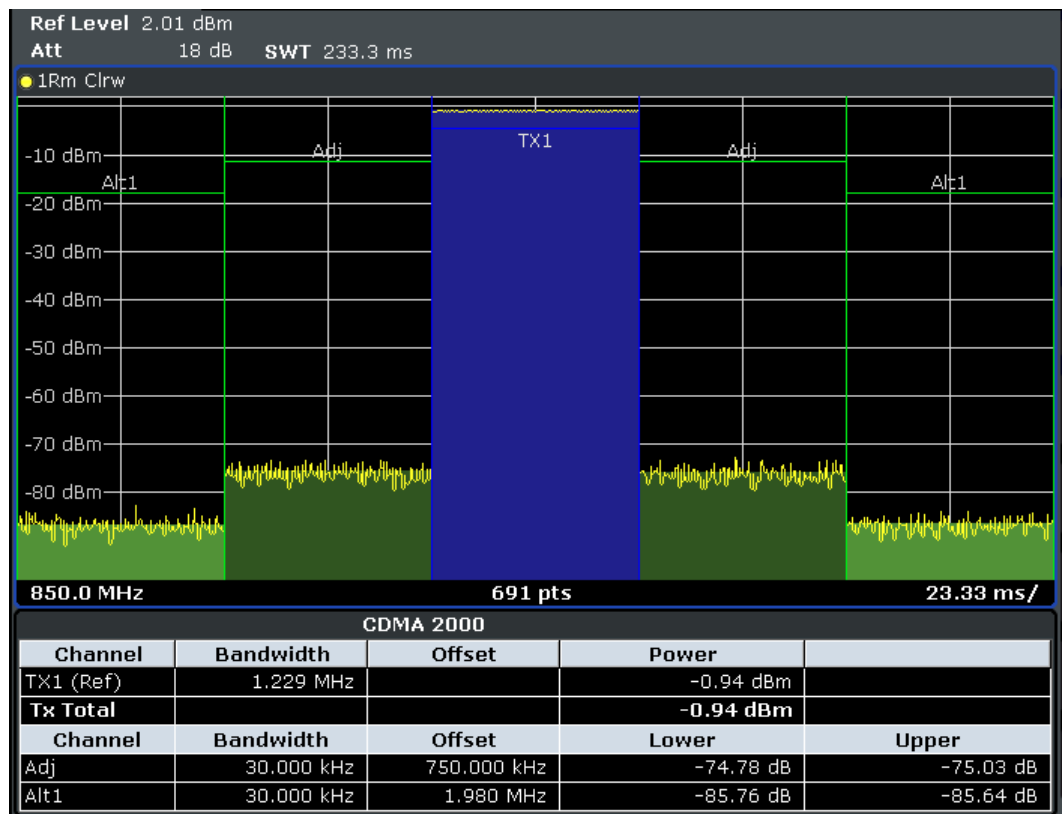

Figure 5-12: Measuring the channel power and adjacent channel power ratio for CDMA2000 1X signals with zero span (Fast ACP)

Assuming a measurement with five channels (1 channel plus 2 lower and 2 upper adjacent channels) and a sweep time of 100 ms, a measurement time per channel of 20 ms is required. The number of effective samples taken into account for power calculation in one channel is the product of sweeptime in channel times the selected resolution bandwidth.

Assuming a sweeptime of 100 ms, there are $(30 \text{ kHz} / 4.19 \text{ MHz}) * 100 \text{ ms} * 10 \text{ kHz} \approx 7$ samples. Whereas in Fast ACLR mode, there are $(100 \text{ ms} / 5) * 30 \text{ kHz} \approx 600$ samples. Comparing these numbers explains the increase of repeatability with a 95% confidence level (2σ) from $\pm 2.8 \text{ dB}$ to $\pm 0.34 \text{ dB}$ for a sweeptime of 100 ms (as shown in Figure 5-13 and).

For the same repeatability, the sweep time would have to be set to 8.5 s with the integration method. The Figure 5-14 shows the standard deviation of the results as a function of the sweep time.

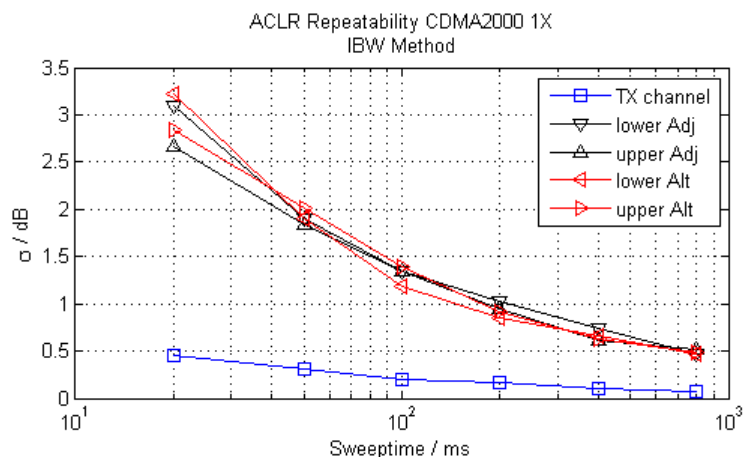

Figure 5-13: Repeatability of adjacent channel power measurement on CDMA2000 standard signals if the integration bandwidth method is used

The Figure 5-14 shows the repeatability of power measurements in the transmit channel and of relative power measurements in the adjacent channels as a function of sweep time. The standard deviation of measurement results is calculated from 100 consecutive measurements. Take scaling into account if comparing power values.

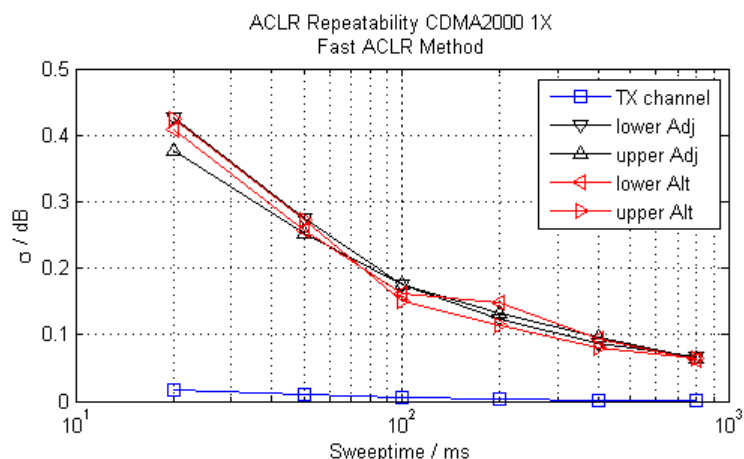
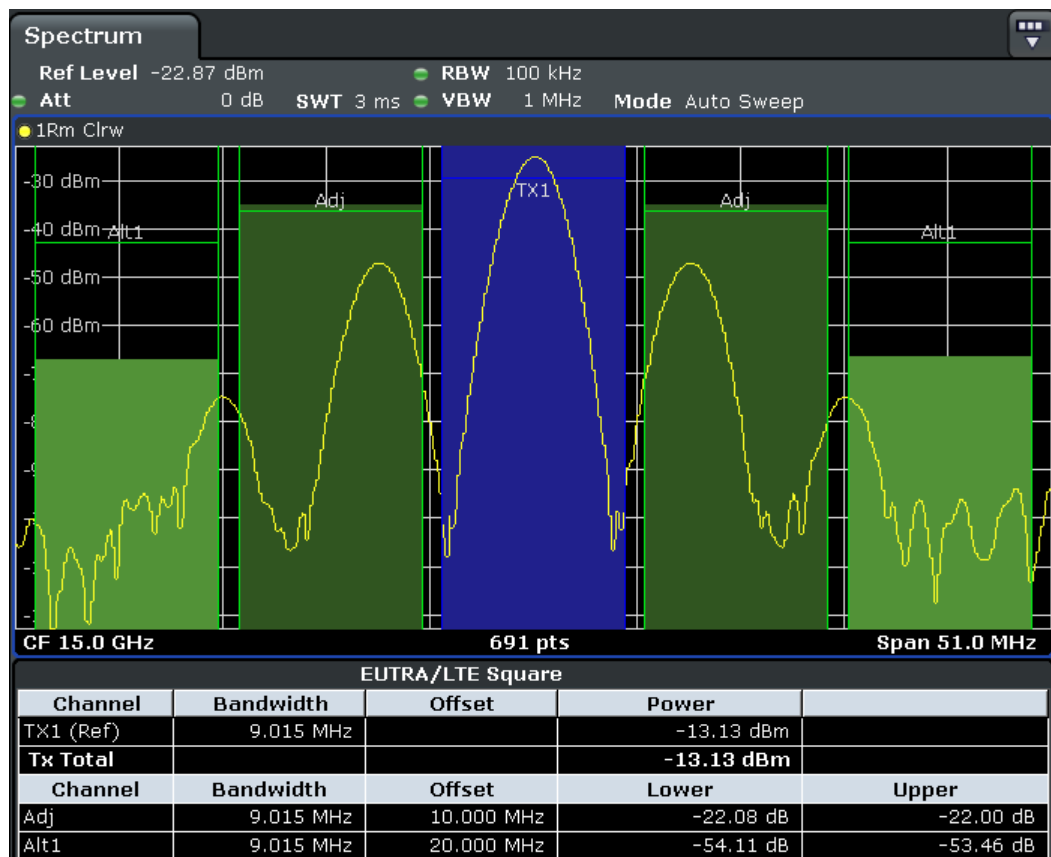

Figure 5-14: Repeatability of adjacent channel power measurements on CDMA2000 signals in the fast ACP mode

Channel Power Measurement Results

For channel or adjacent-channel power measurements, the individual channels are indicated by different colored bars in the diagram. The height of each bar corresponds to the measured power of that channel. In addition, the name of the channel ("Adj", "Alt1", "TX1", etc. or a user-defined name) is indicated above the bar (separated by a line which has no further meaning).



Results are provided for the TX channel and the number of defined adjacent channels *above and below* the TX channel. If more than one TX channel is defined, the carrier channel to which the relative adjacent-channel power values should be referenced must be defined.

The measured power values for the TX and adjacent channels are also output as a table in the second screen. Which powers are measured depends on the number of configured channels, see "[# of Adj Chan](#)" on page 296.

For each channel, the following values are displayed:

Label	Description
Channel	Channel name as specified in the "Channel Settings" (see " Names " on page 299).
Bandwidth	Configured channel bandwidth (see " Bandwidth " on page 297)
Offset	Offset of the channel to the TX channel (Configured channel spacing, see " Spacing " on page 298)
Power (Lower/Upper)	The measured power values for the TX and lower and upper adjacent channels. The powers of the transmission channels are output in dBm or dBm/Hz, or in dBc, relative to the specified reference TX channel.

Retrieving Results via Remote Control

All or specific channel power measurement results can be retrieved using the `CALCulate<n>:MARKer<m>:FUNCTION:POWER:RESult?` command from a remote computer.

Alternatively, the results can be output as channel power density, i.e. in reference to the measurement bandwidth (see `CALCulate<n>:MARKer<m>:FUNCTION:POWER:RESult:PHZ` on page 707).

Furthermore, the measured power values of the displayed trace can be retrieved as usual using the `TRAC:DATA?` commands (see `TRACe<n>[:DATA]?` on page 890). In this case, the measured power value for each sweep point (max. 691) is returned.

Configuring and Performing Channel Power Measurements

Predefined standards contain the main measurement settings for standard measurements. When such a standard is loaded, the required channel settings are automatically set on the R&S FSVA/FSV. However, the settings can be changed, and measurements with user-defined configurations are also possible.

Once the channels have been set up, other instrument settings such as the used filter bandwidths, frequency span and detector and trace settings can be optimized automatically (see "Adjust Settings" on page 302).

For an overview of the softkeys and menus see "Softkeys for Channel and Adjacent-Channel Power Measurements" on page 294.

Selecting a Predefined Standard

Predefined standards contain the main measurement settings for standard measurements. When such a standard is loaded, the required channel settings are automatically set on the R&S FSVA/FSV.

The selected standard defines the following settings:

- "Bandwidth" on page 297
- "Spacing" on page 298
- Detector, see "Optimized Settings for CP/ACLR Test Parameters" on page 306
- Trace averaging, see "Average Mode" on page 225
- RBW, see "Optimized Settings for CP/ACLR Test Parameters" on page 306
- "Weighting Filter" on page 299

► Select a predefined standard via the `CP/ACLR Standard` softkey.

Setting up the Channels

Channel definition is the basis for measuring power levels in certain frequency ranges. Usually, the power levels in one or more carrier (TX) channels and possibly the adjacent channels are of interest. Up to 18 carrier channels and up to 12 adjacent channels can be defined.



In the R&S FSVA/FSV's display, only the first neighboring channel of the carrier (TX) channel is labelled "Adj" (adjacent) channel; all others are labelled "Alt" (alternate) channels. In this manual, "adjacent" refers to both adjacent and alternate channels.

When an ACLR measurement is started by pressing the "Ch Power ACLR" softkey, all settings including the channel bandwidths and channel spacings are set according to the selected standard and can be adjusted afterwards.

Channel setup consists of the following settings:

- The number of transmission (TX) and adjacent channels
- The bandwidth of each channel
- For multi-carrier ACLR measurements: which TX channel is used as a reference ("ACLR Reference")
- The spacing between the individual channels
- Optionally: the names of the channels displayed in the diagram and result table
- Optionally: the influence of individual channels on the total measurement result ("Weighting Filter")
- Optionally: limits for a limit check on the measured power levels



Changes to an existing standard can be stored as a user-defined standard, see "[User-Defined Configurations](#)" on page 293.

- ▶ In the "Ch Power" menu, press [Channel Setup](#), then press the [Channel Setup](#) softkey to configure the channels in the "Channel Setup" dialog box.



In the "Channel Setup" dialog box you define the channel settings for all channels, independent of the defined number of *used* TX or adjacent channels.

- [Defining Channel Bandwidths](#).....291
- [Defining Channel Spacings](#).....292
- [Configuring a Limit Check](#).....293

Defining Channel Bandwidths

The transmission-channel bandwidth is normally defined by the transmission standard. The correct bandwidth is set automatically for the selected standard (see "[Optimized Settings for CP/ACLR Test Parameters](#)" on page 306).

For measurements that require channel bandwidths which deviate from those defined in the selected standard, use the IBW method (see [Fast ACLR \(On/Off\)](#) softkey). With the IBW method, the channel bandwidth borders are right and left of the channel center frequency. Thus, you can visually check whether the entire power of the signal under test is within the selected channel bandwidth.

- ▶ In the "Channel Setup" dialog box, select the "Bandwidth" tab to define the channel bandwidths.

The value entered for any TX channel is automatically also defined for all subsequent TX channels. Thus, only one value needs to be entered if all TX channels have the same bandwidth.

The value entered for any ADJ or ALT channel is automatically also defined for all alternate (ALT) channels. Thus, only one value needs to be entered if all adjacent channels have the same bandwidth.

Defining Channel Spacings

Channel spacings are normally defined by the selected standard but can be changed.

If the spacings are not equal, the channel distribution according to the center frequency is as follows:

Odd number of TX channels	The middle TX channel is centered to center frequency.
Even number of TX channels	The two TX channels in the middle are used to calculate the frequency between those two channels. This frequency is aligned to the center frequency.

- ▶ In the "Channel Setup" dialog box, select the "Spacing" tab to define the channel spacings.
The value entered for any TX channel is automatically also defined for all subsequent TX channels. Thus, only one value needs to be entered if all TX channels have the same spacing.
If the channel spacing for the adjacent or an alternate channel is changed, all higher alternate channel spacings are multiplied by the same factor (new spacing value/old spacing value). The lower adjacent-channel spacings remain unchanged.
Only one value needs to be entered for equal channel spacing.

Example: Defining channel spacing

In the default setting, the adjacent channels have the following spacing: 20 kHz ("ADJ"), 40 kHz ("ALT1"), 60 kHz ("ALT2"), 80 kHz ("ALT3"), 100 kHz ("ALT4"), ...

If the spacing of the first adjacent channel ("ADJ") is set to 40 kHz, the spacing of all other adjacent channels is multiplied by factor 2 to result in 80 kHz ("ALT1"), 120 kHz ("ALT2"), 160 kHz ("ALT3"), ...

If, starting from the default setting, the spacing of the 5th adjacent channel ("ALT4") is set to 150 kHz, the spacing of all higher adjacent channels is multiplied by factor 1.5 to result in 180 kHz ("ALT5"), 210 kHz ("ALT6"), 240 kHz ("ALT7"), ...



For the R&S FSVA/FSV, the channel spacing is defined as the distance between the center frequency of the adjacent channel and the center frequency of the transmission channel. The definition of the adjacent-channel spacing in standards IS95C and CDMA 2000 is different. These standards define the adjacent-channel spacing from the center of the transmission channel to the closest border of the adjacent channel. This definition is also used for the R&S FSVA/FSV if the standards marked with an asterisk *) are selected.

Configuring a Limit Check

During an ACLR measurement, the power values can be checked whether they exceed user-defined limits. A relative or absolute limit can be defined, or both. Both limit types are considered, regardless whether the measured levels are absolute or relative values. The check of both limit values can be activated independently. If any active limit value is exceeded, the measured value is displayed in red and marked by a preceding asterisk in the result table.

W-CDMA 3GPP FWD				
Channel	Bandwidth	Offset	Power	
TX1 (Ref)	3.840 MHz		-124.39 dBm	
Tx Total			-124.39 dBm	
Channel	Bandwidth	Offset	Lower	Upper
Adj*	3.840 MHz	5.000 MHz	81.17 dB*	81.17 dB*
Alt1*	3.840 MHz	10.000 MHz	0.00 dB*	0.00 dB*

To configure a limit check

1. In the "Channel Setup" dialog box, select the "Limits" tab to define a limit check.
2. For each channel, define a relative or absolute value that should not be exceeded.
3. Select the channels to be included in the limit check by activating the "Check" option.
4. Activate limit checking for the selected channels by setting "Limit Checking" to *On*.

Performing a Channel Power Measurement

A channel power measurement is started automatically according to the currently selected standard when you press the "Ch Power ACLR" softkey in the [MEAS] menu.

- ▶ To start a new measurement after changing the settings, press the [RUN Single] or [RUN CONT] hardkeys.
Alternatively, you can save your settings as a user standard (see ["User-Defined Configurations"](#) on page 293), then select that standard and start the measurement as usual by pressing the "Ch Power ACLR" softkey.

The configured measurement is performed (depending on the number of defined channels, see ["# of Adj Chan"](#) on page 296) and the results are displayed in the graphic and the result table.

User-Defined Configurations

You can define measurement configurations independently of a predefined standard and save the current ACLR configuration as a "user standard" in an xml file. You can then load the file and thus the settings again at a later time.

User-defined standards are not supported for "Fast ACLR" and Multi-Carrier ACLR measurements.



Compatibility to R&S FSP

User standards created on an analyzer of the R&S FSP family are compatible to the R&S FSVA/FSV. User standards created on an R&S FSVA/FSV, however, are not necessarily compatible to the analyzers of the R&S FSP family and may not work there.

To store a user-defined configuration

1. Select the "User Standard" softkey in the "Ch Power" menu.
2. Press "Save".
3. Define a file name for the user standard and select its storage location.
By default, the xml file is stored in C:\R_S\Instr\acp_std\. However, you can define any other storage location.
4. Press "Save".

The following parameter definitions are saved:

- "# of Adj Chan" on page 296
- Channel spacing and adjacent-channel spacing, see "Spacing" on page 298
- Channel bandwidth of transmission (Tx), adjacent (Adj) and alternate (Alt) channels, see "Bandwidth" on page 297
- Resolution bandwidth, see "Res BW Auto" on page 206
- Video bandwidth, see "Video BW Auto" on page 207
- Detector, see "Detector" on page 222
- ACLR limits and their state, see "Limits" on page 300
- Sweep time and sweep time coupling, see "Sweep Time" on page 302
- Trace and power mode, see "Select Trace" on page 302 and "Power Mode" on page 301

To load a user-defined configuration

- ▶ Press "User Standard > Load" and select the user standard file.

Softkeys for Channel and Adjacent-Channel Power Measurements

Ch Power ACLR.....	295
L CP/ACLR Standard.....	295
L CP/ACLR Settings.....	296
L # of TX Chan.....	296
L # of Adj Chan.....	296
L Channel Setup.....	296
L Bandwidth.....	297
L ACLR Reference.....	298
L Spacing.....	298
L Names.....	299
L Weighting Filter.....	299
L Limits.....	300
L Limit Checking.....	300
L Relative Limit.....	301
L Absolute Limit.....	301
L Check.....	301

L Chan Pwr/Hz.....	301
L Power Mode.....	301
L Clear/Write.....	301
L Max Hold.....	302
L Select Trace.....	302
L ACLR (Abs/Rel).....	302
L Adjust Settings.....	302
L Sweep Time.....	302
L Fast ACLR (On/Off).....	303
L Set CP Reference.....	303
L User Standard.....	303
L Load.....	304
L Save.....	304
L Delete.....	304
L Noise Correction.....	304
L Adjust Ref Lvl.....	305

Ch Power ACLR

Activates the active channel or adjacent-channel power measurement either for a single carrier signal or for several carrier signals, depending on the current measurement configuration, and opens a submenu to configure the channel power measurement. With default settings the measurement is performed by integrating the powers at the display points within the specified channels (IBW method).

If several TX channels (carriers) are activated, the number of measured values is increased to ensure that adjacent-channel powers are measured with adequate accuracy.

For general information on performing channel or adjacent-channel power measurements, see [Chapter 5.3.5.2, "Measuring Channel Power and Adjacent-Channel Power"](#), on page 283.

Remote command:

`CALCulate<n>:MARKer<m>:FUNCTION:POWER:SElect` on page 707

`CALCulate<n>:MARKer<m>:FUNCTION:POWER:RESult?` on page 704

`CALCulate<n>:MARKer<m>:FUNCTION:POWER[:STATe]` on page 708

CP/ACLR Standard ← Ch Power ACLR

Opens an edit dialog box to select the settings according to predefined standards. For details on the available standards see ["Predefined CP/ACLR Standards"](#) on page 305. By default no standard is set.

The selection of the standard influences the following parameters (see ["Optimized Settings for CP/ACLR Test Parameters"](#) on page 306):

- channel spacing and adjacent-channel spacing
- channel bandwidth, adjacent-channel bandwidth, and type of filtering
- resolution bandwidth
- video bandwidth
- detector
- # of adjacent channels
- trace averaging (switched off)

Remote command:

[CALCulate<n>:MARKer<m>:FUNCTION:POWER:PRESet](#) on page 703

CP/ACLR Settings ← Ch Power ACLR

Opens a submenu to configure the channel power and adjacent channel power measurement independently of the predefined standards (for details see also "[Predefined CP/ACLR Standards](#)" on page 305 and "[Optimized Settings for CP/ACLR Test Parameters](#)" on page 306).

of TX Chan ← CP/ACLR Settings ← Ch Power ACLR

Opens an edit dialog box to enter the number of carrier signals to be taken into account in channel and adjacent-channel power measurements. Values from 1 to 18 are allowed.

Remote command:

[\[SENSe:\]POWER:ACHannel:TXChannel:COUNT](#) on page 854

of Adj Chan ← CP/ACLR Settings ← Ch Power ACLR

Opens an edit dialog box to enter the number of adjacent channels to be considered in the adjacent-channel power measurement. Values from 0 to 12 are allowed.

The following measurements are performed depending on the number of the channels:

0	Only the channel powers are measured.
1	The channel powers and the power of the upper and lower adjacent channel are measured.
2	The channel powers, the power of the upper and lower adjacent channel, and of the next higher and lower channel (alternate channel 1) are measured.
3	The channel power, the power of the upper and lower adjacent channel, the power of the next higher and lower channel (alternate channel 1), and of the next but one higher and lower adjacent channel (alternate channel 2) are measured.
...	...
12	The channel power, the power of the upper and lower adjacent channel, and the power of the all higher and lower channels (alternate channel 1 to 11) are measured.

Remote command:

[\[SENSe:\]POWER:ACHannel:ACPairs](#) on page 845

Channel Setup ← CP/ACLR Settings ← Ch Power ACLR

Opens a dialog to define the channel settings for all channels, independent of the defined number of *used* TX or adjacent channels.

Channel	Bandwidth	Channel	Bandwidth
TX 1	14.0 kHz	ADJ	14.0 kHz
TX 2	14.0 kHz	ALT1	14.0 kHz
TX 3	14.0 kHz	ALT2	14.0 kHz
TX 4	14.0 kHz	ALT3	14.0 kHz
TX 5	14.0 kHz	ALT4	14.0 kHz
TX 6	14.0 kHz	ALT5	14.0 kHz
TX 7	14.0 kHz	ALT6	14.0 kHz
TX 8	14.0 kHz	ALT7	14.0 kHz
TX 9	14.0 kHz	ALT8	14.0 kHz
TX 10	14.0 kHz	ALT9	14.0 kHz
TX 11	14.0 kHz	ALT10	14.0 kHz
TX 12	14.0 kHz	ALT11	14.0 kHz

ACLR Reference: TX CHANNEL 1

The dialog contains the following tabs:

- "Bandwidth" on page 297
- "Spacing" on page 298
- "Names" on page 299
- "Weighting Filter" on page 299
- "Limits" on page 300

Bandwidth ← Channel Setup ← CP/ACLR Settings ← Ch Power ACLR

Define the channel bandwidths for the transmission channels and the adjacent channels. "TX" is only available for the multi-carrier ACLR measurement. When you change the bandwidth for one channel, the value is automatically also defined for all subsequent channels of the same type.

The transmission-channel bandwidth is normally defined by the transmission standard. The correct bandwidth is set automatically for the selected standard (see "Optimized Settings for CP/ACLR Test Parameters" on page 306).

- Measurements in zero span (see [Fast ACLR \(On/Off\)](#) softkey) are performed in the zero span mode. The channel limits are indicated by vertical lines. For measurements requiring channel bandwidths deviating from those defined in the selected standard the IBW method is to be used.
- With the IBW method (see [Fast ACLR \(On/Off\)](#) softkey), the channel bandwidth limits are marked by two vertical lines right and left of the channel center frequency. Thus you can visually check whether the entire power of the signal under test is within the selected channel bandwidth.

If measuring according to the IBW method ("Fast ACLR Off"), the bandwidths of the different adjacent channels are to be entered numerically. Since all adjacent channels often have the same bandwidth, the other alternate channels are set to the bandwidth of the adjacent channel when it is changed. Thus, only one value needs to be entered in case of equal adjacent channel bandwidths.

For details on available channel filters see [Chapter 5.2.6.3, "Selecting the Appropriate Filter Type"](#), on page 211.

Remote command:

[SENSe:] POWER:ACHannel:BANDwidth|BWIDth[:CHANnel<channel>]

on page 846

[SENSe:] POWER:ACHannel:BANDwidth|BWIDth:ACHannel on page 846

[SENSe:] POWER:ACHannel:BANDwidth|BWIDth:ALternate<channel>

on page 846

ACLR Reference ← Bandwidth ← Channel Setup ← CP/ACLR Settings ← Ch Power ACLR

Select the transmission channel to which the relative adjacent-channel power values should be referenced.

TX Channel 1	Transmission channel 1 is used.
Min Power TX Channel	The transmission channel with the lowest power is used as a reference channel.
Max Power TX Channel	The transmission channel with the highest power is used as a reference channel.
Lowest & Highest Channel	The outer left-hand transmission channel is the reference channel for the lower adjacent channels, the outer right-hand transmission channel that for the upper adjacent channels.

Remote command:

[SENSe:] POWER:ACHannel:REference:TXCHannel:MANual on page 852

[SENSe:] POWER:ACHannel:REference:TXCHannel:AUTO on page 851

Spacing ← Channel Setup ← CP/ACLR Settings ← Ch Power ACLR

Define the channel spacings for the TX channels and for the adjacent channels.

- TX channels (left column)

TX1-2	spacing between the first and the second carrier
TX2-3	spacing between the second and the third carrier
...	...

The spacings between all adjacent TX channels can be defined separately. When you change the spacing for one channel, the value is automatically also defined for all subsequent TX channels in order to set up a system with equal TX channel spacing quickly. For different spacings, a setup from top to bottom is necessary.

If the spacings are not equal, the channel distribution according to the center frequency is as follows:

Odd number of TX channels	The middle TX channel is centered to center frequency.
Even number of TX channels	The two TX channels in the middle are used to calculate the frequency between those two channels. This frequency is aligned to the center frequency.

- **Adjacent channels (right column)**
 Since all the adjacent channels often have the same distance to each other, the modification of the adjacent-channel spacing (ADJ) causes a change in all higher adjacent-channel spacings (ALT1, ALT2, ...): they are all multiplied by the same factor (new spacing value/old spacing value). Thus only one value needs to be entered in case of equal channel spacing. A modification of a higher adjacent-channel spacing (ALT1, ALT2, ...) causes a change by the same factor in all higher adjacent-channel spacings, while the lower adjacent-channel spacings remain unchanged.

Example:

In the default setting, the adjacent channels have the following spacing: 20 kHz ("ADJ"), 40 kHz ("ALT1"), 60 kHz ("ALT2"), 80 kHz ("ALT3"), 100 kHz ("ALT4"), ...
 If the spacing of the first adjacent channel ("ADJ") is set to 40 kHz, the spacing of all other adjacent channels is multiplied by factor 2 to result in 80 kHz ("ALT1"), 120 kHz ("ALT2"), 160 kHz ("ALT3"), ...

If, starting from the default setting, the spacing of the 5th adjacent channel ("ALT4") is set to 150 kHz, the spacing of all higher adjacent channels is multiplied by factor 1.5 to result in 180 kHz ("ALT5"), 210 kHz ("ALT6"), 240 kHz ("ALT7"), ...

If a ACLR or MC-ACLR measurement is started, all settings according to the standard including the channel bandwidths and channel spacings are set and can be adjusted afterwards.

Remote command:

[SENSe:] POWer:ACHannel:SPACing:CHANnel<channel> on page 853

[SENSe:] POWer:ACHannel:SPACing[:ACHannel] on page 852

[SENSe:] POWer:ACHannel:SPACing:ALternate<channel> on page 853

Names ← Channel Setup ← CP/ACLR Settings ← Ch Power ACLR

Define user-specific channel names for each channel. The names defined here are displayed in the result diagram and result table.

Remote command:

[SENSe:] POWer:ACHannel:NAME:ACHannel on page 849

[SENSe:] POWer:ACHannel:NAME:ALternate<channel> on page 850

[SENSe:] POWer:ACHannel:NAME:CHANnel<channel> on page 850

Weighting Filter ← Channel Setup ← CP/ACLR Settings ← Ch Power ACLR

Define weighting filters for all channels. Weighting filters are not available for all supported standards and cannot always be defined manually where they are available.

The dialog contains the following fields:

Field	Description
Channel	<ul style="list-style-type: none"> • TX 1-18: TX channels • ADJ: Adjacent channel • ALT1-11: Alternate channels
Active	Activates/Deactivates the weighting filter for the selected and any subsequent channels of the same type
Alpha	Defines the alpha value for the weighting filter for the selected and any subsequent channels of the same type

Remote command:

POW:ACH:FILT:CHAN1 ON, see [SENSe:]POWer:ACHannel:FILTer[:STATe]:CHANnel<channel> on page 849

Activates the weighting filter for TX channel 1.

POW:ACH:FILT:ALPH:CHAN1 0,35 see [SENSe:]POWer:ACHannel:FILTer:ALPHa:CHANnel<channel> on page 848

Sets the alpha value for the weighting filter for TX channel 1 to 0,35.

POW:ACH:FILT:ACH ON see [SENSe:]POWer:ACHannel:FILTer[:STATe]:ACHannel on page 848

Activates the weighting filter for the adjacent channel.

POW:ACH:FILT:ALPH:ACH 0,35 see [SENSe:]POWer:ACHannel:FILTer:ALPHa:ACHannel on page 847

Sets the alpha value for the weighting filter for the adjacent channel to 0,35.

POW:ACH:FILT:ALT1 ON see [SENSe:]POWer:ACHannel:FILTer[:STATe]:ALTernate<channel> on page 848

Activates the alpha value for the weighting filter for the alternate channel 1.

POW:ACH:FILT:ALPH:ALT1 0,35 see [SENSe:]POWer:ACHannel:FILTer:ALPHa:ALTernate<channel> on page 847

Sets the alpha value for the weighting filter for the alternate channel 1 to 0,35.

Limits ← Channel Setup ← CP/ACLR Settings ← Ch Power ACLR

Activate and define the limits for the ACLR measurement.

Limit Checking ← Limits ← Channel Setup ← CP/ACLR Settings ← Ch Power ACLR

Activate or deactivate limit checking for the ACLR measurement.

The following rules apply for the limits:

- A separate limit can be defined for each adjacent channel. The limit applies to both the upper and the lower adjacent channel.
- A relative and/or absolute limit can be defined. The check of both limit values can be activated independently.
- The R&S FSVA/FSV checks adherence to the limits irrespective of whether the limits are absolute or relative or whether the measurement is carried out with absolute or relative levels. If both limits are active and if the higher of both limit values is exceeded, the measured value is marked by a preceding asterisk.

Remote command:

[CALCulate<n>:LIMit<k>:ACPowEr\[:STATe\]](#) on page 645

[CALCulate<n>:LIMit<k>:ACPowEr:ACHannel:RESult](#) on page 648

[CALCulate<n>:LIMit<k>:ACPowEr:ALternate<channel>\[:RELative\]](#)
on page 649

Relative Limit ← Limits ← Channel Setup ← CP/ACLR Settings ← Ch Power ACLR

Defines a limit relative to the carrier signal.

Remote command:

`CALC:LIM:ACP ON`, see [CALCulate<n>:LIMit<k>:ACPowEr\[:STATe\]](#)
on page 645

`CALC:LIM:ACP:<adjacent-channel> 0dBc,0dBc`

`CALC:LIM:ACP:<adjacent-channel>:STAT ON`

Absolute Limit ← Limits ← Channel Setup ← CP/ACLR Settings ← Ch Power ACLR

Defines an absolute limit.

Remote command:

`CALC:LIM:ACP ON`, see [CALCulate<n>:LIMit<k>:ACPowEr\[:STATe\]](#)
on page 645

`CALC:LIM:ACP:<adjacent-channel>:ABS -10dBm,-10dBm`

`CALC:LIM:ACP:<adjacent-channel>:ABS:STAT ON`, see [CALCulate<n>:LIMit<k>:ACPowEr:ACHannel:ABSolute:STATe](#) on page 647

Check ← Limits ← Channel Setup ← CP/ACLR Settings ← Ch Power ACLR

Activate or deactivate the limit to be considered during a limit check. The check of both limit values can be activated independently.

Chan Pwr/Hz ← CP/ACLR Settings ← Ch Power ACLR

If deactivated, the channel power is displayed in dBm. If activated, the channel power density is displayed instead. Thus, the absolute unit of the channel power is switched from dBm to dBm/Hz. The channel power density in dBm/Hz corresponds to the power inside a bandwidth of 1 Hz and is calculated as follows:

"channel power density = channel power – log₁₀(channel bandwidth)"

By means of this function it is possible e.g. to measure the signal/noise power density or use the additional functions "[ACLR \(Abs/Rel\)](#)" on page 302 and "[ACLR Reference](#)" on page 298 to obtain the signal to noise ratio.

Remote command:

[CALCulate<n>:MARKer<m>:FUNctIon:POWer:RESult:PHZ](#) on page 707

Power Mode ← CP/ACLR Settings ← Ch Power ACLR

Opens a submenu to select the power mode.

Clear/Write ← Power Mode ← CP/ACLR Settings ← Ch Power ACLR

If this mode is activated, the channel power and the adjacent channel powers are calculated directly from the current trace (default mode).

Remote command:

CALC:MARK:FUNC:POW:MODE WRIT, see [CALCulate<n>:MARKer<m>:FUNction:POWer:MODE](#) on page 702

Max Hold ← Power Mode ← CP/ACLR Settings ← Ch Power ACLR

If this mode is activated, the power values are calculated from the current trace and compared with the previous power value using a maximum algorithm. The higher value is retained. If activated, the enhancement label "Pwr Max" is displayed.

Remote command:

CALC:MARK:FUNC:POW:MODE MAXH, see [CALCulate<n>:MARKer<m>:FUNction:POWer:MODE](#) on page 702

Select Trace ← CP/ACLR Settings ← Ch Power ACLR

Opens an edit dialog box to enter the trace number on which the CP/ACLR measurement is to be performed. Only activated traces can be selected.

For details on trace modes see [Chapter 5.2.8.4, "Trace Mode Overview"](#), on page 231.

Remote command:

[\[SENSe:\]POWer:TRACe](#) on page 855

ACLR (Abs/Rel) ← CP/ACLR Settings ← Ch Power ACLR

Switches between absolute and relative power measurement in the adjacent channels.

Abs	The absolute power in the adjacent channels is displayed in the unit of the y-axis, e.g. in dBm, dBμV.
Rel	The level of the adjacent channels is displayed relative to the level of the transmission channel in dBc.

Remote command:

[\[SENSe:\]POWer:ACHannel:MODE](#) on page 849

Adjust Settings ← CP/ACLR Settings ← Ch Power ACLR

Automatically optimizes all instrument settings for the selected channel configuration (channel bandwidth, channel spacing) within a specific frequency range (channel bandwidth). The adjustment is carried out only once. If necessary, the instrument settings can be changed later.

For details on the settings of span, resolution bandwidth, video bandwidth, detector and trace averaging see ["Optimized Settings for CP/ACLR Test Parameters"](#) on page 306.

Remote command:

[\[SENSe:\]POWer:ACHannel:PRESet](#) on page 850

Sweep Time ← Ch Power ACLR

Opens an edit dialog box to enter the sweep time. With the RMS detector, a longer sweep time increases the stability of the measurement results.

The function of this softkey is identical to the [SweepTime Manual](#) softkey in the "Bandwidth" menu.

Remote command:

[SENSe:] SWEep:TIME on page 862

Fast ACLR (On/Off) ← Ch Power ACLR

Switches between the IBW method ("Fast ACLR Off") and the zero span method ("Fast ACLR On").

When switched on, the R&S FSVA/FSV sets the center frequency consecutively to the different channel center frequencies and measures the power with the selected measurement time (= sweep time/number of channels). The RBW filters suitable for the selected standard and frequency offset are automatically used (e.g. root raised cos with IS 136). For details on available channel filters see [Chapter 5.2.6.3, "Selecting the Appropriate Filter Type"](#), on page 211.

The RMS detector is used for obtaining correct power measurement results. Therefore this requires no software correction factors.

Measured values are output as a list. The powers of the transmission channels are output in dBm, the powers of the adjacent channels in dBm.

The sweep time is selected depending on the desired reproducibility of results. Reproducibility increases with sweep time since power measurement is then performed over a longer time period. As a general approach, it can be assumed that approx. 500 non-correlated measured values are required for a reproducibility of 0.5 dB (99 % of the measurements are within 0.5 dB of the true measured value). This holds true for white noise. The measured values are considered as non-correlated if their time interval corresponds to the reciprocal of the measured bandwidth.

With IS 136 the measurement bandwidth is approx. 25 kHz, i.e. measured values at an interval of 40 µs are considered as non-correlated. A measurement time of 40 ms is thus required per channel for 1000 measured values. This is the default sweep time which the R&S FSVA/FSV sets in coupled mode. Approx. 5000 measured values are required for a reproducibility of 0.1 dB (99 %), i.e. the measurement time is to be increased to 200 ms.

Remote command:

[SENSe:] PWEr:HSPEed on page 854

Set CP Reference ← Ch Power ACLR

Defines the currently measured channel power as the reference value if channel power measurement is activated. The reference value is displayed in the "Tx1 (Ref) Power" field; the default value is 0 dBm.

The softkey is available only for multi carrier ACLR measurements.

In adjacent-channel power measurement with one or several carrier signals, the power is always referenced to a transmission channel, i.e. no value is displayed for "Tx1 (Ref) Power".

Remote command:

[SENSe:] PWEr:ACHannel:REfERENCE:AUTO ONCE on page 851

User Standard ← Ch Power ACLR

Opens a submenu to configure customized standards.

Load ← User Standard ← Ch Power ACLR

Opens a dialog to select and load a user defined ACLR standard.

Note: Compatibility to R&S FSP. User standards created on an analyzer of the R&S FSP family are compatible to the R&S FSV. User standards created on an R&S FSV, however, are not necessarily compatible to the analyzers of the R&S FSP family and may not work there.

Remote command:

Querying available standards:

`CALCulate<n>:MARKer<m>:FUNCTION:POWER:STANDARD:CATALOG?`

on page 709

Loading a standard:

`CALCulate<n>:MARKer<m>:FUNCTION:POWER:PRESet` on page 703

Save ← User Standard ← Ch Power ACLR

Saves the current ACLR configuration in an xml file in order for you to use it again at a later time. You can define the drive, path and file name in the corresponding dialog.

The default location is `C:\R_S\Instr\acp_std\`.

Note that the ACLR user standard is not supported by Fast ACLR and Multi Carrier ACLR measurements.

If you create your own standard, you can customize the following parameters:

- number of adjacent channels
- channel bandwidth of transmission (Tx), adjacent (Adj) and alternate (Alt) channels
- channel spacings
- resolution and video bandwidth
- ACLR limits and their state
- sweep time and sweep time coupling
- detector
- trace mode

Remote command:

Configuring channels:

see "[SENSe:POWER Subsystem](#)" on page 845

Saving custom channel configurations:

`CALCulate<n>:MARKer<m>:FUNCTION:POWER:STANDARD:SAVE` on page 709

Delete ← User Standard ← Ch Power ACLR

Deletes the user standard that you select in the corresponding dialog box. Note that the R&S FSVA/FSV deletes the file without further notice.

Remote command:

`CALCulate<n>:MARKer<m>:FUNCTION:POWER:STANDARD:DELETE` on page 709

Noise Correction ← Ch Power ACLR

If activated, the results are corrected by the instrument's inherent noise, which increases the dynamic range.

"ON"	<p>A reference measurement of the instrument's inherent noise is carried out. The noise power measured is then subtracted from the power in the channel that is being examined.</p> <p>The inherent noise of the instrument depends on the selected center frequency, resolution bandwidth and level setting. Therefore, the correction function is disabled whenever one of these parameters is changed. A disable message is displayed on the screen. Noise correction must be switched on again manually after the change.</p>
"OFF"	No noise correction is performed.
"AUTO"	Noise correction is performed. After a parameter change, noise correction is restarted automatically and a new correction measurement is performed.

Remote command:

`[SENSe:]POWer:NCORrection` on page 854

Adjust Ref Lvl ← Ch Power ACLR

Adjusts the reference level to the measured channel power. This ensures that the settings of the RF attenuation and the reference level are optimally adjusted to the signal level without overloading the R&S FSVA/FSV or limiting the dynamic range by a too small S/N ratio.

For details on manual settings see "[Optimized Settings for CP/ACLR Test Parameters](#)" on page 306.

The reference level is not influenced by the selection of a standard. To achieve an optimum dynamic range, the reference level has to be set in a way that places the signal maximum close to the reference level without forcing an overload message. Since the measurement bandwidth for channel power measurements is significantly lower than the signal bandwidth, the signal path may be overloaded although the trace is still significantly below the reference level.

Remote command:

`[SENSe:]POWer:ACHannel:PRESet:RLEVel` on page 851

Predefined CP/ACLR Standards

When using predefined standards for ACLR measurement, the test parameters for the channel and adjacent-channel measurements are configured automatically. The available standards are listed below.



Predefined standards are selected using the "CP/ACLR Standard" softkey or the `CALC:MARK:FUNC:POW:PRES` command.

Standard	GUI-Parameter	SCPI-Parameter
EUTRA/LTE Square	EUTRA/LTE Square	EUTRa
EUTRA/LTE Square/RRC	EUTRA/LTE Square/RRC	REUTRa
W-CDMA 3.84 MHz forward	W-CDMA 3GPP FWD	FW3G
W-CDMA 3.84 MHz reverse	W-CDMA 3GPP REV	RW3G

Standard	GUI-Parameter	SCPI-Parameter
CDMA IS95A forward	CDMA IS95A FWD	F8CD FIS95a
CDMA IS95A reverse	CDMA IS95A REV	R8CD RIS95a
CDMA IS95C Class 0 forward*)	CDMA IS95C Class 0 FWD	FIS95c0
CDMA IS95C Class 0 reverse*)	CDMA IS95C Class 0 REV	RIS95c0
CDMA J-STD008 forward	CDMA J-STD008 FWD	F19C FJ008
CDMA J-STD008 reverse	CDMA J-STD008 REV	R19C RJ008
CDMA IS95C Class 1 forward*)	CDMA IS95C Class 1 FWD	FIS95c1
CDMA IS95C Class 1 reverse*)	CDMA IS95C Class 1 REV	RIS95c1
CDMA 2000	CDMA 2000	S2CD
TD-SCDMA forward	TD SCDMA FWD	FTCD TCDMa
TD-SCDMA reverse	TD SCDMA REV	RTCD
WLAN 802.11A	WLAN 802.11A	AWLan
WLAN 802.11B	WLAN 802.11B	BWLan
WiMAX	WiMAX	WiMAX
WIBRO	WIBRO	WIBRO
GSM	GSM	GSM
RFID 14443	RFID 14443	RFID14443
TETRA	TETRA	TETRA
PDC	PDC	PDC
PHS	PHS	PHS
CDPD	CDPD	CDPD
APCO-25 Phase 2	APCO-25 P2	PAPCo25



For the R&S FSVA/FSV, the channel spacing is defined as the distance between the center frequency of the adjacent channel and the center frequency of the transmission channel. The definition of the adjacent-channel spacing in standards IS95C and CDMA 2000 is different. These standards define the adjacent-channel spacing from the center of the transmission channel to the closest border of the adjacent channel. This definition is also used for the R&S FSVA/FSV if the standards marked with an asterisk *) are selected.

Optimized Settings for CP/ACLR Test Parameters

The "Adjust Settings" softkey (see ["Adjust Settings"](#) on page 302) automatically optimizes all instrument settings for the selected channel configuration, as described in the following:

- **Frequency span**

The frequency span must at least cover the channels to be measured plus a measurement margin of approx. 10 %.

If the frequency span is large in comparison to the channel bandwidth (or the adjacent-channel bandwidths) being examined, only a few points on the trace are available per channel. This reduces the accuracy of the waveform calculation for the channel filter used, which has a negative effect on the measurement accuracy. It is therefore strongly recommended that the formulas mentioned be taken into consideration when selecting the frequency span.

For channel power measurements the [Adjust Settings](#) softkey sets the frequency span as follows:

"(No. of transmission channels – 1) x transmission channel spacing + 2 x transmission channel bandwidth + measurement margin"

For adjacent-channel power measurements, the [Adjust Settings](#) softkey sets the frequency span as a function of the number of transmission channels, the transmission channel spacing, the adjacent-channel spacing, and the bandwidth of one of adjacent-channels ADJ, ALT1 or ALT2, whichever is furthest away from the transmission channels:

"(No. of transmission channels – 1) x transmission channel spacing + 2 x (adjacent-channel spacing + adjacent-channel bandwidth) + measurement margin"

The measurement margin is approx. 10 % of the value obtained by adding the channel spacing and the channel bandwidth.

- **Resolution bandwidth (RBW)**

To ensure both, acceptable measurement speed and required selection (to suppress spectral components outside the channel to be measured, especially of the adjacent channels), the resolution bandwidth must not be selected too small or too large. As a general approach, the resolution bandwidth is to be set to values between 1% and 4% of the channel bandwidth.

A larger resolution bandwidth can be selected if the spectrum within the channel to be measured and around it has a flat characteristic. In the standard setting, e.g. for standard IS95A REV at an adjacent channel bandwidth of 30 kHz, a resolution bandwidth of 30 kHz is used. This yields correct results since the spectrum in the neighborhood of the adjacent channels normally has a constant level.

With the exception of the IS95 CDMA standards, the [Adjust Settings](#) softkey sets the resolution bandwidth (RBW) as a function of the channel bandwidth:

" $RBW \leq 1/40$ of channel bandwidth"

The maximum possible resolution bandwidth (with respect to the requirement $RBW \leq 1/40$) resulting from the available RBW steps (1, 3) is selected.

- **Video bandwidth (VBW)**

For a correct power measurement, the video signal must not be limited in bandwidth. A restricted bandwidth of the logarithmic video signal would cause signal averaging and thus result in a too low indication of the power (-2.51 dB at very low video bandwidths). The video bandwidth should therefore be selected at least three times the resolution bandwidth:

" $VBW \geq 3 \times RBW$ "

The [Adjust Settings](#) softkey sets the video bandwidth (VBW) as a function of the channel bandwidth (see formula above) and the smallest possible VBW with regard to the available step size will be selected.

- **Detector**

The **Adjust Settings** softkey selects the RMS detector. This detector is selected since it correctly indicates the power irrespective of the characteristics of the signal to be measured. The whole IF envelope is used to calculate the power for each measurement point. The IF envelope is digitized using a sampling frequency which is at least five times the resolution bandwidth which has been selected. Based on the sample values, the power is calculated for each measurement point using the following formula:

$$P_{\text{RMS}} = \sqrt{\frac{1}{N} \cdot \sum_{i=1}^N s_i^2}$$

where:

" s_i = linear digitized video voltage at the output of the A/D converter"

"N = number of A/D converter values per measurement point"

" P_{RMS} = power represented by a measurement point"

When the power has been calculated, the power units are converted into decibels and the value is displayed as a measurement point.

In principle, the sample detector would be possible as well. Due to the limited number of measurement points used to calculate the power in the channel, the sample detector would yield less stable results.

- **Trace averaging**

The **Adjust Settings** softkey switches off this function. Averaging, which is often performed to stabilize the measurement results, leads to a too low level indication and should therefore be avoided. The reduction in the displayed power depends on the number of averages and the signal characteristics in the channel to be measured.

- **Reference level**

The **Adjust Settings** softkey does not influence the reference level. It can be adjusted separately using the "Adjust Ref Lvl" softkey (see "**Adjust Ref Lvl**" on page 305).

5.3.5.3 Measuring the Carrier-to-Noise Ratio

The R&S FSVA/FSV can easily determine the carrier-to-noise ratio, also normalized to a 1 Hz bandwidth.

The largest signal in the frequency span is the carrier. It is searched when the C/N or C/NO function is activated (see "**C/N, C/No**" on page 310) and is marked using a fixed reference marker ("FXD").

To determine the noise power, a channel at the defined center frequency is examined. The bandwidth of the channel is defined by the "Channel Bandwidth" setting. The power within this channel is integrated to obtain the noise power level. (If the carrier is within this channel, an extra step is required to determine the correct noise power level, see below.)

The noise power of the channel is subtracted from the maximum carrier signal level, and in the case of a C/NO measurement, it is referred to a 1 Hz bandwidth.



For this measurement, the RMS detector is activated.

The carrier-to-noise measurements are only available in the frequency domain (span >0).

There are two methods to measure the carrier-to-noise ratio:

- The carrier is outside the examined channel: In this case, it is sufficient to switch on the desired measurement function and to set the channel bandwidth. The carrier/noise ratio is displayed on the screen.
- The carrier is inside the examined channel: In this case, the measurement must be performed in two steps:
 - First, perform the reference measurement by switching on either the C/N or the C/NO measurement and waiting for the end of the next measurement run. The fixed reference marker is set to the maximum of the measured carrier signal.
 - Then, switch off the carrier so that only the noise of the test setup is active in the channel. The carrier-to-noise ratio is displayed after the subsequent measurement has been completed.



The frequency span should be set to approximately 4 times the channel bandwidth in order to measure the carrier-to-noise ratio correctly. This setting is defined automatically by the "Adjust Settings" function.

To determine the carrier-to-noise ratio

1. Press the "C/N, C/NO" softkey to configure the carrier-to-noise ratio measurement.
2. To change the channel bandwidth to be examined, press the "Channel Bandwidth" softkey.
3. To optimize the settings for the selected channel configuration, press the "Adjust Settings" softkey.
4. To activate the measurements without reference to the bandwidth, press the "C/N" softkey.
To activate the measurements with reference to the bandwidth, press the "C/NO" softkey .
5. If the carrier signal is located within the examined channel bandwidth, switch off the carrier signal so that only the noise is displayed in the channel and perform a second measurement.

The carrier-to-noise ratio is displayed after the measurement has been completed.

Measurement results

As a result of the carrier-to-noise measurement the evaluated bandwidth and the calculated C/N ratio are indicated beneath the diagram.

You can also query the determined carrier-to-noise ratio via the remote command `CALC:MARK:FUNC:POW:RES? CN` or `CALC:MARK:FUNC:POW:RES? CN0`, see [CALCulate<n>:MARKer<m>:FUNction:POWer:RESult?](#) on page 704.

Softkeys for Carrier-to-Noise Ratio Measurements

C/N, C/No.....	310
L C/N.....	310
L C/No.....	310
L Channel Bandwidth	310
L Adjust Settings	311

C/N, C/No

Opens a submenu to configure the carrier/noise ratio measurement. Measurements without (C/N) and measurements with reference to the bandwidth (C/No) are possible.

Carrier-to-noise measurements are not available in zero span mode.

Note: As of firmware version 2.0, carrier-to-noise measurements are also available in the I/Q Analyzer, but only for **Spectrum** displays (see ["Display Config"](#) on page 418).

For general information on performing carrier-to-noise ratio measurements see [Chapter 5.3.5.3, "Measuring the Carrier-to-Noise Ratio"](#), on page 308.

C/N ← C/N, C/No

Switches the measurement of the carrier/noise ratio on or off. If no marker is active, marker 1 is activated.

The measurement is performed on the trace that marker 1 is assigned to. To shift marker 1 and measure another trace, use the [Marker to Trace](#) softkey in the "Marker To" menu.

Remote command:

[CALCulate<n>:MARKer<m>:FUNction:POWer:SElect](#) on page 707

[CALCulate<n>:MARKer<m>:FUNction:POWer:RESult?](#) on page 704

[CALCulate<n>:MARKer<m>:FUNction:POWer\[:STATe\]](#) on page 708

C/No ← C/N, C/No

Switches the measurement of the carrier/noise ratio with reference to a 1 Hz bandwidth on or off. If no marker is active, marker 1 is activated.

The measurement is performed on the trace that marker 1 is assigned to. To shift marker 1 and measure another trace, use the [Marker to Trace](#) softkey in the "Marker To" menu.

Remote command:

[CALCulate<n>:MARKer<m>:FUNction:POWer:SElect](#) on page 707

[CALCulate<n>:MARKer<m>:FUNction:POWer:RESult?](#) on page 704

[CALCulate<n>:MARKer<m>:FUNction:POWer\[:STATe\]](#) on page 708

Channel Bandwidth ← C/N, C/No

Opens an edit dialog box to enter the measurement channel bandwidth for each channel.

The default setting is 14 kHz.

Note that in the I/Q Analyzer the channel bandwidth does not change the measurement span or sampling rate; it merely defines the range for the carrier-to-noise analysis.

Remote command:

[SENSe:]POWER:ACHannel:ACPairs on page 845

Adjust Settings ← C/N, C/No

Enables the RMS detector (see also [Chapter 5.2.8.6, "Detector Overview"](#), on page 234) and adjusts the span to the selected channel bandwidth according to:

"4 x channel bandwidth + measurement margin"

The adjustment is performed once; if necessary, the setting can be changed later on.

Note: in the I/Q Analyzer, this function is not available. The channel bandwidth defines the range for the carrier-to-noise analysis.

Remote command:

[SENSe:]POWER:ACHannel:PRESet on page 850

5.3.5.4 Measuring the Occupied Bandwidth

An important characteristic of a modulated signal is its occupied bandwidth. In a radio communications system for instance the occupied bandwidth must be limited to enable distortion-free transmission in adjacent channels. The occupied bandwidth is defined as the bandwidth containing a defined percentage of the total transmitted power. A percentage between 10 % and 99.9 % can be set.

The measurement principle is the following: The bandwidth containing 99% of the signal power is to be determined, for example. The routine first calculates the total power of all displayed points of the trace. In the next step, the points from the right edge of the trace are summed up until 0.5 % of the total power is reached. Auxiliary marker 1 is positioned at the corresponding frequency. Then the points from the left edge of the trace are summed up until 0.5 % of the power is reached. Auxiliary marker 2 is positioned at this point. 99 % of the power is now between the two markers. The distance between the two frequency markers is the occupied bandwidth which is displayed in the marker field.



New: OBW now also possible within defined search limits - multi-carrier OBW measurement in one sweep

As of R&S FSVA/FSV firmware version 1.71, the occupied bandwidth of the signal can be determined within defined search limits instead of for the entire signal. Thus, only a single sweep is required to determine the OBW for a multi-carrier signal. To do so, search limits are defined for an individual carrier and the OBW measurement is restricted to the frequency range contained within those limits. Then the search limits are adapted for the next carrier and the OBW is automatically re-calculated for the new range.

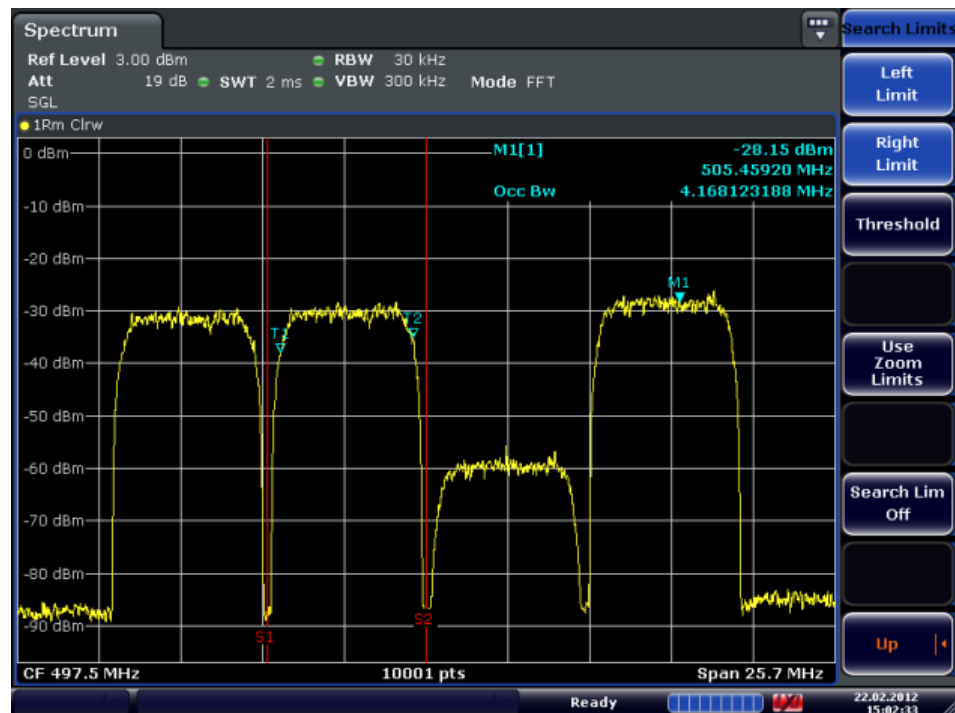

The OBW measurement uses the same search limits as defined for marker search (see "Search Limits" on page 273). However, only the left and right limits are considered.

To ensure correct power measurement, especially for noise signals, and to obtain the correct occupied bandwidth, the following prerequisites and settings are necessary:

- Only the signal to be measured is displayed on the screen. An additional signal would falsify the measurement.
- $RBW \ll$ occupied bandwidth
(approx. $1/20$ of occupied bandwidth, for voice communication type 300 Hz or 1 kHz)
- $VBW \geq 3 \times RBW$
- RMS detector
- $Span \geq 2$ to $3 \times$ occupied bandwidth

Some of the measurement specifications (e.g. PDC, RCR STD-27B) require measurement of the occupied bandwidth using a peak detector. The detector setting of the R&S FSVA/FSV has to be changed accordingly then.



A remote control programming example is described in [Chapter 6.4.5, "Occupied Bandwidth Measurement"](#), on page 1028.

To determine the occupied bandwidth

1. Press the **OBW** softkey to activate the measurement of the occupied bandwidth. The corresponding submenu is displayed.
2. Press the "% Power Bandwidth" softkey to enter the percentage of power (see "[% Power Bandwidth \(span > 0\)](#)" on page 314).
3. To change the channel bandwidth for the transmission channel, press the "Channel Bandwidth" softkey (see "[Channel Bandwidth \(span > 0\)](#)" on page 314).
4. To optimize the settings for the selected channel configuration, press the **Adjust Settings** softkey. For details see also "[Optimized Settings for CP/ACLR Test Parameters](#)" on page 306.
5. To adjust the reference level to the measured total power after the first sweep, press the **Adjust Ref Lvl** softkey.

Measurement results

As a result of the OBW measurement the occupied bandwidth ("Occ BW") is indicated in the marker results. Furthermore, the marker at the center frequency and the temporary markers are indicated.



The OBW calculation is repeated if the [Search Limits](#) are changed, without performing a new sweep. Thus, the OBW for a multi-carrier signal can be determined using only one sweep.

The determined occupied bandwidth can also be queried using the remote command `CALC:MARK:FUNC:POW:RES? OBW` or `CALC:MARK:FUNC:POW:RES? AOBW`. While the `OBW` parameter returns only the occupied bandwidth, the `AOBW` parameter also returns the position and level of the temporary markers T1 and T2 used to calculate the occupied bandwidth.

Softkeys for Occupied Bandwidth (OBW) Measurements

OBW	314
L % Power Bandwidth (span > 0).....	314
L Channel Bandwidth (span > 0).....	314
L Adjust Ref Lvl (span > 0).....	314
L Adjust Settings.....	315

OBW

Activates measurement of the occupied bandwidth according to the current configuration and opens a submenu to configure the measurement. The occupied bandwidth is displayed in the marker display field and marked on the trace by temporary markers. For details see [Chapter 5.3.5.4, "Measuring the Occupied Bandwidth"](#), on page 311.

This measurement is not available in zero span.

The measurement is performed on the trace with marker 1. In order to evaluate another trace, marker 1 must be placed on another trace (see the [Marker to Trace](#) softkey in the "Marker" menu).

Remote command:

[CALCulate<n>:MARKer<m>:FUNCTION:POWER:SElect](#) on page 707

[CALCulate<n>:MARKer<m>:FUNCTION:POWER:RESult?](#) on page 704

[CALCulate<n>:MARKer<m>:FUNCTION:POWER\[:STATe\]](#) on page 708

% Power Bandwidth (span > 0) ← OBW

Opens an edit dialog box to enter the percentage of total power in the displayed frequency range which defines the occupied bandwidth. Values from 10% to 99.9% are allowed.

Remote command:

[\[SENSe:\] POWER: BANDwidth| BWIDth](#) on page 854

Channel Bandwidth (span > 0) ← OBW

Opens an edit dialog box to enter the channel bandwidth for the transmission channel. The specified channel bandwidth is used for optimization of the test parameters (for details see ["Optimized Settings for CP/ACLR Test Parameters"](#) on page 306). The default setting is 14 kHz.

For measurements in line with a specific transmission standard, the bandwidth specified by the standard for the transmission channel must be entered.

Remote command:

[\[SENSe:\] POWER: ACHannel: BANDwidth| BWIDth\[:CHANnel<channel>\]](#)
on page 846

Adjust Ref Lvl (span > 0) ← OBW

Adjusts the reference level to the measured total power of the signal. the softkey is activated after the first sweep with active measurement of the occupied bandwidth has been completed and the total power of the signal is thus known.

Adjusting the reference level ensures that the signal path will not be overloaded and the dynamic range not limited by too low a reference level. Since the measurement bandwidth for channel power measurements is significantly lower than the signal bandwidth, the signal path may be overloaded although the trace is distinctly below the reference level. If the measured channel power is equal to the reference level, the signal path cannot be overloaded.

Remote command:

[\[SENSe:\] POWER: ACHannel: PRESet: RLEVEL](#) on page 851

Adjust Settings ← OBW

Automatically optimizes all instrument settings for the selected channel configuration (channel bandwidth, channel spacing) within a specific frequency range (channel bandwidth). The adjustment is carried out only once. If necessary, the instrument settings can be changed later.

For details on the settings of span, resolution bandwidth, video bandwidth, detector and trace averaging see "[Optimized Settings for CP/ACLR Test Parameters](#)" on page 306.

Remote command:

[SENSe:]POWER:ACHannel:PRESet on page 850

5.3.5.5 Measuring with Spectrum Emission Masks

The Spectrum Emission Mask (SEM) measurement defines a measurement that monitors compliance with a spectral mask. The SEM measurement is used to measure the excess emissions of a TX channel that would interfere to other channels or to other systems.

The SEM measurement of the base unit allows a flexible definition of all parameters in the SEM measurement. It is performed using the [Spectrum Emission Mask](#) softkey in the "Measurement" menu. Most parameters are defined in the "Sweep List" dialog box (see "[Sweep List dialog box](#)" on page 318). After a preset, the sweep list contains a set of default ranges and parameters. For each range, you can change the parameters. For information on other SEM settings, see the description of the corresponding softkeys ("[Spectrum Emission Mask](#)" on page 317).

If you want a parameter set to be available permanently, you can create an XML file for this configuration and, if necessary, export this file to another application (for details refer to "[Format Description of Spectrum Emission Mask XML Files](#)" on page 335 and "[ASCII File Export Format \(Spectrum Emission Mask\)](#)" on page 340).

Some predefined XML files are provided that contain ranges and parameters according to the selected standard (see "[Provided XML Files for the Spectrum Emission Mask Measurement](#)" on page 332).

In order to improve the performance of the R&S FSVA/FSV for spectrum emission mask measurements, a "Fast SEM" mode is available. For details see "[Fast Spectrum Emission Mask Measurements](#)" on page 341.

Monitoring compliance of the spectrum is supported by a special limit check for SEM measurements, see "[Working with Limit Lines in SEM Measurements](#)" on page 330.



A remote control programming example is described in [Chapter 6.4.12, "Spectrum Emission Mask Measurement"](#), on page 1039.

Softkeys for Spectrum Emission Mask (SEM) Measurements.....	316
Result Evaluation.....	327
Ranges and Range Settings.....	329
Working with Limit Lines in SEM Measurements.....	330

Provided XML Files for the Spectrum Emission Mask Measurement.....	332
Format Description of Spectrum Emission Mask XML Files.....	335
ASCII File Export Format (Spectrum Emission Mask).....	340
Fast Spectrum Emission Mask Measurements.....	341

Softkeys for Spectrum Emission Mask (SEM) Measurements

Spectrum Emission Mask.....	317
L Sweep List.....	317
L Sweep List dialog box.....	318
L Range Start / Range Stop.....	318
L Fast SEM.....	318
L Filter Type.....	318
L RBW.....	319
L VBW.....	319
L Sweep Time Mode.....	319
L Sweep Time.....	319
L Ref. Level.....	319
L RF Att. Mode.....	319
L RF Attenuator.....	319
L Preamp.....	319
L Transd. Factor.....	320
L Limit Check 1-4.....	320
L Abs Limit Start.....	320
L Abs Limit Stop.....	320
L Rel Limit Start.....	321
L Rel Limit Stop.....	321
L Close Sweep List.....	321
L Insert before Range.....	321
L Insert after Range.....	321
L Delete Range.....	321
L Symmetric Setup.....	322
L Edit Reference Range.....	322
L List Evaluation.....	323
L List Evaluation (On/Off).....	323
L Margin.....	323
L Show Peaks.....	323
L Save Evaluation List.....	323
L ASCII File Export.....	323
L Decim Sep.....	324
L Edit Reference Range.....	324
L Edit Power Classes.....	325
L Used Power Classes.....	325
L PMin/PMax.....	326
L Sweep List.....	326
L Add/Remove.....	326
L Load Standard.....	326

- L Save As Standard..... 326
- L Meas Start/Stop..... 326
- L Restore Standard Files..... 327

Spectrum Emission Mask

Opens a submenu to configure the Spectrum Emission Mask measurement.

The Spectrum Emission Mask (SEM) measurement defines a measurement that monitors compliance with a spectral mask. The SEM measurement of the base unit allows a flexible definition of all parameters in the SEM measurement.

For general information on performing SEM measurements, see [Chapter 5.3.5.5, "Measuring with Spectrum Emission Masks"](#), on page 315.

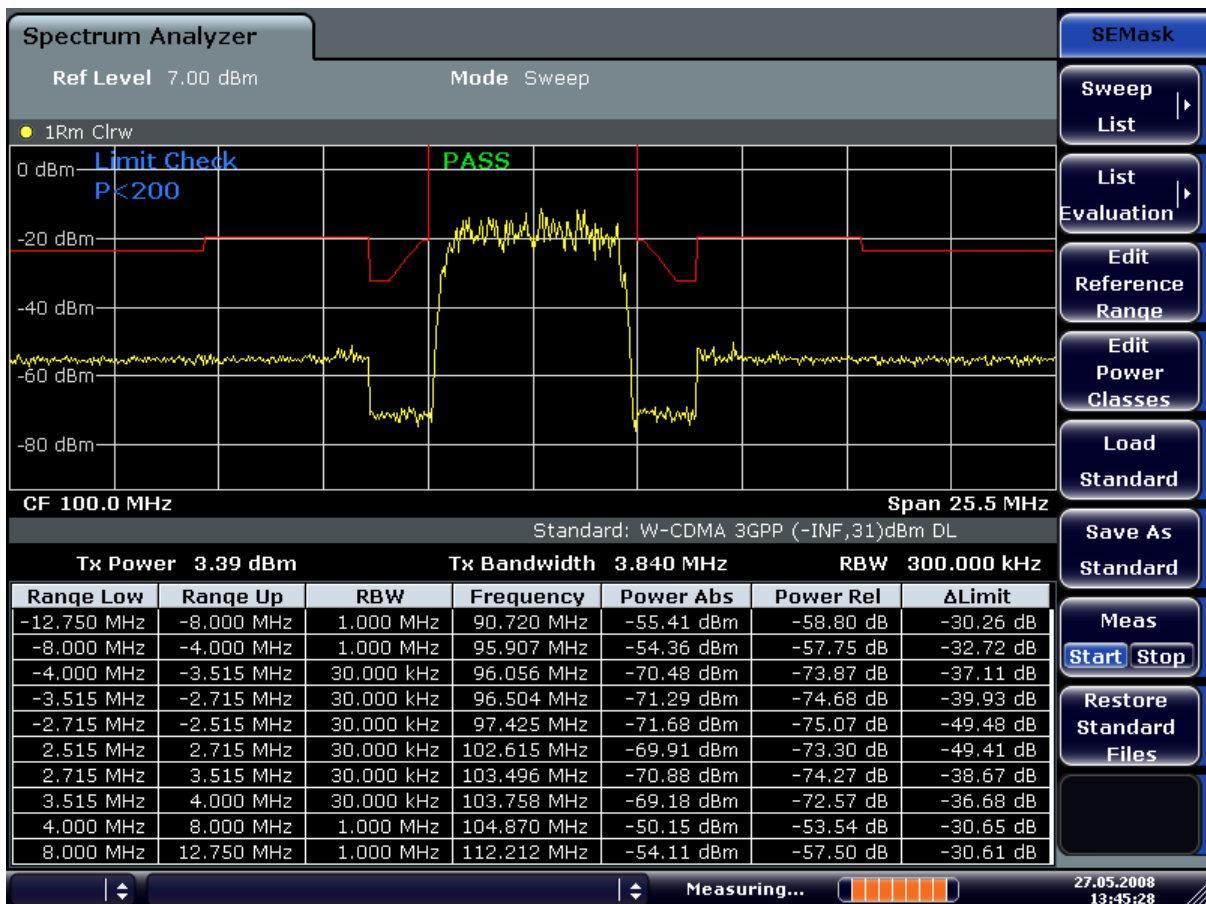

Remote command:

SENS : SWE : MODE ESP, see [SENSe :] SWEep : MODE on page 861

Sweep List ← Spectrum Emission Mask

Opens a submenu to edit the sweep list and displays the "Sweep List" dialog box.

Sweep List dialog box ← Sweep List ← Spectrum Emission Mask

After a preset, the sweep list contains a set of default ranges and parameters. For each range, you can change the parameters listed below. To insert or delete ranges, use the "Insert Before Range", "Insert After Range", "Delete Range" softkeys. The measurement results are not updated during editing but on closing the dialog box ("Edit Sweep List/ Close Sweep List" softkey, see ["Close Sweep List"](#) on page 321).

The changes of the sweep list are only kept until you load another parameter set (by pressing PRESET or by loading an XML file). If you want a parameter set to be available permanently, create an XML file for this configuration (for details refer to ["Format Description of Spectrum Emission Mask XML Files"](#) on page 335).

If you load one of the provided XML files ("Load Standard" softkey, see ["Load Standard"](#) on page 326), the sweep list contains ranges and parameters according to the selected standard. For further details refer also to ["Provided XML Files for the Spectrum Emission Mask Measurement"](#) on page 332.

Note: If you edit the sweep list, always follow the rules and consider the limitations described in ["Ranges and Range Settings"](#) on page 329.

Range Start / Range Stop ← Sweep List dialog box ← Sweep List ← Spectrum Emission Mask

Sets the start frequency/stop frequency of the selected range. Follow the rules described in ["Ranges and Range Settings"](#) on page 329.

In order to change the start/stop frequency of the first/last range, select the appropriate span with the SPAN key. If you set a span that is smaller than the overall span of the ranges, the measurement includes only the ranges that lie within the defined span and have a minimum span of 20 Hz. The first and last ranges are adapted to the given span as long as the minimum span of 20 Hz is not violated.

Frequency values for each range have to be defined relative to the center frequency. The reference range has to be centered on the center frequency. The minimum span of the reference range is given by the current TX Bandwidth.

Remote command:

`[SENSe:]ESpectrum:RANGe<range>[:FREQuency]:START` on page 802

`[SENSe:]ESpectrum:RANGe<range>[:FREQuency]:STOP` on page 802

Fast SEM ← Sweep List dialog box ← Sweep List ← Spectrum Emission Mask

Activates "Fast SEM" mode for all ranges in the sweep list. For details see ["Fast Spectrum Emission Mask Measurements"](#) on page 341.

Note: If "Fast SEM" mode is deactivated while [Symmetric Setup](#) mode is on, "Symmetrical Setup" mode is automatically also deactivated.

If "Fast SEM" mode is activated while "Symmetrical Setup" mode is on, not all range settings can be set automatically.

Remote command:

`[SENSe:]ESpectrum:HighSPeed` on page 798

Filter Type ← Sweep List dialog box ← Sweep List ← Spectrum Emission Mask

Sets the filter type for this range. For details on filters see also [Chapter 5.2.6.3, "Selecting the Appropriate Filter Type"](#), on page 211.

Remote command:

[SENSe:]ESpectrum:RANGe<range>:FILTer:TYPE on page 801

RBW ← Sweep List dialog box ← Sweep List ← Spectrum Emission Mask

Sets the RBW value for this range.

Remote command:

[SENSe:]ESpectrum:RANGe<range>:BANDwidth[:RESolution] on page 800

VBW ← Sweep List dialog box ← Sweep List ← Spectrum Emission Mask

Sets the VBW value for this range.

Remote command:

[SENSe:]ESpectrum:RANGe<range>:BANDwidth:VIDeo on page 800

Sweep Time Mode ← Sweep List dialog box ← Sweep List ← Spectrum Emission Mask

Activates or deactivates the auto mode for the sweep time.

Remote command:

[SENSe:]ESpectrum:RANGe<range>:SWEep:TIME:AUTO on page 807

Sweep Time ← Sweep List dialog box ← Sweep List ← Spectrum Emission Mask

Sets the sweep time value for the range.

Remote command:

[SENSe:]ESpectrum:RANGe<range>:SWEep:TIME on page 807

Ref. Level ← Sweep List dialog box ← Sweep List ← Spectrum Emission Mask

Sets the reference level for the range.

Remote command:

[SENSe:]ESpectrum:RANGe<range>:RLEVEL on page 806

RF Att. Mode ← Sweep List dialog box ← Sweep List ← Spectrum Emission Mask

Activates or deactivates the auto mode for RF attenuation.

Remote command:

[SENSe:]ESpectrum:RANGe<range>:INPut:ATTenuation:AUTO on page 803

RF Attenuator ← Sweep List dialog box ← Sweep List ← Spectrum Emission Mask

Sets the attenuation value for that range.

Remote command:

[SENSe:]ESpectrum:RANGe<range>:INPut:ATTenuation on page 803

Preamp ← Sweep List dialog box ← Sweep List ← Spectrum Emission Mask

Switches the preamplifier on or off.

Remote command:

[SENSe:]ESpectrum:RANGe<range>:INPut:GAIN:STATe on page 803

Transd. Factor ← Sweep List dialog box ← Sweep List ← Spectrum Emission Mask

Sets a transducer for the specified range. You can only choose a transducer that fulfills the following conditions:

- The transducer overlaps or equals the span of the range.
- The x-axis is linear.
- The unit is dB.

Remote command:

[SENSe:]ESpectrum:RANGe<range>:TRANsducer on page 807

Limit Check 1-4 ← Sweep List dialog box ← Sweep List ← Spectrum Emission Mask

Sets the type of limit check for all ranges.

For details on limit checks see "[Working with Limit Lines in SEM Measurements](#)" on page 330.

For details on limit checks see the base unit description "Working with Lines in SEM".

The limit state affects the availability of all limit settings ("[Abs Limit Start](#)" on page 320, "[Abs Limit Stop](#)" on page 320, "[Rel Limit Start](#)" on page 321, "[Rel Limit Stop](#)" on page 321).

Depending on the number of active power classes (see "Power Class" dialog box), the number of limits that can be set varies. Up to four limits are possible. The sweep list is extended accordingly.

Remote command:

[SENSe:]ESpectrum:RANGe<range>:LIMit<source>:STATe on page 806

CALCulate<n>:LIMit<k>:FAIL? on page 642

Abs Limit Start ← Sweep List dialog box ← Sweep List ← Spectrum Emission Mask

Sets an absolute limit value at the start frequency of the range [dBm].

This parameter is only available if the limit check is set accordingly (see "[Limit Check 1-4](#)" on page 320).

Remote command:

[SENSe:]ESpectrum:RANGe<range>:LIMit<source>:ABSolute:START

on page 804

Abs Limit Stop ← Sweep List dialog box ← Sweep List ← Spectrum Emission Mask

Sets an absolute limit value at the stop frequency of the range [dBm].

This parameter is only available if the limit check is set accordingly (see "[Limit Check 1-4](#)" on page 320).

Remote command:

[SENSe:]ESpectrum:RANGe<range>:LIMit<source>:ABSolute:STOP

on page 805

Rel Limit Start ← Sweep List dialog box ← Sweep List ← Spectrum Emission Mask

Sets a relative limit value at the start frequency of the range [dBc].

This parameter is only available if the limit check is set accordingly (see ["Limit Check 1-4"](#) on page 320).

Remote command:

`[SENSe:]ESpectrum:RANGe<range>:LIMit<source>:RELative:START`
on page 805

Rel Limit Stop ← Sweep List dialog box ← Sweep List ← Spectrum Emission Mask

Sets a relative limit value at the stop frequency of the range [dBc].

This parameter is only available if the limit check is set accordingly (see ["Sweep List dialog box"](#) on page 318).

Remote command:

`[SENSe:]ESpectrum:RANGe<range>:LIMit<source>:RELative:STOP`
on page 805

Close Sweep List ← Sweep List ← Spectrum Emission Mask

Closes the "Sweep List" dialog box and updates the measurement results.

Insert before Range ← Sweep List ← Spectrum Emission Mask

Inserts a new range to the left of the currently focused range. The range numbers of the currently focused range and all higher ranges are increased accordingly. The maximum number of ranges is 20.

For further details refer to ["Ranges and Range Settings"](#) on page 329.

Remote command:

`ESP:RANG3:INS BEF`, see `[SENSe:]ESpectrum:RANGe<range>:INSert`
on page 804

Insert after Range ← Sweep List ← Spectrum Emission Mask

Inserts a new range to the right of the currently focused range. The range numbers of all higher ranges are increased accordingly. The maximum number of ranges is 20.

For further details refer to ["Ranges and Range Settings"](#) on page 329.

Remote command:

`ESP:RANG1:INS AFT`, see `[SENSe:]ESpectrum:RANGe<range>:INSert`
on page 804

Delete Range ← Sweep List ← Spectrum Emission Mask

Deletes the currently focused range, if possible. The range numbers are updated accordingly. For further details refer to ["Ranges and Range Settings"](#) on page 329.

Remote command:

`[SENSe:]ESpectrum:RANGe<range>:DELete` on page 801

Symmetric Setup ← Sweep List ← Spectrum Emission Mask

If activated, the current sweep list configuration is changed to define a symmetrical setup regarding the reference range. The number of ranges to the left of the reference range is reflected to the right, i.e. any missing ranges on the right are inserted, while superfluous ranges are removed. The values in the ranges to the right of the reference range are adapted symmetrically to those in the left ranges.

Any changes to the range settings in active "Symmetric Setup" mode lead to symmetrical changes in the other ranges (where possible). In particular, this means:

- Inserting ranges: a symmetrical range is inserted on the other side of the reference range
- Deleting ranges: the symmetrical range on the other side of the reference range is also deleted
- Editing range settings: the settings in the symmetrical range are adapted accordingly

Note: If "Fast SEM" mode is deactivated while "Symmetric Setup" mode is on, "Sym Setup" mode is automatically also deactivated.

If "Fast SEM" mode is activated while "Symmetric Setup" mode is on, not all range settings can be set automatically.

Edit Reference Range ← Sweep List ← Spectrum Emission Mask

Opens the "Reference Range" dialog box to edit the additional settings used for SEM measurements.

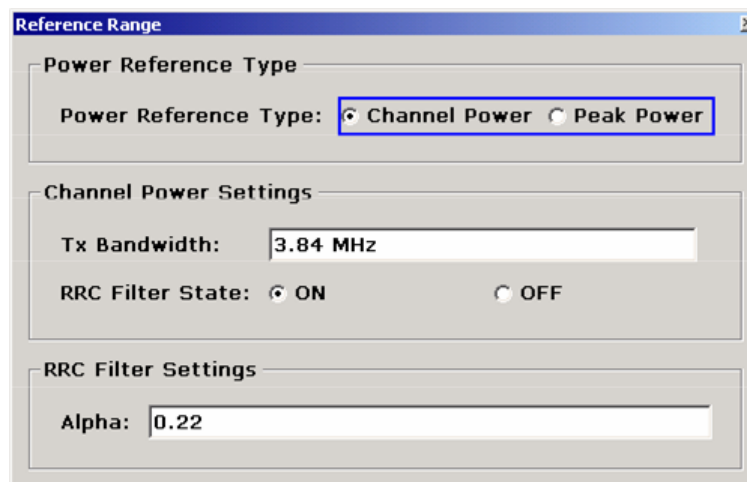

Two different power reference types are supported:

- "Peak Power"
Measures the highest peak within the reference range.
- "Channel Power"
Measures the channel power within the reference range (integral bandwidth method).
If the "Channel Power" reference power type is activated, the dialog box is extended to define additional settings:
- "Tx Bandwidth"
Defines the bandwidth used for measuring the channel power:
minimum span ≤ value ≤ span of reference range

- "RRC Filter State"
Activates or deactivates the use of an RRC filter.
- "RRC Filter Settings"
Sets the alpha value of the RRC filter. This window is only available if the RRC filter is activated.

For further details refer to "[Ranges and Range Settings](#)" on page 329.

Remote command:

[\[SENSe:\]ESpectrum:RTYPe](#) on page 808

[\[SENSe:\]ESpectrum:BWID](#) on page 797

[\[SENSe:\]ESpectrum:FILTer\[:RRC\]\[:STATe\]](#) on page 798

[\[SENSe:\]ESpectrum:FILTer\[:RRC\]:ALPHa](#) on page 798

List Evaluation ← Spectrum Emission Mask

Opens a submenu to edit the list evaluation settings.

List Evaluation (On/Off) ← List Evaluation ← Spectrum Emission Mask

Activates or deactivates the list evaluation.

Remote command:

Turning list evaluation on and off:

[CALCulate<n>:PEAKsearch|PSEarch:AUTO](#) on page 735

Querying list evaluation results:

[TRACe<n>\[:DATA\]?](#) on page 890

Margin ← List Evaluation ← Spectrum Emission Mask

Opens an edit dialog box to enter the margin used for the limit check/peak search.

Remote command:

[CALCulate<n>:PEAKsearch|PSEarch:MARGIN](#) on page 735

Show Peaks ← List Evaluation ← Spectrum Emission Mask

In the diagram, marks all peaks with blue squares that have been listed during an active list evaluation.

Remote command:

[CALCulate<n>:ESpectrum:PSEarch|:PEAKsearch:PSHow](#) on page 638

Save Evaluation List ← List Evaluation ← Spectrum Emission Mask

Opens the "ASCII File Export Name" dialog box to save the result in ASCII format to a specified file and directory. For further details refer also to the "ASCII File Export" soft-key ("[ASCII File Export](#)" on page 264).

Remote command:

[MMEMory:STORe<n>:LIST](#) on page 774

ASCII File Export ← Save Evaluation List ← List Evaluation ← Spectrum Emission Mask

Opens the "ASCII File Export Name" dialog box and saves the active peak list in ASCII format to the specified file and directory.

The file consists of the header containing important scaling parameters and a data section containing the marker data. For details on an ASCII file see [Chapter 5.2.8.7, "ASCII File Export Format"](#), on page 235.

This format can be processed by spreadsheet calculation programs, e.g. MS-Excel. It is necessary to define ';' as a separator for the data import. Different language versions of evaluation programs may require a different handling of the decimal point. It is therefore possible to select between separators '.' (decimal point) and ',' (comma) using the "Decim Sep" softkey (see ["Decim Sep"](#) on page 168).

An example of an output file for Spectrum Emission Mask measurements is given in ["ASCII File Export Format \(Spectrum Emission Mask\)"](#) on page 340.

Remote command:

`FORMat:DEXPort:DSEParator` on page 759

`MMEMory:STORE<n>:LIST` on page 774

Decim Sep ← Save Evaluation List ← List Evaluation ← Spectrum Emission Mask

Selects the decimal separator with floating-point numerals for the ASCII Trace export to support evaluation programs (e.g. MS-Excel) in different languages. The values '.' (decimal point) and ',' (comma) can be set.

Remote command:

`FORMat:DEXPort:DSEParator` on page 759

Edit Reference Range ← Spectrum Emission Mask

Opens the "Reference Range" dialog box to edit the additional settings used for SEM measurements.

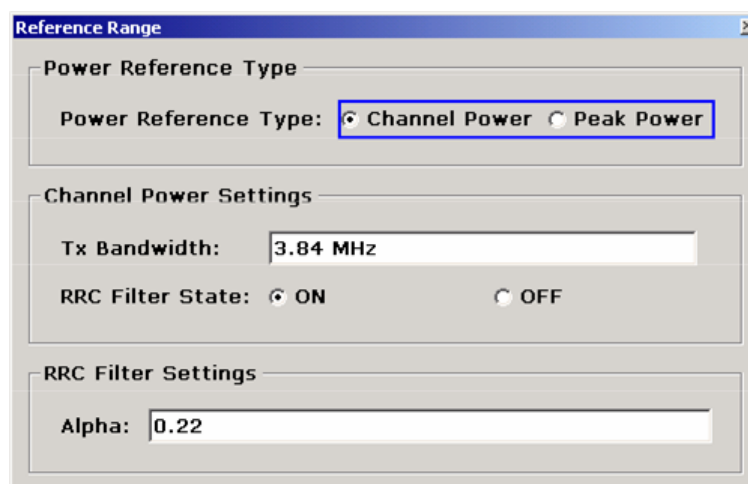

Two different power reference types are supported:

- "Peak Power"
Measures the highest peak within the reference range.
- "Channel Power"
Measures the channel power within the reference range (integral bandwidth method).
If the "Channel Power" reference power type is activated, the dialog box is extended to define additional settings:

- "Tx Bandwidth"
Defines the bandwidth used for measuring the channel power:
minimum span \leq value \leq span of reference range
- "RRC Filter State"
Activates or deactivates the use of an RRC filter.
- "RRC Filter Settings"
Sets the alpha value of the RRC filter. This window is only available if the RRC filter is activated.

For further details refer to "[Ranges and Range Settings](#)" on page 329.

Remote command:

[SENSe:]ESpectrum:RTYPE on page 808

[SENSe:]ESpectrum:BWID on page 797

[SENSe:]ESpectrum:FILTer[:RRC][:STATe] on page 798

[SENSe:]ESpectrum:FILTer[:RRC]:ALPHA on page 798

Edit Power Classes ← Spectrum Emission Mask

Opens a dialog box to modify the power class settings.

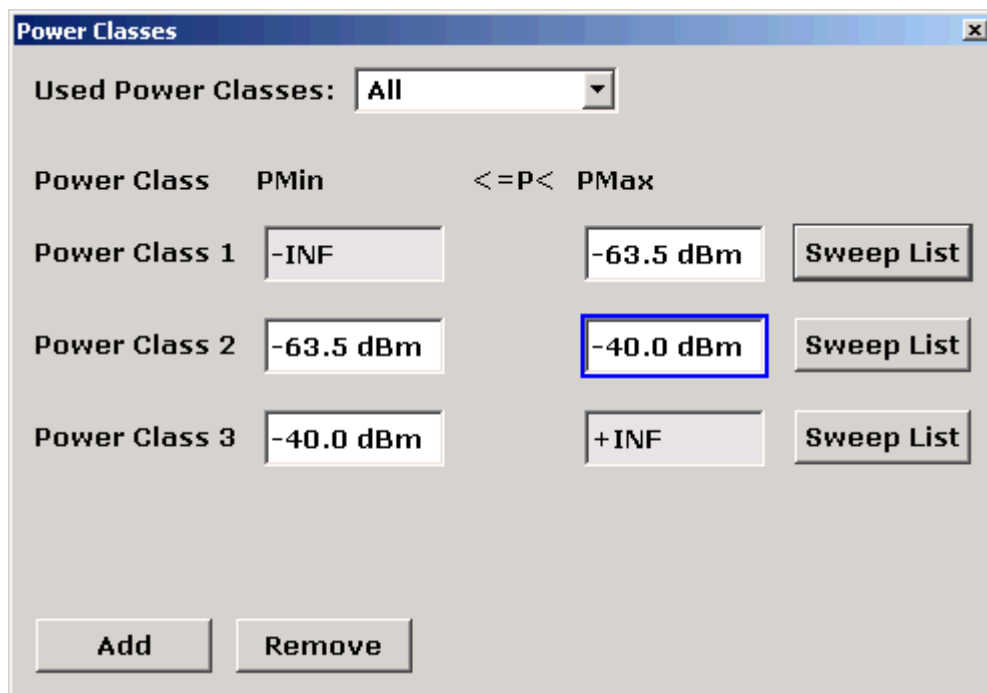

Used Power Classes ← Edit Power Classes ← Spectrum Emission Mask

Choose the power classes to be used from this dropdown menu. It is only possible to select either one of the defined power classes or all of the defined power classes together.

Only power classes for which limits are defined are available for selection.

If "All" is selected, the power class that corresponds to the currently measured power in the reference range is used. The limits assigned to that power class are applied (see "[PMin/PMax](#)" on page 326).

Remote command:

`CALCulate<n>:LIMit<k>:ESpectrum:PClass<Class>[:EXCLusive]`

on page 657

To define all limits in one step:

`CALCulate<n>:LIMit<k>:ESpectrum:PClass<Class>:LIMit[:STATe]`

on page 658

PMin/PMax ← Edit Power Classes ← Spectrum Emission Mask

Defines the level limits for each power class. The range always starts at -200 dBm (-INF) and always stops at 200 dBm (+INF). These fields cannot be modified. If more than one Power Class is defined, the value of "PMin" must be equal to the value of "PMax" of the last Power Class and vice versa.

Note that the power level may be equal to the lower limit, but must be lower than the upper limit:

$$P_{\min} \leq P < P_{\max}$$

Remote command:

`CALCulate<n>:LIMit<k>:ESpectrum:PClass<Class>:MINimum` on page 659

`CALCulate<n>:LIMit<k>:ESpectrum:PClass<Class>:MAXimum` on page 658

Sweep List ← Edit Power Classes ← Spectrum Emission Mask

See "[Sweep List](#)" on page 317

Add/Remove ← Edit Power Classes ← Spectrum Emission Mask

Activates or deactivates power classes to be defined. Up to four power classes can be defined. The number of active power classes affects the availability of the items of the Used Power Classes dropdown menu.

Remote command:

`CALCulate<n>:LIMit<k>:ESpectrum:PClass<Class>[:EXCLusive]`

on page 657

Load Standard ← Spectrum Emission Mask

Opens a dialog box to select an XML file which includes the desired standard specification. For details on the provided XML files refer to "[Provided XML Files for the Spectrum Emission Mask Measurement](#)" on page 332.

Remote command:

`[SENSe:]ESpectrum:PRESet[:STANdard]` on page 799

Save As Standard ← Spectrum Emission Mask

Opens the "Save As Standard" dialog box, in which the currently used SEM settings and parameters can be saved and exported into an *.xml file. Enter the name of the file in the "File name" field. For details on the structure and contents of the XML file refer to "[Format Description of Spectrum Emission Mask XML Files](#)" on page 335.

Remote command:

`[SENSe:]ESpectrum:PRESet:STORe` on page 800

Meas Start/Stop ← Spectrum Emission Mask

Aborts/restarts the current measurement and displays the status:

- "Start" The measurement is currently running.
- "Stop" The measurement has been stopped, or, in single sweep mode, the end of the sweep has been reached.

Remote command:

[ABORt](#) on page 616

[INITiate<n>:ESpectrum](#) on page 762

Restore Standard Files ← Spectrum Emission Mask

Copies the XML files from the C:\R_S\instr\sem_backup folder to the C:\R_S\instr\sem_std folder. Files of the same name are overwritten.

Remote command:

[\[SENSe:\]ESpectrum:PRESet:REStore](#) on page 799

Result Evaluation

As a result of the Spectrum Emission Mask measurement, the measured signal levels, the result of the limit check (mask monitoring) and the defined limit line are displayed in a diagram (see also ["Working with Limit Lines in SEM Measurements"](#) on page 330). Furthermore, the TX channel power "P" is indicated in relation to the defined power class ranges.

Example:

For example, "P<31" is indicated if the lowest power class is defined from infinity to 31 and the power is currently 17 dBm.

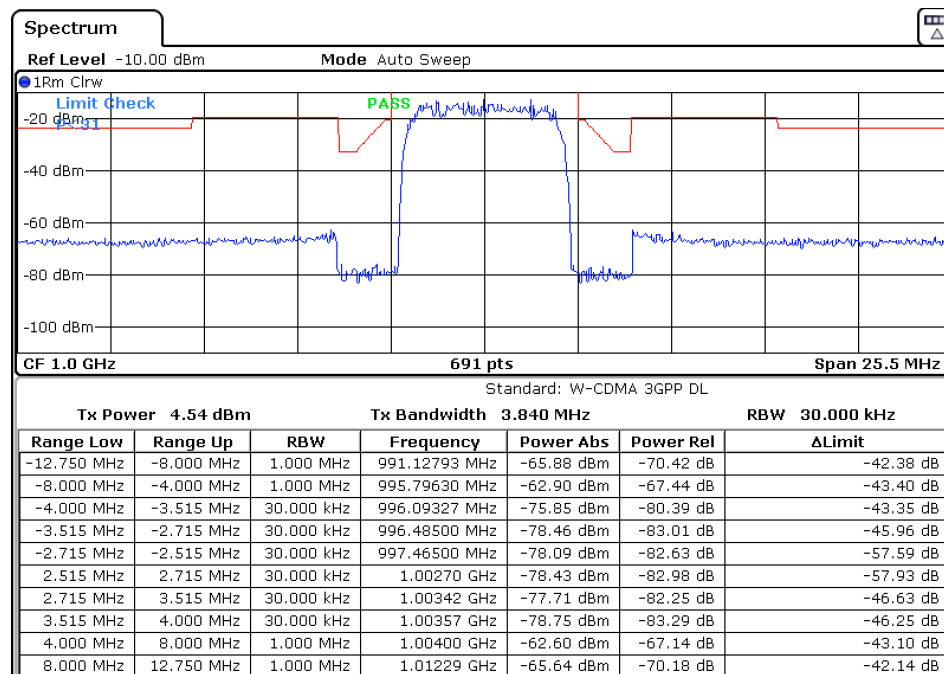

In addition to the graphical results of the SEM measurement displayed in the diagram, a result table is displayed to evaluate the limit check results (see also ["Working with Limit Lines in SEM Measurements"](#) on page 330).

The following information is provided in the result table:

Label	Description
General Information	
Standard	Loaded standard settings
Tx Power	Tx channel power
Tx Bandwidth	Tx channel bandwidth
RBW	RBW for the Tx channel
Range results	
Range Low	Frequency range start for range the peak value belongs to
Range Up	Frequency range stop for range the peak value belongs to
RBW	RBW of the range
Frequency	Frequency
Power Abs	Absolute power level
Power Rel	Power level relative to the TX channel power
Δ Limit	Deviation of the power level from the defined limit

In which detail the data is displayed in the result table can be defined in the [List Evaluation](#) menu. By default, one peak per range is displayed. However, you can change the settings to display only peaks that exceed a threshold ("Margin").

In addition to listing the peaks in the list evaluation, detected peaks can be indicated by blue squares in the diagram ("Show Peaks").

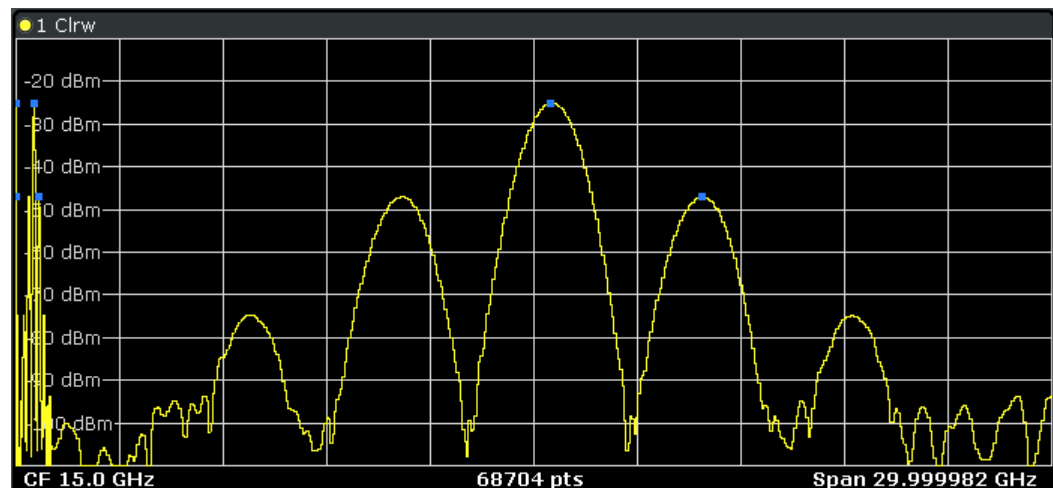

Furthermore, you can save the evaluation list to a file ("Save Evaluation List").

Retrieving Results via Remote Control

The measurement results of the spectrum emission mask test can be retrieved using the `CALCulate<n>:LIMit<k>:FAIL?` command from a remote computer.

The power result for the reference range can be queried using

`CALC:MARK:FUNC:POW:RES? CPOW`, the peak power for the reference range using
`CALC:MARK:FUNC:POW:RES? PPOW`.

For details see [CALCulate<n>:MARKer<m>:FUNction:POWer:RESult?](#)
on page 704.

Ranges and Range Settings

In the Spectrum Emission Mask measurements, a range defines a segment for which you can define the following parameters separately:

- Start and stop frequency
- RBW
- VBW
- Sweep time
- Sweep points
- Reference level
- Attenuator settings
- Limit values

Via the sweep list, you define the ranges and their settings. For details on settings refer to "[Sweep List dialog box](#)" on page 318.

For details on defining the limits (masks) see "[Working with Limit Lines in SEM Measurements](#)" on page 330.

For details on defining the limits (masks) see the base unit description "[Working with Lines in SEM](#)".

The following rules apply to ranges:

- The minimum span of a range is 20 Hz.
- The individual ranges must not overlap (but need not directly follow one another).
- The maximum number of ranges is 20.
- A minimum of three ranges is mandatory.
- The reference range cannot be deleted (it is marked in blue color).
- The reference range has to be centered on the center frequency.
- The minimum span of the reference range is given by the current TX Bandwidth.
- Frequency values for each range have to be defined relative to the center frequency.

In order to change the start frequency of the first range or the stop frequency of the last range, select the appropriate span with the [SPAN] key. If you set a span that is smaller than the overall span of the ranges, the measurement includes only the ranges that lie within the defined span and have a minimum span of 20 Hz. The first and last ranges are adapted to the given span as long as the minimum span of 20 Hz is not violated.



Symmetrical ranges

You can easily define a sweep list with symmetrical range settings, i.e. the ranges to the left and right of the center range are defined symmetrically. In the "Sweep List" menu, select the "Symmetrical Setup" softkey to activate symmetrical setup mode. The current sweep list configuration is changed to define a symmetrical setup regarding the reference range. The number of ranges to the left of the reference range is reflected to the right, i.e. any missing ranges on the right are inserted, while superfluous ranges are removed. The values in the ranges to the right of the reference range are adapted symmetrically to those in the left ranges.

For details see ["Symmetric Setup"](#) on page 322.

Symmetrical ranges fulfill the conditions required for "Fast SEM" mode (see ["Fast Spectrum Emission Mask Measurements"](#) on page 341).

Working with Limit Lines in SEM Measurements

Using the R&S FSVA/FSV, the spectrum emission mask is defined using limit lines. Limit lines allow you to check the measured data against specified limit values. Generally, it is possible to define limit lines for any measurement in Spectrum mode using the [Lines] key. For SEM measurements, however, special limit lines are available via the "Sweep List", and it is strongly recommended that you use only these limit line definitions.

In the "Sweep List" you can define a limit line for each power class that varies its level according to the specified frequency ranges. Distinguished limit lines ("_SEM_LINE_ABS<0...3>"/"_SEM_LINE_REL<0...3>") are automatically defined for each power class according to the current "Sweep List" settings every time the settings change.

The limit line defined for the current power class is indicated by a red line in the display, and the result of the limit check is indicated at the top of the diagram. Note that only "Pass" or "Fail" is indicated; a "margin" function as for general limit lines is not available.

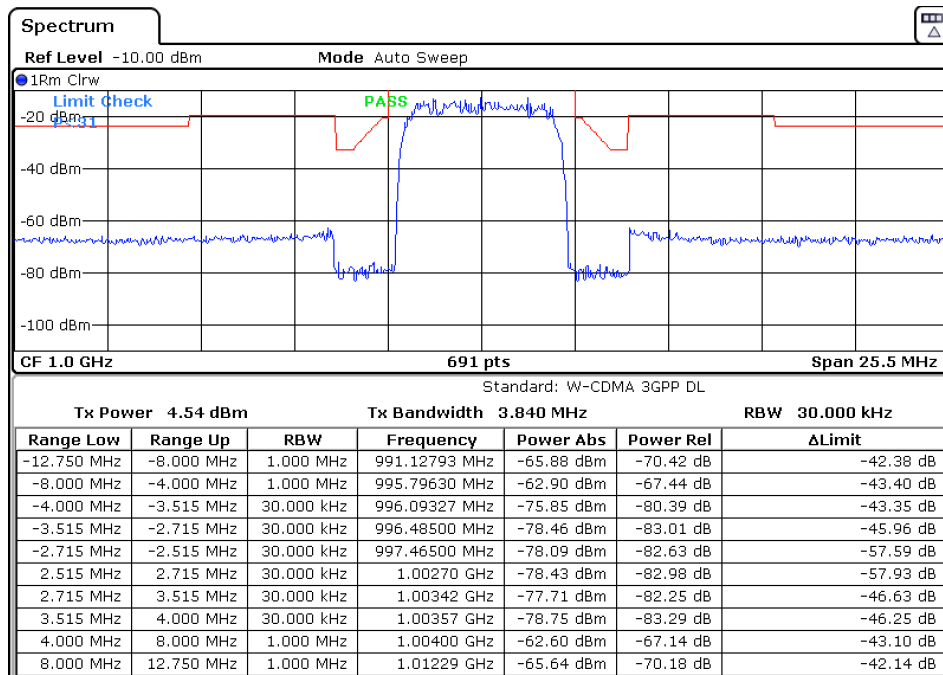

The indicated limit line depends on the settings in the "Sweep List". Several types of limit checks are possible:

Limit check type	Pass/fail criteria	Indicated limit line
Absolute	Absolute power levels may not exceed limit line	Defined by the "Abs Limit Start"/ "Abs Limit Stop" values for each range
Relative	Power deviations relative to the TX channel power may not exceed limit line	Defined by the "Rel Limit Start"/ "Rel Limit Stop" values (relative to the center frequency) for each range
Abs and Rel	Only if the power exceeds both the absolute and the relative limits, the check fails.	The less strict (higher) limit line is displayed for each range.
Abs or Rel	If the power exceeds either the absolute or the relative limits, the check fails.	The stricter (lower) limit line is displayed for each range.

The largest deviations of the power from the limit line for each range are displayed in the evaluation list. Furthermore, the absolute powers for those values, as well as the relative deviation from the TX channel power are displayed. Values that exceed the limit are indicated in red and by an asterisk (*).

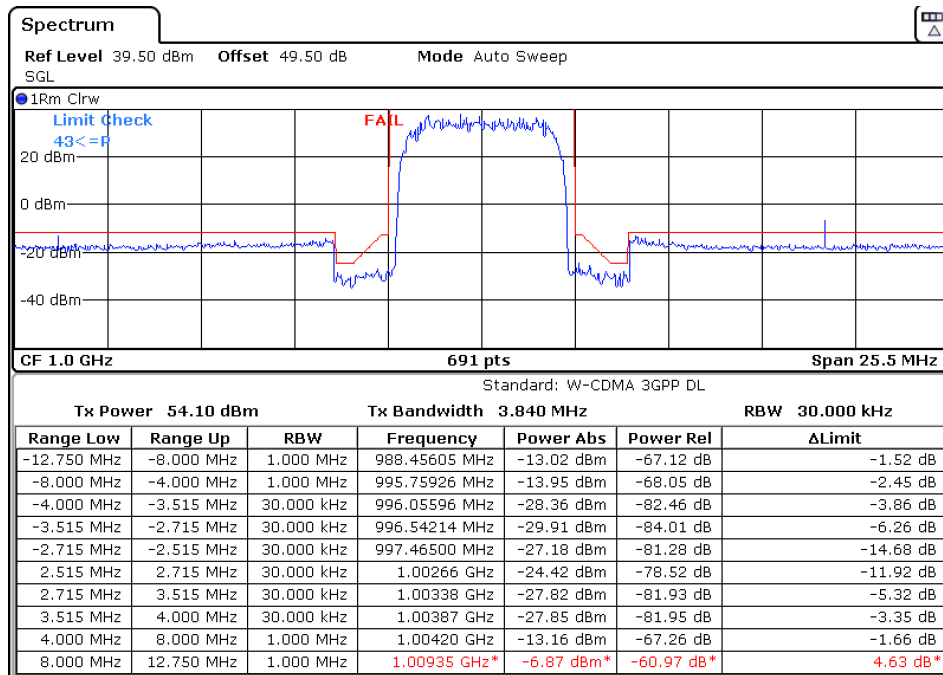

Although a margin functionality is not available for the limit check, a margin (threshold) for the peak values to be displayed in the evaluation list can be defined in the list evaluation settings. For details see "Result Evaluation" on page 327.

Provided XML Files for the Spectrum Emission Mask Measurement

You can change the settings manually or via XML files. The XML files offer a quick way to change the configuration. A set of ready-made XML files for different standards is already provided. For details see Table 5-6. You can also create and use your own XML files (for details see "Format Description of Spectrum Emission Mask XML Files" on page 335). All XML files are stored under "C:\r_s\instr\sem_std". Use the "Load Standard" softkey for quick access to the available XML files (see "Load Standard" on page 326).

Table 5-6: Provided XML files

Path	XML file name	Displayed standard characteristics*
cdma2000\DL	default0.xml	CDMA2000 BC0 DL
	default1.xml	CDMA2000 BC1 DL
cdma2000\UL	default0.xml	CDMA2000 BC0 UL
	default1.xml	CDMA2000 BC1 UL
WCDMA\3GPP\DL	PowerClass_31_39.xml	W-CDMA 3GPP (31,39)dBm DL
	PowerClass_39_43.xml	W-CDMA 3GPP (39,43)dBm DL
	PowerClass_43_INF.xml	W-CDMA 3GPP (43,INF)dBm DL

Path	XML file name	Displayed standard characteristics*
	PowerClass_negINF_31.xml	W-CDMA 3GPP (-INF,31)dBm DL
WIBRO\DL	PowerClass_29_40.xml	WiBro TTA (29,40)dBm DL
	PowerClass_40_INF.xml	WiBro TTA (40,INF)dBm DL
	PowerClass_negINF_29.xml	WiBro TTA (-INF,29)dBm DL
WIBRO\UL	PowerClass_23_INF.xml	WiBro TTA (23,INF)dBm UL
	PowerClass_negINF_23.xml	WiBro TTA (23,INF)dBm UL
WIMAX\DL\ETSI\...MHz (1.75 MHz, 2.00 MHz, 3.5 MHz, 7.00 MHz, 14.00 MHz, 28 MHz)	System_Type_E.xml	WIMAX System Type E DL
	System_Type_F.xml	WIMAX System Type F DL
	System_Type_G.xml	WIMAX System Type G DL
WIMAX\DL\IEEE	10MHz.xml	WIMAX 10MHz DL
	20MHz.xml	WIMAX 20MHz DL
WIMAX\UL\ETSI\...MHz (1.75 MHz, 2.00 MHz, 3.5 MHz, 7.00 MHz, 14.00 MHz, 28 MHz)	System_Type_E.xml	WIMAX System Type E UL
	System_Type_F.xml	WIMAX System Type F UL
	System_Type_G.xml	WIMAX System Type G UL
WIMAX\UL\IEEE	10MHz.xml	WIMAX 10MHz UL
	20MHz.xml	WIMAX 20MHz UL
WLAN\802_11_TURBO	ETSI.xml	IEEE 802.11
	IEEE.xml	IEEE 802.11
WLAN\802_11a	ETSI.xml	IEEE 802.11a
	IEEE.xml	IEEE 802.11a
WLAN\802_11b	IEEE.xml	IEEE 802.11b
WLAN\802_11j_10MHz	ETSI.xml	IEEE.802.11j
	IEEE.xml	IEEE.802.11j
WLAN\802_11j_20MHz	ETSI.xml	IEEE 802.11j
	IEEE.xml	IEEE 802.11j
EUTRA-LTE\DL\CategoryA\	BW_01_4_MHz__CFhigher1GHz.xml	LTE Cat. A >1GHz DL
EUTRA-LTE\DL\CategoryA\	BW_01_4_MHz__CFlower1GHz.xml	LTE Cat. A <1GHz DL
EUTRA-LTE\DL\CategoryA\	BW_03_0_MHz__CFhigher1GHz.xml	LTE Cat. A >1GHz DL
EUTRA-LTE\DL\CategoryA\	BW_03_0_MHz__CFlower1GHz.xml	LTE Cat. A <1GHz DL

Path	XML file name	Displayed standard characteristics*
EUTRA-LTE\DL\CategoryA\	BW_05_0_MHz__CFhigher1GHz.xml	LTE Cat. A >1GHz DL
EUTRA-LTE\DL\CategoryA\	BW_05_0_MHz__CFlower1GHz.xml	LTE Cat. A <1GHz DL
EUTRA-LTE\DL\CategoryA\	BW_10_0_MHz__CFhigher1GHz.xml	LTE Cat. A >1GHz DL
EUTRA-LTE\DL\CategoryA\	BW_10_0_MHz__CFlower1GHz.xml	LTE Cat. A >1GHz DL
EUTRA-LTE\DL\CategoryA\	BW_15_0_MHz__CFhigher1GHz.xml	LTE Cat. A >1GHz DL
EUTRA-LTE\DL\CategoryA\	BW_15_0_MHz__CFlower1GHz.xml	LTE Cat. A <1GHz DL
EUTRA-LTE\DL\CategoryA\	BW_20_0_MHz__CFhigher1GHz.xml	LTE Cat. A >1GHz DL
EUTRA-LTE\DL\CategoryA\	BW_20_0_MHz__CFlower1GHz.xml	LTE Cat. A <1GHz DL
EUTRA-LTE\DL\CategoryB\	BW_01_4_MHz__CFhigher1GHz.xml	LTE Cat. B >1GHz DL
EUTRA-LTE\DL\CategoryB\	BW_01_4_MHz__CFlower1GHz.xml	LTE Cat. B <1GHz DL
EUTRA-LTE\DL\CategoryB\	BW_03_0_MHz__CFhigher1GHz.xml	LTE Cat. B >1GHz DL
EUTRA-LTE\DL\CategoryB\	BW_03_0_MHz__CFlower1GHz.xml	LTE Cat. B <1GHz DL
EUTRA-LTE\DL\CategoryB\	BW_05_0_MHz__CFhigher1GHz.xml	LTE Cat. B >1GHz DL
EUTRA-LTE\DL\CategoryB\	BW_05_0_MHz__CFlower1GHz.xml	LTE Cat. B <1GHz DL
EUTRA-LTE\DL\CategoryB\	BW_10_0_MHz__CFhigher1GHz.xml	LTE Cat. B >1GHz DL
EUTRA-LTE\DL\CategoryB\	BW_10_0_MHz__CFlower1GHz.xml	LTE Cat. B >1GHz DL
EUTRA-LTE\DL\CategoryB\	BW_15_0_MHz__CFhigher1GHz.xml	LTE Cat. B >1GHz DL
EUTRA-LTE\DL\CategoryB\	BW_15_0_MHz__CFlower1GHz.xml	LTE Cat. B <1GHz DL
EUTRA-LTE\DL\CategoryB\	BW_20_0_MHz__CFhigher1GHz.xml	LTE Cat. B >1GHz DL
EUTRA-LTE\DL\CategoryB\	BW_20_0_MHz__CFlower1GHz.xml	LTE Cat. B <1GHz DL
EUTRA-LTE\UL\Standard\	BW_05_0_MHz.xml	LTE UL
EUTRA-LTE\UL\Standard\	BW_10_0_MHz.xml	LTE UL
EUTRA-LTE\UL\Standard\	BW_15_0_MHz.xml	LTE UL
EUTRA-LTE\UL\Standard\	BW_20_0_MHz.xml	LTE UL

*Used abbreviations:

BC: band class

UL: uplink

DL: downlink

TTA: Telecommunications Technology Association

Format Description of Spectrum Emission Mask XML Files

The files for importing range settings are in XML format and therefore obey the rules of the XML standard. Below, the child nodes, attributes, and structure defined for the data import is described. Build your own XML files according to these conventions because the R&S FSVA/FSV can only interpret XML files of a known structure. For example files look in the C:\r_s\instr\sem_std directory.

Spectrum Emission Mask						
Tx Power -47.93 dBm			Standard: W-CDMA 3GPP (39,43)dBm DL		Tx Bandwidth 3.840 MHz	
					RBW 30.000 kHz	
Range Low	Range Up	RBW	Frequency	Power Abs	Power Rel	ΔLimit
-12.750 MHz	-8.000 MHz	1.000 MHz	14.99094 GHz*	-74.76 dBm*	-26.83 dB*	27.67 dB*
-8.000 MHz	-4.000 MHz	1.000 MHz	14.99598 GHz	-36.79 dBm	11.14 dB	-25.29 dB
-4.000 MHz	-3.515 MHz	30.000 kHz	14.99628 GHz	-100.18 dBm	-52.25 dB	-75.68 dB
-3.515 MHz	-2.715 MHz	30.000 kHz	14.99648 GHz	-103.55 dBm	-55.63 dB	-79.05 dB
-2.715 MHz	-2.515 MHz	30.000 kHz	14.99747 GHz	-108.91 dBm	-60.98 dB	-96.41 dB
2.515 MHz	2.715 MHz	30.000 kHz	15.00251 GHz	-48.25 dBm	-0.32 dB	-35.75 dB
2.715 MHz	3.515 MHz	30.000 kHz	15.00272 GHz	-52.48 dBm	-4.56 dB	-39.98 dB
3.515 MHz	4.000 MHz	30.000 kHz	15.00398 GHz	-74.53 dBm	-26.60 dB	-50.03 dB
4.000 MHz	8.000 MHz	1.000 MHz	15.00769 GHz	-74.76 dBm	-26.83 dB	-63.26 dB
8.000 MHz	12.750 MHz	1.000 MHz	15.01273 GHz*	-36.79 dBm*	11.14 dB*	65.64 dB*

Figure 5-15: Example Spectrum emission mask standard file (PowerClass_39_43.xml)



Be sure to follow the structure exactly as shown below or else the R&S FSVA/FSV is not able to interpret the XML file and error messages are shown on the screen. Therefore, we recommend you make a copy of an existing file (see [Save As Standard](#) softkey) and edit the copy of the file.

Alternatively, edit the settings using the "Spectrum Emission Mask" softkey and the [Sweep List dialog box](#) and save the XML file with the [Save As Standard](#) softkey afterwards. This way, no modifications have to be done in the XML file itself.

Basically, the file consists of three elements that can be defined:

- The "BaseFormat" element
- The "PowerClass" element
- The "Range" element

The "BaseFormat" element

It carries information about basic settings. In this element only the "ReferencePower" child node has any effects on the measurement itself. The other attributes and child nodes are used to display information about the Spectrum Emission Mask Standard on the measurement screen. The child nodes and attributes of this element are shown in [Table 5-7](#).

In the example above (PowerClass_39_43.xml under C:\r_s\instr\sem_std\WCDMA\3GPP, see [Figure 5-15](#)), these attributes are defined as follows:

- Standard="W-CDMA 3GPP"
- LinkDirection="DL"

- PowerClass="(39,43)dBm"

The "PowerClass" element

It is embedded in the "BaseFormat" element and contains settings information about the power classes. Up to four different power classes can be defined. For details refer to the "Sweep List" softkey ("[Sweep List](#)" on page 317) and the corresponding parameter description. The child nodes and attributes of this element are shown in [Table 5-8](#).

The "Range" element

This element is embedded in the "PowerClass" element. It contains the settings information of the range. There have to be at least three defined ranges: one reference range and at least one range to either side of the reference range. The maximum number of ranges is 20. Note that the R&S FSVA/FSV uses the same ranges in each power class. Therefore, the contents of the ranges of each defined power class have to be identical to the first power class. An exception are the Start and Stop values of the two Limit nodes that are used to determine the power class. Note also, that there are two Limit nodes to be defined: one that gives the limit in absolute values and one in relative values. Make sure units for the Start and Stop nodes are identical for each Limit node.

For details refer to the "Sweep List" softkey ("[Sweep List](#)" on page 317) and the corresponding parameter description. The child nodes and attributes of this element are shown in [Table 5-9](#).

The following tables show the child nodes and attributes of each element and show if a child node or attribute is mandatory for the R&S FSVA/FSV to interpret the file or not. Since the hierarchy of the XML can not be seen in the tables, either view one of the default files already stored on the R&S FSVA/FSV in the "C:\r_s\instr\sem_std" directory or check the structure as shown below.

Below, a basic example of the structure of the file is shown, containing all mandatory attributes and child nodes. Note that the "PowerClass" element and the range element are themselves elements of the "BaseFormat" element and are to be inserted where noted. The separation is done here simply for reasons of a better overview. Also, no example values are given here to allow a quick reference to the tables above. *Italic font* shows the placeholders for the values.

- The "BaseFormat" element is structured as follows:
 - `<RS_SEM_ACP_FileFormat Version=""1.0.0.0"">`
`<Name>"Standard"</Name>`
`<Instrument>`
`<Type>"Instrument Type"</Type>`
`<Application>"Application"</Application>`
`</Instrument>`
`<LinkDirection Name=""Name"">`
`<ReferencePower>`
`<Method>"Method"</Method>`
`</ReferencePower>`
`<PowerClass Index=""n"">`
`<!-- For contents of the PowerClass node see`

Table 5-8 -->

```

<!-- Define up to four PowerClass nodes -->
</PowerClass>
</LinkDirection>
</RS_SEM_ACP_File>

```

- The "PowerClass" element is structured as follows:
 - <PowerClass Index=""n">

```

<StartPower Unit=""dBm"" InclusiveFlag=""true"" Value=""StartPowerValue""/>
<StopPower Unit=""dBm"" InclusiveFlag=""false"" Value=""StopPowerValue""/>
<DefaultLimitFailMode>"Limit Fail Mode"</DefaultLimitFailMode>
<Range Index=""n">
<!-- For contents of the Range node see Table 5-9 -->
<!-- Define up to twenty Range nodes -->
</Range>
...
</PowerClass>

```
- The "Range" element is structured as follows:
 - <Range Index=""n">

```

<Name=""Name"">
<ChannelType>"Channel Type"</Channel Type>
<WeightingFilter>
<Type>"FilterType"</Type>
<RollOffFactor>"Factor"</RollOffFactor>
<Bandwidth>"Bandwidth"</Bandwidth>
</WeightingFilter>
<FrequencyRange>
<Start>"RangeStart"</Start>
<Stop>"RangeStop"</Stop>
</FrequencyRange>
<Limit>
<Start Unit=""Unit"" Value=""Value""/>
<Stop Unit=""Unit"" Value=""Value""/>
</Limit>
<Limit>
<Start Unit=""Unit"" Value=""Value""/>
<Stop Unit=""Unit"" Value=""Value""/>
</Limit>
<RBW Bandwidth=""Bandwidth"" Type=""FilterType""/>
<VBW Bandwidth=""Bandwidth""/>
<Detector>"Detector"</Detector>
<Sweep Mode=""SweepMode"" Time=""SweepTime""/>
<Amplitude>
<ReferenceLevel Unit=""dBm"" Value=""Value""/>
<RFAttenuation Mode=""Auto"" Unit=""dB"" Value=""Value""/>
<Preamplifier State=""State""/>
</Amplitude>
</Range>

```

Table 5-7: Attributes and child nodes of the BaseFormat element

Child Node	Attribute	Value	Parameter Description	Mand.
	FileFormatVersion	1.0.0.0		Yes
	Date	YYYY-MM-DD HH:MM:SS	Date in ISO 8601 format	No
Name		<string>	Name of the standard	Yes
Instrument	Type	FSL	Name of the instrument	No
	Application	SA K72 K82	Name of the application	No
LinkDirection	Name	Downlink Uplink None		Yes
	ShortName	DL UL		No
Reference- Power				Yes
Method	TX Channel Power TX Channel Peak Power			Yes
Reference- Channel	<string>			No

Table 5-8: Attributes and child nodes of the PowerClass element

Child Node	Attribute	Value	Parameter Description	Mand.
StartPower	Value	<power in dBm>	The start power must be equal to the stop power of the previous power class. The StartPower value of the first range is -200	Yes
	Unit	dBm		Yes
	InclusiveFlag	true		Yes
StopPower	Value	<power in dBm>	The stop power must be equal to the start power of the next power class. The StopPower value of the last range is 200	Yes
	Unit	dBm		
	InclusiveFlag	false		Yes
DefaultLimitFailMode		Absolute Relative Absolute and Rel- ative Absolute or Relative		Yes

Table 5-9: Attributes and child nodes of the Range element (normal ranges)

Child Node	Attribute	Value	Parameter Description	Mand.
	Index	0...19	Indexes are continuous and have to start with 0	Yes
	Name	<string>	Name of the range	Only if ReferenceChannel contains a name and the range is the reference range
	Short-Name	<string>	Short name of the range	No
ChannelType		TX Adjacent		Yes
WeightingFilter				Only if ReferencePower method is TX Channel Power and the range is the reference range
Type		RRC CFilter	Type of the weighting filter	Yes
Roll Off Factor		0...1	Excess bandwidth of the filter	Only if the filter type is RRC
Bandwidth		<bandwidth in Hz>	Filter bandwidth	Only if the filter type is RRC
FrequencyRange				Yes
Start		<frequency in Hz>	Start value of the range	Yes
Stop		<frequency in Hz>	Stop value of the range	Yes
Limit		dBm/Hz dBm dBc dBr dB	A Range must contain exactly two limit nodes; one of the limit nodes has to have a relative unit (e.g. dBc), the other one must have an absolute unit (e.g. dBm)	Yes
Start	Value	<numeric_value>	Power limit at start frequency	Yes
	Unit	dBm/Hz dBm dBc dBr dB	Sets the unit of the start value	
Stop	Value	<numeric_value>	Power limit at stop frequency	
	Unit	dBm/Hz dBm dBc dBr dB	Sets the unit of the stop value	
LimitFailMode		Absolute Relative Absolute and Relative Absolute or Relative	If used, it has to be identical to DefaultLimitFailMode	No
RBW	Bandwidth	<bandwidth in Hz>	"RBW" on page 319	Yes

Child Node	Attribute	Value	Parameter Description	Mand.
	Type	NORM PULS CFIL RRC		No
VBW	Bandwidth	<bandwidth in Hz>	"VBW" on page 319	Yes
Detector		NEG POS SAMP RMS AVER QUAS	If used, it has to be identical in all ranges.	No
Sweep	Mode	Manual Auto	"Sweep Time Mode" on page 319	Yes
	Time	<time in sec>	"Sweep Time" on page 319	No
Amplitude				No
ReferenceLevel	Value	<power in dBm>	"Ref. Level" on page 319	Yes, if the Refer- enceLevel child node is used
	Unit	dBm	Defines dBm as unit	Yes, if the Refer- enceLevel node is used
RFAttenuation	Mode	Manual Auto	"RF Att. Mode" on page 319	Yes, if the Refer- enceLevel child node is used
Preamplifier		ON OFF	"Preamp" on page 319	Yes

ASCII File Export Format (Spectrum Emission Mask)

The first part of the file lists information about the signal analyzer and the general setup. For a detailed description refer to [Chapter 5.2.8.7, "ASCII File Export Format"](#), on page 235.

File contents	Description
RefType; CPOWER; TxBandwidth;9540000;Hz Filter State; ON; Alpha;0.22;	reference range setup, for details see "Edit Reference Range" on page 322
PeaksPerRange;1; Values;4;	evaluation list information
0;-22500000;-9270000;1000000;2986455000;-74.762840270996094; -10.576210021972656;-45.762840270996094;PASS; 1;-9270000;-4770000;1000000;2991405000;-100.17695617675781; -35.990325927734375;-1.490325927734375;PASS 3;4770000;9270000;1000000;3005445000;-100.17695617675781; -35.990325927734375;-1.490325927734375;PASS; 4;9270000;22500000;1000000;3018225000;-74.762840270996094; -10.576210021972656;-45.762840270996094;PASS;	information about each peak: <range number>; <start frequency>; <stop frequency>; <resolution bandwidth of range>; <frequency of peak>; <absolute power in dBm of peak>; <relative power in dBc of peak (related to the channel power)>; <distance to the limit line in dB (positive value means above the limit)>; <limit fail (pass = 0, fail =1)>;

Fast Spectrum Emission Mask Measurements

In order to improve the performance of the R&S FSVA/FSV for spectrum emission mask measurements, a "Fast SEM" mode is available. If this mode is activated, several consecutive ranges with identical sweep settings are combined to one sweep internally, which makes the measurement considerably more efficient. The displayed results remain unchanged and still consist of several ranges. Thus, measurement settings that apply only to the results, such as limits or transducer factors, can nevertheless be defined individually for each range.

Prerequisites

"Fast SEM" mode is available if the following criteria apply:

- The frequency ranges are consecutive, without frequency gaps
- The following sweep settings are identical:
 - "Filter Type", see ["Filter Type"](#) on page 318
 - "RBW", see ["RBW"](#) on page 319
 - "VBW", see ["VBW"](#) on page 319
 - "Sweep Time Mode", see ["Sweep Time Mode"](#) on page 319
 - "Ref Level", see ["Ref. Level"](#) on page 319
 - "Rf Att. Mode", see ["RF Att. Mode"](#) on page 319
 - "RF Attenuator", see ["RF Att. Mode"](#) on page 319
 - "Preamp", see ["Preamp"](#) on page 319

Activating Fast SEM mode

"Fast SEM" mode is activated in the sweep list (see "[Fast SEM](#)" on page 318) or using a remote command. Activating the mode for one range automatically activates it for all ranges in the sweep list.

In the provided XML files for the Spectrum Emission Mask measurement, "Fast SEM" mode is activated by default.

SCPI command:

`[SENSe:]ESpectrum:HighSPeed` on page 798

Consequences

When the "Fast SEM" mode is activated, the ranges for which these criteria apply are displayed as one single range. The sweep time is defined as the sum of the individual sweep times, initially, but can be changed. When the "Fast SEM" mode is deactivated, the originally defined individual sweep times are reset.



If "Symmetrical Setup" mode is active when "Fast SEM" mode is activated, not all sweep list settings can be configured symmetrically automatically (see also "[Symmetric Setup](#)" on page 322).

Any other changes to the sweep settings of the combined range are applied to each included range and remain changed even after deactivating "Fast SEM" mode.

Example

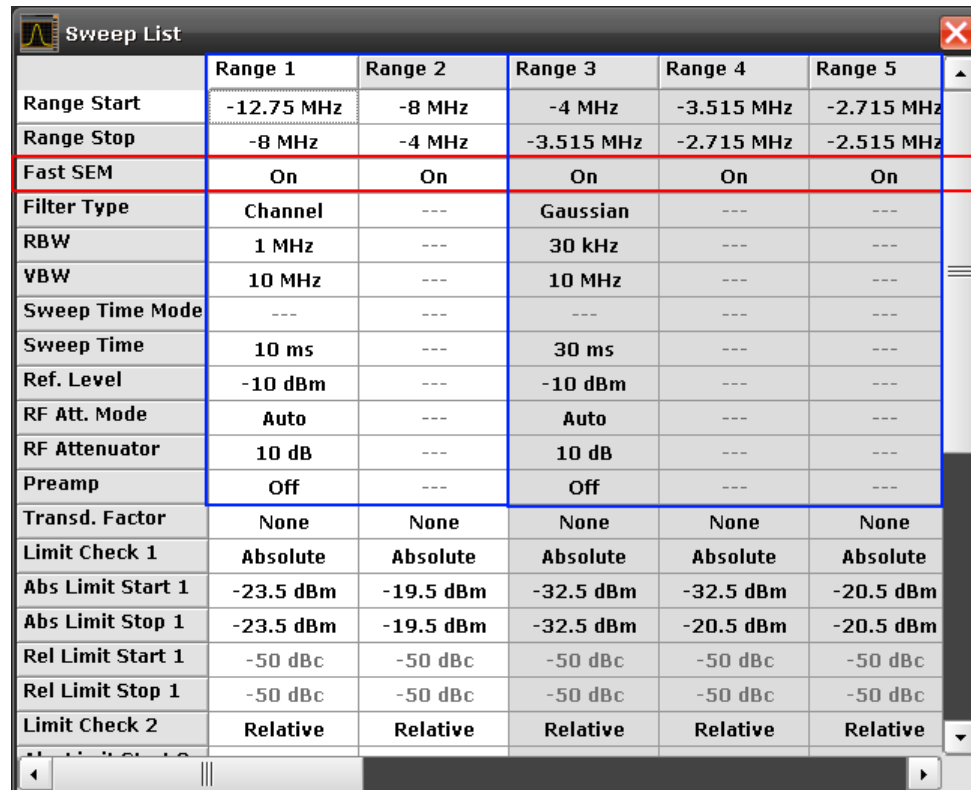

	Range 1	Range 2	Range 3	Range 4	Range 5
Range Start	-12.75 MHz	-8 MHz	-4 MHz	-3.515 MHz	-2.715 MHz
Range Stop	-8 MHz	-4 MHz	-3.515 MHz	-2.715 MHz	-2.515 MHz
Fast SEM	On	On	On	On	On
Filter Type	Channel	---	Gaussian	---	---
RBW	1 MHz	---	30 kHz	---	---
VBW	10 MHz	---	10 MHz	---	---
Sweep Time Mode	---	---	---	---	---
Sweep Time	10 ms	---	30 ms	---	---
Ref. Level	-10 dBm	---	-10 dBm	---	---
RF Att. Mode	Auto	---	Auto	---	---
RF Attenuator	10 dB	---	10 dB	---	---
Preamp	Off	---	Off	---	---
Transd. Factor	None	None	None	None	None
Limit Check 1	Absolute	Absolute	Absolute	Absolute	Absolute
Abs Limit Start 1	-23.5 dBm	-19.5 dBm	-32.5 dBm	-32.5 dBm	-20.5 dBm
Abs Limit Stop 1	-23.5 dBm	-19.5 dBm	-32.5 dBm	-20.5 dBm	-20.5 dBm
Rel Limit Start 1	-50 dBc	-50 dBc	-50 dBc	-50 dBc	-50 dBc
Rel Limit Stop 1	-50 dBc	-50 dBc	-50 dBc	-50 dBc	-50 dBc
Limit Check 2	Relative	Relative	Relative	Relative	Relative

Figure 5-16: Sweep list using Fast SEM mode

In [Figure 5-16](#), a sweep list is shown for which Fast SEM is activated. The formerly 5 separately defined ranges are combined to 2 sweep ranges internally.

5.3.5.6 Measuring Spurious Emissions

The Spurious Emissions measurement defines a measurement that monitors unwanted RF products outside the assigned frequency band generated by an amplifier. The spurious emissions are usually measured across a wide frequency range. The Spurious Emissions measurement allows a flexible definition of all parameters. A result table indicates the largest deviations of the absolute power from the limit line for each range, and the results can be checked against defined limits automatically.

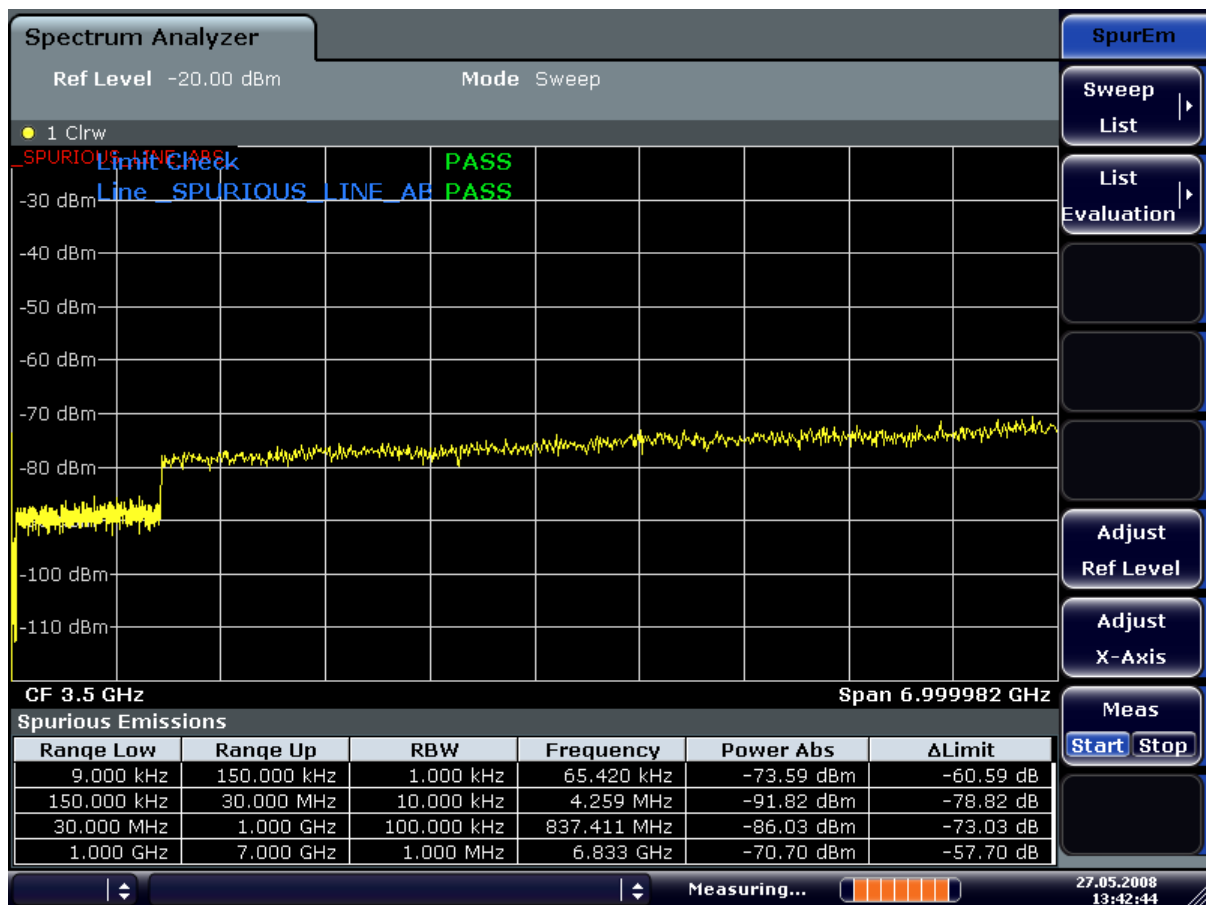

Spurious Emissions measurements are performed using the "Spurious Emissions" softkey in the "Measurement" menu (see ["Spurious Emissions"](#) on page 349).

Most parameters are defined in the "Sweep List" dialog box (see ["Sweep List dialog box"](#) on page 349). For information on other parameters, see the corresponding softkeys (["Spurious Emissions"](#) on page 349).

Conditions for ranges

The following rules apply to ranges:

- The minimum span of a range is 20 Hz.
- The individual ranges must not overlap (but need not directly follow one another).
- The maximum number of ranges is 20.
- The maximum number of sweep points in all ranges is limited to 100001.

In order to change the start/stop frequency of the first/last range, select the appropriate span with the [SPAN] key. If you set a span that is smaller than the overall span of the ranges, the measurement includes only the ranges that lie within the defined span and have a minimum span of 20 Hz. The first and last ranges are adapted to the given span as long as the minimum span of 20 Hz is not violated.



Defining ranges by remote control

In Spurious Emissions measurements, there are no remote commands to insert new ranges between existing ranges directly. However, you can delete or re-define the existing ranges to create the required order.

A remote command example for defining parameters and ranges in spurious emissions measurements can be found in chapter 7 "Remote Control – Programming Examples" of the Operating manual.

Result Evaluation

In addition to the graphical results of the spurious measurement displayed in the diagram, a result table can be displayed to evaluate the limit check results (see also "[Working with Limit Lines in Spurious Measurements](#)" on page 346). Which data is displayed in the evaluation list can be defined in the "List Evaluation" menu (see "[List Evaluation](#)" on page 352).

The following information is provided in the evaluation list:

Column	Description
Range Low	Frequency range start for range the peak value belongs to
Range Up	Frequency range stop for range the peak value belongs to
RBW	RBW of the range
Frequency	Frequency at the peak value
Power Abs	Absolute power level at the peak value
Δ Limit	Deviation of the absolute power level from the defined limit for the peak value

By default, one peak per range is displayed. However, you can change the settings to:

- Display all peaks ("Details ON")
- Display a certain number of peaks per range ("Details ON" + "Peaks per Range")
- Display only peaks that exceed a threshold ("Margin")

In addition to listing the peaks in the list evaluation, detected peaks can be indicated by blue squares in the diagram ("Show Peaks").

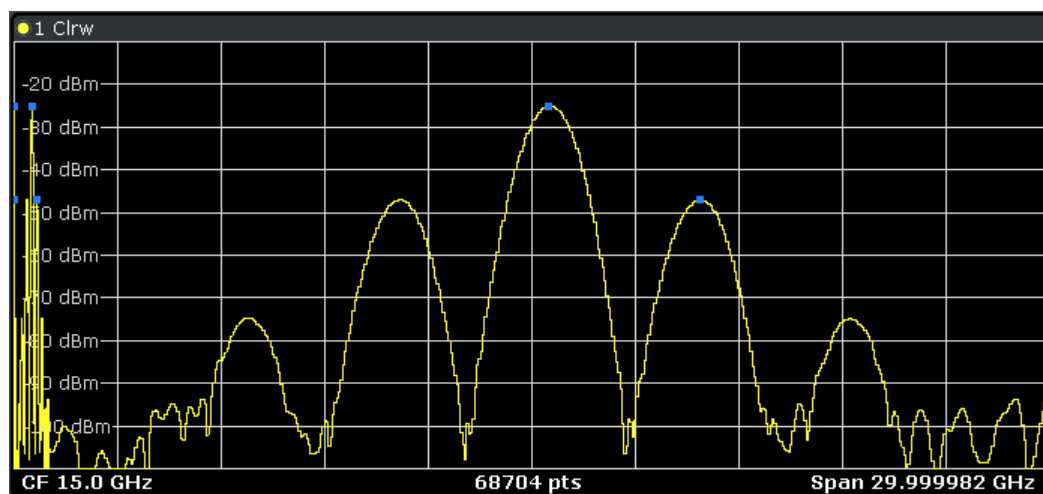

Furthermore, you can save the evaluation list to a file ("Save Evaluation List").

Retrieving Results via Remote Control

The spurious measurement results can be retrieved using the `CALC:PSE?` command from a remote computer (see `CALCulate<n>:PEAKsearch|PSEarch[:IMMediate]` for a detailed description).

Alternatively, the measured spurious values of the displayed trace can be retrieved using the `TRAC:DATA? SPUR` command (see `TRACe<n>[:DATA]?` on page 890).

Working with Limit Lines in Spurious Measurements

Limit lines allow you to check the measured data against specified limit values. Generally, it is possible to define limit lines for any measurement in Spectrum mode using the `[Lines]` key. For Spurious measurements, however, a special limit line is available via the "Sweep List", and it is strongly recommended that you use only this limit line definition.

In the "Sweep List" you can define a limit line that varies its level according to the specified frequency ranges. A distinguished limit line ("`_SPURIOUS_LINE_ABS`") is automatically defined according to the current "Sweep List" settings every time the settings change.

If a limit check is activated in the "Sweep List", the "`_SPURIOUS_LINE_ABS`" limit line is indicated by a red line in the display, and the result of the limit check is indicated at the top of the diagram. Note that only "Pass" or "Fail" is indicated; a "margin" function as for general limit lines is not available. Also, only absolute limits can be checked, not relative ones.

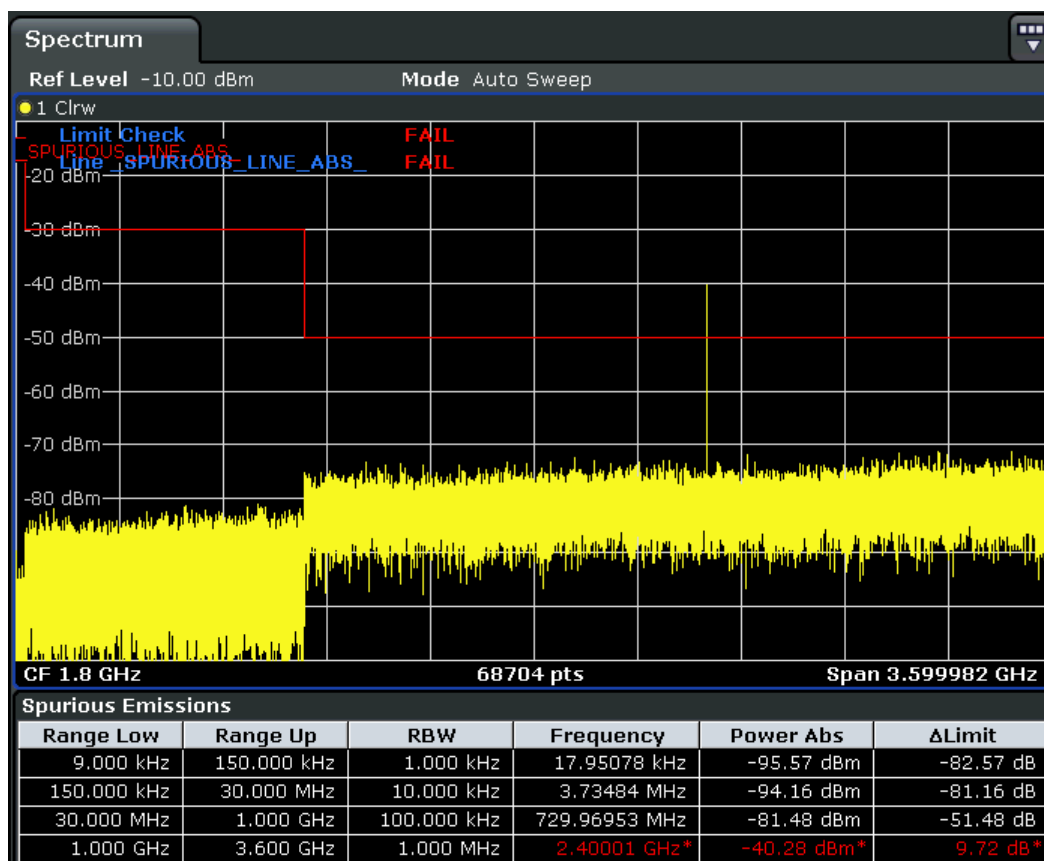

As for general limit lines, the results of each limit line check are displayed (here: "_SPURIOUS_LINE_ABS"), as well as the combined result for all defined limit lines ("Limit Check").

In addition to the limit line itself, the largest deviations of the absolute power from the limit line for each range are displayed in the evaluation list if the limit check is activated. Values that exceed the limit are indicated in red and by an asterisk (*).



Although a margin functionality is not available for the limit check, a margin (threshold) for the peak values to be displayed in the evaluation list can be defined in the list evaluation settings. Furthermore, you can define how many peaks per range are listed. For details see ["Result Evaluation"](#) on page 345.

To define a limit check for spurious measurements

The limit check is defined in the "Sweep List" dialog box, see ["Sweep List dialog box"](#) on page 349 for details.

1. Press the [Meas Config] key to open the main "Spurious" menu.
2. Press the "Sweep List" softkey to open the "Sweep List" dialog box.

3. In the "Sweep List" dialog box, define the limit line for each range using the "Abs Limit Start" and "Abs Limit Stop" settings.
The limit values are absolute values for the absolute power level.
4. Set the "Limit Check" setting to "Absolute" to activate the limit check.
5. Close the "Sweep List" dialog box.
The limit line and the result of the limit check are displayed in the diagram and the result table displays the largest deviations from the limit for each range.
6. To reduce the number of displayed delta values, change the margin (threshold) for peak detection in the list evaluation. By default, this value is very high (200 dB), so that initially all peaks are detected.
In the "Spurious" menu, press "List Evaluation > Margin" and enter a value in dB.
Only delta values that exceed this margin are displayed in the result table.

Softkeys for Spurious Emissions Measurement

Spurious Emissions.....	349
L Sweep List.....	349
L Sweep List dialog box.....	349
L Range Start / Range Stop.....	349
L Filter Type.....	349
L RBW.....	350
L VBW.....	350
L Sweep Time Mode.....	350
L Sweep Time.....	350
L Detector.....	350
L Ref. Level.....	350
L RF Att. Mode.....	350
L RF Attenuator.....	350
L Preamp.....	350
L Sweep Points.....	351
L Stop After Sweep.....	351
L Transd. Factor.....	351
L Limit Check 1-4.....	351
L Abs Limit Start.....	351
L Abs Limit Stop.....	351
L Close Sweep List.....	352
L Insert before Range.....	352
L Insert after Range.....	352
L Delete Range.....	352
L Adjust Ref Lvl (span > 0).....	352
L Adjust X-Axis.....	352
L List Evaluation.....	352
L List Evaluation (On/Off).....	353
L Details On/Off.....	353
L Margin.....	353
L Peaks per Range.....	353
L Show Peaks.....	353
L Save Evaluation List.....	353

L ASCII File Export.....	353
L Decim Sep.....	354
L Adjust Ref Lvl (span > 0).....	354
L Adjust X-Axis.....	354
L Meas Start/Stop.....	354

Spurious Emissions

Opens a submenu to configure the Spurious Emissions measurement and immediately starts a measurement.

For general information on performing Spurious Emissions measurements see [Chapter 5.3.5.6, "Measuring Spurious Emissions"](#), on page 343.

Remote command:

[SENSe:] SWEep:MODE on page 861

Sweep List ← Spurious Emissions

Opens a submenu to edit the sweep list and displays the "Sweep List" dialog box.

Note: If you edit the sweep list, always follow the rules described in [Chapter 5.3.5.6, "Measuring Spurious Emissions"](#), on page 343.

Sweep List dialog box ← Sweep List ← Spurious Emissions

After a preset, the sweep list contains a set of default ranges and parameters. For each range, you can change the parameters listed below. To insert or delete ranges, use the "Insert Before Range", "Insert After Range", "Delete Range" softkeys. The measurement results are not updated during editing but on closing the dialog box.

For details and limitations regarding spurious emissions configuration, see [Chapter 5.3.5.6, "Measuring Spurious Emissions"](#), on page 343.

Range Start / Range Stop ← Sweep List dialog box ← Sweep List ← Spurious Emissions

Sets the start frequency/stop frequency of the selected range. Follow the rules described in [Chapter 5.3.5.6, "Measuring Spurious Emissions"](#), on page 343.

In order to change the start/stop frequency of the first/last range, select the appropriate span with the SPAN key. If you set a span that is smaller than the overall span of the ranges, the measurement includes only the ranges that lie within the defined span and have a minimum span of 20 Hz. The first and last ranges are adapted to the given span as long as the minimum span of 20 Hz is not violated.

Frequency values for each range have to be defined relative to the center frequency. The reference range has to be centered on the center frequency. The minimum span of the reference range is given by the current TX Bandwidth.

Remote command:

[SENSe:] LIST:RANGe<range> [:FREQuency] :START on page 821

[SENSe:] LIST:RANGe<range> [:FREQuency] :STOP on page 821

Filter Type ← Sweep List dialog box ← Sweep List ← Spurious Emissions

Sets the filter type for this range. For details on filters see also [Chapter 5.2.6.3, "Selecting the Appropriate Filter Type"](#), on page 211.

Remote command:

[SENSe:]LIST:RANGe<range>:FILTer:TYPe on page 821

RBW ← Sweep List dialog box ← Sweep List ← Spurious Emissions

Sets the RBW value for this range.

Remote command:

[SENSe:]LIST:RANGe<range>:BANDwidth[:RESolution] on page 818

VBW ← Sweep List dialog box ← Sweep List ← Spurious Emissions

Sets the VBW value for this range.

Remote command:

[SENSe:]LIST:RANGe<range>:BANDwidth:VIDeo on page 819

Sweep Time Mode ← Sweep List dialog box ← Sweep List ← Spurious Emissions

Activates or deactivates the auto mode for the sweep time.

Remote command:

[SENSe:]LIST:RANGe<range>:SWEep:TIME:AUTO on page 825

Sweep Time ← Sweep List dialog box ← Sweep List ← Spurious Emissions

Sets the sweep time value for the range.

Remote command:

[SENSe:]LIST:RANGe<range>:SWEep:TIME on page 825

Detector ← Sweep List dialog box ← Sweep List ← Spurious Emissions

Sets the detector for the range. For details refer to [Chapter 5.2.8.6, "Detector Overview"](#), on page 234.

Remote command:

[SENSe:]LIST:RANGe<range>:DETector on page 820

Ref. Level ← Sweep List dialog box ← Sweep List ← Spurious Emissions

Sets the reference level for the range.

Remote command:

[SENSe:]LIST:RANGe<range>:RLEVel on page 824

RF Att. Mode ← Sweep List dialog box ← Sweep List ← Spurious Emissions

Activates or deactivates the auto mode for RF attenuation.

Remote command:

[SENSe:]LIST:RANGe<range>:INPut:ATTenuation:AUTO on page 822

RF Attenuator ← Sweep List dialog box ← Sweep List ← Spurious Emissions

Sets the attenuation value for that range.

Remote command:

[SENSe:]LIST:RANGe<range>:INPut:ATTenuation on page 822

Preamp ← Sweep List dialog box ← Sweep List ← Spurious Emissions

Switches the preamplifier on or off.

Remote command:

[SENSe:] LIST:RANGe<range>:INPut:GAIN:STATe on page 823

Sweep Points ← Sweep List dialog box ← Sweep List ← Spurious Emissions

Sets the number of sweep points for the specified range.

Remote command:

[SENSe:] LIST:RANGe<range>:POINTs on page 824

Stop After Sweep ← Sweep List dialog box ← Sweep List ← Spurious Emissions

This command configures the sweep behavior.

"ON" The R&S FSVA/FSV stops after one range is swept and continues only if you confirm (a message box is displayed).

"OFF" The R&S FSVA/FSV sweeps all ranges in one go.

Remote command:

[SENSe:] LIST:RANGe<range>:BREak on page 819

Transd. Factor ← Sweep List dialog box ← Sweep List ← Spurious Emissions

Sets a transducer for the specified range. You can only choose a transducer that fulfills the following conditions:

- The transducer overlaps or equals the span of the range.
- The x-axis is linear.
- The unit is dB.

Remote command:

[SENSe:] LIST:RANGe<range>:TRANsducer on page 825

Limit Check 1-4 ← Sweep List dialog box ← Sweep List ← Spurious Emissions

Sets the type of limit check for all ranges. Possible states are:

Absolute	Checks the absolute limits defined.
None	No limit check performed.

The limit settings are only available if limit check is activated ("Absolute"). If activated, the limit line and the results of the check are indicated in the diagram.

Remote command:

[SENSe:] LIST:RANGe<range>:LIMit:STATe on page 823

CALCulate<n>:LIMit<k>:FAIL? on page 642

Abs Limit Start ← Sweep List dialog box ← Sweep List ← Spurious Emissions

Sets an absolute limit value at the start frequency of the range [dBm].

This parameter is only available if the limit check is set to "Absolute" (see "Limit Check 1-4" on page 351).

Remote command:

[SENSe:] LIST:RANGe<range>:LIMit:START on page 823

Abs Limit Stop ← Sweep List dialog box ← Sweep List ← Spurious Emissions

Sets an absolute limit value at the stop frequency of the range [dBm].

This parameter is only available if the limit check is set to "Absolute" (see ["Limit Check 1-4"](#) on page 351).

Remote command:

`[SENSe:]LIST:RANge<range>:LIMit:STOP` on page 824

Close Sweep List ← Sweep List ← Spurious Emissions

Closes the "Sweep List" dialog box and updates the measurement results.

Insert before Range ← Sweep List ← Spurious Emissions

Inserts a new range to the left of the currently focused range. The range numbers of the currently focused range and all higher ranges are increased accordingly. The maximum number of ranges is 20.

For further details refer to ["Ranges and Range Settings"](#) on page 329.

Insert after Range ← Sweep List ← Spurious Emissions

Inserts a new range to the right of the currently focused range. The range numbers of all higher ranges are increased accordingly. The maximum number of ranges is 20.

For further details refer to ["Ranges and Range Settings"](#) on page 329.

Delete Range ← Sweep List ← Spurious Emissions

Deletes the currently focused range, if possible. The range numbers are updated accordingly. For further details refer to ["Ranges and Range Settings"](#) on page 329.

Remote command:

`[SENSe:]LIST:RANge<range>:DELete` on page 820

Adjust Ref Lvl (span > 0) ← Sweep List ← Spurious Emissions

Adjusts the reference level to the measured total power of the signal. The softkey is activated after the first sweep with active measurement of the occupied bandwidth has been completed and the total power of the signal is thus known.

Adjusting the reference level ensures that the signal path will not be overloaded and the dynamic range not limited by too low a reference level. Since the measurement bandwidth for channel power measurements is significantly lower than the signal bandwidth, the signal path may be overloaded although the trace is distinctly below the reference level. If the measured channel power is equal to the reference level, the signal path cannot be overloaded.

Remote command:

`[SENSe:]ADJust:LEVel` on page 781

Adjust X-Axis ← Sweep List ← Spurious Emissions

Adjusts the frequency axis of measurement diagram automatically so that the start frequency matches the start frequency of the first sweep range, and the stop frequency of the last sweep range.

List Evaluation ← Spurious Emissions

Opens a submenu to edit the list evaluation settings.

For more information on list evaluation see ["Result Evaluation"](#) on page 345.

List Evaluation (On/Off) ← List Evaluation ← Spurious Emissions

Activates or deactivates the list evaluation.

Remote command:

[CALCulate<n>:PEAKsearch|PSEarch:AUTO](#) on page 735

[TRACe<n>\[:DATA\]?](#) on page 890

Details On/Off ← List Evaluation ← Spurious Emissions

Configures the list contents.

On	Displays the whole list contents.
Off	Displays only the highest peaks (one peak per range).

Remote command:

[CALCulate<n>:ESpectrum:PEAKsearch|PSEarch:DEtails](#) on page 638

Margin ← List Evaluation ← Spurious Emissions

Opens an edit dialog box to enter the margin used for the limit check/peak search.

Only peaks that exceed the limit and are larger than the specified margin are indicated in the evaluation list.

Remote command:

[CALCulate<n>:PEAKsearch|PSEarch:MARGin](#) on page 735

Peaks per Range ← List Evaluation ← Spurious Emissions

Opens an edit dialog box to enter the number of peaks per range that are stored in the list. Once the selected number of peaks has been reached, the peak search is stopped in the current range and continued in the next range. The maximum value is 50.

Remote command:

[CALCulate<n>:PEAKsearch|PSEarch:SUBRanges](#) on page 736

Show Peaks ← List Evaluation ← Spurious Emissions

In the diagram, marks all peaks with blue squares that have been listed during an active list evaluation.

Remote command:

[CALCulate<n>:PEAKsearch|PSEarch:PSHow](#) on page 735

Save Evaluation List ← List Evaluation ← Spurious Emissions

Opens the "ASCII File Export Name" dialog box and a submenu to save the result in ASCII format to a specified file and directory.

Remote command:

[MMEMory:STORe<n>:LIST](#) on page 774

ASCII File Export ← Save Evaluation List ← List Evaluation ← Spurious Emissions

Saves the evaluation list in ASCII format to a specified file and directory.

Remote command:

[MMEMory:STORe<n>:LIST](#) on page 774

Decim Sep ← Save Evaluation List ← List Evaluation ← Spurious Emissions

Selects the decimal separator with floating-point numerals for the ASCII Trace export to support evaluation programs (e.g. MS-Excel) in different languages. The values '.' (decimal point) and ',' (comma) can be set.

Remote command:

`FORMat:DEXPort:DSEParator` on page 759

Adjust Ref Lvl (span > 0) ← Spurious Emissions

Adjusts the reference level to the measured total power of the signal. The softkey is activated after the first sweep with active measurement of the occupied bandwidth has been completed and the total power of the signal is thus known.

Adjusting the reference level ensures that the signal path will not be overloaded and the dynamic range not limited by too low a reference level. Since the measurement bandwidth for channel power measurements is significantly lower than the signal bandwidth, the signal path may be overloaded although the trace is distinctly below the reference level. If the measured channel power is equal to the reference level, the signal path cannot be overloaded.

Remote command:

`[SENSe:]ADJust:LEVel` on page 781

Adjust X-Axis ← Spurious Emissions

Adjusts the frequency axis of measurement diagram automatically so that the start frequency matches the start frequency of the first sweep range, and the stop frequency of the last sweep range.

Meas Start/Stop ← Spurious Emissions

Aborts/restarts the current measurement and displays the status:

"Start"	The measurement is currently running.
"Stop"	The measurement has been stopped, or, in single sweep mode, the end of the sweep has been reached.

5.3.5.7 Measuring the Power in Zero Span

Using the power measurement function, the R&S FSVA/FSV determines the power of the signal in zero span by summing up the power at the individual measurement points and dividing the result by the number of measurement points. Thus it is possible to measure the power of TDMA signals during transmission, for example, or during the muting phase. Both the mean power and the RMS power can be measured.

For this measurement, the sample detector is activated.

Measurement results

Several different power results can be determined simultaneously:

Mode	Description
Peak	Peak value from the points of the displayed trace or a segment thereof.
RMS	RMS value from the points of the displayed trace or a segment thereof.
Mean	Mean value from the points of the displayed trace or a segment thereof. The linear mean value of the equivalent voltages is calculated. For example to measure the mean power during a GSM burst
Std Dev	The standard deviation of the measurement points from the mean value.

The result is displayed in the marker results, indicated by "Power" and the selected power mode, e.g. "RMS". The measured values are updated after each sweep or averaged over a user-defined number of sweeps (trace averaging).

The results can also be queried using the remote commands described in "[CALCulate:MARKer:FUNCTion:SUMMary Subsystem](#)" on page 718.

Restricting the measurement range using limit lines

The range of the measured signal to be evaluated for the power measurement can be restricted using limit lines. The left and right limit lines (S1, S2) define the evaluation range and are indicated by vertical red lines in the diagram. If activated, the power results are only calculated from the levels within the limit lines.

For example, if both the on and off phase of a burst signal are displayed, the measurement range can be limited to the transmission or to the muting phase. The ratio between signal and noise power of a TDMA signal for instance can be measured using a measurement as a reference value and then varying the measurement range.

To measure the power in the time domain

1. Press the "Time Domain Power" softkey to activate the power measurement.
2. Select the type of power measurement using the "Peak", "Mean", "RMS" or "Std Dev" softkeys.
3. To limit the power evaluation range, switch on the limits ("Limits (On/Off)" softkey) and enter the limits using the "Left Limit" and "Right Limit" softkeys.

Softkeys for Time Domain Power Measurements

Time Domain Power.....	356
L Peak.....	356
L RMS.....	356
L Mean.....	356
L Std Dev.....	356
L Limits (On/Off).....	356
L Left Limit.....	357
L Right Limit.....	357

Time Domain Power

Activates the power measurement in zero span and opens a submenu to configure the power measurement. For more details see also [Chapter 5.3.5.7, "Measuring the Power in Zero Span"](#), on page 354.

Remote command:

`CALCulate<n>:MARKer<m>:FUNCTION:SUMMARY[:STATE]` on page 731

Peak ← Time Domain Power

Activates the calculation of the peak value from the points of the displayed trace or a segment thereof.

Remote command:

`CALCulate<n>:MARKer<m>:FUNCTION:SUMMARY:PPEak[:STATE]` on page 725

`CALCulate<n>:MARKer<m>:FUNCTION:SUMMARY:PPEak:RESULT?` on page 725

RMS ← Time Domain Power

Activates the calculation of the RMS value from the points of the displayed trace or a segment thereof.

Remote command:

`CALCulate<n>:MARKer<m>:FUNCTION:SUMMARY:RMS[:STATE]` on page 728

`CALCulate<n>:MARKer<m>:FUNCTION:SUMMARY:RMS:RESULT?` on page 727

Mean ← Time Domain Power

Activates the calculation of the mean value from the points of the displayed trace or a segment thereof. The linear mean value of the equivalent voltages is calculated.

This can be used for instance to measure the mean power during a GSM burst.

Remote command:

`CALCulate<n>:MARKer<m>:FUNCTION:SUMMARY:MEAN[:STATE]` on page 723

`CALCulate<n>:MARKer<m>:FUNCTION:SUMMARY:MEAN:RESULT?` on page 722

Std Dev ← Time Domain Power

Activates the calculation of the standard deviation of measurement points from the mean value and displays them as measured value. The measurement of the mean power is automatically switched on at the same time.

Remote command:

`CALCulate<n>:MARKer<m>:FUNCTION:SUMMARY:SDEVIation[:STATE]`

on page 730

`CALCulate<n>:MARKer<m>:FUNCTION:SUMMARY:SDEVIation:RESULT?`

on page 730

Limits (On/Off) ← Time Domain Power

Switches the limitation of the evaluation range on or off. Default setting is off.

If switched off, the evaluation range is not limited. If switched on, the evaluation range is defined by the left and right limit. If only one limit is set, it corresponds to the left limit and the right limit is defined by the stop frequency. If the second limit is also set, it defines the right limit.

Remote command:

`CALCulate<n>:MARKer<m>:X:SLIMITs[:STATE]` on page 678

Left Limit ← Time Domain Power

Opens an edit dialog box to enter a value for line 1.

Remote command:

`CALCulate<n>:MARKer<m>:X:SLIMits:LEFT` on page 678

Right Limit ← Time Domain Power

Opens an edit dialog box to enter a value for line 2.

Remote command:

`CALCulate<n>:MARKer<m>:X:SLIMits:RIGHT` on page 679

5.3.5.8 Calculating Signal Amplitude Statistics

To measure the amplitude distribution, the R&S FSVA/FSV has simple measurement functions to determine both the APD = Amplitude Probability Distribution and CCDF = Complementary Cumulative Distribution Function.

To determine the amplitude distribution

- ▶ To activate and configure the measurement of the amplitude probability distribution (APD), press the "APD" softkey (see "APD" on page 282).
To activate and configure the measurement of the complementary cumulative distribution (CCDF), press the "CCDF" softkey (see "CCDF" on page 283).

Only one of the signal statistic functions can be switched on at a time. When a statistic function is switched on, the R&S FSVA/FSV is set into zero span mode automatically. The R&S FSVA/FSV measures the statistics of the signal applied to the RF input with the defined resolution bandwidth. To avoid affecting the peak amplitudes the video bandwidth is automatically set to 10 times the resolution bandwidth. The sample detector is used for detecting the video voltage.

About the Statistical Measurements.....	357
Result Evaluation.....	359
Softkeys for APD Measurements.....	361
Softkeys for CCDF Measurements.....	366
Defining Gated Triggering for APD and CCDF.....	372

About the Statistical Measurements

Digital modulated signals are similar to white noise within the transmit channel, but are different in their amplitude distribution. In order to transmit the modulated signal without distortion all amplitudes of the signal have to be transmitted linearly, e.g. from the output power amplifier. Most critical are the peak amplitude values. Degradation in transmit quality caused by a transmitter two port network is dependent on the amplitude of the peak values as well as on their probability.

If modulation types are used that do not have a constant zero span envelope, the transmitter has to handle peak amplitudes that are greater than the average power. This includes all modulation types that involve amplitude modulation, QPSK for exam-

ple. CDMA transmission modes in particular may have power peaks that are large compared to the average power.

For signals of this kind, the transmitter must provide large reserves for the peak power to prevent signal compression and thus an increase of the bit error rate at the receiver. The peak power or the crest factor of a signal is therefore an important transmitter design criterion. The crest factor is defined as the peak power/mean power ratio or, logarithmically, as the peak level minus the average level of the signal. To reduce power consumption and cut costs, transmitters are not designed for the largest power that could ever occur, but for a power that has a specified probability of being exceeded (e.g. 0.01 %).

The probability of amplitude values can be measured with the APD function (Amplitude Probability Distribution). During a selectable measurement time all occurring amplitude values are assigned to an amplitude range. The number of amplitude values in the specific ranges is counted and the result is displayed as a histogram.

Alternatively, the Complementary Cumulative Distribution Function (CCDF) can be displayed. It shows the probability that the mean signal power amplitude will be exceeded in percent.

Bandwidth selection

When the amplitude distribution is measured, the resolution bandwidth must be set so that the complete spectrum of the signal to be measured falls within the bandwidth. This is the only way of ensuring that all the amplitudes will pass through the IF filter without being distorted. If the selected resolution bandwidth is too small for a digitally modulated signal, the amplitude distribution at the output of the IF filter becomes a Gaussian distribution according to the central limit theorem and thus corresponds to a white noise signal. The true amplitude distribution of the signal therefore cannot be determined.

Selecting the number of samples

For statistics measurements with the R&S FSVA/FSV, the number of samples to be measured is defined instead of the sweep time. Since only statistically independent samples contribute to statistics, the acquisition or sweep time is calculated automatically and displayed in the channel bar (AQT). The samples are statistically independent if the time difference is at least 1/RBW. The acquisition time AQT is, therefore, expressed as follows:

$$\text{AQT} = N_{\text{Samples}}/\text{RBW}$$

Statistic measurements on pulsed signals

Statistic measurements on pulsed signals can be performed using a gated trigger. An external frame trigger is required as a time (frame) reference. For details see ["Defining Gated Triggering for APD and CCDF"](#) on page 372.



Measurement examples are described in [Chapter 4.6.6.2, "Amplitude Distribution Measurements"](#), on page 132.

Result Evaluation

Amplitude Probability Distribution (APD)

As a result of the APD function (Amplitude Probability Distribution), the probability of measured amplitude values is displayed. During a selectable measurement time all occurring amplitude values are assigned to an amplitude range. The number of amplitude values in the specific ranges is counted and the result is displayed as a histogram. Each bar of the histogram represents the percentage of measured amplitudes within the specific amplitude range. The x-axis is scaled in absolute values in dBm.

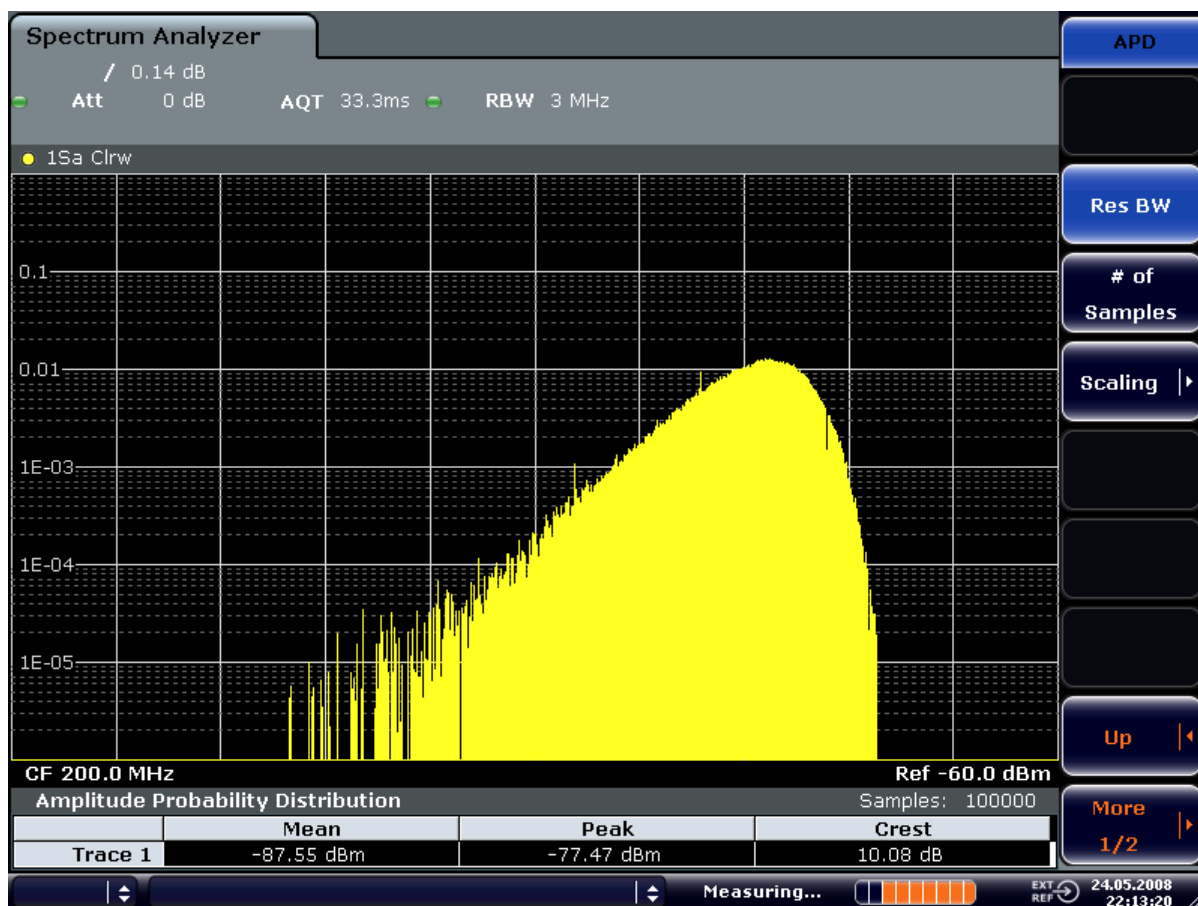

Figure 5-17: Amplitude probability distribution of white noise

In addition to the histogram, a result table is displayed containing the following information:

- Number of samples used for calculation
- For each displayed trace:
 - Mean amplitude
 - Peak amplitude
 - Crest factor

Complementary Cumulative Distribution Function (CCDF)

The Complementary Cumulative Distribution Function (CCDF) shows the probability that the mean signal power amplitude will be exceeded in percent. The level above the mean power is plotted along the x-axis of the graph. The origin of the axis corresponds to the mean power level. The probability that a level will be exceeded is plotted along the y-axis.

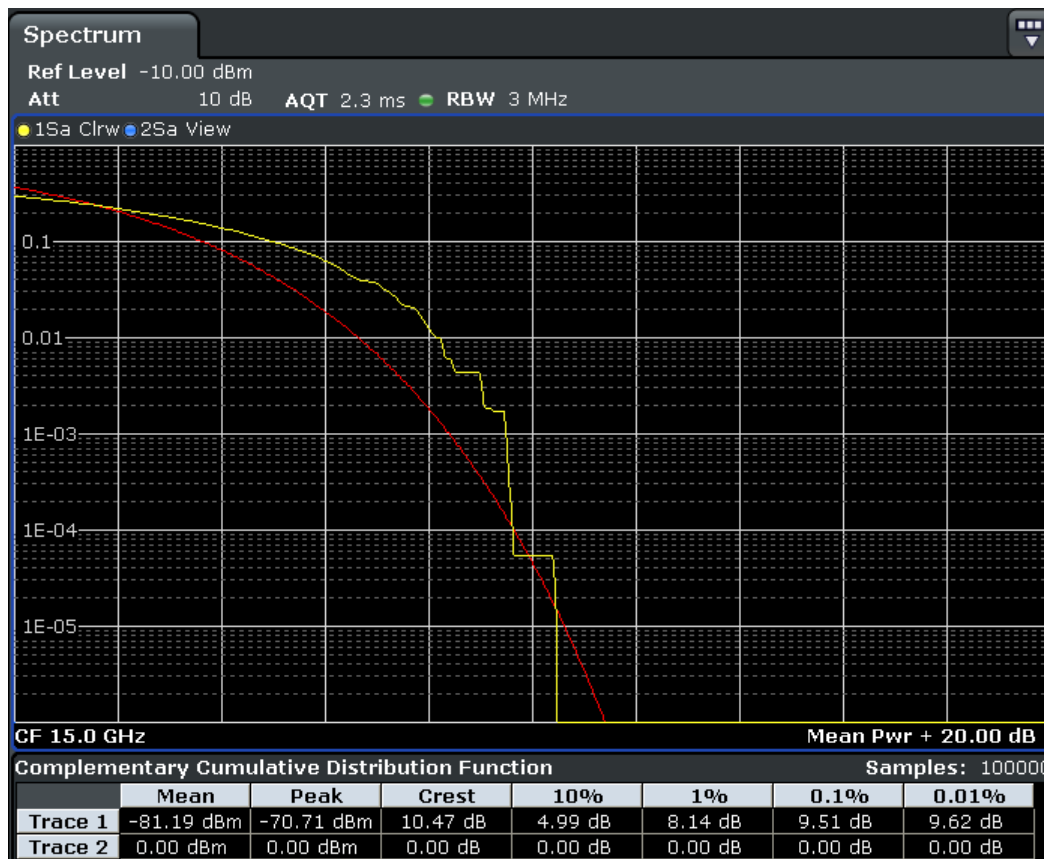

Figure 5-18: CCDF of white noise



A red line indicates the ideal Gaussian distribution for the measured amplitude range (white noise).

The displayed amplitude range is indicated as "Mean Pwr + <x dB>"

In addition to the histogram, a result table is displayed containing the following information:

- Number of samples used for calculation
- For each displayed trace:

Mean	Mean power
Peak	Peak power

Crest	Crest factor (peak power – mean power)
0,01 %	Level values over 0,01 % above mean power
0,1 %	Level values over 0,1 % above mean power
1 %	Level values over 1 % above mean power
10 %	Level values over 10 % above mean power

Softkeys for APD Measurements

APD.....	361
L Res BW.....	361
L # of Samples.....	362
L Scaling.....	362
L x-Axis Ref Level.....	362
L x-Axis Range.....	362
L Range Log 100 dB.....	362
L Range Log 50 dB.....	362
L Range Log 10 dB.....	363
L Range Log 5 dB.....	363
L Range Log 1 dB.....	363
L Range Log Manual.....	363
L Range Linear %.....	364
L Range Lin. Unit.....	364
L y-Axis Max Value.....	364
L y-Axis Min Value.....	364
L y-Unit % / Abs.....	364
L Default Settings.....	364
L Adjust Settings.....	365
L Gated Trigger (On/Off).....	365
L Gate Ranges.....	365
L Adjust Settings.....	366

APD

Activates the function to measure the amplitude probability density (APD) and opens a submenu.

For general information on calculating signal statistics see [Chapter 5.3.5.8, "Calculating Signal Amplitude Statistics"](#), on page 357.

Remote command:

`CALCulate<n>:STATistics:APD[:STATe]` on page 741

Res BW ← APD

Opens an edit dialog box to set the resolution bandwidth directly.

For correct measurement of the signal statistics the resolution bandwidth has to be wider than the signal bandwidth in order to measure the actual peaks of the signal amplitude correctly. In order not to influence the peak amplitudes the video bandwidth is automatically set to 10 MHz. The sample detector is used for detecting the video voltage.

Remote command:

[SENSe:]BANDwidth|BWIDth[:RESolution] on page 785

of Samples ← APD

Opens an edit dialog box to set the number of power measurements that are taken into account for the statistics.

Apart from the number of measurements the overall measurement time depends also on the set resolution bandwidth as the resolution bandwidth directly influences the sampling rate.

For details see "Selecting the number of samples" on page 358.

Remote command:

CALCulate<n>:STATistics:NSAMples on page 742

Scaling ← APD

Opens a submenu to change the scaling parameters of x- and y-axis.

x-Axis Ref Level ← Scaling ← APD

Opens an edit dialog box to enter the reference level in the currently active unit (dBm, dBμV, etc). The function of this softkey is identical to the "Ref Level" softkey in the "Amplitude" menu (see "Ref Level" on page 193).

For the APD function this value is mapped to the right diagram border. For the CCDF function there is no direct representation of this value on the diagram as the x-axis is scaled relatively to the measured mean power.

Remote command:

CALCulate<n>:STATistics:SCALE:X:RLEVel on page 744

x-Axis Range ← Scaling ← APD

Opens the "Range" submenu to select a value for the level range to be covered by the statistics measurement selected.

Remote command:

CALCulate<n>:STATistics:SCALE:X:RANGE on page 744

Range Log 100 dB ← x-Axis Range ← Scaling ← APD

Sets the level display range to 100 dB.

Remote command:

Logarithmic scaling:

DISP:WIND:TRAC:Y:SPAC LOG, see DISPLAY[:WINDow<n>]:TRACe<t>:Y:

SPACing on page 753

Display range:

DISP:WIND:TRAC:Y 100DB, see DISPLAY[:WINDow<n>]:TRACe<t>:Y[:SCALE] on page 753

Range Log 50 dB ← x-Axis Range ← Scaling ← APD

Sets the level display range to 50 dB.

Remote command:

Logarithmic scaling:

DISP:WIND:TRAC:Y:SPAC LOG, see [DISPlay\[:WINDow<n>\]:TRACe<t>:Y:SPACing](#) on page 753

Display range:

DISP:WIND:TRAC:Y 50DB, see [DISPlay\[:WINDow<n>\]:TRACe<t>:Y\[:SCALE\]](#) on page 753

Range Log 10 dB ← x-Axis Range ← Scaling ← APD

Sets the level display range to 10 dB.

Remote command:

Logarithmic scaling:

DISP:WIND:TRAC:Y:SPAC LOG, see [DISPlay\[:WINDow<n>\]:TRACe<t>:Y:SPACing](#) on page 753

Display range:

DISP:WIND:TRAC:Y 10DB, see [DISPlay\[:WINDow<n>\]:TRACe<t>:Y\[:SCALE\]](#) on page 753

Range Log 5 dB ← x-Axis Range ← Scaling ← APD

Sets the level display range to 5 dB.

Remote command:

Logarithmic scaling:

DISP:WIND:TRAC:Y:SPAC LOG, see [DISPlay\[:WINDow<n>\]:TRACe<t>:Y:SPACing](#) on page 753

Display range:

DISP:WIND:TRAC:Y 5DB, see [DISPlay\[:WINDow<n>\]:TRACe<t>:Y\[:SCALE\]](#) on page 753

Range Log 1 dB ← x-Axis Range ← Scaling ← APD

Sets the level display range to 1 dB.

Remote command:

Logarithmic scaling:

DISP:WIND:TRAC:Y:SPAC LOG, see [DISPlay\[:WINDow<n>\]:TRACe<t>:Y:SPACing](#) on page 753

Display range:

DISP:WIND:TRAC:Y 1DB, see [DISPlay\[:WINDow<n>\]:TRACe<t>:Y\[:SCALE\]](#) on page 753

Range Log Manual ← x-Axis Range ← Scaling ← APD

Opens an edit dialog box to define the display range of a logarithmic level axis manually.

Remote command:

Logarithmic scaling:

DISP:WIND:TRAC:Y:SPAC LOG, see [DISPlay\[:WINDow<n>\]:TRACe<t>:Y:SPACing](#) on page 753

Display range:

[DISPlay\[:WINDow<n>\]:TRACe<t>:Y\[:SCALE\]](#) on page 753

Range Linear % ← x-Axis Range ← Scaling ← APD

Selects linear scaling for the level axis in %.

The grid is divided into decadal sections.

Markers are displayed in the selected unit ("Unit" softkey). Delta markers are displayed in % referenced to the voltage value at the position of marker 1. This is the default setting for linear scaling.

Remote command:

DISP:TRAC:Y:SPAC LIN, see [DISPlay\[:WINDow<n>\]:TRACe<t>:Y:SPACing](#) on page 753

Range Lin. Unit ← x-Axis Range ← Scaling ← APD

Selects linear scaling in dB for the level display range, i.e. the horizontal lines are labeled in dB.

Markers are displayed in the selected unit ("Unit" softkey). Delta markers are displayed in dB referenced to the power value at the position of marker 1.

Remote command:

DISP:TRAC:Y:SPAC LDB, see [DISPlay\[:WINDow<n>\]:TRACe<t>:Y:SPACing](#) on page 753

y-Axis Max Value ← Scaling ← APD

Opens an edit dialog box to define the upper limit of the displayed probability range.

Values on the y-axis are normalized which means that the maximum value is 1.0. The y-axis scaling is defined via the [y-Unit % / Abs](#) softkey. The distance between max and min value must be at least one decade.

Remote command:

[CALCulate<n>:STATistics:SCALE:Y:UPPer](#) on page 745

y-Axis Min Value ← Scaling ← APD

Opens an edit dialog box to define the lower limit of the displayed probability range.

Values in the range $1e^{-9} < value < 0.1$ are allowed. The y-axis scaling is defined via the [y-Unit % / Abs](#) softkey. The distance between max and min value must be at least one decade.

Remote command:

[CALCulate<n>:STATistics:SCALE:Y:LOWer](#) on page 744

y-Unit % / Abs ← Scaling ← APD

Defines the scaling type of the y-axis. The default value is absolute scaling.

Remote command:

[CALCulate<n>:STATistics:SCALE:Y:UNIT](#) on page 745

Default Settings ← Scaling ← APD

Resets the x- and y-axis scalings to their preset values.

x-axis ref level:	-10 dBm
x-axis range APD:	100 dB
x-axis range CCDF:	20 dB

y-axis upper limit:	1.0
y-axis lower limit:	1E-6

Remote command:

[CALCulate<n>:STATistics:PRESet](#) on page 742

Adjust Settings ← Scaling ← APD

Adjusts the level settings according to the measured difference between peak and minimum power for APD measurement or peak and mean power for CCDF measurement in order to obtain maximum power resolution. Adjusts the reference level to the current input signal. For details see also the [Adjust Ref Lvl](#) softkey.

Remote command:

[CALCulate<n>:STATistics:SCALE:AUTO ONCE](#) on page 743

Gated Trigger (On/Off) ← APD

Activates and deactivates the gating for statistics functions for the ACP and the CCDF channel. The trigger source is changed to "EXTERN" if this function is switched on. The gate ranges are defined using the ["Gate Ranges"](#) on page 365 softkey.

Remote command:

[\[SENSe:\]SWEep:EGATe](#) on page 857

[\[SENSe:\]SWEep:EGATe:SOURce](#) on page 858

Gate Ranges ← APD

Opens a dialog to configure up to 3 gate ranges for each trace.

For details on configuration, see ["Defining Gated Triggering for APD and CCDF"](#) on page 372.

Gate Ranges						
	Trace 1	Trace 2	Trace 3	Trace 4	Trace 5	Trace 6
Comment	SlotA					
Period	8 ms	8 ms	8 ms	8 ms	8 ms	8 ms
Range 1 Start	1 ms	1 μs	1 μs	1 μs	1 μs	1 μs
Range 1 Stop	3 ms	1 μs	1 μs	1 μs	1 μs	1 μs
Range 1 Use	On	Off	Off	Off	Off	Off
Range 2 Start	1 μs	1 μs	1 μs	1 μs	1 μs	1 μs
Range 2 Stop	1 μs	1 μs	1 μs	1 μs	1 μs	1 μs
Range 2 Use	Off	Off	Off	Off	Off	Off
Range 3 Start	1 μs	1 μs	1 μs	1 μs	1 μs	1 μs
Range 3 Stop	1 μs	1 μs	1 μs	1 μs	1 μs	1 μs
Range 3 Use	Off	Off	Off	Off	Off	Off

Remote command:

[SWE:EGAT ON](#) (see [\[SENSe:\]SWEep:EGATe](#) on page 857)

Switches on the external gate mode.

[SWE:EGAT:TRAC1:COMM "SlotA"](#) (see [\[SENSe:\]SWEep:EGATe:TRACe<k>:COMMENT](#) on page 859)

Adds a comment to trace 1.

SWE:EGAT:TRAC1:STAT1 ON (see [SENSe:]SWEep:EGATe:TRACe<k>[:STATe<range>] on page 859)

Activates tracing for range 1 of trace 1.

SWE:EGAT:TRAC1:STAR1 3ms (see [SENSe:]SWEep:EGATe:TRACe<k>:STARt<range> on page 859)

Sets the starting point for range 1 on trace 1 at 3 ms.

SWE:EGAT:TRAC1:STOp1 5ms (see [SENSe:]SWEep:EGATe:TRACe<k>:STOP<range> on page 860)

Sets the stopping point for range 1 on trace 1 at 5 ms.

SWE:EGAT:TRAC1:PER 5ms (see [SENSe:]SWEep:EGATe:TRACe<k>:PERiod on page 860)

Defines the period for gated triggering to 5 ms.

Adjust Settings ← APD

Adjusts the level settings according to the measured difference between peak and minimum power for APD measurement or peak and mean power for CCDF measurement in order to obtain maximum power resolution. Adjusts the reference level to the current input signal. For details see also the [Adjust Ref Lvl](#) softkey.

Remote command:

CALCulate<n>:STATistics:SCALE:AUtO ONCE on page 743

Softkeys for CCDF Measurements

CCDF.....	366
L Percent Marker.....	367
L Res BW.....	367
L # of Samples.....	367
L Scaling.....	368
L x-Axis Ref Level.....	368
L x-Axis Range.....	368
L Range Log 100 dB.....	368
L Range Log 50 dB.....	368
L Range Log 10 dB.....	368
L Range Log 5 dB.....	369
L Range Log 1 dB.....	369
L Range Log Manual.....	369
L Range Linear %.....	369
L Range Lin. Unit.....	370
L y-Axis Max Value.....	370
L y-Axis Min Value.....	370
L y-Unit % / Abs.....	370
L Default Settings.....	370
L Adjust Settings.....	371
L Gated Trigger (On/Off).....	371
L Gate Ranges.....	371
L Adjust Settings.....	372

CCDF

Activates the function to measure the complementary cumulative distribution function (CCDF) and opens a submenu.

After a CCDF measurement, the results are displayed in a table beneath the diagram.

Mean	Mean power
Peak	Peak power
Crest	Crest factor (peak power – mean power)
0,01 %	Level values over 0,01 % above mean power
0,1 %	Level values over 0,1 % above mean power
1 %	Level values over 1 % above mean power
10 %	Level values over 10 % above mean power

In addition, a red reference line indicating the calculated Gauss distribution is displayed.

Remote command:

[CALCulate<n>:STATistics:CCDF\[:STATe\]](#) on page 741

Activates the CCDF measurement.

[CALCulate<n>:STATistics:CCDF:X<Trace>](#) on page 741

Reads out the level values for 1 % probability.

Percent Marker ← CCDF

Opens an edit dialog box to enter a probability value and to position marker 1. Thus, the power which is exceeded with a given probability can be determined very easily. If marker 1 is deactivated, it will be switched on automatically.

As all markers, the percent marker can be moved simply by touching it with a finger or mouse cursor and dragging it to the desired position.

Remote command:

[CALCulate<n>:MARKer<m>:Y:PERCent](#) on page 681

Res BW ← CCDF

Opens an edit dialog box to set the resolution bandwidth directly.

For correct measurement of the signal statistics the resolution bandwidth has to be wider than the signal bandwidth in order to measure the actual peaks of the signal amplitude correctly. In order not to influence the peak amplitudes the video bandwidth is automatically set to 10 MHz. The sample detector is used for detecting the video voltage.

Remote command:

[\[SENSe:\]BANDwidth|BWIDth\[:RESolution\]](#) on page 785

of Samples ← CCDF

Opens an edit dialog box to set the number of power measurements that are taken into account for the statistics.

Apart from the number of measurements the overall measurement time depends also on the set resolution bandwidth as the resolution bandwidth directly influences the sampling rate.

For details see "[Selecting the number of samples](#)" on page 358.

Remote command:

[CALCulate<n>:STATistics:NSAMples](#) on page 742

Scaling ← CCDF

Opens a submenu to change the scaling parameters of x- and y-axis.

x-Axis Ref Level ← Scaling ← CCDF

Opens an edit dialog box to enter the reference level in the currently active unit (dBm, dBμV, etc). The function of this softkey is identical to the "Ref Level" softkey in the "Amplitude" menu (see ["Ref Level"](#) on page 193).

For the APD function this value is mapped to the right diagram border. For the CCDF function there is no direct representation of this value on the diagram as the x-axis is scaled relatively to the measured mean power.

Remote command:

[CALCulate<n>:STATistics:SCALE:X:RLEVEL](#) on page 744

x-Axis Range ← Scaling ← CCDF

Opens the "Range" submenu to select a value for the level range to be covered by the statistics measurement selected.

Remote command:

[CALCulate<n>:STATistics:SCALE:X:RANGE](#) on page 744

Range Log 100 dB ← x-Axis Range ← Scaling ← CCDF

Sets the level display range to 100 dB.

Remote command:

Logarithmic scaling:

[DISP:WIND:TRAC:Y:SPAC LOG](#), see [DISPlay\[:WINDow<n>\]:TRACe<t>:Y:SPACing](#) on page 753

Display range:

[DISP:WIND:TRAC:Y 100DB](#), see [DISPlay\[:WINDow<n>\]:TRACe<t>:Y\[:SCALE\]](#) on page 753

Range Log 50 dB ← x-Axis Range ← Scaling ← CCDF

Sets the level display range to 50 dB.

Remote command:

Logarithmic scaling:

[DISP:WIND:TRAC:Y:SPAC LOG](#), see [DISPlay\[:WINDow<n>\]:TRACe<t>:Y:SPACing](#) on page 753

Display range:

[DISP:WIND:TRAC:Y 50DB](#), see [DISPlay\[:WINDow<n>\]:TRACe<t>:Y\[:SCALE\]](#) on page 753

Range Log 10 dB ← x-Axis Range ← Scaling ← CCDF

Sets the level display range to 10 dB.

Remote command:

Logarithmic scaling:

DISP:WIND:TRAC:Y:SPAC LOG, see [DISPlay\[:WINDow<n>\]:TRACe<t>:Y:SPACing](#) on page 753

Display range:

DISP:WIND:TRAC:Y 10DB, see [DISPlay\[:WINDow<n>\]:TRACe<t>:Y\[:SCALE\]](#) on page 753

Range Log 5 dB ← x-Axis Range ← Scaling ← CCDF

Sets the level display range to 5 dB.

Remote command:

Logarithmic scaling:

DISP:WIND:TRAC:Y:SPAC LOG, see [DISPlay\[:WINDow<n>\]:TRACe<t>:Y:SPACing](#) on page 753

Display range:

DISP:WIND:TRAC:Y 5DB, see [DISPlay\[:WINDow<n>\]:TRACe<t>:Y\[:SCALE\]](#) on page 753

Range Log 1 dB ← x-Axis Range ← Scaling ← CCDF

Sets the level display range to 1 dB.

Remote command:

Logarithmic scaling:

DISP:WIND:TRAC:Y:SPAC LOG, see [DISPlay\[:WINDow<n>\]:TRACe<t>:Y:SPACing](#) on page 753

Display range:

DISP:WIND:TRAC:Y 1DB, see [DISPlay\[:WINDow<n>\]:TRACe<t>:Y\[:SCALE\]](#) on page 753

Range Log Manual ← x-Axis Range ← Scaling ← CCDF

Opens an edit dialog box to define the display range of a logarithmic level axis manually.

Remote command:

Logarithmic scaling:

DISP:WIND:TRAC:Y:SPAC LOG, see [DISPlay\[:WINDow<n>\]:TRACe<t>:Y:SPACing](#) on page 753

Display range:

[DISPlay\[:WINDow<n>\]:TRACe<t>:Y\[:SCALE\]](#) on page 753

Range Linear % ← x-Axis Range ← Scaling ← CCDF

Selects linear scaling for the level axis in %.

The grid is divided into decadal sections.

Markers are displayed in the selected unit ("Unit" softkey). Delta markers are displayed in % referenced to the voltage value at the position of marker 1. This is the default setting for linear scaling.

Remote command:

DISP:TRAC:Y:SPAC LIN, see [DISPlay\[:WINDow<n>\]:TRACe<t>:Y:SPACing](#) on page 753

Range Lin. Unit ← x-Axis Range ← Scaling ← CCDF

Selects linear scaling in dB for the level display range, i.e. the horizontal lines are labeled in dB.

Markers are displayed in the selected unit ("Unit" softkey). Delta markers are displayed in dB referenced to the power value at the position of marker 1.

Remote command:

DISP:TRAC:Y:SPAC LDB, see [DISPlay\[:WINDow<n>\]:TRACe<t>:Y:SPACing](#) on page 753

y-Axis Max Value ← Scaling ← CCDF

Opens an edit dialog box to define the upper limit of the displayed probability range. Values on the y-axis are normalized which means that the maximum value is 1.0. The y-axis scaling is defined via the [y-Unit % / Abs](#) softkey. The distance between max and min value must be at least one decade.

Remote command:

[CALCulate<n>:STATistics:SCALE:Y:UPPer](#) on page 745

y-Axis Min Value ← Scaling ← CCDF

Opens an edit dialog box to define the lower limit of the displayed probability range. Values in the range $1e^{-9} < value < 0.1$ are allowed. The y-axis scaling is defined via the [y-Unit % / Abs](#) softkey. The distance between max and min value must be at least one decade.

Remote command:

[CALCulate<n>:STATistics:SCALE:Y:LOWer](#) on page 744

y-Unit % / Abs ← Scaling ← CCDF

Defines the scaling type of the y-axis. The default value is absolute scaling.

Remote command:

[CALCulate<n>:STATistics:SCALE:Y:UNIT](#) on page 745

Default Settings ← Scaling ← CCDF

Resets the x- and y-axis scalings to their preset values.

x-axis ref level:	-10 dBm
x-axis range APD:	100 dB
x-axis range CCDF:	20 dB
y-axis upper limit:	1.0
y-axis lower limit:	1E-6

Remote command:

[CALCulate<n>:STATistics:PRESet](#) on page 742

Adjust Settings ← Scaling ← CCDF

Adjusts the level settings according to the measured difference between peak and minimum power for APD measurement or peak and mean power for CCDF measurement in order to obtain maximum power resolution. Adjusts the reference level to the current input signal. For details see also the [Adjust Ref Lvl](#) softkey.

Remote command:

`CALCulate<n>:STATistics:SCALE:AUTO ONCE` on page 743

Gated Trigger (On/Off) ← CCDF

Activates and deactivates the gating for statistics functions for the ACP and the CCDF channel. The trigger source is changed to "EXTERN" if this function is switched on. The gate ranges are defined using the ["Gate Ranges"](#) on page 365 softkey.

Remote command:

`[SENSe:]SWEep:EGATe` on page 857

`[SENSe:]SWEep:EGATe:SOURce` on page 858

Gate Ranges ← CCDF

Opens a dialog to configure up to 3 gate ranges for each trace.

For details on configuration, see ["Defining Gated Triggering for APD and CCDF"](#) on page 372.

Gate Ranges						
	Trace 1	Trace 2	Trace 3	Trace 4	Trace 5	Trace 6
Comment	SlotA					
Period	8 ms	8 ms	8 ms	8 ms	8 ms	8 ms
Range 1 Start	1 ms	1 μs	1 μs	1 μs	1 μs	1 μs
Range 1 Stop	3 ms	1 μs	1 μs	1 μs	1 μs	1 μs
Range 1 Use	On	Off	Off	Off	Off	Off
Range 2 Start	1 μs	1 μs	1 μs	1 μs	1 μs	1 μs
Range 2 Stop	1 μs	1 μs	1 μs	1 μs	1 μs	1 μs
Range 2 Use	Off	Off	Off	Off	Off	Off
Range 3 Start	1 μs	1 μs	1 μs	1 μs	1 μs	1 μs
Range 3 Stop	1 μs	1 μs	1 μs	1 μs	1 μs	1 μs
Range 3 Use	Off	Off	Off	Off	Off	Off

Remote command:

`SWE:EGAT ON` (see [\[SENSe:\]SWEep:EGATe](#) on page 857)

Switches on the external gate mode.

`SWE:EGAT:TRAC1:COMM "SlotA"` (see [\[SENSe:\]SWEep:EGATe:TRACe<k>:COMMENT](#) on page 859)

Adds a comment to trace 1.

`SWE:EGAT:TRAC1:STAT1 ON` (see [\[SENSe:\]SWEep:EGATe:TRACe<k>\[:STATE<range>\]](#) on page 859)

Activates tracing for range 1 of trace 1.

`SWE:EGAT:TRAC1:STAR1 3ms` (see [\[SENSe:\]SWEep:EGATe:TRACe<k>:START<range>](#) on page 859)

Sets the starting point for range 1 on trace 1 at 3 ms.

`SWE:EGAT:TRAC1:STOp1 5ms` (see [\[SENSe:\]SWEep:EGATe:TRACe<k>:STOP<range>](#) on page 860)

Sets the stopping point for range 1 on trace 1 at 5 ms.

`SWE:EGAT:TRAC1:PER 5ms` (see `[SENSe:]SWEp:EGATe:TRACe<k>:PERiod` on page 860)

Defines the period for gated triggering to 5 ms.

Adjust Settings ← CCDF

Adjusts the level settings according to the measured difference between peak and minimum power for APD measurement or peak and mean power for CCDF measurement in order to obtain maximum power resolution. Adjusts the reference level to the current input signal. For details see also the [Adjust Ref Lvl](#) softkey.

Remote command:

`CALCulate<n>:STATistics:SCALE:AUTO ONCE` on page 743

Defining Gated Triggering for APD and CCDF

Statistic measurements on pulsed signals can be performed using GATED TRIGGER. An external frame trigger is required as a time (frame) reference.

The gate ranges define the part of the I/Q capture data taken into account for the statistics calculation. These ranges are defined relative to a reference point T=0. The gate interval is repeated for each period until the end of the I/Q capture buffer.

The reference point T=0 is defined by the external trigger event and the instrument's trigger offset.

For each trace you can define up to 3 separate ranges of a single period to be traced.

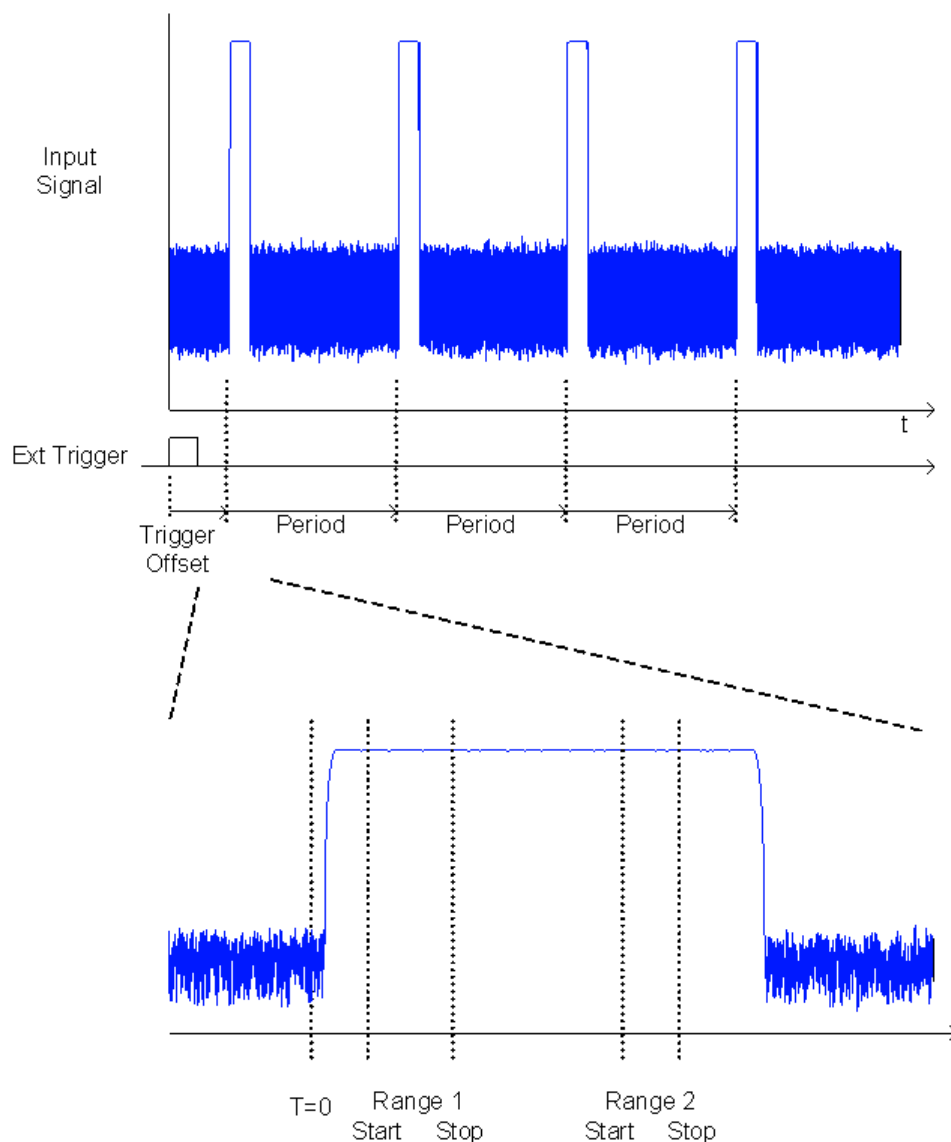

Defining gated triggering

1. Press the "Gated Trigger" softkey to activate gated triggering (see ["Gated Trigger \(On/Off\)"](#) on page 365).
2. Press the "Gate Ranges" softkey to open the "Gate Ranges" dialog (see ["Gate Ranges"](#) on page 365).
3. Define the length of the period to be analyzed in the "Period" field.

Note: The period is the same for all traces. If you change the period for one trace, it is automatically changed for all traces.

Make sure the defined period is not longer than the acquisition time of the current measurement. Keep in mind that the acquisition time depends on the bandwidth and the number of samples settings (see ["Selecting the number of samples"](#) on page 358). The current acquisition time is indicated as "AQT" in the channel bar.

4. Optionally, define a description of the trace in the "Comment" field.
5. Activate tracing for the range by selecting "On" in the "Range <number> Use" field for the corresponding range and trace.

The start and stop time edit fields are ready for input.

Note: The time values have full numerical resolution and are only rounded for display.

6. Define the starting point of the range within the period.
7. Define the stopping point for the range within the period. Make sure the value for the stopping time is smaller than the length of the period.
8. To define further ranges for the same period in the same trace, repeat steps 5- 7 for the same trace.
To define further ranges for the same period in a different trace, repeat steps 4- 7 for a different trace.
9. If necessary, activate the configured traces in the "Trace" menu.

Gated statistics configuration example

A statistics evaluation has to be done over the useful part of the signal between t_3 and t_4 . The period of the GSM signal is 4.61536 ms

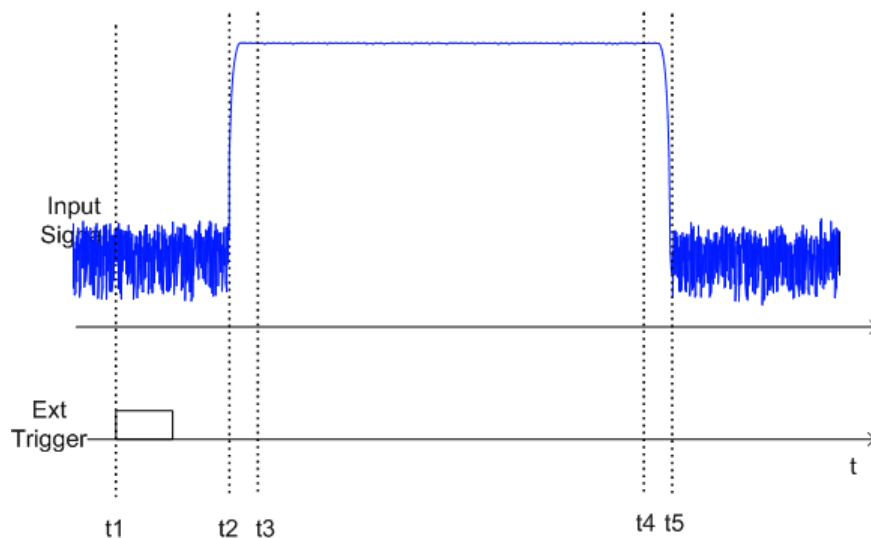

- t_1 : External positive trigger slope
- t_2 : Begin of burst (after 25 μ s)
- t_3 : Begin of useful part, to be used for statistics (after 40 μ s)
- t_4 : End of useful part, to be used for statistics (after 578 μ s)
- t_5 : End of burst (after 602 μ s)

The instrument has to be configured as follows:

Trigger Offset	$t_2 - t_1 = 25 \mu\text{s}$	now the gate ranges are relative to t_2
Range1 Start	$t_3 - t_2 = 15 \mu\text{s}$	start of range 1 relative to t_2
Range1 End	$t_4 - t_2 = 553 \mu\text{s}$	end of range 1 relative to t_2

5.3.5.9 Measuring the Third Order Intercept Point (TOI)

In order to measure the third order intercept point (TOI), a two-tone signal with equal carrier levels is expected at the R&S FSVA/FSV input. Marker 1 and marker 2 (both normal markers) are set to the maximum of the two signals. Marker 3 and marker 4 are placed on the intermodulation products.

The R&S FSVA/FSV calculates the third order intercept point from the level difference between the first 2 markers and the markers 3 and 4 and displays it in the marker field.

The third order intercept point is measured using the "TOI" softkey, see "TOI" on page 283.



A measurement example is described in "[Measurement Example – Measuring the R&S FSVA/FSV's Intrinsic Intermodulation](#)" on page 110.

About TOI Measurement

If several signals are applied to a transmission two-port device with nonlinear characteristic, intermodulation products appear at its output at the sums and differences of the signals. The nonlinear characteristic produces harmonics of the useful signals which intermodulate at the characteristic. The intermodulation products of lower order have a special effect since their level is largest and they are near the useful signals. The intermodulation product of third order causes the highest interference. It is the intermodulation product generated from one of the useful signals and the 2nd harmonic of the second useful signal in case of two-tone modulation.

The frequencies of the intermodulation products are above and below the useful signals. The [Figure 5-19](#) shows intermodulation products P_{I1} and P_{I2} generated by the two useful signals P_{U1} and P_{U2} .

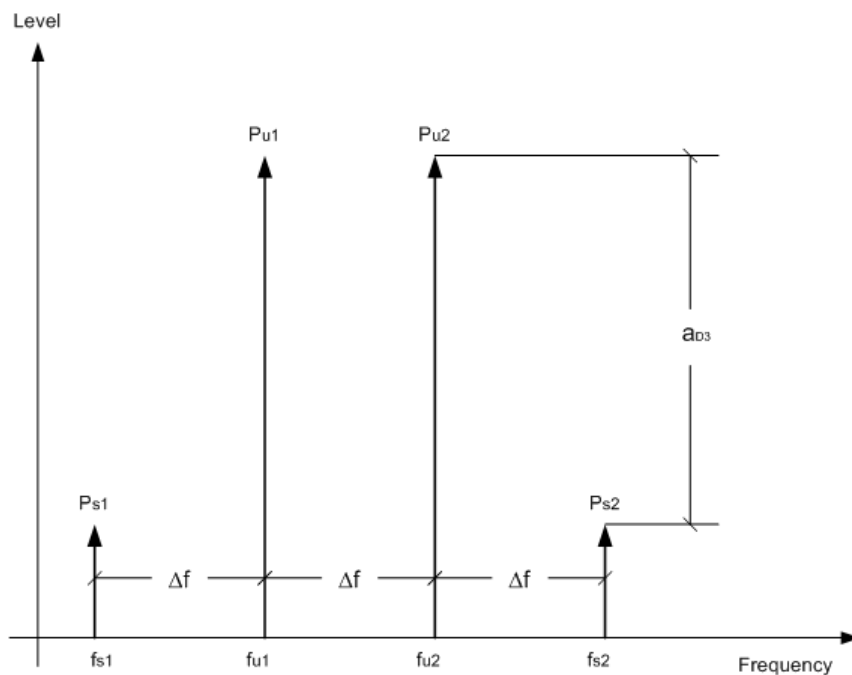

Figure 5-19: Intermodulation products PU1 and PU2

The intermodulation product at f_{i2} is generated by mixing the 2nd harmonic of useful signal P_{U2} and signal P_{U1} , the intermodulation product at f_{i1} by mixing the 2nd harmonic of useful signal P_{U1} and signal P_{U2} .

$$f_{i1} = 2 \times f_{u1} - f_{u2} \quad (6)$$

$$f_{i2} = 2 \times f_{u2} - f_{u1} \quad (7)$$

Dependency on level of useful signals

The level of the intermodulation products depends on the level of the useful signals. If the two useful signals are increased by 1 dB, the level of the intermodulation products increases by 3 dB, which means that spacing a_{D3} between intermodulation signals and useful signals are reduced by 2 dB. This is illustrated in Figure 5-20.

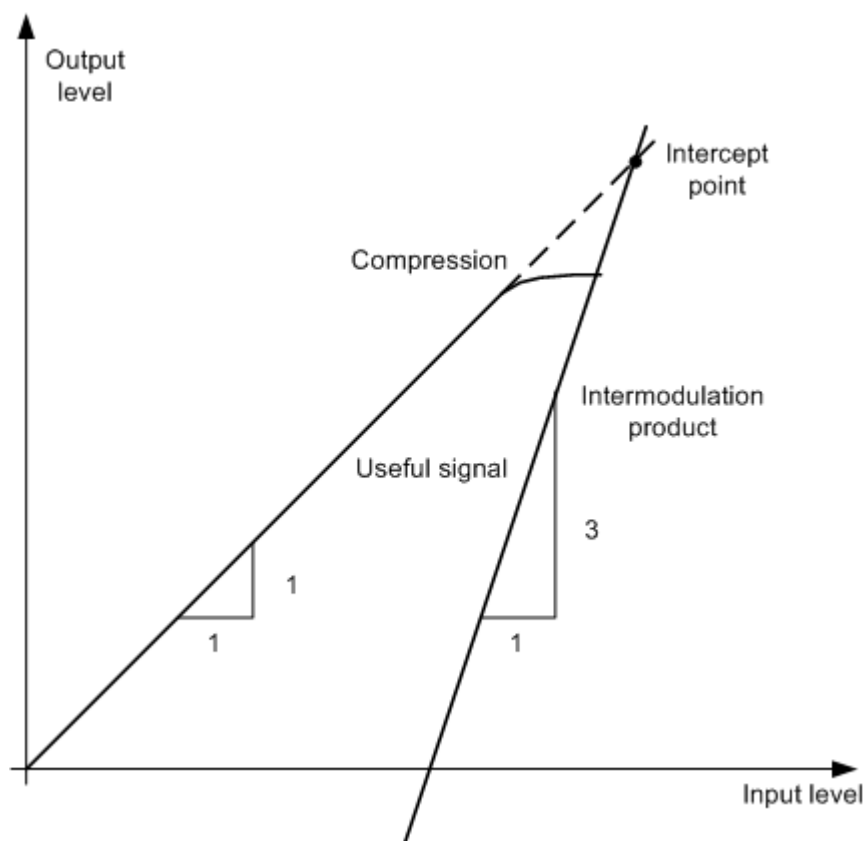

Figure 5-20: Dependency of intermodulation level on useful signal level

The useful signals at the two-port output increase proportionally with the input level as long as the two-port is in the linear range. A level change of 1 dB at the input causes a level change of 1 dB at the output. Beyond a certain input level, the two-port goes into compression and the output level stops increasing. The intermodulation products of the third order increase three times as much as the useful signals. The intercept point is the fictitious level where the two lines intersect. It cannot be measured directly since the useful level is previously limited by the maximum two-port output power.

Calculation method

It can be calculated from the known line slopes and the measured spacing a_{D3} at a given level according to the following formula:

$$IP3 = \frac{a_{D3}}{2} + P_N$$

The 3rd order intercept point (TOI), for example, is calculated for an intermodulation of 60 dB and an input level P_U of -20 dBm according to the following formula:

$$IP3 = \frac{60}{2} + (-20dBm) = 10dBm$$

Intermodulation-free dynamic range

The "Intermodulation-free dynamic range", i.e. the level range in which no internal intermodulation products are generated if two-tone signals are measured, is determined by the 3rd order intercept point, the phase noise and the thermal noise of the signal analyzer. At high signal levels, the range is determined by intermodulation products. At low signal levels, intermodulation products disappear below the noise floor, i.e. the noise floor and the phase noise of the signal analyzer determine the range. The noise floor and the phase noise depend on the resolution bandwidth that has been selected. At the smallest resolution bandwidth, the noise floor and phase noise are at a minimum and so the maximum range is obtained. However, a large increase in sweep time is required for small resolution bandwidths. It is, therefore, best to select the largest resolution bandwidth possible to obtain the range that is required. Since phase noise decreases as the carrier-offset increases, its influence decreases with increasing frequency offset from the useful signals.

The following diagrams illustrate the intermodulation-free dynamic range as a function of the selected bandwidth and of the level at the input mixer (= signal level – set RF attenuation) at different useful signal offsets.

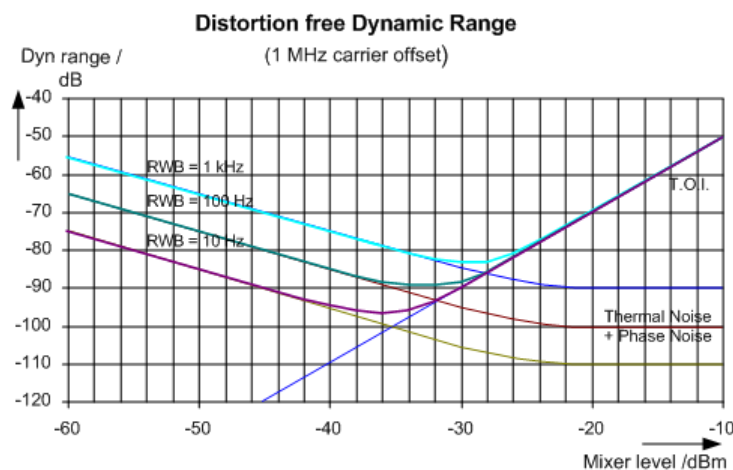

Figure 5-21: Intermodulation-free range of the R&S FSVA/FSV as a function of level at the input mixer and the set resolution bandwidth

(Useful signal offset = 1 MHz, DANL = -145 dBm/Hz, TOI = 15 dBm; typical values at 2 GHz)

The optimum mixer level, i.e. the level at which the intermodulation distance is at its maximum, depends on the bandwidth. At a resolution bandwidth of 10 Hz, it is approx. -35 dBm and at 1 kHz increases to approx. -30 dBm.

Phase noise has a considerable influence on the intermodulation-free range at carrier offsets between 10 and 100 kHz ([Figure 5-21](#)). At greater bandwidths, the influence of the phase noise is greater than it would be with small bandwidths. The optimum mixer level at the bandwidths under consideration becomes almost independent of bandwidth and is approx. -40 dBm.

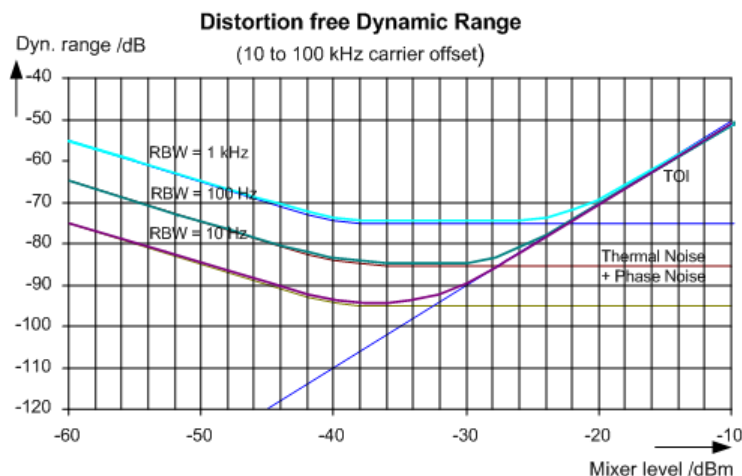

Figure 5-22: Intermodulation-free dynamic range of the R&S FSVA/FSV as a function of level at the input mixer and of the selected resolution bandwidth

(Useful signal offset = 10 to 100 kHz, DANL = -145 dBm/Hz, TOI = 15 dBm; typical values at 2 GHz).



If the intermodulation products of a DUT with a very high dynamic range are to be measured and the resolution bandwidth to be used is therefore very small, it is best to measure the levels of the useful signals and those of the intermodulation products separately using a small span. The measurement time will be reduced- in particular if the offset of the useful signals is large. To find signals reliably when frequency span is small, it is best to synchronize the signal sources and the R&S FSVA/FSV.

Measurement Results

As a result of the TOI measurement, the following values are displayed in the marker area of the diagram:

Label	Description
TOI	Third-order intercept point
M1	Maximum of first useful signal
M2	Maximum of second useful signal
M3	First intermodulation product
M4	Second intermodulation product

Remote command

The TOI can also be queried using the remote command `CALCulate<n>:MARKer<m>:FUNCTION:TOI:RESult?` on page 697.

Softkeys for TOI Measurements

TOI.....	380
L Marker 1 / Marker 2 / Marker 3 / ... Marker 16,/ Marker Norm/Delta.....	380
L Search Signals.....	380

TOI

Opens a submenu and activates the measurement of the 3rd order intercept point.

A two-tone signal with equal carrier levels is expected at the R&S FSVA/FSV input. Marker 1 and marker 2 (both normal markers) are set to the maximum of the two signals. Marker 3 and marker 4 are placed on the intermodulation products.

The R&S FSVA/FSV calculates the third order intercept point from the level difference between the first 2 markers and the markers 3 and 4 and displays it in the marker field.

For general information on measuring the TOI see [Chapter 5.3.5.9, "Measuring the Third Order Intercept Point \(TOI\)"](#), on page 375.

Remote command:

`CALCulate<n>:MARKer<m>:FUNCTion:TOI[:STATe]` on page 697

`CALCulate<n>:MARKer<m>:FUNCTion:TOI:RESult?` on page 697

Marker 1 / Marker 2 / Marker 3 / ... Marker 16,/ Marker Norm/Delta ← TOI

The "Marker X" softkey activates the corresponding marker and opens an edit dialog box to enter a value for the marker to be set to. Pressing the softkey again deactivates the selected marker.

If a marker value is changed using the rotary knob, the step size is defined via the [Stepsize Standard](#) or [Stepsize Sweep Points](#) softkeys.

Marker 1 is always the reference marker for relative measurements. If activated, markers 2 to 16 are delta markers that refer to marker 1. These markers can be converted into markers with absolute value display using the "Marker Norm/Delta" softkey. If marker 1 is the active marker, pressing the "Marker Norm/Delta" softkey switches on an additional delta marker.

Remote command:

`CALCulate<n>:MARKer<m>[:STATe]` on page 668

`CALCulate<n>:MARKer<m>:X` on page 677

`CALCulate<n>:MARKer<m>:Y?` on page 680

`CALCulate<n>:DELTamarker<m>[:STATe]` on page 618

`CALCulate<n>:DELTamarker<m>:X` on page 628

`CALCulate<n>:DELTamarker<m>:X:RELative?` on page 629

`CALCulate<n>:DELTamarker<m>:Y?` on page 629

Search Signals ← TOI

Activates all markers.

Remote command:

`CALCulate<n>:MARKer<m>:FUNCTion:TOI:SEARChsignal ONCE` on page 697

5.3.5.10 Measuring the AM Modulation Depth

The AM modulation depth, also known as a modulation index, indicates by how much the modulated signal varies around the carrier amplitude. It is defined as:

$$MDepth = \text{peak signal amplitude} / \text{unmodulated carrier amplitude}$$

So for MDepth = 0.5, for example, the carrier amplitude varies by 50% above and below its unmodulated level, and for h = 1.0 it varies by 100%.

You can measure the modulation depth of a modulated signal using the [AM Mod Depth](#) function.

When this function is activated, marker 1 is set to the peak level, which is considered to be the carrier level. Deltamarkers 2 and 3 are automatically set symmetrically to the carrier on the adjacent peak values of the trace. The markers can be adjusted manually, if necessary.

The R&S FSVA/FSV calculates the power at the marker positions from the measured levels. The AM modulation depth is calculated as the ratio between the power values at the reference marker and at the delta markers. If the powers of the two AM side bands are unequal, the mean value of the two power values is used for AM modulation depth calculation.



A remote control programming example is described in [Chapter 6.4.2.3, "Measuring the AM Modulation Depth"](#), on page 1023 and an example of how to perform the measurement manually in [Chapter 4.5.3.2, "Measuring the Modulation Depth of an AM-Modulated Carrier \(Span > 0\)"](#), on page 89.

Measurement results

The AM modulation depth in percent is displayed as a result of the measurement, indicated in the marker results as "MDepth".

It can also be queried using the remote command `CALCulate<n>:MARKer<m>:FUNction:MDEPth:RESult?` on page 690.

Softkeys for AM Modulation Depth Measurements

AM Mod Depth.....	381
L Marker 1 / Marker 2 / Marker 3 / ... Marker 16, / Marker Norm/Delta.....	382
L Search Signals.....	382

AM Mod Depth

Activates the measurement of the AM modulation depth. An AM-modulated carrier is required on the screen to ensure correct operation.

When this function is activated, marker 1 is set to the peak level, which is considered to be the carrier level. Deltamarkers 2 and 3 are automatically set symmetrically to the carrier on the adjacent peak values of the trace. An edit dialog box is displayed for deltamarker 2 in order to adjust the position manually.

When the position of deltamarker 2 is changed, deltamarker 3 is moved symmetrically with respect to the reference marker 1.

Deltamarker 3, on the other hand, can be moved for fine adjustment irrespective of marker 2.

Marker 1 can also be moved manually for re-adjustment without affecting the position of the deltamarkers.

For general information on measuring the AM modulation depth see [Chapter 5.3.5.10, "Measuring the AM Modulation Depth"](#), on page 381.

Remote command:

`CALCulate<n>:MARKer<m>:FUNction:MDEPth[:STATe]` on page 691

`CALCulate<n>:MARKer<m>:FUNction:MDEPth:RESult?` on page 690

Marker 1 / Marker 2 / Marker 3 / ... Marker 16,/ Marker Norm/Delta ← AM Mod Depth

The "Marker X" softkey activates the corresponding marker and opens an edit dialog box to enter a value for the marker to be set to. Pressing the softkey again deactivates the selected marker.

If a marker value is changed using the rotary knob, the step size is defined via the [Stepsize Standard](#) or [Stepsize Sweep Points](#) softkeys.

Marker 1 is always the reference marker for relative measurements. If activated, markers 2 to 16 are delta markers that refer to marker 1. These markers can be converted into markers with absolute value display using the "Marker Norm/Delta" softkey. If marker 1 is the active marker, pressing the "Marker Norm/Delta" softkey switches on an additional delta marker.

Remote command:

`CALCulate<n>:MARKer<m>[:STATe]` on page 668

`CALCulate<n>:MARKer<m>:X` on page 677

`CALCulate<n>:MARKer<m>:Y?` on page 680

`CALCulate<n>:DELTamarker<m>[:STATe]` on page 618

`CALCulate<n>:DELTamarker<m>:X` on page 628

`CALCulate<n>:DELTamarker<m>:X:RELative?` on page 629

`CALCulate<n>:DELTamarker<m>:Y?` on page 629

Search Signals ← AM Mod Depth

Activates all markers.

Remote command:

`CALCulate<n>:MARKer<m>:FUNction:MDEPth:SEARChsignal ONCE`

on page 691

5.3.5.11 Measuring Harmonic Distortion

The harmonics and their distortion can be measured using the ["Harmonic Distortion"](#) on page 283 function.

With this measurement it is possible to measure the harmonics e.g. from a VCO easily. In addition the THD (total harmonic distortion) is calculated in % and dB.

With span > 0 Hz, an automatic search for the first harmonic is carried out within the set frequency range. Also the level is adjusted. In zero span, the center frequency is unchanged.

As a result, the zero span sweeps on all harmonics are shown, as well as the RMS values and the THD (total harmonic distortion).



A measurement example is described in [Chapter 4.6.2, "Measurement of Harmonics"](#), on page 107

About Harmonics Distortion Measurement

Measuring the harmonics of a signal is a frequent problem which can be solved best using a signal analyzer. In general, every signal contains harmonics which are larger than others. Harmonics are particularly critical regarding high-power transmitters such as transceivers because large harmonics can interfere with other radio services.

Harmonics are generated by nonlinear characteristics. They can often be reduced by low pass filters. Since the signal analyzer has a nonlinear characteristic, e.g. in its first mixer, measures must be taken to ensure that harmonics produced in the signal analyzer do not cause spurious results. If necessary, the fundamental wave must be selectively attenuated with respect to the other harmonics with a high pass filter.

Obtainable dynamic range

When harmonics are being measured, the obtainable dynamic range depends on the second harmonic intercept of the signal analyzer. The second harmonic intercept is the virtual input level at the RF input mixer at which the level of the 2nd harmonic becomes equal to the level of the fundamental wave. In practice, however, applying a level of this magnitude would damage the mixer. Nevertheless, the available dynamic range for measuring the harmonic distance of a DUT can be calculated relatively easily using the second harmonic intercept.

As shown in [Figure 5-23](#), the level of the 2nd harmonic drops by 20 dB if the level of the fundamental wave is reduced by 10 dB.

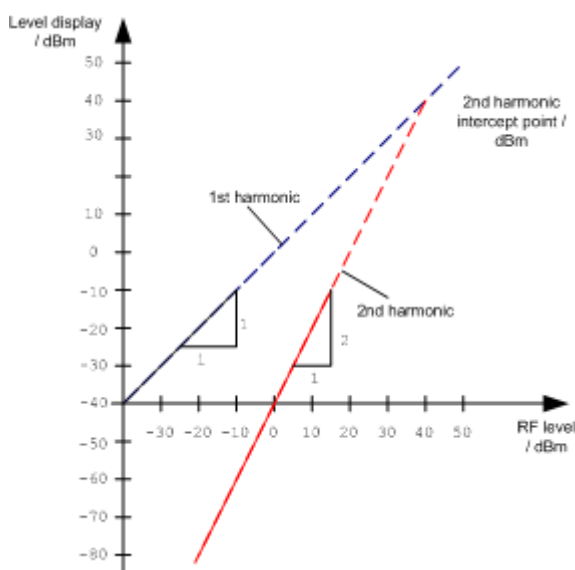

Figure 5-23: Extrapolation of the 1st and 2nd harmonics to the 2nd harmonic intercept at 40 dBm

The following formula for the obtainable harmonic distortion d_2 in dB is derived from the straight-line equations and the given intercept point:

$$d_2 = \text{S.H.I} - P_1 \quad (1)$$

where:

d2	=	harmonic distortion
P_1	=	mixer level/dBm
S.H.I.	=	second harmonic intercept



The mixer level is the RF level applied to the RF input minus the set RF attenuation.

The formula for the internally generated level P_1 at the 2nd harmonic in dBm is:

$$P_1 = 2 * P_1 - \text{S.H.I.} \quad (2)$$

The lower measurement limit for the harmonic is the noise floor of the signal analyzer. The harmonic of the measured DUT should – if sufficiently averaged by means of a video filter – be at least 4 dB above the noise floor so that the measurement error due to the input noise is less than 1 dB.

The following rules for measuring high harmonic ratios can be derived:

- Select the smallest possible IF bandwidth for a minimal noise floor.
- Select an RF attenuation which is high enough to just measure the harmonic ratio.

The maximum harmonic distortion is obtained if the level of the harmonic equals the intrinsic noise level of the receiver. The level applied to the mixer, according to (2), is:

$$P_1 = \frac{P_{\text{noise}} / \text{dBm} + \text{IP2}}{2}$$

At a resolution bandwidth of 10 Hz (noise level -143 dBm, S.H.I. = 40 dBm), the optimum mixer level is – 51.5 dBm. According to (1) a maximum measurable harmonic distortion of 91.5 dB minus a minimum S/N ratio of 4 dB is obtained.



If the harmonic emerges from noise sufficiently (approx. >15 dB), it is easy to check (by changing the RF attenuation) whether the harmonics originate from the DUT or are generated internally by the signal analyzer. If a harmonic originates from the DUT, its level remains constant if the RF attenuation is increased by 10 dB. Only the displayed noise is increased by 10 dB due to the additional attenuation. If the harmonic is exclusively generated by the signal analyzer, the level of the harmonic is reduced by 20 dB or is lost in noise. If both – the DUT and the signal analyzer – contribute to the harmonic, the reduction in the harmonic level is correspondingly smaller.

High-Sensitivity Harmonics Measurements

If harmonics have very small levels, the resolution bandwidth required to measure them must be reduced considerably. The sweep time is, therefore, also increased considerably. In this case, the measurement of individual harmonics is carried out with the R&S FSV/FSV set to a small span. Only the frequency range around the harmonics will then be measured with a small resolution bandwidth.

Measurement Results

As a result of the harmonics distortion measurement, the zero span sweeps on all detected harmonics are shown in the diagram, separated by red display lines. This provides a very good overview of the measurement.

In addition, a result table is displayed providing the following information:

- 1st harmonic frequency
- THD (total harmonic distortion), relative and absolute values
- For each detected harmonic:
 - Frequency
 - RBW
 - Power

The results can also be queried using the remote commands:

THD: `CALCulate<n>:MARKer<m>:FUNction:HARMonics:DISToRtion?`
on page 699

List of harmonics: `CALCulate<n>:MARKer<m>:FUNction:HARMonics:LIST?`
on page 700

Softkeys for Harmonic Distortion Measurements

Harmonic Distortion.....	385
L No. of Harmonics.....	386
L Harmonic Sweep Time.....	386
L Harmonic RBW Auto.....	386
L Adjust Settings.....	386

Harmonic Distortion

Opens a submenu to determine the settings for harmonics measurement and activates the harmonic distortion measurement.

With this measurement you can measure the harmonics of a signal. In addition the THD (total harmonic distortion) is calculated in % and dB.

With span > 0 Hz, an automatic search for the first harmonic is carried out within the set frequency range. Also the level is adjusted. In zero span, the center frequency is unchanged.

In the upper window, the zero span sweeps on all harmonics are shown, separated by display lines. In the lower window, the mean RMS results are displayed in numerical values. The THD values are displayed in the marker field.

For details see [Chapter 5.3.5.11, "Measuring Harmonic Distortion"](#), on page 382.

Remote command:

`CALCulate<n>:MARKer<m>:FUNCTION:HARMonics[:STATe]` on page 701

`CALCulate<n>:MARKer<m>:FUNCTION:HARMonics:DIStortion?` on page 699

`CALCulate<n>:MARKer<m>:FUNCTION:HARMonics:LIST?` on page 700

No. of Harmonics ← Harmonic Distortion

Sets the number of harmonics that shall be measured. The range is from 1 to 26.

Remote command:

`CALCulate<n>:MARKer<m>:FUNCTION:HARMonics:NHARmonics` on page 701

Harmonic Sweep Time ← Harmonic Distortion

For details refer to the [SweepTime Manual](#) softkey in the "Bandwidth" menu.

Harmonic RBW Auto ← Harmonic Distortion

Enables/disables the automatic adjustment of the resolution bandwidth for filter types Normal (3dB) (Gaussian) and 5-Pole filters. The automatic adjustment is carried out according to:

$RBW_n = RBW_1 * n$

If RBW_n is not available, the next higher value is used.

Remote command:

`CALCulate<n>:MARKer<m>:FUNCTION:HARMonics:BANDwidth:AUTO`
on page 699

Adjust Settings ← Harmonic Distortion

Activates the frequency search in the frequency range that was set before starting the harmonic measurement (if harmonic measurement was with span > 0) and adjusts the level.

Remote command:

`CALCulate<n>:MARKer<m>:FUNCTION:HARMonics:PRESet` on page 701

5.3.6 Measurement Configuration – MEAS CONFIG Key

The MEAS CONFIG key displays the submenu of the currently activated and running measurement function, e.g. the submenu of "TOI" or "Harmonic Distortion" (see [Chapter 5.3.5, "Power Measurements – MEAS Key"](#), on page 280, for quick access to the measurement configuration. If no measurement function is activated, this key has no effect.

5.3.7 Using Limit Lines and Display Lines – LINES Key

The [LINES] key is used to configure limit and display lines.

To open the Lines menu

- Press the [LINES] key.

The "Lines" menu and the "Select Limit Line" dialog box are displayed. For details on the "Select Limit Line" dialog box refer to [Chapter 5.3.7.5, "Selecting a Limit Line"](#), on page 393.

Menu and softkey description

- [Chapter 5.3.7.1, "Softkeys of the Lines Menu"](#), on page 387

Further information

- [Chapter 5.3.7.2, "Display Lines"](#), on page 391
- [Chapter 5.3.7.3, "Limit Lines \(Frequency/Time Lines\)"](#), on page 392

Tasks

- [Chapter 5.3.7.4, "Working with Lines"](#), on page 392
- [Chapter 5.3.7.5, "Selecting a Limit Line"](#), on page 393
- [Chapter 5.3.7.6, "Creating a New Limit Line"](#), on page 394
- [Chapter 5.3.7.7, "Editing an Existing Limit Line"](#), on page 397
- [Chapter 5.3.7.8, "Creating a New Limit Line Based upon an Existing Limit Line"](#), on page 397
- [Chapter 5.3.7.9, "Activating/Deactivating a Limit Line"](#), on page 398

5.3.7.1 Softkeys of the Lines Menu

The following table shows all softkeys available in the "Lines" menu.

(Lines are only available for RF measurements.)

Further information

- [Chapter 5.3.7.2, "Display Lines"](#), on page 391
- [Chapter 5.3.7.3, "Limit Lines \(Frequency/Time Lines\)"](#), on page 392

Tasks

- [Chapter 5.3.7.4, "Working with Lines"](#), on page 392
- [Chapter 5.3.7.5, "Selecting a Limit Line"](#), on page 393
- [Chapter 5.3.7.6, "Creating a New Limit Line"](#), on page 394
- [Chapter 5.3.7.7, "Editing an Existing Limit Line"](#), on page 397
- [Chapter 5.3.7.8, "Creating a New Limit Line Based upon an Existing Limit Line"](#), on page 397
- [Chapter 5.3.7.9, "Activating/Deactivating a Limit Line"](#), on page 398

Select Traces to check.....	388
Deselect All.....	388
New.....	388
L Edit Name.....	388
L Edit Comment.....	388

L Edit Margin.....	389
L Edit Value.....	389
L Insert Value.....	389
L Delete Value.....	389
L Save Limit Line.....	389
Edit.....	389
Copy to.....	389
Delete.....	390
X Offset.....	390
Y Offset.....	390
Display Lines.....	390
L Display Line 1 / Display Line 2.....	390
L Frequency Line 1 / Frequency Line 2.....	391
L Time Line 1 / Time Line 2.....	391

Select Traces to check

Opens a dialog box to activate the selected limit line for a trace. One limit line can be activated for several traces simultaneously. For details see also [Chapter 5.3.7.9, "Activating/Deactivating a Limit Line"](#), on page 398.

Remote command:

`CALCulate<n>:LIMit<k>:TRACe` on page 644

`CALCulate<n>:LIMit<k>:STATe` on page 643

Deselect All

Deactivates the selected limit line for all assigned traces. For details see also [Chapter 5.3.7.9, "Activating/Deactivating a Limit Line"](#), on page 398.

Remote command:

`CALCulate<n>:LIMit<k>:STATe` on page 643

New

Opens the "Edit Limit Line" dialog box and a submenu to define a new limit line. For details see also [Chapter 5.3.7.3, "Limit Lines \(Frequency/Time Lines\)"](#), on page 392 and [Chapter 5.3.7.5, "Selecting a Limit Line"](#), on page 393.

Edit Name ← New

Sets the focus on the "Name" field to enter or change the limit line name. All names must be compatible with the Windows conventions for file names. The limit line data are stored under this name. The instrument stores all limit lines with LIM as extension.

Remote command:

`CALCulate<n>:LIMit<k>:LOWer:MODE` on page 661

Edit Comment ← New

Sets the focus on the "Comment" field to enter or change a comment for the limit line. The text must not exceed 40 characters.

Remote command:

`CALCulate<n>:LIMit<k>:COMMeNt` on page 641

Edit Margin ← New

Sets the focus on the "Margin" field to enter or change a margin for the limit line. The default setting is 0 dB (i.e. no margin).

Edit Value ← New

Opens an edit dialog box to change an existing x or y value, depending on the selected column. The softkey is only available if an existing value is selected.

The desired data points are entered in ascending order (two repeated frequencies/time values are permitted).

Remote command:

[CALCulate<n>:LIMit<k>:CONTrol\[:DATA\]](#) on page 653

[CALCulate<n>:LIMit<k>:UPPer\[:DATA\]](#) on page 664

[CALCulate<n>:LIMit<k>:LOWer\[:DATA\]](#) on page 660

Insert Value ← New

Creates an empty line above the selected data point to enter a new data point.

It is also possible to add a data point at the end of the list, if the focus is set below the last entry line of the list.

The data points are entered in ascending order (two repeated frequencies/time values are permitted). If the entered values are not in accordance with the ascending order rule, an error message is displayed and the values are discarded.

Delete Value ← New

Deletes the selected data point (x and y value). All succeeding data points are shifted up accordingly. This softkey is only available if an existing value is selected.

Save Limit Line ← New

Saves the currently edited limit line under the name defined in the "Name" field.

Edit

Opens a submenu to edit limit lines. For details see also [Chapter 5.3.7.3, "Limit Lines \(Frequency/Time Lines\)"](#), on page 392 and [Chapter 5.3.7.7, "Editing an Existing Limit Line"](#), on page 397.

The submenu contains the same commands as the "New" menu, see ["New"](#) on page 388.

Remote command:

see [Chapter 6.4.3, "Limit Lines and Limit Test"](#), on page 1023

Copy to

Copies the data of the selected limit line and displays it in the "Edit Limit Line" dialog box. If the limit line is edited and saved under a new name, a new limit line can be easily generated by parallel translation or editing of an existing limit line.

For details see also [Chapter 5.3.7.3, "Limit Lines \(Frequency/Time Lines\)"](#), on page 392 and [Chapter 5.3.7.8, "Creating a New Limit Line Based upon an Existing Limit Line"](#), on page 397.

The submenu contains the same commands as the "New" menu, see ["New"](#) on page 388.

Remote command:

[CALCulate<n>:LIMit<k>:COPY](#) on page 641

Delete

Deletes the selected limit line.

Remote command:

[CALCulate<n>:LIMit<k>:DELeTe](#) on page 641

X Offset

Horizontally shifts a limit line that has been specified for relative frequencies or times (x-axis). The softkey opens an edit dialog box in which the value for shifting can be entered numerically or via the rotary knob.

Note: This softkey does not have any effect on limit lines that represent absolute values for the x-axis.

Remote command:

[CALCulate<n>:LIMit<k>:CONTRol:OFFSet](#) on page 654

Y Offset

Vertically shifts a limit line that has relative values for the y-axis (levels or linear units such as volt). The softkey opens an edit dialog box in which the value for shifting can be entered numerically or via the rotary knob.

Note: This softkey does not have any effect on limit lines that represent absolute values for the y-axis.

Remote command:

[CALCulate<n>:LIMit<k>:LOWer:OFFSet](#) on page 661

[CALCulate<n>:LIMit<k>:UPPer:OFFSet](#) on page 665

Display Lines

Opens a submenu to enable, disable and set display lines. Which softkeys are available depends on the display mode (frequency or time range).

For details see also [Chapter 5.3.7.2, "Display Lines"](#), on page 391 and [Chapter 5.3.7.4, "Working with Lines"](#), on page 392.

The submenu contains the following functions:

- ["Display Line 1 / Display Line 2"](#) on page 390
- ["Display Line 1 / Display Line 2"](#) on page 390
- ["Frequency Line 1 / Frequency Line 2 "](#) on page 391
- ["Frequency Line 1 / Frequency Line 2 "](#) on page 391
- ["Time Line 1 / Time Line 2"](#) on page 391
- ["Time Line 1 / Time Line 2"](#) on page 391

Display Line 1 / Display Line 2 ← Display Lines

Enables or disables the level lines 1/2 and opens an edit dialog box to enter the position of the lines.

For details see also [Chapter 5.3.7.2, "Display Lines"](#), on page 391 and [Chapter 5.3.7.4, "Working with Lines"](#), on page 392.

Remote command:

`CALCulate<n>:DLINe<k>` on page 636

`CALCulate<n>:DLINe<k>:STATe` on page 637

Frequency Line 1 / Frequency Line 2 ← Display Lines

Enables or disables the frequency lines 1/2 (span > 0) and opens an edit dialog box to enter the position of the lines.

For details see also [Chapter 5.3.7.2, "Display Lines"](#), on page 391 and [Chapter 5.3.7.4, "Working with Lines"](#), on page 392.

Remote command:

`CALCulate<n>:FLINe<k>` on page 639

`CALCulate<n>:FLINe<k>:STATe` on page 639

Time Line 1 / Time Line 2 ← Display Lines

Enables or disables the time lines 1/2 (zero span) and opens an edit dialog box to enter the position of the lines.

For details see also [Chapter 5.3.7.2, "Display Lines"](#), on page 391 and [Chapter 5.3.7.4, "Working with Lines"](#), on page 392.

Remote command:

`CALCulate<n>:TLINe<Line>` on page 746

`CALCulate<n>:TLINe<Line>:STATe` on page 746

5.3.7.2 Display Lines

Display lines help to evaluate a trace – as do markers. The function of a display line is comparable to that of a ruler that can be shifted on the trace in order to mark absolute values. They are used exclusively to visually mark relevant frequencies or points in time (span = 0), as well as constant level values. It is not possible to check automatically whether the points are below or above the marked level values.

For details on setting and switching the display lines on/off see [Chapter 5.3.7.4, "Working with Lines"](#), on page 392.

Two different types of display lines are provided:

- Two horizontal level lines for marking levels – Display Line 1 and 2
The level lines are continuous horizontal lines across the entire width of a diagram and can be shifted in y direction.
- Two vertical frequency or time lines for marking frequencies or points in time – Frequency/Time Line 1 and 2
The frequency or time lines are continuous vertical lines across the entire height of the diagram and can be shifted in x direction.

Labels

Each line is identified by one of the following abbreviations in the display:

- D1: Display Line 1
- D2: Display Line 2

- F1: Frequency Line 1
- F2: Frequency Line 2
- T1: Time Line 1
- T2: Time Line 2

5.3.7.3 Limit Lines (Frequency/Time Lines)

Limit lines are used to define amplitude curves or spectral distribution boundaries on the display screen which are not to be exceeded. They indicate, for example, the upper limits for interference radiation or spurious waves which are allowed from a device under test (DUT). For transmission of information in TDMA systems (e.g. GSM), the amplitude of the bursts in a timeslot must adhere to a curve that falls within a specified tolerance band. The lower and upper limits may each be specified by a limit line. Then, the amplitude curve can be controlled either visually or automatically for any violations of the upper or lower limits (GO/NOGO test).

The instrument supports limit lines with a maximum of 50 data points. 8 of the limit lines stored in the instrument can be activated simultaneously. The number of limit lines stored in the instrument is only limited by the capacity of the flash disk used. Which softkeys are available depends on the display mode (frequency or time range). For details see also [Chapter 5.3.7.5, "Selecting a Limit Line"](#), on page 393.

Limit lines are compatible with the current measurement settings, if the following applies:

- The x unit of the limit line has to be identical to the current setting.
- The y unit of the limit line has to be identical to the current setting with the exception of dB based units; all dB based units are compatible with each other.

At the time of entry, the R&S FSVA/FSV immediately checks that all limit lines are in accordance with the following guidelines:

- The frequencies/times for each data point must be entered in ascending order, however, for any single frequency/time, two data points may be entered (vertical segment of a limit line).
- The data points are allocated in order of ascending frequency/time. Gaps are not allowed. If gaps are desired, two separate limit lines must be defined and then both enabled.
- The entered frequencies/times need not necessarily be selectable in R&S FSVA/FSV. A limit line may also exceed the specified frequency or time range. The minimum frequency for a data point is -200 GHz, the maximum frequency is 200 GHz. For the time range representation, negative times may also be entered. The allowed range is -1000 s to +1000 s.

5.3.7.4 Working with Lines

If a line is switched on, the softkey is highlighted.

Switching a line on or off

1. Press the **Display Lines** softkey.
2. Press the softkey for the required line, e.g. **Display Line 1 / Display Line 2**.
An edit dialog box is opened to enter the position of the line. If the line was switched off, it is switched on. If it was switched on, it remains switched on.
3. If another softkey is pressed, the edit dialog box for the line is closed, but the line remains switched on (softkey with highlighted background).
4. When you press the **Display Line 1 / Display Line 2** softkey for the second time, the edit dialog box for the line is opened again.
5. When you press the **Display Line 1 / Display Line 2** softkey the third time, the line is switched off (softkey without highlighted background).

5.3.7.5 Selecting a Limit Line

- To display the "Select Limit Line" dialog box, press the LINES key.

All limit lines saved in the default directory and all subdirectories are displayed. For each limit line, the following information is given:

"Unit"	unit of the y-axis
"Traces"	selected traces to check
"Show"	limit line displayed in the measurement diagram or hidden
"Compatible"	compatibility of the limit line to the current measurement settings
"Offset"	user-definable X- and Y-offset for the limit line

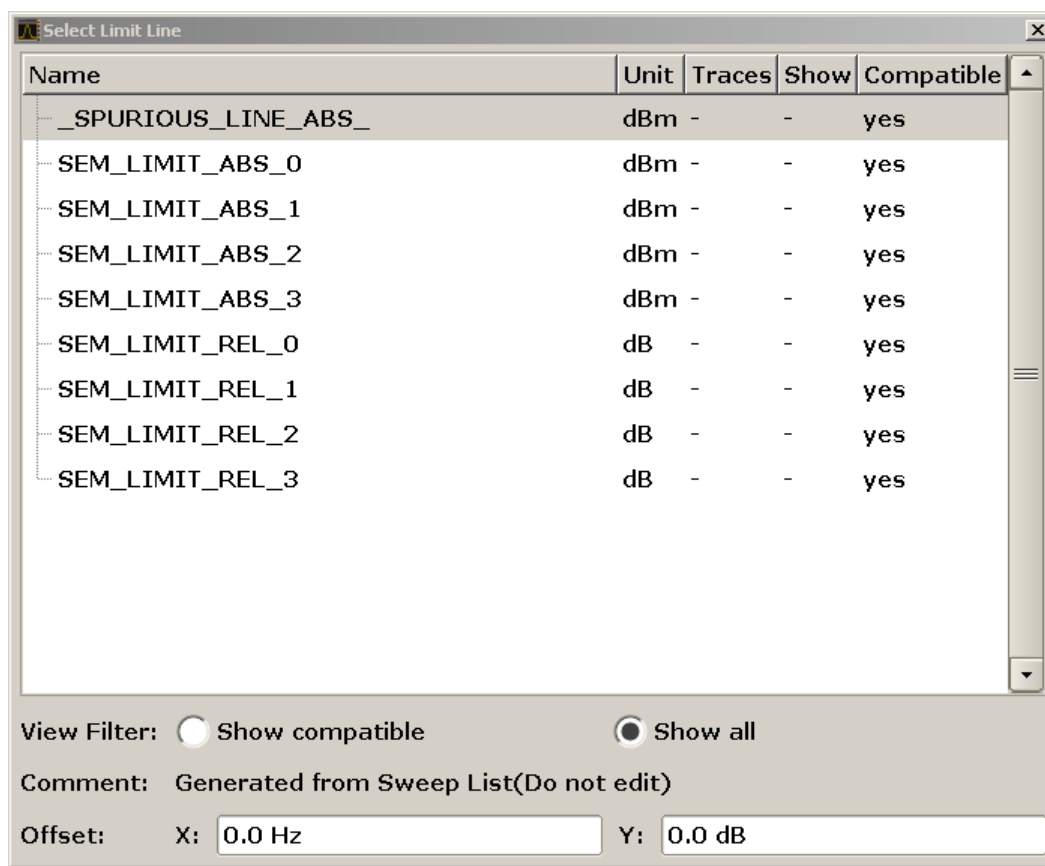

- To display only the limit lines that are compatible, activate the "Show compatible" option. For details on compatibility refer to [Chapter 5.3.7.3, "Limit Lines \(Frequency/Time Lines\)"](#), on page 392.

5.3.7.6 Creating a New Limit Line

Press the **New** softkey to define a new limit line.

The "Edit Limit Line" dialog box is displayed. For more details on limit lines refer also to [Chapter 5.3.7.3, "Limit Lines \(Frequency/Time Lines\)"](#), on page 392. The following settings can be defined:

Setting	Description
Name	The name under which the limit line is to be stored in the main directory. To save the limit line in an existing subdirectory, enter the relative path. A new subdirectory can only be created using the [FILE] key (for details refer to "Save File / Recall File" on page 165).
Comment	Optional description
Threshold	Absolute threshold value that works as a lower limit for the relative limit values (only for relative scaling of the y-axis).

Setting	Description
Margin	A fixed distance to the limit line. Margins are not as strict as limits and belong to the valid value range, but violation is also indicated in the display.
Position	Position of data point
Value	Value of data point
X-Axis:	
Span setting	<ul style="list-style-type: none"> • "Hz" for span > 0 Hz • "s" for zero span
Scale mode	<ul style="list-style-type: none"> • Absolute: The frequencies or times are interpreted as absolute physical units. • Relative: In the data point table, the frequencies are referred to the currently set center frequency. In the zero span mode, the left boundary of the diagram constitutes the reference. <p>Relative scaling is always suitable if masks for bursts are to be defined in zero span or if masks for modulated signals are required for span > 0 Hz.</p>
Scale	<ul style="list-style-type: none"> • Linear • Logarithmic
Y-Axis:	
Scale unit	Unit of the y-axis
Scale mode	<ul style="list-style-type: none"> • Absolute: The limit values refer to absolute levels or voltages. • Relative: The limit values refer to the reference level (Ref Level). Limit values with the unit dB are always relative values.
Limit type	<ul style="list-style-type: none"> • Upper limit • Lower limit

In addition, the following functions are available for the limit line:

Defining a threshold

If the scaling of the y-axis is relative, you can define an absolute threshold value that works as a lower limit for the relative limit values (see figure below).

- ▶ Enter a value in the "Threshold" field of the "Edit Limit Line" dialog box.

The function is especially useful for mobile radio applications provided the limit values are defined in relation to the carrier power as long as they are above an absolute limit value.

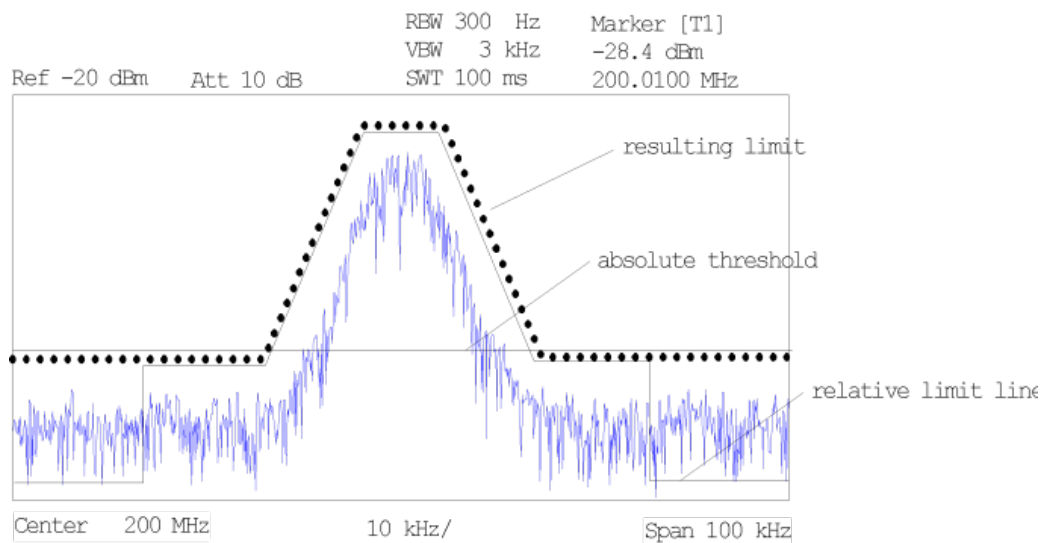

Defining a margin

A margin is similar to a limit, but less strict and it still belongs to the valid data range. It can be used as a warning that the limit is almost reached. The margin is not indicated by a separate line in the display.

- ▶ Enter a value in the "Margin" field of the "Edit limit Line" dialog box.
 If the limit line is defined as an upper limit, the margin is below the limit line. If the limit line is defined as a lower limit, the margin is above the limit line.

Entering a new data point

1. Press the "Insert value" button in the dialog, or select an existing data point in the table and press the [Insert Value](#) softkey.
2. Enter the new position (x) and value (y) in the edit dialog box.

Changing a data point

1. Press on the data point to be changed in the table.
2. Enter the new position (x) and value (y) in the edit dialog box.

Deleting a data point

1. Press on the data point to be deleted in the table.
2. Press the "Delete" button in the dialog.

Shifting a limit line horizontally

- ▶ Select the "Shift x" button and enter a shift width for the x value in the edit dialog box.

Shifting a limit line vertically

- ▶ Select the "Shift y" button and enter a shift width for the y value in the edit dialog box.

Saving the limit line settings

- ▶ Press the "Save" button in the dialog.
If an existing name is used, a message box is displayed. You have to confirm before the limit line is overwritten.

5.3.7.7 Editing an Existing Limit Line

In the "Select Limit Line" dialog box, select the limit line you want to change. For details see also [Chapter 5.3.7.5, "Selecting a Limit Line"](#), on page 393.



Note that any changes to the special limit lines for spurious and SEM measurements are automatically overwritten when the sweep list settings are changed.

1. Press the "Edit" on page 389 softkey.
2. Edit the data as described in [Chapter 5.3.7.6, "Creating a New Limit Line"](#), on page 394.
3. Save the limit line ("Save Limit Line" on page 389 softkey).

5.3.7.8 Creating a New Limit Line Based upon an Existing Limit Line

1. In the "Select Limit Line" dialog box, select the limit line you want to use as a basis for a new limit line. For details see also [Chapter 5.3.7.5, "Selecting a Limit Line"](#), on page 393.
2. Press the [Copy to](#) softkey to transfer the data of the limit line into the "Edit Limit Line" dialog box.
3. Press the [Edit Name](#) softkey and enter a new name.
4. To shift the complete limit line parallel in the horizontal direction, select the "Shift x" button and enter an x shift value. In this manner, a new limit line can be easily generated based upon an existing limit line which has been shifted horizontally.
5. To shift the complete limit line parallel in the vertical direction, select the "Shift y" button and enter a y shift value. In this manner, a new limit line can be easily generated based upon an existing limit line which has been shifted vertically.
6. If required, edit the data as described in [Chapter 5.3.7.5, "Selecting a Limit Line"](#), on page 393.
7. Save the limit line ([Save Limit Line](#) softkey).

5.3.7.9 Activating/Deactivating a Limit Line

Prerequisites:

The x- and y-units of limit line and current measurement setting have to be compatible. For details refer to [Chapter 5.3.7.3, "Limit Lines \(Frequency/Time Lines\)"](#), on page 392.

The limit line has to consist of 2 or more data points.

1. In the "Select Limit Line" dialog box, select the limit line you want to activate/deactivate. For details see also [Chapter 5.3.7.5, "Selecting a Limit Line"](#), on page 393.
2. To activate or deactivate a limit line for a trace, press the ["Select Traces to check"](#) on page 388 softkey and select or deselect the trace(s) to which this limit line applies.
3. To deactivate the limit line for all traces, press the ["Deselect All"](#) on page 388 softkey.

5.3.8 Input/Output Configuration – INPUT/OUTPUT Key

The [INPUT/OUTPUT] key is used to configure input and output sources for measurement functions.

5.3.8.1 Softkeys of the Input/Output Menu

The following table shows all softkeys available in the "Input/Output" menu. It is possible that your instrument configuration does not provide all softkeys. If a softkey is only available with a special option, model or (measurement) mode, this information is provided in the corresponding softkey description.

Input (AC/DC).....	399
Noise Source.....	399
Video Output.....	399
Tracking Generator.....	399
Power Sensor.....	399
Trigger Out.....	399
External Mixer.....	400
Probe Config.....	400
Signal Source.....	400
L Input Path.....	400
L Connected Device.....	400
L Input Sample Rate.....	400
L Full Scale Level.....	400
L Level Unit.....	401
L Adjust Reference Level to Full Scale Level.....	401
EXIQ.....	401
L TX Settings.....	401
L RX Settings.....	401

L Send To	401
L Firmware Update	401
L R&S Support	402
L DigIConf	402
Digital Output	402
Digital IQ Info	403

Input (AC/DC)

Toggles the RF input of the R&S FSVA/FSV between AC and DC coupling.

This function is not available for input from the R&S Digital I/Q Interface (option R&S FSV-B17).

Remote command:

[INPut:COUPling](#) on page 764

Noise Source

Switches the supply voltage for an external noise source on or off.

Remote command:

[DIAGnostic<n>:SERVice:NSource](#) on page 922

Video Output

Sends a video output signal according to the measured level to the connector on the rear panel of the R&S FSVA/FSV.

Note: Video output does not return valid values in IQ or FFT mode.

Remote command:

[OUTPut:IF VID](#), see [OUTPut:IF\[:SOURce\]](#) on page 953

Tracking Generator

This softkey is only available if the R&S FSV option Tracking Generator (R&S FSV-B9) or External Tracking Generator (R&S FSV-B10) or both are installed. It is not available in I/Q Analyzer mode.

For details see the base unit description.

Power Sensor

For precise power measurement a power sensor can be connected to the instrument via the front panel (USB connector) or the rear panel (power sensor, option R&S FSV-B5). The Power Sensor Support firmware option (R&S FSV-K9) provides the power measurement functions for this test setup.

This softkey is only available if the Power Sensor option (R&S FSV-K9) is installed.

For details see [Chapter 5.9, "Instrument Functions - Power Sensor \(R&S FSV-K9\)"](#), on page 509.

Trigger Out

Sets the Trigger Out port in the Additional Interfaces (option R&S FSV-B5 only) to low or high. Thus, you can trigger an additional device via the external trigger port, for example.

Remote command:

[OUTPut:TRIGger](#) on page 953

External Mixer

Opens the submenu for the external mixer.

For details see the base unit description.

Probe Config

With firmware R&S FSVA/FSV 1.61SP2 or newer, active probes are supported (via an adapter). This softkey opens an edit dialog box to activate and configure a connected probe which is to provide an input signal. It is only available if a probe is connected to the instrument's [RF Input] and USB connectors.

For details see [Chapter 5.3.8.2, "Using Active Probes for Input"](#), on page 403.

Remote command:

[PROBe\[:STATe\]](#) on page 779

[PROBe:SETup:MODE](#) on page 779

Signal Source

Opens a dialog box to select the signal source.

For "Digital Baseband (I/Q)", the source can also be configured here.

Input Path ← Signal Source

Defines whether the "RF Radio Frequency" or the "Digital IQ" input path is used for measurements. "Digital IQ" is only available if option R&S FSV-B17 (R&S Digital I/Q Interface) is installed.

Note: Note that the input path defines the characteristics of the signal, which differ significantly between the RF input and digital input.

Remote command:

[INPut:SElect](#) on page 769

Connected Device ← Signal Source

Displays the name of the device connected to the optional R&S Digital I/Q Interface (R&S FSV-B17) to provide Digital IQ input. The device name cannot be changed here.

The device name is unknown.

Remote command:

[INPut:DIQ:CDEvice](#) on page 764

Input Sample Rate ← Signal Source

Defines the sample rate of the digital I/Q signal source. This sample rate must correspond with the sample rate provided by the connected device, e.g. a generator.

Remote command:

[INPut:DIQ:SRATe](#) on page 767

Full Scale Level ← Signal Source

The "Full Scale Level" defines the level that should correspond to an I/Q sample with the magnitude "1".

The level can be defined either in dBm or Volt.

Remote command:

[INPut:DIQ:RANGe\[:UPPer\]](#) on page 766

Level Unit ← Signal Source

Defines the unit used for the full scale level.

Remote command:

`INPut:DIQ:RANGe[:UPPer]:UNIT` on page 766

Adjust Reference Level to Full Scale Level ← Signal Source

If enabled, the reference level is adjusted to the full scale level automatically if any change occurs.

(See the [Auto Level](#) softkey).

Remote command:

`INPut:DIQ:RANGe:COUPling` on page 765

EXIQ

Opens a configuration dialog box for an optionally connected R&S EX-IQ-BOX and a submenu to access the main settings quickly.

Note: The EX-IQ-Box functionality is not supported for R&S FSV models 1307.9002Kxx.

If the optional R&S DigiConf software is installed, the submenu consists only of one key to access the software. **Note that R&S DigiConf requires a USB connection (not LAN!) from the R&S FSVA/FSV to the R&S EX-IQ-BOX in addition to the R&S Digital I/Q Interface connection. R&S DigiConf version 2.10 or higher is required.**

For typical applications of the R&S EX-IQ-BOX see also the description of the R&S Digital I/Q Interface (R&S FSV-B17) in the base unit manual.

For details on configuration see the "R&S®Ex I/Q Box - External Signal Interface Module Manual".

For details on installation and operation of the R&S DigiConf software, see the "R&S®EX-IQ-BOX Digital Interface Module R&S®DigiConf Software Operating Manual".

TX Settings ← EXIQ

Opens the "EX-IQ-BOX Settings" dialog box to configure the R&S FSVA/FSV for digital output to a connected device ("Transmitter" Type).

RX Settings ← EXIQ

Opens the "EX-IQ-BOX Settings" dialog box to configure the R&S FSVA/FSV for digital input from a connected device ("Receiver" Type).

Send To ← EXIQ

The configuration settings defined in the dialog box are transferred to the R&S EX-IQ-BOX.

Firmware Update ← EXIQ

If a firmware update for the R&S EX-IQ-BOX is delivered with the R&S FSVA/FSV firmware, this function is available. In this case, when you select the softkey, the firmware update is performed.

R&S Support ← EXIQ

Stores useful information for troubleshooting in case of errors.

This data is stored in the `C:\R_S\Instr\user\Support` directory on the instrument.

If you contact the Rohde&Schwarz support to get help for a certain problem, send these files to the support in order to identify and solve the problem faster.

DigIConf ← EXIQ

Starts the optional R&S DigIConf application. This softkey is only available if the optional software is installed.

To return to the R&S FSVA/FSV application, press any key on the front panel. The application is displayed with the "EXIQ" menu, regardless of which key was pressed.

For details on the R&S DigIConf application, see the "R&S®EX-IQ-BOX Digital Interface Module R&S®DigIConf Software Operating Manual".

Note: If you close the R&S DigIConf window using the "Close" icon, the window is minimized, not closed.

If you select the "File > Exit" menu item in the R&S DigIConf window, the application is closed. Note that in this case the settings are lost and the EX-IQ-BOX functionality is no longer available until you restart the application using the "DigIConf" softkey in the R&S FSVA/FSV once again.

Remote command:

Remote commands for the R&S DigIConf software always begin with `SOURce:EBOX`. Such commands are passed on from the R&S FSVA/FSV to the R&S DigIConf automatically which then configures the R&S EX-IQ-BOX via the USB connection. All remote commands available for configuration via the R&S DigIConf software are described in the "R&S®EX-IQ-BOX Digital Interface Module R&S®DigIConf Software Operating Manual".

Example 1:

```
SOURce:EBOX:*RST
SOURce:EBOX:*IDN?
```

Result:

"Rohde&Schwarz,DigIConf,02.05.436 Build 47"

Example 2:

```
SOURce:EBOX:USER:CLOCK:REFERENCE:FREQUENCY 5MHZ
```

Defines the frequency value of the reference clock.

Digital Output

Opens a dialog box to enable a digital output stream to the optional R&S Digital I/Q Interface (R&S FSV-B17), if available.

The displayed sample rate is identical to the sample rate defined under [Data Acquisition](#) (I/Q Analyzer) and is not editable here.

For details see "Digital Output" in the description of the R&S Digital I/Q Interface for the base unit.

Remote command:

`OUTPut:DIQ` on page 776

Digital IQ Info

Displays a dialog box with information on the digital I/Q input and output connection via the optional R&S Digital I/Q Interface (R&S FSV-B17), if available. The information includes:

- Device identification
- Used port
- (Maximum) digital input/output sample rates and maximum digital input/output transfer rates
- Status of the connection protocol
- Status of the PRBS descewing test

For details see "Interface Status Information" in "Instrument Functions - R&S Digital I/Q Interface (Option R&S FSV-B17)" in the description of the base unit.

Remote command:

`INPut:DIQ:CDEvice` on page 764

5.3.8.2 Using Active Probes for Input

When the input from the device under test requires high impedance, an active probe can be connected between the device and the R&S FSVA/FSV.

With firmware R&S FSVA/FSV 1.61SP2 or newer, active probes from the R&S RT-ZS series are supported when using the new probe adapter RT-ZA9.

When the probe has been connected to and recognized by the R&S FSVA/FSV, a pre-defined "Generic Probe" transducer factor with 20 dB is automatically activated and the unit of the spectrum analyzer is changed to dB μ V. (The same applies after presetting the instrument.) Then the system is ready to analyze circuit points that cannot be loaded with the 50 Ω of the analyzer input, but require a higher impedance.

Optionally, the probe can be deactivated while remaining connected to the R&S FSVA/FSV, for instance to analyze the digital input from the probe without considering the transducer factor.

All RT probes (except for ZS10E) have a micro button. The action for the micro button can be defined. Currently, either a single sweep or no action can be performed when the button is pressed. By default, when you press the probe's micro button, the R&S FSVA/FSV is set to single sweep mode and a single sweep is performed. This allows you to start a measurement whilst applying the probe to a certain pin on the board under test.

When using RT probes, consider the following:

- Active probes require operating power from the instrument and have a proprietary interface to the instrument.
- The probe is automatically recognized by the instrument, no adjustment is required.
- Connections should be as short as possible to keep the usable bandwidth high.
- Observe the operating voltage range.

For more information on RT probes, refer to the probe's documentation.

Connecting Active Probes

In order to use active probes with an R&S FSVA/FSV, an RT-ZA9 adapter is required. The RT-ZA9 provides an interface between the probe's BNC socket and the analyzer's N-socket and provides the necessary supply voltages for the probe via the USB connection. Using this adapter, the following probes are currently supported:

- R&S RT-ZS10
- RT-ZS10E
- RT-ZS20
- RT-ZS30

To connect an active probe, proceed as follows:

1. Connect the adapter to the RF Input connector on the R&S FSVA/FSV.
2. Connect the adapter's USB cable to a USB connector on the R&S FSVA/FSV.
3. Connect the probe to the adapter.

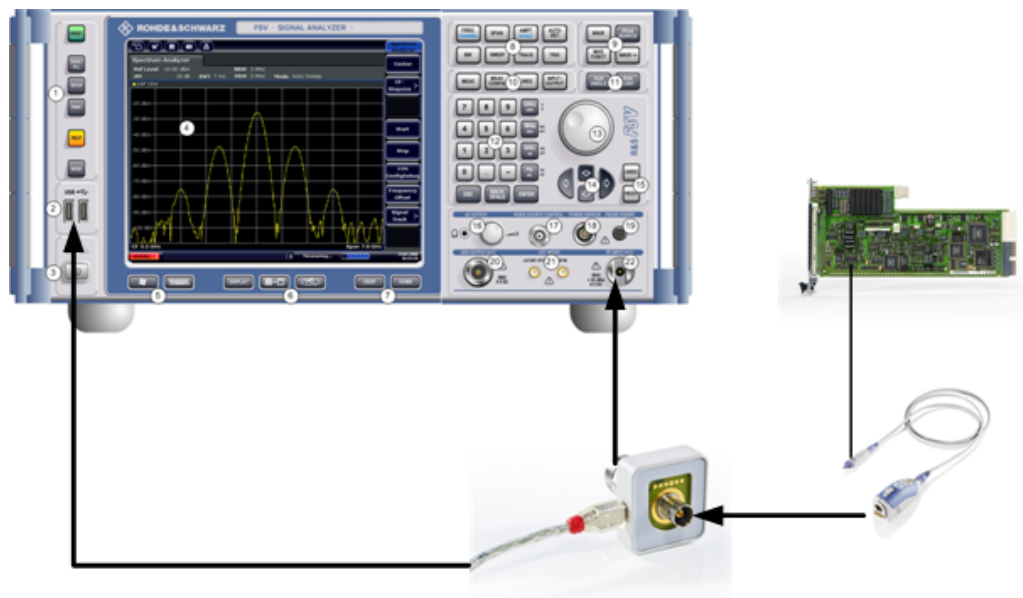

Once the probe and adapter have been connected to the R&S FSVA/FSV correctly and the analyzer has recognized the probe, the "Generic Probe" transducer is activated and you can start a measurement.



To determine whether the probe has been connected properly and recognized by the R&S FSVA/FSV, use the remote control command `PROB:SET:STAT?` (see `PROBe:SETup:STATe?` on page 779).

To perform a measurement with the probe

- ▶ Place the probe on the required position on the test equipment, then press the micro button on the probe to perform a single sweep measurement.

Probe Configuration

Principally, the probe is automatically recognized by the instrument and no further adjustment is required. However, you can switch off the probe while leaving it connected, and you can configure which action is to be performed when the probe's micro button is pressed.

To display the "Probe Configuration" dialog box, select the [INPUT/OUTPUT] key and then the "Probe Config" softkey.

The following settings are available:

State.....	405
Name.....	405
Serial Number.....	405
Part number.....	405
Micro Button Action.....	405

State

Activates a connected probe. Use this command to switch off the probe and measure the digital input without considering the transducer factor of the probe.

Remote command:

[PROBe \[: STATe \]](#) on page 779

Name

Indicates the name of the connected probe.

Remote command:

[PROBe : SETup : NAME ?](#) on page 779

Serial Number

Indicates the serial number of the connected probe.

Remote command:

[PROBe : ID : SRNumber ?](#) on page 778

Part number

Indicates the material part number of the connected probe.

Remote command:

[PROBe : ID : PARTnumber ?](#) on page 778

Micro Button Action

Defines which action is taken when the probe's micro button is pressed.

"RunSingle" A single sweep is performed.

"No Action" No action is taken.

Remote command:

[PROBe : SETup : MODE](#) on page 779

5.3.9 Performing Measurements – RUN SINGLE/RUN CONT Keys

The [RUN SINGLE] and [RUN CONT] keys are used to start measurement tasks.

- [RUN SINGLE] switches to single sweep mode and performs a single sweep, just as the [Single Sweep](#) softkey in the "Sweep" menu does.
- [RUN CONT] switches to continuous sweep mode and starts sweeping, just as the [Continuous Sweep](#) softkey in the "Sweep" menu does.

5.4 Measurement Modes

This section describes the provided measurement modes, the change of measurement modes and the access to the menus of all active measurement modes. For details refer to the following sections:

- [Chapter 5.4.1, "Measurement Mode Selection – MODE Key"](#), on page 406
- [Chapter 5.4.2, "Measurement Mode Menus – HOME Key"](#), on page 411

5.4.1 Measurement Mode Selection – MODE Key

The MODE key provides a quick access to the menu of the current measurement mode and a fast change of the measurement mode.



The "Power Sensor" mode can be accessed via the [Input/Output] key. This mode provides measurement functions for Power Sensors. The "Power Sensor" mode requires an instrument equipped with the corresponding optional software.



Spectrogram mode

Equipped with the firmware option R&S FSV-K14, the R&S FSV/FSV provides a graphical overview of changes in frequency and amplitude over a specified period of time. Spectrogram mode can be accessed via the [TRACE] key.

For details see the description of R&S FSV-K14 in the base unit document.

To change the measurement mode

1. Press the MODE key.
A menu with the currently available measurement modes is displayed.
2. To activate a different mode, press the corresponding softkey.



Storing application-specific settings when switching modes

To store application-specific settings when you switch modes, activate the "Application Setup Recovery" softkey in the "Setup" menu before starting a new mode (see "Application Setup Recovery" on page 160).

• Spectrum Mode.....	407
• I/Q Analyzer Mode.....	408
• Analog Demodulation Mode (Analog Demodulation Option, R&S FSV-K7).....	408
• FM Stereo Mode (Option R&S FSV-K7S).....	408
• Bluetooth Mode (Option R&S FSV-K8).....	408
• GSM/EDGE Analyzer Mode (GSM/EDGE Option, R&S FSV-K10).....	408
• Noise Figure Mode (Noise Figure Measurements Option, R&S FSV-K30).....	408
• Phase Noise Mode (Phase Noise Measurements Option, R&S FSV-K40).....	409
• Vector Signal Analysis mode (VSA Option, R&S FSV-K70).....	409
• 3G FDD BTS Mode (3GPP Base Station Measurements Option, R&S FSV-K72)	409
• 3G FDD UE Mode (3GPP User Equipment Measurements Option, R&S FSV-K73)	409
• TDS BTS and TDS UE Mode (Option R&S FSV-K76/-K77).....	409
• CDMA2000 BTS and MS Mode (Options R&S FSV-K82/-K83).....	409
• 1xEV-DO BTS and MS Mode (Options R&S FSV-K84/-K85).....	410
• WLAN Mode (WLAN TX Measurements Option, R&S FSV-K91).....	410
• WiMAX Mode (WiMAX IEEE 802.16 OFDM, OFDMA Measurements Option, R&S FSV-K93).....	410
• LTE Mode.....	410
• 5G NR Mode.....	411

5.4.1.1 Spectrum Mode

In the "Spectrum" mode the provided functions correspond to those of a conventional spectrum analyzer. The analyzer measures the frequency spectrum of the test signal over the selected frequency range with the selected resolution and sweep time, or, for a fixed frequency, displays the waveform of the video signal. This mode is set in the initial configuration.

You can use up to four spectrum displays simultaneously. The additional spectrum displays are independent of each other. You can set up each display as you like without affecting measurement configurations in another one. Each additional spectrum display opens in an extra tab labelled "Spectrum 1" to "Spectrum 4".

- ▶ To add a new spectrum display, press the "New Spectrum" softkey.
The R&S FSVA/FSV opens an additional "Spectrum" tab each time you press the softkey up to a maximum of four.

SCPI Command:

`INSTRument[:SElect]` on page 770

`INSTRument:NSElect` on page 772

[INSTRument:CREate\[:NEW\]](#) on page 771

5.4.1.2 I/Q Analyzer Mode

The "I/Q Analyzer" mode provides measurement and display functions for digital I/Q signals. For details refer to [Chapter 5.5, "Instrument Functions - I/Q Analyzer"](#), on page 411.

5.4.1.3 Analog Demodulation Mode (Analog Demodulation Option, R&S FSV-K7)

The "Analog Demodulation" mode requires an instrument equipped with the corresponding optional software. This mode provides measurement functions for demodulating AM, FM, or PM signals.

For details see the R&S FSV-K7 document.

5.4.1.4 FM Stereo Mode (Option R&S FSV-K7S)

The "FM Stereo" mode provides measurement functions for demodulating FM Stereo signals. This mode requires an instrument equipped with the corresponding optional software, as well as the Analog Demodulation option (R&S FSV-K7).

For details see the R&S FSV-K7 document.

5.4.1.5 Bluetooth Mode (Option R&S FSV-K8)

The "Bluetooth" mode requires an instrument equipped with the corresponding optional software. This mode provides measurement functions for performing Bluetooth measurements.

For details see the R&S FSV-K8 document.

5.4.1.6 GSM/EDGE Analyzer Mode (GSM/EDGE Option, R&S FSV-K10)

The "GSM/EDGE Analyzer" mode requires an instrument equipped with the corresponding optional software. This mode provides measurement functions for downlink or uplink signals according to the Third Generation Partnership Project (3GPP) standards for GSM/EDGE in different domains (Time, Frequency, I/Q).

For details see the R&S FSV-K10 document.

5.4.1.7 Noise Figure Mode (Noise Figure Measurements Option, R&S FSV-K30)

The "Noise Figure" mode requires an instrument equipped with the corresponding optional software. This mode provides noise figure measurements.

For details see the R&S FSV-K30 document.

5.4.1.8 Phase Noise Mode (Phase Noise Measurements Option, R&S FSV-K40)

The "Phase Noise" mode requires an instrument equipped with the corresponding optional software. This mode provides measurements for phase noise tests.

For details see the R&S FSV-K40 document.

5.4.1.9 Vector Signal Analysis mode (VSA Option, R&S FSV-K70)

The "Vector Signal Analysis" (VSA) mode requires an instrument equipped with the corresponding optional software. This mode provides measurement functions for vector signal analysis.

For details refer to the R&S FSV-K70 document.

5.4.1.10 3G FDD BTS Mode (3GPP Base Station Measurements Option, R&S FSV-K72)

The "3G FDD BTS" mode requires an instrument equipped with the corresponding optional software. This mode provides test measurements for WCDMA downlink signals (base station signals) according to the test specification.

For details see the R&S FSV-K72 document.

5.4.1.11 3G FDD UE Mode (3GPP User Equipment Measurements Option, R&S FSV-K73)

The "3G FDD UE" mode requires an instrument equipped with the corresponding optional software. This mode provides test measurements for WCDMA uplink signals (mobile signals) according to the test specification.

For details see the R&S FSV-K73 document.

5.4.1.12 TDS BTS and TDS UE Mode (Option R&S FSV-K76/-K77)

Equipped with the firmware application R&S FSV-K76, the R&S FSVA/FSV performs code domain measurements on forward link signals according to the 3GPP standard (Third Generation Partnership Project). TD-SCDMA BTS Analysis is performed in "TDS BTS" mode.

Equipped with the firmware application R&S FSV-K77, the R&S FSV performs code domain measurements on downlink signals according to the 3GPP standard. TD-SCDMA ue Analysis is performed in "TDS ue" mode.

For details see the R&S FSV-K76/-K77 document.

5.4.1.13 CDMA2000 BTS and MS Mode (Options R&S FSV-K82/-K83)

The "CDMA2000 BTS" mode requires an instrument equipped with the optional software R&S FSV-K82. This mode provides test measurements for basic CDMA2000 base station tests.

The "CDMA2000 MS" mode requires an instrument equipped with the optional software R&S FSV-K83. This mode provides test measurements for basic CDMA2000 mobile station tests.

FSVNeu_k82_k83, 2, en_US For details see the R&S FSV-K82/-K83 document.

5.4.1.14 1xEV-DO BTS and MS Mode (Options R&S FSV-K84/-K85)

The "1xEV-DO BTS" mode requires an instrument equipped with the optional software R&S FSV-K84. This mode provides Code Domain measurements on forward link signals according to the 3GPP2 Standard (Third Generation Partnership Project 2) High Rate Packet Data, generally referred to as "1xEV-DO".

The "1xEV-DO MS" mode requires an instrument equipped with the optional software R&S FSV-K85. This mode provides Code Domain measurements on reverse link signals according to the 3GPP2 Standard (Third Generation Partnership Project 2) High Rate Packet Data, generally referred to as "1xEV-DO".

For details see the R&S FSV-K84/-K85 document.

5.4.1.15 WLAN Mode (WLAN TX Measurements Option, R&S FSV-K91)

The "WLAN" mode requires an instrument equipped with the corresponding optional software. This mode provides Wireless LAN TX measurement functions according to IEEE 802.11 a, b, g and j standards.

This option is not available for R&S FSVA/FSV 40 model 1307.9002K39.

For details see the R&S FSV-K91 document.

5.4.1.16 WiMAX Mode (WiMAX IEEE 802.16 OFDM, OFDMA Measurements Option, R&S FSV-K93)

The "WiMAX" mode requires an instrument equipped with the WiMAX IEEE 802.16 OFDM, OFDMA Measurements option (R&S FSV-K93). This mode provides WiMAX and WiBro measurement functions according to IEEE standards 802.16-2004 OFDM and 802.16e-2005 OFDMA/WiBro. It includes the WiMAX 802.16 OFDM Measurements option.

This option is not available for R&S FSVA/FSV 40 model 1307.9002K39.

For details see the R&S FSV-K93 document.

5.4.1.17 LTE Mode

The LTE mode requires an instrument equipped with one of the EUTRA/LTE DL measurement applications that are available for the R&S FSVA/FSV.

- R&S FSV-K100 LTE FDD DL
- R&S FSV-K101 LTE FDD UL
- R&S FSV-K104 LTE TDD DL

- R&S FSV-K105 LTE TDD UL

The application provides EUTRA/LTE measurement functions according to the 3GPP standard.

This option is not available for R&S FSV/FSV 40 model 1307.9002K39.

For details see the corresponding manuals.

5.4.1.18 5G NR Mode

The 5G NR mode requires an instrument equipped with the R&S FSV-K144 measurement application.

The application provides 5G NR measurement functions according to the 3GPP standard.

For details see the corresponding manuals.

5.4.2 Measurement Mode Menus – HOME Key

The HOME key provides a quick access to the root menu of the current measurement mode.

For the basic "Spectrum" mode (except for tracking generator measurements, see [Chapter 5.6, "Instrument Functions – Tracking Generator \(Options R&S FSV-B9/ R&S FSV-B10\)"](#), on page 445), the softkeys of this menu are identical to the [Chapter 5.2.2.1, "Softkeys of the Frequency Menu"](#), on page 186.

For details on changing the mode refer to [Chapter 5.4.1, "Measurement Mode Selection – MODE Key"](#), on page 406.

5.5 Instrument Functions - I/Q Analyzer

The I/Q Analyzer provides functions to capture, visualize and evaluate I/Q data. These functions include:

- capturing data from the RF input or an R&S Digital I/Q Interface (with R&S FSV-B17 option)
- displaying I/Q data in various result types, e.g. separate Real/Imag diagrams or as an I/Q-vector
- providing I/Q data to a digital output for further processing in other devices (with R&S FSV-B17 option)

Menu and softkey description

The "I/Q Analyzer" menu is displayed when you select the "I/Q Analyzer" softkey in the [Mode] menu. The same menu is displayed when you press the [MEAS] or [MEAS Config] keys in "I/Q Analyzer" mode. For details see [Chapter 5.5.1, "Softkeys and Parameters of the I/Q Analyzer Menu"](#), on page 413.

The "Amplitude" menu, which is displayed when you select the [AMPT] key, is described in [Chapter 5.5.2, "Softkeys of the Amplitude Menu in I/Q Analyzer Mode"](#), on page 422.

The "Input/Output" menu, which is displayed when you select the [INPUT/OUTPUT] key, as well as the "Save/Recall" menu ([Save/Rcl] key) contain the same functions in I/Q Analyzer mode as in "Spectrum" mode (see [Chapter 5.3.8.1, "Softkeys of the Input/Output Menu"](#), on page 398).

The "Marker" menu is identical to the one in Spectrum mode for display modes "Magnitude", "Real/Imag" and "Spectrum" (except for "Marker Zoom"), see ["Display Config"](#) on page 418. For the other display modes this menu is not available.

The "Marker To" menu is identical to the one in Spectrum mode. For the "Real / Imag (I/Q)" display mode, an additional function is available, see [Chapter 5.5.4, "Softkeys of the Marker To Menu in I/Q Analyzer Mode"](#), on page 434.

The "Marker Function" menu, which is displayed when you select the [Mkr func] key, is described in [Chapter 5.5.5, "Softkeys of the Marker Function Menu in I/Q Analyzer Mode"](#), on page 435.

The "Trace" menu is identical to the one in Spectrum mode, except in "I/Q Vector" display mode. In this case, only 1 trace is available and no detector can be selected (see [Chapter 5.2.8.1, "Softkeys of the Trace Menu"](#), on page 220).

The "Trigger" menu, which is displayed when you select the [TRIG] key, is described in see [Chapter 5.5.3, "Softkeys of the Trigger Menu in I/Q Analyzer Mode"](#), on page 429.

The "Span", "BW", and "Lines" menus are not available in this mode. For digital input, the "Frequency" menu is also not available. All other menus are identical to those described for "Spectrum" mode (see [Chapter 5.2, "Measurement Parameters"](#), on page 182 and [Chapter 5.3, "Measurement Functions"](#), on page 248).

Remote Control

Measurements with the I/Q Analyzer can also be performed via remote control.

The required commands are contained in the following subsystems:

- [Chapter 6.3.3.9, "INPut Subsystem"](#), on page 763
- ["TRACe:IQ Subsystem"](#) on page 894
- [Chapter 6.3.3.12, "OUTPut Subsystem"](#), on page 775

Further information

- Some general information on working with I/Q data can be found in [Chapter 5.5.6, "Working with I/Q Data"](#), on page 439.
- When measuring I/Q data, you may make use of the optional R&S Digital I/Q Interface (R&S FSV-B17); for details see [Chapter 5.7, "Instrument Functions - R&S Digital I/Q Interface \(Option R&S FSV-B17\)"](#), on page 470.

5.5.1 Softkeys and Parameters of the I/Q Analyzer Menu

This section describes the softkeys and parameters of the "I/Q Analyzer" submenu which is displayed when you select the "I/Q Analyzer" softkey in the [MODE] menu. The same menu is displayed when you press the [MEAS] or [MEAS Config] keys in "I/Q Analyzer" mode.

I/Q Analyzer.....	413
L Signal Source.....	414
L Input Path.....	414
L Connected Device.....	414
L Input Sample Rate.....	414
L Full Scale Level.....	414
L Level Unit.....	414
L Adjust Reference Level to Full Scale Level.....	414
L EXIQ.....	415
L TX Settings.....	415
L RX Settings.....	415
L Send To.....	415
L Firmware Update.....	415
L R&S Support.....	415
L DigiConf.....	415
L Level.....	416
L Reference Level.....	416
L Auto Level.....	416
L Preamp On/Off.....	416
L Data Acquisition.....	417
L Sample Rate.....	417
L Filter BW.....	417
L No Filter.....	417
L Maximum Bandwidth.....	417
L Meas Time.....	418
L Record Length.....	418
L Display Config.....	418
L Digital Output.....	420
L Digital IQ Info.....	421
L C/N, C/No.....	421
L C/N.....	421
L C/No.....	421
L Channel Bandwidth.....	422
L Adjust Settings.....	422

I/Q Analyzer

Starts the I/Q Analyzer evaluation mode and opens the submenu for the I/Q analyzer, which allows you to configure and display measurements of I/Q data, e.g. digital base-band signals.

Remote command:

Starting I/Q Analyzer:

TRACe<n>: IQ[:STATe] on page 895

Selecting evaluation mode:

[TRACe<n>:IQ:EVAL](#) on page 902

Selecting the I/Q Analyzer display configuration

[CALCulate<n>:FORMat](#) on page 747

Signal Source ← I/Q Analyzer

Opens a dialog box to select the signal source.

For "Digital Baseband (I/Q)", the source can also be configured here.

Input Path ← Signal Source ← I/Q Analyzer

Defines whether the "RF Radio Frequency" or the "Digital IQ" input path is used for measurements. "Digital IQ" is only available if option R&S FSV-B17 (R&S Digital I/Q Interface) is installed.

Note: Note that the input path defines the characteristics of the signal, which differ significantly between the RF input and digital input.

Remote command:

[INPut:SElect](#) on page 769

Connected Device ← Signal Source ← I/Q Analyzer

Displays the name of the device connected to the optional R&S Digital I/Q Interface (R&S FSV-B17) to provide Digital IQ input. The device name cannot be changed here.

The device name is unknown.

Remote command:

[INPut:DIQ:CDEvice](#) on page 764

Input Sample Rate ← Signal Source ← I/Q Analyzer

Defines the sample rate of the digital I/Q signal source. This sample rate must correspond with the sample rate provided by the connected device, e.g. a generator.

Remote command:

[INPut:DIQ:SRATe](#) on page 767

Full Scale Level ← Signal Source ← I/Q Analyzer

The "Full Scale Level" defines the level that should correspond to an I/Q sample with the magnitude "1".

The level can be defined either in dBm or Volt.

Remote command:

[INPut:DIQ:RANGe\[:UPPer\]](#) on page 766

Level Unit ← Signal Source ← I/Q Analyzer

Defines the unit used for the full scale level.

Remote command:

[INPut:DIQ:RANGe\[:UPPer\]:UNIT](#) on page 766

Adjust Reference Level to Full Scale Level ← Signal Source ← I/Q Analyzer

If enabled, the reference level is adjusted to the full scale level automatically if any change occurs.

(See the [Auto Level](#) softkey).

Remote command:

[INPut:DIQ:RANGe:COUPling](#) on page 765

EXIQ ← I/Q Analyzer

Opens a configuration dialog box for an optionally connected R&S EX-IQ-BOX and a submenu to access the main settings quickly.

Note: The EX-IQ-Box functionality is not supported for R&S FSV models 1307.9002Kxx.

If the optional R&S DigIConf software is installed, the submenu consists only of one key to access the software. **Note that R&S DigIConf requires a USB connection (not LAN!) from the R&S FSVA/FSV to the R&S EX-IQ-BOX in addition to the R&S Digital I/Q Interface connection. R&S DigIConf version 2.10 or higher is required.**

For typical applications of the R&S EX-IQ-BOX see also the description of the R&S Digital I/Q Interface (R&S FSV-B17) in the base unit manual.

For details on configuration see the "R&S®Ex I/Q Box - External Signal Interface Module Manual".

For details on installation and operation of the R&S DigIConf software, see the "R&S®EX-IQ-BOX Digital Interface Module R&S®DigIConf Software Operating Manual".

TX Settings ← EXIQ ← I/Q Analyzer

Opens the "EX-IQ-BOX Settings" dialog box to configure the R&S FSVA/FSV for digital output to a connected device ("Transmitter" Type).

RX Settings ← EXIQ ← I/Q Analyzer

Opens the "EX-IQ-BOX Settings" dialog box to configure the R&S FSVA/FSV for digital input from a connected device ("Receiver" Type).

Send To ← EXIQ ← I/Q Analyzer

The configuration settings defined in the dialog box are transferred to the R&S EX-IQ-BOX.

Firmware Update ← EXIQ ← I/Q Analyzer

If a firmware update for the R&S EX-IQ-BOX is delivered with the R&S FSVA/FSV firmware, this function is available. In this case, when you select the softkey, the firmware update is performed.

R&S Support ← EXIQ ← I/Q Analyzer

Stores useful information for troubleshooting in case of errors.

This data is stored in the `C:\R_S\Instr\user\Support` directory on the instrument.

If you contact the Rohde&Schwarz support to get help for a certain problem, send these files to the support in order to identify and solve the problem faster.

DigIConf ← EXIQ ← I/Q Analyzer

Starts the optional R&S DigIConf application. This softkey is only available if the optional software is installed.

To return to the R&S FSVA/FSV application, press any key on the front panel. The application is displayed with the "EXIQ" menu, regardless of which key was pressed. For details on the R&S DigIConf application, see the "R&S®EX-IQ-BOX Digital Interface Module R&S®DigIConf Software Operating Manual".

Note: If you close the R&S DigIConf window using the "Close" icon, the window is minimized, not closed.

If you select the "File > Exit" menu item in the R&S DigIConf window, the application is closed. Note that in this case the settings are lost and the EX-IQ-BOX functionality is no longer available until you restart the application using the "DigIConf" softkey in the R&S FSVA/FSV once again.

Remote command:

Remote commands for the R&S DigIConf software always begin with `SOURce:EBOX`. Such commands are passed on from the R&S FSVA/FSV to the R&S DigIConf automatically which then configures the R&S EX-IQ-BOX via the USB connection.

All remote commands available for configuration via the R&S DigIConf software are described in the "R&S®EX-IQ-BOX Digital Interface Module R&S®DigIConf Software Operating Manual".

Example 1:

`SOURce:EBOX:*RST`

`SOURce:EBOX:*IDN?`

Result:

"Rohde&Schwarz,DigIConf,02.05.436 Build 47"

Example 2:

`SOURce:EBOX:USER:CLOCK:REFERENCE:FREQUENCY 5MHZ`

Defines the frequency value of the reference clock.

Level ← I/Q Analyzer

Opens a dialog box to define the level settings.

Reference Level ← Level ← I/Q Analyzer

Specifies the reference level for the I/Q measurement.

Remote command:

`DISPlay[:WINDow<n>]:TRACe<t>:Y[:SCALE]:RVALue` on page 755

Auto Level ← Level ← I/Q Analyzer

If enabled, the reference level is adjusted to the full scale level automatically if the full scale level changes.

Remote command:

`INPut:DIQ:RANGE:COUPling` on page 765

Preamp On/Off ← Level ← I/Q Analyzer

Switches the preamplifier on and off.

If option R&S FSV-B22 is installed, the preamplifier is only active below 7 GHz.

If option R&S FSV-B24 is installed, the preamplifier is active for all frequencies.

When measuring Spurious Emissions, using this softkey automatically opens the "Sweep List" dialog, see "[Sweep List dialog box](#)" on page 349.

This function is not available for input from the R&S Digital I/Q Interface (option R&S FSV-B17).

Remote command:

[INPut:GAIN:STATe](#) on page 769

Data Acquisition ← I/Q Analyzer

Opens a dialog box to configure data acquisition in I/Q Analyzer mode.

Sample Rate ← Data Acquisition ← I/Q Analyzer

Defines the I/Q data sample rate of the R&S FSVA/FSV.

This rate may differ from the sample rate of the connected device (see ["Input Sample Rate"](#) on page 400).

If the R&S Digital I/Q Interface (R&S FSV-B17) is active, restrictions to the sample rate apply, see [Table 5-13](#).

For R&S FSVA/FSV 40 model 1307.9002K39, the maximum sample rate is 12.5 MHz.

Remote command:

[TRACe<n>:IQ:SRATe](#) on page 906

Filter BW ← Data Acquisition ← I/Q Analyzer

Displays the flat, usable bandwidth of the final I/Q data.

This value is dependent on the defined [Data Acquisition](#) and the defined [Signal Source](#) and cannot be edited manually.

To avoid using a filter and use the [Input Sample Rate](#) instead, select the "No Filter" option.

Remote command:

[TRACe<n>:IQ:BWIDth](#) on page 896

No Filter ← Data Acquisition ← I/Q Analyzer

This setting is only available when using the Digital Baseband Interface (R&S FSV-B17).

If enabled, no digital decimation filter is used during data acquisition. Thus, the [Sample Rate](#) is identical to the input sample rate configured for the Digital I/Q input source (see ["Input Sample Rate"](#) on page 400).

Note, however, that in this case noise, artifacts, and the second IF side band may not be suppressed in the captured I/Q data.

Remote command:

[TRACe<n>:IQ:DIQFilter](#) on page 900

Maximum Bandwidth ← Data Acquisition ← I/Q Analyzer

Defines the maximum bandwidth to be used by the R&S FSVA/FSV for I/Q data acquisition

This function is only available if the bandwidth extension option R&S FSV-B160 is installed and no other restrictions for its use apply (see ["Restrictions"](#) on page 441).

For details on the maximum bandwidth see [Chapter 5.5.6.2, "Sample Rate and Maximum Usable Bandwidth \(RF Input\)"](#), on page 441.

"Auto"	(Default) The maximum available bandwidth is used for all sample rates. If the bandwidth extension option R&S FSV-B160 is installed, it is activated for bandwidths as of 64 MHz (if no other restrictions for its use apply, see " Restrictions " on page 441). Thus, sample rates up to 400 MHz and an I/Q bandwidth up to 160 MHz are possible. Note that using the bandwidth extension may cause more spurious effects.
"40 MHz"	Deactivates use of the bandwidth extension option R&S FSV-B160, thus reducing possible spurious effects, while restricting the analysis bandwidth to 40 MHz. Sample rates higher than 128 MHz can only be achieved using the bandwidth extension.
"160 MHz"	The bandwidth extension option R&S FSV-B160 is always used (if no other restrictions for its use apply, see " Restrictions " on page 441), thus raising the minimum possible sample rate to 32 MHz.

Remote command:

[TRACe: IQ:WBANd\[:STATe\]](#) on page 906

To query the currently used bandwidth:

[TRACe<n>: IQ:BWIDth](#) on page 896

Meas Time ← Data Acquisition ← I/Q Analyzer

Defines the I/Q acquisition time. By default, the measurement time is calculated as the number of I/Q samples ("Record Length") divided by the sample rate. If you change the measurement time, the [Record Length](#) is automatically changed, as well.

For details on the maximum number of samples see also [Chapter 5.5.6, "Working with I/Q Data"](#), on page 439.

Remote command:

[\[SENSe:\] SWEep: TIME](#) on page 862

Record Length ← Data Acquisition ← I/Q Analyzer

Defines the number of I/Q samples to record. By default, the number of sweep points is used. The record length is calculated as the measurement time multiplied by the sample rate. If you change the record length, the [Meas Time](#) is automatically changed, as well.

Remote command:

[TRACe<n>: IQ: RLENgth](#) on page 903

[TRACe<n>: IQ: SET](#) on page 904

Display Config ← I/Q Analyzer

Opens a selection list to specify the result display configuration. The following displays are available:

"Magnitude" Shows the values in time domain

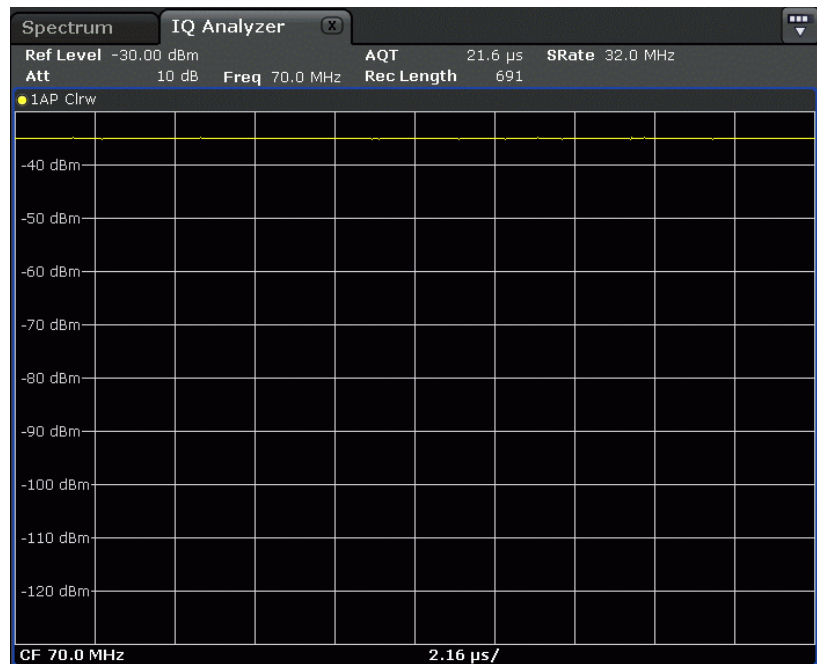

"Spectrum" Displays the frequency spectrum of the captured I/Q samples.

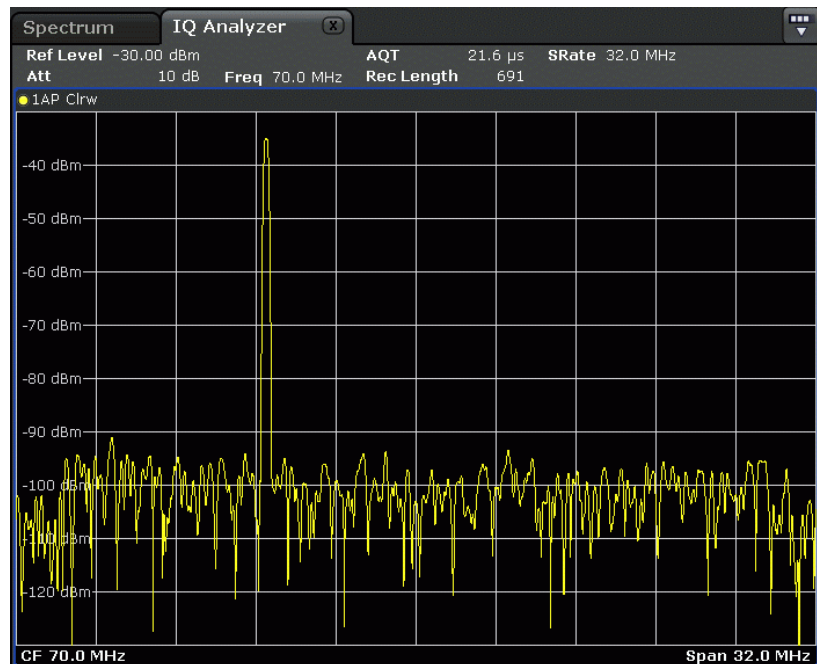

"I/Q-Vector" Displays the captured samples in an I/Q-plot. The samples are connected by a line.

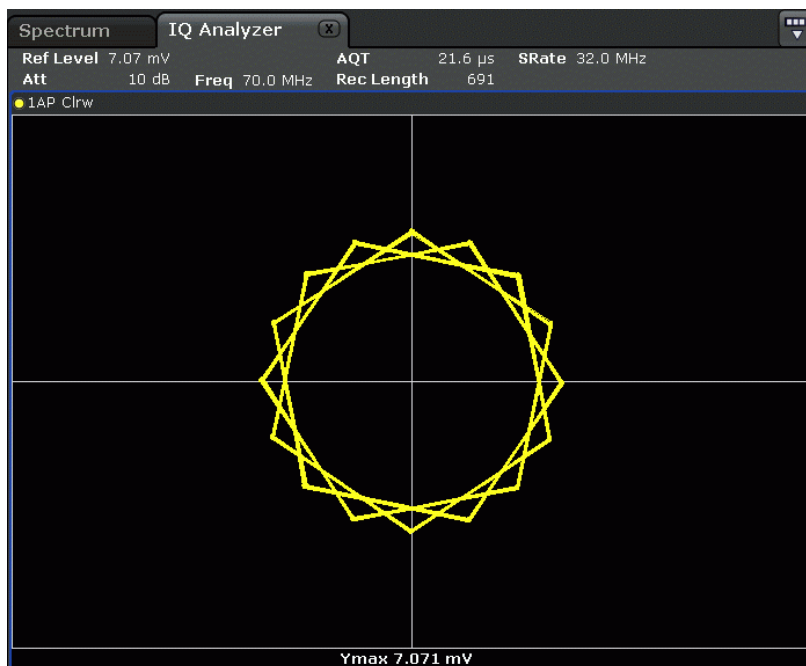

"Real/Imag (I/Q)" Displays the I and Q values in separate diagrams.

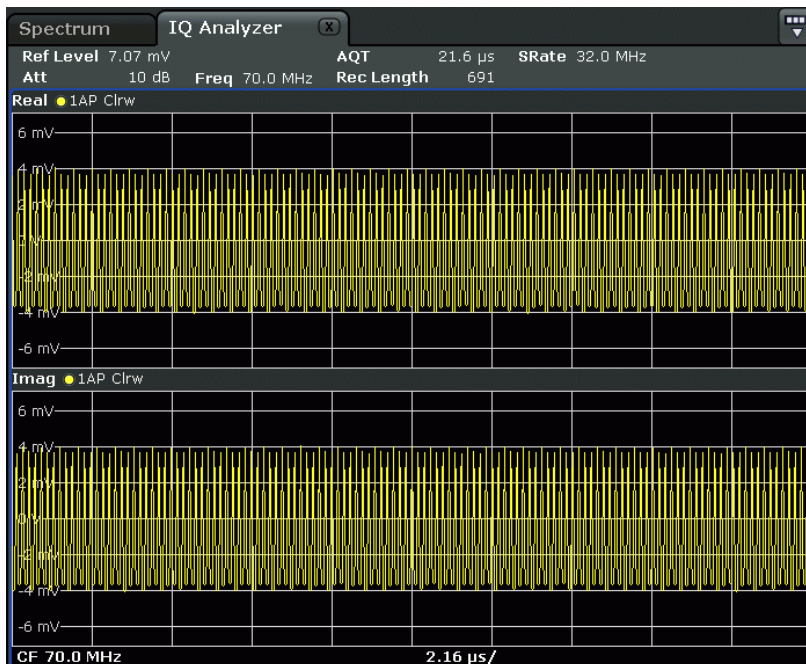

Remote command:

[CALCulate<n>:FORMat](#) on page 747

Digital Output ← I/Q Analyzer

Opens a dialog box to enable a digital output stream to the optional R&S Digital I/Q Interface (R&S FSV-B17), if available.

The displayed sample rate is identical to the sample rate defined under [Data Acquisition](#) (I/Q Analyzer) and is not editable here.

For details see "Digital Output" in the description of the R&S Digital I/Q Interface for the base unit.

Remote command:

`OUTPut:DIQ` on page 776

Digital IQ Info ← I/Q Analyzer

Displays a dialog box with information on the digital I/Q input and output connection via the optional R&S Digital I/Q Interface (R&S FSV-B17), if available. The information includes:

- Device identification
- Used port
- (Maximum) digital input/output sample rates and maximum digital input/output transfer rates
- Status of the connection protocol
- Status of the PRBS descewing test

For details see "Interface Status Information" in "Instrument Functions - R&S Digital I/Q Interface (Option R&S FSV-B17)" in the description of the base unit.

Remote command:

`INPut:DIQ:CDEvice` on page 764

C/N, C/No ← I/Q Analyzer

Opens a submenu to configure the carrier/noise ratio measurement. Measurements without (C/N) and measurements with reference to the bandwidth (C/No) are possible.

Carrier-to-noise measurements are not available in zero span mode.

Note: As of firmware version 2.0, carrier-to-noise measurements are also available in the I/Q Analyzer, but only for **Spectrum** displays (see "[Display Config](#)" on page 418).

For general information on performing carrier-to-noise ratio measurements see [Chapter 5.3.5.3, "Measuring the Carrier-to-Noise Ratio"](#), on page 308.

C/N ← C/N, C/No ← I/Q Analyzer

Switches the measurement of the carrier/noise ratio on or off. If no marker is active, marker 1 is activated.

The measurement is performed on the trace that marker 1 is assigned to. To shift marker 1 and measure another trace, use the [Marker to Trace](#) softkey in the "Marker To" menu.

Remote command:

`CALCulate<n>:MARKer<m>:FUNction:POWer:SElect` on page 707

`CALCulate<n>:MARKer<m>:FUNction:POWer:RESult?` on page 704

`CALCulate<n>:MARKer<m>:FUNction:POWer[:STATe]` on page 708

C/No ← C/N, C/No ← I/Q Analyzer

Switches the measurement of the carrier/noise ratio with reference to a 1 Hz bandwidth on or off. If no marker is active, marker 1 is activated.

The measurement is performed on the trace that marker 1 is assigned to. To shift marker 1 and measure another trace, use the **Marker to Trace** softkey in the "Marker To" menu.

Remote command:

`CALCulate<n>:MARKer<m>:FUNCTION:POWER:SElect` on page 707

`CALCulate<n>:MARKer<m>:FUNCTION:POWER:RESult?` on page 704

`CALCulate<n>:MARKer<m>:FUNCTION:POWER[:STATe]` on page 708

Channel Bandwidth ← C/N, C/No ← I/Q Analyzer

Opens an edit dialog box to enter the measurement channel bandwidth for each channel.

The default setting is 14 kHz.

Note that in the I/Q Analyzer the channel bandwidth does not change the measurement span or sampling rate; it merely defines the range for the carrier-to-noise analysis.

Remote command:

`[SENSe:]POWER:ACHannel:ACPairs` on page 845

Adjust Settings ← C/N, C/No ← I/Q Analyzer

Enables the RMS detector (see also [Chapter 5.2.8.6, "Detector Overview"](#), on page 234) and adjusts the span to the selected channel bandwidth according to:

"4 x channel bandwidth + measurement margin"

The adjustment is performed once; if necessary, the setting can be changed later on.

Note: in the I/Q Analyzer, this function is not available. The channel bandwidth defines the range for the carrier-to-noise analysis.

Remote command:

`[SENSe:]POWER:ACHannel:PRESet` on page 850

5.5.2 Softkeys of the Amplitude Menu in I/Q Analyzer Mode

In I/Q Analyzer mode, the "Amplitude" menu, which is displayed when you select the [AMPT] key, contains the following functions.



If the display configuration for the I/Q Analyzer is set to "I/Q Vector" or "Real/Imag (I/Q)", the **Range** and **Unit** functions are not available.

Ref Level.....	423
Y-Axis Max.....	423
Range.....	423
L Range Log 100 dB.....	423
L Range Log 50 dB.....	423
L Range Log 10 dB.....	424
L Range Log 5 dB.....	424
L Range Log 1 dB.....	424
L Range Log Manual.....	424

L Range Linear %.....	425
L Range Lin. Unit.....	425
Unit.....	425
Preamp On/Off.....	425
RF Atten Manual/Mech Att Manual.....	426
RF Atten Auto/Mech Att Auto.....	426
EI Atten On/Off.....	426
EI Atten Mode (Auto/Man).....	427
Ref Level Offset.....	427
Ref Level Position.....	427
Grid Abs/Rel	428
Noise Correction.....	428
Input (AC/DC).....	428
Input 50 Ω /75 Ω	428

Ref Level

Opens an edit dialog box to enter the reference level in the current unit (dBm, dB μ V, etc).

The reference level is the maximum value the AD converter can handle without distortion of the measured value. Signal levels above this value will not be measured correctly, which is indicated by the "IFOVL" status display.

Remote command:

`DISPlay[:WINDow<n>]:TRACe<t>:Y[:SCALe]:RLEVel` on page 754

Y-Axis Max

Opens an edit dialog box to specify the maximum value of the y-axis in either direction (in Volts). Thus, the y-axis scale starts at -<Y-AxisMax> and ends at +<Y-AxisMax>.

This command is only available if the display configuration for the I/Q Analyzer is set to "I/Q Vector" or "Real/Imag (I/Q)", see "Display Config" on page 418.

Range

Opens a submenu to define the display range of the level axis.

Range Log 100 dB ← Range

Sets the level display range to 100 dB.

Remote command:

Logarithmic scaling:

`DISP:WIND:TRAC:Y:SPAC LOG`, see `DISPlay[:WINDow<n>]:TRACe<t>:Y:SPACing` on page 753

Display range:

`DISP:WIND:TRAC:Y 100DB`, see `DISPlay[:WINDow<n>]:TRACe<t>:Y[:SCALe]` on page 753

Range Log 50 dB ← Range

Sets the level display range to 50 dB.

Remote command:

Logarithmic scaling:

DISP:WIND:TRAC:Y:SPAC LOG, see [DISPlay\[:WINDow<n>\]:TRACe<t>:Y:SPACing](#) on page 753

Display range:

DISP:WIND:TRAC:Y 50DB, see [DISPlay\[:WINDow<n>\]:TRACe<t>:Y\[:SCALE\]](#) on page 753

Range Log 10 dB ← Range

Sets the level display range to 10 dB.

Remote command:

Logarithmic scaling:

DISP:WIND:TRAC:Y:SPAC LOG, see [DISPlay\[:WINDow<n>\]:TRACe<t>:Y:SPACing](#) on page 753

Display range:

DISP:WIND:TRAC:Y 10DB, see [DISPlay\[:WINDow<n>\]:TRACe<t>:Y\[:SCALE\]](#) on page 753

Range Log 5 dB ← Range

Sets the level display range to 5 dB.

Remote command:

Logarithmic scaling:

DISP:WIND:TRAC:Y:SPAC LOG, see [DISPlay\[:WINDow<n>\]:TRACe<t>:Y:SPACing](#) on page 753

Display range:

DISP:WIND:TRAC:Y 5DB, see [DISPlay\[:WINDow<n>\]:TRACe<t>:Y\[:SCALE\]](#) on page 753

Range Log 1 dB ← Range

Sets the level display range to 1 dB.

Remote command:

Logarithmic scaling:

DISP:WIND:TRAC:Y:SPAC LOG, see [DISPlay\[:WINDow<n>\]:TRACe<t>:Y:SPACing](#) on page 753

Display range:

DISP:WIND:TRAC:Y 1DB, see [DISPlay\[:WINDow<n>\]:TRACe<t>:Y\[:SCALE\]](#) on page 753

Range Log Manual ← Range

Opens an edit dialog box to define the display range of a logarithmic level axis manually.

Remote command:

Logarithmic scaling:

DISP:WIND:TRAC:Y:SPAC LOG, see [DISPlay\[:WINDow<n>\]:TRACe<t>:Y:SPACing](#) on page 753

Display range:

[DISPlay\[:WINDow<n>\]:TRACe<t>:Y\[:SCALE\]](#) on page 753

Range Linear % ← Range

Selects linear scaling for the level axis in %.

The grid is divided into decadal sections.

Markers are displayed in the selected unit ("Unit" softkey). Delta markers are displayed in % referenced to the voltage value at the position of marker 1. This is the default setting for linear scaling.

Remote command:

DISP:TRAC:Y:SPAC LIN, see [DISPlay\[:WINDow<n>\]:TRACe<t>:Y:SPACing](#) on page 753

Range Lin. Unit ← Range

Selects linear scaling in dB for the level display range, i.e. the horizontal lines are labeled in dB.

Markers are displayed in the selected unit ("Unit" softkey). Delta markers are displayed in dB referenced to the power value at the position of marker 1.

Remote command:

DISP:TRAC:Y:SPAC LDB, see [DISPlay\[:WINDow<n>\]:TRACe<t>:Y:SPACing](#) on page 753

Unit

Opens the "Unit" submenu to select the unit for the level axis.

The default setting is dBm.

If a transducer is switched on, the softkey is not available.

In general, the signal analyzer measures the signal voltage at the RF input. The level display is calibrated in RMS values of an unmodulated sine wave signal. In the default state, the level is displayed at a power of 1 mW (= dBm). Via the known input impedance (50 Ω or 75 Ω), conversion to other units is possible. The following units are available and directly convertible:

- dBm
- dBmV
- dBμV
- dBμA
- dBpW
- Volt
- Ampere
- Watt

Remote command:

[CALCulate<n>:UNIT:POWer](#) on page 747

Preamp On/Off

Switches the preamplifier on and off.

If option R&S FSV-B22 is installed, the preamplifier is only active below 7 GHz.

If option R&S FSV-B24 is installed, the preamplifier is active for all frequencies.

When measuring Spurious Emissions, using this softkey automatically opens the "Sweep List" dialog, see ["Sweep List dialog box"](#) on page 349.

This function is not available for input from the R&S Digital I/Q Interface (option R&S FSV-B17).

Remote command:

`INPut:GAIN:STATe` on page 769

RF Atten Manual/Mech Att Manual

Opens an edit dialog box to enter the attenuation, irrespective of the reference level. If electronic attenuation is activated (option R&S FSV-B25 only; "EI Atten Mode Auto" softkey), this setting defines the mechanical attenuation.

The mechanical attenuation can be set in 10 dB steps.

The RF attenuation can be set in 5 dB steps (R&S FSV with option R&S FSV-B25 or R&S FSV-A: 1 dB steps). The range is specified in the data sheet. If the current reference level cannot be set for the set RF attenuation, the reference level is adjusted accordingly.

This function is not available for input from the R&S Digital I/Q Interface (option R&S FSV-B17).

The RF attenuation defines the level at the input mixer according to the formula:

$$\text{level}_{\text{mixer}} = \text{level}_{\text{input}} - \text{RF attenuation}$$

Note: As of firmware version 1.61, the maximum mixer level allowed is **0 dBm**. Mixer levels above this value may lead to incorrect measurement results, which are indicated by the "OVL" status display. The increased mixer level allows for an improved signal, but also increases the risk of overloading the instrument!

When measuring spurious emissions, using this softkey automatically opens the "Sweep List" dialog box, see "[Sweep List dialog box](#)" on page 349.

Remote command:

`INPut:ATTenuation` on page 763

RF Atten Auto/Mech Att Auto

Sets the RF attenuation automatically as a function of the selected reference level. This ensures that the optimum RF attenuation is always used. It is the default setting.

When measuring spurious emissions, using this softkey automatically opens the "Sweep List" dialog, see "[Sweep List dialog box](#)" on page 349.

This function is not available for input from the R&S Digital I/Q Interface (option R&S FSV-B17).

Remote command:

`INPut:ATTenuation:AUTO` on page 764

EI Atten On/Off

This softkey switches the electronic attenuator on or off. This softkey is only available with option R&S FSV-B25.

When the electronic attenuator is activated, the mechanical and electronic attenuation can be defined separately. Note however, that both parts must be defined in the same mode, i.e. either both manually, or both automatically.

This function is not available for input from the R&S Digital I/Q Interface (option R&S FSV-B17).

- To define the mechanical attenuation, use the [RF Atten Manual/Mech Att Manual](#) or [RF Atten Auto/Mech Att Auto](#) softkeys.
- To define the electronic attenuation, use the [EI Atten Mode \(Auto/Man\)](#) softkey.

Note: This function is not available for stop frequencies (or center frequencies in zero span) >7 GHz. In this case, the electronic and mechanical attenuation are summarized and the electronic attenuation can no longer be defined individually. As soon as the stop or center frequency is reduced below 7 GHz, this function is available again. When the electronic attenuator is switched off, the corresponding RF attenuation mode (auto/manual) is automatically activated.

Remote command:

[INPut:EATT:AUTO](#) on page 767

EI Atten Mode (Auto/Man)

This softkey defines whether the electronic attenuator value is to be set automatically or manually. If manual mode is selected, an edit dialog box is opened to enter the value. This softkey is only available with option R&S FSV-B25, and only if the electronic attenuator has been activated via the [EI Atten On/Off](#) softkey.

Note: This function is not available for stop frequencies (or center frequencies in zero span) >7 GHz. In this case, the electronic and mechanical attenuation are summarized and the electronic attenuation can no longer be defined individually. As soon as the stop or center frequency is reduced below 7 GHz, electronic attenuation is available again. If the electronic attenuation was defined manually, it must be re-defined.

The attenuation can be varied in 1 dB steps from 0 to 30 dB. Other entries are rounded to the next lower integer value.

To re-open the edit dialog box for manual value definition, select the "Man" mode again.

If the defined reference level cannot be set for the given RF attenuation, the reference level is adjusted accordingly and the warning "Limit reached" is output.

Remote command:

[INPut:EATT:AUTO](#) on page 767

[INPut:EATT](#) on page 767

Ref Level Offset

Opens an edit dialog box to enter the arithmetic level offset. This offset is added to the measured level irrespective of the selected unit. The scaling of the y-axis is changed accordingly. The setting range is ± 200 dB in 0.1 dB steps.

Remote command:

[DISPlay\[:WINDow<n>\]:TRACe<t>:Y\[:SCALe\]:RLEVel:OFFSet](#) on page 755

Ref Level Position

Opens an edit dialog box to enter the reference level position, i.e. the position of the maximum AD converter value on the level axis. The setting range is from -200 to +200 %, 0 % corresponding to the lower and 100 % to the upper limit of the diagram.

Remote command:

[DISPlay\[:WINDow<n>\]:TRACe<t>:Y\[:SCALe\]:RPOSition](#) on page 755

Grid Abs/Rel

Switches between absolute and relative scaling of the level axis (not available with "Linear" range).

- "Abs" Absolute scaling: The labeling of the level lines refers to the absolute value of the reference level. Absolute scaling is the default setting.
- "Rel" Relative scaling: The upper line of the grid is always at 0 dB. The scaling is in dB whereas the reference level is always in the set unit (for details on unit settings see the "Unit" softkey).

Remote command:

`DISPlay[:WINDow<n>]:TRACe<t>:Y[:SCALe]:MODE` on page 754

Noise Correction

If activated, the results are corrected by the instrument's inherent noise, which increases the dynamic range.

- "ON" A reference measurement of the instrument's inherent noise is carried out. The noise power measured is then subtracted from the power in the channel that is being examined. The inherent noise of the instrument depends on the selected center frequency, resolution bandwidth and level setting. Therefore, the correction function is disabled whenever one of these parameters is changed. A disable message is displayed on the screen. Noise correction must be switched on again manually after the change.
- "OFF" No noise correction is performed.
- "AUTO" Noise correction is performed. After a parameter change, noise correction is restarted automatically and a new correction measurement is performed.

Remote command:

`[SENSe:]POWer:NCORrection` on page 854

Input (AC/DC)

Toggles the RF input of the R&S FSVA/FSV between AC and DC coupling.

This function is not available for input from the R&S Digital I/Q Interface (option R&S FSV-B17).

Remote command:

`INPut:COUPling` on page 764

Input 50 Ω/75 Ω

Uses 50 Ω or 75 Ω as reference impedance for the measured levels. Default setting is 50 Ω.

The setting 75 Ω should be selected if the 50 Ω input impedance is transformed to a higher impedance using a 75 Ω adapter of the RAZ type (= 25 Ω in series to the input impedance of the instrument). The correction value in this case is 1.76 dB = 10 log (75 Ω/50 Ω).

All levels specified in this Operating Manual refer to the default setting of the instrument (50 Ω).

This function is not available for input from the R&S Digital I/Q Interface (option R&S FSV-B17).

Remote command:

[INPut : IMPedance](#) on page 769

5.5.3 Softkeys of the Trigger Menu in I/Q Analyzer Mode

In I/Q Analyzer mode, the "Trigger" menu, which is displayed when you select the [TRIG] key, contains the following functions:

Trg/Gate Source.....	429
L Free Run.....	429
L External.....	430
L Video.....	430
L RF Power.....	430
L IF Power/BB Power.....	431
L Power Sensor.....	431
L Time.....	432
L Digital IQ.....	432
Trigger Level.....	433
Trigger Polarity.....	433
Trigger Offset.....	433
Repetition Interval.....	434
Trigger Hysteresis.....	434
Trigger Holdoff.....	434

Trg/Gate Source

Opens the "Trigger/Gate Source" dialog box to select the trigger/gate mode.

As gate modes, all modes except "Power Sensor" are available. For details see also [Chapter 5.2.9.3, "Using Gated Sweep Operation"](#), on page 246.

The default setting is "Free Run". If a trigger mode other than "Free Run" has been set, the enhancement label "TRG" is displayed and the trigger source is indicated.

Note: When triggering or gating is activated, the squelch function is automatically disabled (see ["Squelch"](#) on page 261).

IF power and RF power triggers are not available together with the bandwidth extension option R&S FSV-B160.

Remote command:

[TRIGger<n>\[:SEQuence\]:SOURce](#) on page 912

[\[SENSe:\]SWEep:EGATe:SOURce](#) on page 858

Free Run ← Trg/Gate Source

The start of a sweep is not triggered. Once a measurement is completed, another is started immediately.

Remote command:

[TRIG:SOUR IMM](#), see [TRIGger<n>\[:SEQuence\]:SOURce](#) on page 912

External ← Trg/Gate Source

Defines triggering via a TTL signal at the "EXT TRIG/GATE IN" input connector on the rear panel.

Remote command:

TRIG:SOUR EXT, see TRIGger<n>[:SEQuence]:SOURce on page 912

SWE:EGAT:SOUR EXT for gated triggering, see [SENSe:]SWEep:EGATe:SOURce on page 858

Video ← Trg/Gate Source

Defines triggering by the displayed voltage.

A horizontal trigger line is shown in the diagram. It is used to set the trigger threshold from 0 % to 100 % of the diagram height.

Video mode is only available in the time domain.

Remote command:

TRIG:SOUR VID, see TRIGger<n>[:SEQuence]:SOURce on page 912

SWE:EGAT:SOUR VID for gated triggering, see [SENSe:]SWEep:EGATe:SOURce on page 858

RF Power ← Trg/Gate Source

Defines triggering of the measurement via signals which are outside the measurement channel.

This trigger mode is available with detector board 1307.9554.02 Rev 05.00 or higher. It is not available for input from the R&S Digital I/Q Interface (option R&S FSV-B17). If RF Power trigger mode is selected and digital baseband input is activated, the trigger mode is automatically switched to "Free Run".

RF power triggers are not available together with the bandwidth extension option R&S FSV-B160.

In RF Power trigger mode the instrument uses a level detector at the first intermediate frequency. The detector threshold can be selected in a range between -50 dBm and -10 dBm at the input mixer. The resulting trigger level at the RF input lies within the following range:

$(-24\text{dBm} + \text{RF Att}) \leq \text{Triggerlevel} \leq (+5\text{dBm} + \text{RF Att}), \text{ max. } 30 \text{ dBm}, \text{ for Preamp} = \text{OFF}$

$(-40\text{dBm} + \text{RF Att}) \leq \text{Triggerlevel} \leq (-11\text{dBm} + \text{RF Att}), \text{ max. } 30 \text{ dBm}, \text{ for Preamp} = \text{ON}$
with

$500 \text{ MHz} \leq \text{InputSignal} \leq 7 \text{ GHz}$

Note: If input values outside of this range occur (e.g. for fullspan measurements), the sweep may be aborted and a message indicating the allowed input values is displayed in the status bar.

A [Trigger Offset](#), [Trg/Gate Polarity](#) and [Trigger Holdoff](#) can be defined for the RF trigger to improve the trigger stability, but no hysteresis.

Remote command:

TRIG:SOUR RFP, see TRIGger<n>[:SEQuence]:SOURce on page 912

SWE:EGAT:SOUR RFP for gated triggering, see [SENSe:]SWEep:EGATe:SOURce on page 858

IF Power/BB Power ← Trg/Gate Source

Defines triggering of the measurement using the second intermediate frequency.

For this purpose, the R&S FSVA/FSV uses a level detector at the second intermediate frequency.

The available trigger levels depend on the RF attenuation and preamplification. A reference level offset, if defined, is also considered.

For details on available trigger levels and trigger bandwidths see the data sheet.

The bandwidth at the intermediate frequency depends on the RBW and sweep type:

Sweep mode:

- RBW > 500 kHz: 40 MHz, nominal
- RBW ≤ 500 kHz: 6 MHz, nominal

FFT mode:

- RBW > 20 kHz: 40 MHz, nominal
- RBW ≤ 20 kHz: 6 MHz, nominal

Note: Be aware that in auto sweep type mode, due to a possible change in sweep types, the bandwidth may vary considerably for the same RBW setting.

The R&S FSVA/FSV is triggered as soon as the trigger level is exceeded around the selected frequency (= start frequency in the frequency sweep).

Thus, the measurement of spurious emissions, e.g. for pulsed carriers, is possible even if the carrier lies outside the selected frequency span.

For digital input via the R&S Digital I/Q Interface (R&S FSV-B17), the baseband power ("BB Power") is used as the trigger source.

IF power triggers are not available together with the bandwidth extension option R&S FSV-B160.

Remote command:

TRIG:SOUR IFP, see [TRIGger<n>\[:SEQuence\]:SOURce](#) on page 912

TRIG:SOUR BBP for digital input

SWE:EGAT:SOUR IFP for gated triggering, see [\[SENSe:\]SWEep:EGATe:SOURce](#) on page 858

Power Sensor ← Trg/Gate Source

Uses an external power sensor as a trigger function. This option is only available if the R&S FSV-K9 Power Sensor option is installed and a power sensor is connected and configured.

(See [Chapter 5.9, "Instrument Functions - Power Sensor \(R&S FSV-K9\)"](#), on page 509.)

Power sensors are configured in the "Input/Output" menu, see [Chapter 5.9.3, "Configuring an External Power Trigger"](#), on page 514.

If a power sensor is selected as the trigger mode, the following softkeys are not available; these settings are configured in the "Power Sensor Configuration" dialog box (see [Chapter 5.9.5, "Power Sensor Configuration Dialog"](#), on page 518).

- [Trg/Gate Level](#)
- [Trg/Gate Polarity](#)
- [Trigger Hysteresis](#)
- [Trigger Holdoff](#)

Note: For R&S power sensors, the "Gate Mode" *Lvl* is not supported. The signal sent by these sensors merely reflects the instant the level is first exceeded, rather than a time period. However, only time periods can be used for gating in level mode. Thus, the trigger impulse from the sensors is not long enough for a fully gated measurement; the measurement cannot be completed.

Remote command:

TRIG:SOUR PSE, see TRIGger<n>[:SEQuence]:SOURce on page 912

SWE:EGAT:SOUR PSE for gated triggering, see [SENSe:]SWEep:EGATe:SOURce on page 858

TRACe<n>:IQ:SET on page 904

Time ← Trg/Gate Source

Opens an edit dialog box to define a repetition interval in which the measurement is triggered. The shortest interval is 2 ms.

Remote command:

TRIG:SOUR TIME TRIGger<n>[:SEQuence]:SOURce on page 912

Digital IQ ← Trg/Gate Source

For I/Q Analyzer or AnalogDemod mode only:

Defines triggering of the measurement directly via the LVDS connector. In the sub-menu you must specify which general purpose bit (GP0 to GP5) will provide the trigger data.

This trigger mode is available for input from the R&S Digital I/Q Interface (option R&S FSV-B17) only.

A [Trigger Offset](#), and [Trg/Gate Polarity](#) can be defined for the Digital IQ trigger to improve the trigger stability, but no hysteresis or holdoff value.

The following table describes the assignment of the general purpose bits to the LVDS connector pins.

(See [Table 5-20](#))

Table 5-10: Assignment of general purpose bits to LVDS connector pins

Bit	LVDS pin
GP0	SDATA4_P - Trigger1
GP1	SDATA4_P - Trigger2
GP2	SDATA0_P - Reserve1
GP3	SDATA4_P - Reserve2
GP4	SDATA0_P - Marker1
GP5	SDATA4_P - Marker2

Remote command:

TRIG:SOUR GP0, see TRIGger<n>[:SEQuence]:SOURce on page 912

SWE:EGAT:SOUR RFP for gated triggering, see [SENSe:]SWEep:EGATe:SOURce on page 858

Trigger Level

Defines the trigger level as a numeric value.

In the trigger mode "Time", this softkey is not available.

Remote command:

[TRIGger<n>\[:SEQuence\]:LEVel:IFPower](#) on page 911

[TRIGger<n>\[:SEQuence\]:LEVel:VIDeo](#) on page 911

For digital input via the R&S Digital I/Q Interface, R&S FSV-B17:

[TRIGger<n>\[:SEQuence\]:LEVel:BBPower](#) on page 910

Trigger Polarity

Sets the polarity of the trigger source.

The sweep starts after a positive or negative edge of the trigger signal. The default setting is "Pos". The setting applies to all modes with the exception of the "Free Run" and "Time" mode.

"Pos" Level triggering: the sweep is stopped by the logic "0" signal and restarted by the logical "1" signal after the gate delay time has elapsed.

"Neg" Edge triggering: the sweep is continued on a "0" to "1" transition for the gate length duration after the gate delay time has elapsed.

Remote command:

[TRIGger<n>\[:SEQuence\]:SLOPe](#) on page 912

[\[SENSe:\]SWEep:EGATe:POLarity](#) on page 858

Trigger Offset

Opens an edit dialog box to enter the time offset between the trigger signal and the start of the sweep.

offset > 0:	Start of the sweep is delayed
offset < 0:	<p>Sweep starts earlier (pre-trigger)</p> <p>Only possible for span = 0 (e.g. I/Q Analyzer mode) and gated trigger switched off</p> <p>Maximum allowed range limited by the sweep time: $\text{pretrigger}_{\text{max}} = \text{sweep time}$</p> <p>When using the R&S Digital I/Q Interface (R&S FSV-B17) with I/Q Analyzer mode, the maximum range is limited by the number of pretrigger samples.</p> <p>See Table 5-14.</p>

In the "External" or "IF Power" trigger mode, a common input signal is used for both trigger and gate. Therefore, changes to the gate delay will affect the trigger delay (trigger offset) as well.

Tip: To determine the trigger point in the sample (for "External" or "IF Power" trigger mode), use the [TRACe<n>:IQ:TPISample?](#) command.

In the "Time" trigger mode, this softkey is not available.

Remote command:

[TRIGger<n>\[:SEQuence\]:HOLDoff\[:TIME\]](#) on page 909

Repetition Interval

Opens an edit dialog box to define a repetition interval in which the measurement is triggered. The shortest interval is 2 ms. This softkey is only available if the trigger source "Time" is selected (see "Time" on page 241).

Remote command:

`TRIGger<n>[:SEquence]:TIME:RINTerval` on page 913

Trigger Hysteresis

Defines the value for the trigger hysteresis for "IF power" or "RF Power" trigger sources. The hysteresis in dB is the value the input signal must stay below the power trigger level in order to allow a trigger to start the measurement. The range of the value is between 3 dB and 50 dB with a step width of 1 dB.

Remote command:

`TRIGger<n>[:SEquence]:IFPower:HYSteresis` on page 910

Trigger Holdoff

Defines the value for the trigger holdoff. The holdoff value in s is the time which must pass before triggering, in case another trigger event happens.

This softkey is only available if "IFPower", "RF Power" or "BBPower" is the selected trigger source.

Remote command:

`TRIGger<n>[:SEquence]:IFPower:HOLDoff` on page 909

For digital input via the R&S Digital I/Q Interface, R&S FSV-B17:

`TRIGger<n>[:SEquence]:BBPower:HOLDoff` on page 909

5.5.4 Softkeys of the Marker To Menu in I/Q Analyzer Mode

In I/Q Analyzer mode, The "Marker To" menu is identical to the one in Spectrum mode (see Chapter 5.3.4.1, "Softkeys of the Marker To Menu", on page 271). For the "Real/Imag (I/Q)" display mode, however, an additional function is available.

Search Settings

Opens a dialog box to define which data is used for marker search functions.

Note: The search settings apply to all markers, not only the currently selected one.

"Search Real"	Marker search functions are performed on the real trace of the I/Q measurement.
"Search Imag"	Marker search functions are performed on the imaginary trace of the I/Q measurement.
"Search Magnitude"	Marker search functions are performed on the magnitude of the I and Q data.

Remote command:

`"CALCulate:MARKer:FUNCTION Subsystem"` on page 681

5.5.5 Softkeys of the Marker Function Menu in I/Q Analyzer Mode

In I/Q Analyzer mode, the "Marker Function" menu is similar to the one in Spectrum mode (see [Chapter 5.3.3.1, "Softkeys of the Marker Function Menu"](#), on page 257). For the "I/Q Vector" display mode, however, this menu is not available.

Select Marker (No).....	435
Signal Count.....	435
n dB down.....	436
Marker Peak List.....	436
L Peak List On/Off.....	436
L Sort Mode Freq/Lvl.....	437
L Max Peak Count.....	437
L Peak Excursion.....	437
L Left Limit.....	437
L Right Limit.....	437
L Threshold.....	437
L ASCII File Export.....	438
L Decim Sep.....	438
L Marker Number.....	438
Band Power.....	438
L Select Marker (No).....	438
L Band Power On/Off.....	439
L Span.....	439
L Power.....	439
L Density.....	439

Select Marker (No)

Opens a submenu to select one of 16 markers and define whether the marker is a normal or a delta marker (see "[Marker 1 / Marker 2 / Marker 3 / ... Marker 16, / Marker Norm/Delta](#)" on page 250). "(No)" indicates the number of the currently active marker.

See "[Marker 1 / Marker 2 / Marker 3 / ... Marker 16, / Marker Norm/Delta](#)" on page 250.

Signal Count

Switches the frequency counter on or off, and opens an edit dialog box to define the resolution of the frequency counter, if enabled. The frequency is counted at the position of the reference marker (marker 1). If no marker is activate, marker 1 is switched on and positioned on the largest signal.

The sweep stops at the reference marker until the frequency counter has delivered a result. The result is displayed in the marker field (see [Figure 5-9](#)), labeled with [Tx CNT].

For more information see [Chapter 5.3.3.5, "Frequency Measurement with the Frequency Counter"](#), on page 267.

Remote command:

`CALCulate<n>:MARKer<m>:COUNT` on page 668

`CALCulate<n>:MARKer<m>:COUNT:FREQuency?` on page 669

n dB down

Opens an edit dialog box to enter a value to define the level spacing of the two temporary markers to the right and left of marker 1 (default setting: 3 dB). Activates the temporary markers T1 and T2. The values of the temporary markers (T1, T2) and the entered value (ndB) are displayed in the marker field.

If a positive value is entered, the markers T1 and T2 are placed below the active reference marker. If a negative value (e.g. for notch filter measurements) is entered, the markers T1 and T2 are placed above the active reference marker. Marker T1 is placed to the left and marker T2 to the right of the reference marker.

In the marker table, the following results are displayed:

Span setting	Parameter name	Description
span > 0	Bw	frequency spacing of the two temporary markers
	Q factor	quality of the displayed bandwidth value (Bw)
span = 0	PWid	pulse width between the two temporary markers

If it is not possible to form the frequency spacing for the n dB value (e.g. because of noise display), dashes instead of a measured value are displayed.

Remote command:

CALC:MARK1:FUNC:NDBD:STAT ON, see [CALCulate<n>:MARKer<m>:FUNCTION:NDBDown:STATe](#) on page 694

CALC:MARK1:FUNC:NDBD 3dB, see [CALCulate<n>:MARKer<m>:FUNCTION:NDBDown](#) on page 692

CALC:MARK1:FUNC:NDBD:RES? , see [CALCulate<n>:MARKer<m>:FUNCTION:NDBDown:RESult?](#) on page 694

CALC:MARK:FUNC:NDBD:QFAC?, see [CALCulate<n>:MARKer<m>:FUNCTION:NDBDown:QFACTOR](#) on page 693

CALC:MARK1:FUNC:NDBD:FREQ? (span > 0), see [CALCulate<n>:MARKer<m>:FUNCTION:NDBDown:FREQuency?](#) on page 693

CALC:MARK1:FUNC:NDBD:TIME? (span = 0), see [CALCulate<n>:MARKer<m>:FUNCTION:NDBDown:TIME?](#) on page 695

Marker Peak List

Opens the "Peak List" submenu to define criteria for the sort order and the contents of the peak list. For each listed peak the frequency ("Stimulus") and level ("Response") values are given. In addition, the peaks are indicated in the trace display. A maximum of 50 entries are listed.

Remote command:

[CALCulate<n>:MARKer<m>:FUNCTION:FPEaks:COUNT?](#) on page 687

[CALCulate<n>:MARKer<m>:FUNCTION:FPEaks:X](#) on page 689

[CALCulate<n>:MARKer<m>:FUNCTION:FPEaks:Y?](#) on page 690

Peak List On/Off ← Marker Peak List

Activates/deactivates the marker peak list. If activated, the peak list is displayed and the peaks are indicated in the trace display.

Remote command:

[CALCulate<n>:MARKer<m>:FUNCTION:FPEaks:STAT](#) on page 689

Sort Mode Freq/Lvl ← Marker Peak List

Defines the criteria for sorting:

"Freq" sorting in ascending order of frequency values (span > 0) or time values (span = 0)

"Lvl" sorting in ascending order of the level

Remote command:

[CALCulate<n>:MARKer<m>:FUNCTION:FPEaks:SORT](#) on page 688

Max Peak Count ← Marker Peak List

Defines the maximum number of peaks to be determined and displayed.

Remote command:

[CALCulate<n>:MARKer<m>:FUNCTION:FPEaks:LIST:SIZE](#) on page 688

Peak Excursion ← Marker Peak List

Opens an edit dialog box for level measurements to enter the minimum level value by which a signal must rise or fall so that it will be identified as a maximum or a minimum by the search functions. Entries from 0 dB to 80 dB are allowed; the resolution is 0.1 dB. The default setting for the peak excursion is 6 dB.

For more information see "Specifying the suitable peak excursion" and "Effect of different peak excursion settings".

Remote command:

[CALCulate<n>:MARKer<m>:PEXCursion](#) on page 676

Left Limit ← Marker Peak List

Opens an edit dialog box to enter a value for the lower limit (left vertical line: S1 for span > 0; T1 for zero span). The search is performed between the lines of the left and right limit (see also [Right Limit](#) softkey).

Remote command:

[CALCulate<n>:MARKer<m>:X:SLIMits:LEFT](#) on page 678

Right Limit ← Marker Peak List

Opens an edit dialog box to enter a value for the upper limit (left vertical line: S2 for span > 0; T2 for zero span). The search is performed between the lines of the left and right limit (see also [Left Limit](#) softkey). If no value is set, the upper limit corresponds to the stop frequency.

Remote command:

[CALCulate<n>:MARKer<m>:X:SLIMits:RIGHT](#) on page 679

Threshold ← Marker Peak List

Opens an edit dialog box to define the threshold line. The threshold line represents the lower level limit for a "Peak" search and the upper level limit for a "Min" search.

Remote command:

[CALCulate<n>:THReshold:STATe](#) on page 746

[CALCulate<n>:THReshold](#) on page 745

ASCII File Export ← Marker Peak List

Opens the "ASCII File Export Name" dialog box and saves the active peak list in ASCII format to the specified file and directory.

The file consists of the header containing important scaling parameters and a data section containing the marker data. For details on an ASCII file see [Chapter 5.2.8.7, "ASCII File Export Format"](#), on page 235.

This format can be processed by spreadsheet calculation programs, e.g. MS-Excel. It is necessary to define ';' as a separator for the data import. Different language versions of evaluation programs may require a different handling of the decimal point. It is therefore possible to select between separators '.' (decimal point) and ',' (comma) using the "Decim Sep" softkey (see ["Decim Sep"](#) on page 168).

An example of an output file for Spectrum Emission Mask measurements is given in ["ASCII File Export Format \(Spectrum Emission Mask\)"](#) on page 340.

Remote command:

[FORMat:DEXPort:DSEPARATOR](#) on page 759

[MEMory:STORe<n>:LIST](#) on page 774

Decim Sep ← Marker Peak List

Selects the decimal separator with floating-point numerals for the ASCII Trace export to support evaluation programs (e.g. MS-Excel) in different languages. The values '.' (decimal point) and ',' (comma) can be set.

Remote command:

[FORMat:DEXPort:DSEPARATOR](#) on page 759

Marker Number ← Marker Peak List

If enabled, the determined peaks are indicated by their corresponding marker number in the trace display.

Remote command:

[CALCulate<n>:MARKer<m>:FUNCTION:FPEaks:ANNOtation:LABel:STATe](#) on page 687

Band Power

Opens a submenu to activate and configure a band power marker. Band power markers allow you to measure the integrated power for a defined span (band) around a marker. The result can be displayed either as a power (dBm) or density (dBm/Hz). The span is indicated by lines in the diagram.

Band power markers are only available for standard frequency measurements in Spectrum mode.

Note: As of firmware version 2.0, Band Power markers are also available in the I/Q Analyzer, but only for **Spectrum** displays (see ["Display Config"](#) on page 418).

For more information see [Chapter 5.3.3.8, "Performing Band Power Measurements"](#), on page 269.

Select Marker (No) ← Band Power

Opens a submenu to select one of 16 markers and define whether the marker is a normal or a delta marker (see ["Marker 1 / Marker 2 / Marker 3 / ... Marker 16, / Marker Norm/Delta"](#) on page 250). "(No)" indicates the number of the currently active marker.

See "[Marker 1 / Marker 2 / Marker 3 / ... Marker 16 / Marker Norm/Delta](#)" on page 250.

Band Power On/Off ← Band Power

Activates or deactivates the band power marker. When switched to on, if no marker is active yet, marker 1 is activated. Otherwise, the currently active marker is used as a band power marker (all other marker functions for this marker are deactivated). All markers can be defined as band power markers, each with a different span.

Remote command:

`CALCulate<n>:MARKer<m>:FUNCTION:BPowEr[:STATe]` on page 683

Span ← Band Power

Defines the span (band) around the marker for which the power is measured. The span is indicated by lines in the diagram.

Remote command:

`CALCulate<n>:MARKer<m>:FUNCTION:BPowEr:SPAN` on page 683

Power ← Band Power

Selects the power mode for the band power marker, i.e. the result is displayed in dBm.

Remote command:

`CALCulate<n>:MARKer<m>:FUNCTION:BPowEr:MODE` on page 682

`CALCulate<n>:MARKer<m>:FUNCTION:BPowEr:RESult?` on page 682

Density ← Band Power

Selects the density mode for the band power marker, i.e. the result is displayed in dBm/Hz.

Remote command:

`CALCulate<n>:MARKer<m>:FUNCTION:BPowEr:MODE` on page 682

`CALCulate<n>:MARKer<m>:FUNCTION:BPowEr:RESult?` on page 682

5.5.6 Working with I/Q Data

I/Q data can be captured either from RF input, or via the optional R&S Digital I/Q Interface (R&S FSV-B17), or it can be imported from a file (see [Chapter 5.1.2.3, "Importing and Exporting I/Q Data"](#), on page 172). The captured I/Q data can then be processed further, e.g. using the I/Q Analyzer, or in the applications that support the R&S Digital I/Q Interface. Additionally, the captured I/Q data can be exported to a file in order to process it in another application, e.g. Vector Signal Analysis, if available.

Working with digital input is described in [Chapter 5.7, "Instrument Functions - R&S Digital I/Q Interface \(Option R&S FSV-B17\)"](#), on page 470 and in the applications that support that interface.

This section describes I/Q data processing of RF input, e.g. in the I/Q Analyzer.

The block diagram in [Figure 5-24](#) shows the analyzer hardware for active RF input from the IF section to the processor.

The A/D converter samples the IF signal at a rate of 128 MHz. The digital signal is down-converted to the complex baseband, lowpass-filtered, and the sample rate is

reduced. The continuously adjustable sample rates are realized using an optimal decimation filter and subsequent resampling on the set sample rate.

The I/Q data is written to a single memory, the data acquisition is hardware-triggered.

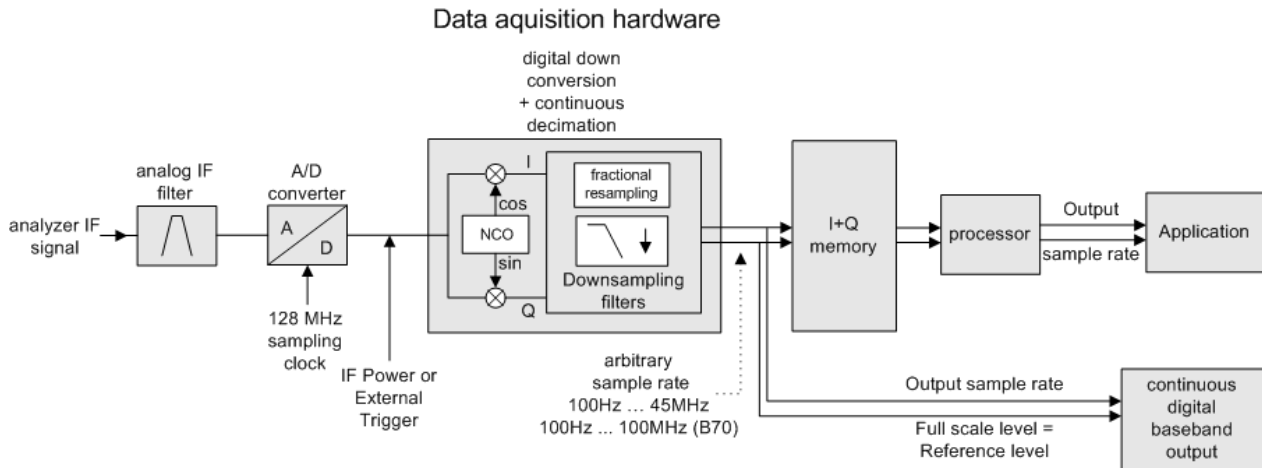

Figure 5-24: Block diagram illustrating the R&S FSVA/FSV signal processing

Maximum number of samples

The maximum number of samples for RF input is 200 MS.

For digital input using the R&S Digital I/Q Interface (R&S FSV-B17), see [Table 5-14](#).

5.5.6.1 Bandwidth Extension Option R&S FSV-B160

The bandwidth extension option R&S FSV-B160 provides additional hardware, which makes a maximum I/Q bandwidth of 160 MHz and sample rates up to 400 MHz possible. If this option is installed and active, signals are processed with the new hardware for sample rates as of 64 MHz (or 32 MHz, depending on the [Maximum Bandwidth](#) setting):

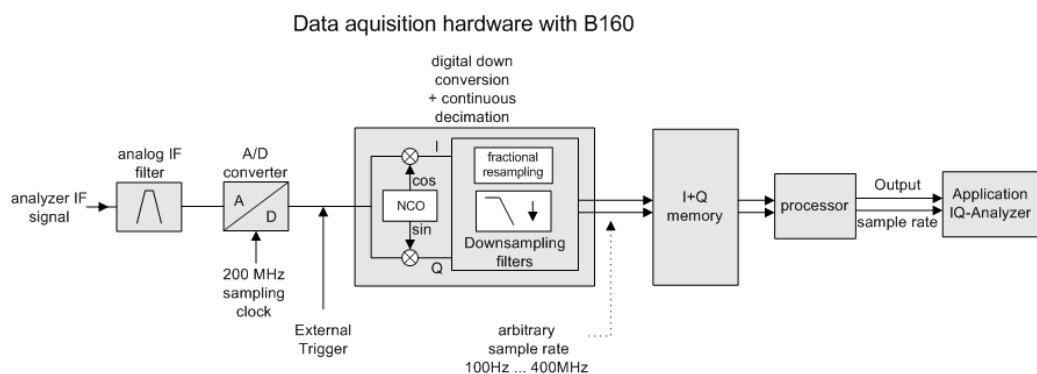

Figure 5-25: Block diagram illustrating the R&S FSVA/FSV signal processing (with option B160)

Usage of the optional hardware can be deactivated manually for sample rates between 64 MHz and 128 MHz, if necessary, for example to reduce possible spurious effects. In this case, the signal is processed as described in [Figure 5-24](#).

Restrictions

The optional bandwidth extension R&S FSV-B160 can not be activated if any of the following conditions apply:

- R&S FSV firmware versions previous to 2.0
- R&S FSV models 1307.9002Kx
- For R&S FSV models 1321.3008K13/30/39/40: For center frequencies larger than 7 GHz
- For sample rates < 32 MHz
- With active internal or external tracking generators (B9/B10)
- With any trigger except for an external trigger

Maximum record length

When using the bandwidth extension R&S FSV-B160, the maximum record length is restricted; see "[R&S FSVA/FSV with activated option B160 \(I/Q Bandwidth Extension\)](#)" on page 443.

5.5.6.2 Sample Rate and Maximum Usable Bandwidth (RF Input)



Information on sample rates and maximum usable bandwidths for Digital I/Q input is described in [Table 5-13](#).

Definitions

- **Input sample rate (ISR):** the sample rate of the useful data provided by the connected instrument to the R&S FSVA/FSV input
- (User, Output) **Sample rate (SR):** the sample rate that is defined by the user (e.g. in the "Data Acquisition" dialog box in the "I/Q Analyzer" application) and which is used as the basis for analysis or output
- **Usable I/Q (Analysis) bandwidth:** the bandwidth range in which the signal remains undistorted in regard to amplitude characteristic and group delay; this range can be used for accurate analysis by the R&S FSVA/FSV

For the I/Q data acquisition, digital decimation filters are used internally. The passband of these digital filters determines the *maximum usable I/Q bandwidth*. In consequence, signals within the usable I/Q bandwidth (passband) remain unchanged, while signals outside the usable I/Q bandwidth (passband) are suppressed. Usually, the suppressed signals are noise, artifacts, and the second IF side band. If frequencies of interest to you are also suppressed, you should try to increase the output sample rate, since this increases the maximum usable I/Q bandwidth.

Relationship between sample rate and usable bandwidth

The diagram Figure 5-26 shows the maximum usable I/Q bandwidths depending on the user sample rates.

As a rule, the usable bandwidth is proportional to the output sample. Yet, when the I/Q bandwidth reaches the bandwidth of the analog IF filter (at very high sample rates), the curve breaks.

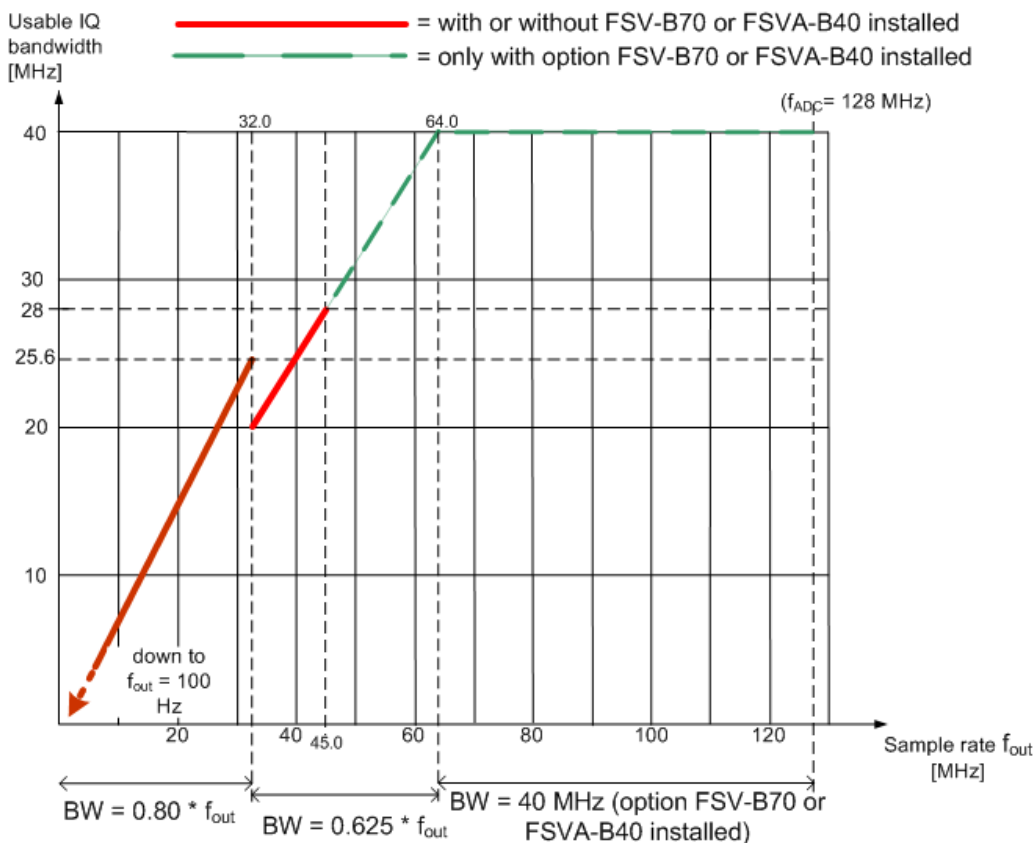

Figure 5-26: Relation between maximum usable bandwidth and sample rate (RF input)

R&S FSVA/FSV without additional bandwidth extension options

Sample rate: 100 Hz - 45 MHz

Maximum I/Q bandwidth: 28 MHz

Sample rate	Maximum I/Q bandwidth
100 Hz to 32 MHz	proportional up to 25.6 MHz <i>Usable I/Q bandwidth = 0.8 * Output sample rate</i>
32 MHz to 45 MHz	proportional up to 28 MHz <i>Usable I/Q bandwidth = 0.625 * Output sample rate</i>

R&S FSV40 models 1307.9002K37 / 1307.9002K39

For the R&S FSV models 1307.9002K37 / 1307.9002K39, the following values apply. No bandwidth extension options are available for these models.

Sample rate: 100 Hz to 12.5 MHz

Maximum I/Q bandwidth: proportional up to 12.5 MHz

*Usable I/Q bandwidth = 0.8 * Output sample rate*

R&S FSV with option B70 or R&S FSVA with option B40 (I/Q Bandwidth Extension)

Sample rate: 100 Hz - 128 MHz

Maximum I/Q bandwidth: 40 MHz

Sample rate	Maximum I/Q bandwidth
100 Hz to 32 MHz	proportional up to 25.6 MHz <i>Usable I/Q bandwidth = 0.8 * Output sample rate</i>
32 MHz to 64 MHz	proportional up to 40 MHz <i>Usable I/Q bandwidth = 0.625 * Output sample rate</i>
64 MHz to 128 MHz	40 MHz

R&S FSVA/FSV with activated option B160 (I/Q Bandwidth Extension)

If the bandwidth extension option B160 is installed, but not active, the sample rates and I/Q bandwidths described in [Figure 5-26](#) apply.

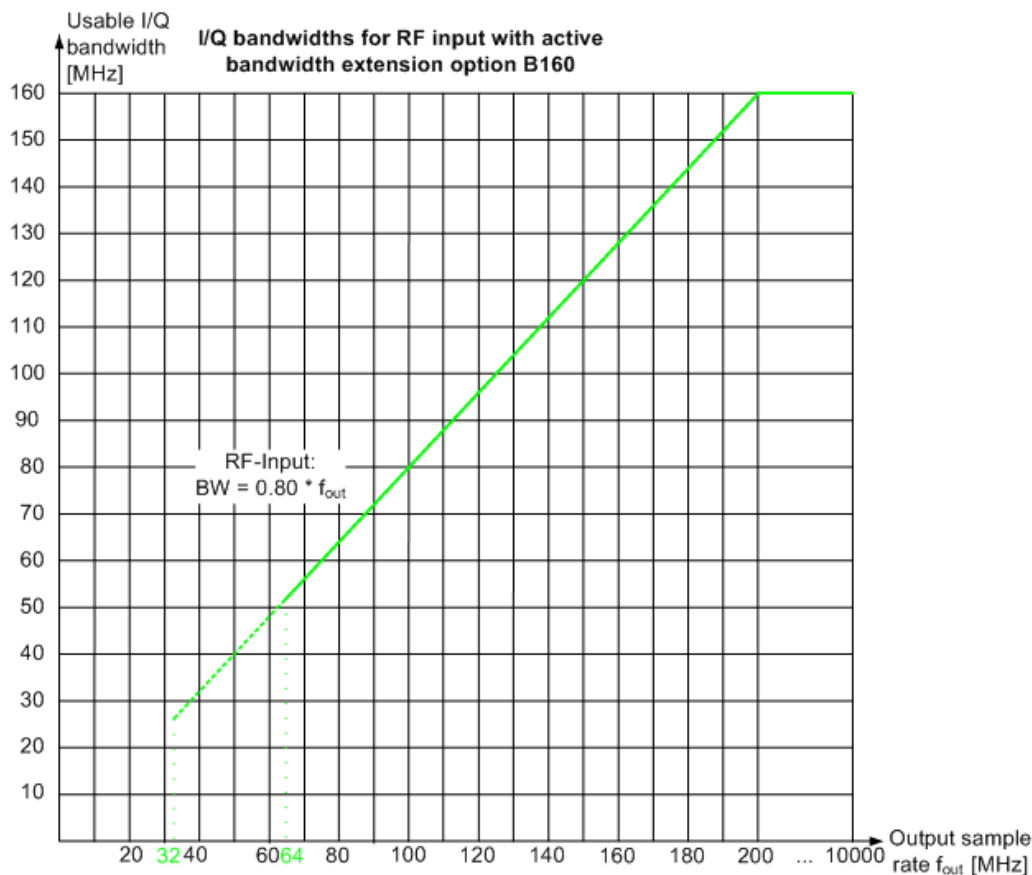

Sample rate: 100 Hz - 400 MHz (B160 hardware used only for 32 MHz / 64 MHz - 400 MHz, depending on the [Maximum Bandwidth](#) setting)

Maximum I/Q bandwidth: 160 MHz

Sample rate	Maximum I/Q bandwidth
100 Hz to 400 MHz	proportional up to maximum 160 MHz

Maximum record length (=number of samples to be captured):

*(100 MS * sample rate / 400 MHz) - group delay in samples*

for a sample rate of 32 MHz / 64 MHz - 400 MHz



200 MS record length for non-triggered measurements

As of firmware version 2.30, for non-triggered measurements (trigger source = "Free Run"), with a sample rate of 400 MHz, the maximum record length is now **200 MS**.

Note, however, that for very large data amounts data processing may become very slow and the [TRACe<n>: IQ:DATA:MEMory?](#) command may fail.

For *triggered* measurements with the R&S FSV-B160 option, the restriction above still applies.

5.6 Instrument Functions – Tracking Generator (Options R&S FSV-B9/ R&S FSV-B10)

If the R&S FSV/FSV Tracking Generator option (R&S FSV-B9) is installed, an internal tracking generator emits a signal at the exact input frequency of the analyzer during operation. The generated signal is sent to the DUT, thus allowing the analyzer to control the input frequency of the device directly.

Using the R&S FSV/FSV External Tracking Generator option (B10), you can operate various commercially available generators as a tracking generator on the R&S FSV/FSV. Thus, scalar network analysis with the R&S FSV/FSV is also possible outside the frequency range of the internal tracking generator, when the appropriate generators are used.

The R&S FSV/FSV also allows you to set a frequency offset for frequency-converting measurements. For harmonics measurements or frequency-converting measurements, when external generators are used you can also enter a factor by which the generator frequency is increased or reduced, compared to the receive frequency of the R&S FSV/FSV. Make sure, however, that the resulting generator frequencies do not exceed the allowed setting range of the generator.

Both the internal and external tracking generator options can be installed simultaneously. However, only one tracking generator (internal or one of two possible external generators) can be used at any time. Which tracking generator is currently active, if any, is indicated by the "Source RF Internal (On/ Off)" on page 446 softkey. It can be changed using the "Source Config" on page 450 softkey. For details see [Chapter 5.6.3, "Configuring Tracking Generators"](#), on page 454.



Tracking generator control (both internal and external) is only available in the "Spectrum" mode for frequency, time (zero span) or I/Q measurements, as well as in "Analog Demodulation" mode. If you switch to a mode other than "Spectrum" or "Analog Demodulation", any currently active tracking generator is deactivated.

Tracking generator control is not available together with the bandwidth extension option R&S FSV-B160.

Special measurement functions are not available with tracking generator control. The corresponding softkeys in the "Measurement" menu are deactivated in this case.

Menu and softkey description

- [Chapter 5.6.1, "Softkeys of the Tracking Generator Menu"](#), on page 446

Further information

- [Chapter 5.6.2, "Connecting External Tracking Generators"](#), on page 450
- [Chapter 5.6.3, "Configuring Tracking Generators"](#), on page 454
- [Chapter 5.6.4, "Tracking Generator Functions"](#), on page 461
- [Chapter 5.6.5, "Displayed Information and Errors"](#), on page 469

5.6.1 Softkeys of the Tracking Generator Menu

The "Tracking Generator" menu is displayed when you press the INPUT/OUTPUT key and then "Tracking Generator".

This softkey is only available if the R&S FSV option Tracking Generator (B9) or External Tracking Generator (B10) or both are installed. The following table shows all softkeys available in the "Tracking Generator" menu.



As long as a tracking generator is active, the HOME key also displays the "Tracking Generator" menu.

Source RF Internal (On/ Off).....	446
Source Power.....	446
Source Cal.....	447
L Calibrate Transmission.....	447
L Calibrate Reflection Short.....	447
L Calibrate Reflection Open.....	447
L Normalize.....	447
L Reference Value Position.....	448
L Reference Value.....	448
L Recall.....	448
L Save As Trd Factor.....	448
Modulation.....	448
L External AM.....	449
L External FM.....	449
L External I/Q.....	449
L Modulation OFF.....	449
Power Sweep.....	449
L Power Sweep (On /Off).....	449
L Power Sweep Start.....	450
L Power Sweep Stop.....	450
Source Config.....	450

Source RF Internal (On/ Off)

Switches the selected tracking generator on or off. Default setting is off. The currently selected generator is indicated on the softkey.

Tracking generator control is not available together with the bandwidth extension option R&S FSV-B160.

Remote command:

`OUTPut [:STATe]` on page 777

Activates the internal tracking generator (B9).

`SOURce<n>:EXTernal<generator> [:STATe]` on page 866

Activates the external tracking generator 1 (B10).

Source Power

Opens an edit dialog box to quickly change the output power of the currently selected tracking generator, alternatively to the "Tracking Generator configuration" dialog box (see "Source Config" on page 450 softkey).

The default output power is -20 dBm. The range is specified in the data sheet.

Remote command:

`SOURce<n>:POWER[:LEVel][:IMMediate][:AMPLitude]` on page 872

Source Cal

Opens a submenu to configure calibration for transmission and reflection measurement for tracking generators. For details on the test setups see [Chapter 5.6.4.2, "Calibrating for transmission and reflection measurement"](#), on page 462.

Calibrate Transmission ← Source Cal

Starts a sweep that records a reference trace. This trace is used to calculate the difference for the normalized values.

Remote command:

`[SENSe:]CORRection:METhod` on page 794

Selects the transmission method and starts the sweep to record a reference trace.

Calibrate Reflection Short ← Source Cal

Starts a sweep as a reference trace for short-circuit calibration.

If both calibrations (open circuit, short circuit) are carried out, the calibration curve is calculated by averaging the two measurements and stored in the memory. The order of the two calibration measurements is irrelevant.

Remote command:

`[SENSe:]CORRection:METhod` on page 794

Selects the reflection method.

`[SENSe:]CORRection:COLLect[:ACQuire]` on page 789

Starts the sweep for short-circuit calibration.

Calibrate Reflection Open ← Source Cal

Starts a sweep as a reference trace for the open-circuit calibration.

If both calibrations (open circuit, short circuit) are carried out, the calibration curve is calculated by averaging the two measurements and stored in the memory. The order of the two calibration measurements is irrelevant.

Remote command:

`[SENSe:]CORRection:METhod` on page 794

Selects the reflection method.

`[SENSe:]CORRection:COLLect[:ACQuire]` on page 789

Starts the sweep for open-circuit calibration.

Normalize ← Source Cal

Switches the normalization on or off. The softkey is only available if the memory contains a reference trace. For details on normalization see [Chapter 5.6.4.5, "Normalization"](#), on page 463.

Remote command:

`[SENSe:]CORRection[:STATe]` on page 795

Reference Value Position ← Source Cal

Switches the reference line on or off. The reference line marks the reference position at which the normalization result (calculated difference to a reference trace) is displayed. For details on the reference line see [Chapter 5.6.4.5, "Normalization"](#), on page 463.

Remote command:

`DISPlay[:WINDow<n>]:TRACe<t>:Y[:SCALe]:RPOSition` on page 755

Reference Value ← Source Cal

Opens an edit dialog box to enter a position value that shifts the reference line vertically. By default, the reference line corresponds to a difference of 0 dB between the currently measured trace and the reference trace.

If a 10 dB attenuation is inserted into the signal path between DUT and R&S FSVA/FSV input, for example after a source calibration, the measurement trace is moved down by 10 dB. Entering a reference value of -10 dB will also shift the reference line down by 10 dB and place the measurement trace on the reference line. The deviation from the nominal power level can be displayed with higher resolution (e.g. 1 dB/div). The power is still displayed in absolute values.

Remote command:

`DISPlay[:WINDow<n>]:TRACe<t>:Y[:SCALe]:RVALue` on page 755

Recall ← Source Cal

Restores the settings that were used during source calibration. This can be useful if instrument settings were changed after calibration (e.g. center frequency, frequency deviation, reference level, etc).

Remote command:

`[SENSe:]CORRection:RECall` on page 795

Save As Trd Factor ← Source Cal

Uses the normalized measurement data to generate a transducer factor with up to 625 points. The trace data is converted to a transducer with unit dB and stored in a file with the specified name and the suffix.trd under "c:\r_s\instr\trd". The frequency points are allocated in equidistant steps between start and stop frequency. The generated transducer factor can be further adapted using the "Transducer" softkey in the "SETUP" menu.

The "Save As Trd Factor" softkey is only available if normalization is switched on.

Remote command:

`[SENSe:]CORRection:TRANsducer:GENerator` on page 795

Modulation

Opens a submenu to define modulation settings. This submenu contains the following commands:

- ["External AM"](#) on page 449
- ["External FM"](#) on page 449
- ["External I/Q"](#) on page 449
- ["Modulation OFF"](#) on page 449

External AM ← Modulation

Activates an AM modulation of the tracking generator output signal.

The modulation signal is applied to the TG IN I/AM connector. An input voltage of 1 V corresponds to 100 % amplitude modulation.

Switching on an external AM disables the active I/Q modulation.

Remote command:

[SOURce<n>:AM:STATe](#) on page 865

External FM ← Modulation

Activates the FM modulation of the tracking generator output signal. The modulation signal is applied to the TG IN Q/FM connector. Switching on an external FM disables the active I/Q modulation.

Remote command:

[SOURce<n>:FM:STATe](#) on page 871

[SOURce<n>:FM:DEVIation](#) on page 871

External I/Q ← Modulation

Activates the external I/Q modulation of the tracking generator output signal. The signals for modulation are applied to the two input connectors TG IN I and TG IN Q at the rear panel of the unit. The input voltage range is ± 1 V into 50 Ω . Switching on an external I/Q modulation disables the active AM or FM modulation.

Remote command:

[SOURce<n>:DM:STATe](#) on page 865

Modulation OFF ← Modulation

Deactivates external modulation of the tracking generator output signal.

Remote command:

[SOURce<n>:AM:STATe](#) on page 865

[SOURce<n>:DM:STATe](#) on page 865

[SOURce<n>:FM:STATe](#) on page 871

Power Sweep

Opens a submenu to define power sweep settings.

This softkey is only available if the (internal) Tracking Generator option (B9) is installed.

This submenu contains the following commands:

- ["Power Sweep \(On /Off\)"](#) on page 449
- ["Power Sweep Start"](#) on page 450
- ["Power Sweep Stop"](#) on page 450

Power Sweep (On /Off) ← Power Sweep

Activates or deactivates the power sweep. If the power sweep is on, the analyzer is set to zero span mode (span = 0Hz). During the sweep time of the zero span, the power at the internal tracking generator is changed linearly from start power to stop power. The start and stop power for the power sweep are displayed in the diagram header ("INT TG <start power>... <stop power>", see also [Chapter 5.6.5, "Displayed Information and Errors"](#), on page 469.

The start power can be set between -30 dBm and +0 dBm.

The stop value can also be set between -30 dBm and +0 dBm and may be smaller than the start value.

The difference between the start and stop values may not exceed 10 dB.

This softkey is only available if the (internal) Tracking Generator option (B9) is installed.

Remote command:

`SOURce<n>:POWer:MODE` on page 873

Power Sweep Start ← Power Sweep

Defines the start power of the power sweep.

The start power can be set between -30 dBm and +0 dBm. If the start power is set above 7 GHz, it is automatically limited to 7 GHz.

The difference between the start and stop values may not exceed 10 dB.

This softkey is only available if the (internal) Tracking Generator option (B9) is installed.

Remote command:

`SOURce<n>:POWer:START` on page 873

Power Sweep Stop ← Power Sweep

Defines the stop power of the power sweep.

The stop power can be set between -30 dBm and +0 dBm. It can be smaller than the start value. If the stop power is set above 7 GHz, it is automatically limited to 7 GHz.

The difference between the start and stop values may not exceed 10 dB.

This softkey is only available if the (internal) Tracking Generator option (B9) is installed.

Remote command:

`SOURce<n>:POWer:STOP` on page 874

Source Config

Opens the "Tracking Generator Configuration" dialog, see [Chapter 5.6.3, "Configuring Tracking Generators"](#), on page 454.

5.6.2 Connecting External Tracking Generators

The external tracking generator is controlled either via a LAN connection or via the – optional – second GPIB interface of the R&S FSVA/FSV (= IEC2, supplied with the option).

Using GPIB, with some Rohde & Schwarz generators, additionally the TTL synchronization interface included in the AUX interface of the R&S FSVA/FSV can be used.



Using the TTL interface allows for considerably higher measurement rates than pure GPIB control, because the frequency stepping of the R&S FSVA/FSV is directly coupled with the frequency stepping of the generator.

Therefore, the frequency sweep differs according to the capabilities of the employed generator:

- For generators without a TTL interface, the generator frequency is set for each frequency point via GPIB first, then the setting procedure has to be completed before recording of measured values is possible.
- For generators with a TTL interface, a list of the frequencies to be set is entered into the generator before the beginning of the first sweep. Then the sweep is started and the next frequency point is selected using the TTL handshake line TRIGGER. Recording measured values is only enabled when the generator signals the end of the setting procedure via the BLANK signal. This method is considerably faster than pure GPIB control.

The "Tracking Generator Configuration" dialog provides a list of the supported generators with the frequency and level range, as well as the capabilities used. The interface settings are defined using the "Source Config" on page 450 softkey. For details see [Chapter 5.6.3.2, "External Tracking Generator"](#), on page 456.

In order to use the functions of the external tracking generator, an appropriate generator must be connected and configured correctly. If no external generator is selected, if the GPIB or TCP/IP address is not correct, or the generator is not ready for operation, an error message is displayed ("Ext. Generator GPIB Handshake Error!" or "Ext. Generator TCPIP Handshake Error!").

[Figure 5-27](#) illustrates the TTL connection using an SMU generator, for example.

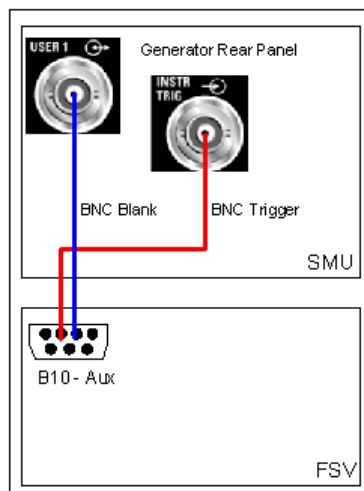

Figure 5-27: TTL connection for an SMU generator



In order to enhance measurement accuracy, a common reference frequency should be used for both the R&S FSVA/FSV and the generator. If no independent 10 MHz reference frequency is available, it is recommended that you connect the reference output of the generator with the reference input of the R&S FSVA/FSV and that you enable usage of the external reference on the R&S FSVA/FSV via "SETUP" >"Reference EXT".

5.6.2.1 Overview of Generators Supported by the R&S FSVA/FSV



The R&S SMA and R&S SMU require the following firmware versions:

R&S SMA: V2.10.x or higher

R&S SMU: V1.10 or higher

Generator	Interface Type	Generator Min Freq	Generator Max Freq	Generator Min Power dBm	Generator Max Power dBm
SMA01A	TTL	9 kHz	3.0 GHz	-145	+30
SMBV100A3	TTL	9 kHz	3.2 GHz	-145	+30
SMBV100A6	TTL	9 kHz	6.0 GHz	-145	+30
SMC100A1	TTL	9 kHz	1.1 GHz	-120	+30
SMC100A3	TTL	9 kHz	3.2 GHz	-145	+30
SME02	TTL	5 kHz	1.5 GHz	-144	+16
SME03	TTL	5 kHz	3.0 GHz	-144	+16
SME06	TTL	5 kHz	6.0 GHz	-144	+16
SMG	GPIB	100 kHz	1.0 GHz	-137	+13
SMGL	GPIB	9 kHz	1.0 GHz	-118	+30
SMGU	GPIB	100 kHz	2.16 GHz	-140	+13
SMH	GPIB	100 kHz	2.0 GHz	-140	+13
SMHU	GPIB	100 kHz	4.32 GHz	-140	+13
SMIQ02B	TTL	300 kHz	2.2 GHz	-144	+13
SMIQ02E	GPIB	300 kHz	2.2 GHz	-144	+13
SMIQ03B	TTL	300 kHz	3.3 GHz	-144	+13
SMIQ03E	GPIB	300 kHz	3.3 GHz	-144	+13
SMIQ04B	TTL	300 kHz	4.4 GHz	-144	+10
SMIQ06B	TTL	300 kHz	6.4 GHz	-144	+10
SML01	GPIB	9 kHz	1.1 GHz	-140	+13
SML02	GPIB	9 kHz	2.2 GHz	-140	+13
SML03	GPIB	9 kHz	3.3 GHz	-140	+13

1) Requires the option SMR-B11 to be fitted.

2) Maximum/minimum power depends on presence of Option SMR-B15/-B17 and set frequency range. For more details see SMR data sheet.

3) Maximum/minimum power depends on presence of Option SMP-B15/-B17 and set frequency range. For more details see SMP data sheet.

4) Requires firmware version V3.20.200 or higher on the signal generator

Instrument Functions – Tracking Generator (Options R&S FSV-B9/ R&S FSV-B10)

Generator	Interface Type	Generator Min Freq	Generator Max Freq	Generator Min Power dBm	Generator Max Power dBm
SMR20	TTL	1 GHz	20 GHz	-130 ²⁾	+11 ²⁾
SMR20B11 ¹⁾	TTL	10 MHz	20 GHz	-130 ²⁾	+13 ²⁾
SMR27	TTL	1 GHz	27 GHz	-130 ²⁾	+11 ²⁾
SMR27B11 ¹⁾	TTL	10 MHz	27 GHz	-130 ²⁾	+12 ²⁾
SMR30	TTL	1 GHz	30 GHz	-130 ²⁾	+11 ²⁾
SMR30B11 ¹⁾	TTL	10 MHz	30 GHz	-130 ²⁾	+12 ²⁾
SMR40	TTL	1 GHz	40 GHz	-130 ²⁾	+9 ²⁾
SMR40B11 ¹⁾	TTL	10 MHz	40 GHz	-130 ²⁾	+12 ²⁾
SMR50	TTL	1 GHz	50 GHz	-130 ²⁾	+9 ²⁾
SMR50B11 ¹⁾	TTL	10 MHz	50 GHz	-130 ²⁾	+12 ²⁾
SMR60	TTL	1 GHz	60 GHz	-130 ²⁾	+9 ²⁾
SMR60B11 ¹⁾	TTL	10 MHz	60 GHz	-130 ²⁾	+12 ²⁾
SMP02	TTL	10 MHz	20 GHz	-130 ³⁾	+17 ³⁾
SMP03	TTL	10 MHz	27 GHz	-130 ³⁾	+13 ³⁾
SMP04	TTL	10 MHz	40 GHz	-130 ³⁾	+12 ³⁾
SMP22	TTL	10 MHz	20 GHz	-130 ³⁾	+20 ³⁾
SMT02	GPIB	5.0 kHz	1.5 GHz	-144	+13
SMT03	GPIB	5.0 kHz	3.0 GHz	-144	+13
SMT06	GPIB	5.0 kHz	6.0 GHz	-144	+13
SMV03	GPIB	9 kHz	3.3 GHz	-140	+13
SMU200A	TTL	100 kHz	2.2 GHz	-145	+13
SMU02B31	TTL	100 kHz	2.2 GHz	-145	+19
SMU03	TTL	100 kHz	3 GHz	-145	+13
SMU03B31	TTL	100 kHz	3 GHz	-145	+19
SMU04	TTL	100 kHz	4 GHz	-145	+13
SMU04B31	TTL	100 kHz	4 GHz	-145	+19
SMU06	TTL	100 kHz	6 GHz	-145	+13

1) Requires the option SMR-B11 to be fitted.

2) Maximum/minimum power depends on presence of Option SMR-B15/-B17 and set frequency range. For more details see SMR data sheet.

3) Maximum/minimum power depends on presence of Option SMP-B15/-B17 and set frequency range. For more details see SMP data sheet.

4) Requires firmware version V3.20.200 or higher on the signal generator

Instrument Functions – Tracking Generator (Options R&S FSV-B9/ R&S FSV-B10)

Generator	Interface Type	Generator Min Freq	Generator Max Freq	Generator Min Power dBm	Generator Max Power dBm
SMU06B31	TTL	100 kHz	6 GHz	-145	+19
SMW20	TTL ⁴⁾	100 kHz	20 GHz	-145	+30
SMW40	TTL ⁴⁾	100 kHz	40 GHz	-145	+30
SMX	GPIB	100 kHz	1.0 GHz	-137	+13
SMY01	GPIB	9 kHz	1.04 GHz	-140	+13
SMY02	GPIB	9 kHz	2.08 GHz	-140	+13
HP8340A	GPIB	10 MHz	26.5 GHz	-110	10
HP8648	GPIB	9 kHz	4 GHz	-136	10
HP ESG-A Series 1000A, 2000A, 3000A, 4000A	GPIB	250 kHz	4 GHz	-136	20
HP ESG-D SERIES E4432B	GPIB	250 kHz	3 GHz	-136	+10

1) Requires the option SMR-B11 to be fitted.
2) Maximum/minimum power depends on presence of Option SMR-B15/-B17 and set frequency range. For more details see SMR data sheet.
3) Maximum/minimum power depends on presence of Option SMP-B15/-B17 and set frequency range. For more details see SMP data sheet.
4) Requires firmware version V3.20.200 or higher on the signal generator

5.6.3 Configuring Tracking Generators

The "Tracking Generator Configuration" dialog box is opened via the "Source Config" softkey in the "Tracking Generator" menu.

This dialog box allows you to define measurement settings, as well as connection settings for the optional external generators (option B10 only). Depending on which options are installed, the corresponding tabs for internal or external generators, or both, are displayed.

- [Chapter 5.6.3.1, "Internal Tracking Generator"](#), on page 454
- [Chapter 5.6.3.2, "External Tracking Generator"](#), on page 456

5.6.3.1 Internal Tracking Generator

The internal tracking generator is configured in the "Internal" tab of the "tracking Generator Configuration" dialog box.

In the top half of the dialog box, the measurement configurations can be defined. In the lower half of the dialog box, the capabilities of the internal tracking generator are displayed for reference only.

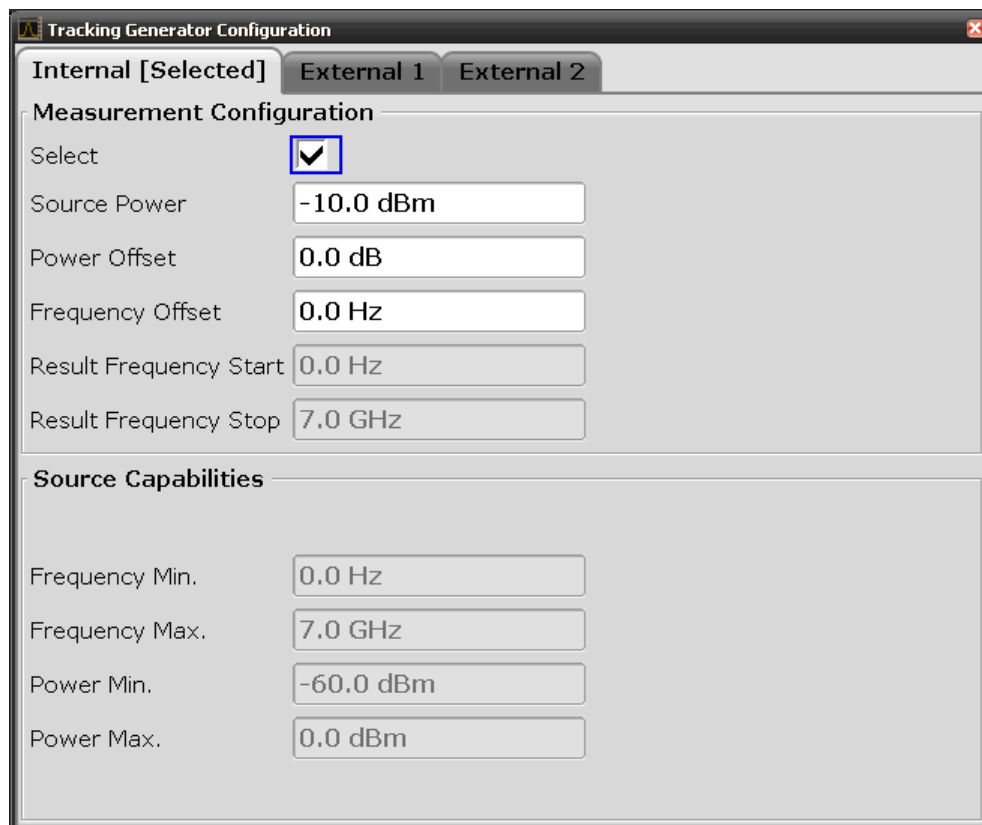

The configuration dialog box contains the following fields:

Select

Selects the internal tracking generator as the current tracking generator source. "Internal" is displayed as the source on the "Source RF" softkey. All tracking generator functions are performed with the currently selected source.

Note: Note that the generator is not automatically activated when it is selected. To activate the currently selected generator, click the "Source RF On" softkey.

Source Power

The tracking generator output power. The default output power is -20 dBm. The range is specified in the data sheet.

Remote command:

`SOURce<n>:POWer[:LEVel][:IMMediate][:AMPLitude]` on page 872

Power Offset

Constant level offset for the tracking generator. Values from -200 dB to +200 dB in 1 dB steps are allowed. The default setting is 0 dB. Offsets are indicated by the enhancement label "LVL" in the diagram header (see also [Chapter 5.6.5, "Displayed Information and Errors"](#), on page 469).

With this offset, attenuators or amplifiers at the output connector of the tracking generator can be taken into account for the displayed output power values on screen or during data entry, for example. Positive offsets apply to an amplifier and negative offsets to an attenuator subsequent to the tracking generator.

Remote command:

`SOURce<n>:POWER[:LEVel][:IMMediate]:OFFSet` on page 873

Frequency Offset

Constant frequency offset between the output signal of the tracking generator and the input frequency of the R&S FSVA/FSV. Possible offsets are in a range of ± 1 GHz in 0.1 Hz steps.

The default setting is 0 Hz. Offsets $\neq 0$ Hz are marked with the enhancement label "FRQ" in the diagram header (see also [Chapter 5.6.5, "Displayed Information and Errors"](#), on page 469).

If a positive frequency offset is entered, the tracking generator generates an output signal above the receive frequency of the R&S FSVA/FSV. In case of a negative frequency offset it generates a signal below the receive frequency of the R&S FSVA/FSV. The output frequency of the tracking generator is calculated as follows:

Tracking generator frequency = receive frequency + frequency offset.

Remote command:

`SOURce<n>:FREQuency:OFFSet` on page 872

Result Frequency Start

For reference only: The start frequency for the generator, calculated from the configured generator frequency and the start value defined for the analyzer.

Result Frequency Stop

For reference only: The stop frequency for the generator, calculated from the configured generator frequency and the stop value defined for the analyzer.

Frequency Min.

For reference only: Lower frequency limit for the generator.

Frequency Max.

For reference only: Upper frequency limit for the generator.

Power Min.

For reference only: Lower power limit for the generator.

Power Max.

For reference only: Upper power limit for the generator.

5.6.3.2 External Tracking Generator

The external tracking generators are configured in the "External" tabs of the "Tracking Generator Configuration" dialog box.

In the top section of the dialog box, the measurement configurations can be defined. In the middle section, interface settings for the connection to the external generator are defined. In the lower section of the dialog box, the capabilities of the external tracking generator are displayed for reference only.

The configuration dialog box contains the following fields:

Select

Selects the specified external tracking generator as the current tracking generator source. "External 1" or "External 2" is displayed as the source on the "Source RF" softkey. All tracking generator functions are performed with the currently selected source.

Note: Note that the generator is not automatically activated when it is selected. To activate the currently selected generator, click the "Source RF On" softkey.

Source Frequency Coupling

Enables or disables frequency coupling between the analyzer and the generator.

- "Auto" Default setting: the frequencies are coupled (see "[Generator Frequency \(Numerator/Denominator/Offset\)](#)" on page 458).
- "Manual" The generator uses a fixed frequency, defined in the ([Fixed\) Generator Frequency](#) field which is displayed when you select "Manual" coupling.

Remote command:

`SOURce<n>:EXTeRnal<generator>:FREQuency:COUPling[:STATe]`
on page 867

(Fixed) Generator Frequency

Defines the fixed frequency to be used by the generator.

Remote command:

`SOURce<n>:EXTernal<generator>:FREQuency` on page 866

Source Power

The output power of the external tracking generator. The default output power is -20 dBm. The range is specified in the data sheet.

Remote command:

`SOURce<n>:EXTernal<generator>:POWer[:LEVel]` on page 870

Power Offset

Constant level offset for the tracking generator. Values from -200 dB to +200 dB in 1 dB steps are allowed. The default setting is 0 dB. Offsets are indicated by the enhancement label "LVL" in the diagram header (see also [Chapter 5.6.5, "Displayed Information and Errors"](#), on page 469).

With this offset, attenuators or amplifiers at the output connector of the tracking generator can be taken into account for the displayed output power values on screen or during data entry, for example. Positive offsets apply to an amplifier and negative offsets to an attenuator subsequent to the tracking generator.

Remote command:

`SOURce<n>:POWer[:LEVel][:IMMediate]:OFFSet` on page 873

Generator Frequency (Numerator/Denominator/Offset)

The frequency used by the generator may differ from the input from the analyzer. The RF frequency may be multiplied by a specified factor, or a frequency offset can be added, or both.

Note: The input for the generator frequency is not validated, i.e. you can enter any values. However, if the allowed frequency ranges of the generator are exceeded, an error message is displayed on the analyzer screen and the values for [Start](#) and [Stop](#) are corrected to comply with the range limits.

The value range for the offset depends on the selected generator. The default setting is 0 Hz. Offsets \neq 0 Hz are marked with the enhancement label "FRQ" in the diagram header (see also [Chapter 5.6.5, "Displayed Information and Errors"](#), on page 469).

If a positive frequency offset is entered, the tracking generator generates an output signal above the receive frequency of the analyzer. For a negative frequency offset it generates a signal below the receive frequency of the analyzer.

The output frequency of the generator is calculated as follows:

$$F_{\text{Generator}} = \left| F_{\text{Analyzer}} * \frac{\text{Numerator}}{\text{Denominator}} + F_{\text{Offset}} \right|$$

Figure 5-28: Output frequency of the generator

Note: Make sure that the frequencies resulting from the start and stop frequency of the R&S FSVA/FSV do not exceed the allowed generator range:

- If the start frequency lies below F MIN, the generator is only switched on when F MIN is reached.

Instrument Functions – Tracking Generator (Options R&S FSV-B9/ R&S FSV-B10)

- If the stop frequency lies above F MAX, the generator is switched off. When the generator is subsequently switched on using the "Source RF Internal (On/ Off)" on page 446 softkey, the stop frequency is limited to F MAX.
- If the stop frequency lies below F MIN, the generator is switched off and an error message is displayed.

Remote command:

`SOURce<n>:EXTernal<generator>:FREQuency[:FACTor]:NUMerator`
on page 868

`SOURce<n>:EXTernal<generator>:FREQuency[:FACTor]:DENominator`
on page 867

`SOURce<n>:EXTernal<generator>:FREQuency:OFFSet<m>` on page 869

Reverse sweep

The "Offset" setting can be used to sweep in the reverse direction. You can do this by setting a "negative" offset in the tracking generator configuration.

Example for reverse sweep:

$F_{\text{AnalyzerStart}} = 100 \text{ MHz}$

$F_{\text{AnalyzerStop}} = 200 \text{ MHz}$

$F_{\text{Offset}} = -300 \text{ MHz}$

Numerator = Denominator = 1

$\rightarrow F_{\text{GeneratorStart}} = 200 \text{ MHz}$

$\rightarrow F_{\text{GeneratorStop}} = 100 \text{ MHz}$

If the offset is adjusted so that the sweep of the generator crosses the minimum generator frequency, a message is displayed in the status bar ("Reverse Sweep via min. Ext. Generator Frequency!").

Example for reverse sweep via minimum frequency:

$F_{\text{AnalyzerStart}} = 100 \text{ MHz}$

$F_{\text{AnalyzerStop}} = 200 \text{ MHz}$

$F_{\text{Offset}} = -150 \text{ MHz}$

$F_{\text{min}} = 20 \text{ MHz}$

Numerator = Denominator = 1

$\rightarrow F_{\text{GeneratorStart}} = 50 \text{ MHz}$

$\rightarrow F_{\text{GeneratorStop}} = 50 \text{ MHz via } F_{\text{min}}$

Result Frequency Start

For reference only: The start frequency for the generator, calculated from the configured generator frequency and the start value defined for the analyzer.

Result Frequency Stop

For reference only: The stop frequency for the generator, calculated from the configured generator frequency and the stop value defined for the analyzer.

Type

Generator type. See also [Chapter 5.6.2.1, "Overview of Generators Supported by the R&S FSVA/FSV"](#), on page 452.

Remote command:

`SYSTem:COMMunicate:RDEvice:GENerator<generator>:TYPE` on page 887

Interface

Type of interface connection used. The following interfaces are currently supported:

- TCP/IP
- GPIB

For details on interfaces see [Chapter 4.1, "Front and Rear Panel View"](#), on page 11.

Remote command:

`SYSTem:COMMunicate:RDEvice:GENerator<generator>:INTerface`
on page 886

TTL Synchronization

If available for the specified generator type, this option activates TTL synchronization for GPIB connections.

See also [Chapter 5.6.2, "Connecting External Tracking Generators"](#), on page 450.

For Noise Figure measurements (K30) this setting currently has no effect.

Remote command:

`SYSTem:COMMunicate:RDEvice:GENerator<generator>:LINK` on page 886

Address

For LAN connections: TCP/IP address.

For GPIB connections: GPIB address.

For more information on configuring interfaces see [Chapter 6.1.1, "Remote Control Interfaces and Protocols"](#), on page 537.

Remote command:

`SYSTem:COMMunicate:RDEvice:GENerator<generator>:LINK` on page 886

Reference

Selects internal or external reference for the generator (default: internal).

Note: Using the TTL interface allows for considerably higher measurement rates than pure GPIB control, because the frequency stepping of the R&S FSVA/FSV is directly coupled with the frequency stepping of the generator.

Remote command:

`SOURce<n>:EXTernal<generator>:ROSCillator[:SOURce]` on page 870

Edit Generator Setup File

Displays the setup file for the currently selected generator (see [Type](#) field) in read-only mode in an editor.

Adding new generator types

Although the existing setup files are displayed in read-only mode in the editor, they can be saved under a different name (using "File > SaveAs"). To add a new generator type to the selection list in the [Type](#) field, edit the setup file for an existing generator as required, then save the file with the extension ".gen" (select "Save as type: All Files (*.*)"). After you close the configuration dialog and re-open it, a new generator is available in the [Type](#) list with the name of the saved setup file.

Be careful, however, to adhere to the required syntax and commands. Errors will only be detected and displayed when you try to use the new generator (see also [Chapter 5.6.5, "Displayed Information and Errors"](#), on page 469).

Frequency Min.

For reference only: Lower frequency limit for the generator.

Frequency Max.

For reference only: Upper frequency limit for the generator.

Power Min.

For reference only: Lower power limit for the generator.

Power Max.

For reference only: Upper power limit for the generator.

5.6.4 Tracking Generator Functions

The following functions are available if the optional Tracking Generator or the optional External Tracking Generator is installed.

• Calibration mechanism	461
• Calibrating for transmission and reflection measurement	462
• Transmission measurement	463
• Reflection measurement	463
• Normalization	463
• Modulation (internal Tracking Generator only)	467

5.6.4.1 Calibration mechanism

Calibration means calculating the difference between the currently measured power and a reference curve, independent of the selected type of measurement (transmission/reflection). The hardware settings used for measuring the reference curve are included in the reference dataset.

Even with normalization switched on, the instrument settings can be changed in a wide area without stopping the normalization. This reduces the necessity to carry out a new normalization to a minimum.

Therefore, the reference dataset (trace with n measured values, where n is the number of [Sweep Points](#)) is stored internally as a table of n points (frequency/level).

Differences in level settings between the reference curve and the current instrument settings are taken into account automatically. If the span is reduced, a linear interpolation of the intermediate values is applied. If the span increases, the values at the left or right border of the reference dataset are extrapolated to the current start or stop frequency, i.e. the reference dataset is extended by constant values.

An enhancement label is used to mark the different levels of measurement accuracy. This enhancement label is displayed at the right diagram border if normalization is

switched on and a deviation from the reference setting occurs. Three accuracy levels are defined:

Table 5-11: Measurement accuracy levels

Accuracy	Enhancement label	Reason/Limitation
high	NOR	No difference between reference setting and measurement
medium	APX (approximation)	Change of the following settings: <ul style="list-style-type: none"> • coupling (RBW, VBW, SWT) • reference level, RF attenuation • start or stop frequency • output level of tracking generator • detector (max. peak, min. peak, sample, etc.) • change of frequency: max. 691 points within the set sweep limits (corresponds to a doubling of the span)
–	Aborted normalization	More than 500 extrapolated points within the current sweep limits (in case of span doubling)



At a reference level of -10 dBm and at a tracking generator output level of the same value, the R&S FSVA/FSV operates without overrange reserve. That means the R&S FSVA/FSV is in danger of being overloaded if a signal is applied whose amplitude is higher than the reference line. In this case, either the message "OVL" for overload or "IFOVL" for exceeded display range (clipping of the trace at the upper diagram border = overrange) is displayed in the status line.

Overloading can be avoided as follows:

- Reducing the output level of the tracking generator (**"Source Config"** on page 450 softkey in the Tracking Generator menu)
- Increasing the reference level (**Ref Level** softkey in the "Amplitude" menu)

5.6.4.2 Calibrating for transmission and reflection measurement

Prerequisite: The instrument is in tracking generator measurement mode.

1. To enter the generator output level, press the **"Source Power"** on page 446 softkey.
2. To enter a constant level offset for the tracking generator, press the **"Source Config"** on page 450 softkey and enter a "Power Offset".
3. To open the submenu for calibration, press the **"Source Cal"** on page 447 softkey.
4. To record a reference trace for transmission measurement, press the **"Calibrate Transmission"** on page 447 softkey.
The recording of the reference trace and the completion of the calibration sweep are indicated by message bo XE s.
5. To record a reference trace for reflection measurement, press the **"Calibrate Reflection Short"** on page 447 or **"Calibrate Reflection Open"** on page 447 softkey.

The recording of the reference trace and the completion of the calibration sweep are indicated by message boxes.

6. To switch on the normalization, press the "Normalize" on page 447 softkey.
7. To display the reference line, press the "Reference Value Position" on page 448 softkey.
8. To enter a value to shift the reference line, press the "Reference Value" on page 448 softkey.
9. To restore the settings used for source calibration, press the "Recall" on page 448 softkey.

5.6.4.3 Transmission measurement

This measurement yields the transmission characteristics of a two-port network. The internal or external tracking generator serves as a signal source. It is connected to the input connector of the DUT. The input of the R&S FSVA/FSV is fed from the output of the DUT. A calibration can be carried out to compensate for the effects of the test setup (e.g. frequency response of connecting cables).

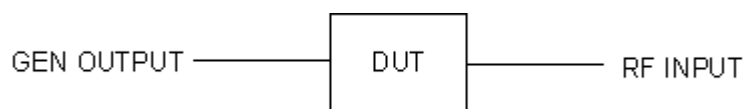

Figure 5-29: Test setup for transmission measurement

5.6.4.4 Reflection measurement

Scalar reflection measurements can be carried out by means of a reflection-coefficient measurement bridge.

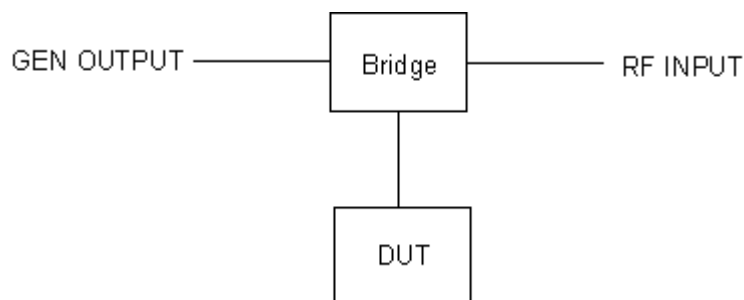

Figure 5-30: Test setup for reflection measurement

5.6.4.5 Normalization

The "NORMALIZE" softkey switches normalization on or off. The softkey is only available if the memory contains a correction trace.

You can shift the relative reference point within the grid using the "Reference Value Position" on page 448 softkey. Thus, the trace can be shifted from the top grid margin to the middle of the grid:

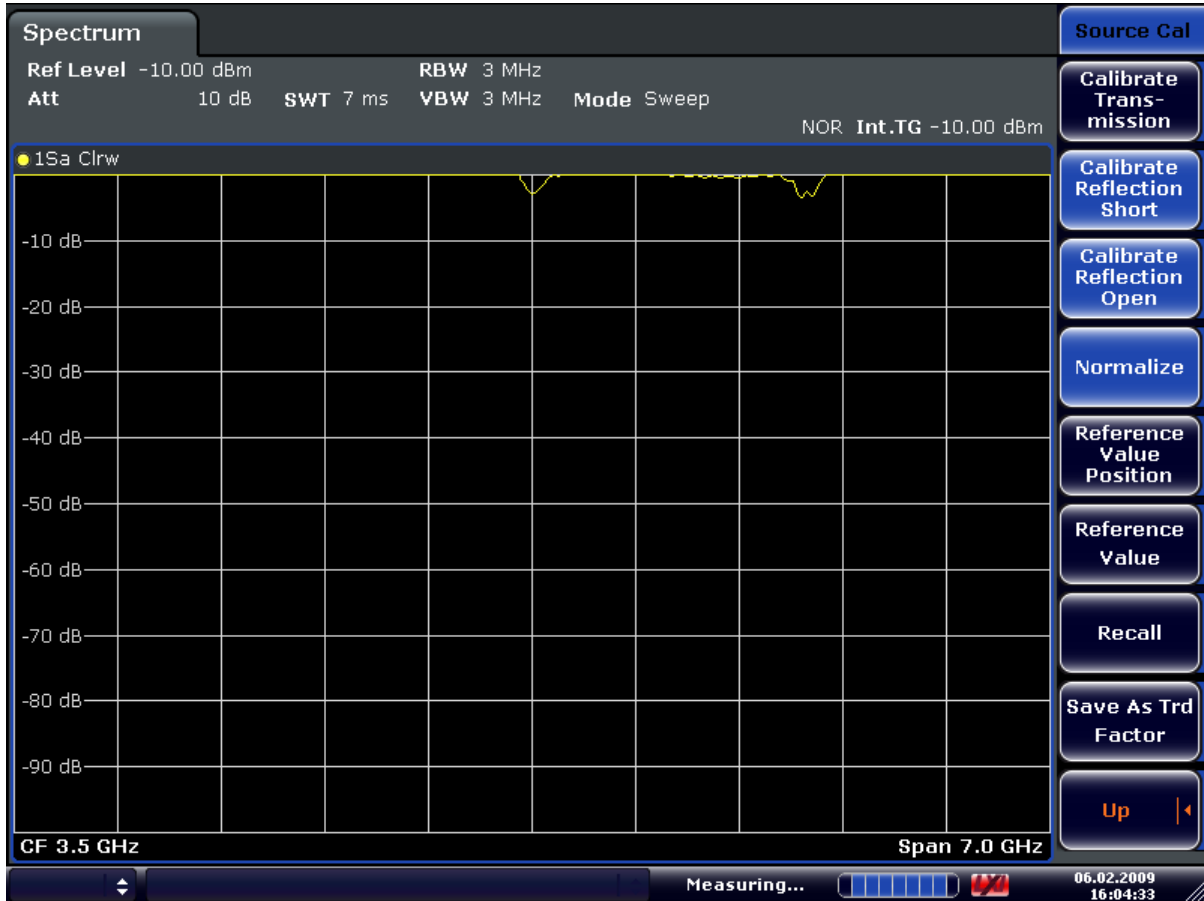

Figure 5-31: Normalized display

CORR ON, see [SENSe:]CORRection[:STATe] on page 795

Instrument Functions – Tracking Generator (Options R&S FSV-B9/ R&S FSV-B10)

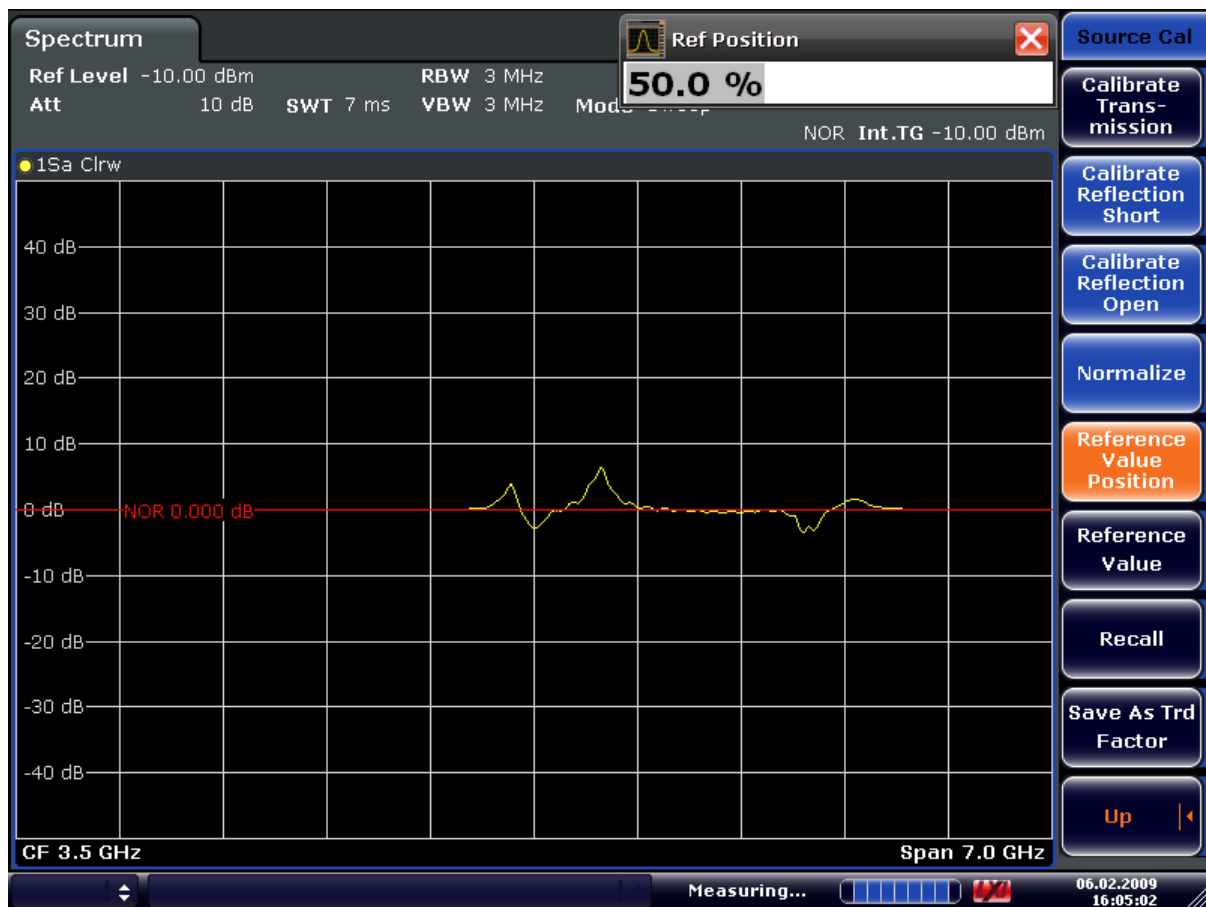

Figure 5-32: Normalized measurement, shifted with Reference Value Position= 50%

DISP:WIND:TRAC:Y:RPOS 10PCT, see [DISPlay\[:WINDow<n>\]:TRACe<t>:Y\[:SCALE\]:RPOSition](#) on page 755



Figure 5-33: Measurement with Reference Value: +10dB and Reference Value Position = 50%

After the reference line has been shifted by entering +10 dB as the "Reference Value" on page 448, deviations from the nominal value can be displayed with high resolution (e.g. 2 dB/Div.). The absolute measured values are still displayed; in the above example, 2 dB below nominal value (reference line) = 8 dB attenuation.

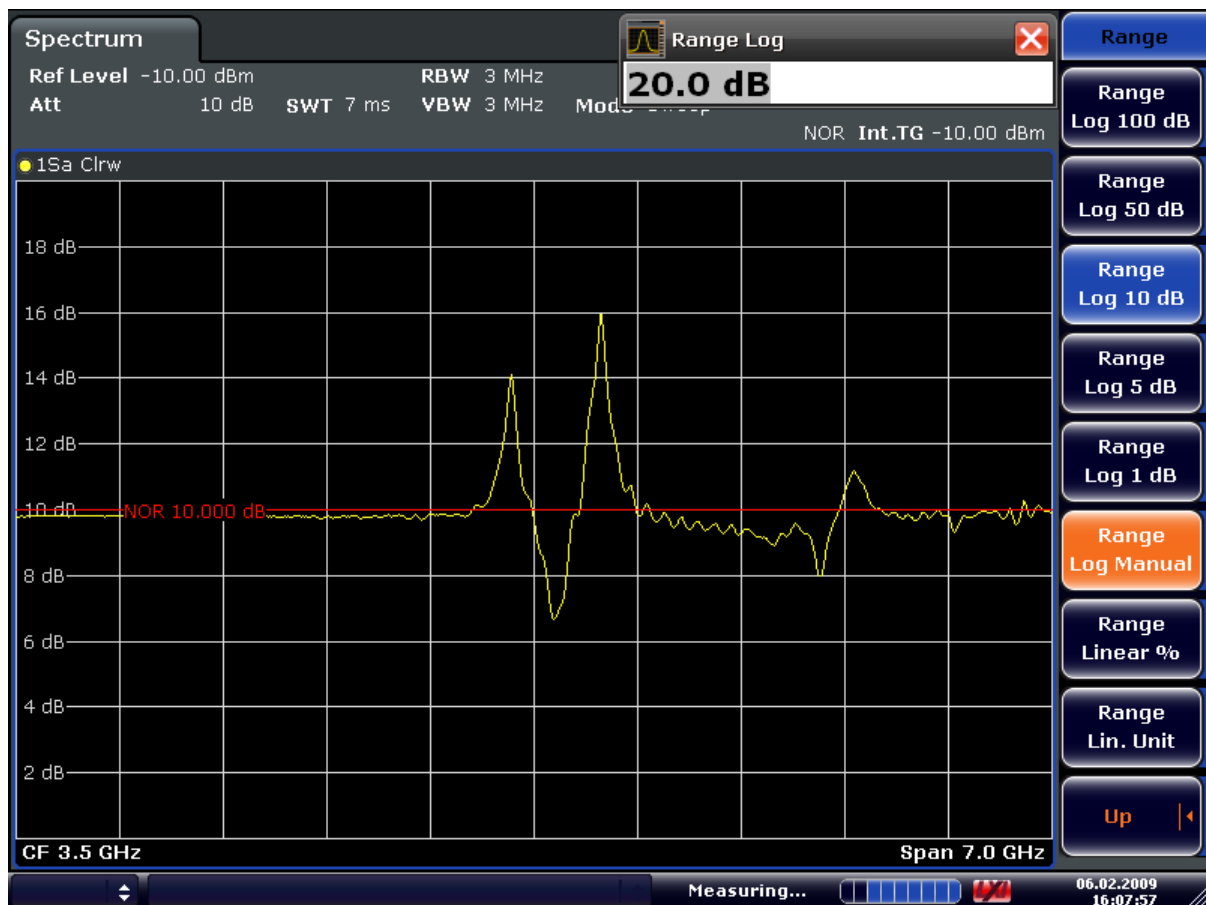

Figure 5-34: Measurement of a 10-dB attenuator pad with 2dB/Div

DISP:WIND:TRAC:Y:RVAL +10dB, see [DISPlay\[:WINDow<n>\]:TRACe<t>:Y\[:SCALE\]:RVALue](#) on page 755

5.6.4.6 Modulation (internal Tracking Generator only)

The time characteristics of the tracking generator output signal can be influenced by means of external signals (input voltage range -1 V to +1 V).

Two BNC connectors at the rear panel are available as signal inputs. Their function changes depending on the selected modulation:

- **TG IN I/AM** and
- **TG IN Q/FM**

The modulation modes can be combined with each other and with the frequency offset function up to a certain degree. The following table shows which modulation modes are possible at the same time and which ones can be combined with the frequency offset function.

Table 5-12: Simultaneous modes of modulation (tracking generator)

Modulation	Frequency offset	EXT AM	EXT FM	EXT I/Q
Frequency offset		•	•	•
EXT AM	•		•	
EXT FM	•	•		
EXT I/Q	•			

• = can be combined

External AM

The "External AM" on page 449 softkey activates an AM modulation of the tracking generator output signal.

The modulation signal is applied to the TG IN I/AM connector. An input voltage of 1 V corresponds to 100% amplitude modulation.

Switching on an external AM disables the active I/Q modulation.

External FM

The "External FM" on page 449 softkey activates the FM modulation of the tracking generator output signal.

The modulation frequency range is 1 kHz to 100 kHz, the deviation can be set in 1-decade steps in the range of 100 Hz to 10 MHz at an input voltage of 1 V. The phase deviation h should not exceed the value 100.

Phase deviation $h = \text{deviation/modulation frequency}$

The modulation signal is applied to the TG IN Q/FM connector.

Switching on an external FM disables the active I/Q modulation.

External IQ

The "External I/Q" on page 449 softkey activates the external I/Q modulation of the tracking generator.

The signals for modulation are applied to the two input connectors TG IN I and TG IN Q at the rear panel of the unit. The input voltage range is ± 1 V into 50 Ω .

Switching on an external I/Q modulation disables the active external AM or FM.

Functional description of the quadrature modulator:

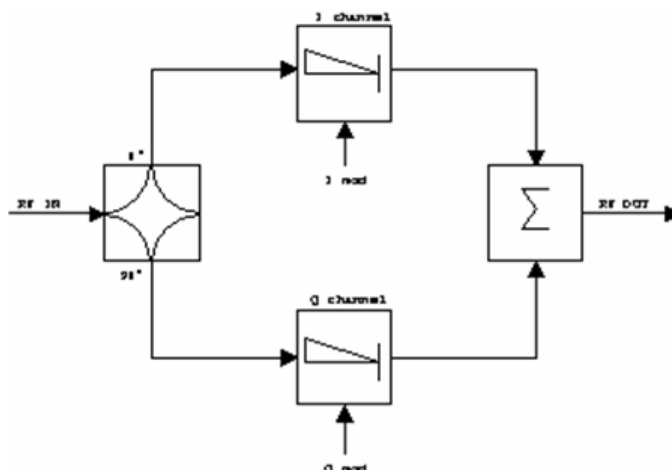

Figure 5-35: I/Q modulation

I/Q modulation is performed by means of the built-in quadrature modulator. The RF signal is divided into two orthogonal I and Q components (in phase and quadrature phase). Amplitude and phase are controlled in each path by the I and Q modulation signal. By adding the two components an RF output signal is generated that can be controlled in amplitude and phase.

Remote command:

[SOURce<n>:DM:STATe](#) on page 865

5.6.5 Displayed Information and Errors

Diagram header

In Tracking Generator measurement mode, some additional information is displayed in the diagram header.

Label	Description
INT TG: <source power>	Internal tracking generator active
INT TG: <start power>... <stop power>	Internal tracking generator with power sweep active
EXT TG <1 2>: <source power>	External tracking generator (1 or 2) active
LVL	Power Offset (see Chapter 5.6.3, "Configuring Tracking Generators" , on page 454)
FRQ	Frequency Offset (see Chapter 5.6.3, "Configuring Tracking Generators" , on page 454)
Measurement accuracy levels	
NOR	Normalization on; No difference between reference setting and measurement

Label	Description
APX (approximation)	Normalization on; Deviation from the reference setting occurs
-	Aborted normalization

For details on measurement accuracy levels, see [Chapter 5.6.4.5, "Normalization"](#), on page 463.

Error and status messages

Message	Description
"Ext. Generator GPIB Handshake Error!" / "Ext. Generator TCPIP Handshake Error!" / "Ext. Generator TTL Handshake Error!"	Connection to the generator is not possible, e.g. due to a cable damage or loose connection or wrong address.
"Ext. Generator Limits Exceeded!"	The allowed frequency or power ranges for the generator were exceeded.
"Reverse Sweep via min. Ext. Generator Frequency!"	Reverse sweep is performed; frequencies are reduced to the minimum frequency, then increased again; see Figure 5-28
"Ext. Generator File Syntax Error!"	Syntax error in the generator setup file (see "Edit Generator Setup File" on page 460)
"Ext. Generator Command Error!"	Missing or wrong command in the generator setup file (see "Edit Generator Setup File" on page 460)
"Ext. Generator Visa Error!!"	Error with Visa driver provided with installation (very unlikely)

5.7 Instrument Functions - R&S Digital I/Q Interface (Option R&S FSV-B17)

In the standard configuration, the R&S FSVA/FSV provides an internal I/Q memory in order to capture and evaluate I/Q data, which can be output via GPIB or the LAN interface. If the R&S FSVA/FSV R&S Digital I/Q Interface option (R&S FSV-B17) is installed, an online digital I/Q data interface is provided on the rear panel of the instrument for input and output.



This option is not available for R&S FSV 40 model 1307.9002K39.

Using the R&S Digital I/Q Interface for input, the digital baseband signal from the digital interface is used for measurement, rather than the digitalized IF signal. If the digital output is enabled, the I/Q data is continuously output at the connector at the rear of the instrument.



Alternatively, the I/Q data can be exported to a file (see [Chapter 5.1.2.3, "Importing and Exporting I/Q Data"](#), on page 172).

In the base unit, the input and output I/Q data can be evaluated using the I/Q Analyzer, for example (see [Chapter 5.5, "Instrument Functions - I/Q Analyzer"](#), on page 411). Other applications (e.g. VSA, R&S FSV-K70) also support digital input, see the descriptions of the individual firmware options for details.

The digital input and output can be enabled in the base unit or in one of the applications (where available). Alternatively, I/Q data can also be captured via remote control. The required commands are contained in the following subsystems:

- [Chapter 6.3.3.9, "INPut Subsystem"](#), on page 763
- ["TRACe:IQ Subsystem"](#) on page 894
- [Chapter 6.3.3.12, "OUTPut Subsystem"](#), on page 775

Information on the `STATus:QUESTionable:DIQ` register can be found in ["STATus:QUESTionable:DIQ Register"](#) on page 558.

5.7.1	Typical Applications for the R&S Digital I/Q Interface.....	471
5.7.2	Digital Input.....	473
5.7.3	Digital Output.....	479
5.7.4	Softkeys and Parameters of the R&S Digital I/Q Interface.....	480
5.7.5	Interface Status Information.....	484
5.7.6	Description of the LVDS Connector.....	487

5.7.1 Typical Applications for the R&S Digital I/Q Interface

The following typical applications use the R&S Digital I/Q Interface:

- Capturing and evaluating digital I/Q data in the I/Q Analyzer mode of the R&S FSVA/FSV base unit or other (optional) applications, e.g. R&S FSV-K70 (VSA). See [Chapter 5.5, "Instrument Functions - I/Q Analyzer"](#), on page 411 or the description of the individual firmware options.

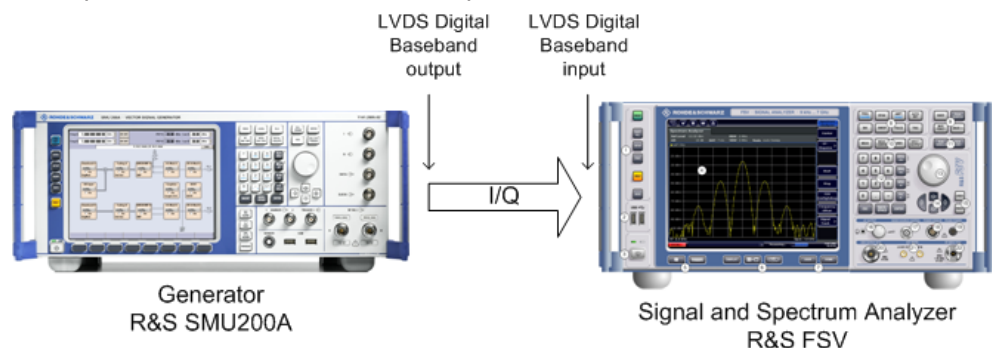

- Output of digital I/Q data to a selected receiver, e.g. to implement fading (simulating mobile radio communication participants) using a generator.

Instrument Functions - R&S Digital I/Q Interface (Option R&S FSV-B17)

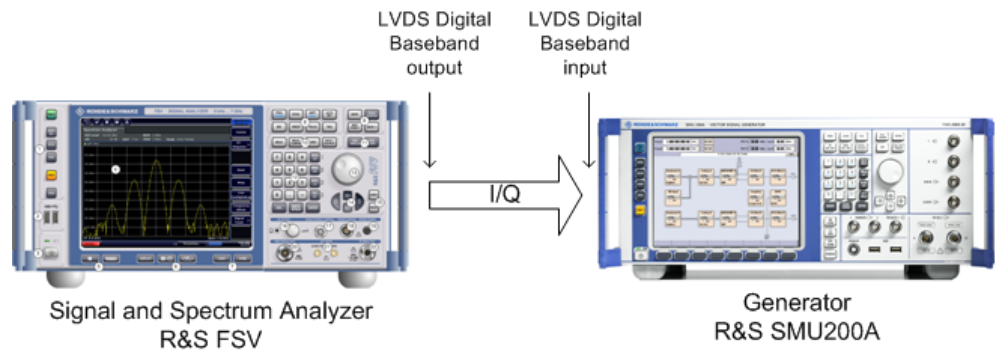

- Output of digital I/Q data to a device with a user-specific interface using an R&S EX-IQ-BOX (see the "R&S®EX-IQ-BOX - External Signal Interface Module Manual". The EX-IQ-Box functionality is not supported for R&S FSVA/FSV models 1321.3008Kxx.)

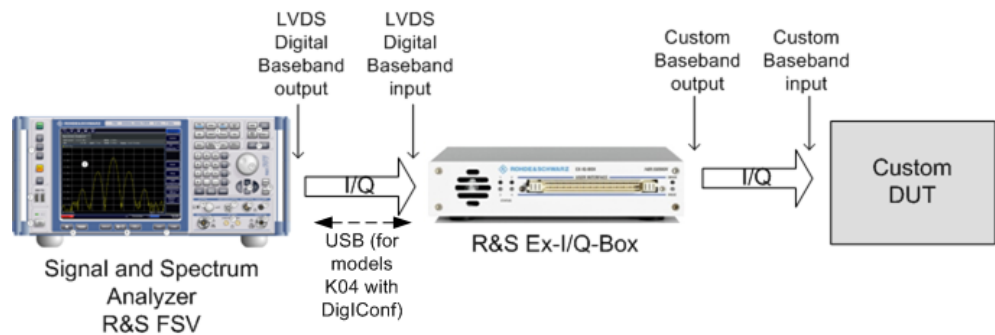

- Capturing and evaluating digital I/Q data from a device with a user-specific interface using an R&S EX-IQ-BOX (see the "R&S®EX-IQ-BOX - External Signal Interface Module Manual". The EX-IQ-Box functionality is not supported for R&S FSVA/FSV models 1321.3008Kxx.).

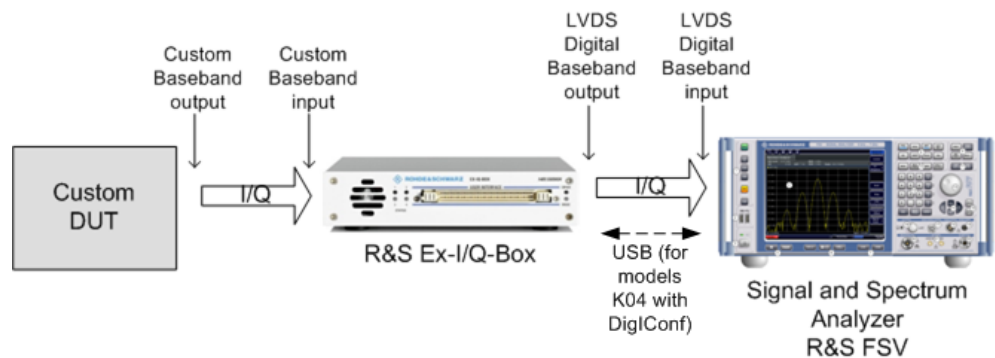



R&S EX-IQ-BOX and R&S DigIConf

The R&S EX-IQ-BOX is a configurable interface module that converts signal properties and the transmission protocol of the R&S instruments into user-defined or standardized signal formats and vice versa.

The EX-IQ-Box functionality is **not supported** for R&S FSVA/FSV models **1321.3008Kxx**.

The latest R&S EX-IQ-BOX (model 1409.5505K04) provides the configuration software R&S DigIConf which can be installed directly on the R&S FSVA/FSV. The software R&S DigIConf (Digital Interface Configurator for the R&S EX-IQ-BOX, version 2.10 or higher) controls the protocol, data and clock settings of the R&S EX-IQ-BOX independently from the connected R&S instrument. Besides basic functions of the user-defined protocols, this software utility supports the settings for standardized protocols, as e.g. CPRI, OBSAI or DigRF. **Note that R&S DigIConf requires a USB connection (not LAN!) to the R&S FSVA/FSV in addition to the R&S Digital I/Q Interface connection.**

Remote control is possible and very simple. Remote commands for the R&S DigIConf software always begin with `SOURCE: EBOX`. Such commands are passed on from the R&S FSVA/FSV to the R&S EX-IQ-BOX automatically via the USB connection.

A setup file, included in delivery, consists of an installation wizard, the executable program and all necessary program and data files. The latest software versions can be downloaded free of charge from the R&S website: www.rohde-schwarz.com/en/products/test_and_measurement/signal_generation/EX-IQ-Box. Simply execute the Setup file and follow the instructions in the installation wizard.

For details on installation and operation of the R&S DigIConf software, see the "R&S®EX-IQ-BOX Digital Interface Module R&S®DigIConf Software Operating Manual".

5.7.2 Digital Input

Digital input is enabled by selecting the "Digital Baseband (I/Q)" input path in the "Signal Source" dialog box (available either in the "Measurement" menu of the "I/Q Analyzer" mode, or in the "Input/Output" menu of the base unit and some applications, see "Signal Source" on page 400).



The digital input and output cannot be used simultaneously.

Signal Source

The device that provides digital input must be connected to the R&S Digital I/Q Interface at the rear of the R&S FSVA/FSV. The signal source is then configured in the "Signal Source" dialog box.

In the "Signal Source" dialog box the detected input device is indicated. For "Digital Baseband (I/Q)" sources, you can configure the basic connection settings, e.g. the input sample rate. Each time the device is disconnected or the configuration is

changed, a connection protocol is executed, and before the first measurement, a PRBS descewing test is performed. Information on the connection status and the results of the connection tests are provided in the "Digital IQ Info" dialog box, see [Chapter 5.7.5, "Interface Status Information"](#), on page 484.

Measurement Settings

The "Full Scale Level" defines the level that should correspond to an I/Q sample with the magnitude "1" and can be defined either in dBm or Volt (see ["Full Scale Level"](#) on page 400). When converting the measured power into dBm, an impedance of 50 Ω is assumed.

Processing digital input

The digital input signal is brought to the desired sample rate using a downsampling filter and fractional resampling. The word length of the data is 18 bits fixed point for each I and Q. The resulting data can be processed by the selected application (see [Chapter 5.7.1, "Typical Applications for the R&S Digital I/Q Interface"](#), on page 471). As illustrated in [Figure 5-36](#), the sample rate is dependant on the input sample rate.

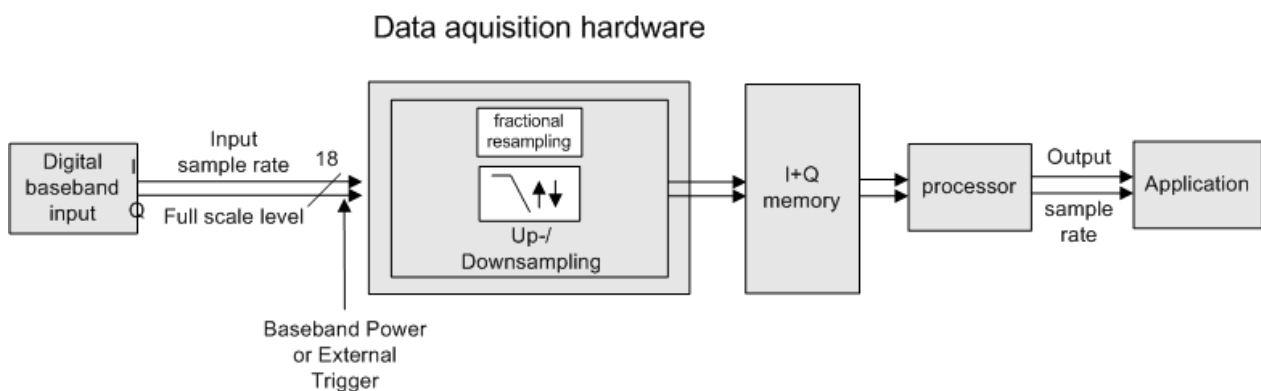

Figure 5-36: Signal path using digital input

Sample rates, bandwidths and other limitations

The calculation of the usable I/Q bandwidth for active digital input is described in [Table 5-13](#).



Abbreviations

The following abbreviations are used in this section:

- **SR**: sample rate: the sample rate that is defined by the user (e.g. in the "Data Acquisition" dialog box in the "I/Q Analyzer" mode, see ["Sample Rate"](#) on page 417)
- **ISR**: Input sample rate: the sample rate of the data provided by the connected device to the digital input
- **Ms**: 1 Ms = 1024 * 1024 samples

Table 5-13: Calculation of the usable I/Q bandwidth for active digital input

Precondition	Bandwidth
$\frac{SR}{ISR} < 0.95$	0.8 * SR
$0.95 \leq \frac{SR}{ISR}$	0.76 * ISR

**Unfiltered I/Q data input**

The values in [Table 5-13](#) apply for the default data processing using the decimation filter and resampler. If the filter is deactivated (see "[No Filter](#)" on page 417, the sample rate is identical to the input sample rate. In this case, the usable I/Q bandwidth is not restricted by the R&S FSVA/FSV.

The following table describes the dependencies for digital in- and output:

Table 5-14: Dependencies for digital in- and output

Type of Limit	Precondition	Range / Value
Input sample rate (ISR)		100 Hz ... 10 GHz (*)
Minimum sample rate (SR)		100 Hz (*)
Maximum sample rate (SR)	Digital input active	45 MHz (without R&S FSV-B70/R&S FSVA-B40) (*) 254 * ISR, max. 10 GHz (with R&S FSV-B70/R&S FSVA-B40) (*)
	Digital output active	45 MHz (without R&S FSV-B70/R&S FSVA-B40) 100 MHz (with R&S FSV-B70/R&S FSVA-B40)
(*) Note the relationship between the sample rate and the input sample rate, which may restrict the value ranges further: $ISR_{min} = SR/254$ $ISR_{max} = SR * 2 * 1048576$		

Type of Limit	Precondition	Range / Value
Maximum number of samples		$\text{Min}\left(100Ms, 100Ms \cdot \frac{SR}{ISR}\right) - \text{group delay in samples}$ <p>Note: the internal filter settling time depends on the relation:</p> $\frac{SR}{ISR}$ <p>Some R&S FSVA/FSV applications limit the maximum number of samples to reasonable values.</p> <p>In I/Q Analyzer mode (Eval mode, see TRACe<n>: IQ: EVAL on page 902), the maximum number of samples is restricted to:</p> $\text{Min}\left(10Mio, 100Ms \cdot \frac{SR}{ISR}\right) - \text{group delay in samples}$
Maximum number of I/Q pretrigger samples		-(MaxNoOfSamples-1) to + (MaxNoOfSamples-1)
<p>(*) Note the relationship between the sample rate and the input sample rate, which may restrict the value ranges further:</p> $ISR_{\min} = SR/254$ $ISR_{\max} = SR \cdot 2 \cdot 1048576$		

Table 5-15: Typical values for the maximum number of samples depending on the SR/ISR relation

SR/ISR	Max number of samples
100	104857600
10	104857600
1	104857600
1/10	10485686
1/100	1048508



SlowIQ measurements

"SlowIQ" measurements are measurements where the sample rate exceeds the rate used to transfer valid samples. In the R&S FSVA/FSV, the sample rate may exceed 100 MHz for "SlowIQ" measurements. This happens, for example, when an analog signal is sampled by external hardware, e.g. an oscilloscope, with a sample rate > 100 MHz, is stored there in a memory temporarily and then read from the memory and transmitted to the R&S FSVA/FSV. In this case, make sure the source sample rate is defined correspondingly for the connected device (see ["Input Sample Rate"](#) on page 400).

Bandwidths

Depending on the sample rate, the following bandwidths are available:

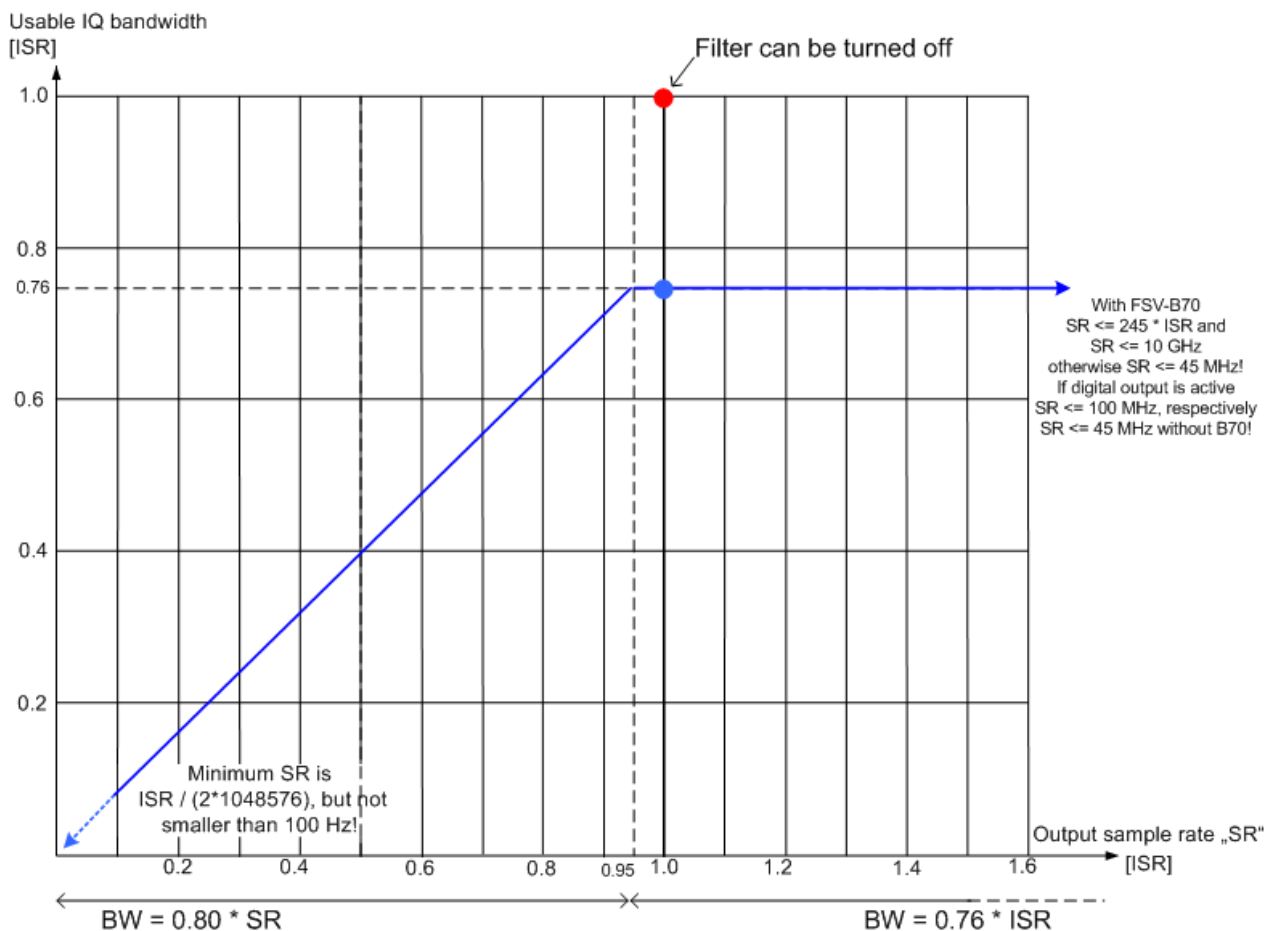

Figure 5-37: Bandwidths depending on sample rate for active digital input

Table 5-16: Bandwidths depending on sample rate for active digital input (with R&S FSV-B70/ R&S FSVA-B40)

Exemplary digital input sample rates	Possible output sample rates and the corresponding IQ bandwidths			
	Linear increase from the minimum possible output sample rate up to break point		Constant IQ bandwidth from break point up to the maximum possible output sample rate	
	minimum	break point	break point	maximum
Minimum: ISR = 100 Hz	Not allowed		SR = 100 Hz ¹⁾ BW = 0.76 * ISR = 76 Hz	SR = 254 * ISR = 25.64 kHz BW = 0.76 * ISR = 76 Hz
Example ISR = 30 MHz	SR = 100 Hz ¹⁾ BW = 0.8 * SR = 80 Hz	SR = 0.95*ISR = 28.5 MHz BW = 0.8 * SR = 22.8 MHz	SR = 0.95*ISR = 28.5 MHz BW = 0.76 * ISR = 22.8 MHz	SR = 254 * ISR = 7.62 GHz BW = 0.76 * ISR = 22.8 MHz
¹⁾ max(ISR/(2*1048576), 100 Hz) ²⁾ min(254*ISR, 10GHz)				

Exemplary digital input sample rates	Possible output sample rates and the corresponding IQ bandwidths			
	Linear increase from the minimum possible output sample rate up to break point		Constant IQ bandwidth from break point up to the maximum possible output sample rate	
	minimum	break point	break point	maximum
Example ISR = 50 MHz	SR = 100 Hz ¹⁾ BW = 0.8 * SR = 80 Hz	SR = 0.95*ISR = 47.5 MHz BW = 0.8 * SR = 38 MHz	SR = 0.95*ISR = 47.5 MHz BW = 0.76 * ISR = 38 MHz	SR = 10 GHz ²⁾ BW = 0.76 * ISR = 38 MHz
Example ISR = 500 MHz	SR = ISR/ (2*1048576) = 239 Hz BW = 0.8 * SR = 191.2 Hz	SR = 0.95*ISR = 475 MHz BW = 0.8 * SR = 380 MHz	SR = 0.95*ISR = 475 MHz BW = 0.76 * ISR = 380 MHz	SR = 10 GHz ²⁾ BW = 0.76 * ISR = 380 MHz
Maximum: ISR = 10 GHz	SR = ISR/ (2*1048576) = 4.769 kHz BW = 0.8 * SR = 3.8152 kHz	SR = 0.95*ISR = 9.5 GHz BW = 0.8 * SR = 7.6 GHz	SR = 0.95*ISR = 9.5 GHz BW = 0.76 * ISR = 7.6 GHz	SR = 10 GHz ²⁾ BW = 0.76 * ISR = 7.6 GHz
¹⁾ max(ISR/(2*1048576), 100 Hz) ²⁾ min(254*ISR, 10GHz)				

Table 5-17: Bandwidths depending on sample rate for active digital input (without R&S FSV-B70/ R&S FSVA-B40)

Exemplary digital input sample rates	Possible output sample rates and the corresponding IQ bandwidths			
	Linear increase from the minimum possible output sample rate up to break point		Constant IQ bandwidth from break point up to the maximum possible output sample rate	
	minimum	break point	break point	maximum
Minimum: ISR = 100 Hz	Not allowed		SR = 100 Hz ¹⁾ BW = 0.76 * ISR = 76 Hz	SR = 254 * ISR = 25.64 kHz BW = 0.76 * ISR = 76 Hz
Example ISR = 30 MHz	SR = 100 Hz ¹⁾ BW = 0.8 * SR = 80 Hz	SR = 0.95*ISR = 28.5 MHz BW = 0.8 * SR = 22.8 MHz	SR = 0.95*ISR = 28.5 MHz BW = 0.76 * ISR = 22.8 MHz	SR = 45 MHz ²⁾ BW = 0.76 * ISR = 22.8 Hz
Example ISR = 50 MHz	SR = 100 Hz ¹⁾ BW = 0.8 * SR = 80 Hz	SR = 45 MHz ²⁾ BW = 0.8 * SR = 36 MHz	Not allowed	
¹⁾ max(ISR/(2*1048576), 100 Hz) ²⁾ min(254*ISR, 45 MHz)				

Exemplary digital input sample rates	Possible output sample rates and the corresponding IQ bandwidths			
	Linear increase from the minimum possible output sample rate up to break point		Constant IQ bandwidth from break point up to the maximum possible output sample rate	
	minimum	break point	break point	maximum
Example ISR = 500 MHz	SR = ISR/ (2*1048576) = 239 Hz BW = 0.8 * SR = 191.2 Hz	SR = 45 MHz ²⁾ BW = 0.8 * SR = 36 MHz	Not allowed	
Maximum: ISR = 10 GHz	SR = ISR/ (2*1048576) = 4.769 kHz BW = 0.8 * SR = 3.8152 kHz	SR = 45 MHz ²⁾ BW = 0.8 * SR = 36 MHz	Not allowed	
¹⁾ max(ISR/(2*1048576), 100 Hz) ²⁾ min(254*ISR, 45 MHz)				

Triggering

The following trigger modes are supported:

- External (see "External" on page 239)
- BB Power (see "IF Power/BB Power" on page 240)
- Time (see "Time" on page 241)

If external triggering is used, the external trigger must be applied via the connector on the rear panel of the instrument (as for analog input).



Gating

Gating is not supported for digital input.

5.7.3 Digital Output

Digital output is enabled in the I/Q Analyzer mode (see Chapter 5.5, "Instrument Functions - I/Q Analyzer", on page 411).



The digital input and output cannot be used simultaneously.

Processing digital output

Digital output is processed almost identically to RF input in I/Q mode (see Chapter 5.5.6, "Working with I/Q Data", on page 439). I/Q data is sampled blockwise, according to the defined sample rate, and stored in the I/Q memory. From the memory,

the I/Q data is processed in the I/Q Analyzer mode. Simultaneously, the data is written to the R&S Digital I/Q Interface continuously. Using this interface, the I/Q data can be processed in an external device as an alternative to internal processing in the R&S FSVA/FSV.



The sample rate at the digital output corresponds to the user-defined sample rate (maximum 100 MHz, see "Sample Rate" on page 417). The current sample rate is displayed in the "Digital Output" dialog box (read-only) when the digital output is enabled (see "Digital Output" on page 402).

For digital output, the full scale level corresponds to the defined reference level (without the reference level offset and transducer; see also "Full Scale Level" on page 400 and "Reference Level" on page 416).

The data rate for digital output via the R&S Digital I/Q Interface is 100 MHz, i.e. any connected device must be capable of processing digital input at a data rate of 100 MHz.

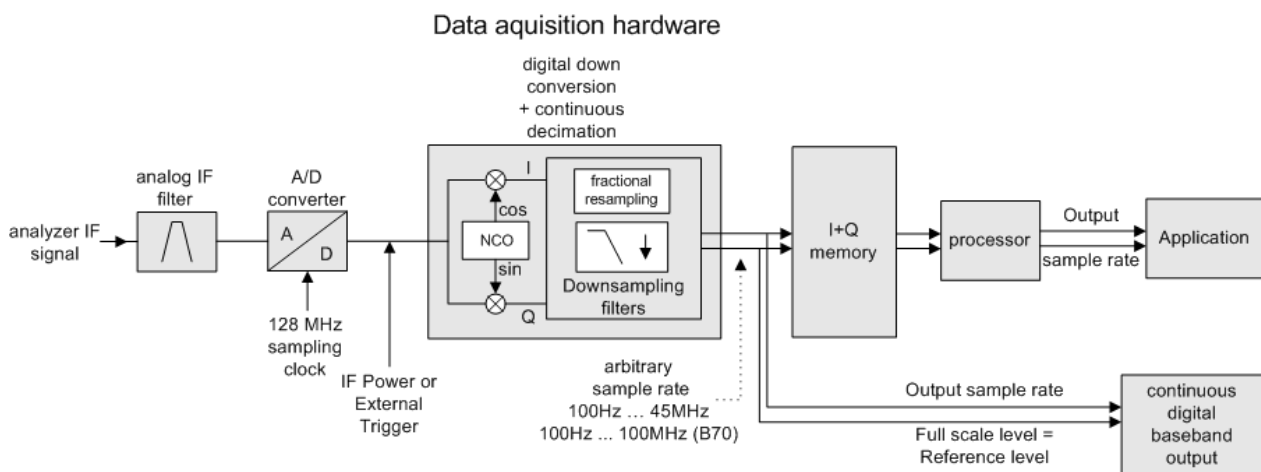

Figure 5-38: Signal path using the digital output

5.7.4 Softkeys and Parameters of the R&S Digital I/Q Interface

The following softkeys and parameters are available for the R&S Digital I/Q Interface in the applications that support it.

Signal Source.....	481
L Input Path.....	481
L Connected Device.....	481
L Input Sample Rate.....	481
L Full Scale Level.....	481
L Level Unit.....	481
L Adjust Reference Level to Full Scale Level.....	482
Digital Output.....	482
Digital IQ Info.....	482
EXIQ.....	482

L TX Settings.....	483
L RX Settings.....	483
L Send To.....	483
L Firmware Update.....	483
L R&S Support.....	483
L DigIConf.....	483

Signal Source

Opens a dialog box to select the signal source.

For "Digital Baseband (I/Q)", the source can also be configured here.

Input Path ← Signal Source

Defines whether the "RF Radio Frequency" or the "Digital IQ" input path is used for measurements. "Digital IQ" is only available if option R&S FSV-B17 (R&S Digital I/Q Interface) is installed.

Note: Note that the input path defines the characteristics of the signal, which differ significantly between the RF input and digital input.

Remote command:

[INPut:SElect](#) on page 769

Connected Device ← Signal Source

Displays the name of the device connected to the optional R&S Digital I/Q Interface (R&S FSV-B17) to provide Digital IQ input. The device name cannot be changed here.

The device name is unknown.

Remote command:

[INPut:DIQ:CDEvice](#) on page 764

Input Sample Rate ← Signal Source

Defines the sample rate of the digital I/Q signal source. This sample rate must correspond with the sample rate provided by the connected device, e.g. a generator.

Remote command:

[INPut:DIQ:SRATe](#) on page 767

Full Scale Level ← Signal Source

The "Full Scale Level" defines the level that should correspond to an I/Q sample with the magnitude "1".

The level can be defined either in dBm or Volt.

Remote command:

[INPut:DIQ:RANGe\[:UPPer\]](#) on page 766

Level Unit ← Signal Source

Defines the unit used for the full scale level.

Remote command:

[INPut:DIQ:RANGe\[:UPPer\]:UNIT](#) on page 766

Adjust Reference Level to Full Scale Level ← Signal Source

If enabled, the reference level is adjusted to the full scale level automatically if any change occurs.

(See the [Auto Level](#) softkey).

Remote command:

[INPut:DIQ:RANGe:COUPling](#) on page 765

Digital Output

Opens a dialog box to enable a digital output stream to the optional R&S Digital I/Q Interface (R&S FSV-B17), if available.

The displayed sample rate is identical to the sample rate defined under [Data Acquisition](#) (I/Q Analyzer) and is not editable here.

For details see "Digital Output" in the description of the R&S Digital I/Q Interface for the base unit.

Remote command:

[OUTPut:DIQ](#) on page 776

Digital IQ Info

Displays a dialog box with information on the digital I/Q input and output connection via the optional R&S Digital I/Q Interface (R&S FSV-B17), if available. The information includes:

- Device identification
- Used port
- (Maximum) digital input/output sample rates and maximum digital input/output transfer rates
- Status of the connection protocol
- Status of the PRBS descewing test

For details see "Interface Status Information" in "Instrument Functions - R&S Digital I/Q Interface (Option R&S FSV-B17)" in the description of the base unit.

Remote command:

[INPut:DIQ:CDEVIce](#) on page 764

EXIQ

Opens a configuration dialog box for an optionally connected R&S EX-IQ-BOX and a submenu to access the main settings quickly.

Note: The EX-IQ-Box functionality is not supported for R&S FSV models 1307.9002Kxx.

If the optional R&S DigIConf software is installed, the submenu consists only of one key to access the software. **Note that R&S DigIConf requires a USB connection (not LAN!) from the R&S FSVA/FSV to the R&S EX-IQ-BOX in addition to the R&S Digital I/Q Interface connection. R&S DigIConf version 2.10 or higher is required.**

For typical applications of the R&S EX-IQ-BOX see also the description of the R&S Digital I/Q Interface (R&S FSV-B17) in the base unit manual.

For details on configuration see the "R&S®Ex I/Q Box - External Signal Interface Module Manual".

For details on installation and operation of the R&S DigIConf software, see the "R&S®EX-IQ-BOX Digital Interface Module R&S®DigIConf Software Operating Manual".

TX Settings ← EXIQ

Opens the "EX-IQ-BOX Settings" dialog box to configure the R&S FSVA/FSV for digital output to a connected device ("Transmitter" Type).

RX Settings ← EXIQ

Opens the "EX-IQ-BOX Settings" dialog box to configure the R&S FSVA/FSV for digital input from a connected device ("Receiver" Type).

Send To ← EXIQ

The configuration settings defined in the dialog box are transferred to the R&S EX-IQ-BOX.

Firmware Update ← EXIQ

If a firmware update for the R&S EX-IQ-BOX is delivered with the R&S FSVA/FSV firmware, this function is available. In this case, when you select the softkey, the firmware update is performed.

R&S Support ← EXIQ

Stores useful information for troubleshooting in case of errors.

This data is stored in the `C:\R_S\Instr\user\Support` directory on the instrument.

If you contact the Rohde&Schwarz support to get help for a certain problem, send these files to the support in order to identify and solve the problem faster.

DigIConf ← EXIQ

Starts the optional R&S DigIConf application. This softkey is only available if the optional software is installed.

To return to the R&S FSVA/FSV application, press any key on the front panel. The application is displayed with the "EXIQ" menu, regardless of which key was pressed.

For details on the R&S DigIConf application, see the "R&S®EX-IQ-BOX Digital Interface Module R&S®DigIConf Software Operating Manual".

Note: If you close the R&S DigIConf window using the "Close" icon, the window is minimized, not closed.

If you select the "File > Exit" menu item in the R&S DigIConf window, the application is closed. Note that in this case the settings are lost and the EX-IQ-BOX functionality is no longer available until you restart the application using the "DigIConf" softkey in the R&S FSVA/FSV once again.

Remote command:

Remote commands for the R&S DigIConf software always begin with `SOURCE: EBOX`. Such commands are passed on from the R&S FSVA/FSV to the R&S DigIConf automatically which then configures the R&S EX-IQ-BOX via the USB connection.

All remote commands available for configuration via the R&S DigIConf software are described in the "R&S®EX-IQ-BOX Digital Interface Module R&S®DigIConf Software Operating Manual".

Example 1:

SOURce:EBOX:*RST

SOURce:EBOX:*IDN?

Result:

"Rohde&Schwarz,DigIConf,02.05.436 Build 47"

Example 2:

SOURce:EBOX:USER:CLOCK:REFerence:FREQuency 5MHZ

Defines the frequency value of the reference clock.

5.7.5 Interface Status Information

When a digital input or output device is connected to the R&S Digital I/Q Interface, a dialog box and status icons in the status bar provide information on the status of the connection. To display the dialog box, select the "Digital IQ Info" softkey in the "Input/Output" menu (see "Digital IQ Info" on page 403).

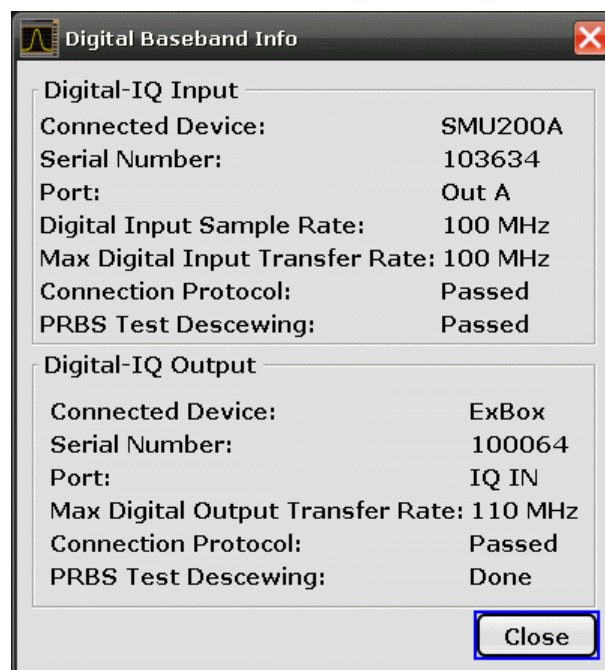

The following information is displayed:

Table 5-18: Displayed Information for Digital Baseband Connections

Label	Description
Digital I/Q input connection	
Digital-I/Q Input	Device connected to R&S FSVA/FSV input interface
Serial Number	Serial number of the connected device
Port	Port name used by the connected device
(Max.) Digital Output Sample Rate	Maximum possible or currently used sample rate of the connected device; depends on the used connection protocol version (see "<SampleRate-Type>" parameter described in INPut:DIQ:CDEvice on page 764)

Label	Description
Max. Digital Output Transfer Rate	Maximum data transfer rate of the connected device in Hz
Connection Protocol	State of the connection protocol which is used to identify the connected device
PRBS Test Descewing	State of the PRBS test
Digital I/Q output connection	
Digital-I/Q Output	Device connected to R&S FSVA/FSV output interface
Serial Number	Serial number of the connected device
Port	Port name used by the connected device
Max. Digital Input Transfer Rate	Maximum input data transfer rate that can be processed by the connected device
Connection Protocol	State of the connection protocol which is used to identify the connected device
PRBS Test Descewing	State of the PRBS test



You can query the information in this dialog box using remote commands, see [INPut:DIQ:CDEvice](#) on page 764.

Connection tests

Each time a device is (re-)connected to the R&S FSVA/FSV, a connection protocol is executed. This test identifies the connected device. This test may take 2 seconds to complete. If a connection cannot be established within 30 seconds, the test is aborted and an error is indicated in the dialog box and the status bar.

Before the first measurement is started after a device has been (re-)connected to the R&S FSVA/FSV, a PRBS Descewing test is performed to identify the properties of the used cable. The state of this test is also indicated in the dialog box and the status bar.

If either of the tests fail, check the cable to the connected device as a first step. Also make sure the data rate of the R&S FSVA/FSV and the connected device comply with the specification.

Status icons

The status of the connection tests are indicated in the "Digital IQ Info" dialog box and as icons in the status bar. The status icons have the following meaning:

Table 5-19: Status information for digital baseband connections

Icon	Status
Digital input	
	Connection established, protocol not yet started

Instrument Functions - R&S Digital I/Q Interface (Option R&S FSV-B17)

Icon	Status
	Connection protocol in progress
	Connection protocol passed
	PRBS test in progress
	PRBS test passed
	Connection protocol failed
	PRBS test failed
	No cable connected although "Signal Source" = "DigIQ"
Digital output	
	Connection established, protocol not yet started
	Connection protocol in progress
	Connection protocol passed
	Connection protocol failed
	No cable connected although "Digital Output" enabled.

Error messages

If errors occur, a message is displayed in the status bar. The following table describes the most common errors and possible solutions.

Message	Possible solutions
"Dig. Input Sample Rate too high!"	<ul style="list-style-type: none"> • Increase the sample rate • Reduce the input sample rate
"Dig. Input Sample Rate too low!"	<ul style="list-style-type: none"> • Reduce the sample rate • Increase the input sample rate
"Output Sample Rate too high!"	<ul style="list-style-type: none"> • Reduce the sample rate • Increase the input sample rate

Message	Possible solutions
"Number of I/Q Capture Samples too high!"	<ul style="list-style-type: none"> • Reduce the number of I/Q samples • Reduce the ratio input sample rate / sample rate by increasing the sample rate or decreasing the input sample rate
Keyword: "FIFO OVL"	Reduce the input sample rate

5.7.6 Description of the LVDS Connector

The R&S Digital I/Q Interface is a proprietary LVDS serial interface. For adaption to industrial standard interfaces use the R&S EX-IQ-BOX (see the "R&S®EX-IQ-BOX - External Signal Interface Module Manual". The EX-IQ-Box functionality is not supported for R&S FSVA/FSV models 1321.3008Kxx.).

The LVDS Connector is a 26 pin female 0.050" Mini D Ribbon connector (e.g.: 3M 102XX-1210VE series).



For the connection, use the cables provided with the R&S EX-IQ-BOX or an R&S®SMU-Z6 cable (order no.: 1415.0201.02).

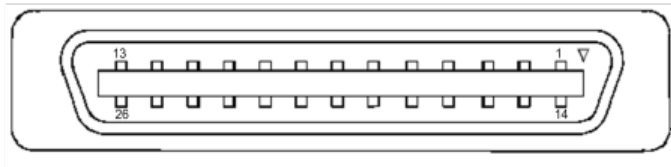

Figure 5-39: LVDS connector on the R&S FSVA/FSV rear panel, connector front view

The [Table 5-20](#) shows the multiplexed data at the output of the LVDS transmitter.

Table 5-20: LVDS connector pin description

Pin	Signal	Level	
1			reserved for future use
2	GND	0V	Ground, shield of pair 1-14, for future use
3	SDAT0_P	LVDS	Serial data channel 0 positive pin; carries the bits VALID, ENABLE, MARKER_1 (GP4), Reserve_1 (GP2), RE_0, RE_1
4	SDAT1_P	LVDS	Serial data channel 1 positive pin; carries the bits RE_2, RE_3, RE_4, RE_5, RE_6, RE_7
5	SDAT2_P	LVDS	Serial data channel 2 positive pin; carries the bits RE_8, RE_9, RE_10, RE_11, RE_12, RE_13
6	CLK1_P	LVDS	Clock 1 positive pin; clock for transmission on LVDS link
7	S_CLK	TTL	(for future use)
8	+5VD	+5.0V	Supply voltage (for future use)

Pin	Signal	Level	
9	SDAT3_P	LVDS	Serial data channel 3 positive pin; carries the bits RE_14, RE_15, RE_16, RE_17, RE_18, RE_19
10	SDAT4_P	LVDS	Serial data channel 4 positive pin; carries the bits TRIGGER_1 (GP0), TRIGGER_2 (GP1), MARKER_2 (GP5), Reserve_2 (GP3), IM_0, IM_1
11	SDAT5_P	LVDS	Serial data channel 5 positive pin; carries the bits IM_2, IM_3, IM_4, IM_5, IM_6, IM_7
12	SDAT6_P	LVDS	Serial data channel 6 positive pin; carries the bits IM_8, IM_9, IM_10, IM_11, IM_12, IM_13
13	SDAT7_P	LVDS	Serial data channel 7 positive pin; carries the bits IM_14, IM_15, IM_16, IM_17, IM_18, IM_19
14			reserved for future use
15	SDAT0_M	LVDS	Serial data channel 0 negative pin
16	SDAT1_M	LVDS	Serial data channel 1 negative pin
17	SDAT2_M	LVDS	Serial data channel 2 negative pin
18	CLK1_M	LVDS	Clock 1 negative pin
19	DGND	0V	Power ground; ground return for 5V supply voltage (for future use)
20	S_DATA	TTL	(for future use)
21	SDAT3_M	LVDS	Serial data channel 3 negative pin
22	SDAT4_M	LVDS	Serial data channel 4 negative pin
23	SDAT5_M	LVDS	Serial data channel 5 negative pin
24	SDAT6_M	LVDS	Serial data channel 6 negative pin
25	SDAT7_M	LVDS	Serial data channel 7 negative pin
26	GND	0V	LVDS ground; shielding of transmission lines and shielding of cable

5.8 Instrument Functions – External Mixer (Option R&S FSV-B21)

If the R&S FSVA/FSV External Mixer option (R&S FSV-B21) is installed, an external mixer can be connected to the R&S FSVA/FSV to increase the available frequency range.



External mixers - once activated - are available for all instrument applications. (De-)Activation is only possible in the base unit, i.e. in "Spectrum" mode.

Connecting External Mixers

How to connect external mixers is described in the R&S FSVA/FSV Quick Start Guide, "Optional Front Panel Connectors".

General information

Some general information on working with external mixers can be found in [Chapter 5.8.1, "General Information on External Mixers"](#), on page 489.

Menu and softkey description

The "External Mixer" menu is displayed when you select the "External Mixer" softkey in the "Home" menu of the "Spectrum" mode.

For details see [Chapter 5.8.2, "Softkeys of the External Mixer \(Option B21\)"](#), on page 495.

Measurement Example

An introductory example of operating an external mixer is provided in [Chapter 5.8.3, "Introductory Example of Operation"](#), on page 506.

- [General Information on External Mixers](#).....489
- [Softkeys of the External Mixer \(Option B21\)](#).....495
- [Introductory Example of Operation](#)..... 506

5.8.1 General Information on External Mixers

This section contains some general information on external mixers and their application.

5.8.1.1	Frequency Range.....	489
5.8.1.2	Bias Current.....	490
5.8.1.3	Conversion Loss Tables.....	491
5.8.1.4	Full Screen Level.....	492
5.8.1.5	Remarks on Signal Identification with Auto ID.....	492

5.8.1.1 Frequency Range

The frequency of the input signal can be expressed as a function of the LO frequency and the selected harmonic of the first LO as follows:

$$f_{in} = n * f_{LO} + f_{IF}$$

where:

f_{in} : frequency of input signal

n : order of harmonic used for conversion

f_{LO} : frequency of first LO: 7.73 GHz to 15.23 GHz

f_{IF} : intermediate frequency 729.9 MHz

For pre-defined bands, the resulting frequency ranges are as follows:

Table 5-21: Frequency ranges for pre-defined bands

Band	Frequency start [GHz]	Frequency stop [GHz]
K	18.0	26.5
KA (A) *)	26.5	40.0
Q	33.0	50.0
U	40.0	60.0
V	50.0	75.0
E	60.0	90.0
W	75.0	110.0
F	90.0	140.0
D	110.0	170.0
G	140.0	220.0
J	220.0	325.0
Y	325.0	500.0
USER	31.65 (default)	60.1901 (default)

*) The band formerly referred to as "A" is now named "KA".

5.8.1.2 Bias Current

Single-diode mixers generally require a DC voltage which is applied via the LO line. This DC voltage is to be tuned to the minimum conversion loss versus frequency. Such a DC voltage can be set via the "BIAS" function using the D/A converter of the R&S FSVA/FSV. The value to be entered is not the voltage but the short-circuit current. The current is defined in the "Bias Settings" or set to the value of the conversion loss table (see "Bias Settings" on page 503 and "Bias" on page 501).

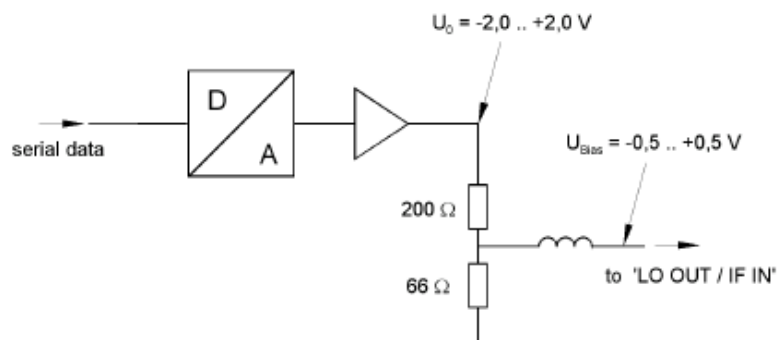

Figure 5-40: Bias circuit of the R&S FSVA/FSV

The voltage U_0 at the output of the operational amplifier can be set in the range -2.0 to $+2.0$ V. An open-circuit voltage V_{bias} of -0.5 to $+0.5$ V is obtained accordingly at the output of the voltage divider. A short-circuit current of $I_{\text{short}} = V_0 / 200 \Omega = 10$ mA to $+10$ mA is obtained for a short circuit at the output of the voltage divider. For using biasing it is not important to know exactly the current flowing through the diode since the conversion loss must be set to minimum with the frequency. It therefore makes no difference whether the setting is performed by an open-circuit voltage or by a short-circuit current. A DC return path is ensured via the 66Ω resistor, which is an advantage in some mixers.

5.8.1.3 Conversion Loss Tables

Conversion loss tables consist of value pairs that describe the correction values for conversion loss at certain frequencies. Correction values for frequencies between the reference values are obtained by interpolation. Linear interpolation is performed if the table contains only two values. If it contains more than two reference values, spline interpolation is carried out. Outside the frequency range covered by the table the conversion loss is assumed to be the same (see Figure 5-41) as that for the first and last reference value.

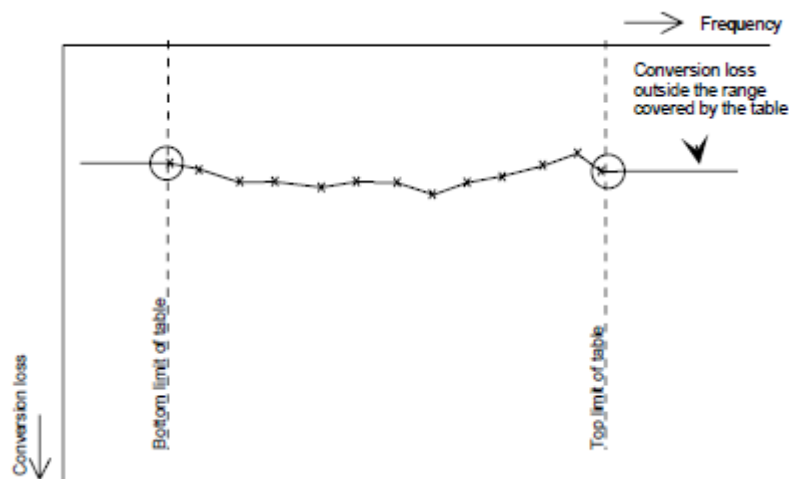

Figure 5-41: Conversion loss outside the band's frequency range

Predefined conversion loss tables are often provided with the external mixer and can be imported to the R&S FSVA/FSV. Alternatively, you can define your own conversion loss tables. Conversion loss tables are configured and managed in the "Conversion Loss Table Setup" tab of the "External Mixer Configuration" dialog box (see "Conversion Loss Table Setup" on page 499).

The conversion loss table to be used for a particular range is defined in the "External Mixer Configuration" dialog box. All tables stored on the instrument in the `C:\r_s\instr\user\cvl\` directory are offered for selection. A validation check is then performed on the selected table to ensure that it complies with the settings. In particular, the following is checked:

- the assigned band name
- the harmonic order
- the mixer type
- the table must contain at least one frequency that lies within the frequency range for the band

5.8.1.4 Full Screen Level

The maximum possible reference level depends on the maximum used conversion loss value. Thus, the reference level can be adjusted for each range according to the used conversion loss table or average conversion loss value. If a conversion loss value is used which exceeds the maximum reference level, the reference level is adjusted to the maximum value permitted by the firmware.

5.8.1.5 Remarks on Signal Identification with Auto ID

Test sweep and reference sweep

Depending on which of the automatic signal identification functions are used, the traces are used to display either the test sweep (the upper side-band sweep) or the reference sweep (lower side-band sweep).

Function	Trace 1	Trace 2	Trace 3
Signal ID	Signal ID upper side-band	Signal ID lower side-band	-
Auto ID	Auto ID	-	-
Signal ID + Auto ID	Signal ID upper side-band	Signal ID lower side-band	Auto ID

Type of signal

The automatic comparison of the test sweep and reference sweep with the "Auto ID" function can only be usefully applied for signals with time-constant spectrum since the two sweeps are always required to determine the actual spectrum.

Tolerance for the comparison of test sweep and reference

Since the LO frequency is displaced downwards in the reference sweep, the conversion loss of the mixer may differ from that of the test sweep. The reasons for this are the LO output power of the R&S FSV varying with the frequency and the non-ideal characteristics of the mixer. A certain tolerance should therefore be permitted for the comparison of the signal levels in the test sweep and reference sweep. The user can set this tolerance using the "AUTO ID THRESHOLD" function. If the tolerance is defined too narrow, the signal collected with the reference sweep may be displayed even for the identification of real signals.

Mixer products with low S/N ratio

If the S/N ratio of a mixer product is less than the tolerance set with "AUTO ID THRESHOLD", the level difference between the test sweep and reference sweep at the frequency of this mixer product is always within limits, even if the signal occurs in one of the sweeps only. Such mixer products cannot be identified by "AUTO ID". It is therefore recommended to perform a visual comparison of the test sweep and reference sweep using the function "SIGNAL ID".

An unwanted signal with a S/N ratio that corresponds approximately to the tolerance set with "AUTO ID THRESHOLD" may not be blanked out permanently. Due to the fact that the noise display varies from one sweep to another, the S/N ratio changes and thus the level difference between the test sweep and reference sweep measured at a frequency changes as well. As a result, the criterion for detecting unwanted signals is not fulfilled. To blank out unwanted signals permanently, an almost constant noise indication is therefore required. This can be achieved by reducing the video bandwidth. Since the average noise indication lies well below the generated noise peak values, the minimum level diminishes. For identification using "AUTO ID" signals should have this minimum level.

Examining unwanted mixer products with small span

With large spans in which non-modulated sinewave signals are represented as single lines, unwanted mixer products are generally completely blanked out. However, if you examine the frequency range containing a blanked signal in detail using a small span, e.g. an image-frequency response, part of the signal may nevertheless be displayed. This happens when the displayed components of a blanked signal have a level difference which is smaller than the tolerance predefined with "AUTO ID THRESHOLD" when compared with the noise floor. These components are therefore not blanked out.

Display of mixer products at the same frequency

If the input signal consists of a very large number of spectral components, it will become more and more probable that two different unwanted mixer products will be displayed at the same frequency in the test sweep and reference sweep.

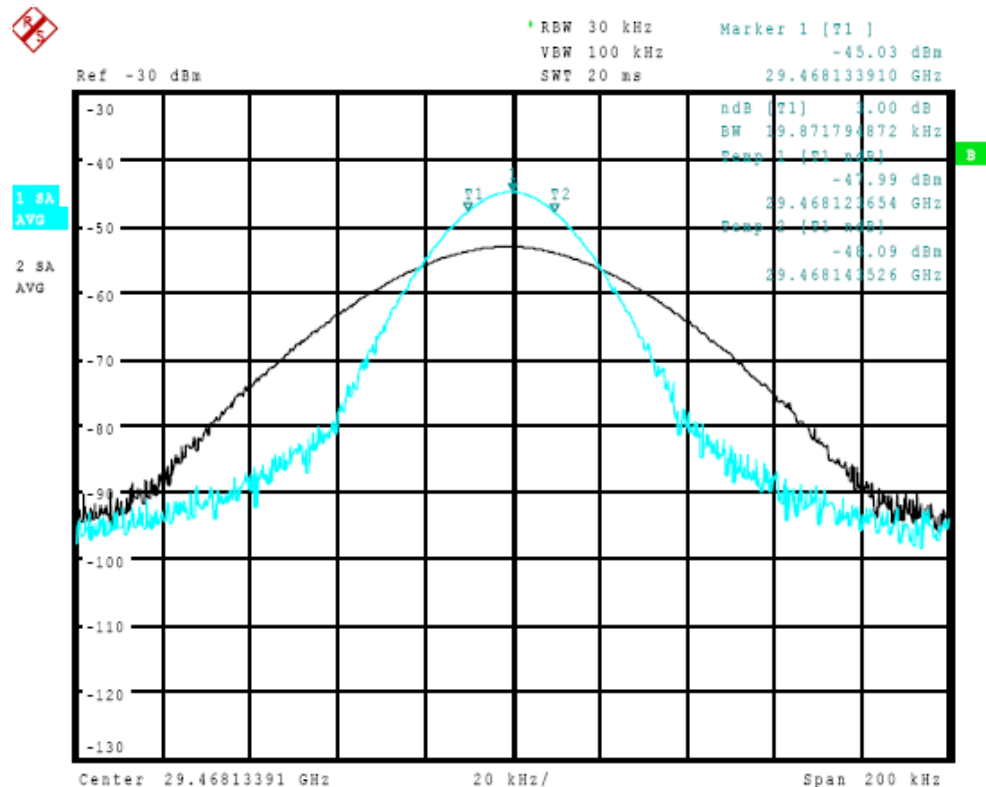

Figure 5-42: Different mixer products displayed at the same frequency in the test sweep and reference sweep

The external mixer has been working using 2nd order harmonic. The signal recorded in the test sweep is displayed by trace 1. The IF filter of the R&S FSVA/FSV is represented at a 3 dB bandwidth of 20 kHz, the real IF bandwidth being 30 kHz. If, however, the 3 dB bandwidth (trace 2) of the signal recorded in the reference sweep is examined, it will be found to be larger exactly by a factor of 2. This shows that the two products were generated by mixing with LO harmonics of different orders. The signal recorded in the test sweep was generated by mixing with 3rd order harmonic. Since the frequency axis scaling is based on the 2nd order, the mixer product or the resulting diagram of the IF filter is compressed by a factor of 2/3. The signal recorded in the reference sweep was generated by mixing with the fundamental of the LO signal. Since the frequency axis scaling is based on the 2nd order, the mixer product or the resulting diagram of the IF filter is expanded by a factor of 2.

Automatic identification with a large span is not possible since the two mixer products are displayed at the same frequency. The diagram shown in [Figure 5-43](#) is obtained when examining products with a narrow span using "AUTO ID". You can easily recognize unwanted mixer products from the clear diagram obtained using "AUTO ID" or "SIGNAL ID".

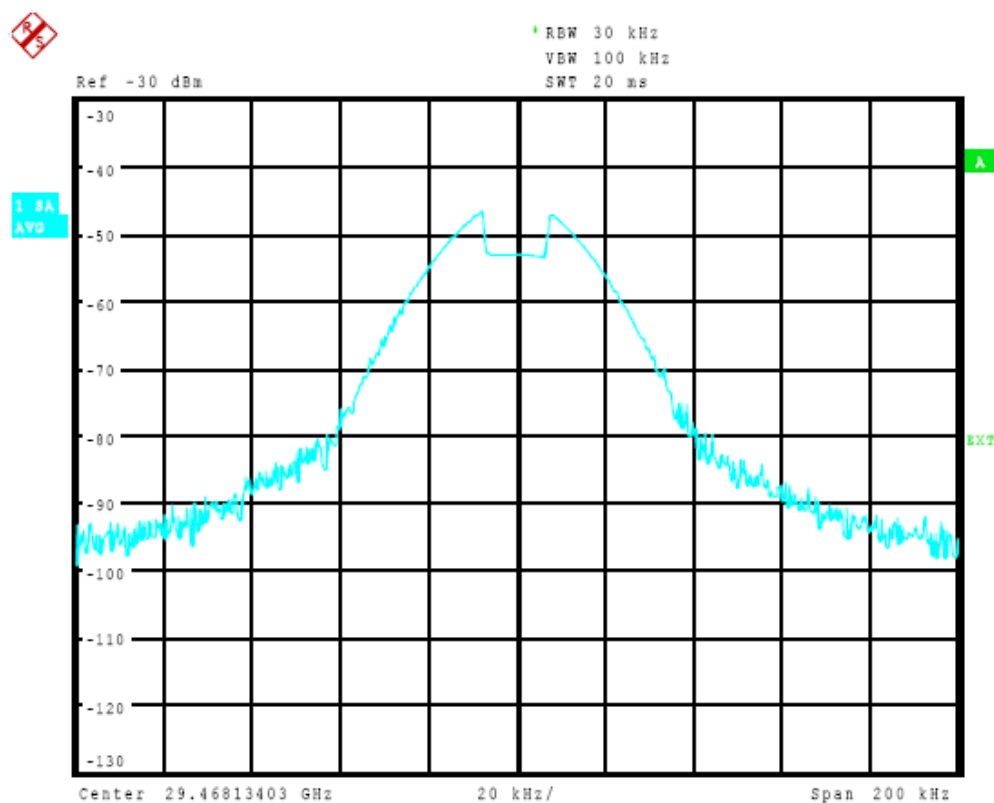

Figure 5-43: Signal as in Screen A: Unwanted mixer product with the use of AUTO ID

5.8.2 Softkeys of the External Mixer (Option B21)

External Mixer.....	496
L External Mixer (On/Off).....	496
L External Mixer Config.....	496
L External Mixer Setup.....	497
L RF Start.....	497
L RF Stop.....	497
L Handover Freq.....	497
L Band.....	497
L RF Overrange.....	497
L Preset Band.....	497
L Mixer Type.....	498
L Harmonic Type.....	498
L Range 1/2.....	498
L Harmonic Order.....	498
L Conversion Loss.....	498
L Conversion Loss Table Setup.....	499
L New Table.....	500
L File Name.....	500
L Comment.....	500

Instrument Functions – External Mixer (Option R&S FSV-B21)

- L Band..... 500
- L Harmonic Order..... 501
- L Bias..... 501
- L Mixer Name..... 501
- L Mixer S/N..... 501
- L Mixer Type..... 501
- L Position/Value..... 501
- L Insert..... 502
- L Delete..... 502
- L Shift x..... 503
- L Shift y..... 503
- L Save..... 503
- L Edit Table..... 503
- L Delete Table..... 503
- L Import Table..... 503
- L Bias Settings..... 503
 - L Write to <CVL table name>..... 504
- L LO Level..... 504
- L Signal ID (On/Off)..... 504
- L Auto ID (On/Off)..... 505
- L Auto ID Threshold..... 506

External Mixer

Opens the submenu for the external mixer.

External Mixer (On/Off) ← External Mixer

Switches the external mixer on or off. Once activated, the external mixer is available for all applications on the instrument.

Remote command:

[SENSe:]MIXer[:STATe] on page 826

External Mixer Config ← External Mixer

Opens the "External Mixer Configuration" dialog box that contains two tabs:

- "External Mixer Setup" on page 497
- "Conversion Loss Table Setup" on page 499

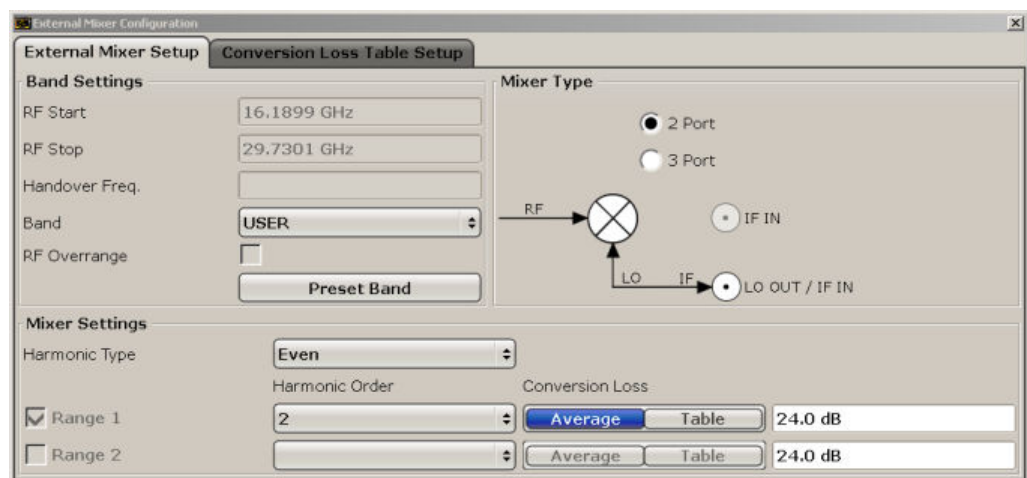

External Mixer Setup ← External Mixer Config ← External Mixer

In this tab you configure the band and mixer settings.

RF Start ← External Mixer Setup ← External Mixer Config ← External Mixer

Displays the start frequency of the selected band. For pre-defined bands, the frequency range is set automatically (see [Table 5-21](#)).

Remote command:

`[SENSe:]MIXer:FREQuency:STARt?` on page 828

RF Stop ← External Mixer Setup ← External Mixer Config ← External Mixer

Displays the stop frequency of the selected band. For pre-defined bands, the frequency range is set automatically (see [Table 5-21](#)).

Remote command:

`[SENSe:]MIXer:FREQuency:STOP?` on page 828

Handover Freq. ← External Mixer Setup ← External Mixer Config ← External Mixer

Defines the frequency at which the mixer switches from one range to the next (if two different ranges are selected). The handover frequency can be selected freely within the overlapping frequency range.

Remote command:

`[SENSe:]MIXer:FREQuency:HANDOver` on page 828

Band ← External Mixer Setup ← External Mixer Config ← External Mixer

Defines the waveguide band or user-defined band to be used by the mixer.

The start and stop frequencies of the selected band are displayed in the "RF Start" and "RF Stop" fields.

For a definition of the frequency range for the pre-defined bands, see [Table 5-21](#)).

The mixer settings for the user-defined band can be selected freely. The frequency range for the user band is defined via the harmonics configuration (see ["Range 1/2"](#) on page 498).

Note: The band formerly referred to as "A" is now named "KA".

Remote command:

`[SENSe:]MIXer:HARMonic:BAND` on page 829

RF Overrange ← External Mixer Setup ← External Mixer Config ← External Mixer

Specifies whether the band limits are extended beyond "RF Start" and "RF Stop" due to the capabilities of the used harmonics.

Remote command:

`[SENSe:]MIXer:RFOVerrange[:STATe]` on page 827

Preset Band ← External Mixer Setup ← External Mixer Config ← External Mixer

Restores the presettings for the selected band.

Note: changes to the band and mixer settings are maintained even after using the [PRESET] function. This function allows you to restore the original band settings.

Remote command:

[\[SENSe:\]MIXer:HARMonic:BAND:PRESet](#) on page 829

Mixer Type ← External Mixer Setup ← External Mixer Config ← External Mixer

The R&S FSVA/FSV option B21 allows for the following external mixer types:

"2 Port" LO and IF data uses the same port

"3 Port" LO and IF data uses separate ports

Remote command:

[\[SENSe:\]MIXer:PORTs](#) on page 832

Harmonic Type ← External Mixer Setup ← External Mixer Config ← External Mixer

Defines if only even, only odd, or even and odd harmonics can be used for conversion. Depending on this selection, the order of harmonic to be used for conversion changes (see "[Harmonic Order](#)" on page 498).

Remote command:

[\[SENSe:\]MIXer:HARMonic:TYPE](#) on page 830

Range 1/2 ← External Mixer Setup ← External Mixer Config ← External Mixer

Enables the use of a second harmonic to cover the band's frequency range.

For each range you can define which harmonic to use and how the [Conversion Loss](#) is handled.

Remote command:

[\[SENSe:\]MIXer:HARMonic:HIGH:STATE](#) on page 829

Harmonic Order ← Range 1/2 ← External Mixer Setup ← External Mixer Config ← External Mixer

Defines which of the available harmonic orders are used to cover the frequency range.

By default, the lowest order of the specified harmonic type is selected that allows conversion of input signals in the whole band. If due to the LO frequency the conversion is not possible using one harmonic, the band is splitted.

For the band "USER", the order of harmonic is defined by the user. The order of harmonic can be between 2 and 100, the lowest usable frequency being 26,5 GHz.

Remote command:

[\[SENSe:\]MIXer:HARMonic\[:LOW\]](#) on page 830

[\[SENSe:\]MIXer:HARMonic:HIGH\[:VALue\]](#) on page 830

Conversion Loss ← Range 1/2 ← External Mixer Setup ← External Mixer Config ← External Mixer

Defines how the conversion loss is handled. The following possibilities are available:

"Average" Defines the average conversion loss for the entire range in dB.

"Table" Defines the conversion loss via the table selected from the list. Pre-defined conversion loss tables are often provided with the external mixer and can be imported to the R&S FSVA/FSV. Alternatively, you can define your own conversion loss tables. Conversion loss tables are configured and managed in the [Conversion Loss Table Setup](#) tab. For details on conversion loss tables, see [Chapter 5.8.1.3, "Conversion Loss Tables"](#), on page 491. For details on importing tables, see ["Import Table"](#) on page 503.

All tables stored on the instrument in the `C:\r_s\instr\user\cvl\` directory are offered for selection. A validation check is then performed on the selected table to ensure that it complies with the settings. In particular, the following is checked:

- the assigned band name
- the harmonic order
- the mixer type
- the table must contain at least one frequency that lies within the frequency range for the band

Remote command:

[\[SENSe:\]MIXer:LOSS\[:LOW\]](#) on page 832

Average for range 1

[\[SENSe:\]MIXer:LOSS:TABLE\[:LOW\]](#) on page 831

Table for range 1

[\[SENSe:\]MIXer:LOSS:HIGH](#) on page 831

Average for range 2

[\[SENSe:\]MIXer:LOSS:TABLE:HIGH](#) on page 831

Table for range 2

Conversion Loss Table Setup ← External Mixer Config ← External Mixer

In this tab you configure and manage conversion loss tables. Conversion loss tables consist of value pairs that describe the correction values for conversion loss at certain frequencies. The correction values for frequencies between the reference points are obtained via interpolation.

The currently selected table for each range is displayed at the top of the dialog box.

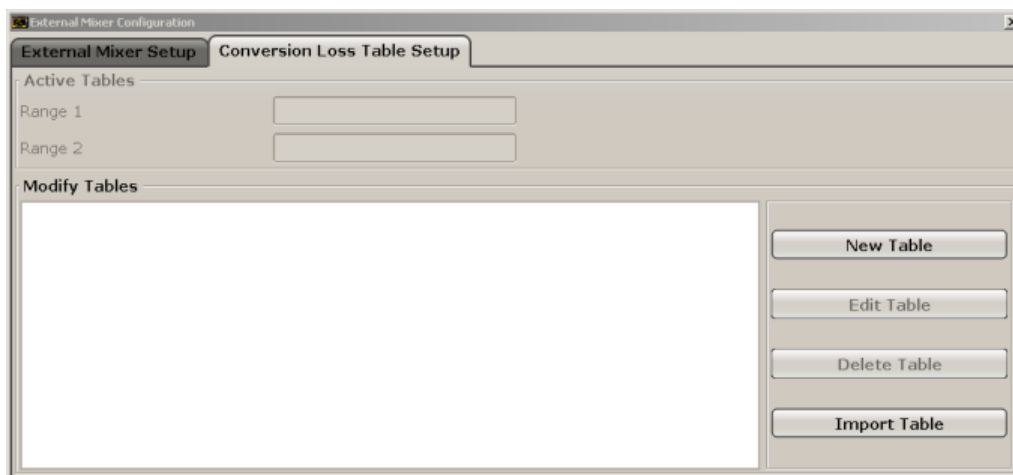

New Table ← Conversion Loss Table Setup ← External Mixer Config ← External Mixer

Opens the "Edit Conversion Loss Table" dialog box to configure a new conversion loss table.

Position	Value
10.00 Hz	1.00 dB
20.00 Hz	2.00 dB

A preview pane displays the current configuration of the conversion loss function as described by the Position/Value entries.

Remote command:

[\[SENSe:\]CORRection:CVL:SELeCt](#) on page 791

File Name ← New Table ← Conversion Loss Table Setup ← External Mixer Config ← External Mixer

Defines the name under which the table is stored in the C:\r_s\instr\user\cvl\ directory on the instrument. The name of the table is identical with the name of the file (without extension) in which the table is stored. The entry in this field is mandatory. The .ACL extension is automatically appended during storage.

Remote command:

[\[SENSe:\]CORRection:CVL:SELeCt](#) on page 791

Comment ← New Table ← Conversion Loss Table Setup ← External Mixer Config ← External Mixer

An optional comment that describes the conversion loss table. The comment can be freely defined by the user.

Remote command:

[\[SENSe:\]CORRection:CVL:COMMeNt](#) on page 793

Band ← New Table ← Conversion Loss Table Setup ← External Mixer Config ← External Mixer

The waveguide or user-defined band for which the table is to be applied.

For a definition of the frequency range for the pre-defined bands, see [Table 5-21](#)).

Remote command:

[SENSe:]CORRection:CVL:BAND on page 790

Harmonic Order ← **New Table** ← **Conversion Loss Table Setup** ← **External Mixer Config** ← **External Mixer**

The harmonic order for which the table is to be applied.

Remote command:

[SENSe:]CORRection:CVL:HARMonic on page 792

Bias ← **New Table** ← **Conversion Loss Table Setup** ← **External Mixer Config** ← **External Mixer**

The bias current which is required to set the mixer to its optimum operating point. It corresponds to the short-circuit current. The bias current can range from -10 mA to 10 mA. The actual bias current is lower because of the forward voltage of the mixer diode(s).

Tip: You can also define the bias interactively while a preview of the trace with the changed setting is displayed, see "[Bias Settings](#)" on page 503.

Remote command:

[SENSe:]CORRection:CVL:BIAS on page 793

Mixer Name ← **New Table** ← **Conversion Loss Table Setup** ← **External Mixer Config** ← **External Mixer**

Specifies the name of the external mixer for which the table is to be applied.

Remote command:

[SENSe:]CORRection:CVL:MIXer on page 791

Mixer S/N ← **New Table** ← **Conversion Loss Table Setup** ← **External Mixer Config** ← **External Mixer**

Specifies the serial number of the external mixer for which the table is to be applied.

Remote command:

[SENSe:]CORRection:CVL:SNUMber on page 791

Mixer Type ← **New Table** ← **Conversion Loss Table Setup** ← **External Mixer Config** ← **External Mixer**

Specifies whether the external mixer for which the table is to be applied is a two-port or three-port type.

Remote command:

[SENSe:]CORRection:CVL:PORTs on page 792

Position/Value ← **New Table** ← **Conversion Loss Table Setup** ← **External Mixer Config** ← **External Mixer**

Each position/value pair defines the correction value for conversion loss for a specific frequency. The reference values must be entered in order of increasing frequencies. A maximum of 50 reference values can be entered.

Correction values for frequencies between the reference values are obtained by interpolation. Linear interpolation is performed if the table contains only two values. If it contains more than two reference values, spline interpolation is carried out. Outside the frequency range covered by the table the conversion loss is assumed to be the same (see Figure 5-41) as that for the first and last reference value.

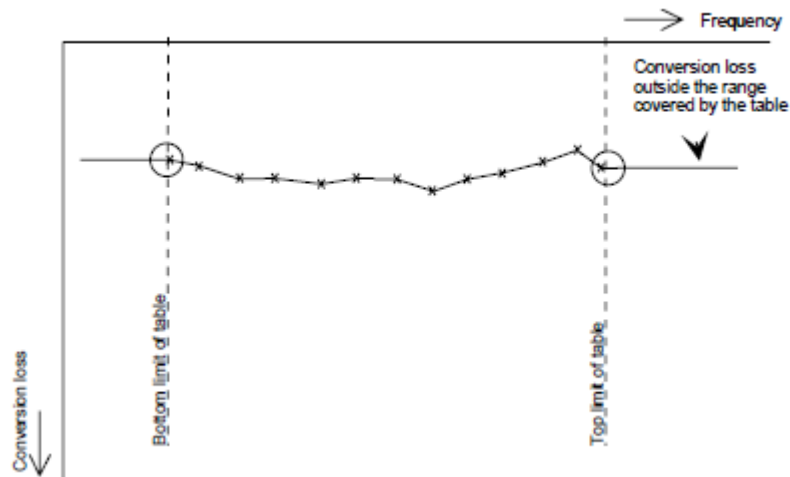

Figure 5-44: Conversion loss outside the band's frequency range

The current configuration of the conversion loss function as described by the Position/Value entries is displayed in the preview pane to the right of the table.

The following functions are available to define the table:

- [Insert an entry](#)
- [Delete an entry](#)
- [Shift all positions by a specific value \(shift x\)](#)
- [Shift all conversion loss values by a specific value \(shift y\)](#)

Remote command:

`[SENSe:]CORRection:CVL:DATA` on page 793

Insert ← **New Table** ← **Conversion Loss Table Setup** ← **External Mixer Config** ← **External Mixer**

Inserts a new position/value entry in the table.

If the table is empty, a new entry at 0 Hz is inserted.

If entries already exist, a new entry is inserted above the selected entry. The position of the new entry is selected such that it divides the span to the previous entry in half.

Delete ← **New Table** ← **Conversion Loss Table Setup** ← **External Mixer Config** ← **External Mixer**

Deletes the currently selected position/value entry.

Shift x ← New Table ← Conversion Loss Table Setup ← External Mixer Config ← External Mixer

Shifts all positions in the table by a specific value. The value can be entered in the edit dialog box. The conversion loss function in the preview pane is shifted along the x-axis.

Shift y ← New Table ← Conversion Loss Table Setup ← External Mixer Config ← External Mixer

Shifts all conversion loss values by a specific value. The value can be entered in the edit dialog box. The conversion loss function in the preview pane is shifted along the y-axis.

Save ← New Table ← Conversion Loss Table Setup ← External Mixer Config ← External Mixer

The conversion loss table is stored under the specified name in the C:\r_s\instr\user\cvl\ directory of the instrument.

Edit Table ← Conversion Loss Table Setup ← External Mixer Config ← External Mixer

Opens the "Edit Conversion Loss Table" dialog box to edit the selected conversion loss table. For details on table configuration see "New Table" on page 500.

Remote command:

[SENSe:]CORRection:CVL:SElect on page 791

Delete Table ← Conversion Loss Table Setup ← External Mixer Config ← External Mixer

Deletes the currently selected conversion loss table after you confirm the action.

Remote command:

[SENSe:]CORRection:CVL:CLEar on page 794

Import Table ← Conversion Loss Table Setup ← External Mixer Config ← External Mixer

Imports a stored conversion loss table from any directory to the instrument's C:\r_s\instr\user\cvl\ directory.

Bias Settings ← External Mixer

Opens a dialog box to define the bias current for each range, which is required to set the mixer to its optimum operating point. It corresponds to the short-circuit current. The bias current can range from -10 mA to 10 mA. The actual bias current is lower because of the forward voltage of the mixer diode(s).

The trace is adapted to the settings immediately so you can check the results. To store the bias setting in the currently selected conversion loss table, select the [Write to <CVL table name>](#) button.

Remote command:

[SENSe:]MIXer:BIAS:LOW on page 827

[SENSe:]MIXer:BIAS:HIGH on page 827

Write to <CVL table name> ← Bias Settings ← External Mixer

Stores the bias setting in the currently selected "Conversion Loss Table" for the range (see "Conversion Loss Table Setup" on page 499).

Remote command:

[SENSe:]CORRection:CVL:BIAS on page 793

LO Level ← External Mixer

Opens an edit dialog box to change the LO level of the external mixer's LO port from 13.0 dBm to 17.0 dBm in 0.1 dB steps. Default value is 15.5 dB.

Remote command:

[SENSe:]MIXer:LOPower on page 830

Signal ID (On/Off) ← External Mixer

The SIGNAL ID softkey activates or deactivates visual signal identification. Two sweeps are performed alternately. Trace 1 shows the trace measured on the upper side band (USB) of the LO (the test sweep), trace 2 shows the trace measured on the lower side band (LSB), i.e. the reference sweep. (See also Chapter 5.8.1.5, "Remarks on Signal Identification with Auto ID", on page 492).

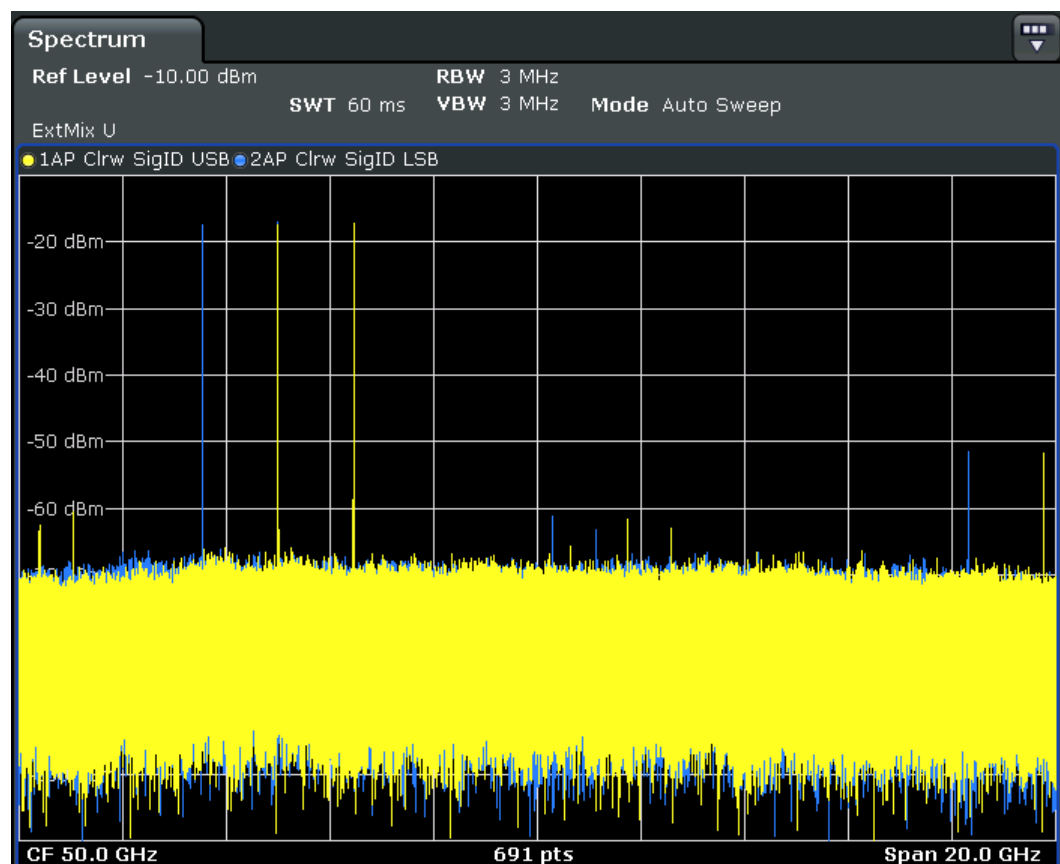

The reference sweep is performed using a LO setting shifted downwards by $2 \cdot \text{IF} / \langle \text{Harmonic order} \rangle$. Input signals in the wanted sideband that are converted using the specified harmonic are displayed in both traces at the same position on the frequency axis. Image signals and mixer products caused by other harmonics are displayed in both traces at different positions. The user identifies the signals visually by comparing the two traces.

Since the LO frequency is displaced downwards in the reference sweep, the conversion loss of the mixer may differ from the test sweep. Therefore the level should only be measured in the test sweep (trace 1).

Mathematical functions with traces and trace copy cannot be used with the Signal ID function.

Remote command:

[SENSe:]MIXer:SIGNal on page 832

Auto ID (On/Off) ← External Mixer

Activates or deactivates automatic signal identification.

Auto ID basically functions like [Signal ID \(On/Off\)](#). However, the test and reference sweeps are converted into a single trace by a comparison of maximum peak values of each sweep point. The result of this comparison is displayed in trace 3 if "Signal ID" is active at the same time. If "Signal ID" is not active, the result can be displayed in any of the traces 1 to 3. Unwanted mixer products are suppressed in this calculated trace. (See also [Chapter 5.8.1.5, "Remarks on Signal Identification with Auto ID"](#), on page 492).

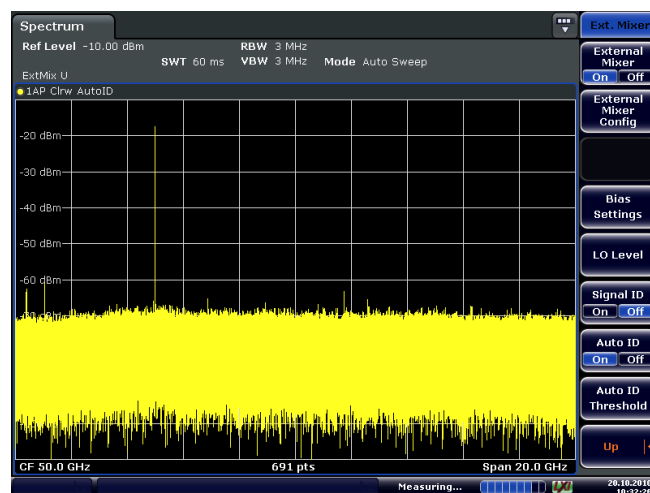

Real input signals are displayed at the same frequency in the test and reference sweeps, i.e. theoretically identical signal levels are expected in the two sweeps at the frequency of the real mixer product. If the level difference is lower than the tolerance set with [Auto ID Threshold](#), the signal obtained in the test sweep is displayed. If a signal occurs only in the test sweep or reference sweep, it is an unwanted mixer product. The level of this signal is compared to the noise floor in the other sweep. If the S/N ratio is sufficiently large, the tolerance limit for the maximum permissible level difference is exceeded. This means that the signal with the lower level, i.e. noise in this case, is displayed.

Note that "Auto ID" functions according to the fail-safe principle, i.e. unwanted mixer products may not be detected as such but signals which are in fact real input signals are not blanked out. See also [Chapter 5.8.1.5, "Remarks on Signal Identification with Auto ID"](#), on page 492.

Remote command:

[SENSe:]MIXer:SIGNal on page 832

Auto ID Threshold ← External Mixer

Allows the maximum permissible level difference between test sweep and reference sweep to be corrected during automatic comparison ([Auto ID](#) function). The input range is between 0.1 dB and 100 dB. Values of about 10 dB (i.e. default setting) generally yield satisfactory results. See also [Chapter 5.8.1.5, "Remarks on Signal Identification with Auto ID"](#), on page 492.

Remote command:

[SENSe:]MIXer:THReshold on page 833

5.8.3 Introductory Example of Operation

The following example gives an example of the operation of external mixers as well as the required settings: A sine wave signal with $f = 14.5$ GHz is applied to the input of a multiplier. The spectrum at the multiplier output is to be recorded in the range of 52 to 60 GHz using a 2-port mixer for the V band. The mixer used is a double-diode mixer. The example of operation is described in the following steps:

- Test Setup
- Activating the External Mixer and Selecting the Mode
- Default Settings
- Level Correction
- Frequency-dependant Level Correction
- Level Correction with an Average Value
- Taking into Account the Cable Loss in the IF Path
- Functions for Signal Identification

Test Setup

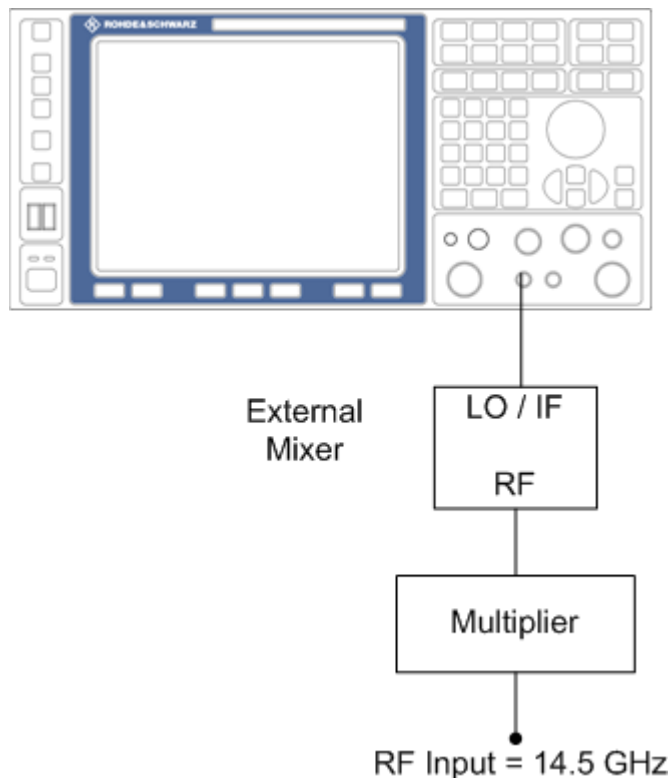

Figure 5-45: External mixer test setup

1. 1. Connect the "LO OUT / IF IN" output of the R&S FSVA/FSV to the LO/IF port of the external mixer.
2. Connect the multiplier to the external mixer.
3. Apply a sine wave signal with $f = 14.5 \text{ GHz}$ to the input of the multiplier.

Activating the External Mixer and Selecting the Mode

- ▶ Activate the external mixing for all applications by selecting "FREQ > External Mixer > External Mixer ON" in Spectrum mode.

Default Settings

Prior to the measurement select the required band (in this case the V band).

1. Select "FREQ > External Mixer > External Mixer Config".
2. From the "Band" selection list, select the "V" band.

Level Correction

The conversion loss of the mixer can be taken into account either as a function of frequency (table with reference values) or using an average value. The frequency-dependent level correction is used in this example in order to obtain a higher precision. As an alternative, level correction based on average value can be used (see below).

1. Select "FREQ > External Mixer > External Mixer Config".
2. For Range 1, select "Table".
3. From the selection list, select a conversion loss table stored on the instrument.
If the selected table is not valid for the selected band, an error message is displayed.

5.8.3.1 Frequency-dependent Level Correction

1. Open the external mixer configuration settings by selecting "FREQ > External Mixer > External Mixer Config".
2. Select the required "Band".
3. For "Range 1", select "Table".
4. From the selection list, select a conversion loss table stored on the instrument. No further settings are necessary since the selected file contains all required parameters. If the selected table is not valid for the selected band, an error message is displayed.
If no conversion loss table is available yet, create a new table first (in the "Conversion Loss Table Setup" tab, see ["New Table"](#) on page 500).
5. A span is automatically set which covers the whole V band (50 to 75 GHz).
6. Set the frequency range to be examined by selecting "FREQ > Frequency Start"=*52 GHz* and "FREQ > Frequency Stop"=*60 GHz*.
7. Reduce the video bandwidth by selecting "BW > Video Bandwidth Manual"=*1 MHz*. This allows for correct signal identification using "AUTO ID" (see also [Chapter 5.8.1.5, "Remarks on Signal Identification with Auto ID"](#), on page 492).

5.8.3.2 Level Correction with an Average Value

To take an average value into account instead of the frequency-dependent level correction, enter the following parameters for the selected band in the external mixer configuration settings:

1. Open the external mixer configuration settings by selecting "FREQ > External Mixer > External Mixer Config".
2. Select the required "Band".
3. For "Range 1", select "Average".

4. Enter the average of the conversion loss.

The entered average value is taken into account for the spectrum display irrespective of the frequency. The precision that can be obtained depends on the frequency response of the mixer. With this type of level correction, measurements can be easily performed at single frequencies.

5.8.3.3 Taking into Account the Cable Loss in the IF Path

On performing level correction, the conversion loss of the mixer and also the insertion loss a_0 of the cable used to tap off the IF signal are to be taken into account. This additional loss is frequency-dependent.

1. Determine the insertion of the cable at the intermediate frequency $f_{IF} = 729.9 \text{ MHz}$.
2. For level correction with average value, add the cable insertion loss to the average conversion loss.

For frequency-dependent level correction, increase each reference value by the insertion loss to the same extent. To do so, you can enter the cable loss using a transducer table. Such a table should only contain two reference values (band start and end) for which a_0 is specified.

5.9 Instrument Functions - Power Sensor (R&S FSV-K9)

For precise power measurement up to 4 power sensors can be connected to the instrument via the power sensor interface (option R&S FSV-B5, front panel) or the USB connector (front or rear panel). The Power Sensor Support firmware option provides the power measurement functions for this test setup. Both manual operation and remote control are supported. The power sensor results are displayed in the marker table.

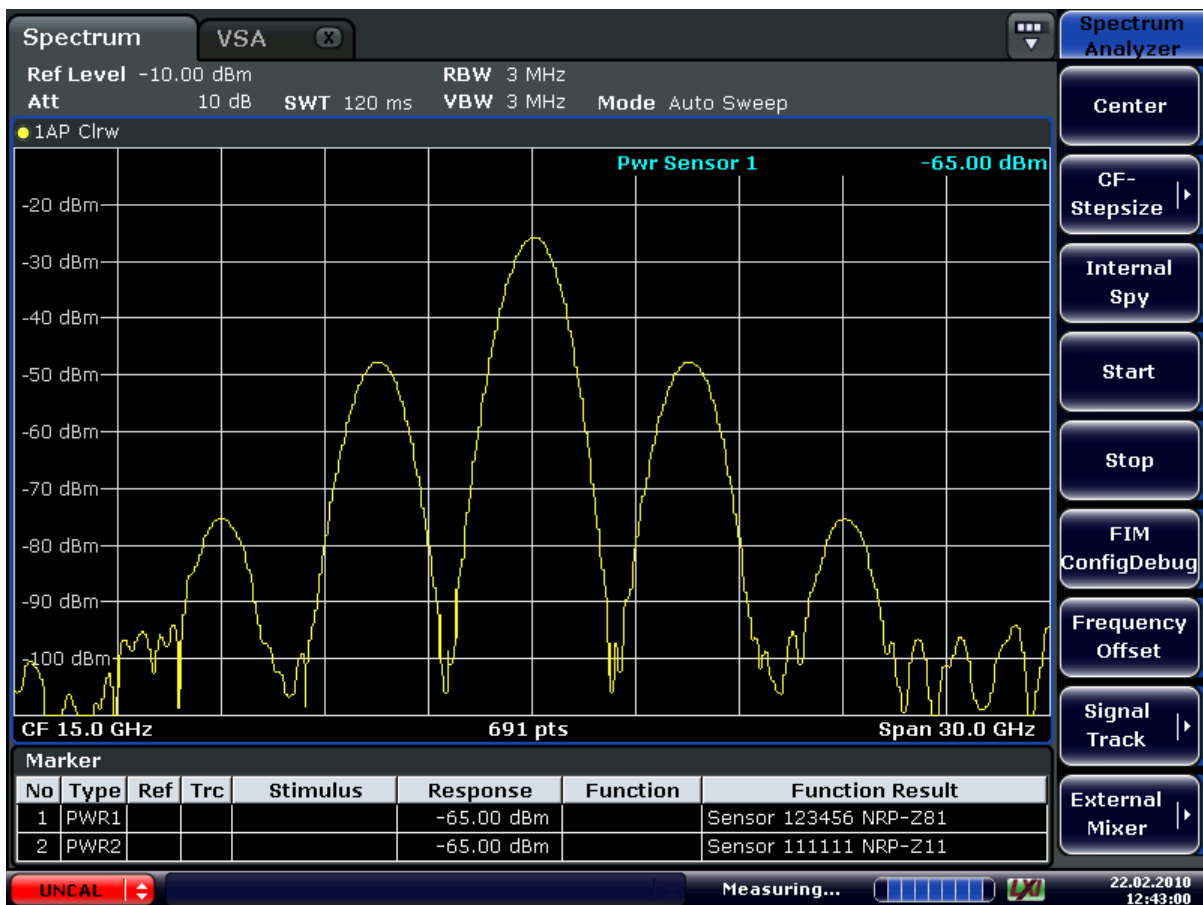

For details on the connectors and compatible power sensors refer to the Quick Start Guide, chapter 1, "Front and Rear Panel".

For details on compatible power sensors refer to the data sheet.

Power Sensors can also be used to trigger a measurement at a specified power level, e.g. from a signal generator.

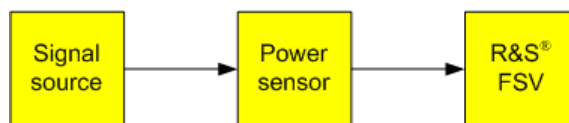

Figure 5-46: Power sensor support – standard test setup



Using the power sensor with several applications

The power sensor cannot be used from the R&S FSVA/FSV firmware and the R&S Power Viewer (virtual power meter for displaying results of the R&S NRP power sensors) simultaneously. After using the Power Viewer, close the application, then unplug and replug the sensor. Afterwards the power sensor can be used by the R&S FSVA/FSV again.

To open the Power Sensor menu

The power sensor option R&S FSV-K9 is integrated within the "Input/Output" menu.

- Press the [INPUT/OUTPUT] key.
- Press the "Power Sensor" softkey. The "Power Sensor" menu is displayed.

Menu and softkey description

- [Chapter 5.9.4, "Softkeys of the Power Sensor Menu \(R&S FSV-K9\)", on page 516](#)
- [Chapter 5.9.5, "Power Sensor Configuration Dialog", on page 518](#)

Remote operation

Power sensors can be operated using the following remote command subsystems:

- ["CALCulate:PMETer Subsystem \(Power Sensor, R&S FSV-K9\)" on page 733](#)
- [Chapter 6.3.3.3, "CALibration:PMETer Subsystem \(Power Sensor, R&S FSV-K9\)", on page 748](#)
- [Chapter 6.3.3.6, "FETCh:PMETer Subsystem \(Power Sensor, R&S FSV-K9\)", on page 758](#)
- [Chapter 6.3.3.14, "READ:PMETer Subsystem", on page 780](#)
- ["SENSe:PMETer<p> Subsystem \(Power Sensor, R&S FSV-K9\)" on page 837](#)
- [Chapter 6.3.3.21, "UNIT Subsystem", on page 914](#)

Results display

The results of the power sensor measurements are displayed in the marker table. For each power sensor, a row is inserted. The sensor index is indicated in the "Function" column.

Marker						
No	Type	Trc	Stimulus	Response	Function	Function Result
1	PWR2			---	Sensor 2	Sensor ?
2	PWR3			---	Sensor 3	Sensor ?
3	PWR4			---	Sensor 4	Sensor ?

Alternatively, you can query the results using the remote command `FETCh<n>:PMETer<p>?` on page 759.

Tasks

The following tasks with Power Sensors are described in this chapter:

- [Chapter 5.9.2, "Zeroing the Power Sensor", on page 513](#)
- [Chapter 5.9.1, "Using Power Sensors", on page 512](#)
- [Chapter 5.9.3, "Configuring an External Power Trigger", on page 514](#)

Further information

Information on possible error messages when using the Power Sensor is provided in [Chapter 5.9.6, "Error Messages"](#), on page 521.

5.9.1	Using Power Sensors.....	512
5.9.2	Zeroing the Power Sensor.....	513
5.9.3	Configuring an External Power Trigger.....	514
5.9.4	Softkeys of the Power Sensor Menu (R&S FSV-K9).....	516
5.9.5	Power Sensor Configuration Dialog.....	518
5.9.6	Error Messages.....	521

5.9.1 Using Power Sensors

Up to 4 external power sensors can be configured separately and used for precise power measurement, as a trigger, or both. All power sensors can be activated and deactivated individually.

The following procedure describes in detail how to configure and activate power sensors.



For details on the settings in the "Power Sensor Configuration" dialog box, see [Chapter 5.9.5, "Power Sensor Configuration Dialog"](#), on page 518.

1. Press [Input/Output] > "Power Sensor" to display the "Power Sensor" menu.
2. Press "Power Sensor Config" to display the configuration dialog box.
3. Select the tab for the power sensor index you want to configure, e.g. "Sensor 1".
Note: if automatic assignment is active (default) and a power sensor is already connected to the R&S FSVA/FSV, the serial number of the sensor is indicated in one of the tabs. In this case, you configure that particular sensor in the corresponding tab. If no serial number is indicated, you can set up a configuration and assign a sensor manually later.
4. Press "Select" to evaluate the power sensor when power measurement is activated.
5. Define the frequency of the signal whose power you want to measure.
 - a) To define the frequency manually, select "Frequency Manual" and enter a frequency.
 - b) To determine the frequency automatically, select "Frequency Coupling" and then either "Center", to use the center frequency, or "Marker", to use the frequency defined by marker 1.
6. Select the "Unit" for the power result display.

7. Select the measurement time for which the average is calculated. To define the number of readings to be taken into account manually, select "Manual" and enter the number in the "Number of Readings" field.
8. To activate the duty cycle correction, select "DutyCycle" and enter a percentage as the correction value.
9. If you selected "dB" or "%" as units (relative display), define a reference value:
 - a) To set the currently measured power as a reference value, press the "Meas -> Ref" button.
 - b) Alternatively, enter a value manually in the "Reference Value" field.
 - c) Optionally, select the "Use Ref Level Offset" option to take the reference level offset set for the analyzer ([Ref Level Offset](#) softkey) into account for the measured power.
10. Optionally, define the usage of an external power trigger (see [Chapter 5.9.3, "Configuring an External Power Trigger"](#), on page 514).
11. If necessary, repeat steps 3-10 for another power sensor.
12. By default, automatic assignment is active. If a power sensor is already connected to the R&S FSVA/FSV, it is automatically assigned to an index and the serial number of the sensor is indicated on the corresponding tab. In this case, you already configured the settings for the assigned power sensor. Otherwise, assign the connected power sensors to the power sensor configurations manually:
 - a) Press the "Power Sensor Assignment" softkey in the "Power Sensor" menu to display the assignment dialog box.
 - b) For each configuration, define whether it is to be assigned automatically or manually by activating or deactivating the "Auto Assignment" option for the corresponding power sensor index.
 - c) For manual assignment, select the serial number of one of the connected power sensors from the list.
13. Press the "Power Sensor On" softkey in the "Power Sensor" menu to activate power measurement for the selected power sensors.

The results of the power measurement are displayed in the marker table (Function: "Sensor<1...4>") and can be queried via the remote command `FETC:PMET<p>?` (see [FETCh<n>:PMETer<p>?](#) on page 759).

5.9.2 Zeroing the Power Sensor

You can reset each power sensor to zero. This can be done using the remote command `CALibration:PMETer<p>:ZERO:AUTO ONCE` on page 748 or manually, as described here.

1. In the "Power Sensor" menu ([Input/Output] > "Power Sensor"), press "Power Sensor Config" to display the configuration dialog box.

2. Select the tab that is assigned to the power sensor you want to zero.
3. Press the "Zeroing Power Sensor" button.
A dialog box is displayed that prompts you to disconnect all signals from the input of the power sensor.
4. Disconnect all signals from the input of the power sensor and press [ENTER] to continue.
5. Wait until zeroing is complete.
A corresponding message is displayed.

5.9.3 Configuring an External Power Trigger

Power Sensors can be used to trigger a measurement at a specified power level, e.g. from a signal generator.



Currently, the following power sensors are supported:

- R&S NRP-Z81/85/86
- all NRPxxS/SN
- all NRPxxT/TN

As of firmware version 1.60 (with an appropriate detector board as of version 5.00), the power sensors can be connected to the "Power Sensor" interface directly, and no further cables are required. They can then be configured as an external trigger or a power sensor trigger. The measured power results are displayed as usual.

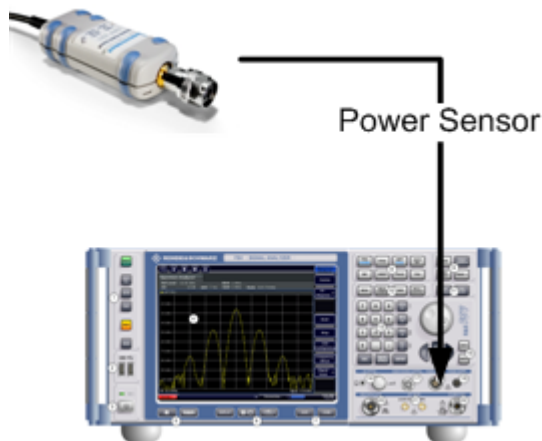

The previous connection and configuration of a power sensor as an external trigger is still supported. It is not necessary to change an existing trigger setup unless you want to evaluate the measured power results further.

Power Trigger Parameters

With the new implementation of the power sensor triggers some additional trigger parameters were introduced. The following figure illustrates the trigger parameters for an external power trigger.

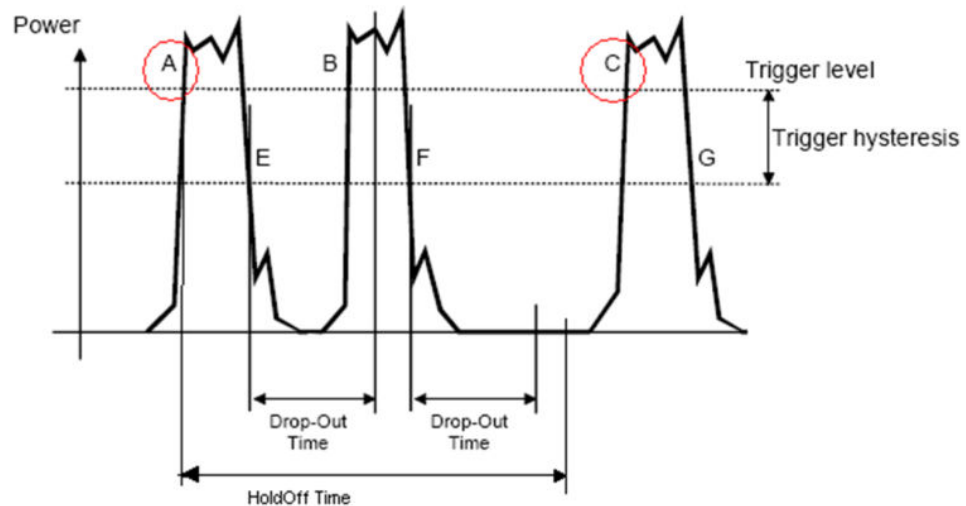

Figure 5-47: Power Sensor Trigger Parameters

- **Level:** Power that triggers the measurement
- **Hysteresis:** Distance the input signal must stay below the trigger level before triggering again
- **Holdoff time:** Time which must pass before triggering again
- **Dropout time:** Time the input signal must stay below the trigger level before triggering again
- **Slope:** Direction of edge on which the trigger occurs (positive = rising, negative = falling)

Example:

In [Power Sensor Trigger Parameters](#), the events A and C are valid trigger events for triggering on a positive slope. The trigger level is exceeded and the dropout time and holdoff time have elapsed. For triggering on a negative slope, E and G are valid trigger events. B and F, however, are not valid trigger events: For B, the dropout time has not elapsed; for F, the holdoff time has not yet elapsed.

To configure a power sensor as an external power sensor (PSE) trigger

This is the way to configure a power sensor as an explicit power sensor trigger.

1. Connect the power sensor to the "Power Sensor" interface on the front panel of the R&S FSVA/FSV.
2. Configure the power sensor for use as described in [Chapter 5.9.1, "Using Power Sensors"](#), on page 512.

3. Select the "External Power Trigger" option.
4. Enter the power level at which the measurement is to be triggered ("External Trigger Level").
5. Enter the minimum power difference that should occur between two trigger events ("Hysteresis").
6. Enter the minimum time that should pass between two trigger events ("Holdoff").
7. Enter the minimum time the signal should remain beneath the trigger level before the next trigger event occurs ("Dropout").
8. Select whether the measurement is triggered on a rising (positive) or falling (negative) edge ("Slope").
9. Press the [TRIG] key on the front panel of the instrument to display the "Trigger" menu.
10. Press the "Trg/Gate Source" softkey.
11. Select the "Power Sensor" softkey.
12. If necessary, configure the "Gate Settings" to define a gated sweep (see [Chapter 5.2.9.3, "Using Gated Sweep Operation"](#), on page 246).



The "Gate Mode" *Lvl* is not supported for R&S power sensors. The trigger impulse sent by these sensors is not long enough to be used as a level for the gated sweep.

The R&S FSVA/FSV is configured to trigger when the defined conditions for the power sensor occur. Power measurement results are provided as usual.

5.9.4 Softkeys of the Power Sensor Menu (R&S FSV-K9)

The following table shows all softkeys available in the "Power Sensor" menu. It is possible that your instrument configuration does not provide all softkeys. If a softkey is only available with a special option, model or (measurement) mode, this information is delivered in the corresponding softkey description.

For details on how to configure and activate power sensors, see [Chapter 5.9.1, "Using Power Sensors"](#), on page 512.

Power Sensor On/Off	516
Power Sensor Config	517
Power Sensor Assignment	517
Continuous Value Update	517

Power Sensor On/Off

Switches the power measurement for all power sensors on or off. Note that in addition to this general setting, each power sensor can be activated or deactivated individually in the "Power Sensor Configuration" dialog box (see ["Power Sensor Config"](#) on page 517). However, the general setting overrides the individual settings.

Remote command:

[\[SENSe:\] PMETer<p>\[:STATe\]](#) on page 838

Power Sensor Config

Opens the "Power Sensor Configuration" dialog box to configure up to 4 different power sensors. Each sensor configuration is displayed on a separate tab. The serial number of the power sensor connected to the instrument and currently assigned to the displayed configuration is indicated on the tab.

Power Sensor Assignment

Opens the "Power Sensor Assignment" dialog box to assign the connected power sensors to the configuration sets.

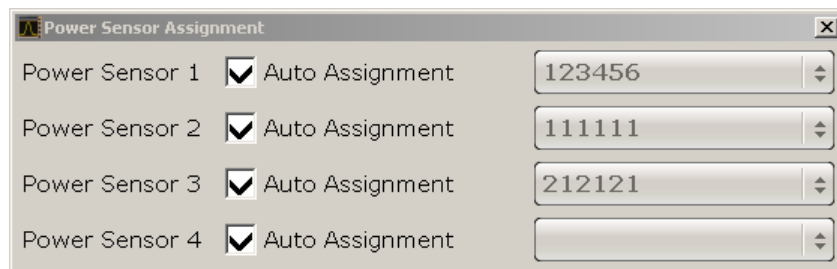

The detected serial numbers of the power sensors connected to the instrument are provided in a selection list. For each of the four available power sensor indexes ("Power Sensor 1"... "Power Sensor 4"), which correspond to the tabs in the configuration dialog, one of the detected serial numbers can be assigned. The physical sensor is thus assigned to the configuration setting for the selected power sensor index.

By default, serial numbers not yet assigned are automatically assigned to the next free power sensor index for which "Auto Assignment" is selected.

Alternatively, you can assign the sensors manually by deactivating the "Auto Assignment" option and selecting a serial number from the list.

Remote command:

[SYSTem:COMMunicate:RDEvice:PMETer<p>:DEFine](#) on page 887

[SYSTem:COMMunicate:RDEvice:PMETer<p>:CONFigure:AUTO\[:STATe\]](#) on page 888

[SYSTem:COMMunicate:RDEvice:PMETer<p>:COUNT?](#) on page 889

Continuous Value Update

If activated, the power sensor data is updated continuously even after a single sweep has completed. For continuous sweeps this setting is irrelevant.

This function cannot be activated for individual sensors; if you change the setting for one sensor, it is automatically applied to all sensors.

If the power sensor is being used as a trigger (see ["Power Sensor"](#) on page 241), continuous update is not possible; this setting is ignored.

Remote command:

[\[SENSe:\] PMETer<p>:UPDate\[:STATe\]](#) on page 844

5.9.5 Power Sensor Configuration Dialog

Power sensors are configured in the "Power Sensor Configuration" dialog box, which is displayed when you select the "Power Sensor Config" softkey in the "Power Sensor" menu.

Up to 4 different power sensors can be configured. Each sensor configuration is displayed on a separate tab. The serial number of the power sensor connected to the instrument and currently assigned to the displayed configuration is indicated on the tab.



For details on how to configure and activate power sensors, see [Chapter 5.9.1, "Using Power Sensors"](#), on page 512.

Select

If enabled, the power sensor is evaluated when power measurement is activated.

Remote command:

[SENSe:] PMETer<p> [:STATe] on page 838

Zeroing Power Sensor

Starts zeroing of the power sensor. For details on the zeroing process refer to [Chapter 5.9.2, "Zeroing the Power Sensor"](#), on page 513 .

Remote command:

CALibration:PMETer<p>:ZERO:AUTO ONCE on page 748

Frequency Manual

The frequency of the signal to be measured. The power sensor has a memory with frequency-dependent correction factors. This allows extreme accuracy for signals of a known frequency.

Remote command:

[SENSe:] PMETer<p>: FREQuency on page 839

Frequency Coupling

If enabled, the frequency is coupled to the center frequency of the instrument or to the frequency of marker 1 automatically.

Remote command:

[SENSe:] PMETer<p>: FREQuency: LINK on page 839

Unit / Scale

Select the unit with which the measured power is to be displayed. Available units are dBm, dB, W and %.

If dB or % is selected, the display is relative to a reference value that is defined either by the measurement (**Meas -> Ref**) or the value in the **Reference Value** field.

Remote command:

UNIT<n>: PMETer<p>: POWer on page 914

UNIT<n>: PMETer<p>: POWer: RATio on page 915

Meas Time / Average

Selects the measurement time or switches to manual averaging mode. In general, results are more precise with longer measurement times. The following settings are recommended for different signal types to obtain stable and precise results:

Short	Stationary signals with high power (> -40dBm), because they require only a short measurement time and short measurement time provides the highest repetition rates.
Normal	Signals with lower power or of modulated signals
Long	Signals at the lower end of the measurement range (<-50 dBm) or signals with lower power to minimize the influence of noise.
Manual	Switches to manual averaging mode. The average count is defined by the "Number of Readings" on page 520 value.

Remote command:

[SENSe:] PMETer<p>: MTIME on page 840

[SENSe:] PMETer<p>: MTIME: AVERage [: STATe] on page 840

Duty Cycle

Sets the duty cycle to a percentage for the correction of pulse-modulated signals and activates the duty cycle correction. If enabled, the sensor calculates the signal pulse power from this value and the mean power.

Remote command:

[SENSe:] PMETer<p>: DCYCLe: STATe on page 838

[SENSe:] PMETer<p>: DCYCLe: VALue on page 839

Meas -> Ref

Sets the currently measured power as a reference value for the relative display. The reference value can also be set manually via the **Reference Value** setting.

Remote command:

`CALCulate<n>:PMETer<p>:RELative[:MAGNitude]:AUTO ONCE` on page 733

Reference Value

Defines the reference value for relative measurements in the unit dBm.

Remote command:

`CALCulate<n>:PMETer<p>:RELative[:MAGNitude]` on page 733

Use Ref Level Offset

If activated, takes the reference level offset set for the analyzer ([Ref Level Offset](#) soft-key) into account for the measured power.

Remote command:

`[SENSe:] PMETer<p>:ROFFset[:STATe]` on page 841

Number of Readings

Defines the number of readings (averagings) to be performed after a single sweep has been started. This setting is only available if manual averaging is selected ([Meas Time / Average](#) setting).

The values for the average count range from 0 to 256 in binary steps (1, 2, 4, 8, ...). For average count = 0 or 1, one reading is performed. The averaging and sweep count of the "Trace" menu are independent from this setting.

Results become more stable with extended averaging, particularly if signals with low power are measured. This setting can be used to minimize the influence of noise in the power sensor measurement.

Remote command:

`[SENSe:] PMETer<p>:MTIME:AVERage:COUNT` on page 841

External Power Trigger

Activates the creation of a trigger signal in the power sensor.

For details see [Figure 5-47](#).

For supported power sensors see the data sheet or [Chapter 5.9.3, "Configuring an External Power Trigger"](#), on page 514.

When you select this option, the following settings in the configuration dialog become unavailable:

- Unit/Scale
- Reference Value
- Use Ref Lev Offset
- Number of Readings

The following trigger settings become available.

Remote command:

`[SENSe:] PMETer<p>:TRIGger[:STATe]` on page 842

Selecting this option causes the transmission of the following remote commands to the power sensor:

```
*RST
SENS:AVER:STAT OFF
TRIG:MAST:STAT ON
```

```
TRIG:SOUR INT
TRIG:SLOP POS
TRIG:DTIM 100e-6
INIT:CONT ON
```

External Trigger Level ← External Power Trigger

Defines the trigger level for the external power trigger.

Remote command:

[\[SENSe:\] PMETer<p>:TRIGger:LEVel](#) on page 843

Hysteresis ← External Power Trigger

Defines the value for the trigger hysteresis. The hysteresis in dB is the value the input signal must stay below the IF power trigger level in order to allow a trigger to start the measurement. The range of the value is between 3 dB and 50 dB with a step width of 1 dB.

Remote command:

[\[SENSe:\] PMETer<p>:TRIGger:HYSTeresis](#) on page 843

Holdoff ← External Power Trigger

Defines the holdoff value in s, which is the time which must pass before triggering, in case another trigger event happens.

Remote command:

[\[SENSe:\] PMETer<p>:TRIGger:HOLDoff](#) on page 842

Dropout ← External Power Trigger

Defines the time the input signal must stay below the IF power trigger level in order to allow a trigger to start the measurement. The range of the value is between 0 s and 1 s with a step width of 100 ns.

Remote command:

[\[SENSe:\] PMETer<p>:TRIGger:DTIME](#) on page 842

Slope ← External Power Trigger

Defines whether the sweep starts after a positive or negative edge of the trigger signal. The default setting is "Pos".

Remote command:

[\[SENSe:\] PMETer<p>:TRIGger:SLOPe](#) on page 844

5.9.6 Error Messages

Error messages are entered in the error/event queue of the status reporting system in the remote control mode and can be queried with the command `SYSTEM:ERRor?`.

A short explanation of the device-specific error messages for R&S FSV-K9 is given below.

Status bar message	Description
Zeroing could not be performed	Zeroing could not be performed because the RF power applied is too high.
Power sensor zero failed	

5.10 Instrument Functions - Spectrogram Measurements

Equipped with the firmware option R&S FSV-K14, the R&S FSVA/FSV provides a graphical overview of changes in frequency and amplitude over a specified period of time.

Not all measurement types available in spectrum mode can be displayed in the "Spectrogram" result display. If the "Spectrogram Measurement" option is active and a measurement cannot be displayed in form of a spectrogram, the softkey of the corresponding measurement is disabled.

All settings of the base unit are also valid for the spectrogram view and vice versa.

The following chapter describes the instrument functions specific to "Spectrogram" measurements.

To open the Spectrogram view

The "Spectrogram" result display and its softkey menu is part of the "Trace" menu of the base unit.

1. Press the [TRACE] key.
2. Press the "Spectrogram" softkey.

The menu for the "Spectrogram" result display opens.

Menus and Softkeys

The main menu for the "Spectrogram" result display is part of the "Trace" menu of the base unit and is described in [Chapter 5.10.2, "Softkeys of the Spectrogram Menu"](#), on page 526.

Furthermore, some special "Spectrogram" functions are included in the "Sweep" menu, see [Chapter 5.2.7.1, "Softkeys of the Sweep Menu"](#), on page 214.

The "ASCII Trace Export" softkey stores the data for all frames in the history buffer of the spectrogram to a file. See [Chapter 5.10.4, "ASCII File Export Format for Spectrograms"](#), on page 533 for details.



Marker functions

The functions in the "Marker" menu ([MKR] key) are the same as for the base unit (see [Chapter 5.3.1.1, "Softkeys of the Marker Menu"](#), on page 250). However, note the slightly different behavior as described in [Chapter 5.10.1, "General Information"](#), on page 523.

Tasks

- [Chapter 5.10.3, "Configuring Color Settings for Spectrograms"](#), on page 527

Remote Operation

Remote commands for "Spectrogram" measurements are included in the following subsystems:

- ["CALCulate:DELTaMarker:SGRam subsystem"](#) on page 630
- ["CALCulate:MARKer:SGRam subsystem"](#) on page 709
- ["CALCulate:SGRam Subsystem"](#) on page 736
- [Chapter 6.3.4.7, "MMEMory Subsystem"](#), on page 939

5.10.1	General Information.....	523
5.10.2	Softkeys of the Spectrogram Menu.....	526
5.10.3	Configuring Color Settings for Spectrograms.....	527
5.10.3.1	Selecting the Color Scheme.....	528
5.10.3.2	Defining the Value Range of the Color Map.....	528
5.10.3.3	Defining the Shape and Focus of the Color Curve.....	530
5.10.3.4	Color Mapping Dialog.....	531
5.10.4	ASCII File Export Format for Spectrograms.....	533

5.10.1 General Information

This section provides some basic information about using the firmware application and about performing measurements with the firmware application.

Screen Layout

The Spectrogram view is divided into two screens: the spectrum analyzer result display (upper screen) and the spectrogram result display (lower screen).

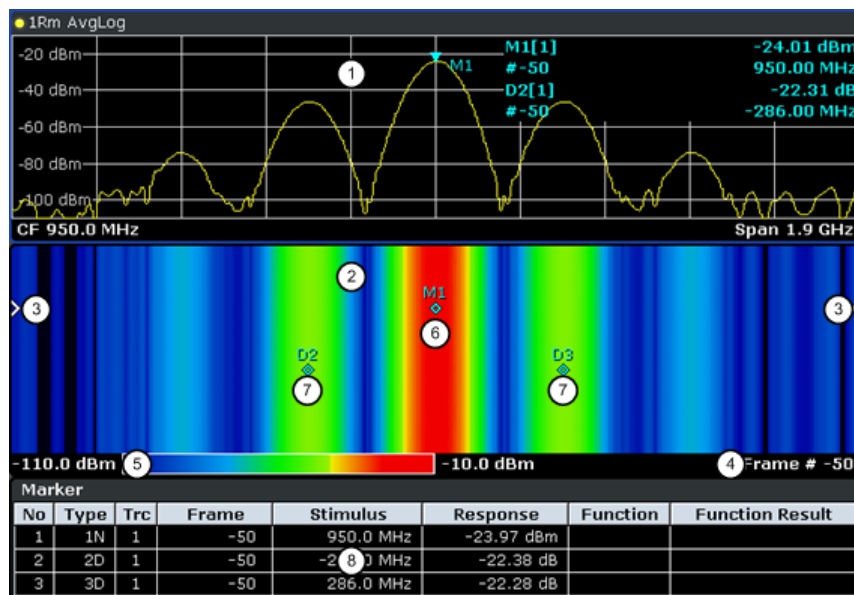

Figure 5-48: Screen layout of the spectrogram result display

- 1 = Spectrum result display
- 2 = Spectrogram result display
- 3 = Frame indicator
- 4 = Time stamp / frame number
- 5 = Color map
- 6 = Marker
- 7 = Deltamarker
- 8 = Marker list

- Spectrum Analyzer result display (1 in Figure 5-48)

This result display is the same as the Spectrum Analyzer with the x-axis representing the frequency span or time (span = 0) and the y-axis the power level. Configure and use this display in the same way as you would in Spectrum Analyzer mode. All traces are available and you can view those traces just like in the base unit (see Chapter 5.2.8.4, "Trace Mode Overview", on page 231). The trace modes View and Blank are not available for trace 1.

While performing a measurement the trace is updated continuously. You can also restore the trace to a point that has already been recorded by selecting a specific frame (see "Select Frame" on page 218). This is possible in Single Sweep mode or if the sweep has been stopped.
- Spectrogram result display (2)

The data displayed in the Spectrogram is always based on the data of trace 1 in the Spectrum Analyzer result display. The Spectrogram can handle measurements in the frequency domain (span > 0) as well as measurements in the time domain (span = 0)

The Spectrogram is a cartesian diagram. The x-axis shows the power distribution of a measured signal over a specified frequency or time range. Different power levels are displayed in different colors. The y-axis represents the time with the top of the diagram being the current timeframe (the measurement runs from top to bottom). Each line (or trace) of the y-axis represents one captured frame. The frames are sorted in chronological order. One frame is equal to a certain number of sweep

points, depending on the dimension of the x-axis. If there are more measurement values than measurement points, several measured values are combined in one measurement point using the selected detector (see [Chapter 5.2.8.6, "Detector Overview"](#), on page 234). Frames are sorted in chronological order, beginning with the most recently recorded frame or frame number 0 at the top of the diagram. After that and below frame 0 is the frame recorded before the current frame (frame -1) and so on until the maximum number of captured frames is reached. The maximum number of frames that you can capture is summarized in the table below (see [Table 5-22](#)). A marker in the form of an arrow (3) on the left and right border of the Spectrogram indicates the currently selected frame.

The actual number of the currently selected frame is shown below the diagram (4). If the time stamp is active, the R&S FSVA/FSV shows the time stamp instead of the frame number (see [Time Stamp \(On Off\)](#)).

Below the diagram there is also a color map (5) that shows the power levels corresponding to the displayed colors. The minimum value of the y-axis is on the left of the color map. The maximum value is on the right of the map. You can also change the color scheme in use (see [Color Mapping](#)). The colors corresponding to the power levels, however, are always assigned automatically.

Markers and deltamarkers (6) (7) take the form of diamonds in the Spectrogram.

They are only displayed in the Spectrogram, if the marker position is inside the visible area of the spectrogram. If more than two markers are active, it is possible to display a [Marker Table](#) at the bottom of the display (8).

Table 5-22: Correlation between number of sweep points and number of frames stored in the history buffer

Sweep Points	Max. History Depth
≤1250	20000
2001	12488
4001	6247
8.001	3124
16.001	1562
32.001	781

Markers and Marker Values

In the Spectrum Analyzer result display, the markers and their frequency and level values (1) are displayed in the marker field just like in the base unit (see [Chapter 5.3.1, "Using Markers and Delta Markers – MKR Key"](#), on page 249). In addition to the base unit functionality, the frame number is displayed to indicate the position of the marker in time (2).



In the Spectrogram result display, you can activate up to 16 markers or deltamarkers at the same time. Any marker can be assigned to a different frame. Therefore, in addition

to the frequency (1) you can set the frame number (2) when activating a new marker. If no frame number is specified, the marker is positioned on the currently selected frame.

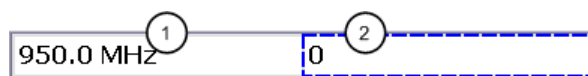

- ① Input Field for Marker Frequency
- ② Input Field for Marker Frame Number

In the Spectrogram result display all markers are visible that are positioned on a visible frame.

In the Spectrum Analyzer result display, only the markers positioned on the currently selected frame are visible. In Continuous Sweep mode this means that only markers positioned on frame 0 are visible. To view markers that are positioned on a frame other than frame 0 in the Spectrum Analyzer result display, it is necessary to stop the measurement and select the corresponding frame.

5.10.2 Softkeys of the Spectrogram Menu

The following chapter describes all softkeys available in the "Spectrogram" menu. It is possible that your instrument configuration does not provide all softkeys. If a softkey is only available with a special option, model or (measurement) mode, this information is delivered in the corresponding softkey description.

To display the "Spectrogram" menu, press the [TRACE] key and then select the "Spectrogram" softkey.

Spectrogram.....	526
L Spectrogram (On Off).....	526
L History Depth.....	526
L Color Mapping.....	527
L Time Stamp (On Off).....	527
L Clear Spectrogram.....	527

Spectrogram

Opens the submenu for the spectrogram view.

Spectrogram (On Off) ← Spectrogram

Activates and deactivates the Spectrogram result display

Remote command:

`CALCulate<n>:SGRam[:STATe]` on page 739

History Depth ← Spectrogram

Sets the number of frames that the R&S FSVA/FSV stores in its memory. The maximum number of frames depends on the Sweep Points (see [Chapter 5.10.1, "General Information"](#), on page 523).

If the memory is full, the R&S FSVA/FSV deletes the oldest frames stored in the memory and replaces them with the new data.

Remote command:

[CALCulate<n>:SGRam:HDEPth](#) on page 738

Color Mapping ← Spectrogram

Displays the "Color Mapping" dialog box to configure the display of the spectrogram (assignment of colors to power levels).

For details see [Chapter 5.10.3, "Configuring Color Settings for Spectrograms"](#), on page 527.

Remote command:

[CALCulate<n>:SGRam:COLor](#) on page 736

[DISPlay:WINDow:SGRam:COLor:LOWer](#) on page 757

[DISPlay:WINDow:SGRam:COLor:UPPer](#) on page 758

Time Stamp (On Off) ← Spectrogram

Activates and deactivates the time stamp. The time stamp shows the system time while the measurement is running. In single sweep mode or if the sweep is stopped, the time stamp shows the time and date of the end of the sweep.

When active, the time stamp replaces the display of the frame number.

Remote command:

[CALCulate<n>:SGRam:TSTamp\[:STATe\]](#) on page 739

Clear Spectrogram ← Spectrogram

Resets the Spectrogram result display and clears the history buffer.

Remote command:

[CALCulate<n>:SGRam:CLEar\[:IMMediate\]](#) on page 736

5.10.3 Configuring Color Settings for Spectrograms

Spectrograms assign power levels to different colors in order to visualize them. The color display is highly configurable to adapt the spectrograms to your needs. You can define:

- Which colors to use (Color scheme, see ["Hot/Cold/Radar/Grayscale"](#) on page 532)
- Which value range to apply the color scheme to (see [Chapter 5.10.3.2, "Defining the Value Range of the Color Map"](#), on page 528)
- How the colors are distributed within the value range, i.e where the focus of the visualization lies (shape of the color curve, see [Chapter 5.10.3.3, "Defining the Shape and Focus of the Color Curve"](#), on page 530)

5.10.3.1	Selecting the Color Scheme.....	528
5.10.3.2	Defining the Value Range of the Color Map.....	528
5.10.3.3	Defining the Shape and Focus of the Color Curve.....	530
5.10.3.4	Color Mapping Dialog.....	531

5.10.3.1 Selecting the Color Scheme

You can select which colors are assigned to the measured values. Four different color ranges or "schemes" are available:

- **Hot**



Uses a color range from blue to red. Blue colors indicate low levels, red colors indicate high ones.

- **Cold**



Uses a color range from red to blue. Red colors indicate low levels, blue colors indicate high ones.

The "Cold" color scheme is the inverse "Hot" color scheme.

- **Radar**



Uses a color range from black over green to light turquoise with shades of green in between. Dark colors indicate low levels, light colors indicate high ones.

- **Grayscale**



Shows the results in shades of gray. Dark gray indicates low levels, light gray indicates high ones.

To select a color scheme

1. Tap the color map in the spectrogram display, or select the "Color Mapping" Soft-key in the "Spectrogram" menu.
2. In the "Color Mapping" dialog box, select the option for the color scheme to be used.

5.10.3.2 Defining the Value Range of the Color Map

If the measured values only cover a small area in the spectrogram, you can optimize the displayed value range so it becomes easier to distinguish between values that are close together, and only parts of interest are displayed at all.

The distribution of the measured values is displayed as a histogram in the "Color Mapping" dialog box (see [Figure 5-51](#)). To cover the entire measurement value range, make sure the first and last bar of the histogram are included. To remove noise from the display, exclude the bottom 10 or 20 dB of the histogram.



The value range of the color map must cover at least 10% of the value range on the horizontal axis of the diagram.

The value range can be set numerically or graphically.

To set the value range graphically using the color range sliders

1. Tap the color map in the spectrogram display, or select the "Color Mapping" Soft-key in the "Spectrogram" menu to display the "Color Mapping" dialog box.
2. Select and drag the bottom color curve slider (indicated by a gray box at the left of the color curve pane) to the lowest value you want to include in the color mapping.
3. Select and drag the top color curve slider (indicated by a gray box at the right of the color curve pane) to the highest value you want to include in the color mapping.

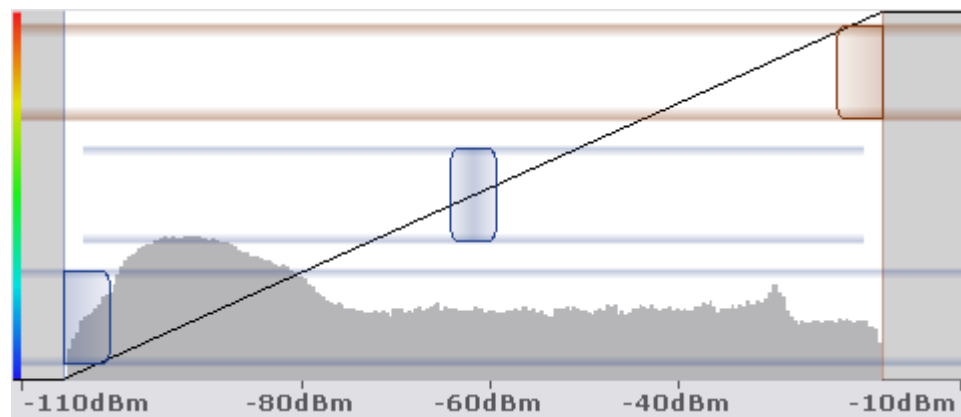

To set the value range numerically

1. Tap the color map in the spectrogram display, or select the "Color Mapping" Soft-key in the "Spectrogram" menu to display the "Color Mapping" dialog box.
2. In the "Start" field, enter the percentage from the left border of the histogram that marks the beginning of the value range.
3. In the "Stop" field, enter the percentage from the right border of the histogram that marks the end of the value range.

Example:

The color map starts at -100 dBm and ends at 0 dBm (i.e. a range of 100 dB). In order to suppress the noise, you only want the color map to start at -90 dBm. Thus, you enter 10% in the "Start" field. The R&S FSVA/FSV shifts the start point 10% to the right, to -90 dBm.



Adjusting the reference level and level range

Note that changing the reference level and level range of the measurement also affects the color mapping in the spectrogram.

5.10.3.3 Defining the Shape and Focus of the Color Curve

The color mapping function assigns a specified color to a specified power level in the spectrogram display. By default, colors on the color map are distributed evenly, i.e. the color range is applied to the value range linearly. However, if a certain area of the value range is to be visualized in greater detail than the rest, you can set the focus of the color mapping to that area. Changing the focus is performed by changing the shape of the color curve.

The color curve is a tool to shift the focus of the color distribution on the color map. By default, the color curve is linear, i.e. the colors on the color map are distributed evenly. If you shift the curve to the left or right, the distribution becomes non-linear. The slope of the color curve increases or decreases. One end of the color palette then covers a large amount of results, while the other end distributes several colors over a relatively small result range.

You can use this feature to put the focus on a particular region in the diagram and to be able to detect small variations of the signal.

Example:



Figure 5-49: Linear color curve shape = 0; colors are distributed evenly over the complete result range

In the color map based on the linear color curve, the range from -105.5 dBm to -60 dBm is covered by blue and a few shades of green only. The range from -60 dBm to -20 dBm is covered by red, yellow and a few shades of green.



Figure 5-50: Non-linear color curve shape = -0.5

After shifting the color curve to the left (negative value), more colors cover the range from -105.5 dBm to -60 dBm (blue, green and yellow). The range from -60 dBm to -20 dBm on the other hand is dominated by various shades of red, but no other colors.

The color curve shape can be set numerically or graphically.

To set the color curve shape graphically using the slider

1. Tap the color map in the spectrogram display, or select the "Color Mapping" Soft-key in the "Spectrogram" menu to display the "Color Mapping" dialog box.
2. Select and drag the color curve shape slider (indicated by a gray box in the middle of the color curve) to the left or right. The area beneath the slider is focussed, i.e. more colors are distributed there.

To set the color curve shape numerically

1. Tap the color map in the spectrogram display, or select the "Color Mapping" Soft-key in the "Spectrogram" menu to display the "Color Mapping" dialog box.
2. In the "Shape" field, enter a value to change the shape of the curve:
 - A negative value (-1 to <0) focusses the lower values
 - 0 defines a linear distribution
 - A positive value (>0 to 1) focusses the higher values

5.10.3.4 Color Mapping Dialog

The Color Mapping dialog box is displayed when you press the "Color Mapping" soft-key in the "Spectrogram" menu, or tap the color map in the Spectrogram display.

In addition to the available color settings, the dialog box displays the current color map and provides a preview of the display with the current settings.

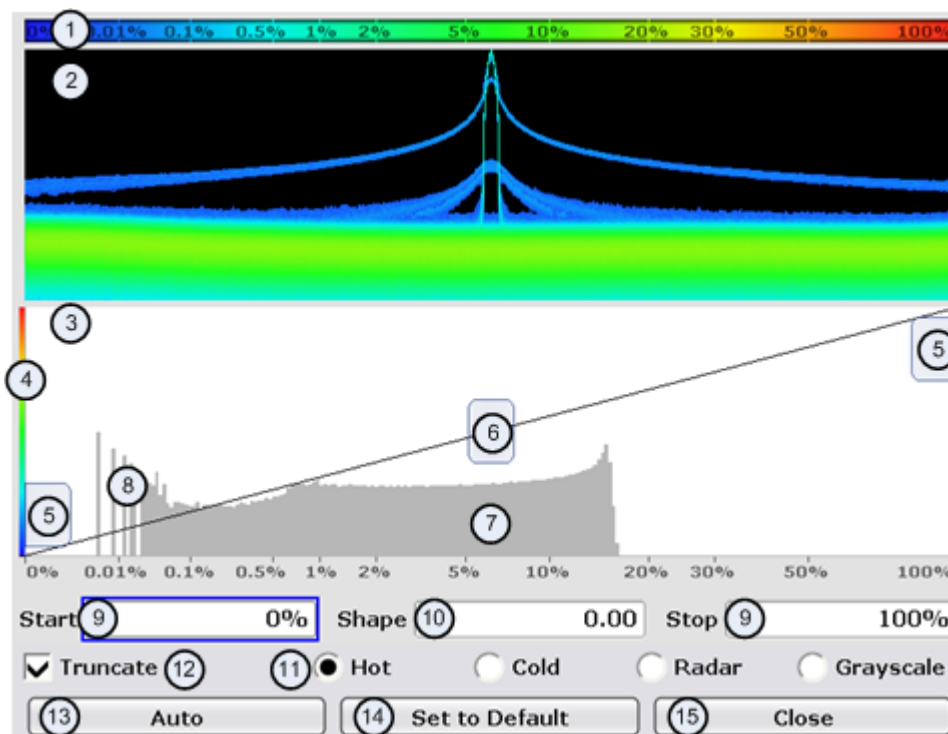

Figure 5-51: Color Mapping dialog box

- 1 = Color map: shows the current color distribution
- 2 = Preview pane: shows a preview of the spectrogram with any changes that you make to the color scheme
- 3 = Color curve pane: graphical representation of all settings available to customize the color scheme
- 4 = Color curve in its linear form
- 5 = Color range start and stop sliders: define the range of the color map or amplitudes for the spectrogram
- 6 = Color curve slider: adjusts the focus of the color curve
- 7 = Histogram: shows the distribution of measured values
- 8 = Scale of the horizontal axis (value range)

Start

Defines the lower boundary of the value range of the spectrogram.

For details on defining the value range see [Chapter 5.10.3.2, "Defining the Value Range of the Color Map"](#), on page 528.

Remote command:

`DISPlay:WINDow:SGRam:COLor:LOWer` on page 757

Shape

Defines the shape and focus of the color curve for the spectrogram result display.

For details see [Chapter 5.10.3.3, "Defining the Shape and Focus of the Color Curve"](#), on page 530.

"-1 to <0" More colors are distributed among the lower values

"0" Colors are distributed linearly among the values

">0 to 1" More colors are distributed among the higher values

Remote command:

`DISPlay:WINDow:SGRam:COLor:SHAPE` on page 757

Stop

Defines the upper boundary of the value range of the spectrogram.

For details on defining the value range see [Chapter 5.10.3.2, "Defining the Value Range of the Color Map"](#), on page 528.

Remote command:

`DISPlay:WINDow:SGRam:COLor:UPPer` on page 758

Hot/Cold/Radar/Grayscale

Sets the color scheme for the spectrogram. For details see [Chapter 5.10.3.1, "Selecting the Color Scheme"](#), on page 528

Remote command:

`DISPlay:WINDow:SGRam:COLor[:STYLE]` on page 758

Auto

Defines the color range automatically according to the existing measured values for optimized display.

Set to Default

Sets the color mapping to the default settings.

Remote command:

`DISPlay:WINDow:SGRam:COLor:DEFault` on page 757

Close

Closes the dialog box and adapts the display to the defined color settings.

5.10.4 ASCII File Export Format for Spectrograms

If the spectrogram display is selected when you select the "ASCII Trace Export" soft-key, the entire histogram buffer with all frames is exported to a file. The data corresponding to a particular frame begins with information about the frame number and the time that frame was recorded.

The data of the file header consist of three columns, each separated by a semicolon: parameter name; numeric value; basic unit. The data section starts with the keyword "Trace <n>" (<n> = number of stored trace), followed by the measured data in one or several columns (depending on measurement) which are also separated by a semicolon.

File contents: header	Description
Type;R&S FSVA/FSV;	Instrument model
Version;5.00;	Firmware version
Date;01.Oct 2006;	Date of data set storage
Mode;ANALYZER; SPECTROGRAM	Instrument mode
Center Freq;55000;Hz	Center frequency
Freq Offset;0;Hz	Frequency offset
Span;90000;Hz	Frequency range (0 Hz in zero span and statistics measurements)
x-Axis;LIN;	Scaling of x-axis linear (LIN) or logarithmic (LOG)
Start;10000;Hz Stop;100000;Hz	Start/stop of the display range. Unit: Hz for span > 0, s for span = 0, dBm/dB for statistics measurements
Ref Level;-30;dBm	Reference level
Level Offset;0;dB	Level offset
Ref Position;75; %	Position of reference level referred to diagram limits (0 % = lower edge)
y-Axis;LOG;	Scaling of y-axis linear (LIN) or logarithmic (LOG)
Level Range;100;dB	Display range in y direction. Unit: dB with x-axis LOG, % with x-axis LIN
Rf Att;20;dB	Input attenuation
RBW;100000;Hz	Resolution bandwidth
VBW;30000;Hz	Video bandwidth
SWT;0.005;s	Sweep time
Trace Mode;AVERAGE;	Display mode of trace: CLR/WRITE,AVERAGE,MAXHOLD,MINHOLD
Detector;AUTOPEAK;	Detector set: AUTOPEAK,MAXPEAK,MINPEAK,AVERAGE,RMS,SAMPLE,QUASPEAK
Sweep Count;20;	Number of sweeps set

File contents: data section of the file	Description
Trace 1;;	Selected trace
x-Unit;Hz;	Unit of x values: Hz with span > 0; s with span = 0; dBm/dB with statistics measurements
y-Unit;dBm;	Unit of y values: dB*/V/A/W depending on the selected unit with y-axis LOG or % with y-axis LIN
Values; 691;	Number of measurement points
Frames;2;	Number of exported frames
Frame;0;	Most recent frame number
Timestamp;17.Mar 11;11:27:05.990	Timestamp of this frame
10000;-10.3;-15.7 10130;-11.5;-16.9 10360;-12.0;-17.4 ...;...;	Measured values, identical to spectrum data: <x value>, <y1>, <y2>; <y2> being available only with detector AUTOPEAK and containing in this case the smallest of the two measured values for a measurement point.
Frame;-1;	Next frame
Timestamp;17.Mar 11;11:27:05.342	Timestamp of this frame
...	

6 Remote Control

This chapter describes how to control the R&S FSVA/FSV via a remote computer. After an introduction to the basic principles of remote control, the individual commands are described in detail. At the end of this chapter, some helpful programming examples are provided.

Conventions used in SCPI command descriptions

Note the following conventions used in the remote command descriptions:

- **Command usage**
If not specified otherwise, commands can be used both for setting and for querying parameters.
If a command can be used for setting or querying only, or if it initiates an event, the usage is stated explicitly.
- **Parameter usage**
If not specified otherwise, a parameter can be used to set a value and it is the result of a query.
Parameters required only for setting are indicated as **Setting parameters**.
Parameters required only to refine a query are indicated as **Query parameters**.
Parameters that are only returned as the result of a query are indicated as **Return values**.
- **Conformity**
Commands that are taken from the SCPI standard are indicated as **SCPI con-firmed**. All commands used by the R&S FSVA/FSV follow the SCPI syntax rules.
- **Asynchronous commands**
A command which does not automatically finish executing before the next command starts executing (overlapping command) is indicated as an **Asynchronous command**.
- **Reset values (*RST)**
Default parameter values that are used directly after resetting the instrument (*RST command) are indicated as ***RST** values, if available.
- **Default unit**
The default unit is used for numeric values if no other unit is provided with the parameter.
- **Manual operation**
If the result of a remote command can also be achieved in manual operation, a link to the description is inserted.

6.1 Remote Control - Basics	537
6.1.1 Remote Control Interfaces and Protocols.....	537
6.1.2 Starting a Remote Control Session.....	539
6.1.3 Returning to Manual Operation.....	540
6.1.4 SCPI Command Structure.....	540
6.1.5 Command Sequence and Synchronization.....	548

6.1.6	Status Reporting System.....	550
6.1.7	General Programming Recommendations.....	565
6.1.8	The IECWIN Tool.....	566
6.2	Controlling the R&S FSVA/FSV Remotely.....	567
6.2.1	Operation with Windows Remote Desktop	567
6.2.2	Operation with a VNC Client.....	574
6.2.3	Brief Introduction to Remote Control.....	575
6.2.4	Configuring the GPIB Interface.....	594
6.2.5	Setting Up a Network (LAN) Connection.....	595
6.2.6	How to Configure the LAN Using the LXI Web Browser Interface.....	601
6.2.7	Configuring the Network.....	604
6.3	Remote Control – Commands.....	607
6.3.1	Notation.....	608
6.3.2	Common Commands.....	610
6.3.3	Remote Control – Description of Analyzer Commands.....	615
6.3.4	Remote Control – Description of Measurement-Independant Commands.....	916
6.3.5	GPIB Commands of HP Models 856xE, 8566A/B, 8568A/B and 8594E.....	977
6.3.6	Reference: Command Set of Emulated PSA Models.....	1007
6.4	Remote Control – Programming Examples.....	1011
6.4.1	Service Request.....	1013
6.4.2	Using Marker and Delta Marker.....	1021
6.4.3	Limit Lines and Limit Test.....	1023
6.4.4	Measuring the Channel and Adjacent Channel Power.....	1025
6.4.5	Occupied Bandwidth Measurement.....	1028
6.4.6	Time Domain Power Measurement.....	1029
6.4.7	Fast Power Measurement on Power Ramps.....	1030
6.4.8	Fast Level Measurement Using Frequency Lists.....	1033
6.4.9	Level Correction of Transducers.....	1035
6.4.10	Measuring the Magnitude and Phase of a Signal.....	1036
6.4.11	Reading and Writing Files.....	1038
6.4.12	Spectrum Emission Mask Measurement.....	1039
6.4.13	Spurious Emissions Measurement.....	1043

6.4.14	Averaging I/Q Data.....	1046
6.4.15	Using IQ Gating.....	1047
6.4.16	Usage of Four Spectrum Instances.....	1052

6.1 Remote Control - Basics

This chapter provides basic information on operating an instrument via remote control.



The computer that is used for remote operation is called "controller" here.

For hints and tricks on remote control of spectrum analyzers see the Rohde & Schwarz Application Note [1EF62](#).

6.1.1 Remote Control Interfaces and Protocols

The instrument supports different interfaces and protocols for remote control. The following table gives an overview.

Table 6-1: Remote control interfaces and protocols

Interface	Protocols, VISA ^{*)} address string	Remarks
Local Area Network (LAN)	<ul style="list-style-type: none"> HiSLIP High-Speed LAN Instrument Protocol (IVI-6.1) TCPIP::host address::hislip0[::INSTR] VXI-11 TCPIP::host address::inst0[::INSTR] Library: VISA 	<p>The interface is based on TCP/IP and supports various protocols.</p> <p>For a description of the protocols refer to:</p> <p>VXI-11 Protocol HiSLIP Protocol</p>

^{*)} VISA is a standardized software interface library providing input and output functions to communicate with instruments. A VISA installation on the controller is a prerequisite for remote control using the indicated interfaces.

6.1.1.1 LAN Interface

For remote control via a network, the PC and the instrument must be connected via the LAN interface to a common network with TCP/IP network protocol. They are connected using a commercial RJ45 cable (shielded or unshielded twisted pair category 5). The TCP/IP network protocol and the associated network services are preconfigured on the instrument. Software for instrument control and the VISA program library must be installed on the controller.

VISA library

IP address

Only the IP address or a valid DNS host name is required to set up the connection. The host address is part of the "VISA resource string" used by the programs to identify and control the instrument.

The VISA resource string has the form:

```
TCPIP::::[LAN device name][::INSTR]
```

where:

- **TCPIP** designates the network protocol used
- **host address** is the IP address or host name of the device
- **LAN device name** defines the protocol and the instance number of a sub-instrument;
 - `inst0` selects the VXI-11 protocol (default)
 - `hislip0` selects the newer HiSLIP protocol
- **INSTR** indicates the instrument resource class (optional)

Example:

- Instrument has the IP address *192.1.2.3*; the valid resource string using VXI-11 protocol is:
`TCPIP::192.1.2.3::INSTR`
- The DNS host name is *FSV4-123456*; the valid resource string using HiSLIP is:
`TCPIP::FSV4-123456::hislip0`



Identifying instruments in a network

If several instruments are connected to the network, each instrument has its own IP address and associated resource string. The controller identifies these instruments by means of the resource string.

- [VXI-11 Protocol](#)..... 538
- [HiSLIP Protocol](#)..... 538

VXI-11 Protocol

The VXI-11 standard is based on the ONC RPC (Open Network Computing Remote Procedure Call) protocol which in turn relies on TCP/IP as the network/transport layer. The TCP/IP network protocol and the associated network services are preconfigured. TCP/IP ensures connection-oriented communication, where the order of the exchanged messages is adhered to and interrupted links are identified. With this protocol, messages cannot be lost.

HiSLIP Protocol

The HiSLIP (**H**igh **S**peed **L**AN **I**nstrument **P**rotocol) is the successor protocol for VXI-11 for TCP-based instruments specified by the IVI foundation. The protocol uses

two TCP sockets for a single connection - one for fast data transfer, the other for non-sequential control commands (e.g. `Device Clear` or `SRQ`).

HiSLIP has the following characteristics:

- High performance as with raw socket network connections
- Compatible IEEE 488.2 support for Message Exchange Protocol, Device Clear, Serial Poll, Remote/Local, Trigger, and Service Request
- Uses a single IANA registered port (4880), which simplifies the configuration of firewalls
- Supports simultaneous access of multiple users by providing versatile locking mechanisms
- Usable for IPv6 or IPv4 networks



Using VXI-11, each operation is blocked until a VXI-11 device handshake returns. However, using HiSLIP, data is sent to the device using the "fire and forget" method with immediate return. Thus, a successful return of a VISA operation such as `viWrite()` does not guarantee that the instrument has finished or started the requested command, but is delivered to the TCP/IP buffers.

For more information see also the application note:

[1MA208: Fast Remote Instrument Control with HiSLIP](#)

6.1.2 Starting a Remote Control Session

When you switch on the instrument, it is always in manual operation state ("local" state) and can be operated via the front panel.

Starting remote control

1. Send an addressed command (`GTR` - Go to Remote) from a controller to the instrument.

The instrument is switched to remote control ("remote" state). Operation via the front panel is disabled. Only the "Local" softkey is displayed to return to manual operation. The instrument remains in the remote state until it is reset to the manual state via the instrument or via remote control interfaces. Switching from manual operation to remote control and vice versa does not affect the other instrument settings.

2. During program execution, send the `SYSTEM:DISPlay:UPDate ON` command to activate the display of results.

The changes in the device settings and the recorded measurement values are displayed on the instrument screen.

3. To obtain optimum performance during remote control, send the `SYSTEM:DISPlay:UPDate OFF` command to hide the display of results and diagrams again (default setting in remote control).

4. To prevent unintentional return to manual operation, disable the keys of the instrument using the universal command `LLO`.

Switching to manual mode is only possible via remote control then. This function is only available for the GPIB interface.

5. To enable the keys of the R&S FSVA/FSV again, switch the instrument to local mode (`GTL` - Go to Local), i.e. deactivate the `REN` line of the remote control interface.



If the instrument is operated exclusively in remote control, it is recommended that you switch on the power-save mode for the display. For more details on this mode refer to "[Switching the Screen Display On and Off](#)" on page 578.

6.1.3 Returning to Manual Operation

Before you switch back to manual operation, all remote command processing must be completed. Otherwise, the instrument will switch back to remote control immediately.

- ▶ Press the "Local" softkey or the [PRESET] key, or use the following GPIB command:

```
status = viGpibControlREN(vi, VI_GPIB_REN_ADDRESS_GTL)
```



If you select the "Local" softkey while a self-alignment or a self-test is still running (which was started remotely), the instrument only returns to the manual operation state when the alignment or test is completed.

6.1.4 SCPI Command Structure

SCPI commands consist of a header and, in most cases, one or more parameters. The header and the parameters are separated by a "white space" (ASCII code 0 to 9, 11 to 32 decimal, e.g. blank). The headers may consist of several mnemonics (keywords). Queries are formed by appending a question mark directly to the header.

The commands can be either device-specific or device-independent (common commands). Common and device-specific commands differ in their syntax.

6.1.4.1 Syntax for Common Commands

Common (= device-independent) commands consist of a header preceded by an asterisk (*), and possibly one or more parameters.

Table 6-2: Examples of common commands

*RST	RESET	Resets the instrument.
*ESE	EVENT STATUS ENABLE	Sets the bits of the event status enable registers.

*ESR?	EVENT STATUS QUERY	Queries the contents of the event status register.
*IDN?	IDENTIFICATION QUERY	Queries the instrument identification string.

6.1.4.2 Syntax for Device-Specific Commands



Not all commands used in the following examples are necessarily implemented in the instrument. For demonstration purposes only, assume the existence of the following commands for this section:

- DISPLAY[:WINDow<1...4>]:MAXimize <Boolean>
- FORMat:READings:DATA <type>[,<length>]
- HCOpy:DEvice:COLor <Boolean>
- HCOpy:DEvice:CMAP:COLor:RGB <red>,<green>,<blue>
- HCOpy[:IMMediate]
- HCOpy:ITEM:ALL
- HCOpy:ITEM:LABel <string>
- HCOpy:PAGE:DIMensions:QUADrant [<N>]
- HCOpy:PAGE:ORientation LANDscape | PORTrait
- HCOpy:PAGE:SCALE <numeric value>
- MMEMory:COpy <file_source>,<file_destination>
- SENSE:BANDwidth|BWIDth[:RESolution] <numeric_value>
- SENSE:FREQuency:STOP <numeric value>
- SENSE:LIST:FREQuency <numeric_value>{,<numeric_value>}

- [Long and short form](#)..... 541
- [Numeric Suffixes](#)..... 542
- [Optional Mnemonics](#)..... 542

Long and short form

The mnemonics feature a long form and a short form. The short form is marked by upper case letters, the long form corresponds to the complete word. Either the short form or the long form can be entered; other abbreviations are not permitted.

Example:

HCOpy:DEvice:COLor ON is equivalent to HCOP:DEV:COL ON.



Case-insensitivity

Upper case and lower case notation only serves to distinguish the two forms in the manual, the instrument itself is case-insensitive.

Numeric Suffixes

If a command can be applied to multiple instances of an object, e.g. specific channels or sources, the required instances can be specified by a suffix added to the command. Numeric suffixes are indicated by angular brackets (<1...4>, <n>, <i>) and are replaced by a single value in the command. Entries without a suffix are interpreted as having the suffix 1.

Example:

Definition: `HCOPY:PAGE:DIMensions:QUADrant [<N>]`

Command: `HCOP:PAGE:DIM:QUAD2`

This command refers to the quadrant 2.



Different numbering in remote control

For remote control, the suffix may differ from the number of the corresponding selection used in manual operation. SCPI prescribes that suffix counting starts with 1. Suffix 1 is the default state and used when no specific suffix is specified.

Some standards define a fixed numbering, starting with 0. If the numbering differs in manual operation and remote control, it is indicated for the corresponding command.

Optional Mnemonics

Some command systems permit certain mnemonics to be inserted into the header or omitted. These mnemonics are marked by square brackets in the description. The instrument must recognize the long command to comply with the SCPI standard. Some commands are considerably shortened by these optional mnemonics.

Example:

Definition: `HCOPY[:IMMEDIATE]`

Command: `HCOP:IMM` is equivalent to `HCOP`



Optional mnemonics with numeric suffixes

Do not omit an optional mnemonic if it includes a numeric suffix that is relevant for the effect of the command.

Example:

Definition: `DISPlay[:WINDow<1...4>]:MAXimize <Boolean>`

Command: `DISP:MAX ON` refers to window 1.

In order to refer to a window other than 1, you must include the optional `WINDow` parameter with the suffix for the required window.

`DISP:WIND2:MAX ON` refers to window 2.

6.1.4.3 SCPI Parameters

Many commands are supplemented by a parameter or a list of parameters. The parameters must be separated from the header by a "white space" (ASCII code 0 to 9, 11 to 32 decimal, e.g. blank).

The parameters required for each command and the allowed range of values are specified in the command description.

Allowed parameters are:

• Numeric Values	543
• Special Numeric Values	544
• Boolean Parameters	544
• Text Parameters	544
• Character Strings	545
• Block Data	545

Numeric Values

Numeric values can be entered in any form, i.e. with sign, decimal point and exponent. Values exceeding the resolution of the instrument are rounded up or down. The mantissa may comprise up to 255 characters, the exponent must lie inside the value range -32000 to 32000. The exponent is introduced by an "E" or "e". Entry of the exponent alone is not allowed.

Example:

```
SENS:FREQ:STOP 1500000 = SENS:FREQ:STOP 1.5E6
```

Units

For physical quantities, the unit can be entered. If the unit is missing, the basic unit is used. Allowed unit prefixes are:

- G (giga)
- MA (mega), MOHM, MHZ
- K (kilo)
- M (milli)
- U (micro)
- N (nano)

Example:

```
SENSe:FREQ:STOP 1.5GHz = SENSe:FREQ:STOP 1.5E9
```

Some settings allow relative values to be stated in percent. According to SCPI, this unit is represented by the PCT string.

Example:

```
HCOP:PAGE:SCAL 90PCT
```

Special Numeric Values

The following mnemonics are special numeric values. In the response to a query, the numeric value is provided.

- **MIN and MAX:** denote the minimum and maximum value.
- **DEF:** denotes a preset value which has been stored in the EPROM. This value conforms to the default setting, as it is called by the *RST command.
- **UP and DOWN:** increases or reduces the numeric value by one step. The step width can be specified via an allocated step command for each parameter which can be set via UP and DOWN.
- **INF and NINF:** INFinity and negative INFinity (NINF) represent the numeric values 9.9E37 or -9.9E37, respectively. INF and NINF are only sent as instrument responses.
- **NAN:** Not A Number (NAN) represents the value 9.91E37. NAN is only sent as a instrument response. This value is not defined. Possible causes are the division of zero by zero, the subtraction of infinite from infinite and the representation of missing values.

Example:

Setting command: `SENSe:LIST:FREQ MAXimum`

Query: `SENS:LIST:FREQ?`

Response: `3.5E9`



Queries for special numeric values

The numeric values associated to `MAXimum`/`MINimum`/`DEFault` can be queried by adding the corresponding mnemonic after the quotation mark.

Example: `SENSe:LIST:FREQ? MAXimum`

Returns the maximum numeric value as a result.

Boolean Parameters

Boolean parameters represent two states. The "ON" state (logically true) is represented by "ON" or a numeric value 1. The "OFF" state (logically untrue) is represented by "OFF" or the numeric value 0. The numeric values are provided as the response for a query.

Example:

Setting command: `HCOPY:DEV:COL ON`

Query: `HCOPY:DEV:COL?`

Response: `1`

Text Parameters

Text parameters observe the syntactic rules for mnemonics, i.e. they can be entered using a short or long form. Like any parameter, they have to be separated from the

header by a white space. In the response to a query, the short form of the text is provided.

Example:

Setting command: `HCOPY:PAGE:ORIENTATION LANDscape`

Query: `HCOP:PAGE:ORI?`

Response: `LAND`

Character Strings

Strings must always be entered in quotation marks (' or ").

Example:

`HCOP:ITEM:LABEL "Test1"`

`HCOP:ITEM:LABEL 'Test1'`

Block Data

Block data is a format which is suitable for the transmission of large amounts of data. For example, a command using a block data parameter has the following structure:

`FORMat:READings:DATA #45168xxxxxxxx`

The ASCII character # introduces the data block. The next number indicates how many of the following digits describe the length of the data block. In the example the 4 following digits indicate the length to be 5168 bytes. The data bytes follow. During the transmission of these data bytes all end or other control signs are ignored until all bytes are transmitted.

#0 specifies a data block of indefinite length. The use of the indefinite format requires a `NL^END` message to terminate the data block. This format is useful when the length of the transmission is not known or if speed or other considerations prevent segmentation of the data into blocks of definite length.

6.1.4.4 Overview of Syntax Elements

The following tables provide an overview of the syntax elements and special characters.

Table 6-3: Syntax elements

:	The colon separates the mnemonics of a command.
;	The semicolon separates two commands of a command line. It does not alter the path.
,	The comma separates several parameters of a command.
?	The question mark forms a query.
*	The asterisk marks a common command.
' '	Quotation marks introduce a string and terminate it (both single and double quotation marks are possible).

#	The hash symbol introduces binary, octal, hexadecimal and block data. <ul style="list-style-type: none"> • Binary: #B10110 • Octal: #O7612 • Hexa: #HF3A7 • Block: #21312
	A "white space" (ASCII-Code 0 to 9, 11 to 32 decimal, e.g. blank) separates the header from the parameters.

Table 6-4: Special characters

	<p>Parameters</p> <p>A vertical stroke in parameter definitions indicates alternative possibilities in the sense of "or". The effect of the command differs, depending on which parameter is used.</p> <p>Example:</p> <p>Definition: <code>HCOPY:PAGE:ORIENTATION LANDscape PORtrait</code></p> <p>Command <code>HCOP:PAGE:ORI LAND</code> specifies landscape orientation</p> <p>Command <code>HCOP:PAGE:ORI PORT</code> specifies portrait orientation</p> <p>Mnemonics</p> <p>A selection of mnemonics with an identical effect exists for several commands. These mnemonics are indicated in the same line; they are separated by a vertical stroke. Only one of these mnemonics needs to be included in the header of the command. The effect of the command is independent of which of the mnemonics is used.</p> <p>Example:</p> <p>Definition: <code>SENSE:BANDwidth BWIDth[:RESolution] <numeric_value></code></p> <p>The two following commands with identical meaning can be created:</p> <p><code>SENS:BAND:RES 1</code></p> <p><code>SENS:BWID:RES 1</code></p>
[]	<p>Mnemonics in square brackets are optional and may be inserted into the header or omitted.</p> <p>Example: <code>HCOPY[:IMMEDIATE]</code></p> <p><code>HCOP:IMM</code> is equivalent to <code>HCOP</code></p>
{}	<p>Parameters in curly brackets are optional and can be inserted once or several times, or omitted.</p> <p>Example: <code>SENSe:LIST:FREQuency <numeric_value>{,<numeric_value>}</code></p> <p>The following are valid commands:</p> <p><code>SENS:LIST:FREQ 10</code></p> <p><code>SENS:LIST:FREQ 10,20</code></p> <p><code>SENS:LIST:FREQ 10,20,30,40</code></p>

6.1.4.5 Structure of a Command Line

A command line may consist of one or several commands. It is terminated by one of the following:

- <New Line>
- <New Line> with EOI
- EOI together with the last data byte

Several commands in a command line must be separated by a semicolon ";".

Example:

```
MMEM:COPY "Test1","MeasurementXY";:HCOP:ITEM ALL
```

This command line contains two commands. The first command belongs to the MMEM system, the second command belongs to the HCOP system. If the next command belongs to a different command system, the semicolon is followed by a colon.

Example:

```
HCOP:ITEM ALL;:HCOP:IMM
```

This command line contains two commands. Both commands are part of the HCOP command system, i.e. they have one level in common.

If the successive commands belong to the same system, having one or several levels in common, the command line can be abbreviated. When abbreviating the command line, the second command begins with the level below HCOP. The colon after the semicolon is omitted. The abbreviated form of the command line reads as follows:

```
HCOP:ITEM ALL;IMM
```

Example:

```
HCOP:ITEM ALL
```

```
HCOP:IMM
```

A new command line always begins with the complete path.

6.1.4.6 Responses to Queries

A query is defined for each setting command unless explicitly specified otherwise. It is formed by adding a question mark to the associated setting command. According to SCPI, the responses to queries are partly subject to stricter rules than in standard IEEE 488.2.

- The requested parameter is transmitted without a header.
Example: `HCOP:PAGE:ORI?`, **Response:** `LAND`
- Maximum values, minimum values and all other quantities that are requested via a special text parameter are returned as numeric values.
Example: `SENSe:FREQuency:STOP? MAX`, **Response:** `3.5E9`
- Numeric values are output without a unit. Physical quantities are referred to the basic units or to the units set using the `Unit` command. The response `3.5E9` in the previous example stands for 3.5 GHz.
- Truth values (Boolean values) are returned as 0 (for OFF) and 1 (for ON).
Example:
Setting command: `HCOPy:DEV:COL ON`
Query: `HCOPy:DEV:COL?`
Response: `1`
- Text (character data) is returned in a short form.
Example:
Setting command: `HCOPy:PAGE:ORIENTATION LANDscape`
Query: `HCOP:PAGE:ORI?`

Response: `LAND`

- Invalid numerical results
In some cases, particularly when a result consists of multiple numeric values, invalid values are returned as `9.91E37` (not a number).

6.1.5 Command Sequence and Synchronization

IEEE 488.2 defines a distinction between overlapped and sequential commands:

- A **sequential command** is one which finishes executing before the next command starts executing. Commands that are processed quickly are usually implemented as sequential commands.
- An **overlapping command** is one which does not automatically finish executing before the next command starts executing. Usually, overlapping commands take longer to process and allow the program to do other tasks while being executed. If overlapping commands do have to be executed in a defined order, e.g. in order to avoid wrong measurement results, they must be serviced sequentially. This is called synchronization between the controller and the instrument.

Setting commands within one command line, even though they may be implemented as sequential commands, are not necessarily serviced in the order in which they have been received. In order to make sure that commands are actually carried out in a certain order, each command must be sent in a separate command line.

Example: Commands and queries in one message

The response to a query combined in a program message with commands that affect the queried value is not predictable.

The following commands always return the specified result:

```
:FREQ:STAR 1GHZ;SPAN 100 :FREQ:STAR?
```

Result:

```
1000000000 (1 GHz)
```

Whereas the result for the following commands is not specified by SCPI:

```
:FREQ:STAR 1GHz;STAR?;SPAN 1000000
```

The result could be the value of `START` before the command was sent since the instrument might defer executing the individual commands until a program message terminator is received. The result could also be 1 GHz if the instrument executes commands as they are received.



As a general rule, send commands and queries in different program messages.

Example: Overlapping command with *OPC

The instrument implements `INITiate[:IMMEDIATE]` as an overlapped command. Assuming that `INITiate[:IMMEDIATE]` takes longer to execute than `*OPC`, sending the following command sequence results in initiating a sweep and, after some time, setting the `OPC` bit in the `ESR`:

```
INIT; *OPC.
```

Sending the following commands still initiates a sweep:

```
INIT; *OPC; *CLS
```

However, since the operation is still pending when the instrument executes `*CLS`, forcing it into the "Operation Complete Command Idle" State (OCIS), `*OPC` is effectively skipped. The `OPC` bit is not set until the instrument executes another `*OPC` command.

The following list includes the commands for which a synchronization via `*OPC`, `*OPC?` or `*WAI` is mandatory:

Command	Purpose
INIT	start measurement
INIT:CONM	continue measurement
CALC:MARK:FUNC:ZOOM	zoom frequency range around marker 1
CALC:STAT:SCAL:AUTO ONCE	optimize level settings for signal statistic measurement functions
[SENS:]POW:ACH:PRES:RLEV	optimize level settings for adjacent channel power measurements

6.1.5.1 Preventing Overlapping Execution

To prevent an overlapping execution of commands, one of the commands `*OPC`, `*OPC?` or `*WAI` can be used. All three commands cause a certain action only to be carried out after the hardware has been set. The controller can be forced to wait for the corresponding action to occur.

Table 6-5: Synchronization using *OPC, *OPC? and *WAI

Command	Action	Programming the controller
*OPC	Sets the Operation Complete bit in the <code>ESR</code> after all previous commands have been executed.	<ul style="list-style-type: none"> Setting bit 0 in the <code>ESE</code> Setting bit 5 in the <code>SRE</code> Waiting for service request (<code>SRQ</code>)
*OPC?	Stops command processing until 1 is returned. This occurs when all pending operations are completed.	Send <code>*OPC?</code> directly after the command whose processing must be terminated before other commands can be executed.
*WAI	Stops further command processing until all commands sent before <code>*WAI</code> have been executed.	Send <code>*WAI</code> directly after the command whose processing must be terminated before other commands are executed.

Command synchronization using `*WAI` or `*OPC?` is a good choice if the overlapped command takes only little time to process. The two synchronization commands simply

block overlapped execution of the command. Append the synchronization command to the overlapping command, for example:

```
SINGLE; *OPC?
```

For time consuming overlapped commands, you can allow the controller or the instrument to do other useful work while waiting for command execution. Use one of the following methods:

***OPC with a service request**

1. Set the OPC mask bit (bit no. 0) in the ESE: *ESE 1
2. Set bit no. 5 in the SRE: *SRE 32 to enable ESB service request.
3. Send the overlapped command with *OPC .
4. Wait for a service request.

The service request indicates that the overlapped command has finished.

***OPC? with a service request**

1. Set bit no. 4 in the SRE: *SRE 16 to enable MAV service request.
2. Send the overlapped command with *OPC?.
3. Wait for a service request.

The service request indicates that the overlapped command has finished.

Event status register (ESE)

1. Set the OPC mask bit (bit no. 0) in the ESE: *ESE 1
2. Send the overlapped command without *OPC, *OPC? or *WAI.
3. Poll the operation complete state periodically (with a timer) using the sequence:
*OPC; *ESR?

A return value (LSB) of 1 indicates that the overlapped command has finished.

6.1.6 Status Reporting System

The status reporting system stores all information on the current operating state of the instrument, and on errors which have occurred. This information is stored in the status registers and in the error queue. Both can be queried via GPIB bus or LAN interface (STATus... commands).

6.1.6.1 Hierarchy of Status Registers

As shown in the following figure, the status information is of hierarchical structure.

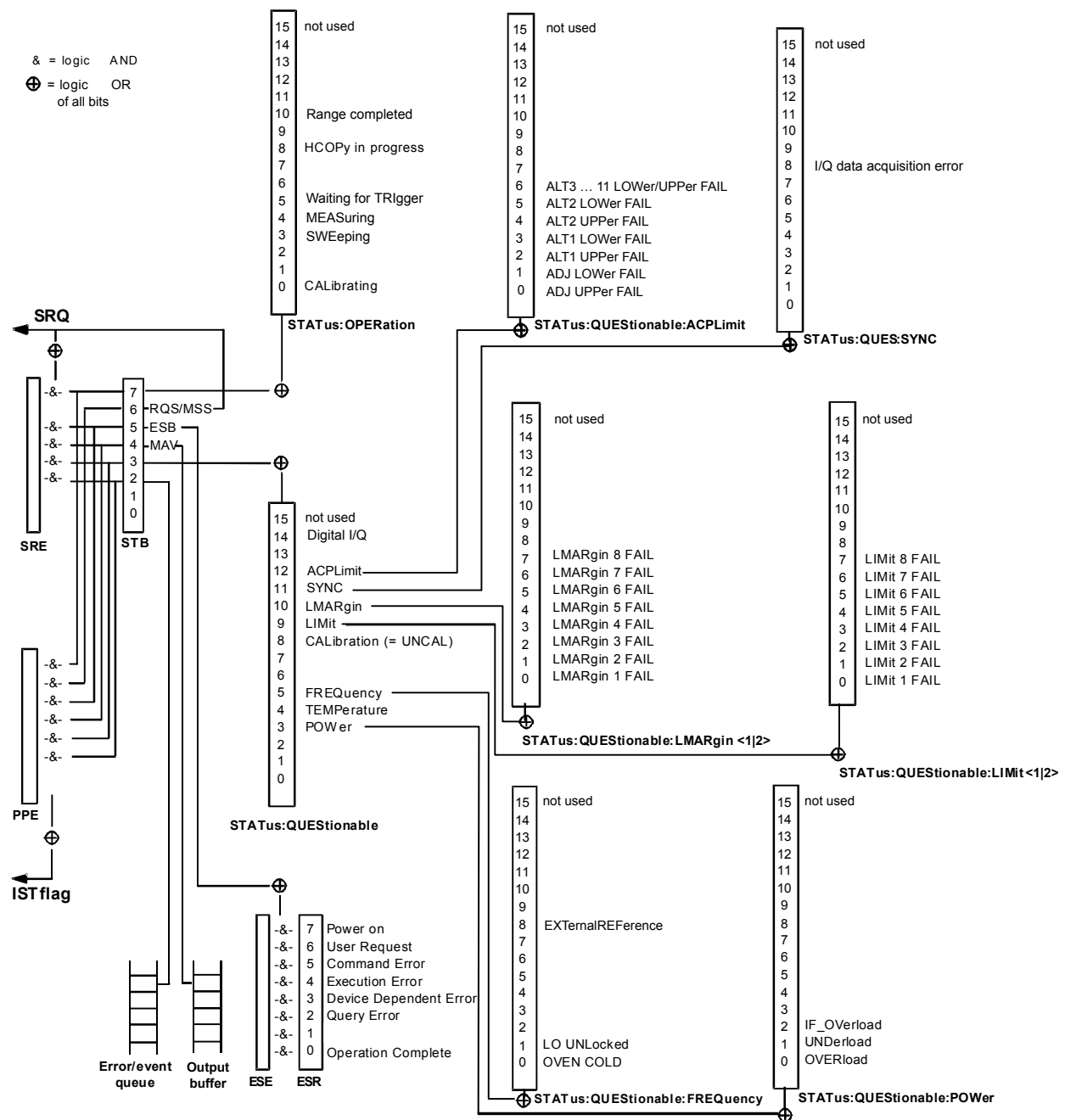

Figure 6-1: Overview of status registers in the R&S FSV

- STB, SRE**
 The STatus Byte (STB) register and its associated mask register Service Request Enable (SRE) form the highest level of the status reporting system. The STB provides a rough overview of the instrument status, collecting the information of the lower-level registers.
- ESR, SCPI registers**
 The STB receives its information from the following registers:

- The Event Status Register (ESR) with the associated mask register standard Event Status Enable (ESE)
- The STATUS:OPERation and STATUS:QUEStionable registers which are defined by SCPI and contain detailed information on the instrument
- **IST, PPE**
The IST flag ("Individual Status"), like the SRQ, combines the entire instrument status in a single bit. The PPE fulfills the same function for the IST flag as the SRE for the service request.
- **Output buffer**
The output buffer contains the messages the instrument returns to the controller. It is not part of the status reporting system but determines the value of the MAV bit in the STB and thus is represented in the overview.

All status registers have the same internal structure.



SRE, ESE

The service request enable register SRE can be used as ENABLE part of the STB if the STB is structured according to SCPI. By analogy, the ESE can be used as the ENABLE part of the ESR.

6.1.6.2 Structure of a SCPI Status Register

Each standard SCPI register consists of 5 parts. Each part has a width of 16 bits and has different functions. The individual bits are independent of each other, i.e. each hardware status is assigned a bit number which is valid for all five parts. Bit 15 (the most significant bit) is set to zero for all parts. Thus the contents of the register parts can be processed by the controller as positive integers.

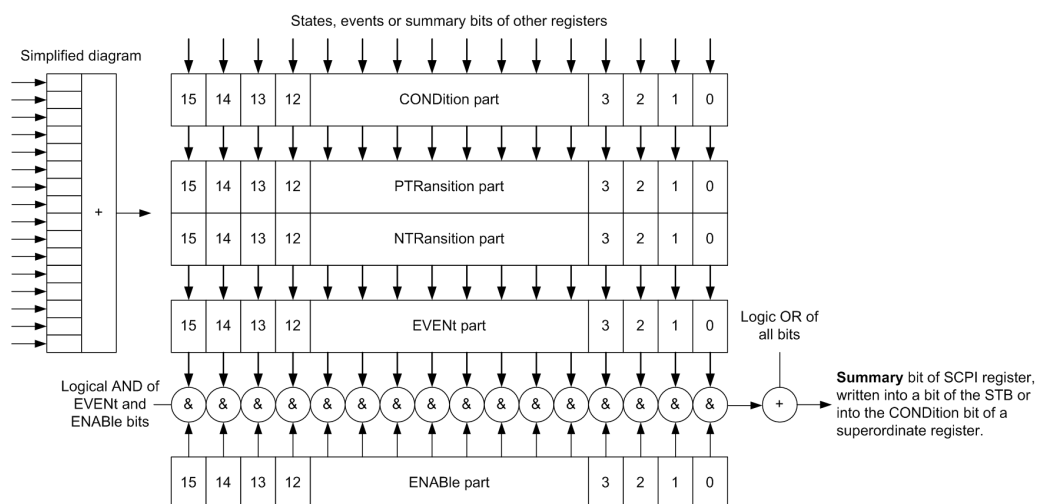

Figure 6-2: The status-register model

Description of the five status register parts

The five parts of a SCPI register have different properties and functions:

- **CONDition**

The **CONDition** part is written into directly by the hardware or the sum bit of the next lower register. Its contents reflect the current instrument status. This register part can only be read, but not written into or cleared. Its contents are not affected by reading.

- **PTRansition / NTRansition**

The two transition register parts define which state transition of the **CONDition** part (none, 0 to 1, 1 to 0 or both) is stored in the **EVENT** part.

The **Positive-TRansition** part acts as a transition filter. When a bit of the **CONDition** part is changed from 0 to 1, the associated **PTR** bit decides whether the **EVENT** bit is set to 1.

- **PTR** bit =1: the **EVENT** bit is set.
- **PTR** bit =0: the **EVENT** bit is not set.

This part can be written into and read as required. Its contents are not affected by reading.

The **Negative-TRansition** part also acts as a transition filter. When a bit of the **CONDition** part is changed from 1 to 0, the associated **NTR** bit decides whether the **EVENT** bit is set to 1.

- **NTR** bit =1: the **EVENT** bit is set.
- **NTR** bit =0: the **EVENT** bit is not set.

This part can be written into and read as required. Its contents are not affected by reading.

- **EVENT**

The **EVENT** part indicates whether an event has occurred since the last reading, it is the "memory" of the condition part. It only indicates events passed on by the transition filters. It is permanently updated by the instrument. This part can only be read by the user. Reading the register clears it. This part is often equated with the entire register.

- **ENABLE**

The **ENABLE** part determines whether the associated **EVENT** bit contributes to the sum bit (see below). Each bit of the **EVENT** part is "ANDed" with the associated **ENABLE** bit (symbol '&'). The results of all logical operations of this part are passed on to the sum bit via an "OR" function (symbol '+').

ENABLE bit = 0: the associated **EVENT** bit does not contribute to the sum bit

ENABLE bit = 1: if the associated **EVENT** bit is "1", the sum bit is set to "1" as well.

This part can be written into and read by the user as required. Its contents are not affected by reading.

Sum bit

The sum bit is obtained from the **EVENT** and **ENABLE** part for each register. The result is then entered into a bit of the **CONDition** part of the higher-order register.

The instrument automatically generates the sum bit for each register. Thus an event can lead to a service request throughout all levels of the hierarchy.

6.1.6.3 Contents of the Status Registers

In the following sections, the contents of the status registers are described in more detail.

Status Byte (STB) and Service Request Enable Register (SRE)

The `STatus Byte` (STB) is already defined in IEEE 488.2. It provides a rough overview of the instrument status by collecting the pieces of information of the lower registers. A special feature is that bit 6 acts as the sum bit of the remaining bits of the status byte.

The STB can thus be compared with the `CONDition` part of an SCPI register and assumes the highest level within the SCPI hierarchy.

The STB is read using the command `*STB?` or a serial poll.

The `STatus Byte` (STB) is linked to the `Service Request Enable` (SRE) register. Each bit of the STB is assigned a bit in the SRE. Bit 6 of the SRE is ignored. If a bit is set in the SRE and the associated bit in the STB changes from 0 to 1, a service request (SRQ) is generated. The SRE can be set using the command `*SRE` and read using the command `*SRE?`.

Table 6-6: Meaning of the bits used in the status byte

Bit No.	Meaning
0...1	Not used
2	Error Queue not empty The bit is set when an entry is made in the error queue. If this bit is enabled by the SRE, each entry of the error queue generates a service request. Thus an error can be recognized and specified in greater detail by polling the error queue. The poll provides an informative error message. This procedure is to be recommended since it considerably reduces the problems involved with remote control.
3	QUESTionable status register summary bit The bit is set if an <code>EVENT</code> bit is set in the <code>QUESTionable</code> status register and the associated <code>ENABLE</code> bit is set to 1. A set bit indicates a questionable instrument status, which can be specified in greater detail by querying the <code>STatus:QUESTionable</code> status register.
4	MAV bit (message available) The bit is set if a message is available in the output queue which can be read. This bit can be used to enable data to be automatically read from the instrument to the controller.
5	ESB bit Sum bit of the event status register. It is set if one of the bits in the event status register is set and enabled in the event status enable register. Setting of this bit indicates a serious error which can be specified in greater detail by polling the event status register.

Bit No.	Meaning
6	MSS bit (master status summary bit) The bit is set if the instrument triggers a service request. This is the case if one of the other bits of this registers is set together with its mask bit in the service request enable register SRE.
7	STATUS:OPERation status register summary bit The bit is set if an EVENT bit is set in the OPERATION status register and the associated ENABLE bit is set to 1. A set bit indicates that the instrument is just performing an action. The type of action can be determined by querying the STATUS:OPERation status register.

IST Flag and Parallel Poll Enable Register (PPE)

As with the SRQ, the IST flag combines the entire status information in a single bit. It can be read by means of a parallel poll (see "Parallel Poll" on page 563) or using the command `*IST?`.

The parallel poll enable register (PPE) determines which bits of the STB contribute to the IST flag. The bits of the STB are "ANDed" with the corresponding bits of the PPE, with bit 6 being used as well in contrast to the SRE. The IST flag results from the "ORing" of all results. The PPE can be set using commands `*PRE` and read using command `*PRE?`.

Event Status Register (ESR) and Event Status Enable Register (ESE)

The Event Status Register (ESR) is the source for the registers on the highest levels and is similar to the EVENT part of a SCPI register. It is defined by IEEE 488.2. You can read out the ESR with `*ESR?`.

The corresponding ENABLE part of the ESR is the Event Status Enable mask register (ESE). The ESE is directly linked to the ESR. You can control the ESE with `*ESE`.

Table 6-7: Meaning of the bits used in the event status register

Bit No.	Meaning
0	Operation Complete This bit is set on receipt of the command <code>*OPC</code> exactly when all previous commands have been executed.
1	Unused
2	Query Error This bit is set if either the controller wants to read data from the instrument without having sent a query, or if it does not fetch requested data and sends new instructions to the instrument instead. The cause is often a query which is faulty and hence cannot be executed.
3	Device-dependent Error This bit is set if a device-dependent error occurs. The R&S FSVA/FSV adds a number to the error queue. The number is either in the range between -300 and -399 or greater than 0. If the number is positive, it indicates the error type in greater detail.
4	Execution Error This bit is set if a received command is syntactically correct but cannot be performed for other reasons. An error message with a number between -200 and -300, which denotes the error in greater detail, is entered into the error queue.

Bit No.	Meaning
5	Command Error This bit is set if a remote command is undefined or has a incorrect syntax. The R&S FSVA/FSV adds a number to the error queue. The number is in the range between -100 and -200 and indicates the error type in greater detail.
6	User Request This bit is set when you press the "Local" softkey.
7	Power On (supply voltage on) This bit is set when you turn on the instrument.

STATus:OPERation Register

The STATus:OPERation register contains information on current activities of the R&S FSVA/FSV. It also contains information on activities that have been executed since the last read out.

You can read out the register with `STATus:OPERation:CONDition` or `STATus:OPERation[:EVENT]`.

Table 6-8: Meaning of the bits used in the STATus:OPERation register

Bit No.	Meaning
0	CALibrating This bit is set as long as the instrument is performing a calibration.
1-2	Not used
3	SWEeping Sweep is being performed; identical to bit 4
4	MEASuring Measurement is being performed; identical to bit 3
5	Waiting for TRigger Instrument is ready to trigger and waiting for trigger signal
6-7	Not used
8	HardCOpy in progress This bit is set while the instrument is printing a hardcopy.
9	Not used
10	Stop after Range This bit is set when a range in the sweep list has been completed if "Stop after Range" has been activated.
11-14	Not used
15	This bit is always 0.

STATus:QUEStionable Register

The STATus:QUEStionable register contains information on instrument states that do not meet the specifications.

You can read out the register with `STAT:QUES:COND` or `STAT:QUES:EVEN`.

Table 6-9: Meaning of the bits used in the `STATus:QUEStionable` register

Bit No.	Meaning
0 - 2	Unused
3	POWer This bit is set if the measured power level is questionable. The STATus:QUEStionable:POWer Register provides more information on the error type.
4	TEMPerature This bit is set if the temperature is questionable.
5	FREQuency This bit is set if there is anything wrong with the frequency of the local oscillator or the reference frequency. The STATus:QUEStionable:FREQuency Register provides more information on the error type.
6 - 7	Unused
8	CALibration This bit is set if the R&S FSVA/FSV is unaligned ("UNCAL" display)
9	LIMit (device-specific) This bit is set if a limit value is violated. The STATus:QUEStionable:LIMit Register provides more information on the error type.
10	LMARgin (device-specific) This bit is set if a margin is violated. The STATus:QUEStionable:LMARgin Register provides more information on the error type.
11	SYNC (device-specific) This bit is set if the R&S FSVA/FSV is not synchronized to the signal that is applied. The R&S FSVA/FSV is not synchronized if <ul style="list-style-type: none"> • it cannot synchronize to midamble during a measurement or premeasurement • it cannot find a burst during a measurement or premeasurement • the results deviate too much from the expected value during premeasurements
12	ACPLimit (device-specific) This bit is set if a limit during ACLR measurements is violated. The STATus:QUEStionable:ACPLimit Register provides more information on the error type.
13	Not used
14	Digital I/Q (device-specific) This bit is set if a connection error occurs at the R&S Digital I/Q Interface (R&S FSV-B17 option), see " STATus:QUEStionable:DIQ Register " on page 558 The STATus:QUEStionable:DIQ Register provides more information on the error type.
15	This bit is always 0.

STATus:QUEStionable:ACPLimit Register

The `STATus:QUEStionable:ACPLimit` register contains information about the results of a limit check during ACLR measurements.

You can read out the register with `STATUS:QUESTIONable:ACPLimit:CONDition?` or `STATUS:QUESTIONable:ACPLimit[:EVENT]?`

Table 6-10: Meaning of the bits used in the STATUS:QUESTIONable:ACPLimit register

Bit No.	Meaning
0	ADJ UPPer FAIL This bit is set if the limit is exceeded in the upper adjacent channel
1	ADJ LOWer FAIL This bit is set if the limit is exceeded in the lower adjacent channel.
2	ALT1 UPPer FAIL This bit is set if the limit is exceeded in the upper 1st alternate channel.
3	ALT1 LOWer FAIL This bit is set if the limit is exceeded in the lower 1st alternate channel.
4	ALT2 UPPer FAIL This bit is set if the limit is exceeded in the upper 2nd alternate channel.
5	ALT2 LOWer FAIL This bit is set if the limit is exceeded in the lower 2nd alternate channel.
6	ALT3 ... 11 LOWer/UPPer FAIL This bit is set if the limit is exceeded in one of the lower or upper alternate channels 3 ... 11.
7 to 14	Unused
15	This bit is always 0.

STATUS:QUESTIONable:DIQ Register

This register contains information about the state of the digital I/Q input and output. This register is available with option R&S FSV-B17.

The status of the `STATUS:QUESTIONable:DIQ` register is indicated in bit 14 of the "STATUS:QUESTIONable" register.

You can read out the state of the register with `STATUS:QUESTIONable:DIQ:CONDition?` on page 876 and `STATUS:QUESTIONable:DIQ[:EVENT]?` on page 877.

Bit No.	Meaning
0	Digital I/Q Input Device connected This bit is set if a device is recognized and connected to the R&S Digital I/Q Interface of the analyzer.
1	Digital I/Q Input Connection Protocol in progress This bit is set while the connection between analyzer and digital baseband data signal source (e.g. R&S SMW, R&S Ex-I/Q-Box) is established.
2	Digital I/Q Input Connection Protocol error This bit is set if an error occurred during establishing of the connect between analyzer and digital I/Q data signal source (e.g. R&S SMW, R&S Ex-I/Q-Box) is established.
3-5	not used

Bit No.	Meaning
6	Digital I/Q Input FIFO Overload This bit is set if the input transfer rate is too high. The R&S FSVA/FSV can process a maximum transfer rate of 128MHz.
7	not used
8	Digital I/Q Output Device connected This bit is set if a device is recognized and connected to the Digital I/Q Output.
9	Digital I/Q Output Connection Protocol in progress This bit is set while the connection between analyzer and digital I/Q data signal sink (e.g. R&S SMW, R&S Ex-I/Q-Box) is established.
10	Digital I/Q Output Connection Protocol error This bit is set if an error occurred while the connection between analyzer and digital I/Q data signal sink (e.g. R&S SMW, R&S Ex-I/Q-Box) is established.
11-14	not used
15	This bit is always set to 0.

STATus:QUESTionable:FREQuency Register

The STATus:QUESTionable:FREQuency register contains information about the condition of the local oscillator and the reference frequency.

You can read out the register with `STATus:QUESTionable:FREQuency:CONDition?` or `STATus:QUESTionable:FREQuency[:EVENT]?`.

Table 6-11: Meaning of the bits used in the STATus:QUESTionable:FREQuency register

Bit No.	Meaning
0	OVEN COLD This bit is set if the reference oscillator has not yet attained its operating temperature. "OCXO" is displayed.
1	LO UNLocked This bit is set if the local oscillator no longer locks. "LOUNL" is displayed.
2 to 7	Unused
8	EXTernalREFerence This bit is set if you have selected an external reference oscillator but did not connect a useable external reference source. In that case the synthesizer can not lock. The frequency in all probability is not accurate.
9 to 14	Unused
15	This bit is always 0.

STATus:QUESTionable:LIMit Register

The STATus:QUESTionable:LIMit register contains information about the results of a limit check when you are working with limit lines.

The number of LIMit registers depends on the number of measurement windows available in any operating mode.

You can read out the register with `STATUS:QUESTIONABLE:LIMit<m>:CONDition?` or `STATUS:QUESTIONABLE:LIMit<m>:CONDition?`.

Table 6-12: Meaning of the bits used in the STATUS:QUESTIONABLE:LIMit register

Bit No.	Meaning
0	LIMit 1 FAIL This bit is set if limit line 1 is violated.
1	LIMit 2 FAIL This bit is set if limit line 2 is violated.
2	LIMit 3 FAIL This bit is set if limit line 3 is violated.
3	LIMit 4 FAIL This bit is set if limit line 4 is violated.
4	LIMit 5 FAIL This bit is set if limit line 5 is violated.
5	LIMit 6 FAIL This bit is set if limit line 6 is violated.
6	LIMit 7 FAIL This bit is set if limit line 7 is violated.
7	LIMit 8 FAIL This bit is set if limit line 8 is violated.
8 to 14	Unused
15	This bit is always 0.

STATUS:QUESTIONABLE:LMARgin Register

This register contains information about the observance of limit margins.

It can be read using the commands

`STATUS:QUESTIONABLE:LMARgin:CONDition?` and

`STATUS:QUESTIONABLE:LMARgin[:EVENT]?`.

Table 6-13: Meaning of the bits used in the STATUS:QUESTIONABLE:LMARgin register

Bit No.	Meaning
0	LMARgin 1 FAIL This bit is set if limit margin 1 is violated.
1	LMARgin 2 FAIL This bit is set if limit margin 2 is violated.
2	LMARgin 3 FAIL This bit is set if limit margin 3 is violated.
3	LMARgin 4 FAIL This bit is set if limit margin 4 is violated.

Bit No.	Meaning
4	LMARgin 5 FAIL This bit is set if limit margin 5 is violated.
5	LMARgin 6 FAIL This bit is set if limit margin 6 is violated.
6	LMARgin 7 FAIL This bit is set if limit margin 7 is violated.
7	LMARgin 8 FAIL This bit is set if limit margin 8 is violated.
8 to 14	Not used
15	This bit is always 0.

STATus:QUEStionable:POWer Register

The STATus:QUEStionable:POWer register contains information about possible overload situations that may occur during operation of the R&S FSVA/FSV.

You can read out the register with [STATus:QUEStionable:POWer:CONDition?](#) or [STATus:QUEStionable:POWer\[:EVENT\]?](#)

Table 6-14: Meaning of the bits used in the STATus:QUEStionable:POWer register

Bit No.	Meaning
0	OVERload This bit is set if an overload occurs at the RF input. The R&S FSVA/FSV displays the enhancement label "OVLD".
1	UNDerload This bit is set if an underload occurs at the RF input. The R&S FSVA/FSV displays the enhancement label "UNLD".
2	IF_Overload This bit is set if an overload occurs in the IF path. The R&S FSVA/FSV displays the enhancement label "IFOVL".
3 to 14	Unused
15	This bit is always 0.

STATus:QUEStionable:SYNC Register

This register contains information about the state of the I/Q data acquisition. This register is used with option Digital Baseband Interface (R&S FSV-B17).

The status of the STATus:QUEStionable:SYNC register is indicated in bit 11 of the STATus:QUEStionable register.

You can read out the state of the register with [STATus:QUEStionable:SYNC:CONDition?](#) on page 884 and [STATus:QUEStionable:SYNC\[:EVENT\]?](#) on page 883.

Bit No.	Meaning
0-7	not used
8	I/Q data acquisition error This bit is set if an error occurs during I/Q data acquisition because the input sample rates or number of samples between the signal source and the R&S FSV/FSV do not match.
9-14	not used
15	This bit is always set to 0.

6.1.6.4 Application of the Status Reporting System

The purpose of the status reporting system is to monitor the status of one or several devices in a measuring system. To do this and react appropriately, the controller must receive and evaluate the information of all devices. The following standard methods are used:

- **Service request** (SRQ) initiated by the instrument
- **Serial poll** of all devices in the bus system, initiated by the controller in order to find out who sent a SRQ and why
- **Parallel poll** of all devices
- Query of a **specific instrument status** by means of commands
- Query of the **error queue**

Service Request

Under certain circumstances, the instrument can send a service request (SRQ) to the controller. Usually this service request initiates an interrupt at the controller, to which the control program can react appropriately. As evident from [Figure 6-1](#), an SRQ is always initiated if one or several of bits 2, 3, 4, 5 or 7 of the status byte are set and enabled in the SRE. Each of these bits combines the information of a further register, the error queue or the output buffer. The `ENABLe` parts of the status registers can be set such that arbitrary bits in an arbitrary status register initiate an SRQ. In order to make use of the possibilities of the service request effectively, all bits should be set to "1" in enable registers SRE and ESE.

Use of the command *OPC to generate an SRQ at the end of a sweep

1. `CALL InstrWrite(analyzer, "*ESE 1")` 'Set bit 0 in the ESE (Operation Complete)
2. `CALL InstrWrite(analyzer, "*SRE 32")` 'Set bit 5 in the SRE (ESB)
3. `CALL InstrWrite(analyzer, "*INIT;*OPC")` 'Generate an SRQ after operation complete

After its settings have been completed, the instrument generates an SRQ.

The SRQ is the only possibility for the instrument to become active on its own. Each controller program should cause the instrument to initiate a service request if errors occur. The program should react appropriately to the service request.

A detailed example for a service request routine can be found in [Chapter 6.4.1, "Service Request"](#), on page 1013.

Serial Poll

In a serial poll, just as with command `*STB`, the status byte of an instrument is queried. However, the query is realized via interface messages and is thus clearly faster.

The serial poll method is defined in IEEE 488.1 and used to be the only standard possibility for different instruments to poll the status byte. The method also works for instruments which do not adhere to SCPI or IEEE 488.2.

The serial poll is mainly used to obtain a fast overview of the state of several instruments connected to the controller.

Parallel Poll

In a parallel poll, up to eight instruments are simultaneously requested by the controller using a single command to transmit 1 bit of information each on the data lines, i.e., to set the data line allocated to each instrument to a logical "0" or "1".

In addition to the SRE register, which determines the conditions under which an SRQ is generated, there is a Parallel Poll Enable register (PPE) which is ANDed with the STB bit by bit, considering bit 6 as well. This register is ANDed with the STB bit by bit, considering bit 6 as well. The results are ORed, the result is possibly inverted and then sent as a response to the parallel poll of the controller. The result can also be queried without parallel poll using the command `*IST?`.

The instrument first has to be set for the parallel poll using the command `PPC`. This command allocates a data line to the instrument and determines whether the response is to be inverted. The parallel poll itself is executed using `PPE`.

The parallel poll method is mainly used to find out quickly which one of the instruments connected to the controller has sent a service request. To this effect, SRE and PPE must be set to the same value.

Query of an instrument status

Each part of any status register can be read using queries. There are two types of commands:

- The common commands `*ESR?`, `*IDN?`, `*IST?`, `*STB?` query the higher-level registers.
- The commands of the `STATus` system query the SCPI registers (`STATus:QUEStionable...`)

The returned value is always a decimal number that represents the bit pattern of the queried register. This number is evaluated by the controller program.

Queries are usually used after an SRQ in order to obtain more detailed information on the cause of the SRQ.

Decimal representation of a bit pattern

The STB and ESR registers contain 8 bits, the SCPI registers 16 bits. The contents of a status register are specified and transferred as a single decimal number. To make this possible, each bit is assigned a weighted value. The decimal number is calculated as the sum of the weighted values of all bits in the register that are set to 1.

Bits	0	1	2	3	4	5	6	7	...
Weight	1	2	4	8	16	32	64	128	...

Example:

The decimal value $40 = 32 + 8$ indicates that bits no. 3 and 5 in the status register (e.g. the `QUESTIONable` status summary bit and the `ESB` bit in the `STatus Byte`) are set.

Error Queue

Each error state in the instrument leads to an entry in the error queue. The entries of the error queue are detailed plain text error messages that can be looked up in the Error Log or queried via remote control using `SYSTem:ERRor[:NEXT]?`. Each call of `SYSTem:ERRor[:NEXT]?` provides one entry from the error queue. If no error messages are stored there any more, the instrument responds with 0, "No error".

The error queue should be queried after every SRQ in the controller program as the entries describe the cause of an error more precisely than the status registers. Especially in the test phase of a controller program the error queue should be queried regularly since faulty commands from the controller to the instrument are recorded there as well.

6.1.6.5 Reset Values of the Status Reporting System

The following table contains the different commands and events causing the status reporting system to be reset. None of the commands, except `*RST` and `SYSTem:PRESet`, influence the functional instrument settings. In particular, `DCL` does not change the instrument settings.

Table 6-15: Resetting the status reporting system

Event	Switching on supply voltage Power-On-Status-Clear		DCL, SDC (Device Clear, Selected Device Clear)	*RST or SYS- Tem:PRE Set	STA- Tus:PRE- Set	*CLS
	0	1				
Clear STB, ESR	-	yes	-	-	-	yes
Clear SRE, ESE	-	yes	-	-	-	-
Clear PPE	-	yes	-	-	-	-

Event	Switching on supply voltage Power-On-Status-Clear		DCL, SDC (Device Clear, Selected Device Clear)	*RST or SYS-Tem:PRE Set	STA-Tus:PRE-Set	*CLS
	0	1				
Clear EVENT parts of the registers	-	yes	-	-	-	yes
Clear ENABLE parts of all OPERATION and QUESTIONABLE registers; Fill ENABLE parts of all other registers with "1".	-	yes	-	-	yes	-
Fill PTRansition parts with "1"; Clear NTRansition parts	-	yes	-	-	yes	-
Clear error queue	yes	yes	-	-	-	yes
Clear output buffer	yes	yes	yes	1)	1)	1)
Clear command processing and input buffer	yes	yes	yes	-	-	-

1) The first command in a command line that immediately follows a <PROGRAM MESSAGE TERMINATOR> clears the output buffer.

6.1.7 General Programming Recommendations

Initial instrument status before changing settings

Manual operation is designed for maximum possible operating convenience. In contrast, the priority of remote control is the "predictability" of the instrument status. Thus, when a command attempts to define incompatible settings, the command is ignored and the instrument status remains unchanged, i.e. other settings are not automatically adapted. Therefore, control programs should always define an initial instrument status (e.g. using the *RST command) and then implement the required settings.

Command sequence

As a general rule, send commands and queries in different program messages. Otherwise, the result of the query may vary depending on which operation is performed first (see also Preventing Overlapping Execution).

Reacting to malfunctions

The service request is the only possibility for the instrument to become active on its own. Each controller program should instruct the instrument to initiate a service request in case of malfunction. The program should react appropriately to the service request.

Error queues

The error queue should be queried after every service request in the controller program as the entries describe the cause of an error more precisely than the status registers. Especially in the test phase of a controller program the error queue should be queried regularly since faulty commands from the controller to the instrument are recorded there as well.

6.1.8 The IECWIN Tool

The R&S FSVA/FSV is delivered with *IECWIN* installed, an auxiliary tool provided free of charge by R&S. IECWIN is a program to send SCPI commands to a measuring instrument either interactively or from a command script.



The R&S IECWIN32 tool is provided free of charge. The functionality may change in a future version without notice.

IECWIN offers the following features:

- Connection to instrument via several interfaces/protocols (GPIB, VISA, named pipe (if IECWIN is run on the instrument itself), RSIB)
- Interactive command entry
- Browsing available commands on the instrument
- Error checking following every command
- Execution of command scripts
- Storing binary data to a file
- Reading binary data from a file
- Generation of a log file

For command scripts, IECWIN offers the following features:

- Synchronization with the instrument on every command
- Checking expected result for query commands (as string or numeric value)
- Checking for expected errors codes
- Optional pause on error
- Nested command scripts
- Single step mode
- Conditional execution, based on the *IDN and *OPT strings



You can use the IECWIN to try out the programming examples provided in the R&S FSVA/FSV User Manuals.

Starting IECWIN

IECWIN is available from the Windows "Start" menu on the R&S FSVA/FSV, or by executing the following file:

C:\Program Files\Rohde-Schwarz\FSVA\<<version>\iecwin32.exe

You can also copy the program to any Windows PC or laptop. Simply copy the `iecwin32.exe`, `iecwin.chm` and `rsib32.dll` files from the location above to the same folder on the target computer.

When the tool is started, a "Connection settings" dialog box is displayed. Define the connection from the computer the IECWIN tool is installed on to the R&S FSVA/FSV you want to control. If you are using the tool directly on the R&S FSVA/FSV, you can use an NT Pipe (COM Parser) connection, which requires no further configuration. For help on setting up other connection types, check the tool's online help (by clicking the "Help" button in the dialog box).



The IECWIN offers an online help with extensive information on how to work with the tool.

6.2 Controlling the R&S FSVA/FSV Remotely

In addition to working with the R&S FSVA/FSV interactively, located directly at the instrument, it is also possible to operate and control it from a remote PC.

Various methods for remote control are supported:

- Using the Windows Remote Desktop application in a LAN network (see [Chapter 6.2.1, "Operation with Windows Remote Desktop"](#), on page 567)
- Using Virtual Network Computing (VNC, see [Chapter 6.2.2, "Operation with a VNC Client"](#), on page 574)
- Connecting the instrument to a (LAN) network (see [Chapter 6.2.5, "Setting Up a Network \(LAN\) Connection"](#), on page 595)

For details on remote control interfaces see [Chapter 6.1.1, "Remote Control Interfaces and Protocols"](#), on page 537

• Operation with Windows Remote Desktop	567
• Operation with a VNC Client	574
• Brief Introduction to Remote Control	575
• Configuring the GPIB Interface	594
• Setting Up a Network (LAN) Connection	595
• How to Configure the LAN Using the LXI Web Browser Interface	601
• Configuring the Network	604

6.2.1 Operation with Windows Remote Desktop

In production test and measurement, a common requirement is central monitoring of the T&M instruments for remote maintenance and remote diagnostics. Equipped with the Windows Remote Desktop software, the R&S FSVA/FSV ideally meets require-

ments for use in production. (The computer that is used for remote operation is called "controller" here.)

- Access to the control functions via a virtual front panel (soft front panel)
- Printout of measurement results directly from the controller
- Storage of measured data on the controller's hard disk

The R&S FSVA/FSV is connected via a LAN, in which case the Windows operating system also supports a connection via a modem. This section describes the configuration of the R&S FSVA/FSV and the Remote Desktop Client of the controller. Details on how to set up a modem connection are described in the Windows documentation.

6.2.1.1 Configuring the R&S FSVA/FSV for Remote Operation



To avoid problems, use a fixed IP address.

When a DHCP server is used, a new IP address is assigned each time the instrument is restarted. This address must first be determined on the instrument itself. Thus, using a DHCP server is not suitable for remote operation of the R&S FSVA/FSV via Remote Desktop.



With the factory settings, the default "instrument" user can connect to the R&S FSVA/FSV with the Remote Desktop program of the controller immediately. No further configuration is required. However, if the connection fails or other users need to connect, this section provides basic instructions on setting up the Remote Desktop for the R&S FSVA/FSV.

1. Press the "Windows" key on the external keyboard or the [CTRL + ESC] key combination on your keyboard to access the operating system.
2. In the Windows "Start" menu, select "Settings > System".
3. Search for "remote access".
4. Select "Allow remote access to your computer".
5. Define which users are to be given access to the R&S FSVA/FSV via Remote Desktop.

Note: The user account under which configuration is carried out is automatically enabled for Remote Desktop.

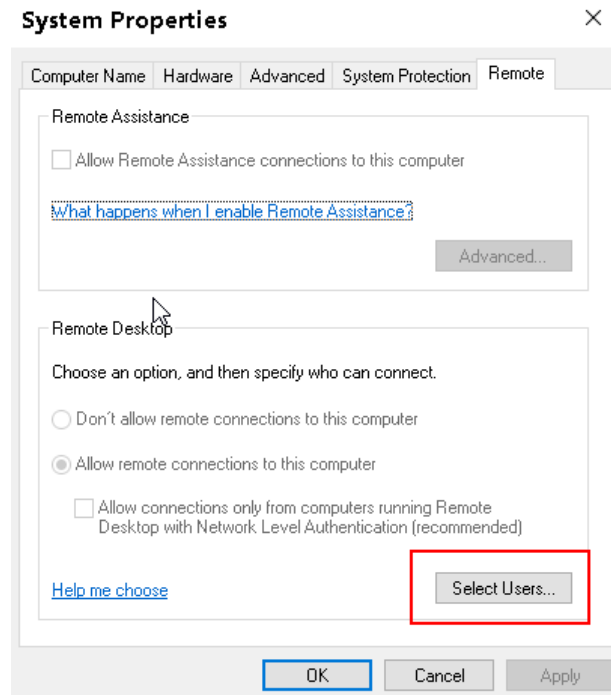

- a) Select the "Select Users" button.
 - b) Select the users or create new user accounts as described in [Chapter 6.2.7.2, "Creating Users"](#), on page 604.
 - c) Select "OK" to confirm the settings.
6. The R&S FSVA/FSV is now ready for connection setup with the Remote Desktop program of the controller.

6.2.1.2 Configuring the Controller



Remote Desktop Client

The Windows Remote Desktop Client is part of the operating system and can be accessed via "Start > All Applications > Windows Accessories > Remote Desktop Connection".

1. Press the "Windows" key on the external keyboard or the [CTRL + ESC] key combination on your keyboard to access the operating system.
2. From the "Start" menu, select "All Programs > Accessories > Remote Desktop Connection".
The "Remote Desktop Connection" dialog box is displayed.
3. Select the "Options >>" button.
The dialog box is expanded to display the configuration data.

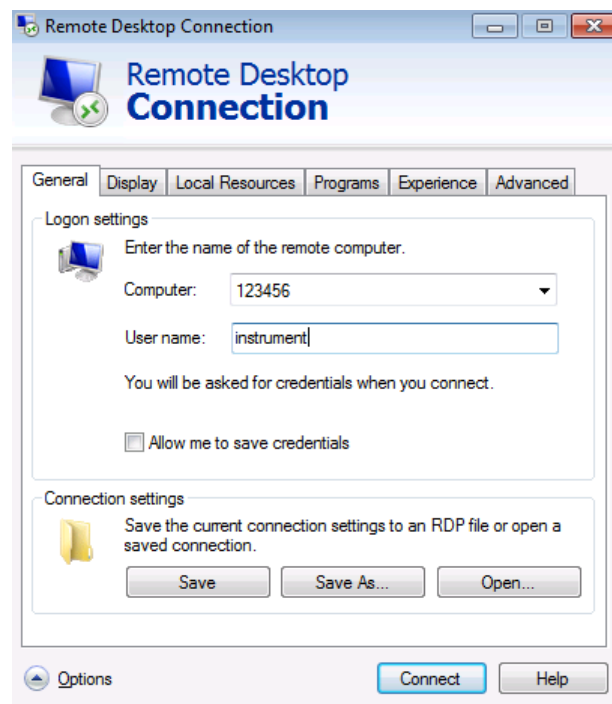

4. Open the "Experience" tab.
The settings on this tab are used to select and optimize the connection speed.
5. In the list, select the appropriate connection (for example: LAN (10 Mbps or higher)).
Depending on your selection (and how powerful the connection is), the options are activated or deactivated.
6. To improve the performance, you can deactivate the "Desktop background", "Show contents of window while dragging" and "Menu and window animation" options.
7. Open the "Local Resources" tab for enabling printers, local drives and serial interfaces.
8. If you will need to access drives of the controller from the R&S FSVA/FSV (e.g. in order to store settings or to copy files from the controller to the R&S FSVA/FSV), select "More", then enable the "Drives" option.

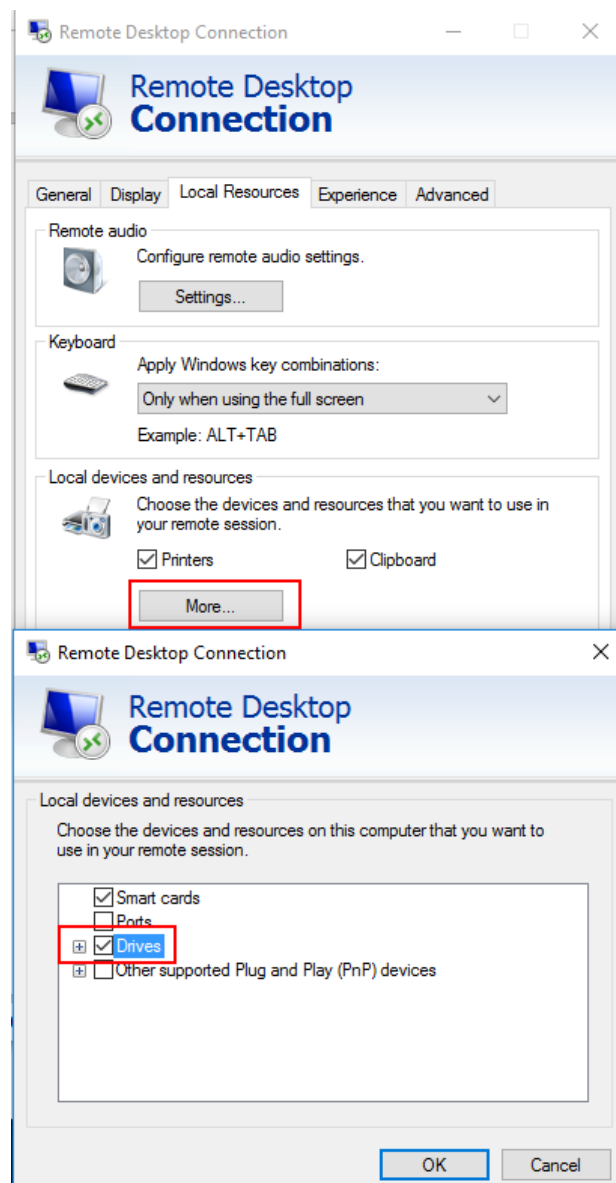

Windows will then map drives of the controller to the corresponding network drives.

9. To use printers connected to the controller while accessing them from the R&S FSVA/FSV, activate the "Printers" option. Do not change the remaining settings.
10. Open the "Display" tab.
The options for configuring the R&S FSVA/FSV screen display are displayed.
11. Under "Remote desktop size", you can set the size of the R&S FSVA/FSV window on the desktop of the controller.
12. Under "Colors", do not change the settings.
13. Set the "Display the connection bar when I use the full screen" option:

- If activated, a bar showing the network address of the R&S FSVA/FSV will appear at the top edge of the screen. You can use this bar to reduce, minimize or close the window.
- If deactivated, the only way you can return to the controller desktop from the R&S FSVA/FSV screen in full screen mode is to select "Disconnect" from the "Start" menu.

6.2.1.3 Starting and Terminating Remote Operation

Setting up a connection to the R&S FSVA/FSV

1. In the "Remote Desktop Connection" dialog box (see [Chapter 6.2.1, "Operation with Windows Remote Desktop"](#), on page 567), open the "General" tab.
2. In the "Computer" field, enter the IP address of the R&S FSVA/FSV.
In the "User name" field, enter *instrument* to log in as an administrator, or *Normal User* to log in as a standard user.
In the "Password" field, enter *894129*.
3. To save the connection configuration for later use:
 - a) Select the "Save As" button.
The "Save As" dialog box is displayed.
 - b) Enter the name for the connection information (*.RDP).
4. To load an existing connection configuration:
 - a) Select the "Open" button.
The "Open" dialog box is displayed.
 - b) Select the *.RDP file.
5. Select the "Connect" button.
The connection is set up.
6. If the "Drives" option is activated on the "Local Resources" tab, a warning is displayed indicating that the drives are enabled for access from the R&S FSVA/FSV. Select "OK" to confirm the warning.
7. After a few moments, the R&S FSVA/FSV screen is displayed.
If a dark screen appears or a dark square appears in the upper left-hand corner of the screen, you must restart the R&S FSVA/FSV in order to see the modified screen resolution.

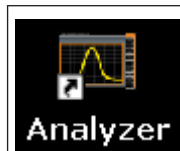

- Press the key combination [ALT] + [F4].
- The R&S FSVA/FSV firmware is shut down, which may take a few seconds.
- On the desktop, double-tap the "Analyzer" icon.

The firmware restarts and then automatically opens the "Soft Front Panel", i.e. the user interface on which all front panel controls and the rotary knob are mapped to buttons.

8. To deactivate or activate the "Soft Front Panel", press the [F6] key. After the connection is established, the R&S FSVA/FSV screen is displayed in the "Remote Desktop" application window.

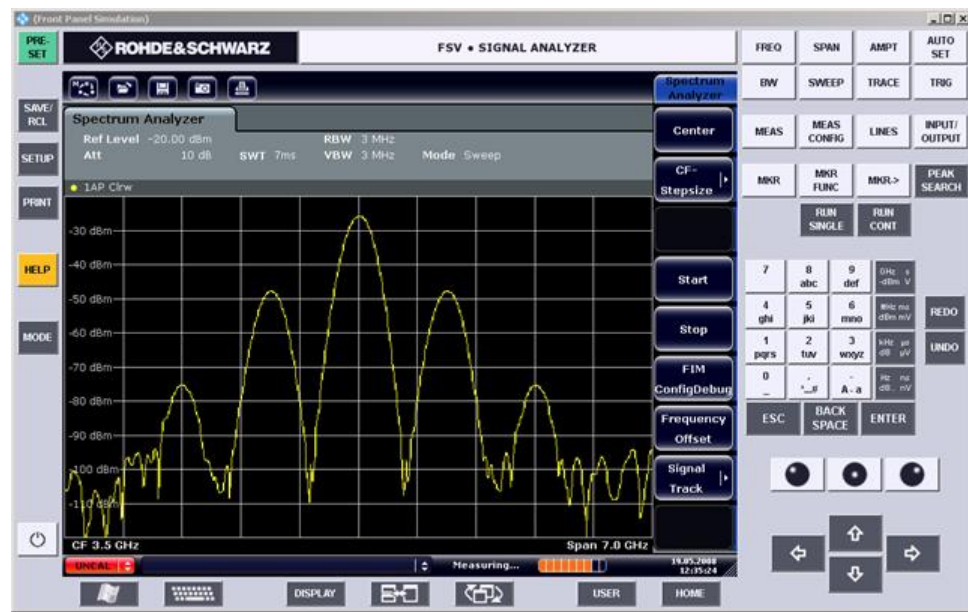

You can operate all keys and softkeys using the mouse. The rotary knob is simulated using the knob buttons.

The Windows "Start" menu can be made available by expanding the "Remote Desktop" window to full size.

During the connection with the controller, the login entry is displayed on the R&S FSVA/FSV screen.

Terminating Remote Desktop control

The connection can be terminated by the controller or by a user at the R&S FSVA/FSV:

- ▶ ● On the controller, close the "Remote Desktop" window. The connection to the R&S FSVA/FSV is terminated (any time is possible).
- On the R&S FSVA/FSV, a user logs on. The connection to the controller is terminated as a result. A message is displayed on the controller display indicating that another user has assumed control of the instrument.

Restoring the connection to the R&S FSVA/FSV

Follow the instructions above for setting up a connection to the R&S FSVA/FSV. If the connection is terminated and then restored, the R&S FSVA/FSV remains in the same state.

6.2.1.4 Deactivating the R&S FSVA/FSV via Remote Operation

1. Click the R&S FSVA/FSV soft front panel and close the application with the key combination [ALT] + [F4].
2. Click the desktop and press the key combination [ALT] + [F4] to shut down the R&S FSVA/FSV.
A safety query is displayed to warn you that the instrument cannot be reactivated via remote operation and asks you whether you want to continue the shutdown process.
3. Respond to the safety query with "Yes".
The connection with the controller is terminated and the R&S FSVA/FSV is shut down.

6.2.2 Operation with a VNC Client

Virtual Network Computing (VNC) allows you to control the R&S FSVA/FSV (the VNC server) from a remote computer (the VNC client), for example to monitor the instruments in a production line. The handling of a VNC system is similar to using the Windows Remote Desktop, but VNC has some advantages compared to the Remote Desktop.

- You can view the contents of the instrument display on more than one client
- VNC clients are available for many operating systems. Thus, a VNC is independent of the platform you are using.
- You can still control the instrument itself when a remote connection has been established, and see what is happening on both the instrument display and the client. With the display running, you can also change settings both on the instrument and with the client simultaneously. (Using the Remote Desktop turns off the display and viewing the display contents is only possible on the controlling computer.)
- The complete mini soft front panel is available on the client ("Alt-M" opens the mini soft front panel).

All R&S FSVA/FSV instruments as of firmware version 3.0 support a VNC and are delivered with a version of the TightVNC software. On the client side, you can use a web browser or a VNC client to access the instrument.

Using a web browser

If you are using a web browser (for example Microsoft Internet Explorer), enter the IP address of the instrument and the port you are using for the connection into the address bar to establish a connection (for example "192.0.2.0:5800").

The browser then opens an interface that allows you to control the instrument after you have entered the password.

The default port is 5800 and the default password is 894129, but you can change this on the VNC software that comes with the instrument if required.

Note that using a browser requires you to install Java in order to run properly.

Using a VNC client

Alternatively, you can install a VNC client on your computer (for example a program like TightVNC) and use that to access the instrument. In that case, start the client and enter the IP address of the instrument to establish a connection.

6.2.3 Brief Introduction to Remote Control

The instrument can be remote-controlled via the network (LAN interface). For details on configuring the LAN interface see [Chapter 6.2.5, "Setting Up a Network \(LAN\) Connection"](#), on page 595.

For details on setting the interface see [Chapter 6.2.4, "Configuring the GPIB Interface"](#), on page 594.

The following programming examples are structured hierarchically, i.e. the later examples are based on the preceding ones. This allows you to easily assemble a well-functioning program by using the modules of the program examples. More complex examples are provided in the Operating Manual, chapter "Remote Control - Programming Examples"

6.2.3.1 Basic Steps in Remote Control Programming

The following examples explain how to program the instrument and can be used as a basis for solving enhanced programming tasks.

Visual Basic was used as the programming language. However, the programs can be implemented in other languages as well.



Using backslashes

In programming languages such as C, C++ or programs such as MATLAB or NI Interactive Control, a backslash starts an escape sequence (e.g. "\n" is used to start a new line). In these programming languages and programs, two backslashes instead of one must be used in remote commands, e.g. in ["Storing Instrument Settings"](#) on page 591

```
instead of MMEM:STOR:STAT 1, 'C:\USER\DATA\TEST1 '  
use MMEM:STOR:STAT 1, 'C:\\USER\\DATA\\TEST1 '
```

Linking the Remote Control Library for Visual Basic

Programming notes:

- **Outputting text using the print function**
Using the print method, this example displays the value of the variable `MyVar` in the "Immediate" window of the Visual Basic development environment. Note that the print method only applies to objects that can display text.

```
Debug.Print MyVar
```

- **Accessing the functions of the VISA32 .DLL**

To enable users to create Visual Basic control applications, the VISA32 .BAS file must be added to a project so that functions of the VISA32 .DLL can be called. In addition, the VPPTYPE .BAS file must be added to the project. This file contains constants and definitions for error handling, timeout values, etc.

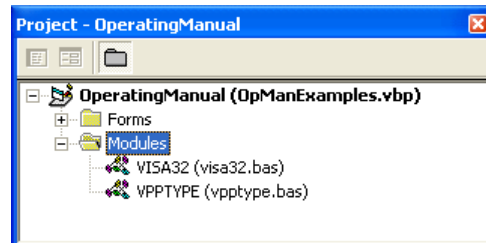

The modules visa32.bas and vpptype.bas can be found under <VXIpnPath>\WinNT\include (typically C:\VXIpn\WinNT\include). As an alternative, a reference to the VISA32 .DLL can be added to the project.

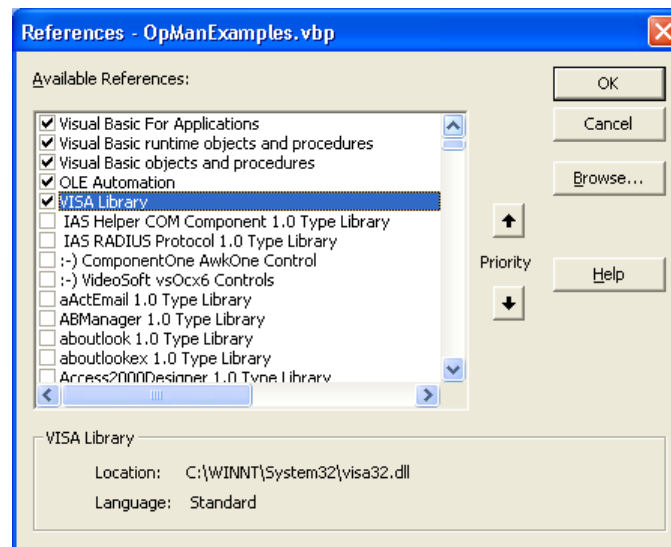

- **Creating a response buffer**

Since the DLL returns zero-terminated strings in responses, a string of sufficient length must be created before the functions InstrRead() and ilrd() are called, because Visual Basic inserts a length specification in front of the strings and this specification is not updated by the DLL. The following two means of creating the length specification for a string are provided:

```
Dim Rd as String * 100
```

```
Dim Rd as String
Rd = Space$(100)
```

- **Creating Wrapper Procedures for Writing and Reading**

Since the "VISA" functions require command and response strings and their corresponding length in two separate parameters, the main program code is easier to read and maintain if the read and write functions are encapsulated. Here, the procedure InstrWrite() encapsulates the function viWrite() and InstrRead() encapsulates viRead(). In addition, these wrappers include status checking:

```

Public Sub InstrWrite(ByVal vi As Long, ByVal Cmd As String)
Dim status As Long
Dim retCount As Long
    'Send command to instrument and check for status
status = viWrite(vi, Cmd, Len(Cmd), retCount)
    'Check for errors - this will raise an error if status is not VI_SUCCESS
CALL CheckError(vi, status)
End Sub

Public Sub InstrRead(ByVal vi As Long, Response As String, _
    ByVal count As Long, retCount As Long)
Dim status As Long
'Initialize response string
Response = Space(count)
    '...and read
status = viRead(vi, Response, count, retCount)
    'Check for errors - this will raise an error if status is not VI_SUCCESS
CALL CheckError(vi, status)
    'adjust string length
Response = Left(Response, retCount)
End Sub

```

The following function illustrates status/error checking. The procedure raises an exception when a VISA error occurs:

```

Public Sub CheckError(ByVal vi As Long, status As Long)
Dim ErrorMessage As String * 1024

'Initialize error message string
ErrorMessage = ""
If (status < 0) Then
    'Query the error message from VISA
    If (viStatusDesc(vi, status, ErrorMessage) = VI_SUCCESS) Then
        Err.Description = ErrorMessage
    End If
    Err.Raise (status)
End If
End Sub

```

Initialization and Default State

At the start of each program, the global variables used by all subroutines must be created. The remote control and the instrument settings will then be changed to a defined default state. The two subroutines `InitController` and `InitDevice` are used for this.

Creating Global Variables

In Visual Basic, global variables are stored in modules (data extension `.BAS`). Thus, at least one module (e.g. `GLOBALS.BAS`) must be created that contains the variables used by all subroutines, e.g. the variables for device addresses used by the remote control driver.

For all example programs shown below, the file must contain the following instructions:

```
Global analyzer As Long
Global defaultRM As Long
```

Initializing the Remote Control Session

```
REM ----- Initializing the remote control session -----
Public SUB Initialize()
    Dim status As Long
    'CALL viOpenDefaultRM to get the resource manager handle
    'Store this handle in defaultRM. The function viStatusDesc
    'returns a text description of the status code returned by viOpenDefaultRM
    status = viOpenDefaultRM(defaultRM)
    status = viStatusDesc(defaultRM, status, Response)
    'Open the connection to the device and store the handle
    'Note: The timeout value in viOpen() applies only for opening the interface
    'For setting the communication timeout, set the VI_ATTR_TMO_VALUE attribute
    'timeout values are in milliseconds
    'This example assumes the instrument IP address 10.0.0.10
    'If the network provides a name resolution mechanism, the hostname of
    'the instrument can be used instead of the numeric IP address
    'the resource string for GPIB would be "GPIB::20::INSTR"
    status = viOpen(defaultRM, "TCPIP::10.0.0.10::INSTR", 0, 1000, analyzer)
    'status = viOpen(defaultRM, "TCPIP::<hostname>::INSTR", 0, 1000, analyzer)
    'status = viOpen(defaultRM, "GPIB::20::INSTR", 0, 1000, analyzer)
    'Set timeout value - here 5s
    status = viSetAttribute(vi, VI_ATTR_TMO_VALUE, 5000)
END SUB
REM *****
```

Initializing the Instrument

Set the remote control status registers and instrument settings to the default state.

```
REM ----- Initializing the instrument -----
Public SUB InitDevice()
CALL InstrWrite(analyzer, "*CLS")    'Reset status register
CALL InstrWrite(analyzer, "*RST")    'Reset instrument
END SUB
REM*****
```

Switching the Screen Display On and Off

In the default setting, all remote control commands are carried out with the screen display switched off in order to attain optimum measurement speed. During the development phase of remote control programs, however, the screen display is required in order to visually check both the programming of the settings and the measurement results.

The following examples show functions with which the screen display can be switched on or off during remote control operation.

```
REM ----- Switching on the screen display -----
Public SUB DisplayOn()
```

```

CALL InstrWrite(analyzer, "SYST:DISP:UPD ON")
    'Switch on screen display
END SUB
REM*****
REM ----- Switching off the screen display -----
Public SUB DisplayOff()
CALL InstrWrite(analyzer, "SYST:DISP:UPD OFF")
    'Switch off screen display
END SUB
REM*****

```

Configuring the Power Save Function for the Display

During remote control operation, it is often unnecessary to display the measurement results on screen. Although the command `SYSTem:DISPlay:UPDate OFF` switches off the display of the measurement results, thus significantly improving speed in remote control operation, the display itself and the background lighting in particular remain switched on.

If you also want to switch off the display itself, you must use the power save function by setting the response time in minutes prior to activation.



The display is reactivated immediately when you press a key on the instrument's front panel.

```

Public SUB PowerSave()
CALL InstrWrite(analyzer, "DISPlay:PSAVE:HOLDoff 1")
    'Set response time to 1 minute
CALL InstrWrite(analyzer, "DISPlay:PSAVE ON")
    'Switch on Power Save function

```

Sending Simple Instrument Setting Commands

This example shows how the center frequency, span and reference level of the instrument are set.

```

REM ----- Instrument setting commands -----
PUBLIC SUB SimpleSettings()
CALL InstrWrite(analyzer, "FREQUENCY:CENTER 128MHz")
    'Center frequency 128 MHz
CALL InstrWrite(analyzer, "FREQUENCY:SPAN 10MHZ")
    'Set span to 10 MHz
CALL InstrWrite(analyzer, "DISPLAY:TRACE:Y:RLEVEL -10dBm")
    'Set reference level to -10dBm
END SUB
REM *****

```

Switching to Manual Operation

```

REM ----- Switching instrument to manual operation -----
CALL viGpibControlREN(analyzer, VI_GPIB_REN_ADDRESS_GTL)

```

```
'Set instrument to Local state
REM *****
```

Reading Out Instrument Settings

The settings made above can now be read out. To do so, the abbreviated commands are used.

```
REM ----- Reading out instrument settings -----
PUBLIC SUB ReadSettings()
Dim retCount as Long
CFfrequency$ = SPACE$(20) 'Provide text variable (20 characters)
CALL InstrWrite(analyzer, "FREQ:CENT?")
'Request center frequency
CALL InstrRead(analyzer, CFfrequency$, 20, retCount)
'Read value
CR&S FSVan$ = SPACE$(20) 'Provide text variable (20 characters)
CALL InstrWrite(analyzer, "FREQ:SPAN?")
'Request span
CALL InstrRead(analyzer, CR&S FSVan$, 20, retCount)
'Read value
RLlevel$ = SPACE$(20) 'Provide text variable (20 characters)
CALL InstrWrite(analyzer, "DISP:TRAC:Y:RLEV?")
'Request ref level setting
CALL InstrRead(analyzer, RLlevel$, 20, retCount)
'Read value
REM ----- Displaying values in the Immediate window -----
Debug.Print "Center frequency: "; CFfrequency$,
Debug.Print "Span: "; CR&S FSVan$,
Debug.Print "Reference level: "; RLlevel$,
END SUB
REM*****
```

Marker Positioning and Readout

```
REM ----- Example of marker function -----
PUBLIC SUB ReadMarker()
Dim retCount as Long
CALL InstrWrite(analyzer, "CALC:MARKER ON;MARKER:MAX")
'Activate marker 1 and search for peak
MKmark$ = SPACE$(30) 'Provide text variable (30 characters)
CALL InstrWrite(analyzer, "CALC:MARK:X?;Y?")
'Query frequency and level
CALL InstrRead(analyzer, MKmark$, 30, retCount)
'Read value
REM ----- Displaying values in the Immediate window -----
Debug.Print "Marker frequency/level "; MKmark$,
END SUB
REM *****
```

Command Synchronization

The synchronization methods used in the following example are described in the Operating Manual, chapter "Remote Control - Basics", section "Command Sequence and Command Synchronization".

```

REM ----- Commands for command synchronization -----
PUBLIC SUB SweepSync()
Dim retCount as Long
Dim SRQWaitTimeout As Long
Dim eventType As Long
Dim eventVi As Long
REM The command INITiate[:IMMediate] starts a single sweep if the
REM command INIT:CONT OFF has already been sent. The next command
REM must not be carried out until a full sweep has been completed.
CALL InstrWrite(analyzer, "INIT:CONT OFF")
REM ----- First method: Using *WAI -----
CALL InstrWrite(analyzer, "ABOR;INIT:IMM; *WAI")
REM ----- Second method: Using *OPC? -----
OpcOk$ = SPACE$(2) 'Provide space for *OPC? response
CALL InstrWrite(analyzer, "ABOR;INIT:IMM; *OPC?")
REM ----- In this case, the controller can use other instruments -----
CALL InstrRead(analyzer, OpcOk$, 2, retCount)
'Wait for "1" from *OPC?
REM ----- Third method: Using *OPC -----
REM In order for the Service Request function to be used with a GPIB
REM driver from National Instruments, the setting "Disable
REM Auto Serial Poll" must be set to "yes" with IBCONF!
CALL InstrWrite(analyzer, "*SRE 32") 'Enable Service Request for ESR
CALL InstrWrite(analyzer, "*ESE 1") 'Set event enable bit for operation
'complete bit
CALL viEnableEvent(vi, VI_EVENT_SERVICE_REQ, VI_QUEUE, 0)
'Enable the event for service request
CALL InstrWrite(analyzer, "ABOR;INIT:IMM; *OPC")
'Start sweep with Synchronization to OPC
SRQWaitTimeout = 5000 'Allow 5s for sweep completion
'Now wait for the service request
CALL viWaitOnEvent(vi, VI_EVENT_SERVICE_REQ, SRQWaitTimeout, _
eventType, eventVi)
CALL viClose(eventVi) 'Close the context before continuing
CALL viDisableEvent(vi, VI_EVENT_SERVICE_REQ, VI_QUEUE)
'Disable subsequent events
REM Resume main program here.
END SUB
REM *****

```

Reading Output Buffers

```

REM ----- Subroutine for the individual STB bits -----
Public SUB Outputqueue() 'Reading the output queue
Dim retCount as Long

```

```

result$ = SPACE$(100)      'Create space for response
CALL InstrRead(analyzer, result$, 100, retCount)
Debug.Print "Contents of Output Queue : "; result$
END SUB
REM *****

```

Reading Error Messages

```

REM ----- Subroutine for evaluating the error queue -----
Public SUB ErrorQueueHandler()
Dim retCount as Long
ERROR$ = SPACE$(100)      Subroutine for evaluating the error queue
CALL InstrWrite(analyzer, "SYSTEM:ERROR?")
CALL InstrRead(analyzer, ERROR$, 100, retCount)
Debug.Print "Error Description : "; ERROR$
END SUB
REM *****

```

6.2.3.2 Detailed Programming Examples

In the following sections, typical programming examples for setting measurement parameters and functions, general settings, printout and data management are provided.

Default Setting of the R&S FSVA/FSV

The following settings provide typical examples of how to change the default setting of the R&S FSVA/FSV.

Note that only some of the settings are necessary depending on the application example. In many cases, it is not necessary to set resolution bandwidth, video bandwidth and sweep time since these parameters are automatically calculated in the default setting when the span is changed. Likewise, the input attenuation is automatically calculated in the default setting as a function of the reference level. Last of all, the level detectors are linked to the selected trace mode in the default setting.

The settings automatically calculated in the default setting are indicated with an asterisk (*) in the following program example.

Setting the Remote Control Status Registers

```

REM *****
Public Sub SetupStatusReg()

'----- IEEE 488.2 status register -----
CALL InstrWrite(analyzer,"*CLS")      'Reset status registers
CALL InstrWrite(analyzer,"*SRE 168")  'Enable Service Request for
    'STAT:OPER-,STAT:QUES- and ESR-Register
CALL InstrWrite(analyzer,"*ESE 61")   'Set event enable bit for:
    'operation complete 'command-, execution-,
    'device dependent- and query error
'----- SCPI status register -----

```

```

CALL InstrWrite(analyzer,"STAT:OPER:ENAB 0")
    'Disable OPERATION Status reg
CALL InstrWrite(analyzer,"STAT:QUES:ENAB 0")
    'Disable questionable Statusreg
End Sub
REM *****

```

Default Settings for Measurements

```

REM *****
Public Sub SetupInstrument()

'----- Default setting f the R&S FSV -----
CALL SetupStatusReg    'Configure status registers
CALL InstrWrite(analyzer,"*RST")    'Reset instrument
CALL InstrWrite(analyzer,"SYST:DISP:UPD ON")
    'ON: screen display on
    'OFF: off (improved performance)
CALL InstrWrite(analyzer,"INIT:CONT OFF")
    'Single sweep mode

'----- Frequency setting -----
CALL InstrWrite(analyzer,"FREQUENCY:CENTER 100MHz")
    'Center frequency
CALL InstrWrite(analyzer,"FREQ:SPAN 1 MHz")
    'Span

'----- Level setting -----
CALL InstrWrite(analyzer,"DISP:WIND:TRAC:Y:RLEV -20dBm")
    'Reference level
CALL InstrWrite(analyzer,"INP:ATT 10dB")
    'Input attenuation (*)

'----- Level scaling -----
CALL InstrWrite(analyzer,"DISP:WIND:TRAC:Y:SPAC LOG")
    'Log level axis
CALL InstrWrite(analyzer,"DISP:WIND:TRAC:Y:SCAL 100dB")
    'Level range
CALL InstrWrite(analyzer,"DISP:WIND:TRAC:Y:SCAL:MODE ABS")
    'Absolute scaling
CALL InstrWrite(analyzer,"CALC:UNIT:POW DBM")
    'y meas. unit

'----- Trace and detector setting -----
CALL InstrWrite(analyzer,"DISP:TRAC1:MODE AVER")
    'Trace1 average
CALL InstrWrite(analyzer,"AVER:TYPE VID")
    'Average mode video; "LIN" for linear
CALL InstrWrite(analyzer,"SWE:COUN 10")
    'Sweep count
CALL InstrWrite(analyzer,"DISP:TRAC2 OFF")
    'Trace2 blank
CALL InstrWrite(analyzer,"DISP:TRAC3 OFF")
    'Trace3 blank

```

```

CALL InstrWrite(analyzer,"DISP:TRAC4 OFF")
    'Trace4 blank
CALL InstrWrite(analyzer,"DISP:TRAC5 OFF")
    'Trace5 blank
CALL InstrWrite(analyzer,"DISP:TRAC6 OFF")
    'Trace6 blank
CALL InstrWrite(analyzer,"CALC:MATH:STAT OFF")
    'Trace difference off
CALL InstrWrite(analyzer,"DET1 RMS")
    'Detector Trace1  (*)
CALL InstrWrite(analyzer,"DET2:AUTO ON")
    'Detector Trace2  (*)
CALL InstrWrite(analyzer,"DET3:AUTO ON")
    'Detector Trace3  (*)
CALL InstrWrite(analyzer,"DET4:AUTO ON")
    'Detector Trace4  (*)
CALL InstrWrite(analyzer,"DET5:AUTO ON")
    'Detector Trace5  (*)
CALL InstrWrite(analyzer,"DET6:AUTO ON")
    'Detector Trace6  (*)
'----- Bandwidths and sweep time -----
CALL InstrWrite(analyzer,"BAND:RES 100KHz")
    'Resolution bandwidth (*)
CALL InstrWrite(analyzer,"BAND:VID 1MHz")
    'Video bandwidth  (*)
CALL InstrWrite(analyzer,"SWE:TIME 100ms")
    'Sweep time  (*)
END SUB

```

Using Markers and Delta Markers

The markers are used for marking points on traces, reading out measurement results and for selecting a display area quickly.

Marker Search Functions, Restricting the Search Range

The following example is based on an AM-modulated signal at 100 MHz that has the following characteristics:

Carrier signal level	-30 dBm
AF frequency	100 kHz
Modulation depth	50 %

Marker 1 and then delta marker 2 are set to the largest maximum points on the trace. The frequency and level are then read. In the following measurements, the instrument's default setting can be used for measurements (SetupInstrument).

```

REM *****
Public Sub MarkerSearch()
Dim retCount as Long

```

```

result$ = Space$(100)
CALL SetupInstrument      'Default Setting
'----- Peak search without search range limits-----
CALL InstrWrite(analyzer,"INIT:CONT OFF")
      'Switch to single sweep
CALL InstrWrite(analyzer,"CALC:MARK:PEXC 6DB")
      'Define peak excursion
CALL InstrWrite(analyzer,"CALC:MARK:STAT ON")
      'Enable marker 1
CALL InstrWrite(analyzer,"CALC:MARK:TRAC 1")
      'Set marker 1 to trace 1
CALL InstrWrite(analyzer,"INIT;*WAI")      'Perform sweep with sync
CALL InstrWrite(analyzer,"CALC:MARK:MAX;X?;Y?")
      'Marker to peak; read frequency and level
CALL InstrRead(analyzer, result$, 100, retCount)
Debug.Print "Marker 1: ";result$
CALL InstrWrite(analyzer,"CALC:DELT2:STAT ON;MAX;MAX:LEFT")
      'Activate delta marker 2,
      'set to peak and then to next peak left
CALL InstrWrite(analyzer,"CALC:DELT2:X?;Y?")
      'Read delta marker 2 frequency and level
result$ = Space$(100)
CALL InstrRead(analyzer, result$, 100, retCount)
Debug.Print "Delta 2: ";result$
'----- Peak search with search range limit in x direction -----
CALL InstrWrite(analyzer,"CALC:MARK:X:SLIM:STAT ON;LEFT _
      0Hz;RIGHT 100.05MHz")
      'Activate search limit,
      'set at right below AF
CALL InstrWrite(analyzer,"CALC:DELT3:STAT ON;MAX;MAX:RIGHT")
      'Activate delta marker 3,
      'set to peak and then to next peak right
CALL InstrWrite(analyzer,"CALC:DELT3:X:REL?;:CALC:DELT3:Y?")
      'Read delta marker 3 frequency and level;
      'both must have a value of 0
result$ = Space$(100)
CALL InstrRead(analyzer, result$, 100, retCount)
Print "Delta 3: ";result$
'----- Peak search with search range limit in y direction -----
CALL InstrWrite(analyzer,"CALC:THR:STAT ON")
CALL InstrWrite(analyzer,"CALC:THR -35DBM")
      'Activate threshold and set it above the AF
CALL InstrWrite(analyzer,"CALC:DELT3:STAT ON;MAX;MAX:NEXT")
      'Activate delta marker 3,
      'set to peak and then to next peak
      '=> is not found
CALL InstrWrite(analyzer,"CALC:DELT3:X:REL?;:CALC:DELT3:Y?")
      'Query and read delta marker 3
      'frequency and level;
      'both must have a value of 0

```

```

result$ = Space$(100)
CALL InstrRead(analyzer, result$, 100, retCount)
Debug.Print "Delta 3: ";result$
'---- Setting center frequency and reference level with markers -----
CALL InstrWrite(analyzer,"CALC:MARK2:FUNC:CENT")
'Delta marker 2 -> marker and
'center frequency = marker 2
CALL InstrWrite(analyzer,"CALC:MARK2:FUNC:REF")
'Ref level = marker 2
CALL InstrWrite(analyzer,"INIT;*WAI")      'Sweep with sync
END SUB
REM *****

```

Frequency Counting

The following example is based on a signal at 100 MHz with a level of -30 dBm. Again, the instrument's default setting can be used (SetupInstrument). The purpose of frequency counting is to determine the exact frequency of the signal at 100 MHz.

```

REM *****
Public Sub MarkerCount()
Dim retCount as Long
CALL SetupInstrument      'Default setting
'----- Defining signal frequency with frequency counter -----
CALL InstrWrite(analyzer,"INIT:CONT OFF")
'Switch to single sweep
CALL InstrWrite(analyzer,"CALC:MARK:PEXC 6DB")
'Define peak excursion
CALL InstrWrite(analyzer,"CALC:MARK:STAT ON")
'Activate marker 1
CALL InstrWrite(analyzer,"CALC:MARK:TRAC 1")
'Set marker 1 to trace 1
CALL InstrWrite(analyzer,"CALC:MARK:X 100MHz")
'Set marker 1 to 100 MHz
CALL InstrWrite(analyzer,"CALC:MARK:COUNT ON")
'Activate frequency counter
CALL InstrWrite(analyzer,"INIT;*WAI")      'Perform sweep with sync
CALL InstrWrite(analyzer,"CALC:MARK:COUNT:FREQ?")
'Query and read measured frequency
result$ = Space$(100)
CALL InstrRead(analyzer, result$, 100, retCount)
Debug.Print "Marker Count Freq: ";result$
END SUB
REM *****

```

Working with a Fixed Reference Point

The following example is based on a signal at 100 MHz with a level of -20 dBm. Thus, the harmonics of the signal are located at 200 MHz, 300 MHz, etc. For high-quality signal sources, these harmonics may be located outside the dynamic range of the R&S FSVA/FSV. Nevertheless, to measure the harmonic suppression, the level setting

must be changed to higher sensitivity when measuring the harmonics. In this case, it may be necessary to suppress the carrier by using a notch filter in order to prevent the RF input of the R&S FSVA/FSV from being overloaded.

Thus, two measurements with different level settings are performed in the following example. First, a high reference level is used on the carrier frequency, and then a low reference level is used on the frequency of the third harmonic.

The default setting of the R&S FSVA/FSV for measurements ("SetupInstrument") is also used as a starting point here, after which adaptations for the measurement are carried out.

```

REM *****
Public Sub RefFixed()
Dim retCount as Long
CALL SetupInstrument 'Default setting
'----- Measuring the reference point -----
CALL InstrWrite(analyzer,"INIT:CONT OFF")
'Switch to single sweep
CALL InstrWrite(analyzer,"CALC:MARK:PEXC 6DB")
'Define peak excursion
CALL InstrWrite(analyzer,"CALC:MARK:STAT ON")
'Activate marker 1
CALL InstrWrite(analyzer,"CALC:MARK:TRAC 1")
'Set marker 1 to trace 1
CALL InstrWrite(analyzer,"INIT;*WAI") 'Perform sweep with sync
CALL InstrWrite(analyzer,"CALC:MARK:MAX")
'Set marker 1 to 100 MHz
CALL InstrWrite(analyzer,"CALC:DELT:FUNC:FIX ON")
'Define reference point
'----- Setting frequency, level and bandwidth for measuring harmonics -----
CALL InstrWrite(analyzer,"FREQ:CENT 400MHz;Span 1MHz")
'Set freq of 3rd harmonic
CALL InstrWrite(analyzer,"BAND:RES 1kHz")
'Set suitable RBW
CALL InstrWrite(analyzer,"SWEEP:TIME:AUTO ON")
'Couple sweep time
CALL InstrWrite(analyzer,"INP:ATT:AUTO ON")
'Select more sensitive level setting
CALL InstrWrite(analyzer,"DISP:WIND:TRAC:Y:RLEV -50dBm")
CALL InstrWrite(analyzer,"INIT;*WAI") 'Perform sweep with sync
CALL InstrWrite(analyzer,"CALC:DELT:MAX;X:REL?;Y?")
'Read delta marker
result$ = Space$(100)
CALL InstrRead(analyzer, result$, 100, retCount)
'Read frequency and level
Debug.Print "Deltamarker 1: "; result$
END SUB
REM *****

```

Measuring Noise and Phase Noise

When phase noise is measured, the noise power related to a bandwidth of 1 Hz is set in relation to the power of an adjacent carrier signal. A commonly used offset between the measured frequency and the carrier frequency is 10 kHz.

When noise is measured, the measured absolute level is related to a bandwidth of 1 Hz.

The following example is also based on a signal at 100 MHz with a level of -30 dBm. Two markers are used to determine both the noise and the phase noise at a 10 kHz offset from the carrier signal.

```

REM *****
Public Sub Noise()
Dim retCount as Long
'----- Default setting of the R&S FSV -----
CALL SetupStatusReg 'Configure status register
CALL InstrWrite(analyzer,"*RST") 'Reset instrument
CALL InstrWrite(analyzer,"INIT:CONT OFF")
'Single sweep mode
'----- Setting the frequency -----
CALL InstrWrite(analyzer,"FREQUENCY:CENTER 100MHz")
'Center frequency
CALL InstrWrite(analyzer,"FREQ:SPAN 100 kHz")
'Span
'----- Setting the level -----
CALL InstrWrite(analyzer,"DISP:WIND:TRAC:Y:RLEV -20dBm")
'Reference level
CALL InstrWrite(analyzer,"INIT;*WAI") 'Perform sweep with sync
'----- Setting the reference point -----
CALL InstrWrite(analyzer,"CALC:MARK:PEXC 6DB")
'Define peak excursion
CALL InstrWrite(analyzer,"CALC:MARK:STAT ON")
'Activate marker 1
CALL InstrWrite(analyzer,"CALC:MARK:TRAC 1")
'Set marker 1 to trace 1
CALL InstrWrite(analyzer,"CALC:MARK:MAX")
'Set marker 1 to 100 MHz
CALL InstrWrite(analyzer,"CALC:DELT:FUNC:PNO ON")
'Define reference point for phase noise
'----- Measuring the phase noise -----
CALL InstrWrite(analyzer,"CALC:DELT:X 10kHz")
'Position delta marker
CALL InstrWrite(analyzer,"CALC:DELT:FUNC:PNO:RES?")
'Query and output phase noise result
result$ = Space$(100)
CALL InstrRead(analyzer, result$, 100, retCount)
Debug.Print "Phase Noise [dBc/Hz]: "; result$
'----- Measuring the noise -----
CALL InstrWrite(analyzer,"CALC:MARK:X 99.96MHz")
'Position marker 1

```



```
CALL InstrWrite(analyzer,"CALC:MARK:FUNC:NOIS:RES?")
    'Query and output result
result$ = Space$(100)
CALL InstrRead(analyzer, result$, 100, retCount)
Print "Noise [dBm/Hz]: "; result$
END SUB
REM *****
```

Reading Out Trace Data

In the following example, the trace data obtained with the default setting is read from the instrument and displayed in a list on the screen. Readout occurs first in binary format and then in ASCII format, once with the span > 0 and once with the span = 0.

In binary format, the header of the message with the length specification is evaluated and used to calculate the x-axis values.

In ASCII format, merely the list of level values is output.

Binary data is read out in three steps:

1. The number of digits in the length specification is read out.
2. The length specification itself is read out.
3. The trace data itself is read out.

The procedure is required for programming languages that only support structures with data types of the same type (arrays, such as with Visual Basic), because the data types of the header and data sections are different in binary data.

The "VISA" library provides only a mechanism for reading into string buffers. In order to convert the data into an array of single precision values, the string contents must be copied into a buffer of that type. The following example uses an operating system function for the copy operation. The function declaration must be added to a module (.bas) as follows:



Array dimensions

The arrays for the measured data are dimensioned so they provide sufficient space for trace data of the R&S FSVA/FSV (691 measurement points).

```
REM *****
Public Sub ReadTrace()
'----- Creating variables -----
Dim traceData(1400) As Single    'Buffer for floating point binary data
Dim digits As Byte              'Number of characters in
    'length specification
Dim traceBytes As Integer       'Len. of trace data in bytes
Dim traceValues As Integer      'No. of meas. values in buff.
Dim BinBuffer as String * 5600  'String buffer for binary data
Dim retCount as Long
asciiResult$ = Space$(28000)    'Buffer for ASCII trace data
```

```

result$ = Space$(100)      'Buffer for simple results
startFreq$ = Space$(100)   'Buffer for start frequency
span$ = Space$(100)       'Buffer for span
'----- Default setting of the R&S FSV -----
CALL SetupInstrument      'Default setting
CALL InstrWrite(analyzer,"INIT:CONT OFF")
    'Switch to single sweep
CALL InstrWrite(analyzer,"INIT;*WAI")      'Perform sweep with sync
'----- Defining the frequency range for output -----
CALL InstrWrite(analyzer,"FREQ:START?")    'Read start frequency
CALL InstrRead(analyzer,startFreq$, 100, retCount)
startFreq = Val(startFreq$)
CALL InstrWrite(analyzer,"FREQ:SPAN?")     'Read span
CALL InstrRead(analyzer,span$, 100, retCount)
span = Val(span$)
'----- Reading out in binary format -----
CALL InstrWrite(analyzer, "FORMAT REAL,32")
    'Set binary format
CALL InstrWrite(analyzer, "TRAC1? TRACE1")
    'Read trace 1
CALL InstrRead(analyzer, result$, 2, retCount)
    'Read and store length
digits = Val(Mid$(result$, 2, 1))         'spec. for number of characters
result$ = Space$(100)                    'Reinitialize buffer
CALL InstrRead(analyzer, result$, digits, retCount)
    'Read and store length
traceBytes = Val(Left$(result$, digits))
    'specification
CALL InstrRead(analyzer, BinBuffer, traceBytes, retCount)
    'Read trace data into buffer
CopyMemory traceData(0), ByVal BinBuffer, traceBytes
    'Copy data into float array
'----- Outputting binary data as frequency/level pairs -----
traceValues = traceBytes/4              'Single precision = 4 bytes
stepsize = span/traceValues            'Calculate frequency step size
For i = 0 To traceValues - 1
Debug.Print "Value["; i; "] = "; startFreq+stepsize*i; ", "; traceData(i)
Next i
'----- Default setting of zero span -----
CALL InstrWrite(analyzer,"FREQ:SPAN 0Hz")
    'Switch to zero span
CALL InstrWrite(analyzer,"INIT;*WAI")    'Perform sweep with sync
'----- Reading out in ASCII format -----
CALL InstrWrite(analyzer,"FORMAT ASCII")
    'Set ASCII format
CALL InstrWrite(analyzer,"TRAC1? TRACE1")
    'Read and output
CALL InstrRead(analyzer, asciiResult$)
Print "Contents of Trace1: ",asciiResult$      'trace 1

```

```
END SUB
REM *****
```

Storing and Loading Instrument Settings

Settings and measured data can be stored and loaded. You can define which data set is loaded when the instrument is preset or started.

Storing Instrument Settings

In the following example, the settings/measured data to be stored are defined initially, in which case only the hardware settings are stored. However, the selection commands for the other settings are specified with the state "OFF" for the sake of completeness.

```
REM *****
Public Sub StoreSettings()
' This subroutine selects the settings to be stored and creates the
' data record "TEST1" in the directory C:\R_S\Instr\user. It uses the default
' setting and resets the instrument after the setting is stored.
'----- Default settings of the R&S FSV -----
CALL SetupInstrument
CALL InstrWrite(analyzer,"INIT:CONT OFF")
' Change to single sweep
CALL InstrWrite(analyzer,"INIT;*WAI") ' Perform sweep with sync
'----- Selection of settings to be stored -----
CALL InstrWrite(analyzer,"MMEM:SEL:HWS ON")
' Store hardware settings
CALL InstrWrite(analyzer,"MMEM:SEL:TRAC OFF")
' Do not store any traces
CALL InstrWrite(analyzer,"MMEM:SEL:LIN:ALL OFF")
' Store only the activated limit lines
'----- Storing on the instrument -----
CALL InstrWrite(analyzer,"MMEM:STOR:STAT 1,'C:\R_S\Instr\user\TEST1'")
'----- Resetting the instrument -----
CALL InstrWrite(analyzer,"*RST")
END SUB
REM *****
```

Loading Instrument Settings

In the following example, the TEST1 data record stored under C:\R_S\Instr\user is loaded by the instrument:

```
REM *****
Public Sub LoadSettings()
' This subroutine loads the TEST1 data record in the directory
' C:\R_S\Instr\user.
'----- Default setting of the status register -----
CALL SetupStatusReg ' Configure status register
'----- Loading the data record -----
CALL InstrWrite(analyzer,"MMEM:LOAD:STAT 1,'C:\R_S\Instr\user\TEST1'")
'----- Perform measurement using loaded data record -----
```

```
CALL InstrWrite(analyzer,"DISP:TRAC1:MODE WRIT")
    'Set trace to Clr/Write
CALL InstrWrite(analyzer,"INIT;*WAI")    'Start sweep
END SUB
REM *****
```

Setting the Data Record for Startup Recall

In the following example, the first step is to change the R&S FSVA/FSV to the default state. In the next step, the TEST1 data record stored under C:\R_S\Instr\user is selected for the startup recall function, i.e. the data record is then set after each *RST, presetting and each time the instrument is started. For demonstration purposes, the command *RST is carried out again.

```
REM *****
Public Sub StartupRecallSettings()
'----- Resetting the R&S FSV -----
CALL InstrWrite(analyzer,"*RST")
'----- Default setting of the status register -----
CALL SetupStatusReg    'Configure status register
'----- Selecting the startup recall data record -----
CALL InstrWrite(analyzer,"MMEM:LOAD:AUTO 1,'C:\R_S\Instr\user\TEST1'")
'----- Activating the startup recall data record -----
CALL InstrWrite(analyzer,"*RST")
END SUB
REM *****
```

Configuring and Starting a Printout

The following example shows how to configure the output format and output device for printing out a measurement screen. The procedure is as follows:

1. Set the measurement you want for the printout.
2. Check which output devices are available on the instrument.
3. Select an output device.
4. Select the output interface.
5. Configure the output format.
6. Start the printout with synchronization to completion.

It is assumed that the desired setting is a signal at 100 MHz with a power of -20 dBm. It is also assumed that the sixth printer out of the available printers that are listed is the one you want. The printout is first output to the selected printer and then to a file.

```
REM *****
Public Sub HCopy()
Dim retCount as Long
Dim SRQWaitTimeout As Long
Dim eventType As Long
```

```

Dim eventVi As Long
Dim statusSRQ As Long
DIM Devices(100) as string      'Create buffer for printer name
FOR i = 0 TO 49
    Devices$(i) = Space$(50)    'Preallocate buffer for printer name
NEXT i
'----- Default setting of the R&S FSV -----
CALL SetupStatusReg      'Configure status register
CALL InstrWrite(analyzer,"*RST")      'Reset instrument
CALL InstrWrite(analyzer,"INIT:CONT OFF")
    'Single sweep mode
CALL InstrWrite(analyzer,"SYST:DISP:UPD ON")
    'Screen display on
'----- Measurement settings -----
CALL InstrWrite(analyzer,"FREQ:CENT 100MHz;SPAN 10MHz")
    'Frequency setting
CALL InstrWrite(analyzer,"DISP:TRAC:Y:RLEV -10dBm")
    'Reference level
CALL InstrWrite(analyzer,"INIT;*WAI")      'Perform measurement
'----- Querying the available output devices -----
CALL InstrWrite(analyzer,"SYST:COMM:PRIN:ENUM:FIRST?")
    'Read out and display first output device
CALL InstrRead(analyzer,Devices$(0), 50, retCount)
Debug.Print "Printer 0: "+Devices$(0)
For i = 1 to 99
    CALL InstrWrite(analyzer,"SYST:COMM:PRIN:ENUM:NEXT?")
        'Read out next printer name
    CALL InstrRead(analyzer,Devices$(i))
    IF Left$(Devices$(i),2) = "" THEN GOTO SelectDevice
        'Stop at end of list
    Debug.Print "Printer"+Str$(i)+"": " Devices$(i)
        'Display printer name
NEXT i
SelectDevice:
'---- Selection of output device, printer language and output interface ----
CALL InstrWrite(analyzer,"SYST:COMM:PRIN:SEL "+ Devices(6))
    'Printer selection #6
CALL InstrWrite(analyzer,"HCOP:DEST 'SYST:COMM:PRIN'")
    'Configuration: "Printout to
    'printer interface"
CALL InstrWrite(analyzer,"HCOP:DEV:LANG GDI")
    'Printers require printer language 'GDI'
'----- Selection of orientation (portrait/landscape) and colour/BW -----
CALL InstrWrite(analyzer,"HCOP:PAGE:ORI PORT")
    'Portrait orientation
CALL InstrWrite(analyzer,"HCOP:DEV:COL OFF")
    'Black-and-white printout
'----- Configuring and starting the printout -----
CALL InstrWrite(analyzer,"HCOP:ITEM:ALL")
    'All screen contents

```

```

'CALL InstrWrite(analyzer,"HCOP:ITEM:TRAC:STAT ON")
'Alternative: only traces
CALL InstrWrite(analyzer,"*CLS") 'Reset status registers
CALL viEnableEvent(vi, VI_EVENT_SERVICE_REQ, VI_QUEUE, 0)
'Enable the event for service request
CALL InstrWrite(analyzer,"HCOP;*OPC")
'Start printout
SRQWaitTimeout = 5000 'Allow 5s for completion
'Now wait for the service request
statusSRQ = viWaitOnEvent(vi, VI_EVENT_SERVICE_REQ, SRQWaitTimeout, _
eventType, eventVi)
CALL viClose(eventVi) 'Close the context before continuing
CALL viDisableEvent(vi, VI_EVENT_SERVICE_REQ, VI_QUEUE)
'Disable subsequent events
IF NOT(statusSRQ = 0) THEN CALL Srq 'If SRQ not detected =>
'Subroutine for evaluation
'---- Printout in WMF format (BMP format) to file -----
CALL InstrWrite(analyzer,"HCOP:DEST 'MMEM'")
'Configuration: "Printout to file"
CALL InstrWrite(analyzer,"HCOP:DEV:LANG WMF")
'WMF file format
'CALL InstrWrite(analyzer,"HCOP:DEV:LANG BMP")
'BMP file format
CALL InstrWrite(analyzer,"MMEM:NAME 'C:\R_S\Instr\user\PRINT1.WMF'")
'Define file name
CALL InstrWrite(analyzer,"*CLS") 'Reset Status registers
CALL viEnableEvent(vi, VI_EVENT_SERVICE_REQ, VI_QUEUE, 0)
'Enable the event for service request
CALL InstrWrite(analyzer,"HCOP:IMMEDIATE;*OPC")
'Start printout
SRQWaitTimeout = 5000 'Allow 5s for completion
' Now wait for the service request
statusSRQ = viWaitOnEvent(vi, VI_EVENT_SERVICE_REQ, SRQWaitTimeout, _
eventType, eventVi)
CALL viClose(eventVi) 'Close the context before continuing
CALL viDisableEvent(vi, VI_EVENT_SERVICE_REQ, VI_QUEUE)
'Disable subsequent events
IF NOT(statusSRQ = 0) THEN CALL Srq 'If SRQ not detected =>
'Subroutine for evaluation
END SUB
REM *****

```

6.2.4 Configuring the GPIB Interface

A GPIB interface is integrated on the rear panel of the instrument. You can set the GPIB address and the ID response string. The GPIB language is set as SCPI by default and cannot be changed for the R&S FSVA/FSV.

For details on the GPIB interface see "[GPIB interface](#)" on page 21).

Displaying the GPIB submenu

1. Press the [SETUP] key.
2. Press the "General Setup" softkey.
3. Press the "GPIB" softkey.

The submenu for setting the parameters of the remote control interface is displayed.

Setting the GPIB address

- ▶ In the "GPIB" menu, press the "GPIB Address" softkey.

The edit dialog box for the GPIB address is displayed. The setting range is from 0 to 30. If SCPI is selected as the GPIB language, the default address is 20.

Remote command:

```
SYST:COMM:GPIB:ADDR 20
```

Setting the default ID response string

- ▶ In the "GPIB" menu, press the "ID String Factory" softkey to select the default response to the *IDN? command.

Setting a user-defined ID response string

- ▶ In the "GPIB" menu, press the "ID String User" softkey to enter a user-defined response to the *IDN? command. The maximum length of the output string is 36 characters.

6.2.5 Setting Up a Network (LAN) Connection

A LAN connection is the prerequisite for all network operations. The LAN connection settings can be configured directly in the Windows operating system.

The R&S FSVA/FSV is equipped with a network interface and can be connected to an Ethernet LAN (local area network). Provided the network administrator has assigned you the appropriate rights and adapted the Windows firewall configuration, you can use the interface, for example:

- To transfer data between a controlling device and the test device, e.g. to run a remote control program.
See chapter "Remote Control".
- To access or control the measurement from a remote computer using the "Remote Desktop" application (or a similar tool)
- To connect external network devices (e.g. printers)
- To transfer data from a remote computer and back, e.g. using network folders

This section describes how to configure the LAN interface. It includes the following topics:

- [Chapter 6.2.5.1, "Connecting the Instrument to the Network"](#), on page 596

- [Chapter 6.2.5.2, "Assigning the IP Address"](#), on page 597

Note that only user accounts with administrator rights can configure LAN networks.



LXI

The R&S FSVA/FSV supports the LXI core features. LXI gives you direct access to the LAN settings described below.

For further information on the LXI interface, refer to the "LXI Configuration".

6.2.5.1 Connecting the Instrument to the Network

There are two methods to establish a LAN connection to the instrument:

- A non-dedicated network (Ethernet) connection from the instrument to an existing network made with an ordinary RJ-45 network cable. The instrument is assigned an IP address and can coexist with a computer and with other hosts on the same network.
- A dedicated network connection (Point-to-point connection) between the instrument and a single computer made with a (crossover) RJ-45 network cable. The computer must be equipped with a network adapter and is directly connected to the instrument. The use of hubs, switches, or gateways is not required, however, data transfer is still performed using the TCP/IP protocol. You must assign an IP address to the instrument and the computer, see [Chapter 6.2.5.2, "Assigning the IP Address"](#), on page 597.

Note: As the R&S FSVA/FSV uses a 1 GBit LAN, a crossover cable is not necessary (due to Auto-MDI(X) functionality).

NOTICE

Risk of network failure

Consult your network administrator before performing the following tasks:

- Connecting the instrument to the network
- Configuring the network
- Changing IP addresses
- Exchanging hardware

Errors can affect the entire network.

- ▶ To establish a non-dedicated network connection, connect a commercial RJ-45 cable to one of the LAN ports.
To establish a dedicated connection, connect a (crossover) RJ-45 cable between the instrument and a single PC.

If the instrument is connected to the LAN, Windows automatically detects the network connection and activates the required drivers.

The network card can be operated with a 1 GBit Ethernet IEEE 802.3u interface.

6.2.5.2 Assigning the IP Address

Depending on the network capacities, the TCP/IP address information for the instrument can be obtained in different ways.

- If the network supports dynamic TCP/IP configuration using the Dynamic Host Configuration Protocol (DHCP), all address information can be assigned automatically.
- If the network does not support DHCP, or if the instrument is set to use alternate TCP/IP configuration, the addresses must be set manually.

By default, the instrument is configured to use dynamic TCP/IP configuration and obtain all address information automatically. This means that it is safe to establish a physical connection to the LAN without any previous instrument configuration.

NOTICE

Risk of network errors

Connection errors can affect the entire network. If your network does not support DHCP, or if you choose to disable dynamic TCP/IP configuration, you must assign valid address information before connecting the instrument to the LAN. Contact your network administrator to obtain a valid IP address.

Assigning the IP address on the instrument

1. Press the [SETUP] key.
2. Press the "General Setup" softkey.
3. Press the "Network Address" softkey.
The submenu is displayed.
4. Toggle the "DHCP On/Off" softkey to the required mode.
If DHCP is "Off", you must enter the IP address manually, as described in the following steps.

Note: When DHCP is changed from "On" to "Off", the previously set IP address and subnet mask are retrieved.

If DHCP is "On", the IP address of the DHCP server is obtained automatically. The configuration is saved, and you are prompted to restart the instrument. You can skip the remaining steps.

Note: When a DHCP server is used, a new IP address may be assigned each time the instrument is restarted. This address must first be determined on the instrument itself. Thus, when using a DHCP server, it is recommended that you use the permanent computer name, which determines the address via the DNS server (see [Chapter 6.2.5.3, "Using Computer Names"](#), on page 600).

5. Press the "IP Address" softkey and enter the IP address, for example *192.0.2.0*. The IP address consists of four number blocks separated by dots. Every block contains a maximum of 3 numbers.
6. Press the "Subnet Mask" softkey and enter the subnet mask, for example *255.255.255.0*. The subnet mask consists of four number blocks separated by dots. Every block contains a maximum of 3 numbers.

If you have entered an invalid IP address or subnet mask, the message "out of range" is displayed in the status line. The "Edit" dialog box remains open, and you can start again. If the settings are correct, the configuration is saved, and you are prompted to restart the instrument.
7. Confirm the displayed message ("Yes" button) to restart the instrument.

Assigning the IP address on the instrument

1. Press the [SETUP] key.
2. Press the "Network + Remote" softkey.
3. Select the "Network" tab.
4. In the "Network + Remote" dialog, toggle the "DHCP On/Off" setting to the required mode.
If DHCP is "Off", you must enter the IP address manually, as described in the following steps.
Note: When DHCP is changed from "On" to "Off", the previously set IP address and subnet mask are retrieved.
If DHCP is "On", the IP address of the DHCP server is obtained automatically. The configuration is saved, and you are prompted to restart the instrument. You can skip the remaining steps.
Note: When a DHCP server is used, a new IP address may be assigned each time the instrument is restarted. This address must first be determined on the instrument itself. Thus, when using a DHCP server, it is recommended that you use the permanent computer name, which determines the address via the DNS server (See ["Using a DNS server to determine the IP address"](#) on page 599 and [Chapter 6.2.5.3, "Using Computer Names"](#), on page 600).
5. Enter the "IP Address", for example *192.0.2.0*. The IP address consists of four number blocks separated by dots. Every block contains a maximum of 3 numbers.
6. Enter the "Subnet Mask", for example *255.255.255.0*. The subnet mask consists of four number blocks separated by dots. Every block contains a maximum of 3 numbers.
7. Select "Configure Network".

If you have entered an invalid IP address or subnet mask, the message "out of range" is displayed in the status line. If the settings are correct, the configuration is saved, and you are prompted to restart the instrument.
8. Confirm the displayed message ("Yes" button) to restart the instrument.

Using a DNS server to determine the IP address

If a DNS server is configured on the R&S FSVA/FSV, the server can determine the current IP address for the connection using the permanent computer name.

1. Obtain the name of your DNS domain and the IP addresses of the DNS and WINS servers on your network.
2. Press the "Windows" key on the external keyboard or the [CTRL + ESC] key combination on your keyboard to access the operating system.
3. Select "Start > Settings > Network & Internet > Ethernet > Network and Sharing Center > Connections: Ethernet".

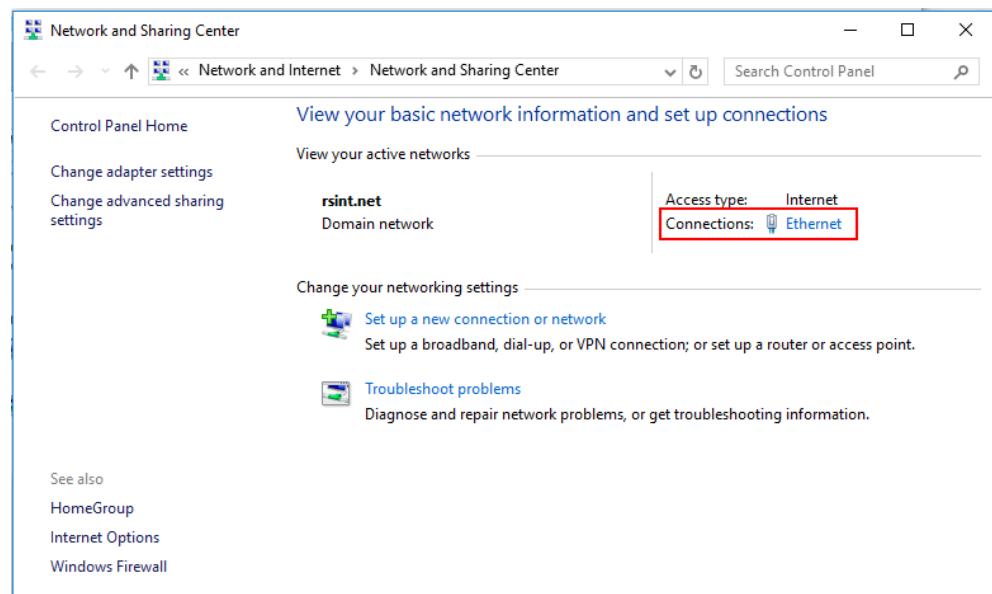

4. In the "Ethernet Status" dialog box, select the "Properties" button.
The items used by the LAN connection are displayed.

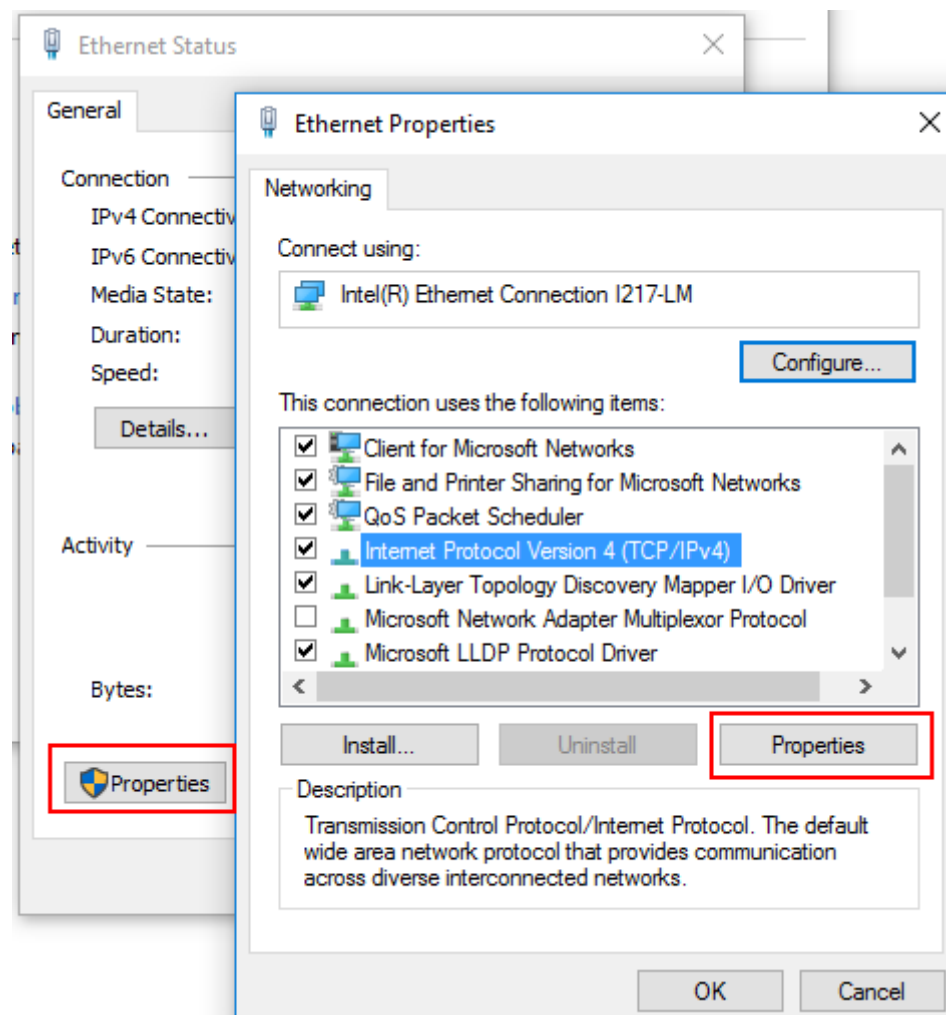

5. Tap the entry named "Internet Protocol Version 4 (TCP/IPv4)" to highlight it.
6. Select the "Properties" button.
7. On the "General" tab, select "Use the following DNS server addresses" and enter your own DNS addresses.

For more information, refer to the Windows operating system help.

6.2.5.3 Using Computer Names

In a LAN that uses a DNS server (Domain Name System server), each PC or instrument connected in the LAN can be accessed via an unambiguous computer name instead of the IP address. The DNS server translates the host name to the IP address. This is especially useful when a DHCP server is used, as a new IP address may be assigned each time the instrument is restarted.

Each instrument is delivered with an assigned computer name, but this name can be changed.

The default instrument name is a non-case-sensitive string with the following syntax:

<Type><variant>-<serial_number>

The serial number can be found on the rear panel of the instrument. It is the third part of the device ID printed on the bar code sticker:



For example, FSV4-123456

To change the computer name

1. Press the [Setup] key and select "General setup" > "Computer name".
The current computer name is displayed here.
2. Enter the new computer name.
3. Confirm the entry.

6.2.5.4 Changing the Windows Firewall Settings

A firewall protects an instrument by preventing unauthorized users from gaining access to it through a network. Rohde & Schwarz highly recommends the use of the firewall on your instrument. Rohde & Schwarz instruments are shipped with the Windows firewall enabled and preconfigured in such a way that all ports and connections for remote control are enabled.

For more details on firewall configuration, see the following Rohde & Schwarz White Paper:

- [1EF96: Malware Protection Windows 10](#)

Note that changing firewall settings requires administrator rights.

6.2.6 How to Configure the LAN Using the LXI Web Browser Interface

The instrument's LXI browser interface works correctly with all W3C compliant browsers.

- ▶ In the web browser, open the `http://<instrument-hostname>` or `http://<instrument-ip-address>` page, e.g. `http://10.113.10.203`.
The default password to change LAN configurations is *LxiWebIfc*.
The "Instrument Home Page" (welcome page) opens.

The screenshot shows a web browser window titled "Instrument Home Page" with the URL `/web/html/ihp.php?mID=10`. The page features the Rohde & Schwarz logo and an LXI interface. A left-hand navigation pane includes sections for LXI (Home, Lan Configuration, Status, Utilities), Instrument Control (VNC Control), License Manager (Manage Licenses), and Help (Glossary, www.rohde-schwarz.com). The main content area is titled "Instrument Properties" and displays the following information:

Instrument Model	R&S FSV Spectrum Analyzer
Manufacturer	Rohde & Schwarz GmbH & Co. KG
Serial Number	[REDACTED]
Description	R&S FSV [REDACTED]
LXI Version	1.4 LXI Core 2011
LXI Extended Features	LXI HiSLIP
DNS Host Name(s)	[REDACTED]
MAC Address	[REDACTED]
IP Address	[REDACTED]
Firmware Revision	3.20
Current Time	Friday, 2017/03/10, 12:08:01
Current Time source	Operating System
VISA resource string	TCPIP::[REDACTED]:inst0::INSTR TCPIP::[REDACTED]:hislip0::INSTR
Device Indicator	<input type="button" value="INACTIVE (press to toggle)"/>

The instrument home page displays the device information required by the LXI standard including the VISA resource string in read-only format.

The most important control elements in the navigation pane of the browser interface are the following:

- "LAN Configuration" opens the menu with configuration pages.
- "Status" displays information about the LXI status of the instrument.
- "Help > Glossary" opens a document with a glossary of terms related to the LXI standard.

6.2.6.1 LAN Configuration

The LAN configuration consists of three parts:

- "IP configuration" provides all mandatory LAN parameters.
- "Advanced LAN Configuration" provides LAN settings that are not declared mandatory by the LXI standard.
- "Ping Client" provides the ping utility to verify the connection between the instrument and other devices.

IP Configuration

The "LAN Configuration > IP configuration" web page displays all mandatory LAN parameters and allows their modification.

The "TCP/IP Mode" configuration field controls how the IP address for the instrument gets assigned (see also [Chapter 6.2.5.2, "Assigning the IP Address"](#), on page 597).

For the manual configuration mode, the static IP address, subnet mask, and default gateway are used to configure the LAN. The automatic configuration mode uses DHCP server or Dynamic Link Local Addressing (Automatic IP) to obtain the instrument IP address.



Changing the LAN configuration is password-protected. The default password is *Lxi-WebIfc* (notice upper and lower case characters).

Advanced LAN Configuration

The "LAN Configuration > Advanced LAN Configuration" parameters are used as follows:

- The "Negotiation" configuration field provides different Ethernet speed and duplex mode settings. In general, the "Auto Detect" mode is sufficient.
- "ICMP Ping" must be enabled to use the ping utility.
- "VXI-11" is the protocol that is used to detect the instrument in the LAN. According to the standard, LXI devices must use VXI-11 to provide a detection mechanism; other additional detection mechanisms are permitted.
- mDNS and DNS-SD are two additional protocols: Multicast DNS and DNS Service Discovery. They are used for device communication in zero configuration networks working without DNS and DHCP

Ping Client

Ping is a utility that verifies the connection between the LXI-compliant instrument and another device. The ping command uses the ICMP echo request and echo reply packets to determine whether the LAN connection is functional. Ping is useful for diagnosing IP network or router failures. The ping utility is not password-protected.

To initiate a ping between the LXI-compliant instrument and a second connected device:

1. Enable "ICMP Ping" on the "Advanced LAN Configuration" page (enabled after an LCI).
2. Enter the IP address of the second device **without the ping command and without any further parameters** into the "Destination Address" field (e.g. *10.113.10.203*).
3. Select "Submit".

6.2.7 Configuring the Network

After network support has been installed, data can be exchanged between the instrument and other computers, and network printers can be used.

Network operation is only possible if you are authorized to access network resources. Typical resources are file directories of other computers or even central printers. Authorization is assigned by the network or server administrator.

WARNING

Connection to networks

Before connecting the instrument to the network or configuring the network, consult your network administrator, particularly for large LAN installations. Errors may affect the entire network.

Never connect your analyzer to a network unprotected against virus infection because this may cause damage to the instrument software.

To integrate the instrument into your network, you can change the following system properties:

- Computer name
- Domain
- Workgroup

Operation on the network includes the following administrative tasks:

- [Operating the Instrument Without a Network](#)..... 604
- [Creating Users](#)..... 604
- [Changing the User Password](#)..... 605
- [Mapping Network Drives](#)..... 605
- [Sharing Directories \(only with Microsoft Networks\)](#)..... 607

6.2.7.1 Operating the Instrument Without a Network

To operate the instrument without a network connection either temporarily or permanently, no special measures are necessary. Windows automatically detects the interruption of the network connection and does not set up the connection when the instrument is switched on.

If you are not prompted to enter the user name and password, see "[Automatic Login Function](#)" on page 45.

6.2.7.2 Creating Users

After the software for the network has been installed, the instrument issues an error message the next time it is switched on because there is no user named "instrument" (= user ID for Windows automatic login) in the network. Thus, a matching user must be created in Windows and in the network, the password must be adapted to the network password, and the automatic login mechanism must then be deactivated.

The network administrator is responsible for creating new users in the network.

1. Press the "Windows" key on the external keyboard or the [CTRL + ESC] key combination on your keyboard to access the operating system.
2. Select "Start > Settings > Accounts > Other users".
3. Select "Add someone else to this PC".
4. In the "Microsoft account" dialog box, enter the new user name and password.
5. Select "OK".
6. Select "Finish".
The new user is created.

6.2.7.3 Changing the User Password

After the new user has been created on the instrument, the password must be adapted to the network password.

1. Press the "Windows" key on the external keyboard or the [CTRL + ESC] key combination on your keyboard to access the operating system.
2. Press [Ctrl + Alt + Delete], then select "Change a password".
3. Enter the user account name.
4. Enter the old password.
5. Enter the new password in the upper text line and repeat it in the following line.
6. Press [Enter].
The new password is now active.



Logging on to the Network

At the same time you log on to the operating system, you are automatically logged on to the network (see "[Automatic Login Function](#)" on page 45). As a prerequisite, the user name and the password must be identical under Windows and on the network.

6.2.7.4 Mapping Network Drives

1. Press the [SAVE/ RCL] key on the front panel of the R&S FSVA/FSV.
2. Press the "File Manager" softkey.
3. Press the "More" softkey.
4. Press the "Network Drive" softkey.
The "Map Network Drive" dialog box is displayed.

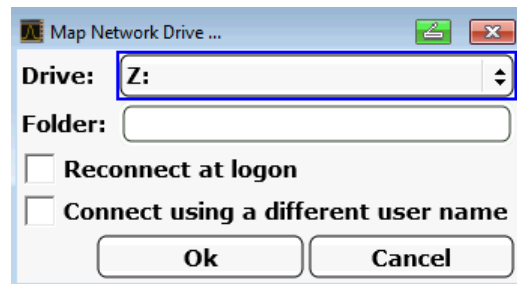

5. Press the "Drive" list to open the network drive list and select the drive you want to map.
Alternatively:
 - Press the "Map Network Drive" softkey to set the focus on the "Drive" list.
 - Press [ENTER] to open the network drive list and select the drive you want to map using the arrow keys.
6. To have the connection set up automatically each time the instrument is started, in the "Map Network Drive" dialog box, activate the "Reconnect at logon" option.
7. To connect using a different user name, activate the "Connect using a different user name" option.
The "Map Network Drive" dialog box is extended by the "User name" and "Password" fields.

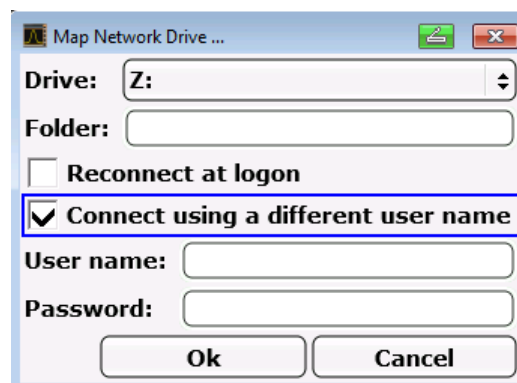

8. Enter your user name and password.
 9. Confirm with "OK".
The drive is displayed in the Explorer.
- Note:** Only networks that you authorized to access are connected.

Disconnecting network drives

1. Press the [SAVE/ RCL] key on the front panel of the R&S FSVA/FSV.
2. Press the "File Manager" softkey.
3. Press the "More" softkey.
4. Press the "Network Drive" softkey.

5. Press the "Disconnect Network Drive" softkey.
The "Disconnect Network Drive" dialog box is displayed.
6. In the "Drive" list, select the drive you want to disconnect.
7. Confirm with "OK".

6.2.7.5 Sharing Directories (only with Microsoft Networks)

Sharing directories makes data available for other users. This is only possible in Microsoft networks. Sharing is a property of a file or directory.

1. Press the "Windows" key on the external keyboard or the [CTRL + ESC] key combination on your keyboard to access the operating system.
2. Open the "Windows Explorer".
3. Select the desired folder with the right mouse button.
4. In the context menu, select "Share with > Specific people".
5. Select the users on your network you want to allow access to the directory to.
6. Select "Share" to confirm the settings.
7. Select "Done" to close the dialog box.
The drive is shared and can be accessed by the selected users.

6.3 Remote Control – Commands

This chapter describes all remote control commands for the "Spectrum" mode (Analyzer) functions, and the basic measurement-mode independent functions of the R&S FSVA/FSV in detail.

Each subsystem starts with a list of commands, which provides quick access to all commands of the subsystem. Be aware, that for one subsystem more than one SCPI command lists can exist, depending on the functionality (analyzer and basic functions, and possibly firmware-option specific functions). For details on the notation refer to [Chapter 6.3.1, "Notation"](#), on page 608.

Remote commands of the base unit firmware

- [Chapter 6.3.3, "Remote Control – Description of Analyzer Commands"](#), on page 615
- [Chapter 6.3.4, "Remote Control – Description of Measurement-Independent Commands"](#), on page 916

6.3.1 Notation

In the following sections, all commands implemented in the instrument are first listed and then described in detail, arranged according to the command subsystems. The notation is adapted to the SCPI standard. The SCPI conformity information is included in the individual description of the commands.

Individual Description

The individual description contains the complete notation of the command. An example for each command, the *RST value and the SCPI information are included as well.

The options and operating modes for which a command can be used are indicated by the following abbreviations:

Abbreviation	Description
A	spectrum analysis
A-F	spectrum analysis – span > 0 only (frequency mode)
A-T	spectrum analysis – zero span only (time mode)
ADEMOD	analog demodulation (option R&S FSV-K7)
BT	Bluetooth (option R&S FSV-K8)
CDMA	CDMA 2000 base station measurements (option R&S FSV-K82)
EVDO	1xEV-DO base station analysis (option R&S FSV-K84)
GSM	GSM/Edge measurements (option R&S FSV-K10)
IQ	IQ Analyzer mode
OFDM	WiMAX IEEE 802.16 OFDM measurements (option R&S FSV-K93)
OFDMA/WiBro	WiMAX IEEE 802.16e OFDMA/WiBro measurements (option R&S FSV-K93)
NF	Noise Figure measurements (R&S FSV-K30)
PHN	Phase Noise measurements (R&S FSV-K40)
PSM	Power Sensor measurements (option R&S FSV-K9)
SFM	Stereo FM measurements (option R&S FSV-K7S)
SPECM	Spectrogram mode (option R&S FSV-K14)
TDS	TD-SCDMA base station / UE measurements (option R&S FSV-K76/K77)
VSA	Vector Signal Analysis (option R&S FSV-K70)
WCDMA	3GPP Base Station measurements (option R&S FSV-K72), 3GPP UE measurements (option R&S FSV-K73)
WLAN	WLAN TX measurements (option R&S FSV-K91)



The spectrum analysis mode is implemented in the basic unit. For the other modes, the corresponding options are required.

Upper/Lower Case Notation

Upper/lower case letters are used to mark the long or short form of the key words of a command in the description. The instrument itself does not distinguish between upper and lower case letters.

Special Characters

	A selection of key words with an identical effect exists for several commands. These keywords are indicated in the same line; they are separated by a vertical stroke. Only one of these keywords needs to be included in the header of the command. The effect of the command is independent of which of the keywords is used.
--	---

Example:

```
SENSe:FREQuency:CW|:FIXed
```

The two following commands with identical meaning can be created. They set the frequency of the fixed frequency signal to 1 kHz:

```
SENSe:FREQuency:CW 1E3
```

```
SENSe:FREQuency:FIXed 1E3
```

A vertical stroke in parameter indications marks alternative possibilities in the sense of "or". The effect of the command differs, depending on which parameter is used.

Example: Selection of the parameters for the command

```
[SENSe<1...4>:]AVERage<1...4>:TYPE VIDEo | LINear
```

[]	Key words in square brackets can be omitted when composing the header. The full command length must be accepted by the instrument for reasons of compatibility with the SCPI standards. Parameters in square brackets can be incorporated optionally in the command or omitted as well.
----	---

{}	Parameters in braces can be incorporated optionally in the command, either not at all, once or several times.
----	---

Description of Parameters

Due to the standardization, the parameter section of SCPI commands consists always of the same syntactical elements. SCPI has therefore specified a series of definitions, which are used in the tables of commands. In the tables, these established definitions are indicated in angled brackets (<...>) and is briefly explained in the following.

For details see [Chapter 6.1.4.3, "SCPI Parameters"](#), on page 543.

<Boolean>

This keyword refers to parameters which can adopt two states, "on" and "off". The "off" state may either be indicated by the keyword OFF or by the numeric value 0, the "on" state is indicated by ON or any numeric value other than zero. Parameter queries are always returned the numeric value 0 or 1.

<numeric_value> <num>

These keywords mark parameters which may be entered as numeric values or be set using specific keywords (character data). The following keywords given below are permitted:

- **MAXimum**: This keyword sets the parameter to the largest possible value.
- **MINimum**: This keyword sets the parameter to the smallest possible value.
- **DEFault**: This keyword is used to reset the parameter to its default value.
- **UP**: This keyword increments the parameter value.
- **DOWN**: This keyword decrements the parameter value.

The numeric values associated to MAXimum/MINimum/DEFault can be queried by adding the corresponding keywords to the command. They must be entered following the quotation mark.

Example:

```
SENSe:FREQuency:CENTer? MAXimum
```

Returns the maximum possible numeric value of the center frequency as result.

<arbitrary block program data>

This keyword is provided for commands the parameters of which consist of a binary data block.

6.3.2 Common Commands

Common commands are described in the IEEE 488.2 (IEC 625-2) standard. These commands have the same effect and are employed in the same way on different devices. The headers of these commands consist of "*" followed by three letters. Many common commands are related to the Status Reporting System.

Available common commands:

*CAL?	611
*CLS	611
*ESE	611
*ESR?	611
*IDN?	612
*IST?	612
*OPC	612
*OPT?	612
*PCB	613
*PRE	613
*PSC	613
*RST	614
*SRE	614
*STB?	614

*TRG.....	614
*TST?.....	615
*WAI.....	615

*CAL?

Calibration query

Initiates a calibration of the instrument and then queries the calibration status. Responses > 0 indicate errors.

Note: If you start a self-alignment remotely, then select the "Local" softkey while the alignment is still running, the instrument only returns to the manual operation state after the alignment is completed.

Usage: Query only

Manual operation: See "Self Alignment" on page 145

*CLS

Clear status

Sets the status byte (STB), the standard event register (ESR) and the `EVENT` part of the `QUESTIONABLE` and the `OPERATION` registers to zero. The command does not alter the mask and transition parts of the registers. It clears the output buffer.

Usage: Setting only

*ESE <Value>

Event status enable

Sets the event status enable register to the specified value. The query returns the contents of the event status enable register in decimal form.

Parameters:

<Value> Range: 0 to 255

*ESR?

Event status read

Returns the contents of the event status register in decimal form and then sets the register to zero.

Return values:

<Contents> Range: 0 to 255

Usage: Query only

***IDN? <Format>**

Identification

Returns the instrument identification.

Query parameters:

<Format> LEGacy | NEW

LEGacy

"Rohde&Schwarz,<device type>,<serial number>/<model>,<firmware version>"

NEW

"Rohde&Schwarz,<device type>,<part number>/<serial number>,<firmware version>"

Example:

Legacy format:

Rohde&Schwarz,R&S FSV-7,101768/007,1.05

New format:

Rohde&Schwarz,R&S

FSV-7,1307.9002K07/101768,1.05

Usage:

Query only

Manual operation:See "[*IDN Format Leg./New](#)" on page 152See "[Versions+Options](#)" on page 158

***IST?**

Individual status query

Returns the contents of the IST flag in decimal form. The IST flag is the status bit which is sent during a parallel poll.

Return values:

<ISTflag> 0 | 1

Usage:

Query only

***OPC**

Operation complete

Sets bit 0 in the event status register when all preceding commands have been executed. This bit can be used to initiate a service request. The query writes a "1" into the output buffer when all preceding commands have been executed, which is useful for command synchronization.

***OPT?**

Option identification query

Queries the options included in the instrument. For a list of all available options and their description, refer to the data sheet.

Return values:

<Options> The query returns a list of all installed and activated options, separated by commas, where:
 B<number> describes hardware options.
 K<number> describes software options.
 For PSA89600 emulation, the option is indicated as "B7J" for the *OPT? query ("B7J, 140" if SYST:PSA:WID is activated).
 (See [SYSTem:PSA:WIDeband](#) on page 974.)
 Note that B99 indicates the R&S FSVA models (as opposed to the R&S FSV models).

Example: B4, B5, B6, B7, B8, B10, B22, B30, B31, K7, K9

Usage: Query only

Manual operation: See "[Versions+Options](#)" on page 158

***PCB <Address>**

Pass control back

Indicates the controller address to which remote control is returned after termination of the triggered action.

Setting parameters:

<Address> Range: 0 to 30

Usage: Setting only

***PRE <Value>**

Parallel poll register enable

Sets parallel poll enable register to the indicated value. The query returns the contents of the parallel poll enable register in decimal form.

Parameters:

<Value> Range: 0 to 255

***PSC <Action>**

Power on status clear

Determines whether the contents of the `ENABLE` registers are preserved or reset when the instrument is switched on. Thus a service request can be triggered when the instrument is switched on, if the status registers ESE and SRE are suitably configured. The query reads out the contents of the "power-on-status-clear" flag.

Parameters:

<Action> 0 | 1

0

The contents of the status registers are preserved.

1

Resets the status registers.

***RST**

Reset

Sets the instrument to a defined default status. The default settings are indicated in the description of commands.

The command is equivalent to `SYSTem:PRESet`.

Note that the factory set default values can be modified to user-defined settings (see `MMEMory:LOAD:STATe` on page 945). For more details on default values, see [Chapter 5.2.1, "Initializing the Configuration – PRESET Key"](#), on page 183.

Usage: Setting only

***SRE <Contents>**

Service request enable

Sets the service request enable register to the indicated value. This command determines under which conditions a service request is triggered.

Parameters:

<Contents> Contents of the service request enable register in decimal form.
Bit 6 (MSS mask bit) is always 0.
Range: 0 to 255

***STB?**

Status byte query

Reads the contents of the status byte in decimal form.

Usage: Query only

***TRG**

Trigger

Triggers all actions waiting for a trigger event. In particular, *TRG generates a manual trigger signal. This common command complements the commands of the `TRIGger` subsystem.

*TRG corresponds to the `INITiate:IMMediate` command. For details, see the "Remote Control - Description of Analyzer Commands", "TRIGger Subsystem".

Usage: Event

***TST?**

Self-test query

Initiates self-tests of the instrument and returns an error code.

Note: If you start a self-test remotely, then select the "Local" softkey while the test is still running, the instrument only returns to the manual operation state after the test is completed. In this case, the self-test cannot be aborted.

Return values:

<ErrorCode> **integer > 0 (in decimal format)**
 An error occurred.
 (For details, see the Service Manual supplied with the instrument).
0
 No errors occurred.

Usage: Query only

Manual operation: See "[Selftest](#)" on page 162

***WAI**

Wait to continue

Prevents servicing of the subsequent commands until all preceding commands have been executed and all signals have settled (see also command synchronization and [*OPC](#)).

Usage: Event

6.3.3 Remote Control – Description of Analyzer Commands

In this section all remote control commands for "Spectrum" mode functions are described in detail. For details on commands that are independent of a particular measurement mode refer to [Chapter 6.3.4, "Remote Control – Description of Measurement-Independent Commands"](#), on page 916.

Subsystems of the analyzer

• ABORt Subsystem	616
• CALCulate Subsystem	616
• CALibration:PMETer Subsystem (Power Sensor, R&S FSV-K9)	748
• DISPlay Subsystem	748
• DISPlay Commands for Spectrograms	757
• FETCh:PMETer Subsystem (Power Sensor, R&S FSV-K9)	758
• FORMat Subsystem	759
• INITiate Subsystem	760
• INPUt Subsystem	763
• INSTrument Subsystem	770
• MMEMory Subsystem	772

•	OUTPut Subsystem.....	775
•	PROBe subsystem.....	778
•	READ:PMETer Subsystem.....	780
•	SENSe Subsystem.....	780
•	SOURce Subsystem.....	864
•	STATus:QUEStionable Subsystem.....	874
•	SYSTem Subsystem.....	885
•	TRACe Subsystem.....	890
•	TRIGger Subsystem.....	908
•	UNIT Subsystem.....	914
•	Formats for Returned Values: ASCII Format and Binary Format.....	915

6.3.3.1 ABORt Subsystem

The ABORt subsystem contains the commands for aborting triggered actions. An action can be triggered again immediately after being aborted. All commands trigger events, and therefore they have no *RST value.

ABORt

This command aborts a current measurement and resets the trigger system.

Example: ABOR; INIT: IMM

Mode: all

Manual operation: See "Meas Start/Stop" on page 326

6.3.3.2 CALCulate Subsystem

The CALCulate subsystem contains commands for converting instrument data, transforming and carrying out corrections. These functions are carried out subsequent to data acquisition, i.e. following the SENSe subsystem.



Some applications offer up to four measurement windows. For those, the suffix <n> for CALCulate selects the measurement window. For all other applications, the suffix is irrelevant.

•	CALCulate:DELTamarker Subsystem.....	617
•	CALCulate:DELTamarker:SGRam subsystem.....	630
•	CALCulate:DLINe Subsystem.....	636
•	CALCulate:ESpectrum Subsystem.....	637
•	CALCulate:FLINe Subsystem.....	639
•	CALCulate:LIMit Subsystem.....	640
•	CALCulate:LIMit:ACPower Subsystem.....	644
•	CALCulate:LIMit:CONTRol Subsystem.....	653
•	CALCulate:LIMit:ESpectrum subsystem.....	656
•	CALCulate:LIMit:LOWer Subsystem.....	660
•	CALCulate:LIMit:UPPer Subsystem.....	663
•	CALCulate:MARKer Subsystem.....	667

• CALCulate:MARKer:FUNCTion Subsystem.....	681
• CALCulate:MARKer:FUNCTion:HARMonics Subsystem.....	698
• CALCulate:MARKer:FUNCTion:POWer Subsystem.....	702
• CALCulate:MARKer:SGRam subsystem.....	709
• Predefined CP/ACLR Standards.....	715
• CALCulate:MARKer:FUNCTion:STRack Subsystem.....	716
• CALCulate:MARKer:FUNCTion:SUMMary Subsystem.....	718
• CALCulate:MATH Subsystem.....	731
• CALCulate:PMETer Subsystem (Power Sensor, R&S FSV-K9).....	733
• CALCulate:PSEarch PEAKsearch Subsystem.....	734
• CALCulate:SGRam Subsystem.....	736
• CALCulate:STATistics Subsystem.....	740
• CALCulate:THReshold Subsystem.....	745
• CALCulate:TLINe Subsystem.....	746
• CALCulate:UNIT Subsystem.....	747
• Other commands in the Calculate subsystem.....	747

CALCulate:DELTamarker Subsystem

The CALCulate:DELTamarker subsystem controls the delta marker functions of the instrument.

Commands of the CALCulate:DELTamarker Subsystem

CALCulate<n>:DELTamarker<m>[:STATe].....	618
CALCulate<n>:DELTamarker<m>:AOFF.....	618
CALCulate<n>:DELTamarker<m>:FUNCTion:BPOWer:MODE.....	618
CALCulate<n>:DELTamarker<m>:FUNCTion:BPOWer:RESult?.....	619
CALCulate<n>:DELTamarker<m>:FUNCTion:BPOWer:SPAN.....	619
CALCulate<n>:DELTamarker<m>:FUNCTion:BPOWer[:STATe].....	619
CALCulate<n>:DELTamarker<m>:FUNCTion:FIXed[:STATe].....	620
CALCulate<n>:DELTamarker<m>:FUNCTion:FIXed:RPOint:MAXimum[:PEAK].....	620
CALCulate<n>:DELTamarker<m>:FUNCTion:FIXed:RPOint:X.....	621
CALCulate<n>:DELTamarker<m>:FUNCTion:FIXed:RPOint:Y.....	621
CALCulate<n>:DELTamarker<m>:FUNCTion:FIXed:RPOint:Y:OFFSet.....	622
CALCulate<n>:DELTamarker<m>:FUNCTion:PNOise[:STATe].....	622
CALCulate<n>:DELTamarker<m>:FUNCTion:PNOise:AUTO.....	623
CALCulate<n>:DELTamarker<m>:FUNCTion:PNOise:RESult?.....	623
CALCulate<n>:DELTamarker<m>:LINK.....	623
CALCulate<n>:DELTamarker<m>:MODE.....	624
CALCulate<n>:DELTamarker<m>:MAXimum[:PEAK].....	624
CALCulate<n>:DELTamarker<m>:MAXimum:LEFT.....	625
CALCulate<n>:DELTamarker<m>:MAXimum:NEXT.....	625
CALCulate<n>:DELTamarker<m>:MAXimum:RIGHT.....	625
CALCulate<n>:DELTamarker<m>:MINimum[:PEAK].....	626
CALCulate<n>:DELTamarker<m>:MINimum:LEFT.....	626
CALCulate<n>:DELTamarker<m>:MINimum:RIGHT.....	627
CALCulate<n>:DELTamarker<m>:MINimum:NEXT.....	627
CALCulate<n>:DELTamarker<m>:MREF.....	628
CALCulate<n>:DELTamarker<m>:TRACe.....	628

CALCulate<n>:DELTamarker<m>:X.....	628
CALCulate<n>:DELTamarker<m>:X:RELative?.....	629
CALCulate<n>:DELTamarker<m>:Y?.....	629

CALCulate<n>:DELTamarker<m>[:STATE] <State>

This command turns delta markers on and off.

If the corresponding marker was a normal marker, it is turned into a delta marker.

No suffix at DELTmarker turns on delta marker 1.

Suffix:

<n> Selects the measurement window.

<m> Selects the marker.

Parameters:

<State> ON | OFF

*RST: OFF

Example:

CALC:DELT1 ON

Switches marker 1 to delta marker mode.

Manual operation: See ["Marker 1 / Marker 2 / Marker 3 / ... Marker 16,/ Marker Norm/Delta"](#) on page 250
See ["Marker Wizard"](#) on page 251

CALCulate<n>:DELTamarker<m>:AOFF

This command turns all active delta markers off.

Suffix:

<n> Selects the measurement window.

<m> Selects the marker.

Example:

CALC:DELT:AOFF

Switches off all delta markers.

CALCulate<n>:DELTamarker<m>:FUNCTION:BPOWer:MODE <Mode>

This command selects the way the results for a band power delta marker are displayed.

Suffix:

<n> irrelevant

<m> irrelevant

Parameters:

<Mode> **POWer**
Result is displayed as a power in dBm.

DENSity
Result is displayed as a density in dBm/Hz.

*RST: POW

Example: CALC:DELT:BPOW:MODE DENS

CALCulate<n>:DELTaMarker<m>:FUNctioN:BPOWer:RESult?

This command queries the results of the band power measurement.

Suffix:

<n> irrelevant

<m> irrelevant

Return values:

<Power> Signal power over the delta marker bandwidth.

Example:

Activate the delta band power marker:

```
CALC:DELT:BPOW:STAT ON
```

Select the density mode for the result:

```
CALC:DELT:BPOW:MODE DENS
```

Query the result:

```
CALC:DELT:BPOW:RES?
```

Response:

```
20dBm/Hz
```

Usage: Query only

CALCulate<n>:DELTaMarker<m>:FUNctioN:BPOWer:SPAN

This command defines the bandwidth around the delta marker position. The span is indicated by lines in the diagram.

Suffix:

<n> irrelevant

<m> irrelevant

Parameters:

 Numeric value that defines the span in Hz.
The maximum span depends on the marker position and R&S FSV model.

*RST: 5% of current span

Example: CALC:DELT:BPOW:SPAN 20

CALCulate<n>:DELTaMarker<m>:FUNctioN:BPOWer[:STATe] <State>

This command turns delta markers for band power measurements on and off.

If necessary, the command also turns on a reference marker.

For details see [Chapter 5.3.3.8, "Performing Band Power Measurements"](#), on page 269.

Suffix:

<n> irrelevant

<m> irrelevant

Parameters:

<State> **ON | OFF**

When switched to on, if no marker is active yet, marker 1 is activated. Otherwise, the currently active marker is used as a delta band power marker (all other marker functions for this marker are deactivated).

*RST: OFF

Example:

CALC:DELT:BPOW:STAT ON

CALCulate<n>:DELTamarker<m>:FUNction:FIXed[:STATe] <State>

This command switches the relative measurement to a fixed reference value on or off. Marker 1 is activated previously and a peak search is performed, if necessary. If marker 1 is activated, its position becomes the reference point for the measurement. The reference point can then be modified with the `CALCulate<n>:DELTamarker<m>:FUNction:FIXed:RPOint:X` commands and `CALCulate<n>:DELTamarker<m>:FUNction:FIXed:RPOint:Y` independently of the position of marker 1 and of a trace. It applies to all delta markers as long as the function is active.

Suffix:

<n> Selects the measurement window.

<m> Selects the marker.

Parameters:

<State> **ON | OFF**

*RST: OFF

Example:

CALC:DELT:FUNC:FIX ON

Switches on the measurement with fixed reference value for all delta markers.

CALC:DELT:FUNC:FIX:RPO:X 128 MHZ

Sets the frequency reference to 128 MHz.

CALC:DELT:FUNC:FIX:RPO:Y 30 DBM

Sets the reference level to +30 dBm.

Manual operation: See "[Ref. Fixed On/Off](#)" on page 260

CALCulate<n>:DELTamarker<m>:FUNction:FIXed:RPOint:MAXimum[:PEAK]

This command moves the fixed reference marker to the peak power.

When measuring the phase noise, the command defines a new reference point level for delta marker 2.

Suffix:

<n> Selects the measurement window.

<m> Selects the marker.

Example: `CALC:DELT:FUNC:FIX:RPO:MAX`
Sets the reference point level for delta markers to the peak of the selected trace.

Usage: Event

Manual operation: See "[Peak Search](#)" on page 259

CALCulate<n>:DELTaMarker<m>:FUNctioN:FIXed:RPOint:X <Reference>

This command defines the horizontal position of the fixed delta marker reference point. The coordinates of the reference may be anywhere in the diagram.

When measuring the phase noise, the command defines the frequency reference for delta marker 2.

Suffix:

<n> Selects the measurement window.

<m> Selects the marker.

Parameters:

<Reference> Numeric value that defines the horizontal position of the reference.

For frequency domain measurements, it is a frequency in Hz.
For time domain measurements, it is a point in time in s.

*RST: Fixed reference: OFF

Example: `CALC:DELT:FUNC:FIX:RPO:X 128 MHz`
Sets the frequency reference to 128 MHz.

Manual operation: See "[Ref Point Frequency \(span > 0\)/Ref Point Time \(zero span\)](#)" on page 259

CALCulate<n>:DELTaMarker<m>:FUNctioN:FIXed:RPOint:Y <RefPointLevel>

This command defines the vertical position of the fixed delta marker reference point. The coordinates of the reference may be anywhere in the diagram.

When measuring the phase noise, the command defines the level reference for delta marker 2.

Suffix:

<n> Selects the measurement window.

<m> Selects the marker.

Parameters:

<RefPointLevel> Numeric value that defines the vertical position of the reference. The unit and value range is variable.

*RST: Fixed reference: OFF

Example: `CALC:DELTA:FUNC:FIX:RPO:Y -10dBm`
Sets the reference point level for delta markers to -10 dBm.

Manual operation: See "[Ref Point Level](#)" on page 259

CALCulate<n>:DELTamarker<m>:FUNctio:n:FIXed:RPOint:Y:OFFSet <Offset>

This command defines a level offset for the fixed delta marker reference point.

When measuring the phase noise, the command defines an additional level offset for delta marker 2.

Suffix:

<n> Selects the measurement window.

<m> Selects the marker.

Parameters:

<Offset> Level offset that is added to the display of all delta markers.

*RST: 0 dB

Example: `CALC:DELTA:FUNC:FIX:RPO:Y:OFFS 10dB`
Sets the level offset for the measurement with fixed reference value or the phase-noise measurement to 10 dB.

CALCulate<n>:DELTamarker<m>:FUNctio:n:PNOise[:STATe] <State>

This command turns the phase noise measurement at the delta marker position on and off.

The correction values for the bandwidth and the log amplifier are taken into account in the measurement.

The reference marker for phase noise measurements is either a normal marker or a fixed reference. If necessary, the command turns on the reference marker

A fixed reference point can be modified with the `CALCulate<n>:DELTamarker<m>:FUNctio:n:FIXed:RPOint:X` and `CALCulate<n>:DELTamarker<m>:FUNctio:n:FIXed:RPOint:Y` commands independent of the position of marker 1 and of a trace.

Suffix:

<n> Selects the measurement window.

<m> irrelevant

Note: marker 2 is always the deltamarker for phase noise measurement results.

Parameters:

<State> ON | OFF

*RST: OFF

Example: `CALC:DELT:FUNC:PNO ON`
 Switches on the phase-noise measurement with all delta markers.
`CALC:DELT:FUNC:FIX:RPO:X 128 MHZ`
 Sets the frequency reference to 128 MHz.
`CALC:DELT:FUNC:FIX:RPO:Y 30 DBM`
 Sets the reference level to +30 dBm

Manual operation: See ["Phase Noise On/Off"](#) on page 259

CALCulate<n>:DELTamarker<m>:FUNCTion:PNOise:AUTO <State>

This command turns an automatic peak search for the fixed reference marker at the end of a sweep on and off.

Suffix:
 <n> Selects the measurement window.
 <m> irrelevant

Parameters:
 <State> ON | OFF
 *RST: OFF

Example: `CALC:DELT:FUNC:PNO:AUTO ON`
 Activates an automatic peak search for the reference marker in a phase-noise measurement.

Manual operation: See ["Ph. Noise Auto Peak Search"](#) on page 259

CALCulate<n>:DELTamarker<m>:FUNCTion:PNOise:RESult?

This command queries the result of the phase noise measurement.

If necessary, the command activates the measurement first..

Suffix:
 <n> Selects the measurement window.
 <m> 2
 Marker 2 is always the deltamarker for phase noise measurements.

Example: `CALC:DELT2:FUNC:PNO:RES?`
 Outputs the result of phase-noise measurement of the delta-marker 2.

Usage: Query only

Manual operation: See ["Phase Noise On/Off"](#) on page 259

CALCulate<n>:DELTamarker<m>:LINK <State>

This command links delta marker 1 to marker 1.

If you change the horizontal position of the marker, so does the delta marker.

Suffix:

<n> Selects the measurement window.
 <m> 1
 irrelevant

Parameters:

<State> ON | OFF
 *RST: OFF

Example: CALC:DELT:LINK ON

Manual operation: See "[Link Mkr1 and Delta1](#)" on page 253

CALCulate<n>:DELTamarker<m>:MODE <Mode>

This command selects the delta marker mode.

Suffix:

<n> Selects the measurement window.
 <m> Selects the marker.

Parameters:

<Mode> **ABSolute**
 Delta marker position in absolute terms.
 RELative
 Delta marker position in relation to a reference marker.
 *RST: REL

Example: CALC:DELT:MODE ABS
 Absolute delta marker position.

CALCulate<n>:DELTamarker<m>:MAXimum[:PEAK]

This command positions the delta marker to the current trace maximum. If necessary, the corresponding delta marker is activated first.

In "Spectrogram" mode, this command positions the specified delta marker on the current peak level of the x-axis. The search is performed within the current frame. It does not change the position of the deltamarker on the y-axis.

Suffix:

<n> Selects the measurement window.
 <m> Selects the marker.

Example:

CALC:DELT3:MAX
 Sets delta marker 3 to the maximum value of the associated trace.

Manual operation: See "[Peak](#)" on page 272
 See "[Marker Search Type](#)" on page 276

CALCulate<n>:DELTamarker<m>:MAXimum:LEFT

This command positions the delta marker to the next smaller trace maximum on the left of the current value (i.e. descending X values). The corresponding delta marker is activated first, if necessary.

If no next higher minimum value is found on the trace (level spacing to adjacent values < peak excursion), an execution error (error code: -200) is produced.

In "Spectrogram" mode, this command positions the specified delta marker on the next peak level of the x-axis. The search includes only the data to the left of the current marker position in the current frame. It does not change the position of the deltamarker on the y-axis.

Suffix:

<n> Selects the measurement window.

<m> Selects the marker.

Example:

`CALC:DELT:MAX:LEFT`

Sets delta marker 1 to the next smaller maximum value to the left of the current value.

Manual operation: See "[Next Mode](#)" on page 274

CALCulate<n>:DELTamarker<m>:MAXimum:NEXT

This command positions the delta marker to the next smaller trace maximum. The corresponding delta marker is activated first, if necessary.

If no next higher minimum value is found on the trace (level spacing to adjacent values < peak excursion), an execution error (error code: -200) is produced.

In "Spectrogram" mode, this command positions the specified delta marker on the next peak level of the x-axis. The search includes the data in both directions of the current marker position in the current frame. It does not change the position of the delta marker on the y-axis.

Suffix:

<n> Selects the measurement window.

<m> Selects the marker.

Example:

`CALC:DELT2:MAX:NEXT`

Sets delta marker 2 to the next smaller maximum value.

Manual operation: See "[Next Peak](#)" on page 272

See "[Next Mode](#)" on page 274

CALCulate<n>:DELTamarker<m>:MAXimum:RIGHT

This command positions the delta marker to the next smaller trace maximum on the right of the current value (i.e. ascending X values). The corresponding delta marker is activated first, if necessary.

If no next higher minimum value is found on the trace (level spacing to adjacent values < peak excursion), an execution error (error code: -200) is produced.

In "Spectrogram" mode, this command positions the specified delta marker on the next peak level of the x-axis. The search includes only the data to the right of the current marker position in the current frame. It does not change the position of the delta marker on the y-axis.

Suffix:

<n> Selects the measurement window.

<m> Selects the marker.

Example:

`CALC:DELT:MAX:RIGH`

Sets delta marker 1 to the next smaller maximum value to the right of the current value.

Manual operation: See ["Next Mode"](#) on page 274

CALCulate<n>:DELTamarker<m>:MINimum[:PEAK]

This command positions the delta marker to the current trace minimum. The corresponding delta marker is activated first, if necessary.

In "Spectrogram" mode, this command positions the specified delta marker on the current minimum level of the x-axis. The search is performed within a specific frame. It does not change the position of the deltamarker on the y-axis.

Suffix:

<n> Selects the measurement window.

<m> Selects the marker.

Example:

`CALC:DELT3:MIN`

Sets delta marker 3 to the minimum value of the associated trace.

Manual operation: See ["Min"](#) on page 272
See ["Marker Search Type"](#) on page 276

CALCulate<n>:DELTamarker<m>:MINimum:LEFT

This command positions the delta marker to the next higher trace minimum on the left of the current value (i.e. descending X values). The corresponding delta marker is activated first, if necessary.

If no next higher minimum value is found on the trace (level spacing to adjacent values < peak excursion), an execution error (error code: -200) is produced.

In "Spectrogram" mode, this command positions the specified delta marker on the next minimum level of the x-axis. The search includes only the data to the left of the current marker position in the current frame. It does not change the position of the delta marker on the y-axis.

Suffix:

<n> Selects the measurement window.

<m> Selects the marker.

Example:

```
CALC:DELT:MIN:LEFT
```

Sets delta marker 1 to the next higher minimum to the left of the current value.

Manual operation: See "Next Mode" on page 274

CALCulate<n>:DELTamarker<m>:MINimum:RIGHT

This command positions the delta marker to the next higher trace minimum on the right of the current value (i.e. ascending X values). The corresponding delta marker is activated first, if necessary.

If no next higher minimum value is found on the trace (level spacing to adjacent values < peak excursion), an execution error (error code: -200) is produced.

In "Spectrogram" mode, this command positions the specified delta marker on the next minimum level of the x-axis. The search includes only the data to the right of the current marker position in the current frame. It does not change the position of the delta marker on the y-axis.

Suffix:

<n> Selects the measurement window.

<m> Selects the marker.

Example:

```
CALC:DELT:MIN:RIGH
```

Sets delta marker 1 to the next higher minimum value to the right of the current value.

Manual operation: See "Next Mode" on page 274

CALCulate<n>:DELTamarker<m>:MINimum:NEXT

This command positions the delta marker to the next higher trace minimum. The corresponding delta marker is activated first, if necessary.

If no next higher minimum value is found on the trace (level spacing to adjacent values < peak excursion), an execution error (error code: -200) is produced.

In "Spectrogram" mode, this command positions the specified delta marker on the next minimum level of the x-axis. The search includes the data in both directions of the current marker position in the current frame. It does not change the position of the delta marker on the y-axis.

Suffix:

<n> Selects the measurement window.

<m> Selects the marker.

Example:

```
CALC:DELT2:MIN:NEXT
```

Sets delta marker 2 to the next higher minimum value.

Manual operation: See "Next Min" on page 273
See "Next Mode" on page 274

CALCulate<n>:DELTamarker<m>:MREF <RefMarkerNo>

This command defines the reference marker for a delta marker other than marker 1.
The reference may be another marker or the fixed reference.

Suffix:

<n> Selects the measurement window.
<m> Selects the marker.

Parameters:

<RefMarkerNo> **1 ... 16**
Selects markers 1 to 16 as the reference.

FIXed

Selects the fixed reference as the reference.

Example:

`CALC:DELT3:MREF 2`
Specifies that the values of delta marker 3 are relative to marker 2.

Manual operation: See "Marker Wizard" on page 251

CALCulate<n>:DELTamarker<m>:TRACe <TraceNumber>

This command selects the trace a delta marker is positioned on.
The corresponding trace must have a trace mode other than "Blank".

Suffix:

<n> Selects the measurement window.
<m> Selects the marker.

Parameters:

<TraceNumber> **1 ... 6**
Trace number the marker is positioned on.

Example:

`CALC:DELT3:TRAC 2`
Assigns delta marker 3 to trace 2.

Manual operation: See "Marker to Trace" on page 251
See "Marker Wizard" on page 251

CALCulate<n>:DELTamarker<m>:X <Position>

This command positions a delta marker on a particular coordinate on the x-axis.
The position is an absolute value.

You can enter a relative value, if you activate relative entry first with `CALCulate<n>:DELTamarker<m>:MODE`.

If fixed reference is active, the position is relative to the fixed reference (`CALCulate<n>:DELTaMarker<m>:FUNction:FIXed[:STATe]` is ON). A query always returns the absolute position.

Suffix:

<n> Selects the measurement window.
 <m> Selects the marker.

Parameters:

<Position> 0 to maximum frequency or sweep time

Example:

`CALC:DELT:X?`
 Outputs the absolute frequency/time of delta marker 1.

Manual operation: See "[Marker 1 / Marker 2 / Marker 3 / ... Marker 16, / Marker Norm/Delta](#)" on page 250

CALCulate<n>:DELTaMarker<m>:X:RELative?

This command queries the x-value of the selected delta marker relative to marker 1 or to the reference position (for `CALC:DELT:FUNC:FIX:STAT ON`). The command activates the corresponding delta marker, if necessary.

Suffix:

<n> Selects the measurement window.
 <m> Selects the marker.

Example:

`CALC:DELT3:X:REL?`
 Outputs the frequency of delta marker 3 relative to marker 1 or relative to the reference position.

Usage: Query only

Manual operation: See "[Marker 1 / Marker 2 / Marker 3 / ... Marker 16, / Marker Norm/Delta](#)" on page 250

CALCulate<n>:DELTaMarker<m>:Y?

This command queries the measured value of a delta marker. The corresponding delta marker is activated, if necessary. The output is always a relative value referred to marker 1 or to the reference position (reference fixed active).

To obtain a correct query result, a complete sweep with synchronization to the sweep end must be performed between the activation of the delta marker and the query of the y value. This is only possible in single sweep mode.

Depending on the unit defined with `CALC:UNIT:POW` or on the activated measuring functions, the query result is output in the units below:

Table 6-16: Base unit

Parameter, measuring function or result display	Output unit
DBM DBPW DBUV DBMV DBUA	dB (lin/log)
WATT VOLT AMPere	dB (lin), % (log)
statistics function (APD or CCDF) on	dimensionless output

Suffix:

<n> Selects the measurement window.

<m> Selects the marker.

Example:

```
INIT:CONT OFF
```

Switches to single sweep mode.

```
INIT;*WAI
```

Starts a sweep and waits for its end.

```
CALC:DELT2 ON
```

Switches on delta marker 2.

```
CALC:DELT2:Y?
```

Outputs measurement value of delta marker 2.

Usage:

Query only

Manual operation: See "[Marker 1 / Marker 2 / Marker 3 / ... Marker 16, / Marker Norm/Delta](#)" on page 250

CALCulate:DELTamarker:SGRam subsystem

The following commands control the deltamarkers when you are using the spectrogram.

The spectrogram is available if option R&S FSV-K14 is installed.

CALCulate<n>:DELTamarker<m>:SGRam:FRAMe	630
CALCulate<n>:DELTamarker<m>:SGRam:SARea	631
CALCulate<n>:DELTamarker<m>:SGRam:XY:MAXimum[:PEAK]	632
CALCulate<n>:DELTamarker<m>:SGRam:XY:MINimum[:PEAK]	632
CALCulate<n>:DELTamarker<m>:SGRam:Y:MAXimum:ABOVe	633
CALCulate<n>:DELTamarker<m>:SGRam:Y:MAXimum:BELow	633
CALCulate<n>:DELTamarker<m>:SGRam:Y:MAXimum:NEXT	634
CALCulate<n>:DELTamarker<m>:SGRam:Y:MAXimum[:PEAK]	634
CALCulate<n>:DELTamarker<m>:SGRam:Y:MINimum:ABOVe	634
CALCulate<n>:DELTamarker<m>:SGRam:Y:MINimum:BELow	635
CALCulate<n>:DELTamarker<m>:SGRam:Y:MINimum:NEXT	635
CALCulate<n>:DELTamarker<m>:SGRam:Y:MINimum[:PEAK]	636

CALCulate<n>:DELTamarker<m>:SGRam:FRAMe <Frame> | <Time>

This command positions the delta marker on a particular frame. The frame is relative to the position of marker 1.

The command is available for the spectrogram.

Suffix:

<n> 1...4
Selects the measurement window.

<m> 1...16
Selects the marker.

Parameters:

<Frame> | <Time> **<Frame> (if time stamp is off)**
Defines the distance of the deltamarker in frames and in relation to the position of marker 1.

<time> (if time stamp is on)

Defines the distance of the deltamarker in seconds and in relation to the position of marker 1. The reference is the time stamp of marker 1.

Example:

```
CALC:DELT4:SGR:FRAM -20
```

Sets fourth deltamarker 20 frames below marker 1.

```
CALC:DELT4:SGR:FRAM 2 s
```

Sets fourth deltamarker 2 seconds above the position of marker 1.

CALCulate<n>:DELTamarker<m>:SGRam:SARea <SearchArea>

This command defines the deltamarker search area.

The command is available for the spectrogram.

Suffix:

<n> 1...4
Selects the measurement window.

<m> 1...16
Selects the marker.

Parameters:

<SearchArea>

VISible

Performs a search in the visible frames.

Note that VISible is ignored if Spectrogram is not visible for any reason (e.g. if the Spectrum Analyzer is in full screen mode or display update is inactive).

MEMory

Performs a search over all frames in the memory.

```
*RST: VISible
```

Example:

```
CALC:DELT:SGR:SAR MEM
```

Performs a search over all frames in the memory.

Manual operation: See "[Marker Search Area](#)" on page 276

CALCulate<n>:DELTaMarker<m>:SGRam:XY:MAXimum[:PEAK]

This command positions the specified delta marker on the current peak level of the spectrogram. The possible position depends on the deltamarker search area.

The command is available for the spectrogram.

For more information, see [CALCulate<n>:DELTaMarker<m>:SGRam:SARea](#) on page 631.

Suffix:

<n>	1...4 Selects the measurement window.
<m>	1...16 Selects the marker.

Example:

```
CALC:DELT2:SGR: SAR VIS
CALC:DELT2:SGR:XY:MAX
```

Activates and positions delta marker 2 on the peak level in the visible Spectrogram.

Usage: Event

Manual operation: See "[Marker Search Type](#)" on page 276

CALCulate<n>:DELTaMarker<m>:SGRam:XY:MINimum[:PEAK]

This command positions the specified delta marker on the current minimum level of the spectrogram. The possible position depends on the deltamarker search area.

The command is available for the spectrogram.

For more information, see [CALCulate<n>:DELTaMarker<m>:SGRam:SARea](#) on page 631.

Suffix:

<n>	1...4 Selects the measurement window.
<m>	1...16 Selects the marker.

Example:

```
CALC:DELT3:SGR: SAR VIS
CALC:DELT3:SGR:XY:MIN
```

Activates and positions delta marker 3 on the minimum level in the visible Spectrogram.

Usage: Event

Manual operation: See "[Marker Search Type](#)" on page 276

CALCulate<n>:DELTamarker<m>:SGRam:Y:MAXimum:ABOVe

This command positions the specified delta marker on the next peak level of the vertical axis. The search includes only frames above the current marker position. It does not change the horizontal position of the delta marker.

The command is available for the spectrogram.

Suffix:

<n> 1...4
Selects the measurement window.

<m> 1...16
Selects the marker.

Example:

`CALC:DELT2:SGR:Y:MAX`

Activates and positions delta marker 2 on the peak level of the y-axis.

`CALC:DELT2:SGR:Y:MAX:ABOV`

Positions delta marker 2 on the next higher level found in the diagram area above the current marker position.

Usage: Event

Manual operation: See "[Search Mode for Next Peak in Y Direction](#)" on page 275

CALCulate<n>:DELTamarker<m>:SGRam:Y:MAXimum:BELow

This command positions the specified delta marker on the next peak level of the vertical axis. The search includes only frames below the current marker position. It does not change the horizontal position of the delta marker.

The command is available for the spectrogram.

Suffix:

<n> 1...4
Selects the measurement window.

<m> 1...16
Selects the marker.

Example:

`CALC:DELT2:SGR:Y:MAX`

Activates and positions delta marker 2 on the peak level of the y-axis.

`CALC:DELT2:SGR:Y:MAX:BEL`

Positions delta marker 2 on the next higher level found in the diagram area below the current marker position.

Usage: Event

Manual operation: See "[Search Mode for Next Peak in Y Direction](#)" on page 275

CALCulate<n>:DELTamarker<m>:SGRam:Y:MAXimum:NEXT

This command positions the specified delta marker on the next peak level of the vertical axis. The search includes frames above and below the current marker position. It does not change the horizontal position of the delta marker.

The command is available for the spectrogram.

Suffix:

<n> 1...4
Selects the measurement window.

<m> 1...16
Selects the marker.

Example:

`CALC:DELT2:SGR:Y:MAX`

Activates and positions delta marker 2 on the peak level of the y-axis.

`CALC:DELT2:SGR:Y:MAX:NEXT`

Positions delta marker 2 on the next higher level.

Usage: Event

Manual operation: See "[Search Mode for Next Peak in Y Direction](#)" on page 275

CALCulate<n>:DELTamarker<m>:SGRam:Y:MAXimum[:PEAK]

This command positions the specified delta marker on the current peak level of the vertical axis. The search is performed over all frames. It does not change the horizontal position of the deltamarker.

The command is available for the spectrogram.

Suffix:

<n> 1...4
Selects the measurement window.

<m> 1...16
Selects the marker.

Example:

`CALC:DELT2:SGR:Y:MAX`

Activates and positions delta marker 2 on the peak level of the y-axis.

Usage: Event

Manual operation: See "[Marker Search Type](#)" on page 276

CALCulate<n>:DELTamarker<m>:SGRam:Y:MINimum:ABOVE

This command positions the specified delta marker on the next minimum level of the vertical axis. The search includes only frames above the current marker position. It does not change the horizontal position of the delta marker.

The command is available for the spectrogram.

Suffix:

<n> 1...4
Selects the measurement window.

<m> 1...16
Selects the marker.

Example:

```
CALC:DELT2:SGR:Y:MIN
```

Activates and positions delta marker 2 on the minimum level of the y-axis.

```
CALC:DELT2:SGR:Y:MIN:ABOV
```

Positions delta marker 2 on the next minimum level found in the diagram area above the current marker position.

Usage: Event

Manual operation: See ["Search Mode for Next Peak in Y Direction"](#) on page 275

CALCulate<n>:DELTamarker<m>:SGRam:Y:MINimum:BELOW

This command positions the specified delta marker on the next minimum level of the vertical axis. The search includes only frames below the current marker position. It does not change the horizontal position of the delta marker.

The command is available for the spectrogram.

Suffix:

<n> 1...4
Selects the measurement window.

<m> 1...16
Selects the marker.

Example:

```
CALC:DELT2:SGR:Y:MIN
```

Activates and positions delta marker 2 on the minimum level of the y-axis.

```
CALC:DELT2:SGR:Y:MAX:BEL
```

Positions delta marker 2 on the next minimum level found in the diagram area below the current marker position.

Usage: Event

Manual operation: See ["Search Mode for Next Peak in Y Direction"](#) on page 275

CALCulate<n>:DELTamarker<m>:SGRam:Y:MINimum:NEXT

This command positions the specified delta marker on the next minimum level of the vertical axis. The search includes frames above and below the current marker position. It does not change the horizontal position of the delta marker.

The command is available for the spectrogram.

Suffix:

<n> 1...4
Selects the measurement window.

<m>	1...16 Selects the marker.
Example:	<code>CALC:DELT2:SGR:Y:MIN</code> Activates and positions delta marker 2 on the minimum level of the y-axis. <code>CALC:DELT2:SGR:Y:MIN:NEXT</code> Positions delta marker 2 on the next minimum level.
Usage:	Event
Manual operation:	See " Search Mode for Next Peak in Y Direction " on page 275

CALCulate<n>:DELTaMarker<m>:SGRaM:Y:MINimum[:PEAK]

This command positions the specified delta marker on the current minimum level of the vertical axis. The search is performed over all captured frames. It does not change the horizontal position of the delta marker.

The command is available for the spectrogram.

Suffix:

<n>	1...4 Selects the measurement window.
<m>	1...16 Selects the marker.

Example:	<code>CALC:DELT2:SGR:Y:MIN</code> Activates and positions delta marker 2 on the minimum level of the y-axis.
Usage:	Event
Manual operation:	See " Marker Search Type " on page 276

CALCulate:DLINe Subsystem

The CALCulate:DLINe subsystem defines the position of the display lines.

CALCulate<n>:DLINe<k>	636
CALCulate<n>:DLINe<k>:STATe	637

CALCulate<n>:DLINe<k> <Position>

This command defines the (vertical) position of a display line.

Suffix:

<n>	Selects the measurement window.
<k>	1 2 Selects the display line.

Parameters:

<Position> The value range is variable.
The unit depends on `CALCulate<n>:UNIT:POWer`.
*RST: (state is OFF)

Example: `CALC:DLIN -20dBm`

Manual operation: See "Display Line 1 / Display Line 2" on page 390

CALCulate<n>:DLINe<k>:STATe <State>

This command turns a display line on and off.

Suffix:

<n> Selects the measurement window.

<k> 1 | 2
Selects the display line.

Parameters:

<State> ON | OFF
*RST: OFF

Example: `CALC:DLIN2:STAT OFF`

Manual operation: See "Display Line 1 / Display Line 2" on page 390

CALCulate:ESPectrum Subsystem

The CALCulate:ESPectrum subsystem contains the remote commands for Spectrum Emission Mask (SEM) measurements. Both groups of commands (PSEarch and PEAKsearch) perform the same functions.

<code>CALCulate<n>:ESPectrum:PSEarch PEAKsearch:[IMMediate]</code>	637
<code>CALCulate<n>:ESPectrum:PSEarch PEAKsearch:AUTO</code>	637
<code>CALCulate<n>:ESPectrum:PEAKsearch PSEarch:DEtails</code>	638
<code>CALCulate<n>:ESPectrum:PSEarch PEAKsearch:MARGin</code>	638
<code>CALCulate<n>:ESPectrum:PSEarch PEAKsearch:PSHow</code>	638

CALCulate<n>:ESPectrum:PSEarch|PEAKsearch:[IMMediate]

This command starts the list evaluation.

Suffix:

<n> Selects the measurement window.

Example: `CALC:ESP:PSE`

Usage: Event

CALCulate<n>:ESPectrum:PSEarch|PEAKsearch:AUTO <State>

This command activates or deactivates the list evaluation.

Suffix:
<n> Selects the measurement window.

Parameters:
<State> ON | OFF
*RST: ON

Example: CALC:ESP:PSE:AUTO OFF
Deactivates the list evaluation.

CALCulate<n>:ESPectrum:PEAKsearch|PSEarch:DEtails <State>

This command configures how detailed the list in the Result Summary is.

Suffix:
<n> Selects the measurement window.

Parameters:
<State> ON | OFF | 1 | 0
ON | 1
Includes all detected peaks (up to a maximum defined by [CALCulate<n>:PEAKsearch|PSEarch:SUBRanges](#) on page 736).
OFF | 0
Includes only one peak per range.
*RST: 0

Example: CALC:ESP:PSE:DET ON
CALC:PSE:SUBR 10
Includes up to 10 peaks per range in the list.

Manual operation: See "[Details On/Off](#)" on page 353

CALCulate<n>:ESPectrum:PSEarch|PEAKsearch:MARGin <Margin>

This command sets the margin used for the limit check/peak search.

Suffix:
<n> Selects the measurement window.

Parameters:
<Margin> -200 to 200 dB
*RST: 200 dB

Example: CALC:ESP:PSE:MARG 100
Sets the margin to 100 dB.

CALCulate<n>:ESPectrum:PSEarch|PEAKsearch:PSHow <State>

This command marks all peaks with blue squares in the diagram.

Suffix:
 <n> Selects the measurement window.

Parameters:
 <State> ON | OFF
 *RST: OFF

Example: CALC:ESP:PSE:PSH ON
 Marks all peaks with blue squares.

Manual operation: See "Show Peaks" on page 323

CALCulate:FLINE Subsystem

The CALCulate:FLINE subsystem defines the position of the frequency lines.

CALCulate<n>:FLINE<k>.....	639
CALCulate<n>:FLINE<k>:STATe.....	639

CALCulate<n>:FLINE<k> <Frequency>

This command defines the position of a frequency line.

Suffix:
 <n> Selects the measurement window.
 <k> 1 | 2
 Selects the frequency line.

Parameters:
 <Frequency> Range: 0 Hz to fmax
 *RST: (STATe to OFF)

Example: CALC:FLIN2 120MHz

Manual operation: See "Frequency Line 1 / Frequency Line 2 " on page 391

CALCulate<n>:FLINE<k>:STATe <State>

This command turns a frequency line on and off.

Suffix:
 <n> Selects the measurement window.
 <k> 1 | 2
 Selects the frequency line.

Parameters:
 <State> ON | OFF
 *RST: OFF

Example: CALC:FLIN2:STAT ON

Manual operation: See "Frequency Line 1 / Frequency Line 2 " on page 391

CALCulate:LIMit Subsystem

The CALCulate:LIMit subsystem contains commands for the limit lines and the corresponding limit checks. Limit lines can be defined as upper or lower limit lines. The individual Y values of the limit lines correspond to the values of the x-axis (CONTROL). The number of X and Y values must be identical. For details on limit lines refer to [Chapter 5.3.7, "Using Limit Lines and Display Lines – LINES Key"](#), on page 386.

Further information

- [Chapter 6.4.3, "Limit Lines and Limit Test"](#), on page 1023

CALCulate<n>:LIMit<k>:ACTive?	640
CALCulate<n>:LIMit<k>:CLEar[:IMMEDIATE]	640
CALCulate<n>:LIMit<k>:COMMeNt	641
CALCulate<n>:LIMit<k>:COpy	641
CALCulate<n>:LIMit<k>:DELeTe	641
CALCulate<n>:LIMit<k>:FAIL?	642
CALCulate<n>:LIMit<k>:NAME	643
CALCulate<n>:LIMit<k>:STATe	643
CALCulate<n>:LIMit<k>:UNIT	643
CALCulate<n>:LIMit<k>:TRACe	644

CALCulate<n>:LIMit<k>:ACTive?

This command queries the names of all active limit lines.

Suffix:

<n>	irrelevant
<k>	irrelevant

Return values:

<LimitLines>	String containing the names of all active limit lines in alphabetical order.
--------------	--

Example: `CALC:LIM:ACT?`
Queries the names of all active limit lines.

Usage: Query only

CALCulate<n>:LIMit<k>:CLEar[:IMMEDIATE]

This command deletes the result of the current limit check for all limit lines in all windows.

Suffix:

<n>	irrelevant
<k>	irrelevant

Example: `CALC:LIM:CLE`
Deletes the result of the limit check.

Usage: Event

CALCulate<n>:LIMit<k>:COMMent <Comment>

This command defines a comment for the selected limit line in all windows.

Suffix:

<n> irrelevant

<k> Selects the limit line.

Parameters:

<Comment> String containing the comment. The maximum number of characters the string may contain is 40.

Example: `CALC:LIM5:COMM 'Upper limit for spectrum'`
Defines the comment for limit line 5.

Manual operation: See ["Edit Comment"](#) on page 388

CALCulate<n>:LIMit<k>:COPY <Line>

This command copies a limit line.

Suffix:

<n> irrelevant

<k> Selects the limit line.

Parameters:

<Line> **1 to 8**
number of the new limit line

<name>

String containing the name of the limit line.

Example: `CALC:LIM1:COPY 2`
Copies limit line 1 to line 2.
`CALC:LIM1:COPY 'FM2'`
Copies limit line 1 to a new line named FM2.

Manual operation: See ["Copy to"](#) on page 389

CALCulate<n>:LIMit<k>:DELete

This command deletes a limit line.

Suffix:

<n> irrelevant

<k> Selects the limit line.

Example: `CALC:LIM1:DEL`
Deletes limit line 1.

Usage: Event

Manual operation: See ["Delete"](#) on page 390

CALCulate<n>:LIMit<k>:FAIL?

This command queries the result of a limit check.

Note that for SEM measurements, the limit line suffix <k> is irrelevant, as only one specific SEM limit line is checked for the currently relevant power class.

To get a valid result, you have to perform a complete measurement with synchronization to the end of the measurement before reading out the result. This is only possible for single sweeps.

Suffix:

<n>	irrelevant
<k>	limit line For option WLAN TX Measurements, R&S FSV-K91/91n, see table below

Return values:

<Result>	0 PASS
	1 FAIL

Example:

```
INIT; *WAI
Starts a new sweep and waits for its end.
CALC:LIM3:FAIL?
Queries the result of the check for limit line 3.
```

Usage:

Query only

Manual operation: See "[Limit Check 1-4](#)" on page 320
See "[Limit Check 1-4](#)" on page 351

For option WLAN TX Measurements, R&S FSV-K91/91n, the numeric suffix <k> specifies the limit lines as follows:

Suffix	Limit
1 to 2	These indexes are not used
3	ETSI Spectrum Mask limit line
4	Spectrum Flatness (Upper) limit line
5	Spectrum Flatness (Lower) limit line
6	IEEE Spectrum Mask limit line
7	PVT Rising Edge max limit
8	PVT Rising Edge mean limit
9	PVT Falling Edge max limit
10	PVT Falling Edge mean limit

CALCulate<n>:LIMit<k>:NAME <Name>

This command selects a limit line that already exists or defines a name for a new limit line.

Suffix:

<n> irrelevant
 <k> 1...8 (NF: 1...6)
 Selects the limit line.

Parameters:

<Name> String containing the limit line name.
 *RST: REM1 to REM8 for lines 1 to 8

Example:

CALC:LIM1:NAME 'FM1'
 Assigns the name FM1 to limit line 1.

CALCulate<n>:LIMit<k>:STATe <State>

This command turns the limit check on and off.

To query the limit check result, use `CALCulate<n>:LIMit<k>:FAIL?`.

Suffix:

<n> irrelevant
 <k> Selects the limit line.

Parameters:

<State> ON | OFF
 *RST: OFF

Example:

CALC:LIM:STAT ON
 Switches on the limit check for limit line 1.

Manual operation: See "[Select Traces to check](#)" on page 388
 See "[Deselect All](#)" on page 388

CALCulate<n>:LIMit<k>:UNIT <Unit>

This command defines the unit of a limit line.

Upon selection of the unit DB the limit line is automatically switched to the relative mode. For units different from DB the limit line is automatically switched to absolute mode.

Suffix:

<n> irrelevant
 <k> Selects the limit line.

Parameters:

<Unit> DBM | DBPW | WATT | DBUV | DBMV | VOLT | DBUA | AMPere | DB | DBUV_M | DBUA_M | DEG | RAD | S | HZ | PCT | (unitless)

If you select dB as the limit line unit, the command automatically turns the limit line into a relative limit line.

In spectrum mode, units deg, rad, s, Hz and PCT are unavailable.

*RST: DBM

Example:

```
CALC:LIM4:UNIT DBUV
Sets the unit of limit line 4 to dBµV.
```

CALCulate<n>:LIMit<k>:TRACe <TraceNumber>

This command links a limit line to one or more traces.

Suffix:

<n> irrelevant

<k> Selects the limit line.

Parameters:

<TraceNumber> Range: 1 to 6
*RST: 1

Example:

```
CALC:LIM2:TRAC 3
Assigns limit line 2 to trace 3.
```

Manual operation: See "[Select Traces to check](#)" on page 388

CALCulate:LIMit:ACPower Subsystem

The CALCulate:LIMit:ACPower subsystem defines the limit check for adjacent channel power measurement.

CALCulate<n>:LIMit<k>:ACPower[:STATe].....	645
CALCulate<n>:LIMit<k>:ACPower:ACHannel[:RELative].....	645
CALCulate<n>:LIMit<k>:ACPower:ACHannel[:RELative]:STATe.....	646
CALCulate<n>:LIMit<k>:ACPower:ACHannel:ABSolute.....	646
CALCulate<n>:LIMit<k>:ACPower:ACHannel:ABSolute:STATe.....	647
CALCulate<n>:LIMit<k>:ACPower:ACHannel:RESult.....	648
CALCulate<n>:LIMit<k>:ACPower:ALternate<channel>[:RELative].....	649
CALCulate<n>:LIMit<k>:ACPower:ALternate<Channel>[:RELative]:STATe.....	650
CALCulate<n>:LIMit<k>:ACPower:ALternate<Channel>:ABSolute.....	650
CALCulate<n>:LIMit<k>:ACPower:ALternate<Channel>:ABSolute:STATe.....	651
CALCulate<n>:LIMit<k>:ACPower:ALternate<Channel>:RESult?.....	652

CALCulate<n>:LIMit<k>:ACPpower[:STATe] <State>

This command switches on and off the limit check for adjacent-channel power measurements. The commands `CALCulate<n>:LIMit<k>:ACPpower:ACHannel[:RELative]:STATe` or `CALCulate<n>:LIMit<k>:ACPpower:ALternate<Channel>[:RELative]:STATe` must be used in addition to specify whether the limit check is to be performed for the upper/lower adjacent channel or for the alternate adjacent channels.

Suffix:

<n> Selects the measurement window.

<k> irrelevant

Parameters:

<State> ON | OFF

*RST: OFF

Example:

`CALC:LIM:ACP ON`

Switches on the ACLR limit check.

Manual operation: See "Limit Checking" on page 300
See "Relative Limit" on page 301
See "Absolute Limit" on page 301

CALCulate<n>:LIMit<k>:ACPpower:ACHannel[:RELative] <LowerLimit>, <UpperLimit>

This command defines the relative limit of the upper/lower adjacent channel for adjacent-channel power measurements. The reference value for the relative limit value is the measured channel power.

It should be noted that the relative limit value has no effect on the limit check as soon as it is below the absolute limit value defined with the `CALCulate<n>:LIMit<k>:ACPpower:ACHannel:ABSolute` command. This mechanism allows automatic checking of the absolute basic values of adjacent-channel power as defined in mobile radio standards.

Suffix:

<n> Selects the measurement window.

<k> irrelevant

Parameters:

<LowerLimit>, <UpperLimit> 0 to 100dB; the value for the lower limit must be lower than the value for the upper limit

*RST: 0 dB

Example:

`CALC:LIM:ACP:ACH 30DB, 30DB`

Sets the relative limit value for the power in the lower and upper adjacent channel to 30 dB below the channel power.

CALCulate<n>:LIMit<k>:ACPpower:ACHannel[:RELative]:STATe <State>

This command activates the limit check for the relative limit value of the adjacent channel when adjacent-channel power measurement is performed. Before this command, the limit check must be activated using `CALCulate<n>:LIMit<k>:ACPpower[:STATe]`.

The result can be queried with `CALCulate<n>:LIMit<k>:ACPpower:ACHannel:RESult`. Note that a complete measurement must be performed between switching on the limit check and the result query, since otherwise no correct results are available.

Suffix:

<n> Selects the measurement window.
 <k> irrelevant

Parameters:

<State> ON | OFF
 *RST: OFF

Example:

```
CALC:LIM:ACP:ACH 30DB, 30DB
```

Sets the relative limit value for the power in the lower and upper adjacent channel to 30 dB below the channel power.

```
CALC:LIM:ACP:ACH:ABS -35DBM, -35DBM
```

Sets the absolute limit value for the power in the lower and upper adjacent channel to -35 dBm.

```
CALC:LIM:ACP ON
```

Switches on globally the limit check for the channel/adjacent channel measurement.

```
CALC:LIM:ACP:ACH:STAT ON
```

Switches on the check of the relative limit values for adjacent channels.

```
CALC:LIM:ACP:ACH:ABS:STAT ON
```

Switches on the check of absolute limit values for the adjacent channels.

```
INIT;*WAI
```

Starts a new measurement and waits for the sweep end.

```
CALC:LIM:ACP:ACH:RES?
```

Queries the limit check result in the adjacent channels.

CALCulate<n>:LIMit<k>:ACPpower:ACHannel:ABSolute <LowerLimit>, <UpperLimit>

This command defines the absolute limit value for the lower/upper adjacent channel during adjacent-channel power measurement (Adjacent Channel Power).

Note that the absolute limit value has no effect on the limit check as soon as it is below the relative limit value defined with `CALCulate<n>:LIMit<k>:ACPpower:ACHannel[:RELative]`. This mechanism allows automatic checking of the absolute basic values of adjacent-channel power as defined in mobile radio standards.

Suffix:

<n> Selects the measurement window.

<k> irrelevant

Parameters:

<LowerLimit>, first value: -200DBM to 200DBM; limit for the lower and the
<UpperLimit> upper adjacent channel

*RST: -200DBM

Example:

CALC:LIM:ACP:ACH:ABS -35DBM, -35DBM

Sets the absolute limit value for the power in the lower and upper adjacent channel to -35 dBm.

CALCulate<n>:LIMit<k>:ACPower:ACHannel:ABSolute:STATe <State>

This command activates the limit check for the adjacent channel when adjacent-channel power measurement (Adjacent Channel Power) is performed. Before the command, the limit check for the channel/adjacent-channel measurement must be globally switched on using [CALCulate<n>:LIMit<k>:ACPower\[:STATe\]](#).

The result can be queried with [CALCulate<n>:LIMit<k>:ACPower:ACHannel:RESult](#). It should be noted that a complete measurement must be performed between switching on the limit check and the result query, since otherwise no correct results are available.

Suffix:

<n> Selects the measurement window.

<k> irrelevant

Parameters:

<State> ON | OFF

*RST: OFF

Example:

```
CALC:LIM:ACP:ACH 30DB, 30DB
```

Sets the relative limit value for the power in the lower and upper adjacent channel to 30 dB below the channel power.

```
CALC:LIM:ACP:ACH:ABS -35DBM, -35DBM
```

Sets the absolute limit value for the power in the lower and upper adjacent channel to -35 dBm.

```
CALC:LIM:ACP ON
```

Switches on globally the limit check for the channel/adjacent-channel measurement.

```
CALC:LIM:ACP:ACH:REL:STAT ON
```

Switches on the check of the relative limit values for adjacent channels.

```
CALC:LIM:ACP:ACH:ABS:STAT ON
```

Switches on the check of absolute limit values for the adjacent channels.

```
INIT;*WAI
```

Starts a new measurement and waits for the sweep end.

```
CALC:LIM:ACP:ACH:RES?
```

Queries the limit check result in the adjacent channels.

Manual operation: See "[Absolute Limit](#)" on page 301

CALCulate<n>:LIMit<k>:ACPpower:ACHannel:RESult

This command queries the result of the limit check for the upper/lower adjacent channel when adjacent channel power measurement is performed.

If the power measurement of the adjacent channel is switched off, the command produces a query error.

Suffix:

<n> Selects the measurement window.

<k> irrelevant

Return values:

Result The result is returned in the form <result>, <result> where <result> = PASSED | FAILED, and where the first returned value denotes the lower, the second denotes the upper adjacent channel.

Example:

```
CALC:LIM:ACP:ACH 30DB, 30DB
```

Sets the relative limit value for the power in the lower and upper adjacent channel to 30 dB below the channel power.

```
CALC:LIM:ACP:ACH:ABS -35DBM, -35DBM
```

Sets the absolute limit value for the power in the lower and upper adjacent channel to -35 dB.

```
CALC:LIM:ACP ON
```

Switches on globally the limit check for the channel/adjacent channel measurement.

```
CALC:LIM:ACP:ACH:STAT ON
```

Switches on the limit check for the adjacent channels.

```
INIT;*WAI
```

Starts a new measurement and waits for the sweep end.

```
CALC:LIM:ACP:ACH:RES?
```

Queries the limit check result in the adjacent channels.

Manual operation: See "[Limit Checking](#)" on page 300

CALCulate<n>:LIMit<k>:ACPpower:ALTErnate<channel>[:RELative] <LowerLimit>, <UpperLimit>

This command defines the limit for the alternate adjacent channels for adjacent channel power measurements. The reference value for the relative limit value is the measured channel power.

Note that the relative limit value has no effect on the limit check as soon as it is below the absolute limit defined with `CALCulate<n>:LIMit<k>:ACPpower:ALTErnate<Channel>:ABSolute`. This mechanism allows automatic checking of the absolute basic values of adjacent-channel power as defined in mobile radio standards.

Suffix:

<n> Selects the measurement window.

<k> irrelevant

<Channel> 1...11
the alternate channel

Parameters:

<LowerLimit>, <UpperLimit> first value: 0 to 100dB; limit for the lower and the upper alternate adjacent channel

*RST: 0 DB

Example:

```
CALC:LIM:ACP:ALT2 30DB, 30DB
```

Sets the relative limit value for the power in the lower and upper second alternate adjacent channel to 30 dB below the channel power.

Manual operation: See "[Limit Checking](#)" on page 300

CALCulate<n>:LIMit<k>:ACPpower:ALTErnate<Channel>[:RELative]:STATe
 <State>

This command activates the limit check for the alternate adjacent channels for adjacent channel power measurements. Before the command, the limit check must be activated using `CALCulate<n>:LIMit<k>:ACPpower[:STATe]`.

The result can be queried with `CALCulate<n>:LIMit<k>:ACPpower:ALTErnate<channel>[:RELative]`. Note that a complete measurement must be performed between switching on the limit check and the result query, since otherwise no correct results are obtained.

Suffix:

<n>	Selects the measurement window.
<k>	irrelevant
<Channel>	1...11 the alternate channel

Parameters:

<State>	ON OFF
*RST:	OFF

Example:

```
CALC:LIM:ACP:ALT2 30DB, 30DB
```

Sets the relative limit value for the power in the lower and upper second alternate adjacent channel to 30 dB below the channel power.

```
CALC:LIM:ACP:ALT2:ABS -35DBM, -35DBM
```

Sets the absolute limit value for the power in the lower and upper second alternate adjacent channel to -35 dBm.

```
CALC:LIM:ACP ON
```

Switches on globally the limit check for the channel/adjacent channel measurement.

```
CALC:LIM:ACP:ALT2:STAT ON
```

Switches on the check of the relative limit values for the lower and upper second alternate adjacent channel.

```
CALC:LIM:ACP:ALT2:ABS:STAT ON
```

Switches on the check of absolute limit values for the lower and upper second alternate adjacent channel.

```
INIT;*WAI
```

Starts a new measurement and waits for the sweep end.

```
CALC:LIM:ACP:ALT2:RES?
```

Queries the limit check result in the second alternate adjacent channels.

CALCulate<n>:LIMit<k>:ACPpower:ALTErnate<Channel>:ABSolute <LowerLimit>,
 <UpperLimit>

This command defines the absolute limit value for the lower/upper alternate adjacent-channel power measurement (Adjacent Channel Power).

Note that the absolute limit value for the limit check has no effect as soon as it is below the relative limit value defined with `CALCulate<n>:LIMit<k>:ACPoweR:ACHannel[:RELative]`. This mechanism allows automatic checking of the absolute basic values defined in mobile radio standards for the power in adjacent channels.

Suffix:

<n>	Selects the measurement window.
<k>	irrelevant
<Channel>	1...11 the alternate channel

Parameters:

<LowerLimit>, <UpperLimit>	first value: -200DBM to 200DBM; limit for the lower and the upper alternate adjacent channel
*RST:	-200DBM

Example:

```
CALC:LIM:ACP:ALT2:ABS -35DBM, -35DBM
```

Sets the absolute limit value for the power in the lower and upper second alternate adjacent channel to -35 dBm.

CALCulate<n>:LIMit<k>:ACPoweR:ALTErnate<Channel>:ABSolute:STATe <State>

This command activates the limit check for the alternate adjacent channels for adjacent-channel power measurement (Adjacent Channel Power).

Before the command, the limit check must be globally switched on for the channel/adjacent-channel power with the `CALCulate<n>:LIMit<k>:ACPoweR[:STATe]` command.

The result can be queried with `CALCulate<n>:LIMit<k>:ACPoweR:ALTErnate<channel>[:RELative]`. Note that a complete measurement must be performed between switching on the limit check and the result query, since otherwise no correct results are available.

Suffix:

<n>	Selects the measurement window.
<k>	irrelevant
<Channel>	1...11 the alternate channel

Parameters:

<State>	ON OFF
*RST:	OFF

Example:

```
CALC:LIM:ACP:ALT2 30DB, 30DB
```

Sets the relative limit value for the power in the lower and upper second alternate adjacent channel to 30 dB below the channel power.

```
CALC:LIM:ACP:ALT2:ABS -35DBM, -35DBM
```

Sets the absolute limit value for the power in the lower and upper second alternate adjacent channel to -35 dBm.

```
CALC:LIM:ACP ON
```

Switches on globally the limit check for the channel/adjacent channel measurement.

```
CALC:LIM:ACP:ALT2:STAT ON
```

Switches on the check of the relative limit values for the lower and upper second alternative adjacent channels.

```
CALC:LIM:ACP:ALT2:ABS:STAT ON
```

Switches on the check of absolute limit values for the lower and upper second alternative adjacent channels.

```
INIT;*WAI
```

Starts a new measurement and waits for the sweep end.

```
CALC:LIM:ACP:ALT2:RES?
```

Queries the limit check result in the second alternate adjacent channels.

CALCulate<n>:LIMit<k>:ACPpower:ALternate<Channel>:RESult?

This command queries the result of the limit check for the alternate adjacent channels for adjacent channel power measurements.

If the power measurement of the adjacent channel is switched off, the command produces a query error.

Suffix:

<n>	Selects the measurement window.
<k>	irrelevant
<Channel>	1...11 the alternate channel

Return values:

<Result>	The result is returned in the form <result>, <result> where <result> = PASSED FAILED and where the first (second) returned value denotes the lower (upper) alternate adjacent channel.
----------	--

Example:

```
CALC:LIM:ACP:ALT2 30DB, 30DB
```

Sets the relative limit value for the power in the lower and upper second alternate adjacent channel to 30 dB below the channel power.

```
CALC:LIM:ACP:ALT2:ABS -35DBM, -35DBM
```

Sets the absolute limit value for the power in the lower and upper second alternate adjacent channel to -35 dBm.

```
CALC:LIM:ACP ON
```

Switches on globally the limit check for the channel/adjacent channel measurement.

```
CALC:LIM:ACP:ALT2:STAT ON
```

Switches on the limit check for the lower and upper second adjacent channel.

```
INIT;*WAI
```

Starts a new measurement and waits for the sweep end.

```
CALC:LIM:ACP:ALT2:RES?
```

Queries the limit check result in the second alternate adjacent channels.

Usage:

Query only

CALCulate:LIMit:CONTRol Subsystem

The CALCulate:LIMit:CONTRol subsystem defines the x-axis (CONTRol axis).

CALCulate<n>:LIMit<k>:CONTRol[:DATA]	653
CALCulate<n>:LIMit<k>:CONTRol:DOMain	654
CALCulate<n>:LIMit<k>:CONTRol:MODE	654
CALCulate<n>:LIMit<k>:CONTRol:OFFSet	654
CALCulate<n>:LIMit<k>:CONTRol:SHIFt	655
CALCulate<n>:LIMit<k>:CONTRol:SPACing	655

CALCulate<n>:LIMit<k>:CONTRol[:DATA] <LimitLinePoints>

This command defines the horizontal definition points of a lower limit line.

Suffix:

<n>	Selects the measurement window.
<k>	1...8 Selects the limit line.

Parameters:

<LimitLinePoints>	Variable number of x-axis values. Note that the number of horizontal values has to be the same as the number of vertical values set with <code>CALCulate<n>:LIMit<k>:LOWer[:DATA]</code> or <code>CALCulate<n>:LIMit<k>:UPPer[:DATA]</code> . If not, the R&S FSVA/FSV either adds missing values or ignores surplus values. The unit is Hz or s, depending on <code>CALCulate<n>:LIMit<k>:CONTRol:DOMain</code> .
-------------------	--

*RST: - (CALC:LIM is set to OFF)

Example: `CALC:LIM2:CONT 1 MHz,30 MHz,100 MHz,300 MHz,1 GHz`
 Defines 5 reference values for the x-axis of limit line 2.
`CALC:LIM2:CONT?`
 Outputs the reference values for the x-axis of limit line 2 separated by a comma.

Manual operation: See "Edit Value" on page 389

CALCulate<n>:LIMit<k>:CONTrol:DOMain <SpanSetting>

This command selects the domain of the limit line.

Suffix:

<n> Selects the measurement window.
 <k> 1...8
 Selects the limit line.

Parameters:

<SpanSetting> FREQUENCY | TIME
 *RST: FREQUENCY

Example: `CALC:LIM2:CONT:DOM TIME`
 Defines zero span for the x-axis of limit line 2.

CALCulate<n>:LIMit<k>:CONTrol:MODE <Mode>

This command selects the horizontal limit line scaling.

Suffix:

<n> Selects the measurement window.
 <k> 1...8
 Selects the limit line.

Parameters:

<Mode> **ABSolute**
 Limit line is defined by absolute physical values (Hz or s).
RELative
 Limit line is defined by relative values related to the center frequency (frequency domain) or the left diagram border (time domain).
 *RST: ABSolute

Example: `CALC:LIM2:CONT:MODE REL`
 Defines the x-axis of limit line 2 as relatively scaled.

CALCulate<n>:LIMit<k>:CONTrol:OFFSet <Offset>

This command defines an offset for a complete limit line.

Compared to shifting the limit line, an offset does not actually change the limit line definition points.

Suffix:

<n> Selects the measurement window.

<k> 1...8
Selects the limit line.

Parameters:

<Offset> Numeric value that defines the offset.
The unit of the offset depends on the scale of the x-axis.

*RST: 0

Example:

`CALC:LIM2:CONT:OFFS 100us`

Sets the X offset for limit line 2 (defined in zero span) to 100µs.

Manual operation: See "[X Offset](#)" on page 390

CALCulate<n>:LIMit<k>:CONTrol:SHIFt <Distance>

This command moves a complete limit line horizontally.

Compared to defining an offset, this command actually changes the limit line definition points by the value you define.

Suffix:

<n> Selects the measurement window.

<k> Selects the limit line.

Parameters:

<Distance> Numeric value that defines the distance of the shift.
The unit depends on the scale of the x-axis.

Example:

`CALC:LIM2:CONT:SHIF 50KHZ`

Shifts all reference values of limit line 2 by 50 kHz.

CALCulate<n>:LIMit<k>:CONTrol:SPACing <InterpolMode>

This command selects linear or logarithmic interpolation for the calculation of limit lines from frequency points.

Suffix:

<n> Selects the measurement window.

<k> 1...8
Selects the limit line.

Parameters:

<InterpolMode> LINear | LOGarithmic

*RST: LIN

Example:

`CALC:LIM:CONT:SPAC LIN`

CALCulate:LIMit:ESpectrum subsystem

The `CALCulate:LIMit:ESpectrum` subsystem defines the limit check for the Spectrum Emission Mask.

<code>CALCulate<n>:LIMit<k>:ESpectrum:LIMits</code>	656
<code>CALCulate<n>:LIMit<k>:ESpectrum:MODE</code>	656
<code>CALCulate<n>:LIMit<k>:ESpectrum:PClass<Class>[:EXCLusive]</code>	657
<code>CALCulate<n>:LIMit<k>:ESpectrum:PClass<Class>:COUNT</code>	657
<code>CALCulate<n>:LIMit<k>:ESpectrum:PClass<Class>:LIMit[:STATe]</code>	658
<code>CALCulate<n>:LIMit<k>:ESpectrum:PClass<Class>:MAXimum</code>	658
<code>CALCulate<n>:LIMit<k>:ESpectrum:PClass<Class>:MINimum</code>	659
<code>CALCulate<n>:LIMit<k>:ESpectrum:RESTore</code>	659
<code>CALCulate<n>:LIMit<k>:ESpectrum:VALue</code>	659

CALCulate<n>:LIMit<k>:ESpectrum:LIMits <Limits>

This command sets or queries up to 4 power classes in one step.

Suffix:

<code><n></code>	irrelevant
<code><k></code>	irrelevant

Parameters:

<code><Limits></code>	1–3 numeric values between -200 and 200, separated by commas -200, <0-3 numeric values between -200 and 200, in ascending order, separated by commas>, 200
-----------------------------	---

Example:

```

CALC:LIM:ESP:LIM -50,50,70
Defines the following power classes:
<-200, -50>
<-50, 50>
<50, 70>
<70, 200>
Query:
CALC:LIM:ESP:LIM?
Response:
-200,-50,50,70,200

```

CALCulate<n>:LIMit<k>:ESpectrum:MODE <Mode>

This command activates or deactivates the automatic selection of the limit line in the Spectrum Emission Mask measurement.

Suffix:

<code><n></code>	1...4 window
<code><k></code>	irrelevant

Parameters:

<code><Mode></code>	AUTO MANUAL
---------------------------	---------------

AUTO

The limit line depends on the measured channel power.

MANUAL

One of the three specified limit lines is set. The selection is made with the "[CALCulate:LIMit:ESpectrum subsystem](#)" on page 656 command.

*RST: AUTO

Example:

```
CALC:LIM:ESP:MODE AUTO
```

Activates automatic selection of the limit line.

CALCulate<n>:LIMit<k>:ESpectrum:PCLass<Class>[:EXCLUSIVE] <State>

This command sets the power classes used in the spectrum emission mask measurement. It is only possible to use power classes for which limits are defined. Also, either only one power class at a time or all power classes together can be selected.

Suffix:

<n> irrelevant
 <k> irrelevant
 <Class> 1...4
 the power class to be evaluated

Parameters:

<State> ON | OFF
 *RST: OFF

Example:

```
CALC:LIM:ESP:PCL1 ON
```

Activates the first defined power class.

Manual operation: See "[Used Power Classes](#)" on page 325
 See "[Add/Remove](#)" on page 326

CALCulate<n>:LIMit<k>:ESpectrum:PCLass<Class>:COUNT <NoPowerClasses>

This command sets the number of power classes to be defined.

Suffix:

<n> irrelevant
 <k> irrelevant
 <Class> irrelevant

Parameters:

<NoPowerClasses> 1 to 4
 *RST: 1

Example:

```
CALC:LIM:ESP:PCL:COUN 2
```

Two power classes can be defined.

CALCulate<n>:LIMit<k>:ESPectrum:PCLass<Class>:LIMit[:STATe] <State>

This command defines which limits are evaluated in the measurement.

Suffix:

<n>	irrelevant
<k>	irrelevant
<Class>	1...4 the power class to be evaluated

Parameters:

<State> ABSolute | RELative | AND | OR

ABSolute

Evaluates only limit lines with absolute power values

RELative

Evaluates only limit lines with relative power values

AND

Evaluates limit lines with relative and absolute power values. A negative result is returned if both limits fail.

OR

Evaluates limit lines with relative and absolute power values. A negative result is returned if at least one limit failed.

*RST: REL

Example:

CALC:LIM:ESP:PCL:LIM ABS

Manual operation: See "[Used Power Classes](#)" on page 325

CALCulate<n>:LIMit<k>:ESPectrum:PCLass<Class>:MAXimum <Level>

This command sets the upper limit level for one power class. The unit is dBm. The limit always ends at + 200 dBm, i.e. the upper limit of the last power class can not be set. If more than one power class is in use, the upper limit must equal the lower limit of the next power class.

Suffix:

<n>	irrelevant
<k>	irrelevant
<Class>	1...4 the power class to be evaluated

Parameters:

<Level> <numeric value>

*RST: +200

Example:

CALC:LIM:ESP:PCL1:MAX -40 dBm

Sets the maximum power value of the first power class to -40 dBm.

Manual operation: See "[PMin/PMax](#)" on page 326

CALCulate<n>:LIMit<k>:ESPectrum:PCLass<Class>:MINimum <Level>

This command sets the minimum lower level limit for one power class. The unit is dBm. The limit always start at – 200 dBm, i.e. the first lower limit can not be set. If more than one power class is in use, the lower limit must equal the upper limit of the previous power class.

Suffix:

<n>	irrelevant
<k>	irrelevant
<Class>	1...4 the power class to be evaluated

Parameters:

<Level>	<numeric_value> *RST: -200 for class1, otherwise +200
---------	---

Example:

`CALC:LIM:ESP:PCL2:MIN -40 dBm`
Sets the minimum power value of the second power class to -40 dBm.

Manual operation: See "[PMin/PMax](#)" on page 326

CALCulate<n>:LIMit<k>:ESPectrum:RESTore

This command restores the predefined limit lines for the Spectrum Emission Mask measurement. All modifications made to the predefined limit lines are lost and the factory-set values are restored.

Suffix:

<n>	1...4 window
<k>	irrelevant

Example:

`CALC:LIM:ESP:REST`
Resets the limit lines for the Spectrum Emission Mask to the default setting.

CALCulate<n>:LIMit<k>:ESPectrum:VALue <Power>

This command activates the manual limit line selection and specifies the expected power as a value. Depending on the entered value, one of the predefined limit lines is selected.

Suffix:

<n>	1...4 window
-----	-----------------

<k> irrelevant

Parameters:

<Power> 33 | 28 | 0
33
 $P \geq 33$
28
 $28 < P < 33$
0
 $P < 28$
 *RST: 0

Example:

CALC:LIM:ESP:VAL 33

Activates manual selection of the limit line and selects the limit line for $P = 33$.

CALCulate:LIMit:LOWer Subsystem

The CALCulate:LIMit:LOWer subsystem defines the lower limit line.

CALCulate<n>:LIMit<k>:LOWer[:DATA]	660
CALCulate<n>:LIMit<k>:LOWer:MARGin	661
CALCulate<n>:LIMit<k>:LOWer:MODE	661
CALCulate<n>:LIMit<k>:LOWer:OFFSet	661
CALCulate<n>:LIMit<k>:LOWer:SHIFt	662
CALCulate<n>:LIMit<k>:LOWer:SPACing	662
CALCulate<n>:LIMit<k>:LOWer:STATe	663
CALCulate<n>:LIMit<k>:LOWer:THReshold	663

CALCulate<n>:LIMit<k>:LOWer[:DATA] <LimitLinePoints>

This command defines the vertical definition points of a lower limit line.

If the measured values are smaller than the LOWer limit line, the limit check is violated.

The units DEG, RAD, S, HZ, PCT are not available in the "Spectrum" mode.

Suffix:

<n> irrelevant
 <k> 1...8
 Selects the limit line.

Parameters:

<LimitLinePoints> Variable number of x-axis values.
 Note that the number of horizontal values has to be the same as the number of vertical values set with CALCulate<n>:LIMit<k>:CONTrol[:DATA]. If not, the R&S FSVA/FSV either adds missing values or ignores surplus values.
 The unit depends on CALCulate<n>:LIMit<k>:UNIT.
 *RST: (LIMit:STATe is set to OFF)

Example: `CALC:LIM2:LOW -30,-40,-10,-40,-30`
 Defines 5 lower limit values for limit line 2 in the preset unit.
`CALC:LIM2:LOW?`
 Outputs the lower limit values of limit line 2 separated by a comma.

Manual operation: See "Edit Value" on page 389

CALCulate<n>:LIMit<k>:LOWer:MARGin <Margin>

This command defines an area around a lower limit line where limit check violations are still tolerated.

Suffix:

<n> irrelevant
 <k> 1...8
 Selects the limit line.

Parameters:

<Margin> Numeric value that defines the margin.
 In spectrum mode, the unit is always dB.
 *RST: 0

Example: `CALC:LIM:LOW:MARG 10dB`

CALCulate<n>:LIMit<k>:LOWer:MODE <Mode>

This command selects the vertical limit line scaling.

Suffix:

<n> irrelevant
 <k> 1...8
 Selects the limit line.

Parameters:

<Mode> **ABSolute**
 Limit line is defined by absolute physical values. The unit is variable.
RELative
 Limit line is defined by values relative to the reference level (dB).
 *RST: ABSolute

Example: `CALC:LIM:LOW:MODE REL`
 Defines the y-axis of limit line 2 as relative scaled.

Manual operation: See "Edit Name" on page 388

CALCulate<n>:LIMit<k>:LOWer:OFFSet <Offset>

This command defines an offset for a complete lower limit line.

Compared to shifting the limit line, an offset does not actually change the limit line definition points.

Suffix:

<n> irrelevant
 <k> 1...8
 Selects the limit line.

Parameters:

<Offset> Numeric value that defines the offset.
 *RST: 0

Example:

CALC:LIM2:LOW:OFFS 3dB
 Shifts limit line 2 by 3 dB upwards.

Manual operation: See "Y Offset" on page 390

CALCulate<n>:LIMit<k>:LOWer:SHIFt <Distance>

This command moves a complete lower limit line vertically.

Compared to defining an offset, this command actually changes the limit line definition points by the value you define.

Suffix:

<n> irrelevant
 <k> Selects the limit line.

Parameters:

<Distance> Numeric value that defines the distance of the shift.
 The unit depends on CALCulate<n>:LIMit<k>:UNIT on page 643.

Example:

CALC:LIM3:LOW:SHIF 20DB
 Shifts all Y values of limit line 3 by 20 dB.

CALCulate<n>:LIMit<k>:LOWer:SPACing <InterpolType>

This command selects linear or logarithmic interpolation for the lower limit line.

Suffix:

<n> irrelevant
 <k> 1...8
 Selects the limit line.

Parameters:

<InterpolType> LINear | LOGarithmic
 *RST: LIN

Example:

CALC:LIM:LOW:SPAC LIN

CALCulate<n>:LIMit<k>:LOWer:STATe <State>

This command turns a lower limit line on and off.

Before you can use this command, you have to select a limit line with

[CALCulate<n>:LIMit<k>:NAME](#).

The limit check is activated separately with [CALCulate<n>:LIMit<k>:STATe](#). The result of the limit check can be queried with [CALCulate<n>:LIMit<k>:FAIL?](#).

Suffix:

<n> irrelevant
 <k> 1...8
 Selects the limit line.

Parameters:

<State> ON | OFF
 *RST: OFF

Example:

`CALC:LIM4:LOW:STAT ON`
 Switches on limit line 4 (lower limit).

CALCulate<n>:LIMit<k>:LOWer:THReshold <Threshold>

This command defines a threshold for relative limit lines.

The R&S FSVA/FSV uses the threshold for the limit check, if the limit line violates the threshold.

Suffix:

<n> irrelevant
 <k> 1...8
 Selects the limit line.

Parameters:

<Threshold> Numeric value that defines the threshold.
 The unit depends on [CALCulate<n>:LIMit<k>:UNIT](#).
 *RST: -200 dBm

Example:

`CALC:LIM2:LOW:THR -35DBM`
 Defines an absolute threshold value for limit line 2.

CALCulate:LIMit:UPPer Subsystem

The `CALCulate:LIMit:UPPer` subsystem defines the upper limit line.

[CALCulate<n>:LIMit<k>:UPPer\[:DATA\]](#)..... 664
[CALCulate<n>:LIMit<k>:UPPer:MARGin](#)..... 664
[CALCulate<n>:LIMit<k>:UPPer:MODE](#)..... 665
[CALCulate<n>:LIMit<k>:UPPer:OFFSet](#)..... 665
[CALCulate<n>:LIMit<k>:UPPer:SHIFt](#)..... 665

CALCulate<n>:LIMit<k>:UPPer:SPACing.....	666
CALCulate<n>:LIMit<k>:UPPer:STATe.....	666
CALCulate<n>:LIMit<k>:UPPer:THReshold.....	666

CALCulate<n>:LIMit<k>:UPPer[:DATA] <LimitLinePoints>

This command defines the vertical definition points of an upper limit line.

If the measured values exceed the UPPer limit line, the limit is violated.

Suffix:

<n>	irrelevant
<k>	1...8 Selects the limit line.

Parameters:

<LimitLinePoints>	Variable number of x-axis values. Note that the number of horizontal values has to be the same as the number of vertical values set with <code>CALCulate<n>:LIMit<k>:CONTRol[:DATA]</code> . If not, the R&S FSVA/FSV either adds missing values or ignores surplus values. The unit depends on <code>CALCulate<n>:LIMit<k>:UNIT</code> . *RST: (LIMit:STATe is set to OFF)
-------------------	--

Example:

```
CALC:LIM2:UPP -10,0,0,-10,-5
```

Defines 5 upper limit values for limit line 2 in the preset unit.

```
CALC:LIM2:UPP?
```

Outputs the upper limit values for limit line 2 separated by a comma.

Manual operation: See "Edit Value" on page 389

CALCulate<n>:LIMit<k>:UPPer:MARGin <Margin>

This command defines an area around a upper limit line where limit check violations are still tolerated.

Suffix:

<n>	irrelevant
<k>	1...8 Selects the limit line.

Parameters:

<Margin>	Numeric value that defines the margin. In spectrum mode, the unit is always dB. *RST: 0
----------	---

Example:

```
CALC:LIM2:UPP:MARG 10dB
```

Defines the margin of limit line 2 to 10 dB below the limit value.

CALCulate<n>:LIMit<k>:UPPer:MODE <Mode>

This command selects the vertical limit line scaling.

Suffix:

<n>	irrelevant
<k>	1...8 Selects the limit line.

Parameters:

<Mode>	ABSolute Limit line is defined by absolute physical values. The unit is variable.
	RELative Limit line is defined by values relative to the reference level (dB).
*RST:	ABSolute

Example:

```
CALC:LIM2:UPP:MODE REL
```

Defines the y-axis of limit line 2 as relative scaled.

CALCulate<n>:LIMit<k>:UPPer:OFFSet <Offset>

This command defines an offset for a complete upper limit line.

Compared to shifting the limit line, an offset does not actually change the limit line definition points.

Suffix:

<n>	irrelevant
<k>	1...8 Selects the limit line.

Parameters:

<Offset>	Numeric value that defines the offset.
*RST:	0

Example:

```
CALC:LIM2:UPP:OFFS 3dB
```

Shifts limit line 2 by 3 dB upwards.

Manual operation: See "Y Offset" on page 390

CALCulate<n>:LIMit<k>:UPPer:SHIFt <Value>

This command moves a complete upper limit line vertically.

Compared to defining an offset, this command actually changes the limit line definition points by the value you define.

Suffix:

<n>	irrelevant
<k>	1...8 Selects the limit line.

Parameters:

<Distance> Numeric value that defines the distance of the shift.
The unit depends on [CALCulate<n>:LIMit<k>:UNIT](#)
on page 643.

Example:

`CALC:LIM3:UPP:SHIF 20`
Shifts all Y values of limit line 3 by 20 limit line units, e.g. dB.

Usage:

Event

CALCulate<n>:LIMit<k>:UPPer:SPACing <InterpolType>

This command selects linear or logarithmic interpolation for the upper limit line.

Suffix:

<n> irrelevant
<k> 1...8
Selects the limit line.

Parameters:

<InterpolType> LINear | LOGarithmic
*RST: LIN

Example:

`CALC:LIM:UPP:SPAC LIN`

CALCulate<n>:LIMit<k>:UPPer:STATe <State>

This command turns a lower limit line on and off.

Before you can use this command, you have to select a limit line with
[CALCulate<n>:LIMit<k>:NAME](#).

The limit check is activated separately with [CALCulate<n>:LIMit<k>:STATe](#). The
result of the limit check can be queried with [CALCulate<n>:LIMit<k>:FAIL?](#).

Suffix:

<n> irrelevant
<k> 1...8
Selects the limit line.

Parameters:

<State> ON | OFF
*RST: OFF

Example:

`CALC:LIM4:UPP:STAT ON`
Switches on limit line 4 (upper limit).

CALCulate<n>:LIMit<k>:UPPer:THReshold <Threshold>

This command defines a threshold for relative limit lines.

The R&S FSVA/FSV uses the threshold for the limit check, if the limit line violates the threshold.

Suffix:

<n>	irrelevant
<k>	1...8 Selects the limit line.

Parameters:

<Threshold>	Numeric value that defines the threshold. The unit depends on <code>CALCulate<n>:LIMit<k>:UNIT</code> .
*RST:	-200 dBm

Example:

```
CALC:LIM2:UPP:THR -35DBM
Defines an absolute threshold value for limit line 2.
```

CALCulate:MARKer Subsystem

The CALCulate:MARKer subsystem checks the marker functions of the instrument.

<code>CALCulate<n>:MARKer<m>[:STATe]</code>	668
<code>CALCulate<n>:MARKer<m>:AOFF</code>	668
<code>CALCulate<n>:MARKer<m>:COUNT</code>	668
<code>CALCulate<n>:MARKer<m>:COUNT:FREQuency?</code>	669
<code>CALCulate<n>:MARKer<m>:COUNT:RESolution</code>	670
<code>CALCulate<n>:MARKer<m>:LINK</code>	670
<code>CALCulate<n>:MARKer<m>:LOEXclude</code>	670
<code>CALCulate<n>:MARKer<m>:MAXimum[:PEAK]</code>	671
<code>CALCulate<n>:MARKer<m>:MAXimum:AUTO</code>	671
<code>CALCulate<n>:MARKer<m>:MAXimum:LEFT</code>	672
<code>CALCulate<n>:MARKer<m>:MAXimum:NEXT</code>	672
<code>CALCulate<n>:MARKer<m>:MAXimum:RIGHT</code>	673
<code>CALCulate<n>:MARKer<m>:MINimum[:PEAK]</code>	673
<code>CALCulate<n>:MARKer<m>:MINimum:AUTO</code>	674
<code>CALCulate<n>:MARKer<m>:MINimum:LEFT</code>	674
<code>CALCulate<n>:MARKer<m>:MINimum:NEXT</code>	675
<code>CALCulate<n>:MARKer<m>:MINimum:RIGHT</code>	675
<code>CALCulate<n>:MARKer<m>:PEXCursion</code>	676
<code>CALCulate<n>:MARKer<m>:SEARCh</code>	676
<code>CALCulate<n>:MARKer<m>:TRACe</code>	677
<code>CALCulate<n>:MARKer<m>:X</code>	677
<code>CALCulate<n>:MARKer<m>:X:SLIMits[:STATe]</code>	678
<code>CALCulate<n>:MARKer<m>:X:SLIMits:LEFT</code>	678
<code>CALCulate<n>:MARKer<m>:X:SLIMits:RIGHT</code>	679
<code>CALCulate<n>:MARKer<m>:X:SLIMits:ZOOM</code>	679
<code>CALCulate<n>:MARKer<m>:X:SSize</code>	680
<code>CALCulate<n>:MARKer<m>:Y?</code>	680
<code>CALCulate<n>:MARKer<m>:Y:PERCent</code>	681

CALCulate<n>:MARKer<m>[:STATe] <State>

This command turns markers on and off.

If the corresponding marker number is currently active as a deltamarker, it is turned into a normal marker.

Suffix:

<n>	Selects the measurement window.
<m>	depends on mode Selects the marker.

Parameters:

<State>	ON OFF
*RST:	OFF

Example:

CALC:MARK3 ON
Switches on marker 3 or switches to marker mode.

Manual operation: See "[Marker 1 / Marker 2 / Marker 3 / ... Marker 16, / Marker Norm/Delta](#)" on page 250
See "[Marker Wizard](#)" on page 251

CALCulate<n>:MARKer<m>:AOFF

This command all markers off, including delta markers and marker measurement functions.

Suffix:

<n>	Selects the measurement window.
<m>	depends on mode irrelevant

Example:

CALC:MARK:AOFF
Switches off all markers.

Usage:

Event

Manual operation: See "[All Marker Off](#)" on page 252

CALCulate<n>:MARKer<m>:COUNT <State>

This command turns the frequency counter at the marker position for marker 1 on and off.

The count result is queried with `CALCulate<n>:MARKer<m>:COUNT:FREQuency?`.

The frequency counter works for one marker only. If you perform a frequency count with another marker, the R&S FSV/FSV deactivates the frequency count of the first marker.

To get a valid result, you have to perform a complete measurement with synchronization to the end of the measurement before reading out the result. This is only possible for single sweeps.

Suffix:	
<n>	Selects the measurement window.
<m>	irrelevant
Parameters:	
<State>	ON OFF
	*RST: OFF
Example:	<pre>INIT:CONT OFF Switches to single sweep mode. CALC:MARK ON Switches on marker 1. CALC:MARK:COUN ON Switches on the frequency counter for marker 1. INIT;*WAI Starts a sweep and waits for the end. CALC:MARK:COUN:FREQ? Outputs the measured value.</pre>
Manual operation:	See " Signal Count " on page 258

CALCulate<n>:MARKer<m>:COUNT:FREQUency?

This command queries the result of the frequency counter for marker 1.

To get a valid result, you have to perform a complete measurement with synchronization to the end of the measurement before reading out the result. This is only possible for single sweeps.

Suffix:	
<n>	Selects the measurement window.
<m>	irrelevant
Return values:	
<Frequency>	Frequency at the marker position.
Example:	<pre>INIT:CONT OFF Switches to single sweep mode. CALC:MARK ON Switches on marker 2. CALC:MARK:COUN ON Activates the frequency counter for marker 1. INIT;*WAI Starts a sweep and waits for the end. CALC:MARK:COUN:FREQ? Outputs the measured value of marker 1.</pre>
Usage:	Query only
Manual operation:	See " Signal Count " on page 258

CALCulate<n>:MARKer<m>:COUNT:RESolution <Resolution>

This command specifies the resolution of the frequency counter (marker 1).

Suffix:

<n> Selects the measurement window.
 <m> irrelevant

Parameters:

<Resolution> 0.001 | 0.01 | 0.1 | 1 | 10 | 100 | 1000 | 10000 Hz
 *RST: 0.1 Hz

Example:

CALC:MARK:COUN:RES 1kHz
 Sets the resolution of the frequency counter to 1 kHz.

CALCulate<n>:MARKer<m>:LINK <DisplayType>

Links the markers in all displays of the specified type.

Suffix:

<n> 1...4
 window
 <m> 1...16
 marker

Parameters:

<DisplayType> TIME | SPECTrum | BOTH | NONE

TIME

Links the markers in all time domain diagrams

SPECTrum

Links the markers in all AF Spectrum displays

BOTH

Links the markers both in the time domain diagrams and in the AF Spectrum displays

NONE

Markers are not linked.

*RST: NONE

Example:

CALC1:MARK1:LINK TIME
 Links the marker 1 in all time domain diagrams in screen A.

Mode:

ADEMOD

CALCulate<n>:MARKer<m>:LOEXclude <State>

This command turns the local oscillator suppression during a peak search on or off.

Suffix:

<n> Selects the measurement window.
 <m> irrelevant

Parameters:

<State> ON | OFF
 *RST: ON

Example: CALC:MARK:LOEX ON

Manual operation: See ["Exclude LO"](#) on page 274

CALCulate<n>:MARKer<m>:MAXimum[:PEAK]

This command positions the marker on the current trace maximum.

The corresponding marker is activated first or switched to the marker mode.

If no maximum value is found on the trace (level spacing to adjacent values < peak excursion), an execution error (error code: -200) is produced.

In "Spectrogram" mode, this command positions the specified marker on the current peak level of the x-axis. The search is performed within the current frame. It does not change the position of the marker on the y-axis.

Suffix:

<n> Selects the measurement window.
 <m> depends on mode
 Selects the marker.

Example: CALC:MARK2:MAX
 Positions marker 2 to the maximum value of the trace.

Usage: Event

Manual operation: See ["Peak"](#) on page 272
 See ["Marker Search Type"](#) on page 276

CALCulate<n>:MARKer<m>:MAXimum:AUTO <State>

This command turns an automatic marker peak search for a trace maximum on and off. The command performs the peak search after each sweep.

An automatic peak search may be used during adjustments of a device under test to keep track of the actual peak marker position and level.

If no maximum value is found on the trace (level spacing to adjacent values < peak excursion), an execution error (error code: -200) is produced.

Suffix:

<n> Selects the measurement window.
 <m> Selects the marker.

Parameters:

<State> ON | OFF
 *RST: OFF

Example: `CALC:MARK:MAX:AUTO ON`
 Activates the automatic peak search function for marker 1 at the end of each particular sweep.

Usage: Event

Manual operation: See ["Auto Max Peak/Auto Min Peak"](#) on page 273

CALCulate<n>:MARKer<m>:MAXimum:LEFT

This command positions a marker to the next smaller trace maximum on the left of the current position (i.e. in descending X values).

If no next smaller maximum value is found on the trace (level spacing to adjacent values < peak excursion), an execution error (error code: -200) is produced.

In "Spectrogram" mode, this command positions the specified marker on the next peak level of the x-axis. The search includes only the data to the left of the current marker position in the current frame. It does not change the position of the marker on the y-axis.

Suffix:

<n> Selects the measurement window.

<m> Selects the marker.

Example: `CALC:MARK2:MAX:LEFT`
 Positions marker 2 to the next lower maximum value to the left of the current value.

Usage: Event

Manual operation: See ["Next Mode"](#) on page 274
 See ["Search Mode for Next Peak in X Direction"](#) on page 275

CALCulate<n>:MARKer<m>:MAXimum:NEXT

This command positions the marker to the next smaller trace maximum.

If no next smaller maximum value is found on the trace (level spacing to adjacent values < peak excursion), an execution error (error code: -200) is produced.

In "Spectrogram" mode, this command positions the specified marker on the next peak level of the x-axis. The search includes the data in both directions of the current marker position in the current frame. It does not change the position of the marker on the y-axis.

Suffix:

<n> Selects the measurement window.

<m> Selects the marker.

Example: `CALC:MARK2:MAX:NEXT`
 Positions marker 2 to the next lower maximum value.

Usage: Event

Manual operation: See ["Next Peak"](#) on page 272
 See ["Next Mode"](#) on page 274
 See ["Search Mode for Next Peak in X Direction"](#) on page 275

CALCulate<n>:MARKer<m>:MAXimum:RIGHT

This command positions a marker to the next smaller trace maximum on the right of the current value (i.e. in ascending X values).

If no next smaller maximum value is found on the trace (level spacing to adjacent values < peak excursion), an execution error (error code: -200) is produced.

In "Spectrogram" mode, this command positions the specified marker on the next peak level of the x-axis. The search includes only the data to the right of the current marker position in the current frame. It does not change the position of the delta marker on the y-axis.

Suffix:

<n> Selects the measurement window.

<m> Selects the marker.

Example:

`CALC:MARK2:MAX:RIGHT`

Positions marker 2 to the next lower maximum value to the right of the current value.

Usage: Event

Manual operation: See ["Next Mode"](#) on page 274
 See ["Search Mode for Next Peak in X Direction"](#) on page 275

CALCulate<n>:MARKer<m>:MINimum[:PEAK]

This command positions the marker on the current trace minimum.

The corresponding marker is activated first or switched to marker mode, if necessary.

If no minimum value is found on the trace (level spacing to adjacent values < peak excursion), an execution error (error code: -200) is produced.

In "Spectrogram" mode, this command positions the specified marker on the current minimum level of the x-axis. The search is performed within the current frame. It does not change the position of the marker on the y-axis / frames.

Suffix:

<n> Selects the measurement window.

<m> depends on mode
 Selects the marker.

Example:

`CALC:MARK2:MIN`

Positions marker 2 to the minimum value of the trace.

Usage: Event

Manual operation: See ["Min"](#) on page 272
See ["Marker Search Type"](#) on page 276

CALCulate<n>:MARKer<m>:MINimum:AUTO <State>

This command turns an automatic marker peak search for a trace maximum on and off. The command performs the peak search after each sweep.

An automatic peak search may be used during adjustments of a device under test to keep track of the actual peak marker position and level.

If no maximum value is found on the trace (level spacing to adjacent values < peak excursion), an execution error (error code: -200) is produced.

Suffix:

<n> Selects the measurement window.

<m> Selects the marker.

Parameters:

<State> ON | OFF
*RST: OFF

Example: `CALC:MARK:MIN:AUTO ON`
Activates the automatic minimum value search function for marker 1 at the end of each particular sweep.

Manual operation: See ["Auto Max Peak/Auto Min Peak"](#) on page 273

CALCulate<n>:MARKer<m>:MINimum:LEFT

This command positions a marker to the next higher trace minimum on the left of the current value (i.e. in descending X direction).

If no next higher minimum value is found on the trace (level spacing to adjacent values < peak excursion), an execution error (error code: -200) is produced.

In "Spectrogram" mode, this command positions the specified marker on the next minimum level of the x-axis. The search includes only the data to the left of the current marker position in the current frame. It does not change the position of the marker on the y-axis.

Suffix:

<n> Selects the measurement window.

<m> Selects the marker.

Example: `CALC:MARK2:MIN`
Positions marker 2 to the minimum value of the trace.
`CALC:MARK2:MIN:LEFT`
Positions marker 2 to the next higher minimum value to the left of the current value.

Usage: Event

Manual operation: See ["Next Mode"](#) on page 274
See ["Search Mode for Next Peak in X Direction"](#) on page 275

CALCulate<n>:MARKer<m>:MINimum:NEXT

This command positions the marker to the next higher trace minimum.

If no next higher minimum value is found on the trace (level spacing to adjacent values < peak excursion), an execution error (error code: -200) is produced.

In "Spectrogram" mode, this command positions the specified marker on the next minimum level of the x-axis. The search includes the data in both directions of the current marker position in the current frame. It does not change the position of the marker on the y-axis.

Suffix:

<n> Selects the measurement window.

<m> Selects the marker.

Example:

CALC:MARK2:MIN

Positions marker 2 to the minimum value of the trace.

CALC:MARK2:MIN:NEXT

Positions marker 2 to the next higher maximum value.

Usage: Event

Manual operation: See ["Next Min"](#) on page 273
See ["Next Mode"](#) on page 274
See ["Search Mode for Next Peak in X Direction"](#) on page 275

CALCulate<n>:MARKer<m>:MINimum:RIGHT

This command positions a marker to the next higher trace minimum on the right of the current value (i.e. in ascending X direction).

If no next higher minimum value is found on the trace (level spacing to adjacent values < peak excursion), an execution error (error code: -200) is produced.

In "Spectrogram" mode, this command positions the specified marker on the current peak level of the x-axis. The search is performed within the current frame. It does not change the position of the marker on the y-axis.

Suffix:

<n> Selects the measurement window.

<m> Selects the marker.

Example:

CALC:MARK2:MIN

Positions marker 2 to the minimum value of the trace.

CALC:MARK2:MIN:RIGHT

Positions marker 2 to the next higher minimum value to the right of the current value.

Usage: Event

Manual operation: See ["Next Mode"](#) on page 274
See ["Search Mode for Next Peak in X Direction"](#) on page 275

CALCulate<n>:MARKer<m>:PEXCursion <Excursion>

This command defines the peak excursion

The peak excursion sets the requirements for a peak to be detected during a peak search.

The unit depends on the selected operating mode and measurement.

Mode/Display mode	Unit
Spectrum	dB
ADEMOD, RF display	dB
ADEMOD, AM display	PCT
ADEMOD, FM display	kHz
ADEMOD, PM display	RAD

Suffix:

<n> Selects the measurement window.
<m> irrelevant

Parameters:

<Excursion> The peak excursion is the distance to a trace maximum that must be attained before a new maximum is recognized, or the distance to a trace minimum that must be attained before a new minimum is recognized
*RST: 6dB in "Spectrum" mode and RF displays; 5 PCT in AM displays, 50 kHz in FM displays, (0.5 RAD in PM displays)

Example: `CALC:MARK:PEXC 10dB`
Defines peak excursion 10 dB.

Manual operation: See ["Peak Excursion"](#) on page 263

CALCulate<n>:MARKer<m>:SEARch <MarkReallmag>

This command selects the trace type a marker search is performed on.

Suffix:

<n> Selects the measurement window.
<m> Selects the marker.

Parameters:

<MarkReallmag> **REAL**
Marker search functions are performed on the real trace of the "I/Q" measurement.

IMAG

Marker search functions are performed on the imaginary trace of the "I/Q" measurement.

MAGN

Marker search functions are performed on the magnitude of the I and Q data.

*RST: REAL

Example: CALC4:MARK:SEAR IMAG

CALCulate<n>:MARKer<m>:TRACe <Trace>

This command selects the trace a marker is positioned on.

The corresponding trace must have a trace mode other than "Blank".

If necessary, the corresponding marker is switched on prior to the assignment.

Suffix:

<n> Selects the measurement window.

<m> depends on mode
Selects the marker.

Parameters:

<Trace> **1 ... 6**
Trace number the marker is positioned on.

Example: CALC:MARK3:TRAC 2
Assigns marker 3 to trace 2.

Manual operation: See "[Marker to Trace](#)" on page 251
See "[Marker Wizard](#)" on page 251

CALCulate<n>:MARKer<m>:X <Position>

This command positions a marker on a particular coordinate on the x-axis.

If marker 2, 3 or 4 is selected and used as delta marker, it is switched to marker mode.

Suffix:

<n> Selects the measurement window.

<m> Selects the marker.

Parameters:

<Position> Numeric value that defines the marker position on the x-axis.
The unit is either Hz (frequency domain) or s (time domain) or dB (statistics).

Range: The range depends on the current x-axis range.

Example: CALC:MARK2:X 1.7MHz
Positions marker 2 to frequency 1.7 MHz.

Manual operation: See ["Marker 1 / Marker 2 / Marker 3 / ... Marker 16, / Marker Norm/Delta"](#) on page 250

CALCulate<n>:MARKer<m>:X:SLIMits[:STATe] <State>

This command turns marker search limits on and off.

If the power measurement in zero span is active, this command limits the evaluation range on the trace.

Suffix:

<n> Selects the measurement window.

<m> marker

Parameters:

<State> ON | OFF

*RST: OFF

Example:

CALC:MARK:X:SLIM ON

Switches on search limitation.

Manual operation: See ["Search Limits"](#) on page 273
 See ["Search Lim Off"](#) on page 274
 See ["Limits \(On/Off\)"](#) on page 356

CALCulate<n>:MARKer<m>:X:SLIMits:LEFT <Limit>

This command sets the left limit of the marker search range.

If the power measurement in zero span is active, this command limits the evaluation range to the trace.

Note: The function is only available if the search limit for marker and delta marker is switched on (see [CALCulate<n>:MARKer<m>:X:SLIMits\[:STATe\]](#)).

Suffix:

<n> Selects the measurement window.

<m> irrelevant

Parameters:

<Limit> The value range depends on the span or sweep time.
 The unit is Hz for frequency domain measurements and s for time domain measurements.

Range: 0 to MAX

*RST: left diagram border

Example:

CALC:MARK:X:SLIM ON

Switches the search limit function on.

CALC:MARK:X:SLIM:LEFT 10MHz

Sets the left limit of the search range to 10 MHz.

Manual operation: See ["Left Limit"](#) on page 263
 See ["Left Limit"](#) on page 357

CALCulate<n>:MARKer<m>:X:SLIMits:RIGHT <Limit>

This command sets the right limit of the marker search range.

If the power measurement in zero span is active, this command limits the evaluation range to the trace.

Note: The function is only available if the search limit for marker and delta marker is switched on (`CALCulate<n>:MARKer<m>:X:SLIMits[:STATe]`).

Suffix:

<n> Selects the measurement window.
 <m> irrelevant

Parameters:

<Limit> The value range depends on the span or sweep time.
 The unit is Hz for frequency domain measurements and s for
 time domain measurements.

Range: 0 to MAX
 *RST: left diagram border

Example:

```
CALC:MARK:X:SLIM ON
Switches the search limit function on.
CALC:MARK:X:SLIM:RIGH 20MHz
Sets the right limit of the search range to 20 MHz.
```

Manual operation: See "[Right Limit](#)" on page 264
 See "[Right Limit](#)" on page 357

CALCulate<n>:MARKer<m>:X:SLIMits:ZOOM <State>

This command sets the limits of the marker search range to the zoom area.

Note: The function is only available if the search limit for marker and delta marker is switched on (see `CALCulate<n>:MARKer<m>:X:SLIMits[:STATe]`).

Suffix:

<n> irrelevant
 <m> irrelevant

Parameters:

<State> ON | OFF
 *RST: OFF

Example:

```
CALC:MARK:X:SLIM:ZOOM ON
Switches the search limit function on.
CALC:MARK:X:SLIM:RIGH 20MHz
Sets the right limit of the search range to 20 MHz.
```

Manual operation: See "[Use Zoom Limits](#)" on page 274

CALCulate<n>:MARKer<m>:X:SSize <StepSize>

This command defines the step size of the rotary knob for marker or delta marker value changes. It only takes effect in manual operation.

The marker step size is unavailable for statistical measurements.

Suffix:

<n> irrelevant

<m> irrelevant

Parameters:

<StepSize>

STANDARD

step size corresponds to space between two pixels

POINTS

step size corresponds to space between two measured values (number of measured values is defined via the

[SENSe<n>:]SWEep:POINts command, see [SENSe:]SWEep:POINts on page 861)

*RST: POINTs

Example:

CALC:MARK:X:SSIZ STAN

Sets the measured value step size.

Manual operation:

See "Stepsize Standard" on page 252

See "Stepsize Sweep Points" on page 253

CALCulate<n>:MARKer<m>:Y?

This command queries the measured value of a marker.

The corresponding marker is activated before or switched to marker mode, if necessary.

To get a valid result, you have to perform a complete measurement with synchronization to the end of the measurement before reading out the result. This is only possible for single sweeps.

Suffix:

<n> Selects the measurement window.

<m> Selects the marker.

Return values:

<Result>

The measured value of the selected marker is returned.

The unit is variable and depends on the one you have currently set.

In I/Q Analyzer mode, if the result display configuration "Real/Imag (I/Q)" is selected, this query returns the Real (I) value of the marker first, then the Imag (Q) value.

Example: INIT:CONT OFF
Switches to single sweep mode.
CALC:MARK2 ON
Switches marker 2.
INIT;*WAI
Starts a sweep and waits for the end.
CALC:MARK2:Y?
Outputs the measured value of marker 2.
In I/Q Analyzer mode, for "Real/Imag (I/Q)", for example:
1.852719887E-011,0

Usage: Query only

Manual operation: See "[Marker 1 / Marker 2 / Marker 3 / ... Marker 16 / Marker Norm/Delta](#)" on page 250

CALCulate<n>:MARKer<m>:Y:PERCent <Probability>

This command positions the selected marker to the given probability.

If you use the command in combination with a delta marker, that delta marker is turned into a normal marker.

Note: The command is only available for CCDF measurements. You can query the associated level value with `CALCulate<n>:MARKer<m>:X`.

Suffix:

<n> Selects the measurement window.
<m> Selects the marker.

Parameters:

<Probability> Range: 0 to 100
Default unit: PCT

Example: CALC1:MARK:Y:PERC 95PCT
Positions marker 1 to a probability of 95 %.

Manual operation: See "[Percent Marker](#)" on page 367

CALCulate:MARKer:FUNction Subsystem

The CALCulate:MARKer<m>:FUNction subsystem checks the marker functions in the instrument.

CALCulate<n>:MARKer<m>:FUNction:BPOWer:MODE.....	682
CALCulate<n>:MARKer<m>:FUNction:BPOWer:RESult?.....	682
CALCulate<n>:MARKer<m>:FUNction:BPOWer:SPAN.....	683
CALCulate<n>:MARKer<m>:FUNction:BPOWer[:STATe].....	683
CALCulate<n>:MARKer<m>:FUNction:CENTer.....	684
CALCulate<n>:MARKer<m>:FUNction:CSep.....	684
CALCulate<n>:MARKer<m>:FUNction:DEModulation:CONTInuous.....	684
CALCulate<n>:MARKer<m>:FUNction:DEModulation:HOLDoff.....	685
CALCulate<n>:MARKer<m>:FUNction:DEModulation:SElect.....	685

CALCulate<n>:MARKer<m>:FUNctioN:DEModulation[:STATe].....	686
CALCulate<n>:MARKer<m>:FUNctioN:FPEaks[:IMMediate].....	686
CALCulate<n>:MARKer<m>:FUNctioN:FPEaks:ANNotation:LABel:STATe.....	687
CALCulate<n>:MARKer<m>:FUNctioN:FPEaks:COUNt?.....	687
CALCulate<n>:MARKer<m>:FUNctioN:FPEaks:LIST:SIZE.....	688
CALCulate<n>:MARKer<m>:FUNctioN:FPEaks:SEAR:AUTO.....	688
CALCulate<n>:MARKer<m>:FUNctioN:FPEaks:SORT.....	688
CALCulate<n>:MARKer<m>:FUNctioN:FPEaks:STAT.....	689
CALCulate<n>:MARKer<m>:FUNctioN:FPEaks:X.....	689
CALCulate<n>:MARKer<m>:FUNctioN:FPEaks:Y?.....	690
CALCulate<n>:MARKer<m>:FUNctioN:MDEPth:RESult?.....	690
CALCulate<n>:MARKer<m>:FUNctioN:MDEPth:SEARChsignal ONCE.....	691
CALCulate<n>:MARKer<m>:FUNctioN:MDEPth[:STATe].....	691
CALCulate<n>:MARKer<m>:FUNctioN:NDBDown.....	692
CALCulate<n>:MARKer<m>:FUNctioN:NDBDown:FREQuency?.....	693
CALCulate<n>:MARKer<m>:FUNctioN:NDBDown:QFACTOR.....	693
CALCulate<n>:MARKer<m>:FUNctioN:NDBDown:RESult?.....	694
CALCulate<n>:MARKer<m>:FUNctioN:NDBDown:STATe.....	694
CALCulate<n>:MARKer<m>:FUNctioN:NDBDown:TIME?.....	695
CALCulate<n>:MARKer<m>:FUNctioN:NOISe[:STATe].....	695
CALCulate<n>:MARKer<m>:FUNctioN:NOISe:RESult.....	696
CALCulate<n>:MARKer<m>:FUNctioN:REFerence.....	696
CALCulate<n>:MARKer<m>:FUNctioN:TOI:RESult?.....	697
CALCulate<n>:MARKer<m>:FUNctioN:TOI:SEARChsignal ONCE.....	697
CALCulate<n>:MARKer<m>:FUNctioN:TOI[:STATe].....	697
CALCulate<n>:MARKer<m>:FUNctioN:ZOOM.....	698

CALCulate<n>:MARKer<m>:FUNctioN:BPOWer:MODE <Mode>

This command selects the way the results for a band power marker are displayed.

Suffix:

<n> irrelevant

<m> irrelevant

Parameters:

<Mode>

POWer

Result is displayed as a power in dBm.

DENSity

Result is displayed as a density in dBm/Hz.

*RST: POW

Example:

CALC:MARK:FUNC:BPOW:MODE DENS

Manual operation:

See "Power" on page 265

See "Density" on page 265

CALCulate<n>:MARKer<m>:FUNctioN:BPOWer:RESult?

This command queries the results of the band power measurement.

Suffix:

<n> irrelevant

<m> irrelevant

Return values:

<Power> Signal power over the marker bandwidth.

Example:

Activate the band power marker:

```
CALC:MARK:FUNC:BPOW:STAT ON
```

Select the density mode for the result:

```
CALC:MARK:FUNC:BPOW:MODE DENS
```

Query the result:

```
CALC:MARK:FUNC:BPOW:RES?
```

Response:

```
20dBm/Hz
```

Usage: Query only

Manual operation: See "Power" on page 265
See "Density" on page 265

**CALCulate<n>:MARKer<m>:FUNCTion:BPOWER:SPAN **

This command defines the bandwidth around the marker position.

Suffix:

<n> irrelevant

<m> irrelevant

Parameters:

 Numeric value that defines the span in Hz.
The maximum span depends on the marker position and R&S FSV model.

*RST: 5% of current span

Example: `CALC:MARK:FUNC:BPOW:SPAN 20`

Manual operation: See "Span" on page 265

CALCulate<n>:MARKer<m>:FUNCTion:BPOWER[:STATe] <State>

This command turns markers for band power measurements on and off.

If necessary, the command also turns on a marker. If a marker is already on, the currently active marker is used as the band power marker (all other marker functions for this marker are deactivated).

For details see [Chapter 5.3.3.8, "Performing Band Power Measurements"](#), on page 269.

Suffix:

<n> irrelevant

<m> irrelevant

Parameters:

<State> **ON | OFF**
 *RST: OFF

Example: CALC:MARK:FUNC:BPOW:STAT ON

Manual operation: See "[Band Power On/Off](#)" on page 265

CALCulate<n>:MARKer<m>:FUNCTion:CENTer

This command matches the center frequency to the frequency of a marker.

If you use the command in combination with a delta marker, that delta marker is turned into a normal marker.

Suffix:

<n> Selects the measurement window.
 <m> Selects the marker.

Example: CALC:MARK2:FUNC:CENT
 Sets the center frequency to the frequency of marker 2.

Manual operation: See "[Center =Mkr Freq \(span > 0\)](#)" on page 272

CALCulate<n>:MARKer<m>:FUNCTion:CSTep

This command matches the center frequency step size to the current marker frequency.

The command turns delta markers into normal markers.

Suffix:

<n> Selects the measurement window.
 <m> Selects the marker.

Example: CALC:MARK3:FUNC:CST
 Sets the center frequency to the same value as the frequency of marker 3.

Usage: Event

CALCulate<n>:MARKer<m>:FUNCTion:DEModulation:CONTInuous <State>

This command turns continuous demodulation of the signal at the marker position in the frequency domain on and off.

Thus acoustic monitoring of the signals can be performed.

In the time domain continuous demodulation is always on.

This command is only available if the R&S FSV-B3 option (Audio Demodulator) is installed.

Suffix:

<n> Selects the measurement window.

<m> Selects the marker.

Parameters:

<State> ON | OFF

*RST: OFF

Example:

CALC2:MARK3:FUNC:DEM:CONT ON
Switches on the continuous ' demodulation.

Manual operation: See "[Continuous Demod \(span > 0\)](#)" on page 261

CALCulate<n>:MARKer<m>:FUNCTion:DEModulation:HOLDoff <Duration>

This command defines for how long the the signal at the marker position is demodulated.

This command is only available if the R&S FSV-B3 option (Audio Demodulator) is installed.

Suffix:

<n> Selects the measurement window.

<m> Selects the marker.

Parameters:

<Duration> Range: 10 ms to 1000 s

*RST: Marker demodulation = OFF

Example:

CALC:MARK:FUNC:DEM:HOLD 3s

Manual operation: See "[Mkr Stop Time](#)" on page 261

CALCulate<n>:MARKer<m>:FUNCTion:DEModulation:SElect <DemodMode>

This command selects the demodulation mode for the audio demodulator.

This command is only available if the R&S FSV-B3 option (Audio Demodulator) is installed.

Suffix:

<n> Selects the measurement window.

<m> irrelevant

Parameters:

<DemodMode> AM | FM

*RST: AM

Example:

CALC:MARK:FUNC:DEM:SEL FM

Manual operation: See "[AM](#)" on page 261
See "[FM](#)" on page 261

CALCulate<n>:MARKer<m>:FUNction:DEModulation[:STATe] <State>

This command turns the audio demodulator on and off when the measurement reaches a marker position.

In the frequency domain, the hold time can be defined at the corresponding marker position with `CALCulate<n>:MARKer<m>:FUNction:DEModulation:HOLDoff`.

In the time domain continuous demodulation is always on.

This command is only available if the R&S FSV-B3 option (Audio Demodulator) is installed.

Suffix:

<n> Selects the measurement window.
 <m> Selects the marker.

Parameters:

<State> ON | OFF
 *RST: OFF

Example:

`CALC:MARK3:FUNC:DEM ON`
 Switches on the demodulation for marker 3.

Manual operation: See "Mkr Demod On/Off" on page 261

CALCulate<n>:MARKer<m>:FUNction:FPEaks[:IMMEDIATE] <NoMaxima>

This command initiates a peak search.

The results can be queried with:

- Position of a peak on the x-axis: `CALCulate<n>:MARKer<m>:FUNction:FPEaks:X`
- Position of a peak on the y-axis: `CALCulate<n>:MARKer<m>:FUNction:FPEaks:Y?`
- Number of peaks in the list: `CALCulate<n>:MARKer<m>:FUNction:FPEaks:COUNT?`

The order the results are returned in is selected with `CALCulate<n>:MARKer<m>:FUNction:FPEaks:SORT`.

The trace the peaks search is performed on is selected with `CALCulate<n>:MARKer<m>:TRACe`.

Number of found maxima

The number of maxima found depends on the waveform and value set for the Peak Excursion parameter (see `CALCulate<n>:MARKer<m>:PEXCursion`), however, a maximum number of 200 maxima are determined. Only the signals which exceed their surrounding values at least by the value indicated by the peak excursion parameter are recognized as maxima. Therefore, the number of maxima found is not automatically the same as the number of maxima desired.

Suffix:

<n> Selects the measurement window.

<m> Selects the marker.

Parameters:

<NoMaxima> Range: 1 to 200

Example:

```
INIT:CONT OFF
```

Switches to single sweep mode

```
INIT;*WAI
```

Starts measurement and synchronizes to end

```
CALC:MARK:TRAC 1
```

Sets marker 1 to trace 1

```
CALC:MARK:FUNC:FPE:SORT X
```

Sets the sort mode to increasing X values

```
CALC:MARK:FUNC:FPE 3;*WAI
```

Searches the 3 highest maxima for trace 1 and synchronizes to end

```
CALC:MARK:FUNC:FPE:COUN?
```

Queries the number of maxima found

```
CALC:MARK:FUNC:FPE:Y?
```

Queries the level of maxima found

```
CALC:MARK:FUNC:FPE:X?
```

Queries the frequencies (span <> 0) or time (span = 0) of maxima found.

CALCulate<n>:MARKer<m>:FUNCtion:FPEaks:ANNotation:LABel:STATe <State>

This command turns labels for peaks found during a peak search on and off.

The labels correspond to the marker number in the marker peak list.

Suffix:

<n> Selects the measurement window.

<m> Selects the marker.

Parameters:

<State> **ON | OFF**

```
*RST: ON
```

Example:

```
CALC:MARK:FUNC:FPE:ANN:LAB:STAT OFF
```

Removes the peak labels from the diagram

Manual operation: See "[Marker Number](#)" on page 264

CALCulate<n>:MARKer<m>:FUNCtion:FPEaks:COUNt?

This command queries the number of peaks that have been found during a peak search.

Suffix:

<n> irrelevant

<m> Selects the marker.

Return values:

<NumberOfPeaks>

Example:

`CALC:MARK:FUNC:FPE 3`

Searches the 3 highest maxima for trace 1

`CALC:MARK:FUNC:FPE:COUN?`

Queries the number of maxima found

Usage:

Query only

Manual operation: See "[Marker Peak List](#)" on page 263

CALCulate<n>:MARKer<m>:FUNCTion:FPEaks:LIST:SIZE <MaxNoPeaks>

This command defines the maximum number of peaks the marker peak list may contain.

Suffix:

<n> Selects the measurement window.

<m> Selects the marker.

Parameters:

<MaxNoPeaks> Maximum number of peaks to be determined.

*RST: 50

Example:

`CALC:MARK:FUNC:FPE:LIST:SIZE 10`

The marker peak list will contain a maximum of 10 peaks.

Manual operation: See "[Max Peak Count](#)" on page 263

CALCulate<n>:MARKer<m>:FUNCTion:FPEaks:SEAR:AUTO <State>

This command turns the marker peak search on and off.

This command is retained for compatibility with R&S FSP only. Use [CALCulate<n>:MARKer<m>:FUNCTion:FPEaks:STAT](#) instead.

Suffix:

<n> Selects the measurement window.

<m> Selects the marker.

Parameters:

<State> ON | OFF

*RST: OFF

Example:

`CALC:MARK:FUNC:FPE:SEAR:AUTO ON`

Activates marker peak search

CALCulate<n>:MARKer<m>:FUNCTion:FPEaks:SORT <SortMode>

This command selects the order in which the results of a peak search are returned.

Suffix:

<n> Selects the measurement window.

<m> Selects the marker.

Parameters:

<SortMode>

X

Sorts the peaks according to increasing position on the x-axis.

Y

Sorts the peaks according to decreasing position on the y-axis.

Example:

`CALC:MARK:FUNC:FPE:SORT Y`

Sets the sort mode to decreasing y values

Manual operation: See "[Sort Mode Freq/Lvl](#)" on page 263

CALCulate<n>:MARKer<m>:FUNCTion:FPEaks:STAT <State>

This command turns a peak search on and off.

Suffix:

<n> Selects the measurement window.

<m> Selects the marker.

Parameters:

<State>

ON | OFF

*RST: OFF

Example:

`CALC:MARK:FUNC:FPE:STAT ON`

Activates marker peak search

Manual operation: See "[Peak List On/Off](#)" on page 263

CALCulate<n>:MARKer<m>:FUNCTion:FPEaks:X

This command queries the position of the peaks on the x-axis.

The order depends on the sort order that has been set with [CALCulate<n>:MARKer<m>:FUNCTion:FPEaks:SORT](#) on page 688.

The number of peaks on the number that has been set with [CALCulate<n>:MARKer<m>:FUNCTion:FPEaks:COUNT?](#).

Suffix:

<n> Selects the measurement window.

<m> Selects the marker.

Return values:

<PeakPosition>

Position of the peaks on the x-axis. The unit depends on the measurement.

Example:

```
CALC:MARK:FUNC:FPE:SORT Y
Sets the sort mode to decreasing y values
CALC:MARK:FUNC:FPE 3
Searches the 3 highest maxima for trace 1
CALC:MARK:FUNC:FPE:COUN?
Queries the number of maxima found
CALC:MARK:FUNC:FPE:X?
Queries the frequencies (span <> 0) or. time (span = 0) of the
maxima found
107.5E6,153.8E6,187.9E6
frequencies in increasing order
2.05E-3,2.37E-3, 3.71e-3
times in increasing order
```

Manual operation: See "[Marker Peak List](#)" on page 263

CALCulate<n>:MARKer<m>:FUNction:FPEaks:Y?

This command queries the position of the peaks on the y-axis.

The order depends on the sort order that has been set with [CALCulate<n>:MARKer<m>:FUNction:FPEaks:SORT](#) on page 688.

The number of peaks on the number that has been set with [CALCulate<n>:MARKer<m>:FUNction:FPEaks:COUNT?](#).

Suffix:

<n> Selects the measurement window.
 <m> Selects the marker.

Return values:

<PeakPosition> Position of the peaks on the y-axis. The unit depends on the measurement.

Example:

```
CALC:MARK:FUNC:FPE:SORT Y
Sets the sort mode to decreasing y values
CALC:MARK:FUNC:FPE 3
Searches the 3 highest maxima for trace 1
CALC:MARK:FUNC:FPE:COUN?
Queries the number of maxima found
CALC:MARK:FUNC:FPE:Y?
Queries the levels of the maxima found
```

Usage: Query only

Manual operation: See "[Marker Peak List](#)" on page 263

CALCulate<n>:MARKer<m>:FUNction:MDEPth:RESult?

This command queries the results of the AM modulation depth measurement..

To get a valid result, you have to perform a complete measurement with synchronization to the end of the measurement before reading out the result. This is only possible for single sweeps.

Suffix:

<n> Selects the measurement window.
 <m> irrelevant

Example:

```
INIT:CONT OFF
```

Switches to single sweep mode.

```
CALC:MARK:X 10MHZ
```

Sets the reference marker (marker 1) to the carrier signal at 10 MHz.

```
CALC:MARK:FUNC:MDEP ON
```

Switches on the modulation depth measurement.

```
INIT;*WAI
```

Starts a sweep and waits for the end.

```
CALC:MARK:FUNC:MDEP:RES?
```

Outputs the measured value.

Usage: Query only

Manual operation: See ["AM Mod Depth"](#) on page 283
 See ["AM Mod Depth"](#) on page 381

CALCulate<n>:MARKer<m>:FUNCTion:MDEPth:SEARChsignal ONCE

This command initiates a search for the signals required for the AM depth measurement.

Note that the command does not perform a new measurement, but looks for the signals on the current trace.

Suffix:

<n> Selects the measurement window.
 <m> irrelevant

Example:

```
CALC:MARK:FUNC:MDEP:SEAR ONCE
```

Executes the search of an AM modulated signal at the currently available trace.

Usage: Event
 SCPI confirmed

Manual operation: See ["Search Signals"](#) on page 382

CALCulate<n>:MARKer<m>:FUNCTion:MDEPth[:STATe] <State>

This command turns the AM Modulation Depth measurement on and off.

To work correctly, the measurement requires an AM modulated signal.

If necessary, the command positions marker 1 on the signal with the highest level.

The level value of marker 1 is regarded as the carrier level. On activating the function, marker 2 and marker 3 are automatically set as delta markers symmetrically to the carrier to the adjacent maxima of the trace.

If the position of delta marker 2 is changed, delta marker 3 is moved symmetrically with respect to the reference marker (marker 1). If the position of delta marker 3 is changed, fine adjustment can be performed independently of delta marker 2.

The power at the marker positions is calculated from the measured levels.

The AM modulation depth is calculated from the ratio of power values at the reference marker and the delta markers. If the two AM sidebands differ in power, the average value of the two power values is used for calculating the AM modulation depth.

Suffix:

<n> Selects the measurement window.

<m> irrelevant

Parameters:

<State> ON | OFF

*RST: OFF

Example:

`CALC:MARK:X 10MHZ`

Sets the reference marker (marker 1) to the carrier signal at 10 MHz.

`CALC:MARK:FUNC:MDEP ON`

Switches on the modulation depth measurement.

`CALC:DELT2:X 10KHZ`

Sets delta markers 2 and 3 to the signals at 10 kHz from the carrier signal.

`CALC:DELT3:X 9.999KHZ`

Corrects the position of delta marker 3 relative to delta marker 2.

Manual operation: See ["AM Mod Depth"](#) on page 283

See ["AM Mod Depth"](#) on page 381

CALCulate<n>:MARKer<m>:FUNction:NDBDown <Distance>

This command defines the distance of the n dB down markers to the reference marker.

The temporary markers T1 and T2 are positioned n dB below the active reference marker. The frequency and time position of these markers can be queried with `CALCulate<n>:MARKer<m>:FUNction:NDBDown:FREQuency?` and `CALCulate<n>:MARKer<m>:FUNction:NDBDown:TIME?`. The bandwidth between the markers can be queried with `CALCulate<n>:MARKer<m>:FUNction:NDBDown:RESult?`.

Suffix:

<n> Selects the measurement window.

<m> irrelevant

Parameters:

<Distance> Distance of the temporary markers to the reference marker in dB.

*RST: 6dB

Example:

CALC:MARK:FUNC:NDBD 3dB

Sets the level spacing to 3 dB.

Manual operation: See "[n dB down](#)" on page 262

CALCulate<n>:MARKer<m>:FUNCTion:NDBDown:FREQuency?

This command queries the position of the n dB down markers on the x-axis when measuring in the frequency domain.

To get a valid result, you have to perform a complete measurement with synchronization to the end of the measurement before reading out the result. This is only possible for single sweeps.

Suffix:

<n> Selects the measurement window.

<m> irrelevant

Return values:

<Frequency>

<frequency 1>

absolute frequency of the n dB marker to the left of the reference marker in Hz

<frequency 2>

absolute frequency of the n dB marker to the right of the reference marker in Hz

Example:

INIT:CONT OFF

Switches to single sweep mode.

CALC:MARK:FUNC:NDBD ON

Switches on the n dB down function.

INIT;*WAI

Starts a sweep and waits for the end.

CALC:MARK:FUNC:NDBD:FREQ?

Outputs the frequencies of the temporary markers.

Usage: Query only

Manual operation: See "[n dB down](#)" on page 262

CALCulate<n>:MARKer<m>:FUNCTion:NDBDown:QFACTOR

This command queries the Q factor (quality) of n dB down measurements.

Suffix:

<n> Selects the measurement window.

<m> Selects the marker.

Example:

```
INIT:CONT OFF
Switches to single sweep mode.
CALC:MARK:FUNC:NDBD ON
Switches on the n dB down function.
INIT;*WAI
Starts a sweep and waits for the end.
CALC:MARK:FUNC:NDBD:QFAC?
Queries the Q factor of the measured bandwidth.
```

Manual operation: See "n dB down" on page 262

CALCulate<n>:MARKer<m>:FUNCtion:NDBDown:RESult?

This command queries the distance of the n dB down markers from each other.

To get a valid result, you have to perform a complete measurement with synchronization to the end of the measurement before reading out the result. This is only possible for single sweeps.

Suffix:

<n> Selects the measurement window.
 <m> irrelevant

Parameters:

<Distance> The result depends on the span.
 In case of frequency domain measurements, the command returns the bandwidth between the two n dB down markers in Hz. In case of time domain measurements, the command returns the pulse width between the two n dB down markers in seconds.

Example:

```
INIT:CONT OFF
Switches to single sweep mode.
CALC:MARK:FUNC:NDBD ON
Switches on the n dB down function.
INIT;*WAI
Starts a sweep and waits for the end.
CALC:MARK:FUNC:NDBD:RES?
Outputs the measured value.
```

Usage: Query only

Manual operation: See "n dB down" on page 262

CALCulate<n>:MARKer<m>:FUNCtion:NDBDown:STATe <State>

This command turns the n dB Down marker function on and off.

Suffix:

<n> Selects the measurement window.
 <m> irrelevant

Parameters:

<State> ON | OFF
 *RST: OFF

Example:

CALC:MARK:FUNC:NDBD:STAT ON
 Switches on the "N dB Down" function.

Manual operation: See "n dB down" on page 262

CALCulate<n>:MARKer<m>:FUNCTION:NDBDown:TIME?

This command queries the position of the n dB down markers on the x-axis when measuring in the time domain.

To get a valid result, you have to perform a complete measurement with synchronization to the end of the measurement before reading out the result. This is only possible for single sweeps.

Suffix:

<n> Selects the measurement window.
 <m> irrelevant

Return values:

<Time> **<time 1>**
 absolute position in time of the n dB marker to the left of the reference marker in seconds
<time 2>
 absolute position in time of the n dB marker to the right of the reference marker in seconds

Example:

INIT:CONT OFF
 Switches to single sweep mode
 CALC:MARK:FUNC:NDBD ON
 Switches on the n dB down function.
 INIT;*WAI
 Starts a sweep and waits for the end.
 CALC:MARK:FUNC:NDBD:TIME?
 Outputs the time values of the temporary markers.

Usage: Query only

Manual operation: See "n dB down" on page 262

CALCulate<n>:MARKer<m>:FUNCTION:NOISe[:STATe] <State>

This command turns the noise measurement for all markers on or off.

If on, the R&S FSVA/FSV measures the noise power density at the marker position.

The result can be queried with `CALCulate<n>:MARKer<m>:FUNCTION:NOISe:RESult`.

Suffix:

<n> Selects the measurement window.

<m> Selects the marker.

Parameters:

<State> ON | OFF

*RST: OFF

Example:

CALC:MARK:FUNC:NOIS ON

Switches on the noise measurement.

Manual operation: See "Noise Meas On/Off" on page 258

CALCulate<n>:MARKer<m>:FUNCCtion:NOISe:RESult

This command queries the result of the noise measurement.

To get a valid result, you have to perform a complete measurement with synchronization to the end of the measurement before reading out the result. This is only possible for single sweeps.

Suffix:

<n> Selects the measurement window.

<m> Selects the marker.

Example:

INIT:CONT OFF

Switches to single sweep mode.

CALC:MARK2 ON

Switches on marker 2.

CALC:MARK:FUNC:NOIS ON

Switches on noise measurement.

INIT;*WAI

Starts a sweep and waits for the end.

CALC:MARK2:NOIS:RES?

Outputs the noise result of marker 2.

Manual operation: See "Noise Meas On/Off" on page 258

CALCulate<n>:MARKer<m>:FUNCCtion:REFerence

This command sets the reference level to the power measured by a marker.

If you use the command in combination with a delta marker, that delta marker is turned into a normal marker.

Suffix:

<n> Selects the measurement window.

<m> Selects the marker.

Example:

CALC:MARK2:FUNC:REF

Sets the reference level to the level of marker 2.

Manual operation: See "Ref Lvl =Mkr Lvl" on page 272

CALCulate<n>:MARKer<m>:FUNCtion:TOI:RESult?

This command queries the results for the third order intercept point measurement.

To get a valid result, you have to perform a complete measurement with synchronization to the end of the measurement before reading out the result. This is only possible for single sweeps.

Suffix:

<n> Selects the measurement window.
 <m> irrelevant

Return values:

<TOI> Third order intercept point.

Example:

```
INIT:CONT OFF
Switches to single sweep mode.
CALC:MARK:FUNC:TOI ON
Switches the intercept measurement.
INIT;*WAI
Starts a sweep and waits for the end.
CALC:MARK:FUNC:TOI:RES?
Outputs the measured value.
```

Usage: Query only

Manual operation: See "TOI" on page 283
 See "TOI" on page 380

CALCulate<n>:MARKer<m>:FUNCtion:TOI:SEARChsignal ONCE

This command initiates a search for signals in the current trace to determine the third intercept point.

No new measurement is performed. Only the currently available trace selected for the TOI measurement is used.

Suffix:

<n> Selects the measurement window.
 <m> Selects the marker.

Example:

```
CALC:MARK:FUNC:TOI:SEAR ONCE
Executes the search for 2 signals and their intermodulation product at the currently available trace.
```

Usage: Event
 SCPI confirmed

Manual operation: See "Search Signals" on page 380

CALCulate<n>:MARKer<m>:FUNCtion:TOI[:STATe] <State>

This command initiates a measurement to determine the third intercept point.

A two-tone signal with equal carrier levels is expected at the RF input of the instrument. Marker 1 and marker 2 (both normal markers) are set to the maximum of the two signals. Delta marker 3 and delta marker 4 are positioned to the intermodulation products. The delta markers can be modified separately afterwards with `CALCulate<n>:DELTaMarker<m>:X`.

The third-order intercept is calculated from the level spacing between the normal markers and the delta markers.

Suffix:

<n> Selects the measurement window.
 <m> irrelevant

Parameters:

<State> ON | OFF
 *RST: OFF

Example:

`CALC:MARK:FUNC:TOI ON`
 Switches on the measurement of the third-order intercept.

Manual operation: See "TOI" on page 283
 See "TOI" on page 380

CALCulate<n>:MARKer<m>:FUNCTion:ZOOM <Range>

This command defines the range to be zoomed around marker 1. Marker 1 is activated first, if necessary.

The subsequent frequency sweep is stopped at the marker position and the frequency of the signal is counted. This frequency becomes the new center frequency, and the zoomed span is set.

Note that you should perform a complete measurement with synchronization to the end of the measurement. This is only possible for single sweeps.

Suffix:

<n> Selects the measurement window.
 <m> Selects the marker.

Parameters:

<Range> <numeric_value>

Example:

`INIT:CONT OFF`
 Switches to single sweep mode
`CALC:MARK:FUNC:ZOOM 1kHz;*WAI`
 Activates zooming and waits for its end.

Manual operation: See "Marker Zoom (span > 0)" on page 253

CALCulate:MARKer<m>:FUNCTion:HARMonics Subsystem

The `CALCulate:MARKer<m>:FUNCTion:HARMonics` subsystem contains the commands to define the settings for harmonics measurement.

CALCulate<n>:MARKer<m>:FUNcTion:HARMonics:BANDwidth:AUTO.....	699
CALCulate<n>:MARKer<m>:FUNcTion:HARMonics:DISToRTion?.....	699
CALCulate<n>:MARKer<m>:FUNcTion:HARMonics:LIST?.....	700
CALCulate<n>:MARKer<m>:FUNcTion:HARMonics:NHARmonics.....	701
CALCulate<n>:MARKer<m>:FUNcTion:HARMonics:PRESet.....	701
CALCulate<n>:MARKer<m>:FUNcTion:HARMonics[:STATe].....	701

CALCulate<n>:MARKer<m>:FUNcTion:HARMonics:BANDwidth:AUTO <State>

This command selects the resolution bandwidth of the harmonic in respect to the bandwidth of the first harmonic.

For details refer to "[Harmonic RBW Auto](#)" on page 386.

Suffix:

<n>	Selects the measurement window.
<m>	irrelevant

Parameters:

<State>	OFF ON
	OFF
	identical
	ON
	a multiple
*RST:	ON

Example:

```
CALC:MARK:FUNC:HARM:BAND:AUTO OFF
```

Deactivates the automatic bandwidth enlargement.

Manual operation: See "[Harmonic RBW Auto](#)" on page 386

CALCulate<n>:MARKer<m>:FUNcTion:HARMonics:DISToRTion?

This command queries the total harmonic distortion of the signal.

To get a valid result, you have to perform a complete measurement with synchronization to the end of the measurement before reading out the result. This is only possible for single sweeps.

Suffix:

<n>	Selects the measurement window.
<m>	irrelevant

Parameters:

TOTAL

Return values:

<Result>	<Distortion_%>,<Distortion_dB>
----------	--------------------------------

Pair of values, one showing the THD in %, one in dB.

Example:	<pre>INIT:CONT OFF</pre> <p>Switches to single sweep mode.</p> <pre>CALC:MARK:FUNC:HARM:NHARM 3</pre> <p>Sets the number of harmonics to be measured to 3.</p> <pre>CALC:MARK:FUNC:HARM ON</pre> <p>Activates the harmonic distortion measurement.</p> <pre>INIT;*WAI</pre> <p>Starts a sweep and waits for the end of the sweep.</p> <pre>CALC:MARK:FUNC:HARM:DIST? TOT</pre> <p>Returns the total distortion in % and dB.</p>
Usage:	Query only
Manual operation:	<p>See "Harmonic Distortion" on page 283</p> <p>See "Harmonic Distortion" on page 385</p>

CALCulate<n>:MARKer<m>:FUNCTION:HARMonics:LIST?

This command queries the position of the harmonics.

To get a valid result, you have to perform a complete measurement with synchronization to the end of the measurement before reading out the result. This is only possible for single sweeps.

Suffix:

<n>	Selects the measurement window.
<m>	Selects the marker.

Parameters:

<Harmonics>	<p>Returns one value for every harmonic.</p> <p>The first value is the absolute power of the first harmonic. The unit is variable. The other values are power levels relative to the first harmonic. The unit for these is dB.</p>
-------------	--

Example:	<pre>INIT:CONT OFF</pre> <p>Switches to single sweep mode.</p> <pre>CALC:MARK:FUNC:HARM:NHARM 3</pre> <p>Sets the number of harmonics to be measured to 3.</p> <pre>CALC:MARK:FUNC:HARM ON</pre> <p>Activates the harmonic distortion measurement.</p> <pre>INIT;*WAI</pre> <p>Starts a sweep and waits for the end of the sweep.</p> <pre>CALC:MARK:FUNC:HARM:LIST?</pre> <p>Returns the values for the 3 measured harmonics.</p>
-----------------	--

Usage: Query only

Manual operation: See ["Harmonic Distortion"](#) on page 283
See ["Harmonic Distortion"](#) on page 385

CALCulate<n>:MARKer<m>:FUNCtion:HARMonics:NHARmonics <NoHarmonics>

This command sets the number of harmonics to be measured.

Suffix:

<n> Selects the measurement window.
<m> irrelevant

Parameters:

<NoHarmonics> Range: 1 to 26
 *RST: 10

Example:

CALC:MARK:FUNC:HARM:NHARM 3
Sets the number of harmonics to be measured to 3.

Manual operation: See "[No. of Harmonics](#)" on page 386

CALCulate<n>:MARKer<m>:FUNCtion:HARMonics:PRESet

This command initiates a measurement to determine the ideal configuration for the harmonic distortion measurement.

The method depends on the span.

- Frequency domain (span > 0)
Frequency and level of the first harmonic are determined and used for the measurement list.
- Time domain (span = 0)
The level of the first harmonic is determined. The frequency remains unchanged.

Suffix:

<n> Selects the measurement window.
<m> irrelevant

Example:

CALC:MARK:FUNC:HARM:PRESet
Optimizes the device settings for the harmonic measurement.

Usage: Event

Manual operation: See "[Adjust Settings](#)" on page 386

CALCulate<n>:MARKer<m>:FUNCtion:HARMonics[:STATE] <State>

This command turns the harmonic distortion measurement on and off.

Note the following:

- If you perform the measurement in the frequency domain, the search range for the frequency of the first harmonic, whose power is determined, is defined by the last span.
- If you perform the measurement in the time domain, the current center frequency is used as the frequency of the first harmonic. Thus, the frequency search is

bypassed. The first harmonic frequency is set by a specific center frequency in zero span before the harmonic measurement is started.

Suffix:

<n> Selects the measurement window.

<m> irrelevant

Parameters:

<State> ON | OFF

*RST: OFF

Example:

CALC:MARK:FUNC:HARM ON

Activates the harmonic distortion measurement.

Manual operation: See ["Harmonic Distortion"](#) on page 283

See ["Harmonic Distortion"](#) on page 385

CALCulate:MARKer:FUNCTION:POWER Subsystem

The CALCulate:MARKer<m>:FUNCTION:POWER subsystem contains the commands for control of power measurement.

Further information

- ["Predefined CP/ACLR Standards"](#) on page 715

CALCulate<n>:MARKer<m>:FUNCTION:POWER:MODE	702
CALCulate<n>:MARKer<m>:FUNCTION:POWER:PRESet	703
CALCulate<n>:MARKer<m>:FUNCTION:POWER:RESult?	704
CALCulate<n>:MARKer<m>:FUNCTION:POWER:RESult:PHZ	707
CALCulate<n>:MARKer<m>:FUNCTION:POWER:SElect	707
CALCulate<n>:MARKer<m>:FUNCTION:POWER[:STATe]	708
CALCulate<n>:MARKer<m>:FUNCTION:POWER:STANdard:CATalog?	709
CALCulate<n>:MARKer<m>:FUNCTION:POWER:STANdard:DELeTe	709
CALCulate<n>:MARKer<m>:FUNCTION:POWER:STANdard:SAVE	709

CALCulate<n>:MARKer<m>:FUNCTION:POWER:MODE <Mode>

This commands defines the method by which the channel power values are calculated from the current trace in the window specified by the suffix <n>.

Suffix:

<n> Selects the measurement window.

<m> Selects the marker.

Parameters:

<Mode> WRITe | MAXHold

WRITe

The channel power and the adjacent channel powers are calculated directly from the current trace

MAXHold

The power values are calculated from the current trace and compared with the previous power value using a maximum algorithm.

Example:

```
CALC:MARK:FUNC:POW:MODE MAXH
```

Sets the Maxhold channel power mode.

Manual operation:

See ["Clear/Write"](#) on page 301

See ["Max Hold"](#) on page 302

CALCulate<n>:MARKer<m>:FUNctioN:POWer:PRESet <Standard> | <UserStandard>

This command selects the power measurement setting for a standard and switches on the corresponding measurement, if required.

The configuration for a standard comprises of the parameters weighting filter, channel bandwidth and spacing, resolution and video bandwidth, as well as detector and sweep time.

The settings for standards IS95A and C differ as far as the calculation method of channel spacings is concerned. For IS95A and J-STD008 the spacing is calculated from the center of the main channel to the center of the corresponding adjacent channel, for IS95C from the center of the main channel to the nearest border of the adjacent channel.

Suffix:

<n> Selects the measurement window.

<m> Selects the marker.

Setting parameters:

<Standard> Note that predefined standards go without quotes, while user standards have to be in quotes ('user standard').

<Predefined standard>

Predefine standard according to table in ["Predefined CP/ACLR Standards"](#) on page 715.

'<string>'

User-defined standard with <string> being the name of the user standard.

Return values:

<Standard> <Predefined standard> | USER | NONE

<Predefined standard>

Predefine standard according to table in ["Predefined CP/ACLR Standards"](#) on page 715.

USER

User-defined standard is set

NONE

not yet defined

with <string> being the name of a user standard. Note that predefined standards go without quotes, while user standards have to be in quotes ('user standard').

For further details refer to "[Predefined CP/ACLR Standards](#)" on page 715.

Example: `CALC:MARK:FUNC:POW:PRES TETRA`
Selects the standard setting for TETRA

Example: `CALC:MARK:FUNC:POW:PRES 'my_aclr_standard'`
Selects the user standard my_aclr_standard

Manual operation: See "[CP/ACLR Standard](#)" on page 295
See "[Load](#)" on page 304

CALCulate<n>:MARKer<m>:FUNctioN:POWer:RESult? <ResultType>

This command queries the result of the performed power measurement in the window specified by the suffix <n>. If necessary, the measurement is switched on prior to the query.

The channel spacings and channel bandwidths are configured in the `SENSe:POWer` subsystem.

To obtain a correct result, a complete sweep with synchronization to the end of the sweep must be performed before a query is output. Synchronization is possible only in the single sweep mode.

Suffix:

<n> Selects the measurement window.

<m> Selects the marker.

Parameters:

<ResultType> ACPower | AOBW | CN | CN0 | CPOWer | PPOWer | MCACpower | OBANdwidth | OBWidth | BANDwidth

ACPower

Adjacent-channel power measurement

Results are output in the following sequence, separated by commas:

Power of transmission channel

Power of lower adjacent channel

Power of upper adjacent channel

Power of lower alternate channel 1

Power of upper alternate channel 1

Power of lower alternate channel 2

Power of upper alternate channel 2

The number of measured values returned depends on the number of adjacent/alternate channels selected with `[SENSe:]POWER:ACHannel:ACPairs`.

`[SENSe:]POWER:ACHannel:ACPairs`.

With logarithmic scaling (RANGE "LOG"), the power is output in the currently selected level unit; with linear scaling (RANGE "LIN dB" or "LIN %"), the power is output in W. If `[SENSe:]POWER:ACHannel:MODE` is set to "REL", the adjacent/alternate-channel power is output in dB.

AOBW (AllOccupiedBandWidth)

Returns the occupied bandwidth, as well as the position and level of the temporary markers T1 and T2 used to calculate the occupied bandwidth.

The syntax of the result is:

<Occupied bandwidth>,<T1 x-value>,<T1 y-value>,<T2 x-value>,<T2 y-value>

CN

Measurement of carrier-to-noise ratio

The carrier-to-noise ratio in dB is returned.

CNO

Measurement of carrier-to-noise ratio referenced to 1 Hz bandwidth.

The carrier-to-noise ratio in dB/Hz is returned.

CPOWER

Channel power measurement

In a Spectrum Emission Mask measurement, the query returns the power result for the reference range, if this power reference type is selected.

With logarithmic scaling (RANGE LOG), the channel power is output in the currently selected level unit; with linear scaling (RANGE LIN dB or LIN %), the channel power is output in W.

PPOWER

Power of the highest peak

In a Spectrum Emission Mask measurement, the query returns the power result for the reference range, if this power reference type is selected.

MCACpower

Channel/adjacent-channel power measurement with several carrier signals

Results are output in the following sequence, separated by commas:

Power of carrier signal 1 to 18s in ascending order

Total power of all carrier signals

Power of lower adjacent channel

Power of upper adjacent channel

Power of lower alternate channel 1

Power of upper alternate channel 1

Power of lower alternate channel 2

Power of upper alternate channel 2

The number of measured values returned depends on the number of carrier signals and adjacent/alternate channels selected with `[SENSe:]POWer:ACHannel:TXChannel:COUNT` and `[SENSe:]POWer:ACHannel:ACPairs`.

If only one carrier signal is measured, the total value of all carrier signals is not output.

With logarithmic scaling (RANGE LOG), the power is output in dBm; with linear scaling (RANGE LIN dB or LIN %), the power is output in W. If `[SENSe:]POWer:ACHannel:MODE` is set to "REL", the adjacent/alternate-channel power is output in dB.

OBANdwidth | OBWidth

Measurement of occupied bandwidth

The occupied bandwidth in Hz is returned.

Example:

For an example of channel/adjacent-channel power measurement see [Chapter 6.4.4, "Measuring the Channel and Adjacent Channel Power"](#), on page 1025.

Example of occupied bandwidth measurement

```
POW:BAND 90PCT
```

Defines 90 % as the percentage of the power to be contained in the bandwidth range to be measured.

```
INIT:CONT OFF
```

Switches over to single sweep mode.

```
INIT:*WAI
```

Starts a sweep and waits for the end of the sweep.

```
CALC:MARK:FUNC:POW:RES? OBW
```

Queries the occupied bandwidth measured.

Manual operation:

See ["Ch Power ACLR"](#) on page 281

See ["OBW \(span > 0\)"](#) on page 282

See ["Ch Power ACLR"](#) on page 295

See ["C/N"](#) on page 310

See ["C/No"](#) on page 310

See ["OBW"](#) on page 314

CALCulate<n>:MARKer<m>:FUNCTION:POWer:RESult:PHZ <State>

This command switches the query response of the power measurement results between output of absolute values and output referred to the measurement bandwidth.

The measurement results are output with the [CALCulate<n>:MARKer<m>:FUNCTION:POWer:RESult?](#) command.

Suffix:

<n> Selects the measurement window.
 <m> Selects the marker.

Parameters:

<State> ON | OFF
ON
 Results output: channel power density in dBm/Hz
OFF
 Results output: channel power is displayed in dBm
 *RST: OFF

Example:

`CALC:MARK:FUNC:POW:RES:PHZ ON`
 Output of results referred to the channel bandwidth.
 For details on a complete measurement example refer to [CALCulate<n>:MARKer<m>:FUNCTION:POWer:RESult?](#) on page 704.

Manual operation: See "[Chan Pwr/Hz](#)" on page 301

CALCulate<n>:MARKer<m>:FUNCTION:POWer:SElect <MeasType>

This command selects – and switches on – the specified power measurement type in the window specified by the suffix <n>.

The channel spacings and channel bandwidths are configured in the `SENSe:POWer` subsystem.

Note: If `CPOWer` is selected, the number of adjacent channels ([\[SENSe:\]POWer:ACHannel:ACPairs](#)) is set to 0. If `ACPOWer` is selected, the number of adjacent channels is set to 1, unless adjacent-channel power measurement is switched on already.

The channel/adjacent-channel power measurement is performed for the trace selected with [\[SENSe:\]POWer:TRACe](#).

The occupied bandwidth measurement is performed for the trace on which marker 1 is positioned. To select another trace for the measurement, marker 1 is to be positioned on the desired trace by means of [CALCulate<n>:MARKer<m>:TRACe](#).

Suffix:

<n> Selects the measurement window.

<m> Selects the marker.

Parameters:

<MeasType>

ACPower | CPOWer | MCACpower | OBANdwidth | OBWidth | CN | CNO

ACPower

Adjacent-channel power measurement with a single carrier signal

CPOWer

Channel power measurement with a single carrier signal (equivalent to adjacent-channel power measurement with "NO. OF ADJ CHAN" = 0)

MCACpower

Channel/adjacent-channel power measurement with several carrier signals

OBANdwidth | OBWidth

Measurement of occupied bandwidth

CN

Measurement of carrier-to-noise ratio

CNO

Measurement of carrier-to-noise ratio referenced to 1 Hz bandwidth

Example:

CALC:MARK:FUNC:POW:SEL ACP

Switches on adjacent-channel power measurement.

Manual operation:

See "Ch Power ACLR" on page 281

See "OBW (span > 0)" on page 282

See "Ch Power ACLR" on page 295

See "C/N" on page 310

See "C/No" on page 310

See "OBW" on page 314

CALCulate<n>:MARKer<m>:FUNCtion:POWer[:STATe] <State>

This command switches off the power measurement in the window specified by the suffix <n>.

Suffix:

<n> Selects the measurement window.

<m> Selects the marker.

Parameters:

<State> OFF

Example:

CALC:MARK:FUNC:POW OFF

Switches off the power measurement.

Usage:

Event

Manual operation: See "Ch Power ACLR" on page 281
 See "OBW (span > 0)" on page 282
 See "Ch Power ACLR" on page 295
 See "C/N" on page 310
 See "C/No" on page 310
 See "OBW" on page 314

CALCulate<n>:MARKer<m>:FUNctio:n:POWer:STANdard:CATalog?

This command queries all available standards, including user standards.

The numeric suffix at MARKer is irrelevant.

Example: `CALC:MARK:FUNC:POW:STAN:CAT?`
 Queries the available standards.

Usage: Query only

Manual operation: See "Load" on page 304

CALCulate<n>:MARKer<m>:FUNctio:n:POWer:STANdard:DELeTe <Standard>

This command deletes an ACLR standard.

The numeric suffix at MARKer is irrelevant.

Parameters:
 <Standard> Name of the standard you want to delete.

Example: `CALC:MARK:FUNC:POW:STAN:DEL 'CDMA2000'`
 Deletes the CDMA2000 standard.

Manual operation: See "Delete" on page 304

CALCulate<n>:MARKer<m>:FUNctio:n:POWer:STANdard:SAVE <Standard>

This command saves a customized ACLR standard.

The numeric suffix at MARKer is irrelevant.

Parameters:
 <Standard> Specifies the name of the user standard.

Example: `CALC:MARK:FUNC:POW:STAN:SAVE 'CDMA2000'`
 Saves the user standard with the name CDMA2000.

Manual operation: See "Save" on page 304

CALCulate:MARKer:SGRam subsystem

The following commands control the markers when you are using the spectrogram.

The spectrogram is available if option R&S FSV-K14 is installed.

CALCulate<n>:MARKer<m>:SGRam:FRAMe.....	710
CALCulate<n>:MARKer<m>:SGRam:SARea.....	710
CALCulate<n>:MARKer<m>:SGRam:XY:MAXimum[:PEAK].....	711
CALCulate<n>:MARKer<m>:SGRam:XY:MINimum[:PEAK].....	711
CALCulate<n>:MARKer<m>:SGRam:Y:MAXimum:ABOVe.....	712
CALCulate<n>:MARKer<m>:SGRam:Y:MAXimum:BELOW.....	712
CALCulate<n>:MARKer<m>:SGRam:Y:MAXimum:NEXT.....	713
CALCulate<n>:MARKer<m>:SGRam:Y:MAXimum[:PEAK].....	713
CALCulate<n>:MARKer<m>:SGRam:Y:MINimum:ABOVe.....	714
CALCulate<n>:MARKer<m>:SGRam:Y:MINimum:BELOW.....	714
CALCulate<n>:MARKer<m>:SGRam:Y:MINimum:NEXT.....	715
CALCulate<n>:MARKer<m>:SGRam:Y:MINimum[:PEAK].....	715

CALCulate<n>:MARKer<m>:SGRam:FRAMe <Frame> | <Time>

This command positions the marker on a particular frame.

The command is available for the spectrogram.

Suffix:

<n>	1...4 Selects the measurement window.
<m>	1...16 Selects the marker.

Parameters:

<Frame> <Time>	<p><Frame> (if time stamp is off) Defines the frame to place the marker on. The range is {0...number of recorded frames-1}</p> <p><time> (if time stamp is on) Defines the distance of the marker in seconds to the last measured frame (frame 0).</p>
------------------	--

Example:

```
CALC:MARK:SGR:FRAM -20
Sets the marker on the 20th frame before the present.
CALC:MARK2:SGR:FRAM 2 s
Sets second marker on the frame 2 seconds ago.
```

CALCulate<n>:MARKer<m>:SGRam:SARea <SearchArea>

This command defines the marker search area.

The command is available for the spectrogram.

Suffix:

<n>	1...4 Selects the measurement window.
-----	--

<m> 1...16
Selects the marker.

Parameters:

<SearchArea>

VISible

Performs a search in the visible frames.

Note that VISible is ignored if Spectrogram is not visible for any reason (e.g. if the Spectrum Analyzer is in full screen mode or display update is inactive).

MEMory

Performs a search over all frames in the memory.

*RST: VISible

Example:

CALC:DELT:SGR:SAR MEM

Performs a search over all frames in the memory.

Manual operation: See "[Marker Search Area](#)" on page 276

CALCulate<n>:MARKer<m>:SGRam:XY:MAXimum[:PEAK]

This command positions the specified marker on the current peak level of the spectrogram. The possible position depends on the marker search area.

The command is available for the spectrogram.

For more information, see [CALCulate<n>:MARKer<m>:SGRam:SARea](#) on page 710.

Suffix:

<n> 1...4
Selects the measurement window.

<m> 1...16
Selects the marker.

Example:

CALC:MARK2:SGR:SAR VIS

CALC:MARK2:SGR:XY:MAX

Activates and positions marker 2 on the peak level in the visible Spectrogram.

Usage: Event

Manual operation: See "[Marker Search Type](#)" on page 276

CALCulate<n>:MARKer<m>:SGRam:XY:MINimum[:PEAK]

This command positions the specified marker on the current minimum level of the spectrogram. The possible position depends on the marker search area.

The command is available for the spectrogram.

For more information, see [CALCulate<n>:MARKer<m>:SGRam:SARea](#) on page 710 .

Suffix:

<n> 1...4
Selects the measurement window.

<m> 1...16
Selects the marker.

Example: `CALC:MARK3:SGR:SAR VIS`
`CALC:MARK3:SGR:XY:MIN`
Activates and positions marker 3 on the minimum level in the visible Spectrogram.

Usage: Event

Manual operation: See "[Marker Search Type](#)" on page 276

CALCulate<n>:MARKer<m>:SGRam:Y:MAXimum:ABOVe

This command positions the specified marker on the next peak level of the vertical axis. The search includes only frames above the current marker position. It does not change the horizontal position of the marker.

The command is available for the spectrogram.

Suffix:

<n> 1...4
Selects the measurement window.

<m> 1...16
Selects the marker.

Example: `CALC:MARK2:SGR:Y:MAX`
Activates and positions marker 2 on the peak level of the y-axis.
`CALC:MARK2:SGR:Y:MAX:ABV`
Positions marker 2 on the next higher level found in the diagram area above the current marker position.

Usage: Event

Manual operation: See "[Search Mode for Next Peak in Y Direction](#)" on page 275

CALCulate<n>:MARKer<m>:SGRam:Y:MAXimum:BELOW

This command positions the specified marker on the next peak level of the vertical axis. The search includes only frames below the current marker position. It does not change the horizontal position of the marker.

The command is available for the spectrogram.

Suffix:

<n> 1...4
Selects the measurement window.

<m> 1...16
Selects the marker.

- Example:** `CALC:MARK2:SGR:Y:MAX`
 Activates and positions marker 2 on the peak level of the y-axis.
`CALC:MARK2:SGR:Y:MAX:BEL`
 Positions marker 2 on the next higher level found in the diagram area below the current marker position.
- Usage:** Event
- Manual operation:** See ["Search Mode for Next Peak in Y Direction"](#) on page 275

CALCulate<n>:MARKer<m>:SGRam:Y:MAXimum:NEXT

This command positions the specified marker on the next peak level of the vertical axis. The search includes frames above and below the current marker position. It does not change the horizontal position of the marker.

The command is available for the spectrogram.

Suffix:

- <n> 1...4
 Selects the measurement window.
- <m> 1...16
 Selects the marker.

- Example:** `CALC:MARK2:SGR:Y:MAX`
 Activates and positions marker 2 on the peak level of the y-axis.
`CALC:MARK2:SGR:Y:MAX:NEXT`
 Positions marker 2 on the next higher level.

Usage: Event

Manual operation: See ["Search Mode for Next Peak in Y Direction"](#) on page 275

CALCulate<n>:MARKer<m>:SGRam:Y:MAXimum[:PEAK]

This command positions the specified marker on the current peak level of the vertical axis. The search is performed over all frames. It does not change the horizontal position of the marker.

The command is available for the spectrogram.

Suffix:

- <n> 1...4
 Selects the measurement window.
- <m> 1...16
 Selects the marker.

- Example:** `CALC:MARK2:SGR:Y:MAX`
 Activates and positions marker 2 on the peak level of the y-axis.

Usage: Event

Manual operation: See ["Marker Search Type"](#) on page 276

CALCulate<n>:MARKer<m>:SGRam:Y:MINimum:ABOVE

This command positions the specified marker on the next minimum level of the vertical axis. The search includes only frames above the current marker position. It does not change the horizontal position of the marker.

The command is available for the spectrogram.

Suffix:

<n> 1...4
Selects the measurement window.

<m> 1...16
Selects the marker.

Example:

`CALC:MARK2:SGR:Y:MIN`

Activates and positions marker 2 on the minimum level of the y-axis.

`CALC:MARK2:SGR:Y:MIN:ABOV`

Positions marker 2 on the next minimum level found in the diagram area above the current marker position.

Usage: Event

Manual operation: See "[Search Mode for Next Peak in Y Direction](#)" on page 275

CALCulate<n>:MARKer<m>:SGRam:Y:MINimum:BELOW

This command positions the specified marker on the next minimum level of the vertical axis. The search includes only frames below the current marker position. It does not change the horizontal position of the marker.

The command is available for the spectrogram.

Suffix:

<n> 1...4
Selects the measurement window.

<m> 1...16
Selects the marker.

Example:

`CALC:MARK2:SGR:Y:MIN`

Activates and positions marker 2 on the minimum level of the y-axis.

`CALC:MARK2:SGR:Y:MAX:BEL`

Positions marker 2 on the next minimum level found in the diagram area below the current marker position.

Usage: Event

Manual operation: See "[Search Mode for Next Peak in Y Direction](#)" on page 275

CALCulate<n>:MARKer<m>:SGRam:Y:MINimum:NEXT

This command positions the specified marker on the next minimum level of the vertical axis. The search includes frames above and below the current marker position. It does not change the horizontal position of the marker.

The command is available for the spectrogram.

Suffix:

<n> 1...4
Selects the measurement window.

<m> 1...16
Selects the marker.

Example:

`CALC:MARK2:SGR:Y:MIN`

Activates and positions marker 2 on the minimum level of the y-axis.

`CALC:MARK2:SGR:Y:MIN:NEXT`

Positions marker 2 on the next minimum level.

Usage: Event

Manual operation: See "[Search Mode for Next Peak in Y Direction](#)" on page 275

CALCulate<n>:MARKer<m>:SGRam:Y:MINimum[:PEAK]

This command positions the specified marker on the current minimum level of the vertical axis. The search is performed over all captured frames. It does not change the horizontal position of the delta marker.

The command is available for the spectrogram.

Suffix:

<n> 1...4
Selects the measurement window.

<m> 1...16
Selects the marker.

Example:

`CALC:MARK2:SGR:Y:MIN`

Activates and positions marker 2 on the minimum level of the y-axis.

Usage: Event

Manual operation: See "[Marker Search Type](#)" on page 276

Predefined CP/ACLR Standards

Parameter	Standard
W-CDMA 3GPP FWD	W-CDMA 3.84 MHz forward
W-CDMA 3GPP REV	W-CDMA 3.84 MHz reverse

Parameter	Standard
CDMA IS95A FWD	CDMA IS95A forward
CDMA IS95A REV	CDMA IS95A reverse
CDMA IS95C Class 0 FWD	CDMA IS95C Class 0 forward
CDMA IS95C Class 0 REV	CDMA IS95C Class 0 reverse
CDMA J-STD008 FWD	CDMA J-STD008 forward
CDMA J-STD008 REV	CDMA J-STD008 reverse
CDMA IS95C Class 1 FWD	CDMA IS95C Class 1 forward
CDMA IS95C Class 1 REV	CDMA IS95C Class 1 reverse
CDMA 2000	CDMA 2000
TD SCDMA FWD	TD-SCDMA forward
TD SCDMA REV	TD-SCDMA reverse
WLAN 802.11A	WLAN 802.11A
WLAN 802.11B	WLAN 802.11B
WiMAX	WiMAX
WIBRO	WIBRO
RFID 14443	RFID 14443
EUTRa	EUTRA/LTE Square
REUTra	EUTRA/LTE Square/RRC
TETRA	TETRA
PDC	PDC
PHS	PHS
CDPD	CDPD
GSM	GSM

CALCulate:MARKer:FUNction:STRack Subsystem

The CALCulate:MARKer<m>:FUNction:STRack subsystem defines the settings of the signal track.

CALCulate<n>:MARKer<m>:FUNction:STRack:BANDwidth BWIDTH.....	716
CALCulate<n>:MARKer<m>:FUNction:STRack:THReshold.....	717
CALCulate<n>:MARKer<m>:FUNction:STRack:TRACe.....	717
CALCulate<n>:MARKer<m>:FUNction:STRack[:STATe].....	718

CALCulate<n>:MARKer<m>:FUNction:STRack:BANDwidth|BWIDTH <Bandwidth>

This command defines the bandwidth around the center frequency that is included in the signal tracking process.

Note that you have to turn on signal tracking before you can use the command (`CALCulate<n>:MARKer<m>:FUNction:STRack[:STATE]`).

Suffix:

<n> Selects the measurement window.

<m> Selects the marker.

Parameters:

<Bandwidth> 10 Hz to MAX (span)

*RST: (= span/10 on activating the function)

Example:

`CALC:MARK:FUNC:STR:BAND 1 MHZ`

Sets the search bandwidth to 1 MHz.

`CALC:MARK:FUNC:STR:BWID 1 MHZ`

Alternative command for the same function.

Manual operation: See "[Track BW \(span > 0\)](#)" on page 189

CALCulate<n>:MARKer<m>:FUNction:STRack:THReshold <Level>

This command defines a threshold above which the signal is tracked.

Note that you have to turn on signal tracking before you can use the command (`CALCulate<n>:MARKer<m>:FUNction:STRack[:STATE]`).

The unit depends on `CALCulate<n>:UNIT:POWer`.

Suffix:

<n> Selects the measurement window.

<m> Selects the marker.

Parameters:

<Level> Range: -130 dBm to 30 dBm

*RST: -120 dBm

Default unit: dBm

Example:

`CALC:MARK:FUNC:STR:THR -50DBM`

Sets the threshold for signal tracking to -50 dBm.

Manual operation: See "[Track Threshold \(span > 0\)](#)" on page 189

CALCulate<n>:MARKer<m>:FUNction:STRack:TRACe <TraceNumber>

This command defines the trace on which the signal is tracked.

Suffix:

<n> Selects the measurement window.

<m> Selects the marker.

Parameters:

<TraceNumber> Range: 1 to 6

*RST: 1

Example: `CALC:MARK:FUNC:STR:TRAC 3`
Defines trace 3 as the trace for signal tracking.

Manual operation: See "Select Trace (span > 0)" on page 189

CALCulate<n>:MARKer<m>:FUNctioN:STRack[:STATe] <State>

This command turns signal tracking on and off.

When signal tracking is on, the R&S FSVA/FSV determines the maximum signal after each frequency sweep. The center frequency is then set to the frequency of this signal. Thus, the center frequency follows the frequency when you measure drifting signals.

Suffix:

<n> Selects the measurement window.

<m> Selects the marker.

Parameters:

<State> ON | OFF

*RST: OFF

Example: `CALC:MARK:FUNC:STR ON`
Switches on the signal track function.

Manual operation: See "Track On/Off (span > 0)" on page 189

CALCulate:MARKer:FUNctioN:SUMMary Subsystem

This subsystem contains the control commands for the power functions in zero span.

<code>CALCulate<n>:MARKer<m>:FUNctioN:MSUMmary?</code>	719
<code>CALCulate<n>:MARKer<m>:FUNctioN:SUMMary:AOff</code>	720
<code>CALCulate<n>:MARKer<m>:FUNctioN:SUMMary:AVERage</code>	720
<code>CALCulate<n>:MARKer<m>:FUNctioN:SUMMary:MEAN:AVERage:RESult?</code>	721
<code>CALCulate<n>:MARKer<m>:FUNctioN:SUMMary:MEAN:PHOLd:RESult?</code>	722
<code>CALCulate<n>:MARKer<m>:FUNctioN:SUMMary:MEAN:RESult?</code>	722
<code>CALCulate<n>:MARKer<m>:FUNctioN:SUMMary:MEAN[:STATe]</code>	723
<code>CALCulate<n>:MARKer<m>:FUNctioN:SUMMary:MODE</code>	723
<code>CALCulate<n>:MARKer<m>:FUNctioN:SUMMary:PHOLd</code>	723
<code>CALCulate<n>:MARKer<m>:FUNctioN:SUMMary:PPEak:AVERage:RESult?</code>	724
<code>CALCulate<n>:MARKer<m>:FUNctioN:SUMMary:PPEak:PHOLd:RESult?</code>	724
<code>CALCulate<n>:MARKer<m>:FUNctioN:SUMMary:PPEak:RESult?</code>	725
<code>CALCulate<n>:MARKer<m>:FUNctioN:SUMMary:PPEak[:STATe]</code>	725
<code>CALCulate<n>:MARKer<m>:FUNctioN:SUMMary:REFerence:AUTO ONCE</code>	726
<code>CALCulate<n>:MARKer<m>:FUNctioN:SUMMary:RMS:AVERage:RESult?</code>	726
<code>CALCulate<n>:MARKer<m>:FUNctioN:SUMMary:RMS:PHOLd:RESult?</code>	727
<code>CALCulate<n>:MARKer<m>:FUNctioN:SUMMary:RMS:RESult?</code>	727
<code>CALCulate<n>:MARKer<m>:FUNctioN:SUMMary:RMS[:STATe]</code>	728
<code>CALCulate<n>:MARKer<m>:FUNctioN:SUMMary:SDEVIation:AVERage:RESult?</code>	728
<code>CALCulate<n>:MARKer<m>:FUNctioN:SUMMary:SDEVIation:PHOLd:RESult?</code>	729

CALCulate<n>:MARKer<m>:FUNction:SUMMary:SDEVIation:RESult?.....	730
CALCulate<n>:MARKer<m>:FUNction:SUMMary:SDEVIation[:STATe].....	730
CALCulate<n>:MARKer<m>:FUNction:SUMMary[:STATe].....	731

CALCulate<n>:MARKer<m>:FUNction:MSUMmary?

The commands of this subsystem are used to determine the power of a sequence of signal pulses that have the same interval in the window specified by the suffix <n>, as for example the slots of a GSM signal typically do. The number of pulses to be measured as well as the measurement time and the period can be set. To define the position of the first pulse in the trace, a suitable offset can be entered.

The evaluation is performed on the measurement data of a previously recorded trace. The data recorded during the set measurement time is combined to a measured value for each pulse according to the detector specified and the indicated number of results is output as a list.

Trace 1 is always used by the function.

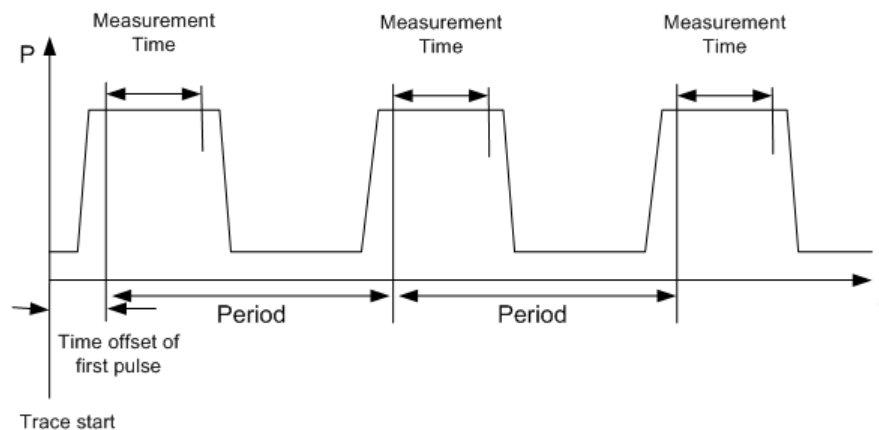

Suffix:

<n> Selects the measurement window.

<m> Selects the marker.

Return values:

<Result> <time offset of first pulse>, <measurement time>, <period>, < # of pulses to measure>

Example:	<pre>DISP:WIND:TRAC:Y:RLEV -10dBm Sets the reference level to 10 dB INP:ATT 30 dB Sets the input attenuation to 30 dB FREQ:CENT 935.2MHz;SPAN 0 Hz Sets the receive frequency to 935.2 MHz and the span to 0 Hz BAND:RES 1 MHz;VID 3 MHz Sets the resolution bandwidth to 1 MHz and the video bandwidth to 3 MHz DET RMS Sets the RMS detector TRIG:SOUR VID;LEV:VID 50 PCT Selects the trigger source VIDEO and sets the level of the video trigger source to 50 PCT SWE:TIME 50 ms Sets the sweep time to 50 ms INIT;*WAI Starts the measurement with synchronization CALC:MARK:FUNC:MSUM? 50US,450US,576.9US,8 Queries 8 bursts with an offset of 50 µs, a test time of 450 µs and a period of 576.9 µs</pre>
Usage:	Query only

CALCulate<n>:MARKer<m>:FUNCTion:SUMMery:AOff

This command turns all time domain power measurements off.

Suffix:

<n>	Selects the measurement window.
<m>	Selects the marker.

Example:	<pre>CALC:MARK:FUNC:SUMM:AOff</pre> <p>Switches off the functions for power measurement in zero span.</p>
-----------------	---

Usage:	Event
---------------	-------

CALCulate<n>:MARKer<m>:FUNCTion:SUMMery:AVERage <State>

This command turns averaging for the active power measurement in zero span on and off.

Averaging is reset by switching it off and on again.

The number of results required for the calculation of average is defined with [\[SENSe:\]AVERage<n>:COUNT](#).

To get a valid result, you have to perform a complete measurement with synchronization to the end of the measurement before reading out the result. This is only possible for single sweeps.

Suffix:	
<n>	Selects the measurement window.
<m>	Selects the marker.
Parameters:	
<State>	ON OFF
	*RST: OFF
Example:	<pre>INIT:CONT OFF Switches to single sweep mode. CALC:MARK:FUNC:SUMM:AVER ON Switches on the calculation of average. AVER:COUN 200 Sets the measurement counter to 200. INIT;*WAI Starts a sweep and waits for the end.</pre>

CALCulate<n>:MARKer<m>:FUNctioN:SUMMery:MEAN:AVERAge:RESult?

This command queries the average mean time domain power. The query is only possible if averaging has been activated previously using `CALCulate<n>:MARKer<m>:FUNctioN:SUMMery:AVERAge`.

To get a valid result, you have to perform a complete measurement with synchronization to the end of the measurement before reading out the result. This is only possible for single sweeps.

Suffix:	
<n>	Selects the measurement window.
<m>	Selects the marker.
Return values:	
<MeanPower>	Mean power of the signal during the measurement time.
Example:	<pre>INIT:CONT OFF Switches to single sweep mode. CALC:MARK:FUNC:SUMM:MEAN ON Switches on the function. CALC:MARK:FUNC:SUMM:AVER ON Switches on the average value calculation. INIT;*WAI Starts a sweep and waits for the end. CALC:MARK:FUNC:SUMM:MEAN:AVER:RES? Outputs the result.</pre>
Usage:	Query only

CALCulate<n>:MARKer<m>:FUNction:SUMMery:MEAN:PHOLd:RESult?

This command queries the maximum mean time domain power. The query is only possible if the peak hold function has been activated previously using `CALCulate<n>:MARKer<m>:FUNction:SUMMery:PHOLd`.

To get a valid result, you have to perform a complete measurement with synchronization to the end of the measurement before reading out the result. This is only possible for single sweeps.

Suffix:

<n> Selects the measurement window.

<m> Selects the marker.

Return values:

<MeanPower> Mean power of the signal during the measurement time.

Example:

```
INIT:CONT OFF
Switches to single sweep mode.
CALC:MARK:FUNC:SUMM:MEAN ON
Switches on the function.
CALC:MARK:FUNC:SUMM:PHOL ON
Switches on the peak value measurement.
INIT;*WAI
Starts a sweep and waits for the end.
CALC:MARK:FUNC:SUMM:MEAN:PHOL:RES?
Outputs the result.
```

Usage: Query only

CALCulate<n>:MARKer<m>:FUNction:SUMMery:MEAN:RESult?

This command queries the mean time domain power.

To get a valid result, you have to perform a complete measurement with synchronization to the end of the measurement before reading out the result. This is only possible for single sweeps.

Suffix:

<n> Selects the measurement window.

<m> Selects the marker.

Return values:

<MeanPower> Mean power of the signal during the measurement time.

Example:

```
INIT:CONT OFF
Switches to single sweep mode.
CALC:MARK:FUNC:SUMM:MEAN ON
Switches on the function.
INIT;*WAI
Starts a sweep and waits for the end.
CALC:MARK:FUNC:SUMM:MEAN:RES?
Outputs the result.
```

Usage: Query only
Manual operation: See "Mean" on page 356

CALCulate<n>:MARKer<m>:FUNction:SUMMery:MEAN[:STATe] <State>

This command turns the measurement of the mean time domain power on and off.

Note: The measurement is performed on the trace marker 1 is positioned. In order to evaluate another trace, marker 1 must be positioned on another trace with `CALCulate<n>:MARKer<m>:TRACe`.

Suffix:

<n> Selects the measurement window.
 <m> Selects the marker.

Parameters:

<State> ON | OFF
 *RST: OFF

Example: `CALC:MARK:FUNC:SUMM:MEAN ON`
 Switches on the function.

Manual operation: See "Mean" on page 356

CALCulate<n>:MARKer<m>:FUNction:SUMMery:MODE <Mode>

This command selects absolute or relative power measurement in zero span.

The reference power for relative measurement is defined with `CALCulate<n>:MARKer<m>:FUNction:SUMMery:REfERENCE:AUTO ONCE`. If the reference power is not defined, the value 0 dBm is used.

Suffix:

<n> Selects the measurement window.
 <m> irrelevant

Parameters:

<Mode> ABSolute | RELative
 *RST: ABSolute

Example: `CALC:MARK:FUNC:SUMM:MODE REL`
 Switches the power measurement in zero span to relative.

CALCulate<n>:MARKer<m>:FUNction:SUMMery:PHOLD <State>

This command turns the peak hold function for the active power measurement in zero span on and off.

If on, the measurement results show only the maximum power that has been measured for each sweep point.

The peak hold function is reset by switching it off and on again.

Suffix:

<n> Selects the measurement window.

<m> Selects the marker.

Parameters:

<State> ON | OFF

*RST: OFF

Example:

CALC:MARK:FUNC:SUMM:PHOL ON
Switches on the function.

CALCulate<n>:MARKer<m>:FUNction:SUMMary:PPEak:AVERage:RESult?

This command queries the average positive peak time domain power. The query is only possible if averaging has been activated previously using [CALCulate<n>:MARKer<m>:FUNction:SUMMary:AVERage](#).

To get a valid result, you have to perform a complete measurement with synchronization to the end of the measurement before reading out the result. This is only possible for single sweeps.

Suffix:

<n> Selects the measurement window.

<m> Selects the marker.

Return values:

<PeakPower> Peak power of the signal during the measurement time.

Example:

INIT:CONT OFF
Switches to single sweep mode.
CALC:MARK:FUNC:SUMM:PPE ON
Switches on the function.
CALC:MARK:FUNC:SUMM:AVER ON
Switches on the calculation of average.
INIT;*WAI
Starts a sweep and waits for the end.
CALC:MARK:FUNC:SUMM:PPE:AVER:RES?
Outputs the result.

Usage: Query only

CALCulate<n>:MARKer<m>:FUNction:SUMMary:PPEak:PHOLd:RESult?

This command queries the maximum positive peak time domain power. The query is only possible if the peak hold function has been activated previously using [CALCulate<n>:MARKer<m>:FUNction:SUMMary:PHOLd](#).

To get a valid result, you have to perform a complete measurement with synchronization to the end of the measurement before reading out the result. This is only possible for single sweeps.

Suffix:	
<n>	Selects the measurement window.
<m>	Selects the marker.
Return values:	
<PeakPower>	Peak power of the signal during the measurement time.
Example:	<pre>INIT:CONT OFF Switches to single sweep mode. CALC:MARK:FUNC:SUMM:PPE ON Switches on the function. CALC:MARK:FUNC:SUMM:PHOL ON Switches on the measurement of the peak value. INIT;*WAI Starts a sweep and waits for the end. CALC:MARK:FUNC:SUMM:PPE:PHOL:RES? Outputs the result.</pre>
Usage:	Query only

CALCulate<n>:MARKer<m>:FUNCtion:SUMMary:PPEak:RESult?

This command queries the positive peak time domain power.

To get a valid result, you have to perform a complete measurement with synchronization to the end of the measurement before reading out the result. This is only possible for single sweeps.

Suffix:	
<n>	Selects the measurement window.
<m>	Selects the marker.
Return values:	
<PeakPower>	Peak power of the signal during the measurement time.
Example:	<pre>INIT:CONT OFF Switches to single sweep mode. CALC:MARK:FUNC:SUMM:PPE ON Switches on the function. INIT;*WAI Starts a sweep and waits for the end. CALC:MARK:FUNC:SUMM:PPE:RES? Outputs the result.</pre>
Usage:	Query only
Manual operation:	See "Peak" on page 356

CALCulate<n>:MARKer<m>:FUNCtion:SUMMary:PPEak[:STATe] <State>

This command turns the measurement of the positive peak time domain power on and off.

Note: The measurement is performed on the trace marker 1 is positioned. In order to evaluate another trace, marker 1 must be positioned on another trace with `CALCulate<n>:MARKer<m>:TRACe`.

Suffix:

<n> Selects the measurement window.
 <m> Selects the marker.

Parameters:

<State> ON | OFF
 *RST: OFF

Example:

`CALC:MARK:FUNC:SUMM:PPE ON`
 Switches on the function.

Manual operation: See "Peak" on page 356

CALCulate<n>:MARKer<m>:FUNCTION:SUMMARY:REFERENCE:AUTO ONCE

This command sets the currently measured average value (`CALCulate<n>:MARKer<m>:FUNCTION:SUMMARY:MEAN[:STATE]`) and RMS value (`CALCulate<n>:MARKer<m>:FUNCTION:SUMMARY:RMS[:STATE]`) as reference values for relative measurements in zero span.

If the measurement of RMS value and average is not activated, the reference value 0 dBm is used.

If the function `CALCulate<n>:MARKer<m>:FUNCTION:SUMMARY:AVERAGE` or `CALCulate<n>:MARKer<m>:FUNCTION:SUMMARY:PHOLD` is switched on, the current value is the accumulated measurement value at the time considered.

Suffix:

<n> Selects the measurement window.
 <m> irrelevant

Example:

`CALC:MARK:FUNC:SUMM:REF:AUTO ONCE`
 Takes the currently measured power as reference value for the relative power measurement in zero span.

Usage:

Event

CALCulate<n>:MARKer<m>:FUNCTION:SUMMARY:RMS:AVERAGE:RESULT?

This command queries the average RMS time domain power. The query is only possible if averaging has been activated previously using `CALCulate<n>:MARKer<m>:FUNCTION:SUMMARY:AVERAGE`.

To get a valid result, you have to perform a complete measurement with synchronization to the end of the measurement before reading out the result. This is only possible for single sweeps.

Suffix:

<n> Selects the measurement window.

<m>	Selects the marker.
Return values:	
<RMSPower>	RMS power of the signal during the measurement time.
Example:	<pre>INIT:CONT OFF Switches to single sweep mode. CALC:MARK:FUNC:SUMM:RMS ON Switches on the function. CALC:MARK:FUNC:SUMM:AVER ON Switches on the average value calculation. INIT;*WAI Starts a sweep and waits for the end. CALC:MARK:FUNC:SUMM:RMS:AVER:RES? Outputs the result.</pre>
Usage:	Query only

CALCulate<n>:MARKer<m>:FUNction:SUMMary:RMS:PHOLd:RESult?

This command queries the maximum RMS time domain power. The query is only possible if the peak hold function has been activated previously using [CALCulate<n>:MARKer<m>:FUNction:SUMMary:PHOLd](#).

To get a valid result, you have to perform a complete measurement with synchronization to the end of the measurement before reading out the result. This is only possible for single sweeps.

Suffix:	
<n>	Selects the measurement window.
<m>	Selects the marker.
Return values:	
<RMSPower>	RMS power of the signal during the measurement time.
Example:	<pre>INIT:CONT OFF Switches to single sweep mode. CALC:MARK:FUNC:SUMM:RMS ON Switches on the function. CALC:MARK:FUNC:SUMM:PHOL ON Switches on the peak value measurement. INIT;*WAI Starts a sweep and waits for the end. CALC:MARK:FUNC:SUMM:RMS:PHOL:RES? Outputs the result.</pre>
Usage:	Query only

CALCulate<n>:MARKer<m>:FUNction:SUMMary:RMS:RESult?

This command queries the RMS time domain power.

To get a valid result, you have to perform a complete measurement with synchronization to the end of the measurement before reading out the result. This is only possible for single sweeps.

Suffix:

<n> Selects the measurement window.
 <m> Selects the marker.

Return values:

<RMSPower> RMS power of the signal during the measurement time.

Example:

```
INIT:CONT OFF
Switches to single sweep mode.
CALC:MARK:FUNC:SUMM:RMS ON
Switches on the function.
INIT;*WAI
Starts a sweep and waits for the end.
CALC:MARK:FUNC:SUMM:RMS:RES?
Outputs the result.
```

Usage: Query only

Manual operation: See "RMS" on page 356

CALCulate<n>:MARKer<m>:FUNCTION:SUMMARY:RMS[:STATe] <State>

This command turns the measurement of the RMS time domain power on and off.

Note: The measurement is performed on the trace marker 1 is positioned. In order to evaluate another trace, marker 1 must be positioned on another trace with [CALCulate<n>:MARKer<m>:TRACe](#).

Suffix:

<n> Selects the measurement window.
 <m> Selects the marker.

Parameters:

<State> ON | OFF
 *RST: OFF

Example:

```
CALC:MARK:FUNC:SUM:RMS ON
Switches on the function.
```

Manual operation: See "RMS" on page 356

CALCulate<n>:MARKer<m>:FUNCTION:SUMMARY:SDEVIation:AVERage:RESult?

This command queries the average standard deviation of the time domain power. The query is only possible if averaging has been activated previously using [CALCulate<n>:MARKer<m>:FUNCTION:SUMMARY:AVERage](#).

To get a valid result, you have to perform a complete measurement with synchronization to the end of the measurement before reading out the result. This is only possible for single sweeps.

Suffix:

<n> Selects the measurement window.
 <m> Selects the marker.

Return values:

<StandardDeviation> Standard deviation of the signal during the measurement time.

Example:

```
INIT:CONT OFF
Switches to single sweep mode.
CALC:MARK:FUNC:SUMM:SDEV ON
Switches on the function.
CALC:MARK:FUNC:SUMM:AVER ON
Switches on the calculation of average.
INIT;*WAI
Starts a sweep and waits for the end.
CALC:MARK:FUNC:SUMM:MEAN:SDEV:RES?
Outputs the result.
```

Usage: Query only

CALCulate<n>:MARKer<m>:FUNCTion:SUMMery:SDEViation:PHOLd:RESult?

This command queries the maximum standard deviation of the time domain power. The query is only possible if the peak hold function has been activated previously using [CALCulate<n>:MARKer<m>:FUNCTion:SUMMery:PHOLd](#).

To get a valid result, you have to perform a complete measurement with synchronization to the end of the measurement before reading out the result. This is only possible for single sweeps.

Suffix:

<n> Selects the measurement window.
 <m> Selects the marker.

Return values:

<StandardDeviation> Standard deviation of the signal during the measurement time.

Example:

```
INIT:CONT OFF
Switches to single sweep mode.
CALC:MARK:FUNC:SUMM:SDEV ON
Switches on the function.
CALC:MARK:FUNC:SUMM:PHOL ON
Switches on the peak value measurement.
INIT;*WAI
Starts a sweep and waits for the end.
CALC:MARK:FUNC:SUMM:SDEV:PHOL:RES?
Outputs the result.
```

Usage: Query only

CALCulate<n>:MARKer<m>:FUNction:SUMMary:SDEViation:RESult?

This command queries the standard deviation of the time domain power.

To get a valid result, you have to perform a complete measurement with synchronization to the end of the measurement before reading out the result. This is only possible for single sweeps.

Suffix:

<n> Selects the measurement window.
 <m> Selects the marker.

Return values:

<StandardDeviation> Standard deviation of the signal during the measurement time.

Example:

```
INIT:CONT OFF
Switches to single sweep mode.
CALC:MARK:FUNC:SUMM:SDEV ON
Switches on the function.
INIT;*WAI
Starts a sweep and waits for the end.
CALC:MARK:FUNC:SUMM:SDEV:RES?
Outputs the result.
```

Usage: Query only

Manual operation: See "[Std Dev](#)" on page 356

CALCulate<n>:MARKer<m>:FUNction:SUMMary:SDEViation[:STATe] <State>

This command turns the measurement of the standard deviation of the time domain power on and off.

Note: The measurement is performed on the trace marker 1 is positioned. In order to evaluate another trace, marker 1 must be positioned on another trace with [CALCulate<n>:MARKer<m>:TRACe](#).

Suffix:

<n> Selects the measurement window.
 <m> Selects the marker.

Parameters:

<State> ON | OFF
 *RST: OFF

Example:

```
CALC:MARK:FUNC:SUMM:SDEV ON
Switches on the measurement of the standard deviation.
```

Manual operation: See "[Std Dev](#)" on page 356

CALCulate<n>:MARKer<m>:FUNCTION:SUMMARY[:STATe] <State>

This command turns time domain power measurements on and off. This measurement is only available in zero span.

Thus one or several measurements can be first selected and then switched on and off together using this command.

Suffix:

<n> Selects the measurement window.
 <m> Selects the marker.

Parameters:

<State> ON | OFF
 *RST: OFF

Example: CALC:MARK:FUNC:SUMM:STAT ON

Manual operation: See ["Time Domain Power \(zero span\)"](#) on page 282
 See ["Time Domain Power"](#) on page 356

CALCulate:MATH Subsystem

The CALCulate:MATH subsystem allows data from the SENSE-subsystem to be processed in numeric expressions.

CALCulate<n>:MATH[:EXPRESSION][:DEFine]	731
CALCulate<n>:MATH:POSition	732
CALCulate<n>:MATH:STATe	732
CALCulate<n>:MATH:MODE	732

CALCulate<n>:MATH[:EXPRESSION][:DEFine] <Expression>

This command defines the mathematical expression for relating traces to trace1.

Suffix:

<n> irrelevant

Parameters:

<Expression> (TRACe1-TRACe2) | (TRACe1-TRACe3) | (TRACe1-TRACe4) |
 (TRACe1-TRACe5) | (TRACe1-TRACe6)
(TRACe1-TRACe2)
 Subtracts trace 2 from trace 1.
(TRACe1-TRACe3)
 Subtracts trace 3 from trace 1.
(TRACe1-TRACe4)
 Subtracts trace 4 from trace 1.
(TRACe1-TRACe5)
 Subtracts trace 5 from trace 1.
(TRACe1-TRACe6)
 Subtracts trace 6 from trace 1.

Example: `CALC1:MATH (TRACe1 - TRACe2)`
 Selects the subtraction of trace 2 from trace 1.

Manual operation: See ["Trace Math"](#) on page 227

CALCulate<n>:MATH:POSition <Position>

This command defines the position of the result of the trace mathematics. The indication is in % of the screen height, with 100 % corresponding to the upper diagram border.

Suffix:
 <n> Selects the measurement window.

Parameters:
 <Position> -100PCT to 200PCT
 *RST: 50PCT

Example: `CALC:MATH:POS 50PCT`
 Sets the position to the horizontal diagram center.

Manual operation: See ["Trace Math Position"](#) on page 228

CALCulate<n>:MATH:STATe <State>

This command switches the mathematical relation of traces on or off.

Suffix:
 <n> irrelevant

Parameters:
 <State> ON | OFF
 *RST: OFF

Example: `CALC:MATH:STAT ON`
 Switches on the trace mathematics.

Manual operation: See ["Trace Math"](#) on page 227
 See ["Trace Math Off"](#) on page 228

CALCulate<n>:MATH:MODE <Method>

This command selects the method for the trace math calculations.

For details see ["Trace Math Mode"](#) on page 227.

Suffix:
 <n> irrelevant

Parameters:
 <Method> LINear | LOGarithmic | POWer
 *RST: LOG

Example: `CALC:MATH:MODE LIN`
Selects linear averaging for trace math calculations.

Manual operation: See "Lin" on page 228
See "Log" on page 228
See "Power" on page 228

CALCulate:PMETer Subsystem (Power Sensor, R&S FSV-K9)

This subsystem controls the instrument settings for power sensor measurements. It is only available if the R&S FSV-K9 Power Sensor option is installed.

For details see [Chapter 5.9, "Instrument Functions - Power Sensor \(R&S FSV-K9\)"](#), on page 509.

CALCulate<n>:PMETer<p>:RELative[:MAGNitude].....	733
CALCulate<n>:PMETer<p>:RELative[:MAGNitude]:AUTO ONCE.....	733
CALCulate<n>:PMETer<p>:RELative:STATe.....	734

CALCulate<n>:PMETer<p>:RELative[:MAGNitude] <Value>

This command sets the reference value for relative measurements for the selected power sensor.

Suffix:

<n>	irrelevant
<p>	1...4 Power sensor index

Parameters:

<Value>	-200 to 200
*RST:	0

Example: `CALC:PMET2:REL -30`
Sets the reference value for relative measurements to -30 dBm for power sensor 2.

Mode: PSM

Manual operation: See "Reference Value" on page 520

CALCulate<n>:PMETer<p>:RELative[:MAGNitude]:AUTO ONCE

This command takes the current measurement value as reference value for relative measurements for the selected power sensor.

Suffix:

<n>	irrelevant
<p>	1...4 Power sensor index

Example:	<code>CALC:PMET2:REL:AUTO ONCE</code> Takes the current measurement value as reference value for relative measurements for power sensor 2.
Mode:	PSM
Manual operation:	See " Meas -> Ref " on page 519

CALCulate<n>:PMETer<p>:RELative:STATe <State>

This command switches between relative and absolute display of the measured power for the selected power sensor.

Suffix:

<n>	irrelevant
<p>	1...4 Power sensor index

Parameters:

<State>	ON OFF
*RST:	OFF

Example:	<code>CALC:PMET2:REL:STAT ON</code> Activates the relative display of the measured value for power sensor 2.
-----------------	---

Mode:	PSM
--------------	-----

CALCulate:PSEarch|PEAKsearch Subsystem

The CALCulate:PSEarch|PEAKsearch subsystem contains the remote commands for Spurious Emissions measurements. Both groups of commands (PSEarch and PEAKsearch) perform the same functions.

CALCulate<n>:PEAKsearch PSEarch[:IMMEDIATE]	734
CALCulate<n>:PEAKsearch PSEarch:AUTO	735
CALCulate<n>:PEAKsearch PSEarch:MARGIN	735
CALCulate<n>:PEAKsearch PSEarch:PSHOW	735
CALCulate<n>:PEAKsearch PSEarch:SUBRANGES	736

CALCulate<n>:PEAKsearch|PSEarch[:IMMEDIATE]

This command switches the spurious limit check off.

If you want to read out the values peak values including the delta to a limit, you have to switch on the limit again.

This command is only for FSP compatibility, and not necessary to use on the R&S FSVA/FSV.

Suffix:

<n>	irrelevant
-----	------------

Example: `CALC:PSE`
Starts to determine the list.

CALCulate<n>:PEAKsearch|PSEarch:AUTO <State>

This command activates or deactivates the list evaluation.

Suffix:
<n> Selects the measurement window.

Parameters:
<State> `ON | OFF`
*RST: `ON`

Example: `CALC:ESP:PSE:AUTO OFF`
Deactivates the list evaluation.

Manual operation: See "[List Evaluation \(On/Off\)](#)" on page 323
See "[List Evaluation \(On/Off\)](#)" on page 353

CALCulate<n>:PEAKsearch|PSEarch:MARGIN <Margin>

This command sets the margin used for the limit check/peak search.

Suffix:
<n> Selects the measurement window.

Parameters:
<Margin> `-200 to 200 dB`
*RST: `200 dB`

Example: `CALC:ESP:PSE:MARG 100`
Sets the margin to 100 dB.

Manual operation: See "[Margin](#)" on page 323
See "[Margin](#)" on page 353

CALCulate<n>:PEAKsearch|PSEarch:PSHOW

This command marks all peaks with blue squares in the diagram.

Suffix:
<n> Selects the measurement window.

Parameters:
<State> `ON | OFF`
*RST: `OFF`

Example: `CALC:ESP:PSE:PSH ON`
Marks all peaks with blue squares.

Manual operation: See "[Show Peaks](#)" on page 353

CALCulate<n>:PEAKsearch|PSEarch:SUBRanges <NumberPeaks>

This command sets the number of peaks per range that are stored in the list. Once the selected number of peaks has been reached, the peak search is stopped in the current range and continued in the next range.

Suffix:

<n> irrelevant

Parameters:

<NumberPeaks> 1 to 50
*RST: 25

Example:

CALC:PSE:SUBR 10
Sets 10 peaks per range to be stored in the list.

Manual operation: See "[Peaks per Range](#)" on page 353

CALCulate:SGRam Subsystem

These commands are only available if the "Spectrogram" measurements option R&S FSV-K14 is installed.

CALCulate<n>:SGRam:CLEAr[:IMMediate].....	736
CALCulate<n>:SGRam:COLor.....	736
CALCulate<n>:SGRam:CONT.....	737
CALCulate<n>:SGRam:FRAMe:COUNt.....	737
CALCulate<n>:SGRam:FRAMe:SElect.....	738
CALCulate<n>:SGRam:HDEPth.....	738
CALCulate<n>:SGRam[:STATe].....	739
CALCulate<n>:SGRam:TSTamp[:STATe].....	739
CALCulate<n>:SGRam:TSTamp:DATA?.....	740

CALCulate<n>:SGRam:CLEAr[:IMMediate]

This command resets the Spectrogram result display and clears the history buffer.

Suffix:

<n> 1...4
Selects the measurement window.

Example:

CALC:SGR:CLE
Resets the result display and clears the memory.

Usage:

Event

Manual operation:

See "[Spectrogram Clear](#)" on page 219
See "[Clear Spectrogram](#)" on page 527

CALCulate<n>:SGRam:COLor <Color>

This command selects the color scheme of the spectrogram result display.

This command is available for R&S FSV-K14 only. To define the color scheme in the spectrogram of the realtime analyzer, use `DISPlay:WINDow:SGRam:COLor[:STYLE]` on page 758.

Suffix:

<n> 1...4
Selects the measurement window.

Parameters:

<Color> **COLor**
RGB colors
RADar
black - green - white
GRAYscale
black and white
*RST: COLor

Example:

`CALC:SGR:COL GRAY`
Selects black and white color scheme.

Manual operation: See "[Color Mapping](#)" on page 527

CALCulate<n>:SGRam:CONT <State>

This command determines whether the results of the last measurement are deleted before starting a new measurement in single sweep mode.

Suffix:

<n> 1...4
Selects the measurement window.

Parameters:

<State> **ON | OFF**
*RST: OFF

Example:

`INIT:CONT OFF`
Selects single sweep mode.
`INIT;*WAI`
Starts the sweep and waits for the end of the sweep.
`CALC:SGR:CONT ON`
Repeats the single sweep measurement without deleting the results of the last measurement.

Manual operation: See "[Continue Frame \(On Off\)](#)" on page 218

CALCulate<n>:SGRam:FRAME:COUNT <Frames>

This command sets the number of frames to be recorded in a single sweep.

Suffix:

<n> 1...4
Selects the measurement window.

Parameters:

<Frames> The maximum number of frames depends on the `.CALCulate<n>:SGRam:HDEPth` on page 738

Range: 1 to depends on history depth
 Increment: 1
 *RST: 1

Example:

```
INIT:CONT OFF
Selects single sweep mode.
CALC:SGR:FRAM:COUN 200
Sets the number of frames to 200.
```

Manual operation: See "[Frame Count](#)" on page 218

CALCulate<n>:SGRam:FRAM:SElect <Frame>

This command selects a specific frame for further analysis. The command is available only if no measurement is running or after a single sweep has ended.

Suffix:

<n> 1...4
 Selects the measurement window.

Parameters:

<Frame> **<frame_number> (if time stamp is off)**
 Selects the frame. The range is {0...number of recorded frames-1}

<time> (if time stamp is on)
 Time distance in seconds. It selects the frame that is x seconds away from frame 0.

Example:

```
INIT:CONT OFF
Stop the continuous sweep.
CALC:SGR:FRAM:SEL -25
Selects frame number -25.
```

Manual operation: See "[Select Frame](#)" on page 218

CALCulate<n>:SGRam:HDEPth <HistoryDepth>

This command sets the number of frames to be stored in the R&S FSVA/FSV's memory.

Suffix:

<n> 1...4
 Selects the measurement window.

Parameters:

<HistoryDepth> The maximum number of frames depends on the number of sweep points.

Range: 781 to 20000

Increment: 1

*RST: 3000

Example:

CALC:SGR:HDEP 1500

Sets the history depth to 1500.

Manual operation:

See ["Frame Count"](#) on page 218

See ["History Depth"](#) on page 526

CALCulate<n>:SGRam[:STATe] <State>

This command turns the spectrogram result display on and off.

Suffix:

<n> 1...4

Selects the measurement window.

Parameters:

<State> **ON | OFF**

*RST: OFF

Example:

CALC:SGR ON

Activates the Spectrogram result display.

Manual operation:

See ["Spectrogram \(On Off\)"](#) on page 526

CALCulate<n>:SGRam:TSTamp[:STATe] <State>

This command activates and deactivates the time stamp.

If the time stamp is active, some commands do not address frames as numbers, but as (relative) time values:

- [CALCulate<n>:DELTaMarker<m>:SGRam:FRAMe](#) on page 630
- [CALCulate<n>:MARKer<m>:SGRam:FRAMe](#) on page 710
- [CALCulate<n>:SGRam:FRAMe:SElect](#) on page 738

Suffix:

<n> 1...4

Selects the measurement window.

Parameters:

<State> **ON | OFF**

*RST: OFF

Example:

CALC:SGR:TST ON

Activates the time stamp.

Manual operation:

See ["Time Stamp \(On Off\)"](#) on page 527

CALCulate<n>:SGRam:TSTamp:DATA? <Mode>

This command queries the time stamp of the frames.

All available frame results are returned via the `TRACe<n> [:DATA] ?` command.

Suffix:

<n> 1...4
Selects the measurement window.

Query parameters:

<Mode>

CURRent

Returns the time stamp of the current frame.

ALL

Returns the time stamps of all frames. The result are sorted in descending order, beginning with the current frame.

Return values:

<TimeStamp>

The return values consist of four values for each frame. The first value is the date of the measurement in seconds that have passed since 01.01.1970 in seconds. For a better resolution the second value shows the additional milliseconds. This value is also displayed on screen. These numbers are appropriate for relative uses, but you can also calculate the absolute date and time as displayed on the screen. The third and fourth value are reserved for future uses. If the Spectrogram is empty, the command returns '0,0,0,0'

Example:

```
CALC:SGR:TST ON
```

Activates the time stamp.

```
CALC:SGR:TST:DATA? ALL
```

Returns the time stamp of all frames sorted in a descending order.

Usage:

Query only

CALCulate:STATistics Subsystem

The `CALCulate:STATistics` subsystem controls the statistical measurement functions in the instrument.

<code>CALCulate<n>:STATistics:APD[:STATe]</code>	741
<code>CALCulate<n>:STATistics:CCDF[:STATe]</code>	741
<code>CALCulate<n>:STATistics:CCDF:X<Trace></code>	741
<code>CALCulate<n>:STATistics:NSAMples</code>	742
<code>CALCulate<n>:STATistics:PRESet</code>	742
<code>CALCulate<n>:STATistics:RESult<Trace></code>	743
<code>CALCulate<n>:STATistics:SCALE:AUTO ONCE</code>	743
<code>CALCulate<n>:STATistics:SCALE:X:RANGe</code>	744
<code>CALCulate<n>:STATistics:SCALE:X:RLEVel</code>	744

CALCulate<n>:STATistics:SCALE:Y:LOWer.....	744
CALCulate<n>:STATistics:SCALE:Y:UNIT.....	745
CALCulate<n>:STATistics:SCALE:Y:UPPer.....	745

CALCulate<n>:STATistics:APD[:STATe] <State>

This command switches on or off the measurement of amplitude distribution (APD). On activating this function, the CCDF measurement is switched off.

Suffix:

<n> irrelevant

Parameters:

<State> ON | OFF
*RST: OFF

Example:

CALC:STAT:APD ON
Switches on the APD measurement.

Manual operation: See "APD" on page 282
See "APD" on page 361

CALCulate<n>:STATistics:CCDF[:STATe] <State>

This command switches on or off the measurement of the complementary cumulative distribution function (CCDF). On activating this function, the APD measurement is switched off.

Suffix:

<n> irrelevant

Parameters:

<State> ON | OFF
*RST: OFF

Example:

CALC:STAT:CCDF ON
Switches on the CCDF measurement.

Manual operation: See "CCDF" on page 283
See "CCDF" on page 366

CALCulate<n>:STATistics:CCDF:X<Trace> <Probability>

This command queries the results of the complementary cumulative distribution function (CCDF) for the specified probability (corresponding to the "Percent Marker" in the display, see "Percent Marker" on page 367). The suffix of X defines the trace number.

Suffix:

<n> irrelevant

<Trace> 1...6
trace

Parameters:

<Probability> P0_01: Level value for 0.01 % probability
 P0_1: Level value for 0.1 % probability
 P1: Level value for 1 % probability
 P10: Level value for 10 % probability

Example:

CALC:STAT:CCDF:X1? P10

Returns the level values that are over 10 % above the mean value.

Manual operation: See "[CCDF](#)" on page 366

CALCulate<n>:STATistics:NSAMples <NoMeasPoints>

This command sets the number of measurement points to be acquired for the statistical measurement functions.

Suffix:

<n> irrelevant

Parameters:

<NoMeasPoints> 100 to 1E9
 *RST: 100000

Example:

CALC:STAT:NSAM 500

Sets the number of measurement points to be acquired to 500.

Manual operation: See "[# of Samples](#)" on page 362

CALCulate<n>:STATistics:PRESet

This command resets the scaling of the X and Y axes in a statistical measurement. The following values are set:

x-axis ref level:	-20 dBm
x-axis range APD:	100 dB
x-axis range CCDF:	20 dB
y-axis upper limit:	1.0
y-axis lower limit:	1E-6

Suffix:

<n> irrelevant

Example:

CALC:STAT:PRESet

Resets the scaling for statistical functions

Manual operation: See "[Default Settings](#)" on page 364

CALCulate<n>:STATistics:RESult<Trace> <ResultType>

This command reads out the results of statistical measurements of a recorded trace.

Suffix:

<n>	irrelevant
<Trace>	1...6 trace

Parameters:

<ResultType> MEAN | PEAK | CFACTor | ALL

MEAN

Average (=RMS) power in dBm measured during the measurement time.

PEAK

Peak power in dBm measured during the measurement time.

CFACTor

Determined CREST factor (= ratio of peak power to average power) in dB.

ALL

Results of all three measurements mentioned before, separated by commas: <mean power>,<peak power>,<crest factor>

The required result is selected via the following parameters:

Example:

```
CALC:STAT:RES2? ALL
```

Reads out the three measurement results of trace 2. Example of answer string: 5.56,19.25,13.69 i.e. mean power: 5.56 dBm, peak power 19.25 dBm, CREST factor 13.69 dB

CALCulate<n>:STATistics:SCALe:AUTO ONCE

This command optimizes the level setting of the instrument depending on the measured peak power, in order to obtain maximum instrument sensitivity.

To obtain maximum resolution, the level range is set as a function of the measured spacing between peak power and the minimum power for the APD measurement and of the spacing between peak power and mean power for the CCDF measurement. In addition, the probability scale for the number of test points is adapted.

Subsequent commands have to be synchronized with *WAI, *OPC or *OPC? to the end of the auto range process which would otherwise be aborted.

Suffix:

<n>	irrelevant
-----	------------

Example:

```
CALC:STAT:SCAL:AUTO ONCE; *WAI
```

Adapts the level setting for statistical measurements.

Manual operation: See "[Adjust Settings](#)" on page 365

CALCulate<n>:STATistics:SCALe:X:RANGe <Value>

This command defines the level range for the x-axis of the measurement diagram. The setting is identical to the level range setting defined with the `DISPlay[:WINDow<n>]:TRACe<t>:Y[:SCALe]` command.

Suffix:

<n> irrelevant

Parameters:

<Value> 10dB to 200dB
*RST: 100dB

Example: `CALC:STAT:SCAL:X:RANG 20dB`

Manual operation: See "[x-Axis Range](#)" on page 362

CALCulate<n>:STATistics:SCALe:X:RLEVel <Value>

This command defines the reference level for the x-axis of the measurement diagram. The setting is identical to the reference level setting using the `DISPlay[:WINDow<n>]:TRACe<t>:Y[:SCALe]:RLEVel` command.

With the reference level offset <> 0 the indicated value range of the reference level is modified by the offset.

The unit depends on the setting performed with `CALCulate<n>:UNIT:POWer`.

Suffix:

<n> irrelevant

Parameters:

<Value> -120dBm to 20dBm
*RST: -20dBm

Example: `CALC:STAT:SCAL:X:RLEV -60dBm`

Manual operation: See "[x-Axis Ref Level](#)" on page 362

CALCulate<n>:STATistics:SCALe:Y:LOWer <Value>

This command defines the lower limit for the y-axis of the diagram in statistical measurements. Since probabilities are specified on the y-axis, the entered numeric values are dimensionless.

Suffix:

<n> selects the screen

Parameters:

<Value> 1E-9 to 0.1
*RST: 1E-6

Example: `CALC:STAT:SCAL:Y:LOW 0.001`

Manual operation: See "[y-Axis Min Value](#)" on page 364

CALCulate<n>:STATistics:SCALe:Y:UNIT <Unit>

This command defines the scaling type of the y-axis.

Suffix:

<n> selects the screen

Parameters:

<Unit> PCT | ABS

*RST: ABS

Example:

CALC:STAT:SCAL:Y:UNIT PCT

Sets the percentage scale.

Manual operation: See "y-Unit % / Abs" on page 364

CALCulate<n>:STATistics:SCALe:Y:UPPer <Value>

This command defines the upper limit for the y-axis of the diagram in statistical measurements. Since probabilities are specified on the y-axis, the entered numeric values are dimensionless.

Suffix:

<n> irrelevant

Parameters:

<Value> 1E-8 to 1.0

*RST: 1.0

Example:

CALC:STAT:SCAL:Y:UPP 0.01

Manual operation: See "y-Axis Max Value" on page 364

CALCulate:THReshold Subsystem

The CALCulate:THReshold subsystem controls the threshold value for the maximum/minimum search of markers.

[CALCulate<n>:THReshold.....](#) 745

[CALCulate<n>:THReshold:STATe.....](#) 746

CALCulate<n>:THReshold <Threshold>

This command defines a threshold value for the marker peak search.

A threshold line is automatically turned on.

Suffix:

<n> irrelevant

Parameters:

<Threshold> The unit depends on [CALCulate<n>:UNIT:POWer](#).

*RST: (STATe to OFF)

Example: `CALC:THR -82DBM`
Sets the threshold value to -82 dBm.

Manual operation: See ["Threshold"](#) on page 264

CALCulate<n>:THReshold:STATe <State>

This command turns the threshold line for the marker peak search on and off.

Suffix:
<n> irrelevant

Parameters:
<State> ON | OFF
*RST: OFF

Example: `CALC:THR:STAT ON`
Switches on the threshold line.

Manual operation: See ["Threshold"](#) on page 264
See ["Search Lim Off"](#) on page 274

CALCulate:TLINe Subsystem

The CALCulate:TLINe subsystem defines the position of the time lines.

[CALCulate<n>:TLINe<Line>](#)..... 746
[CALCulate<n>:TLINe<Line>:STATe](#)..... 746

CALCulate<n>:TLINe<Line> <Time>

This command defines the position of a time line.

Suffix:
<n> irrelevant
<Line> 1 | 2
Selects the time line.

Parameters:
<Time> Range: 0 to 30000000000
*RST: (STATe to OFF)
Default unit: s

Example: `CALC:TLIN 10ms`

Manual operation: See ["Time Line 1 / Time Line 2"](#) on page 391

CALCulate<n>:TLINe<Line>:STATe <State>

This command turns a time line on and off.

Suffix:
<n> irrelevant

<Line> 1 | 2
Selects the time line.

Parameters:

<State> ON | OFF
*RST: OFF

Example: CALC:TLIN2:STAT ON

Manual operation: See "Time Line 1 / Time Line 2" on page 391

CALCulate:UNIT Subsystem

The CALCulate:UNIT subsystem defines the units for the parameters that can be set and the measurement results.

CALCulate<n>:UNIT:POWER <Unit>

This command selects the unit of the y-axis.

The unit applies to all measurement windows.

Suffix:

<n> irrelevant

Parameters:

<Unit> DBM | V | A | W | DBPW | WATT | DBUV | DBMV | VOLT |
DBUA | AMPere
*RST: dBm

Example: CALC:UNIT:POW DBM
Sets the power unit to dBm.

Manual operation: See "Unit" on page 195

Other commands in the Calculate subsystem**CALCulate<n>:FORMat <Format>**

This command defines the display type of the IQ data.

Suffix:

<n> irrelevant

Parameters:

<Format> **RIMag**
IQ data
MAGNitude
Magnitude
FREQuency
Spectrum
VECTor
IQ-Vector

Manual operation: See "I/Q Analyzer" on page 413
See "Display Config" on page 418

6.3.3.3 CALibration:PMETer Subsystem (Power Sensor, R&S FSV-K9)

The CALibration:PMETer Subsystem determines the error correction data for measurements in the power meter mode. It is only available if the R&S FSV-K9 Power Sensor option is installed.

For details see Chapter 5.9, "Instrument Functions - Power Sensor (R&S FSV-K9)", on page 509.

CALibration:PMETer<p>:ZERO:AUTO ONCE..... 748

CALibration:PMETer<p>:ZERO:AUTO ONCE

This command starts zeroing of the selected power sensor.

Note: Before starting the zeroing process disconnect all signals from the input of the power sensor.

Suffix:

<p> 1...4
Power sensor index

Example:

CAL:PMET2:ZERO:AUTO ONCE;*WAI

Starts zeroing the power sensor 2 and delays the execution of further commands until zeroing is concluded.

Mode: PSM

Manual operation: See "Zeroing Power Sensor" on page 518

6.3.3.4 DISPlay Subsystem

The DISPlay subsystem controls the selection and presentation of textual and graphic information as well as of measurement data on the display.



Some applications offer up to four measurement windows. For those, the suffix <1...4> for WINDow selects the measurement window. For all other applications, the suffix is irrelevant.

DISPlay:MTABLE.....	749
DISPlay[:WINDow<n>][:SUBWindow<m>]:SIZE.....	749
DISPlay[:WINDow<n>][:SUBWindow<m>]:SElect.....	750
DISPlay[:WINDow<n>]:TRACe<t>[:STATe].....	750
DISPlay[:WINDow<n>]:TRACe<t>:MODE.....	751
DISPlay[:WINDow<n>]:TRACe<t>:MODE:HCONtinuous.....	752
DISPlay[:WINDow<n>]:TRACe<t>:X:SPACing.....	752
DISPlay[:WINDow<n>]:TRACe<t>:Y:SPACing.....	753
DISPlay[:WINDow<n>]:TRACe<t>:Y[:SCALE].....	753
DISPlay[:WINDow<n>]:TRACe<t>:Y[:SCALE]:MODE.....	754

DISPlay[:WINDow<n>]:TRACe<t>:Y[:SCALe]:RLEVel.....	754
DISPlay[:WINDow<n>]:TRACe<t>:Y[:SCALe]:RLEVel:OFFSet.....	755
DISPlay[:WINDow<n>]:TRACe<t>:Y[:SCALe]:RPOSition.....	755
DISPlay[:WINDow<n>]:TRACe<t>:Y[:SCALe]:RVALue.....	755
DISPlay[:WINDow<n>]:ZOOM:AREA.....	756
DISPlay[:WINDow<n>]:ZOOM:STATe.....	756

DISPlay:MTABLE <DisplayMode>

This command turns the marker table on and off.

Parameters:

<DisplayMode>	ON Marker table is displayed.
	OFF Marker table is not displayed.
	AUTO Marker table is only displayed if 2 or more markers are active.
*RST:	AUTO

Example:

To activate the table display:

```
DISP:MTAB ON
```

To query the current state of the marker table display:

```
DISP:MTAB?
```

Manual operation: See "[Marker Table](#)" on page 252

DISPlay[:WINDow<n>][:SUBWindow<m>]:SIZE <Size>

This command configures the measurement display.

Suffix:

<n>	1 2 window; Channel and adjacent-channel power measurements: Only "1" is allowed as a suffix for the window. Spectrum Emission Mask and Spurious Emissions measurements: selects the window that is displayed in full size (if no suffix is defined, "1" is used): 1: diagram/result list 2: marker table
<m>	1 2 selects the item in the window to be displayed in full size: 1: diagram 2: result list

Parameters:

<Size>	LARGE SMALL
--------	---------------

LARGE

Channel and adjacent-channel power measurements: diagram in full screen.

Spectrum Emission Mask and Spurious Emissions measurements: diagram or list in full screen, depending on the value of the suffix.

SMALI

split screen (diagram and list and table)

*RST: SMALI

Example:

DISP:SIZE LARG

Displays the measurement diagram in full screen size.

DISP:WIND1:SUBW2:SIZE LARG

Displays the result list in full screen size.

DISP:WIND2:SIZE LARG

Displays the marker table in full screen size.

Mode:

all

DISPlay[:WINDow<n>][:SUBWindow<m>]:SElect

This command selects which window (screen) is active for applications with more than one measurement window. For measurements with additional subwindows (e.g. SEM, ACLR), the subwindow can also be selected.

Suffix:

<n> 1...4

window; For applications that do not have more than 1 measurement window, the suffix <n> is irrelevant.

<m> 1...2

1: graphic

2: table

For applications that do not have subwindows, the suffix <m> is irrelevant.

Example:

DISP:WIND1:SEL

Sets the window 1 active.

DISP:WIND1:SUBW2:SEL

Sets the focus on the table of window 1.

DISPlay[:WINDow<n>]:TRACe<t>[:STATe] <State>

This command switches on or off the display of the corresponding trace. The other measurements are not aborted but continue running in the background.

Suffix:

<n> window; For applications that do not have more than 1 measurement window, the suffix <n> is irrelevant.

<t> trace

Parameters:

<State> ON | OFF
 *RST: ON for TRACe1, OFF for TRACe2 to 6

Example: DISP:TRAC3 ON

Manual operation: See "Blank" on page 222

DISPlay[:WINDow<n>]:TRACe<t>:MODE <Mode>

This command defines the type of display and the evaluation of the traces. WRITE corresponds to the Clr/Write mode of manual operation. The trace is switched off (= BLANK in manual operation) with `DISPlay[:WINDow<n>]:TRACe<t>[:STATe]`.

The number of measurements for AVERage, MAXHold and MINHold is defined with the `[SENSe:]AVERage<n>:COUNT` or `[SENSe:]SWEep:COUNT` commands. It should be noted that synchronization to the end of the indicated number of measurements is only possible in single sweep mode.

If calculation of average values is active, selection between logarithmic and linear averaging is possible. For more detail see `[SENSe:]AVERage<n>:TYPE` on page 785.

Suffix:

<n> window; For applications that do not have more than 1 measurement window, the suffix <n> is irrelevant.
 <t> trace

Parameters:

<Mode> WRITe | VIEW | AVERage | MAXHold | MINHold | BLANK
 *RST: WRITe for TRACe1, STATe OFF for TRACe2/3/4/5/6
 For details on trace modes refer to [Chapter 5.2.8.4, "Trace Mode Overview"](#), on page 231.

Example:

```
INIT:CONT OFF
Switching to single sweep mode.
SWE:COUN 16
Sets the number of measurements to 16.
DISP:TRAC3:MODE MAXH
Switches on the calculation of the maximum peak for trace 3.
INIT;*WAI
Starts the measurement and waits for the end of the 16 sweeps.
```

Manual operation: See "Clear Write" on page 221
 See "Max Hold" on page 221
 See "Min Hold" on page 221
 See "Average" on page 222
 See "View" on page 222

DISPlay[:WINDow<n>]:TRACe<t>:MODE:HCONtinuous <State>

This command defines whether traces in Min Hold, Max Hold and Average mode (see [DISPlay\[:WINDow<n>\]:TRACe<t>:MODE](#) on page 751) are reset after a parameter is changed.

Normally, the measurement is started anew after parameter changes, before the measurement results are evaluated (e.g. using a marker). In all cases that require a new measurement after parameter changes, the trace is reset automatically to avoid false results (e.g. with span changes). For applications that require no reset after parameter changes, the automatic reset can be switched off.

Suffix:

<n> window; For applications that do not have more than 1 measurement window, the suffix <n> is irrelevant.

<t> trace

Parameters:

<State> **ON**
The automatic reset is switched off.

OFF
After certain parameter changes the traces are reset.

*RST: OFF

Example: DISP:WIND:TRAC3:MODE:HCON ON
Switches off the reset function.

Manual operation: See "[Hold/Cont](#)" on page 222

DISPlay[:WINDow<n>]:TRACe<t>:X:SPACing <ScalingType>

This command toggles between linear and logarithmic display of the x-axis.

Suffix:

<n> window; For applications that do not have more than 1 measurement window, the suffix <n> is irrelevant.

<t> irrelevant

Parameters:

<ScalingType> LOGarithmic | LINear

LOGarithmic
Selects logarithmic scaling.

LINear
Selects linear scaling.

*RST: LINear

Example: DISP:TRAC:X:SPAC LOG

Mode: A, ADEMOD

DISPlay[:WINDow<n>]:TRACe<t>:Y:SPACing <ScalingType>

This command selects the scaling of the y-axis.

Suffix:

<n> Selects the measurement window.
 <t> irrelevant

Parameters:

<ScalingType> **LOGarithmic**
 Logarithmic scaling.
 LINear
 Linear scaling in %.
 LDB
 Linear scaling in dB.
 *RST: LOGarithmic

Example:

DISP:TRAC:Y:SPAC LIN
 Select a linear scale.

Manual operation: See "Range Log 100 dB" on page 194
 See "Range Log 50 dB" on page 194
 See "Range Log 10 dB" on page 194
 See "Range Log 5 dB" on page 194
 See "Range Log 1 dB" on page 195
 See "Range Log Manual" on page 195
 See "Range Linear %" on page 195
 See "Range Lin. Unit" on page 195

DISPlay[:WINDow<n>]:TRACe<t>:Y[:SCALe] <Range>

This command defines the display range of the y-axis with logarithmic scaling.

The command works only for a logarithmic scaling. You can select the scaling with [DISPlay\[:WINDow<n>\]:TRACe<t>:Y:SPACing](#) on page 753.

Suffix:

<n> window; For applications that do not have more than 1 measurement window, the suffix <n> is irrelevant.
 <t> irrelevant

Parameters:

<Range> Range: 10 to 200
 *RST: 100
 Default unit: dB

Example:

DISP:TRAC:Y 110dB

Manual operation: See "Range Log 100 dB" on page 194
 See "Range Log 50 dB" on page 194
 See "Range Log 10 dB" on page 194
 See "Range Log 5 dB" on page 194
 See "Range Log 1 dB" on page 195
 See "Range Log Manual" on page 195

DISPlay[:WINDow<n>]:TRACe<t>:Y[:SCALe]:MODE <Mode>

This command selects the type of scaling of the y-axis.

When `SYSTem:DISPlay:UPDate` is turned off, this command has no immediate effect on the screen.

Suffix:

<n> window; For applications that do not have more than 1 measurement window, the suffix <n> is irrelevant.

<t> irrelevant

Parameters:

<Mode> **ABSolute**
 absolute scaling of the y-axis
RELative
 relative scaling of the y-axis
 *RST: ABS

Example: `DISP:TRAC:Y:MODE REL`

Manual operation: See "Grid Abs/Rel" on page 198

DISPlay[:WINDow<n>]:TRACe<t>:Y[:SCALe]:RLEVel <ReferenceLevel>

This command defines the reference level.

With the reference level offset $\neq 0$, the value range of the reference level is modified by the offset.

The unit depends on the setting defined with `CALCulate<n>:UNIT:POWer`.

Suffix:

<n> irrelevant.

<t> irrelevant

Parameters:

<ReferenceLevel> The unit is variable.
 Range: see datasheet
 *RST: -10dBm

Example: `DISP:TRAC:Y:RLEV -60dBm`

Manual operation: See "Ref Level" on page 193

DISPlay[:WINDow<n>]:TRACe<t>:Y[:SCALe]:RLEVel:OFFSet <Value>

This command defines a reference level offset.

Suffix:

<n> irrelevant.
<t> irrelevant

Parameters:

<Value> Range: -200 to 200
*RST: 0
Default unit: dB

Example: DISP:TRAC:Y:RLEV:OFFS -10dB

Manual operation: See ["Ref Level Offset"](#) on page 198

DISPlay[:WINDow<n>]:TRACe<t>:Y[:SCALe]:RPOSition <Position>

This command defines the position of the reference level on the display grid..

When using a tracking generator (only with option R&S FSV-B9 or -B10, requires active normalization), and in Bluetooth mode (option R&S FSV-K8) this command defines the position of the reference value for all windows.

Suffix:

<n> Selects the measurement window.
<t> irrelevant

Parameters:

<Position> 0 PCT corresponds to the lower display border, 100% corresponds to the upper display border.
Range: 0 to 100
*RST: Spectrum mode: 100 PCT, with tracking generator
or time display: 50 PCT
Default unit: PCT

Example: DISP:TRAC:Y:RPOS 50PCT

Manual operation: See ["Ref Level Position"](#) on page 198
See ["Reference Value Position"](#) on page 448

DISPlay[:WINDow<n>]:TRACe<t>:Y[:SCALe]:RVALue <Value>

The command defines the power value assigned to the reference position in the grid.

When using a tracking generator, this command requires active normalization.

Suffix:

<n> irrelevant
<t> irrelevant

Parameters:

<Value> *RST: 0 dB, coupled to reference level

Example:

DISP:TRAC:Y:RVAL -20dBm

Defines a reference position of -20 dBm.

Manual operation:

See "Reference Level" on page 416

See "Reference Value" on page 448

DISPlay[:WINDow<n>]:ZOOM:AREA <x1>, <y1>, <x2>, <y2>

This command defines the zoom area.

Before you can define a zoom area, you first have to turn the zoom on.

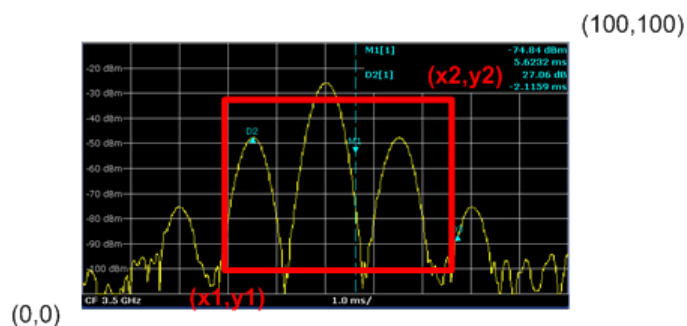
**Suffix:**

<n>

window; For applications that do not have more than 1 measurement window, the suffix <n> is irrelevant.

Parameters:

<x1>, <y1>,
<x2>, <y2>

Diagram coordinates in % of the complete diagram that define the zoom area.

The lower left corner is the origin of coordinate system. The upper right corner is the end point of the system.

Range: 0 to 100

Default unit: PCT

Example:

DISP:ZOOM ON

Activates the zoom mode.

DISP:ZOOM:AREA 5, 30, 20, 100

Enlarges the display of the measurement results in the area defined by the coordinates (5,30) and (20,100).

DISPlay[:WINDow<n>]:ZOOM:STATe <State>

This command turns the zoom on and off.

Suffix:

<n>

Selects the measurement window.

Parameters:

<State> ON | OFF
 *RST: OFF

Example:

DISP:ZOOM ON
 Activates the zoom mode.

6.3.3.5 DISPlay Commands for Spectrograms

This chapter describes commands required in the optional Spectrogram Mode (R&S FSV-K14).

DISPlay:WINDow:SGRam:COLor:DEFault.....	757
DISPlay:WINDow:SGRam:COLor:LOWer.....	757
DISPlay:WINDow:SGRam:COLor:SHAPE.....	757
DISPlay:WINDow:SGRam:COLor:UPPer.....	758
DISPlay:WINDow:SGRam:COLor[:STYLE].....	758

DISPlay:WINDow:SGRam:COLor:DEFault

This command sets the color settings for the spectrogram result display to its default state.

Usage: Event

Manual operation: See "[Set to Default](#)" on page 532

DISPlay:WINDow:SGRam:COLor:LOWer <Percentage>

This command sets the lower percentage boundary of the spectrogram.

Parameters:

<Percentage> Statistical frequency percentage.
 Range: 0 to 66
 *RST: 0
 Default unit: %

Example:

DISP:WIND:SGR:COL:LOW 10
 Sets the start of the color map to 10%.

Manual operation: See "[Color Mapping](#)" on page 527
 See "[Start](#)" on page 532

DISPlay:WINDow:SGRam:COLor:SHAPE <Shape>

This command defines the shape and focus of the color curve for the spectrogram result display.

Parameters:

<Shape> Shape of the color curve.
 Range: -1 to 1
 *RST: 0

Manual operation: See "[Shape](#)" on page 532

DISPlay:WINDow:SGRam:COLor:UPPer <Percentage>

This command sets the upper percentage boundary of the spectrogram.

Parameters:

<Percentage> Statistical frequency percentage.
 Range: 0 to 66
 *RST: 0
 Default unit: %

Example: DISP:WIND:SGR:COL:UPP 95
 Sets the start of the color map to 95%.

Manual operation: See "[Color Mapping](#)" on page 527
 See "[Stop](#)" on page 532

DISPlay:WINDow:SGRam:COLor[:STYLE] <ColorScheme>

This command sets the color scheme for the spectrogram.

Parameters:

<ColorScheme> **HOT**
 Uses a color range from blue to red. Blue colors indicate low levels, red colors indicate high ones.

COLD
 Uses a color range from red to blue. Red colors indicate low levels, blue colors indicate high ones.

RADar
 Uses a color range from black over green to light turquoise with shades of green in between. Dark colors indicate low levels, light colors indicate high ones.

GRAYscale
 Shows the results in shades of gray. Dark gray indicates low levels, light gray indicates high ones.

*RST: HOT

Example: DISP:WIND:SGR:COL GRAY
 Changes the color scheme of the spectrogram to black and white.

Manual operation: See "[Hot/Cold/Radar/Grayscale](#)" on page 532

6.3.3.6 FETCh:PMETer Subsystem (Power Sensor, R&S FSV-K9)

The FETCh:PMETer subsystem contains commands to read measurement results of power sensor measurements without starting the measurement itself. It is only available if the R&S FSV-K9 Power Sensor option is installed.

For details see [Chapter 5.9, "Instrument Functions - Power Sensor \(R&S FSV-K9\)"](#), on page 509.

[FETCh<n>:PMETer<p>?](#).....759

FETCh<n>:PMETer<p>?

This command reads the result of the power sensor measurement for the selected power sensor. These results are also displayed in the marker table.

If no measurement has been performed, this command will lead to a query error.

Suffix:

<n>	irrelevant
<p>	1...4 Power sensor index

Example:

FETC:PMET2?
Reads the result of the power sensor measurement for the power sensor 2.

Usage: Query only

Mode: PSM

6.3.3.7 FORMat Subsystem

The FORMat subsystem specifies the data format of the data transmitted from and to the instrument.

[FORMat:DEXPort:DSEPARATOR](#)..... 759
[FORMat:DEXPort:TRACes](#)..... 760

FORMat:DEXPort:DSEPARATOR <Separator>

This command defines which decimal separator (decimal point or comma) is to be used for outputting measurement data to the file in ASCII format. Different languages of evaluation programs (e.g. MS-Excel) can thus be supported.

Parameters:

<Separator>	POINT COMMA
*RST:	(factory setting is POINT; *RST does not affect setting)

Example:

FORM:DEXP:DSEP POIN
Sets the decimal point as separator.

Manual operation: See "[ASCII Trace Export](#)" on page 167
See "[Decim Sep](#)" on page 168
See "[ASCII File Export](#)" on page 264

FORMat:DEXPort:TRACes <Selection>

This command selects the data to be included in a data export file.

Parameters:

<Selection>

ALL

Selects all active traces for export to an ASCII file.

The <trace> parameter for the `MMEMory:STORe<n>:TRACe` command is ignored.

SINGLE

Only a single trace is selected for export, namely the one specified by the `MMEMory:STORe<n>:TRACe` command.

*RST: SINGLE

Manual operation: See "ASCII Trace Export" on page 167

6.3.3.8 INITiate Subsystem

The INITiate subsystem is used to control the init-measurement function.

INITiate<n>[:IMMediate].....	760
INITiate<n>:CONMeas.....	761
INITiate<n>:CONTinuous.....	761
INITiate<n>:DISPlay.....	762
INITiate<n>:ESpectrum.....	762
INITiate<n>:SPURious.....	762

INITiate<n>[:IMMediate]

The command initiates a new measurement sequence.

With sweep count > 0 or average count > 0, this means a restart of the indicated number of measurements. With trace functions MAXHold, MINHold and AVERage, the previous results are reset on restarting the measurement.

In single sweep mode, you can synchronize to the end of the measurement with *OPC, *OPC? or *WAI. In continuous sweep mode, synchronization to the end of the measurement is not possible. Thus, it is not recommended that you use continuous sweep mode in remote control, as results like trace data or markers are only valid after a single sweep end synchronization.

Suffix:

<n> irrelevant

Example:

```
INIT:CONT OFF
```

Switches to single sweep mode.

```
DISP:WIND:TRAC:MODE AVER
```

Switches on trace averaging.

```
SWE:COUN 20
```

Setting the sweep counter to 20 sweeps.

```
INIT;*WAI
```

Starts the measurement and waits for the end of the 20 sweeps.

Mode: all

INITiate<n>:CONMeas

This command restarts a measurement that has been stopped in single sweep mode.

The measurement is restarted at the first sweep point.

As opposed to `INITiate<n>[:IMMediate]`, this command does not reset traces in maxhold, minhold or average mode. Therefore it can be used to continue measurements using max hold or averaging functions.

In single sweep mode, you can synchronize to the end of the measurement with `*OPC`, `*OPC?` or `*WAI`. In continuous sweep mode, synchronization to the end of the measurement is not possible. Thus, it is not recommended that you use continuous sweep mode in remote control, as results like trace data or markers are only valid after a single sweep end synchronization.

Suffix:

<n> irrelevant

Example:

```
INIT:CONT OFF
```

Switches to single sweep mode.

```
DISP:WIND:TRAC:MODE AVER
```

Switches on trace averaging.

```
SWE:COUN 20
```

Setting the sweep counter to 20 sweeps.

```
INIT;*WAI
```

Starts the measurement and waits for the end of the 20 sweeps.

```
INIT:CONM;*WAI
```

Continues the measurement (next 20 sequences) and waits for the end.

Manual operation: See "[Continue Single Sweep](#)" on page 215

INITiate<n>:CONTinuous <State>

This command determines whether the trigger system is continuously initiated (continuous) or performs single measurements (single).

The sweep is started immediately.

In the "Spectrum" mode, this setting refers to the sweep sequence (switching between continuous/single sweep).

In single sweep mode, you can synchronize to the end of the measurement with `*OPC`, `*OPC?` or `*WAI`. In continuous sweep mode, synchronization to the end of the measurement is not possible. Thus, it is not recommended that you use continuous sweep mode in remote control, as results like trace data or markers are only valid after a single sweep end synchronization.

Suffix:

<n> irrelevant

Parameters:

<State> ON | OFF
 *RST: ON

Example:

INIT:CONT OFF
 Switches the sequence to single sweep.
 INIT:CONT ON
 Switches the sequence to continuous sweep.

Mode: all

Manual operation: See "[Continuous Sweep](#)" on page 214
 See "[Single Sweep](#)" on page 215

INITiate<n>:DISPlay <State>

This command turns the display during a single sweep measurement on or off.

Suffix:

<n> irrelevant

Parameters:

<State> ON | OFF
 *RST: ON

Example:

INIT:CONT OFF
 Switches to single sweep mode
 INIT:DISP OFF
 Sets the display behavior to OFF
 INIT;*WAI
 Starts the measurement with display switched off.

INITiate<n>:ESpectrum

This command starts a Spectrum Emission Mask measurement.

Suffix:

<n> irrelevant

Example:

INIT:ESP
 Starts a Spectrum Emission Mask measurement.

Manual operation: See "[Meas Start/Stop](#)" on page 326

INITiate<n>:SPURious

This command initiates a Spurious Emissions measurement.

Suffix:

<n> irrelevant

Example:

INIT:SPUR
 Starts a Spurious Emissions measurement.

Usage: Event

6.3.3.9 INPut Subsystem

The INPut subsystem controls the input characteristics of the RF inputs of the instrument.

INPut:ATTenuation.....	763
INPut:ATTenuation:AUTO.....	764
INPut:COUPling.....	764
INPut:DIQ:CDEvice.....	764
INPut:DIQ:RANGe:COUPling.....	765
INPut:DIQ:RANGe[:UPPer].....	766
INPut:DIQ:RANGe[:UPPer]:UNIT.....	766
INPut:DIQ:SRATe.....	767
INPut:EATT.....	767
INPut:EATT:AUTO.....	767
INPut:EATT:STATe.....	768
INPut:FILTer:YIG[:STATe].....	768
INPut:GAIN:STATe.....	769
INPut:IMPedance.....	769
INPut:SELect.....	769
INPut:UPORT?.....	770
INPut:UPORT:STATe.....	770

INPut:ATTenuation <Value>

This command programs the input attenuator. To protect the input mixer against damage from overloads, the setting 0 dB can be obtained by entering numerals, not by using the DOWN command.

The RF attenuation can be set in 5 dB steps (R&S FSV with option R&S FSV-B25 or R&S FSVA: 1 dB steps). The range is specified in the data sheet. If the current reference level cannot be set for the set RF attenuation, the reference level is adjusted accordingly.

In the default state with "Spectrum" mode, the attenuation set on the step attenuator is coupled to the reference level of the instrument. If the attenuation is programmed directly, the coupling to the reference level is switched off.

This function is not available if the R&S Digital I/Q Interface (R&S FSV-B17) is active.

Parameters:

<Value> *RST: 10 dB (AUTO is set to ON)

Example:

```
INP:ATT 30dB
```

Sets the attenuation on the attenuator to 30 dB and switches off the coupling to the reference level.

Mode: all

Manual operation: See "RF Atten Manual/Mech Att Manual" on page 196

INPut:ATTenuation:AUTO <State>

This command automatically couples the input attenuation to the reference level (state ON) or switches the input attenuation to manual entry (state OFF).

This function is not available if the R&S Digital I/Q Interface (R&S FSV-B17) is active.

Parameters:

<State> ON | OFF
*RST: ON

Example:

INP:ATT:AUTO ON
Couples the attenuation set on the attenuator to the reference level.

Manual operation: See "[RF Atten Auto/Mech Att Auto](#)" on page 197

INPut:COUPling <CouplingType>

Toggles the RF input of the R&S FSVA/FSV between AC and DC coupling.

This function is not available if the R&S Digital I/Q Interface (R&S FSV-B17) is active.

Parameters:

<CouplingType> AC | DC
*RST: AC

Example:

INP:COUP DC

Manual operation: See "[Input \(AC/DC\)](#)" on page 199

INPut:DIQ:CDEvice

This command queries the current configuration and the status of the digital baseband input from the optional R&S Digital I/Q Interface (option R&S FSV-B17).

For details see the section "Interface Status Information" for the R&S Digital I/Q Interface (R&S FSV-B17) in the description of the base unit.

Return values:

<ConnState> Defines whether a device is connected or not.
0
No device is connected.
1
A device is connected.

<DeviceName> Device ID of the connected device

<SerialNumber> Serial number of the connected device

<PortName> Port name used by the connected device

<SampleRate> Maximum or currently used sampling rate of the connected device in Hz (depends on the used connection protocol version; indicated by <SampleRateType> parameter)

<MaxTransferRate>	Maximum data transfer rate of the connected device in Hz
<ConnProtState>	State of the connection protocol which is used to identify the connected device. Not Started Has to be Started Started Passed Failed Done
<PRBSTestState>	State of the PRBS test. Not Started Has to be Started Started Passed Failed Done
<SampleRateType>	0 Maximum sampling rate is displayed 1 Current sampling rate is displayed
<Placeholder>	for future use; currently "0"
Example:	INP:DIQ:CDEV? Result: 1, SMU200A, 103634, Out A, 70000000, 100000000, Passed, Not Started, 0, 0
Mode:	IQ, VSA, EVDO, CDMA, WCDMA, GSM, ADEMOD, TDS
Manual operation:	See " Connected Device " on page 400 See " Digital IQ Info " on page 403

INPut:DIQ:RANGe:COUPling <State>

If enabled, the reference level for digital input is adjusted to the full scale level automatically if the fullscale level changes.

(See the [Auto Level](#) softkey).

This command is only available if the optional R&S Digital I/Q Interface (option R&S FSV-B17) is installed.

For details see the R&S Digital I/Q Interface (R&S FSV-B17) description of the base unit.

Parameters:

<State> ON | OFF
 *RST: OFF

Example:

INP:DIQ:RANG:COUP OFF

Mode:

IQ, VSA, EVDO, CDMA, WCDMA, GSM, ADEMOD, TDS

Manual operation:

See ["Adjust Reference Level to Full Scale Level"](#) on page 401
 See ["Auto Level"](#) on page 416

INPut:DIQ:RANGe[:UPPer] <Level>

Defines or queries the "Full Scale Level", i.e. the level that should correspond to an I/Q sample with the magnitude "1".

It can be defined either in dBm or Volt (see ["Full Scale Level"](#) on page 400).

This command is only available if the optional R&S Digital I/Q Interface (option R&S FSV-B17) is installed.

For details see [Chapter 5.7.5, "Interface Status Information"](#), on page 484.

Parameters:

<Level> <numeric value>
 Range: 70.711 nV to 7.071 V
 *RST: 1 V

Example:

INP:DIQ:RANG 1V

Mode:

A, IQ, NF, TDS, VSA, CDMA, EVDO, WCDMA, ADEMOD, GSM, OFDM, OFDMA/WiBro, WLAN

Manual operation:

See ["Full Scale Level"](#) on page 400

INPut:DIQ:RANGe[:UPPer]:UNIT <Unit>

Defines the unit of the full scale level (see ["Level Unit"](#) on page 401). The availability of units depends on the measurement application you are using.

This command is only available if the optional R&S Digital I/Q Interface (option R&S FSV-B17) is installed.

For details see the R&S Digital I/Q Interface (R&S FSV-B17) description of the base unit.

Parameters:

<Level> V | dBm | dBpW | W | dBmV | dBuV | dBuA | A
 *RST: Volt

Example:

INP:DIQ:RANG:UNIT A

Mode:

IQ, VSA, EVDO, CDMA, WCDMA, GSM, ADEMOD, TDS

Manual operation:

See ["Level Unit"](#) on page 401

INPut:DIQ:SRATe <SampleRate>

This command specifies or queries the sample rate of the input signal from the R&S Digital I/Q Interface (see ["Input Sample Rate"](#) on page 400).

Note: the final user sample rate of the R&S FSVA/FSV may differ and is defined using TRAC:IQ:SRAT (see [TRACe<n>:IQ:SRATe](#) on page 906).

This command is only available if the optional R&S Digital I/Q Interface (option R&S FSV-B17) is installed.

For details see the R&S Digital I/Q Interface (R&S FSV-B17) description of the base unit.

Parameters:

<SampleRate> Range: 1 Hz to 10 GHz
 *RST: 32 MHz

Example: INP:DIQ:SRAT 200 MHz

Mode: A, IQ, NF, TDS, VSA, CDMA, EVDO, WCDMA, ADEMOD, GSM, OFDM, OFDMA/WiBro, WLAN

Manual operation: See ["Input Sample Rate"](#) on page 400

INPut:EATT <Attenuation>

This command defines the electronic attenuation.

If necessary, the command also turns the electronic attenuator on.

This command is only available with option R&S FSV-B25, but not if R&S FSV-B17 is active.

The attenuation can be varied in 1 dB steps from 0 to 25 dB. Other entries are rounded to the next lower integer value.

If the defined reference level cannot be set for the given RF attenuation, the reference level is adjusted accordingly and the warning "Limit reached" is output.

Parameters:

<Attenuation> 0...25
 *RST: 0 dB (OFF)

Example: INP1:EATT 10 dB

Mode: all

Manual operation: See ["EI Atten Mode \(Auto/Man\)"](#) on page 197

INPut:EATT:AUTO <State>

This command switches the automatic behaviour of the electronic attenuator on or off. If activated, electronic attenuation is used to reduce the operation of the mechanical attenuation whenever possible.

This command is only available with option R&S FSV-B25, but not if R&S FSV-B17 is active.

Parameters:

<State> ON | OFF
*RST: ON

Example: INP1:EATT:AUTO OFF

Mode: all

Manual operation: See "[EI Atten On/Off](#)" on page 197
See "[EI Atten Mode \(Auto/Man\)](#)" on page 197

INPut:EATT:STATe <State>

This command turns the electronic attenuator on or off.

This command is only available with option R&S FSV-B25, but not if R&S FSV-B17 is active.

Parameters:

<State> ON | OFF
*RST: OFF

Example: INP:EATT:STAT ON
Switches the electronic attenuator into the signal path.

INPut:FILTer:YIG[:STATe] <State>

If the option R&S FSVA-B11 is installed, the YIG preselector can be bypassed.

This function is only available for R&S FSVA instruments.

If the YIG preselector at the input of the R&S FSVA is removed from the signal path, you can use the maximum bandwidth for signal analysis. However, image-frequency rejection is no longer ensured.

Note that the YIG preselector is active only on frequencies greater than 7 GHz. Therefore, switching the YIG preselector on and off has no effect if the frequency is below that value.

Parameters:

<State> ON | OFF | 0 | 1
*RST: 1 (0 for I/Q Analyzer, GSM, VSA measurements)

Example: INP:FILT:YIG OFF
Deactivates the YIG preselector.

Manual operation: See "[\(Bypassing the \)YIG Filter](#)" on page 199

INPut:GAIN:STATe <State>

This command turns the preamplifier on and off. (For the exact amplification value, see the data sheet).

With option R&S FSV-B22, the preamplifier only has an effect below 7 GHz.

With option R&S FSV-B24, the amplifier applies to the entire frequency range.

This command is not available when using R&S Digital I/Q Interface (R&S FSV-B17).

Parameters:

<State> ON | OFF
*RST: OFF

Example: INP:GAIN:STAT ON
Turns the preamplifier on.

Manual operation: See "[Preamp On/Off](#)" on page 196

INPut:IMPedance <Impedance>

This command selects the nominal input impedance.

75 Ω should be selected if the 50 Ω input impedance is transformed to a higher impedance using a 75 Ω adapter of the RAZ type (= 25 Ω in series to the input impedance of the instrument). The correction value in this case is 1.76 dB = 10 log (75 Ω /50 Ω).

This function is not available if the R&S Digital I/Q Interface (R&S FSV-B17) is active.

Parameters:

<Impedance> 50 | 75
*RST: 50 Ω

Example: INP:IMP 75

Manual operation: See "[Input 50 \$\Omega\$ /75 \$\Omega\$](#) " on page 199

INPut:SELEct <Source>

This command selects the signal source for measurements.

Parameters:

<Source> **RF**
Radio Frequency ("RF INPUT" connector)
DIQ
Digital IQ (only available with R&S Digital I/Q Interface, option R&S FSV-B17)
*RST: RF

Example: INP:SEL RF

Mode: A, IQ, NF, TDS, VSA, CDMA, EVDO, WCDMA, ADEMOD, GSM, OFDM, OFDMA/WiBro, WLAN

Manual operation: See ["Input Path"](#) on page 400

INPut:UPORt?

This command queries the control lines of the user ports.

Example: INP:UPOR?

Usage: Query only

INPut:UPORt:STATe <State>

This command selects if the user port control lines are used as a input or as a output.

Parameters:

<State> **ON**
 User port is used as a input.
 OFF
 User port is used as a output.
 *RST: ON

Example: INP:UPOR:STAT ON

6.3.3.10 INSTrument Subsystem

The INSTrument subsystem selects the operating mode of the unit either via text parameters or fixed numbers.

INSTrument[:SElect] <Mode> | <ChannelName>

This command selects the measurement mode using text parameters.

Note: To select an **I/Q Analyzer** channel in simple mode, you have to use [TRACe<n>:IQ\[:STATe\]](#).

Also see

- [INSTrument:CREate\[:NEW\]](#) on page 771
- Remote program example: [Chapter 6.4.16, "Usage of Four Spectrum Instances"](#), on page 1052

Setting parameters:

<Mode> values see [Table 6-17](#)
 *RST: SANalyzer

Example: INST SAN
 Switches the instrument to "Spectrum" mode.

Example: INST 'Spectrum 2'
 Selects the second spectrum channel named "Spectrum 2".

Usage: Setting only
 SCPI confirmed

Table 6-17: Instrument mode parameters

Mode	Text parameter (INST:SEL)	Numeric parameter (INST:NSEL)	Option number
Spectrum	SANalyzer	1	
IQ Analyzer (eval mode)	IQ	-	
Analog demodulation	ADEMod	3	R&S FSV-K7
FM Stereo	SFM	7	R&S FSV-K7S
Bluetooth	BT0oth	12	R&S FSV-K8
GSM	GSM (Query: MGSM.)	5	R&S FSV-K10
Noise Figure Measurements	NOISe	19	R&S FSV-K30
Phase Noise mode	PNOise	20	R&S FSV-K40
VSA	DDEM	2	R&S FSV-K70
3G FDD BTS mode	BWCD	8	R&S FSV-K72
3G FDD UE mode	MWCD	9	R&S FSV-K73
TD-SCDMA BTS mode	BTDS	17	R&S FSV-K76
TD-SCDMA UE mode	MTDS	18	R&S FSV-K77
CDMA2000 BS Analysis	BCK2	10	R&S FSV-K82
CDMA2000 MS	MC2K	11	
1xEV-DO BS Analysis	BDO	14	R&S FSV-K84
1xEV-DO MS	MDO	15	
WLAN TX	WLAN	16	R&S FSV-K91/91n
WiMax	WiMAX	23	R&S FSV-K93
LTE (uplink and downlink)	LTE	100	R&S FSV-K101/K102/K103/K104/ K105

INSTrument:CREate[:NEW] <ChannelType>, <ChannelName>

This command adds an additional spectrum display. You can add up to three additional spectrum displays.

Also see

- [INSTrument\[:SElect\]](#) on page 770
- [INSTrument:DELeTe](#) on page 772
- Remote program example: [Chapter 6.4.16, "Usage of Four Spectrum Instances"](#), on page 1052

Parameters:

<ChannelType> **SANalyzer**
 The channel type is always `SANalyzer` to add a new spectrum display.

<ChannelName> String containing the name of the channel you want to create.

Example: `INST:CRE SAN, 'Spectrum 2'`
 Adds a second spectrum display.

INSTrument:DELeTe <ChannelName>

This command deletes a spectrum display.

Also see

- [INSTrument:CREate\[:NEW\]](#) on page 771
- Remote program example: [Chapter 6.4.16, "Usage of Four Spectrum Instances"](#), on page 1052

Parameters:

<ChannelName> String containing the name of the channel you want to delete.
 A channel must exist in order to be able delete it.

Example: `INST:DEL 'Spectrum 4'`
 Deletes the fourth spectrum display.

INSTrument:NSELeCt <Mode>

This command selects the operating mode by means of numbers (see [Table 6-17](#)).

Parameters:

<Mode> *RST: 1

Example: `INST:NSEL 1`
 Switches the instrument to "Spectrum" mode.

Usage: SCPI confirmed

Mode: all

6.3.3.11 MMEMory Subsystem

The MMEMory (mass memory) subsystem provides commands which allow for access to the storage media of the instrument and for storing and loading various instrument settings.

In this section all MMEMory commands for "Spectrum" mode are described in detail. For details on commands that are independant of a particular measurement mode and information on the MMEMory subsystem in general, see [Chapter 6.3.4.7, "MMEMory Subsystem"](#), on page 939.

MMEMory:LOAD:IQ:STATe.....	773
MMEMory:STORe:IQ:STATe.....	773
MMEMory:STORe:IQ:COMM.....	773
MMEMory:STORe<n>:LIST.....	774
MMEMory:STORe<n>:PEAK.....	774
MMEMory:STORe:SGRam.....	774
MMEMory:STORe<n>:SPURious.....	775
MMEMory:STORe<n>:TRACe.....	775

MMEMory:LOAD:IQ:STATe 1, <FileName>

This command loads the I/Q data from the specified `.iq.tar` file.

Note: switch to single sweep mode (`INIT:CONT OFF`) before importing I/Q data as otherwise the instrument will continue to measure data and display the current results rather than the imported data.

Parameters:

<FileName> Complete file name including the path

Example:

```
MMEM:LOAD:IQ:STAT 1, 'C:
\R_S\Instr\user\data.iq.tar'
```

Loads I/Q data from the specified file.

Usage: Setting only

Manual operation: See "IQ Import" on page 168

MMEMory:STORe:IQ:STATe 1, <FileName>

This command stores the complex I/Q data to the specified `.iq.tar` file in 32-bit floating point format.

Parameters:

<FileName> Complete file name including the path

Example:

```
MMEM:STOR:IQ:STAT 1, 'C:
\R_S\Instr\user\data.iq.tar'
```

Stores I/Q data to the specified file.

Manual operation: See "IQ Export" on page 168

MMEMory:STORe:IQ:COMM <Description>

Defines a description of the export file which is stored with the data and also displayed in the file selection dialog box for I/Q data import and export.

Parameters:

<Description>

Example: `MMEM:STOR:IQ:COMM 'Device test 1b'`
Creates a description for the export file.
`MMEM:STOR:IQ:STAT 1, 'C:\R_S\Instr\user\data.iq.tar'`
Stores I/Q data and the comment to the specified file.

Manual operation: See ["IQ Export"](#) on page 168

MMEMory:STORe<n>:LIST <FileName>

This command stores the current list evaluation results in a `<file name>.dat` file. The file consists of a data section containing the list evaluation results.

Suffix:
<n> irrelevant

Parameters:
<FileName> <file name>

Example: `MMEM:STOR:LIST 'test'`
Stores the current list evaluation results in the `test.dat` file.

Manual operation: See ["ASCII File Export"](#) on page 264
See ["Save Evaluation List"](#) on page 323
See ["Save Evaluation List"](#) on page 353
See ["ASCII File Export"](#) on page 353

MMEMory:STORe<n>:PEAK <FileName>

This command exports the marker peak list to a `*.dat` file.

Suffix:
<n> Selects the measurement window.

Parameters:
<FileName> String containing the path and name of the target file.

Example: `MMEM:STOR:PEAK 'test'`
Saves the current marker peak list in the file `test.dat`.

Usage: Event

MMEMory:STORe:SGRam <File>

This command exports the spectrogram data to a ASCII file.

The file contains the data for every frame in the history buffer. The data corresponding to a particular frame begins with information about the frame number and the time that frame was recorded.

Note that, depending on the size of the history buffer, the process of exporting the data can take a while.

Parameters:

<File> string containing the file name of the destination file

Example:

MMEM:STOR:SGR

Copies the spectrogram data to a file.

Manual operation: See "[ASCII Trace Export](#)" on page 167

MMEMory:STORe<n>:SPURious <FileName>

This command exports the marker peak list available for spurious emission measurements to a file.

Suffix:

<n> irrelevant

Parameters:

<FileName> String containing the path and name of the target file.

Example:

MMEM:STOR:SPUR 'test'

Saves the current marker peak list in the file test.dat.

Usage:

Event

MMEMory:STORe<n>:TRACe <Trace>, <FileName>

This command stores the selected trace in the specified window in a file with ASCII format. The file format is described in [Chapter 5.2.8.7, "ASCII File Export Format"](#), on page 235

The decimal separator (decimal point or comma) for floating-point numerals contained in the file is defined with the `FORMat:DEXPort:DSEParator` command (see [FORMat:DEXPort:DSEParator](#) on page 759).

Suffix:

<n> window; For applications that do not have more than 1 measurement window, the suffix <n> is irrelevant.

Parameters:

<Trace> 1 to 6

Selected a trace.

<FileName>

DOS file name

The file name includes indication of the path and the drive name. Indication of the path complies with DOS conventions.

Example:

MMEM:STOR:TRAC 3, 'TEST.ASC'

Stores trace 3 in the file TEST.ASC.

Manual operation: See "[ASCII Trace Export](#)" on page 167

6.3.3.12 OUTPut Subsystem

The OUTPut subsystem controls the output-related features of the instrument.

OUTPut:DIQ.....	776
OUTPut:DIQ:CDEvice.....	776
OUTPut[:STATe].....	777
OUTPut:UPORT.....	777
OUTPut:UPORT:STATe.....	778

OUTPut:DIQ <State>

If enabled, the captured IQ data is output to the R&S Digital I/Q Interface in a continuous stream. This function requires the LVDS interface option (R&S FSV-B17).

Digital input and digital output cannot be used simultaneously.

Parameters:

<State> **ON | OFF**
 *RST: OFF

Example: OUTP:DIQ ON

Mode: ADEMOD, IQ, VSA

Manual operation: See "[Digital Output](#)" on page 402

OUTPut:DIQ:CDEvice

This command queries the current configuration and the status of the digital baseband output to the optional R&S Digital I/Q Interface (option R&S FSV-B17).

For details see the R&S Digital I/Q Interface description for the base unit.

Return values:

<ConnState> Defines whether a device is connected or not.
 0
 No device is connected.
 1
 A device is connected.

<DeviceName> Device ID of the connected device

<SerialNumber> Serial number of the connected device

<PortName> Port name used by the connected device

<NotUsed> to be ignored

<MaxTransferRate> Maximum data transfer rate of the connected device in Hz

<ConnProtState> State of the connection protocol which is used to identify the connected device.
 Not Started
 Has to be Started
 Started
 Passed
 Failed

	Done
<PRBSTestState>	State of the PRBS test.
	Not Started
	Has to be Started
	Started
	Passed
	Failed
	Done
<NotUsed>	to be ignored
<Placeholder>	for future use; currently "0"
Example:	<pre> OUTP:DIQ:CDEV? Result: 1,SMU200A,103634,Out A,70000000,100000000,Passed,Not Started,0,0 </pre>
Mode:	IQ, VSA

OUTPut[:STATe] <State>

This command switches the selected tracking generator on or off.

The command is available with an (external) tracking generator (options R&S FSV-B9 or -B10).

Parameters:

<State> ON | OFF
*RST: OFF

Example: OUTP1 ON
Switches on the external tracking generator 1.

Usage: SCPI confirmed

Manual operation: See "[Source RF Internal \(On/ Off\)](#)" on page 446

OUTPut:UPORt <Value>

This command defines the control lines of the user ports.

The assignment of the pin numbers to the bits is as follows:

Bit	7	6	5	4	3	2	1	0
Pin	N/A	N/A	5	3	4	7	6	2

Bits 7 and 6 are not assigned to pins and must always be 0.

The user port is written to with the given binary pattern. If the user port is programmed to input instead of output (see `INPut:UPORt:STATe` on page 770), the output value is temporarily stored.

Parameters:

<Value> #B00000000 to #B00111111

Example:

`OUTP:UPOR #B00100100`
Sets pins 5 and 7 to 5 V.

OUTPut:UPORt:STATe <State>

This command selects if the user port control lines are used as a input or as a output.

This command switches the control line of the user ports between INPut and OUTPut. The user port is switched to OUTPut with parameter ON, to INPut with OFF.

Parameters:

<State> **ON**
User port is used as a input.
ON
User port is used as a output.
***RST: ON**

Example:

`OUTP:UPOR:STAT ON`

6.3.3.13 PROBe subsystem

With firmware R&S FSVA/FSV 1.61SP2 or newer, active probes are supported (via an adapter). The following commands activate and configure a connected probe which is to provide an input signal. They are only available if a probe is connected to the instrument's [RF Input] and USB connectors.

For details see [Chapter 5.3.8.2, "Using Active Probes for Input"](#), on page 403.

PROBe:ID:PARTnumber?

This command returns the material part number of the connected probe.

Example: `PROB:ID:PART?`

Usage: Query only

Manual operation: See "[Part number](#)" on page 405

PROBe:ID:SRNumber?

This command returns the serial number of the connected probe.

Example: `PROB:ID:SRN?`

Usage: Query only

Manual operation: See "[Serial Number](#)" on page 405

PROBe:SETup:MODE <Mode>

This command defines which action is taken when the probe's micro button is pressed.

Parameters:

<Mode>	RSINgLe A single sweep is performed.
	NOACtion No action is taken.
	*RST: OFF

Example: PROB:SET:STAT ON

Manual operation: See "[Probe Config](#)" on page 400
See "[Micro Button Action](#)" on page 405

PROBe:SETup:NAME?

This command returns the name of the connected probe.

Example: PROB:SET:NAME?

Usage: Query only

Manual operation: See "[Name](#)" on page 405

PROBe:SETup:STATe?

This command queries whether a probe is connected to the instrument's [RF Input] and USB connectors and was recognized by the R&S FSVA/FSV.

Example: PROB:SET:STAT ON

Usage: Query only

PROBe[:STATe] <State>

This command activates a connected probe. Use this command to switch off the probe and measure the digital input without considering the transducer factor of the probe.

Parameters:

<State>	ON OFF
	*RST: OFF

Example: PROB:STAT ON

Manual operation: See "[Probe Config](#)" on page 400
See "[State](#)" on page 405

6.3.3.14 READ:PMETer Subsystem

This subsystem contains commands to start power sensor measurements and to read the results after the measurement is concluded. It is only available if the R&S FSV-K9 Power Sensor option is installed.

For details see [Chapter 5.9, "Instrument Functions - Power Sensor \(R&S FSV-K9\)"](#), on page 509.

READ<n>:PMETer<p>?.....780

READ<n>:PMETer<p>?

This command starts a power sensor measurement and reads the result for the selected power sensor after the measurement is concluded. These results are also displayed in the marker table.

Suffix:

<n>	irrelevant
<p>	1...4 Power sensor index

Example:

READ:PMET3?
Starts a measurement and reads the result.

Usage:

Query only

Mode:

PSM

6.3.3.15 SENSE Subsystem

The SENSE subsystem is organized in several subsystems. The commands of these subsystems directly control device-specific settings, they do not refer to the signal characteristics of the measurement signal.

The SENSE subsystem controls the essential parameters of the analyzer. In accordance with the SCPI standard, the keyword "SENSE" is optional for this reason, which means that it is not necessary to include the SENSE node in command sequences.

SENSE:ADJust Subsystem.....	781
SENSE:AVERAge Subsystem.....	783
SENSE:BANDwidth Subsystem.....	785
SENSE:CORRection Subsystem.....	789
SENSE:DEMod Subsystem.....	796
SENSE:ESpectrum Subsystem.....	797
SENSE:FREQUency Subsystem.....	808
SENSE:LIST Subsystem.....	812
SENSE:LIST:RANGe Subsystem.....	818

SENSe:MIXer Subsystem.....	826
SENSe:MPOWer Subsystem.....	833
SENSe:PMETer<p> Subsystem (Power Sensor, R&S FSV-K9).....	837
SENSe:POWer Subsystem.....	845
SENSe:SWEEp Subsystem.....	855
SENSe:[WINDow:]DETEctor Subsystem.....	863

SENSe:ADJust Subsystem

The ADJust subsystem controls automatic definition of frequency and level settings.

[SENSe:]ADJust:ALL.....	781
[SENSe:]ADJust:FREQuency.....	781
[SENSe:]ADJust:LEVel.....	781
[SENSe:]ADJust:CONFIgure:LEVel:DURation.....	782
[SENSe:]ADJust:CONFIgure:LEVel:DURation:MODE.....	782
[SENSe:]ADJust:CONFIguration:HYSTeresis:LOWer.....	782
[SENSe:]ADJust:CONFIguration:HYSTeresis:UPPer.....	783
[SENSe:]ADJust:CONFIgure:TRIG.....	783

[SENSe:]ADJust:ALL

This command determines the ideal frequency and level configuration for the current measurement.

Example: ADJ:ALL

Manual operation: See "[Auto All](#)" on page 202

[SENSe:]ADJust:FREQuency

This command defines the center frequency and the reference level automatically by determining the highest level in the frequency span.

Example: ADJ:FREQ

Manual operation: See "[Auto Freq](#)" on page 202

[SENSe:]ADJust:LEVel

This command automatically sets the optimal reference level for the current measurement.

You can define a threshold that the signal must exceed before the reference level is adjusted, see [\[SENSe:\]ADJust:CONFIguration:HYSTeresis:UPPer](#) and [\[SENSe:\]ADJust:CONFIguration:HYSTeresis:LOWer](#).

Example: ADJ:LEV

Manual operation: See "Auto Level" on page 203
 See "Adjust Ref Lvl (span > 0)" on page 352
 See "Adjust Ref Lvl (span > 0)" on page 354

[SENSe:]ADJust:CONFigure:LEVel:DURation <Duration>

This command defines the duration of the level measurement used to determine the optimal reference level automatically (for `SENS:ADJ:LEV ON`).

Parameters:

<Duration> <numeric value> in seconds
 Range: 0.001 to 16000.0
 *RST: 0.001
 Default unit: s

Example: `ADJ:CONF:LEV:DUR:5`

Manual operation: See "Meas Time Manual" on page 203

[SENSe:]ADJust:CONFigure:LEVel:DURation:MODE <Mode>

This command selects the way the R&S FSVA/FSV determines the length of the measurement that is performed while determining the ideal reference level.

Parameters:

<Mode> **AUTO**
 Automatically determines the measurement length.
 MANual
 Manual definition of the measurement length.
 *RST: AUTO

Example: `ADJ:CONF:LEV:DUR:MODE MAN`
 Specifies manual definition of the measurement duration.
 `ADJ:CONF:LEV:DUR:5`
 Specifies the duration manually.

[SENSe:]ADJust:CONFigure:HYSTeresis:LOWer <Threshold>

This command defines a lower threshold the signal must drop below before the reference level is automatically adjusted when the "Auto Level" function is performed.

For more information see [\[SENSe:\]ADJust:LEVel](#).

Parameters:

<Threshold> Range: 0 to 200
 *RST: +1 dB
 Default unit: dB

Example: `SENS:ADJ:CONF:HYST:LOW 2`

Example: For an input signal level of currently 20 dBm, the reference level will only be adjusted when the signal level falls below 18 dBm.

Manual operation: See "[Lower Level Hysteresis](#)" on page 203

[SENSe:]ADJust:CONFIguration:HYSTeresis:UPPer <Threshold>

This command defines an upper threshold the signal must exceed before the reference level is automatically adjusted when the "Auto Level" function is performed.

For more information see [\[SENSe:\]ADJust:LEVel](#)).

Parameters:

<Threshold> Range: 0 to 200
 *RST: +1 dB
 Default unit: dB

Example:

SENS:ADJ:CONF:HYST:UPP 2

For an input signal level of currently 20 dBm, the reference level will only be adjusted when the signal level rises above 22 dBm.

Manual operation: See "[Upper Level Hysteresis](#)" on page 203

[SENSe:]ADJust:CONFIgure:TRIG <State>

This command defines the behaviour of the measurement when adjusting a setting automatically (using `SENS:ADJ:LEV ON`, for example).

For more information see "[Adjusting settings automatically during triggered measurements](#)" on page 202.

Parameters:

<State> **ON**
 The measurement for automatic adjustment waits for the trigger.

OFF
 The measurement for automatic adjustment is performed immediately, without waiting for a trigger.

 *RST: ON

Example:

ADJ:CONF:TRIG OFF

SENSe:AVERage Subsystem

The SENSE:AVERage subsystem calculates the average of the acquired data. A new test result is obtained from several successive measurements.

There are two types of average calculation: logarithmic and linear. In case of logarithmic average calculation (denoted with VIDEO), the average value of the measured logarithmic power is calculated and in case of linear average calculation, the linear power is averaged before the logarithm is applied.

[\[SENSe:\]AVERage<n>\[:STATe<Trace>\]](#)..... 784
[\[SENSe:\]AVERage<n>:COUNT](#)..... 784
[\[SENSe:\]AVERage<n>:TYPE](#)..... 785

[SENSe:]AVERage<n>[:STATe<Trace>] <State>

This command turns averaging for a particular trace in a particular window on and off.

Suffix:

<n> Selects the measurement window.
 <Trace> 1...6
 Selects the trace.

Parameters:

<State> ON | OFF
 *RST: OFF

Example:

```
AVER OFF
Switches off the average calculation for trace 1.
AVER:STAT3 ON
Switches on the average calculation for trace 3.
```

[SENSe:]AVERage<n>:COUNT <NoMeasurements>

This command defines the number of measurements which contribute to the average value.

Note that continuous averaging is performed after the indicated number has been reached in continuous sweep mode.

In single sweep mode, the sweep is stopped as soon as the indicated number of measurements (sweeps) is reached. Synchronization to the end of the indicated number of measurements is only possible in single sweep mode.

This command has the same effect as the [SENSe<source>:]SWEep:COUNT command. In both cases, the number of measurements is defined whether the average calculation is active or not.

The number of measurements applies to all traces in the window.

Suffix:

<n> Selects the measurement window.

Parameters:

<NoMeasurements> 0 to 32767
 *RST: 0

Example:

```
SWE:CONT OFF
Switching to single sweep mode.
AVER:COUN 16
Sets the number of measurements to 16.
AVER:STAT ON
Switches on the calculation of average.
INIT;*WAI
Starts the measurement and waits for the end of the 16 sweeps.
```

[SENSe:]AVERage<n>:TYPE <FunctionType>

This command selects the type of average function.

Suffix:

<n> Selects the measurement window.

Parameters:

<FunctionType> VIDEo | LINear | POWer

VIDeo

The logarithmic power values are averaged.

LINear

The power values are averaged before they are converted to logarithmic values.

POWer

The power level values are converted into unit Watt prior to averaging. After the averaging, the data is converted back into its original unit.

*RST: VIDEo

Example:

AVER:TYPE LIN

Switches to linear average calculation.

Manual operation:

See "[Lin](#)" on page 226

See "[Log](#)" on page 226

See "[Power](#)" on page 226

SENSe:BANDwidth Subsystem

This subsystem controls the setting of the instruments filter bandwidths. Both groups of commands (BANDwidth and BWIDth) perform the same functions.

[SENSe:]BANDwidth BWIDth[:RESolution]	785
[SENSe:]BANDwidth BWIDth[:RESolution]:AUTO	786
[SENSe:]BANDwidth BWIDth[:RESolution]:FFT	786
[SENSe:]BANDwidth BWIDth[:RESolution]:RATIo	787
[SENSe:]BANDwidth BWIDth[:RESolution]:TYPE	787
[SENSe:]BANDwidth BWIDth:VIDeo	788
[SENSe:]BANDwidth BWIDth:VIDeo:AUTO	788
[SENSe:]BANDwidth BWIDth:VIDeo:RATIo	788
[SENSe:]BANDwidth BWIDth:VIDeo:TYPE	789

[SENSe:]BANDwidth|BWIDth[:RESolution] <Bandwidth>

This command defines the resolution bandwidth.

The available resolution bandwidths are specified in the data sheet. For details on the correlation between resolution bandwidth and filter type refer to [Chapter 5.2.6.3, "Selecting the Appropriate Filter Type"](#), on page 211.

A change of the resolution bandwidth automatically turns the coupling to the span off.

Parameters:

<Bandwidth> refer to data sheet
 *RST: (AUTO is set to ON)

Example:

BAND 1 MHz
 Sets the resolution bandwidth to 1 MHz

Manual operation:

See "Res BW Manual" on page 206
 See "Res BW" on page 361

[SENSe:]BANDwidth|BWIDth[:RESolution]:AUTO <State>

This command couples and decouples the resolution bandwidth to the span.

The automatic coupling adapts the resolution bandwidth to the current frequency span according to the relationship between frequency span and resolution bandwidth.

The 6 dB bandwidths 200 Hz, 9 kHz and 120 kHz and the channel filters available are not set by the automatic coupling.

Use [SENSe:]BANDwidth|BWIDth[:RESolution]:RATio to define the ratio RBW/span.

Parameters:

<State> ON | OFF
 *RST: ON

Example:

BAND:AUTO OFF
 Switches off the coupling of the resolution bandwidth to the span.

Manual operation:

See "Res BW Manual" on page 206
 See "Res BW Auto" on page 206
 See "Default Coupling" on page 210

[SENSe:]BANDwidth|BWIDth[:RESolution]:FFT <FilterMode>

This command defines the filter mode of FFT filters by defining the partial span size. The partial span is the span which is covered by one FFT analysis.

This command is only available for sweep type "FFT".

Parameters:

<FilterMode> **AUTO**
 The firmware determines whether to use wide or narrow filters to obtain the best measurement results.

NARRow

The FFT filters with the smaller partial span are used. This allows you to perform measurements near a carrier with a reduced reference level due to a narrower analog prefilter.

*RST: AUTO

- Example:** BAND:TYPE FFT
Select FFT filter.
- Example:** BAND:FFT NARR
Select narrow partial span for FFT filter.
- Manual operation:** See "Auto" on page 204
See "Narrow" on page 204

[SENSe:]BANDwidth|BWIDth[:RESolution]:RATio <Ratio>

This command defines the ratio between the resolution bandwidth (Hz) and the span (Hz).

Note that the ratio defined with the remote command (RBW/span) is reciprocal to that of the manual operation (span/RBW).

Parameters:

<Ratio> Range: 0.0001 to 1
 *RST: 0.01

Example: BAND:RAT 0.01

Manual operation: See "Span/RBW Manual" on page 210

[SENSe:]BANDwidth|BWIDth[:RESolution]:TYPE <FilterType>

This command selects the type of resolution filter.

For detailed information on filters see [Chapter 5.2.6.3, "Selecting the Appropriate Filter Type"](#), on page 211 and [Chapter 5.2.6.4, "List of Available RRC and Channel Filters"](#), on page 212.

When changing the filter type, the next larger filter bandwidth is selected if the same filter bandwidth is not available for the new filter type.

5 Pole filters are not available when using the sweep type "FFT".

Parameters:

<FilterType> **NORMal**
 Gaussian filters

CFILter
 channel filters

RRC
 RRC filters

P5
 5 Pole filters

 *RST: NORMal

Example: BAND:TYPE NORM

Manual operation: See "Filter Type" on page 211

[SENSe:]BANDwidth|BWIDth:VIDeo <Bandwidth>

This command defines the video bandwidth. The available video bandwidths are specified in the data sheet.

Parameters:

<Bandwidth> refer to data sheet
*RST: (AUTO is set to ON)

Example: BAND:VID 10 kHz

Manual operation: See "[Video BW Manual](#)" on page 206

[SENSe:]BANDwidth|BWIDth:VIDeo:AUTO <State>

This command couples and decouples the VBW to the RBW.

Use [[SENSe:\]BANDwidth|BWIDth:VIDeo:RATio](#) to define the ratio VBW/RBW.

Parameters:

<State> ON | OFF
*RST: ON

Example: BAND:VID:AUTO OFF

Manual operation: See "[Video BW Manual](#)" on page 206
See "[Video BW Auto](#)" on page 207
See "[Default Coupling](#)" on page 210

[SENSe:]BANDwidth|BWIDth:VIDeo:RATio <Ratio>

This command defines the ratio between video bandwidth (Hz) and resolution bandwidth (Hz).

Note that the ratio defined with the remote command (VBW/RBW) is reciprocal to that of the manual operation (RBW/VBW).

Parameters:

<Ratio> Range: 0.01 to 1000
*RST: 3

Example: BAND:VID:RAT 3
Sets the coupling of video bandwidth to video bandwidth = 3*resolution bandwidth

Manual operation: See "[RBW/VBW Sine \[1/1\]](#)" on page 209
See "[RBW/VBW Pulse \[.1\]](#)" on page 209
See "[RBW/VBW Noise \[10\]](#)" on page 209
See "[RBW/VBW Manual](#)" on page 210
See "[Span/RBW Auto \[100\]](#)" on page 210

[SENSe:]BANDwidth|BWIDth:VIDeo:TYPE <Mode>

This command selects the position of the video filter in the signal path.

Parameters:

<Mode>

LINear

The video filter is applied in front of the logarithmic amplifier. In linear mode, measurements with a logarithmic level scale result in flatter falling edges compared to logarithmic mode. The reason is the conversion of linear power values into logarithmic level values: if you halve the linear power, the logarithmic level decreases by 3 dB.

LOGarithmic

The video filter is applied after the logarithmic amplifier.

*RST: LINear

Example:

BAND:VID:TYPE LIN

Video filter ahead of the logarithmic amplifier

SENSe:CORRection Subsystem

This subsystem controls calibration and normalization during operation with the tracking generator (only with option R&S FSV-B9 or R&S FSV-B10).

Furthermore, configuration of conversion loss tables for external mixers (option B21) is performed using these commands.

[SENSe:]CORRection:COLLect[:ACQuire].....	789
[SENSe:]CORRection:CVL:BAND.....	790
[SENSe:]CORRection:CVL:CATalog?.....	791
[SENSe:]CORRection:CVL:SElect.....	791
[SENSe:]CORRection:CVL:MIXer.....	791
[SENSe:]CORRection:CVL:SNUMber.....	791
[SENSe:]CORRection:CVL:HARMonic.....	792
[SENSe:]CORRection:CVL:PORTs.....	792
[SENSe:]CORRection:CVL:BIAS.....	793
[SENSe:]CORRection:CVL:COMMeNt.....	793
[SENSe:]CORRection:CVL:DATA.....	793
[SENSe:]CORRection:CVL:CLEar.....	794
[SENSe:]CORRection:EGain:INPut[:MAGNitude].....	794
[SENSe:]CORRection:METHod.....	794
[SENSe:]CORRection:RECall.....	795
[SENSe:]CORRection[:STATe].....	795
[SENSe:]CORRection:TRANsducer:GENerator.....	795

[SENSe:]CORRection:COLLect[:ACQuire] <MeasType>

This command initiates a reference measurement (calibration). The reference measurement is the basis for the measurement normalization.

To obtain a correct reference measurement, a complete sweep with synchronization to the end of the sweep must have been carried out. This is only possible in the single sweep mode.

The command is available if a tracking generator is installed and has been turned on.

Parameters:

<MeasType>

THRough

"TRANsmission" mode: calibration with direct connection between tracking generator and device input

"REFLection" mode: calibration with short circuit at the input

OPEN

only allowed in "REFLection" mode: calibration with open input

Example:

```
INIT:CONT OFF
```

Selects single sweep operation

```
CORR:COLL THR;*WAI
```

Starts the measurement of reference data using direct connection between generator and device input and waits for the sweep end.

Usage:

Setting only

SCPI confirmed

Manual operation:

See ["Calibrate Reflection Short"](#) on page 447

See ["Calibrate Reflection Open"](#) on page 447

[SENSe:]CORRection:CVL:BAND <Type>

This command defines the waveguide band in the conversion loss table. Before this command can be performed, the conversion loss table must be selected (see [\[SENSe:\]CORRection:CVL:SElect](#) on page 791).

This command is only available with option B21 (External Mixer) installed.

Parameters:

<Band>

K | A | KA | Q | U | V | E | W | F | D | G | Y | J | USER

Standard waveguide band or user-defined band.

Note: The band formerly referred to as "A" is now named "KA"; the input parameter "A" is still available and refers to the same band as "KA".

For a definition of the frequency range for the pre-defined bands, see [Table 5-21](#).

```
*RST:      F (90 GHz - 140 GHz)
```

Example:

```
CORR:CVL:SEL 'LOSS_TAB_4'
```

Selects the conversion loss table.

```
CORR:CVL:BAND KA
```

Sets the band to KA (26.5 GHz - 40 GHz).

Mode:

all

Manual operation:

See ["Band"](#) on page 500

[SENSe:]CORRection:CVL:CATalog?

This command queries all available conversion loss tables saved in the C:\r_s\instr\user\cvl\ directory on the instrument.

This command is only available with option B21 (External Mixer) installed.

Example: CORR:CVL:CAT?

Usage: Query only

Mode: all

[SENSe:]CORRection:CVL:SElect <FileName>

This command selects the conversion loss table with the specified file name. If <file_name> is not available, a new conversion loss table is created.

This command is only available with option B21 (External Mixer) installed.

Parameters:

<FileName> '<File name>'

Example: CORR:CVL:SEL 'LOSS_TAB_4'

Mode: all

Manual operation: See "New Table" on page 500
See "File Name" on page 500
See "Edit Table" on page 503

[SENSe:]CORRection:CVL:MIXer <Type>

This command defines the mixer name in the conversion loss table. Before this command can be performed, the conversion loss table must be selected (see [SENSe:]CORRection:CVL:SElect on page 791).

This command is only available with option B21 (External Mixer) installed.

Parameters:

<Type> Name of mixer with a maximum of 16 characters

Example: CORR:CVL:SEL 'LOSS_TAB_4'
Selects the conversion loss table.
CORR:CVL:MIX 'FS_Z60'

Mode: all

Manual operation: See "Mixer Name" on page 501

[SENSe:]CORRection:CVL:SNUMber <SerialNo>

This command defines the serial number of the mixer in the conversion loss table. Before this command can be performed, the conversion loss table must be selected (see [SENSe:]CORRection:CVL:SElect on page 791).

This command is only available with option B21 (External Mixer) installed.

Parameters:

<SerialNo> Serial number with a maximum of 16 characters

Example:

```
CORR:CVL:SEL 'LOSS_TAB_4'
Selects the conversion loss table.
CORR:CVL:MIX '123.4567'
```

Mode: all

Manual operation: See "[Mixer S/N](#)" on page 501

[SENSe:]CORRection:CVL:HARMonic <HarmOrder>

This command defines the harmonic order used in the conversion loss table. Before this command can be performed, the conversion loss table must be selected (see [\[SENSe:\]CORRection:CVL:SElect](#) on page 791).

This command is only available with option B21 (External Mixer) installed.

Parameters:

<HarmOrder> **<numeric value>**
Range: 2 to 65

Example:

```
CORR:CVL:SEL 'LOSS_TAB_4'
Selects the conversion loss table.
CORR:CVL:HARM 3
```

Mode: all

Manual operation: See "[Harmonic Order](#)" on page 501

[SENSe:]CORRection:CVL:PORTs <PortNo>

This command defines the mixer type in the conversion loss table. Before this command can be performed, the conversion loss table must be selected (see [\[SENSe:\]CORRection:CVL:SElect](#) on page 791).

This command is only available with option B21 (External Mixer) installed.

Parameters:

<PortType> **2 | 3**
*RST: 2

Example:

```
CORR:CVL:SEL 'LOSS_TAB_4'
Selects the conversion loss table.
CORR:CVL:PORT 3
```

Mode: all

Manual operation: See "[Mixer Type](#)" on page 501

[SENSe:]CORRection:CVL:BIAS <BiasSetting>

This command defines the bias setting in the conversion loss table. Before this command can be performed, the conversion loss table must be selected (see [SENSe:]CORRection:CVL:SELEct on page 791).

This command is only available with option B21 (External Mixer) installed.

Parameters:

<BiasSetting> *RST: 0.0 A
 Default unit: A

Example:

```
CORR:CVL:SEL 'LOSS_TAB_4'
Selects the conversion loss table.
CORR:CVL:BIAS 3A
```

Mode: all

Manual operation: See "Bias" on page 501
 See "Write to <CVL table name>" on page 504

[SENSe:]CORRection:CVL:COMMeNt <Text>

This command defines a comment in the conversion loss table. Before this command can be performed, the conversion loss table must be selected (see [SENSe:]CORRection:CVL:SELEct on page 791).

This command is only available with option B21 (External Mixer) installed.

Parameters:

<Text>

Example:

```
CORR:CVL:SEL 'LOSS_TAB_4'
Selects the conversion loss table.
CORR:CVL:COMM 'Conversion loss table for
FS_Z60'
```

Mode: all

Manual operation: See "Comment" on page 500

[SENSe:]CORRection:CVL:DATA <Freq>,<Level>

This command defines the reference values of the selected conversion loss tables. The values are entered as a set of frequency/level pairs. A maximum of 50 pairs of frequency/level may be entered. Before this command can be performed, the conversion loss table must be selected (see [SENSe:]CORRection:CVL:SELEct on page 791).

This command is only available with option B21 (External Mixer) installed.

Parameters:

<Freq> The frequencies have to be sent in ascending order.
 <Level>

Example: `CORR:CVL:SEL 'LOSS_TAB_4'`
 Selects the conversion loss table.
`CORR:CVL:DATA 1MHZ,-30DB,2MHZ,-40DB`

Mode: all

Manual operation: See "Position/Value" on page 501

[SENSe:]CORRection:CVL:CLEar

This command deletes the selected conversion loss table. Before this command can be performed, the conversion loss table must be selected (see [\[SENSe:\]CORRection:CVL:SElect](#) on page 791).

This command is only available with option B21 (External Mixer) installed.

Example: `CORR:CVL:SEL 'LOSS_TAB_4'`
 Selects the conversion loss table.
`CORR:CVL:CLE`

Usage: Event

Mode: all

Manual operation: See "Delete Table" on page 503

[SENSe:]CORRection:EGain:INPut[:MAGNitude] <Gain>

This command makes an external gain known to the analyzer, which will take it into account during the display of measurement results. With this function the gain of an antenna or of an external preamplifier can be taken into account for the measurement values.

The command is available if a tracking generator is installed and has been turned on.

Parameters:

<Gain> Range: -200 dB to 200 dB
 *RST: 0 dB

Example: `CORR:EGA:INP 10DB`
 Takes 10 dB external gain into account.

[SENSe:]CORRection:METHod <Type>

This command selects the type of measurement to be performed with the tracking generator.

The command is available if a tracking generator is installed and has been turned on.

Parameters:

<Type> **REFlection**
 Selects reflection measurements.

TRANsmission
 Selects transmission measurements.

*RST: TRANsmission

Example: CORR:METH TRAN
Sets the type of measurement to "transmission".

Manual operation: See ["Calibrate Transmission"](#) on page 447
See ["Calibrate Reflection Short"](#) on page 447
See ["Calibrate Reflection Open"](#) on page 447

[SENSe:]CORRection:RECall

This command restores the measurement configuration used for calibration.
The command is available if a tracking generator is installed and has been turned on.

Example: CORR:REC

Usage: Event
SCPI confirmed

Manual operation: See ["Recall"](#) on page 448

[SENSe:]CORRection[:STATe] <State>

This command turns correction of measurement results (normalization) on and off.
The command is available after you have defined a reference trace for the selected measurement type with [\[SENSe:\]CORRection:COLLect\[:ACQuire\]](#) on page 789.
The command is available if a tracking generator is installed and has been turned on.

Parameters:

<State> ON | OFF
*RST: OFF

Example: CORR ON
Activates normalization.

Usage: SCPI confirmed

Manual operation: See ["Normalize"](#) on page 447

[SENSe:]CORRection:TRANsducer:GENerator <Name>

This command uses the normalized measurement data to generate a transducer factor with up to 625 points. The trace data is converted to a transducer with unit dB and stored in a file with the specified name and the suffix.trd under `c:\r_s\instr\trd`. The frequency points are allocated in equidistant steps between start and stop frequency. The generated transducer factor can be further adapted using the commands of the `[SENSe<source>:]CORRection:TRANsducer` subsystem (see [\[SENSe:\]CORRection:TRANsducer:DELeTe](#) on page 955).

This command is only available if the R&S FSV-B10 option (External Tracking Generator) is installed and normalization is switched on.

Parameters:**<Name>** '<name>**Example:**

CORR:TRAN:GEN 'SMU01'

Creates the transducer file C:\r_s\instr\trd\SMU01.trd.

Manual operation: See ["Save As Trd Factor"](#) on page 448**SENSe:DEMod Subsystem**

This subsystem controls demodulation of audible AF signals.

[\[SENSe:\]DEMod:SQUelch:LEVel](#)..... 796[\[SENSe:\]DEMod:SQUelch\[:STATe\]](#)..... 796**[SENSe:]DEMod:SQUelch:LEVel <Threshold>**

This command defines the threshold for selective demodulation. Squelching must be active for this command to work (see [\[SENSe:\]DEMod:SQUelch\[:STATe\]](#)).

All signals below the threshold are not demodulated.

This command is only available if the R&S FSV-B3 option (Audio Demodulation) is installed.

Parameters:**<Threshold>** The threshold level as a percentage of the display height.

Range: 0 to 100

*RST: 60

Example:

DEM:SQU:LEV 80

Sets the squelch level to 80% of the displayed signal.

Usage:

SCPI confirmed

Manual operation: See ["Squelch Level"](#) on page 262**[SENSe:]DEMod:SQUelch[:STATe] <State>**

This command turns selective demodulation at the marker position on and off.

A video trigger is automatically activated with the same level as the squelch level, any other trigger or gate settings are deactivated.

This command is only available if the R&S FSV-B3 option (Audio Demodulation) is installed.

Parameters:**<State>** ON | OFF

*RST: OFF

Example:

DEM:SQU ON

Signals below the level threshold are not sent to the audio output.

Usage:

SCPI confirmed

Manual operation: See "Squelch" on page 261

SENSe:ESpectrum Subsystem

The `SENSe:ESpectrum` subsystem contains the remote commands to configure Spectrum Emission Mask (SEM) measurements.



The sweep list cannot be configured using remote commands during an on-going sweep operation.

<code>[SENSe:]ESpectrum:BWID</code>	797
<code>[SENSe:]ESpectrum:FILTer[:RRC][:STATe]</code>	798
<code>[SENSe:]ESpectrum:FILTer[:RRC]:ALPHa</code>	798
<code>[SENSe:]ESpectrum:HighSPeed</code>	798
<code>[SENSe:]ESpectrum:PRESet[:STANdard]</code>	799
<code>[SENSe:]ESpectrum:PRESet:REStore</code>	799
<code>[SENSe:]ESpectrum:PRESet:StORe</code>	800
<code>[SENSe:]ESpectrum:RANGe<range>:BANDwidth[:RESolution]</code>	800
<code>[SENSe:]ESpectrum:RANGe<range>:BANDwidth:VIDeo</code>	800
<code>[SENSe:]ESpectrum:RANGe<range>:COUnT</code>	801
<code>[SENSe:]ESpectrum:RANGe<range>:DELeTe</code>	801
<code>[SENSe:]ESpectrum:RANGe<range>:FILTer:TYPE</code>	801
<code>[SENSe:]ESpectrum:RANGe<range>[:FREQuency]:StARt</code>	802
<code>[SENSe:]ESpectrum:RANGe<range>[:FREQuency]:StOP</code>	802
<code>[SENSe:]ESpectrum:RANGe<range>:INPut:ATTenuation</code>	803
<code>[SENSe:]ESpectrum:RANGe<range>:INPut:ATTenuation:AUTO</code>	803
<code>[SENSe:]ESpectrum:RANGe<range>:INPut:GAIn:STATe</code>	803
<code>[SENSe:]ESpectrum:RANGe<range>:INStert</code>	804
<code>[SENSe:]ESpectrum:RANGe<range>:LIMit<source>:ABSolute:StARt</code>	804
<code>[SENSe:]ESpectrum:RANGe<range>:LIMit<source>:ABSolute:StOP</code>	805
<code>[SENSe:]ESpectrum:RANGe<range>:LIMit<source>:RELative:StARt</code>	805
<code>[SENSe:]ESpectrum:RANGe<range>:LIMit<source>:RELative:StOP</code>	805
<code>[SENSe:]ESpectrum:RANGe<range>:LIMit<source>:STATe</code>	806
<code>[SENSe:]ESpectrum:RANGe<range>:RLEVel</code>	806
<code>[SENSe:]ESpectrum:RANGe<range>:SWEep:TIME</code>	807
<code>[SENSe:]ESpectrum:RANGe<range>:SWEep:TIME:AUTO</code>	807
<code>[SENSe:]ESpectrum:RANGe<range>:TRANSDucer</code>	807
<code>[SENSe:]ESpectrum:RRANGe</code>	808
<code>[SENSe:]ESpectrum:RTYPE</code>	808

`[SENSe:]ESpectrum:BWID` <Bandwidth>

This command defines the bandwidth used for measuring the channel power (reference range). This setting takes only effect if channel power is selected as power reference type (see `[SENSe:]ESpectrum:RTYPE` on page 808).

Parameters:

<Bandwidth> minimum span ≤ value ≤ span of reference range
 *RST: 3.84 MHz

Example: ESP:RTYP CPOW
Sets the power reference type to channel power.
ESP:BWID 1 MHZ
Sets the Tx bandwidth to 1 MHz.

Manual operation: See ["Edit Reference Range"](#) on page 322

[SENSe:]ESpectrum:FILTer[:RRC][:STATe] <State>

This command activates or deactivates the use of an RRC filter. This setting only takes effect if channel power is selected as power reference type (see [\[SENSe:\]ESpectrum:RTYPe](#) on page 808).

Parameters:

<State> ON | OFF
*RST: ON

Example: ESP:RTYP CPOW
Sets the power reference type to channel power.
ESP:FILT OFF
Deactivates the use of an RRC filter.

Manual operation: See ["Edit Reference Range"](#) on page 322

[SENSe:]ESpectrum:FILTer[:RRC]:ALPHA <Value>

This command sets the alpha value of the RRC filter. This setting takes only effect if channel power is selected as power reference type ([\[SENSe:\]ESpectrum:RTYPe](#) command) and if the RRC filter is activated ([\[SENSe:\]ESpectrum:FILTer\[:RRC\]\[:STATe\]](#) command).

Parameters:

<Value> 0 to 1
*RST: 0.22

Example: ESP:RTYP CPOW
Sets the power reference type to channel power.
ESP:FILT ON
Activates the use of an RRC filter.
ESP:FILT:ALPH 0.5
Sets the alpha value of the RRC filter to 0.5.

Manual operation: See ["Edit Reference Range"](#) on page 322

[SENSe:]ESpectrum:HighSPeed <State>

This command activates Fast SEM mode to accelerate spurious emission mask measurements. For details see ["Fast Spectrum Emission Mask Measurements"](#) on page 341.

Note that in Fast SEM mode, the following parameters cannot be changed in all ranges:

- Filter type, see [\[SENSe:\]ESpectrum:RANGe<range>:FILTer:TYPE](#) on page 801
- RBW, see [\[SENSe:\]ESpectrum:RANGe<range>:BANDwidth\[:RESolution\]](#) on page 800
- VBW, see [\[SENSe:\]ESpectrum:RANGe<range>:BANDwidth:VIDeo](#) on page 800
- Sweep Time Mode, see [\[SENSe:\]ESpectrum:RANGe<range>:SWEep:TIME:AUTO](#) on page 807
- Sweep Time, see [\[SENSe:\]ESpectrum:RANGe<range>:SWEep:TIME](#) on page 807
- Reference level, see [\[SENSe:\]ESpectrum:RANGe<range>:RLEVel](#) on page 806
- RF Att Mode, see [\[SENSe:\]ESpectrum:RANGe<range>:INPut:ATTenuation:AUTO](#) on page 803
- Rf Attenuation, see [\[SENSe:\]ESpectrum:RANGe<range>:INPut:ATTenuation](#) on page 803
- Preamp, see [\[SENSe:\]ESpectrum:RANGe<range>:INPut:GAIN:STate](#) on page 803

Parameters:

<State> ON | OFF
 *RST: OFF

Example: ESP:HSP ON

Manual operation: See "[Fast SEM](#)" on page 318

[SENSe:]ESpectrum:PRESet[:STANdard]

This command selects the specified XML file under C:\r_s\instr\sem_std. If the file is stored in a subdirectory, include the relative path.

Example: ESP:PRES 'WCDMA\3GPP\DL\PowerClass_31_39.xml'
 Selects the PowerClass_31_39.xml XML file in the C:\R_S\instr\sem_std\WCDMA\3GPP\DL directory.
 ESP:PRES?
 W-CDMA 3GPP DL (31,39) dBm
 The query returns information about the selected standard, the link direction and the power class. If no standard has been selected, the query returns None.

Manual operation: See "[Load Standard](#)" on page 326

[SENSe:]ESpectrum:PRESet:RESTore

This command copies the XML files from the C:\R_S\instr\sem_backup folder to the C:\R_S\instr\sem_std folder. Files of the same name are overwritten.

Example: ESP:PRES:REST
Restores the originally provided XML files.

Manual operation: See ["Restore Standard Files"](#) on page 327

[SENSe:]ESpectrum:PRESet:STORE <FileName>

This command stores the current settings as presettings in the specified XML file under C:\r_s\instr\sem_backup.

Parameters:

<FileName>

Example: ESP:PRES:STOR
'WCDMA\3GPP\DL\PowerClass_31_39.xml'
Stores the settings in the PowerClass_31_39.xml file in the C:\R_S\instr\sem_std\WCDMA\3GPP\DL directory.

Manual operation: See ["Save As Standard"](#) on page 326

[SENSe:]ESpectrum:RANGe<range>:BANDwidth[:RESolution] <Value>

This command sets the RBW value for the specified range.

Note that this parameter can not be set for all ranges if "Fast SEM" mode is activated (see [\[SENSe:\]ESpectrum:HighSPeed](#) on page 798).

Suffix:

<range> 1...20
range

Parameters:

<Value> Refer to the data sheet.
*RST: 30.0 kHz

Example: ESP:RANG2:BAND:RES 5000
Sets the RBW for range 2 to 5 kHz.

Manual operation: See ["RBW"](#) on page 319

[SENSe:]ESpectrum:RANGe<range>:BANDwidth:VIDeo <Value>

This command sets the VBW value for the specified range.

Note that this parameter can not be set for all ranges if "Fast SEM" mode is activated (see [\[SENSe:\]ESpectrum:HighSPeed](#) on page 798).

Suffix:

<range> 1...20
range

Parameters:

<Value> Refer to the data sheet.
*RST: 10.0 MHz

Example: `ESP:RANG1:BAND:VID 5000000`
Sets the VBW for range 1 to 5 MHz.

Manual operation: See "[VBW](#)" on page 319

[SENSe:]ESpectrum:RANGe<range>:COUNT

This command returns the number of defined ranges.

Suffix:
<range> 1...20
 range

Example: `ESP:RANG:COUNT?`
Returns the number of defined ranges.

[SENSe:]ESpectrum:RANGe<range>:DELEte

This command deletes the specified range. The range numbers are updated accordingly. The reference range cannot be deleted. A minimum of three ranges is mandatory.

Suffix:
<range> 1...20
 range

Example: `ESP:RANG4:DEL`
Deletes range 4.

Manual operation: See "[Delete Range](#)" on page 321

[SENSe:]ESpectrum:RANGe<range>:FILTer:TYPE <Type>

This command sets the filter type for the specified range.

Note that this parameter can not be set for all ranges if "Fast SEM" mode is activated (see [\[SENSe:\]ESpectrum:HighSPeed](#) on page 798).

Suffix:
<range> 1...20
 range

Parameters:
<Type> **NORMal**
 Gaussian filters
 CFILter
 channel filters
 RRC
 RRC filters
 PULSe
 EMI (6dB) filters

P5

5 Pole filters

***RST:** NORM

The available bandwidths of the filters are specified in the data sheet.

Example:

ESP:RANG1:FILT:TYPE RRC

Sets the RRC filter type for range 1.

Manual operation:See "[Filter Type](#)" on page 318**[SENSe:]ESpectrum:RANGe<range>[:FREQUENCY]:STARt <Frequency>**

This command sets the start frequency for the specified range.

In order to change the start/stop frequency of the first/last range, select the appropriate span. If you set a span that is smaller than the overall span of the ranges, the measurement includes only the ranges that lie within the defined span and have a minimum span of 20 Hz. The first and last range are adapted to the given span as long as the minimum span of 20 Hz is not violated.

Note the rules for the <Frequency> parameter specified in "[Ranges and Range Settings](#)" on page 329.

Suffix:

<range> 1...20
range

Parameters:

<Frequency> numeric value
***RST:** -250.0 MHz (range 1), -2.52 MHz (range 2), 2.52 MHz (range 3)

Example:

ESP:RANG1:STAR 100000000

Sets the start frequency for range 1 to 100 MHz.

Manual operation:See "[Range Start / Range Stop](#)" on page 318**[SENSe:]ESpectrum:RANGe<range>[:FREQUENCY]:STOP <Frequency>**

This command sets the stop frequency for the specified range. For further details refer to the `[SENSe:]ESpectrum:RANGe<range>[:FREQUENCY]:STARt` command.

Note the rules for the <Frequency> parameter specified in "[Ranges and Range Settings](#)" on page 329.

Suffix:

<range> 1...20
range

Parameters:

<Frequency> numeric value
***RST:** -2.52 MHz (range 1), 2.52 MHz (range 2), 250.0 MHz (range 3)

Example: `ESP:RANG3:STOP 10000000`
Sets the stop frequency for range 2 to 10 MHz.

Manual operation: See "[Range Start / Range Stop](#)" on page 318

[SENSe:]ESpectrum:RANGe<range>:INPut:ATTenuation <Value>

This command sets the attenuation for the specified range.

Note that this parameter can not be set for all ranges if "Fast SEM" mode is activated (see [\[SENSe:\]ESpectrum:HighSPeed](#) on page 798).

Suffix:
<range> 1...20
range

Parameters:
<Value> Refer to the data sheet.
*RST: 0 dB

Example: `ESP:RANG3:INP:ATT 10`
Sets the attenuation of range 3 to 10 dB.

Manual operation: See "[RF Attenuator](#)" on page 319

[SENSe:]ESpectrum:RANGe<range>:INPut:ATTenuation:AUTO <State>

This command activates or deactivates the automatic RF attenuation setting for the specified range.

Note that this parameter can not be set for all ranges if "Fast SEM" mode is activated (see [\[SENSe:\]ESpectrum:HighSPeed](#) on page 798).

Suffix:
<range> 1...20
range

Parameters:
<State> ON | OFF
*RST: ON

Example: `ESP:RANG2:INP:ATT:AUTO OFF`
Deactivates the RF attenuation auto mode for range 2.

Manual operation: See "[RF Att. Mode](#)" on page 319

[SENSe:]ESpectrum:RANGe<range>:INPut:GAIN:STATe <State>

This command switches the preamplifier on or off for the specified range.

Note that this parameter can not be set for all ranges if "Fast SEM" mode is activated (see [\[SENSe:\]ESpectrum:HighSPeed](#) on page 798).

Suffix:
 <range> 1...20
 range

Parameters:
 <State> ON | OFF
 *RST: OFF

Example: ESP:RANG3:INP:GAIN:STATe ON
 Switches the preamplifier for range 3 on or off.

Manual operation: See "[Preamp](#)" on page 319

[SENSe:]ESPeCtrum:RANGe<range>:INSert <Mode>

This command inserts a new range before or after the specified range. The range numbers are updated accordingly.

Suffix:
 <range> 1...20
 range

Parameters:
 <Mode> AFTer | BEFore

Example: ESP:RANG3:INS BEF
 Inserts a new range before range 3.
 ESP:RANG1:INS AFT
 Inserts a new range after range 1.

Manual operation: See "[Insert before Range](#)" on page 321
 See "[Insert after Range](#)" on page 321

[SENSe:]ESPeCtrum:RANGe<range>:LIMit<source>:ABSolute:STARt <Level>

This command sets an absolute limit value at the start frequency of the specified range. Different from manual operation, this setting is independently of the defined limit check type.

Suffix:
 <range> 1...20
 range

Parameters:
 <Level> -400 to in 400 dBm
 *RST: 13 dBm

Example: ESP:RANG1:LIM:ABS:STAR 10
 Sets an absolute limit of 10 dBm at the start frequency of the range.

Manual operation: See "[Abs Limit Start](#)" on page 320

[SENSe:]ESpectrum:RANGe<range>:LIMit<source>:ABSolute:STOP <Level>

This command sets an absolute limit value at the stop frequency of the specified range. Different from manual operation, this setting is independent of the defined limit check type.

Suffix:

<range> 1...20
range

Parameters:

<Level> -400 to in 400 dBm
*RST: 13 dBm

Example:

ESP:RANG1:LIM:ABS:STOP 20

Sets an absolute limit of 20 dBm at the stop frequency of the range.

Manual operation: See "[Abs Limit Stop](#)" on page 320

[SENSe:]ESpectrum:RANGe<range>:LIMit<source>:RELative:STARt <Limit>

This command sets a relative limit value at the start frequency of the specified range. Different from manual operation, this setting is independent of the defined limit check type.

Suffix:

<range> 1...20
range

Parameters:

<Limit> -400 to in 400 dBc
*RST: -50 dBc

Example:

ESP:RANG3:LIM:REL:STAR -20

Sets a relative limit of -20 dBc at the start frequency of the range.

Manual operation: See "[Rel Limit Start](#)" on page 321

[SENSe:]ESpectrum:RANGe<range>:LIMit<source>:RELative:STOP <Limit>

This command sets a relative limit value at the stop frequency of the specified range. Different from manual operation, this setting is independently of the defined limit check type.

Suffix:

<range> 1...20
range

Parameters:

<Limit> -400 to in 400 dBc
*RST: -50 dBc

Example: `ESP:RANG3:LIM:REL:STOP 20`
Sets a relative limit of 20 dBc at the stop frequency of the range.

Manual operation: See "[Rel Limit Stop](#)" on page 321

[SENSe:]ESpectrum:RANGe<range>:LIMit<source>:STATe <State>

This command sets the type of limit check for all ranges.

Suffix:
<range> irrelevant

Parameters:
<State> ABSolute | RELative | AND | OR

ABSolute

Checks only the absolute limits defined.

RELative

Checks only the relative limits. Relative limits are defined as relative to the measured power in the reference range.

AND

Combines the absolute and relative limit. The limit check fails when both limits are violated.

OR

Combines the absolute and relative limit. The limit check fails when one of the limits is violated.

*RST: REL

Example: `ESP:RANG3:LIM:STAT AND`
Sets for all ranges the combined absolute/relative limit check.

Manual operation: See "[Limit Check 1-4](#)" on page 320

[SENSe:]ESpectrum:RANGe<range>:RLEVel <Value>

This command sets the reference level for the specified range.

Note that this parameter can not be set for all ranges if "Fast SEM" mode is activated (see [\[SENSe:\]ESpectrum:HighSPeed](#) on page 798).

Suffix:
<range> 1...20
range

Parameters:
<Value> Refer to the data sheet.
*RST: -20 dBm

Example: `ESP:RANG2:RLEV 0`
Sets the reference level of range 2 to 0 dBm.

Manual operation: See "[Ref. Level](#)" on page 319

[SENSe:]ESpectrum:RANGe<range>:SWEep:TIME <SweepTime>

This command sets the sweep time for the specified range.

Note that this parameter can not be set for all ranges if "Fast SEM" mode is activated (see [\[SENSe:\]ESpectrum:HighSPeed](#) on page 798).

Suffix:

<range> 1...20
range

Parameters:

<SweepTime> Allowed values depend on the ratio of span to RBW and RBW to VBW. For details refer to the data sheet.

*RST: 0.27 s

Example:

ESP:RANG1:SWE:TIME 1

Sets the sweep time for range 1 to 1 s.

Manual operation: See "[Sweep Time](#)" on page 319

[SENSe:]ESpectrum:RANGe<range>:SWEep:TIME:AUTO <State>

This command activates or deactivates the automatic sweep time setting for the specified range.

Note that this parameter can not be set for all ranges if "Fast SEM" mode is activated (see [\[SENSe:\]ESpectrum:HighSPeed](#) on page 798).

Suffix:

<range> 1...20
range

Parameters:

<State> ON | OFF

*RST: ON

Example:

ESP:RANG3:SWE:TIME:AUTO OFF

Deactivates the sweep time auto mode for range 3.

Manual operation: See "[Sweep Time Mode](#)" on page 319

[SENSe:]ESpectrum:RANGe<range>:TRANsducer <TransducerName>

This command sets a transducer for the specified range. You can only choose a transducer that fulfills the following conditions:

- The transducer overlaps or equals the span of the range.
- The x-axis is linear.
- The unit is dB.

Suffix:

<range> 1...20
range

Parameters:

<TransducerName> 'string' = name of the transducer

Example:

```
ESP:RANG1:TRAN 'test'
```

Sets the transducer called test for range 1.

Manual operation: See "[Transd. Factor](#)" on page 320

[SENSe:]ESpectrum:RRANge

This command returns the current position (number) of the reference range.

Example:

```
ESP:RRAN?
```

Returns the current position (number) of the reference range.

[SENSe:]ESpectrum:RTYPE <Type>

This command sets the power reference type.

Parameters:

<Type> PEAK | CPOWER

PEAK

Measures the highest peak within the reference range.

CPOWER

Measures the channel power within the reference range (integral bandwidth method).

```
*RST: CPOWER
```

Example:

```
ESP:RTYP PEAK
```

Sets the peak power reference type.

Manual operation: See "[Edit Reference Range](#)" on page 322

SENSe:FREQuency Subsystem

The SENSE:FREQuency subsystem defines the frequency axis of the active display. The frequency axis can either be defined via the start/stop frequency or via the center frequency and span.

[SENSe:]FREQuency:CENTer.....	809
[SENSe:]FREQuency:CENTer:STEP.....	809
[SENSe:]FREQuency:CENTer:STEP:AUTO.....	809
[SENSe:]FREQuency:CENTer:STEP:LINK.....	809
[SENSe:]FREQuency:CENTer:STEP:LINK:FACTor.....	810
[SENSe:]FREQuency:MODE.....	810
[SENSe:]FREQuency:OFFSet.....	811
[SENSe:]FREQuency:SPAN.....	811
[SENSe:]FREQuency:SPAN:FULL.....	811
[SENSe:]FREQuency:START.....	812
[SENSe:]FREQuency:STOP.....	812

[SENSe:]FREQuency:CENTer <Frequency>

This command defines the center frequency (frequency domain) or measuring frequency (time domain).

Parameters:

<Frequency> Range: 0 to fmax
 *RST: fmax/2
 Default unit: Hz
 f_{max} is specified in the data sheet. min span is 10 Hz
 (SEM and Spurious: min span = 20 Hz)

Example: `FREQ:CENT 100 MHz`

Manual operation: See "[Center](#)" on page 186

[SENSe:]FREQuency:CENTer:STEP <StepSize>

This command defines the center frequency step size.

Parameters:

<StepSize> Range: 1 to fmax
 *RST: 0.1 x
 Default unit: Hz

Example: `FREQ:CENT:STEP 120 MHz`

Manual operation: See "[Manual](#)" on page 188

[SENSe:]FREQuency:CENTer:STEP:AUTO <State>

This command couples the step size of the center frequency to the span (ON) or sets the value of the center frequency entered via `[SENSe:]FREQuency:CENTer` (OFF).

Parameters:

<State> ON | OFF
 *RST: ON

Example: `FREQ:CENT:STEP:AUTO ON`
 Activates the coupling of the step size to the span.

[SENSe:]FREQuency:CENTer:STEP:LINK <CouplingType>

This command couples and decouples the center frequency step size to the span or the resolution bandwidth.

Parameters:

<CouplingType> **SPAN**
 Couples the step size to the span. Available for measurements in the frequency domain.

RBW

Couples the step size to the resolution bandwidth. Available for measurements in the time domain.

OFF

Decouples the step size (manual input).

*RST: SPAN

Example:

FREQ:CENT:STEP:LINK SPAN

Manual operation:

See "0.1*Span (span > 0)" on page 187

See "0.1*RBW (span > 0)" on page 187

See "0.5*Span (span > 0)" on page 187

See "0.5*RBW (span > 0)" on page 187

See "x*Span (span > 0)" on page 187

See "x*RBW (span > 0)" on page 187

[SENSe:]FREQuency:CENTer:STEP:LINK:FACTor <Factor>

This command defines a step size factor if the center frequency step size is coupled to the span or the resolution bandwidth.

Parameters:

<Factor> Range: 1 to 100
 *RST: 10
 Default unit: PCT

Example:

FREQ:CENT:STEP:LINK:FACT 20PCT

Manual operation:

See "0.1*Span (span > 0)" on page 187

See "0.1*RBW (span > 0)" on page 187

See "0.5*Span (span > 0)" on page 187

See "0.5*RBW (span > 0)" on page 187

[SENSe:]FREQuency:MODE <Mode>

This command selects the frequency mode.

between span > 0 and zero span in the "Spectrum" mode.

Parameters:

<Mode>

CW

Selects the time domain (span = 0).

In the time domain, define the measurement frequency with

[SENSe:]FREQuency:CENTer.

FIXed

Selects the time domain (span = 0).

In the time domain, define the measurement frequency with

[SENSe:]FREQuency:CENTer.

SWEep

Selects the frequency domain (span > 0).

In the frequency domain, define the frequency characteristics with the following commands:

- [SENSe:]FREQuency:START
- [SENSe:]FREQuency:STOP
- [SENSe:]FREQuency:SPAN
- [SENSe:]FREQuency:CENTer

*RST: SWEep

Example: FREQ:MODE SWE
Selects the frequency domain.

Usage: SCPI confirmed

[SENSe:]FREQuency:OFFSet <Offset>

This command defines the frequency offset.

Parameters:

<Offset> Range: -100 GHz to 100 GHz
*RST: 0 Hz
Default unit: Hz

Example: FREQ:OFFS 1GHZ

Manual operation: See "[Frequency Offset](#)" on page 188

**[SENSe:]FREQuency:SPAN **

This command defines the frequency span.

Parameters:

 min span to fmax
*RST: fmax
f_{max} is specified in the data sheet. min span is 10 Hz
(SEM and Spurious: min span = 20 Hz)

Example: FREQ:SPAN 10MHz

Manual operation: See "[Span Manual](#)" on page 192
See "[Zero Span](#)" on page 192

[SENSe:]FREQuency:SPAN:FULL

This command sets the frequency span to its maximum.

Example: FREQ:SPAN:FULL

Manual operation: See "[Full Span](#)" on page 192

[SENSe:]FREQuency:STARt <Frequency>

This command defines the start frequency for measurements in the frequency domain.

Parameters:

<Frequency> 0 to (fmax - min span)
 *RST: 0
 f_{\max} is specified in the data sheet. min span is 10 Hz
 (SEM and Spurious: min span = 20 Hz)

Example: `FREQ:STAR 20MHz`

Manual operation: See "[Start](#)" on page 188

[SENSe:]FREQuency:STOP <Frequency>

This command defines the stop frequency for measurements in the frequency domain.

Parameters:

<Frequency> min span to fmax
 *RST: fmax
 f_{\max} is specified in the data sheet. min span is 10 Hz
 (SEM and Spurious: min span = 20 Hz)

Example: `FREQ:STOP 2000 MHz`

Manual operation: See "[Stop](#)" on page 188

SENSe:LIST Subsystem

The commands of this subsystem are used for measuring the power at a list of frequency points with different device settings. The measurement is always performed in zero span. A new trigger event is required for each test point (exception: trigger "FREE RUN").

The results are output as a list in the order of the entered frequency points. The number of results per test point depends on the number of concurrently active measurements (peak/RMS/average). The number of frequencies is limited to 200 entries.

Selection of concurrently active measurements and setting of parameters that are constant for the whole measurement is performed via a configuration command (`[SENSe:]LIST:POWer:SET`). This also includes the setting for trigger and gate parameters.



Settings that are not directly included in commands of this subsystem can be configured by sending the corresponding commands prior to the [SENSe:LIST Subsystem](#) commands.

Please note that changes to the trigger level have to be executed in zero span in order to take effect for the [SENSe:LIST Subsystem](#) commands.

The sweep list cannot be configured using remote commands during an on-going sweep operation.

The following subsystem is included:

"SENSe:LIST:RANGe Subsystem" on page 818

Further information

- "SENSe:LIST Subsystem" on page 812

More details on the SENSe:LIST Subsystem

The following setting parameters can be selected independently for each frequency point:

- analyzer frequency
- reference level
- resolution filter
- resolution bandwidth
- video bandwidth
- measurement time
- detector

The commands of this subsystem can be used in two different ways:

- Instrument setup, measurement and querying of the results in a single command line. With this method, there is the least delay between the measurement and the result output. However, it requires the control computer to wait for the response from the instrument.
- Instrument setup and querying of the result list at the end of the measurement: With this method, the control computer may be used for other activities while the measurement is being performed. However, more time is needed for synchronization via service request.

[SENSe:]LIST:POWer:RESult?	813
[SENSe:]LIST:POWer[:SEQuence]	814
[SENSe:]LIST:POWer:SET	817
[SENSe:]LIST:POWer:STATe	818

[SENSe:]LIST:POWer:RESult?

This command queries the results of the list evaluation.

This command may be used to obtain measurement results in an asynchronous way, using the service request mechanism for synchronization to the end of the measurement.

If there are no results, the command returns an error.

Return values:

<PowerLevel>

Power level for each frequency included in the measurement. The command returns up to 3 power levels for each frequency, depending on the number of evaluation modes you have turned on with `[SENSe:]LIST:POWer:SET` on page 817. The result is a list of floating point values separated by commas. The unit depends on `[SENSe:]LIST:POWer[:SEquence]`.

Example:

*ESE 1

*SRE 32

Configuration of the status reporting system for the generation of an SRQ on operation complete

SENSe:LIST:POWer

935.2 MHz, -20dBm, 10dB, OFF, NORM, 1 MHz, 3 MHz, 434us, 0,

935.4 MHz, -20dBm, 10dB, 10dB, NORM, 30 kHz, 100 kHz, 434us, 0,

935.6 MHz, -20dBm, 10dB, 20dB, NORM, 30 kHz, 100 kHz, 434us, 0;

*OPC

Configuring and starting the measurement

...

Further actions of the control computer during measurement

On SRQ:

SENSe:LIST:POWer:RESult?

Response to service request

Usage:

Query only

[SENSe:]LIST:POWer[:SEquence]

<Frequency>,<RefLevel>,<RfAtt>,<EIAtt>,<FilterType>,<RBW>,<VBW>,<Meas Time>,<TriggerLevel>

This command configures and initiates the List Evaluation measurement.

The list can contain up to 200 entries (frequencies). You can define a different instrument setup for each frequency that is in the list.

If you synchronize the measurement with *OPC, the R&S FSVA/FSV produces a service request when all frequencies have been measured and the number of individual measurements has been performed.

To reduce the setting time, all indicated parameters are set up simultaneously at each test point.

The measurement is performed in zero span and therefore the span is set to 0 Hz. If the span > 0 is set, the function is automatically switched off.

The measurement is not compatible with other measurements, especially as far as marker, adjacent channel power measurement or statistics are concerned. The corresponding commands thus automatically deactivate the function.

The function is only available in REMOTE operation. It is deactivated when switching the instrument back to LOCAL.

Note that using the command as a query initiates the measurement and returns the results if all frequencies have been measured. For more information on querying the results see [\[SENSe:\]LIST:POWer:RESult?](#) on page 813 .

The following parameters are the settings for an individual frequency point. They are repeated for each frequency point.

Setting parameters:

<Frequency>	Defines the receive frequency. Each frequency corresponds to one list entry. Range: 0 Hz to fmax
<RefLevel>	Defines the reference level for a list entry. Range: -130 dBm to 30 dBm Increment: 0.01 dBm
<RfAtt>	Defines the RF attenuation for a list entry. Range: 0 dB to 70 dB (75 dB with option R&S FSV-B25) Increment: 5 dB (1 dB with option R&S FSV-B25)
<EIAtt>	Defines the electronic attenuation for a list entry. Requires option R&S FSV-B25; OFF Turns electronic attenuation off. <AttenuationLevel> Numeric value that defines the attenuation level. Range: 0 dB to 30 dB Increment: 1 dB
<FilterType>	Selects the filter type for a list entry. For more information see [SENSe:]BANDwidth BWIDth[:RESolution]:TYPE on page 787.
<RBW>	Defines the resolution bandwidth for a list entry. For the range of values refer to "Res BW Manual" on page 206. Refer to Chapter 5.2.6.3, "Selecting the Appropriate Filter Type" , on page 211 for possible combinations of filter type and filter bandwidth for the <filter type> = CFILter and <filter type> = RRC.
<VBW>	Defines the video bandwidth for a list entry. The value is ignored for <filter type> = "CFILter" or "RRC" Range: 1 Hz to 10 MHz in 1, 3, 10 steps
<MeasTime>	Defines the measurement time for a list entry. For details refer to "Sweeptime Manual" on page 207. Range: 1 µs to 16000 s
<TriggerLevel>	The trigger level must be 0.

Return values:

<PowerLevel>

Power level for each frequency included in the measurement. The command returns up to 3 power levels for each frequency, depending on the number of evaluation modes you have turned on with `[SENSe:]LIST:POWer:SET` on page 817. The result is a list of floating point values separated by commas. The unit depends on `CALCulate<n>:UNIT:POWer`.

Example:

```
SENSe:LIST:POWer?
935.2 MHz,0 dBm,10 dB,OFF,NORM,1 MHz,3 MHz,
440us,0,
935.4 MHz,0dBm,10dB,10dB,NORM,30 kHz,100 kHz,
440us,0,
935.6 MHz,0dBm,10dB,20dB,NORM,30 kHz,100 kHz,
440us,0
```

Result list:

-28.3,-30.6,-38.1

Example:

```
SENSe:LIST:POWer:SET ON,ON,ON,IMM,POS,0,0
```

Activates the power measurement of the peak, RMS and average values.

```
SENSe:LIST:POWer?
935.2 MHz,0dBm,10dB,OFF,NORM,1 MHz,3 MHz,440us,
0,
935.4 MHz,0dBm,10dB,10dB,NORM,30 kHz,100 kHz,
440us,0,
935.6 MHz,0dBm,10dB,20dB,NORM,30 kHz,100 kHz,
440us,0
```

Result list (3 results per frequency point):

-28.3, -29.6, 1.5, -30.6, -31.9, 0.9, -38.1, -40.0, 2.3

Example:

```
SENSe:LIST:POWer
935.2 MHz,0dBm,10dB,OFF,NORM,1 MHz,3 MHz,440us,
0,
935.4 MHz,0dBm,10dB,10dB,CFIL,30 kHz,100 kHz,
440us,0,
935.6 MHz,0dBm,10dB,20dB,CFIL,30 kHz,100 kHz,
440us,0
```

Performs a measurement sequence with the settings described in [Table 6-18](#).

```
SENSe:LIST:POWer?
935.2 MHz,0dBm,10dB,OFF,NORM,1 MHz,3 MHz,440us,
0,
935.4 MHz,0dBm,10dB,10dB,CFIL,30 kHz,100 kHz,
440us,0,
935.6 MHz,0dBm,10dB,20dB,CFIL,30 kHz,100 kHz,
440us,0
```

Performs the same measurement and returns the result list immediately after the last frequency point.

Table 6-18: Settings for power list example

Step	Freq. [MHz]	Ref Level [dBm]	RF Att [dB]	eI Att [dB]	Filter type	RBW	VBW	Meas Time [us]	TRG Level (reserved)
1	935.2	0	10	OFF	Normal	1 MHz	3 MHz	440	0
2	935.4	0	10	10	Channel	30 kHz	100 kHz	440	0
3	935.6	0	10	20	Channel	30 kHz	100 kHz	440	0

[SENSe:]LIST:POWER:SET

<PeakPower>, <RMSPower>, <AVGPower>, <TriggerSource>, <TriggerSlope>, <TriggerOffset>, <GateLength>

This command defines global List Evaluation parameters.

These parameters are valid for every frequency you want to measure.

The state of the first three parameters (<PeakPower>, <RMSPower> and <AVGPower>) define the number of results for each frequency in the list.

Note that you have to set the trigger level *after* sending this command.

Parameters:

<PeakPower>	ON OFF Turns peak power evaluation on and off. *RST: ON
<RMSPower>	ON OFF Turns RMS power evaluation on and off. *RST: OFF
<AVGPower>	ON OFF Turns average power evaluation on and off. *RST: OFF
<TriggerSource>	IMMEDIATE EXTERNAL VIDEO IFPOWER RFPower Selects a trigger source. For more information see " Trg/Gate Source " on page 239. *RST: IMM
<TriggerSlope>	NEGATIVE POSITIVE Selects the trigger slope. *RST: POS
<TriggerOffset>	Defines the trigger delay. The trigger delay is the time between the detection of the trigger signal and the start of the measurement at the next frequency point. Range: span = 0 Hz: (-sweep time) to 30 s; span > 10 Hz: 31.25 ns to 30 s *RST: 0 s

<GateLength>	<p>Defines the gate length for gated measurements. Setting 0 seconds turns gated measurements off. Other values activate the gated trigger function. To perform gated measurements, the trigger source must be different from IMMEDIATE.</p> <p>Range: 31.25 ns to 30 s *RST: 0 s</p>
Example:	<pre>SENSe:LIST:POWer:SET ON,OFF,OFF,EXT,POS,10US,434US</pre>

[SENSe:]LIST:POWer:STATe <State>

This command turns the List Evaluation off.

Parameters:

<State> OFF

Example: SENS:LIST:POW:STAT OFF

SENSe:LIST:RANGe Subsystem

The SENSe:LIST:RANGe Subsystem contains the remote commands to configure Spurious Emissions measurements.

[SENSe:]LIST:RANGe<range>:BANDwidth[:RESolution].....	818
[SENSe:]LIST:RANGe<range>:BANDwidth:VIDeo.....	819
[SENSe:]LIST:RANGe<range>:BREak.....	819
[SENSe:]LIST:RANGe<range>:COUNT.....	820
[SENSe:]LIST:RANGe<range>:DELeTe.....	820
[SENSe:]LIST:RANGe<range>:DETEctor.....	820
[SENSe:]LIST:RANGe<range>[:FREQuency]:START.....	821
[SENSe:]LIST:RANGe<range>[:FREQuency]:STOP.....	821
[SENSe:]LIST:RANGe<range>:FILTer:TYPE.....	821
[SENSe:]LIST:RANGe<range>:INPut:ATTenuation.....	822
[SENSe:]LIST:RANGe<range>:INPut:ATTenuation:AUTO.....	822
[SENSe:]LIST:RANGe<range>:INPut:GAIN:STATe.....	823
[SENSe:]LIST:RANGe<range>:LIMit:START.....	823
[SENSe:]LIST:RANGe<range>:LIMit:STATe.....	823
[SENSe:]LIST:RANGe<range>:LIMit:STOP.....	824
[SENSe:]LIST:RANGe<range>:POINts.....	824
[SENSe:]LIST:RANGe<range>:RLEVel.....	824
[SENSe:]LIST:RANGe<range>:SWEep:TIME.....	825
[SENSe:]LIST:RANGe<range>:SWEep:TIME:AUTO.....	825
[SENSe:]LIST:RANGe<range>:TRANsducer.....	825

[SENSe:]LIST:RANGe<range>:BANDwidth[:RESolution] <Value>

This command sets the RBW value for the specified range.

Suffix:	
<range>	1...20 range
Parameters:	
<Value>	Refer to the data sheet. *RST: 30.0 kHz
Example:	LIST:RANG2:BAND:RES 5000 Sets the RBW for range 2 to 5 kHz.
Manual operation:	See "RBW" on page 350

[SENSe:]LIST:RANGe<range>:BANDwidth:VIDeo

This command sets the VBW value for the specified range.

Suffix:	
<range>	1...20 range
Parameters:	
<Value>	Refer to the data sheet. *RST: 10.0 MHz
Example:	LIST:RANG1:BAND:VID 5000000 Sets the VBW for range 1 to 5 MHz.
Manual operation:	See "VBW" on page 350

[SENSe:]LIST:RANGe<range>:BREak <State>

This command configures the sweep behavior.

The suffixes are irrelevant.

Suffix:	
<range>	1...20 range
Parameters:	
<State>	ON The R&S FSVA/FSV stops after one range is swept and continues only if you confirm (a message box is displayed). OFF The R&S FSVA/FSV sweeps all ranges in one go. *RST: OFF
Example:	LIST:RANG:BRE ON Configures a stop after each range.
Manual operation:	See "Stop After Sweep" on page 351

[SENSe:]LIST:RANGe<range>:COUNT

This command returns the number of defined ranges.

Suffix:

<range> 1...20
 range

Example:

LIST:RANG:COUNT?
Returns the number of defined ranges.

[SENSe:]LIST:RANGe<range>:DELeTe

This command deletes the specified range. The range numbers are updated accordingly. The reference range cannot be deleted. A minimum of three ranges is mandatory.

Suffix:

<range> 1...20
 range

Example:

LIST:RANG4:DEL
Deletes range 4.

Manual operation: See "[Delete Range](#)" on page 352

[SENSe:]LIST:RANGe<range>:DETeCtor <Detector>

This command sets the detector for the specified range. For details refer to "[Detector](#)" on page 350.

Suffix:

<range> 1...20
 range

Parameters:

<Detector> NEGative | POSitive | SAMPlE | RMS | AVERAge

NEGative

minimum peak detector

POSitive

peak detector

SAMPlE

sample detector

RMS

RMS detector

AVERAge

average detector

*RST: RMS

Example:

LIST:RANGe3:DET SAMP
Sets the sample detector for range 3.

Manual operation: See "Detector" on page 350

[SENSe:]LIST:RANGe<range>[:FREQUENCY]:START <Frequency>

This command sets the start frequency for the specified range.

In order to change the start/stop frequency of the first/last range, select the appropriate span. If you set a span that is smaller than the overall span of the ranges, the measurement includes only the ranges that lie within the defined span and have a minimum span of 20 Hz. The first and last range are adapted to the given span as long as the minimum span of 20 Hz is not violated.

Suffix:

<range> 1...20
range

Parameters:

<Frequency> see rules in chapter 4, "Ranges and settings"
*RST: -250.0 MHz (range 1), -2.52 MHz (range 2), 2.52 MHz (range 3)

Example:

LIST:RANG1:STAR 100000000
Sets the start frequency for range 1 to 100 MHz.

Manual operation: See "Range Start / Range Stop" on page 349

[SENSe:]LIST:RANGe<range>[:FREQUENCY]:STOP <Frequency>

This command sets the stop frequency for the specified range. See also [SENSe:]LIST:RANGe<range>[:FREQUENCY]:START on page 821.

Suffix:

<range> 1...20
range

Parameters:

<Frequency> see rules in chapter 4, "Ranges and settings"
*RST: -2.52 MHz (range 1), 2.52 MHz (range 2), 250.0 MHz (range 3)

Example:

LIST:RANG3:STOP 10000000
Sets the stop frequency for range 2 to 10 MHz.

Manual operation: See "Range Start / Range Stop" on page 349

[SENSe:]LIST:RANGe<range>:FILTer:TYPE <Type>

This command sets the filter type for the specified range.

Suffix:	
<range>	1...20 range
Parameters:	
<Type>	NORMAL Gaussian filters CFILter channel filters RRC RRC filters PULSe EMI (6dB) filters P5 5 Pole filters *RST: NORM The available bandwidths of the filters are specified in the data sheet.
Example:	<code>LIST:RANG1:FILT:TYPE RRC</code> Sets the RRC filter type for range 1.
Manual operation:	See " Filter Type " on page 349

[SENSe:]LIST:RANGe<range>:INPut:ATTenuation <Value>

This command sets the attenuation for the specified range.

Suffix:	
<range>	1...20 range
Parameters:	
<Value>	Refer to the data sheet. *RST: 0 dB
Example:	<code>LIST:RANG3:INP:ATT 10</code> Sets the attenuation of range 3 to 10 dB.
Manual operation:	See " RF Attenuator " on page 350

[SENSe:]LIST:RANGe<range>:INPut:ATTenuation:AUTO <State>

This command activates or deactivates the automatic RF attenuation setting for the specified range.

Suffix:	
<range>	1...20 range

Parameters:

<State> ON | OFF
 *RST: ON

Example:

LIST:RANG2:INP:ATT:AUTO OFF
 Deactivates the RF attenuation auto mode for range 2.

Manual operation: See "[RF Att. Mode](#)" on page 350

[SENSe:]LIST:RANGe<range>:INPut:GAIN:STATe <State>

This command switches the preamplifier on or off for the specified range.

Suffix:

<range> 1...20
 range

Parameters:

<State> ON | OFF
 *RST: OFF

Example:

LIST:RANG3:INP:GAIN:STATe ON
 Switches the preamplifier for range 3 on or off.

Manual operation: See "[Preamp](#)" on page 350

[SENSe:]LIST:RANGe<range>:LIMit:STARt <Limit>

This command sets an absolute limit value at the start frequency of the specified range. Different from manual operation, this setting is independent of the defined limit check type.

Suffix:

<range> 1...20
 range

Parameters:

<Limit> -400 to in 400 dBm
 *RST: 13 dBm

Example:

LIST:RANG1:LIM:ABS:STAR 10
 Sets an absolute limit of 10 dBm at the start frequency of the range.

Manual operation: See "[Abs Limit Start](#)" on page 351

[SENSe:]LIST:RANGe<range>:LIMit:STATe

This command activates or deactivates the limit check for all ranges.

Suffix:

<range> irrelevant

Parameters:

<State> ON | OFF
 *RST: OFF

Example:

LIST:RANG3:LIM:STAT ON
 Activates a limit check for all ranges.

Manual operation: See "[Limit Check 1-4](#)" on page 351

[SENSe:]LIST:RANGe<range>:LIMit:STOP <Limit>

This command sets an absolute limit value at the stop frequency of the specified range. Different from manual operation, this setting is independent of the defined limit check type.

Suffix:

<range> 1...20
 range

Parameters:

<Limit> -400 to in 400 dBm
 *RST: 13 dBm

Example:

LIST:RANG1:LIM:STOP 20
 Sets an absolute limit of 20 dBm at the stop frequency of the range.

Manual operation: See "[Abs Limit Stop](#)" on page 351

[SENSe:]LIST:RANGe<range>:POINts <Value>

This command sets the number of sweep points for the specified range.

Suffix:

<range> 1...20
 range

Parameters:

<Value> For details on possible values refer to chapter 4, **Sweep Points** softkey of the "Sweep" menu.

*RST: 691

Example:

LIST:RANG3:POIN 601
 Sets 601 sweep points for range 3.

Manual operation: See "[Sweep Points](#)" on page 351

[SENSe:]LIST:RANGe<range>:RLEVel <Value>

This command sets the reference level for the specified range.

Suffix:	
<range>	1...20 range
Parameters:	
<Value>	Refer to the data sheet.
	*RST: -20 dBm
Example:	LIST:RANG2:RLEV 0 Sets the reference level of range 2 to 0 dBm.
Manual operation:	See " Ref. Level " on page 350

[SENSe:]LIST:RANGe<range>:SWEep:TIME

This command sets the sweep time for the specified range.

Suffix:	
<range>	1...20 range
Parameters:	
<SweepTime>	Allowed values depend on the ratio of span to RBW and RBW to VBW. For details refer to the data sheet.
	*RST: 0.27 s
Example:	LIST:RANG1:SWE:TIME 1 Sets the sweep time for range 1 to 1 s.
Manual operation:	See " Sweep Time " on page 350

[SENSe:]LIST:RANGe<range>:SWEep:TIME:AUTO

This command activates or deactivates the automatic sweep time setting for the specified range.

Suffix:	
<range>	1...20 range
Parameters:	
<State>	ON OFF
	*RST: ON
Example:	LIST:RANG3:SWE:TIME:AUTO OFF Deactivates the sweep time auto mode for range 3.
Manual operation:	See " Sweep Time Mode " on page 350

[SENSe:]LIST:RANGe<range>:TRANsducer <TransducerName>

This command sets a transducer for the specified range. You can only choose a transducer that fulfills the following conditions:

- The transducer overlaps or equals the span of the range.
- The x-axis is linear.
- The unit is dB.

Suffix:

<range> 1...20
 range

Parameters:

<TransducerName> 'string' = name of the transducer

Example:

SENS:LIST:RANG1:TRAN 'test'
Sets the transducer called "test" for range 1.

Manual operation: See "Transd. Factor" on page 351

SENSe:MIXer Subsystem

The MIXer subsystem controls the external mixer settings. These commands are only available if the R&S FSV-B21 (Exeternal Mixer) option is installed.

[SENSe:]MIXer[:STATe].....	826
[SENSe:]MIXer:BIAS:HIGH.....	827
[SENSe:]MIXer:BIAS:LOW.....	827
[SENSe:]MIXer:RFOVerrange[:STATe].....	827
[SENSe:]MIXer:FREQuency:HANdOver.....	828
[SENSe:]MIXer:FREQuency:STARt?.....	828
[SENSe:]MIXer:FREQuency:STOP?.....	828
[SENSe:]MIXer:HARMonic:BAND.....	829
[SENSe:]MIXer:HARMonic:BAND:PRESet.....	829
[SENSe:]MIXer:HARMonic:HIGH:STATe.....	829
[SENSe:]MIXer:HARMonic:HIGH[:VALue].....	830
[SENSe:]MIXer:HARMonic[:LOW].....	830
[SENSe:]MIXer:HARMonic:TYPE.....	830
[SENSe:]MIXer:LOPower.....	830
[SENSe:]MIXer:LOSS:HIGH.....	831
[SENSe:]MIXer:LOSS:TABLE:HIGH.....	831
[SENSe:]MIXer:LOSS:TABLE[:LOW].....	831
[SENSe:]MIXer:LOSS[:LOW].....	832
[SENSe:]MIXer:PORTs.....	832
[SENSe:]MIXer:SIGNal.....	832
[SENSe:]MIXer:THReshold.....	833

[SENSe:]MIXer[:STATe] <State>

This command activates the external mixer.

Parameters:

<State> **ON | OFF**
 *RST: OFF

Example: MIX ON

Mode: all

Manual operation: See "[External Mixer \(On/Off\)](#)" on page 496

[SENSe:]MIXer:BIAS:HIGH <BiasSetting>

This command defines the bias current for the high range (see also [Chapter 5.8.1.2, "Bias Current"](#), on page 490).

This command is only available if the external mixer is active (see [\[SENSe:\]MIXer\[:STATe\]](#) on page 826).

Parameters:

<BiasSetting> *RST: 0.0 A
Default unit: A

Example:

```
MIX ON
Activates the external mixer.
MIX:BIAS:HIGH 2A
Sets the bias for the high range to 2 A.
```

Mode: all

Manual operation: See "[Bias Settings](#)" on page 503

[SENSe:]MIXer:BIAS:LOW <BiasSetting>

This command defines the bias current for the low range (see also [Chapter 5.8.1.2, "Bias Current"](#), on page 490).

This command is only available if the external mixer is active (see [\[SENSe:\]MIXer\[:STATe\]](#) on page 826).

Parameters:

<BiasSetting> *RST: 0.0 A
Default unit: A

Example:

```
MIX ON
Activates the external mixer.
MIX:BIAS:LOW 2A
Sets the bias for the low range to 2 A.
```

Mode: all

Manual operation: See "[Bias Settings](#)" on page 503

[SENSe:]MIXer:RFOVerrange[:STATe] <State>

This command specifies whether the frequencies beyond the defined band limits are to be used.

This command is only available if the external mixer is active (see [\[SENSe:\]MIXer\[:STATe\]](#) on page 826).

Parameters:

<State> **ON | OFF**
 *RST: OFF

Example: MIX:RFOV ON

Mode: all

Manual operation: See "[RF Overrange](#)" on page 497

[SENSe:]MIXer:FREQuency:HANDoVer <Frequency>

This command defines the frequency at which the mixer switches from one range to the next (if two different ranges are selected). The handover frequency for each band can be selected freely within the overlapping frequency range.

This command is only available if the external mixer is active (see [\[SENSe:\]MIXer\[:STATe\]](#) on page 826).

Parameters:

<Frequency>

Example: MIX ON
 Activates the external mixer.
 MIX:FREQ:HAND 78.0299GHz
 Sets the handover frequency to 78.0299 GHz.

Mode: all

Manual operation: See "[Handover Freq.](#)" on page 497

[SENSe:]MIXer:FREQuency:STARt?

This command queries the frequency at which the external mixer band starts.

Example: MIX:FREQ:STAR?
 Queries the start frequency of the band.

Usage: Query only

Mode: all

Manual operation: See "[RF Start](#)" on page 497

[SENSe:]MIXer:FREQuency:STOP?

This command queries the frequency at which the external mixer band stops.

Example: MIX:FREQ:STOP?
 Queries the stop frequency of the band.

Usage: Query only

Mode: all

Manual operation: See "[RF Stop](#)" on page 497

[SENSe:]MIXer:HARMonic:BAND <Band>

This command selects the external mixer band. The query returns the currently selected band.

This command is only available if the external mixer is active (see [\[SENSe:\]MIXer\[:STATe\]](#) on page 826).

Parameters:

<Band>

A | KA | Q | U | V | E | W | F | D | G | Y | J | USER

Standard waveguide band or user-defined band.

Note: The band formerly referred to as "A" is now named "KA"; the input parameter "A" is still available and refers to the same band as "KA".

For a definition of the frequency range for the pre-defined bands, see [Table 5-21](#)).

*RST: F (90 GHz - 140 GHz)

Example:

MIX ON

Activates the external mixer.

MIX:HARM:BAND A

Sets the band to A (26.5 GHz - 40 GHz).

Mode: all**Manual operation:** See ["Band"](#) on page 497**[SENSe:]MIXer:HARMonic:BAND:PRESet**

This command restores the preset frequency ranges for the standard waveguide bands.

Example:

MIX:HARM:BAND:PRESet

Presets the waveguide bands.

Usage: Event**Mode:** all**Manual operation:** See ["Preset Band"](#) on page 497**[SENSe:]MIXer:HARMonic:HIGH:STATe <State>**

This command specifies whether a second (high) harmonic is to be used to cover the band's frequency range.

Parameters:

<State>

ON | OFF

*RST: OFF

Example:

MIX:HARM:HIGH:STAT ON

Mode: all**Manual operation:** See ["Range 1/2"](#) on page 498

[SENSe:]MIXer:HARMonic:HIGH[:VALue] <HarmOrder>

This command specifies the harmonic order to be used for the high range.

Parameters:

<HarmOrder> **<numeric value>**
Range: 2 to 100 (USER band); for other bands: see band definition

Example: MIX:HARM:HIGH 2

Mode: all

Manual operation: See "[Harmonic Order](#)" on page 498

[SENSe:]MIXer:HARMonic[:LOW] <HarmOrder>

This command specifies the harmonic order to be used for the LOW range.

Parameters:

<HarmOrder> **<numeric value>**
Range: 2 to 100 (USER band); for other bands: see band definition
*RST: 2 (for band F)

Example: MIX:HARM 3

Mode: all

Manual operation: See "[Harmonic Order](#)" on page 498

[SENSe:]MIXer:HARMonic:TYPE <OddEven>

This command specifies whether the harmonic order to be used should be odd, even, or both.

Parameters:

<OddEven> **ODD | EVEN | EODD**
*RST: EVEN

Example: MIX:HARM:TYPE ODD

Mode: all

Manual operation: See "[Harmonic Type](#)" on page 498

[SENSe:]MIXer:LOPower <Level>

This command specifies the LO level of the external mixer's LO port.

Parameters:

<Level> <numeric value>
 Range: 13.0 dBm to 17.0 dBm
 Increment: 0.1 dB
 *RST: 15.5 dBm

Example: MIX:LOP 16.0dBm

Mode: all

Manual operation: See "[LO Level](#)" on page 504

[SENSe:]MIXer:LOSS:HIGH <Average>

This command defines the average conversion loss to be used for the entire high range.

Parameters:

<Average> <numeric value>
 Range: 0 to 100
 *RST: 40.0 dB
 Default unit: dB

Example: MIX:LOSS:HIGH 20dB

Mode: all

Manual operation: See "[Conversion Loss](#)" on page 498

[SENSe:]MIXer:LOSS:TABLE:HIGH <FileName>

This command defines the file name of the conversion loss table to be used for the high range.

Parameters:

<FileName> <file name>

Example: MIX:LOSS:HIGH 20dB

Mode: all

Manual operation: See "[Conversion Loss](#)" on page 498

[SENSe:]MIXer:LOSS:TABLE[:LOW] <FileName>

This command defines the file name of the conversion loss table to be used for the low range.

Parameters:

<FileName> <file name>

Example: MIX:LOSS:TABLE mix_1_4
 Specifies the conversion loss table *mix_1_4*.

Mode: all

Manual operation: See ["Conversion Loss"](#) on page 498

[SENSe:]MIXer:LOSS[:LOW] <Average>

This command defines the average conversion loss to be used for the entire low range.

Parameters:

<Average> <numeric value>
 Range: 0 to 100
 *RST: 40.0 dB
 Default unit: dB

Example: MIX:LOSS 20dB

Mode: all

Manual operation: See ["Conversion Loss"](#) on page 498

[SENSe:]MIXer:PORTs <PortType>

This command specifies whether the mixer is a 2-port or 3-port type.

Parameters:

<PortType> 2 | 3
 *RST: 2

Example: MIX:PORT 3

Mode: all

Manual operation: See ["Mixer Type"](#) on page 498

[SENSe:]MIXer:SIGNal <State>

This command specifies whether automatic signal detection is active or not.

Parameters:

<State> **OFF | ON | AUTO | ALL**
OFF
 No automatic signal detection is active.
ON
 Automatic signal detection (Signal ID) is active.
AUTO
 Automatic signal detection (Auto ID) is active.
ALL
 Both automatic signal detection functions (Signal ID+Auto ID) are active.
 *RST: OFF

Example: MIX:SIGN AUTO

Mode: all

Manual operation: See "Signal ID (On/Off)" on page 504
See "Auto ID (On/Off)" on page 505

[SENSe:]MIXer:THReshold <Value>

This command defines the maximum permissible level difference between test sweep and reference sweep to be corrected during automatic comparison (see [SENSe:]MIXer:SIGNal on page 832).

Parameters:

<Value> <numeric value>
Range: 30 dBm to -130 dBm
*RST: 0.0 dBm

Example: MIX:PORT 3

Mode: all

Manual operation: See "Auto ID Threshold" on page 506

SENSe:MPOWER Subsystem

The commands of this subsystem are used to determine the mean burst power or peak burst power for a given number of signal bursts, and for outputting the results in a list. Since all the settings required for a measurement are combined in a single command, the measurement speed is considerably higher than when using individual commands.

For measuring the signal bursts, the gated sweep function is used in zero span. The gate is controlled either by an external trigger signal or by the video signal. An individual trigger event is required for each burst to be measured. If an external trigger signal is used, the threshold is fixed to TTL level, while with a video signal the threshold can be set as desired.

More Details on the SENSe:MPOWER Subsystem

The following graphics shows the relation between trigger time, trigger offset (for delayed gate opening) and measurement time.

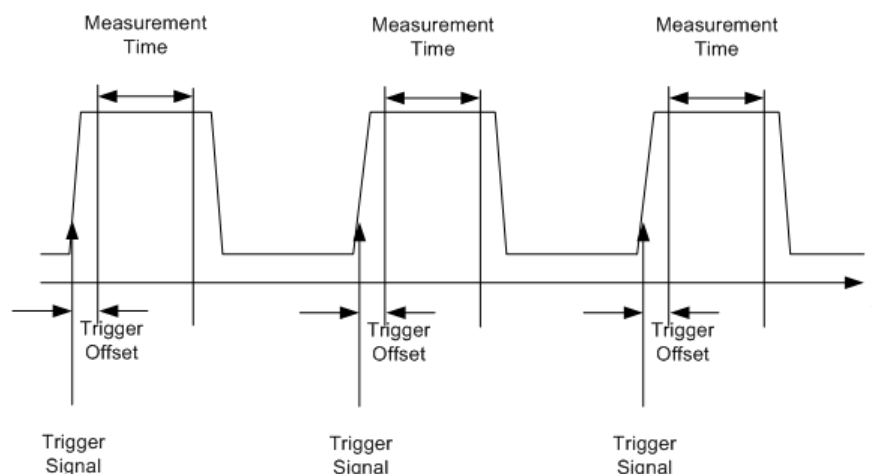

Depending on the settings made, the measurements are performed with the RMS detector for RMS power or the PEAK detector for peak power. For all these measurements, trace 1 of the selected system is used.

The setting parameters for this measurement are:

- analyzer frequency
 - resolution bandwidth
 - measurement time used for a single burst
 - trigger source
 - trigger level
 - trigger offset
 - type of power measurement (PEAK, MEAN)
 - number of bursts to be measured
- The commands of this subsystem can be used in two different ways:
- Setting up the instrument and at the same time querying the result list: This method ensures the smallest delay between measurement and the output of the measured values, but requires the control computer to wait actively for the response of the instrument.
 - Setting up the instrument and querying the result list after synchronization to the end of measurement: With this method the control computer can be used for other activities while the instrument is performing the measurement at the cost of additional time needed for synchronization via service request.

[SENSe:]MPOWer:FTYPE.....	834
[SENSe:]MPOWer:RESult[:LIST]?.....	834
[SENSe:]MPOWer:RESult:MIN?.....	835
[SENSe:]MPOWer[:SEquence].....	835

[SENSe:]MPOWer:FTYPE <FilterType>

This command selects the filter type for pulse power measurements.

Parameters:

<FilterType> NORMal | CFILter | RRC

Example:

SENSe:MPOWer:FTYPE CFILter

[SENSe:]MPOWer:RESult[:LIST]?

This command queries the results of the pulse power measurement.

This command may be used to obtain measurement results in an asynchronous way, using the service request mechanism for synchronization to the end of the measurement.

If there are no results, the command returns an error.

Parameters:

<PulsePower> List of pulse powers.
The number of values depends on the number of pulses you have been measuring.
The unit is dBm.

Example:

```
*ESE 1
*SRE 32
```

Configuration of status reporting systems for the generation of an SRQ on operation complete

```
SENSe:MPOWer 935.2MHz,1MHz,434us,VIDEO,50PCT,
5us,MEAN,20;*OPC
```

Configuring and starting the measurement

...

Further actions of the control computer during measurement

On SRQ:

Response to service request

```
SENSe:MPOWer:RESult?
```

Usage:

Query only

[SENSe:]MPOWer:RESult:MIN?

This command queries the lowest pulse power that has been measured during a pulse power measurement.

If there are no results, the command returns an error.

Return values:

<PulsePower> Lowest power level of the pulse power measurement.
The unit is dBm.

Example:

```
*ESE 1
*SRE 32
```

Configuration of status reporting systems for the generation of an SRQ on operation complete

```
SENSe:MPOWer 935.2MHz,1MHz,434us,VIDEO,50PCT,
5us,MEAN,20;*OPC
```

Configuring and starting the measurement

...

Further actions of the control computer during measurement

On SRQ:

Response to service request

```
SENSe:MPOWer:RESult:MIN?
```

Usage:

Query only

[SENSe:]MPOWer[:SEQUENCE] <Frequency>, <RBW>, <MeasTime>, <TriggerSource>, <TriggerLevel>, <TriggerOffset>, <Detector>, <#OfPulses>

This command configures and initiates the pulse power measurement.

The R&S FSVA/FSV caches all measurement parameters that you can set with this command. If you use the command repeatedly, the R&S FSVA/FSV only changes those settings that you have actually changed before initiating the measurement. Thus, measurement times are kept as low as possible.

If you synchronize the measurement with *OPC, the R&S FSVA/FSV produces a service request when all frequencies have been measured and the number of individual measurements has been performed.

Note that using the command as a query initiates the measurement and returns the results if all frequencies have been measured. For more information on querying the results see .

To reduce the setting time, the setup is performed simultaneously for all selected parameters.

The query adapts the instrument settings, performs the defined number of measurements and outputs the measurement results list.

This measurement is not compatible with other measurements, especially as far as marker functions, adjacent-channel measurement or statistics are concerned. The corresponding functions are therefore automatically switched off. In return, incompatible commands automatically deactivate the multi burst power function.

The function is only available in the REMOTE operation. It is deactivated on switching back to LOCAL.

Parameters:

<Frequency> Defines the pulse frequency.

Range: 0 Hz to fmax

<RBW> Defines the resolution bandwidth.

Range: 10 Hz to 10 MHz in steps of 1, 3, 10

<MeasTime> Defines the measurement time.

Range: 1 µs to 30 s

<TriggerSource> Selects a trigger source.

EXternal

The trigger signal is fed from the "Ext. Trigger/Gate" input on the rear of the unit.

VIDeo

The internal video signal is used as trigger signal.

<TriggerLevel> Defines a trigger level.

The trigger level is available for the video trigger. In that case, the level is a percentage of the diagram height.

In case of an external trigger, the R&S FSVA/FSV uses a fix TTL level.

Range: 0 PCT to 100 PCT

<TriggerOffset>	<p>Defines the trigger delay. The trigger delay is the time between the detection of the trigger signal and the start of the measurement.</p> <p>Range: see data sheet</p>
<Detector>	<p>Selects the detector and therefore the way the measurement is evaluated.</p> <p>MEAN Calculates the RMS pulse power.</p> <p>PEAK Calculates the peak pulse power.</p>
<#OfPulses>	<p>Defines the number of pulses included in the measurement.</p> <p>Range: 1 to 32001</p>
Return values:	
<PowerLevel>	<p>Pulse power level.</p> <p>The result is a list of floating point values separated by commas. The unit is dBm.</p>
Example:	<p>Sample setting:</p> <pre>SENSe:MPOWer 935.2MHz, 1MHz, 434us, VIDEO, 50PCT, 5us, MEAN, 20</pre> <p>Performs a measurement sequence with the following settings: Frequency = 935.2 MHz, Resolution bandwidth = 1 MHz Measurement time = 434 µs Trigger source = VIDEO Trigger threshold = 50 % Trigger offset = 5 µs Type of measurement = MEAN power No. of measurements = 20</p> <p>Sample query:</p> <pre>SENSe:MPOWer? 935.2MHz, 1MHz, 434us, VIDEO, 50PCT, 5us, MEAN, 20</pre> <p>Performs the same measurement and in addition returns the results list immediately after completion of the last measurement.</p> <p>Sample result:</p> <pre>18.3,18.6,18.1,18.0,17.9,18.3,18.6,18.1,18.0,17.9,18.3,18.6,18.1,18.0,17.9,18.3,18.6,18.1,18.0,17.9,18.3,18.6,18.1,18.0,17.9</pre>

SENSe:PMETer<p> Subsystem (Power Sensor, R&S FSV-K9)

This subsystem controls the device settings for power sensor measurements. It is only available if the R&S FSV-K9 Power Sensor option is installed.

For details see [Chapter 5.9, "Instrument Functions - Power Sensor \(R&S FSV-K9\)"](#), on page 509.

[SENSe:]PMETer<p>[:STATe].....	838
[SENSe:]PMETer<p>:DCYClE:STATe.....	838
[SENSe:]PMETer<p>:DCYClE:VALue.....	839
[SENSe:]PMETer<p>:FREQuency.....	839
[SENSe:]PMETer<p>:FREQuency:LiNK.....	839
[SENSe:]PMETer<p>:MTIME.....	840
[SENSe:]PMETer<p>:MTIME:AVERAge[:STATe].....	840
[SENSe:]PMETer<p>:MTIME:AVERAge:COUnT.....	841
[SENSe:]PMETer<p>:ROFFSet[:STATe].....	841
[SENSe:]PMETer<p>:TRIGGer[:STATe].....	842
[SENSe:]PMETer<p>:TRIGGer:DTIME.....	842
[SENSe:]PMETer<p>:TRIGGer:HOLDOff.....	842
[SENSe:]PMETer<p>:TRIGGer:HYSTerEsis.....	843
[SENSe:]PMETer<p>:TRIGGer:LEVel.....	843
[SENSe:]PMETer<p>:TRIGGer:SLOPe.....	844
[SENSe:]PMETer<p>:UPDate[:STATe].....	844

[SENSe:]PMETer<p>[:STATe] <State>

This command switches the power sensor measurement for the selected power sensor on or off.

Suffix:

<p> 1...4
Power sensor index

Parameters:

<State> ON | OFF
*RST: OFF

Example:

PMET1 ON
Switches the power sensor measurements on.

Mode: PSM

Manual operation: See "Power Sensor On/Off" on page 516
See "Select" on page 518

[SENSe:]PMETer<p>:DCYClE:STATe <State>

This command activates the duty cycle correction for the selected power sensor.

Suffix:

<p> 1...4
Power sensor index

Parameters:

<State> ON | OFF
*RST: OFF

Example:

PMET2:DCYC:STAT ON

Mode: PSM

Manual operation: See ["Duty Cycle"](#) on page 519

[SENSe:]PMETer<p>:DCYCLe:VALue <Percentage>

This command sets the duty cycle for the selected power sensor to a percent value for the correction of pulse modulated signals. With the correction activated, the sensor calculates the signal pulse power from this value and the mean power.

Suffix:

<p> 1...4
Power sensor index

Parameters:

<Percentage> Range: 0.001 to 99.999
*RST: 99.999
Default unit: %

Example:

```
PMET2:DCYC:STAT ON
Activates the duty cycle correction.
PMET2:DCYC:VAL 0.5
Sets the correction value to 0.5%.
```

Mode: PSM

Manual operation: See ["Duty Cycle"](#) on page 519

[SENSe:]PMETer<p>:FREQUency <Frequency>

This command sets the frequency of the selected power sensor. The limits f_{min} and f_{max} are defined by the power sensor.

Suffix:

<p> 1...4
Power sensor index

Parameters:

<Frequency> f_{min} ... f_{max}
*RST: 50 MHz

Example:

```
PMET2:FREQ 1GHZ
Sets the frequency of the power sensor to 1 GHz.
```

Mode: PSM

Manual operation: See ["Frequency Manual"](#) on page 518

[SENSe:]PMETer<p>:FREQUency:LINK <Coupling>

This command sets the frequency coupling of the selected power sensor.

Suffix:	
<p>	1...4 Power sensor index
Parameters:	
<Coupling>	CENTer Couples the frequency to the center frequency of the analyzer MARKer1 couples the frequency to the position of marker 1 OFF switches the frequency coupling off *RST: CENT
Example:	PMET2:FREQ:LINK CENT Couples the frequency to the center frequency of the analyzer
Mode:	PSM
Manual operation:	See " Frequency Coupling " on page 519

[SENSe:]PMETer<p>:MTIME <Duration>

This command sets the measurement duration of the selected power sensor.

Suffix:	
<p>	1...4 Power sensor index
Parameters:	
<Duration>	SHORT NORMAl LONG *RST: NORM
Example:	PMET2:MTIM SHOR Sets a short measurement duration for measurements of stationary high power signals for the selected power sensor.
Mode:	PSM
Manual operation:	See " Meas Time / Average " on page 519

[SENSe:]PMETer<p>:MTIME:AVERAge[:STATe] <State>

This command activates or deactivates manual averaging for the selected power sensor. The average count is set with the [SENSe:]PMETer<p>:MTIME:AVERAge:COUNT command.

Suffix:	
<p>	1...4 Power sensor index
Parameters:	
<State>	ON OFF *RST: OFF

Example: PMET2:MTIM:AVER ON
Activates manual averaging.

Mode: PSM

Manual operation: See "[Meas Time / Average](#)" on page 519

[SENSe:]PMETer<p>:MTIME:AVERAge:COUNT <NumberReadings>

This command defines the number of readings (averagings) to be performed after a single sweep has been started for the selected power sensor. This command is only available if the [\[SENSe:\]PMETer<p>:MTIME:AVERAge\[:STATe\]](#) command is set to ON.

Results become more stable with extended average, particularly if signals with low power are measured. This setting can be used to minimize the influence of noise in the power meter measurement.

Suffix:
<p> 1...4
Power sensor index

Parameters:
<NumberReadings> 0 to 256 in binary steps (1, 2, 4, 8,...)
For average count = 0 or 1, one reading is performed.

Example: PMET2:MTIM:AVER ON
Activates manual averaging.
PMET2:MTIM:AVER:COUNT 8
Sets the number of readings to 8.

Mode: PSM

Manual operation: See "[Number of Readings](#)" on page 520

[SENSe:]PMETer<p>:ROFFset[:STATe] <State>

This command defines whether the reference level offset set for the analyzer is taken into account for the measured power or not for the selected power sensor.

Suffix:
<p> 1...4
Power sensor index

Parameters:
<State> **ON**
Adds the offset defined by the [DISPlay\[:WINDow<n>\]:TRACe<t>:Y\[:SCALE\]:RLEVel:OFFSet](#) command to the measured level.

OFF
Takes no offset into account.

*RST: ON

Example: `PMET2:ROFF OFF`
Takes no offset into account for the measured power.

Mode: PSM

Manual operation: See ["Use Ref Level Offset"](#) on page 520

[SENSe:]PMETer<p>:TRIGger[:STATe] <State>

This command switches the external power trigger on or off for the selected power sensor.

For details on configuring an external power trigger and supported power sensors, see [Chapter 5.9.3, "Configuring an External Power Trigger"](#), on page 514.

Suffix:
<p> 1...4
Power sensor index

Parameters:
<State> ON | OFF
*RST: OFF

Example: `PMET2:TRIG ON`
Switches the external power trigger on

Mode: PSM

Manual operation: See ["External Power Trigger"](#) on page 520

[SENSe:]PMETer<p>:TRIGger:DTIME <Value>

Defines the time the input signal must stay below the IF power trigger level in order to allow a trigger to start the measurement.

Suffix:
<p> 1...4
Power sensor index

Parameters:
<Value> 0 to 1 s
Increment: 100 ns
*RST: 100 µs

Example: `PMET2:TRIG:DTIME 0.001`

Mode: PSM

Manual operation: See ["Dropout"](#) on page 521

[SENSe:]PMETer<p>:TRIGger:HOLDoff <Value>

Defines the holdoff value in s, which is the time which must pass before triggering, in case another trigger event happens.

For details see [Figure 5-47](#).

Suffix:

<p> 1...4
Power sensor index

Parameters:

<Value> 0 to 1 s
Increment: 100 ns
*RST: 0 s

Example:

PMET2:TRIG:HOLD 0.1
Sets the holdoff time of the trigger to 100 ms

Mode: PSM

Manual operation: See "[Holdoff](#)" on page 521

[SENSe:]PMETer<p>:TRIGger:HYSTeresis <Value>

Defines the value for the trigger hysteresis of an external power trigger. The hysteresis in dB is the value the input signal must stay below the IF power trigger level in order to allow a trigger to start the measurement.

For details see [Figure 5-47](#).

Suffix:

<p> 1...4
Power sensor index

Parameters:

<Value> 3 to 50 dB
Increment: 1 dB
*RST: 0 dB

Example:

PMET2:TRIG:HYST 10
Sets the hysteresis of the trigger to 10 dB.

Mode: PSM

Manual operation: See "[Hysteresis](#)" on page 521

[SENSe:]PMETer<p>:TRIGger:LEVel <Value>

This command sets the power level for the external power trigger for the selected power sensor.

For details on configuring an external power trigger and supported power sensors, see [Chapter 5.9.3, "Configuring an External Power Trigger"](#), on page 514.

For details see [Figure 5-47](#).

Suffix:

<p> 1...4
Power sensor index

Parameters:

<Value> -20 to +20 dBm
 *RST: -10 dBm

Example:

PMET2:TRIG:LEV -10 dBm
 Sets the level of the trigger

Mode: PSM

Manual operation: See "[External Trigger Level](#)" on page 521

[SENSe:]PMETer<p>:TRIGger:SLOPe <Edge>

Defines whether the sweep starts after a positive or negative edge of the trigger signal.

For details see [Figure 5-47](#).

Suffix:

<p> 1...4
 Power sensor index

Parameters:

<Edge> POSitive | NEGative
 *RST: POS

Example:

PMET2:TRIG:SLOP NEG

Mode: PSM

Manual operation: See "[Slope](#)" on page 521

[SENSe:]PMETer<p>:UPDate[:STATe] <State>

This command switches the continuous update of the power sensor measurement for the selected power sensor on or off. If activated, even after a single sweep has been completed, the data from the power sensor is updated.

Suffix:

<p> 1...4
 Power sensor index

Parameters:

<State> ON | OFF
 *RST: OFF

Example:

PMET1:UPD ON
 The data from power sensor 1 is updated continuously.

Mode: PSM

Manual operation: See "[Continuous Value Update](#)" on page 517

SENSe:POWer Subsystem

This subsystem controls the setting of the instruments channel and adjacent channel power measurements.

[SENSe:]POWer:ACHannel:ACPairs.....	845
[SENSe:]POWer:ACHannel:BANDwidth BWIDth[:CHANnel<channel>].....	846
[SENSe:]POWer:ACHannel:BANDwidth BWIDth:ACHannel.....	846
[SENSe:]POWer:ACHannel:BANDwidth BWIDth:ALTErnate<channel>.....	846
[SENSe:]POWer:ACHannel:FILTer:ALPHA:ACHannel.....	847
[SENSe:]POWer:ACHannel:FILTer:ALPHA[:ALL].....	847
[SENSe:]POWer:ACHannel:FILTer:ALPHA:ALTErnate<channel>.....	847
[SENSe:]POWer:ACHannel:FILTer:ALPHA:CHANnel<channel>.....	848
[SENSe:]POWer:ACHannel:FILTer[:STATe]:ALL.....	848
[SENSe:]POWer:ACHannel:FILTer[:STATe]:ACHannel.....	848
[SENSe:]POWer:ACHannel:FILTer[:STATe]:ALTErnate<channel>.....	848
[SENSe:]POWer:ACHannel:FILTer[:STATe]:CHANnel<channel>.....	849
[SENSe:]POWer:ACHannel:MODE.....	849
[SENSe:]POWer:ACHannel:NAME:ACHannel.....	849
[SENSe:]POWer:ACHannel:NAME:ALTErnate<channel>.....	850
[SENSe:]POWer:ACHannel:NAME:CHANnel<channel>.....	850
[SENSe:]POWer:ACHannel:PRESet.....	850
[SENSe:]POWer:ACHannel:PRESet:RLEVel.....	851
[SENSe:]POWer:ACHannel:REFerence:AUTO ONCE.....	851
[SENSe:]POWer:ACHannel:REFerence:TXCHannel:AUTO.....	851
[SENSe:]POWer:ACHannel:REFerence:TXCHannel:MANual.....	852
[SENSe:]POWer:ACHannel:SPACing[:ACHannel].....	852
[SENSe:]POWer:ACHannel:SPACing:ALTErnate<channel>.....	853
[SENSe:]POWer:ACHannel:SPACing:CHANnel<channel>.....	853
[SENSe:]POWer:ACHannel:TXCHannel:COUNt.....	854
[SENSe:]POWer:BANDwidth BWIDth.....	854
[SENSe:]POWer:HSPeed.....	854
[SENSe:]POWer:NCORrection.....	854
[SENSe:]POWer:TRACe.....	855

[SENSe:]POWer:ACHannel:ACPairs <ChannelPairs>

This command sets the number of adjacent channels (upper and lower channel in pairs). The figure 0 stands for pure channel power measurement.

Parameters:

<ChannelPairs> 0 to 12
 *RST: 1

Example:

POW:ACH:ACP 3

Sets the number of adjacent channels to 3, i.e. the adjacent channel and alternate adjacent channels 1 and 2 are switched on.

Manual operation:

See "[# of Adj Chan](#)" on page 296

See "[Channel Bandwidth](#)" on page 310

**[SENSe:]POWer:ACHannel:BANDwidth|BWIDth[:CHANnel<channel>]
<Bandwidth>**

This command sets the channel bandwidth of the specified TX channel in the radio communication system. The bandwidths of adjacent channels are not influenced by this modification.

With [SENSe<source>:] POWer:HSPEED set to ON, steep-edged channel filters are available. For further information on filters refer to [Chapter 5.2.6.4, "List of Available RRC and Channel Filters"](#), on page 212.

Parameters:

<Bandwidth> 100 Hz to 40 GHz
*RST: 14 kHz

Example: POW:ACH:BWID:CHAN2 30 kHz
Sets the bandwidth of the TX channel 2 to 30 kHz.

Manual operation: See "[Bandwidth](#)" on page 297
See "[Channel Bandwidth \(span > 0\)](#)" on page 314

[SENSe:]POWer:ACHannel:BANDwidth|BWIDth:ACHannel <Bandwidth>

This command defines the channel bandwidth of the adjacent channel of the radio transmission system. If the bandwidth of the adjacent channel is changed, the bandwidths of all alternate adjacent channels are automatically set to the same value.

With [SENSe<source>:] POWer:HSPEED set to ON, steep-edged channel filters are available. For further information on filters refer to [Chapter 5.2.6.4, "List of Available RRC and Channel Filters"](#), on page 212 .

Parameters:

<Bandwidth> 100 Hz to 40 GHz
*RST: 14 kHz

Example: POW:ACH:BWID:ACH 30 kHz
Sets the bandwidth of all adjacent channels to 30 kHz.

Manual operation: See "[Bandwidth](#)" on page 297

**[SENSe:]POWer:ACHannel:BANDwidth|BWIDth:ALternate<channel>
<Bandwidth>**

This command defines the channel bandwidth of the specified alternate adjacent channels of the radio transmission system. If the channel bandwidth of one alternate adjacent channel is changed (e.g. channel 3), the bandwidth of all subsequent alternate adjacent channels (e.g. 4–11) is automatically set to the same value.

With [SENSe<source>:] POWer:HSPEED set to ON, steep-edged channel filters are available. For further information on filters refer to [Chapter 5.2.6.4, "List of Available RRC and Channel Filters"](#), on page 212 .

Suffix:
 <channel> 1...11
 the alternate adjacent channel

Parameters:
 <Bandwidth> 100 Hz to 40 GHz
 *RST: 14 kHz

Example: POW:ACH:BWID:ALT2 30 kHz

Manual operation: See "[Bandwidth](#)" on page 297

[SENSe:]POWer:ACHannel:FILTer:ALPHa:ACHannel <Alpha>

This command defines the roll-off factor for the weighting filter of the adjacent channel.

Parameters:
 <Alpha> <numeric value>
 *RST: 0,22

Example: POW:ACH:FILT:ALPH:ACH 0,35

Manual operation: See "[Weighting Filter](#)" on page 299

[SENSe:]POWer:ACHannel:FILTer:ALPHa:[ALL] <Alpha>

This command defines the roll-off factor for the weighting filter of all channels.

Parameters:
 <Alpha> <numeric value>
 *RST: 0,22

Example: POW:ACH:FILT:ALPH:ALL 0,35

[SENSe:]POWer:ACHannel:FILTer:ALPHa:ALTerNate<channel> <Alpha>

This command defines the roll-off factor for the weighting filter of the specified alternate channel.

Suffix:
 <channel> 1...11
 the alternate channel

Parameters:
 <Alpha> <numeric value>
 *RST: 0,22

Example: POW:ACH:FILT:ALPH:ALT3 0,35
 Sets the alpha value for the weighting filter for the alternate channel 3 to 0,35.

Manual operation: See "[Weighting Filter](#)" on page 299

[SENSe:]POWer:ACHannel:FILTer:ALPHA:CHANnel<channel> <Alpha>

This command defines the roll-off factor for the weighting filter of the specified TX channel.

Suffix:

<channel> 1...11
the TX channel

Parameters:

<Alpha> <numeric value>
*RST: 0,22

Example:

POW:ACH:FILT:ALPH:CHAN3 0,35
Sets the alpha value for the weighting filter for the TX channel 3 to 0,35.

Manual operation: See "[Weighting Filter](#)" on page 299

[SENSe:]POWer:ACHannel:FILTer[:STATe]:ALL <State>

This command activates the weighting filter for all channels.

Parameters:

<State> ON | OFF
*RST: OFF

Example:

POW:ACH:FILT ON

[SENSe:]POWer:ACHannel:FILTer[:STATe]:ACHannel <State>

This command activates the weighting filter for the adjacent channel.

Parameters:

<State> ON | OFF
*RST: OFF

Example:

POW:ACH:FILT:ACH ON

Manual operation: See "[Weighting Filter](#)" on page 299

[SENSe:]POWer:ACHannel:FILTer[:STATe]:ALternate<channel> <State>

This command activates the weighting filter for the specified alternate channel.

Suffix:

<channel> 1...11
the alternate adjacent channel

Parameters:

<State> ON | OFF
*RST: OFF

Example: `POW:ACH:FILT:ALT3 ON`
 Activates the weighting filter for alternate channel 3.

Manual operation: See "[Weighting Filter](#)" on page 299

[SENSe:]POWer:ACHannel:FILTer[:STATe]:CHANnel<channel> <State>

This command activates the weighting filter for the specified TX channel.

Suffix:
 <channel> 1...18
 the TX channel

Parameters:
 <State> ON | OFF
 *RST: OFF

Example: `POW:ACH:FILT:CHA3 ON`
 Activates the weighting filter for TX channel 3.

Manual operation: See "[Weighting Filter](#)" on page 299

[SENSe:]POWer:ACHannel:MODE <Mode>

This command switches between absolute and relative adjacent channel measurement. The command is only available with span > 0 and if the number of adjacent channels is greater than 0.

For the relative measurement the reference value is set to the currently measured channel power using the command `[SENSe:]POWer:ACHannel:REference:AUTO ONCE`.

Parameters:
 <Mode> ABSolute | RELative
ABSolute
 absolute adjacent channel measurement
RELative
 relative adjacent channel measurement
 *RST: RELative

Example: `POW:ACH:MODE REL`
 Sets the adjacent channel measurement mode to relative.

Manual operation: See "[ACLR \(Abs/Rel\)](#)" on page 302

[SENSe:]POWer:ACHannel:NAME:ACHannel <Name>

This command defines a name for the adjacent channel. The name is displayed in the result diagram and the result table.

Parameters:
 <Name> *RST: Adj

Example: `POW:ACH:NAME:ACH 'XYZ'`
 Defines the name of the adjacent channel as 'XYZ'.

Manual operation: See "[Names](#)" on page 299

[SENSe:]POWer:ACHannel:NAME:ALTErnate<channel> <Name>

This command defines a name for the specified alternate channel. The name is displayed in the result diagram and the result table.

Suffix:
 <channel> 1...11
 the alternate channel

Parameters:
 <Name> *RST: ALT<1...11>

Example: `POW:ACH:NAME:ALT3 'XYZ'`
 Defines the name of the third alternate channel as 'XYZ'.

Manual operation: See "[Names](#)" on page 299

[SENSe:]POWer:ACHannel:NAME:CHANnel<channel> <Name>

This command defines a name for the specified TX channel. The name is displayed in the result diagram and the result table.

Suffix:
 <channel> 1...12
 the TX channel

Parameters:
 <Name> *RST: TX<1...12>

Example: `POW:ACH:NAME:CHAN3 'XYZ'`
 Defines the name of the third transmission channel as 'XYZ'.

Manual operation: See "[Names](#)" on page 299

[SENSe:]POWer:ACHannel:PRESet <Setting>

This command adjusts the frequency span, the measurement bandwidths and the detector as required for the number of channels, the channel bandwidths and the channel spacings selected in the active power measurement. If necessary, adjacent-channel power measurement is switched on prior to the adjustment.

To obtain correct results, a complete sweep with synchronization to the end of the sweep must be performed after the adjustment. Synchronization is possible only in the single sweep mode.

The result is queried with the `CALCulate<n>:MARKer<m>:FUNCTION:POWer:RESult?` command.

Parameters:

<Setting> ACPower | CPOWer | MCACpower | OBANdwidth | OBWidth | CN | CNO

Example:

```
POW:ACH:PRES ACP
```

Sets the frequency span, the measurement bandwidths and the detector as required for the ACLR measurement.

```
INIT:CONT OFF
```

Switches over to single sweep mode.

```
INIT;*WAI
```

Starts a sweep and waits for the end of the sweep.

```
CALC:MARK:FUNC:POW:RES? ACP
```

Queries the result of the adjacent-channel power measurement.

Manual operation: See ["Adjust Settings"](#) on page 302
See ["Adjust Settings "](#) on page 311

[SENSe:]POWer:ACHannel:PRESet:RLEVel

This command adapts the reference level to the measured channel power and – if required – switches on previously the adjacent channel power measurement. This ensures that the signal path of the instrument is not overloaded. Since the measurement bandwidth is significantly smaller than the signal bandwidth in channel power measurements, the signal path can be overloaded although the trace is still significantly below the reference level. If the measured channel power equals the reference level, the signal path is not overloaded.

Subsequent commands have to be synchronized with *WAI, *OPC or *OPC? to the end of the auto range process which would otherwise be aborted.

Example:

```
POW:ACH:PRES:RLEV;*WAI
```

Adapts the reference level to the measured channel power.

Manual operation: See ["Adjust Ref Lvl"](#) on page 305
See ["Adjust Ref Lvl \(span > 0\)"](#) on page 314

[SENSe:]POWer:ACHannel:REFerence:AUTO ONCE

This command sets the reference value to the currently measured channel power for the relative measurement.

Example:

```
POW:ACH:REF:AUTO ONCE
```

Manual operation: See ["Set CP Reference"](#) on page 303

[SENSe:]POWer:ACHannel:REFerence:TXCHannel:AUTO <Channel>

This command activates the automatic selection of a transmission channel to be used as a reference channel in relative adjacent-channel power measurements.

The transmission channel with the highest power, the transmission channel with the lowest power, or the transmission channel nearest to the adjacent channels can be defined as a reference channel.

The command is available only for multicarrier channel and adjacent-channel power measurements with span > 0 ([CALCulate<n>:MARKer<m>:FUNction:POWer:SElect](#) on page 707).

Parameters:

<Channel> MINimum | MAXimum | LHIGhest

MINimum
Transmission channel with the lowest power

MAXimum
Transmission channel with the highest power

LHIGhest
Lowermost transmission channel for the lower adjacent channels, uppermost transmission channel for the upper adjacent channels

Example:

POW:ACH:REF:TXCH:AUTO MAX

The transmission channel with the highest power is used as a reference channel.

Manual operation: See "[ACLR Reference](#)" on page 298

[SENSe:]POWer:ACHannel:REFerence:TXCHannel:MANual <ChannelNumber>

This command selects a transmission channel to be used as a reference channel in relative adjacent-channel power measurements.

The command is available only for multicarrier channel and adjacent-channel power measurements with span > 0 ([CALCulate<n>:MARKer<m>:FUNction:POWer:SElect](#) on page 707).

Parameters:

<ChannelNumber> 1 to 18

*RST: 1

Example:

POW:ACH:REF:TXCH:MAN 3

Transmission channel 3 is used as a reference channel.

Manual operation: See "[ACLR Reference](#)" on page 298

[SENSe:]POWer:ACHannel:SPACing[:ACHannel] <Spacing>

This command defines the spacing between the carrier signal and the adjacent channel (ADJ). The modification of the adjacent-channel spacing (ADJ) causes a change in all higher adjacent-channel spacings (ALT1, ALT2, ...): they are all multiplied by the same factor (new spacing value/old spacing value).

Parameters:

<Spacing> 100 Hz to 20 GHz
 *RST: 14 kHz

Example:

POW:ACH:SPAC 33kHz

Sets the spacing between the carrier signal and the adjacent channel to 33 kHz, the alternate adjacent channel 1 to 66 kHz, the alternate adjacent channel 2 to 99 kHz, and so on.

Manual operation: See "[Spacing](#)" on page 298

[SENSe:]POWer:ACHannel:SPACing:ALTErnate<channel> <Spacing>

This command defines the spacing between the alternate adjacent channels and the TX channel (ALT1, ALT2, ...). A modification of a higher adjacent-channel spacing causes a change by the same factor (new spacing value/old spacing value) in all higher adjacent-channel spacings, while the lower adjacent-channel spacings remain unchanged.

Suffix:

<channel> 1...11
 the alternate adjacent channel

Parameters:

<Spacing> 100 Hz to 20 GHz
 *RST: 40 kHz (ALT1), 60 kHz (ALT2), 80 kHz (ALT3), ...

Example:

POW:ACH:SPAC:ALT1 100 kHz

Sets the spacing between TX channel and alternate adjacent channel 1 (ALT1) from 40 kHz to 100 kHz. In consequence, the spacing between the TX channel and all higher alternate adjacent channels is increased by the factor $100/40 = 2.5$: ALT2 = 150 kHz, ALT3 = 200 kHz, ALT4 = 250 kHz.

Manual operation: See "[Spacing](#)" on page 298

[SENSe:]POWer:ACHannel:SPACing:CHANnel<channel> <Spacing>

This command defines the channel spacing for the carrier signals.

Suffix:

<channel> 1...11
 the TX channel

Parameters:

<Spacing> 14 kHz to 20 GHz
 *RST: 20 kHz

Example:

POW:ACH:SPAC:CHAN 25kHz

Manual operation: See "[Spacing](#)" on page 298

[SENSe:]POWer:ACHannel:TXChannel:COUNT <Number>

This command selects the number of carrier signals.

The command is available only for multicarrier channel and adjacent-channel power measurements with span > 0 (see [CALCulate<n>;MARKer<m>;FUNction:POWer:SELEct](#) on page 707).

Parameters:

<Number> 1 to 18
*RST: 1

Example: POW:ACH:TXCH:COUN 3

Manual operation: See "[# of TX Chan](#)" on page 296

[SENSe:]POWer:BANDwidth|BWIDth <Percentage>

This command defines the percentage of the power with respect to the total power.

This value is the basis for the occupied bandwidth measurement (see [\[SENSe:\]POWer:ACHannel:PRESet](#) on page 850).

Parameters:

<Percentage> 10 to 99.9PCT
*RST: 99PCT

Example: POW:BWID 95PCT

Manual operation: See "[% Power Bandwidth \(span > 0\)](#)" on page 314

[SENSe:]POWer:HSPeed <State>

This command switches on or off the high-speed channel/adjacent channel power measurement. The measurement itself is performed in zero span on the center frequencies of the individual channels. The command automatically switches to zero span and back.

Depending on the selected mobile radio standard, weighting filters with characteristic or very steep-sided channel filters are used for band limitation.

Parameters:

<State> ON | OFF
*RST: OFF

Example: POW:HSP ON

Manual operation: See "[Fast ACLR \(On/Off\)](#)" on page 303

[SENSe:]POWer:NCORrection <Mode>

This command turns noise cancellation on and off.

If noise cancellation is on, the R&S FSVA/FSV performs a reference measurement to determine its inherent noise and subtracts the result from the channel power measurement result (first active trace only).

The inherent noise of the instrument depends on the selected center frequency, resolution bandwidth and level setting. Therefore, the correction function is disabled whenever one of these parameters is changed. A corresponding message is displayed on the screen. Noise correction must be turned on again manually after the change.

Parameters:

<Mode>

ON

Performs noise correction.

OFF

Performs no noise correction.

AUTO

Performs noise correction.

After a parameter change, noise correction is restarted automatically and a new correction measurement is performed.

*RST: OFF

Example:

POW:NCOR ON

Manual operation: See "[Noise Correction](#)" on page 198

[SENSe:]POWer:TRACe <TraceNumber>

This command assigns the channel/adjacent channel power measurement to the indicated trace. The corresponding trace must be active, i.e. its state must be different from blank.

Note: The measurement of the occupied bandwidth (OBW) is performed on the trace on which marker 1 is positioned. To evaluate another trace, marker 1 must be positioned to another trace with [CALCulate<n>:MARKer<m>:TRACe](#).

Parameters:

<TraceNumber> 1 to 6

Example:

POW:TRAC 2

Assigns the measurement to trace 2.

Manual operation: See "[Select Trace](#)" on page 302

SENSe:SWEEp Subsystem

The SENSe:SWEEp subsystem controls the sweep parameters.

[SENSe:]SWEEp:COUNT	856
[SENSe:]SWEEp:COUNT:CURRENT?	856
[SENSe:]SWEEp:EGATE	857
[SENSe:]SWEEp:EGATE:HOLDoff	857
[SENSe:]SWEEp:EGATE:LENGTH	858
[SENSe:]SWEEp:EGATE:POLarity	858
[SENSe:]SWEEp:EGATE:SOURCE	858

[SENSe:]SWEep:EGATe:TRACe<k>:COMMeNt.....	859
[SENSe:]SWEep:EGATe:TRACe<k>[:STATe<range>].....	859
[SENSe:]SWEep:EGATe:TRACe<k>:STARt<range>.....	859
[SENSe:]SWEep:EGATe:TRACe<k>:STOP<range>.....	860
[SENSe:]SWEep:EGATe:TRACe<k>:PERiod.....	860
[SENSe:]SWEep:EGATe:TYPE.....	860
[SENSe:]SWEep:MODE.....	861
[SENSe:]SWEep:POINts.....	861
[SENSe:]SWEep:TIME.....	862
[SENSe:]SWEep:TIME:AUTO.....	862
[SENSe:]SWEep:TYPE.....	863
[SENSe:]SWEep:TYPE:USED?.....	863

[SENSe:]SWEep:COUNT <NumberSweeps>

This command defines the number of sweeps started with single sweep, which are used for calculating the average or maximum value. If the values 0 or 1 are set, one sweep is performed.

Parameters:

<NumberSweeps> 0 to 32767
 *RST: 0 (GSM: 200, PHN:1)

Example:

```
SWE:COUN 64
Sets the number of sweeps to 64.
INIT:CONT OFF
Switches to single sweep mode.
INIT;*WAI
Starts a sweep and waits for its end.
```

Manual operation: See "[Sweep Count](#)" on page 217

[SENSe:]SWEep:COUNT:CURRent?

This query command returns the current number of started sweeps. A sweep count value should be set and the device should be in single sweep mode.

Example:

```
SWE:COUNT 64
Sets sweep count to 64
INIT:CONT OFF
Switches to single sweep mode
INIT
Starts a sweep (without waiting for the sweep end!)
SWE:COUN:CURR?
Queries the number of started sweeps
```

Usage: Query only

[SENSe:]SWEep:EGATe <State>

This command switches on/off the sweep control by an external gate signal. If the external gate is selected the trigger source is automatically switched to EXTERNAL as well.

When triggering or gating is activated, the squelch function is automatically disabled (see "[SENSe:DEMod Subsystem](#)" on page 796).

In case of measurement with external gate, the measured values are recorded as long as the gate is opened. During a sweep the gate can be opened and closed several times. The synchronization mechanisms with *OPC, *OPC? and *WAI remain completely unaffected.

The sweep end is detected when the required number of measurement points (691 in "Spectrum" mode) has been recorded.

Parameters:

<State> ON | OFF
*RST: OFF

Example:

```
SWE:EGAT ON
Switches on the external gate mode.
SWE:EGAT:TYPE EDGE
Switches on the edge-triggered mode.
SWE:EGAT:HOLD 100US
Sets the gate delay to 100 µs.
SWE:EGAT:LEN 500US
Sets the gate opening time to 500 µs.
INIT;*WAI
Starts a sweep and waits for its end.
```

Manual operation: See "[Gated Trigger](#)" on page 244
See "[Gated Trigger \(On/Off\)](#)" on page 365
See "[Gate Ranges](#)" on page 365

[SENSe:]SWEep:EGATe:HOLDoff <DelayTime>

This command defines the delay time between the external gate signal and the continuation of the sweep.

Note: Using gate mode "level" (see [\[SENSe:\]SWEep:EGATe:TYPE](#) on page 860) and an IFP trigger (see [TRIGger<n>\[:SEQUENCE\]:SOURCE](#) on page 912), the holdoff time for the IFP trigger is ignored for frequency sweep, FFT sweep, zero span and IQ mode measurements.

Parameters:

<DelayTime> 0 s to 30 s
*RST: 0s

Example:

```
SWE:EGAT:HOLD 100us
```

Manual operation: See "[Gate Delay](#)" on page 244

[SENSe:]SWEep:EGATe:LENGth <TimeInterval>

This command defines a gate length.

Parameters:

<TimeInterval> 125 ns to 30 s
*RST: 400µs

Example: SWE:EGAT:LENG 10ms

Manual operation: See "[Gate Length \(Gate Mode Edge\)](#)" on page 245

[SENSe:]SWEep:EGATe:POLarity <Polarity>

This command determines the polarity of the external gate signal. The setting applies both to the edge of an edge-triggered signal and the level of a level-triggered signal.

Parameters:

<Polarity> POSitive | NEGative
*RST: POSitive

Example: SWE:EGAT:POL POS

Manual operation: See "[Trg/Gate Polarity](#)" on page 242
See "[Trigger Polarity](#)" on page 433

[SENSe:]SWEep:EGATe:SOURce <Source>

This command selects the signal source for gated measurements.

If an IF power signal is used, the gate is opened as soon as a signal at > -20 dBm is detected within the IF path bandwidth (10 MHz).

For details see the "[Trg/Gate Source](#)" on page 239 softkey.

Parameters:

<Source> EXTernal | IFPower | VIDeo | RFPower | PSEN
*RST: IFPower

Example: SWE:EGAT:SOUR IFP
Switches the gate source to IF power.

Manual operation: See "[Trg/Gate Source](#)" on page 239
See "[External](#)" on page 239
See "[Video](#)" on page 239
See "[RF Power](#)" on page 239
See "[IF Power/BB Power](#)" on page 240
See "[Power Sensor](#)" on page 241
See "[Digital IQ](#)" on page 241
See "[Gated Trigger](#)" on page 244
See "[Gated Trigger \(On/Off\)](#)" on page 365

[SENSe:]SWEep:EGATe:TRACe<k>:COMMeNt <Comment>

Defines a comment for one of the traces for gated triggering.

Suffix:

<k> 1...6
 trace

Parameters:

<Comment>

Example: SWE:EGAT:TRAC1:COMM "SlotA"

Manual operation: See "[Gate Ranges](#)" on page 365

[SENSe:]SWEep:EGATe:TRACe<k>[:STATe<range>] <State>

This command activates or deactivates tracing for a specific range using gated triggering.

Suffix:

<k> 1...6
 trace

<range> 1...3
 range

Parameters:

<State> ON | OFF
 *RST: OFF

Example: SWE:EGAT:TRAC1:STAT1 ON
 Activates tracing for range 1 of trace 1.

Manual operation: See "[Gate Ranges](#)" on page 365

[SENSe:]SWEep:EGATe:TRACe<k>:STARt<range> <Value>

This command defines the starting point for the range to be traced using gated triggering.

Suffix:

<k> 1...6
 trace

<range> 1...3
 range

Parameters:

<Value> <numeric value>
 *RST: OFF

Example: SWE:EGAT:TRAC1:STAR1 3ms
 Sets the Starting point for range 1 on trace 1 at 3 ms.

Manual operation: See "[Gate Ranges](#)" on page 365

[SENSe:]SWEep:EGATe:TRACe<k>: STOP<range> <Value>

This command defines the stopping point for the range to be traced using gated triggering

Suffix:

<k>	1...6 trace
<range>	1...3 range

Parameters:

<Value>	<numeric value>
	*RST: 1 μ s

Example: `SWE:EGAT:TRAC1:STOP1 5ms`
Sets the stopping point for range 1 on trace 1 at 5 ms.

Manual operation: See "[Gate Ranges](#)" on page 365

[SENSe:]SWEep:EGATe:TRACe<k>: PERiod <Value>

This command defines the length of the period to be traced using gated triggering.

Suffix:

<k>	1...6 trace
-----	----------------

Parameters:

<Value>	<numeric value>
	*RST: 0 s

Example: `SWE:EGAT:TRAC1:PER 5ms`
Defines the period for gated triggering to 5 ms.

Manual operation: See "[Gate Ranges](#)" on page 365

[SENSe:]SWEep:EGATe:TYPE <Type>

This command sets the type of triggering by the external gate signal.

A delay between applying the gate signal and the start of recording measured values can be defined, see [\[SENSe:\]SWEep:EGATe:HOLDoFF](#) on page 857.

Parameters:

<Type>	LEVEl EDGE
--------	--------------

LEVel

The gate is level-triggered:

After detection of the gate signal, the gate remains open until the gate signal disappears. The gate opening time cannot be defined with the command `[SENSe:]SWEep:EGATe:HOLDoff`.

Note: Using gating with gate mode "level" and an IFP trigger (see `TRIGger<n>[:SEQuence]:SOURce` on page 912), the holdoff time for the IFP trigger is ignored for frequency sweep, FFT sweep, zero span and IQ mode measurements.

EDGE

The gate is edge-triggered:

After detection of the set gate signal edge, the gate remains open until the gate delay (`[SENSe:]SWEep:EGATe:HOLDoff`) has expired.

*RST: EDGE

Example: `SWE:EGAT:TYPE EDGE`

Manual operation: See "[Gate Mode \(Lvl/Edge\)](#)" on page 244

[SENSe:]SWEep:MODE <Mode>

This command selects the spurious emission and spectrum emission mask measurements.

Parameters:

<Mode> AUTO | ESpectrum | LIST

AUTO

Switches to "Spectrum" measurement mode or stays in the current mode if it is not ESP/LIST

ESpectrum

"Spectrum Emission Mask" measurement mode

LIST

"Spurious Emissions" measurement mode

*RST: AUTO

Example: `SWE:MODE ESP`
Sets the Spectrum Emission Mask measurement mode.

Manual operation: See "[Spectrum Emission Mask](#)" on page 282
See "[Spurious Emissions](#)" on page 282
See "[Spectrum Emission Mask](#)" on page 317
See "[Spurious Emissions](#)" on page 349

[SENSe:]SWEep:POINTs <NumberPoints>

This command defines the number of measurement points to be collected during one sweep.

Note: For Spurious Emissions measurements the maximum number of sweep points in all ranges is limited to 100001.

Parameters:

<NumberPoints> Range: 101 to 32001
 *RST: 691

Example: SWE:POIN 150

Manual operation: See "[Sweep Points](#)" on page 217

[SENSe:]SWEep:TIME <Time>

This command defines the sweep time.

The range depends on the frequency span.

If this command is used in "Spectrum" mode, automatic coupling to resolution bandwidth and video bandwidth is switched off.

Parameters:

<Time> refer to data sheet
 *RST: (automatic)

Example: SWE:TIME 1s

Manual operation: See "[Sweeptime Manual](#)" on page 207
 See "[Sweep Time](#)" on page 302
 See "[Meas Time](#)" on page 418

[SENSe:]SWEep:TIME:AUTO <State>

In realtime mode, this command automatically sets the sweep time to 32 ms.

In analyzer mode, this command controls the automatic coupling of the sweep time to the frequency span and bandwidth settings. If [[SENSe:](#)] [SWEep:TIME](#) is used, automatic coupling is switched off.

Parameters:

<State> ON | OFF
 *RST: ON

Example: SWE:TIME:AUTO ON
 Activates automatic sweep time.

Manual operation: See "[Sweeptime Manual](#)" on page 207
 See "[Sweeptime Auto](#)" on page 208
 See "[Default Coupling](#)" on page 210

[SENSe:]SWEep:TYPE <Type>

This command selects the sweep type.

Parameters:

<Type>

SWE

Selects analog frequency sweeps.

AUTO

Automatically selects the sweep type (FFT or analog frequency sweep).

FFT

Selects FFT sweeps.

*RST: AUTO

Example:

SWE:TYPE FFT

Selects FFT sweeps.

Manual operation: See "Sweep" on page 204

See "FFT" on page 204

See "Auto" on page 204

[SENSe:]SWEep:TYPE:USED?

This command queries the sweep type if you have turned on automatic selection of the sweep type.

Return values:

<Type>

SWE | FFT

SWE

Normal sweep

FFT

FFT mode

*RST: SWE

Example:

SWE:TYPE:USED?

Usage:

Query only

SENSe:[WINDow:]DETEctor Subsystem

The SENSe:DETEctor subsystem controls the acquisition of measurement data via the selection of the detector for the corresponding trace.

[SENSe:][WINDow:]DETEctor<trace>[:FUNCTion]..... 863

[SENSe:][WINDow:]DETEctor<trace>[:FUNCTion]:AUTO..... 864

[SENSe:][WINDow:]DETEctor<trace>[:FUNCTion] <Function>

This command selects the detector for the data acquisition in the selected trace.

Suffix:

<trace> 1...6
Selects the trace.

<trace> 1...6
trace

Parameters:

<Function> APEak | NEGative | POSitive | SAMPlE | RMS | AVERage | QPEak

*RST: APEak

For details on detectors refer to [Chapter 5.2.8.6, "Detector Overview"](#), on page 234.

Example:

DET POS
Sets the detector to "positive peak".

Manual operation:

See ["Auto Peak"](#) on page 223
See ["Positive Peak"](#) on page 223
See ["Negative Peak"](#) on page 224
See ["Sample"](#) on page 224
See ["RMS"](#) on page 224
See ["Average"](#) on page 224
See ["Quasipeak"](#) on page 224
See ["CISPR Average"](#) on page 224
See ["RMS Average"](#) on page 225

[SENSe:][WINDow:]DETEctor<trace>[:FUNCTion]:AUTO <State>

This command either couples the detector to the current trace setting or turns coupling off.

Suffix:

<trace> 1...6
trace

Parameters:

<State> ON | OFF

*RST: ON

Example:

DET:AUTO OFF

Manual operation: See ["Auto Select"](#) on page 223

6.3.3.16 SOURce Subsystem

The SOURce subsystem controls the output signals of the instrument.

- [SOURce Subsystem commands](#).....865
- [SOURce:POWER Subsystem](#)..... 872

SOURce Subsystem commands

SOURce<n>:AM:STATe.....	865
SOURce<n>:DM:STATe.....	865
SOURce<n>:EXternal<generator>[:STATe].....	866
SOURce<n>:EXternal<generator>:FREQUency.....	866
SOURce<n>:EXternal<generator>:FREQUency:COUPling[:STATe].....	867
SOURce<n>:EXternal<generator>:FREQUency[:FACTor]:DENominator.....	867
SOURce<n>:EXternal<generator>:FREQUency[:FACTor]:NUMerator.....	868
SOURce<n>:EXternal<generator>:FREQUency:OFFSet<m>.....	869
SOURce<n>:EXternal<generator>:FREQUency:SWEEp[:STATe].....	869
SOURce<n>:EXternal<generator>:POWer[:LEVel].....	870
SOURce<n>:EXternal<generator>:ROSCillator[:SOURce].....	870
SOURce<n>:FM:DEVIation.....	871
SOURce<n>:FM:STATe.....	871
SOURce<n>:FREQUency:OFFSet.....	872

SOURce<n>:AM:STATe <State>

This command turns external amplitude modulation of the tracking generator on and off.

External I/Q modulation is switched off, if active. This command is available with a tracking generator (option R&S FSV-B9).

Suffix:

<n> 1...4
Selects the measurement window.

Parameters:

<State> ON | OFF
*RST: OFF

Example:

SOUR2 : AM : STAT ON
Switches on the external amplitude modulation of the tracking generator for screen B.

Usage: SCPI confirmed

Manual operation: See "External AM" on page 449
See "Modulation OFF" on page 449

SOURce<n>:DM:STATe <State>

This command turns external I/Q modulation of the tracking generator on and off.

External AM and external FM are switched off, if active. This command is available with a tracking generator (option R&S FSV-B9).

Suffix:

<n> 1...4
Selects the measurement window.

Parameters:

<State> ON | OFF
 *RST: OFF

Example:

SOUR2:DM:STAT ON
 Switches on the external I/Q modulation of the tracking generator for screen B.

Usage:

SCPI confirmed

Manual operation:

See ["External I/Q"](#) on page 449
 See ["Modulation OFF"](#) on page 449
 See ["External IQ"](#) on page 468

SOURce<n>:EXTeRnal<generator>[:STATe] <State>

This command activates or deactivates the external generator indicated by the suffix <generator>.

This command is only valid for the External Tracking Generator option (R&S FSV-B10).

Suffix:

<n> irrelevant
 <generator> 1 | 2
 external generator

Parameters:

<State> ON | OFF
 *RST: OFF

Example:

```
SYST:COMM:RDEV:GEN1:TYPE 'SMP02'
Selects SMP02 as generator 1.
"SYST:COMM:RDEV:GEN1:LINK TTL"
Selects GPIB + TTL link as interface.
"SYST:COMM:RDEV:GEN1:ADDR 28"
Sets the generator address to 28.
"SOUR:EXT1:FREQ:SWE ON"
Activates the frequency sweep for generator 1.
"SOUR:EXT ON"
Activates the external generator
```

Manual operation: See ["Source RF Internal \(On/ Off\)"](#) on page 446

SOURce<n>:EXTeRnal<generator>:FREQuency <Frequency>

This command defines a fixed source frequency for the external tracking generator.

This command is only valid for the External Tracking Generator option (R&S FSV-B10).

Suffix:

<n> 1...4
 window

<m> 1 | 2
tracking generator

Parameters:

<Frequency> Source frequency of the external tracking generator.
*RST: RST value

Example: SOUR:EXT2:FREQ 10MHz

Manual operation: See "(Fixed) Generator Frequency" on page 457

SOURce<n>:EXTernal<generator>:FREQuency:COUPling[:STATe] <State>

This command couples or decouples the analyzer and generator frequencies.

This command is only valid for the External Tracking Generator option (R&S FSV-B10).

Suffix:

<generator> 1 | 2
tracking generator

Parameters:

<State> ON | OFF
ON
OFF

The fixed frequency defined using SOURce<n>:
EXTernal<generator>:FREQuency is used as a source frequency.

*RST: OFF

Example: SOUR:EXT2:FREQ:COUP ON

Manual operation: See "Source Frequency Coupling" on page 457

SOURce<n>:EXTernal<generator>:FREQuency[:FACTor]:DENominator <Value>

This command defines the denominator of the factor with which the analyzer frequency is multiplied in order to obtain the transmit frequency of the selected generator.

This command is only valid for the External Tracking Generator option (R&S FSV-B10).

Select the multiplication factor such that the frequency range of the generator is not exceeded if the following formula is applied to the start and stop frequency of the analyzer:

$$F_{Generator} = \left| F_{Analyzer} * \frac{Numerator}{Denominator} + F_{Offset} \right|$$

Suffix:

<n> irrelevant

<generator> 1 | 2
tracking generator
For Noise Figure measurements (K30): 1 only

Parameters:

<Value> <numeric value>
*RST: 1

Example:

SOUR:EXT:FREQ:NUM 4"
"SOUR:EXT:FREQ:DEN 3"

Sets a multiplication factor of 4/3, i.e. the transmit frequency of the generator is 4/3 times the analyzer frequency.

Mode: A, NF

Manual operation: See "[Generator Frequency \(Numerator/Denominator/Offset\)](#)" on page 458

SOURce<n>:EXTernal<generator>:FREQuency[:FACTor]:NUMerator <Value>

This command defines the numerator of the factor with which the analyzer frequency is multiplied in order to obtain the transmit frequency of the selected generator.

This command is only valid for the External Tracking Generator option (R&S FSV-B10).

Select the multiplication factor such that the frequency range of the generator is not exceeded if the following formula is applied to the start and stop frequency of the analyzer:

$$F_{Generator} = \left| F_{Analyzer} * \frac{Numerator}{Denominator} + F_{Offset} \right|$$

Suffix:

<n> irrelevant

<generator> 1 | 2
tracking generator
For Noise Figure measurements (K30): 1 only

Parameters:

<Value> <numeric value>
*RST: 1

Example:

SOUR:EXT:FREQ:NUM 4"
"SOUR:EXT:FREQ:DEN 3"

Sets a multiplication factor of 4/3, i.e. the transmit frequency of the generator is 4/3 times the analyzer frequency.

Mode: A, NF

Manual operation: See "[Generator Frequency \(Numerator/Denominator/Offset\)](#)" on page 458

SOURce<n>:EXTernal<generator>:FREQUENCY:OFFSet<m> <Offset>

This command defines the frequency offset of the selected generator with reference to the receive frequency.

This command is only valid for the External Tracking Generator option (R&S FSV-B10).

Suffix:

<n>	irrelevant
<generator>	1 2 tracking generator For Noise Figure measurements (K30): 1 only
<m>	1 2 offset (for Noise Figure measurements (K30) only)

Parameters:

<Offset> <numeric value>, specified in Hz, kHz, MHz or GHz, rounded to the nearest Hz

*RST: 0 Hz

Select the multiplication factor such that the frequency range of the generator is not exceeded if the following formula is applied to the start and stop frequency of the analyzer:

$$F_{\text{Analyzer}} = \left| F_{\text{Start}} * \frac{\text{Numerator}}{\text{Denominator}} + F_{\text{Stop}} \right|$$

For Noise Figure measurements (R&S FSV-K30), the following formula applies:

Generator Frequency = [(LO + Offset 1) * Factor 1 / Factor 2] + Offset 2

Example:

SOUR:EXT:FREQ:OFFS 1GHZ

Sets a frequency offset of the generator transmit frequency compared to the analyzer receive frequency of 1 GHz.

Mode: A, NF

Manual operation: See "[Generator Frequency \(Numerator/Denominator/Offset\)](#)" on page 458

SOURce<n>:EXTernal<generator>:FREQUENCY:SWEEp[:STATe] <State>

This command activates or deactivates the frequency sweep for the selected generator.

This command is requires the optional External Tracking Generator.

Suffix:

<n>	irrelevant
<generator>	1 2 external generator

Parameters:

<State> ON | OFF
*RST: OFF

Example: `SOUR:EXT1:FREQ:SWE ON`
 Activates the frequency sweep for external generator 1.

SOURce<n>:EXTernal<generator>:POWER[:LEVel] <Level>

This command sets the output power of the selected generator.

This command is only valid for the External Tracking Generator option (R&S FSV-B10).

Suffix:

<n> irrelevant
 <generator> 1 | 2
 tracking generator
 For Noise Figure measurements (K30): 1 only

Parameters:

<Level> <numeric value>
 *RST: -20 dBm

Example: `SOUR:EXT:POW -30dBm`
 Sets the generator level to -30 dBm

Mode: A, NF

Manual operation: See "[Source Power](#)" on page 458

SOURce<n>:EXTernal<generator>:ROSCillator[:SOURce] <Source>

This command controls selection of the reference oscillator for the external tracking generator (requires option R&S FSV-B10).

If the external reference oscillator is selected, the reference signal must be connected to the rear panel of the instrument.

Suffix:

<n> irrelevant
 <generator> 1 | 2
 tracking generator
 For Noise Figure measurements (K30): 1 only

Parameters:

<Source> **INTernal**
 the internal reference is used
 EXTernal
 the external reference is used; if none is available, an error flag
 is displayed in the status bar
 EAUTO
 the external reference is used as long as it is available, then the
 instrument switches to the internal reference (Spectrum mode
 only)
 *RST: INT

Example: SOUR:EXT:ROSC EXT
Switches to external reference oscillator

Mode: A, NF

Manual operation: See "[Reference](#)" on page 460

SOURce<n>:FM:DEVIation <Frequency>

This command defines the maximum frequency deviation at 1 V input voltage at the FM input of the tracking generator.

This command is available with a tracking generator (option R&S FSV-B9).

Suffix:
<n> 1...4
Selects the measurement window.

Parameters:
<Frequency> The possible value range is 100 Hz to 10 MHz in steps of 10 Hz.
Range: 100 Hz to 10 MHz
Increment: 10 Hz
*RST: 100 Hz

Example: SOUR1:FM:DEV 1 MHz
Sets the maximum frequency deviation of the tracking generator for screen A to 1 MHz.

Usage: SCPI confirmed

Manual operation: See "[External FM](#)" on page 449

SOURce<n>:FM:STATe <State>

This command turns external frequency modulation of the tracking generator on and off.

External I/Q modulation is switched off, if active. This command is available with a tracking generator (option R&S FSV-B9).

Suffix:
<n> 1...4
Selects the measurement window.

Parameters:
<State> ON | OFF
*RST: OFF

Example: SOUR2:FM:STAT ON
Switches on the external frequency modulation of the tracking generator for screen B.

Usage: SCPI confirmed

Manual operation: See "External FM" on page 449
See "Modulation OFF" on page 449

SOURce<n>:FREQuency:OFFSet <Offset>

This command defines a frequency offset of the tracking generator. Frequency-converting DUTs can be measured with this setting.

External I/Q modulation is switched off, if active. This command is available with a tracking generator (option R&S FSV-B9).

Suffix:

<n> 1...4
Selects the measurement window.

Parameters:

<Offset> Note that the values (start frequency – tracking frequency offset) and (stop frequency – tracking frequency offset) are both > 1 kHz or both < –1 kHz.
Range: -200 MHz to 200 MHz
*RST: 0 Hz

Example: SOUR:FREQ:OFFS 10MHz
Defines a frequency offset of the tracking generator of 10 MHz.

Usage: SCPI confirmed

Manual operation: See "Frequency Offset" on page 456

SOURce:POWer Subsystem

The SOURce:POWer subsystem controls the power of the tracking generator signal (only with option R&S FSV-B9 or R&S FSV-B10).

SOURce<n>:POWer[:LEVel][:IMMediate][:AMPLitude].....	872
SOURce<n>:POWer[:LEVel][:IMMediate]:OFFSet.....	873
SOURce<n>:POWer:MODE.....	873
SOURce<n>:POWer:START.....	873
SOURce<n>:POWer:STOP.....	874

SOURce<n>:POWer[:LEVel][:IMMediate][:AMPLitude] <Level>

This command defines the output level of the tracking generator.

Parameters:

<Level> Output level in dBm. The level range is specified in the data sheet.
*RST: -20 dBm

Example: SOUR:POW -20dBm
Sets the tracking generator level to -20 dBm.

Usage: SCPI confirmed

Manual operation: See "Source Power" on page 446
See "Source Power" on page 455

SOURce<n>:POWER[:LEVel][:IMMediate]:OFFSet <Offset>

This command defines a level offset for the tracking generator level. Thus, for example, attenuators or amplifiers at the output of the tracking generator can be taken into account for the setting.

Parameters:

<Offset> Range: -200 dB to +200 dB
 *RST: 0dB

Example: SOUR:POW:OFFS -10dB
Sets the level offset of the tracking generator to – 20 dBm.

Usage: SCPI confirmed

Manual operation: See "Power Offset" on page 455
See "Power Offset" on page 458

SOURce<n>:POWER:MODE <Mode>

This command turns the power sweep on and off.

Suffix:

<n> 1...4
Selects the measurement window.

Parameters:

<Mode> **FIXed**
Power sweep is off.

SWEEp
Power sweep is on.
If the power sweep is on, the R&S FSVA/FSV enters the time domain (span = 0 Hz). During the sweep time, the power at the internal tracking generator is changed linearly from start power to stop power. The start and stop power for the power sweep are displayed in the diagram header ("INT TG <start power>... <stop power>").

*RST: FIXed

Example: SOUR:POW:MODE SWE
Activates power sweep.

Usage: SCPI confirmed

Manual operation: See "Power Sweep (On /Off)" on page 449

SOURce<n>:POWER:START <Power>

This command defines the start power of the power sweep.

Suffix:	
<n>	1...4 Selects the measurement window.
Parameters:	
<Power>	Range: -30 dBm to +5 dBm *RST: 0 dBm
Example:	SOUR:POW:STAR -20dBm
Usage:	SCPI confirmed
Manual operation:	See " Power Sweep Start " on page 450

SOURce<n>:POWER:STOP <Power>

This command defines the stop power of the power sweep. The stop value can be smaller than the start value.

Suffix:	
<n>	1...4 Selects the measurement window.
Parameters:	
<Power>	Range: -30 dBm to +5 dBm *RST: 0 dBm
Example:	SOUR:POW:STOP -20dBm
Usage:	SCPI confirmed
Manual operation:	See " Power Sweep Stop " on page 450

6.3.3.17 STATus:QUEStionable Subsystem

The STATus subsystem contains the commands for the status reporting system (for details refer to [Chapter 6.1.6, "Status Reporting System"](#), on page 550). *RST does not influence the status registers.

The STATus:QUEStionable subsystem contains information about the observance of limits during adjacent power measurements, the reference and local oscillator, the observance of limit lines and limit margins and possible overloads of the unit.

STATus:QUEStionable:ACPLimit[:EVENT]?.....	875
STATus:QUEStionable:ACPLimit:CONDition?.....	875
STATus:QUEStionable:ACPLimit:ENABle.....	876
STATus:QUEStionable:ACPLimit:NTRansition.....	876
STATus:QUEStionable:ACPLimit:PTRansition.....	876
STATus:QUEStionable:DIQ:CONDition?.....	876
STATus:QUEStionable:DIQ[:EVENT]?.....	877
STATus:QUEStionable:DIQ:ENABle.....	877
STATus:QUEStionable:DIQ:NTRansition.....	877
STATus:QUEStionable:DIQ:PTRansition.....	877
STATus:QUEStionable:FREQuency:CONDition?.....	877

STATus:QUESTionable:FREQuency:ENABle.....	878
STATus:QUESTionable:FREQuency[:EVENT]?	878
STATus:QUESTionable:FREQuency:NTRansition.....	878
STATus:QUESTionable:FREQuency:PTRansition.....	878
STATus:QUESTionable:LIMit<m>[:EVENT]?	879
STATus:QUESTionable:LIMit<m>:CONDition?	879
STATus:QUESTionable:LIMit<m>:ENABle.....	879
STATus:QUESTionable:LIMit<m>:NTRansition.....	880
STATus:QUESTionable:LIMit<m>:PTRansition.....	880
STATus:QUESTionable:LMARgin<m>[:EVENT]?	880
STATus:QUESTionable:LMARgin<m>:CONDition?	881
STATus:QUESTionable:LMARgin<m>:ENABle.....	881
STATus:QUESTionable:LMARgin<m>:NTRansition.....	881
STATus:QUESTionable:LMARgin<m>:PTRansition.....	882
STATus:QUESTionable:POWer[:EVENT]?	882
STATus:QUESTionable:POWer:CONDition?	882
STATus:QUESTionable:POWer:ENABle.....	883
STATus:QUESTionable:POWer:NTRansition.....	883
STATus:QUESTionable:POWer:PTRansition.....	883
STATus:QUESTionable:SYNC[:EVENT]?	883
STATus:QUESTionable:SYNC:CONDition?	884
STATus:QUESTionable:SYNC:ENABle.....	884
STATus:QUESTionable:SYNC:NTRansition.....	884
STATus:QUESTionable:SYNC:PTRansition.....	884

STATus:QUESTionable:ACPLimit[:EVENT]?

This command queries the contents of the "EVENT" part of the STATus:QUESTionable:ACPLimit register. Readout deletes the contents of the "EVENT" part.

Example: STAT:QUES:ACPL?

Usage: Query only

Mode: all

STATus:QUESTionable:ACPLimit:CONDition?

This command queries the contents of the "CONDition" part of the STATus:QUESTionable:ACPLimit register (see "STATus:QUESTionable:ACPLimit Register" on page 557). Readout does not delete the contents of the "CONDition" part.

Example: STAT:QUES:ACPL:COND?

Usage: Query only

Mode: all

STATus:QUESTIONable:ACPLimit:ENABLE <BitDefinition>

This command sets the bits of the "ENABLE" part of the `STATus:QUESTIONable:ACPLimit` register. The "ENABLE" register selectively enables the individual events of the associated "EVENT" part for the summary bit.

Parameters:

<BitDefinition> 0 to 65535

Example:

`STAT:QUES:ACPL:ENAB 65535`

Mode:

all

STATus:QUESTIONable:ACPLimit:NTRansition <BitDefinition>

This command sets the edge detectors of all bits of the `STATus:QUESTIONable:ACPLimit` register from 1 to 0 for the transitions of the "CONDition" bit.

Parameters:

<BitDefinition> 0 to 65535

Example:

`STAT:QUES:ACPL:NTR 65535`

Mode:

all

STATus:QUESTIONable:ACPLimit:PTRansition <BitDefinition>

This command sets the edge detectors of all bits of the `STATus:QUESTIONable:ACPLimit` register from 0 to 1 for the transitions of the "CONDition" bit.

Parameters:

<BitDefinition> 0 to 65535

Example:

`STAT:QUES:ACPL:PTR 65535`

Mode:

all

STATus:QUESTIONable:DIQ:CONDition?

This command queries the contents of the "CONDition" part of the `STATus:QUESTIONable:DIQ` register for IQ measurements (see "[STATus:QUESTIONable:DIQ Register](#)" on page 558). Readout does not delete the contents of the "CONDition" part.

Example:

`STAT:QUES:DIQ:COND?`

Usage:

Query only

Mode:

IQ

STATus:QUESTionable:DIQ[:EVENT]?

This command queries the contents of the "EVENT" part of the `STATus:QUESTionable:DIQ` register for IQ measurements.

Readout deletes the contents of the "EVENT" part.

Example: `STAT:QUES:DIQ?`

Usage: Query only

Mode: IQ

STATus:QUESTionable:DIQ:ENABLE <Enable>**Setting parameters:**

<Enable> numeric value

Usage: SCPI confirmed

Mode: all

STATus:QUESTionable:DIQ:NTRansition <NTransition>**Setting parameters:**

<NTransition> numeric value

Usage: SCPI confirmed

Mode: all

STATus:QUESTionable:DIQ:PTRansition <PTranstion>**Setting parameters:**

<PTranstion> numeric value

Usage: SCPI confirmed

Mode: all

STATus:QUESTionable:FREQuency:CONDition?

This command queries the contents of the "CONDition" part of the `STATus:QUESTionable:FREQuency` register (see "[STATus:QUESTionable:FRE-Quency Register](#)" on page 559). Readout does not delete the contents of the "CONDition" part.

Example: `STAT:QUES:FREQ:COND?`

Usage: Query only

Mode: all

STATus:QUESTIONable:FREQuency:ENABLE <BitDefinition>

This command sets the bits of the "ENABLE" part of the `STATus:QUESTIONable:FREQuency` register. The "ENABLE" register selectively enables the individual events of the associated "EVENT" part for the summary bit.

Parameters:

<BitDefinition> 0 to 65535

Example:

`STAT:QUES:FREQ:ENAB 65535`

Mode:

all

STATus:QUESTIONable:FREQuency[:EVENT]?

This command queries the contents of the "EVENT" part of the `STATus:QUESTIONable:FREQuency` register.

Readout deletes the contents of the "EVENT" part.

Example:

`STAT:QUES:FREQ?`

Usage:

Query only

Mode:

all

STATus:QUESTIONable:FREQuency:NTRansition <BitDefinition>

This command sets the edge detectors of all bits of the `STATus:QUESTIONable:FREQuency` register from 1 to 0 for the transitions of the "CONDition" bit.

Parameters:

<BitDefinition> 0 to 65535

Example:

`STAT:QUES:FREQ:NTR 65535`

Mode:

all, except NF

STATus:QUESTIONable:FREQuency:PTRansition <BitDefinition>

This command sets the edge detectors of all bits of the `STATus:QUESTIONable:FREQuency` register from 0 to 1 for the transitions of the "CONDition" bit.

Parameters:

<BitDefinition> 0 to 65535

Example:

`STAT:QUES:FREQ:PTR 65535`

Mode:

all, except NF

STATus:QUESTionable:LIMit<m> [:EVENT]?

This command queries the contents of the "EVENT" part of the `STATus:QUESTionable:LIMit` register. Readout deletes the contents of the "EVENT" part.

Suffix:

<m> 1...4
window
For applications that do not have more than one measurement window, the suffix <1...4> is irrelevant.

Example: `STAT:QUES:LIM?`

Usage: Query only

Mode: all

STATus:QUESTionable:LIMit<m>:CONDition?

This command queries the contents of the "CONDition" part of the `STATus:QUESTionable:LIMit` register (see "[STATus:QUESTionable:LIMit Register](#)" on page 559).

Readout does not delete the contents of the "CONDition" part.

Suffix:

<m> 1...4
window
For applications that do not have more than one measurement window, the suffix <1...4> is irrelevant.

Example: `STAT:QUES:LIM:COND?`

Usage: Query only

Mode: all

STATus:QUESTionable:LIMit<m>:ENABle <BitDefinition>

This command sets the bits of the "ENABle" part of the `STATus:QUESTionable` register. The "ENABle" register selectively enables the individual events of the associated "EVENT" part for the summary bit.

Suffix:

<m> 1...4
window
For applications that do not have more than one measurement window, the suffix <1...4> is irrelevant.

Parameters:

<BitDefinition> 0 to 65535

Example: `STAT:QUES:LIM:ENAB 65535`

Mode: all

STATus:QUESTionable:LIMit<m>:NTRansition <BitDefinition>

This command sets the edge detectors of all bits of the STATus:QUESTionable:LIMit register from 1 to 0 for the transitions of the "CONDition" bit.

Suffix:

<m> 1...4
window

For applications that do not have more than one measurement window, the suffix is irrelevant.

Parameters:

<BitDefinition> 0 to 65535

Example:

STAT:QUES:LIM:NTR 65535

Mode: all, except NF

STATus:QUESTionable:LIMit<m>:PTRansition <BitDefinition>

This command sets the edge detectors of all bits of the STATus:QUESTionable:LIMit register from 0 to 1 for the transitions of the "CONDition" bit.

Suffix:

<m> 1...4
window

For applications that do not have more than one measurement window, the suffix is irrelevant.

Parameters:

<BitDefinition> 0 to 65535

Example:

STAT:QUES:LIM:PTR 65535

Mode: all, except NF

STATus:QUESTionable:LMARgin<m>[:EVENT]?

This command queries the contents of the "EVENT" part of the STATus:QUESTionable:LMARgin register. Readout deletes the contents of the "EVENT" part.

Suffix:

<m> 1...4
window

For applications that do not have more than one measurement window, the suffix is irrelevant.

Example:

STAT:QUES:LMAR?

Usage: Query only
Mode: all

STATus:QUESTIONable:LMARgin<m>:CONDition?

This command queries the contents of the "CONDition" part of the `STATus:QUESTIONable:LMARgin` register (see "[STATus:QUESTIONable:LMARgin Register](#)" on page 560). Readout does not delete the contents of the "CONDition" part.

Suffix:
 <m> 1...4
 window
 For applications that do not have more than one measurement window, the suffix is irrelevant.

Example: `STAT:QUES:LMAR:COND?`

Usage: Query only
Mode: all

STATus:QUESTIONable:LMARgin<m>:ENABLE <BitDefinition>

This command sets the bits of the "ENABLE" part of the `STATus:QUESTIONable:LMARgin` register. The "ENABLE" register selectively enables the individual events of the associated "EVENT" part for the summary bit.

Suffix:
 <m> 1...4
 window
 For applications that do not have more than one measurement window, the suffix is irrelevant.

Parameters:
 <BitDefinition> 0 to 65535

Example: `STAT:QUES:LMAR:ENAB 65535`

Mode: all

STATus:QUESTIONable:LMARgin<m>:NTRansition <BitDefinition>

This command sets the edge detectors of all bits of the `STATus:QUESTIONable:LMARgin` register from 1 to 0 for the transitions of the "CONDition" bit.

Suffix:
 <m> 1...4
 window
 For applications that do not have more than one measurement window, the suffix is irrelevant.

Parameters:**<BitDefinition>** 0 to 65535**Example:**

STAT:QUES:LMAR:NTR 65535

Mode:

all

STATus:QUESTIONable:LMARgin<m>:PTRansition <BitDefinition>

This command sets the edge detectors of all bits of the STATus:QUESTIONable:LMARgin register from 0 to 1 for the transitions of the "CONDition" bit.

Suffix:**<m>** 1...4

window

For applications that do not have more than one measurement window, the suffix is irrelevant.

Parameters:**<BitDefinition>** 0 to 65535**Example:**

STAT:QUES:LMAR:PTR 65535

Mode:

all

STATus:QUESTIONable:POWER[:EVENT]?

This command queries the contents of the "EVENT" part of the STATus:QUESTIONable:POWER register. Readout deletes the contents of the "EVENT" part.

Example:

STAT:QUES:POW?

Usage:

Query only
SCPI confirmed

Mode:

all

STATus:QUESTIONable:POWER:CONDition?

This command queries the contents of the "CONDition" part of the STATus:QUESTIONable:POWER register (see ["STATus:QUESTIONable:POWER Register"](#) on page 561). Readout does not delete the contents of the "CONDition" part.

Example:

STAT:QUES:POW:COND?

Usage:

Query only
SCPI confirmed

Mode:

all

STATus:QUESTIONable:POWer:ENABle <BitDefinition>

This command sets the bits of the "ENABLE" part of the `STATus:QUESTIONable:POWer` register. The "ENABLE" register selectively enables the individual events of the associated "EVENT" part for the summary bit.

Parameters:

<BitDefinition> 0 to 65535

Example:

`STAT:QUES:POW:ENAB 65535`

Usage:

SCPI confirmed

Mode:

all

STATus:QUESTIONable:POWer:NTRansition <BitDefinition>

This command sets the edge detectors of all bits of the `STATus:QUESTIONable:POWer` register from 1 to 0 for the transitions of the "CONDition" bit.

Parameters:

<BitDefinition> 0 to 65535

Example:

`STAT:QUE:POWS:NTR 65535`

Usage:

SCPI confirmed

Mode:

all

STATus:QUESTIONable:POWer:PTRansition <BitDefinition>

This command sets the edge detectors of all bits of the `STATus:QUESTIONable:POWer` register from 0 to 1 for the transitions of the "CONDition" bit.

Parameters:

<BitDefinition> 0 to 65535

Example:

`STAT:QUES:POW:PTR 65535`

Usage:

SCPI confirmed

Mode:

all

STATus:QUESTIONable:SYNC[:EVENT]?

This command queries the contents of the "EVENT" part of the `STATus:QUESTIONable:SYNC` register. For details see the description for the individual firmware applications.

Readout deletes the contents of the "EVENT" part.

Example:

`STAT:QUES:SYNC?`

Usage:

Query only

Mode: This command is required by the firmware applications only.

STATus:QUESTionable:SYNC:CONDition?

This command queries the contents of the "CONDition" part of the `STATus:QUESTionable:SYNC` register. For details see the description for the individual firmware applications.

Readout does not delete the contents of the "CONDition" part.

Example: `STAT:QUES:SYNC:COND?`

Usage: Query only

Mode: This command is required by the firmware applications only.

STATus:QUESTionable:SYNC:ENABLE <BitDefinition>

This command sets the bits of the "ENABLE" part of the `STATus:QUESTionable:SYNC` register. The "ENABLE" register selectively enables the individual events of the associated "EVENT" part for the summary bit.

Parameters:
<BitDefinition> 0 to 65535

Example: `STAT:QUES:SYNC:ENAB 65535`

Mode: This command is required by the firmware applications only.

STATus:QUESTionable:SYNC:NTRansition <BitDefinition>

This command sets the edge detectors of all bits of the `STATus:QUESTionable:SYNC` register from 1 to 0 for the transitions of the "CONDition" bit.

Parameters:
<BitDefinition> 0 to 65535

Example: `STAT:QUES:SYNC:NTR 65535`

Mode: This command is required by the firmware applications only.

STATus:QUESTionable:SYNC:PTRansition <BitDefinition>

This command sets the edge detectors of all bits of the `STATus:QUESTionable:SYNC` register from 0 to 1 for the transitions of the "CONDition" bit.

Parameters:
<BitDefinition> 0 to 65535

Example: `STAT:QUES:SYNC:PTR 65535`

Mode: This command is required by the firmware applications only.

6.3.3.18 SYSTem Subsystem

SYSTem:COMMunicate:GPIB:RDEvice:COMMand.....	885
SYSTem:COMMunicate:GPIB:RDEvice:GENerator<generator>:ADDRess.....	885
SYSTem:COMMunicate:RDEvice:GENerator<generator>:INTerface.....	886
SYSTem:COMMunicate:RDEvice:GENerator<generator>:LINK.....	886
SYSTem:COMMunicate:RDEvice:GENerator<generator>:TYPE.....	887
SYSTem:COMMunicate:RDEvice:PMETer<p>:DEFine.....	887
SYSTem:COMMunicate:RDEvice:PMETer<p>:CONFigure:AUTO[:STATe].....	888
SYSTem:COMMunicate:RDEvice:PMETer<p>:COUNT?.....	889
SYSTem:COMMunicate:TCPip:RDEvice:GENerator<generator>:ADDRess.....	889
SYSTem:SPEaker:VOLume.....	889

SYSTem:COMMunicate:GPIB:RDEvice:COMMand <GPIBAddress>, <Command>

.This command sends a command or query string to the external generator connected via the GPIB interface.

This command is only available if the R&S FSV-B10 option (External Tracking Generator) is installed.

Parameters:

<GPIBAddress>, <0...30>: GPIB address of the external generator connected via the GPIB interface.

<command>: String with the command. Only basic I/O is possible.

Example:

```
"SYST:COMM:GPIB:RDEF:COMM 18, '*RST'"
```

Resets generator.

```
"SYST:COMM:GPIB:RDEF:COMM 18, 'SOURCE:FREQ:CW 2E9'"
```

Sets generator frequency to 2 GHz.

```
"SYST:COMM:GPIB:RDEF:COMM 18, 'SOUR:POW 0'"
```

Sets generator power to 0dBm.

```
"SYST:COMM:GPIB:RDEF:COMM? 18, 'SENS:POW?'"
```

Queries the generator power.

Mode: A

SYSTem:COMMunicate:GPIB:RDEvice:GENerator<generator>:ADDRess <Number>

Changes the IEC/IEEE-bus address of the external tracking generator.

This command is only available if the R&S FSV-B10 option (External Tracking Generator) is installed.

Suffix:

<generator> 1 | 2
tracking generator
For Noise Figure measurements (K30): 1 only

Parameters:

<Number> Range: 0 to 30
 *RST: 28

Example:

SYST:COMM:GPIB:RDEV:GEN1:ADDR 15

Mode:

A, NF

SYSTem:COMMunicate:RDEvice:GENerator<generator>:INTerface <Type>

Defines the interface used for the connection to the external tracking generator.

This command is only available if the R&S FSV-B10 option (External Tracking Generator) is installed.

Suffix:

<generator> 1 | 2
 tracking generator
 For Noise Figure measurements (K30): 1 only

Parameters:

<Type> GPIB | TCPip
 *RST: GPIB

Example:

SYST:COMM:RDEV:GEN1:INT TCP

Mode:

A, NF

Manual operation: See "[Interface](#)" on page 460

SYSTem:COMMunicate:RDEvice:GENerator<generator>:LINK <Type>

This command selects the link type of the external generator if the GPIB interface is used.

The difference between the two GPIB operating modes is the execution speed. While, during GPIB operation, each frequency to be set is transmitted to the generator separately, a whole frequency list can be programmed in one go if the TTL interface is also used. Frequency switching can then be performed per TTL handshake which results in considerable speed advantages.

Notes: Only one of the two generators can be operated via the TTL interface at a time. The other generator must be configured via GPIB.

For Noise Figure measurements (K30), TTL synchronization has no effect.

This command is only available if the R&S FSV-B10 option (External Tracking Generator) is installed.

Suffix:

<generator> 1 | 2
 tracking generator
 For Noise Figure measurements (K30): 1 only

Parameters:

<Type> GPIB | TTL

GPIB

GPIB connection without TTL synchronization (for all generators of other manufacturers and some Rohde & Schwarz devices)

TTL

GPIB connection with TTL synchronization (if available; for most Rohde&Schwarz devices)

*RST: GPIB

Example:

```
SYST:COMM:RDEV:GEN:LINK TTL
```

Selects GPIB + TTL interface for generator operation.

Mode:

A, NF

Manual operation:

See "[TTL Synchronization](#)" on page 460

See "[Address](#)" on page 460

SYSTem:COMMunicate:RDEVice:GENerator<generator>:TYPE <Name>

This command selects the type of external generator. For a list of the available generator types including the associated interface, see [Chapter 5.6.2.1, "Overview of Generators Supported by the R&S FSVA/FSV"](#), on page 452.

If no external generator type is currently configured, the query returns "NONE".

This command is only available if the R&S FSV-B10 option (External Tracking Generator) is installed.

Suffix:

<generator>

1 | 2

tracking generator

For Noise Figure measurements (K30): 1 only

Parameters:

<Name>

Generator name | NONE

*RST: NONE

Example:

```
SYST:COMM:RDEV:GEN2:TYPE 'SME02'
```

Selects SME02 as generator 2

Mode:

A, NF

Manual operation:

See "[Type](#)" on page 459

SYSTem:COMMunicate:RDEVice:PMETER<p>:DEFine <Placeholder>, <Type>, <Interface>, <SerialNo>

This command assigns the power sensor with the specified serial number to the selected power sensor index (configuration).

The query returns the power sensor type and serial number of the sensor assigned to the specified index.

Suffix:

<p> 1...4
Power sensor index

Setting parameters:

<Placeholder> Currently not evaluated
<SerialNo> Serial number of a connected power sensor

Query parameters:

<Type> The power sensor type, e.g. "NRP-Z81".
<Interface> Currently not evaluated

Return values:

<Placeholder> Currently not used
<Type> Detected power sensor type, e.g. "NRP-Z81".
<Interface> Interface the power sensor is connected to; always "USB"
<SerialNo> Serial number of the power sensor assigned to the specified index

Example:

```
SYST:COMM:RDEV:PMET2:DEF ' ', 'NRP-Z81', ' ', '123456'
```

Assigns the power sensor with the serial number '123456' to the configuration "Power Sensor 2".

```
SYST:COMM:RDEV:PMET2:DEF?
```

Queries the sensor assigned to "Power Sensor 2".

Result:

```
' ', 'NRP-Z81', 'USB', '123456'
```

The NRP-Z81 power sensor with the serial number '123456' is assigned to the "Power Sensor 2".

Mode: all

Manual operation: See ["Power Sensor Assignment"](#) on page 517

SYSTem:COMMunicate:RDEvice:PMETer<p>:CONFigure:AUTO[:STATE] <State>

This command defines whether the selected power sensor index is automatically assigned to a subsequently connected power sensor. See also ["Power Sensor Assignment"](#) on page 517.

Suffix:

<p> 1...4
Power sensor index

Parameters:

<State> **ON | OFF**
*RST: ON

Example:

```
SYST:COMM:RDEV:PMET:CONF:AUTO OFF
```

Mode: ALL

Manual operation: See ["Power Sensor Assignment"](#) on page 517

SYSTem:COMMunicate:RDEvice:PMETer<p>:COUNT?

This command queries the number of power sensors currently connected to the R&S FSVA/FSV.

Suffix:
 <p> 1...4
 irrelevant

Example: SYST:COMM:RDEV:PMET:COUN?

Usage: Query only

Mode: ALL

Manual operation: See ["Power Sensor Assignment"](#) on page 517

SYSTem:COMMunicate:TCPIp:RDEvice:GENerator<generator>:ADDRESS <Address>

Configures the TCP/IP address for the external tracking generator 1 or 2.

This command is only available if the R&S FSV-B10 option (External Tracking Generator) is installed.

Suffix:
 <generator> 1 | 2
 tracking generator
 For Noise Figure measurements (K30): 1 only

Parameters:
 <Address> TCP/IP address between 0.0.0.0 and 0.255.255.255
 *RST: 0.0.0.0

Example: SYST:COMM:TCP:RDEV:GEN1:ADDR 130.094.122.195

Mode: A

SYSTem:SPEaker:VOLume <Volume>

This command defines the volume of the built-in loudspeaker for demodulated signals.

The command is available with the audio demodulator (option R&S FSV-B3) and in the time domain in Spectrum mode.

Parameters:
 <Volume> Range: 0 to 1
 *RST: 0.5

Example: SYST:SPE:VOL 0
 Switches the loudspeaker to mute.

6.3.3.19 TRACe Subsystem

The TRACe subsystem controls access to the instruments internal trace memory.



Some applications offer up to four measurement windows. For those, the suffix <n> for TRACe selects the measurement window. For all other applications, the suffix is irrelevant.

The TRACe subsystem contains the following subsystem:

- "TRACe:IQ Subsystem" on page 894

Some further information on working with IQ data is provided here:

- Chapter 5.5.6, "Working with I/Q Data", on page 439
- "I/Q Gating" on page 907

Commands of the TRACe subsystem.....	890
TRACe:IQ Subsystem.....	894
I/Q Gating.....	907

Commands of the TRACe subsystem

TRACe<n>:COPY <TraceNumber>, <TraceNumber>

This command copies data from one trace to another.

Suffix:

<n> window; For applications that do not have more than 1 measurement window, the suffix <n> is irrelevant.

Parameters:

<TraceNumber>, TRACE1 | TRACE2 | TRACE3 | TRACE4 | TRACE5 | TRACE6,
 <TraceNumber> TRACE1 | TRACE2 | TRACE3 | TRACE4 | TRACE5 | TRACE6
 The first argument is the destination of the data to be copied, the second argument describes the source.

Example: TRAC:COPY TRACE1,TRACE2

Manual operation: See "Copy Trace" on page 225

TRACe<n>[:DATA]? <ResultType>

This command returns the current trace data or measurement results. In case of several result displays, you have to use specific parameters to query the results.

The data format is variable. You can set it with `FORMAt [:DATA]` on page 933. For more information on data formats see Chapter 6.3.3.22, "Formats for Returned Values: ASCII Format and Binary Format", on page 915.

For details on saving and recalling data refer to Chapter 6.3.4.7, "MMEMory Subsystem", on page 939.

Suffix:

<n> 1...4
window; For applications that have only one measurement screen, the suffix is irrelevant.

Query parameters:

<ResultType> TRACE1 | TRACE2 | TRACE3 | TRACE4 | TRACE5 | TRACE6 | SPECTrogram | SGRam | LIST | SPURious

Selects the type of result to be returned.

TRACE1 | ... | TRACE6

The query returns a list of results with one value for each sweep point in the currently set level unit.

For details see [Table 6-19](#)

LIST

Returns the results of the list evaluation of the Spectrum Emission Mask and Spurious Emissions measurement (Spectrum mode only). For a description of the syntax see [Table 6-20](#) below.

SPURious

Returns the peak list of the Spurious Emissions measurement (Spectrum mode only)

SPECTrogram | SGRam

Returns the complete spectrogram trace data (requires R&S FSV-K14 option).

For details see [Table 6-21](#).

Example:

TRAC? TRACE1

Returns the trace data for Trace 1.

Usage:

Query only

Mode:

A, ADEMOD, BT, NF, PHN, TDS

Manual operation:

See "[List Evaluation \(On/Off\)](#)" on page 323

See "[List Evaluation \(On/Off\)](#)" on page 353

Table 6-19: Results for <TRACe...> ResultTypes

The query returns a list of results with one value for each sweep point in the currently set level unit. By default, the list contains 691 values. The currently used number of sweep points can be determined using SWE:POIN?, see [\[SENSe:\] SWEep:POINts](#) on page 861.

FORMat REAL, 32 is used as format for binary transmission, and FORMat ASCii for ASCII transmission.

For details on formats refer to [Chapter 6.3.3.22, "Formats for Returned Values: ASCII Format and Binary Format"](#), on page 915.

With the auto peak detector, only positive peak values can be read out.

In **IQ Analyzer mode**, if the result display configuration "Real/Imag (I/Q)" is selected, this query returns the I values of each trace point first, then the Q values:

<result>= I₁,I₂,...,I_n, Q₁,Q₂,...,Q_n

Table 6-20: Results for <LIST> ResultType

Using the LIST parameter, the query returns the results of the list evaluation of the Spectrum Emission Mask and Spurious Emissions measurement (Spectrum mode only) with the following syntax:

<no>, <start>, <stop>, <rbw>, <freq>, <power abs>, <power rel>, <delta>, <limit check>, <unused1>, <unused2>

where:

<no>:	peak number
<start>:	start frequency of range
<stop>:	stop frequency of range
<rbw>:	resolution bandwidth of range
<freq>:	frequency of peak
<power abs>:	absolute power in dBm of peak
<power rel>:	relative power in dBc (related to the channel power) of peak
<delta>:	distance to the limit line in dB (positive indicates value above the limit, fail)
<limit check>:	limit fail (pass = 0, fail = 1)
<unused1>:	reserved (0.0)
<unused2>:	reserved (0.0)

Table 6-21: Results for Spectrogram measurements

For spectrogram measurements, the query returns the complete spectrogram trace data (requires R&S FSV-K14 option). For each frame, the trace data is returned as a comma-separated list in the following order:

<TraceData_{Frame0}>, <TraceData_{Frame1}>, ...<TraceData_{FrameMinX}>

where <FrameMinX> is determined by `CALC:SGR:FRAM:SEL MIN` (see also example below)

The trace data for each frame corresponds to the syntax described for the <TRACe> result type.

To calculate the amount of returned values for <SPECTrogram> results:

```
CALC:SGR:FRAM:SEL MIN
CALC:SGR:FRAM:SEL? //returns value <FrameMinX>, e.g. -34
SWE:POIN? //returns number of sweep points, e.g. 691
TRACE:DATA? SGR
//returns 34*691 = 25494 comma separated values for the spectrogram
```

TRACe<n>[:DATA] <Trace>, <Data>

The command transfers trace data from a control computer to the R&S FSVA/FSV. The transfer of trace data into the R&S FSVA/FSV memory is available only in spectrum analyzer mode.

The data format is variable. You can set it with `FORMat [:DATA]` on page 933. For more information on data formats see [Chapter 6.3.3.22, "Formats for Returned Values: ASCII Format and Binary Format"](#), on page 915.

For details on saving and recalling data refer to [Chapter 6.3.4.7, "MMEMory Subsystem"](#), on page 939.

Suffix:	
<n>	Sets the screen number you want to apply the command to. For applications that have only one measurement screen, the suffix is irrelevant.
Parameters:	
<Trace>	TRACE1 TRACE2 TRACE3 TRACE4 TRACE5 TRACE6 Selects the trace you want to write data to.
Setting parameters:	
<Data>	Defines the data you want to transfer.
Example:	TRAC TRACE1, +A\$ A\$ is a placeholder for the data list in the current format.
Usage:	Setting only
Mode:	A

TRACe<n>[:DATA]:MEMory? <Trace>,<OffsSwPoint>,<NoOfSwPoints>

This command queries the previously acquired trace data for the specified trace from the memory. As an offset and number of sweep points to be retrieved can be specified, the trace data can be retrieved in smaller portions, making the command faster than the `TRAC:DATA?` command. This is useful if only specific parts of the trace data are of interest.

If no parameters are specified with the command, the entire trace data is retrieved; in this case, the command is identical to `TRAC:DATA? TRACE1`

For details on the returned values see the [TRAC:DATA? <TRACE...>](#) command.

Suffix:	
<n>	1...4 Selects the measurement window.
Query parameters:	
<Trace>	TRACE1 TRACE2 TRACE3 TRACE4 TRACE5 TRACE6
<OffsSwPoint>	The offset in sweep points related to the start of the measurement at which data retrieval is to start.
<NoOfSwPoints>	Number of sweep points to be retrieved from the trace.
Example:	TRAC:DATA:MEM? TRACE1,25,100 Retrieves 100 sweep points from trace 1, starting at sweep point 25.
Usage:	Query only

TRACe<n>[:DATA]:X? <TraceNumber>

This command reads the x-values of the selected trace.

Suffix:	
<n>	1...4 window; For applications that have only one measurement screen, the suffix is irrelevant.
Query parameters:	
<TraceNumber>	TRACE1 TRACE2 TRACE3 TRACE4 TRACE5 TRACE6 Trace number
Example:	TRACe:DATA:X? TRACE1 Returns the x-values for trace 1.
Usage:	Query only

TRACe:IQ Subsystem

The commands of this subsystem are used for acquisition and output of measured IQ data.

Some further information on working with IQ data is provided here:

- [Chapter 5.5.6, "Working with I/Q Data"](#), on page 439
- ["I/Q Gating"](#) on page 907



Different remote modes available

In remote control, two different modes for the I/Q analyzer functions are available. A quick mode for pure data acquisition, and a more sophisticated mode for acquisition and evaluation. The sophisticated evaluation mode can be enabled by a special command (see [TRACe<n>:IQ:EVAL](#) on page 902). In the quick data acquisition mode, which is activated by default with the [TRACe<n>:IQ\[:STATe\]](#) command, the new visualization functions are not available; however, performance is slightly improved.

The measurement results are output in the form of a list, three different formats can be selected for this list ([TRACe<n>:IQ:DATA:FORMat](#) command).

The [FORMat](#) command can be used to select between binary output (32 bit IEEE 754 floating-point values) and output in ASCII format.

For details on formats refer to [Formats for Returned Values: ASCII Format and Binary Format](#).

Different procedures

The commands of this subsystem can be used in two ways:

- Measurement and result query with one command:
This method causes the least delay between measurement and output of the result data, but it requires the control computer to wait actively for the response data.
- Setting up the instrument, start of the measurement via INIT and query of the result list at the end of the measurement:

With this method, the control computer can be used for other activities during the measurement. However, the additional time needed for synchronization via service request must be taken into account.

TRACe<n>:IQ[:STATe].....	895
TRACe<n>:IQ:AVERAge:COUNT.....	896
TRACe<n>:IQ:AVERAge[:STATe].....	896
TRACe<n>:IQ:BWIDth.....	896
TRACe<n>:IQ:DATA.....	897
TRACe<n>:IQ:DATA:FORMat.....	897
TRACe<n>:IQ:DATA:MEMory?.....	899
TRACe<n>:IQ:DIQFilter.....	900
TRACe<n>:IQ:EGATe.....	901
TRACe<n>:IQ:EGATe:GAP.....	901
TRACe<n>:IQ:EGATe:LENGth.....	901
TRACe<n>:IQ:EGATe:NOFGateperiods.....	902
TRACe<n>:IQ:EGATe:TYPE.....	902
TRACe<n>:IQ:EVAL.....	902
TRACe<n>:IQ:RLENGth.....	903
TRACe<n>:IQ:SET.....	904
TRACe<n>:IQ:SRATe.....	906
TRACe<n>:IQ:TPISample?.....	906
TRACe:IQ:WBANd[:STATe].....	906

TRACe<n>:IQ[:STATe] <State>

This command switches the I/Q data acquisition on or off.

I/Q data acquisition is not compatible with other measurement functions. Therefore, all other measurement functions are switched off as soon as the I/Q measurement function is switched on. The trace display is also switched off by this command. Therefore, all traces are set to "BLANK".

To switch trace display back on, use the `TRACe<n>:IQ:EVAL` command.

Note: to enable the evaluation functions of the IQ Analyzer, you must also execute the command `TRACe<n>:IQ:EVAL`.

Suffix:

<n> irrelevant

Parameters:

<State> ON | OFF
 *RST: OFF

Example: TRAC:IQ ON
 Switches on I/Q data acquisition

Manual operation: See "I/Q Analyzer" on page 413

TRACe<n>:IQ:AVERAge:COUNT <NumberSets>

This command defines the number of I/Q data sets that are to serve as a basis for averaging.

Suffix:

<n> irrelevant

Parameters:

<NumberSets> 0 to 32767
*RST: 0

Example:

```
TRAC:IQ ON
Switches on acquisition of I/Q data.
TRAC:IQ:AVER ON
Enables averaging of the I/Q measurement data
TRAC:IQ:AVER:COUN 10
Selects averaging over 10 data sets
TRAC:IQ:DATA?
Starts the measurement and reads out the averaged data.
```

Usage: SCPI confirmed

TRACe<n>:IQ:AVERAge[:STATe] <State>

The command enables averaging of the recorded I/Q data, provided that I/Q data acquisition was previously enabled with [TRACe<n>:IQ\[:STATe\]](#) on page 895.

With I/Q data averaging enabled, the maximum amount of I/Q data is limited to 512kS (524288 complex samples).

Suffix:

<n> irrelevant

Parameters:

<State> ON | OFF
*RST: OFF

Example:

```
TRAC:IQ ON
Switches on acquisition of I/Q data.
TRAC:IQ:AVER ON
Enables averaging of the I/Q measurement data.
TRAC:IQ:AVER:COUN 10
Selects averaging over 10 data sets.
TRAC:IQ:DATA?
Starts the measurement and reads out the averaged data.
```

TRACe<n>:IQ:BWIDth

This command queries the flat, usable filter bandwidth of the final I/Q data.

The bandwidth depends on the defined user sample rate and the defined signal source (RF/Digital IQ), see also [Figure 5-37](#). This value can not be changed by the user.

Suffix:	
<n>	irrelevant
Example:	TRAC:IQ:BWID?
Manual operation:	See "Filter BW" on page 417 See "Maximum Bandwidth" on page 417

TRACe<n>:IQ:DATA

This command starts a measurement with the settings defined via `TRACe<n>:IQ:SET` and returns the list of measurement results (I/Q samples) immediately after they are corrected in terms of frequency response. The number of measurement results depends on the settings defined with `TRACe<n>:IQ:SET`, the output format depends on the settings of the FORMat subsystem. The format of the data list is defined by the command `TRACe<n>:IQ:DATA:FORMat`.

The command requires all response data to be read out completely before the instrument accepts further commands.

The result values are scaled linearly in Volts and correspond to the voltage at the RF or digital input of the instrument. The number of the returned values is 2 * the number of samples.

Note: Using the command with the *RST values for the `TRACe<n>:IQ:SET` command, the following minimum buffer sizes for the response data are recommended:

ASCII format: 10 kBytes

Binary format: 2 kBytes

Suffix:	
<n>	irrelevant
Example:	<pre>TRAC:IQ:STAT ON Enables acquisition of I/Q data TRAC:IQ:SET NORM,10MHz,32MHz,EXT,POS,0,4096 Measurement configuration: Sample Rate = 32 MHz Trigger Source = External Trigger Slope = Positive Pretrigger Samples = 0 Number of Samples = 4096 FORMat REAL,32 Selects format of response data TRAC:IQ:DATA? Starts measurement and reads results</pre>

TRACe<n>:IQ:DATA:FORMat <Format>

This command defines the transfer format of the I/Q data.

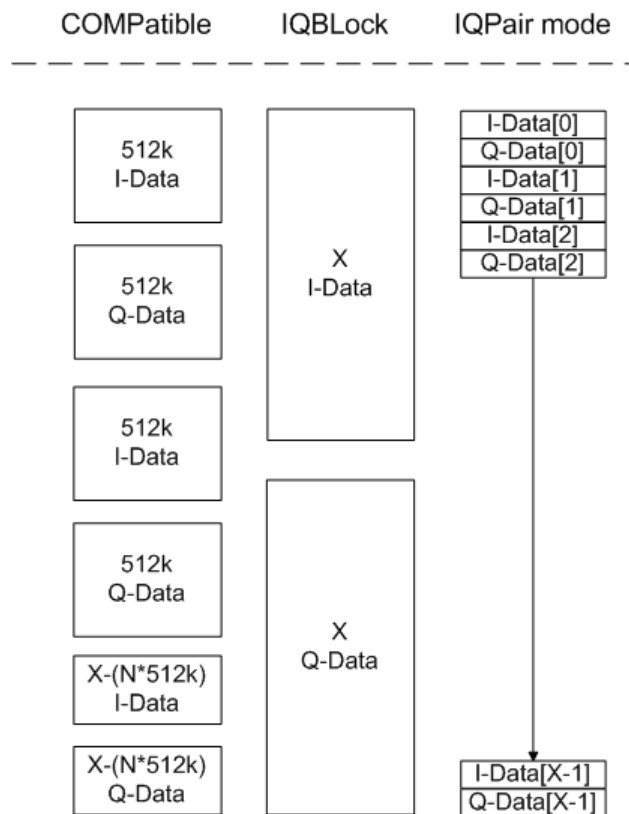

Figure 6-3: IQ data formats

Note: 512k corresponds to 524288 samples

$$\# \text{ of } I\text{-Data} = \# \text{ of } Q\text{-Data} = \frac{\# \text{ of } \text{DataBytes}}{8}$$

$$Q\text{-Data - Offset} = \frac{(\# \text{ of } \text{DataBytes})}{2} + \text{LengthIndicatorDigits}$$

Suffix:

<n> irrelevant

Parameters:

<Format> COMPAtible | IQBLock | IQPair

*RST: IQBL

For maximum performance, the formats "Compatible" or "IQPair" should be used. Furthermore, for large amounts of data, the data should be in binary format to improve performance.

For further details on formats refer to [Chapter 6.3.3.22, "Formats for Returned Values: ASCII Format and Binary Format"](#), on page 915 .

TRACe<n>:IQ:DATA:MEMory? <OffsetSamples>,<NoOfSamples>

This command reads out previously acquired (and frequency response corrected) I/Q data from the memory. Furthermore, the offset related to the start of measurement and the number of I/Q samples are given. Thus, a previously acquired data set can be read out in smaller portions. If no parameters are given, all data is read from the memory. The maximum amount of available data depends on the settings of the [TRACe<n>:IQ:SET](#) command, the output format on the settings in the FORMat subsystem.

The returned values are scaled linear in unit Volt and correspond to the voltage at the RF or digital input of the instrument.

The format of the output buffer corresponds to the [TRACe<n>:IQ:DATA](#) command.

The command requires all response data to be read out completely before the instrument accepts further commands.

If no I/Q data is available in memory because the corresponding measurement was not started, the command causes a query error.

Note: For very large data amounts data processing may become very slow and for record lengths >200 Ms, only the first 200 Ms can be retrieved using the [TRACe<n>:IQ:DATA:MEMory?](#) command. Afterwards, the command may fail.

Suffix:

<n> irrelevant

Parameters:

<OffsetSamples>	Offset of the values to be read, in relation to the start of the acquired data. Range: 0 to <# of samples> – 1, with <# of samples> being the value set by the "TRACe:IQ:SET" command *RST: 0
<NoOfSamples>	Number of measurement values to be read. Range: 1 to <# of samples> - <offset samples> with <# of samples> being the value set by the "TRACe:IQ:SET" command *RST: <# of samples>

Example:

```
TRAC:IQ:STAT ON
```

Enables acquisition of I/Q data

```
TRAC:IQ:SET NORM,10MHz,32MHz,EXT,POS,100,4096
```

Measurement configuration:

Sample Rate = 32 MHz

Trigger Source = External

Trigger Slope = Positive

Pretrigger Samples = 100

Number of Samples = 4096

```
INIT;*WAI
```

Starts measurement and wait for sync

```
FORMat REAL,32
```

Determines output format

To read the results:

```
TRAC:IQ:DATA:MEM?
```

Reads all 4096 I/Q data

```
TRAC:IQ:DATA:MEM? 0,2048
```

Reads 2048 I/Q data starting at the beginning of data acquisition

```
TRAC:IQ:DATA:MEM? 2048,1024
```

Reads 1024 I/Q data from half of the recorded data

```
TRAC:IQ:DATA:MEM? 100,512
```

Reads 512 I/Q data starting at the trigger point (<Pretrigger Samples> was 100)

Usage:

Query only

TRACe<n>:IQ:DIQFilter <State>

This command is only available when using the Digital Baseband Interface (R&S FSV-B17).

By default, a decimation filter is used during data acquisition to reduce the sample rate to the value defined using [TRACe<n>:IQ:SRATe](#).

If the filter is bypassed, the sample rate is identical to the input sample rate configured for the Digital I/Q input source (see [INPut:DIQ:SRATe](#) on page 767).

Suffix:

<n> irrelevant

Parameters:

<State> ON | OFF

ON

The digital I/Q filter bypass is on, i.e. no filter or resampler is used during I/Q data acquisition.

OFF

The filter bypass is off, i.e. decimation filter and resampler are used during I/Q data acquisition.

```
*RST: OFF
```

Example:

```
TRAC:IQ:DIQF ON
```

Mode: IQ

Manual operation: See ["No Filter"](#) on page 417

TRACe<n>:IQ:EGATe <State>

Activates or deactivates the gate function for IQ data measurements. This command is only valid for TRAC:IQ ON and trigger modes "EXT" and "IFP". The gate trigger is specified using [TRACe<n>:IQ:SET](#) on page 904. For details see ["I/Q Gating"](#) on page 907.

This function is not available if the R&S Digital I/Q Interface (R&S FSV-B17) is active.

Suffix:

<n> irrelevant

Parameters:

<State> ON | OFF

*RST: OFF

Example: TRAC:IQ:EGAT: ON

TRACe<n>:IQ:EGATe:GAP <Samples>

Defines the interval between several gate periods in samples. For details see ["I/Q Gating"](#) on page 907.

This function is not available if the R&S Digital I/Q Interface (R&S FSV-B17) is active.

Suffix:

<n> irrelevant

Parameters:

<Samples> <numeric value>

Max = MaxPreTriggerSamples * 128 MHz/sample rate
pretrigger samples defined by [TRACe<n>:IQ:SET](#);
sample rate defined by [TRACe<n>:IQ:SRATe](#))

Range: 1...Max (samples)

*RST: 100

Example: TRAC:IQ:EGAT:GAP 2

TRACe<n>:IQ:EGATe:LENGth <GateLength>

Defines the gate length in samples in edge mode. For details see ["I/Q Gating"](#) on page 907.

This function is not available if the R&S Digital I/Q Interface (R&S FSV-B17) is active.

Suffix:

<n> irrelevant

Parameters:

<GateLength> <numeric value>
 Max = MaxPreTriggerSamples * 128 MHz/sample rate
 pretrigger samples defined by [TRACe<n>:IQ:SET](#);
 sample rate defined by [TRACe<n>:IQ:SRATE](#))
 Range: 1...Max (samples)
 *RST: 100

Example: TRAC:IQ:EGAT:LENG 2000

TRACe<n>:IQ:EGAT:NOFgateperiods <Number>

Defines the number of gate periods after a trigger signal. For details see "[I/Q Gating](#)" on page 907.

This function is not available if the R&S Digital I/Q Interface (R&S FSV-B17) is active.

Suffix:

<n> irrelevant

Parameters:

<Number> 1...1023
 *RST: 1

Example: TRAC:IQ:EGAT:NOF 2

TRACe<n>:IQ:EGAT:TYPE <Type>

Specifies the gate trigger type used for data collection. For details see "[I/Q Gating](#)" on page 907.

Note: Using gating with gate mode "level" and an IFP trigger ([TRIGger<n>\[:SEQUENCE\]:SOURCE](#)), the holdoff time for the IFP trigger (see [TRIGger<n>\[:SEQUENCE\]:IFPower:HOLDoff](#) on page 909) is ignored.

This function is not available if the R&S Digital I/Q Interface (R&S FSV-B17) is active.

Suffix:

<n> irrelevant

Parameters:

<Type> LEVEL | EDGE
 *RST: EDGE

Example: TRAC:IQ:EGAT:TYPE LEV

TRACe<n>:IQ:EVAL <State>

This command enables or disables the IQ data evaluation mode and is a prerequisite for the IQ Analyzer functions.

Before this command can be executed, IQ data acquisition must be enabled (see [TRACe<n>:IQ\[:STATe\]](#) on page 895). This command automatically disables the IQ data evaluation mode to provide optimum performance for IQ-data acquisition.

If you start the IQ Analyzer manually by selecting the "IQ Analyzer" mode in the R&S FSVA/FSV, or use the [CALCulate<n>:FORMat](#) command, the IQ data evaluation mode is automatically activated.

The maximum number of samples for RF input is 200 MS. For details see [Chapter 5.5.6, "Working with I/Q Data"](#), on page 439.

For digital input see [Table 5-14](#).

Suffix:

<n> irrelevant

Parameters:

<State> ON | OFF

ON

all functions of the IQ Analyzer are available

OFF

no traces or marker operations are available; IQ data can only be captured, but with a better performance than in active IQ data evaluation mode

*RST: OFF

Example:

TRAC:IQ ON

Enables IQ data acquisition

TRAC:IQ:EVAL ON

Enables the IQ data evaluation mode.

Manual operation: See "[I/Q Analyzer](#)" on page 413

TRACe<n>:IQ:RLENgth <NoOfSamples>

This command sets the record length for the acquired I/Q data. Increasing the record length automatically also increases the measurement time.

Note: Alternatively, you can define the measurement time using the [SENS:SWE:TIME](#) command.

Suffix:

<n> irrelevant

Parameters:

<NoOfSamples> Number of measurement values to record.
 For digital input via the R&S Digital I/Q Interface (R&S FSVB17) the valid number of samples is described in [Table 5-14](#).
 If the I/Q bandwidth extension option R&S FSV-B160 is activated, the maximum number of samples is described in [Chapter 5.5.6.2, "Sample Rate and Maximum Usable Bandwidth \(RF Input\)"](#), on page 441.

Range: 1 ... 209715200(= 200*1024*1024);
 *RST: 691

Example:

```
TRAC:IQ:RLEN 256
```

Manual operation: See ["Record Length"](#) on page 418

TRACe<n>:IQ:SET NORM,<Placeholder>, <SampleRate>, <TriggerMode>, <TriggerSlope>, <PretriggerSamp>, <NumberSamples>

This command defines the settings of the R&S FSVA/FSV hardware for the measurement of I/Q data. This allows setting the sample rate, trigger conditions and the record length.

If this command is omitted, the current instrument settings are used for the corresponding parameters.

This command switches to IQ mode automatically (see also [TRACe<n>:IQ\[:STATE\]](#) on page 895).

The trigger level can be set using the [TRIGger<n>\[:SEQUENCE\]:SOURCE](#) command.

Note: When using the default settings with the [TRACe<n>:IQ:DATA](#) command, the following minimum buffer sizes for the response data are recommended: ASCII format 10 kBytes, Binary format 2 kBytes.

Tip: To determine the trigger point in the sample (for "External" or "IF Power" trigger mode), use the [TRACe<n>:IQ:TPISample?](#) on page 906 command.

Parameters:

NORM is not evaluated, but must be inserted

<Placeholder> numeric value
 is not evaluated, but must be inserted

<SampleRate> Sample rate of the I/Q data (user sample rate). See [Chapter 5.5.6.2, "Sample Rate and Maximum Usable Bandwidth \(RF Input\)"](#), on page 441 for possible values.
 For digital input via the R&S Digital I/Q Interface (R&S FSVA/FSVB17) the valid sample rates are described in [Table 5-14](#)

<TriggerMode>	<p>IMMediate EXTernal IFPower BBPower PSE</p> <p>Selection of the trigger source used for the measurement. For details on trigger sources, see "Trg/Gate Source" on page 239.</p> <p>For IMM mode, gating is automatically deactivated.</p> <p>*RST: IMM</p>
<TriggerSlope>	<p>POSitive NEGative</p> <p>Used trigger slope.</p> <p>*RST: POS</p>
<PretriggerSamp>	<p>Defines the trigger offset in terms of pretrigger samples. Negative values correspond to a trigger delay. This value also defines the interval between the trigger signal and the gate edge in samples.</p> <p>Range:</p> <p>RF input without gating: 0 to (200 MS - 1)</p> <p>RF input with gating: 0 to [(200 MS * SR/128 MHz)-1]</p> <p>Digital input: 0 to (MaxNofSamples -1); MaxNofSamples as defined in Table 5-15</p> <p>Range: 0 to (MaxPreTriggerSamples * 128 MHz/sample rate).</p> <p>*RST: 0</p>
<NumberSamples>	<p>Number of measurement values to record (including the pretrigger samples).</p> <p>For digital input via the R&S Digital I/Q Interface (R&S FSV-B17) the valid number of samples is described in Table 5-14.</p> <p>If the I/Q bandwidth extension option R&S FSV-B160 is activated, the maximum number of samples is described in Chapter 5.5.6.2, "Sample Rate and Maximum Usable Bandwidth (RF Input)", on page 441.</p> <p>Range: 1 ... 209715200(= 200*1024*1024);</p> <p>*RST: 128</p>
Example:	<p>TRAC:IQ:SET NORM,10 MHz,32 MHz,EXT,POS,0,2048</p> <p>Reads 2048 I/Q-values starting at the trigger point.</p> <p>sample rate = 32 MHz</p> <p>trigger = External</p> <p>slope = Positive</p> <p>TRAC:IQ:SET NORM,10 MHz,4 MHz,EXT,POS,1024,512</p> <p>Reads 512 I/Q-values from 1024 measurement points before the trigger point.</p> <p>sample rate = 4 MHz</p> <p>trigger = External</p> <p>slope = Positive</p>
Manual operation:	<p>See "Power Sensor" on page 241</p> <p>See "Record Length" on page 418</p>

TRACe<n>:IQ:SRATe <SampleRate>

This command sets the final user sample rate for the acquired I/Q data. Thus, the sample rate can be modified without affecting the other settings.

Note: The smaller the user sample rate, the smaller the usable I/Q bandwidth, see [TRACe<n>:IQ:BWIDth](#) on page 896.

Suffix:

<n> irrelevant

Parameters:

<SampleRate> Sample rate of the I/Q data (user sample rate). See [Chapter 5.5.6.2, "Sample Rate and Maximum Usable Bandwidth \(RF Input\)"](#), on page 441 for possible values.

For digital input via the R&S Digital I/Q Interface (R&S FSVA/FSVB17) the valid sample rates are described in "Sample rates, bandwidths and other limitations" in the description of the B17 option in the base unit.

*RST: 32 MHz (for R&S FSV40 model 1307.9002K39:
12.5 MHz)

Example: TRAC:IQ:SRAT 4 MHZ

Manual operation: See ["Sample Rate"](#) on page 417

TRACe<n>:IQ:TPISample?

This command determines the time offset of the trigger in the sample (trigger position in sample = TPIS). This value can only be determined in triggered measurements using external or IFPower triggers, otherwise the value is 0. The value is not user-definable.

This command is not available if the R&S Digital I/Q Interface (R&S FSV-B17 option) is active.

Suffix:

<n> irrelevant

Example: TRAC:IQ:TPIS?

Usage: Query only

Manual operation: See ["Trigger Offset"](#) on page 243

TRACe:IQ:WBANd[:STATe] <State>

Activates or deactivates the bandwidth extension option R&S FSV-B160, if installed.

Sample rates higher than 128 MHz can only be achieved using the bandwidth extension.

Parameters:

<State> ON | OFF | FORCe160

ON

(Default) The maximum available bandwidth is used for all sample rates.

If the bandwidth extension option R&S FSV-B160 is installed, it is activated for bandwidths as of 64 MHz (if no other restrictions for its use apply, see "[Restrictions](#)" on page 441).

Thus, sample rates up to 400 MHz and an I/Q bandwidth up to 160 MHz are possible.

Note that using the bandwidth extension may cause more spurious effects.

OFF

Deactivates use of the bandwidth extension option R&S FSV-B160, thus reducing possible spurious effects, while restricting the analysis bandwidth to 40 MHz.

FORCe160

The bandwidth extension option R&S FSV-B160 is always used (if no other restrictions for its use apply, see "[Restrictions](#)" on page 441), thus raising the minimum possible sample rate to 32 MHz.

*RST: ON

Manual operation: See "[Maximum Bandwidth](#)" on page 417

I/Q Gating

Sometimes in spectrum analysis, measurements are based on a certain length of time called the gate area. With I/Q gating, you can define the gate area using the gate length, the distance between the periods and the number of periods. The gate length and the distance between the capture periods are specified in samples.



I/Q gating is only available using remote commands; manual configuration is not possible.

Using I/Q gating, the gate area can be defined using the following methods:

- Edge triggered recording
After a trigger signal, the gate period is defined by a gate length and a gate distance. All data in the gate period is recorded until the required number of samples has been recorded.

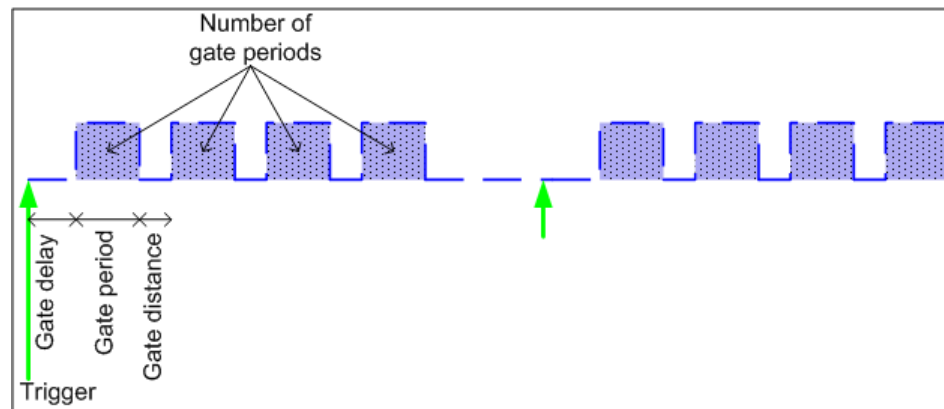

SCPI command: `TRACE:IQ:EGATE:TYPE EDGE`, see `TRACe<n>:IQ:EGATE:TYPE` on page 902

- Level triggered recording
After a trigger signal, all data is recorded in which the gate signal is set to 1, which means it has exceeded a level. In this case, the gate signal can be generated by the IFP trigger, for example: each time the IFP level is exceeded, the IFP trigger signal is set to 1 and the samples in this area are recorded as gate samples.

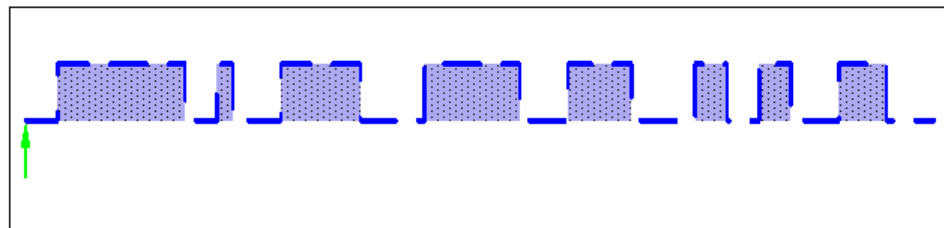

The number of complex samples to be recorded prior to the trigger event can be selected (see `TRACe<n>:IQ:SET` on page 904) for all available trigger sources, except for "Free Run".

SCPI command: `TRACE:IQ:EGATE:TYPE LEV`, see `TRACe<n>:IQ:EGATE:TYPE` on page 902

6.3.3.20 TRIGger Subsystem

The TRIGger subsystem is used to synchronize instrument actions with events. It is thus possible to control and synchronize the start of a sweep.

<code>TRIGger<n>[:SEQUENCE]:HOLDoff[:TIME]</code>	909
<code>TRIGger<n>[:SEQUENCE]:BBPower:HOLDoff</code>	909
<code>TRIGger<n>[:SEQUENCE]:IFPower:HOLDoff</code>	909
<code>TRIGger<n>[:SEQUENCE]:IFPower:HYSteresis</code>	910
<code>TRIGger<n>[:SEQUENCE]:LEVel:BBPower</code>	910
<code>TRIGger<n>[:SEQUENCE]:LEVel[:EXternal]</code>	910
<code>TRIGger<n>[:SEQUENCE]:LEVel:IFPower</code>	911
<code>TRIGger<n>[:SEQUENCE]:LEVel:RFPower</code>	911
<code>TRIGger<n>[:SEQUENCE]:LEVel:VIDeo</code>	911

Parameters:

<Value> *RST: 150 ns

Example:

TRIG:SOUR IFP

Sets the IF power trigger source.

TRIG:IFP:HOLD 200 ns

Sets the holding time to 200 ns.

Manual operation: See "[Trigger Holdoff](#)" on page 243

TRIGger<n>[:SEQUence]:IFPower:HYSteresis <Value>

This command sets the limit that the hysteresis value for the IF power trigger has to fall below in order to trigger the next measurement.

Suffix:

<n> irrelevant

Parameters:

<Value> *RST: 3 dB

Example:

TRIG:SOUR IFP

Sets the IF power trigger source.

TRIG:IFP:HYST 10DB

Sets the hysteresis limit value.

Manual operation: See "[Trigger Hysteresis](#)" on page 243

TRIGger<n>[:SEQUence]:LEVel:BBPower <Level>

This command sets the level of the baseband power trigger source (for digital input via the R&S Digital I/Q Interface, R&S FSV-B17).

Suffix:

<n> irrelevant

Parameters:

<Level> Range: -50 dBm to +20 dBm

*RST: -20 DBM

Example:

TRIG:LEV:BB -30DBM

Mode:

All

Manual operation: See "[Trigger Level](#)" on page 433

TRIGger<n>[:SEQUence]:LEVel[:EXTernal] <TriggerLevel>

This command sets the level of the external trigger source in Volt.

Suffix:

<n> irrelevant

Parameters:

<TriggerLevel> Range: 0.5 V to 3.5 V
 *RST: 1.4 V

Example: TRIG:LEV 2V

TRIGger<n>[:SEQUENCE]:LEVel:IFPower <TriggerLevel>

This command defines the power level at the third intermediate frequency that must be exceeded to cause a trigger event. Note that any RF attenuation or preamplification is considered when the trigger level is analyzed. If defined, a reference level offset is also considered.

Suffix:

<n> irrelevant

Parameters:

<TriggerLevel> *RST: -20 dBm

Example: TRIG:LEV:IFP -30DBM

Manual operation: See "[Trg/Gate Level](#)" on page 242
 See "[Trigger Level](#)" on page 433

TRIGger<n>[:SEQUENCE]:LEVel:RFPower <TriggerLevel>

This command defines the power level at the third intermediate frequency that must be exceeded to cause a trigger event. Note that any RF attenuation or preamplification is considered when the trigger level is analyzed. If defined, a reference level offset is also considered.

Suffix:

<n> irrelevant

Parameters:

<TriggerLevel> *RST: -20 dBm

Example: TRIG:LEV:RFP -30dBm

TRIGger<n>[:SEQUENCE]:LEVel:VIDeo <Value>

This command sets the level of the video trigger source.

Suffix:

<n> irrelevant

Parameters:

<Value> 0 to 100 PCT
 *RST: 50 PCT

Example: TRIG:LEV:VID 50PCT

Manual operation: See "[Trg/Gate Level](#)" on page 242
 See "[Trigger Level](#)" on page 433

TRIGger<n>[:SEQuence]:SLOPe <Type>

This command selects the slope of the trigger signal. The selected trigger slope applies to all trigger signal sources.

Suffix:

<n> irrelevant

Parameters:

<Type> POSitive | NEGative
*RST: POSitive

Example: TRIG:SLOP NEG

Manual operation: See "Trg/Gate Polarity" on page 242
See "Trigger Polarity" on page 433

TRIGger<n>[:SEQuence]:SOURce <Source>

This command selects the trigger source.

Note: Using gating with gate mode "level" (`TRACe<n>:IQ:EGATe:TYPE` on page 902/ `[SENSe:]SWEep:EGATe:TYPE`) and an IFP trigger, the holdoff time for the IFP trigger (see `TRIGger<n>[:SEQuence]:HOLDoff[:TIME]` on page 909) is ignored for frequency sweep, FFT sweep, zero span and IQ mode measurements.

When triggering or gating is activated, the squelch function is automatically disabled (see `[SENSe:]DEMod:SQUelch[:STATE]`).

IF power and RF power triggers are not available together with the bandwidth extension option R&S FSV-B160.

For details on trigger modes refer to "Trg/Gate Source" on page 239.

For details on trigger modes refer to the "Trg/Gate Source" softkey in the base unit description.

Suffix:

<n> irrelevant

Parameters:

<Source> **IMMediate**
Free Run
EXTern
External trigger
IFPower
Power trigger at the second intermediate frequency
RFPower
Power trigger at the first intermediate frequency

GP0 | GP1 | GP2 | GP3 | GP4 | GP5

For I/Q Analyzer or AnalogDemod mode only:

Defines triggering of the measurement directly via the LVDS connector. The parameter specifies which general purpose bit (0 to 5) will provide the trigger data.

This trigger mode is available for input from the R&S Digital I/Q Interface (option R&S FSV-B17) only.

The assignment of the general purpose bits used by the Digital IQ trigger to the LVDS connector pins is provided in [Table 6-22](#) (See also [Table 5-20](#)).

VIDeo

Video mode is only available in the time domain and only in Spectrum mode.

BBPower

Baseband power (for digital input via the R&S Digital I/Q Interface, R&S FSV-B17)

PSEN

External power sensor (requires R&S FSV-K9 option)

*RST: IMMEDIATE

Example:

```
TRIG:SOUR EXT
```

Selects the external trigger input as source of the trigger signal

Manual operation:

See ["Trg/Gate Source"](#) on page 239

See ["Free Run"](#) on page 239

See ["External"](#) on page 239

See ["Video"](#) on page 239

See ["RF Power"](#) on page 239

See ["IF Power/BB Power"](#) on page 240

See ["Power Sensor"](#) on page 241

See ["Time"](#) on page 241

See ["Digital IQ"](#) on page 241

Table 6-22: Assignment of general purpose bits to LVDS connector pins

Bit	LVDS pin
GP0	SDATA4_P - Trigger1
GP1	SDATA4_P - Trigger2
GP2	SDATA0_P - Reserve1
GP3	SDATA4_P - Reserve2
GP4	SDATA0_P - Marker1
GP5	SDATA4_P - Marker2

```
TRIGger<n>[:SEquence]:TIME:RINterval <Interval>
```

This command sets the repetition interval for the time trigger source.

Suffix:	
<n>	irrelevant
Parameters:	
<Interval>	2.0 ms to 5000
	*RST: 1.0
Example:	TRIG:SOUR TIME Selects the time trigger input for triggering. TRIG:TIME:RINT 50 The sweep starts every 50 s.
Mode:	All
Manual operation:	See " Repetition Interval " on page 243

6.3.3.21 UNIT Subsystem

The UNIT subsystem sets the basic unit of the setting parameters.

UNIT<n>:POWER <Unit>

This command selects the default unit.

The unit is the same for all measurement windows.

Parameters:

<Unit>	DBM V A W DBPW WATT DBPT DBUV DBMV VOLT DBUA AMPere
	*RST: DBM

Example:	UNIT:POW DBUV Sets the power unit to dBm.
-----------------	--

Usage:	SCPI confirmed
---------------	----------------

UNIT<n>:PMETer<p>:POWER <Unit>

This command selects the unit for absolute power sensor measurement for the selected sensor.

Suffix:

<n>	irrelevant
<p>	1...4 Power sensor index

Parameters:

<Unit>	DBM WATT W
	*RST: DBM

Example:	UNIT:PMET:POW DBM
-----------------	-------------------

Usage:	SCPI confirmed
---------------	----------------

Mode:	PSM
--------------	-----

Manual operation: See "Unit / Scale" on page 519

UNIT<n>:PMETer<p>:POWer:RATio <Unit>

This command selects the unit for relative power sensor measurement for the selected sensor.

Suffix:

<n>	irrelevant
<p>	1...4 Power sensor index

Parameters:

<Unit>	DB PCT
*RST:	DB

Example: UNIT:PMET:POW:RAT DB

Usage: SCPI confirmed

Mode: PSM

Manual operation: See "Unit / Scale" on page 519

UNIT:THD <Mode>

Selects the unit for THD measurements.

Parameters:

<Mode>	DB PCT
*RST:	DB

Example: UNIT:THD PCT

Mode: ADEMOD, SFM

6.3.3.22 Formats for Returned Values: ASCII Format and Binary Format

ASCII Format (FORMat ASCII)

The command reads out a list of comma separated values (CSV) of the measured values in floating point format.



Reading out data in binary format is quicker than in ASCII format. Thus, binary format is recommended for large amounts of data.

Binary Format (FORMat REAL,32)

The command reads out binary data (Definite Length Block Data according to IEEE 488.2), each measurement value being formatted in 32 Bit IEEE 754 Floating-Point-Format.

Depending on the number of samples to be transferred, 2 different kinds of syntax are used:

For $<10^{10}$ samples:

The schema of the result string is as follows:

#<NoOfDigits><NoOfDataBytes><value1><value2>...<value n>, with

#	Header prefix, 1 byte
<NoOfDigits>	Number of digits of the following number of data bytes (= 4 in the example), 1 byte
<NoOfDataBytes>	Number of following data bytes in decimal form (= 1024 in the example), 1...9 bytes
<Value>	Data values, each one is a 4-byte floating point value

Example:

#41024<value1><value2>...<value 256>

4: the following number of data bytes has 4 digits

1024: 1024 Bytes of following data; float: 4 Bytes / value => 1024 / 4 = 256 values (128 I and 128 Q values)

<value x>: 4 Byte values, must be interpreted as float

For $\geq 10^{10}$ samples:

The schema of the result string is as follows:

(<NoOfDataBytes>) <value1><value2>...<value n>, with

#	Header prefix, 1 byte
(1 byte
<NoOfDataBytes>	number of following data bytes (= 1024 in the example), 10 bytes
)	1 byte
<Value>	Data values, each one is a 4-byte floating point value

Example:

#(1677721600)<value 1><value 2> ... <value 419430400>

(1677721600): 1677721600 Bytes of following data; float: 4 Bytes / value ==> 1677721600 / 4 = 419430400 values (200Ms I and 200Ms Q values)

<value x>: 4 Byte values, must be interpreted as float

6.3.4 Remote Control – Description of Measurement-Independent Commands

In this section all remote control commands that are independent of a particular measurement mode are described in detail.

For details on specific "Spectrum" mode commands refer to [Chapter 6.3.3, "Remote Control – Description of Analyzer Commands"](#), on page 615.

6.3.4.1	CALibration Subsystem.....	917
6.3.4.2	DIAGnostic Subsystem.....	919
6.3.4.3	DISPlay Subsystem.....	925
6.3.4.4	CMAp Suffix Assignment.....	931
6.3.4.5	FORMat Subsystem.....	932
6.3.4.6	HCOPy Subsystem.....	933
6.3.4.7	MMEMory Subsystem.....	939
6.3.4.8	OUTPut Subsystem (Option Additional Interfaces, B5).....	953
6.3.4.9	SENSE Subsystem.....	953
	SENSe:CORREction Subsystem.....	953
	SENSe:ROSCillator Subsystem.....	957
6.3.4.10	SOURce Subsystem.....	958
	SOURce:TEMPerature Subsystem.....	958
	SOURce:EXTernal Subsystem.....	959
6.3.4.11	STATus Subsystem.....	959
6.3.4.12	SYSTem Subsystem.....	963

6.3.4.1 CALibration Subsystem

The commands of the CALibration subsystem determine the data for system error correction in the instrument.

CALibration:ABORt	917
CALibration[:ALL]?	917
CALibration:RESult?	918
CALibration:STATe	918

CALibration:ABORt

This command aborts the current calibration routine.

Example: CAL:ABORt
 Aborts calibration.

Usage: Event
 SCPI confirmed

CALibration[:ALL]?

This command initiates a calibration routine and queries if calibration was successful.

During the acquisition of correction data the instrument does not accept any remote control commands.

In order to recognize when the acquisition of correction data is completed, the MAV bit in the status byte can be used. If the associated bit is set in the Service Request Enable Register, the instrument generates a service request after the acquisition of correction data has been completed.

Return values:

<CalibrationState> **0**
The command returns a '0' if calibration was successful.

Example:

```
*CLS
Resets the status management.
*SRE 16
Enables MAV bit in the Service Request Enable Register.
*CAL?
Starts the correction data recording, and then a service request
is generated.
```

Usage: Query only
SCPI confirmed

CALibration:RESult?

This command returns the results collected during calibration.

Return values:

<CalibrationData> String containing the calibration data.

Example:

```
CAL:RES?
would return, e.g.
Total Calibration Status:
PASSED, Date (dd/mm/yyyy): 12/07/2004,
Time: 16:24:54, Runtime: 00.06
```

Usage: Query only

Manual operation: See "[Show Align Results](#)" on page 145

CALibration:STATe <State>

This command includes or excludes calibration data in the actual measurement.

Parameters:

<State> ON | OFF

Example:

```
CAL:STAT OFF
Sets up the instrument to ignore the calibration data.
```

Usage: SCPI confirmed

6.3.4.2 DIAGnostic Subsystem

The DIAGnostic subsystem contains the commands which support instrument diagnostics for maintenance, service and repair. In accordance with the SCPI standard, all of these commands are device-specific.

DIAGnostic<n>:SERVice:BIOSinfo?	919
DIAGnostic<n>:SERVice:HWInfo?	919
DIAGnostic<n>:SERVice:INPut:PULSed:CFRequency	920
DIAGnostic<n>:SERVice:INPut:PULSed:MCFRequency	920
DIAGnostic<n>:SERVice:INPut:PULSed:WBFRequency	921
DIAGnostic<n>:SERVice:INPut:PULSed:WB2Requency	921
DIAGnostic<n>:SERVice:INPut[:SElect]	922
DIAGnostic<n>:SERVice:NSource	922
DIAGnostic<n>:SERVice:SFUNction	922
DIAGnostic<n>:SERVice:SFUNction:LASTresult?	923
DIAGnostic<n>:SERVice:SFUNction:RESults:DElete	923
DIAGnostic<n>:SERVice:SFUNction:RESults:SAVE	923
DIAGnostic<n>:SERVice:STESt:RESult?	924
DIAGnostic<n>:SERVice:TEMPerature:FRONt?	924
DIAGnostic<n>:SERVice:VERSinfo?	924

DIAGnostic<n>:SERVice:BIOSinfo?

This command queries the CPU board BIOS version.

Suffix:

<n> irrelevant

Return values:

<Version> ASCII string containing the BIOS version, e.g. 47.11.

Example:

DIAG:SERV:BIOS?
Returns the BIOS version.

Usage:

Query only

DIAGnostic<n>:SERVice:HWInfo?

This command queries the hardware information.

Suffix:

<n> irrelevant

Return values:

<HardwareInfo> "<component 1>|<serial #>|<order #>|<model>| <hardware code>|<revision>|<subrevision>",
"<component 2>|<serial #>|<order #>|<model>| <hardware code>|<revision>|<subrevision>",
...
Table lines are output as string data and are separated by commas. The individual columns of the table are separated from each other by |.

Example: `DIAG:SERV:HWIN?`
 Queries the hardware information.
`"FRONTEND|100001/003|1300.3009|03|01|00|00",`
`"MOTHERBOARD|123456/002|1300.3080|02|00|00|00",`
 . . .

Usage: Query only

Manual operation: See "[Hardware Info](#)" on page 158

DIAGnostic<n>:SERVice:INPut:PULSed:CFrequency <Frequency>

This command defines the frequency of the calibration signal.

Before you can use the command, you have to feed in a calibration signal with [DIAGnostic<n>:SERVice:INPut\[:SElect\]](#) on page 922.

Suffix:
 <n> irrelevant

Parameters:
 <Frequency> Possible frequencies of the calibration signal are fixed. If you define a frequency that is not available, the R&S FSVA/FSV uses the next available frequency. Example: a frequency of 20 MHz is rounded up to the next available frequency (21.33 MHz).

*RST: 64 MHz

Example: `DIAG:SERV:INP:PULS:CFR 128 MHz`
 Defines a calibration signal frequency of 128 MHz.

Usage: SCPI confirmed

Manual operation: See "[Calibration Frequency RF](#)" on page 161

DIAGnostic<n>:SERVice:INPut:PULSed:MCFrequency <Frequency>

This command sets the calibration frequency for frequencies greater than 7 GHz. This command only takes effect if a microwave calibration signal is selected for input ([DIAGnostic<n>:SERVice:INPut\[:SElect\]](#) on page 922).

Suffix:
 <n> irrelevant

Parameters:
 <Frequency> **<numeric value>**

*RST: 7 GHz

Example: `DIAG:SERV:INP:PULS:MCFR 7,1 GHz`

Usage: SCPI confirmed

Manual operation: See "[Calibration Frequency MW](#)" on page 161

DIAGnostic<n>:SERVice:INPut:PULSed:WBFrequency <Frequency>

Defines the frequency of the internal broadband calibration signal to be used for IF filter calibration.

This command is only available if the bandwidth extension option R&S FSV-B160 is installed.

Before you can use the command, you have to feed in a calibration signal with [DIAGnostic<n>:SERVice:INPut\[:SElect\]](#) on page 922.

Suffix:

<n> irrelevant

Parameters:

<Frequency> 2 MHz | 4 MHz | 8 MHz | 16 MHz

If you define a frequency that is not available, the R&S FSVA/FSV uses the next available frequency.

*RST: 16 MHz

Example:

```
DIAG:SERV:INP:PULS:WBFR 8 MHz
```

Defines a calibration signal frequency of 8 MHz.

Usage:

SCPI confirmed

Manual operation: See "[Calibration Frequency WB](#)" on page 161

DIAGnostic<n>:SERVice:INPut:PULSed:WB2Frequency <Frequency>

Defines the frequency of the internal broadband calibration signal to be used for IF filter calibration.

This function is only available for R&S FSVA instruments. It is independent of the bandwidth extension option R&S FSV-B160.

Before you can use the command, you have to define the use of a calibration signal with [DIAGnostic<n>:SERVice:INPut\[:SElect\]](#) on page 922.

Suffix:

<n> irrelevant

Parameters:

<Frequency> 16 MHz | 32 MHz

*RST: 32 MHz

Example:

```
DIAG:SERV:INP:SEL WB2
```

```
DIAG:SERV:INP:PULS:WB2F 16 MHz
```

Defines an internal wideband calibration signal frequency of 16 MHz.

Usage:

SCPI confirmed

Manual operation: See "[Calibration Frequency WB2](#)" on page 162

DIAGnostic<n>:SERVice:INPut[:SElect] <Signal>

This command selects the source of the signal.

You can feed in a signal from the RF input or the calibration signal.

Suffix:

<n> irrelevant

Parameters:

<Signal>

RF

RF input

CALibration

Calibration

MCALibration

Microwave calibration (for R&S FSVA/FSV 13 and 30 only)

WBCal

Broadband signal for calibration of the IF filter.

WB2Cal

Broadband signal for calibration of the IF filter (independantly of the B160 option).

This option is only available for R&S FSVA instruments.

*RST: RF

Example:

DIAG:SERV:INP CAL

Selects the calibration signal as the input signal

Manual operation:

See ["RF"](#) on page 161

See ["Calibration Frequency WB"](#) on page 161

See ["Calibration Frequency WB2"](#) on page 162

DIAGnostic<n>:SERVice:NSOource <State>

This command switches the 28 V supply of the noise source on the front panel on or off.

Suffix:

<n> irrelevant

Parameters:

<State>

ON | OFF

*RST: OFF

Example:

DIAG:SERV:NSO ON

Manual operation:

See ["Noise Source"](#) on page 399

DIAGnostic<n>:SERVice:SFUNction <ServiceFunction>

This command starts a service function.

The service functions are available after you have entered the level 1 or level 2 system password.

Suffix:

<n> irrelevant

Parameters:

<ServiceFunction> String containing the ID of the service function.
The ID of the service function is made up out of five numbers, separated by a point.

- function group number
- board number
- function number
- parameter 1 (see the Service Manual)
- parameter 2 (see the Service Manual)

Example: `DIAG:SERV:SFUN '2.0.2.12.1'`

Usage: Event

Manual operation: See "[Service Function](#)" on page 162

DIAGnostic<n>:SERVice:SFUNction:LASTresult?

This command queries the results of the most recent service function you have used.

Suffix:

<n> irrelevant

Example: `DIAG:SERV:SFUN:LAST?`

Usage: Query only

DIAGnostic<n>:SERVice:SFUNction:RESults:DELeTe

This command deletes the results of the most recent service function you have used.

Suffix:

<n> irrelevant

Example: `DIAG:SERV:SFUN:RES:DEL`

Usage: Event

DIAGnostic<n>:SERVice:SFUNction:RESults:SAVE <FileName>

This command saves the results of the most recent service function you have used in a file.

Suffix:

<n> irrelevant

Parameters:

<FileName> String containing the file name.

Example: `DIAG:SERV:SFUN:RES:SAVE "C:\diag"`

DIAGnostic<n>:SERVice:STESt:RESult?

This command queries the self test results.

Suffix:
<n> irrelevant

Parameters:
<Results> String of data containing the results.
The rows of the self test result table are separated by commas.

Example: `DIAG:SERV:STES:RES?`
would return, e.g.:
"Total Selftest Status:
PASSED", "Date (dd/mm/yyyy): 09/07/2004 TIME:
16:24:54", "Runtime: 00:06", "..."

Usage: Query only

Manual operation: See "[Selftest Results](#)" on page 162

DIAGnostic<n>:SERVice:TEMPerature:FRONT?

This command queries the temperature of the frontend.

Parameters:
<Temperature> Temperature of the frontend.

Example: `DIAG:SERV:TEMP:FRON?`

Usage: Query only

DIAGnostic<n>:SERVice:VERSinfo?

This command queries information about the hardware and software components.

Suffix:
<n> irrelevant

Return values:
<Information> String containing the version of hardware and software components including the types of licenses for installed firmware options.

Example: `DIAG:SERV:VERS?`
Queries the version information.
Response:
Instrument Firmware |1.60
BIOS |5.1.22.3
Image Version |3.0
CPLD |3.0
PCI-FPGA |8.007
Data Sheet Version |01.00
Time Control Management ||active
RF Preamplifier B22| |permanent
Electronic Attenuator B25| |permanent
Frequency Extension 20 Hz B29| |permanent
40 MHz Bandwidth B70| |permanent
Analog Demod K7| |permanent
FM Stereo K7S| |permanent
Bluetooth K8| |permanent
Power Sensor Support K9| |permanent
Spectrogram K14| |permanent
Vector Signal Analysis K70|1.60|permanent
3GPP Base Station K72|1.60|permanent
3GPP Mobile Station K73|1.60|permanent
TD-SCDMA Base Station K76|1.60|permanent
TD-SCDMA Mobile Station K77|1.60|permanent
CDMA2000 Base Station K82|1.60|permanent
CDMA2000 Mobile Station K83|1.60|permanent
1xEV-DO Base Station K84|1.60|permanent
1xEV-DO Mobile Station K85|1.60|permanent
OFDM-VSA K96| |permanent
LTE FDD Downlink K100| |permanent
LTE FDD Uplink K101| |permanent
LTE Downlink MIMO K102| |permanent
LTE TDD Downlink K104| |permanent
LTE TDD Uplink K105| |permanent

Usage: Query only
SCPI confirmed

6.3.4.3 DISPlay Subsystem

The DISPLay subsystem controls the selection and presentation of textual and graphic information as well as of measurement data on the display.



Some applications offer up to four measurement windows. For those, the suffix <1...4> for WINDow selects the measurement window. For all other applications, the suffix is irrelevant.

Further Information

- [Chapter 6.3.4.4, "CMAP Suffix Assignment"](#), on page 931

DISPlay:ANNotation:FREQuency.....	926
DISPlay:CMAP<item>:DEFault.....	926
DISPlay:CMAP<item>:HSL.....	927
DISPlay:CMAP<item>:PDEFined.....	927
DISPlay:LOGO.....	928
DISPlay:PSAVe:HOLDoff.....	928
DISPlay:PSAVe[:STATe].....	928
DISPlay:SBAR[:STATe].....	928
DISPlay:SKEYs[:STATe].....	929
DISPlay:TBAR[STATe].....	929
DISPlay:THEMe:CATalog?.....	929
DISPlay:THEMe:SElect.....	929
DISPlay:TOUChscreen:STATe.....	929
DISPlay[:WINDow<n>]:TEXT[:DATA].....	930
DISPlay[:WINDow<n>]:TEXT:STATe.....	930
DISPlay[:WINDow<n>]:TIME.....	930
DISPlay[:WINDow<n>]:TIME:FORMat.....	931

DISPlay:ANNotation:FREQuency <State>

This command switches the x-axis annotation on or off.

Parameters:

<State> ON | OFF
 *RST: ON

Example: DISP:ANN:FREQ OFF

Usage: SCPI confirmed

Manual operation: See "[Annotation \(On/Off\)](#)" on page 155

DISPlay:CMAP<item>:DEFault <Setting>

This command resets the screen colors of all display items to their default settings.

Suffix:

<item> irrelevant

Parameters:

<Setting> 1 | 2
 Default settings DEFault1 and DEFault2

Example: DISP:CMAP:DEF2
 Selects default setting 2 for setting the colors.

Usage: Event
 SCPI confirmed

Manual operation: See ["Select Screen Color Set"](#) on page 156
See ["Set to Default"](#) on page 157

DISPlay:CMAP<item>:HSL <ColorTable>

This command defines the color table of the instrument.

The set values are not changed by *RST.

Suffix:

<item> Selects the display item. For more information see [Chapter 6.3.4.4, "CMAP Suffix Assignment"](#), on page 931.

Parameters:

<ColorTable> hue | sat | lum

hue

TINT

sat

SATURATION

lum

BRIGHTNESS

The value range is 0 to 1 for all parameters.

Example: DISP:CMAP2:HSL 0.3,0.8,1.0
Changes the grid color.

Usage: SCPI confirmed

Manual operation: See ["Screen Colors"](#) on page 156
See ["Select Object"](#) on page 156
See ["User Defined Colors"](#) on page 157

DISPlay:CMAP<item>:PDEFined <Color>

This command defines the color table of the instrument using predefined color values. Each suffix of CMAP is assigned to one or several graphical elements which can be modified by varying the corresponding color setting.

The values set are not changed by *RST.

Suffix:

<item> Selects the display item. For more information see [Chapter 6.3.4.4, "CMAP Suffix Assignment"](#), on page 931.

Parameters:

<Color> BLACK | BLUE | BROWn | GREen | CYAN | RED | MAGenta |
YELLow | WHITe | DGRAY | LGRAY | LBLUe | LGREen | LCYan |
LRED | LMAGenta

Example: DISP:CMAP2:PDEF GRE

Usage: SCPI confirmed

Manual operation: See ["Predefined Colors"](#) on page 156

DISPlay:LOGO <State>

This command switches the company logo on the screen on or off.

Parameters:

<State> ON | OFF
*RST: ON

Example: DISP:LOGO OFF

Manual operation: See "[Print Logo \(On/Off\)](#)" on page 155

DISPlay:PSAVe:HOLDoff <Minutes>

This command sets the holdoff time for the power-save mode of the display. The available value range is 1 to 60 minutes, the resolution 1 minute. The entry is dimensionless.

Parameters:

<Minutes> 1 to 60
*RST: 15

Example: DISP:PSAV:HOLD 30

Manual operation: See "[Display Pwr Save \(On/Off\)](#)" on page 158

DISPlay:PSAVe[:STATe] <State>

This command switches on or off the power-save mode of the display. With the power-save mode activated the display including backlight is completely switched off after the elapse of the response time (see [DISPlay:PSAVe:HOLDoff](#) command).

This mode is recommended to protect the display, especially if the instrument is operated exclusively via remote control.

Parameters:

<State> ON | OFF
*RST: OFF

Example: DISP:PSAVe ON
Switches on the power-save mode.

Manual operation: See "[Display Pwr Save \(On/Off\)](#)" on page 158

DISPlay:SBAR[:STATe] <State>

This command turns the status bar in the display on and off.

Parameters:

<State> ON | OFF
*RST: ON

Example: DISP:SBAR OFF

Manual operation: See "[Status Bar](#)" on page 155

DISPlay:SKEYs[:STATe] <State>

This command turns the softkey bar in the display on and off.

Parameters:

<State> ON | OFF
 *RST: ON

Example: DISP:SKEY OFF

DISPlay:TBAR[STATe] <State>

This command turns the toolbar in the display on or off.

Parameters:

<State> ON | OFF
 *RST: OFF

Example: DISP:TOOL ON

Manual operation: See "[Tool Bar State \(On/Off\)](#)" on page 154

DISPlay:THEME:CATalog?

This command queries the available themes for the display.

Example: DISP:THEME:CAT?

Usage: Query only

DISPlay:THEME:SElect <Theme>

This command selects a theme for the screen display. The theme defines the colors used for keys and screen elements, for example.

Parameters:

<Theme> String containing the name of the theme.
 *RST: SPL

Example: DISP:THEM:SEL "OceanBlue"

Manual operation: See "[Theme Selection](#)" on page 155

DISPlay:TOUCHscreen:STATe <State>

This command turns the touch screen functionality on, off, or partially on.

Parameters:

<State> ON | OFF | FRAME

ON

Touch screen function is active for entire screen

OFF

Touch screen is deactivated for entire screen

FRAME

Touch screen is deactivated for the diagram area of the screen, but active for the surrounding Softkeys, toolbars and menus.

*RST: ON

Example: DISP:TOUC:STAT ON

DISPlay[:WINDow<n>]:TEXT[:DATA] <Comment>

This command defines a comment (max. 20 characters) which can be displayed in one of the measurement windows.

Suffix:

<n> Selects the measurement window.

Parameters:

<Comment> *RST: (empty)

Example: DISP:WIND:TEXT 'Noise Measurement'
Defines the screen title.

Manual operation: See "[Screen Title \(On/Off\)](#)" on page 155

DISPlay[:WINDow<n>]:TEXT:STATe <State>

This command turns the display of the comment (screen title) on and off.

Suffix:

<n> Selects the measurement window.

Parameters:

<State> ON | OFF
*RST: OFF

Example: DISP:TEXT:STAT ON
Switches on the title.

DISPlay[:WINDow<n>]:TIME <State>

This command turns the display of date and time on and off.

Suffix:

<n> irrelevant

Parameters:

<State> ON | OFF
*RST: OFF

Example: DISP:TIME ON

Manual operation: See "Screen Title (On/Off)" on page 155
See "Time+Date (On/Off)" on page 155

DISPlay[:WINDow<n>]:TIME:FORMat <Format>

This command selects the time and date display format.

Suffix:

<n> irrelevant

Parameters:

<Format> US | DE
*RST: DE

Example:

```
DISP:TIME ON
Switches the screen display of date and time on.
DISP:TIME:FORM US
Switches the date and time format to US.
```

Manual operation: See "Time+Date Format (US/DE)" on page 155

6.3.4.4 CMAP Suffix Assignment

Each suffix of CMAP is assigned one or several graphical elements which can be modified by varying the corresponding color setting. The following assignment applies:

Suffix	Description
CMAP1	Background
CMAP2	Grid
CMAP3 *)	Common Text
CMAP4 *)	Check Status OK
CMAP5 *)	Check Status Error
CMAP6 *)	Text Special 1
CMAP7 *)	Text Special 2
CMAP8	Trace 1
CMAP9	Trace 2
CMAP10	Trace 3
CMAP11	Marker Info Text
CMAP12	Limit Lines
CMAP13	Limit and Margin Check – "Pass"
CMAP14	Limit and Margin Check – "Fail"
CMAP15 *)	Softkey Text
CMAP16 *)	Softkey Background

Suffix	Description
CMAP17 *)	Selected Field Text
CMAP18 *)	Selected Field Background
CMAP19 *)	Softkey 3D Bright Part
CMAP20 *)	Softkey 3D Dark Part
CMAP21 *)	Softkey State "On"
CMAP22 *)	Softkey State "Dialog open"
CMAP23 *)	Softkey Text Disabled
CMAP24	Logo
CMAP25	Trace 4
CMAP26	Grid – Minorlines
CMAP27	Marker
CMAP28	Display Lines
CMAP29 *)	Sweepcount – Text
CMAP30	Limit and Margin Check – Text
CMAP31	Limit and Margin Check – \\"Margin\"
CMAP32 *)	Table Overall – Title Text
CMAP33 *)	Table Overall – Title Background
CMAP34 *)	Table Overall – Text
CMAP35 *)	Table Overall – Background
CMAP36 *)	Table Value – Title Text
CMAP37 *)	Table Value – Title Background
CMAP38 *)	Table Value – Text
CMAP39 *)	Table Value – Background
CMAP40	Trace 5
CMAP41	Trace 6

*) these settings can only be defined via the theme, see [Chapter 6.3.4.3, "DISPlay Subsystem"](#), on page 925, and are thus ignored in the SCPI command

6.3.4.5 FORMat Subsystem

The FORMat subsystem specifies the data format of the data transmitted from and to the instrument.

FORMat[:DATA] <Format>

This command selects the data format for the data transmitted from the R&S FSVA/FSV to the controlling computer. It is used for the transmission of trace data. The data format of trace data received by the instrument is automatically recognized, regardless of the format which is programmed.

In the "Spectrum" mode, the format setting REAL, 32 is used for the binary transmission of trace data.

(See also [TRACe<n>\[:DATA\]?](#) on page 890).

Parameters:

<Format>

ASCIi

ASCII data are transmitted in plain text, separated by commas.

REAL

REAL data are transmitted as 32-bit IEEE 754 floating-point numbers in the "definite length block format".

*RST: ASCII

Example:

```
FORM REAL, 32
FORM ASC
```

6.3.4.6 HCOPy Subsystem

The HCOPy subsystem controls the output of display information for documentation purposes on output devices or files. The instrument allows two independent printer configurations which can be set separately with the suffix <1|2>.

HCOPy:ABORT.....	933
HCOPy:CMAP<item>:DEFault.....	934
HCOPy:CMAP<item>:HSL.....	934
HCOPy:CMAP<item>:PDEFined.....	935
HCOPy:DESTination<1 2>.....	935
HCOPy:DEvice:COLor.....	936
HCOPy:DEvice:LANGuage<1 2>.....	936
HCOPy[:IMMediate<1 2>].....	937
HCOPy[:IMMediate<1 2>]:NEXT.....	937
HCOPy:ITEM:ALL.....	938
HCOPy:ITEM:WINDow:TABLE:STATE.....	938
HCOPy:ITEM:WINDow:TEXT.....	938
HCOPy:PAGE:ORientation<1 2>.....	939
HCOPy:TDSamp:STATE<1 2>.....	939

HCOPy:ABORT

This command aborts a running hardcopy output.

Example: HCOP:ABOR

Usage: Event
SCPI confirmed

HCOPY:CMAP<item>:DEFault <ColorSet>

This command defines the color scheme for print jobs.

Suffix:

<item> Selects the item for which the color scheme is to be defined.
For details on the CMAP assignment refer to [Chapter 6.3.4.4, "CMAP Suffix Assignment"](#), on page 931.

Parameters:

<ColorSet> 1 | 2 | 3 | 4

1
current screen colors with the background in white and the grid in black.

2
optimized color set

3
user defined color set

4
current screen colors without any changes (setting for hardcopies)

Example:

HCOPY:CMAP:DEF2

Selects the optimized color set for the color settings of a printout or a hardcopy.

Usage:

Event
SCPI confirmed

Manual operation:

See ["Set to Default"](#) on page 157
See ["Select Print Color Set"](#) on page 157

HCOPY:CMAP<item>:HSL <hue>,<sat>,<lum>

This command selects the color for various screen elements in print jobs.

The values set are not changed by *RST.

Suffix:

<item> Selects the item for which the color scheme is to be defined.
For details on the CMAP assignment refer to [Chapter 6.3.4.4, "CMAP Suffix Assignment"](#), on page 931.

Parameters:

<hue> numeric value
tint of the color
Range: 0 to 1

<sat> numeric value
saturation of the color
Range: 0 to 1

<lum>	numeric value brightness of the color Range: 0 to 1
Example:	HCOP:CMAP2:HSL 0.3,0.8,1.0 Changes the grid color
Usage:	SCPI confirmed
Manual operation:	See " Select Object " on page 156 See " User Defined Colors " on page 157 See " Print Colors " on page 157

HCOPY:CMAP<item>:PDEFined <Color>

This command selects a predefined color for various screen elements in print jobs.

The values set are not changed by *RST.

Suffix:

<item> Selects the item for which the color scheme is to be defined.
For details on the CMAP assignment refer to [Chapter 6.3.4.4, "CMAP Suffix Assignment"](#), on page 931.

Parameters:

<Color> BLACK | BLUE | BROWN | GREEN | CYAN | RED | MAGenta |
YELLOW | WHITE | DGRAY | LGRAY | LBLUE | LGREEN | LCYan |
LRED | LMAGenta

Example: HCOP:CMAP2:PDEF GRE

Usage: SCPI confirmed

Manual operation: See "[Predefined Colors](#)" on page 156

HCOPY:DESTination<1|2> <Medium>

This command selects the destination of a print job.

The type of instrument is selected with [SYSTEM:COMMunicate:PRINter:SElect <1|2>](#), which automatically selects a default output medium. Therefore [HCOPY:DESTination](#) should always be sent after setting the device type.

The suffix <1|2> selects the printing device.

Parameters:

<Medium> **'MMEM'**
Sends the hardcopy to a file.
You can select the file name with [MMEMory:NAME](#)
You can select the file format with [HCOPY:DEVIce:LANGuage<1|2>](#).

'SYST:COMM:PRIN'

Sends the hardcopy to the printer.

You can select the printer with `SYSTem:COMMunicate:PRINter:SElect <1|2>`.

'SYST:COMM:CLIP'

Sends the hardcopy to the clipboard.

The format should be WEMF.

*RST: SYST:COMM:CLIP

Example:

`SYST:COMM:PRIN:SEL2 'LASER on LPT1'`

Selects the printer and output medium for device 2.

`HCOP:DEST2 'SYST:COMM:PRIN'`

Selects the printer interface as device 2.

Usage:

SCPI confirmed

Manual operation: See "[Device Setup](#)" on page 179

HCOPY:DEvice:COLor <State>

This command turns color printing on and off.

Parameters:

<State>

ON | OFF

ON

Color output

OFF

Black and white output

*RST: OFF

Example:

`HCOP:DEV:COL ON`

Usage:

SCPI confirmed

Manual operation: See "[Color \(On/Off\)](#)" on page 158

HCOPY:DEvice:LANGuage<1|2> <Format>

This command selects the file format for a print job.

The suffix <1|2> selects the printing device.

Parameters:

<Format>

GDI

Graphics Device Interface:

Default format for the output to a printer configured under Windows. Must be selected for the output to the printer interface.

Can be used for the output to a file. The printer driver configured under Windows is used in this case and a printer-specific file format is thus generated.

(see also `HCOPY:DESTination<1|2>` command)

WMF | EWMF

WINDOWS Metafile and Enhanced Metafile Format:

Data formats for output files which can be integrated in corresponding programs for documentation purposes at a later time. WMF can only be used for output to a file and EWMF also for the output to the clipboard.

(see also [HCOPY:DESTINATION<1|2>](#) command)

BMP | JPG | PNG

Data format for output to files only.

- Example:** `HCOP:DEV:LANG WMF`
- Usage:** SCPI confirmed
- Manual operation:** See "[Device Setup](#)" on page 179

HCOPY[:IMMEDIATE<1|2>]

This command initiates a print job.

If you are printing to a file, the file name depends on [MMEMORY:NAME](#).

The suffix <1|2> selects the printing device.

- Example:** `HCOP:DEV:LANG BMP`
 Selects the data format.
`HCOP:DEST 'MMEM'`
 Directs the hardcopy to a file.
`MMEM:NAME 'C:\R_S\instr\user\Print.bmp'`
 Selects the file name. If the file Print.bmp already exists, it is replaced.
`HCOP`
 Saves the hardcopy output into the file Print.bmp.
- Usage:** Event
 SCPI confirmed
- Manual operation:** See "[ScreenShot](#)" on page 167
 See "[Print Screen](#)" on page 179

HCOPY[:IMMEDIATE<1|2>]:NEXT

This command initiates a print job.

If you are printing to a file, the file name depends on [MMEMORY:NAME](#). This command adds a consecutive number to the file name.

The suffix <1|2> selects the printing device.

Example: HCOP:DEV:LANG BMP
Selects the data format.
HCOP:DEST 'MMEM'
Directs the hardcopy to a file.
MMEM:NAME 'C:\R_S\instr\user\Print.bmp'
Selects the file name.
HCOP
Saves the hardcopy output into the file Print.bmp.
HCOP:NEXT
Saves the hardcopy output into the file Print_001.bmp.
HCOP:NEXT
Saves the hardcopy output into the file Print_002.bmp.

Usage: Event
SCPI confirmed

Manual operation: See "[Print Screen](#)" on page 179

HCOPY:ITEM:ALL

This command includes all screen elements in the printout.
The screen elements include comments, title, time and date.

Example: HCOPY:ITEM:ALL

Usage: Event
SCPI confirmed

Manual operation: See "[Print Screen](#)" on page 179

HCOPY:ITEM:WINDOW:TABLE:STATE <State>

This command turns printing of the currently active table on and off.

Parameters:
<State> ON | OFF
*RST: OFF

Example: HCOPY:ITEM:WINDOW:TABLE:STATE ON

HCOPY:ITEM:WINDOW:TEXT <Comment>

This command defines a comment added to the printout.

Parameters:
<Comment> String containing the comment with a maximum of 120 characters. The line feed is by means of the characters @.

Example: HCOPY:ITEM:WINDOW:TEXT 'comment'

Manual operation: See "[Comment](#)" on page 180

HCOPY:PAGE:ORIENTATION<1|2> <Orientation>

The command selects the format of the printout.

The command is only available if the output device is a printer (see [HCOPY:DESTINATION<1|2>](#) on page 935).

Parameters:

<Orientation> LANDscape | PORTrait
*RST: PORT

Example: HCOPY:PAGE:ORI LAND

Usage: SCPI confirmed

Manual operation: See "[Device Setup](#)" on page 179

HCOPY:TDSTAMP:STATE<1|2> <State>

This command includes or excludes the time and date in the printout.

The suffix <1|2> selects the printing device.

Parameters:

<State> ON | OFF
*RST: OFF

Example: HCOPY:TDST:STAT OFF

Manual operation: See "[Device Setup](#)" on page 179

6.3.4.7 MMEMemory Subsystem

The MMEMemory (mass memory) subsystem provides commands which allow for access to the storage media of the instrument and for storing and loading various instrument settings.

The various drives can be addressed via the "mass storage unit specifier" <msus> using the conventional DOS syntax. The internal hard disk is addressed by "C:". For details on drives refer to [Chapter 5.1.2, "Saving and Recalling Settings Files – SAVE/RCL Key"](#), on page 163.

The file names <file_name> are indicated as string parameters with the commands being enclosed in quotation marks. They also comply with DOS conventions.

DOS file names consist of max. 8 ASCII characters and an extension of up to three characters separated from the file name by a dot "." Both, the dot and the extension are optional. The dot is not part of the file name. DOS file names do not distinguish between uppercase and lowercase notation. All letters and digits are permitted as well as the special characters "_", "^", "\$", "~", "!", "#", "%", "&", "-", "{", "}", "(", ")", "@", and "'". Reserved file names are CLOCK\$, CON, AUX, COM1 to COM4, LPT1 to LPT3, NUL and PRN.

The two characters "*" and "?" have the function of so-called "wildcards", i.e., they are variables for selection of several files. The question mark "?" replaces exactly one

character, the asterisk means any of the remaining characters in the file name. "*" thus means all files in a directory.

In this section all MMEMory commands that are independant of a particular measurement mode are described in detail. For details on specific "Spectrum" mode commands refer to [Chapter 6.3.3.11, "MMEMory Subsystem"](#), on page 772.

MMEMory:CATalog?	940
MMEMory:CATalog:LONG?	941
MMEMory:CDIRectory	942
MMEMory:CLEar:ALL	942
MMEMory:CLEar:STATe 1,	942
MMEMory:COMMeNt	943
MMEMory:COpy	943
MMEMory:DATA	944
MMEMory:DELeTe	944
MMEMory:LOAD:AUTO	945
MMEMory:LOAD:STATe	945
MMEMory:MDIRectory	946
MMEMory:MOVe	946
MMEMory:MSIS	947
MMEMory:NAME	947
MMEMory:NETWork:DISConnect	948
MMEMory:NETWork:MAP	948
MMEMory:NETWork:UNUSeddrives?	948
MMEMory:NETWork:USEDdrives?	949
MMEMory:RDIRectory	949
MMEMory:SElect[:ITEM]:ALL	949
MMEMory:SElect[:ITEM]:DEFault	949
MMEMory:SElect[:ITEM]:HWSettings	950
MMEMory:SElect[:ITEM]:LINES:ALL	950
MMEMory:SElect[:ITEM]:NONE	950
MMEMory:SElect[:ITEM]:SGRam	950
MMEMory:SElect[:ITEM]:TRACe[:ACTive]	951
MMEMory:SElect[:ITEM]:TRANSDucer:ALL	951
MMEMory:STORe<n>:STATe	951
MMEMory:STORe<n>:STATe:NEXT	952
MMEMory:USER<Softkey>	952

MMEMory:CATalog?

This command reads the indicated directory.

Query parameters:

<Path> <path>

DOS Path name

The path name should be conform to DOS conventions and may also include the drive name. According to DOS convention, wild-card characters can be entered in order to query e.g. a list of all files of a certain type.

Return values:

Result List of file names in the form of strings separated by commas

Example:

MMEM:CAT? 'C:\R_S\Instr\user*.DFL'

Returns all files in C:\R_S\Instr\user with extension ".DFL"

MMEM:CAT? 'C:\R_S\Instr\user\SPOOL?.WMF'

Returns all files in C:\R_S\Instr\user whose names start with SPOOL, have 6 letters and the extension ".WMF".

SPOOL1.WMF, SPOOL2.WMF, SPOOL3.WMF

Usage:

Query only

SCPI confirmed

Manual operation: See "[Select File](#)" on page 165

MMEMory:CATalog:LONG?

Corresponds to [MMEMory:CATalog?](#) on page 940, but displays extended information on the files contained in the current or specified directory.

This command is an event and therefore has no *RST value and no query.

Query parameters:

<Path>

<path>

DOS Path name

The path name should be in conformance with DOS conventions and may also include the drive name.

Following this value, for each file, a string is listed according to the following syntax:

"<File name>, <suffix>, <Length of file in bytes>"

Return values:

Result

<total number of bytes the directory contains>,"<File name1>, <suffix1>, <Length of file 2 in bytes>","<File name 2>, <suffix2>, <Length of file2 in bytes>","...","<File name n>, <suffix n>, <Length of file n in bytes>"

The response value consists of a list of strings, separated by commas. It begins with the total number of bytes the directory contains. Then the information for each file is returned.

The <suffix> may be:

- ASCii
- BINary
- STAT

Example: MMEM:CAT:LONG? 'C:\R_S\Instr\user
 Returns all files in C:\R_S\Instr\user:
 1776,3331993600, "autolog.txt,ASC,1520",
 "autologin.reg,BIN,144", "no_autologin.reg,BIN,
 112"
 Query for the current directory:
 MMEM:CDIR?
 Response:
 C:\R_S\Instr\user
 MMEM:CAT:LONG?
 Returns all files in C:\R_S\Instr\user.

Usage: Query only
 SCPI confirmed

MMEMory:CDIRectory <Directory>

This command changes the current directory.

Parameters:

<Directory> <directory_name>
<directory_name>
 DOS path name

In addition to the path name, the indication of the directory may contain the drive name. The path name complies with the DOS conventions.

Example: MMEM:CDIR 'C:\R_S\Instr\user'
 Selects the directory C:\R_S\Instr\user.

Usage: SCPI confirmed

Manual operation: See ["Edit Path"](#) on page 168

MMEMory:CLEar:ALL

This command deletes all instrument configuration files in the current directory.

You can select the directory with [MMEMory:CDIRectory](#) on page 942. The default directory is C:\R_S\Instr\user.

Example: MMEM:CLE:ALL

Usage: Event

MMEMory:CLEar:STATe 1, <FileName>

This command deletes the instrument settings file selected by <file_name>. All associated files on the mass memory storage are cleared.

Parameters:

<FileName> 1,<file_name>
 with <file_name> = DOS file name without extension
 The file name includes indication of the path and may also include the drive. The path name complies with DOS conventions.

Example: MMEM:CLE:STAT 1, 'TEST'

Usage: Event

Manual operation: See "[Delete File](#)" on page 166

MMEMory:COMMeNt <Comment>

This command defines a comment for the stored settings.

Parameters:

<Comment>

Example: MMEMory:COMMeNt "ACP measurement with Standard Tetra from 23.05."
 MMEMory::MMEMory:STORE1:STATE 1, "ACP_T"
 As a result, in the selection list for recall settings, the comment "ACP measurement with Standard Tetra from 23.05." is added to the ACP entry.

Usage: SCPI confirmed

MMEMory:COpy <FileSource>,<FileDestination>

This command copies the files indicated in <file_source> to the destination directory indicated with <file_destination> or to the destination file indicated by <file_destination> if <file_source> is just a file.

Parameters:

<FileSource>,<FileDestination>,<file_source>,<file_destination> = <file_name>
 <file_source>,<file_destination> = <file_name>
 DOS file name

The indication of the file name may include the path and the drive name. The file names and path information must be in accordance with the DOS conventions.

Example: MMEM:COpy 'C:\R_S\Instr\user\SETUP.CFG', 'E:'

Usage: Event
 SCPI confirmed

Manual operation: See "[Copy](#)" on page 169

MMEMory:DATA <FileName>, [<Block>]

This command writes the block data contained in <block> into the file characterized by <file_name>. The delimiter must be set to EOI to obtain error-free data transfer.

The associated query command reads the indicated file from the mass memory and transfers it to the remote control computer. It should be noted that the buffer memory of the control computer should be large enough to store the file. The setting of the delimiter is irrelevant in this case.

The command is useful for reading stored settings files or trace data from the instrument or for transferring them to the instrument.

Parameters:

<FileName>	'<file name>' (file name in single quotes) selects the file to be transferred
<Block>	binary data block with the following structure: #<digit for the length of the length information><length information (number of bytes) for the binary data><binary data>

Example:

```
MMEM:DATA 'TEST01.HCP',#216 This is the file
where:
```

#2: the next 2 characters are the length indication

16: number of subsequent binary data bytes

This is the file: 16 bytes stored as binary data in the file

```
TEST01.HCP
```

```
MMEM:DATA? 'TEST01.HCP'
```

Transfers the file TEST01.HCP from the instrument to the control computer.

Usage: SCPI confirmed

MMEMory:DELeTe <FileName>

This command deletes the indicated files.

Parameters:

<FileName>	<file_name> = DOS file name The indication of the file name contains the path and, optionally, the drive name. Indication of the path complies with DOS conventions.
------------	---

Example:

```
MMEM:DEL 'TEST01.HCP'
```

The file TEST01.HCP is deleted.

Usage: SCPI confirmed

Manual operation: See "[Delete](#)" on page 169

MMEMemory:LOAD:AUTO <Mode>

This command defines which settings file is automatically loaded after the device is switched on. The contents of the file are read after switching on the device and used to define the new device state.

The settings file defined as auto recall set can also be restored by the **RST* on page 614 command.

Parameters:

<Mode> 1,'FACTORY' | 1,'<file_name>' | with <file_name>
1,'FACTORY'
 deactivates the startup recall function
1,'<file_name>'
 activates the startup recall function and defines the settings file to be loaded
with <file_name>
 DOS file name with or without extension
 The file name includes indication of the path and may also include the drive name. The path name complies with DOS conventions.

Example: MMEM:LOAD:AUTO 1, 'C:\R_S\Instr\user\TEST'

Usage: Event

Manual operation: See "[Startup Recall \(On/Off\)](#)" on page 167

MMEMemory:LOAD:STATE 1, <FileName>

This command restores and activates an instrument configuration stored in a *.dfl file.

Note that files with other formats cannot be loaded with this command.

The contents that are reloaded from the file are defined by the last selection made either in the "Save/Recall" dialogs (manual operation) or through the `MMEMemory:SElect[:ITEM]` commands (remote operation; the settings are identical in both cases).

By default, the selection is limited to the user settings ("User Settings" selection in the dialogs, `HWSettings` in SCPI). The selection is not reset by [Preset] or **RST*.

As a consequence, the results of a SCPI script using the `MMEMemory:LOAD:STATE` command without a previous `MMEMemory:SElect[:ITEM]` command may vary, depending on previous actions in the GUI or in previous scripts, even if the script starts with the **RST* command.

It is therefore recommended that you use the appropriate `MMEMemory:SElect[:ITEM]` command before using `MMEMemory:LOAD:STATE`.

Parameters:

1

<FileName> DOS file name with or without extension
The file name includes indication of the path and may also include the drive name. The path name complies with DOS conventions.

Example:

```
MMEM:SEL:ALL
//Save all items (User Settings, All Traces, All Limit Lines) from
the R&S FSVA/FSV.
MMEM:LOAD:STAT 1, 'C:\R_S\Instr\user\TEST01'
//Reloads all items
In the "Recall" dialog, select only "User Settings" and "All Limit
Lines".
MMEM:LOAD:STAT 1, 'C:\R_S\Instr\user\TEST01'
//Reloads user settings and all limit lines.
*RST
//Reset instrument.
MMEM:LOAD:STAT 1, 'C:\R_S\Instr\user\TEST01'
//Selected items are retained. Reloads user settings and all limit
lines.
Restart the instrument (using the [ON/OFF] key on the front
panel).
MMEM:LOAD:STAT 1, 'C:\R_S\Instr\user\TEST01'
// Selected items are set to default. Reloads only the user set-
tings.
```

Usage: SCPI confirmed

Manual operation: See ["Save File / Recall File"](#) on page 165
See ["Recall"](#) on page 166

MMEMory:MDIRectory <Directory>

This command creates a new directory. The file name includes indication of the path and may also include the drive name. The path name complies with DOS conventions.

Parameters:

<Directory> <directory_name> = DOS path name

Example: MMEM:MDIR 'C:\R_S\Instr\user'

Usage: Event

Manual operation: See ["New Folder"](#) on page 168

MMEMory:MOVE <FileSource>,<FileDestination>

This command renames existing files, if <file_destination> contains no path indication. Otherwise the file is moved to the indicated path and stored under the file name specified there, if any.

Parameters:

<FileSource>, <FileDestination>, <file_destination> = <file_name> = DOS file name

The file name includes indication of the path and may also include the drive. The path name complies with DOS conventions.

Example:

```
MMEM:MOVE 'C:\TEST01.CFG', 'SETUP.CFG'
```

Renames TEST01.CFG in SETUP.CFG in directory C:\.

```
MMEM:MOVE 'C:\TEST01.CFG', 'C:\R_S\Instr\user
```

Moves TEST01.CFG from C:\ to C:\R_S\Instr\user.

```
MMEM:MOVE 'C:\TEST01.CFG', 'C:
```

```
\R_S\Instr\user\SETUP.CFG'
```

Moves TEST01.CFG from C:\ to C:\R_S\Instr\user and renames the file in SETUP.CFG.

Usage:

Event

SCPI confirmed

Manual operation: See ["Rename"](#) on page 169

MMEMory:MSIS <Device>

This command changes to the drive indicated. The drive may be the internal hard disk C:.

Parameters:

<Device> <device> = A: | C: ... Z:

*RST: n.a.

The path name complies with DOS conventions.

Example:

```
MMEM:MSIS 'C: '
```

Usage:

SCPI confirmed

Manual operation: See ["Edit Path"](#) on page 168

MMEMory:NAME <FileName>

This command defines a destination file for the printout started with the [HCOPY\[: IMMEDIATE<1|2>\]](#) on page 937 command. In this case the printer output must be routed to a file as destination.

Parameters:

<FileName> <file_name> = DOS file name

The file name includes indication of the path and may also include the drive name. The file name and path information comply with DOS conventions.

Example:

```
MMEM:NAME 'C:\R_S\instr\user\PRINT1.BMP'
```

Selects the file name.

Usage:

Event

SCPI confirmed

MMEMory:NETWork:DISConnect <Drive>

This command disconnects the selected drive.

Parameters:

<Drive>

Example: MMEM:NETW:DISC 'T: '
 Disconnects network drive T:

Usage: Event

Manual operation: See "[Disconnect Network Drive](#)" on page 170

MMEMory:NETWork:MAP <Drive>, <HostName> [, <UserName>, <Password>][, <Reconnect>]

This command maps a drive to a server or server directory of the network.

Note that you have to allow sharing for a server or folder in Microsoft networks first.

Parameters:

<Drive> String containing the drive name or path of the directory you want to map.

<HostName> String containing the host name of the computer or the IP address and the share name of the drive.
'<host name or IP address\share name>'

<UserName> String containing a user name in the network.
The user name is optional.

<Password> String containing the password corresponding to the <User-Name>.
The password is optional.

<Reconnect> ON | OFF
ON
Reconnects at logon with the same user name.
OFF
Does not reconnect at logon.

Usage: Event

Manual operation: See "[Map Network Drive](#)" on page 170

MMEMory:NETWork:UNUSeddrives?

This command lists all unused network drive names.

This command is only a query and therefore has no *RST value.

Example: MMEM:NETW:UNUS?
 Lists all unused network drive names.

Usage: Query only

Manual operation: See ["Map Network Drive"](#) on page 170

MMEMory:NETWork:USEDdrives? <ResultType>

This command lists all mapped network drives.

Query parameters:

<ResultType> **ON**
 Lists all mapped network drives including the folder information.

OFF
 Lists all mapped network drive names.

*RST: OFF

Example: MMEM:NETW:USED? ON
 Lists all mapped network drives including the folder information.

Usage: Query only

Manual operation: See ["Map Network Drive"](#) on page 170

MMEMory:RDIRECTory <Directory>

This command deletes the indicated directory. The directory name includes indication of the path and may also include the drive name. The path name complies with DOS conventions.

Parameters:

<Directory> <directory_name> = DOS path name

Example: MMEM:RDIR 'C:\TEST'

Usage: Event

Manual operation: See ["Delete"](#) on page 169

MMEMory:SElect[:ITEM]:ALL

This command includes all data subsets in the list of device settings to be stored/loaded.

Example: MMEM:SEL:ALL

Usage: Event

Manual operation: See ["Enable all Items"](#) on page 166

MMEMory:SElect[:ITEM]:DEFault

This command includes the default list in the settings file to be stored/loaded. For details on hardware settings refer to the [MMEMory:SElect\[:ITEM\]:HWSettings](#) on page 950 command.

Example: MMEM:SEL:DEFault

MMEMory:SElect[:ITEM]:HWSettings <State>

This command includes the hardware settings in the settings file to be stored/loaded. The hardware settings include:

- current configuration of general device parameters (general setup)
- current setting of the measurement hardware including markers
- activated limit lines:

A settings file may include 8 limit lines at maximum. This number includes the activated limit lines and, if available, the de-activated limit lines last used.

Therefore the combination of the non-activated restored limit lines depends on the sequence of use with the `MMEMory:LOAD:STATE` on page 945 command.

- user-defined color setting
- configuration for the hardcopy output

Parameters:

<State> ON | OFF
*RST: ON

Example: `MMEM:SEL:HWS ON`

Manual operation: See "[Select Items](#)" on page 165

MMEMory:SElect[:ITEM]:LINes:ALL <State>

This command includes all limit lines (activated and de-activated) in the settings file to be stored/loaded.

Parameters:

<State> ON | OFF
*RST: OFF

Example: `MMEM:SEL:LIN:ALL ON`

Manual operation: See "[Select Items](#)" on page 165

MMEMory:SElect[:ITEM]:NONE

This command excludes all items from the settings file to be stored/loaded.

Example: `MMEM:SEL:NONE`

Usage: Event

Manual operation: See "[Disable all Items](#)" on page 166

MMEMory:SElect[:ITEM]:SGRam <boolean>

This command adds the spectrogram data to the list of data subsets of a save/recall device setting.

Parameters:

<boolean> **ON | OFF**
 *RST: OFF

Example:

MEM:SEL:SGR ON
 Adds the spectrogram data to the list of data subsets.

Mode: SPECM

MMEMory:SElect[:ITEM]:TRACe[:ACTive] <State>

This command includes the active traces in the settings file to be stored/loaded. Active traces are all traces whose state is not blank.

Parameters:

<State> ON | OFF
 *RST: OFF, i.e. no traces is stored

Example:

MMEM:SEL:TRAC ON

Manual operation: See ["Select Items"](#) on page 165

MMEMory:SElect[:ITEM]:TRANsducer:ALL <State>

This command includes all transducer factors and sets in the settings file to be stored/loaded.

Parameters:

<State> ON | OFF
 *RST: OFF

Example:

MMEM:SEL:TRAN:ALL ON

Manual operation: See ["Select Items"](#) on page 165

MMEMory:STORe<n>:STATe <State>

This command stores the current device settings in a *.dfl file.

Suffix:

<n> irrelevant

Parameters:

<State> 1,<file_name>
with <file_name>
 DOS file name with or without extension

The file name includes the indication of the path and may also include the drive name. The path name complies with DOS conventions.

Example:

MMEM:STOR:STAT 1, 'Save'
 Saves the current device settings in the file Save.dfl.

Usage: Event
SCPI confirmed

Manual operation: See ["Save File / Recall File"](#) on page 165

MMEMory:STORe<n>:STATe:NEXT

This command stores the current device settings in a *.dfl file. The file name used in the last saving process is automatically counted up to the next unused name.

Suffix:
<n> irrelevant

Example: `MMEM:STOR:STAT 1, 'Save '`
Saves the current device settings in the file `Save.dfl`.
`MMEM:STOR:STAT:NEXT`
Saves the current device settings in the file `Save_001.dfl`
`MMEM:STOR:STAT:NEXT`
Saves the current device settings in the file `Save_002.dfl`

Usage: Event

Manual operation: See ["Save File / Recall File"](#) on page 165

MMEMory:USER<Softkey> <Filename>, <Label>

This command defines the settings file to be loaded when the specified user-definable softkey is selected. The settings file must exist, otherwise an error occurs.

Suffix:
<Softkey> 1 | 2 | 3 | 4 | 5 | 6 | 7 | 8
Number of the softkey in the "User" menu.

Parameters:
<Filename> string
This parameter defines the path and file name of the settings to be loaded.

<Label> string
This parameter defines the label of the user-definable softkey.

*RST: User<Softkey_number>

Example: `MMEM:USER1 'C:\MySaveSets\Set1', 'Set1'`
Loads settings file `Set1` when the "Set1" softkey in the "User" menu is selected.

Example: `MMEM:USER3 'C:\MySaveSets\Set3', ''`
Loads settings file `Set3` when the "User3" softkey in the "User" menu is selected.

6.3.4.8 OUTPUT Subsystem (Option Additional Interfaces, B5)

The OUTPUT subsystem controls the output features of the instrument.

OUTPut:IF[:SOURce].....	953
OUTPut:TRIGger.....	953

OUTPut:IF[:SOURce] <Source>

This command selects the source of the IF output.

Parameters:

<Source>	IF Outputs the intermediate frequency.
	VIDeo Outputs the video signal (200 mV).
*RST:	IF

Example: OUTP:IF VID
Selects the video signal for the IF output connector.

Manual operation: See "Video Output" on page 399

OUTPut:TRIGger <PortLevel>

This command selects level of the Trigger Out port. Thus, you can trigger an additional device via the external trigger port, for example.

Parameters:

<PortLevel>	LOW HIGH
*RST:	LOW

Example: OUTP:TRIG HIGH

Manual operation: See "Trigger Out" on page 399

6.3.4.9 SENSE Subsystem

The SENSE subsystem is organized in several subsystems. The commands of these subsystems directly control device-specific settings; they do not refer to the signal characteristics of the measurement signal.

The SENSE subsystem controls the essential parameters of the analyzer. In accordance with the SCPI standard, the keyword "SENSE" is optional for this reason, which means that it is not necessary to include the SENSE node in command sequences.

SENSE:CORREction Subsystem.....	953
SENSE:ROSCillator Subsystem.....	957

SENSE:CORREction Subsystem

This subsystem controls calibration and normalization.

[SENSe:]CORRection:TRANsducer:ADJust:RLEVel[:STATe].....	954
[SENSe:]CORRection:TRANsducer:COMment.....	954
[SENSe:]CORRection:TRANsducer:DATA.....	955
[SENSe:]CORRection:TRANsducer:DELeTe.....	955
[SENSe:]CORRection:TRANsducer:SCALing.....	955
[SENSe:]CORRection:TRANsducer:SELeCt.....	956
[SENSe:]CORRection:TRANsducer[:STATe].....	956
[SENSe:]CORRection:TRANsducer:UNIT.....	956
[SENSe:]CORRection:TRANsducer:VIEW.....	957

[SENSe:]CORRection:TRANsducer:ADJust:RLEVel[:STATe] <State>

This command turns automatic adjustment of the reference level regarding the transducer factor characteristics on and off.

Before you can use the command, you have to select a transducer factor with [\[SENSe:\]CORRection:TRANsducer:SELeCt](#).

Parameters:

<State>	ON Automatically adjusts the reference level with respect to the transducer factor characteristics.
	OFF Manual adjustment of the reference level with respect to the transducer factor characteristics is necessary.
	*RST: OFF

Example:

```
CORR:TRAN:SEL 'FACTOR'
CORR:TRAN:STAT ON
Selects and turns on a transducer factor.
CORR:TRAN:ADJ:RLEV ON
Adjusts the reference level to the characteristics of the transducer.
```

Manual operation: See ["Ref Level Adjust \(Man/Auto\)"](#) on page 145

[SENSe:]CORRection:TRANsducer:COMment <Comment>

This command defines a comment for a transducer factor.

Before you can use the command, you have to select a transducer factor with [\[SENSe:\]CORRection:TRANsducer:SELeCt](#) on page 956.

Parameters:

<Comment>	String containing the comment.
	*RST: (empty comment)

Example:

```
CORR:TRAN:SEL 'FACTOR'
CORR:TRAN:STAT ON
Selects and turns on a transducer factor.
CORR:TRAN:COMM 'FACTOR FOR ANTENNA'
Defines a comment for the selected transducer factor.
```

Manual operation: See "Edit" on page 143

[SENSe:]CORRection:TRANsducer:DATA <Frequency>,<Level>

This command defines the shape of the transducer factor.

A transducer factor may contain up to 625 reference values. Each reference value is a combination of a frequency and a level value.

Before you can use this command, you have to select a transducer factor with [\[SENSe:\]CORRection:TRANsducer:SElect](#) on page 956.

Parameters:

<Frequency> Numeric value in Hz.
The frequency values have to be in ascending order.

<Level> The unit depends on [\[SENSe:\]CORRection:TRANsducer:UNIT](#) on page 956. By default, it is dB.

Example:

```
SENS:CORR:TRAN:SEL 'TRAN_1'
```

Selects the transducer factor

```
CORR:TRAN:UNIT 'DB'
```

Selects the unit for the transducer.

```
CORR:TRAN:DATA 1MHZ,-30,2MHZ,-40
```

Defines the frequency/level pairs 1 MHz, -30 dB and 2 MHz, -40 dB.

Manual operation: See "Edit Value" on page 143

[SENSe:]CORRection:TRANsducer:DElete

This command deletes a transducer factor.

Before you can use the command, you have to select a transducer factor with [\[SENSe:\]CORRection:TRANsducer:SElect](#).

Example:

```
CORR:TRAN:SEL 'Transducer 1'
```

```
CORR:TRAN:DEL
```

Deletes the selected transducer.

Usage: Event

Manual operation: See "Delete" on page 144

[SENSe:]CORRection:TRANsducer:SCALing <Scale>

This command selects the scale of the transducer factor.

Before you can use the command, you have to select a transducer factor with [\[SENSe:\]CORRection:TRANsducer:SElect](#) on page 956 R&S FSVA/FSV.

Parameters:

<Scale> LINear | LOGarithmic

*RST: LINear

Example: CORR:TRAN:SEL 'FACTOR'
 CORR:TRAN:SCAL LOG
 Selects a transducer and scales it logarithmically.

Manual operation: See ["Interpolation Lin/Log"](#) on page 144

[SENSe:]CORRection:TRANsducer:SElect <FileName>

This command creates or selects a transducer factor.

Parameters:

<FileName> String containing the name of the transducer factor.
 If the name does not exist yet, the R&S FSVA/FSV creates a transducer factor by that name.

Example: CORR:TRAN:SEL 'Transducer 1'
 Selects the corresponding transducer factor.

Manual operation: See ["Transducer"](#) on page 142
 See ["Active \(On/Off\)"](#) on page 142
 See ["Edit Name"](#) on page 143

[SENSe:]CORRection:TRANsducer[:STATe] <State>

This command turns a transducer factor on and off.

Before you can use the command, you have to select a transducer factor with [\[SENSe:\]CORRection:TRANsducer:SElect](#).

You can turn on up to 8 transducer factors at the same time.

Parameters:

<State> ON | OFF
 *RST: OFF

Example: CORR:TRAN:SEL 'Transducer 1'
 CORR:TRAN ON
 Turns the transducer factor on.

Manual operation: See ["Active \(On/Off\)"](#) on page 142

[SENSe:]CORRection:TRANsducer:UNIT <Unit>

This command selects the unit of a transducer factor.

Before you can use the command, you have to select a transducer factor with [\[SENSe:\]CORRection:TRANsducer:SElect](#).

Note that the unit of all active transducer factors must be the same or in relative terms (dB).

Parameters:

<Unit> String containing one of the following units:
 DB | DBM | DBMV | DBUV | DBUV/M | DBUA DBUA/M | DBPW |
 DBPT
 *RST: DB

Example:

```
CORR:TRAN:SEL 'FACTOR'
CORR:TRAN:UNIT 'DBUV'
Selects a transducer based on the unit dBµV.
```

Manual operation: See ["Edit Unit"](#) on page 143

[SENSe:]CORRection:TRANsducer:VIEW <State>

This command includes or excludes a figure of a transducer factor in the diagram.

Before you can use the command, you have to select a transducer factor with [\[SENSe:\]CORRection:TRANsducer:SElect](#).

Parameters:

<State> ON | OFF
 *RST: OFF

Example:

```
CORR:TRAN:SEL 'FACTOR'
CORR:TRAN:VIEW ON
Selects and displays a transducer factor.
```

SENSe:ROSCillator Subsystem

This subsystem controls the reference oscillator. The suffix in SENSE is irrelevant for the commands of this subsystem.

SOURce:EXTernal<1 2>:ROSCillator: EXTernal:FREQUENCY	957
[SENSe:]ROSCillator:EXTernal:FREQUENCY	957
[SENSe:]ROSCillator:SOURce	958
[SENSe:]ROSCillator:SOURce:EAUTO?	958

**SOURce:EXTernal<1|2>:ROSCillator: EXTernal:FREQUENCY
[SENSe:]ROSCillator:EXTernal:FREQUENCY <Frequency>**

This command defines the frequency of the external reference oscillator.

If the external reference oscillator is selected, the reference signal must be connected to the rear panel of the instrument.

Parameters:

<Frequency> Range: 1 MHz to 20 MHz

Example:

```
ROSC:EXT:FREQ 13
Sets the frequency to 13 MHz.
SOUR:EXT:ROSC:EXT:FREQ 13
```

Usage:

SCPI confirmed

[SENSe:]ROSCillator:SOURce <Source>

This command selects the reference oscillator.

If the external reference oscillator is selected, the reference signal must be connected to the rear panel of the instrument.

Parameters:

<Source>

INTernal

The internal reference is used (10 MHz)

EXTernal

The external reference is used; if none is available, an error flag is displayed in the status bar

EAUTO

The external reference is used as long as it is available, then the instrument switches to the internal reference

Example:

```
ROSC:SOUR EXT
```

Usage:

SCPI confirmed

Manual operation:

See ["Reference Int/Ext"](#) on page 141

See ["Show Error Flag"](#) on page 142

See ["Auto select Reference"](#) on page 142

[SENSe:]ROSCillator:SOURce:EAUTO?

This command queries the current reference type in case you have activated an automatic switch to the internal reference if the external reference is missing.

Return values:

<Reference>

INT

internal reference

EXT

external reference

Example:

```
SENS:ROSC:SOUR:EAUT?
```

Queries the currently available reference type.

Usage:

Query only

6.3.4.10 SOURce Subsystem

The SOURce subsystem controls the output signals of the instrument.

SOURce:TEMPerature Subsystem**SOURce<n>:TEMPerature:APRobe? <HW>**

This command queries the sensor temperature.

Suffix:

<n>

irrelevant

Query parameters:

<HW> 1 (CPU)

Example:

SOUR:TEMP:APR? 1

Queries the temperature of the CPU sensor.

Mode:

all

SOURce:EXTernal Subsystem

The SOURce:EXTernal subsystem controls the operation of the unit with option External Generator Control (R&S FSV-B10). The commands are only valid for the selected window. The suffix <generator> specifies the external generator 1 or 2.



The commands of the SOURce:EXTernal subsystem assume that the addressed generator was correctly configured with the commands of subsystem

SYSTem:COMMunicate.

If no external generator is selected, if the GPIB or TCP/IP address is not correct, or the generator is not ready for operation, an error message is displayed ("Ext. Generator GPIB Handshake Error!" or "Ext. Generator TCPIP Handshake Error!").

[SOURce<n>:EXTernal<generator>:ROSCillator\[:SOURce\]](#).....959

SOURce<n>:EXTernal<generator>:ROSCillator[:SOURce] <Source>

This command switches between external and internal reference oscillator.

Note: in Spectrum mode, this command defines the reference oscillator for the external tracking generator, see [SOURce<n>:EXTernal<generator>:ROSCillator\[:SOURce\]](#) on page 870.

Suffix:

<n> irrelevant

<generator> irrelevant

Parameters:

<Source> INTernal | EXTernal

*RST: INT

Example:

SOUR:EXT:ROSC EXT

Switches to external reference oscillator

Mode:

all

6.3.4.11 STATus Subsystem

The STATus subsystem contains the commands for the status reporting system (see the Operating Manual, chapter 5 "Remote Control – Basics"). *RST does not influence the status registers.

STATus:OPERation[:EVENT].....	960
STATus:OPERation:CONDition.....	960
STATus:OPERation:ENABle.....	960
STATus:OPERation:PTRansition.....	960
STATus:OPERation:NTRansition.....	961
STATus:PRESet.....	961
STATus:QUEStionable:CONDition.....	961
STATus:QUEStionable[:EVENT]?.....	962
STATus:QUEStionable:ENABle.....	962
STATus:QUEStionable:PTRansition.....	962
STATus:QUEStionable:NTRansition.....	962
STATus:QUEue[:NEXT]?.....	963

STATus:OPERation[:EVENT]

This command queries the contents of the EVENT part of the STATus:OPERation register. The contents of the EVENT part are deleted after readout.

Example: STAT:OPER?

Mode: all

STATus:OPERation:CONDition

This command queries the CONDition part of the STATus:OPERation register (see the base unit description of status registers in the Remote Control Basics chapter).

Readout does not delete the contents of the CONDition part. The value returned reflects the current hardware status.

Example: STAT:OPER:COND?

Mode: all

STATus:OPERation:ENABle

This command sets the bits of the ENABle section of the STATus:OPERation register. The ENABle register selectively enables the individual events of the associated EVENT section for the summary bit in the status byte.

Parameters:

<SumBit> 0 to 65535

Example: STAT:OPER:ENAB 65535

Usage: SCPI confirmed

Mode: all

STATus:OPERation:PTRansition

This command sets the edge detectors of all bits of the STATus:OPERation register from 0 to 1 for the transitions of the CONDition bit.

Parameters:**<SumBit>** 0 to 65535**Example:**

STAT:OPER:PTR 65535

Usage:

SCPI confirmed

Mode:

all

STATus:OPERation:NTRansition

This command sets the edge detectors of all bits of the STATus:OPERation register from 1 to 0 for the transitions of the CONDition bit.

Parameters:**<SumBit>** 0 to 65535**Example:**

STAT:OPER:NTR 65535

Usage:

SCPI confirmed

Mode:

all

STATus:PRESet

This command resets the edge detectors and ENABLE parts of all registers to a defined value. All PTRansition parts are set to FFFFh, i.e. all transitions from 0 to 1 are detected. All NTRansition parts are set to 0, i.e. a transition from 1 to 0 in a CONDition bit is not detected. The ENABLE part of the STATus:OPERation and STATus:QUESTionable registers are set to 0, i.e. all events in these registers are not passed on.

Example:

STAT:PRES

Usage:

SCPI confirmed

Mode:

all

STATus:QUESTionable:CONDition

This command queries the CONDition part of the "STATus:QUESTionable" register. This part contains the sum bit of the next lower register. This register part can only be read, but not written into or cleared. Readout does not delete the contents of the CONDition part.

Example:

STAT:QUES:COND?

Mode:

all

STATus:QUEStionable[:EVENT]?

This command queries the contents of the EVENT part of the STATus:QUEStionable register. The EVENT part indicates whether an event has occurred since the last reading, it is the "memory" of the condition part. It only indicates events passed on by the transition filters. It is permanently updated by the instrument. This part can only be read by the user. Reading the register clears it.

Example: STAT:QUES?

Usage: Query only

Mode: all

STATus:QUEStionable:ENABLE

This command sets the bits of the ENABLE section of the STATus:QUEStionable register. The ENABLE register selectively enables the individual events of the associated EVENT section for the summary bit in the status byte.

Parameters:

<SumBit> 0 to 65535

Example: STAT:QUES:ENAB 65535

Usage: SCPI confirmed

Mode: all

STATus:QUEStionable:PTRansition

This command sets the edge detectors of all bits of the STATus:QUEStionable register from 0 to 1 for the transitions of the CONDition bit.

Parameters:

<SumBit> 0 to 65535

Example: STAT:QUES:PTR 65535

Usage: SCPI confirmed

Mode: all

STATus:QUEStionable:NTRansition

This command sets the edge detectors of all bits of the STATus:OPERation register from 1 to 0 for the transitions of the CONDition bit.

Parameters:

<SumBit> 0 to 65535

Example: STAT:QUES:NTR 65535

Usage: SCPI confirmed

Mode: all

STATus:QUEue[:NEXT]??

This command queries the earliest error queue entry and deletes it.

Positive error numbers indicate device-specific errors, negative error numbers are error messages defined by SCPI. If the error queue is empty, the error number 0, "No error", is returned. This command is identical to the `SYSTem:ERRor[:NEXT]?` command.

Example:	<code>STAT:QUES?</code>
Usage:	Query only SCPI confirmed
Mode:	all

6.3.4.12 SYSTem Subsystem

This subsystem contains a series of commands for general functions.

<code>SYSTem:APPLication:SRECovery[:STATe]</code>	964
<code>SYSTem:CLOGging</code>	964
<code>SYSTem:COMMunicate:GPIB[:SELF]:ADDRess</code>	964
<code>SYSTem:COMMunicate:GPIB[:SELF]:RTERminator</code>	965
<code>SYSTem:COMMunicate:PRINter:ENUMerate:FIRSt?</code>	965
<code>SYSTem:COMMunicate:PRINter:ENUMerate[:NEXT]?</code>	966
<code>SYSTem:COMMunicate:PRINter:SElect <1 2></code>	966
<code>SYSTem:COMMunicate:TCPIp:CONTRol?</code>	966
<code>SYSTem:COMPatible</code>	966
<code>SYSTem:DATE</code>	967
<code>SYSTem:DID?</code>	967
<code>SYSTem:DEVIce:ID?</code>	967
<code>SYSTem:DISPlay:FPANel</code>	967
<code>SYSTem:DISPlay:LANGuage</code>	968
<code>SYSTem:DISPlay:UPDate</code>	968
<code>SYSTem:ERRor:CLEar:ALL</code>	968
<code>SYSTem:ERRor:LIST?</code>	968
<code>SYSTem:ERRor[:NEXT]?</code>	969
<code>SYSTem:FIRMware:UPDate</code>	969
<code>SYSTem:FORMat:IDENT</code>	969
<code>SYSTem:HPCoupling</code>	970
<code>SYSTem:IDENTify:FACTory</code>	970
<code>SYSTem:IDENTify[:STRing]</code>	970
<code>SYSTem:IFGain:MODE</code>	971
<code>SYSTem:KLOCK</code>	971
<code>SYSTem:LANGuage</code>	971
<code>SYSTem:LXI:INFo?</code>	972
<code>SYSTem:LXI:LANReset</code>	972
<code>SYSTem:LXI:MDEScription</code>	972
<code>SYSTem:LXI:PASSword</code>	973
<code>SYSTem:PASSword[:CENable]</code>	973
<code>SYSTem:PASSword:RESet</code>	973
<code>SYSTem:PRESet</code>	973

SYSTem:PSA:WIDeband.....	974
SYSTem:REBoot.....	974
SYSTem:REVisIon:FACTory.....	974
SYSTem:REVisIon[:STRing].....	975
SYSTem:RSW.....	975
SYSTem:SHUTdown.....	975
SYSTem:TIME.....	975
SYSTem:TWALking.....	976
SYSTem:VERSion?.....	976

SYSTem:APPLication:SRECovery[:STATe] <State>

Controls instrument behavior when switching between measurement applications, e.g. from "Spectrum" to "Analog Demod" and back.

If activated, the current instrument settings are stored when you switch to a different application. When you switch back to the previous application, the corresponding instrument settings are restored. Thus, the settings of the individual applications are independent of each other.

If deactivated (default), only a few parameters of the current instrument setting are passed between applications (e.g. center frequency, level settings).

Note that although the default value is "OFF", this parameter is not reset using the [PRESET] key. Thus it must be deactivated manually, if necessary.

Parameters:

<State> ON | OFF
 *RST: OFF (not restored using the "PRESET" function)

Example: SYST:APPL:SREC ON

Manual operation: See "[Application Setup Recovery](#)" on page 160

SYSTem:CLOGging <State>

This command turns logging of remote commands on and off.

Parameters:

<State> **ON**
 Writes all remote commands that have been sent to a file.
 The destination is C:
 \R_S\instr\ScpiLogging\ScpiLog.txt.
OFF
 *RST: OFF

Manual operation: See "[I/O Logging \(On/Off\)](#)" on page 152

SYSTem:COMMunicate:GPIB[:SELf]:ADDRess <Address>

This command changes the GPIB address of the unit.

Parameters:

<Address> 0 to 30
 *RST: (no influence on this parameter, factory default 20)

Example:

SYST:COMM:GPIB:ADDR 18

Usage:

SCPI confirmed

Manual operation: See "[GPIB Address](#)" on page 148

SYSTem:COMMunicate:GPIB[:SELF]:RTERminator <Terminator>

This command changes the GPIB receive terminator.

According to the standard the terminator in ASCII is <LF> and/or <EOI>. For binary data transfers (e.g. trace data) from the control computer to the instrument, the binary code (0AH) used for <LF> might be included in the binary data block, and therefore should not be interpreted as a terminator in this particular case. This can be avoided by changing the receive terminator to EOI.

Output of binary data from the instrument to the control computer does not require such a terminator change.

Parameters:

<Terminator> LFEOI | EOI
 *RST: (no influence on this parameter, factory default LFEOI)

Example:

SYST:COMM:GPIB:RTER EOI

Manual operation: See "[GPIB Terminator LFEOI/EOI](#)" on page 152

SYSTem:COMMunicate:PRINter:ENUMerate:FIRSt?

This command queries the name of the first printer (in the list of printers) available under Windows operating system.

The names of other installed printers can be queried with the [SYSTem:COMMunicate:PRINter:ENUMerate\[:NEXT\]?](#) command.

If no printer is configured an empty string is output.

Return values:

<PrinterName> *RST: NONE

Example:

SYST:COMM:PRIN:ENUM:FIRS?

Usage:

Query only

Manual operation: See "[Device Setup](#)" on page 179

SYSTem:COMMunicate:PRINter:ENUMerate[:NEXT]?

This command queries the name of the next printer installed under Windows operating system. After all available printer names have been output, an empty string enclosed by quotation marks (") is output for the next query. Further queries are answered by a query error.

The `SYSTem:COMMunicate:PRINter:ENUMerate:FIRSt?` command should be sent previously to return to the beginning of the printer list and query the name of the first printer.

Example: `SYST:COMM:PRIN:ENUM?`

Usage: Query only

Manual operation: See "Device Setup" on page 179

SYSTem:COMMunicate:PRINter:SElect <1|2> <PrinterName>

This command selects one of the printers configured under Windows operating system, including the associated output destination.

The specified printer name must be a string (entered in quotes) as returned by the commands

`SYSTem:COMMunicate:PRINter:ENUMerate:FIRSt?` or

`SYSTem:COMMunicate:PRINter:ENUMerate[:NEXT]?`

The `HCOPY:DESTination<1|2>` on page 935 command is used to select an output medium other than the default one.

Parameters:

<PrinterName> "<printer_name>"
*RST: NONE

Example: `SYST:COMM:PRIN:SEL "LASER on LPT1"`

SYSTem:COMMunicate:TCPIP:CONTRol?

This command outputs the control port for the LAN socket connection. An error indicates that the socket connection is not supported.

Example: `SYST:COMM:TCP:CONT?`

Usage: Query only

SYSTem:COMPatible <Mode>

Sets the device in a state compatible to previous R&S signal analyzers, e.g. regarding the number of sweep points.

Parameters:

<Mode> DEFault | FSU | FSP

Example:	SYST:COMP FSP
Usage:	SCPI confirmed
Manual operation:	See " Compatibility Mode " on page 148 See " Mode Default " on page 149 See " Mode R&S FSP " on page 149 See " Mode R&S FSU " on page 149

SYSTem:DATE <Date>

This command is used to enter the date for the internal calendar.

The sequence of entry is year, month, day.

Only user accounts with administrator rights can set the date.

Parameters:

<Date> 1980 to 2099, 1 to 12, 1 to 31

Example: SYST:DATE 2000, 6, 1

Usage: SCPI confirmed

Manual operation: See "[Time+Date](#)" on page 152

SYSTem:DID?**SYSTem:DEvice:ID?**

Returns the unique ID of the R&S FSVA/FSV instrument.

Example: SYST:DEV:ID?
1307.9002K07-100123-aZ

Usage: Query only
SCPI confirmed

Manual operation: See "[Versions+Options](#)" on page 158

SYSTem:DISPlay:FPANel <State>

This command activates or deactivates the display of the front panel keys on the screen.

With the display activated, the instrument can be operated on the screen using the mouse by pressing the corresponding buttons.

Parameters:

<State> ON | OFF
*RST: OFF

Example: SYST:DISP:FPAN ON

Manual operation: See "[Soft Frontpanel](#)" on page 153

SYSTem:DISPlay:LANGuage <Language>

Changes the language of the graphical user interface (softkeys, dialog boxes, input settings etc.) to the selected language, if any other than the default are installed.

Parameters:

<Language> string containing the ISO language code
*RST: en

Example:

```
SYST:DISP:LANG 'ru'
```

Switches to a Russian interface (if installed).

```
SYST:DISP:LANG 'en'
```

Switches back to the default English interface.

Manual operation: See "[Language](#)" on page 153

SYSTem:DISPlay:UPDate <State>

In remote control mode, this command switches on or off the instrument display. If switched on, only the diagrams, traces and display fields are displayed and updated.

The best performance is obtained if the display output is switched off during remote control.

Parameters:

<State> ON | OFF
*RST: OFF

Example:

```
SYST:DISP:UPD ON
```

Manual operation: See "[Display Update \(On/Off\)](#)" on page 152

SYSTem:ERRor:CLEar:ALL

This command deletes all entries in the table SYSTEM MESSAGES.

Example:

```
SYST:ERR:CLE:ALL
```

Usage:

Event

Manual operation: See "[Clear All Messages](#)" on page 159

SYSTem:ERRor:LIST?

This command reads all system messages and returns a list of comma separated strings. Each string corresponds to an entry in the table SYSTEM MESSAGES.

If the error list is empty, an empty string " is returned.

This command is a query and therefore has no *RST value.

Example:

```
SYST:ERR:LIST?
```

Usage:

Query only

Manual operation: See "[System Messages](#)" on page 159

SYSTem:ERRor[:NEXT]?

This command queries the earliest error queue entry and deletes it.

Positive error numbers indicate device-specific errors, negative error numbers are error messages defined by SCPI. If the error queue is empty, the error number 0, "No error", is returned.

This command is a query and therefore has no *RST value.

Example: STAT:ERR?

Usage: Query only
SCPI confirmed

SYSTem:FIRMware:UPDate

This command starts a firmware update using the *.msi files in the selected directory. The default path is D:\FW_UPDATE. The path is changed via the [MMEMemory:COMMENT](#) command. To store the update files the [MMEMemory:DATA](#) command is used.

Only user accounts with administrator rights can perform a firmware update.

Example: SYST:FIRM:UPD 'D:\FW_UPDATE'
Starts the firmware update from directory "D:\FW_UPDATE".

Usage: Event

Manual operation: See "[Firmware Update](#)" on page 160

SYSTem:FORMat:IDENt <Format>

This command defines the response format to the [*IDN?](#) on page 612 command. This function is intended for re-use of existing control programs together with the R&S FSVA/FSV.

Parameters:

<Format> FSL | LEGacy | NEW

LEGacy
Format is compatible to the R&S FSP/FSU/FSQ family

NEW
R&S FSVA/FSV format

FSL
Format is compatible to the R&S FSL family

*RST: not reset!

Example: SYST:FORM:IDEN LEG
Adapts the return value of *IDN? to the R&S FSP/FSU/FSQ family.

Manual operation: See "[*IDN Format Leg./New](#)" on page 152

SYSTem:HPCoupling <CouplingType>

Controls the default coupling ratios in the HP emulation mode for:

- span and resolution bandwidth (Span/RBW) and
- resolution bandwidth and video bandwidth (RBW/VBW)

For FSP (=FSV), the standard parameter coupling of the instrument is used. As a result, in most cases a shorter sweep time is used than in case of HP.

This command is only available if a HP language is selected using [SYSTem:LANGuage](#).

Parameters:

<CouplingType> HP | FSP
 *RST: FSP

Example: SYSTem:HPC HP

Usage: SCPI confirmed

Manual operation: See "[Coupling \(FSx/HP\)](#)" on page 150

SYSTem:IDENtify:FACTory

Resets the response to the *IDN? query to the default value, e.g. after a user string was defined using the [ID String User](#) softkey.

Example: SYST:IDEN:FACT
 *IDN?
Response:
 Rohde&Schwarz,R&S FSVA/FSV-7,
 1307.9002K07/101768,1.05

Usage: Event
 SCPI confirmed

Manual operation: See "[ID String Factory](#)" on page 148

SYSTem:IDENtify[:STRing] <String>

Sets the response to the *IDN? query to the defined string, e.g. after the default value was reset using the [ID String Factory](#) softkey.

Parameters:

<String>

Example: Set the response to 'MyDevice':
 SYST:IDEN:STR 'MyDevice'
Query the response:
 SYST:IDEN:STR?
Response:
 MyDevice

Usage: SCPI confirmed

Manual operation: See ["ID String User"](#) on page 148

SYSTem:IFGain:MODE <Mode>

Configures the internal IF gain settings in HP emulation mode due to the application needs. This setting is only taken into account for resolution bandwidth < 300 kHz and is only available if a HP language is selected using [SYSTem:LANGuage](#).

Parameters:

<Mode> NORM | PULS

NORM
Optimized for high dynamic range, overload limit is close to reference level.

PULS
Optimized for pulsed signals, overload limit up to 10 dB above reference level.

*RST: NORM

Example: SYST:IFG:MODE PULS

Usage: SCPI confirmed

Manual operation: See ["IF Gain \(Norm/Puls\)"](#) on page 150

SYSTem:KLOCK <State>

This command activates the local lockout (remote control) or returns to the local mode.

Parameters:

<State> **ON**
LLO (local lockout)

OFF
GTL (go to local)

*RST: OFF

Example: SYST:KLOK ON
Activates LLO (remote control)

SYSTem:LANGuage <Language>

This command defines the system language. Default is SCPI which defines the standard remote control behavior of the instrument. The other parameters are to simulate the corresponding HP analyzer. The parameter "PSA89600" sets the device in a state in which it can be used for IQ capturing from the 89600 vector signal analyzer software.

Parameters:

<Language> "SCPI" | "8560E" | "8561E" | "8562E" | "8563E" | "8564E" |
 "8565E" | "8566A" | "8566B" | "8568A" | "8568A_DC" | "8568B" |
 "8568B_DC" | "8591E" | "8594E" | "71100C" | "71200C" |
 "71209A" | "PSA89600" | "PSA" | "ESA"
 *RST: SCPI

Example:

```
SYST:LANG '8560E'
```

Sets the system language to 8560E to simulate the HP analyzer.

Manual operation: See "[GPIB Language](#)" on page 149

Note: If you use "**PSA89600**", you must switch to an HP language first before returning to SCPI (in remote operation only). For the identical language "PSA", this intermediate step is not necessary.

SYSTem:LXI:INFo?

This query returns the current parameters of the LXI class C.

Only user accounts with administrator rights are able to use LXI functionality.

Return values:

Return values <current version> | <LXI class> | <Computername> |
 (example) <MAC adress> | <IP adress> | <Auto MDIX>

Usage: Query only

Manual operation: See "[Info](#)" on page 147

SYSTem:LXI:LANReset

This command resets the LAN configuration to the values required by the LXI standard. In addition, the password is reset to its initial state as well as the LXI instrument description.

Only user accounts with administrator rights are able to use LXI functionality.

Example: `SYST:LXI:LANR`

Usage: Event

Manual operation: See "[LAN Reset](#)" on page 148

SYSTem:LXI:MDEscription <String>

This command shows the LXI instrument description. Also, the instrument description can be changed using this command.

Only user accounts with administrator rights are able to use LXI functionality.

Parameters:

<String>

Example: `SYST:LXI:MDES`

Manual operation: See ["Description"](#) on page 147

SYSTem:LXI:PASSword <Password>

This command shows or changes the LXI password.

Only user accounts with administrator rights are able to use LXI functionality.

Parameters:

<Password> <password>

Example: SYST:LXI:PASS

Manual operation: See ["Password"](#) on page 147

SYSTem:PASSword[:CENable] <Password>

This command enables access to the service functions by means of the password.

Parameters:

<Password> <password>

Example: SYST:PASS XXXX

Usage: Event
SCPI confirmed

Manual operation: See ["Password"](#) on page 162

SYSTem:PASSword:RESet

This command resets the service password.

Example: SYST:PASS:RES

Usage: Event
SCPI confirmed

Manual operation: See ["Reset Password"](#) on page 162

SYSTem:PRESet

This command initiates an instrument reset.

The effect of this command corresponds to that of the **PRESET** key with manual operation or to the [*RST](#) command. For details on preset settings refer to [Chapter 5.2.1, "Initializing the Configuration – PRESET Key"](#), on page 183.

Example: SYST:PRES

Usage: SCPI confirmed

SYSTem:PSA:WIDeband <State>

This command defines which option is returned when the *OPT? query is executed, depending on the state of the wideband option.

It is only available for PSA89600 emulation.

Parameters:

<State> ON | OFF | HIGH

OFF
The option is indicated as "B7J"

ON
The 40 MHz wideband is used.
The option is indicated as "B7J, 140".

HIGH
The 80 MHz wideband is used.
The option is indicated as "B7J, 122".

*RST: OFF

Manual operation: See "[Wideband](#)" on page 151

SYSTem:REBoot

This command reboots the instrument, including the operating system.

Usage: Event

SYSTem:REVision:FACTory

Resets the response to the REV? query to the default value, e.g. after a user string was defined using the `SYSTem:REVision[:STRing]` command. (REV? query available for HP emulation only, see [Chapter 6.3.5, "GPIB Commands of HP Models 856xE, 8566A/B, 8568A/B and 8594E"](#), on page 977.)

Example: Define the system language:
`SYST:LANG '8563E'`

Set the response back to factory setting:
`SYS:REV:FACT`

Query the revision:
`REV?`

Response:
920528

Usage: Event
SCPI confirmed

Manual operation: See "[REV String Factory](#)" on page 151

SYSTem:REVision[:STRing] <Name>

Sets the response to the `REV?` query to the defined string (HP emulation only, see [Chapter 6.3.5, "GPIB Commands of HP Models 856xE, 8566A/B, 8568A/B and 8594E"](#), on page 977).

Parameters:

<Name>

Example:

Define the system language:

```
SYST:LANG '8563E'
```

Query the revision:

```
REV?
```

Response:

```
920528
```

Set the response to 'NewRevision':

```
SYST:REV:STR 'NewRevision'
```

Query the response:

```
SYST:REV:STR?
```

Response:

```
NewRevision
```

Manual operation: See ["REV String User"](#) on page 151

SYSTem:RSW <State>

Controls a repeated sweep of the E1 and MKPK HI/HL HP model commands (for details on the commands refer to [Chapter 6.3.5, "GPIB Commands of HP Models 856xE, 8566A/B, 8568A/B and 8594E"](#), on page 977). If the repeated sweep is OFF, the marker is set without sweeping before.

This command is only available if a HP language is selected using `SYSTem:LANGuage`.

Parameters:

<State> ON | OFF

```
*RST: OFF
```

Example:

```
SYSTem:RSW ON
```

Usage:

SCPI confirmed

Manual operation: See ["Sweep Repeat \(On/Off\)"](#) on page 150

SYSTem:SHUTdown

This command shuts down the instrument.

Usage:

Event

SYSTem:TIME <Time>

This command sets the internal clock. The sequence of entry is hour, minute, second.

Only user accounts with administrator rights are able to set the time.

Parameters:

<Time> 0 to 23, 0 to 59, 0 to 59

Example: SYST:TIME 12,30,30

Usage: SCPI confirmed

Manual operation: See "[Time+Date](#)" on page 152

SYSTem:TWALking <Mode>

Defines how remote control programs are evaluated, in particular multiple commands in one command line.

Note that the default setting is `NORM`; however, the setting defined by this command is retained after a [preset] (*RST) operation.

Parameters:

<Mode>

NORM

SCPI-conform behaviour

The first command is always referenced to the root node. Subsequent commands, however, are referenced to the same tree level as the previous command in a message unit.

ENHanced

If subsequent commands are not found on the same tree level as the previous command, the SCPI parser searches "backwards up the tree" of defined SCPI commands. If the command is found at a higher node, that command is used. Only if the command is not found anywhere, an error message is returned.

*RST: setting is retained

Example:

```
*RST
:SYSTem:TWALking ENHanced
:SENSe:SWEep:MODE LIST
INIT:CONT OFF
LIST:RANG4:DEL;RANG3:DEL
```

//without enhanced tree walking this command would deliver an error

Manual operation: See "[Tree Walking](#)" on page 151

SYSTem:VERSion?

This command queries the number of the SCPI version, which is relevant for the instrument.

This command is a query and therefore has no *RST value.

Example: SYST:VERS?

Usage: Query only
SCPI confirmed

6.3.5 GPIB Commands of HP Models 856xE, 8566A/B, 8568A/B and 8594E

The R&S FSV analyzer family supports a subset of the GPIB commands of HP models 8560E, 8561E, 8562E, 8563E, 8564E, 8565E, 8566A, 8566B, 8568A, 8568B and 8594E.

Despite the differences in system architecture and device features, the supported commands have been implemented in a way to ensure a sufficiently high degree of correspondence with the original.

This includes the support of syntax rules for not only newer device families (B and E models) but for the previous A family as well.

In many cases the selection of commands supported by the R&S FSV is sufficient to run an existing GPIB program without adaptation.

After the introduction, this section includes the following topics:

• GPIB Languages	977
• Command Set of Models 8560E, 8561E, 8562E, 8563E, 8564E, 8565E, 8566A/B, 8568A/B, 8591E, 8594E, 71100C, 71200C, and 71209A	979
• Special Features of the Syntax Parsing Algorithms for 8566A and 8568A Models	1003
• Special Behavior of Commands	1004
• Model-Dependent Default Settings	1005
• Data Output Formats	1006
• Trace Data Output Formats	1006
• Trace Data Input Formats	1007
• GPIB Status Reporting	1007

6.3.5.1 GPIB Languages

The R&S FSVA/FSV analyzer family supports a subset of the GPIB commands used by other devices. Thus it can emulate other devices in order to use existing remote control programs.

The device model to be emulated is selected manually using the key sequence "SETUP > General Setup > GPIB > Compatible Mode > GPIB Language". Via the GPIB interface using the command.

In order to emulate device models that are not part of the selection list of the "GPIB Language" softkey, you can modify the identification string received in response to the ID command (key sequence "SETUP > General Setup > GPIB > ID String User"). Thus, any device model whose command set is compatible with one of the supported device models can be emulated.

Supported languages

Language	Comment
SCPI	
71100C	Compatible to 8566A/B
71200C	Compatible to 8566A/B
71209A	Compatible to 8566A/B
8560E	
8561E	
8562E	
8563E	
8564E	
8565E	
8566A	Command sets A and B are available. Command sets A and B differ in the rules regarding the command structure.
8566B	
8568A	Command sets A and B are available. Command sets A and B differ in the rules regarding the command structure.
8568A_DC	Uses DC input coupling by default if supported by the instrument
8568B	Command sets A and B are available. Command sets A and B differ in the rules regarding the command structure.
8568B_DC	Uses DC input coupling by default if supported by the instrument
8591E	Compatible to 8594E
8594E	Command sets A and B are available. Command sets A and B differ in the rules regarding the command structure.
ESA	

Notes:

- If you select a language other than "SCPI", the GPIB address is set to 18 if it was 20 before.
- The Start/stop frequency, reference level and number of sweep points are adapted to the selected instrument model.
- When you switch between remote control languages, the following settings or changes are made:
 - SCPI:**
The instrument performs a PRESET.
 - 8566A/B, 8568A/B, 8594E; FSEA, FSEB, FSEM; FSEK:**
 - The instrument performs a PRESET.
 - The following instrument settings are changed:

Table 6-23: Instrument settings for emulation of 8566A/B, 8568A/B, 8594E; FSEA, FSEB, FSEM; FSEK instruments

Model	# of Trace Points	Start Freq.	Stop Freq.	Ref Level	Input Coupling
8566A/B	1001	2 GHz	22 GHz	0 dBm	AC
8568A/B	1001	0 Hz	1.5 GHz	0 dBm	AC
8560E	601	0 Hz	2.9 GHz	0 dBm	AC
8561E	601	0 Hz	6.5 GHz	0 dBm	AC
8562E	601	0 Hz	13.2 GHz	0 dBm	AC
8563E	601	0 Hz	26.5 GHz	0 dBm	AC
8564E	601	0 Hz	40 GHz	0 dBm	AC
8565E	601	0 Hz	50 GHz	0 dBm	AC
8594E	401	0 Hz	3 GHz	0 dBm	AC

Note: The stop frequency indicated in the table may be limited to the corresponding frequency of the R&S FSVA/FSV, if required.

6.3.5.2 Command Set of Models 8560E, 8561E, 8562E, 8563E, 8564E, 8565E, 8566A/B, 8568A/B, 8591E, 8594E, 71100C, 71200C, and 71209A

As with the original units, the R&S FSVA/FSV includes the command set of the A models in the command set of the B models.



The HP model 8591E is compatible to HP model 8594E, the HP models 71100C, 71200C, and 71209A are compatible to HP models 8566A/B.

Command	Supported subset	Function	Corresp. HP-Models	Status
A1	A1	Clear/Write A	HP 8566A/ HP 8568A	available
A2	A2	Max Hold A	HP 8566A/ HP 8568A	available
A3	A3	View A	HP 8566A/ HP 8568A	available
A4	A4	Blank A	HP 8566A/ HP 8568A	available
ABORT ¹⁾	ABORT	Stop previous function	HP 856xE/ HP 8566B/HP 8568B/HP 8594E	available

Command	Supported subset	Function	Corresp. HP-Models	Status
ADD		Add	HP 8566B/ HP 8568B/ HP 8594E	available
ADJALL	ADJALL	Adjust all	HP 856xE/ HP 8566B/ HP 8568B/ HP 8594E	available
ADJCRT ²⁾	ADJCRT	Adjust CRT	HP 856xE/ HP 8566B/ HP 8568B/ HP 8594E	available
ADJIF ²⁾	ADJIF	Auto adjust IF	HP 856xE/ HP 8566B/ HP 8568B/ HP 8594E	available
AMB	AMB ON OFF AMB 1 0 AMB?	Trace A – B -> Trace A	HP 856xE/ HP 8594E	available
AMBPL	AMBPL ON OFF AMBPL 1 0 AMBPL?		HP 856xE/ HP 8566B/ HP 8568B/ HP 8594E	available
AMPCORDATA	AMPCORDATA <freq>,<amp>,... AMPCORDATA?	Amplitude Correction Data	HP 856xE	available
AMPCOR	AMPCOR ON OFF AMPCOR 1 0 AMPCOR?	Amplitude Correction	HP 856xE	available
AMPCORSIZE	AMPCORSIZE?	Amplitude Correction Data Array Size	HP 856xE	available
AMPCORRCL	AMPCORRCL <numeric value>	Amplitude Correction Recall	HP 856xE	available
AMPCORSAVE	AMPCORSAVE <numeric value>	Amplitude Correction Save	HP 856xE	available
ANNOT	ANNOT ON OFF ANNOT 1 0 ANNOT?	Annotation	HP 856xE/ HP 8566B/ HP 8568B/ HP 8594E	available

Command	Supported subset	Function	Corresp. HP-Models	Status
APB	APB	Trace A + B -> Trace A	HP 856xE/ HP 8566B/ HP 8568B/ HP 8594E	available
AT	AT <numeric_value> DB DM AT DN AT UP AT AUTO AT?	Attenuation	HP 8566A/ HP 8568A/ HP 856xE/ HP 8566B/ HP 8568B/ HP 8594E	available
AUNITS	AUNITS DBM DBMV DBUV AUNITS?	Amplitude Units	HP 856xE/ HP 8566B/ HP 8568B/ HP 8594E	available
AUTOCP	AUTOCP	Coupling default	HP 856xE/ HP 8566B/ HP 8568B/ HP 8594E	available
AXB	AXB	Exchange trace A and B	HP 856xE/ HP 8566B/ HP 8568B/ HP 8594E	available
B1	B1	Clear/Write B	HP 8566A/ HP 8568A	available
B2	B2	Max Hold B	HP 8566A/ HP 8568A	available
B3	B3	View B	HP 8566A/ HP 8568A	available
B4	B4	Blank B	HP 8566A/ HP 8568A	available
BL	BL	Trace B – Display Line - > Trace B	HP 8566A/ HP 8568A	available
BML	BML	Trace B – Display Line - > Trace B	HP 856xE/ HP8594E	available
BTC	BTC	Transfer Trace B -> C	HP 856xE/ HP 8566B/ HP 8568B/ HP 8594E	available

Command	Supported subset	Function	Corresp. HP-Models	Status
BXC	BXC	Exchange Trace B and C	HP 856xE/ HP 8566B/ HP 8568B/ HP 8594E	available
BLANK	BLANK TRA TRB TRC	Blank Trace	HP 856xE/ HP 8566B/ HP 8568B/ HP 8594E	available
C1	C1	A-B off	HP 8566A/ HP 8568A	available
C2	C2	A-B -> A	HP 8566A/ HP 8568A	available
CA	CA	Couple Attenuation	HP 8566A/ HP 8568A	available
CAL ¹⁾	CAL ALL CAL ON CAL OFF	Start analyzer self alignment	HP 856xE/ HP 8566B/ HP 8568B/ HP 8594E	available
CF	CF <numeric_value> HZ KHZ MHZ GHZ CF UP CF DN CF?	Center Frequency	HP 8566A/ HP 8568A/ HP 856xE/ HP 8566B/ HP 8568B/ HP 8594E	available
CHANPWR	CHANPWR TRA TRB, <numeric_value>,<?>	Channel Power Measurement	HP 856xE/ HP 8594E	available
CHPWRBW	CHPWRBW <numeric_value> HZ KHZ MHZ GHZ	Channel Power Bandwidth	HP 856xE/ HP 8594E	available
CLRW	CLRW TRA TRB TRC	Clear/Write Trace	HP 856xE/ HP 8566B/ HP 8568B/ HP 8594E	available
CLS ¹⁾	CLS	Clear all status bits	HP 856xE/ HP 8566B/ HP 8568B/ HP 8594E	available

Command	Supported subset	Function	Corresp. HP-Models	Status
CONTS	CONTS		HP 856xE/ HP 8566B/ HP 8568B/ HP 8594E	available
COUPLE	COUPLE AC DC	Input coupling	HP 856xE/ HP 8566B/ HP 8568B/ HP 8594E	available
CR	CR	Couple RBW	HP 8566A/ HP 8568A	available
CS	CS	Couple Step Size	HP 8566A/ HP 8568A	available
CT	CT	Couple SWT	HP 8566A/ HP 8568A	available
CTA		Convert to absolute units	HP 8566B/ HP 8568B/ HP 8594E	available
CV	CV	Couple VBW	HP 8566A/ HP 8568A	available
D1 ²⁾	D1	Display Size normal	HP 8566A/ HP 8568A	available
DA ²⁾	DA	Display address		available
DEMODO ¹⁾	DEMODO ON OFF AM FM	AF Demodulator	HP 856xE/ HP 8566B/ HP 8568B/ HP 8594E	available
DEMODOAGC ²⁾	DEMODOAGC ON OFF 1 0 DEMODOAGC?	Demodulation AGC	HP 856xE/ HP 8566B/ HP 8568B/ HP 8594E	available
DEMODT	DEMODT <numeric_value> S MS US SC DEMODT UP DN DEMODT?	Demodulation time	HP 856xE/ HP 8566B/ HP 8568B/ HP 8594E	available
DET	DET POS SMP NEG DET?	Detector	HP 856xE/ HP 8566B/ HP 8568B/ HP 8594E	available

Command	Supported subset	Function	Corresp. HP-Models	Status
DISPOSE ²⁾	ONEOS TRMATH ONSWP ALL <numeric_value>			available
DIV		Divide	HP 8566B/ HP 8568B/ HP 8594E	available
DL	DL <numeric_value> DB DM DL DN DL UP DL ON DL OFF DL?	Display Line	HP 856xE/ HP 8566B/ HP 8568B/ HP 8594E	available
DLE	DLE ON OFF	Display Line enable	HP 856xE/ HP 8566B/ HP 8568B/ HP 8594E	available
DONE	DONE DONE?	Done query	HP 856xE/ HP 8566B/ HP 8568B/ HP 8594E	available
DW ²⁾	DW	Write to display and increment address		available
E1	E1	Peak Search	HP 8566A/ HP 8568A	available
E2	E2	Marker to Center Freq.	HP 8566A/ HP 8568A	available
E3	E3	Deltamarker Step Size	HP 8566A/ HP 8568A	available
E4	E4	Marker to Ref. Level	available	available
EDITDONE		limit line edit done	HP 856xE	available
EDITLIML		edit limit line	HP 856xE	available

Command	Supported subset	Function	Corresp. HP-Models	Status
ERR	ERR 250 cal level error ERR 300 LO unlock ERR 472 cal error digital filter ERR 473 cal error analog filter ERR 552 cal error log amp ERR 902 unscale tracking generator ERR 906 oven cold ERR 117 numeric unit error ERR 112 Unrecognized Command	Now some FSx errors are mapped to HP errors.	HP8568A HP856xE	not yet available
ERR?	ERR?	Error queue query	HP 856xE/ HP 8566B/ HP 8568B/ HP 8594E	not yet available
EX	EX	Exchange trace A and B	HP 8566A/ HP 8568A	available
FA	FA <numeric_value> HZ KHZ MHZ GHZ FA UP FA DN FA?	Start Frequency	HP 8566A/ HP 8568A/ HP 856xE/ HP 8566B/ HP 8568B/ HP 8594E	available
FB	FB <numeric_value> HZ KHZ MHZ GHZ FB UP FB DN FB?	Stop Frequency	HP 8566A/ HP 8568A/ HP 856xE/ HP 8566B/ HP 8568B/ HP 8594E	available
FDSP		Frequency display off	8560E 8561E 8562E 8563E 8564E 8565E	available
FOFFSET ¹⁾	FOFFSET <numeric_value> HZ KHZ MHZ GHZ FOFFSET?	Frequency Offset	HP 856xE/ HP 8566B/ HP 8568B/ HP 8594E	available

Command	Supported subset	Function	Corresp. HP-Models	Status
FREF	FREF INT EXT	Reference Frequency	HP 856xE/ HP 8566B/ HP 8568B/ HP 8594E	available
FS	FS	Full Span	HP 8566A/ HP 8568A	available
FUNCDEF		Define Function Function must be in one line between delimiters @	HP 8594E/ HP 856xE/ HP 8566B	available
GATE ¹⁾	GATE ON OFF GATE 1 0		HP 856xE/ HP 8566B/ HP 8568B/ HP 8594E	available
GATECTL ¹⁾	GATECTL EDGE LEVEL GATECTL?		HP 856xE/ HP 8566B/ HP 8568B/ HP 8594E	available
GD ¹⁾	GD <numeric_value> US MS SC GD DN GD UP GD?		HP 856xE/ HP 8566B/ HP 8568B/ HP 8594E	available
GL ¹⁾	GL <numeric_value> US MS SC GL DN GL UP GL?		HP 856xE/ HP 8566B/ HP 8568B/ HP 8594E	available
GP ¹⁾	GP POS NEG GP?		HP 856xE/ HP 8566B/ HP 8568B/ HP 8594E	available
GRAT ²⁾	GRAT ON OFF	Graticule	HP 856xE/ HP 8566B/ HP 8568B/ HP 8594E	available
I1	I1		HP 8566A/ HP 8568A	available
I2	I2		HP 8566A/ HP 8568A	available

Command	Supported subset	Function	Corresp. HP-Models	Status
ID	ID ID?	Identify	HP 8566A/ HP 8568A/ HP 856xE/ HP 8566B/ HP 8568B/ HP 8594E	available
INZ ¹⁾	INZ 75 INZ 50 INZ?	Input Impedance	HP 856xE/ HP 8566B/ HP 8568B/ HP 8594E	available
IP	IP	Instrument preset	HP 8566A/ HP 8568A	available
KEYDEF	KEYDEF	Key definition	HP 8566B/ HP 856xE/ HP 859xE	available
KEYEXEC	KEYEXEC	Key execute	HP 8566B	available
KS=	KS= <numeric_value> HZ KHZ MHZ GHZ KS= DN KS= UP KS=?	Marker Frequency Counter Resolution	HP 8566A/ HP 8568A	available
KS/	KS/	Manual Peaking	HP 8566A/ HP 8568A	available
KS(KS(Lock register	HP 8566A/ HP 8568A	available
KS)	KS)	Unlock register	HP 8566A/ HP 8568A	available
KS91	KS91	Read Amplitude Error	HP 8566A/ HP 8568A	available
KSA	KSA	Amplitude Units in dBm	HP 8566A/ HP 8568A	available
KSB	KSB	Amplitude Units in dBmV	HP 8566A/ HP 8568A	available
KSC	KSC	Amplitude Units in dBuV	HP 8566A/ HP 8568A	available
KSD	KSD	Amplitude Units in V	HP 8566A/ HP 8568A	available
KSE	KSE <numeric_value> <char data>@	Title mode	HP 8566A/ HP 8568A	available

Command	Supported subset	Function	Corresp. HP-Models	Status
KSG	KSG KSG ON KSG <numeric_value>	Video Averaging on	HP 8566A/ HP 8568A	available
KSH	KSH	Video Averaging Off	HP 8566A/ HP 8568A	available
KSK		Marker to Next Peak	HP 8566A/ HP 8568A	available
KSL		Marker Noise off	HP 8566A/ HP 8568A	available
KSM		Marker Noise on	HP 8566A/ HP 8568A	available
KSO	KSO	Deltamarker to span	HP 8566A/ HP 8568A	available
KSP	KSP <numeric_value>	HPIB address	HP 8566A/ HP 8568A	available
KSQ ²⁾	KSQ	Band lock off	HP 8566A/ HP 8568A	available
KST	KST	Fast Preset	HP 8566A/ HP 8568A	available
KSV	KSV <numeric_value> HZ KHZ MHZ GHZ KSV?	Frequency Offset	HP 8566A/ HP 8568A	available
KSW	KSW	Error Correction Routine	HP 8566A/ HP 8568A	available
KSX	KSX	Correction Values On	HP 8566A/ HP 8568A	available
KSY	KSY	Correction Values Off	HP 8566A/ HP 8568A	available
KSZ	KSZ <numeric_value> DB KSZ?	Reference Value Offset	HP 8566A/ HP 8568A	available
KSa	KSa	Normal Detection	HP 8566A/ HP 8568A	available
KSb	KSb	Pos Peak Detection	HP 8566A/ HP 8568A	available
KSd	KSd	Neg Peak Detection	HP 8566A/ HP 8568A	available

Command	Supported subset	Function	Corresp. HP-Models	Status
KSe	KSe	Sample Detection	HP 8566A/ HP 8568A	available
KSg		CRT beam off		available
KSh		CRT beam on		available
KSj	KSj	View Trace C	HP 8566A/ HP 8568A	available
KSk	KSk	Blank Trace C	HP 8566A/ HP 8568A	available
KSl	KSl	Transfer B to C	HP 8566A/ HP 8568A	available
KSm	KSm	Graticule off	HP 8566A/ HP 8568A	available
KSn ²⁾	KSn	Grid on	HP 8566A/ HP 8568A	available
KSo	KSn	Character display off	HP 8566A/ HP 8568A	available
KSp	KSp	Character display on	HP 8566A/ HP 8568A	available
KSr	KSr	Create service request	HP 8566A/ HP 8568A	available
KSt ²⁾	KSt	Band lock on	HP 8566A/ HP 8568A	available
KV ²⁾	KVv	Signal ident on	HP 8566A/ HP 8568A	available
L0	L0	Display line off	HP 8566A/ HP 8568A	available
LB	LB <numeric_value> <char data>@	Label	HP 8566A/ HP 8568A	available
LF	LF	Low frequency band pre- set	HP 8566A/ HP 8568A	available
LIMD		limit line delta	HP 856xE	available
LIMF		limit line frequency	HP 856xE	available
LIMIFAIL		limit fail query	HP 856xE	available
LIMIPURGE		purge limit line	HP 856xE	available
LIMIRCL		recall limit line	HP 856xE	available
LIMIREL		relative limit line	HP 856xE	available

Command	Supported subset	Function	Corresp. HP-Models	Status
LIMISAV		save limit line	HP 856xE	available
LIMITEST		limit line test	HP 856xE	available
LIML		lower limit line value	HP 856xE	available
LIMM		middle limit line value	HP 856xE	available
LIMTFL		flat limit line segment	HP 856xE	available
LIMTSL		slope limit line segment	HP 856xE	available
LIMU		upper limit line value	HP 856xE	available
LG	LG <numeric_value> DB DM LG?	Amplitude Scale Log	HP 856xE/ HP 8566B/ HP 8568B/ HP 8594E	available
LL ²⁾	LL	Plot command	HP 8566A/ HP 8568A	available
LN	LN	Amplitude Scale Lin	HP 856xE/ HP 8566B/ HP 8568B/ HP 8594E	available
M1	M1	Marker Off	HP 8566A/ HP 8568A	available
M2	M2 M2 <numeric_value> HZ KHZ MHZ GHZ M2 DN M2 UP M2?	Marker Normal	HP 8566A/ HP 8568A	available
M3	M3 M3 <numeric_value> HZ KHZ MHZ GHZ M3 DN M3 UP M3?	Delta Marker	HP 8566A/ HP 8568A	available
M4	M4 <numeric_value> HZ KHZ MHZ GHZ	Marker Zoom	HP 8566A/ HP 8568A	available
MA	MA	Marker Amplitude	HP 8566A/ HP 8568A	available
MC0	MC0	Marker Count off	HP 8566A/ HP 8568A	available

Command	Supported subset	Function	Corresp. HP-Models	Status
MC1	MC1	Marker Count on	HP 8566A/ HP 8568A	available
MDS	MDS	Measurement data size	HP 8566B	available
MEAS		Measurement status	HP 856xE	available
MF	MF MF?	Marker Frequency	HP 8566A/ HP 8568A/ HP 856xE/ HP 8566B/ HP 8568B/ HP 8594E	available
MINH ¹⁾	MINH TRC	Minimum Hold	HP 856xE/ HP 8566B/ HP 8568B/ HP 8594E	available
MKA	MKA <numeric_value> MKA?	Marker Amplitude	HP 856xE/ HP 8566B/ HP 8568B/ HP 8594E	available
MKACT	MKACT 1 MKACT?	Select the active marker	HP 856xE/ HP 8566B/ HP 8568B/ HP 8594E	not available
MKBW ¹⁾	MKBW <numeric_value> MKBW ON MKBW OFF	N dB Down	HP 856xE/ HP 8566B/ HP 8568B/ HP 8594E	available
MKD	MKD MKD <numeric_value> HZ KHZ MHZ GHZ MKD DN MKD UP MKD ON MKD OFF MKD?	Delta Marker	HP 856xE/ HP 8566B/ HP 8568B/ HP 8594E	available
MKDR	MKDR <numeric_value> HZ KHZ MHZ GHZ S SC MS MSEC USMKDR?	Delta Marker reverse	HP 856xE/ HP 8566B/ HP 8568B/ HP 8594E	available

Command	Supported subset	Function	Corresp. HP-Models	Status
MKDR?		Delta Marker reverse query		available
MKF	MKF <numeric_value> HZ KHZ MHZ GHZ MKF?	Set Marker Frequency	HP 856xE/ HP 8566B/ HP 8568B/ HP 8594E	available
MKFC	MKFC ON OFF	Frequency Counter on/off	HP 856xE/ HP 8566B/ HP 8568B/ HP 8594E	available
MKFCR ¹⁾	MKFCR <numeric_value> HZ KHZ MHZ GHZ MKFCR DN MKFCR UP MKFCR?	Frequency Counter Resolution	HP 856xE/ HP 8566B/ HP 8568B/ HP 8594E	available
MKMIN	MKMIN	Marker -> Min	HP 856xE/ HP 8566B/ HP 8568B/ HP 8594E	available
MKN	MKN MKN <numeric_value> HZ KHZ MHZ GHZ MKN DN MKN UP MKN ON MKN OFF MKN?	Normal Marker	HP 856xE/ HP 8566B/ HP 8568B/ HP 8594E	available
MKNOISE	MKNOISE ON OFF MKNOISE 1 0 MKNOISE?	Noise Measurement	HP 856xE/ HP 8566B/ HP 8568B/ HP 8594E	available
MKOFF	MKOFF MKOFF ALL	Marker off	HP 856xE/ HP 8566B/ HP 8568B/ HP 8594E	available
MKP	MKP <numeric_value> MKP?	Marker position	HP 856xE/ HP 8566B/ HP 8568B/ HP 8594E	available

Command	Supported subset	Function	Corresp. HP-Models	Status
MKPK	MKPK MKPK HI MKPK NH MKPK NR MKPK NL	Marker Search	HP 856xE/ HP 8566B/ HP 8568B/ HP 8594E	available
MKPT	MKPT MKPT HI MKPT NH MKPT NR MKPT NL	Marker Peak Threshold	HP 856xE/ HP 8566B/ HP 8568B/ HP 8594E	available
MKPX	MKPX <numeric_value> DB MKPX DN MKPX UP MKPX?	Peak Excursion	HP 856xE/ HP 8566B/ HP 8568B/ HP 8594E	available
MKRL	MKRL	Ref Level = Marker Level	HP 856xE/ HP 8566B/ HP 8568B/ HP 8594E	available
MKSP	MKSP	Deltamarker to span	HP 856xE/ HP 8566B/ HP 8568B/ HP 8594E	available
MKSS	MKSS	CF Stepsize = Marker Freq	HP 856xE/ HP 8566B/ HP 8568B/ HP 8594E	available
MKT	MKT <numeric_value> S MS US SC MKT?	MKF = fstart + MKT/ SWT*Span	HP 856xE/ HP 8594E	available
MKTRACE	MKTRACE TRA TRB TRC	Marker to Trace	HP 856xE/ HP 8566B/ HP 8568B/ HP 8594E	available
MKTRACK	MKTRACK ON OFF MKTRACK 1 0 MKTRACK?	Signal Track	HP 856xE/ HP 8566B/ HP 8568B/ HP 8594E	available

Command	Supported subset	Function	Corresp. HP-Models	Status
MKTYPE	MKTYPE AMP MK TYPE?	Marker type	HP 856xE/ HP 8566B/ HP 8568B/ HP 8594E	available
ML		Mixer level	HP 856xE	available
MOV	MOV TRA TRB TRC, TRA TRB T RC	Move Trace Contents	HP 856xE/ HP 8566B/ HP 8568B/ HP 8594E	available
MPY		Multiply	HP 8566B/ HP 8568B/ HP 8594E	available
MT0	MT0	Marker Track Off	HP 8566A/ HP 8568A	available
MT1	MT1	Marker Track On	HP 8566A/ HP 8568A	available
MXMH	MXMH TRA TRB	Maximum Hold	HP 856xE/ HP 8566B/ HP 8568B/ HP 8594E	available
NORMALIZE	NORMALIZE	Normalize trace	HP 856xE/ HP 8566B/ HP 8568B/ HP 8594E	not available available
NRL ¹⁾	NRL <numeric_value> DB DM NRL?	Normalized Reference Level	HP 856xE/ HP 8566B/ HP 8568B/ HP 8594E	available
NRPOS	NRPOS <numeric_value> NRL?	Normalize position	HP 856xE/ HP 8566B/ HP 8568B/ HP 8594E	available
O1	O1	Format ASCII, Values 0 to 4095	HP 8566A/ HP 8568A	available
O2	O2	Format Binary, Values 0 to 4095	HP 8566A/ HP 8568A	available
O3	O3	Format ASCII	HP 8566A/ HP 8568A	available

Command	Supported subset	Function	Corresp. HP-Models	Status
OA	OA	Output All	HP 8566A/ HP 8568A	available
OL	OL <80 characters> OL?	Output Learn String	HP 8566A/ HP 8568A	available
OT	OT	Output Trace Annotations	HP 8566A/ HP 8568A	available
PA	PA <numeric_value>, <numeric_value	Plot command	HP 8566A/ HP 8568A	available
PD	PD <numeric_value>, <numeric_value	Plot command	HP 8566A/ HP 8568A	available
PH_MKF		Spot frequency in Hz	HP 856xE	available
PH_FMIN		Min offset frequency to be measured	HP 856xE	available
PH_FMAX		Max offset frequency to be measured	HP 856xE	available
PH_MKA		Queries amplitude at the spot frequency	HP 856xE	available
PH_DRIFT		0: for stable signals, 1: for drifty	HP 856xE	available
PH_RLVL		Reference level for the log plot	HP 856xE	available
PH_SMTHV		Trace smoothing	HP 856xE	available
PH_VBR		Filtering	HP 856xE	available
PH_RMSPT		Amount of data points to skip when doing the integration	HP 856xE	available
PH_RMSFL		Lower integration frequency in Hz	HP 856xE	available
PH_RMSFU		Upper integration frequency in Hz	HP 856xE	available
PH_EXIT		Quits phase noise	HP 856xE	available
PH_F_UDT		Updates internal frequency variables	HP 856xE	available
PH_LMT_L		Apply limits to PH_FMIN and PH_FMAX	HP 856xE	available
PH_MEAS		Generates log frequency plot	HP 856xE	available
PH_MKF_D		Updates the spot frequency	HP 856xE	available

Command	Supported subset	Function	Corresp. HP-Models	Status
PH_RMS		Requests the rms phase noise	HP 856xE	available
PH_RMSFT		Updates internal frequency variables	HP 856xE	available
PH_RMSX		Calculates the rms phase noise	HP 856xE	available
PH_SPOTF		Executes the spot frequency measurement	HP 856xE	available
PLOTORG ²⁾	PLOTORG DSP GRT	Plot command	HP 856xE/ HP 8566B/ HP 8568B/ HP 8594E	available
PLOTSRC ²⁾	PLOTSRC ANNT GRT TRB TRA ALLDSP GRT	Plot command	HP 856xE/ HP 8566B/ HP 8568B/ HP 8594E	available
PP	PP	Preselector Peaking	HP 8566A/ HP 8568A	available
PRINT ¹⁾	PRINT PRINT 1 0	Hardcopy	HP 856xE/ HP 8566B/ HP 8568B/ HP 8594E	available
PSDAC ²⁾	PSDAC <numeric_value> PSDAC UP DN	Preselector DAC value	HP 856xE/ HP 8566B/ HP 8568B/ HP 8594E	available
PSTATE ²⁾	PSTATE ON OFF 1 0	Protect State	HP 856xE/ HP 8566B/ HP 8568B/ HP 8594E	available
PU	PU	Pen Up	HP 8566A/ HP 8568A	available
PWRBW	PWRBW	Power Bandwidth	HP 8566B/ HP 859x/ HP 856xE	available
R1	R1	Set Status Bit Enable	HP 8566A/ HP 8568A	available
R2	R2	Set Status Bit Enable	HP 8566A/ HP 8568A	available

Command	Supported subset	Function	Corresp. HP-Models	Status
R3	R3	Set Status Bit Enable	HP 8566A/ HP 8568A	available
R4	R4	Set Status Bit Enable	HP 8566A/ HP 8568A	available
RB	RB <numeric_value> HZ KHZ MHZ GHZ RB DN RB UP RB AUTO RB?	Resolution Bandwidth	HP 856xE/ HP 8566B/ HP 8568B/ HP 8594E	available
RBR	RBR <numeric_value> RBR DN RBR UP RBR?	Resolution Bandwidth Ratio	HP 856xE/ HP 8566B/ HP 8568B/ HP 8594E	available
RC1...6	RC1...6	Recall Last State	HP 8566A/ HP 8568A	available
RCLS	RCLS <numeric_value>	Recall State Register	HP 856xE/ HP 8566B/ HP 8568B/ HP 8594E	available
RCLT	RCLT TRA TRB, <number>	Recall Trace	HP856xE/ HP8594E	available
RESET	RESET	Instrument preset	HP 856xE/ HP 8566B/ HP 8568B/ HP 8594E	available
REV	REV REV?	Firmware revision	HP 856xE/ HP 8566B/ HP 8568B/ HP 8594E	available
RL	RL <numeric_value> DB DM RL DN RL UP RL?	Reference Level	HP 856xE/ HP 8566B/ HP 8568B/ HP 8594E	available
RLCAL	RLCAL <numeric_value> RL?	Reference Level Calibration	HP 856xE/ HP 8566B/ HP 8568B/ HP 8594E	available

Command	Supported subset	Function	Corresp. HP-Models	Status
RCLOSCAL	RCLOSCAL	Recall Open/Short Average	HP 856xE/ HP 8594E	not available
RCLTHRU	RCLTHRU	Recall Thru	HP 856xE/ HP 8594E	not available
RLPOS ¹⁾	RLPOS <numeric_value> RLPOS DN RLPOS UP RLPOS?	Reference Level Position	HP 856xE/ HP 8566B/ HP 8568B/ HP 8594E	available
ROFFSET	ROFFSET <numeric_value> DB DM ROFFSET?	Reference Level Offset	HP 856xE/ HP 8566B/ HP 8568B/ HP 8594E	available
RQS	RQS	Service Request Bit mask	HP 856xE/ HP 8566B/ HP 8568B/ HP 8594E	available
S1	S1	Continuous Sweep	HP 8566A/ HP 8568A	available
S2	S2	Single Sweep	HP 8566A/ HP 8568A	available
SADD		add a limit line segment	HP 856xE	available
SAVES	SAVES <numeric_value>	Save State Register	HP 856xE/ HP 8566B/ HP 8568B/ HP 8594E	available
SAVET	SAVET TRA TRB,<number>	Save Trace	HP856xE/ HP8594E	available
SDEL		delete limit line segment	HP 856xE	available
SDON		limit line segment done	HP 856xE	available
SEDI		edit limit line segment	HP 856xE	available
SMOOTH	SMOOTH TRA TRB TRC, <number of points>	Smooth Trace	HP 856xE/ HP 8566B/ HP 8568B/ HP 8594E	available
SNGLS	SNGLS	Single Sweep	HP 856xE/ HP 8566B/ HP 8568B/ HP 8594E	available

Command	Supported subset	Function	Corresp. HP-Models	Status
SQUELCH ²⁾	SQUELCH <numeric_value> DM DB SQUELCH UP DN SQUELCH ON OFF	Squelch	HP 856xE/ HP 8566B/ HP 8568B/ HP 8594E	available
SP	SP <numeric_value> HZ KHZ MHZ GHZ SP DN SP UP SP?	Span	HP 8566A/ HP 8568A/ HP 856xE/ HP 8566B/ HP 8568B/ HP 8594E	available
SRCNORM ¹⁾	SRCNORM ON OFF SRCNORM 1 0	Source Normalization	HP 856xE/ HP 8566B/ HP 8568B/ HP 8594E	not available
SRCPOFS ¹⁾	SRCPOFS <numeric_value> DB DM SRCPOFS DN SRCPOFS UP SRCPOFS?	Source Power Offset	HP 856xE/ HP 8566B/ HP 8568B/ HP 8594E	not available
SRCPWR ¹⁾	SRCPWR <numeric_value> DB DM SRCPWR DN SRCPWR UP SRCPWR ON SRCPWR OFF SRCPWR?	Source Power	HP 856xE/ HP 8566B/ HP 8568B/ HP 8594E	not available
SS	SS <numeric_value> HZ KHZ MHZ GHZ SS DN SS UP SS AUTO SS?	CF Step Size	HP 8566A/ HP 8568A/ HP 856xE/ HP 8566B/ HP 8568B/ HP 8594E	available
ST	ST <numeric_value> US MS SC ST DN ST UP ST AUTO ST?	Sweep Time	HP 8566A/ HP 8568A/ HP 856xE/ HP 8566B/ HP 8568B/ HP 8594E	available

Command	Supported subset	Function	Corresp. HP-Models	Status
STB	STB	Status byte query	HP 856xE/ HP 8566B/ HP 8568B/ HP 8594E	available
STOREOPEN	STOREOPEN	Store Open	HP 856xE/ HP 8594E	not available
STORESHORT	STORESHORT	Store Short	HP 856xE/ HP 8594E	not available
STORETHRU	STORETHRU	Store Thru	HP 856xE/ HP 8594E	not available
SUB		Subtract	HP 8566B/ HP 8568B/ HP 8594E	available
SUM		sum of trace amplitudes	HP 8566B/ HP 8568B/ HP 8594E	available
SV1...6	SV1...6	Save State	HP 8566A/ HP 8568A	available
SWPCPL ²⁾	SWPCPL SA SR SWPCPL?	Sweep Couple	HP 856xE/ HP 8566B/ HP 8568B/ HP 8594E	available
SWPOUT ²⁾	SWPOUT FAV FAVA RAMP SWPOUT?	Sweep Output	HP 856xE/ HP 8566B/ HP 8568B/ HP 8594E	available
T0	T0	Threshold off	HP 8566A/ HP 8568A	available
T1	T1	Free Run Trigger	HP 8566A/ HP 8568A	available
T2 ²⁾	T2	Line Trigger	HP 8566A/ HP 8568A	available
T3	T3	External Trigger	HP 8566A/ HP 8568A	available
T4	T4	Video Trigger	HP 8566A/ HP 8568A	available
TA	TA	Transfer A	HP 8566A/ HP 8568A	available

Command	Supported subset	Function	Corresp. HP-Models	Status
TACL	TACL?	Returns instantaneous measurement results. See TRACe<trace #>:IMMediate:LEVel? for full description.		not available
TBCL	TBCL?			
TCCL	TCCL?			
TACR	TACR?	Returns instantaneous measurement results. See TRACe<trace #>:IMMediate:LEVel? for full description.		not available
TBCR	TBCR?			
TCCR	TCCR?			
TB	TB	Transfer B	HP 8566A/ HP 8568A	available
TDF	TDF P TDF M TDF B TDF A TDF I	Trace Data Format	HP 856xE/ HP 8566B/ HP 8568B/ HP 8594E	available
TH	TH <numeric_value> DB DM TH DN TH UP TH ON TH OFF TH AUTO TH?	Threshold	HP 856xE/ HP 8566B/ HP 8568B/ HP 8594E	available
THE	THE ON OFF	Threshold Line enable	HP 856xE/ HP 8566B/ HP 8568B/ HP 8594E	available
TIMEDSP ¹⁾	TIMEDSP ON OFF TIMEDSP 1 0 TIMEDSP?	Time Display	HP 856xE/ HP 8566B/ HP 8568B/ HP 8594E	available
TM	TM FREE VID EXT LINE ²⁾ TM?	Trigger Mode	HP 856xE/ HP 8566B/ HP 8568B/ HP 8594E	available
TM LINE ²⁾	TM LINE	Trigger Line	HP 8566B	available

Command	Supported subset	Function	Corresp. HP-Models	Status
TRA	TRA B TRA A TRA I	Transfer A	HP 856xE/ HP 8566B/ HP 8568B/ HP 8594E	available
TRB	TRB B TRB A TRB I	Transfer B	HP 856xE/ HP 8566B/ HP 8568B/ HP 8594E	available
TRSTAT	TRSTAT?	Trace State Query	HP 856xE/ HP 8566B/ HP 8568B/ HP 8594E	available
TS	TS	Take Sweep	HP 856xE/ HP 8566B/ HP 8568B/ HP 8594E	available
UR ²⁾	UR	Plot Command	HP 8566A/ HP 8568A	available
VARDEF	VARDEF	Variable definition, arrays are not supported	HP 8566B/ HP 8568B/ HP 8594E	available
VAVG	VAVG VAVG TRA TRB TRC	Video Averaging	HP 856xE/ HP 8566B/ HP 8568B/ HP 8594E	available
VB	VB <numeric_value> HZ KHZ MHZ GHZ VB DN VB UP VB AUTO VB?	Video Bandwidth	HP 856xE/ HP 8566B/ HP 8568B/ HP 8594E	available
VBR ¹⁾	VBR <numeric_value> VBR DN VBR UP VBR?	Video Bandwidth Ratio	HP 856xE/ HP 8566B/ HP 8568B/ HP 8594E	available
VIEW	VIEW TRA TRB TRC		HP 856xE/ HP 8566B/ HP 8568B/ HP 8594E	available

Command	Supported subset	Function	Corresp. HP-Models	Status
VTL	VTL <numeric_value> DB DM VTL DN VTL UP VTL?	Video Trigger Level	HP 856xE/ HP 8594E	not available
1) HP 8594E only				
2) Command is accepted without error message, but is ignored				

6.3.5.3 Special Features of the Syntax Parsing Algorithms for 8566A and 8568A Models

The command syntax is very different for models A and B. Different names are assigned to identical instrument functions, and the command structure likewise differs considerably between models A and models B.

The command structure for models A is as follows:

```
<command> ::= <command
code> [<SPC>] [<data>|<step>] [<SPC>] [<delimiter>] [<command
code>]...<delimiter>
```

```
<data> ::= <Value> [<SPC>] [<units
code>] [<SPC>] [<delimiter>] [<SPC>] [<data>]...
```

```
<step> ::= UP|DN
```

where

<command code> = see Table "Supported Commands"

<Value> = integer or floating-point numerical value

<units code> = DM | -DM | DB | HZ | KZ | MZ | GZ | MV | UV | SC | MS | US

<delimiter> = <CR> | <LF> | <, > | <; > | <ETX>

<SPC> = 32₁₀

<ETX> = 3₁₀

Command sections given in [] are optional.

The R&S FSVA/FSV GPIB hardware differs from that used in the HP analyzers. Therefore, the following constraint exists:

<LF> | <EOI> are still used as delimiters since the GPIB hardware is able to identify them. The other delimiters are identified and evaluated during syntax analysis.

6.3.5.4 Special Behavior of Commands

Command	Known Differences
ABORT	Does not automatically set the command complete bit (bit 4) in the status byte. An additional DONE is required for that purpose.
ANNOT	Only frequency axis annotation is affected.
AT	AT DN/UP: Step size
CAL	The CAL commands do not automatically set the command complete bit (bit 4) in the status byte. An additional DONE command is required for that purpose.
CF	Default value, range, step size
CR	Default ratio Span/RBW
CT	Formula for coupled sweep time
CV	Default ratio RBW/VBW
DEMOD	requires option R&S FSV-B3
DET	DET? returns SAMP instead of SMP on the R&S FSVA/FSV. DET not automatically set the command complete bit (bit 4) in the status byte. An additional DONE is required for that purpose.
ERR?	Deletes the error bit in the status register but always returns a '0' in response.
FA	Default value, range, step size
FB	Default value, range, step size
ID	Query of instrument type. The instrument type entered with "SETUP > General Setup > GPIB > ID String User" is returned.
M2	Default value, range, step size
M3	Default value, range, step size
MKACT	Only marker 1 is supported as the active marker.
MKBW	Default value
MKPT	Step size
MKPX	Step size
OL?	Storage of instrument settings: 80 characters are returned as information on the instrument settings. The contents of the 80 characters returned does not correspond to the original data contents of the 8566A/8568A family.
OL	Readout of instrument settings: The 80 characters read by means of OL? are accepted as information on the corresponding instrument settings. The contents of the 80 characters read does not correspond to the original data contents of the 8566A/8568A family.
RB	Default value, range, step size
RL	Default value, step size

Command	Known Differences
RLPOS	Adapts the position of the reference level even if the tracking generator normalization is not active.
RQS	Supported bits: 1 (Units key pressed) 2 (End of Sweep) 3 (Device error) 4 (Command complete) 5 (Illegal command)

SRCNORM	Requires option R&S FSV-B9 or R&S FSV-B10
SRCPWR	Requires option R&S FSV-B9 or R&S FSV-B10
SP	Default value, range, step size
SS	Default value, range, step size
ST	Default value, range, step size
STB	The status bits are mapped as described with command RQS. Note: Bit 2 and 4 are always set in parallel if "Command Complete" or "End of Sweep" are recognized. The R&S FSVA/FSV cannot distinguish between these conditions. Additionally these bits are not suitable for synchronization on the end of sweep in continuous sweep operation.
TA	Output of 1001 trace points of trace A in O1 or O3 format.
TB	Output of 1001 trace points of trace B in O1 or O3 format.
TH	Default value
VB	Range
VBR	Default value

6.3.5.5 Model-Dependent Default Settings

If the GPIB language is switched over to an 85xx model, the GPIB address is automatically switched over to 18 provided that the default address of the R&S FSVA/FSV (20) is still set. If a different value is set, this value is maintained. Upon return to SCPI, this address remains unchanged.

The following table shows the default settings obtained after a change of the GPIB language and for the commands IP, KST and RESET:

Model	# of Trace Points	Start Freq.	Stop Freq.	Ref Level	Input Coupling
8566A/B	1001	2 GHz	22 GHz	0 dBm	AC
8568A/B	1001	0 Hz	1.5 GHz	0 dBm	AC
8560E	601	0 Hz	2.9 GHz	0 dBm	AC
8561E	601	0 Hz	6.5 GHz	0 dBm	AC

Model	# of Trace Points	Start Freq.	Stop Freq.	Ref Level	Input Coupling
8562E	601	0 Hz	13.2 GHz	0 dBm	AC
8563E	601	0 Hz	26.5 GHz	0 dBm	AC
8564E	601	0 Hz	40 GHz	0 dBm	AC
8565E	601	0 Hz	50 GHz	0 dBm	AC
8594E	401	0 Hz	3 GHz	0 dBm	AC



Stop frequency

The stop frequency given in the table may be limited to the corresponding frequency range of the R&S FSVA/FSV.

Command LF sets the stop frequency for 8566A/B to a maximum value of 2 GHz.

Test points (trace points)

The number of trace points is switched over only upon transition to the REMOTE state.

6.3.5.6 Data Output Formats

In the case of the SCPI and IEEE488.2 standards, the output formats for numerical data are flexible to a large extent. The output format for the HP units, by contrast, is accurately defined with respect to the number of digits. The memory areas for reading instrument data have therefore been adapted accordingly in the remote-control programs for instruments of this series.

Therefore, in response to a query, the R&S FSVA/FSV returns data of the same structure as that used by the original instruments; this applies in particular to the number of characters returned.

Two formats are currently supported when trace data is output: Display Units (command O1) and physical values (command O2, O3 or TDF P). As to the "Display Units" format, the level data of the R&S FSVA/FSV is converted to match the value range and the resolution of the 8566/8568 series. Upon transition to the **REMOTE** state, the R&S FSVA/FSV is reconfigured such that the number of test points (trace points) corresponds to that of the 85xx families (1001 for 8566A/B and 8568A/B, 601 for 8560E to 8565E, 401 for 8594E).

6.3.5.7 Trace Data Output Formats

All formats are supported for trace data output: display units (command O1), display units in two byte binary data (command O2 or TDF B and MDS W), display units in one byte binary data (command O4 or TDF B and MDS B) and physical values (commands O3 or TDF P). With format "display units" the level data is converted into value range and resolution of the 8566/8568 models. On transition to REMOTE state the number of trace points are reconfigured in order to be conform to the selected instrument model (1001 for 8566A/B and 8568 A/B, 601 for 8560E to 8565E, 401 for 8594E).

6.3.5.8 Trace Data Input Formats

Trace data input is only supported for binary date (TDF B, TDF A, TDF I, MDS W, MDS B).

6.3.5.9 GPIB Status Reporting

The assignment of status bits by commands R1, R2, R3, R4, RQS is supported.

The STB command and the serial poll respond with an 8-bit value with the following assignment:

Bit enabled by RQS	Description
0	not used (value 0)
1	Units key pressed
2	End of Sweep
3	Device Error
4	Command Complete
5	Illegal Command
6	Service Request
7	not used (value 0)

Bits 0 and 7 are not used and always have the value 0.

Please note that the R&S FSVA/FSV reports any key pressed on the front panel rather than only the unit keys if bit 1 was enabled.

Another difference is the behavior of bit 6 when using the STB? query. On the HP analyzers this bit monitors the state of the SRQ line on the bus. On the R&S FSVA/FSV this is not possible. Therefore this bit is set, as soon as one of the bits 1 to 5 is set. It won't be reset by performing a serial poll.

6.3.6 Reference: Command Set of Emulated PSA Models

The R&S FSVA/FSV analyzer family supports a subset of the GPIB commands of PSA89600 and ESA instruments.

Despite the differences in system architecture and device features, the supported commands have been implemented in a way to ensure a sufficiently high degree of correspondence with the original.

In many cases the selection of commands supported by the R&S FSVA/FSV is sufficient to run an existing GPIB program without adaptation.

Supported 89600 commands
*CAL?
*CLS
*ESE
*ESR?
*IDN?
*IST?
*OPC
*OPT?
*PCB
*PRE
*PSC
*RST
*SRE
*STB?
*TRG
*TST?
*WAI
:CALibration:AUTO OFF ON ALERT
:CALibration:TCORrections AUTO ON OFF
:CONFigure:WAVeform
:DIAGnostic:EABY ON OFF
:DIAGnostic:LATCh:VALue <numeric>
:DIAGnostic:LATCh:SElect <string>
:DISPlay:ANNotation:TITLe:DATA <string>
:DISPlay:ENABle OFF ON
:DISPlay:WINDow:TRACe:Y:[SCALe]:PDIVision <numeric>
:DISPlay:WINDow:TRACe:Y:[SCALe]:RLEVel <numeric>
:DISPlay:WINDow:TRACe:Y:[SCALe]:RLEVel:OFFSet <numeric>
:FORMat:BORDer NORMAl SWAPped
:FORMat[:DATA] ASCIi REAL UINT MATLAB,<numeric>
:INITiate:CONTInuous OFF ON
:INITiate[:IMMediate]
:INSTrument:CATalog?

Supported 89600 commands
:INSTrument:NSElect <numeric>
:MMEMory:CATalog? <dir_name>
:MMEMory:COpy <'file_name1'>,<'file_name2'>
:MMEMory:DATA <'file_name'>,<definite_length_block>
:MMEMory:DELeTe <'file_name'>
:MMEMory:LOAD:STATe 1,<'file_name'>
:MMEMory:LOAD:TRACe 1,<'file_name'>
:MMEMory:MDIRectory <'dir_name'>
:MMEMory:MOVE <'file_name1'>,<'file_name2'>
:MMEMory:STORE:STATe 1,<'file_name'>
:MMEMory:STORE:TRACe <numeric>,<'file_name'>
:READ:WAVform?
[:SENSe]:FREQuency:CENTer <numeric>
[:SENSe]:FREQuency:STARt <numeric>
[:SENSe]:FREQuency:STOP <numeric>
[:SENSe]:FREQuency:SPAN <numeric>
[:SENSe]:POWer:ATTenuation <numeric>
[:SENSe]:ROSCillator:EXTernal:FREQuency <numeric>
[:SENSe]:ROSCillator:OUTPut OFF ON
[:SENSe]:ROSCillator:SOURce INTernal EXTernal EAUTO
[:SENSe]:SPECtrum:TRIGger:SOURce EXTernal<1 2> IF IMMEDIATE
[:SENSe]:WAVeform:ADC:RANGE P6
[:SENSe]:WAVeform:APER?
[:SENSe]:WAVeform:AVERage:TACount <numeric>
[:SENSe]:WAVeform:BWIDth:ACTive?
[:SENSe]:WAVeform:BWIDth:TYPE FLAT GAUSSian
[:SENSe]:WAVeform:IFGain <numeric>
[:SENSe]:WAVeform:IFPath NARRow WIDE
[:SENSe]:WAVeform:NCPTTrace ON OFF
[:SENSe]:WAVeform:PDIT ON OFF
[:SENSe]:WAVeform:SRATe <numeric>
[:SENSe]:WAVeform:SWEep:TIME <numeric>
[:SENSe]:WAVeform:TRIGger:EOFFset?

Supported 89600 commands
[:SENSe]:WAVeform:TRIGger:INTerpolation ON OFF
[:SENSe]:WAVeform:TRIGger:SOURce EXTernal<1 2> IF IMMediate
:STATus:QUEStionable:CONDition?
:STATus:QUEStionable:ENABle <number>
:STATus:QUEStionable:NTRansition <number>
:STATus:QUEStionable:PTRansition <number>
:STATus:QUEStionable[:EVENT]?
:STATus:QUEStionable:CALibration:CONDition?
:STATus:QUEStionable:CALibration:ENABle <number>
:STATus:QUEStionable:CALibration:NTRansition <number>
:STATus:QUEStionable:CALibration:PTRansition <number>
:STATus:QUEStionable:CALibration[:EVENT]?
:STATus:QUEStionable:FREQuency:CONDition?
:STATus:QUEStionable:FREQuency:ENABle <number>
:STATus:QUEStionable:FREQuency:NTRansition <number>
:STATus:QUEStionable:FREQuency:PTRansition <number>
:STATus:QUEStionable:FREQuency[:EVENT]?
:STATus:QUEStionable:INTegrity:CONDition?
:STATus:QUEStionable:INTegrity:ENABle <number>
:STATus:QUEStionable:INTegrity:NTRansition <number>
:STATus:QUEStionable:INTegrity:PTRansition <number>
:STATus:QUEStionable:INTegrity[:EVENT]?
:STATus:OPERation:CONDition?
:STATus:OPERation:ENABle <integer>
:STATus:OPERation:NTRansition <integer>
:STATus:OPERation:PTRansition <integer>
:STATus:OPERation[:EVENT]?
:SYSTem:COMMunicate:GPIB[:SELF]:ADDRess <integer>
:SYSTem:DATE <year>,<month>,<day>
:SYSTem:ERRor[:NEXT]?
:SYSTem:KLOCK?
:SYSTem:MESSage <string>
:SYSTem:PRESet

Supported 89600 commands
:SYSTem:TIME <hour>,<minute>,<second>
:SYSTem:VERSion?
:TRACe:COPIY <src_trace>,<dest_trace>
:TRACe[:DATA] TRACE1 TRACE2 TRACE3 TRACE4 TRACE5 TRACE6, <definite_length_block> <comma_separated_ASCII_data>
:TRACe:MODE WRITe MAXHold MINHold VIEW BLANK
:TRIGger[:SEQuence]:DELay <numeric>
:TRIGger[:SEQuence]:DELay:STATe OFF ON 0 1
:TRIGger[:SEQuence]:EXTerMal:DELay <numeric>
:TRIGger[:SEQuence]:EXTerMal:LEVel <numeric>
:TRIGger[:SEQuence]:EXTerMal:SLOPe POSitive NEGative
:TRIGger[:SEQuence]:HOLDoff <numeric>
:TRIGger[:SEQuence]:IF:DELay <numeric>
:TRIGger[:SEQuence]:IF:LEVel <numeric>
:TRIGger[:SEQuence]:IF:SLOPe POSitive NEGative
:TRIGger[:SEQuence]:SLOPe POSitive NEGative
:TRIGger[:SEQuence]:SOURce IMMEDIATE VIDeo EXTerMal<1 2>
:TRIGger[:SEQuence]:VIDeo:LEVel <numeric>
:TRIGger[:SEQuence]:VIDeo:LEVel:FREQuency <freq>

6.4 Remote Control – Programming Examples

In this chapter, more complex programming examples are given. In [Chapter 6.2.3, "Brief Introduction to Remote Control"](#), on page 575, basic steps in remote control programming are provided.

The following programming examples have a hierarchical structure, i.e. subsequent examples are based on previous ones. It is thus possible to compile an operational program from the modules of the given examples very easily. VISUAL BASIC has been used as programming language. However, the programs can be translated into other languages.



In programming languages as C, C++ or programs as MATLAB, NI Interactive Control, a backslash starts an escape sequence (e.g. "\n" is used to start a new line). In these programming languages and programs, two backslashes instead of one must be used in remote commands (for an example refer to [Chapter 6.2.3.1, "Basic Steps in Remote Control Programming"](#), on page 575.)

6.4.1	Service Request.....	1013
6.4.1.1	Initiate Service Request.....	1013
6.4.1.2	Waiting for the Arrival of a Service Request.....	1015
6.4.1.3	Waiting Without Blocking the Keyboard and Mouse.....	1016
6.4.1.4	Service Request Routine.....	1017
6.4.1.5	Reading Out the Output Buffer.....	1018
6.4.1.6	Reading Error Messages.....	1018
6.4.1.7	Evaluation of SCPI Status Registers.....	1019
6.4.1.8	Evaluation of Event Status Register.....	1020
6.4.2	Using Marker and Delta Marker.....	1021
6.4.2.1	Shape Factor Measurement (using n dB down).....	1021
6.4.2.2	Measuring the Third Order Intercept Point.....	1022
6.4.2.3	Measuring the AM Modulation Depth.....	1023
6.4.3	Limit Lines and Limit Test.....	1023
6.4.4	Measuring the Channel and Adjacent Channel Power.....	1025
6.4.5	Occupied Bandwidth Measurement.....	1028
6.4.6	Time Domain Power Measurement.....	1029
6.4.7	Fast Power Measurement on Power Ramps.....	1030
6.4.7.1	Power Measurement with Multi-Summary Marker.....	1030
6.4.7.2	Multi-Burst Power Measurement.....	1032
6.4.8	Fast Level Measurement Using Frequency Lists.....	1033
6.4.9	Level Correction of Transducers.....	1035
6.4.10	Measuring the Magnitude and Phase of a Signal.....	1036
6.4.11	Reading and Writing Files.....	1038
6.4.11.1	Reading a File from the Instrument.....	1038
6.4.11.2	Creating a File on the Instrument.....	1039
6.4.12	Spectrum Emission Mask Measurement.....	1039
6.4.12.1	Using Predefined Standard Wibro.....	1040
6.4.12.2	Defining 5 Ranges with all Parameters.....	1040
6.4.13	Spurious Emissions Measurement.....	1043
6.4.14	Averaging I/Q Data.....	1046
6.4.15	Using IQ Gating.....	1047
6.4.16	Usage of Four Spectrum Instances.....	1052

6.4.1 Service Request

The service request routine requires an extended initialization of the instrument in which the relevant bits of the transition and enable registers are set. In addition the service request event must be enabled in the VISA session.

6.4.1.1 Initiate Service Request

```

REM ---- Example of initialization of the SRQ in the case
' of errors -----
PUBLIC SUB SetupSRQ()
CALL InstrWrite (analyzer, "*CLS") 'Reset status reporting system
CALL InstrWrite (analyzer, "*SRE 168") 'Enable service request for
' STAT:OPER, STAT:QUES and ESR
' register
CALL InstrWrite (analyzer, "*ESE 60") 'Set event enable bit for
' command, execution, device-
' dependent and query error
CALL InstrWrite (analyzer, "STAT:OPER:ENAB 32767")
' Set OPERATION enable bit for
' all events
CALL InstrWrite (analyzer, "STAT:OPER:PTR 32767")
' Set appropriate OPERATION
' Ptransition bits
CALL InstrWrite (analyzer, "STAT:QUES:ENAB 32767")
' Set questionable enable bits
' for all events
CALL InstrWrite (analyzer, "STAT:QUES:PTR 32767")
' Set appropriate questionable
' Ptransition bits
CALL viEnableEvent(analyzer, VI_EVENT_SERVICE_REQ, VI_QUEUE, 0)
' Enable the event for service
' request
Status = viWaitOnEvent(analyzer, VI_EVENT_SERVICE_REQ, SRQWaitTimeout, VI_NULL,
VI_NULL)
IF (status = VI_SUCCESS) THEN CALL Srq
' If SRQ is recognized =>
' subroutine for evaluation
END SUB
REM *****

Private mbSession As MessageBasedSession

Sub Main()
    Console.WriteLine("Example of initialization _
                        of the SRQ in the case of errors.")
    Dim SRQWaitTimeout = 4000 ' Timeout As Integer for WaitOnEvent
    ' Opening session
    Try
        ' Analyzer is alias, instead of using resource string.

```

```

        'For example on TCP use TCPIP0::192.168.1.2::inst0::INSTR
mbSession = CType(ResourceManager.GetLocalManager().Open("Analyzer"), _
                    MessageBasedSession)
mbSession.TerminationCharacterEnabled = True
Try
    mbSession.Write("*CLS") 'Reset status reporting system
    mbSession.Write("*SRE 168") 'Enable service request for
    'STAT:OPER, STAT:QUES and ESR register
    mbSession.Write("*ESE 60") 'Set event enable bit for
    'command, execution, device-dependent and query error
    mbSession.Write("STAT:OPER:ENAB 32767")
    'Set OPERation enable bit for all events
    mbSession.Write("STAT:OPER:PTR 32767")
    'Set appropriate OPERation Ptransition bits
    mbSession.Write("STAT:QUES:ENAB 32767")
    'Set questionable enable bits for all events
    mbSession.Write("STAT:QUES:PTR 32767")
    'Set appropriate questionable Ptransition bits
    Console.WriteLine("Wait on event - Blocking")
    mbSession.EnableEvent(MessageBasedSessionEventType.ServiceRequest, _
                          EventMechanism.Queue)
    'Enable the event for service request

    '-----
    ' Your command plase use here
    ' mbSession.Write("Your command")
    '-----

    Dim Status = mbSession.WaitOnEvent( _
        MessageBasedSessionEventType.ServiceRequest, SRQWaitTimeout)
    If (Status.EventType() = _
        MessageBasedSessionEventType.ServiceRequest) Then
        Console.WriteLine("SRQ is recognized")
        'If SRQ is recognized => subroutine for evaluation
        Srq()
    End If
Catch exp As Exception
    Console.WriteLine(exp.Message)
End Try
Catch exp As InvalidCastException
    Console.WriteLine("Resource selected must be a message-based session")
Catch exp As Exception
    Console.WriteLine(exp.Message)
End Try

' Close session
mbSession.Dispose()
' Wait for end
Console.WriteLine("Press any key to end")

```

```

        Console.ReadKey()
    End Sub

```

6.4.1.2 Waiting for the Arrival of a Service Request

There are basically two methods of waiting for the arrival of a service request:

Blocking (user inputs not possible):

This method is appropriate if the waiting time until the event to be signaled by an SRQ is short (shorter than the selected timeout), if no response to user inputs is required during the waiting time, and if – as the main criterion – the event is absolutely certain to occur.

Reason:

From the time the `viWaitOnEvent()` function is called until the occurrence of the expected event, it does not allow the program to respond to mouse clicks or key entries during the waiting time. Moreover, it returns an error if the SRQ event does not occur within the predefined timeout period.

The method is, therefore, in many cases not suitable for waiting for measurement results, especially when using triggered measurements.

The following function calls are required:

```

Status = viWaitOnEvent(analyzer, VI_EVENT_SERVICE_REQ, SRQWaitTimeout, VI_NULL,
    VI_NULL)
'Wait for service request user
'inputs are not possible during
'the waiting time!
IF (status = VI_SUCCESS) THEN CALL Srq
'If SRQ is recognized =>
'subroutine for evaluation

'----- Sweep in first Spectrum Tab and query marker -----
Dim Status = mbSession.WaitOnEvent( _
    MessageBasedSessionEventType.ServiceRequest, SRQWaitTimeout)
'Wait for service request user inputs are not possible
'during the waiting time!
If (Status.EventType() = MessageBasedSessionEventType.ServiceRequest) Then
'If SRQ is recognized => subroutine for evaluation
    Srq()
End If

```

Non-blocking (user inputs possible):

This method is recommended if the waiting time until the event to be signaled by an SRQ is long (longer than the selected timeout), and user inputs should be possible during the waiting time, or if the event is not certain to occur. This method is, therefore, the preferable choice for waiting for the end of measurements, i.e. the output of results, especially in the case of triggered measurements.

The method necessitates a waiting loop that checks the status of the SRQ line at regular intervals and returns control to the operating system during the time the expected event has not yet occurred. In this way, the system can respond to user inputs (mouse clicks, key entries) during the waiting time.

It is advisable to employ the Hold() auxiliary function, which returns control to the operating system for a selectable waiting time (see section [Waiting Without Blocking the Keyboard and Mouse](#)), so enabling user inputs during the waiting time.

```

result% = 0
For i = 1 To 10 'Abort after max. 10 loop
'iterations
Status = viWaitOnEvent(analyzer, VI_EVENT_SERVICE_REQ, VI_TMO_IMMEDIATE, VI_NULL,
VI_NULL)
'Check event queue
If (status = VI_SUCCESS) Then
result% = 1
CALL Srq 'If SRQ is recognized =>
'subroutine for evaluation
Else
CALL Hold(20) 'Call hold function with
'20 ms 'waiting time. User inputs
'are possible.
Endif
Next i
If result% = 0 Then
Debug.Print "Timeout Error; Program aborted" 'Output error message
STOP 'Stop software
Endif

```

6.4.1.3 Waiting Without Blocking the Keyboard and Mouse

A frequent problem with remote control programs using Visual Basic is to insert waiting times without blocking the keyboard and the mouse.

If the program is to respond to user inputs also during a waiting time, control over the program events during this time must be returned to the operating system. In Visual Basic, this is done by calling the `DoEvents` function. This function causes keyboard-or mouse-triggered events to be executed by the associated elements. For example, it allows the operation of buttons and input fields while the user waits for an instrument setting to be completed.

The following programming example describes the `Hold()` function, which returns control to the operating system for the period of the waiting time selectable in milliseconds.

```

Rem *****
Rem The waiting function below expects the transfer of the desired
Rem waiting time in milliseconds. The keyboard and the mouse remain
Rem operative during the waiting period, thus allowing desired elements
Rem to be controlled
Rem *****

```

```

Public Sub Hold(delayTime As Single)
Start = Timer 'Save timer count on calling the
'function
Do While Timer < Start + delayTime/1000 'Check timer count
DoEvents 'Return control to operating
'system to enable control of
'desired elements as long as
'timer has not elapsed
Loop
End Sub
Rem *****

```

The waiting procedure is activated simply by calling Hold(<Waiting time in milliseconds>).

6.4.1.4 Service Request Routine

A service request is processed in the service request routine.



The variables userN% and userM% must be pre-assigned usefully!

```

REM ----- Service request routine -----
Public SUB Srq()
ON ERROR GOTO noDevice 'No user existing
CALL viReadSTB(analyzer, STB%) 'Serial poll, read status byte
IF STB% > 0 THEN 'This instrument has bits set in
'the STB
SRQFOUND% = 1
IF (STB% AND 16) > 0 THEN CALL Outputqueue
IF (STB% AND 4) > 0 THEN CALL ErrorQueueHandler
IF (STB% AND 8) > 0 THEN CALL Questionablestatus
IF (STB% AND 128) > 0 THEN CALL Operationstatus
IF (STB% AND 32) > 0 THEN CALL Esrread
END IF
noDevice:
END SUB 'End of SRQ routine
Rem *****

REM ----- Subroutine for evaluation Service Request Routine -----

Public Sub Srq()
Try
Dim mySTB As Short = mbSession.ReadStatusByte()
'Serial poll, read status byte
Console.WriteLine("Reading Service Request Routine:" + mySTB.ToString())
If mySTB > 0 Then 'This instrument has bits set in the STB
If (mySTB And 16) > 0 Then Call Outputqueue()
If (mySTB And 4) > 0 Then Call ErrorQueueHandler()

```

```

        If (mySTB And 8) > 0 Then Call Questionablestatus()
        If (mySTB And 128) > 0 Then Call Operationstatus()
        If (mySTB And 32) > 0 Then Call Esrread()
    End If
Catch exp As Exception
    Console.WriteLine(exp.Message)
End Try
End Sub 'End of SRQ routine

```

Reading out the status event registers, the output buffer and the error/event queue is effected in subroutines.

6.4.1.5 Reading Out the Output Buffer

```

REM ----- Subroutine for the individual STB bits -----
Public SUB Outputqueue() 'Reading the output buffer
result$ = SPACE$(100) 'Make space for response
CALL InstrRead(analyzer, result$)
Debug.Print "Contents of Output Queue:"; result$
END SUB
REM *****

REM ----- Subroutine for the output queue -----
Public Sub Outputqueue() 'Reading the output buffer
    Try
        Dim result As String = mbSession.ReadString()
        Console.WriteLine("Contents of Output Queue:" + result)
    Catch exp As Exception
        Console.WriteLine(exp.Message)
    End Try
End Sub

```

6.4.1.6 Reading Error Messages

```

REM ----- Subroutine for reading the error queue -----
Public SUB ErrorQueueHandler()
ERROR$ = SPACE$(100) 'Make space for error variable
CALL InstrWrite (analyzer, "SYSTEM:ERROR?")
CALL InstrRead(analyzer, ERROR$)
Debug.Print "Error Description:"; ERROR$
END SUB
REM *****

REM ----- Subroutine for reading the error queue -----
Sub ErrorQueueHandler()
    Dim result As String
    Dim hasErr As Boolean = True
    Do
        mbSession.Write("SYST:ERR?")
        result = mbSession.ReadString()
    Loop

```

```

        Dim parts As String() = result.Split(",")
        If parts(0) = 0 Then
            hasErr = False
            Console.WriteLine(result)
        Else
            Console.WriteLine(result)
        End If
    Loop While hasErr
End Sub

```

6.4.1.7 Evaluation of SCPI Status Registers

```

REM ----- Subroutine for evaluating Questionable Status Register -----
Public SUB Questionablestatus()
Ques$ = SPACE$(20)
'Preallocate blanks to text
'variable
CALL InstrWrite (analyzer, "STATus:QUEStionable:EVENT?")
CALL InstrRead(analyzer, Ques$)
Debug.Print "Questionable Status: "; Ques$
END SUB
REM *****
REM ----- Subroutine for evaluating Operation Status Register -----
Public SUB Operationstatus()
Oper$ = SPACE$(20) 'Preallocate blanks to text
'variable
CALL InstrWrite (analyzer, "STATus:OPERation:EVENT?")
CALL InstrRead(analyzer, Oper$)
Debug.Print "Operation Status: "; Oper$
END SUB
REM *****

REM ----- Subroutine for evaluating Questionable Status Register -----
Public Sub Questionablestatus()
    Dim myQSR As String = Nothing
    Try
        myQSR = mbSession.Query("STATus:QUEStionable:EVENT?") 'Read QSR
        Console.WriteLine("Questionable Status:" + myQSR)
    Catch exp As Exception
        Console.WriteLine(exp.Message)
    End Try
End Sub

REM ----- Subroutine for evaluating Operation Status Register -----
Public Sub Operationstatus()
    Dim myOSR As String = Nothing
    Try
        myOSR = mbSession.Query("STATus:OPERation:EVENT?") 'Read OSR
        Console.WriteLine("Operation Status:" + myOSR)
    Catch exp As Exception

```

```

        Console.WriteLine(exp.Message)
    End Try
End Sub

```

6.4.1.8 Evaluation of Event Status Register

```

REM ----- Subroutine for evaluating the Event Status Register -----
Public SUB Esrread()
Esr$ = SPACE$(20) 'Preallocate blanks to text
'variable
CALL InstrWrite (analyzer, "*ESR?") 'Read ESR
CALL InstrRead(analyzer, Esr$)
IF (VAL(Esr$) AND 1) > 0 THEN Debug.Print "Operation complete"
IF (VAL(Esr$) AND 2) > 0 THEN Debug.Print "Request Control"
IF (VAL(Esr$) AND 4) > 0
THEN Debug.Print "Query Error"
IF (VAL(Esr$) AND 8) > 0
THEN Debug.Print "Device dependent error"
IF (VAL(Esr$) AND 16) > 0
THEN Debug.Print "Execution Error; Program aborted" 'Output error message
STOP 'Stop software
END IF
IF (VAL(Esr$) AND 32) > 0
THEN Debug.Print "Command Error; Program aborted" 'Output error message
STOP 'Stop software
END IF
IF (VAL(Esr$) AND 64) > 0 THEN Debug.Print "User request"
IF (VAL(Esr$) AND 128) > 0 THEN Debug.Print "Power on"END SUB
REM *****

REM ----- Subroutine for evaluating the Event Status Register -----
Public Sub Esrread()
    Try
        Dim myESR As Short = mbSession.Query("*ESR?") 'Read ESR
        If (myESR And 1) > 0 Then Console.WriteLine("Operation complete")
        If (myESR And 2) > 0 Then Console.WriteLine("Request Control")
        If (myESR And 4) > 0 Then Console.WriteLine("Query Error")
        If (myESR And 8) > 0 Then Console.WriteLine("Device dependent error")
        If (myESR And 16) > 0 Then
            Console.WriteLine("Execution Error; Program aborted") 'Output error message
            Stop 'Stop software
        End If
        If (myESR And 32) > 0 Then
            Console.WriteLine("Command Error; Program aborted") 'Output error message
            Stop 'Stop software
        End If
        If (myESR And 64) > 0 Then Console.WriteLine("User request")
        If (myESR And 128) > 0 Then Console.WriteLine("Power on")
    Catch exp As Exception
        Console.WriteLine(exp.Message)
    End Try
End Sub

```



```

End Try
End Sub

```

6.4.2 Using Marker and Delta Marker

6.4.2.1 Shape Factor Measurement (using n dB down)

The n-dB-down function of the R&S FSVA/FSV is used twice to determine the shape factor of a filter (ratio of bandwidths at 60 dB and 3 dB below the filter maximum).

The following example is again based on a signal with a level of -30 dBm at 100 MHz. The shape factor is determined for the 30 kHz resolution bandwidth. The default setting of the R&S FSVA/FSV is used for measurements (SetupInstrument).

```

REM *****
Public Sub ShapeFactor()
result$ = Space$(100)
'----- R&S FSV default setting -----
CALL SetupInstrument 'Default setting
CALL InstrWrite (analyzer, "INIT:CONT OFF") 'Single sweep
'----- Set frequency -----
CALL InstrWrite (analyzer, "FREQ:SPAN 1 MHz")
'Span
CALL InstrWrite (analyzer, "BAND:RES 30 kHz")
'Resolution bandwidth
CALL InstrWrite (analyzer, "INIT;*WAI") 'Perform sweep with sync
'----- Measure 60 dB value -----
CALL InstrWrite (analyzer, "CALC:MARK:PEXC 6 DB")
'Peak excursion
CALL InstrWrite (analyzer, "CALC:MARK:STAT ON")
'Marker1 on
CALL InstrWrite (analyzer, "CALC:MARK:TRAC 1")
'Assign marker1 to trace1
CALL InstrWrite (analyzer, "CALC:MARK:MAX") 'Set marker1 to 100 MHz
CALL InstrWrite (analyzer, "CALC:MARK:FUNC:NDBD 45 dB")
'Read out bandwidth measured at
'45 dB
CALL InstrWrite (analyzer, "CALC:MARK:FUNC:NDBD:RES?")
CALL InstrRead(analyzer, result$)
result60 = Val(result$)
'----- Measure 3 dB down value-----
CALL InstrWrite (analyzer, "CALC:MARK:FUNC:NDBD 3 dB")
'Read out bandwidth measured at
'3 dB
CALL InstrWrite (analyzer, "CALC:MARK:FUNC:NDBD:RES?")
CALL InstrRead(analyzer, result$)
result3 = Val(result$)
'----- Read out shape factor-----

```

```
Print "Shapefaktor 60 dB/3 dB:";result60/result3
END SUB
REM *****
```

6.4.2.2 Measuring the Third Order Intercept Point

The third order intercept point (TOI) is the (virtual) level of two adjacent useful signals at which the intermodulation products of third order have the same level as the useful signals.

The intermodulation product at f_{s2} is obtained by mixing the first harmonic of the useful signal P_{N2} with signal P_{N1} , the intermodulation product at f_{s1} by mixing the first harmonic of the useful signal P_{N1} with signal P_{N2} .

$$f_{s1} = 2 \times f_{n1} - f_{n2} \quad (1)$$

$$f_{s2} = 2 \times f_{n2} - f_{n1} \quad (2)$$

The following example is based on two adjacent signals with a level of -30 dBm at 100 MHz and 110 MHz. The intermodulation products lie at 90 MHz and 120 MHz according to the above formula. The frequency is set so that the examined mixture products are displayed in the diagram. Otherwise, the default setting of the R&S FSVA/FSV is used for measurements (`SetupInstrument`).

```
REM *****
Public Sub TOI()
result$ = Space$(100)
'----- R&S FSV default setting -----
CALL SetupStatusReg 'Set status registers
CALL InstrWrite (analyzer, "*RST") 'Reset instrument
CALL InstrWrite (analyzer, "INIT:CONT OFF") 'Single sweep
CALL InstrWrite (analyzer, "SYST:DISP:UPD ON")
'ON: display on'OFF: off
'----- Set frequency -----
CALL InstrWrite (analyzer, "FREQ:START 85 MHz;STOP 125 MHz")
'Span
'----- Set level -----
CALL InstrWrite (analyzer, "DISP:WIND:TRAC:Y:RLEV -20 dBm")
'Reference level
CALL InstrWrite (analyzer, "INIT;*WAI") 'Perform sweep with sync
'----- TOI measurement -----
CALL InstrWrite (analyzer, "CALC:MARK:PEXC 6 DB")
'Peak excursion
CALL InstrWrite (analyzer, "CALC:MARK:FUNC:TOI ON")
'Switch on TOI measurement
CALL InstrWrite (analyzer, "CALC:MARK:FUNC:TOI:RES?")
'and read out results
CALL InstrRead(analyzer, result$)
'----- Read out result -----
Print "TOI [dBm]:";result$
```

```
END SUB
REM *****
```

6.4.2.3 Measuring the AM Modulation Depth

The example below is based on an AM-modulated signal at 100 MHz with the following characteristics:

Carrier signal level	-30 dBm
AF frequency	100 kHz
Modulation depth	50 %

The default setting of the analyzer for measurements can be used for the measurements described below (SetupInstrument).

```
REM *****
Public Sub AMMod()
result$ = Space$(100)
CALL SetupInstrument 'Default setting
CALL InstrWrite (analyzer, "BAND:RES 30 kHz") 'Set appropriate RBW
'----- Peak search -----
CALL InstrWrite (analyzer, "INIT:CONT OFF") 'Single sweep
CALL InstrWrite (analyzer, "INIT;*WAI") 'Perform sweep with sync
CALL InstrWrite (analyzer, "CALC:MARK:PEXC 6 DB")
'Peak excursion
CALL InstrWrite (analyzer, "CALC:MARK:STAT ON")
'Marker 1 on
CALL InstrWrite (analyzer, "CALC:MARK:TRAC 1")
'Assign marker1 to trace1
'----- Measure modulation depth -----
CALL InstrWrite (analyzer, "CALC:MARK:MAX;FUNC:MDEP ON")
'Marker to Peak;
CALL InstrWrite (analyzer, "CALC:MARK:FUNC:MDEP:RES?")
'Measure mod. depth
CALL InstrRead(analyzer, result$) 'Read out result
'----- Read out result -----
Print "AM Mod Depth [%]:";result$
END SUB
REM *****
```

6.4.3 Limit Lines and Limit Test

The example below shows the definition and use of a new limit line 5 for trace 1 with the following characteristics:

- Upper limit line
- Absolute x-axis in the frequency range
- 7 reference values:

- 120 MHz/-70 dB,
- 126 MHz/-40 dB,
- 127 MHz/-40 dB,
- 128 MHz/-10 dB,
- 129 MHz/-40 dB,
- 130 MHz/-40 dB,
- 136 MHz/-70 dB
- Relative y-axis with unit dB
- Absolute threshold at –75 dBm
- No margin

The signal of the integrated calibration source (128 MHz, -30 dBm) is used to check the limit test.

```

REM *****
Public Sub LimitLine()
result$ = Space$(100)
'----- R&S FSV default setting -----
CALL SetupInstrument 'Default setting
CALL InstrWrite (analyzer, "FREQUENCY:CENTER 128 MHz;Span 10 MHz")
'Span
CALL InstrWrite (analyzer, "Diag:Serv:Inp Cal")
'Cal signal on
'----- Definition of limit lines -----
CALL InstrWrite (analyzer, "CALC:LIM5:NAME 'TEST1'")
'Define name
CALL InstrWrite (analyzer, "CALC:LIM5:COMM 'Upper limit'")
'Define comment
CALL InstrWrite (analyzer, "CALC:LIM5:TRAC 1")
'Assign trace
CALL InstrWrite (analyzer, "CALC:LIM5:CONT:DOM FREQ")
'Define x-axis range
CALL InstrWrite (analyzer, "CALC:LIM5:CONT:MODE ABS")
'Define x-axis scaling
CALL InstrWrite (analyzer, "CALC:LIM5:UNIT DB")
'Define y-axis unit
CALL InstrWrite (analyzer, "CALC:LIM5:UPP:MODE REL")
'Define y-axis scaling
'----- Definition of data points and threshold -----
xlimit$ = "CALC:LIM5:CONT 120 MHz,126 MHz,127 MHz,128 MHz,129 MHz,130 MHz,136 MHz"
CALL InstrWrite (analyzer, xlimit$) 'Set values for x-axis
CALL InstrWrite (analyzer, "CALC:LIM5:UPP -70,-40,-40,-20,-40,-40,-70")
'Set values for y-axis
CALL InstrWrite (analyzer, "CALC:LIM5:UPP:THR -75 DBM")
'Set y threshold (only
'possible for relative
'y-axis)
'----- Definition of margin or x/y offset-----
'A margin or an x/y offset can be defined here.

```

```

'----- Activate and evaluate the limit line -----
CALL InstrWrite (analyzer, "CALC:LIM5:UPP:STAT ON")
'Activate line 5
CALL InstrWrite (analyzer, "CALC:LIM5:STAT ON")
'Activate limit check
CALL InstrWrite (analyzer, "INIT;*WAI") 'Perform sweep with sync
CALL InstrWrite (analyzer, "CALC:LIM5:FAIL?")
'Query result of limit check
CALL InstrRead(analyzer, result$) 'Result: 1 (= FAIL)
'----- Read out result -----
Print "Limit Result Line 5: ";result$
'----- Evaluate limit line by means of status register -----
CALL InstrWrite (analyzer, "*CLS") 'Reset status register
'----- Measure -----
CALL InstrWrite (analyzer, "INIT;*OPC") 'Perform sweep with sync
CALL viEnableEvent(analyzer, VI_EVENT_SERVICE_REQ, VI_QUEUE, 0)
Status = viWaitOnEvent(analyzer, VI_EVENT_SERVICE_REQ, SRQWaitTimeout, VI_NULL, VI_NULL)
IF (status = VI_SUCCESS) THEN CALL Srq 'If SRQ is recognized =>
'subroutine for evaluation
'----- Read out result -----
IF (status% = 1) THEN
CALL InstrWrite (analyzer, "STAT:QUES:LIM1:COND?")
'Read out STAT:QUES:LIMit
'register
CALL InstrRead(analyzer, result$)
IF ((Val(result$) And 16) <> 0) THEN
Print "Limit5 failed"ELSE
Print "Limit5 passed"END IF
END IF
END SUB
REM *****

```

6.4.4 Measuring the Channel and Adjacent Channel Power

In the following example, the channel and adjacent channel power is first measured on a signal with a level of 0 dBm at 800 MHz to IS95. Then the channel and adjacent channel power is measured on a GSM signal at 935.2 MHz with fast ACP measurement (FAST ACP).

In addition, the limit test is activated.

```

REM *****
Public Sub ACP()
result$ = Space$(100)
'----- R&S FSV default setting -----
CALL SetupStatusReg 'Set status register
CALL InstrWrite (analyzer, "*RST") 'Reset instrument
CALL InstrWrite (analyzer, "INIT:CONT OFF") 'Single sweep
CALL InstrWrite (analyzer, "SYST:DISP:UPD ON")
'ON: display on

```

```

'OFF: off
'----- Set frequency -----
CALL InstrWrite (analyzer, "FREQ:CENT 800 MHz")
'Set frequency
'----- Set level -----
CALL InstrWrite (analyzer, "DISP:WIND:TRAC:Y:RLEV 10 dBm")
'Reference level
'----- Example 1: Configure CP/ACP for CDMA-----
CALL InstrWrite (analyzer, "CALC:MARK:FUNC:POW:SEL ACP")
'ACP measurement on
CALL InstrWrite (analyzer, "CALC:MARK:FUNC:POW:PRES F8CDMA")
'Select CDMA800 FWD
CALL InstrWrite (analyzer, "SENS:POW:ACH:ACP 2")
'Select 2 adjacent channels
CALL InstrWrite (analyzer, "SENS:POW:ACH:PRES ACP")
'Optimize settings
CALL InstrWrite (analyzer, "SENS:POW:ACH:PRES:RLEV")
'Optimize reference level
CALL InstrWrite (analyzer, "SENS:POW:ACH:MODE ABS")
'Absolute measurement
CALL InstrWrite (analyzer, "SENS:POW:HSP ON")
'Fast ACP measurement
'----- Perform measurement and query results -----
CALL InstrWrite (analyzer, "INIT;*WAI") 'Perform sweep with sync
CALL InstrWrite (analyzer, "CALC:MARK:FUNC:POW:RES? ACP")
'Query result CALL InstrRead(analyzer, result$)
'----- Read out result -----
Print "Result (CP, ACP low, ACP up, Alt low, Alt up):"Print result$
'----- Example 2: Configure CP/ACP manually for GSM-----
result$ = Space$(100)
CALL InstrWrite (analyzer, "FREQ:CENT 935.2 MHz")
'Set frequency
CALL InstrWrite (analyzer, "CALC:MARK:FUNC:POW:SEL ACP")
'ACP measurement on
CALL InstrWrite (analyzer, "SENS:POW:ACH:ACP 1")
'1 adjacent channel
CALL InstrWrite (analyzer, "SENS:POW:ACH:BAND 200 KHZ")
'Channel bandw. 200 kHz
CALL InstrWrite (analyzer, "SENS:POW:ACH:BAND:ACH 200 KHZ")
'Adjacent channel band-
'width 200 kHz
CALL InstrWrite (analyzer, "SENS:POW:ACH:SPAC 200 KHZ")
'Channel spacing 200 kHz
CALL InstrWrite (analyzer, "SENS:POW:ACH:PRES ACP")
'Optimize settings
CALL InstrWrite (analyzer, "SENS:POW:ACH:PRES:RLEV")
'Optimize reference level
CALL InstrWrite (analyzer, "SENS:POW:ACH:MODE ABS")
'Absolute measurement
'----- Start measurement and query result -----

```

```

CALL InstrWrite (analyzer, "INIT;*WAI") 'Perform sweep with sync
CALL InstrWrite (analyzer, "CALC:MARK:FUNC:POW:RES? ACP")
'Query result
CALL InstrRead(analyzer, result$)
'----- Read out result -----
Print "Result (CP, ACP low, ACP up):"Print result$
'----- Active limit check -----
result$ = Space$(100)
CALL InstrWrite (analyzer, "CALC:LIM:ACP:ACH 30 DB, 30 DB")
'Set relative limit
CALL InstrWrite (analyzer, "CALC:LIM:ACP:ACH:ABS -35 DBM,-35 DBM")
'Set absolute limit
CALL InstrWrite (analyzer, "CALC:LIM:ACP:ACH:STAT ON")
'Rel. limit check on
CALL InstrWrite (analyzer, "CALC:LIM:ACP:ACH:ABS:STAT ON")
'Abs. limit check on
CALL InstrWrite (analyzer, "CALC:LIM:ACP ON")
'Limit check on
'----- Start measurement and query result -----
CALL InstrWrite (analyzer, "INIT;*WAI") 'Perform sweep with sync
CALL InstrWrite (analyzer, "CALC:LIM:ACP:ACH:RES?")
'Query result of limit check
CALL InstrRead(analyzer, result$)
'----- Read out result -----
Print "Result Limit Check:";result$
END SUB
REM *****

```

Example of channel/adjacent-channel power measurement

POW:ACH:ACP 3

Sets the number of adjacent/alternate channels to 3.

POW:ACH:BAND 30 KHZ

Sets the bandwidth of the transmission channel to 30 kHz.

POW:ACH:BAND:ACH 40 KHZ

Sets the bandwidth of each adjacent channel to 40 kHz.

POW:ACH:BAND:ALT1 50 KHZ

Sets the bandwidth of each alternate channel to 50 kHz.

POW:ACH:BAND:ALT2 60 KHZ

Sets the bandwidth of alternate channel 2 to 60 kHz.

POW:ACH:SPAC 30 KHZ

Sets the spacing between the transmission channel and the adjacent channel to 30 kHz, the spacing between the transmission channel and alternate channel 1 to 60 kHz, and the spacing between the transmission channel and alternate channel 2 to 90 kHz.

```
POW:ACH:SPAC:ALT1 100 KHZ
```

Sets the spacing between the alternate adjacent channels and the TX channel. For details refer to [\[SENSe:\]POWer:ACHannel:SPACing:ALTernate<channel>](#) on page 853.

```
POW:ACH:SPAC:ALT2 140 KHZ
```

Sets the spacing between the transmission channel and alternate channel 2 to 140 kHz.

```
POW:ACH:MODE ABS
```

Switches on absolute power measurement.

```
CALC:MARK:FUNC:POW:SEL ACP
```

Switches on the adjacent-channel power measurement.

```
INIT:CONT OFF
```

Switches over to single sweep mode.

```
INIT;*WAI
```

Starts a sweep and waits for the end of the sweep.

```
CALC:MARK:FUNC:POW:RES? ACP
```

Queries the result of adjacent-channel power measurement.

```
POW:ACH:REF:AUTO ONCE
```

Defines the measured channel power as the reference value for relative power measurements.

If the channel power only is to be measured, all commands relating to adjacent/alternate channel bandwidth and channel spacings are omitted. The number of adjacent/alternate channels is set to 0 with [\[SENSe:\]POWer:ACHannel:ACPairs](#) on page 845.

6.4.5 Occupied Bandwidth Measurement

In the following example, the bandwidth is to be found in which 95 % of the power of a GSM signal is contained. Signal frequency is 935.2 MHz; channel bandwidth is 200 kHz.

```
REM *****
Public Sub OBW()
result$ = Space$(100)
'----- R&S FSV default setting -----
CALL SetupStatusReg 'Set status register
CALL InstrWrite (analyzer, "*RST") 'Reset instrument
CALL InstrWrite (analyzer, "INIT:CONT OFF") 'Single sweep
CALL InstrWrite (analyzer, "SYST:DISP:UPD ON")
'ON: display on
'OFF: off
```



```

'----- Configure R&S FSV for OBW for GSM-----
CALL InstrWrite (analyzer, "FREQ:CENT 935.2 MHz")
'Set frequency
CALL InstrWrite (analyzer, "CALC:MARK:FUNC:POW:SEL OBW")
'OBW measurement on
CALL InstrWrite (analyzer, "SENS:POW:ACH:BAND 200 KHZ")
'Channel bandw. 200 kHz
CALL InstrWrite (analyzer, "SENS:POW:BWID 95PCT")
'Percentage of power
CALL InstrWrite (analyzer, "SENS:POW:ACH:PRES OBW")
'Set frequency and optimize reference level
CALL InstrWrite (analyzer, "SENS:POW:ACH:PRES:RLEV")
CALL InstrWrite (analyzer, "SENS:POW:NCOR OFF")
'Noise correction
'OFF: switch off
'ON: switch on
'----- Perform measurement and query results -----
CALL InstrWrite (analyzer, "INIT;*WAI") 'Perform sweep with sync
CALL InstrWrite (analyzer, "CALC:MARK:FUNC:POW:RES? OBW")
'Query result
CALL InstrRead(analyzer, result$)
Print result$
END SUB
REM *****

```

6.4.6 Time Domain Power Measurement

In the following example, the mean carrier power of a signal with 300 kHz bandwidth at 100 MHz is to be determined. In addition, the peak power, the rms value and the standard deviation are measured. To do this, the time-domain-power measurement functions are used.

```

REM *****
Public Sub TimeDomainPower()
result$ = Space$(100)
'----- R&S FSV default setting -----
CALL SetupStatusReg 'Set status register
CALL InstrWrite (analyzer, "*RST") 'Reset instrument
CALL InstrWrite (analyzer, "INIT:CONT OFF") 'Single sweep
CALL InstrWrite (analyzer, "SYST:DISP:UPD ON")
'ON: display on
'OFF: off
'----- Configure R&S FSV for time domain power measurement -----
CALL InstrWrite (analyzer, "FREQ:CENT 100 MHz;SPAN 0Hz")
'Set frequency
CALL InstrWrite (analyzer, "BAND:RES 300 kHz")
'Resolution bandwidth
CALL InstrWrite (analyzer, "SWE:TIME 200US") 'Sweep time
CALL InstrWrite (analyzer, "CALC:MARK:FUNC:SUMM:PPE ON")

```

```

'Peak measurement on
CALL InstrWrite (analyzer, "CALC:MARK:FUNC:SUMM:MEAN ON")
'Mean measurement on
CALL InstrWrite (analyzer, "CALC:MARK:FUNC:SUMM:RMS ON")
'RMS measurement on
CALL InstrWrite (analyzer, "CALC:MARK:FUNC:SUMM:SDEV ON")
'Standard deviation on
'----- Perform measurement and query results -----
CALL InstrWrite (analyzer, "INIT;*WAI") 'Perform sweep with sync
'Query results:
query$ = "CALC:MARK:FUNC:SUMM:PPE:RES?;" 'Peak measurement
query$ = query$ + ":CALC:MARK:FUNC:SUMM:MEAN:RES?;" 'Mean measurement
query$ = query$ + ":CALC:MARK:FUNC:SUMM:RMS:RES?;" 'RMS measurement
query$ = query$ + ":CALC:MARK:FUNC:SUMM:SDEV:RES?" 'Standard deviation
CALL InstrWrite (analyzer, query$)
CALL InstrRead(analyzer, result$)
Print result$
END SUB
REM *****

```

6.4.7 Fast Power Measurement on Power Ramps

A frequent task in mobile radio tests is measurement of a DUT at various power control levels at the highest possible speed. The R&S FSVA/FSV offers two test functions for this task, which can be used depending on the signal characteristics.

In the following, the two methods are presented by means of two examples.

6.4.7.1 Power Measurement with Multi-Summary Marker

The multi-summary marker function is suitable for measuring the power of a sequence of pulses with the following characteristics:

- The pulses occur at identical time intervals, which is typical of GSM transmission in slots, for example.
- The level of the first signal is reliably above threshold.
- The subsequent pulses may have any levels.
- The function uses the first pulse as a trigger signal. The power of the subsequent pulses is determined exclusively via the timing pattern selected for the pulse sequence. The function is, therefore, suitable for adjustments where the DUT output power varies considerably and is not reliably above the trigger threshold.
- The measurement accuracy is determined by the ratio of pulse duration to total measurement time; this should not be below 1:50.
- The function always uses TRACE 1.

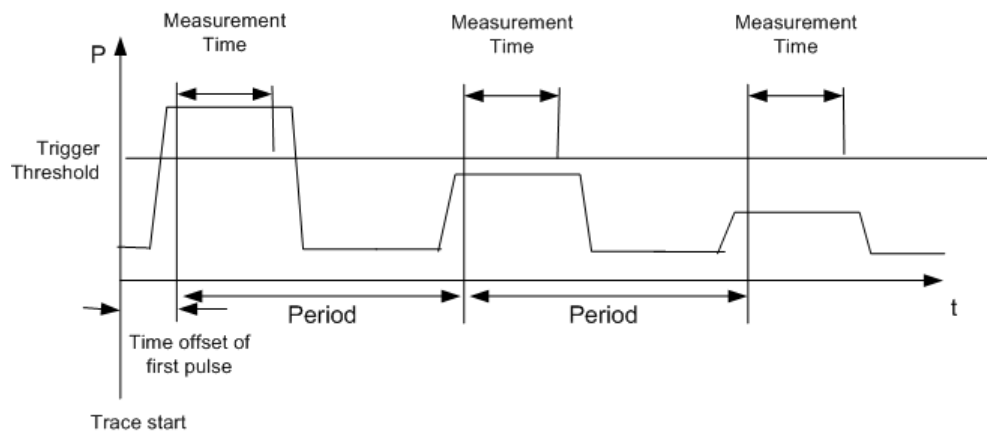

Figure 6-4: Block diagram illustrating signal processing in analyzer

In the example below, a GSM pulse sequence of 8 pulses is measured with an offset of 50 μs of the first pulse, 450 μs measurement time/pulse and 576.9 μs pulse period.

```

REM *****
Public Sub MultiSumMarker()
result$ = Space$(200)
'----- R&S FSV default setting-----
CALL SetupStatusReg 'Configure status register
CALL InstrWrite (analyzer, "*RST") 'Reset instrument
CALL InstrWrite (analyzer, "INIT:CONT OFF") 'Single sweep mode
CALL InstrWrite (analyzer, "SYST:DISP:UPD ON")
'ON: switch display on
'OFF: switch display off
'----- Configure R&S FSV for power measurement in time domain -----
CALL InstrWrite (analyzer, "FREQ:CENT 935.2 MHz;SPAN 0Hz")
'Frequency setting
CALL InstrWrite (analyzer, "DISP:WIND:TRAC:Y:RLEV 10 dBm")
'Set reference level to 10 dB
CALL InstrWrite (analyzer, "INP:ATT 30 dB") 'Set input attenuation to 30 dB
CALL InstrWrite (analyzer, "BAND:RES 1 MHz;VID 3 MHz")
'Bandwidth setting
CALL InstrWrite (analyzer, "DET RMS") 'Select RMS detector
CALL InstrWrite (analyzer, "TRIG:SOUR VID") 'Trigger source: video
CALL InstrWrite (analyzer, "TRIG:LEV:VID 50 PCT")
'Trigger threshold: 50 %
CALL InstrWrite (analyzer, "SWE:TIME 50ms") 'Sweep time  $\geq$  1 frame
'----- Perform measurement and query results -----
CALL InstrWrite (analyzer, "INIT;*WAI") 'Perform sweep with sync
'Query results:
cmd$ = "CALC:MARK:FUNC:MSUM?"cmd$ = cmd$ + "50US," 'Offset of first pulse
cmd$ = cmd$ + "450US," 'Measurement time
cmd$ = cmd$ + "576.9US," 'Pulse period
cmd$ = cmd$ + "8" 'Number of bursts
CALL InstrWrite (analyzer, cmd$)
CALL InstrRead(analyzer, result$) 'Read results

```

```

Print result$
END SUB
REM *****

```

6.4.7.2 Multi-Burst Power Measurement

The multi-burst power measurement function is suitable for measuring the power of a sequence of pulses with the following characteristics:

- The pulses occur at variable time intervals.
- The levels of all pulses of the sequence are reliably above the trigger threshold, or an external trigger signal is used.
- The function requires one trigger event per pulse. This means that if the video trigger or the IF power trigger is used, the levels of all pulses must be above the trigger threshold.
- The function is, therefore, particularly suitable for re-measuring DUTs already adjusted and whose output power is within the specified range. The measurement is optimized for minimum overhead relative to the actual measurement time.

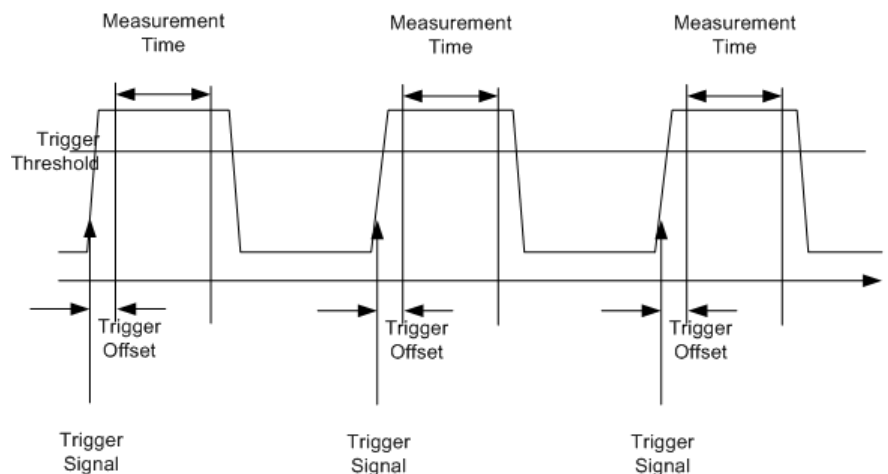

Figure 6-5: Block diagram illustrating signal processing in analyzer

Either the root-mean-square power or the peak power is measured, depending on whether the RMS detector or the PEAK detector is selected. The function always uses TRACE 1.

The following parameters are to be set for this measurement:

- Analyzer frequency
- Resolution bandwidth
- Measurement time per single pulse
- Trigger source
- Trigger threshold
- Trigger offset
- Type of power measurement (PEAK, MEAN)

- Number of pulses to be measured

During the measurement, each pulse is mapped into a pixel of the screen, i.e. any change of the trace can be detected only at the left-hand edge of the screen. Maximum measurement speed is as usual achieved with the display switched off.

In the example below, a GSM pulse sequence of 8 pulses is measured with 5 μ s trigger offset, 434 μ s measurement time/pulse, video trigger with 50 % trigger threshold, and peak detection:

```
REM *****
Public Sub MultiBurstPower()
result$ = Space$(200)
'----- R&S FSV default setting -----
CALL SetupStatusReg 'Configure status register
CALL InstrWrite (analyzer, "*RST") 'Reset instrument
CALL InstrWrite (analyzer, "INIT:CONT OFF") 'Single sweep mode
CALL InstrWrite (analyzer, "SYST:DISP:UPD OFF")
'OFF: display off
'----- Perform measurement and query results -----
cmd$ = "MPOW? "cmd$ = cmd$ + "935.2 MHZ," 'Center frequency
cmd$ = cmd$ + "1 MHZ," 'Resolution bandwidth
cmd$ = cmd$ + "434US," 'Measurement time
cmd$ = cmd$ + "VID," 'Trigger source
cmd$ = cmd$ + "50PCT," 'Trigger threshold
cmd$ = cmd$ + "1US," 'Trigger offset
cmd$ = cmd$ + "PEAK," 'Peak detector
cmd$ = cmd$ + "8" 'Number of bursts
CALL InstrWrite (analyzer, cmd$)
CALL InstrRead(analyzer, result$) 'Read results
Print result$
END SUB
REM *****
```

6.4.8 Fast Level Measurement Using Frequency Lists

A typical task for the R&S FSVA/FSV is power measurement at a number of frequency points, e.g. at multiples of the fundamental (harmonics measurement), or at frequencies defined by a mobile radio standard (e.g. spectrum due to transients at ± 200 kHz, ± 400 kHz, etc about the carrier frequency of a GSM signal). In many cases, different level and/or bandwidth settings are required for the different frequency points to match the channel spacing and meet the requirements of dynamic range.

Especially for this application, the R&S FSVA/FSV offers a number of remote-control functions (commands available in SENSE:LIST subsystem) that allow level measurement based on a frequency list with different instrument settings assigned to different frequencies. Not only the frequency list can be programmed, but also the measurement types (PEAK, RMS, AVG) to be performed simultaneously can be selected.

The example below describes a harmonics measurement on a dual-band amplifier. The harmonics level in general decreases as the frequency increases. To boost mea-

surement sensitivity, therefore, the reference level is lowered by 10 dB from the third harmonic.

The following settings are used:

Reference level:	10.00 dBm up to first harmonic, 0 dBm from 2nd harmonic
RF attenuation:	20 dB
Electronic attenuation:	0 dB (OFF)
Filter type:	NORMal
RBW:	1 MHz
VBW:	3 MHz
Measurement time:	300 µs
Trigger delay:	100 µs
Trigger:	video, 45 %

Frequency	Type
935.2 MHz	GSM 900 fundamental
1805.2 MHz	GSM 1800 fundamental
1870.4 MHz	GSM 900 2 nd harmonic
2805.6 MHz	GSM 900 3 rd harmonic
3610.4 MHz	GSM 1800 2 nd harmonic
3740.8 MHz	GSM 900 4 th harmonic
5815.6 MHz	GSM 1800 3 rd Harmonic

The frequencies are selected in ascending order to minimize system-inherent waiting times resulting from frequency changes.

At each frequency point the peak power and the rms power are measured. The peak power and the rms power values are stored alternately in the results memory.

```
REM *****
Public Sub FrequencyList()
result$ = Space$(500)
'----- R&S FSV default setting -----
CALL SetupStatusReg 'Configure status register
CALL InstrWrite (analyzer, "*RST") 'Reset instrument
CALL InstrWrite (analyzer, "INIT:CONT OFF") 'Single sweep mode
CALL InstrWrite (analyzer, "SYST:DISP:UPD OFF") 'Display off
'-----Configure R&S FSV for power measurement based on frequency list -
CALL InstrWrite (analyzer, "TRIG:LEV:IFP -20 dBm")
'Set IF power trigger level
CALL InstrWrite (analyzer, "LIST:POWER:SET ON,ON,OFF,IFP,POS,100us,0")
'----- Perform measurement and query results -----
```

```

cmd$ = "LIST:POWer?"cmd$ = cmd$ + "935.2 MHz, 10 dBm, 20 dB,OFF,NORM,1 MHz,3 MHz,
300 us, 0, "
cmd$ = cmd$ + "1805.2 MHz, 10 dBm, 20 dB,OFF,NORM,1 MHz,3 MHz,300 us, 0, "
cmd$ = cmd$ + "1870.4 MHz, 10 dBm, 20 dB,OFF,NORM,1 MHz,3 MHz,300 us, 0, "
cmd$ = cmd$ + "2805.6 MHz, 0 dBm, 20 dB,OFF,NORM,1 MHz,3 MHz,300 us, 0, "
cmd$ = cmd$ + "3610.4 MHz, 10 dBm,20 dB,OFF,NORM,1 MHz,3 MHz,300 us, 0, "
cmd$ = cmd$ + "3740.8 MHz, 0 dBm, 20 dB, OFF, NORM, 1 MHz,3 MHz,300 us, 0, "
cmd$ = cmd$ + "5815.6 MHz, 0 dBm, 20 dB, OFF, NORM, 1 MHz, 3 MHz, 300 us, 0"
CALL InstrWrite (analyzer, cmd$)
CALL InstrRead(analyzer, result$)
Print result$
END SUB
REM *****

```

6.4.9 Level Correction of Transducers

In more complex test systems, the frequency response of the test setup must be taken into account in all power measurements to avoid any measurement errors being introduced from sources other than the DUT.

The R&S FSVA/FSV offers the possibility of defining a frequency-dependent attenuation correction factor (transducer factor).

In the example below, a factor with the following characteristics is defined:

Name:	Transtest
Unit:	dB
Scaling:	lin
Comment:	simulated cable correction
Frequency	Level
10 MHz	0 dB
100 MHz	3 dB
1 GHz	7 dB
3 GHz	10 dB

The factor is defined and can be activated as required.

```

REM *****
Public Sub TransducerFactor()
'----- Define transducer factor -----
CALL InstrWrite (analyzer, "CORR:TRAN:SEL 'TRANSTEST'")
'Define "Transtest" transducer factor
CALL InstrWrite (analyzer, "CORR:TRAN:UNIT 'DB'")
'Unit 'dB'
CALL InstrWrite (analyzer, "CORR:TRAN:SCAL LIN")
'Linear frequency-axis
CALL InstrWrite (analyzer, "CORR:TRAN:COMM 'Simulated cable correction'")

```

```

cmd$ = "CORR:TRAN:DATA" 'Enter frequency and level
cmd$ = cmd$ + "10 MHz, 0," 'values. Level values without
cmd$ = cmd$ + "100 MHz, 3," 'unit!
cmd$ = cmd$ + "1GHz, 7,"cmd$ = cmd$ + "3GHz, 10"
CALL InstrWrite (analyzer,cmd$) 'Enter frequency and level values
'----- Activate transducer -----
CALL InstrWrite (analyzer, "CORR:TRAN:STAT ON")
'Activate transducer factor
END SUB
REM *****

```

6.4.10 Measuring the Magnitude and Phase of a Signal

Due to the R&S FSVA/FSV's internal architecture, it is capable of measuring and outputting the magnitude and phase of a signal in addition to its power values. This opens up a variety of possibilities for more in-depth analysis (FFT, demodulation, etc).

I/Q data is stored in memory areas each containing 512 k words. Hardware triggering controls the memory.

The following example shows the steps necessary to collect data at a predefined sampling rate and read it from the I/Q memory.

1. Data is output in the form of voltage values referred to the analyzer input. Data can be read in binary or ASCII format.
 - In binary format, the length information carried in the message header is evaluated and used for calculating the x-axis values.
 - In ASCII format, only a list of voltage values is output.
2. Binary data is read in three steps:
3. The number of digits carrying the length information is read.
4. The length information itself is read.
5. The trace data is read.

This procedure is necessary with programming languages like Visual Basic which support only structures of identical data types (arrays), whereas the binary data format uses different data types in the header and the data section.



The arrays for measured data are dimensioned in such a way that they can accommodate the I/Q data of the R&S FSVA/FSV (2 × 512 k).

```

REM *****
Public Sub ReadIQData()
'----- Create variables -----
Dim IData(131072) As Single 'Buffer for floating-point
'I data (= 512*1024 bytes)
Dim QData(131072) As Single 'Buffer for floating-point

```



```

'Q data (= 512*1024 bytes)
'Note:
'Visual Basic cannot read in
'data volumes larger than
'512 k words!
Dim digits As Byte 'No. of digits as length
Dim IQBytes As Long 'Length of trace data in bytes
Dim IQValues As Long 'No. of meas. values in buffer
Dim retCount As Integer 'Return count from read
asciiResult$ = Space$(6553600) 'Buffer for ASCII I/Q data
' (= 25*2*1024 bytes)
result$ = Space$(100) 'Buffer for simple results
'----- Default setting -----
CALL SetupInstrument 'Default setting
CALL InstrWrite (analyzer, "TRAC:IQ:STAT ON")
'Activate I/Q data
'acquisition mode; must be
'done before TRAC:IQ:SET !
'Select number of test points
' (= 512 * 1024 - 512) at
'RBW 10 MHz, 'sample rate 32 MHz,
'trigger free run, pos. trigger
'edge and 0 s trigger delay.
CALL InstrWrite (analyzer, "TRAC:IQ:SET NORM,10 MHz,32 MHz,IMM,POS,0,130560")
'----- Read-out in binary format-----
CALL InstrWrite (analyzer, "FORMAT REAL,32")
'Set binary format
CALL InstrWrite (analyzer, "TRAC:IQ:DATA?")
'Measure + read out I/Q data
CALL viRead(analyzer, result$, 2, retCount)
'Read and store length for
digits = Val(Mid$(result$, 2, 1)) 'number of digits
result$ = Space$(100) 'Re-initialize buffer
CALL viRead(analyzer, result$, digits, retCount)
'Read and store length
IQBytes = Val(Left$(result$, digits))
IQBytes = IQBytes/2 'Divide no. per buffer in half
CALL viRead(analyzer, IData(0), IQBytes, retCount)
'Read I data in buffer
CALL viRead(analyzer, QData(0), IQBytes, retCount)
'Read Q data in buffer
CALL viRead(analyzer, result$, 1, retCount)
'Read in end character <NL>
'----- Output of binary data as frequency/level pair -----
IQValues = IQBytes/4 'Single Precision = 4 Bytes
For i = 0 To IQValues - 1
Print "I-Value["; i; "] = "; IData(i)
Print "Q-Value["; i; "] = "; QData(i)
Next i
'----- Read-out in ASCII format -----

```

```

CALL InstrWrite (analyzer, "FORMAT ASCII") 'Set ASCII format
CALL InstrWrite (analyzer, "TRAC:IQ:DATA?")
'Re-measure and read out
'I/Q data
CALL InstrRead(analyzer, asciiResult$)
CALL InstrWrite (analyzer, "TRAC:IQ:STAT OFF")
'Stop I/Q data aquisition
'mode if no further
'measurements are to be
'done
END SUB
REM *****

```

6.4.11 Reading and Writing Files

6.4.11.1 Reading a File from the Instrument

In the following example, the TEST1.R&S FSV.DFL file stored under C:\R_S\Instr\user is read from the instrument and stored in the controller.

```

REM *****
Public Sub ReadFile()
'----- Generate variables -----
Dim digits As Byte 'Number of digits of
'length information
Dim fileBytes As Long 'Length of file with trace data
'in bytes
result$ = Space$(100) 'Buffer for simple results
'----- Default setting of status register -----
CALL SetupStatusReg 'Configure status register
'----- Read out file -----
CALL InstrWrite (analyzer, "MMEM:DATA? 'C:\R_S\Instr\user\TEST1.R&S FSV.DFL'")
'Select file
CALL ilrd(analyzer, result$, 2) 'Read and store number of
digits = Val(Mid$(result$, 2, 1)) 'digits of length information
CALL ilrd(analyzer, result$, digits) 'Read and store length
fileBytes = Val(Left$(result$, digits)) 'information
FileBuffer$ = Space$(fileBytes) 'Buffer for file
CALL ilrd(analyzer, FileBuffer, fileBytes)
'Read file into buffer
CALL ilrd(analyzer, result$, 1) 'Read terminator <NL>
'----- Store file to controller -----
Open "TEST1.R&S FSV.DFL" For Output As #1
Print #1, FileBuffer; '; to avoid linefeed at
'end of file
Close #1

```

```
END SUB
REM *****
```

6.4.11.2 Creating a File on the Instrument

In the following example, the TEST1.R&S FSV.DFL file available on the controller is stored in the instrument under C:\R_S\Instr\user\DUPLICAT.R&S FSV.DFL.

```
REM *****
Public Sub WriteFile()
'----- Generate variables -----
FileBuffer$ = Space$(100000) 'Buffer for file
Dim digits As Long 'Number of digits of
'length information
Dim fileBytes As Long 'Length of file in bytes
fileSize$ = Space$(100) 'Length of file as a string
result$ = Space$(100) 'Buffer for simple results
'----- Default setting of status register -----
CALL SetupStatusReg 'Configure status register
'----- Prepare the definite length block data -----
fileBytes = FileLen("H:\work\vb\TEST1.R&S FSV.DFL")
'Determine length of file
fileSize$ = Str$(fileBytes)
digits = Len(fileSize$) - 1 'Determine number of digits of
fileSize$ = Right$(fileSize$, digits) 'length information
FileBuffer$ = "#" + Right$(Str$(digits), 1) + fileSize$
'Store length information in
'file buffer
'----- Read file from controller -----
Open "H:\work\vb\TEST1.R&S FSV.DFL" For Binary As #1
FileBuffer$ = FileBuffer$ + Left$(Input(fileBytes, #1), fileBytes)
Close #1
'----- Write file -----
CALL InstrWrite (analyzer, "SYST:COMM:GPIB:RTER EOI") 'Set receive
'terminator on the
'instrument
CALL InstrWrite (analyzer, "MMEM:DATA
'DUPLICAT.R&S FSV.DFL', " + FileBuffer$)
'Select file
END SUB
REM *****
```

6.4.12 Spectrum Emission Mask Measurement

You can configure Spectrum Emission Mask measurements via XML files provided for different standards or by defining ranges and parameters. For both ways an example is given.

6.4.12.1 Using Predefined Standard Wibro

In the following example, the Spectrum Emission Mask measurement is configured using a predefined standard XML file.

```

REM *****
'----- General settings of the instrument -----
CALL InstrWrite (analyzer, "*RST") 'Reset instrument
CALL InstrWrite (analyzer, "INIT:CONT OFF") 'Switch to single sweep
CALL InstrWrite (analyzer, "INIT:IMM;*WAI") 'Make sure no sweep is running
CALL InstrWrite (analyzer, ":SENSE1:SWEep:MODE ESpectrum")
'Set measurement mode
Rem After preset 3 ranges are available where the middle one is
Rem the reference range for calculating the TX power
CALL InstrWrite (analyzer, ":SENSE1:FREQuency:CENTer 2.2 GHz")
'Center frequency 2.2 GHz
CALL InstrWrite (analyzer, ":SENSE1:DETEctor1 RMS")
'Set RMS detector
'----- Setting up the gated trigger -----
CALL InstrWrite (analyzer, ":SENSE1:SWEep:EGATE ON")
'Switch on the external gate mode
CALL InstrWrite (analyzer, ":SENSE1:SWEep:EGATE:SOURce EXTernal")
'Set external gate source
CALL InstrWrite (analyzer, ":SENSE1:SWEep:EGATE:HOLDoff 0s")
'Set delay time to 0 s
CALL InstrWrite (analyzer, ":SENSE1:SWEep:EGATE:LENGth 200 US")
'Set time interval
'----- Setting the standard -----
CALL InstrWrite (analyzer, "SENSE1:ESpectrum:PRESet:STANDARD
'WIBRO\DL\PowerClass_29_40.xml")
'Set WiBro standard
'----- Measuring -----
CALL InstrWrite (analyzer, "INIT;*WAI") 'Perform sweep, wait for sweep
'end
'----- Reading out results -----
CALL InstrWrite (analyzer, ":TRACe1:DATA? LIST")
'Query list results
CALL InstrWrite (analyzer, ":CALCulate:LIMit:FAIL?")
'Query result of limit check
CALL InstrRead(analyzer, result$)
REM *****

```

6.4.12.2 Defining 5 Ranges with all Parameters

In the following example, the Spectrum Emission Mask measurement is configured by defining ranges and parameters.

```

REM *****
'----- General settings of the instrument -----
CALL InstrWrite (analyzer, "*RST") 'Reset instrument

```

Remote Control – Programming Examples

```

CALL InstrWrite (analyzer, "INIT:CONT OFF") 'Switch to single sweep
CALL InstrWrite (analyzer, "INIT:IMM;*WAI") 'Make sure no sweep is running
CALL InstrWrite (analyzer, ":SENSE1:SWEep:MODE ESpectrum")
'Set measurement mode
Rem After preset 3 ranges are available where the middle one is
Rem the reference range for calculating the TX power
CALL InstrWrite (analyzer, ":SENSE1:FREQuency:CENTer 2.2GHz")
'Center frequency 2.2 GHz
CALL InstrWrite (analyzer, ":SENSE1:DETEctor1 RMS")
'Set RMS detector
CALL InstrWrite (analyzer, ":TRIGger1:SEQUence:SOURce IMMEDIATE")
'Trigger setup
'----- Setting up the gated trigger -----
Rem If a free run trigger is not appropriate a gated trigger can
Rem the be set up (just comment in the following lines).
Rem CALL InstrWrite (analyzer, ":SENSE1:SWEep:EGATE ON")
Rem Switch on the external gate mode
Rem CALL InstrWrite (analyzer, ":SENSE1:SWEep:EGATE:SOURce EXTERNAL")
Rem Set external gate source
Rem CALL InstrWrite (analyzer, ":SENSE1:SWEep:EGATE:HOLDoff 0s")
Rem Set delay time to 0 s
Rem CALL InstrWrite (analyzer, ":SENSE1:SWEep:EGATE:LENGth 200 US")
Rem Set time interval
'----- Setting the span -----
CALL InstrWrite (analyzer, ":SENSE1:FREQuency:SPAN 8 MHz")
'Set the span to 8 MHz
'----- Inserting new ranges -----
Rem Enlarge number of ranges to 5 by adding one at the end
Rem and one at the beginnig. This ensures that the reference range
Rem remains in the middle
CALL InstrWrite (analyzer, ":SENSE1:ESpectrum:RANGe2:INSert AFter")
'Insert a range after range 2
CALL InstrWrite (analyzer, ":SENSE1:ESpectrum:RANGe1:INSert BEFore")
'Insert a range before range 1
'----- Defining the limit check for all ranges -----
CALL InstrWrite (analyzer, ":SENSE1:ESpectrum:RANGe:LIMit:STATe AND")
'Set check for absolute and 'relative limit
'----- Defining the reference range settings -----
Rem The bandwidth of the reference range limits the minimum span
Rem of the reference range definition later in the script.
CALL InstrWrite (analyzer, ":SENSE1:ESpectrum:RTYPE CPOWer")
'Set power reference type
CALL InstrWrite (analyzer, ":SENSE1:ESpectrum:BWID 2 MHz")
'Set bandwidth
'----- Defining the settings of range 1 -----
CALL InstrWrite (analyzer, ":SENSE1:ESpectrum:RANGe1:FREQuency:STARt -4 MHz")
'Set the start frequency
CALL InstrWrite (analyzer, ":SENSE1:ESpectrum:RANGe1:FREQuency:STOP -2 MHz")
'Set the stop frequency
CALL InstrWrite (analyzer, ":SENSE1:ESpectrum:RANGe1:BANDwidth:RESolution 1 MHz")

```

Remote Control – Programming Examples

```

'Set the resolution bandwidth
CALL InstrWrite (analyzer, ":SENSe1:ESpectrum:RANGe1:FILTer:TYPE CFILTer")
'Set the channel filters
CALL InstrWrite (analyzer, ":SENSe1:ESpectrum:RANGe1:BANDwidth:VIDeo 3 MHz")
'Set the video bandwidth to 3 MHz
CALL InstrWrite (analyzer, ":SENSe1:ESpectrum:RANGe1:SWEep:TIME 20 ms")
'Set the sweep time to 20 ms
CALL InstrWrite (analyzer, ":SENSe1:ESpectrum:RANGe1:RLEVel 5 DBM")
'Set the reference level to 5 dBm
CALL InstrWrite (analyzer, ":SENSe1:ESpectrum:RANGe1:INPut:ATTenuation 20 DB")
'Set the attenuation to 20 dB
CALL InstrWrite (analyzer, ":SENSe1:ESpectrum:RANGe1:LIMit:ABSolute:START -50")
'Set an absolute limit of -50 dBm
CALL InstrWrite (analyzer, ":SENSe1:ESpectrum:RANGe1:LIMit:ABSolute:STOP -50")
'Set an absolute limit of -50 dBm
CALL InstrWrite (analyzer, ":SENSe1:ESpectrum:RANGe1:LIMit:RELative:START -70")
'Set a relative limit of -70 dBc
CALL InstrWrite (analyzer, ":SENSe1:ESpectrum:RANGe1:LIMit:RELative:STOP -60")
'Set a relative limit of -60 dBc
'----- Defining the settings of range 2 -----
CALL InstrWrite (analyzer, ":SENSe1:ESpectrum:RANGe2:FREQuency:START -2 MHz")
CALL InstrWrite (analyzer, ":SENSe1:ESpectrum:RANGe2:FREQuency:STOP -1 MHz")
CALL InstrWrite (analyzer, ":SENSe1:ESpectrum:RANGe2:BANDwidth:RESolution
100 kHz")
CALL InstrWrite (analyzer, ":SENSe1:ESpectrum:RANGe2:FILTer:TYPE NORM")
CALL InstrWrite (analyzer, ":SENSe1:ESpectrum:RANGe2:BANDwidth:VIDeo 300 kHz")
CALL InstrWrite (analyzer, ":SENSe1:ESpectrum:RANGe2:SWEep:TIME 50 ms")
CALL InstrWrite (analyzer, ":SENSe1:ESpectrum:RANGe2:RLEVel 10 DBM")
CALL InstrWrite (analyzer, ":SENSe1:ESpectrum:RANGe2:INPut:ATTenuation 30 DB")
CALL InstrWrite (analyzer, ":SENSe1:ESpectrum:RANGe2:LIMit:ABSolute:START
-40")
CALL InstrWrite (analyzer, ":SENSe1:ESpectrum:RANGe2:LIMit:RELative:START
-60")
CALL InstrWrite (analyzer, ":SENSe1:ESpectrum:RANGe2:LIMit:ABSolute:STOP -40")
CALL InstrWrite (analyzer, ":SENSe1:ESpectrum:RANGe2:LIMit:RELative:STOP -40")
'----- Defining the settings of range 3 -----
CALL InstrWrite (analyzer, ":SENSe1:ESpectrum:RANGe3:FREQuency:START -1 MHz")
CALL InstrWrite (analyzer, ":SENSe1:ESpectrum:RANGe3:FREQuency:STOP 1 MHz")
CALL InstrWrite (analyzer, ":SENSe1:ESpectrum:RANGe3:BANDwidth:RESolution
30 kHz")
CALL InstrWrite (analyzer, ":SENSe1:ESpectrum:RANGe3:FILTer:TYPE NORM")
CALL InstrWrite (analyzer, ":SENSe1:ESpectrum:RANGe3:BANDwidth:VIDeo 100 kHz")
CALL InstrWrite (analyzer, ":SENSe1:ESpectrum:RANGe3:SWEep:TIME 5 ms")
CALL InstrWrite (analyzer, ":SENSe1:ESpectrum:RANGe3:RLEVel 20 DBM")
CALL InstrWrite (analyzer, ":SENSe1:ESpectrum:RANGe3:INPut:ATTenuation 30 DB")
CALL InstrWrite (analyzer, ":SENSe1:ESpectrum:RANGe3:LIMit:ABSolute:START 200")
CALL InstrWrite (analyzer, ":SENSe1:ESpectrum:RANGe3:LIMit:ABSolute:STOP 200")
CALL InstrWrite (analyzer, ":SENSe1:ESpectrum:RANGe3:LIMit:RELative:START 200")
CALL InstrWrite (analyzer, ":SENSe1:ESpectrum:RANGe3:LIMit:RELative:STOP 200")
'----- Defining the settings of range 4 -----

```

```

CALL InstrWrite (analyzer, ":SENSE1:ESpectrum:RANGE4:FREQuency:STARt 1 MHz")
CALL InstrWrite (analyzer, ":SENSE1:ESpectrum:RANGE4:FREQuency:STOP 2 MHz")
CALL InstrWrite (analyzer, ":SENSE1:ESpectrum:RANGE4:BANDwidth:RESolution
100 kHz")
CALL InstrWrite (analyzer, ":SENSE1:ESpectrum:RANGE4:FILTer:TYPE NORM")
CALL InstrWrite (analyzer, ":SENSE1:ESpectrum:RANGE4:BANDwidth:VIDeo 300 kHz")
CALL InstrWrite (analyzer, ":SENSE1:ESpectrum:RANGE4:SWEep:TIME 50 ms")
CALL InstrWrite (analyzer, ":SENSE1:ESpectrum:RANGE4:RLEVel 10 DBM")
CALL InstrWrite (analyzer, ":SENSE1:ESpectrum:RANGE4:INPut:ATTenuation 30 DB")
CALL InstrWrite (analyzer, ":SENSE1:ESpectrum:RANGE4:LIMit:ABSolute:STARt
-40")
CALL InstrWrite (analyzer, ":SENSE1:ESpectrum:RANGE4:LIMit:ABSolute:STOP -40")
CALL InstrWrite (analyzer, ":SENSE1:ESpectrum:RANGE4:LIMit:RELative:STARt
-40")
CALL InstrWrite (analyzer, ":SENSE1:ESpectrum:RANGE4:LIMit:RELative:STOP -60")
'----- Defining the settings of range 5 -----
CALL InstrWrite (analyzer, ":SENSE1:ESpectrum:RANGE5:FREQuency:STARt 2 MHz")
CALL InstrWrite (analyzer, ":SENSE1:ESpectrum:RANGE5:FREQuency:STOP 4 MHz")
CALL InstrWrite (analyzer, ":SENSE1:ESpectrum:RANGE5:BANDwidth:RESolution 1 MHz")
CALL InstrWrite (analyzer, ":SENSE1:ESpectrum:RANGE5:FILTer:TYPE CFILter")
CALL InstrWrite (analyzer, ":SENSE1:ESpectrum:RANGE5:BANDwidth:VIDeo 3 MHz")
CALL InstrWrite (analyzer, ":SENSE1:ESpectrum:RANGE5:SWEep:TIME 20 ms")
CALL InstrWrite (analyzer, ":SENSE1:ESpectrum:RANGE5:RLEVel 5 DBM")
CALL InstrWrite (analyzer, ":SENSE1:ESpectrum:RANGE5:INPut:ATTenuation 20 DB")
CALL InstrWrite (analyzer, ":SENSE1:ESpectrum:RANGE5:LIMit:ABSolute:STARt
-50")
CALL InstrWrite (analyzer, ":SENSE1:ESpectrum:RANGE5:LIMit:ABSolute:STOP -50")
CALL InstrWrite (analyzer, ":SENSE1:ESpectrum:RANGE5:LIMit:RELative:STARt -60")
CALL InstrWrite (analyzer, ":SENSE1:ESpectrum:RANGE5:LIMit:RELative:STOP -70")
'----- Measuring -----
CALL InstrWrite (analyzer, "INIT;*WAI") 'Perform sweep, wait for sweep
'end
'----- Reading out results -----
CALL InstrWrite (analyzer, ":TRACe1:DATA? LIST")
'Query list results
CALL InstrWrite (analyzer, ":CALCulate:LIMit:FAIL?")
'Query result of limit check
CALL InstrRead(analyzer, result$)
REM *****

```

6.4.13 Spurious Emissions Measurement

In the following example, the Spurious Emissions measurement is configured by defining ranges and parameters.

```

REM *****
'----- General settings of the instrument -----
CALL InstrWrite (analyzer, "*RST") 'Reset instrument
Rem After preset 4 ranges are available. Range settings can be questioned

```

```

Rem independent from the set measurement mode.
'----- Deleting all ranges -----
Rem Delete all ranges to prepare for setting up a new measurement
CALL InstrWrite (analyzer, "SENSe1:LIST:RANGe4:DELeTe")
'Delete range 4
CALL InstrWrite (analyzer, "SENSe1:LIST:RANGe3:DELeTe")
CALL InstrWrite (analyzer, "SENSe1:LIST:RANGe2:DELeTe")
CALL InstrWrite (analyzer, "SENSe1:LIST:RANGe1:DELeTe")
'----- Defining the start frequency for all ranges -----
CALL InstrWrite (analyzer, "SENSe1:LIST:RANGe1:FREQuency:START 1000000")
Rem Setting the start frequency of range 1 will create the ranges and
Rem every other range value will be set to the default value.
CALL InstrWrite (analyzer, "SENSe1:LIST:RANGe2:FREQuency:START 2000000")
CALL InstrWrite (analyzer, "SENSe1:LIST:RANGe3:FREQuency:START 3000000")
CALL InstrWrite (analyzer, "SENSe1:LIST:RANGe4:FREQuency:START 4000000")
CALL InstrWrite (analyzer, "SENSe1:LIST:RANGe5:FREQuency:START 5000000")
CALL InstrWrite (analyzer, "SENSe1:LIST:RANGe:COUNT?")
'Queries the number of defined
'ranges
'----- Querying the parameters of range 1 -----
CALL InstrWrite (analyzer, "SENSe1:LIST:RANGe1:FREQuency:START?")
CALL InstrWrite (analyzer, "SENSe1:LIST:RANGe1:FREQuency:STOP?")
CALL InstrWrite (analyzer, "SENSe1:LIST:RANGe1:FILTeR:TYPe?")
CALL InstrWrite (analyzer, "SENSe1:LIST:RANGe1:BANdwidth:RESolution?")
CALL InstrWrite (analyzer, "SENSe1:LIST:RANGe1:BANdwidth:VIDeo?")
CALL InstrWrite (analyzer, "SENSe1:LIST:RANGe1:SWEep:TIME:AUTO?")
CALL InstrWrite (analyzer, "SENSe1:LIST:RANGe1:DETeCtor?")
CALL InstrWrite (analyzer, "SENSe1:LIST:RANGe1:RLEVel?")
CALL InstrWrite (analyzer, "SENSe1:LIST:RANGe1:INPut:ATTenuation:AUTO?")
CALL InstrWrite (analyzer, "SENSe1:LIST:RANGe1:INPut:GAIN:STATe?")
CALL InstrWrite (analyzer, "SENSe1:LIST:RANGe1:BReAk?")
CALL InstrWrite (analyzer, "SENSe1:LIST:RANGe1:TRANsducer?")
CALL InstrWrite (analyzer, "SENSe1:LIST:RANGe1:SWEep:TIME?")
CALL InstrWrite (analyzer, "SENSe1:LIST:RANGe1:INPut:ATTenuation?")
CALL InstrWrite (analyzer, "SENSe1:LIST:RANGe1:POINts?")
CALL InstrWrite (analyzer, "SENSe1:LIST:RANGe1:LIMit:START?")
CALL InstrWrite (analyzer, "SENSe1:LIST:RANGe1:LIMit:STOP?")
CALL InstrWrite (analyzer, "SENSe1:LIST:RANGe1:LIMit:STATe?")
'----- Changing into the Spurious Emissions measurement mode -----
CALL InstrWrite (analyzer, ":SENSe1:SWEEP:MODE LIST")
Rem In continuous sweep mode, editing the ranges is not allowed.
Rem You have to stop the measurement first.
Rem In single sweep mode, you can edit the ranges at the end of the sweep.
'----- Single sweep version -----
CALL InstrWrite (analyzer, "INIT:CONT OFF") 'Switch to single sweep
CALL InstrWrite (analyzer, "SENSe1:LIST:RANGe1:FREQuency:START 500000")
'Change the start frequency
CALL InstrWrite (analyzer, "INIT;*WAI") 'Perform sweep, wait for sweep
'end
'----- Continuous sweep version -----

```

Remote Control – Programming Examples

```

CALL InstrWrite (analyzer, "INIT:CONT ON") 'Switch to continuous sweep
CALL InstrWrite (analyzer, "ABORT") 'Stop the measurement
CALL InstrWrite (analyzer, "SENSE1:LIST:RANGE1:FREQUENCY:START 500000")
'Change the start frequency
CALL InstrWrite (analyzer, ":INITiate1:SPURious") 'Restart the measurement
'----- Defining the range settings in single sweep mode -----
CALL InstrWrite (analyzer, "INIT:CONT OFF") 'Switch to single sweep
CALL InstrWrite (analyzer, "INIT;*WAI") 'Perform sweep, wait for sweep
'end

Rem Edit one range at a time. Make sure to edit the ranges in a correct
Rem order to prevent limit violations. Ranges cannot overlap.
Rem The best way is to start with range 1.
CALL InstrWrite (analyzer, "SENSE1:LIST:RANGE1:FREQUENCY:START 500000")
CALL InstrWrite (analyzer, "SENSE1:LIST:RANGE1:FREQUENCY:STOP 550000")
CALL InstrWrite (analyzer, "SENSE1:LIST:RANGE1:FILTer:TYPE NORM")
CALL InstrWrite (analyzer, "SENSE1:LIST:RANGE1:BANDwidth:RESolution 3000000")
CALL InstrWrite (analyzer, "SENSE1:LIST:RANGE1:BANDwidth:VIDeo 10000000")
CALL InstrWrite (analyzer, "SENSE1:LIST:RANGE1:SWEep:TIME:AUTO ON")
CALL InstrWrite (analyzer, "SENSE1:LIST:RANGE1:DETECTOR RMS")
CALL InstrWrite (analyzer, "SENSE1:LIST:RANGE1:RLEVel -10")
CALL InstrWrite (analyzer, "SENSE1:LIST:RANGE1:INPut:ATTenuation:AUTO ON")
CALL InstrWrite (analyzer, "SENSE1:LIST:RANGE1:POINts 8001")
CALL InstrWrite (analyzer, "SENSE1:LIST:RANGE1:INPut:GAIN:STATE OFF")
CALL InstrWrite (analyzer, "SENSE1:LIST:RANGE1:BREak OFF")
CALL InstrWrite (analyzer, "SENSE1:LIST:RANGE1:LIMit:START -20")
CALL InstrWrite (analyzer, "SENSE1:LIST:RANGE1:LIMit:STOP -20")
CALL InstrWrite (analyzer, "SENSE1:LIST:RANGE1:LIMit:STATE ON")
Rem Proceed with range 2.
CALL InstrWrite (analyzer, "SENSE1:LIST:RANGE2:FREQUENCY:START 1000000")
CALL InstrWrite (analyzer, "SENSE1:LIST:RANGE2:FREQUENCY:STOP 2000000000")
CALL InstrWrite (analyzer, "SENSE1:LIST:RANGE2:FILTer:TYPE CFILter")
CALL InstrWrite (analyzer, "SENSE1:LIST:RANGE2:BANDwidth:RESolution 5000000")
CALL InstrWrite (analyzer, "SENSE1:LIST:RANGE2:DETECTOR POS")
CALL InstrWrite (analyzer, "SENSE1:LIST:RANGE2:RLEVel -20")
CALL InstrWrite (analyzer, "SENSE1:LIST:RANGE2:INPut:ATTenuation 0")
CALL InstrWrite (analyzer, "SENSE1:LIST:RANGE2:POINts 32001")
CALL InstrWrite (analyzer, "SENSE1:LIST:RANGE2:INPut:GAIN:STATE ON")
Rem Proceed with range 3.
CALL InstrWrite (analyzer, "SENSE1:LIST:RANGE3:FREQUENCY:START 2500000000")
CALL InstrWrite (analyzer, "SENSE1:LIST:RANGE3:FREQUENCY:STOP 10000000000")
CALL InstrWrite (analyzer, "SENSE1:LIST:RANGE3:FILTer:TYPE RRC")
CALL InstrWrite (analyzer, "SENSE1:LIST:RANGE3:POINts 32001")
Rem Proceed with range 4.
CALL InstrWrite (analyzer, "SENSE1:LIST:RANGE4:FREQUENCY:START 1200000000")
CALL InstrWrite (analyzer, "SENSE1:LIST:RANGE4:FREQUENCY:STOP 4000000000")
CALL InstrWrite (analyzer, "SENSE1:LIST:RANGE4:FILTer:TYPE PULSe")
CALL InstrWrite (analyzer, "SENSE1:LIST:RANGE4:POINts 251")
Rem Proceed with range 5.
CALL InstrWrite (analyzer, "SENSE1:LIST:RANGE5:FREQUENCY:START 5000000000")
CALL InstrWrite (analyzer, "SENSE1:LIST:RANGE5:FREQUENCY:STOP 6000000000")

```

```

CALL InstrWrite (analyzer, "SENSE1:LIST:RANGE5:POINTS 7001")
'----- Defining the limit check for all ranges -----
CALL InstrWrite (analyzer, "SENSE1:LIST:RANGE1:LIMIT:STATE ON")
'Activate the limit check
'----- Setting the span to include all ranges -----
CALL InstrWrite (analyzer, ":SENSE1:FREQUENCY:START 500000")
CALL InstrWrite (analyzer, ":SENSE1:FREQUENCY:STOP 6000000000")
'----- Measuring -----
CALL InstrWrite (analyzer, "INIT;*WAI") 'Perform sweep, wait for sweep
'end
'----- Reading out results -----
CALL InstrWrite (analyzer, ":TRACE1:DATA? LIST")
'Query list results
CALL InstrWrite (analyzer, ":CALCULATE1:PSEARCH[:IMMEDIATE]")
'Deactivate limit line and
'just look for peaks
Rem Or set margin to 200 in order to find all peaks
CALL InstrWrite (analyzer, ":TRACE1:DATA? SPUR")
'Query just the peaks
CALL InstrWrite (analyzer, ":CALCULATE:LIMIT:FAIL?")
'Query result of limit check
CALL InstrRead(analyzer, result$)
REM *****

```

6.4.14 Averaging I/Q Data

The R&S FSVA/FSV has averaging capability also for I/Q measurements, i.e. I/Q data can be averaged over several test runs. This is subject to the following conditions:

- An external trigger signal must be available for data measurement, and the trigger signal must be phase-locked to the signal measured.
- The same reference-frequency signal must be used for the DUT and the R&S FSVA/FSV.
- Internal I/Q data averaging is supported up to 512 k I/Q samples.

If all of the above conditions are fulfilled, no phase shift will occur between consecutive test runs. Phase shift may falsify the measured average so that in extreme cases a value of 0 is obtained.

The default setting of the instrument for data measurement without averaging has to be changed as follows:

```

REM *****
'----- R&S FSV default setting -----
CALL SetupInstrument 'Default setting
CALL InstrWrite (analyzer, "TRAC:IQ:STAT ON")
'Activate I/Q data acquisition
'mode; this must be
'done before TRAC:IQ:SET!
'Select max. number of test points (= 512 * 1024) at 10 MHz RBW,

```

```
'32 MHz sampling rate, external
'trigger, pos. trigger edge and
'0 s trigger delay.
CALL InstrWrite (analyzer, "TRAC:IQ:SET NORM,10 MHz,32 MHz,EXT,POS,0,524288")
CALL InstrWrite (analyzer, "TRAC:IQ:AVER ON") 'Switch on I/Q averaging
CALL InstrWrite (analyzer, "TRAC:IQ:AVER:COUN 10") 'Set 10 test runs
'----- Read data in binary format -----
...
REM *****
```

6.4.15 Using IQ Gating

IQ gating refers to recording IQ samples in certain time intervals – the gate areas. There are different modes to define the gate areas:

- Edge triggered recording
- Level triggered recording

For more information, see "IQ Gating" in the "Remote Commands" chapter under "Trace:IQ" subsystem.

Measurement example: Level mode

With IQ gating in level mode, the area in which the gate signal is active is recorded. In this example, the gate signal is generated by the IFP trigger. The [Figure 6-6](#) shows the signal (triggered externally) in IQ mode. The following sample program records the signal in level mode with an external trigger.

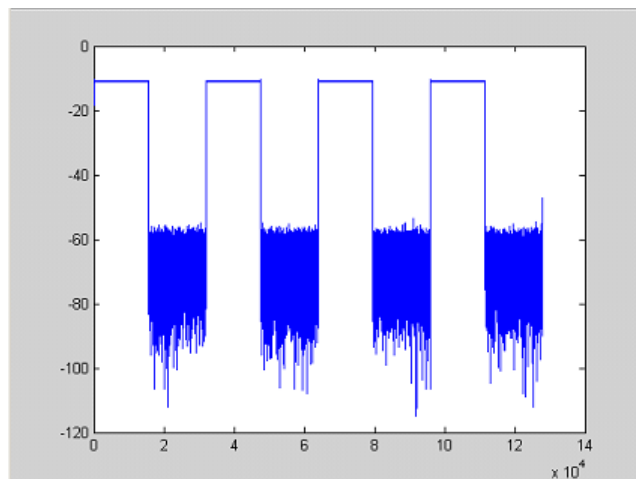

Figure 6-6: Signal to be recorded in IQ mode

Used values

sample rate: 32 MHz

number of IQ samples: 128000

trigger mode: IFP

Program

```
:TRACel:IQ ON  
  
Trace:iq:set NORM,0,32000000,IFP,POS,0,128000  
  
:TRIGger1:SEQuence:LEVel:IFPower -20  
  
:TRACel:IQ:EGATe ON  
  
:TRACel:IQ:EGATe:TYPE LEVel
```

Result

In [Figure 6-7](#), the recorded signal using IQ gating in level mode is displayed. Edges are only visible around the IFP trigger point, otherwise only the signal level is recorded.

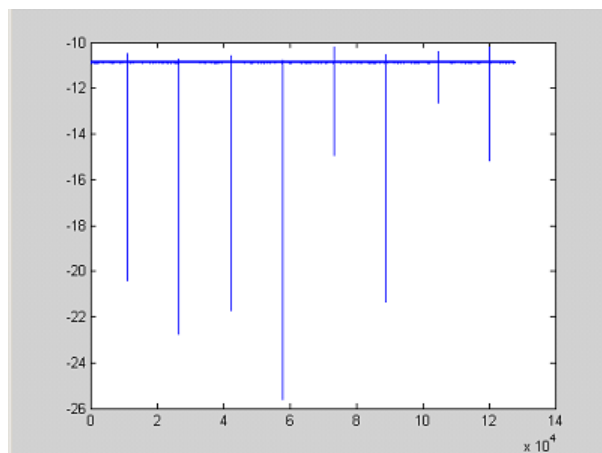

Figure 6-7: Recorded signal using IQ gating in level mode

Measurement example: Edge mode

In edge mode, the gate area is defined by:

- delay (pretrigger samples)
- length
- number of periods
- gap between the periods

The gate starting point can be defined using an IFP or external trigger.

The [Figure 6-8](#) shows the signal to be recorded in IQ mode.

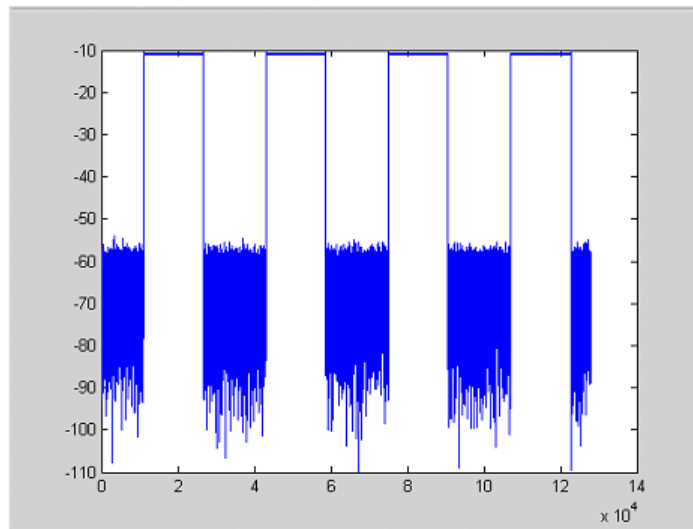

Figure 6-8: Signal to be recorded in IQ mode

Example 1: Signal only

The following sample program records the signal in edge mode and displays only the signal, without gaps and noise.

Used values

sample rate: 32 MHz

number of IQ samples: 128000

delay = 11020 samples

length = 15500 samples

trigger mode: EXT

Program

```
:TRACel:IQ ON
Trace:iq:set NORM,0,32000000,EXT,POS, 11020,128000
:TRACel:IQ:EGATe ON
:TRACel:IQ:EGATe:TYPE EDGE
:TRACel:IQ:EGATe:LENGth 15500
```

Result

Figure 6-9: Result: signal only (no gaps, no noise)

Example 2: Noise only

The following sample program records the signal in edge mode and displays only the noise.

Used values

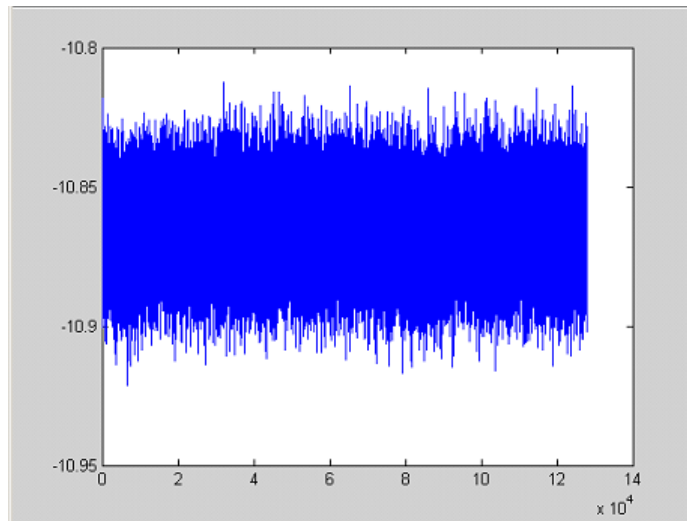
sample rate: 32 MHz

number of IQ samples: 128000

delay = 0 samples

length = 9000 samples

trigger mode: EXT

Program

```
:TRACel:IQ ON
Trace:iq:set NORM,0,32000000,EXT,POS, 0,128000
:TRACel:IQ:EGATE ON
:TRACel:IQ:EGATE:TYPE EDGE
:TRACel:IQ:EGATE:LENGTH 9000
```

Result

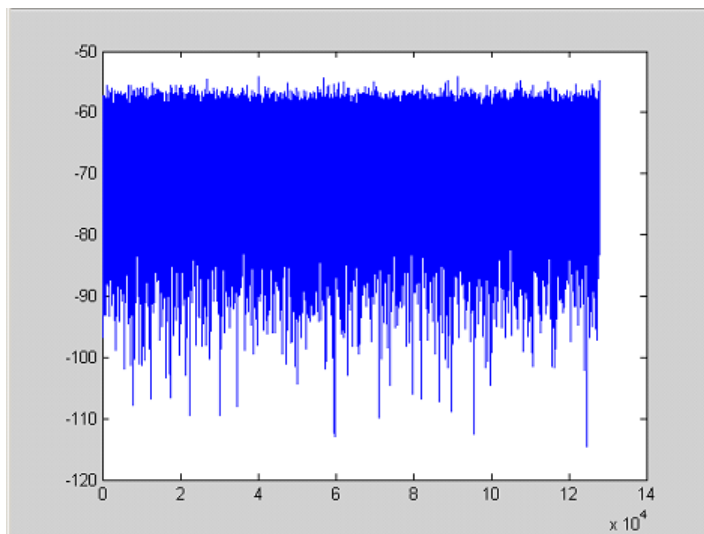

Figure 6-10: Result: noise only

Measurement example: Periodic signal intervals in edge mode

The gate area can also be defined by a number of gate periods and the distance between two periods (gap). In this example, a power ramp is recorded, triggered by the IFP on the highest edge (see Figure 6-11). As a result, only the levels of the individual ramp areas of the first 3 periods are displayed (see Figure 6-12).

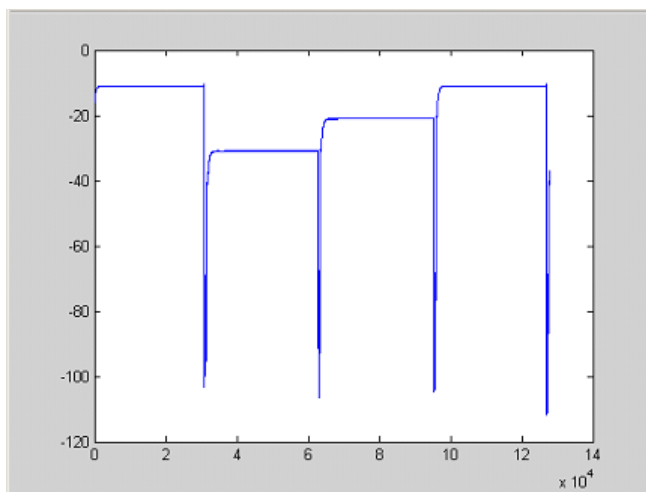

Figure 6-11: Periodic signal recording in edge mode

Used values:

sample rate: 3,2 MHz

number of IQ samples: 228000

trigger mode: IFP

length: 28800

number of periods: 3

gap: 3800 samples

Program

```
:TRACel:IQ ON
trace:iq:set NORM,0,3200000,IFP,POS,0,228000
:TRIGger1:SEQuence:LEVel:IFPower -20
:TRACel:IQ:EGATe ON
:TRACel:IQ:EGATe:TYPE EDGE
:TRACel:IQ:EGATe:LENGth 28800
:TRACel:IQ:EGATe:NOF 3
:TRACel:IQ:EGATe:GAP 3800
```

Result

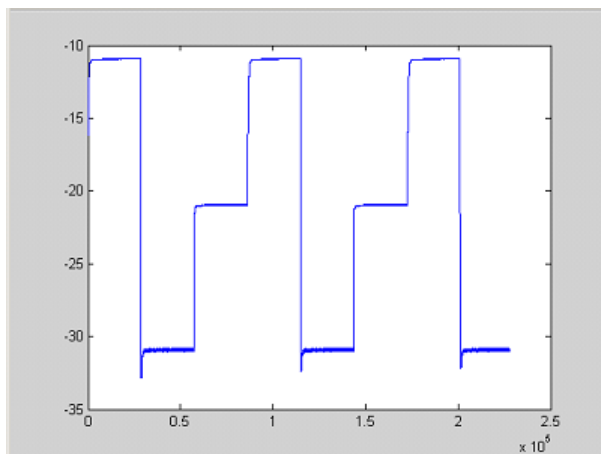

Figure 6-12: Result: periodic power ramp levels

6.4.16 Usage of Four Spectrum Instances

As of R&S FSVA/FSV firmware version 1.50, you can open up to four tabs for spectrum mode with the softkey "New Spectrum" in the "MODE" menu. The following remote example shows how to set up four tabs with four different measurements on a WCDMA signal.

```
REM *****
Public Sub 4SpectrumTabs()
result$ = Space$(100)

'----- R&S FSV default setting -----
CALL SetupStatusReg           'Set status registers
```

Remote Control – Programming Examples

```

CALL InstrWrite(analyzer,"*RST")          'Reset instrument
CALL InstrWrite(analyzer,"INIT:CONT OFF")  'Single sweep

'----- Setup the first Spectrum tab (Spectrum Overview Measurement) -----
CALL InstrWrite(analyzer,"INIT:CONT OFF")  'Single sweep
CALL InstrWrite(analyzer,"DISP:WIND:TRAC:Y:SCAL:RLEV 10 dBm")'Reference level
CALL InstrWrite(analyzer,"FREQ:START 100MHz;STOP 6 GHz")  'Span

'----- Setup the Spectrum 2 Tab (ACLR measurement) -----
CALL InstrWrite(analyzer,"INST:CRE SAN,'Spectrum 2'")      'Create Tab 2

'--- After creation the tab is in standard preset setup ---
CALL InstrWrite(analyzer,"INIT:CONT OFF")  'Single sweep
CALL InstrWrite(analyzer,"DISP:WIND:TRAC:Y:SCAL:RLEV 10 dBm")'Reference level
CALL InstrWrite(analyzer,"FREQ:CENT 2.1175GHz")          'different CF
CALL InstrWrite(analyzer,"CALC:MARK:FUNC:POW:SEL ACP")    'select ACLR meas
CALL InstrWrite(analyzer,"CALC:MARK:FUNC:POW:PRES FW3Gppcdma")
      'select WCDMA BTS standard

'----- Setup the Spectrum 3 Tab (OBW measurement) -----
CALL InstrWrite(analyzer,"INST:CRE SAN,'Spectrum 3'")      'Create Tab 3
CALL InstrWrite(analyzer,"INIT:CONT OFF")  'Single sweep
CALL InstrWrite(analyzer,"DISP:WIND:TRAC:Y:SCAL:RLEV 10 dBm")'Reference level
CALL InstrWrite(analyzer,"FREQ:CENT 2.1175GHz")          'different CF
CALL InstrWrite(analyzer,"CALC:MARK:FUNC:POW:SEL OBW")    'select OBW meas
CALL InstrWrite(analyzer,"CALC:MARK:FUNC:POW:PRES FW3Gppcdma")
      ' select WCDMA BTS standard

'----- Setup the Spectrum 4 Tab (CCDF measurement) -----
CALL InstrWrite(analyzer,"INST:CRE SAN,'Spectrum 4'")      'Create Tab 4
CALL InstrWrite(analyzer,"INIT:CONT OFF")  'Single sweep
CALL InstrWrite(analyzer,"DISP:WIND:TRAC:Y:SCAL:RLEV 10 dBm")'Reference level
CALL InstrWrite(analyzer,"FREQ:CENT 2.1175GHz")          'different CF
CALL InstrWrite(analyzer," CALC:STAT:CCDF ON")            'select CCDF meas

'----- Sweep in first Spectrum Tab and query marker -----
CALL InstrWrite(analyzer,"INST:SEL SAN")                  'Select Tab 1
CALL InstrWrite(analyzer,"INIT;*WAI")                    'Perform sweep with sync
CALL InstrWrite(analyzer,"CALC:MARK1:MAX")                'Marker to peak
CALL InstrWrite(analyzer,"CALC:MARK1:X?")                'Query Marker x value
CALL InstrRead(analyzer,result$)
Print "Spectrum 1 Marker x [Hz]: ";result$
CALL InstrWrite(analyzer,"CALC:MARK1:Y?")                'Query Marker y value
CALL InstrRead(analyzer,result$)
Print "Spectrum 1 Marker y [dBm]: ";result$

'----- Sweep in Spectrum 2 Tab and query ACLR results -----
CALL InstrWrite(analyzer," INST:SEL 'Spectrum 2'")        'Select Tab 2
CALL InstrWrite(analyzer,"INIT;*WAI")                    'Perform sweep with sync
CALL InstrWrite(analyzer,"CALC:MARK:FUNC:POW:RES? ACP")  'Query ACLR results
CALL InstrRead(analyzer,result$)
Print "Spectrum 2 ACRL results : ";result$

'----- Sweep in Spectrum 3 Tab and query OBW results -----
CALL InstrWrite(analyzer," INST:SEL 'Spectrum 3'")        'Select Tab 3

```

```

CALL InstrWrite(analyzer,"INIT;*WAI")           'Perform sweep with sync
CALL InstrWrite(analyzer,"CALC:MARK:FUNC:POW:RES? OBW") 'Query OBW results
CALL InstrRead(analyzer,result$)
Print "Spectrum 3 OBW results : ";result$

'----- Sweep in Spectrum 4 Tab and query CCDF results -----
CALL InstrWrite(analyzer," INST:SEL 'Spectrum 4'") 'Select Tab 4
CALL InstrWrite(analyzer,"INIT;*WAI")           'Perform sweep with sync
CALL InstrWrite(analyzer,"CALC:STAT:RES1? ALL") 'Query CCDF results
CALL InstrRead(analyzer,result$)
Print "Spectrum 4 CCDF results : ";result$
'----- Now the sweep part can be redone without the need of -----
'----- doing the setup of all 4 measurements again. -----
END SUB
REM *****

```

7 Maintenance

The following chapter contains information on the maintenance of the R&S FSVA/FSV. The instrument does not need a periodic maintenance. What is necessary is essentially the cleaning of the instrument. However, it is recommended to check the rated data from time to time.

Follow the instructions in the service manual and the safety instructions when exchanging modules or ordering spares. The order no. for spare parts is included in the service manual. The service manual includes further information particularly on troubleshooting, repair, exchange of modules (including battery exchange, adjustment of the OCXO oscillator) and alignment.

The address of our support center and a list of all Rohde & Schwarz service centers can be found at the beginning of this manual.

7.1 Cleaning

⚠ WARNING**Risk of electric shock**

If moisture enters the casing, for example if you clean the instrument using a moist cloth, contact with the instrument can lead to electric shock. Before cleaning the instrument other than with a dry cloth, make sure that the instrument is switched off and disconnected from all power supplies.

NOTICE**Instrument damage caused by cleaning agents**

Cleaning agents contain substances such as solvents (thinners, acetone, etc.), acids, bases, or other substances. Solvents can damage the front panel labeling, plastic parts, or screens, for example.

Never use cleaning agents to clean the outside of the instrument. Use a soft, dry, lint-free dust cloth instead.

NOTICE**Risk of instrument damage due to obstructed fans**

If the instrument is operated in dusty areas, the fans become obstructed by dust or other particles over time. Check and clean the fans regularly to ensure that they always operate properly. If the instrument is run with obstructed fans for a longer period, the instrument overheats, which can disturb the operation and even cause damage.

1. Clean the outside of the instrument using a soft, dry, lint-free dust cloth.
2. Check and clean the fans regularly to ensure that they always operate properly.

7.2 Storing and Packing

The storage temperature range of the instrument is given in the data sheet. If the instrument is to be stored for a longer period of time, it must be protected against dust.

Repack the instrument as it was originally packed when transporting or shipping. The two protective foam plastic parts prevent the control elements and connectors from being damaged. The antistatic packing foil avoids any undesired electrostatic charging to occur.

If you do not use the original packaging, provide for sufficient padding to prevent the instrument from slipping inside the package. Wrap antistatic packing foil around the instrument to protect it from electrostatic charging.

7.3 List of Available Power Cables

Table 7-1: List of power cables available

Stock No.	Earthed-contact connector	Preferably used in
DS 006.7013.00	BS1363: 1967' complying with IEC 83: 1975 standard B2	Great Britain
DS 006.7020.00	Type 12 complying with SEV-reg- ulation 1011.1059, standard sheet S 24 507	Switzerland
DS 006.7036.00	Type 498/13 complying with US-regulation UL 498, or with IEC 83	USA/Canada
DS 006.7107.00	Type SAA3 10 A, 250 V, complying with AS C112-1964 Ap.	Australia
DS 0025.2365.00	DIN 49 441, 10 A, 250 V, angular	Europe (except Switzerland)
DS 0099.1456.00	DIN 49 441, 10 A, 250 V, straight	

8 Error Messages

Error messages are entered in the error/event queue of the status reporting system in the remote control mode and can be queried with the command `SYSTem:ERRor?`. The answer format of R&S FSVA/FSV to the command is as follows:

```
<error code>, "<error text with queue query>;
<remote control command concerned>"
```

The indication of the remote control command with prefixed semicolon is optional.

Example:

The command "TEST:COMMAND" generates the following answer to the query `SYSTem:ERRor?`

```
-113, "Undefined header;TEST:COMMAND"
```

There are two types of error messages:

- Error messages defined by SCPI are marked by negative error codes. These messages are defined and described in the SCPI standard and not listed here.
- Device-specific error messages use positive error codes. These messages are listed below.

The right-hand column in the following tables contains the error text in bold which is entered in the error/event queue and can be read out by means of query `SYSTem:ERRor?`. A short explanation of the error cause is given. The left-hand column contains the associated error code.

Additionally, option-specific warnings and error messages displayed in the status bar are explained.

Table 8-1: Device-specific error messages

Error code	Error text in the case of queue poll Error explanation
1052	Frontend LO is Unlocked This message is displayed when the phase regulation of the local oscillator fails in the RF front-end.
1060	Trigger-Block Gate Delay Error- gate length < Gate Delay This message is displayed when the gate signal length is not sufficient for the pull-in delay with a predefined gate delay.
1064	Tracking LO is Unlocked This message is displayed when the phase regulation of the local oscillator fails on the tracking generator module.
2028	Hardcopy not possible during measurement sequence This message is displayed when a printout is started during scan sequences that cannot be interrupted. Such sequences are for example: <ul style="list-style-type: none"> • Recording the system error correction data (alignment) • Instrument self test In such cases synchronization to the end of the scan sequence should be performed prior to starting the printout.

Error code	Error text in the case of queue poll Error explanation
2033	Printer Not Available This message is displayed when the selected printer is not included in the list of available output devices. A possible cause is that the required printer driver is missing or incorrectly installed.
2034	CPU Temperature is too high This message is displayed when the temperature of the processor exceeds 70 °C.

List of Commands

[SENSe:][WINDow:]DETEctor<trace>[:FUNction].....	863
[SENSe:][WINDow:]DETEctor<trace>[:FUNction]:AUTO.....	864
[SENSe:]ADJust:ALL.....	781
[SENSe:]ADJust:CONFIguration:HYSteresis:LOWer.....	782
[SENSe:]ADJust:CONFIguration:HYSteresis:UPPer.....	783
[SENSe:]ADJust:CONFIgure:LEVel:DURation.....	782
[SENSe:]ADJust:CONFIgure:LEVel:DURation:MODE.....	782
[SENSe:]ADJust:CONFIgure:TRIG.....	783
[SENSe:]ADJust:FREQUency.....	781
[SENSe:]ADJust:LEVel.....	781
[SENSe:]AVERAge<n>:COUNT.....	784
[SENSe:]AVERAge<n>:TYPE.....	785
[SENSe:]AVERAge<n>[:STATe<Trace>].....	784
[SENSe:]BANDwidth BWIDth:VIDeo.....	788
[SENSe:]BANDwidth BWIDth:VIDeo:AUTO.....	788
[SENSe:]BANDwidth BWIDth:VIDeo:RATIo.....	788
[SENSe:]BANDwidth BWIDth:VIDeo:TYPE.....	789
[SENSe:]BANDwidth BWIDth[:RESolution].....	785
[SENSe:]BANDwidth BWIDth[:RESolution]:AUTO.....	786
[SENSe:]BANDwidth BWIDth[:RESolution]:FFT.....	786
[SENSe:]BANDwidth BWIDth[:RESolution]:RATIo.....	787
[SENSe:]BANDwidth BWIDth[:RESolution]:TYPE.....	787
[SENSe:]CORRection:COLLect[:ACQuire].....	789
[SENSe:]CORRection:CVL:BAND.....	790
[SENSe:]CORRection:CVL:BIAS.....	793
[SENSe:]CORRection:CVL:CATalog?.....	791
[SENSe:]CORRection:CVL:CLEar.....	794
[SENSe:]CORRection:CVL:COMMeNt.....	793
[SENSe:]CORRection:CVL:DATA.....	793
[SENSe:]CORRection:CVL:HARMonic.....	792
[SENSe:]CORRection:CVL:MIXer.....	791
[SENSe:]CORRection:CVL:PORTs.....	792
[SENSe:]CORRection:CVL:SELEct.....	791
[SENSe:]CORRection:CVL:SNUMber.....	791
[SENSe:]CORRection:EGain:INPUt[:MAGNitude].....	794
[SENSe:]CORRection:METHod.....	794
[SENSe:]CORRection:RECall.....	795
[SENSe:]CORRection:TRANsducer:ADJust:RLEVel[:STATe].....	954
[SENSe:]CORRection:TRANsducer:COMMeNt.....	954
[SENSe:]CORRection:TRANsducer:DATA.....	955
[SENSe:]CORRection:TRANsducer:DELEte.....	955
[SENSe:]CORRection:TRANsducer:GENerator.....	795
[SENSe:]CORRection:TRANsducer:SCALing.....	955
[SENSe:]CORRection:TRANsducer:SELEct.....	956
[SENSe:]CORRection:TRANsducer:UNIT.....	956
[SENSe:]CORRection:TRANsducer:VIEW.....	957
[SENSe:]CORRection:TRANsducer[:STATe].....	956

[SENSe:]CORRection[:STATe].....	795
[SENSe:]DEMod:SQUelch:LEVel.....	796
[SENSe:]DEMod:SQUelch[:STATe].....	796
[SENSe:]ESpectrum:BWID.....	797
[SENSe:]ESpectrum:FILTer[:RRC]:ALPHa.....	798
[SENSe:]ESpectrum:FILTer[:RRC][:STATe].....	798
[SENSe:]ESpectrum:HighSPeed.....	798
[SENSe:]ESpectrum:PRESet:REStore.....	799
[SENSe:]ESpectrum:PRESet:StORe.....	800
[SENSe:]ESpectrum:PRESet[:STANdard].....	799
[SENSe:]ESpectrum:RANGe<range>:BANDwidth:VIDeo.....	800
[SENSe:]ESpectrum:RANGe<range>:BANDwidth[:RESolution].....	800
[SENSe:]ESpectrum:RANGe<range>:COUnT.....	801
[SENSe:]ESpectrum:RANGe<range>:DELeTe.....	801
[SENSe:]ESpectrum:RANGe<range>:FILTer:TYPE.....	801
[SENSe:]ESpectrum:RANGe<range>:INPut:ATTenuation.....	803
[SENSe:]ESpectrum:RANGe<range>:INPut:ATTenuation:AUTO.....	803
[SENSe:]ESpectrum:RANGe<range>:INPut:GAIN:STATe.....	803
[SENSe:]ESpectrum:RANGe<range>:INSert.....	804
[SENSe:]ESpectrum:RANGe<range>:LIMit<source>:ABSolute:StARt.....	804
[SENSe:]ESpectrum:RANGe<range>:LIMit<source>:ABSolute:StOP.....	805
[SENSe:]ESpectrum:RANGe<range>:LIMit<source>:RELative:StARt.....	805
[SENSe:]ESpectrum:RANGe<range>:LIMit<source>:RELative:StOP.....	805
[SENSe:]ESpectrum:RANGe<range>:LIMit<source>:STATe.....	806
[SENSe:]ESpectrum:RANGe<range>:RLEVel.....	806
[SENSe:]ESpectrum:RANGe<range>:SWEep:TIME.....	807
[SENSe:]ESpectrum:RANGe<range>:SWEep:TIME:AUTO.....	807
[SENSe:]ESpectrum:RANGe<range>:TRANsducer.....	807
[SENSe:]ESpectrum:RANGe<range>[:FREQUency]:StARt.....	802
[SENSe:]ESpectrum:RANGe<range>[:FREQUency]:StOP.....	802
[SENSe:]ESpectrum:RRANGe.....	808
[SENSe:]ESpectrum:RTYPE.....	808
[SENSe:]FREQUency:CENTer.....	809
[SENSe:]FREQUency:CENTer:STEP.....	809
[SENSe:]FREQUency:CENTer:STEP:AUTO.....	809
[SENSe:]FREQUency:CENTer:STEP:LINK.....	809
[SENSe:]FREQUency:CENTer:STEP:LINK:FACTor.....	810
[SENSe:]FREQUency:MODE.....	810
[SENSe:]FREQUency:OFFSet.....	811
[SENSe:]FREQUency:SPAN.....	811
[SENSe:]FREQUency:SPAN:FULL.....	811
[SENSe:]FREQUency:StARt.....	812
[SENSe:]FREQUency:StOP.....	812
[SENSe:]LIST:POWer:RESult?.....	813
[SENSe:]LIST:POWer:SET.....	817
[SENSe:]LIST:POWer:STATe.....	818
[SENSe:]LIST:POWer[:SEQUence].....	814
[SENSe:]LIST:RANGe<range>:BANDwidth:VIDeo.....	819
[SENSe:]LIST:RANGe<range>:BANDwidth[:RESolution].....	818
[SENSe:]LIST:RANGe<range>:BREak.....	819

[SENSe:]LIST:RANGe<range>:COUNT.....	820
[SENSe:]LIST:RANGe<range>:DELeTe.....	820
[SENSe:]LIST:RANGe<range>:DETeCtor.....	820
[SENSe:]LIST:RANGe<range>:FILTer:TYPE.....	821
[SENSe:]LIST:RANGe<range>:INPut:ATTenuation.....	822
[SENSe:]LIST:RANGe<range>:INPut:ATTenuation:AUTO.....	822
[SENSe:]LIST:RANGe<range>:INPut:GAIN:STATe.....	823
[SENSe:]LIST:RANGe<range>:LIMit:START.....	823
[SENSe:]LIST:RANGe<range>:LIMit:STATe.....	823
[SENSe:]LIST:RANGe<range>:LIMit:STOP.....	824
[SENSe:]LIST:RANGe<range>:POINts.....	824
[SENSe:]LIST:RANGe<range>:RLEVel.....	824
[SENSe:]LIST:RANGe<range>:SWEep:TIME.....	825
[SENSe:]LIST:RANGe<range>:SWEep:TIME:AUTO.....	825
[SENSe:]LIST:RANGe<range>:TRANsducer.....	825
[SENSe:]LIST:RANGe<range>[:FREQUency]:START.....	821
[SENSe:]LIST:RANGe<range>[:FREQUency]:STOP.....	821
[SENSe:]MIXer:BIAS:HIGH.....	827
[SENSe:]MIXer:BIAS:LOW.....	827
[SENSe:]MIXer:FREQUency:HANDOver.....	828
[SENSe:]MIXer:FREQUency:START?.....	828
[SENSe:]MIXer:FREQUency:STOP?.....	828
[SENSe:]MIXer:HARMonic:BAND.....	829
[SENSe:]MIXer:HARMonic:BAND:PRESet.....	829
[SENSe:]MIXer:HARMonic:HIGH:STATe.....	829
[SENSe:]MIXer:HARMonic:HIGH[:VALue].....	830
[SENSe:]MIXer:HARMonic:TYPE.....	830
[SENSe:]MIXer:HARMonic[:LOW].....	830
[SENSe:]MIXer:LOPower.....	830
[SENSe:]MIXer:LOSS:HIGH.....	831
[SENSe:]MIXer:LOSS:TABLE:HIGH.....	831
[SENSe:]MIXer:LOSS:TABLE[:LOW].....	831
[SENSe:]MIXer:LOSS[:LOW].....	832
[SENSe:]MIXer:PORTs.....	832
[SENSe:]MIXer:RFOVerrange[:STATe].....	827
[SENSe:]MIXer:SIGNAL.....	832
[SENSe:]MIXer:THReShold.....	833
[SENSe:]MIXer[:STATe].....	826
[SENSe:]MPOWer:FTYPE.....	834
[SENSe:]MPOWer:RESult:MIN?.....	835
[SENSe:]MPOWer:RESult[:LIST]?.....	834
[SENSe:]MPOWer[:SEQUence].....	835
[SENSe:]PMETer<p>:DCYCLe:STATe.....	838
[SENSe:]PMETer<p>:DCYCLe:VALue.....	839
[SENSe:]PMETer<p>:FREQUency.....	839
[SENSe:]PMETer<p>:FREQUency:LINK.....	839
[SENSe:]PMETer<p>:MTIME.....	840
[SENSe:]PMETer<p>:MTIME:AVERAge:COUNT.....	841
[SENSe:]PMETer<p>:MTIME:AVERAge[:STATe].....	840
[SENSe:]PMETer<p>:ROFFset[:STATe].....	841

[SENSe:]PMETer<p>:TRIGger:DTIME.....	842
[SENSe:]PMETer<p>:TRIGger:HOLDoff.....	842
[SENSe:]PMETer<p>:TRIGger:HYSteresis.....	843
[SENSe:]PMETer<p>:TRIGger:LEVel.....	843
[SENSe:]PMETer<p>:TRIGger:SLOPe.....	844
[SENSe:]PMETer<p>:TRIGger[:STATe].....	842
[SENSe:]PMETer<p>:UPDate[:STATe].....	844
[SENSe:]PMETer<p>[:STATe].....	838
[SENSe:]POWer:ACHannel:ACPairs.....	845
[SENSe:]POWer:ACHannel:BANDwidth BWIDth:ACHannel.....	846
[SENSe:]POWer:ACHannel:BANDwidth BWIDth:ALTernate<channel>.....	846
[SENSe:]POWer:ACHannel:BANDwidth BWIDth[:CHANnel<channel>].....	846
[SENSe:]POWer:ACHannel:FILTer:ALPHa:ACHannel.....	847
[SENSe:]POWer:ACHannel:FILTer:ALPHa:ALTernate<channel>.....	847
[SENSe:]POWer:ACHannel:FILTer:ALPHa:CHANnel<channel>.....	848
[SENSe:]POWer:ACHannel:FILTer:ALPHa[:ALL].....	847
[SENSe:]POWer:ACHannel:FILTer[:STATe]:ACHannel.....	848
[SENSe:]POWer:ACHannel:FILTer[:STATe]:ALL.....	848
[SENSe:]POWer:ACHannel:FILTer[:STATe]:ALTernate<channel>.....	848
[SENSe:]POWer:ACHannel:FILTer[:STATe]:CHANnel<channel>.....	849
[SENSe:]POWer:ACHannel:MODE.....	849
[SENSe:]POWer:ACHannel:NAME:ACHannel.....	849
[SENSe:]POWer:ACHannel:NAME:ALTernate<channel>.....	850
[SENSe:]POWer:ACHannel:NAME:CHANnel<channel>.....	850
[SENSe:]POWer:ACHannel:PRESet.....	850
[SENSe:]POWer:ACHannel:PRESet:RLEVel.....	851
[SENSe:]POWer:ACHannel:REFerence:AUTO ONCE.....	851
[SENSe:]POWer:ACHannel:REFerence:TXCHannel:AUTO.....	851
[SENSe:]POWer:ACHannel:REFerence:TXCHannel:MANual.....	852
[SENSe:]POWer:ACHannel:SPACing:ALTernate<channel>.....	853
[SENSe:]POWer:ACHannel:SPACing:CHANnel<channel>.....	853
[SENSe:]POWer:ACHannel:SPACing[:ACHannel].....	852
[SENSe:]POWer:ACHannel:TXCHannel:COUNT.....	854
[SENSe:]POWer:BANDwidth BWIDth.....	854
[SENSe:]POWer:HSPeed.....	854
[SENSe:]POWer:NCORrection.....	854
[SENSe:]POWer:TRACe.....	855
[SENSe:]ROSCillator:EXTernal:FREQuency.....	957
[SENSe:]ROSCillator:SOURce.....	958
[SENSe:]ROSCillator:SOURce:EAUTO?.....	958
[SENSe:]SWEep:COUNT.....	856
[SENSe:]SWEep:COUNT:CURRent?.....	856
[SENSe:]SWEep:EGATe.....	857
[SENSe:]SWEep:EGATe:HOLDoff.....	857
[SENSe:]SWEep:EGATe:LENGth.....	858
[SENSe:]SWEep:EGATe:POLarity.....	858
[SENSe:]SWEep:EGATe:SOURce.....	858
[SENSe:]SWEep:EGATe:TRACe<k>:PERiod.....	860
[SENSe:]SWEep:EGATe:TRACe<k>:STOP<range>.....	860
[SENSe:]SWEep:EGATe:TRACe<k>:COMMeNt.....	859

[SENSe:]SWEep:EGATe:TRACe<k>:STARt<range>.....	859
[SENSe:]SWEep:EGATe:TRACe<k>[:STATe<range>].....	859
[SENSe:]SWEep:EGATe:TYPE.....	860
[SENSe:]SWEep:MODE.....	861
[SENSe:]SWEep:POINts.....	861
[SENSe:]SWEep:TIME.....	862
[SENSe:]SWEep:TIME:AUTO.....	862
[SENSe:]SWEep:TYPE.....	863
[SENSe:]SWEep:TYPE:USED?.....	863
*CAL?.....	611
*CLS.....	611
*ESE.....	611
*ESR?.....	611
*IDN?.....	612
*IST?.....	612
*OPC.....	612
*OPT?.....	612
*PCB.....	613
*PRE.....	613
*PSC.....	613
*RST.....	614
*SRE.....	614
*STB?.....	614
*TRG.....	614
*TST?.....	615
*WAI.....	615
ABORt.....	616
CALCulate<n>:DELtAmarker<m>:AOFF.....	618
CALCulate<n>:DELtAmarker<m>:FUNctIon:BPOWer:MODE.....	618
CALCulate<n>:DELtAmarker<m>:FUNctIon:BPOWer:RESult?.....	619
CALCulate<n>:DELtAmarker<m>:FUNctIon:BPOWer:SPAN.....	619
CALCulate<n>:DELtAmarker<m>:FUNctIon:BPOWer[:STATe].....	619
CALCulate<n>:DELtAmarker<m>:FUNctIon:FIXed:RPOint:MAXimum[:PEAK].....	620
CALCulate<n>:DELtAmarker<m>:FUNctIon:FIXed:RPOint:X.....	621
CALCulate<n>:DELtAmarker<m>:FUNctIon:FIXed:RPOint:Y.....	621
CALCulate<n>:DELtAmarker<m>:FUNctIon:FIXed:RPOint:Y:OFFSet.....	622
CALCulate<n>:DELtAmarker<m>:FUNctIon:FIXed[:STATe].....	620
CALCulate<n>:DELtAmarker<m>:FUNctIon:PNOise:AUTO.....	623
CALCulate<n>:DELtAmarker<m>:FUNctIon:PNOise:RESult?.....	623
CALCulate<n>:DELtAmarker<m>:FUNctIon:PNOise[:STATe].....	622
CALCulate<n>:DELtAmarker<m>:LINK.....	623
CALCulate<n>:DELtAmarker<m>:MAXimum:LEFT.....	625
CALCulate<n>:DELtAmarker<m>:MAXimum:NEXT.....	625
CALCulate<n>:DELtAmarker<m>:MAXimum:RIGHT.....	625
CALCulate<n>:DELtAmarker<m>:MAXimum[:PEAK].....	624
CALCulate<n>:DELtAmarker<m>:MINimum:LEFT.....	626
CALCulate<n>:DELtAmarker<m>:MINimum:NEXT.....	627
CALCulate<n>:DELtAmarker<m>:MINimum:RIGHT.....	627
CALCulate<n>:DELtAmarker<m>:MINimum[:PEAK].....	626
CALCulate<n>:DELtAmarker<m>:MODE.....	624

CALCulate<n>:DELtAmarker<m>:MREF.....	628
CALCulate<n>:DELtAmarker<m>:SGRam:FRAMe.....	630
CALCulate<n>:DELtAmarker<m>:SGRam:SARea.....	631
CALCulate<n>:DELtAmarker<m>:SGRam:XY:MAXimum[:PEAK].....	632
CALCulate<n>:DELtAmarker<m>:SGRam:XY:MINimum[:PEAK].....	632
CALCulate<n>:DELtAmarker<m>:SGRam:Y:MAXimum:ABOVe.....	633
CALCulate<n>:DELtAmarker<m>:SGRam:Y:MAXimum:BELow.....	633
CALCulate<n>:DELtAmarker<m>:SGRam:Y:MAXimum:NEXT.....	634
CALCulate<n>:DELtAmarker<m>:SGRam:Y:MAXimum[:PEAK].....	634
CALCulate<n>:DELtAmarker<m>:SGRam:Y:MINimum:ABOVe.....	634
CALCulate<n>:DELtAmarker<m>:SGRam:Y:MINimum:BELow.....	635
CALCulate<n>:DELtAmarker<m>:SGRam:Y:MINimum:NEXT.....	635
CALCulate<n>:DELtAmarker<m>:SGRam:Y:MINimum[:PEAK].....	636
CALCulate<n>:DELtAmarker<m>:TRACe.....	628
CALCulate<n>:DELtAmarker<m>:X.....	628
CALCulate<n>:DELtAmarker<m>:X:RELative?.....	629
CALCulate<n>:DELtAmarker<m>:Y?.....	629
CALCulate<n>:DELtAmarker<m>[:STATe].....	618
CALCulate<n>:DLINe<k>.....	636
CALCulate<n>:DLINe<k>:STATe.....	637
CALCulate<n>:ESPectrum:PEAKsearch PSEarch:DETAils.....	638
CALCulate<n>:ESPectrum:PSEarch[:PEAKsearch[:IMMEdiate].....	637
CALCulate<n>:ESPectrum:PSEarch[:PEAKsearch:AUTO.....	637
CALCulate<n>:ESPectrum:PSEarch[:PEAKsearch:MARGIn.....	638
CALCulate<n>:ESPectrum:PSEarch[:PEAKsearch:PSHow.....	638
CALCulate<n>:FLINe<k>.....	639
CALCulate<n>:FLINe<k>:STATe.....	639
CALCulate<n>:FORMat.....	747
CALCulate<n>:LIMit<k>:ACPowEr:ACHannel:ABSolute.....	646
CALCulate<n>:LIMit<k>:ACPowEr:ACHannel:ABSolute:STATe.....	647
CALCulate<n>:LIMit<k>:ACPowEr:ACHannel:RESult.....	648
CALCulate<n>:LIMit<k>:ACPowEr:ACHannel[:RELative].....	645
CALCulate<n>:LIMit<k>:ACPowEr:ACHannel[:RELative]:STATe.....	646
CALCulate<n>:LIMit<k>:ACPowEr:ALTErnate<Channel>:ABSolute.....	650
CALCulate<n>:LIMit<k>:ACPowEr:ALTErnate<Channel>:ABSolute:STATe.....	651
CALCulate<n>:LIMit<k>:ACPowEr:ALTErnate<Channel>:RESult?.....	652
CALCulate<n>:LIMit<k>:ACPowEr:ALTErnate<channel>[:RELative].....	649
CALCulate<n>:LIMit<k>:ACPowEr:ALTErnate<Channel>[:RELative]:STATe.....	650
CALCulate<n>:LIMit<k>:ACPowEr[:STATe].....	645
CALCulate<n>:LIMit<k>:ACTive?.....	640
CALCulate<n>:LIMit<k>:CLEAr[:IMMEdiate].....	640
CALCulate<n>:LIMit<k>:COMMent.....	641
CALCulate<n>:LIMit<k>:CONTRol:DOMain.....	654
CALCulate<n>:LIMit<k>:CONTRol:MODE.....	654
CALCulate<n>:LIMit<k>:CONTRol:OFFSet.....	654
CALCulate<n>:LIMit<k>:CONTRol:SHIFt.....	655
CALCulate<n>:LIMit<k>:CONTRol:SPACIng.....	655
CALCulate<n>:LIMit<k>:CONTRol[:DATA].....	653
CALCulate<n>:LIMit<k>:COPY.....	641
CALCulate<n>:LIMit<k>:DELete.....	641

CALCulate<n>:LIMit<k>:ESpectrum:LIMits.....	656
CALCulate<n>:LIMit<k>:ESpectrum:MODE.....	656
CALCulate<n>:LIMit<k>:ESpectrum:PCLass<Class>:COUNT.....	657
CALCulate<n>:LIMit<k>:ESpectrum:PCLass<Class>:LIMit[:STATE].....	658
CALCulate<n>:LIMit<k>:ESpectrum:PCLass<Class>:MAXimum.....	658
CALCulate<n>:LIMit<k>:ESpectrum:PCLass<Class>:MINimum.....	659
CALCulate<n>:LIMit<k>:ESpectrum:PCLass<Class>[:EXCLUSIVE].....	657
CALCulate<n>:LIMit<k>:ESpectrum:RESTore.....	659
CALCulate<n>:LIMit<k>:ESpectrum:VALue.....	659
CALCulate<n>:LIMit<k>:FAIL?.....	642
CALCulate<n>:LIMit<k>:LOWer:MARGIN.....	661
CALCulate<n>:LIMit<k>:LOWer:MODE.....	661
CALCulate<n>:LIMit<k>:LOWer:OFFSet.....	661
CALCulate<n>:LIMit<k>:LOWer:SHIFt.....	662
CALCulate<n>:LIMit<k>:LOWer:SPACing.....	662
CALCulate<n>:LIMit<k>:LOWer:STATe.....	663
CALCulate<n>:LIMit<k>:LOWer:THReshold.....	663
CALCulate<n>:LIMit<k>:LOWer[:DATA].....	660
CALCulate<n>:LIMit<k>:NAME.....	643
CALCulate<n>:LIMit<k>:STATe.....	643
CALCulate<n>:LIMit<k>:TRACe.....	644
CALCulate<n>:LIMit<k>:UNIT.....	643
CALCulate<n>:LIMit<k>:UPPer:MARGIN.....	664
CALCulate<n>:LIMit<k>:UPPer:MODE.....	665
CALCulate<n>:LIMit<k>:UPPer:OFFSet.....	665
CALCulate<n>:LIMit<k>:UPPer:SHIFt.....	665
CALCulate<n>:LIMit<k>:UPPer:SPACing.....	666
CALCulate<n>:LIMit<k>:UPPer:STATe.....	666
CALCulate<n>:LIMit<k>:UPPer:THReshold.....	666
CALCulate<n>:LIMit<k>:UPPer[:DATA].....	664
CALCulate<n>:MARKer<m>:AOFF.....	668
CALCulate<n>:MARKer<m>:COUNT.....	668
CALCulate<n>:MARKer<m>:COUNT:FREQuency?.....	669
CALCulate<n>:MARKer<m>:COUNT:RESolution.....	670
CALCulate<n>:MARKer<m>:FUNction:BPOWER:MODE.....	682
CALCulate<n>:MARKer<m>:FUNction:BPOWER:RESult?.....	682
CALCulate<n>:MARKer<m>:FUNction:BPOWER:SPAN.....	683
CALCulate<n>:MARKer<m>:FUNction:BPOWER[:STATe].....	683
CALCulate<n>:MARKer<m>:FUNction:CENTer.....	684
CALCulate<n>:MARKer<m>:FUNction:CSTep.....	684
CALCulate<n>:MARKer<m>:FUNction:DEModulation:CONTinuous.....	684
CALCulate<n>:MARKer<m>:FUNction:DEModulation:HOLDoff.....	685
CALCulate<n>:MARKer<m>:FUNction:DEModulation:SElect.....	685
CALCulate<n>:MARKer<m>:FUNction:DEModulation[:STATe].....	686
CALCulate<n>:MARKer<m>:FUNction:FPEaks:ANNotation:LABel:STATe.....	687
CALCulate<n>:MARKer<m>:FUNction:FPEaks:COUNT?.....	687
CALCulate<n>:MARKer<m>:FUNction:FPEaks:LIST:SIZE.....	688
CALCulate<n>:MARKer<m>:FUNction:FPEaks:SEAR:AUTO.....	688
CALCulate<n>:MARKer<m>:FUNction:FPEaks:SORT.....	688
CALCulate<n>:MARKer<m>:FUNction:FPEaks:STAT.....	689

CALCulate<n>:MARKer<m>:FUNction:FPEaks:X.....	689
CALCulate<n>:MARKer<m>:FUNction:FPEaks:Y?.....	690
CALCulate<n>:MARKer<m>:FUNction:FPEaks[:IMMediate].....	686
CALCulate<n>:MARKer<m>:FUNction:HARMonics:BANDwidth:AUTO.....	699
CALCulate<n>:MARKer<m>:FUNction:HARMonics:DISTortion?.....	699
CALCulate<n>:MARKer<m>:FUNction:HARMonics:LIST?.....	700
CALCulate<n>:MARKer<m>:FUNction:HARMonics:NHARmonics.....	701
CALCulate<n>:MARKer<m>:FUNction:HARMonics:PRESet.....	701
CALCulate<n>:MARKer<m>:FUNction:HARMonics[:STATe].....	701
CALCulate<n>:MARKer<m>:FUNction:MDEPth:RESult?.....	690
CALCulate<n>:MARKer<m>:FUNction:MDEPth:SEARChsignal ONCE.....	691
CALCulate<n>:MARKer<m>:FUNction:MDEPth[:STATe].....	691
CALCulate<n>:MARKer<m>:FUNction:MSUMmary?.....	719
CALCulate<n>:MARKer<m>:FUNction:NDBDown.....	692
CALCulate<n>:MARKer<m>:FUNction:NDBDown:FREQuency?.....	693
CALCulate<n>:MARKer<m>:FUNction:NDBDown:QFACtor.....	693
CALCulate<n>:MARKer<m>:FUNction:NDBDown:RESult?.....	694
CALCulate<n>:MARKer<m>:FUNction:NDBDown:STATe.....	694
CALCulate<n>:MARKer<m>:FUNction:NDBDown:TIME?.....	695
CALCulate<n>:MARKer<m>:FUNction:NOISe:RESult.....	696
CALCulate<n>:MARKer<m>:FUNction:NOISe[:STATe].....	695
CALCulate<n>:MARKer<m>:FUNction:POWer:MODE.....	702
CALCulate<n>:MARKer<m>:FUNction:POWer:PRESet.....	703
CALCulate<n>:MARKer<m>:FUNction:POWer:RESult:PHZ.....	707
CALCulate<n>:MARKer<m>:FUNction:POWer:RESult?.....	704
CALCulate<n>:MARKer<m>:FUNction:POWer:SELEct.....	707
CALCulate<n>:MARKer<m>:FUNction:POWer:STANdard:CATalog?.....	709
CALCulate<n>:MARKer<m>:FUNction:POWer:STANdard:DELEte.....	709
CALCulate<n>:MARKer<m>:FUNction:POWer:STANdard:SAVE.....	709
CALCulate<n>:MARKer<m>:FUNction:POWer[:STATe].....	708
CALCulate<n>:MARKer<m>:FUNction:REFerence.....	696
CALCulate<n>:MARKer<m>:FUNction:STRack:BANDwidth BWIDTH.....	716
CALCulate<n>:MARKer<m>:FUNction:STRack:THREShold.....	717
CALCulate<n>:MARKer<m>:FUNction:STRack:TRACe.....	717
CALCulate<n>:MARKer<m>:FUNction:STRack[:STATe].....	718
CALCulate<n>:MARKer<m>:FUNction:SUMMary:AOFF.....	720
CALCulate<n>:MARKer<m>:FUNction:SUMMary:AVERAge.....	720
CALCulate<n>:MARKer<m>:FUNction:SUMMary:MEAN:AVERAge:RESult?.....	721
CALCulate<n>:MARKer<m>:FUNction:SUMMary:MEAN:PHOLd:RESult?.....	722
CALCulate<n>:MARKer<m>:FUNction:SUMMary:MEAN:RESult?.....	722
CALCulate<n>:MARKer<m>:FUNction:SUMMary:MEAN[:STATe].....	723
CALCulate<n>:MARKer<m>:FUNction:SUMMary:MODE.....	723
CALCulate<n>:MARKer<m>:FUNction:SUMMary:PHOLd.....	723
CALCulate<n>:MARKer<m>:FUNction:SUMMary:PPEAk:AVERAge:RESult?.....	724
CALCulate<n>:MARKer<m>:FUNction:SUMMary:PPEAk:PHOLd:RESult?.....	724
CALCulate<n>:MARKer<m>:FUNction:SUMMary:PPEAk:RESult?.....	725
CALCulate<n>:MARKer<m>:FUNction:SUMMary:PPEAk[:STATe].....	725
CALCulate<n>:MARKer<m>:FUNction:SUMMary:REFerence:AUTO ONCE.....	726
CALCulate<n>:MARKer<m>:FUNction:SUMMary:RMS:AVERAge:RESult?.....	726
CALCulate<n>:MARKer<m>:FUNction:SUMMary:RMS:PHOLd:RESult?.....	727

CALCulate<n>:MARKer<m>:FUNction:SUMMary:RMS:RESult?.....	727
CALCulate<n>:MARKer<m>:FUNction:SUMMary:RMS[:STATe].....	728
CALCulate<n>:MARKer<m>:FUNction:SUMMary:SDEVIation:AVERAge:RESult?.....	728
CALCulate<n>:MARKer<m>:FUNction:SUMMary:SDEVIation:PHOLd:RESult?.....	729
CALCulate<n>:MARKer<m>:FUNction:SUMMary:SDEVIation:RESult?.....	730
CALCulate<n>:MARKer<m>:FUNction:SUMMary:SDEVIation[:STATe].....	730
CALCulate<n>:MARKer<m>:FUNction:SUMMary[:STATe].....	731
CALCulate<n>:MARKer<m>:FUNction:TOI:RESult?.....	697
CALCulate<n>:MARKer<m>:FUNction:TOI:SEARChsignal ONCE.....	697
CALCulate<n>:MARKer<m>:FUNction:TOI[:STATe].....	697
CALCulate<n>:MARKer<m>:FUNction:ZOOM.....	698
CALCulate<n>:MARKer<m>:LINK.....	670
CALCulate<n>:MARKer<m>:LOEXclude.....	670
CALCulate<n>:MARKer<m>:MAXimum:AUTO.....	671
CALCulate<n>:MARKer<m>:MAXimum:LEFT.....	672
CALCulate<n>:MARKer<m>:MAXimum:NEXT.....	672
CALCulate<n>:MARKer<m>:MAXimum:RIGHT.....	673
CALCulate<n>:MARKer<m>:MAXimum[:PEAK].....	671
CALCulate<n>:MARKer<m>:MINimum:AUTO.....	674
CALCulate<n>:MARKer<m>:MINimum:LEFT.....	674
CALCulate<n>:MARKer<m>:MINimum:NEXT.....	675
CALCulate<n>:MARKer<m>:MINimum:RIGHT.....	675
CALCulate<n>:MARKer<m>:MINimum[:PEAK].....	673
CALCulate<n>:MARKer<m>:PEXCursion.....	676
CALCulate<n>:MARKer<m>:SEARCh.....	676
CALCulate<n>:MARKer<m>:SGRam:FRAMe.....	710
CALCulate<n>:MARKer<m>:SGRam:SARea.....	710
CALCulate<n>:MARKer<m>:SGRam:XY:MAXimum[:PEAK].....	711
CALCulate<n>:MARKer<m>:SGRam:XY:MINimum[:PEAK].....	711
CALCulate<n>:MARKer<m>:SGRam:Y:MAXimum:ABOVE.....	712
CALCulate<n>:MARKer<m>:SGRam:Y:MAXimum:BELOW.....	712
CALCulate<n>:MARKer<m>:SGRam:Y:MAXimum:NEXT.....	713
CALCulate<n>:MARKer<m>:SGRam:Y:MAXimum[:PEAK].....	713
CALCulate<n>:MARKer<m>:SGRam:Y:MINimum:ABOVE.....	714
CALCulate<n>:MARKer<m>:SGRam:Y:MINimum:BELOW.....	714
CALCulate<n>:MARKer<m>:SGRam:Y:MINimum:NEXT.....	715
CALCulate<n>:MARKer<m>:SGRam:Y:MINimum[:PEAK].....	715
CALCulate<n>:MARKer<m>:TRACe.....	677
CALCulate<n>:MARKer<m>:X.....	677
CALCulate<n>:MARKer<m>:X:SLIMits:LEFT.....	678
CALCulate<n>:MARKer<m>:X:SLIMits:RIGHT.....	679
CALCulate<n>:MARKer<m>:X:SLIMits:ZOOM.....	679
CALCulate<n>:MARKer<m>:X:SLIMits[:STATe].....	678
CALCulate<n>:MARKer<m>:X:SSIZE.....	680
CALCulate<n>:MARKer<m>:Y:PERCent.....	681
CALCulate<n>:MARKer<m>:Y?.....	680
CALCulate<n>:MARKer<m>[:STATe].....	668
CALCulate<n>:MATH:MODE.....	732
CALCulate<n>:MATH:POSition.....	732
CALCulate<n>:MATH:STATe.....	732

CALCulate<n>:MATH[:EXpression][:DEFine].....	731
CALCulate<n>:PEAKsearch PSEarch:AUTO.....	735
CALCulate<n>:PEAKsearch PSEarch:MARGin.....	735
CALCulate<n>:PEAKsearch PSEarch:PSHOW.....	735
CALCulate<n>:PEAKsearch PSEarch:SUBRanges.....	736
CALCulate<n>:PEAKsearch PSEarch[:IMMediate].....	734
CALCulate<n>:PMETER<p>:RELative:STATe.....	734
CALCulate<n>:PMETER<p>:RELative[:MAGNitude].....	733
CALCulate<n>:PMETER<p>:RELative[:MAGNitude]:AUTO ONCE.....	733
CALCulate<n>:SGRam:CLear[:IMMediate].....	736
CALCulate<n>:SGRam:COLor.....	736
CALCulate<n>:SGRam:CONT.....	737
CALCulate<n>:SGRam:FRAME:COUNT.....	737
CALCulate<n>:SGRam:FRAME:SELEct.....	738
CALCulate<n>:SGRam:HDEPth.....	738
CALCulate<n>:SGRam:TSTamp:DATA?.....	740
CALCulate<n>:SGRam:TSTamp[:STATe].....	739
CALCulate<n>:SGRam[:STATe].....	739
CALCulate<n>:STATistics:APD[:STATe].....	741
CALCulate<n>:STATistics:CCDF:X<Trace>.....	741
CALCulate<n>:STATistics:CCDF[:STATe].....	741
CALCulate<n>:STATistics:NSAMples.....	742
CALCulate<n>:STATistics:PRESet.....	742
CALCulate<n>:STATistics:RESult<Trace>.....	743
CALCulate<n>:STATistics:SCALE:AUTO ONCE.....	743
CALCulate<n>:STATistics:SCALE:X:RANGe.....	744
CALCulate<n>:STATistics:SCALE:X:RLEVel.....	744
CALCulate<n>:STATistics:SCALE:Y:LOWer.....	744
CALCulate<n>:STATistics:SCALE:Y:UNIT.....	745
CALCulate<n>:STATistics:SCALE:Y:UPPer.....	745
CALCulate<n>:THReshold.....	745
CALCulate<n>:THReshold:STATe.....	746
CALCulate<n>:TLINe<Line>.....	746
CALCulate<n>:TLINe<Line>:STATe.....	746
CALCulate<n>:UNIT:POWER.....	747
CALibration:ABORT.....	917
CALibration:PMETER<p>:ZERO:AUTO ONCE.....	748
CALibration:RESult?.....	918
CALibration:STATe.....	918
CALibration[:ALL]?.....	917
DIAGnostic<n>:SERVice:BIOSinfo?.....	919
DIAGnostic<n>:SERVice:HWINfo?.....	919
DIAGnostic<n>:SERVice:INPut:PULSed:CFRequency.....	920
DIAGnostic<n>:SERVice:INPut:PULSed:MCFRequency.....	920
DIAGnostic<n>:SERVice:INPut:PULSed:WB2FRequency.....	921
DIAGnostic<n>:SERVice:INPut:PULSed:WBFRequency.....	921
DIAGnostic<n>:SERVice:INPut[:SELEct].....	922
DIAGnostic<n>:SERVice:NSource.....	922
DIAGnostic<n>:SERVice:SFUNction.....	922
DIAGnostic<n>:SERVice:SFUNction:LASTresult?.....	923

DIAGnostic<n>:SERvice:SFUNction:RESults:DELeTe.....	923
DIAGnostic<n>:SERvice:SFUNction:RESults:SAVE.....	923
DIAGnostic<n>:SERvice:STESt:RESult?.....	924
DIAGnostic<n>:SERvice:TEMPerature:FRONt?.....	924
DIAGnostic<n>:SERvice:VERSInfo?.....	924
DISPlay:ANNotation:FREQuency.....	926
DISPlay:CMAP<item>:DEFault.....	926
DISPlay:CMAP<item>:HSL.....	927
DISPlay:CMAP<item>:PDEFined.....	927
DISPlay:LOGO.....	928
DISPlay:MTABLE.....	749
DISPlay:PSAVe:HOLDoff.....	928
DISPlay:PSAVe[:STATe].....	928
DISPlay:SBAR[:STATe].....	928
DISPlay:SKEYs[:STATe].....	929
DISPlay:TBAR[STATe].....	929
DISPlay:THEMe:CATalog?.....	929
DISPlay:THEMe:SElect.....	929
DISPlay:TOUChscreen:STATe.....	929
DISPlay:WINDow:SGRam:COLor:DEFault.....	757
DISPlay:WINDow:SGRam:COLor:LOWer.....	757
DISPlay:WINDow:SGRam:COLor:SHAPE.....	757
DISPlay:WINDow:SGRam:COLor:UPPer.....	758
DISPlay:WINDow:SGRam:COLor[:STYLE].....	758
DISPlay[:WINDow<n>]:TEXT:STATe.....	930
DISPlay[:WINDow<n>]:TEXT[:DATA].....	930
DISPlay[:WINDow<n>]:TIME.....	930
DISPlay[:WINDow<n>]:TIME:FORMat.....	931
DISPlay[:WINDow<n>]:TRACe<t>:MODE.....	751
DISPlay[:WINDow<n>]:TRACe<t>:MODE:HCONTinuous.....	752
DISPlay[:WINDow<n>]:TRACe<t>:X:SPACing.....	752
DISPlay[:WINDow<n>]:TRACe<t>:Y:SPACing.....	753
DISPlay[:WINDow<n>]:TRACe<t>:Y[:SCALE].....	753
DISPlay[:WINDow<n>]:TRACe<t>:Y[:SCALE]:MODE.....	754
DISPlay[:WINDow<n>]:TRACe<t>:Y[:SCALE]:RLEVEL.....	754
DISPlay[:WINDow<n>]:TRACe<t>:Y[:SCALE]:RLEVEL:OFFSet.....	755
DISPlay[:WINDow<n>]:TRACe<t>:Y[:SCALE]:RPOSITION.....	755
DISPlay[:WINDow<n>]:TRACe<t>:Y[:SCALE]:RVALue.....	755
DISPlay[:WINDow<n>]:TRACe<t>[:STATe].....	750
DISPlay[:WINDow<n>]:ZOOM:AREA.....	756
DISPlay[:WINDow<n>]:ZOOM:STATe.....	756
DISPlay[:WINDow<n>][:SUBWIndow<m>]:SElect.....	750
DISPlay[:WINDow<n>][:SUBWIndow<m>]:SIZE.....	749
FETCH<n>:PMEter<p>?.....	759
FORMat:DEXPort:DSEParator.....	759
FORMat:DEXPort:TRACes.....	760
FORMat[:DATA].....	933
HCOPY:ABORt.....	933
HCOPY:CMAP<item>:DEFault.....	934
HCOPY:CMAP<item>:HSL.....	934

HCOPY:CMAP<item>:PDEFined.....	935
HCOPY:DESTination<1 2>.....	935
HCOPY:DEvice:COLor.....	936
HCOPY:DEvice:LANGuage<1 2>.....	936
HCOPY:ITEM:ALL.....	938
HCOPY:ITEM:WINDow:TABLE:STATe.....	938
HCOPY:ITEM:WINDow:TEXT.....	938
HCOPY:PAGE:ORlentation<1 2>.....	939
HCOPY:TDSamp:STATe<1 2>.....	939
HCOPY[:IMMEDIATE<1 2>].....	937
HCOPY[:IMMEDIATE<1 2>]:NEXT.....	937
INITiate<n>:CONMeas.....	761
INITiate<n>:CONTinuous.....	761
INITiate<n>:DISPlay.....	762
INITiate<n>:ESPECTrum.....	762
INITiate<n>:SPURious.....	762
INITiate<n>[:IMMEDIATE].....	760
INPut:ATTenuation.....	763
INPut:ATTenuation:AUTO.....	764
INPut:COUPling.....	764
INPut:DIQ:CDEvice.....	764
INPut:DIQ:RANGe:COUPling.....	765
INPut:DIQ:RANGe[:UPPer].....	766
INPut:DIQ:RANGe[:UPPer]:UNIT.....	766
INPut:DIQ:SRATe.....	767
INPut:EATT.....	767
INPut:EATT:AUTO.....	767
INPut:EATT:STATe.....	768
INPut:FILTer:YIG[:STATe].....	768
INPut:GAIN:STATe.....	769
INPut:IMPedance.....	769
INPut:SElect.....	769
INPut:UPORt:STATe.....	770
INPut:UPORt?.....	770
INSTRument:CREate[:NEW].....	771
INSTRument:DELeTe.....	772
INSTRument:NSElect.....	772
INSTRument[:SElect].....	770
MMEMory:CATalog:LONG?.....	941
MMEMory:CATalog?.....	940
MMEMory:CDIRectory.....	942
MMEMory:CLEar:ALL.....	942
MMEMory:CLEar:STATe 1,.....	942
MMEMory:COMMeNt.....	943
MMEMory:COpy.....	943
MMEMory:DATA.....	944
MMEMory:DELeTe.....	944
MMEMory:LOAD:AUTO.....	945
MMEMory:LOAD:IQ:STATe.....	773
MMEMory:LOAD:STATe.....	945

MMEMory:MDIRectory.....	946
MMEMory:MOVE.....	946
MMEMory:MSIS.....	947
MMEMory:NAME.....	947
MMEMory:NETWork:DISConnect.....	948
MMEMory:NETWork:MAP.....	948
MMEMory:NETWork:UNUSeddrives?.....	948
MMEMory:NETWork:USEDdrives?.....	949
MMEMory:RDIRectory.....	949
MMEMory:SELEct[:ITEM]:ALL.....	949
MMEMory:SELEct[:ITEM]:DEFault.....	949
MMEMory:SELEct[:ITEM]:HWSettings.....	950
MMEMory:SELEct[:ITEM]:LINES:ALL.....	950
MMEMory:SELEct[:ITEM]:NONE.....	950
MMEMory:SELEct[:ITEM]:SGRam.....	950
MMEMory:SELEct[:ITEM]:TRACe[:ACTive].....	951
MMEMory:SELEct[:ITEM]:TRANsducer:ALL.....	951
MMEMory:STORE:IQ:COMM.....	773
MMEMory:STORE:IQ:STATe.....	773
MMEMory:STORE:SGRam.....	774
MMEMory:STORE<n>:LIST.....	774
MMEMory:STORE<n>:PEAK.....	774
MMEMory:STORE<n>:SPURious.....	775
MMEMory:STORE<n>:STATe.....	951
MMEMory:STORE<n>:STATe:NEXT.....	952
MMEMory:STORE<n>:TRACe.....	775
MMEMory:USER<Softkey>.....	952
OUTPut:DIQ.....	776
OUTPut:DIQ:CDEVice.....	776
OUTPut:IF[:SOURce].....	953
OUTPut:TRIGger.....	953
OUTPut:UPORt.....	777
OUTPut:UPORt:STATe.....	778
OUTPut[:STATe].....	777
PROBe:ID:PARTnumber?.....	778
PROBe:ID:SRNumber?.....	778
PROBe:SETup:MODE.....	779
PROBe:SETup:NAME?.....	779
PROBe:SETup:STATe?.....	779
PROBe[:STATe].....	779
READ<n>:PMETer<p>?.....	780
SOURce:EXTErnal<1 2>:ROSCillator: EXTErnal:FREQuency.....	957
SOURce<n>:AM:STATe.....	865
SOURce<n>:DM:STATe.....	865
SOURce<n>:EXTErnal<generator>:FREQuency.....	866
SOURce<n>:EXTErnal<generator>:FREQuency:COUPling[:STATe].....	867
SOURce<n>:EXTErnal<generator>:FREQuency:OFFSet<m>.....	869
SOURce<n>:EXTErnal<generator>:FREQuency:SWEep[:STATe].....	869
SOURce<n>:EXTErnal<generator>:FREQuency[:FACtor]:DENominator.....	867
SOURce<n>:EXTErnal<generator>:FREQuency[:FACtor]:NUMerator.....	868

SOURce<n>:EXTErnal<generator>:POWEr[:LEVEl].....	870
SOURce<n>:EXTErnal<generator>:ROSCillator[:SOURce].....	870
SOURce<n>:EXTErnal<generator>:ROSCillator[:SOURce].....	959
SOURce<n>:EXTErnal<generator>[:STATe].....	866
SOURce<n>:FM:DEVIation.....	871
SOURce<n>:FM:STATe.....	871
SOURce<n>:FREQUency:OFFSet.....	872
SOURce<n>:POWEr:MODE.....	873
SOURce<n>:POWEr:START.....	873
SOURce<n>:POWEr:STOP.....	874
SOURce<n>:POWEr[:LEVEl][:IMMediate]:OFFSet.....	873
SOURce<n>:POWEr[:LEVEl][:IMMediate][:AMPLitude].....	872
SOURce<n>:TEMPerature:APRObe?.....	958
STATus:OPERation:CONDition.....	960
STATus:OPERation:ENABle.....	960
STATus:OPERation:NTRansition.....	961
STATus:OPERation:PTRansition.....	960
STATus:OPERation[:EVENT].....	960
STATus:PRESet.....	961
STATus:QUEStionable:ACPLimit:CONDition?.....	875
STATus:QUEStionable:ACPLimit:ENABle.....	876
STATus:QUEStionable:ACPLimit:NTRansition.....	876
STATus:QUEStionable:ACPLimit:PTRansition.....	876
STATus:QUEStionable:ACPLimit[:EVENT]?.....	875
STATus:QUEStionable:CONDition.....	961
STATus:QUEStionable:DIQ:CONDition?.....	876
STATus:QUEStionable:DIQ:ENABle.....	877
STATus:QUEStionable:DIQ:NTRansition.....	877
STATus:QUEStionable:DIQ:PTRansition.....	877
STATus:QUEStionable:DIQ[:EVENT]?.....	877
STATus:QUEStionable:ENABle.....	962
STATus:QUEStionable:FREQUency:CONDition?.....	877
STATus:QUEStionable:FREQUency:ENABle.....	878
STATus:QUEStionable:FREQUency:NTRansition.....	878
STATus:QUEStionable:FREQUency:PTRansition.....	878
STATus:QUEStionable:FREQUency[:EVENT]?.....	878
STATus:QUEStionable:LIMit<m>[:EVENT]?.....	879
STATus:QUEStionable:LIMit<m>:CONDition?.....	879
STATus:QUEStionable:LIMit<m>:ENABle.....	879
STATus:QUEStionable:LIMit<m>:NTRansition.....	880
STATus:QUEStionable:LIMit<m>:PTRansition.....	880
STATus:QUEStionable:LMARgin<m>:CONDition?.....	881
STATus:QUEStionable:LMARgin<m>:ENABle.....	881
STATus:QUEStionable:LMARgin<m>:NTRansition.....	881
STATus:QUEStionable:LMARgin<m>:PTRansition.....	882
STATus:QUEStionable:LMARgin<m>[:EVENT]?.....	880
STATus:QUEStionable:NTRansition.....	962
STATus:QUEStionable:POWEr:CONDition?.....	882
STATus:QUEStionable:POWEr:ENABle.....	883
STATus:QUEStionable:POWEr:NTRansition.....	883

STATus:QUEStionable:POWer:PTRansition.....	883
STATus:QUEStionable:POWer[:EVENT]?.....	882
STATus:QUEStionable:PTRansition.....	962
STATus:QUEStionable:SYNC:CONDition?.....	884
STATus:QUEStionable:SYNC:ENABLE.....	884
STATus:QUEStionable:SYNC:NTRansition.....	884
STATus:QUEStionable:SYNC:PTRansition.....	884
STATus:QUEStionable:SYNC[:EVENT]?.....	883
STATus:QUEStionable[:EVENT]?.....	962
STATus:QUEue[:NEXT]??.....	963
SYSTem:APPLication:SRECovery[:STATE].....	964
SYSTem:CLOGging.....	964
SYSTem:COMMunicate:GPIB:RDEvice:COMMand.....	885
SYSTem:COMMunicate:GPIB:RDEvice:GENerator<generator>:ADDRess.....	885
SYSTem:COMMunicate:GPIB[:SELF]:ADDRess.....	964
SYSTem:COMMunicate:GPIB[:SELF]:RTERminator.....	965
SYSTem:COMMunicate:PRINter:ENUMerate:FIRSt?.....	965
SYSTem:COMMunicate:PRINter:ENUMerate[:NEXT]?.....	966
SYSTem:COMMunicate:PRINter:SElect <1 2>.....	966
SYSTem:COMMunicate:RDEvice:GENerator<generator>:INTerface.....	886
SYSTem:COMMunicate:RDEvice:GENerator<generator>:LINK.....	886
SYSTem:COMMunicate:RDEvice:GENerator<generator>:TYPE.....	887
SYSTem:COMMunicate:RDEvice:PMETer<p>:CONFigure:AUTO[:STATE].....	888
SYSTem:COMMunicate:RDEvice:PMETer<p>:COUNT?.....	889
SYSTem:COMMunicate:RDEvice:PMETer<p>:DEFine.....	887
SYSTem:COMMunicate:TCPip:CONTRol?.....	966
SYSTem:COMMunicate:TCPip:RDEvice:GENerator<generator>:ADDRess.....	889
SYSTem:COMPAtible.....	966
SYSTem:DATE.....	967
SYSTem:DEvice:ID?.....	967
SYSTem:DID?.....	967
SYSTem:DISPlay:FPANel.....	967
SYSTem:DISPlay:LANGuage.....	968
SYSTem:DISPlay:UPDate.....	968
SYSTem:ERRor:CLEar:ALL.....	968
SYSTem:ERRor:LIST?.....	968
SYSTem:ERRor[:NEXT]?.....	969
SYSTem:FIRMware:UPDate.....	969
SYSTem:FORMat:IDENT.....	969
SYSTem:HPCoupling.....	970
SYSTem:IDENtify:FACTory.....	970
SYSTem:IDENtify[:STRing].....	970
SYSTem:IFGain:MODE.....	971
SYSTem:KLOCK.....	971
SYSTem:LANGuage.....	971
SYSTem:LXI:INFo?.....	972
SYSTem:LXI:LANReset.....	972
SYSTem:LXI:MDEscription.....	972
SYSTem:LXI:PASSword.....	973
SYSTem:PASSword:RESet.....	973

SYSTem:PASSword[:CENable].....	973
SYSTem:PRESet.....	973
SYSTem:PSA:WIDeband.....	974
SYSTem:REBoot.....	974
SYSTem:REVision:FACTory.....	974
SYSTem:REVision[:STRing].....	975
SYSTem:RSW.....	975
SYSTem:SHUTdown.....	975
SYSTem:SPEaker:VOLume.....	889
SYSTem:TIME.....	975
SYSTem:TWALking.....	976
SYSTem:VERSion?.....	976
TRACe:IQ:WBANd[:STATe].....	906
TRACe<n>:COPY.....	890
TRACe<n>:IQ:AVERAge:COUNT.....	896
TRACe<n>:IQ:AVERAge[:STATe].....	896
TRACe<n>:IQ:BWIDth.....	896
TRACe<n>:IQ:DATA.....	897
TRACe<n>:IQ:DATA:FORMat.....	897
TRACe<n>:IQ:DATA:MEMory?.....	899
TRACe<n>:IQ:DIQFilter.....	900
TRACe<n>:IQ:EGATe.....	901
TRACe<n>:IQ:EGATe:GAP.....	901
TRACe<n>:IQ:EGATe:LENGth.....	901
TRACe<n>:IQ:EGATe:NOFgateperiods.....	902
TRACe<n>:IQ:EGATe:TYPE.....	902
TRACe<n>:IQ:EVAL.....	902
TRACe<n>:IQ:RELEngth.....	903
TRACe<n>:IQ:SET.....	904
TRACe<n>:IQ:SRATe.....	906
TRACe<n>:IQ:TPISAmple?.....	906
TRACe<n>:IQ[:STATe].....	895
TRACe<n>[:DATA].....	892
TRACe<n>[:DATA]:MEMory?.....	893
TRACe<n>[:DATA]:X?.....	893
TRACe<n>[:DATA]?.....	890
TRIGger<n>[:SEQuence]:BBPower:HOLDoff.....	909
TRIGger<n>[:SEQuence]:HOLDoff[:TIME].....	909
TRIGger<n>[:SEQuence]:IFPower:HOLDoff.....	909
TRIGger<n>[:SEQuence]:IFPower:HYSTeresis.....	910
TRIGger<n>[:SEQuence]:LEVel:BBPower.....	910
TRIGger<n>[:SEQuence]:LEVel:IFPower.....	911
TRIGger<n>[:SEQuence]:LEVel:RFPower.....	911
TRIGger<n>[:SEQuence]:LEVel:VIDeo.....	911
TRIGger<n>[:SEQuence]:LEVel[:EXTernal].....	910
TRIGger<n>[:SEQuence]:SLOPe.....	912
TRIGger<n>[:SEQuence]:SOURce.....	912
TRIGger<n>[:SEQuence]:TIME:RINTerval.....	913
UNIT:THD.....	915
UNIT<n>:PMEter<p>:POWER.....	914

UNIT<n>:PMETer<p>:POWer:RATIo..... 915
UNIT<n>:POWer.....914

Index

Symbols

*OPC	549
*OPC?	549
*RST	565
*WAI	549
1xEV-DO BTS mode (K84)	410
3G FDD BTS mode (K72)	409
5G NR mode (K144)	411
9.91E37	
Remote control	548
75 Ω (enhancement label)	53

A

AC supply fuse	28
ACLR	
absolute limit	301
adjacent channel name (remote control)	849
alternate channel name (remote control)	850
Channel Bandwidth	297
channel name (remote control)	850
channel names	299
Channel Spacing	298
limit check	300
Limit Checking	300
number of channels	296
reference	298
relative limit	301
Weighting Filter	299
ACLR User Standard	303
Delete	304
Load	304
Save	304
Acquisition time	
Statistics	358
ACT	
Statistics	358
Active probes	
Activating	400
Configuring	405
Connecting	404
State	405
Using	403
Administrator rights	47
Aligning	
Touchscreen	38
Alignment	
Results	145
Touch screen	146
Alphanumeric parameters	65
AM demodulation	261
AM modulation	449, 468
depth	381
Depth	283
AM Modulation depth	
Measurement	381
Results	381
Amplitude	
electronic attenuation	200
Menu	193
option B25	200
Amplitude distribution	357

AMPT key	193
Analog Demodulation mode (K7)	408
Analysis	
Bandwidth, definition	441
Annotation	155
AP (trace information)	54
Application cards	10
Application notes	10
APX	
tracking generator	461, 469
AQT (hardware setting)	52
Arrow Keys	61
ASCII Trace export	235, 533
Att (hardware setting)	51
attenuation	
(option B25)	197, 427
Attenuation	
(option B25)	197, 426
Automatic	197, 426
Manual	196, 426, 763
Option B25	196, 426
Audio demodulation	
volume (remote control)	889
Auto adjustment	
triggered measurement	783
Auto ID	
External Mixer (B21, remote control)	832
External Mixer (B21)	492
Softkey	505
Auto ID Threshold	
External Mixer (B21, remote control)	833
Softkey	506
Auto level	
Hysteresis	203
Auto Level	
Baseband Digital	416
Auto Peak detector	234
AUTO SET key	201
Automatic loading	
Settings	104
AUX PORT	
Connector	22
AV (trace information)	54
Average detector	234
Average trace mode	222, 232
averaging	
continuous sweep	232
single sweep	232
sweep count	232

B

Band	
Conversion Loss Table (B21)	500
External Mixer (B21, remote control)	829
External Mixer (B21)	497
Band Power	
remote control	619, 683
softkey	265, 438, 439
Bandwidth	
Extension	417
Extension options	443
Maximum	417

- Maximum usable 441
- Menu 205
- Occupied 311
- Resolution 206, 245
- Video 206
- Bandwidth extension
 - Option B160 440
 - Restrictions for use 441
- Baseband power
 - Trigger mode 240, 431
- Bias
 - Conversion Loss Table (B21) 501
 - External Mixer (B21, remote control) 827
 - external mixers (B21) 490
- Bias Settings
 - Conversion Loss Table (B21) 504
 - Softkey 503
- Blank trace mode 222, 232
- Block data 545
- Bluetooth mode (K8) 408
- Boolean parameters 544
- Brackets 545
- Brochures 10
- BW key 205
- C**
- CA (trace information) 54
- calibration
 - reflection measurement 462
 - tracking generator 461
 - transmission measurement 447, 462
- Calibration
 - Remote 611
- Canceling entry 60
- Case-sensitivity
 - SCPI 541
- CDMA2000 BTS mode (K82) 409
- CDMA2000 MS mode (K83) 409
- Center frequency 186
 - Step size 186
- channel
 - bandwidth 297, 314
 - number 296
 - spacing 298
- Channel 51
 - Bandwidth 310, 422
- Channel bar
 - Information 52
- Channel Power
 - Configuring 290
 - Fast ACLR 285
 - Measurement Repeatability 286
 - Measurements 283
 - Methods 284
 - Performing 290
 - Results 288
- Characters
 - Special 609
- Cleaning 1055
- Clear status
 - Remote 611
- Clear Write trace mode 221, 231
- CLRWR (trace information) 54
- CNT (marker functions) 54, 255
- Colon 545
- Color curve 530
- Color mapping
 - Color curve 532
 - Color range 532
 - Color scheme 532
- Color Mapping 527
- Color printout 157
- Color scheme
 - Spectrogram 532
- Color settings
 - Default 156
- Color setup dialog box 156
- Colors
 - Screen 38
- Comma 545
- Command sequence
 - recommendation 565
 - Remote 615
- Commands
 - Brackets 545
 - Colon 545
 - Comma 545
 - Command line structure 546
 - Description 608
 - Double dagger 545
 - Overlapping 548
 - Question mark 545
 - Quotation mark 545
 - Sequential 548
 - Syntax elements 545
 - Tracking 152
 - Vertical stroke 545
 - White space 545
- CommandS
 - Programming examples 1011
- Common commands
 - Syntax 540
- Compatible mode (hardware setting) 52
- Computer name
 - Changing 600
- Concluding entry 60
- CONDition 553
- Connector
 - AC power supply 20
 - AF output 17
 - AUX PORT 22
 - EXT TRIGGER / GATE IN 21
 - External mixer 18
 - GPIO interface 21
 - IF/VIDEO 21
 - LAN 21
 - MONITOR (VGA) 21
 - Noise source control 16
 - OcXO 22, 141
 - Power Sensor 17
 - Probe power 16
 - REF IN 21
 - REF OUT 21
 - RF Input 50Ω 16
 - Tracking generator 17
 - TRIGGER OUTPUT 21
 - Ultra high precision reference 23
 - USB 16, 22
- Connectors
 - Front panel 16
- Continuous sweep 214
- Continuous Value Update
 - Softkey 517

- Controller 537
- Conversion Loss
 - External Mixer (B21, remote control) 831, 832
- Conversion Loss tables 500, 503
 - Available (remote control) 791
 - Band (remote control) 790
 - Bias (remote control) 793
 - Configuring (B21) 500
 - Deleting (remote control) 794
 - External Mixer (B21, remote control) 831
 - External Mixer (B21) 498
 - External mixers (B21) 491
 - Harmonic order (remote control) 792
 - mixer type (remote control) 792
 - Selecting (remote control) 791
- Correction
 - inherent noise 198, 304, 428
- coupling
 - default settings 210
- Coupling
 - Resolution bandwidth 206
 - Sweep time 208, 216
 - Video bandwidth 207
- create folder 169
- D**
- Data acquisition
 - Errors 561
- Data Acquisition
 - Softkey 417
- Data sheets 10
- Date 155
 - Setting 37
- DBW (hardware setting) 52
- DC power supply
 - Option B30 28
- DEF 544
- Default color settings 156
- default scalings of x- and y-axis 364, 370
- Default values
 - Remote 614
- definition of transducer factors 1035
- delay
 - gate signal 244
- Delta markers 249
- Density
 - remote control 618, 619, 682, 683
 - softkey 265, 439
- detector
 - overview 234
- Detector
 - Auto Peak 223
 - Autoselect 223
 - Average 224
 - CISPR Average 224
 - Negative Peak 224
 - Positive Peak 223
 - Quasi Peak 224
 - RMS 224
 - RMS Average 225
 - Sample 224
- Device ID 158
- DHCP 597
- DHCP server
 - LAN configuration 600
- Diagram area
 - Enhancement labels 52
 - Hardware settings 51
 - Status display 55
 - Trace information 54
- diagram header
 - tracking generator 469
- Diagram title 155
- Dialog boxes
 - Working with 64
- Dig Out (hardware setting) 52
- DigIConf
 - Softkey 402, 415, 483
- Digital Baseband Info
 - Remote control 776
- Digital Baseband Interface (B17) 23
 - Status registers 561
- Digital IQ 241, 432
- Digital IQ data
 - device 400, 414, 481
- Digital IQ Info
 - Remote control 764
 - Softkey 403, 421, 482
- Digital Output
 - Enabling 402, 420, 482
 - Softkey 402, 420, 482
- Display
 - Date 155
 - Enlarging 73
 - maximized 70, 749
 - Power-save mode 158
 - split 70, 749
 - Split screen 70
 - Table 70
 - Time 155
 - Update Rate 77
- Display Config
 - Softkey 418
- Display lines 390, 391
- display range
 - level 194, 195, 362, 363, 368, 369, 423, 424
- Display range
 - Frequency 186
- display settings
 - Softkey Bar State (remote control) 929
 - Status Bar State (remote control) 928
- DNS server
 - LAN configuration 600
- Double dagger 545
- DOWN 544
- Dynamic range
 - Intermodulation-free 378
 - Measuring 383
- E**
- Edit dialog box 64
- Edit Limit Line dialog box 394, 397
- Electronic attenuator
 - option B25 200
 - setting 200
- Electronic input attenuation
 - FSV-B25 767
- Electrostatic discharge 24
- ENABLE 553
- Enable registers
 - Remote 613

- Enhancement labels 52
- Entry
 - Canceling 60
 - Concluding 60
- error messages
 - device-specific 1057
- Error messages 1057
- Error queue 554
- Error queues
 - recommendations 566
- Errors
 - Data acquisition 561
- ESD 24
- ESE (Event Status Enable register) 555
- ESR (Event Status Register) 551, 555
- EVENT 553
- Event status enable register (ESE)
 - Remote 611
- Event Status Enable register (ESE) 555
- Event status register (ESR)
 - Remote 611
- Event Status Register (ESR) 555
- EX-IQ-BOX 401, 415, 473, 482
 - DigiConf 402, 415, 483
- Export
 - I/Q data (remote) 773
- export format 235, 533
- Exporting
 - I/Q data (remote) 773
- EXREF (status display) 56
- Ext 56
- EXT TRIGGER
 - Connector 21
- External mixer
 - Connector 18
- External Mixer (B21) 488
 - activating (remote control) 826, 827
 - Band 497
 - band settings 497, 828, 829
 - Band settings 497
 - Bias current 490
 - configuration 496
 - Conversion Loss 498
 - Conversion Loss Tables 491, 500, 503
 - General information 489
 - Handover frequency 497
 - Harmonic Order 498
 - Harmonic Type 498
 - Measurement example 506
 - Preset Band 497
 - Range 498
 - remote control 789, 826
 - RF Overrange 497
 - RF Start 497
 - RF Stop 497
 - softkey 400
 - Softkey 189, 496
 - Type 498
- External Mixer Config
 - Softkey 496
- external noise source 399
- external trigger 239, 430
- F**
- Fast ACLR 285
- FFT Filter Mode
 - Auto 204, 209, 217
 - Narrow 204, 209, 217
 - softkey 204, 209, 217
- file
 - copying 169
 - deleting 169
 - renaming 169
- File Manager dialog box 168
- Filter
 - Digital I/Q (remote control) 900
- Filter bandwidth
 - Baseband Digital 417
 - Digital I/Q (remote control) 896
- Filter types
 - 5-Pole 211
 - EMI (6dB) 211
 - Normal (3dB) 211
 - RRC 211
- Filters
 - Baseband Digital 417
 - I/Q data 417
 - Overview 212
 - Selecting 211
 - Types 211
- Firmware
 - Options 49
 - Update 47
 - Version 158
- fixed reference 260
- FM demodulation 261
- FM modulation 449, 468
- FM Stereo mode (K7S) 408
- Focus
 - Changing 70
- folder
 - renaming 169
- FREQ key 185
- frequency
 - line 392
 - offset 188
 - start 188
 - stop 188
- Frequency
 - Axis 185
 - Center 186
 - Display 155
 - Lines 391
 - Reference 36
 - tracking generator 457
- Frequency Denominator
 - tracking generator 458
- Frequency Max.
 - tracking generator 456, 461
- Frequency menu 186
- Frequency Min.
 - tracking generator 456, 461
- Frequency Numerator
 - tracking generator 458
- Frequency Offset
 - tracking generator 456, 458
- FRQ
 - tracking generator 469
- Frq (enhancement label) 53
- Full Scale Level
 - Digital I/Q Interface (remote control) 765, 766
 - Digital IQ 400, 414, 481

Full screen
 see Display, maximized 70
Full screen level
 External Mixer (B21) 492
Fuse 28
FXD (marker functions) 54, 255

G

GAT (enhancement label) 53
gate
 delay 244
 length 245
 ranges 372
Gate
 External/internal 244
 MODE <mode> 244
GATE IN
 Connector 21
gated statistics
 configuration 372
 configuration example 374
 example 374
gated trigger 372
generator type
 tracking generator 459
Getting started 9
GPIO
 tracking generator 460
GPIO bus control
 Remote 613
GPIO interface
 Configuring 594
 Connector 21
GPIO Language 977
GSM/EDGE Analyzer mode (K10) 408

H

Handover frequency
 External Mixer (B21, remote control) 828
 External Mixer (B21) 497
Hardware information dialog box 158
Hardware settings
 Display 51
Harmonic Distortion
 Measurement 382
 Results 385
Harmonic order
 Conversion Loss Table (B21) 501
 External Mixer (B21) 498
Harmonic Type
 External Mixer (B21, remote control) 830
 External Mixer (B21) 498
Harmonics
 External Mixer (B21, remote control) 829, 830
 Measurement 283, 385
HiSLIP 538
 Protocol 538
 Resource string 538
HOME key 411
HP emulation 977
Hysteresis
 Lower (Auto level) 203
 Upper (Auto level) 203

I

I/Q Analyzer 411
 Softkey 413
I/Q Analyzer mode 408
I/Q data
 Export (remote control) 773
 Import (remote control) 773
 Maximum bandwidth 441
 Sample rate 441
 trigger point in sample (TPIS) 906
I/Q data acquisition 1036
I/Q Gating
 edge triggered 907
 level triggered 907
I/Q modulation 449, 468
I/Q-Vector
 I/Q Analyzer 418
Icons
 Toolbar 57
ID String User 977
Identification
 Remote 612
IEC/IEEE bus
 Command description 608
IECWIN 566
 Accessing 47
IF power
 Trigger mode 240, 431
IF WIDE OUTPUT
 Connector 417
IF/VIDEO
 Connector 21
IFOVL
 tracking generator 461, 469
IFOVL (status display) 56
Impedance
 Input 199, 428
Importing
 I/Q data (remote) 773
INF 544
Inherent noise
 correction 198, 304, 428
initial configuration 184
Input sample rate
 Digital IQ 400, 414, 481
Input sample rate (ISR)
 Definition 441
Input/Output menu 398
Instrument security procedures 10
Interfaces
 LAN 537
intermodulation product 375
Interrupt 562
Invalid results
 Remote control 548
IP address 538
 Changing 597
IP configuration
 LXI 603
IQ data
 remote control 894
IQ Export
 Softkey 168
IQ Import
 Softkey 168
IST 551

- IST flag 555
 - Remote 612
- K**
- key
 - AMPT 193
 - AUTO SET 201
 - BW 205
 - DISPLAY 929
 - ESC 640
 - LINES 386
 - MEAS 281
 - MEAS CONFIG 386
 - MKR 250
 - MKR FUNC 256, 257
 - MKR-> 271
 - MODE (remote control) 770, 772
 - PEAK SEARCH 256
 - PRESET 183, 973
 - PRINT 178
 - RUN CONT 406
 - RUN SINGLE 406
 - SAVE/RCL 163
 - SETUP 138
 - SPAN 191
 - SWEEP 214
 - TRACE 219
 - TRIG 238
 - USER 181
- Key
 - Alphanumeric 60
 - BACK 60
 - Decimal point 60
 - DNARROW 61
 - ENTER 60
 - ESC/CANCEL 60
 - FREQ 185
 - GHz/dBm 60
 - HOME 62, 411
 - Hz/-dB 60
 - kHz/dB 60
 - LEFTARROW 61
 - MKR 249
 - MODE 406
 - REDO 62
 - RIGHTARROW 61
 - Sign 60
 - UNDO 62
 - Unit 60
 - UPARROW 61
- Keyboard
 - On-screen 59
- Keys
 - SPLIT/MAXIMIZE key 70
- Keywords
 - see Mnemonics 540
- L**
- labels
 - tracking generator 469
- LAN
 - Configuration 595
 - Configuring 601
 - Connector 21
 - Interface 537
- IP address 538
- Remote control interface 537
- VISA 538
- VXI protocol 538
- Language
 - Changing 36, 153
- level
 - axis 195, 425
 - display range 194, 195, 362, 363, 368, 369, 423, 424
 - range 194, 195, 362, 363, 368, 369, 423, 424
 - trigger 242
- Level
 - Reference 193, 423
 - Softkey 416
- Level Unit
 - Digital I/Q Interface (remote control) 766
 - Digital IQ 401, 414, 481
- limit
 - ACLR measurement 301
- Limit
 - Evaluation range 356
- limit check
 - ACLR measurement 300
- limit line
 - scaling 395
 - shift 397
 - span setting 395
- Limit lines
 - Copying 389
 - Deleting 390
 - Editing 389, 397
 - New 388
 - Offset 390
 - Recalling 163
 - Saving 163
 - Spurious Emissions 346
 - Time Domain Power measurement 355
- line
 - frequency 392
 - limit 392
 - threshold 264, 273, 437
 - time 392
- Lines
 - display 391
 - Frequency (Frequency Line 1, 2) 391
 - Menu 387
 - Time (Time Line 1, 2) 391
- LINES key 386
- LO exclude 274
- LO level
 - External Mixer (B21, remote control) 830
- LO Level
 - Softkey 504
- Loading
 - Instrument configuration 104
 - Measurement data 104
- local menu 177
- Login
 - Operating system 45
- Logo 155
- LOUNL (status display) 56
- Lower Level Hysteresis
 - Softkey 203
- Lower-case (commands) 609
- LTE mode (K100/K101/K104/K105) 410
- LVDS connector
 - B17 487

- LVL
 - tracking generator 469
- LXI
 - Browser interface 601
 - LAN configuration 603
 - Ping 603
- M**
- Magnitude
 - I/Q Analyzer 418
- maintenance 1055
- Malfunctions
 - reacting 565
- manual operation 177
 - changing to 177
- marker
 - center frequency to 272
 - peak 272
 - reference level to 272
 - search limit 273
- Marker
 - Zoom 253
- Marker Function menu 257
- Marker menu 250
- Marker Number
 - softkey 264, 438
- Marker Peak List
 - Activating/Deactivating 263, 436
 - Configuring 263, 436
 - Number display 264, 438
 - Number of entries 263, 437
- Marker Search Area
 - Softkey 276
- Marker Search Type
 - Softkey 276
- Marker To menu 271
- Marker Wizard
 - softkey 251
- Markers 249
 - Field 249
 - Set to trace 251, 272
 - Signal track 189
- MAX 544
- Max Hold trace mode 221, 231
- Max Peak Count
 - softkey 263, 437
- MAXH (trace information) 54
- maximum search 272
- maximum value 356
- MC-ACLR 295
- Mean power (GSM burst) 356
- MEAS CONFIG key 386
- MEAS key 281
- Meas Time
 - Baseband Digital 418
- measurement
 - functions 248
 - parameters 182
 - reflection 463
 - transmission 463
- measurement accuracy
 - tracking generator 461
- Measurement data
 - Loading 104
 - Storing 104
- measurement example
 - amplitude distribution 132
 - harmonics 107
 - high-sensitivity harmonics 385
 - intermodulation 375
 - modulated signals 125
 - noise 118
 - signals in the vicinity of noise 113
 - spectra of complex signals 109
 - test setup 106
- Measurement example
 - AF of AM-modulated signal 90
 - AF of FM-modulated signal 99
 - AM modulation 89
 - First and second harmonic 82
 - Level and frequency 78
 - Power of burst signals 92
 - Separating signals 85
 - Signal frequency using frequency counter 80
 - Signal-to-noise ratio 96
- Measurement menu 281
- Measurement modes
 - 1xEV-DO BTS (K84) 410
 - 3G FDD BTS (K72) 409
 - 5G NR (K144) 411
 - Analog Demodulation (K7) 408
 - Bluetooth (K8) 408
 - CDMA2000 BTS (K82) 409
 - CDMA2000 MS (K83) 409
 - Changing 406
 - Displaying main menus 411
 - FM Stereo (K7S) 408
 - GSM/EDGE Analyzer (K10) 408
 - I/Q Analyzer 408
 - LTE (K100/K101/K104/K105) 410
 - Noise Figure (K30) 408
 - Phase Noise (K40) 409
 - Power Sensor (K9) 406
 - Spectrogram (K14) 406
 - Spectrum 407
 - TDS BTS 409
 - TDS UE 409
 - Vector Signal Analysis (K70) 409
 - WiMAX/WiBro (K92/92) 410
 - WLAN (K91) 410
- menu
 - Auto Set 201
 - Input/Output 398
 - Marker 250
 - Marker Function 257
 - Marker To 271
 - Phase Noise 259
 - Power Sensor (K9) 511, 516
 - Print 178
 - SAVE/RCL 164
 - Span 191
 - Sweep 214
 - Trace 220
 - Trigger 238, 429
 - User 181
- Menu
 - Amplitude 193
 - Bandwidth 205
 - Frequency 186
 - Lines 387
 - Meas 281
 - Setup 139

- MI (trace information) 54
- MIN 544
- Min Hold trace mode 221, 232
- MINH (trace information) 54
- Mini Front Panel 70
- minimum search 272
- Mixer settings
 - Conversion Loss Table (B21) 501
- Mixer Type
 - External Mixer (B21) 498, 832
- MKR FUNC key 256, 257
- MKR key 249, 250
- MKR-> key 271
- Mnemonics 540
- Optional 542
- MOD (marker functions) 54, 255
- mode
 - trigger 239, 429
- Mode
 - see also Measurement modes 406
- Mode (hardware setting) 52
- MODE key 406
- Modulation
 - Depth 283, 381
- Modulation depth 381
- Modulation index 381
- Modulation mode (hardware setting) 52
- MONITOR (VGA)
 - Connector 21
- More
 - Softkey 62
- More Traces
 - softkey 225
- Multi-carrier
 - ACLR 295
 - multi-carrier ACLR measurement 284
 - Multiple signals measurement 85
- N**
- n dB down
 - marker function 262, 436
- NAN 544
- NAN (not a number)
 - Remote control 548
- NCoR (enhancement label) 53
- Negative Peak detector 234
- Network 604
 - Changing user passwords 605
 - Connecting drives 605
 - Creating users 604
 - Disconnecting drives 605
 - Setting up 567
 - Sharing directories 607
- Next Mode X
 - Softkey 275
- Next Mode Y
 - Softkey 275
- NINF 544
- NOI (marker functions) 54, 255
- noise
 - correction 198, 304, 428
 - source, external 399
- Noise Figure mode (K30) 408
- Noise source control
 - Connector 16
- NOR
 - tracking generator 461, 469
- normalization 447, 463
 - tracking generator 469
- NTRansition 553
- Numeric parameters 65, 543
- Numeric values
 - Special 544
- O**
- OBW
 - Multi-carrier signal 312
 - Search limits 312
- Occupied bandwidth 311
- OCCO 32
 - Connector 22
 - Internal reference 141
- offset
 - frequency 188
 - gate signal 244
 - reference level 198, 427
- Offset
 - Limit line 390
 - Trigger 243, 433
- Offset (hardware setting) 52
- On-screen keyboard 59
- Online help
 - Working with 6
- Operating system 44
 - Login 45
 - service packs 44
- Operation complete
 - Remote 612
- Options
 - Activating 49
 - Additional Interfaces (B5) 509
 - B30 28
 - B160 417
 - B160 (Bandwidth extension) 440
 - Bandwidth extension 417, 443
 - FSV-B25 196, 426, 767
 - Identification (remote) 612
 - Installed 158
 - Licenses 49
 - Power Sensor (K9) 509
 - RF Preamplifier (B22) 196, 416, 425
- Output
 - Sample rate, definition 441
- Output buffer 551
- OVEN (status display) 56
- Overlapping commands 548
 - Preventing 549
- overload
 - tracking generator 461
- Overwrite mode 221, 231
- OVLD
 - tracking generator 461, 469
- OVLD (status display) 56
- P**
- Pa (enhancement label) 53
- packing 1056
- Paint
 - Accessing 47

- Parallel poll register enable
 - Remote 613
- Parameters
 - Block data 545
 - Boolean 544
 - Entering 65
 - Numeric values 543
 - SCPI 543
 - Special numeric values 544
 - String 545
 - Text 544
- Passwords
 - Changing 605
- path 165
- Peak List On/Off
 - softkey 263, 436
- Peak search
 - Area (spectrograms) 276
 - Mode 275
 - Mode (spectrograms) 275
 - Type (spectrograms) 276
- PEAK SEARCH key 256
- PEAKSEARCH 272
- Persistence spectrum
 - color curve 530
 - Color mapping 527
- Ph. Noise Auto Peak Search
 - remote control 623
- Phase Noise mode (K40) 409
- PHN (marker functions) 54, 255
- Ping 603
- PK (trace information) 54
- polarity
 - external trigger 433
 - external trigger/gate 242
 - trigger edge 242, 433
- Ports
 - External Mixer (B21, remote control) 832
 - User 777
- Positive Peak detector 234
- power
 - bandwidth percentage 314
- Power
 - Mean 356
 - remote control 618, 619, 682, 683
 - Remote control 619
 - softkey 265, 439
- power cables 1056
- Power Classes
 - SEM 325
- Power Max.
 - tracking generator 456, 461
- power measurement 280
 - trace 302
 - zero span 354
- Power measurement
 - Occupied bandwidth 311
- Power Min.
 - tracking generator 456, 461
- Power Offset
 - tracking generator 455, 458
- Power Sensor
 - assignment 517
 - configuration 517
 - Configuration 518
 - Continuous Value Update 517
 - Continuous Value Update (remote control) 844
- Dropout 521
- Duty Cycle 519
- Duty Cycle (remote control, K9) 838, 839
- External Power Trigger 520
- External Trigger Level 521
- Frequency 518
- Frequency Coupling 519
- Frequency Coupling (remote control, K9) 839
- Frequency Manual (remote control, K9) 839
- Holdoff 521
- Hysteresis 521
- Meas Time / Average 519
- Meas Time/Average (remote control, K9) 840
- menu (K9) 511
- Number of Readings 520
- Number of Readings (remote control, K9) 841
- Ref Level Offset 520
- Reference from measurement 519
- Reference Value 520
- Selecting 518
- Slope 521
- Trigger (remote control) 842, 843, 844
- Trigger Level (remote control) 843
- Trigger mode 241, 431
- Unit / Scale 519
- Use Ref Lev Offset (remote control, K9) 841
- Zeroing 518
- Power Sensor (K9)
 - menu 516
 - results 511
- Power Sensor Assignment
 - softkey 517
- Power Sensor Config
 - softkey 517
- Power Sensor Support (K9) 406
- Power Sensors
 - Configuring 514
 - Connecting 514
- Power Sensors (K9) 509
- Power supply
 - Connector 20
 - Switching on 32
- power sweep
 - tracking generator 449
- Power Trigger
 - Parameters 515
- PPE 551
- PPE register 555
- pre-trigger 243, 433
- Preamplifier (B22) 196, 416, 425
- preset instrument 183
- PRESET key 183
- print
 - screen 179
- PRINT key 178
- Print menu 178
- Printers
 - Selecting 42
- Printers and Faxes window 180
- Probe power
 - Connector 16
- Probes
 - Activating 400
 - Active 403
 - Configuration (Softkey) 400

- programming examples
 - averaging I/Q data 1046
 - channel power measurement 1025
 - I/Q data 1036
 - level measurement 1033
 - limit lines and limit test 1023
 - occupied bandwidth measurement 1028
 - power ramp measurement 1030
 - reading files 1038
 - Spectrum Emission Mask measurement 1039
 - Spurious Emissions measurement 1043
 - time domain power measurement 1029
 - transducers 1035
 - writing files 1039
- Programming examples
 - Service request 1013
- Protocol
 - VXI 538
- PSA emulation 1007
- PSA89600
 - Wideband 151
- PTRansition 553
- Q**
- QP (trace information) 54
- Queries 547
 - Status 563
- Question mark 545, 547
- Quotation mark 545
- R**
- R&S DigiConf 473
- R&S Digital I/Q Interface (B17) 402, 403, 420, 421, 470, 482, 764, 776
 - Applications 471
 - Description 487
 - settings (remote control) 904
- R&S EX-IQ-BOX 487
- R&S Support
 - softkey 402, 415, 483
- RA (trace information) 54
- Rackmounting 27
- RBW (hardware setting) 52
- Ready for trigger
 - Status register 556
- Real/Imag (I/Q)
 - I/Q Analyzer 418
- Realtime mode
 - color curve 530
 - Color mapping 527
- Rebooting
 - remote control 974
- Recall dialog box 166, 170
- Recalling
 - Settings 170
- Recommendations
 - remote control programming 565
- Record Length
 - Baseband Digital 418
- Ref (hardware setting) 51
- REF IN
 - Connector 21
- REF OUT
 - Connector 21
- reference
 - fixed 260
 - level to marker level 272
 - tracking generator 460
 - value (channel power) 303
- Reference
 - External 36, 141
 - Internal 36, 141
- Reference frequency
 - OCXO 22
 - OCXO (option B4) 141
 - Ultra high precision (option B14) 23, 141
- reference level
 - channel power 305
 - offset 198, 427
 - to marker level 272
- Reference level 193, 423
- Reference Level
 - Baseband Digital 416
 - Digital IQ 401, 414, 482
- reference point
 - frequency 259, 260
 - level 259, 260
 - peak search 259, 260
 - time 259, 260
- reflection measurement 463
 - calibration 462
- Registers 551
- Release notes 10
- remote 902
- remote control
 - changing to 177
- Remote control
 - Basics 537
 - Command synchronization 581
 - Configuration 567
 - Deactivating the instrument 574
 - Display power save 579
 - Ending session 572
 - Global variables 577
 - Improving performance 77
 - Initialization 577
 - Instrument settings 580
 - Interfaces 537
 - Library 575
 - Programming examples 1011
 - Protocols 537
 - Sending commands 579
 - Setting up a connection 572
 - Starting 539
 - Stopping 540
 - Switching screen display on and off 578
 - Using markers 580
 - VNC 574
- Remote control programming example
 - Changing default settings 582
 - Printout 592
 - Reading out trace data 589
 - Storing and loading settings 591
 - Using markers and delta markers 584
- Remote operation
 - Setting up 567
- Repetition interval
 - Time trigger 243, 434
- reset
 - switch on or off 222

- Reset values
 - Remote 614
 - Resolution bandwidth 206, 245
 - Result Frequency Start
 - tracking generator 456, 459
 - Result Frequency Stop
 - tracking generator 456, 459
 - REV string factory
 - Softkey 151
 - REV string user
 - Softkey 151
 - RF Input
 - Active probes 403
 - RF Overrange
 - External Mixer (B21, remote control) 827
 - External Mixer (B21) 497
 - RF Power trigger 239, 430
 - RF Preamplifier (B22) 196, 416, 425
 - RM (trace information) 54
 - RMS
 - VBW 207, 235
 - RMS detector 234
 - RMS value 356
 - Rotary knob 61
 - RUN CONT key 406
 - RUN SINGLE key 406
 - RX Settings
 - softkey 401, 415, 483
- S**
- SA (trace information) 54
 - Safety instructions 10
 - Sample detector 234
 - sample number 362, 367
 - Sample rate
 - Definition 441
 - Digital I/Q Interface (remote control) 767
 - Digital IQ 400, 414, 481
 - Maximum 441
 - Sample Rate
 - I/Q Analyzer 417
 - Samples
 - Statistics 358
 - Save dialog box 165, 170
 - SAVE/RCL key 163
 - SAVE/RCL menu 164
 - Saving
 - Results 170
 - scalar reflection measurement 463
 - scaling
 - level axis 198, 428
 - x- and y-axis (signal statistic) 362, 368
 - SCPI
 - Conformity information 608
 - Parameters 543
 - Syntax 540
 - Screen
 - Colors 38
 - search
 - minimum 272
 - peak 272
 - range 273
 - Search
 - Bandwidth 189
 - Search limits
 - OBW 312
 - Search Mode
 - Softkey 275
 - Search Settings
 - softkey (B17) 434
 - Security procedures 10
 - Select Limit Line dialog box 397
 - Select screen color set dialog box 156
 - Self test 162
 - Self-test
 - Remote 615
 - SEM
 - Results 327
 - sensitivity
 - APD measurement 365, 366, 371, 372
 - CCDF measurement 365, 366, 371, 372
 - Sequential commands 548
 - Service manual 9
 - Service packs 44
 - Service request (SRQ) 554, 562
 - Service request enable register (SRE) 554
 - Remote 614
 - Settings
 - Automatic loading 104
 - Loading 104
 - Recalling 170
 - Saving 170
 - Storing 103
 - setup
 - general 146
 - SETUP key 138
 - Setup menu 139
 - Sgl (enhancement label) 52
 - shutdown
 - remote control 975
 - signal count 258, 435
 - Signal ID
 - External Mixer (B21, remote control) 832
 - Softkey 504
 - Signal Source
 - I/Q Analyzer 400, 414, 481
 - Remote control 769
 - Softkey 400, 414, 481
 - Signal tracking 189
 - Search bandwidth 189
 - Sinusoidal signal measurements 78
 - Harmonics 82
 - Soft Front Panel 70
 - mini 70
 - softkey 302, 315
 - 365, 366, 371, 372
 - (remote control) 866, 869
 - # of Adj Chan 296
 - # of Adj Chan (remote control) 845
 - # of Samples 362, 367
 - # of Samples (remote control) 742
 - # of TX Chan 296
 - # of TX Chan (remote control) 854
 - % Power Bandwidth 314
 - % Power Bandwidth (remote control) 854
 - = Center 188
 - = Marker 188
 - 0.1 * RBW 187
 - 0.1 * RBW (remote control) 809, 810
 - 0.1 * Span 187
 - 0.1 * Span (remote control) 809, 810
 - 0.1*Demod BW (K7) 187
 - 0.5 * RBW 187

- 0.5 * RBW (remote control) 809, 810
- 0.5 * Span 187
- 0.5 * Span (remote control) 809, 810
- 0.5*Demod BW (K7) 187
- ACLR Abs/Rel 302
- ACLR Abs/Rel (remote control) 849
- ACLR Ref Setting (remote control) 851
- ACLR Ref Spacing (remote control) 852
- Active On/Off (remote control) 956
- Adjust Ref Level 305
- Adjust Ref Level (remote control) 851
- Adjust Ref Lvl 314
- Adjust Settings (remote control) 743, 850
- All Functions off 282, 283
- All Functions off (remote control) 720
- All Marker Off 252
- AM (remote control) 685
- Ampere 195, 425
- APD (remote control) 741, 743
- Application Setup Recovery(remote control) 964
- ASCII File Export 264, 323, 438
- ASCII File Export (remote control) 774
- ASCII Trace Export 167, 226
- ASCII Trace Export (remote control) 775
- Auto (remote control) 863
- Auto All 202
- Auto Max Peak 273
- Auto Max Peak (remote control) 671
- Auto Min Peak 273
- Auto Min Peak (remote control) 674
- Average Mode (remote control) 785
- Band Power 265, 438
- Band Power On/Off 265, 439
- C/N (remote control) 704, 707
- C/No (remote control) 704, 707
- Calibrate Reflection Open 447
- Calibrate Reflection Short 447
- Calibrate Transmission 447
- Calibration Frequency MW 920
- Calibration Frequency RF 920
- Calibration Frequency WB 921
- CCDF (remote control) 741, 743
- Center =Mkr Freq 272
- Center =Mkr Freq (remote control) 684
- CF Stepsize (remote control) 809
- Chan Pwr/Hz 301
- Chan Pwr/Hz (remote control) 707
- Channel Bandwidth 314
- Channel Bandwidth (remote control) 846
- Channel Settings 296
- Channel Spacing (remote control) 852, 853
- Clear All Messages (remote control) 968, 969
- Clear/Write 301
- Color (On/Off) 180
- Color On/Off (remote control) 936
- Colors 179
- Comment 180
- Cont Demod (remote control) 684
- Cont Meas (remote control) 760
- Continue Single Sweep (remote control) 760, 761
- Continuous Sweep (remote control) 760
- Copy 169
- Copy (remote control) 943
- Copy to (remote control) 641
- Copy Trace 225
- Copy Trace (remote control) 890
- Corr Data On/Off (remote control) 917, 918
- Coupling (FSx/HP)(remote control) 970
- Coupling Ratio 209
- CP, ACP, MC-ACLR (remote control) 704, 707
- CP/ACLR Config 296
- CP/ACLR Standard 295
- Current File List (1/2) 169
- Cut 169
- Date 169
- dBm 195, 425
- dBmV 195, 425
- dBpW 195, 425
- dBµA 195, 425
- dBµV 195, 425
- Decim Sep 168, 227, 264, 324, 354, 438
- Default Coupling 210
- Default Settings 364, 370
- Default Settings (remote control) 742, 744
- Delete 169
- Delete (remote control) 641, 944, 949, 955
- Delete File 166
- Delete File (remote control) 942
- Delete Range 321, 352
- Delete Range (remote control) 801
- Density 265, 439
- Description 972
- Detector Auto Select (remote control) 864
- Detector Manual Select (remote control) 863
- Deviation Lin/Log (remote control) 753
- Device (1/2) 179
- Device 1/2 (remote control) 947
- Device Setup 179
- Device Setup (remote control) .. 935, 936, 939, 965, 966
- Disable all Items 166
- Disable all Items (remote control) 950
- Disconnect Network Drive 170
- Disconnect Network Drive (remote control) 948
- Display Line 1 (remote control) 636, 637
- Display Line 2 (remote control) 636, 637
- Edit (remote control) 641, 643, 654, 655, 664, 665, 666, 954
- Edit ACLR Limit (remote control) 645, 646, 647, 649, 650, 651
- Edit Comment 165
- Edit File Name 165
- Edit Name (remote control) 956
- Edit Path 168
- Edit Path (remote control) 942, 943, 947
- Edit Power Classes 325
- Edit Reference Range 322, 324
- Edit Reference Range (remote control) 797, 798, 808
- Edit Unit (remote control) 956
- Edit Values (remote control) 955
- EI Atten Mode (Auto/Man) 197, 427
- Enable all Items 166
- Enable all Items (remote control) 949
- Exclude LO (remote control) 670
- Export 167
- Extension 169
- External 239, 430
- External AM 449, 468
- External AM (remote control) 865
- External FM 449, 468
- External FM (remote control) 871
- External I/Q 449
- External IQ (remote control) 865
- Fast ACLR On/Off 303
- Fast ACLR On/Off (remote control) 854

File Lists (1/2)	169	Marker 1-16	250, 380, 382
File Manager	168	Marker 1, Marker 2 ... 16	250, 380, 382
Filter Type	211	Marker 2 (remote control)	618
Filter Type (remote control)	786, 787	Marker 3 (remote control)	618
Firmware Update (remote control)	969	Marker 4 (remote control)	618
FM (remote control)	685	Marker List (remote control)	686
Free Run	239, 429	Marker Norm/Delta	250, 380, 382
Freq Axis (Lin/Log) (remote control)	752	Marker Norm/Delta (remote control)	618
Frequency Line 1 (remote control)	639	Marker Stepsize	252
Frequency Line 2 (remote control)	639	Marker Stepsize (remote control)	680
Frequency Offset	188	Marker Table (Off/On/Aut) (remote control)	749
Full Span (remote control)	811	Marker Table (On/Off)	252
Gate Delay (remote control)	857	Marker to Trace (remote control)	628
Gate Length (remote control)	858	Marker Wizard	251
Gate Mode Lvl/Edge (remote control)	860, 863	Marker Zoom (remote control)	698
Gate Ranges	365, 371	Max Hold	302
Gate Ranges (remote control)	859, 860	Mean (remote control)	722, 723
Gated Trigger (On/Off)	365, 371	Meas Start/Stop	326
Gated Trigger (remote control)	857, 858	Meas Start/Stop (remote control)	762
GPIO Address (remote control)	964	Meas Time Auto	203, 782
GPIO Language (remote control)	971	Meas Time Manual	203, 782
GPIO Terminator LFEOI/EOI (remote control)	965	Meas to Ref (remote control, K9)	733
Grid Abs/Rel	198, 428	Min	272
Grid Abs/Rel (remote control)	754	Min (remote control)	626, 673
Hardware Info (remote control)	919	Mkr Demod On/Off (remote control)	686
Hold/Cont	222	Mkr List On/Off (remote control)	686
ID String Factory (remote control)	970, 974	Mkr Stop Time (remote control)	685
ID String User (remote control)	970	Modulation	448
IF Gain (Norm/Puls)(remote control)	971	Modulation OFF	449
IF Output IF/Video (remote control)	953	More Markers	251
Import	168	n dB down	262, 436
Info	972	n dB down (remote control)	692, 693, 694, 695
Input 50 W/75 W (remote control)	769	Name	169
Input RF/Cal/TG (remote control)	922	Name (remote control)	643
Insert after Range	321, 352	Network Drive	170
Insert after Range (remote control)	804	New (remote control) 641, 643, 654, 655, 664, 665, 666	
Insert before Range	321, 352	New Folder	168
Insert before Range (remote control)	804	New Folder (remote control)	946
Install Printer	180	Next Min	273
Installed Options (remote control)	919	Next Min (remote control)	627, 674, 675
Interpolation Lin/Log (remote control)	955	Next Mode </abs/>	274
LAN Reset	972	Next Peak	272
Last Span	192	Next Peak (remote control)	625, 626, 627, 672, 673, 674, 675
Left Limit	263, 273, 437	Noise Correction	198, 304, 428
Left Limit (remote control)	678	Noise Meas On/Off	258
Limit Chk On/Off (remote control)	645, 648, 652	Noise Meas On/Off (remote control)	695, 696
Limit Line Select dialog box (remote control)	663, 666	Noise Source	399
Limits On/Off (remote control)	678	Noise Src On/Off (remote control)	922
Lin	226, 228	Normalize	447
Link AF Spectrum Marker (remote control)	670	NORMALIZE	463
Link Mkr1 and Delta1	253	OBW (remote control)	707
Link Mrk1 and Delta1 (remote control)	623	Password	973
Link Time Marker (remote control)	670	Password (remote control)	973
List Evaluation	323	Paste	169
List Evaluation On/Off	323	Peak	272
List Evaluation On/Off (remote control)	637	Peak (remote control)	624, 671, 725
Load Standard	326	Peak Excursion	263, 276, 437
Local	178	Peak Excursion (remote control)	676
Log	228	Peak Search	259, 260
Manual	188	Peak Search (remote control) ... 620, 686, 687, 689, 690	
Manual (remote control)	809	Percent Marker	367, 741
Map Network Drive	170	Percent Marker (remote control)	681
Map Network Drive (remote control)	948, 949	Ph Noise On/Off (remote control)	620, 622, 623
Margin	323	Ph Noise/Ref Fixed (remote control)	620, 622
Margin (remote control)	638	Phase Noise	259
Marker 1 (remote control)	618	Phase Noise Auto Peak Search	259
Marker 1 to 4 (remote control)	628, 629, 668, 677		

Phase Noise On/Off	259	Res BW (remote control)	785
Power	226, 228, 265, 439	Res BW Auto (remote control)	786, 787
Power Mode	301	Res BW Manual (remote control)	785, 786
Power Mode (remote control)	702	Restore Standard Files	327
Power Sensor	398	Right Limit	264, 273, 437
Power Sensor Assign	888	Right Limit (remote control)	679
Power Sensor Assignment	517	RMS (remote control)	727, 728
Power Sensor Config	517	Save	165
Power Sensor On/Off (K9)	516	Save As Standard	326
Power Sensor On/Off (remote control, K9)	838	Save As Standard (remote control)	800
Power Sweep	449	Save As Trd Factor	448
Power Sweep (On/Off)	449	Save Evaluation List	323
Power Sweep (On/Off) (remote control)	873	Save Evaluation List (remote control)	774
Power Sweep Start	450, 873	Save File	165
Power Sweep Start (remote control)	873	Save File (remote control)	951, 952
Power Sweep Stop	450	Scaling	362, 368
Power Sweep Stop (remote control)	874	Screen Colors (remote control)	934
Predefined Colors	180	ScreenShot	167
Predefined Colors (remote control)	935	Search Lim Off	274
Print Screen	179	Search Lim Off (remote control)	678, 746
Print Screen (remote control)	937, 938, 947	Search Limits	273
R&S Support	402, 415, 483	Search Limits (remote control)	678
Range	194, 423	Select 1 2 3 4 (remote control)	668
Range Lin. Unit	195, 364, 370, 425	Select Dataset	167
Range Lin. Unit (remote control)	752, 753	Select Directory (remote control)	956
Range Linear %	195, 364, 369, 425	Select File	165
Range Linear % (remote control)	752, 753	Select Items	165
Range Log (remote control)	753	Select Items (remote control)	950, 951
Range Log 1 dB	195, 363, 369, 424	Select Marker (No)	258, 260, 265, 435, 438
Range Log 5 dB	194, 363, 369, 424	Select Object	180
Range Log 10 dB	194, 363, 368, 424	Select Path	165
Range Log 50 dB	194, 362, 368, 423	Select Print Color Set	180
Range Log 100 dB	194, 362, 368, 423	Select Print Color Set (remote control)	934
Range Log Manual	195, 363, 369, 424	Select Trace	302
RBW/VBW Manual	210	Select Trace (remote control)	717, 855
RBW/VBW Noise [10]	209	Select Traces to check (remote control)	643, 644
RBW/VBW Pulse [1]	209	Self Align (remote control)	917
RBW/VBW Sine [1/3]	209	Selftest Results (remote control)	924
Recall	166, 448	Service Function (remote control)	922, 923
Recall (remote control)	799	Set CP Reference	303
Recall File	165	Set Standard (remote control)	799
Recall File (remote control)	945	Set to Default	180
Ref Fixed	260	Set to Default (remote control)	934
Ref Level (remote control)	744	Settings	203
Ref Level Adjust Man/Auto (remote control)	954	Shift X Limit Line (remote control)	655
Ref Level Offset	198, 427	Shift Y Limit Line (remote control)	665
Ref Level Offset (remote control)	755	Show Align Results (remote control)	918
Ref Level Position	198, 427	Show Peaks	323
Ref Level Position (remote control)	755	Show Peaks (remote control)	638
Ref Lvl =Mkr Lvl	272	Sig Count	258, 435
Ref Lvl =Mkr Lvl (remote control)	696	Sig Count On/Off (remote control)	668, 669
Ref Point Frequency	259, 260	Signal Track (remote control)	718
Ref Point Frequency (remote control)	621	Single Meas (remote control)	760
Ref Point Level	259, 260	Single Sweep (remote control)	760
Ref Point Level (remote control)	621	Size	169
Ref Point Time (remote control)	621	Soft Frontpanel (remote control)	967
Ref Value (remote control)	755	Sort Mode	169
Ref Value Position (remote control)	755	Sort Mode Freq/Lvl (remote control)	688, 689
Reference Fixed On/Off	260	Source Cal	447
Reference Int/Ext (remote control)	870, 957, 958, 959	Source Config	450
Reference Position (remote control)	755	Source Power	446
Reference Value	448	Source Power (remote control)	870, 872
Reference Value (remote control, K9)	733	Source RF (On/ Off)	446
Reference Value Position	448	Source RF (On/Off) (remote control)	777
Rename	169	Span	265, 439
Rename (remote control)	946	Span Manual	192
Res BW	361, 367	Span Manual (remote control)	811

Span/RBW Auto [50]	210
Span/RBW Manual	210
Start	188
Start (remote control)	812
Start Frequency (remote control)	812
Startup Recall	166
Startup Recall (On/Off)	167
Startup Recall On/Off(remote control)	945
Std Dev (remote control)	730
Stepsize Standard	252
Stepsize Standard (remote control)	680
Stepsize Sweep Points	253
Stepsize Sweep Points (remote control)	680
Stop	188
Stop (remote control)	812
Stop Frequency (remote control)	812
Sweep Count	217
Sweep List (remote control)	800, 801, 802, 803, 804, 805, 806, 807, 818, 819, 820, 821, 822, 823, 824, 825
Sweep Points	217
Sweep Points (remote control)	861
Sweep Rep (On/Off)(remote control)	975
Sweep Time	245, 302
Sweeptime Auto (remote control)	862
System Messages (remote control)	968, 969
T1-T2 ->T1	227
T1-T3 ->T1	227
T1-T4 ->T1	227
T1-T5 ->T1	227
T1-T6 ->T1	227
THD Unit %/DB (remote control)	915
Threshold	264, 273, 437
Threshold (remote control)	745, 746
Time Domain Power (remote control)	731
Time Line 1 (remote control)	746
Time Line 2 (remote control)	746
Time+Date (remote control)	966, 967, 975
Trace 1 2 3 4 5 6 (remote control)	750
Trace Math	227
Trace Math (remote control)	731, 732
Trace Math Mode	227
Trace Math Mode (remote control)	732
Trace Math Off	228
Trace Math Position	228
Trace Mode (remote control) ...	720, 721, 722, 723, 724, 726, 727, 728, 729, 754
Track BW (remote control)	716
Track On/Off (remote control)	718
Track Threshold (remote control)	717
Tracking Generator	398
Trg/Gate Level	242
Trg/Gate Level (remote control)	911
Trg/Gate Polarity Pos/Neg	242
Trg/Gate Polarity Pos/Neg (remote control)	858, 912
Trg/Gate Source (remote control)	858, 910, 911
Trigger Holdoff (remote control)	909
Trigger Out (Low/High)(remote control)	953
Trigger Polarity	433
Unit	195, 425
Unit (remote control)	747, 914
Unit/Scale (remote control, K9)	734, 914, 915
Update Path (remote control)	969
Use Zoom Limits	274
Use Zoom Limits (remote control)	679
User Defined Colors	180
User Defined Colors (remote control)	934
User Pref Setup	181
Value (remote control)	653, 660, 664
Versions + Options (remote control)	924
Versions+Options (remote control)	967
Video	239, 430
Video BW Auto (remote control)	788
Video BW Manual (remote control)	788
Video Output	399
Volt	195, 425
Watt	195, 425
Weight ADJ (On/Off) (remote control)	848
Weight TX (On/Off) (remote control)	848, 849
Weighting Filter (remote control)	847, 848
X * RBW	187
X * RBW (remote control)	809, 810
X * Span	187
X * Span (remote control)	809, 810
x Offset (remote control)	654
x-Axis Range	362, 368
x-Axis Range (remote control)	744
x-Axis Ref Level	362, 368
x-Axis Ref Level (remote control)	744
x*Demod BW (K7)	187
y Offset (remote control)	665
y-Axis Max Value	364, 370
y-Axis Max Value (remote control)	745
y-Axis Min Value	364, 370
y-Unit %/Abs	364, 370
y-Unit %/Abs (remote control)	745
Zero (remote control, K9)	748
Zero Span	192
Zero Span (remote control)	811
Softkey	62
*IDN format legacy	152
= Marker (remote control)	684
Active (On/Off)	142
Adjust Settings	311, 386, 422
Adjust X-Axis	352, 354
Alignment	145
AM	261
AM Mod Depth	283, 381
AM Mod Depth (remote control)	690, 691
Annotation (On/Off)	155
Annotation On/Off (remote control)	926, 929
APD	282, 361
Application setup recovery	160
ASCII File Export	353
AUTO	204, 208, 216
Auto Freq	202
Auto Level	203
Auto select reference	142
Average	222, 232
Average Mode	225
Band Power (remote control)	619, 683
BB Power	240, 431
BB Power Retrigger Holdoff (remote control)	909
Blank	222, 232
C/N	310, 421
C/N (remote control)	708
C/N, C/No	281, 310, 421
C/No	310, 421
C/No (remote control)	708
Calibrate Reflection Open (remote control)	789, 794
Calibrate Reflection Short (remote control)	794
Calibrate Transmission (remote control)	794
Calibration frequency MW	161
Calibration frequency RF	161
CCDF	283, 366

Center	186	Gate Delay	244
Center (remote control)	809	Gate Length	245
CF Stepsize	186	Gate Mode Lvl/Edge	244
Ch Power ACLR	281, 295	Gate Settings	244
Channel Bandwidth	310, 422	Gated Trigger	244
Clear all messages	159	General setup	146
Clear Write	221, 231	GPIB	148
Close Sweep List	321, 352	GPIB address	148
Color (On/Off)	156, 158	GPIB language	149
Color Mapping	527	GPIB terminator LFEOI/EOI	152
Colors	156	Handle missing Ext. ref	141
Compatibility mode	148	Hardware info	158
Computer name	146	Harmonic Distortion	283, 385
Configure monitor	153	Harmonic RBW Auto	386
Cont Demod	261	Harmonic Sweep Time	386
Cont Meas (remote control)	761	I/O logging (On/Off)	152
Continue Single Sweep	215	ID string factory	148
Continuous Sweep	214	ID string user	148
Continuous Sweep (remote control)	761	IF gain (Norm/Puls)	150
Copy to	144, 389	IF Power	240, 431
Coupling (FSx/HP)	150	IF Power Retrigger Holdoff (remote control)	909
CP, ACP, MC-ACLR (remote control)	708	IF Power Retrigger Hysteresis (remote control)	910
CP/ACLR Standard (remote control)	703	Import (remote control)	773
Decim Sep (remote control)	759	Info (LXI)	147
Default Colors 1 (remote control)	926	Input (AC/DC)	199, 399, 428
Default Colors 2 (remote control)	926	Input (AC/DC)(remote control)	764
Delete	144, 390	Input 50 Ω/75 Ω	199, 428
Delete (ACLR User Standard)	304	Input source	161
Delete value	144	Insert value	143
Delete Value	389	Insert Value	389
Density (remote control)	618, 619, 682, 683	Install option	160
Description	147	Install option by XML	160
Deselect all	388	Interpolation Lin/Log	144
Details On/Off	353	IP address	146
DHCP (On/Off)	147	IQ Export	168
DigiConf	402, 415, 483	IQ Import	168
Digital IQ	241, 432	LAN reset	148
Display Line 1	390	Language	153
Display Line 2	390	Left Limit	357
Display lines	390	Limits On/Off	356
Display pwr save	158	List Evaluation	352
Display Pwr Save (remote control)	928	List Evaluation On/Off	353
Display setup	154	Load (ACLR User Standard)	304
Display update (On/Off)	152	Log	226
Edit	143, 389	Logo (On/Off)	155
Edit (remote control)	661, 662, 663	Logo On/Off (remote control)	928
Edit Comment	388	LXI	147
Edit Margin	389	Margin	353
Edit name	143	Marker 1 to 4 (remote control)	629, 680
Edit Name	388	Marker Demod	260
Edit unit	143	Marker Number	264, 438
Edit Value	389	Marker Number (remote control)	687
Edit values	143	Marker Peak List	263, 436
EL Atten (remote control)	768	Marker to Trace	251, 272
EL Atten Mode (Auto/Man) (remote control)	767	Marker to Trace (remote control)	677
EI Atten On/Off	197, 426	Marker Zoom	253
EX-IQ-BOX	401, 415, 482	Max Hold	221, 231
Exclude LO	274	Max Peak Count	263, 437
Export (remote control)	773	May Peak Size (remote control)	688
FFT	204, 208, 216	Mean	356
FFT Filter Mode	204, 209, 217	Meas Start/Stop	354
Firmware update	160	Mech Atten Auto	197, 426
FM	261	Mech Atten Auto (remote control)	764
Frequency Line 1	391	Mech Atten Manual	196, 426
Frequency Line 2	391	Mech Atten Manual (remote control)	763
Frequency Offset (remote control)	811	Min Hold	221, 232
Full Span	192	Mkr Demod On/Off	261

Mkr Stop Time	261	Show Peaks	353
Mode default	149	Signal Track	189
Mode R&S FSP	149	Single Meas (remote control)	761
Mode R&S FSU	149	Single Sweep	215
Network address	146	Single Sweep (remote control)	761
New	144, 388	Soft frontpanel	153
New (remote control)	661, 662, 663	Sort Mode Freq/Lvl	263, 437
New Spectrum (remote control)	771	Spectrum Emission Mask	282, 317
No. of Harmonics	386	Spurious Emissions	282, 349
Normalize (remote control)	795	Squelch	261
OBW	282, 314	Squelch (remote control)	796
OBW (remote control)	708	Squelch Level	262
Option licenses	160	Std Dev	356
Other LAN settings	146	Subnet mask	147
Password	147, 162	Sweep	204, 208, 216
Peak	356	Sweep Count (remote control)	856
Peak List (remote control)	688	Sweep List	317, 349
Peak List On/Off	263, 436	Sweep repeat (On/Off)	150
Peaks per Range	353	Sweep Time (remote control)	862
Power (remote control)	618, 619, 682, 683	Sweep Type	203, 208, 216
Preamplifier On/Off	196, 416, 425	Sweeptime Auto	208, 216
Preamplifier On/Off (remote control)	769	Sweeptime Manual	207, 215
Predefined colors	156	Sweeptime Manual (remote control)	862
Predefined Colors (remote control)	927	System info	158
Print colors	157	System messages	159
Recall (remote control)	795	Theme selection	155
Ref Level	193, 423	Time Domain Power	282, 356
Ref Level (remote control)	754	Time Line 1	391
Ref level adjust (Man/Auto)	145	Time Line 2	391
Reference Int/Ext	141	Time+date	152
Res BW Auto	206	Time+date (On/Off)	155
Res BW Manual	206, 245	Time+date format	155
Reset password	162	Time+Date Format (remote control)	931
RF	161	Time+Date On/Off (remote control)	930
RF Atten Auto	197, 426	TOI	283, 380
RF Atten Auto (remote control)	764	TOI (remote control)	697
RF Atten Manual	196, 426	Tool bar state (On/Off)	154
RF Atten Manual (remote control)	763	Tool Bar State On/Off (remote control)	929
RF Power	239, 430	Touch screen alignment	146
Right Limit	357	Trace 1	221
RMS	356	Trace 2	221
Save (ACLR User Standard)	304	Trace 3	221
Save (remote control)	775	Trace 4	221
Save As Trd Factor (remote control)	795	Trace 5	221
Save Evaluation List	353	Trace 6	221
Save factor	144	Trace Mode (remote control)	751
Save Limit Line	389	Track BW	189
Screen Colors (remote control)	927	Track On/Off	189
Screen title	155	Track Threshold	189
Screen Title (remote control)	930	Transducer	142
Search Signals	380, 382	Trg/Gate Source	239, 429
Select 1 2 3 4 (remote control)	680	Trg/Gate Source (remote control)	910, 911, 912
Select color set	156, 157	Trigger Holdoff	243, 434
Select directory	145	Trigger Hysteresis	243, 434
Select object	156	Trigger Offset	243, 433
Select Trace	189	Trigger Out	399
Select Traces to check	388	User Standard	303
Self-Alignment	145	User-Defined colors	157
Selftest	162	Versions+options	158
Selftest results	162	Video BW Auto	207
Service	161	Video BW Manual	206
Service function	162	View	222, 232
Set to default	157	X Offset	390
Set to Default (remote control)	926	Y Offset	390
Shift Y Limit Line (remote control)	662	y Offset (remote control)	661
Show align results	145		
Show error flag	142		

- Softkeys
 - Autoselect 223
 - Continuous Value Update 517
 - Detector Auto Peak 223
 - Detector Average 224
 - Detector CISPR Average 224
 - Detector Manual Select 222
 - Detector Negative Peak 224
 - Detector Positive Peak 223
 - Detector Quasi Peak 224
 - Detector RMS 224
 - Detector RMS Average 225
 - Detector Sample 224
 - Firmware Update 47
 - Lower Level Hysteresis 203
 - Marker Search Area 276
 - Marker Search Type 276
 - More 62
 - Next Mode X 275
 - Next Mode Y 275
 - Power Sensor 241, 431
 - Probe Config 400
 - Search Mode 275
 - Up 62
 - Upper Level Hysteresis 203
 - Source Power
 - tracking generator 455, 458
 - Span
 - softkey 265, 439
 - SPAN key 191
 - Span menu 191
 - Speaker
 - remote control 889
 - Special characters 609
 - Spectrogram
 - color curve 530
 - Color mapping 527
 - Color scheme 532
 - Displaying 522
 - Menu 526
 - Spectrogram mode (K14) 522
 - Spectrum Emission Mask
 - Measurements 315
 - Power Classes 325
 - Softkey 282, 317
 - Spectrum mode 407
 - SPLIT/MAXIMIZE
 - Key 70, 749
 - Spurious Emissions
 - Limit lines 346
 - Measurements 343
 - Results 345
 - Softkey 282
 - Squelch
 - Remote control 796
 - Softkey 261
 - Squelch Level
 - Softkey 262
 - SRE 551
 - SRE (service request enable register) 554
 - SRQ (service request) 554, 562
 - Stand-alone operation 604
 - start frequency 188
 - statistic measurements
 - gated trigger 372
 - Status
 - Queries 563
 - Status bar
 - Hiding/restoring 155
 - Status byte
 - Remote 611, 614
 - Status byte (STB) 554
 - Status display 55
 - Status registers 551
 - CONDition 553
 - ENABLE 553
 - EVENT 553
 - model 552
 - NTRansition 553
 - parts 552
 - PTRansition 553
 - STATus:OPERation 556
 - STATus:QUESTionable 556
 - STATus:QUESTionable:ACPLimit 557
 - STATus:QUESTionable:FREQUency 559
 - STATus:QUESTionable:LIMit 559
 - STATus:QUESTionable:LMARgin 560
 - STATus:QUESTionable:POWER 561
 - STATus:QUESTionable:SYNC 561
 - Status reporting system 550
 - Application 562
 - Common commands 610
 - STB 551
 - Step size
 - Center frequency 186
 - stop frequency 188
 - storing 1056
 - Storing
 - Instrument configuration 103
 - Measurement data 104
 - String in remote commands 545
 - Suffixes 542
 - supply voltage, external noise source 399
 - sweep
 - count 217
 - Free Run 239, 429
 - gated 246
 - Sweep
 - Continue single sweep 215
 - Continuous 214
 - Gated 244
 - Single 215
 - Time 207, 215
 - SWEEP key 214
 - sweep list
 - Fast SEM (remote control) 798
 - Sweep List
 - Symmetrical 322
 - Sweep menu 214
 - Sweep status
 - Status register 556
 - Sweep time
 - Coupling 208, 216
 - Statistics 358
 - SWT (hardware setting) 52
 - Syntax elements
 - SCPI 545
 - System messages dialog box 159
- ## T
- Task bar
 - Accessing 47

- TCP/IP
 - tracking generator 460
 - TCP/IP address
 - tracking generator 460
 - Tdf (enhancement label) 53
 - TDS BTS mode 409
 - TDS UE mode 409
 - Test
 - Self test 162
 - Text parameters in remote commands 544
 - Themes
 - Display 76
 - threshold
 - line 264, 273, 437
 - Threshold
 - Signal tracking 189
 - Time 155
 - Setting 37
 - softkey 241, 432
 - Time Domain Power
 - Restricting range 355
 - Results 354
 - time line 392
 - Time line 391
 - Time trigger
 - Repetition interval 243, 434
 - Title
 - Diagram 155
 - Toggling
 - Span values 60
 - TOI
 - Measurement 375
 - Results 379
 - TOI (marker functions) 54, 255
 - Toolbar
 - Icon 57
 - Toggle 57
 - Touch screen
 - Alignment 146
 - Touchscreen
 - Aligning 38
 - Display 15
 - TPIS
 - I/Q data 906
 - trace
 - power measurement 302
 - Trace
 - Clear Write 221, 231
 - Signal tracking 189
 - Trace information
 - Detector type 54
 - Trace number 54
 - TRACE key 219
 - Trace menu 220
 - Trace mode 221
 - Average 222, 232
 - Blank 222, 232
 - Clear Write 221, 231
 - Max Hold 221, 231
 - Min Hold 221, 232
 - View 222, 232
 - TRACe:IQ subsystem 894
 - Traces
 - Loading 104
 - Storing 104
 - tracking generator
 - configuration (remote control) 885, 886, 889
 - display 469
 - error messages 469
 - Power Offset (remote control) 873
 - power sweep 449
 - reverse sweep 449
 - selecting 455, 457
 - TTL Synchronization (remote control) 886
 - Tracking generator
 - Connector 17
 - Tracking Generator
 - Denominator (remote control) 867
 - Frequency Offset (remote control) 869, 872
 - Numerator (remote control) 868
 - Tracking Generators
 - remote control 789
 - transducer 142
 - Transducer
 - Activating 142
 - Transducers
 - Recalling 163
 - Saving 163
 - transmission measurement
 - calibration 462
 - tracking generator 463
 - Tree walking
 - Softkey 151
 - TRG (enhancement label) 53
 - TRIG key 238
 - trigger
 - external 239, 430
 - level 242
 - slope 242, 433
 - Trigger
 - Event (remote) 614
 - External gate 244
 - Gated sweep 244
 - Holdoff 243, 434
 - Hysteresis 243, 434
 - Level 433
 - Offset 243, 433
 - Status register 556
 - Trigger menu 238, 429
 - trigger mode 239, 429
 - External 239, 430
 - Free Run 239, 429
 - Video 239, 430
 - Trigger mode
 - BB power 240, 431
 - Digital IQ 241, 432
 - IF power 240, 431
 - RF power 239, 430
 - TRIGGER OUTPUT
 - Connector 21
 - Triggers
 - Power Sensor 515
 - TRK (marker functions) 54, 255
 - TTL synchronization
 - tracking generator 460
 - TX Settings
 - EX-IQ-BOX 401, 415, 483
- U**
- Ultra high precision reference 141
 - Connector 23

UNCAL (status display)	56
Up	
Softkey	62
UP	544
Update rate	
Display	77
Updates	47
Upper Level Hysteresis	
Softkey	203
Upper-case (commands)	609
Usable I/Q bandwidth	
Definition	441
USB	
Connector	22
User account	47
USER key	181
Remote	952
User ports	
Remote control	777
User sample rate	
Definition	441
user-defined menu	181

V

VBW	
RMS detector	207, 235
VBW (hardware setting)	52
Vector Signal Analysis mode (K70)	409
Versions/Options dialog box	158
Vertical stroke	545
Video bandwidth	206
video triggering	239, 430
View Filter	394
View trace mode	222, 232
Virus protection	44
VISA	537, 538
Resource string	538
VNC	574
Volume	
remote control	889
VXI protocol	538

W

Wait	
Remote	615
Waiting for trigger	
Status register	556
Web browser	
Configuration interface	601
weighting filter	299
White papers	10
White space	545
Wideband	
PSA89600	151
WiMAX mode (K92/92)	410
Windows 10	44
Access	47
WLAN mode (K91)	410
WordPad	
Accessing	47

Y

Y-Axis Max	
I/Q Analyzer	423

YIG filter	
see YIG preselector	199
YIG preselector	
Activating/Deactivating	199, 768

Z

zero span	192
Zero span measurements	92
zeroing (K9)	513
zoom	
area (remote control)	756
remote control	756
Zoom	253
Amplitude	222, 232