

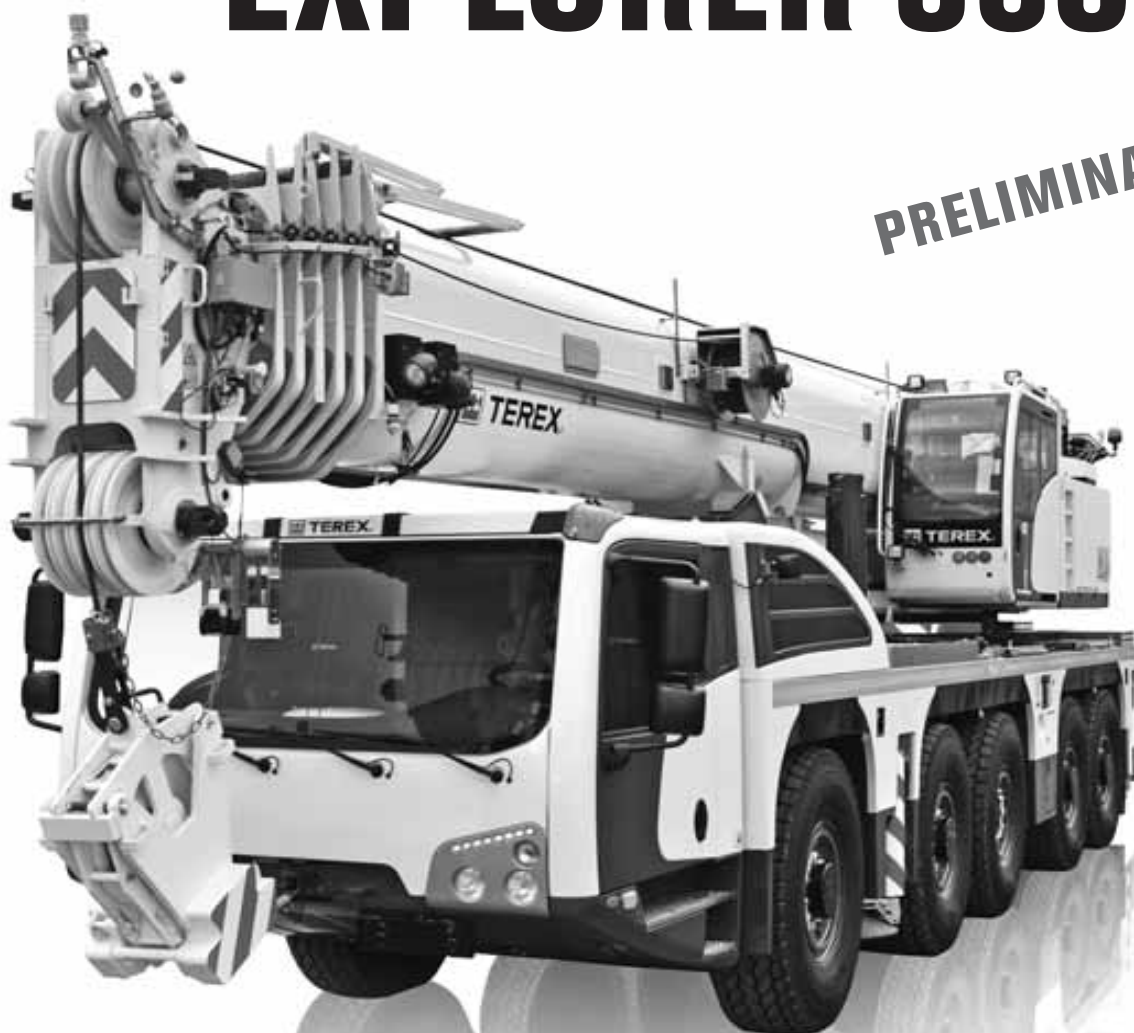

EXPLORER 5600
180 Ust capacity class
All Terrain Crane
Datasheet
imperial

EXPLORER 5600

PRELIMINARY



WORKS FOR YOU.™



CONTENTS

EXPLORER 5600

	Page:
Dimensions	4
Specifications	6
Equipment	7
Counterweight	8

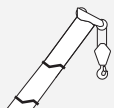

HA

Main boom	9
------------------------	---



HAV

Folding swing-away jib	14
-------------------------------------	----



HAV-VA

Variable extension with swing-away jib	18
---	----

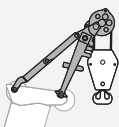

MS















Runner	22
---------------------	----

Technical description	28
------------------------------------	----



KEY

EXPLORER 5600

	Counterweight
	Lifting capacities on outriggers - 360°
	Radius
	Main boom
	Folding swing-away jib
	Runner
	Max. axle loads
	Mechanism
	Tires
	Hook block
	Hoist
	Dolly
	Travel speed
	Gradeability - road
	Gradeability - off road

	Slewing
	Boom telescoping
	Boom elevation
	Working speeds
	Max. line pull
	Rope diameter
	Rope length
	Hook block (capacity-sheaves-rope diameter)
	Number of lines
	Possible load of hook block
	Weight of hook block
	Distance head sheave axle - hook ground
	Number of sheaves in boom head
	Supporting force
	Length of stroke (support cylinders)
	Payload incl. rear storage box

DIMENSIONS

EXPLORER 5600

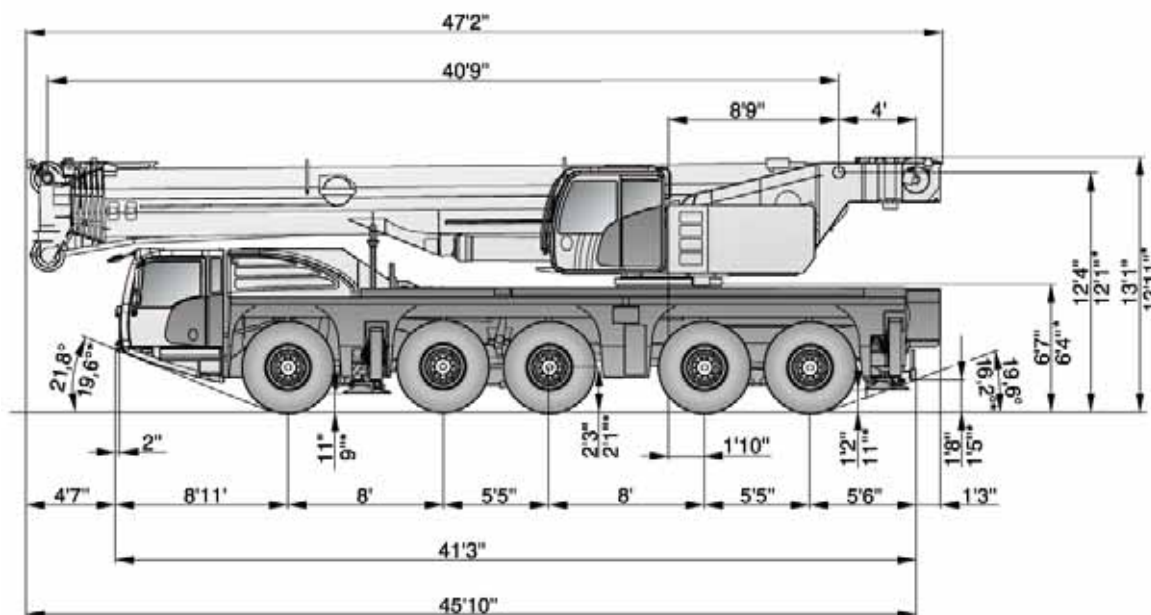

⊙ 445/95 R25 / 525/80 R25

* ⊙ 385/95 R25





TEREX®



DIMENSIONS

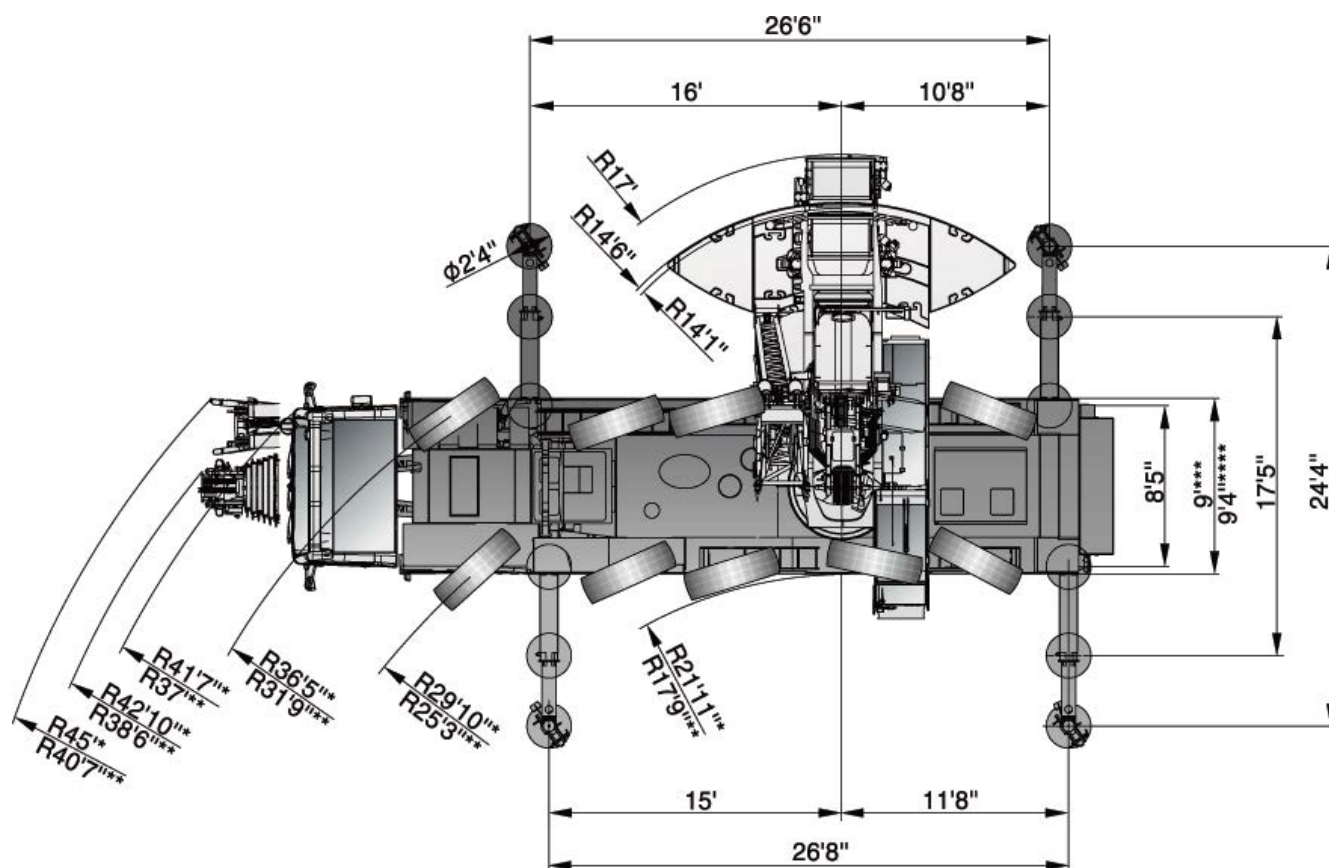







EXPLORER 5600

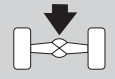
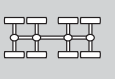







- * steering mode 2
- ** steering mode 3
- ***  385/95 R25 / 445/95 R25
- ****  525/80 R25
- see page 6



SPECIFICATIONS

EXPLORER 5600



									
	Total								
< 20,000 lb				on request					X
18,300 lb	83,800 lb	10 x 6 x 10	385/95R25	-	-	8,160 lb	-	-	-
26,500 lb	132,300 lb	10 x 8 x 10	445/95R25	223.1 ft	80-3-21	13,900 lb	-	1,000 lb	-
26,500 lb	132,300 lb	10 x 8 x 10	445/95R25	223.1 ft	80-3-21	8,160 lb	68.9 ft	1,320 lb	-
36,400 lb	180,800 lb	10 x 8 x 10	445/95R25	223.1 ft	80-3-21	56,000 lb	68.9 ft	2,000 lb	-











	1	Highway > 28 mph		4*	Off-wall
	2	City < 28 mph		5*	Crab steer mode
	3*	Minimum turning radius < 3.1 mph		6*	All wheel steering







* must be activated

	163,200 lb	183,000 lb	52.8 mph ¹⁾
	19.7 in	23 in	

¹⁾ Depending on tire type, size and country specific legislation

	385/95R25 14.00 R25	445/95R25 16.00 R25	525/80R25 20.50 R25
	47 %	40 %	40 %
	64 %	53 %	53 %

				
	394 ft/min	22,076 lb	0.83 in	1132 ft
	394 ft/min	22,076 lb	0.83 in	1132 ft
	1,57 min ⁻¹			
	ca. 516 s (40.7 - 223.1 ft)			
	ca. 33 s (-1,5° - 82°)			

					
1	21,800	12-0-21	4	770 lb	6.6 ft
2	43,400	32-1-21	4	1,320 lb	8.9 ft
3	64,800	32-1-21	4	1,320 lb	8.9 ft
4	86,200	80-3-21	4	1,870 lb	9.8 ft
5	107,200	80-3-21	4	1,870 lb	9.8 ft
6	127,900	80-3-21	4	1,870 lb	9.8 ft
7	148,400	80-3-21	4	1,870 lb	9.8 ft
8	168,900	125-5-21	4	2,480 lb	9.8 ft
9	189,000	125-5-21	4 + S1	2,480 lb	9.8 ft
10	209,000	125-5-21	4 + S1	2,480 lb	9.8 ft
11	228,700	160-7-21	4 + S1	3,310 lb	9.8 ft
12	244,800	160-7-21	4 + S1	3,310 lb	9.8 ft



EQUIPMENT

EXPLORER 5600

HAV / HAV-VA

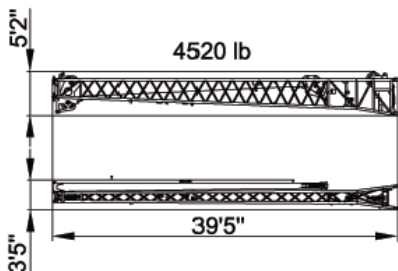

VA

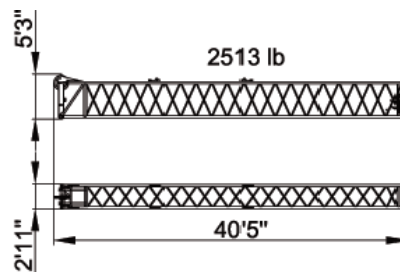

HAV-VA 108.3 ft

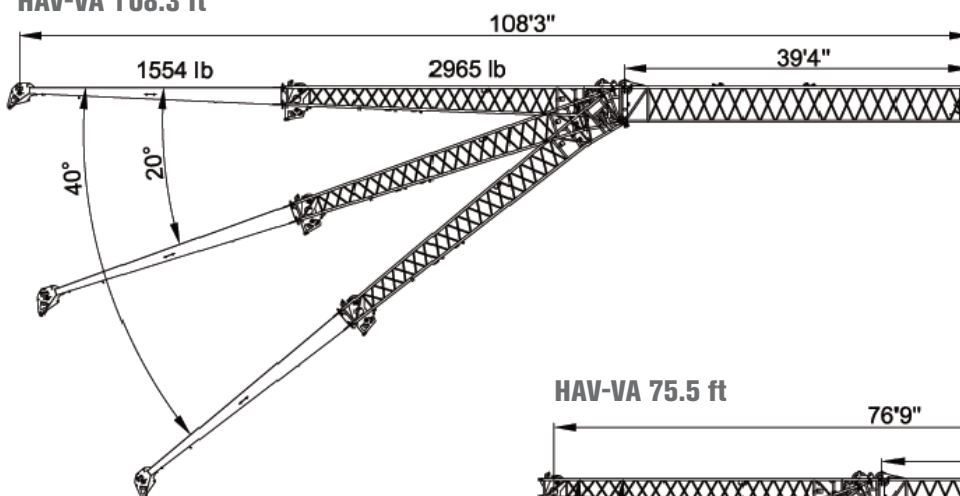

HAV-VA 75.5 ft

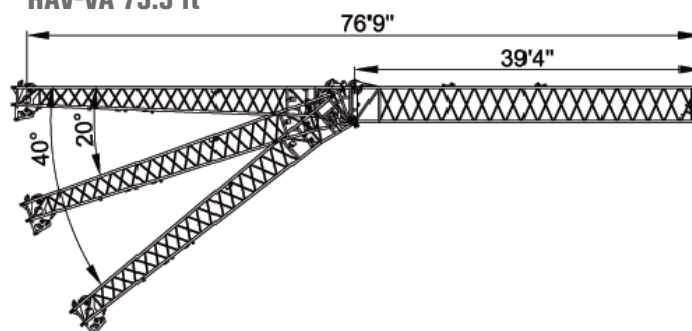

HAV 68.9 ft

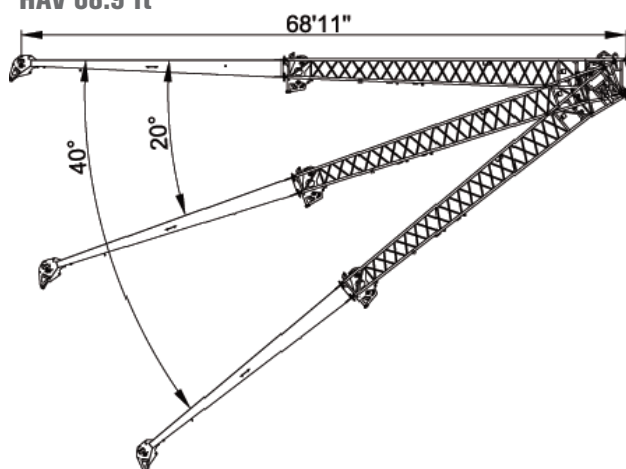

HAV 36.1 ft

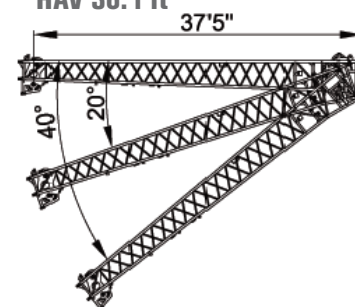

COUNTERWEIGHT

EXPLORER 5600

Parts

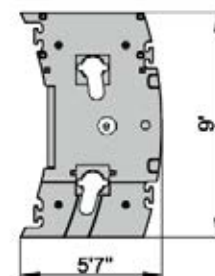
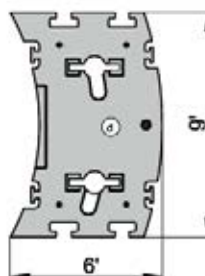
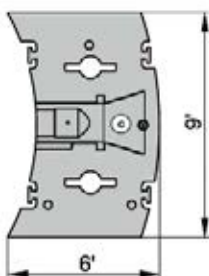
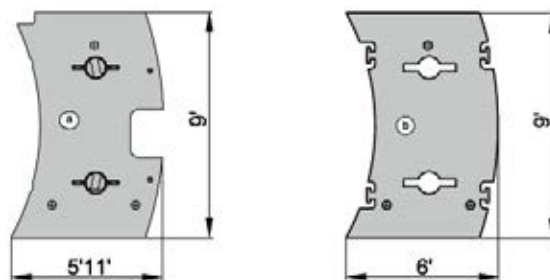
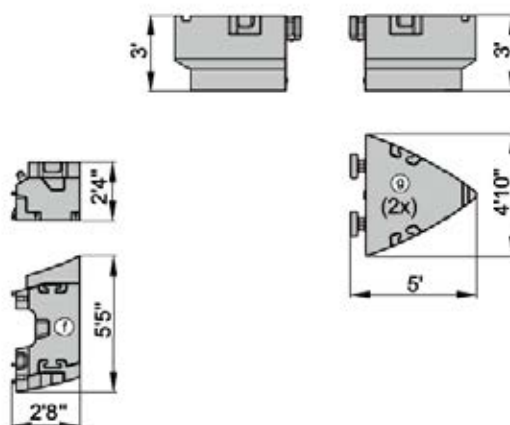
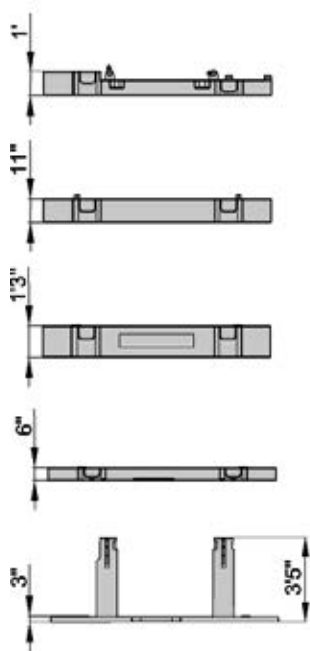
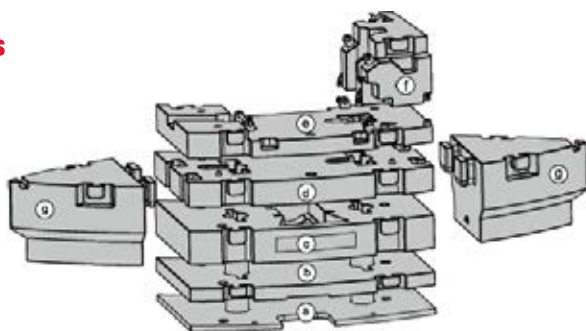

Configurations

	Ⓐ 5,700 lb	Ⓑ 9,500 lb	Ⓒ 21,400 lb	Ⓓ 15,900 lb	Ⓔ 11,300 lb	Ⓕ 8,200 lb	Ⓖ 14,800 lb	Ⓗ 14,800 lb
0 lb								
8,200 lb						X		
13,900 lb	X					X		
19,400 lb					X	X		
23,400 lb	X	X				X		
25,100 lb	X				X	X		
34,600 lb	X	X			X	X		
44,800 lb	X	X	X			X		
56,000 lb	X	X	X		X	X		
60,600 lb	X	X	X	X		X		
71,900 lb	X	X	X	X	X	X		
101,400 lb	X	X	X	X	X	X	X	X



HA

EXPLORER 5600

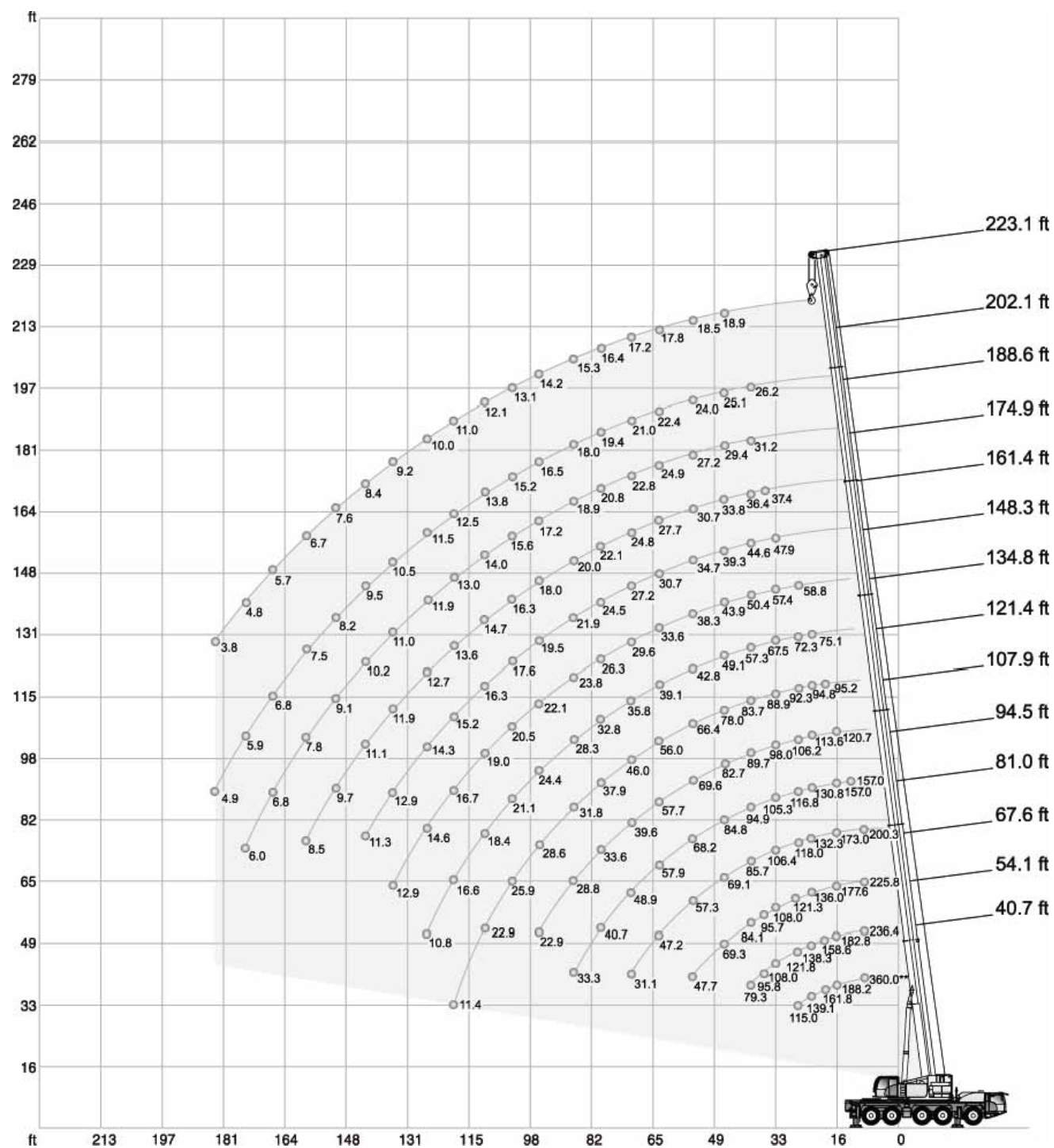
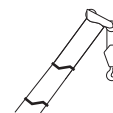

** Capacity class



HA

EXPLORER 5600

101,400 lb		26.7 ft m x 24.6 ft										360°			85 %	
40.7 ft * 40.7 ft		54.1 ft	67.6 ft	81.0 ft	94.5 ft	107.9 ft	121.4 ft	134.8 ft	148.3 ft	161.4 ft	174.9 ft	188.6 ft	202.1 ft	223.1 ft		
ft		1,000 lb												ft		
10	360,0**	-	-	-	-	-	-	-	-	-	-	-	-	-	-	10
10	243,0	243,0	236,4	225,8	200,3	-	-	-	-	-	-	-	-	-	-	10
12	222,1	221,9	215,4	209,1	197,1	157,0	-	-	-	-	-	-	-	-	-	12
14	204,0	202,3	197,7	192,4	185,8	157,0	-	-	-	-	-	-	-	-	-	14
16	188,2	185,0	182,8	177,6	173,0	157,0	120,7	-	-	-	-	-	-	-	-	16
18	174,7	170,8	170,4	165,5	161,2	151,9	120,4	-	-	-	-	-	-	-	-	18
20	161,8	157,7	158,6	154,1	150,0	145,5	119,9	95,2	-	-	-	-	-	-	-	20
24	139,1	136,7	138,3	136,0	132,3	130,8	113,6	94,8	75,1	-	-	-	-	-	-	24
28	115,0	115,0	121,8	121,3	118,0	116,8	106,2	92,3	72,3	58,8	-	-	-	-	-	28
32	-	-	108,0	108,0	106,4	105,3	98,0	88,9	67,5	57,4	47,9	-	-	-	-	32
36	-	-	95,8	95,7	94,7	94,9	89,7	83,7	62,3	54,1	46,3	37,4	-	-	-	36
40	-	-	79,3	84,1	85,7	84,8	82,7	78,0	57,3	50,4	44,6	36,4	31,2	26,2	-	40
48	-	-	-	69,3	69,1	68,2	69,6	66,4	49,1	43,9	39,3	33,8	29,4	25,1	18,9	48
56	-	-	-	47,7	57,3	57,9	57,7	56,0	42,8	38,3	34,7	30,7	27,2	24,0	18,5	56
64	-	-	-	-	47,2	48,9	47,8	46,0	39,1	33,6	30,7	27,7	24,9	22,4	17,8	64
72	-	-	-	-	31,1	40,7	39,6	37,9	35,8	29,6	27,2	24,8	22,8	21,0	17,2	72
80	-	-	-	-	-	33,3	33,6	31,8	32,8	26,3	24,5	22,1	20,8	19,4	16,4	80
88	-	-	-	-	-	-	28,8	28,6	28,3	23,8	21,9	20,0	18,9	18,0	15,3	88
96	-	-	-	-	-	-	22,9	25,9	24,4	22,1	19,5	18,0	17,2	16,5	14,2	96
104	-	-	-	-	-	-	-	22,9	21,1	20,5	17,6	16,3	15,6	15,2	13,1	104
112	-	-	-	-	-	-	-	11,4	18,4	19,0	16,3	14,7	14,0	13,8	12,1	112
120	-	-	-	-	-	-	-	-	16,6	16,7	15,2	13,6	13,0	12,5	11,0	120
128	-	-	-	-	-	-	-	-	10,8	14,6	14,3	12,7	11,9	11,5	10,0	128
136	-	-	-	-	-	-	-	-	-	12,9	12,9	11,9	11,0	10,5	9,2	136
144	-	-	-	-	-	-	-	-	-	-	11,3	11,1	10,2	9,5	8,4	144
152	-	-	-	-	-	-	-	-	-	-	-	9,7	9,1	8,2	7,6	152
160	-	-	-	-	-	-	-	-	-	-	-	-	8,5	7,8	7,5	160
168	-	-	-	-	-	-	-	-	-	-	-	-	-	6,8	6,8	168
176	-	-	-	-	-	-	-	-	-	-	-	-	-	6,0	5,9	176
184	-	-	-	-	-	-	-	-	-	-	-	-	-	-	4,9	184
192	-	-	-	-	-	-	-	-	-	-	-	-	-	-	-	192
1)	45,0	45,0	32,8	25,6	20,3	16,3	13,0	10,4	7,9	6,0	4,6	2,9	0	0	0	1)

1) Capacities with horizontal boom



* over rear

** Capacity class



HA

EXPLORER 5600

71,900 lb		26.7 ft m x 24.6 ft														360°		85 %	
		40.7 ft	54.1 ft	67.6 ft	81.0 ft	94.5 ft	107.9 ft	121.4 ft	134.8 ft	148.3 ft	161.4 ft	174.9 ft	188.6 ft	202.1 ft	223.1 ft				
ft		1,000 lb														ft			
10	242,9	236,4	225,8	200,3	-	-	-	-	-	-	-	-	-	-	-	-	10		
12	220,5	215,4	209,1	197,1	157,0	-	-	-	-	-	-	-	-	-	-	-	12		
14	200,3	197,7	192,4	185,8	157,0	-	-	-	-	-	-	-	-	-	-	-	14		
16	183,2	182,8	177,6	173,0	157,0	120,7	-	-	-	-	-	-	-	-	-	-	16		
18	169,1	169,7	165,5	161,2	151,9	120,4	-	-	-	-	-	-	-	-	-	-	18		
20	155,9	157,3	154,1	150,0	145,5	119,9	95,2	-	-	-	-	-	-	-	-	-	20		
24	134,6	136,1	135,2	132,3	130,8	113,6	94,8	75,1	-	-	-	-	-	-	-	-	24		
28	113,3	116,8	116,8	115,9	116,1	106,2	92,3	72,3	58,8	-	-	-	-	-	-	-	28		
32	-	100,4	100,1	100,9	100,9	98,0	88,9	67,5	57,4	47,9	-	-	-	-	-	-	32		
36	-	88,9	87,6	89,3	88,4	87,4	82,4	62,3	54,1	46,3	37,4	-	-	-	-	-	36		
40	-	70,2	78,1	77,9	77,0	78,6	74,8	57,3	50,4	44,6	36,4	31,2	26,2	-	-	-	40		
48	-	-	58,4	59,2	60,0	58,7	56,8	49,1	43,9	39,3	33,8	29,4	25,1	18,9	-	-	48		
56	-	-	38,0	47,5	46,9	45,6	43,8	42,8	38,3	34,7	30,7	27,2	24,0	18,5	56	-	56		
64	-	-	-	38,3	37,6	36,5	36,9	36,1	32,9	30,7	27,7	24,9	22,4	17,8	64	-	64		
72	-	-	-	28,4	31,0	30,9	31,2	29,5	28,1	26,8	24,8	22,8	21,0	17,2	72	-	72		
80	-	-	-	-	26,1	27,4	26,2	24,5	25,3	23,1	21,9	20,8	19,4	16,4	80	-	80		
88	-	-	-	-	-	23,5	22,2	22,1	21,3	20,2	19,1	18,5	18,0	15,3	88	-	88		
96	-	-	-	-	-	20,3	19,0	19,6	18,0	18,1	17,2	16,6	16,2	14,2	96	-	96		
104	-	-	-	-	-	-	17,5	16,9	16,7	15,5	15,3	14,6	13,8	13,1	104	-	104		
112	-	-	-	-	-	-	11,4	14,6	14,6	13,8	13,3	12,2	12,0	11,3	112	-	112		
120	-	-	-	-	-	-	-	13,4	12,6	12,3	11,5	10,6	10,4	9,3	120	-	120		
128	-	-	-	-	-	-	-	10,8	11,0	10,6	10,2	9,7	8,6	7,7	128	-	128		
136	-	-	-	-	-	-	-	-	9,9	9,1	9,3	8,3	7,1	6,1	136	-	136		
144	-	-	-	-	-	-	-	-	-	8,2	8,0	7,1	5,8	4,9	144	-	144		
152	-	-	-	-	-	-	-	-	-	-	6,9	5,8	4,7	3,6	152	-	152		
160	-	-	-	-	-	-	-	-	-	-	5,9	4,8	3,7	-	160	-	160		
168	-	-	-	-	-	-	-	-	-	-	-	4,0	-	-	168	-	168		
176	-	-	-	-	-	-	-	-	-	-	-	3,2	-	-	176	-	176		
1)	45,0	32,8	25,6	20,3	16,3	13,0	10,4	7,9	6,0	4,6	2,9	0	0	0	0	1)			

1) Capacities with horizontal boom

HA

EXPLORER 5600

56,000 lb **26.7 ft m x 24.6 ft** **360°** **85 %**

	40.7 ft	54.1 ft	67.6 ft	81.0 ft	94.5 ft	107.9 ft	121.4 ft	134.8 ft	148.3 ft	161.4 ft	174.9 ft	188.6 ft	202.1 ft	223.1 ft	
ft	1,000 lb														ft
10	242,8	236,4	225,8	200,3	-	-	-	-	-	-	-	-	-	-	10
12	219,4	215,4	209,1	197,1	157,0	-	-	-	-	-	-	-	-	-	12
14	199,3	197,7	192,4	185,8	157,0	-	-	-	-	-	-	-	-	-	14
16	182,3	182,8	177,6	173,0	157,0	120,7	-	-	-	-	-	-	-	-	16
18	168,3	169,3	165,5	161,2	151,9	120,4	-	-	-	-	-	-	-	-	18
20	155,0	156,1	154,0	150,0	145,5	119,9	95,2	-	-	-	-	-	-	-	20
24	130,3	132,2	132,2	130,8	130,3	113,6	94,8	75,1	-	-	-	-	-	-	24
28	110,0	111,7	111,7	111,2	112,5	103,0	92,3	72,3	58,8	-	-	-	-	-	28
32	-	96,5	95,5	97,0	94,6	92,2	85,1	67,5	57,4	47,9	-	-	-	-	32
36	-	81,1	81,8	81,7	80,5	80,1	74,3	62,3	54,1	46,3	37,4	-	-	-	36
40	-	59,2	67,7	69,7	69,6	68,3	63,7	57,2	50,4	44,6	36,4	31,2	26,2	-	40
48	-	-	51,9	52,3	51,5	50,2	48,3	46,6	43,3	39,3	33,8	29,4	25,1	18,9	48
56	-	-	30,9	40,5	39,9	38,6	39,5	38,3	35,4	33,8	30,7	27,2	24,0	18,5	56
64	-	-	-	32,5	31,8	33,1	32,1	30,3	30,3	28,3	27,1	24,9	22,4	17,8	64
72	-	-	-	26,8	27,8	27,5	26,1	26,5	25,3	23,6	23,2	22,5	21,0	17,2	72
80	-	-	-	-	23,7	23,0	22,4	22,4	21,3	21,2	20,1	19,6	19,1	16,4	80
88	-	-	-	-	-	19,5	19,9	19,0	19,0	17,8	17,5	16,5	15,8	14,7	88
96	-	-	-	-	-	17,3	17,1	16,7	16,0	15,7	14,9	14,1	13,7	12,0	96
104	-	-	-	-	-	-	14,6	14,6	14,0	13,3	13,0	12,4	11,3	9,7	104
112	-	-	-	-	-	-	11,4	12,5	12,0	11,2	11,4	10,3	9,2	7,8	112
120	-	-	-	-	-	-	-	11,1	10,3	10,3	9,5	8,7	7,3	6,3	120
128	-	-	-	-	-	-	-	9,6	8,8	8,9	8,0	7,2	5,8	4,8	128
136	-	-	-	-	-	-	-	-	7,5	7,6	6,7	5,8	4,7	3,5	136
144	-	-	-	-	-	-	-	-	-	6,4	5,6	4,7	3,4	2,3	144
152	-	-	-	-	-	-	-	-	-	-	4,5	3,6	-	-	152
160	-	-	-	-	-	-	-	-	-	-	3,7	2,6	-	-	160
1)	45,0	32,8	25,6	20,3	16,3	13,0	10,4	7,9	6,0	4,6	2,9	0	0	0	1)

1) Capacities with horizontal boom



HA

EXPLORER 5600

		13,900 lb														26.7 ft m x 24.6 ft		360°		85 %			
		40.7 ft	54.1 ft	67.6 ft	81.0 ft	94.5 ft	107.9 ft	121.4 ft	134.8 ft	148.3 ft	161.4 ft	174.9 ft	188.6 ft	202.1 ft	223.1 ft								
		1,000 lb																					
ft	ft															ft	ft						
10	239,5	236,4	225,8	200,3	-	-	-	-	-	-	-	-	-	-	-	-	-	-	-	-	10		
12	216,1	215,4	209,1	197,1	157,0	-	-	-	-	-	-	-	-	-	-	-	-	-	-	-	12		
14	196,5	197,3	192,4	185,8	157,0	-	-	-	-	-	-	-	-	-	-	-	-	-	-	-	14		
16	176,5	178,1	177,1	166,9	152,1	120,7	-	-	-	-	-	-	-	-	-	-	-	-	-	-	16		
18	157,8	159,6	153,9	141,5	132,5	114,6	-	-	-	-	-	-	-	-	-	-	-	-	-	-	18		
20	139,5	141,1	129,6	122,4	114,7	106,4	93,6	-	-	-	-	-	-	-	-	-	-	-	-	-	20		
24	100,5	104,1	99,1	96,2	89,5	82,3	75,0	68,6	-	-	-	-	-	-	-	-	-	-	-	-	24		
28	70,5	75,4	79,0	76,3	71,5	65,7	62,7	58,2	52,3	-	-	-	-	-	-	-	-	-	-	-	28		
32	-	58,8	61,0	61,1	58,4	56,3	53,5	48,8	46,0	41,4	-	-	-	-	-	-	-	-	-	-	32		
36	-	47,5	49,6	49,9	48,5	49,1	45,4	42,0	40,0	36,3	33,3	-	-	-	-	-	-	-	-	-	36		
40	-	29,1	40,3	40,6	42,4	41,6	38,7	38,0	35,5	33,1	31,5	28,4	25,8	-	-	-	-	-	-	-	40		
48	-	-	30,0	30,8	30,6	31,1	30,8	29,6	28,7	26,7	25,1	23,0	20,3	18,0	-	-	-	-	-	-	48		
56	-	-	22,5	23,4	24,0	24,2	23,7	23,1	22,6	21,9	20,2	18,2	16,0	13,6	56	-	-	-	-	-	56		
64	-	-	-	18,2	19,0	19,0	18,8	18,3	17,5	17,4	15,8	13,8	11,6	9,4	64	-	-	-	-	-	64		
72	-	-	-	14,4	15,1	15,1	14,9	14,4	13,5	13,7	12,2	10,2	8,2	6,2	72	-	-	-	-	-	72		
80	-	-	-	-	12,1	12,0	11,7	11,3	10,4	10,6	9,4	7,6	5,7	3,9	80	-	-	-	-	-	80		
88	-	-	-	-	-	9,6	9,4	9,0	8,1	8,3	7,2	5,5	3,8	-	88	-	-	-	-	-	88		
96	-	-	-	-	-	7,6	7,4	7,0	6,1	6,3	5,3	3,8	-	-	96	-	-	-	-	-	96		
104	-	-	-	-	-	-	5,9	5,3	4,6	4,6	3,7	2,4	-	-	104	-	-	-	-	-	104		
112	-	-	-	-	-	-	-	4,6	3,9	3,2	3,2	-	-	-	112	-	-	-	-	-	112		
120	-	-	-	-	-	-	-	-	2,8	-	-	-	-	-	120	-	-	-	-	-	120		
1)	45,0	29,5	20,1	13,9	10,1	6,8	4,4	0	0	0	0	0	0	0	0	0	0	0	0	0	1)		

		8,200 lb														26.7 ft m x 24.6 ft		360°		85 %			
		40.7 ft	54.1 ft	67.6 ft	81.0 ft	94.5 ft	107.9 ft	121.4 ft	134.8 ft	148.3 ft	161.4 ft	174.9 ft	188.6 ft	202.1 ft	223.1 ft								
		1,000 lb																					
ft	ft															ft	ft						
10	239,4	236,4	225,8	200,3	-	-	-	-	-	-	-	-	-	-	-	-	-	-	-	-	10		
12	215,3	215,4	209,1	197,1	157,0	-	-	-	-	-	-	-	-	-	-	-	-	-	-	-	12		
14	195,7	197,0	192,4	184,9	157,0	-	-	-	-	-	-	-	-	-	-	-	-	-	-	-	14		
16	174,0	176,0	172,8	157,3	142,3	120,7	-	-	-	-	-	-	-	-	-	-	-	-	-	-	16		
18	155,0	152,7	145,3	135,0	120,9	110,0	-	-	-	-	-	-	-	-	-	-	-	-	-	-	18		
20	135,9	132,4	122,5	111,8	106,8	97,1	86,5	-	-	-	-	-	-	-	-	-	-	-	-	-	20		
24	90,7	94,7	90,9	88,1	81,7	74,7	69,0	65,4	-	-	-	-	-	-	-	-	-	-	-	-	24		
28	63,1	70,2	71,9	69,6	64,7	61,0	58,6	52,9	49,0	-	-	-	-	-	-	-	-	-	-	-	28		
32	-	53,0	55,2	55,4	53,0	52,5	48,0	45,6	42,6	39,2	-	-	-	-	-	-	-	-	-	-	32		
36	-	42,6	44,7	45,1	45,8	44,5	40,7	39,8	36,9	34,2	31,7	-	-	-	-	-	-	-	-	-	36		
40	-	24,7	37,5	38,5	38,3	37,3	36,9	34,4	33,1	31,1	28,9	25,9	23,7	-	40	-	-	-	-	-	40		
48	-	-	26,9	27,7	28,3	28,2	28,2	26,9	25,5	24,9	22,9	20,6	18,2	15,8	48	-	-	-	-	-	48		
56	-	-	20,0	20,9	21,8	21,6	21,4	20,8	19,7	19,3	17,5	15,4	13,1	10,8	56	-	-	-	-	-	56		
64	-	-	-	15,9	16,8	16,7	16,5	16,1	15,2	14,9	13,2	11,3	9,1	6,9	64	-	-	-	-	-	64		
72	-	-	-	12,2	13,1	12,9	12,9	12,2	11,5	11,5	10,0	8,0	6,0	4,0	72	-	-	-	-	-	72		
80	-	-	-	-	10,4	10,2	10,0	9,5	8,7	8,9	7,4	5,7	3,9	-	80	-	-	-	-	-	80		
88	-	-	-	-	-	8,0	7,7	7,3	6,6	6,6	5,4	3,9	-	-	88	-	-	-	-	-	88		
96	-	-	-	-	-	6,2	6,0	5,6	4,7	4,9	3,8	-	-	-	96	-	-	-	-	-	96		
104	-	-	-	-	-	-	4,6	3,9	3,3	3,3	2,4	-	-	-	104	-	-	-	-	-	104		
112	-	-	-	-	-	-	3,2	-	-	-	-	-	-	-	112	-	-	-	-	-	112		
120	-	-	-	-	-	-	-	-	-	-	-	-	-	-	120	-	-	-	-	-	120		
1)	45,0	26,2	17,6	11,9	8,4	5,3	3,1	0	0	0	0	0	0	0	0	0	0	0	0	0	1)		

1) Capacities with horizontal boom

HAV

EXPLORER 5600

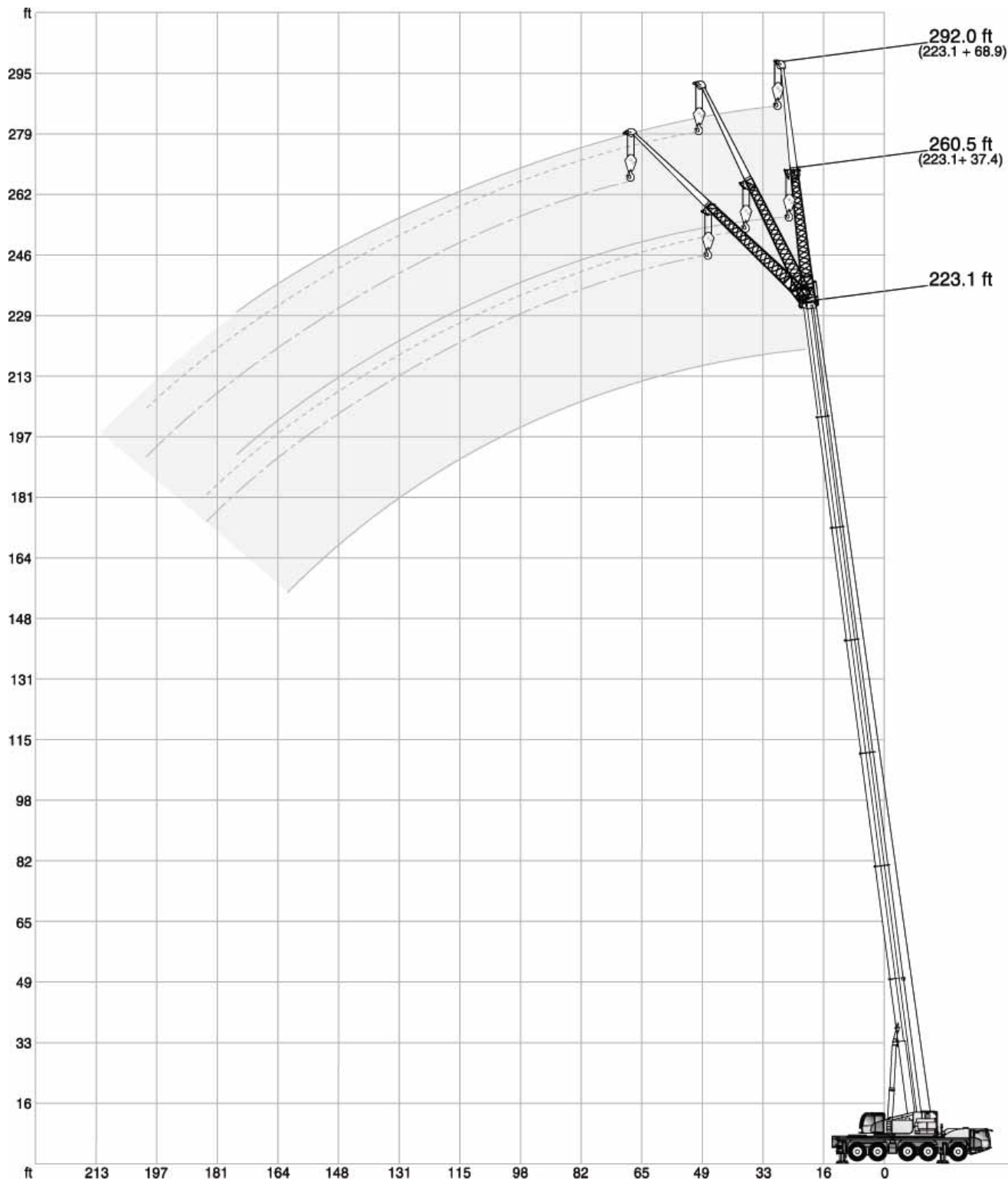

HAV

EXPLORER 5600

101,400 lb **26.7 ft m x 24.6 ft** **360°** **85 %**

40.7 ft

ft	37.4 ft			68.9 ft		
	0°	20°	40°	0°	20°	40°
	1,000 lb					
10	41,2	-	-	-	-	-
12	41,2	-	-	19,4	-	-
14	41,2	-	-	19,4	-	-
16	41,2	-	-	19,4	-	-
18	41,2	-	-	19,3	-	-
20	41,2	32,9	-	19,1	-	-
24	40,6	30,2	-	18,6	-	-
28	37,6	28,1	-	17,9	-	-
32	34,0	26,2	21,4	17,1	-	-
36	31,0	24,5	20,4	16,4	-	-
40	28,3	23,0	19,5	15,7	12,7	-
48	24,1	20,7	18,0	13,7	11,4	-
56	21,3	19,0	17,2	12,2	10,4	-
64	19,0	18,0	-	10,9	9,6	8,7
72	-	-	-	9,9	9,1	8,2
80	-	-	-	9,1	8,3	7,9
88	-	-	-	8,4	8,1	7,7
96	-	-	-	8,0	7,9	-

121.4 ft

ft	37.4 ft			68.9 ft		
	0°	20°	40°	0°	20°	40°
	1,000 lb					
24	36,2	-	-	-	-	-
28	36,2	-	-	14,8	-	-
32	36,0	-	-	14,8	-	-
36	35,3	-	-	14,8	-	-
40	34,7	27,0	-	14,7	-	-
48	33,0	25,4	20,1	14,4	-	-
56	30,1	23,8	19,5	14,0	11,8	-
64	27,3	22,3	18,7	13,7	11,1	-
72	25,2	21,0	18,1	13,2	10,6	-
80	23,3	19,7	17,6	12,9	10,1	8,4
88	21,7	18,8	17,1	12,2	9,7	8,3
96	20,2	17,9	16,7	11,5	9,3	8,0
104	19,1	17,1	16,3	10,9	8,9	7,9
112	18,0	16,5	16,1	10,3	8,6	7,7
120	15,8	15,9	15,9	9,9	8,3	7,7
128	13,8	14,5	7,1	9,5	8,2	7,7
136	11,9	12,5	-	8,9	8,0	7,6
144	10,8	11,1	-	8,6	7,7	7,5
152	5,5	-	-	8,3	7,7	7,5
160	-	-	-	8,1	7,7	4,2
168	-	-	-	7,7	3,6	-
176	-	-	-	7,1	3,3	-
184	-	-	-	3,0	-	-

202.1 ft

ft	37.4 ft			68.9 ft		
	0°	20°	40°	0°	20°	40°
	1,000 lb					
48	12,8	-	-	-	-	-
56	12,8	-	-	7,7	-	-
64	12,8	-	-	7,7	-	-
72	12,8	12,8	-	7,7	-	-
80	12,7	12,7	12,6	7,7	-	-
88	12,4	12,3	12,5	7,7	7,7	-
96	11,8	12,0	12,1	7,7	7,7	-
104	11,3	11,3	11,5	7,5	7,7	-
112	10,8	10,8	10,8	7,5	7,5	7,5
120	10,2	10,2	10,2	7,2	7,4	7,2
128	9,4	9,5	9,7	6,9	7,1	6,9
136	8,6	8,8	9,0	6,7	6,7	6,7
144	7,8	8,2	8,2	6,4	6,4	6,4
152	7,2	7,4	7,6	5,9	6,1	6,1
160	6,3	6,8	6,9	5,3	5,8	5,9
168	5,2	5,9	6,1	4,8	5,3	5,5
176	4,5	4,8	5,0	4,3	4,9	5,1
184	3,8	4,2	4,3	3,4	4,3	4,7
192	-	3,6	-	-	3,6	4,2
200	-	2,8	-	-	2,8	3,4

223.1 ft

ft	37.4 ft			68.9 ft		
	0°	20°	40°	0°	20°*	40°*
	1,000 lb					
56	8,8	-	-	-	-	-
64	8,8	-	-	-	-	-
72	8,8	-	-	5,7	-	-
80	8,8	8,8	-	5,7	-	-
88	8,8	8,8	8,8	5,7	-	-
96	8,7	8,8	8,8	5,7	-	-
104	8,4	8,8	8,8	5,7	6,2	-
112	8,1	8,6	8,8	5,7	6,2	-
120	7,9	8,3	8,5	5,7	6,2	6,2
128	7,6	7,7	8,2	5,4	6,1	6,2
136	7,2	7,3	7,6	5,1	5,8	6,0
144	6,4	6,9	7,1	5,1	5,5	5,7
152	5,9	6,3	6,3	4,8	5,2	5,3
160	5,3	5,6	5,8	4,5	4,8	5,0
168	4,5	5,0	5,2	3,9	4,4	4,7
176	3,6	4,5	4,5	3,4	4,0	4,2
184	-	3,6	3,7	-	3,6	3,8
192	-	-	-	-	3,2	3,4
200	-	-	-	-	2,5	3,0

*** 219.2 ft**



HAV

EXPLORER 5600

71,900 lb **26.7 ft m x 24.6 ft** **360°** **85 %**

40.7 ft

ft	37.4 ft			68.9 ft		
	0°	20°	40°	0°	20°	40°
	1,000 lb					
10	41,2	-	-	-	-	-
12	41,2	-	-	19,4	-	-
14	41,2	-	-	19,4	-	-
16	41,2	-	-	19,4	-	-
18	41,2	-	-	19,3	-	-
20	41,2	32,9	-	19,1	-	-
24	40,6	30,2	-	18,6	-	-
28	37,6	28,1	-	17,9	-	-
32	34,0	26,2	21,4	17,1	-	-
36	31,0	24,5	20,4	16,4	-	-
40	28,3	23,0	19,5	15,7	12,7	-
48	24,1	20,7	18,0	13,7	11,4	-
56	21,3	19,0	17,2	12,2	10,4	-
64	19,0	18,0	-	10,9	9,6	8,7
72	-	-	-	9,9	9,1	8,2
80	-	-	-	9,1	8,3	7,9
88	-	-	-	8,4	8,1	7,7
96	-	-	-	8,0	7,9	-

121.4 ft

ft	37.4 ft			68.9 ft		
	0°	20°	40°	0°	20°	40°
	1,000 lb					
24	36,2	-	-	-	-	-
28	36,2	-	-	14,8	-	-
32	36,0	-	-	14,8	-	-
36	35,3	-	-	14,8	-	-
40	34,7	27,0	-	14,7	-	-
48	33,0	25,4	20,1	14,4	-	-
56	30,1	23,8	19,5	14,0	11,8	-
64	27,3	22,3	18,7	13,7	11,1	-
72	25,2	21,0	18,1	13,2	10,6	-
80	23,3	19,7	17,6	12,9	10,1	8,4
88	20,6	18,8	17,1	12,2	9,7	8,3
96	17,8	17,9	16,7	11,5	9,3	8,0
104	15,4	16,3	16,3	10,9	8,9	7,9
112	13,3	14,2	14,4	10,3	8,6	7,7
120	12,2	12,1	12,7	9,9	8,3	7,7
128	10,8	11,0	7,1	9,4	8,2	7,7
136	9,3	9,8	-	8,7	8,0	7,6
144	8,6	8,6	-	7,6	7,7	7,5
152	5,5	-	-	7,0	7,4	7,1
160	-	-	-	6,4	6,6	4,2
168	-	-	-	5,6	3,6	-
176	-	-	-	5,1	3,3	-
184	-	-	-	3,0	-	-

202.1 ft

ft	37.4 ft			68.9 ft		
	0°	20°	40°	0°	20°	40°
	1,000 lb					
48	12,8	-	-	-	-	-
56	12,8	-	-	7,7	-	-
64	12,8	-	-	7,7	-	-
72	12,8	12,8	-	7,7	-	-
80	12,7	12,7	12,6	7,7	-	-
88	12,4	12,3	12,5	7,7	7,7	-
96	11,8	12,0	12,1	7,7	7,7	-
104	11,3	11,3	11,5	7,5	7,7	-
112	10,3	10,8	10,8	7,5	7,5	7,5
120	8,6	10,0	10,2	7,1	7,4	7,2
128	7,6	8,3	9,1	6,3	7,1	6,9
136	6,3	7,2	7,6	5,3	6,7	6,7
144	4,9	6,0	6,7	4,2	5,8	6,4
152	3,8	4,7	5,3	3,2	5,1	6,1
160	2,7	3,6	4,1	-	4,1	5,2
168	-	-	-	-	-	4,4
176	-	-	-	-	-	3,4

223.1 ft

ft	37.4 ft			68.9 ft		
	0°	20°	40°	0°	20°*	40°*
	1,000 lb					
56	8,8	-	-	-	-	-
64	8,8	-	-	-	-	-
72	8,8	-	-	5,7	-	-
80	8,8	8,8	-	5,7	-	-
88	8,8	8,8	8,8	5,7	-	-
96	8,7	8,8	8,8	5,7	-	-
104	8,4	8,8	8,8	5,7	6,2	-
112	8,1	8,6	8,8	5,7	6,2	-
120	7,6	8,3	8,5	5,7	6,2	6,2
128	5,9	7,3	8,2	5,0	6,1	6,2
136	4,7	5,8	7,0	3,8	5,8	6,0
144	3,6	4,7	5,6	2,7	5,1	5,7
152	-	3,6	4,3	-	4,0	5,2
160	-	-	3,2	-	3,0	4,5
168	-	-	-	-	-	3,5
176	-	-	-	-	-	2,6

* **219.2 ft**



HAV

EXPLORER 5600

56,000 lb **26.7 ft m x 24.6 ft** **360°** **85 %**

40.7 ft

ft	37.4 ft			68.9 ft		
	0°	20°	40°	0°	20°	40°
	1,000 lb					
10	41,2	-	-	-	-	-
12	41,2	-	-	19,4	-	-
14	41,2	-	-	19,4	-	-
16	41,2	-	-	19,4	-	-
18	41,2	-	-	19,3	-	-
20	41,2	32,9	-	19,1	-	-
24	40,6	30,2	-	18,6	-	-
28	37,6	28,1	-	17,9	-	-
32	34,0	26,2	21,4	17,1	-	-
36	31,0	24,5	20,4	16,4	-	-
40	28,3	23,0	19,5	15,7	12,7	-
48	24,1	20,7	18,0	13,7	11,4	-
56	21,3	19,0	17,2	12,2	10,4	-
64	19,0	18,0	-	10,9	9,6	8,7
72	-	-	-	9,9	9,1	8,2
80	-	-	-	9,1	8,3	7,9
88	-	-	-	8,4	8,1	7,7
96	-	-	-	8,0	7,9	-

121.4 ft

ft	37.4 ft			68.9 ft		
	0°	20°	40°	0°	20°	40°
	1,000 lb					
24	36,2	-	-	-	-	-
28	36,2	-	-	14,8	-	-
32	36,0	-	-	14,8	-	-
36	35,3	-	-	14,8	-	-
40	34,7	27,0	-	14,7	-	-
48	33,0	25,4	20,1	14,4	-	-
56	30,1	23,8	19,5	14,0	11,8	-
64	27,3	22,3	18,7	13,7	11,1	-
72	24,5	21,0	18,1	13,2	10,6	-
80	21,0	19,7	17,6	12,9	10,1	8,4
88	17,9	18,2	17,1	12,2	9,7	8,3
96	14,9	15,9	16,1	11,5	9,3	8,0
104	13,4	13,3	14,2	10,9	8,9	7,9
112	11,4	12,2	12,1	10,3	8,6	7,7
120	10,2	10,4	10,8	9,3	8,3	7,7
128	9,1	9,3	7,1	8,4	8,2	7,7
136	8,0	8,4	-	7,4	7,6	7,6
144	7,1	7,1	-	6,6	7,1	7,3
152	5,5	-	-	5,9	6,3	6,5
160	-	-	-	5,3	5,5	4,2
168	-	-	-	4,5	3,6	-
176	-	-	-	4,0	3,3	-
184	-	-	-	3,0	-	-

202.1 ft

ft	37.4 ft			68.9 ft		
	0°	20°	40°	0°	20°	40°
	1,000 lb					
48	12,8	-	-	-	-	-
56	12,8	-	-	7,7	-	-
64	12,8	-	-	7,7	-	-
72	12,8	12,8	-	7,7	-	-
80	12,7	12,7	12,6	7,7	-	-
88	12,4	12,3	12,5	7,7	7,7	-
96	10,9	12,0	12,1	7,7	7,7	-
104	9,2	10,4	11,5	7,5	7,7	-
112	7,4	8,9	9,8	6,3	7,5	7,5
120	5,9	7,3	8,4	5,0	7,1	7,2
128	4,5	5,8	6,8	3,6	6,1	6,9
136	3,3	4,5	5,4	2,4	4,7	6,2
144	2,3	3,4	4,2	-	3,6	5,3
152	-	-	2,9	-	-	4,0
160	-	-	-	-	-	3,1

223.1 ft

ft	37.4 ft			68.9 ft		
	0°	20°	40°	0°	20°*	40°*
	1,000 lb					
56	8,8	-	-	-	-	-
64	8,8	-	-	-	-	-
72	8,8	-	-	5,7	-	-
80	8,8	8,8	-	5,7	-	-
88	8,8	8,8	8,8	5,7	-	-
96	8,7	8,8	8,8	5,7	-	-
104	7,5	8,8	8,8	5,7	6,2	-
112	5,7	7,4	8,7	4,6	6,2	-
120	4,2	5,8	7,1	3,2	6,0	6,2
128	2,9	4,3	5,4	-	5,0	6,2
136	-	2,9	4,0	-	3,6	5,5
144	-	-	2,9	-	2,5	4,5
152	-	-	-	-	-	3,2

* **219.2 ft**

HAV-VA

EXPLORER 5600

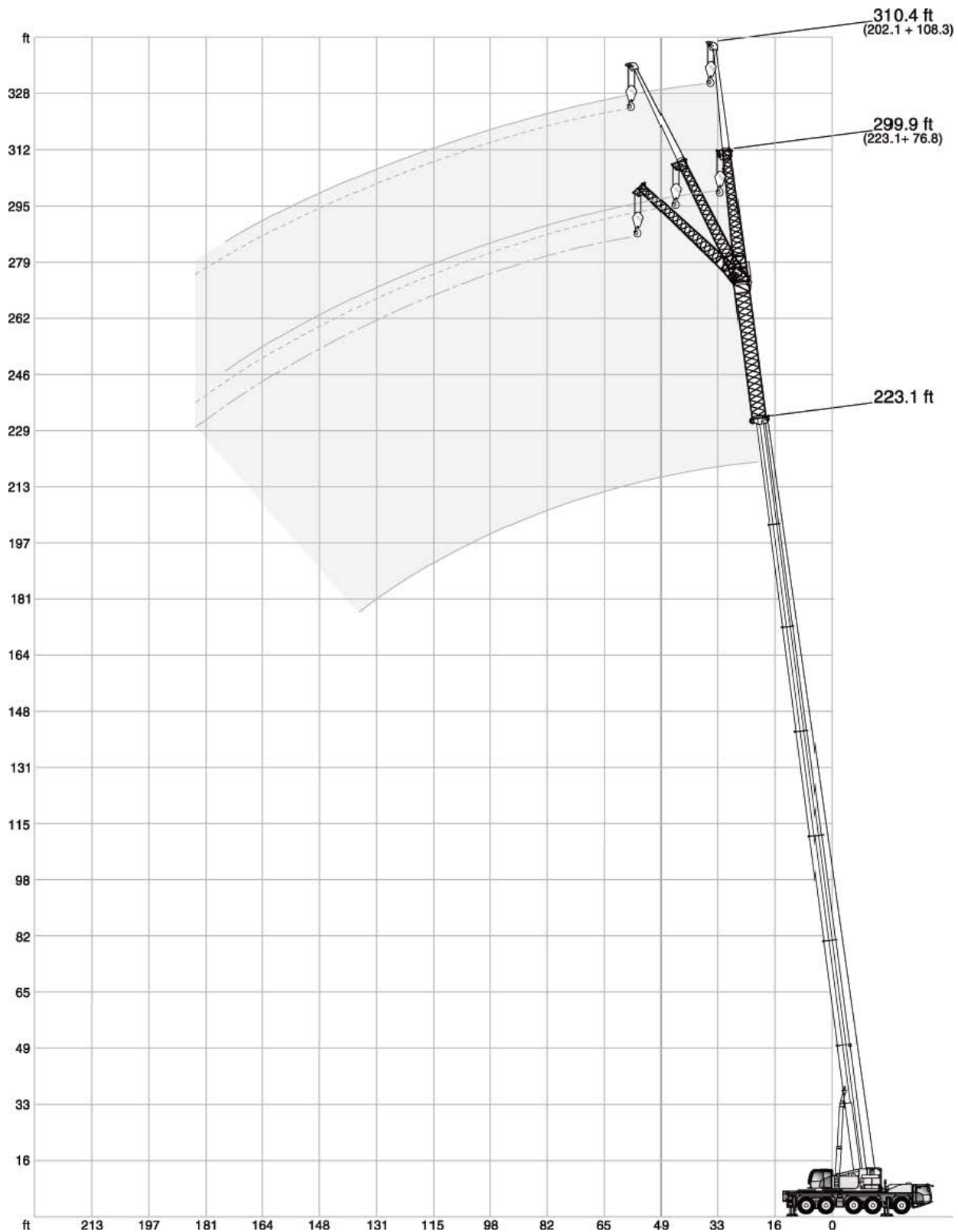
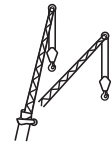
**TEREX®**

HAV-VA

EXPLORER 5600

101,400 lb **26.7 ft m x 24.6 ft** **360°** **85 %**

40.7 ft

ft	76.8 ft			108.3 ft		
	0°	20°	40°	0°	20°	40°
	1,000 lb					
16	34,9	-	-	-	-	-
18	33,6	-	-	-	-	-
20	32,4	-	-	15,2	-	-
24	29,0	-	-	15,2	-	-
28	26,0	-	-	15,1	-	-
32	23,4	20,7	-	14,8	-	-
36	21,3	19,1	-	14,6	-	-
40	19,4	17,7	16,4	14,2	-	-
48	16,8	15,4	14,4	12,9	12,0	-
56	14,6	13,5	12,9	11,5	10,7	-
64	12,7	12,0	11,5	10,2	9,5	-
72	11,3	10,8	10,6	9,1	8,4	-
80	10,2	9,8	9,6	8,0	7,6	-
88	9,2	9,0	8,9	7,2	6,9	-
96	8,4	8,3	-	6,4	6,2	-
104	7,8	7,8	-	5,8	5,6	-
112	-	-	-	5,3	5,3	-
120	-	-	-	4,8	4,8	-
128	-	-	-	4,5	4,5	-
136	-	-	-	4,2	-	-

121.4 ft

ft	76.8 ft			108.3 ft		
	0°	20°	40°	0°	20°	40°
	1,000 lb					
36	20,8	-	-	-	-	-
40	20,7	-	-	11,0	-	-
48	19,9	17,3	-	11,0	-	-
56	18,7	16,1	-	10,8	-	-
64	17,5	15,0	13,4	10,6	-	-
72	16,1	13,9	12,6	10,2	9,3	-
80	14,8	13,1	12,0	9,6	8,7	-
88	13,6	12,3	11,3	9,1	8,2	-
96	12,7	11,5	10,7	8,5	7,7	-
104	11,8	10,9	10,4	8,0	7,1	-
112	11,0	10,3	9,9	7,7	6,6	-
120	10,4	9,8	9,6	7,1	6,3	-
128	9,7	9,3	9,1	6,6	5,9	-
136	9,2	8,9	8,7	6,2	5,6	-
144	8,8	8,4	8,4	6,0	5,3	-
152	8,3	8,1	8,1	5,5	5,0	-
160	7,8	7,9	3,4	5,2	4,8	-
168	7,0	7,3	-	4,9	4,6	-
176	6,5	6,5	-	4,7	4,4	-
184	4,1	-	-	4,4	4,3	-
192	-	-	-	4,2	4,2	-
200	-	-	-	4,0	4,0	-
208	-	-	-	3,7	-	-
216	-	-	-	3,3	-	-

202.1 ft

ft	76.8 ft			108.3 ft		
	0°	20°	40°	0°	20°	40°
	1,000 lb					
64	7,7	-	-	-	-	-
72	7,7	-	-	3,7	-	-
80	7,7	7,3	-	3,7	-	-
88	7,6	7,3	6,3	3,7	-	-
96	7,5	7,3	6,2	3,7	-	-
104	7,3	7,1	6,0	3,7	3,7	-
112	7,0	6,8	5,9	3,7	3,7	-
120	6,7	6,8	5,7	3,7	3,7	-
128	6,3	6,4	5,7	3,6	3,7	-
136	6,0	6,0	5,6	3,5	3,7	-
144	5,5	5,7	5,5	3,3	3,7	-
152	5,2	5,4	5,3	3,3	3,5	-
160	4,8	5,0	5,1	3,2	3,3	-
168	4,4	4,6	4,7	3,0	3,2	-
176	3,8	4,0	4,2	2,7	2,9	-
184	2,9	3,4	3,7	-	2,6	-

223.1 ft

ft	76.8 ft		
	0°	20°*	40°*
	1,000 lb		
72	4,9	-	-
80	4,9	-	-
88	4,9	5,3	-
96	4,9	5,3	4,9
104	4,9	5,3	4,9
112	4,9	5,3	4,8
120	4,8	5,3	4,6
128	4,5	5,3	4,6
136	4,2	5,0	4,5
144	4,2	4,6	4,2
152	3,9	4,3	4,2
160	3,7	3,9	3,9
168	3,3	3,5	3,6
176	2,9	3,1	3,3
184	-	2,9	3,0

* **219.2 ft**



HAV-VA

EXPLORER 5600

71,900 lb **26.7 ft m x 24.6 ft** **360°** **85 %**

40.7 ft

ft	76.8 ft			108.3 ft		
	0°	20°	40°	0°	20°	40°
	1,000 lb					
16	34,9	-	-	-	-	-
18	33,6	-	-	-	-	-
20	32,4	-	-	15,2	-	-
24	29,0	-	-	15,2	-	-
28	26,0	-	-	15,1	-	-
32	23,4	20,7	-	14,8	-	-
36	21,3	19,1	-	14,6	-	-
40	19,4	17,7	16,4	14,2	-	-
48	16,8	15,4	14,4	12,9	12,0	-
56	14,6	13,5	12,9	11,5	10,7	-
64	12,7	12,0	11,5	10,2	9,5	-
72	11,3	10,8	10,6	9,1	8,4	-
80	10,2	9,8	9,6	8,0	7,6	-
88	9,2	9,0	8,9	7,2	6,9	-
96	8,4	8,3	-	6,4	6,2	-
104	7,8	7,8	-	5,8	5,6	-
112	-	-	-	5,3	5,3	-
120	-	-	-	4,8	4,8	-
128	-	-	-	4,5	4,5	-
136	-	-	-	4,2	-	-

121.4 ft

ft	76.8 ft			108.3 ft		
	0°	20°	40°	0°	20°	40°
	1,000 lb					
36	20,8	-	-	-	-	-
40	20,7	-	-	11,0	-	-
48	19,9	17,3	-	11,0	-	-
56	18,7	16,1	-	10,8	-	-
64	17,5	15,0	13,4	10,6	-	-
72	16,1	13,9	12,6	10,2	9,3	-
80	14,8	13,1	12,0	9,6	8,7	-
88	13,6	12,3	11,3	9,1	8,2	-
96	12,7	11,5	10,7	8,5	7,7	-
104	11,8	10,9	10,4	8,0	7,1	-
112	11,0	10,3	9,9	7,7	6,6	-
120	10,3	9,8	9,6	7,1	6,3	-
128	9,5	9,3	9,1	6,6	5,9	-
136	8,5	8,7	8,7	6,2	5,6	-
144	7,3	8,0	8,2	6,0	5,3	-
152	6,1	6,7	6,9	5,5	5,0	-
160	5,6	5,6	3,4	5,0	4,8	-
168	4,9	5,1	-	4,2	4,5	-
176	4,2	4,4	-	3,6	4,2	-
184	-	-	-	3,1	3,5	-
192	-	-	-	-	3,0	-
200	-	-	-	-	2,6	-

202.1 ft

ft	76.8 ft			108.3 ft		
	0°	20°	40°	0°	20°	40°
	1,000 lb					
64	7,7	-	-	-	-	-
72	7,7	-	-	3,7	-	-
80	7,7	7,3	-	3,7	-	-
88	7,6	7,3	6,3	3,7	-	-
96	7,5	7,3	6,2	3,7	-	-
104	7,3	7,1	6,0	3,7	3,7	-
112	7,0	6,8	5,9	3,7	3,7	-
120	6,6	6,8	5,7	3,7	3,7	-
128	5,6	6,4	5,7	3,6	3,7	-
136	4,8	5,5	5,6	3,2	3,7	-
144	3,6	4,9	5,3	-	3,7	-
152	-	3,8	4,3	-	3,4	-
160	-	2,7	3,6	-	-	-

223.1 ft

ft	76.8 ft		
	0°	20°*	40°*
	1,000 lb		
72	4,9	-	-
80	4,9	-	-
88	4,9	5,3	-
96	4,9	5,3	4,9
104	4,9	5,3	4,9
112	4,9	5,3	4,8
120	4,8	5,3	4,6
128	4,3	5,3	4,6
136	3,2	4,8	4,5
144	-	3,8	4,2
152	-	-	3,6

* **219.2 ft**



HAV-VA

EXPLORER 5600

56,000 lb **26.7 ft m x 24.6 ft** **360°** **85 %**

40.7 ft

ft	76.8 ft			108.3 ft		
	0°	20°	40°	0°	20°	40°
	1,000 lb					
16	34,9	-	-	-	-	-
18	33,6	-	-	-	-	-
20	32,4	-	-	15,2	-	-
24	29,0	-	-	15,2	-	-
28	26,0	-	-	15,1	-	-
32	23,4	20,7	-	14,8	-	-
36	21,3	19,1	-	14,6	-	-
40	19,4	17,7	16,4	14,2	-	-
48	16,8	15,4	14,4	12,9	12,0	-
56	14,6	13,5	12,9	11,5	10,7	-
64	12,7	12,0	11,5	10,2	9,5	-
72	11,3	10,8	10,6	9,1	8,4	-
80	10,2	9,8	9,6	8,0	7,6	-
88	9,2	9,0	8,9	7,2	6,9	-
96	8,4	8,3	-	6,4	6,2	-
104	7,8	7,8	-	5,8	5,6	-
112	-	-	-	5,3	5,3	-
120	-	-	-	4,8	4,8	-
128	-	-	-	4,5	4,5	-
136	-	-	-	4,2	-	-

121.4 ft

ft	76.8 ft			108.3 ft		
	0°	20°	40°	0°	20°	40°
	1,000 lb					
36	20,8	-	-	-	-	-
40	20,7	-	-	11,0	-	-
48	19,9	17,3	-	11,0	-	-
56	18,7	16,1	-	10,8	-	-
64	17,5	15,0	13,4	10,6	-	-
72	16,1	13,9	12,6	10,2	9,3	-
80	14,8	13,1	12,0	9,6	8,7	-
88	13,6	12,3	11,3	9,1	8,2	-
96	12,7	11,5	10,7	8,5	7,7	-
104	11,8	10,9	10,4	8,0	7,1	-
112	10,7	10,3	9,9	7,7	6,6	-
120	8,9	9,5	9,4	7,1	6,3	-
128	7,8	8,4	8,7	6,6	5,9	-
136	6,8	7,4	7,5	6,1	5,6	-
144	6,0	6,4	6,6	5,5	5,3	-
152	5,1	5,4	5,6	4,7	5,0	-
160	4,5	4,7	3,4	3,8	4,5	-
168	4,0	4,1	-	3,3	3,9	-
176	3,3	3,4	-	2,7	3,1	-
184	-	-	-	-	2,4	-

202.1 ft

ft	76.8 ft			108.3 ft		
	0°	20°	40°	0°	20°	40°
	1,000 lb					
64	7,7	-	-	-	-	-
72	7,7	-	-	3,7	-	-
80	7,7	7,3	-	3,7	-	-
88	7,6	7,3	6,3	3,7	-	-
96	7,5	7,3	6,2	3,7	-	-
104	6,9	7,1	6,0	3,7	3,7	-
112	5,9	6,8	5,9	3,7	3,7	-
120	4,3	5,7	5,7	-	3,7	-
128	3,1	4,5	5,2	-	3,6	-
136	-	3,2	4,3	-	2,9	-
144	-	-	3,1	-	-	-

223.1 ft

ft	76.8 ft		
	0°	20°*	40°*
	1,000 lb		
72	4,9	-	-
80	4,9	-	-
88	4,9	5,3	-
96	4,9	5,3	4,9
104	4,9	5,3	4,9
112	4,1	5,3	4,8
120	-	4,7	4,6
128	-	3,2	4,3
136	-	-	3,2

* **219.2 ft**



MS

EXPLORER 5600

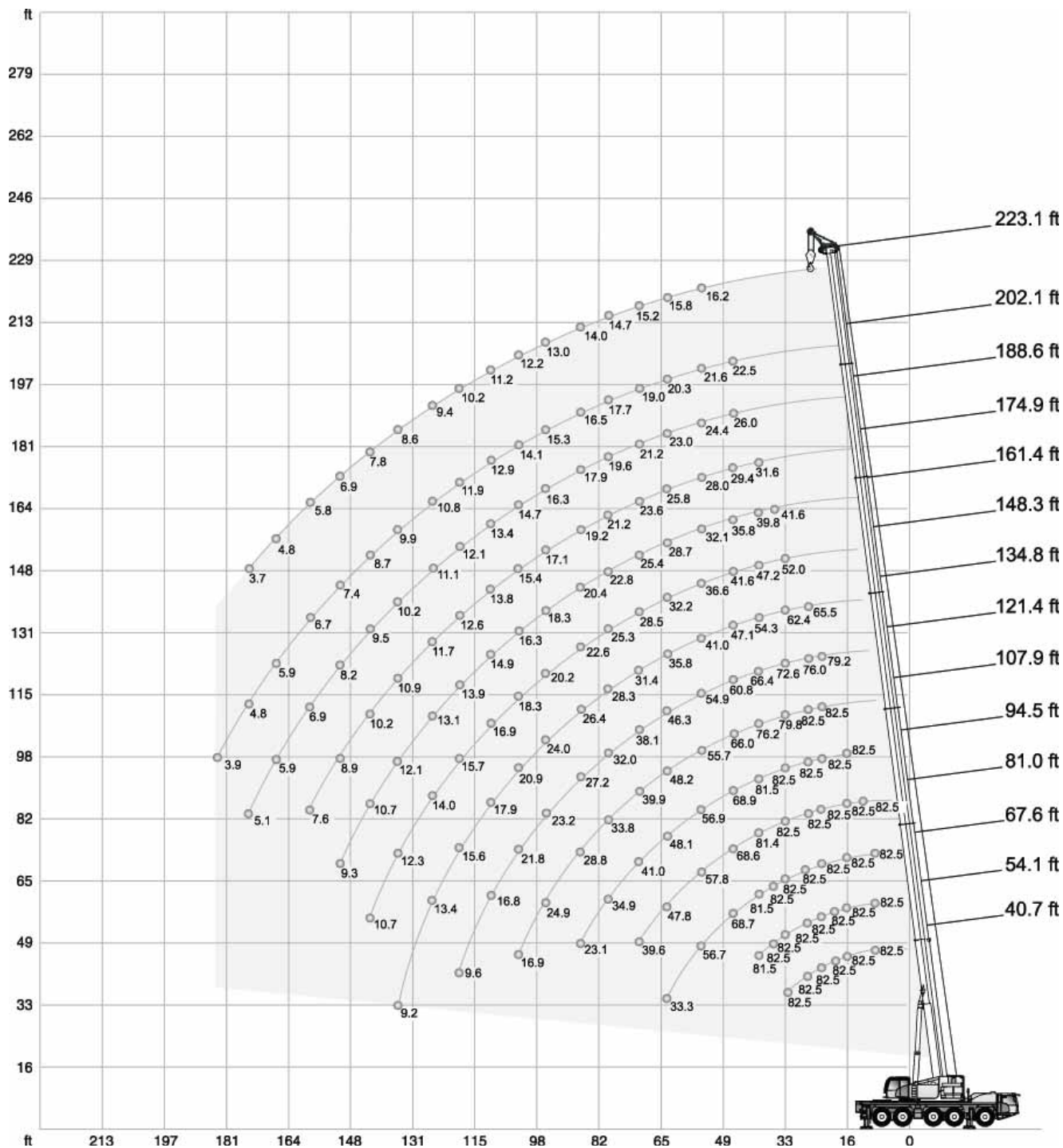
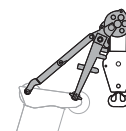

MS

EXPLORER 5600

101,400 lb		26.7 ft m x 24.6 ft														360°		85 %										
40.7 ft		54.1 ft		67.6 ft		81.0 ft		94.5 ft		107.9 ft		121.4 ft		134.8 ft		148.3 ft		161.4 ft		174.9 ft		188.6 ft		202.1 ft		223.1 ft		
ft		1,000 lb																								ft		
10	82,5	82,5	82,5	-	-	-	-	-	-	-	-	-	-	-	-	-	-	-	-	-	-	-	-	-	-	-	-	10
12	82,5	82,5	82,5	82,5	-	-	-	-	-	-	-	-	-	-	-	-	-	-	-	-	-	-	-	-	-	-	-	12
14	82,5	82,5	82,5	82,5	82,5	-	-	-	-	-	-	-	-	-	-	-	-	-	-	-	-	-	-	-	-	-	-	14
16	82,5	82,5	82,5	82,5	82,5	82,5	-	-	-	-	-	-	-	-	-	-	-	-	-	-	-	-	-	-	-	-	-	16
18	82,5	82,5	82,5	82,5	82,5	82,5	82,5	-	-	-	-	-	-	-	-	-	-	-	-	-	-	-	-	-	-	-	-	18
20	82,5	82,5	82,5	82,5	82,5	82,5	82,5	-	-	-	-	-	-	-	-	-	-	-	-	-	-	-	-	-	-	-	-	20
24	82,5	82,5	82,5	82,5	82,5	82,5	82,5	79,2	-	-	-	-	-	-	-	-	-	-	-	-	-	-	-	-	-	-	-	24
28	82,5	82,5	82,5	82,5	82,5	82,5	82,5	76,0	65,5	-	-	-	-	-	-	-	-	-	-	-	-	-	-	-	-	-	-	28
32	82,5	82,5	82,5	82,5	82,5	82,5	82,5	72,6	62,4	52,0	-	-	-	-	-	-	-	-	-	-	-	-	-	-	-	-	-	32
36	-	82,5	82,5	82,5	82,5	82,5	79,8	69,4	58,4	49,7	41,6	-	-	-	-	-	-	-	-	-	-	-	-	-	-	-	-	36
40	-	81,5	81,5	81,4	81,5	76,2	66,4	54,3	47,2	39,8	31,6	-	-	-	-	-	-	-	-	-	-	-	-	-	-	-	-	40
48	-	-	68,7	68,6	68,9	66,0	60,8	47,1	41,6	35,8	29,4	26,0	22,5	-	-	-	-	-	-	-	-	-	-	-	-	-	-	48
56	-	-	56,7	57,8	56,9	55,7	54,9	41,0	36,6	32,1	28,0	24,4	21,6	16,2	56	-	-	-	-	-	-	-	-	-	-	-	-	56
64	-	-	33,3	47,8	48,1	48,2	46,3	35,8	32,2	28,7	25,8	23,0	20,3	15,8	64	-	-	-	-	-	-	-	-	-	-	-	-	64
72	-	-	-	39,6	41,0	39,9	38,1	31,4	28,5	25,4	23,6	21,2	19,0	15,2	72	-	-	-	-	-	-	-	-	-	-	-	-	72
80	-	-	-	-	34,9	33,8	32,0	28,3	25,3	22,8	21,2	19,6	17,7	14,7	80	-	-	-	-	-	-	-	-	-	-	-	-	80
88	-	-	-	-	23,1	28,8	27,2	26,4	22,6	20,4	19,0	17,9	16,5	14,0	88	-	-	-	-	-	-	-	-	-	-	-	-	88
96	-	-	-	-	-	24,9	23,2	24,0	20,2	18,3	17,1	16,3	15,3	13,0	96	-	-	-	-	-	-	-	-	-	-	-	-	96
104	-	-	-	-	-	16,9	21,8	20,9	18,3	16,3	15,4	14,7	14,1	12,2	104	-	-	-	-	-	-	-	-	-	-	-	-	104
112	-	-	-	-	-	-	16,8	17,9	16,9	14,9	13,8	13,4	12,9	11,2	112	-	-	-	-	-	-	-	-	-	-	-	-	112
120	-	-	-	-	-	-	9,6	15,6	15,7	13,9	12,6	12,1	11,9	10,2	120	-	-	-	-	-	-	-	-	-	-	-	-	120
128	-	-	-	-	-	-	-	13,4	14,0	13,1	11,7	11,1	10,8	9,4	128	-	-	-	-	-	-	-	-	-	-	-	-	128
136	-	-	-	-	-	-	-	9,2	12,3	12,1	10,9	10,2	9,9	8,6	136	-	-	-	-	-	-	-	-	-	-	-	-	136
144	-	-	-	-	-	-	-	-	10,7	10,7	10,2	9,5	8,7	7,8	144	-	-	-	-	-	-	-	-	-	-	-	-	144
152	-	-	-	-	-	-	-	-	-	9,3	8,9	8,2	7,4	6,9	152	-	-	-	-	-	-	-	-	-	-	-	-	152
160	-	-	-	-	-	-	-	-	-	-	7,6	6,9	6,7	5,8	160	-	-	-	-	-	-	-	-	-	-	-	-	160
168	-	-	-	-	-	-	-	-	-	-	-	5,9	5,9	4,8	168	-	-	-	-	-	-	-	-	-	-	-	-	168
176	-	-	-	-	-	-	-	-	-	-	-	5,1	4,8	3,7	176	-	-	-	-	-	-	-	-	-	-	-	-	176
184	-	-	-	-	-	-	-	-	-	-	-	-	3,9	-	184	-	-	-	-	-	-	-	-	-	-	-	-	184
1)	38,8	29,1	22,7	18,1	14,6	11,5	9,0	6,6	4,9	3,5	0	0	0	0	1)	-	-	-	-	-	-	-	-	-	-	-	-	-

1) Capacities with horizontal boom



MS

EXPLORER 5600



71,900 lb		26.7 ft m x 24.6 ft												360°		85 %	
ft		40.7 ft	54.1 ft	67.6 ft	81.0 ft	94.5 ft	107.9 ft	121.4 ft	134.8 ft	148.3 ft	161.4 ft	174.9 ft	188.6 ft	202.1 ft	223.1 ft	ft	
1,000 lb																	
10	82,5	82,5	82,5	-	-	-	-	-	-	-	-	-	-	-	-	10	
12	82,5	82,5	82,5	82,5	-	-	-	-	-	-	-	-	-	-	-	12	
14	82,5	82,5	82,5	82,5	-	-	-	-	-	-	-	-	-	-	-	14	
16	82,5	82,5	82,5	82,5	82,5	-	-	-	-	-	-	-	-	-	-	16	
18	82,5	82,5	82,5	82,5	82,5	82,5	-	-	-	-	-	-	-	-	-	18	
20	82,5	82,5	82,5	82,5	82,5	82,5	-	-	-	-	-	-	-	-	-	20	
24	82,5	82,5	82,5	82,5	82,5	82,5	79,2	-	-	-	-	-	-	-	-	24	
28	82,5	82,5	82,5	82,5	82,5	82,5	76,0	65,5	-	-	-	-	-	-	-	28	
32	82,5	82,5	82,5	82,5	82,5	82,5	72,6	62,4	52,0	-	-	-	-	-	-	32	
36	-	81,5	81,0	80,7	81,1	79,7	69,4	58,4	49,7	41,6	-	-	-	-	-	36	
40	-	78,8	77,7	77,4	77,9	75,1	66,3	54,3	47,2	39,8	31,6	-	-	-	-	40	
48	-	-	59,6	59,2	58,0	57,7	57,6	47,1	41,6	35,8	29,4	26,0	22,5	-	-	48	
56	-	-	46,3	47,1	47,4	46,2	44,3	41,0	36,6	32,1	28,0	24,4	21,6	16,2	56		
64	-	-	30,2	38,7	38,1	37,0	35,1	33,9	32,2	28,7	25,8	23,0	20,3	15,8	64		
72	-	-	-	31,9	31,2	30,1	29,2	29,4	27,4	25,4	23,6	21,2	19,0	15,2	72		
80	-	-	-	-	26,2	25,1	26,2	24,5	22,5	21,6	21,1	19,6	17,7	14,7	80		
88	-	-	-	-	16,2	22,6	22,2	20,3	20,5	18,6	18,1	17,7	16,5	14,0	88		
96	-	-	-	-	-	20,1	18,8	18,7	17,5	17,1	15,8	15,4	15,2	13,0	96		
104	-	-	-	-	-	13,5	16,0	16,4	14,9	14,9	14,3	13,7	12,9	12,2	104		
112	-	-	-	-	-	-	10,7	14,0	13,8	12,7	12,5	11,4	11,4	10,3	112		
120	-	-	-	-	-	-	9,6	12,1	12,1	11,5	10,8	9,9	9,5	8,4	120		
128	-	-	-	-	-	-	-	9,7	10,4	9,9	9,4	8,8	7,7	6,6	128		
136	-	-	-	-	-	-	-	9,2	9,2	8,3	8,4	7,4	6,3	5,2	136		
144	-	-	-	-	-	-	-	-	6,0	7,3	7,1	6,0	4,9	3,8	144		
152	-	-	-	-	-	-	-	-	-	6,0	6,0	4,9	3,8	-	152		
160	-	-	-	-	-	-	-	-	-	-	5,0	3,9	2,7	-	160		
1)	38,8	29,1	22,7	18,1	14,6	11,5	9,0	6,6	4,9	3,5	0	0	0	0	1)		

1) Capacities with horizontal boom



MS

EXPLORER 5600

56,000 lb		26.7 ft m x 24.6 ft														360°		85 %	
		40.7 ft	54.1 ft	67.6 ft	81.0 ft	94.5 ft	107.9 ft	121.4 ft	134.8 ft	148.3 ft	161.4 ft	174.9 ft	188.6 ft	202.1 ft	223.1 ft				
ft		1,000 lb														ft			
10		82,5	82,5	82,5	-	-	-	-	-	-	-	-	-	-	-	-	10		
12		82,5	82,5	82,5	82,5	-	-	-	-	-	-	-	-	-	-	-	12		
14		82,5	82,5	82,5	82,5	-	-	-	-	-	-	-	-	-	-	-	14		
16		82,5	82,5	82,5	82,5	82,5	-	-	-	-	-	-	-	-	-	-	16		
18		82,5	82,5	82,5	82,5	82,5	-	-	-	-	-	-	-	-	-	-	18		
20		82,5	82,5	82,5	82,5	82,5	82,5	-	-	-	-	-	-	-	-	-	20		
24		82,5	82,5	82,5	82,5	82,5	82,5	79,2	-	-	-	-	-	-	-	-	24		
28		82,5	82,5	82,5	82,5	82,5	82,5	76,0	65,5	-	-	-	-	-	-	-	28		
32		82,5	82,5	82,5	82,5	82,5	82,5	72,6	62,4	52,0	-	-	-	-	-	-	32		
36		-	76,4	76,2	76,7	76,0	74,1	68,5	58,4	49,7	41,6	-	-	-	-	-	36		
40		-	68,5	69,4	69,0	67,7	64,0	63,8	54,3	47,2	39,8	31,6	-	-	-	-	40		
48		-	-	51,2	52,1	52,5	51,1	49,1	46,1	41,6	35,8	29,4	26,0	22,5	-	-	48		
56		-	-	41,0	41,2	40,5	39,2	37,4	36,7	34,9	32,1	28,0	24,4	21,6	16,2	56			
64		-	-	24,4	32,8	32,3	31,0	31,4	30,3	28,5	27,0	25,8	23,0	20,3	15,8	64			
72		-	-	-	26,8	26,1	26,9	26,1	24,8	24,3	22,8	21,9	21,2	19,0	15,2	72			
80		-	-	-	-	22,7	22,8	21,7	21,8	20,5	19,7	18,8	18,0	17,4	14,7	80			
88		-	-	-	-	14,2	19,2	18,7	18,5	17,5	16,9	16,6	15,9	14,7	13,4	88			
96		-	-	-	-	-	16,2	16,7	15,4	15,4	14,8	14,1	13,2	12,7	10,9	96			
104		-	-	-	-	-	13,5	14,2	13,8	13,0	12,4	12,0	11,5	10,2	8,6	104			
112		-	-	-	-	-	-	10,3	12,0	11,4	10,3	10,5	9,4	8,3	6,7	112			
120		-	-	-	-	-	-	9,6	10,3	9,5	9,4	8,7	7,8	6,5	5,1	120			
128		-	-	-	-	-	-	-	8,8	8,0	8,0	7,2	6,2	5,0	3,6	128			
136		-	-	-	-	-	-	-	7,5	6,7	6,7	5,8	4,9	3,6	2,4	136			
144		-	-	-	-	-	-	-	-	3,6	5,6	4,7	3,6	2,5	-	144			
152		-	-	-	-	-	-	-	-	-	3,6	3,6	-	-	-	152			
160		-	-	-	-	-	-	-	-	-	-	2,8	-	-	-	160			
1)		38,8	29,1	22,7	18,1	14,6	11,5	9,0	6,6	4,9	3,5	0	0	0	0	1)			

1) Capacities with horizontal boom



MS

EXPLORER 5600

		13,900 lb														26.7 ft m x 24.6 ft		360°		85 %	
		1,000 lb																			
		40.7 ft	54.1 ft	67.6 ft	81.0 ft	94.5 ft	107.9 ft	121.4 ft	134.8 ft	148.3 ft	161.4 ft	174.9 ft	188.6 ft	202.1 ft	223.1 ft						
ft	ft															ft					
10	82,5	82,5	82,5	-	-	-	-	-	-	-	-	-	-	-	-	10					
12	82,5	82,5	82,5	82,5	-	-	-	-	-	-	-	-	-	-	-	12					
14	82,5	82,5	82,5	82,5	82,5	-	-	-	-	-	-	-	-	-	-	14					
16	82,5	82,5	82,5	82,5	82,5	82,5	-	-	-	-	-	-	-	-	-	16					
18	82,5	82,5	82,5	82,5	82,5	82,5	-	-	-	-	-	-	-	-	-	18					
20	82,5	82,5	82,5	82,5	82,5	82,3	-	-	-	-	-	-	-	-	-	20					
24	82,5	82,5	82,5	81,7	79,7	77,8	74,2	-	-	-	-	-	-	-	-	24					
28	73,7	75,7	76,3	73,0	69,9	66,1	61,4	55,4	-	-	-	-	-	-	-	28					
32	56,3	59,9	60,9	62,0	58,7	54,2	50,9	47,4	44,4	-	-	-	-	-	-	32					
36	-	48,4	51,3	51,5	49,4	45,9	43,9	40,9	38,6	34,7	-	-	-	-	-	36					
40	-	39,8	41,3	41,5	40,9	41,2	38,2	35,2	33,9	31,9	28,3	-	-	-	-	40					
48	-	-	29,7	30,5	31,2	30,3	29,6	28,3	27,3	25,8	23,9	21,2	19,3	-	-	48					
56	-	-	23,1	23,7	23,4	23,8	23,2	23,0	21,7	20,7	19,4	17,3	15,0	12,6	-	56					
64	-	-	17,7	18,4	18,6	18,8	18,4	17,9	17,0	16,5	14,9	12,8	10,7	8,5	-	64					
72	-	-	-	14,4	14,9	14,6	14,4	13,8	12,9	12,9	11,1	9,3	7,3	5,1	-	72					
80	-	-	-	-	11,7	11,5	11,3	10,6	9,8	9,9	8,4	6,7	4,7	-	-	80					
88	-	-	-	-	9,4	9,2	8,9	8,1	7,4	7,4	6,2	4,4	-	-	-	88					
96	-	-	-	-	-	7,2	6,9	6,2	5,4	5,4	4,5	2,8	-	-	-	96					
104	-	-	-	-	-	5,5	5,3	4,6	3,9	3,9	2,8	-	-	-	-	104					
112	-	-	-	-	-	-	3,9	3,2	-	-	-	-	-	-	-	112					
120	-	-	-	-	-	-	2,8	-	-	-	-	-	-	-	-	120					
1)	38,8	24,5	17,0	11,7	8,4	5,3	3,1	0	0	0	0	0	0	0	0	1)					

		8,200 lb														26.7 ft m x 24.6 ft		360°		85 %	
		1,000 lb																			
		40.7 ft	54.1 ft	67.6 ft	81.0 ft	94.5 ft	107.9 ft	121.4 ft	134.8 ft	148.3 ft	161.4 ft	174.9 ft	188.6 ft	202.1 ft	223.1 ft						
ft	ft															ft					
10	82,5	82,5	82,5	-	-	-	-	-	-	-	-	-	-	-	-	10					
12	82,5	82,5	82,5	82,5	-	-	-	-	-	-	-	-	-	-	-	12					
14	82,5	82,5	82,5	82,5	82,5	-	-	-	-	-	-	-	-	-	-	14					
16	82,5	82,5	82,5	82,5	82,5	82,5	-	-	-	-	-	-	-	-	-	16					
18	82,5	82,5	82,5	82,5	82,5	82,5	-	-	-	-	-	-	-	-	-	18					
20	82,5	82,5	82,5	82,5	82,4	82,2	-	-	-	-	-	-	-	-	-	20					
24	80,8	82,2	81,1	79,4	77,2	75,0	69,2	-	-	-	-	-	-	-	-	24					
28	67,7	71,8	70,8	67,6	65,1	59,8	56,1	51,8	-	-	-	-	-	-	-	28					
32	50,5	54,1	56,7	56,8	53,1	49,6	47,3	43,7	40,6	-	-	-	-	-	-	32					
36	-	44,6	46,4	46,6	44,5	42,8	40,6	37,1	34,7	32,3	-	-	-	-	-	36					
40	-	35,7	37,2	37,4	39,0	37,3	35,2	33,5	31,2	29,2	27,6	-	-	-	-	40					
48	-	-	27,5	28,3	27,9	27,7	27,4	26,4	24,8	23,2	22,0	19,7	17,4	-	-	48					
56	-	-	20,5	21,2	21,4	21,4	21,2	20,2	18,9	18,4	16,5	14,5	12,2	-	-	56					
64	-	-	15,5	16,1	16,7	16,5	16,3	15,5	14,5	14,0	12,3	10,3	8,2	-	-	64					
72	-	-	-	12,2	12,9	12,6	12,4	11,8	10,9	10,7	9,1	7,1	5,1	-	-	72					
80	-	-	-	-	10,0	9,8	9,5	8,9	8,0	8,0	6,5	4,7	-	-	-	80					
88	-	-	-	-	7,7	7,5	7,3	6,6	5,8	5,8	4,4	-	-	-	-	88					
96	-	-	-	-	-	5,8	5,4	4,8	4,0	4,0	2,8	-	-	-	-	96					
104	-	-	-	-	-	4,4	3,9	3,3	2,6	2,6	-	-	-	-	-	104					
1)	35,5	21,6	14,8	9,9	6,8	4,0	0	0	0	0	0	0	0	0	0	1)					

1) Capacities with horizontal boom



NOTES TO LIFTING CAPACITY

EXPLORER 5600

Ratings are in compliance with ASME B30.5.

Lifting capacities do not exceed 85% of tipping load.

Weight of hook blocks and slings is part of the load, and is to be deducted from the capacity ratings.

Consult operation manual for further details.

Note: Data published herein is intended as a guide only and shall not be construed to warrant applicability for lifting purposes.

Crane operation is subject to the computer charts and operation manual both supplied with the crane.



TECHNICAL DESCRIPTION

EXPLORER 5600

Basic equipment

Carrier

Engine 405-4;	Scania DC13; Diesel engine; 405 kW / 1900 1/min (550 HP), torque 2380 Nm / 1300 1/min;
Euromot 4/Tier 4F	The engine complies with Euromot 4/Tier 4F; Exhaust system complete stainless steel.
Fuel tank	Fuel tank 127 gallons Diesel (no RME / Bio-Diesel); 16 gallons tank for AdBlue.
Transmission AS12INT	ZF AS-Tronic; Automated gearbox with integrated hydraulic secondary retarder brake, 12 forward speeds and 2 reverse; 2-stage transfer case with switchable off-road gear.
Axles 10 x 6 x 10	10 x 6 x 10; 5 axles, axles 2, 4, 5 are driven and equipped with disengageable axle-differential lock; Axles 4 with selectable longitudinal lock; All axles are steered.
Suspension	Hydropneumatic suspension with axle load compensation; Hydraulically lockable; Manual or automatic levelling alternatively; Maintenance-free suspension cylinders with position measuring system; Axle load display in carrier cabin.
Steering	Dual-circuit steering system with independent rear axle steering; Axles 1, 2, 3 mechanically connected; Axle 4 and 5 electro-hydraulically connected; All axles steered with 6 different steering programs.
Brakes	Pneumatic dual circuit service brake with antilock system, acting on all wheels; Disc brakes; Hydraulic retarder integrated into transmission as wearless, sustained-action brake; Additional exhaust brake; Spring-loaded parking brake with hill-holder function.
Wheels 385/95 R25 (14.00R25)	Wheels 385/95 R25 (14.00R25); Steel rim 9,5-25/1,7"; Magna MA03 170F; or similar.
Cab carrier 2500	S-PACE type 8.2 ft; Adjustable driver seat with seat heating, armrests and pneumatic suspension; Co-driver's seat; Steering wheel height and tilt adjustable; Power windows; Tinted glass; Power door locks; Power mirrors with heater; Radio-preparation.
Heating carrier	Engine-dependent warm water heating with 12 kW heating power.
Aircondition carrier	Aircondition for carrier cab with 7 kW rated cooling capacity.
Driving lights	Including low beams, high beams, daytime running lights, front fog lamps, and cornering lamps.
Cruise control	Automatic speed control; Automatic brake control.
Electronic immobiliser system	Prevents uncontrolled vehicle mobilisation; Incl. 3 electronic keys.
Pneumatic tire inflating plug	Pneumatic tire inflating plug for self-inflating of the wheels.

Crane

Telescopic boom HA68	40.7 ft - 223.1 ft; Single cylinder telescoping system, automatic telescoping; Attachments for all equipment and extensions; 4 sheaves integrated in boom head for max. capacity of 169,000 lb.
Boom luffing	1 luffing cylinder with automatic lowering brake valve.
Rotary drive	1 slewing gear unit with spring-loaded multi-disc brake; Different operating modes selectable.
H1	Hoist with spring-loaded multi-disc brake; Resolver (hoist rotation indicator); Rope twist prevention is not included.
Counterweight 71,900 lb	Counterweight 71,900 lb, 6 pieces (a-f); Automatic rigging system; Expandable to max. 101,400 lb.
Outriggers	H-4-Point design; Vertical and horizontal movement fully hydraulic; Manual or automatic levelling alternatively; 3 outrigger bases of 8.27 ft, 17.4 ft and 24.6 ft.
Outrigger pads 038PA	4 round outrigger pads A = 1.25 ft ² Polyamid, with transport position at vertical cylinder.
Outrigger load indicator	The outrigger load is indicated in the operator cab and the outrigger control box.
Outrigger basis monitoring	Surveillance of each outrigger beam for detection of horizontal stroke; Warning in case of anomaly in superstructure cab.
Control system	Enabling 4 simultaneous working movements; Electric pilot controls via 2 two-axis joysticks; Different control modes selectable for hydraulic circuits.
Operator aids	IC-1, with integrated load moment indicator acc. EN13000; Colour display; Displaying of current operating conditions, load charts, fault indicator; Signal lights indicating LMI-load; Crane data logger.
Working range limiter	Displaying and programmability of the work range limits by IC-1.
Cab superstructure 875	S-PACE type 875; Tilt infinitely variable 16°; Seat heating; Sliding windows in rear; Fold-out front window; Extendable side pedestal, front pedestal; Handrails; Tinted safety glass; Pull-down sun visor and light curtains; Radio-preparation.
Heating superstructure	Engine-independent warm water heating with 5 kW heating power.
Aircondition superstructure	Aircondition in superstructure cab with 5 kW rated cooling capacity.

Diverse

Illumination	1 x work prefield at superstructure cab, 2 x outriggers left, 2 x outriggers right.
Rotary beacons	2 x covered beacons on carrier cab, 2 x disconnectable on superstructure tail.
Anemometer	Disconnectable, to allow use with all extensions.
Jump starting device	Jump starting device; Enabling jump start by using separate energy source.
Contour safety marking	Continuous reflective strips on the sides of the chassis and in the back.
Toolkit	Toolkit for light repairs and service.



TECHNICAL DESCRIPTION

EXPLORER 5600

Options

Carrier

Axles 10 x 8 x 10	10 x 8 x 10; 5 axles, axles 1, 2, 4, 5 are driven and equipped with disengageable axle-differential lock; Axles 2 and 4 with a disengageable center-differential lock; All axles are steered.
Active tire pressure monitoring system	System with real-time tire pressure monitoring; Makes it possible to reduce tire wear.
Rear view camera	Display in driver's cab; Two cameras installed left and right on rear of vehicle.
Wheels 445/95 R25 (16.00R25)	Wheels 445/95 R25 (16.00R25); Steel rim 11-25/1,7"; Magna MA03 174F; or TechKing ETGC 174F; or similar.
Wheels 525/80 R25 (20.50R25)	Wheels 525/80 R25 (20.50R25); Steel rim 17-25/1,7"; TechKing ETGC 177F; or similar; Incl. carrier broadening to 9.35 ft.
Long range fuel tank	Additional long range fuel tank 37 gallons; For total 164 gallons Diesel in the carrier (no RME / Biodiesel).

Crane

Quick connection main boom (HA)	Hydraulic bolt extractors and hydraulic and electric quick couplings for fast main boom (dis-) assembly; Incl. switchable suspension calibration for light travel configurations without main boom; Incl. storage space for luffing cylinder.
S1 Heavy lift attachment stage 1	2 additional sheaves; Dis-/connectable; For total 6 sheaves at boom head; Max. lifting capacity of 244,800 lb.
Remote control	Control of rigging and superstructure operations via wireless remote control.
2nd hoist (H2)	2nd hoist; Spring-loaded multi-disc brake; Resolver (hoist rotation indicator); Incl. quick couplings and transport frame.
Self-rigging H2	Makes it possible to mount H2 without assist crane.
Additional counterweight	Additional counterweight 29,600 lb; 2 pieces; For max. 101,400 lb à 8 pieces.
Positioning light	Disconnectable LED obstruction light, to allow use with all extensions.
Central lubrication carrier	Automatic central lubrication system for the majority of the lubricating points on the chassis.
Central lubrication superstructure	Central lubricant distributor for luffing cylinder pins, hoist thrust bearing, slewing ring, and boom base pins.
Gas heating superstructure	Auxiliary, engine independent gas heating for superstructure cab.

Extensions

HAV 36.1 ft	37.4 ft; Lattice section, manual offset 20° / 40°; 1-sheave head; Incl. transport storage; Position light required.
HAV 68.9 ft	68.9 ft; Double folding swing-away jib, manual offset 20° / 40°; 1-sheave head; Incl. transport storage; Includes HAV 36.1 ft; Position light required.
HAV-VA 108.3 ft	108.3 ft; Variable extension; 1 piece 39.4 ft; Lattice section and double folding swing-away jib, manual offset 20° / 40°; 1-sheave head; Incl. transport storage for swing-away jib; Includes HAV 68.9 ft and HAV-VA 75.5 ft; Position light required.
HAV-HY 36.1 ft	37.4 ft; Lattice section, hydraulic stepless offset 0°-40°; 1-sheave head; Incl. transport storage; Position light required.
HAV-HY 68.9 ft	68.9 ft; Double folding swing-away jib, hydraulic, stepless offset 0°-40°; 1-sheave head; Incl. transport storage; Includes HAV-HY 36.1 ft; Position light required.
HAV-HY-VA 108.3 ft	108.3 ft; Variable extension; 1 piece 39.4 ft; Lattice section with double folding swing-away jib, hydraulic, stepless offset 0°-40°; 1-sheave head; Incl. transport storage for swing-away jib; Includes HAV-HY 68.9 ft and HAV-HY-VA 75.5 ft; Position light required.
Preparation for HAV	Preparation required for later retrofitting of HAV.
Preparation HAV-HY MSF2 (Runner)	For later HAV-HY retrofitting; Incl. programming HAV-HY 36.1 ft up to HAV-HY-VA 108.3 ft; Incl. transport storage.
Preparation for MSF (Preparation Runner)	5.3 ft; Assembly jib with fixed angle; 2-sheaved for max. capacity 86,200 lb; Incl. transport storage at boom head.
R1 (Swing-away rooster sheave)	For later MSF retrofitting; Incl. programming.
	Swing-away rooster sheave, incl. transport storage; For single-reeving operation with elevated hook height.

Diverse

Hook block 125-5-21-D-1125	125-5-21-D (2,480 lb); Hook block with ramshorn hook; with white red signal stripes.
Hook block 80-3-21-D-850	80-3-21-D (1,870 lb); Hook block with ramshorn hook; with white red signal stripes.
Hook block 80-3-21-E-850	80-3-21-E (1,870 lb); Hook block with single hook; with white red signal stripes.
Hook block 32-1-21-D-600	32-1-21-D (1,320 lb); Hook block with ramshorn hook; with white red signal stripes.
Hook block 32-1-21-E-600	32-1-21-E (1,320 lb); Hook block with single hook; with white red signal stripes.
Hook 12-0V-E-350	12-0V-E (770 lb); Single hook with vertical swivel; red.
Dolly preparation 4-point variable (4PV)	4-point support brackets enable individual positioning of a dolly; Incl. freewheel for slewing gear unit and luffing cylinder, quick couplings for brake air and electrics; Dolly and dollyadapter are not included.
Refinery Kit	Electric emergency stop device and intake air shut off valves; Emergency engine shutdown prevents overspeed of engine in environments with flammable gas or vapour.

Weight data may deviate from posted values based on road / travel configuration, equipment configuration, and component weight tolerances.



Effective Date: February 2014.

Product specifications and prices are subject to change without notice or obligation. The photographs and/or drawings in this document are for illustrative purposes only. Refer to the appropriate Operator's Manual for instructions on the proper use of this equipment. Failure to follow the appropriate Operator's Manual when using our equipment or to otherwise act irresponsibly may result in serious injury or death. The only warranty applicable to our equipment is the standard written warranty applicable to the particular product and sale and Terex makes no other warranty, express or implied. Products and services listed may be trademarks, service marks or trade-names of Terex Corporation and/or its subsidiaries in the USA and other countries. All rights are reserved. Terex® is a registered trademark of Terex Corporation in the USA and many other countries.

Copyright Terex Cranes 2014

Terex Cranes, Global Marketing, Dinglerstraße 24, 66482 Zweibrücken, Germany
Tel. +49 (0) 6332 830, Email: info.cranes@terex.com, www.terexcranes.com



www.terexcranes.com

Brochure Reference: TC-DS-I-E-Explorer 5600-02/14



WORKS FOR YOU.™

