

EMC TEST EQUIPMENT PART 1



Power Signal Generator - PSG-300
acc. to IEC/EN 61000-4-16



Compact Immunity Test System / BCI Test System - CIT-10
acc. to IEC/EN 61000-4-6 / ISO 11452-4 / MIL-STD 461E



**Compact Magnetic Field Test System /
Low Frequency Test System - MTS-800**
acc. to automotive standards and MIL-STD 461E



Compact Test & Control Unit - ECU-3/-6
9 kHz - 3 or 6 GHz



Control Software - CR-LAB
incl. RF-LAB, CD-LAB, BCI-LAB



Immunity Test Systems - RIS 3000
acc. to IEC/EN 61000-4-3



FRANKONIA

EMC TEST INSTRUMENTS:

RIS 3000/ RIS 6000	Radiated Immunity Test Systems..... 3-8 according to IEC/EN 61000-4-3 / ISO 11452-2 / MIL-STD 461
ECU-3/-6	Compact Test & Control Unit, 9 kHz – 3 or 6 GHz..... 9-13 including: • Signal Generator 9 kHz to 3 or 6 GHz • RF-Power Meter up to 6 GHz • Directional Couplers • RF-Relay Switching Units
CIT-10	Compact Immunity Test System..... 14-18 for conducted RF-immunity tests according to IEC/EN 61000-4-6 and for BCI tests, 10 kHz – 400 MHz
CDN	for conducted immunity tests according to IEC/EN 61000-4-6..... 19
EM-clamp	EM-Coupling Clamp, type EMCL..... 20 for conducted immunity tests according to IEC/EN 61000-4-6
MTS-800	Magnetic Field Test System / Low Frequency Test System..... 21-26 for emission and immunity tests according to: • Automotive Standards up to 1000 A/m • IEC/EN 55103-1/2 • MIL-STD 461
PSG-300	Compact Test System for low-frequency immunity tests..... 27 according to IEC/EN 61000-4-16, DC – 300 kHz
IT M2345/32-16	Isolation Transformers acc. to IEC/EN 61000-4-16..... 28 Universal Coupling Networks according to IEC/EN 61000-4-16
CN	for conducted immunity tests according to IEC/EN 61000-4-16..... 29
CR-LAB	Control Software CR-LAB for immunity tests (RF-LAB / CD-LAB / BCI LAB)..... 30-31

Immunity Test System RIS 3000 / RIS 6000

acc. to IEC/EN 61000-4-3

Description

The setup of a radiated immunity test system can be done in the conventional way with many separate instruments or in a more comfortable and less risky way with our new EMC control unit, type ECU-3I-6 (please find a detailed description on pages 9 - 13).

In both ways the components which are needed for such a system are in principle the same:

- Signal Generator
- RF-Power Amplifier(s)
- Directional Coupler(s)
- RF-Power Meter
- Antenna(s)
- RF-Field Strength Meter
- Set of RF-Cables
- Control PC and Control Software

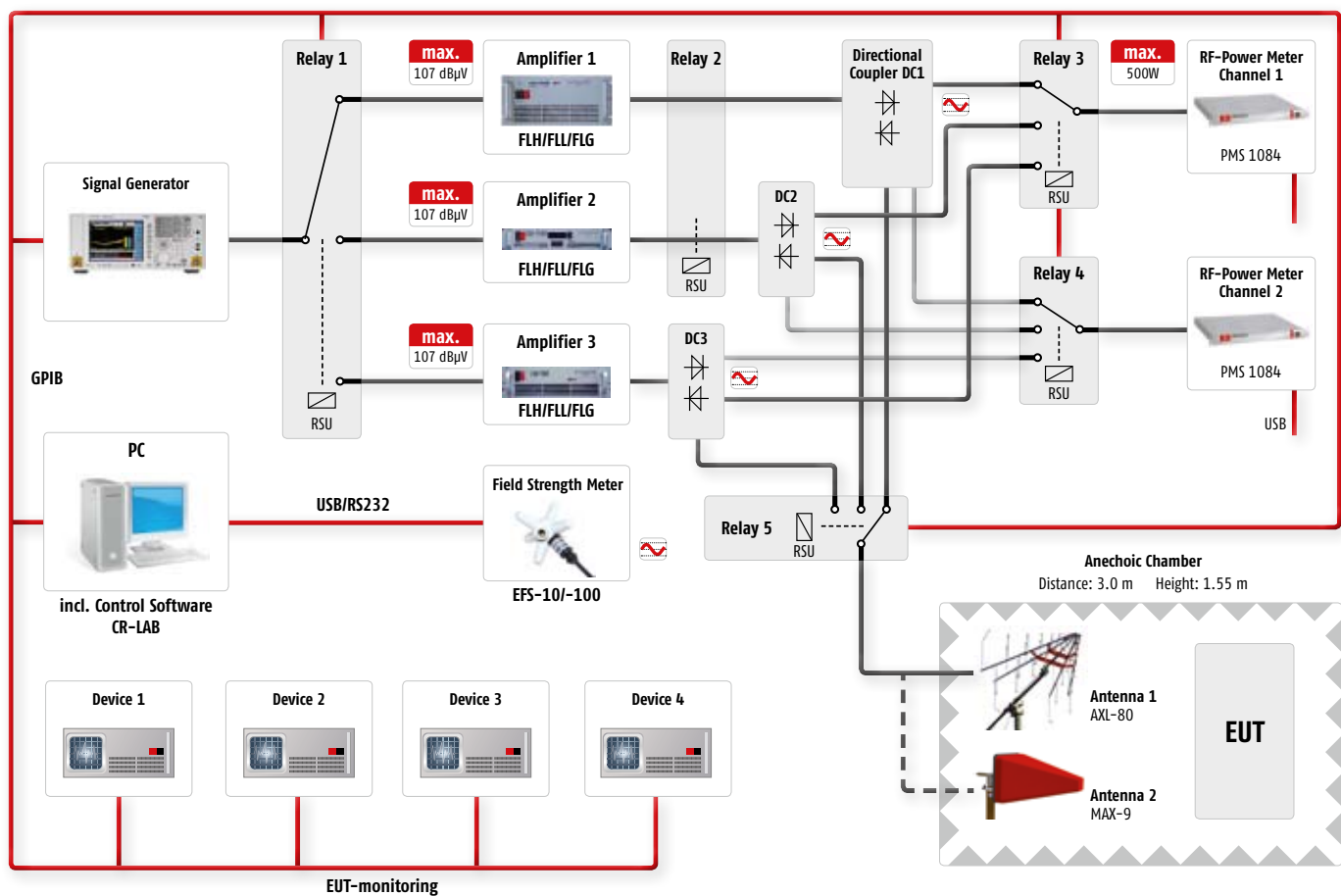

Diagram no. 1

Conventional setup of a radiated immunity test system acc. to IEC/EN 61000-4-3 by means of separate instruments.

Immunity Test System RIS 3000 / RIS 6000

acc. to IEC/EN 61000-4-3

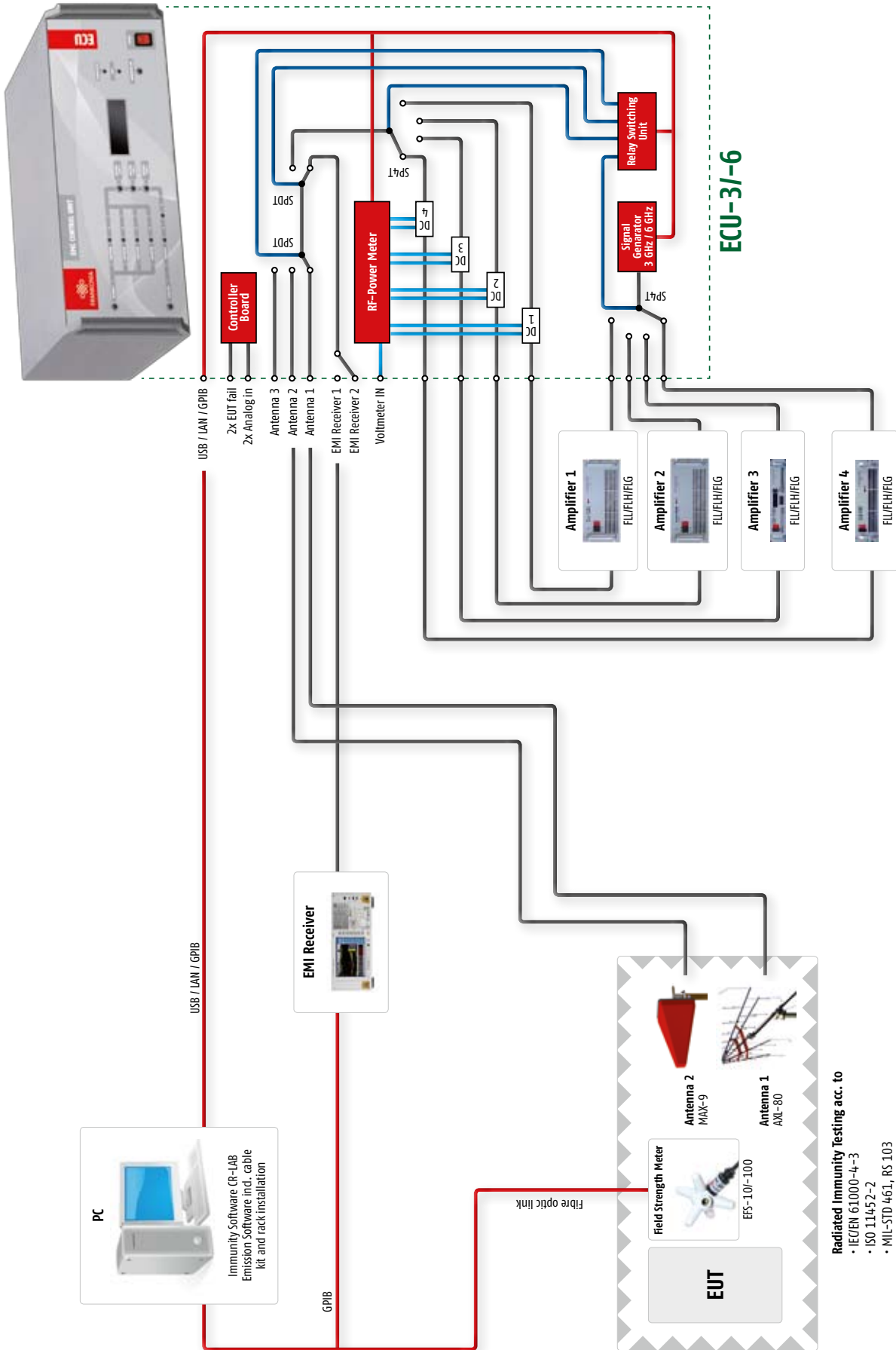

Diagram no. 2
Setup of a radiated immunity test system acc. to IEC/EN 61000-4-3 by means of our EMC control unit, type ECU-3/-6

Control Computer

The controller is a standard PC with operating system Microsoft® Windows. Depending on the system layout GPIB (IEEE488) with National Instruments interface card, serial bus RS232, USB and other bus systems are supported.

Control Software

CR-LAB is fully compliant to IEC/EN 61000-4-3, IEC/EN 61000-4-20, automotive and MIL standards. The software CR-LAB controls the complete test system and creates the test report. It performs measurement of the uniform area and generates reference calibration data from it. Alternatively reference data can be measured directly. Tests may be performed manually and fully automatic. A full automatic monitoring of the EUT's (Equipment Under Test) function is possible whenever its compliance can be controlled with preset tolerance limits. Up to four values can be monitored and recorded for example by means of multimeters.

Essential data of the software are:

- Microsoft® Windows platform
- Simple operator's guide
- Online help function
- Presentation of the results in online graphics and reports
- Export function of the files for further processing under Microsoft® Word, Microsoft® Excel,...
- Measurement of homogeneous field incl. evaluation
- Calculation of reference data
- 2dB saturation test on base of homogeneous field measurement compliant to standard
- Measurement of reference data with fixed test level or profile of level vs. frequency
- Permanent VSWR control during test and operator defined limitation as well as restriction of max. input level of amplifier and max. allowed output power
- Automatic multiple repetition of test
- Manual test mode
- Manual increase/decrease of test level
- Automatic test mode incl. monitoring of the EUT
- Handshake function to EUT via serial interface
- Easy and fast graphical device set-up, system layout can be printed
- Fully compliant to IEC/EN 61000-4-3, IEC/EN 61000-4-20, automotive- and MIL standards
- Control of the test system by GPIB, USB interfaces,...
- Customized modifications possible

Signal Generator

As signal source a commercial signal generator or the built-in signal generator of our EMC test & control unit ECU-3/-6 is used. It should cover at least the required frequency range such as 80 MHz to 6 GHz and allow amplitude modulation with a sine wave of 1 kHz and 80 %, as requested by the standards. Besides, it should meet the requirements regarding frequency step width (1 % of the preceding value). If the equipment offers further modulation depth and modes, as well as a higher frequency range and smaller steps, this might be advantageous for future applications. Minimum requirements are as following:

- Frequency range: 9 kHz – 3.0 GHz (6.0 GHz)
- RF output: -40 dBm to 0 dBm
- Frequency resolution: 1 Hz
- Level resolution: 0.1 dB
- Amplitude modulation: 0 to 99.9 %
- Further modulation types: frequency modulation, phase modulation, pulse modulation
- Interface: GPIB (IEEE-488), RS232, USB



Immunity Test System RIS 3000 / RIS 6000

acc. to IEC/EN 61000-4-3



RF-Power Amplifier

The software controls the level of the signal generator output for each test frequency. This signal level is amplified by the power amplifier output in order to generate the required test field strength around the EUT. It depends on the testing setup, the distance between EUT and antenna (1 m - 3 m) and the test level / test field strength (1 V/m, 3 V/m, 10 V/m or special requirements) whether an amplifier output of 10 W, 30 W, 200 W - 2 kW is required. Normally, field strength of 10 V/m, with 1 kHz / 80% AM, can be obtained with a 200 W amplifier in a testing distance of 3 m.

Main characteristics

- Type: Frankonia FLH, FLG,
- Frequency range: 1 MHz- 6 GHz
- Nominal output: 4 W ... 2000 W
- Input for nominal output: 107 dB μ V (0 dBm)
- Impedance: 50 Ω



RF-Power Meter / Directional Couplers

While testing the field strength probe is replaced by the EUT. A power measurement during the test runs assures that the EUT is actually exposed to the requested test condition. Thus a directional coupler is connected with the amplifier output. A power measuring device type PMS 1084 determines the forward and reverse power up to 6 GHz. Both are stored and recorded by the control software. For this purpose directional couplers are connected with the amplifier output or the built-in directional couplers of our EMC test & control unit ECU-3/-6 is used. The forward and reverse power is measured by our RF-Power Meter PMS 1084 or by the built-in power measuring channels of the ECU-3/-6. Both metering values are recorded and stored by the control software CR-LAB.

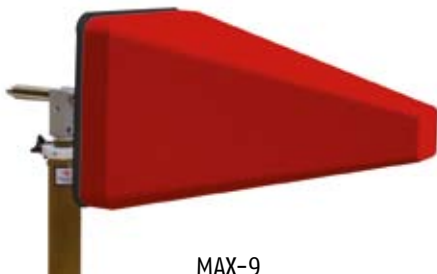

MAX-9

Transmitting Antenna(s)

Broadband antennas, like our model AXL-4000, which cover the whole frequency range from 80 MHz up to 4 GHz may be used as a single-antenna-solution. The advantage of these antennas is that they can be used for immunity tests as well as for emission measurements. In order to save amplifier power and costs it is recommended to use so called double stacked log.-periodical antennas for immunity tests, like our model AXL-80. This antenna type offers a much higher gain compared to the above described broadband antennas. For our systems we recommend the following antenna types:

- 30 MHz - 4 GHz, type ALX-400
- 80 MHz - 4 GHz, type AXL-80
- 1 GHz - 6 GHz, type MAX-9

As an alternative horn antennas can be used in the GHz range if a max. uniform area of 1.0 m is sufficient.



AXL-80

Function and operation of the test system

Homogeneous Field / Uniform Field

To assure the reproducibility of the immunity test, the standard prescribes the homogeneity of the field generated. The immunity test system incl. anechoic chamber must guarantee a homogeneous field within a size of 1.5 m x 1.5 m in a distance of 1 m to 3 m from the transmitting antenna, (e.g. Frankonia type AXL-80). If a smaller surface is sufficient for exposing the EUT and its connection cables to radiation, the homogeneous field can be reduced to 0.5 m x 0.5 m. The lowest part of the homogeneous field surface is situated at 0.8 m above the floor. The level to be set is the max. intended test level incl. modulation. That means for 10 V/m incl. 80 % AM a level of 18 V/m must be provided. To assure the correct display of the field probe the measurements are performed without modulation in the empty anechoic chamber. The homogeneous field has to be established in 1 % steps, starting from 80 MHz up to 6 GHz. The field homogeneity for the respective frequency is met, if the difference between the highest and lowest field strength value lies in between 0 dB and +6 dB (12 of 16 measuring points within a field size of 1.5 m x 1.5 m or 4 of 4 measuring points within a field size of 0.5 m x 0.5 m). The high requirements regarding field homogeneity cannot be met by normal RF-shielded cabins (without absorber lining). The software uses these data to check the 2 dB saturation of the system as required by the standard.

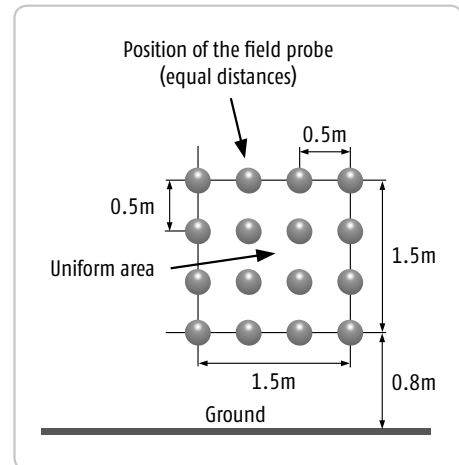

Calculate Reference File

According to the standard the reference data of desired test field strength shall be calculated from data measured in the field homogeneity measurement. This can simply be done by use of this function with our control software CR-LAB.

Individual Reference Measurement

Reference data can be determined with two different methods: <Calculate Reference File> (from data of homogeneous field) and <Individual Reference Measurement>. The software supports individual measurement of reference files. This might be necessary if a defined test level at a defined EUT-position or a profile of test level versus frequency is requested.

Testing

The test setup is described in diagram no. 1 and no. 2. On basis of the reference data (reference calculation or reference measurement) determined for the respective test setup, the required test level and/or test field strength is adjusted reproducibly in the test run by means of the control software for each frequency step. For this purpose, the signal is amplitude-modulated with a sine wave of 1 kHz / 80%. The verification of the EUT's function is performed manually (optically) or, if possible, automatically. In the latter case the EUT's function is tested by means of max. four measuring values with respect to its compliance with preset tolerance values. The determined data, the results, a description of the test system as well as a comment regarding the measurement are summarized by the software in a measuring record. The data can be printed as well as exported into other data processing programs, e. g. Microsoft® Word or Microsoft® Excel.

Immunity Test System RIS 3000 / RIS 6000

acc. to IEC/EN 61000-4-3



RF-Field Strength Meter

A field strength meter is necessary for the measurement of the uniform area. It should be of small size in order to avoid disturbances of the field by the physical size of the field strength meter itself. The data transfer from the anechoic chamber to the control room should be via fibre optic link. It makes sense to integrate the fibre optic converter directly into the sensor because long conductive cables could influence the accuracy, too. The test frequency range from 80 MHz to 3 or 6 GHz should at least be covered by the field strength meter. We suggest the use of our field strength meter type EFS-10/100 which works in the frequency range from 10 or 100 kHz up to 9.25 GHz and with a max. field strength from 0.14 V/m to 500 V/m



RF-Relay Switching Unit RSU

In most cases two or three RF-power amplifiers and two different antennas are needed to cover the whole test frequency range. It would be very time-consuming to change the cabling between the different amplifiers, antennas and power meters manually. For this purpose software controlled switching relays are used, as they work much faster and without any damage to the RF-cables, which might be caused by changing the connections manually. Furthermore, cabling mistakes cannot occur.

Control Software CR-LAB and RF-Cabling

It is rather impossible to set all frequency steps and output levels of the signal generator manually. Also the necessary recording of forward and reverse power as well as the EUT-monitoring would be very time consuming. Not to mention the measurement of the uniform field and the calculation of the forward power, which is needed for each frequency step at each test level. All that is done in a very comfortable way by our control software CR-LAB. With CR-LAB you just select your start/step frequency and your test level. Anything else is carried out by the software automatically.

The RF-cabling work is a very important part of a radiated immunity test system, as the cable-attenuation could finally decide whether you reach your test level or not. All essential RF-cables are included in our systems and in the calculation according to the required amplifier output power.



System installation in a 19"-Rack RIS 3000 / RIS 6000

On request the test systems supplied are installed into a 19"-rack. The picture on the left shows an example of a radiated immunity test system acc. to IEC/EN 61000-4-3, type RIS 3000.

Features:

- Moveable rack (on big rubber wheels)
- Instruments are installed into rack and cabled
- Main switch
- Easy mountable cover for front and rear side of the rack included
- Typical dimensions (HxDxW): 1,270 x 710 x 540 mm
- Weight without instruments: 50 kg



- Signal Generator, 9 kHz – 3/6 GHz
- RF-Power Meter, 10 kHz – 6 GHz
- Directional Couplers, 10 kHz – 6 GHz
- RF-Relay Switching Unit
- EUT-monitoring
- Control of up to four external RF-Power Amplifiers
- Control of up to two external EMI-Receivers

Special Features:

- Conducted immunity tests according to IEC/EN 61000-4-6, 10 kHz – 230 MHz
- BCI-tests according to ISO 11452-5 and MIL-STD 461, CS 114
- Radiated immunity tests according to:
 - IEC/EN 61000-4-3
 - ISO 11452-2/3/4/5
 - MIL-STD 461, RS 103
- Automatic switching between up to four external power amplifiers and connected coupling units / antennas
- Automatic switching between up to two EMI-receivers, spectrum analyzers and three different antennas
- Easy integration into any control software by dII-driver
- Integrated interlock safety system

EMC Test and Control Unit – ECU-3/-6

Description

The ECU-3/-6 is a central EMC test and control unit, which combines in just one compact box many major test components like signal generator, power meter, directional couplers and relay switching unit, which are needed for EMC tests. That reduces the cabling work and possible cabling mistakes to a minimum. Furthermore it includes general functions like EUT-monitoring and an interlock safety-system. With all the functions described above, the ECU-3/-6 is a real all-rounder, which can be used for many different conducted and radiated immunity tests as well as control unit to switch between EMI-receiver and spectrum analyzer and different measuring antennas without time consuming cabling work. It allows to control and to switch automatically between up to four external amplifiers, all connected to the ECU-3/-6 and up to three different outputs for antennas or coupling devices (CDNs, EM-coupling clamp, BCI-clamps). The integrated signal generator is available to cover the frequency range from 9 kHz to 3 GHz or from 9 kHz to 6 GHz. Amplitude modulation is available with a modulation rate of 1 Hz to 30 kHz and a modulation depth of 0 % to 90 %. Pulse modulation can be switched on with a repetition frequency of 0.1 Hz to 100 kHz and a duty cycle of 1 % - 99 %. In a word, it includes all requirements according to present EMC standards and it is best prepared for possible future changes.

Technical specifications	ECU-3	ECU-6
Signal Generator		
Output	50 Ω, N male	
Output (Relay)	3 x N male	4 x N male
Frequency range	9 kHz to 3 GHz	9 kHz to 6.5 GHz
Frequency resolution	0.1 Hz	0.001 Hz
Output level range	-65 dBm to +10 dBm	-100 dBm to +13 dBm
Output level resolution	0.1 dB	
Output level accuracy	±1 dB max.	
Accuracy (frequency)	±5 ppm	±100 ppb
Harmonics	< -30 dBc	
Non harmonics	< -55 dBc	
Amplitude modulation		
Modulation rate	1 Hz to 30 kHz; resolution 0.02 Hz	1 Hz to 20 kHz; resolution 0.1 Hz
Modulation depth	0 to 90 %; resolution 1 %	0 to 90 %; resolution 1 %
Modulation waveforms	sinusoidal, triangular, square	sinusoidal, triangular, square
Pulse modulation		
On/off ratio	> 50 dB	typ. 80 dB
Repetition frequency	0.1 Hz to 100 kHz	0.1 Hz to 100 kHz
Duty cycle	1 % - 99 %; resolution 1 %	1 % - 99 %; resolution 1 %
Frequency modulation		
Modulation rate	---	300 Hz to 300 kHz

EMC Test and Control Unit - ECU-3/-6

Technical specifications	ECU-3	ECU-6
RF-Power Meter		
Number of channels	7	9
Frequency range	10 kHz - 500 MHz (channel 1,2,7) 100 kHz - 6 GHz (channel 3,4,5,6)	10 kHz - 500 MHz (channel 1,2,9) 100 kHz - 6 GHz (channel 3,4,5,6,7,8)
Measuring range	-60 dBm to +20 dBm (10 kHz ≤ f ≤ 4 GHz) -45 dBm to +20 dBm (4 GHz < f ≤ 6 GHz)	
Accuracy	± 1 dB (0.5 dB typical)	
Resolution	0.1 dB	
Max. input level	+27 dBm (= 500 mW)	
VSWR	1.15	
EUT-fail input	2 x TTL/CMOS compatible	
Input resistance	2.2 kΩ	
Level	TTL/CMOS compatible, optical decoupled	
EUT-monitor input		
Input voltage (2 x)	0 - 10 V	
Resolution	2.5 mV	
Input impedance	100 kΩ	
USB-A	Multimeter (for EUT control)	
Remote control		
USB-B	Connection to computer	
GPIO / IEEE488	Connection to computer	
Ethernet / RJ45	option	
Display		
Displayed items	Frequency, Power levels $P_{forw.}$, $P_{rev.}$, modulation (4 lines x 16 characters)	
RF-Relay Switching Unit		
max. power up to 100 MHz	2000 W	
max. power up to 600 MHz	1000 W	
max. power up to 1 GHz	700 W	
max. power up to 3 GHz	400W	
max. power up to 6 GHz	300W	
General data		
Temperature range	0 to 40°C	
Warm-up time	15 min.	
Housing	19"-Subrack or desktop case	
Dimensions (W x H x D)	449 mm x 177 mm x 580 mm	
Weight	approx. 15 kg	
AC input	100 - 240 VAC; 50/60 Hz	

EMC Test and Control Unit - ECU-3/-6

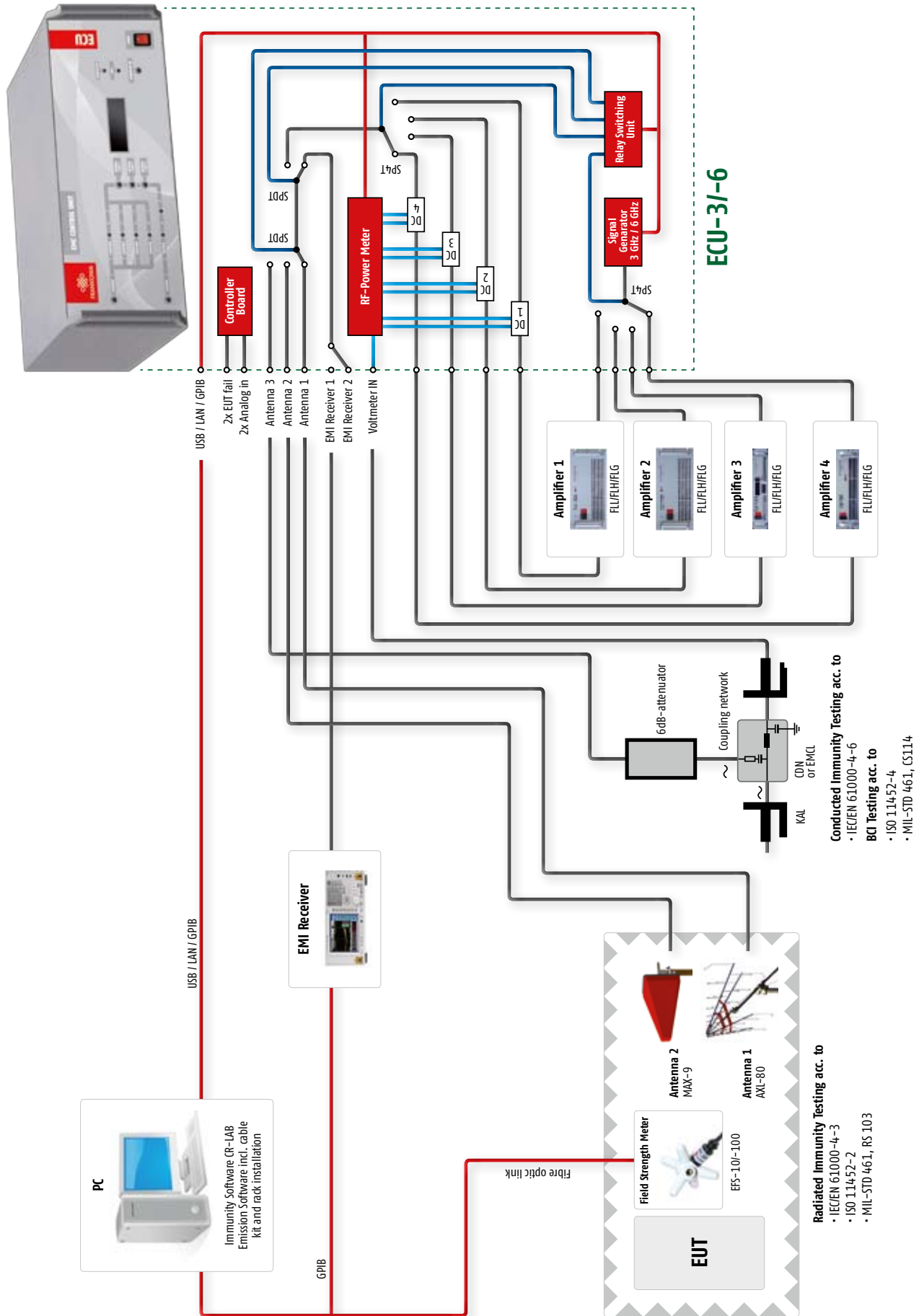

Diagram no. 3
Example of a test system setup with ECU-3/-6

EMC Test and Control Unit - ECU-3/-6

Part Numbers	
ECU-3	Compact EMC control unit, basic Instrument, 9 kHz - 3 GHz
ECU-6	Compact EMC control unit, basic Instrument, 9 kHz - 6 GHz
ECU-DC1A	Directional Coupler, 10 kHz - 250 MHz, 30 dB, 100 W
ECU-DC1B	Directional Coupler, 10 kHz - 400 MHz, 30 dB, 100 W
ECU-DC1C	Directional Coupler, 10 kHz - 250 W, 30 dB, 500 W
ECU-DC2	Directional Coupler, 80 MHz - 1000 MHz, 50dB, 1500 W
ECU-DC3	Directional Coupler, 1 GHz- 4 GHz, 40 dB, 600 W
ECU-DC4	Directional Coupler, 2 GHz - 8 GHz, 40 dB, 600 W
ECU-KS2	Cable-set and GPIB-interface for immunity test systems with 2 amplifiers
ECU-KS3	Cable-set and GPIB-interface for immunity test systems with 3 amplifiers
ECU-KS4	Cable-set and GPIB-interface for immunity test systems with 4 amplifiers
ECU-LAN	Additional interface: LAN
ECU-OUT2	Switching between 2 outputs (antenna/load)
ECU-OUT3	Switching between 3 outputs (antenna/load)
ECU-PM1	RF-Power Meter / RF-milli-voltmeter, 10 kHz - 500 MHz, 1 channel
ECU-PM2	RF-Power Meter / RF-milli-voltmeter, 100 kHz - 6 GHz, 1 channel
ECU-REC1	Switching to emission path and connection of 1 measuring receiver / spectrum analyzer
ECU-REC2	Switching to emission path and connection of 2 measuring receivers / spectrum analyzers
ECU-RI	19"-Rack version
ECU-SW6	Standard software for testing acc. to IEC/EN 61000-4-6 in a system with ECU-3/-6

Compact Immunity Test System CIT-10, 10kHz - 400MHz

acc. to IEC/EN 61000-4-6 / ISO 11452-4 / MIL-STD 461E



Description

The CIT-10 is a complete test system for conducted RF-immunity tests according to IEC/EN 61000-4-6, ISO 11452-4, MIL-STD 461E/F CS114, SAE-J1113-2, DC 10614 and similar standards. Its internal RF-generator and RF-power amplifier produce output signals with max. up to 150 W within a frequency range from 100 (10) kHz up to 400 MHz. Generated signals are measured via one of the max. 3 internal RF-Voltmeters. Furthermore via an optional, internal directional coupler forward and reflected power can be measured. The whole test system allows full automatic tests for the specified frequency range. As a "stand-alone" test system the CIT-10 is convincing by its easy and comfortable handling and the excellent cost-performance ratio. Add-ons like coupling/decoupling devices are available as well.

Special Features:

- Conducted RF immunity tests acc. to IEC/EN 61000-4-6 and BCI tests acc. to ISO 11452-4 and MIL-STD 461E
- Signalgenerator, RF-power amplifier, RF-power meter and directional coupler (optional) in one 19"-case
- Stand-alone operation possible with optional available netbook
- Control-software included
- Most important parameters are shown on an integrated display
- Automatic EUT-monitoring
- Operation via USB port of a PC or Notebook
- Complete range of CDNs available

Applications:

Immunity Testing:

Testing according to IEC/EN 61000-4-6, ISO 11452-4, MIL-STD 461E/F CS114, DC10614 can be performed automatically.

Generation, amplification and verification of RF-Signals:

The internal amplifier amplifies any signal from 100 (10) kHz up to 400 MHz. By using the internal generator a desired narrowband signal can be generated. Signals up to 30 dBm can be measured at the same time. If a directional coupler is installed, forward and reflected power are measured as well.

Compact Immunity Test System CIT-10, 10kHz - 400MHz

acc. to IEC/EN 61000-4-6 / ISO 11452-4 / MIL-STD 461E

Features:

Internal RF-Power Amplifier

Several amplifier modules are available. Highest output power can be 75 W over the specified frequency range. The amplifier input can be accessed via the back panel of the CIT-10, so that the amplifier can also be used with any external generator. 25 W and 75 W amplifiers are available as standard.

Amplitude Modulation

Frequencies generated by the generator can also be modulated with a LF signal. Modulation frequencies may vary from 1 Hz up to 100 kHz, modulation levels are available from 0 % to 100 %.

BCI-Tests with additional RF-Power Meter

For BCI-Tests the CIT-10 can be equipped with up to 3 pieces of internal power meters.

Setup

The CIT-10 is a PC-controlled test equipment. It can be operated by any commercial IBM compatible PC (Microsoft® Windows software) via USB port. All settings of the equipment, e.g. start frequency, stop frequency, step width, test voltage etc. are made by means of the control software which is also included in the delivery. The three functional units RF-signal generator, RF-power amplifier and RF-voltmeter are set automatically by the software, depending on the pre-set test parameters. Each component, however, may also be called and operated as separate measuring and testing equipment. This means: using the CIT-10 as testing system, you have three full, additional "single units" at your disposal, for which separate inputs and outputs are available as BNC connections. Due to the computer-aided control of the CIT-10, any modifications which may become necessary, for example, due to the revision of standards, may be performed without problems and without having to manipulate the hardware of the equipment.

Functioning

The equipment is ready for operation immediately after connection with the USB port and installation of the drivers and the control software. After starting the control software, the main menu offers the manual control of <RF-Generator> and <RF-Power Meter>. Further options in the menu are <Calibration> (<CDN-Calibration>, <Self-Calibration>) and <Test> (<Complete Test>, <Selective Test>).

Internal RF-Voltmeter

Accurate measurements of RF signals from -40 dBm up to +30 dBm are done by the internal RF-voltmeter which can be accessed (for separate use) via a BNC connector. Two internal voltmeters measure the forward and reverse power on an optional available directional coupler. If no directional coupler is installed, the output voltage of the amplifier is measured.

Internal RF-Signal Generator

As the internal generator generates its output signal without any internal mixing components, low harmonics and spurious frequencies are assured.

User defined signals

External signals (e.g. EUT-fail or external instruments) can be connected and monitored using the application software.

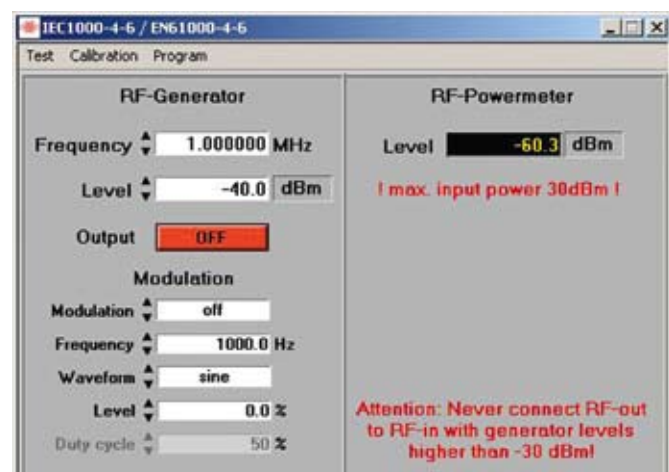

Compact Immunity Test System CIT-10, 10kHz - 400MHz

acc. to IEC/EN 61000-4-6 / ISO 11452-4 / MIL-STD 461E

CDN-Calibration

The CDNs (Coupling/Decoupling Networks) serve to inject the test voltage into the lines to be tested and/or to decouple any connected peripheral equipment from the EUT. The characteristics of the CDNs as well as of the power amplifier are not absolutely linear over the whole frequency range, i.e. the amount of power required to generate a constant test voltage over the whole frequency range varies slightly, depending on the frequency. In the calibration run, the frequency-dependent output level of the signal generator, which is necessary for a constant test voltage, will be determined and stored in the software, together with the defined frequency range and the desired test voltage. The data records thus created may then be stored and recalled for tests.

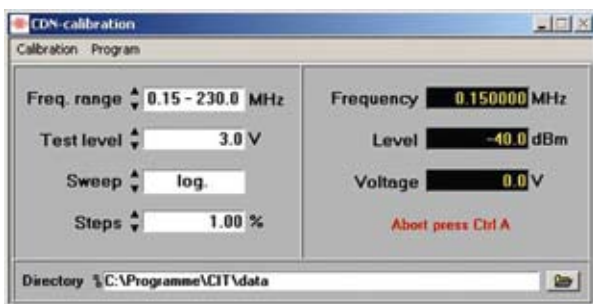

Self-Calibration

When selecting this menu option, the test equipment will perform a self-calibration. In this case, the output of the signal generator must be connected to the input of the voltmeter.

Test

The menu option <Test> offers the selection possibilities <Complete Test>, <Selective Test> and <Protocol>. The settings for a test, e.g. start and stop frequency, step width and test voltage are made automatically via the calibration file of the selected coupling unit. It is now possible to decide whether the test is to be performed exactly according to these pre-settings, i.e. exactly as in the calibration, or whether modifications of the pre-settings shall be admissible. If the calibration run was performed, for example, for a test voltage of 10 V, and the test is to be performed now with 3 V without having to perform a new calibration run for this purpose, this can be done by selecting menu item <Extrapolation>.

Is a suitable measuring instrument connected to the specified serial port of the CIT-10, EUT can be monitored automatically. Data are shown graphically. During all test routines the amplifier output is monitored in a bar display. This guarantees correct tests. In the case of <Complete Test>, a test is performed over the

complete selected frequency range; in this case the test frequency is increased by the control software according to the selected step width and the entered dwell time. If there is a malfunction of the EUT, the test may be stopped at any time. It is then possible to either increase or reduce the frequency by any number of steps, as well as to switch on and off the modulation and test voltage. Besides, a description of the malfunction occurred may be entered in a comment line which is included in the test record.

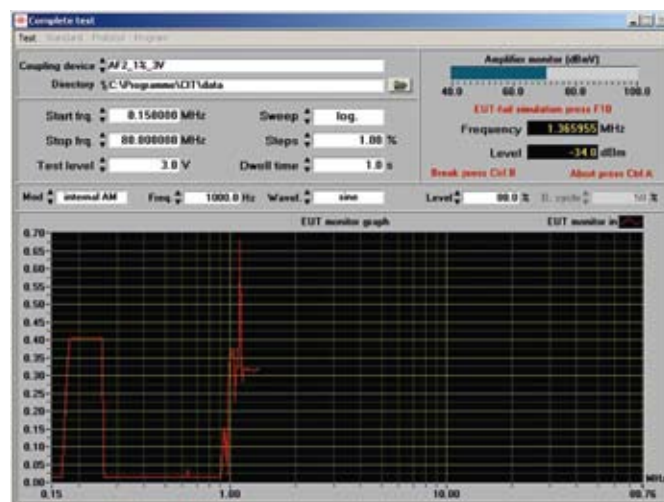

<Selective Test> offers the possibility of testing the EUT at discrete frequencies. This can be done either with a fixed test voltage or, optionally, with a ramp function. In case of the ramp function, the start and stop voltage, the step width by which the test voltage is to be increased, as well as the dwell time between the individual steps may be preset by the tester.

The standard <Protocol> consists of the head of the protocol and a diagram which shows the test results. In the head of the protocol the date and time are taken over from the computer; in addition, details like temperature, air humidity, tester, as well as testing set-up and EUT, may be registered. The protocol may be printed directly. It is also possible to edit the protocol individually.

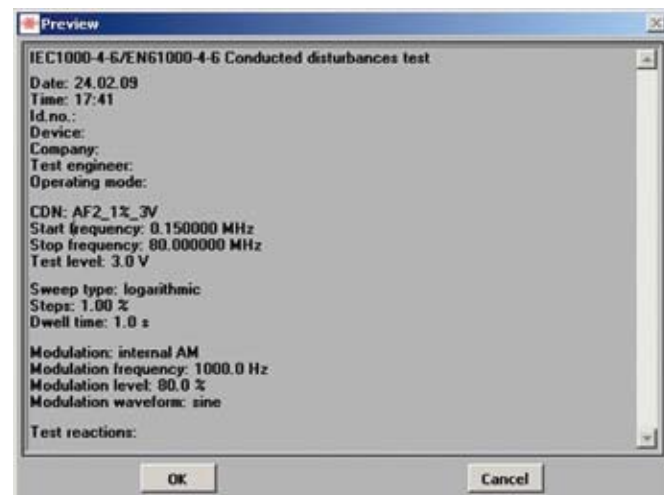

Compact Immunity Test System CIT-10, 10kHz - 400MHz

acc. to IEC/EN 61000-4-6 / ISO 11452-4 / MIL-STD 461E

Technical specifications	
RF Voltmeter (external in-/output)	
Frequency range	10 kHz to 400 MHz
Measuring range	+30 dBm to -40 dBm
Accuracy	±0.5 dB
VSWR	< 1.1 : 1
Input	BNC, 50 Ω
RF-Signal Generator	
Output	BNC, 50 Ω
Frequency range	10 kHz to 400 MHz
Frequency resolution	1 Hz
Output level range	0 to - 60 dBm
Output level resolution	0.1 dB
Output level accuracy	±0.5 dB (± 1 dB max)
Accuracy (frequency)	±5 ppm (TCXO)
Harmonics	< -30 dBc
Non harmonics	< -45 dBc
Amplitude modulation (internal)	0 to 100 %; resolution 0.5 % (internal AF-Generator)
Amplitude modulation (external)	BNC jack 1 Hz to 100 kHz, 0 to 100 % Input impedance > 100 kΩ
Pulse modulation	variable duty cycle 10 - 90 %; resolution 1 % (internal AF Generator)
VSWR	< 1.5:1
AF-Generator	
Output jack	BNC
Frequency range	1 Hz to 100 kHz
Frequency resolution	0.1 Hz
Output voltage	0 to 1 V amplitude; resolution 5 mV
Accuracy (frequency)	±50 ppm
Signal	Sine wave / square wave / triangular
RF-Voltmeter (internal, 2 pcs.)	
Frequency range	10 kHz to 400 MHz
Measuring range	+53 dBm to - 0 dBm
Accuracy	±0.5 dB
Directional coupler (optional)	
Frequency range	10 kHz to 400 MHz
Power	200 W CW
Insertion loss	0.5 dB max
VSWR	1.25 : 1 max
Directivity	20 dB min

Technical specifications	
RF-Power Amplifier	
Frequency range	100 kHz to 400 MHz (75 W) 100 kHz to 250 MHz (25 W)
Gain	51 dB ± 1.5 dB
Output power	75 W 20 W (100 kHz to 230 MHz)
Distortion	<20 dBc at 75 W
Input impedance	50 Ω, VSWR < 1.5:1
Output impedance	50 Ω nom.
EUT-fail input	
Input resistance	2.2 kΩ
Level	TTL/CMOS compatible, optical decoupled
EUT-Monitor input	
Input voltage	0-10 V
Input impedance	100 kΩ
Amplifier monitor	
Output	BNC, 50 Ω
Level	- 40 dB (amplifier output), ±3 dB
Interfaces	
USB-A	Multimeter (for EUT control)
USB-A	Relay switching unit
USB-B	Connection to computer
General data	
Temperature range	0 to 40 °C
Warm-up time	15 min.
Housing	19"-Subrack or desktop case
Dimension (W x H x D)	449 mm x 133 mm x 435.5 mm
AC input	100 - 240 VAC; 50/60 Hz
Volume of delivery	CIT-10 (basic equipment), cabling, system software
Part Number	CIT-10/25 with integrated 25 W RF-power amplifier CIT-10/75 with integrated 75 W RF-power amplifier CIT-10/W without internal RF-power amplifier

Compact Immunity Test System CIT-10, 10kHz - 400MHz

acc. to IEC/EN 61000-4-6 / ISO 11452-4 / MIL-STD 461E

Circuit diagram of a test system according to IEC/EN 61000-4-6:

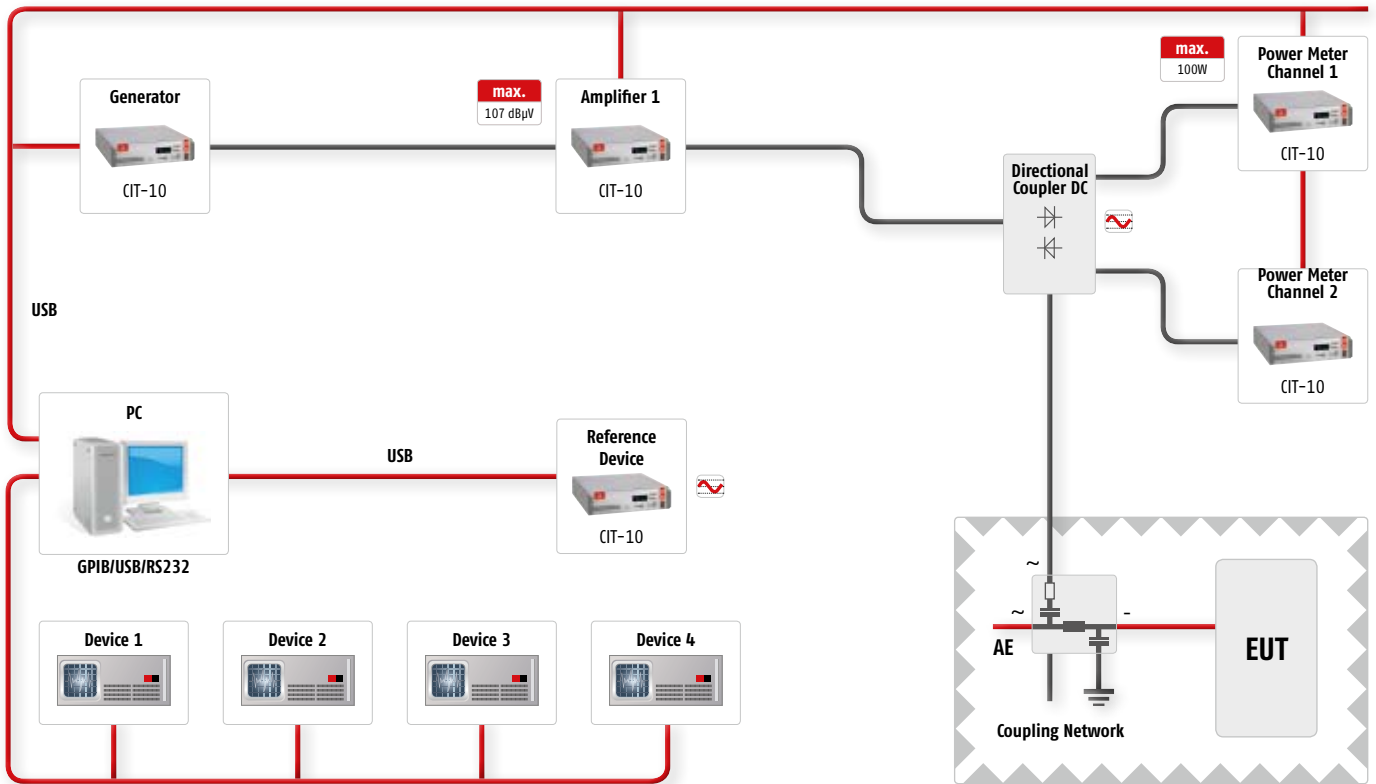

Circuit diagram of a BCI test system:

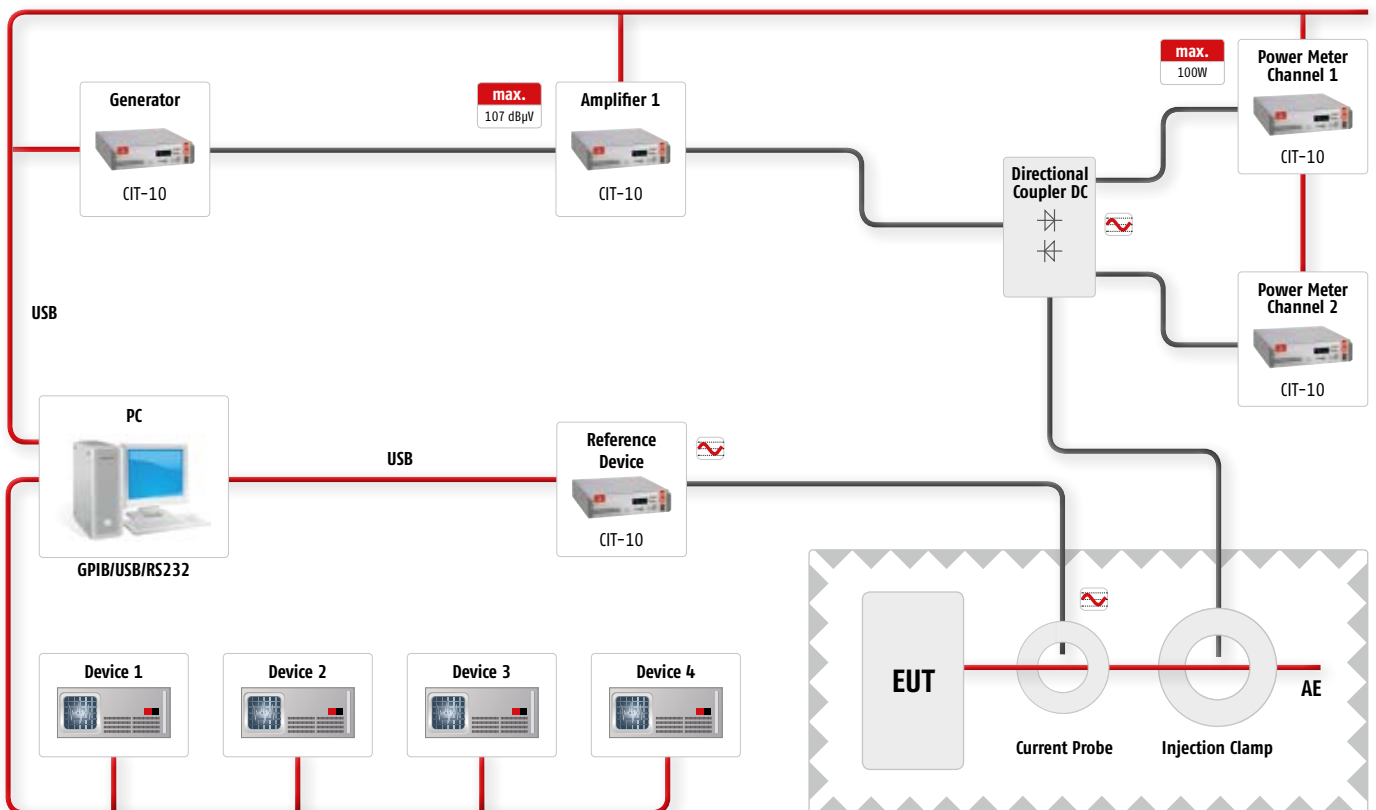

Compact Immunity Test System CIT-10 Coupling / Decoupling Networks (CDNs)

Description

Immunity tests according to IEC/EN require coupling of RF disturbance voltages into any conducting cable of an EUT. Furthermore these disturbances should not be coupled into any further equipment so that a decoupling path to any auxiliary equipment is provided. We offer a wide range of CDNs for different types of interconnected lines which are fully calibrated for the frequency range from 150kHz to 230MHz. The following CDNs are available: M-, AF-, S-, T-, RJ, USB-types. Almost any network can be assembled on customer's requests. Guidance for selecting the appropriate CDN is given in the following table:



Type	Interconnected lines
M1, M2, M3, M4, M5, M2+M3	Unscreened supply (mains)
AF2, AF4, AF5, AF6, AF8	Unscreened nonbalanced lines
S1, S2, S4, S8, S9, S15, S25, S36	Screened lines
T2, T4, T8	Unscreened balanced lines
RJ11, RJ45	Unscreened data lines
RJ11/S, RJ45/S, USB	Screened data lines

Test procedure with Coupling/Decoupling (CDNs) Networks acc. to IEC/EN 61000-4-6:

- The EUT shall be placed on an isolating support, 0.1 m above the ground reference plane. For table-top equipment, the ground reference plane may be placed on a table.
- On all cables to be tested, coupling and decoupling devices shall be inserted.
- The coupling and decoupling devices shall be placed on the ground reference plane, making direct contact with it at about 0.1 – 0.3 m from the EUT.
- The cables between the coupling and decoupling devices and the EUT shall be as short as possible and shall never be bundled or wrapped.
- The height above the ground reference plane shall be between 30 and 50mm (where possible).
- The 6dB attenuator shall be placed to the coupling and decoupling device as near as possible.
- The test shall be performed with the test generator connected to each of the CDNs in turn while the other non-exited RF-input ports of the CDNs are terminated by a 50 Ω load resistor.

Set-up for level setting at the EUT-port of coupling and decoupling devices:

1. The test generator (RF-out) shall be connected to the RF-input port of the coupling device via the 6 dB-attenuator.
2. The EUT port of the coupling device shall be connected in common-mode through the 150 Ω to 50 Ω adaptor to the RF-Voltmeters (calibration).
3. The AE-port shall be loaded in common-mode with a 150 Ω to 50 Ω adaptor, terminated with 50 Ω .

With direct injection to screened cable (CDN S-types), the 150 Ω load at the AE-port is not required as the screen will be connected to the ground reference plane at the AE-port side.

Although the 150 Ω load at the AE-port is mandatory with CDN T-, AF- and M-types calibration data are identical with the AE-port open or short. This is because a capacitor is connected to ground at the AE-port side, which leads to a RF-short-circuit similar to the CDN S-types. This means that even with CDN M-, AF- and T-types the 150 Ω load at the AE-port is not required.

To calibrate a CDN the following items are required:

- adaptor
- fastening angle
- 50 Ω / 150 Ω adaptor

Fastening angle and 50 Ω / 150 Ω adaptor should be ordered for the first CDN. For each following CDN only the specific adaptor has to be ordered.

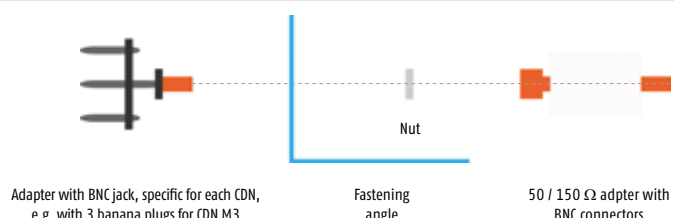

Direct Injection: Any shielded connection to an EUT can also be connected to the RF disturbance voltage via a direct injection adapter.

EM Coupling Clamp – EMCL

for immunity tests acc. to IEC/EN 61000-4-6

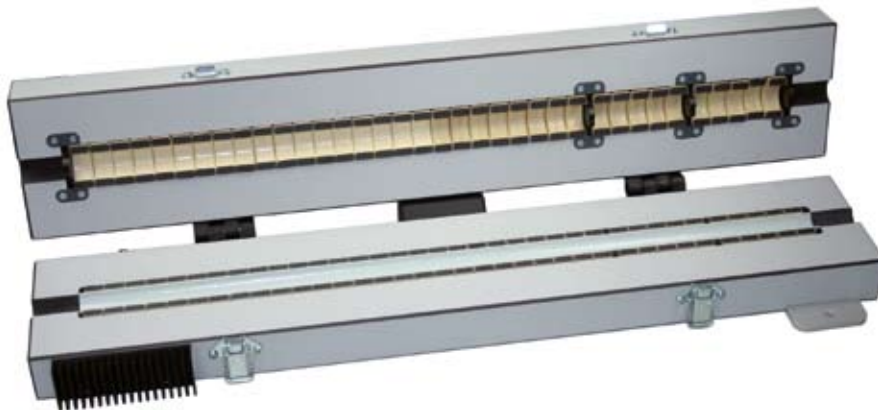

Description

According to IEC/EN 61000-4-6 the preferred coupling and decoupling devices are the CDNs, for reasons of test reproducibility and protection of the AE. However, if they are not suitable or available, clamp injection should be used.

Often, clamp injection needs to be applied to multi-pair balanced cables because suitable CDNs might not be available.

The EM clamp establishes both capacitive and inductive coupling to the cable connected to the EUT.

The EM clamp (in contrast to the conventional current injection clamp) has a directivity ≥ 10 dB, above 10 MHz, so that a defined impedance between the common-mode point of the AE and the ground reference plane is no longer required. Above 10 MHz, the behavior of the EM clamp is similar to that of a CDN.

Features:

- EM-clamp for immunity testing of cables with up to 20 mm diameter
- High coupling factor: less than 15 watts amplifier output power is required to obtain a test level of 10 V
- Calibration unit and calibration data are supplied with each instrument



Calibration unit of EMCL (included as standard)

Technical specifications	
Frequency range	100 kHz – 1000 MHz
Nominal impedance	50 Ω
Connector	N-type female
Maximum input level	
0.15 – 100 MHz	100 W, 15 min.
100 – 230 MHz	100 W, 5 min.
230 – 1000 MHz	50 W, 3 min.
Cable diameter	< 20 mm
Weight	7 kg
Dimension (L x W x D)	655 x 120 x 80 mm

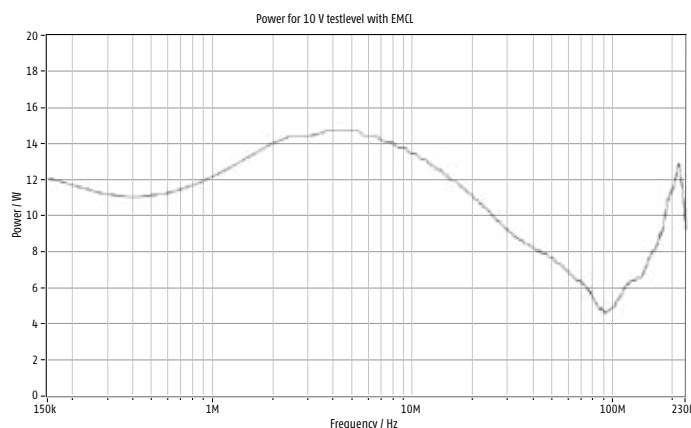

Measured amplifier output power to obtain a test level of 10 V. 6 dB attenuator and 80 % amplitude modulation depth are taken into account.

Magnetic-Field Test System / Low-Frequency Test System for Emission and Immunity Tests / MTS-800



Description

The MTS-800 is a compact test system for broadband generation and measurement of magnetic fields. Its internal components allow automatic EMC tests according to automotive standards where high field strength need to be generated or measured.

In combination with our triaxial Helmholtz coils full automated susceptibility tests are possible at magnetic field strength up to 1000 A/m for frequencies from DC to 1 kHz. Lower field strength can be generated for frequencies up to 250 kHz. Due to the triaxial set-up of our Helmholtz coil major improvement in device handling is achieved because there is no need to turn an EUT during tests.

The MTS-800 complies to all magnetic field requirements of relevant EMC and military standards.

Tests and measurements are controlled by a program which will set most parameter automatically. For any relevant standard, which are fulfilled by the MTS-800, limit values are already included into the software package, although any different value can be defined by a user. After every test full reports will be created automatically. Report layout is pre-defined, though any user-defined layout is possible. High performance is guaranteed by a self-calibration process which utilizes an internal source as reference.

According to

IEC/EN 55103-1/2, IEC/EN 61000-4-16, IEC/EN 61000-4-8, SAE J1113-22, ISO 11452-8, MIL-STD-461E (CE101, RE101, CS101, CS109 and RS101), Automotive manufacturer standards

Special Features:

- Frequency range for emission and immunity measurements: DC – 250 kHz
- 800W precision power amplifier, signal generator and spectrum analyzer in one compact unit
- All instruments may as well be used as stand-alone devices
- Powerful but easy to operate software, fully expandable for future standards modifications
- Standard software allows easy operation, report generation and integration of external measuring instrument for EUT monitoring
- Prepared for connection of external multimeter for EUT control
- Fully automated tests with triaxial Helmholtz coil. Software controlled generation of magnetic field in x-, y- and z- direction; no need to turn the EUT!
- Large variety of extensive accessories available

Magnetic-Field Test System / Low-Frequency Test System for Emission and Immunity Tests / MTS-800

Applications:

Magnetic Field Generation

MTS-800 enables a user to generate strong magnetic fields up to 1000 A/m. Even alternating fields up to 250 kHz can be generated by the magnetic test system.

Automotive Testing

Intensive testing is required for new products which should be used in any automotive application. The MTS-800 allows fast and easy testing according to many automotive standards as described before.

Low Frequency emission and immunity tests

acc. to MIL-STD 461E, CE 101, RE 101, CS 101, CS 109 and RS 101. Individual software modules and hardware accessories are available for each of these tests.

Features:

Automatic Testing Capabilities

Full compliance with several immunity test as ISO 11452-8, MIL-STD-461E/F RS101, CS101, CS109, IEC/EN 55103-2, IEC/EN 61000-4-8, SAE J1113-2, SAE J1113-22, Ford ES-XW7T-1A278-AC, GM W3097, PSA B21 7110, Renault 36-00-808, DC-11224, DC 10614 and similar standards.

Furthermore the MTS-800 allows emission measurements according to MIL-STD-461E/F RE101, CE101 and IEC/EN 55103-1.

Software

Any function is controlled via an application software which also guide the user through any test or measurement. Adaptation of signal strength or measurement graphs are possible at any stage. User defined signals complement the usage for fast and reliable tests. The application software is written in LabVIEW which guarantees stable and fast performance on any Microsoft® Windows platform.

Components

MTS-800 consists of three independent module: a signal generator (DC – 250 kHz), a power amplifier (800 W output maximum, DC – 1MHz bandwidth) and spectrum analyzer (16 Bit, 1 MSPS sampling rate). All modules can be used as stand-alone units.

Self-calibration

Using an ultra-stable voltage source self-calibration correction values are stored in an internal EEPROM. Any voltage signal or voltage measurement device is calibrated at a self-calibration process automatically in about a minute.

Accessories

Frankonia provides also many different coils and loop sensor which are ideally suited for the described tests. Any additional equipment is ready to use without a need for recalibration. Not only our own equipment can be used with the MTS-800, but also user defined coils. A calibration mode is included in the software to complement the magnetic test system with any further equipment.

Magnetic-Field Test System / Low-Frequency Test System for Emission and Immunity Tests / MTS-800

The software starts with the generator/amplifier control panel. This window allows basic settings of generator and amplifier.



Control Panel

Open the Magnetic field measurement window for spectrum analyzer measurements. Perform a single or continuous measurement. Perform test according to predefined standards.

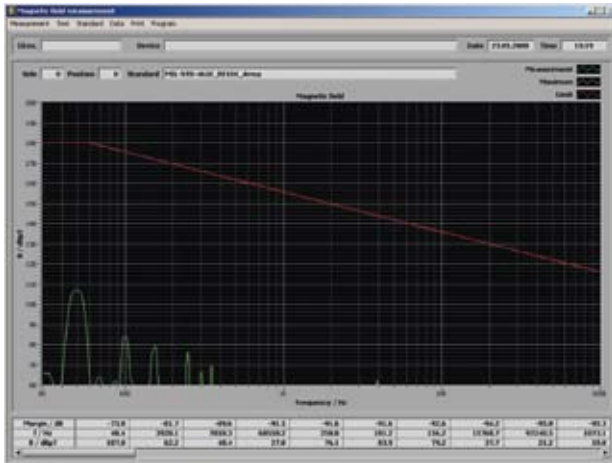

Measurement results

Edit a predefined standard or create a new one. Load, save and print data.

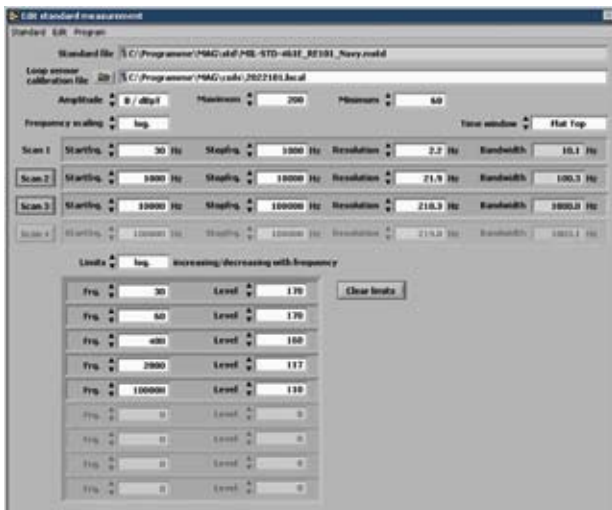

Example standard file for MIL-STD-461E / RS101_Navy

Open the Magnetic field generation window for susceptibility tests according to predefined standards.



Standard generation window

Open the continuous generation window for long term magnetic field test.



Magnetic field continuous generation window

Further features and possibilities:

Susceptibility tests with fixed frequencies and test levels or use the ramp function to sweep from start to stop level. Verify the generated field of any radiating coil with loop sensor.

Short term generation window for short term magnetic field tests (optional).

Scope mode window.

Determine the coil factor of an unknown coil

Self calibration of the MTS-800

Magnetic-Field Test System / Low-Frequency Test System for Emission and Immunity Tests / MTS-800

Technical specifications	
Voltage input (Analyzer)	
Frequency range	DC - 250 kHz
Input impedance	1 M Ω / 50 Ω switchable
Connector	XLR, unbalanced
Max. input voltage	100 V continuous (attenuator autoset at overvoltage); 10 V at 50 Ω
Gain	-20/0/20 dB Preamplifier, 0/20/40 dB ADC Amplifier; Self-calibration with ultra stable on-board reference
Current input	
Frequency range	DC - 250 kHz
Shunts	10 m Ω / 1 Ω / 100 Ω
Max. input current	20 A continuous (overload protection); 1 Ω and 100 Ω shunt are protected by an additional 1.5 A fuse
Connector	4 mm safety jack (+, -) measurement via insulation amplifier or input jacks
Measurement range	20 A, 10 A, 1 A, 100 mA, 10 mA, 1 mA automatic offset and gain; Self-calibration with ultra stable on-board reference
AD converter	
Resolution	16 Bit
Sampling rate	1.25 MSPS
Aliasingfilter	0.01 dB Tschebyscheff filter, fg = 260 kHz; filter may be switched off
Generator	
Frequency range	DC - 250 kHz
Output impedance	50 Ω
Connector	BNC, unbalanced
Signal	Sine wave / triangular /square wave/ DC
Amplitude	0 to 10 VAC, -10 V to +10 VDC
Resolution	12 Bit (2.5 mV), Switchable - 20 dB Attenuator; Self-calibration with ultra stable on-board reference
Amplifier	
Frequency range	DC - 1 MHz
Connector	4 mm safety jacks (output); BNC, unbalanced (input)
Current	16 Arms
Voltage	50 Vrms / 75 VDC
Distortion (DC-100 kHz, load \geq 4 Ω)	< 0.10 %
General data	
EUT control / Connector	9-pin Sub-D; RS232
Connection to Computer	USB
Temperature range	0 to 40 $^{\circ}$ C
Warm-up time	15 min.
Housing	19"-Subrack or desktop case
Dimensions (W x H x D)	449 x 177 x 580 mm
Weight (shipping)	approx. 40 kg (net 34 kg)
Gain	10 \pm 0.1 % (\pm 0.01 % / $^{\circ}$ C)

Magnetic-Field Test System / Low-Frequency Test System for Emission and Immunity Tests / MTS-800

Options

- Common mode test adapter for balanced signal and control connections according to IEC/EN 55103-3
- Calibration network for common mode test adapter according to IEC/EN 55103-2
- Current transducer for balanced video connections according to IEC/EN 55103-2
- Enclosed variable transformer for short term field according to IEC/EN 61000-4-8; prim. 230 V, sec. 0 to 230 V, max. current 20 A; incl. supply cable



Radiating loop RL_120

Helmholtz Coils

Several Helmholtz coils are available for susceptibility tests. We also offer tri-axial Helmholtz coils which are suitable for MTS-800. To achieve 1000 A/m at 1 kHz, it is absolute necessary to use our Helmholtz coils and an optional compensation board.

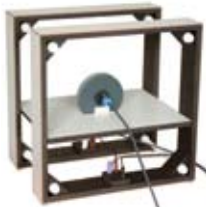

Helmholtz coil HCS_50/28_TAP with loop sensor RLS_133



Triaxial Helmholtz coil HCST_50/28_TAP



Loop sensor LS_40

Coil-Type	Technical specifications
HCST_50/28_TAP	Tapped triaxial Helmholtz coil for immunity tests
HCS_50/28_TAP	Tapped single axis Helmholtz coil for immunity tests
	Designed for the generation of magnetic fields with field strength > 1000 A/m
HCS_125/75_TAP	Tapped single axis Helmholtz coil for immunity tests according to IEC/EN 55103

Loop Sensors / Radiating Loops

For immunity tests we offer radiating loops which are necessary to generate magnetic fields. The required loop sensors for measuring emission can also be ordered.

Coil-Type	Technical specifications
RL_120	120 mm radiating loop according to MIL-STD-461E
LS_040	Electrostatically shielded loop sensor according to MIL-STD-461E
LS_133	Electrostatically shielded loop sensor according to MIL-STD-461E
RLS_133	Electrostatically shielded loop sensor according to IEC/EN 55103-1/2
	Can be used as radiating loop and loop sensor



Loop sensor LS_133

Coupling Transformer

MIL-STD-461E CS 101 requires a coupling transformer for conducted susceptibility tests. Frankonia has developed a coupling transformer which meets all requirements. Due to direct coupling to voltage mains, the coupling transformer has an additional differential amplifier for common mode rejection of the AC mains. Using the coupling transformer without this amplifier can destroy any measurement instrument due to overvoltage.



Coupling transformer CT 2.5/50 AC with differential amplifier

Magnetic-Field Test System / Low-Frequency Test System for Emission and Immunity Tests / MTS-800

Testing equipment acc. to IEC/EN 55103-2:

IEC/EN 55103-2 requires certain immunity tests for frequencies from 50 Hz to 10 kHz. The following test equipment fulfils all requirements according to IEC/EN 55103-2, annex B.



Current transducer incl. correction network



Calibration network



Common mode test adapter

Technical specifications for all accessories are available on request.

Accessories selecting table:

Test equipment MIL-STD 461E	Recommended Model	CE101	CS101	CS109	RE101	RS101
Measurement receiver	MTS-800	•		•	•	•
Current probe	Any commercially available model	•		•		•
Signal generator	MTS-800	•	•	•	•	•
Power amplifier	MTS-800		•	•		•
Data recording device	MTS-800	•			•	
Oscilloscope	MTS-800	•	•			
Coupling transformer	CT_2.5/50 AC		•	•		
Isolation transformer	IT-6/-16/-20/-20/3P		•	•		
LISNs	Any commercially available model	•	•		•	•
Radiating loop 12cm	RL_120					•
Loop sensor 4cm	LS_040					•
Loop sensor 13.3cm	LS_133				•	
Ohmmeter	Any commercially available model				•	
Standards						
CE101	Conducted Emission, Power Leads, 30 Hz to 10 kHz					
CS101	Conducted Susceptibility, Power Leads, 30 Hz to 150 kHz					
CS109	Conducted Susceptibility, Structure Current, 60 Hz to 100 kHz					
RE101	Radiated Emission, Magnetic Field, 30 Hz to 100 kHz					
RS101	Radiated Susceptibility, Magnetic Field, 30 Hz to 100 kHz					

Power Signal Generator – PSG-300

acc. to IEC/EN 61000-4-16, DC – 300kHz and IEC/EN 61543, 1kHz – 150kHz



Option: PSG-E300

Description

The PSG-300 contains a linear precision power amplifier with a wide bandwidth (DC-300 kHz), suitable for all applications concerning fast alternating signals at high output power. The built in generator provides sine, square and triangle waves. Communication between PSG-300 and PC is via USB connection. The application software is suited for general power generator applications and for immunity tests according to IEC/EN 61000-4-16 as well as to IEC/EN 61543. Short term tests are enabled by phase controlled switching of an external power source (optional). The PSG-300 is equipped with a silent, temperature-controlled fan. Internal safeguards protect the amplifier from overheating and high power dissipation. They also assure protection against short-circuits and overload.

The number one choice for all applications with the need for fast and powerful signals, e.g.:

- Simulation of DC/AC supply lines
- Generation of magnetic fields with Helmholtz or similar coils
- Control of piezo actors
- Immunity testing according to IEC/EN 61000-4-16
- Calibration devices etc.

Features:

- Short circuit and overload protection
- Completely linear and low noise design
- Outstanding DC stability
- Over temperature switch off
- Protection / Ready LED
- EUT-fail input
- EUT-monitor input

Options

PSG-E300	External power source for short term test 300 V @ DC, 16 2/3 Hz, 50 Hz, 60 Hz
PSG-EXT	Input connector for phase controlled switching of external power source

Technical specifications	PSG-300	PSG-300A
Amplifier		
Frequency range	DC – 1 MHz (small signal -3 dB)	
Power bandwidth	DC – 200 kHz	
Slew rate	100 V/μs	
Offset	±1 mV (±0.1 mV/°C)	
Gain	10 ±0.1 % (±0.01 %/°C)	
Output voltage	50 V _{eff} / ±75 V _{peak}	
Output current	5 A _{eff} / ±7.5 A _{peak}	16 A _{eff} / ±23 A _{peak}
Power output	250 W	800 W
Distortion (DC – 100 kHz, load ≥ 4 Ω)	< 0.10%	
Input impedance	100 kΩ	
Max. input voltage	80 V (cont.), 100 V (< 1 min)	
Noise (10 Hz – 1 MHz, input: 50 Ω)	0.5 mV _{eff}	
Output connector	4 mm MC	
Output connector 50 Ω	BNC	
Generator		
Frequency range	DC, 0.05 Hz – 300 kHz	
Frequency resolution	0.05 Hz	
Frequency accuracy	± 20 ppm	
Waveform	Sine, square, triangle	
External generator input	BNC	
General data		
Remote control	USB connector	
Dimension (L x W x D)	448,9x132,55x435,50 mm	448,90 x 177 x 585,50 mm
Weight	approx. 14 kg	approx. 30 kg

Isolation Transformers IT-6/-16/-20/-20/3P

Universal Coupling Network M2345/32-16

acc. to IEC/EN 61000-4-16

Isolation Transformers IT-6/-16/-20/-20/3P

Description

Disturbances shall not be coupled into any support instruments. This requires decoupling of the lines. In many cases isolation transformers are used for decoupling. We offer a wide range from 6A/1-phase to 20A/3-phase. All isolation transformers are compliant to IEC/EN 61000-4-16.



Technical specifications	IT-6	IT-16	IT-20	IT-20/3P
Voltage	230 V	230 V	230 V	380 V/230 V
Current	6 A	16 A	20 A	20 A
Phase	1-phase	1-phase	1-phase	3-phase

Universal Coupling Network M2345/32-16



Description

As described in IEC/EN 61000-4-16 at the frequency of the electrical power supply (either DC, 16 2/3 Hz, 50 Hz or 60 Hz) the test stimuli are applied as both continuous and short-duration disturbances. Otherwise, over the frequency range 15 Hz to 150 kHz, the test stimuli are applied as continuous disturbances only. The normal duration for short duration disturbances at the electricity supply frequency is one second. The M2345/32-16 is a multifunctional coupling network for test levels up to ± 300 V in connection with test generators MTS-800, PSG-300 and PSG-E300. In this case the M2345/32-16 is remote controlled via the application software of the test generators. Otherwise the coupling network may be front panel operated as a stand-alone device. The M2345/32-16 operates as a M2, M3, M4 or M5 coupling network. The selection can be made by a rotary switch. The coupling capacitor is shorted out for the DC tests by a push-button. For automated test you may toggle between AC and DC tests via the USB-port.

Features:

- Switchable coupling network M2, M3, M4, M5 acc. IEC/EN 61000-4-16
- Current rating up to 125 A
- For continuous and short term tests up to ± 300 V
- Remote control in connection with MTS-800, PSG-300 and PSG-E300
- May be used as stand-alone device as well

Description

Immunity test for coupling conducted, common mode disturbances in a frequency range from 0 Hz to 150 kHz onto cables of EUT is described in IEC/EN 61000-4-16. It requires a CN (coupling network) depending on the type of line. Following CNs are available: AF-, M- and T-type. The test setup requires a separate decoupling of the AE (additional equipment) which shall be done by means of isolation transformers, fibre optical transmitters etc. An overview that helps to select the appropriate CN is given as follows:

Technical specifications	AF2-16	AF4-16	AF8-16
	for unscreened, non-balanced lines		
Frequency range	DC/15 Hz – 150 kHz		
Test level	50 V cont.		
Number of lines	2	4	8
Max. current	0.5 A		
Max. voltage	40 VAC / 50 VDC		



CN M-type

Technical specifications	M2-16	M3-16	M4-16	M5-16	M2/DC-16	M3/DC-16
	for power supply lines					
Frequency range	15 Hz – 150 kHz				DC	
Test level	50 V cont., 300 V (1s) at energetically used frequencies				50 V cont.	
Number of lines	2	3	4	5	2	3
Max. current	32 A					
Max. voltage	250 VAC / 200 VDC				50 V	

Technical specifications	T2-16
	for unscreened, balanced lines
Frequency range	DC/15 Hz – 150 kHz
Test level	50 V cont.
Number of lines	2
Max. current	0.5 A
Max. voltage	150 VAC / 200 VDC



CN T-type

Control Software - CR-LAB

acc. to IEC/EN 61000-4-3/-6/-20, ISO 11452-4, automotive and military standards

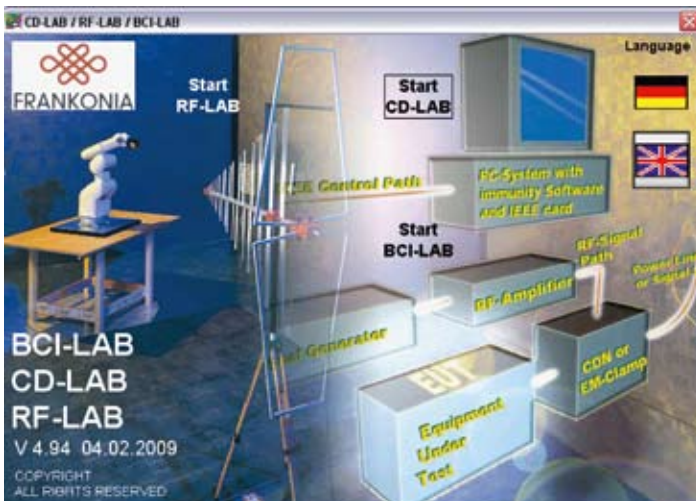

Short description

The software CR-LAB consisting of RF/CD/BCI-LAB controls test systems for radiated, conducted or BCI immunity measurements. The system configuration is done in a graphical setup. Tests can be performed manually with optical monitoring of the EUT or fully-automatic by up to 4 measuring instruments. Calibration data and test results are presented in professional reports, which contain all necessary data. For radiated immunity measurements calibration data can be calculated from the field uniformity measurements or measured calibration runs. For BCI immunity measurements calibration can be performed using online control method or calibrated clamp method. Each version of our software is a separate version and includes special features according to application.

Device selection in RF-LAB

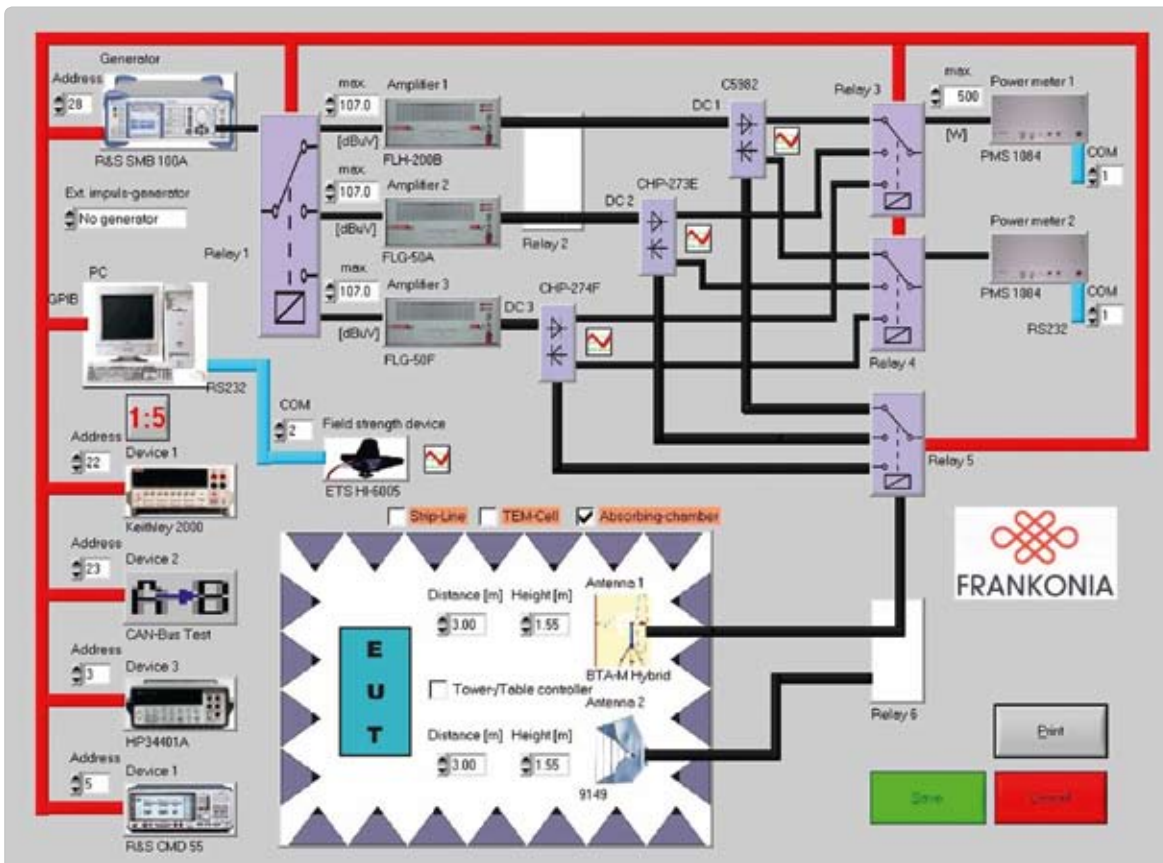

Special Features

- Online-help function
- Graphical device specification
- Input of calibration data for all devices
- Test function for system check
- Generation of calibration file for testing by calculation from homogeneous field data or measurement
- Saturation test of test system as requested by standard
- Testing by manual optical monitoring
- Allows detailed examination by manual increase /decrease of the applied test level during test (RF-LAB/CD-LAB)
- Testing by automatic monitoring / evaluation of EUR with up to 4 measuring instruments
- Measurement and evaluation of field uniformity
- Presentation of results in online graphics
- Professional reporting system
- Export function for files for further processing in Microsoft® Word, Microsoft® Excel,...
- German/English language switchable
- Customized modifications possible

Technical Data

- Microsoft® Windows-platform
- Requires standard PC
- Control of test system by IEEE-488 (GPIB)-BUS, RS232-bus and USB
- Recommended GPIB-interface card: National Instruments

Control Software - CR-LAB

acc. to IEC/EN 61000-4-3/-6/-20, ISO 11452-4, automotive and military standards

Device selection in CD-LAB

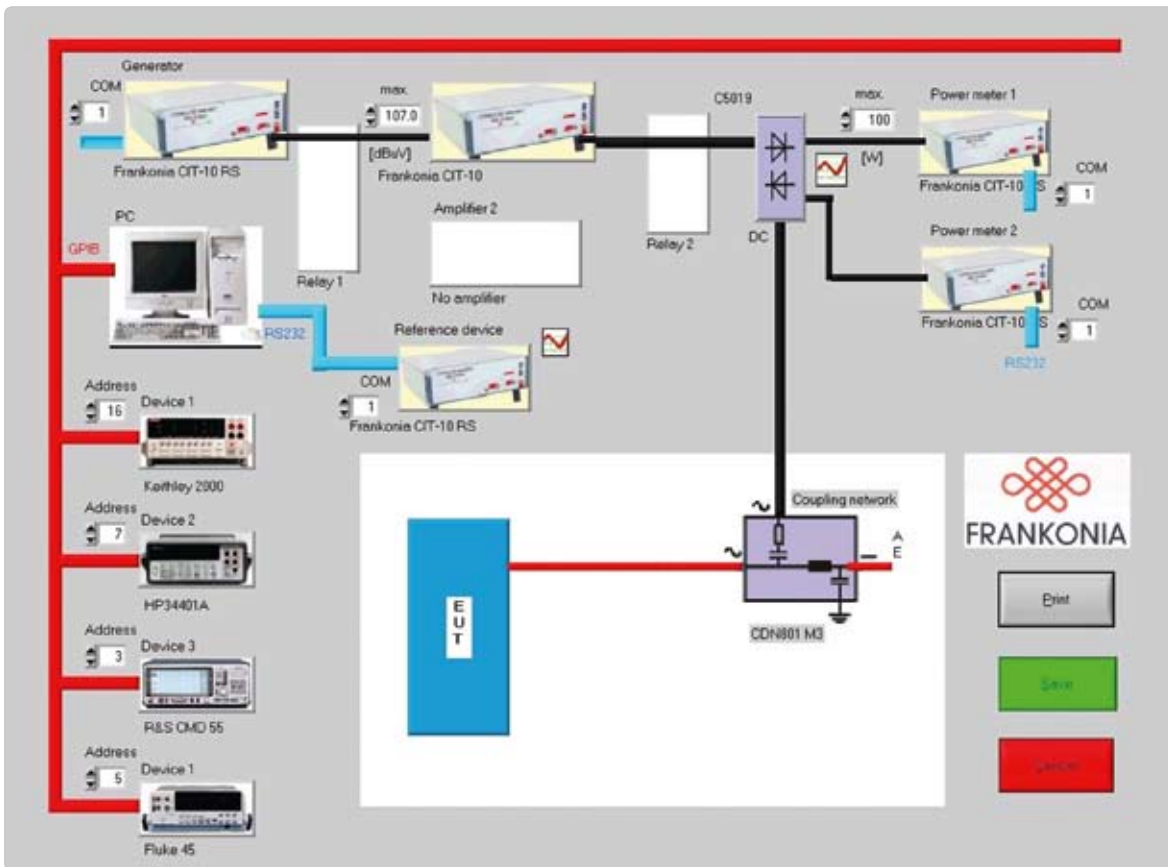

Device selection in BCI-LAB

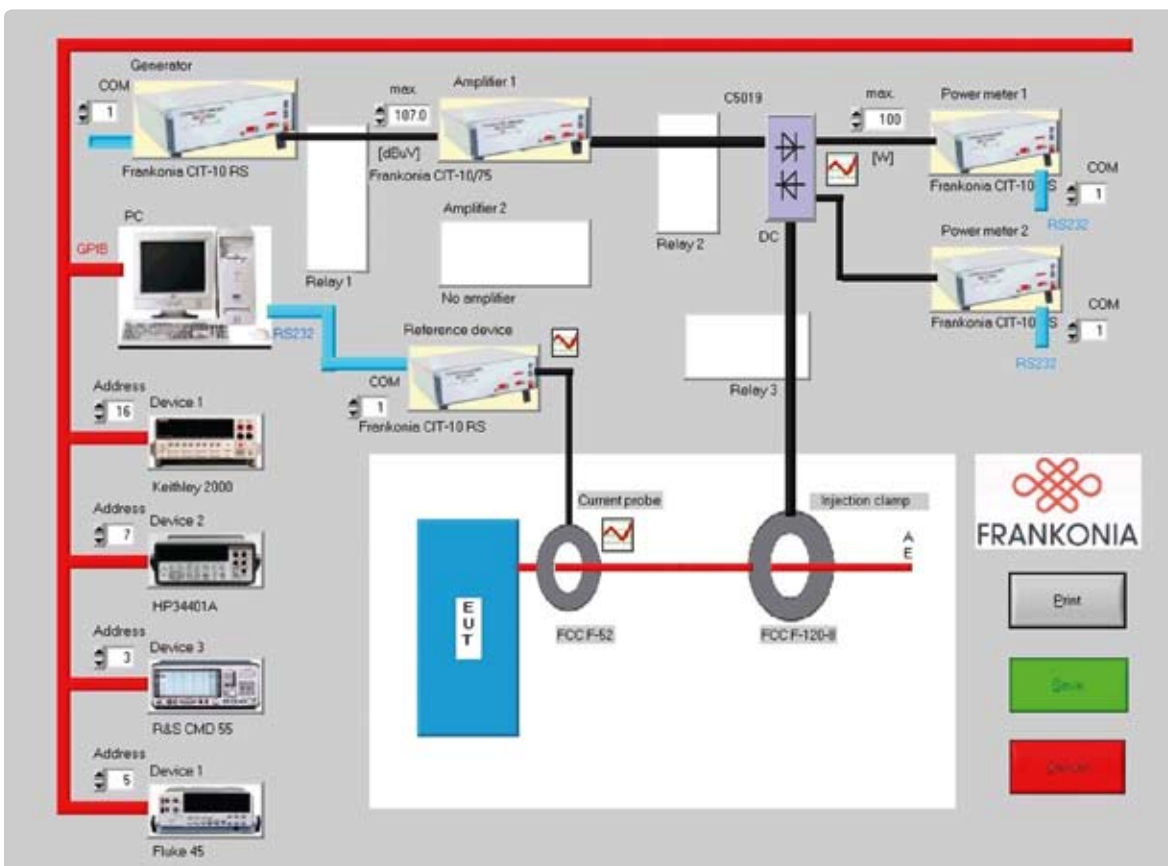

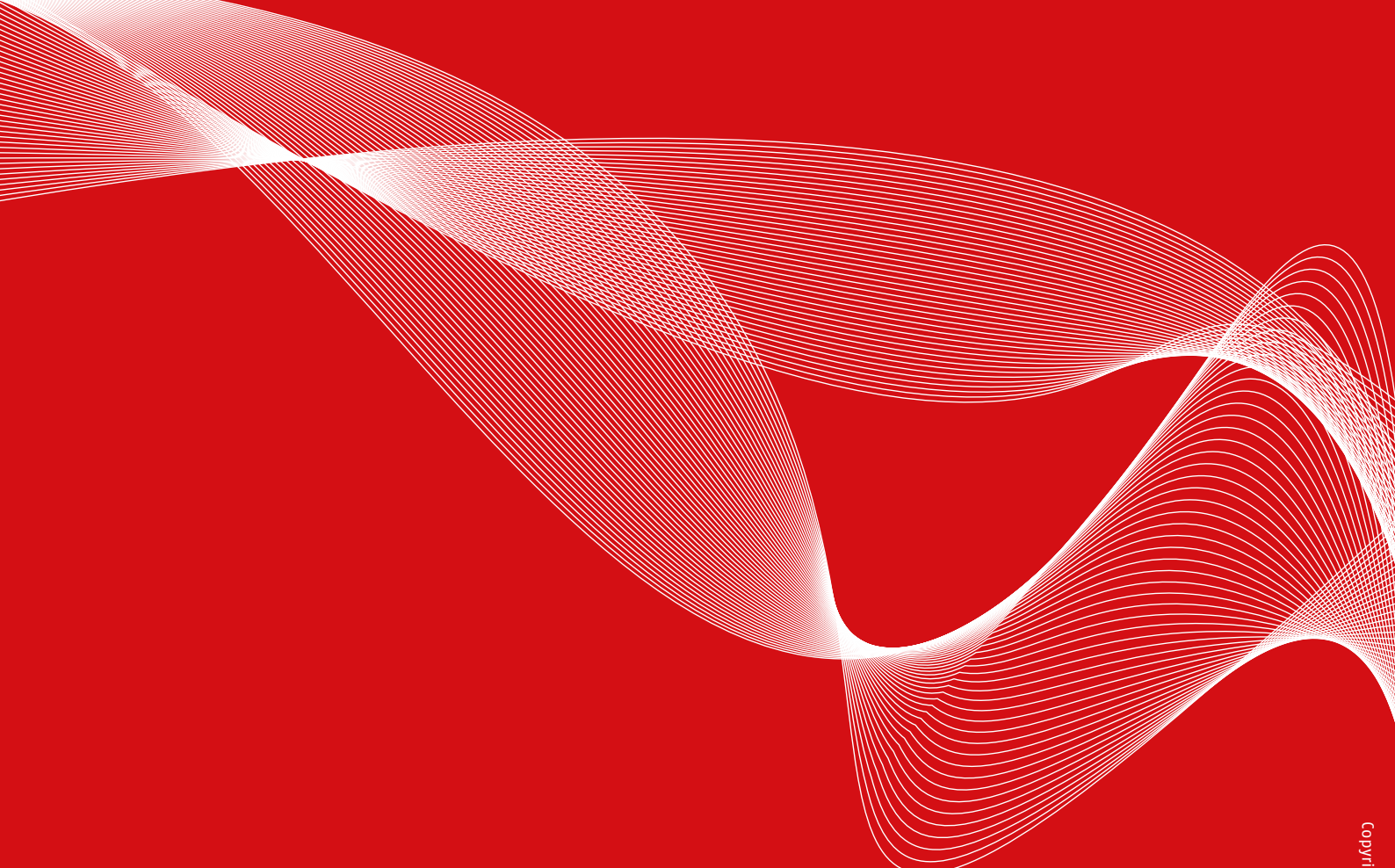

FRANKONIA

Frankonia EMC Test-Systems GmbH
Daimlerstraße 17, 91301 Forchheim
Germany

Web. www.frankonia-emv.com
Mail. sales@frankonia-emv.com

Tel. +49 (0) 91 91 / 73 666 - 0
Fax. +49 (0) 91 91 / 73 666 - 20

Frankonia GmbH
Industriestraße 16, 91180 Heideck
Germany

Web. www.frankoniagroup.com