

Test & Measurement Catalog 2017



R&S®RTO2000
Turn your signals into success

Excellent signal fidelity, high acquisition rate, innovative trigger system and a clever user interface are what you get with a Rohde&Schwarz oscilloscope.



R&S®NRP18SN with R&S®NRP2
Power Sensor with Power Meter



R&S®ESW
EMI Test Receiver



R&S®FPH
Handheld Spectrum Analyzer

Test & Measurement Catalog 2017

Chapter	Contents	Page
	Company profile	2
1	Wireless communications testers and systems	6
	<ul style="list-style-type: none"> ▮ Radio testers ▮ Protocol testers ▮ Conformance and preformance testers ▮ Analog radio testers ▮ System accessories 	
2	Oscilloscopes	33
	<ul style="list-style-type: none"> ▮ Digital oscilloscopes, probes ▮ Hardware and software options, accessories 	
3	Signal and spectrum analyzers	51
	<ul style="list-style-type: none"> ▮ Signal and spectrum analyzers (top class, general pupose, handheld) ▮ Accessories for R&S®FSx analyzers ▮ Application-specific solutions ▮ Modulation analyzers 	
4	Signal generators	103
	<ul style="list-style-type: none"> ▮ RF vector signal generators ▮ RF analog signal generators ▮ Baseband signal generators ▮ Application-specific solutions ▮ Software solutions 	
5	Network analyzers	141
	<ul style="list-style-type: none"> ▮ Vector network analyzers ▮ Converters ▮ Accessories for network analysis 	
6	Mobile network testing	159
	<ul style="list-style-type: none"> ▮ Benchmarking ▮ Optimazation ▮ RF scanner ▮ Service quality monitoring ▮ Software 	
7	EMC and field strength test solutions	178
	<ul style="list-style-type: none"> ▮ EMI precompliance/compliance ▮ EMS/EMF measurements ▮ EMC software ▮ Broadband amplifiers ▮ RF test chambers, EMC accessories 	
8	Power meters and power sensors	215
	<ul style="list-style-type: none"> ▮ Power meters ▮ Power sensors 	
9	Audio analyzers	226
	<ul style="list-style-type: none"> ▮ Audio analyzers, audio switcher 	
10	Modular instruments	231
	<ul style="list-style-type: none"> ▮ Open test platform 	
11	Broadcasting test and multimedia	243
	<ul style="list-style-type: none"> ▮ RF signal generation ▮ RF signal analysis ▮ Audio/video generation ▮ Audio/video analysis 	
12	Power supplies	267
	<ul style="list-style-type: none"> ▮ Power supplies 	
13	Multimeters, power analyzers	271
	<ul style="list-style-type: none"> ▮ Multimeters ▮ Power analyzers 	
14	System components	274
	<ul style="list-style-type: none"> ▮ Open switch and control platform ▮ I/Q data recorder ▮ Test executive software ▮ Step attenuator 	
	Appendix	281
	<ul style="list-style-type: none"> ▮ Service and support, trademarks 	
	Index	293
	<ul style="list-style-type: none"> ▮ Index by type 	

For more than 80 years, Rohde & Schwarz has stood for quality, precision and innovation in all fields of wireless communications.

The privately owned company group has a global presence. It develops, produces and markets a wide range of electronic capital goods for industry, infrastructure operators and government customers.

Rohde & Schwarz is among the market leaders in all of its business fields, including wireless communications, EMC and TV test and measurement, TV broadcasting and technologies related to the interception and analysis of radio signals.

Numerous subsidiaries and representatives not only ensure competent and customer-oriented on-site support anywhere in the world, they also safeguard customer investments with comprehensive service and support offerings.

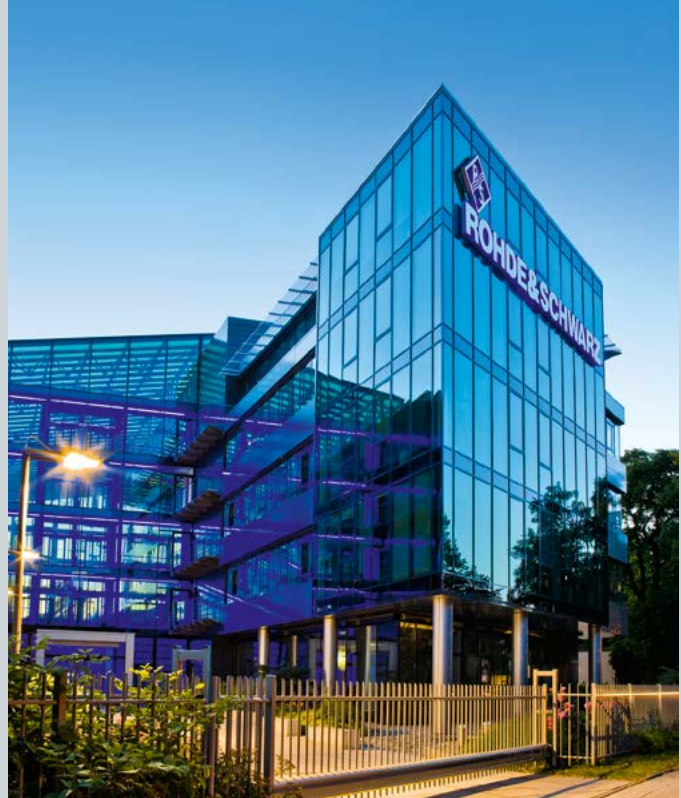

Our business fields

Test and measurement

T&M instruments and systems for wireless communications, automotive, general purpose electronics and aerospace and defense applications

Broadcast and media

Broadcast, T&M and studio equipment for network operators, broadcasters, studios, the film industry and manufacturers of entertainment electronics

Secure communications

Communications systems for air traffic control (ATC) and armed forces, encryption technology for government authorities and critical infrastructures

Cybersecurity

Security products to protect IT infrastructures against cyber attacks

Monitoring and network testing

Spectrum monitoring and mobile network testing systems for regulatory authorities and network operators as well as COMINT and ELINT systems for homeland and external security

Test and measurement

Rohde & Schwarz is one of the world's largest manufacturers of electronic test and measurement equipment. Our products set standards in research, development, production and service. As a key partner of industry, network operators and public institutions, we offer a broad spectrum of market-leading solutions for the latest wireless technologies as well as for microwave applications up to 500 GHz.

The progress that has been made in the fields of aerospace, automotive and material testing as well as the increasing demand for bandwidth in communications promote the trend toward ever higher frequencies in electronics. Rohde & Schwarz meets the needs of these markets by offering cutting-edge products for signal generation, signal analysis, network analysis and power measurements – in all performance classes, from value to high-end. As the market leader, we deliver all the instruments and systems needed to confirm the electromagnetic compatibility of products with their technical environment.

Our test and measurement portfolio

- Test and measurement solutions for all wireless technologies
 - Testers for wireless devices and components
 - Systems for conformance and acceptance testing in line with all standards and test criteria
 - Test and measurement solutions for network optimization
- Signal and spectrum analyzers
- Network analyzers
- Oscilloscopes
- Signal generators
- Mobile network testing
- EMC and field strength test solutions
- Power meters and voltmeters
- Audio analyzers
- Modular instruments
- Power supplies
- RF and microwave accessories
- System components
- Broadcasting and video T&M and monitoring solutions (see next page)

Test and measurement.



Broadcast and media

TV viewers and radio listeners in more than 80 countries receive their programs via transmitters from Rohde&Schwarz. Our transmitters as well as our T&M and studio equipment are advancing the progress of digital broadcasting and the processing of high-resolution video formats around the globe.

We offer broadcasters, studios and network operators solutions for the production, post production and distribution of audiovisual signals. Our solutions support all formats and resolutions and cover the entire signal processing chain – from the recording location to the network feed via headends and to terrestrial broadcasting.

Rohde&Schwarz supplies producers of consumer electronics with all necessary T&M equipment for the development and production of satellite receivers, TVs and other consumer electronics equipment, also and especially for high-resolution formats such as UHD. Rohde&Schwarz multistandard platforms cover the wide variety of broadcast and video technologies, providing great flexibility at all stages of the value chain.

Secure communications

Radiocommunications systems Today's military missions are typically based on joint operations in a multinational environment. The key to success is achieving information superiority through network centric operations. Rohde&Schwarz supplies interoperable radiocommunications systems for deployment on land, at sea and in the air. Our solutions use efficient encryption methods that satisfy the highest national and international security standards.

Civil air traffic control agencies in 80 countries and at more than 200 airports and ATC centers count on reliable radio systems from Rohde&Schwarz. The company offers complete, state-of-the-art, IP-based communications solutions – from the controller working position to the antenna.

Encryption technology Rohde&Schwarz develops highly secure products for protected voice and data transmission via wireless and fixed links – for the military, government authorities and critical infrastructures.

Cybersecurity

According to the estimates of reliable organizations, cyber attacks, especially theft of intellectual property, cause worldwide economic damage in the three-digit billion dollar range. Intangible assets are not the only industry assets that need protection. Confidential personal data, which can run to large volumes in the financial sector, health care and online commerce, also has to be protected.

Our broadcast and media portfolio

- Digital and analog TV transmitters for all power classes and all conventional standards worldwide
- Digital and analog audio broadcast transmitters
- Audio/video headends
- Broadcasting and video T&M and monitoring solutions
- Hardware and software for professional film and video post production

Our secure communications portfolio

- Integrated communications systems for civil and military ATC as well as for the army, navy and air force
- Encryption technology for all classification levels

Broadcast and media.



Secure communications.

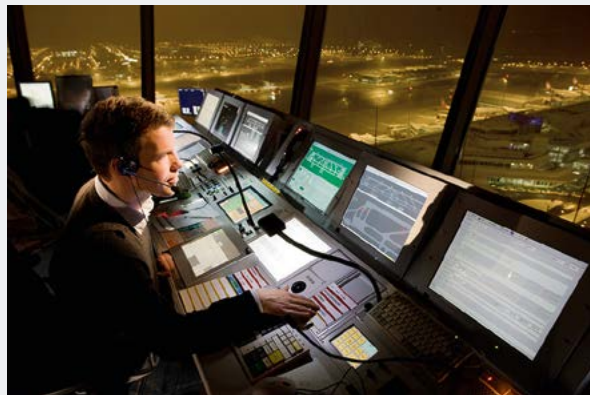

We offer a wide range of technologically leading solutions for protecting IT infrastructures. These range from easy-to-administrate, all-in-one security solutions for small and medium-sized enterprises (SME) to complete, secure IT infrastructures.

Monitoring and network testing

The demand for mobile, wireless exchange of information is continually increasing, but the usable frequency spectrum for radiocommunications and broadcasting is limited. As a result, it can be expensive when the market determines the price, e.g. in spectrum auctions. That is why it is important that regulatory authorities ensure proper technical and legal use of the spectrum. Network operators also have a vital interest in an error-free, performance-optimized infrastructure and require technical means to ensure this service.

Rohde&Schwarz provides the necessary equipment. The company's receivers, direction finders, signal analyzers, antennas and customized systems have made Rohde&Schwarz a reliable partner for its customers for decades. Applications include sovereign spectrum management by regulatory authorities and technical monitoring of radio networks by their operators, as well as securing critical infrastructures such as power plants and electronic intelligence to ensure homeland and external security.

Services

Rohde&Schwarz operates a global service network in order to safeguard the investments of its customers. The following on-site services are offered worldwide:

- ▮ Calibration
- ▮ Maintenance and repair
- ▮ Product updates and upgrades

Rohde&Schwarz regional service centers, plants and specialized subsidiaries provide a wide range of additional services:

- ▮ System integration
- ▮ System support
- ▮ Installation and commissioning
- ▮ Application support
- ▮ Development of customized modules, instruments and systems
- ▮ Software development
- ▮ Mechanical and electrical design
- ▮ Manufacturing to order
- ▮ Technical documentation
- ▮ Logistics concepts

Service that adds value

- ▮ Worldwide
- ▮ Local and personalized
- ▮ Customized and flexible
- ▮ Uncompromising quality
- ▮ Long-term dependability

Our cybersecurity portfolio

- ▮ Firewalls
- ▮ Encryption technology
- ▮ Secure smartphones
- ▮ Secure browsers
- ▮ Secure infrastructures

Our monitoring and network testing portfolio

- ▮ Radio intelligence systems
- ▮ Radar signal analysis systems
- ▮ Spectrum monitoring systems
- ▮ Satellite monitoring systems
- ▮ Signal analysis systems
- ▮ Receivers
- ▮ Direction finders
- ▮ Antennas
- ▮ Solutions for analyzing IP data streams

Monitoring and network testing.



Services.



Chapter 1

Wireless communications testers and systems

To keep the backbone of mobile communications running, powerful mobile networks and mobile devices are needed. Rohde & Schwarz offers a full portfolio of wireless communications testers and systems for the complex measurements involved. The multistandard, modular and highly flexible wireless communications test solutions from Rohde & Schwarz support all main cellular communications, wireless connectivity, GNSS and broadband standards in one box.

They can easily be extended to cover the latest standard enhancements. Benefit from high-speed, high-precision and exceptional flexible testing solutions – Rohde & Schwarz is the right partner to satisfy your test requirements.



Type	Designation	Description	Page
Radio testers			
R&S®CMW500	Wideband radio communication tester	All-in-one test platform for wireless devices	8
R&S®CMW290	Functional radio communication tester	The compact RF tester for service and IoT functional tests	10
R&S®CMW270	Wireless connectivity tester	The non-cellular expert covering WLAN, Bluetooth®, GNSS and various broadcast technologies	11
R&S®CMW100	Communication manufacturing test set	The compact RF tester for production	12
R&S®CMWrun	Sequencer software tool	Ready-to-use solution for configuring RF and data application test sequences by remote control	13
Protocol testers			
R&S®CMW500	Protocol tester	One tester for all phases of development	14
R&S®CMWcards	Signaling tester	Smart network emulation for all wireless device tests	15
R&S®CMWmars	Multifunctional logfile analyzer	Powerful message analyzer for all R&S®CMW applications and use cases	16
R&S®CMW-ATE	Terminal testing solution for IMS and VoLTE	Test solution for testing of IP multimedia subsystem (IMS) and voice over LTE (VoLTE) functionality of wireless devices, from R&D to conformance testing	17
R&S®CMW-PQA	Test system for performance quality analysis	Automated performance quality analysis (PQA) test solution	18
Conformance and preformance testers			
R&S®TS8980	RF/RRM test system for LTE, WCDMA and GSM	Platform for testing needs, from development to conformance testing	19
R&S®TS-ITS100	RF conformance test system for IEEE 802.11p	Integrated test system for testing IEEE802.11p conformity and performance of user equipment	20
R&S®TS-RRM	LTE and WCDMA RRM test system	Standalone platform for radio resource management (RRM) testing of wireless devices in line with 3GPP LTE, 3GPP WCDMA and operator test plans	21
R&S®TS-LBS	Test system for location based services	Comprehensive test solution for network and satellite-based location technology testing of wireless devices and chipsets	22
R&S®TS8991	OTA performance test system	CTIA-compliant OTA measurements – LTE and MIMO inside	24
R&S®TS8996	RSE test system	Fully automatic emission measurements on wireless communications equipment required for R&D and quality assurance	25
R&S®TS8997	Regulatory test system for wireless devices	For compliance with ETSI EN300328 V1.8.1/V1.9.1 in 2.4 GHz band, ETSI EN301893 V1.7.1/V1.8.1 in 5 GHz band and FCC §15.247, FCC §15.407	26
Analog radio testers			
R&S®CMA180	Radio test set	The reference in radio testing	27
R&S®CTH	Portable radio test set	Always on duty	28
System accessories			
R&S®DST200	RF diagnostic chamber	Accurate radiated testing of wireless devices from 400 MHz to 18 GHz	29
R&S®CMW-Z10/-Z11	RF shielding box and antenna coupler	Excellent shielding effectiveness and superior coupling characteristics	30
R&S®TS712x	Shielded RF test chambers	Reliable RF tests on devices with radio interface	30

R&S®CMW500

Wideband Radio Communication Tester



All-in-one test platform for wireless devices

The R&S®CMW500 is the universal tester for testing the air interface of wireless devices. The R&S®CMW500 can be used in all phases of product development and production and supports all common cellular and non-cellular wireless technologies. The R&S®CMW500 supports and tests all protocol layers – from the RF to end-to-end data.

The scalable option-based concept allows it to be adapted to any application.

The R&S®CMW500 can handle the following:

- ▮ LTE-A up to Cat. 10
- ▮ Wireless standards and broadcast technologies, e.g. LTE (incl. MIMO), WLAN or DVB-T and associated inter-RAT measurements
- ▮ All phases of development, verification and production
- ▮ All protocol layers, from RF tests and protocol tests to end-to-end application tests
- ▮ Module tests, system and integration tests, regression tests, conformance tests and production tests
- ▮ Multi-CMW solution for testing more complex LTE-A requirements

To adapt the R&S®CMW500 to the requirements of the application, the user simply has to select the appropriate hardware and software components. Rohde & Schwarz offers preconfigured models for a number of important applications.

Platform overview – preconfigured models

	<p>R&S®CMW500 The all-in-one test platform</p>	<p>The R&S®CMW500 wideband radio communication tester is the universal test platform for RF integration and protocol development. It is available as the R&S®CMW500 callbox and the R&S®CMW500 protocol tester. The R&S®CMW500 includes a fully integrated end-to-end data solution that permits comprehensive IP throughput and quality measurements. Thanks to the internal fading simulator, it is easy to perform tests under realistic propagation conditions. The R&S®CMW500 can be used in all phases – from product development to production to service. It is the solution with the widest range of supported technologies.</p>
	<p>R&S®CMW290 The compact RF tester for basic functional tests</p>	<p>The R&S®CMW290 functional radio communication tester is the cost-effective compact version of the R&S®CMW500. The tester is the right instrument for users who need to measure fundamental RF characteristics or verify the functionality of wireless devices. The R&S®CMW290 provides service companies with a high-quality, customized, automated test environment for functional input and output tests. Powerful network emulation allows IoT/M2M system integrators to functionally test module integration and custom IP applications.</p>
	<p>R&S®CMW270 The expert for all non-cellular technologies</p>	<p>The R&S®CMW270 wireless connectivity tester is a cost-effective alternative for development, production and service. The non-cellular specialist offers features comparable to those of the R&S®CMW500. It supports Bluetooth®, WLAN and broadcast technologies.</p>
	<p>R&S®CMW100 The compact RF tester for production</p>	<p>The R&S®CMW100 communications manufacturing test set is based on the R&S®CMW platform. The flexible RF interface permits simultaneous testing of up to eight RF ports. The R&S®CMW100 remote control and measurement concepts are compatible with the R&S®CMW500. Both testers also use the same methods for optimizing test time and capacity utilization. The R&S®CMW100 can be used to cost-effectively calibrate and verify wireless devices in non-signaling mode (analyzer/generator).</p>

One tester for the entire product lifecycle

The modular R&S®CMW platform covers all test requirements in all phases of the product lifecycle. With just one basic investment, a wireless device can be tested over its

entire lifecycle – from development to certification and network optimization to production and service. An existing configuration can easily be modified to handle other T&M tasks.

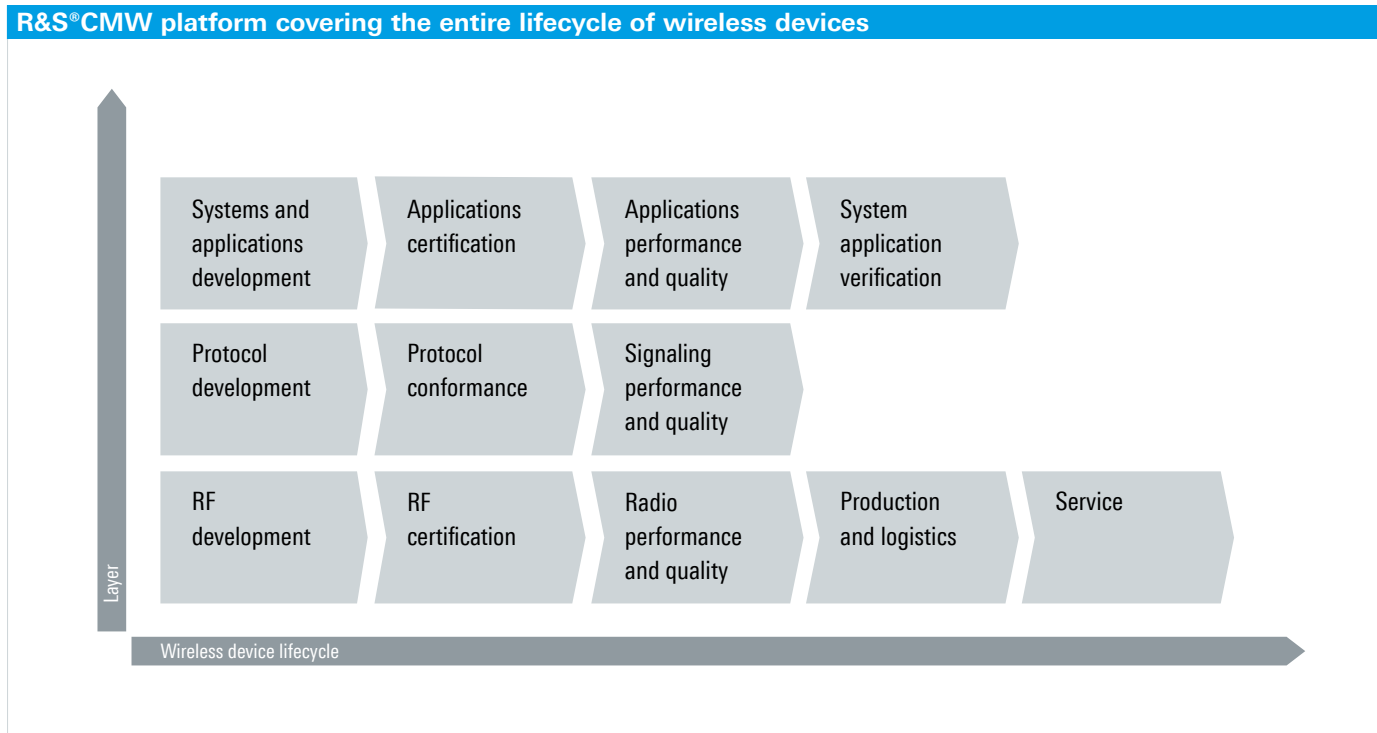

Use of the R&S®CMW platform for wireless technologies

Technology	RF generator	RF analyzer	Network emulation	Protocol testing	End-to-end application testing	Fading support
Cellular technologies						
LTE-A	•	•	•	•	•	•
WCDMA/HSPA+	•	•	•	•	•	•
GSM/GPRS/EGPRS	•	•	•	•	•	•
CDMA2000® 1xRTT, CDMA2000® 1xEV-DO	•	•	•	• (inter-RAT LTE)	•	•
TD-SCDMA	•	•	•	• (conformance tests)	•	•
Non-cellular technologies						
WLAN IEEE 802.11a/b/g/n	•	•	•	• (offloading use cases)	•	
WLAN IEEE 802.11p/ac	•	•				
Bluetooth® (BR/EDR/LE)	•	•	• (LE in direct test mode)			
IEEE 802.15.4 (ZigBee)	•	•				
Z-wave	•	•				
Broadcast technologies						
GNSS (GPS, Glonass, Beidou)	•					
DVB-T	•					
T-DMB	•					
CMMB	•					

R&S®CMW290 Functional Radio Communication Tester



The compact RF tester for service and IoT functional tests

The R&S®CMW290 is the right instrument for users who measure fundamental RF characteristics or perform Go/NoGo checks in line with communications standards. It verifies that the frequencies and levels of the DUTs comply with specifications to ensure proper operation and that they do not interfere with other electronic devices. Since the tester supports all common cellular and non-cellular standards, both handover and coexistence tests can be performed.

The R&S®CMW290 is also the ideal solution for network emulation and functional testing of integrated wireless modules in IoT communications. Not only can users verify that the RF module was correctly installed in the system, they can also verify that the IP-based applications were correctly configured by connecting the devices client software to built-in server software or forwarding IP traffic to external servers.

- Use cases
 - Functional tests of cellular and non-cellular devices in IoT services, reverse logistics and module assembly
 - Calibration of cellular devices in service and reverse logistics
- Simultaneous support of all common wireless communications standards – cellular and non-cellular up to 6 GHz on up to two channels
- Basic RF measurements with/without signaling and pure functional tests
- Configurable, simple R&S®CMWrun user interface (R&S®CMW-KT050) for efficient test sequence execution
- Optional: integration of manufacturer software to adjust RF modules
- Proven R&S®CMW quality, developed for long-term use in production environments

R&S®CMW270 Wireless Connectivity Tester



The non-cellular expert covering WLAN, Bluetooth®, GNSS and various broadcast technologies

The R&S®CMW270 is a cost-effective alternative for the development and production of equipment outside conventional cellular networks, and is specifically designed for the test requirements of IoT (Internet of Things) market. It is a tailored subset within the R&S®CMW500 product family. In addition to WLAN IEEE 802.11a/b/g/n network emulation and Bluetooth® Classic signaling support, the R&S®CMW270 includes generator and analyzer functionality.

The R&S®CMW270 was developed to meet the specific requirements of R&D, production, quality assurance, service and network interoperability testing (IOT) – with a single, tailorable instrument. It is an ideal choice for demanding performance tests and measurements in labs and production – from IP application testing under fully controlled network conditions with a MIMO base station emulator to high-speed RF and baseband alignment with dual-tester configuration.

- Continuous frequency range up to 6 GHz
- Multiple standard RF measurements for WLAN and Bluetooth®
- General-purpose ARB generation for WLAN, Bluetooth®, GPS and broadcast technologies
- WLAN IEEE 802.11a/b/g/n network emulation
- Bluetooth® BR/EDR/LE test mode support
- Bluetooth® classic signaling support
- Simultaneous uplink burst measurements during signaling connection, PER/BER and message analyzer
- IP-based end-to-end test for WLAN
- Dual-tester concept with R&S®Multi-Evaluation list mode for speed and cost-optimized production

Specifications in brief

Frequency		
Frequency range	R&S®CMW270	70 MHz to 6 GHz
Max. frequency drift	R&S®CMW270 base unit	$\pm 1 \times 10^{-6}$
	with R&S®CMW-B690A option (OCXO extension)	$\pm 5 \times 10^{-8}$
	with R&S®CMW-B690B option (highly stable OCXO extension)	$\pm 5 \times 10^{-9}$
RF generator		
RF output level range	continuous wave (CW), RF1 OUT	-130 dBm to +8 dBm
Output level uncertainty	in temperature range from +20°C to +35°C, no overranging, output level > -120 dBm	< 0.6 dB (12-month calibration interval), < 0.8 dB (24-month calibration interval)
IF bandwidth		70 MHz
RF analyzer		
RF input level range	continuous power (CW), RF1 COM, RF2 COM	-84 dBm to +34 dBm
Level uncertainty	in temperature range from +20°C to +35°C	< 0.5 dB (12-month calibration interval), < 0.7 dB (24-month calibration interval)
IF bandwidth		40 MHz
Arbitrary waveform generator (with R&S®CMW-B110A option)		
Arbitrary waveform files	maximum sample length	256 Msample
Sample rate	maximum	100 MHz
Memory size		min. 1 Gbyte

R&S®CMW100 Communication Manufacturing Test Set



The R&S®CMW100 together with the R&S®TS7124 RF shielded box for device testing.

Production solutions for multi-DUT testing

The R&S®CMW100 communication manufacturing test set is a new trendsetting product for calibrating and verifying wireless devices. This follow-up to the R&S®CMW500 focuses on production needs.

The R&S®CMW100 can perform receiver and transmitter tests for cellular and non-cellular technologies. Like the R&S®CMW500, the R&S®CMW100 features high measurement accuracy. The R&S®CMW100 offers parallel testing and can be used to optimize test time and capacity utilization.

The R&S®CMW100 provides high flexibility in a minimum of space. Based on a new eco-friendly hardware concept, it features extremely low energy consumption and a very compact size. The R&S®CMW100 reduces testing costs and is ideal for use in fully automated robotic production lines.

- Turnkey R&S®CMWrun based production solution for different chipset suppliers
- Continuous frequency range up to 6 GHz
- Multitechnology solution
- Parallel testing on up to eight RF ports
- High measurement performance
- High measurement accuracy
- Support of a wide range of methods for reducing test time and maximizing capacity utilization
- Minimum space requirements and footprint
- Low weight
- Silent
- High MTBF

R&S®CMWrun Sequencer Software Tool

Ready-to-use solution for configuring RF and data application test sequences by remote control – for all standards supported by the R&S®CMW family

The R&S®CMWrun sequencer software tool meets all requirements for executing remote-control test sequences on the R&S®CMW500 in R&D, quality assurance, production and service for both current and future wireless equipment. Typical applications are RF pre-conformance tests according to 3GPP, IP throughput test, battery life tests, video and audio (VoLTE) performance tests, coexisting tests and many more.

The software engine is based on the execution of test DLLs (plug-in assemblies). This architecture not only allows easy and straightforward configuration of test sequences without knowledge of specific remote programming of the instrument, it also provides full flexibility in configuring parameters and limits of the test items provided in the R&S®CMWrun package options for the different standards.

When the test focus is on preformance RF testing in line with the specification rather than 3GPP validation testing, the right choice is the R&S®CMW500 RF tester, remotely controlled via R&S®CMWrun. RF preformance testing in line with 3GPP is available for LTE, WCDMA-HSPA, GSM, CDMA2000, 1xRTT/1xEV-DO.

Using a standalone R&S®CMW500 and with just a few configuration clicks for bands, channels and bandwidth, the tool provides a comprehensive result report, giving the user a first impression of in-band compliance. This provides benefits in the very early stage of verification, before doing more complex system tests or validation.

The preformance testing solution is available in the following standard-specific R&S®CMWrun options:

- R&S®CMW-KT053 WCDMA/HSPA and GSM (planned)
- R&S®CMW-KT054 for TDSCDMA
- R&S®CMW-KT055 for LTE/FDD and TDD
- R&S®CMW-KT058 for CDMA2000® 1xRTT/1xEV-DO

R&S®CMWrun use cases

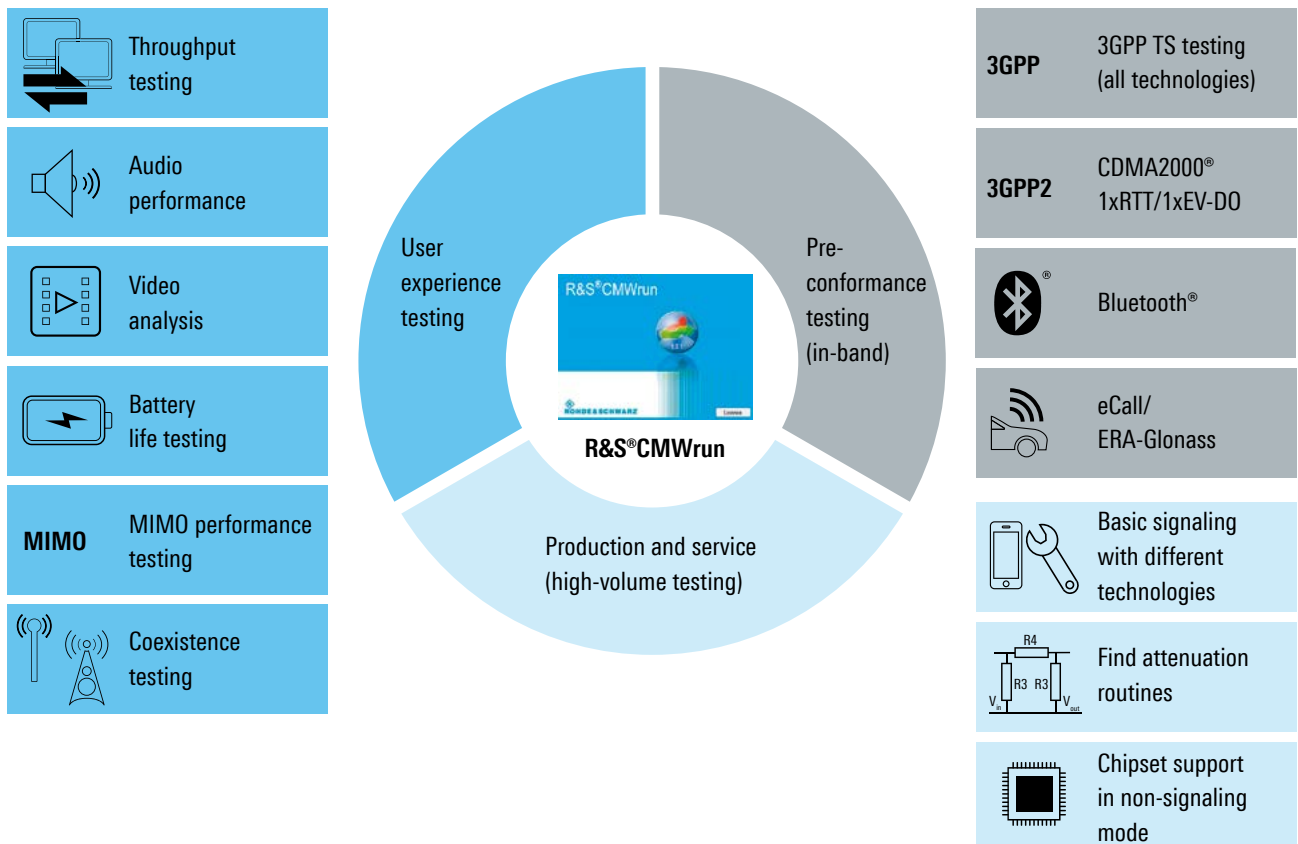

R&S®CMW500 Protocol Tester

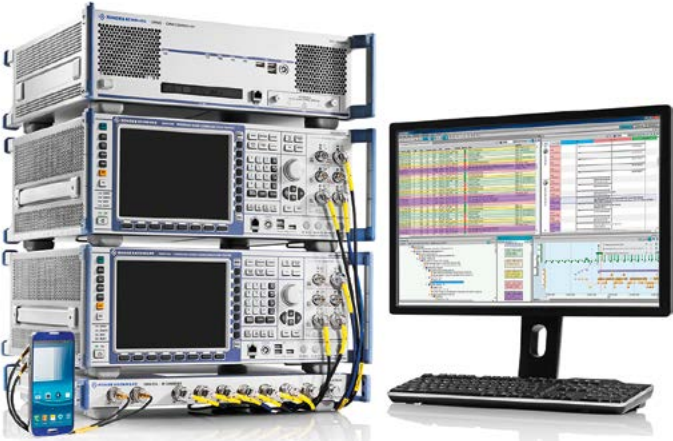

One tester for all phases of development

The R&S®CMW500 is the ideal multitechnology protocol tester, as it provides developers of wireless devices with a radio access network simulation. Equipped with powerful hardware and various interfaces to wireless devices, the R&S®CMW500 can be used throughout all phases of LTE device development – from the initial software module test to the integration of software and chipset in R&D, as well as GCF and PTCRB certification testing of conformance and performance tests of the protocol stack of 3GPP-compliant wireless devices. The R&S®CMW500 provides developers of LTE protocols with a specification-conforming reference implementation of the air interface. The comprehensive functions of the programming interfaces and the highly detailed representation in the analysis tools can be used to quickly detect discrepancies in the DUT protocol stack.

Hardware platform

- ▮ LTE protocol tester with a layer 1 to layer 3 protocol stack implementation in accordance with 3GPP Rel. 8 to Rel. 11, incl. LTE-A features such as CA
- ▮ Future-ready, powerful RF hardware that supports the 3GPP-defined LTE bandwidths from 1.4 MHz to 20 MHz and all 3GPP frequency bands up to 6 GHz
- ▮ For LTE-A, any combination of bands and bandwidth can be tested up to 4 carriers, incl. MIMO (multi-CMW)
- ▮ Data rates up to 600 Mbps in the downlink and 100 Mbps in the uplink
- ▮ Integration of the DUT via RF or digital I/Q interface (realtime, reduced clock); adaptation to customer-specific digital I/Q standards via external adapter unit
- ▮ I/Q over IP mode possible on software-based tests
- ▮ Digital baseband fading with internal fading simulators
- ▮ 2x2, 4x2, 8x2 MIMO
- ▮ Multicell and multi-RAT capability for LTE and LTE-A intracell, intercell and inter-RAT handover tests (GSM, WCDMA, CDMA2000, 1xEV-DO, WLAN)

Software components

- ▮ Development environment for layer 1 to layer 3 signaling scenarios with automatic configuration of the layers below (MLAPI)
- ▮ TTCN2, TTCN3 libraries and software tools for developing LTE signaling conformance test cases
- ▮ Extensive library with preconfigured messages and signaling scenarios for speeding up test development
- ▮ Practice-proven R&S®CMWmars software tool for carrying out, working on, automating and analyzing signaling scenarios
- ▮ Graphical test script tool R&S®CMWcards for simplified creation of wireless signaling tests

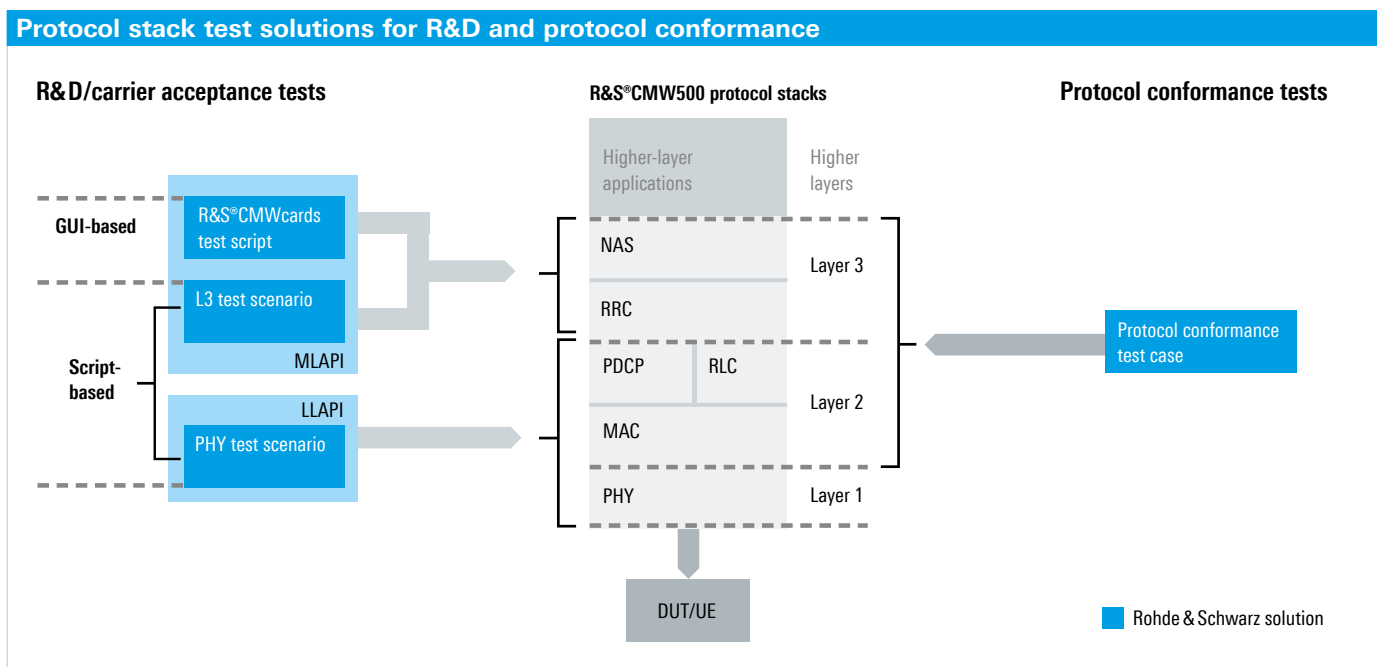

R&S®CMWcards Signaling and Application Tester

Smart network emulation for all wireless device tests

The R&S®CMWcards graphical test script definition tool lets users set up the tests they always wanted, but never had time to implement. Wireless signaling and application tests can be created on the R&S®CMW by simply setting up a hand of cards – no programming required.

Revolutionary card wizards and unique game rules guide users through setting up test sequences that fully comply with test specifications. They can rapidly reproduce signaling scenarios for various wireless communications standards.

Key facts

- ▀ Just GUI, no programming, no code compilation
- ▀ Test creation, parameterization, execution and analysis in a single tool
- ▀ Multicell support (up to six independent cells)

- ▀ Logfile and failure cause analysis with the R&S®CMWmars message analyzer
- ▀ Full test script and DUT automation
- ▀ More than 100 sample test cases included

Applications

- ▀ Protocol stack feature verification
- ▀ Regression testing
- ▀ Replication of field issues
- ▀ Roaming use cases
- ▀ Simulation of network failures and reject causes
- ▀ Data throughput and performance measurements
- ▀ Application tests (data, voice and video)

Testing scope

- ▀ Layer 3 signaling tests for 3GPP LTE (Rel. 8 to Rel. 12), WCDMA, GSM and inter-RAT
- ▀ 3GPP LTE Rel. 10 carrier aggregation
- ▀ LTE-U and LTE-LAA
- ▀ Cell selection, redirections and handovers
- ▀ IMS and VoLTE including CS fallback and SRVCC
- ▀ LTE-WLAN offload
- ▀ Evolved multimedia broadcast multicast service (eMBMS)
- ▀ Failure scenarios
- ▀ CMAS (WEA) and ETWS public warning system

R&S®CMWcards sample scenario for LTE inter-RAT and multicell tests

Test case simulation

Different views for parameterization and monitoring

CMW MAR	OK	Network
Initial Connect Transfer	0	
Initial Packet Data Service Request	0	
Establishment/Handover/Release	3	
Release/Handover/Release	3	
UTRAN-to-LTE Handover	4	
LTE-to-UTRAN Handover	5	
Initial Connect Transfer	6	

R&S®CMWmars Multifunctional Logfile Analyzer

Powerful message analyzer for all R&S®CMW applications and use cases

R&S®CMWmars is the message analyzer for all R&S®CMW signaling applications. Users can efficiently analyze recorded message logfiles or trace information on the fly in realtime while a test is running. The convenient, intuitive R&S®CMWmars user interface combined with various tools and views helps users quickly narrow down the root cause of signaling protocol and lower layer problems.

The multifunctional logfile analyzer provides access to all information elements of all protocol layers for LTE, WCDMA, GSM, TD-SCDMA, CDMA2000®, WLAN and Bluetooth®, including the IP layer. It is well-established as the standard analysis tool for customers such as chipset manufacturers, handset manufacturers and network operators as well as for device certification in test houses.

- Access to all protocol stack layers of all wireless technologies, including the IP data layer
- Easiest filtering thanks to optimized GUI usability
- Inline message and message content comparison
- Pass/fail view at a glance
- Smart UE capability view for DUT features at a glance
- Unique graphical timeline view for chronological analysis
- Easy navigation in logfiles with powerful full-text search features and bookmarks
- Realtime display of message flow (online tracing) during test case execution
- Effective graphical protocol measurement charts for throughput and BLER measurements on all layers
- Postprocessing (offline analysis) of recorded message logs
- Powerful scripting interface for automatic logfile analysis using predefined macros

R&S®CMWmars message logfile for a WLAN offload measurement

The screenshot displays the R&S CMWmars interface with several key components:

- High-level message flow:** A central pane showing a sequence of protocol messages such as RRC Connection Request, RRC Connection Setup Complete, and RRC Connection Setup Request.
- Detailed message flow:** A pane on the left showing a hierarchical tree of message elements and their sub-elements.
- Decoded information elements:** A pane at the bottom showing the bit-level structure of a message, with fields like 'RRC-Connection-Setup-Request' and 'RRC-Connection-Setup-Request-Message' expanded to show their internal structure.
- Throughput measurements on all protocol layers:** A 'Protocol Measurement Charts' pane on the right showing a line graph of throughput over time for various layers (e.g., RRC, NAS, IP).
- Bit analysis of information elements:** A pane on the right showing a table of information elements with columns for 'Element ID', 'Element Name', and 'Information'.
- Relationship of messages within protocol stack:** A pane at the bottom right showing a diagram of the protocol stack layers and how messages are mapped to them.

R&S®CMW-ATE Terminal Testing Solution for IMS and VoLTE

1



Test solution for testing IP multimedia subsystem (IMS) and voice over LTE (VoLTE) functionalities of wireless devices, from R&D to conformance testing

- Dedicated R&D test case package with configurable items
- Option to modify code and create individual IMS test cases
- Dedicated conformance (GCF and PTCRB) and network operator-specific (IOT) test case packages for operator acceptance and certification testing
- GSMA IR.92 and IR.94 compliant
- IMS, VoLTE, SMS over IMS, IMS emergency calls, joyn (rich communication suite) protocol testing of wireless devices and chipsets using different RATs
- Support of various network operator-specific IMS and VoLTE test plans (IOT) such as Verizon Wireless, AT&T, T-Mobile US, Docomo and CMCC
- Support of IMS- and VoLTE-specific GCF WIs and PTCRB RFTs based on 3GPP TS 34.229-1 and OMA specifications
- Wireless device testing for all current and future IP multimedia subsystem (IMS) functionalities
- P-CSCF discovery (PCO/DHCP/DNS)
 - IMS registration and re-registration
 - IMS authentication and re-authentication
 - MO/MT calls (MTSI speech and text calls)
 - Session handling
 - Supplementary services
 - MO/MT SMS over IMS
- Emergency calls over IMS (with and without positioning)
- RCS (rich communication suite)
- Intuitive GUI
 - Easy and fast configuration of test cases with R&S®CONTEST sequencer software
 - Fast and flexible test plan creation
 - Fast and easy changing of parameters
- Powerful reporting
 - Fast and thorough problem analysis through visualization of message flow
 - Automatic pcap file generation for typical IP-based analysis
 - IMS-centric verdict presentation in XML log files
 - Report with pass/fail verdict for seeing results at a glance
- Flexible and scalable solution
 - Upgradeable for LTE protocol testing
 - Upgradeable for R&S®CMW-PQA VoLTE performance testing under realistic network conditions
 - Upgradeable for audio quality tests with the R&S®UPV audio analyzer, supporting audio analysis with established mechanisms
 - Upgradeable for location based services (LBS) and SUPL 2.0 testing
- Fully automated test system

R&S®CMW-PQA Test System for Performance Quality Analysis



Automated performance quality analysis (PQA) test solution

The R&S®CMW-PQA is the test solution for benchmarking and optimizing the performance of chipsets and wireless devices.

The R&S®CMW-PQA makes it possible to measure end-to-end data throughput, call and mobility performance and the quality of services, such as video performance, on chipsets and wireless devices under realistic network conditions. It supports various network operator specific throughput and performance test plans and customized test plans can be created quickly and easily. As a result, the performance of chipsets and wireless devices can be tested under realistic conditions throughout the development process up to approval and bottlenecks during implementation can be identified.

The R&S®CMW-PQA is a test solution for measuring the performance of chipsets and wireless devices under realistic conditions. It simulates the complex network conditions, such as noise, fading and IP impairments, that wireless devices are exposed to in the real world. This is the basis for a variety of throughput and performance measurements.

Wireless device users are promised ever higher data rates. However, users are not just interested in the data rate. What they care about most is the quality of the service they are using on their wireless devices. This is why the R&S®CMW-PQA offers a variety of end-to-end data throughput measurements and above all, can reliably measure the quality of services such as webpage loading and video performance.

Network operators place strong emphasis both on ensuring customer satisfaction and on simplifying network planning. Self-organizing networks (SON) and one of their features (ANR, automatic neighbor relation) represent a first step toward simplifying network optimization. As a result, wireless devices are faced with new requirements, whose fulfillment must be checked. The R&S®CMW-PQA is a platform for call and mobility performance measurements on wireless devices.

- Explore the performance of chipsets and wireless devices from an end-user perspective for numerous technologies (WCDMA, HSPA+, LTE)
- Identify bottlenecks in the wireless device's/chipset's implementation from application down to physical layer
- Evaluate call and mobility performance of chipsets and wireless devices
- Measure the quality of services such as webpage loading and video performance
- Supports throughput and performance test plans of major network operators

Specifications in brief		
Supported technologies		LTE FDD, LTE TDD, WCDMA/HSPA+
Overview of test methods		
Throughput measurements	direction	uplink, downlink, bidirectional, alternating
	data sources	lperf UDP, lperf TCP, ftp, http
Call and mobility performance measurements		call retainability, call accessibility, UE measurement reporting, ANR measurement reporting, reject cause handling
Quality of service measurements		video quality, webpage loading

R&S®TS8980 RF/RRM Test System for LTE, WCDMA and GSM



Platform for testing needs, from development to conformance testing

The R&S®TS8980 RF test system family covers the testing needs from R&D to conformance for WCDMA, (DC-)HSPA, LTE and LTE-Advanced in cellular chipsets and mobile stations. It is modular and fully automated for RF transmitter, receiver and performance measurements. The scalable hardware and software allows cost-efficient testing solutions for R&D and can be upgraded to precompliance and final conformance testing.

Scalable R&S®TS8980 setups for different requirements

- ▮ Precompliance tests in line with
 - 3GPP TS36.521-1 (LTE) incl. LTE-A Pro (UL 64QAM, UL CA, MIoT)
 - 3GPP TS34.121-1 (WCDMA)
 - 3GPP TS51.010-1 (GSM)

- ▮ Full conformance testing in line with
 - LTE-A Pro (UL 64QAM, UL CA)
 - 3GPP TS36.521-1 (LTE)
 - 3GPP TS34.121-1 (WCDMA)
 - 3GPP TS51.010-1 (GSM)
- ▮ Network operator specific tests (AT&T, Sprint, US Cellular, Verizon Wireless, etc.)

Flexible architecture supports upgrading

- ▮ Radio resource management (R&S®TS-RRM)
- ▮ Parallel testing of LTE, WCDMA and GSM

R&S®CONTEST software platform

- ▮ Advanced sequencer tool for all technologies
- ▮ Fully automatic runtime optimization
- ▮ Debugging with breakpoints, step-by-step execution
- ▮ Easy-to-use graphical parameterization of test cases
- ▮ Online report with status of progress and pie diagram
- ▮ Test results in HTML, XML or CSV format and internal and external database access

Consistent RF tests from R&D to conformance

The R&S®TS8980 test system family covers the widest range of applications on the market. Customers can rely on consistent test results from R&D stages all the way to final conformance tests.

Faster time to market

- ▮ Efficient tools
- ▮ Individual definition of tests
- ▮ Comprehensive test logs for efficient debugging

Precise, reproducible measurement results

The fully automated path calibration used in the R&S®TS8980 test system and high-speed self-test mechanisms deliver maximum accuracy and reproducibility of measurement results.

Low cost of ownership

Scalable configurations starting with the R&S®TS8980S ensure an optimum match of budget and functionality. The instruments used in the system can be configured to require external calibration only every 24 months.

Efficient use of test system through automation

The system is designed for 24/7 operation to maximize return on investment and minimize time to market. An optional extension further increases the level of automation by allowing sequential testing of multiple DUTs on one system.

R&S®TS-ITS100 RF Conformance Test System for IEEE 802.11p



Integrated test system for testing IEEE 802.11p conformity and the performance of user equipment

The R&S®TS-ITS100 is an integrated test system for testing IEEE 802.11p conformity and the performance of user equipment used for C2X (car2car/infrastructure) communications. Thanks to its compact size (with or without a rack), the R&S®TS-ITS100 can be used throughout the entire value chain – from development to precompliance and compliance testing.

Complete coverage of worldwide test requirements

- ▮ Complete coverage of regulatory test requirements
 - RF conformance tests for the EU (ETSI EN 302571)
 - RF conformance tests for the USA (IEEE 802.11-2012) and Japan (ARIB STD-T109)
- ▮ Complete coverage of industry performance tests
 - RF performance tests in line with the C2C-CC basic system profile, white paper on antenna characterization and wireless performance aspects

Full automation for high efficiency

- ▮ Fully automatic tests for reproducible test results
- ▮ R&S®OSP-ITS switching module for automatic path switching during test runs
- ▮ Support for multiple antennas
- ▮ Filters for out-of-band tests
- ▮ Manufacturer-specific plug-ins for user equipment
- ▮ Field2Lab testing

Simple operation with R&S®CONTEST software platform

- ▮ Advanced sequencer tool
- ▮ Debugging with breakpoints, step-by-step execution
- ▮ Easy-to-use graphical parameterization of test cases
- ▮ DUT services such as graphical antenna configurations
- ▮ Online report with status of progress and pie diagram
- ▮ Summary report with filter for report explorer
- ▮ Test results in HTML, XML or CSV format and internal and external database access

Future-ready platform

The R&S®TS-ITS100 test system is prepared to handle future features of the intelligent transportation system (ITS) technology. Rohde & Schwarz is constantly implementing new functions that are made available to users in the form of upgrades. As an active contributor to standardization bodies, Rohde & Schwarz helps promote the development of wireless technologies. This knowledge and experience are incorporated into the company's products.

R&S®TS-RRM LTE and WCDMA RRM Test System



Standalone platform for radio resource management (RRM) testing of wireless devices in line with 3GPP LTE, 3GPP WCDMA and operator test plans

The R&S®TS-RRM LTE and WCDMA RRM test system is a test solution for running WCDMA, LTE, inter-RAT RRM test cases on wireless devices. It is the perfect solution for the entire mobile station development lifecycle. The R&S®TS-RRM is a fully automated conformance test system prepared for running validated RRM conformance test cases in the design, precertification and type approval of wireless devices. In addition to the RRM test cases required by GCF/PTCRB, the R&S®TS-RRM also supports network operator specific RRM tests.

- R&S®TS-RRM testing of radio resource management technologies in 3GPP TS 36.521-3 (LTE) and 3GPP TS 34.121-1 (WCDMA) devices and chipsets
- Coverage of RRM conformance and network operator specific test plans
- Reusable for LBS OTDOA/eCID
- Scalable platform for different technologies, covering the various test needs that arise in R&D, conformance and network operator acceptance testing
- Automated for faster test runs and reduction of test time
- Runs on R&S®CONTEST platforms such as the R&S®TS8980

Supported technologies

- WCDMA single mode
- WCDMA inter-RAT to GSM
- LTE single mode
- LTE inter-RAT to WCDMA, GSM, CDMA2000® and TD-SCDMA
- Network operator specific tests for AT&T and Verizon

Different setups

- R&S®TS-RRM standard setup: supports single-mode test cases for GCF and PTCRB with almost 100% of GCF priority 1 release 8 test cases and about 70% of all GCF test cases as well as RX diversity and MIMO
- R&S®TS-RRM advanced setup: supports 100% of all GCF and PTCRB test cases as well as RX diversity and MIMO
- R&S®TS8980FTA in combination with R&S®TS-RRM: for multibox test cases supporting 100% of all GCF and PTCRB test cases as well as RX diversity and MIMO

Configuration example



R&S®TS-RRM advanced setup



R&S®TS8980FTA + R&S®TS-RRM

R&S®TS-LBS Test System for Location Based Services

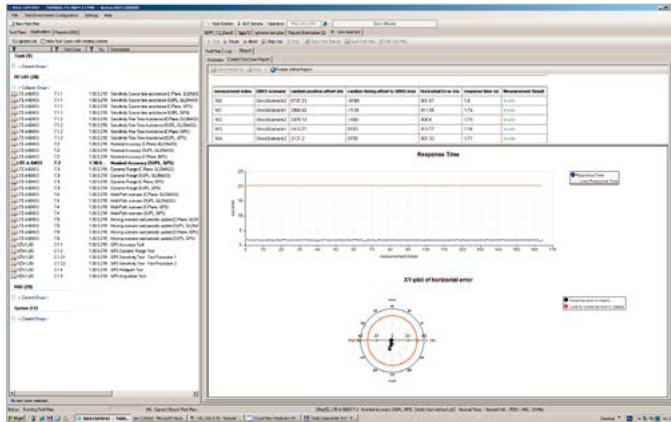

Comprehensive test solution for network and satellite-based location technology testing of wireless devices and chipsets

The R&S®TS-LBS test system family is highly configurable for testing different location technologies of user equipment (UE) and chipsets. The R&S®TS-LBS represents the second generation of Rohde&Schwarz LBS test systems. It fulfills the requirements for LBS conformance testing and operator acceptance testing on GSM, WCDMA and LTE devices and chipsets.

Location based services (LBS) testing of satellite, cellular and hybrid-based location technologies

- ▮ Coverage of 3GPP minimum performance, signaling conformance (C-plane, U-plane) and network operator specific test plans
- ▮ Scalable platform for different technologies, covering various test needs that arise in R&D, conformance and network operator acceptance testing
- ▮ Automated for faster test execution and reduction of test time
 - Automation of DUT for minimum manual intervention during test runs
 - Fully automatic path calibration routines that run with minimum manual intervention

Supported technologies

Support of satellite, cellular and hybrid-based location technologies in UE and chipsets

- ▮ Support of GNSS-based LBS
 - 3GPP minimum performance
 - Protocol conformance
 - Operator test plans
 - OTA LBS
- ▮ Support of cellular network-based LBS (requires the R&S®TS-LBS advanced hardware platform)
 - LTE OTDOA/eCID for LTE
 - Operator test plans
- ▮ Support of hybrid location technologies
 - GNSS and OTDOA/eCID
- ▮ Support of indoor positioning
 - WLAN, Bluetooth®, Barometric, terrestrial beacon
 - LPPe, LPP R13,
 - ToF/TOA

The R&S®TS-LBS provides complete LBS test coverage through all phases

A-GNSS minimum performance	LBS protocol conformance	Network-based positioning OTDOA/eCID	Operator acceptance	LBS hybrid	Field-to-lab	Indoor positioning	LBS development features	A-GNSS OTA
LTE A-GNSS	OMA SUPL2.0 TTCN3	LTE FDD OTDOA eCID	Verizon test plan	LTE A-GNSS OTDOA	Record and playback GPS	WLAN	Margin search	Verizon LTE GPS R&S®AMS32-K32
WCDMA A-GNSS	LTE LPP FDD/TDD C-plane	LTE TDD OTDOA eCID	AT&T test plan	LTE A-GNSS hybrid	Glonass	BT	PEM mode	CTIA 3.4 LTE A-GNSS
GSM A-GPS	WCDMA RRC C-plane	Interband OTDOA	T-Mobile	Position calculation	BeiDou (COMPASS)	NextNav	User def. scenarios	
	GSM RRLP C-plane	CA OTDOA	CMCC		GALILEO	LPPe	OTDOA/eCID R&D	
			DoCoMo			LPP R13	LBS receiver testing	
			Softbank			ToF/TOA	GPS	
						Barometric	Glonass	
							BeiDou	
							GALILEO	

Different setups

Scalable and flexible test system family suitable for applications ranging from R&D to conformance testing of GSM, WCDMA and LTE user equipment (UE) and chipsets

- ▮ Modular hardware and software depending on individual test requirements
- ▮ Scalable hardware and software allowing cost-efficient R&D solutions
- ▮ Availability of upgrade paths for preformance and full conformance testing
- ▮ Upgradeability to R&S®CMW-PQA test system for performance quality analysis
- ▮ Upgradeability to R&S®TS-RRM test system for radio resource management

R&S®CONTEST software platform

Intuitive GUI and powerful reporting capabilities

- ▮ Debugging capabilities: breakpoints, step-by-step execution
- ▮ Easy-to-use graphical parameterization of test cases
- ▮ DUT services including graphical antenna configurations
- ▮ Online report with status of progress and pie diagram for overview
- ▮ Summary report with filter for report explorer
- ▮ Test results in HTML, XML or CSV format and internal and external database access

R&S®TS-LBS on different platforms

GNSS testing (24 channels)



R&S®TS-LBS

R&S®TS-LBS NetOP
(R&S®CMW-PQA
+ R&S®SMBV100A)

OTDOA + eCID (24 entry point)



R&S®TS-LBS advanced
(R&S®TS-RRM advanced)
(R&S®CMW-PQA CA setup)

R&S®TS-LBS advanced
(complete 3GPP
+ NetOP)

R&S®TS8991
OTA performance
test system
+ R&S®SMBV100A

LBS OTDOA/eCID

LBS A-GNSS LTE/WCDMA/GSM

Support by means of CONTEST

R&S®TS8991 OTA Performance Test System



CTIA-compliant OTA measurements

Over-the-air (OTA) measurements are an essential part of the certification testing of wireless devices that require an omnidirectional antenna radiation pattern. The R&S®TS8991 OTA performance test system measures the spatial radiation and sensitivity characteristic as specified by CTIA and 3GPP.

The R&S®AMS32 system software provides ready-to-use test templates for OTA measurements and supports all common wireless standards. The integrated report function collects all measured test data such as graphics or numeric results, test environments, EUT information and hardware setup in one document.

In cooperation with Albatross Projects, a world-leading provider of solutions for RF chambers, various models of wireless performance test chambers (WPTC) were created.

- ▮ Measurement of OTA performance in line with CTIA, Wi-Fi Alliance, CWG, PTCRB standards and test cases
- ▮ For all major cellular and non-cellular technologies, including A-GPS
- ▮ Time-optimized, configurable test sequences for qualification and development, based on R&S®AMS32 system software
- ▮ Can be combined with radiated spurious emission and EMC test systems
- ▮ Turnkey solution with test instruments, system software, WPTC anechoic test chamber, OTA chamber and EUT positioner

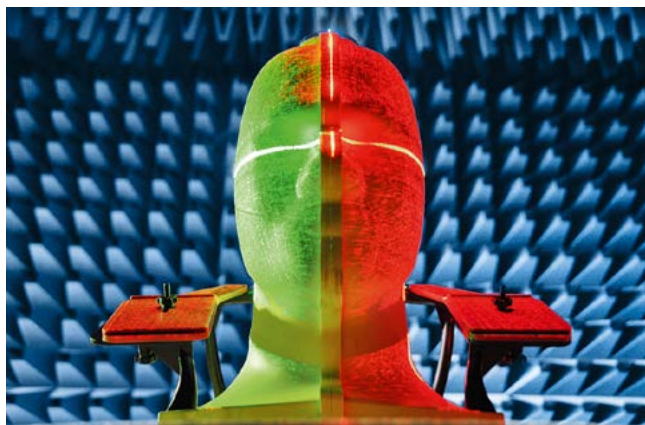

WPTC model overview					
Model	WPTC-XS	WPTC-S	WPTC-M	WPTC-L	WPTC-XL
Outer dimensions of shielding panels, W x H x D	2.43 m x 2.40 m x 2.43 m (7.97 ft x 7.87 ft x 7.97 ft)	3.70 m x 3.00 m x 3.10 m (12.14 ft x 9.84 ft x 10.17 ft)	4.60 m x 3.45 m x 3.70 m (15.09 ft x 11.32 ft x 12.12 ft)	5.20 m x 4.05 m x 4.30 m (17.06 ft x 13.29 ft x 14.12 ft)	5.80 m x 5.10 m x 5.20 m (9.03 ft x 16.73 ft x 17.06 ft)
Frequency range of test chamber	0.6 GHz to 18 GHz	0.6 GHz to 18 GHz	0.6 GHz to 18 GHz	0.4 GHz to 18 GHz	0.4 GHz to 18 GHz
Typical range length	> 0.65 m (2.2 ft)	> 1.02 m (3.3 ft)	> 1.30 m (4.3 ft)	> 1.38 m (4.5 ft)	> 1.83 m (6.0 ft)
CTIA-compliant	– (R&D)	– (R&D)	•	•	•

R&S®TS8996 RSE Test System



Fully automatic emission measurements on wireless communications equipment required for R&D and quality assurance

The R&S®TS8996 RSE test system is used for EMI and spurious emission measurements on wireless communications equipment during EMC and type approval testing. Typical DUTs are mobile phones, base stations, radio sets and short-range devices.

The relevant standards stipulate a wide variety of measurements in a very wide frequency range, all of which can be covered with the R&S®TS8996. For some radiocommunications systems (i.e. short-range devices), higher frequency limits (i.e. 40 GHz) are stipulated for spurious emission measurements. The R&S®TS8996 can be easily adapted to customer requirements.

The modular design of the R&S®OSP-F7x filter unit for carrier frequency suppression allows flexible configuration and easy expansion for various frequency bands. For measuring radiated spurious emissions from radiocommunications equipment, filter configurations for the following technologies have been prepared: GSM, Bluetooth®, WLAN, WCDMA (UMTS) and LTE. Others are available on request.

- Frequency range from 30 MHz to 18 (40) GHz
- Radiated measurements in line with ETSI EN301489, FCC part 15 and 3GPP TS51.010 standards
- Conducted spurious emission measurements from 100 kHz to 12.75 GHz on antenna connector of DUT
- Measurement of spurious emissions from radiocommunications equipment

System software

The R&S®EMC32 software enables fully automatic simple testing. The R&S®EMC32-K2 option offers special features:

- Automatic setup and control of wireless link
- Control of different 3D EUT manipulators
- ERP/EIRP measurement
- Automatic suppression of carrier signal by R&S®T8996 filter unit

The predefined test sequences allow a high degree of automation. Users are freed from tedious extra work and incorrect settings or signal connections can be avoided right from the start. Our product managers assist customers with option selection and system configuration.

R&S®TS8997 Regulatory Test System for Wireless Devices



For compliance with ETSI EN 300328 in 2.4 GHz band, ETSI EN 301893 in 5 GHz band and FCC §15.247, FCC §15.407

All wideband transmission systems in the 2.4 GHz and 5 GHz bands must be tested to verify compliance with ETSI EN 300328 (2.4 GHz band), ETSI EN 301893 (5 GHz band) and FCC §15.247, FCC §15.407. The latest versions of these standards require the use of special automated test procedures and test equipment. The R&S®TS8997 fully

meets these requirements. Measurements are performed using the R&S®WMS32 software platform, which is the standard solution in EMC test labs. The key components in the test system are the R&S®WMS32-K97x options and the R&S®TS8997 specific R&S®OSP module, which provides power measurement and path switching. A menu-driven navigation system guides users through the multi-stage measurements as required for the technology used and the characteristics of the unit under test (DUT). The test system supports all measurements required by the standards, even for complex DUTs such as those featuring MIMO or adaptive hopping.

The R&S®TS8997 measures the technologies typically used in wideband wireless devices, i.e. devices with a radio interface, in the 2.4 GHz and 5 GHz bands:

- ▮ WLAN IEEE 802.11a/b/g/n/ac
- ▮ Bluetooth®
- ▮ Wireless video transmission
- ▮ Radio remote control

Key facts

- ▮ Fast wideband power measurement that exceeds ETSI requirements
- ▮ Support for MIMO DUTs with up to four antenna ports
- ▮ Menu-driven, automatic measurements based on radio technology selected by the user
- ▮ Measurements via RF connection or antenna coupler
- ▮ Tried and tested R&S®WMS32 GUI and software structure
- ▮ Automatic switching of test paths up to 18 GHz

Block diagram of the R&S®TS8997 test system

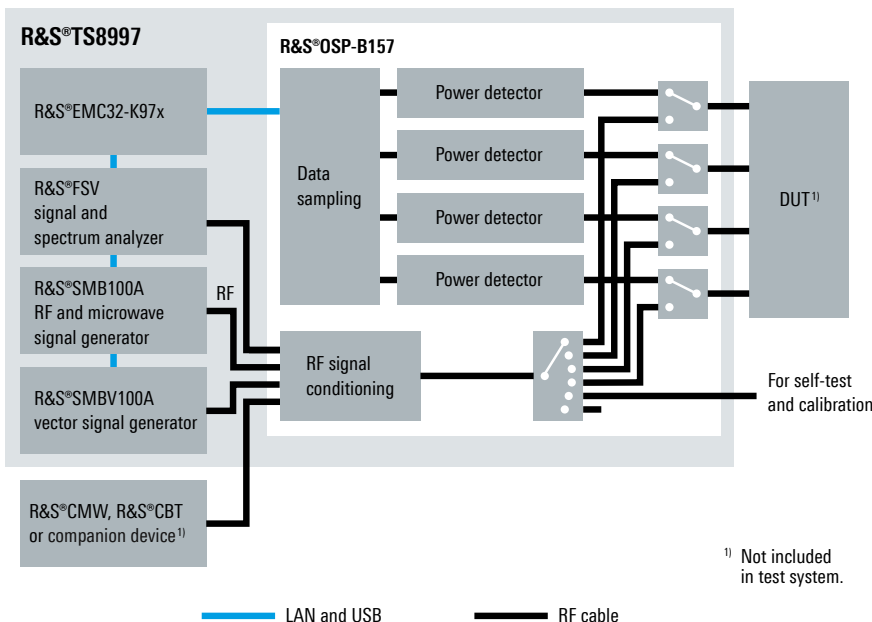

¹ Not included in test system.

R&S®CMA180 Radio Test Set



The reference in radio testing

The R&S®CMA180 is a radiocommunications tester for radio systems that operate in the 100 kHz to 3 GHz range. Its technology is based fully on digital signal processing and advanced computing. Intuitive operation and efficient measurement capabilities make the R&S®CMA180 an indispensable tool for performing radio measurements.

The R&S®CMA180 demodulates and modulates all common analog RF signals, making it ideal for testing transmitters and receivers. For receiver tests, audio signals from the internal generators or from external sources can be modulated onto the RF carrier. The audio signals demodulated by the device under test (DUT) are fed into the R&S®CMA180 via analog or digital inputs and then analyzed. For transmitter tests, the R&S®CMA180 demodulates the received signal and measures the demodulated audio signal and the RF signal.

Using the ARB generator, users can play back nearly any type of signal. These signals can be generated with MATLAB® or R&S®WinIQSIM™, including proprietary waveforms from software defined radios (SDR) and then loaded into the R&S®CMA180 and replayed.

The advanced and efficient user interface makes it easy to learn to use the R&S®CMA180. Users can quickly reach all settings and easily perform measurements. Measurement results are clearly and conveniently displayed.

- Frequency range from 100 kHz to 3 GHz
- Analog modulation and demodulation (CW, AM, FM)
- Up to 150 W peak input power and up to 100 W continuous input power
- Signal level for receiver measurements can be lowered to -140 dBm
- Integrated audio generators
- Audio quality tests (SINAD, THD, SNR)
- Integrated sweeping spectrum analyzer, tracking generator and scope
- Use of R&S®NRP-Zxx and R&S®NRT-Zxx power sensors, no configuration required
- I/Q recorder and ARB generator
- Digital signal analysis

Automation with R&S®CMArun

R&S®CMArun is available for test sequence control. R&S®CMArun provides a graphical user interface for programming a test sequence. Individual settings and measurement tasks can be configured and arranged in a specific sequence. Sequences, loops and conditional queries help users easily create and execute complex test sequences. Each setting and measurement value is logged and then summarized and stored in a report. For measurements with limit values, pass or fail indicators can be displayed for each measurement. The R&S®CMA180 can also be controlled using VISA drivers and SCPI commands.

R&S®CMArun offers a separate run environment in which test sequences are created and executed using a mouse and keyboard. Additionally, an R&S®CMArun component has been integrated into the touchscreen, mainly to execute previously created test sequences.

Specifications in brief

RF frequency range		0.1 MHz to 3000 MHz
Output level range	RF generator	up to +16 dBm (max.)
Max. allowed input power	RF input	150 W
Modulation		CW, AM, FM, SSB
ARB generator	R&S®CMA-B110A	bandwidth up to 20 MHz, 1 Gbyte memory
Spectrum analyzer	R&S®CMA-K120	0.1 MHz to 3000 MHz
FFT spectrum analyzer	span	10 kHz to 20 MHz
Audio signals		analog inputs/outputs, SPDIF, internal AF generators/analyzers
Connectivity		RF, AF, LAN, USB, DVI, Rohde & Schwarz power meters, ref freq in/out, trigger in/out, TTL in/out, GPIB (R&S®CMA-BB12A)

R&S® CTH Portable Radio Test Set



Always on duty

The R&S®CTH allows dependable testing of analog FM radio systems even under challenging environmental conditions. The radio test set was designed especially for outdoor use. Ensuring the smooth functioning of transceivers is the key to successful communications. The R&S®CTH100A/R&S®CTH200A performs this type of work without requiring expert knowledge. The user can simply connect the device under test (DUT) to the R&S®CTH100A/R&S®CTH200A and immediately begin transmitter and receiver measurements.

The R&S®CTH100A/R&S®CTH200A includes all the measurement functions needed for reliable testing of transceivers. The measurement results are clearly presented on a display that is optimized for outdoor use so the measured values are easily readable even under difficult lighting conditions.

With its high measurement accuracy and straightforward operation, the R&S®CTH100A/R&S®CTH200A delivers unrivaled performance and functionality for its class.

- ▮ Frequency measurement
- ▮ Power measurement
- ▮ Over-the-air measurement (R&S®CTH200A)
- ▮ Distance-to-fault measurement (R&S®CTH200A)
- ▮ Voice reporting (R&S®CTH200A)
- ▮ Handy and ergonomic
- ▮ Rugged and all-weatherproof

Model overview

	R&S®CTH100A	R&S®CTH200A
Transmitter measurements		
Forward power	•	•
Reflected power	•	•
Frequency counter	•	•
FM receiver measurements		
Squelch	•	•
Demodulation	•	•
Additional measurements		
Over the air	–	•
Distance to fault	–	•
Voice reporting	–	•

Specifications in brief

Transmit signal		at RADIO connector
Frequency range	R&S®CTH100A	30 MHz to 512 MHz
	R&S®CTH200A	25 MHz to 500 MHz
Frequency setting	R&S®CTH100A	5 MHz channel spacing fixed ($f = n \times 5$ MHz), no frequency setting necessary
	R&S®CTH200A	setting of user defined frequency or usage of counted TX frequency
RF output level	R&S®CTH100A	–97 dBm to –120 dBm
	R&S®CTH200A, $f < 100$ MHz	–97 dBm to –120 dBm
	R&S®CTH200A, $f \geq 100$ MHz	–111 dBm to –134 dBm
RF output level uncertainty		3 dB
FM modulation	FM composite signal	150 Hz and 900 Hz dual tones
	FM composite signal uncertainty	2 Hz
Power measurement		forward power, reverse power, CW or FM signals (constant envelope), VSWR (R&S®CTH200A only)
Frequency range	R&S®CTH100A	30 MHz to 512 MHz
	R&S®CTH200A	25 MHz to 500 MHz
Power level range		0.1 W to 50 W
Power measurement uncertainty		0.8 dB
Frequency measurement		
Frequency range	R&S®CTH100A	30 MHz to 512 MHz
	R&S®CTH200A	25 MHz to 500 MHz
Frequency counter resolution		100 Hz

R&S®DST200 RF Diagnostic Chamber



Accurate radiated testing of wireless devices from 400 MHz to 18 GHz

The R&S®DST200 RF diagnostic chamber is the ideal environment for RF analysis during development. It supports a wide range of radiated test applications for wireless devices and fits on any R&D lab bench, where it can be used at all times during the product design and optimization phase. The R&S®DST200 effectively assists in achieving high first-time pass rates during final type approval, which saves time and money.

High-quality wireless devices have to pass special radiated tests such as desense and coexistence tests to ensure operation without self-interference. Verifying over-the-air (OTA) performance and measuring radiated spurious emissions (RSE) are also mandatory.

The R&S®DST200 provides support for the radiated tests that are required in R&D, quality assurance, production

and service. Compared to applications using large EMC anechoic chambers, test setups with the R&S®DST200 are compact and easy to use and generate consistent, comparable results.

- ▀ Anechoic RF chamber with highly effective shielding > 110 dB for interference-free testing in unshielded environments
- ▀ Wide frequency range from 400 MHz to 18 GHz covering all important wireless standards
- ▀ High reproducibility of measurements due to excellent field uniformity at location of equipment under test (EUT)
- ▀ Compact dimensions suitable for any lab environment
- ▀ Unique mechanical design provides long-term stability and maintains high shielding effectiveness
- ▀ Simple and effective front door locking mechanism without pneumatic components
- ▀ Automated 3D positioner for OTA and RSE precompliance measurements
- ▀ Main test applications
 - Desense (self-interference) and coexistence testing
 - Radiated spurious emission (RSE) testing and EMI scan
 - Verification of over-the-air (OTA) performance



R&S®DST-B165 option.

Specifications in brief

Frequency range		400 MHz to 18 GHz (extended range on request)
Antenna polarization	R&S®DST-B215 option	cross-polarized
	R&S®DST-B220 option	right-hand circular-polarized
	R&S®DST-B270 option	linear-polarized
Shielding effectiveness	700 MHz to 3 GHz, base unit with R&S®DST-B102 option	> 110 dB
	3 GHz to 6 GHz, base unit with R&S®DST-B102 option	> 100 dB
Quiet zone	above EUT table, $\varnothing \times L$ (cylindrical)	200 mm \times 30 mm (7.9 in \times 1.2 in)
Field uniformity	max. field variation in quiet zone with R&S®DST-B220 option	< 3.2 dB (meas.)
Field perturbation	with R&S®DST-B150 option, 300 MHz to 2.7 GHz	-0.6 dB to +0.6 dB (meas.)
	with R&S®DST-B150 option, 2.7 GHz to 6 GHz	-1.5 dB to 1.5 dB (meas.)
	with R&S®DST-B160 option, 700 MHz to 2.7 GHz	-1 dB to +1 dB (meas.)
	with R&S®DST-B160 option, 2.7 GHz to 6 GHz	-2.3 dB to +2.3 dB (meas.)
Max. EUT dimensions	W \times H \times D	400 mm \times 330 mm \times 400 mm (15.7 in \times 13.0 in \times 15.7 in)
	R&S®DST-B150 option	150 mm \times 100 mm \times 20 mm (5.9 in \times 3.9 in \times 0.8 in)
	R&S®DST-B160 option	149 mm \times 100 mm \times 20 mm (5.9 in \times 3.9 in \times 0.8 in)
	R&S®DST-B165 option	257 mm \times 190 mm \times 20 mm (10.1 in \times 7.5 in \times 0.8 in)

System accessories

R&S®CMW-Z10/-Z11 RF Shielding Box and Antenna Coupler



Available options include a D-Sub feedthrough (R&S®CMW-Z12), a USB 2.0 feedthrough (R&S®CMW-Z13), a RF feedthrough (R&S®CMW-Z14) and a tool for audio measurements (R&S®CMW-Z15). All modules are optimized so that their effect on shielding characteristics is kept to a minimum. The module slots are identical, allowing each module to be inserted into any slot. The optional connectors can be flexibly assigned. It is also possible to insert customer-specific modules. The R&S®CMW-Z16 second antenna element enables diversity/MIMO measurements (requires R&S®CMW-Z14).

- Excellent shielding characteristics
- Ultralow reflections
- Broadband spiral antenna allowing a wide variety of applications

- Optimized antenna structure for extremely good RF coupling
- Designed for harsh, continuous duty and ergonomic operation
- Modular options concept and flexible assignment of modules
- Large area for optimum positioning, even of large DUTs

Specifications in brief

- Shielding effectiveness
 - 0.4 GHz to 4 GHz: > 80 dB
 - 4 GHz to 6 GHz: > 60 dB
- Outer dimensions (W × H × D): 320.9 mm × 267.5 mm × 527.7 mm (12.6 in × 10.5 in × 20.8 in)
- Weight: 9 kg (19.8 lb)

R&S®TS7121/TS7123 Shielded RF Test Chambers

**Reliable RF tests on devices with radio interface**

The R&S®TS712x family of RF test chambers has been designed to meet the requirements of automatic production lines. These include long life, rugged design and automatic opening and closing of the RF chamber. Featuring high shielding effectiveness over a wide frequency range, the RF test chambers perform tests on modules and devices with a radio interface in accordance with a wide variety of standards such as ISM, GSM/CDMA2000®/WCDMA, WLAN, Bluetooth®, ZigBee, WiMAX™ and LTE.

- Rugged design for long life
- Two base models that differ in width: R&S®TS7121 and R&S®TS7123
- Automatic and manual version for each model
- High shielding effectiveness up to 14 GHz
- Low reflection due to the use of absorbent material
- Integrated RF connectors and filter feedthroughs
- Variety of options to support application-specific configurations

Specifications in brief

- Wide frequency range: 300 MHz to 14 GHz
- Shielding effectiveness:
 - 500 MHz < f < 3 GHz:
 - R&S®TS7121: typ. 70 dB
 - R&S®TS7123: typ. 60 dB
 - 300 MHz < f < 14 GHz:
 - R&S®TS7121: typ. 35 dB
 - R&S®TS7123: typ. 40 dB
- Antenna coupler: wideband antenna or standard specific antenna
- Standard feedthroughs: RF 4 × N, 1 × 25 and 1 × 9 D-Sub digital I/O filters
- Optional feedthroughs: USB 2.0 (option R&S®TS-F21/23FU2), fiber optic, pneumatic and customer specific
- Outer dimensions (W × H × D) automatic version:
 - R&S®TS7121: 155 mm × 305 mm × 428 mm (6.10 in × 12.00 in × 16.85 in)
 - R&S®TS7123: 330 mm × 347 mm × 428 mm (12.99 in × 13.66 in × 16.85 in)
- Weight:
 - R&S®TS7121: 25 kg (55.12 lb)
 - R&S®TS7123: 35 kg (77.16 lb)

System accessories

R&S®TS7124AS/R&S®TS7124M Shielded RF Test Chambers



The R&S®TS7124AS/M features a large interior working space for measurements on larger DUTs. It offers the possibility to integrate an antenna ring where numerous antennas can be placed to create an own radiation pattern. This makes radiated power measurements possible at selected orientations. The R&S®TS7124 offers higher shielding effectiveness and a rugged mechanical design for reproducible results and a long service life. The soft close option allows operation of the automatic version without additional security equipment.

- Integration into 19" rack (optional)
- Automatically (R&S®TS7124AS) and manually operated (R&S®TS7124M) versions
- Automatic model with soft close
- Antenna couplers for diverse technologies
LTE, Wi-Fi, ISM, GSM/CDMA2000®/WCDMA, WLAN, GPS, Bluetooth®, WiMAX™ and Zigbee

Specifications in brief

- Frequency range: 300 MHz to 6 GHz
- Shielding effectiveness: > 80 dB at 6 GHz
- Antenna couplers: wideband antenna or standard specific antennas
- Standard feedthroughs: RF 4 × N (outside) to SMA (inside)
- Optional feedthroughs: digital I/O filters, USB 2.0 filter, Ethernet filter, fiber optic, pneumatic and customer-specific
- Outer dimensions (W × H × D) of automatic version: 450 mm × 400 mm × 480 mm (17.72 in × 15.75 in × 18.90 in)
- Weight: approx. 35 kg (77.2 lb)



Chapter 2

Oscilloscopes

Excellent signal fidelity, high acquisition rate, innovative trigger system and a clever user interface are what you get with a Rohde & Schwarz oscilloscope. Choose from a wide range of oscilloscopes, from value class for service, maintenance and education to our top instruments for R&D and EMI debugging in the 650 MHz to 6 GHz class.

Benefit from the high quality and in-depth development and production expertise at Rohde & Schwarz. We continually enhance our oscilloscope portfolio with new models, applications and accessories.

Type	Designation	Bandwidth	Channels	Description	Page
Oscilloscopes					
R&S®RTO2000	Digital oscilloscopes	600 MHz, 1 GHz, 2 GHz, 3 GHz, 4 GHz, 6 GHz	2 or 4 4	Turn your signals into success	34
R&S®RTE1000	Digital oscilloscopes	200/350/500 MHz, 1/1.5/2 GHz	2 or 4	Easy to use, powerful	35
R&S®RTM2000	Digital oscilloscopes	200/350/500 MHz, 1 GHz	2 or 4	Compact, precise, versatile	36
R&S®ScopeRider RTH	Handheld digital oscilloscope	60/100/200/350/500 MHz	2 or 4	Lab performance in a rugged and portable design	37
R&S®HMO3000	Digital mixed signal oscilloscopes	300/400/500 MHz	2 or 4	Digital mixed signal oscilloscope with 300 MHz to 500 MHz bandwidth	40
R&S®HMO Compact	Digital mixed signal oscilloscopes	70/100/150/200 MHz	4	Four-channel oscilloscopes with 70 MHz to 200 MHz bandwidth	41
R&S®HMO1002/1202	Digital oscilloscopes	50/70/100/200/300 MHz	2	Two-channel oscilloscopes with 50 MHz to 300 MHz bandwidth	42
Hardware and software options, accessories					
Options and accessories overview for the R&S®RTx series					38
Oscilloscope probes					43
Oscilloscope probe accessories					43

R&S®RTO2000 Digital Oscilloscope



Turn your signals into success

R&S®RTO oscilloscopes combine excellent signal fidelity, up to 16-bit vertical resolution and high acquisition rate in a compact device format in the 600 MHz to 6 GHz class. They offer a fully integrated multi-domain test solution with frequency, protocol and logic analysis functions. The brilliant touchscreen makes the oscilloscopes very comfortable to use.

Best oscilloscope performance

- ▮ Up to 16-bit vertical resolution
- ▮ Trigger on any signal detail you can see
- ▮ Quickly find signal faults with 1 million waveforms/s
- ▮ Integrated spectrum analysis

Widest range of capabilities

- ▮ Industry-leading 2 Gsample deep memory
- ▮ First zone trigger in time and frequency domain
- ▮ Analyze previous acquisitions (history buffer)
- ▮ Deep toolset for signal analysis

Powerful user interface

- ▮ Capacitive touchscreen with gesture support
- ▮ Easily customizable waveform display with R&S®SmartGrid technology
- ▮ Fast access to important tools
- ▮ Color coding for clear overview

Engineered for multi-domain challenges

- ▮ Logic analysis: unrivaled in its power class
- ▮ Serial protocols: easy triggering and decoding
- ▮ Spectrum, signal and power analysis
- ▮ Advanced jitter analysis
- ▮ Automatic compliance tests, EMI debugging

Specifications in brief

Vertical system

Number of channels	R&S®RTO2002/2012/2022/2032	2	
	R&S®RTO2004/2014/2024/2034/2044/2064	4	
Analog bandwidth (–3 dB) and rise time at 50 Ω	R&S®RTO2002 and R&S®RTO2004	600 MHz	583 ps
	R&S®RTO2012 and R&S®RTO2014	1 GHz	350 ps
	R&S®RTO2022 and R&S®RTO2024	2 GHz	175 ps
	R&S®RTO2032 and R&S®RTO2034	3 GHz	116 ps
	R&S®RTO2044	4 GHz	100 ps
	R&S®RTO2064	on 4 channels: 4 GHz; on 2 channels: 6 GHz	86 ps

All instruments can be extended to up to 4 GHz bandwidth.

Input sensitivity	max. bandwidth in all ranges	50 Ω: 1 mV/div to 1 V/div; 1 MΩ: 1 mV/div to 10 V/div
ENOB of A/D converter	full-scale sine wave, < –3 dB frequency bandwidth	> 7 bit (meas.)

Acquisition system

Realtime sampling rate	R&S®RTO200x/201x/202x/203x	max. 10 Gsample/s on each channel
	R&S®RTO2044 and R&S®RTO2064	max. 10 Gsample/s on 4 channels, max. 20 Gsample/s on 2 channels
Acquisition memory	standard configuration, per channel/1 channel active	R&S®RTO 2-channel model: 50/100 Msample, R&S®RTO 4-channel model: 50/200 Msample
	max. upgrade (R&S®RTO-B110 option), per channel/1 channel active	R&S®RTO 2-channel model: 1/2 Gsample, R&S®RTO 4-channel model: 1/2 Gsample
Max. acquisition rate	continuous acquisition and display, 10 Gsample/s, 1 ksample	1 000 000 waveforms/s
	ultra-segmented mode	< 300 ns blind time
Decimation mode	any combination of decimation mode and waveform arithmetics on up to 3 waveforms per channel	sample, peak detect, high resolution, root mean square
Waveform arithmetics		off, envelope, average
Interpolation modes		linear, sin(x)/x, sample&hold
Trigger types	edge, glitch, width, runt, window, timeout, interval, serial bus trigger (optional), zone trigger (optional)	slew rate, data2clock, pattern, state, serial pattern, TV/video,

R&S® RTE Digital Oscilloscope



Truly uncompromised in performance and impressively user-friendly

Tools such as QuickMeas, fast mask tests, powerful spectrum analysis, history function and 77 automatic measurement functions are supplied as standard. Results are available fast thanks to hardware-assisted implementation

of the measurement tools in the Rohde & Schwarz ASIC. The results are based on a large number of waveforms to provide statistically conclusive information. R&S® RTE oscilloscopes support dedicated application solutions for complex analyses, including trigger and decoding options for serial protocols and a power analysis option. The mixed signal option provides 16 digital channels for analyzing logical components in embedded designs.

- High-resolution 10.4" XGA touchscreen
- Bandwidths from 200 MHz to 2 GHz
- Highest sampling rate of 5 Gsample/s and deepest memory of 200 Msample for accurate acquisition of long signal sequences
- Acquisition rate of more than one million waveforms/s for finding signal faults quickly
- Extremely low-noise frontends and 16-bit vertical resolution in high definition mode for precise results
- Highly accurate digital trigger system with virtually no jitter for triggering on smallest signal details in realtime

Specifications in brief		
Vertical system		
Number of channels	R&S® RTE1022/1032/1052/1102/1152/1202	2
	R&S® RTE1024/1034/1054/1104/1154/1204	4
Analog bandwidth (–3 dB) at 50 Ω	R&S® RTE1022/1024; R&S® RTE1032/1034; R&S® RTE1052/1054; R&S® RTE1102/1104; R&S® RTE1152/1154; R&S® RTE1202/1204	≥ 200 MHz; ≥ 350 MHz; ≥ 500 MHz; ≥ 1 GHz; ≥ 1.5 GHz; ≥ 2 GHz
Rise time	R&S® RTE1022/1024; R&S® RTE1032/1034; R&S® RTE1052/1054; R&S® RTE1102/1104; R&S® RTE1152/1154; R&S® RTE1202/1204	< 1.75 ns; < 1 ns; < 700 ps; < 350 ps; < 233 ps; < 175 ps
Input sensitivity	max. bandwidth in all ranges	50 Ω: 500 μV/div to 1 V/div; 1 MΩ: 500 μV/div to 10 V/div
Resolution		8 bit (7-bit ENOB)
	with high resolution decimation	16 bit (sampling rate reduction)
	with R&S® RTE-K17 high definition option	16 bit (no sampling rate reduction)
Acquisition system		
Realtime sampling rate		max. 5 Gsample/s on each channel
Acquisition memory	standard configuration, per channel/1 channel active	R&S® RTE 2-channel model: 10/20 Msample; R&S® RTE 4-channel model: 10/40 Msample
	max. upgrade (R&S® RTE-B102 option), per channel/1 channel active	R&S® RTE 2-channel model: 50/100 Msample; R&S® RTE 4-channel model: 50/200 Msample
Acquisition rate		> 1 000 000 waveforms/s
Decimation modes	any combination of decimation mode and waveform arithmetics	sample, peak detect, high resolution, root mean square
Waveform arithmetics		off, envelope, average
Horizontal system		
Timebase range		50 ps/div to 5000 s/div
Trigger system		
Trigger types	edge, glitch, width, runt, window, timeout, interval, slew rate, data2clock, pattern, state, serial pattern, TV/video, serial bus trigger (optional)	
Sensitivity	definition of trigger hysteresis	can be set automatically or manually from 0 div to 5 div
Analysis and measurement functions		
Automatic measurements		77 measurement functions
Cursor measurements		2 cursor sets, each consisting of 2 horizontal and 2 vertical cursors
Waveform mathematics		4 math waveforms; mathematics, logical operations, comparison, FIR filter, FFT
MSO option		
Digital channels		16 (2 logic probes)
Sampling rate		5 Gsample/s per channel
Acquisition memory		100 Msample per channel
Parallel buses		up to 4

R&S®RTM2000 Digital Oscilloscope

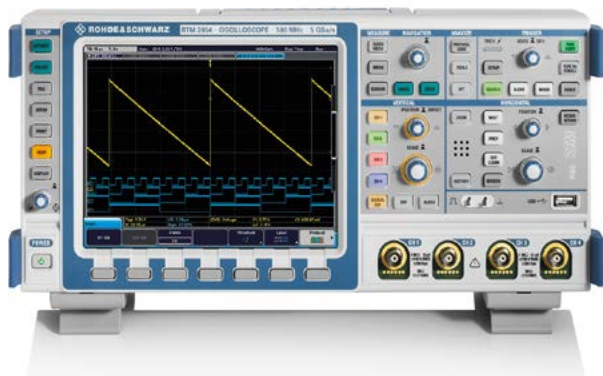

Scope of the art: compact, precise, versatile

Ease of use combined with fast and reliable results is precisely what users get with the R&S®RTM bench oscilloscope. While other oscilloscopes are still booting up, the R&S®RTM is already displaying signals that would otherwise be lost in the noise, and evaluating results. All on one screen with two displays, with lightning fast functions.

The R&S®RTM models with 200/350/500 MHz or 1 GHz bandwidth offer a maximum sampling rate of 5 Gsample/s and a maximum memory depth of 20 Msample. As a result, they can display signals accurately, right down to the details, as well as provide high time resolution, even for long sequences. As a true scope of the art, the R&S®RTM meets the increased demands on bench oscilloscopes for the development, production and servicing of embedded hardware, providing time, frequency, protocol and logic analysis, plus a digital voltmeter in a single box:

- Time analysis: high sensitivity of 1 mV/div to detect signals that would otherwise be lost in the noise
- Frequency analysis: reliable fault detection with integrated FFT and spectrum analysis with spectrogram option
- Logic analysis: 20 Msample with 5 Gsample/s for detailed analysis of digital signals
- Protocol analysis: simple triggering and decoding of serial buses
- Digital voltmeter/frequency counter: key signal parameters at a glance

Specifications in brief

Vertical system		
Number of channels	R&S®RTM2022/2032/2052/2102 R&S®RTM2024/2034/2054/2104	2 4
Bandwidth (-3 dB) at 50 Ω	R&S®RTM2022/2024, R&S®RTM2032/2034, R&S®RTM2052/2054, R&S®RTM2102/2104	200 MHz, 350 MHz, 500 MHz, 1 GHz
Rise time (calculated)	R&S®RTM2032/2034, R&S®RTM2022/2024, R&S®RTM2052/2054, R&S®RTM2102/2104	1 ns, 1,75 ns, 700 ps, 350 ps
Input sensitivity	max. bandwidth in all ranges	50 Ω: 1 mV/div to 2 V/div, 1 MΩ: 1 mV/div to 10 V/div
DC gain accuracy	offset and position = 0, maximum operating temperature change of ±5°C after self-alignment	
	input sensitivity	> 5 mV/div ±1.5%
	input sensitivity	≤ 5 mV/div ±2%
Resolution		8 bit, up to 16 bit with high resolution decimation
Acquisition system		
Maximum realtime sampling rate		2.5 Gsample/s; 5 Gsample/s, interleaved
Acquisition memory	10 Msample; 20 Msample, interleaved; with R&S®RTM-K15 option: 460 Msample segmented memory	
Decimation algorithms	combination of decimation mode and waveform arithmetics possible	sample, peak detect, high resolution
Waveform arithmetics		off, envelope, average, smooth, filter
Horizontal system		
Timebase range	R&S®RTM202x/RTM203x/RTM205x R&S®RTM210x	selectable between 1 ns/div and 500 s/div selectable between 0.5 ns/div and 500 s/div
Trigger system		
Trigger types	edge, width, video (PAL, SECAM, PAL-M, SDTV, HDTV), pattern, runt, slew rate, B trigger; optional: I ² C, SPI, UART/RS-232/RS-422/RS-485, CAN/LIN, MIL-STD-1553, ARINC429	
Trigger level		±10 div from center of screen
Analysis and measurement functions		
QuickMeas	at the push of a button, int. meas. values are written directly onto the waveform and updated continuously	peak-to-peak voltage, pos. peak, neg. peak, rise time, fall time, mean value, RMS value, time, frequency
Automated/cursor measurements		31/14 measurement functions
Waveform mathematics		20 measurement functions
MSO option		
Digital channels		16 (2 logic probes)
Sampling rate	2 logic probes connected, 1 logic probe connected	2.5 Gsample/s per channel, 5 Gsample/s per channel
Acquisition memory	2 logic probes connected, 1 logic probe connected	10 Msample per channel, 20 Msample per channel

R&S®Scope Rider Handheld Digital Oscilloscope



Lab performance in a rugged and portable design

When debugging embedded devices in the lab or analyzing complex problems in the field, the R&S®ScopeRider offers the performance and capabilities of a lab oscilloscope combined with the form factor and ruggedness of a battery-operated handheld device.

- ▮ 60 MHz to 500 MHz, with 5 Gsample/s sampling rate
- ▮ Isolated channels: CAT IV 600 V/CAT III 1000 V
- ▮ 10 bit A/D converter
- ▮ 500 ksample memory depth
- ▮ 50 000 waveforms per second
- ▮ 5 in 1: lab oscilloscope, logic analyzer (MSO), protocol analyzer, data logger and digital multimeter (DMM)
- ▮ 7" capacitive touch display
- ▮ Wireless LAN remote control
- ▮ IP51: rugged, dust and water resistant housing

2

Designation	Type
R&S®Scope Rider model	
60 MHz, 2 channels, DMM	R&S®RTH1002
100 MHz, 2 channels, DMM	R&S®RTH1012
200 MHz, 2 channels, DMM	R&S®RTH1022
350 MHz, 2 channels, DMM	R&S®RTH1032
500 MHz, 2 channels, DMM	R&S®RTH1052
60 MHz, 4 channels	R&S®RTH1004
100 MHz, 4 channels	R&S®RTH1014
200 MHz, 4 channels	R&S®RTH1024
350 MHz, 4 channels	R&S®RTH1034
500 MHz, 4 channels	R&S®RTH1054
60 MHz, 2 channels, MSO, DMM	R&S®RTH1002MSO
100 MHz, 2 channels, MSO, DMM	R&S®RTH1012MSO
200 MHz, 2 channels, MSO, DMM	R&S®RTH1022MSO
350 MHz, 2 channels, MSO, DMM	R&S®RTH1032MSO
500 MHz, 2 channels, MSO, DMM	R&S®RTH1052MSO
60 MHz, 4 channels, MSO	R&S®RTH1004MSO
100 MHz, 4 channels, MSO	R&S®RTH1014MSO
200 MHz, 4 channels, MSO	R&S®RTH1024MSO
350 MHz, 4 channels, MSO	R&S®RTH1034MSO
500 MHz, 4 channels, MSO	R&S®RTH1054MSO



Application areas		
Electric and industrial installation and maintenance	Electronic field service and maintenance	Research and product development
Field use		Lab use
<ul style="list-style-type: none"> ▮ Electric installations ▮ Motors, fans and pumps ▮ Electric drives ▮ Sensors and transducers ▮ Industrial machinery 	<ul style="list-style-type: none"> ▮ Robotic systems ▮ Solar inverters ▮ Backup power supplies ▮ Avionic and military systems ▮ Medical equipment ▮ Rail vehicle systems 	<ul style="list-style-type: none"> ▮ Embedded systems ▮ Industrial controllers ▮ Power electronics ▮ General electronics ▮ Environmental testing
Unmatched performance, versatility and user experience for all kinds of electric troubleshooting.	Laboratory oscilloscope performance and capabilities for advanced troubleshooting applications in the field.	Portable laboratory oscilloscope for all kinds of debugging tasks with the advantage of isolated channels for power electronics applications.

Options and accessories overview for R&S®RTx series

Hardware and software options				
Hardware options (plug-in)	R&S®RTO	R&S®RTE	R&S®RTM	R&S®RTH
Mixed Signal, 400 MHz, 5 Gsample/s, 16 channels, 100 Msample per channel	R&S®RTO-B1	R&S®RTE-B1	R&S®RTM-B1	–
Mixed Signal Upgrade for non-MSO models, 250 MHz	–	–	–	R&S®RTH-B1
OCXO 10 MHz	R&S®RTO-B4	–	–	–
GPIO Interface	R&S®RTO-B10	R&S®RTE-B10	R&S®RTM-B10	–
Additional SSD, incl. preinstalled Windows 7	R&S®RTO-B18	R&S®RTE-B18	–	–
Replacement HDD, incl. preinstalled Windows 7	R&S®RTO-B19	R&S®RTE-B19	–	–
Windows 7 Upgrade Kit	R&S®RTO-U1	–	–	–
Memory Upgrade, 20 Msample per channel	Standard	R&S®RTE-B101	–	–
Memory Upgrade, 50 Msample per channel	R&S®RTO-B101	R&S®RTE-B102	–	–
Memory Upgrade, 100 Msample per channel	R&S®RTO-B102	–	–	–
Memory Upgrade, 200 Msample per channel	R&S®RTO-B103	–	–	–
Memory Upgrade, 400 Msample per channel	R&S®RTO-B104	–	–	–
Memory Upgrade, 1 Gsample per channel	R&S®RTO-B110	–	–	–
Bandwidth upgrades, incl. calibration (depends on oscilloscope family and model) ¹⁾	R&S®RTO-B20x	R&S®RTE-B20x	R&S®RTM-B20x	–
Software options				
I ² C/SPI Serial Triggering and Decoding	R&S®RTO-K1	R&S®RTE-K1	R&S®RTM-K1	R&S®RTH-K1
UART/RS-232/RS-422/RS-485 Serial Triggering and Decoding	R&S®RTO-K2	R&S®RTE-K2	R&S®RTM-K2	R&S®RTH-K2
CAN/LIN Serial Triggering and Decoding	R&S®RTO-K3	R&S®RTE-K3	R&S®RTM-K3	R&S®RTH-K3
FlexRay™ Serial Triggering and Decoding	R&S®RTO-K4	R&S®RTE-K4	–	–
I ² S/LJ/RJ/TDM Serial Triggering and Decoding	R&S®RTO-K5	R&S®RTE-K5	R&S®RTM-K5	–
MIL-STD-1553 Serial Triggering and Decoding	R&S®RTO-K6	R&S®RTE-K6	R&S®RTM-K6	–
ARINC429 Serial Triggering and Decoding	R&S®RTO-K7	R&S®RTE-K7	R&S®RTM-K7	–
Ethernet Serial Decoding	R&S®RTO-K8	R&S®RTE-K8	–	–
CAN FD Serial Triggering and Decoding	R&S®RTO-K9	R&S®RTE-K9	–	–
SENT Serial Triggering and Decoding	R&S®RTO-K10	R&S®RTE-K10	–	–
MIPI RFFE Serial Triggering and Decoding	R&S®RTO-K40	–	–	–
MIPI D-PHY Serial Triggering and Decoding	R&S®RTO-K42	–	–	–
MIPI M-PHY/UniPro Serial Triggering and Decoding	R&S®RTO-K44	–	–	–
Manchester and NRZ Serial Triggering and Decoding	R&S®RTO-K50	R&S®RTE-K50	–	–
8b10b Serial Decoding	R&S®RTO-K52	–	–	–
MDIO Serial Triggering and Decoding	R&S®RTO-K55	R&S®RTE-K55	–	–
USB 2.0/1.1/1.0 Serial Triggering and Decoding	R&S®RTO-K60	R&S®RTE-K60	–	–
Space Wire T&D	R&S®RTO-K65	R&S®RTE-K65	–	–
CXPI Serial Triggering and Decoding	R&S®RTO-K76	R&S®RTE-K76	–	–
I/Q Software Interface	R&S®RTO-K11	–	–	–
Jitter Analysis	R&S®RTO-K12	–	–	–
Clock Data Recovery	R&S®RTO-K13	–	–	–
History and Segmented Memory	Standard	Standard	R&S®RTM-K15	R&S®RTH-K15
High Definition Mode, vertical resolution up to 16 bit	R&S®RTO-K17	R&S®RTE-K17	–	–
Spectrum Analysis and Spectrogram	R&S®RTO-K18	R&S®RTE-K18	R&S®RTM-K18	–
Advanced Triggering	–	–	–	R&S®RTH-K19
USB 2.0 Compliance Test	R&S®RTO-K21	–	–	–
Ethernet Compliance Test (10/100/1000BASE-T)	R&S®RTO-K22	–	–	–
10G Ethernet Compliance Test	R&S®RTO-K23	–	–	–
BroadR-Reach® Compliance Test	R&S®RTO-K24	–	–	–
Ethernet Compliance Test (2.5G/5GBASE-T)	R&S®RTO-K25	–	–	–
MIPI D-PHY Compliance Test	R&S®RTO-K26	–	–	–
eMMC Compliance Test	R&S®RTO-K92	–	–	–
Power Analysis	R&S®RTO-K31	R&S®RTE-K31	R&S®RTM-K31	–
Digital Voltmeter (DVM)	–	–	R&S®RTM-K32	–
Frequency Counter	–	–	–	R&S®RTH-K33
Wireless LAN	–	–	–	R&S®RTH-K200
Web Interface Remote Control	Standard	Standard	–	R&S®RTH-K201

Options and accessories overview for R&S®RTx series

Hardware and software options				
Accessories	R&S®RTO	R&S®RTE	R&S®RTM	R&S®RTH
Front Cover	R&S®RTO-Z1	R&S®RTO-Z1	R&S®RTM-Z1	
Soft Case	R&S®RTO-Z3	R&S®RTO-Z3	R&S®RTM-Z3	R&S®HA-Z220
Hard Shell Protective Carrying Case				R&S®RTH-Z4
Transit Case, with trolley function	R&S®RTO-Z4	R&S®RTO-Z4	R&S®RTM-Z4	–
Probe Pouch	R&S®RTO-Z5	R&S®RTO-Z5	–	–
19" Rackmount Kit	R&S®ZZA-RTO	R&S®ZZA-RTO	R&S®ZZA-RTM	–
Ethernet Cable, length: 2 m, crossover	–	–	–	R&S®HA-Z210
USB Cable, length: 1.8 m, standard/mini USB connector	–	–	–	R&S®HA-Z211
Car Adapter	–	–	–	R&S®HA-Z302
Battery Charger for Lithium-Ion Battery	–	–	–	R&S®HA-Z303
Replacement Battery	–	–	–	R&S®HA-Z306
Spare Power Supply for R&S®RTH incl. power plugs for EU, GB, US	–	–	–	R&S®RT-ZA14

¹⁾ The bandwidth upgrade is performed at a Rohde&Schwarz service center, where the oscilloscope will also be calibrated.

R&S®HMO3000

Digital Mixed Signal Oscilloscopes

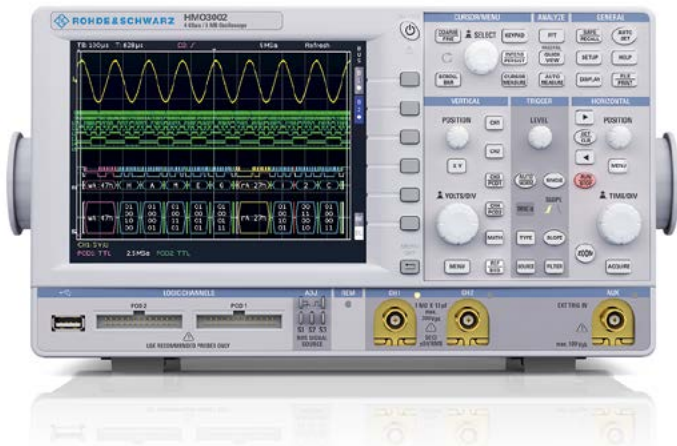

Digital mixed signal oscilloscope with 300 MHz to 500 MHz bandwidth

The R&S®HMO3000 oscilloscope series offers an ideal solution for current bandwidth, sampling rate and memory depth requirements. The two- and four-channel instruments provide bandwidths of 300 MHz, 400 MHz and 500 MHz, a sampling rate of 4 Gsample/s and a memory depth of 8 Mpoints. The instruments feature MSO functionality as standard and several serial bus analysis options to meet all requirements of modern development designs.

Rohde & Schwarz offers the R&S®HMO3000 series exclusively as mixed signal oscilloscopes. Unlike other manufacturers' instruments, the mixed signal functions are not activated via software options. The optional low capacitance logic probe R&S®HO3508 (also available as a double pack, R&S®HO3516) can be used to analyze up to 16 logic channels with a sampling rate of 1 Gsample/s.

The logic probe is not tied to a specific instrument serial number and can be used with all R&S®HMO series digital oscilloscopes. For communications between embedded systems and the environment, the R&S®HMO3000 includes hardware-based signal triggering and decoding for all common protocols (I²C, SPI, UART, CAN and LIN). This option can be activated with an upgrade voucher at any time.

The integrated three-digit digital voltmeter enables service technicians to simultaneously perform voltage measurements on all analog channels.

The R&S®HOO14 segmented memory option can be used to divide the available memory of the R&S®HMO3000 into up to 1000 segments. This procedure allows sampling

rates of 200 000 waveforms/s, making it possible to capture rare anomalies occurring during many short events in quick succession. For analyzing the recorded signals, all R&S®HMO measurement functions are available, including the pass/fail function.

Thanks to the FFT analysis function with 64k test points, the R&S®HMO3000 series competes with significantly larger oscilloscopes in the frequency domain. The time domain signal, measurement window and FFT analysis result are displayed together on a single screen, which makes it easier to evaluate the input waveform. The R&S®HMO3000 series offers time domain, logic, protocol and frequency analysis in a single instrument.

- ▮ 4 Gsample/s realtime sampling rate, low-noise flash A/D converter
- ▮ 8 Mpoint memory, zoom up to 200 000:1
- ▮ Automatically or manually adjustable memory depth
- ▮ Segmented memory option (R&S®HOO14)
- ▮ MSO functionality included as standard (HO3508/HO3516 logic probe required)
- ▮ Vertical sensitivity down to 1 mV/div
- ▮ Trigger modes: slope (A/B), pulse width, video, logic, serial buses (optional), hold-off
- ▮ Serial bus trigger and hardware-accelerated decode including list view options: I²C+SPI+RS-232/UART, CAN+LIN
- ▮ 28 automeasurement parameters plus statistics, formula editor, ratio cursor
- ▮ Six-digit hardware counter
- ▮ FFT up to 64k points (dBm, dBV, V (RMS))
- ▮ Pass/fail tests based on masks
- ▮ Automatic search for user-defined events
- ▮ Display: 12-div x-axis, 20-div y-axis (VirtualScreen)
- ▮ 2 × USB for mass storage, Ethernet/USB dual interface for remote control

Models/options

Designation	Type
300 MHz Two/Four-Channel Mixed Signal Oscilloscope	R&S®HMO3032/ R&S®HMO3034
400 MHz Two/Four-Channel Mixed Signal Oscilloscope	R&S®HMO3042/ R&S®HMO3044
500 MHz Two/Four-Channel Mixed Signal Oscilloscope	R&S®HMO3052/ R&S®HMO3054
Analysis of I ² C, SPI and RS-232/UART signals on analog and logic channels (two buses can be analyzed at the same time)	R&S®HOO10
Analysis of I ² C, SPI and RS-232/UART signals on all analog channels (only one bus available for analysis)	R&S®HOO11
Analysis of CAN and LIN signals on analog and logic channels for two buses	R&S®HOO12
Segmented Memory Option	R&S®HOO14
Bandwidth Upgrade from 300 MHz to 500 MHz for two/four-channel models	R&S®HOO352/ R&S®HOO354
Bandwidth Upgrade from 400 MHz to 500 MHz for two/four-channel models	R&S®HOO452/ R&S®HOO454

R&S®HMO Compact Digital Mixed Signal Oscilloscopes



Four-channel oscilloscopes with 70/100/150/200 MHz bandwidth

The digital mixed signal oscilloscopes in the R&S®HMO compact series unify high sensitivity and multifunctionality with an attractive price. The wide range of applications and measurement functions address a broad group of users – from embedded developers to service technicians to educators.

The four-channel instruments offer bandwidths of 70 MHz, 100 MHz, 150 MHz and 200 MHz, a sampling rate of 2 Gsample/s and a memory depth of 2 Msample. Featuring MSO functionality as standard and a variety of options for serial bus analysis, the instruments meet the demands of modern design development.

Rohde & Schwarz offers the R&S®HMO compact series exclusively as mixed signal oscilloscopes. Unlike other manufacturers' instruments, the mixed signal functions are not activated via software options. The only optional extra is the R&S®HO3508 low-capacitance logic probe that analyzes signals with a sampling rate of 1 Gsample/s on up to 8 logic channels. The probe is not tied to the instrument serial number and can be used with any of the R&S®HMO oscilloscopes.

For communications between embedded systems and the environment, hardware-based signal triggering and decoding for all common protocols (I²C, SPI, UART, CAN and

LIN) has been integrated. It can be activated with an upgrade voucher at any time.

Thanks to the integrated 64k point FFT analysis function, the R&S®HMO compact series competes with significantly larger oscilloscopes in the frequency domain. The time domain signal, measurement window and FFT results are displayed on a single screen, which makes it easier to analyze the input signal waveform.

The R&S®HMO compact series offers time domain, logic, protocol and frequency analysis plus an advanced component tester in a single, compact instrument.

Superior hardware-based acquisition for precise measurement results

- ▮ 2 Gsample/s sampling rate, 2 Msample memory depth
- ▮ High vertical sensitivity down to 1 mV/div
- ▮ Low-noise measurement due to state-of-the-art A/D converter
- ▮ High acquisition rate to identify signal faults

Versatile measurement functions and fast results

- ▮ Wide selection of automatic measurement functions
- ▮ QuickView: key results at the push of a button
- ▮ Advanced math functions with realtime calculations
- ▮ Mask test: a new mask can be easily created with just a few keystrokes
- ▮ FFT: the easy way to analyze the signal spectrum

Logic analysis with the MSO option

- ▮ Mixed signal function as standard
- ▮ Precise triggering on signal events
- ▮ Straightforward display of digital signals
- ▮ Low test point loading due to active probe solution

Serial bus analysis: hardware-based triggering and decoding

- ▮ Versatile trigger options for isolating specific data packets
- ▮ Color-coded display of decoded bus signals
- ▮ Direct export of analyzed data to USB memory drive
- ▮ Simultaneous decoding of two buses in realtime

Future-ready investment and scalability

- ▮ Free firmware updates
- ▮ Serial bus analysis via optional software licenses

Models/options	Type
70/100/150/200 MHz Four-Channel Mixed Signal Oscilloscope	R&S®HMO724/1024/1524/2024
Analysis of I ² C, SPI, RS-232/UART signals on analog and logic channels (2 buses can be analyzed at the same time)	R&S®HOO10
Analysis of I ² C, SPI and RS-232/UART signals on all analog channels (only one bus available for analysis)	R&S®HOO11
Analysis of CAN and LIN signals on analog and logic channels for two buses	R&S®HOO12
Dual Ethernet/USB Interface	HO732
IEEE-488 (GPIB) Interface, galvanically isolated	HO740

R&S®HMO1002/1202 Digital Oscilloscopes



Two-channel oscilloscopes with 50 MHz to 300 MHz bandwidth

High sensitivity, multifunctionality and a great price – that is what makes the R&S®HMO1002 and R&S®HMO1202 digital oscilloscopes so special. The R&S®HMO digital oscilloscopes series offers time domain, logic, protocol and frequency analysis in a single instrument and includes a wide range of upgrade options, providing true investment protection for the future.

The R&S®HMO1002 and R&S®HMO1202 digital oscilloscopes from the Rohde & Schwarz feature a high waveform update rate and high vertical sensitivity, and are available with bandwidths from 50 MHz to 300 MHz. Depending on the specific model, the oscilloscope offers a maximum memory depth of 2 Msample and a sampling rate of 2 Gsample/s.

Like all R&S®HMO oscilloscopes, the R&S®HMO1002 and R&S®HMO1202 include the mixed signal functionality as standard. The separately available R&S®HO3508 logic probe can be used with all R&S®HMO oscilloscopes.

For the analysis of communications between embedded systems, hardware-based signal triggering and decoding for all common protocols (I²C, SPI, UART, CAN and LIN) is included. This option can be activated with an upgrade voucher at any time, even after sale.

The integrated pattern generator for generating protocol messages at up to 50 Mbit/s is ideal for embedded users. In addition to using predefined messages for supported serial protocols, developers can program their own signal patterns (ARB editor). The integrated, three-digit digital voltmeter enables the R&S®HMO1002 and R&S®HMO1202 to simultaneously perform voltage measurements on both analog channels with two values each.

A function generator for different types of signals with frequencies up to 50 kHz is useful in educational settings. Trainees and students can use these basic signals to learn a broad range of measurements. Convenience functions can be switched off in education mode.

Thanks to the powerful FFT over 128 000 test points and the analysis functions in the frequency domain, the R&S®HMO1002 and R&S®HMO1202 compete with significantly larger oscilloscopes. The time domain signal, measurement window, FFT analysis range and measurement result are displayed on a single screen, which makes it easier to measure the spectra.

- High vertical sensitivity down to 1 mV/div
- Low-noise measurement due to state-of-the-art A/D converters
- High acquisition rate to identify signal faults
- Wide selection of automatic measurement functions
- QuickView: key results at the press of a button
- Mask test: easy creation of a new mask with just a few keystrokes
- FFT: the easy way to analyze the signal spectrum
- Mixed signal functionality as standard
- Precise triggering on signal events
- Straightforward display of digital signals
- Low test point loading due to active probes
- Versatile trigger options for isolating specific data packets
- Color-coded display of decoded bus signals
- Direct export of analyzed data to USB flash drive
- Simultaneous decoding of two buses in realtime
- Simultaneous measurement of primary and secondary voltage value per channel
- Free firmware updates
- Bandwidth upgrades as required
- Serial bus analysis options via software licenses

	R&S®HMO1002	R&S®HMO1202
Bandwidth	50 MHz, 70 MHz, 100 MHz (upgrade via software license)	100 MHz, 200 MHz, 300 MHz (upgrade via software license)
Analog channels	2 × 1 MΩ	2 × 1 MΩ or 2 × 50 Ω
Sampling rate	2 × 500 Msample/s or 1 × 1 Gsample/s	2 × 1 Gsample/s or 1 × 2 Gsample/s
Memory depth	2 × 500 ksamples or 1 × 1 Msamples	2 × 1 Msamples or 1 × 2 Msamples
Mixed signal modes	CH1 + POD or CH1 + CH2 (with R&S®HO3508 probe)	CH1 + CH2 + POD (with R&S®HO3508 probe)
Digital channels	8 × 500 Msamples/s at 8 × 500 ksamples	8 × 1 Gsample/s at 8 × 1 Msamples
External trigger input	external trigger only	external trigger, auxiliary logic channel
Mathematics	QuickMath	complex math functions with formula editor
Cooling	fanless	low-noise, temperature-regulated fan control circuit

Oscilloscope probes and probe accessories



Rohde & Schwarz
active probes
(1.0 GHz to 6.0 GHz).



R&S®RT-ZS10/20/30.



R&S®RT-ZD10/20/30.



R&S®RT-ZD01 high-voltage differential probe: safe measurement up to category CAT III.



Passive probes: the allrounders for every oscilloscope.



R&S®RT-ZC20B current probe (100 MHz, 30 A (RMS)).



External power supply for up to four current probes.

Oscilloscope probe accessories	Type
Accessory Set for R&S®RT-ZP10/R&S®RTM-ZP10	R&S®RT-ZA1
Spare Accessory Set for R&S®RT-ZS10/10E/20/30	R&S®RT-ZA2
Pin Set for R&S®RT-ZS10/10E/20/30	R&S®RT-ZA3
Mini Clips	R&S®RT-ZA4
Micro Clips	R&S®RT-ZA5
Lead Set	R&S®RT-ZA6
Pin Set for R&S®RT-ZD20/30	R&S®RT-ZA7
N-Type Adapter for R&S®RT-Zxx oscilloscope probes	R&S®RT-ZA9
SMA Adapter	R&S®RT-ZA10
Probe Power Supply	R&S®RT-ZA13
External Attenuator 10:1, 2.0 GHz, 1 MΩ 1.3 pF, 70 V DC, 46 V AC (peak) for R&S®RT-ZD20/30	R&S®RT-ZA15
Power Deskew Fixture	R&S®RT-ZF20
Accessory Replacement Set for passive probes R&S®RZ-ZI10 and R&S®RZ-ZI11	R&S®RT-ZA20
Extended Set for probes R&S®RT-ZI10/R&S®RT-ZI11	R&S®RT-ZA21
Safety Test Leads, red and black, silicone, 600 V CAT IV	R&S®RT-ZA22
20 dB Preamp for R&S®HZ-15	R&S®HZ-16

Oscilloscope probes and probe accessories



R&S®RT-ZH10 high-voltage, single-ended probe with extensive set of accessories.



Extensive R&S®RT-ZA1 accessory set for optimal contacting.



R&S®RT-ZA4 mini clips and R&S®RT-ZA5 micro clips for reliable contacting, especially when using multiple probes.



Extensive set of standard accessories for the R&S®RT-ZS60 single-ended probe.



R&S®HO3508 eight-channel logic probe (350 MHz, 4 pF).



R&S®RT-ZH11 high-voltage probe 1000:1 (400 MHz, 1 kV (RMS)).



R&S®RT-ZC02 AC/DC current probe (100 A/1000 A, DC to 20 kHz).



R&S®RT-ZS10L 1 GHz active probe (0.9 pF, 1 MΩ, including accessories).



R&S®RT-ZD08 800 MHz active differential probe (10:1, 1 pF, 200 kΩ).



R&S®RT-ZF20 power deskew and calibration test fixture: easy deskewing for measurements on power electronics.

Oscilloscope probes and probe accessories – R&S®RT-ZM modular probe system

Addressing high-speed probing challenges

The R&S®RT-ZM modular probe system delivers high performance in combination with flexible and configurable connectivity. The R&S®RT-ZM probe system includes probe tip modules for various measurement tasks and conditions. The probe tip modules can be connected to amplifier modules with bandwidths ranging from 1.5 GHz to 9 GHz. The modular probe system also offers multimode functionality, enabling users to switch between different measurement modes.

Block diagram of the R&S®RT-ZM modular probe system with exchangeable R&S®RT-ZM probe tip module, connected via a high-performance double-socket SMP snap-on interface to an R&S®RT-ZM probe amplifier module with Rohde&Schwarz probe interface.

The integrated R&S®ProbeMeter functionality makes it possible to perform high-precision DC voltage measurements at the same time.

Multiple measurement modes with a single connection

The multimode functionality allows users to switch between single-ended, differential and common mode measurements without reconnecting or resoldering the probe tip. The multimode functionality is implemented on the company-designed high-speed R&S®RT-ZM amplifier ASIC.

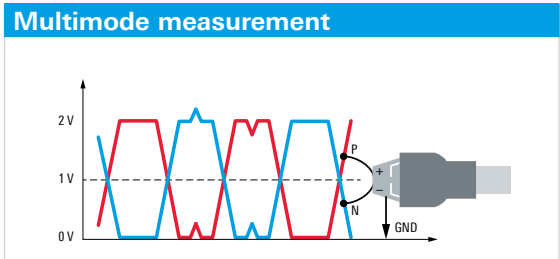
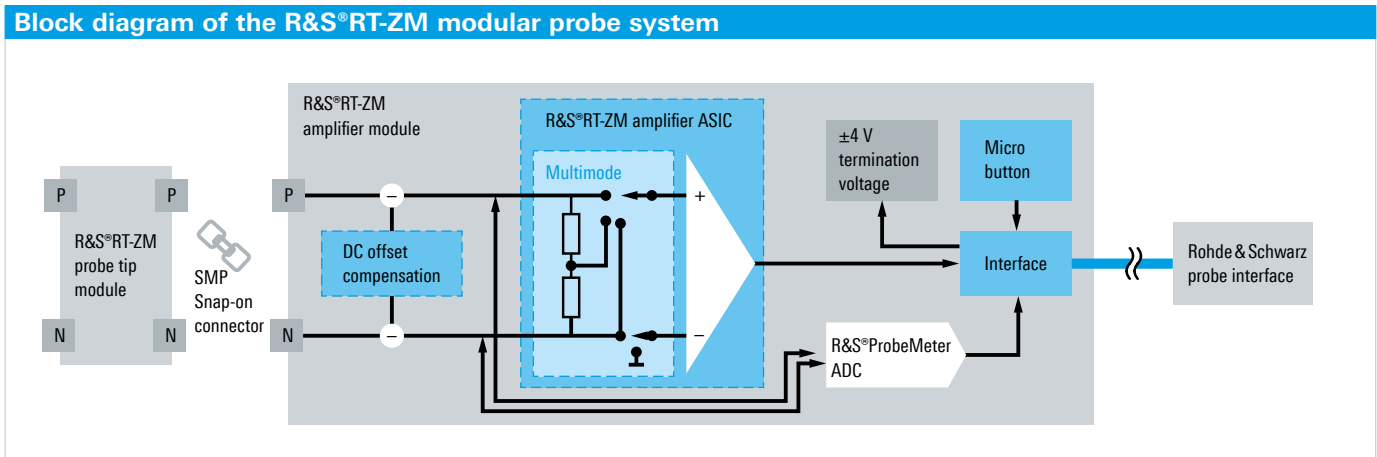

Measurement mode		Description
Differential mode (DM)		Voltage between positive and negative input pin: $V_{DM} = V_P - V_N$
Common mode (CM)		Mean voltage between positive and negative input pin versus ground: $V_{CM} = \frac{V_P + V_N}{2}$
Single-ended modes	<div style="display: flex; justify-content: space-around;"> <div> P mode </div> <div> N mode </div> </div>	Voltage between positive or negative input pin and ground:

Oscilloscopes

Probe	Bandwidth	Attenuation factor	Input impedance	Input capacitance	Dynamic range	Comment/extras
Passive probes						
R&S®RT-ZP1x	38 MHz	1:1	1 MΩ	39 pF	55 V (RMS) CAT II	
R&S®RT-ZP03	300 MHz	1:1/10:1	1 MΩ/10 MΩ	12 pF/82 pF	55 V/400 V (RMS) (CAT II)	no probe detection
R&S®RT-ZP05	500 MHz	10:1	10 MΩ	10 pF	300 V (RMS) (CAT II)	
R&S®RT-ZP10	500 MHz	10:1	10 MΩ	~ 9.5 pF	400 V (RMS) 300 V (RMS) (CAT II)	pre-adjusted for R&S®RTO
R&S®RTM-ZP10	500 MHz	10:1	10 MΩ	~ 9.5 pF	400 V (RMS) 300 V (RMS) (CAT II)	pre-adjusted for R&S®RTM
R&S®RT-ZI10	500 MHz	10:1	10 MΩ	12 pF	600 V (CAT IV) 1000 V (CAT III)	pre-adjusted for R&S®RTH
R&S®RT-ZI10C	500 MHz	10:1	10 MΩ	11 pF	300 V (CAT II)	pre-adjusted for R&S®RTH, compact probe for lab applications
R&S®RT-ZI11	500 MHz	100:1	100 MΩ	4.6 pF	600 V (CAT IV) 1000 V (CAT III) 3540 V (CAT I)	pre-adjusted for R&S®RTH
Passive broadband probes						
R&S®RT-ZZ80	8 GHz	10:1	500 Ω	0.3 pF	20 V (RMS)	
Active broadband probes						
Single-ended						
R&S®RT-ZS10L	1 GHz	10:1	1 MΩ	0.9 pF	±20 V	BNC interface, 50 Ω output
R&S®RT-ZS10E	1 GHz	10:1	1 MΩ	0.8 pF	±8 V	Rohde & Schwarz probe interface
R&S®RT-ZS10	1 GHz	10:1	1 MΩ	0.8 pF	±8 V	R&S®ProbeMeter and micro button for instrument control
R&S®RT-ZS20	1.5 GHz	10:1	1 MΩ	0.8 pF	±8 V	
R&S®RT-ZS30	3 GHz	10:1	1 MΩ	0.8 pF	±8 V	
R&S®RT-ZS60	6 GHz	10:1	1 MΩ	0.3 pF	±8 V	
Differential						
R&S®RT-ZD02	200 MHz	10:1	1 MΩ	3.5 pF	±60 V	BNC interface, 50 Ω output
R&S®RT-ZD08	800 MHz	10:1	200 kΩ	1 pF	±40 V	BNC interface, 50 Ω output
R&S®RT-ZD10	1 GHz	10:1	1 MΩ	0.6 pF	±5 V, with R&S®RT-ZA15:	R&S®ProbeMeter and micro button for instrument control; R&S®RT-ZA15 included with the R&S®RT-ZD10
R&S®RT-ZD20	1.5 GHz	10:1	1 MΩ	0.6 pF	±70 V DC/ ±46 V AC (peak)	
R&S®RT-ZD30	3 GHz	10:1	1 MΩ	0.6 pF		
R&S®RT-ZD40	4.5 GHz	10:1	1 MΩ	0.4 pF	±5 V	
Modular probe system						
Probe amplifier modules (values for input impedance – single-ended mode/differential mode)						
R&S®RT-ZM15	1.5 GHz	2:1/10:1	200 kΩ/400 kΩ	–	±0.5 V, ±2.5 V	integrated high-precision voltmeter and micro button for convenient instrument control
R&S®RT-ZM30	3 GHz	2:1/10:1	200 kΩ/400 kΩ	–	±0.5 V, ±2.5 V	
R&S®RT-ZM60	6 GHz	2:1/10:1	200 kΩ/400 kΩ	–	±0.5 V, ±2.5 V	
R&S®RT-ZM90	9 GHz	2:1/10:1	200 kΩ/400 kΩ	–	±0.5 V, ±2.5 V	
Probe tip modules (values for input impedance, input capacitance – single-ended mode/differential mode)						
R&S®RT-ZMA10	max. 9 GHz	2:1/10:1	200 kΩ/400 kΩ	96 fF/77 fF	rise time 20% to 80% (single-ended mode): 30 ps rise time 10% to 90% (differential mode): 50 ps	
R&S®RT-ZMA11	2.5 GHz	2:1/10:1	200 kΩ/400 kΩ	96 fF/77 fF	rise time 20% to 80% (single-ended mode): 30 ps rise time 10% to 90% (differential mode): 50 ps	
R&S®RT-ZMA12	max. 6 GHz	2:1/10:1	200 kΩ/400 kΩ	521 fF/279 fF	rise time 20% to 80% (single-ended mode): 45 ps rise time 10% to 90% (differential mode): 75 ps	
R&S®RT-ZMA15	max. 9 GHz	2:1/10:1	200 kΩ/400 kΩ	150 fF/109 fF	rise time 20% to 80% (single-ended mode): 30 ps rise time 10% to 90% (differential mode): 50 ps	
R&S®RT-ZMA30	max. 9 GHz	2:1/10:1	200 kΩ/400 kΩ	52 fF/32 fF	rise time 20% to 80% (single-ended mode): 30 ps rise time 10% to 90% (differential mode): 50 ps	
R&S®RT-ZMA40	max. 6 GHz	2:1/10:1	50 Ω/100 Ω	input return loss >12 dB	rise time 20% to 80% (single-ended mode): 30 ps rise time 10% to 90% (differential mode): 50 ps	
R&S®RT-ZMA50	2.5 GHz	2:1/10:1	200 kΩ/400 kΩ	77 fF/96 fF	rise time 20% to 80% (single-ended mode): 90 ps rise time 10% to 90% (differential mode): 140 ps	
Accessory						
R&S®RT-ZMA1	probe tip module case for up to six R&S®RT-ZMAxx probe tip modules					

Probe	Bandwidth	Attenuation factor	Input impedance	Input capacitance	Dynamic range	Comment/extras
High voltage probes						
Single-ended						
R&S®RT-ZH10	400 MHz	100:1	50 MΩ	7.5 pF	1 kV (RMS) (CAT II)	
R&S®RT-ZH11	400 MHz	1000:1	50 MΩ	7.5 pF	1 kV (RMS) (CAT II)	
Differential						
R&S®RT-ZD01	100 MHz	100:1 1000:1	8 MΩ	3.5 pF	±140 V (100:1), ±1400 V (1000:1), 1 kV (RMS) (CAT III)	power supply via USB
Current probes						
R&S®RT-ZC02	20 kHz	0.01 V/A 0.001 V/A	–	–	100 A 1000 A	battery-operated
R&S®RT-ZC03	100 kHz	0.01 V/A	–	–	30 A	battery-operated
R&S®RT-ZC05B	2 MHz	0.01 V/A	–	–	500 A (RMS)	Rohde&Schwarz probe interface for probe detection and power supply
R&S®RT-ZC10	10 MHz	0.01 V/A	–	–	150 A (RMS)	power supply via R&S®RT-ZA13
R&S®RT-ZC10B		0.01 V/A	–	–	150 A (RMS)	Rohde&Schwarz probe interface for probe detection and power supply
R&S®RT-ZC15B	50 MHz	0.1 V/A	–	–	30 A (RMS)	Rohde&Schwarz probe interface for probe detection and power supply
R&S®RT-ZC20	100 MHz	0.1 V/A	–	–	30 A (RMS)	power supply via R&S®RT-ZA13
R&S®RT-ZC20B	100 MHz	0.1 V/A	–	–	30 A (RMS)	Rohde&Schwarz probe interface for probe detection and power supply
R&S®RT-ZC30	120 MHz	1 V/A	–	–	5 A (RMS)	power supply via R&S®RT-ZA13
EMC near field probe						
R&S®HZ-15	30 MHz to 3 GHz	–	–	–	–	E and H near-field probe for EMC debugging, 20 dB gain with R&S®HZ-16

Oscilloscopes

Probes	Scope series	R&S® HMO													
		Model	1002	1002	1002	1212	1222	1232	724	1024	1524	2024	3032/4	3042/4	3052/4
	Bandwidth (MHz) →	50	70	100	100	200	300	70	100	150	200	300	400	500	
Passive probes															
R&S®RT-ZP1x	38 MHz	○	○	○	○	○	○	○	○	○	○	○	○	○	
R&S®RT-ZP03	10 MHz/300 MHz	■	■	■	■	■	■	■	■	■	■	○	○	○	
R&S®RT-ZP05	500 MHz	–	–	–	–	–	–	–	–	–	–	■	■	■	
R&S®RTM-ZP10	500 MHz	○	○	○	○	○	○	○	○	○	○	○	○	○	
R&S®RT-ZP10	500 MHz	○	○	○	○	○	○	○	○	○	○	○	○	○	
Isolated passive probes															
R&S®RT-ZI10	500 MHz; 10:1	–	–	–	–	–	–	–	–	–	–	–	–	–	
R&S®RT-ZI10C	500 MHz; 10:1	–	–	–	–	–	–	–	–	–	–	–	–	–	
R&S®RT-ZI11	500 MHz; 100:1	–	–	–	–	–	–	–	–	–	–	–	–	–	
Passive broadband probe															
R&S®RT-ZZ80	8 GHz	–	–	–	–	–	–	–	–	–	–	–	–	–	
Active probes: single-ended															
R&S®RT-ZS10L	1 GHz	●	●	●	●	●	●	●	●	●	●	●	●	●	
R&S®RT-ZS10E	1 GHz	–	–	–	–	–	–	–	–	–	–	–	–	–	
R&S®RT-ZS10	1 GHz	–	–	–	–	–	–	–	–	–	–	–	–	–	
R&S®RT-ZS20	1.5 GHz	–	–	–	–	–	–	–	–	–	–	–	–	–	
R&S®RT-ZS30	3 GHz	–	–	–	–	–	–	–	–	–	–	–	–	–	
R&S®RT-ZS60	6 GHz	–	–	–	–	–	–	–	–	–	–	–	–	–	
Active probes: differential															
R&S®HZ109	30/40 MHz	●	●	○	○	○	○	●	○	○	○	○	○	○	
R&S®RT-ZD10	1 GHz	–	–	–	–	–	–	–	–	–	–	–	–	–	
R&S®RT-ZD20	1.5 GHz	–	–	–	–	–	–	–	–	–	–	–	–	–	
R&S®RT-ZD30	3 GHz	–	–	–	–	–	–	–	–	–	–	–	–	–	
R&S®RT-ZD40	4.5 GHz	–	–	–	–	–	–	–	–	–	–	–	–	–	
High-voltage probes: single-ended															
R&S®RT-ZH03	100:1	○	○	○	○	○	○	○	○	○	○	○	○	○	
R&S®RT-ZH10	100:1	○	○	○	○	○	○	○	○	○	○	○	○	○	
R&S®RT-ZH11	1000:1	●	●	●	●	●	●	●	●	●	●	●	●	●	
High-voltage probe: differential															
R&S®RT-ZD01	1000 V	○	○	○	○	○	○	○	○	○	○	○	○	○	
R&S®RT-ZD02	200 MHz	○	○	●	●	○	○	○	●	○	○	○	○	○	
R&S®RT-ZD08	800 MHz	○	○	○	○	●	●	○	○	●	●	●	●	●	
Current probes															
R&S®RT-ZC02	±100/1000 A (RMS)	●	●	●	●	●	●	●	●	●	●	●	●	●	
R&S®RT-ZC03	±20 A (RMS)	●	●	●	●	●	●	●	●	●	●	●	●	●	
R&S®RT-ZC05B	±500 A (RMS)	●	●	●	●	●	●	●	●	●	●	●	●	●	
R&S®RT-ZC10 ¹⁾	±150 A (RMS)	●	●	●	●	●	●	●	●	●	●	●	●	●	
R&S®RT-ZC10B	±150 A (RMS)	●	●	●	●	●	●	●	●	●	●	●	●	●	
R&S®RT-ZC15B	±30 A (RMS)	●	●	●	●	●	●	●	●	●	●	●	●	●	
R&S®RT-ZC20 ¹⁾	±30 A (RMS)	●	●	●	●	●	●	●	●	●	●	●	●	●	
R&S®RT-ZC20B ²⁾	±30 A (RMS)	●	●	●	●	●	●	●	●	●	●	●	●	●	
R&S®RT-ZC30	5 A (RMS)	●	●	●	●	●	●	●	●	●	●	●	●	●	
EMC near-field probe															
R&S®HZ-15	30 MHz to 3 GHz	–	–	–	–	–	–	–	–	–	–	–	–	–	
Temperature probe															
R&S®RT-ZA12	PT100, –50 °C to +400 °C, 2-wire	–	–	–	–	–	–	–	–	–	–	–	–	–	

- Standard delivery. One probe per oscilloscope channel.
- Recommended. Available as an option.
- Compatible. System bandwidth may be limited on probe or base unit. Manual configuration on oscilloscope may be necessary for compensation.
- Not available.

R&S® RTM2000				R&S® RTE				R&S® RTO2000				R&S® RTH				
2022/4	2032/4	2052/4	2102/4	1022/4	1032/4	1052/4	1102/4	1002/4	1012/4	1022/4	1044	1002/4	1012/4	1022/4	1032/4	1052/4
200	350	500	1000	200	350	500	1000	600	1000	2000	4000	60	100	200	350	500
○	○	○	○	○	○	○	○	○	○	○	○	—	—	—	—	—
○	○	○	○	■	■	■	■	■	■	■	■	—	—	—	—	—
—	—	—	—	—	—	—	—	—	—	—	—	—	—	—	—	—
■	■	■	■	○	○	○	○	○	○	○	○	—	—	—	—	—
○	○	○	○	■	■	■	■	■	■	■	■	—	—	—	—	—
—	—	—	—	—	—	—	—	—	—	—	—	■	■	■	■	■
—	—	—	—	—	—	—	—	—	—	—	—	●	●	●	●	●
—	—	—	—	—	—	—	—	—	—	—	—	●	●	●	●	●
○	○	○	○	○	○	○	○	●	●	●	●	—	—	—	—	—
●	●	●	●	●	●	●	○	●	○	○	○	—	—	—	—	—
●	●	●	●	●	●	●	○	●	○	○	○	—	—	—	—	—
○	○	○	○	○	○	○	●	○	●	○	○	—	—	—	—	—
○	○	○	○	○	○	○	○	○	○	●	○	—	—	—	—	—
○	○	○	○	○	○	○	○	○	○	○	○	—	—	—	—	—
●	●	●	●	●	●	●	○	●	○	○	○	—	—	—	—	—
○	○	○	○	○	○	○	●	○	●	○	○	—	—	—	—	—
○	○	○	○	○	○	○	○	○	○	○	○	—	—	—	—	—
●	●	●	●	●	●	●	●	●	●	●	●	—	—	—	—	—
●	●	●	●	●	●	●	●	●	●	●	●	—	—	—	—	—
●	●	●	●	●	●	●	●	●	●	●	●	—	—	—	—	—
○	○	○	○	○	○	○	○	○	○	○	○	—	—	—	—	—
○	○	○	○	○	○	○	○	○	○	○	○	—	—	—	—	—
○	○	○	○	○	○	○	○	○	○	○	○	●	●	●	●	●
○	○	○	○	○	○	○	○	○	○	○	○	●	●	●	●	●
●	●	●	●	●	●	●	●	●	●	●	●	—	—	—	—	—
○	○	○	○	○	○	○	○	○	○	○	○	○	○	○	○	○
●	●	●	●	●	●	●	●	●	●	●	●	—	—	—	—	—
●	●	●	●	●	●	●	●	●	●	●	●	○	○	○	○	○
○	○	○	○	●	●	●	●	●	●	●	●	○	○	○	○	○
—	—	—	—	—	—	—	—	—	—	—	—	● ³⁾	● ³⁾	● ³⁾	● ³⁾	● ³⁾

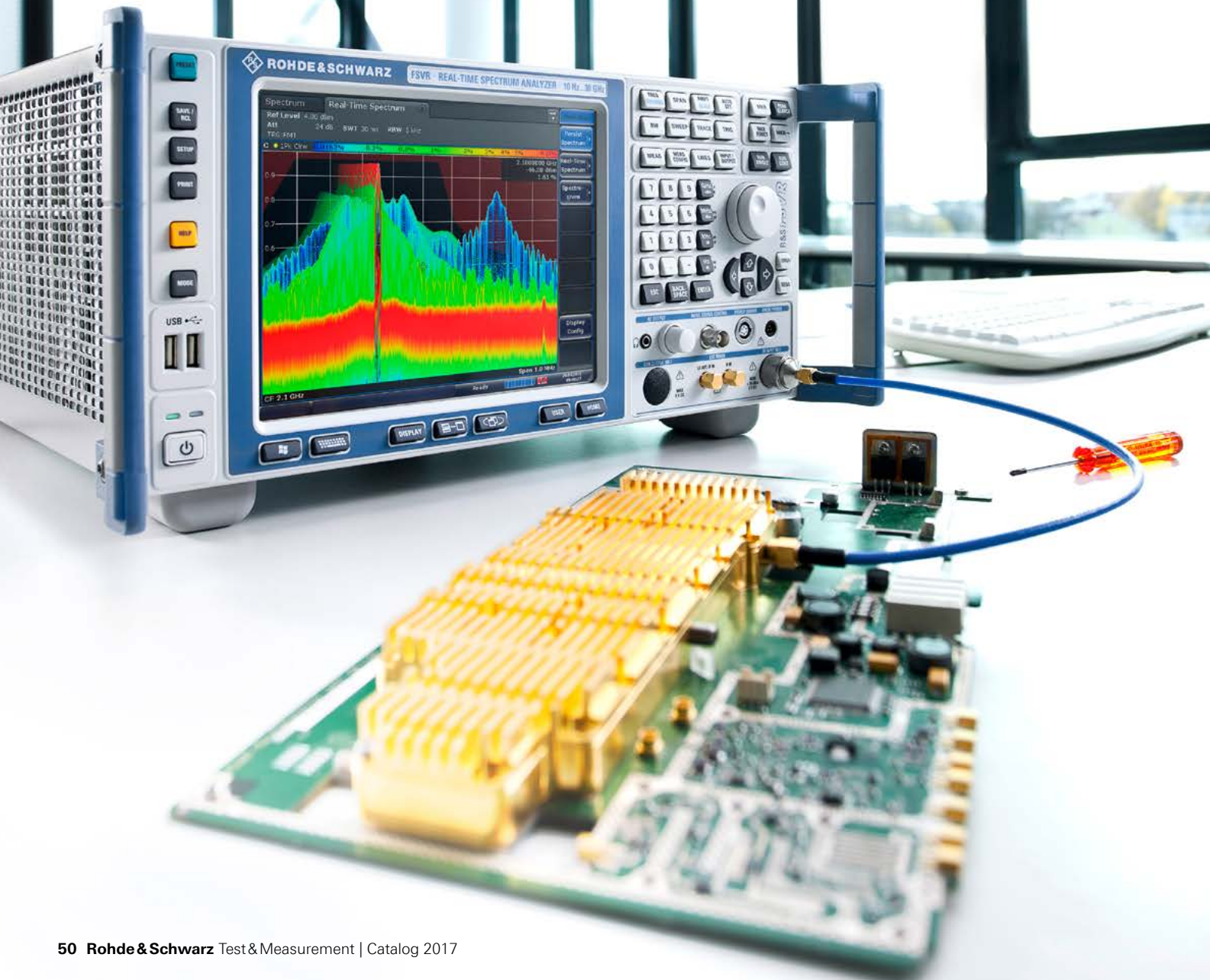

Chapter 3

Signal and spectrum analyzers

All Rohde & Schwarz signal and spectrum analyzers, from basic value and handheld models to benchtop instruments up to 85 GHz, set standards in accuracy, RF performance and usability.

We support performance-oriented, cost-conscious users during the development, production, installation and servicing of RF systems. For production and monitoring systems, we also offer specially designed remote controlled ultra compact spectrum analyzers that require minimal rack space.

Type	Designation	Frequency range	Description	Page
Top class				
R&S®FSW	Signal and spectrum analyzer	2 Hz to 8/13.6/26.5/43/50/67/85 GHz	Setting standards in RF performance and usability	52
R&S®FSWP	Phase noise analyzer and VCO tester	1 MHz to 8/26.5/50 GHz	High-end analysis of signal sources and components	53
R&S®FSMR	Measuring receiver	20 Hz to 3.6/26.5/43/50 GHz	Combines the functions of multiple instruments	55
General purpose				
R&S®FSV/FSVA	Signal and spectrum analyzers	10 Hz to 4/7/13.6/30/40 GHz	The right choice of general purpose analyzers	56
R&S®FSVR	Realtime spectrum analyzer	10 Hz to 7/13.6/30/40 GHz	Discover the unseen	57
R&S®FPS	Signal and spectrum analyzer	10 Hz to 4/7/13.6/30/40 GHz	Compact and fast for automated tests	58
R&S®FSL	Spectrum analyzer	9 kHz to 3/6/18 GHz	Best performance in its class	59
R&S®FSC	Spectrum analyzer	9 kHz to 3/6 GHz	Compact, cost-efficient solution	60
R&S®HMS-X	Spectrum analyzer	100 kHz to 1.6/3 GHz	One base unit, many possibilities	61
Handheld				
R&S®FSH	Handheld spectrum analyzer	9 kHz to 3.6/8/13.6/20 GHz	The all-in-one handheld platform	62
R&S®Spectrum Rider FPH	Handheld spectrum analyzer	5 kHz to 2/3/4 GHz	The quality you expect at an unexpected price	64
Accessories for R&S®FSx analyzers				
R&S®FS-Zxx	Harmonic mixers	40 GHz to 500 GHz	Spectrum analysis in the waveguide bands above 40 GHz	65
Application-specific solutions				
Application firmware/software packages for R&S®Fxx analyzers			Overview	66
Signal analysis software				
R&S®VSE	Vector signal explorer software		Desktop signal analysis	98
Modulation analyzers				
R&S®EVS300	ILS/VOR analyzer	Precision level and modulation analysis for ground and flight inspection		99
R&S®EDS300	DME/pulse analyzer	Precise distance and pulse analysis for ground and air measurements		100
New R&S®EDST300	TACAN/DME station tester	Maintenance checks and signal-in-space analysis on TACAN and DME stations		101

R&S®FSW Signal and Spectrum Analyzer



Setting standards in RF performance and usability

Users in the aerospace and defense (A&D) sector and developers of future, wideband communications systems will find plenty of reasons why the R&S®FSW is the right solution for their T&M requirements. With phase noise unparalleled among signal and spectrum analyzers, the R&S®FSW facilitates the development of oscillators intended for use in radar systems, for example.

The R&S®FSW offers up to 2 GHz analysis bandwidth for measuring wideband-modulated or frequency agile signals. Currently, signal and spectrum analyzers measure different standards (GSM, CDMA2000®, WCDMA, LTE) separately.

The R&S®FSW takes analysis to the next level, providing capability to measure multiple standards simultaneously. Users can quickly and easily detect and eliminate errors caused by interaction between signals.

- ▀ Unmatched phase noise – ideal for measuring oscillators for radar and communications applications
- ▀ Excellent dynamic range for spurious measurements thanks to low DANL
- ▀ Harmonic measurements made easy – due to integrated highpass filters
- ▀ High sensitivity even at low frequencies, high accuracy
- ▀ Unparalleled dynamic range up to 1 GHz with separate receive path
- ▀ Ultrawideband filters in sweep mode
- ▀ Large I/Q memory depth for seamless recording of long signal sequences
- ▀ High-resolution 12.1" (31 cm) touchscreen for convenient operation
- ▀ Efficient operation thanks to optimized user guidance
- ▀ MultiView: multiple results available at a glance
- ▀ Multiple measurement applications can be run and displayed in parallel
- ▀ High measurement rates and fast sweep times with sweep rates of up to 1000 sweep/s
- ▀ Fast switchover between instrument setups
- ▀ Efficient measurement functions speed up operation
- ▀ Integrated support of R&S®NRP power sensors

Specifications in brief		
Frequency range		2 Hz to 8/13.6/26.5/43/50/67/85 GHz
Aging of frequency reference		1 × 10 ⁻⁷ /year
	with R&S®FSW-B4 option	3 × 10 ⁻⁸ /year
Bandwidths		
Resolution bandwidths	standard filter	1 Hz to 10 MHz (80 MHz with R&S®FSW-B8 option)
	RRC filter	18 kHz (NADC), 24.3 kHz (TETRA), 3.84 MHz (3GPP)
	channel filter	100 Hz to 5 MHz
	video filter	1 Hz to 10 MHz
I/Q demodulation bandwidth		10 MHz
	with R&S®FSW-B28/-B40/-B80/-B160/-B320 /-B500/-B2000 options	28/40/80/160/320/512/2000 MHz
Displayed average noise level (DANL)		
	2 GHz	typ. -156 dBm (1 Hz)
	with R&S®FSW-B13 option	typ. -159 dBm (1 Hz)
	8/20/40 GHz	typ. -156 dBm/-150 dBm/-144 dBm (1 Hz)
DANL with preamplifier (R&S®FSW-B24 option)	8/20/40 GHz	typ. -169 dBm/-166 dBm/-165 dBm (1 Hz)
DANL with noise cancellation, preamplifier off	2 GHz	typ. -169 dBm (1 Hz)
Intermodulation		
Third-order intercept (TOI)	f < 1 GHz	typ. +30 dBm
	f < 3 GHz	typ. +25 dBm
	8 GHz to 26 GHz	+17 dBm
	13.6 GHz to 40 GHz	+15 dBm
WCDMA ACLR dynamic range	with noise cancellation	88 dB
Phase noise		
10 kHz offset from carrier	500 MHz/1 GHz/10 GHz carrier	typ. -140 dBc/-137 dBc/-128 dBc (1 Hz)
Total measurement uncertainty	8 GHz	0.4 dB

R&S®FSWP Phase Noise Analyzer and VCO Tester



High-end analysis of signal sources and components

The R&S®FSWP phase noise analyzer and VCO tester combines extremely low-noise internal sources and cross-correlation technology, delivering extremely high sensitivity for phase noise measurements. As a result, it takes just seconds to measure even highly stable sources such as those found in radar applications. Additional options such as pulsed signal measurements, additive phase noise (in-

cluding pulsed) characterization and integrated high-end signal and spectrum analysis make the analyzer a unique test instrument.

- High sensitivity for phase noise measurements thanks to cross-correlation and extremely low-noise internal reference sources
- Simultaneous measurement of amplitude noise and phase noise
- Measurement of phase noise on pulsed sources at the push of a button
- Internal source for measuring additive phase noise, including on pulsed signals
- Signal and spectrum analyzer and phase noise analyzer in a single box
 - Wide dynamic range thanks to low displayed average noise level (DANL) of -156 dBm (1 Hz) (without noise cancellation) and high TOI of typ. 25 dBm
 - 80 MHz signal analysis bandwidth
 - Total measurement uncertainty < 0.4 dB up to 8 GHz
 - Large 12.1" display for simultaneous viewing of multiple measurement windows, touchscreen operation
 - Various measurement applications can be run and displayed in parallel
- High measurement speed
- Low-noise internal DC sources for VCO characterization

3

Base unit

Frequency range, RF input

Phase noise, amplitude noise measurement	R&S®FSWP8/FSWP26/FSWP50	1 MHz to 8/26.5/50 GHz
--	-------------------------	------------------------

Phase noise measurement

Measurement results		SSB phase noise, spurious signals, integrated RMS phase deviation, residual FM, time jitter
Offset frequency range	input signal ≤ 1 GHz	10 mHz to 30% of carrier frequency
	input signal > 1 GHz	10 mHz to 300 MHz

Phase noise sensitivity with R&S®FSWP-B60 option (correlations = 1, start offset = 1 Hz) ¹⁾

RF input frequency	Offset from carrier								
	1 Hz	10 Hz	100 Hz	1 kHz	10 kHz	100 kHz	1 MHz	10 MHz	≥ 30 MHz
10 MHz	-96	-128	-140	-158	-170	-170	-170	-	-
100 MHz	-76	-108	-136	-163	-170	-173	-175	-175	-175
1 GHz	-56	-88	-116	-143	-166	-173	-173	-173	-173
3 GHz	-46	-78	-106	-133	-156	-158	-163	-170	-170
7 GHz	-39	-71	-99	-130	-152	-153	-157	-166	-166
10 GHz	-36	-68	-96	-128	-147	-150	-155	-173	-173
16 GHz	-32	-64	-92	-124	-143	-146	-151	-170	-170
26 GHz	-28	-60	-88	-120	-139	-142	-147	-166	-166
50 GHz	-22	-54	-82	-114	-133	-136	-141	-160	-160

Phase noise sensitivity with R&S®FSWP-B61 option (correlations = 1, start offset = 1 Hz) ¹⁾									
RF input frequency	Offset from carrier								
	1 Hz	10 Hz	100 Hz	1 kHz	10 kHz	100 kHz	1 MHz	10 MHz	≥ 30 MHz
10 MHz	-108	-130	-142	-160	-170	-170	-170	-	-
100 MHz	-92	-115	-140	-166	-170	-173	-175	-175	-175
1 GHz	-72	-95	-120	-150	-166	-173	-173	-173	-173
3 GHz	-62	-85	-110	-140	-156	-158	-163	-170	-170
7 GHz	-55	-78	-103	-133	-152	-153	-157	-166	-166
10 GHz	-52	-75	-100	-133	-152	-153	-157	-173	-175
16 GHz	-48	-71	-96	-129	-148	-149	-153	-170	-171
26 GHz	-44	-67	-92	-125	-144	-145	-149	-166	-167
50 GHz	-38	-61	-86	-119	-138	-139	-143	-160	-161

Amplitude noise measurement									
Offset frequency range		input signal ≤ 100 MHz			10 mHz to 30% of carrier frequency				
		input signal > 100 MHz			10 mHz to 30 MHz				
AM noise sensitivity (values in dBc (1 Hz))									
RF input frequency	Offset from carrier								
	1 Hz	10 Hz	100 Hz	1 kHz	10 kHz	100 kHz	1 MHz	10 MHz	30 MHz
1 GHz	-105	-120	-135	-150	-158	-165	-165	-165	-165
10 GHz	-90	-105	-120	-135	-150	-160	-165	-165	-165

Residual phase noise measurement (R&S®FSWP-B64 option)									
Signal source									
Frequency range		R&S®FSWP8			10 MHz to 8 GHz				
		R&S®FSWP26			10 MHz to 18 GHz				
		R&S®FSWP50			10 MHz to 18 GHz				
Residual phase noise measurement									
Offset frequency range		input signal ≤ 100 MHz			10 mHz to 30% of carrier frequency				
		input signal > 100 MHz			10 mHz to 30 MHz				
Sensitivity (values in dBc (1 Hz))									
RF input frequency)	Offset from carrier								
	1 Hz	10 Hz	100 Hz	1 kHz	10 kHz	100 kHz	1 MHz	3 MHz	
1 GHz	-115	-123	-137	-147	-160	-165	-165	-161	
10 GHz	-85	-104	-120	-138	-148	-154	-164	-160	

R&S®FSWP-B1 signal and spectrum analyzer option		
Frequency range	R&S®FSWP8/FSWP26/FSWP50	1 MHz to 8/26.5/50 GHz
Resolution bandwidths	standard filter	1 Hz to 10 MHz
	R&S®FSWP-B8 option	20 MHz, 50 MHz, 80 MHz additionally
	RRC filter	18 kHz (NADC), 24.3 kHz (TETRA), 3.84 MHz (3GPP)
	channel filter/video filter	100 Hz to 5 MHz/1 Hz to 10 MHz
I/Q demodulation bandwidths		10 MHz
	with R&S®FSWP-B80 option	80 MHz
Displayed average noise level (DANL)	2/8/20/40 GHz	-150/-150/-145/-137 dBm (1 Hz)
DANL with preamplifier	8/20/40 GHz	-162/-160 dBm/-156 dBm (1 Hz)
Phase noise	1 GHz carrier frequency, 10 kHz offset	typ. -138 dBc (1 Hz)
Total measurement uncertainty	< 8 GHz	< 0.4 dB

R&S®FSMR Measuring Receiver



Combines the functions of multiple instruments

The R&S®FSMR measuring receiver has been specially designed to handle the measurement tasks involved in the calibration of signal generators and fixed or adjustable attenuators.

- High-end spectrum analyzer
- High-precision level calibration tool
- Modulation analyzer for AM/FM/φM

- Audio analyzer with total harmonic distortion (THD) and SINAD measurement functionality
- Power meter for connecting R&S®NRP power sensors
- High level linearity of 0.005 dB per 10 dB step for precise level and attenuation calibration
- Wide level measurement range from +30 dBm to –130 dBm
- Measurement of modulation depth, frequency deviation and phase deviation with < 1% measurement uncertainty
- Fast RF frequency counter with 0.01 Hz resolution
- Separate audio input

Level calibration – precise, repeatable and easy

- Exceptionally high linearity and level stability across an extended time and temperature range enable high-precision measurements across a longer period of time
- Automatic VSWR correction when a power sensor with a power splitter is used
- Traceability to national standards, R&S®FSMR-Z2 attenuation calibration kit for verifying the linearity of the R&S®FSMR

Specifications in brief				
	R&S®FSMR3	R&S®FSMR26	R&S®FSMR43	R&S®FSMR50
Frequency range	20 Hz to 3.6 GHz	20 Hz to 26.5 GHz	20 Hz to 43 GHz	20 Hz to 50 GHz
AM modulation measurements				
Modulation depth	0% to 100%	0% to 100%	0% to 100%	0% to 100%
Modulation frequency	10 Hz to 100 kHz	10 Hz to 100 kHz	10 Hz to 100 kHz	10 Hz to 100 kHz
Inherent distortion	0.3%	0.3%	0.3%	0.3%
FM modulation measurements				
Frequency deviation	max. 500 kHz	max. 500 kHz	max. 500 kHz	max. 500 kHz
Modulation frequency	10 Hz to 200 kHz	10 Hz to 200 kHz	10 Hz to 200 kHz	10 Hz to 200 kHz
φM modulation measurements				
Phase deviation	max. 10000 rad	max. 10000 rad	max. 10000 rad	max. 10000 rad
Modulation frequency	10 Hz to 100 kHz	10 Hz to 100 kHz	10 Hz to 100 kHz	10 Hz to 100 kHz
Audio measurements				
Frequency range, level ranges	DC, 20 Hz to 1 MHz, 0.4 V, 4 V		DC, 20 Hz to 1 MHz, 0.4 V, 4 V	
Spectrum analyzer				
Frequency range	20 Hz to 3.6 GHz	20 Hz to 26.5 GHz	20 Hz to 43 GHz	20 Hz to 50 GHz
Resolution bandwidths	10 Hz to 50 MHz; FFT filters: 1 Hz to 30 kHz; channel filters; EMI bandwidths			
Video bandwidth	1 Hz to 10 MHz	1 Hz to 10 MHz	1 Hz to 10 MHz	1 Hz to 10 MHz
Displayed average noise level (RBW 10 Hz)				
1 GHz	typ. –158 dBm	typ. –156 dBm	typ. –156 dBm	typ. –156 dBm
26 GHz	–	typ. –151 dB	typ. –151 dBm	typ. –151 dBm
43 GHz	–	–	typ. –140 dBm	typ. –140 dBm
50 GHz	–	–	–	typ. –133 dBm
Trace detectors	max./min. peak, auto peak, sample, RMS, average, quasi-peak			
Phase noise	–123 dBc (1 Hz) (typ.) at 10 kHz from carrier		–123 dBc (1 Hz) (typ.) at 10 kHz from carrier	
Sweep time				
Span > 10 Hz	2.5 ms to 16000 s	2.5 ms to 16000 s	2.5 ms to 16000 s	2.5 ms to 16000 s
Span = 0 Hz (zero span)	1 μs to 16000 s	1 μs to 16000 s	1 μs to 16000 s	1 μs to 16000 s
Image frequency rejection				
f < 3.6 GHz	typ. 110 dB	typ. 110 dB	typ. 110 dB	typ. 110 dB
f > 3.6 GHz	–	0 dB	0 dB	0 dB
f > 3.6 GHz, with R&S®FSMR-B2 option	–	typ. 100 dB	typ. 100 dB	typ. 100 dB

R&S®FSV/R&S®FSVA

Signal and Spectrum Analyzers

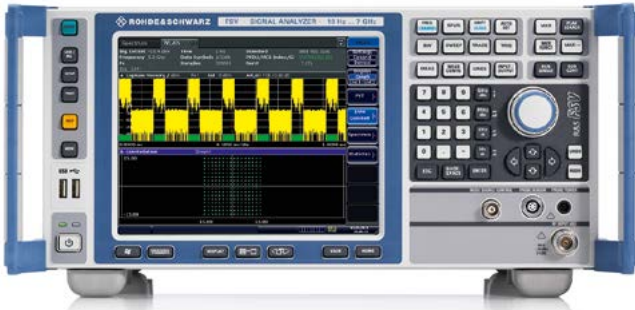

The right choice of general purpose analyzers

The R&S®FSV and the R&S®FSVA are a family of versatile signal and spectrum analyzers for users working in the development, production, installation and servicing of RF systems.

The R&S®FSV and R&S®FSVA signal and spectrum analyzer family always provides the right model with the optimum combination of price and performance, whether for testing wireless devices in production in accordance with the latest communications standards or for measurements on microwave components with low phase noise, high sensitivity and high analysis bandwidth at frequencies up to 40 GHz.

The R&S®FSV and the R&S®FSVA offer up to 160 MHz signal analysis bandwidth. The R&S®FSV analyzes today's cellular and wireless standards, including IEEE 802.11ac, for frequencies up to 7 GHz. The R&S®FSVA features an optional YIG preselector bypass, which allows signal analysis with up to 160 MHz analysis bandwidth for frequencies up to 40 GHz to demodulate satellite or microwave backhaul signals.

Key facts

- ▮ Frequency range up to 4/7/13.6/30/40 GHz
- ▮ Up to 160 MHz signal analysis bandwidth

- ▮ Convenient, intuitive operation with touchscreen-based user interface
- ▮ 0.4 dB level measurement uncertainty up to 7 GHz
- ▮ Low displayed average noise level (DANL) (e.g. typ. -168 dBm (1 Hz) for the R&S®FSVA)
- ▮ High third-order intercept (TOI) (e.g. typ. 20 dBm for the R&S®FSVA)
- ▮ Very low phase noise (e.g. typ. -118 dBc (1 Hz) at 1 GHz and 10 kHz offset for the R&S®FSVA)
- ▮ General-purpose measurement applications for phase noise, noise figure, vector signal analysis, analog demodulation, EMI diagnostics
- ▮ Wireless measurement applications for LTE (including LTE-Advanced), WLAN (including IEEE 802.11ac), WCDMA/HSPA+, TD-SCDMA, GSM/EDGE, CDMA2000®/1xEV-DO, Bluetooth®
- ▮ Frequency range up to 500 GHz with harmonic mixers
- ▮ Keeps test data confidential with removable solid state or hard disk drives

Powerful measurement and analysis functions

- ▮ 200 Msample signal memory for recording long signal sequences
- ▮ Hotkeys for fast access to all important functions
- ▮ Rich set of spectral measurement functions such as channel power/ACLR, C/N, C/N₀, occupied bandwidth, spectrum emission mask (SEM) and spurious emissions
- ▮ Statistical measurements such as amplitude probability distribution (APD) and complementary cumulative distribution function (CCDF)
- ▮ Marker functions for signal count, noise measurements, phase noise, peak search, marker demodulation and n dB down
- ▮ I/Q analyzer for wideband capturing and export of digital I/Q data
- ▮ Scalar network analysis with optional tracking generator up to 7 GHz for easy measurement of frequency response, bandwidth, gain

The R&S®FSV and R&S®FSVA are easy to operate via their touchscreen-based user interface and clearly structured menus.

Key performance parameters of the R&S®FSV	
Third-order intercept (TOI)	+16 dBm
Displayed average noise level (DANL) in 1 Hz bandwidth with preamplifier	-165 dBm
Phase noise at 1 GHz and 10 kHz offset from carrier	-110 dBc (1 Hz)
WCDMA ACLR dynamic range (noise correction on)	70 dB
Max. frequency with 160 MHz analysis bandwidth	7 GHz
Level measurement uncertainty	0.4 dB

Key performance parameters of the R&S®FSVA	
Third-order intercept (TOI)	+20 dBm
Displayed average noise level (DANL) in 1 Hz bandwidth with preamplifier	-168 dBm
Phase noise at 1 GHz and 10 kHz offset from carrier	-118 dBc (1 Hz)
WCDMA ACLR dynamic range (noise correction on)	79 dB
Max. frequency with 160 MHz analysis bandwidth	40 GHz
Level measurement uncertainty	0.4 dB

R&S®FSVR Realtime Spectrum Analyzer

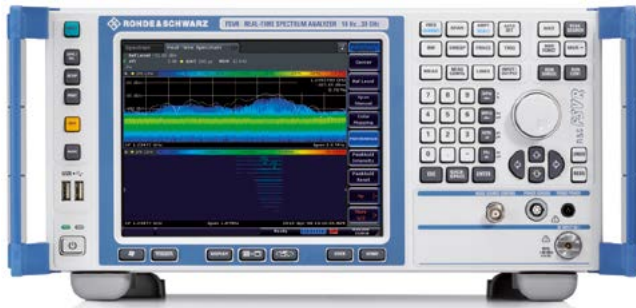

Discover the unseen

The R&S®FSVR combines a full-featured signal and spectrum analyzer with a realtime spectrum analyzer. Therefore, it provides all the capabilities and features that modern T&M instruments of this kind have to offer.

In realtime operation, the R&S®FSVR seamlessly measures and displays the spectrum in the time domain with a span of up to 40 MHz. As a result, it captures every event for analysis, no matter how brief that event might be.

- Frequency range from 10 Hz to 7/13.6/30/40 GHz
- 40 MHz realtime analysis bandwidth for
 - spectrum with persistence function
 - spectrogram display
 - display of power versus time
- Triggering on frequency masks
- Full-featured signal and spectrum analyzer with analysis software for GSM/EDGE, WCDMA/HSPA+, LTE, WiMAX™, WLAN, analog and digital modulation methods, noise figure and phase noise measurements
- Exchangeable hard disk for applications that involve the use of confidential data

3

Specifications in brief

Frequency		
Frequency range		10 Hz to 7/13.6/30/40 GHz
Aging of frequency reference	without/with R&S®FSV-B4 option	$1 \times 10^{-6}/1 \times 10^{-7}$
Realtime spectrum analyzer		
Realtime RF bandwidth		100 Hz to 40 MHz
A/D converter		128 Msample/s, 16 bit
Windowing		Blackman Harris, Gauss, flat top, rectangular, Hanning, Kaiser
Measurement points per trace		801
Resolution bandwidth		realtime RF bandwidth/(100 to 400), depending on windowing
Number of spectra per second		250 000/s
Spectrogram update rate		10 000/s
Screen update rate		30/s
Detectors		average (linear or RMS), max./min. peak, sample
Trace functions		max. hold, min. hold, average
FMT		
Frequency resolution		realtime bandwidth/801
Trigger span		realtime RF bandwidth
Dynamic range		0 dB to -80 dB below reference level
Spectrum analyzer		
Resolution bandwidths	frequency domain	1 Hz to 10 MHz
	zero span	1 Hz to 10/20/40 MHz
	channel filter	100 Hz to 5 MHz
Video filter		1 Hz to 10/20/28/40 MHz
I/Q demodulation bandwidth		40 MHz
Displayed average noise level (DANL)	1 GHz/30 GHz	-152 dBm (1 Hz)/-150 dBm
With R&S®FSV-B22/-B24 preamplifier	1 GHz/30 GHz	-163 dBm/-162 dBm
TOI	$f < 3.6$ GHz	16 dBm
Dynamic range (WCDMA ACLR)	without/with noise compensation	70 dB/73 dB
Phase noise (1 GHz carrier frequency)	10 kHz offset from carrier	-106 dBc (1 Hz)
	100 kHz offset from carrier	-115 dBc (1 Hz)
	1 MHz offset from carrier	-134 dBc (1 Hz)
Total measurement uncertainty	$f < 7$ GHz	0.4 dB

R&S®FPS Signal and Spectrum Analyzer



Compact and fast for automated tests

The R&S®FPS excels with its high measurement speed, 160 MHz signal analysis bandwidth and wide range of analysis packages for analog modulation methods and wireless/wideband communications standards. It is up to five times faster than comparable signal and spectrum analyzers and provides measurement routines optimized for speed and high data throughput, which is a crucial advantage in production applications.

Key facts

- Only 2 HU of rack space required – a reduction of 50% compared with traditional instruments
- 0.4 dB level measurement uncertainty up to 7 GHz

- Measurement applications for GSM/EDGE (including EDGE Evolution), WCDMA/HSPA+, LTE, WLAN, vector signal analysis
- Removable hard disk for applications where security is a concern

High throughput for efficient production

- Up to five times faster than other signal and spectrum analyzers
- Fast switchover between instrument setups
- Fast and accurate measurement results
- Reduced volume in test racks
- Customized test routines for production applications
- Efficient operation via remote control

Ready for tomorrow's standards

- Fully digital backend ensures high measurement accuracy and excellent repeatability
- 160 MHz signal analysis bandwidth, suitable for WLAN IEEE 802.11ac
- Easy transition to the next generation in signal analysis
- „Always up-to-date“

Specifications in brief

Specifications in brief		
Frequency		
Frequency range	R&S®FPS4/7/13/30/40	10 Hz to 4/7/13.6/30/40 GHz
Aging of frequency reference	without/with R&S®FPS-B4 option	$1 \times 10^{-6}/1 \times 10^{-7}$
Resolution bandwidths		
	standard sweep	1 Hz to 10 MHz
	standard sweep, zero span	1 Hz to 10/20/28 MHz, optionally 40 MHz
Signal analysis bandwidth		
		28 MHz
	with R&S®FPS-B40 option	40 MHz
	with R&S®FPS-B160 option	160 MHz
Displayed average noise level (DANL) (1 Hz bandwidth)		
	1 GHz	-152 dBm, typ. -155 dBm
	3 GHz	-150 dBm, typ. -153 dBm
	7 GHz	-146 dBm, typ. -149 dBm
	13 GHz	-148 dBm, typ. -151 dBm
	30 GHz	-144 dBm, typ. -147 dBm
	1 GHz with preamplifier (R&S®FPS-B22)	-162 dBm, typ. -165 dBm
	3 GHz with preamplifier (R&S®FPS-B22)	-160 dBm, typ. -163 dBm
	7 GHz with preamplifier (R&S®FPS-B22)	-156 dBm, typ. -159 dBm
	10 GHz with preamplifier (R&S®FPS-B24)	-164 dBm, typ. -167 dBm
	30 GHz with preamplifier (R&S®FPS-B24)	-159 dBm, typ. -161 dBm
Intermodulation		
Third-order intercept (TOI)	f < 3.6 GHz	+13 dBm, typ. +16 dBm
	3.6 GHz to 30 GHz	+15 dBm, typ. +18 dBm
Dynamic range (WCDMA ACLR)		
	without noise compensation	70 dB
	with noise compensation	73 dB
Phase noise		
1 GHz carrier frequency	10 kHz offset from carrier	-106 dBc (1 Hz), typ. -110 dBc (1 Hz)
	100 kHz offset from carrier	-115 dBc (1 Hz)
	1 MHz offset from carrier	-134 dBc (1 Hz)
Total measurement uncertainty		
	3.6 GHz/7 GHz/13.6 GHz/30 GHz	0.28 dB/0.4 dB/1 dB/1.32 dB

R&S®FSL Spectrum Analyzer

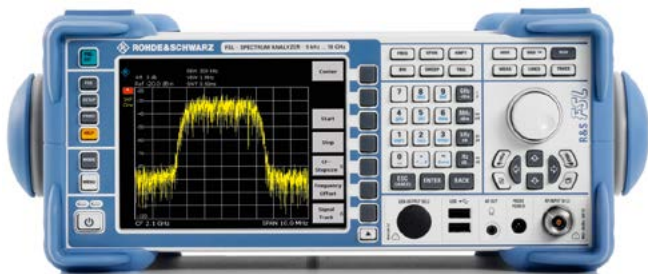

Best performance in its class

The R&S®FSL is an extremely lightweight, compact spectrum analyzer that is ideal for a large number of applications in development, service and production. Though compact, it offers a wealth of functions more typical of the high-end range, ensuring an excellent price/performance ratio.

The R&S®FSL is the only instrument in its class that features a tracking generator up to 18 GHz and can analyze signals with a bandwidth of 28 MHz. In addition, the R&S®FSL18, which operates at frequencies up to 18 GHz, supports applications in the microwave range.

- ▮ Frequency range from 9 kHz to 3/6/18 GHz
- ▮ All models with and without tracking generator
- ▮ Best RF characteristics in its class
- ▮ Largest signal analysis bandwidth in its class (28 MHz)
- ▮ Low measurement uncertainty, even in microwave range
- ▮ High resolution filter accuracy owing to all-digital implementation
- ▮ Robust and compact
- ▮ Carrying handle and low weight (< 8 kg (18 lb))
- ▮ Optional battery operation
- ▮ Wide range of functions, simple operation
- ▮ Easy on-site upgrading with options

3

Specifications in brief

	R&S®FSL3, model .03	R&S®FSL3, model .13	R&S®FSL6, model .06	R&S®FSL6, model .16	R&S®FSL18 model .18	R&S®FSL18 model .28
Frequency range	9 kHz to 3 GHz	9 kHz to 3 GHz	9 kHz to 6 GHz	9 kHz to 6 GHz	9 kHz to 18 GHz (20 GHz in overrange)	
Frequency accuracy	1 × 10 ⁻⁶					
With R&S®FSL-B4, OCXO	1 × 10 ⁻⁷				standard with the R&S®FSL18	
Resolution bandwidths						
Standard	300 Hz to 10 MHz in 1/3 sequence, zero span additionally 20 MHz					
With R&S®FSL-B7	10 Hz to 10 MHz in 1/3 sequence, additionally 1 Hz (FFT filter)					
Video bandwidths	10 Hz to 10 MHz					
Signal analysis bandwidth	28 MHz					
Phase noise	typ. -103 dBc (1 Hz) at 10 kHz from carrier, 1 GHz					
Displayed average noise level (DANL)						
With 300 Hz RBW	typ. -117 dBm					
With 1 Hz FFT RBW and preamplifier (R&S®FSL-B7, R&S®FSL-B22 options)	500 MHz: typ. -162 dBm 3 GHz: typ. -158 dBm					
Third-order intercept (TOI)	typ. +18 dBm					
Detectors	pos./neg. peak, auto peak, RMS, quasi-peak, average, sample					
Level measurement uncertainty	< 0.5 dB (30 kHz ≤ f ≤ 3 GHz), < 0.8 dB (3 GHz < f ≤ 6 GHz), < 1.2 dB (6 GHz < f ≤ 18 GHz)					
Tracking generator	no	yes	no	yes	no	yes
Frequency range	–	1 MHz to 3 GHz	–	1 MHz to 6 GHz	–	10 MHz to 18 GHz
Output level	–	-20 dBm to 0 dBm	–	-20 dBm to 0 dBm	–	-30 dBm to -10 dBm

R&S®FSC Spectrum Analyzer



Compact, cost-efficient solution

The R&S®FSC is a compact, cost-efficient solution that offers all essential features of a professional spectrum analyzer with Rohde&Schwarz quality. It covers a wide range of applications from simple development tasks to production, or can be used for training RF professionals. Moreover, it is ideal for applications in service or maintenance.

The R&S®FSC features a wealth of functions for simplifying and speeding up the development and testing of RF products. Its good RF characteristics and its high measurement accuracy help ensure reliable and reproducible measurement results.

- ▀ Frequency range from 9 kHz to 3 GHz or 6 GHz
- ▀ Resolution bandwidths from 10 Hz to 3 MHz
- ▀ High sensitivity < -141 dBm (1 Hz), with optional preamplifier < -161 dBm (1 Hz)
- ▀ High third-order intercept > 10 dBm, typ. 15 dBm
- ▀ Low measurement uncertainty < 1 dB
- ▀ Precise power measurement with external R&S®NRP USB power sensors
- ▀ Internal tracking generator (models .13/.16)
- ▀ Storage of measurement results on USB flash drive
- ▀ LAN and USB interface for remote control and transfer of measurement data
- ▀ R&S®FSCView software for simple documentation of measurement results
- ▀ Compact dimensions, low power consumption of 12 W

Specifications in brief		R&S®FSC3	R&S®FSC6	
Frequency range		9 kHz to 3 GHz	9 kHz to 6 GHz	
Resolution bandwidth		10 Hz to 3 MHz	10 Hz to 3 MHz	
Displayed average noise level	without preamplifier, RBW = 1 Hz			
	10 MHz to 2 GHz	< -141 dBm, typ. -146 dBm	< -141 dBm, typ. -146 dBm	
	2 GHz to 3 GHz	< -138 dBm, typ. -143 dBm	< -138 dBm, typ. -143 dBm	
	3 GHz to 3.6 GHz	-	< -138 dBm, typ. -143 dBm	
	3.6 GHz to 5 GHz	-	< -142 dBm, typ. -146 dBm	
	5 GHz to 6 GHz	-	< -140 dBm, typ. -144 dBm	
	with R&S®FSC-B22 preamplifier option, RBW = 1 Hz			
	10 MHz to 1 GHz	< -161 dBm, typ. -165 dBm	< -161 dBm, typ. -165 dBm	
	1 GHz to 2 GHz	< -159 dBm, typ. -163 dBm	< -159 dBm, typ. -163 dBm	
	2 GHz to 3 GHz	< -155 dBm, typ. -159 dBm	< -155 dBm, typ. -159 dBm	
TOI	3 GHz to 5 GHz	-	< -155 dBm, typ. -159 dBm	
	5 GHz to 6 GHz	-	< -151 dBm, typ. -155 dBm	
	1 GHz frequency	typ. 15 dBm	typ. 15 dBm	
	Phase noise	500 MHz frequency		
30 kHz carrier offset		< -95 dBc (1 Hz)	< -95 dBc (1 Hz)	
100 kHz carrier offset		< -100 dBc (1 Hz)	< -100 dBc (1 Hz)	
1 MHz carrier offset		< -120 dBc (1 Hz)	< -120 dBc (1 Hz)	
Detectors		sample, max./min. peak, auto peak, RMS		
Level measurement uncertainty	10 MHz < f ≤ 3 GHz	< 1 dB, typ. 0.5 dB	< 1 dB, typ. 0.5 dB	
	3 GHz < f < 3.6 GHz	-	< 1 dB, typ. 0.5 dB	
	3.6 GHz < f ≤ 6 GHz	-	< 1.5 dB, typ. 1 dB	
Tracking generator (models .13/.16)				
	Frequency range	100 kHz to 3 GHz	100 kHz to 6 GHz	
	Output power	0 dBm (nom.)	0 dBm (nom.)	
	Dynamic range (transmission)	100 kHz < f < 300 kHz	> 60 dB, typ. 80 dB	> 60 dB, typ. 80 dB
		300 kHz < f < 3 GHz	> 70 dB, typ. 90 dB	> 70 dB, typ. 90 dB
	3 GHz < f < 6 GHz	-	> 70 dB, typ. 90 dB	
Display		5.7" (14.5 cm) color LCD with VGA resolution		

R&S®HMS-X Spectrum Analyzer



One base unit, many possibilities

We have used the first-class hardware from the R&S®HMS spectrum analyzer and developed a new and flexible instrument concept. It can be individually configured, combined and upgraded for your applications.

Create your R&S®HMS spectrum analyzer by combining a basic unit with any of three available options. In case of growing requirements, upgrade vouchers allow the instrument to be upgraded with all options at any point in time.

- ▮ Frequency range: 100 kHz to 1.6 GHz/3 GHz¹⁾
- ▮ Spectral purity: > -100 dBc (1 Hz) (at 100 kHz)
- ▮ Sweep: 20 ms to 1000 s
- ▮ Various markers/delta markers and peak functions

- ▮ Detectors: auto/min./max. peak, sample, RMS, average, quasi-peak
- ▮ Tracking generator³⁾
 - Frequency range: 5 MHz to 1.6 GHz/3 GHz
 - Output level: -20 dBm to 0 dBm
- ▮ Direct export of data to USB flash drive, RS-232/USB dual interface for remote control
- ▮ Fanless design and fast boot time

EMC precompliance sets

Rohde & Schwarz offers product sets for EMC precompliance measurements, which include all necessary instruments to analyze typical EMC problems. Depending on the requirements, customers can choose between a 1 GHz and a 3 GHz combination.

1 GHz EMC-SET1

- ▮ R&S®HMS-X incl. R&S®HMS-EMC option
- ▮ R&S®HZ530 probe set
- ▮ R&S®HM6050-2 line impedance stabilization network (LISN)
- ▮ R&S®HMEplorer software
 - The R&S®HMEplorer software for EMC measurements is included with every R&S®HMS-X spectrum analyzer with activated EMC option

3 GHz EMC-SET2

Differences to SET1:

- ▮ R&S®HMS-3G option additional
- ▮ R&S®HZ540 3 GHz probe set instead of R&S®HZ530

Specifications in brief		
Frequency range	base unit	100 kHz to 1.6 GHz
	with R&S®HMS-3G (HV212) option	100 kHz to 3 GHz
Spectral purity, SSB phase noise	30 kHz from carrier (500 MHz, +20°C to +30°C)	≤ -85 dBc (1 Hz) ²⁾
	100 kHz from carrier (500 MHz, +20°C to +30°C)	≤ -100 dBc (1 Hz)
Resolution bandwidths	base unit	10 kHz to 1 MHz, 200 kHz
	with R&S®HMS-EMC (HV213) option, -3 dB	100 Hz to 1 MHz, 200 kHz
	with R&S®HMS-EMC (HV213) option, -6 dB	200 Hz, 9 kHz, 120 kHz, 1 MHz
Third-order intercept (TOI)		typ. +13 dbm
Displayed average noise level (DANL)	RBW 10 kHz, VBW 1 kHz, ref. level ≤ -30 dBm, 10 MHz to 1.6 GHz/3 GHz ¹⁾	-95 dBm, typ. -104 dBm
	RBW 100 Hz, VBW 10 Hz, ref. level ≤ -30 dBm, 10 MHz to 1.6 GHz/3 GHz ¹⁾	-115 dBm ²⁾ , typ. -135 dBm ²⁾
	preamplifier ¹⁾ deactivated	typ. -124 dBm ²⁾
Detectors		sample, max./min. peak, auto peak, RMS, average, quasi-peak ²⁾
Level measurement uncertainty		< 1.5 dB, typ. 0.5 dB
Output tracking generator ³⁾	connector	N socket
Output impedance		50 Ω
Frequency range		5 MHz to 1.6 GHz/3 GHz ¹⁾
Output level		-20 dBm to 0 dBm, in 1 dB steps
Display	TFT color VGA display	16.5 cm (6.5")

¹⁾ With R&S®HMS-3G (HV212) option.

²⁾ With R&S®HMS-EMC (HV213) option.

³⁾ With R&S®HMS-TG (HV211) option.

R&S®FSH Handheld Spectrum Analyzer



The all-in-one handheld platform

The R&S®FSH is a handheld spectrum analyzer – and depending on the model and the options installed – a power meter, a cable and antenna tester and a two-port vector network analyzer in a single device. Its ruggedized housing, low weight and easy operation make it indispensable for outdoor work.

- ▮ Frequency range from 9 kHz to 3.6/8/13.6/20 GHz
- ▮ High sensitivity < -141 dBm (1 Hz), with preamplifier < -161 dBm (1 Hz)
- ▮ 20 MHz demodulation bandwidth for analyzing LTE signals
- ▮ Low measurement uncertainty (< 1 dB)
- ▮ Measurement functions for all important measurement tasks related to the startup and maintenance of transmitter systems
- ▮ Internal tracking generator and VSWR bridge with built-in DC voltage supply (bias)
- ▮ Vector network analysis
- ▮ Rugged, splash-proof housing for rough work in the field
- ▮ Easy handling due to low weight (3 kg with battery) and easy-to-reach function keys
- ▮ Easy operation thanks to user configurable, automatic test sequences (wizard)

Spectrum analysis		R&S®FSH4	R&S®FSH8	R&S®FSH13	R&S®FSH20
Frequency range	models .04/.14/.08/.18/.13/.23/.20/.30	9 kHz to 3.6 GHz	9 kHz to 8 GHz	9 kHz to 13.6 GHz	9 kHz to 20 GHz
	models .24/.28	100 kHz to 3.6 GHz	100 kHz to 8 GHz	–	–
Resolution bandwidths		1 Hz to 3 MHz			
Displayed average noise level (DANL)	without preamplifier, RBW = 1 Hz (normalized)				
	9 kHz to 100 kHz (models .04/.14/.08/.18 only)	< -108 dBm, typ. -118 dBm		< -96 dBm, typ. -106 dBm	
	100 kHz to 1 MHz	< -115 dBm, typ. -125 dBm			
	1 MHz to 10 MHz	< -136 dBm, typ. -144 dBm			
	10 MHz to 2 GHz	< -141 dBm, typ. -146 dBm			
	2 GHz to 3.6 GHz	< -138 dBm, typ. -143 dBm			
	3.6 GHz to 5 GHz	–	< -142 dBm, typ. -146 dBm		
	5 GHz to 6.5 GHz	–	< -140 dBm, typ. -144 dBm		
	6.5 GHz to 13.6 GHz	–	< -136 dBm, typ. -141 dBm		
	13.6 GHz to 18 GHz	–	–	–	< -134 dBm, typ. -139 dBm
	18 GHz to 20 GHz	–	–	–	< -130 dBm, typ. -135 dBm
	with preamplifier, RBW = 1 Hz (normalized)				
	100 kHz to 1 MHz	< -133 dBm, typ. -143 dBm		< -133 dBm, typ. -143 dBm	
	1 MHz to 10 MHz	< -157 dBm, typ. -161 dBm		< -155 dBm, typ. -159 dBm	
	10 MHz to 1 GHz	< -161 dBm, typ. -165 dBm		< -161 dBm, typ. -165 dBm	
	1 GHz to 2 GHz	< -159 dBm, typ. -163 dBm		< -159 dBm, typ. -163 dBm	
	2 GHz to 5 GHz	–	< -155 dBm, typ. -159 dBm		
	5 GHz to 6.5 GHz	–	< -151 dBm, typ. -155 dBm		
	6.5 GHz to 8 GHz	–	< -147 dBm, typ. -150 dBm		
	8 GHz to 13.6 GHz	–	–	< -158 dBm, typ. -162 dBm	

Spectrum analysis					
DANL (continued)		R&S®FSH4	R&S®FSH8	R&S®FSH13	R&S®FSH20
	13.6 GHz to 18 GHz	–	–	< –155 dBm, typ. 160 dBm	
	18 GHz to 20 GHz	–	–	–	< –150 dBm, typ. –155 dBm
Third-order intercept (IP3)	300 MHz to 3.6 GHz	> 10 dBm, typ. +15 dBm			
	3.6 GHz to 20 GHz	–	> 3 dBm, typ. +10 dBm		
Phase noise	frequency 500 MHz				
	30 kHz carrier offset	< –95 dBc (1 Hz), typ. –105 dBc (1 Hz)			
	100 kHz carrier offset	< –100 dBc (1 Hz), typ. –110 dBc (1 Hz)			
	1 MHz carrier offset	< –120 dBc (1 Hz), typ. –127 dBc (1 Hz)			
Detectors		sample, max. peak, min. peak, auto peak, RMS			
Level measurement uncertainty	10 MHz < f ≤ 3.6 GHz	< 1 dB, typ. 0.5 dB			
	3.6 GHz < f ≤ 20 GHz	–	< 1.5 dB, typ. 1 dB		
Display		6.5" color LCD with VGA resolution			
Battery operating time (without tracking generator)	R&S®HA-Z204, 4.5 Ah	up to 3 h			
	R&S®HA-Z206, 6.75 Ah	up to 4.5 h			
Dimensions (W × H × D)		194 mm × 300 mm × 69 mm (144 mm) ¹⁾ 7.6 in × 11.8 in × 2.7 in (5.7 in)			
Weight		3 kg (6.6 lb)			

¹⁾ With carrying handle.

Vector network analysis ¹⁾ /vector voltmeter ²⁾					
		R&S®FSH4	R&S®FSH8	R&S®FSH13/20	
Frequency range	models .24/.28/.23/.30	300 kHz to 3.6 GHz	300 kHz to 8 GHz	100 kHz to 8 GHz	
Output power (port 1)		0 dBm to –40 dBm		–	
Output power (port 2)		0 dBm to –40 dBm		0 dBm to –40 dBm	
Reflection measurements (S₁₁, S₂₂)					
Directivity	300 kHz to 3 GHz	> 43 dB (nom.)	> 43 dB (nom.)	> 43 dB (nom.) ³⁾	
	3 GHz to 3.6 GHz	> 37 dB (nom.)	> 37 dB (nom.)	> 37 dB (nom.) ³⁾	
	3.6 GHz to 6 GHz	–	> 37 dB (nom.)	> 37 dB (nom.) ³⁾	
	6 GHz to 8 GHz	–	> 31 dB (nom.)	> 31 dB (nom.) ³⁾	
Display modes	vector reflection and transmission measurement (R&S®FSH-K42)	magnitude, phase, magnitude + phase, Smith chart, VSWR, reflection coefficient, mp, one-port cable loss, electrical length, group delay			
	vector voltmeter (R&S®FSH-K45)	magnitude + phase, Smith chart			
Transmission measurements					
Dynamic range from port 1 to port 2	100 kHz ≤ f < 300 kHz	typ. 70 dB	typ. 70 dB	typ. 70 dB	
	300 kHz ≤ f < 3.6 (6) GHz	> 70 dB, typ. 90 dB	> 70 dB, typ. 90 dB	> 70 dB, typ. 90 dB	
	6 GHz ≤ f < 8 GHz	–	typ. > 50 dB	typ. > 50 dB	
Dynamic range from port 2 to port 1	100 kHz ≤ f < 300 kHz	typ. 80 dB	typ. 80 dB	typ. 80 dB	
	300 kHz ≤ f < 3.6 (6) GHz	> 80 dB, typ. 100 dB	> 80 dB, typ. 100 dB	> 80 dB, typ. 100 dB	
	6 GHz ≤ f < 8 GHz	–	typ. > 60 dB	typ. > 60 dB	
Display modes	vector reflection and transmission measurement (R&S®FSH-K42)	magnitude (attenuation, gain), phase, magnitude + phase, electrical length, group delay			
	vector voltmeter (R&S®FSH-K45)	magnitude + phase			

¹⁾ Available for models .24/.28/.23/.30 only; models .24/.28 require R&S®FSH-K42 additionally.

²⁾ For models .24/.28/.23/.30 only, requires R&S®FSH-K45.

³⁾ Only S₂₂ measurements.

R&S® Spectrum Rider FPH Handheld Spectrum Analyzer

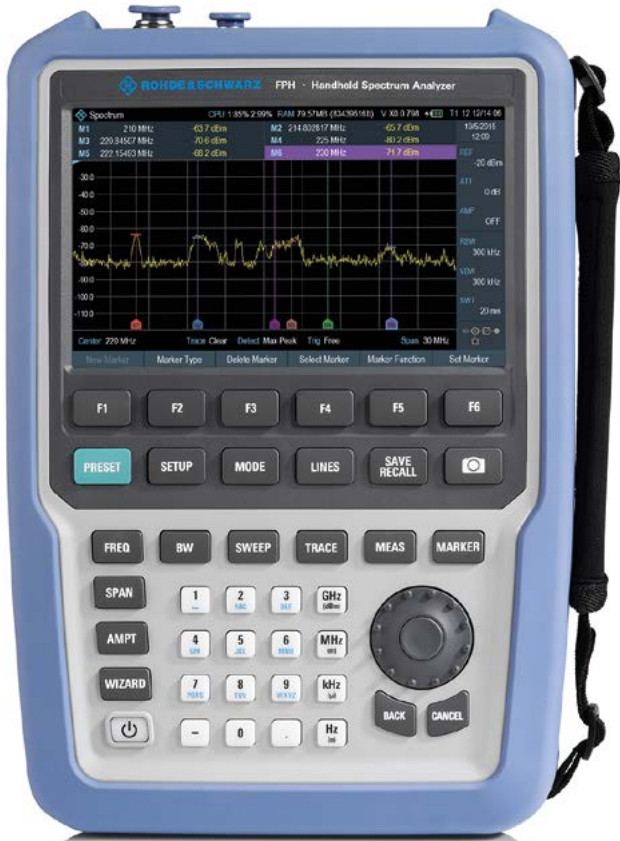

The quality you expect at an unexpected price

The R&S® Spectrum Rider FPH is a versatile, user-friendly instrument in a rugged and appealing design. The frequency range of the basic analyzer is 5 kHz to 2 GHz. The upper frequency limit can easily be extended to 3 GHz or 4 GHz via keycode. It suits both field and lab applications in indoor and outdoor measurement environments.

Specifications in brief

Frequency	
Frequency range	5 kHz to 2 GHz
with R&S®FPH-B3 option	5 kHz to 3 GHz
with R&S®FPH-B4 option (R&S FPH-B3 option required)	5 kHz to 4 GHz
Frequency resolution	1 Hz
Resolution bandwidth	1 Hz to 3 MHz in 1/3 sequence
Displayed average noise level	
0 dB RF attenuation, 50 Ω termination, RBW = 100 Hz, VBW = 10 Hz, sample detector, log scaling, normalized to 1 Hz	
Frequency	preamplifier = off
1 MHz to 10 MHz	< -135 dBm, typ. -142 dBm
10 MHz to 1 GHz	< -142 dBm, typ. -146 dBm
1 GHz to 4 GHz	< -140 dBm, typ. -144 dBm

The R&S® InstrumentView software comes with the instrument, making it easy to postprocess and document measurement results and manage instrument settings.

- ▮ Frequency ranges from 5 kHz to 2/3/4 GHz; upgrade via keycode
- ▮ Solid RF performance
- ▮ Ideal for field use: 8 hour battery life, 2.5 kg (5.5 lb) weight, backlit keypad, fast boot time, non-reflective display, small footprint, ruggedized housing
- ▮ Large color display with touch and gesture operation
- ▮ Measurement wizard that supports measurement campaigns speeds up measurements and prevents errors
- ▮ Features and options for various industries such as aerospace and defense, wireless communications, broadcasting, spectrum regulators and education
- ▮ Easy and cost-efficient upgrades of all options via software keycode
- ▮ Three-year warranty as standard (battery one year)

Standard functions

Two spectrum traces
Six markers absolute or relative
Noise marker
Frequency counter with 0.1 Hz resolution
AM/FM audio demodulator (built-in loudspeaker or headphones)
Limit line monitoring (pass/fail function)
Remote control via USB/LAN interface
Predefined channel tables

Optional software applications

Frequency upgrade from 2 GHz to 3 GHz (R&S®FPH-B3)
Frequency upgrade from 2 GHz to 4 GHz (R&S®FPH-B4 and -B3 required)
Preamplifier (R&S®FPH-B22)
Analog modulation analysis AM/FM (R&S®FPH-K7)
Power sensor support (R&S®FPH-K9)
Interference analysis (R&S®FPH-K15)
Signal strength mapping (R&S®FPH-K16)
Channel power meter (R&S®FPH-K19)
Pulse measurements with power sensors (R&S®FPH-K29)
Receiver mode (R&S®FPH-K43)

Specifications in brief (continued)

Frequency	preamplifier = on
1 MHz to 10 MHz	< -150 dBm, typ. -160 dBm
10 MHz to 3 GHz	< -158 dBm, typ. -163 dBm
3 GHz to 4 GHz	< -156 dBm, typ. -161 dBm
Third-order intercept (IP3)	
Intermodulation-free dynamic range, signal level 2 × -20 dBm, RF attenuation = 0 dB, RF preamplifier = off	
f = 1 GHz	+7 dBm (meas.)
f = 2.4 GHz	+10 dBm (meas.)
Total measurement uncertainty	
95% confidence level, +20°C to +30°C, SNR > 16 dB, 0 dB to -50 dB below reference level, RF attenuation auto	
10 MHz ≤ f ≤ 4 GHz	< 1.25 dB, typ. 0.5 dB

R&S®FS-Zxxx Harmonic Mixers



Spectrum analysis in the waveguide bands above 40 GHz

Frequencies in the high GHz range still require the use of external harmonic mixers. Such mixers can be connected to an R&S®FSW26/43/50/67/85, R&S®FSWP26/50, R&S®FSV30/40, R&S®FSVA30/40, R&S®FSVR30/40 provided that these analyzers are equipped with the R&S®FSx-B21 LO/IF ports option for external mixers. Rohde & Schwarz mixers cover the frequency range up to 500 GHz. If other mixers are used, up to 1.1 THz is possible.

3

Overview of external mixers

	R&S®FS-Z60	R&S®FS-Z75	R&S®FS-Z90	R&S®FS-Z110	RPG FS-Z140
Frequency range	40 GHz to 60 GHz	50 GHz to 75 GHz	60 GHz to 90 GHz	75 GHz to 110 GHz	90 GHz to 140 GHz
Mixer type	balanced dual-diode mixer, no biasing				
RF port	WR19 (UG383/UM)	WR15 (UG385/U)	WR12 (UG387/UM)	WR10 (UG387/UM)	WR08 (UG387/UM)
Conversion loss	typ. 23 dB	typ. 20 dB	typ. 23 dB	typ. 20 dB	typ. 28 dB
VSWR RF	2.5 : 1	1.5 : 1	1.5 : 1	1.5 : 1	1.5 : 1
LO frequency range	9.8 GHz to 15.2 GHz	8.0 GHz to 12.84 GHz	7.44 GHz to 15.34 GHz	7.5 GHz to 14.0 GHz	9.0 GHz to 14.0 GHz
Number of harmonics	4	6	6	8	10

	RPG FS-Z170	RPG FS-Z220	RPG FS-Z325	RPG FS-Z500
Frequency range	110 GHz to 170 GHz	140 GHz to 220 GHz	220 GHz to 325 GHz	325 GHz to 500 GHz
Mixer type	balanced dual-diode mixer, no biasing			
RF port	WR06 (UG387/UM)	WR5.1 (UG387/UM)	WR3.4 (UG387/UM)	WR2.2 (UG387/UM)
Conversion loss	typ. 30 dB	typ. 32 dB	typ. 40 dB	typ. 58 dB
VSWR RF	1.6 : 1	1.5 : 1	2.5 : 1	2.7 : 1
LO frequency range	9.13 GHz to 14.13 GHz	8.72 GHz to 13.72 GHz	10 GHz to 14.77 GHz	9.02 GHz to 13.88 GHz
Number of harmonics	12	16	22	36

LO/IF ports option

	R&S®FSV30/40 with R&S®FSV-B21 R&S®FSVA30/40 with R&S®FSV-B21	R&S®FSWP26/50 with R&S®FSWP-B21	R&S®FSW26/43/50/67/85 with R&S®FSW-B21
LO frequency range	7.65 GHz to 17.45 GHz	7.65 GHz to 17.45 GHz	7.65 GHz to 17.45 GHz
LO level	+15 dBm	+15 dBm	15.5 dBm
IF	730 MHz	404.4 MHz	1.3 GHz

Application-specific solutions

General measurement applications													
Firmware or PC software R&S®FSx/ FPS/RTO		R&S®FSV	R&S®FSVA	R&S®FPS	R&S®FSVR	R&S®FSW	R&S®FSL	R&S®FSMR	R&S®FSWP	R&S®FSH	R&S®FPH	R&S®RTO	Page
-K6/-K6S	Pulse measurements	-	-	•	-	•	-	-	•	-	• ⁷⁾	-	68
-K7	Analog modulation analysis for AM/FM/ϕM inclusive THD and SINAD measurements	•	•	•	•	•	•	•	•	-	• ⁷⁾	-	69
-K7S	FM stereo modulation analysis	•	-	-	•	-	-	-	-	-	-	-	70
-K9	Measurement with power sensors	•	•	-	•	• ¹⁾	•	•	• ¹⁾	• ¹⁾	• ⁷⁾	-	-
-K14	Spectrogram measurements	•	•	-	•	• ¹⁾	•	-	• ¹⁾	• ¹⁾	• ⁷⁾	-	73
-K15	VOR/ILS measurements	-	-	-	-	•	-	•	-	-	-	-	74
-K17	Multicarrier group delay measurements	-	-	-	-	•	-	-	-	-	-	-	-
-K18	Amplifier and envelope tracking measurements	-	-	•	-	•	-	-	-	-	-	-	-
-K20	Cable TV measurements, analog/digital	-	-	-	-	-	•	-	-	-	-	-	-
-K30	Noise figure and gain measurements	•	•	•	•	•	•	•	•	-	-	-	76
-K40	Phase noise measurements	•	•	•	•	•	-	•	-	-	-	-	77
-K50	Spurious measurements	-	-	-	-	•	-	-	-	-	-	-	78
-K54	EMI measurement application	•	•	-	•	•	-	-	-	-	• ⁷⁾	-	79
-K60	Transient measurement application	-	-	-	-	•	-	-	-	-	-	-	80
-K60C	Transient chirp measurement	-	-	-	-	•	-	-	-	-	-	-	80
-K60H	Transient hop measurement	-	-	-	-	•	-	-	-	-	-	-	80
-K70	Vector signal analysis	•	•	•	•	•	-	•	•	-	-	-	81
-K112	NFC measurement software	•	•	-	-	-	•	-	-	-	-	•	92
-K130PC	Distortion analysis	•	•	-	•	•	•	•	-	-	-	-	93
-B160R	Realtime spectrum analysis	-	-	-	-	•	-	-	-	-	-	-	94

Measurements in line with mobile communications standards													
Firmware R&S®FSx/ FPS/RTO		R&S®FSV	R&S®FSVA	R&S®FPS	R&S®FSVR	R&S®FSW	R&S®FSL	R&S®FSMR	R&S®FSWP	R&S®FSH	R&S®FPH	R&S®RTO	Page
-K5	GSM/EDGE	-	-	-	-	-	-	•	-	• ²⁾³⁾	-	-	-
-K10	GSM/EDGE/EDGE Evolution/VAMOS	•	•	•	•	•	-	-	-	-	-	-	72
-K72/-K73	3GPP WCDMA DL/UL	•	•	•	•	•	• ²⁾	•	-	• ²⁾³⁾	-	-	82
-K74	3GPP WCDMA HSDPA	— ⁴⁾	— ⁴⁾	•	— ⁴⁾	— ⁴⁾	— ⁶⁾	•	-	• ²⁾³⁾	-	-	82
-K73+/-K74+	3GPP WCDMA HSPA+	— ⁴⁾⁵⁾	— ⁴⁾⁵⁾	•	— ⁴⁾⁵⁾	— ⁴⁾⁵⁾	-	-	-	• ²⁾³⁾	-	-	82
-K82/-K83	CDMA2000®	•	•	•	•	•	• ²⁾	•	-	• ²⁾³⁾	-	-	84
-K84/-K85	1xEV-DO	•	•	•	-	•	-	•	-	• ²⁾³⁾	-	-	84
-K76/-K77	3GPP TD-SCDMA	•	•	•	•	•	-	•	-	-	-	-	83
-K100/-K101	3GPP LTE FDD	•	•	•	•	•	-	-	-	• ²⁾³⁾	-	-	90
-K102	3GPP LTE MIMO	•	•	•	•	•	-	-	-	-	-	-	90
-K103	3GPP LTE-Advanced uplink	-	-	-	-	•	-	-	-	-	-	-	90
-K104/-K105	3GPP LTE TDD	•	•	•	•	•	-	-	-	• ²⁾³⁾	-	-	90
-K100PC	EUTRA/LTE downlink FDD	•	•	•	•	•	-	-	-	-	-	•	91
-K101PC	EUTRA/LTE uplink FDD	•	•	•	•	•	-	-	-	-	-	•	91
-K102PC	EUTRA/LTE downlink MIMO	•	•	•	•	•	-	-	-	-	-	•	91
-K103PC	EUTRA/LTE uplink MIMO	•	•	•	•	•	-	-	-	-	-	•	91
-K104PC	EUTRA/LTE downlink TDD	•	•	•	•	•	-	-	-	-	-	•	91
-K105PC	EUTRA/LTE uplink TDD	•	•	•	•	•	-	-	-	-	-	•	91

Other wireless applications

Firmware or PC software R&S®FSx		R&S®FSV	R&S®FPS	R&S®FSVR	R&S®FSW	R&S®FSL	R&S®FSMR	R&S®FSWP	R&S®FSH	R&S®RTO	Page
-K8	IEEE 802.15.1 Bluetooth® EDR	•	-	•	-	•	•	•	-	-	71
-K91	IEEE 802.11 a/b/g/j WLAN	•	•	•	•	•	-	-	-	-	86
-K91N	IEEE 802.11 n WLAN	•	•	•	•	•	-	-	-	-	86
-K91AC	IEEE 802.11 ac WLAN	•	-	-	•	-	-	-	-	-	86
-K91P	IEEE 802.11 p WLAN	•	•	-	•	-	-	-	-	-	86
-K93	IEEE 802.16 e-2005 WiMAX™	•	-	•	-	•	-	-	-	-	87
-K95	IEEE 802.11ad WLAN	-	-	-	•	-	-	-	-	-	88
-K96/-K96PC	General OFDM vector signal analysis	•	-	•	•	-	-	•	-	-	87
-K196	5G Air Interface Candidates	•	•	-	•	-	-	-	-	-	97

1) Standard.

2) Base station only.

3) See R&S®FSH data sheet; option number may differ.

4) The functionality of R&S®FS-K74 and R&S®FS-K74+ is included in R&S®FSV-K72.

5) The functionality of R&S®FS-K73+ is included in R&S®FSV-K73.

6) Included in R&S®FSL-K72.

7) See R&S®SpectrumRider FPH data sheet; option number may differ.

Measurement application for wire-connected communications systems

Firmware R&S®FSW		R&S®FSV	R&S®FSVA	R&S®FPS	R&S®FSVR	R&S®FSW	R&S®FSL	R&S®FSMR	R&S®FSWP	R&S®FSH	R&S®RTO	Page
-K192	DOCSIS3.1 downstream	-	-	-	-	•	-	-	-	-	-	95
-K193	DOCSIS3.1 upstream	-	-	-	-	•	-	-	-	-	-	95

Vector signal explorer base software

PC software R&S®VSE		R&S®FSV	R&S®FSVA	R&S®FPS	R&S®FSVR	R&S®FSW	R&S®FSL	R&S®FSMR	R&S®FSWP	R&S®FSH	R&S®RTO	Page
-K6	Pulse measurements	•	•	•	-	•	•	-	•	-	•	98
-K7	Analog demodulation analysis	•	•	•	-	•	•	-	•	-	•	98
-K10	GSM measurements	•	•	•	-	•	•	-	-	-	•	98
-K70	Vector signal analysis	•	•	•	-	•	•	-	•	-	•	98
-K72	3GPP FDD measurements	•	•	•	-	•	•	-	-	-	•	98
-K91	IEEE 802.11a/b/g measurements	•	•	•	-	•	•	-	-	-	•	98
-K91N/AC/P	IEEE 802.11n/ac/p measurements	•	•	•	-	•	•	-	-	-	•	98
-K100	EUTRA/LTE FDD	•	•	•	-	•	•	-	-	-	•	98
-K102	EUTRA/LTE-Advanced and MIMO	•	•	•	-	•	•	-	-	-	•	98
-K104	EUTRA/LTE TDD	•	•	•	-	•	•	-	-	-	•	98

R&S®FSW-K6 Pulse Measurements Application

R&S®FSW-K6S Time Sidelobe Measurements

New



Analysis of a pulse sequence with R&S®FSW-K6.

Measuring pulse parameters at the touch of a key

The R&S®FSW-K6 option measures – at the touch of a key – all relevant parameters such as pulse duration, pulse period, pulse rise and fall times, power drop across a pulse, and intrapulse phase modulation, and produces a trend analysis over many pulses. The user selects the results to be displayed simultaneously on the screen. The R&S®FSW delivers a full picture of a radar system within seconds.

The R&S®FSW-K6 option can be upgraded with the R&S®FSW-K6S option to automatically measure the compression parameters of modulated pulses. Results such as the mainlobe vs. sidelobe level and the time differences between the mainlobe and the sidelobes are displayed in the results summary table.

The user can upload reference pulse waveforms in I/Q format and compare phase and frequency within a pulse with the measured values.

- ▮ Point-in-pulse measurements: frequency, amplitude, phase versus pulse, trends and histograms for all parameters
- ▮ Pulse statistics: standard deviation, average, maximum, minimum
- ▮ Pulse tables
- ▮ User-defined measurement parameters
- ▮ Segmented data capturing
- ▮ Time sidelobe analysis (R&S®FSW-K6S option required)

R&S®FS/FSV/FPS/FSL/FSW-K7 AM/FM/φM Measurement Demodulator

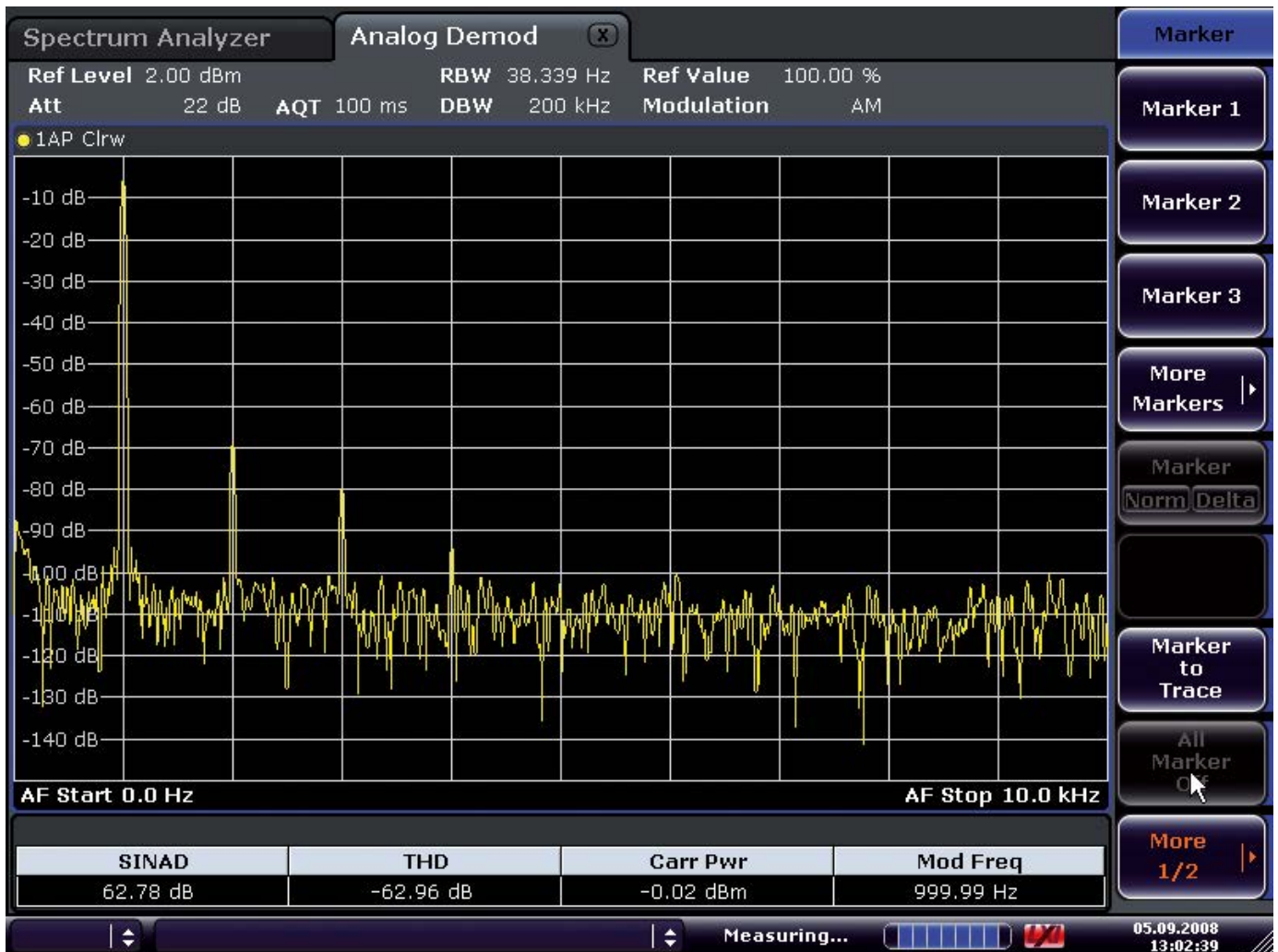

THD measurement on an amplitude-modulated signal. The first harmonic of the modulation signal is well suppressed by 69 dB. This corresponds to a THD (D2) of less than 0.1%.

Analog signal measurement

The R&S®FS/FSV/FPS/FSL/FSW/FSWP-K7 AM/FM/φM measurement demodulator application converts the R&S®FSV/FSVR/FSL/FSMR/FSUP/FSW into an analog modulation analyzer for amplitude, frequency or phase-modulated signals. The following display and analysis alternatives are available:

- ▮ Modulation signal versus time
- ▮ Spectrum of modulation signal (FFT)
- ▮ RF signal power versus time
- ▮ Spectrum of RF signal
- ▮ Table with numeric display of
 - Deviation or modulation factor, RMS weighted, +peak, -peak, ±peak/2
 - Modulation frequency
 - Carrier frequency offset
 - Carrier power
 - Total harmonic distortion (THD) and SINAD

R&S®FSV-K7S FM Stereo Measurements

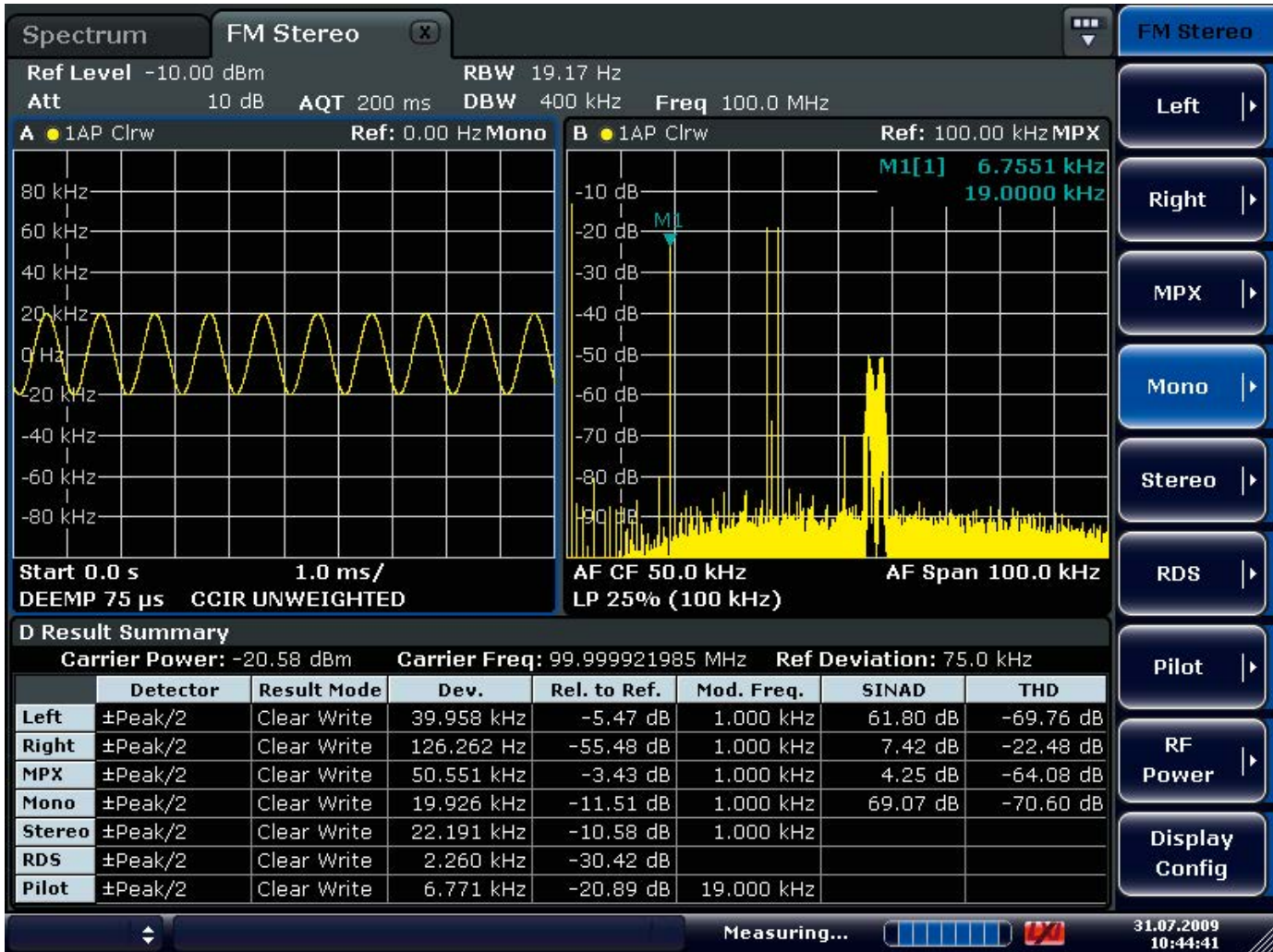

The result summary clearly displays the measurement results of all the channels; switchover is not required. Additional displays such as the mono signal or MPX spectrum display support in-depth analysis.

Comprehensive measurement functions for complete FM stereo analysis

The R&S®FSV-K7S application firmware expands the functionality of the R&S®FSV-K7 application firmware with measurements on FM stereo transmitters.

- Frequency deviation measurement in channels MPX, L, R, M, S and frequency deviation measurement of pilot and RDS carrier
- Carrier power and carrier frequency measurement
- Audio frequency measurement
- Absolute and relative deviation measurement for easy-to-perform S/N ratio and crosstalk attenuation measurement
- AF spectrum display and display per channel
- Up to 4 measurement windows

Wide variety of audio filters and detectors for standard-compliant measurements

- CCIR filter, weighted and unweighted
- 20 Hz, 50 Hz, 300 Hz highpass filters and 3 kHz, 15 kHz, 23 kHz, 150 kHz lowpass filters
- Selectable deemphasis of 50 μ s, 75 μ s, 750 μ s
- Detectors: \pm peak/2, +peak, -peak, RMS, RMSxSQR2, quasi-peak (in line with CCIR 468) and quasi-peakxSQR2

R&S®FS/FSV/FSL-K8 Transmitter Measurements for Bluetooth® V2.0 and EDR

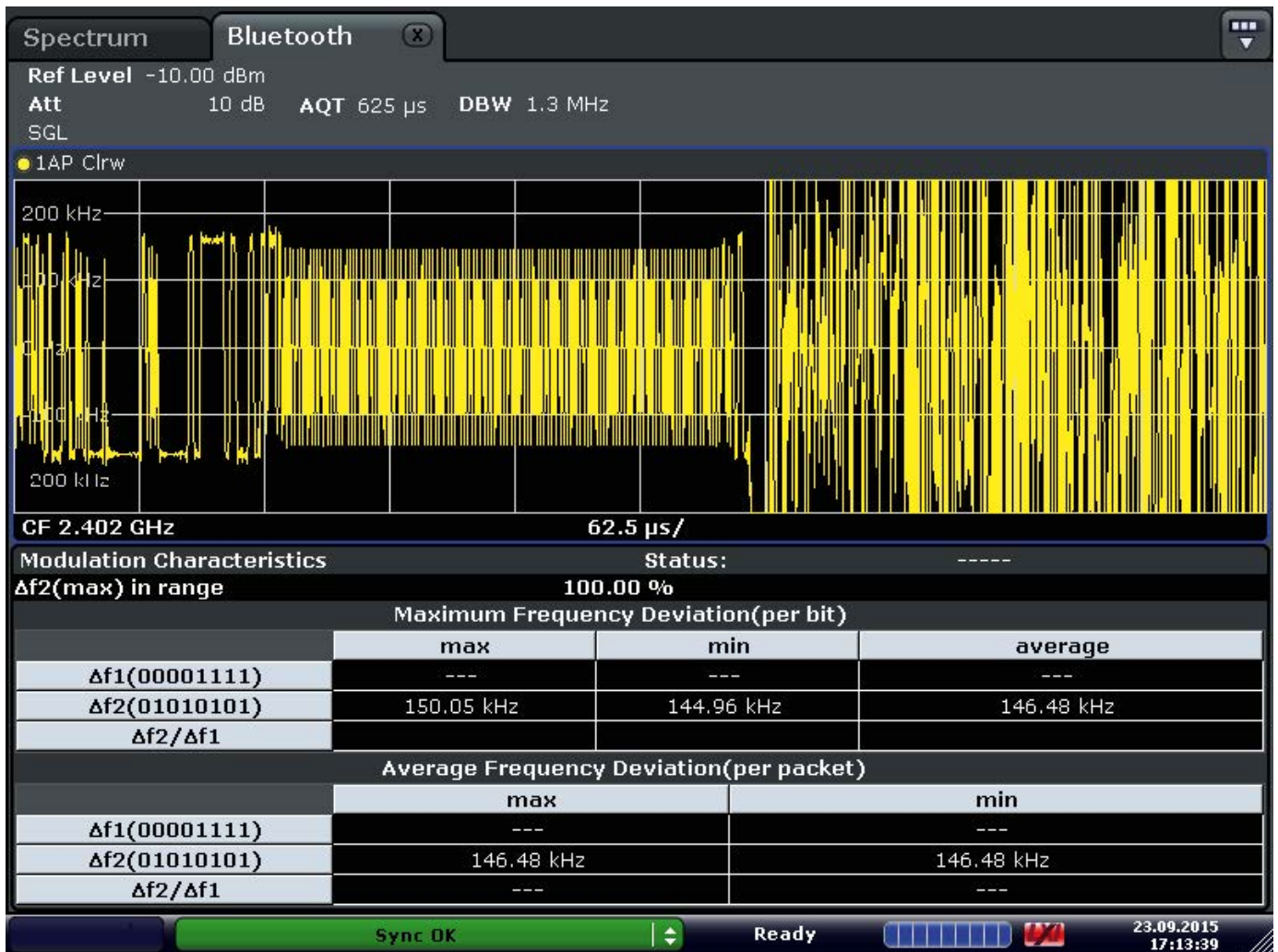

Analysis of a Bluetooth® signal with R&S®FSx-K8.

Transmitter measurements for Bluetooth®

The R&S®FS/FSV/FSL-K8 application firmware enhances the range of applications of the R&S®FSUP/FSMR/FSV/FSVR/FSL spectrum analyzers to include measurements on Bluetooth® transmitters. All measurements are carried out in line with the Bluetooth® RF Test Specification (Bluetooth® SIG) Rev. 2.0+EDR and cover basic rate as well as EDR. Integrated limit value monitoring is provided for all measurements and allows analysis of the results in the development and production of Bluetooth® modules.

Basic rate measurements

- ▮ Output power
- ▮ ACP over up to 79 channels
- ▮ Modulation characteristics
- ▮ Initial carrier frequency tolerance
- ▮ Carrier frequency drift

EDR measurements

- ▮ Output power and relative transmit power
- ▮ In-band spurious emissions, gated
- ▮ Carrier frequency stability and modulation accuracy (DEVm)
- ▮ Differential phase encoding

R&S®FS/FSV/FPS/FSW-K10 GSM/EDGE/EDGE Evolution Analysis

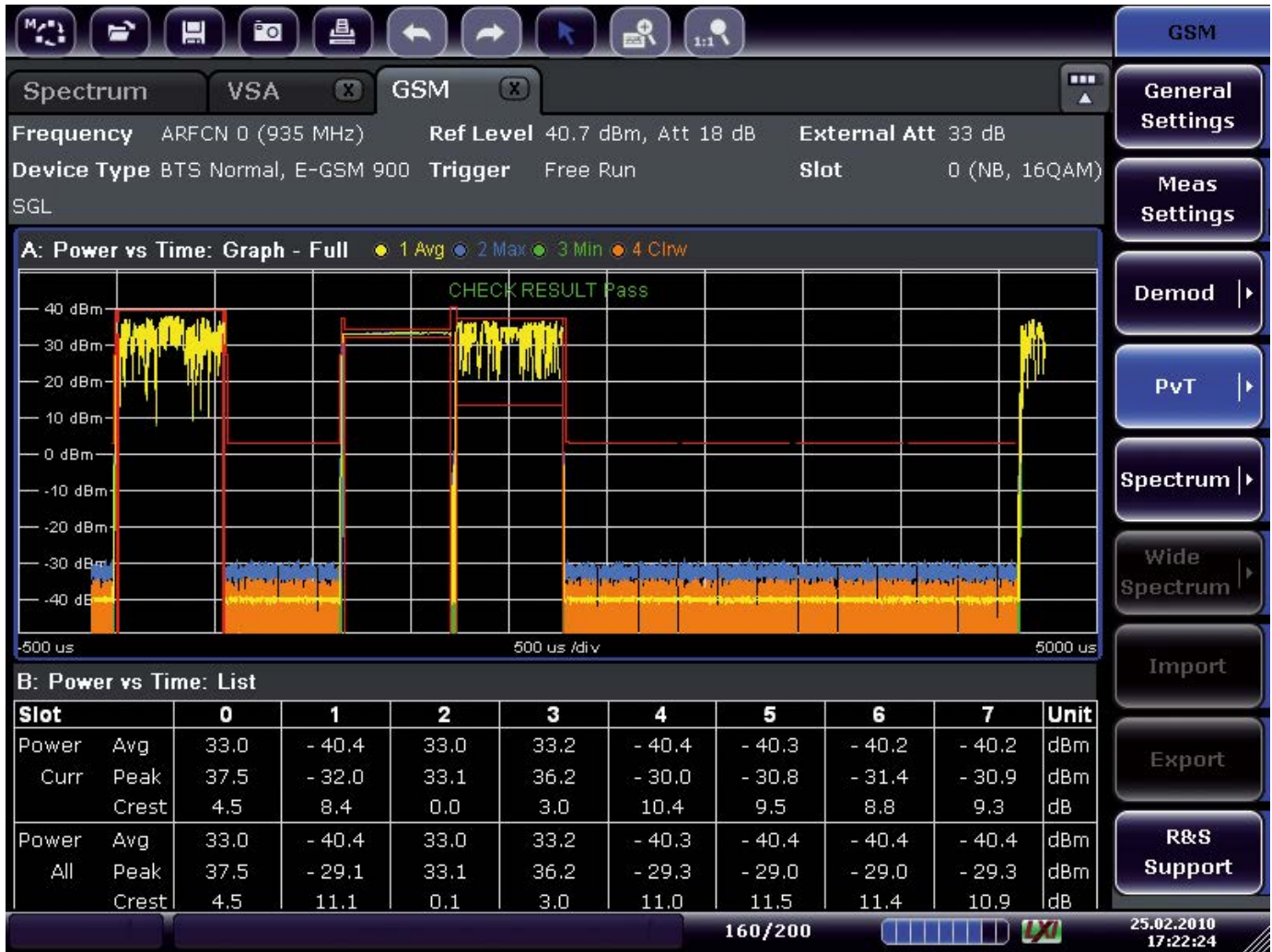

Power versus time analysis of a GSM signal with R&S®FPS/FSx-K8.

Evolution analysis

The R&S®FS/FSV/FPS/FSW-K10 measurement application firmware enables transmitter tests on mobile stations and base stations. It provides all the functionality needed for GSM/EDGE, EDGE Evolution and VAMOS.

- ▮ Power measurement in time domain including carrier power
- ▮ Modulation quality
 - EVM
 - Phase/frequency error
 - Origin offset suppression
- ▮ Spectrum measurements
 - Modulation spectrum
 - Transient spectrum
 - Spurious emissions

R&S®FSV/FSL-K14 Spectrogram Measurements

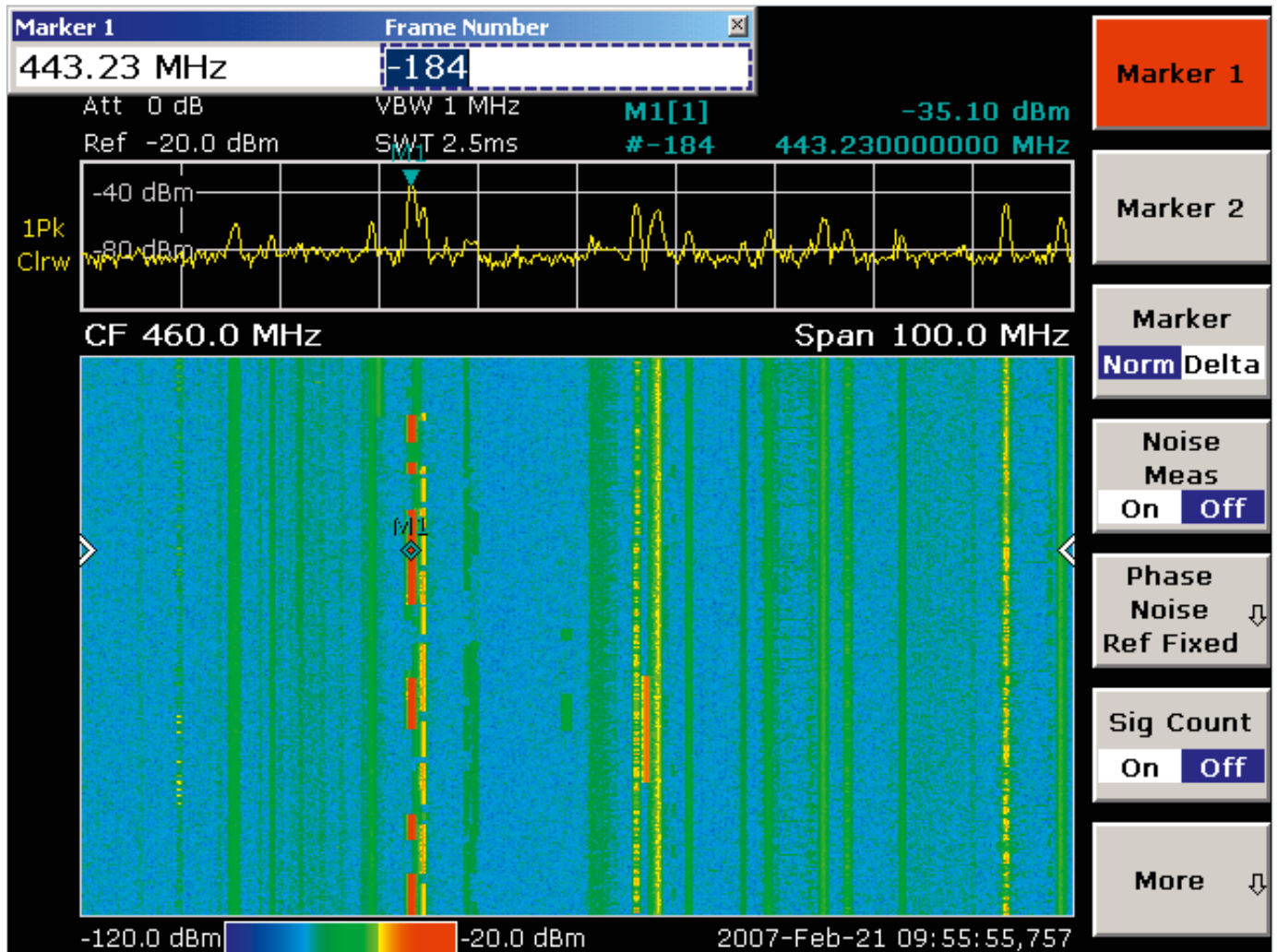

Spectrogram measurements

The R&S®FSV/FSL-K14 application firmware adds a spectrogram display and trace recording to the R&S®FSV/FSL. The spectrogram view shows a history of the spectrum and helps analyze intermittent problems or variations in frequency and level versus time. It also adds a new trigger, i.e. a time trigger that makes it possible to record a trace at a regular time interval.

- Recording of up to 20000 traces: approx. 5.5 h continuous monitoring with repetition interval set to 1 s
- Time trigger, 100 ms to 5000 s repetition interval: allows unattended continuous monitoring
- Scrolling through recorded traces with markers: replay and repeated analysis of recorded data

R&S®FSW-K15 VOR/ILS Measurements

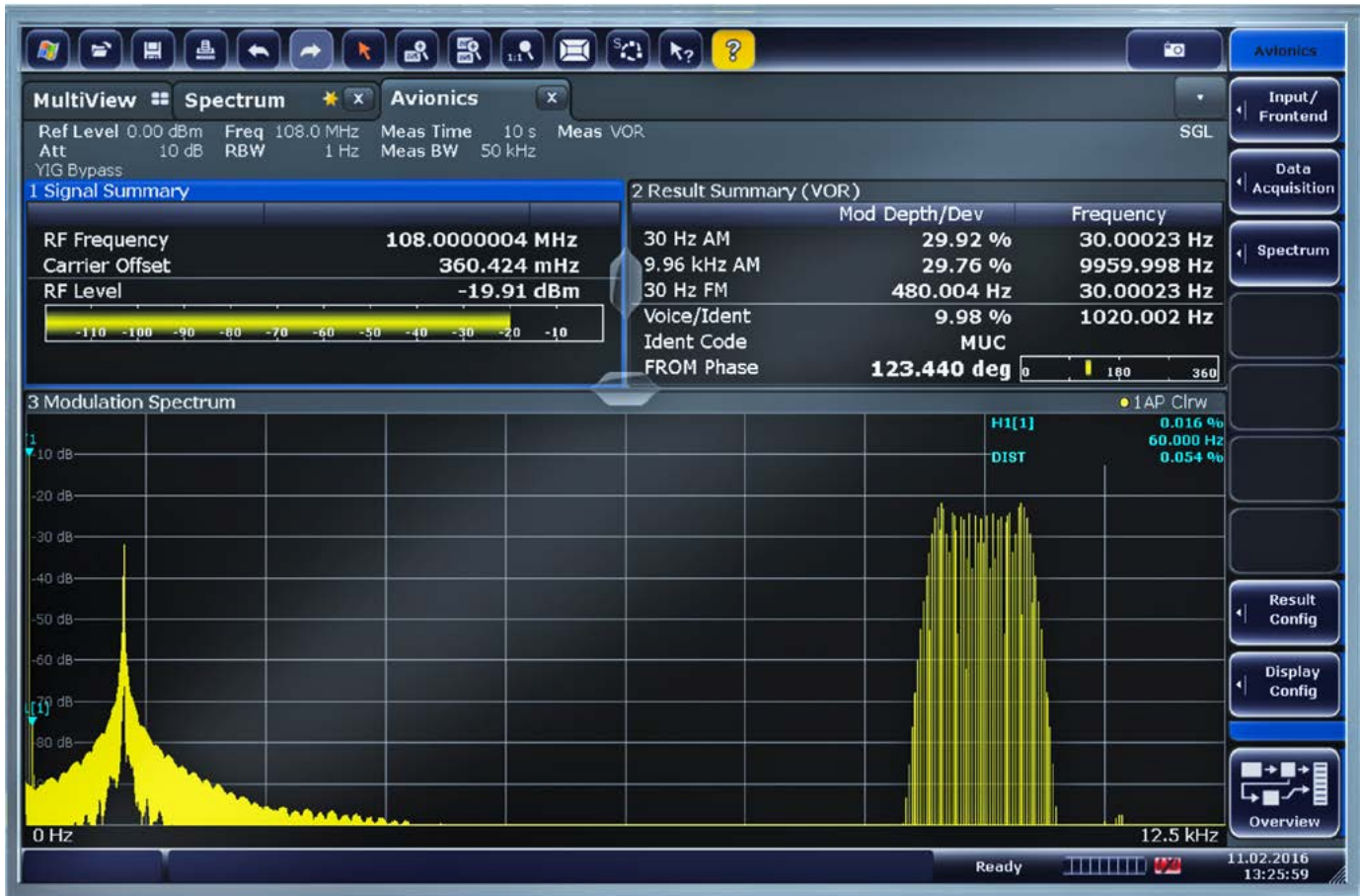

Precise VOR and ILS modulation analysis for calibration, development, production and service

The option R&S®FSW-K15 brings VOR/ILS analysis into the R&S®FSW. In the R&S®FSW analyzer, the option extends the calibration possibilities to include VOR/ILS signal generators (for example R&S®SMBV100A with R&S®SMBV-K151/-K152) and navigation/ramp testers (for example R&S®CMA).

With the R&S®FSW and the R&S®FSW-K15 option, such instruments can be calibrated by a single box without the need for an additional VOR/ILS tester.

The R&S®FSW-K15 is designed to replace the R&S®FS-K15 option for the R&S®FSMR, R&S®FSU and R&S®FSQ. It offers the same function set for VOR/ILS analysis, adds some features and has the same uncertainty specification as the R&S®FS-K15.

- Low measurement uncertainty for
 - ILS DDM (difference in depth of modulation)
 - VOR phase
 - Modulation parameters of single signal components such as 90/150 Hz tones, 30 Hz/9.96 kHz subcarrier
- All measurement parameters and spectrum overview at a glance
- Selective distortion measurements for all AM and FM components of VOR and ILS signals
- Identifier measurement and Morse code indication (1020 Hz)
- Easy to operate: user simply has to select between VOR and ILS

R&S®FSW-K18/FPS-K18 Amplifier Measurement Application

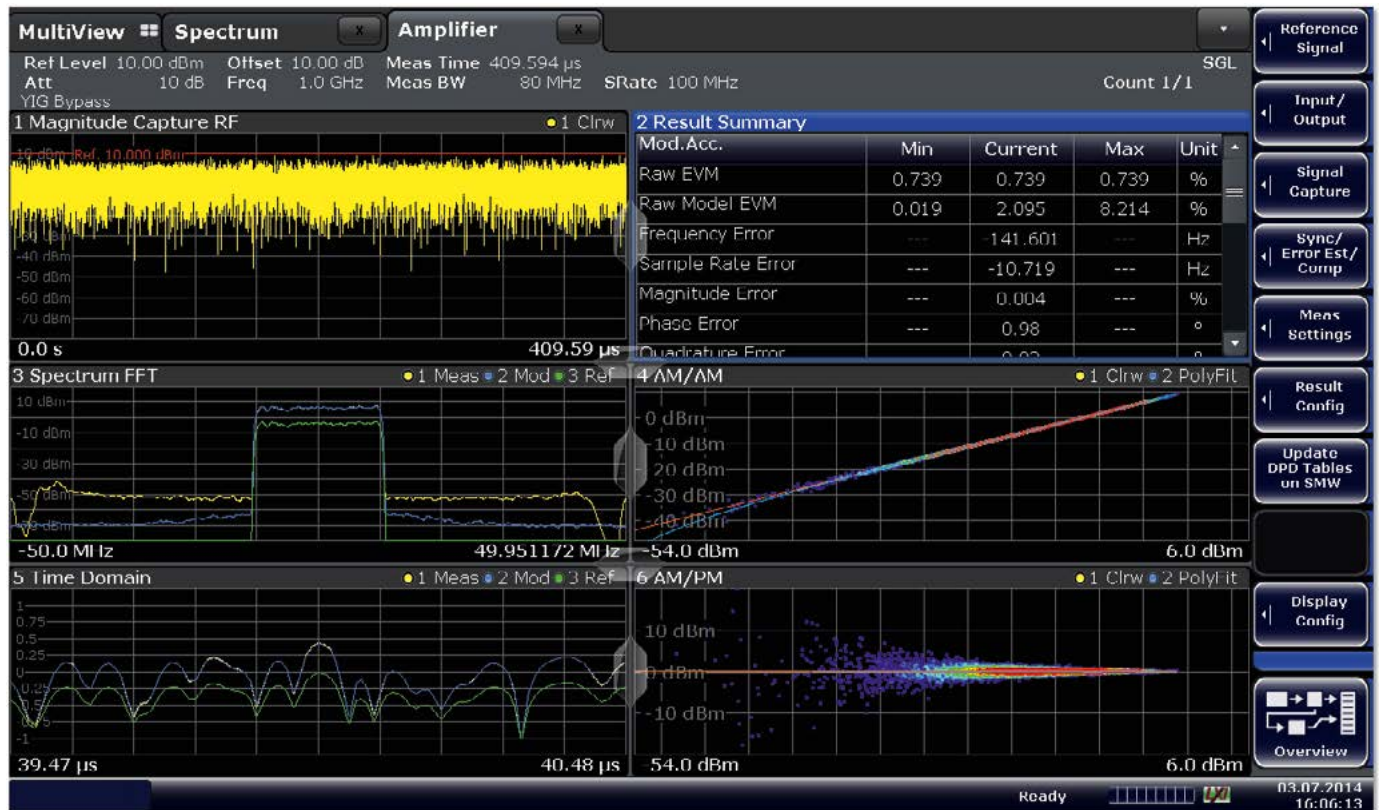

Characterization and optimization of power amplifiers, including envelope tracking measurements

The R&S®FSW-K18/FPS-K18 amplifier measurement application enables users to characterize and optimize power amplifiers. The R&S®FSW-K18/FPS-K18 supports the following measurements:

- Conventional power amplifier measurements
 - Fast and easy characterization of amplifiers, including AM/AM and AM/φM traces. Measures and models the linear and nonlinear distortions of amplifiers
- Envelope tracking measurements
 - Full characterization of envelope tracking power amplifiers
 - Measures the impact of envelope tracking on power efficiency and signal quality, including instantaneous power-added efficiency (PAE) (R&S®FSW only)
- Digital predistortion
 - Modeling of the amplifier and computation of a polynomial model of the power amplifier. The coefficients can be used by the R&S®SMW-K541 real-time predistortion option

The R&S®FSW-K18/FPS-K18 controls a Rohde & Schwarz vector signal generator, including downloading the currently used waveform and setting the frequency and power. The R&S®FSW-K18/FPS-K18 synchronizes the measured data with an ideal I/Q file (reference signal). In addition, the R&S®FSW-K18/FPS-K18 is also capable of generating and uploading its own waveforms with user-configurable parameters.

R&S®FS/FSV/FSL/FSW/FSWP-K30 Noise Figure and Gain Measurements

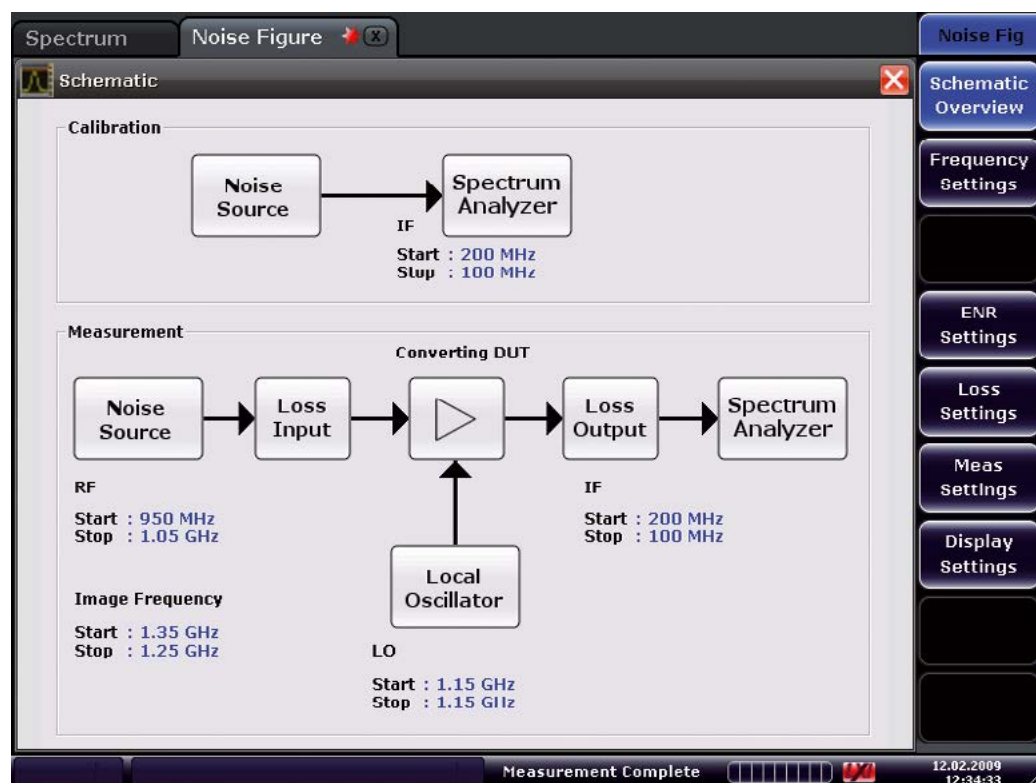

The schematic view of the test setup simplifies measurements on frequency-converting DUTs.

Wide variety of RF measurements

The R&S®FS/FSV/FSL/FSW-K30 application firmware expands the R&S®FSV/FSVR/FSL/FSW signal and spectrum analyzers by adding measurement functionality otherwise only provided by special noise measurement analyzers. The following parameters can be measured at a specified frequency or in a selectable frequency range:

- Noise figure in dB
- Noise temperature in °K
- Gain in dB

Noise measurements

- Measurement range from 0 dB to 35 dB
- Resolution of 0.01 dB
- Device measurement uncertainty of 0.05 dB

Gain measurements

- Measurement range from -20 dB to +60 dB
- Resolution of 0.01 dB
- Measurement accuracy of ± 0.2 dB

R&S®FS/FSV/FSW-K40 Phase Noise Measurements



Phase noise measurement of a signal source with an R&S®FSW signal analyzer and R&S®FSW-K40 option.

Blue: original trace.

Yellow: trace with a smoothing factor of 10 %. Residual noise and spot noise results are displayed in tables.

Fast and easy phase noise measurements

The R&S®FS/FSV/FSW-K40 application firmware enables the R&S®FSMR/FSV/FSVR/FSW signal and spectrum analyzers to perform fast and easy phase noise measurements in development and production.

- Carrier offset frequency range selectable from 1 Hz to 1 GHz in 1/3/10 sequence (1 Hz, 3 Hz, 10 Hz, 30 Hz, etc.)
- Number of averages, sweep mode and filter bandwidth for every measurement subrange can be individually selected to optimize the measurement speed
- Fast results for the subranges are obtained by starting the measurement at the maximum carrier offset
- Verification of carrier frequency and power prior to each measurement prevents incorrect measurements
- Improved dynamic range by measuring the thermal inherent noise in a reference trace and performing noise correction
- Tabular display of residual FM, residual ϕ M and RMS jitter in addition to measurement trace
- Limit lines with PASS/FAIL indication

R&S®FSW-K50 Spurious Measurements

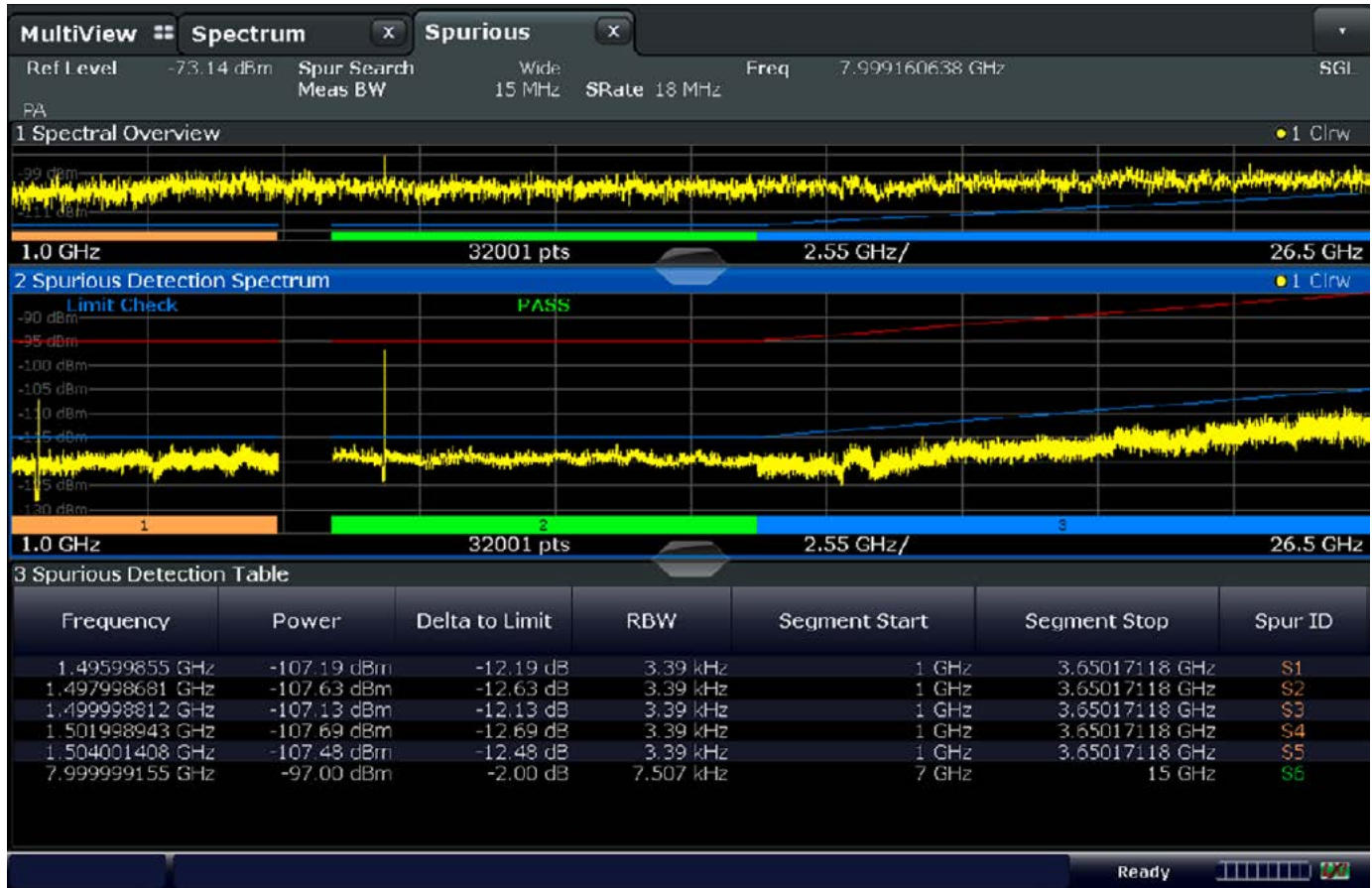

Spurious measurements between 1 GHz and 26.5 GHz.

Advanced techniques for spurious search

The R&S®FSW signal and spectrum analyzer equipped with the R&S®FSW-K50 application firmware speeds up low-level spur search in the design, verification and production of RF and microwave devices.

- Automatically sets RBW based on measured analyzer noise floor, spur detection threshold and required signal to noise ratio
- Automatically calculates the optimum RBW for each frequency range
- Performs a high-speed search around each detected spur frequency
- Identifies and removes analyzer residual spurs
- Spur search table can be updated manually, imported from a previous search or from a .csv file
- It is possible to set two limit lines: one for pass/fail, another for the spur detection threshold
- Search regions are highlighted in different colors for easy recognition; single spurs are identified

R&S®FSV/FSVR/FSW-K54 EMI Measurement Application

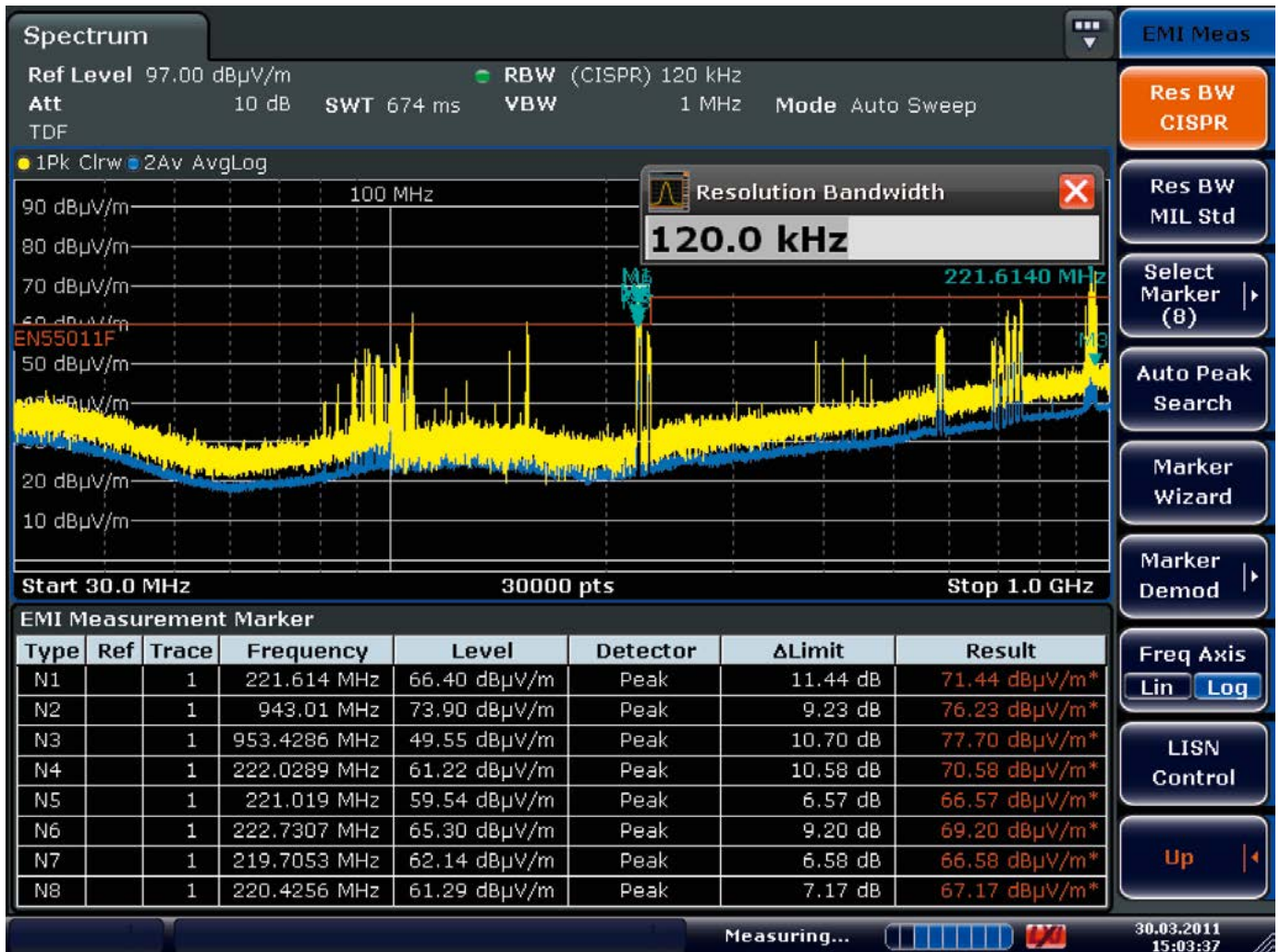

Bandwidth selection.

Finding, classifying and eliminating electromagnetic interference

The R&S®FSV/FSW-K54 EMI measurement application adds EMI diagnostic functionality to the R&S®FSV/FSW signal and spectrum analyzers and the R&S®FSVR real-time spectrum analyzer. R&S®FSV/FSW-K54 offers EMI bandwidths for commercial and military applications, detectors such as quasi-peak, CISPR-average and RMS-average, limit lines and correction factors. It allows users to analyze the effectiveness of shielding measures and the effects of changes in the circuit or design prior to testing in the EMC lab.

- EMI bandwidths for commercial and military standards
- Standard EMI detectors: quasi-peak, CISPR-average, RMS-average
- Linking of measurement markers to various EMI detectors
- Limit lines and transducers for typical measurement tasks
- Choice of linear or logarithmic scale on frequency axis
- Seamless analysis of frequency spectrum up to 40 MHz using the R&S®FSVR

R&S®FSW-K60 Transient Analysis



Analysis of a chirp signal with R&S®FSW-K60C. Simultaneous display of spectrogram, chirp rate, chirp rate deviation and summary table.

Analyzing transient signals, for example signals from frequency hopping radios or radar chirps

The R&S®FSW-K60 transient analysis option and its extensions R&S®FSW-K60H and R&S®FSW-K60C are designed to analyze transient signals, for example signals from frequency hopping radios or radar chirps. Detailed numerical results such as switching times, dwell times or rate of frequency changes as well as corresponding frequency/amplitude/phase vs time displays are provided.

The R&S®FSW-K60H adds hop analysis. It detects frequency hops automatically or measures according to a predefinable hop table. Results include dwell time/hop, switching time, frequency, deviation and many more.

The R&S®FSW-K60C adds chirp analysis. It detects FMCW chirps automatically or from a predefinable chirp table. It measures parameters such as the chirp rate, chirp length and linearity of FMCW chirps.

R&S®FSV/FPS/FSW/FSWP-K70 Vector Signal Analysis



Demodulation of a 512QAM signal with R&S®FSW-K70.

Flexible modulation analysis from MSK to 64QAM

The R&S®FSV/FPS/FSW-K70 application firmware enables users to flexibly analyze digitally modulated single carriers down to the bit level using the R&S®FSV/FPS/FSVR/FSW. The clear-cut operating concept simplifies measurements, despite the wide range of analysis tools.

- Modulation formats:
 - MSK, DMSK, BPSK, QPSK, 8PSK, DQPSK, D8PSK, $\pi/4$ -DQPSK, $3\pi/8$ -D8PSK, 16QAM to 2048QAM (R&S®FSW)
- Symbol rate up to 2 GHz
- Analysis length up to 50000 symbols
- Analysis bandwidth depends on base unit
- Numerous standard-specific default settings
 - GSM, GSM/EDGE, WCDMA, TETRA
- Display choices for amplitude, frequency, phase, I/Q, eye diagram, amplitude, phase or frequency error, constellation or vector diagram
- Fast and easy-to-operate equalizer (R&S®FSW-K70)
- Data-aided and non-data-aided demodulation

R&S®FS-K72/-K73/-K73+/-K74/-K74+, R&S®FSV/FPS/FSW-K72/-K73 WCDMA 3GPP Measurements



Demodulation of a WCDMA base-station signal with R&S®FSW-K72.

Code domain power measurements (3GPP FDD)

The application firmware adds measurement functions in line with the 3GPP specifications for the FDD mode to Rohde&Schwarz signal and spectrum analyzers.

- Measurement of modulation quality: EVM, peak code domain error and relative code domain error
- Automatic detection of active channels and their data rate
- Scrambling code search
- Automatic detection of modulation formats in HSDPA and HSPA+
- Provides the functionality needed for base station testing

Option	Description
R&S®FS-K72/-K73	provides all the functionality for testing base stations (R&S®FS-K72) or user equipment (R&S®FS-K73) in line with WCDMA Release 99
R&S®FS-K74	extends the capabilities of R&S®FS-K72 to encompass HSPA (high speed packet access) for base station testing (R&S®FS-K74)
R&S®FS-K73+	adds HSPA+ capabilities to R&S®FS-K73
R&S®FS-K74+	provides additional functionality for HSPA+ testing in line with 3GPP Release 7
R&S®FSV/FPS-K72	3GPP BS (DL) analysis, incl. HSDPA
R&S®FSV/FPS-K73	3GPP UE (UL) analysis, incl. HSUPA
R&S®FSW-K72	3GPP FDD (WCDMA) BS measurements, incl. HSDPA and HSDPA+
R&S®FSW-K73	3GPP FDD (WCDMA) MS measurements, incl. HSDPA and HSDPA+

R&S®FS/FSV/FPS/FSW-K76/-K77 TD-SCDMA Test



Demodulation of a TD-SCDMA base station signal with R&S®FSW-K76.

Base station and mobile station tests on TD-SCDMA with the R&S®FSMR/FSV/FSW analyzers

The R&S®FS/FSV/FPS/FSW-K76/-K77 application firmware adds measurement functions in line with 3GPP as well as China Wireless Telecommunication Standard Group (CWTS) specifications to the R&S®FSMR/FSV/FPS/FSW signal and spectrum analyzers. It enhances the range of applications to include code domain power and modulation measurements on TD-SCDMA base stations.

- ▮ Code domain power measurement
- ▮ Easy measurement of modulation quality
- ▮ Automatic detection of active channels
- ▮ Spectrum emission mask
- ▮ Remote control

R&S®FS/FSV/FPS/FSW-K76

Provides the functionality needed for base station testing.

R&S®FS/FSV/FPS/FSW-K77

Provides user equipment (UE) functionality.

R&S®FS/FSV/FPS/FSW-K82/-K84 Base Station Test

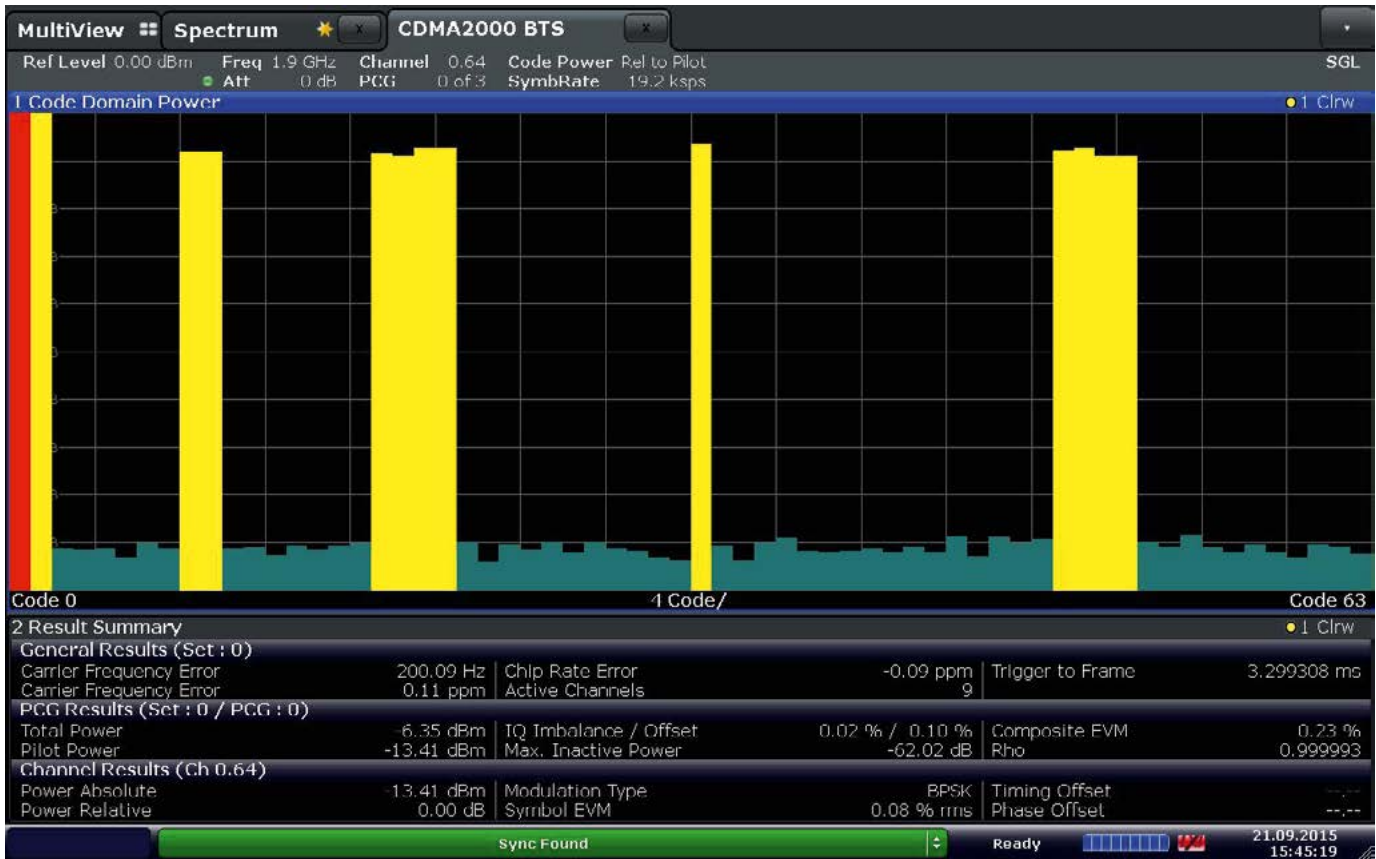

Demodulation of a CDMA2000® base station signal with R&S®FSW-K82.

CDMA2000®/IS-95 base station testing

The R&S®FS/FSV/FPS/FSW-K82 application firmware enhances the range of applications to include code domain power and modulation measurements on CDMA2000® signals for radio configurations 1 to 5 and radio configuration 10. cdmaOne base station signals can be analyzed by using radio configuration 1 or 2.

1xEV-DO base station testing

The R&S®FS/FSV/FPS/FSW-K84 application firmware adds the capability to measure code domain power modulation accuracy on all four channel types (pilot, preamble, MAC and DATA) of a 1xEV-DO base station signal.

Measurement parameters

- Code domain power (code domain analyzer)
- Code domain power versus time (R&S®FS/FSV/FPS/FSW-K82)
- Rho
- Error vector magnitude (EVM)
- Peak code domain error
- Power versus symbol
- Symbol constellation
- Channel table
- Code domain error power

R&S®FS/FSV/FPS/FSW-K83/-K85 Mobile Station Test



Demodulation of a CDMA2000® mobile station signal with R&S®FSW-K83.

Transmitter measurements on 3GPP2 signals with the R&S®FSMR/FSV/FSW analyzers

The R&S®FS/FSV/FPS/FSW-K83 application firmware enhances the range of applications to include code domain power and modulation measurements on CDMA2000® signals for radio configurations 3 and 4. 1xEV-DV reverse link channels of release C are also supported. The R&S®FS/FSV/FPS/FSW-K85 application firmware adds the capability to measure code domain power modulation accuracy on all five channel types (PICH, RRI, DATA, ACK and DRC) as well as TRAFFIC and ACCESS operating modes of an access terminal.

Measurement parameters

- ▮ Code domain power
- ▮ Code domain power versus time
- ▮ Rho
- ▮ Error vector magnitude (EVM)
- ▮ Peak code domain error
- ▮ Power versus symbol
- ▮ Symbol constellation
- ▮ Channel table
- ▮ Code domain error power
- ▮ Power versus chip (R&S®FS/FSV/FPS/FSW-K85)

R&S®FSx-K91/-K91n/-K91ac/-K91p/-K91ax WLAN TX Measurements

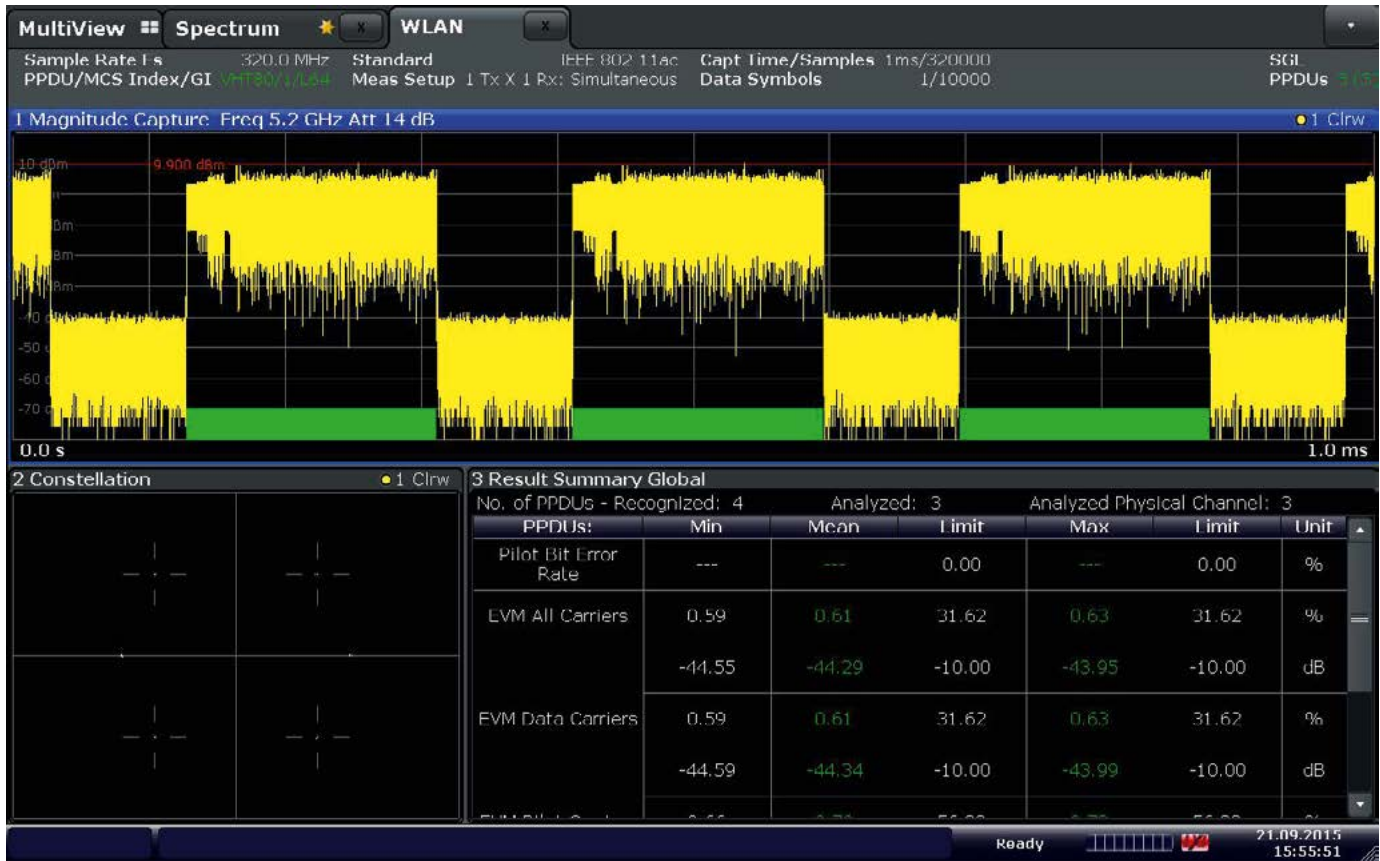

Demodulation of a WLAN 802.11ac signal with R&S®FSW-K91AC.

WLAN TX measurements with Rohde & Schwarz analyzers

The R&S®FSx-K91/-K91n/-K91ac/-K91ax application firmware enables the R&S®FSW/FSV/FPS/FSVR/FSL signal and spectrum analyzers to perform spectrum and modulation measurements on signals in line with the WLAN IEEE 802.11a/b/g/j/n/ac standard.

- ▮ Analysis at the RF or in the analog/digital baseband
- ▮ Demodulation bandwidth of 28 MHz/40 MHz/120 MHz
- ▮ Modulation formats for IEEE 802.11a/g/j/n/p/ac: BPSK, QPSK, 16QAM, 64QAM, 256QAM
- ▮ Modulation formats for IEEE 802.11b: DBPSK, DQPSK, CCK, short PLCP, long PLCP
- ▮ Very low residual EVM of -44 dB/-46 dB (0.7% at 2.4 GHz)
- ▮ Legacy/mixed/Greenfield mode of IEEE 802.11n signals
- ▮ Support of up to four MIMO streams
- ▮ Provides complex WLAN measurements at a keystroke (automatic setting of modulation format)
- ▮ Allows remote control of all functions via IEC/IEEE bus or LAN

R&S®FSV-K93 WiMAX™/MIMO TX Measurements

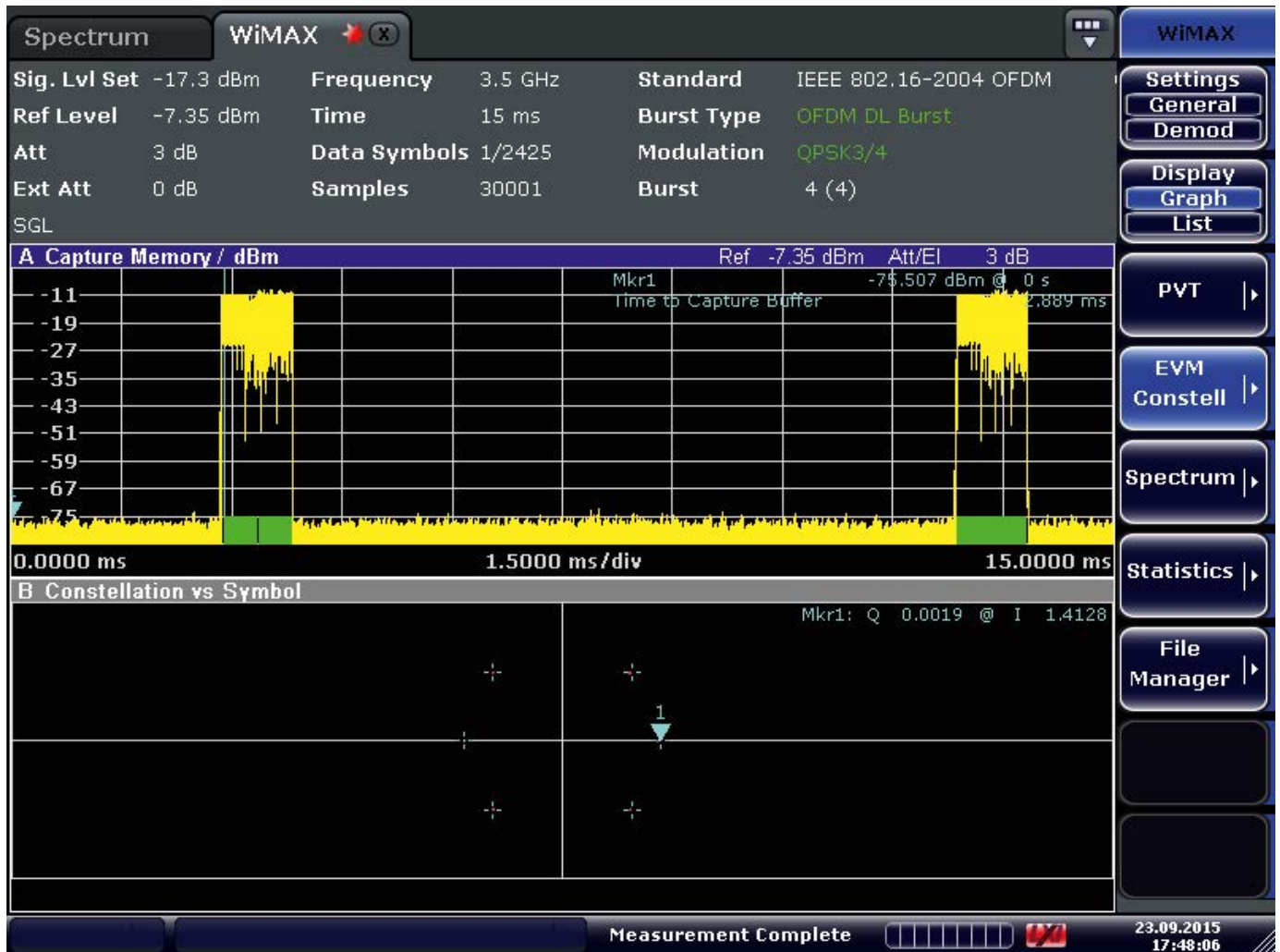

Demodulation of a WiMAX™ signal with R&S®FSV-K93.

TX measurements on OFDM and OFDMA signals

The R&S®FSV-K93 application firmware allows TX measurements on OFDM and OFDMA signals in line with the WiMAX™ IEEE 802.16-2004 and IEEE 802.16e-2005 standards.

- Enhances the R&S®FSL/FSV analyzers by adding the capability to perform spectrum and modulation measurements on signals in line with the IEEE 802.16-2004 and IEEE 802.16e-2005 standards
- Supports OFDM and OFDMA
- Complex WiMAX™ measurements at a keystroke
- Measurements in RF/IF range and baseband
- Remote control of all functions via IEC/IEEE bus or LAN

R&S®FSW-K95 IEEE 802.11ad Measurements



Analysis of a WLAN 802.11ad signal at 60.48 GHz with a 16QAM modulation and an EVM of -32 dB.

Transmitter measurements on WLAN 802.11ad signals

R&S®FSW-K95 analyzes uplink and downlink signals in line with WLAN standard 802.11ad in the 60 GHz range. Beside spectral measurements, the R&S®FSW-K95 can analyze modulation accuracy as well. The R&S®FSW-B2000 option and an additional R&S®RTO are needed to obtain a 2 GHz wide analysis bandwidth for the 1.8 GHz wide signal.

Modulation quality

- | EVM (pilot, data)
- | Constellation diagram
- | I/Q offset
- | I/Q imbalance
- | Gain imbalance
- | Symbol clock error
- | Center frequency error
- | Time skew
- | Phase error versus symbol
- | Phase tracking versus symbol

Spectrum measurements

- | Spectrum mask
- | Power spectrum
- | Channel frequency response

R&S®FS-K96/-K96PC OFDM Vector Signal Analysis

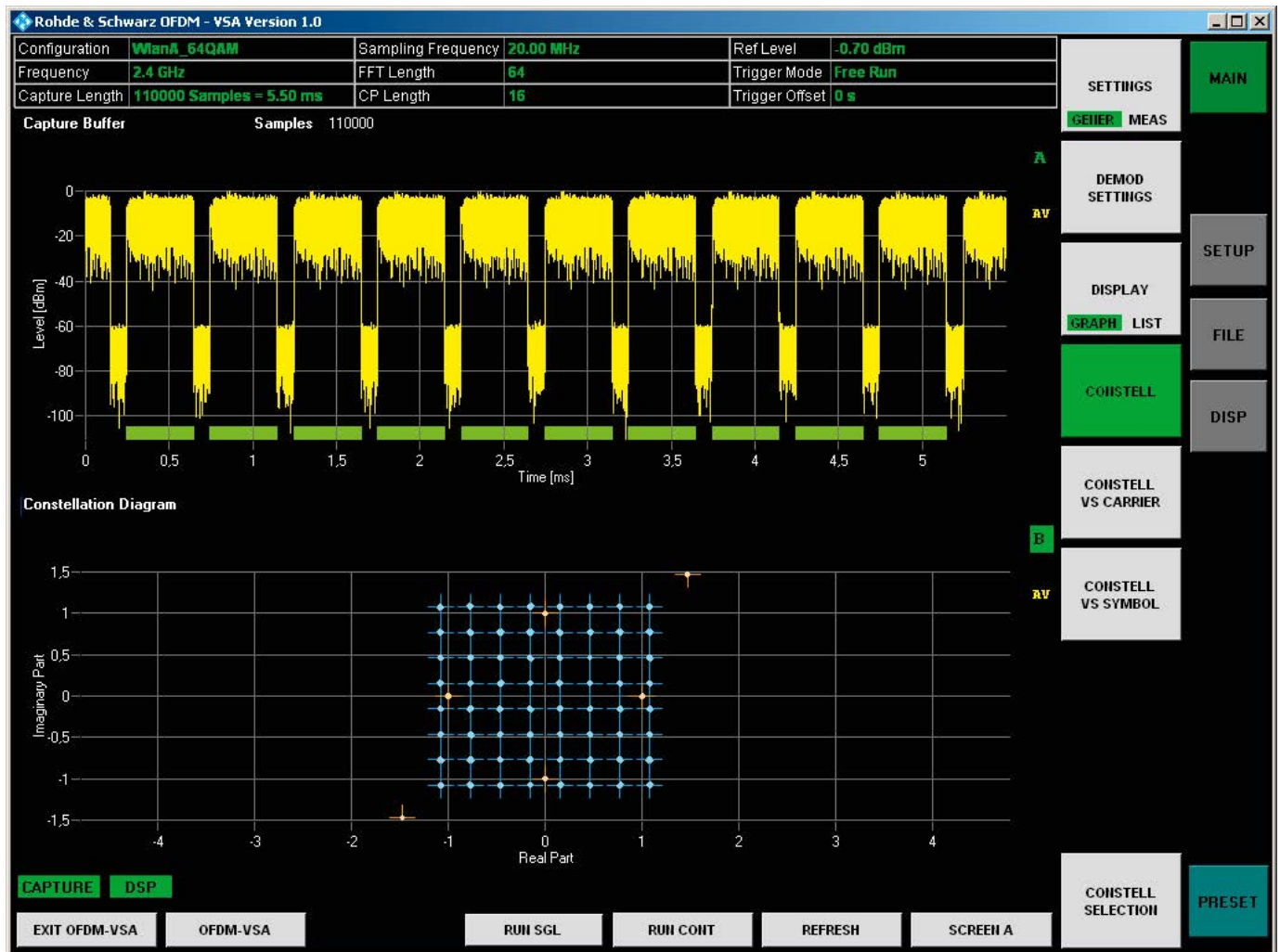

The upper part of the display shows the recorded signal in the time domain. The lower part shows the constellation diagram.

Modulation measurements on general OFDM signals

The R&S®FS-K96 software expands the R&S®FSW/FSUP/FSV/FSVR signal analyzers to feature modulation measurements on general OFDM signals. The OFDM demodulator is user-configurable and standard-independent.

The R&S®FS-K96 runs only when a LAN or GPIB connection to the Rohde&Schwarz analyzer is established. The R&S®FS-K96PC runs with and without connection to an analyzer.

- Support of OFDM and OFDMA
- Support of any PSK or QAM modulation format
- Frequency range from 50 MHz to 3/8/26.5/40 GHz, depending on analyzer used
- Very low residual EVM of below -51 dB for DVB-T, 2k mode
- RF measurement or I/Q baseband measurement (optional)
- Numerous measurements for OFDM signal analysis

R&S®FSV/FPS/FSW-K100/-K101/-K102/-K104/-K105 EUTRA/LTE Signal Analysis

**Transmitter measurements on LTE signals**

The software analyzes the modulation quality, e.g. EVM or I/Q imbalance, of 3GPP EUTRA FDD and TDD signals in both uplink and downlink. When combining two or up to four signal analyzers, these tasks can even be performed on MIMO transmitters.

The most important measurement results are listed in a table to provide a quick overview of the performance of the transmitter.

- Error vector magnitude (EVM) of all carriers
- EVM physical channel
- EVM physical signal
- Frequency error
- Sampling error
- Modulation parameters: I/Q error, gain imbalance, quadrature error
- Power
- Crest factor

For advanced analysis, a number of graphical displays is available.

Designation	Type
EUTRA/LTE FDD downlink measurement application	R&S®FSx-K100
EUTRA/LTE FDD uplink measurement application	R&S®FSx-K101
EUTRA/LTE downlink MIMO measurement application (requires R&S®FSx-K100 or R&S®FSx-K104)	R&S®FSx-K102
EUTRA/LTE-Advanced uplink measurement application	R&S®FSW-K103
EUTRA/LTE TDD downlink measurement application	R&S®FSx-K104
EUTRA/LTE TDD uplink measurement application	R&S®FSx-K105

R&S®FS-K100PC/-K101PC/-K102PC/-K103PC/-K104PC/-K105PC EUTRA/LTE and LTE-Advanced Signal Analysis



Transmitter measurements on LTE signals

The R&S®FS-K10xPC software is used for transmitter measurements on 3GPP long term evolution (LTE) and LTE-Advanced base stations and user equipment. Analysis of MIMO transmitters provides detailed insight into the performance of the complete system.

- Convenient analysis due to automatic detection of modulation formats
- Large number of display formats to evaluate transmitter performance
- Extensive TDD support
- Spectrum emission mask and adjacent channel leakage power measurement included for ease of use
- Automatic measurements

Designation	Type
EUTRA/LTE downlink FDD software (requires license dongle) on R&S®FS-K100/-K101/-K104/-K105	R&S®FS-K100PC
EUTRA/LTE uplink FDD software (requires license dongle) on R&S®FS-K100/-K101/-K104/-K105	R&S®FS-K101PC
EUTRA/LTE downlink MIMO software (requires R&S®FS-K100 or R&S®FS-K104)	R&S®FS-K102PC
EUTRA/LTE downlink MIMO software (requires R&S®FS-K100 or R&S®FS-K104)	R&S®FS-K103PC
EUTRA/LTE downlink TDD software	R&S®FS-K104PC
EUTRA/LTE uplink TDD software	R&S®FS-K105PC
License dongle (only one dongle per PC required)	R&S®FSPC

R&S®FS-K112 NFC Measurement Software

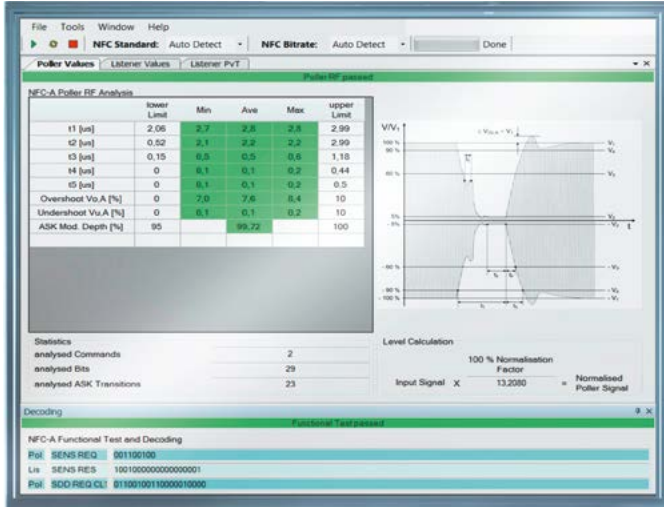

For spectrum analyzers and oscilloscopes from Rohde & Schwarz

The R&S®FS-K112PC NFC measurement software extends the functionality of the R&S®FSV and R&S®FSL signal and spectrum analyzers and the R&S®RTO digital oscilloscopes by adding measurement functions for analyzing and measuring NFC signals.

- Automatic detection of NFC-A, NFC-B and NFC-F transmission methods and manual presetting
- Measurement of voltage profiles, modulation depth, modulation index and load modulation including limit monitoring
- Measurement of timing parameters (rise/fall times, frame delay time, overshoot and undershoot)
- Display of transmitted data and evaluation of commands and replies (e.g. SENS_REQ)
- Function test: evaluation of listener response to a poll command
- Signal and spectrum analyzer/digital oscilloscope measurements and analysis of data files
- Use of NFC forum reference polling devices (poller 0, poller 3, poller 6) to accurately determine the load modulation
- Triggering on SENS_REQ and ALL_REQ NFC commands with the R&S®RTO digital oscilloscope with the R&S®RTO-K11 option

R&S®CSNFC-B8 NFC forum reference equipment

- Set of antennas for NFC analog measurements
- Set consisting of three listener antennas, three poller antennas and two 8-shaped coils
- Applicable with the R&S®SMBV100A vector signal generator, R&S®ZVL vector network analyzer, R&S®FSV signal and spectrum analyzer, R&S®FSL spectrum analyzer and R&S®RTO digital oscilloscope

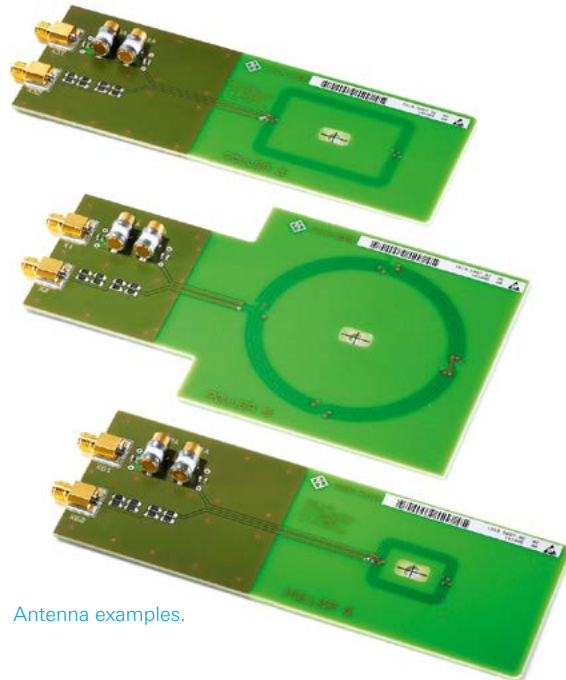

Antenna examples.

R&S®FS-K130PC Distortion Analysis Software

1. Main settings

- a) ARB upload behaviour? Always
- b) IQ reference signal type Pre-recorder reference signal
- c) Clock Rate 16.00 MHz
- d) Pause length 0.00 s
- e) ARB root file name FS_K130

2. Noise and Dual Tone stimulus settings

- a) Bandwidth / Tone spacing 1.00 MHz
- b) Number of samples 4096 Samples
- c) Random seed 1
- d) Crest factor 10.0 dB
- e) Crest factor tries 10
- f) Noise notch width 0.00 Hz

3. File stimulus settings

- a) File type Binary, 1 file ; 32-bit floating point ; IQIQ...
- b) Stimulus file name
- c) Stimulus file name secondary file [single file mode]

4. Marker control

- a) Restart marker Marker 1
- b) Marker 1 offset 0 Samples
- c) Marker 2 offset 0 Samples
- d) Marker 3 offset 0 Samples

h) IQ reference signal type
Selects the type and origin of the reference signal you want to use for the measurement.

0. Signal flow

- a) Sync mode Frequency, Timing, Phase, Gain, IQ
- b) Channel estimation Yes
- c) Modelling Volterra
- d) DPD Yes

1. Signal synchronization

- a) Periods to analyze 1000
- b) Search tolerance 0.05
- c) Compensate IQ imbalance Yes
- d) Compensate IQ Offset Yes
- e) Compensate frequency error Yes
- f) Compensate timing offset Yes
- g) Compensate amplitude droop Yes

2. Generic parameter calculation

- a) Nonlinear estimation order 7

3. Channel estimation

- a) Impulse response taps 1024
- b) Impulse response overlap 0.75

4.1. System identification - Polynomial

- a) Full fit maximum order 7

e) Modelling
Type of modeling to run.

Power - Spectrum

Numerical Results

Group	Item	Result
1. Power measurement		
	DUT Input - RMS	-20.4 dBm
	DUT Input - Peak	-11.0 dBm
	DUT Input - Crest	9.4 dB
	DUT Output - RMS	0.0 dBm
	DUT Output - Peak	8.5 dBm
	DUT Output - Crest	8.5 dB
	DUT Output - Leveling error	0.0 dB
2. Signal synchronization		
	Averages executed	2
	Confidence	99.93 %
	Frequency offset	143.08 Hz
	Phase offset	128.41 °
	Trigger offset	2.19 Samples
	IQ offset	-24.9 dB

Hardware Configuration

```

graph LR
    IQ_Gen[I/Q Generator] --> Input_Mixer[Input Mixer]
    Input_Mixer --> DUT_In[DUT Input Alteration]
    DUT_In --> DUT[DUT]
    DUT --> DUT_Out[DUT Output Alteration]
    DUT_Out --> Output_Mixer[Output Mixer]
    Output_Mixer --> IQ_Rec[I/Q Recorder]
  
```

Ref: Meas DSP Status: Measurement: Finished CPU usage

Block diagram functions make setup configuration and instrument settings easy and intuitive. The wide variety of measurement results that can be simultaneously displayed provides a quick overview. The configurable windows can be easily adjusted to suit various tasks.

Amplifier modeling and linearization

The R&S®FS-K130PC distortion analysis software measures and models the linear and nonlinear distortions of amplifiers, mixers and baseband components. This simplifies and accelerates the development of linearized components, such as power amplifiers. The most important measurement results are listed in a table to provide a quick overview of the performance of the transmitter.

- Measurement of distortion behavior of amplifiers, mixers and transposers and also direct control of required measuring instruments, such as signal generators and signal analyzers, via IEC/IEEE bus, LAN or USB
- Calculation of coefficients of a distortion model for DUTs with and without memory in accordance with the different selectable models (polynomial or Volterra)
- Calculation of predistortion coefficients
- Verification of spectral regrowth improvement achieved

R&S®FSW-B160R/-B512R Realtime Extension

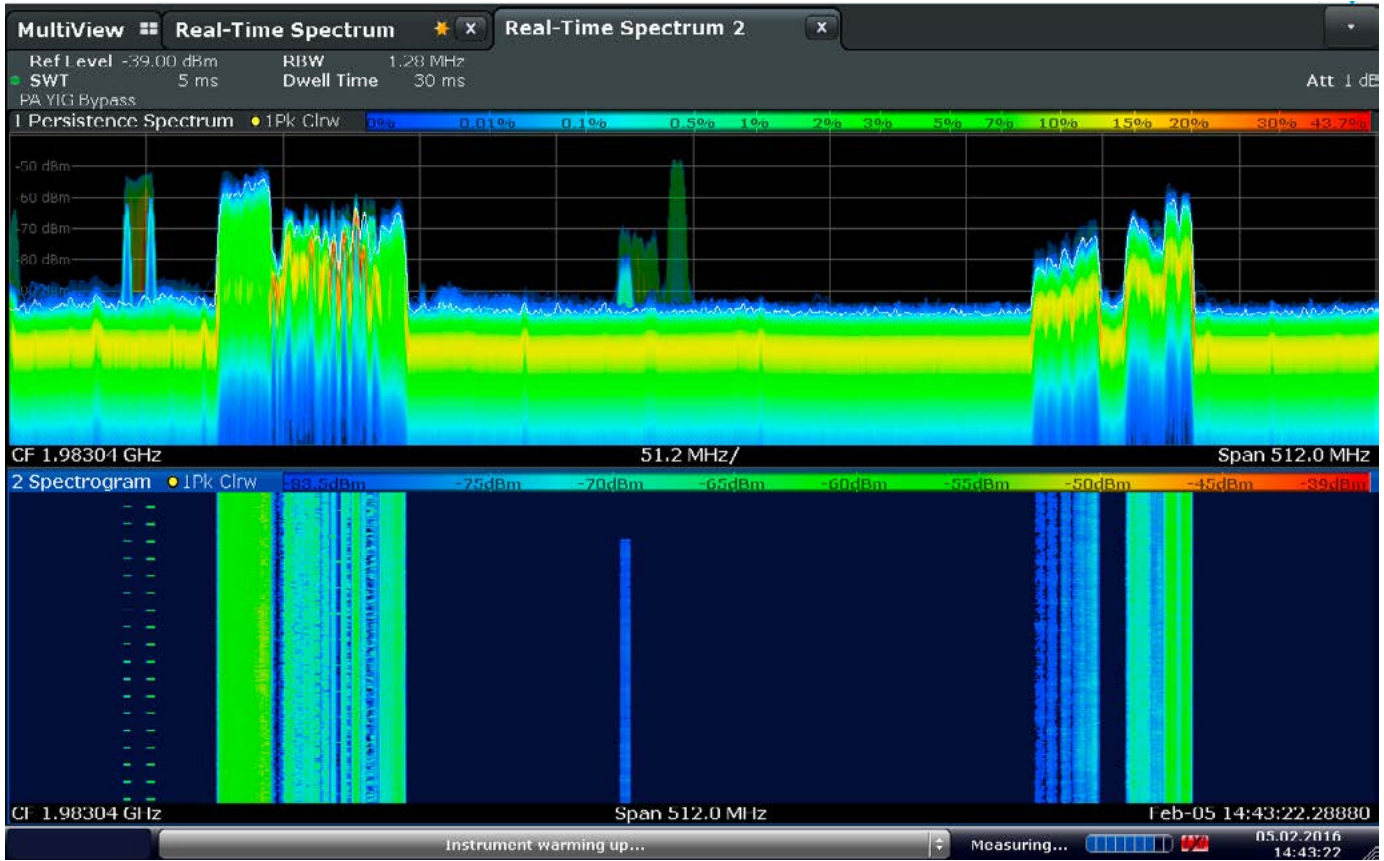

Realtime spectrum.

Seamless display of RF spectra

Equipped with the R&S®FSW-B160R/512R realtime spectrum analyzer options, the R&S®FSW seamlessly displays 160/512MHz wide RF spectra. It offers a real-time spectrogram in addition to the instantaneous spectrum and a persistence mode with the signal amplitudes shown in different colors according to their frequency of occurrence.

Frequency-dependent masks help the user reliably detect sporadic signals in the spectrum. While realtime analysis functionality previously required an extra device, it can now be provided by simply configuring or retrofitting the R&S®FSW signal and spectrum analyzer with the R&S®FSW-B160R or B512R option.

Key parameters in realtime analysis			
	R&S®FSW-B512R	R&S®FSW-B160R	R&S®FSW-B160RE
FFT length	1024 to 32k	1024 to 16k	1024 to 16k
Max. realtime analysis bandwidth	512 MHz	160 MHz	160 MHz
Max. FFT rate	1 171 875	585 938	58 824
POI	0.91 µs	1.87 µs	> 15 µs
RBW freely configurable for span/RBW ratio	6.25 to 6400	6.35 to 3200	6.25 to 3200

R&S®FSW-K192 DOCSIS 3.1 OFDM Downstream

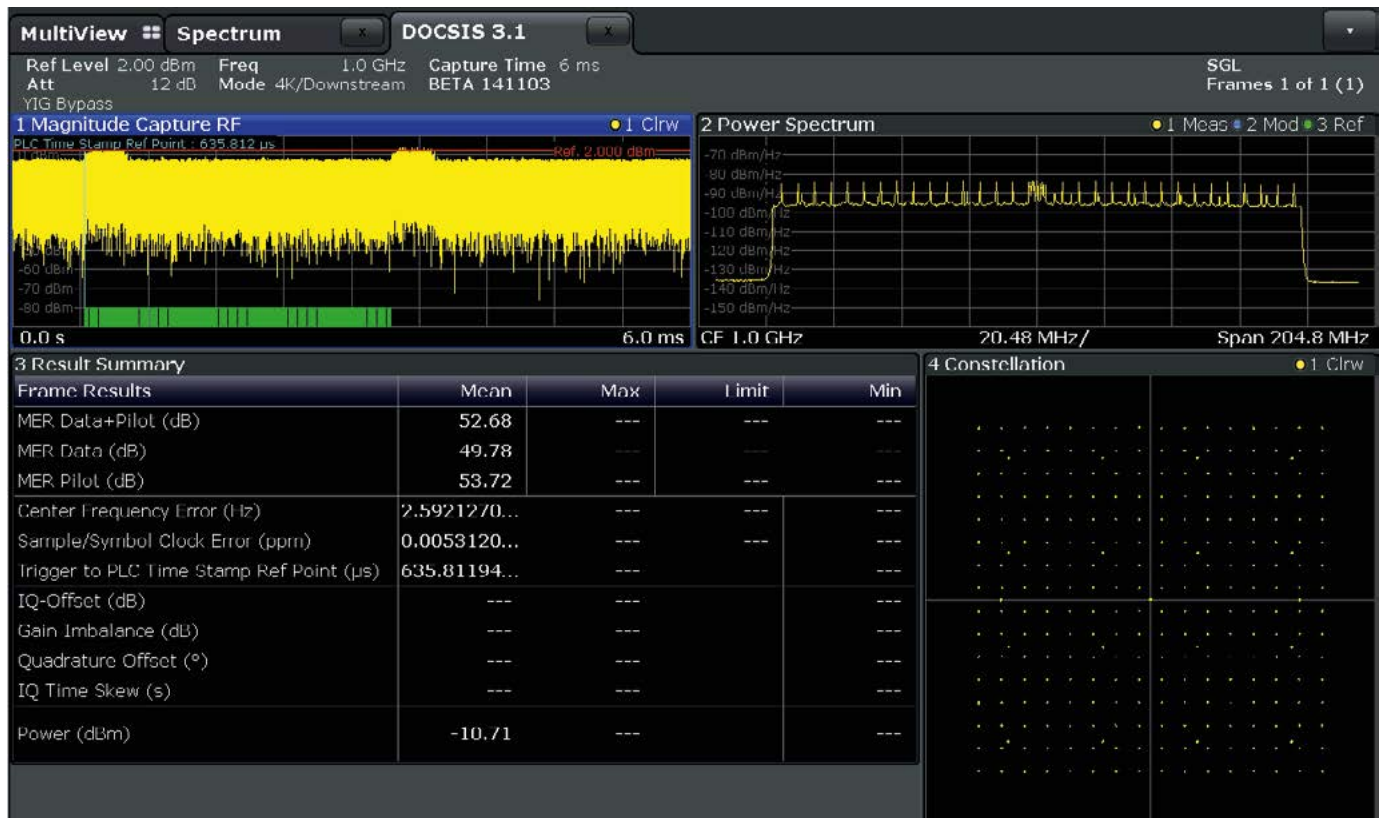

Analysis of DOCSIS3.1 signal with R&S®FSW-K192 option.

Analysis of DOCSIS3.1 downstream signals

Cable network providers can use the existing cable TV network to maximize both the downstream (DS) and upstream (US) data throughput by employing the data over cable service interface specification DOCSIS3.1.

The R&S®FSW-K192 analyzes DOCSIS3.1 downstream signals. This software application offers a wide range of graphical displays with detailed results as well as tables listing the key measurement parameters. In addition to manual input of signal configurations, the R&S®FSW-K192 also offers automatic detection of a variety of signal parameters.

Modulation quality

- ▮ MER approx. 57 dB
- ▮ MER versus carrier
- ▮ MER versus symbol
- ▮ MER versus symbol x carrier
- ▮ MER (pilot, data)
- ▮ Constellation diagram
- ▮ Center frequency error
- ▮ Symbol clock error
- ▮ Group delay

Decoding

- ▮ LDPC BER
- ▮ LDPC CWER
- ▮ Trigger to frame

R&S®FSW-K193 DOCSIS 3.1 OFDM Upstream

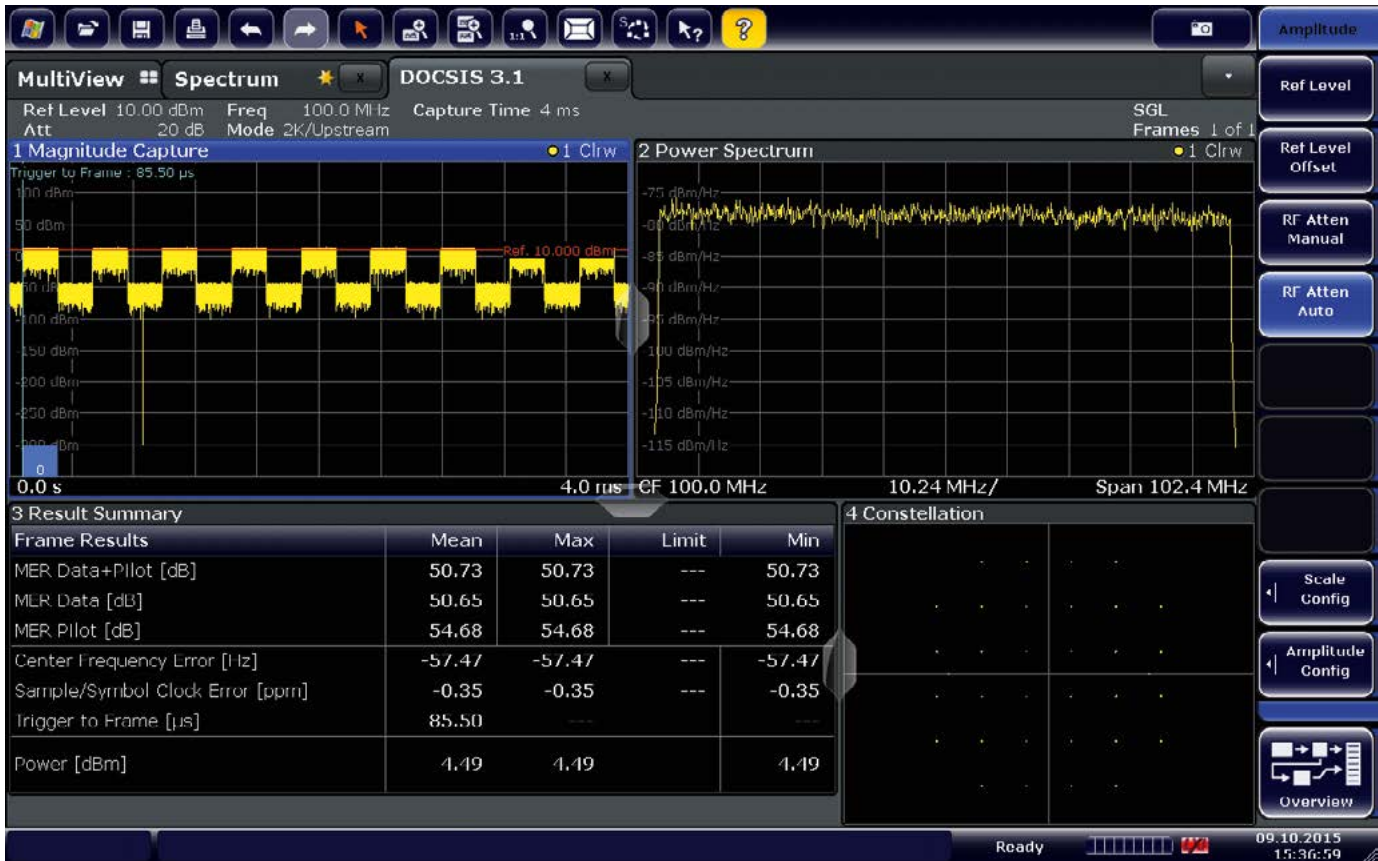

Analysis of DOCSIS3.1 upstream signal with option R&S®FSW-K193.

Analysis of DOCSIS3.1 upstream signals

Cable network providers can use the existing cable TV network to maximize both the downstream (DS) and upstream (US) data throughput by employing the data over cable service interface specification DOCSIS3.1.

The R&S®FSW-K193 analyzes DOCSIS3.1 upstream signals. The graphical results and tables are similar to R&S®FSW-K192, even if this signal has a burst structure and covers a maximum bandwidth of only 96 MHz.

Modulation quality

- | MER ~57 dB
- | MER versus carrier
- | MER versus symbol
- | MER versus symbol \times carrier
- | MER (pilot, data)
- | Constellation diagram
- | Center frequency error
- | Symbol clock error
- | Group delay

Spectrum measurements

- | Power spectrum
- | Power versus carrier (synchronous ACP)
- | Spectrum flatness

R&S®FS-K196 5G Air Interface Candidates

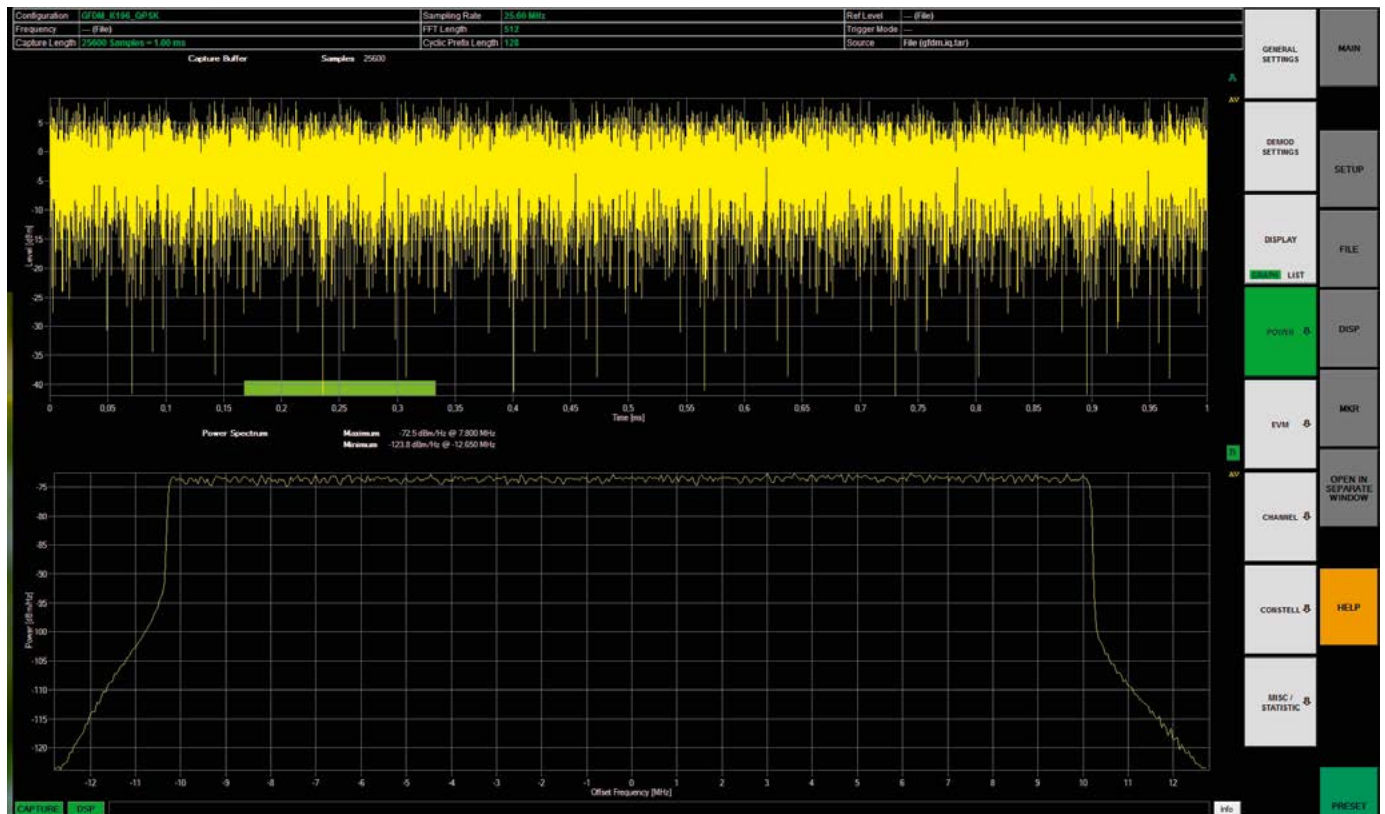

Support of generalized frequency division multiplexing (GFDM).

Extends the capabilities of R&S®FS-K96 and R&S®FS-K96PC

The R&S®FS-K196 enables R&D engineers to investigate the in-band signal properties of generalized frequency division multiplexing (GFDM) and universal filtered multicarrier (UFMC), which are two of the proposed formats for a 5G air interface – start developing your 5G transmitter today.

The R&S®FS-K196 extends the capabilities of the R&S®FS-K96 and R&S®FS-K96PC general purpose OFDM demodulators by adding two new formats: GFDM and UFMC. GFDM and UFMC are proposed air interface candidates for 5G. They address the relatively high out-of-band emissions from OFDM signals by filtering the signal, which changes the signal's in-band performance.

Researchers and development engineers can use the R&S®FS-K196 to investigate the effects on signal quality, such as error vector magnitude and the distribution of signal distortion over both frequency and time. The R&S®FS-K196 facilitates the measurement of modulator parameters such as I/Q imbalance and offset during the early stages of developing a 5G transmitter, enabling faster development.

R&S®VSE Vector Signal Explorer Software



The R&S®VSE vector signal explorer software was developed to bring the power of R&S®FSW signal processing to the engineer's PC. It analyzes signals from a wide range of instruments as well as files originating from simulations or recorded measurements.

Desktop signal analysis

The R&S®VSE vector signal explorer software brings the experience and power of Rohde&Schwarz signal analysis to the desktop, offering a wide range of analysis tools for troubleshooting and optimizing designs on your PC. The software enables users to analyze and solve problems in analog and digitally modulated signals for a wide range of standards using the signal and spectrum analyzers and digital oscilloscopes from Rohde&Schwarz.

- Support of R&S®FSL/FPS/FSV/FSW/RTO
- Control of multiple instruments from one PC
- Remote controllable and compatible with R&S®FSW
- Advanced pulse analysis with R&S®RTO
- Support of all relevant mobile and wireless communications standards

R&S®EVS300 VOR/ILS Analyzer



Precision level and modulation analysis for ground and flight inspection

The R&S®EVS300 is a portable level and modulation analyzer designed especially for starting up, checking and maintaining ILS, VOR and marker beacon systems.

The integrated rechargeable battery (R&S®EVS-B3 option) and robust design make it the ideal choice for mobile, mains-independent measurements in the field. Due to the high measurement speed and the trigger/synchronization functions, the R&S®EVS300 is also tailor-made for deployment in flight inspection systems.

- Extremely fast (100 measurements per second)
- Synchronization via GPS, trigger and remote interfaces
- Digital separation of course and clearance signals using only one signal processing channel (R&S®EVS-K3 option)
- Expandable to support a second signal processing channel for simultaneous localizer and glide slope measurements (R&S®EVS-B1 option)
- Support for R&S®NRP-Zxx and R&S®NRT-Zxx power sensors (R&S®EVS-K5 option)
- Measurement of GBAS and SCAT systems (R&S®EVS-K9 and R&S®EVS-K10 options)

3

Specifications in brief	
Frequency	
Frequency range	70 MHz to 350 MHz
Preselection filter range	
Marker beacon	74.7 MHz to 75.3 MHz
ILS LLZ	108 MHz to 112 MHz
ILS GS	320 MHz to 340 MHz
VOR, GBAS, SCAT I	108 MHz to 118 MHz
Temperature drift (−10°C to +55°C)	1 ppm
Level	
Max. input power	+13 dBm
Display range ¹⁾ (autorange mode)	−120 dBm to +20 dBm
Accuracy at −30 dBm	< 0.8 dB
Linearity error (−70 dB to +0 dB)	< 0.5 dB
Inherent noise (low noise mode)	< −115 dBm
Intermodulation	
TOI, 2 × 10 dBm, f > 200 kHz, low distortion	> 20 dBm
ILS signal analysis	
Input level range	−80 dBm to +10 dBm
Modulation depth (0% to 95%)	
Accuracy (90/150 Hz ± 2.5% ²⁾)	≤ 0.5%
Accuracy (voice/identifier)	≤ 1.0%
AF, accuracy (90/150 Hz ± 5 Hz ²⁾)	≤ 0.05 Hz
AF, accuracy (1020 Hz ± 50 Hz ²⁾)	≤ 5.0 Hz
Phase angle (90/150 Hz)	
Measuring range; accuracy	0° to +120° or ±60°; ≤ 0.2°
DDM measurement, localizer mode	
Accuracy (≤ ±10% DDM)	≤ 0.04% DDM ± 0.1% of reading
Accuracy (> ±10% DDM)	≤ 0.04% DDM ± 0.2% of reading
DDM measurement, glideslope mode	
Accuracy (≤ ±20% DDM)	≤ 0.08% DDM ± 0.1% of reading
Accuracy (> ±20% DDM)	≤ 0.08% DDM ± 0.2% of reading
VOR signal analysis	
Input level range	−90 dBm to +10 dBm ³⁾
Azimuth, accuracy	≤ ±0.1° ⁴⁾
AM modulation depth (0% to 50%)	
Accuracy (30/9960 Hz ± 2% ²⁾)	≤ 0.5%
Accuracy (voice/identifier)	≤ 1.0%
Accuracy (AM distortion)	≤ 1.0%

Specifications in brief	
AF frequency	
Accuracy (30 Hz ± 3 Hz ²⁾)	≤ 0.03 Hz
Accuracy (1020 Hz ± 50 Hz ²⁾)	≤ 5.0 Hz
Accuracy (9960 Hz ± 100 Hz ²⁾)	≤ 0.5 Hz
FM accuracy	≤ 0.1 Hz ± 0.5% of reading
Frequency scan (R&S®EVS-K1 option)	
Frequency range	70 MHz to 350 MHz
Start/stop or center/span	user-selectable in range from 70 MHz to 350 MHz
Resolution bandwidths	1/3/10/30 kHz
Inputs and outputs (front panel)	
RF input	N connector, 50 Ω
AF output	3.5 mm jack socket
USB	double connector (USB flash drive, etc.)
Power supply of antenna	output for feeding and remote controlling active antennas
GBAS mode (R&S®EVS-K9 option) and SCAT I mode (R&S®EVS-K10 option)	
Input level range	−90 dBm to +10 dBm
Accuracy at −30 dBm	< 1.0 dB
Linearity error in range from −70 dBm to 0 dBm	< 0.8 dB
Slots	A to H
Simultaneously measured values in every slot	station ID, transmission length, message block ID, FEC, message type
Supported message types	message types 1 and 4
Inputs and outputs (rear panel)	
Remote interface and GPS/GSM interface (R&S®EVS-B2 and R&S®EVS-K2 options)	RS-232, 9-pin D-Sub connector
LAN interface	RJ-45, 100BASE-T
DC output	12 V, max. 300 mA
DC input	10 V to 28 V
Baseband/trigger input	BNC connector, 1 MΩ, nominal
Analog output (2 outputs)	BNC connector, 50 Ω, nominal

¹⁾ Overload display if in-band or out-of-band signals are overloading.

²⁾ Max. frequency drift of modulation signal.

³⁾ Measurement time for input range −90 dBm to −80 dBm: 500 ms.

⁴⁾ Azimuth accuracy for input level −90 dBm to −80 dBm: < ±0.3°.

R&S®EDS300 DME/Pulse Analyzer



Precise distance and reply analysis for ground and air measurements

The R&S®EDS300 is a level and modulation analyzer designed for installing and maintaining pulsed, terrestrial navigation services. Its high sensitivity and compact design make the R&S®EDS300 ideal for conducting field measurements on the ground and in the air. The DME/pulse analyzer also features trigger and synchronization

capabilities for easy integration into test vehicles and flight inspection systems. The R&S®EDS300 offers high-precision distance measurements within a range of up to 400 nautical miles (NM) for terrestrial, pulsed navigation signals from 960 MHz to 1215 MHz (e.g. distance measurement equipment (DME)). The R&S®EDS300 can precisely determine peak power and reply efficiency and can identify the ground station to be measured.

- ▮ High-precision measurement of DME and TACAN systems on the ground and in the air (in line with ICAO Doc. 8071, ICAO Annex 10, STANAG 5034 and MIL-STD-291C)
- ▮ Precise measurement of all signal parameters (e.g. peak power, distance, reply efficiency, modulation data) and detailed pulse shape analysis
- ▮ Multi-DME mode for measuring up to ten DME stations quasi-simultaneously, i.e. within 50 ms (R&S®EDS-K5)
- ▮ Extremely compact design due to integrated interrogator in different power classes (one-box solution)
- ▮ Synchronization via GPS, trigger and remote interfaces

Specifications in brief	
Frequency	
Frequency range	960 MHz to 1215 MHz
Reference frequency, internal	
Aging per year	≤ 1 ppm
Level	
Absolute level (autorange mode)	
Measurement range (average) ¹⁾	-110 dBm to +13 dBm (nom.)
Measurement range (peak) ¹⁾	-100 dBm to +13 dBm (nom.)
DME signal analysis	
Standard	ICAO Annex 10, ICAO Doc. 8071
Input level range (pulse recognition efficiency > 70%)	-95 dBm to +10 dBm (nom.)
DME measurement	
Total peak level deviation (standard DME signal in line with ICAO Annex 10, level range 0 dBm to -70 dBm, 95% confidence level, +20°C to +30°C)	< 1 dB (nom.)
Pulse spacing uncertainty	< 0.05 μs
TACAN signal analysis (R&S®EDS-K1 option)	
Standard	STANAG 5034, MIL-STD-291C
Input level range	-94 dBm to +10 dBm
Bearing	
Deviation (-90 dBm to +10 dBm, standard TACAN signal in line with STANAG 5034, modulation depth of 15 Hz and 135 Hz signals = 20%, measurement time ≥ 1 s)	< 0.5°
Bearing acquisition time	< 3 s
DME distance measurement (R&S®EDS-K4 option)²⁾	
Standard	ICAO Annex 10, ICAO Doc. 8071
Input level range	-97 dBm to +10 dBm (nom.)

Specifications in brief	
Distance measurement	
Distance range	0 NM to 400 NM (nom.)
Deviation (-97 dBm to +10 dBm, measurement time ≥ 500 ms, 95 % confidence level)	≤ 500 ns, ≤ 75 m (nom.), ≤ 0.05 NM (nom.)
Multi-DME measurement (R&S®EDS-K5 option)³⁾	
Standard	ICAO Annex 10, ICAO Doc. 8071
Distance measurement (search/track mode)	up to 10 DME channels
Input level range	-95 dBm to +10 dBm (nom.)
Additional level measurement uncertainty	< 1 dB
Distance range	0 NM to 310 NM (nom.)
Deviation (-95 dBm to +10 dBm, measurement time: 100 ms/channel, 95 % confidence level)	≤ 0.05 NM (nom.), 75 m (nom.)
Low-power interrogator (R&S®EDS-B2 option)	
Standard	ICAO Annex 10, ICAO Doc. 8071
Maximum output power (DME peak power), into 50 Ω load	20 W (+43 dBm) ± 1.5 dB
Setting range	-30 dBm to +43 dBm in 0.5 dB steps
High-power interrogator (R&S®EDS-B4 option)	
Standard	ICAO Annex 10, ICAO Doc. 8071
Maximum output power (DME peak power), into 50 Ω load	500 W (+57 dBm) ± 1.5 dB
Power steps	100 W, 250 W, 500 W

¹⁾ Overload display in the event of an overload condition caused by in-band or out-of-band signals.

²⁾ Minimum requirement: 20 W low-power interrogator (R&S®EDS-B2), optional: 500 W high-power interrogator (R&S®EDS-B4).

³⁾ Minimum requirement: additional RX unit (R&S®EDS-B1) and 20 W low-power interrogator (R&S®EDS-B2), optional: 500 W high-power interrogator (R&S®EDS-B4).

R&S®EDST300 TACAN/DME Station Tester

New



Maintenance checks and signal-in-space analysis on TACAN and DME stations

The R&S®EDST300 provides high-precision stimulus and analysis functions for terrestrial pulsed navigation signals in the frequency range from 960 MHz to 1215 MHz. It performs the TX/RX measurements required for TACAN and DME ground stations in line with the relevant civil and military standards accurately and efficiently. The R&S®EDST300 can precisely determine characteristic pa-

rameters such as peak power, main delay, reply efficiency, and can decode the identifier of the ground station to be tested. The instrument also measures the parameters of TACAN stations (R&S®EDST-K1 option) and performs in-depth pulse analysis (R&S®EDST-K2 option). The modular design of the R&S®EDST300 provides a high degree of flexibility to adapt it to the task at hand. An interrogator (R&S®EDST-B2 option) with adjustable output power (–80 dBm to +30 dBm peak power) is available for RX measurements. An internal battery (R&S®EDST-B3 option) and a test antenna (R&S®EDST-Z1) provide maximum flexibility when carrying out field measurements.

- High-precision TX/RX measurements on TACAN and DME systems (in line with ICAO Annex 10, ICAO Doc. 8071, MIL-STD-291C and STANAG 5034)
- All required measurements with a single instrument
- High dynamic range (110 dB) and precise peak power measurements
- Precise, efficient measurement of characteristic TACAN/DME parameters (main delay < 50 ns, bearing < 0.2°)
- Detailed, automated time domain analysis

Specifications in brief

Frequency range	960 MHz to 1215 MHz
Reference frequency, internal	
Aging per year	≤ 1 ppm
TX power measurement (R&S®EDST300 analyzer)	
Measurement range (peak detector, autorange mode)	
RF input 1	–80 dBm to +30 dBm
RF input 2	–100 dBm to +10 dBm
Peak level deviation	0.3 dB
Standard TACAN signal in line with MIL-STD-291C or standard DME signal in line with ICAO Annex 10, RF input 1, level range 15 dBm to 25 dBm, 95 % confidence level, +20 °C to +30 °C)	
Transponder delay/distance measurement	
Input level range (RF input 1)	–80 dBm to +30 dBm (nom.)
Deviation	≤ 50 ns, –70 dBm to +30 dBm, RF input 1, measurement time ≥ 200 ms, PRR ≥ 100/s, 95% confidence level
	≤ 7.5 m (nom.), ≤ 0.005 NM (nom.)
TACAN modulation analysis (R&S®EDST-K1 option)	
Input level range (RF input 1)	–80 dBm to +30 dBm
Bearing	
Deviation	< 0.2°
–70 dBm to +30 dBm, RF input 1, standard TACAN signal in line with STANAG 5034, modulation depth of 15 Hz and 135 Hz signals = 21 %, measurement time ≥ 1 s	
Bearing acquisition time	< 3 s
Pulse shape analysis (time domain, R&S®EDST-K2 option)	
Resolution bandwidth (selectable)	0.5 MHz, 10 MHz (nom.)
Reference level	–70 dBm to +30 dBm
Trace functions	clear/write, average, max. hold

Specifications in brief

Trigger	
Trigger source	level/external/DME pulse/ interrogator, MRB/ARB trigger source
Trigger delay	–500 μs to +8000 μs
Pulse shape analysis (pulse 1, pulse 2)	rise time, duration, decay time
Deviation	< 0.05 μs (nom.)
Pulse spacing	
Deviation	< 0.05 μs
RX measurement (R&S®EDST300 generator, R&S®EDST-B2 option)	
Output power	–80 dBm to +30 dBm
Output power step size	0.1 dB
Level uncertainty (+20 °C to +30 °C)	< 1 dB, 0.5 dB (typ.)
Pulse rate (default mode)	5 Hz to 6000 Hz in 1 Hz steps
Pulse rate (ICAO compliant mode, search/ track)	5 Hz to 150 Hz / 5 Hz to 30 Hz in 1 Hz steps
Pulse counter	
Frequency range	2 Hz to 1 MHz
Uncertainty	< 1 Hz (nom.)
Test antenna	
Gain	11 dBi (nom.)
Front-to-back ratio	> 26 dB (nom.)
Power supply	
Rated voltage	
base unit	20 V to 28 V DC
external power supply	100 V to 240 V AC (±10%)
Battery operating time	> 2.5 h
With R&S®EDST-B3 option (new, fully charged battery)	



Chapter 4

Signal generators

Baseband, RF and microwave signal generators from Rohde & Schwarz excel in signal quality, flexibility and usability. Rohde & Schwarz signal generators offer wide frequency ranges up to 43.5 GHz (up to 170 GHz with frequency multipliers), feature modulation bandwidths up to 2 GHz and support all major

mobile communications and wireless digital standards. The portfolio ranges from ultracompact and unexcelled fast analog and digital signal sources, optimized for use in production and automated solutions, to premium class vector signal generators with multichannel and fading simulation capabilities for the most demanding applications.

Type	Designation	Frequency range	Description	Page
RF vector signal generators				
R&S®SMW200A	Vector signal generator	100 kHz to 3/6/12.75/20/31.8/40 GHz	The fine art of signal generation	104
R&S®SMBV100A	Vector signal generator	9 kHz to 3.2 GHz/6 GHz	Generating signals for today and tomorrow	105
R&S®SGT100A	SGMA vector RF source	1 MHz to 3 GHz or 6 GHz	Fast and compact production solution	106
R&S®SGS100A	SGMA RF source	1 MHz to 6/12.75 GHz (CW) 80 MHz to 12.75 GHz (I/Q)	Compact – fast – reliable	107
R&S®SGU100A	SGMA up-converter	12 GHz to 20/40 GHz (CW) 12 GHz to 20/40 GHz (I/Q)	High performance up to microwave frequencies	108
RF analog signal generators				
R&S®SMF100A	Microwave signal generator	100 kHz/1 GHz to 22/31.8/43.5 GHz	Signal generation redefined	109
R&S®SMA100A	Signal generator	9 kHz to 3 GHz/6 GHz	The standard of excellence in the analog signal generator class	110
R&S®SMB100A	RF and microwave signal generator	9 kHz to 1.1/2.2/3.2/6 GHz 100 kHz to 12.75/20/40 GHz	Versatile, compact solution for signal generation up to 40 GHz	111
R&S®SMC100A	Signal generator	9 kHz to 1.1 GHz/3.2 GHz	Flexible and universal all-purpose signal generator	112
R&S®SGS100A	SGMA RF source	1 MHz to 6/12.75 GHz (CW) 80 MHz to 12.75 GHz (I/Q)	Compact – fast – reliable	107
R&S®SGU100A	SGMA up-converter	12 GHz to 20 GHz (CW) 12 GHz to 20 GHz (I/Q)	High performance up to microwave frequencies	108
R&S®SMZ	Frequency multiplier	50/60/75/110 GHz to 75/90/110/170 GHz	Precise and adjustable output levels (for R&S®SMZ75, R&S®SMZ90 and R&S®SMZ110)	113
Baseband signal generators				
R&S®AFQ100A R&S®AFQ100B	I/Q modulation generator UWB signal and I/Q modulation generator		High-performance baseband signals	114
R&S®HMF2525 R&S®HMF2550	Arbitrary function generators	10 µHz to 25/50 MHz	Accurate, versatile and price convenient	115
R&S®EX-IQ-Box	Digital signal interface module		Digital I/Q interface adapter for Rohde & Schwarz signal generators, analyzers and communications testers	116
Application-specific solutions				
Application firmware packages for Rohde & Schwarz signal generators			Overview	117
Software solutions				
R&S®WinIQSIM2™	Simulation software		Ideal for the generation of digitally modulated signals	135
R&S®Sxx-Kxxx	Pulse sequencing, direction finding, DFS signal generation, extended sequencing		Generation of pulsed signals with basic modulation schemes	136

R&S®SMW200A Vector Signal Generator



The fine art of signal generation

The R&S®SMW200A is the ideal generator for the digitally modulated signals required to develop the new wideband communications systems, to verify 3G and 4G base stations or in the aerospace and defense sector.

The I/Q modulation bandwidth of up to 2 GHz with internal baseband satisfies fourth and fifth generation standards (e.g. 5G, LTE-Advanced and IEEE802.11ac/ad), and the R&S®SMW200A is designed to meet future requirements. Its modular scalable architecture allows users to optimize the generator to their applications and to upgrade it as required.

A second RF path can be added, as well as a maximum of two baseband and four fading simulator modules – without compromising signal quality. As a result, the R&S®SMW200A can create signal scenarios that previously required multiple instruments or could not be implemented at all.

From MIMO up to 8x4 and LTE-Advanced carrier aggregation including fading to multistandard radio – never before has an instrument offered such high-class signal generation capability.

If more than two RF paths are required, additional R&S®SGMA signal generator modules can be connected. The intuitive, touchscreen-based operating concept provides the user with an overview of measurements, no matter how complex, and quickly delivers the desired results.

- ▮ Wideband baseband and vector signal generator in one box
- ▮ Ideal for MIMO, MSR or LTE-Advanced applications thanks to up to eight signal sources and up to 32 fading channels
- ▮ Modular architecture for optimal adaptation to the application at hand
- ▮ Options for all important digital communications standards
- ▮ Support of all important digital standards
- ▮ No separate PC software required for digital standards
- ▮ Generation of radar signal scenarios for module, receiver and DFS tests
- ▮ LTE and 3GPP test case wizards for easy base station conformance testing in line with 3GPP TS25.141 or 3GPP TS36.141
- ▮ Envelope tracking and AM/AM, AM/φM predistortion options for full testing and verification of ET modulator chipsets
- ▮ Intuitive operation via touchscreen with block diagram as key element

Specifications in brief	
Frequency, level	
Frequency range, RF path A	100 kHz to 3/6/12.75/20/31.8/40 GHz
RF path B (optional)	100 kHz to 3/6/12.75/20 GHz
Setting time (SCPI, f < 6 GHz)	< 1.2 ms, typ. 600 μs
Specified level range	
3 MHz ≤ f < 20 GHz	-120 dBm to +18 dBm (PEP)
Setting time (SCPI mode)	< 1 ms, typ. 600 μs
Spectral purity	
Nonharmonics (200 MHz < f ≤ 1500 MHz)	
Standard (carrier offset > 10 kHz)	< -80 dBc
With R&S®SMW-B22 option	< -90 dBc
SSB phase noise (CW, carrier offset = 20 kHz, f = 1 GHz)	
Standard	< -131 dBc, typ. -135 dBc
With R&S®SMW-B22 option	< -136 dBc, typ. -139 dBc
SSB phase noise (CW, carrier offset = 20 kHz, f = 10 GHz)	
Standard	< -111 dBc, typ. -115 dBc
With R&S®SMW-B22 option	< -116 dBc, typ. -119 dBc
Analog modulation	
Supported analog modulation modes	AM, FM (optional), φM (optional), pulse (optional)

Specifications in brief	
I/Q modulation	
RF modulation bandwidth	
With internal wideband baseband, I/Q wideband on	
300 MHz ≤ f ≤ 2.5 GHz	±40% of carrier frequency
f > 2.5 GHz	±1 GHz
With internal standard baseband, "I/Q wideband" on, f ≥ 250 MHz	
±80 MHz	
Baseband generator	
Max. waveform length	64/512 Msample, 1 Gsample
Supported standards and modulation systems	
5G air interface candidates, LTE Release 8/9/10/11/12, 3GPP FDD/HSPA/HSPA+, GSM/EDGE/EDGE Evolution, CDMA2000®, 1xEV-DO Rev. A/B, WLAN IEEE 802.11a/b/g/n/l/p/ac/ad, AWGN and more	
Fading and MIMO	
Fading bandwidth	max. 160 MHz
MIMO fading scenarios (depending on options)	2x2, 3x3, 4x4, 8x4, 4x8, 2x2x2, 2x4x2, 2x2x4, 4x2x2 and more
Fading profiles	Rayleigh, Rice, pure Doppler, static path, Gaussian, customized and more

R&S®SMBV100A Vector Signal Generator



Generating signals for today and tomorrow

The R&S®SMBV100A offers excellent RF performance along with very high output level and short setting times. At the same time, the R&S®SMBV100A can be equipped with an internal baseband generator to allow generation of a number of digital standards. The wide frequency range from 9 kHz to 6 GHz covers all of the important bands for digital modulation.

Due to its optimal scalability, the R&S®SMBV100A is easy to customize to meet specific customer requirements. For production applications, a cost-effective solution for playing back predefined test sequences is available with the

optional baseband arbitrary waveform generator (ARB). And where it really matters, the optional baseband coder provides impressive realtime capabilities. It allows the generation of even complex signals directly in the instrument – no external signal generation software is required.

The R&S®SMBV100A has also been designed for ease of servicing. Together with its scalability, this helps ensure very low cost of ownership. The instrument's compact size and graphical user interface for intuitive operation help fulfill all possible requirements.

These features make the R&S®SMBV100A ideal in development applications as well as in production and service. This instrument truly does the job wherever signals with digital modulation are needed.

- Internal signal generation for all major digital radio standards and use as GNSS simulator, both with optional integrated baseband source
- Fully-fledged GNSS simulator for GPS, Glonass and Galileo
- Highest output level in its class up to 6 GHz, combined with excellent RF characteristics
- Lowest cost of ownership due to outstanding price/performance ratio and on-site service capabilities

Specifications in brief

Frequency	
Frequency range	9 kHz to 3.2/6 GHz (CW mode) 1 MHz to 3.2/6 GHz (I/Q mode)
Setting time	< 1.5 ms, < 3 ms (if I/Q modulation is on)
Setting time in list mode	< 1.0 ms
Level	
Specified level range	-120 dBm to +18 dBm (PEP)
Setting time	< 1.5 ms, < 3 ms (if I/Q modulation is on)
Setting time in list mode	< 1.0 ms
Spectral purity (at f = 1 GHz)	
Nonharmonics (CW, carrier offset > 10 kHz, level > -10 dBm)	< -70 dBc, typ. -84 dBc
SSB phase noise (20 kHz carrier offset, 1 Hz measurement bandwidth)	< -122 dBc, typ. -127 dBc
Wideband noise (carrier offset > 10 MHz, 1 Hz measurement bandwidth, CW)	< -142 dBc
RF modulation bandwidth	
Using external I/Q inputs	528 MHz
Using internal baseband section	60/120/160 MHz
Baseband generator	
Max. waveform length	32 Msample, 256 Msample, 1 Gsample
Supported standards and digital systems	
Depending on options: 3GPP LTE FDD/TDD incl. Rel. 9 and Rel. 10, 3GPP FDD/HSPA/HSPA+, GSM/EDGE/EDGE Evolution, TD-SCDMA, cdmaOne, CDMA2000®, 1xEV-DO, IEEE 802.11a/b/g/n/j/p/ac, WiMAX™, TETRA Release 2, Bluetooth®, NFC, user-defined multicarrier CW, AWGN, GNSS (see below), DVB-H/DVB-T, DAB/T-DMB, XM Radio, Sirius, HD Radio™, ILS, VOR, DME, bit error tester	
GNSS simulation (in realtime)	
Supported systems	GPS, Glonass, Galileo, BeiDou including Augmentation Systems (SBAS, QZSS, GBAS)
Number of satellites	up to 24
Special functions	moving scenarios (import of NMEA files), multipath, dynamic power control, atmospheric modeling, HIL, support for RINEX files

R&S®SGT100A SGMA Vector RF Source



Fast and compact production solution

The R&S®SGT100A is an RF vector signal generator with an integrated baseband generator. It has been optimized for use in production and automated applications. Designed as a fast and compact, space-saving solution, it provides top speed to ensure optimized throughput and fits into any test system.

- ▮ Fastest vector signal generator with frequency and level switchover times of typ. 240 µs for optimized throughput in production
- ▮ Smallest standalone vector signal generator up to 6 GHz with integrated baseband generator (1 HU ½ 19")
- ▮ Integrated baseband generator with I/Q modulation bandwidth of up to 160 MHz (in RF) supporting all advanced digital standards, including IEEE 802.11ac
- ▮ Excellent RF performance for EVM and ACLR
- ▮ Easy signal generation for digital standards such as LTE and LTE-Advanced using the R&S®WinIQSIM2™ simulation software
- ▮ Ideal enhancement for the R&S®SMW200A in MIMO applications with more than two receiving antennas

Specifications in brief		
Frequency		
Frequency range	CW mode and I/Q mode	1 MHz to 3 GHz
with the R&S®SGT-KB106 option	CW mode and I/Q mode	1 MHz to 6 GHz
Setting time	with PCIe remote control	< 500 µs
Input frequency for external reference	into R&S®SGT100A	10 MHz, 13 MHz, 100 MHz, 1000 MHz
Level		
Specified level range		-120 dBm to +17 dBm (PEP)
Setting time	with PCIe/Ethernet remote control, setting characteristic: AUTO	< 500 µs
Spectral purity		
Harmonics	level ≤ 8 dBm, CW, I/Q wideband off	< -30 dBc
Nonharmonics	level > -10 dBm, offset > 10 kHz from carrier, f ≤ 1.5 GHz	< -76 dBc
Wideband noise	10 MHz carrier offset, level > 5 dBm, 1 Hz meas. bandwidth, CW	< -145 dBc
SSB phase noise	20 kHz carrier offset, 1 Hz measurement bandwidth	
	f = 1 GHz	< -126 dBc; typ. -133 dBc
	f = 6 GHz	< -110 dBc; typ. -117 dBc
Pulse modulation		
Minimum pulse width	optional, with the R&S®SGT-K22 option using the integrated pulse generator	on/off ratio > 80 dB 20 ns
I/Q modulation		
I/Q modulator bandwidth (RF)	using an external analog signal, 100 MHz < f ≤ 2.5 GHz, I/Q wideband	20% of carrier frequency
	2.5 GHz < f ≤ 6 GHz, I/Q wideband integrated baseband source	1 GHz
	▮ R&S®SGT-K521 option	60 MHz
	▮ R&S®SGT-K521 and R&S®SGT-K522 options	120 MHz
	▮ R&S®SGT-K521, R&S®SGT-K522 and R&S®SGT-K523 options	160 MHz
		240 MHz
Waveform length	in one-sample steps	1 sample to 32 Msample
	R&S®SGT-K511 option	1 sample to 256 Msample
	R&S®SGT-K511 and R&S®SGT-K512 options	1 sample to 1 Gsample
Waveform changeover time in multisegment waveform mode	50 MHz clock rate (external trigger, without clock change)	5 µs (meas.)
Sample resolution	equivalent to D/A converter	16 bit
ACLR	WCDMA 3GPP FDD, TM 1-64	> 68 dB; typ. 71 dB
EVM	IEEE 802.11ac, 160 MHz, MCS 9	typ. 0.4%
Supported standards through R&S®WinIQSIM2™ with additional options	EUTRA/LTE, LTE-Advanced, 3GPP FDD incl. HSPA/HSPA+, GSM/EDGE/EDGE Evolution, TD-SCDMA, CDMA2000®/1xEV-DO, TETRA, IEEE 802.11a/b/g/n/p/ac, IEEE 802.16, Bluetooth®, NFC, DVB-H/DVB-T, DAB/T-DMB, GPS, Galileo, Glonass, BeiDou	

R&S®SGS100A SGMA RF Source



Compact – fast – reliable

The R&S®SGS100A is an RF source designed to meet the requirements of automated test systems. It is available as a CW source or as a vector signal generator with an integrated I/Q modulator. With its frequency range of up to 12.75 GHz, the vector signal generator version covers the essential digital signals. The CW version can be used as a flexible local oscillator as well as for interference testing against mobile radio standards.

- Smallest fully integrated vector signal generator on the market, space-saving design for system integration
- High throughput due to very short frequency and level setting times of typ. 280 μ s via PCIe interface
- Smallest fully integrated vector signal generator on the market, space-saving design for system integration
- Enables high throughput due to very short frequency and level setting times of typ. 280 μ s via PCIe interface
- Excellent RF performance in a compact format
- Maximum output level of typ. +22 dBm for compensating losses in the setup
- Closed ALC loop for CW and I/Q modes for highest level repeatability
- Wear-free electronic attenuator for high reliability up to 12.75 GHz
- Low initial costs and low cost of ownership

4

Specifications in brief

Frequency		
Frequency range	with the R&S®SGS-B106 option	1 MHz to 6 GHz
	with the R&S®SGS-B106 and R&S®SGS-B112 options	1 MHz to 12.75 GHz
	with the R&S®SGS-B106V option	1 MHz to 6 GHz (CW), 80 MHz to 6 GHz (I/Q)
	with the R&S®SGS-B106V and R&S®SGS-B112V options	1 MHz to 12.75 GHz (CW), 80 MHz to 12.75 GHz (I/Q)
Level		
Specified level range		-10 dBm to +15 dBm (PEP)
	with the R&S®SGS-B26 option	-120 dBm to +15 dBm (PEP) ¹⁾
Resolution of setting		0.01 dB
Level error	setting characteristic: auto, temperature range from +18 °C to +33 °C	
	1 MHz \leq f \leq 3 GHz	< 0.5 dB
	3 GHz < f \leq 12.75 GHz	< 0.9 dB
Spectral purity		
Harmonics	level \leq 8 dBm, CW, I/Q wideband off	< -30 dBc
Nonharmonics	level > -10 dBm, offset > 10 kHz from carrier	
	f \leq 1.5 GHz	< -76 dBc
	1.5 GHz < f \leq 3 GHz	< -70 dBc
	3 GHz < f \leq 6 GHz	< -64 dBc
	6 GHz < f \leq 12.75 GHz	< -58 dBc
Subharmonics	level > -10 dBm ²⁾	
	f \leq 3 GHz	< -76 dBc
	3 GHz < f \leq 6.5 GHz	< -68 dBc
	6.5 GHz \leq f \leq 12.75 GHz	< -60 dBc
SSB phase noise	20 kHz carrier offset, 1 Hz measurement bandwidth	
	f = 1 GHz	< -126 dBc, -133 dBc (meas.)
	f = 2 GHz	< -120 dBc, -127 dBc (meas.)
	f = 10 GHz	< -106 dBc, -113 dBc (meas.)
I/Q modulator		
Modulation bandwidth	80 MHz < f \leq 1 GHz	\pm 5% of carrier frequency
	1 GHz < f \leq 12.7 GHz	\pm 50 MHz
	100 MHz < f \leq 2.5 GHz, I/Q wideband	\pm 20% of carrier frequency
	2.5 GHz < f \leq 12.25 GHz, I/Q wideband	\pm 500 MHz
Carrier leakage	without input signal, referenced to full-scale input	< -45 dBc, < -55 dBc (meas.)
Suppression of image sideband	up to \pm 10 MHz	40 dB (meas.)
Error vector	measured with 16QAM, filter root cosine $\alpha = 0.5$, 10 kHz symbol rate	
	f > 80 MHz, RMS	< (0.4% + 0.2% \times f/GHz)
	f > 80 MHz, peak value	< (0.8% + 0.4% \times f/GHz)

¹⁾ PEP = peak envelope power.

²⁾ > 0 dBm for instruments without the R&S®SGS-B26 electronic step attenuator.

R&S®SGU100A SGMA Upconverter



Two instruments into one: one RF output for the entire frequency range

The R&S®SGU100A SGMA upconverter offers a frequency extension to 20 GHz or 40 GHz. When the R&S®SGS100A and the R&S®SGU100A are connected, they act as a single instrument for both remote control and manual operation via the R&S®SGMA-GUI PC software. The R&S®SGU-Z4 ex-

ension kit provides the required electrical connections and mechanical stabilization on the front and rear panel. The combined instruments offer the same connections as the R&S®SGS100A itself: one RF output for the entire frequency range and one analog I/Q input for vector modulation. In this setup, tasks are spread automatically and transparently between the two instruments so that users feel as if they are operating one instrument instead of two.

Seamless integration into existing user interfaces

When connected via LAN or PCIe, the R&S®SGU100A is controlled completely via the R&S®SGS100A. The R&S®SGMA-GUI PC software displays the R&S®SGU100A as an extension to the R&S®SGS100A and adjusts the maximum settable frequency range.

Equipped with the R&S®SGU100A, the R&S®SGS100A covers the entire frequency range from 10 MHz to 40 GHz without modulation and from 80 MHz to 40 GHz with vector modulation.

Specifications in brief

Frequency		
Output frequency range	with R&S®SGU-B120, R&S®SGU-B120V options with R&S®SGU-B140, R&S®SGU-B140V options	10 MHz to 20 GHz 10 MHz to 40 GHz
Input frequency range	<ul style="list-style-type: none"> For frequency settings below 12 GHz, the CW or modulated input signal is amplified and sent to the output of the instrument or to the optional step attenuator For frequency settings > 12 GHz, the input CW signal is used to generate the I/Q modulator LO or CW output RF signal 	10 MHz to 12.75 GHz
Level		
Specified level range ¹⁾	instruments equipped with R&S®SGU-B120 or R&S®SGU-B120V, without option R&S®SGU-B26	
	10 MHz < f ≤ 50 MHz (bypass mode)	-10 dBm to +8 dBm (PEP)
	50 MHz < f ≤ 12 GHz (bypass mode)	-10 dBm to +15 dBm (PEP)
	12 GHz < f ≤ 20 GHz	-10 dBm to +17 dBm (PEP)
	instruments equipped with R&S®SGU-B140 or R&S®SGU-B140V, without option R&S®SGU-B26	
	10 MHz < f ≤ 50 MHz (bypass mode)	-10 dBm to +7 dBm (PEP)
	50 MHz < f ≤ 12 GHz (bypass mode)	-10 dBm to +13 dBm (PEP)
	12 GHz < f ≤ 40 GHz	-10 dBm to +15 dBm (PEP)
Level error ¹⁾	setting characteristic: AUTO, temperature range from +18 °C to +33 °C, CW or I/Q mode with full scale modulation	
	10 MHz < f ≤ 12 GHz	< 0.9 dB (meas.)
	12 GHz < f ≤ 20 GHz, > -30 dBm	< 0.9 dB
	12 GHz < f ≤ 20 GHz, ≤ -30 dBm	< 1.1 dB
	20 GHz < f ≤ 40 GHz, > -30 dBm	< 0.9 dB
	20 GHz < f ≤ 40 GHz, -70 dBm to -30 dBm	< 1.1 dB
	20 GHz < f ≤ 40 GHz, < -70 dBm	< 1.5 dB
Spectral purity		
Harmonics	f > 12 GHz, level ≤ 8 dBm	< -30 dBc
Nonharmonics ²⁾	level > -10 dBm, offset > 10 kHz from carrier, 12 GHz < f ≤ 20 GHz	< -56 dBc (meas.)
	level > -10 dBm, offset > 10 kHz from carrier, f > 20 GHz	< -50 dBc (meas.)
Subharmonics	f > 12 GHz	< -55 dBc, typ. < -65 dBc
I/Q modulator		
Modulation bandwidth	f > 12 GHz	up to ±1000 MHz
RF frequency response	up to ±100 MHz	< 2 dB (meas.)
	up to ±1000 MHz	< 6 dB (meas.)
Carrier leakage	without input signal, referenced to full-scale input ²⁾	< -35 dBc, typ. < -45 dBc
Suppression of image sideband	up to ±10 MHz ²⁾	40 dB (meas.)
Error vector ¹⁾	measured with 16QAM, filter root cosine, α = 0.5, symbol rate 10 MHz	
	f > 12 GHz, RMS	< (2% + 0.04% × f/GHz)
	f > 12 GHz, peak value	< (5% + 0.1% × f/GHz)

¹⁾ In combination with R&S®SGS100A.

²⁾ Value applies after internal readjustment.

R&S®SMF100A Microwave Signal Generator



Signal generation redefined

Signal quality, speed and flexibility are decisive properties for a signal generator in the microwave range.

The R&S®SMF100A microwave signal generator is a first-rate, state-of-the-art microwave signal generator that sets new standards. It covers the numerous fields of application encountered in R&D, production, service, maintenance and repair.

The R&S®SMF100A operates in the wide frequency range from 100 kHz to 43.5 GHz with specific configurations. In addition to CW signals, all common types of analog modulation (AM, FM, ϕ M, PM) or combinations thereof can be generated.

The R&S®SMF100A signal generator offers a modern graphical user interface for fast and intuitive operation. The settings – which, for the first time in a microwave signal generator, can be controlled via a block diagram – and the signal flow can be seen at a glance.

- Max. frequency range from 100 kHz to 22/31.8/43.5 GHz
- Excellent SSB phase noise of -120 dBc (typ.) (at 10 GHz with 10 kHz carrier offset)
- Very high output power of typ. $+25$ dBm
- Optional pulse modulator with excellent data:
 - > 80 dB on/off ratio, < 10 ns rise/fall time,
 - < 20 ns pulse width
- Optional pulse generator
- Optional removable compact flash disk to meet high security requirements
- Connector for R&S®NRP power sensors for precise power measurement
- Usable for scalar network analysis with R&S®NRP power sensors connected
- Remote control via GPIB, Ethernet or USB

4

Specifications in brief

Frequency	
Frequency range	100 kHz/1 GHz to 22/31.8/43.5 GHz
Setting time	< 4 ms
Setting time in list mode	typ. < 750 μ s
Level	
Level range (depending on options)	-130 dBm to $+24$ dBm (PEP)
Setting time	< 3 ms
Setting time in list mode	typ. < 750 μ s
Spectral purity (at $f = 10$ GHz)	
Nonharmonics (carrier offset > 3 kHz)	< -62 dBc
SSB phase noise (20 kHz carrier offset, 1 Hz measurement bandwidth)	< -115 dBc
Wideband noise (carrier offset > 10 MHz, 1 Hz measurement bandwidth, CW)	typ. < -148 dBc
Analog modulation	
Pulse	
Rise/fall time ($f > 1$ GHz)	< 10 ns
On/off ratio	> 80 dB
AM depth	0% to 100%
Maximum FM deviation	40 MHz ($f > 21$ GHz)
Maximum ϕ M deviation	640 rad ($f > 21$ GHz)
Special features	
Depending on options	analog ramp sweep, logarithmic AM, pulse train, power analysis (with R&S®NRP power sensors)

R&S®SMA100A Signal Generator



The standard of excellence in the analog signal generator class

Signal quality, speed and flexibility are the criteria by which signal generators are measured today. The R&S®SMA100A perfectly meets these criteria and is a premium-class analog generator that sets standards due to its outstanding characteristics.

The R&S®SMA100A combines superior signal quality with very high setting speed, which makes it ideal for any task. Whether in development, production, service or maintenance, the R&S®SMA100A does an excellent job.

In the frequency range from 9 kHz to 6 GHz, it can generate CW signals as well as all common types of analog modulation (AM, FM, ϕ M, PM). Excellent specifications and a wide range of modulation signals are the characteristic features of the R&S®SMA100A.

In addition, a low-jitter clock synthesizer option supplies differential clock signals of up to 1.5 GHz independently of the RF frequency. This makes the R&S®SMA100A suitable for a variety of applications – from use in phase noise test systems through to tests on mixed-signal ICs.

The R&S®SMA100A signal generator also offers a modern graphical user interface for fast and intuitive operation.

The R&S®NRPxxS/SN power sensors can be connected to the R&S®SMA100A. The user can therefore perform very precise power measurements directly with the signal generator.

- ▀ Very low SSB phase noise of typ. -134 dBc (20 kHz carrier offset, $f = 1$ GHz, 1 Hz measurement bandwidth), typ. -139.5 dBc with the R&S®SMA-B22 enhanced phase noise performance option
- ▀ Wideband noise of -162 dBc (meas.) with carrier offset > 40 MHz, $f = 1$ GHz, level = 9 dBm, 1 Hz measurement bandwidth
- ▀ Nonharmonics < -96 dBc (carrier offset > 10 kHz, $f < 750$ MHz, with the R&S®SMA-B22 option)
- ▀ High-stability reference oscillator as standard
- ▀ Very low phase noise at low frequencies due to internal division of the fundamental frequency range (750 MHz to 1500 MHz) down to 6.6 MHz

Specifications in brief

Frequency

Frequency range	9 kHz to 3/6 GHz
Setting time	< 2 ms
Setting time in list mode	< 450 μ s

Level

Level range	-145 dBm to $+18$ dBm (PEP)
Setting time	< 1.5 ms
Setting time in list mode	< 450 μ s

Spectral purity (at $f = 1$ GHz)

Nonharmonics (carrier offset > 10 kHz)	
Standard	< -80 dBc
With option	< -92 dBc
SSB phase noise (20 kHz carrier offset, 1 Hz measurement bandwidth)	
Standard	< -131 dBc, typ. -134 dBc
With option	< -136 dBc, typ. -141 dBc
Wideband noise (carrier offset > 10 MHz, 1 Hz measurement bandwidth, CW)	< -153 dBc

Analog modulation

Pulse	
Rise/fall time ($f > 180$ MHz)	< 20 ns, typ. < 7 ns
On/off ratio	> 80 dB
AM depth	0% to 100%
Maximum FM deviation	40 MHz ($f > 3$ GHz)
Maximum ϕ M deviation	80 rad ($f > 3$ GHz)

Special features

Depending on options	VOR/ILS, DME signal generation, pulse train, power analysis (with R&S®NRPxxS/SN power sensors)
----------------------	--

R&S®SMB100A RF and Microwave Signal Generator

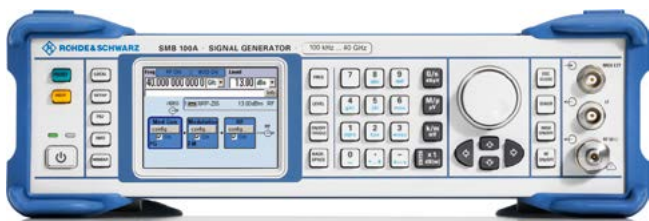

Versatile, compact solution for signal generation up to 40 GHz; 170 GHz with upconverter

The R&S®SMB100A provides RF and microwave characteristics that are exceptional in its class, making it an excellent general-purpose instrument. These outstanding characteristics plus its compact size and low weight make the instrument ideal for a wide range of applications. The R&S®SMB100A is optimally suited for use in development, production and service.

The R&S®SMB100A is the perfect choice for applications in the important ISM bands up to 5.7 GHz as well as for EMC applications because of its lower frequency limit of 9 kHz. Furthermore, the R&S®SMB100A can be ideally used for measuring the blocking characteristic up to a CW frequency of 12.75 GHz, as specified in various telecommunications standards. When it comes to frequently

changing level settings, this is the first time that a wear-free electronic step attenuator is used in this frequency range.

Two frequency options up to 20 GHz and 40 GHz are available to cover the microwave range. These options are suitable for tests on radar systems and antennas in the X and K bands, for example for wideband receiver tests. For even higher frequencies, the frequency range of the R&S®SMB100A can be easily extended up to 170 GHz with the R&S®SMZ frequency multiplier.

In addition to pure CW signals, the R&S®SMB100A also provides the most common analog AM and FM/φM modulation modes as standard. Moreover, the R&S®SMB100A can be equipped with an excellent pulse generator and pulse modulator that makes it possible to generate user-programmable pulse scenarios, also referred to as pulse trains.

- Wide frequency range from 9 kHz to 6 GHz or from 100 kHz to 40 GHz
- Excellent signal characteristics with low SSB phase noise of typ. -128 dBc (at 1 GHz, 20 kHz offset)
- High output power of up to +27 dBm (meas.)
- All important analog modulations with AM, FM/φM and pulse modulation supported
- Optional internal low harmonic filters for the 20 GHz and 40 GHz model to lower the harmonics to less than -50 dBc for frequencies above 150 MHz

4

Specifications in brief

Frequency		
Frequency range (depending on options)	R&S®SMB-B101/-B102/-B103/-B106 R&S®SMB-B112/-B112L/-B120/-B120L/-B131/-B140/-B140L/-B140N	9 kHz to 1.1/2.2/3.2/6 GHz 100 kHz to 12.75/20/31.8/40 GHz
Setting time		< 3 ms
Level		
Maximum output power	R&S®SMB-B101/-B102/-B103/-B106/-B112/-B112L; 1 MHz < f ≤ 12.75 GHz R&S®SMB-B120 with R&S®SMB-B31; 50 MHz < f ≤ 20 GHz R&S®SMB-B120L with R&S®SMB-B31; 100 MHz < f ≤ 20 GHz R&S®SMB-B131 with R&S®SMB-B32; 50 MHz < f ≤ 31.8 GHz R&S®SMB-B140/-B140N with R&S®SMB-B32; 50 MHz < f ≤ 40 GHz R&S®SMB-B140L with R&S®SMB-B32; 50 MHz < f ≤ 40 GHz	> +18 dBm > +16 dBm > +19 dBm > +13 dBm > +13 dBm > +16 dBm
Setting time	without switching the mechanical attenuator with switching the mechanical attenuator	< 2.5 ms < 25 ms
SSB phase noise	f = 1 GHz, carrier offset = 20 kHz, 1 Hz measurement bandwidth f = 10 GHz, carrier offset = 20 kHz, 1 Hz measurement bandwidth	< -122 dBc, typ. -128 dBc < -102 dBc, typ. -108 dBc
Analog modulation		
Pulse	rise/fall time on/off ratio	< 15 ns, typ. 9 ns > 80 dB
AM depth		0% to 100%
Maximum FM deviation	f > 25.5 GHz	138 MHz
Maximum φM deviation	f > 25.5 GHz	1280 rad
Connectivity		
Remote control		GPIO IEEE-488.2, Ethernet (TCP/IP), USB
Peripherals		USB

R&S®SMC100A Signal Generator



Flexible and universal all-purpose signal generator

The R&S®SMC100A offers outstanding signal quality at an attractive price. It covers the frequency range from 9 kHz to 1.1 GHz or 3.2 GHz. Output power is typ. > +17 dBm. All important functions (AM, FM, ϕ M, PM) are already integrated in the instrument. This makes the R&S®SMC100A signal generator a flexible and versatile instrument.

Total cost of ownership is an important factor when purchasing a measuring instrument. The R&S®SMC100A, apart from offering a low initial cost, also boasts low service costs since users can replace defective modules on their own and verify the level repeatability and accuracy by using the R&S®NRP-Z91/R&S®NRP-Z92 power sensors.

These outstanding features make the R&S®SMC100A ideal for use in service and maintenance labs. Due to its small dimensions and lightweight design, the R&S®SMC100A is also the perfect choice for field applications or training and education environments.

- Smallest size and best price/performance ratio in its class
- Frequency range from 9 kHz to 1.1 GHz/3.2 GHz
- Maximum output level of typ. > +17 dBm
- AM/FM/ ϕ M/PM provided as standard
- Integrated overvoltage protection
- Wear-free electronic attenuator
- Minimized total cost of ownership

Specifications in brief	
Frequency	
Frequency range	9 kHz to 1.1/3.2 GHz
Setting time	< 5 ms, typ. 2 ms
Level	
Level range	-145 dBm to +18 dBm (PEP)
Setting time	< 5 ms, typ. 2 ms
Spectral purity (at f = 1 GHz)	
Nonharmonics (carrier offset > 10 kHz)	< -60 dBc
SSB phase noise (20 kHz carrier offset, 1 Hz measurement bandwidth)	< -105 dBc, typ. -111 dBc
Wideband noise (carrier offset > 10 MHz, 1 Hz measurement bandwidth, CW)	< -138 dBc, typ. -148 dBc
Analog modulation	
Pulse	
Rise/fall time	< 500 ns, typ. 100 ns
On/off ratio	> 80 dB
AM depth	0% to 100%
Maximum FM deviation	4 MHz (f > 1.6 GHz)
Maximum ϕ M deviation	40 rad (f > 1.6 GHz)

R&S®SMZ Frequency Multiplier



Precise output levels from 50 GHz to 170 GHz

The R&S®SMZ family of frequency multipliers combines easy handling and precise output levels in the frequency range from 50 GHz to 170 GHz. It can be used in diverse applications, e.g. in the automotive sector with distance radars, in astronomy with sophisticated telescopes and in radar interferometry for analyzing the earth's surface.

The family of frequency multipliers consists of four models R&S®SMZ75/90/110/170 as well as optional attenuators (the attenuator is not available for R&S®SMZ170). The attenuator is integrated into the same housing as the frequency multiplier, which simplifies handling. The R&S®SMZ can be controlled via USB in different ways. The most convenient way is to use the R&S®SMZ together with the R&S®SMF100A or R&S®SMB100A microwave signal generator.

This combination operates as a single unit allowing users to directly enter the wanted frequency and the target level at the R&S®SMZ output on the R&S®SMF100A or R&S®SMB100A (input of the target level is not possible for the R&S®SMZ170). The alternative is to use the R&S®SMZ-K1 external PC software for controlling the R&S®SMZ frequency multiplier and the microwave signal generator.

Compared with conventional setups, this one-box solution significantly simplifies setup and operation. Via USB, the R&S®SMF100A or R&S®SMB100A receives all necessary data of the connected R&S®SMZ, such as the configuration, the multiplication factor and in particular the pre-calibrated frequency response. The R&S®SMF100A or R&S®SMB100A is able to perform automatic correction, which helps ensure that the frequency and level values set on the R&S®SMF100A or R&S®SMB100A will actually be available at the R&S®SMZ output. A costly, error-prone and time-consuming level measurement using level detectors or power sensors, which is common for conventional setups, is no longer required.

Very low single sideband phase noise is achieved owing to the interaction with the high-end R&S®SMF100A microwave signal generator. For a CW signal of 60 GHz, for example, an outstanding -100 dBc (10 kHz offset) is achieved after six-fold frequency multiplication with the R&S®SMZ75.

Specifications in brief

Frequency		
Input frequency range	R&S®SMZ75	8.33 GHz to 12.5 GHz
	R&S®SMZ90	10 GHz to 15 GHz
	R&S®SMZ110	12.5 GHz to 18.4 GHz
	R&S®SMZ170	9.1 GHz to 14.2 GHz
Output frequency range	R&S®SMZ75	50 GHz to 75 GHz
	R&S®SMZ90	60 GHz to 90 GHz
	R&S®SMZ110	75 GHz to 110 GHz
	R&S®SMZ170	110 GHz to 170 GHz
Level		
Input level	R&S®SMZ75/90/110/170	+6.7 dBm to +7.3 dBm
Output level	R&S®SMZ75/90/110	typ. +5 dBm
	with mechanically controlled attenuator	typ. +4 dBm
	with electronically controlled attenuator	typ. +1 dBm
	R&S®SMZ170	typ. +8 dBm
Minimum output level	with R&S®SMZ-B75M/-B90M/-B110M option (mechanically controlled attenuator)	< -25 dBm
	with R&S®SMZ-B75E/-B90E/-B110E option (electronically controlled attenuator)	< -15 dBm
Spectral purity		
Harmonics, subharmonics, in-band spurious	R&S®SMZ75/90/110/170	typ. < -20 dBc
Connectors		
Input	R&S®SMZ75/90/110/170	K female (50 Ω)
Output	R&S®SMZ75/90/110/170	WR15/WR12/WR10/WR6.5 waveguide

R&S®AFQ100A I/Q Modulation Generator, R&S®AFQ100B UWB Signal and I/Q Modulation Generator



High-performance baseband signals

Whether in the commercial or aerospace and defense field, customers require excellent signal quality, speed and high flexibility when selecting a signal source. Besides, there is a growing need for development and testing in the digital baseband domain. The signals to be created are increasingly complex and dynamic. They use complex modulation schemes and demand more and more bandwidth. The R&S®AFQ100A and the R&S®AFQ100B are two state-of-the-art, self-contained and flexible baseband sources that perfectly meet these requirements.

Featuring a maximum clock rate of 300 MHz, a bandwidth of 200 MHz (RF) and a waveform memory of up to 1 Gsample, the R&S®AFQ100A provides the functionality and flexibility that is required for development and production tests on receivers and components of digital communications standards such as WLAN and LTE.

The R&S®AFQ100B with a bandwidth of 528 MHz (RF), a clock rate of 600 MHz and a waveform memory of up to 1 Gsample is perfectly suited for applications that require more bandwidth. Examples are the support of broadband digital communications systems such as ultrawideband (UWB) or radar applications where signals with extremely short pulses and short rise and fall times are needed.

Both R&S®AFQ family members combine flexibility with outstanding signal quality. Their spurious suppression, for example, is first-rate and their frequency response extremely linear. All these essential features combined with a wealth of other functions make the R&S®AFQ100A and the R&S®AFQ100B very versatile baseband generators.

Specifications in brief

Output memory

Memory clock of the R&S®AFQ100A	1 kHz to 300 MHz
Memory clock of the R&S®AFQ100B	1 kHz to 300 MHz (mode 1), 600 MHz (mode 2)
Max. waveform length (data and markers)	256 Msample/512 Msample/1 Gsample
Amplitude resolution of data words	16 bit, analog and digital

System bandwidth (RF) of the R&S®AFQ100A 200 MHz

System bandwidth (RF) of the R&S®AFQ100B 200 MHz (mode 1), 528 MHz (mode 2)

Signal output

Number of outputs	1 (I and Q)
Resolution	14 bit
Output (unbalanced)	1 V (V_{pp})
Level range	0 V to 1.5 V (V_{pp})
Frequency response	±0.1 dB up to 100 MHz
Output (balanced) of the R&S®AFQ100A	2 V (V_{pp})
Level range	0 V to 3 V (V_{pp})
Frequency response	±0.1 dB up to 100 MHz
Output (balanced) of the R&S®AFQ100B	1 V (V_{pp})
Level range	0 V to 1.4 V (V_{pp})
Frequency response	±2.5 dB up to 264 MHz
Spurious-free dynamic range of the R&S®AFQ100A	typ. 83 dBc
Spurious-free dynamic range of the R&S®AFQ100B	typ. 78 dBc

Digital outputs

Port 1	multiplexed I/Q data stream, compatible with other Rohde & Schwarz equipment
Port 2	parallel I/Q interface

Supported standards and digital systems (with R&S®WinIQSIM2™)

R&S®AFQ100A/R&S®AFQ100B, depending on options	3GPP LTE FDD/TDD, 3GPP FDD/HSPA/HSPA+, TD-SCDMA, GSM/EDGE/EDGE Evolution, cdmaOne, CDMA2000®, 1xEV-DO, TETRA Release 2, IEEE802.11a/b/g/n/ac, WiMAX™, Bluetooth®, user-defined multicarrier CW, AWGN, GPS, DVB-H/DVB-T, DAB/T-DMB, XM Radio, HD Radio™
R&S®AFQ100B, depending on options	ECMA-368/IEEE 802.15.3a (UWB)

R&S®HMF2525/R&S®HMF2550 Arbitrary Function Generators



Accurate, versatile and attractively priced

- Frequency range: 10 μ Hz to 25/50 MHz
- Triangle waveforms up to 10 MHz
- Output voltage: 5 mV to 10 V (V_{pp}) into 50 Ω load
- Total harmonic distortion: 0.04% ($f < 100$ kHz)
- Waveforms: sine, square, triangle/ramp, pulse, arbitrary (incl. predefined waveforms such as white/pink noise, cardinal sine, exponential rise/fall)

- Modulation modes: AM, FM, pulse, PWM, FSK (internal and external)
- External connectors: TRIGGER (I/O), SWEEP (O), MODULATION (I)
- External reference input/output (10 MHz) via BNC connector
- Arbitrary waveform generator: 250 Msample/s, 14 bit, 256k points
- PC software (free of charge) to easily create user-defined waveforms
- Oscillographic signal display in realtime
- Front USB connector to easily save and recall waveforms and settings
- RS-232/USB dual interface for remote control
- Fanless design

Options

Designation	Type
Dual Ethernet/USB interface	R&S®HO732
IEEE 488 (GPIB) interface, galvanically isolated	R&S®HO740

4

Specifications in brief

Device characteristics (all specifications valid into 50 Ω load)

Models		
R&S®HMF2525		1 channel, frequency range to 25 MHz
R&S®HMF2550		1 channel, frequency range to 50 MHz
Waveforms		
Standard		sine, square, pulse, ramp, triangle
Arbitrary waveforms		up to 256 ksample
Predefined waveforms		sine, square (50%), ramp (positive/negative), triangle (50%), noise (white/pink), cardinal sine, exponential (rise/fall)
Operation modes		
Modulation types		AM, FM, PM, FSK, PWM
Temperature stability	+18°C to +28°C	1×10^{-6}
Aging (after one year)	+25°C	$\pm 1 \times 10^{-6}$
Output characteristics		
Waveform output		BNC socket, front panel
Output impedance		50 Ω
Signal output		on, off, inverted
Overload protection		short-circuit-proof, max. ± 15 V of external voltage
Amplitude		
Range	into 50 Ω open circuit	5 mV (V_{pp}) to 10 V (V_{pp}) 10 mV (V_{pp}) to 20 V (V_{pp})
Resolution		1 mV
Units		V (V_{pp}) or dBm, selectable
Accuracy		$\pm 1\%$ of setting, ± 1 mV (V_{pp}) at 1 kHz
DC Offset		
Range	into 50 Ω open circuit	± 5 mV to 5 V ± 10 mV to 10 V
Resolution	into 50 Ω	1 mV
Units		V
Accuracy		$\pm 2\%$ of offset setting, $\pm 0.5\%$ of amplitude setting, ± 2 mV, ± 1 mV/MHz

R&S®EX-IQ-Box Digital Signal Interface Module

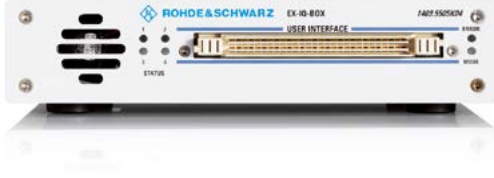

Digital I/Q interface adapter for Rohde & Schwarz signal generators, analyzers and communications testers

The R&S®EX-IQ-Box is a digital signal interface module that provides flexible digital baseband inputs or outputs for Rohde&Schwarz signal generators, signal analyzers and communications testers. Its main application field is the conversion of digital I/Q signals of Rohde&Schwarz instruments into user-defined or standardized digital signal formats and vice versa. The device under test (DUT) is connected via adapter boards (= breakout boards) that are plugged directly into the R&S®EX-IQ-Box.

Key facts

- ▮ Conversion of digital I/Q signals to and from the DUT
- ▮ Flexible user-defined digital I/Q interface settings (I/Q format, bit alignment, clock rate, logic levels, etc.)
- ▮ Two breakout boards included (single-ended, differential connectors) for connection of the DUT
- ▮ Easy interface configuration via enclosed R&S®DigIConf software
- ▮ Transient recorder in R&S®DigIConf for visual control of generated digital signals (I/Q diagram, vector diagram, CCDF, spectrum)

CPRI™ digital interface protocol

- ▮ Test of CPRI™ radio equipment (RE) and/or radio equipment control (REC)
- ▮ Predefined interface settings
- ▮ Flexible or packed antenna-carrier (AxC) allocation
- ▮ Antenna-carrier (AxC) grouping
- ▮ Easy interface configuration via R&S®DigIConf software
- ▮ Direct waveform playback from 64 Msample R&S®EX-IQ-Box waveform memory (optional)
- ▮ Multiwaveform playback for output of up to four waveforms (optional)
- ▮ Recording memory (512 Mbyte) for capturing I/Q data that is received via the CPRI™ link (optional)
- ▮ Support of R&S®WinIQSIM2™ waveform creation software

Specifications in brief	
User-defined digital interface protocol	
I/Q format	parallel, serial
Sample rate	1 kHz to 100 MHz/200 MHz (SN > 102000)
Word size	4 bit to 18 bit (depending on Rohde&Schwarz instrument)
Logic level	LVTTL, CMOS, LVDS
Max. clock rate	100 MHz (parallel)/400 MHz (serial)
CPRI™ digital interface protocol (optional)	
Simulation mode	REC (to test RE), RE (to test REC)
Link direction	uplink, downlink, full-duplex
Supported mobile standards	3GPP FDD (incl. HSDPA, HSUPA, HSPA+), 3GPP LTE FDD/TDD incl. Rel. 9, CDMA2000®, WiMAX™
I/Q payload input	realtime via attached instrument, PN16 or PN20 bit pattern via internal test generator, internal waveform memory (optional)
I/Q payload output	one selectable I/Q signal inside received CPRI™ frame in realtime via attached instrument, internal recording memory (optional)
Control and management	fast C&M (Ethernet), slow C&M (HDLC), vendor-specific data
Visualization	graphical display of CPRI™ basic frame configuration
CPRI™ specific breakout board	support of SFP modules for optical link, SMA connectors for monitoring or supply of RX input signal

Application-specific solutions

The tables provide an overview of the digital modulation systems supported by Rohde&Schwarz signal generators and show the wide range of applications covered.

Digital modulation systems for Rohde & Schwarz signal generators (internal signal generation)				
Option R&S®SMW R&S®SMBV		R&S®SMW200A	R&S®SMBV100A	Page
-K40	GSM/EDGE	•	•	125
-K41	EDGE Evolution (incl. VAMOS)	•	•	125
-K42	3GPP FDD ¹⁾	•	•	124
-K43	3GPP Enhanced BS/MS Tests incl. HSDPA ¹⁾	–	•	124
-K44	GPS ¹⁾	–	•	128
-K45	3GPP FDD HSUPA	–	•	124
-K46	CDMA2000®	•	•	126
-K47	1xEV-DO Rev. A	•	•	126
-K48	IEEE 802.11 (a/b/g)	–	•	126
-K49	IEEE 802.16	•	•	124
-K50	TD-SCDMA ¹⁾	•	•	127
-K51	TD-SCDMA Enhanced BS/MS Tests ¹⁾	•	•	127
-K52	DVB-H/DVB-T	•	•	133
-K53	DAB/T-DMB	–	•	133
-K54	IEEE 802.11 (a/b/g/n/j/p)	•	•	129
-K55	EUTRA/LTE	•	•	121
-K57	FM stereo/RDS	–	•	133
-K58	Sirius	–	•	133
-K59	HSPA+	–	•	124
-K60	Bluetooth® (incl. EDR, low energy)	•	•	132
-K61	Multicarrier CW	•	•	120
-K62	AWGN	•	•	120
-K65	Assisted GPS	–	•	128
-K66	Galileo	–	•	128
-K68	TETRA Release 2	•	•	127
-K69	LTE Closed-loop BS Test	•	–	121
-K71	Dynamic fading and enhanced resolution	•	–	120
-K72	Extended statistics functions	•	–	120
-K73	OTA-MIMO fading enhancements	•	–	120
-K74	MIMO fading	•	–	120
-K75	Higher order MIMO	•	–	120
-K76	Multiple entities	•	–	120
-K78	Radar Echo Generation	•	–	134
-K81	LTE log file generation	•	–	121
-K83	3GPP FDD HSPA/HSDPA+, Enhanced BS/MS Tests	•	–	124
-K84	LTE Release 9 and enhanced features	•	•	121
-K85	LTE Release 10/LTE-Advanced	•	•	121
-K86	IEEE 802.11ac	•	•	129
-K87	1xEV-DO Rev. B	•	•	126
-K89	NFC A/B/F	•	•	134
-K91	GNSS extension to 12 satellites	–	•	128
-K92	GNSS Enhanced	–	•	128
-K93	GPS P code	–	•	128
-K94	Glonass	–	•	128

Digital modulation systems for Rohde & Schwarz signal generators (internal signal generation), continued				
Option R&S®SMW R&S®SMBV		R&S®SMW200A	R&S®SMBV100A	Page
-K95	Assisted Glonass	–	•	128
-K96	GNSS extension to 24 satellites	–	•	128
-K101	GNSS obscuration and automatic multipath	–	•	128
-K102	GNSS antenna pattern	–	•	128
-K103	GNSS spinning/attitude	–	•	128
-K105	OZSS	–	•	128
-K107	BeiDou	–	•	128
-K110	SBAS	–	•	128
-K111	GBAS	–	•	128
-K112	LTE Release 11 and enhanced features	•	•	121
-K113	EUTRA/LTE Release 12	•	•	122
-K114	5G air interface candidates	•	–	123
-K141	Physical layer signals in line with IEEE 802.11ad	•	–	130
-K151	ILS	–	•	–
-K152	VOR	–	•	–
-K153	DME	–	•	–
-K820	Customized dynamic fading	•	–	–

¹⁾ Functionality is instrument-specific.

– Not usable

• Available

Digital modulation systems for Rohde & Schwarz signal generators (R&S®WinIQSIM2™)								
Option R&S®SMW R&S®SMBV R&S®SGT R&S®AFQ R&S®EXBOX		R&S®SMW200A	R&S®SMBV100A	R&S®SGT100A	R&S®AFQ100A	R&S®AFQ100B	R&S®EX-IO-Box ²⁾	Page
-K240	GSM/EDGE	•	•	•	•	•	•	125
-K241	EDGE Evolution (incl. VAMOS)	•	•	•	•	•	•	125
-K242	3GPP FDD	•	•	•	•	•	•	124
-K243	3GPP Enhanced BS/MS Tests incl. HSDPA	–	•	–	•	•	•	124
-K244	GPS ³⁾	•	•	•	•	•	–	128
-K245	3GPP FDD HSUPA	–	•	–	•	•	•	124
-K246	CDMA2000®	•	•	•	•	•	•	126
-K247	1xEV-DO Rev. A	•	•	•	•	•	•	126
-K248	IEEE 802.11 (a/b/g)	–	•	–	•	•	–	129
-K249	IEEE 802.16	•	•	•	•	•	•	131
-K250	TD-SCDMA	•	•	•	•	•	•	127
-K251	TD-SCDMA Enhanced BS/MS Tests	•	•	•	•	•	•	127
-K252	DVB-H/DVB-T	•	•	•	•	•	–	133
-K253	DAB/T-DMB	•	•	•	•	•	–	133
-K254	IEEE 802.11 (a/b/g/n/l/p)	•	•	•	•	•	•	129
-K255	EUTRA/LTE	•	•	•	•	•	•	121
-K259	HSPA+	–	•	–	•	•	•	124
-K260	Bluetooth® (incl. EDR, low energy)	•	•	•	•	•	–	129
-K261	Multicarrier CW	•	•	•	•	•	–	–
-K264	ECMA-368 IEEE 802.15.3a (UWB)	–	–	–	–	•	–	–
-K266	Galileo ³⁾	•	•	•	•	•	–	128
-K268	TETRA Release 2	•	•	•	•	•	–	127

Digital modulation systems for Rohde & Schwarz signal generators (R&S®WinIQSIM2™), continued

Option R&S®SMW R&S®SMBV R&S®SGT R&S®AFQ R&S®EXBOX		R&S®SMW200A	R&S®SMBV100A	R&S®SGT100A	R&S®AFQ100A	R&S®AFQ100B	R&S®EX-IO-Box ²⁾	Page
-K283	3GPP FDD HSPA/HSDPA+, Enhanced BS/MS Tests	•	–	•	–	–	–	124
-K284	LTE Release 9 and enhanced features	•	•	•	•	•	•	121
-K285	LTE Release 10/LTE-Advanced	•	•	•	•	•	•	121
-K286	IEEE 802.11ac	•	•	•	•	•	•	129
-K287	1xEV-DO Rev. B	•	•	•	•	•	–	126
-K289	NFC A/B/F	•	•	•	–	–	–	134
-K294	Glonass ³⁾	•	•	•	•	•	–	128
-K407	BeiDou	•	•	•	•	•	–	–
-K412	LTE Release 11 and enhanced features	•	•	•	–	–	–	121
-K413	EUTRA/LTE Release 12	•	•	•	–	–	–	122
-K441	IEEE 802.11ad	•	–	–	–	–	–	130

Digital modulation systems for Rohde & Schwarz signal generators (external PC software or waveforms)

Option R&S®SMx R&S®SGT R&S®AFQ		R&S®SMW200A	R&S®SMBV100A	R&S®SGT100A	R&S®AFQ100A	R&S®AFQ100B	R&S®EX-IO-Box ²⁾	Page
-K256	Playback of XM Radio waveforms	–	•	–	•	•	–	133
-K300	Pulse sequencer	•	•	•	–	–	–	136
-K301	Enhanced pulse sequencer	•	•	•	–	–	–	136
-K308	Direction finding	•	–	–	–	–	–	137
-K350	DFS signal generation	•	•	•	–	–	–	138
-K352	Playback of HD Radio™ waveforms	–	•	–	•	•	–	133
-K353	DAB+ streams	–	•	–	–	–	–	133
-K354	T-DMB/DAB streams	–	•	–	–	–	–	133
-K501	Extended Sequencing	•	–	–	–	–	–	139

²⁾ Only together with CPRI™ digital interface standard.

³⁾ One satellite only.

- Not usable
- Available

R&S®SMW-B14/-K62/-K71/-K72/-K73/-K74/-K75/-K76 Multipath and Channel Simulation



Fading: Power delay profile configuration.

Multichannel, fading and interference simulation with the R&S®SMW200A

The multichannel R&S®SMW200A can simulate up to 8 SISO channels as well as sophisticated MIMO channels. It is a cost-effective and powerful solution for testing the behavior of products under realistic transmission conditions. The R&S®SMW200A fading simulator allows emulation of both static and dynamically changing fading conditions. Complex correlation between the fading paths, geometric antenna setup definition (via AoA/AoD) as well as channel matrix inversion and user defined antenna patterns for OTA-MIMO are supported. Together with the AWGN simulation capability, the signal generator is ideal for performance tests in line with all important digital communications standards as well as multistandard radio (MSR) test scenarios.

Channel simulation options	
Fading simulator	R&S®SMW-B14
AWGN	R&S®SMW-K62
Dynamic fading and enhanced resolution	R&S®SMW-K71
Extended statistics functions	R&S®SMW-K72
OTA-MIMO enhancements	R&S®SMW-K73
MIMO fading	R&S®SMW-K74
Higher order MIMO	R&S®SMW-K75
Multiple entities	R&S®SMW-K76

Specifications in brief	
Multi-path configuration	
Number of RF paths	1 or 2
With additional R&S®SGS100A modules	up to 4
With additional R&S®SGT100A modules	up to 8
Number of baseband sources	up to 8
Fading and MIMO	
Installable fading simulators	1, 2, or 4
Max. number of fading channels	16
Fading paths (per fading channel)	20
Max. bandwidth	160 MHz
Minimum path delay resolution	2.5 ps

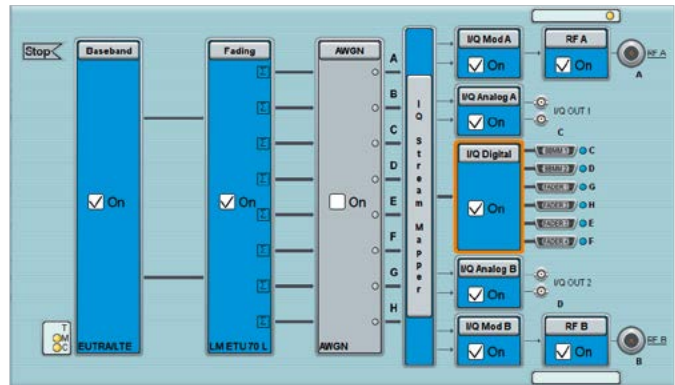

2x8 MIMO signal generation and channel simulation.

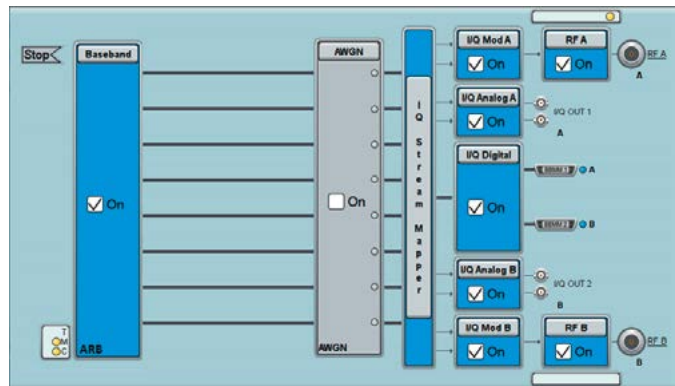

8xSISO configuration (without fading).

Specifications in brief

Supported MIMO modes

With R&S®SMW-K74 + 2 x R&S®SMW-B14	1x2, 2x1, 2x2
With R&S®SMW-K74 + 4 x R&S®SMW-B14	1x2, 2x1, 2x2, 2x3, 3x2, 2x4, 4x2, 3x3, 3x4, 4x3, 4x4, 8x1, 8x2, 1x8, 2x8, 2x2x2
With R&S®SMW-K74 + 4 x R&S®SMW-B14 + R&S®SMW-K75	2x2x4, 2x4x2, 4x8, 8x4, 2x4x4
With R&S®SMW-K74 + 4 x R&S®SMW-B14 + R&S®SMW-K76	3x2x2, 4x2x2

Supported SISO modes

With R&S®SMW-K76	up to 8 SISO channels without fading simulation
With R&S®SMW-K76 + 4 x R&S®SMW-B14	up to 8 SISO channels with fading simulation

Fading profiles

Standard: Rayleigh, pure Doppler, Rice, lognormal, static, constant phase
 With R&S®SMW-K71: moving delay, birth-death, 2-channel interferer, HST
 With R&S®SMW-K72: Gauss, Gauss DAB, WiMAX™ Doppler, WiMAX™ Rice, customized Doppler

Predefined settings

Standard: CDMA2000®, 1xEV-DO, GSM, NADC, PCN, TETRA, HiperLAN/2, WiMAX™ ITU, LTE (except HST)
 With R&S®SMW-K71: 3GPP FDD WCDMA, 3GPP LTE HST
 With R&S®SMW-K72: WiMAX™ SUI, DAB, IEEE802.11p, SCME
 With R&S®SMW-K74: WiMAX™ MIMO, LTE MIMO, WLAN 802.11n/ac MIMO

AWGN (R&S®SMW-K62)

C/N	-50 dB to +45 dB
System bandwidth	up to 160 MHz

R&S®SMW/R&S®SMBV-K55/-K69/-K81/-K84/-K85/-K112 LTE Signal Generation



R&S®SMW-K55 LTE time plan example ([download](#)).

LTE receiver and performance testing

The LTE signal generation options allow comprehensive LTE testing of base stations, mobile devices, modules and components.

R&S®SMW/R&S®SMBV-K55, general features

- ▮ In line with 3GPP LTE Release 8
- ▮ FDD and TDD
- ▮ Downlink (OFDMA) and uplink (SC-FDMA)

R&S®SMW/R&S®SMBV-K55 LTE downlink functionality

- ▮ PBCH, PDSCH, PDCCH, PCFICH, PHICH
- ▮ Full MIMO and TX diversity support
- ▮ P-SYNC, S-SYNC and DL reference signals
- ▮ Channel coding and scrambling for PDSCH/PBCH
- ▮ Predefined test models
- ▮ LTE test case wizard

R&S®SMW/R&S®SMBV-K55 LTE uplink functionality

- ▮ PUSCH incl. channel coding, scrambling and multiplexing
- ▮ PUCCH, PRACH
- ▮ Demodulation and sounding reference signals
- ▮ PUSCH frequency hopping type 1 and type 2
- ▮ Group and sequence hopping

R&S®SMW-K69 (together with R&S®SMW-K55)

- ▮ Support of uplink closed-loop base station tests in line with 3GPP TS36.141
- ▮ Realtime processing of feedback commands for HARQ feedback, timing adjustment and timing advance

R&S®SMW-K81 (together with R&S®SMW-K55)

- ▮ Output of log files with intermediate results (bits/symbols) from the signal generation chain
- ▮ Generation of summary log files with LTE signal description

R&S®SMW/R&S®SMBV-K84 (together with R&S®SMW/R&S®SMBV-K55)

- ▮ In line with 3GPP LTE Release 9
- ▮ MBMS/MBSFN subframes including PMCH
- ▮ Downlink positioning reference signals (PRS)
- ▮ Dual-layer beamforming (TX mode 8)
- ▮ Mapping of logical antenna ports to physical TX antennas

R&S®SMW/R&S®SMBV-K85 (together with R&S®SMW/R&S®SMBV-K55)

- ▮ In line with 3GPP LTE Release 10/LTE-Advanced
- ▮ Carrier aggregation
- ▮ Enhanced SC-FDMA
- ▮ PUSCH/PUCCH synchronous transmission
- ▮ Clustered PUSCH
- ▮ PUCCH format 3
- ▮ Generation of CSI reference signals
- ▮ Eight-layer transmission (TX mode 9)
- ▮ UL-MIMO

R&S®SMW/R&S®SMBV-K112 (together with R&S®SMW/R&S®SMBV-K55)

- ▮ In line with 3GPP LTE Release 11
- ▮ TDD special subframe configurations
- ▮ DL auto sequence (enhanced Auto DCI)

LTE signal generation options

LTE Release 8	R&S®xxx-K55, R&S®xxx-K255
LTE Closed-loop BS Test	R&S®xxx-K69
LTE log file generation	R&S®xxx-K81
LTE Release 9 and enhanced features	R&S®xxx-K84, R&S®xxx-K284
LTE Release 10/LTE-Advanced	R&S®xxx-K85, R&S®xxx-K285
LTE Release 11 and enhanced features	R&S®xxx-K112

For supported instruments, see pages 117 to 119.

R&S®SMW/R&S®SMBV-K113 EUTRA/LTE Release 12

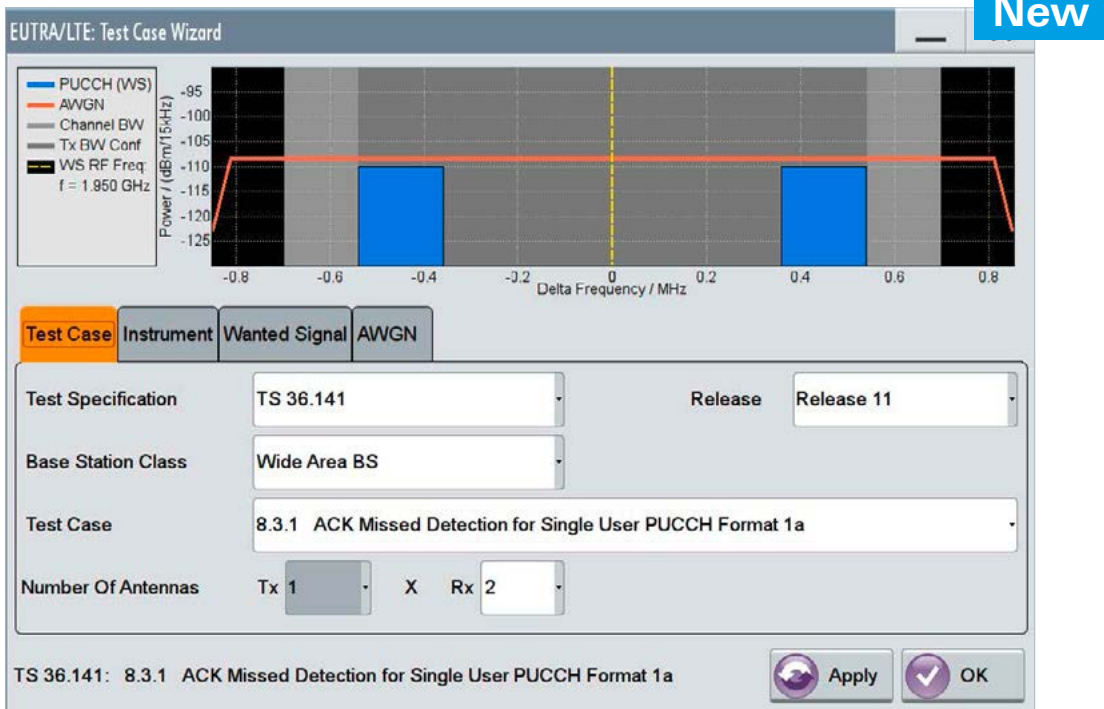

Single user PUCCH format 1a demodulation tests.

Physical layer signal generation

3GPP LTE Release 12 is a significant enhancement of LTE. On the physical layer it adds e.g. features for joint FDD/TDD operation for carrier aggregation, important small cell related improvements such as 256QAM or mechanisms for enhanced interference mitigation and traffic adaptation (eIMTA).

Using the R&S®SMW/R&S®SMBV-K113 option, the R&S®SMW200A and the R&S®SMBV100A vector signal generators generate physical layer signals in line with release 12 of the 3GPP LTE standard.

The R&S®SMW/R&S®SMBV-K113 option requires the R&S®SMW/R&S®SMBV-K55 LTE option.

- In line with 3GPP LTE Release 12
- LTE FDD and TD-LTE support
- Uplink and downlink signal generation
- 256QAM in downlink
- Enhanced test models for 256QAM
- DCI format 1C for enhanced interference mitigation and traffic adaptation (eIMTA)
- Mixed carrier aggregation TDD/FDD in uplink

R&S®SMW-K114 5G Air Interface Candidates

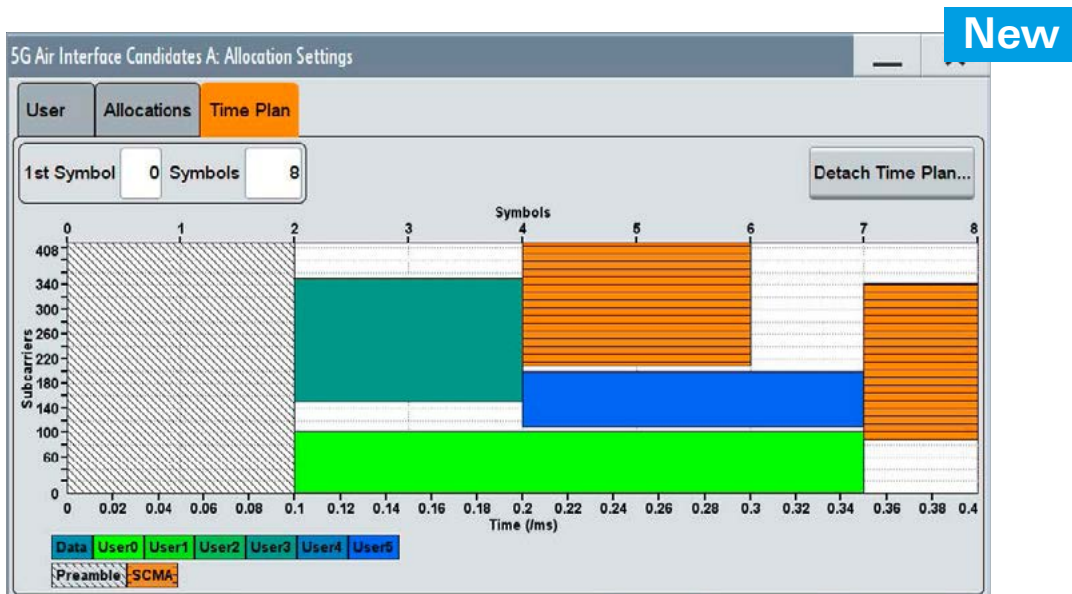

The x-axis shows the allocation in the time domain, expressed in both time and number of symbols. The y-axis shows the occupied subcarriers as the smallest allocation granularity in the frequency domain.

Customized 5G air interface candidate signal generation

The R&S®SMW200A vector signal generator is the ideal tool for early 5G physical layer testing. Using the R&S®SMW-K114 option, the R&S®SMW200A flexibly generates customized 5G air interface candidate signals.

The user can choose from various waveform types such as GFDM, FBMC, UFMC or f-OFDM and parameterize the signals as desired. Pulse shaping filters, subcarrier spacing and the number of carriers as well as the modulation and data content can be set. Preamble generation, a configurable cyclic prefix length and support for sparse code multiple access (SCMA) allow the testing of components or receivers with realistic pre-5G physical layer signals. Direct internal signal generation – without the need for any external PC software – helps to speed up the signal creation process.

Optionally, the R&S®SMW200A can also be equipped with a second signal generation path. This allows simultaneous generation of a 5G candidate signal and a legacy LTE signal from a single signal generator without complicated synchronization of multiple separate signal sources. Interdependencies between LTE and 5G are hence quickly simulated. And interference that occurs in the device under test (DUT) due to the simultaneous presence of 5G and LTE are easily discovered.

- Create customized 5G signals
- GFDM, UFMC, FBMC, f-OFDM
- Sparse code multiple access (SCMA)
- Easy waveform parameterization
- Allocation time plan for visualization
- PN sequences, data patterns or user data lists
- BPSK, QPSK, 16QAM, 64QAM, 256QAM

R&S®SMW/R&S®SMBV-K42/-K43/-K45/-K59/-K83 3GPP FDD/HSPA/HSPA+

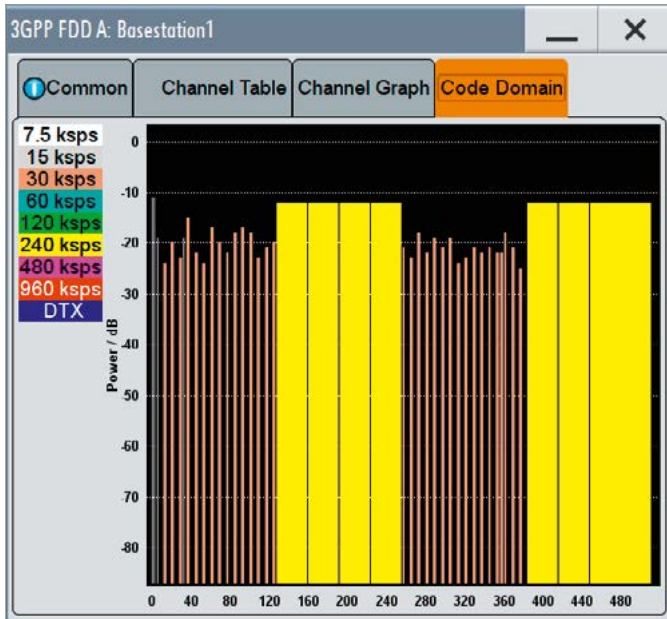

Example of 3GPP code domain display (downlink, test model 6).

3GPP signal generation

These options provide signal generation capabilities in line with 3GPP FDD Release 11, including HSDPA, HSUPA and HSPA+.

The R&S®SMW/R&S®SMBV options combine realtime operation and arbitrary waveform mode for realtime generation of the P-CCPCH and up to three DPCHs in the downlink, for example. In the uplink, one UE can be simulated in realtime; up to 128 UEs can be simulated via the ARB and added to the realtime signal.

The R&S®SMBV-K43 option extends the R&S®SMBV-K42 option to full HSDPA support and dynamic power control. It allows the simulation of HS-SCCH (high speed shared control channel) and HS-PDSCH (high speed physical downlink shared channel) in the downlink in line with TS25.211. Generation of HSDPA H-Sets is also supported. In addition, it is possible to simulate a HS-DPCCH (high speed dedicated physical control channel) in realtime operation (UE1) and arbitrary waveform mode (UE2 to UE4).

The R&S®SMx/R&S®SMBV-K45 option can generate all HSUPA physical channels. In the uplink, it supports simulation of one E-DPCCH and up to four E-DPDCHs with channel coding.

The R&S®SMBV-K59 HSPA+ option supports higher-order modulation (64QAM) for higher data rates, multiple input multiple output (MIMO) for higher data throughput in the downlink and continuous packet connectivity (CPC) for reduction of latency and control information overhead.

The R&S®SMW-K83 combines the functionality of the R&S®SMBV-K43/-K45 and R&S®SMBV-K59 in one option for the R&S®SMW200A.

3GPP signal generation options

3GPP FDD	R&S®xxx-K42, R&S®xxx-K242
3GPP FDD Enhanced BS/MS Tests incl. HSDPA	R&S®xxx-K43, R&S®xxx-K243 R&S®xxx-K83, R&S®xxx-K283
3GPP FDD HSUPA	R&S®xxx-K45, R&S®xxx-K245 R&S®xxx-K83, R&S®xxx-K283
HSPA+	R&S®xxx-K59, R&S®xxx-K259 R&S®xxx-K83, R&S®xxx-K283

For supported instruments, see pages 117 to 119.

R&S®SMW/R&S®SMBV-K40/-K41

GSM/EDGE/EDGE Evolution

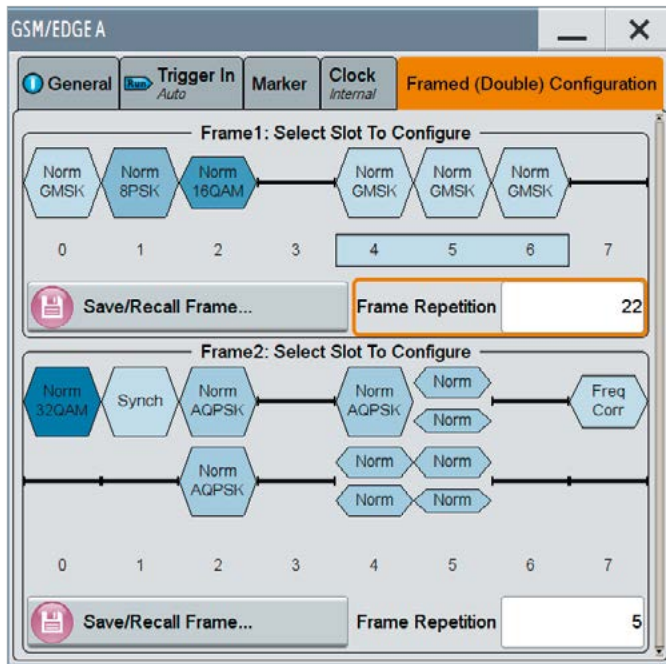

Main GSM/EDGE signal configuration menu of the R&S®SMW200A.

GSM/EDGE signal generation

With the R&S®SMW/R&S®SMBV-K40 option, GSM/EDGE signals can be generated in realtime, whereas the type of modulation can be changed from slot to slot. In addition, eight different power levels can be defined for the timeslots. All necessary burst types (e.g. normal (full and half rate), EDGE, synchronization, access) are supported.

The R&S®SMW/R&S®SMBV-K41 option adds EDGE Evolution and VAMOS features such as:

- Higher symbol rate (325 kHz)
- Higher-order modulation types: 16QAM, 32QAM
- Mixed frames with GSM, EDGE and EGPRS2 slots in one frame (with same symbol rate per frame)
- “Framed double” sequence mode for generation of realistic test scenarios with changing frame content
- Adaptive QPSK (AQPSK) modulation scheme

GSM/EDGE signal generation options

GSM/EDGE	R&S®xxx-K40, R&S®xxx-K240
EDGE Evolution	R&S®xxx-K41, R&S®xxx-K241

For supported instruments, see pages 117 to 119.

R&S®SMW/R&S®SMBV-K46/-K47/-K87 CDMA2000® incl. 1xEV-DV and 1xEV-DO

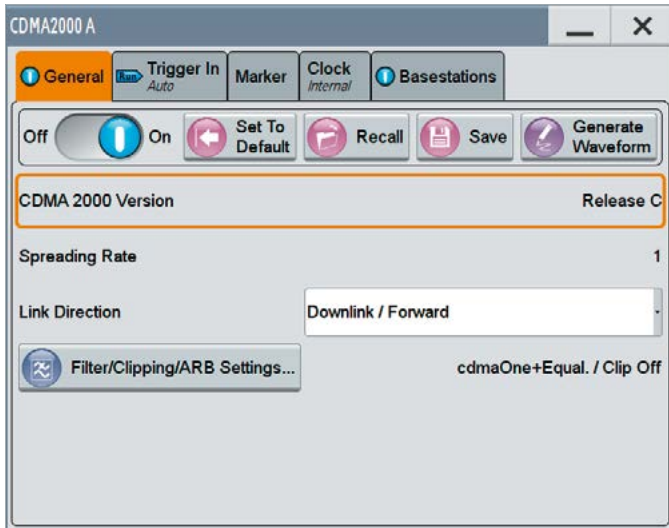

Start screen including basic settings for CDMA2000® of the R&S®SMW200A.

CDMA2000®, 1xEV-DV and 1xEV-DO signal generation

The R&S®SMW/R&S®SMBV-K46 option generates signals for CDMA2000®, the North American standard for the third mobile radio generation including IS-95 as a subset. Even signals for 1xEV-DV can be generated using R&S®SMW/R&S®SMBV-K46.

R&S®SMW/R&S®SMBV-K46 option for generating CDMA2000® signals

- ▮ Configuration of up to four base stations or four mobile stations
- ▮ All special channels and up to 78 channels in the downlink (depending on radio configuration)
- ▮ Packet channel in line with 1xEV-DV in the downlink
- ▮ Operating modes in the uplink: traffic, access, enhanced access and common control
- ▮ Simulation of up to 64 additional mobile stations
- ▮ All channel coding modes included in IS-2000 (frame quality indicator, convolutional encoder, turbo encoder, symbol puncture, interleaver, etc.)

R&S®SMW/R&S®SMBV-K47 option for generating signals for 1xEV-DO (Rev. A)

- ▮ Simulation of up to four users in the downlink and up to four terminals in the uplink
- ▮ Physical layer subtypes 0 and 1 or 2 selectable
- ▮ Downlink data rate selectable through rate index and packet size
- ▮ Matrix for reverse power control (RPC) allowing flexible testing of power control
- ▮ Traffic and access mode in the uplink; automatic setting of different data rates and modulations by selected payload size

R&S®SMW/R&S®SMBV-K87 option for generating signals for 1xEV-DO (Rev. B)

- ▮ Independent configuration of up to four traffic channels in the downlink or four access terminals in the uplink
- ▮ Support of physical layer subtypes 0, 1, 2 and 3
- ▮ Support of multicarrier operation with up to 16 simultaneous carriers
- ▮ Operating modes in the uplink: traffic and access
- ▮ Simulation of up to 360 additional MAC users
- ▮ Supports configuration of public data as defined in the standard, such as long code masks for I and Q channel, preamble length, DRC length

CDMA2000® signal generation options

CDMA2000®	R&S®xxx-K46, R&S®xxx-K246
1xEV-DO Rev. A	R&S®xxx-K47, R&S®xxx-K247
1xEV-DO Rev. B	R&S®xxx-K87, R&S®xxx-K287

For supported instruments, see pages 117 to 119.

R&S®SMW/R&S®SMBV-K50/-K51 TD-SCDMA Signal Generation

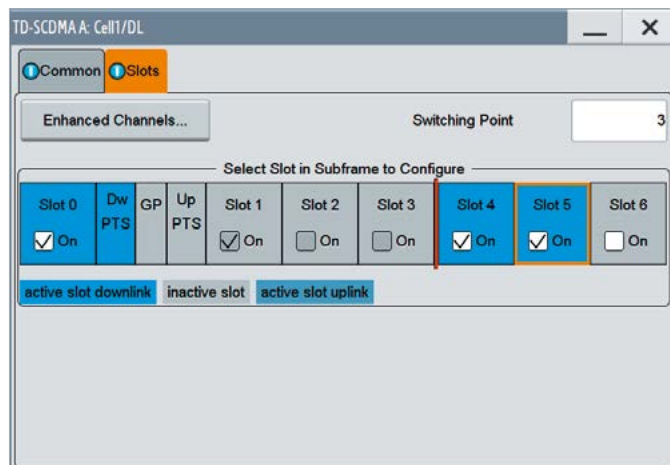

TD-SCDMA slot configuration menu of the R&S®SMW200A.

TD-SCDMA signal generation

The combination of the R&S®SMW/R&S®SMBV-K50 and -K51 options offers easy, flexible configuration of real-time, fully coded (transport and physical layer) TD-SCDMA (3GPP TDD LCR) test signals for evaluating components, power amplifiers, digital baseband receiver chips and RF receivers in user equipment and base stations. The TD-SCDMA signal generation is in accordance with 3GPP TDD LCR with a chip rate of 1.28 Mcps (low chip rate mode) and contains the HSDPA and HSUPA functionality for TD-SCDMA.

R&S®SMW/R&S®SMBV-K68 TETRA Release 2 Signal Generation

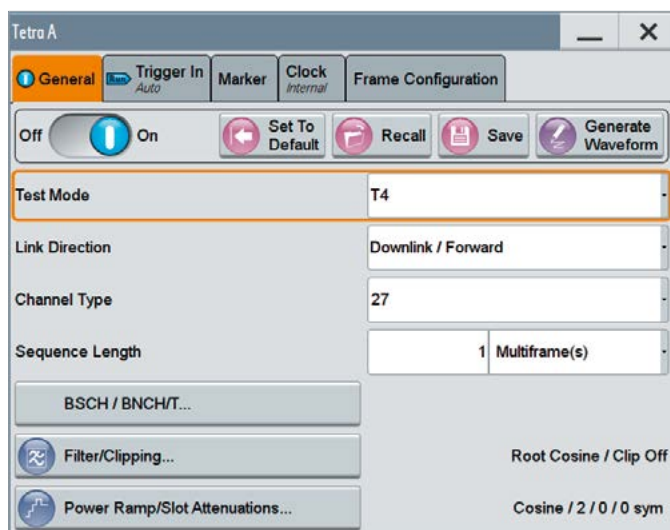

TETRA Release 2 main menu of the R&S®SMW200A.

R&S®SMW/R&S®SMBV-K50 TD-SCDMA functionality

- Simulation of up to four TD-SCDMA cells with variable switching point of uplink and downlink
- User-configurable channel table for each slot and simulation of downlink and uplink pilot timeslot
- PRACH can be generated in the uplink

R&S®SMW/R&S®SMBV TD-SCDMA enhanced functionality

- Enhancing R&S®SMW/R&S®SMBV-K50 to support full channel coding in fixed coding schemes and user-defined coding schemes, HSDPA and HSUPA
- Simulation of up to four TD-SCDMA cells with generation of the coded P-CCPCH (BCH with running SFN) in the downlink
- Fixed reference measurement channels RMC 12.2 kbps up to RMC 384 kbps in both uplink and downlink; user configuration supported
- Simulation of HSDPA channels HS-SCCH, HS-PDSCH, HS-SICH and H-RMC 0.5 Mbps, 1.1 Mbps, 1.6 Mbps, 2.2 Mbps, 2.8 Mbps (QPSK and 16QAM), H-RMC 64QAM; user configuration supported
- Simulation of HSUPA channels E-DCH FRC from 1 to 4 (QPSK and 16QAM); user configuration supported

TD-SCDMA signal generation options

TD-SCDMA	R&S®xxx-K50, R&S®xxx-K250
TD-SCDMA Enhanced BS/MS Tests	R&S®xxx-K51, R&S®xxx-K251

For supported instruments, see pages 117 to 119.

TETRA Release 2 digital standard

- In line with ETSI EN 300392-2 digital standard (V3.2.1) and TETRA conformance testing specification ETSI EN 300394-1 (V3.1.1)
- Link direction: downlink and uplink (not for T3)
- T1 downlink channels 0, 1, 2, 3, 4, 21, 22, 24
- T1 uplink channels 7, 8, 9, 10, 11, 21, 23, 24
- T2 TETRA interferer phase modulation, QAM
- T3 CW interferer
- T4 downlink channel 27
- T4 uplink channels 25, 26

TETRA signal generation options

TETRA Release 2	R&S®xxx-K68, R&S®xxx-K268
-----------------	---------------------------

For supported instruments, see pages 117 to 119.

R&S®SMBV-K44/-K65/-K66/-K67/-K91/ -K92/-K93/-K94/-K95/-K96/-K101/-K102/ -K103/-K105/-K107/-K110/-K111 GNSS Simulation with GPS, Galileo, Glonass, BeiDou including Augmentation Systems (QZSS, SBAS, GBAS)

GNSS simulation

Whether in the R&D lab or in production, the global navigation satellite system (GNSS) solution for the R&S®SMBV100A sets new standards in the field of satellite simulation. It supports all possible scenarios, from simple setups with individual, static satellites all the way to flexible scenarios generated in realtime with up to 24 dynamic satellites from the available GNSS systems.

- ▮ Support of GPS L1/L2 (C/A and P code), Glonass L1/L2, Galileo E1, BeiDou B1/B2 and QZSS/SBAS L1, including hybrid constellations
- ▮ Realtime simulation of realistic constellations with up to 24 satellites and unlimited simulation time
- ▮ Flexible scenario generation including moving scenarios, dynamic power control and atmospheric modeling
- ▮ Configuration of realistic user environments, including obscuration and multipath, antenna characteristics and vehicle attitude
- ▮ Static mode for basic receiver testing using signals with zero or constant Doppler shift
- ▮ Support of Assisted GNSS (A-GNSS) test scenarios, including generation of assistance data for GPS, Glonass, Galileo, BeiDou and QZSS/SBAS
- ▮ Realtime external trajectory feed for hardware in the loop (HIL) applications
- ▮ Logging of simulation data
- ▮ High signal dynamics¹⁾, simulation of spinning vehicles and precision code (P code) simulations to support aerospace and defense applications
- ▮ Enhanced simulation capabilities for aerospace applications by supporting ground-based augmentation systems (GBAS)
- ▮ Support of other digital communications and radio standards in the same instrument

¹⁾ May be subject to export restrictions.

Start screen with simulation mode selection for the different applications, hybrid setup for selecting the GNSS used and signal parameters such as time and location.

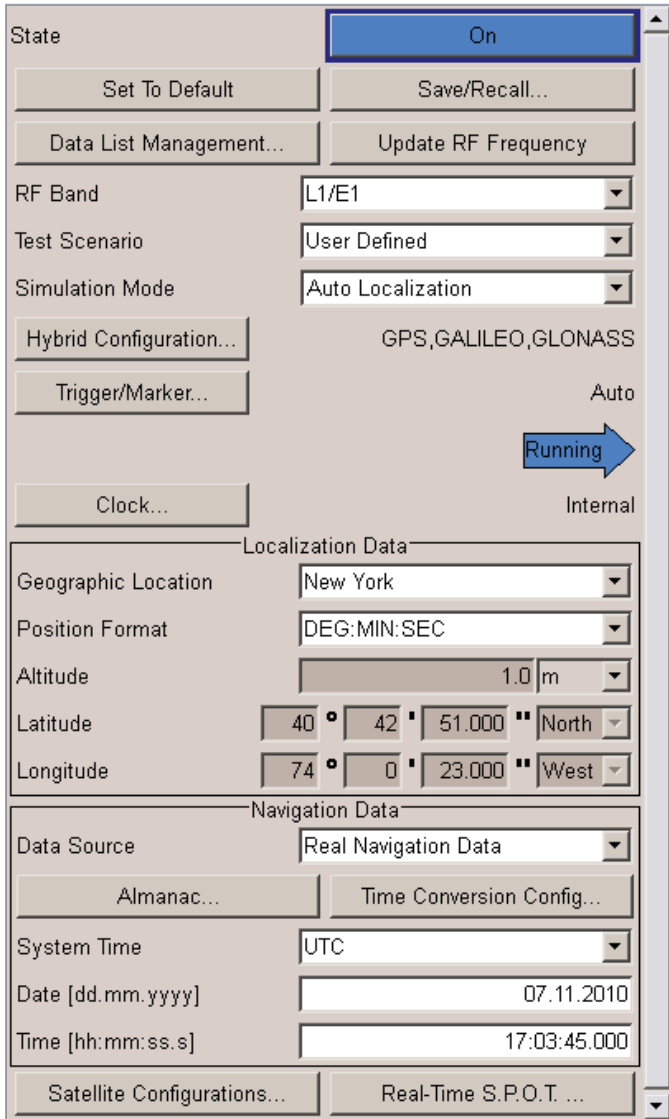

The realtime SPOT (satellites and position online tracker) view is a dynamic display of the current satellite constellation and provides dynamic realtime information about parameters such as HDOP, PDOP, receiver's location and current simulation time.

R&S®SMW/R&S®SMBV-K54/-K86 IEEE 802.11a/b/g/n/j/p/ac

	Std.	Type	Physical Mode	Tx Mode	Frames	Idle Time /ms	Data	DList / Pattern	Boost /dB	PPDU	Data Rate /Mbps	State
1	11ac	Data	Mixed Mode	VHT-160MHz	1	0.100 0	A-MPDU	Conf...	0.00	Conf...	117.00	On
2	11p/j	Data	Legacy	L-10MHz	1	0.100 0	Pattern	0	-10.00	Conf...	9.00	On
3 >	11n	Data	Mixed Mode	HT-40MHz	1	0.100 0	PN 9		0.00	Conf...	27.00	On
4	11b/g	Data	Legacy	CCK	1	0.100 0	PN 21		0.00	Conf...	11.00	On
5	11a/g	Data	Legacy	L-20MHz	1	0.100 0	PN 9		0.00	Conf...	18.00	On
6	User	Data	Green Field	HT-20MHz	1	0.100 0	PN 9		0.00	Conf...	13.00	On

IEEE802.11 frameblock sequencer configuration menu of the R&S®SMW200A.

WLAN signal generation

The R&S®SMW/SMBV-K54 option allows the generation of signals in line with the IEEE 802.11a/b/g/n/j/p/ac WLAN standards.

For IEEE 802.11n signal generation, channel bandwidths of 20 MHz and 40 MHz are supported. The high throughput (HT) mode allows high data rate IEEE 802.11n signals to be generated. Furthermore, this option includes MIMO capabilities (generation of one to four spatial streams; one to four TX antennas).

R&S®SMW/R&S®SMBV-K86 (together with R&S®SMW/R&S®SMBV-K54) for IEEE 802.11ac

- ▮ Support of all mandatory physical layer modes
- ▮ Very high throughput (VHT) frames with 20 MHz, 40 MHz, 80 MHz and 160 MHz transmission bandwidth
- ▮ VHT preambles and signal fields
- ▮ Frame block sequencer for alternating legacy (11a/b/g/j/p), 11n or 11ac frames within one ARB waveform
- ▮ MIMO modes with 4 transmit antennas
- ▮ BPSK, QPSK, 16QAM, 64QAM and 256QAM modulation

WLAN signal generation options

IEEE 802.11a/b/g/n/j/p	R&S®xxx-K54, R&S®xxx-K254
IEEE 802.11ac	R&S®xxx-K86, R&S®xxx-K286

For supported instruments, see pages 117 to 119.

R&S®SMW-K141 IEEE 802.11ad

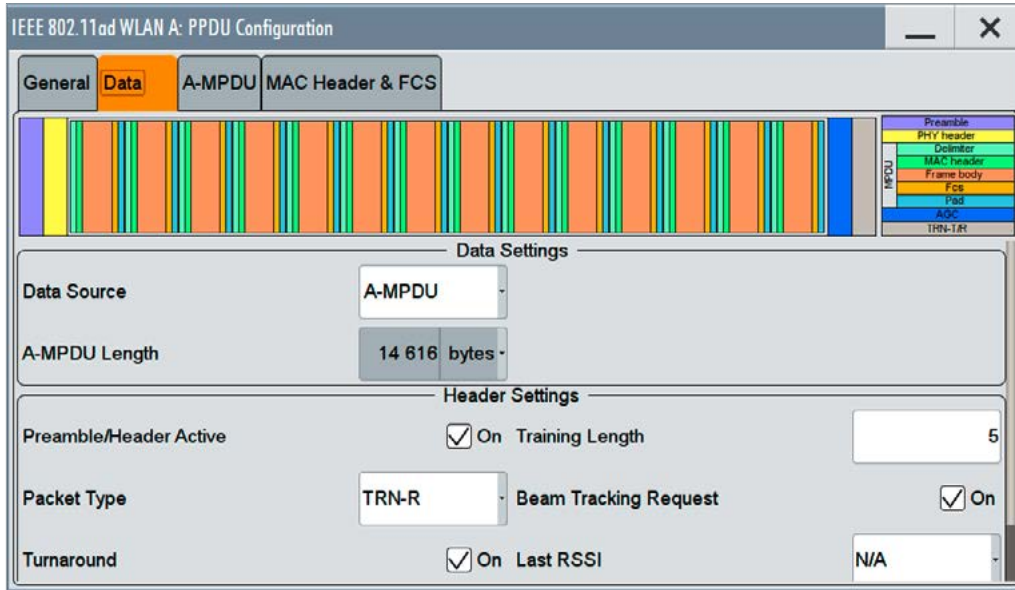

MAC header and MAC frame control field settings.

Physical layer signals in line with IEEE 802.11ad

The R&S®SMW-K141 option enables the R&S®SMW200A with R&S®SMW-B9 wideband baseband option to generate physical layer signals in line with the IEEE 802.11ad standard.

The R&S®SMW200A excels with extraordinary flat frequency response over 2 GHz bandwidth – and that without the need for a special external calibration procedure. Baseband signals or IF signals at frequencies up to 40 GHz (depending on the R&S®SMW frequency option) are directly available at high quality out of a single instrument.

As a result, the R&S®SMW200A instantly delivers outstanding EVM performance for IEEE 802.11ad signals. The user has full control over the IEEE 802.11ad signal configuration and does not need to run any tedious calibration of the test setup – not when setting up the signal scenario the first time nor when changing signal parameters, signal content, level or frequency while working.

- PHY modes: single carrier and control
- Modulation and coding schemes (MCS) 0 to 12
- DBPSK, $\pi/2$ -BPSK, $\pi/2$ -QPSK, $\pi/2$ -16QAM
- LDPC channel coding and scrambling
- MAC header and FCS support
- Data source: all 1, all 0, pattern, PN sequences, data list
- A-MPDU support (up to 64 MDPUs)
- Settable last RSSI value (for single carrier signal)
- Support for training sequences TRN-T and TRN-R with settable length

WLAN physical layers generation options

IEEE 802.11ad	R&S®SMW-K141, R&S®SMW-K441
---------------	----------------------------

For supported instruments, see pages 117 to 119.

R&S®SMW/R&S®SMBV-K49 WiMAX™ Signal Generation

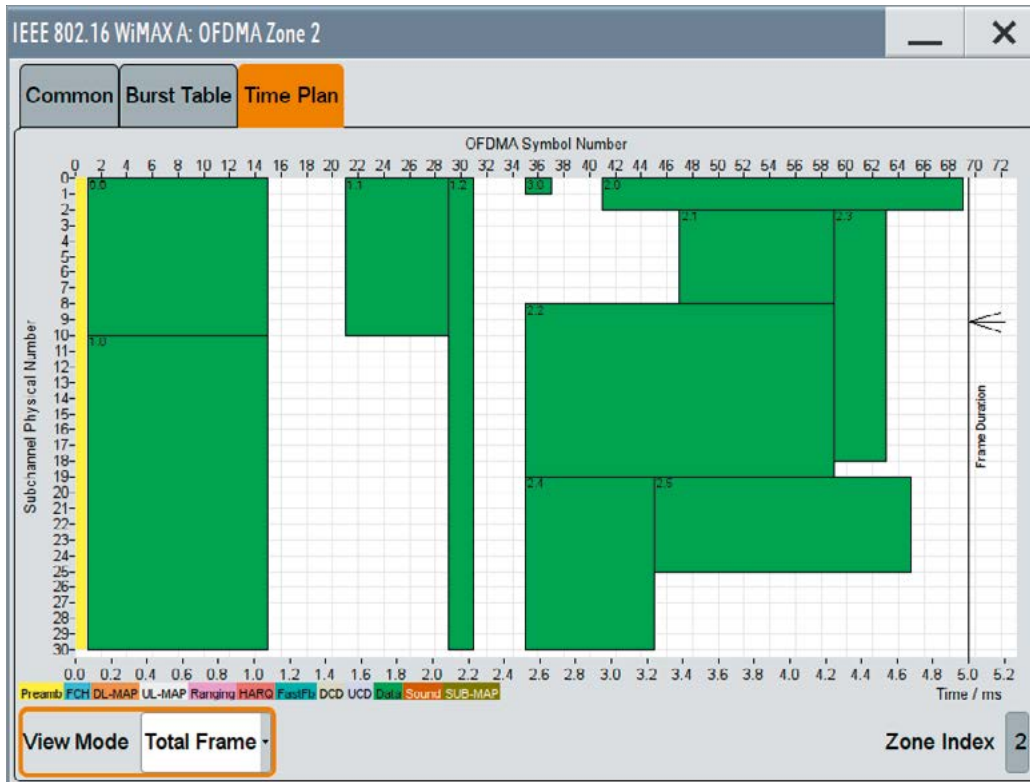

The signal generator graphically displays the configured WiMAX™ signal. The time plan shows the different WiMAX™ zones, segments and burst types.

WiMAX™ signal generation

The R&S®SMW/R&S®SMBV-K49 option allows convenient generation of OFDM and OFDMA signals in line with WiMAX™ IEEE 802.16 Rev. 2 (incl. WiBro) as well as WiMAX™ IEEE 802.16-2004 and IEEE 802.16e-2005 standards. It covers uplink and downlink as well as SISO and MIMO signal generation.

- ▮ Full CC and CTC channel coding
- ▮ FCH, DL-MAP and UL-MAP, either automatic or user-defined
- ▮ DCD, UCD, submaps
- ▮ HARQ, ranging and fast feedback bursts
- ▮ Optional generic MAC headers and CRC for each burst
- ▮ Predefined frames for receiver tests
- ▮ Subchannelization modes
- ▮ Space time coding for up to four antennas (matrix A, B, C, collaborative spatial multiplexing, CSTD)
- ▮ Multiple zones and segments

WiMAX™ signal generation options

IEEE 802.16	R&S®xxx-K49, R&S®xxx-K249
-------------	---------------------------

For supported instruments, see pages 117 to 119.

R&S®SMW/R&S®SMBV-K60 Bluetooth® V 4.0 and EDR

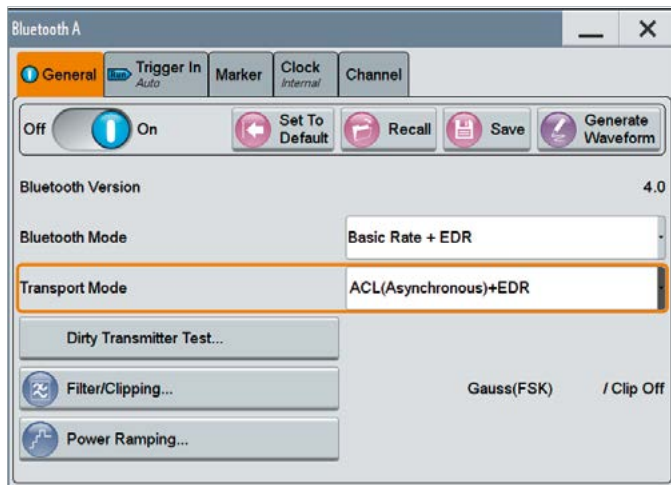

Main Bluetooth® signal configuration menu.

Bluetooth® V 4.0 and EDR signal generation

The R&S®SMW/R&S®SMBV-K60 option enables Rohde&Schwarz signal generators to generate Bluetooth® signals in line with version 4.0 including EDR and Bluetooth® low energy. The solution allows straightforward testing of Bluetooth® receivers and chipsets. Standard-compliant packets as well as packets with user-defined content – e.g. for intensive R&D tests – can easily be generated.

- Bluetooth® 4.0, basic rate + EDR
- Bluetooth® low energy
- ACL+EDR, SCO and eSCO+EDR transport modes
- Support of all packet types
- Up to 5238 frames (depending on signal generator)
- Intuitive packet editor
- Optional data whitening
- Support of dirty transmitter test
- Power ramp control including ramp time, rise and fall offset
- Setting of clipping, filter and modulation parameters

Bluetooth® signal generation options

Bluetooth® V 4.0 and EDR

R&S®xxx-K60, R&S®xxx-K260

For supported instruments, see pages 117 to 119.

R&S®SMBV-K52/-K53/-K57/-K58/ -K256/-K352/-K353/-K354 DVB-H/DVB-T, DAB/T-DMB, XM Radio, FM Stereo/RDS, Sirius, HD Radio™

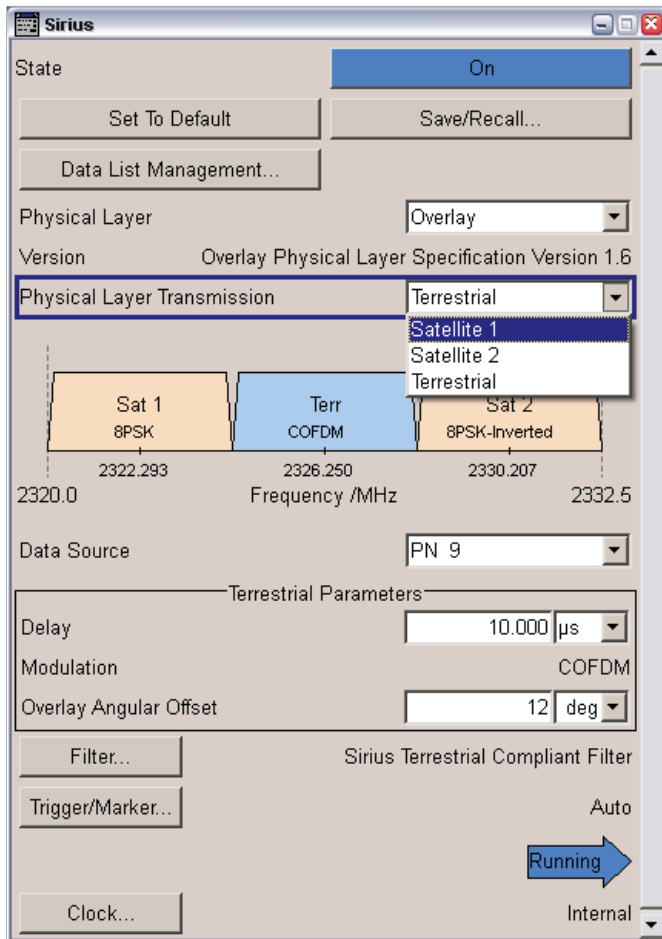

Sirius main menu.

Signal generation options for radio and video standards

- Testing mobile communications standards (such as WCDMA 3GPP FDD, TD-SCDMA, GSM/EDGE) and video standards with only one signal generator
- Realtime signal generation for the XM Radio and Sirius standards
- Solution tested and approved by Sirius for software testing and for manufacturing
- R&S®SMBV-K352 option for playback of all test vectors as supplied by iBiquity (iBiquity license required)
- Realtime generation of FM stereo signals; closed-loop testing with R&S®UPV or R&S®UPP audio analyzers possible

Signal generation options for radio/video standards

DVB-H/DVB-T	R&S®xxx-K52, R&S®xxx-K252
DAB/T-DMB	R&S®xxx-K53, R&S®xxx-K253
XM Radio	R&S®xxx-K256
FM stereo	R&S®xxx-K57
Sirius	R&S®xxx-K58
HD Radio™ test waveforms (iBiquity license required)	R&S®xxx-K352
DAB+ streams	R&S®xxx-K353
T-DMB/DAB streams	R&S®xxx-K354

For supported instruments, see pages 117 to 119.

HD Radio™ is a trademark of iBiquity Digital Corp.

R&S®SMW-K78 Radar Echo Generation

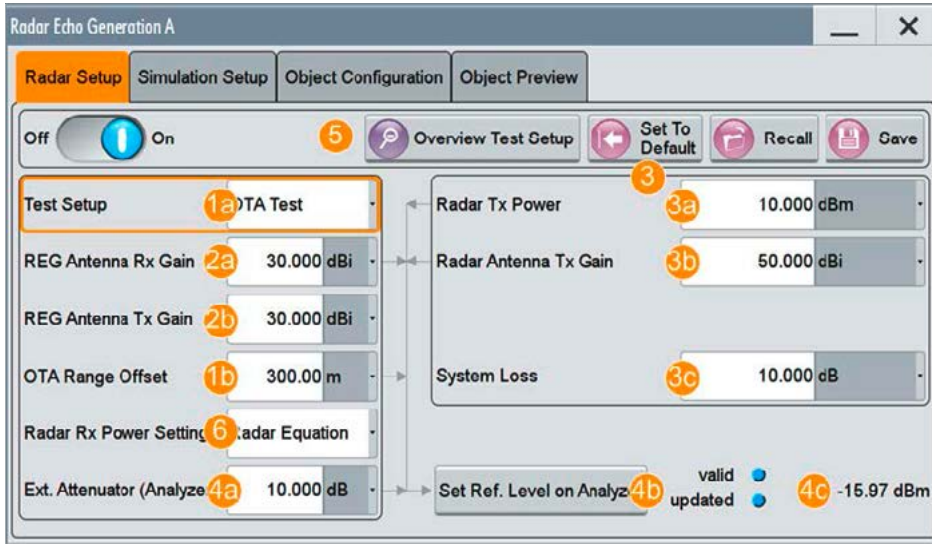

Radar setup.

Radar echo generation

The R&S®SMW-K78 radar echo generation option, in conjunction with the R&S®SMW200A vector signal generator and the R&S®FSW spectrum and signal analyzer, makes it possible to artificially generate radar signal echoes. These tests can be performed via a wired connection (conducted test) or via the air interface (over the air test), eliminating much of the need for time-consuming and costly field tests.

- ▀ Realtime capability for echo generation
- ▀ Simulation of up to 24 independent virtual static or moving objects
- ▀ 160 MHz RF bandwidth throughout the entire frequency range up to 40 GHz
- ▀ Possibility to add interferers and noise
- ▀ Internal generator solution, no need for external PC
- ▀ Intuitive and easy-to-use graphical user interface

R&S®SMW/R&S®SMBV-K89 NFC A/B/F Digital Standard

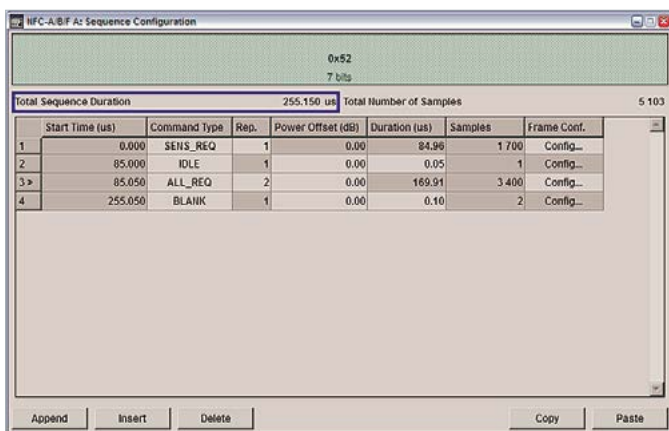

R&S®SMBV-K89 NFC sequence configuration panel.

NFC A/B/F signal generation

NFC is based on RFID technology and makes mobile phones suitable for numerous applications including, for example, contactless payment of tickets, downloading of information from a passive RFID tag, use as security ID, etc. Other than with RFID, some devices can also act as a reader (poller) and as a listener. There are three types of NFC, all working on the same frequency of 13.56 MHz but with different data rates and modulation characteristics: NFC-A, NFC-B and NFC-F. The R&S®SMW/SMBV-K89 supports all three.

- ▀ Standard-conforming signals for NFC A/B/F
- ▀ Sequence generator with all signals from standard
- ▀ Predefined sequences for polling applications
- ▀ Flexible definition for pulse forms
- ▀ Support for EMV type A and EMV type B

NFC signal generation options

NFC A/B/F digital standard	R&S®xxx-K89, R&S®xxx-K289
----------------------------	---------------------------

For supported instruments, see pages 117 to 119.

R&S®WinIQSIM2™ Simulation Software

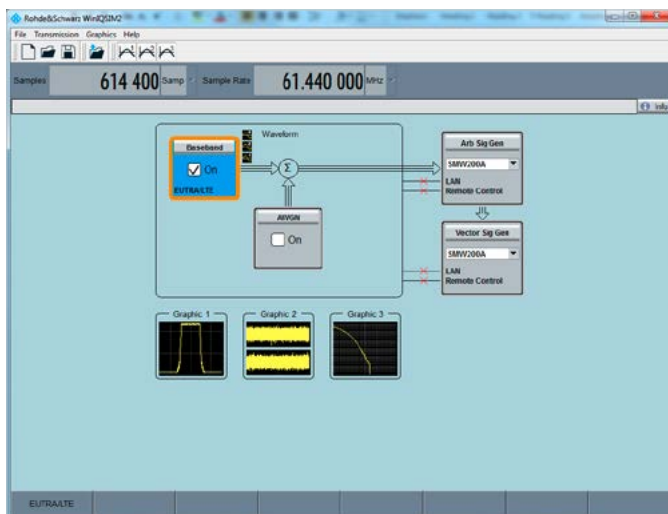

Ideal for the generation of digitally modulated signals

R&S®WinIQSIM2™ has been especially developed for easily generating digitally modulated signals. The graphical user interface allows intuitive operation, supported by context-sensitive help. By offering a convenient way to create any standard-conforming waveform with all the included standards and to generate multicarrier signals as well as multisegment waveforms, R&S®WinIQSIM2™ is suitable for a wide range of applications.

Signals generated with the aid of the R&S®WinIQSIM2™ software can be output by the R&S®AFQ100A and R&S®AFQ100B arbitrary waveform generators as well as by the R&S®SMW200A (R&S®SMW-B9/-B10 options), R&S®SMBV100A (R&S®SMBV-B10/-B51 options) and R&S®SGT100A (R&S®SGT-K510 option) vector signal generators. Some standards also work for the R&S®CMW500/R&S®CMW280 wideband radio communication tester, the R&S®CMW270 wireless connectivity tester, the R&S®CMA180 radio test set and the R&S®EX-IQ-Box digital signal interface module.

R&S®WinIQSIM2™ is delivered with these arbitrary waveform generators free of charge; it is also available on the Rohde&Schwarz website.

Large variety of digital standards

- ▮ EUTRA/LTE incl. Rel. 9, Rel. 10, Rel. 11 and Rel. 12
- ▮ GSM/EDGE
- ▮ EDGE Evolution, VAMOS
- ▮ 3GPP FDD with HSDPA, HSUPA and HSPA+ (HSPA evolution)
- ▮ CDMA2000® with 1xEV-DV
- ▮ 1xEV-DO Rev. A, Rev. B
- ▮ TD-SCDMA
- ▮ WLAN IEEE 802.11a/b/g/n/j/p/ac/ad
- ▮ IEEE 802.16 WiMAX™ supporting OFDM and OFDMA
- ▮ DVB-T/DVB-H
- ▮ DAB/T-DMB
- ▮ UWB (ECMA-368)
- ▮ GPS, Glonass, Galileo, BeiDou (Compass)
- ▮ Bluetooth®
- ▮ TETRA Release 2
- ▮ NFC A/B/F including EMV type A/B 1

Additional systems in R&S®WinIQSIM2™

- ▮ Custom digital waveforms allow the generation of user-definable digital signals while offering user-selectable modulation parameters
- ▮ Multicarrier CW signal generation
- ▮ Multicarrier generation allows several digital signals to be combined to form one waveform with different frequency offsets
- ▮ Multisegment waveform function makes it possible to have multiple different waveforms in an arbitrary waveform generator's memory and ensures minimum transition times; even seamless transitions are possible
- ▮ AWGN generation and addition to the signal
- ▮ Import function to import I/Q samples via a server connection into the R&S®WinIQSIM2™ signal generation chain where filtering can be performed and AWGN can be added

Extended graphics

- ▮ I and Q versus time
- ▮ Absolute value and phase versus time
- ▮ Vector diagram
- ▮ Constellation diagram
- ▮ FFT magnitude showing the spectrum of the signal
- ▮ Eye diagram of I and Q
- ▮ Complementary cumulative distribution function (CCDF)

Convenient connections

- ▮ Waveform transmission via GPIB, USB and LAN
- ▮ Waveforms can be locally stored on the PC; a USB memory stick can be used for data transmission
- ▮ Control of instruments via remote desktop connection via LAN

R&S®SMW/R&S®SMBV/R&S®SGT-K300 Pulse Sequencing R&S®SMW/R&S®SMBV/R&S®SGT-K301 Enhanced Pulse Sequencing

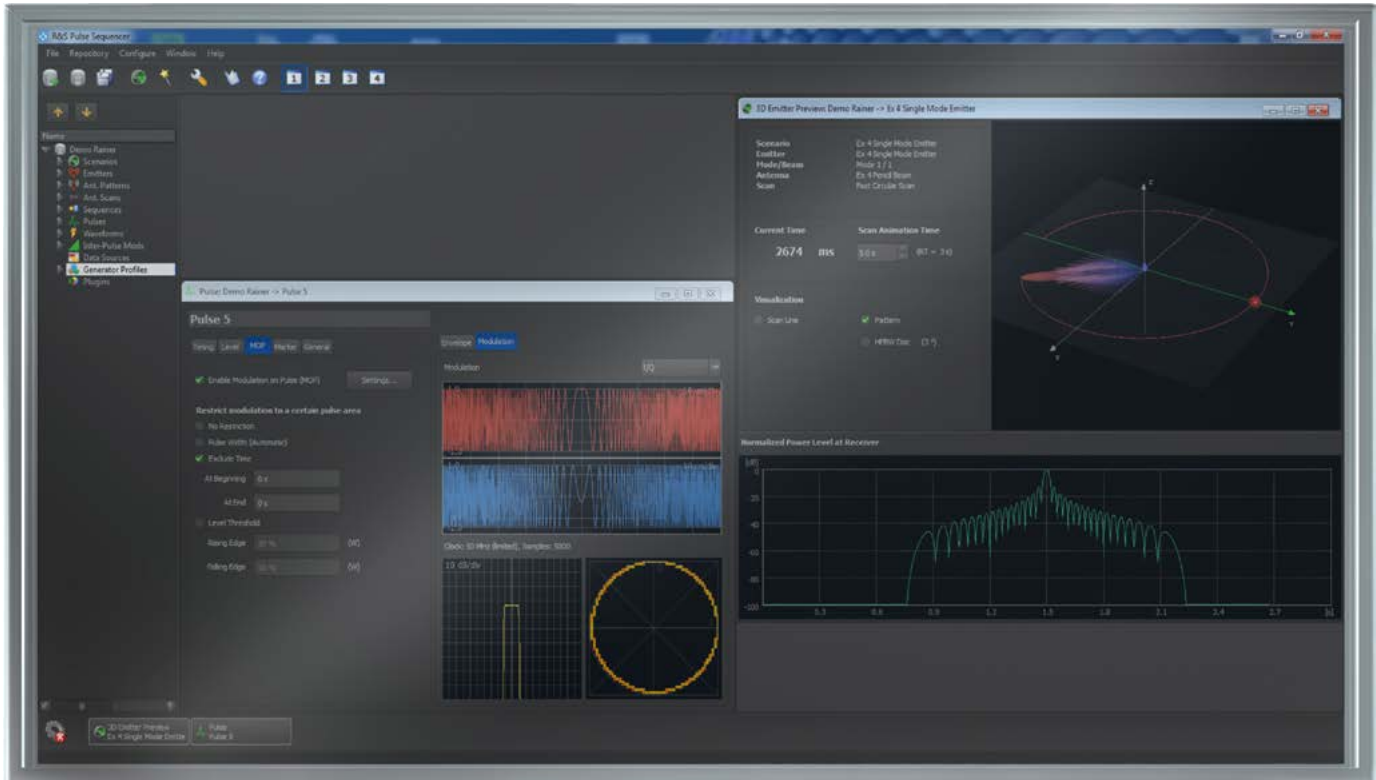

Generation of pulsed signals with basic modulation schemes

The R&S®Pulse Sequencer software together with the R&S®SMW/SMBV/SGT-K300 option makes it possible to generate pulsed signals with basic modulation schemes. Signals with simple pulses, pulse trains and repetition of pulses can be generated. In addition, pulse trains with different pulses and pulse breaks can be generated sequentially.

All major modulation formats for modulation on pulse are available with internal and external data sources. Typical pulse parameters like rise and fall time, ripple, droop, overshoot, etc. can be defined. Only deterministic interpulse modulation with frequency hops, staggered pulse repetition intervals and user-defined lists can be used. Instead of pulses, waveform files can be used in the sequencer with a repetition count.

- ▮ ARB-based signal generation
- ▮ Multisegment waveform sequencing
- ▮ Pulse shape definition with rise and fall time, droop, ripple, overshoot
- ▮ Modulation on pulse with all major formats such as chirps, barker codes, polyphase codes, PSKs, AM, FM

- ▮ Single pulse, pulse train generation with repetition count per pulse
- ▮ Interpulse modulation of amplitude, phase, frequency and other values from pulse to pulse
- ▮ Internal and external data sources for modulation
- ▮ Import of waveform files for sequencing with repetition count

Enhanced pulse sequencing

The R&S®Pulse Sequencer software together with the R&S®SMW/SMBV/SGT-K301 option enhances the capabilities of the R&S®SMW/SMBV/SGT-K300 option. The R&S®SMW/SMBV/SGT-K301 option allows users to utilize various control elements like loops, nested loops, overlays, fillers and subsequences for sequencing applications. The -K301 option can only be used together with the -K300 option.

- ▮ ARB-based signal generation and multisegment waveform sequencing
- ▮ Single pulse and pulse train generation with repetition count per pulse
- ▮ Powerful sequencing tool with loops, nested loops, subsequences and overlays
- ▮ Antenna diagram definition and antenna scan definition

- Antenna diagrams such as pencil beams, cosecant beams, Gaussian diagrams, user-defined antenna diagrams, phased array antenna diagrams
- Antenna scan types such as helical scans, circular scans, conical scans
- Emitter definition based on waveforms, antenna diagram, antenna scan, attitude information, EIRP and carrier frequency
- Receiver definition based on antenna diagram, antenna scan and attitude information
- Calculation of signal taking into account one-way free space propagation according to emitter and receiver location on the 2D map
- Import of R&S®WinIQSIM2™ or customer waveforms for interference generation

R&S®SMW-K308 Direction Finding

New

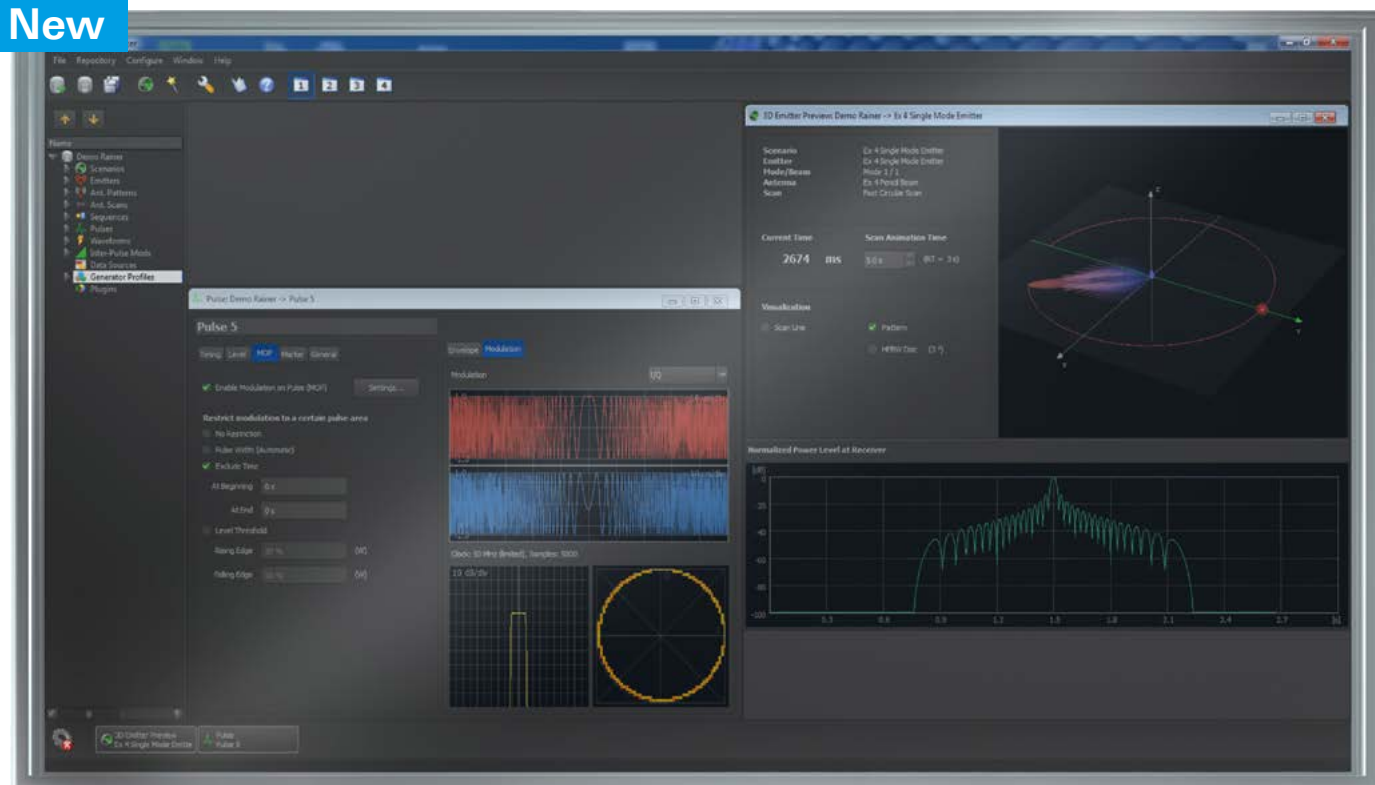

Configure test scenarios for multichannel receivers in direction finding applications

The R&S®Pulse Sequencer software together with R&S®SMW-K308 option enhances the capabilities of R&S®SMW-K300 and R&S®SMW-K301 options. The R&S®SMW-K308 option allows the user to configure test scenarios for multichannel receivers in direction finding applications. This option provides a receiver as a new simulation component. The receiver can store individual antenna patterns for each channel. Each antenna can be assigned a position, an antenna pattern and a pointing direction. The ensemble of all individual antennas is an antenna system.

On the 2D map, the antenna system itself can be assigned attitude and height information. In combination with an emitter placed on the 2D map, the R&S®Pulse Sequencer software automatically calculates the individual power lev-

els at the output of each individual receiver antenna taking into consideration free space propagation and the attitude information.

- Sequencing of arbitrary waveform files
- Support of loops, nested loops and repetitions
- Realtime change of amplitude, offset frequencies, relative phase and off times for waveform files instead of many individual segments
- Realtime signal generation of CW, unmodulated rectangular CW pulses and pulses with linear frequency modulation or Barker codes with the R&S®Pulse Sequencer software together with the R&S®SMW-K300 and R&S®SMW-K301 options
- Ultralong playtimes
- Can be used manually via sequencing lists and waveform segments or via the R&S®Pulse Sequencer Software and R&S®SMW-K300 and R&S®SMW-K301 options

R&S®SMW/R&S®SMBV/R&S®SGT-K350 DFS Signal Generation

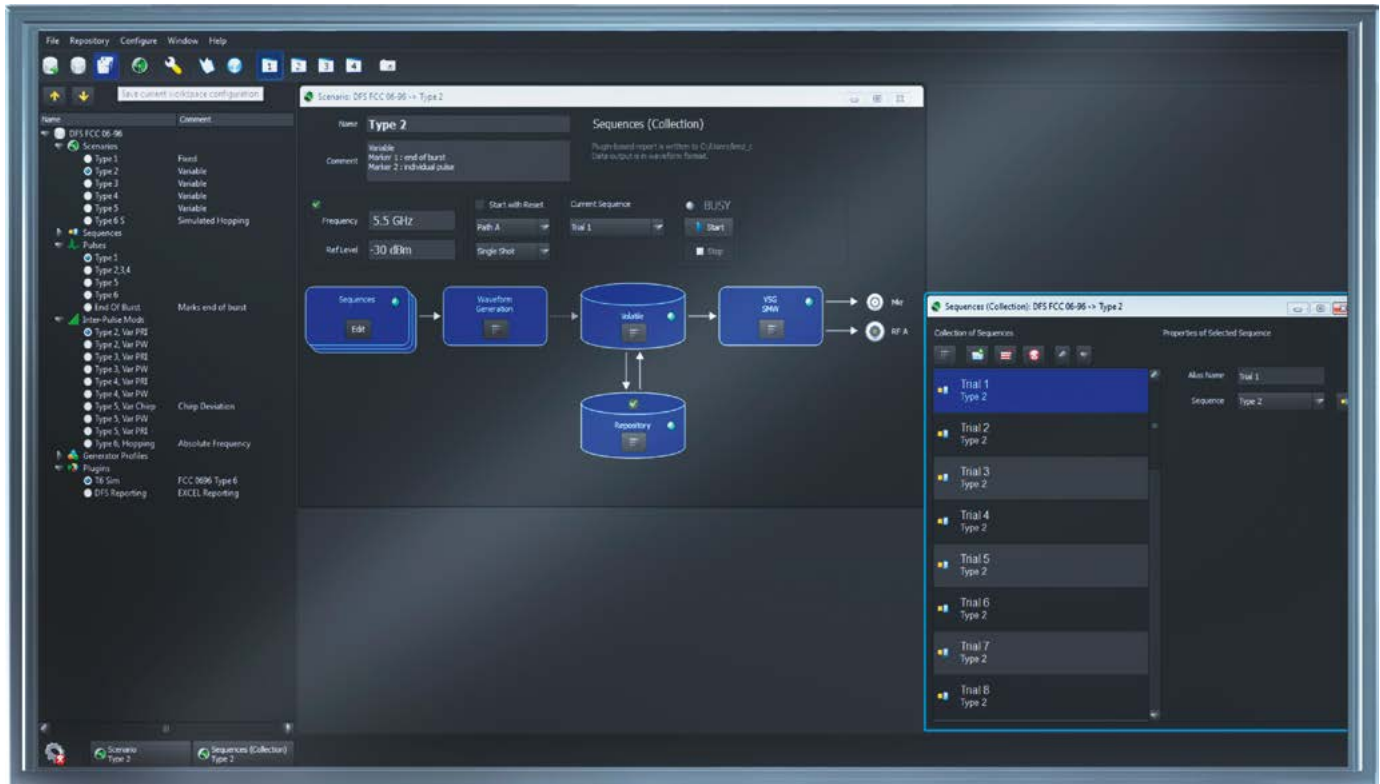

Generation of radar signals

The R&S®Pulse Sequencer (DFS) software and its respective software option for the Rohde&Schwarz signal generators have been especially developed for generation of radar signals as specified by the FCC, ETSI or the Telec T403 standards.

- Supported standards for Europe, US and Japan
 - United States: FCC 06-96, FCC 13-22A1)
 - Europe: ETSI EN 301893 V1.7.1 (2012-06), ETSI EN 302502 V1.2.1 (2008-02)
 - Japan: TELECOM-T403 (Japan)

- Australia/New Zealand: AS/NZS 4268:2008 (radio equipment and systems, short range devices, limits and methods of measurement) (this document refers under section A9.4 (b) to the DFS test procedures published by the U.S. Federal Communications Commission (FCC))

R&S®SMW-K501 Extended Sequencing

New

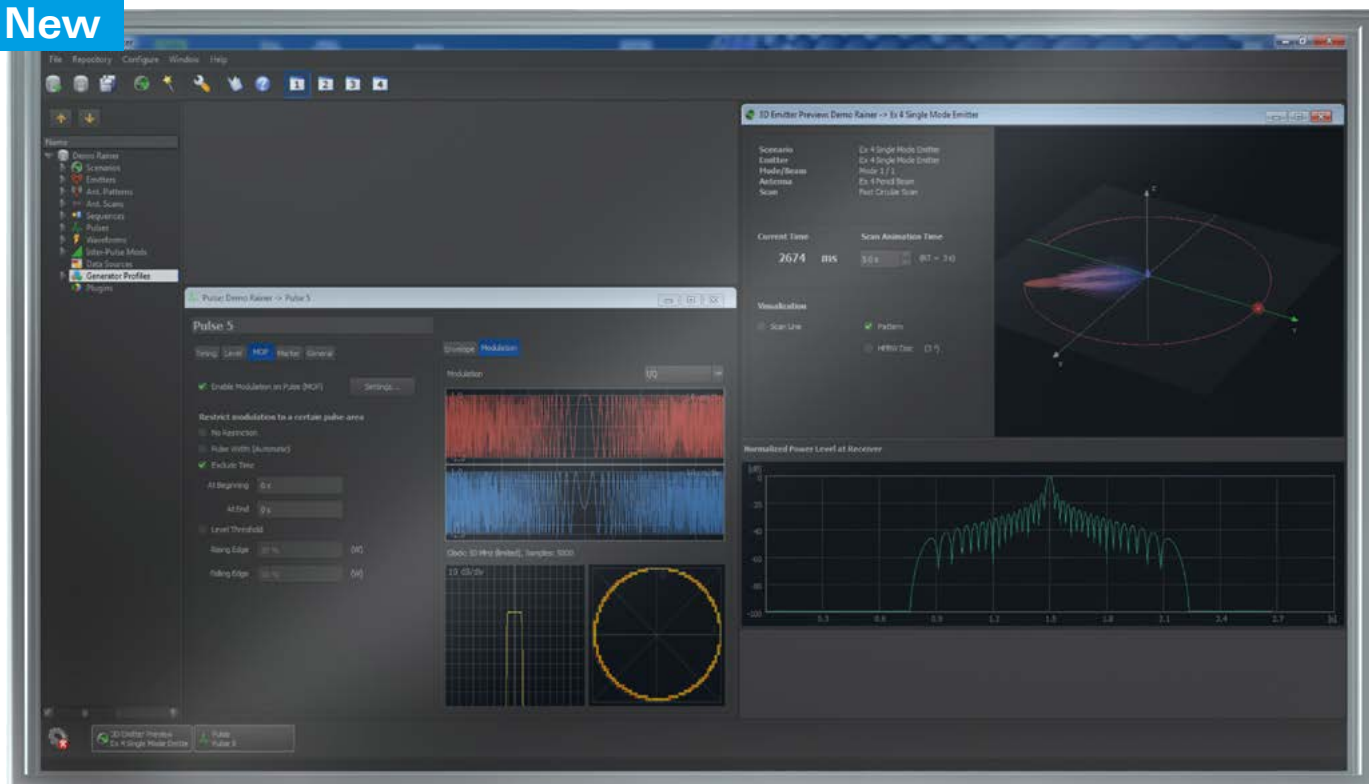

4

Reduces memory requirements to a minimum and increases playtime enormously

The R&S®SMW-K501 extended sequencing option can be used manually via sequencing lists and waveform segments or via the R&S®Pulse Sequencer software and its R&S®SMW-K300 and R&S®SMW-K301 options. In both cases, memory requirements are reduced to a minimum and playtime is increased enormously.

In manual user mode, the R&S®SMW-K501 option allows sequencing of waveforms. It supports loops, nested loops and repetitions, enabling ultralong playtimes.

If used with the R&S®Pulse Sequencer software and its options, the software calculates all required signals and required sequencing lists and transfers them to the signal generator.

Continuous wave signals, unmodulated rectangular CW pulses and pulses with linear frequency modulation or Barker codes are calculated in realtime inside the R&S®SMW200A.

Changes in amplitude, offset frequency, offset phase and off time are always applied in realtime as defined by the sequencing list.

- Direction finding with a single emitter
- Up to 10 individual antenna elements
- Predefined antenna patterns or user-defined antenna patterns
- Consideration of attitude information of receiver and emitter
- Consideration of co- and cross-polarization
- ARB-based signal generation

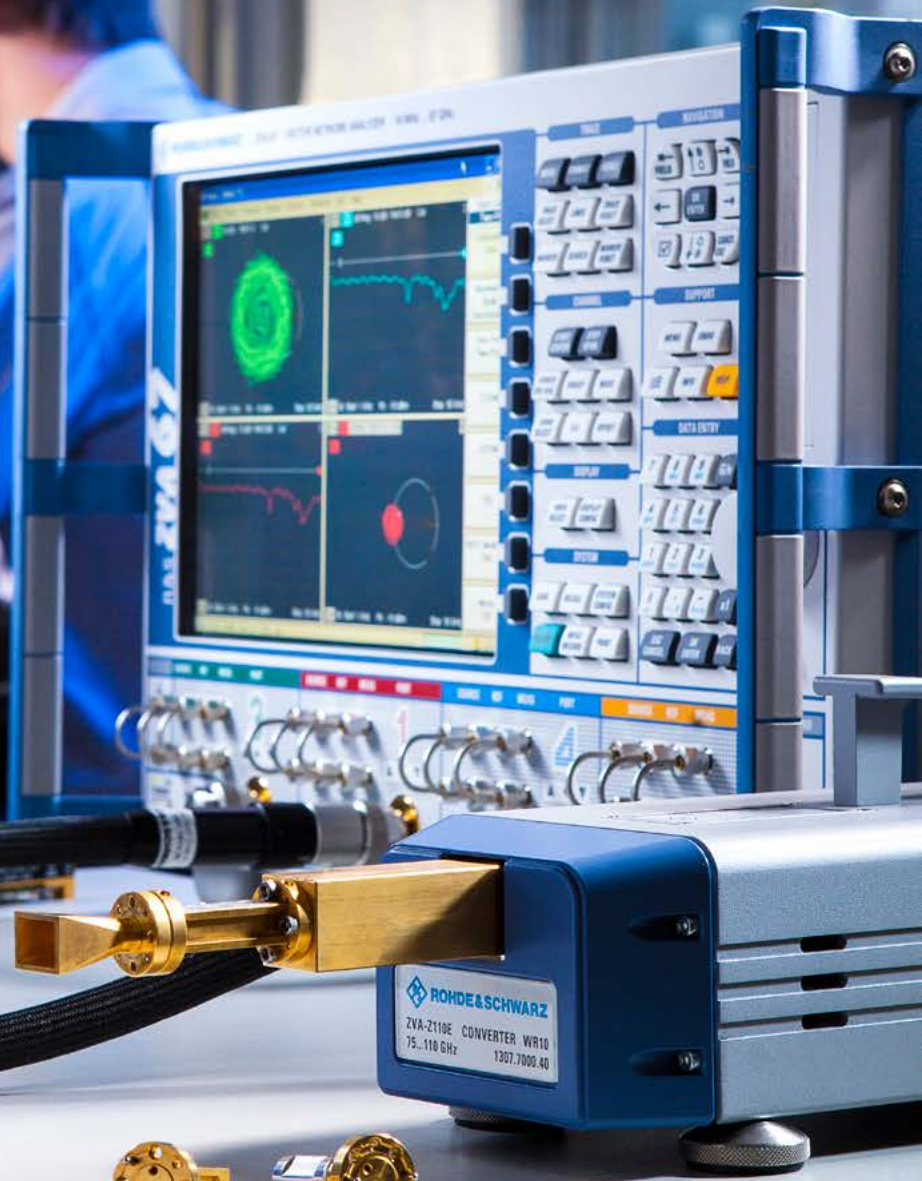
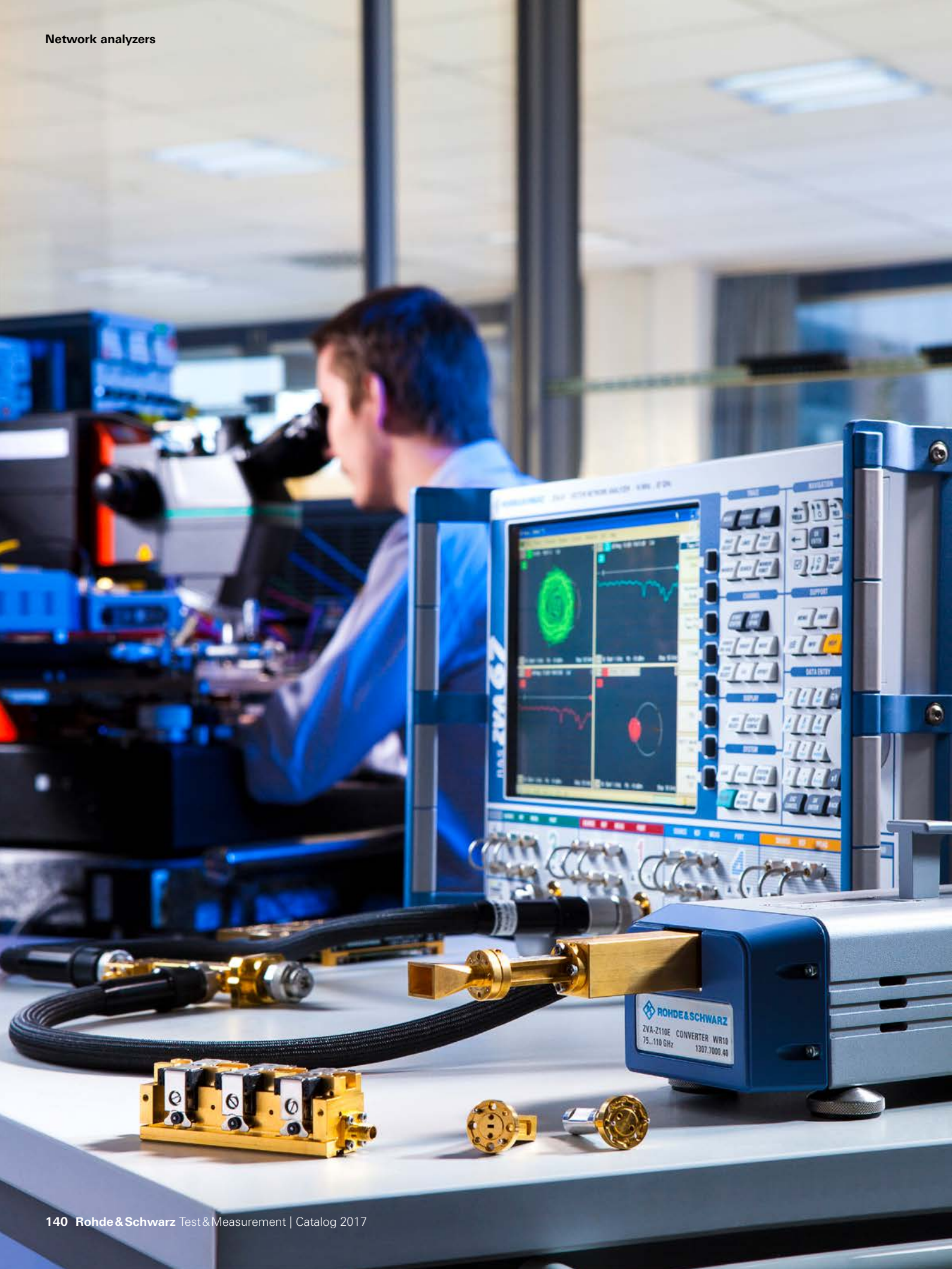

Chapter 5

Network analyzers

Vector network analysis (VNA) is one of the most essential RF and microwave measurement approaches. Rohde & Schwarz offers a wide range of versatile, high-performance network analyzers up to 500 GHz and multiport solutions up to 48 ports. A Rohde & Schwarz vector network analyzer is the

perfect tool for analyzing passive and active components such as filters, amplifiers, mixers and multiport modules. The network analyzers feature excellent RF characteristics and a wide variety of analysis functions that help the user evaluate important parameters at a glance.

Type	Designation	Frequency range	Description	Page
Vector network analyzers				
R&S®ZVA	Vector network analyzer	300 kHz to 8 GHz; 10 MHz to 24/40/50/67/110 GHz	High-end VNA with up to four sources for sophisticated measurements up to 110 GHz	142
R&S®ZVT	Multiport vector network analyzer	300 kHz to 8 GHz 10 MHz to 20 GHz	Network analysis with up to eight test ports	143
R&S®ZNB4/8 R&S®ZNB20 R&S®ZNB40	Vector network analyzer	9 kHz to 4.5/8.5 GHz 100 kHz to 20 GHz 10 MHz to 40 GHz	Leading in speed, dynamic range and ease of operation	144
R&S®ZNB8 R&S®ZNB20	Multiport vector network analyzers	9 kHz to 8.5 GHz 100 kHz to 20 GHz	Network analysis with up to 24 test ports	145
R&S®ZNC	Vector network analyzer	9 kHz to 3 GHz	Solid performance on a future-oriented platform	146
R&S®ZND	Vector network analyzer	100 kHz to 4.5/8.5 GHz	Basic, solid-performance network analysis	147
R&S®ZVL	Vector network analyzer	9 kHz to 3/6/13.6 GHz	Cost-efficient compact class	148
R&S®ZVH	Cable and antenna analyzer	100 kHz to 3.6/8 GHz	The benchmark for efficiency in the field	149
System				
R&S®TS6710	TRM radar test solution		All-in-one solution for efficient RF characterization	150
Converters				
R&S®ZCxxx	Millimeterwave converters	110 GHz to 500 GHz	Millimeterwave measurements – network analysis from 110 GHz to 500 GHz, depending on model	152
R&S®ZVA-Zxxx	Millimeterwave converters	50 GHz to 500 GHz	Millimeterwave measurements in the V, E, W, F, D, G, J and Y bands – network analysis from 50 GHz to 500 GHz, depending on converter model	153
RPG ZRX	High dynamic receivers for VNAs	110 GHz to 500 GHz	High-performance VNA frequency extension up to 500 GHz, depending on model	154
Accessories for network analysis				
R&S®ZNrun	Automated test software		PC-based server platform for automated VNA tests	155
R&S®ZVAX-TRM	Extension unit	10 MHz to 67 GHz	Advanced measurements on active devices	156
R&S®ZN-Z84/-Z85	Switch matrix	10 MHz to 8.5/20 GHz	Two or four VNA ports, up to 48/12 test ports	156
R&S®ZV-WRxx	Waveguide calibration kits	50 GHz up to 500 GHz	Manual calibration kits (coaxial)	157
R&S®ZCAN	Calibration kit	0 Hz to 3 GHz	Manual calibration kit (coaxial)	156
R&S®ZV-Z2xx	Calibration kits	0 Hz to 67 GHz	Manual calibration of VNAs (precision)	156
R&S®ZV-Z170/ -Z135/-Z129	Calibration kits	0 Hz to 9 GHz/15 GHz/40 GHz	Manual calibration of vector network analyzers (economy)	156
R&S®ZN-Z15x/ ZN-Z51/ZV-Z5x	Automatic calibration units	100 kHz to 50 GHz	Automatic calibration of vector network analyzers (2 up to 24 ports)	157
R&S®ZV-Z3xx/-Z4xx	Verification kits	45 MHz to 50 GHz	Verification of VNA specifications after system error corrections	157

R&S®ZVA Vector Network Analyzer

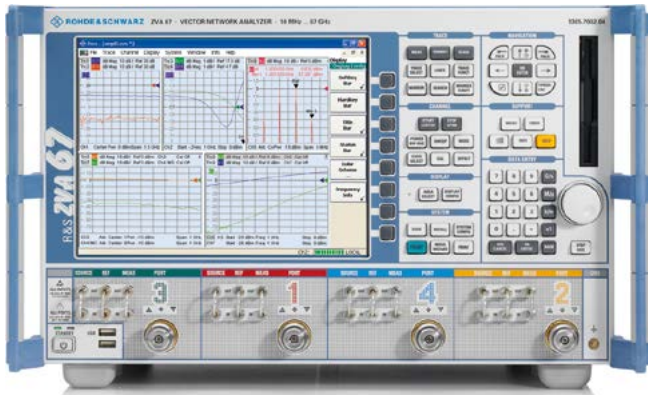

High performance up to 110 GHz with up to four test ports

The R&S®ZVA series is an ideal choice for demanding measurements on active and passive components and modules which require high performance and wide versatility. All instruments support scalar and vector measurements on mixers and converters (linear and nonlinear) and noise measurements on amplifiers as well as pulsed measurements for aerospace and defense applications. The frequency range of the high-frequency models can be extended to 500 GHz.

- First vector network analyzer
 - with four internal sources up to 67 GHz for fast two-tone measurements on amplifiers and mixers
 - up to 67 GHz that generates phase-coherent signals
 - with IF bandwidths up to 30 MHz for pulsed measurements on amplifiers and converters
- Phase and group delay measurements on converters, or T/R-modules with and without LO access
- Harmonic, compression, intermodulation and hot S_{22} measurements on amplifiers and mixers
- New method for noise figure measurement without noise source
- Point-in-pulse, average pulse and pulse profile measurements
- Two internal pulse generators
- Internal pulse modulators and combiner by means of the R&S®ZVAX-TRM
- Embedding/deembedding for impedance matching using virtual networks
- True differential measurements to characterize nonlinear effects of balanced devices
- Versatile calibration techniques: TOSM, TRL/LRL, TOM, TRM, TNA, UOSM and AutoCal
- Operating system: Windows 7

Specifications in brief

Number of test ports	2 or 4
Number of internal sources	up to 4 (depending on the model)
Frequency range	
R&S®ZVA8	300 kHz to 8 GHz
R&S®ZVA24/40/50/67/110	10 MHz to 24/40/50/67(70)/110 GHz
Measurement time per test point	< 3.5 μ s
Measurement time, 201 test points	4.7 ms
Data transfer time, 201 test points	
Via IEC/IEEE bus	< 2.9 ms
Via VX11 over 100 Mbit/s LAN	< 1.3 ms
Via RSIB over 100 Mbit/s LAN	< 0.7 ms
Switching time	
Between channels	< 1 ms
Between instrument setups	< 10 ms
Max. dynamic range at 10 Hz measurement bandwidth	
Between test ports	
R&S®ZVA8	130 dB, typ. > 140 dB
R&S®ZVA24	130 dB, typ. > 135 dB
R&S®ZVA40	130 dB, typ. > 140 dB
R&S®ZVA50	130 dB, typ. > 140 dB
R&S®ZVA67	125 dB, typ. > 135 dB
R&S®ZVA110	typ. 130 dB
With direct receiver access	
R&S®ZVA8/24/40/50	typ. > 150 dB
R&S®ZVA67	typ. > 145 dB
Output power at test port	
R&S®ZVA8	> 13 dBm, typ. 15 dBm
R&S®ZVA24	> 13 dBm, typ. 18 dBm
R&S®ZVA40	> 13 dBm, typ. 18 dBm
R&S®ZVA50	> 13 dBm, typ. 18 dBm
R&S®ZVA67	> 13 dBm, typ. 18 dBm
R&S®ZVA110	typ. 8 dBm
Power sweep range	> 40 dB, typ. 50 dB
IF bandwidths	1 Hz to 30 MHz (> 1 MHz with options)
Channels, diagrams, traces	> 100
Test points per trace	1 to 60001

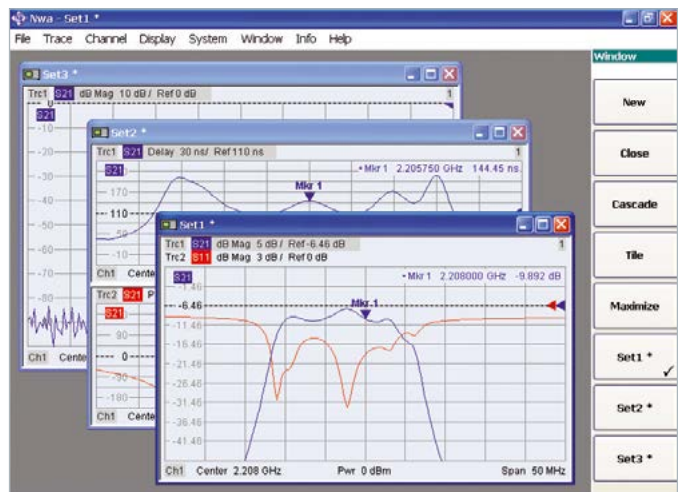

Switching between setups at the click of a mouse.

R&S®ZVT Multiport Vector Network Analyzer



Network analysis with up to eight test ports from 300 kHz to 20 GHz

The R&S®ZVT8 contains up to four internal generators and up to 8 ports with 16 receivers. The R&S®ZVT20 includes up to three internal generators and up to 6 ports with 12 receivers. This unique concept with one generator per two test ports makes the R&S®ZVT ideal for intermodulation measurements, even on mixers, (true) differential balanced measurements, multireceiver measurements with antennas or high throughput and efficiency in production.

Hardware options such as direct generator/receiver access for the individual ports enable versatile test set configuration. Based on this concept, the R&S®ZVT multiport vector network analyzers provide solutions for even the most demanding measurement tasks.

The R&S®ZVT provides all functions of the R&S®ZVA, plus features based on multichannel and multireceiver capability

- ▮ Arbitrary frequency conversion measurements
- ▮ Multiport measurements, avoiding any time loss due to matrix control
- ▮ Flexible configuration of test ports for balanced and single-ended measurements
- ▮ True differential measurements, coherence mode
- ▮ Multiple-signal measurements, e.g. intermodulation measurements on mixers or double-converting DUTs
- ▮ Enhanced performance by parallel measurements on several DUTs
- ▮ Multichannel receiver with simultaneous sampling of channels, e.g. for phase measurements on antenna arrays
- ▮ Automatic calibration units
- ▮ Point-in-pulse and pulse profile measurements with up to 16 receivers
- ▮ Embedding/deembedding

5

R&S®ZVT with direct generator/receiver access

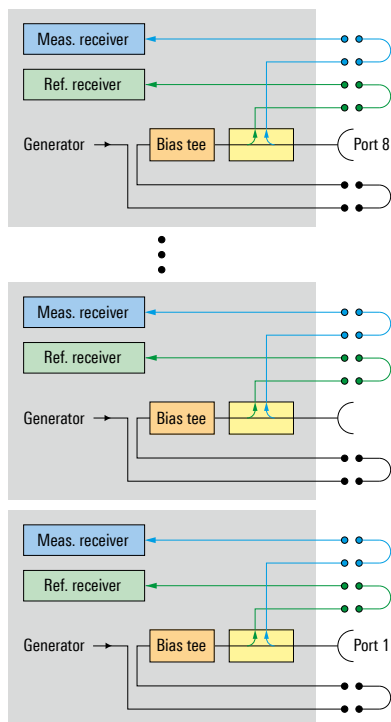

Specifications in brief

	R&S®ZVT8	R&S®ZVT20
Number of test ports ¹⁾	2 to 8	2 to 6
Frequency range	300 kHz to 8 GHz	10 MHz to 20 GHz
Measurement time (201 points)	5 ms	
Data transfer time (201 points)		
Via IEC/IEEE bus	< 2.9 ms	
Via VX11 (100 Mbit/s LAN)	< 1.3 ms	
Via RSIB (100 Mbit/s LAN)	< 0.7 ms	
Switching time		
Between channels	< 1 ms	
Between instrument setups of up to 2001 points	< 10 ms	
Electronic power sweep range	> 50 dB	> 40 dB
Dynamic range (at test ports)	120 dB	
Output level	+13 dBm	+10 dBm
Sensitivity at 10 Hz measurement bandwidth	-110 dBm	-105 dBm
IF bandwidths	1 Hz to 1 MHz ²⁾	
Number of channels and traces	> 100 ³⁾	
Number of points per trace	60001	

¹⁾ Depending on installed options.

²⁾ With options up to 30 MHz.

³⁾ Limited by available RAM capacity.

R&S®ZNB Vector Network Analyzer



Leading in speed, dynamic range and ease of operation

With frequency ranges of 9 kHz to 4.5 GHz, 9 kHz to 8.5 GHz, 100 kHz to 20 GHz and 100 kHz to 40 GHz, the network analyzers are targeted at applications in the mobile communications, electronic goods and aerospace and defense sectors, plus they can be used in high-speed printed board design. The R&S®ZNB is the right choice when it comes to developing, producing and servicing RF components such as amplifiers, mixers, filters, connectors and cables. The R&S®ZNB vector network analyzers feature a wide dynamic range of up to 140 dB (at 10 Hz IF bandwidth), low trace noise of less than 0.004 dB RMS (at 10 kHz IF bandwidth) and high output power of up to +13 dBm, which can be adjusted electronically in a range of more than 95 dB.

The R&S®ZNB analyzers combine high measurement accuracy with exceptional speed – better than 5 μs per point. They feature excellent temperature and long-term stability, which ensures reliable measurements over several days without having to recalibrate the units.

The short-depth, compact two-port and four-port analyzers leave plenty of space on the workbench for the measurement application. They feature low operating noise thanks to low power consumption and a sophisticated cooling concept. The low power consumption also reduces operating costs and protects the environment.

- ▮ Short sweep times, e.g. 4 ms for 401 points
- ▮ High temperature stability of typ. 0.01 dB/°C
- ▮ Wide power sweep range of 98 dB
- ▮ Wide range of IF bandwidths from 1 Hz to 10 MHz
- ▮ Manual and automatic calibration
- ▮ Four-port model with two independent generators
- ▮ Expansion to up to 48 ports using switch matrices
- ▮ Large, high-resolution 12.1" screen
- ▮ Flat and clear menu structures for efficient operation
- ▮ Optimal display configuration for each measurement task
- ▮ Testfixture compensation
- ▮ Embedding/deembedding
- ▮ Fast data output

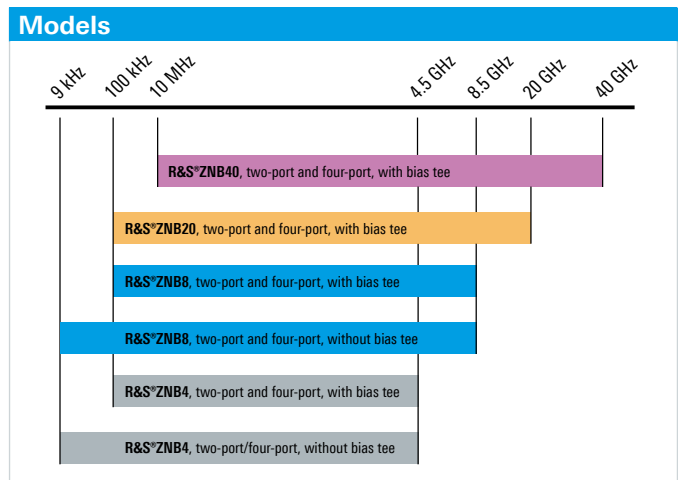

Typical effective system data (best in available frequency range)			
	R&S®ZNB4/8	R&S®ZNB20	R&S®ZNB40
Directivity	46 dB	46 dB	42 dB
Source match	41 dB	43 dB	38 dB
Load match	45 dB	44 dB	40 dB
Reflection tracking	0.02 dB	0.05 dB	0.05 dB
Transmission tracking	0.018 dB	0.025 dB	0.02 dB

Measurement speed	
Sweep 401 points, normalized, 800 MHz to 1 GHz, 1 MHz IFBW	4 ms
Data transfer 201 points, via Rohde & Schwarz RSIB protocol and 1 Gbit/s LAN	typ. 1.0 ms
Switching between channels Up to 2001 points	< 5 ms
Switching between instrument setups Up to 2001 points	< 5 ms

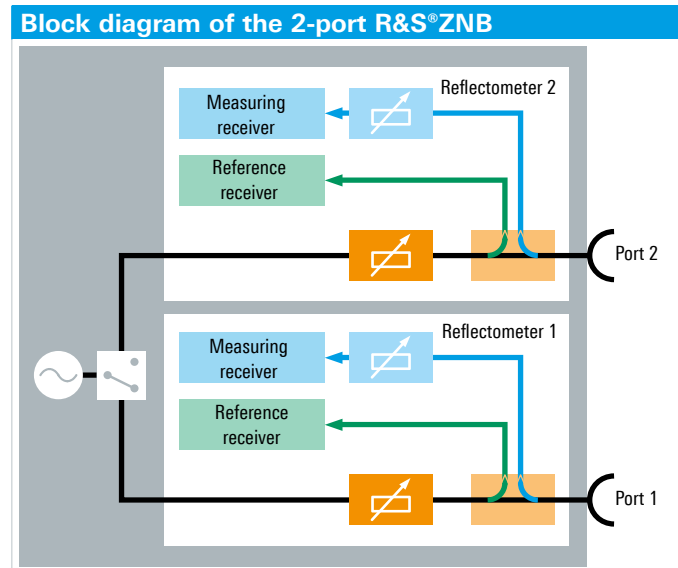

R&S®ZNB^T Vector Network Analyzer

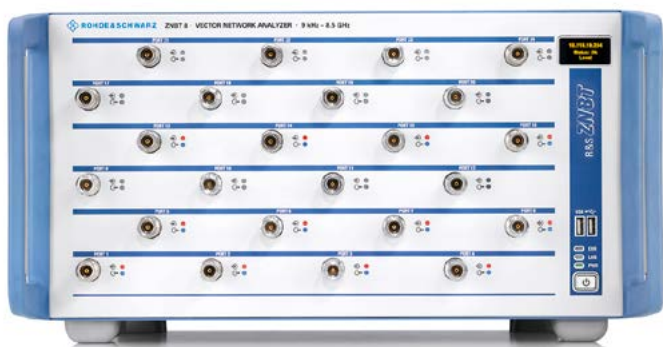

Network analysis with up to 24 test ports

The R&S®ZNB^T8/20 is the first multiport vector network analyzer offering up to 24 integrated test ports. The instrument can simultaneously test multiple DUTs or measure one DUT with up to 24 ports.

The R&S®ZNB^T8/20 offers short measurement times even in scenarios with a large number of ports. Other highlights include a wide dynamic range, high output power levels and inputs featuring high power-handling capacity. The instrument operates in a frequency range from 9 kHz to 8.5 GHz for the R&S®ZNB^T8 and 100 kHz to 20 GHz for the R&S®ZNB^T20. These features make the R&S®ZNB^T8/20 ideal for applications in the mobile radio, wireless communications and electronic goods industries. The instrument is primarily used in the development and production of active and passive multiport components, such as GPS, WLAN, Bluetooth® and frontend modules for multiband mobile phones. Its outstanding performance also allows efficient analysis of base station filters and other highly selective components.

The R&S®ZNB^T8/20 outperforms switch matrix based multiport systems in values like dynamic range, output power or speed. Its high integration density makes it a very compact solution for analyzing components with up to 24 ports – occupying the same rack space as an R&S®ZNB. The convenient user interface makes it easy to handle even very complex multiport measurements. The R&S®ZNB^T8/20 supports various remote control options and is easy to integrate into automated test systems.

- Four-port R&S®ZNB^T8 base unit (upgradeable to 8, 12, 16, 20 or 24 ports)
- Eight-port R&S®ZNB^T20 base unit (upgradeable to 12 or 16 ports)
- Frequency range from 9 kHz to 8.5 GHz (R&S®ZNB^T8) and from 100 kHz to 20 GHz (R&S®ZNB^T20)
- Wide dynamic range of up to typ. 140 dB
- Short sweep times (e.g. 6 ms for 201 points)

- Wide power sweep range up to 98 dB (with extended power range option)
- High power-handling capacity
- IF bandwidths from 1 Hz to 10 MHz
- High temperature stability of 0.01 dB/°K
- More than 100 traces and channels
- Simple configuration of multiport measurements
- Manual and automatic calibration methods optimized for multiport applications
- Compatible with all vector network analyzers from the R&S®ZVx and R&S®ZNx families
- Testfixture compensation
- Embedding/deembedding
- Fast data output
- Parallel measurement

Block diagram of an R&S®ZNB^T8

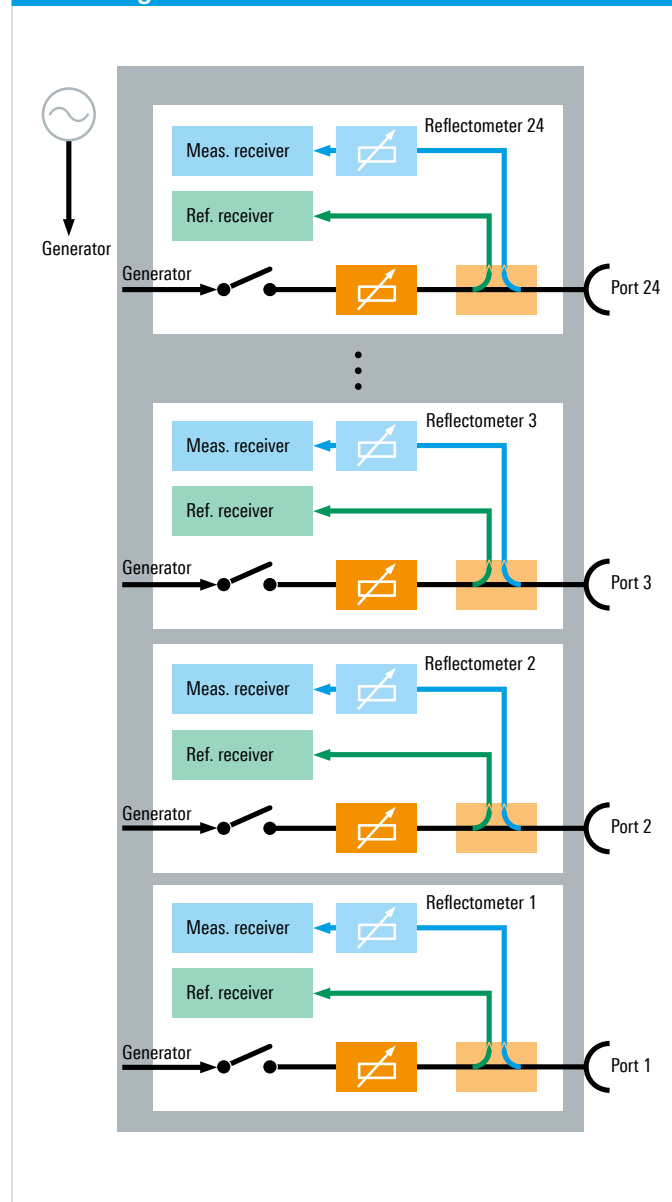

R&S®ZNC Vector Network Analyzer



Solid performance on a future-oriented platform

High reliability, outstanding ease of operation, maximum precision and a wide dynamic range – this is what customers expect from a network analyzer. Using state-of-the-art technology and a user-friendly operating concept, Rohde & Schwarz has implemented all these features in its R&S®ZNC vector network analyzer.

Operating in a range from 9 kHz to 3 GHz, the network analyzer is targeted at applications in the mobile communications and electronic goods industries. The R&S®ZNC is the right choice when it comes to developing, producing and servicing RF components such as filters and cables.

The R&S®ZNC has a bidirectional test set for measuring all four S-parameters of active and passive DUTs. Plus, it offers calibration methods suitable for a wide range of T&M environments in development and production. The analyzer features excellent temperature and long-term stability, which ensures reliable measurements over several days without having to recalibrate the unit.

This short-depth, compact two-port analyzer leaves plenty of space on the workbench for the measurement application. It features low operating noise thanks to low power consumption and a sophisticated cooling concept. The low power consumption also reduces operating costs and protects the environment.

- ▮ Frequency range from 9 kHz to 3 GHz
- ▮ Dynamic range of up to 130 dB
- ▮ Short sweep times of 8 ms for 201 points
- ▮ High temperature stability of typ. 0.01 dB/°C
- ▮ Wide power sweep range from typ. -50 dBm to +13 dBm
- ▮ IF bandwidths from 1 Hz to 300 kHz
- ▮ Manual and automatic calibration
- ▮ Low trace noise of 0.004 dB RMS at 10 kHz IF bandwidth
- ▮ Large, high-resolution 12.1" screen
- ▮ Touchscreen user interface
- ▮ Embedding/deembedding
- ▮ Testfixture compensation

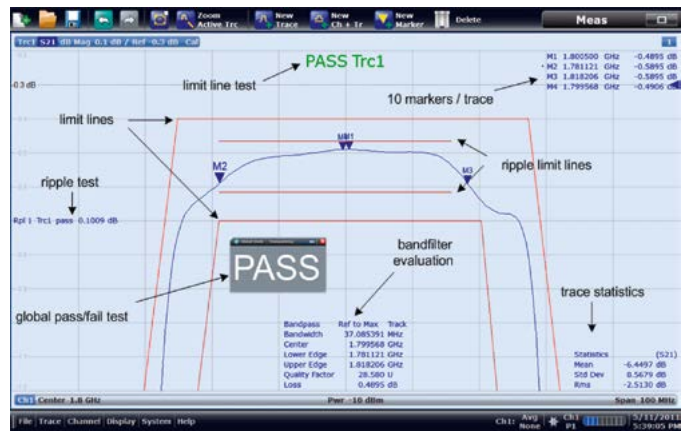

Wide range of analysis functions, e.g. for filter adjustment.

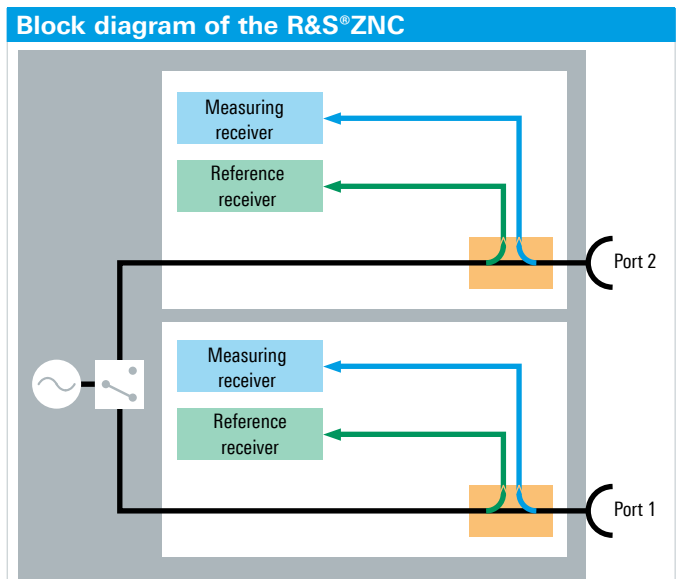

Typical effective system data		
	9 kHz to 100 kHz	100 kHz to 3 GHz
Directivity	46 dB	45 dB
Source match	41 dB	40 dB
Load match	44 dB	45 dB
Reflection tracking	0.02 dB	0.02 dB
Transmission tracking	0.028 dB	0.018 dB

Measurement speed	
Measurement time 201 points, 200 MHz span, 300 kHz measurement bandwidth with 900 MHz center frequency	< 8 ms
Measurement time per point 300 kHz measurement bandwidth, CW mode	< 4 μs
Time for measurement and data transfer 201 points, 800 MHz start frequency, 1 GHz stop frequency, 300 kHz measurement bandwidth	8 ms (typ.)
Switching between channels Up to 2001 points	< 5 ms
Switching between instrument setups Up to 2001 points	< 5 ms

R&S®ZND Vector Network Analyzer



Basic, solid-performance network analysis

The R&S®ZND is a basic network analyzer that provides unidirectional measurements up to 4.5 GHz. Options are available to perform bidirectional measurements and to extend the frequency range to 8.5 GHz.

The R&S®ZND supplements the R&S®ZNB family of network analyzers. The unidirectional R&S®ZND base model can be used to measure the S-parameters S_{11} and S_{21} .

The R&S®ZND can easily be upgraded to provide bidirectional measurements and to extend the frequency range up to 8.5 GHz. Users can tailor the instrument to their specific needs in RF component production and development.

The easy-to-operate R&S®ZND is also ideal for training purposes. The analyzer's large touchscreen makes it possible to display multiple results simultaneously.

The R&S®ZND has the same remote control command set as the analyzers from the R&S®ZNB family. Users can switch between instruments without having to modify control programs.

- Two-port network analyzer for unidirectional measurements from 100 kHz to 4.5 GHz
- Frequency range can be extended to 8.5 GHz
- Test set can be enhanced for bidirectional measurements
- Touchscreen operation
- Dynamic range up to 120 dB
- Power sweep range up to 48 dB
- Bandwidths from 1 Hz to 300 kHz
- More than 100 traces and channels
- Compatible with all Rohde&Schwarz network analyzers
- Embedding/deembedding

5

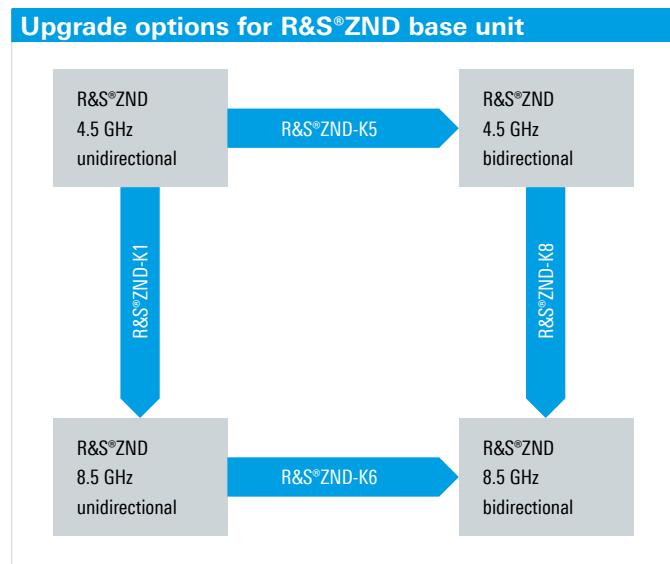
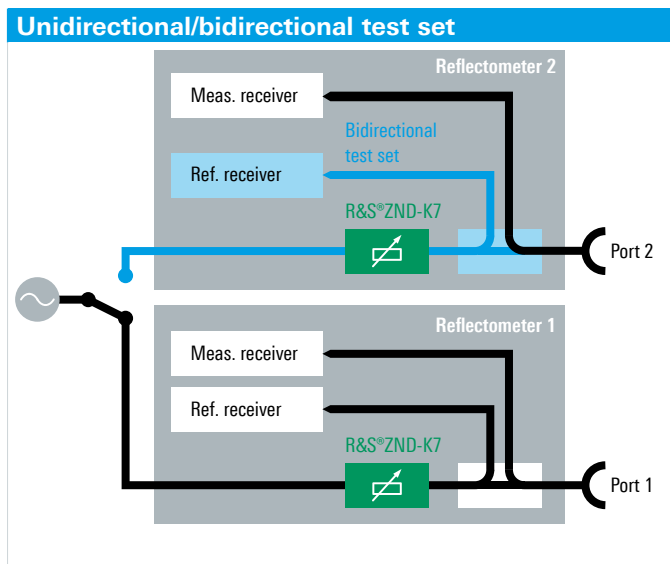

R&S®ZVL Vector Network Analyzer



The cost-efficient compact class in network analysis

- ▀ Network analyzer, spectrum analyzer and power meter in a single box
- ▀ Digital communications standards
- ▀ Bidirectional test set for displaying all four S-parameters
- ▀ R&S®ZVL3-75: 75 Ω vector network analyzer for TV and CATV measurements with exchangeable N connector
- ▀ Multitrace display for displaying all relevant parameters
- ▀ Distance-to-fault measurement for detecting cable faults
- ▀ Time domain analysis
- ▀ Operation with mouse or hardkeys/softkeys; convenient user interface with wizards and context menus
- ▀ Undo/redo softkey for reversing up to six preceding operating steps
- ▀ USB connector for R&S®NRPxxS/SN and R&S®NRP-Zxx power sensors for precise power measurements
- ▀ DVI-D connector for external monitor
- ▀ Internal battery and 12 V DC operation
- ▀ Small, compact, lightweight and portable (< 7 kg)

Specifications in brief

Frequency range	
R&S®ZVL3/6/13, specified	9 kHz to 3 GHz/6 GHz/13.6 GHz
R&S®ZVL3/6/13, unspecified	5 kHz to 3 GHz/6 GHz/15 GHz
Network analysis	
Measurement time (201 measurement points, full two-port-calibrated)	< 75 ms
Data transfer (201 measurement points)	1.5 ms (via RSIB over 100 Mbit/s LAN)
Dynamic range at 10 Hz measurement bandwidth	> 115 dB, typ. 123 dB
Output power	> 0 dBm, typ. +10 dBm
Measurement bandwidths	10 Hz to 500 kHz in 1/2/5 steps
Weight (without battery)	< 7 kg (15.43 lb)
Channels, diagrams and traces	> 100
Measurement points per trace	2 to 4001
Operating system	Windows XP Embedded
Spectrum analysis	
Resolution bandwidths	
Standard	300 Hz to 10 MHz in 1/3 steps, 20 MHz at zero span
With R&S®FSL-B7 option	(1 Hz) 10 Hz to 10 MHz in 1/3 steps
Video bandwidths	10 Hz to 10 MHz
I/O demodulation bandwidth	20 MHz
SSB phase noise at 500 MHz	-103 dBc (1 Hz) (typ.), 10 kHz carrier offset
Displayed average noise level	
Without preamplifier at 1 GHz	< -140 dBm (1 Hz)
With preamplifier at 1 GHz	< -156 dBm (1 Hz), typ. -163 dBm
TOI	> +5 dBm, typ. +12 dBm
Detectors	max./min. peak, auto peak, RMS, quasi-peak, average, sample
Level measurement uncertainty (95% confidence level)	< 0.5 dB

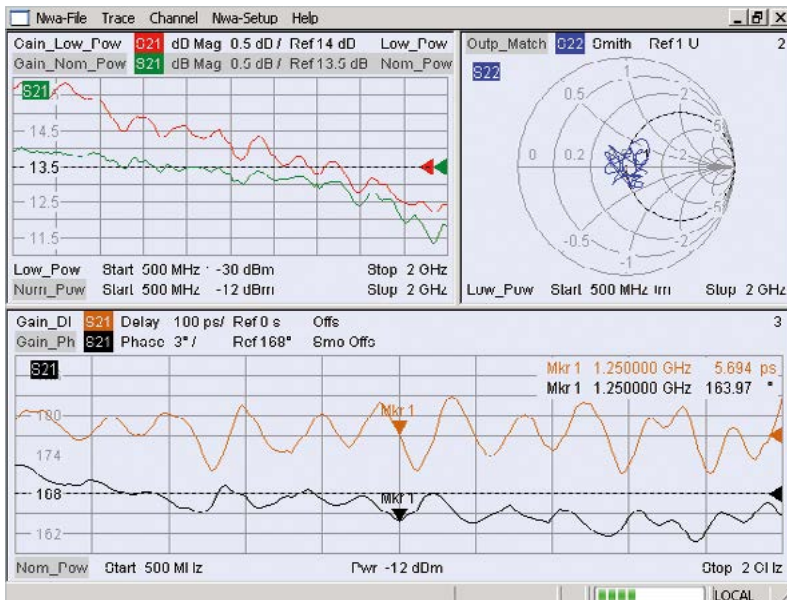

Multitrace display for faster DUT characterization.

R&S®ZVH Cable and Antenna Analyzer



The benchmark for efficiency in the field

The R&S®ZVH cable and antenna analyzer is rugged, handy and designed for use in the field. Its low weight and simple operation make it indispensable for anyone who needs an efficient measuring instrument outdoors for the installation and maintenance of antenna systems.

- ▮ Frequency range from 100 kHz to 3.6 GHz or 8 GHz
- ▮ typ. 100 dB dynamic range for filter and antenna isolation measurements
- ▮ Built-in DC voltage supply (bias) for active components such as amplifiers
- ▮ Power meter option for external power sensors and built-in channel power meter option
- ▮ Saving of measurement results on SD card or USB stick
- ▮ Easy operation with user-configurable automatic tests (wizard), "one-click" customizable report
- ▮ Easy-to-replace Li-ion battery for up to 4.5 h of operation
- ▮ Rugged, splash-proof housing for rough work in the field
- ▮ Easy handling due to low weight (3 kg with battery) and easy-to-reach function keys
- ▮ Spectrum analyzer option
- ▮ Vector network analyzer option

5

Specifications in brief

		R&S®ZVH4	R&S®ZVH8
Frequency range		100 kHz to 3.6 GHz	100 kHz to 8 GHz
Standard measurement functions		reflection, distance-to-fault, one-port cable loss	
Output power (port 1, port 2)		0 dBm to -40 dBm (nom.), in 1 dB steps	
Maximum permissible spurious signal level (RF attenuation = 30 dB)		+17 dBm (nom.)	
Number of points		101, 201, 401, 601, 631, 801, 1001, 1201	
Distance-to-fault (DTF) measurement			
Display modes		return loss (dB), VSWR	
Resolution in meters		(1.58 × velocity factor/span)	
Horizontal display range		0 m to 1500 m	
Reflection measurement			
Directivity	100 kHz to 3 GHz (nominal)	> 43 dB (nom.)	> 43 dB (nom.)
	3 GHz to 3.6 GHz	> 37 dB (nom.)	> 37 dB (nom.)
	3.6 GHz to 6 GHz	–	> 37 dB (nom.)
	6 GHz to 8 GHz	–	> 30 dB (nom.)
Display modes		S_{11} , return loss (dB), VSWR, one-port cable loss	
	vector network analysis (R&S®ZVH-K42)	S_{11} , S_{22} , magnitude, phase, magnitude + phase, Smith chart, VSWR, reflection coefficient, mp, one-port cable loss, electrical length, group delay	
	vector voltmeter (R&S®ZVH-K45)	magnitude + phase, Smith chart	
Transmission measurement (with R&S®ZVH-K39 or R&S®ZVH-K42)			
Dynamic range (S_{21})	100 kHz to 300 kHz	> 50 dB (nominal)	
	300 kHz to 2.5 GHz	> 80 dB, typ. 100 dB	
	2.5 GHz to 3.6 GHz	> 70 dB, typ. 90 dB	
	3.6 GHz to 6 GHz	–	> 70 dB, typ. 90 dB
	6 GHz to 8 GHz	–	> 50 dB (nominal)
Display modes	transmission measurement (R&S®ZVH-K39)	S_{21} , magnitude in dB (loss, gain)	
	vector network analysis (R&S®ZVH-K42)	S_{21} , S_{12} , magnitude, phase, magnitude + phase, electrical length, group delay, Smith Chart	
	vector voltmeter (R&S®ZVH-K45)	magnitude + phase	
DC voltage supply (DC bias, port 1 and port 2)			
Voltage range	internal voltage supply	+12 V to +32 V, in 1 V steps	
Maximum output power/current		4 W (battery), 10 W (AC supply)/500 mA	
Maximum voltage/current	external voltage supply	50 V/600 mA	

R&S®TS6710 TRM Radar Test Solution

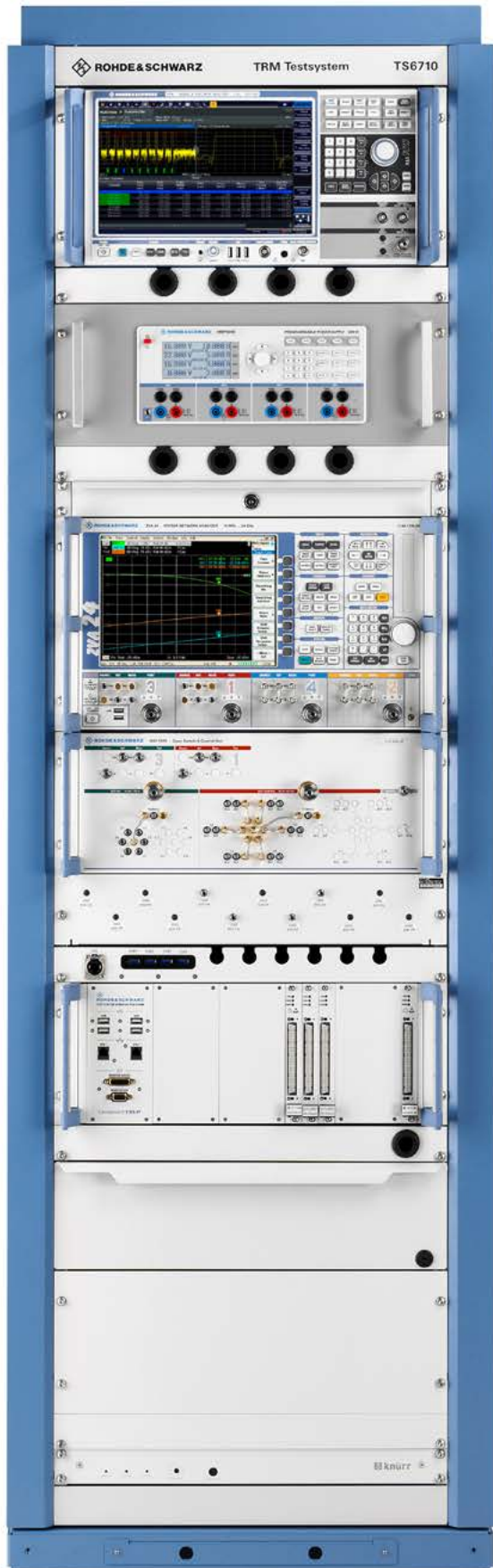

All-in-one solution for efficient RF characterization

The R&S®TS6710 TRM radar test system allows manufacturers of state-of-the-art AESA radar equipment to perform fast, automatic RF measurements on transmit-receive modules (TRM) in development and production. The R&S®TRM-LIB test case library covers all common tests for a TR module and its components. The module control can be implemented locally by an open C# interface.

State-of-the-art AESA radars contain several thousand TRMs each and each TRM must be tested separately during development and production. To handle the large number of different measurements and measurement values involved, testing requires a high degree of automation.

This test automation is carried out by the R&S®TRM-LIB test software together with the R&S®ZVA network analyzer and the R&S®ZVAX-TRM signal conditioning units or R&S®OSP-TRM. Because the R&S®ZVA can cover all test cases, the use of the R&S®FSW spectrum analyzer within the setup is optional for enhanced performance.

Typical system configuration

R&S®TRM-LIB	Automation software with open interface to DUT
R&S®ZVA	Network analyzer
R&S®ZVAX-TRM or R&S®OSP-TRM	Signal conditioning unit
R&S®FSW (optional)	Spectrum analyzer
R&S®TSVP (optional)	DUT control interface and system controller
Power supplies and accessories (optional)	

Combined with device specific components for DUT power supply and control the all-in-one solution R&S®TS6710 offers extremely short test times for ensuring the high throughput required in production. In addition, it allows measurements to be flexibly configured for development. These capabilities help the manufacturer develop modules, reduce production cycles and make production more efficient.

Since the test details can be adapted to the customer requirements and because of the wide parameter ranges, the R&S®TS6710 supports the measurement of TRMs for diverse applications, e.g. due to its wide frequency range for future broadband radar equipment.

- ▮ Very short test times
- ▮ Optional multiplexing of 12 DUTs per test system
- ▮ Test sequencer for user-configurable test runs
- ▮ Open C# interface for control of customer DUT
- ▮ Turnkey solution from a single source
- ▮ Based on Rohde&Schwarz standard components
 - R&S®ZVA high-end network analyzer for RF measurements
 - R&S®ZVAX-TRM or R&S®OSP-TRM for RF signal conditioning and DUT multiplexing
 - R&S®CompactTSVP for fast communications with the TRM

Hardware configuration with R&S®ZVA/R&S®ZVAX-TRM.



R&S®ZCxxx Millimeterwave Converters



Network analysis up to 500 GHz

The converters' wide dynamic range is particularly beneficial for measurements on high-blocking filters and for on-wafer amplifier measurements, for example. It also speeds up measurements in general, as it enables the use of wider bandwidths while maintaining the same excellent performance.

- Wide frequency range
 - 110 GHz to 170 GHz (R&S®ZC170)
 - 140 GHz to 220 GHz (R&S®ZC220)
 - 220 GHz to 330 GHz (R&S®ZC330)
 - 325 GHz to 500 GHz (R&S®ZC500)
- For use with an R&S®ZVA24, R&S®ZVA40, R&S®ZVA50, R&S®ZVA67 or R&S®ZVT20 network analyzer
- Wide dynamic range
 - > 100 dB, typ. 110 dB (R&S®ZC170)
 - > 100 dB, typ. 110 dB (R&S®ZC220)
 - > 100 dB, typ. 115 dB (R&S®ZC330)
 - > 80 dB, typ. 110 dB (R&S®ZC500)
- Variable output power
- Output power variation by RF input power control
- Automatic parameter setting
- Easy handling
- Highly stable measurements

Specifications in brief				
	R&S®ZC170	R&S®ZC220	R&S®ZC330	R&S®ZC500
Waveguide designation				
IEEE 1785	WM-1651	WM-1295	WM-864	WM-570
Connector type				
Anti-cocking flange	precision waveguide flange compatible with UG-387/U-M			
Frequency range	110 GHz to 170 GHz	140 GHz to 220 GHz	220 GHz to 330 GHz	325 GHz to 500 GHz
Output power at +7 dBm input power from the R&S®ZVA/R&S®ZVT20	> +5 dBm, typ. +7 dBm	> -3 dBm, typ. +1 dBm	> -11 dBm, typ. -8 dBm	> -19 dBm, typ. -15 dBm
Output power attenuation	manually adjustable from 0 dB to 40 dB			
Dynamic range	>100 dB, typ. 110 dB	>100 dB, typ. 110 dB	> 100 dB, typ. 115 dB	>80 dB, typ. 110 dB

R&S®ZVA-Zxx Millimeterwave Converters



Network analysis up to 500 GHz

Featuring a wide dynamic range, these Rohde & Schwarz converters offer high operating convenience and allow fast measurements. Two-port measurements can be performed using a four-port network analyzer and two converters; no external generator is required.

When using a two-port network analyzer, an external generator is needed to supply the LO signals. The wide dynamic range is particularly important for high-blocking filters, for example, but it also speeds up measurements in general, as it enables the use of wider bandwidths while maintaining the same excellent performance.

- ▮ Millimeterwave measurements in the V, E, W, F, G, J and Y bands
- ▮ Network analysis from 50 GHz to 500 GHz depending on converter model
- ▮ Variable output power
- ▮ Electronic power control (R&S®ZVA-Z110E)
- ▮ Automatic parameter setting
- ▮ Multiport and true differential measurements
- ▮ Pulsed measurements
- ▮ Calibration
- ▮ Applications
 - On-wafer measurements
 - True differential measurements

5

Specifications in brief				
	R&S®ZVA-Z75	R&S®ZVA-Z90	R&S®ZVA-Z110	R&S®ZVA-Z110E
Waveguide designation				
Electronic Industries Alliance (EIA)	WR15	WR12	WR10	WR10
Connector type				
Anti-cocking flange	precision waveguide flange compatible with UG387/U-M			
Frequency range	50 GHz to 75 GHz	60 GHz to 90 GHz	75 GHz to 110 GHz	75 GHz to 110 GHz
Output power	at +7 dBm input power from the R&S®ZVA/R&S®ZVT			
	> 0 dBm, typ. +4 dBm	> 6 dBm, typ. +10 dBm	> 7 dBm, typ. +10 dBm	> -3 dBm, typ. 0 dBm
Output power attenuation	manually variable attenuator	adjustable by reduction of RF input power	manually adjustable from 0 dB to 40 dB; adjustable by reduction of RF input power from 0 dB to 70 dB	electronic power control
Range	0 dB to 40 dB	0 dB to 70 dB	0 dB to 70 dB	0 dB to 25 dB
Dynamic range	> 90 dB, typ. 110 dB	> 100 dB, typ. 115 dB	> 100 dB, typ. 110 dB	> 95 dB, typ. 110 dB
Specifications for R&S®ZVA-Z140, R&S®ZVA-Z325, R&S®ZVA-Z500				
	R&S®ZVA-Z140	R&S®ZVA-Z325	R&S®ZVA-Z500	
Waveguide designation				
Electronic Industries Alliance (EIA)	WR08	WR03	WR02	
Connector type				
Anti-cocking flange	precision waveguide flange compatible with UG387/U-M			
Frequency range	90 GHz to 140 GHz	220 GHz to 325 GHz	325 GHz to 500 GHz	
Output power	at +7 dBm input power from the R&S®ZVA/R&S®ZVT			
	> -1 dBm (n. trc.) ¹⁾ , typ. +3 dBm	> -22 dBm (n. trc.) ¹⁾ , typ. -20 dBm	<ul style="list-style-type: none"> ▮ for f < 480 GHz: > -25 dBm (n. trc.)¹⁾, typ. -22 dBm ▮ for f > 480 GHz: > -30 dBm (n. trc.)¹⁾, typ. -27 dBm 	
Output power attenuation	manually variable attenuator			
Range	0 dB to 40 dB	0 dB to 40 dB	0 dB to 40 dB	
Dynamic range	> 85 dB, typ. 105 dB	> 80 dB, typ. 100 dB	> 70 dB, typ. 90 dB	

¹⁾ n. trc.: not traceable.

RPG ZRX High Dynamic Receivers for VNAs



High-performance VNA frequency extension up to 500 GHz

The RPG ¹⁾ vector network analyzer extenders (VNA extenders) extend the frequency of vector network analyzers up to 500 GHz.

The RPG ZRXxxx high dynamic receivers offer superior broadband conversion performance. Antenna measurements are a typical application. A typical setup includes an RPG ZRXxxx on the receiving side and an R&S®ZCxxx millimeterwave converter on the transmitting side. The available models cover a frequency range up to 500 GHz. Passive cooling is a standard feature with all these modules. They are compatible with the R&S®ZCxxx millimeterwave converters. The R&S®ZCPS power supply is also available for the RPG ZRX receivers.

- Fullband operation
- Compatible with R&S®ZCxxx converters
- Applications
 - Vector network analysis
 - Signal and spectrum analysis
- LO input power +7 dBm
- IF frequency range 1 MHz to 2.5 GHz

¹⁾ RPG – A Rohde&Schwarz company.

Overview of high dynamic receivers					
	RPG ZRX170	RPG ZRX220	RPG ZRX260	RPG ZRX330	RPG ZRX500
Frequency range	110 GHz to 170 GHz	140 GHz to 220 GHz	170 GHz to 260 GHz	220 GHz to 330 GHz	325 GHz to 500 GHz
RF port	WR6.5 (UG387/UM)	WR5.1 (UG385/U)	WR4.3 (UG387/UM)	WR3.4 (UG387/UM)	WR2.2 (UG387/UM)
Receiver response	typ. +5 dB	typ. +5 dB	typ. +5 dB	typ. +5 dB	+15 dB
System NF	typ. 15 dB	typ. 15 dB	typ. 15 dB	typ. 15 dB	typ. 25 dB
Dynamic	typ. 130 dB	typ. 135 dB	typ. 120 dB	typ. 135 dB	typ. 115 dB
VSWR LO	2:1	1.6:1	2:1	2:1	2:1
VSWR IF	1.5:1	1.5:1	2.3:1	2.3:1	2.3:1
LO frequency range	6.875 GHz to 10.625 GHz	11.66 GHz to 18.34 GHz	14.16 GHz to 21.67 GHz	9.16 GHz to 13.54 GHz	13.88 GHz to 20.83 GHz
LO multiplication factor	12	12	12	24	36

R&S®ZRun Automated Test Software

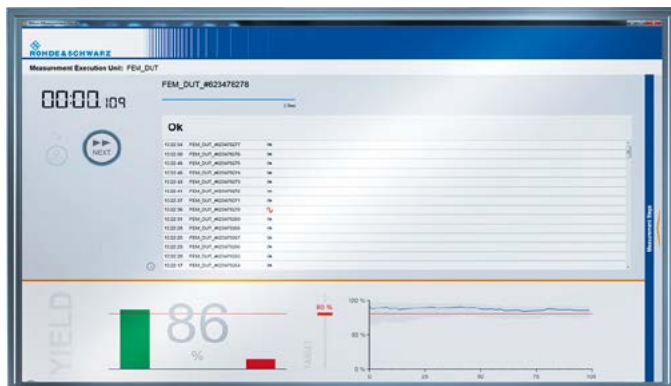

PC-based server platform for automated VNA tests

In production environments, measurements need to be performed on devices under test (DUT) with an ever-increasing number of ports. Vector network analyzers (VNA) are often used in combination with other test equipment in order to perform these tests as quickly and efficiently as possible. With the R&S®ZRun automated test software, Rohde&Schwarz offers a powerful control software application for automated measurements. Characterization of a complex DUT, such as a frontend module, requires detailed configuration of the test setup and precise definition of the test sequence.

The R&S®ZRun automated test software simplifies these tasks. In a first step, the user sets the test equipment to be used, the number of ports on the DUT and the measurements to be performed.

The R&S®ZRun automated test software then takes over communications with the test equipment and configures it in accordance with the user's specifications.

The R&S®ZRun automated test software helps users boost measurement speed. The software executes the pre-configured measurements in an optimized sequence that requires the fewest possible changes to the system between one measurement and the next. If a switch matrix is used, the software keeps the number of switching operations and switching levels to a minimum.

To configure the test, the user can utilize the graphical user interface (GUI) as well as plug-ins. It is up to the user to decide whether to use one or the other, or a combination of the two. For example, a test can be configured in the GUI and plug-ins can be used to add further test equipment to the VNA. This ability to mix and match gives users a powerful tool for obtaining the best possible performance from the equipment on hand.

- Configuration of tests with vector network analyzers in production systems
- One software package to manage and control multiple test setups
- Optimization of production system speed
- Integration of external components (power supplies, multimeters, etc.) in test sequences by using plug-ins
- Control of DUT, e.g. via RFFE GPIO interface
- Efficient system error correction on test system
- Test setups centered around the DUT
- Graphical visualization and analyzing of the measured data

5



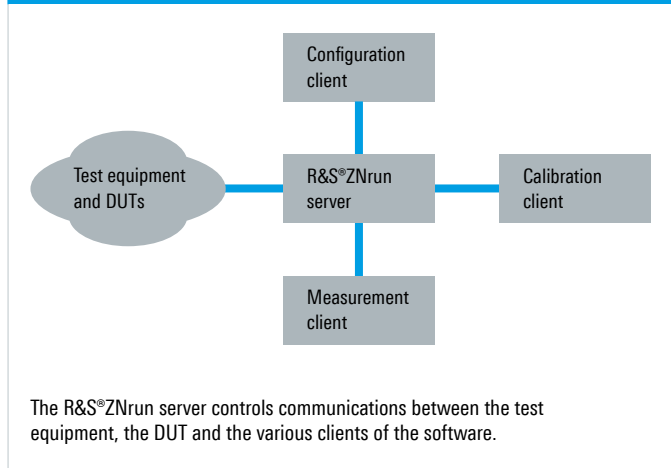

Functional model of R&S®ZRun software

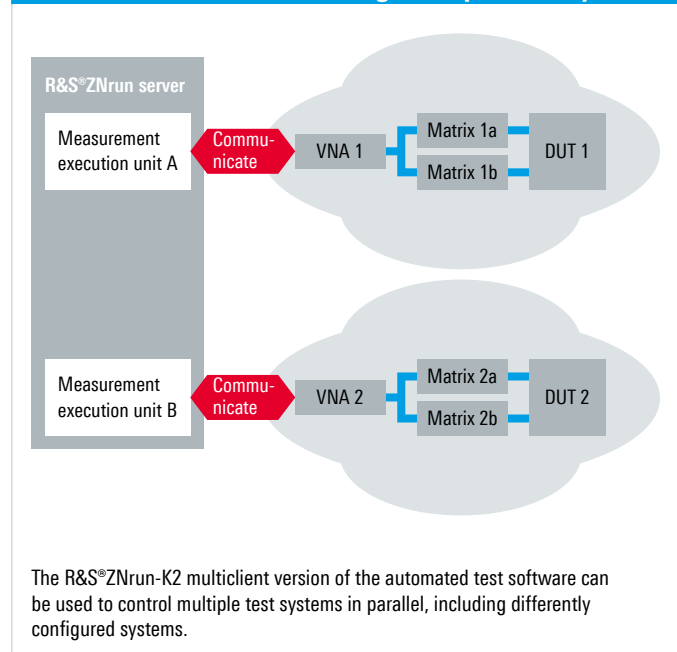

R&S®ZRun-K2 for controlling multiple test systems



Accessories for network analysis

<p>R&S®ZVAX-TRM Extension Unit</p> 	<p>Measurements on active devices made easy The R&S®ZVAX-TRMxx (xx = 24, 40, 50, 67 GHz) extension unit for the R&S®ZVA(T) simplifies intermodulation, high-power, noise figure, embedded LO group delay and pulsed measurements on active devices, mainly transmit/receive modules or amplifiers. Besides the standard high-power test set, components for signal conditioning, such as combiners, pulse modulators and preamplifier can be fitted as options.</p>	<p>The R&S®ZVAX-TRMxx is directly controlled by the R&S®ZVA via a graphical user interface. The combination of an R&S®ZVA and the R&S®ZVAX-TRMxx behaves like a fully integrated single box. However, if multiple R&S®ZVA analyzers are being used in a lab, they can share one extension unit. This helps ensure optimum investment utilization.</p>
<p>R&S®ZN-Z84 Switch Matrix</p> 	<p>Two or four VNA ports, up to 48 test ports Frequency range: 10 MHz to 8.5 GHz Test ports: 6, 12, 18 or 24 ports, SMA(f) Up to 48 ports by combining two R&S®ZN-Z84 matrices Port connector: SMA(f) Damage level: +23 dBm</p>	<ul style="list-style-type: none"> Damage DC voltage: 12 V Impedance: 50 Ω Switching time: <ul style="list-style-type: none"> USB: < 1 ms (nom.) LAN: < 2 ms (nom.) Direct connect: < 100 μs (nom.) Remote control: USB, LAN, direct connect Directly controlled by R&S®ZNB
<p>R&S®ZN-Z85 Switch Matrix</p> 	<p>Two VNA ports with 6 test ports or four VNA ports with 12 test ports Frequency range: 10 MHz to 20 GHz Test ports: 6 or 12 ports, SMA(f) Up to 12 ports by combining two R&S®ZN-Z85 matrices Port connector: SMA(f) Damage level: +23 dBm</p>	<ul style="list-style-type: none"> Damage DC voltage: 12 V Impedance: 50 Ω Switching time: <ul style="list-style-type: none"> USB: < 1 ms (nom.) LAN: < 2 ms (nom.) Direct connect: < 100 μs (nom.) Remote control: USB, LAN, direct connect Directly controlled by R&S®ZNB
<p>R&S®ZCAN/ZV-Z2xx/ZV-Z170/-Z135/-Z129 Manual Calibration Kits (coaxial)</p> 	<p>Type, connectors R&S®ZCAN, N (m) and N (f), 75 Ω R&S®ZCAN, N (m) and N (f), 50 Ω R&S®ZV-Z270, N (m) or N (f) R&S®ZV-Z235, 3.5 mm (m) or 3.5 mm (f) R&S®ZV-Z235E, 3.5 mm (m) or 3.5 mm (f) R&S®ZV-Z229, 2.92 mm (m) or 2.92 mm (f) R&S®ZV-Z224, 2.4 mm (m) or 2.4 mm (f) R&S®ZV-Z218, 1.85 mm (m) or 1.85 mm (f) R&S®ZV-Z210, 1.0 mm (m) or 1.0 mm (f)</p> <p>4-in-1 calibration kits R&S®ZV-Z170, N (m) or N (f) R&S®ZV-Z135, 3.5 mm (m) or 3.5 mm (f) R&S®ZV-Z129, 2.92 mm (m) or 2.92 mm (f)</p>	<p>Frequency range 0 Hz to 3 GHz 0 Hz to 3 GHz 0 Hz to 18 GHz 0 Hz to 24 GHz 0 Hz to 33 GHz 0 Hz to 40 GHz 0 Hz to 50 GHz 0 Hz to 67 GHz 0 Hz to 110 GHz</p> <p>Frequency range 0 Hz to 9 GHz 0 Hz to 15 GHz 0 Hz to 40 GHz</p>

Accessories for network analysis

R&S®ZN-Z15x/ZN-Z51/ZV-Z5x Automatic Calibration Units

**Type, connector**

- ▮ R&S®ZN-Z151, N (f)
- ▮ R&S®ZN-Z151, SMA (f)
- ▮ R&S®ZN-Z152, SMA (f)
- ▮ R&S®ZN-Z153, SMA (f)
- ▮ R&S®ZN-Z154, SMA (f)
- ▮ R&S®ZN-Z156, 1.85 mm (f)
- ▮ R&S®ZN-Z51, N (f) or 3.5 mm (f), individual configuration of each port possible
- ▮ R&S®ZV-Z52, N (f)
- ▮ R&S®ZV-Z52, 3.5 mm (f)
- ▮ R&S®ZV-Z53, N (f), 75 Ω
- ▮ R&S®ZV-Z53, N (f)
- ▮ R&S®ZV-Z53, 3.5 mm (f)
- ▮ R&S®ZV-Z54, 2.92 mm (f)
- ▮ R&S®ZV-Z55, 2.4 mm (f)
- ▮ R&S®ZV-Z58, N (f), for R&S®ZVT8 with up to 8 test ports
- ▮ R&S®ZV-Z58, 3.5 mm (f)
- ▮ R&S®ZV-Z59, 3.5 mm (f)

Frequency range, ports

- ▮ 100 kHz to 8.5 GHz, 2 ports
- ▮ 100 kHz to 8.5 GHz, 2 ports
- ▮ 100 kHz to 8.5 GHz, 6 ports
- ▮ 100 kHz to 8.5 GHz, 4 ports
- ▮ 100 kHz to 8.5 GHz, 6, 12, 18 or 24 ports¹⁾
- ▮ 5 GHz to 67 GHz, 2 ports
- ▮ 100 kHz to 8.5 GHz, 2 or 4 ports
- ▮ 100 kHz to 18 GHz, 4 ports
- ▮ 10 MHz to 24 GHz, 4 ports
- ▮ 300 kHz to 3 GHz, 2 ports
- ▮ 300 kHz to 18 GHz, 2 ports
- ▮ 300 kHz to 24 GHz, 2 ports
- ▮ 10 MHz to 40 GHz, 2 ports
- ▮ 10 MHz to 50 GHz, 2 ports
- ▮ 300 kHz to 8 GHz, 8 ports
- ▮ 10 MHz to 20 GHz, 6 ports

¹⁾ 6-port base model with options for port extensions R&S®ZN154-B22, R&S®ZN154-B32 and R&S®ZN154-B42.

R&S®ZV-WRxx Manual Waveguide Calibration Kits

Designation

- ▮ Calibration kit WR15
- ▮ Calibration kit WR12
- ▮ Calibration kit WR10
- ▮ Calibration kit WR08
- ▮ Calibration kit WR06
- ▮ Calibration kit WR05
- ▮ Calibration kit WR03
- ▮ Calibration kit WR02
- ▮ Calibration kit WM-570

Type (models with/without sliding match)

- ▮ R&S®ZV-WR15
- ▮ R&S®ZV-WR12
- ▮ R&S®ZV-WR10
- ▮ R&S®ZV-WR08
- ▮ R&S®ZV-WR06
- ▮ R&S®ZV-WR05
- ▮ R&S®ZV-WR03
- ▮ R&S®ZV-WR02
- ▮ R&S®ZCWM-570

Frequency range

- ▮ 50 GHz to 75 GHz
- ▮ 60 GHz to 90 GHz
- ▮ 75 GHz to 110 GHz
- ▮ 90 GHz to 140 GHz
- ▮ 110 GHz to 170 GHz
- ▮ 140 GHz to 220 GHz
- ▮ 220 GHz to 325 GHz
- ▮ 325 GHz to 500 GHz
- ▮ 330 GHz to 500 GHz

R&S®ZV-Z3xx/ZV-Z4xx Verification Kits

Type

- R&S®ZV-Z370
- R&S®ZV-Z335
- R&S®ZV-Z329
- R&S®ZV-Z324
- R&S®ZV-Z470
- R&S®ZV-Z435
- R&S®ZV-Z429
- R&S®ZV-Z424

Frequency range

- ▮ 45 MHz to 18 GHz
- ▮ 45 MHz to 26.5 GHz
- ▮ 45 MHz to 40 GHz
- ▮ 45 MHz to 50 GHz
- ▮ 45 MHz to 18 GHz
- ▮ 45 MHz to 26.5 GHz
- ▮ 45 MHz to 40 GHz
- ▮ 45 MHz to 50 GHz

Description

- ▮ T-Check verification device, type N (f to m)
- ▮ T-Check verification device, 3.5 mm (f to m)
- ▮ T-Check verification device, 2.92 mm (f to m)
- ▮ T-Check verification device, 2.4 mm (f to m)
- ▮ Verification kit, type N
- ▮ Verification kit, 3.5 mm
- ▮ Verification kit, 2.92 mm
- ▮ Verification kit, 2.4 mm

R&S®ZN-ZTW Torque Wrench

**Type**

- ▮ R&S®ZN-ZTW (model .71)
- ▮ R&S®ZN-ZTW (model .35)
- ▮ R&S®ZN-ZTW (model .10)
- ▮ R&S®ZN-ZTW (model .12)

Description

- ▮ For type N connectors, 1.5 Nm, 20 mm width
- ▮ For 3.5/2.92/2.4/1.85 mm connectors, 0.9 Nm, 8 mm width
- ▮ For 1.0 mm connectors, 0.45 Nm, 6 mm width
- ▮ For 1.0 mm connectors, 0.34 Nm, 6 mm width



Chapter 6

Mobile network testing

Rohde & Schwarz, together with its subsidiaries SwissQual and R&S®Cybersecurity, offers an unparalleled breadth of solutions for mobile network testing, from the radio access network to the backhaul and the core network, helping to ensure network performance and subscriber quality of service.

The mobile network test solutions are coordinated across different applications, including network planning, deployment, optimization and operation. Rohde & Schwarz is the only supplier to offer such a range and depth of mobile network testing solutions to ensure network performance.

Type	Designation	Description	Page	
Benchmarking				
	SwissQual	Diversity Benchmarker II	Large scale and fully fledged drive-test-based QoE benchmarking	160
New	SwissQual	Diversity Benchmarker II Go	Ad-hoc drive test-based quality of experience benchmarking	161
	SwissQual	TCM Test Device Containment Module	The test device container for reliable and stable mobile network testing	162
	SwissQual	QualiPoc Freerider III	Extended walk- and drive-test-based QoE benchmarking and optimization	163
Optimization				
	R&S®ROMES4	Drive test software	Mobile coverage and QoS measurements in wireless communications	164
	SwissQual	QualiPoc Android	Handheld voice and data service quality troubleshooting and optimization	165
	SwissQual	QualiPoc Android Probe	Unattended, network-wide 24/7 service quality monitoring and optimization	166
RF scanner				
	R&S®TSMA	Autonomous mobile network scanner	Walk and drive testing with flexible connectivity	167
	R&S®TSME	Ultracompact drive test scanner	All bands, all technologies, simultaneously	168
	R&S®TSMW	Universal radio network analyzer	Scanner for drive tests and I/Q streaming	169
	R&S®TSMW-CW	CW radio network analyzer	Powerful scanner for mobile applications	170
	R&S®TSMX-PPS2	GPS module	GPS receiver module with PPS output and dead reckoning	170
Software				
	SwissQual	NetQual NQDI II	Business intelligence for quality of experience benchmarking and optimization	171
	SwissQual	NetQual NQDI Classic	Scalable data analysis and reporting for optimization and benchmarking	172
	SwissQual	NetQual NQView	Control and monitoring of data collection	173
New	R&S®Cybersecurity	R&S®PACE 2 Protocol and Application Classification Engine	Deep packet inspection, behavioral, heuristic and statistical analysis	174
New	R&S®Cybersecurity	R&S®Net Reporter 2 Traffic Analytics	Actionable intelligence for network operators	175
New	R&S®Cybersecurity	R&S®Net Reporter Compact	All-in-one network probe and subscriber analytics	176
New	R&S®Cybersecurity	R&S®Net Sensor	IP application classification probe for network operators	177

SwissQual Diversity Benchmarker II



Large scale and fully fledged drive-test-based quality of experience benchmarking

Diversity Benchmarker II is a fully fledged solution for large-scale drive-test-based quality of experience benchmarking campaigns. It allows mobile operators and testing service providers to assess and compare service quality (QoS and QoE) based on the most comprehensive set of key performance indicators (KPI) and accurate test scenarios.

Benchmarker II is based on a highly reliable, modular and scalable hardware platform which guarantees unmatched system stability, outstanding testing flexibility, high operational efficiency and maximum future readiness. Combined with SwissQual's versatile and productive data management, analysis and reporting suite NetQual, SwissQual offers the most powerful solution for network service benchmarking.

The scalable, multichannel solution can measure multiple operators and their services in parallel (up to 48 channels), collecting voice, messaging, video and data KPIs. In addition, an optional RF scanner, such as the Rohde&Schwarz R&S®TSMW or R&S®TSME, can be supported to provide a full representation of the physical RF environment.

- Extensive technology test support including GSM, GPRS, EDGE, WCDMA, HSDPA, HSUPA, HSPA+, CDMA, EV-DO, LTE, LTE-A (Cat6)

- More than 200 devices supported, including the latest Android smartphones, USB modems and RF scanners (Rohde&Schwarz, PCTel)
- Comprehensive KPI analysis: more than 250 key performance indicators (incl. ETSI) available in realtime as well as in postprocessing
- Full logging and decoding of multiple protocol layers on all technologies: 3GPP, L2, L3, TCP/IP text decoding of L3 messages and TCP/IP packets
- Wide range of options for benchmarking and service testing:
 - Voice telephony: call to any number, speech MOS
 - Data: ping, FTP/HTTPS DL/UL, HTTP/HTTPS DL/UL, PING, DL capacity, lperf UDP/TCP
 - Browsing: HTTP
 - Messaging: SMS, MMS, email (SMTP, POP3, IMAP)
 - Video streaming (YouTube)



SwissQual Diversity Benchmarker II Go

New



Ad-hoc drive test-based quality of experience benchmarking

The Benchmarker II Go is designed for ad-hoc drive test campaigns. The highly scalable and flexible benchmarking solution uses the same base components as the industry's leading mobile network testing system, the Benchmarker II.

The system comes precabled with up to eight commercially available smartphones and is ready to start measurements immediately. It can be installed in virtually every standard vehicle (e.g. rental car) and is powered via standard car cigarette lighter sockets. The robust transport case contains the complete test equipment, including the power supply. The in-car installation is simple and plug-and-play-like.

Thanks to its transportability and easy installation, the Benchmarker II Go is the most suitable and reliable product for benchmarking drive test campaigns abroad – saving costs in logistics, installation and transport. Weight and dimensions are within the standard limits and regulations for international flight transport and therefore Benchmarker II Go can be shipped as luggage on any flight.

This facilitates moving the complete system to a remote location. At the destination, the system can be installed in a rental car and the drive test campaign can be started immediately.



SwissQual TCM Test Device Containment Module



The test device container for reliable and stable mobile network testing

The TCM test device containment module sets optimal conditions for uninterrupted data collection in a stable environment. It ensures maximum data quality for large-scale benchmarking campaigns with Diversity Benchmarker II and offers the following key product benefits:

- Enables the use of unmodified test devices (smartphones) and their built-in RF antennas
- Ensures stable thermal environments and uniform conditions for all test devices to guarantee comparable results
- Allows simulation of multiple end-user scenarios (handheld, beside head) in different environments (pedestrian, in-car, in-house), using configurable RF attenuation per device
- Supports a unique device self-healing feature to minimize failures or lost data to prevent repeat drives
- Offers convenient test device access and simplifies future product updates

The TCM is fully compatible with SwissQual's Diversity Benchmarker II and can be used as an alternative to the existing audio slide-in module (ASM). The TCM enables multiple use cases for large-scale and fully fledged drive-test-based quality of experience benchmarking campaigns.

Vehicle roof box setup

TCMs can be installed in the specially designed SwissQual VRB vehicle roof box and connected to SwissQual's Diversity Benchmarker II. The VRB can contain up to 16 TCMs (measurement channels) and ensures uniform RF and temperature conditions. The roof box and the IP65 rated cable duct for the cable entry into the vehicle are ready for any weather condition.

Customized installation

TCMs can also be installed in a customized setup, based on the drive test vehicle's configuration (e.g. in-car) or customer-specific requirements.

Superior temperature control

The TCM features a patent pending thermal conditioning mechanism. This unique feature provides active cooling and heating inside the TCM and a forced airflow around the device itself. As a result, the sensor-controlled system ensures that all test devices operate at a stable and uniform temperature level, independent of varying TCM ambient temperatures. TCM is the foundation for true benchmarking and guarantees maximum data quality and comparable results, also for repetitive measurements (e.g. in different climatic conditions).



SwissQual QualiPoc Freerider III



Extended walk- and drive-test-based quality of experience benchmarking and optimization

Freerider III marks the third generation of SwissQual's smartphone-based and portable benchmarking solution for extended walk- and drive-test-based quality of experience benchmarking and optimization.

The compact, lightweight and well-designed backpack provides extensive functionalities to test voice, data, video and messaging to assess quality of service (QoS) and quality of experience (QoE) from a real end-user perspective, including the complete information about the physical RF environment.

Its future-ready concept, the various applications, the outstanding performance and the ease-of-use make QualiPoc Freerider III the ultimate portable benchmarking solution.

- Extensive technology support including GSM, GPRS, EDGE, WCDMA, HSDPA, HSUPA, HSPA+, CDMA, EV-DO, LTE, LTE-A (Cat6)
- Support of a wide range of Android smartphones
- Optional multiband and multitechnology R&S®TSME RF scanner
- Full range of service testing options
 - Voice telephony: call to any number, speech MOS
 - Data: ping, FTP DL/UL, HTTP DL/UL, PING, DL capacity, lperf UDP/TCP
 - Browsing: HTTP
 - Messaging: SMS, MMS, email (SMTP, POP3, IMAP)
 - Video streaming (YouTube)
- Comprehensive KPI analysis: more than 250 key performance indicators (incl. ETSI) available in realtime as well as in postprocessing
- Full logging and decoding of multiple protocol layers on all technologies: 3GPP, L2, L3, TCP/IP, IMS, SIP and text decoding of L3 messages, TCP/IP and RTP packets

6

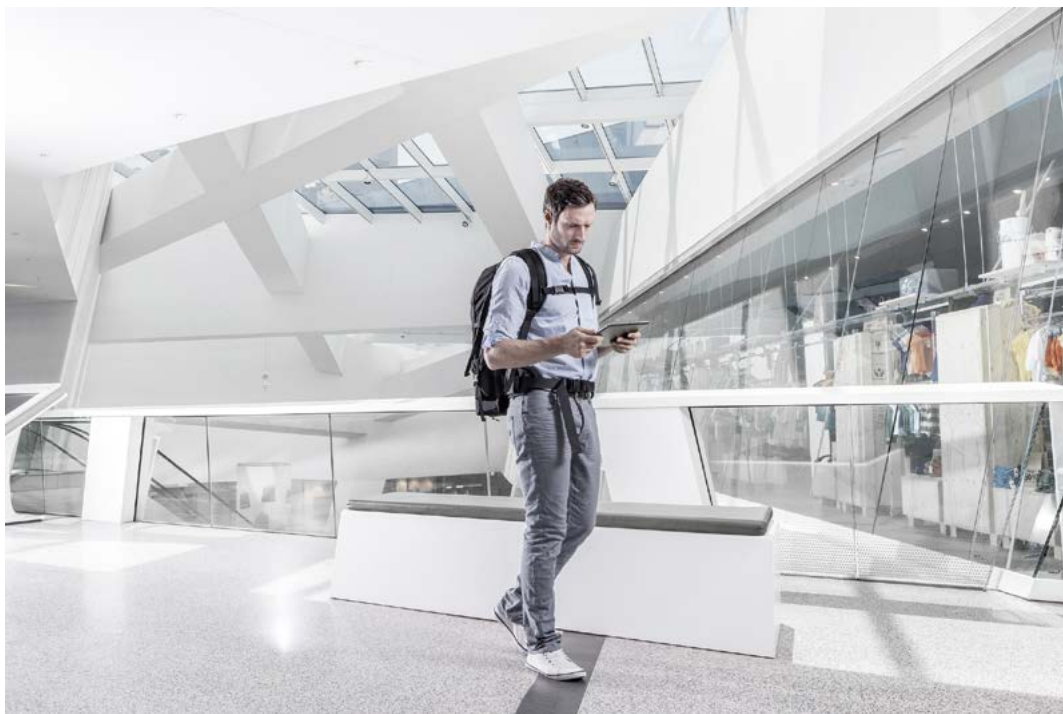

R&S®ROMES4 Drive Test Software incl. R&S®ROMES4NPA Network Problem Analyzer

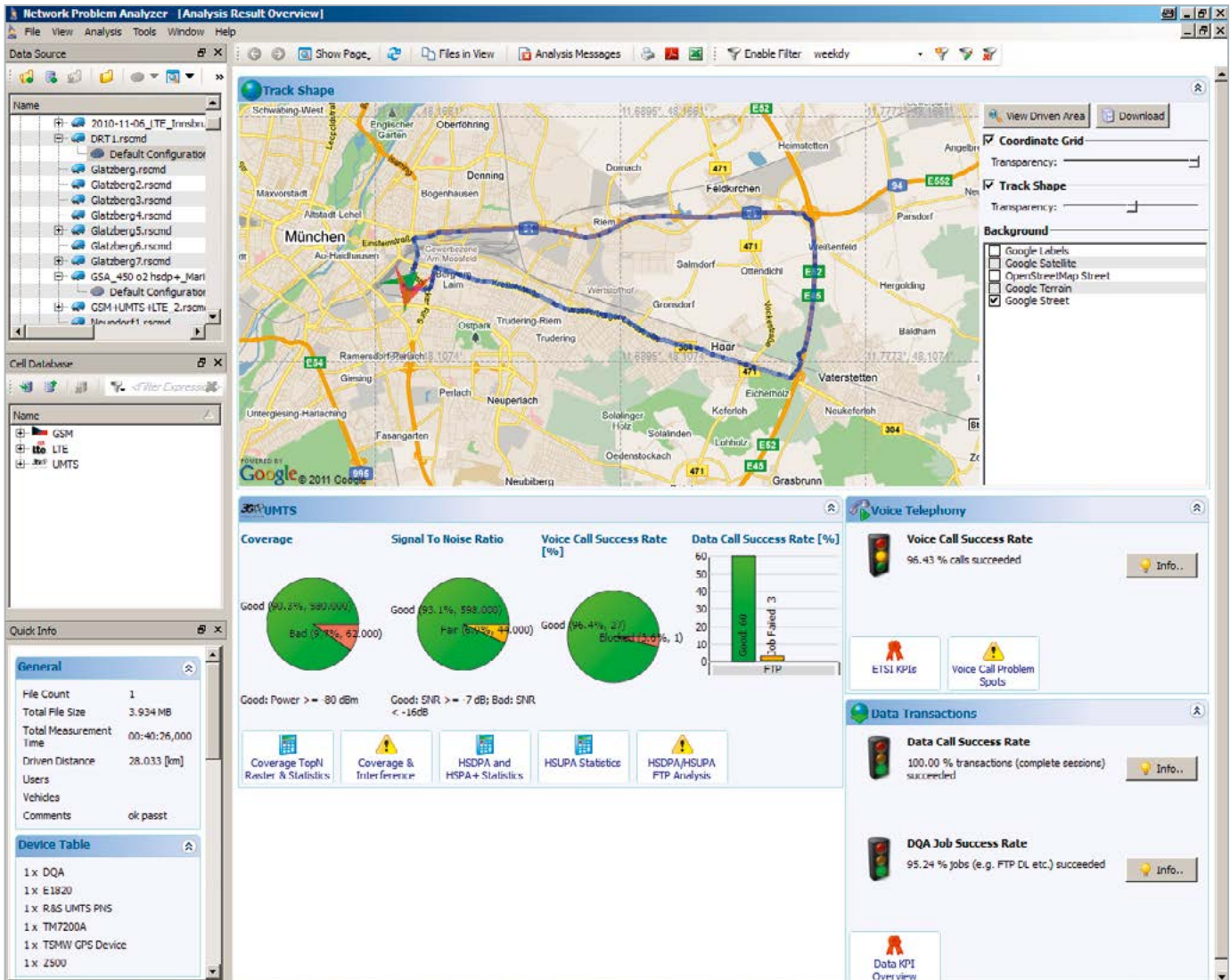

Mobile coverage and QoS measurements

R&S®ROMES4 is a test platform for mobile measurements in all modern radio networks. In combination with scanners and test mobile phones, it forms a complete system for coverage and quality of service (QoS) measurements. Besides pure recording and visualization of test parameters, data is processed instantly and statistics are calculated in realtime. Currently, the following technologies are supported: GSM/EDGE, WCDMA/HSPA+, CDMA2000® 1xEV-DO Rev. A, WLAN, WiMAX™ (IEEE 802.16e), TETRA, TD-LTE and LTE-FDD. Standard-compliant RF level measurements can be time- and distance-triggered.

- One software solution for all technologies
- Flexible handling of licenses reduces startup costs
- Use of highly accurate, fast RF test and measurement equipment (Rohde&Schwarz scanners): many reliable measured values and results

- Parallel measurements with up to 8 mobile phones per license; this saves time, allowing existing resources to be utilized more effectively and saving operating expenses (OPEX)
- Automatic evaluation after completion of measurement by means of the integrated replay function or R&S®ROMES4NPA network problem analyzer, which considerably reduces OPEX
- Unique scanner support for six technologies (GSM, WCDMA, CDMA2000® 1xEV-DO, WiMAX™, TD-LTE, LTE-FDD and TETRA)
- Mobile support including LTE carrier aggregation, VoLTE and voice quality measurements
- Automatic transmitter detection feature minimizes the setup time for a scan and ensures that all present and relevant channels are evaluated

SwissQual QualiPoc Android



Handheld voice and data service quality troubleshooting and optimization

QualiPoc Android is a multifunctional smartphone-based tool for voice and data service quality troubleshooting and RF optimization. As the premier handheld troubleshooter, QualiPoc Android sets a new industry standard for smartphone-based mobile network testing.

QualiPoc is based on the latest commercial Android smartphones. It supports all mobile network technologies used worldwide and covers multiple protocol layers as well as the IP stack in realtime. QualiPoc Android provides extensive test functions for voice, including MOS, data, video streaming and messaging tests to assess and reflect the real end-user experience (QoS/QoE) within a mobile network.

The multifunctional QualiPoc Android is a cost-efficient and powerful pocket solution for every RF engineer who performs daily tasks such as site verification and commissioning, troubleshooting and RF optimization.

- ▮ Extensive technology test support including GSM, GPRS, EDGE, WCDMA, HSDPA, HSUPA, HSPA+, CDMA, EV-DO, LTE, LTE-A (Cat6)
- ▮ Extensive set of service tests for voice, data, video and messaging such as
 - GSM, GPRS, EDGE, WCDMA, HSDPA, HSUPA, HSDPA DC, LTE-FDD & TD-LTE, CDMA2000®, EV-DO
 - Full recording and decoding of protocol layers on the supported technologies: 3GPP, L2, L3, TCP/IP, IMS, SIP
 - Direct decoding of L3 text messages and TCP/IP, RTP packets on smartphones
- ▮ Full logging and decoding of multiple protocol layers on all technologies
 - 3GPP, L2, L3, TCP/IP, IMS, SIP and text decoding of L3 messages, TCP/IP and RTP packets
- ▮ Video quality (VMOS)
 - Video quality testing for multimedia IP-based video services (e.g. YouTube) in the presence of encrypted bitstream data using the J.343.1 algorithm
- ▮ Optimization testing
 - Configuration of standard voice and data testing tasks
 - Static forcing of technology as well as channel and cell locking
 - BTS list with cell name identification
 - Customizable notification for L3 messages and L1 values

6

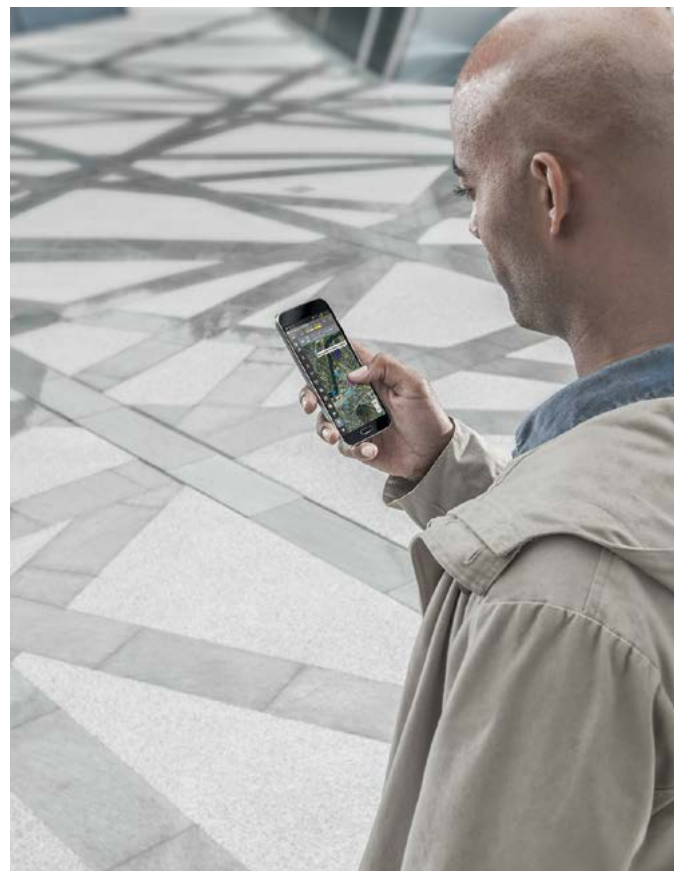

SwissQual QualiPoc Android Probe



QualiPoc Android Probe is an essential component to cost-effectively monitor service quality status in realtime from a real end-user perspective and helps to reduce operational costs in the field. Ultimately, QualiPoc Android Probe ensures seamless quality of service.

Targeted, 24/7 and unattended service quality monitoring in hotspots

Thanks to its smart design and self-healing functions, QualiPoc Android Probe continuously reports the perceived end-user service quality in realtime. Installed in stationary and moving hotspots, such as shopping malls, airports, business districts, trains, metros, etc., QualiPoc Android Probe enables mobile operators to ensure stable quality of service where it matters most. Network and service instabilities or errors that have an adverse effect on end-user experience are immediately detected. Network and service operation centers are instantly alarmed so that they can take prompt action.

Unattended network-wide 24/7 service quality monitoring and optimization

QualiPoc Android Probe is a versatile, smartphone-based mobile network probe for unattended network-wide non-stop service quality monitoring and optimization. It is remotely controlled and in realtime delivers a continuous stream of KPIs and insight into network quality just as the customer perceives it. This enables multiple applications in fixed or moving locations. These include targeted 24/7 service quality monitoring in realtime or large-scale data collection on one or more mobile networks for the purpose of optimization.

24/7 and unattended large-scale data collection for network optimization (drive test)

QualiPoc Android Probe deployed in fleets, for example in taxis, buses, couriers, etc., offers a cost-efficient way to collect measurements for optimization and enables mobile operators, infrastructure vendors and testing service providers to continuously collect data from a real end-user perspective. The fleets are monitored via a web-based application that displays the status of the probes in cockpits and on maps such as OpenStreetMap (OSM). Tests are remotely configured and scheduled. The performance of each service is visible in a dedicated dashboard displaying test results and alarms in realtime.



R&S®TSMA Autonomous Mobile Network Scanner



Walk and drive testing with flexible connectivity

The compact R&S®TSMA autonomous mobile network scanner offers all that is needed for walk and drive tests. WLAN or Bluetooth® connects the smartphones/tablets used for data collection such as QualiPoc Android Probe. The autonomous mobile network scanner can also run comprehensive drive test software, such as R&S®ROMES or R&S®NESTOR, on its built-in i5 processor. Multitechnology and multiband measurements provide full flexibility.

As in-building traffic in cellular networks grows, there is an increased need for indoor measurements. While traditional drive test systems consist of a laptop with test mobile phones and scanners, there are also walk test solutions that use tablets and smartphones. The R&S®TSMA enhances such solutions, providing the user with accurate insight into the RF environment.

The R&S®TSMA combines the technology of the R&S®TSME ultracompact drive test scanner with a high-performance Intel processor. The scanner can run

PC-based drive test software and smartphones can be connected via USB. The scanner measures up to eight technologies simultaneously in the 350 MHz to 4.4 GHz wireless communications bands. It can be combined with an R&S®TSME to perform LTE MIMO measurements.

With its light weight of only 1180 g and optional hot-swappable batteries, the R&S®TSMA is the ideal companion on a walk test campaign or for remote or unattended operation.

- Multiband support from 350 MHz to 4.4 GHz
- GSM, WCDMA, LTE FDD, LTE TDD, CDMA2000®, 1xEV-DO, TETRA, WiMAX™, CW and spectrum analysis simultaneously in one scanner
- Connects to Windows PC, Android UE or tablet
- Integrated Intel PC can run Windows-based software with R&S®TSME support
- Compact, lightweight design
- Internal GPS/Glonass receiver

Technology	Technology supported	SIB decoding
GSM	•	•
WCDMA	•	•
CDMA2000®	•	•
1xEV-DO (Rel. 0/Rev. A/Rev. B)	•	•
WiMAX™ IEEE802.16e	•	•
TD-LTE	•	•
LTE-FDD	•	•
TETRA, TETRA DMO	•	•
TD-SCDMA	•	•
RF power scan	•	–
CW channel power RSSI scan	•	–

R&S®TSME Ultracompact Drive Test Scanner



All bands, all technologies, simultaneously

The extremely compact R&S®TSME offers all that is required for mobile use. Multitechnology measurements and multiband support provide full flexibility and an optimal price/performance ratio for both drive tests and walk tests.

The scanner measures up to eight technologies simultaneously and seamlessly in wireless communications bands from 350 MHz to 4.4 GHz. It is possible to cascade multiple scanners. For LTE applications, R&S®TSME scanners can be combined for measurements. The LTE Downlink Allocation Analyzer Feature allows to nonintrusively measure the load in an LTE cell. Also LTE eMBMS measurements are supported. The scanner supports automatic channel detection in WCDMA, LTE FDD/TDD, CDMA, EV-DO and TETRA networks.

With its light weight of only 650 g and low power consumption of max. 15 W, the R&S®TSME meets all the requirements placed on a drive test scanner.

- ▮ Multiband support from 350 MHz to 4.4 GHz
- ▮ Up to eight technologies simultaneously in one scanner
- ▮ Compact, lightweight design
- ▮ Low power consumption
- ▮ Internal GPS/Glonass receiver

R&S®TSME-Z3 backpack system

- ▮ Maximum autonomy
- ▮ Flexible measurement configuration
- ▮ Rugged and lightweight



	Technologies supported	SIB decoding
GSM	•	•
WCDMA	•	•
CDMA2000®	•	•
1xEV-DO (Rel. 0/Rev. A/Rev. B)	•	•
WiMAX™ IEEE 802.16e	•	•
TD-LTE	•	•
LTE-FDD	•	•
TETRA, TETRA DMO	•	•
TD-SCDMA	•	•
RF power scan	•	–
CW channel power RSSI scan	•	–

R&S®TSME-Z3 backpack system.

R&S®TSMW Universal Radio Network Analyzer



Scanner for drive tests and I/Q streaming

The R&S®TSMW universal radio network analyzer is a platform for optimizing all conventional wireless communications networks. Two frontends for any input frequency from 30 MHz to 6 GHz, preselection and software-defined architecture offer unsurpassed performance while providing maximum flexibility. In addition to functioning as a scanner for wireless communications networks, the R&S®TSMW is also an ideal digital I/Q baseband receiver.

Owing to its hardware platform, the R&S®TSMW universal radio network analyzer offers maximum flexibility. For example, the R&S®TSMW comes in handy as an LTE scanner and it can be utilized together with the R&S®ROMES4 drive test software to roll out and optimize 3GPP EUTRA networks. With its two frontends, the scanner supports 2x2 and 4x2 LTE FDD and TDD MIMO measurements. The LTE downlink allocation analyzer feature allows noninvasive measurement of the load in an LTE cell. In addition to LTE, other wireless communications technologies such as GSM, WCDMA, CDMA2000® 1xEV-DO, TETRA and WiMAX™ are supported simultaneously. The scanner supports automatic channel detection in WCDMA, LTE FDD/TDD, CDMA, EV-DO and TETRA networks.

Moreover, the R&S®TSMW can be used as a realtime scanner for I/Q baseband data. The R&S®TSMW-K1 option offers a MATLAB® and a C++ interface via which I/Q measurement data can be captured and evaluated.

- User-definable input frequency range from 30 MHz to 6 GHz
- Two independent RF and signal processing paths, each with a bandwidth of up to 20 MHz
- Integrated preselection for high intermodulation suppression while dynamic range is high
- Support of
 - LTE-FDD and TD-LTE
 - LTE eMBMS and LTE-A
 - TD-SCDMA
- Parallel measurements in GSM, WCDMA, LTE, CDMA2000®, 1xEV-DO, TETRA and WiMAX™ networks with the R&S®ROMES4 drive test software
- Spectrum measurements with the RF power scan option
- I/Q baseband streaming and capturing
- Integrated GPS
- Open interfaces for integration into individual software solutions
- Flexibility in choice of drive test software

	Technologies supported	SIB decoding
GSM	•	•
WCDMA	•	•
CDMA2000®	•	•
1xEV-DO (Rel. 0/Rev. A/Rev. B)	•	•
WiMAX™ IEEE 802.16e	•	•
TD-LTE	•	•
LTE FDD	•	•
TETRA, TETRA 2, TETRA DMO	•	•
TD-SCDMA	•	•
CW channel power RSSI scan	•	–

R&S®TSML-CW CW Radio Network Analyzer



Powerful scanner for mobile applications

The R&S®TSML-CW is a compact receiver for channel power (CW) and spectrum measurements. It supports a frequency range from 80 MHz to 6 GHz.

The R&S®TSML-CW can be used in combination with R&S®ROMES drive test software, and it can be integrated via an open interface into a third party application. It supports distance triggered (wheel trigger) channel power measurements.

- ▮ Power measurements from 80 MHz to 6 GHz
- ▮ Low power consumption
- ▮ Handy, portable and compact solution
- ▮ RF-shielded, solid case
- ▮ Fast data transfer via IEEE 1394 (FireWire) interface
- ▮ Controlled via R&S®ROMES drive test software
- ▮ Open user interface
- ▮ The R&S®TSML-CW performs RF channel power measurements from 80 MHz to 6 GHz

R&S®TSMX-PPS2 GPS Module



GPS receiver module with PPS output and dead reckoning

The R&S®TSMX-PPS2 is a GPS receiver module with time synchronization pulse/PPS output and automotive dead reckoning (ADR) for high-precision measurements, e.g. in combination with the R&S®TSMx drive test scanners.

The accuracy of scanner measurements is highly dependent on synchronization with the wanted signals. Synchronization can be achieved by means of synchronization signals that are found inside mobile radios but that nevertheless exhibit a certain lack of accuracy. This is why the R&S®TSMX-PPS2 GPS module is a better alternative. It evaluates GPS signals and returns position data and a highly precise time reference at the PPS connector.

- ▮ Highly sensitive GPS receiver with integrated automotive dead reckoning (ADR)

- ▮ Pulses per second (PPS) output
- ▮ 50 channels
- ▮ Update rate of 1 Hz
- ▮ Compact, light and versatile

Specifications in brief

GPS receiver

GPS chipset	u-blox LEA-6R
Number of channels	50
Sensitivity ¹⁾	typ. -160 dBm
Update rate	1 Hz
Accuracy ²⁾	typ. 2.5 m CEP
Startup time ³⁾	
Cold start	typ. < 32 s
Hot start	typ. < 3 s

Physical characteristics

Operating temperature range	0°C to +50°C
Power consumption at 5 V	450 mW

Connectors

GPS antenna (GPS ANT)	SMA
PPS output (PPS OUT)	SMA
Sensor input for ADR (SENSOR IN)	ODU MINI-SNAP (6-pin)
USB (signal and voltage supply)	type B

¹⁾ Sensitivity with supplied antenna, for "acquisition and reacquisition" and tracking. Cold start requires higher signal level.

²⁾ Circular error probability (CEP): radius of a horizontal circle at the true antenna site that includes 50% of all position calculations.

³⁾ Measured with good satellite view and -130 dBm signal level.

SwissQual NetQual NQDI II

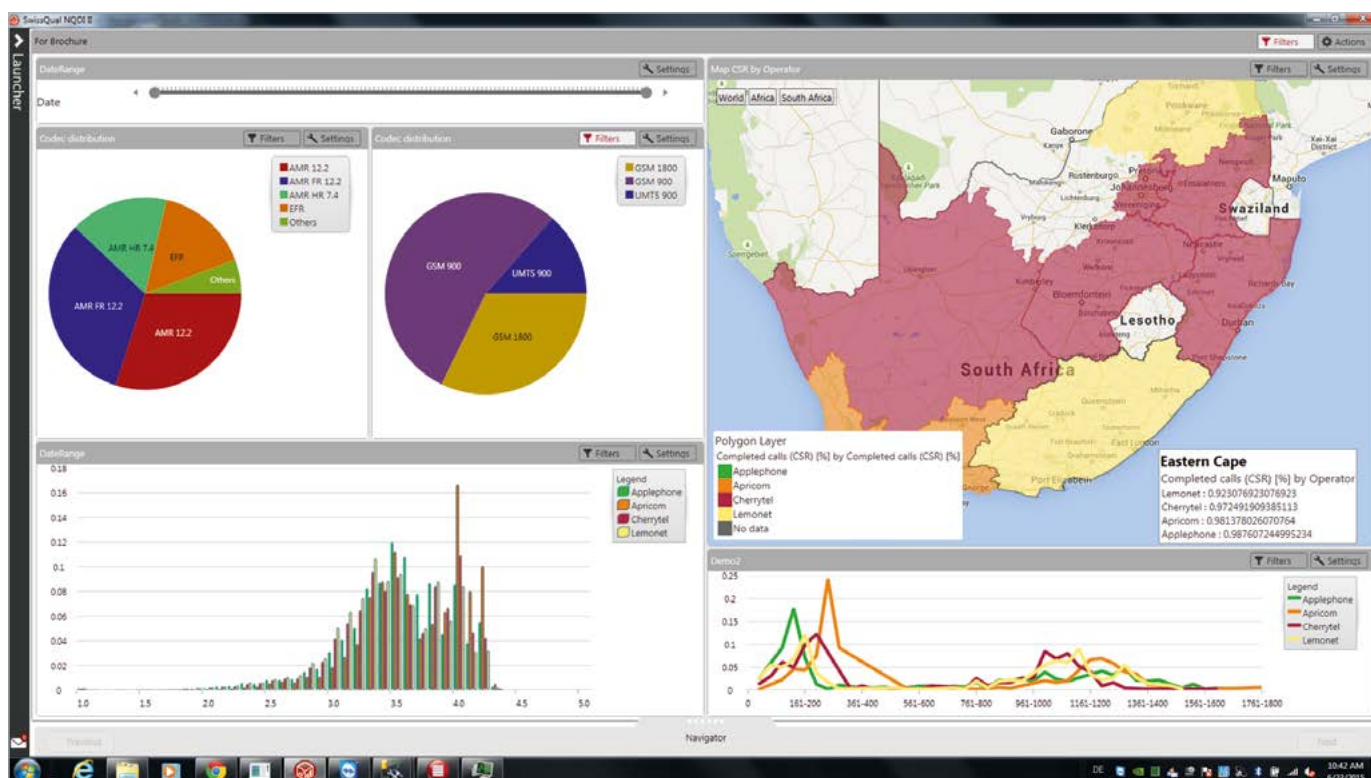

Business intelligence for quality of experience benchmarking and optimization

The NQDI II network quality data investigator is the post-processing system that maximizes the potential of collected measurement data for network and service optimization and benchmarking. Based on data from all radio technologies, service quality and network information, NQDI II provides automated data validation, detailed quality analysis, troubleshooting and long-term reporting.

Intuitive workflows, designed around practical use cases, allow fast statistical analysis and flexible troubleshooting. Workflows can be easily created, modified and shared, increasing productivity and knowledge reuse. SQL databases combined with online analytical processing (OLAP) cubes provide extremely fast execution of data slicing-and-dicing and enable full interactivity, introducing a new concept for reporting. Drilldown and filtering of big data to single measurement values are also possible. Consequently, the insights gained through high-quality benchmarking data empower engineers to take action and managers to make strategic decisions – with just a few clicks.

- Analysis of a wide range of services
 - Voice, data, browsing, messaging, video over IP
- Extensive technology test support including GSM, GPRS, EDGE, WCDMA, LTE, LTE DC, VoLTE, HSPA+, HSDPA DC, PSTN, ISDN, IP

- Off-the-shelf reporting:
 - Rich set of predefined workflow reports available to cover major use cases
- Automated analysis
 - CS calls and PS services with failure cause categorization to immediately find the top quality-degrading network problems detected in the measurement data
- Voice and video analysis
 - Using the unique Squad, VMon, VQuad and videoMOS quality algorithms and data analysis based on the correlation of information from service and application layers down to RF
- Web compatibility
 - Fully compatible with the NetQual NQWeb platform for corporate-wide distributed presentation and reporting
 - Ready to integrate into Microsoft SQL Reporting Services® using the SSAS OLAP cubes
- Database management
 - OLAP cubes storing aggregated results for long-term trend and correlation analysis
 - NQDI databases and OLAP cubes are easily managed with the integrated data management tool, without the need for specific SQL server or database knowledge

SwissQual NetQual NQDI Classic

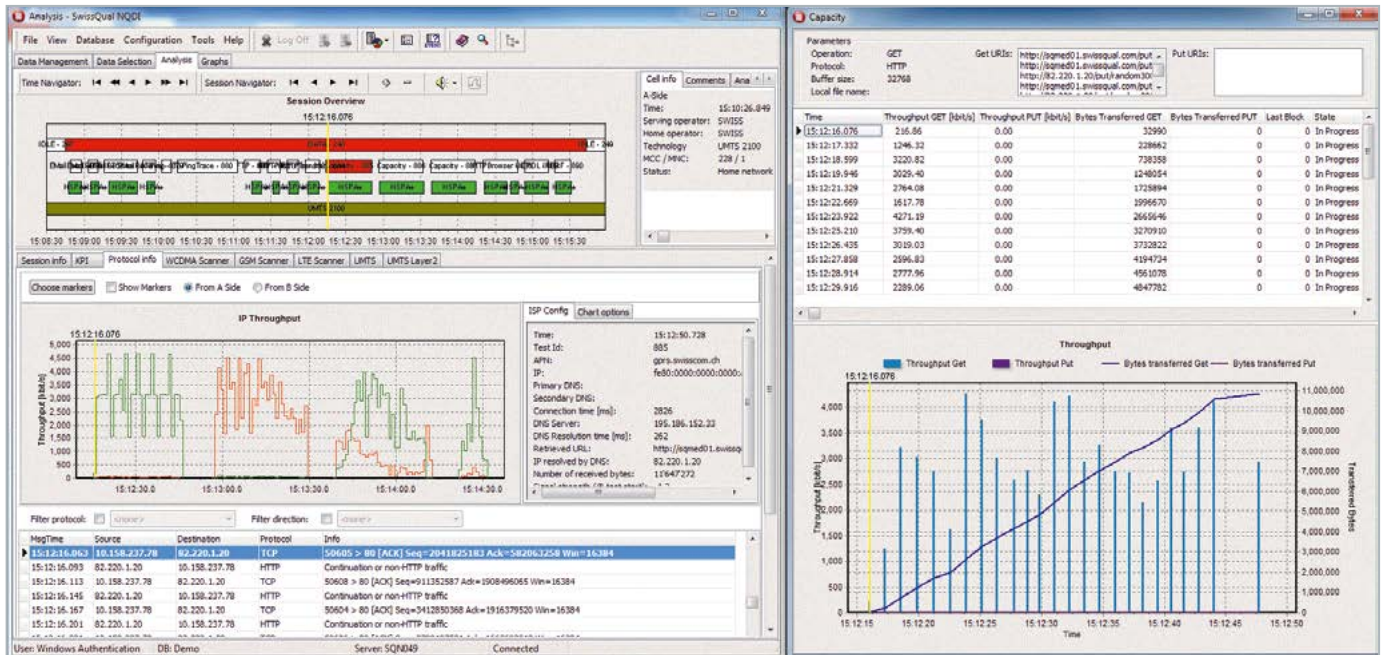

Scalable data analysis and reporting for optimization and benchmarking

Today's increasing network complexity requires an increased level of intelligence in order to evaluate network and service performance and take action to improve it. Data collected during measurements campaigns represents a mine of information, but without a proper analysis layer the potential of such information remains unexploited. While evaluating the collected data is imperative, critical decisions should be made based on automatically validated data that is in accordance with the highest quality standards.

SwissQual's NQDI Classic network quality data investigator is a postprocessing system that maximizes the potential of data collected by QualiPoc and Diversity products for network and service optimization and benchmarking. Based on data from all radio technologies, NQDI Classic provides automated data validation, detailed quality analysis, troubleshooting and long-term reporting for voice and data services.

- Extensive technology test support including GSM, GPRS, EDGE, WCDMA, LTE, CDMA/EV-DO, WiMAX™, HSPA+, HSDPA DC, iDEN, IS-136, TDMA, PSTN, ISDN and IP
- Postprocessing provides in-depth voice and video analysis using the unique Squad, VMon and VQuad quality algorithms and data analysis based on the correlation of information from service and application layers down to RF

- More than 200 KPIs available for network and service performance, reporting and trending with several possible sorting parameters, including operator, technology and map region
 - The extensive set of standard reports includes voice, video, data, messaging, GSM, WCDMA, CDMA, GPRS/EDGE, HSPA+, HSPA DC, LTE
- Web compatibility
 - Fully compatible with the NetQual NQWeb platform for corporate-wide distributed presentation and reporting
- Database management
 - NQDI Classic databases are easily managed with the integrated data management tool, without the need for specific SQL server or database knowledge
 - NQDI Classic can create and build historical databases to provide a global overview and trending over time

SwissQual NetQual NQView

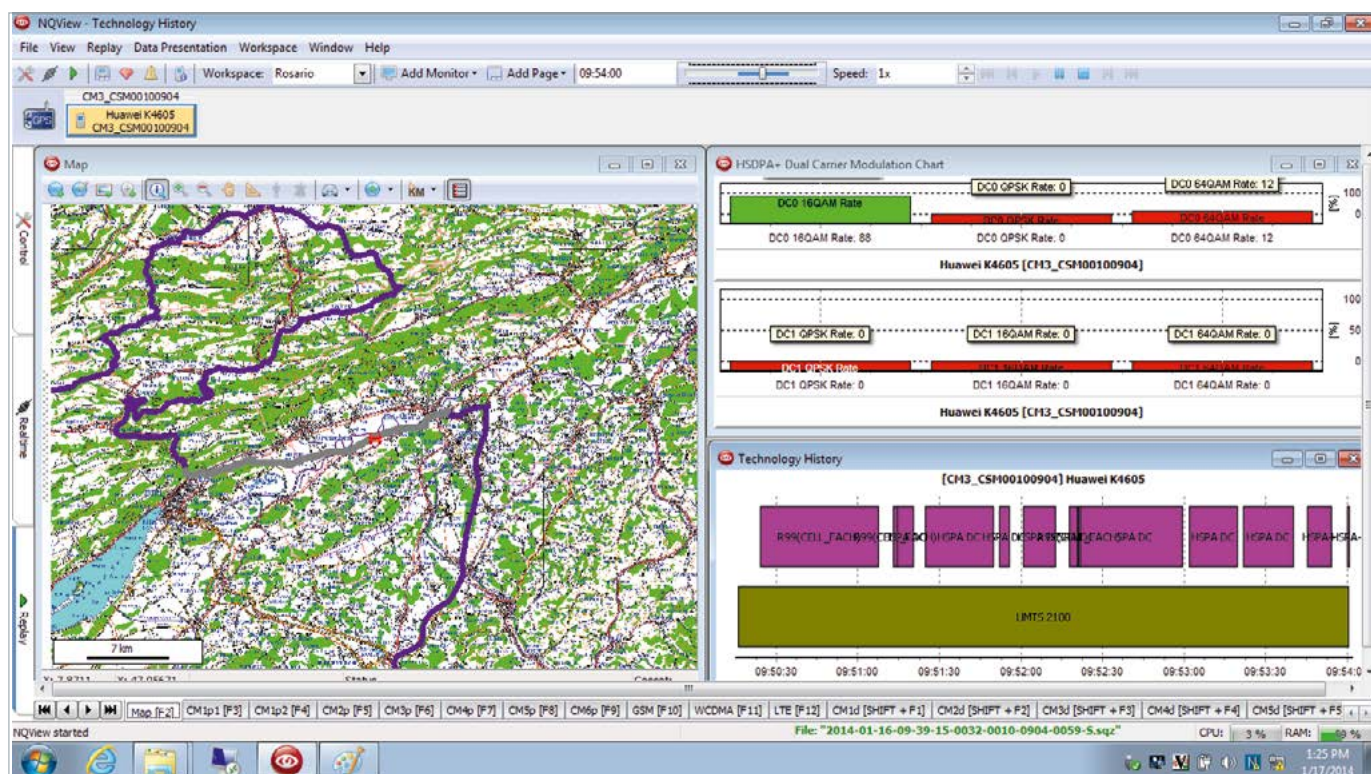

Test configuration and control, data live display and file replay

NetQual NQView is the unique graphical user interface for SwissQual's Diversity Benchmarking II and Diversity Optimizer. Whether a quick summary on an ongoing test or thorough troubleshooting, NQView allows users to create individual workspaces and fully customized monitors. For a quick start, a complete set of predefined monitors offers a glance at the radio conditions or a comprehensive summary of the ongoing drive test.

NQView is designed for drive tests with intelligent functions that make it safe. For example, it includes customizable audio alarms that send alerts only when necessary. The Safe Driver mode gives the user a restricted amount of information which is clearly visible when the speed limit has been reached.

NQView allows the user to configure test scenarios, monitor the status of tasks and campaigns and replay measurement files for in-depth and immediate postprocessing of the executed measurement. NQView is also able to replay QualiPoc files for quick and effective troubleshooting and postprocessing.

- Laptops or tablets with Windows 7 (32- or 64-bit). Dedicated NQView consoles available depending on use case and license
- Extensive technology test support including GSM, GPRS, EDGE, WCDMA, LTE, LTE-A, CDMA/EV-DO, HSPA+, HSDPA DC, PSTN, ISDN and IP
- More than 70 predefined monitors for application, network, L3 signaling, device technology and RF scanning
- Benchmarking operation
 - Display mode for phones, data devices, PSTN/ISDN channels, LAN adapters and RF scanners
 - Powerful overview status display of all devices, including test results
- Optimization operation
 - Easy configuration of standard voice and data testing tasks
 - Static and dynamic realtime forcing of technology, frequency band, channel, cell barring and handover
- Replay mode supporting loading multiple files from Diversity and QualiPoc
 - Play controls with play speed setting, step forward or backward and slide bar control
 - Find function with time, event, layer 3 message and KPI search support

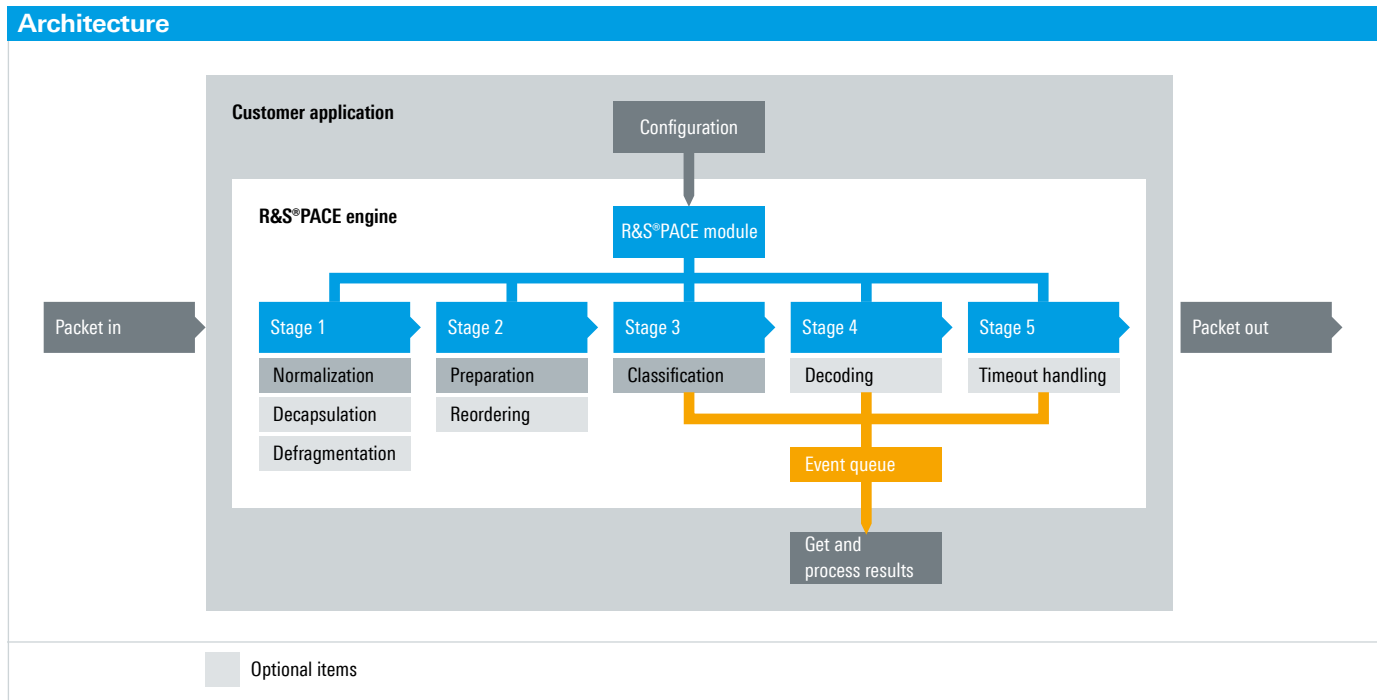

Deep packet inspection, behavioral, heuristic and statistical analysis

R&S®PACE 2 protocol and application classification engine is a software used by network and security equipment vendors to enhance their network traffic products with state-of-the-art IP traffic analytics capabilities supplying data related to classification of:

- Protocols such as HTTP, SSL or Bittorrent
 - Applications such as Facebook, Skype or Tor
 - Application attributes such as Skype Video Call or Skype Text Messaging
- and extraction of:
- Content such as URLs and executable files
 - Metadata such as bandwidth usage, traffic volume, connection duration, attachment types
 - QoS/QoE indicators such as jitter, throughput and packet loss

R&S®PACE 2 uses deep packet inspection technology together with a comprehensive toolbox of methodologies such as atomic pattern matching, heuristics and behavioral analysis to reliably detect in realtime even encrypted and actively hiding applications and protocols with a very low false negative rate and virtually no false positives.

R&S®PACE 2 accelerates time to market and is designed for quick and easy integration. R&S®PACE 2 reduces costs and risks for vendors compared to developing a solution in-house and can be deployed in a variety of use cases, including network security (IDS/IPS, next-generation firewalls, SIEM, UTM), network monitoring and traffic management, policy and charging, application delivery and optimization, analytics and business intelligence, mobile gateways and mobile data offload.

Specifications in brief	
Operating systems/distributions	Linux Standard Base, Windows, FreeBSD, Android
CPU architectures	x86 (32- and 64-bit), PowerPC (32-bit), MIPS (64-bit), ARMv7 (32-bit)
Examples of applications and protocols	<ul style="list-style-type: none"> ■ VoIP/messaging: Skype, Oscar (ICQ & AIM), SIP, Skinny, H323, WhatsApp, WeChat, LINE, etc. ■ Social networking: Facebook, Twitter, MySpace, LinkedIn, Sina Weibo, Instagram, Tumblr, RenRen, etc. ■ P2P/filesharing: BitTorrent, eDonkey, Rapidshare, Uploaded.to, Xunlei, 4shared, etc. ■ Streaming: YouTube, Netflix, Hulu, Deezer, MyVideo, Vimeo, QQLive, Youku, iTunes Radio, etc. ■ Enterprise: Citrix, Blackberry, SAP, MS Lync, MS Exchange, Lotus Notes, WebEx, etc.
Examples of metadata	<ul style="list-style-type: none"> ■ Traffic volume: per user, per protocol, per application, etc. ■ QoS KPIs: jitter, throughput, latency, roundtrip time, packet loss rate (per direction), packet direction, etc. ■ User ID: MSIDN, diameter/RADIUS login, email address, callee, caller, sender, receiver, etc. ■ User info: call state, used operating system, tethering status, clicked URL, etc. ■ Client/server indication: per subscriber

R&S®Net Reporter 2 Traffic Analytics

New

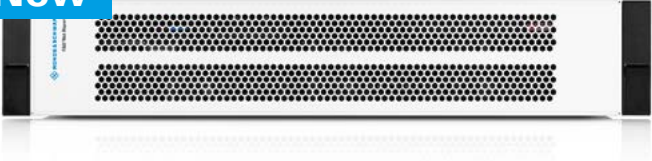

Actionable intelligence for network operators

Together, the new R&S®Net Reporter 2 and the closely integrated R&S®Net Sensor intelligent IP probe deliver a powerful, highly versatile, carrier-grade solution. The solution’s qualitative analytics approach requires less hardware and delivers similar or better results than competing products – at a much more attractive price. It features short deployment times along with flexible options to customize the solution and integrate it with third-party systems such as CRMs or big data systems. Customers benefit from quick time-to-market for new business cases.

- Unique, carrier-grade, end-to-end solution consisting of the R&S®Net Sensor intelligent IP probe and the R&S®Net Reporter 2 flexible analytics platform
- Qualitative analytics approach is a very cost-efficient solution that delivers similar or better results than competing solutions while using significantly fewer probes
- Powered by R&S®PACE 2
- Short deployment time with passive, nonintrusive probes
- Agnostic to type of network (wireless, wireline or converged)
- Customizable to network operator needs
- Open APIs for integration with third party systems (e.g. CRM, big data)
- Part of the comprehensive range of Rohde&Schwarz mobile network testing solutions

6

Deployment

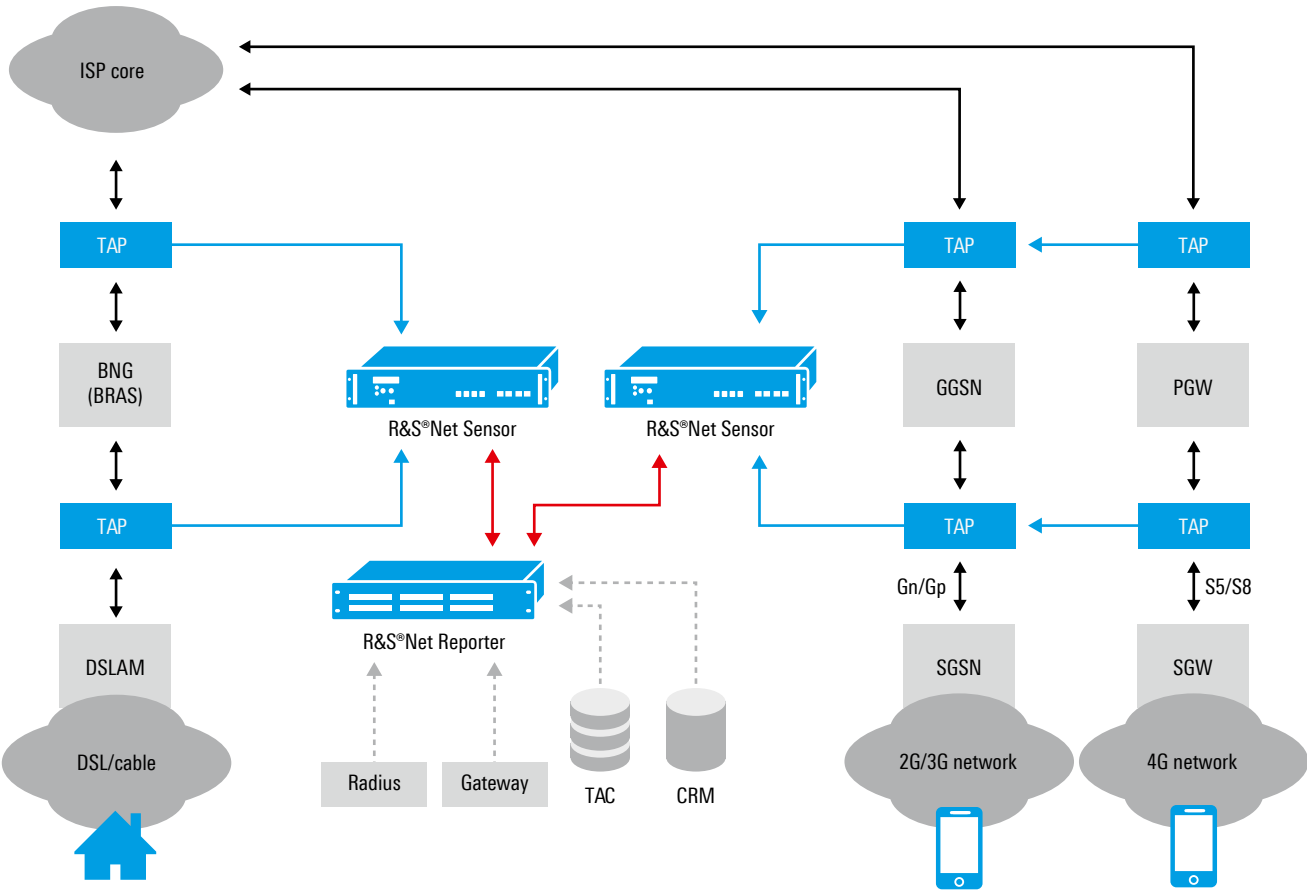

- Monitored/probed control and user plane network traffic
- Tapped or mirrored network traffic
- IP data records reported by the probes
- - - Integration of operational systems (e.g. TAC, CRM, Big Data)

R&S®Net Reporter Compact

New



All-in-one network probe and subscriber analytics

R&S®Net Reporter Compact combines the R&S®Net Reporter, R&S®Cybersecurity's proven traffic analysis and storage engine, with an application classification probe from Rohde&Schwarz to provide network operators with a kick start in advanced application and subscriber analytics. As an integrated, all-in-one solution, R&S®Net Reporter Compact enables operators to quickly and cost-effectively monitor and analyze subscriber traffic based on selection criteria such as protocol, device and location. Near-realtime statistics facilitate operational network monitoring and troubleshooting, and long-term IP traffic reports provide marketing and network planning departments with actionable data for revenue generation and capacity planning.

Gaining business intelligence from network and subscriber data is an increasingly important success factor. Operators can deliver improved quality of experience and develop additional revenue streams by understanding subscriber usage and behavior. Mobile network operators can use business intelligence to market enhanced subscriber packages and monetize new services as well as plan capacity and optimize the delivery of content for specific services such as video. With R&S®Net Reporter Compact (NRC), the benefits of advanced application and subscriber analytics are now easily accessible for small to medium network operators. Scalable to up to 100 000 subscribers, R&S®NRC provides detailed analytics such as traffic peaks, protocol usage per subscriber and top protocol statistics in one fully pre-installed and pre-configured server that starts collecting data immediately after setup.

- Easy to install and cost-efficient
- All-in-one probe and IP traffic analytics
- IP service monitoring
- Detailed application and subscriber usage statistics
- Seamless near-realtime and long-term network monitoring
- Fully customizable direct view and email reports top HTTP domains by hits and volume
- SIP calls and call minutes

R&S®Net Reporter Compact can be deployed in various network locations

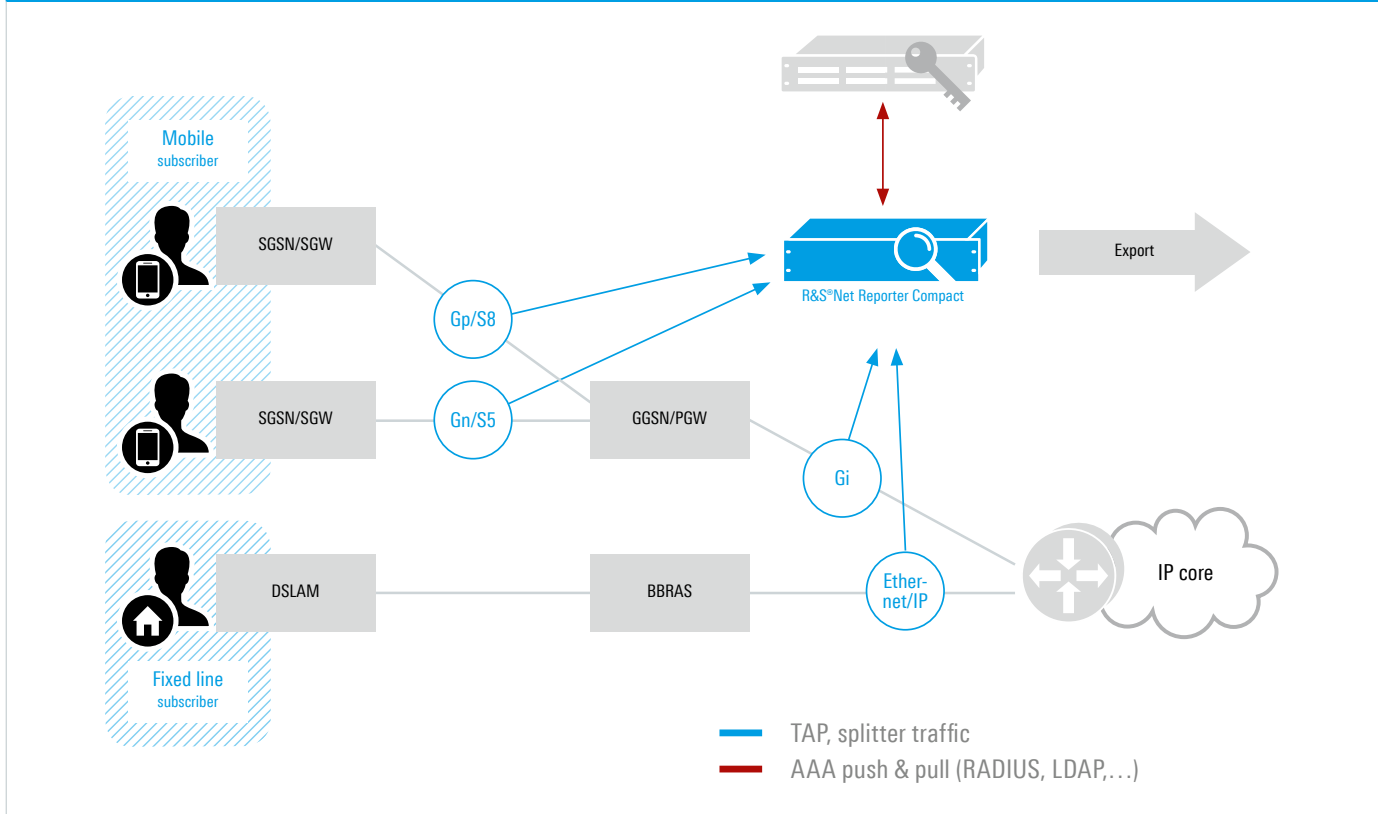

R&S®Net Sensor

New



IP application classification probe for network operators

R&S®Net Sensor is a technically advanced, intelligent IP probe that allows network operators and service providers to extract meaningful network traffic and subscriber behavior data as well as identify statistical trends in mobile and fixed networks. When deployed in combination with an analytics system such as R&S®Net Reporter, it delivers valuable insights into the traffic on the operator’s network for a better understanding of new trends, important sub-

scriber behavior and their quality of experience. Providers can use this data to efficiently plan network capacity, introduce new services and generate additional revenue through targeted marketing. R&S®Net Sensor uses the R&S®PACE 2 leading application classification engine from R&S®Cybersecurity to deliver high accuracy application and protocol detection. The detection list covers thousands of applications and protocols from all geographical regions and across various business fields. By providing the full classification vector for layer 3 to layer 7 and above, R&S®Net Sensor provides full traffic awareness and consistent performance reporting capabilities.

- Versatile IP probe that can provide valuable data about subscribers and traffic
- Very high application and protocol classification rate thanks to the R&S®PACE leading embedded application classification and metadata extraction engine
- Flexible and reliable reporting API that allows realtime reporting of counters and classification results to analytics systems
- Deployable in mobile, fixed and converged networks
- End-to-end capture and statistical analysis system together with R&S®Net Reporter
- Available with flexible interface configurations for extended connectivity
- Part of the most comprehensive range of Rohde&Schwarz mobile network testing solutions

6

R&S®Net Sensor deployment in mobile networks

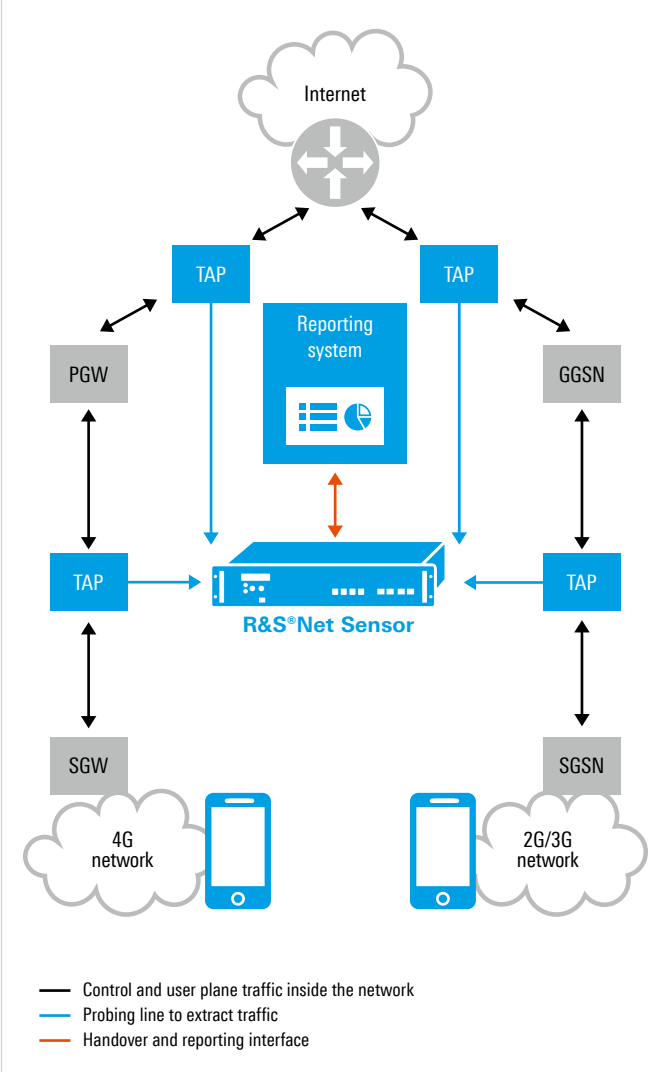

R&S®Net Sensor deployment in fixed networks

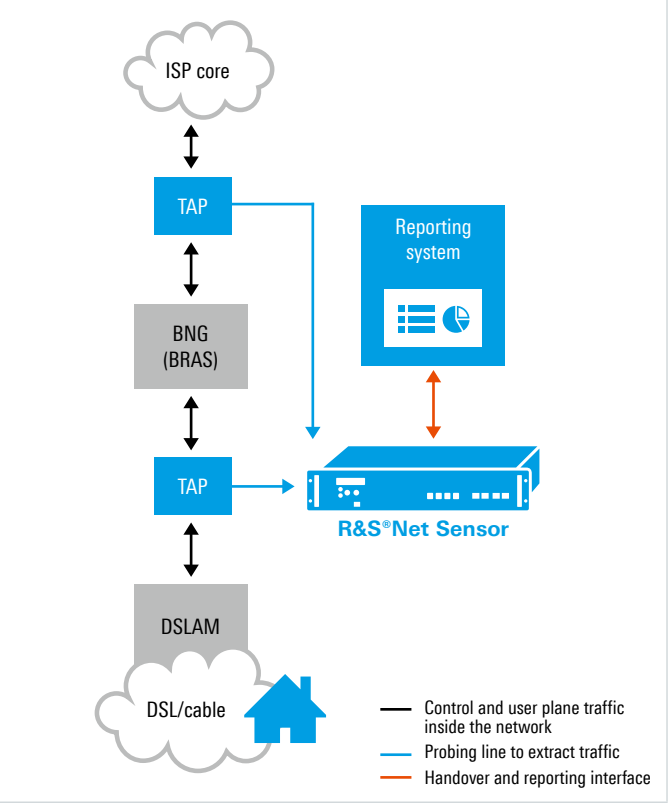

Chapter 7

EMC and field strength test solutions

Rohde & Schwarz offers an exceptional range of EMC and field strength test equipment, from stand-alone instruments to customized turnkey test chambers. EMI and EMS test instruments and systems from Rohde & Schwarz determine the causes and effects of electromagnetic interference and ensure compliance with the relevant EMC standards.

The EMC test solutions support all relevant commercial, automotive, military and aerospace standards as well as ETSI and FCC standards for radiated spurious emissions and audio breakthrough measurements. Decades of experience in the field of EMC measurements has made us the world market leader.



Type	Designation	Description	Page	
EMI precompliance/compliance				
New	R&S®ESW	EMI test receiver, 2 Hz to 8/26.5/44 GHz	Unrivalled dynamic range, extremely fast standard-compliant EMI measurements, 80 MHz realtime spectrum analysis	184
	R&S®ESR	EMI test receiver, 9 kHz to 3/7/26 GHz	More speed – more insight – more intelligence	185
	R&S®ESRP	EMI test receiver, 9 kHz to 3/7 GHz	Precompliance measurements – fast and straightforward	186
	R&S®ESL	EMI test receiver, 9 kHz to 3/6 GHz	The EMC expert for every lab bench	187
	R&S®TS9975	EMI test system	Tests in accordance with commercial, A&D and automotive standards	188
EMS measurements				
	R&S®CEMS100	Compact EMS/EMI test platform	Standard-compliant all-in-one solution for EMS measurements	190
	R&S®TS9980	EMS test system for audio and video and TV monitoring	EMS measurements on sound and TV broadcast receivers, satellite receivers and DVB/DAB receivers	193
	R&S®TS9982	EMS test system	Radiated and conducted EMS measurements in line with commercial, wireless, automotive and A&D standards	191
EMF measurements				
	R&S®TS-EMF	Portable EMF measurement system	Simple, frequency-selective measurement of EMF emissions	195
EMC software				
	R&S®ES-SCAN	EMI software	User-friendly software for EMI measurements	196
	R&S®EMC32	EMC measurement software platform	For use in development, for compliance and batch testing	197
	R&S®AdVISE	Visual inspection software	A new way to eliminate human inattention	199
Broadband amplifiers				
	R&S®BBA150	Broadband amplifier	Excellent microwave amplifiers with high power density	200
	R&S®BBL200	Broadband amplifier	Liquid-cooled power amplifiers for high field strengths	201
RF test chambers				
	Albatross Projects	Test chambers	Compact diagnostic chambers, fully anechoic rooms for EMC and field strength test solutions up to test sites for automotive test solutions	202
EMC accessories				
Disturbance voltage measurements				
	R&S®ENV216/ENV432/ENV4200, R&S®ESH3-Z6	V-networks for EMC measurements on power supply networks	205	
	R&S®ENY21/ENY41/ENY81, R&S®ENY81-CA6	Coupling networks for EMC measurements on telecommunications ports	206	
	R&S®EZ-12, R&S®EZ-25	Antenna impedance converter, 150 kHz highpass filter	207	
	R&S®ESH2-Z3, R&S®ESH3-Z2	Voltage probe, pulse limiter	207	
Disturbance current measurements				
	R&S®EZ-17, R&S®ESV-Z1	Current probes for disturbance current measurements on cables	208	
Disturbance power measurements				
	R&S®MDS-21	Absorbing clamp for EMC measurements on cables	208	
Field strength measurements				
	R&S®HZ-14/HZ-15/HZ-16	E and H near-field probe sets	209	
	R&S®HFH2-Z2/HFH2-Z6	Loop/rod antennas	210	
	R&S®HZ-9	Power supply	210	
	R&S®AM524	Active antenna system	210	
	R&S®HL033/HL040E/HL046E/HL050(E)/HL223	Log-periodic antennas	211	
	R&S®HM020	Triple-loop antenna	212	
	R&S®HK116E, R&S®HF907, R&S®HL562E	Biconical antenna, double-ridged waveguide horn antenna, ULTRALOG antenna	213	

Introduction

EMC = EMI + EMS

Electromagnetic compatibility (EMC) is the capability of an electrical device or system to operate in its electromagnetic environment without disturbing it or being disturbed by it. EMC is an important criterion of product quality. To ensure EMC of a product in the most economical way, appropriate measures should be taken early in the design phase.

In line with the definition, EMC is subdivided into electromagnetic interference (EMI) and electromagnetic susceptibility (EMS). Legislation prescribes compliance with maximum values for EMI and minimum values for EMS. The applicable limits, the measurement methods and instruments to be employed are specified in the relevant standards.

Conformity mark

To show their conformity to the EMC requirements prescribed by law, all electrical devices have to be marked accordingly, e.g. by the CE conformity mark required in the entire European Economic Area.

EMI measurements

For measuring electromagnetic disturbance, the disturbance sink, which in the commercial sector is the radio listener or TV viewer, is replaced by the measuring instrument. As a result, all test receivers for commercial EMI measurements should have human-like response built in: they must have a quasi-peak-weighting detector to show the human perception of disturbance as a measured value. Disturbance measurements higher than 1 GHz use peak, CISPR-average and RMS-average weighting.

In the military sector, the disturbance sink is assumed to be a technical device that responds to the maximum disturbance level. Therefore, the peak level of disturbance is measured.

Disturbance is emitted by the equipment under test in various ways of coupling. Therefore, the EMC standards contain procedures for coupling the test receiver to the equipment under test, as well as for the environment of the EUT and its operation.

EMS measurements

For measuring electromagnetic susceptibility, the different disturbance sources occurring in practice are replaced by appropriate generators, the interfering signals of which are applied to the EUT via suitable coupling/decoupling networks.

For monitoring the proper functioning of the EUT, suitable monitoring equipment can be provided, which so far has not been defined in the relevant EMC standards. In many cases, highly shielded video cameras with a monitor are used for this purpose.

EMC measurement software

Reproducible EMC measurements are only possible if a number of rules and standards for the measuring instruments and the measurement methods used are complied with.

For computer-controlled EMC measurements, two different software tools are available. The R&S®ES-SCAN EMI software is used to quickly and easily collect, evaluate and document disturbance voltage, power and field strength data. The R&S®EMC32 software platform includes various modules for electromagnetic interference (EMI) and electromagnetic susceptibility (EMS) measurements. Due to its flexible structure the software can be optimally adapted to the requirements of almost any commercial or military EMC application.

These tools relieve the user of routine settings and offer every convenience – from automatic consideration of frequency-dependent transducer factors of the coupling/decoupling networks, automatic selection of the applicable limit lines, display of the results in graphical or tabular form to the generation of test reports. Similar convenience is provided by the automatic EMI test routines implemented in the R&S®ESW, R&S®ESR, R&S®ESRP and R&S®ESL test receivers. They allow fully automatic time-saving measurements without an external controller, so that very compact test setups can be implemented.

EMC test systems

Planning and implementation of practice-oriented EMC test systems requires a great deal of specialized knowledge and experience. This is what Rohde&Schwarz specialists have. All their expertise goes into turnkey EMC test systems, which are the fastest means for obtaining correct EMC measurements.

These systems are always tailored to the specific needs of the customer to provide the optimum solution to the tasks at hand. We can offer everything from small systems to complete test houses with shielded anechoic chamber and the required infrastructure, covering all major standards in the commercial, automotive, wireless and military range.

EMC standards in the European Economic Area

The number of standards published in the Official Journals are steadily increasing. The different types of standards include generic standards, which can be applied in all cases not covered by specific product or product family standards. The product (family) standards are divided into standards limiting low-frequency and high-frequency emission (radio disturbance suppression) and standards defining the requirements of immunity to electromagnetic emission. There is also a series of specific product standards that define EMC requirements.

Generic standards – emission

- ▮ **EN 61000-6-3:** Residential, commercial and light-industrial environments
- ▮ **EN 61000-6-4:** Industrial environments

Generic standards – immunity

- ▮ **EN 61000-6-1:** Residential, commercial and light-industry environments
- ▮ **EN 61000-6-2:** Industrial environments

Product family standards and product standards for low-frequency emission

- ▮ **EN 61000-3-2:** Limits for harmonic currents up to 16 A per phase
- ▮ **EN 61000-3-3/EN 61000-3-11:** Limits for voltage fluctuations and flicker up to 16 A/75 A per phase
- ▮ **EN 61000-3-12:** Limits for harmonic currents up to 75 A per phase

Product family standards for high-frequency emission

- ▮ **EN 55011:** ISM equipment
- ▮ **EN 55012:** Automotive equipment – protection of off-board receivers
- ▮ **EN 55013:** Sound and TV broadcast receivers
- ▮ **EN 55014-1:** Household appliances, electric tools and similar apparatus
- ▮ **EN 55015:** Lighting equipment
- ▮ **EN 55022:** Information technology equipment
- ▮ **EN 55025:** Automotive equipment – protection of on-board receivers
- ▮ **EN 55032:** Multimedia equipment
- ▮ **EN 55103-1:** Audio/video equipment for professional use

Product standards for immunity

- ▮ **EN 55014-2:** Household appliances, electric tools and similar apparatus
- ▮ **EN 61547:** Lighting equipment
- ▮ **EN 55020:** Sound and TV broadcast receivers
- ▮ **EN 55024:** Information technology equipment
- ▮ **EN 55035:** Multimedia equipment
- ▮ **EN 55103-2:** Audio/video equipment for professional use

Special standards for signal transmission in low-voltage installations

- ▮ **EN 50065-1:** Signaling on low-voltage electrical installations, Part 1: General requirements, frequency bands and electromagnetic disturbances
- ▮ **EN 50065-2-x:** Immunity

Product standards containing EMC requirements

- ▮ **EN 50083-2:** Cable networks for TV and sound signals
- ▮ **EN 50090-2-2:** Electronic systems for homes and buildings
- ▮ **EN 62040-2:** Uninterruptible power systems
- ▮ **EN 50130-4:** Alarm systems
- ▮ **EN 50148:** Electronic taximeters
- ▮ **EN 60974-10:** Arc welding equipment
- ▮ **EN 50263:** Measuring relays and protection equipment
- ▮ **EN 50270:** Gas sensors
- ▮ **EN 50293:** Road traffic signal systems
- ▮ **EN 50295, EN 60439-1, EN 60947-x-x:** Low-voltage switchgear and control gear
- ▮ **EN 50370-1, -2:** Machine tools
- ▮ **EN 60034-1:** Rotating electrical machines
- ▮ **EN 60204-31:** Sewing machines
- ▮ **EN 62052-x, EN 62053-x, EN 62054-x:** Several AC watt-hour meters, tariff and load control equipment
- ▮ **EN 60601-1-2:** Medical electrical equipment
- ▮ **EN 50428, EN 60669-2-x:** Switches for household and similar fixed electrical installations
- ▮ **EN 60730-x-x:** Automatic electric controls for household and similar use
- ▮ **EN 60870-2-1:** Telecontrol equipment and systems
- ▮ **EN 60945:** Maritime navigational equipment
- ▮ **EN 61008-1, EN 61009-1, EN 61543:** Residual current circuit breakers
- ▮ **EN 61037:** Electronic ripple control receivers for tariff and load control
- ▮ **EN 61204-3:** Low-voltage power supplies
- ▮ **EN 61131-2:** Programmable controllers
- ▮ **EN 61326-x:** Electrical equipment for measurement, control and laboratory use
- ▮ **EN 61800-3:** Adjustable speed electrical power drive systems
- ▮ **EN 61812-1:** Time relays for industrial and residential use
- ▮ **EN 617, EN 618, EN 619, EN 620:** Continuous handling equipment
- ▮ **EN 12015, EN 12016:** Elevators and escalators
- ▮ **EN 12895:** Industrial trucks
- ▮ **EN 13241:** Doors and gates
- ▮ **EN 13309:** Construction machinery with internal power supply
- ▮ **EN 14010:** Power driven parking equipment for vehicles
- ▮ **EN ISO 14982:** Agricultural and forestry machinery
- ▮ **ETSI EN 301489:** Radio equipment and services

EN 300127	EN 300220, 330, 440 9 kHz to 40 GHz	EN 301489-3	EN 301489-5 PMR equipment	EN 301489-6 DECT equipment	EN 300339 Generic EMC standard for radio equipment	EN 301489-1 ERMES paging receivers	EN 300340	EN 301489-7 GSM 900 MHz	EN 301489-8 GSM 1800 MHz	EN 300385 Fixed radio links	EN 301489-4	EN 301489-9	EN 301489-10	EN 301489-11 EN 302016-2 ETS 300384/447	EN 301489-12	EN 301489-13	EN 300741 EN 301489-2	EN 301489-15 EN 301769-2	EN 301489-17	EN 301489-18	EN 301843-2	EN 301489-19	EN 300831 EN 301489-20	EN 300832 EN 301721	Telecom systems of large dimensions	
																										Short range devices (SRD)
																										9 kHz to 40 GHz
																										PMR equipment
																										DECT equipment
																										Generic EMC standard for radio equipment
																										ERMES paging receivers
																										GSM 900 MHz
																										GSM 1800 MHz
																										Fixed radio links
																										Wireless microphones and similar equipment
																										Second generation cordless telephones (CT2)
																										VHF FM broadcasting transmitters
																										VHF FM broadcasting transmitters
																										VSAT, SNG and TES equipment
																										CB radio and ancillary equipment
																										On-site and wide-area paging equipment
																										Commercially available amateur radio equipment
																										2.4 GHz wideband transmission and HiperLAN
																										TETRA and ancillary equipment
																										VHF maritime mobile radio telephone
																										1.5 GHz receive-only MES for data communications
																										1.5/1.6/2.4 GHz MES for satellite GSM
																										< 1 GHz MES with LBDDC using LEDs

Legend

- Necessary accessory.
- Recommended extra.
- ¹⁾ R&S®ESRP and R&S®ESL have limited compliance with CISPR 16-1-1.
- ²⁾ For FCC Part 15 only.
- ⁴⁾ VG up to 200 kHz.
- ⁵⁾ VG.
- ⁶⁾ VG, MIL, MIL-STD-461D, MIL-STD-461E.
- ⁷⁾ VG, DEF-STAN.
- ⁸⁾ See R&S®EZ-25.
- ⁹⁾ For MIL-STD-461 only.

Current probe from 5 Hz to 2 MHz/20 Hz to 100 MHz

Current probe from 20 Hz to 100 MHz

Passband from 150 kHz to 30 MHz

Shielded, calibrated field pickup coil from 5 Hz to 10 MHz

Tripod for R&S®HFH2-Z2 loop antenna

Active loop antenna from 9 kHz to 30 MHz

Tripod for R&S®HFH2-Z6 rod antenna

Active rod antenna from 9 kHz to 30 MHz

V-network up to 32 A, four-line LISN

V-network up to 115 A (500 A), single-phase LISN

V-network up to 16 A, two-line LISN

V-network up to 200 A, four-line LISN, from 150 kHz

Two-wire ISN from 150 kHz

Four-wire ISN from 150 kHz

Eight-wire ISN from 150 kHz

Passive probe for disturbance voltage measurement

Antenna impedance converter from 9 kHz to 30 MHz

Near-field probe set from 9 kHz to 1 GHz

Triple-loop antenna from 9 kHz to 30 MHz

Power supply cables, length: 3 m/10 m

Power supply for R&S®HFH2-Z2/-Z6 active antennas and antenna impedance converter

Current probe from 20 Hz to 100 MHz

Current probe from 20 Hz to 600 MHz

Absorbing clamp from 30 Hz to 1000 MHz

Near-field probe set from 9 kHz to 1 GHz

Near-field probe set from 30 MHz to 3 GHz

Biconical antenna from 30 MHz to 300 MHz

Log-periodic antenna from 200 MHz to 1300 MHz

Biconical hybrid antenna from 30 MHz to 6 GHz

Tripod for R&S®HK116, R&S®HL223

Directional antenna from 1 GHz to 18 GHz, e.g. log-periodic antenna, or double-ridged waveguide horn antenna

Directional antenna from 1 GHz to 18 GHz, e.g. log-periodic antenna, or double-ridged waveguide horn antenna

Double-ridged waveguide horn antenna

R&S®ESW EMI Test Receiver

New



Unrivalled dynamic range, extremely fast standard-compliant EMI measurements, 80 MHz realtime spectrum analysis

Due to its outstanding RF characteristics – especially its dynamic range and exceptional sensitivity – the R&S®ESW EMI test receiver meets the highest standards for compliance in line with CISPR 16-1-1, MIL-STD-461, DO-160 and FCC. With an optimized preselection filter module (including notch filters for ISM bands) and time domain scan, disturbance spectra are instantly captured and analyzed. The powerful spectrum analyzer with realtime analysis and spectrogram function enables detailed analysis of disturbance signals and their history. The test receiver features a simple operating menu and touchscreen operation as well as numerous analysis functions. Results are clearly displayed, even when using the MultiView function which lets users see all measurements and modes at a glance.

- ▮ Frequency range from 2 Hz to 8 GHz/26.5 GHz/44 GHz
- ▮ Compliant with CISPR 16-1-1 Ed. 3.1/MIL-STD-461/FCC standards
- ▮ Widest dynamic range for the highest standards requirements
- ▮ Ultrafast measurement speed with FFT-based time domain scan (TD scan)
- ▮ Optimized preselection filter with integrated preamplifier, switchable highpass and ISM band notch filters
- ▮ Realtime spectrum analysis with a bandwidth of 80 MHz
- ▮ TD scan, sweep, scan, realtime spectrum analysis and IF analysis modes, each with a spectrogram function
- ▮ Auto test – automates complex test sequences – flexible configuration of parameters for preview measurement, peak search criteria and final measurement with CISPR weighting detectors
- ▮ Integrated test report generator for generating documents – flexible template design
- ▮ Parameter coupling for fast switching between operating modes (spectrum analysis <-> receiver)
- ▮ Rotary knobs that can be assigned diverse test parameters for quick comparison of the effects of varying e.g. the measurement bandwidth, measurement time, preamplifier and RF attenuation
- ▮ Easy operation, flat menu structure, intuitive GUI
- ▮ MultiView for clear, efficient display of several receiver and spectrum analyzer modes, also with spectrogram history

Specifications in brief

Frequency	R&S®ESW8	R&S®ESW26	R&S®ESW44
Frequency range, RF input 1	2 Hz to 8 GHz	2 Hz to 26.5 GHz	2 Hz to 44 GHz
Frequency range, RF input 2	20 Hz to 1 GHz	20 Hz to 1 GHz	20 Hz to 1 GHz
Reference frequency	aging 1×10^{-7} /year, optionally 3×10^{-9} /year (R&S®FSW-B4)		
Bandwidths, preselection, preamplifier			
Resolution bandwidths (standard, -3 dB)	1 Hz to 10 MHz (20 MHz, 50 MHz, 80 MHz with R&S®ESW-B8 option)		
Resolution bandwidths (EMI, -6 dB)	10/100/200 Hz, 1/9/10/100/120 kHz, 1 MHz (20 MHz, 50 MHz, 80 MHz with R&S®ESW-B8 option)		
Channel filters (RRC filter (analyzer mode))	45 bandwidths, 100 Hz to 10 MHz (20 MHz, 28 MHz, 40 MHz, 80 MHz with R&S®ESW-B8 option)		
Preselection	19 preselection filters, can be switched off in analyzer mode		
Preamplifier	switchable, 20 dB gain (1 kHz to 8 GHz) or 30 dB gain (8 GHz to 44 GHz)		
Intermodulation			
Third-order intercept (TOI), $10 \text{ MHz} \leq f_{in} < 1 \text{ GHz}$, level $2 \times -15 \text{ dBm}$, $\Delta f > 5 \times \text{RBW}$	$> +25 \text{ dBm}$, typ. 30 dBm (YIG preselector on, EMI preselection off, RF preamplifier off)		
1 dB compression point, RF attenuation = 0 dB, EMI preselection and RF preamplifier off	+15 dBm (nom., RF attenuation = 0 dB,)		
Receiver mode, time domain scan			
CISPR band B, 150 kHz to 30 MHz	110 ms (meas., RBW = 9 kHz, measurement time = 100 ms, peak detector)		
CISPR band B, 150 kHz to 30 MHz	2 s (meas., RBW = 9 kHz, measurement time = 1 s, quasi-peak detector)		
CISPR band C/D, 30 MHz to 1000 MHz	520 ms (meas., RBW = 120 kHz, measurement time = 10 ms, peak detector)		
CISPR band C/D, 30 MHz to 1000 MHz	820 ms (meas., RBW = 9 kHz, measurement time = 10 ms, peak detector)		
CISPR band C/D, 30 MHz to 1000 MHz	80 s (meas., RBW = 120 kHz, measurement time = 1 s, quasi-peak detector)		
Total measurement uncertainty	$\pm 0.27 \text{ dB}$ ($10 \text{ MHz} < f \leq 3.6 \text{ GHz}$, YIG preselector on, EMI preselector off)		

R&S® ESR EMI Test Receiver



More speed – more insight – more intelligence

The R&S® ESR measures conducted and radiated disturbances in the frequency range from 10 Hz to 26 GHz in compliance with the CISPR 16-1-1 standard. Using an FFT-based time domain scan, the instrument measures electromagnetic disturbances at an extremely high speed. At

the same time, the R&S® ESR functions as a full-featured, powerful signal and spectrum analyzer for lab applications. Featuring realtime spectrum analysis capability with a wide range of diagnostic tools, the test receiver also enables detailed analysis of disturbance signals and their history. The R&S® ESR comes with a clearly structured, intuitive touchscreen interface and is very easy to use.

- EMI test receiver and signal/spectrum analyzer combined in a single instrument
- Compliant with CISPR 16-1-1 Ed. 3.1
- Preselection with integrated 20 dB preamplifier
- Resolution bandwidths in line with CISPR and in decade steps from 10 Hz to 1 MHz (MIL-STD-461, DO-160)
- Ultrafast time domain scan in addition to conventional stepped frequency scan
- Realtime spectrum analysis with up to 40 MHz span for detailed investigation of disturbance signals
- Time domain display with high resolution (50 μ s)
- Automatic test routines

Specifications in brief

Frequency		
Frequency range	R&S® ESR3/R&S® ESR7/R&S® ESR26	9 kHz to 3.6 GHz/7 GHz/26 GHz
Preselection	can be switched off in analyzer mode	16 fixed filters
Preamplifier	can be switched on/off	1 kHz to 7 GHz, 20 dB gain (nom.)
Level		
Max. RF level (CW)	RF attenuation \geq 10 dB; RF preamplifier off RF attenuation \geq 10 dB; RF preamplifier on	30 dBm (= 1 W) 23 dBm (= 0.2 W)
Max. pulse voltage	RF attenuation \geq 10 dB input 1 input 2	150 V 450 V
Max. pulse energy	RF attenuation \geq 10 dB; 10 μ s input 1 input 2	1 mWs 20 mWs
1 dB compression	RF attenuation 0 dB; RF preamplifier and preselection off	+3 dBm (nom.)
IF and resolution bandwidths		
3 dB bandwidths		10 Hz to 10 MHz in 1/2/3/5/10 steps
6 dB bandwidths		200 Hz, 9 kHz, 120 kHz, 1 MHz (impulse bandwidth)
Detectors	receiver mode	max./min. peak, quasi-peak, RMS, average, average with meter time constant (CISPR-average), RMS-average (CISPR-RMS)
Displayed average noise level (DANL)	receiver mode, nominal, average detector (AV), RF attenuation = 0 dB, 50 Ω termination preamplifier off	
	500 MHz, bandwidth = 120 kHz	< 6 dB μ V
	3 GHz, bandwidth = 1 MHz	< 17 dB μ V
	preamplifier on	
	500 MHz, bandwidth = 120 kHz	< -7 dB μ V
	3 GHz, bandwidth = 1 MHz	< 5 dB μ V
Number of sweep (trace) points	analyzer mode (standard)	101 to 32001
	analyzer mode (EMI)	101 to 200001
	receiver mode	max. 4000000
	realtime analyzer (option)	801

R&S®ESRP EMI Test Receiver



Precompliance measurements – fast and straightforward

The R&S®ESRP EMI test receiver has been designed for diagnostic measurements during development and for pre-compliance measurements in order to prepare products for final certification testing. It measures electromagnetic disturbances in the frequency range from 10 Hz to 7 GHz, using either conventional stepped frequency scan or an FFT-based time domain scan, a method that significantly speeds up measurements.

At the same time, the R&S®ESRP is a full-featured, powerful signal and spectrum analyzer for lab applications. The R&S®ESRP comes with a straightforward menu structure that together with the intuitive touchscreen makes the test receiver very easy to operate in any mode.

- EMI test receiver and signal/spectrum analyzer combined in one box
- Optional preselection and preamplifier (R&S®ESRP-B2)
- Resolution bandwidths in line with CISPR, optionally in decade steps from 10 Hz to 1 MHz (R&S®ESRP-B29)
- Weighting detectors: max./min. peak, average, RMS, quasi-peak, average with meter time constant and RMS in line with current CISPR 16-1-1 version
- Standard-compliant disturbance measurements for pulsed disturbances with repetition frequencies ≥ 10 Hz (with R&S®ESRP-B2 preselection/preamplifier option)
- Very fast FFT-based time domain scan option (R&S®ESRP-K53)
- Automatic test routines
- IF analysis option (R&S®ESRP-K56)

Specifications in brief

Frequency		
Frequency range	R&S®ESRP3/R&S®ESRP7	9 kHz to 3.6 GHz/7 GHz
Preselection (R&S®ESRP-B2 option)	can be switched off in analyzer mode	16 fixed filters
Preamplifier (R&S®ESRP-B2 option)	can be switched on/off	1 kHz to 7 GHz, 20 dB gain (nom.)
Level		
Max. RF level (CW)	RF attenuation ≥ 10 dB; RF preamplifier off RF attenuation ≥ 10 dB; RF preamplifier on	30 dBm (= 1 W) 23 dBm (= 0.2 W)
Max. pulse voltage	RF attenuation ≥ 10 dB	150 V
Max. pulse energy	RF attenuation ≥ 10 dB, 10 μ s	1 mWs
1 dB compression	RF attenuation 0 dB, RF preamplifier and preselection off	+ 3 dBm (nom.)
IF and resolution bandwidths		
3 dB bandwidths	analyzer (span ≥ 10 Hz) and receiver	10 Hz to 10 MHz in 1/2/3/5/10 steps
6 dB bandwidths	analyzer and receiver	200 Hz, 9 kHz, 120 kHz, 1 MHz (impulse bandwidth)
Detectors		
	receiver mode	max./min. peak, quasi-peak, RMS, average, average with meter time constant (CISPR-average), RMS-average (CISPR-RMS)
Displayed average noise level (DANL)		
	receiver mode, nominal, average detector (AV), RF attenuation = 0 dB, 50 Ω termination preamplifier off	
	500 MHz, bandwidth = 120 kHz	< 6 dB μ V
	3 GHz, bandwidth = 1 MHz	< 17 dB μ V
	preamplifier on	
	500 MHz, bandwidth = 120 kHz	< -7 dB μ V
	3 GHz, bandwidth = 1 MHz	< 5 dB μ V
Number of sweep (trace) points		
	analyzer (standard)	101 to 32001
	analyzer (EMI)	101 to 200001
	receiver	max. 4000000

R&S®ESL EMI Test Receiver

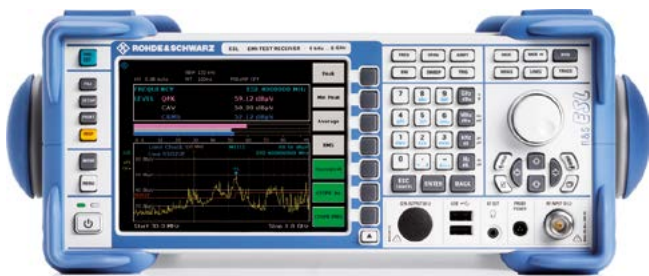

Compact, cost-effective measuring receiver

The R&S®ESL EMI test receiver combines two instruments in one, measuring EMC disturbances in accordance with the latest standards and also serving as a full-featured spectrum analyzer for diverse lab applications. The R&S®ESL is designed to meet the needs of cost-conscious users who want to perform diagnostic and precompliance EMI measurements from 9 kHz up to 3 GHz or 6 GHz.

The combination of good RF characteristics and all of the important functions needed for fast, precise measurement and evaluation of the EMC of a device under test in accordance with commercial standards is unmatched in this instrument class. The diverse analysis capabilities and time-saving automated test routines make the R&S®ESL the obvious choice for any development lab that needs to prepare for EMC certification tests.

- First-ever combination of an EMI test receiver and spectrum analyzer in the entry-level class
- All major functions of an advanced EMI test receiver, including fully automated test routines
- Weighting detectors: max./min. peak, average, RMS, quasi-peak as well as average with meter time constant (CISPR-average) and RMS-average (CISPR-RMS)
- Predefined transducer factors
- Library of limit lines for commercial standards
- Compact, lightweight instrument, can be battery-powered for mobile applications

Specifications in brief				
	R&S®ESL3 (model .03)	R&S®ESL3 (model .13)	R&S®ESL6 (model .06)	R&S®ESL6 (model .16)
Frequency range	9 kHz to 3 GHz	9 kHz to 3 GHz	9 kHz to 6 GHz	9 kHz to 6 GHz
Frequency accuracy (standard)	1 × 10 ⁻⁶			
With R&S®FSL-B4 (OCXO)	1 × 10 ⁻⁷			
Measurement time				
Receiver mode/scan (per frequency step)	selectable from 100 μs to 100 s			
Analyzer mode/sweep time	selectable from 2.5 ms to 16000 s, zero span from 1 μs to 16000 s			
Resolution bandwidths				
3 dB bandwidths	10 Hz to 10 MHz in 1/3 sequence			
6 dB bandwidths (EMI)	200 Hz, 9 kHz, 120 kHz, 1 MHz (impulse bandwidth)			
Video bandwidth, analyzer mode	1 Hz to 10 MHz in 1/3 sequence			
Level				
Max. RF level (input attenuation ≥ 10 dB)	+30 dBm (= 1 W)			
Max. pulse energy (10 μs pulse width)	10 mWs			
Max. pulse voltage	150 V			
Third-order intercept (f ≥ 30 MHz)	typ. +18 dBm			
1 dB compression (0 dB RF attenuation, preamplifier = off, f > 200 MHz)	+ 5 dBm			
Displayed average noise level (0 dB RF attenuation, 50 Ω termination, RBW = 1 kHz, VBW = 1 Hz, sample detector, log scaling, normalized to 1 Hz, R&S®FSL-B22 preamplifier option on)				
9 kHz < f < 3 MHz	typ. -130 dBm			
f = 500 MHz	typ. -162 dBm			
f = 3 GHz	typ. -158 dBm			
Detectors (EMI)				
	max./min. peak, quasi-peak, RMS, average, average with meter time constant (CISPR-average), RMS-average (CISPR-RMS)			
Level measurement uncertainty (95% confidence level, +20°C to +30°C, S/N >16 dB, 0 dB to -50 dB from reference level)	10 MHz < f ≤ 3 GHz: < 0.5 dB 3 GHz < f ≤ 6 GHz: < 0.8 dB			
Tracking generator				
	no	yes	no	yes
Frequency range	-	1 MHz to 3 GHz	-	1 MHz to 6 GHz
Output level	-	-20 dBm to 0 dBm	-	-20 dBm to 0 dBm

R&S®TS9975 EMI Test System

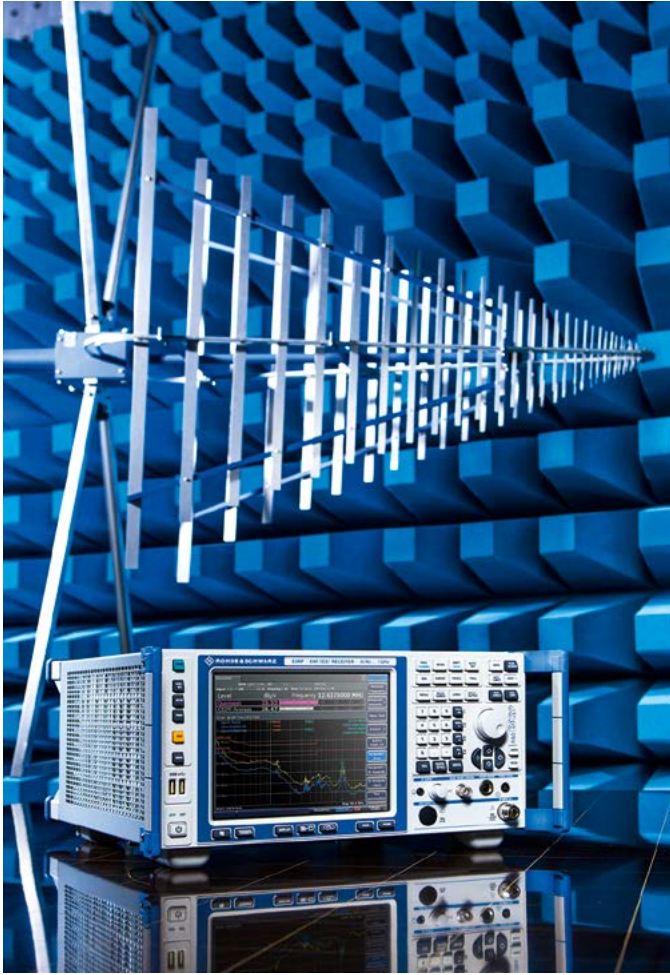

Commercial application in anechoic test chamber with R&S®ESRP EMI test receiver.

Tests in line with commercial, A&D and automotive standards

The R&S®TS9975 is the base system for conducted and radiated EMI measurements. Due to its modular design, it covers a wide range of applications and can be very easily adapted to the measurement task at hand. Any configuration is possible – from conducted measurements and a small precompliance system with compact test cell to an accredited test system for complete vehicles. Combinations of different applications or incremental expansion can also be implemented without any problem.

From system design and implementation to installation and training, these turnkey systems and our EMC experts provide everything from a single source, enabling the customer to concentrate on testing.

Commercial standards (examples)

- CISPR 11 to 32
- IEC/EN 55011 to IEC/EN 55032
- ANSI-C63.4
- FCC Part 15, Part 18
- 2014/30/EU
- Customer-specific requirements
- IEC 60601-1-2 Edition 4.0

A&D standards (examples)

- MIL-STD-461
- RTCA DO160
- Country-specific requirements
- Customer-specific requirements

Automotive standards (examples)

- CISPR 12
- CISPR 25
- UN/ECE R10
- Customer-specific requirements

For tests in line with wireless EMC standards, e.g. ETSI EN 301489, see our R&S®TS8996 RSE test system for radiated spurious emissions measurements.

For a combined EMS/EMI solution in line with commercial standards, see our R&S®CEMS100 EMC test system.

Main features

- Conducted EMI measurements from 0.15 MHz to 30 MHz
- Radiated EMI measurements from 30 MHz to 40 GHz (200 GHz)
- System automation via automatic path switching
- Equipment for system calibration

System configuration

The system features a highly modular hardware and software concept. Customized systems can be configured from a variety of instruments. The system is a complete package of hardware, user-friendly software, system services and installation. Users can very quickly learn to use the system.

R&S®TS9975 block diagram

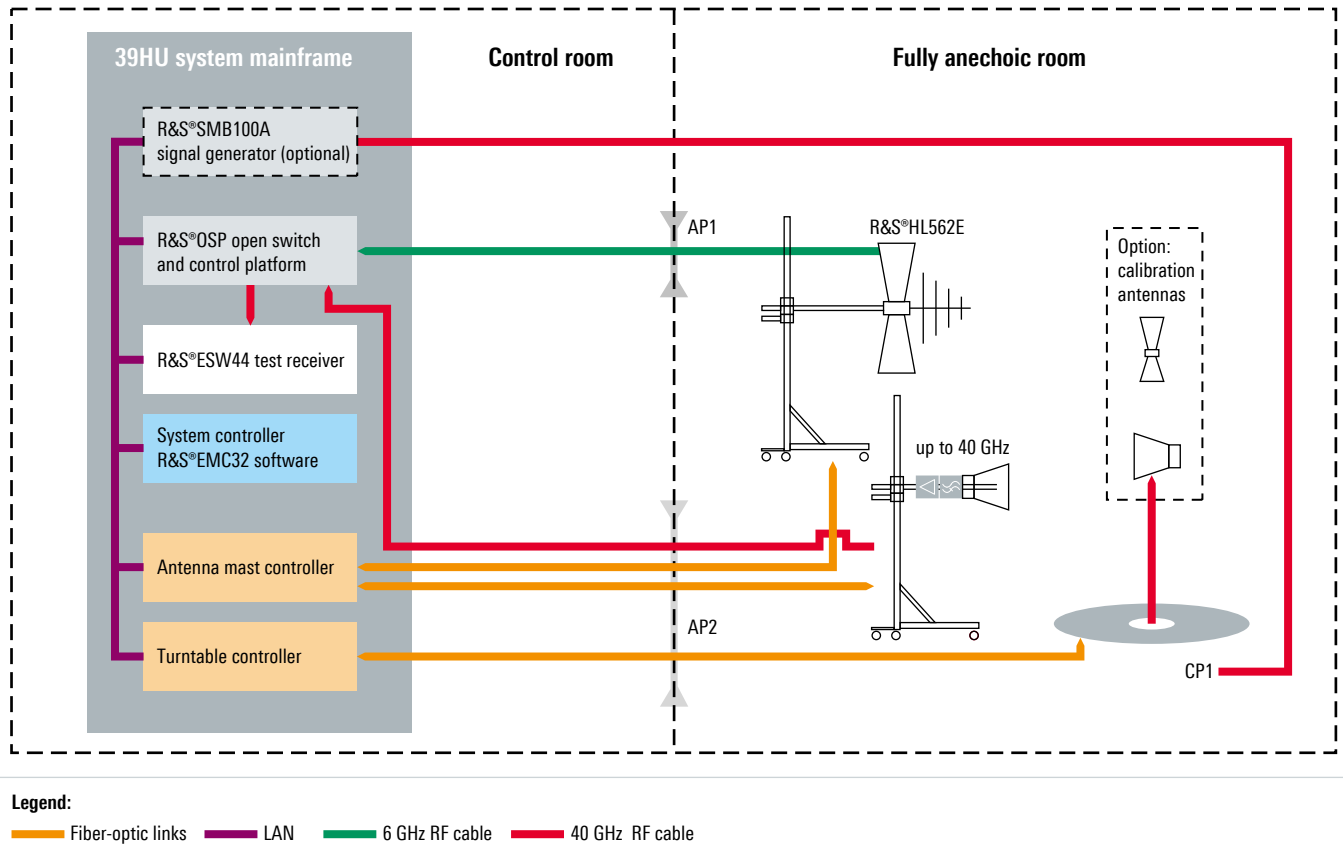

Anechoic chamber

Radiated emissions are measured mostly in an anechoic chamber as an alternative to an open area test site (OATS). This requires a remote controlled turntable and an automatic antenna mast with a control unit. These optional components can be supplied with the system and controlled by the system software. For development and quality assurance purposes, smaller test cells that easily fit into the lab are available. The upper frequency limit of the test system is 40 GHz (200 GHz using mixers) and depends on the type of DUT and the applied standard.

Test receiver

The test receiver (R&S®ESW, R&S®ESR or R&S®ESRP) forms the core of the system. It evaluates and displays emissions in line with the relevant standards. If precompliance measurements are sufficient for EMC testing, a spectrum analyzer can be used instead of the test receiver.

Test antennas and LISN

Suitable test antennas such as the R&S®HL562E and R&S®HF907 as well as artificial mains networks (LISN) are used for measuring emissions.

Switching unit

The R&S®OSP switching unit configured with appropriate plug-in modules for switching antennas and transducers is integrated into the system.

Test software

The R&S®TS9975 EMI test system comes with the R&S®EMC32 test software. The software makes it possible to carry out automatic and manual EMI measurements in line with all relevant standards. The R&S®EMC32 test software is a convenient, cost-effective and reliable tool, enabling fast and easy system operation and high throughput. The extended test and configuration capabilities ensure high reproducibility of results.

R&S®CEMS100 Compact EMS/EMI Test Platform



Standard-compliant all-in-one solution for EMS measurements

Setting up an EMS/EMI test system is a very complex process requiring significant investment. The steps involved include custom planning, design, installation and configuration of various components and stand-alone instruments as well as the RF-shielded anechoic chamber. Rohde & Schwarz is offering the standardized R&S®CEMS100 test platform that is a flexible, reliable and cost-effective off-the-shelf solution for radiated EMS measurements in line with IEC/EN 61000-4-3. It covers the most common frequency ranges and field strengths needed for precompliance tests and certification.

The R&S®CEMS100 control software is the tried and tested R&S®EMC32, which is used on a daily basis in many test laboratories worldwide. User experience is tapped continuously to aid in further development of the software. Users and test houses that already rely on the R&S®EMC32 software have confirmed that it is very easy to integrate the R&S®CEMS100 into existing test environments.

- ▮ Certifiable base system for commercial standards
- ▮ EMS measurements from 80 MHz to 3 GHz, 10 V/m
- ▮ EMS and EMI measurements without changing antennas
- ▮ Scalable and expandable for further EMC applications
- ▮ Various proven EUT monitoring capabilities
- ▮ Immediate deployment with preconfigured hardware and software

Components of the R&S®CEMS100

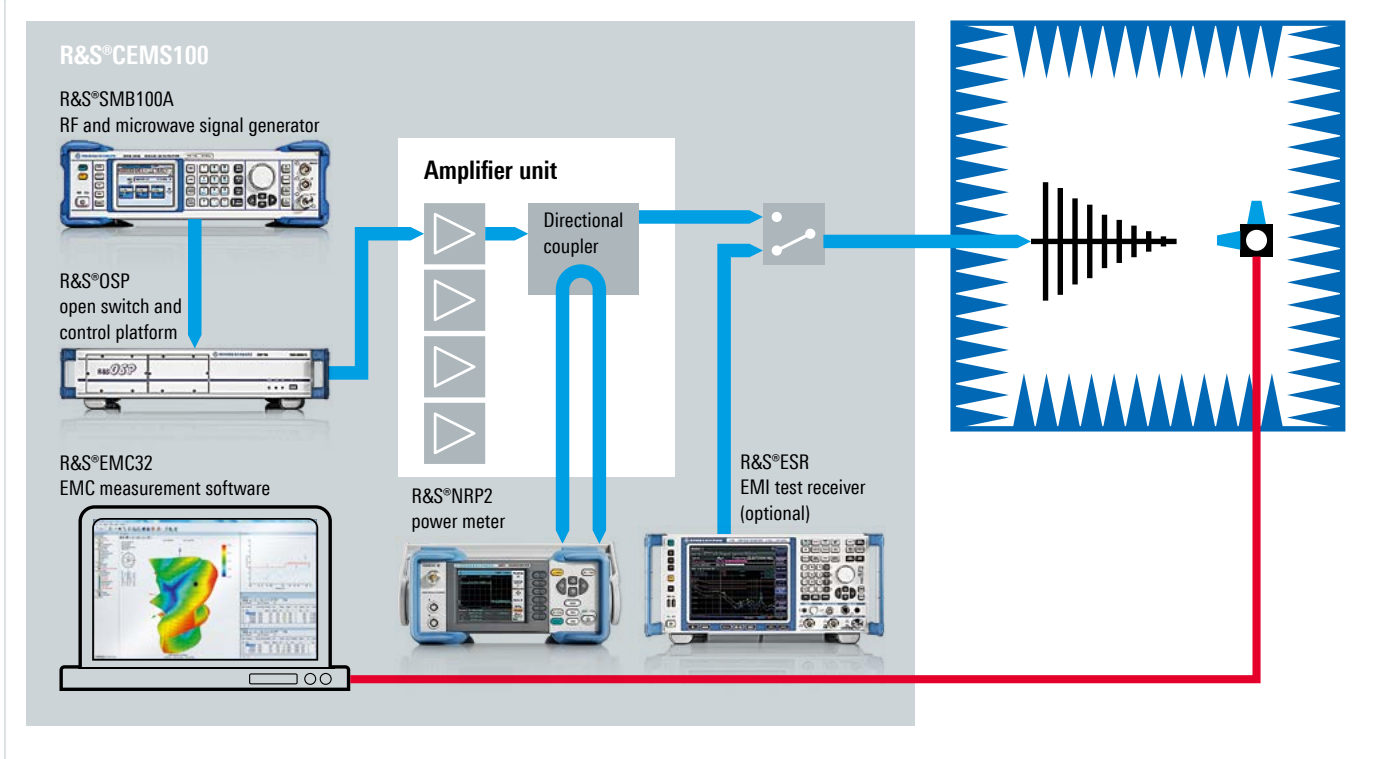

R&S®TS9982 EMS Test System

Radiated and conducted EMS measurements in line with commercial, wireless, automotive and A&D standards

The R&S®TS9982 EMS test system is the base system for conducted and radiated EMS measurements. Due to its modular design, it covers a wide range of applications and can be very easily adapted to the measurement task at hand. Any configuration is possible – from conducted measurements and a small precompliance system with compact test cell to an accredited test system for complete vehicles with a field strength level of 200 V/m or greater. Combinations of different applications or incremental expansion can also be implemented without any problem. All test systems are controlled by the R&S®EMC32 test software with its various capabilities, including extensive DUT and system monitoring. From system design and implementation to installation and training, these turnkey systems and our EMC experts provide everything from a single source, enabling the customer to concentrate on testing.

System configuration

The R&S®TS9982 consists of an EMS control unit, one or more amplifiers, transducers for conducted measurements (CDNs, injection clamps, etc.), antennas for radiated measurements and a field probe. The system is software controlled, which allows reproducible and fully automatic test sequences. You can also activate the interactive test mode for running further tests or making modifications. The EMS control unit contains a signal generator, a power meter and the R&S®OSP switching unit, which is configured with appropriate plug-in modules. This includes the control of an interlock circuit and the possibility to drive external power relays up to 10 kW. Based on experience gained from the large number of systems implemented world-

wide, all system components have been ideally matched to one another, yielding efficient field generation on the DUT.

In the 1 GHz to 40 GHz frequency range, a mobile microwave test system is used directly adjacent to the DUT, thus preventing high RF cable loss above 3 GHz. Provisions for safety are included in the system, for example, we integrate an interlock circuit that switches off the RF power when the door of the chamber is opened.

Test software

The R&S®TS9982 EMS test system comes with R&S®EMC32 EMC test software. The software makes it possible to carry out automatic and manual EMS measurements to all relevant standards. R&S®EMC32 is a convenient, cost-effective and reliable tool, enabling fast and easy system operation and high throughput. The extended test and configuration capabilities ensure high reproducibility of results.

Commercial tests

Covered standards (examples)

This test system covers all relevant standards for radiated and conducted commercial measurements for the different ranges of applications.

- IEC/EN 61000-4-3, -6, -20 and -21
- EN 61000-6-1 and -2
- CISPR 24/EN 55024
- CISPR 35/EN 55035
- EN 60601-1-2 Edition 4.0

Features

A typical test level is 10 V (+80% AM 1 kHz modulation) in the 150 kHz to 80 MHz frequency range for conducted measurements and a field strength of 10 V/m (+80% AM 1 kHz modulation) from 80 MHz to 6 GHz in a uniform field area of 1.5 m × 1.5 m.



System design

Transducers (conducted): The system can include a coupling/decoupling network (CDN), EM clamp and a bulk current injection (BCI) clamp as transducers.

Antenna: The EMS antenna is optimally designed for efficient field generation in line with EN61000-4-3. Due to its compact design, it is also suitable for small anechoic chambers.

Amplifiers: The amplifier power is optimally adapted to the transducers or the antenna as well as to the required test level, yielding an excellent price/performance ratio. The R&S®BBA and R&S®BBL series amplifiers are designed in such a way that with the required upward modulation of 80%, the amplifier's 1 dB compression point is not exceeded and spurious emissions do not exceed a value of -15 dBc. In line with EN61000-4-3, the amplifier saturation check after completion of the field uniformity calibration is mandatory. Monitoring of the amplifier's forward and reflected power and of the injected current in the case of BCI, is integrated in the system.

Accessories: The system comes with all accessories (such as a field probe, including tripod and load resistor) necessary for operation and calibration. Also all test routines for multimedia tests in line with the new EN55035 are available.

Wireless tests

Standards

Measurements of this type are based on the standards and technical regulations published by the European Telecommunications Standards Institute (ETSI). EMC is defined in ETSI EN301489 with its subparts for the different wireless services.

- ▮ CDMA2000®, 1xEV-DO
- ▮ GSM, GPRS, EDGE
- ▮ UMTS, HSPA, HSPA+
- ▮ LTE
- ▮ Bluetooth®
- ▮ WLAN IEEE 802.11

Coverage of other standards is available on request. In addition, measurements in line with the commercial standards for ITE and telecommunications equipment conforming to IEC/EN61000-4-3, -6 (EMS) are available. The system can be used both in design and type approval testing.

Main features

The standards specify a wide variety of measurements in a very wide frequency range.

- ▮ Conducted and radiated EMS measurements
- ▮ Audio breakthrough measurement to monitor audio quality in uplink and downlink
- ▮ Multiple monitoring capabilities

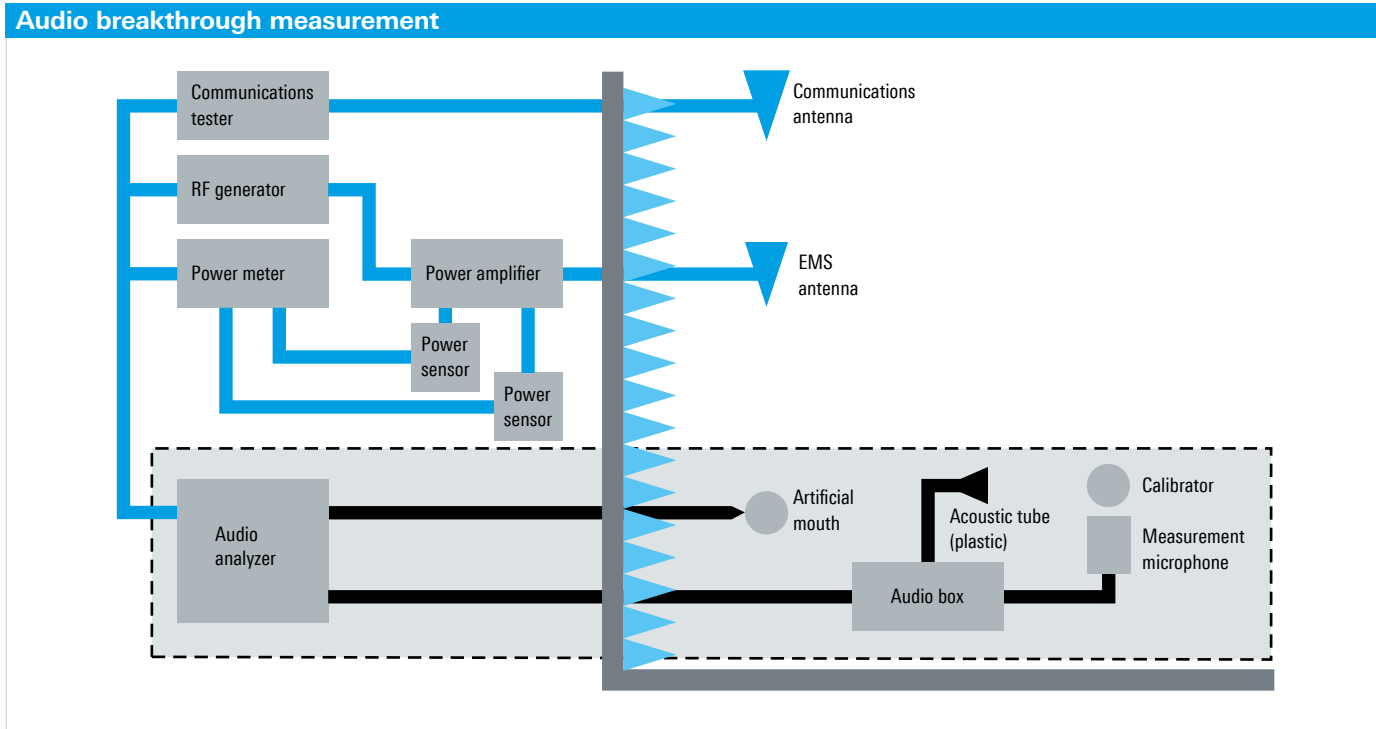

- Automatic stimulation and monitoring of the air link to the wireless device
- Automatic handover between different services or frequency bands
- System automation through automatic path switching
- Equipment for calibration of the audio path and system check

Test software

The R&S®EMC32 control software features all necessary measurement routines for testing wireless devices. It supports fully automatic measurements for certification as well as interactive measurements during development and device modification.

System design

The R&S®TS9982 EMS test system is based on a standard commercial EMS test system as defined by IEC/EN61000-4-3 and -6 for radiated and conducted measurements. In addition, it is equipped with all necessary components to establish and maintain the radio link and to monitor DUT performance. This includes the monitoring of audio quality, bit error rate measurements and interfaces to equipment for end-to-end data testing.

Communications tester

An R&S®CMW500 wideband radio communication tester is integrated into the test system to set up, switch and control the link to the DUT in a defined operating state. It combines all common wireless standards in one unit. The R&S®CMW500 is also used for analysis of the wireless link quality to the DUT and as an interface for audio and data throughput monitoring.

Audio equipment

The audio measurement is carried out by the R&S®UPP audio analyzer. All accessories for measurement and calibration such as microphone and artificial mouth are included.



The audio test system must be very sensitive and it must not interact with the electric field applied at the DUT. Therefore, the audio signal is transferred from the DUT to the reception unit via a plastic tube. The reception unit itself is shielded against electromagnetic fields and placed at an appropriate distance from the DUT.

Automotive tests

Standards

- ISO 11451 and ISO 11452
- UNECE Regulation 10
- Customer-specific requirements

Features

The system allows tests to be performed in line with the above standards. It can also take additional requirements into account, such as those of different vehicle manufacturers – in particular special test levels and frequency ranges as well as pulse modulations as they are used to test electromagnetic susceptibility to radar applications. Pre-compliance test systems based on test cells (e.g. GTEM cells) are also available. The scope of systems ranges from compact car component test systems to test sites for vehicles, including electric powered and hybrid cars.

System design

These systems are designed on the basis of customer requirements. Due to the high field strengths and the associated amplifier power (R&S®BBA and R&S®BBL series amplifiers), stringent demands are placed on the infrastructure, while the large DUTs require special concepts for efficient field generation. In addition to pure field generation, features such as efficient system utilization, high degree of system automation, complex interfaces to the DUT and service concepts are important factors for these projects.



Software

The R&S®EMC32 software includes the specific functionality necessary for automotive applications. Versatile monitoring possibilities – from TTL levels to TCP/IP, GPIB and RS-232 communications to CAN, LIN, MOST and FlexRay™ bus monitoring – are also important for these measurements.

A&D tests

Standards

- ▮ MIL-STD-461
- ▮ MIL-STD-464
- ▮ RTCA DO 160
- ▮ Customer-specific requirements
- ▮ Country-specific requirements

Features

The detailed configuration of the test system depends on the required measurements, test levels and the DUT characteristics. It may range from a test system for a single test to the coverage of all EMC tests in line with MIL-STD-461 and RTCA DO160. The system design is based on experience gained from the large number of A&D test systems implemented worldwide.

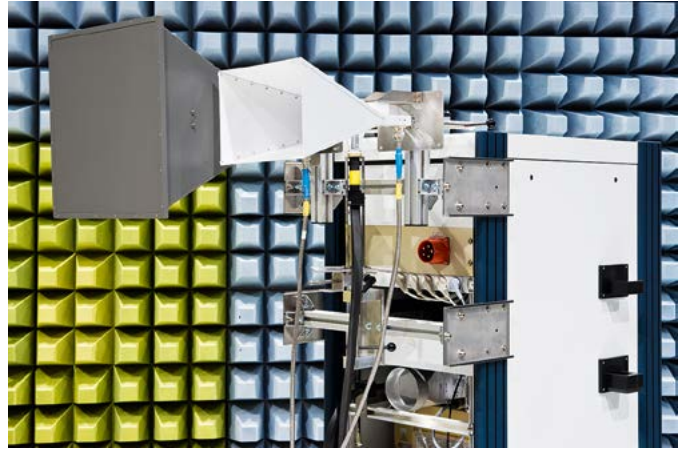

EMS microwave test.

Microwave tests up to 40 GHz

The test system for 1 GHz to 18 GHz or 40 GHz is a mobile rack that includes all necessary equipment such as signal generator, power amplifier and power meter. This prevents cable losses, allowing more amplifier power to be used for field generation. The system can be configured for different test levels up to 200 V/m CW and 3000 V/m pulsed at a test distance of 1 m. It is controlled by the EMC software from outside the chamber via fiber-optic link.



R&S®TS-EMF Portable EMF Measurement System



Simple, frequency-selective measurement of EMF emissions

In combination with Rohde&Schwarz spectrum analyzers, the R&S®TS-EMF measurement system detects high-frequency electromagnetic fields (EMF). The isotropic antenna, together with the software, which has been specifically designed for EMF measurements, allows simple and precise on-site evaluation of total and individual emissions.

- ▮ Automated EMF measurements
- ▮ Precise measurements of even complex scenarios and RF signals
- ▮ Wide frequency range from 9 kHz to 6 GHz using isotropic antennas
- ▮ Isotropic antenna for detecting fields independent of direction and polarization
- ▮ Combined use possible with various Rohde&Schwarz spectrum analyzers and test receivers

Safety based on exact measurements for reproducible and reliable results

- ▮ Evaluation of total emissions, individual radio services or individual frequencies
- ▮ Measurements in line with all common EMF standards and measurement methods
- ▮ Correct evaluation of even complex scenarios or RF signals
- ▮ Excellent reproducibility using automated measurements

Efficient on-site measurements

- ▮ Fast, simple measurements owing to predefined test routines
- ▮ On-site interpretation of results using integrated report generation
- ▮ Easy adaptation to local conditions
- ▮ Versatile use due to the compact one-box solution with the R&S®FSL spectrum analyzer

Suitable for a wide range of applications

- ▮ Investigation of specific problems or radio signals by directly setting individual measurement parameters
- ▮ Additional manual measurements using a full-featured spectrum analyzer
- ▮ Optional storage of raw measurement data for further in-depth result evaluation
- ▮ Precise extrapolation for WCDMA using CPICH demodulation
- ▮ Support for LTE measurements through decoding and frequency-selective procedure

Future-oriented

- ▮ Coverage of the complete frequency range from 9 kHz to 6 GHz, extendable up to 40 GHz using additional antennas
- ▮ Measurements of advanced radio services with wide bandwidths and high crest factors

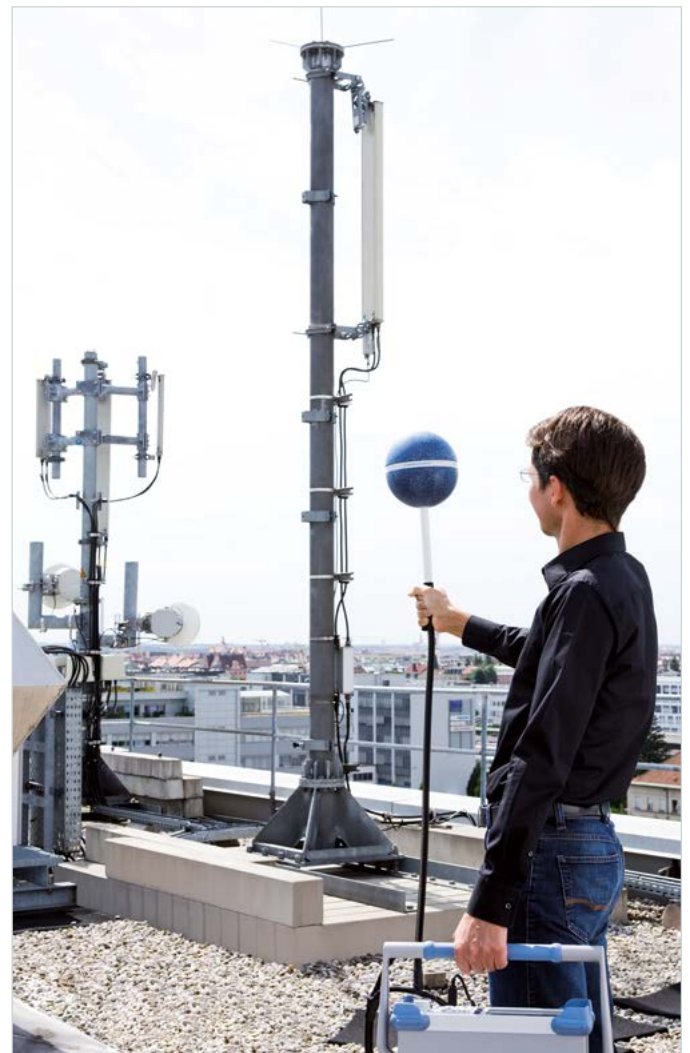

R&S®ES-SCAN EMI Software

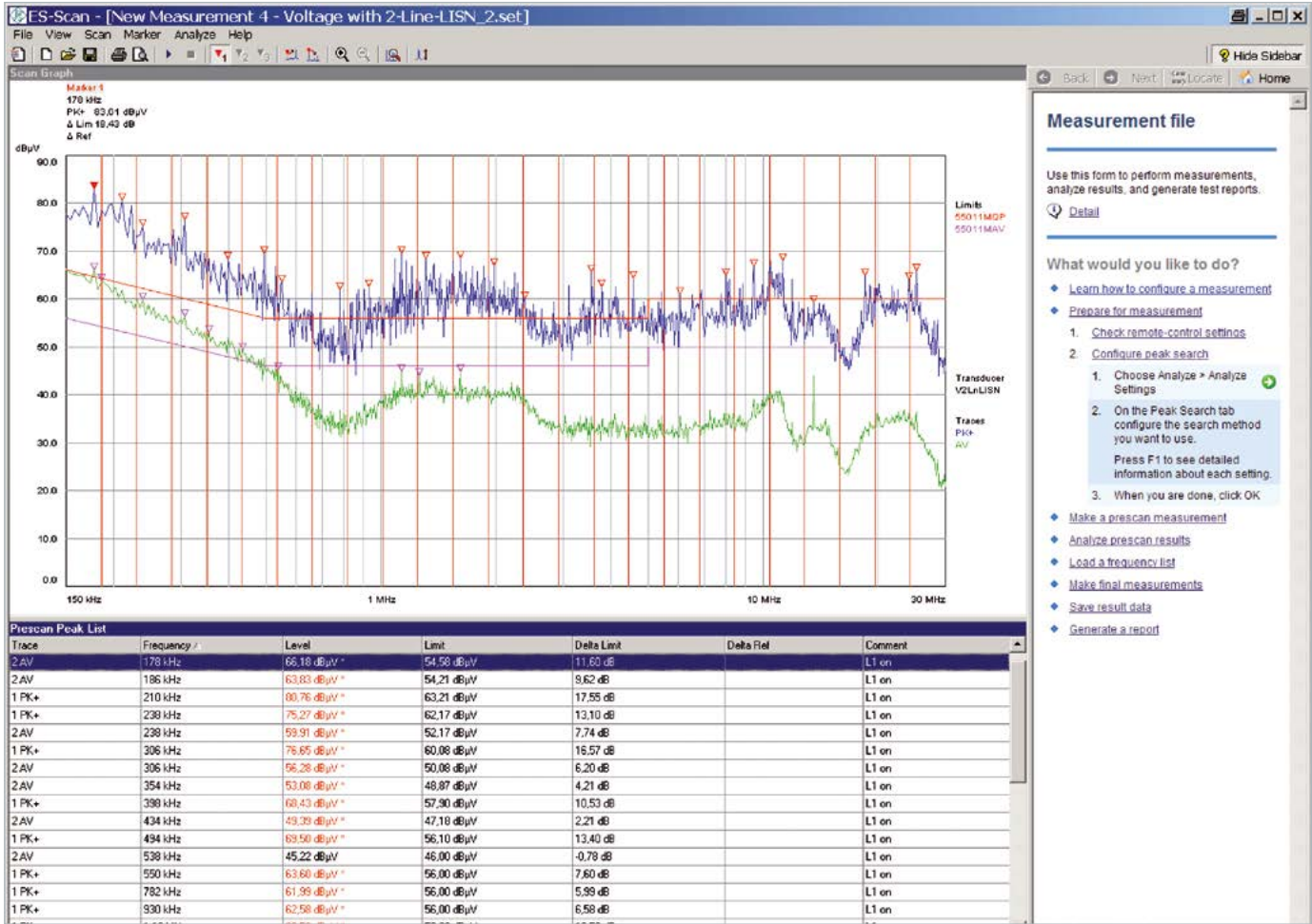

User-friendly software for EMI measurements

R&S®ES-SCAN is a cost-efficient and user-friendly Windows software application that has been developed for Rohde&Schwarz test receivers and spectrum analyzers. The main requirements of EMI measurements have been combined in an easy-to-use application: measurement settings and storage, scan data acquisition and display with automatic data reduction, peak search with acceptance limit and selection of subranges, final measurement with worst-case selection, report generation and measurement data storage.

R&S®ES-SCAN offers all the advantages of an up-to-date software tool, including operation via keyboard and mouse, table editor, configurable report generation and printout of reports on any Windows printer. A wizard supports the user of the R&S®ES-SCAN EMI software at all stages of operation. Online help texts explain all software functions; an operating manual is therefore not required.

- Menu-controlled configuration of test receivers and signal/spectrum analyzers and storage of settings on controller, including limit lines and transducer factors
- Reliable acquisition, evaluation and documentation of measurement data
- Graphical display of scan data with automatic data reduction
- Marker function, including marker to peak and tune receiver to marker frequency
- Automatic peak search with selectable acceptance limit and selectable subranges
- Editable frequency list for semi-automatic or interactive final measurements
- Fine tuning function for fast detection of local maxima
- Flexible configuration of report generation for different report layouts
- For use with the R&S®ESPI, R&S®ESCI, R&S®ESR, R&S®ESRP and R&S®ESL EMI test receivers, the R&S®FSL spectrum analyzer, the R&S®FSV signal and spectrum analyzer and the R&S®FSVR realtime spectrum analyzer and R&S®FSW spectrum analyzer

R&S®EMC32 EMC Measurement Software Platform

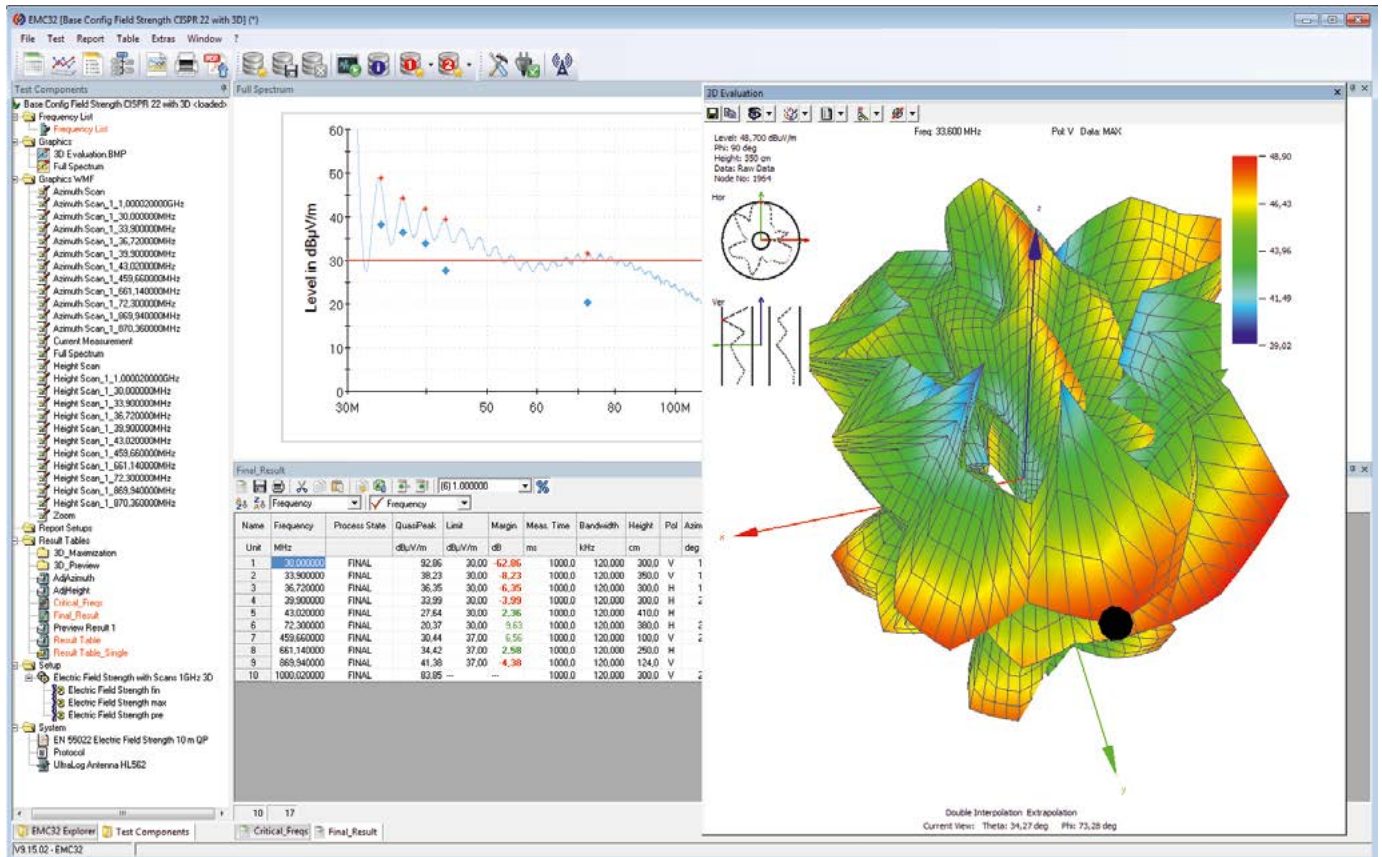

R&S®EMC32 as virtual instrument, e.g. user interface for 3D result evaluation.

For use in development, for compliance and batch testing

The R&S®EMC32 EMC measurement software can be used for all electromagnetic interference (EMI) and electromagnetic susceptibility (EMS) measurements. The software is a modern and powerful tool for controlling and monitoring Rohde&Schwarz devices as well as third-party equipment. Its comprehensive and modular configuration capabilities and its open software structure ensure reliable collection, evaluation and documentation of measurement results.

- Cost-efficient
- Flexible and scalable
- Future-ready
- Modular concept allowing flexible adaptation to customer needs
- Predefined hardware setups to support easy generation of test setups
- Support of measurements in line with all major standards in the commercial, wireless, automotive and military range
- Manual and automatic EMI and EMS measurements
- Fully automatic and interactive sequences

- Customer or EUT-specific data handling
- Extensive EUT monitoring capabilities and user-specific actions
- Interface to lab management system
- User administration for managing different user profiles

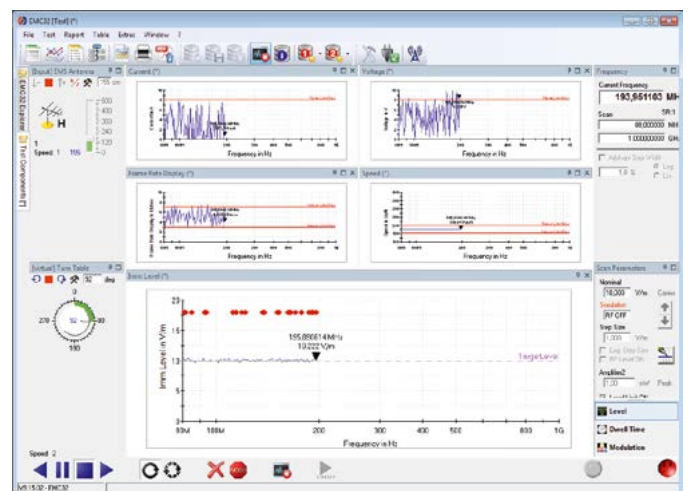

EMS qualification test with several EUT monitoring channels.

Basic packages and expansion modules for the R&S®EMC32 EMC measurement software

Module	Application
R&S®EMC32-S	Basic package for EMS measurements
R&S®EMC32-EB	Basic package for EMI measurements
R&S®EMC32-K1	Enhanced EMS functionality for automotive/A&D measurements
R&S®EMC32-K2	Measurement of audio breakthrough and spurious emissions in wireless communications
R&S®EMC32-K3	Susceptibility measurements in reverberation chambers in line with EN61000-4-21 (R&S®EMC32-K4 also required)
R&S®EMC32-K4	EMS auto test functionality
R&S®EMC32-K6	Measurements in line with MIL-STD-461E/F CS103/4/5
R&S®EMC32-K7	Generic drivers for RF generators, power meters and oscilloscopes
R&S®EMC32-K8	Database interface to laboratory management systems
R&S®EMC32-K10	EMI auto test functionality
R&S®EMC32-K10A	EMI auto test extension for spurious measurements in line with ETSI EN300328, 301893
R&S®EMC32-K11	Test plan generation and automatic control with test sequencer
R&S®EMC32-K21	Automation of additional measurement tasks using macro language
R&S®EMC32-K22	Measurement of RF radiation patterns of antennas and EUTs
R&S®EMC32-K23	3D evaluation for R&S®EMC32-K10 EMI auto test
R&S®EMC32-K24	Interactive measurement for R&S®EMC32-K10 EMI auto test
R&S®EMC32-K251	TD-SCDMA option for R&S®EMC32-K2
R&S®EMC32-K26	LTE option for R&S®EMC32-K2
R&S®EMC32-K27	Dual receiver measurement
R&S®EMC32-K33	EMI measurements in reverberation chambers in line with EN61000-4-21 (R&S®EMC32-K10 also required)
R&S®EMC32-K35	Measurements in line with CISPR35 and CISPR33; EMS measurements on multimedia receivers in line with CISPR35/EN55035
R&S®EMC32-K48	Shielding effectiveness measurement

Basic packages and expansion modules for the R&S®EMC32 EMC measurement software

R&S®EMC32-K51	EMI evaluation with flexible scan sequences (e.g. in line with GMW3091/3097)
R&S®EMC32-K56	EMI measurement in line with MIL-STD: transmitter in transmit mode
R&S®EMC32-K84	Report interface to word processing apps
R&S®EMC32-U9E	Update to version 9 for R&S®EMC32-EB, -E and -E+ basic package
R&S®EMC32-U9S	Update to version 9 for R&S®EMC32-S basic package

Application overview (examples)

Application	Standards EMS	Standards EMI
Industrial and household products (commercial)	IEC/EN 61000-4-3, -6	CISPR 11/EN 55011, CISPR 14-1/EN 55014-1, ANSI-C 63.4 FCC 15, 18
Information technology/multimedia devices (commercial)	CISPR 24/EN 55024, CISPR 35/EN 55035, IEC/EN 61000-4-3, -6	CISPR 22/EN 55022, CISPR 32/EN 55032, ANSI-C 63.4 FCC 15, 18
Medical devices (commercial)	EN 60601-1-2, EN 60601-2-x	EN 60601-1-2, CISPR 11/EN 55011
Wireless devices (commercial)	ETSI EN 301498-x, ETSI EN 300826	ETSI EN 301489-x, 3GPP TS 51.010, ETSI EN 301908-1, ETSI EN 300328-1, FCC part 15
Automotive	ISO 11451, ISO 11452, SAE J1113, SAE J551, UNECE Regulation 10, reverberation chamber (mode-tuned)	2004/104/EC CISPR 12, SAE J551/2 CISPR 25, SAE J1113/41 reverberation chamber (mode-tuned)
Military/avionics	MIL-STD-461, CS 103, CS 104, CS 105, RTCA/DO-160, MIL-STD-464	MIL-STD-461, CE 101, CE 102, CE 106, RE 101, RE 102, RE 103, RTCA/DO-160, VG 95370-95377, DEF-STAN 49-41, GAM-EG 13
Consumer products, radio/TV (commercial)		CISPR 13/EN 55013, CISPR 32/EN 55032

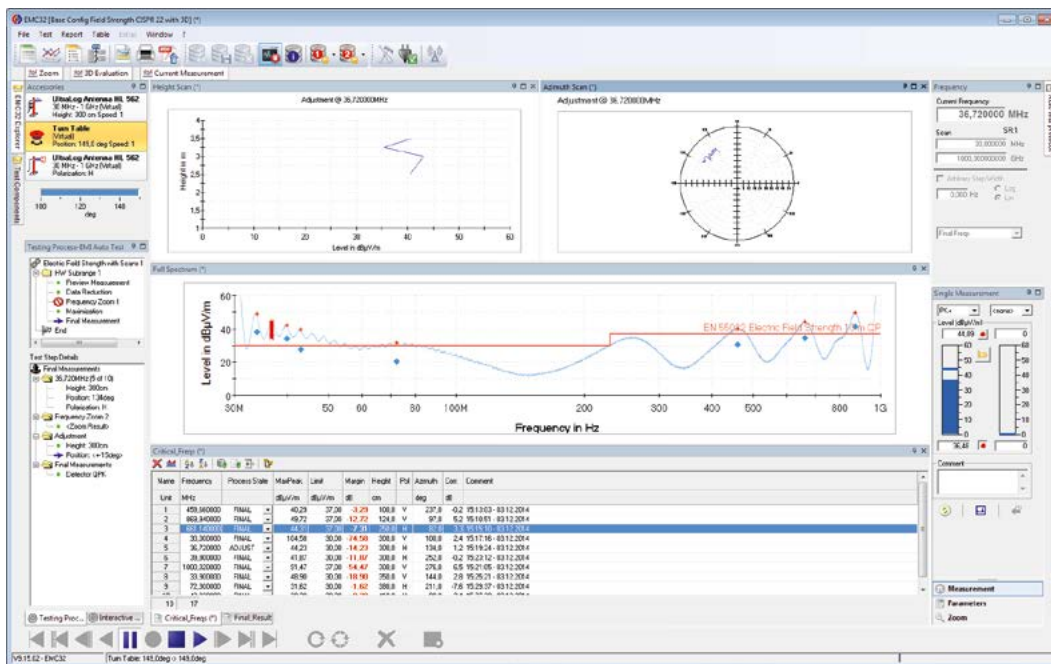

Interactive measurement mode in EMI measurements.

R&S®AdVISE Visual Inspection Software



A new way to eliminate human inattention

R&S®AdVISE is a video-based monitoring/advisory system for use in an EMC test environment. This video detection system is designed to automate the process of visually detecting failures of a device under test (DUT) during immunity testing, eliminating human inattention and saving test time.

The primary objective of the R&S®AdVISE visual inspection software is to provide the operator with a tool to automate the process of visually detecting failures of devices under test. R&S®AdVISE is available in two versions:

- As an adjunct system to the R&S®EMC32 EMS system
- As a standalone system for video analysis outside the scope of an EMC system

When R&S®AdVISE runs with the R&S®EMC32 or a similar system, it will provide the highest level of automation for controlling EMC equipment. The analysis comprises a comparison of each video frame with a reference frame for changes in specified areas referred to as regions of interest (ROI). ROIs are defined by the operator during test configuration and stored in a database.

This test configuration information is used by the R&S®AdVISE video analysis subsystem to analyze each frame in realtime. Additionally, R&S®AdVISE has the capability to capture sound emanating from the device under test and allows it to be manually analyzed for abnormalities.

The R&S®AdVISE system is not limited to only functioning in an EMC environment. The R&S®AdVISE system can be used in any environment where the user wishes to visually monitor events that are deviations from a reference or standard. The R&S®AdVISE system analyzes data at rates of up to 30 frames per second per camera and can "see" transitory events that a human may miss.

- Automated video failure detection system capable of supporting up to two SD/HD/2K video streams to eliminate human inattention
- Support of video streams at up to 30 frames per second and continuous monitoring of video streams to detect configured changes
- User-defined regions of interest (items to be monitored); 32 ROIs per video stream possible

Model overview	
Type	Features
R&S®AdVISE-LT (Lite)	<ul style="list-style-type: none"> ■ R&S®EMC32 can be run on the same hardware platform ■ Only 1 camera supported ■ Max. 30 frames per second ■ 16 ROIs supported
R&S®AdVISE-ML (mid-level)	<ul style="list-style-type: none"> ■ R&S®EMC32 can be run on the same hardware platform ■ Only 1 camera supported ■ Max. 30 frames per second ■ 32 ROIs supported
R&S®AdVISE-HP (high-performance)	<ul style="list-style-type: none"> ■ Support of 2 cameras ■ 30 to 60 frames per second per camera ■ Min. 32 ROIs per camera ■ Dedicated PC platform required ■ Separate hardware platform required to run R&S®EMC32

R&S®BBA150 Broadband Amplifier



Excellent amplifiers from 9 kHz to 6 GHz with high power density

The R&S®BBA150 broadband amplifier family generates power in the frequency range from 9 kHz to 6 GHz. The compact amplifiers are rugged and feature high availability. They are ideal for amplitude, frequency, phase and pulse modulation. Extensive switching options for input, output and sample ports are available for different applications.

The R&S®BBA150 broadband amplifiers cover a total of four frequency bands: 9 kHz to 250 MHz, 80 MHz to 1 GHz, 0.69 GHz to 3.2 GHz and 2.5 GHz to 6 GHz. They can be used to address a variety of applications, including the various standards for EMS measurements up to 6 GHz. In the industry environment, the R&S®BBA150 broadband amplifiers are suitable for development and product valida-

tion tests in quality assurance and in the development and production of components. Other fields of use include research, physical engineering and communications.

The R&S®BBA150 broadband amplifiers are based on a modular, lightweight design that is optimized for the required frequency band. They are available in two versions. The low-power amplifier comes as a 4 HU 19" rackmount that can be used as a desktop model or installed in a rack. Devices with higher power must be installed in racks. The amplifiers are operated either using display and buttons, or via remote control interface (automated operation) or via a web browser.

The modular concept is a prerequisite for upgrading power and frequency range later on. The worldwide service concept and the global availability of spare parts promote the trust and confidence of customers.

- Frequency ranges: 9 kHz to 250 MHz, 80 MHz to 1.0 GHz, 0.69 GHz to 3.2 GHz and 2.5 GHz to 6.0 GHz
- Output power from 15 W to 3000 W
- 100% mismatch tolerance
- Suitable for amplitude, frequency, phase and pulse modulation
- Three-year warranty and worldwide spare parts availability

Specifications in brief

RF specifications		
Frequency ranges	instantaneously	9 kHz to 250 MHz 80 MHz to 1 GHz 0.69 GHz to 3.2 GHz 2.5 GHz to 6.0 GHz
Nominal power	9 kHz to 250 MHz	125/160/200/400/700/1300/2500 W (51.0/52.0/53.0/56.0/58.4/61.1/64.0 dBm)
	80 MHz to 1 GHz	70/125/160/250/500/1000/1250/1500/2000/3000 W (48.5/51.0/52.0/54.0/57.0/60.0/61.0/61.8/63.0/64.8 dBm)
	690 MHz to 3.2 GHz	30/60/110/200/400/800 W (44.8/47.8/50.4/53.0/56.0/59.0 dBm)
	2.5 GHz to 6.0 GHz	15/30/60/100/200/400 W (41.8/44.8/47.8/50.0/53.0/56.0 dBm)
Gain flatness		±3.8 dB (or better, see data sheet)
Gain adjustment range		> 15 dB
Spurious		-80 dBc, max. -65 dBc
Modulation capability		AM, FM, φM, PM
Input level for nominal output power		-3.4 dBm
Nominal forward output power	VSWR < 6:1	continuous, without foldback
	VSWR > 6:1	continuous, with gradual foldback to approx. 50% of output power, depending on load impedance
Output mismatch protection, VSWR		100%, without damage

R&S®BBL200 Broadband Amplifier



Liquid-cooled power amplifiers for high field strengths

The R&S®BBL200 broadband amplifiers from 9 kHz to 225 MHz open up applications requiring high field strengths and high amplifier power. Especially in EMC environments, they easily fulfill typical requirements as specified by relevant standards as well as those resulting from the physical characteristics of the antennas being used. This includes outstanding performance at 1 dB compression and high mismatch tolerance. The amplifiers are designed for continuous operation even under mismatch conditions.

The R&S®BBL200 broadband amplifiers are liquid-cooled, which makes them compact and especially quiet. The pump units, compression tanks and amplifier components are all located in the rack. Only the compact heat exchanger needs to be located separately, which has the advantage that the bulk of the waste heat can be dissipated outside the amplifier room. All of the liquid cooling components are already in use in Rohde&Schwarz high-power TV transmitters. Thousands of these transmitters have been in operation worldwide for years, offering unparalleled reliability.

The R&S®BBL200 amplifier family's modular design makes it easy, for example, to remove amplifier plug-ins. The liquid cooling is also straightforward. Self-connecting and self-shutting valves reliably ensure perfect sealing, even during maintenance and service.

- Frequency range from 9 kHz to 225 MHz
- 3000 W, 5000 W and 10000 W output power
- 100% mismatch tolerance
- Liquid-cooled, compact and quiet
- For amplitude, frequency, phase and pulse modulation
- Worldwide service network and global spare parts availability

Specifications in brief

RF data

Frequency range	instantaneously	9 kHz to 225 MHz
Nominal power		3000/5000/10000 W (64.8/ 67.0/70.0 dBm)
Gain flatness		±3.0 dB
Gain adjustment range		> 15 dB
Spurious, carrier offset > 100 kHz		-80 dBc , max. -70 dBc
Modulation capability		AM, FM, φM, PM
Input level for nominal output power		-3.4 dBm
Nominal forward output power	VSWR < 6:1	continuous, without foldback
	VSWR > 6:1	continuous, with gradual foldback to approx. 50% of output power, depending on load impedance
Output mismatch protection, VSWR		100%, without damage

Compact Diagnostic Chambers

Precompliant test sites provide consistent and reproducible measurements of an EUT's EMI performance. They allow fully compliant EMS tests for certification. Recognized as a working tool to assist R&D engineers during development, the family of precompliant EMC test sites includes semi-anechoic chambers (SAC) as well as fully anechoic rooms (FAR) for 3 m test distance.

The end user has a choice between the two types of test sites. In connection with chamber validation, correlation factors from the 3 m FAR performance to a 10 m OATS

can be worked out and provided. Compact in size with a total height between 2.6 m (8.4 ft) and 3.6 m (11.8 ft), the precompliant test site (CDC) is ideal for office and laboratory areas.

The completely modular configuration of the CDC and the durable pan shielding system allows time-and cost-efficient upgrading to a compliant 3 m test site at a later stage. All precompliant test sites provide shielding in line with EN50147-1. Conducted EMC measurements in accordance with all relevant standards can be performed in all chambers, provided that the geometry of the test site allows it.



Room dimensions without white caps FAR/SAC			
Room type (L x W x H)	Total required space	Shielding external	Clear internal
E-CDC, QZ Ø 1 m	6.1 m x 3.1 m x 2.71 m (20 ft x 10.1 ft x 8.9 ft)	6.1 m x 3.1 m x 2.55 m (20 ft x 10.1 ft x 8.4 ft)	5.52 m x 2.2 m x 1.66 m/1.97 m (18.1 ft x 7.2 ft x 5.44 ft/6.5 ft)
M-CDC, QZ Ø 1 m	7.3 m x 3.1 m x 3.16 m (24 ft x 10.1 ft x 10.4 ft)	7.3 m x 3.1 m x 3.0 m (24 ft x 10.1 ft x 9.8 ft)	6.59 m x 1.93 m x 1.86 m/2.30 m (21.6 ft x 6.3 ft x 6.1 ft/7.55 ft)
C-CDC, QZ Ø 1.2 m	7.5 m x 3.3 m x 3.46 m (24.6 ft x 10.8 ft x 11.4 ft)	7.3 m x 3.4 m x 3.3 m (24 ft x 11.2 ft x 10.8 ft)	6.59 m x 2.23 m x 2.15 m/2.59 m (21.6 ft x 7.3 ft x 7.05 ft/8.5 ft)
XL-CDC, QZ Ø 1.5 m	7.8 m x 4.2 m x 3.76 m (25.6 ft x 13.8 ft x 12.3 ft)	7.6 m x 4.0 m x 3.6 m (24.9 ft x 13.1 ft x 11.8 ft)	6.89 m x 2.83 m x 2.15 m/2.89 m (22.6 ft x 9.3 ft x 7.05 ft/9.4 ft)

Performance					
Example of C-CDC	NSA FS			Site VSWR	Field uniformity
Standard	ANSIC63.4, CISPR 16-1-4, EN55016-1-4			CISPR 16-1-4, EN55016-1-4	IEC61000-4-3, EN61000-4-3
Frequency range	30 MHz to 1 GHz			1 GHz to 18 GHz	80 MHz to 18 GHz
Test distance	3 m			3 m	3 m
Test volume	1.2 m	1.2 m	1.2 m	1.2 m	1.5 m x 1.5 m vertical plane
Test frequency	30 MHz to 100 MHz	101 MHz to 200 MHz	201 MHz to 1 GHz		80 MHz to 18 GHz
Test axis	off axis	off axis	off axis	off axis	in axis
Deviation	±6 dB	±5 dB	±4 dB	≤ 6 dB	0 dB to +6 dB/75% rule

Fully Compliant Anechoic Test Chambers

Fully compliant test sites and their components are designed to have the lowest possible contribution to the total measurement uncertainty of the test facility, (i.e. to allow reproducible, accurate and fast measurements). Our family of fully compliant EMC test sites includes all semi-anechoic chambers (SAC) for 3 m, 5 m and 10 m test distance and fully anechoic rooms (FAR) for 3 m and 5 m test distance.

The chamber validation of these solutions is described in CISPR 16-1-4. The final dimensions of the 10 m semi-anechoic chambers depend a lot on the dimensions of the EUT, whereas the dimensions of the fully-anechoic 3 m and 5 m chambers easily can be standardized. All fully compliant test sites provide shielding compliant to EN 50147-1 and IEEE 299. Conducted EMC measurements, in accordance with all relevant standards can be performed in all chambers, provided that the geometry of the test site allows it.

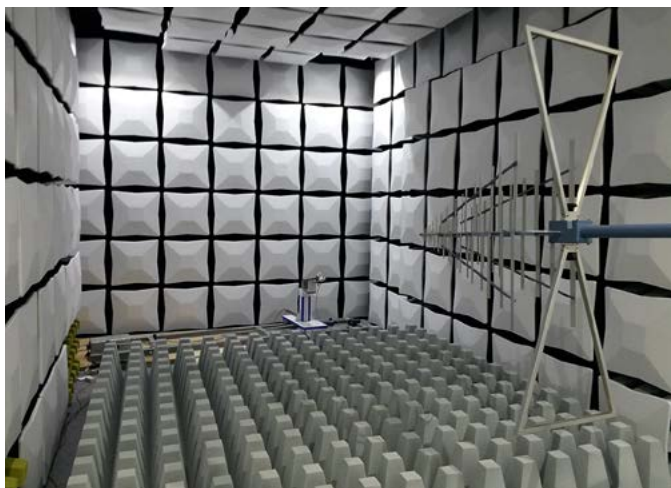

 AlbatrossProjects

7

Room dimensions without white caps

Room type (L x W x H)	Total required space	Shielding external	Clear internal
FAR 3 m, QZ Ø 1.5 m	9.0 m x 4.8 m x 4.4 m (29.5 ft x 15.7 ft x 14.4 ft)	8.8 m x 4.6 m x 4.2 m (28.9 ft x 15.1 ft x 13.8 ft)	7.7 m x 3.4 m x 2.8 m (25.3 ft x 10.9 ft x 10.7 ft)
SAC 3 m, QZ Ø 2 m	10 m x 6.1 m x 6.05 m (32.8 ft x 20.0 ft x 19.8 ft)	9.4 m x 5.5 m x 5.55 m (30.8 ft x 18.0 ft x 18.2 ft)	8.36 m x 4.33 m x 4.8 m (27.4 ft x 14.2 ft x 15.7 ft)
SAC 5 m, QZ Ø 3 m	13.1 m x 8.3 m x 6.5 m (42.9 ft x 27.2 ft x 21.3 ft)	12.1 m x 7.3 m x 6.0 m (39.7 ft x 24.0 ft x 19.7 ft)	11.06 m x 5.5 m x 5.25 m (36.3 ft x 18.0 ft x 17.2 ft)
SAC 10 m, QZ Ø 3 m	20.2 m x 13.0 m x 9.25 m (66.3 ft x 42.7 ft x 30.35 ft)	19 m x 11.8 m x 8.55 m (62.3 ft x 38.7 ft x 28.05 ft)	17.5 m x 10.0 m x 7.15 m (57.4 ft x 32.8 ft x 23.5 ft)
SAC 10 m, QZ Ø 4 m	21.2 m x 13.4 m x 9.25 m (69.6 ft x 43.9 ft x 30.35 ft)	20.2 m x 12.4 m x 8.55 m (66.3 ft x 40.7 ft x 28.05 ft)	18.7 m x 10.6 m x 7.15 m (61.3 ft x 34.7 ft x 23.5 ft)

Performance

Example for 3 m FAR	NSA	Site VSWR	Field uniformity
Standard	CISPR 16-1-4, ANSIC63.4, EN 55016-1-4	CISPR 16-1-4, EN 55016-1-4	IEC 61000-4-3, EN 61000-4-3
Frequency range	30 MHz to 1 GHz	1 GHz to 18 GHz	80 MHz to 18 GHz
Test distance	3 m	3 m	3 m
Test volume	1.5 m	1.5 m	1.5 m x 1.5 m (vertical plane)
Test axis	off axis	off axis	in axis
Deviation	±4 dB	≤ 6 dB	0 dB to +6 dB/75% rule

EMC Test Sites for the Automotive Industry

The family of EMC test sites for the automotive industry and their suppliers of electric and electronic subassemblies (ESA) include semi-anechoic chambers (SAC) for 1 m, 3 m, 5 m and 10 m test distance. For 20 years, the automotive industry has considered the semi-anechoic chamber as “state-of-the-art” for vehicle testing and the same has held true for component testing for the last decade. The CISPR25 and automotive chamber differ in terms of size, cost and the variety of measurements to be performed. CISPR25 or ESA test chambers are used for emission and immunity testing on electronic subassemblies.



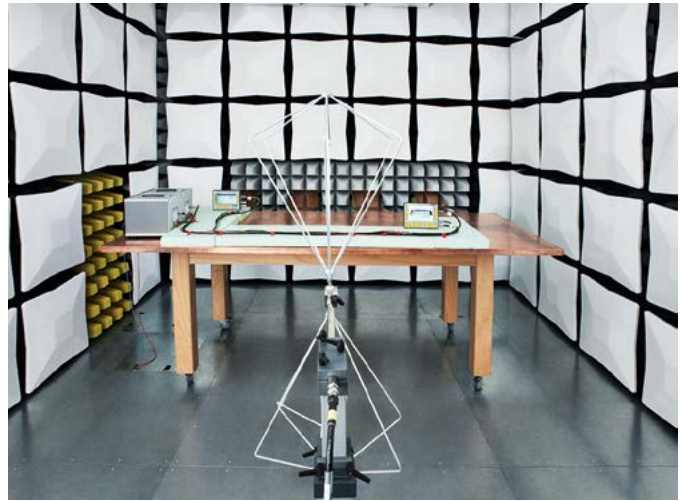

A higher integration along with much higher ESA clock frequencies in vehicles makes the "inner EMC" of vehicles the challenge of today. The vehicle is driven by the chassis dynamometer to simulate various traffic situations and cover all functional stresses. All CISPR25 and automotive test sites provide a shielding compliant to EN50147-1 and IEEE299. Conducted EMC measurements in accordance with all relevant standards can be performed in all chambers, provided that the geometry of the test site and its configuration allows it.



Room dimensions without white caps			
Room type (L x W x H)	Total required space	Shielding external	Clear internal
CISPR25	5.5 m x 4.3 m x 3.5 m (18.04 ft x 14.11 ft x 11.48 ft)	5.5 m x 4.3 m x 3.3 m (18.04 ft x 14.11 ft x 10.83 ft)	4.62 m x 3.42 m x 2.86 m (15.16 ft x 11.22 ft x 9.38 ft)
SAC 5 m, Automotive QZ Ø 4 m	16.1 m x 10.6 m x 6.6 m (52.8 ft x 33.1 ft x 21.65 ft)	15.1 m x 9.1 m x 6.0 m (49.5 ft x 29.9 ft x 19.69 ft)	14.06 m x 7.3 m x 5.2 m (46.1 ft x 24.0 ft x 17.1 ft)
SAC 10 m, Automotive QZ Ø 5.5 m	25.1 m x 16.4 m x 9.8 m (82.3 ft x 53.8 ft x 32.15 ft)	24.1 m x 15.4 m x 9.0 m (79 ft x 50.5 ft x 29.52 ft)	22.64 m x 13.6 m x 7.6 m (74.27 ft x 44.62 ft x 24.9 ft)

Performance			
Site attenuation, example of CISPR25 (ALSE validation)			
Standard	CISPR25	CISPR25	CISPR25
Frequency range	150 kHz to 30 MHz	30 MHz to 1 GHz	1 GHz to 2.5 GHz
Test distance	1 m	1 m	1 m
Test bench size	2.5 m x 1.0 m	2.5 m x 1.0 m	2.5 m x 1.0 m
Test axis	in axis	in axis	in axis
Deviation	±6 dB	±6 dB	±6 dB

EMC accessories for disturbance voltage/current/power and field strength measurements

Disturbance voltage measurements		
<p>R&S®ENV216 Two-Line V-Network</p> 	<p>Disturbance voltage measurements on single-phase EUTs</p> <ul style="list-style-type: none"> Several models for Germany, United Kingdom, France, China/Australia, USA Air-core design and artificial hand Switch-selectable highpass filter of 150 kHz Built-in 10 dB attenuator pad Built-in pulse limiter (can be switched off) Remote control with TTL levels (compatible with Rohde&Schwarz EMI test receivers) Compact, lightweight 	<p>Specifications in brief</p> <ul style="list-style-type: none"> Frequency range: 9 kHz to 30 MHz Continuous current up to 16 A (depending on model) Simulated impedance: $(50 \mu\text{H} + 5 \Omega) \parallel 50 \Omega$ in line with CISPR 16-1-2 Amd. 2:2006 V-network in line with CISPR, EN, VDE, ANSI, FCC Part 15 and MIL-STD-461D, E and F Calibrated in line with CISPR 16-1-2 and ANSI C63.4
<p>R&S®ENV432 Four-Line V-Network</p> 	<p>Disturbance voltage measurements on three-phase EUTs</p> <ul style="list-style-type: none"> Meets the requirements of CISPR 16-1-2, EN55016-1-2 and ANSI C63.4 Air-core design and artificial hand Built-in 10 dB attenuator pad Built-in pulse limiter (can be switched off) Automatic temperature monitoring Remote control with TTL levels (compatible with Rohde&Schwarz measuring receivers) 	<p>Specifications in brief</p> <ul style="list-style-type: none"> Frequency range from 9 kHz to 30 MHz Power-handling capacity up to 32 A, constant current Simulated impedance $(50 \mu\text{H} + 5 \Omega) \parallel 50 \Omega$ in line with CISPR 16-1-2 V-network in line with CISPR, EN, VDE, ANSI, FCC Part 15 and MIL-STD-461D, E and F Calibrated in line with CISPR 16-1-2 and ANSI C63.4
<p>R&S®ENV4200 200 A Four-Line V-Network</p> 	<p>Disturbance voltage measurements at high currents</p> <p>The R&S®ENV4200 V-network meets the requirements of CISPR 16-1-2, EN55016-1-2 and ANSI C63.4 for V-networks with impedance in the frequency range from 150 kHz to 30 MHz. The maximum attainable current of the V-network is limited by the voltage drop at the standardized inductances (CISPR 16-1-2 limits the voltage drop to 5% of the AC supply voltage) and by unavoidable heat losses.</p>	<p>Specifications in brief</p> <ul style="list-style-type: none"> Frequency range: 150 kHz to 30 MHz Impedance: $50 \mu\text{H} \parallel 50 \Omega$, magnitude and phase in line with CISPR 16-1-2 Amd. 2:2006 Artificial hand Continuous current up to $4 \times 200 \text{ A}$ Air-core design Built-in pulse limiter (can be switched off) Remote control with TTL levels (compatible with Rohde&Schwarz EMI test receivers)
<p>R&S®ESH3-Z6 150 A Single-Line V-Network</p> 	<p>Measurements of disturbance voltage and susceptibility in low-impedance power supply networks</p> <p>The R&S®ESH3-Z6 is a single-phase V-network with an equivalent circuit of $(5 \mu\text{H} + 1 \Omega) \parallel 50 \Omega$ for the frequency range from 100 kHz to 200 MHz. The R&S®ESH3-Z6 is rated for a continuous current up to 115 A and can handle surges of up to 500 A for a maximum time of 30 s. Its screw terminals ensure a low-impedance connection of test device and power supply.</p>	<p>Specifications in brief</p> <ul style="list-style-type: none"> Frequency range: 0.1 MHz to 200 MHz Continuous current up to 115 A Impedance: $(5 \mu\text{H} + 1 \Omega) \parallel 50 \Omega$ In line with <ul style="list-style-type: none"> CISPR 25 (on-board power supply systems) CISPR 16-1-2 and EN 55016-1-2 (low-impedance power supplies) MIL-STD-461, DEF-STAN 59-411 and DO-160 Calibrated in line with CISPR 16-1-2 and ANSI C63.4

Disturbance voltage measurements

R&S®ENY21 Two-Wire Coupling Network



Radio disturbance and immunity measurements on unshielded, symmetrical telecommunications ports

- ▮ Radio disturbance measurements in line with
 - CISPR 22:2005 and EN 55022:2010 figure D.1 (150 kHz to 30 MHz)
 - CISPR 32 and EN 55032 figure G.1
- ▮ Immunity measurements in line with CISPR 24 and EN 55024 (150 kHz to 80 MHz)
- ▮ CISPR 16-1-2 compliant
- ▮ Adapter sets to meet standardized LCL requirements (55 dB and 65 dB) and to accommodate various telecommunications interfaces
- ▮ High transmission bandwidth for wanted signal (100 MHz)

Specifications in brief

- ▮ Frequency range
 - Radio disturbance: 150 kHz to 30 MHz
 - Immunity: 150 kHz to 80 MHz
- ▮ Asymmetrical impedance
 - Imped. (0.15 MHz to 30 MHz): $150 \Omega \pm 20 \Omega$
 - Phase angle (0.15 MHz to 30 MHz): $0^\circ \pm 20^\circ$
 - Imped. (> 30 MHz to 80 MHz): $150 \Omega \pm 40 \Omega$
- ▮ Voltage division factor in asymmetrical circuit
 - 150 kHz to 30 MHz: typ. $10 \text{ dB} \pm 1 \text{ dB}$
- ▮ Maximum permissible values
 - Max. RF input voltage: < 15 V
 - Max. DC voltage between line/ground: 100 V
 - Max. AC voltage between line/ground: 63 V
 - Max. DC current: 600 mA (current on each individual wire of one pair or on different pairs)

R&S®ENY41 Four-Wire Coupling Network



Radio disturbance and immunity measurements on unshielded, symmetrical telecommunications ports

- ▮ Radio disturbance measurements in line with
 - CISPR 22:2005 and EN 55022:2010 figure D.2 (150 kHz to 30 MHz)
 - CISPR 32 and EN 55032 figure G.2
- ▮ Immunity measurements in line with CISPR 24 and EN 55024 (150 kHz to 80 MHz)
- ▮ CISPR 16-1-2 compliant
- ▮ Adapter sets to meet standardized LCL requirements (55 dB and 65 dB) and to accommodate various telecommunications interfaces
- ▮ High transmission bandwidth for wanted signal (100 MHz)

Specifications in brief

- ▮ Frequency range
 - Radio disturbance: 150 kHz to 30 MHz
 - Immunity: 150 kHz to 80 MHz
- ▮ Asymmetrical impedance
 - Imped. (0.15 MHz to 30 MHz): $150 \Omega \pm 20 \Omega$
 - Phase angle (0.15 MHz to 30 MHz): $0^\circ \pm 20^\circ$
 - Imped. (> 30 MHz to 80 MHz): $150 \Omega \pm 40 \Omega$
- ▮ Voltage division factor in asymmetrical circuit
 - 150 kHz to 30 MHz: typ. $10 \text{ dB} \pm 1 \text{ dB}$
- ▮ Maximum permissible values
 - Max. RF input voltage: < 15 V
 - Max. DC voltage between line/ground: 100 V
 - Max. AC voltage between line/ground: 63 V
 - Max. DC current: 600 mA (current on each individual wire of one pair or on different pairs)

R&S®ENY81 Eight-Wire Coupling Network



Radio disturbance measurements on unshielded, symmetrical telecommunications ports

- ▮ Radio disturbance measurements in line with
 - CISPR 22:2005 and EN 55022:2010 figure D.3 (150 kHz to 30 MHz)
 - CISPR 32 and EN 55032 figure G.3
- ▮ CISPR 16-1-2 compliant
- ▮ Adapter sets to meet standardized LCL requirements (55 dB and 65 dB) and to accommodate various telecommunications interfaces
- ▮ High transmission bandwidth for wanted signal (100 MHz)

Specifications in brief

- ▮ Frequency range: 150 kHz to 30 MHz
- ▮ Asymmetrical impedance
 - Imped. (0.15 MHz to 30 MHz): $150 \Omega \pm 20 \Omega$
 - Phase angle (0.15 MHz to 30 MHz): $0^\circ \pm 20^\circ$
- ▮ Voltage division factor in asymmetrical circuit
 - 150 kHz to 30 MHz: typ. $10 \text{ dB} \pm 1 \text{ dB}$
- ▮ Maximum permissible values
 - Max. RF input voltage: < 15 V
 - Max. DC voltage between line/ground: 100 V
 - Max. AC voltage between line/ground: 63 V
 - Max. DC current: 600 mA (current on each individual wire of one pair or on different pairs)

R&S®ENY81-CA6 Eight-Wire Coupling Network for cable category CAT 6



Radio disturbance measurements on unshielded, symmetrical telecommunications ports

- ▮ Radio disturbance measurements in line with
 - CISPR 22:2005 and EN 55022:2010 figure D.3
 - CISPR 32 and EN 55032 figure G.3
- ▮ Immunity measurements in line with CISPR 24 and EN 55024 (150 kHz to 80 MHz)
- ▮ CISPR 16-1-2 compliant
- ▮ 75 dB longitudinal conversion loss (LCL)
- ▮ High transmission bandwidth for wanted signal (250 MHz)

Specifications in brief

- ▮ Frequency range
 - Radio disturbance: 150 kHz to 30 MHz
 - Immunity: 150 kHz to 80 MHz
- ▮ Asymmetrical impedance
 - Imped. (0.15 MHz to 30 MHz): $150 \Omega \pm 20 \Omega$
 - Phase angle (0.15 MHz to 30 MHz): $0^\circ \pm 20^\circ$
 - Imped. (> 30 MHz to 80 MHz): $150 \Omega \pm 40 \Omega$
- ▮ Voltage division factor in asymmetrical circuit
 - 150 kHz to 30 MHz: typ. $9.5 \text{ dB} \pm 1 \text{ dB}$
- ▮ Maximum permissible values
 - Max. RF input voltage: < 15 V
 - Max. DC voltage between line/ground: 100 V
 - Max. AC voltage between line/ground: 63 V
 - Max. DC current: 600 mA (current on each individual wire of one pair or on different pairs)

Disturbance voltage measurements

R&S®EZ-12 Antenna Impedance Converter

Broadband matching unit for test receivers and spectrum analyzers with low-impedance inputs

The R&S®EZ-12 is used for high-impedance measurements of disturbance voltage at the feed-point of a vehicle-mounted antenna in the long-, medium-, shortwave and FM bands in line with VDE 0879 Part 2 and CISPR 25. For measurements in the VHF FM range, the antenna signal can be switched to a separate 50 Ω input.

- ▮ Flat frequency response
- ▮ High sensitivity and overload capacity
- ▮ Calibration in line with CISPR 25:2008
- ▮ Remotely controlled FM range switch

Specifications in brief

- ▮ Frequency range: 150 kHz to 30 MHz (120 MHz)
- ▮ RF input: SO 10599-1
- ▮ Input impedance: > 100 kΩ, < 10 pF (at 1 MHz)
- ▮ Gain factor for direct input to antenna connector: +11.2 dB ± 1 dB
- ▮ Correction factor (nom. gain in line with CISPR 25 is 10 dB): 10 dB
- ▮ VSWR: ≤ 1.4
- ▮ Noise voltage at output (input terminated with antenna simulator; AVG, BW = 10 kHz)
 - f > 150 kHz: < -5 dBμV
 - f > 500 kHz: < -7 dBμV
- ▮ 1 dB compression point: > 107 dBμV

R&S®EZ-25 150 kHz Highpass Filter

Conducted emission measurements in the presence of longwave mains disturbance signals

For the measurement of equipment that requires higher selectivity at the transition between 130 kHz and 150 kHz as shown in Fig. 2 of CISPR 16-1-1 (e.g. signaling equipment as defined in EN 50065-1), a highpass filter may be added in front of the measuring receiver to improve the selectivity and achieve the values stipulated in EN 50065 Part 1 without impairing the passband of the measuring receiver.

- ▮ Conducted emission measurements in line with EN 50065 Part 1
- ▮ Very steep slope in line with CISPR 16-1-1
- ▮ Suitable for any CISPR measuring receiver
- ▮ Relative attenuation > 50 dB below 130 kHz
- ▮ Built-in 10 dB attenuation pad for exact 50 Ω termination of LISN
- ▮ High pulse energy capability (50 mWs)
- ▮ Calibrated response

Specifications in brief

- ▮ Passband: 150 kHz to 30 MHz
- ▮ Insertion loss in passband: 9.5 dB to 11.5 dB
- ▮ VSWR in passband: < 1.2
- ▮ Stopband: below 130 kHz
- ▮ Minimum attenuation in stopband: 60 dB
- ▮ Attenuation in transition region
 - 146 kHz: < 12 dB
 - 145 kHz: > 12 dB
 - 140 kHz: > 24 dB
 - 130 kHz: > 60 dB
- ▮ Max. input voltage (continuous): 137 dBμV
- ▮ Max. impulse energy (50 μs): 50 mWs
- ▮ Dimensions (L × W × H): 145 mm × 95 mm × 52 mm (5.7 in × 3.74 in × 2.05 in)
- ▮ Weight: 500 g (1.1 lb)

R&S®ESH2-Z3 Voltage Probe, R&S®ESH2-Z31 Attenuator

R&S®ESH2-Z3 passive voltage probe

The passive voltage probe is suitable for measuring disturbance voltages on AC supply lines. The R&S®ESH2-Z3 meets the requirements of CISPR 16-1-2 and EN 55016-1-2.

R&S®ESH2-Z31 attenuator

For checking the disturbance source impedance in line with EN 55016-2-1 and CISPR 16-2-1

Specifications in brief (R&S®ESH2-Z3)

- ▮ Frequency range: 9 kHz to 30 MHz
- ▮ Measurement range (AVG, 200 Hz IF bandwidth with Rohde & Schwarz test receivers): typ. 10 dBμV to 150 dBμV
- ▮ Attenuation, uncertainty of calibration: 30 dB, 0.5 dB
- ▮ Input impedance: 1.5 kΩ ± 5% || 8 pF
- ▮ Max. input voltage
 - f < 63 Hz: 250 V
 - f > 63 Hz to 30 MHz: 30 V

R&S®ESH3-Z2 Pulse Limiter



High RF input levels and high-energy disturbance pulses generated on artificial mains networks when the DUT is switched on and off can damage the RF input circuits of test receivers. The R&S®ESH3-Z2 pulse limiter limits and reduces the disturbance level.

Specifications in brief

- ▮ Frequency range: 0 Hz to 30 MHz
- ▮ Insertion loss: 10 dB ± 0.3 dB
- ▮ Frequency response: ≤ ± 0.3 dB
- ▮ SWR with 50 Ω termination, input/output: ≤ 1.06/≤ 1.25
- ▮ Power handling capacity in continuous mode: 1 W
- ▮ Pulse power handling capacity: E = 0.1 Ws (6 ms)
- ▮ Dimensions (L × W × H): 94 mm × 25 mm × 25 mm (3.70 in × 0.98 in × 0.98 in)
- ▮ Weight: 120 g (0.26 lb)

Disturbance current measurements

R&S®EZ-17 Current Probe



Emission and susceptibility measurements

The R&S®EZ-17 model .02 with its extremely flat frequency response is optimal for current measurements and for measuring screening effectiveness.

Due to its high load capacity, model .03 is recommended for EMS measurements (bulk current injection).

- Model .02 for emission measurements
- Model .03 for emission and susceptibility measurements
- High sensitivity and overload capability
- Wide frequency range
- High load capacity for DC and AC current
- Small dimensions despite large inner diameter (30 mm)
- Simple clamping thanks to spring-loaded mechanism

Specifications in brief

- Frequency range: 20 Hz to 100 MHz
- Range with constant transducer factor (-3 dB): 1 MHz/2 MHz to 100 MHz
- Transducer factor reduced by 20 dB/decade in range from 20 Hz to 1 MHz/2 MHz
- Source impedance: $\leq 0.8 \Omega / \leq 1 \Omega$
- Transfer impedance Z_t in range with constant transducer factor: $3.16 \Omega / 7.1 \Omega$
- Transducer factor k in range with flat frequency response: -10 dB/-17 dB
- Load capacity (RF current measurement)
 - Max. DC current or peak, AC current: 300 A ($f < 1$ kHz)
 - Max. RF current (RMS): 2 A ($f > 1$ MHz)/1 A ($f > 1$ MHz)
- Load capacity of model .03 (EMS measurement)
 - Max. power at RF connector: 10 W ($f > 1$ MHz)

R&S®ESV-Z1 VHF Current Probe



The R&S®ESV-Z1 current probe is used for selective or broadband measurements of very small or very large RF currents in electric lines. It is shielded against electrostatic effects and complies with CISPR 16-1-2 and VDE 0876.

Specifications in brief

- Frequency range: 9 kHz to 600 MHz
- Measurement range (AVG, 7.5 kHz IF bandwidth): -33 dB μ A to +117 dB μ A
- Transfer admittance ($Y_t = \ln/V_{out}$): 0.1 S (20 MHz to 600 MHz)
- Transducer factor ($k = 20 \log(Y_t/s)$): -20 dB (20 MHz to 600 MHz)
- Max. current (superimposed on RF current or peak AC current): 50 A
- Max. diameter of conductor: 13.5 mm (0.53 in)
- Dimensions ($\varnothing \times$ height): 55 mm \times 20 mm (2.17 in \times 0.79 in)
- Weight: 130 g (0.29 lb)

Disturbance power measurements

R&S®MDS-21 Absorbing Clamp



Measurement of disturbance power and screening effectiveness on cables

The R&S®MDS-21 absorbing clamp meets the requirements of CISPR 16-1-3/EN 55016-1-3 for disturbance power measurements in the frequency range of 30 MHz to 1000 MHz and is applicable for screening effectiveness measurements.

The disturbance emitted by electrical appliances, machines and systems must comply with the limits specified in national and international standards. Meyer de Stadelhofen (MDS) absorbing clamps in conjunction with EMI measuring receivers are used to measure the disturbance power on cables in line with CISPR 13/EN 55013, CISPR 14-1/EN 55014-1 and EN 50083-2.

They can also be used in conjunction with two-port measuring devices to measure the screening effectiveness of cables in line with IEC 62153-4 and EN 50083-2.

MDS absorbing clamps are also used to test the efficiency of disturbance suppression devices for high-voltage ignition systems in line with CISPR 12/EN 55012.

Specifications in brief

- Frequency range from 30 MHz to 1000 MHz
- Maximum cable diameter: 20 mm
- Clamp opens for easy insertion of the test cable
- Ball bearing rollers for continuous use in automatic measurements
- Requirements and calibration in line with CISPR 16-1-3

Field strength measurements

R&S®HZ-14 H Near-Field Probe Set

**Diagnostic tools for detecting EMC trouble spots**

The R&S®HZ-14 near-field probe set can be used together with test receivers, spectrum analyzers or oscilloscopes to determine electromagnetic emissions of any type. The main application is the diagnosis of emissions from printed boards, cables and leakage spots in shielded enclosures. The two passive H-field probes can be used for a local susceptibility test. The R&S®HZ-14 probe set allows quantitative analysis. It comes in a handy transit case.

Equipment supplied

- Two passive H-field probes (9 kHz to 30 MHz and 30 MHz to 1 GHz)
- One active E-field probe (9 kHz to 1 GHz)
- One 30 dB preamplifier for the H-field probe (can be powered from all Rohde&Schwarz test receivers and spectrum analyzers)
- Test jig for functional testing of H-field probes and simplified normalization of H-field measurements with the aid of a tracking generator and normalization functions provided in spectrum analyzers

Specifications in brief

- H-field probes
 - Max. input power:
 - ≤ 30 MHz: 0.5 W; > 30 MHz: 0.25 W
 - VSWR (f > 30 MHz): < 2
- E-field probe
 - Frequency response: ±3 dB
 - Sensitivity: 13 mV/V
- Connectors: SMA female
- Preamplifier
 - Frequency range: 9 kHz to 1 GHz
 - Gain: 30 dB ± 2 dB, typ. ±1 dB
 - Noise figure: < 4 dB (at +25 °C, 100 MHz), typ. < 3 dB
 - Max. output level (1 dB compression): 8 dBm
 - Input/output: BNC female/N male
 - Impedance: 50 Ω
 - VSWR: < 1.5
 - DC powering: 10/15 V ± 0.1 V, < 100 mA
 - DC connector: LEMO

R&S®HZ-15 Probe Set and R&S®HZ-16 Preamplifier for E and H Near-Field Emission Measurements



The R&S®HZ-15 probe set contains special probes from 30 MHz to 3 GHz for near-field emission measurements on electronic modules and can be used together with test receivers, spectrum analyzers and oscilloscopes. Inserting the R&S®HZ-16 preamplifier between the near-field probe and the spectrum analyzer makes it easier to measure very weak high-frequency fields of up to 3 GHz.

- Five probes for easy diagnostic measurements
- Special, electrically shielded magnetic field probes
- Probe tips adapted to near-field measurement
- High-resolution measurements
- Easy-to-determine magnetic field orientation
- Easy operation and handling

Specifications in brief (R&S®HZ-15)

- Frequency range: 30 MHz to 3 (1.5) GHz
- One E-field probe with large surface of approx. 2 cm × 5 cm up to 1.5 GHz
- One E-field probe with sharp tip of 0.2 mm in width
- Two H-field probes with loop diameter of approx. 10 mm and 25 mm
- One H-field probe with active groove of 0.5 mm

Specifications in brief (R&S®HZ-16)

- Frequency range: 100 kHz to 3 GHz
- Gain: 20 dB (from 1.5 GHz decreasing to 17 dB)
- Noise figure: 4.5 dB
- Max. input power: +13 dBm
- Operating voltage: 12 V
- Plug-in power supply: 100 V to 240 V, 50 Hz/60 Hz, Euro connector (2 mm × 4 mm), adapter for USA and Japan

Field strength measurements

R&S®HFH2-Z2 Loop Antenna



Broadband active loop antenna for measuring the magnetic field strength

- ▮ Frequency range: 9 kHz to 30 MHz
- ▮ Antenna factor k, referred to 1/m: 20 dB (E-field)
- ▮ Accuracy: 1 dB
- ▮ Measurement range (200 Hz IF bandwidth, AV ind.)
 - Lower limit, frequency-dependent, 9 kHz to 1 MHz: +40 dB(μV/m) to +10 dB(μV/m)
 - Lower limit, frequency-dependent, 1 MHz to 30 MHz: +10 dB(μV/m) to +5 dB(μV/m)
 - Upper limit: 140 dB(μV/m)
- ▮ Connectors
 - RF: BNC female, 50 Ω
 - Supply and coding (antenna factor): 12-contact Tuchel female
 - Length of connecting cables: 10 m (32.8 ft)
- ▮ Current drain (±10 V): < 40 mA
- ▮ Dimensions (loop diameter): 590 mm (23.23 in)
- ▮ Weight in transit case, without cable: 12 kg (26.46 lb)

R&S®HFH2-Z6 Rod Antenna

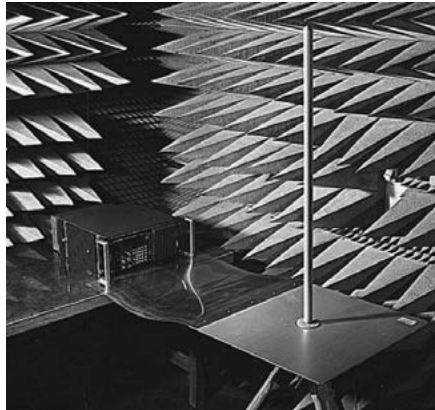

Broadband active rod antenna for measuring the electrical component of radiated EMI in test setups in line with CISPR 25

- ▮ Frequency range: 9 kHz to 30 MHz
- ▮ Antenna factor k, referred to 1/m: 10/20 dB, selectable
- ▮ Accuracy: 1 dB
- ▮ Measurement range (200 Hz IF bandwidth, AV ind.)
 - Lower limit, frequency-dependent: +15 dB(μV/m) to -18 dB(μV/m)
 - Upper limit: 140 dB(μV/m), 130 dB(μV/m) with k = 10 dB
- ▮ Connectors
 - RF: BNC female, 50 Ω
 - Supply and coding (antenna factor): 12-contact Tuchel female
 - Length of connecting cables: 10 m (32.8 ft)
- ▮ Current drain (±10 V): < 45 mA
- ▮ Dimensions
 - Counterpoise: 600 mm × 600 mm (23.62 in × 23.62 in)
 - Rod height: 1000 mm (39.37 in)
- ▮ Weight without cable: 5 kg (11.02 lb)

R&S®HZ-9 Power Supply



Power supply for the R&S®EZ-12 antenna impedance converter and the R&S®HZ-14 probe set for E and H near-field measurements in situations where these instruments cannot be supplied directly from a measuring receiver or when it is not possible to connect the instrument to the measuring receiver (standalone operation)

Specifications in brief

- ▮ Output voltages: ±10 V ± 0.1 V
- ▮ Max. current load: 100 mA
- ▮ DC connector: 12-contact Tuchel female
- ▮ AC supply: 100 V to 120 V/220 V to 240 V, ±10%
- ▮ Dimensions (W × H × D): 129 mm × 67 mm × 205 mm (5.08 in × 2.64 in × 8.07 in)
- ▮ Weight: 1.7 kg (3.75 lb)

R&S®AM524 Active Antenna System

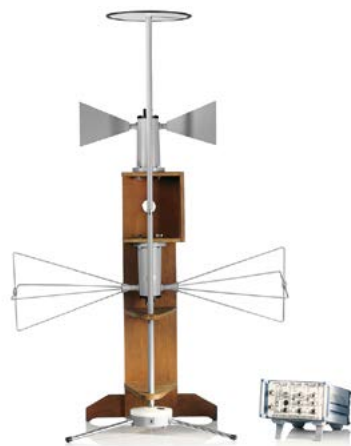

For measuring low-level signals in anechoic chambers

The R&S®AM524 active antenna system has been designed for measuring low-level signals in anechoic chambers. Criteria for dimensioning such antennas are different from those of active antennas used outside shielded rooms.

Essential parameters for antennas used in anechoic chambers are for instance low dimensions, high large-signal immunity and maximum sensitivity.

- ▮ Extremely high sensitivity
- ▮ Excellent large-signal characteristics
- ▮ Wide frequency range
- ▮ Especially suitable for TEMPEST measurements
- ▮ Individual calibration in line with ANSI C63.5

Specifications in brief

- ▮ Frequency range (in three subranges)
 - 100 Hz to 1 GHz
- ▮ Input impedance 50 Ω
- ▮ Antenna factor (without attenuator or amplifier)
 - 100 Hz to 30 MHz: 0 dB
 - 100 MHz: -10 dB
 - 1 GHz: typ. 19 dB
- ▮ Field sensitivity (Δf = 1 Hz, S/N = 0 dB)
 - 100 Hz: typ. 0 dB(μV/m)
 - 100 kHz: typ. -43 dB(μV/m)
 - 30 MHz: typ. -51 dB(μV/m)
 - 100 MHz: typ. -54 dB(μV/m)
 - 1 GHz: typ. -37 dB(μV/m)

Field strength measurements

R&S®HL033 Log-Periodic Broadband Antenna

**Detection and measurement of RF signals**

- ▮ Extremely broadband
- ▮ Only one antenna required to cover a wide frequency range
- ▮ Low frequency dependence of radiation patterns and input impedance
- ▮ Can be used as transmit antenna
- ▮ Metal parts electrically connected to mast flange for protection against electric charges and lightning
- ▮ Highly weatherproof
- ▮ Stable installation due to optional center bracket
- ▮ Individual calibration in line with ANSI C63.5

Specifications in brief

- ▮ Frequency range: 80 MHz to 2 GHz
- ▮ Polarization: linear
- ▮ Input impedance: 50 Ω
- ▮ VSWR: ≤ 2
- ▮ Max. input power ($T_{amb} = +30^{\circ}\text{C}$)
 - 80 MHz: 460 W + 100% AM
 - 2 GHz: 120 W + 100% AM
- ▮ Gain: typ. 6.5 dBi
- ▮ Max. wind speed (without ice deposit): 150 km/h
- ▮ Dimensions (L × W): approx. 1800 mm × 1960 mm (70.87 in × 77.17 in)
- ▮ Weight: approx. 5 kg (11.02 lb)

R&S®HL040E Log-Periodic Broadband Antenna

**For broadband transmission and reception under open-field and laboratory conditions**

Precise construction and optionally available individual calibration make the antenna suitable for field strength and EMI measurements.

Power rating and matching (VSWR) allow its use in EMS measurements where field strengths of 10 V/m or higher are required.

- ▮ Wide frequency range
- ▮ Suitable for susceptibility and emission measurements
- ▮ Stable radiation patterns over frequency range ensure optimum illumination of EUT
- ▮ Low cross-polarization
- ▮ Compact size, low weight
- ▮ Ease of handling
- ▮ Sturdy design

Specifications in brief

- ▮ Frequency range: 400 MHz to 6 GHz
- ▮ Polarization: linear
- ▮ Input impedance: 50 Ω
- ▮ VSWR: < 2.0
- ▮ Max. input power:
 - 400 MHz: 100 W CW
 - 1 GHz: 90 W CW
 - 3 GHz: 50 W CW
 - 6 GHz: 35 W CW
- ▮ Gain: typ. 5.5 dBi
- ▮ Front-to-back ratio
 - 400 MHz to 4.5 GHz: > 20 dB
 - 4.5 GHz to 6 GHz: > 15 dB
- ▮ Cross-polarization: typ. -25 dB
- ▮ Max. wind speed (without ice deposit): 275 km/h
- ▮ Dimensions (H × W × L): approx. 130 mm × 430 mm × 550 mm (5.1 in × 16.9 in × 21.6 in)
- ▮ Weight: approx. 2.5 kg (5.5 lb)





R&S®HL046E High Gain Log-Periodic Antenna

**Antenna for EMS measurements**

- ▮ High antenna gain, i.e. low amplifier power required
- ▮ No change of antennas needed over wide frequency range
- ▮ Uniform object irradiation due to optimized radiation patterns
- ▮ Small size, suitable for use in test chambers
- ▮ Reduced influence of test chamber
- ▮ Antenna gain approximately constant over entire frequency range
- ▮ Wall mounting possible

Specifications in brief

- ▮ Frequency range: 80 MHz to 3 GHz
- ▮ Polarization: linear
- ▮ Input impedance: 50 Ω
- ▮ VSWR: < 2 (< 2.5 GHz); < 2.5 (≥ 2.5 GHz)
- ▮ Practical gain: typ. > 8 dBi
- ▮ Max. input power
 - 80 MHz: 1400 W + 100% AM
 - 3 GHz: 250 W + 100% AM
- ▮ Optional trolley
 - Height continuously adjustable between approx. 1 m and 1.75 m above ground
 - Optional pneumatic actuators

Field strength measurements		
<p>R&S®HL050 Log-Periodic Antenna</p> 	<p>Log-periodic directional antenna for linear polarization</p> <ul style="list-style-type: none"> Extremely wide frequency range Rotation-symmetrical radiation patterns High gain due to V-shaped configuration of antenna elements Can be used in the lab and for open-area applications Can be used as a separate antenna or as a feed for microwave directional antennas 	<p>Specifications in brief</p> <ul style="list-style-type: none"> Frequency range: 850 MHz to 26.5 GHz Polarization: linear Input impedance: 50 Ω VSWR: ≤ 2.5 Max. input power: 10 W to 2 W Gain: typ. 8.5 dBi Max. wind speed (without ice deposit): 180 km/h Dimensions (∅ × H, with radome): approx. 210 mm × 300 mm (8.27 in × 11.81 in) Weight: approx. 0.7 kg (1.54 lb)
<p>R&S®HL050E Log-Periodic Antenna</p> 	<p>For EMI and EMS measurements</p> <p>Outstanding power rating and matching (VSWR) allow its use in EMS applications where field strengths of 10 V/m or higher are required.</p> <ul style="list-style-type: none"> Wide frequency range Suitable for susceptibility and emission measurements Stable radiation patterns over frequency range ensure optimum illumination of EUT Very low cross-polarization Compact size, low weight Ease of handling Outstanding power rating up to 6 GHz 	<p>Specifications in brief</p> <ul style="list-style-type: none"> Frequency range: 750 MHz to 6 GHz Polarization: linear Input impedance: 50 Ω VSWR: typ. ≤ 2.5; < 2 Max. input power: 100 W CW Gain: 8.5 dBi (typ.) Dimensions (∅ × H, with radome): approx. 210 mm × 450 mm (8.3 in × 17.7 in) Weight: approx. 1.4 kg (3.1 lb)
<p>R&S®HL223 Log-Periodic Antenna</p> 	<p>For measurement, monitoring and transmission</p> <p>Owing to its broadband characteristics and the virtually frequency-independent radiation patterns, the R&S®HL223 covers a very wide frequency range. The sturdy construction makes the antenna suitable for stationary and mobile applications. Each antenna is supplied with an individual calibration certificate so that measurements can be performed in addition to monitoring and transmitting.</p>	<p>Specifications in brief</p> <ul style="list-style-type: none"> Frequency range: 200 MHz to 1.3 GHz Polarization: linear Input impedance: 50 Ω VSWR: typ. ≤ 2, 1.6 Max. input power: 1500 W to 600 W CW Gain: > 6 dBi Max. wind speed (without ice deposit): 200 km/h Dimensions (L × W): approx. 710 mm × 765 mm (27.95 in × 30.12 in) Weight: approx. 2 kg (4.41 lb)
<p>R&S®HM020 Triple-Loop Antenna</p> 	<p>Large loop antenna system</p> <p>The R&S®HM020 is a large loop antenna system in line with CISPR 16-1-4, for electric lighting equipment in line with CISPR 15 and for induction sources in line with CISPR 11.</p> <ul style="list-style-type: none"> Frequency range: 9 kHz to 30 MHz Loops switchable between X, Y and Z planes Transducer factor of current probe: 0 dB, referred to 1 S RF connector: N female, 50 Ω 	<p>Dimensions (W × H × D); weight</p> <ul style="list-style-type: none"> Loops set up, normal mode: 2.49 m × 2.57 m × 2.07 m; 45 kg (98.03 in × 101.18 in × 81.50 in; 99.21 lb) Loops set up, reduced height: 2.49 m × 2.09 m × 2.07 m (98.03 in × 82.28 in × 81.50 in) Transport crate: 2.68 m × 2.32 m × 0.57 m (105.51 in × 91.34 in × 22.44 in) R&S®HM020Z1 basic pedestal: 0.9 m × 1 m × 0.9 m; 40 kg (35.43 in × 39.37 in × 35.43 in; 88.18 lb) R&S®HM020Z2 adapter pedestal: 0.9 m × max. 0.5 m × 0.9 m; 30 kg (35.43 in × max. 19.69 in × 35.43 in; 66.14 lb)

Field strength measurements

R&S®HK116E Biconical Antenna

**For radiated emission measurements**

- ▮ Wide frequency range
- ▮ Radiation patterns virtually independent of frequency
- ▮ Individual calibration in line with ANSI C63.5 (free-space calibration) and ARP958
- ▮ Low weight

Specifications in brief

- ▮ Frequency range: 20 MHz to 300 MHz
- ▮ Polarization: linear
- ▮ Input impedance: 50 Ω
- ▮ VSWR: typ. 2.5
- ▮ Max. input power: 75 W CW
- ▮ Dimensions (L × W × H): approx. 1380 mm × 530 mm × 780 mm (54.3 in × 20.9 in × 30.7 in)
- ▮ Weight: approx. 3 kg (6.6 lb)

R&S®HF907 Double-Ridged Waveguide Horn Antenna

**Broadband directional antenna, ideal for EMC measurements**

- ▮ Wide frequency range
- ▮ High gain and low VSWR for measurement of weak signals and generation of high field strengths without any significant return loss
- ▮ Radiation pattern contains only one main lobe over the entire frequency range
- ▮ Ideal for use in EMC laboratories
- ▮ Compact size, low weight
- ▮ Each antenna is calibrated individually in line with ANSI C63.5 and SAE ARP958

Specifications in brief

- ▮ Frequency range: 800 MHz to 18 GHz
- ▮ Polarization: linear
- ▮ Polarization decoupling: > 25 dB, typ. > 30 dB
- ▮ Input impedance: 50 Ω
- ▮ VSWR: ≤ 3.0 (f < 1.5 GHz); < 2.0 (f ≥ 1.5 GHz)
- ▮ Max. input power: 300 W CW/500 W PEP
- ▮ Gain: typ. 5 dBi to 14 dBi
- ▮ Dimensions (L × W × H): approx. 305 mm × 280 mm × 226 mm (12.0 in × 11.0 in × 8.9 in)
- ▮ Weight: approx. 1.9 kg (4.2 lb)

R&S®HL562E ULTRALOG Antenna

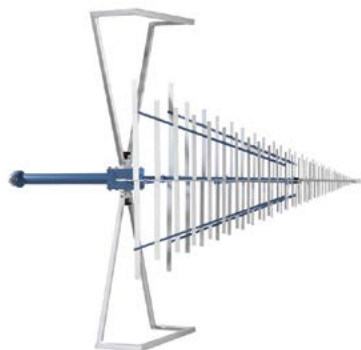
**EMI and EMS measurements in an extremely wide frequency range**

- ▮ Suitable for susceptibility and emission measurements
- ▮ No change of antennas needed throughout the whole frequency range
- ▮ Radiation patterns in E and H plane practically rotationally symmetrical (from 200 MHz to 6 GHz)
- ▮ Compact size, low weight
- ▮ High gain, low antenna factor
- ▮ Movable tripod optionally available
- ▮ Individual calibration in line with ANSI C63.5

Specifications in brief

- ▮ Frequency range: 30 MHz to 6 GHz
- ▮ Polarization: linear
- ▮ Cross-polarization: < -20 dB
- ▮ Nominal impedance: 50 Ω
- ▮ VSWR: typ. < 2
- ▮ Max. input power ($T_{amb} = +40^{\circ}\text{C}$)
 - 30 MHz: 225 W CW
 - 80 MHz: 900 W CW
 - 250 MHz: 750 W CW
 - 1 GHz: 420 W CW
 - 3 GHz: 270 W CW
 - 6 GHz: 150 W CW
- ▮ Gain: typ. 8 dBi from 200 MHz

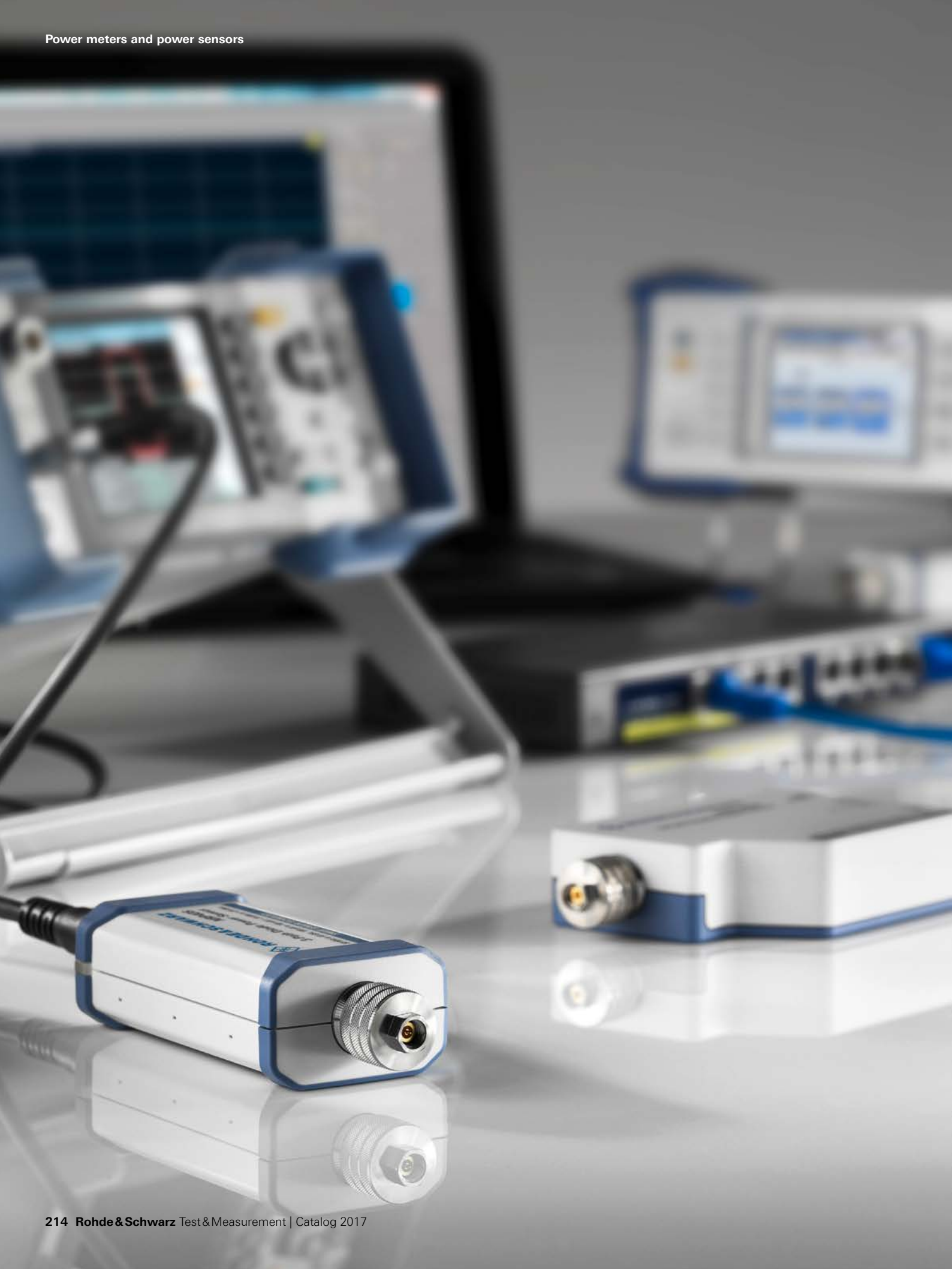

Chapter 8

Power meters and power sensors

Power meters and power sensors from Rohde & Schwarz stand for highest measurement accuracy and reliability – and have done so for decades. Rohde & Schwarz power sensors are intelligent standalone instruments with a flexible connection concept.

The comprehensive USB-capable sensor portfolio is designed to operate with the power meter base unit or a PC/laptop. The latest power sensor family can also be controlled via LAN. This makes power meters from Rohde & Schwarz unique on the market.

	Type	Designation	Description	Page
	R&S®NRP2	Power meter	The ultimate solution for power measurements	216
New	R&S®NRP	Power sensors	USB and LAN power sensors	217
	R&S®NRP-Zxx	Power sensors	USB power sensors for power measurements with a base unit or standalone on a PC	220
	R&S®NRPV	Virtual power meter	RF power measurements with R&S®NRP and R&S®NRP-Zxx power sensors on a PC	222
	R&S®NRP-Z5	Sensor hub	Connecting up to four R&S®NRPxxS/SN and R&S®NRP-Zxx power sensors	222
	R&S®NRPC	Calibration kits	Calibration of power sensors	223
	R&S®NRT	Power reflection meter	Power measurement on transmitters, amplifiers, industrial RF and microwave generators	224
	R&S®NRT-Zxx/ R&S®NAP-Zx	Power sensors	Intelligent sensors: simply plug in and measure	224
New	R&S®NRPM	Over-the-air (OTA) power measurement solution	For WLAN IEEE802.11ad, IEEE802.11ay and 5G	225

R&S®NRP2 Power Meter



The ultimate solution for power measurements

The R&S®NRP2 power meter is ideal for a vast number of applications in R&D, production and maintenance as well as in calibration laboratories. In addition to the R&S®NRP2 base unit, there are a number of power sensors available to perform diverse measurements. Complex signals with digital modulation (e.g. as required by advanced mobile radio standards such as WCDMA and LTE) are handled as easily as are CW signals, carriers with analog modulation (e.g. AM, FM) and pulsed RF.

The R&S®NRP2 simultaneously supports up to four power sensors of the R&S®NRP family. Function keys on the front panel provide quick access to the most important functions. Users can open the frequency setting menu or zero the connected sensors at the push of a button. The mode key provides direct access to all available measurement functions. User-programmable save/recall memory locations allow fast access to personal settings. Presets for all major mobile radio standards, such as 3GPP LTE, 3GPP WCDMA, GSM/EDGE, WLAN and Bluetooth®, ensure correct measurement with a minimum of keystrokes.

The brilliant TFT color display supports the intuitive, window-based operating concept. Key parameters and functions are color-coded and can be seen at a glance. Results are presented in numerical and graphical display windows that can be easily configured.

- Small, lightweight and ruggedized base unit for production, laboratory and mobile applications
- Simple operation due to window-based graphical user interface
- Presets for fast, standard-compliant measurements
- Simultaneous operation of up to four power sensors (with the R&S®NRP-B2 and R&S®NRP-B5 options)
- Sensor check source (R&S®NRP-B1 option)
- Ethernet, USB and GPIB remote interfaces for integration in automated test setups as standard

Emulation of other common power meters

The R&S®NRP2 can interpret the command set of other power meters. Legacy instruments in existing systems can be quickly replaced by the R&S®NRP2 without additional programming effort.

Expandable to up to four measurement channels

The R&S®NRP2 standard configuration includes one measurement channel. The base unit can be optionally expanded to two (R&S®NRP-B2) or four (R&S®NRP-B2 and R&S®NRP-B5) measurement channels.

Dual-mode test generator

An optionally integrated high-precision 1 mW reference source (R&S®NRP-B7 sensor check source) can be used in CW mode to check the function of all R&S®NRP power sensors. In the pulse mode, the test generator can be used to check the pulse measurement performance of the R&S®NRP-Z8x wideband power sensors.

Multiple ways to operate the R&S®NRPxxS(N), R&S®NRPxxT(N) and R&S®NRPxxA(N) power sensors

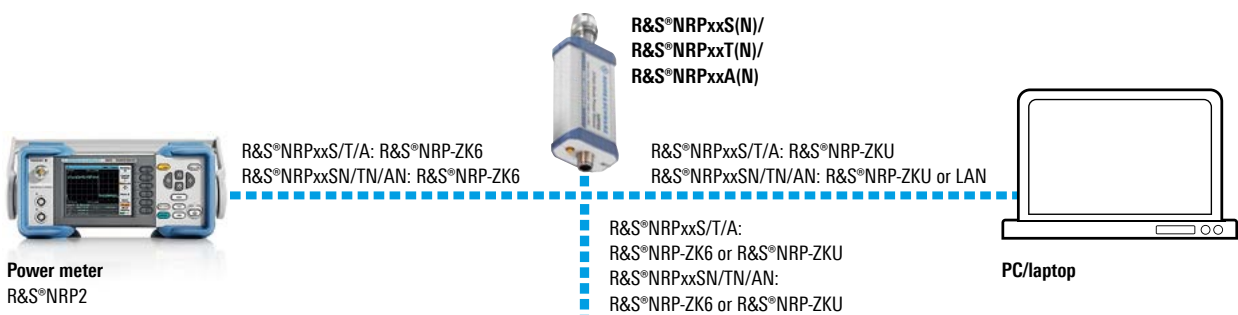

Supported Rohde & Schwarz instruments



Signal generators
e.g. R&S®SMW200A



Signal and spectrum analyzers
e.g. R&S®FSW



Network analyzers
e.g. R&S®ZVA

R&S®NRP USB and LAN Power Sensors

The R&S®NRP power sensors have long been recognized for delivering supreme precision and speed. The R&S®NRPxxS(N), R&S®NRPxxT(N) and R&S®NRPxxA(N) power sensors take power measurements to the next level. They offer USB capability and can be additionally controlled via LAN. This makes the R&S®NRP power meter portfolio unique in the industry.



Taking power measurements to the next level

The R&S®NRPxxS(N) three-path diode power sensors, R&S®NRPxxT(N) thermal power sensors and R&S®NRPxxA(N) average power sensors are self-contained, fully characterized instruments. They can be operated with the R&S®NRP2 base unit, with a laptop/PC via USB, and with many Rohde&Schwarz instruments (e.g. signal generators, signal and spectrum analyzers, network analyzers). The R&S®NRPxxSN, R&S®NRPxxTN and R&S®NRPxxAN power sensors additionally offer LAN capability, allowing remote control over large distances.

Key facts

- Maximum dynamic range: -70 dBm to +45 dBm
- Frequency range: DC to 110 GHz
- More than 50000 readings/s
- Flexible operation with R&S®NRP2 base unit, laptop/PC and many Rohde&Schwarz instruments
- Control and monitoring via LAN and USB
- Easy LAN operation from a web browser
- R&S®NRPxxS(N) for widest dynamic range
- R&S®NRPxxT(N) for highest accuracy
- R&S®NRPxxA(N) for EMC applications

Sensor types

Three-path diode power sensors

R&S®NRP8S(N)	8 GHz (LAN) power sensor
R&S®NRP18S(N)	18 GHz (LAN) power sensor
R&S®NRP33S(N)	33 GHz (LAN) power sensor
R&S®NRP40S(N)	40 GHz (LAN) power sensor
R&S®NRP50S(N)	50 GHz (LAN) power sensor
R&S®NRP18S-10	18 GHz (LAN) power sensor, high power, up to 2 W
R&S®NRP18S-20	18 GHz (LAN) power sensor high power, up to 15 W
R&S®NRP18S-25	18 GHz (LAN) power sensor high power, up to 30 W
R&S®NRP33SN-V	33 GHz LAN power sensor, TVAC-compliant

Thermal power sensors

R&S®NRP18T(N)	18 GHz thermal (LAN) power sensor
R&S®NRP33T(N)	33 GHz thermal (LAN) power sensor
R&S®NRP40T(N)	40 GHz thermal (LAN) power sensor
R&S®NRP50T(N)	50 GHz thermal (LAN) power sensor
R&S®NRP67T(N)	67 GHz thermal (LAN) power sensor
R&S®NRP110T	110 GHz thermal power sensor

Average power sensors

R&S®NRP6A(N)	6 GHz average (LAN) power sensor
R&S®NRP18A(N)	18 GHz average (LAN) power sensor

Functions and performance features

- ▮ Fully characterized power sensors
- ▮ Minimized measurement uncertainty
- ▮ Intelligent averaging function minimizes measurement time
- ▮ Versatile measurement functions
- ▮ USBTMC for easy system integration
- ▮ Built-in trigger I/O port
- ▮ Sensor status at a glance with status LED
- ▮ Detachable cables for flexible operation

Intelligent, LAN enabled power measurements

- ▮ Almost every sensor available as LAN model
- ▮ Remote monitoring via LAN over any distance
- ▮ Power supply via Power over Ethernet (PoE)
- ▮ Built-in web GUI with full power measurement support

R&S®NRPxxS(N) three-path diode power sensors

- ▮ Ideal for universal applications
- ▮ 93 dB dynamic range thanks to improved three-path concept

- ▮ Unprecedented measurement speed and accuracy even at low levels
- ▮ More than 50 000 readings/s
- ▮ 10 000 triggered measurements/s
- ▮ Sensors for high-power applications

R&S®NRP33SN-V TVAC-compliant three-path diode power sensor

- ▮ Specially designed for use in thermal vacuum (TVAC) chambers
- ▮ Outgassing reduced to a minimum

R&S®NRPxxT(N) thermal power sensors

- ▮ Outstanding performance for reference applications
- ▮ Excellent impedance matching
- ▮ Sophisticated connector concept
- ▮ Internal calibration test

R&S®NRPxxA(N) EMC average power sensors

- ▮ Specially designed for EMC applications

Specifications in brief						
Sensor type, connector type	Frequency range	Power measurement range	Impedance matching (SWR)	Rise time, video bandwidth	Uncertainty for power measurements at +20°C to +25°C	
					absolute (in dB)	relative (in dB)
Three-path diode power sensors						
R&S®NRP8S(N) N (m)	10 MHz to 8 GHz	100 pW to 200 mW (-70 dBm to +23 dBm)	10 MHz to 2.4 GHz: < 1.13 > 2.4 GHz to 8.0 GHz: < 1.20	< 5 µs > 100 kHz	0.053 to 0.065	0.022 to 0.050
R&S®NRP18S(N) N (m)	10 MHz to 18 GHz	100 pW to 200 mW (-70 dBm to +23 dBm)	10 MHz to 2.4 GHz: < 1.13 > 2.4 GHz to 8.0 GHz: < 1.20 > 8.0 GHz to 18.0 GHz: < 1.25		0.053 to 0.094	0.022 to 0.069
R&S®NRP33S(N) 3.5 mm (m)	10 MHz to 33 GHz	100 pW to 200 mW (-70 dBm to +23 dBm)	10 MHz to 2.4 GHz: < 1.13 > 2.4 GHz to 8.0 GHz: < 1.20 > 8.0 GHz to 18.0 GHz: < 1.25 > 18.0 GHz to 26.5 GHz: < 1.30 > 26.5 GHz to 33.0 GHz: < 1.35		0.053 to 0.134	0.022 to 0.136
R&S®NRP40S(N) 2.92 mm (m)	50 MHz to 40 GHz	100 pW to 100 mW (-70 dBm to +20 dBm)	50 MHz to 2.4 GHz: < 1.13 > 2.4 GHz to 8.0 GHz: < 1.20 > 8.0 GHz to 18.0 GHz: < 1.25 > 18.0 GHz to 26.5 GHz: < 1.30 > 26.5 GHz to 33.0 GHz: < 1.35 > 33 GHz to 40.0 GHz: < 1.37		0.073 to 0.138	0.028 to 0.142
R&S®NRP50S(N) 2.4 mm (m)	50 MHz to 50 GHz	100 pW to 100 mW (-70 dBm to +20 dBm)	50 MHz to 2.4 GHz: < 1.13 > 2.4 GHz to 8.0 GHz: < 1.20 > 8.0 GHz to 18.0 GHz: < 1.25 > 18.0 GHz to 26.5 GHz: < 1.30 > 26.5 GHz to 33.0 GHz: < 1.35 > 33 GHz to 40.0 GHz: < 1.37 > 40 GHz to 50.0 GHz: < 1.40		0.073 to 0.183	0.028 to 0.184
High-power three-path diode power sensor						
R&S®NRP18S-10 N (m)	10 MHz to 18 GHz	1 nW to 2 W (-60 dBm to +33 dBm)	10 MHz to 2.4 GHz: < 1.13 > 2.4 GHz to 8.0 GHz: < 1.20 > 8.0 GHz to 18.0 GHz: < 1.25	< 5 µs > 100 kHz	0.053 to 0.094	0.022 to 0.069
R&S®NRP18S-20 N (m)	10 MHz to 18 GHz	10 nW to 15 W (-50 dBm to +42 dBm)	10 MHz to 2.4 GHz: < 1.13 > 2.4 GHz to 8.0 GHz: < 1.20 > 8.0 GHz to 18.0 GHz: < 1.25		0.053 to 0.094	0.022 to 0.069
R&S®NRP18S-25 N (m)	10 MHz to 18 GHz	30 nW to 30 W (-45 dBm to +45 dBm)	10 MHz to 2.4 GHz: < 1.13 > 2.4 GHz to 8.0 GHz: < 1.20 > 8.0 GHz to 18.0 GHz: < 1.25		0.053 to 0.094	0.022 to 0.069

Specifications in brief						
Sensor type, connector type	Frequency range	Power measurement range	Impedance matching (SWR)	Rise time, video bandwidth	Uncertainty for power measurements at +20 °C to +25 °C	
					absolute (in dB)	relative (in dB)
TVAC-compliant three-path diode power sensor						
R&S®NRP33SN-V 3.5 mm (m)	10 MHz to 33 GHz	100 pW to 200 mW (-70 dBm to +23 dBm)	10 MHz to 2.4 GHz: < 1.13 > 2.4 GHz to 8.0 GHz: < 1.20 > 8.0 GHz to 18.0 GHz: < 1.25 > 18.0 GHz to 26.5 GHz: < 1.30 > 26.5 GHz to 33.0 GHz: < 1.35	< 5 µs > 100 kHz	0.053 to 0.134	0.022 to 0.136
Thermal power sensors						
R&S®NRP18T(N) N (m)	DC to 18 GHz	300 nW to 100 mW (-35 dBm to +20 dBm)	DC to 100 MHz: < 1.03 > 100 MHz to 2.4 GHz: < 1.06 > 2.4 GHz to 12.4 GHz: < 1.13 > 12.4 GHz to 18.0 GHz: < 1.16	-	0.040 to 0.082	0.010
R&S®NRP33T(N) 3.5 mm (m)	DC to 33 GHz	300 nW to 100 mW (-35 dBm to +20 dBm)	DC to 100 MHz: < 1.03 > 100 MHz to 2.4 GHz: < 1.06 > 2.4 GHz to 12.4 GHz: < 1.13 > 12.4 GHz to 18.0 GHz: < 1.16 > 18.0 GHz to 26.5 GHz: < 1.22 > 26.5 GHz to 33.0 GHz: < 1.28		0.040 to 0.101	0.010
R&S®NRP40T(N) 2.92 mm (m)	DC to 40 GHz	300 nW to 100 mW (-35 dBm to +20 dBm)	DC to 100 MHz: < 1.03 > 100 MHz to 2.4 GHz: < 1.06 > 2.4 GHz to 12.4 GHz: < 1.13 > 12.4 GHz to 18.0 GHz: < 1.16 > 18.0 GHz to 26.5 GHz: < 1.22 > 26.5 GHz to 40.0 GHz: < 1.28		0.040 to 0.108	0.010
R&S®NRP50T(N) 2.4 mm (m)	DC to 50 GHz	300 nW to 100 mW (-35 dBm to +20 dBm)	DC to 100 MHz: < 1.03 > 100 MHz to 2.4 GHz: < 1.06 > 2.4 GHz to 12.4 GHz: < 1.13 > 12.4 GHz to 18.0 GHz: < 1.16 > 18.0 GHz to 26.5 GHz: < 1.22 > 26.5 GHz to 40.0 GHz: < 1.28 > 40.0 GHz to 50.0 GHz: < 1.30		0.040 to 0.143	0.010
R&S®NRP67T(N) 1.85 mm (m)	DC to 67 GHz	300 nW to 100 mW (-35 dBm to +20 dBm)	DC to 100 MHz: < 1.03 > 100 MHz to 2.4 GHz: < 1.06 > 2.4 GHz to 12.4 GHz: < 1.13 > 12.4 GHz to 18.0 GHz: < 1.16 > 18.0 GHz to 26.5 GHz: < 1.22 > 26.5 GHz to 40.0 GHz: < 1.28 > 40.0 GHz to 50.0 GHz: < 1.30 > 50.0 GHz to 67.0 GHz: < 1.35		0.040 to 0.248	0.010
R&S®NRP110T 1 mm (m)	DC to 110 GHz	300 nW to 100 mW (-35 dBm to +20 dBm)	DC to 100 MHz: < 1.05 > 100 MHz to 2.4 GHz: < 1.08 > 2.4 GHz to 12.4 GHz: < 1.18 > 12.4 GHz to 18.0 GHz: < 1.23 > 18.0 GHz to 26.5 GHz: < 1.28 > 26.5 GHz to 40.0 GHz: < 1.38 > 40.0 GHz to 50.0 GHz: < 1.46 > 50.0 GHz to 67.0 GHz: < 1.56 > 67.0 GHz to 80.0 GHz: < 1.60 > 80.0 GHz to 95.0 GHz: < 1.66 > 95.0 GHz to 110 GHz: < 1.70		0.040 to 0.318	0.014
Average power sensors						
R&S®NRP6A(N) N (m)	8 kHz to 6 GHz	100 pW to 200 mW (-70 dBm to +23 dBm)	8 kHz to < 20 kHz: < 1.25 20 kHz to 2.4 GHz: < 1.13 > 2.4 GHz to 6 GHz: < 1.20	-	0.051 to 0.056	0.022 to 0.050
R&S®NRP18A(N) N (m)	8 kHz to 18 GHz	100 pW to 200 mW (-70 dBm to +23 dBm)	8 kHz to < 20 kHz: < 1.25 20 kHz to 2.4 GHz: < 1.13 > 2.4 GHz to 6 GHz: < 1.20 > 8 GHz to 18 GHz: < 1.25		0.051 to 0.094	0.022 to 0.069

R&S®NRP-Zxx power sensors



The right sensor for all applications

The R&S®NRP-Zxx power sensors function as independent measuring instruments and are completely characterized over frequency, level and temperature. The sensors can be operated either on an R&S®NRP2 base unit or directly on a laptop/PC. They are also supported by numerous signal generators, signal analyzers, spectrum analyzers and network analyzers from Rohde & Schwarz.

The R&S®NRP-Z4 passive USB adapter cable is all that is needed to connect the sensors to a laptop/PC. To measure power levels below the minimum trigger threshold, an external trigger signal is required. This signal can be conveniently supplied via the trigger input of the R&S®NRP-Z3 active USB adapter cable or the R&S®NRP-Z5 sensor hub. The sensor hub allows users to connect up to four sensors to a laptop/PC without additional adapters and to simultaneously start the measurements using an external trigger signal.

R&S®NRP-Z22/-Z23/-Z24 three-path diode power sensors

- ▮ Truly universal power sensors for a vast number of applications up to 18 GHz
- ▮ Innovative three-path diode power sensor with enhanced inter-range performance
- ▮ 90 dB dynamic range for CW und modulated signals
- ▮ Continuous average, burst average, timeslot average, time gating and trace mode supported (100 kHz video bandwidth)
- ▮ Automatic burst detection and acquisition
- ▮ Up to 1500 measurements/s (buffered mode)
- ▮ Low sensitivity to harmonics

R&S®NRP-Z211/-Z221 two-path diode power sensors

- ▮ Excellent price/performance ratio
- ▮ 80 dB dynamic range for CW and modulated signals
- ▮ Two-path diode power sensor with enhanced inter-range performance
- ▮ Continuous average, burst average, timeslot average, time gating and trace mode supported (50 kHz video bandwidth)
- ▮ Automatic burst detection and acquisition

R&S®NRP-Z8x wideband power sensors

- ▮ Peak power measurements of radar and mobile communications signals up to 44 GHz with up to 30 MHz RF video bandwidth; sensor rise time < 13 ns
- ▮ Automatic burst detection and acquisition
- ▮ Ultrafast statistical analysis (one-million point CCDF within < 25 ms)
- ▮ Accurate continuous power measurements on modulated and unmodulated signals in the range from -60 dBm to +20 dBm
- ▮ High measurement repeatability due to very low zero drift of < 150 nW for single-shot events and statistics, < 2 nW for repetitive measurements

R&S®NRP-Z27/-Z37 power sensor modules

- ▮ Power sensor with additional RF signal output
- ▮ Developed for use with the R&S®FSMR measuring receiver
- ▮ For precise calibration of T&M equipment
- ▮ DC to 18 GHz (R&S®NRP-Z27)
- ▮ DC to 26.5 GHz (R&S®NRP-Z37)
- ▮ Level range from -24 dBm to +26 dBm

R&S®NRP-Z28/-Z98 level control sensors

The sensors are used where high-precision RF power is required as a reference source over a high dynamic range.

- ▮ Integrated one-box solution for classic power splitter/power sensor combination
- ▮ Special directional power sensor with integrated power splitter
- ▮ For applications requiring a precisely known level to be fed in (e.g. calibration of measuring receivers)
- ▮ 10 MHz to 18 GHz (R&S®NRP-Z28)
- ▮ 9 kHz to 6 GHz (R&S®NRP-Z98)
- ▮ Improvement of the absolute level accuracy of signal generators

Recommended extras for NRP-Zxx power sensors

- R&S®NRP-Z2 sensor extension cable
- R&S®NRP-Z3 active USB adapter cable
- R&S®NRP-Z4 passive USB adapter cable
- R&S®NRP-Z5 sensor hub for up to four R&S®NRP-Zxx power sensors
- R&S®NRPZ-K1 option key for R&S®NRPV virtual power meter PC application

Specifications in brief							
Sensor type, connector	Frequency range	Power measurement range, maximum input power	Impedance matching (SWR)	Rise time, video bandwidth	Uncertainty for power measurements at +20 °C to +25 °C		
					absolute (in dB)	relative (in dB)	
Three-path diode power sensors							
R&S®NRP-Z22, N (m)	10 MHz to 18 GHz	2 nW to 2 W (-57 dBm to +33 dBm) max. 3 W (AVG)/ 10 W (PK, 10 µs)	10 MHz to 2.4 GHz: < 1.14 > 2.4 GHz to 8.0 GHz: < 1.20 > 8.0 GHz to 12.4 GHz: < 1.25 > 12.4 GHz to 18.0 GHz: < 1.30	< 8 µs > 50 kHz	0.079 to 0.178	0.022 to 0.112	
R&S®NRP-Z23, N (m)	10 MHz to 18 GHz	20 nW to 15 W (-47 dBm to +42 dBm) max. 18 W (AVG)/ 100 W (PK, 10 µs)	10 MHz to 2.4 GHz: < 1.14 > 2.4 GHz to 8.0 GHz: < 1.25 > 8.0 GHz to 12.4 GHz: < 1.30 > 12.4 GHz to 18.0 GHz: < 1.41		0.078 to 0.199	0.022 to 0.110	
R&S®NRP-Z24, N (m)	10 MHz to 18 GHz	60 nW to 30 W (-42 dBm to +45 dBm) max. 36 W (AVG)/ 300 W (PK, 10 µs)	10 MHz to 2.4 GHz: < 1.14 > 2.4 GHz to 8.0 GHz: < 1.25 > 8.0 GHz to 12.4 GHz: < 1.30 > 12.4 GHz to 18.0 GHz: < 1.41		0.078 to 0.222	0.022 to 0.110	
Two-path diode power sensors							
R&S®NRP-Z211, N (m)	10 MHz to 8 GHz	1.0 nW to 100 mW (-60 dBm to +20 dBm)	10 MHz to 2.4 GHz: < 1.13 > 2.4 GHz to 8.0 GHz: < 1.20	< 10 µs > 40 kHz	0.054 to 0.110	0.022 to 0.112	
R&S®NRP-Z221, N (m)	10 MHz to 18 GHz	max. 400 mW (AVG)/ 2 W (PK, 10 µs)	10 MHz to 2.4 GHz: < 1.13 > 2.4 GHz to 8.0 GHz: < 1.20 > 8.0 GHz to 18.0 GHz: < 1.25		0.054 to 0.143	0.022 to 0.142	
Wideband power sensors							
R&S®NRP-Z81, N (m)	50 MHz to 18 GHz	1 nW to 100 mW (-60 dBm to +20 dBm) max. 200 mW (AVG)/ 1 W (PK, 1 µs)	50 MHz to 2.4 GHz: < 1.16 > 2.4 GHz to 8.0 GHz: < 1.20 > 8.0 GHz to 18.0 GHz: < 1.25	< 13 ns > 30 MHz	0.130 to 0.150	0.039 to 0.148	
R&S®NRP-Z85, 2.92 mm (m)	50 MHz to 40 GHz		50 MHz to 2.4 GHz: < 1.16 > 2.4 GHz to 8.0 GHz: < 1.20 > 8.0 GHz to 18.0 GHz: < 1.25 > 18.0 GHz to 26.5 GHz: < 1.30 > 26.5 GHz to 40.0 GHz: < 1.35		0.130 to 0.180	0.039 to 0.165	
R&S®NRP-Z86, 2.4 mm (m)	50 MHz to 40 GHz		50 MHz to 2.4 GHz: < 1.16 > 2.4 GHz to 8.0 GHz: < 1.20 > 8.0 GHz to 18.0 GHz: < 1.25 > 18.0 GHz to 26.5 GHz: < 1.30 > 26.5 GHz to 40.0 GHz: < 1.35		0.130 to 0.180	0.039 to 0.165	
R&S®NRP-Z86, 2.4 mm (m)	50 MHz to 44 GHz		50 MHz to 2.4 GHz: < 1.16 > 2.4 GHz to 8.0 GHz: < 1.20 > 8.0 GHz to 18.0 GHz: < 1.25 > 18.0 GHz to 26.5 GHz: < 1.30 > 26.5 GHz to 40.0 GHz: < 1.35 > 40.0 GHz to 44.0 GHz: < 1.40		0.130 to 0.190	0.039 to 0.165	
Power sensor modules							
R&S®NRP-Z27, N (m)	DC to 18 GHz	4 µW to 400 mW (-24 dBm to +26 dBm) max. 500 mW (AVG)/ 30 W (PK, 1 µs)	DC to 2.0 GHz: < 1.15 > 2.0 GHz to 4.2 GHz: < 1.18 > 4.2 GHz to 8.0 GHz: < 1.23 > 8.0 GHz to 12.4 GHz: < 1.25 > 12.4 GHz to 18.0 GHz: < 1.35	-	0.070 to 0.112	0.032	
R&S®NRP-Z37, 3.5 mm (m)	DC to 26.5 GHz		DC to 2.0 GHz: < 1.15 > 2.0 GHz to 4.2 GHz: < 1.18 > 4.2 GHz to 8.0 GHz: < 1.23 > 8.0 GHz to 12.4 GHz: < 1.25 > 12.4 GHz to 18.0 GHz: < 1.30 > 18.0 GHz to 26.5 GHz: < 1.45		0.070 to 0.122	0.032	
Level control sensors							
R&S®NRP-Z28, N (m)	10 MHz to 18 GHz	200 pW to 100 mW (-67 dBm to +20 dBm) max. 700 mW (AVG)/ 4 W (PK, 10 µs)	10 MHz to 2.4 GHz: < 1.11 > 2.4 GHz to 4.0 GHz: < 1.15 > 4.0 GHz to 8.0 GHz: < 1.22 > 8.0 GHz to 18 GHz: < 1.30	< 8 µs > 50 kHz	0.047 to 0.130	0.022 to 0.110	
R&S®NRP-Z98, N (m)	9 kHz to 6 GHz		9 kHz to 2.4 GHz: < 1.11 > 2.4 GHz to 4.0 GHz: < 1.15 > 4.0 GHz to 6.0 GHz: < 1.22	-	0.047 to 0.083	0.022 to 0.066	

R&S®NRPV Virtual Power Meter



Easy power measurements via PC application

In combination with the R&S®NRPV virtual power meter software, the USB capability of the R&S®NRPxxS/SN and R&S®NRP-Zxx power sensors can be ideally utilized. The software covers all sensor functions and supports up to four sensors connected to a laptop/PC. The sensors are automatically detected when plugged in and added to all open measurement windows (hot plugging).

- ▮ Support of all sensor dependent measurement modes
- ▮ Supports all NRPxxS/SN power sensors
- ▮ NRP-Zxx operational with a sensor based keycode option R&S®NRPZ-K1
- ▮ Multiple traces in one measurement window
- ▮ Automatic pulse analysis
- ▮ Flexible marker functionality

Specifications in brief

Measurement modes	continuous average (numeric), time gate (numeric), timeslot (bar-graph), burst average (numeric), trace (graphical), statistics (graphical)
Number of power sensors to be used simultaneously (= number of channels)	1 to 4
Continuous average	
Max. number of measurements per measurement window	4
Measurand	average, peak, random
Timeslot	
Max. number of timeslots	16
Nominal width	0 s to 999.999 s
Exclude areas at start and end of slot	0 to nominal width
Fences	1 (valid for all slots), length: 0 to nominal width
Time gate	
Max. number of gates	4
Gate length	0 s to 999.999 s
Fences	1 per gate, length: 0 to gate length
Trace	
Max. number of traces per measurement window	8 (4 physical plus 4 math)
Measurand	average, peak, random
Math functions	ratio, difference, SWR
Statistics	
Max. number of traces per measurement window	5 (4 physical plus AWGN reference trace)
Aperture	10 ns to 1 s
Distribution function	CCDF (lin), CCDF (log), CDF (lin), CDF (log), PDF (lin)

R&S®NRP-Z5 Sensor Hub



Connecting up to four

R&S®NRPxxS/SN and R&S®NRP-Zxx power sensors

The R&S®NRP-Z5 can host up to four R&S®NRPxxS/SN and R&S®NRP-Zxx power sensors. A professional trigger solution allows simultaneous internal and external triggering of all connected sensors.

- ▮ Connection of up to four R&S®NRPxxS/SN and R&S®NRP-Zxx power sensors
- ▮ Internal triggering, individual for each sensor
- ▮ Bidirectional trigger bus for external and synchronous triggering
- ▮ Trigger master mode (with R&S®NRP-Z8x)

R&S®NRPC Calibration Kits



Calibration of power sensors

The four modular R&S®NRPC calibration kits are used to calibrate power sensors of the R&S®NRP and R&S®FSH families, as well as other makes, to a very high level of accuracy. Following calibration, the sensors are within the specified calibration uncertainties and usually remain below these uncertainties. Each calibration kit includes a highly accurate power standard that is traceable to primary power standards of the Physikalisch-Technische Bundesanstalt (PTB, Germany's national metrology institute) by means of a calibration certified by the Deutsche Akkreditierungsstelle (DAkkS, Germany's national accreditation body).

In combination with a remotely controllable microwave generator, an R&S®NRP2 power meter and the free-of-charge R&S®Recal+ PC software, the calibration kits enable users to calibrate the power sensors of the R&S®NRP and R&S®FSH families in just a few minutes. Calibration also includes writing the updated calibration values to the sensor's data memory. Plug-ins for the R&S®ZVA and R&S®ZVB vector network analyzers are available for impedance calibration. The calibration uncertainty is determined individually for each power sensor, taking the relevant influence quantities into account.

Four models are currently available:

- R&S®NRPC18 for power sensors with N connector (DC to 18 GHz)
- R&S®NRPC33 for power sensors with 3.5 mm connector (DC to 33 (26.5) GHz)
- R&S®NRPC40 for power sensors with 2.92 mm connector (DC to 40 GHz)
- R&S®NRPC50 for power sensors with 2.4 mm connector (DC to 50 GHz)

The R&S®NRPCxx-B1 option is used for regular verification of each R&S®NRPC model. It consists of a thermal power sensor calibrated to the associated power standard and aligned such that it displays, for each frequency point, the same value as the power standard.

Key facts

- Program-controlled calibration of the power sensors of the R&S®NRP and R&S®FSH families
- Short measurement times for high throughput
- Modular concept for cost-effective, flexible operation
- DAkkS-certified, PTB-traceable

R&S®NRT Power Reflection Meter



Power measurement on transmitters, amplifiers, industrial RF and microwave generators

- ▮ Simultaneous display of power and reflection
- ▮ Measurement of average power irrespective of modulation mode
- ▮ Measurement of peak power, crest factor and average burst power
- ▮ Compatible with all main digital standards, such as GSM/EDGE, WCDMA, cdmaOne, CDMA2000®, PHS, NADC, PDC, TETRA, DECT, DAB, DVB-T
- ▮ Intelligent sensors: simply plug in and measure
- ▮ Digital interface between power sensor and base unit
- ▮ Direct connection of power sensor to a PC

Specifications in brief (base unit)	
Frequency range	200 kHz to 4 GHz (sensor-dependent)
Power measurement range	0.7 mW to 2 kW (sensor-dependent)
Measurement inputs	1 to 3 (4), one active
For R&S®NRT-Zxx power sensors	one input on front panel, two additional inputs on rear panel (R&S®NRT-B2 option)
For R&S®NAP-Zx power sensors	one input on rear panel (R&S®NRT-B1 option)
Measurement functions	
Power	forward power and power absorbed by load in W, dBm, dB or % (dB and % referenced to measured value or reference value)
Power parameters	average power, average burst power, peak envelope power, peak-to-average ratio (crest factor), complementary cumulative distribution function
Reflection	SWR, return loss, reflection coefficient, reverse-to-forward power ratio in %, reverse power



R&S®NRT-Z44 directional power sensor.

Specifications in brief (directional power sensors)			
	R&S®NRT-Z14	R&S®NRT-Z43	R&S®NRT-Z44
Power measurement range	0.006 W to 120 W (average), 300 W (peak)	0.0007 W to 30 W (average), 75 W (peak)	0.003 W to 120 W (average), 300 W (peak)
Frequency range	25 MHz to 1 GHz	400 MHz to 4 GHz	200 MHz to 4 GHz
SWR (referenced to 50 Ω)	max. 1.06	max. 1.07 (from 0.4 GHz to 3 GHz), max. 1.12 (from 3 GHz to 4 GHz)	max. 1.07 (from 0.2 GHz to 3 GHz), max. 1.12 (from 3 GHz to 4 GHz)
Insertion loss	max. 0.06 dB	max. 0.06 dB (from 0.4 GHz to 1.5 GHz), max. 0.09 dB (from 1.5 GHz to 4 GHz)	max. 0.06 dB (from 0.2 GHz to 1.5 GHz), max. 0.09 dB (from 1.5 GHz to 4 GHz)
Directivity	min. 30 dB	min. 30 dB (from 0.4 GHz to 3 GHz), min. 26 dB (from 3 GHz to 4 GHz)	min. 30 dB (from 0.2 GHz to 3 GHz), min. 26 dB (from 3 GHz to 4 GHz)
	R&S®NAP-Z6	R&S®NAP-Z7	R&S®NAP-Z8
Power measurement range	0.3 W to 1.1 kW	0.05 W to 200 W	0.5 W to 2 kW
Frequency range	25 MHz to 1 GHz	0.4 MHz to 80 MHz	0.2 (0.4) MHz to 80 MHz
SWR (referenced to 50 Ω)	max. 1.07	max. 1.03 (max. 1.02 from 1.5 MHz to 30 MHz)	
Insertion loss			
Up to 0.3 GHz	max. 0.05 dB	–	–
Up to 0.5 GHz	max. 0.10 dB	–	–
Entire frequency range	max. 0.15 dB	max. 0.015 dB	max. 0.015 dB
Directivity	min. 25 dB	min. 35 dB (from 1.5 MHz to 30 MHz)	

R&S®NRPM Over-the-Air (OTA) Power Measurement Solution



For WLAN IEEE 802.11ad, IEEE 802.11ay and 5G

WLAN IEEE 802.11ad, IEEE 802.11ay and 5G will use higher carrier frequencies and higher signal bandwidths in order to achieve very high data rates. This requires the use of phased array antennas in wireless devices and base stations. These antennas use beamforming to control the direction of radiation of the transmit antenna, thus maximizing the power level at the receiver. The R&S®NRPM OTA power measurement solution is designed to calibrate the transmit antenna output power and test the beamforming function.

Free-space propagation loss and diffraction loss increase when data is transmitted at high frequencies. To counteract these physical effects and still achieve the desired data rates, beamforming is used to optimally direct the phased array antenna beam. Since this antenna (DUT) features high integration density and has no RF connectors, it is not possible to access its transmit signal via cable. The DUT transmit power is measured over the air during the production of wireless devices, base stations and RF modules. The antenna beamforming performance must also be verified; this is done using antennas that are spatially distributed.

The R&S®NRPM OTA power measurement solution is ideal for these measurements. It supports the frequency range from 27.5 GHz to 75 GHz, covering the 28 GHz band for 5G currently under discussion, the 57 GHz to 66 GHz band defined for WLAN IEEE 802.11ad, and frequencies > 66 GHz for WLAN IEEE 802.11ay.

The R&S®NRPM antenna modules have an integrated diode detector to measure the power directly on the receive antenna. The number of antenna modules can be selected to scale the system to meet different test requirements. The economical base configuration with one antenna module measures the power of the incident wave from the DUT to the antenna module. More antenna modules can be added to test the beamforming function.

- OTA power measurement solution
- For WLAN IEEE 802.11ad, IEEE 802.11ay and 5G
- Frequency range from 27.5 GHz to 75 GHz
- Ideal for beamforming tests
- Antenna module with integrated diode detector
- Scalable to customer requirements
- Fits perfectly into R&S®TS7124 shielded RF test box

Chapter 9

Audio analyzers

Measurement accuracy and dynamic range at the limits of what is possible combined with unique measurement capabilities make audio analyzers from Rohde & Schwarz ideal for research, development and quality assurance tasks.

Rohde & Schwarz audio analyzers enable users to perform virtually all measurements required in the audio world. For analog and digital interfaces, audio analyzers specially designed for use in production deliver the high measurement speed, parallel signal processing in multichannel applications and stable continuous operation that are vital in this environment.

Type	Designation	Description	Page
R&S®UPV	Audio analyzer	Compact instrument for all audio measurements	227
R&S®UPP	Audio analyzer	Audio analyzer for use in the lab and in production	228
R&S®UPZ	Audio switcher	Multichannel switcher for audio channel inputs and outputs	229



R&S®UPV Audio Analyzer



Compact instrument for all audio measurements

The R&S®UPV enables users to perform virtually all measurements that are necessary in the audio world: frequency response measurement, total harmonic distortion (THD) displays, spectral displays, analysis of digital interfaces and much more. The generator is just as versatile. It can be used to create any conceivable signal from sine-wave and noise signals up to multisine-wave signals.

- ▮ Suitable for all interfaces: analog, digital and combined
- ▮ Simultaneous display of multiple measurement functions
- ▮ Sampling rate up to 400 kHz
- ▮ User-programmable filters for analyzer and generator
- ▮ Compact all-in-one instrument with integrated PC
- ▮ Slots for optional interfaces

¹⁾ PESQ®, PEAQ® and POLQA® are registered trademarks of OPTICOM Dipl.-Ing. M. Keyhl GmbH, Germany.

All test signals/measurement functions in a single box

- ▮ Wide variety of analog and digital (optional) test signals
- ▮ Extensive measurement capabilities, on analog and digital (optional) interfaces
- ▮ Efficient as well as multichannel FFT analysis with a resolution down to the mHz range
- ▮ User-programmable filters can be adapted to the measurement task at hand in only a few seconds
- ▮ Everything included; no peripherals required

Largest variety of interfaces in a single instrument

- ▮ Analog generator outputs as standard
- ▮ Dual-channel analyzer with analog inputs as standard
- ▮ Expansion up to 16 measurement channels
- ▮ Digital audio interfaces (optional)
- ▮ Digital protocol analysis and generation (optional)
- ▮ Jitter and interface test (optional)
- ▮ Test of audio ICs with I²S interfaces (optional)
- ▮ The universal serial interface allows virtually any audio circuit to be adapted (optional)

Options for other applications

- ▮ The PESQ®¹⁾ measurement option analyzes speech signals in line with psycho-acoustic methods
- ▮ The PEAQ® measurement option analyzes broadband audio signals in line with psycho-acoustic methods
- ▮ The POLQA® measurement option analyzes broadband speech quality in line with psycho-acoustic methods
- ▮ Standard-compliant measurements on hearing aids
- ▮ Acoustic measurements on mobile phones

Specifications in brief

Dual-channel analog analyzer

Frequency range	DC/10 Hz to 21.76 kHz/40 kHz/80 kHz/250 kHz
Voltage range	0.1 µV to 110 V
Measurement functions (base unit and options)	RMS wideband, RMS selective, peak, quasi-peak, S/N, DC, FFT, THD, THD+N, SINAD, Mod Dist, DFD, DIM, polarity, waveform, frequency, phase, group delay, rub&buzz, 1/n octave analysis, undersample FFT, PESQ®, PEAQ®, POLQA®

Analog generator

Voltage (balanced, RMS, sine, open circuit)	0.1 mV to 20 V
Output signals (base unit and options)	sine, multisine, sine burst, sine ² burst, Mod Dist, DFD, noise, arbitrary waveform, polarity, FM, AM, DC, play WAV files, stereo sine, DIM, square

Digital analyzer/generator

Digital audio interfaces (optional)	
Audio bits	8 bit to 24 bit
Clock rate	30 kHz to 200 kHz
Format	professional and consumer format in line with AES3 and IEC60958
I ² S interface (optional)	
Audio bits	8 bit to 32 bit
Clock rate	6.75 kHz to 400 kHz
Universal serial interface (optional)	
Data lines	1 to 4
Audio bits	8 bit to 32 bit
Clock rate	0.85 kHz to 400 kHz

R&S®UPP Audio Analyzer



Audio analyzer for use in the lab and in production

High measurement speed, parallel signal processing in multichannel applications and high reliability in continuous operation are vital requirements to be met by audio analyzers used in production. If, on top of that, a cost-efficient instrument is what you need, the solution is the R&S®UPP audio analyzer.

Depending on the model, two, four or eight channels are processed in parallel; by cascading multiple instruments, users can simultaneously trigger up to 48 measurement channels.

The R&S®UPP audio analyzer is a compact instrument of low height and comes without front panel control elements or integrated display. In combination with an external monitor, mouse and keyboard, it becomes a full-featured, manually operable measuring instrument. It has an integrated controller and the required software is already installed. Users can start taking measurements right away.

When used in test systems, the R&S®UPP can be remote-controlled via LAN, USB or IEC/IEEE bus. Here too, the integrated controller is advantageous: Since the analyses are performed on the instrument's computer, the test system's controller does not have to provide any additional performance. Featuring the same operating philosophy and remote control commands, the R&S®UPV and R&S®UPP audio analyzers support convenient teamwork – for example, when R&D and production use both Rohde&Schwarz audio analyzer types.

All test signals and measurement functions in a single box

- Generation of a wide variety of analog and – optionally – digital test signals
- Broad scope of measurements on both analog and – optionally – digital interfaces

- Powerful, multichannel FFT analysis with resolution down to below 1 Hz; overlapping FFT analysis available as option
- User-programmable filters that take only seconds to adapt to the individual measurement task
- Integrated controller; manual operation requires only an external monitor, a mouse and a keyboard

Large variety of interfaces in a single instrument

- Analog generator outputs (two-channel)
- Two, four or eight-channel analyzer with analog inputs
- Digital audio interfaces for professional studio operation and for consumer electronics (R&S®UPP-B2 option)
- I²S interfaces for testing audio ICs (R&S®UPP-B2 option)
- HDMI™ device testing (R&S®UPP-B4 option)

R&S®UPP-B2 option providing digital audio interfaces in line with AES/EBU and S/PDIF as well as I²S interfaces

This option provides the digital audio interfaces (balanced, unbalanced and optical) for measurements on digital audio devices as well as I²S interfaces for measurements on integrated circuits.

HDMI™ device testing (R&S®UPP-B4 option)

High-definition multimedia interface (HDMI™) is used to digitally transmit high-definition video signals and up to eight audio channels in maximum quality via a single common cable. The R&S®UPP-B4 option provides the R&S®UPP audio analyzer with HDMI 1.4.

Decoding of Dolby®-coded data streams (R&S®UPP-K41 option)

The HDMI standard also provides for the transmission of coded audio signals. The R&S®UPP-K41 option allows real-time decoding of compressed audio data streams in line with the Dolby® Digital and Dolby® Digital Plus methods on the S/PDIF and HDMI inputs of the R&S®UPP-B4 option.

Extended audio/video measurements (R&S®UPP-K45 option)

This option extends the functionality of the R&S®UPP-B4 option to include generator signals and measurements that go beyond purely audio operation: examples are bit error rate testing, lip sync function and basic video parameter analysis.

R&S®UPP-B8 eight-channel generator

This option generates up to eight test signals that can consist of multiple signal components and differ from channel to channel. Analog and digital generator signals (S/PDIF format) are available at two D-Sub female connectors. This option can also be used to generate background noise in line with ETSI ES202396-1 for mobile phone measurements.

Dolby® compliance testing

Dolby Laboratories¹⁾ requires that new products utilizing Dolby® technologies be subjected to comprehensive compliance tests. Licensees may not sell any new product unless and until it has been tested and approved by Dolby®. Software packages available for the R&S®UPP audio analyzer enable Dolby® licensees to largely automate these tests.

The software guides the user through the entire test. The individual test steps are compiled exactly in line with

Dolby® specifications as required for the type of DUT and its inputs and outputs. The software lets Dolby® licensees run the required tests automatically and provides the necessary documentation to supply to Dolby® to make the test process easier, quicker and less prone to error. It allows the entire compliance test to be performed in much less time.

The required test software for the R&S®UPP audio analyzer is distributed by Dolby Laboratories directly to its licensees at no additional cost.

Specifications in brief	
Analog analyzer	
Frequency range (bandwidth 22/40/80 kHz)	DC/10 Hz to 21.76/40/80 kHz
Voltage range (RMS, sine)	1 µV to 50 V
Measurement functions: RMS wideband, RMS selective, peak, S/N, DC, FFT, THD, THD+N, SINAD, Mod Dist, DFD, polarity, waveform, frequency, phase, group delay	
Analog generator	
Voltage (balanced, RMS, sine, open circuit)	0.2 mV to 14 V
Output signals: sine, stereo sine, multisine, sine burst, Mod Dist, DFD, noise, arbitrary waveform, polarity, DC, play WAV files	
Digital analyzers/generators	
Digital audio interfaces (optional)	
Audio bits	8 bit to 24 bit
Clock rate	30 kHz to 200 kHz
Format	professional and consumer format in line with AES3 or IEC 60958
I ² S interface (optional)	
Audio bits	8 bit to 32 bit
Word clock rate	6.75 kHz to 200 kHz
HDMI™ interface (optional)	
Channels	1 to 8
Audio bits	8 bit to 24 bit
Clock rate	32 kHz to 192 kHz

¹⁾ Dolby® is a registered trademark of Dolby Laboratories.

R&S®UPZ Audio Switcher



Multichannel switcher for audio channel inputs and outputs

As an add-on unit to the Rohde & Schwarz audio analyzers, the R&S®UPZ audio switcher can be used whenever input or output signals have to be switched over to multiple channels or DUTs. Users can directly operate the switcher from the graphical user interface of the R&S®UPV and R&S®UPP audio analyzers.

Control via any PC is also possible. Up to 16 input switchers plus 16 output switchers can be cascaded, allowing up to 128 input or output channels to be switched.

Specifications in brief	
Nominal switching capacity (resistive load) ¹⁾	33 V, 0.5 A
Crosstalk (balanced 600 Ω load) ²⁾	
20 kHz	typ. -140 dB
100 kHz	typ. -126 dB
Series resistance (per signal pin)	typ. < 0.3 Ω
Shunt capacitance (each signal pin to ground)	typ. < 90 pF

¹⁾ For max. relay life: max. 5 W or 0.2 A.

²⁾ Between any two channels into 600 Ω.



25 km/h



Chapter 10

Modular instruments

Production testing is performed in various industries, from automotive to communications to infotainment. Testing departments need to flexibly

configure required functions in compact units to cover present and future requirements without large additional investments.

Type	Designation	Description	Page	
R&S®TS-PCA3	CompactTSVP test and measurement chassis	Open test platform based on CompactPCI and PXI	232	
R&S®TS-PWA3	PowerTSVP switching application chassis	Open test platform based on CAN bus	232	
System controllers				
R&S®TS-PSC57	System controller	CompactPCI embedded system controller	233	
R&S®TS-PSCX	Interface panel	Front interface panel for R&S®TS-PSC5 system controller	233	
R&S®TS-PSC0	System controller	CompactPCI – PCI remote system controller	233	
R&S®TS-PSC07	System controller	CompactPCI – PCIe remote system controller	233	
Digital multimeter and in-circuit test				
R&S®TS-PSAM	Analog source and measurement module	Scanning multimeter and data acquisition unit	234	
R&S®TS-PICT	In-circuit test extension	Analog ICT in conjunction with the R&S®TS-PSAM	234	
Signal routing and switching				
R&S®TS-PMB	Switch matrix module	High-density, 90-channel, full matrix relay-multiplexer module	234	
R&S®TS-PSM1	Power switching module	High-power multiplexer and multiple DUT power switching module	234	
R&S®TS-PSM2	Multiplex and switch module	Medium-power multiplexer and switching module	235	
R&S®TS-PSM3	High-power switching module	Automotive DUT supply and load switching up to 30 A	235	
R&S®TS-PSM4	Multiplex and switch module	Power multiplexer and DUT power switching module	235	
R&S®TS-PSM5	High-power switching module	Automotive DUT supply and load switching up to 50 A	235	
Communications, digital I/O and mixed signal acquisition				
R&S®TS-PDFT	Digital functional test module	Programmable 32-bit digital pattern I/O and serial communications interfaces	237	
R&S®TS-PXM1	Switching extension module	Switching extension module with a total of 32 switches	237	
R&S®TS-PXB2	Backplane extension module	Fast, comprehensive tests in automobile production	237	
R&S®TS-PIO2	Analog and digital I/O module	Analog and digital 16-channel stimulus and measurement unit for mixed signal DUT testing	238	
R&S®TS-PIO3B and R&S®TS-PTRF	Digital I/O module and signal port and transmission module	Digital control and coil driver with power outputs	238	
New	R&S®TS-PIO4	32-channel programmable digital I/O module	Flexibly programmable 32-bit digital inputs and 32-bit digital outputs that are able to acquire and generate static or dynamic digital patterns	238
New	R&S®TS-PIO5	LVDS digital functional test module	Very flexibly programmable bidirectional LVDS channels to acquire and generate static or dynamic digital patterns	239
Arbitrary waveform generator and signal analyzer				
R&S®TS-PFG	Function generator module	Dual-channel arbitrary waveform generator with isolated outputs	239	
R&S®TS-PAM	Signal analyzer module	Eight-channel digitizer and waveform analyzer	239	
Power supplies				
R&S®TS-PSU	Power supply and load module	Four-quadrant source with integrated measurement unit	240	
R&S®TS-PSU12	Power supply and load module	Four-quadrant source with integrated measurement unit	240	
In-system calibration				
R&S®TS-ISC	In-system calibration kit	On-site calibration solution for the R&S®CompactTSVP	241	
R&S®TS-PCAL2	Calibration module	On-site calibration module for chassis rear I/O	241	

R&S®TS-PCA3 CompactTSVP Test and Measurement Chassis



Open test platform based on CompactPCI and PXI

The R&S®CompactTSVP family has been developed for high-performance ATE applications. The chassis contains a mechanical frame, digital backplane, analog backplane, mains switching and filtering, power supply and diagnostic extensions.

For cost-effective peripheral control via CAN bus, the R&S®TS-PSYS1 CAN controller interface is included as a rear I/O module.

The R&S®CompactTSVP is offered as a test and measurement platform (R&S®TS-PCA3) and as a switching application platform (R&S®TS-PWA3). Various measurement modules for industrial use in research, development and production are available.

Specifications in brief

Modular instrument chassis for CompactPCI and PXI modules

Enclosure	standard 19" rackmount, 4 HU, suitable for 3 HU CompactPCI
-----------	--

Peripheral slots	14
------------------	----

Control backplane

Bus systems	<ul style="list-style-type: none"> ■ CompactPCI/PXI, 32 bit, 33 MHz in line with PICMG 2.0 Rev. 3.0 ■ Rear I/O support IEEE 1101.11-1998 ■ CAN 2.0b, 1 Mbit ■ PXI trigger bus, 8 signals
-------------	--

R&S®TS-PWA3 PowerTSVP Switching Application Chassis



Open test platform based on CAN bus

The R&S®TS-PWA3 PowerTSVP chassis was created as a cost-efficient subsystem for switching applications. It can be used to build systems ranging from dedicated switching instruments to complex switching applications in test and measurement systems.

The chassis contains a mechanical frame, digital backplane, analog backplane, mains switching and filtering, power supply and diagnostic extensions. For cost-effective peripheral control via CAN bus, the R&S®TS-PSYS2 slave interface is included as a rear I/O module.

Various Rohde&Schwarz switching and measurement modules controlled by the CAN bus interface can be deployed in this chassis.

Specifications in brief

Modular instrument chassis for dedicated Rohde&Schwarz modules with CAN bus control

Enclosure	standard 19" rackmount, 4 HU, suitable for 3 HU CompactPCI
-----------	--

Peripheral slots	16
------------------	----

Control backplane

Bus systems	<ul style="list-style-type: none"> ■ CAN 2.0b, 1 Mbit ■ Slots 1 to 16, peripheral slots for CAN-bus-controlled modules
-------------	--

Modules of the R&S® CompactTSVP family: system controllers

R&S®TS-PSC57 System Controller



CompactPCI embedded system controller

Test and measurement computing platform for R&S®CompactTSVP instruments

The CompactPCI system controller board combines the performance of Intel's Core™2 Duo 2.26 GHz CPU with the high integration of the GS45 Express chipset. Legacy interfaces can be accessed on the R&S®CompactTSVP instrument rear panel via the additional rear I/O module, which is included.

Specifications in brief

- ▮ Packaging:
 - ▮ 3 U dual-slot CompactPCI CPU board
- ▮ Processor: Intel® Core™2 Duo 2.26 GHz
- ▮ RAM: 4 Gbyte DDR3 SO-DIMM
- ▮ HDD: 250 Gbyte, enhanced availability type (around-the-clock access)
- ▮ Computer interfaces
 - ▮ 5 × USB 2.0
 - ▮ 3 × 1 Gbit Ethernet
 - ▮ 1 × PS/2
 - ▮ 1 × RS-232
 - ▮ 1 × DVI-I
- ▮ Operating system: Windows 7 Ultimate

R&S®TS-PSCX Interface Panel



Front interface panel for system controller TS-PSC5

Accessory product to expand the legacy ports of the R&S®TS-PSC5 industrial embedded computer

The R&S®CompactTSVP chassis can be equipped to be deployed as a benchtop instrument.

Specifications in brief

- ▮ Legacy expansion panel for R&S®TS-PSC5 system controller
- ▮ 4 × USB 2.0
- ▮ 2 × Ethernet, RJ-45
- ▮ DVI and VGA monitor

R&S®TS-PSC0 System Controller



CompactPCI - PCI remote system controller

- ▮ An external PC – can be used as R&S®CompactTSVP system controller for the R&S®CompactTSVP chassis (R&S®TS-PCA3)
- ▮ Ideal for solutions where the system design requires the PCI-bus-based hardware to be integrated into the system

The transparent, serial StarFabric interface is ready to run without any software installation and has nearly no influence on the system performance compared to the embedded controller solution.

Specifications in brief

- ▮ Remote interface: StarFabric
- ▮ External host PC: PCI bus
- ▮ Implementation: transparent PCI bridge, serial PCI to CompactPCI link
- ▮ Interface location: rear panel of R&S®CompactTSVP chassis, controller slot 1

R&S®TS-PSC07 System Controller



CompactPCI - PCIe remote system controller

Modern desktop and industrial PCs that are equipped with PCIe extension slots can also be used as a system controller for the R&S®CompactTSVP chassis (R&S®TS-PCA3).

The transparent downstream PCIe X1 cable interface is ready to run without software driver installation and provides sophisticated system performance.

Specifications in brief

- ▮ Remote interface: PCIe express
- ▮ External host PC: PCIe express bus
- ▮ Implementation: transparent PCIe bridge
- ▮ Interface location: rear panel of R&S®CompactTSVP chassis, controller slot 1

Modules of the R&S®CompactTSVP family: digital multimeter and in-circuit test

R&S®TS-PSAM Analog Source and Measurement Module

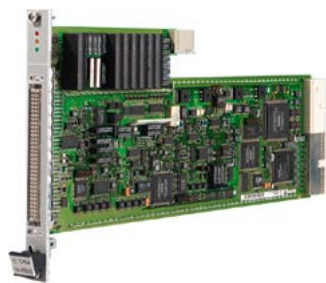

Scanning multimeter and data acquisition unit

- ▮ Floating measurement of voltage, current (AC/DC) and resistance in 2 und 4-wire mode
- ▮ Analog in-circuit test with short, contact and continuity test
- ▮ Test of resistors, diodes, bipolar transistors, jumpers/switches and discharge of capacitors
- ▮ Measurement synchronization via PXI clock and trigger

Specifications in brief

- ▮ Voltage ranges
 - DC: ± 10 mV to ± 125 V
 - AC: ± 20 mV to ± 90 V (RMS)
- ▮ Current ranges
 - DC: ± 1 μ A to ± 1 A
 - AC: ± 100 μ A to ± 1 A
- ▮ Resistance ranges: 1 Ω to 10 M Ω
- ▮ Sample rate: 0.01 sample/s to 200 ksample/s
- ▮ DC source: ± 5 V, 100 mA, 4-quadrant
- ▮ Discharge unit: max. 125 V DC, 400 mA
- ▮ Bus interface: CompactPCI/PXI

R&S®TS-PICT In-Circuit Test Extension



Analog ICT in conjunction with the R&S®TS-PSAM

- ▮ Test of R, L, C, diodes, transistors, parallel R-C
- ▮ For guarded measurements in 3, 4, 6-wire technology
- ▮ Measurement of inductors, capacitors and impedances

Specifications in brief

- ▮ AC source: referenced to GND
- ▮ Voltage: 0.1 V, 0.2 V, 1.0 V
- ▮ Voltage offset: off, pos., neg.
- ▮ Impedance: 1 Ω , 10 Ω , 1 k Ω , 10 k Ω
- ▮ Frequency: DC, 100 Hz, 1 kHz, 10 kHz
- ▮ Measurement unit: referenced to GND
- ▮ Current ranges: 1 μ A to 200 mA
- ▮ Sample rate: max. 200 ksample/s
- ▮ Working voltage: max. 60 V DC
- ▮ Bus interface: CompactPCI/PXI

R&S®TS-PMB Switch Matrix Module



High-density, 90-channel, full matrix relay-multiplexer module

The R&S®TS-PMB establishes test channels for functional and in-circuit tests. It provides all routing of signals between DUT and measurement modules via the R&S®CompactTSVP analog bus.

The general-purpose switch matrix module can handle input signals up to 125 V and up to 1 A. It provides self-test capability and fast switching of signal paths.

Specifications in brief

- ▮ Switching: relay, full matrix
- ▮ Configuration: 90 channels to 2 x 4 buses
- ▮ Deployed as
 - Single matrix: 90 pins to 4 bus lines
 - Single matrix: 45 pins to 8 bus lines
 - Dual matrix: 45 pins to 4 bus lines
- ▮ Analog measurement bus access to 8 bus lines
- ▮ Voltage: max. 125 V DC
- ▮ Current: max. 1 A
- ▮ Power: max. 10 W
- ▮ Switch time: 0.5 ms (incl. bouncing)
- ▮ Bus interface: CAN

R&S®TS-PSM1 Power Switching Module



High-power multiplexer and multiple DUT power switching module

- ▮ Power switching module for supplies and loads
- ▮ Can handle voltages up to 70 V with
 - 8 high-power channels with max. 16 A
 - 10 power channels with max. 2 A
 - 4 high-power 4-to-1 multiplexer channels with max. 16 A
- ▮ Indirect high-current measurements on high-power channels via shunt resistors; routing of corresponding voltage via analog measurement bus
- ▮ Self-test of all relays via analog measurement bus and R&S®TS-PSAM

Specifications in brief

- ▮ Switching: high and medium-power relays
- ▮ Configuration MP: 10 x SPST front – front/rear
- ▮ Configuration HP
 - 8 x SPST rear – front, shunt
 - 2 x SP 4:1 MUX front – front
 - 2 x SP 4:1 MUX rear – rear
- ▮ Voltage: max. 60 V DC
- ▮ Current MP/HP: max. 2 A/16 A
- ▮ Power MP/HP: max. 150 W/480 W
- ▮ Switch time MP: 5 ms (incl. bouncing)
- ▮ Switch time HP: 10 ms (incl. bouncing)
- ▮ Bus interface: CAN

Modules of the R&S® CompactTSVP family: signal routing and switching

R&S®TS-PSM2 Multiplex and Switch Module



Medium-power multiplexer and switching module

- ▮ Medium-power switching module for voltages up to 125 V and 2 A
- ▮ Eight independent groups of 3 SPST/1 SPDT relay channels or 4-to-1 DPST relay multiplexers
- ▮ Relay multiplexers can be cascaded via local power buses
- ▮ Indirect current measurements on each SPxT channel via shunt resistors
- ▮ Direct current measurements up to 1 A on all channels via R&S®CompactTSVP analog measurement bus and R&S®TS-PSAM

Specifications in brief

- ▮ Switching: 8 independent relay groups
- ▮ Configuration
 - 3 × SPST + SPDT, shunt or
 - DP 4:1 MUX
- ▮ Voltage: max. 125 V DC
- ▮ Current: max. 2 A
- ▮ Power: max. 60 W
- ▮ Switch time: 5 ms (incl. bouncing)
- ▮ Bus interface: CAN

R&S®TS-PSM3 High-Power Switching Module

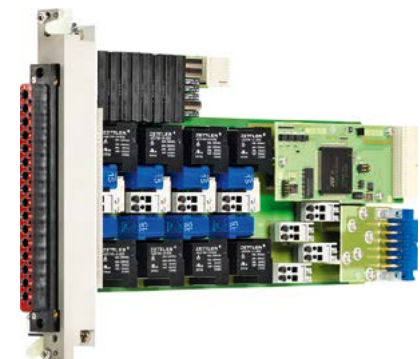

Automotive DUT supply and load switching up to 30 A

- ▮ 8 high-power channels for currents up to 30 A
- ▮ 8 medium-power channels for currents up to 2 A
- ▮ Switching voltage up to 30 V
- ▮ Integrated current measurement via current sensors and analog bus coupling
- ▮ Rear I/O access to the power signals for unique flexibility during system integration and seamless adaptation to power supplies and loads within a system paradigm based on R&S®PowerTSVP
- ▮ Unique comprehensive selftest and measurement of relay contact resistance

Specifications in brief

- ▮ High-power channels
 - Switching voltage: max. DC 30 V
 - Switching current: max. 30 A
 - Switching power: max. DC 900 W
 - Operate/release time: typ. < 8 ms
- ▮ Medium-power channels
 - Switching voltage: max. DC 30 V
 - Switching current: max. 2 A
 - Switching power: max. DC 60 W
 - Operate/release time: typ. < 6 ms
- ▮ Adaptation to R&S®TS-PRIO3 rear I/O module
 - All high-power and medium-power channels

R&S®TS-PSM4 Multiplex and Switch Module



Power multiplexer and DUT power switching module

- ▮ 12 high-power channels for currents up to 16 A
- ▮ 8 medium-power channels for currents up to 2 A
- ▮ Switching voltage up to 30 V
- ▮ Integrated current measurement via shunt resistors and analog bus coupling
- ▮ Rear I/O access to the power signals for unique flexibility during system integration and seamless adaptation to power supplies and loads within a system paradigm based on R&S®PowerTSVP
- ▮ Unique comprehensive selftest and measurement of relay contact resistance

Specifications in brief

- ▮ High-power channels
 - Switching voltage: max. DC 30 V
 - Switching current: max. 30 A
 - Switching power: max. DC 900 W
 - Operate/release time: typ. < 8 ms
- ▮ Medium-power channels
 - Switching voltage: max. DC 30 V
 - Switching current: max. 2 A
 - Switching power: max. DC 60 W
 - Operate/release time: typ. < 6 ms
- ▮ Adaptation to R&S®TS-PRIO2 rear I/O module
 - All high-power and medium-power channels

R&S®TS-PSM5 High-Power Switching Module

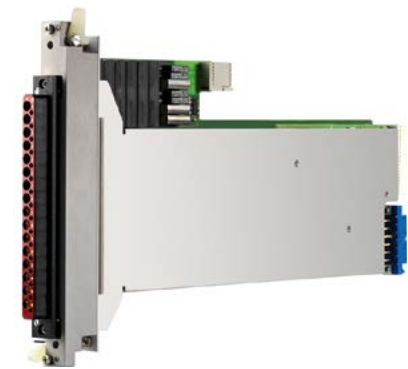

Automotive DUT supply and load switching up to 50 A

- ▮ 4 high-power channels for currents up to 50 A
- ▮ 4 medium-power channels for currents up to 2 A
- ▮ Switching voltage up to 24 V
- ▮ Integrated current measurement via current sensors and analog bus coupling
- ▮ Rear I/O access to the power signals for unique flexibility during system integration and seamless adaptation to power supplies and loads within a system paradigm based on R&S®PowerTSVP
- ▮ Unique comprehensive selftest and measurement of relay contact resistance

Specifications in brief

- ▮ High-power channels
 - Switching voltage: max. DC 24 V
 - Switching current: max. 50 A
 - Switching power: max. DC 1120 W
 - Operate/release time: typ. < 14 ms
- ▮ Medium-power channels
 - Switching voltage: max. DC 30 V
 - Switching current: max. 2 A
 - Switching power: max. DC 60 W
 - Operate/release time: typ. < 6 ms
- ▮ Adaptation to R&S®TS-PRIO5 rear I/O module
 - All high-power and medium-power channels

Modules of the R&S®CompactTSVP family: rear I/O instrument extensions

Support slide – rear I/O module application

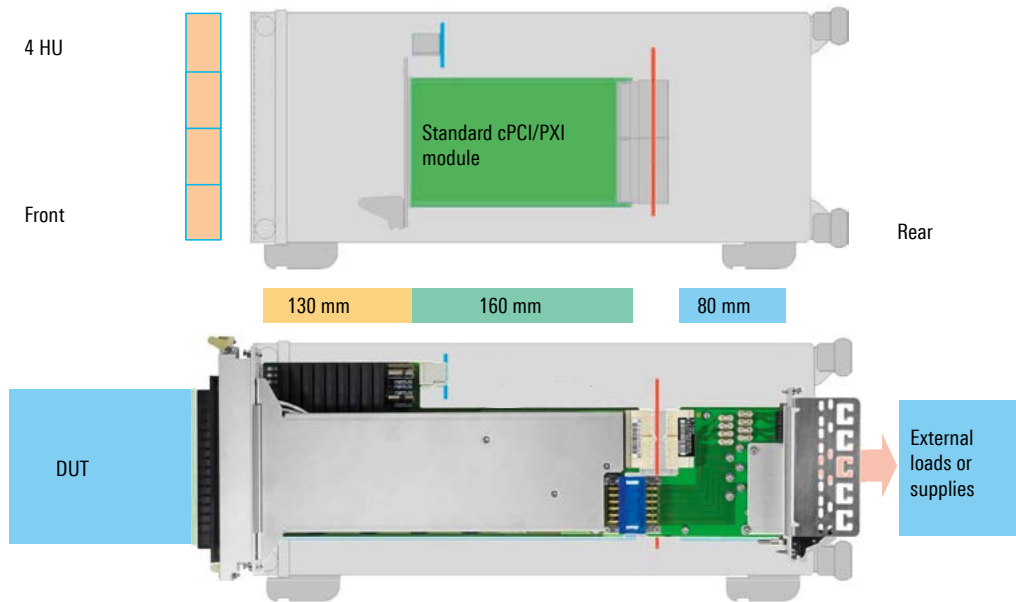

Rear I/O extensions for switching modules

R&S®TS-PRIOx rear I/O instrument extensions

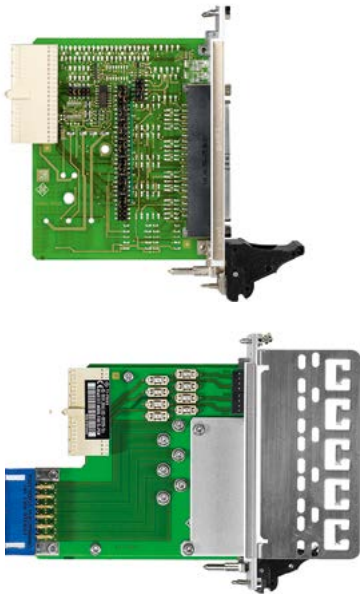

The R&S®TS-PRIOx modules are a ruggedized implementation of modular rear I/O switching module extensions to make high current switching an intrinsic part of the test system.

- ▮ Distribution of a power supply to multiple DUTs
- ▮ Flexible distribution of power supplies to DUTs including sense lines via medium-power relays
- ▮ Connection of test loads, original loads or simulated and electronic actuators in automotive test scenarios
- ▮ Multiplexing of power supplies and electronic loads

Switching module

R&S®TS-PIO3B, R&S®TS-PTR
 R&S®TS-PMB, R&S®TS-PSM2
 R&S®TS-PSM3
 R&S®TS-PSM4
 R&S®TS-PSM5

Suitable rear I/O

R&S®TS-PRIO4
 R&S®TS-PRIO
 R&S®TS-PRIO3
 R&S®TS-PRIO2
 R&S®TS-PRIO5

Specifications in brief

- ▮ Feedthrough from rear panel to switching module
- ▮ All switching lines typically supported
- ▮ In conjunction with power switch modules, both force and sense lines are supported
- ▮ High-power rear I/O provides mounting brackets for ground terminals

Modules of the R&S® CompactTSVP family: communications, digital I/O and mixed signal acquisition

R&S®TS-PDFT Digital Functional Test Module



Programmable 32-bit digital pattern I/O and serial communications interfaces

- ▮ 32 digital output channels with pattern acquisition rate up to 20 MHz
- ▮ One programmable output level per group
- ▮ High output current and short-circuit protection
- ▮ Four high-power open drain channels, fully protected and capable of pulse width modulation
- ▮ Five SPST relay channels
- ▮ 32 digital input channels with two programmable input threshold levels per group for hysteresis or level monitoring

Specifications in brief

- ▮ Output channels: 32, in 4 groups
- ▮ Voltage/group: -3 V to +10 V, tristate
- ▮ Current/channel: 80 mA
- ▮ Sample rate: 0.01 sample/s to 20 Msample/s
- ▮ Input channels: 32, in 4 groups
- ▮ Threshold/group: 0 V to 9.5 V
- ▮ Data buffer: 128/64/32 kbyte at 8/16/32 bit
- ▮ DUT interfaces: CAN, K-line, RS-232, SPI, I²C
- ▮ Bus interface: CompactPCI/PXI

R&S®TS-PXM1 Switching Extension Module



General-purpose switching extension of the R&S®TS-PIO3B digital I/O module

- ▮ Breakout and routing of internal signals from adjacent PXI modules, e.g. boundary scan lines
- ▮ Discrete wiring of DUTs with auxiliary voltages in the functional test
- ▮ Connection of load resistances to DUT outputs
- ▮ Simple control via one R&S®TS-PIO3B control port each for up to eight R&S®TS-PXM1 switching extension modules
- ▮ Can be used on slots A1 to A4, which in the past were ordinarily not used for DUT connections and in front of controller slots 1 and 2; if needed, PXI slots can be kept free for additional measurement modules

Specifications in brief

- ▮ Relay organization: 8 × 4PDT
- ▮ Switching voltage: 30 V DC (max.)
- ▮ Switching current: 2 A (max.)
- ▮ Switching power: 60 W (max.)
- ▮ Relay control: 8-bit, low active

R&S®TS-PXB2 Backplane Extension Module



Flexible expansion of the R&S®CompactTSVP and R&S®PowerTSVP with two additional CAN bus slots

The R&S®TS-PXB2 is a backplane extension module for slots A1 and A2.

As a result, PXI slots can be kept free to preferably equip them with measurement modules.

The cabling kit for the backplane option likewise includes a breakout of the system CAN bus on the rear I/O slot 4 for controlling remote modules directly in the test fixture.

Furthermore, the R&S®TS-PXB2 option makes it possible to route 24 signals to the instrument's backplane, e.g. to the R&S®TS-PIO3B option's digital I/O ports 5, 6 and 7.

Specifications in brief

- ▮ Expansion by two CAN bus slots at slots A1, A2 without linkup to the analog bus
- ▮ Breakout of the CAN bus to the rear panel
- ▮ Breakout of each of the 24 digital I/O channels of slots A1 and A2 on the rear panel
- ▮ Use in the R&S®CompactTSVP and R&S®PowerTSVP
- ▮ Bus interface: CAN

Modules of the R&S®CompactTSVP family: communications, digital I/O and mixed signal acquisition

R&S®TS-PIO2 Analog and Digital I/O Module



Analog and digital 16-channel stimulus and measurement unit for mixed signal DUT testing

- ▮ Analog and digital signal acquisition with high measurement resolution of 24 bit for level ranges up to ± 27 V
- ▮ Sampling rate of up to 5 ksample/s for inputs and outputs
- ▮ Autocorrection feature for all input and output channels
- ▮ Analog and digital stimulus outputs, offering static and dynamic signal outputs
- ▮ 16-bit resolution, high output level up to ± 27 V
- ▮ Versatile signal switching and DUT interconnection
- ▮ Stimulus and acquisition channels providing floating operation

Specifications in brief

- ▮ Output channels: 16, in 4 groups, floating high/low voltage: ± 27 V/ ± 27 V (L per group)
- ▮ Current/channel: 12×15 mA, 4×100 mA
- ▮ Modes: analog, digital, frequency
- ▮ Input channels: 16, in 4 groups, floating
- ▮ High/low threshold: ± 27 V/ ± 27 V (both per group)
- ▮ Data buffer: 4×5 ksample ($A_{out}/D_{out}/A_{in}/D_{in}$)
- ▮ Sample rate: 0.01 sample/s to 5 ksample/s
- ▮ Bus interface: CAN

R&S®TS-PIO3B Digital I/O Module and R&S®TS-PTRF Signal Port and Transmission Module

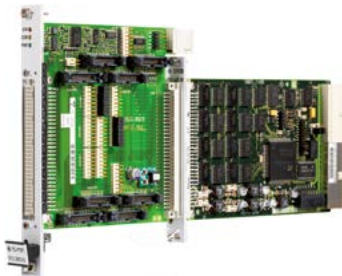

Digital control and coil driver with power outputs

The R&S®TS-PIO3B is a versatile digital I/O module with 64 channels. It offers eight ports with eight digital I/O lines each that have MOSFET output drivers. The circuitry is designed to drive RF relays with all common control voltages. The high current-carrying capacity makes the module a universal coil driver. An SPI interface offers the capability to control external SPI modules.

The transmission to front module R&S®TS-PTRF is designed to either route the digital signals to the front connector or distribute digital ports to control auxiliary modules, e.g. R&S®TS-PXM1.

Specifications in brief

- ▮ Digital I/O channels: 64, in 8 groups
- ▮ Voltage: 0 V to 35 V
- ▮ Current output: max. 200 mA per bit, 1 A per port
- ▮ Analog inputs: 8
- ▮ Level range : 0 V to 5 V
- ▮ Resolution: 10 bit
- ▮ Accuracy: $\pm(100$ mV + 5%)
- ▮ SPI interface: SPI SCLK
MOSI 5 V TTL output with 300 Ω series
MISO 5 V TTL input
- ▮ Bus interface: CAN

R&S®TS-PIO4 32-Channel Programmable Digital I/O Module

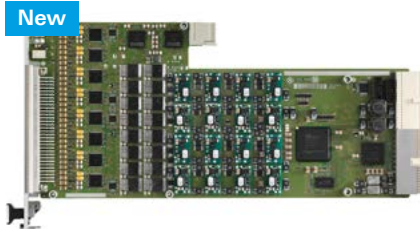

Flexibly programmable 32-bit digital inputs and 32-bit digital outputs that are able to acquire and generate static or dynamic digital patterns

- ▮ 32 digital input and 32 digital output channels
- ▮ 40 MHz sample rate, depending on levels and number of channels
- ▮ 12.5 ns resolution
- ▮ 8 groups of 4 channels each: -6 V to $+10$ V
- ▮ Tristate control for every output channel in dynamic mode
- ▮ Programmable DIO level (high and low) per group with 14-bit resolution
- ▮ Two programmable input threshold levels per group for hysteresis mode or level monitoring in compare mode
- ▮ High output current with 150 mA per channel
- ▮ FPGA-based flexibility and realtime task execution independent of the operating system used
- ▮ Synchronization/triggering (bidirectional) via PXI trigger bus or XTI (TTL)
- ▮ External clock input via EXT_CLK input pin (TTL)
- ▮ Selftest software
- ▮ Soft front panels for immediate use
- ▮ LabWindows/CVI device driver support
- ▮ R&S®GTSL generic test software library in DLL format

Specifications in brief

- ▮ Output channels: 32, in 8 groups of 4 bit
- ▮ Voltage/group: -6 V to $+10$ V, tristate
- ▮ Current/channel: max. 150 mA
- ▮ Input channels: 32, in 8 groups of 4 bit
- ▮ Threshold/group: -6.0 V to 7.1 V
- ▮ Sample rate: 0.01 sample/s to 40 Msample/s
- ▮ Data buffer: 2 Msample at 32 bit
- ▮ Bus interface: CompactPCI/PXI

Modules of the R&S® CompactTSVP family: in-system calibration

R&S®TS-PIO5 LVDS Digital Functional Test Module

New



Very flexibly programmable bidirectional LVDS channels to acquire and generate static or dynamic digital patterns

- ▮ Two MDR connectors with 10 LVDS channels each (8 × data, 1 × general purpose, 1 × clock); bidirectional LVDM with fixed termination (100 Ω) onboard
- ▮ Two single-ended control lines per connector
- ▮ 10 RS-485 (RS-422) compatible I/O channels with interface connector onboard
- ▮ Stimulation with digital realtime data streams with 2 Mpattern (32-bit) memory onboard
- ▮ Acquisition of digital realtime data streams
- ▮ LVDS transceivers with internal ESD protection
- ▮ FPGA based flexibility and simultaneous task operation independent of the operating system
- ▮ Self-test software
- ▮ Software front panels for immediate use
- ▮ LabWindows/CVI device driver support
- ▮ Test software library GTSL in DLL format

Specifications in brief

- ▮ 5 V/max. 0.30 A power supply available at each digital connector, protected by diode and fuse
- ▮ Pattern rate up to 200 Mbit, 5 ns resolution
- ▮ Triggering (bidirectional) via PXI trigger bus; resolution based on PXI or external clock, ≥ 10 ns
- ▮ Synchronization via
 - TTL external clock input (SMB plug)
 - LVDS clock lines (MDR connector)
 - PXI clock 10 MHz
- ▮ Jitter and signal delay compensation in steps of typically 2.5 ns, 180° phase shift or delay of numerous clock cycles (combination possible)

Modules of the R&S® CompactTSVP family: arbitrary waveform generator and signal analyzer

R&S®TS-PFG Function Generator Module



Dual-channel arbitrary waveform generator with isolated outputs

- ▮ Arbitrary waveform generator module featuring two floating signal outputs with independent channel isolation
- ▮ High output level range up to 40 V (V_{pp})
- ▮ High sampling rate of 25 Msample/s per channel
- ▮ Output of standard waveforms up to 1 MHz sine, square, triangle, arbitrary waveform
- ▮ Sequencing of multiple memory sections and multiple repetitions

Specifications in brief

- ▮ Channels: 2, fully independent, floating, cascadable
- ▮ Voltage ranges: ±1 V, ±5 V, ±10 V, ±20 V
- ▮ Voltage resolution: 16 bit
- ▮ Output current: max. 250 mA
- ▮ Data buffer: 1 Msample per channel
- ▮ Sample rate: 0.01 sample/s to 25 Msample/s
- ▮ Standard waveforms: sine wave, triangle, square wave (1 Hz to 1 MHz), DC static
- ▮ Pulse: min. 500 ns (1% to 99%)
- ▮ Output ranges: ±1 V to ±20 V, max. 40 V (V_{pp})
- ▮ Output current: max. ±250 mA
- ▮ Bus interface: CompactPCI/PXI

R&S®TS-PAM Signal Analyzer Module



Eight-channel digitizer and waveform analyzer

- ▮ Digitizer module featuring two fully independent, floating acquisition units
- ▮ Acquisition modes with up to eight single-ended or four differential channels
- ▮ High sampling rate of 20 Msample/s for each acquisition unit
- ▮ Multichannel signal recording for up to eight channels at 5 Msample/s
- ▮ Synchronous acquisition of eight programmable comparator signals and PXI trigger
- ▮ Wide dynamic range with 14-bit resolution

Specifications in brief

- ▮ Acquisition units: 2, fully independent and floating
- ▮ Data buffer: 1 Msample per acquisition unit
- ▮ Channels per unit: 4
- ▮ Voltage ranges: ±0.2 V to 100 V (per channel)
- ▮ Resolution: 14 bit
- ▮ Sample rate: 0.02 sample/s to 20 Msample/s
- ▮ Relay multiplexer: 3:1 per channel
- ▮ Bus interface: CompactPCI/PXI

10

Modules of the R&S® CompactTSVP family: power supplies

R&S®TS-PSU Power Supply and Load Module

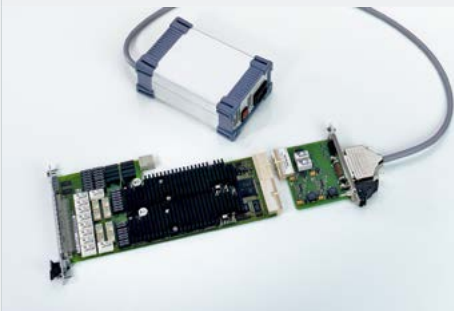

Four-quadrant source with integrated measurement unit

- ▮ Two independent, floating channels of four-quadrant sources with separate sensing per channel
- ▮ Programmable current and voltage limiting
- ▮ Integrated voltage and current measurement unit per channel
- ▮ Electronic load simulation of 20 W per channel
- ▮ Output and recording of voltage and current profiles
- ▮ Protection against overvoltage, overcurrent, overtemperature and short circuits
- ▮ 4-to-1 relay multiplexer for force and sense lines of each channel

Specifications in brief

- ▮ Output channels: 2, floating, fully independent, 4 quadrants, cascadable
- ▮ Voltage ranges: ± 15 V, ± 50 V (16 bit)
- ▮ Current ranges: 10 mA, 100 mA, 3 A (16 bit)
- ▮ Data buffer: 2×10 ksample (V_{out}/I_{out})
- ▮ Measurement unit: voltage or current
- ▮ Data buffer: 10 ksample
- ▮ Sample rate: 0.01 sample/s to 10 ksample/s
- ▮ Bus interface: CAN

R&S®TS-PSU12 Power Supply and Load Module



Four-quadrant source with integrated measurement unit

- ▮ Two independent, floating channels of four-quadrant sources with separate sensing per channel
- ▮ Programmable current and voltage limiting
- ▮ Same feature set as the R&S®TS-PSU but with R&S®TS-PDC internal primary power supply

Specifications in brief

- ▮ Output channels: 2, floating, fully independent, 4 quadrants, cascadable
- ▮ Voltage ranges: ± 12 V (16 bit)
- ▮ Current ranges: 10/100/500 mA (16 bit)
- ▮ Data buffer: 2×10 ksample (V_{out}/I_{out})
- ▮ Measurement unit: voltage or current
- ▮ Data buffer: 10 ksample
- ▮ Sample rate: 0.01 sample/s to 10 ksample/s
- ▮ Bus interface: CAN

Modules of the R&S® CompactTSVP family: in-system calibration

R&S®TS-ISC In-System Calibration Kit



On-site calibration solution for the R&S® CompactTSVP

The R&S®TS-ISC in-system calibration kit contains the fundamental tools for calibrating all modular instruments available for the R&S® CompactTSVP product family.

The most important benefit for systems deployed on the factory floor is that all modules that must be calibrated may remain in the instrument chassis slots. Additionally, a dedicated type of highly accurate multimeter is required to achieve a corresponding measuring accuracy during calibration.

Specifications in brief

The R&S®TS-ISC in-system calibration kit consists of the following components:

- R&S®TS-PCAL2 calibration module
- Calibration adapters
 - R&S®TS-PCALA
 - R&S®TS-PCALB
 - R&S®TS-PCALC
- R&S®TS-PKL cable for connecting the adapters to the external multimeter

R&S®TS-PCAL2 Calibration Module



On-site calibration module for chassis rear I/O

The R&S®TS-PCAL2 calibration module is used to provide traceable calibration signals. It can be integrated into multiple chassis on the factory floor to prepare each R&S® CompactTSVP instrument for on-site calibration without changing the module configuration.

An on-board relay multiplexer connects the components to the analog bus lines on an R&S®TS-PMB module which has to be installed in front of the R&S®TS-PCAL2 module.

Specifications in brief

The R&S®TS-PCAL2 provides the following functionalities:

- Floating 5 V reference source
- Three reference resistors for resistance measurements
- Ground-referenced current source, adjustable up to 1 A current measurements
- Floating signal generator for dynamic measurements of
 - DC: -40 V to +40 V
 - AC, sinusoidal:
 - 2 V to 80 V (V_{pp}) in frequency range from 20 Hz to 50 kHz
 - 0.2 V to 2 V (V_{pp}) in frequency range from 50 kHz to 1 MHz



Chapter 11

Broadcasting and multimedia test and measurement solutions

Rohde & Schwarz supplies producers of consumer electronics with all the T&M equipment needed to develop and produce satellite receivers, TVs and other consumer electronics equipment, including high-resolution formats such as UltraHD. For broadcasters as well as cable network operators, we offer

high-performance instruments for digital and analog baseband generation, modulation, demodulation and analysis, including baseband analysis. Our multistandard platforms cover the wide variety of broadcast and video technologies, providing great flexibility at all stages of the value chain.

Type	Designation	Description	Page
RF signal generation			
R&S®BTC	Broadcast test center	Reference signal generator with audio/video analysis functions	244
R&S®AVBrun	Test suite software	Pre-conformance testing in line with D-Book, NorDig and E-Book	245
R&S®SFE	Broadcast tester	Compact signal generator for digital and analog TV and audio broadcasting standards	246
R&S®SFE100	Test transmitter	Powerful broadcast signal generator for production test systems	247
R&S®SFC	Compact modulator	Test signals for TV and audio broadcasting – compact and cost-effective	248
R&S®SFC-U	USB compact modulator	Test signals for TV and audio broadcasting – compact and cost-effective	249
R&S®SFD	DOCSIS® signal generator	Signal generator for DOCSIS3.1 downstream and upstream	250
R&S®CLGD	DOCSIS cable load generator	Multichannel signal generator for DOCSIS3.1 downstream and upstream	251
R&S®SLG	Satellite load generator	Multichannel digital satellite TV modulator	252
RF signal analysis			
R&S®ETL	TV analyzer	Universal reference for analyzing TV, mobile TV and sound broadcasting signals	253
R&S®ETH	Handheld TV analyzer	Portable digital TV signal analysis up to 3.6 GHz/8 GHz	254
R&S®ETC	Compact TV analyzer	Economical TV transmitter testing	255
R&S®EFL110/ R&S®EFL120	Cable TV analyzer and leakage detector	Detecting interference in cable TV and LTE networks	256
R&S®EFL240/ R&S®EFL340	Portable TV test receiver	Professional installation of cable and satellite TV systems and antennas	257
R&S®DVMS	Digital TV monitoring system family	Ensuring high quality of digital TV network operation	258
R&S®BCDRIVE	Broadcast drive test software	Efficient coverage analysis for terrestrial broadcast signals	261
Audio/video generation			
R&S®VTC/VTE	Video test center/video tester	A/V interface testing of consumer electronics devices	262
R&S®VTS	Compact video tester		
R&S®DVSG	Digital video signal generator	Development and quality assurance of 2D/3D TV displays	264
R&S®Stream Libraries		Test signal libraries for development, production and testing of TV components	265
Audio/video analysis			
R&S®DVMS	Digital TV monitoring system family	Ensuring high quality of digital TV network operation	258
R&S®VTC/VTE	Video test center/video tester	A/V interface testing of consumer electronics devices	262
R&S®VTS	Compact video tester		

R&S®BTC Broadcast Test Center



Reference signal generator with audio/video analysis functions

The R&S®BTC broadcast test center is a reference signal generator featuring analysis functions and automated tests for audio, video and multimedia applications. It is a unique combination of outstanding technical features and a modular, flexible design to meet the highest demands.

The multistandard R&S®BTC offers a complete DUT environment in a single instrument. As a high-end signal generator, it generates RF signals for all global broadcasting

standards, simulates transmission channels and simultaneously carries out audio and video tests on DUTs. All this is made possible by using diverse interface, generator and analysis modules.

Due to its extremely fine scalability, the R&S®BTC can be tailored to meet different customer and test requirements while simultaneously optimizing costs. This eliminates the need for expensive and time-consuming test setups with many separate T&M instruments.

Integrated and automated test sequence control as well as test suites ensure that test results are reproducible while reducing test times.

- Signal generation and DUT analysis
- Modular design
- Automated test sequences in line with recognized test specifications
- Realtime video/audio transport stream generation
- Realtime signal generation for all global broadcasting standards

Specifications in brief

RF signal		
Frequency range	R&S®BTC-B3103/R&S®BTC-B3203	100 kHz to 3300 MHz
	R&S®BTC-B3106/R&S®BTC-B3206	100 kHz to 6000 MHz
Frequency resolution		0.001 Hz
Level	base unit	-120 dBm to +18 dBm (PEP)
Level accuracy	auto mode: 100 kHz ≤ f ≤ 6 GHz	< 0.5 dB
Internal I/Q bandwidth		160 MHz
Broadband noise	at 1 Hz and > 10 MHz offset	typ. < -157 dBc
Modulation systems		
Terrestrial TV and mobile TV	DVB-T2, DVB-T2 Lite, DVB-T, DVB-H, DTMB, CMMB, T-DMB, ISDB-T, ISDB-Tmm, ISDB-T _g , ISDB-T 1 seg., ATSC/8VSB, ATSC-M/H	
Cable TV	DVB-C2, DVB-C (J.83/A), ISDB-C (J.83/C), J.83/B (US cable)	
Satellite TV	DVB-S2X, DVB-S2, DVB-S, DSNG, DirecTV	
Analog TV	B/G, D/K, I/I1, M/N, L/L'	
Digital audio broadcasting	DRM/DRM+, DAB, DAB+, ISDB-T _{sr} XM Radio (in preparation)	
Analog audio broadcasting	AM, FM mono, FM stereo with RDS	
Additional functions		
Multimedia generator, T2-MI Gateway	elementary stream generator, transport stream player, transport stream analyzer, transport stream multiplexer, error injection, table editor and table masking, T2-MI realtime gateway (optional)	
Audio/video generator	file format	Rohde & Schwarz proprietary
AWGN noise generator	signal-to-noise ratio (SNR)	-30 dB to +60 dB
Noise generator extension	operating modes	<ul style="list-style-type: none"> ■ impulsive noise ■ phase noise ■ noise with bandwidth limitation
Fading simulator	up to max. 4 fading simulators, with 2x2 and 4x4 MIMO profiles and 1x2, 1x3, 1x4 MRC testing	40 paths per fading simulator
BER measurement		PRBS, MPEG-2 TS measurement

R&S®AVBrun Test Suite Software

Pre-conformance testing in line with D-Book, NorDig and E-Book

Set-top boxes and multimedia devices that use audio, video and wireless protocols require a reliable, high-performance, efficient automated test system. The R&S®AVBrun test suite software allows users to organize, manage and execute test sequences for product validation and production testing.

R&S®AVBrun test suite software supports composite, component and HDMI™ input signals and offers a comprehensive solution for video and audio quality analysis. The entire test suite software runs on a single box, the R&S®BTC and reduces the complexity of test setups and handling procedures. The minimum hardware translates to minimum service and maintenance. R&S®AVBrun reduces testing and development time, effectively lowers investment and maintenance costs and increases manpower efficiency.

The R&S®AVBrun test suite software is based on the digital terrestrial television (DTT) precompliance testing requirements for interoperable TV as specified in D-Book, European E-Book and NorDig Unified Test Plan for Integrated Receiver Decoders.

R&S®AVBrun features an easy-to-use user interface and covers testing configurations such as loss compensation, multiple interfering signals and smart learning for controlling the DUT using infrared remote control.

Users simply click the run button to execute the test sequences. DUT performance is then compared against the threshold limits defined in each standard specification and a report log of the test results is generated. The flexible R&S®AVBrun test suite software also allows users to customize their test methods and to define their own threshold limits for evaluating picture degradation and BER measurements.

For further data processing, users can save and export the test results as a report in different common file formats, such as CSV, PDF or TXT. The report summarizes all test cases and includes test parameters and status as measured against the specified limits.

- Upgradeable to other TV and radio broadcast standards
- Customizable test methods and parameters
- User-friendly drag and drop test execution with path compensation
- Perceptual evaluation of video quality using the R&S®VTC
- Ensured reproducibility and consistency in test results

The R&S®BTC with R&S®AVBrun test suite software offers users an automated test environment

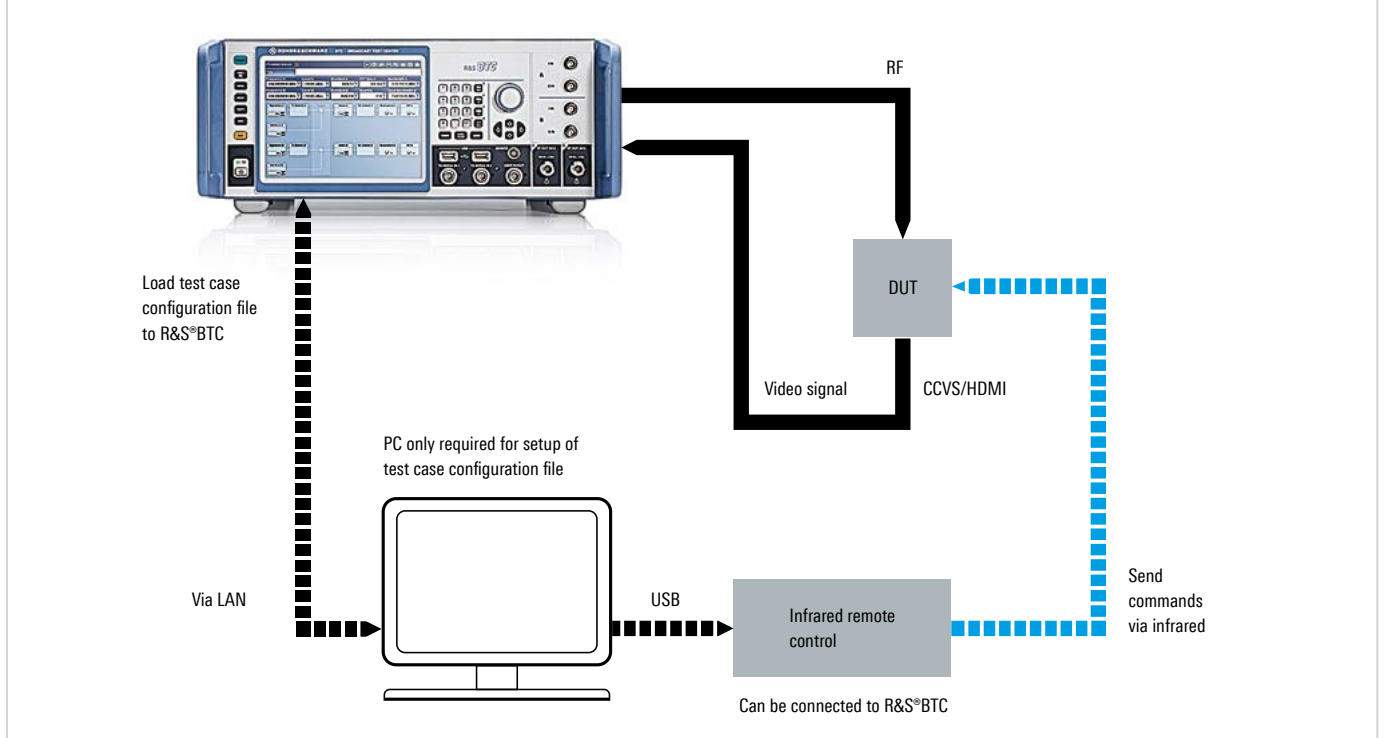

R&S®SFE Broadcast Tester



Compact signal generator for digital and analog TV and audio broadcasting standards

The R&S®SFE is a multistandard signal generator that supports all common TV standards and a number of audio broadcasting standards. Whether analog or digital terrestrial TV, cable, satellite or mobile TV, or sound broadcasting – the R&S®SFE modulates all these signals in realtime. For this purpose, it combines a high-quality RF modulator, a universal realtime coder and diverse baseband signal sources in a single unit.

- ▮ Versatile multistandard signal generator with realtime coding
- ▮ High-precision signal generation over wide frequency and level range
- ▮ Integrated transport stream generator and A/V generator
- ▮ Flexible signal generation with ARB waveform generator
- ▮ Simulation of multipath propagation and single-frequency networks
- ▮ Receiver tests with noise source and BER tester
- ▮ Compact design and convenient graphical user interface

Specifications in brief

RF signal		
Frequency range		100 kHz to 2.7 GHz
Frequency resolution		1 Hz
Level		-110 dBm to +15 dBm
Level accuracy		< 1.0 dB
Spectral purity		
SSB phase noise	at 300 MHz and 20 kHz carrier offset	< -115 dBc (1 Hz)
Broadband noise	> 10 MHz	< -135 dBc (1 Hz)
Digital realtime modulation systems		
Terrestrial TV		DVB-T2, DVB-T, DTMB, ISDB-T, ISDB-T _B , ATSC/8VSB
Cable TV		DVB-C2, DVB-C, J.83/B, ISDB-C
Satellite TV		DVB-S, DVB-S2, DIRECTV
Mobile TV		DVB-H, T-DMB, ISDB-T 1 seg., CMMB, ATSC-M/H
Digital audio broadcasting		DAB, DAB+, ISDB-T _{SB}
Analog realtime modulation systems		
Analog TV		B/G, D/K, I, M/N, L
Analog audio broadcasting		AM, FM mono, FM stereo with RDS
ARB-based modulation systems		
Digital audio broadcasting		HD Radio™, DRM, DRM+, XM Radio (in preparation)
Digital TV		DVB-T2, CMMB
Baseband signal sources		
Transport stream generator	file format	GTS, Rohde&Schwarz proprietary
	data rate (including null packets)	100 kbit/s to 214 Mbit/s
Transport stream player	file format	TRP, T10, ETI, MFS, PMS, BIN, MDI
	data rate	100 kbit/s to 90 Mbit/s
ARB waveform generator	memory	256 Msample
	sample rate	up to 100 Msample/s
Simulation and analysis functions		
AWGN generator	signal-to-noise ratio (SNR)	-30 dB to +60 dB
Fading simulator	number of paths	12
	fading profiles	static, constant phase, pure Doppler, Rayleigh, Rice
	PRBS measurement	clock, data, enable inputs
BER measurement	MPEG-2 transport stream measurement	ASI input

R&S®SFE100 Test Transmitter



Powerful broadcast signal generator for production test systems

The R&S®SFE100 is a multistandard test transmitter providing realtime coding for broadcast signals. It supports all common digital and analog TV standards and a number of audio broadcasting standards. Its flexible customization options make the R&S®SFE100 suitable for a wide variety of applications – from production and quality assurance to simple development applications. The R&S®SFE100 is available with or without front panel controls.

- Versatile multistandard test transmitter with realtime coding
- High-precision signal generation over wide frequency and level range
- Integrated power amplifier for high output levels (optional)
- Integrated baseband signal sources
- User-friendly control elements and convenient remote operation
- Economical models without display and keys
- Optimized for use in production test systems
- Low power consumption

Specifications in brief

RF signal		
Frequency range	without power amplifier	100 kHz to 2.7 GHz
	with power amplifier	47 MHz to 862 MHz
Frequency resolution		1 Hz
Level	without power amplifier	-110 dBm to +15 dBm
	with power amplifier	+27 dBm, adjustable from 0 dB to 30 dB
Spectral purity		
SSB phase noise	at 300 MHz and 20 kHz carrier offset	< -115 dBc (1 Hz)
Broadband noise	> 10 MHz	< -135 dBc (1 Hz)
Digital realtime modulation systems		
Terrestrial TV		DVB-T2, DVB-T, DTMB, ISDB-T, ISDB-T _B , ATSC/8VSB
Cable TV		DVB-C2, DVB-C, J.83/B, ISDB-C
Satellite TV		DVB-S, DVB-S2, DIRECTV
Mobile TV		DVB-H, T-DMB, ISDB-T 1 seg., CMMB, ATSC-M/H
Digital audio broadcasting		DRM/DRM+, DAB, DAB+, ISDB-T _{SB}
Analog realtime modulation systems		
Analog TV		B/G, D/K, I, M/N, L
Analog audio broadcasting		AM, FM mono, FM stereo with RDS
ARB-based modulation systems		
Digital audio broadcasting		HD Radio™, DRM, DRM+, XM Radio
Digital TV		DVB-T2, CMMB
Baseband signal sources		
Transport stream generator	file format	GTS, Rohde&Schwarz proprietary
	data rate (including null packets)	100 kbit/s to 214 Mbit/s
Transport stream player	file format	TRP, T10, ETI, MFS, PMS, BIN, MDI
	data rate	100 kbit/s to 90 Mbit/s
ARB waveform generator	memory	256 Msample
	sample rate	up to 100 Msample/s
Noise generator		
AWGN, signal-to-noise ratio (SNR)		-30 dB to +60 dB

R&S®SFC Compact Modulator



Test signals for TV and audio broadcasting – compact and cost-effective

The R&S®SFC compact modulator is an economical multistandard signal source. It supports realtime coding for all conventional digital and analog TV and audio broadcasting standards. The R&S®SFC is equipped with a built-in computer, making it ideal for standalone operation.

The R&S®SFC has an extremely compact design. Though small in size, it is a full-featured TV and audio broadcasting

signal generator with integrated transport stream player, audio/video generator and optional noise source.

The R&S®SFC compact modulator is particularly well-suited for rack installation in production test systems. It is controlled using remote desktop via LAN or remotely with SCPI commands. The instrument can also be operated directly with a mouse, keyboard and monitor – with the same tried and tested graphical user interface (GUI) as the R&S®SFU and R&S®SFE.

- Optimized for use in production test systems
- Low power consumption for reduced operating costs
- Multistandard signal generator with realtime coding
- Integrated baseband signal sources
- Integrated AWGN generator
- ASI transport stream input
- Digital I/Q input

Specifications in brief		
RF characteristics		
Frequency range	base unit	30 MHz to 900 MHz
	with R&S®SFC-K83 option	30 MHz to 3000 MHz
Frequency setting resolution		1 Hz
Level setting range	base unit	-31.5 dBm to 0 dBm (RMS) for DVB-T
	with R&S®SFC-K84 option	-110 dBm to 0 dBm (RMS) for DVB-T
Modulation systems		
Terrestrial TV and mobile TV		DVB-T2, DVB-T, DVB-H, DTMB, CMMB, T-DMB, ISDB-T, ISDB-T _{br} , ISDB-T 1 seg., ATSC/8VSB, ATSC-M/H
Cable TV		DVB-C2, DVB-C, ISDB-C, J.83/B
Satellite TV		DVB-S2, DVB-S, DIRECTV
Analog TV		B/G, D/K, I, M/N, L
Digital audio broadcasting		DAB, DAB+, ISDB-T _{SB}
Analog audio broadcasting		FM mono, FM stereo with RDS
Additional functionality		
Transport stream player	file format	TRP, T10, ETI, MFS, PMS, BIN
Audio/video generator	file format	Rohde & Schwarz proprietary
AWGN	signal-to-noise ratio (SNR)	-30 dB to +60 dB
General data		
Operating temperature range		+5°C to +45°C
Dimensions	W x H x D, without handles	229 mm x 54.4 mm x 406 mm (9.02 in x 2.14 in x 16 in)
Weight		4 kg (8.82 lb)

R&S®SFC-U USB Compact Modulator



Test signals for TV and audio broadcasting – compact and cost-effective

The R&S®SFC-U USB compact modulator is an economical multistandard signal source. It supports realtime coding for all conventional digital and analog TV and audio broadcasting standards. The R&S®SFC-U is a USB device designed for use with a PC.

The R&S®SFC-U has an extremely compact design. Though small in size, it is a full-featured TV and audio broadcasting signal generator with integrated transport stream player, audio/video generator and optional noise source.

The R&S®SFC-U USB compact modulator offers the same signal generator functions as the R&S®SFC in an even smaller housing, making room on the lab bench for the DUT and other equipment. The R&S®SFC-U is connected to the USB port of a host PC and controlled from the PC. The wide range of functions make the R&S®SFC-U ideal for developing software and hardware for TVs and set-top boxes.

- ▀ Optimized for use in production test systems
- ▀ Low power consumption for reduced operating costs
- ▀ Multistandard signal generator with realtime coding
- ▀ Integrated baseband signal sources
- ▀ Integrated AWGN generator
- ▀ ASI transport stream input
- ▀ Digital I/Q input

Specifications in brief		
RF characteristics		
Frequency range	base unit	30 MHz to 900 MHz
	with R&S®SFC-U-K83 option	30 MHz to 3000 MHz
Frequency setting resolution		1 Hz
Level range	base unit	-31.5 dBm to 0 dBm RMS for DVB-T
	with R&S®SFC-U-K84 option	-110 dBm to 0 dBm RMS for DVB-T
Level setting resolution		0.1 dB
MER	for OFDM modulation	> 40 dB
Modulation systems		
Terrestrial TV and mobile TV		DVB-T2, DVB-T, DVB-H, DTMB, CMMB, T-DMB, ISDB-T, ISDB-T _B , ISDB-T 1 seg., ATSC/8VSB, ATSC-M/H
Cable TV		DVB-C2, DVB-C, ISDB-C, J.83/B
Satellite TV		DVB-S2, DVB-S, DIRECTV
Analog TV		B/G, D/K, I, M/N, L
Digital audio broadcasting		DAB, DAB+, ISDB-T _{SB}
Analog audio broadcasting		FM mono, FM stereo with RDS
Additional functionality		
Transport stream player	file format	TRP, T10, ETI, MFS, PMS, BIN
Audio/video generator	file format	Rohde&Schwarz proprietary
AWGN	signal-to-noise ratio (SNR)	-30 dB to +60 dB
General data		
Operating temperature range		+5°C to +45°C
Dimensions	W x H x D, without handles	177 mm x 40 mm x 241 mm (6.97 in x 1.57 in x 9.49 in)
Weight		1.5 kg (3.31 lb)

R&S®SFD DOCSIS® Signal Generator



Signal generator for DOCSIS 3.1 downstream and upstream

The DOCSIS®3.1 standard is driving the trend in cable TV networks toward all-IP. The R&S®SFD generates a DOCSIS 3.1 OFDM broadband signal as well as the previous cable signals such as DOCSIS 3.0, digital and analog TV channels in the downstream. In the upstream, it generates a DOCSIS 3.1 or DOCSIS 3.0 signal.

Thanks to its digital signal generation capabilities, the R&S®SFD is ideal for testing tuners, cable modems and upstream CMTS receivers in R&D and production and also for simulating DOCSIS 3.1 signals in real cable segments. For realistic signal generation, the R&S®SFD can add interference such as noise, phase noise, hum, tilt and even a defined bit error rate.

The complex signal generation process can be conveniently configured from a PC or via a web interface. Remote control through SCPI commands enables the generator to be used in automatic test systems.

- Frequency range in downstream: 47 MHz to 1218 MHz (extendable to 1794 MHz)
- Frequency range in upstream: 5 MHz to 204 MHz
- DOCSIS 3.1, DOCSIS 3.0, J.83/A/B/C and analog TV
- Up to 192 MHz signal bandwidth for DOCSIS 3.1
- ARB generator bandwidth up to 200 MHz
- Signal interference and distortion simulation

Specifications in brief

RF parameters		
Frequency range		47 MHz to 1218 MHz
	with R&S®SFD-K3018 option	47 MHz to 1794 MHz
Frequency range in upstream:		5 MHz to 204 MHz
Level	192 MHz DOCSIS 3.1	59 dBmV
	J.83/A/B/C (DOCSIS 3.0)	62 dBmV
MER	192 MHz DOCSIS 3.1	typ. 57 dB
	J.83/A/B/C	typ. 48 dB
Downstream modulation (R&S®SFD-K200 option)		
DOCSIS 3.1	bandwidth	up to 192 MHz
	constellation	16QAM to 4096QAM, overrange 8kQAM, 16kQAM
	FFT mode	4k, 8k
J.83/A/B/C	bandwidth	6 MHz, 7 MHz, 8 MHz
	constellation	64QAM, 256QAM
Analog TV		PAL, NTSC
Downstream modulation (R&S®SFD-K201 option)		
Enhanced functions		insertion of timestamps in the downstream PLC, display of transmission data rate, R&S®FSW compatibility
Upstream modulation (R&S®SFD-K300 option)		
DOCSIS 3.1	modulation mode	OFDM
	bandwidth	6.4 MHz to 96 MHz
DOCSIS 3.0	modulation mode	A-TDMA, S-CDMA
	bandwidth	800 kHz, 1.6 MHz, 3.2 MHz, 6.4 MHz
ARB waveform generator		
Bandwidth		200 MHz
Memory		256 Mbyte
Sample rate		240 Msample/s
Waveform		DOCSIS 3.1, DOCSIS 3.0, J.83, PAL, NTSC, A-TDMA, S-CDMA
Waveform	included in R&S®CLGD-K2	FM spectrum, additional PAL and SECAM signals
Signal interference (R&S®SFD-K1050 option)		
Bit error rate		1×10^{-2} to 1×10^{-6}
Noise		AWGN, phase noise
AC hum	amplitude modulation	47 Hz to 200 Hz, 0% to 6%
Tilt	DOCSIS 3.1	± 15 dB/GHz

R&S®CLGD DOCSIS Cable Load Generator



Multichannel signal generator for DOCSIS 3.1 downstream and upstream

The R&S®CLGD is a multichannel signal generator for simulating a cable TV network with full channel loading. It generates broadband data signals for DOCSIS 3.1 as well as digital and analog TV channels. In the downstream or upstream, signals can be freely combined, allowing users to simulate any conceivable channel loading scenario in the lab.

The R&S®CLGD is the first generator that simultaneously produces signals for DOCSIS 3.1, DOCSIS 3.0, digital cable TV in line with J.83/A/B/C and analog cable TV. Its downstream frequency range is 47 MHz to 1002 MHz for TV and 47 MHz to 1794 MHz for DOCSIS 3.1. Within this range, the R&S®CLGD generates multiple DOCSIS 3.1 channels with up to 192 MHz bandwidth each.

The level, frequency, forward error correction (FEC) and constellation of these channels can be set independently. At the same time, the R&S®CLGD produces a large number of digital and analog TV signals that can be placed anywhere below or between the DOCSIS 3.1 signals.

The DOCSIS 3.1 channels and digital TV channels are implemented in realtime. The data to be transmitted can be fed in via IP or internally generated by the R&S®CLGD. The upstream frequency range is from 5 MHz to 204 MHz. Within this range, DOCSIS 3.1 orthogonal frequency division multiple access (OFDMA) signals can be freely combined with DOCSIS 3.0 TDMA or CDMA signals.

The flexible multichannel signal generation capabilities of the R&S®CLGD enable it to simulate network loading in a reproducible manner, making it ideal for testing tuners, cable modems and upstream CMTS receivers. The influence of QAM and TDMA/CDMA signals in adjacent channels on DOCSIS 3.1 signal reception is a research topic of great interest. The R&S®CLGD makes such simulations realistic by adding different types of interference, such as noise, reflections and narrowband interference.

The generator is accommodated in a 19" housing that takes up a mere two height units. The complex signal generation process can be conveniently controlled from a PC or via a web interface. Remote control through SCPI commands enables the generator to be used in automatic test systems. The R&S®CLGD can be adapted to various application requirements thanks to its software option concept.

- Frequency range in downstream: 47 MHz to 1218 MHz (extendable to 1794 MHz)
- Frequency range in upstream: 5 MHz to 204 MHz
- DOCSIS 3.1, DOCSIS 3.0, J.83/A/B/C and analog TV
- Up to six times 192 MHz signal bandwidth for DOCSIS 3.1
- ARB generator bandwidth up to 200 MHz

Specifications in brief	
RF parameters	
Frequency range	
Downstream	47 MHz to 1218 MHz
with R&S®CLGD-K3018 option	47 MHz to 1794 MHz
Upstream	5 MHz to 204 MHz
Level, per channel	100 dBμV
Level, total	62 dBmV
MER, OFDM	in line with DOCSIS3.1 specification
MER, J.83/A/B/C	typ. 45 dB
Downstream modulation	
DOCSIS3.1	
Bandwidth	up to 192 MHz
Constellation	16QAM to 4096QAM, overrange 8kQAM, 16kQAM
FFT mode	4k, 8k
J.83/A/B/C	
Bandwidth	6 MHz, 7 MHz, 8 MHz
Constellation	64QAM, 256QAM
Symbol rate	5.0 Msymbol/s to 7.0 Msymbol/s

Specifications in brief	
Upstream modulation	
DOCSIS 3.1	
modulation mode	OFDM
bandwidth	24 MHz, 48 MHz, 96 MHz
DOCSIS 3.0	
modulation mode	TDMA, CDMA
bandwidth	800 kHz, 1.6 MHz, 3.2 MHz, 6.4 MHz
ARB waveform generator	
Bandwidth	200 MHz
Number of files played simultaneously, bandwidth	
up to 10 MHz	4
10 MHz to 100 MHz	2
100 MHz to 200 MHz	1
Interference simulation	
Noise	AWGN, impulsive noise, phase noise
Microreflections	in line with SCTE 40
AC hum, amplitude modulation	47 Hz to 200 Hz, 0% to 6%
Narrowband interference	ARB waveform up to 20 MHz bandwidth

R&S®SLG Satellite Load Generator



Multichannel digital satellite TV modulator

The R&S®SLG satellite load generator is a multichannel signal generator for digital satellite TV. It is the world's first integrated instrument to simulate TV satellite bands with full channel load. The R&S®SLG generates satellite TV signals using different standards and parameters and combines them in any desired manner. Users can simulate any conceivable uplink and downlink configurations in the lab.

The R&S®SLG has a frequency range from 250 MHz to 3225 MHz, covering all satellite IF frequency bands used worldwide. The R&S®SLG can simultaneously generate up to 32 digital satellite TV transponder signals in line with DVB-S/DVB-S2/DVB-S2X and ISDB-S/S2, ISDB-S3, or a signal in line with DVB-S2 wideband. Up to 16 transponders can transmit MPEG transport streams; the other transponders carry PRBS data. The transport streams are fed into the instrument via IP or ASI inputs. The R&S®SLG uses its integrated transport stream generator to play short transport stream files. Each channel can contain an ARB waveform or a CW carrier instead of a TV signal.

The R&S®SLG is primarily suited for performing RF tests on satellite TV components. Its interfaces, which are commonly used in consumer electronics and professional satellite electronics, make the generator ideal for testing tuners and set-top boxes as well as upconverters, amplifiers and satellite payloads. Because it can simultaneously generate multiple channels with high symbol rates, the R&S®SLG is also well suited for performing stress tests on systems that process large data quantities, such as transcoders, conditional access middleware and military surveillance data processing systems.

The R&S®SLG can be fully remote controlled, making it ideal for integration into automatic test systems. All this functionality has been packed into a compact 19" 1 HU housing. Previously a rack full of modulators was needed to generate as many satellite TV signals as the R&S®SLG does.

- ▮ Satellite IF range from 250 MHz to 3225 MHz
- ▮ Up to 32 simultaneous transponder signals
- ▮ Independent setting of symbol rate, FEC, level and frequency
- ▮ DVB-S/S2, DVB-S2 wideband, DVB-S2X, DVB-S2X channel bonding and ISDB-S/S2 and ISDB-S3 modulation standards
- ▮ Echostar turbo coding
- ▮ Signal quality of typ. 40 dB MER

Specifications in brief

RF parameters	
Frequency range	250 MHz to 3225 MHz
Number of channels, in one 500 MHz band	max. 32
Frequency response, in one 500 MHz band	$\leq \pm 1.25$ dB
Level	
per carrier	≥ -14.5 dBm
overall	≥ -3 dBm
Level setting range	
Step size	0 dB to -30 dB
	0.1 dB
Modulations	
Satellite TV standards	DVB-S/DSNG, DVB-S2, DVB-S2X, ISDB-S/S2, ISDB-S3
Symbol rate	
for 32 carriers	0.1 Msymbol/s to 30 Msymbol/s
for 8 carriers	5 Msymbol/s to 72 Msymbol/s
for 1 carrier	45 Msymbol/s to 416 Msymbol/s
MER in bands 3, 4 and 5	
for 32 carriers with 30 Msymbol/s	typ. 46 dB with equalizer, typ. 40 dB without equalizer
for 8 carriers with 72 Msymbol/s	typ. 46 dB with equalizer, typ. 36.5 dB without equalizer
for 1 carrier with 416 Msymbol/s	typ. 40 dB with equalizer, typ. 30.5 dB without equalizer

Specifications in brief

AWGN and phase noise	
AWGN bandwidth, 1 dB drop	510 MHz
C/N setting range	up to -10 dB
Phase noise, for each active carrier	user-defined up to 10 MHz offset from carrier
Arbitrary waveform generator	
Memory space, total	≥ 400 Mbyte
Number of files played simultaneously	max. 4
File size	≤ 256 Mbyte/number of played files
Aggregate sample rate, sum of all played files	≤ 288 Msample/s
Interfaces	
RF outputs	
primary	50 Ω SMA
secondary	75 Ω F; DiSEqC™ version 2.1, level 2.2
Monitor outputs, RF, ASI	2 \times BNC
Transport stream inputs	
ASI	2 \times 75 Ω BNC
ASI, IP	2 \times 10/100/1000BASE-T, RJ-45, 1 \times SFP+
Control interface	
Ethernet	10/100BASE-T, RJ-45
Format	web browser interface, SCPI, SNMP

R&S®ETL TV Analyzer



Universal reference for analyzing TV, mobile TV and sound broadcasting signals

The R&S®ETL TV analyzer has been successful on the market for years. For many network operators and manufacturers, it is the ultimate reference measurement tool.

The R&S®ETL combines the functionality of a TV and FM (radio) signal analyzer, a video and MPEG TS analyzer and a spectrum analyzer in a single instrument. The R&S®ETL also contains generators to create analog video signals, audio signals and MPEG-2 transport streams.

Its wide range of functions and flexible configuration make the R&S®ETL TV analyzer the universal reference for the analysis of TV signals – for TV and cable network operators, transmitter manufacturers, service technicians and regulatory authorities.

- ▮ Frequency range from 500 kHz to 3 GHz
- ▮ TV, FM (radio), video, audio, MPEG-2 transport stream and spectrum analysis in a single box
- ▮ FPGA and chip-based realtime demodulators for analog TV, DVB-T, DVB-T2, DVB-H, ATSC/8VSB, ATSC Mobile DTV, ISDB-T_B, J.83/A/C, DVB-C, J.83/B, DTMB, T-DMB/DAB and FM (radio)

- ▮ Baseband outputs
- ▮ Preselection with additional 75 Ω RF input
- ▮ Video signal generator
- ▮ Audio signal generator
- ▮ MPEG-2 transport stream generator/recorder
- ▮ Support of power sensors
- ▮ DC input and rechargeable Lithium-ion battery
- ▮ Display with high readability
- ▮ SSD with 256 Gbyte
- ▮ Fast USB interface
- ▮ Windows 8 operating system

Main applications

Acceptance testing, maintenance and servicing of TV, mobile TV, DAB and FM transmitters

- ▮ Precise analysis of signal quality at transmitter output
- ▮ Measurements to optimize transmitter operating parameters
- ▮ Measurement of spurious emissions
- ▮ Detection of faults
- ▮ Documentation of signal parameters
- ▮ Remote maintenance via IP networks with remote desktop function

Quality assurance during the production of modulators and TV, DAB and FM transmitters

- ▮ Reproducible analysis of signal quality of modulators and transmitters

Optimization of TV, mobile TV, DAB and FM transmitter networks

- ▮ Measurement of receive levels and signal quality at reception site
- ▮ Checking and optimization of digital single-frequency networks (SFN)
- ▮ Systematic determination of receive quality in transmission area (coverage measurement)

Specifications in brief

Frequency range		500 kHz to 3 GHz
Displayed average noise level (DANL)	FM (radio)	75 MHz to 110 MHz
	50 MHz to 3 GHz, preamplifier off	≤ -140 dBm (1 Hz)
	500 MHz, preamplifier on, preselector on	typ. -166 dBm (1 Hz)
Level	3 GHz, preamplifier on, preselector on	typ. -161 dBm (1 Hz)
	quasi-error-free for digital standards depending on transmission modes	-90 dBm to +10 dBm
Inherent modulation error ratio (MER)	T-DMB/DAB with R&S®ETL-B203 preselector, preamplifier on	-92 dBm
	signal level ≥ -30 dBm, f ≤ 1.3 GHz	≥ 40 dB, typ. 46 dB
Video S/N	DTMB	≥ 34 dB
	analog TV mode	≥ 60 dB

R&S®ETH Handheld TV Analyzer



Portable digital TV signal analysis up to 3.6 GHz/8 GHz

The R&S®ETH handheld TV analyzer was specially developed for coverage measurements as well as for service and maintenance work on DVB-T, DVB-H and ISDB-T gap-filler and low-power transmitters. The universal capabilities of the R&S®ETH also make it useful in the repair and development of TV components. The R&S®ETH handheld TV analyzer is the compact combination of a TV analyzer, spectrum analyzer and network analyzer.

- ▮ Comprehensive TV, spectrum and network analysis functionality
- ▮ Display of constellation diagram, channel impulse response and MER(k)
- ▮ Integrated preselection
- ▮ Fast and precise measurement due to realtime demodulation
- ▮ BER measurement and ASI transport stream output
- ▮ Optimized for field use
- ▮ Compact, lightweight, rugged
- ▮ Splashproof and dustproof
- ▮ Easy-to-replace lithium-ion battery
- ▮ Network coverage measurement with R&S®BCDRIVE
- ▮ Easy operation and convenient data exchange with PC

Specifications in brief		
RF characteristics		
Frequency range	model .14	100 kHz to 3.6 GHz
	model .18	100 kHz to 8.0 GHz
DVB-T/DVB-H receiver (R&S®ETH-K140 option) and ISDB-T receiver (R&S®ETH-K160 option)		
Quasi-error-free input level range	RF = 500 MHz, RF preselection on	typ. -76 dBm to +10 dBm
Inherent modulation error ratio (MER)	RF = 500 MHz, RF preselection off, level = -30 dBm	> 43 dB, typ. 46 dB
	RF = 500 MHz, RF preselection on, level = -45 dBm	> 41 dB, typ. 44 dB
Phase noise	RF = 500 MHz, $\Delta f = 30$ kHz	< 98 dBc (1 Hz)
	RF = 500 MHz, $\Delta f = 100$ kHz	< 100 dBc (1 Hz)
	RF = 500 MHz, $\Delta f = 1$ MHz	< 125 dBc (1 Hz)
Third-order intermodulation (TOI)	0 dB RF attenuation, RF preselection off	typ. +7 dBm
	0 dB RF attenuation, RF preselection on	typ. -6 dBm
Spectrum analysis		
Displayed average noise level (DANL)	10 MHz < RF < 2 GHz, 0 dB RF attenuation	
	RF preselection off	typ. -156 dBm (1 Hz)
	RF preselection on	typ. -165 dBm (1 Hz)
Resolution bandwidths		100 Hz to 3 MHz in 1/3 sequence
Video bandwidths		10 Hz to 3 MHz in 1/3 sequence
Network analysis		
Tracking generator output level		-40 dBm to 0 dBm in 1 dB steps
Data points		631
Dynamic range for transmission measurements	300 kHz to 3.6 GHz	> 70 dB, typ. 90 dB
General data		
Battery operating time		up to 4.5 h
Weight	including battery	3.3 kg (7.28 lb)

R&S®ETC Compact TV Analyzer



Economical TV transmitter testing

The R&S®ETC compact TV analyzer offers a comprehensive set of measurement functions for DVB-T2, DVB-T/ DVB-H and ISDB-T digital TV transmitter testing. It is also useful for service and maintenance of TV transmitters as well as for testing modulators in R&D or quality assurance environments. The design of the analyzer is ideal for coverage measurements in broadcast network planning.

The R&S®ETC is specialized in TV analysis and also performs spectrum and scalar network analysis as well as power measurements. For tests that require higher sensi-

tivity and selectivity, users can activate an integrated pre-selector followed by a preamplifier.

The core component of the R&S®ETC is an FPGA-based realtime digital TV demodulator that optimizes realtime BER measurements and provides a demodulated MPEG-2 transport stream at the ASI output. The instrument also offers a comprehensive set of transmitter measurement functions including amplitude, phase and group delay measurements for DVB-T2, DVB-T and ISDB-T. Further advantages of the compact TV analyzer are its high measurement speed and fast booting and mode switching times, which significantly reduces the time needed for test procedures.

- Support of DVB-T2, DVB-T/DVB-H and ISDB-T digital TV standards
- Wide frequency range up to 3.6 GHz or 8 GHz
- Precision MER measurement in realtime (typ. 44 dB at 500 MHz)
- Wide input level range from -76 dBm to +10 dBm for quasi-error-free transport stream decoding
- Spectrum analyzer DANL of typ. -165 dBm (1 Hz)
- Comprehensive analysis of digital signal transmission
- Support of MPEG decoding and analysis
- Easy operation, network coverage analysis and automatic test measurement

Specifications in brief		
DVB-T2 analysis (R&S®ETC-K240), DVB-T/DVB-H analysis (R&S®ETC-K140) and ISDB-T analysis (R&S®ETC-K160)		
Quasi-error-free input level range	RF = 500 MHz, RF preselection on, 64QAM, CR 1/2	-76 dBm to +10 dBm (typ.)
Inherent modulation error ratio (MER)	0 dB RF attenuation, 64QAM nonhierarchical modulation, 8K FFT, 1/32 guard interval, slow channel adaptation	
	level = -30 dBm, RF preselection off	
	RF = 50 MHz to 862 MHz	> 40 dB
	RF = 500 MHz	typ. 44 dB
	level = -45 dBm, RF preselection on	
	RF = 50 MHz to 862 MHz	> 38 dB
	RF = 500 MHz	typ. 43 dB
Phase noise	RF = 500 MHz	
	$\Delta f = 30$ kHz	< 98 dBc (1 Hz)
	$\Delta f = 100$ kHz	< 100 dBc (1 Hz)
	$\Delta f = 1$ MHz	< 125 dBc (1 Hz)
Noise figure	RF = 500 MHz	
	RF preselection off	< 22 dB, typ. 18 dB
	RF preselection on	< 14 dB, typ. 11 dB
Third-order intermodulation (TOI)	0 dB RF attenuation	
	RF preselection off	typ. +7 dBm
	RF preselection on	typ. -6 dBm
Second-harmonic intercept point (SHI)	50 MHz < RF < 1.5 GHz, 0 dB RF attenuation	
	RF preselection off	typ. +30 dBm
	RF preselection on	typ. +60 dBm
Signal level uncertainty	RF < 3.6 GHz	< 1.0 dB, typ. < 0.5 dB
Frequency uncertainty	internal reference	2×10^{-6}
	with the R&S®HA-Z240 GPS receiver	2.5×10^{-8}

R&S®EFL110/EFL210 Cable TV Analyzer and Leakage Detector

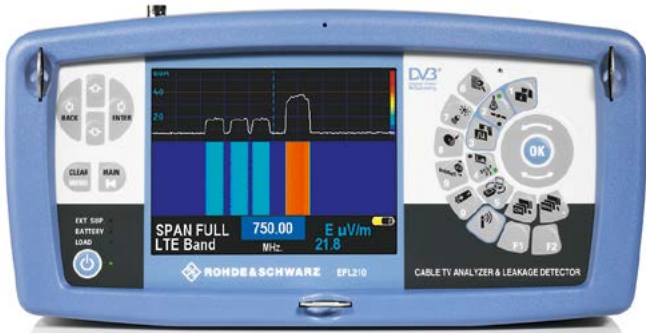

Detecting interference in cable TV and LTE networks

The R&S®EFL110/EFL210 cable TV analyzer and leakage detector is a handy, portable instrument for detecting radiated emissions. It is rugged, easy to operate and has been optimized for use in the field.

Thanks to its sensitive receiver and straightforward graphical display, the R&S®EFL110/210 can detect even weak and sporadic interference. Specially for troubleshooting US cable TV networks, the R&S®EFL210 has been equipped with a test receiver that supports the J.83/B and NTSC cable TV standards.

The R&S®EFL110/210 receiver offers unprecedented sensitivity in its class and can be used to verify compliance with the strict limits defined by the US FCC regulatory authority. The R&S®EFL110/210 can be operated as a spectrum analyzer and as an FFT analyzer. The spectrogram display of measurement results makes it possible to detect even sporadic interference and simplifies working with a directional antenna. A directional antenna suitable for the UHF and VHF band is available as an accessory.

Field measurements must be fast and simple. The R&S®EFL110/210 helps in many ways: Its clear-cut, ergonomic keypad allows intuitive operation. Preinstalled channel tables save valuable time when entering parameters. The supplied R&S®EFL-Suite software transfers measurement results saved in log files to a PC.

The R&S®EFL110/EFL210 has been optimized for mobile use. It is compact, lightweight and robust and its lithium ion battery supplies power for more than four hours of operation. The instrument and its wide range of accessories come in a carrying bag.

- Frequency range from 5 MHz to 2500 MHz
- Minimum detectable signal level 11 µV/m in E-UTRA bands 12, 13, 14 and 17
- Minimum detectable signal level 19 µV/m in aeronautical radio band from 108 MHz to 139 MHz
- Battery operation > 4 h

Specifications in brief	
FFT analyzer	
Frequency bands	
FM radio band	80 MHz to 108 MHz
Aeronautical radio band ¹⁾	108 MHz to 139 MHz
VHF/UHF band	139 MHz to 700 MHz
700 MHz LTE band ¹⁾	700 MHz to 800 MHz
GSM band	800 MHz to 950 MHz
Wi-Fi band	2400 MHz to 2500 MHz
Minimum detectable signal with R&S®EFL-Z100	
in the aeronautical radio band, RBW 18 kHz, 10 MHz span	19 µV/m
in the 700 MHz LTE band, RBW 18 kHz, 10 MHz span	11 µV/m
FFT analysis	
Maximum span	100 MHz
FFT bandwidth	20 MHz
Marker functions	peak search, peak to center, delta
Graphical display, split screen	FFT spectrum and waterfall
Acoustic signal, built-in loudspeaker	pitch of tone proportional to measured field strength

Specifications in brief	
Spectrum analyzer	
Frequency range	5 MHz to 2500 MHz
Span	100 kHz to 2500 MHz
Bandwidth	
Resolution bandwidth	300 Hz to 6.4 MHz
Video bandwidth	100 Hz to 1 MHz
Level	
Maximum level	22 dBm
Setting range	-105 dBm to +20 dBm
Sensitivity	
RBW 800 kHz, 100 MHz span	≤ -88 dBm
RBW 36 kHz, 5 MHz span	≤ -100 dBm
Trace function, 2 traces	max. hold, min. hold
Markers, 3 markers	peak, search, delta
TV test receiver (only R&S®EFL210)	
Measurement functions	
Digital: J.83/B	level, C/N, MER, BER, constellation, MPEG, video and audio output
Analog: NTSC, PAL, SECAM	videoscope, level, V/A, C/N, video and audio output

¹⁾ The instrument is optimized for maximum sensitivity in the aeronautical band and in the 700 MHz LTE band.

R&S®EFL240/R&S®EFL340 Portable TV Test Receiver



Professional installation of cable and satellite TV systems and antennas

The R&S®EFL240/R&S®EFL340 is a compact, portable TV test receiver for satellite, cable and terrestrial television. Its versatile measurement functions and its operating convenience are ideal for the installation of cable TV systems, satellite receiver systems, in-building distribution systems and antennas.

Its favorable price makes the test receiver extremely attractive for these applications. The clear-cut ergonomic keypad of the R&S®EFL240/R&S®EFL340 allows intuitive operation. The scan and log function and the macro measurement function largely automate frequent measurement tasks. Pre-installed channel tables and transponder lists save the user valuable time when entering parameters.

- Multistandard test receiver for DVB-T2, DVB-T, DVB-H, DVB-C, DVB-S, DVB-S2, analog TV and FM radio
- Extensive measurement functions for cable, satellite and antenna
- Measurement of constellation, MER(f) and echos
- MPEG-2 and MPEG-4 decoding and video output
- Videoscope functionality
- Spectrum measurement with zoom function and combo mode
- Common interface for encrypted programs
- 5.7" TFT color display for SD and HD video output
- Ergonomic design and easy operation
- Automated measurements simplify routine work
- Wide range of accessories supplied
- R&S®EFL-Suite software for transferring measurement results to a PC
- Battery operation > 4 h

Specifications in brief

RF parameters		
Frequency range	spectrum analysis	5 MHz to 2500 MHz
	cable TV return channel	5 MHz to 47 MHz
	FM sound broadcasting	88 MHz to 108 MHz
	terrestrial and cable TV	47 MHz to 1500 MHz
	satellite TV	950 MHz to 2200 MHz
Dynamic range	terrestrial standards and cable standards	60 dB
	satellite standards	55 dB
Digital TV		
Level range		15 dB μ V to 130 dB μ V
Standards	terrestrial, cable, satellite	DVB-T2/DVB-T/DVB-H, DVB-C, DVB-S/DVB-S2
MPEG analysis	parameter display	NID, video PID, audio SID, service information
Video and audio output	video	MPEG-2, MPEG-4, SD, HD (1080p)
	audio	MPEG-1 L2, Dolby, AC3, AAC, DD+
Analog TV		
level range		10 dB μ V to 130 dB μ V
	video and audio output	PAL (B/G, D/K, I), SECAM (B/G, D/K, L), NTSC, teletext
Spectrum analyzer		
span		100 kHz to 2500 MHz (full span)
	resolution bandwidth	300 Hz to 6.4 MHz
	enhanced functions	max./min. hold, zoom, marker, trigger
Interfaces		
RF input		75 Ω
	ASI input/output	BNC, female, 75 Ω
	video input/output	SCART, HDMI™ (output only)
	LNB and antenna control, via RF socket	DC out, 22 kHz tone, DiSEqC, SCR
General data		
operating temperature range		0°C to +40°C
	weight, including battery	2.48 kg (5.47 lb)

R&S®DVMS

Digital TV Monitoring System Family



Front view of the R&S®DVMS1.



Rear view of the R&S®DVMS1.



Front view of the R&S®DVMS4.



Rear view of the R&S®DVMS4.

Ensuring high quality of digital TV network operation

The R&S®DVMS family is a professional, attractively priced and compact solution for monitoring digital TV networks. It includes the R&S®DVMS1 and the R&S®DVMS4. Typical fields of applications for the R&S®DVMS family are signal monitoring at transmitter site, satellite uplink or headend.

The R&S®DVMS1 (1 HU, ½ rack width) makes it possible to simultaneously monitor an RF signal and an ASI signal or as an alternative up to four IP flows. The R&S®DVMS4 (1 HU) allows simultaneous monitoring of up to four RF/IP/ASI signals. Interface modules for DVB-T/DVB-T2, DVB-S/DVB-S2 as well as for IP (optical/electrical) are available.

Comparison of models		
	R&S®DVMS1	R&S®DVMS4
Number of module slots	1	4
Maximum number of simultaneously monitored inputs	4 (1 × TS and/or 1 × RF or 4 × TS IP)	4 (TS, RF and TS IP in any combination)
TS interfaces integrated in base unit	–	4 × TS
Total maximum bit rates of all inputs used	360 Mbit/s (IP), 86 Mbit/s (ASI/RF)	360 Mbit/s (IP + ASI + RF)
Integrated display (configure IP address, check firmware version or input status)	–	yes
Width	½ rack	full rack

All relevant errors at the RF, IP, TS and T2-MI level are recognized and reported immediately. Thumbnail display and electronic program guide (EPG) simplify visual monitoring of the transmitted contents. Remote access is supported via an integrated web server allowing independent, simultaneous access from different locations. SNMP and SNMP traps are supported for integration into central network management systems.

High-quality analysis functions and easy-to-understand displays complement the system's extensive array of monitoring functions. The analysis functions include program clock reference (PCR) analysis and buffer analysis as well as analysis of data and object carousels as used for system software update (SSU) and HbbTV®, for example. As a result, the R&S®DVMS is also ideal for troubleshooting, for example at a multiplex center or headend. Due to its small size, the R&S®DVMS1 in particular is a versatile and valuable tool for development.

- ▮ Simultaneous monitoring of up to four signals
- ▮ RF modules for DVB-T/DVB-T2 and DVB-S/DVB-S2
- ▮ IP module for electrical and optical (SFP) connections
- ▮ Support for DVB, ATSC and ISDB-T/ISDB-T_B transport streams
- ▮ T2-MI and BTS support
- ▮ Optional functions for detailed analysis
- ▮ Modular and extremely compact design (1 HU)

Immediate detection of all relevant errors at the RF, IP, TS, T2-MI and BTS level

- ▮ Extensive RF measurements for DVB-T/DVB-T2 and DVB-S/DVB-S2 signals
- ▮ Extensive IP measurements
- ▮ Template function for transmission parameters
- ▮ Monitoring of DVB, ATSC and ISDB-specific TS
- ▮ T2-MI monitoring
- ▮ Template function for transport stream characteristics
- ▮ Detection of transport stream changes
- ▮ Data rate monitoring
- ▮ EPG/EIT monitoring
- ▮ MIP monitoring in SFN networks
- ▮ Encryption monitoring

Extensive analysis and visualization functions

- ▮ Constellation display
- ▮ Spectrum display (DVB-T and DVB-T2)
- ▮ Echo pattern display (DVB-T and DVB-T2)
- ▮ MDI display (IP flows)
- ▮ Thumbnail display
- ▮ EPG display
- ▮ Graphic display of data rates and table repetition rates
- ▮ Table interpreter
- ▮ PCR analysis
- ▮ PTS analysis

- Elementary stream analysis for video and audio according to buffer model
- Analysis of DVB object and data carousels
- Analysis of video encoding quality (qPSNR analysis)

Simple operation and configuration

- Clearly structured dialogs for all settings (monitoring characteristics, signal input and instrument)
- Detailed configuration capabilities for all monitoring functions and limits
- Convenient callup of measurement functions via view selector window
- Protection against unauthorized use by defining user-specific operation rights

Extensive range of monitoring features

- Monitoring of multiple DVB-T/DVB-H and DVB-S/DVB-S2 signals through a single input with scheduler suite
- Triggered recording and archiving of transport stream segments
- Detailed monitoring and error logging
- Different profiles for bit rate measurements for long-term and peak evaluation
- Permanent or temporary suppression of error messages with hiding of events function

Powerful network functions

- Multiple user access via standard web browser (Java-based) or VNC viewer
- Integration in network management systems via built-in SNMP interface
- Simple data exchange using FTP
- Firewall-protected access
- Streaming of selected program or PID to any point in network

Use cases

Monitoring of a single DVB-T2 transmitter including related transmitter feed

The R&S®DVMS1 is used to monitor both the broadcast signal (RF and PLP characteristics) and the T2-MI signal fed to the transmitter (see figure).

- Monitored signals
 - Transmitter feed (T2-MI over ASI)
 - Transmitter output (DVB-T2)
- Required module
 - One R&S®DVMS-B55 DVB-T/DVB-T2 receiver module

Monitoring of one MUX at transmitter site

The R&S®DVMS4 is used for monitoring one MUX at a transmitter site. The SFN characteristics are monitored using directional antennas to receive the signals from all transmitters in the SFN (see upper figure on next page).

- Monitored signals
 - Signal reception (DVB-S2)
 - Transmitter feed (T2-MI over IP)
 - Transmitter output (DVB-T2)
 - SFN characteristics (DVB-T2)
- Required modules
 - Two R&S®DVMS-B55DVB-T/DVB-T2 receiver modules
 - One R&S®DVMS-B51 DVB-S/DVB-S2 receiver module
 - One R&S®DVMS-B40 IP module

Monitoring of a single DVB-T2 transmitter including related transmitter feed

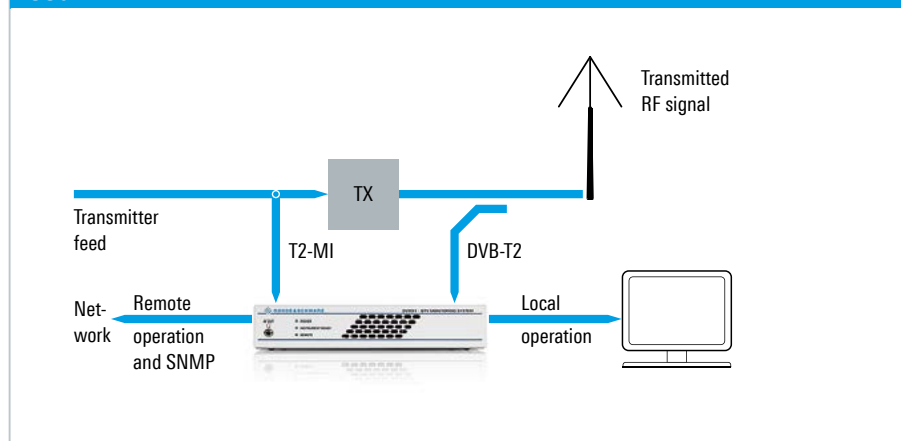

Simultaneous monitoring of one DVB-T and one DVB-T2 transmitter and related transmitter feeds

The R&S®DVMS4 is used to monitor both the broadcast signals (RF and PLP/TS characteristics) and the T2-MI/TS signals fed to the transmitter (see lower figure).

- Monitored signals
 - 2 × transmitter feed (T2-MI over IP and TS over IP)
 - 2 × transmitter output (DVB-T and DVB-T2)
- Required modules
 - Two R&S®DVMS-B55 DVB-T/DVB-T2 receiver modules
 - One R&S®DVMS-B40 IP module

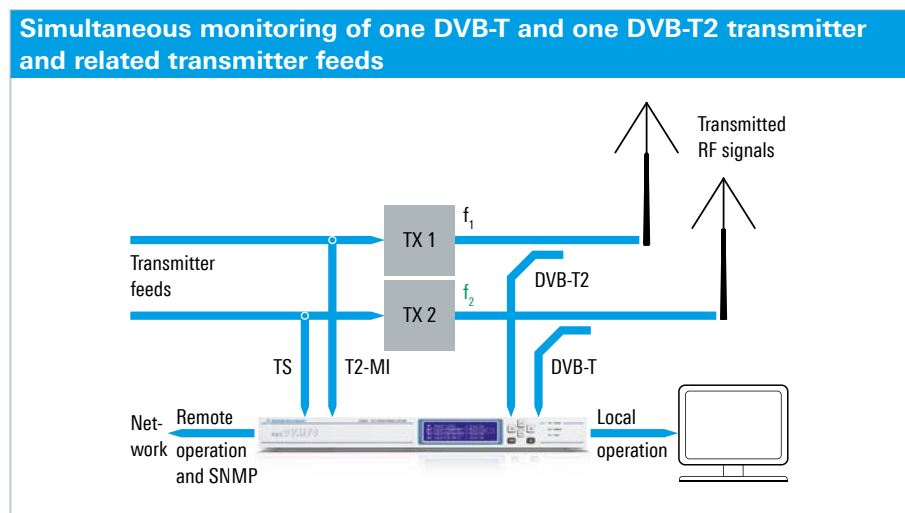
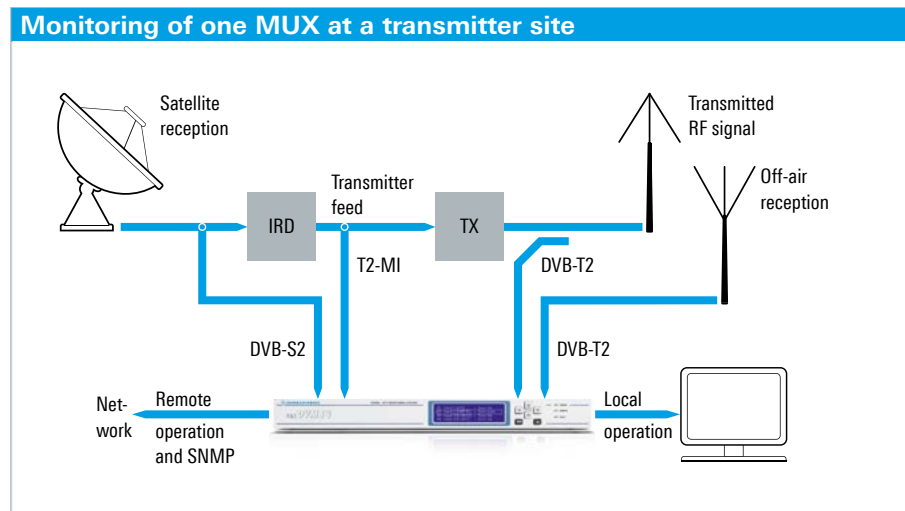

R&S®BCDRIVE Broadcast Drive Test Software

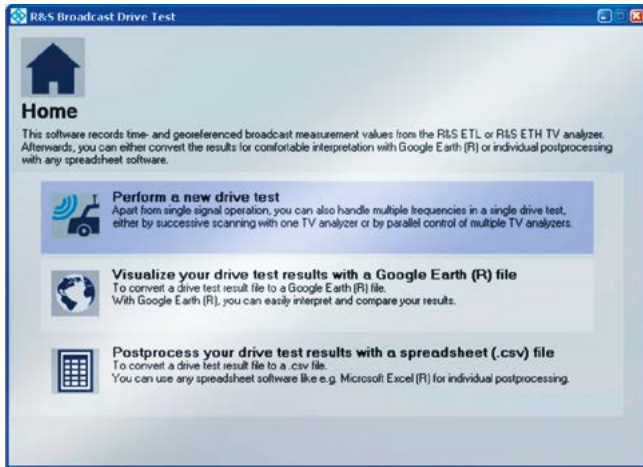

Efficient coverage analysis for terrestrial broadcast signals

Reliable coverage of specific regions is of central importance for terrestrial broadcast network operators. A series of real field measurements are needed after commission-

ing to verify that the planned network coverage has been achieved.

The R&S®BCDRIVE broadcast drive test software manages this task quickly with a minimum of resources. Depending on the number of frequencies to be measured in parallel, the program can control one or more R&S®ETL, R&S®ETC or R&S®ETH TV analyzers to quickly and accurately perform the measurements needed for quality assessment and root cause analysis in line with a variety of terrestrial broadcast standards. The R&S®ETL can run the software directly, eliminating the need for an additional control computer. All that is needed are a USB GPS receiver and the corresponding antennas.

- Support of all relevant measurements in line with a variety of terrestrial broadcast standards
- Highly informative output through precise signal quality recording every second using the R&S®ETL, R&S®ETC or R&S®ETH TV analyzer
- Efficient drive tests through intuitive program operation and measurement of multiple frequencies in parallel
- Effective conversion of test results for Google Earth, or alternatively in CSV format for maximum flexibility

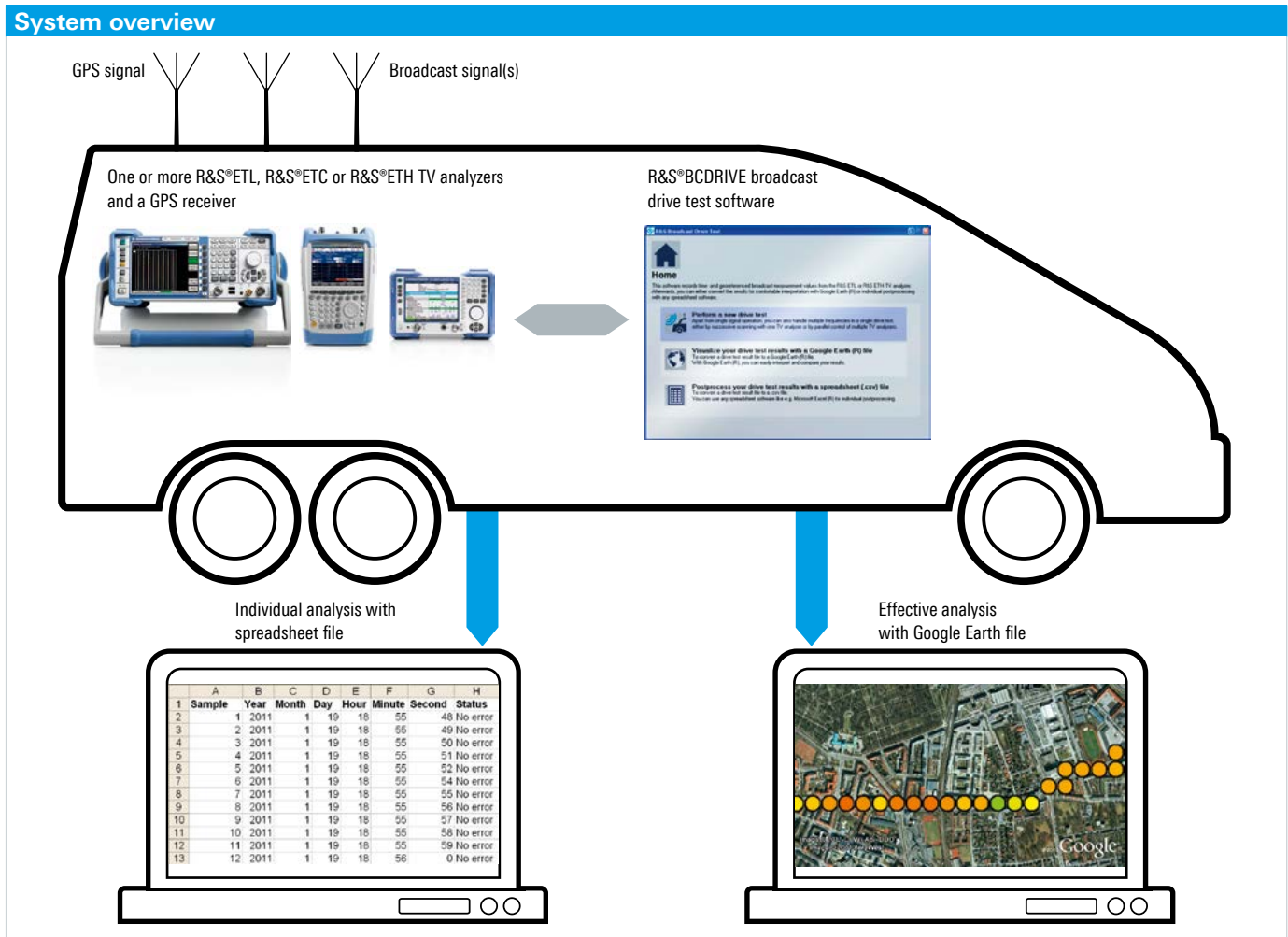

R&S®VTC Video Test Center, R&S®VTE Video Tester, R&S®VTS Compact Video Tester

Model overview		
 <p>The R&S VTC Video Test Center is a large, rack-mounted device with a prominent 11.6-inch touchscreen. The screen displays a complex software interface with multiple panels, including video thumbnails and data tables. The device has a blue and silver color scheme and a control panel on the right side.</p>	<p>R&S®VTC video test center High-end platform for A/V interface testing of consumer electronics devices</p>	<p>Accommodates up to eight different test modules</p> <ul style="list-style-type: none"> Large 11.6" touchscreen 4 HU, 19" Extensive protocol testing and audio/video analysis capabilities Powerful built-in PC with up to two hard drives
 <p>The R&S VTE Video Tester is a compact, rack-mounted device with a 7-inch touchscreen. The screen shows a similar software interface to the VTC model but with a more focused layout. It has a blue and silver design and a control panel on the right.</p>	<p>R&S®VTE video tester Compact all-purpose tester for A/V interface testing in quality assurance and for test system integration</p>	<p>Accommodates up to three different test modules</p> <ul style="list-style-type: none"> 7" touchscreen 3 HU, ½ 19" Extensive protocol testing and audio/video analysis capabilities Powerful built-in PC with up to two hard drives
 <p>The R&S VTS Compact Video Tester is a very slim, rack-mounted device. It features a front panel with various ports and a small display area. The design is blue and silver, consistent with the other models.</p>	<p>R&S®VTS compact video tester A/V interface testing in device manufacturing</p>	<p>Cost-effective A/V interface testing with one test module</p> <ul style="list-style-type: none"> Extremely compact with only 1 HU, ½ 19" Operation via remote control/operation or external I/O Protocol testing and basic audio/video analysis capabilities Power-saving built-in PC

A/V interface testing of consumer electronics devices

Rohde & Schwarz offers audio/video T&M instruments covering the entire value chain in the consumer electronics sector – the R&S®VTC video test center for development applications, the R&S®VTE video tester for automated applications in test setups and the R&S®VTS compact video tester for manufacturing applications. The R&S®VTC/VTE/VTS video testers are used for testing video and audio interfaces on consumer electronics equipment.

With test modules for HDMI™ and analog A/V interfaces and comprehensive analysis capabilities, these instruments support a spectrum of applications. The future-oriented, modular platforms accommodate up to eight (R&S®VTC), three (R&S®VTE) or one (R&S®VTS) test module(s) and can be equipped with additional software to optimally suit the requirements of specific applications. The test instruments perform standard interface protocol tests and also analyze media content in realtime during application tests on consumer electronics equipment.

This makes it easy to verify whether mobile devices provide the required video quality when video content is transmitted over a Long Term Evolution (LTE) link. It is also possible to measure the picture failure point (PFP) on broadcast and cellular terminal devices.

Key facts

- ▮ Universal platform for HDMI 2.0, MHL 1.4/2.2 and analog A/V interfaces
- ▮ Protocol compliance testing
- ▮ Enhanced video and audio analysis
- ▮ Touchscreen user interface with multilingual support
- ▮ Integrated test automation and report generation

Mobile high-definition link (MHL) interface testing

- ▮ Realtime protocol analysis
- ▮ Control bus (CBUS) testing
- ▮ Generation of user-defined patterns and patterns in line with MHL, CEA-861-E
- ▮ Compliance testing of sources, sinks and dongles for MHL interfaces

High-definition multimedia interface (HDMI) testing

- ▮ HDMI signal analysis up to 18 Gbit/s
- ▮ HDMI signal generation up to 18 Gbit/s (6G mode)
- ▮ HDMI 1.4 and 2.0a testing in line with the HDMI compliance test specification (CTS)

Time domain analysis solution with full 6 Gbps support for TMDS sources

- ▮ Powerful eye diagram analysis using subsampling
- ▮ Precompliance measurement solution for HDMI sources

Analog audio/video interface testing

- ▮ Composite (CCVS, CVBS) signal analysis
- ▮ YCbCr/RGB/RGBHV component signal analysis
- ▮ Powerful two-channel audio analysis

RF test signal generation for TV and audio broadcast standards

- ▮ Realtime coding of all relevant analog and digital standards
- ▮ Integrated transport stream player and analog audio/video generator
- ▮ Extensive test signal libraries of transport streams and analog test patterns

Complementary functions for media content analysis

- ▮ Video analysis of composite or digital component signals in the time domain
- ▮ Double-ended video and audio quality analysis
- ▮ Audio analysis
- ▮ Psycho-acoustic measurements

Easy operation

- ▮ Local operation via touchscreen
- ▮ Remote control and remote operation over a network from a tablet or PC
- ▮ Remote control for integration in automated test systems
- ▮ Integrated R&S®AVBrun test sequencer

R&S®DVSG Digital Video Signal Generator



Development and quality assurance of 2D/3D TV displays

The R&S®DVSG digital video signal generator supports the development and quality assurance of latest-generation TV sets and projectors. It is a cost-efficient, one-box solution that generates the audio and video signals required for these tasks.

- Configurable digital and analog video and audio output
- HDTV, SDTV and 3D formats up to 1080p in line with HDMI 1.4
- PC formats up to WUXGA
- Reference source for moving sequences
- Preinstalled Konica Minolta analysis software
- MPEG-2 transport stream recording and playback

Uncompressed, high-precision video and audio signals

The R&S®DVSG-K10 A/V signal generator option makes it possible to test displays with up to 12-bit color depth. The A/V signal generator outputs uncompressed 2D and 3D video content with a maximum resolution of 1080p in line with HDMI 1.4 and PC resolutions of up to 1920 × 1200 (WUXGA). In addition, multi-motion test sequences help enhance picture quality by checking motion blur, deinterlacing and film detection, for example. Comprehensive audio functionalities have been added to the A/V signal generator to allow the assessment of sound quality.

Output of compressed live signals

The R&S®DVSG-B30 A/V signal player option provides exactly the type of signals that a display must be able to handle when operated by an end user. The A/V signals are generated on the basis of MPEG-2 transport streams. In addition to the large set of signals supplied with the option, users can also use their own recordings of 2D and 3D transport streams. This feature makes it possible to easily simulate any live scenario in the lab.

Recording and playing of transport streams

The R&S®DVSG-K20 TS player and recorder option can record and play MPEG-2 transport streams. The numerous transport streams supplied with the option are played in a seamless loop. It is also no problem to play transport stream recordings of other devices.

R&S®Stream Libraries

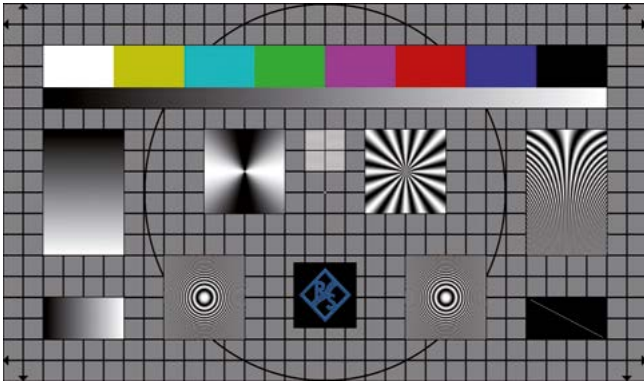

Test signal libraries for development, production and testing of TV components

Whenever the development, production and testing of TV components or devices is involved, suitable test signals are needed. To meet this need, Rohde&Schwarz offers not only the generators and modulators that are required but also an extensive collection of stream libraries. The R&S®DV-ASC advanced stream combiner software complements the stream library collection. This software provides an easy way to generate customized MPEG-2 transport streams for DVB, ATSC and ISDB-T. Alternatively, Rohde&Schwarz offers the generation of customized test signals as a service.

- ▮ Support of numerous transmission standards
- ▮ High-quality video and audio contents
- ▮ Efficient use

Extensive collection of libraries

- ▮ HEVC stream library
- ▮ Basic stream library
- ▮ Extended SDTV library
- ▮ Extended HDTV library
- ▮ 3D TV library
- ▮ ISDB-T transport streams
- ▮ CMMB transport streams
- ▮ ATSC and ATSC Mobile DTV streams
- ▮ DVB-T2-MI streams
- ▮ T-DMB/DAB streams
- ▮ DAB+ streams
- ▮ French DMB streams
- ▮ MDI streams
- ▮ Transport streams for EMC tests
- ▮ Analog TV test pattern

Baseband streams for special customer requirements

- ▮ Generation of customer-specific transport streams with the R&S®DV-ASC advanced stream combiner software
- ▮ Generation of customer-specific transport streams or analog CCVS signals as a service

Large variety of applications

- ▮ Testing of TVs, set-top boxes and mobile TV handsets
- ▮ EMC testing of TVs in line with CISPR
- ▮ Testing of decoders and encoders
- ▮ Testing of analog/digital TV networks and transmitters
- ▮ Testing of radio receivers

Support of numerous transmission standards

- ▮ Digital TV
- ▮ Mobile TV
- ▮ Audio broadcasting
- ▮ Analog TV

High-quality video contents

- ▮ High-quality video sequences also for 4k
- ▮ Precise test patterns
- ▮ Numerous resolutions, including full HD
- ▮ MPEG-2, H.264 coding and HEVC coding

High-quality audio contents

- ▮ Detailed audio signals
- ▮ Precise test tones
- ▮ Surround/multichannel sound
- ▮ Various coding methods, including MPEG-4 HE-AAC v2

Efficient use

- ▮ Standard-compliant, reliable operation worldwide
- ▮ Available at the push of a button
- ▮ Clear and simple property rights
- ▮ Comprehensive documentation

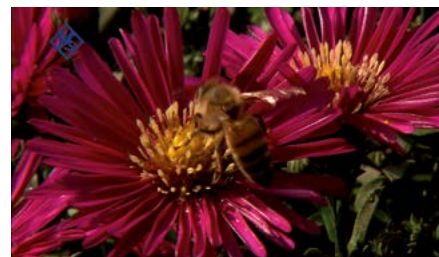

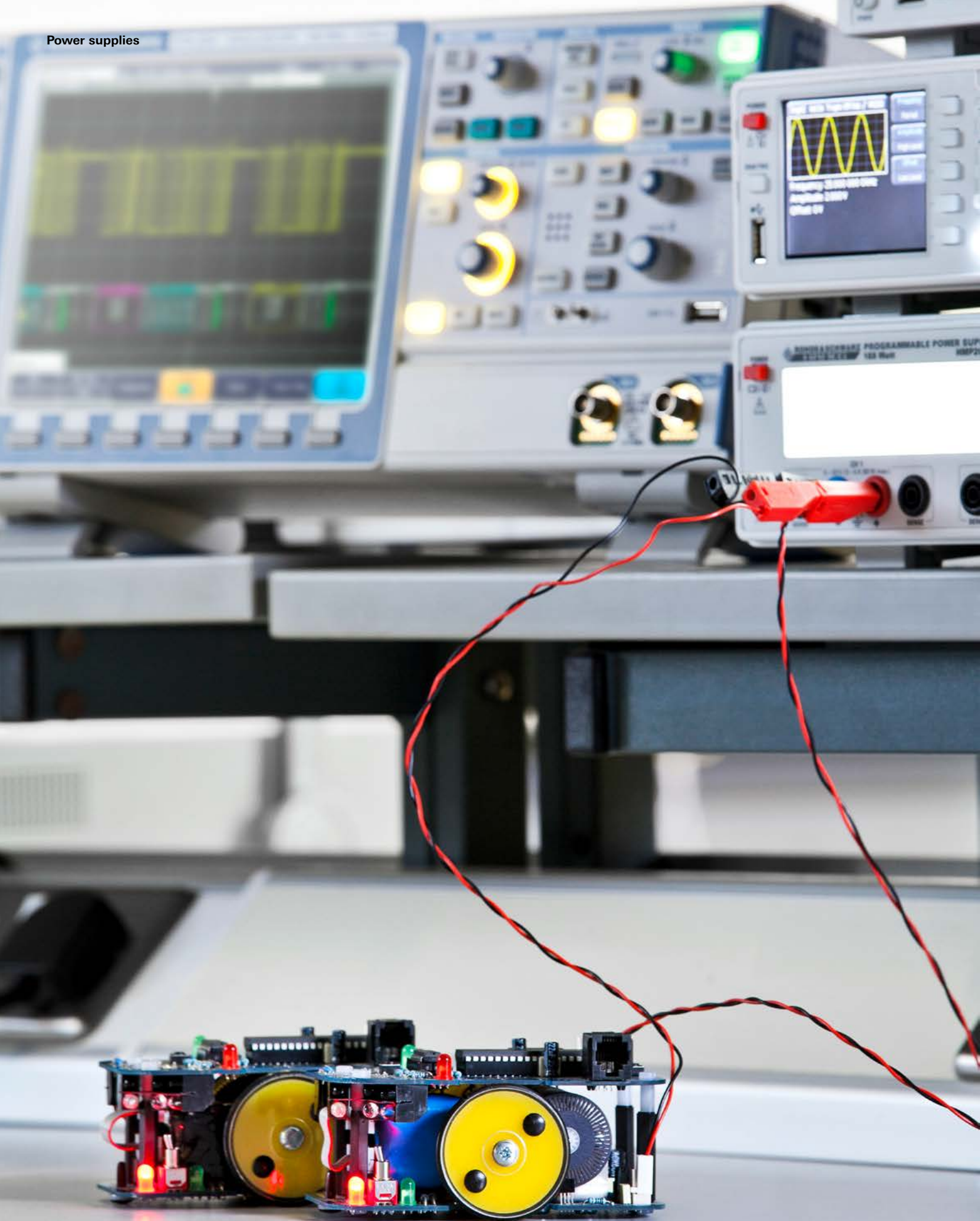

Chapter 12

Power supplies

Having the right power supply for the right application is crucial. Rohde & Schwarz provides a wide range of laboratory power supplies that are tailored to a variety of uses with the features required for a specific application.

Type	Designation	Description	Page
R&S®HMP4030 R&S®HMP4040	Programmable three/four-channel power supplies	384 W, up to 32 V and up to 10 A per channel	268
R&S®HMP2020 R&S®HMP2030	Programmable two/three-channel power supplies	188 W, up to 32 V and up to 10 A per channel	269
R&S®HMC8041 R&S®HMC8042 R&S®HMC8043	Programmable one/two/three-channel power supplies	100 W, up to 32 V and up to 10 A	270

R&S®HMP4030/R&S®HMP4040 Programmable Three/Four-Channel Power Supplies



384 W, up to 32 V and up to 10 A per channel

- ▮ R&S®HMP4030: 3 × 0 V to 32 V/0 A to 10 A (384 W)
- ▮ R&S®HMP4040: 4 × 0 V to 32 V/0 A to 10 A (384 W)
- ▮ Low residual ripple due to linear postregulators
- ▮ Realtime voltage, current and power values
- ▮ High setting and readback resolution: 1 mV and 0.1/0.2/1.0 mA (depending on current and model)
- ▮ FuseLink (electronic fuse) freely combinable for all channels
- ▮ FuseDelay tunable up to 250 ms
- ▮ EasyArb function directly programmable on device
- ▮ PC software (free of charge) for easy generation of user-defined waveforms
- ▮ Independently adjustable overvoltage protection (OVP) for each channel
- ▮ Advanced parallel and serial operation via V/I tracking
- ▮ Front connectors: 4 mm (0.16 in) safety sockets
- ▮ Rear connectors for all channels, including SENSE
- ▮ RS-232/USB dual interface, remote control via SCPI-based commands

Models/options

Designation	Type
Programmable Three-Channel Power Supply	R&S®HMP4030
Programmable Four-Channel Power Supply	R&S®HMP4040
Dual Ethernet/USB Interface	HO732
IEEE-488 (GPIB) Interface, galvanically isolated	HO740

Specifications in brief

Outputs	advanced parallel and series operation	<ul style="list-style-type: none"> ▮ simultaneous switching on/off of active channels via “output” button ▮ common voltage and current control using tracking mode (individual channel linking) ▮ individual mapping of channels which shall be affected by FuseLink overcurrent protection (switchoff) ▮ all channels galvanically isolated from each other and the protective earth
Compensation of lead resistances	sense	typ. 1 V
Overvoltage/overcurrent protection	OVP/OCP	adjustable for each channel
Electronic fuse		adjustable for each channel, may be combined using FuseLink
Response time		< 10 ms
Output values	R&S®HMP4040	4 × 0 V to 32 V/0 A to 10 A (5 A at 32 V, 160 W max.)
	R&S®HMP4030	3 × 0 V to 32 V/0 A to 10 A (5 A at 32 V, 160 W max.)
Residual ripple	voltage, 3 Hz to 100 kHz	< 150 µV (RMS)
	current, 3 Hz to 100 kHz	typ. < 1 mA (RMS)
	voltage, 3 Hz to 20 MHz	typ. 1.5 mV (RMS)
Arbitrary function EasyArb	parameters of points	voltage, current, time
	number of points	128
	dwelt time	10 ms to 60 s
	repetition rate	continuous or burst mode with 1 to 255 repetitions
	trigger	manually via keyboard or via interface

R&S®HMP2020/R&S®HMP2030 Programmable Two/Three-Channel Power Supplies



Models/options

Designation	Type
Programmable Two-Channel Power Supply	R&S®HMP2020
Programmable Three-Channel Power Supply	R&S®HMP2030
Dual Ethernet/USB Interface	HO732
IEEE-488 (GPIB) Interface, galvanically isolated	HO740

188 W, up to 32 V and up to 10 A per channel

- R&S®HMP2020: 1 × 0 V to 32 V/0 A to 10 A; 1 × 0 V to 32 V/0 A to 5 A (188 W)
- R&S®HMP2030: 3 × 0 V to 32 V/0 A to 5 A (188 W)
- Low residual ripple due to linear postregulators
- Realtime voltage, current and power values
- High setting and readback resolution: 1 mV and 0.1/0.2/1.0 mA (depending on current and model)
- FuseLink (electronic fuse) freely combinable for all channels
- FuseDelay tunable up to 250 ms
- EasyArb function directly programmable on device
- PC software (free of charge) for easy generation of user-defined waveforms
- Independently adjustable overvoltage protection (OVP) for each channel
- Advanced parallel and serial operation via V/I tracking
- Front connectors: 4 mm (0.16 in) safety sockets
- Rear connectors for all channels including SENSE
- RS-232/USB dual interface, remote control via SCPI-based commands

Specifications in brief

Outputs	advanced parallel and series operation	<ul style="list-style-type: none"> ■ simultaneous switching on/off of active channels via "output" button ■ common voltage and current control using tracking mode (individual channel linking) ■ individual mapping of channels which shall be affected by FuseLink overcurrent protection (switchoff) ■ all channels galvanically isolated from each other and protective earth typ. 1 V
Compensation of lead resistances	sense	
Overvoltage/overcurrent protection	OVP/OCP	adjustable for each channel
Electronic fuse		adjustable for each channel, may be combined using FuseLink
Response time		< 10 ms
Output values	R&S®HMP2030	3 × 0 V to 32 V/0 A to 5 A (2.5 A at 32 V, 80 W max.)
	R&S®HMP2020	1 × 0 V to 32 V/0 A to 10 A (5 A at 32 V, 160 W max.) 1 × 0 V to 32 V/0 A to 5 A (2.5 A at 32 V, 80 W max.)
Residual ripple	voltage, 3 Hz to 100 kHz	< 150 μV (RMS)
	current, 3 Hz to 100 kHz	typ. < 1 mA (RMS)
	voltage, 3 Hz to 20 MHz	typ. 1.5 mV (RMS)
Arbitrary function EasyArb	parameters of points	voltage, current, time
	number of points	128
	dwelt time	10 ms to 60 s
	repetition rate	continuous or burst mode with 1 to 255 repetitions
	trigger	manually via keyboard or via interface

R&S®HMC8041/8042/8043

Programmable One/Two/Three-Channel Power Supplies



Models/options	
Designation	Type
Power Supply, 3 channels, 100 W (33 W/channel, 3 A (max.)), with GPIB interface	R&S®HMC8043-G
Power Supply, 3 channels, 100 W (33 W/channel, 3 A (max.)), without GPIB interface	R&S®HMC8043
Power Supply, 2 channels, 100 W (50 W/channel, 5 A (max.)), with GPIB interface	R&S®HMC8042-G
Power Supply, 2 channels, 100 W (50 W/channel, 5 A (max.)), without GPIB interface	R&S®HMC8042
Power Supply, 1 channel, 100 W (10 A (max.)), with GPIB interface	R&S®HMC8041-G
Power Supply, 1 channel, 100 W (10 A (max.)), without GPIB interface	R&S®HMC8041

100 W, up to 32 V and up to 10 A

One, two or three channels – the R&S®HMC804x power supplies with their specifications and wide range of functions are ideal for use in development labs and industrial environments. Thanks to their high energy efficiency, the linear power supplies remain cool and quiet, even at maximum load. Practical interfaces and connectors allow users to work quickly and conveniently with the R&S®HMC804x, even in 19" racks.

Key facts

- ▮ 0 V to 32 V per channel, 3/5/10 A per channel (model dependent)
- ▮ High energy efficiency, low heat dissipation and quiet fans
- ▮ Low residual ripple due to linear postregulation
- ▮ Convenient parallel and serial operation via V/I tracking
- ▮ Overvoltage protection (OVP) for all outputs
- ▮ Overpower protection (OPP) for all outputs
- ▮ FuseLink (freely combinable electronic fuses)
- ▮ EasyArb function for user-definable V/I curves
- ▮ EasyRamp for simulating a start-up curve (directly programmable on device)
- ▮ Sequencing (sequenced start of channels)
- ▮ Analog input for external control via voltage (0 V to 10 V) and current (4 mA to 20 mA)
- ▮ Trigger input for starting/controlling EasyArb
- ▮ Data logging to USB flash drive in CSV format

Specifications in brief

Line and load regulation (sense connected)		
Constant voltage mode	R&S®HMC8043	< 0.02 % + 3 mV
	R&S®HMC8042, R&S®HMC8041	< 0.03 % + 5 mV
Constant current mode	R&S®HMC8043	< 0.03 % + 200 µA
	R&S®HMC8042, R&S®HMC8041	< 0.03 % + 300 µA
Voltage ripple, 20 Hz to 20 MHz (front connector) (V = 16 V, I = I _{max} × 0.5)	R&S®HMC8043, R&S®HMC8042	450 µV (RMS)/4 mV (V pp)
Current ripple, 20 Hz to 20 MHz (V = 16 V, I = I _{max} × 0.5)	R&S®HMC8041	1 mV (RMS)/5 mV (V pp)
	all models	typ. < 1 mA (RMS)
Response time with SENSE compensation	10% to 90% load change	1 ms (±20 mV)
Compensation of lead resistances	sense	typ. 1 V

Chapter 13

Multimeters, power analyzers

Get accurate and reliable voltage, current, power, frequency, impedance and temperature measurements with Rohde & Schwarz meters.

Type	Designation	Description	Page
R&S®HMC8012	Digital multimeter	5¼-digit digital multimeter (480 000 points)	272
R&S®HMC8015	Power analyzer	Multifunctional power analyzer	273



R&S®HMC8012 Digital Multimeter

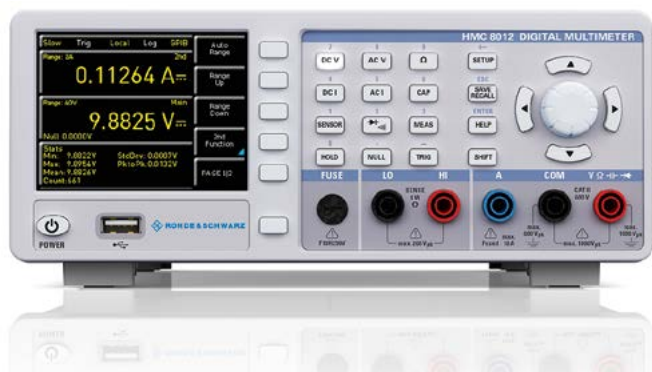

Models/options

Designation	Type
Digital Multimeter, 5½-digit	R&S®HMC8012
Digital Multimeter, 5½-digit, incl. IEEE-488 (GPIB)	R&S®HMC8012-G
IEEE-488 (GPIB) Interface, for R&S®HMC series	R&S®HOC740

5¾-digit digital multimeter (480 000 points)

- Measurement range: DC to 100 kHz
- Resolution: 1 µV, 100 nA, 1 mΩ, 1 pF, 1 Hz, 0.1 °C/F
- Basic accuracy: 0.015% (DC)
- True RMS measurement, AC and AC+DC
- 5¾-digit display (480 000 counts)
- Simultaneous display of three measurement functions, e.g. DC+AC+statistics
- Measurement rate: up to 200 values/s
- Measurement functions: V (DC), I (DC), V (AC), I (AC), frequency, resistance (two- and four-wire), temperature (PT100/PT500/PT1000), capacitance, diode and continuity test
- Mathematic functions: limit testing, min./max., average, offset, DC power, dB, dBm
- Data logging to internal memory or USB flash drive in CSV format
- Interfaces: USB-TMC/VCP, Ethernet (LXI) IEEE-488 (GPIB)
- SCPI commands largely compatible with Agilent 34410A

Specifications in brief

Display		<ul style="list-style-type: none"> ■ 5¾ digits (480 000 counts) ■ up to three values simultaneously ■ color TFT
Measurements		<ul style="list-style-type: none"> ■ voltage ■ current ■ frequency ■ power ■ resistance (two and four-wire) ■ temperature ■ capacitance ■ diode ■ continuity
Measurement rate		up to 200 values/s
Measurement range	voltage (DC/AC)	400 mV to 1000 V/750 V (5 ranges, resolution 1 µV)
	current (DC/AC)	20 mA to 10 A (4 ranges, resolution 100 nA)
	resistance	400 Ω to 250 MΩ (7 ranges, resolution 1 mΩ)
	capacitance	5 nF to 500 µF (6 ranges, resolution 1 pF)
Basic accuracy		0.015%
Frequency range	voltage (AC)	10 Hz to 100 kHz
	current (AC)	20 Hz to 10 kHz

R&S®HMC8015 Power Analyzer



Multifunctional power analyzer for measurements up to 100 kHz

Simultaneous acquisition of voltage and current, high resolution and a perfect balance between sampling rate and bandwidth: top-class technical characteristics and a wide range of functions make the R&S®HMC8015 power analyzer a practical choice for development labs and industrial environments, for service and support and for educational settings. State-of-the-art, powerful technology coupled with versatile and practical connection options meet the needs of a broad variety of users while satisfying demanding customer requirements.

Optional current probes significantly extend the power measurement range of the R&S®HMC8015. They are connected to the sensor input using 4 mm safety connectors.

- Measurement range: DC to 100 kHz
- Simultaneous measurement of voltage and current with separate 16 bit ADC's working in parallel
- Sampling rate: 2 × 500 ksample/s
- Basic accuracy: 0.05 %
- 26 measurement and mathematical functions
- Data logging to USB flash drive in CSV format or remotely via interface
- Oscillographic waveform diagram (HVC151 option)
- Display of harmonics as a bargraph or table (HVC151 option)
- Realtime integrator
- Limit tests with pass/fail indication (HVC152 option)
- Automatic measurement and reporting in line with EN 50564, EN 61000-3-2, IEC 62301 (HVC153 option)

Models/options

Designation	Type
Power Analyzer	R&S®HMC8015
Power Analyzer, incl. IEEE-488 (GPIB) interface	R&S®HMC8015-G
Advanced Analysis Option, voucher	HVC151
Advanced I/O Option, voucher	HVC152
One-Box Tester Option, voucher	HVC153
Line Adapter for R&S®HMC8015, EU connector	R&S®HMC815-EU
Line Adapter for R&S®HMC8015, GB connector	R&S®HMC815-GB
Line Adapter for R&S®HMC8015, US connector	R&S®HMC815-US
Line Adapter for R&S®HMC8015, CHN/AUS connector	R&S®HMC815-CHN
AC/DC Current Probe, 30 A, 4 mm connectors	R&S®HMC50
AC/DC Current Probe, 1000 A, 4 mm connectors	R&S®HMC51

Specifications in brief

Display		<ul style="list-style-type: none"> ■ 5 digits ■ split display for 6 or 10 values simultaneously ■ harmonics as bargraph or table (option) ■ graphical signal trend chart (option) ■ color TFT
Measurements		<ul style="list-style-type: none"> ■ voltage (RMS, AVG, PEAK) ■ current (RMS, AVG, PEAK), up to 1000 A with optional current probe ■ active power ■ apparent power ■ reactive power ■ power factor ■ phase shift ■ frequency ■ THD ■ energy ■ extended analysis (option)
Acquisition rate		simultaneous acquisition of voltage and current with 500 ksample/s
Measurement range	voltage	15 V to 1800 V (peak, 7 ranges, 100 μ V)
	current	15 mA to 60 A (peak, 12 ranges, 100 nA)
Basic accuracy		0.05 %

Chapter 14

System components

For demanding computational tasks, Rohde & Schwarz offers system controllers, switch units and test chambers that are versatile and flexible in everyday use. Excellent EMC shielding, reliable test results and modular solutions are core benefits of these instruments.

Type	Designation	Description	Page
R&S®OSP	Open switch and control platform	Modular solution for RF switch and control tasks	275
R&S®IQR	I/Q data recorder	Realtime recording and streaming of digital I/Q data	278
R&S®RSC	Step attenuator	Precise signal levels and high repeatability	279
R&S®QuickStep	Test executive software	Flexibility and excellent performance	280

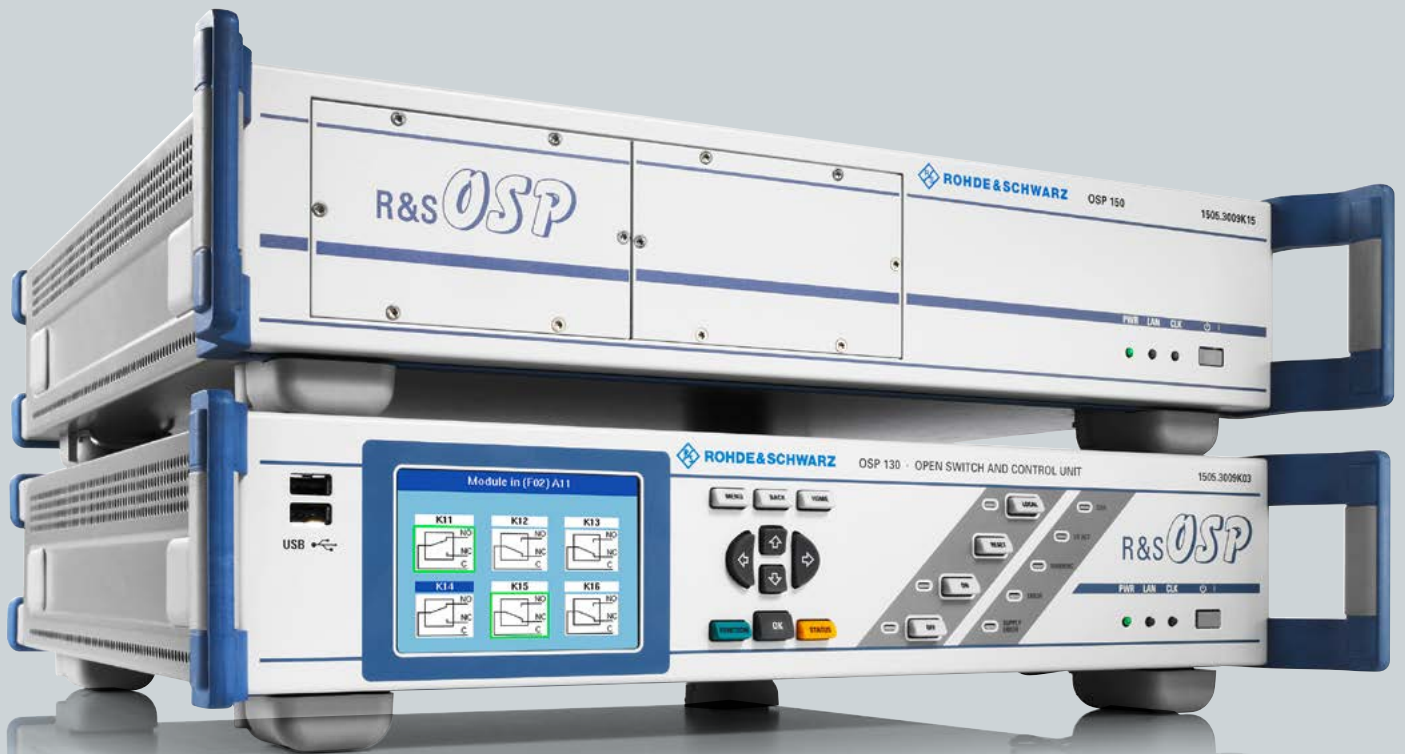

R&S®OSP Open Switch and Control Platform

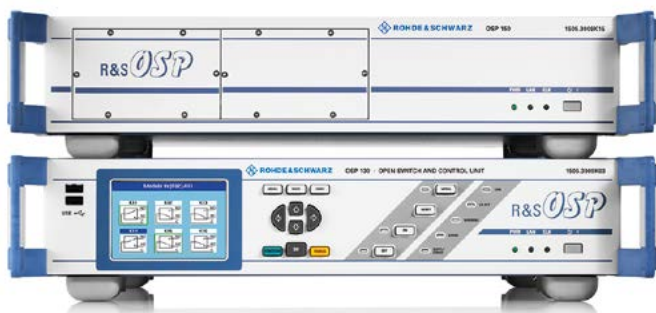

Modular solution for RF switch and control tasks

The R&S®OSP open switch and control platform is a modular platform designed to handle RF switch and control tasks. A number of optional modules make the R&S®OSP ideal for a wide range of applications from simple RF switch functions to automatic path switchover in complex RF test systems such as EMC systems.

The R&S®OSP120 and R&S®OSP130 base units can be controlled via Ethernet. The R&S®OSP130 has a display with a control panel. The individual switch and control modules of the R&S®OSP130 and of all connected R&S®OSP150 extension units can be manually operated using the control panel.

Modular, reliable, cost-efficient

The modularity of the R&S®OSP family helps ensure the fast setup of test and measurement configurations for applications in production, test labs and development departments. The ability to implement complex wiring by means of a single switch and control platform is an essential prerequisite for reliable and reproducible measurements that can be automated to enable cost-efficient test sequences.

Compact and flexible

The R&S®OSP units are accommodated in a compact 19" 2 HU cabinet. The sophisticated CPU control functionality provides maximum flexibility for controlling switch and control modules and makes high-performance external interfaces available.

Powerful control and RF relay modules

The switch and control modules are inserted into the three rear module slots¹⁾. The versatile 18 GHz or 40 GHz RF relay modules, 10 GHz semiconductor relay modules and digital input/output modules and modules with terminated relays can be combined as required, allowing users to configure the R&S®OSP cost-efficiently according to the application.

Special modules such as the R&S®OSP-B104, R&S®OSP-B114 and R&S®OSP-PM-I make it easier to implement EMS test systems.

Expandability

Up to four R&S®OSP150 extension units can be connected via the CAN bus port of the base units. This allows the range of functions of the base units to be considerably expanded while also making it possible to economically meet increasing requirements at a later point in time.

Easy control and system integration

All base units of the platform can be controlled via the Ethernet interface. This interface makes it possible to connect the platform directly to a PC, integrate it into test systems or remotely operate it via a corporate network.

Unlike the R&S®OSP120, the R&S®OSP130 has a control panel with a keyboard for direct manual operation of the R&S®OSP130 and any extension units that are connected. Manual operation of the R&S®OSP120 is possible by connecting an external keyboard and a monitor. The supplied operating software or a web GUI can be used to control the switch and control modules easily and directly without special software knowledge.

Of course, it is also possible to control the platform from application programs such as LabVIEW, LabWindows/CVI, Agilent VEE, C++, C#, Visual Basic, Visual Basic .NET.

¹⁾ As an alternative, it is also possible to insert one or two modules into the two front slots of the R&S®OSP120 and R&S®OSP150.

Front view of the R&S®OSP120 and rear view of the R&S®OSP

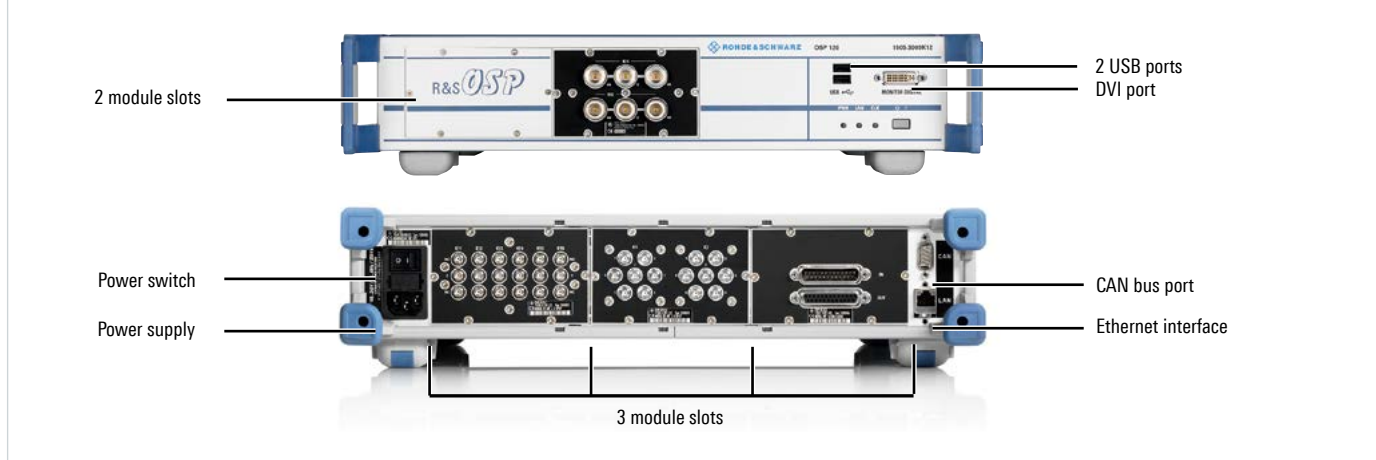

Combinations of the R&S®OSP120 or R&S®OSP130 with the R&S®OSP150

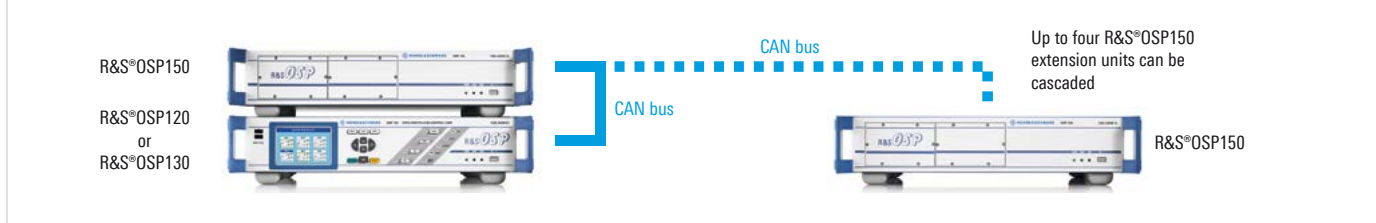

A few example modules



Overview of modules		
Designation and description	Type	Module width
Base units		
Open Switch and Control Platform, with monitor interface ¹⁾	R&S®OSP120	
Open Switch and Control Platform, with display and control panel ¹⁾	R&S®OSP130	
Extension Unit ¹⁾	R&S®OSP150	
Universal RF switch modules with SMA plug		
RF Switch Module, 6 × coaxial changeover relays (SPDT), 0 Hz to 18 GHz	R&S®OSP-B101	standard
RF Switch Module, 6 × coaxial changeover relays (SPDT), (SMA), 0 Hz to 18 GHz, latching	R&S®OSP-B101L	standard
RF Switch Module, 2 × coaxial multiposition relays (SP6T), 0 Hz to 18 GHz	R&S®OSP-B102	standard
RF Switch Module, 2 × SP6T (SMA), 0 Hz to 18 GHz, not terminated, latching	R&S®OSP-B102L	standard
RF Switch Module, 6 × coaxial changeover relays (SPDT), 0 Hz to 40 GHz	R&S®OSP-B111	standard
RF Switch Module, 2 × coaxial multiposition relays (SP6T), 0 Hz to 40 GHz	R&S®OSP-B112	standard
RF Switch Module, 2 × DPDT (SMA), 0 Hz to 18 GHz, not terminated	R&S®OSP-B116	standard
RF Switch Module, 1 × SP8T (SMA), 2 × SPDT (SMA), 0 Hz to 18 GHz, not terminated	R&S®OSP-B119	standard
RF Switch Module, 6 × SPDT (SMA), SSR, 9 kHz to 6 GHz	R&S®OSP-B107	standard
RF Switch Module, 6 × SPDT (SMA), SSR, 9 kHz to 10 GHz, terminated	R&S®OSP-B127	standard
RF Switch Module, n × SP6T (SMA), SSR, 9 kHz to 10 GHz, terminated, n = 1 to 3	R&S®OSP-B128	standard
RF Switch Module, 3 × DP3T (SMA), power SSR 10 W, 9 kHz to 8 GHz, ext. termination optional	R&S®OSP-B142	standard
RF Switch Module, 3 × SPDT (SMA), 0 Hz to 18 GHz, terminated	R&S®OSP-B121	standard
RF Switch Module, 3 × SPDT (SMA 2.92, K), 0 Hz to 40 GHz, terminated	R&S®OSP-B121H	standard
RF Switch Module, 1 × SP6T (SMA), 0 Hz to 18 GHz, terminated	R&S®OSP-B122	standard
RF Switch Module, 6 × SPDT (SMA) and 1 × SP6T, 0 Hz to 18 GHz, terminated	R&S®OSP-B123 ²⁾	double
RF Switch Module, 3 × SPDT (SMA) and 2 × SP6T, 0 Hz to 18 GHz, terminated	R&S®OSP-B124 ²⁾	double
RF Switch Module, 6 × SPDT (SMA) and 3 × SP6T, 0 Hz to 18 GHz, terminated	R&S®OSP-B125 ²⁾	triple
RF Switch Module, 3 × SP6T (SMA), 0 Hz to 18 GHz, terminated	R&S®OSP-B126 ²⁾	triple
RF Switch Module, 1 × SP8T (SMA), terminated, 2 × SPDT (SMA), not terminated, 0 Hz to 18 GHz	R&S®OSP-B129	standard
Universal RF switch modules with N plug		
RF Switch Module, 3 × SPDT (N), 0 Hz to 12.4 GHz and 3 × SPDT (BNC), 0 Hz to 900 MHz	R&S®OSP-B106	double
RF Switch Module, 2 × SPDT (N), 0 Hz to 12.4 GHz	R&S®OSP-B131	standard
RF Switch Module, 6 × SPDT (N), 0 Hz to 12.4 GHz	R&S®OSP-B132	double
RF Switch Module, 2 × DPDT (N), 0 Hz to 12.4 GHz	R&S®OSP-B136	standard
Special modules		
Passive Module for integration of one R&S®NRPxxS/SN or R&S®NRP-Zxx power sensor	R&S®OSP-PM-I	standard
EMS Module with drivers for four external power relays, additional digital inputs/outputs, interlock	R&S®OSP-B104	standard
EMS Module for small systems with 1 × N relay (DPDT), digital inputs/outputs, interlock with SPDT	R&S®OSP-B114	standard
Digital I/O Module, 16 × digital inputs, 16 × digital outputs	R&S®OSP-B103	standard
Digital I/O Module, 16 × digital inputs, 16 × RS-422 outputs, 4 × analog voltages	R&S®OSP-B158	standard
Multiplexer Module, 6-channel, 4-wire multiplexer	R&S®OSP-B108	standard

¹⁾ Accessories, see data sheet PD 5213.9928.22.

²⁾ The R&S®OSP-B119, R&S®OSP-B122 to R&S®OSP-B126 and R&S®OSP-B129 relay modules can be built in or retrofitted in the R&S®OSP120/130/150 models produced as of May 2010.

R&S®IQR I/Q Data Recorder



Realtime recording and streaming of digital I/Q data

The R&S®IQR is a high-speed recorder for recording and playing digital I/Q data streams. When used in combination with one Rohde & Schwarz instrument that has the R&S®Digital I/Q Interface, the R&S®IQR can store and play data in realtime.

The R&S®IQR is an ideal storage medium for applications such as providing interference or test signals, drive tests, realtime storage of data when archiving RF signals and for playing recorded I/Q signals. The I/Q data recorder is well suited for research and development applications, for drive tests when measuring GNSS signals, wireless communications and broadcast signals and for military applications.

- ▀ Recording and playing of digital I/Q data with a sample rate of up to 99.5 Msample/s or up to 398 Mbyte/s
- ▀ 2 × 16 bit I/Q data width
- ▀ Touchscreen for easy manual operation
- ▀ Two models for various requirements: R&S®IQR20 with up to 20 Msample/s and R&S®IQR100 with up to 99.5 Msample/s depending on the memory packs used
- ▀ Easily removable memory packs with hard disk drives (HDD) for stationary use and with solid state drives (SSD) for higher data rates and mobile use
- ▀ More than 10 hours recording of I/Q data with a bandwidth of 20 MHz (e.g. FM radio) when using the R&S®IQR-B138F memory pack (1.9 Tbyte)
- ▀ Very robust in combination with the R&S®IQR-B1xxF memory pack (SSD, no moving parts as with HDD)
- ▀ Very compact combination of devices for receiving (R&S®TSMW) and recording (R&S®IQR)
- ▀ R&S®IQR-K101 option allowing I/Q data recorded with the R&S®FSx or R&S®TSMW to be exported for further processing, e.g. to MATLAB®
- ▀ R&S®IQR-K102 option for GPS meta data recording, e.g. when performing drive tests with a combination of the R&S®TSMW and R&S®IQR
- ▀ R&S®IQR-K103 option uses the recorded coordinates (R&S®IQR-K102 option) to additionally display the traveled route or the current position on a map section
- ▀ R&S®IQR-K105 option supports the recording and export of multiplexed I/Q data streams using the R&S®TSMW
- ▀ Extensive internal and external trigger modes for controlling recording and playing
- ▀ Optional recording of and playing of two I/Q data streams using R&S®TSMW and two generators (R&S®IQR-K105 and -K107).

Specifications in brief

Data interfaces

DIGITAL IQ IN/OUT (R&S®Digital I/Q Interface)	no simultaneous data transfer in both directions	1 × I/Q input, 1 × I/Q output
	input clock rate	66 MHz to 100 MHz
	output clock rate	100 MHz
I/O 1 to I/O 8	trigger signals, synchronization signals	max. two trigger and synchronization signals
Reference clock	BNC input socket	10 MHz
	BNC output socket	10 MHz

I/Q data

I/Q word size		16 bit per channel
Sample rate	R&S®IQR20	1 ksample/s to 20 Msample/s
	R&S®IQR100	1 ksample/s to 99.5 Msample/s ¹⁾
Data rate	R&S®IQR20	up to 80 Mbyte/s
	R&S®IQR100	up to 398 Mbyte/s ¹⁾

¹⁾ Depending on the memory pack used.

R&S®RSC Step Attenuator



Precise signal levels and high repeatability

The R&S®RSC is a switchable, mechanical step attenuator. It is available in various models with different upper frequency limits (6 GHz or 18 GHz), maximum attenuation ranges and minimum settable step sizes. The R&S®RSC can also control external step attenuators with frequency ranges from DC to 40 GHz or 67 GHz.

The R&S®RSC step attenuator is an ideal choice in all applications that call for precise signal levels. Operation is intuitive and all settings are visible at a glance. Featuring high attenuation accuracy and high linearity, the R&S®RSC delivers reliable results and ensures stable conditions for the test setup. This simplifies work for developers of RF components.

In automated test systems, the R&S®RSC stands out for its high repeatability of 0.02 dB, long life and high reliability with specified 10 million switching cycles. Various frequency ranges from DC to 6 GHz, 18 GHz, 40 GHz and

67 GHz are available to meet the requirements of wireless communications, electronic products and aerospace and defense. The R&S®RSC is available with one internal step attenuator and allows up to four additional external step attenuators to be controlled.

The R&S®RSC offers a wide scope of functions, including frequency response correction and display of attenuation deviation relative to a nominal value. Moreover, it can display an overall attenuation value, taking into account additional test setup components such as high-power attenuators. The R&S®RSC covers a broad range of applications from power measurements to high-precision calibration.

Its low weight and compact dimensions make the R&S®RSC ideal for flexible applications in the lab. The step attenuator can be manually operated via its front panel keypad. The built-in screen shows current device settings at a glance. The R&S®RSC takes up just half a rack width (½ 19"). It can be delivered with RF connectors optionally on the front or rear panel. Various interfaces (IEC/IEEE, LAN and USB) are available for remote control. These features make the device ideal for system applications as well.

- Step attenuators with frequency ranges up to 6 GHz, 18 GHz, 40 GHz and 67 GHz
- Maximum attenuation ranges up to 139.9 dB, 115 dB and 75 dB
- Minimum step sizes of 0.1 dB, 1 dB and 5 dB
- Control of one internal plus up to four external step attenuators by a single R&S®RSC
- Outstanding accuracy due to frequency response correction and user calibration

Specifications in brief		R&S®RSC model .03/.13 ¹⁾	R&S®RSC model .04/.14 ¹⁾	R&S®RSC model .05/.15 ¹⁾	R&S®RSC-Z405 external step attenuator	R&S®RSC-Z675 external step attenuator
Frequency range		DC to 6 GHz	DC to 6 GHz	DC to 18 GHz	DC to 40 GHz	DC to 67 GHz
Attenuation range		0 dB to 139 dB	0 dB to 139.9 dB	0 dB to 115 dB	0 dB to 75 dB	0 dB to 75 dB
Connectors		type N (f)	type N (f)	type N (f)	2.92 mm (f)	1.85 mm (f)
Minimum attenuation step size		1 dB	0.1 dB	5 dB	5 dB	5 dB
Matching	up to	> 20 dB	> 20 dB	> 20 dB	> 20 dB	> 20 dB
Attenuation uncertainty (relative to attenuation at 0 dB)	up to	< 0.2 dB + 1% of attenuation value	< 0.07 dB + 0.5% of attenuation value (corrected)	< 0.6 dB + 1% of attenuation value	< 0.5 dB	< 0.5 dB
Repeatability		typ. 0.02 dB				
Maximum power handling capability	CW	1 W				
	pulse < 10 µs	200 W				
Maximum voltage	pulse < 10 µs	150 V				
Operating life		> 10 × 10 ⁶ switching cycles		> 1 × 10 ⁶ switching cycles		
Switching speed		< 25 ms		< 30 ms		

¹⁾ Model .0x: RF connectors on front panel; model .1x: RF connectors on rear panel.

R&S®QuickStep Test Executive Software

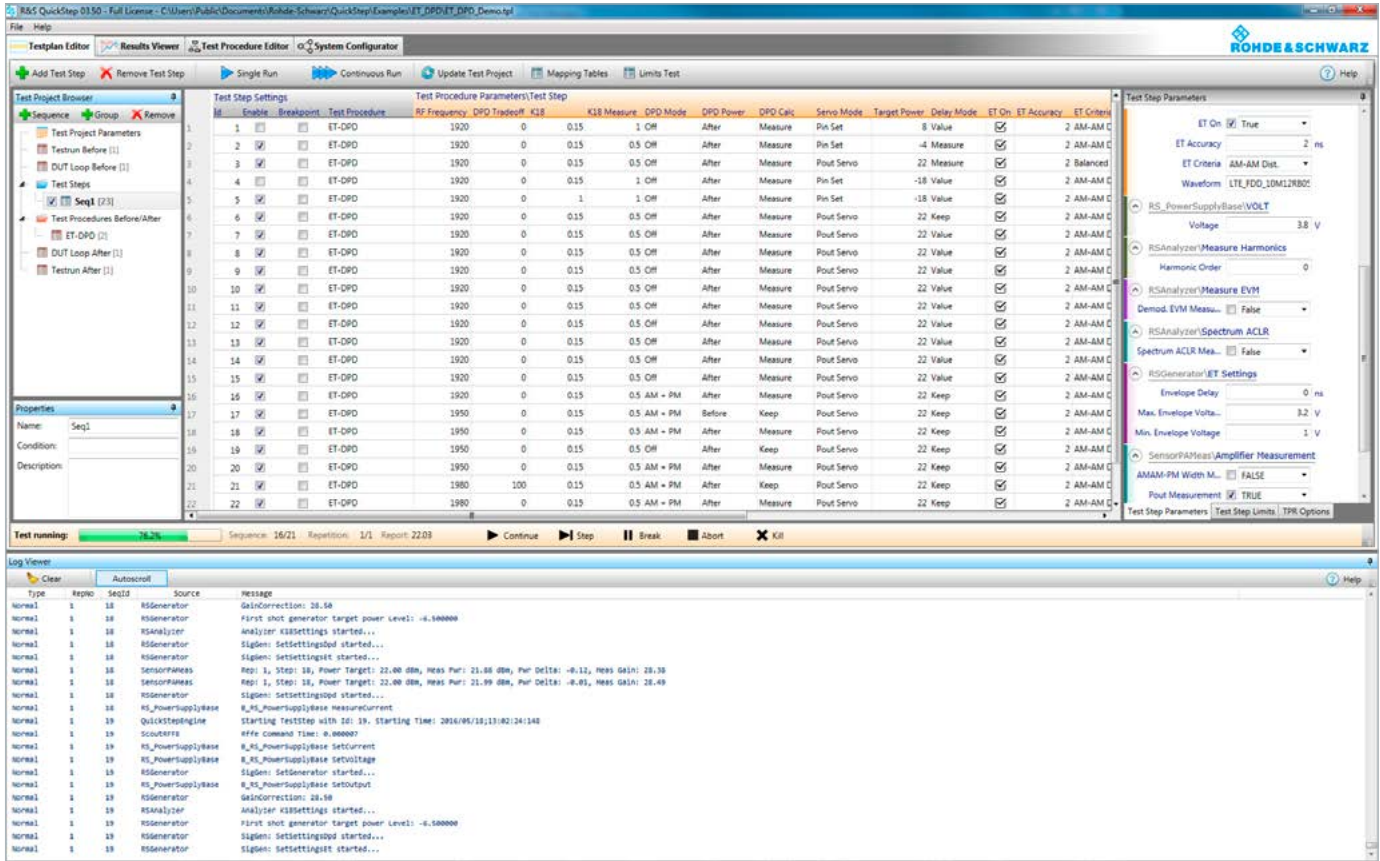

Test execution with R&S®QuickStep.

Flexibility and excellent performance

The powerful R&S®QuickStep test executive software fulfills the demanding performance requirements of production tests and provides the flexibility for test automation in R&D and verification. The use of R&S®QuickStep in combination with Rohde&Schwarz instruments significantly increases test development efficiency and minimizes the effort for transfer and correlation of tests between different test systems in R&D, verification and production.

R&S®QuickStep provides a high-speed test sequencer in combination with a powerful graphical user interface for the parameterization and control of test execution. Test procedures are designed in a graphical editor as flowcharts, based on the provided or additionally developed test functions. New test functions can be developed with Visual Studio® in C++ or C# based on automatically generated source code templates or in Python with R&S®Forum.

Users with different needs and profiles – including R&D engineers, application experts, test engineers, test technicians right up to the operator on the production floor – are involved in the development and execution of tests. R&S®QuickStep takes this into account by providing role-

specific graphical user interfaces and intrinsic workflows. Special software development skills and intensive education are not necessary, not even for the development of new test functionalities.

The use of one common test executive in all domains increases the efficiency of test development and shortens the time to market due to significantly reduced effort for test transfer and correlation.

- Performance-optimized design for low overhead test execution
- Intrinsic parallelism for efficient use of test system resources
- Role-specific graphical user interfaces with excellent usability
- Graphical editor for simple development of new test procedures
- Efficient and simple extension of available test functions
- Development of new functions in C++ or C# with Microsoft Visual Studio® based on source code templates
- Development of new functions in Python in combination with R&S®Forum
- Graphical test procedure editor

Appendix

Service and support



Description	Page
Rohde & Schwarz contact information	282
Service that adds value	283
Training and application support	286
The future lies with systems	288
Service for systems	290
Global sales and service locations, trademarks	292
Index by type	293

Rohde & Schwarz contact information

Rohde & Schwarz GmbH & Co. KG

www.rohde-schwarz.com

Corporate communications

Rohde & Schwarz GmbH & Co. KG
Corporate Communications
Mühlendorfstraße 15
81671 Munich, Germany
Phone +49 89 4129 139 58
Fax +49 89 4129 135 63
press@rohde-schwarz.com

Sales

The addresses of the local sales companies can be found at: www.sales.rohde-schwarz.com

Rohde & Schwarz training

www.training.rohde-schwarz.com

Customer support

Our regional support centers will be happy to answer any questions regarding our products and service:

- Europe, Africa, Middle East
Phone +49 89 4129 123 45
customersupport@rohde-schwarz.com
- North America
Phone 1 888 837 87 72 (1 888 TEST RSA)
customer.support@rsa.rohde-schwarz.com
- Latin America
Phone +1 410 910 79 88
customersupport.la@rohde-schwarz.com
- Asia Pacific
Phone +65 65 13 04 88
customersupport.asia@rohde-schwarz.com
- China
Phone +86 800 810 82 28 (+86 400 650 58 96)
customersupport.china@rohde-schwarz.com

Rohde & Schwarz Cybersecurity

Rohde & Schwarz Cybersecurity is an IT security company that protects companies and public institutions around the world against espionage and cyberattacks. With around 400 employees, the company develops and produces technologically leading solutions for information and network security. Development of the trusted IT solutions is based on the security-by-design approach for proactively preventing cyberattacks.

Rohde & Schwarz Cybersecurity GmbH

Mühlendorfstraße 15 | 81671 München
Info: +49 89 4129-206 000
E-mail: cybersecurity@rohde-schwarz.com
www.cybersecurity.rohde-schwarz.com

Plants

Memmingen plant

info.memmingen@rohde-schwarz.com

Teisnach plant

info.teisnach@rohde-schwarz.com

Vimperk plant

info.vimperk@rohde-schwarz.com

Singapore and Malaysia plants

Phone +65 6307 0000

Service that adds value

Dear Customers,
we are often asked what has made Rohde & Schwarz so successful over so many decades and enabled the company to drive technological progress in its fields of business. One aspect is the passion with which we work every day in our development labs to push the limits of what is physically feasible. Another is our desire to create only products that meet customer expectations in terms of technology, functionality and quality.

Our service philosophy is another key factor to our success. For us it goes without saying that we offer our customers the best possible support in all phases of the product lifecycle. We therefore provide a wide variety of customized service offerings, which we plan in dialog with our customers and our specialists as early as the product development phase. This lets us identify and cater to individual needs early on, in order to minimize costs while maximizing availability and autonomy. Our comprehensive and continually growing range of services is designed to ensure that you are satisfied with every aspect of our products. We are convinced that this commitment, implemented by our worldwide network of dedicated, expert service personnel, is one of the major factors behind the success of our company.

Investment protection, tailor-made

Rohde & Schwarz offers full-range service at your command. You can mix and match our services according to your technical and budgetary requirements.

R&S® Extended Warranty

The R&S® Extended Warranty offers cost control while giving you full service from the start. If there is a problem, you are insured against extra service costs. For a fraction of the purchase price, you can rest easy for years with the security afforded by manufacturer service.

- ▮ Low, predictable costs
- ▮ Safe and dependable
- ▮ Transparent and flexible

To make sure you get the full benefit of the functionality and precision of your instruments for the longest possible time, we offer a range of services that are tailored to your specific needs. Choose extended warranty for complete protection in case of repair, or the attractive extended warranty with calibration coverage package for additional regular calibration of your instrument. Both are available with terms of one to four years.

Extended warranty:

- ▮ Repair in case of malfunction
- ▮ R&S® Manufacturer Calibration if necessary during repair
- ▮ Firmware updates
- ▮ Preventive maintenance and reliability modifications

Extended warranty with calibration coverage additionally covers:

- ▮ Planned calibrations in line with Rohde & Schwarz guidelines and ISO/IEC 17025
- ▮ Calibration as needed during technical upgrades

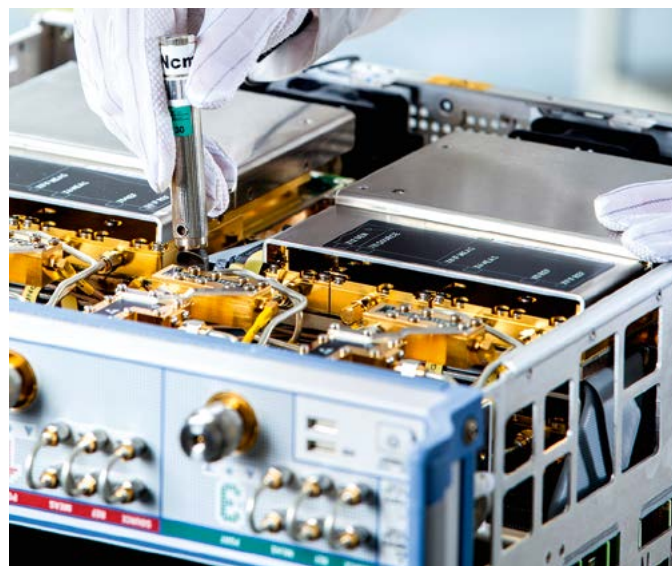

Rohde & Schwarz calibration services

Our various calibration products enable us to tailor our services to your individual needs. Whether you choose our Rohde & Schwarz manufacturer calibration or a Rohde & Schwarz accredited calibration – you will always receive a service package that is more complete and comprehensive than what a pure service provider can provide. We offer attractive contract solutions for all our products. Our sales and service representatives will be happy to help you determine the right solution for your requirements.

R&S® Accredited Calibration

R&S® Accredited Calibration ensures compliance with international standards and calibration data traceability. Many standards require R&S® Accredited Calibration as proof of competence. Our accredited service centers not only measure accredited parameters, they also verify all product characteristics. R&S® Accredited Calibration is as comprehensive and in-depth as R&S® Manufacturer Calibration and provides additional accreditation documentation.

R&S® Manufacturer Calibration

R&S® Manufacturer Calibration ensures you a comprehensive range of services. As the manufacturer, we take care of all required adjustments, software updates and hardware modifications. We document each calibration with a certificate that contains both the incoming and outgoing status of your instrument. This enables you to evaluate your instrument's past performance and draw conclusions

about future performance. Like all Rohde & Schwarz calibrations, R&S® Manufacturer Calibration is based on national and international standards.

Multivendor Performance Calibration

We also service other manufacturers' instruments. As an equipment manufacturer, we know the relevant parameters for a definitive calibration. That is what makes us a competent partner for calibrating other manufacturers' instruments. During multivendor performance calibration, all required manufacturer-specified instrument parameters are measured. You receive a calibration certificate and documentation of measurement results. These services are also available as accredited services.

Depot calibration

Take advantage of all the benefits of our fast and efficient depot service. With Rohde & Schwarz depot calibration, your instrument is returned after just a few days. Express depot calibration takes just one day plus shipping time. We will be happy to take care of the logistics for you – just ask.

On-site calibration

Would you like to reduce your downtime even more? We can come to you with our mobile calibration system – no need for time-consuming packing and shipping. Our sales and service representatives will be happy to sit down with you and tailor a calibration concept to your needs.

	R&S® Accredited Calibration	R&S® Manufacturer Calibration	Multivendor Performance Calibration
ISO 17025 accredited	•	–	optionally accredited
ISO 9001 certified	•	•	•
Calibrated in line with ISO 17025	•	•	•
Traceability to national/international standards	•	•	•
Virus and malware scan for Rohde & Schwarz products	•	•	•
Incoming results	•	•	•
Comprehensive measurement in line with manufacturer specifications	•	•	•
Firmware update	•	•	–
Required adjustments	•	•	–
Preventive maintenance/performance modifications	•	•	–
Outgoing results (after repair or adjustment)	•	•	–
Calibration certificate	•	•	•
R&S® Online Service Management	•	•	•
Service report	•	•	•
Cleaning	•	•	•
Electrical safety test	•	•	•

Rohde&Schwarz standard price repair

If a Rohde&Schwarz product ever does need to be repaired, smooth handling is required: without hassle, without losing time and without any unpleasant surprises regarding costs. That's why Rohde&Schwarz offers its customers a standard price repair option: an intelligent comprehensive solution featuring guaranteed all-inclusive fixed prices, little handling effort and efficient procedures.

Scope of the Rohde&Schwarz standard price repair:

- ▮ Repair of the equipment
- ▮ Full calibration in line with ISO 17025, including documentation of the test results¹⁾
- ▮ 12-month service warranty on the entire equipment²⁾
- ▮ Latest firmware and hardware updates³⁾

With the standard price repair, you are always on the safe side:

- ▮ Defined fixed price
- ▮ Smooth handling
- ▮ Minimum effort
- ▮ Reliable repair by the manufacturer
- ▮ Updates and calibration included
- ▮ Extensive service warranty

R&S®Online Service Management

R&S®Online Service Management provides you with a clear overview and helps you save time by simplifying the management of instrument data, service cases and test equipment. You also benefit from numerous service management functions. A clear user interface makes operation intuitive.

Advantages

- ▮ **Secure:** R&S®Online Service Management gives you secure access to all service-related data, 24/7. Just log on to the password-protected area at my.rohde-schwarz.com/service to conveniently manage your service requests and calibration schedule, wherever you are
- ▮ **Comprehensive:** To make sure that you have more time for your core business, we put all your instrument data together in one place for an easy overview. It shows you all the documentation and configuration data for your instruments, as well as the status of repairs and calibrations. At a glance, you can track service cases, make new requests and see active and inactive warranties

¹⁾ For equipment requiring calibration.

²⁾ Applies to the repaired component if the system consists of several components, e.g. amplifier modules. Please see our General Conditions of Delivery and Service for more warranty information.

³⁾ Such modifications, e.g. precautionary component replacement, are performed as part of the continuous product improvement process and do not change the specifications or other product characteristics.

- ▮ **Efficient:** A good management system should make even complex things easier. The R&S®Online Service Management helps you organize your service cases, making previous, current and scheduled calibrations easy to enter and manage. The easy operation and clear navigation save you time as well as unnecessary paperwork

Functions and operation

- ▮ **Equipment:** Manage your equipment – see at a glance whether an instrument was recently calibrated or needs to be in the near future
- ▮ **Service requests:** Place service requests, track the status of orders or review past services. You can also download calibration and service reports
- ▮ **Contracts and more:** Keep your contracts in view and store your personal data – user, division, contact information and much more



Training and application support

The product portfolio of Rohde & Schwarz is accompanied by a comprehensive choice of training seminars and detailed application notes. By offering comprehensive application notes and practice-oriented training, we want to show you how to use our products most effectively. This ranges from first-time users who can choose from detailed introductory courses and practical T&M examples up to seasoned users who can gain deep insight into the numerous – and very special – ways to use the high-performance solutions from Rohde & Schwarz.

Training

The extensive choice of seminars includes everything from standard training classes on numerous topics in radio engineering and test and measurement to practice-oriented product training for Rohde & Schwarz solutions. If needed, customer-specific training programs specially designed to meet your wishes and requirements are held in order to achieve optimum benefit for the participants. Skilled trainers convey concise, practice-oriented knowledge at our state-of-the-art, fully equipped training center in Munich. Alternatively, training can also be held on the customer's premises or at any other location of choice. Limiting the number of participants helps ensure better communications between participant and trainer.



Knowledge is conveyed more intensely and extra time is available for questions so that the participants can put their newly gained knowledge and skills into practice immediately after the seminar.

Comprehensive choice of training seminars		
<p>Standard seminars Detailed seminars are offered on numerous topics in radio engineering and T&M such as RF and EMC testing, as well as classes covering the fields of wireless communications, television and antennas from the basics up to workshop level.</p>	<p>Customized seminars These seminars aim at providing optimum benefit for customers and their participants. The training content is tailored specifically to the customer's wishes and requirements.</p>	<p>Hands-on experience Practical exercises are an essential part of all seminars to help ensure that the material just learned can be tried out immediately using state-of-the-art test setups. This is crucial for understanding and clarifying the training content in detail.</p>
<p>Small groups The number of participants is intentionally kept small so that everyone has sufficient time for questions as well as the opportunity to try out the class content in a hands-on environment.</p>	<p>Trainers/training staff The trainers continuously keep their technical knowledge up to date. They not only possess technical expertise, they are also able to convey it in an understandable and lasting manner.</p>	<p>Location Classes may be held at the state-of-the-art training center at company headquarters in Munich. Optionally, seminars can take place on the customer's premises or at any other suitable location.</p>
<p>Timetable Standard training classes are scheduled twice a year. For dates, see the Rohde & Schwarz homepage. The schedule for customized seminars is drawn up together with the individual customer.</p>	<p>Languages The seminars are conducted either in German or English. If needed, special training classes can be held in other languages.</p>	<p>Registration and organization All detailed information regarding the seminars – including class descriptions, registration, cost, procedure and content – is provided on the Rohde & Schwarz homepage.</p>

Skill and up-to-date knowledge are top priorities in all our seminars. The company's intensive participation in relevant bodies – such as for the standardization of state-of-the-art wireless communications – is reflected in training classes, which are always cutting-edge both in theory and T&M expertise. Our customers also benefit from this.

Application support

Rohde&Schwarz has created a series of application notes, application cards and application videos to share our knowledge of instruments, principles and methods and to assist you in getting the best performance from your Rohde&Schwarz instruments. Comprehensive white papers inform about changes in standardization, latest trends in our fields of business, or the state of the art in emerging technologies.

- Local application engineers help you successfully implement your specific application on site using Rohde&Schwarz T&M solutions and provide advice on all T&M matters
- Application-relevant questions will be answered at tm-applications@rohde-schwarz.com
- A large number of application notes, often combined with helpful application programs or T&M examples, can be downloaded from www.rohde-schwarz.com/appnote
- Use apps from Rohde&Schwarz on your smart phone or tablet on Google Play, Apple App Store or Windows Phone Store



Abstracts of some popular application notes

Download application notes from www.rohde-schwarz.com/appnote

Narrowband Internet of Things (3GPP NB-IoT) White Paper (1MA266)

As part of Release 13, 3GPP has specified a new radio interface. NB-IoT is optimized for machine-type traffic. It is kept as simple as possible in order to reduce device costs and to minimize battery consumption. In addition, it is also adapted to work in difficult radio conditions. In this white paper we introduce the NB-IoT technology and its close connection to LTE.

Doherty, Balanced, Push-Pull & Spatial Amplifier Optimization Application Note (1MA279)

The advent of 5G, with its inevitable microwave and millimeterwave air interfaces, increase the design challenges associated with its construction; not least of all because of the potential for increased dispersion in the constituent amplifiers and combiners. This application note describes a measurement-based development methodology by which the Doherty amplifier may be enhanced, increasing performance and/or performance bandwidth. The methodology may also be extended to balanced, spatially combined and anti-phase ("push-pull") amplifiers.

R&S®Commander – Versatile Software Tool for use with Rohde & Schwarz Instruments (1MA74)

R&S®Commander is a popular software tool that makes your daily business easier when operating Rohde&Schwarz T&M instruments and especially when using them via remote control. In addition to many other useful functions, screenshots from T&M instruments can be generated and trace data can be output in order to process it on your computer. The tool also provides convenient access to the T&M equipment's file management system.

Radar Echo Generator – Application Note (1MA283)

In-the-field RADAR tests are expensive to carry out and have a complicated setup and operation. One of the main advantages of the radar echo generator is its ability to generate arbitrary virtual radar echo signals in realtime in the laboratory using only commercial measurement equipment. This not only allows to reproduce the results and automate the tests, but also significantly reduces measurement efforts and costs while providing greater utility for the existing common test equipment. This application note presents a solution for testing the complete radar system by generating any kind of radar echo signals with arbitrary range, doppler frequency and radar cross section.

The future lies with systems

Customer-specific solutions are implemented to an increasing extent by integrating measuring instruments and specially developed devices into overall systems. Rohde & Schwarz has many years of experience implementing turnkey EMC test centers, conformance test systems for mobile phones, mobile test systems for coverage measurements and mobile phone production lines.

System applications

In numerous branches of industry, measurements and tests often have to be carried out repeatedly on a series of DUTs, e.g. in:

- Incoming inspection: component and module tests
- Production: automatic alignment
- Quality assurance: testing at the various stages of production and final testing
- Research and development: series measurements on prototypes
- Service: long-time measurements (e.g. of temperature) at defined test intervals

Project handling by Rohde & Schwarz

A high-performance measurement system requires extensive development and design efforts. The choice of the right instruments and components as well as their careful installation are essential for the high performance and availability of a system.

System design at Rohde & Schwarz ensures full utilization of a large variety of measuring instruments of advanced technology and highest precision from both Rohde & Schwarz and other manufacturers. System responsibility lies always with Rohde & Schwarz, irrespective of the origin of the measuring equipment and individual system components.

Rohde & Schwarz has experienced, optimally trained staff to implement a project from the initial planning to the operational system.

Rohde & Schwarz test systems

- Production test systems, board testers
- Conformance test systems for mobile phones
- Conformance test system for IEEE802.11p
- Mobile network testing systems for cellular networks
- EMC and antenna test systems

Production test systems, board testers – a strong concept

A development and production chain is only as strong as its weakest links, which used to be highly complex measurement systems and time-consuming final testing. Market launch of the products was often subject to delays. Today, to reduce test time, production test systems and conformance systems from Rohde & Schwarz can be used wherever electronic equipment is produced. Efficient solutions in this field range from precompliance test equipment to complete production lines.

The unique Rohde & Schwarz modular hardware and software concept supports a large variety of test combinations for alignment, RF test, optical check, board test, etc.

Our production test systems are tailored to customer needs and provide overall solutions: measurements with DUT adaptation also in the RF range via test prods; with conveyor belts; networking within user-specific computer networks; logistics; consulting and advice regarding the selection of suitable tests for optimizing measurement times and test depth.

Conformance test systems for mobile phones and devices of digital radio networks

Rohde & Schwarz test systems, especially for conformance testing, are at the leading edge in their field. Our customers benefit from this high innovation potential. Specialists at Rohde & Schwarz implement the latest requirements for



conformance measurements in the appropriate test systems using ultramodern measuring equipment from our production.

This synergy of available equipment and new system applications yields optimum results. For instance, it is possible to achieve maximum test depth while ensuring the highest degree of ergonomics and operational reliability. Another great advantage is self-calibration. Customers can utilize all these benefits to make their products fit for both present-day and future markets.

Mobile network testing systems for cellular networks

Rohde&Schwarz test systems are not only used where electronics is produced but also where it is made to work: in mobile radio networks, for instance. Our range of mobile coverage and quality measurement systems ensures full monitoring of mobile radio networks as well as smooth, optimal operation.

EMC and antenna test systems

Rohde&Schwarz offers test systems and turnkey test facilities including:

- ▮ Electromagnetic compatibility (EMC)
- ▮ Radiated spurious emission (RSE) and audio breakthrough (ABT)
- ▮ Radiated test of wireless devices (OTA)
- ▮ Antenna test
- ▮ Regulatory test
- ▮ Electromagnetic field measurement (EMF)
- ▮ Interference test
- ▮ Test environment for development, certification and production

Rohde&Schwarz offers complete test systems that can handle all complex aspects in this field. Precompliance tests at the manufacturer, acceptance tests in accredited test houses, market monitoring by government authorities – Rohde&Schwarz always provides an appropriate solution ranging from the compact system based on a test cell to the complete test center.

Applications

- ▮ Commercial
- ▮ Wireless
- ▮ Automotive components
- ▮ Automotive vehicles
- ▮ Aerospace and defense
- ▮ Medical

Future-oriented design

Rohde&Schwarz measurement and test systems feature extremely flexible hardware and software concepts that allow adaptation to modified requirements at any time.

References

Rohde&Schwarz measurement and test systems are successfully used all over the world. Tailored to the needs of the customers, the test systems can be found at renowned industrial companies, test houses and government institutes – an impressive list of references can be supplied on request.

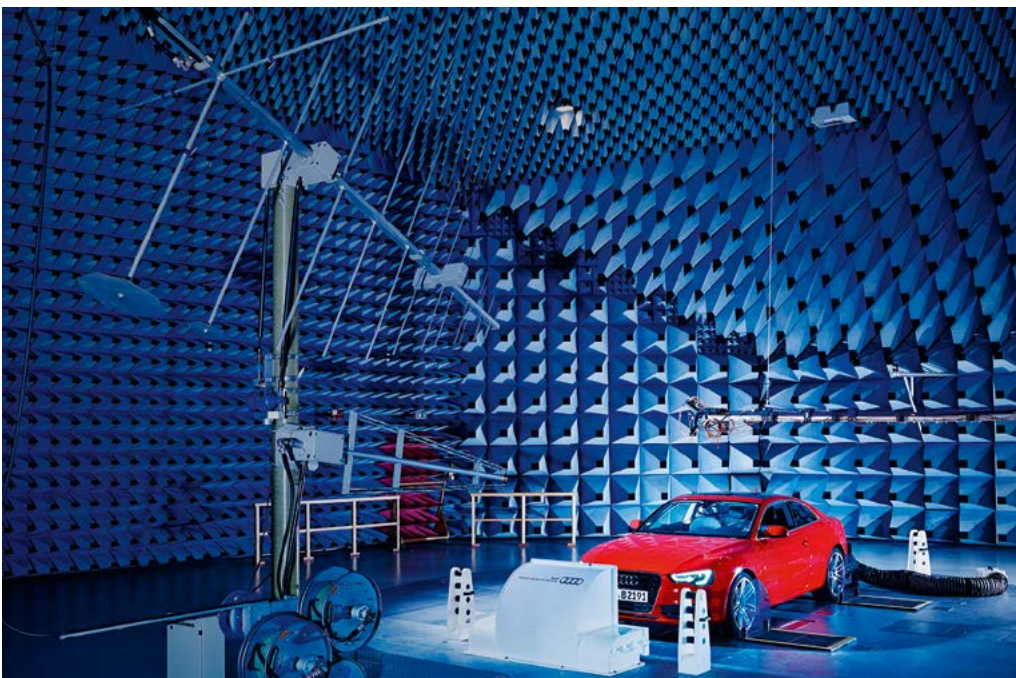

Rohde & Schwarz service for conformance test systems

Rohde & Schwarz systems combine the latest achievements in hardware and software with the know-how and experience gained over many decades. In line with the Rohde & Schwarz system philosophy, the high level of expertise does not stop with system development, but is maintained during the operational life of the systems thanks to the services offered. Hotline support, continual updating of system software and test cases, fast repair and replacement of faulty equipment and modules are essential for maintaining high system availability. Rohde & Schwarz offers complete packages and solutions for servicing the systems. Our objective is customer satisfaction throughout the entire product lifecycle.

Calculable operating costs

Unexpected downtimes disrupt operations and tie up valuable resources in administrative and order approval procedures. Unfortunately, failures in highly complex systems and equipment can never be fully excluded – but



the time and expense associated with such failures can. Rohde & Schwarz system service contracts mean calculable operating costs and allow you to focus on your core tasks.

Contractually assured services

Rohde & Schwarz offers full-range service for test systems. As the original equipment manufacturer, we provide the most qualified, responsive and thorough service available. Customer care is especially important to us. We support you with services tailored to your needs:

- ▮ Short response times are ensured by the Rohde & Schwarz problem report database
- ▮ Short system downtimes due to spare instruments pool
- ▮ High availability of loan units
- ▮ Excellent support by experienced system specialists

After-warranty service

The after-warranty service supplements the standard warranty services of Rohde & Schwarz to satisfy the high demands placed on maximum system availability, optimum performance and efficiency.

Problem report service

- ▮ Access to the Rohde & Schwarz problem report database
- ▮ Analysis of the problem reports and test logs, including tests on Rohde & Schwarz reference test systems
- ▮ Solution proposals

Hotline service

- ▮ Designated support engineer available for all questions related to system hardware, software, functionality and handling

Repair service

- ▮ Repair of system hardware – if possible on-site
- ▮ Access to common pool of loan units, calibrated by an accredited Rohde & Schwarz laboratory
- ▮ Escalation procedure to provide additional resources if problems arise during repair
- ▮ Associated travel and transport cost

Proactive on-site customer visits by system support specialists

- ▮ System performance optimization
- ▮ Face-to-face consultation to maximize system utilization
- ▮ Up-to-date information on the latest software enhancements
- ▮ Collecting requests for new features

Software service

Software service includes enhancements of purchased features and ensures compliance with the latest revisions of industry-standard specifications.



- Implementation of changes in line with relevant 3GPP test specifications and network operator test plans
- Revalidation of GCF/PTCRB relevant test cases (to be performed by approved test laboratories)
- Bug fixes and minor enhancements
- Delivery of updated software including documentation

Service for systems under warranty

The comprehensive standard system warranty from Rohde&Schwarz also includes all after-warranty and software services.

Calibration service

Calibration service assures that system parameters will be checked at recommended system calibration intervals. A correction and/or update will be performed if required.

- R&S®Accredited Calibration in line with EN ISO/IEC 17025 and DIN EN ISO 9001
- Recommendation of system-specific calibration intervals
- Traceability of calibration results to national and international standards
- Delivery of calibration certificates and service reports
- On-site calibration (R&S®Accredited Calibration and R&S®Manufacturer Calibration) for a minimum downtime

Ensuring best product performance through regular maintenance and calibration

Preventive care and maintenance improve a product's reliability and performance. During regular system calibration, our mobile calibration teams take utmost care to maximize equipment reliability and availability. Using our modern test and diagnostic systems, we perform a detailed analysis of your equipment and can detect the first signs of irregularities of any type. Calibration at Rohde&Schwarz is considerably more than merely checking compliance with specifications. We keep your equipment in top shape.

Always on the safe side with Rohde & Schwarz system service contracts

- Defined price
- Smooth handling
- Minimum downtime
- Efficient processes
- Reliable repair by the manufacturer
- 12-month service warranty

Supported systems

- | | | |
|--------------|-----------------|---------------|
| ■ R&S®TS8980 | ■ R&S®TS-ITS100 | ■ R&S®CMW-ATE |
| ■ R&S®TS8991 | ■ R&S®TS-LBS | ■ R&S®CMW-POA |
| ■ R&S®TS8997 | ■ R&S®TS-RRM | |

Global sales and service locations



Trademarks

Trade names are trademarks of the owners

- R&S® is a registered trademark of Rohde&Schwarz GmbH&Co. KG. Example: R&S®FSC spectrum analyzer
- Windows® is a registered trademark of Microsoft Corp., USA
- WiMAX™ Forum is a registered trademark of the WiMAX Forum. WiMAX, the WiMAX Forum logo, WiMAX Forum Certified and the WiMAX Forum Certified logo are trademarks of the WiMAX Forum
- The Bluetooth® word mark and logos are registered trademarks owned by Bluetooth SIG, Inc. and any use of such marks by Rohde&Schwarz is under license
- CDMA2000® is a registered trademark of the Telecommunications Industry Association (TIA-USA)
- Dolby® is a registered trademark of Dolby Laboratories.
- The terms HDMI™ and HDMI High-Definition Multimedia Interface and the HDMI logo are trademarks or registered trademarks of HDMI Licensing LLC in the United States and other countries.
- MHL™, Mobile High-Definition Link and the MHL Logo are trademarks or registered trademarks of the MHL, LLC.

Published by

Rohde&Schwarz GmbH&Co. KG
 Arrangement, layout: Gerhard Krätschmer, department 5MS1

Index by type

Type	Designation	Page
A		
R&S® AdVISE	Visual Inspection Software	199
R&S® AFQ100A	I/Q Modulation Generator	114
R&S® AFQ100B	UWB Signal and I/Q Modulation Generator	114
R&S® AFQ-Kxxx	Application-Specific Solutions (firmware or software – overview)	117
R&S® AM524	Active Antenna System	210
R&S® AVBrun	Pre-Conformance Testing in line with D-Book, NorDig and E-Book	245
B		
R&S® BBA150	Broadband Amplifier	200
R&S® BBL200	Broadband Amplifier	201
R&S® BCDRIVE	Broadcast Drive Test Software	261
R&S® BTC	Broadcast Test Center	244
C		
R&S® CEMS100	Compact EMS/EMI Test Platform	190
R&S® CLGD	DOCSIS Cable Load Generator	251
R&S® CMW-ATE	Terminal Testing Solution for IMS and VoLTE	17
R&S® CMW-PQA	Test System for Performance Quality Analysis	18
R&S® CMW-Z10/-Z11	RF Shielding Box and Antenna Coupler	30
R&S® CMA180	Radio Test Set	27
R&S® CMW100	Communication Manufacturing Test Set	12
R&S® CMW270	Wireless Connectivity Tester	11
R&S® CMW290	Functional Radio Communication tester	10
R&S® CMW500	Wideband Radio Communication Tester	8
R&S® CMW500	Protocol Tester	14
R&S® CMWcards	Signaling Tester	15
R&S® CMWmars	Multifunctional Logfile Analyzer	16
R&S® CMWrun	Sequencer Software Tool	13
R&S® CTH	Portable Radio Test Set	28
R&S® Cybersecurity	New R&S®PACE 2.0 Protocol and Application Classification Engine	174
R&S® Cybersecurity	New R&S®Net Reporter 2 Traffic Analytics	175
R&S® Cybersecurity	New R&S®Net Reporter Compact	176
R&S® Cybersecurity	New R&S®Net Sensor	177
D		
R&S® DST200	RF Diagnostic Chamber	29
R&S® DVMS	Digital TV Monitoring Family	258
R&S® DVSG	Digital Video Signal Generator	264
E		
R&S® EDS300	DME/Pulse Analyzer	100
R&S® EDST300	New Maintenance checks and signal-in-space analysis on TACAN and DME stations	101
R&S® EFL110/EFL120	Cable TV Analyzer and Leakage Detector	256
R&S® EFL240/EFL340	Portable TV Test Receiver	257
R&S® EMC32	EMC Measurement Software Platform	197
R&S® ENV216	Two-Line V-Network	205
R&S® ENV432	Four-Line V-Network	205
R&S® ENV4200	200 A Four-Line V-Network	205
R&S® ENY21/41/81	Two/Four/Eight-Wire Coupling Network	206
R&S® ENY81-CA6	Eight-Wire Coupling Network for Cable Category CAT 6	206
R&S® ES-SCAN	EMI Software	196
R&S® ESH2-Z3	Voltage Probe	207
R&S® ESH3-Z2	Pulse Limiter	207
R&S® ESL	EMI Test Receiver	187
R&S® ESR	EMI Test Receiver	185
R&S® ESRP	EMI Test Receiver	186
R&S® ESV-Z1	VHF Current Probe	208
R&S® ESW	New EMI Test Receiver	184
R&S® ETH	Handheld TV Analyzer	254

Type	Designation	Page
R&S® ETL	TV Analyzer	253
R&S® ETC	Compact TV Analyzer	255
R&S® EVS300	VOR/ILS Analyzer	99
R&S® EX-IQ-Box	Digital Signal Interface Module	116
R&S® EXBOX-Kxxx	Application-Specific Solutions (firmware or software – overview)	118
R&S® EZ-12	Antenna Impedance Converter	207
R&S® EZ-17	Current Probe	208
R&S® EZ-25	150 kHz Highpass Filter	207
F		
R&S® FPS	Signal and Spectrum Analyzer	58
R&S® FPS-Kxxx	Application-Specific Solutions (firmware or software – overview)	66
R&S® FS-Zxx	External Mixers	65
R&S® FSC	Spectrum Analyzer	60
R&S® FSH3	Handheld Spectrum Analyzer	297
R&S® FSH	Handheld Spectrum Analyzer	62
R&S® FSL	Spectrum Analyzer	59
R&S® FSMR	Measuring Receiver	55
R&S® FSx-Kxxx	Application-Specific Solutions (firmware or software – overview)	66
R&S® FSV/FSVA	Signal and Spectrum Analyzer	56
R&S® FSVR	Real-Time Spectrum Analyzer	57
R&S® FSW	Signal and Spectrum Analyzer	52
R&S® FSWP	Phase Noise Analyzer and VCO Tester	53
H		
R&S® HF907	Double-Ridged Waveguide Horn Antenna	213
R&S® HFH2-Z2	Loop Antenna	210
R&S® HFH2-Z6	Rod Antenna	210
R&S® HK116E	Biconical Antenna	213
R&S® HL033/HL040E	Log-Periodic Broadband Antennas	211
R&S® HL046E	High Gain Log-Periodic Antenna	211
R&S® HL050/HL050E/HL223	Log-Periodic Antennas	212
R&S® HL562E	ULTRALOG	213
R&S® HM020	Triple-Loop Antenna	212
R&S® HMC8012	Digital Multimeter	272
R&S® HMC8015	Power Analyzer	273
R&S® HMC804x	Power Supplies	270
R&S® HMF25xx	Arbitrary Function Generators	115
R&S® HMO Compact	Digital Mixed Signal Oscilloscopes	
R&S® HMO1002/1202	Digital Oscilloscopes	
R&S® HMO3000	Digital Mixed Signal Oscilloscopes	40
R&S® HMP20x0	Programmable Two/Three-Channel Power Supply	269
R&S® HMP40x0	Programmable Three/Four-Channel Power Supply	268
R&S® HMS-X	Spectrum Analyzer	61
R&S® HZ-9	Power Supply	210
R&S® HZ-14, R&S® HZ-15	H Near-Field Probe Set, Probe Set for E and H Near-Field Emission Measurements	209
R&S® HZ-16	Preamplifier	209
I		
R&S® IQR	I/Q Data Recorder	278
M		
R&S® MDS-21	Absorbing Clamp	208
N		
R&S® NAP-Zx	Power Sensors	224
R&S® NRP2	Power Meter	216
R&S® NRP	USB and LAN power sensors	217
R&S® NRP-Zxx	Power Sensors	220
R&S® NRP-Z5	Sensor Hub	222
R&S® NRPC	Calibration Kits	223
R&S® NRPM	Over-the-Air (OTA) Power Measurement Solution	225
R&S® NRPV	Virtual Power Meter	222
R&S® NRT/NRT-Zxx	Power Reflection Meter/Power Sensors	224

Type	Designation	Page
O		
R&S® OSP	Open Switch and Control Platform	275
Q		
R&S® QuickStep	New Test Executive Software	280
R		
R&S® ROMES4	Drive Test Software including Network Problem Analyzer R&S®ROMES4NPA	175
R&S® RSC	Step Attenuator	279
R&S® RTE1000	Digital Oscilloscopes	35
R&S® RTM2000	Digital Oscilloscopes	36
R&S® RTO2000	Digital Oscilloscopes	
R&S® RTO-Kxxx	Application-Specific Solutions (firmware or software – overview)	66
R&S® RT-Zxx	Oscilloscope Probes	43
S		
R&S® ScopeRider RTH	Handheld Digital Oscilloscopes	37
R&S® SFC	Compact Modulator	248
R&S® SFC-U	USB Compact Modulator	249
R&S® SFD	DOCSIS® signal generator	250
R&S® SFE	Broadcast Tester	246
R&S® SFE100	Test Transmitter	247
R&S® SGS100A	SGMA RF Source	107
R&S® SGT100A	SGMA Vector RF Source	106
R&S® SGT-Kxxx	Application-Specific Solutions (firmware or software – overview)	117
R&S® SGU100A	SGMA Up-Converter	108
R&S® SLG	Satellite Load Generator	252
R&S® SMA100A	Signal Generator	110
R&S® SMB100A	RF and Microwave Signal Generator	111
R&S® SMBV100A	Vector Signal Generator	105
R&S® SMC100A	Signal Generator	112
R&S® SMF100A	Microwave Signal Generator	109
R&S® SMW200A	Vector Signal Generator	104
R&S® SMx-Kxxx	Application-Specific Solutions (firmware or software – overview)	117
R&S® SMZ	Frequency Multiplier	113
R&S® Spectrum Rider FPH	Handheld Spectrum Analyzer	64
R&S® Stream Libraries	Test Signal Libraries	265
SwissQual	Diversity Benchmarker II	160
SwissQual	New Diversity Benchmarker II Go	161
SwissQual	NetQual NQDI II	171
SwissQual	NetQual NQDI Classic	172
SwissQual	NetQual NQView	173
SwissQual	QualiPoc Android	165
SwissQual	QualiPoc Freerider III	163
SwissQual	QualiPoc Android Probe	166
SwissQual	TCM Test Device Containment Module	162
T		
R&S® T80-K1	System Software	193
R&S® TS-EMF	Portable EMF Measurement System	195
R&S® TS-ISC	In-System Calibration Kit	241
R&S® TS-ITS100	RF Conformance Test System for IEEE 802.11p	20
R&S® TS-LBS	Test System for Location Based Services	22
R&S® TS-PAM	Signal Analyzer Module	239
R&S® TS-PCA3	CompactTSVP Test and Measurement Chassis	232
R&S® TS-PCAL2	Calibration Module	241
R&S® TS-PDFT	Digital Functional Test Module	237
R&S® TS-PFG	Function Generator Module	239
R&S® TS-PICT	In-Circuit Test Extension	234
R&S® TS-PIO2	Analog and Digital I/O Module	238
R&S® TS-PIO3B	Digital I/O Module	238
R&S® TS-PIO4	New 32-Channel Programmable Digital I/O Module	238
R&S® TS-PIO5	New LVDS Digital Functional Test Module	239
R&S® TS-PMB	Switch Matrix Module	234

Type	Designation	Page
R&S®TS-PRIOx	Rear I/O Transmission Module	236
R&S®TS-PSAM	Analog Source and Measurement Module	234
R&S®TS-PSC0	System Controller	233
R&S®TS-PSC07	System Controller	233
R&S®TS-PSC57	System Controller	233
R&S®TS-PSCX	Interface Panel	233
R&S®TS-PSM1	Power Switching Module	234
R&S®TS-PSM2	Multiplex and Switch Module	235
R&S®TS-PSM3	High-Power Switching Module	235
R&S®TS-PSM4	Multiplex and Switch Module	235
R&S®TS-PSM5	High-Power Switching Module	235
R&S®TS-PSU	Power Supply and Load Module	240
R&S®TS-PSU12	Power Supply and Load Module	240
R&S®TS-PWA3	PowerTSVP Switching Application Chassis	232
R&S®TS-PXM1	Switching Extension Module	237
R&S®TS-PXB2	Backplane Extension Module	237
R&S®TS-RRM	LTE and WCDMA RRM Test System	21
R&S®TS712x	Shielded RF Test Chambers	30
R&S®TS6710	TRM Radar Test Solution	150
R&S®TS8980	RF/RRM Test System for LTE, WCDMA and GSM	19
R&S®TS8991	OTA Performance Test System	24
R&S®TS8996	RSE Test System	25
R&S®TS8997	Regulatory Test System for Wireless Devices	26
R&S®TS9975	EMI Test System	188
R&S®TS9982	EMS Test System	191
R&S®TSMA	Autonomous Mobile Network Scanner	167
R&S®TSME	Ultracompact Drive Test Scanner	168
R&S®TSML-CW	CW Radio Network Analyzer	170
R&S®TSMW	Universal Radio Network Analyzer	169
R&S®TSMX-PPS2	GPS Module	170
U		
R&S®UPP	Audio Analyzer	228
R&S®UPV	Audio Analyzer	227
R&S®UPZ	Audio Switcher	229
V		
R&S®VTC/VTE/VTS	Video Test Center/Video Tester/Compact Video Tester	262
W		
R&S®WinIQSIM2™	Simulation Software	135
Z		
R&S®ZCAN	Manual Calibration Kits	156
R&S®ZCxxx	Millimeter-Wave Converters	152
R&S®ZN-Z15x/ZN-Z51	Automatic Calibration Units	157
R&S®ZN-Z84	Switch Matrix	156
R&S®ZN-Z85	Switch Matrix	156
R&S®ZN-ZTW	Torque Wrench	157
R&S®ZNB	Vector Network Analyzer	144
R&S®ZNB8/20	Vector Network Analyzer	145
R&S®ZNC	Vector Network Analyzer	146
R&S®ZND	Vector Network Analyzer	147
R&S®ZRun	Automated Test Software	155
RPG ZRXxxx	High Dynamic Receivers for VNAs	154
R&S®ZV-WRxx	Waveguide Calibration Kits	157
R&S®ZV-Z170/135/129, ZV-Z2xx	Calibration Kits	157
R&S®ZV-Z3xx/ZV-Z4xx/ZV-Z5x	Verification Kits	157
R&S®ZVA-Zxxx	Millimeter-Wave Converters	153
R&S®ZVA	Vector Network Analyzer	142
R&S®ZVAX-TRM	Extension Unit	156
R&S®ZVH	Cable and Antenna Analyzer	149
R&S®ZVL	Vector Network Analyzer	148
R&S®ZVT	Multiport Vector Network Analyzer	143

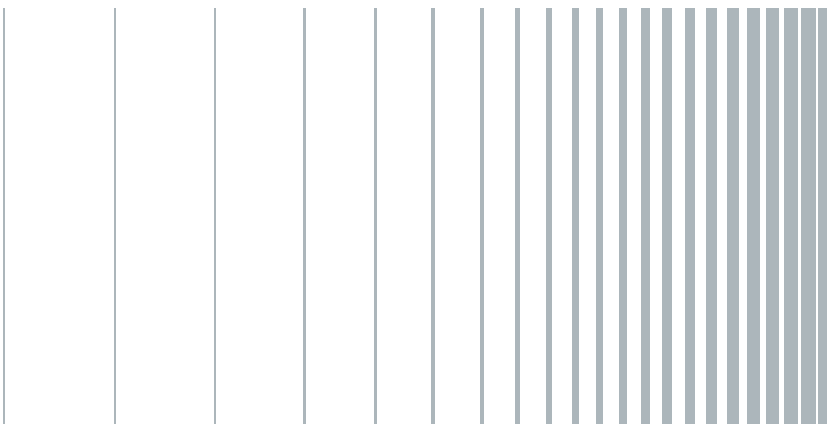
A series of vertical lines of varying heights and thicknesses, transitioning from thin to thick, ending in a standard barcode.

R&S® is a registered trademark of
Rohde & Schwarz GmbH & Co. KG
Trade names are trademarks of the owners
Printed in Germany (GK)
PD 5213.7590.42 | Version 07.00 | January 2017
Subject to change

© 2010 - 2017
Rohde & Schwarz GmbH & Co. KG
81671 Munich, Germany



5213759042