

ARMY NO. 2 DRESS

Officer/Military Expert
(Men)

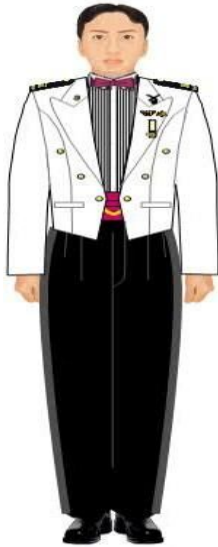

Warrant Officer (Men)



Specialist (Men)



Officer/Military Expert
(Ladies)



Warrant Officer (Ladies)



Specialist (Ladies)



Headdress



White turban with red fifti for Sikh personnel (without cap badge)
No headdress will be worn by others

SAF No.2 DRESS

Epaulettes



BG/ME8 and above



Officer, Warrant Officer, Military Expert and Specialist

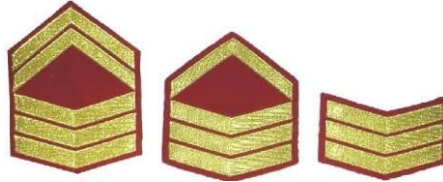

Specialist

Bow Tie



Cummerbund



Arm Badges



Gold Chain



Aiguillette

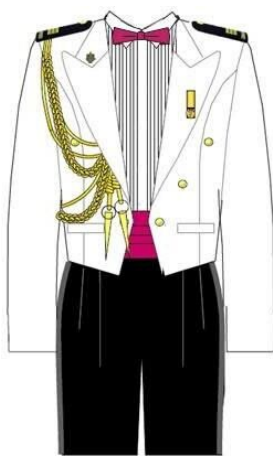

Right hand side (Men)(for ADCs)

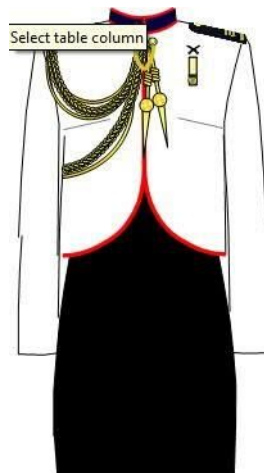

Right hand side (Ladies)(for ADCs)



Left hand side (for Military Attaches, MA and SA)

SAF No.2 DRESS

Footwear



Black leather shoes (Men)



Black court shoes (Ladies)

Medals

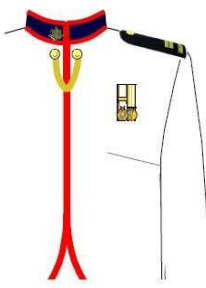
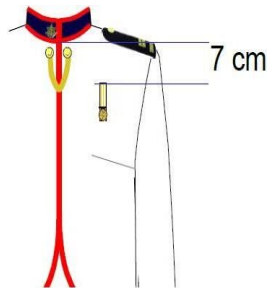
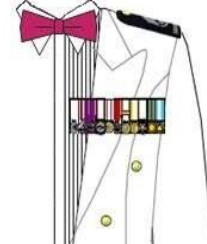
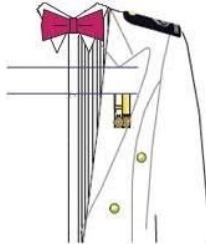
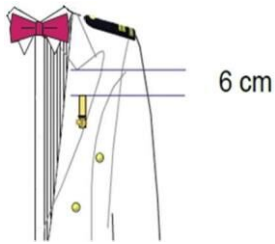

Miniature size medals are worn on Army No.2 dress

Badges

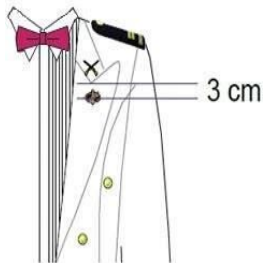

Wearing of single badge and marksmanship without medal

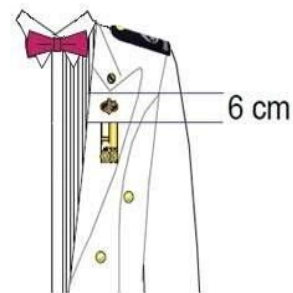

Wearing of single and IPPT badge with medals



Wearing of 3 badges, marksmanship and IPPT badge with medals (maximum of 3 badges is allowed to be worn)

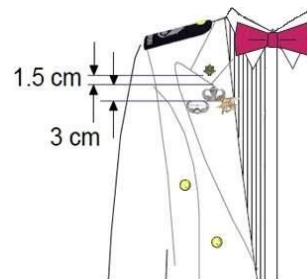

Wearing of 3 foreign badges (maximum of 3 foreign badges is allowed to be worn)

SAF No.2 DRESS

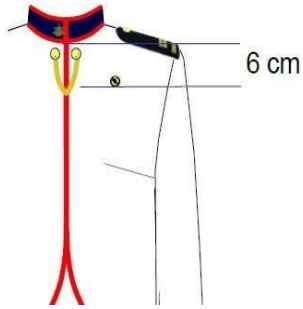

Wearing of single badge without medal
(Ladies)



Wearing of 2 badges with medals (Ladies)



Wearing of 3 badges with medals (Ladies)

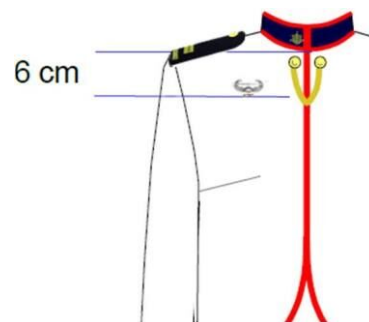

Wearing of single foreign badge (Ladies)

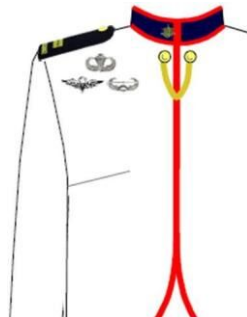

Wearing of 3 foreign badges (Ladies) (maximum of 3 foreign badges is allowed to be worn)

Tabs



Maximum of 2 tabs is allowed to be worn

SAF No.2 DRESS

NAVY NO. 2 DRESS

Officer/Military Expert (Men)



Warrant Officer (Men)



Specialist (Men)



Officer/Military Expert (Ladies)



Warrant Officer (Ladies)



Specialist (Ladies)



Headdress



White turban with black fifti for Sikh personnel (without cap badge)
No headdress will be worn by others

SAF No.2 DRESS

Epaulettes



RADM/ME8 and above



Officer, Warrant Officer, Military Expert and Specialist



Specialist



Officer, Warrant Officer, Military Expert and Specialist (Ladies)

Gold Chain



Bow Tie



Cummerbund



Aiguillette

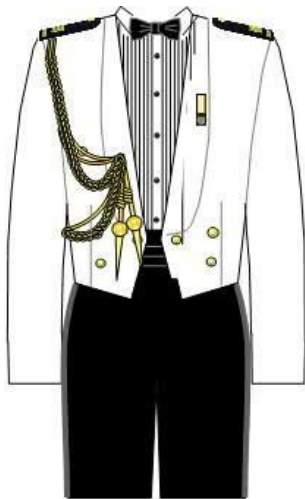

Right hand side (Men)(for ADCs)

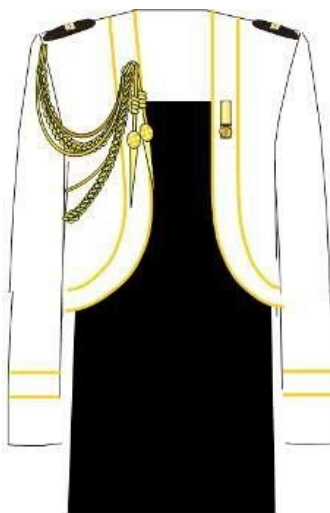

Right hand side (Ladies)(for ADCs)

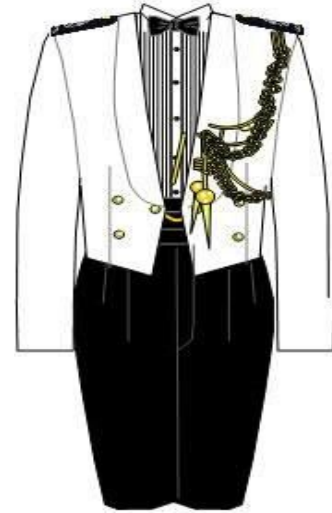

Left hand side (for Military Attaches, MA and SA)

SAF No.2 DRESS

Footwear



Black leather shoes (Men)



Black court shoes (Ladies)

Medals

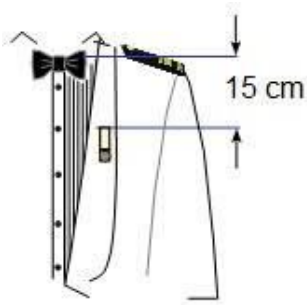

In line with the seam of inner dress



Miniature size medals are worn on Navy No.2 dress

Badges

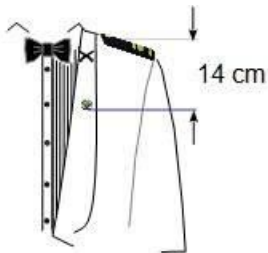

Wearing of single badge and marksmanship without medal

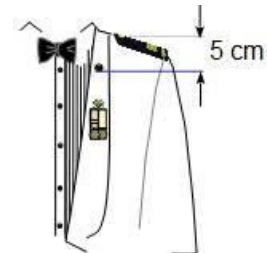

Wearing of single and IPPT badge with medals



Wearing of 3 badges, marksmanship and IPPT badges with medals (maximum of 3 badges is allowed to be worn)

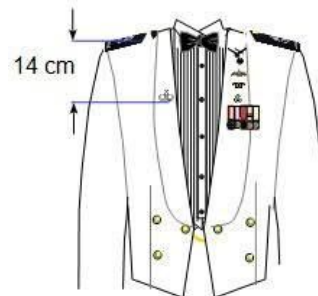

Wearing of single foreign badge (maximum of 3 foreign badges is allowed to be worn)

SAF No.2 DRESS



Wearing of marksmanship badge without medal (Ladies)



Wearing of single badge and marksmanship badge with medals (Ladies)



Wearing of 3 badges, marksmanship and IPPT badges with medals (Ladies)
(maximum of 3 badges is allowed to be worn)



Wearing of single foreign badge (Ladies)



Wearing of 2 foreign badges (Ladies)

Tabs

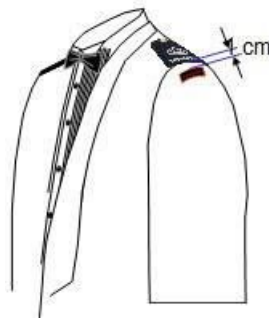

Maximum of 2 tabs is allowed to be worn

SAF No.2 DRESS

RSAF NO. 2 DRESS

Officer/Military Expert/Warrant Officer
(Men)



Specialist (Men)

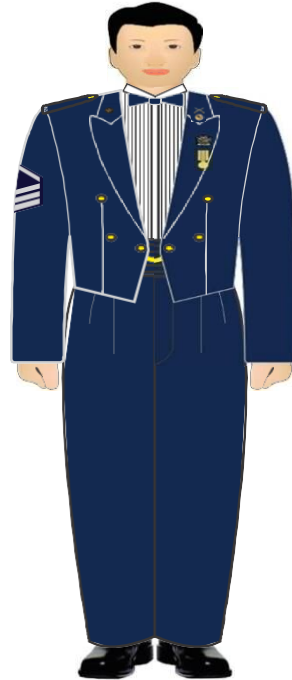

Officer/Military Expert/Warrant Officer
(Ladies)

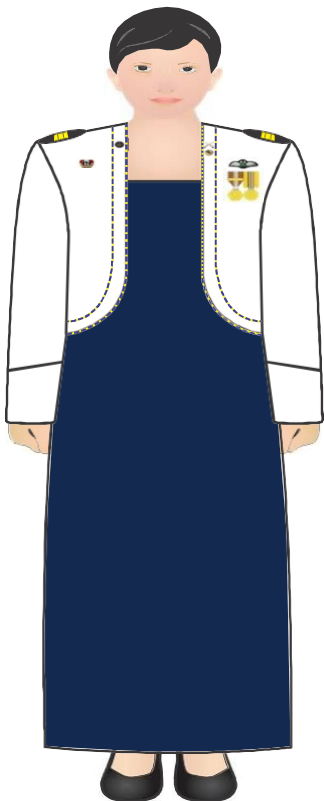

Specialist (Ladies)

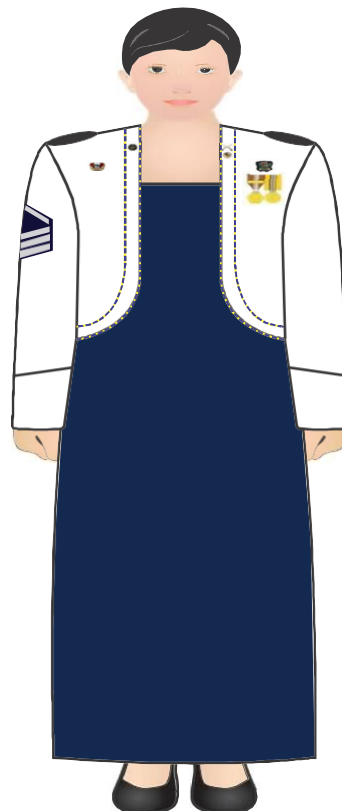

Headdress



Blue turban with blue fifti for Sikh personnel (without cap badge)
No headdress will be worn by others

Epaulettes



Officer, Warrant Officer and Military



Specialist



Officer, Warrant Officer and Military
(Ladies)

Buttons



Bow Tie



Cummerbund



SAF No.2 DRESS

Aiguillette



Right hand side (Men)(for ADCs)

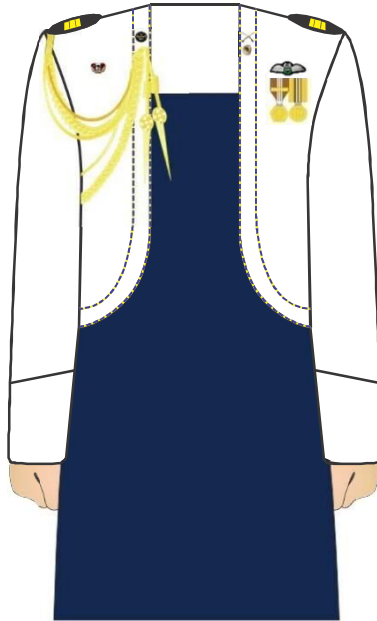

Right hand side (Ladies)(for ADCs)



Left hand side (for Military Attaches, MA and SA)

Footwear



Black leather shoes (Men)



Black court shoes (Ladies)

Medals

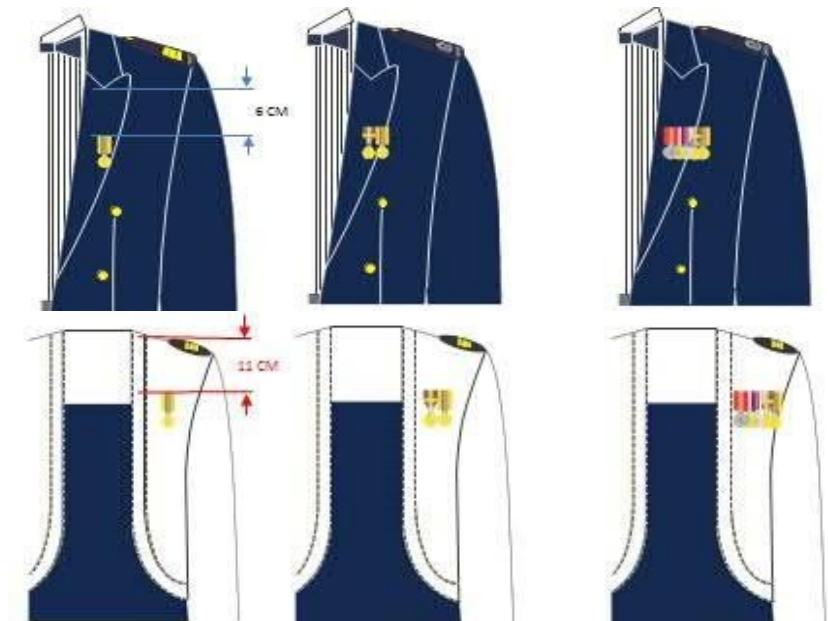

Miniature size medals are worn on RSAF No.2 dress

Badges

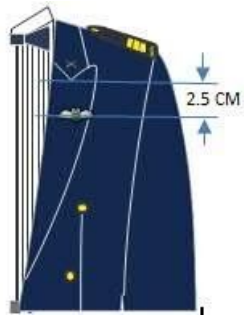

Wearing of single badge and marksmanship without medal

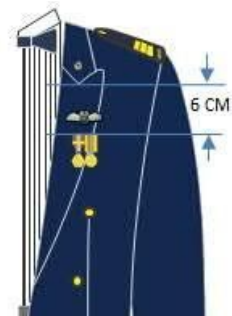

Wearing of single badge and IPPT badge with medals



Wearing of 2 badges, marksmanship and IPPT badge with medals (maximum of 3 badges is allowed to be worn)



Wearing of 2 foreign badges (maximum of 3 foreign badges is allowed to be worn)

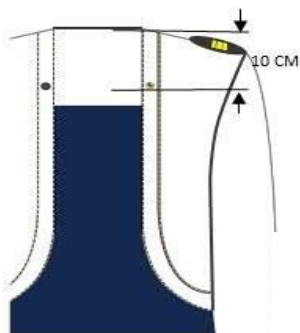

Wearing of IPPT badge without medal (Ladies)



Wearing of IPPT and marksmanship badge with medals (Ladies)

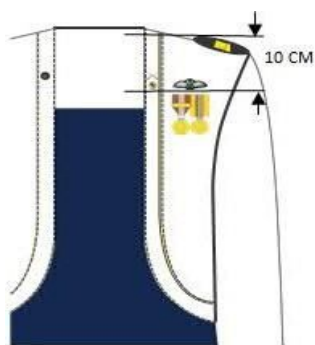

Wearing of 1 badge, marksmanship and IPPT badge with medals (maximum of 3 badges is allowed to be worn)

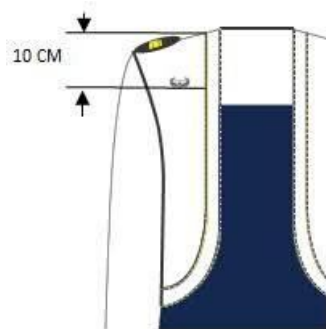

Wearing of single foreign badge (Ladies)



Wearing of two foreign badges (Ladies) (maximum of 3 badges is allowed to be worn)

SAF No.2 DRESS

Tabs

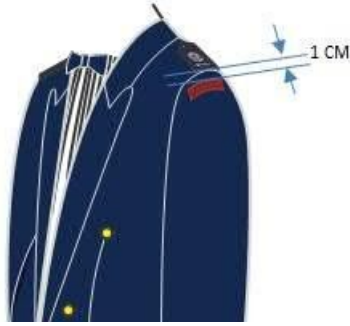

Maximum of 2 tabs is allowed to be worn

DIS NO. 2 DRESS

Officer/Military Expert/ Warrant Officer
(Men)



Specialist (Men)



Officer/Military Expert/ Warrant Officer
(Ladies)



Specialist (Ladies)



SAF No.2 DRESS

Headdress



Dark grey turban with black fifti for Sikh personnel (without cap badge)
No headdress will be worn by others

Epaulettes



BG/ME8 and above



Officer, Warrant Officer and Military Expert



Specialist

Bow Tie



Black bow tie
(Akin to Navy)

Cummerbund



Black Cummerbund
(Akin to Navy)

Buttons



Arms Badges (Army Vocationalist)



SAF No.2 DRESS

Aiguillette

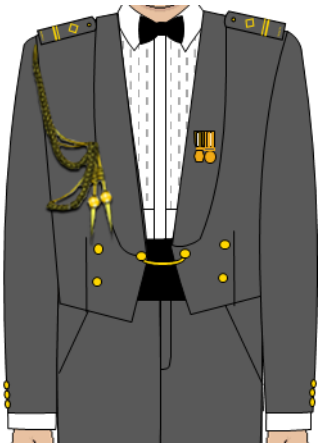

Right hand side (Men) for ADCs

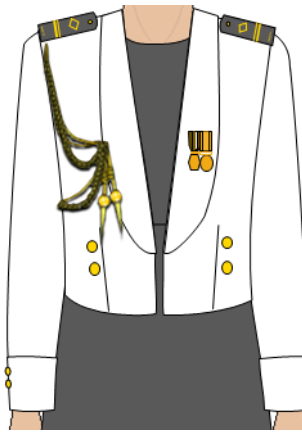

Right hand side (Ladies) for ADCs

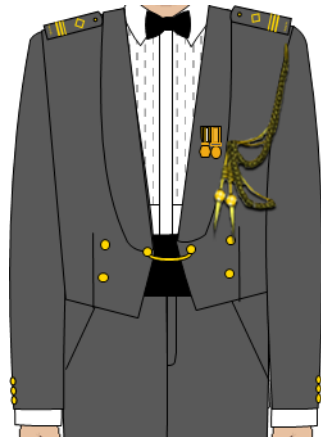

Left hand side (for Military Attaches, MA and SA)

Footwear



Black leather shoes (Men)



Black court shoes (Ladies)

Medals

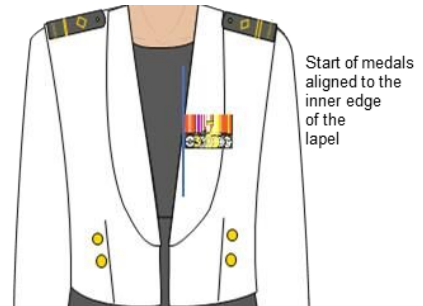
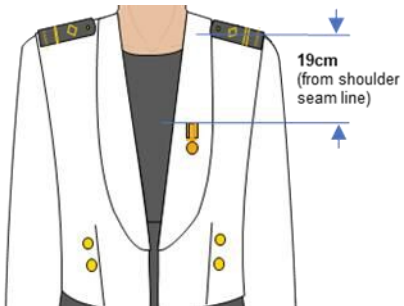
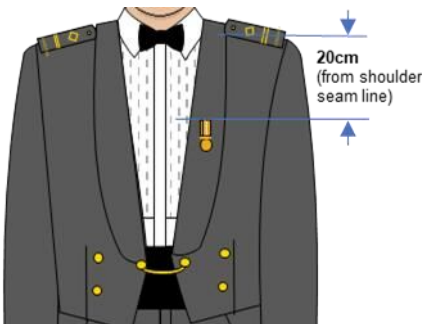

Miniature size medals are worn on DIS No.2 dress

Badges

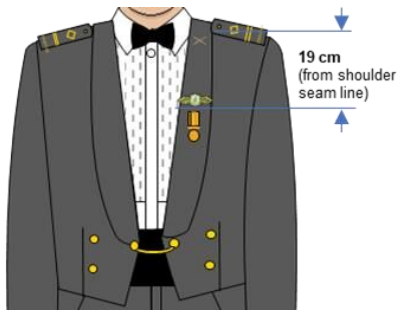

Wearing of single badge and marksmanship without medal

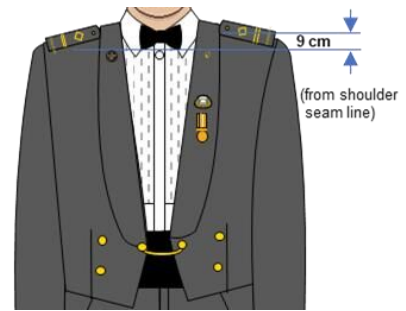

Wearing of single badge, arms badge and IPPT badge with medal



Wearing of 3 badges, marksmanship and IPPT badge with medals (maximum of 3 badges is allowed to be worn)

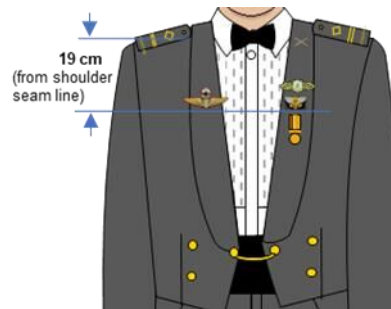

Wearing of foreign badges (maximum of 3 foreign badges is allowed to be worn)

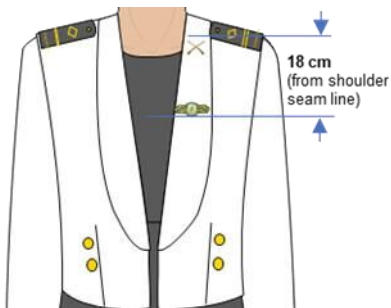

Wearing of single badge and marksmanship without medal

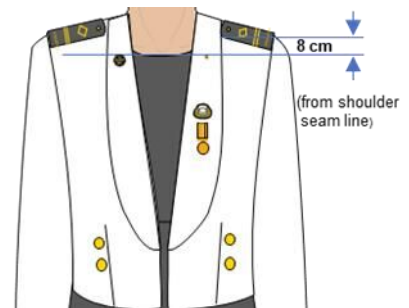

Wearing of single badge, arms badge and IPPT badge with medal



Wearing of 3 badges, marksmanship and IPPT badge with medal (maximum of 3 badges is allowed to be worn)

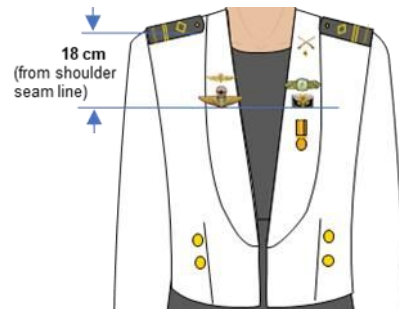

Wearing of 2 foreign badges (maximum of 3 foreign badges is allowed to be worn)

SAF No.2 DRESS

Rank Insignia (Specialist)



Rank insignia is to be worn on the left sleeve

Tabs

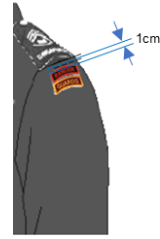

Maximum of 2 tabs is allowed to be worn