

# D-Subminiature Talking Dog

D    B    M    E    25    P    V    K87  
 1       2       3       4       5       6       7       8

## 1. D - Calls out D Subminiature connector

## 2. Shell Size E - A - B - C - D

Signal contacts E=9 (15), A=15 (26), B=25 (44), C=37 (62), D=50 (78)  
 (high density layout)  
*number of signal contacts will vary for Combo-D connectors*

## 3. Class

No Designator	Original D* Series - one piece insulator
M	One piece insulator - commercial
MM	One piece insulator - materials, finishes, and inspection in accordance with Mil-C-24308 where applicable
MA	Little Caesar rear release contact retention assembly
MAM	Little Caesar rear release contact retention assembly - materials, finishes, and inspection in accordance with Mil-C-24308 where applicable.
C	Contact retaining tines, BURGUN-D insulator
U	Contact retaining tines, 94-O black insulator

## 4. Mounting Type

No Designator	Standard 0.120" diameter mounting hole
C	4-40 Rivnut, Bracket and Boardlock
D	4-40 Rivnut, Bracket and 4-40 Screwlock
E	#4-40 clinch nut for rear panel mounting
F	Float mount for rear panel mounting (rivet & washer)
G	4-40 Rivnut, Bracket, Boardlock & 4-40 Screwlock
H	.300 in Standoff and 4-40 Screw Lock
J	4-40 Rivnut, Bracket, Boardlock & M-3 Screwlock
K	0.154" diameter mounting hole- No hardware
L	M-3 Rivnut, Bracket and Boardlock
N	4-40 Standoff, Boardlock & 4-40 Screwlock
O	4-40 Rivnut, Bracket and M-3 Screwlock
P	4-40 Rivnut, Bracket
Q	M-3 Standoff & Boardlock
R	Reverse float mount for front panel mounting (rivet & washer)
S	M-3 Rivnut & Bracket
T	<b>M-3 Standoff /Could also call out a TOOL for crimp connector</b>
U	4-40 Standoff, Boardlock & M-3 Screwlock
V	4-40 Standoff
W	.300 in Standoff and M-3 Screw Lock
X	M-3 Clinch Nut
Y	Dual float mount for both front and rear panel mounting
Z	4-40 Standoff & Boardlock

## 5. Contact Arrangements

Shell size	# of contacts
E	9/15
A	15/26
B	25/44
C	37/62
D	50/78

## 6. Contact Type

P      Pin  
 S      Socket



## 7. Printed Circuit Terminal Modifier

Code	Straight	Right Angle		X +/- .027 (.69)	Y
		With Bracket	Without Bracket		
A		•		.127 (3.22)	.040 (1.02)
B	•			.127 (3.22)	.040 (1.02)
C			•	.127 (3.22)	.040 (1.02)
D		•		.127 (3.22)	.030 (0.76)
E	•			.127 (3.22)	.030 (0.76)
F			•	.127 (3.22)	.030 (0.76)
G		•		.158 (4.01)	.040 (1.02)
H	•			.158 (4.01)	.040 (1.02)
K			•	.158 (4.01)	.040 (1.02)
L		•		.158 (4.01)	.030 (0.76)
M	•			.158 (4.01)	.030 (0.76)
P			•	.158 (4.01)	.030 (0.76)
R			•	.183 (4.65)	.030 (0.76)
S		•		.183 (4.65)	.030 (0.76)
W		•		.183 (4.65)	.040 (1.02)
X	•			.183 (4.65)	.040 (1.02)
Z	•			.183 (4.65)	.030 (0.76)

Connectors are furnished with or without plastic bracket

N	•			.198 (5.03)	.030 (0.76)
J			•	.166 (4.22)	.030 (0.76)
T		•		.166 (4.22)	.030 (0.76)
Y	•			.186 (4.72)	.025 (0.64)
V			•	.197 (5.00)	.025 (0.64)

Note: Straight printed circuit M and Z codes, "MM" and MIL-SPEC versions are be shipped with two 253-0343-000 spacers.

### Special Printer Circuit Terminal Modifier for D\*U and D\*C connectors:

Right Angle Terminal	
AA	Stamped contacts with bracket
AD	Machined contacts with bracket
CA	Stamped contacts with metal bracket
Straight Terminal	
BB	Stamped contacts
BF	Machined contacts

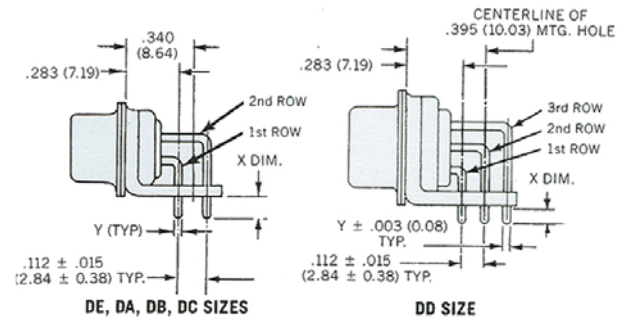

### STRAIGHT TERMINAL

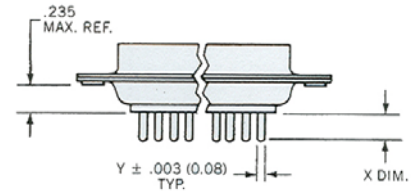

**8. Modification Code--See Cannon Deviation book for more complete listing of modifications**

A101	Yellow Chromate coating over Cadmium
A183	Yellow Chromate coating over Zinc
A197	Tin/lead shells (SKT only)
F0	Connector without contacts (F0 will not be printed on the connector)
F171	Jackscrew assy shipped with parts(not assembled) regular front shells
F172	Jacknut (hardware is assembled here) takes float front shell
F173	Jackscrew assy (hardware is assembled here) takes float front shell
F179	0.024" square post, 0.375" extension
F179A	0.024" square post, 0.500" extension
II	Stamped Contact with Tin/Lead in Solder cups ( <b>Cinch</b> )
K87	Tin/lead dimpled shells (PIN only)
K126	A197 plus 30 microinches in gold contacts
K127	K87 plus 30 microinches in gold contacts
M	Screw Machine contact ( <b>Cinch</b> )
TI	Tin plated shells with grounding indents ( <b>Cinch</b> )
T	Tin plated shells ( <b>Cinch</b> )

## Combo D connectors with contacts installed



NOTE: In a Combo-D layout the 1st number is the number of total contacts, the 2nd number calls for the number of size 8 cavities.

For example 13W6 layout, there is 13 total contacts and 6 of them are for coaxial, or HP, HV contacts, size 8.

**\*\*\*\*Position 1-4 & 6-8 follow the standard talking dog \*\*\*\***

**5. Combination Arrangements are as follows:**

Shell size	Arrangement available.
E	5W1
A	3W3
A	7W2
A	11W1
B	5W5
B	9W4
B	13W3
B	17W2
B	21W1
C	8W8
C	13W6
C	17W5
C	21WA4
C	25W3
C	27W2
D	24W7
D	36W4
D	43W2
D	47W1



## ***Combo D connectors with contacts installed (cont.)***

When there is a letter other than "W" in the above insert arrangements, see the following:  
The printed circuit terminal modifier would call out right angle contacts; If there is no printed circuit terminal modifier, would have the straight P/C contacts.

C	75 $\Omega$ Coax Installed Straight or 90°
G	Guide Pin or Guide Skt Installed
H	High Powered Installed (Standard)
R	90 degree mini high power
V	High Voltage Installed Straight PC only
X	50 $\Omega$ Coax Installed Straight or 90°

Notes: Contacts listed above are for use when W is replace with the COMBO MODIFIER specified above.



# Combo-D Talking Dog

## Product Family Designator

D\*M = Commercial Version

D\*MM = High Rel Version (50 micro in. Gold Plating)

\* = Shell Sizes: E, A, B, C, & D

**DBMC13C3SJA197**

## Hardware Modifier

- = .120in. (3.05 mm) Through Hole
- C = 90° Metal Bracket, 4-40 Fastener, & B/L
- D = 90° Metal Bracket, Fastener, & 4-40 S/L
- E = 4-40 Clinch Nut
- G = 90° Metal Bracket, Fastener, 4-40 S/L, & B/L
- H = .300 in (7.6 mm) Standoff & 4-40 S/L
- J = 90° Metal Bracket, Fastener, M-3 S/L, & B/L
- L = 90° Metal Bracket, M3 Fastener, & B/L
- N = .300 in (7.6 mm) Standoff with 4-40 S/L & B/L
- O = 90° Metal Bracket, Fastener, & M-3 S/L
- P = 90° Metal Bracket, 4-40 Fastener
- Q = .300 in (7.6 mm) M3 Standoff with B/L
- S = 90° Metal Bracket & M3 Fastener
- T = .300 in (7.6 mm) M3 Standoff
- U = .300 in (7.6 mm) Standoff, M-3 S/L, & B/L
- V = .300 in (7.6 mm) 4-40 Standoff
- W = .300 in (7.6 mm) Standoff & M-3 S/L
- X = M3 Clinch Nut
- Y = Dual Roat Mount
- Z = .300 in (7.6 mm) 4-40 Standoff with B/L

## Layout (Total # of Contacts \*# of Size 8 Cavities)

- = Non Combo (9,15,25,37, 50)
- W = Empty Size 8 Cavities
- C = 75 Ohm Coax Installed (Straight or 90°)
- X = 50 Ohm Coax Installed (Straight or 90°)
- H = High Power Installed ("Standard")
- P = High Power Installed ("Euro", 90° Only)
- V = High Voltage Installed (Available in Straight PC Only)
- R = Mini High Power Installed (90° Only)
- G = Guide Pin or Guide Socket Installed

## Gender (Determined by Signal Contact)

- P = Male (Plug, Pin)
- S = Female (Receptacle, Socket)

## PC Tail Modifier

- = Solder Cup (Size 8 Contacts not Loaded on these Versions)
- J = 90° PCB, Standard Footprint signal contacts
- N = Straight, Standard PC tail diameter signal contacts
- V = 90° PCB, European Footprint signal contacts ("1A0N")
- Y = Straight, European PC tail diameter signal contacts ("OL4")

## Plating Modification

- = Gold Plated Contacts, Y/C over Zinc on Shells
- A197 = Gold Plated Contacts, Tin on Shells (Socket only)
- K87 = Gold Plated Contacts, Tin with Dimples on Shells (Pin only)
- K126 = 30 micro in. Gold Plating, Tin on Shells (Socket only)
- K127 = 30 micro in. Gold Plating, Tin with Dimples on Shells (Pin only)

Notes: PC Tail Modifiers "V" & "Y" have Tin Plated PC Tails as do all non MM Sockets to Specify for Other Versions add -A220

PC Tail Modifier "J" used with "H" Power or "Size D" Installed (reverse) Coax Specifies 11.53 mm (.454 in.) Footprint

90° Coax is not Available with the "V" Modifier (Only Reverse or Up-side Down using "J" as Stated Above)



# Insert Arrangements

## Face View Pin Insert

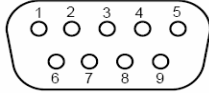

E  
9

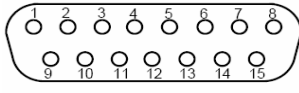

A  
15

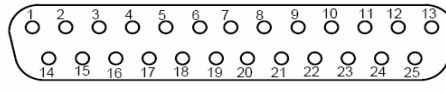

B  
25

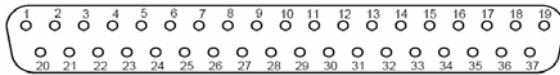

C  
37

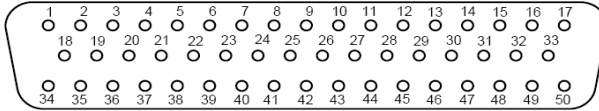

D  
50

## Face View Socket Insert

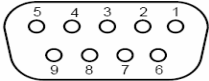

E  
9

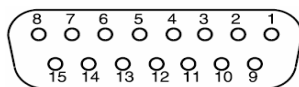

A  
15

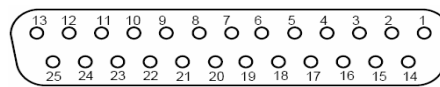

B  
25

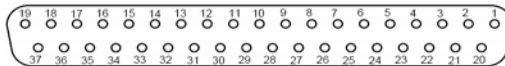

C  
37

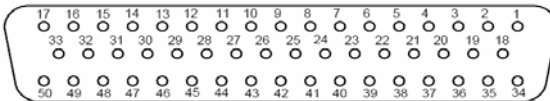

D  
50



# Insert Arrangements con't

## Face View Pin Insert - High Density

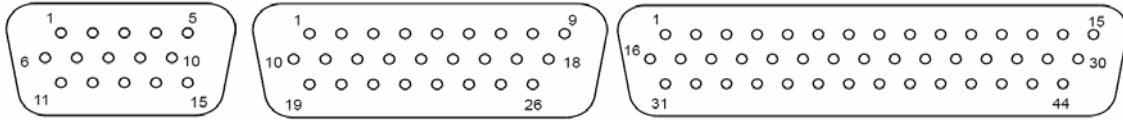

E  
15

A  
26

B  
44

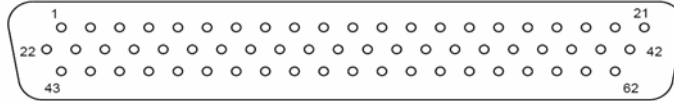

C  
62

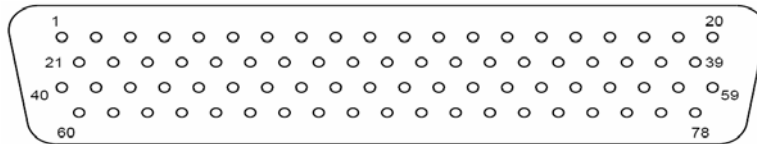

D  
78

## Face View Socket Insert - High Density

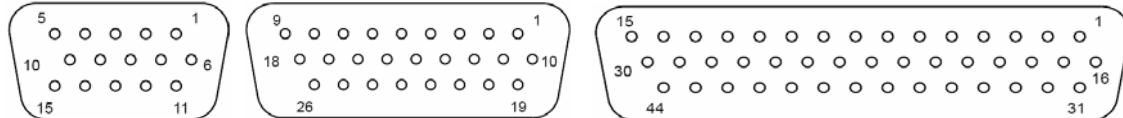

E  
15

A  
26

B  
44

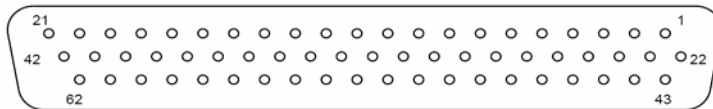

C  
62

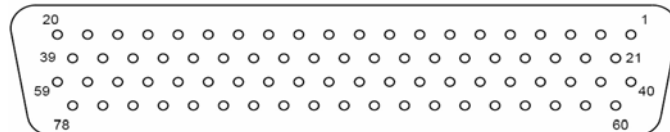

D  
78



# Insert Arrangements con't

## Face View Pin Insert - Combo-D



**E**  
5W1

**A**  
3W3

**A**  
3WK3

**A**  
7W2

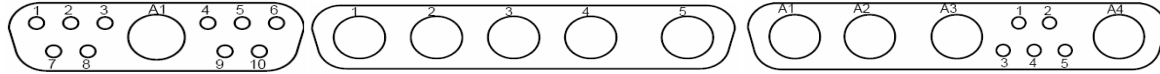

**A**  
11W1

**B**  
5W5

**B**  
9W4



**B**  
13W3

**B**  
17W2

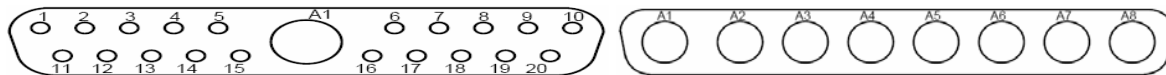

**B**  
21W1

**C**  
8W8

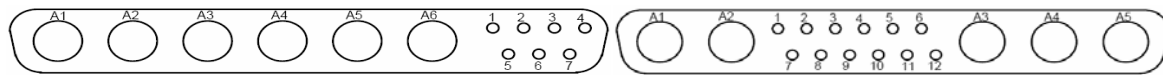

**C**  
13W6

**C**  
17W5

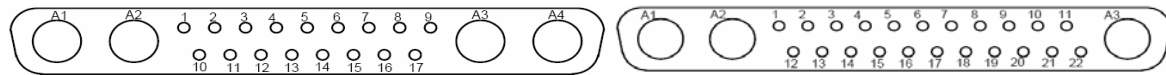

**C**  
21WA4

**C**  
25W3

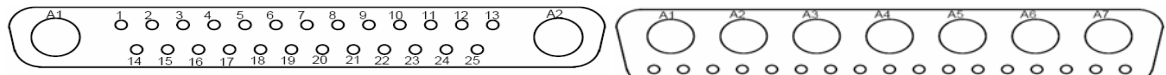

**C**  
27W2

**D**  
24W7

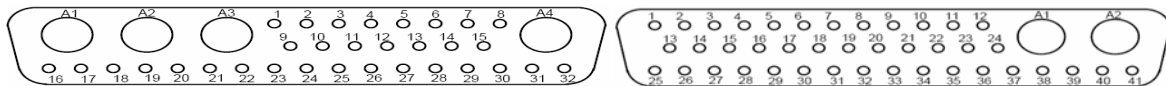

**D**  
36W4

**D**  
43W2

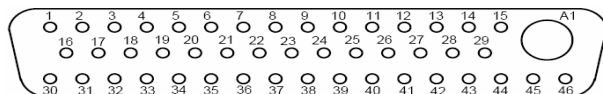

**D**  
47W1

Pin Inserts





# Insert Arrangements con't

## Face View Socket Insert - Combo-D

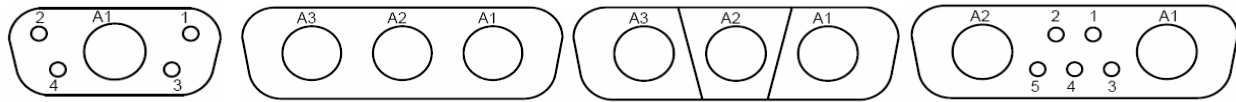

**E**  
5W1

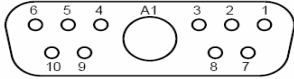

**A**  
3W3

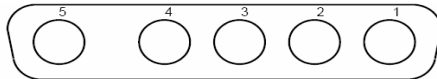

**A**  
3WK3

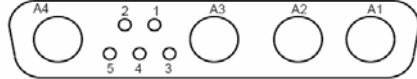

**A**  
7W2

**A**  
11W1

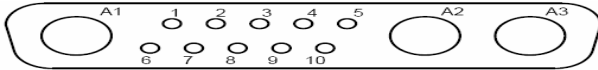

**B**  
5W5

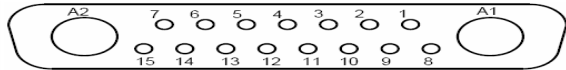

**B**  
9W4

**B**  
13W3

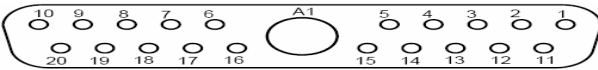

**B**  
17W2

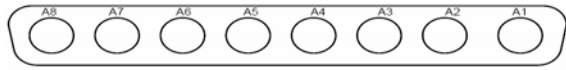

**B**  
21W1

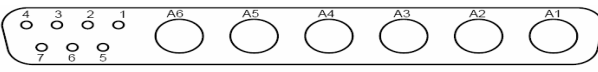

**C**  
8W8

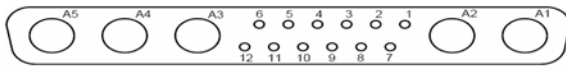

**C**  
13W6

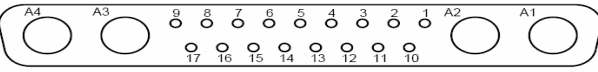

**C**  
17W5

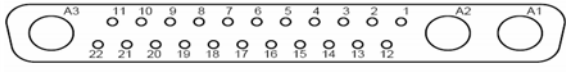

**C**  
21WA4

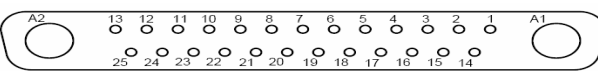

**C**  
25W3

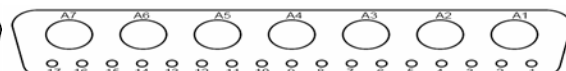

**C**  
27W2

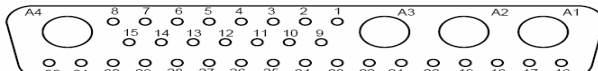

**D**  
24W7



**D**  
36W4

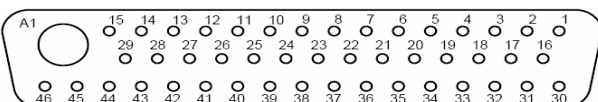

**D**  
43W2

**D**  
47W1

