

Test & Measurement Catalog 2012



R&S®FSW

Signal and Spectrum Analyzer –
setting standards in RF performance
and usability

▷ See page 36



R&S®NRP2
Power Meter



R&S®RTO
Digital Oscilloscope



R&S®ZNB
Vector Network Analyzer

Test & Measurement Catalog 2012

Dear customer: This catalog will give you an overview of all Rohde & Schwarz test and measurement products. For detailed information, please visit our website www.rohde-schwarz.com and enter the product type as the search term.

On our website, you will find this catalog as a PDF file for download. For convenience, this file has navigation functions as well as hyperlinks for quick access to the corresponding product pages on our website.

Example: R&S®FSW Signal and Spectrum Analyzer

▷ search term = FSW

Chapter	Contents	Page
	Company Profile	
	Our business fields and products	2
1	Aerospace and Defense Test Solutions	6
	Radar test systems	
	ILS test system	
2	Wireless Communications Testers and Systems	10
	Wireless device testers	
	Protocol testers	
	Conformance and preformance testers	
	System accessories	
3	Oscilloscopes	24
	Digital oscilloscopes, probes	
4	Signal and Spectrum Analyzers	28
	Spectrum analyzers	
	Signal analyzers	
	Accessories for R&S®FSx analyzers	
	Application firmware	
	Modulation analyzers	
5	Signal Generators	58
	RF vector signal generators	
	RF analog signal generators	
	Microwave signal generators	
	Baseband signal generators	
	Application firmware	
6	Network Analyzers	86
	Vector network analyzers	
	Converters	
	Accessories for network analysis	
7	Drive Test Tools	96
	Hardware, software, systems	
8	EMC and Field Strength Test Solutions	104
	EMI precompliance/compliance	
	EMS/EMF measurements	
	EMC software	
	Broadband amplifiers	
	EMC accessories	
9	Power Meters and Voltmeters	134
	Power meters	
	Power sensors	
	Voltmeters	
10	Audio Analyzers	142
	Audio analyzers, audio switcher	
11	Modular Instruments	146
	Open test platform	
	Infotainment test system	
12	Broadcasting Test and Measurement Solutions	158
	Video and MPEG TS generators	
	RF test transmitters	
	TV analyzers	
	Video and MPEG TS analyzers	
13	System Components	177
	Open switch and control platform	
	I/O data recorder	
	Step attenuator	
	Appendix	182
	Service and support, trademarks	
	Index	192
	Index by type	

For nearly 80 years, Rohde & Schwarz has stood for quality, precision and innovation in all fields of wireless communications.

The privately owned company group has a global presence. It develops, produces and markets a wide range of electronic capital goods for industry, infrastructure operators and government agencies.

Rohde & Schwarz is among the market leaders in all of its business fields, including wireless communications and RF test and measurement, terrestrial TV broadcasting and technologies related to the interception and analysis of radio signals.

Numerous subsidiaries and representatives not only ensure quick and competent on-site support anywhere in the world, but also safeguard customer investments with comprehensive service and support offerings.



Our business fields

Test and measurement

T&M instruments and systems for wireless communications, electronics and microwave applications

Secure communications

(Radio) systems providing encrypted communications for armed forces, government agencies and industry

Radiomonitoring and radiolocation

Spectrum monitoring systems and radiomonitoring equipment for homeland and external security

Broadcasting

Sound and TV broadcasting and measuring equipment

Test and measurement

Rohde&Schwarz is one of the world's largest manufacturers of electronic test and measurement equipment. Our products set standards in research, development, production and service. As a key partner of industry, network operators and public institutions, we offer a broad spectrum of market-leading solutions for state-of-the-art technologies, including LTE-Advanced, the mobile radio standard of the next generation, as well as for extremely high-frequency applications up to 500 GHz.

New applications in the automotive and aerospace fields, in material research and in video technology promote the trend toward ever higher frequencies in electronics. Rohde&Schwarz meets the growing demand by offering cutting-edge products for signal generation, signal analysis, network analysis and power measurement. The company is systematically expanding its oscilloscope portfolio to meet the wide-ranging needs of customers, also in the lower price segment with products from its HAMEG subsidiary that are ideal for general lab applications.

Test and measurement.

Our test and measurement portfolio

- Test and measurement solutions for mobile radio and wireless technologies
 - Wireless device testers
 - Infrastructure testers
 - Protocol testers
 - Conformance/preconformance testers
 - Test systems and accessories
- Signal and spectrum analyzers
- Network analyzers
- Oscilloscopes
- Signal generators
- Coverage measurement systems
- EMC and field strength test solutions
- Power meters and voltmeters
- Audio analyzers
- Modular instruments
- Power supplies
- RF and microwave accessories
- System components
- Broadcasting and video T&M and monitoring solutions



Broadcasting

TV viewers and radio listeners in more than 80 countries receive their programs via transmitters from Rohde&Schwarz. Our innovative portfolio of broadcasting and measuring equipment drives the development of digital broadcasting worldwide.

The high demand for DVB-T2 networks in Europe and its commercial success, mainly in Africa and Latin America, more than compensated for last year's downward trend in the mobile TV market, enabling Rohde&Schwarz to reassert its position as the market leader in terrestrial TV.

To expand the company's leading position as a supplier of products for processing, distributing and transmitting broadcast signals, DVS Digital Video Systems AG was integrated into the corporate group. DVS is a leading international manufacturer of hardware and software for professional film and video post production and storage.

Secure communications

Radiocommunications systems Military, government and civil forces must be able to exchange information efficiently and securely. This is crucial for the success of national and international operations. Rohde&Schwarz supplies armed forces with interoperable radiocommunications systems for use on the ground, at sea and in the air. Our solutions use state-of-the-art encryption methods that satisfy the highest national and international security standards. To be able to serve the needs of future network-centric mission scenarios, Rohde&Schwarz is working intensively on the development of next-generation software defined radio (SDR) systems.

Civil air traffic control agencies in 80 countries and at more than 200 locations – both airports and ATC centers – also use Rohde&Schwarz radio systems. By adding voice communications systems to its product portfolio, the company can now offer integrated all-in-one solutions for ground-cockpit communications – from the controller working position to the antenna.

Communications security Rohde&Schwarz SIT GmbH develops highly secure crypto products and systems for secure voice and data transmission via wireless and fixed links for private industry, government agencies and the military. In addition, the company's expertise ensures confidentiality of communications when using Rohde&Schwarz radio equipment and systems.

Our broadcasting portfolio

- Digital and analog TV transmitters for all power classes and all conventional standards worldwide, including mobile TV
- Digital and analog sound broadcast transmitters
- Broadcast and video T&M and monitoring solutions
- Hardware and software for professional film and video post production

Our secure communications portfolio

- Integrated communications systems for the following
 - Civil and military air traffic control (ATC)
 - Army
 - Navy
 - Air force
- Encryption technology

Broadcasting.



Secure communications.



Radiomonitoring and radiolocation

The need for mobile, wireless exchange of information is increasing drastically, but the usable frequency spectrum for radiocommunications is limited. Rohde&Schwarz develops and produces stationary and mobile systems for detecting, locating and analyzing radiocommunications signals. These systems allow efficient monitoring and allocation of the limited radio frequencies.

The company's receivers, direction finders, signal analyzers, antennas and customized systems have made Rohde&Schwarz a reliable partner for its customers for many decades. Applications include homeland and external security, radiomonitoring by regulatory agencies and frequency management.

Services

Rohde&Schwarz operates a global service network in order to safeguard the investments of its customers.

The following on-site services are offered worldwide:

- ▮ Calibration
- ▮ Maintenance and repair
- ▮ Product updates and upgrades

With its regional Rohde&Schwarz service centers, plants and specialized subsidiaries, the company can provide a wide range of additional services:

- ▮ System integration
- ▮ System support
- ▮ Installation and commissioning
- ▮ Application support
- ▮ Development of customized modules, instruments and systems
- ▮ Software development
- ▮ Mechanical and electrical design
- ▮ Manufacturing to order
- ▮ Technical documentation
- ▮ Logistics concepts

Our radiomonitoring and radiolocation portfolio

- ▮ Radio intelligence systems
- ▮ Spectrum monitoring systems
- ▮ Satellite monitoring systems
- ▮ Signal analysis systems
- ▮ Receivers
- ▮ Direction finders
- ▮ Antennas
- ▮ Solutions for analyzing IP data streams

Service you can rely on

- ▮ Worldwide
- ▮ Local and personalized
- ▮ Customized and flexible
- ▮ Uncompromising quality
- ▮ Long-term dependability

Radiomonitoring and radiolocation.



Services.



Chapter 1

Aerospace and Defense Test Solutions

Radar test solutions from Rohde & Schwarz combine leading-edge performance with expandability for tomorrow's innovations. Modular designs help maintain the value of your investment in our solutions, and our constant innovation ensures that you are always ahead of the technology curve.



Type	Designation	Description	Page
R&S®TS6710	TRM Radar Test System	All-in-one solution for efficient RF characterization	7
R&S®TS6300	ILS Test System	Mobile automatic test solution for ILS ground measurements	8
R&S®TS6600	Radar Test Generator	Tester for phase-coherent measurements on radar frontends	9

R&S®TS6710 TRM Radar Test System

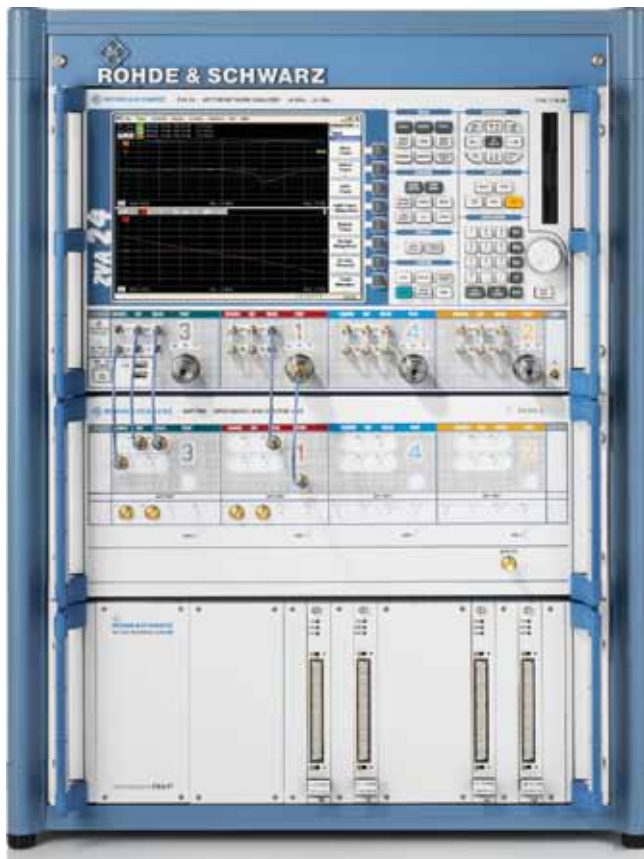

All-in-one solution for efficient RF characterization

The R&S®TS6710 test system allows manufacturers of state-of-the-art AESA radar equipment to perform fast, automatic RF measurements on transmit-receive modules (TRM) in development and production. The test cases supplied with the system are adapted to customer requirements, e.g. to allow automatic control of the module.

State-of-the-art AESA radars contain several thousand TRMs each, and each TRM must be tested separately during development and production. To handle the large number of different measurements and measurement values involved, testing requires a high degree of automation.

The R&S®TS6710 is an all-in-one solution that offers extremely short test times for ensuring the high throughput required in production. In addition, it allows measurements to be flexibly configured for development. These capabilities help the manufacturer develop modules, reduce production cycles and make production more efficient.

Optimum test performance is achieved by specifically adapting the test cases on the basis of the supplied source code, either by Rohde&Schwarz or by experts of the customer. Since the test details can be adapted by the customer, it is easy for customers to protect their intellectual property rights. Because of the wide parameter ranges, the R&S®TS6710 supports the measurement of TRMs for diverse applications, e.g. due to its wide frequency range for future broadband radar equipment.

- Very short test times, e.g. typ. 15 s per module in production
- Optional extension to eight DUTs per test system
- Test sequencer for user-configurable test runs
- Standard test cases with complete source code
- Custom optimization of tests
- Turnkey solution from a single source
- Based on Rohde&Schwarz standard components
 - R&S®ZVA high-end network analyzer for RF measurements
 - R&S®CompactTSVP for fast communications with the TRM
 - R&S®OSP-TRM for RF signal conditioning and DUT multiplexing

Specifications in brief

RF specifications		
Frequency range		1 GHz to 24 GHz
Max. output power of TRM	5 μ s pulse width, max. 2.5% duty cycle	50 W
Max. output power of test system		-2 dBm
Dynamic range of spurious-emission measurement		≤ -60 dBc
Resolution	measurement of pulse shape	30 ns
Typical test times	complete characterization (25000 measurement values)	< 4 min
	measurement of key parameters (2500 measurement values, typ. for production)	< 15 s
TRM control		
Digital control of TRM		<ul style="list-style-type: none"> ■ 40 MHz clock rate ■ programmable level ■ on-board storage of digital commands up to 64M pattern ■ realtime evaluation of response
DUT power supply	multichannel with current measurement	≤ 50 V, 50 W

R&S®TS6300 ILS Test System

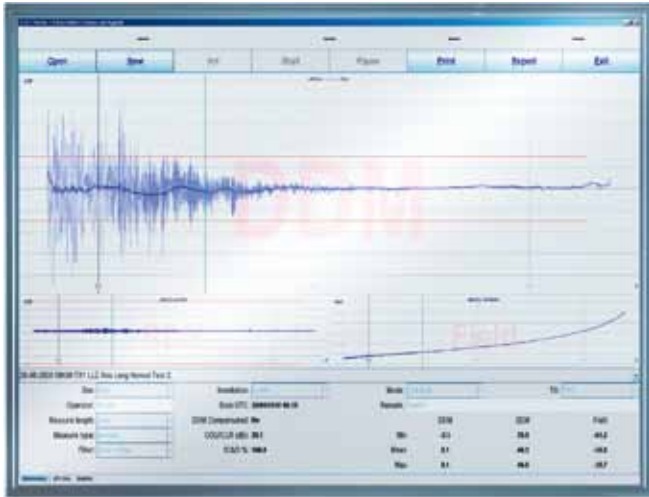

Mobile automatic test solution for ILS ground measurements

The R&S®TS6300 is a modular ILS test system for ILS ground measurements at airports with CAT I to III runways. ICAO standards (ICAO Annex 10 and Doc. 8071) require that ILS ground measurements be performed at regular intervals. These measurements provide test engineers working at air traffic control (ATC) authorities with important information that can be used to perform preventive and corrective maintenance of transmitting systems.

The R&S®EVS300 ILS/VOR analyzer lies at the heart of the R&S®TS6300. This analyzer offers outstanding performance, which makes it ideal for carrying out dynamic measurements. The very high measurement rate of 100 Hz (100 complete data records per second, each containing

more than 50 different values) makes it possible to separately determine and analyze Course and Clearance in a single measurement. Integration and allocation of the GPS data to each measured data record opens up previously unimagined signal analysis possibilities.

The R&S®ILSChecker software was developed in cooperation with the Swiss SKYGUIDE organization. It is used to control the R&S®EVS300 and is based on an elaborate concept that stems from real-world practice (Swiss Air Navigation Services). It has been thoroughly tested by SKYGUIDE and fulfills all the requirements of the ICAO standards.

The system is rounded out by a laptop for measured data acquisition, a GPS receiver, and GPS and ILS antennas. It can be integrated into a vehicle together with a mast. A telescopic mast for Glide Path measurements is available as an option. The complete system is extremely easy to operate and offers very high measurement reproducibility.

- Highly precise measurements, with 100 data records per second (with GPS stamp) independent of weather
- Full support of all required Localizer and Glide Path measurements
- R&S®ILSChecker software filters the DDM data of the Course Structure measurements as required by ICAO Annex 10 specifications
- Significant cost savings through simple “one-man” operation, and reduction of test flights for antenna alignment
- Actual changes in the ILS signal are easy to verify due to the very high measurement reproducibility
- Reproducibility and high accuracy enable good correlation between measurements on the ground and in the air
- Comprehensive analysis capabilities in the test vehicle or in the lab using the R&S®ILSChecker software

Specifications in brief of the R&S®EVS300		
Frequency range		
Preselection filter ranges	marker beacon	70 MHz to 350 MHz
	ILS LLZ	74.7 MHz to 75.3 MHz
	ILS GS	108 MHz to 112 MHz
	VOR	320 MHz to 340 MHz
		108 MHz to 118 MHz
Frequency resolution		100 Hz
Absolute level		
Maximum input power		+13 dBm
Display ranges ¹⁾	Low Noise mode (preamplifier ON)	-120 dBm to -20 dBm
	Normal mode (preamplifier OFF)	-110 dBm to -10 dBm
	Low Distortion mode (RF attenuator ON)	-100 dBm to +20 dBm
	Autorange mode	-120 dBm to +20 dBm
Level resolution		0.1 dB
Accuracy	at -30 dBm	< 0.8 dB
Linearity error	in range from -70 dBm to 0 dBm	< 0.5 dB
Inherent noise	Low Noise mode	< -115 dBm
Spurious response, inherent	without input signal, Low Noise mode	< -90 dBm
Intermodulation		
Third-order intercept point (TOI)	2 × 10 dBm, Δf > 200 kHz, Low Distortion mode	> 20 dBm

¹⁾ Overload display if in-band or out-of-band signals are overloading.

R&S®TS6600 Radar Test Generator



Tester for phase-coherent measurements on radar frontends in development, production and service

To test and calibrate multichannel radar frontends in development, calibration and service, phase-coherent test signals are required. These may be modulated or unmodulated pulse sequences or even complex, real-world scenarios. Vital requirements for such signals are high level and phase accuracy over a wide dynamic range, high measurement speed and automated test sequences.

The R&S®TS6600 test system is an efficient solution for analyzing radar frontends by means of multichannel, phase-coherent signals. High level and phase accuracy, which is required for EUT testing and calibration, is ensured through short recalibration of the test system, which is performed automatically each time the system is started and after each temperature change. In conjunction with the use of all-inclusive test routines, this simplifies tests in production and service. The system is controlled via a GUI or from the customer's main measurement software.

Flexible signal generation is a key requirement in the creation and simulation of radar scenarios. The Rohde&Schwarz test system allows the use of predefined, manually created signal sequences or previously recorded sequences. The R&S®TS6600 test system can be precisely configured to match the specific application and the required parameters. Due to its high degree of scalability the system can be tailored to offer the required functionality for any application from development to servicing.

- Generation of up to ten phase-coherent, synchronous RF signals
- High-speed level and phase variation over 50 dB dynamic range by means of waveforms loaded into the tester (I/Q mode)
- CW and pulse mode
- Generation of I/Q data or use of existing I/Q data of customer-specific waveforms with up to 120 MHz bandwidth, as well as playback of realistic reception scenarios
- Analysis of transmit pulses including power measurement
- EUT multiplexing
- Rapid, integrated temperature compensation of test system > 10 s by means of integrated power meter
- Full system calibration (level and phase) in less than 40 min by means of power meter and combiner
- Software libraries for easy integration into main test software

Specifications in brief

Frequency range	1 GHz to 6 GHz
Signal generation	
Maximum number of RF channels	10
Level range	-135 dBm to -17 dBm
Phase	±360°
Fast leveling mode	< 1 µs/step over 50 dB dynamic range with 0.15 dB relative level accuracy (I/Q mode)
Signal types	<ul style="list-style-type: none"> ■ continuous ■ pulse (≥ 100 ns, 10 ns resolution) ■ stored waveform (up to 120 MHz bandwidth, larger bandwidth on request)
Signal measurement	<ul style="list-style-type: none"> ■ spectrum analysis ■ analysis of analog and digital signals (R&S®CompactTSVP)
Interface to EUT	programmable digital interface for communications with EUT
Interface to test system	software driver for control via standard software (e.g. LabVIEW®)
Temperature range	+10°C to +40°C

Chapter 2

Wireless Communications Testers and Systems

To keep the evolution of wireless communications technology running, innovative mobile devices need to be efficiently developed and manufactured. For the complex measurements involved, Rohde & Schwarz offers a wide range of instruments and systems such as wireless device RF and protocol testers for R&D, conformance and operator acceptance tests.



Type	Designation	Description	Page
Wireless device testers			
R&S®CMW270	Wireless Connectivity Tester	The IEEE802.16e Mobile WiMAX™ and non-cellular expert	11
R&S®CMW500	Wideband Radio Communication Tester	All-in-one test platform for wireless devices	12
R&S®CMU200	Universal Radio Communication Tester	Multitechnology tester for mobile radio devices	13
R&S®CMS54/57	Radiocommunication Service Monitors	Radio testers for service, production and development	14
R&S®CTH	Portable Radio Test Set	Always on duty	15
R&S®CBT/CBT32	Bluetooth® Testers	Fast and comprehensive RF and audio measurements for development, production and verification	16
Protocol testers			
R&S®CRTU-W/G	Protocol Test Platform	Family of protocol testers for GSM and WCDMA mobile radio standards	17
R&S®CMW500-PT	HSPA+ and LTE Protocol Tester	One tester for all phases of development	18
Conformance and preformance testers			
R&S®TS895xG/W/GW	GSM/GPRS/EDGE/WCDMA RF Test System Family	Development, precompliance and conformance testing of mobile phones	19
R&S®TS8980	RF Test System for LTE and WCDMA	Platform for testing needs from development to conformance testing	20
R&S®TS8991	OTA Performance Test System	Perfect characterization of wireless products over the air interface	21
R&S®TS8996	RSE Test System	Fully automatic emission measurements on wireless communications equipment required for R&D and quality assurance	22
System accessories			
R&S®CMW-Z10/-Z11	RF Shielding Box and Antenna Coupler	Excellent shielding effectiveness and superior coupling characteristics	23
R&S®TS712x	Shielded RF Test Chambers	Reliable RF tests on devices with radio interface	23
R&S®DST200	RF Diagnostic Chamber	Ideal environment for RF analysis during development	23

R&S®CMW270 Wireless Connectivity Tester



The IEEE 802.16e Mobile WiMAX™ and non-cellular expert

The R&S®CMW270 is the ideal test solution for integrated wireless communications solutions in laptops, netbooks, game consoles, data cards and wireless headsets, for example. It is a tailored subset within the R&S®CMW500 product family. Besides Mobile WiMAX™, the R&S®CMW270 includes generator and analyzer functionality for standards such as WLAN, FM stereo and Bluetooth® as well as for GPS and broadcast technologies.

The R&S®CMW270 was developed to meet the specific requirements in R&D, production, quality assurance, service and network interoperability testing (IOT) – with a single, tailorable instrument. It is an ideal choice for demanding performance tests and measurements in labs and production – from IP application testing under fully controlled network conditions with a MIMO base station emulator to high-speed RF and baseband alignment with dual-tester configuration.

- Continuous frequency range up to 6 GHz
- Multiple standard RF measurements for WiMAX™, WLAN, FM stereo and Bluetooth®
- General-purpose ARB generation for WiMAX™, WLAN, Bluetooth®, FM stereo, GPS and broadcast technologies
- Mobile WiMAX™ base station emulator with MIMO support for matrix A, matrix B and collaborative
- Simultaneous uplink burst measurements during signaling connection, PER/BER and message analyzer
- IP-based end-to-end test for Mobile WiMAX™ performance verification up to the theoretical limits of 36 Mbit/s
- Dual-tester concept with R&S®Multi-Evaluation List mode for speed and cost-optimized production

Specifications in brief

Frequency		
Frequency range	R&S®CMW270	70 MHz to 6 GHz
Max. frequency drift	R&S®CMW270 base unit	$\pm 1 \times 10^{-6}$
	with R&S®CMW-B690A option (OCXO extension)	$\pm 5 \times 10^{-8}$
	with R&S®CMW-B690B option (highly stable OCXO extension)	$\pm 5 \times 10^{-9}$
RF generator		
RF output level range	continuous wave (CW), RF1 OUT, WiMAX™ band 1	-130 dBm to +8 dBm
Output level uncertainty	in temperature range from +20°C to +35°C, no overranging, output level > -120 dBm	< 0.6 dB (12-month calibration interval) < 0.8 dB (24-month calibration interval)
IF bandwidth		70 MHz
RF analyzer		
RF input level range	continuous power (CW), RF1 COM, RF2 COM	-84 dBm to +34 dBm
Level uncertainty	in temperature range from +20°C to +35°C	< 0.5 dB (one-year calibration interval) < 0.7 dB (two-year calibration interval)
IF bandwidth		40 MHz
Arbitrary waveform generator (with R&S®CMW-B110A option)		
Arbitrary waveform files	maximum sample length	256 Msample
Sample rate	maximum	100 MHz
Memory size		min. 1 Gbyte
Mobile WiMAX™ parameters		
Digital standard		IEEE 802.16e
Physical layer mode		OFDMA, TDD
Bandwidth		3.5 MHz, 5 MHz, 7 MHz, 8.75 MHz, 10 MHz
Frame duration		5 ms
FFT size		512, 1024
Modulation modes and coding rates		BPSK, QPSK 1/2, QPSK 3/4, 16QAM 1/2, 16QAM 3/4, 64QAM 1/2, 64QAM 2/3, 64QAM 3/4, 64QAM 5/6
MAC support		IEEE 802.16e, base station emulation

R&S®CMW500 Wideband Radio Communication Tester



All-in-one test platform for wireless devices

The R&S®CMW500 is the universal tester for testing the air interface of wireless devices. The R&S®CMW500 can be used in all phases of product development and production and supports all common cellular and non-cellular wireless technologies. The R&S®CMW500 supports and tests all protocol layers – from the RF to end-to-end data. It is based on a concept implementing scalable options and can be adapted to any application.

The R&S®CMW500 can handle the following:

- Wireless standards and broadcast technologies, e.g. LTE (incl. MIMO), WLAN or DVB-T and associated inter-RAT measurements
- All phases of development, verification and production
- All protocol layers, from RF tests and protocol tests to end-to-end application tests
- Module tests, system and integration tests, regression tests, conformance tests and production tests

To adapt the R&S®CMW500 to the requirements of the application, the user simply has to select the appropriate hardware and software components. Rohde&Schwarz offers preconfigured models for a number of important applications.

Models	
R&S®CMW500 The all-in-one test platform	The R&S®CMW500 is the universal model for virtually all applications. It offers maximum flexibility – for development and production, for RF and protocol tests as well as for all technologies.
R&S®CMW280 The compact RF tester for production	The R&S®CMW280 is the compact version of the R&S®CMW500 and has 20% less depth. It can be configured exclusively as a single tester and requires only minimum floor space in classic test concepts.
R&S®CMW270 The expert for WiMAX™ and non-cellular technologies	Specially designed for the WiMAX™, WLAN, Bluetooth®, GPS, FM radio and broadcast standards, the R&S®CMW270 is a cost-effective alternative for the development and production of equipment outside the conventional cellular networks.
R&S®CMWPC The R&S®CMW tool set for PC	To maximize the efficiency of the R&S®CMW500 and the R&S®CMW270, any tasks that do not require specialized hardware (e.g. RF converters) can be performed on a PC. The preparation and follow-up of tests or test campaigns or the generation of tests and remote control scripts can be carried out cost-effectively on a standard PC using R&S®CMWPC. R&S®CMWPC is also the basis for virtual protocol testing where the physical layer is replaced by a software emulation.

Use of the R&S®CMW500 for multiple wireless technologies

Technology	RF generator	RF analyzer	Network emulation	Protocol test	End-to-end application test
LTE FDD	•	•	•	•	•
LTE TDD (TD-LTE)	•	•	•	•	•
Mobile WiMAX™	•	•	•		•
CDMA2000® 1xRTT	•	•	•		•
CDMA2000® 1xEV-DO	•	•	•		•
TD-SCDMA	•	•			
WCDMA/HSPA+	•	•	•	•	•
GSM/GPRS/EDGE/EDGE Evolution	•	•	•	•	•
GPS	•				
Bluetooth®	•	•			
WLAN a/b/g/n	•	•			
DVB-T	•				
T-DMB	•				
MediaFLO™	•				
CMMB	•				
FM stereo	•				

R&S®CMU200 Universal Radio Communication Tester



Multitechnology tester for mobile radio devices

The R&S®CMU200 ensures premium cost effectiveness through a variety of features, with extremely fast measurement speed and very high accuracy being the two most important ones. In addition, the secondary remote addressing of the tester's modular architecture makes for intelligent and autonomous processing of complete measurement tasks and fast control program design.

- ▮ Extremely high-speed testing
- ▮ Highly accurate measurements
- ▮ Modular future-ready design
- ▮ Comprehensive spectrum analyzer
- ▮ Fast switching between networks

Supported technologies

- ▮ CDMA2000® 1xRTT
- ▮ CDMA2000® 1xEV-DO
- ▮ WCDMA/HSPA
- ▮ GSM/GPRS/EDGE
- ▮ A-GPS
- ▮ Bluetooth®

Applications

- ▮ RF development
- ▮ Module design
- ▮ Module test in production
- ▮ Adjustment of mobile phones
- ▮ Final test in production
- ▮ Functional test
- ▮ Feature test
- ▮ High-end service
- ▮ Quality inspection
- ▮ Basis for test systems
- ▮ Base station simulation

Models

- ▮ R&S®CMU200V02 for mobile phone testing with network emulation – the signaling specialist
- ▮ R&S®CMU200V10 for high-end servicing of mobile phones – the service tester specialist
- ▮ R&S®CMU200V30 for non-signaling production testing of mobile phones – the calibration specialist

Specifications in brief

RF generator		
Frequency range		100 kHz to 2.7 GHz
Frequency resolution		0.1 Hz
Output level range	RF2, 100 kHz to 2.2 GHz	-130 dBm to -10 dBm
	RF2, 2.2 GHz to 2.7 GHz	-130 dBm to -16 dBm
Output level uncertainty	output level \geq -106 dBm, +20°C to +35°C	
	RF1/2, < 2.2 GHz	< 0.6 dB
Output level resolution		0.1 dB
RF analyzer		
VSWR	RF1, 10 MHz to 2.0 GHz	< 1.2
	RF1, 2.0 GHz to 2.2 GHz	< 1.3
	RF2, 10 MHz to 2.2 GHz	< 1.2
Power meter (wideband)		
Frequency range		100 kHz to 2.7 GHz
Level range	continuous power, 10 MHz to 2.2 GHz	
	RF1, 50 W	+6 dBm to +47 dBm
	RF2, 2 W	-8 dBm to +33 dBm
Level uncertainty	+6 dBm to +33 dBm input level, +5°C to +20°C or +35°C	
	RF2, 50 MHz to 2.7 GHz	< 0.5 dB

R&S®CMS54/57 Radiocommunication Service Monitors



Radio testers for service, production and development

The R&S®CMS is the ideal radio tester for use in service, maintenance and test departments. It is suitable for all transceivers using AM, FM or ϕ M as well as SSB. Optional extensions enable the R&S®CMS to satisfy all requirements of radio measurements and even to cover related fields. Low weight, compact size and low power consumption make this instrument particularly suitable for mobile use.

The autorun control and printer interface allows automatic test routines to be easily configured and stored via the front-panel keypad. Tolerances can be inserted into these test routines to determine and log pass/fail limits. Battery-backed memory cards are used as program and test report library. Test reports, program lists and screen hardcopies can be output on a printer.

- ▮ Frequency range from 400 kHz to 1 GHz
- ▮ Radio tester family including two models to cover all measurement requirements
- ▮ Suitable for every type of radio equipment using AM, FM, ϕ M as well as SSB
- ▮ Transmitter, receiver and duplex measurements on mobile radio equipment, base stations and RF modules
- ▮ Analog signaling
- ▮ Simultaneous display of settings and results
- ▮ Manual and automatic measurements
- ▮ Tracking generator
- ▮ Spectrum monitor
- ▮ Stationary and mobile use
- ▮ Cable fault finder

Both testers provide

- ▮ Transmitter and receiver testing
- ▮ RF spectrum monitor with zero-span to full-span display
- ▮ Extremely sensitive RF frequency counter
- ▮ Transient recorder for frequency versus time and power versus time
- ▮ Fully automatic testing

R&S®CMS54: radio tester for high-end service

Additional equipment:

- ▮ Full-span tracking generator from 0.4 MHz to 1000 MHz
- ▮ Adjacent channel power meter with standard ETSI filters
- ▮ Duplex modulation meter
- ▮ Automatic harmonic measurements
- ▮ Cable fault finder

R&S®CMS57: specialist for avionics

Additional equipment:

- ▮ VOR/ILS signal generator

Specifications in brief	
Basic RF data	
Frequency range	(30 kHz) 1 MHz to 1 GHz
Max. input power	50 W, optionally 100 W
RF generator	
Output level, RF I/O port	-134 dBm to 0 dBm
Level accuracy, up to 1 GHz	± 3 dB
FM deviation accuracy	5%
FM deviation range	0 Hz to 100 kHz
FM modulation frequency	20 Hz to 20 kHz
AM depth range	0% to 99%
AM modulation frequency	0 Hz to 10 kHz
AM accuracy	5%
SSB phase noise	-105 dBc (1 Hz) at 10 kHz
Spectrum analyzer	
Accuracy	± 3 dB
Dynamic range	> 65 dB

Specifications in brief	
Broadband power measurement	
Range, RF I/O	5 mW to 100 W
Accuracy	0.45 dB
Analyzer	
FM demodulation range	0 Hz to 100 kHz
FM demodulation accuracy	± 5 %
AM demodulation range	0% to 99%
AM demodulation accuracy	± 7 %
Distortion measurement	
Range	0.1% to 50%
Accuracy	± 5 %
Input level	0.1 V
SINAD meter	
Frequency	100 Hz to 5 kHz
Input level range	100 mV to 30 V
Accuracy	< 1 dB

R&S®CTH Portable Radio Test Set



Always on duty

The R&S®CTH allows dependable testing of analog FM radio systems even under challenging environmental conditions. The radio test set was designed especially for outdoor use.

Ensuring the smooth functioning of transceivers is the key to successful communications. The R&S®CTH100A/R&S®CTH200A performs this type of work without requiring expert knowledge. The user can simply connect the device under test (DUT) to the R&S®CTH100A/R&S®CTH200A and immediately begin transmitter and receiver measurements.

The R&S®CTH100A/R&S®CTH200A includes all the measurement functions needed for reliable testing of transceivers. The measurement results are clearly presented on a display that is optimized for outdoor use so the measured values are easily readable even under difficult lighting conditions.

With its high measurement accuracy and straightforward operation, the R&S®CTH100A/R&S®CTH200A delivers unrivaled performance and functionality for its class.

- ▮ Frequency measurement
- ▮ Power measurement
- ▮ Over-the-air measurement (R&S®CTH200A)
- ▮ Distance-to-fault measurement (R&S®CTH200A)
- ▮ Voice reporting (R&S®CTH200A)
- ▮ Handy and ergonomic
- ▮ Rugged and all-weatherproof

Model overview

	R&S®CTH100A	R&S®CTH200A
Transmitter measurements		
Forward power	•	•
Reflected power	•	•
Frequency counter	•	•
FM receiver measurements		
Squelch	•	•
Demodulation	•	•
Additional measurements		
Over the air	–	•
Distance to fault	–	•
Voice reporting	–	•

Specifications in brief

Generator		
Frequency range	in fixed steps of 5 MHz (R&S®CTH100A), in adjustable steps of 100/200/500 kHz/1/2/5 MHz (R&S®CTH200A)	30 MHz to 512 MHz
Power level	fixed level (R&S®CTH100A)	–97 dBm
	adjustable level (R&S®CTH200A)	–120 dBm to –97 dBm
FM modulation	audio	900 Hz
	squelch	150 Hz
Level uncertainty		3 dB
Power measurement		
forward and reflected power		
Measurement range		0.1 W to 50 W
Measurement uncertainty		20%
Frequency measurement		
Measurement range		30 MHz to 512 MHz
Measurement uncertainty		2 kHz

R&S® CBT/CBT32 Bluetooth® Testers

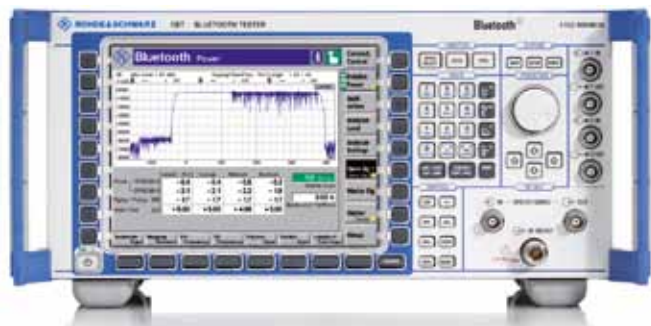

Fast and comprehensive RF and audio measurements for development, production and verification

The R&S® CBT testers perform Bluetooth® RF tests on all channels in hopping or non-hopping mode. They offer a large number of statistical monitoring and measurement functions. It is possible, for instance, to define tolerances for each measured value, or to stop a measurement sequence after a certain number of measurements or when a tolerance has been exceeded.

- Highly flexible troubleshooting in R&D
- Very short measurement times for high throughput in production
- Integrated spectrum measurements
- R&S® CBTGo software supporting 18 Bluetooth® RF test cases
- Bluetooth® audio profiles (handsfree, headset and A2DP)
- Dual-channel audio generator and analyzer
- Bluetooth® low energy RF tests

High-speed Bluetooth® tests in production

The R&S® CBT uses parallel signal processing and therefore performs Bluetooth® tests in production lines at extremely high speed. While conventional Bluetooth® testers sequentially measure power, modulation, frequency accuracy and frequency drift, the R&S® CBT performs all these measurements in a single test cycle.

The highly flexible remote control programming makes it easy to adapt measurement configurations to any specific test requirements. For example, if measurements are to be carried out on five channels instead of the three channels used by conventional testers, the R&S® CBT remote control program can easily be modified to include two more channels. In the case of other testers, this would require running the entire test sequence a second time, which would considerably slow down the measurement process.

R&S® CBT and R&S® CBT32 – the perfect combination for R&D and production

Featuring a wide range of control options and a large display, the R&S® CBT is the ideal choice for R&D applications in the lab. When a product is transferred to production, the remote control program for the tester can be created conveniently on the R&S® CBT, which allows every test step to be verified in manual operation. Later, in the production line, the more favorably priced R&S® CBT32 can be used, which is intended exclusively for remote control and optimized for 19" racks. The R&S® CBT and the R&S® CBT32 have identical hardware and software, the main difference being that the R&S® CBT32 has no control elements.

Specifications in brief

Specifications in brief		
RF generator		
Frequency range	RF menu	2398 MHz to 2499 MHz
	Bluetooth® menu	2402 MHz to 2495 MHz
	Bluetooth® LE menu	2402 MHz to 2480 MHz
Frequency offset range		±250 kHz
Output level range, RF IN/OUT	for basic rate packets and for Bluetooth® low energy packets	-90 dBm to +0 dBm
	for EDR packets (2-DHx, 3-DHx)	-90 dBm to -3 dBm
GFSK modulation	GFSK bit rate, DHx packet types	1 Mbps, B × T = 0.5
	modulation index range, 100 kHz to 220 kHz frequency deviation	0.20 to 0.44
DPSK modulation	π/4DQPSK bit rate, 2-DHx packet types	2 Mbps
	8DPSK bit rate, 3-DHx packet types	3 Mbps
Power meter		
Level range, RF IN/OUT	continuous power	-40 dBm to +22 dBm
	peak envelope power (PEP)	+26 dBm (400 mW)
Modulation analyzer		
Total measurement range for frequency offset and frequency deviation (GFSK)	Bluetooth® menu frequency offset < maximum deviation	-250 kHz to +250 kHz
	Bluetooth® LE menu frequency offset < maximum deviation	-350 kHz to +350 kHz
Frequency resolution (GFSK/DPSK)	manual mode	1 kHz
	remote control mode	1 Hz

R&S®CRTU-W/G Protocol Test Platform



Family of protocol testers for GSM and WCDMA mobile radio standards

The R&S®CRTU-W/G is the unique signaling and protocol test solution for GSM/WCDMA multimode terminals. It provides a maximum level of flexibility from early design and development through to comprehensive conformance and certification testing.

Powerful tools enable the user to define and execute test cases in line with 3GPP test specifications TS51.010 and TS34.123 and to visualize the test results. In addition, customer-specific test scenarios can be implemented in TTCN or C++. Two independent RF channels allow the simulation of two independent cells at the same or at different RF frequencies, which is an indispensable prerequisite for performing WCDMA handovers.

- ▀ Protocol analyzer and system simulator for (E)GPRS/GSM/ HSPA/WCDMA FDD
- ▀ Support of all specified frequency bands
- ▀ Use in protocol stack R&D and conformance testing
- ▀ Complete and convenient tool chain from test generation to result analysis

- ▀ Detailed signaling analysis
- ▀ Full test case coverage for mobile certification according to GCF and PTCRB
- ▀ Fully automatic test cycles
- ▀ Channel extension to up to ten physical channels
- ▀ Ciphering available
- ▀ Windows operating system
- ▀ Upgradeable to RRM and RF conformance test systems

Members of the R&S®CRTU family

R&S®CRTU-G

The R&S®CRTU-G simulates a GSM base station with two completely independent RF channels. The GSM400/850/900/1800/1900 networks are supported.

R&S®CRTU-S

The R&S®CRTU-S was designed as a dual-channel RF expansion for an R&S®CRTU-G acting as master. It comes with all available frequency bands and signaling options and performs all functions supported by the master, requiring no extra options.

R&S®CRTU-W

The R&S®CRTU-W is a highly versatile signaling protocol tester for WCDMA and dual-mode mobile phones. An existing R&S®CRTU GSM protocol tester can be expanded easily and cost-effectively to create a UMTS protocol tester while maintaining its GSM test functionality.

R&S®CRTU-M

Some test cases require more than two UMTS cells. The R&S®CRTU platform concept allows cascading of up to three UMTS protocol testers. An R&S®CRTU-W master can be connected to up to two R&S®CRTU-M slaves to form a multicell system that simulates as many as six UMTS cells.

Specifications in brief

RF generator (CW signals)		
Frequency range		100 kHz to 2700 MHz
Frequency resolution		0.1 Hz
Output level uncertainty (RF1/2)	10 MHz to 2.2 GHz, level ≥ -106 dBm, +20°C to +35°C	< 0.8 dB
Output level resolution		0.1 dB
RF generator (GSM)		
Supported bands		GSM400/850/900/1800/1900
Output level range (RF2)	GMSK	-130 dBm to -16 dBm
	8PSK	-130 dBm to -20 dBm
Output level uncertainty (RF1/2)	level ≥ -117 dBm, +20°C to +35°C	< 0.7 dB
RF generator (WCDMA)		
Supported bands		band I, II, III, IV, V, VI, VII, VIII, IX
Output level range (RF2, RMS value)	max. value depends on channel configuration	-120 dBm to -20 dBm
Output level uncertainty (RF1/2)	level ≥ -120 dBm, $f < 2200$ MHz, +20°C to +35°C	< 0.8 dB

R&S®CMW500-PT HSPA+ and LTE Protocol Tester



One tester for all phases of development

The R&S®CMW500-PT is the ideal UMTS long term evolution (LTE) protocol tester, as it provides developers of wireless devices with a radio access network simulation.

Equipped with powerful hardware and various interfaces to wireless devices, the R&S®CMW500-PT can be used throughout all phases of LTE device development – from the initial software module test to the integration of software and chipset, as well as for conformance and performance tests of the protocol stack of 3GPP-compliant wireless devices.

The R&S®CMW500-PT provides developers of LTE protocols with a specification-conforming reference implementation of the air interface. The comprehensive functions of the programming interfaces and the highly detailed representation in the analysis tools can be used to quickly detect discrepancies in the DUT protocol stack.

Hardware platform

- LTE protocol tester with a layer 1 to layer 3 protocol stack implementation in accordance with 3GPP Rel. 8 specifications TS36.302, TS36.321, TS36.322, TS36.323, TS36.331
- Future-ready, powerful RF hardware that supports the 3GPP-defined LTE bandwidths from 1.4 MHz to 20 MHz and all 3GPP frequency bands up to 6 GHz
- Data rates up to 100 Mbps in the downlink and 50 Mbps in the uplink
- Integration of the DUT via an RF interface or digital I/O interface (realtime, reduced clock); adaptation to customer-specific digital I/O standards via an external adapter unit (future release)
- Digital baseband fading by means of the R&S®AMU200 fading simulator
- 2x2 MIMO and 4x2 MIMO (future release)
- Multicell and multi-RAT capability for LTE intracell, intercell and inter-RAT handover tests (future release)

Software components

- Development environment for layer 1 to layer 3 signaling scenarios with automatic configuration of the layers below
- TTCN3 libraries and software tools for developing LTE signaling conformance test cases (future release)
- Extensive library with preconfigured messages and signaling scenarios for speeding up test development
- Practice-proven software tools for carrying out, working on, automating and analyzing signaling scenarios
- Optional emulation of the physical layer for the development of layer 2 and layer 3 protocol software on PCs

Specifications in brief

Physical layer	
Frequency range	all 3GPP frequency bands up to 6 GHz
Physical layer mode	SISO
	2x2 MIMO from V1.30
Duplexing	FDD mode
Data rate	100 Mbps DL, 50 Mbps UL
	25 Mbps DL, 25 Mbps UL in V1.00
Layer 2 MAC	
Transport channels	BCH, DL-SCH, UL-SCH, PCH, RACH, PDCCH, PUCCH, PCFICH (V1.10)
Logical channels	DTCH, BCCH, DCCH, PCCH, CCCH (V1.10)
Modes	unacknowledged mode, transparent mode, acknowledged mode (V1.10)
PDU operations	assembly, disassembly, multiplexing, demultiplexing, padding
Procedures	duplicate detection, error detection and recovery, discard and reset procedure

R&S®TS895xG/W/GW GSM/GPRS/EDGE/WCDMA RF Test System Family



Development, precompliance and conformance testing of mobile phones

The R&S®TS895x family consists of a full range of highly configurable RF test systems for user equipment (UE) and mobile phones. The R&S®TS8950 represents the top end of the new, third generation of RF test systems from Rohde&Schwarz that fulfills all requirements for RF conformance tests on 2G, 2.5G and 3G devices.

Customized and standard solutions for R&D, development and precompliance testing are available with the R&S®TS895x test solutions, i.e. the R&S®TS8955G, R&S®TS8955W and R&S®TS8955GW in various configurations depending on the required functionalities. The R&S®TS8955 uses the same application software as the R&S®TS8950.

The R&S®TS8950 systems feature fully automatic path calibration routines that run with minimum manual intervention and without the need for any external equipment.

The R&S®TS895x family

- R&S®TS8950G: GSM RF full conformance tests
- R&S®TS8950W: WCDMA RF full conformance tests
- R&S®TS8950GW: dual-mode GSM/WCDMA RF full conformance tests
- R&S®TS8952G: GSM RF receiver conformance tests
- R&S®TS8955G: GSM RF precompliance/R&D tests
- R&S®TS8955GW: WCDMA RF precompliance/R&D tests

System upgrades are possible at any time with only small add-ons, because the R&S®TS895x platform is nearly identical for GSM and WCDMA applications.

Test applications for RF test

- R&S®TS8950G: GSM, GPRS, AMR, DARP, EGPRS and VAMOS in line with 3G TS51.010-1; sections 12/13/14/16/18/21
- R&S®TS8950W: WCDMA FDD 1 to FDD 11 in line with 3G TS34.121, HSDPA, Rel. 7; sections 5/6/7/9/10
- R&S®TS8955G: GSM, GPRS, AMR, DARP and EGPRS in line with 3G TS51.010-1; sections 12/13/14/21
- R&S®TS8955W: WCDMA FDD 1 to FDD 11 in line with 3G TS34.121, HSDPA, Rel. 6; sections 5/6/7/9/10

Radio resource management tests, section 8, are available in a separate test setup or as an extension to the R&S®TS8950W or R&S®TS8950GW. All test cases are implemented based on test methods. The test methods are generic test applications with parameter sets that can be edited via an intuitive Windows user interface.

RF tests for the development of GERAN and UTRAN mobile phones and user equipment

- User-configurable test scenarios based on supplied test methods
- Different system configurations available depending on customer requirements
- Support of customer climatic chambers to run tests under different temperature conditions
- Conformance tests
 - Using sets of validated test cases
 - Using a validated test platform
- Precompliance tests
 - Testing against modified conformance tests
 - Testing against custom tests based on the Rohde&Schwarz test methods
- R&D tests
 - Margin testing, e.g. absolute sensitivity of receiver
- Quality assurance
 - Sample test

R&S®TS8980 RF Test System for LTE and WCDMA



Platform for testing needs from development to conformance testing

The R&S®TS8980 RF test system family covers the testing needs from R&D to conformance for WCDMA and LTE chipsets and mobile stations. It is modular and fully automated for RF transmitter, receiver and performance measurements. The scalable hardware and software allows cost-efficient solutions in R&D and can be upgraded for precompliance and full conformance testing.

Different setups of the R&S®TS8980 for different requirements

- ▮ Layer 1 tests (LTE) (R&S®TS8980S)
- ▮ R&D applications to create user-specific test scenarios (LTE) (R&S®TS8980S)
- ▮ Precompliance tests in line with 3GPP TS36.521-1 (LTE) and 3GPP TS34.121-1 (WCDMA) (R&S®TS8980S)

- ▮ Full conformance testing in line with 3GPP TS36.521-1 (LTE) and 3GPP TS34.121-1 (WCDMA) (R&S®TS8980IB, R&S®TS8980FTA)
- ▮ Network-operator-specific tests (AT&T, Sprint, US Cellular, Verizon Wireless etc.) (R&S®TS8980IB, R&S®TS8980FTA)

Reusable structure supports upgrading

- ▮ Performance quality analysis (POA) as software upgrade
- ▮ Radio resource management (TS-RRM)

R&S®CONTEST software platform

- ▮ R&D applications to create user-specific test scenarios
- ▮ Debugging with breakpoints, step-by-step execution
- ▮ Easy-to-use graphical parameterization of test cases
- ▮ Sequencer tool
- ▮ DUT services such as graphical antenna configurations
- ▮ Online report with status of progress and pie diagram
- ▮ Summary report with filter for report explorer
- ▮ Test results in HTML, XML or CSV format and internal and external database access

Consistent RF tests

The hardware can be expanded to create a conformance test system. This, together with the uniform tester software, ensures optimal results in applications ranging from development to final testing.

Reduced development times

- ▮ Efficient tools
- ▮ Individual definition of tests
- ▮ Test methods included
- ▮ Individual or sequential execution of tests

Precise, reproducible measurement results

The fully automated path calibration used in the R&S®TS8980 LTE RF test system and high-speed self-test mechanisms deliver maximum accuracy and reproducibility of measurement results.

Low cost of ownership

Scalable configurations starting with the R&S®TS8980S ensure an optimum match of budget and functionality. The instruments used in the system require calibration only every 24 months. Between calibrations, automatic path calibration ensures optimum measurement accuracy.

Efficient use of test system through automation

RF tests can be fully automated if required. This makes it possible to use the system continuously, independent of working hours. An optional extension further increases the level of automation by allowing sequential testing of multiple devices under test on one system.

R&S®TS8991 OTA Performance Test System



CTIA-compliant OTA measurements – LTE and MIMO inside

Over-the-air (OTA) measurements are an essential part of the certification testing of wireless devices that require an omnidirectional antenna radiation pattern. The R&S®TS8991 OTA performance test system measures the spatial radiation and sensitivity characteristic as specified by CTIA and 3GPP. MIMO OTA testing is also supported by the R&S®TS8991.

The R&S®AMS32 system software provides ready-to-use test templates for OTA measurements and supports all common wireless standards. The integrated report function collects all measured test data such as graphics or numeric results, test environments, EUT information and hardware setup in one document.

- Measurement of OTA performance in line with CTIA, Wi-Fi Alliance, CWG, PTCRB standards and test cases and WiMAX Forum®
- For all important wireless technologies, including LTE, MIMO and A-GPS
- Time-optimized, configurable test sequences for qualification and development, based on R&S®AMS32 system software
- Can be combined with radiated spurious emission and EMC test systems
- Two different test methods: great circle and conical cut
- Turnkey solution including OTA chamber and EUT positioner
- Cost-effective OTA verification of MIMO-enabled devices with easy-to-use test setup

Configuration example: conical cut solution

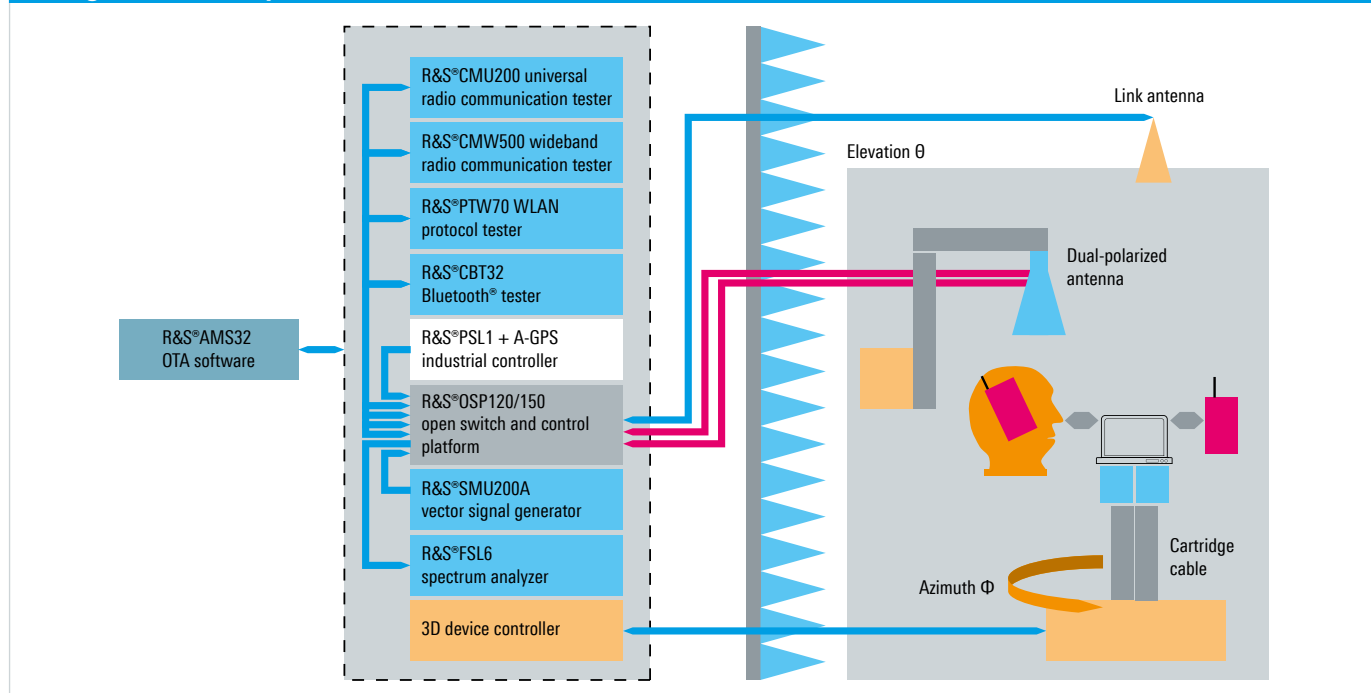

R&S®TS8996 RSE Test System



Fully automatic emission measurements on wireless communications equipment required for R&D and quality assurance

The R&S®TS8996 RSE test system is used for EMI and spurious emission measurements on wireless communications equipment during EMC and type approval testing. Typical DUTs are mobile phones, base stations, radio sets and short-range devices.

The relevant standards stipulate a wide variety of measurements in a very wide frequency range, all of which can be covered with the R&S®TS8996. For some radiocommunications systems (i.e. short-range devices), higher frequency limits (i.e. 40 GHz) are already stipulated for spurious emission measurements. The R&S®TS8996 can be easily adapted to customer requirements.

The modular design of the R&S®OSP-F7x filter unit for carrier frequency suppression allows flexible configuration and easy expansion for various frequency bands. For measuring radiated spurious emissions from radiocommunications equipment, filter configurations for the following technologies are prepared: GSM, Bluetooth®, WLAN, WiMAX™, WCDMA (UMTS) and LTE. Others are available on request.

- ▀ Frequency range from 30 MHz to 18 (40) GHz
- ▀ Radiated measurements in line with ETSI EN301489, FCC part 15 and 3GPP TS51.010 standards
- ▀ Conducted spurious emission measurements from 100 kHz to 12.75 GHz on antenna connector of DUT
- ▀ Measurement of spurious emissions from radiocommunications equipment

System software

The R&S®EMC32 software enables fully automatic simple testing. The R&S®EMC32-K2 option offers special features:

- ▀ Automatic setup and control of wireless link
- ▀ Control of different 3D EUT manipulators
- ▀ ERP/EIRP measurement
- ▀ Automatic suppression of carrier signal by R&S®T8996 filter unit

The predefined test sequences allow a high degree of automation. Users are freed from tedious extra work, and incorrect settings or signal connections can be avoided right from the start. Our product managers assist customers with option selection and system configuration.



R&S®TS8996 RSE test system with R&S®OSP-F7x filter bank, R&S®R-Line compact RF chamber or separate R&S®TS-MAPD positioner.

System accessories

R&S®CMW-Z10/Z11 RF Shielding Box and Antenna Coupler

**Excellent shielding effectiveness and superior coupling characteristics**

The R&S®CMW-Z10 RF shielding box and the R&S®CMW-Z11 antenna coupler offer excellent shielding effectiveness and superior coupling characteristics. Both devices can be used for frequencies up to 6 GHz. These outstanding features combine with a modular options concept to make the R&S®CMW-Z10 and R&S®CMW-Z11 indispensable for any radiocommunications tester.

- Excellent shielding characteristics
- Ultralow reflections
- Broadband spiral antenna allowing a wide variety of applications
- Optimized antenna structure for extremely good RF coupling
- Designed for harsh, continuous duty and ergonomic operation
- Modular options concept and flexible assignment of modules
- Large area for optimum positioning, even of large DUTs

Specifications in brief

- Shielding effectiveness
 - 0.4 GHz to 4 GHz: > 80 dB
 - 4 GHz to 6 GHz: > 60 dB
- Outer dimensions (W × H × D): 320.9 mm × 267.5 mm × 527.7 mm (12.6 in × 10.5 in × 20.8 in)
- Weight: 9 kg (19.8 lb)

R&S®TS712x Shielded RF Test Chambers

**Reliable RF tests on devices with radio interface**

The R&S®TS712x family of RF test chambers has been designed to meet the requirements of automatic production lines. These include long life, rugged design and automatic opening and closing of the RF chamber. Featuring high shielding effectiveness over a wide frequency range, the RF test chambers perform tests on modules and devices with a radio interface in accordance with a wide variety of standards such as ISM, GSM/CDMA2000®/WCDMA, WLAN, Bluetooth®, ZigBee, WiMAX™ and LTE.

- Rugged design for long life
- High shielding effectiveness up to 14 GHz
- Low reflection due to use of absorbent material
- Integrated RF connectors and filter feedthroughs
- Variety of options to support application-specific configurations

R&S®TS7121A and R&S®TS7123M

The R&S®TS712x family includes two base models that differ mainly in width. An automatic and a manual version of each model are also available. The automatic R&S®TS712xA RF test chamber is mainly used in production. The R&S®TS712xM manual version is particularly suited for applications in service, quality assurance and development.

The R&S®TS712xA and R&S®TS712xM automatic and manual versions of the RF test chambers have the same basic design, ensuring the same test functionality for both versions in development, production and service. The exchangeable connector plate allows the user to add application-specific feedthroughs without having to modify the RF test chamber.

R&S®DST200 RF Diagnostic Chamber

**Ideal environment for RF analysis during development**

The R&S®DST200 RF diagnostic chamber supports a wide range of radiated test applications for wireless devices. It fits on the workbench of every R&D lab and is therefore always available during the product design and optimization phase. The R&S®DST200 effectively assists in achieving high first-time pass rates at final type approval, which saves time and money.

- Anechoic RF chamber with highly effective shielding > 110 dB for interference-free testing in unshielded environments
- Wide frequency range from 700 MHz to 6 GHz covering all important wireless standards
- High reproducibility due to excellent uniformity of field distribution at equipment under test (EUT) location
- Small size suitable for any lab environment
- Matchless mechanical design provides long-term stability and maintains the shielding effectiveness
- Easy opening and closing of door: no need for pneumatic components

Specifications in brief

- Frequency range: 700 MHz to 6 GHz (higher frequencies on request)
- Antenna polarization: circular
- Shielding effectiveness (base unit with R&S®DST-B102 option)
 - 700 MHz ≤ f ≤ 3 GHz: > 110 dB
 - 3 GHz < f ≤ 6 GHz: > 100 dB
- Quiet zone (above EUT table, Ø × H): 200 mm × 30 mm (7.9 in × 1.2 in)
- Field uniformity (max. field variation in quiet zone): < 3.2 dB (meas.)
- RF feedthrough connectors (R&S®DST-B102 option): 2 × N, female
- Test antenna connector: 1 × N, female
- Dimensions (W × H × D, with locking handle): 770 mm × 760 mm × 695 mm (30.3 in × 29.9 in × 27.4 in)
- Max. EUT dimensions (W × H × D): 400 mm × 330 mm × 400 mm (15.7 in × 13.0 in × 15.7 in)
- Weight: approx. 55 kg (121 lb)
- Max. EUT weight: 3 kg (6.6 lb)

Chapter 3

Oscilloscopes

What customers have often requested is finally available: oscilloscopes from Rohde & Schwarz. As always, users benefit from the high quality and in-depth development and production expertise at Rohde & Schwarz.

Everything takes place in-house: analog, mixed signal and digital integration; software, RF and digital development; production from printed board to finished product. The result: two new oscilloscope families covering bandwidths from 500 MHz to 2 GHz.



Type	Designation	Bandwidth/channels	Description	Page
Oscilloscopes				
R&S®RTO	Digital Oscilloscope	600 MHz/2 or 4 channels 1 GHz/2 or 4 channels 2 GHz/2 or 4 channels	High performance in the 600 MHz to 2 GHz class	25
R&S®RTM	Digital Oscilloscope	500 MHz/2 or 4 channels	Compact, precise, versatile	26
Probes for the R&S®RTO and R&S®RTM oscilloscope families				
R&S®RT-ZP10	Passive Voltage Probe	500 MHz	Passive, high-impedance	27
R&S®RTM-ZP10	Passive Voltage Probe	500 MHz	Passive, high-impedance	27
R&S®RT-ZS10	Active Voltage Probe	1 GHz	Active, single-ended, with R&S®ProbeMeter and micro button	27
R&S®RT-ZS10E	Active Voltage Probe	1 GHz	Active, single-ended	27
R&S®RT-ZS20	Active Voltage Probe	1.5 GHz	Active, single-ended, with R&S®ProbeMeter and micro button	27
R&S®RT-ZS30	Active Voltage Probe	3 GHz	Active, single-ended, with R&S®ProbeMeter and micro button	27
R&S®RT-ZD20	Differential Voltage Probe	1.5 GHz	Active, differential, with R&S®ProbeMeter and micro button	27
R&S®RT-ZD30	Differential Voltage Probe	3 GHz	Active, differential, with R&S®ProbeMeter and micro button	27
R&S®RT-ZH10	Passive High-Voltage Probe	400 MHz	Passive, high-voltage, single-ended	27
R&S®RT-ZH11	Passive High-Voltage Probe	400 MHz	Passive, high-voltage, single-ended	27

R&S®RTO Digital Oscilloscope



High performance in the 600 MHz to 2 GHz class

The R&S®RTO oscilloscopes combine excellent signal fidelity, high acquisition rate and the world's first realtime digital trigger system with a compact device format in the 600 MHz to 2 GHz class. They offer hardware-accelerated measurement and analysis functions.

- ▮ Fast finding of signal faults
- ▮ Hardware-accelerated analysis
- ▮ Highly accurate digital trigger system
- ▮ New ease of operation
- ▮ Convincing accuracy
- ▮ Triggering and decoding of serial protocols
- ▮ Logic analysis with the MSO option

Specifications in brief of the base unit

Vertical system

Input channels	R&S®RTO1002/RTO1012/RTO1022	2
	R&S®RTO1004/RTO1014/RTO1024	4
Bandwidth (−3 dB) at 50 Ω	R&S®RTO1002 and R&S®RTO1004	600 MHz
	R&S®RTO1012 and R&S®RTO1014	1 GHz
	R&S®RTO1022 and R&S®RTO1024	2 GHz
Input impedance		50 Ω ± 1.5%, 1 MΩ ± 1% with 15 pF (meas.)
Input sensitivity	max. bandwidth in all ranges	50 Ω: 1 mV/div to 1 V/div, 1 MΩ: 1 mV/div to 10 V/div
Effective number of bits (ENOB) of the A/D converter	full-scale sine, frequency < −3 dB bandwidth	> 7 bit (meas.)

Acquisition system

Max. sampling rate (realtime)		10 Gsample/s per channel
Memory depth	standard configuration, per channel/1 channel active	R&S®RTO 2-channel model: 20/40 Msample R&S®RTO 4-channel model: 20/80 Msample
	max. upgrade (R&S®RTO-B102 option), per channel/1 channel active	R&S®RTO 2-channel model: 100/200 Msample R&S®RTO 4-channel model: 100/400 Msample
Max. acquisition rate	continuous acquisition and display, 10 Gsample/s, 1 ksample	1 000 000 waveforms/s
Decimation modes	any combination of decimation mode and waveform arithmetics on up to 3 waveforms per channel	Sample, Peak Detect, High Resolution, Root Mean Square
Waveform arithmetics		Off, Envelope, Average
Interpolation modes		Linear, Sin(x)/x, Sample & Hold

Horizontal system

Time base range		25 ps/div to 50 s/div
Time base accuracy	after delivery/calibration	±5 ppm
	after delivery/calibration (R&S®RTO-B4 option)	±0.02 ppm

Trigger system

Trigger types		Edge, Glitch, Width, Runt, Window, Time-out, Interval, Slew Rate, Data2Clock, Pattern, State, Serial Pattern, I ² C, SPI, optional: UART/RS-232, LIN, CAN, FlexRay
Sensitivity	definition of trigger hysteresis	settable (automatic/manual) from 0.1 div to 5 div
Min. detectable glitch		100 ps

Waveform mathematics

Algebraic categories	mathematics, logical operations, comparison, frequency domain, digital filter	
Hardware-accelerated mathematics	+, −, *, 1/x, x , derivative, log ₁₀ , ln, log ₂ , scaling, FIR, FFT magnitude	

Analysis and measurement functions

Hardware-accelerated analysis	spectrum, histogram, mask test, cursor	
Hardware-accelerated measurements	amplitude measurements, time measurements	

R&S®RTM Digital Oscilloscope

**Compact, precise, versatile**

Due to their excellent measurement properties and wide variety of practical functions, the R&S®RTM oscilloscopes facilitate daily work, whether in product development or service. Their compact dimensions, simple operation and brilliant display make them the first choice for everyday test and measurement tasks.

- ▮ Finding signal faults quickly and effectively
- ▮ Tools for fast signal analysis
- ▮ Smart operating concept
- ▮ Reliable results for stringent demands
- ▮ Triggering and decoding of serial protocols

Specifications in brief

Vertical system		
Input channels	R&S®RTM1052	2
	R&S®RTM1054	4
Bandwidth (-3 dB) at 50 Ω		500 MHz
Rise time (calculated)		700 ps
Input impedance		50 Ω ± 1.5% or 1 MΩ ± 1% with 12 pF ± 1 pF
Input sensitivity	max. bandwidth in all ranges	50 Ω: 1 mV/div to 1 V/div 1 MΩ: 1 mV/div to 10 V/div
Resolution		8 bit
Acquisition system		
Max. sampling rate (realtime)		2.5 Gsample/s; 5 Gsample/s interleaved
Memory depth		4 Msample; 8 Msample interleaved
Decimation modes	combination of decimation mode and waveform arithmetics possible	Sample, Peak Detect, High Resolution
Waveform arithmetics		Off, Envelope, Average, Smooth
Interpolation		Sin(x)/x
Horizontal system		
Time base range		1 ns/div to 50 s/div
Time base accuracy		10 ppm
Trigger system		
Trigger types		Edge, Width, Video, Pattern, B-Trigger; optional: I ² C, SPI, UART/RS-232
Analysis and measurement functions		
QuickMeas	at the push of a button, internally available measurement values are written directly onto the waveform and updated continuously	peak-to-peak voltage, pos. peak, neg. peak, rise time, fall time, mean value, RMS value, period, frequency
Automatic measurements		mean value, RMS value, amplitude, top level, base level, peak-to-peak voltage, pos. peak, neg. peak, period, frequency, number of pulses, number of neg. pulses, number of rising edges, number of falling edges, pulse width, inverted pulse width, duty cycle, neg. duty cycle, rise time, fall time, trigger period, trigger frequency
Cursor measurements		voltage, time, ratio X, ratio Y, number of pulses, peak value, RMS value, mean value, rise time, fall time, vertical marker
Waveforms mathematics		addition, subtraction, multiplication, division, maximum, minimum, square, square root, magnitude, positive wave, negative wave, reciprocal, inverse, integral, differentiation, log ₁₀ , ln, lowpass filter, highpass filter, FFT

R&S®RTO/RTM Probes

R&S®RTO/RTM probe families

The high-quality active probes from Rohde&Schwarz enable full use of the maximum bandwidths of the R&S®RTO oscilloscopes. Besides their excellent specifications, they feature impressive reliability and ease of use.

Rohde&Schwarz offers an entire family of high-quality active probes. Passive probes are suited for general measurements on low-frequency signals with less stringent accuracy requirements. A passive probe for each oscilloscope channel is included as standard equipment.

- ▀ High signal fidelity due to excellent specifications
- ▀ Easy to use, robust and ergonomic
- ▀ Micro button for convenient instrument control



Extensive standard accessories for the R&S®RT-ZS20/-ZS30 active probes.



R&S®RT-ZS20/-ZS30 active probes (1.5 GHz/3.0 GHz).



R&S®RT-ZP10 passive probe (500 MHz).

R&S®RTO/RTM probe family						
Probe	Type	Bandwidth	Input resistance	Input capacitance	Dynamic range	Extras
R&S®RT-ZP10	passive, high-impedance	500 MHz	1 MΩ	~ 10 pF	400 V (V_{RMS})	
R&S®RTM-ZP10	passive, high-impedance	500 MHz	1 MΩ	~ 10 pF	400 V (V_{RMS})	
R&S®RT-ZS10	active, single-ended	1 GHz	1 MΩ	0.8 pF	±8 V	R&S®ProbeMeter, micro button
R&S®RT-ZS10E	active, single-ended	1 GHz	1 MΩ	0.8 pF	±8 V	
R&S®RT-ZS20	active, single-ended	1.5 GHz	1 MΩ	0.8 pF	±8 V	R&S®ProbeMeter, micro button
R&S®RT-ZS30	active, single-ended	3 GHz	1 MΩ	0.8 pF	±8 V	R&S®ProbeMeter, micro button
R&S®RT-ZD20	active, differential	1.5 GHz	1 MΩ	0.6 pF (differential)	±5 V	R&S®ProbeMeter, micro button
R&S®RT-ZD30	active, differential	3 GHz	1 MΩ	0.6 pF (differential)	±5 V	R&S®ProbeMeter, micro button
R&S®RT-ZH10	high-voltage, 100:1	400 MHz	50 MΩ	7.5 pF	1 kV	
R&S®RT-ZH11	high-voltage, 1000:1	400 MHz	50 MΩ	7.5 pF	1 kV	

Chapter 4

Signal and Spectrum Analyzers

Since 1986 Rohde & Schwarz has been standing for innovative test equipment for signal and spectrum measurements. Customers from all over the world rely on the accuracy of spectrum analyzers, signal analyzers and vector signal analyzers from Rohde & Schwarz.



Type	Designation	Frequency range	Description	Page
Signal and spectrum analyzers				
R&S®FSH3/18	Handheld Spectrum Analyzer	100 kHz to 3 GHz 10 MHz to 18 GHz	Compact, flexible, professional and economically priced solutions	29
R&S®FSH4/8	Handheld Spectrum Analyzer	9 kHz to 3.6/8 GHz	Where mobility counts	30
R&S®ZVH	Cable and Antenna Analyzer	100 kHz to 3.6/8 GHz	The new benchmark for efficiency in the field	31
R&S®FSC	Spectrum Analyzer	9 kHz to 3/6 GHz	Compact, cost-efficient solution	32
R&S®FSL	Spectrum Analyzer	9 kHz to 3/6/18 GHz	High-end functions in a lightweight, compact package	33
R&S®FSV	Signal and Spectrum Analyzer	10 Hz to 3.6/7/13.6/30/40 GHz	Signal analysis at its best	34
R&S®FSVR	Real-Time Spectrum Analyzer	10 Hz to 3.6/7/13.6/30/40 GHz	Combines a full-featured signal and spectrum analyzer with a realtime spectrum analyzer	35
R&S®FSW	Signal and Spectrum Analyzer	2 Hz to 8/13.6/26.5 GHz	Setting standards in RF performance and usability	36
R&S®FSU	Spectrum Analyzer	20 Hz to 3.6/8/26.5/43/46/50/67 GHz	High-end spectrum analyzer with unmatched performance	37
R&S®FSG	Spectrum Analyzer	9 kHz to 8/13.6 GHz	Full-fledged high-performance spectrum analyzer	38
R&S®FSQ	Signal Analyzer	20 Hz to 3.6/8/26.5/40 GHz	Signal and spectrum analysis in a single unit	39
R&S®FSUP	Signal Source Analyzer	20 Hz to 8/26.5/50 GHz	Phase noise tester, high-end spectrum and signal analyzer	40
R&S®FMU36	Baseband Signal Analyzer	36 MHz I/Q bandwidth	Universal analyzer for analog baseband signals	41
R&S®FSMR	Measuring Receiver	20 Hz to 3.6/26.5/43/50 GHz	One-box solution for calibrating generators and attenuators	42
Accessories for R&S®FSx analyzers				
R&S®FS-Z10	Coherence Unit	100 MHz to 6 GHz	Phase-coherent RF measurements with two analyzers	43
R&S®FS-Zxx	External Mixers	40 GHz to 110 GHz	Spectrum analysis in the waveguide bands above 40 GHz	43
Application firmware				
Application firmware packages for R&S®FSx analyzers: see overview on page 44 and description on page 45 ff				
Modulation analyzers				
R&S®EVS300	VOR/ILS Analyzer	70 MHz to 350 MHz	Precision level and modulation analysis	56
R&S®FMAx	Modulation Analyzers	50 kHz to 1.36 GHz	Fast and accurate analysis of analog modulated signals	57

R&S®FSH3/18 Handheld Spectrum Analyzer



Compact, flexible, professional and economically priced solutions

The R&S®FSH3/FSH18 are rugged, handheld spectrum analyzers designed for measurement tasks in the field. The functionality of the analyzers matches that of conventional lab instruments.

- ▀ Frequency range up to 3/18 GHz
- ▀ Easy operation, low weight and rugged design for field use
- ▀ Channel power measurements, burst power measurements in time domain
- ▀ RMS detector
- ▀ Quasi-peak detector
- ▀ AM/FM audio demodulator
- ▀ Field-strength measurements with directional and isotropic antenna
- ▀ Receiver mode
- ▀ Terminating power sensors up to 18 GHz
- ▀ Directional power sensors up to 4 GHz
- ▀ Test system for EMF measurements (R&S®TS-EMF)
- ▀ Easy data transfer to PC
- ▀ Up to four hours battery operating time

Specifications in brief

	R&S®FSH3	R&S®FSH18
Spectrum analysis		
Frequency range	100 kHz to 3 GHz	10 MHz to 18 GHz
Resolution bandwidths	100 Hz to 1 MHz	
Video bandwidths	10 Hz to 1 MHz	
Displayed average noise level (DANL)	typ. -135 dBm (100 Hz)	typ. -128 dBm (100 Hz)
TOI	typ. 13 dBm	typ. 7 dBm
SSB phase noise at 100 kHz carrier offset	< -100 dBc (1 Hz)	≤ -90 dBc (1 Hz)
Detectors	Sample, Max Peak, Min Peak, Auto Peak, RMS, Average, Quasi Peak	
Level measurement uncertainty	< 1.5 dB, typ. 0.5 dB	< 1.5 dB up to 6 GHz < 2.5 dB up to 16 GHz < 3 dB up to 18 GHz
Dimensions	170 mm × 120 mm × 270 mm (6.7 in × 4.2 in × 10.6 in)	
Weight	2.5 kg (5.5 lb)	

R&S®FSH4/8 Handheld Spectrum Analyzer

Where mobility counts

The R&S®FSH4/FSH8 are rugged, handy spectrum analyzers designed for use in the field. Their low weight, their simple, well-conceived operation and the large number of measurement functions make them indispensable tools for anyone who needs efficient measuring instruments for outdoor work.

- ▀ Frequency range up to 3.6/8 GHz
- ▀ High sensitivity (< -141 dBm (1 Hz), with preamplifier < -161 dBm (1 Hz))
- ▀ 20 MHz demodulation bandwidth for analyzing LTE signals
- ▀ Low measurement uncertainty (< 1 dB)
- ▀ Measurement functions for all important measurement tasks during startup and maintenance of transmitter systems
- ▀ Analysis of 3GPP WCDMA, CDMA2000®, 1xEV-DO and LTE FDD/TDD transmit signals
- ▀ Internal tracking generator and VSWR bridge with built-in DC voltage supply (bias)
- ▀ Two-port network analyzer
- ▀ Easy-to-replace Li-ion battery for up to 4.5 h of operation
- ▀ Rugged, splash-proof housing for use in the field
- ▀ Easy handling due to low weight (3 kg with battery) and easy-to-reach function keys
- ▀ R&S®FSH4View software for simple documentation of measurement results



Specifications in brief

	R&S®FSH4	R&S®FSH8
Spectrum analysis		
Frequency range, model .04/.14 or model .08/.18	9 kHz to 3.6 GHz	9 kHz to 8 GHz
Frequency range, model .24 or model .28	100 kHz to 3.6 GHz	100 kHz to 8 GHz
Phase noise (f = 500 MHz)	-95 dBc (1 Hz) at 30 kHz carrier offset	
Resolution bandwidths	1 Hz to 3 MHz	
DANL (f = 2 GHz), without preamplifier	< -141 dBm, typ. -146 dBm	
DANL (f = 2 GHz), with preamplifier	< -161 dBm, typ. -65 dBm	
TOI, 300 MHz to 3.6 GHz	> +10 dBm, typ. +15 dBm	
TOI, 3.6 GHz to 8 GHz	-	> +3 dBm, typ. +10 dBm
Total measurement uncertainty, 10 MHz to 3.6 GHz	< 1 dB, typ. 0.5 dB	
Total measurement uncertainty, 3.6 GHz to 8 GHz	-	< 1.5 dB, typ. 1 dB
Detectors	Sample, Max Peak, Min Peak, Auto Peak, RMS	
Vector network analysis		
	model .24 only	model .28 only
Frequency range	300 kHz to 3.6 GHz	300 kHz to 8 GHz
Reflection measurement (S_{11} , S_{22})		
Directivity (f = 3 GHz)	> 43 dB	
Display modes	magnitude, phase, magnitude and phase, Smith chart, VSWR, return loss (dB), reflection coefficient, mp	
Transmission measurement (S_{21} , S_{12})		
Dynamic range (f = 3 GHz)	typ. 100 dB	
Display modes	magnitude (loss, gain), phase, magnitude + phase	
Battery operating time (without tracking generator)	up to 4.5 h	
Weight	3 kg (6.6 lb)	

R&S®ZVH Cable and Antenna Analyzer



The new benchmark for efficiency in the field

The R&S®ZVH cable and antenna analyzer is rugged, handy and designed for use in the field. Its low weight and simple operation make it indispensable for anyone who needs an efficient measuring instrument outdoors for the installation and maintenance of antenna systems.

- ▮ Frequency range from 100 kHz to 3.6 GHz or 8 GHz
- ▮ 100 dB (typ.) dynamic range for filter and antenna isolation measurements
- ▮ Built-in DC voltage supply (bias) for active components such as amplifiers
- ▮ Power meter option
- ▮ Saving of measurement results on SD memory card or USB memory stick
- ▮ Easy operation with configurable test sequences (wizard)
- ▮ Easy-to-replace Li-ion battery for up to 4.5 h of operation
- ▮ Rugged, splash-proof housing for rough work in the field
- ▮ Easy handling due to low weight (3 kg with battery) and easy-to-reach function keys
- ▮ Spectrum analyzer option
- ▮ Vector network analyzer option

Specifications in brief

		R&S®ZVH4	R&S®ZVH8
Frequency range		100 kHz to 3.6 GHz	100 kHz to 8 GHz
Standard measurement functions		reflection, distance-to-fault, one-port cable loss measurement	
Output power (port 1, port 2)		0 dBm to -40 dBm (nominal), in 1 dB steps	
Maximum permissible spurious signal level		+17 dBm (nominal)	
Number of points		101, 201, 401, 601, 631, 801, 1001, 1201	
Distance-to-fault (DTF) measurement			
Display modes		return loss (dB), VSWR	
Resolution in meters		(1.58 × velocity factor/span)	
Horizontal display range		3 m to 1500 m	
Reflection measurement			
Directivity	100 kHz to 3 GHz (nominal)	> 43 dB (nominal)	
	3 GHz to 3.6 GHz	> 37 dB (nominal)	
	3.6 GHz to 6 GHz	–	> 37 dB (nominal)
	6 GHz to 8 GHz	–	> 31 dB (nominal)
Display modes		S ₁₁ , return loss (dB), VSWR, one-port cable loss	
	vector network analysis (R&S®ZVH-K42)	S ₁₁ , S ₂₂ , magnitude, phase, magnitude + phase, Smith chart, VSWR, reflection coefficient, mp, one-port cable loss, electrical length, group delay	
	vector voltmeter (R&S®ZVH-K45)	magnitude + phase, Smith chart	
Transmission measurement (with R&S®ZVH-K39 or R&S®ZVH-K42)			
Dynamic range (S ₂₁)	100 kHz to 300 kHz	> 50 dB (nominal)	
	300 kHz to 2.5 GHz	> 80 dB, typ. 100 dB	
	2.5 GHz to 3.6 GHz	> 70 dB, typ. 90 dB	
	3.6 GHz to 6 GHz	–	> 70 dB, typ. 90 dB
	6 GHz to 8 GHz	–	> 50 dB (nominal)
Display modes	transmission measurement (R&S®ZVH-K39)	S ₂₁ , magnitude in dB (loss, gain)	
	vector network analysis (R&S®ZVH-K42)	S ₂₁ , S ₁₂ , magnitude, phase, magnitude + phase, electrical length, group delay	
	vector voltmeter (R&S®ZVH-K45)	magnitude + phase	
DC voltage supply (DC bias, port 1 and port 2)			
Voltage range	internal voltage supply	+12 V to +32 V, in 1 V steps	
Maximum output power/current		4 W (battery), 10 W (AC supply)/500 mA	
Maximum voltage/current	external voltage supply	50 V/600 mA	

R&S®FSC Spectrum Analyzer

**Compact, cost-efficient solution**

The R&S®FSC is a compact, cost-efficient solution that offers all essential features of a professional spectrum analyzer with Rohde&Schwarz quality. It covers a wide range of applications from simple development tasks to production, or can be used for training RF professionals. Moreover, it is ideal for applications in service or maintenance.

The R&S®FSC features a wealth of functions for simplifying and speeding up the development and testing of RF products. Its good RF characteristics and its high measurement accuracy help to ensure reliable and reproducible measurement results.

- ▀ Frequency range from 9 kHz to 3 GHz or 6 GHz
- ▀ Resolution bandwidths from 10 Hz to 3 MHz
- ▀ High sensitivity (< -141 dBm (1 Hz), with optional preamplifier < -161 dBm (1 Hz))
- ▀ High third order intercept (> 10 dBm, typ. 15 dBm)
- ▀ Low measurement uncertainty (< 1 dB)
- ▀ Precise power measurement with external R&S®NRP-Zxx USB power sensors
- ▀ Internal tracking generator (model .13/.16)
- ▀ Storage of measurement results on USB stick
- ▀ LAN and USB interface for remote control and transfer of measurement data
- ▀ R&S®FSCView software for simple documentation of measurement results
- ▀ Compact dimensions
- ▀ Low power consumption (12 W)

Specifications in brief		R&S®FSC3	R&S®FSC6
Frequency range		9 kHz to 3 GHz	9 kHz to 6 GHz
Resolution bandwidth		10 Hz to 3 MHz	
Displayed average noise level	without preamplifier, RBW = 1 Hz		
	10 MHz to 2 GHz	< -141 dBm, typ. -146 dBm	
	2 GHz to 3 GHz	< -138 dBm, typ. -143 dBm	
	3 GHz to 3.6 GHz	–	< -138 dBm, typ. -143 dBm
	3.6 GHz to 5 GHz	–	< -142 dBm, typ. -146 dBm
	5 GHz to 6 GHz	–	< -140 dBm, typ. -144 dBm
	with R&S®FSC-B22 preamplifier option, RBW = 1 Hz		
10 MHz to 1 GHz	< -161 dBm, typ. -165 dBm		
1 GHz to 2 GHz	< -159 dBm, typ. -163 dBm		
2 GHz to 3 GHz	< -155 dBm, typ. -159 dBm		
3 GHz to 5 GHz	–	< -155 dBm, typ. -159 dBm	
5 GHz to 6 GHz	–	< -151 dBm, typ. -155 dBm	
TOI	1 GHz frequency	typ. 15 dBm	
Phase noise	500 MHz frequency		
	30 kHz carrier offset	< -95 dBc (1 Hz)	
	100 kHz carrier offset	< -100 dBc (1 Hz)	
	1 MHz carrier offset	< -120 dBc (1 Hz)	
Detectors		Sample, Max/Min Peak, Auto Peak, RMS	
Level measurement uncertainty	10 MHz $< f \leq 3$ GHz	< 1 dB, typ. 0.5 dB	
	3 GHz $< f < 3.6$ GHz	–	< 1 dB, typ. 0.5 dB
	3.6 GHz $< f \leq 6$ GHz	–	< 1.5 dB, typ. 1 dB
Tracking generator (model .13/.16)			
Frequency range		100 kHz to 3 GHz	100 kHz to 6 GHz
Output power		0 dBm (nominal)	
Dynamic range (transmission)	100 kHz $< f < 300$ kHz	> 60 dB, typ. 80 dB	
	300 kHz $< f < 3$ GHz	> 70 dB, typ. 90 dB	
	3 GHz $< f < 6$ GHz	–	> 70 dB, typ. 90 dB
Display		5.7" (14.5 cm) color LCD with VGA resolution	

R&S®FSL Spectrum Analyzer



Best performance in its class

The R&S®FSL is an extremely lightweight, compact spectrum analyzer that is ideal for a large number of applications in development, service and production. Though compact, it offers a wealth of functions more typical of the high-end range, ensuring an excellent price/performance ratio.

The R&S®FSL is the only instrument in its class that features a tracking generator up to 18 GHz and can analyze signals with a bandwidth of 28 MHz. In addition, the R&S®FSL18, which operates at frequencies up to 18 GHz, supports applications in the microwave range.

- ▮ Frequency range from 9 kHz to 3/6/18 GHz
- ▮ All 18 GHz models with and without tracking generator
- ▮ Best RF characteristics in its class
- ▮ Largest signal analysis bandwidth in its class (28 MHz)
- ▮ Low measurement uncertainty, even in microwave range
- ▮ High resolution filter accuracy owing to all-digital implementation
- ▮ Robust and compact
- ▮ Carrying handle and low weight (< 8 kg (18 lb))
- ▮ Optional battery operation
- ▮ Wide range of functions, simple operation
- ▮ Easy on-site upgrading with options

Specifications in brief

	R&S®FSL3, model .03	R&S®FSL3, model .13	R&S®FSL6, model .06	R&S®FSL6, model .16	R&S®FSL18 model .18	R&S®FSL18 model .28
Frequency range	9 kHz to 3 GHz	9 kHz to 3 GHz	9 kHz to 6 GHz	9 kHz to 6 GHz	9 kHz to 18 GHz (20 GHz in overrange)	
Frequency accuracy	1 × 10 ⁻⁶					
With R&S®FSL-B4, OCXO	1 × 10 ⁻⁷				standard with the R&S®FSL18	
Resolution bandwidths						
Standard	300 Hz to 10 MHz in 1/3 sequence, zero span additionally 20 MHz					
With R&S®FSL-B7	10 Hz to 10 MHz in 1/3 sequence, additionally 1 Hz (FFT filter)					
Video bandwidths	10 Hz to 10 MHz					
Signal analysis bandwidth	28 MHz					
Phase noise	typ. -103 dBc (1 Hz) at 10 kHz from carrier, 1 GHz					
Displayed average noise level (DANL)						
With 300 Hz RBW	typ. -117 dBm					
With 1 Hz FFT RBW and preamplifier (R&S®FSL-B7, R&S®FSL-B22 options)	500 MHz: typ. -162 dBm, 3 GHz: typ. -158 dBm					
Third order intercept (TOI)	typ. +18 dBm					
Detectors	Pos/Neg Peak, Auto Peak, RMS, Quasi Peak, Average, Sample					
Level measurement uncertainty	< 0.5 dB (30 kHz ≤ f ≤ 3 GHz), < 0.8 dB (3 GHz < f ≤ 6 GHz), < 1.2 dB (6 GHz < f ≤ 18 GHz)					
Tracking generator	no	yes	no	yes	no	yes
Frequency range	–	1 MHz to 3 GHz	–	1 MHz to 6 GHz	–	10 MHz to 18 GHz
Output level	–	-20 dBm to 0 dBm	–	-20 dBm to 0 dBm	–	-30 dBm to -10 dBm

R&S®FSV Signal and Spectrum Analyzer



Signal analysis at its best

The R&S®FSV is an exceptionally fast and versatile signal and spectrum analyzer for performance-oriented, cost-conscious users working in the development, production, installation and servicing of RF systems.

- ▀ Frequency range up to 3.6/7/13.6/30/40 GHz
- ▀ 40 MHz analysis bandwidth
- ▀ 0.4 dB level measurement uncertainty up to 7 GHz
- ▀ Measurement applications for GSM/EDGE (including EDGE Evolution), WCDMA/HSPA+, LTE, WiMAX™, WLAN, CDMA2000®, 1xEV-DO
- ▀ Easy on-site upgrading with options
- ▀ –110 dBc (1 Hz) phase noise at 10 kHz frequency offset
- ▀ +15 dBm third order intercept (TOI)
- ▀ Displayed average noise level (DANL) in 1 Hz bandwidth:
 - 155 dBm at 1 GHz, –147 dBm at 30 GHz,
 - with R&S®FSV-B24 preamplifier: –162 dBm at 30 GHz
- ▀ Exchangeable hard disk for applications that involve the use of confidential data
- ▀ Frequency range up to 110 GHz with the R&S®FSV-B21 option integrated in the R&S®FSV30/40 and the R&S®FS-Z60/-Z75/-Z90/-Z110 harmonic mixers
- ▀ Measurement applications for vector signal analysis

Specifications in brief

Specifications in brief		
Frequency		
Frequency range		10 Hz to 3.6/7/13.6/30/40 GHz
Aging of frequency reference	without/with R&S®FSV-B4 option	$1 \times 10^{-6}/1 \times 10^{-7}$
Resolution bandwidths		
	frequency domain	1 Hz to 10 MHz
	zero span	1 Hz to 10/20/28 MHz ¹⁾ , optionally 40 MHz
	channel filter	100 Hz to 5 MHz
Video filter		
		1 Hz to 10/20/28 MHz, 40 MHz ¹⁾
Signal analysis bandwidth		
	without/with R&S®FSV-B70 option	28 MHz ¹⁾ /40 MHz ²⁾
Displayed average noise level (DANL)		
DANL (1 Hz bandwidth)	1 GHz/1 GHz with preamplifier (R&S®FSV-B22)	–152 dBm, typ. –155 dBm/–162 dBm, typ. –165 dBm
	3 GHz/3 GHz with preamplifier (R&S®FSV-B22)	–150 dBm, typ. –153 dBm/–160 dBm, typ. –163 dBm
	7 GHz/7 GHz with preamplifier (R&S®FSV-B22)	–146 dBm, typ. –149 dBm/–156 dBm, typ. –159 dBm
	13 GHz/10 GHz with preamplifier (R&S®FSV-B24)	–148 dBm, typ. –151 dBm/–164 dBm, typ. –167 dBm
	30 GHz/30 GHz with preamplifier (R&S®FSV-B24)	–144 dBm, typ. –147 dBm/–159 dBm, typ. –162 dBm
	40 GHz/40 GHz with preamplifier (R&S®FSV-B24)	–136 dBm, typ. –139 dBm/–154 dBm, typ. –156 dBm
Third order intercept (TOI)		
	$f < 3.6$ GHz/3.6 GHz to 30 GHz	+13 dBm, typ. +16 dBm/+15 dBm, typ. +18 dBm
Dynamic range (WCDMA ACLR)		
	without/with noise compensation	70 dB/73 dB
Phase noise		
1 GHz carrier frequency	10 kHz offset from carrier	–106 dBc (1 Hz), typ. –110 dBc (1 Hz)
	100 kHz offset from carrier	–115 dBc (1 Hz)
	1 MHz offset from carrier	–134 dBc (1 Hz)
Total measurement uncertainty		
	3.6 GHz/7 GHz	0.29 dB/0.39 dB
R&S®FSV-B9 tracking generator		
Frequency range	R&S®FSV3	100 kHz to 3.6 GHz
	R&S®FSV7/13/30/40	100 kHz to 7 GHz
Frequency offset		up to 1 GHz

¹⁾ Max. bandwidth of the R&S®FSV40 (1307.9002.39): 10 MHz.

²⁾ Not for the R&S®FSV40 (1307.9002.39).

R&S®FSVR Real-Time Spectrum Analyzer



Discover the unseen

The R&S®FSVR combines a full-featured signal and spectrum analyzer with a realtime spectrum analyzer. Therefore, it provides all the capabilities and features that modern T&M instruments of this kind have to offer.

In realtime operation, the R&S®FSVR seamlessly measures and displays the spectrum in the time domain with a span of up to 40 MHz. As a result, it captures every event for analysis, no matter how brief that event might be.

- Frequency range from 10 Hz to 7/13.6/30/40 GHz
- 40 MHz realtime analysis bandwidth for:
 - Spectrum with persistence function
 - Spectrogram display
 - Display of power versus time
- Triggering on frequency masks
- Full-featured signal and spectrum analyzer with analysis software for GSM/EDGE, WCDMA/HSPA+, LTE, WiMAX™, WLAN, analog and digital modulation methods, noise figure and phase noise measurements
- Exchangeable hard disk for applications that involve the use of confidential data

Specifications in brief

Specifications in brief		
Frequency		
Frequency range		10 Hz to 7/13.6/30/40 GHz
Aging of frequency reference	without/with R&S®FSV-B4 option	$1 \times 10^{-6}/1 \times 10^{-7}$
Realtime spectrum analyzer		
Realtime RF bandwidth		100 Hz to 40 MHz
A/D converter		128 Msample/s, 16 bit
Windowing		Blackman Harris, Gauss, flat top, rectangular, Hanning, Kaiser
Measurement points per trace		801
Resolution bandwidth		realtime RF bandwidth/(100 to 400), depending on windowing
Number of spectra per second		250 000/s
Spectrogram update rate		10 000/s
Screen update rate		30/s
Detectors		Average (linear or RMS), Max Peak, Min Peak, Sample
Trace functions		Max Hold, Min Hold, Average
FMT		
Frequency resolution		realtime bandwidth/801
Trigger span		realtime RF bandwidth
Dynamic range		0 dB to -80 dB below reference level
Spectrum analyzer		
Resolution bandwidths	frequency domain	1 Hz to 10 MHz
	zero span	1 Hz to 10/20/40 MHz
	channel filter	100 Hz to 5 MHz
Video filter		1 Hz to 10/20/28/40 MHz
I/Q demodulation bandwidth		40 MHz
Displayed average noise level (DANL)	1 GHz/30 GHz	-152 dBm (1 Hz)/-150 dBm
	With R&S®FSV-B22/-B24 preamplifier	-163 dBm/-162 dBm
TOI	f < 3.6 GHz	16 dBm
Dynamic range (WCDMA ACLR)	without/with noise compensation	70 dB/73 dB
Phase noise (1 GHz carrier frequency)	10 kHz offset from carrier	-106 dBc (1 Hz)
	100 kHz offset from carrier	-115 dBc (1 Hz)
	1 MHz offset from carrier	-134 dBc (1 Hz)
Total measurement uncertainty	f < 7 GHz	0.4 dB

R&S®FSW Signal and Spectrum Analyzer

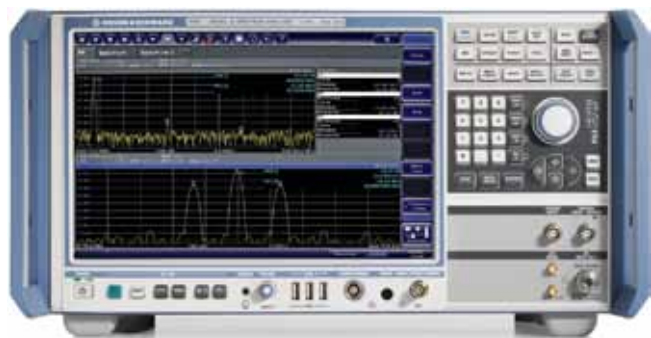

Setting standards in RF performance and usability

The new high-performance R&S®FSW signal and spectrum analyzer was developed to meet demanding customer requirements. Offering low phase noise, wide analysis bandwidth and straightforward and intuitive operation, the analyzer makes measurements fast and easy.

The R&S®FSW offers up to 160 MHz analysis bandwidth for measuring wideband-modulated or frequency-agile signals. Currently, signal and spectrum analyzers measure different standards (GSM, CDMA, WCDMA, LTE) separately. The R&S®FSW takes analysis to the next level, providing capability to measure multiple standards simultaneously. Users can quickly and easily detect and eliminate errors caused by interaction between signals.

- ▀ Frequency range from 2 Hz to 8/13.6/26.5 GHz
- ▀ Low phase noise of -137 dBc (1 Hz) at 10 kHz offset (1 GHz carrier)
- ▀ -88 dBc dynamic range (with noise cancellation) for WCDMA ACLR measurements
- ▀ Up to 160 MHz analysis bandwidth
- ▀ 0.4 dB total measurement uncertainty up to 8 GHz
- ▀ High-resolution 12.1" (31 cm) touchscreen for convenient operation
- ▀ Multiple measurement applications can be run and displayed in parallel

Specifications in brief

Frequency range		2 Hz to 8/13.6/26.5 GHz
Aging of frequency reference		1×10^{-7} /year
	with R&S®FSW-B4 option	3×10^{-9} /year
Bandwidths		
Resolution bandwidths	standard filter	1 Hz to 10 MHz
	RRC filter	18 kHz (NADC), 24.3 kHz (TETRA), 3.84 MHz (3GPP)
	channel filter	100 Hz to 5 MHz
	video filter	1 Hz to 10 MHz
I/Q demodulation bandwidth		10 MHz
	with R&S®FSW-B28 option	28 MHz
	with R&S®FSW-B40 option	40 MHz
	with R&S®FSW-B80 option	80 MHz
	with R&S®FSW-B160 option	160 MHz
Displayed average noise level (DANL)	2 GHz	typ. -156 dBm (1 Hz)
	with R&S®FSW-B13 option	typ. -159 dBm (1 Hz)
	8 GHz	typ. -156 dBm (1 Hz)
	25 GHz	typ. -150 dBm (1 Hz)
DANL with preamplifier (R&S®FSW-B24 option)	8 GHz	typ. -169 dBm (1 Hz)
	26 GHz	typ. -161 dBm (1 Hz)
DANL with noise cancellation, preamplifier off, 2 GHz		typ. -169 dBm (1 Hz)
Intermodulation		
Third order intercept (TOI)	$f < 1$ GHz	typ. $+30$ dBm
	$f < 3$ GHz	typ. $+25$ dBm
	8 GHz to 26 GHz	$+17$ dBm
WCDMA ACLR dynamic range	with noise cancellation	88 dB
Phase noise		
10 kHz offset from carrier	500 MHz carrier	typ. -140 dBc (1 Hz)
	1 GHz carrier	typ. -137 dBc (1 Hz)
	10 GHz carrier	typ. -128 dBc (1 Hz)
Total measurement uncertainty	8 GHz	0.4 dB

R&S®FSU Spectrum Analyzer



High-end spectrum analyzer with unmatched performance

The R&S®FSU spectrum analyzers are performance leaders in dynamic range, phase noise, level accuracy and resolution bandwidth – all factors that are essential for the user's ability to design, characterize and manufacture next-generation wireless elements.

The R&S®FSU67 is the first spectrum analyzer with a direct frequency range up to 67 GHz and fundamental mixing. It allows measurements up to 67 GHz without cumbersome setups with external mixers.

- ▮ R&S®FSU67 – first spectrum analyzer with a direct frequency range up to 67 GHz and fundamental mixing
- ▮ High measurement speed
- ▮ Unmatched number of features
- ▮ Wide selection of standards
- ▮ Frequency range from 20 Hz to 3.6/8/26.5/43/46/50/67 GHz
- ▮ Displayed average noise level of –158 dBm (1 Hz)
- ▮ Phase noise of typ. –133 dBc (1 Hz) at 10 kHz
- ▮ TOI of typ. +25 dBm
- ▮ 1 dB compression point of typ. 13 dBm
- ▮ WCDMA ACLR dynamic range of 77.5 dB/84 dB with noise correction
- ▮ Resolution bandwidth from 1 Hz to 50 MHz
- ▮ Displayed average noise level with R&S®FSU-B24 preamplifier: typ. –168 dBm (1 Hz) at 20 GHz, typ. –155 dBm (1 Hz) at 50 GHz

Specifications in brief							
	R&S®FSU3	R&S®FSU8	R&S®FSU26	R&S®FSU43	R&S®FSU46	R&S®FSU50	R&S®FSU67
Frequency range	20 Hz to 3.6 GHz	20 Hz to 8 GHz	20 Hz to 26.5 GHz	20 Hz to 43 GHz	20 Hz to 46 GHz	20 Hz to 50 GHz	20 Hz to 67 GHz
Reference frequency	aging: 1×10^{-7} /year; with R&S®FSU-B4 option: 3×10^{-8} /year						
Spectral purity							
Phase noise	typ. –133 dBc (1 Hz) at 640 MHz at 10 kHz from carrier						
Sweep time							
Span \geq 10 Hz	2.5 ms to 16000 s						
Span = 0 Hz (zero span)	1 μ s to 16000 s						
Resolution bandwidth	10 Hz to 50 MHz (R&S®FSU43: 10 Hz to 10 MHz), FFT filter: 1 Hz to 30 kHz, channel filter, EMI bandwidth						
Video bandwidth	1 Hz to 10 MHz						
Display range	displayed average noise level to +30 dBm						
Displayed average noise level (1 Hz RBW)							
1 GHz	typ. –158 dBm		typ. –156 dBm			typ. –152 dBm	
7 GHz	–	typ. –154 dBm	typ. –156 dBm	typ. –153 dBm		typ. –148 dBm	
13 GHz	–	–	typ. –153 dBm			typ. –148 dBm	
26 GHz	–	–	–	typ. –148 dBm		typ. –142 dBm	
40 GHz	–	–	–	typ. –143 dBm		typ. –136 dBm	typ. –142 dBm
50 GHz	–	–	–	–	–	typ. –131 dBm	typ. –140 dBm
65 GHz	–	–	–	–	–	–	typ. –132 dBm
Displayed average noise level with preamplifier ON (R&S®FSU-B25), 1 GHz, 1 Hz RBW	< –162 dBm						–
Displayed average noise level with preamplifier ON (R&S®FSU-B24), 26 GHz, 10 Hz RBW	–	–	typ. –166 dBm			–	
Trace detectors	Max Peak, Min Peak, Auto Peak, Sample, RMS, Average, Quasi Peak, CISPR-average, CISPR-RMS						
Total measurement error, $f < 3.6$ GHz	0.3 dB						
Display linearity	0.1 dB (0 dB to –70 dB)						

R&S®FSG Spectrum Analyzer



Full-fledged high-performance spectrum analyzer

The R&S®FSG supports frequencies up to 13.6 GHz and excels due to its high measurement speed and its performance, which is optimized for applications in mobile radio and wireless communications.

- Fast, fully integrated vector signal analysis
 - 28 MHz I/Q demodulation bandwidth
 - 4 Msample I and Q memory
 - I/Q data extraction, e.g. for MCPA adjustment
- Dynamic range of a high-end spectrum analyzer
 - TOI: typ. +25 dBm
 - 1 dB compression: +13 dBm
 - 84 dB ACLR/3GPP with noise correction
- Full choice of detectors for adaptation to a wide range of signal types
 - RMS detector with 100 dB dynamic range
 - Auto Peak, Max Peak, Min Peak, Sample, Average
- Large range of resolution filters
 - Highly selective digital filters from 10 Hz to 100 kHz
 - Standard resolution filters from 10 Hz to 10 MHz
 - 1 Hz to 10 MHz resolution bandwidth (RBW)
 - FFT filters from 1 Hz to 30 kHz
 - Five-pole filter in line with GSM specifications
- High measurement speed
 - Up to 80 measurements/s in manual mode
 - Up to 50/70 measurements/s in GPIB mode
 - Fast FFT filters from 1 Hz to 30 kHz
 - 2.5 ms sweep time in frequency domain
 - 1 μ s sweep time in time domain
 - Fast ACP measurement in time domain
- Full range of analysis functions
 - Time-selective spectrum analysis with gating function
 - Harmonic distortion measurement
 - Statistical signal analysis with CCDF function
 - Spurious emission measurements with up to 100 001 points, in up to 20 segments
 - Full-fledged channel power meter due to time domain power capability
 - TOI marker, noise/phase-noise marker
 - Versatile (multicarrier) channel/adjacent-channel power measurement functions with wide selection of standards; user-configurable
 - Power sensor compatibility
- Spectrum and code domain power measurements for 3GPP FDD/HSPA/HSPA+, CDMA2000® 1xRTT, CDMA2000® 1xEV-DV, CDMA2000® 1xEV-DO, TD-SCDMA
- Spectrum and modulation measurements for GSM/EDGE/EDGE Evolution, Bluetooth®, WLAN IEEE 802.11a/b/g/j/n, WiMAX™, 3GPP LTE; support of MIMO measurements
- Versatile documentation and networking capabilities
 - GPIB interface, IEEE 488.2
 - SCPI-compatible GPIB command set
 - RS-232-C serial interface, 9-pin D-Sub
 - 100BaseT LAN interface
 - USB connector
 - VGA output, 15-pin D-Sub
 - PC-compatible screenshots on USB or hard disk

Specifications in brief

	R&S®FSG8	R&S®FSG13
Frequency range	9 kHz to 8 GHz	9 kHz to 13.6 GHz
Reference frequency	aging: 1×10^{-7} /year	
Spectral purity		
Phase noise	typ. -114 dBc (1 Hz) at 10 kHz carrier offset	
Sweep time		
Span >10 Hz	2.5 ms to 16000 s	
Span = 0 Hz (zero span)	1 μ s to 16000 s	
Resolution bandwidth (RBW)	1 Hz to 10 MHz	
Video bandwidth (VBW)	1 Hz to 30 MHz	
Display range	DANL to +30 dBm	
Displayed average noise level (DANL) (1 Hz RBW)		
1 GHz	typ. -155 dBm	typ. -156 dBm
7 GHz	typ. -154 dBm	typ. -155 dBm
13 GHz	-	typ. -151 dBm
DANL with preamplifier ON (R&S®FSU-B25), 1 GHz, 1 Hz RBW	-162 dBm	
TOI	typ. 25 dBm	
Total measurement uncertainty	0.3 dB	
Signal analysis bandwidth	28 MHz	

R&S®FSQ Signal Analyzer



Signal and spectrum analysis in a single unit

The R&S®FSQ combines the outstanding spectrum analyzer features and functions of the R&S®FSU with a demodulation bandwidth up to 120 MHz. It is ideal for applications in development and production (wireless LAN (WLAN)/3GPP and GSM-MCPA). The R&S®FSQ additionally supports measurements on 2G, 2.5G and 3G mobile radio systems when equipped with suitable application firmware. In addition to broadband demodulation capabilities, the R&S®FSQ provides the dynamic range that is required for multicarrier measurements or the measurement of spurious emissions at base transceiver stations (BTS).

- Signal analyzer for fast measurement and high accuracy
 - 28 MHz I/Q demodulation bandwidth
 - 14 bit A/D converter: 81.6 MHz
 - 16 Msample I and Q memory, expandable up to 705 Msample
 - Digital hardware re-sampler to match the sampling rate to the signal
 - Sampling rate from 10 kHz to 81.6 MHz, adaptable to modulation rate
 - SFDR > 80 dBFS
 - Digital downconversion to baseband with high output bandwidth (28 MHz referenced to RF)
- Dynamic range of a high-end spectrum analyzer
 - TOI: typ. +25 dBm
 - 1 dB compression: +13 dBm
 - 84 dB ACLR/3GPP with noise correction
 - Displayed average noise level: –158 dBm (1 Hz)
 - Phase noise: –160 dBc (1 Hz) at 10 MHz carrier offset
- Full choice of detectors
 - RMS (100 dB dynamic range)
 - Sample, Average, Auto/Max/Peak, Quasi Peak (QPK)
- Most versatile resolution filter characteristics and largest bandwidth
 - Standard resolution filters from 10 Hz to 50 MHz
 - FFT filters from 1 Hz to 30 kHz
 - 32 channel filters, bandwidths from 100 Hz to 5 MHz
 - RRC filters for NADC, TETRA and 3GPP
 - 200 Hz, 9 kHz, 120 kHz EMI filters
- Full range of analysis functions
 - Time domain power capability and channel or RRC filters make the R&S®FSQ a full-fledged channel power meter
 - Code domain power measurement for 3GPP WCDMA (optional)
 - TOI marker, noise/phase-noise marker
 - Versatile channel/adjacent-channel power measurement functions with wide selection of standards
 - Statistical signal analysis with CCDF function
- High measurement speed
 - 2.5 ms sweep time in frequency domain
 - 1 μ s sweep time in time domain
 - Number of measurement points/trace selectable between 155 and 10001
 - Up to 30 measurements/s (GPIB mode)
 - Fast ACP measurement in time domain
- Flexible data interchangeability
 - LAN interface (10/100 BaseT)
 - Special RSIB interface/VXI-1
 - GPIB interface, IEEE 488.2
 - SCPI-compatible GPIB command set
 - R&S®FSE/R&S®FSIQ compatible GPIB command set
 - LXI class C

Specifications in brief

	R&S®FSQ3	R&S®FSQ8	R&S®FSQ26	R&S®FSQ40
Frequency range	20 Hz to 3.6 GHz	20 Hz to 8 GHz	20 Hz to 26.5 GHz	20 Hz to 40 GHz
Reference frequency	aging 1×10^{-7} /year, with R&S®FSU-B4 option: 2×10^{-8}			
Spectral purity				
SSB phase noise	typ. –133 dBc (1 Hz) at 10 kHz carrier offset			
Residual FM	1 Hz			
Sweep				
Span >10 Hz	2.5 ms to 16000 s			
Span = 0 Hz (zero span)	1 μ s to 16000 s			
Resolution bandwidths	10 Hz to 50 MHz, FFT filter: 1 Hz to 30 kHz, channel filter, EMI bandwidths			
Video bandwidths	1 Hz to 10 MHz			
Display range	displayed average noise level up to +30 dBm			

R&S®FSUP Signal Source Analyzer



Phase noise tester, high-end spectrum and signal analyzer in a single box

The R&S®FSUP combines the functionality of a high-end spectrum and signal analyzer with the advantages of a pure phase noise tester. The instrument is a unique and easy-to-use single-box solution for measuring oscillators and synthesizers in development and production applications. In addition, it leads to enormous cost reductions.

One of the primary tasks in developing transmit and receive modules is to measure oscillator phase noise. This is necessary not only in the development and production of state-of-the-art communications and broadcast systems, but also in special high-tech applications such as radar. Apart from phase noise, other parameters that need to be measured when characterizing oscillators include tuning slope, transient response, power, harmonics and spurious emissions. Amplifier noise is of significant interest as well. All of these measurements can be carried out with the R&S®FSUP, the only signal source analyzer that covers the frequencies up to the microwave range in a single box. The R&S®FSUP also features very-low-noise DC sources to enable a wide range of measurements.

- ▮ Frequency range up to 8/26.5/50 GHz
- ▮ Up to 110 GHz with external mixers
- ▮ Low-noise DC outputs for supply and tuning voltages
- ▮ Maximum flexibility for phase noise measurements
- ▮ Noise figure and gain measurements
- ▮ Oscillator characterization
- ▮ Analysis of digital and analog modulated signals

Specifications in brief

Operating modes	signal source analyzer	1 MHz to 8/26.5/50 GHz
	spectrum analyzer	20 Hz to 8/26.5/50 GHz
Signal source analyzer		
Phase noise measurement	with spectrum analyzer	10 MHz to 8/26.5/50 GHz
	with phase comparator	1 MHz to 8/26.5/50 GHz
	internal reference	1 MHz to 8/26.5/50 GHz
	external reference	1 MHz to 8 GHz
	with phase comparator and cross-correlation	1 MHz to 8/26.5/50 GHz
Transients measurement	min. frequency offset	10 mHz
	max. frequency offset	30 MHz
Residual noise	with phase comparator	1 MHz to 8 GHz ¹⁾
AM noise		see diode datasheet

¹⁾ If the internal phase detector is used.

Sensitivity (typical values)

Sensitivity with internal reference and internal phase detector.

Input level > +10 dBm, spurious and harmonics < -30 dBc, mode "averaged", +20°C to +30°C. LNA gain 40 dB, loop bandwidth ≤ 10 × frequency offset, max. 1 kHz. With the R&S®FSUP-B60 low phase noise option and the R&S®FSUP-B61 correlation extension option.

Frequency offset	Input frequency, values in dBc (1 Hz) R&S®FSUP8/26/50						R&S®FSUP26/50		R&S®FSUP50
	5 MHz	10 MHz	100 MHz	1 GHz	3 GHz	7 GHz	10 GHz	20 GHz	40 GHz
1 Hz	-114	-116	-87	-75	-62	-55	-52	-48	-42
10 Hz	-136	-135	-110	-91	-87	-80	-77	-71	-65
100 Hz	-143	-146	-134	-115	-106	-97	-95	-89	-83
1 kHz	-157	-161	-160	-134	-123	-118	-116	-112	-106
10 kHz	-165	-168	-168	-143	-131	-129	-126	-120	-114
100 kHz	-171	-170	-176	-158	-139	-140	-138	-132	-126
1 MHz	-	-175	-177	-165	-160	-155	-150	-146	-140
10 MHz	-	-	-179	-172	-170	-170	-167	-161	-155
30 MHz	-	-	-179	-172	-170	-170	-170	-165	-159

R&S®FMU36 Baseband Signal Analyzer



Universal analyzer for analog baseband signals

The R&S®FMU36 comes equipped with the high-performance R&S®FSQ-K70 vector signal analyzer, adding universal demodulation and analysis down to the bit stream level for digital signals. For maximum flexibility, mappings, receive filters and transmit filters can be designed externally, using free-of-charge tools

- Operation of analog inputs either as single-ended or balanced
- Impedance setting to either 50 Ω or 1 MΩ to match DUT impedance
- Markers, delta markers, noise markers, phase noise markers
- Measurement functions for adjacent channel power, carrier to noise, third order intercept point, occupied bandwidth, modulation depth
- Trace operations such as Average, Max Hold or Min Hold
- Detectors: RMS, Average, Sample, Positive and Negative Peak
- Filters from 10 Hz to 20 MHz in 1-2-3-5-10 steps
- Flattop, Gaussian, rectangular, Hamming, Hanning, Chebyshev windowing functions
- Number of measurement points/trace selectable between 155 and 30001

Specifications in brief	
Frequency range	DC to 36 MHz
Frequency display	with marker
Marker resolution	span/624
Display range for frequency axis (frequency span)	
Real signal	0 Hz, 10 Hz to 36 MHz
Complex signal	0 Hz, 10 Hz to 72 MHz
Spectral purity, SSB phase noise (1 Hz), f = 10 MHz	
Carrier offset = 100 Hz	-115 dBc
Carrier offset = 1 kHz	-135 dBc
Carrier offset ≥10 kHz	-143 dBc
Sweep	
Sweep time, time domain (span = 0 Hz)	1 μs to 16 000 s in 5% steps, max. 800 000/RBW
Measurement in time domain	with marker and cursor lines (24 ns resolution)
Resolution bandwidths	
FFT filters, equivalent noise bandwidths (ENBW)	0.5 Hz to 20 MHz stepped in 1/2/3/5 sequence or any value within this range by entering a bandwidth directly
Window functions	Flattop, Gaussian, Hamming, Hanning, Chebyshev, rectangular
Shape factor 60 dB:3 dB	
Flattop window	2.4, nominal
Gaussian window	4.4, nominal
Chebyshev window	0.96, nominal
3 dB bandwidth/ENBW	
Flattop window	0.99, nominal
Gaussian window	0.94, nominal
Chebyshev window	0.96, nominal
Hamming window	0.97, nominal
Hanning window	0.97, nominal
Rectangular window	0.89, nominal

Specifications in brief	
Level	
Maximum safe input level, 50 Ω, CW power	+30 dBm (1 W)
1 MΩ input impedance, peak	±5 V
Level uncertainty at 1 MHz (full scale)	< 0.25 dB
I/Q imbalance at 1 MHz	< 0.1 dB
Signal to noise ratio, reference level = +10 dBm, signal level equal to reference level	> 139 dBc (1 Hz)
Spurious with input signal equal to reference level	
50 Ω: DC to 36 MHz	< -55 dBc
Spurious without input signal	
> 250 kHz	< -80 dBRef
Intermodulation distortion (2nd and 3rd order), 2 signals, level equal to -6 dB reference level	
50 Ω: DC to 20 MHz	< -70 dBc
I/Q crosstalk (DC to 36 MHz)	-70 dB
I/Q data	
Interface	GPIO or LAN interface
Sampling rate	programmable: 10 kHz to 81.6 MHz in 0.1 Hz steps
ADC sampling rate	81.6 MHz
ADC resolution	14 bit
I/Q memory	
Standard	16 Msample each for I and Q data
R&S®FSQ-B100 option	235 Msample each for I and Q data
R&S®FSQ-B100/-B102 options	705 Msample each for I and Q data
Frequency range, useful bandwidth with flat frequency response as specified (f _s = sampling rate)	
f _s = 40.8 MHz to 81.6 MHz	DC to 0.441 × f _s
f _s > 20.4 MHz to < 40.8 MHz	DC to 0.34 × f _s
f _s = 10 kHz to 20.4 MHz	DC to 0.40 × f _s

R&S®FSMR Measuring Receiver



Combines the functions of multiple instruments

The R&S®FSMR measuring receiver has been specially designed to handle the measurement tasks involved in the calibration of signal generators and fixed or adjustable attenuators.

- ▮ High-end spectrum analyzer
- ▮ High-precision level calibration tool
- ▮ Modulation analyzer for AM/FM/φM

- ▮ Audio analyzer with total harmonic distortion (THD) and SINAD measurement functionality
- ▮ Power meter for connecting R&S®NRP-Zxx power sensors
- ▮ High level linearity of 0.005 dB per 10 dB step for precise level and attenuation calibration
- ▮ Wide level measurement range from +30 dBm to 130 dBm
- ▮ Measurement of modulation depth, frequency deviation and phase deviation with < 1% measurement uncertainty
- ▮ Fast RF frequency counter with 0.01 Hz resolution
- ▮ Separate audio input

Level calibration – precise, repeatable and easy

- ▮ Exceptionally high linearity and level stability across an extended time and temperature range enable high-precision measurements across a longer period of time
- ▮ Automatic VSWR correction when a power sensor with a power splitter is used
- ▮ Traceability to national standards, R&S®FSMR-Z2 attenuation calibration kit for verifying the linearity of the R&S®FSMR

Specifications in brief			
	R&S®FSMR3	R&S®FSMR26	R&S®FSMR50
Frequency range	100 kHz to 3.6 GHz	100 kHz to 26.5 GHz	100 kHz to 50 GHz
AM modulation measurements			
Modulation depth	0% to 100%		
Modulation frequency	50 Hz to 100 kHz		
Inherent distortion	0.3%		
FM modulation measurements			
Frequency deviation	max. 500 kHz		
Modulation frequency	50 Hz to 200 kHz		
φM modulation measurements			
Phase deviation	max. 10 000 rad		
Modulation frequency	50 Hz to 100 kHz		
Audio measurements			
Frequency range	DC, 20 Hz to 1 MHz		
Level ranges	0.4 V, 4 V		
Spectrum analyzer			
Frequency range	20 Hz to 3.6 GHz	20 Hz to 26.5 GHz	20 Hz to 50 GHz
Resolution bandwidths	10 Hz to 50 MHz; FFT filters: 1 Hz to 30 kHz; channel filters; EMI bandwidths		
Video bandwidth	1 Hz to 10 MHz		
Displayed average noise level (RBW 10 Hz)			
1 GHz	typ. -148 dBm	typ. -146 dBm	
26 GHz	–	typ. -141 dB	typ. -143 dBm
50 GHz	–	–	typ. -121 dBm
Trace detectors	Max Peak, Min Peak, Auto Peak, Sample, RMS, Average, Quasi Peak		
Phase noise	typ. -123 dBc (1 Hz) at 10 kHz from carrier		
Sweep time			
Span >10 Hz	2.5 ms to 16000 s		
Span = 0 Hz (zero span)	1 μs to 16000 s		
Image frequency rejection			
f < 3.6 GHz	typ. 110 dB		
f > 3.6 GHz	–	0 dB	
f > 3.6 GHz, with R&S®FSMR-B2 option	–	typ. 100 dB	

R&S®FS-Z10 Coherence Unit

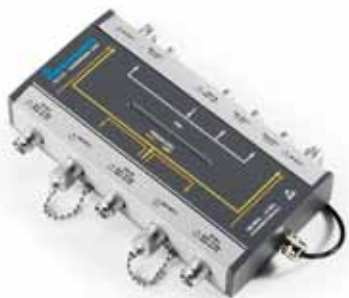

Phase-coherent RF measurements

The R&S®FS-Z10 coherence unit in combination with two R&S®FSQ or R&S®FSG signal and spectrum analyzers enables phase-coherent RF measurements such as measuring the phase, timing and gain differences of two RF signals.

Moreover, it can compensate the phase, timing and gain difference of the digitized RF signal for further calculations. The R&S®FS-Z10 focuses on measurements on multi-antenna systems in aerospace and defense as well as in mobile communications, for instance MIMO beam-forming.

- High-performance signal analyzers with excellent RF performance
- Signal analysis bandwidth up to 120 MHz with low EVM
- Frequency range from 100 MHz to 6 GHz
- Phase-coherent two RF channel operation
- Design, test and calibration of multi-antenna systems
- Measurement of phase, timing and amplitude difference of RF signals
- Compensation of phase, timing and amplitude differences based on I/Q data for further analysis

R&S®FS-Zxx External Mixers



Spectrum analysis in the waveguide bands above 40 GHz

Frequencies in the high GHz range still require the use of external harmonic mixers. Such mixers can be connected to an R&S®FSUP26/50, R&S®FSP40, R&S®FSV30/40, R&S®FSU26/43/46/50/67 or R&S®FSQ26/40 provided that these analyzers are equipped with the R&S®FSx-B21 LO/IF ports option for external mixers. Rohde&Schwarz mixers cover the frequency range up to 110 GHz. If other mixers are used, up to 1.1 THz is possible.

Overview of external mixers				
	R&S®FS-Z60	R&S®FS-Z75	R&S®FS-Z90	R&S®FS-Z110
Frequency range	40 GHz to 60 GHz	50 GHz to 75 GHz	60 GHz to 90 GHz	75 GHz to 110 GHz
Mixer type	balanced dual-diode mixer, no biasing			
Conversion loss	typ. 18 dB	typ. 25 dB	typ. 34 dB	typ. 32 dB
LO frequency range	9.81 GHz to 15.19 GHz	8.61 GHz to 12.62 GHz	8.61 GHz to 12.62 GHz	9.4 GHz to 14 GHz
Number of harmonics	4	6	6	8

LO/IF ports option		
	R&S®FSV30/40 with R&S®FSV-B21 R&S®FSP40 with R&S®FSP-B21	R&S®FSU26/46/50 R&S®FSQ26/40 with R&S®FSU-B21 R&S®FSUP26/50 with R&S®FSUP-B21
LO frequency range	7 GHz to 13.2 GHz	7 GHz to 15.5 GHz
LO level	+15 dBm	+15 dBm
IF	404.4 MHz	404.4 MHz

Application-specific solutions

- ¹⁾ Standard.
²⁾ Base station only.
³⁾ See R&S®FSH data sheets.
⁴⁾ The functionality of R&S®FS-K74 and R&S®FS-K74+ is included in R&S®FSV-K72.
⁵⁾ The functionality of R&S®FS-K73+ is included in R&S®FSV-K73.
⁶⁾ Included in R&S®FSL-K72.
⁷⁾ WiBro only.

The tables provide an overview of the available application firmware/PC software packages and show the wide range of applications covered by the Rohde & Schwarz signal and spectrum analyzers.

General measurement applications													
Firmware or PC software R&S®FSx		R&S®FSU	R&S®FSQ	R&S®FSG	R&S®FSV	R&S®FSVR	R&S®FSP	R&S®FSL	R&S®FSMR	R&S®FSUP	R&S®FMU36	R&S®FSH	Page
-K7	Modulation analysis for AM/FM/φM including THD and SINAD measurements	•	•	•	•	•	•	•	•	• ¹⁾	•	–	45
-K7S	FM stereo modulation analysis	–	–	–	•	•	–	–	–	–	–	–	45
-K9	Measurement with power sensors	•	•	•	•	•	•	•	•	•	–	• ¹⁾	–
-K14	Spectrogram measurements	–	–	–	•	•	–	•	–	–	–	• ¹⁾	47
-K15	VOR/ILS measurements	•	•	–	–	–	–	–	•	–	–	–	55
-K20	Cable TV measurements, analog and digital	–	–	–	–	–	–	•	–	–	–	–	–
-K30	Noise figure and gain measurements	•	•	•	•	•	•	•	•	•	–	–	47
-K40	Phase noise measurements	•	•	•	•	•	•	–	•	• ¹⁾	–	–	48
-K54	EMI measurement application	–	–	–	•	•	–	–	–	–	–	–	54
-K70	General vector signal analysis	•	•	•	•	•	–	–	•	•	• ¹⁾	–	49
-K130PC	Distortion analysis	•	•	•	•	•	•	•	•	• ¹⁾	•	•	54

Measurements in line with mobile radio standards													
Firmware R&S®FSx		R&S®FSU	R&S®FSQ	R&S®FSG	R&S®FSV	R&S®FSVR	R&S®FSP	R&S®FSL	R&S®FSMR	R&S®FSUP	R&S®FMU36	R&S®FSH	Page
-K5	GSM/EDGE	•	•	•	–	–	•	–	•	•	•	–	–
-K10	GSM/EDGE/EDGE Evolution/VAMOS	–	•	•	•	•	–	–	–	–	–	–	46
-K72/-K73	3GPP WCDMA DL/UL	•	•	•	•	•	•	• ²⁾	•	•	•	• ²⁾³⁾	49
-K74	3GPP WCDMA HSDPA	•	•	•	– ⁴⁾	– ⁴⁾	•	– ⁶⁾	•	•	•	• ²⁾³⁾	49
-K73+/-K74+	3GPP WCDMA HSPA+	•	•	•	– ⁴⁾⁵⁾	– ⁴⁾⁵⁾	•	–	–	–	•	• ²⁾³⁾	49
-K82/-K83	CDMA2000®	•	•	•	•	•	•	• ²⁾	•	•	•	–	50
-K84/-K85	1xEV-DO	•	•	•	•	–	•	–	•	•	•	• ²⁾³⁾	50
-K76/-K77	3GPP TD-SCDMA	•	•	•	•	•	•	–	•	•	•	–	50
-K100/-K101	3GPP LTE FDD	–	•	•	•	•	–	–	–	–	–	• ²⁾³⁾	53
-K104/-K105	3GPP LTE TDD	–	•	•	•	•	–	–	–	–	–	• ²⁾³⁾	53
-K102/-K103	3GPP LTE MIMO	–	•	•	•	•	–	–	–	–	–	–	53
-K110	TETRA Release 2/TEDS	•	•	–	–	–	–	–	–	–	–	–	53

Other wireless applications													
Firmware or PC software R&S®FSx		R&S®FSU	R&S®FSQ	R&S®FSG	R&S®FSV	R&S®FSVR	R&S®FSP	R&S®FSL	R&S®FSMR	R&S®FSUP	R&S®FMU36	R&S®FSH	Page
-K92/-K93	IEEE 802.16 e-2005 WiMAX™	–	•	•	•	•	• ⁷⁾	•	–	–	•	–	52
-K94	IEEE 802.16 WiMAX™ MIMO	–	•	•	–	–	–	–	–	–	–	–	52
-K91	IEEE 802.11 a/b/g/j WLAN	•	•	•	•	•	–	•	–	–	•	–	51
-K91n	IEEE 802.11 n WLAN	•	•	•	•	•	–	•	–	–	–	–	51
-K91ac	IEEE 802.11 ac WLAN	–	•	–	–	–	–	–	–	–	–	–	51
-K8	IEEE 802.15.1 Bluetooth® EDR	•	•	•	•	•	•	•	•	•	•	–	46
-K96/-K96PC	General OFDM vector signal analysis	–	•	•	•	•	–	–	–	•	–	–	52

R&S®FS/FSV/FSL-K7 AM/FM/φM Measurement Demodulator

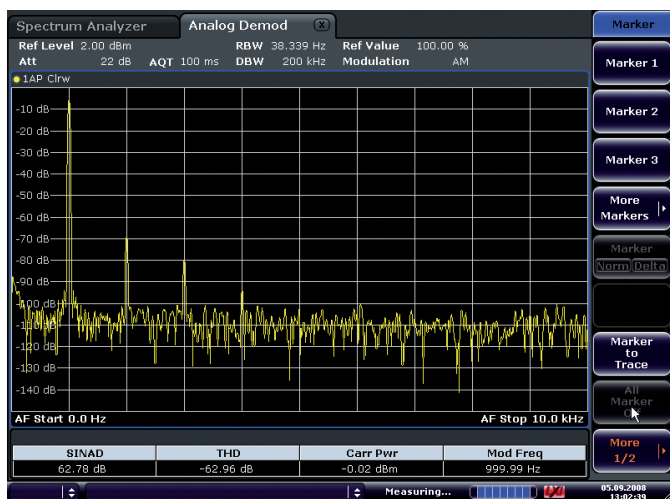

THD measurement on an amplitude-modulated signal. The first harmonic of the modulation signal is well suppressed by 69 dB. This corresponds to a THD (D2) of less than 0.1%.

R&S®FSV-K7S FM Stereo Measurements

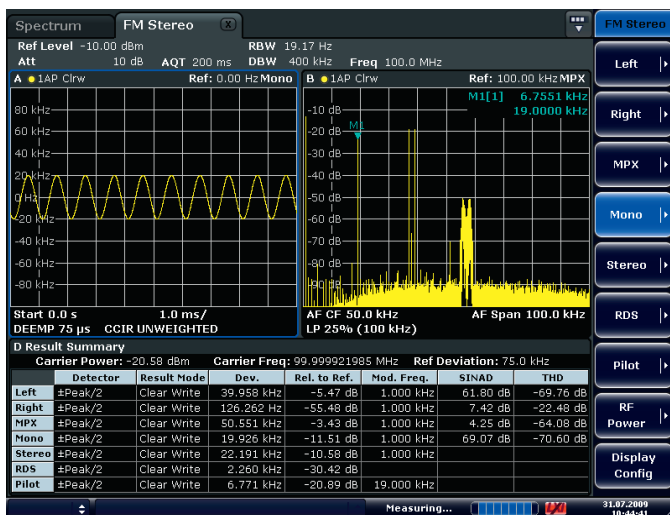

The result summary clearly displays the measurement results of all the channels; switchover is not required. Additional displays such as the mono signal or MPX spectrum display support in-depth analysis.

Analog signal measurement

The R&S®FS/FSV/FSL-K7 AM/FM/φM measurement demodulator application converts the R&S®FSU/FSQ/FSG/FSV/FSVR/FSP/FSL/FSMR/FSUP/FMU36 into an analog modulation analyzer for amplitude, frequency or phase-modulated signals. The following display and analysis alternatives are available:

- Modulation signal versus time
- Spectrum of modulation signal (FFT)
- RF signal power versus time
- Spectrum of RF signal
- Table with numeric display of
 - Deviation or modulation factor, RMS weighted, +Peak, -Peak, ±Peak/2
 - Modulation frequency
 - Carrier frequency offset
 - Carrier power
 - Total harmonic distortion (THD) and SINAD

Comprehensive measurement functions for complete FM stereo analysis

The R&S®FSV-K7S application firmware expands the functionality of the R&S®FSV-K7 application firmware with measurements on FM stereo transmitters.

- Frequency deviation measurement in channels MPX, L, R, M, S and frequency deviation measurement of pilot and RDS carrier
- Carrier power and carrier frequency measurement
- Audio frequency measurement
- Absolute and relative deviation measurement for easy-to-perform S/N ratio and crosstalk attenuation measurement
- AF spectrum display and display per channel
- Up to 4 measurement windows

Wide variety of audio filters and detectors for standard-compliant measurements

- CCIR filter, weighted and unweighted
- 20 Hz, 50 Hz, 300 Hz highpass filters and 3 kHz, 15 kHz, 23 kHz, 150 kHz lowpass filters
- Selectable deemphasis of 50 μs, 75 μs, 750 μs
- Detectors: ±Peak/2, +Peak, -Peak, RMS, RMS × SQRT2, Quasi Peak (in line with CCIR 468) and Quasi Peak × SQRT2

R&S®FS/FSV/FSL-K8 Transmitter Measurements for Bluetooth® V2.0 and EDR

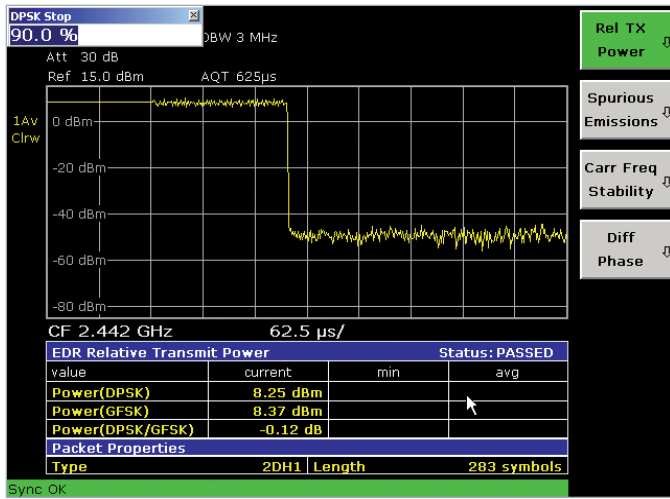

Relative transmit power: The EDR relative transmit power determines the power of the GFSK-modulated and the DPSK-modulated part and the power difference.

The R&S®FS/FSV/FSL-K8 application firmware enhances the range of applications of the R&S®FSP/FSU/FSQ/FSG/FSUP/FSMR/FSV/FSVR/FSL spectrum analyzers to include measurements on Bluetooth® transmitters. All measurements are carried out in line with the Bluetooth® RF Test Specification (Bluetooth® SIG) Rev. 2.0+EDR and cover basic rate as well as EDR. Integrated limit value monitoring is provided for all measurements and allows analysis of the results in the development and production of Bluetooth® modules.

Basic rate measurements

- ▮ Output power
- ▮ ACP over up to 79 channels
- ▮ Modulation characteristics
- ▮ Initial carrier frequency tolerance
- ▮ Carrier frequency drift

EDR measurements

- ▮ Output power and relative transmit power
- ▮ In-band spurious emissions, gated
- ▮ Carrier frequency stability and modulation accuracy (DEVM)
- ▮ Differential phase encoding

R&S®FS/FSV-K10 GSM/EDGE/EDGE Evolution Analysis

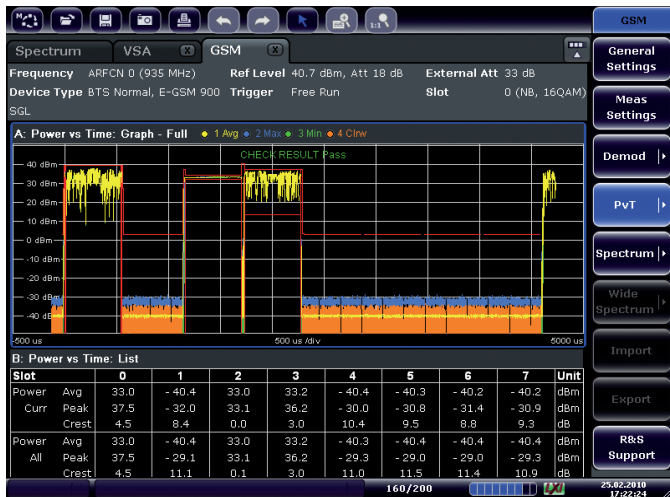

The R&S®FS/FSV-K10 measurement application firmware enables transmitter tests on mobile stations and base stations. It provides all the functionality needed for GSM/EDGE, EDGE Evolution and VAMOS.

- ▮ Power measurement in time domain including carrier power
- ▮ Modulation quality
 - EVM
 - Phase/frequency error
 - Origin offset suppression
- ▮ Spectrum measurements
 - Modulation spectrum
 - Transient spectrum
 - Spurious emissions

R&S®FSV/FSL-K14 Spectrogram Measurements

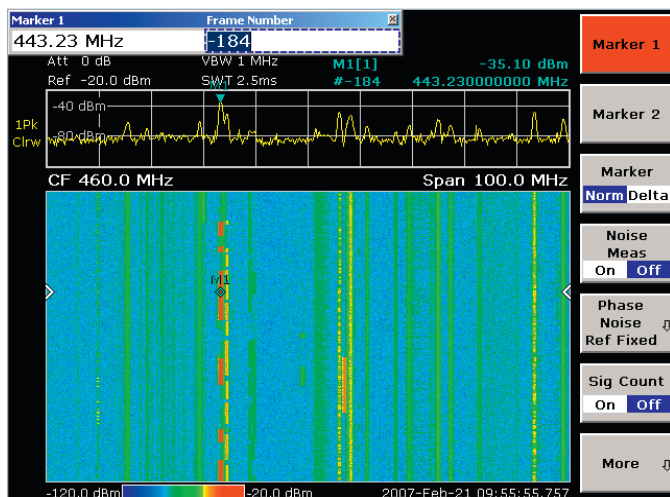

The R&S®FSV/FSL-K14 application firmware adds a spectrogram display and trace recording to the R&S®FSV/FSVR/FSL. The spectrogram view shows a history of the spectrum and helps to analyze intermittent problems or variations in frequency and level versus time. It also adds a new trigger, i.e. a time trigger that makes it possible to record a trace at a regular time interval.

- ▮ Recording of up to 20 000 traces: approx. 5.5 h continuous monitoring with repetition interval set to 1 s
- ▮ Time trigger, 100 ms to 5000 s repetition interval: allows unattended continuous monitoring
- ▮ Scrolling through recorded traces with markers: replay and repeated analysis of recorded data

4

Home

R&S®FS/FSV/FSL-K30 Noise Figure and Gain Measurements

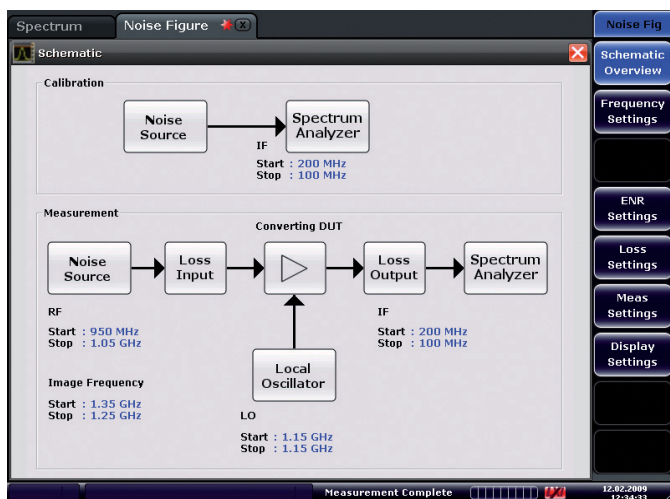

The schematic view of the test setup simplifies measurements on frequency-converting DUTs.

Wide variety of RF measurements

The R&S®FS/FSV/FSL-K30 application firmware expands the R&S®FS/FSV/FSVR/FSL signal and spectrum analyzers by adding measurement functionality otherwise only provided by special noise measurement analyzers. The following parameters can be measured at a specified frequency or in a selectable frequency range:

- ▮ Noise figure in dB
- ▮ Noise temperature in K
- ▮ Gain in dB

Noise measurements

- ▮ Measurement range from 0 dB to 35 dB
- ▮ Resolution of 0.01 dB
- ▮ Device measurement uncertainty of 0.05 dB

Gain measurements

- ▮ Measurement range from -20 dB to +60 dB
- ▮ Resolution of 0.01 dB
- ▮ Measurement accuracy of ± 0.2 dB

R&S®FS/FSV-K40 Phase Noise Measurements

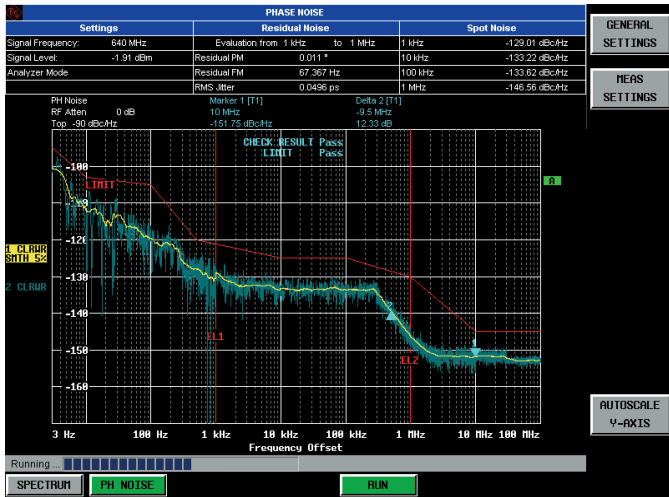

Phase noise measurement of a signal source: blue: original trace; yellow: trace with a smoothing factor of 5%. The red trace is a LIMIT. The measurement result (pass in this example) is displayed directly in the diagram. The vertical red lines mark the range limits for residual FM/φM measurements. Results are displayed in the top center of the screen under residual noise.

Fast and easy phase noise measurements

The R&S®FSQ/FSG/FSU/FSMR/FSV/FSVR signal and spectrum analyzers to perform fast and easy phase noise measurements in development and production.

- Carrier offset frequency range selectable from 1 Hz to 1 GHz in 1/3/10 sequence (1 Hz, 3 Hz, 10 Hz, 30 Hz, etc.)
- Number of averages, sweep mode and filter bandwidth for every measurement subrange can be individually selected to optimize the measurement speed
- Fast results for the subranges are obtained by starting the measurement at the maximum carrier offset
- Verification of carrier frequency and power prior to each measurement avoids incorrect measurements
- Improvement of dynamic range by measuring the thermal inherent noise in a reference trace and performing noise correction
- Tabular display of residual FM, residual φM and RMS jitter in addition to measurement trace
- Limit lines with PASS/FAIL indication

R&S®FSV-K70 Vector Signal Analysis

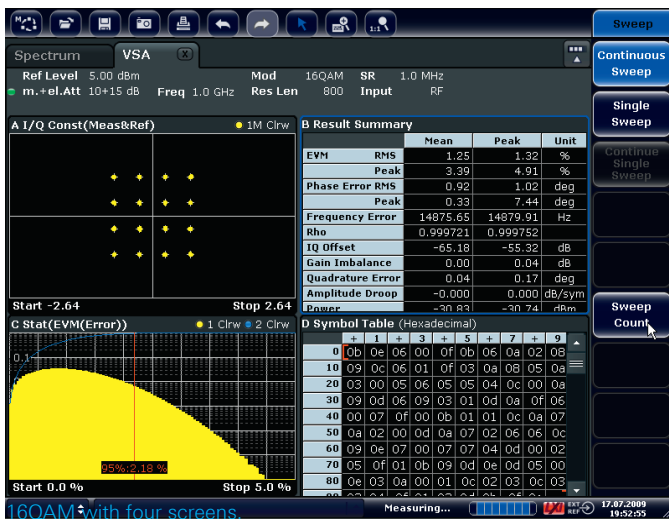

Flexible modulation analysis from MSK to 64QAM

The R&S®FSV-K70 application firmware enables users to flexibly set the analysis of digitally modulated single carriers down to the bit level using the R&S®FSV/FSVR. The clear-cut operating concept simplifies measurements, despite the wide range of analysis tools.

- Modulation formats: MSK, DMSK, BPSK, QPSK, 8PSK, DQPSK, D8PSK, π/4-DQPSK, 3π/8-D8PSK, 16QAM to 64QAM
- Symbol rate up to 32 MHz
- Analysis length up to 50 000 symbols
- 28 MHz signal analysis bandwidth, optionally 40 MHz

Numerous standard-specific default settings

- GSM, GSM/EDGE, WCDMA, TETRA
- Display choices for amplitude, frequency, phase, I/Q, eye diagram, amplitude, phase or frequency error, constellation or vector diagram

R&S®FSQ-K70 Vector Signal Analysis

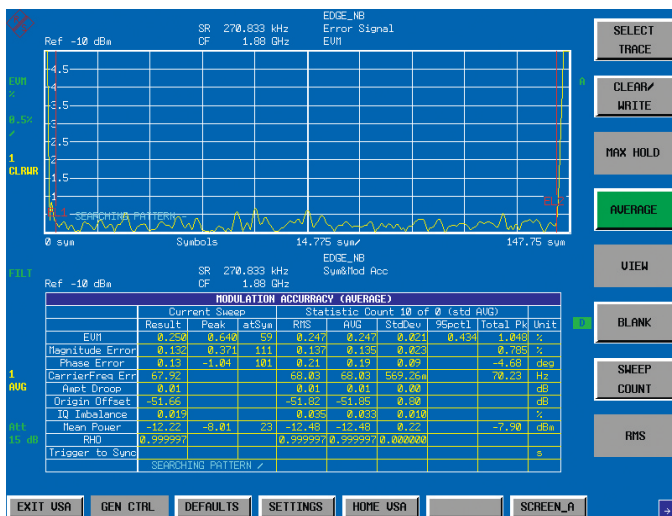

Modulation error measurements on EDGE signals.

Universal demodulation, analysis and documentation of digital radio signals

The R&S®FSQ-K70 application firmware enables users to analyze digitally modulated carriers down to the bit level using the R&S®FSQ/FSU/FSMR/FSUP/FSG signal and spectrum analyzers and the R&S®FMU baseband analyzer.

For all major mobile radio standards

- GSM and EDGE
- WCDMA-QPSK, CDMA2000®-QPSK
- Bluetooth®, TETRA, PDC, PHS, DECT, NADC

For all common digital modulation modes

- BPSK, QPSK, OQPSK, $\pi/4$ -DQPSK
- 8PSK, D8PSK, $3\pi/8$ -8PSK, (G)MSK, 2/4/(G)FSK
- 16, 32, 64, 128, 256 (D)QAM, 8VSB
- 25 MHz symbol rate expandable up to 81.6 MHz
- 28 MHz I/Q demodulation bandwidth expandable up to 120 MHz (R&S®FSQ only)

Optimum representation of results

- In-phase and quadrature signals versus time
- Magnitude and phase versus time
- Eye/vector/constellation diagrams
- Table with modulation errors
- Demodulated bit stream
- Statistical evaluation of modulation parameters
- Spectral evaluation
- Amplifier distortion measurements

R&S®FS-K72/-K73/-K73+/-K74/-K74+ WCDMA 3GPP Measurements

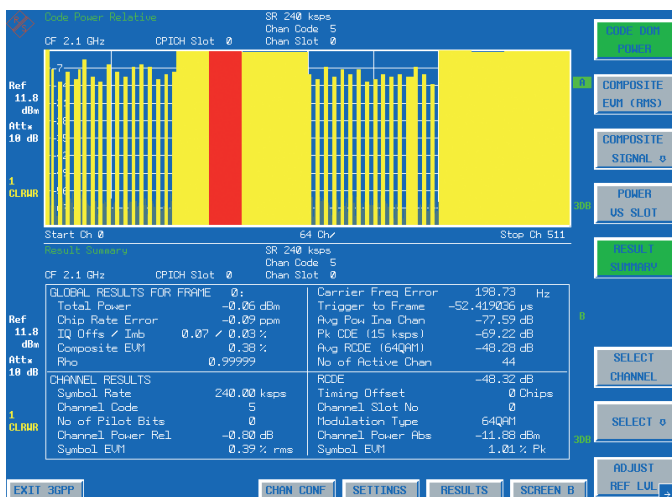

Code domain power measurement on a signal with 44 active codes.

Code domain power measurements (3GPP FDD)

The application firmware adds measurement functions in line with the 3GPP specifications for the FDD mode to the Rohde&Schwarz signal and spectrum analyzers.

- Measurement of modulation quality: EVM, peak code domain error and relative code domain error
- Automatic detection of active channels and their data rate
- Scrambling code search
- Automatic detection of modulation formats in HSDPA and HSPA+
- Provides the functionality needed for base station testing

R&S®FS-K72/-K73

- Provides all the functionality for testing base stations (R&S®FS-K72) or user equipment (R&S®FS-K73) in line with WCDMA Release 99

R&S®FS-K74

- Extends the capabilities of R&S®FS-K72 to encompass HSPA (high speed packet access) for base station testing (R&S®FS-K74)

R&S®FS-K73+

- Adds HSPA+ capabilities to R&S®FS-K73

R&S®FS-K74+

- Provides additional functionality for HSPA+ testing in line with 3GPP Release 7

R&S®FS-K76/-K77 TD-SCDMA Test

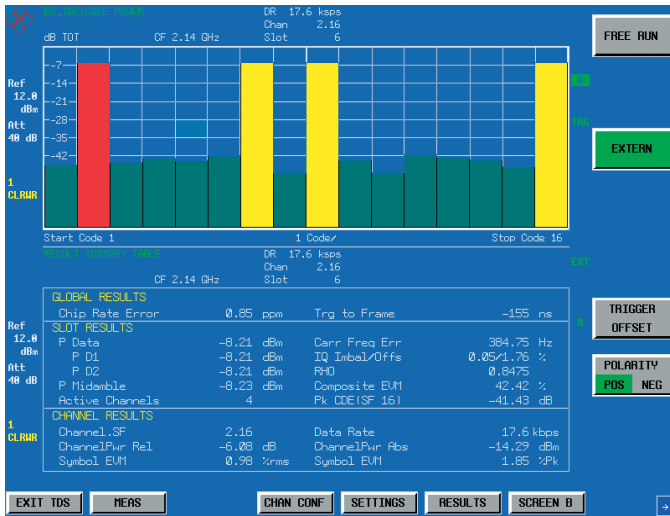

Code domain power measurement on a signal with four active channels: Active and inactive channels are displayed; inactive channels (noise, interference) are displayed with a spreading factor of 16. The table also shows the main parameters of the total signal at a glance, e.g. total power, pilot power, frequency error and error of chip rate, as well as the parameters of the marked code channel such as code power and EVM.

Base station and mobile station tests on TD-SCDMA with the R&S®FSQ/FSU/FSP/FSMR analyzers

The R&S®FS-K76/-K77 application firmware adds measurement functions in line with 3GPP as well as China Wireless Telecommunication Standard Group (CWTS) specifications to the R&S®FSQ/FSU/FSP/FSMR analyzers. It enhances the range of applications to include code domain power and modulation measurements on TD-SCDMA base stations.

- ▮ Code domain power measurement
- ▮ Easy measurement of modulation quality
- ▮ Automatic detection of active channels
- ▮ Spectrum emission mask
- ▮ Remote control

R&S®FS-K76

- ▮ Provides the functionality needed for base station testing

R&S®FS-K77

- ▮ Provides user equipment (UE) functionality

R&S®FS-K82/-K84 Base Station Test

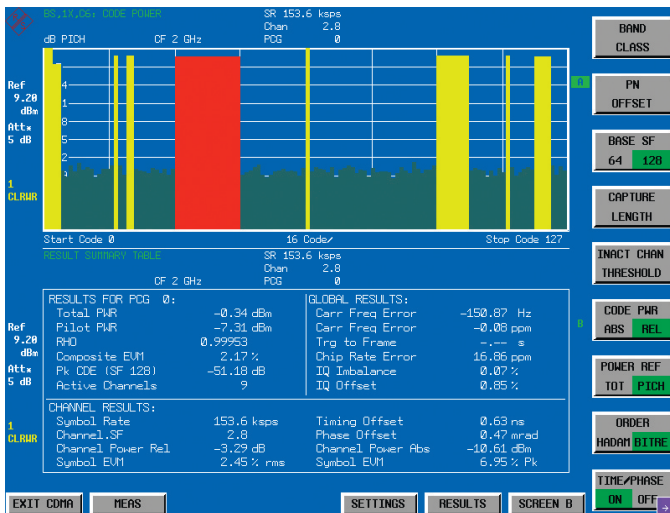

Code domain power measurement on a signal with nine active channels: Active and inactive channels are displayed in bit-reversed order; inactive channels (noise, interference) are displayed with the base spreading factor. The table also shows the main parameters of the total signal at a glance, as well as the parameters of the marked code channel.

CDMA2000®/IS-95 base station test (R&S®FS-K82)

The R&S®FS-K82 application firmware enhances the range of applications to include code domain power and modulation measurements on CDMA2000® signals for radio configurations 1 to 5 and radio configuration 10. cdmaOne base station signals can be analyzed by using radio configuration 1 or 2.

1xEV-DO base station test (R&S®FS-K84)

The R&S®FS-K84 application firmware adds the capability to measure code domain power modulation accuracy on all four channel types (pilot, preamble, MAC and DATA) of a 1xEV-DO base station signal.

Measurement parameters

- ▮ Code domain power (code domain analyzer)
- ▮ Code domain power versus time (R&S®FS-K82)
- ▮ Rho
- ▮ Error vector magnitude (EVM)
- ▮ Peak code domain error
- ▮ Power versus symbol
- ▮ Symbol constellation
- ▮ Channel table
- ▮ Code domain error power

R&S®FS/FSV-K83/-K85 Mobile Station Test

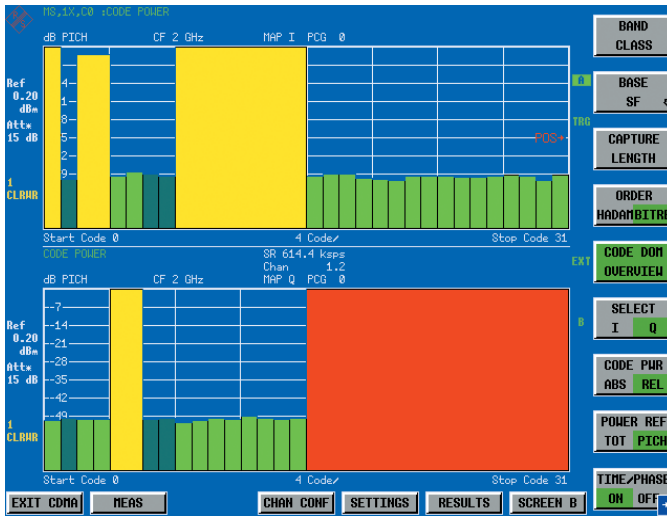

Code domain power measurement on a signal with high data rate transmission: Active and inactive channels are displayed in bit-reversed order; inactive channels (noise, interference) are displayed with the base spreading factor. The upper half shows the in-phase part of the signal, the lower half the quadrature part.

Transmitter measurements on 3GPP2 signals with the R&S®FSQ/FSU/FSP/FSMR analyzers

The R&S®FS-K83 application firmware enhances the range of applications to include code domain power and modulation measurements on CDMA2000® signals for radio configurations 3 and 4. 1xEV-DV reverse link channels of release C are also supported. The R&S®FS-K85 application firmware adds the capability to measure code domain power modulation accuracy on all five channel types (PICH, RRI, DATA, ACK and DRC) as well as TRAFFIC and ACCESS operating modes of an access terminal.

Measurement parameters

- ▮ Code domain power
- ▮ Code domain power versus time
- ▮ Rho
- ▮ Error vector magnitude (EVM)
- ▮ Peak code domain error
- ▮ Power versus symbol
- ▮ Symbol constellation
- ▮ Channel table
- ▮ Code domain error power
- ▮ Power versus chip (R&S®FS-K85)

R&S®FSx-K91/-K91n/-K91ac WLAN TX Measurements

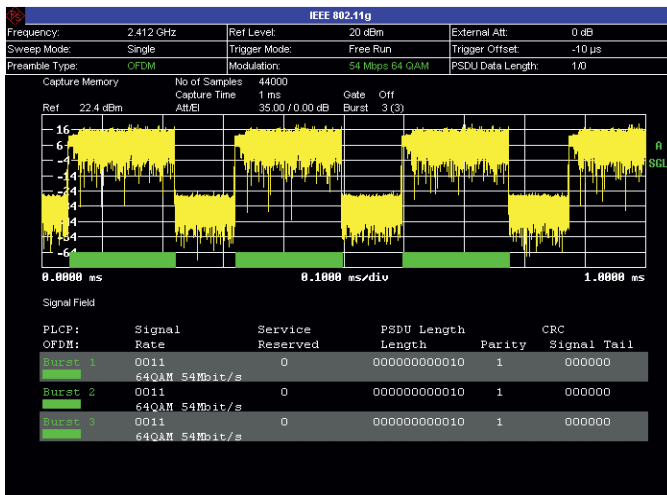

The signal field content is used for automatic modulation setting and can be displayed for further evaluation.

WLAN TX measurements with Rohde & Schwarz analyzers

The R&S®FSx-K91/-K91n/-K91ac application firmware enables the R&S®FSQ/FSG/FSV/FSVR/FSL/FMU signal and spectrum analyzers to perform spectrum and modulation measurements on signals in line with the WLAN IEEE 802.11a/b/g/j/n/ac standard.

- ▮ Analysis at the RF or in the analog/digital baseband (optional for the R&S®FSQ)
- ▮ Demodulation bandwidth of 28 MHz/40 MHz/120 MHz
- ▮ Modulation formats for IEEE 802.11a/g/j/n/ac: BPSK, QPSK, 16QAM, 64QAM, 256QAM
- ▮ Modulation formats for IEEE 802.11b: DBPSK, DQPSK, CCK, short PLCP, long PLCP
- ▮ Very low residual EVM of -44/-46 dB (0.7% at 2.4 GHz)
- ▮ Legacy/mixed/Greenfield mode of IEEE 802.11n signals
- ▮ Support of up to four MIMO streams
- ▮ Provides complex WLAN measurements at a keystroke (automatic setting of modulation format)
- ▮ Allows remote control of all functions via IEC/IEEE bus or LAN

R&S®FSx-K92/-K93, R&S®FSQ-K94 WiMAX™/MIMO TX Measurements

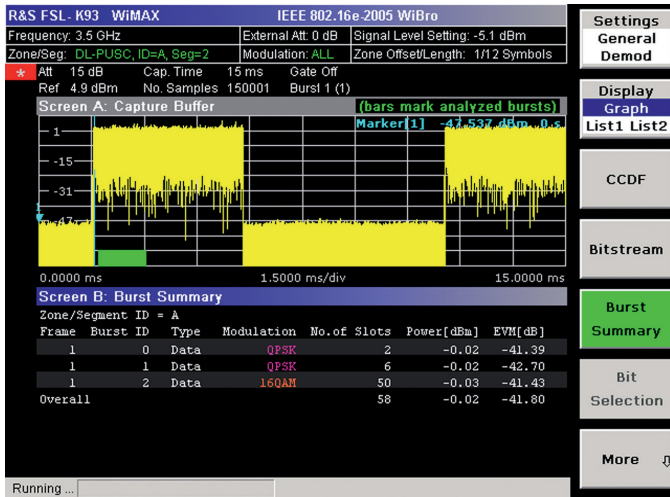

The subranges of the WiMAX™ signal in the time domain (highlighted in green) are demodulated. The burst summary provides information about the bursts of the analyzed zone, e.g. modulation mode and EVM. The raw data bit stream can be displayed for all bursts, including the FCH field.

The R&S®FSx-K92/-K93 application firmware allows TX measurements on OFDM and OFDMA signals in line with the WiMAX™ IEEE 802.16-2004 and IEEE 802.16e-2005 standards. The R&S®FSQ-K94 application firmware enhances the capability of R&S®FSQ-K93 to include analysis of WiMAX™ MIMO signals for the R&S®FSQ and R&S®FSG.

R&S®FSx-K92/-K93

- Enhances the R&S®FSQ/FMU/FSL/FSV/FSG analyzers by adding the capability to perform spectrum and modulation measurements on signals in line with the IEEE 802.16-2004 and IEEE 802.16e-2005 standards
- Supports OFDM and OFDMA
- Complex WiMAX™ measurements at a keystroke
- Measurements in the RF/IF range and in the baseband
- Remote control of all functions via IEC/IEEE bus or LAN

R&S®FSQ-K94

- Enhances the R&S®FSQ and R&S®FSG spectrum analyzers (when equipped with the R&S®FSQ-K93 application firmware) by adding the capability to perform spectrum and modulation measurements on WiMAX™ MIMO signals

R&S®FS-K96/-K96PC OFDM Vector Signal Analysis



The upper part of the display shows the recorded signal in the time domain. The lower part shows the constellation diagram.

The R&S®FS-K96 software expands the R&S®FSQ/FSUP/FSG/FSV/FSVR signal analyzers to feature modulation measurements on general OFDM signals. The OFDM demodulator is user-configurable and standard-independent. The R&S®FS-K96 runs only when a LAN or GPIB connection to the Rohde & Schwarz analyzer is established. The R&S®FS-K96PC runs with and without connection to an analyzer.

- Support of OFDM and OFDMA
- Support of any PSK or QAM modulation format
- Frequency range from 50 MHz to 3/8/26.5/40 GHz, depending on the analyzer used
- Very low residual EVM of below -51 dB for DVB-T, 2k mode
- RF measurement or I/Q baseband measurement (optional)
- Numerous measurements for the analysis of OFDM signals

R&S®FSQ/FSV-K100/-K101/-K102/-K103/ -K104/-K105 EUTRA/LTE Signal Analysis

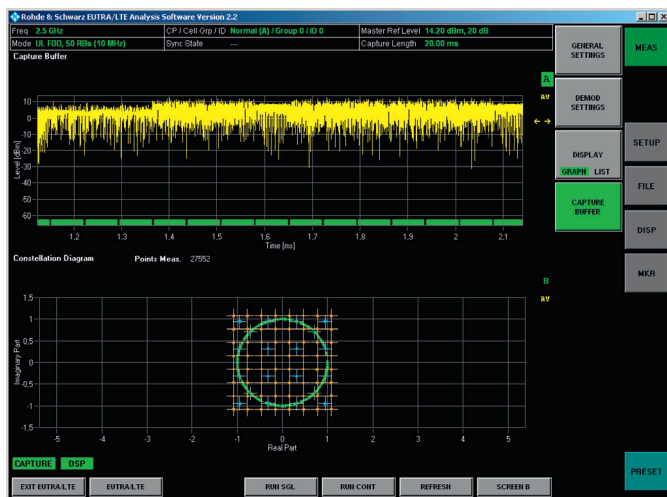

Transmitter measurements on LTE signals

The software analyzes the modulation quality, e.g. EVM or I/Q imbalance, of 3GPP EUTRA FDD and TDD signals in both uplink and downlink. When combining two or up to four signal analyzers, these tasks can even be performed on MIMO transmitters.

The most important measurement results are listed in a table to provide a quick overview of the performance of the transmitter.

- Error vector magnitude (EVM) of all carriers
- EVM physical channel
- EVM physical signal
- Frequency error
- Sampling error
- Modulation parameters: I/Q error, gain imbalance, quadrature error
- Power
- Crest factor

For advanced analysis, a number of graphical displays is available.

Designation	Type
EUTRA/LTE FDD downlink software	R&S®FSQ-K100 R&S®FSV-K100
EUTRA/LTE FDD uplink software	R&S®FSQ-K101 R&S®FSV-K101
EUTRA/LTE downlink MIMO software (requires R&S®FSQ-K100 or R&S®FSQ-K104)	R&S®FSQ-K102 R&S®FSV-K102
EUTRA/LTE TDD downlink software	R&S®FSQ-K104 R&S®FSV-K104
EUTRA/LTE TDD uplink software	R&S®FSQ-K105 R&S®FSV-K105

R&S®FS-K110 TETRA Release 2 Analysis



Adjacent channel power (ACP) measurement: The bandwidth of the TX channel depends on the number of carriers; the power in the adjacent channels is determined by means of a TETRA filter.

Transmitter measurements on TETRA signals

R&S®FS-K110 analyzes uplink and downlink signals in line with the EN 300 392-2 and EN 300 394-1 standards. It measures the modulation quality (e.g. EVM, I/Q imbalance, frequency error) and spectrum parameters such as ACP on continuous and burst signals.

- Supports 25 kHz, 50 kHz, 100 kHz, 150 kHz channels
- Supports 4QAM, 16QAM and 64QAM data symbols
- Measurements
 - Error vector magnitude (EVM)
 - Power versus time (PvT)
 - Adjacent channel power (ACP) due to modulation and transients
 - Constellation diagram, selectable per carrier and per symbol type
 - Bit stream
 - Phase and magnitude error
- Capture length up to 108 slots

R&S®FS-K130PC Distortion Analysis Software

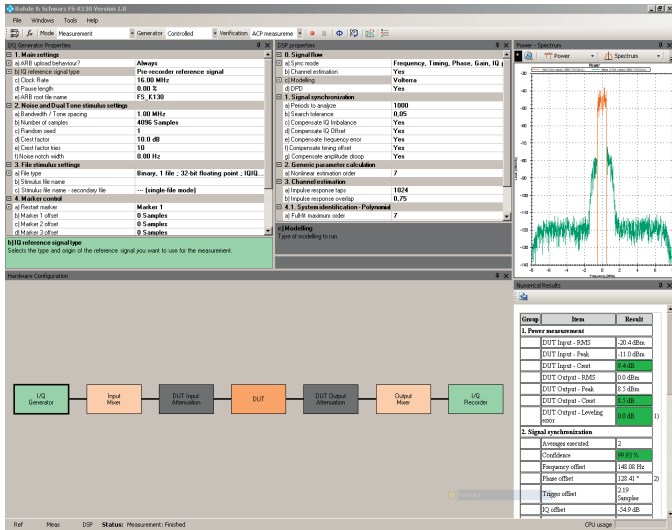

Block diagram functions make setup configuration and instrument settings easy and intuitive. The wide variety of measurement results that can be simultaneously displayed provides a quick overview. The configurable windows can be easily adjusted to suit various tasks

Amplifier modeling and linearization

The R&S®FS-K130PC distortion analysis software measures and models the linear and nonlinear distortions of amplifiers, mixers and baseband components. This simplifies and accelerates the development of linearized components, such as power amplifiers. The most important measurement results are listed in a table to provide a quick overview of the performance of the transmitter.

- Measurement of the distortion behavior of amplifiers, mixers and transposers and also direct control of the required measuring instruments, such as signal generators and signal analyzers, via IEC/IEEE bus, LAN or USB
- Calculation of the coefficients of a distortion model for DUTs with and without memory in accordance with the different selectable models (polynomial or Volterra)
- Calculation of the predistortion coefficients
- Verification of the spectral regrowth improvement achieved

R&S®FSV-K54 EMI Measurement Application

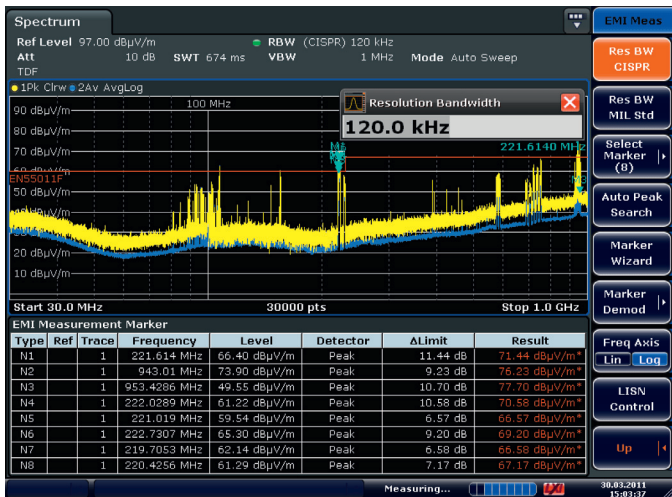

Bandwidth selection.

Finding, classifying and eliminating electromagnetic interference

The R&S®FSV-K54 EMI measurement application adds EMI diagnostic functionality to the R&S®FSV signal and spectrum analyzer and the R&S®FSVR real-time spectrum analyzer. R&S®FSV-K54 offers EMI bandwidths for commercial and military applications, detectors such as Quasi Peak, CISPR-average and RMS-average, limit lines and correction factors. It allows users to analyze the effectiveness of shielding measures and the effects of changes in the circuit or design prior to testing in the EMC lab.

- EMI bandwidths for commercial and military standards
- Standard EMI detectors: Quasi Peak, CISPR-average, RMS-average
- Linking of measurement markers to various EMI detectors
- Limit lines and transducers for typical measurement tasks
- Choice of linear or logarithmic scale on frequency axis
- Seamless analysis of frequency spectrum up to 40 MHz using the R&S®FSVR

R&S®FS-K15 VOR/ILS Demodulator

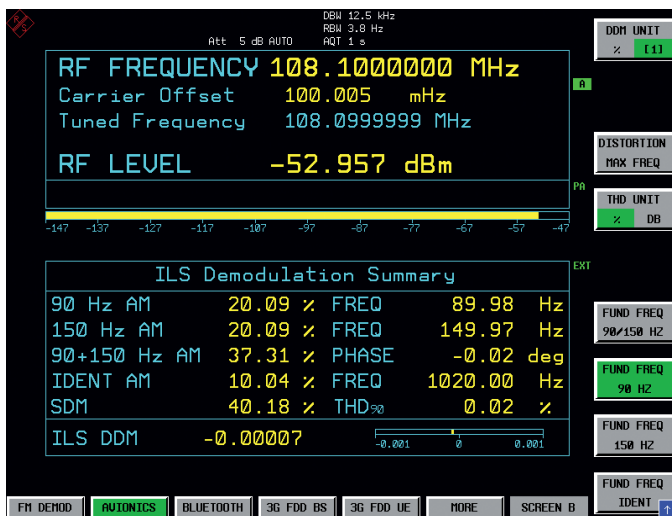

Precise VOR and ILS modulation analysis for calibration, development, production and service

The R&S®FS-K15 application firmware adds VOR/ILS analysis capability to the R&S®FSMR, R&S®FSU and R&S®FSQ. In the R&S®FSMR measuring receiver, the option allows the calibration of VOR/ILS signal generators and communications/navigation testers.

Using the R&S®FSMR and R&S®FS-K15, these instruments can be calibrated by a single box without any additional VOR/ILS tester. In the R&S®FSU/FSQ, R&S®FS-K15 is the ideal toolbox for development, verification, production testing, monitoring of operation and maintenance of ground infrastructure.

R&S®FS-K15 is designed to replace the R&S®FMAV. It provides the same function set for VOR/ILS analysis and meets the uncertainty specifications of the R&S®FMAV.

- Low measurement uncertainty for
 - ILS DDM (difference in depth of modulation)
 - VOR phase
 - Modulation parameters of single signal components such as 90/150 Hz tones, 30 Hz/9.96 kHz subcarrier
- All measurement parameters at a glance in an easy-to-read table
- Selective distortion measurements for the 30 Hz, 90 Hz, 150 Hz, 1020 Hz components
- Analysis from RF or – in the R&S®FSMR – audio input
- Easy to operate: user simply has to select between VOR and ILS

R&S®EVS300 VOR/ILS Analyzer



Precision level and modulation analysis for ground and flight inspection

The R&S®EVS300 is a portable level and modulation analyzer designed especially for starting up, checking and maintaining ILS, VOR and marker beacon systems.

The integrated rechargeable battery and robust design make it the ideal choice for mobile, mains-independent measurements in the field. Due to the high measurement speed and the trigger/synchronization functions, the R&S®EVS300 is also tailor-made for deployment in flight inspection systems.

- Extremely fast (100 measurements per second)
- Synchronization via GPS, trigger and remote interfaces
- Digital separation of course and clearance signals using only one signal processing channel (R&S®EVS-K3 option)
- Expandable to support a second signal processing channel for simultaneous localizer and glideslope measurements (R&S®EVS-B1 option)
- Support for R&S®NRP and R&S®NRT power sensors (R&S®EVS-K5 option)

Specifications in brief	
Frequency	
Frequency range	70 MHz to 350 MHz
Preselection filter range	
Marker beacon	74.7 MHz to 75.3 MHz
ILS LOC/VOR	107 MHz to 119 MHz
ILS GS	319 MHz to 341 MHz
Frequency scan (R&S®EVS-K1)	70 MHz to 350 MHz
Frequency resolution	100 Hz
Temperature drift (−10°C to +55°C)	1 ppm
Level	
Display range ¹⁾ (autorange mode)	−120 dBm to +20 dBm
Deviation at −30 dBm	< 0.8 dB
Linearity error (−40 dB to +30 dB)	< 0.5 dB
Max. input power	+13 dBm
Inherent noise (low noise mode)	< −115 dBm
Intermodulation	
TOI, 2 × 10 dBm, f > 200 kHz, low distortion	> 20 dBm
ILS signal analysis	
Input level range	−80 dBm to +10 dBm
Modulation depth (0% to 95%)	
Deviation 90/150 Hz ± 2% ²⁾	≤ 0.5%
Deviation voice/identifier	≤ 1.0%
AF, deviation 90/150 Hz ± 5 Hz ²⁾	≤ 0.05 Hz
AF, deviation 1020 Hz ± 50 Hz ²⁾	≤ 5.0 Hz
Phase angle 90/150 Hz	
Measuring range	0° to +120° or ±60°
Deviation	≤ 0.2°
DDM measurement, localizer mode	
Deviation ≤ ±10% DDM	≤ 0.04% DDM ± 0.1% of reading
Deviation > ±10% DDM	≤ 0.04% DDM ± 0.2% of reading
DDM measurement, glideslope mode	
Deviation ≤ ±20% DDM	≤ 0.08% DDM ± 0.1% of reading
Deviation > ±20% DDM	≤ 0.08% DDM ± 0.2% of reading
Marker beacon signal analysis	
Input level range	−80 dBm to +10 dBm
Modulation depth (80% to 100%), deviation	
400/1300/3000 Hz ± 2% ²⁾	≤ 0.5%
ID tone 1020 Hz ± 2% ²⁾	≤ 1.0%

Specifications in brief	
AF, deviation	
400/1300/3000 Hz ± 50 Hz ²⁾	≤ 0.5 Hz
ID tone 1020 Hz ± 20 Hz	≤ 5.0 Hz
VOR signal analysis	
Input level range	−80 dBm to +10 dBm
Azimuth, deviation	≤ ±0.1°
AM modulation depth (0% to 50%)	
Deviation 30/9960 Hz ± 2% ²⁾	≤ 0.5%
Deviation voice/identifier	≤ 1.0%
Deviation AM distortion	≤ 1.0%
NF	
Deviation 30 Hz ± 3 Hz ²⁾	≤ 0.03 Hz
Deviation 1020 Hz ± 50 Hz ²⁾	≤ 5.0 Hz
Deviation 9960 Hz ± 100 Hz ²⁾	≤ 0.5 Hz
FM deviation	≤ 0.1 Hz ± 0.5% of reading
Frequency scan (R&S®EVS-K1 option)	
Frequency range	70 MHz to 350 MHz
Start/stop or center/span	user-selectable in range from 70 MHz to 350 MHz
Resolution bandwidths	1/3/10/30 kHz
Inputs and outputs (front panel)	
RF input	N connector, 50 Ω
AF output	3.5 mm jack socket
USB	double connector (USB stick etc.)
Power supply of antenna	output for feeding and remote controlling active antennas
Inputs and outputs (rear panel)	
Remote interface	RS-232-C, 9-pin D-Sub connector
GPS/GSM interface (R&S®EVS-B2 and R&S®EVS-K2 options)	RS-232-C, 9-pin D-Sub connector
LAN interface	RJ-45, 100BaseT
DC output	12 V, max. 500 mA
DC input	10 V to 28 V
Baseband/trigger input	BNC connector
Analog output (2 outputs)	BNC connector, 50 W

¹⁾ Overload display if in-band or out-of-band signals are overloading.

²⁾ Max. frequency drift of modulation signal.

R&S®FMAx Modulation Analyzers



Fast and accurate analysis of all parameters of analog modulated signals

The R&S®FMAx modulation analyzers combine the functionalities of several measuring instruments in a single box (RF counter, power meter, voltmeter, psophometer, distortion meter, FM stereo decoder). The R&S®FMAx modulation analyzers are suitable for measurements in the field of broadcasting (e.g. on AM and FM transmitters) and radio-telephony as well as in the calibration of signal generators. They can be upgraded to perform many other measurement tasks.

- ▮ AM, FM, ϕ M demodulation
- ▮ Fast, automatic frequency adjustment by direct frequency measurement
- ▮ Low-noise synthesizer with high frequency resolution
- ▮ Separate +PK and -PK detectors with extremely short response time
- ▮ True RMS detector
- ▮ Extremely high accuracy
- ▮ High-precision power measurement (typ. error < 0.5 dB)
- ▮ Stereo decoder
- ▮ Audio generator for single and dual tones, stereo MPX

Specifications in brief

Frequency range	
R&S®FMA/FMAB	50 kHz to 1.36 GHz
R&S®FMAS	5 MHz to 1 (1.36) GHz
RF power measurement	0.18 μ W to 1 W (-37.5 dBm to +30 dBm)
AM measurement frequency range	10 Hz to 200 kHz
FM measurement frequency range	10 Hz to 200 kHz
Max. measurable deviation for f_{in}	
50 kHz to 300 kHz	$f_{in}/10$
0.3 MHz to 10 MHz	150 kHz
≥ 10 MHz	700 kHz
ϕ M measurement frequency range	200 Hz to 200 kHz
Max. measurable deviation	
300 kHz to 10 MHz	150 rad
≥ 10 MHz	700 rad
DC voltage measurement range	± 10 μ V to 20 V
AC voltage measurement range	30 μ V to 20 V
Frequency range	10 Hz to 300 kHz
AF detectors	\pm peak, RMS, QP (R&S®FMA-B1)
Weighting filters	
Highpass filters	10/20/300 Hz (2nd/3rd/2nd order)
Lowpass filters:	
	3/23 kHz (4th order), combined with 20 Hz highpass filter in line with ITU-R 468-4, unweighted; 100 kHz (4th order)
R&S®FMA-B1 filter option:	
	ITU-R 468-4 (weighted); ITU-T P53, 5 Hz lowpass, 30 kHz and 120 kHz; Bessel lowpass of 4th order, 4.2 kHz; Cauer lowpass; special ϕ M filter
AF frequency counter	5 digits
Frequency range, resolution	10 Hz to 300 kHz, 1 mHz to 10 Hz

Functions of individual models, options	R&S®FMA	R&S®FMAB	R&S®FMAS
AM/FM/ϕM	•	•	•
Weighting filters (ITU-T, ITU-R): lowpass filter 5 Hz, 4.2 kHz (high skirt selectivity), 30 kHz, 120 kHz (Bessel), special ϕ M filter	R&S®FMA-B1	•	•
DIST/SINAD meter: 10 Hz to 100 kHz, distortion measurable down to typ. < 0.005%	R&S®FMA-B2	•	•
Stereo decoder: RDS demodulator with external evaluation facility	R&S®FMA-B3	•	•
AM/FM calibrator/AF generator: high-precision level calibration, R&S®FMA performance test, complete modulation test set for transmitters and transposers, generation of stereo multiplex signals	R&S®FMA-B4	R&S®FMA-B4	R&S®FMA-B4
Selective AF analysis up to 150 kHz: selective distortion, intermodulation, selective modulation and voltage measurement	R&S®FMA-B8	R&S®FMA-B8	•
RF/IF selection: 5 MHz to 1 GHz, connectible, tracking four-section preselection, selectable IF filters	–	–	•
Reference oscillator (1×10^{-7} /year)	R&S®FMA-B10	R&S®FMA-B10	R&S®FMA-B10

Chapter 5

Signal Generators

Rohde & Schwarz offers analog and digital signal generators with a variety of frequencies, standards, modulations and functions.



Type	Designation	Frequency range	Description	Page
RF vector signal generators				
R&S®SMU200A	Vector Signal Generator	100 kHz to 2.2/3/4/6 GHz	The art of signal generation	59
R&S®SMATE200A	Vector Signal Generator	100 kHz to 3 GHz/6 GHz	Production solution based on the R&S®SMU200A	60
R&S®SMJ100A	Vector Signal Generator	100 kHz to 3 GHz/6 GHz	Versatility in signal generation	61
R&S®SMBV100A	Vector Signal Generator	9 kHz to 3.2 GHz/6 GHz	Generating signals for today and tomorrow	62
R&S®SGS100A	SGMA RF Source	1 MHz to 6/12.75 GHz (CW) 80 MHz to 6 GHz (I/Q)	Compact – fast – reliable	63
RF analog signal generators				
R&S®SMA100A	Signal Generator	9 kHz to 3 GHz/6 GHz	The standard of excellence in the analog signal generator class	64
R&S®SMB100A	RF and Microwave Signal Generator	9 kHz to 1.1/2.2/3.2/6 GHz 100 kHz to 12.75/20/40 GHz	Versatile, compact solution for signal generation up to 40 GHz	65
R&S®SMC100A	Signal Generator	9 kHz to 1.1 GHz/3.2 GHz	Flexible and universal all-purpose signal generator	66
Microwave signal generators				
R&S®SMF100A	Microwave Signal Generator	100 kHz/1 GHz to 22/43.5 GHz	Signal generation redefined	67
R&S®SMZ	Frequency Multiplier	50/60/75 GHz to 75/90/110 GHz	Precise and adjustable output levels	68
Baseband signal generators				
R&S®AMU200A	Baseband Signal Generator and Fading Simulator		Versatile realtime I/Q source and cost-effective baseband fading simulator in a single unit	69
R&S®AFQ100A/B	I/Q Modulation Generator		High-performance baseband signals	70
R&S®EX-IQ-BOX	Digital Signal Interface Module		Digital I/Q interface adapter for Rohde & Schwarz signal generators, analyzers and communications testers	71
Application firmware				
Application firmware packages for Rohde & Schwarz signal generators: see overview on pages 72 and 73 and description on page 74 ff				
Software solutions				
R&S®WinIQSIM2™	Simulation Software		Ideal for the generation of digitally modulated signals	84
R&S®SMx/AMU/AFQ-K6	Pulse Sequencer		Generation of complex pulsed signals	85

R&S®SMU200A Vector Signal Generator



Up to two independent signal generators in one cabinet with unrivaled RF and baseband characteristics

Due to its modular design, the R&S®SMU200A can be optimally adapted to the requirements of different applications. The first RF path can be equipped with one of the four available frequency options. The upper frequency limit of 2.2/3/4 GHz or 6 GHz is user-selectable. In addition, a second RF path can be installed with upper frequency limits of 2.2 GHz and 3 GHz. The lower frequency limit of all frequency options is 100 kHz.

Up to two generators can also be installed in the baseband section. They generate complex signals in realtime and are equipped with an arbitrary waveform generator with up to 128 Msample memory for I and Q. The signals generated in the different basebands can be added. Frequency offset of the individual signals is possible. The modern, intuitive concept of the R&S®SMU200A ensures fast and easy operation.

- ▀ First RF path from 100 kHz to 2.2/3/4/6 GHz
- ▀ Optional second RF path from 100 kHz to 2.2/3 GHz
- ▀ Up to two complete baseband paths
- ▀ Support of 3GPP LTE FDD and TDD, 3GPP FDD/HSPA/HSPA+, GSM/EDGE/EDGE Evolution, TD-SCDMA, IEEE 802.11a/b/g/n/ac and all other important digital standards
- ▀ 2x2 MIMO with realtime fading possible
- ▀ Two instruments combinable for 2x4 or 4x2 MIMO
- ▀ Optional fading simulator with up to 40 fading paths
- ▀ I/Q modulator with 200 MHz RF bandwidth
- ▀ Optional baseband generator with realtime coder and arbitrary waveform generator
- ▀ Outstanding RF performance (SSB phase noise, wideband noise and level repeatability)

Specifications in brief	
Frequency	
Frequency range	100 kHz to 2.2/3/4/6 GHz
Setting time	< 2 ms, typ. 1.5 ms
Setting time in List mode	< 450 μ s, typ. 300 μ s
Level	
Level range	
Standard	-145 dBm to +13 dBm (PEP)
With option	-145 dBm to +19 dBm (PEP)
Setting time	< 2 ms, typ. 1.5 ms
Setting time in List mode	< 450 μ s, typ. 300 μ s
Spectral purity (at f = 1 GHz)	
Nonharmonics	
Standard (carrier offset > 850 kHz)	< -86 dBc
With option (carrier offset > 10 kHz)	< -90 dBc
SSB phase noise (20 kHz carrier offset, 1 Hz measurement bandwidth)	
Standard	< -131 dBc, typ. -135 dBc
With option	< -136 dBc, typ. -139 dBc
Wideband noise (carrier offset > 10 MHz, 1 Hz measurement bandwidth, CW)	< -150 dBc, typ. -153 dBc

Specifications in brief	
I/Q modulation	
RF modulation bandwidth	
Using external I/Q inputs	200 MHz
Using internal baseband section	80 MHz
Baseband generator	
Max. waveform length	16/64/128 Msample
Supported standards and digital systems	
Depending on options	3GPP LTE FDD/TDD incl. Rel. 9 and Rel. 10, 3GPP FDD/HSPA/HSPA+, GSM/EDGE/EDGE Evolution, TD-SCDMA, cdmaOne, CDMA2000®, 1xEV-DO, IEEE 802.11a/b/g/n/ac, WiMAX™, TETRA Release 2, Bluetooth®, user-defined multicarrier CW, AWGN, GPS, A-GPS, DVB-H/DVB-T, DAB/T-DMB, XM Radio™, Sirius, HD Radio™
Fading and MIMO	
Fading taps	up to 40
Bandwidth	up to 80 MHz
MIMO	up to 2x2 with one instrument, up to 2x4 or 4x2 with two instruments
Correlation (per tap)	correlation matrix, Kronecker, AoA/AoD
Fading profiles and supported standards	see page 74

R&S®SMATE200A Vector Signal Generator



Production solution based on the R&S®SMU200A

Based on the successful R&S®SMU200A platform, the R&S®SMATE200A is specifically designed for production environments. The display and front panel user interface have been removed, the connectors moved to the rear, and performance has been optimized for fastest setting times to improve factory throughput. As with the R&S®SMU200A, the two-generators-in-one concept has been kept, occupying four height units – a plus for production where space is at a premium. As regards flexibility, the modular design concept of the R&S®SMATE200A ensures that the instrument can easily be adapted to the task at hand. Users can choose between 3 GHz or 6 GHz

RF outputs in one or two paths and may opt for up to two completely independent baseband sources. As with the R&S®SMU200A, these sources may be used to produce complex signals in realtime or output preloaded waveforms from the internal arbitrary waveform generator.

In addition to its inherent speed, the R&S®SMATE200A also offers a special function that permits fast switching between different test signals. The multisegment waveform function allows users to easily combine waveforms, such as GSM and WCDMA, during test setup for even faster tests in production. This is just one example of the R&S®SMATE200A's capability to meet the special requirements of the production environment.

- Up to two independent signal generators in one unit
- 3 GHz or 6 GHz frequency options in one or two paths
- Very short setting times for frequency and level (frequency changes < 1 ms over GPIB and < 400 µs in List mode)
- Fast Hop mode offering flexibly addressable frequency/level pairs; as fast as normal List mode
- Multisegment waveform function enabling fast switching between different test signals in waveform generator
- Up to two independent baseband sources that not only support realtime signal generation but also offer arbitrary waveform generation with up to 128 Msample each

Specifications in brief

Frequency	
Frequency range	100 kHz to 3/6 GHz
Setting time	< 1 ms, typ. 0.6 ms
Setting time in List mode	< 450 µs, typ. 300 µs
Level	
Level range	
Standard	-145 dBm to +13 dBm (PEP)
With option	-145 dBm to +19 dBm (PEP)
Setting time	< 1 ms, typ. 0.6 ms
Setting time in List mode	< 450 µs, typ. 300 µs
Spectral purity (at f = 1 GHz)	
Nonharmonics	
Standard (carrier offset > 850 kHz)	< -86 dBc
With option (carrier offset > 10 kHz)	< -90 dBc
SSB phase noise (20 kHz carrier offset, 1 Hz measurement bandwidth)	
Standard	< -131 dBc, typ. -135 dBc
With option	< -136 dBc, typ. -139 dBc
Wideband noise (carrier offset > 10 MHz, 1 Hz measurement bandwidth, CW)	< -150 dBc, typ. -153 dBc

Specifications in brief

I/Q modulation	
RF modulation bandwidth	
Using external I/Q inputs	200 MHz
Using internal baseband section	80 MHz
Baseband generator	
Max. waveform length	16/64/128 Msample
Supported standards and digital systems	
Depending on options	3GPP LTE FDD/TDD incl. Rel. 9 and Rel. 10, 3GPP FDD/HSPA/HSPA+, GSM/EDGE/EDGE Evolution, TD-SCDMA, cdmaOne, CDMA2000®, 1xEV-DO, IEEE 802.11a/b/g/n/ac, WiMAX™, TETRA Release 2, Bluetooth®, user-defined multicarrier CW, AWGN, GPS, DVB-H/DVB-T, DAB/T-DMB, XM Radio™

R&S®SMJ100A Vector Signal Generator



The ideal multipurpose vector signal generator, supporting a wide variety of applications

The R&S®SMJ100A meets all challenges that diverse applications place on modern vector signal generators. For example, it offers a convenient graphical user interface (GUI) and the signal quality and flexibility required in research and development. And this is by no means all the R&S®SMJ100A has to offer. In production environments, it excels with its flexible baseband and low setting times. The baseband meets all requirements, from providing real-time signals to replaying precalculated waveforms.

Equipped with a 3 GHz or 6 GHz frequency option, the R&S®SMJ100A covers all important frequency bands essential in digital RF transmission. The internal baseband generator option handles a multitude of digital standards, e.g. GSM/EDGE, 3GPP FDD and CDMA2000®. Its characteristics make the R&S®SMJ100A the ideal multipurpose vector signal generator, supporting a wide variety of applications.

To handle future standards, the R&S®SMJ100A features a large bandwidth; new standards such as LTE pose no problem. The internal arbitrary waveform generator is proof of its versatility. It offers sequences up to 128 Msample in length and can be used with diverse signals from R&S®WinIQSIM2™ or MATLAB®.

- Support of 3GPP LTE FDD and TDD, 3GPP FDD/HSPA/HSPA+, GSM/EDGE/EDGE Evolution, TD-SCDMA, IEEE 802.11a/b/g/n/ac and all other important digital standards
- I/Q modulator with 200 MHz RF bandwidth
- Optional baseband generator with realtime coder and arbitrary waveform generator for maximum flexibility
- Optional ARB-only baseband generator as cost-saving alternative
- Excellent RF performance (SSB phase noise, wideband noise and level repeatability)

Specifications in brief

Frequency	
Frequency range	100 kHz to 3/6 GHz
Setting time	< 2 ms, typ. 1.5 ms
Setting time in List mode	< 450 µs, typ. 300 µs
Level	
Level range	-145 dBm to +13 dBm (PEP)
Setting time	< 2 ms, typ. 1.5 ms
Setting time in List mode	< 450 µs, typ. 300 µs
Spectral purity (at f = 1 GHz)	
Nonharmonics (carrier offset > 850 kHz)	< -86 dBc
SSB phase noise (20 kHz carrier offset, 1 Hz measurement bandwidth)	< -129 dBc, typ. -133 dBc
Wideband noise (carrier offset > 10 MHz, 1 Hz measurement bandwidth, CW)	< -150 dBc, typ. -153 dBc
I/Q modulation	
RF modulation bandwidth	
Using external I/Q inputs	200 MHz
Using internal baseband section	80 MHz
Baseband generator	
Max. waveform length	16/64/128 Msample
Supported standards and digital systems	
Depending on options	3GPP LTE FDD/TDD incl. Rel. 9 and Rel. 10, 3GPP FDD/HSPA/HSPA+, GSM/EDGE/EDGE Evolution, TD-SCDMA, cdmaOne, CDMA2000®, 1xEV-DO, IEEE 802.11a/b/g/n/ac, WiMAX™, TETRA Release 2, Bluetooth®, user-defined multicarrier CW, AWGN, GPS, DVB-H/DVB-T, DAB/T-DMB, XM Radio™, Sirius, HD Radio™

R&S®SMBV100A Vector Signal Generator



Generating signals for today and tomorrow

The R&S®SMBV100A offers excellent RF performance along with very high output level and short setting times. At the same time, the R&S®SMBV100A can be equipped with an internal baseband generator to allow generation of a number of digital standards (e.g. 3GPP FDD, HSPA+, LTE, WLAN IEEE 802.11a/b/g/n/ac, GNSS such as GPS and GLONASS). The wide frequency range from 9 kHz to 6 GHz covers all of the important bands for digital modulation.

Due to its optimal scalability, the R&S®SMBV100A is easy to customize to meet specific customer requirements. For production applications, a cost-effective solution for play-

ing back predefined test sequences is available with the optional baseband arbitrary waveform generator (ARB). And where it really matters, the optional baseband coder provides impressive realtime capabilities. It allows the generation of even complex signals directly in the instrument – no external signal generation software is required.

The R&S®SMBV100A has also been designed for ease of servicing. Together with its scalability, this helps to ensure very low cost of ownership. The instrument's compact size and graphical user interface for intuitive operation help to fulfill all possible requirements.

These features make the R&S®SMBV100A ideal in development applications as well as in production and service. This instrument truly does the job wherever signals with digital modulation are needed.

- Internal signal generation for all major digital radio standards and use as GNSS simulator, both with optional integrated baseband source
- Highest output level in its class up to 6 GHz, combined with excellent RF characteristics
- Lowest cost of ownership due to outstanding price/performance ratio and on-site service capabilities
- Ideal adaptation to customer applications

Specifications in brief	
Frequency	
Frequency range	9 kHz to 3.2/6 GHz (CW mode) 1 MHz to 3.2/6 GHz (I/Q mode)
Setting time	< 3 ms, < 7 ms (if I/Q modulation is ON)
Setting time in List mode	< 1 ms
Level	
Level range	-145 dBm to +18 dBm (PEP)
Setting time	< 2.5 ms, < 7 ms (if I/Q modulation is ON)
Setting time in List mode	< 1 ms
Spectral purity (at f = 1 GHz)	
Nonharmonics (CW, carrier offset > 10 kHz, level > -10 dBm)	< -70 dBc, typ. -84 dBc
SSB phase noise (20 kHz carrier offset, 1 Hz measurement bandwidth)	< -122 dBc, typ. -128 dBc
Wideband noise (carrier offset > 10 MHz, 1 Hz measurement bandwidth, CW)	< -142 dBc, typ. -152 dBc

Specifications in brief	
I/Q modulation	
RF modulation bandwidth	
Using external I/Q inputs	582 MHz
Using internal baseband section	60/120 MHz
Baseband generator	
Max. waveform length	32/256 Msample
Supported standards and digital systems	
Depending on options	3GPP LTE FDD/TDD incl. Rel. 9 and Rel. 10, 3GPP FDD/HSPA/HSPA+, GSM/EDGE/EDGE Evolution, TD-SCDMA, cdmaOne, CDMA2000®, 1xEV-DO, IEEE 802.11a/b/g/n/ac, WiMAX™, TETRA Release 2, Bluetooth®, user-defined multicarrier CW, AWGN, GNSS (see below), DVB-H/DVB-T, DAB/T-DMB, XM Radio™, Sirius, HD Radio™
GNSS simulation (in realtime)	
Supported systems	GPS, GLONASS, Galileo
Number of satellites	up to 12
Special functions	moving scenarios (import of NMEA files), multipath, dynamic power control, atmospheric modeling, support for RINEX files

R&S®SGS100A SGMA RF Source



Compact – fast – reliable

The very compact dimensions of only one height unit and ½ 19" rack width and the extremely fast frequency and level setting times are two features that demonstrate how consistently the R&S®SGS100A has been designed for use in systems. It can also be used in all applications that require either multiple RF signal sources, such as beamforming applications, or where an extremely compact RF generator is needed, e.g. an operating source in customer systems.

Though compact, the R&S®SGS100A provides uncompromising signal purity and level accuracy. It offers performance usually available only from high-end

instruments, including high output power, level repeatability and modulation bandwidth. During development, particular emphasis was placed on the total cost of ownership. A long calibration interval, excellent serviceability and options for expansion maximize the availability of the RF source. When used as a benchtop instrument, the R&S®SGS100A is operated manually using the R&S®SGMA-GUI software included with the instrument.

- Smallest fully integrated vector signal generator on the market, space-saving design for system integration
- Enables high throughput due to very short frequency and level setting times of typ. 280 µs via PCIe interface
- Excellent RF performance in a compact format
- Maximum output level of typ. +22 dBm for compensating losses in the setup
- Closed ALC loop for CW and I/Q modes for highest level repeatability
- High output frequency of up to 12.75 GHz for broad applicability
- Wear-free electronic attenuator for high reliability
- Very cost-efficient with low initial costs and low cost of ownership

Specifications in brief		
Frequency range		1 MHz to 6/12.75 GHz (CW)
		80 MHz to 6 GHz (I/Q)
Setting time	with PCIe remote control	< 500 µs
Input frequency for external reference		10 MHz, 100 MHz, 1000 MHz
Specified level range		-10 dBm to +15 dBm (PEP) ¹⁾
	with the R&S®SGS-B26 option	-120 dBm to +15 dBm (PEP) ¹⁾
Level error	Setting Characteristic: AUTO; temperature range from +18°C to +33°C	
	1 MHz ≤ f ≤ 3 GHz	< 0.5 dB
	3 GHz < f ≤ 12.75 GHz	< 0.9 dB
Setting time	with PCIe remote control, Setting Characteristic: AUTO	< 500 µs
Spectral purity		
Nonharmonics	level > -10 dBm ²⁾ , offset > 10 kHz from carrier, f ≤ 1.5 GHz	< -76 dBc
Subharmonics	level > -10 dBm ²⁾ , f ≤ 3 GHz	< -76 dBc
Wideband noise	1 MHz ≤ f ≤ 6 GHz and 10 MHz carrier offset, AUTO mode, level > 5 dBm, 1 Hz measurement bandwidth, CW	< -145 dBc
SSB phase noise	20 kHz carrier offset, 1 Hz measurement bandwidth	
	f = 1 GHz	< -126 dBc, typ. -130 dBc
	f = 10 GHz	< -106 dBc, typ. -110 dBc
I/Q modulator bandwidth (RF)	100 MHz < f ≤ 2.5 GHz, I/Q wideband	40% of carrier frequency
	2.5 GHz < f ≤ 6 GHz, I/Q wideband	1 GHz
General data		
Remote control interfaces		PCIe, Ethernet, USB 2.0
Dimensions		1 HU, ½ 19" rack width

¹⁾ PEP = peak envelope power.

²⁾ > 0 dBm for instruments without the R&S®SGS-B26 electronic step attenuator.

R&S®SMA100A Signal Generator



The standard of excellence in the analog signal generator class

Signal quality, speed and flexibility are the criteria by which signal generators are measured today. The R&S®SMA100A perfectly meets these criteria, and is a premium-class analog generator that sets standards due to its outstanding characteristics.

The R&S®SMA100A combines superior signal quality with very high setting speed, which makes it ideal for any task. Whether in development, production, service or maintenance, the R&S®SMA100A does an excellent job.

In the frequency range from 9 kHz to 6 GHz, it can generate CW signals as well as all common types of analog modulation (AM, FM, ϕ M, pulse modulation). Excellent specifications and a wide range of modulation signals are the characteristic features of the R&S®SMA100A.

In addition, a low-jitter clock synthesizer option supplies differential clock signals of up to 1.5 GHz independently of the RF frequency. This makes the R&S®SMA100A suitable for a variety of applications – from use in phase noise test systems through to tests on mixed-signal ICs.

The R&S®SMA100A signal generator also offers a modern graphical user interface for fast and intuitive operation.

The R&S®NRP-Zxx power sensors can be connected to the R&S®SMA100A. The user can therefore perform very precise power measurements directly with the signal generator.

- Very low SSB phase noise of typ. -134 dBc (20 kHz carrier offset, $f = 1$ GHz, 1 Hz measurement bandwidth), typ. -139.5 dBc with the R&S®SMA-B22 enhanced phase noise performance option
- Wideband noise of -162 dBc (meas.) with carrier offset > 40 MHz, $f = 1$ GHz, level = 9 dBm, 1 Hz measurement bandwidth
- Nonharmonics < -96 dBc (carrier offset > 10 kHz, $f < 750$ MHz, with the R&S®SMA-B22 option)
- High-stability reference oscillator as standard
- Very low phase noise at low frequencies due to internal division of the fundamental frequency range (750 MHz to 1500 MHz) down to 6.6 MHz

Specifications in brief

Frequency	
Frequency range	9 kHz to 3/6 GHz
Setting time	< 2 ms
Setting time in List mode	< 450 μ s
Level	
Level range	-145 dBm to $+18$ dBm (PEP)
Setting time	< 1.5 ms
Setting time in List mode	< 450 μ s
Spectral purity (at $f = 1$ GHz)	
Nonharmonics (carrier offset > 10 kHz)	
Standard	< -80 dBc
With option	< -90 dBc
SSB phase noise (20 kHz carrier offset, 1 Hz measurement bandwidth)	
Standard	< -131 dBc, typ. -134 dBc
With option	< -136 dBc, typ. -139.5 dBc
Wideband noise (carrier offset > 10 MHz, 1 Hz measurement bandwidth, CW)	< -153 dBc
Analog modulation	
Pulse	
Rise/fall time ($f > 180$ MHz)	< 20 ns, typ. < 7 ns
ON/OFF ratio	> 80 dB
AM depth	0% to 100%
Maximum FM deviation	40 MHz ($f > 3$ GHz)
Maximum ϕ M deviation	80 rad ($f > 3$ GHz)
Special features	
Depending on options	VOR/ILS, DME signal generation, pulse train, power analysis (with R&S®NRP-Zxx power sensors)

R&S®SMB100A RF and Microwave Signal Generator



Versatile, compact solution for signal generation up to 40 GHz

The compact, versatile R&S®SMB100A RF and microwave signal generator with a frequency range up to 40 GHz provides outstanding spectral purity and high output power. In addition, it features easy operation, comprehensive functionality and low cost of ownership.

Its wide frequency range covers a large number of challenging applications. The R&S®SMB100A is the perfect choice for applications in the important ISM bands up

to 5.7 GHz as well as for EMC applications because of its lower frequency limit of 9 kHz. Furthermore, the R&S®SMB100A can be ideally used for measuring the blocking characteristic up to a CW frequency of 12.75 GHz, as specified in various telecommunications standards. When it comes to frequently changing level settings, this is the first time that a wear-free electronic step attenuator is used in this frequency range.

Two frequency options up to 20 GHz and 40 GHz are available to cover the microwave range. These options are suitable for tests on radar systems and antennas in the X and K bands, for example.

- Wide frequency range from 9 kHz to 6 GHz or from 100 kHz to 40 GHz
- Excellent signal characteristics with low SSB phase noise of typ. -128 dBc (at 1 GHz, 20 kHz offset)
- High output power of typ. up to $+27$ dBm
- All important analog modulations with AM, FM/ ϕ M and pulse modulation supported
- Compact size with only two height units and low weight

Specifications in brief

Frequency		
Frequency range	R&S®SMB-B101	9 kHz to 1.1 GHz
	R&S®SMB-B102	9 kHz to 2.2 GHz
	R&S®SMB-B103	9 kHz to 3.2 GHz
	R&S®SMB-B106	9 kHz to 6 GHz
	R&S®SMB-B112/-B112L	100 kHz to 12.75 GHz
	R&S®SMB-B120/-B120L	100 kHz to 20 GHz
	R&S®SMB-B140/-B140L	100 kHz to 40 GHz
Level		
Maximum output power	R&S®SMB-B101/-B102/-B103/-B106/-B112/-B112L 1 MHz < f ≤ 12.75 GHz	> +18 dBm
	R&S®SMB-B120 with R&S®SMB-B31 50 MHz < f ≤ 20 GHz	> +16 dBm
	R&S®SMB-B120L with R&S®SMB-B31 100 MHz < f ≤ 20 GHz	> +19 dBm
	R&S®SMB-B140 with R&S®SMB-B32 50 MHz < f ≤ 40 GHz	> +13 dBm
	R&S®SMB-B140L with R&S®SMB-B32 50 MHz < f ≤ 40 GHz	> +16 dBm
Spectral purity		
SSB phase noise	f = 1 GHz, carrier offset = 20 kHz, 1 Hz measurement bandwidth	< -122 dBc, typ. -128 dBc
	f = 10 GHz, carrier offset = 20 kHz, 1 Hz measurement bandwidth	< -102 dBc, typ. -108 dBc
Connectivity		
Remote control		GPIB IEEE-488.2, Ethernet (TCP/IP), USB
Peripherals		USB

R&S®SMC100A Signal Generator



Flexible and universal all-purpose signal generator

The R&S®SMC100A offers outstanding signal quality at an attractive price. It covers the frequency range from 9 kHz to 1.1 GHz or 3.2 GHz. Output power is typ. > +17 dBm. All important functions (AM/FM/φM/pulse modulation) are already integrated in the instrument. This makes the R&S®SMC100A signal generator a flexible and versatile instrument.

Total cost of ownership is an important factor when purchasing a measuring instrument. The R&S®SMC100A, apart from offering a low initial cost, also boasts low service costs since users can replace defective modules on their own and verify the level repeatability and accuracy by using the R&S®NRP-Z91/R&S®NRP-Z92 power sensors.

These outstanding features make the R&S®SMC100A ideal for use in service and maintenance labs. Due to its small dimensions and lightweight design, the R&S®SMC100A is also the perfect choice for field applications or training and education environments.

- Smallest size and best price/performance ratio in its class
- Frequency range from 9 kHz to 1.1 GHz/3.2 GHz
- Maximum output level of typ. > +17 dBm
- AM/FM/φM/pulse modulation provided as standard
- Integrated overvoltage protection
- Wear-free electronic attenuator
- Minimized total cost of ownership

Specifications in brief	
Frequency	
Frequency range	9 kHz to 1.1/3.2 GHz
Setting time	< 5 ms, typ. 2 ms
Level	
Level range	-145 dBm to +18 dBm (PEP)
Setting time	< 5 ms, typ. 2 ms
Spectral purity (at f = 1 GHz)	
Nonharmonics (carrier offset > 10 kHz)	< -60 dBc
SSB phase noise (20 kHz carrier offset, 1 Hz measurement bandwidth)	< -105 dBc, typ. -111 dBc
Wideband noise (carrier offset > 10 MHz, 1 Hz measurement bandwidth, CW)	< -138 dBc, typ. -148 dBc
Analog modulation	
Pulse	
Rise/fall time	< 500 ns, typ. 100 ns
ON/OFF ratio	> 80 dB
AM depth	0% to 100%
Maximum FM deviation	4 MHz (f > 1.6 GHz)
Maximum φM deviation	40 rad (f > 1.6 GHz)

R&S®SMF100A Microwave Signal Generator



Signal generation redefined

Signal quality, speed and flexibility are decisive properties for a signal generator in the microwave range.

The R&S®SMF100A microwave signal generator is a first-rate, state-of-the-art microwave signal generator that sets new standards. It covers the numerous fields of application encountered in R&D, production, service, maintenance and repair.

The R&S®SMF100A operates in the wide frequency range from 100 kHz to 43.5 GHz with specific configurations. In

addition to CW signals, all common types of analog modulation (AM, FM, ϕ M, pulse modulation) or combinations thereof can be generated.

The R&S®SMF100A signal generator offers a modern graphical user interface for fast and intuitive operation. The settings – which, for the first time in a microwave signal generator, can be controlled via a block diagram – and the signal flow can be seen at a glance.

- Max. frequency range from 100 kHz to 22/43.5 GHz
- Excellent SSB phase noise of typ. -120 dBc (at 10 GHz with 10 kHz carrier offset)
- Very high output power of typ. $+25$ dBm
- Optional pulse modulator with excellent data: > 80 dB ON/OFF ratio, < 10 ns rise/fall time, < 20 ns pulse width
- Optional pulse generator
- Optional removable compact flash disk to meet high security requirements
- Connector for R&S®NRP-Zxx power sensors for precise power measurement
- Usable for scalar network analysis with R&S®NRP-Zxx power sensor connected
- Remote control via GPIB, Ethernet or USB

Specifications in brief

Frequency	
Frequency range	100 kHz/1 GHz to 22/43.5 GHz
Setting time	< 4 ms
Setting time in List mode	typ. < 750 μ s
Level	
Level range (depending on options)	-130 dBm to $+24$ dBm (PEP)
Setting time	< 3 ms
Setting time in List mode	typ. < 750 μ s
Spectral purity (at f = 10 GHz)	
Nonharmonics (carrier offset > 3 kHz)	< -62 dBc
SSB phase noise (20 kHz carrier offset, 1 Hz measurement bandwidth)	< -115 dBc
Wideband noise (carrier offset > 10 MHz, 1 Hz measurement bandwidth, CW)	typ. < -148 dBc
Analog modulation	
Pulse	
Rise/fall time (f > 1 GHz)	< 10 ns
ON/OFF ratio	> 80 dB
AM depth	0% to 100%
Maximum FM deviation	40 MHz (f > 21 GHz)
Maximum ϕ M deviation	640 rad (f > 21 GHz)
Special features	
Depending on options	analog ramp sweep, logarithmic AM, pulse train, power analysis (with R&S®NRP-Zxx power sensors)

R&S®SMZ Frequency Multiplier



Precise and adjustable output levels from 50 GHz to 110 GHz

The R&S®SMZ family of frequency multipliers combines easy handling and precise, adjustable output levels in the frequency range from 50 GHz to 110 GHz. It can be used in diverse applications, e.g. in the automotive sector with distance radars, in astronomy with sophisticated telescopes and in radar interferometry for analyzing the earth's surface.

The family of frequency multipliers consists of the models R&S®SMZ75 (50 GHz to 75 GHz), R&S®SMZ90 (60 GHz to 90 GHz) and R&S®SMZ110 (75 GHz to 110 GHz) as well as optional attenuators. The attenuator is integrated in the same housing as the frequency multiplier, which simplifies handling. The R&S®SMZ including attenuator can be controlled from the R&S®SMF100A microwave signal generator via USB. This combination operates as a single unit allowing users to directly enter the wanted frequency and the target level at the R&S®SMZ output on the R&S®SMF100A.

Very low single sideband phase noise is achieved owing to the interaction with the high-end R&S®SMF100A microwave signal generator. For a CW signal of 60 GHz, for example, an outstanding -100 dBc (10 kHz offset) is achieved after six-fold frequency multiplication with the R&S®SMZ75.

- Wide frequency range
- Wide dynamic range
- Extremely easy handling
- High signal quality

Specifications in brief

Input frequency range

R&S®SMZ75	8.33 GHz to 12.5 GHz
R&S®SMZ90	10 GHz to 15 GHz
R&S®SMZ110	12.5 GHz to 18.4 GHz

Output frequency range

R&S®SMZ75	50 GHz to 75 GHz
R&S®SMZ90	60 GHz to 90 GHz
R&S®SMZ110	75 GHz to 110 GHz

Level

Input level	+6.7 dBm to +7.3 dBm
Output level	typ. +5 dBm
With mechanically controlled attenuator	typ. +4 dBm
With electronically controlled attenuator	typ. +1 dBm

Attenuation

With mechanically controlled attenuator	max. 25 dB
With electronically controlled attenuator	max. 15 dB

Spectral purity

Harmonics, subharmonics, in-band spurious	typ. < -20 dBc
---	------------------

Connectors

Input	K female (50 Ω)
Output	
R&S®SMZ75	WR15 waveguide
R&S®SMZ90	WR12 waveguide
R&S®SMZ110	WR10 waveguide

R&S®AMU200A Baseband Signal Generator and Fading Simulator



Versatile realtime I/Q source and cost-effective baseband fading simulator in a single unit

Growing cost pressure is leading to ever increasing modularization in the design of modern communications equipment and systems. To launch products as early as possible, complex tests are being performed at the module level long before integration into the overall product takes place. This increases test requirements at the baseband level.

The universal R&S®AMU200A baseband generator has been specially devised for this task. It combines the functionality of a realtime I/Q source, an arbitrary waveform generator and a channel simulator in a single unit.

The optional two-path functionality makes it easy to generate even complex signal scenarios. The user can simulate interference, noise, multipath propagation, antenna diversity and MIMO. Plus, the user can determine their effect on a device under test (DUT) reproducibly, with minimum effort and using a single unit.

- Single-path or dual-path instrument
- Up to two complete baseband paths
- Configuration as a fading simulator, an I/Q source, or an all-in-one instrument offering fading simulation and signal generation
- 2x2 MIMO with realtime fading
- Two instruments combinable for 2x4 or 4x2 MIMO
- Baseband generators with universal coders for realtime signal generation
- Arbitrary waveform generators with 16 Msample, 64 Msample or 128 Msample memory depth
- Analog single-ended, analog differential and digital baseband outputs
- Analog single-ended and digital baseband inputs
- Lossless combination of up to four baseband signals in the digital domain (e.g. for testing multistandard base stations)

Specifications in brief

Baseband generator	
Sampling rate	100 MHz
Baseband bandwidth	40 MHz
Max. waveform length	16/64/128 Msample
Signal quality of analog I/Q outputs	
Frequency response, up to 40 MHz	typ. 0.03 dB
I/Q balance, up to 40 MHz	typ. 0.02 dB
SFDR (sine wave) up to 20 MHz	typ. 60 dB
SSB phase noise for 10 MHz sine wave (20 kHz carrier offset, 1 Hz measurement bandwidth)	typ. -150 dBc
Wideband noise for 10 MHz sine wave (1 MHz carrier offset, 1 Hz measurement bandwidth)	typ. -155 dBc
Supported standards and digital systems	
Depending on options	3GPP LTE FDD/TDD incl. Rel. 9, 3GPP FDD/HSPA/HSPA+, GSM/EDGE/EDGE Evolution, TD-SCDMA, cdmaOne, CDMA2000®, 1xEV-DO, IEEE802.11a/b/g/n/ac, WiMAX™, TETRA Release 2, Bluetooth®, user-defined multicarrier CW, AWGN, GPS, A-GPS, DVB-H/DVB-T, DAB/T-DMB
Fading and MIMO	
Fading taps	up to 40
Bandwidth	up to 80 MHz (RF)
MIMO	up to 2x2 with one instrument, up to 2x4 or 4x2 with two instruments
Correlation (per tap)	correlation matrix, Kronecker, AoA/AoD
Fading profiles and supported standards	see page 74

R&S®AFQ100A I/Q Modulation Generator

R&S®AFQ100B UWB Signal and I/Q Modulation Generator



High-performance baseband signals

Whether in the commercial or aerospace and defense field, customers require excellent signal quality, speed and high flexibility when selecting a signal source. Besides, there is a growing need for development and testing in the digital baseband domain. The signals to be created are increasingly complex and dynamic. They use complex modulation schemes and demand more and more bandwidth. The R&S®AFQ100A and the R&S®AFQ100B are two state-of-the-art, self-contained and flexible baseband sources that perfectly meet these requirements.

Featuring a maximum clock rate of 300 MHz, a bandwidth of 200 MHz (RF) and a waveform memory of up to 1 Gsample, the R&S®AFQ100A provides the functionality and flexibility that is required for development and production tests on receivers and components of modern digital communications standards such as WiMAX™ and LTE.

The R&S®AFQ100B with a bandwidth of 528 MHz (RF), a clock rate of 600 MHz and a waveform memory of up to 1 Gsample is perfectly suited for applications that require more bandwidth. Examples are the support of broadband digital communications systems such as ultrawideband (UWB) or radar applications where signals with extremely short pulses and short rise and fall times are needed.

Both R&S®AFQ family members combine flexibility with outstanding signal quality. Their spurious suppression, for example, is first-rate and their frequency response extremely linear. All these essential features combined with a wealth of other functions make the R&S®AFQ100A and the R&S®AFQ100B very versatile baseband generators.

Specifications in brief

Output memory

Memory clock of the R&S®AFQ100A	1 kHz to 300 MHz
Memory clock of the R&S®AFQ100B	1 kHz to 300 MHz (mode 1) 600 MHz (mode 2)
Max. waveform length (data and markers)	256 Msample/512 Msample/1 Gsample
Amplitude resolution of data words	16 bit analog and digital

System bandwidth (RF) of the R&S®AFQ100A

200 MHz

System bandwidth (RF) of the R&S®AFQ100B

200 MHz (mode 1)
528 MHz (mode 2)

Signal output

Number of outputs	1 (I and Q)
Resolution	14 bit
Output (unbalanced)	1 V (V_{pp})
Level range	0 V to 1.5 V (V_{pp})
Frequency response	±0.1 dB up to 100 MHz
Output (balanced) of the R&S®AFQ100A	2 V (V_{pp})
Level range	0 V to 3 V (V_{pp})
Frequency response	±0.1 dB up to 100 MHz
Output (balanced) of the R&S®AFQ100B	1 V (V_{pp})
Level range	0 V to 1.4 V (V_{pp})
Frequency response	±2.5 dB up to 264 MHz
Spurious-free dynamic range of the R&S®AFQ100A	typ. 83 dBc
Spurious-free dynamic range of the R&S®AFQ100B	typ. 78 dBc

Digital outputs

Port 1	multiplexed I/Q data stream, compatible with other Rohde & Schwarz equipment
Port 2	parallel I/Q interface

Supported standards and digital systems (with R&S®WinIQSIM2™)

R&S®AFQ100A/R&S®AFQ100B, depending on options	3GPP LTE FDD/TDD incl. Rel. 9 and Rel. 10, 3GPP FDD/HSPA/HSPA+, TD-SCDMA, GSM/EDGE/EDGE Evolution, cdmaOne, CDMA2000®, 1xEV-DO, TETRA Release 2, IEEE 802.11a/b/g/n/ac, WiMAX™, Bluetooth®, user-defined multicarrier CW, AWGN, GPS, DVB-H/DVB-T, DAB/T-DMB, XM Radio™, Sirius, HD Radio™
R&S®AFQ100B, depending on options	ECMA-368/IEEE 802.15.3a (UWB)

R&S®EX-IQ-BOX Digital Signal Interface Module



Digital I/Q interface adapter for Rohde & Schwarz signal generators, analyzers and communications testers

The R&S®EX-IQ-BOX is a digital signal interface module that provides flexible digital baseband inputs or outputs for Rohde & Schwarz signal generators, signal analyzers and communications testers. Its main application field is the conversion of digital I/Q signals of Rohde & Schwarz instruments into user-defined or standardized digital signal formats, and vice versa. The device under test (DUT) is connected via adapter boards (= breakout boards) that are plugged directly into the R&S®EX-IQ-BOX.

- Conversion of digital I/Q signals to and from the DUT
- Flexible user-defined digital I/Q interface settings (I/Q format, bit alignment, clock rate, logic levels, etc.)

- Two breakout boards included (single-ended, differential connectors) for connection of the DUT
- Easy interface configuration via enclosed R&S®DigIConf software
- Transient recorder in R&S®DigIConf for visual control of generated digital signals (I/Q diagram, vector diagram, CCDF, spectrum)

CPRI™ digital interface protocol

- Test of CPRI™ radio equipment (RE) and/or radio equipment control (REC)
- Predefined interface settings
- Line bit rates of 1228.8 Mbit/s (= 2x), 2457.6 Mbit/s (= 4x) and 3072.0 Mbit/s (= 5x)
- Flexible or packed antenna-carrier (AxC) allocation
- Antenna-carrier (AxC) grouping
- Easy interface configuration via R&S®DigIConf software
- Direct waveform playback from 64 Msample R&S®EX-IQ-BOX waveform memory (optional)
- Multiwaveform playback for output of up to 4 waveforms (optional)
- Recording memory (512 Mbyte) for capturing I/Q data that is received via the CPRI™ link (optional)
- Support of R&S®WinIQSIM2™ waveform creation software

Specifications in brief

User-defined digital interface protocol	
I/Q format	parallel, serial
Sample rate	1 kHz to 100 MHz
Word size	4 bit to 18 bit (depending on Rohde & Schwarz instrument)
Logic level	LVTTTL, CMOS, LVDS
Max. clock rate	100 MHz (parallel)/400 MHz (serial)
CPRI™ digital interface protocol (optional)	
Simulation mode	REC (to test RE), RE (to test REC)
Link direction	uplink, downlink, full-duplex
Supported mobile standards	3GPP FDD (incl. HSDPA, HSUPA, HSPA+), 3GPP LTE FDD/TDD incl. Rel. 9, CDMA2000®, WiMAX™
I/Q payload input	realtime via attached instrument, PN16 or 20 bit pattern via internal test generator, internal waveform memory (optional)
I/Q payload output	one selectable I/Q signal inside received CPRI™ frame in realtime via attached instrument, internal recording memory (optional)
Control and management	fast C & M (Ethernet), slow C & M (HDLC), vendor-specific data
Visualization	graphical display of CPRI™ basic frame configuration
CPRI™ specific breakout board	support of SFP modules for optical link, SMA connectors for monitoring or supply of RX input signal

The tables provide an overview of the digital modulation systems supported by Rohde&Schwarz signal generators and show the wide range of applications covered.

Digital modulation systems for Rohde & Schwarz signal generators (internal signal generation)										
Option R&S®SMx R&S®AMU R&S®AFQ R&S®EXBOX		R&S®SMU200A	R&S®SMJ100A	R&S®SMATE200A	R&S®SMBV100A	R&S®AMU200A	R&S®AFQ100A	R&S®AFQ100B	R&S®EX-IO-BOX	Page
-K40	GSM/EDGE	•	•	•	•	•	-	-	-	77
-K41	EDGE Evolution (incl. VAMOS)	•	•	•	•	•	-	-	-	77
-K42	3GPP FDD ¹⁾	•	•	•	•	•	-	-	-	76
-K43	3GPP enhanced BS/MS tests incl. HSDPA ¹⁾	•	•	•	•	•	-	-	-	76
-K44	GPS ¹⁾	•	•	•	•	•	-	-	-	80
-K45	3GPP FDD HSUPA	•	•	•	•	•	-	-	-	76
-K46	CDMA2000®	•	•	•	•	•	-	-	-	78
-K47	1xEV-DO Rev. A	•	•	•	•	•	-	-	-	78
-K48	IEEE 802.11a/b/g	•	•	•	•	•	-	-	-	81
-K49	IEEE 802.16	•	•	•	•	•	-	-	-	81
-K50	TD-SCDMA ¹⁾	•	•	•	•	•	-	-	-	79
-K51	TD-SCDMA enhanced BS/MS tests ¹⁾	•	•	•	•	•	-	-	-	79
-K52	DVB-H/DVB-T	•	•	•	•	•	-	-	-	83
-K53	DAB/T-DMB	•	•	•	•	•	-	-	-	83
-K54	IEEE 802.11n	•	•	•	•	•	-	-	-	81
-K55	EUTRA/LTE	•	•	•	•	•	-	-	-	75
-K56	XM Radio™	•	•	•	•	•	-	-	-	83
-K57	FM Stereo/RDS	•	•	•	•	•	-	-	-	83
-K58	Sirius	•	•	-	•	-	-	-	-	83
-K59	HSPA+	•	•	•	•	•	-	-	-	76
-K60	Bluetooth® (incl. EDR, low energy)	•	•	•	•	•	-	-	-	82
-K61	Multicarrier CW	•	•	•	•	•	-	-	-	-
-K65	Assisted GPS	•	-	-	-	•	-	-	-	80
-K66	Galileo	-	-	-	•	-	-	-	-	80
-K68	TETRA Release 2	•	•	•	•	•	-	-	-	82
-K69	LTE closed-loop BS test	•	•	•	-	•	-	-	-	75
-K81	LTE log file generation	•	•	•	-	•	-	-	-	75
-K84	LTE Release 9 + enhanced features	•	•	•	•	•	-	-	-	75
-K85	LTE Release 10/LTE-Advanced	•	•	•	•	•	-	-	-	75
-K86	IEEE 802.11ac	•	•	•	•	•	-	-	-	81
-K91	GNSS extension to 12 satellites	-	-	-	•	-	-	-	-	80
-K92	GNSS enhanced	-	-	-	•	-	-	-	-	80
-K93	GPS P code	-	-	-	•	-	-	-	-	80
-K94	GLONASS	-	-	-	•	-	-	-	-	80

¹⁾ Functionality is instrument-specific.

Digital modulation systems for Rohde & Schwarz signal generators (R&S®WinIQSIM2™)										
Option R&S®SMx R&S®AMU R&S®AFQ R&S®EXBOX		R&S®SMU200A	R&S®SMJ100A	R&S®SMATE200A	R&S®SMBV100A	R&S®AMU200A	R&S®AFQ100A	R&S®AFQ100B	R&S®EX-IO-BOX ²⁾	Page
-K240	GSM/EDGE	•	•	-	•	•	•	•	•	77
-K241	EDGE Evolution (incl. VAMOS)	•	•	-	•	•	•	•	•	77
-K242	3GPP FDD	•	•	-	•	•	•	•	•	76
-K243	3GPP enhanced BS/MS tests incl. HSDPA	•	•	-	•	•	•	•	•	76
-K244	GPS ³⁾	•	•	-	•	•	•	•	-	80
-K245	3GPP FDD HSUPA	•	•	-	•	•	•	•	•	76
-K246	CDMA2000®	•	•	-	•	•	•	•	•	78
-K247	1xEV-DO Rev. A	•	•	-	•	•	•	•	•	78
-K248	IEEE802.11a/b/g	•	•	-	•	•	•	•	-	81
-K249	IEEE802.16	•	•	-	•	•	•	•	•	81
-K250	TD-SCDMA	•	•	-	•	•	•	•	•	79
-K251	TD-SCDMA enhanced BS/MS tests	•	•	-	•	•	•	•	•	79
-K252	DVB-H/DVB-T	•	•	-	•	•	•	•	-	83
-K253	DAB/T-DMB	•	•	-	•	•	•	•	-	83
-K254	IEEE802.11n	•	•	-	•	•	•	•	•	81
-K255	EUTRA/LTE	•	•	-	•	•	•	•	•	75
-K259	HSPA+	•	•	-	•	•	•	•	•	76
-K260	Bluetooth® (incl. EDR, low energy)	•	•	-	•	•	•	•	-	82
-K261	Multicarrier CW	•	•	-	•	•	•	•	-	-
-K264	ECMA-368 IEEE802.15.3a (UWB)	-	-	-	-	-	-	•	-	-
-K266	Galileo ³⁾	•	•	-	•	•	•	•	-	80
-K268	TETRA Release 2	•	•	-	•	•	•	•	-	82
-K284	LTE Release 9 + enhanced features	•	•	-	•	•	•	•	•	75
-K285	LTE Release 10/LTE-Advanced	•	•	-	•	•	•	•	•	75
-K286	IEEE802.11ac	•	•	-	•	•	•	•	•	81
-K294	GLONASS ³⁾	•	•	-	•	•	•	•	-	80

Digital modulation systems for Rohde & Schwarz signal generators (external PC software or waveforms)										
Option R&S®SMx R&S®AMU R&S®AFQ R&S®EXBOX		R&S®SMU200A	R&S®SMJ100A	R&S®SMATE200A	R&S®SMBV100A	R&S®AMU200A	R&S®AFQ100A	R&S®AFQ100B	R&S®EX-IO-BOX ²⁾	Page
-K6	Pulse sequencer	•	•	•	•	•	•	•	-	85
-K256	Playback of XM Radio™ waveforms	•	•	-	•	-	•	•	-	83
-K352	Playback of HD Radio™ waveforms	•	•	-	•	-	•	•	-	83

²⁾ Only together with CPRI™ digital interface standard.

³⁾ One satellite only.

R&S®SMU/AMU-B14/-B15/-K62/-K71/-K72/-K74 Channel Simulation Options

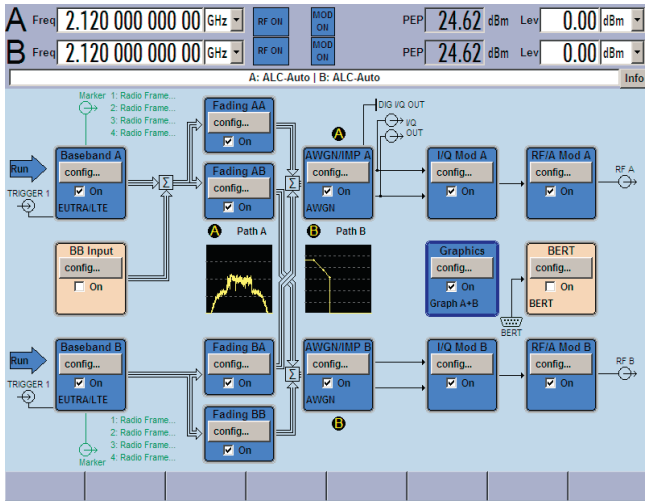

2x2 MIMO signal generation and channel simulation with the R&S®SMU200A.

Fading and interference simulation with the R&S®SMU200A/R&S®AMU200A

The realtime fading simulator of the R&S®SMU200A/R&S®AMU200A is a cost-effective solution for testing the behavior of products under realistic transmission conditions. Both instruments allow simulation of static fading conditions as well as dynamically changing ones. With their dual-path architecture, SISO and MIMO channel simulation can be performed alike. Complex correlation between the fading paths as well as geometric antenna setup definition via angle of arrival/departure is supported. Together with the AWGN simulation capability, the signal generators are ideal for performance tests in line with all important digital communication standards.

Channel simulation options	
Fading simulator	R&S®SMU-B14 R&S®AMU-B14
Fading simulator extension	R&S®SMU-B15 R&S®AMU-B15
AWGN	R&S®SMU-K62 R&S®AMU-K62
Dynamic fading and enhanced resolution	R&S®SMU-K71 R&S®AMU-K71
Extended statistics functions	R&S®SMU-K72 R&S®AMU-K72
MIMO fading	R&S®SMU-K74 R&S®AMU-K74

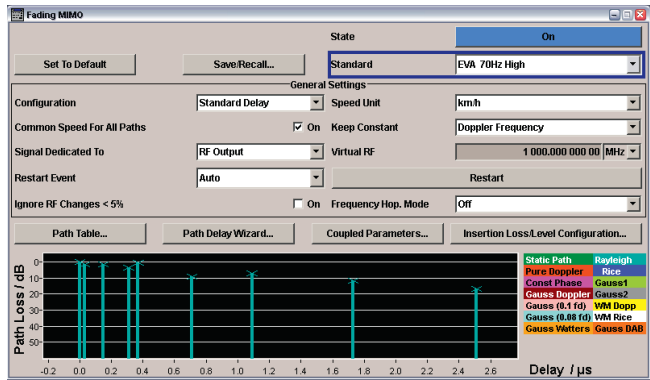

Main fading configuration menu.

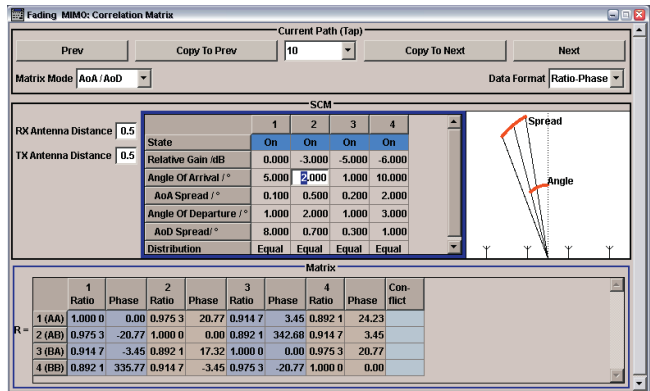

MIMO correlation menu.

Specifications in brief	
Fading and MIMO	
Fading taps	up to 40
Bandwidth	up to 80 MHz
Delay resolution	10 ns 0.01 ns (with R&S®SMU/AMU-K71)
MIMO configurations	up to 2x2 with one instrument up to 2x4 or 4x2 with two instruments
Correlation (per tap)	correlation matrix, Kronecker, AoA/AoD
Fading profiles	
Standard	Rayleigh, pure Doppler, Rice, lognormal, static, constant phase
With R&S®SMU/AMU-K71	fine delay, moving delay, birth-death, 2 channel interferer, HST
With R&S®SMU/AMU-K72	Gauss, Gauss DAB, WiMAX™ Doppler, WiMAX™ Rice

Specifications in brief	
Predefined settings	
Standard	CDMA2000®, 1xEV-DO, GSM, NADC, PCN, TETRA, HiperLan/2, WiMAX™ ITU, LTE
With R&S®SMU/AMU-K71	3GPP FDD WCDMA
With R&S®SMU/AMU-K72	WiMAX™ SUI, DAB
With R&S®SMU/AMU-K74	WiMAX™ MIMO, LTE MIMO
AWGN (R&S®SMU/AMU-K62)	
C/N	-30 dB to +30 dB
System bandwidth	up to 80 MHz

R&S®SMx/AMU-K55/-K69/-K81/-K84/-K85 LTE Signal Generation

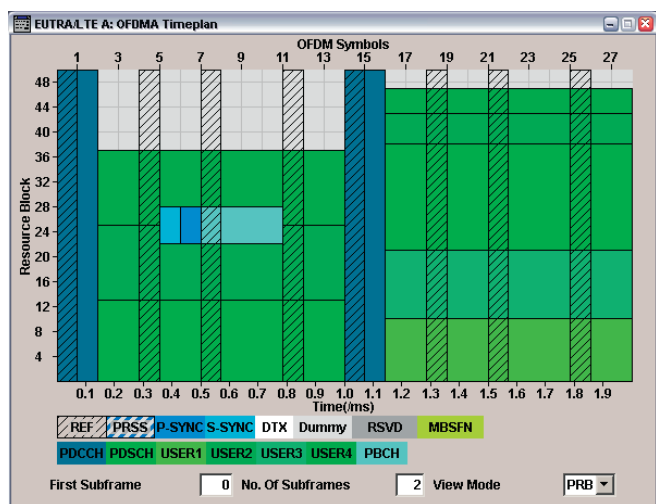

R&S®SMx/AMU-K55 LTE time plan example ([download](#)).

LTE receiver and performance testing

The LTE signal generation options allow comprehensive LTE testing of base stations, mobile devices, modules and components.

R&S®SMx/AMU-K55, general features

- ▮ In line with 3GPP LTE Rel. 8
- ▮ FDD and TDD
- ▮ Downlink (OFDMA) and uplink (SC-FDMA)

R&S®SMx/AMU-K55 LTE downlink functionality

- ▮ PBCH, PDSCH, PDCCH, PCFICH, PHICH
- ▮ Full MIMO and TX diversity support
- ▮ P-SYNC, S-SYNC and DL reference signals
- ▮ Channel coding and scrambling for PDSCH/PBCH
- ▮ Predefined test models
- ▮ LTE test case wizard (not with R&S®AMU-K55)

R&S®SMx/AMU-K55 LTE uplink functionality

- ▮ PUSCH incl. channel coding, scrambling and multiplexing
- ▮ PUCCH, PRACH
- ▮ Demodulation and sounding reference signals
- ▮ PUSCH frequency hopping type 1 and type 2
- ▮ Group and sequence hopping

R&S®SMU/SMJ/SMATE/AMU-K69 (together with R&S®SMx/AMU-K55)

- ▮ Support of uplink closed-loop base station tests in line with 3GPP TS36.141
- ▮ Realtime processing of feedback commands for HARQ feedback, timing adjustment and timing advance

R&S®SMU/AMU-K81 (together with R&S®SMx/AMU-K55)

- ▮ Output of log files with intermediate results (bits/symbols) from the signal generation chain
- ▮ Generation of summary log files with LTE signal description

R&S®SMx/AMU-K84 (together with R&S®SMx/AMU-K55)

- ▮ In line with 3GPP LTE Rel. 9
- ▮ MBMS/MBSFN subframes including PMCH
- ▮ Downlink positioning reference signals (PRS)
- ▮ Dual-layer beamforming (TX mode 8)
- ▮ Mapping of logical antenna ports to physical TX antennas

R&S®SMx/AMU-K85 (together with R&S®SMx/AMU-K55)

- ▮ In line with 3GPP LTE Rel. 10/LTE-Advanced
- ▮ Carrier aggregation
- ▮ Enhanced SC-FDMA
- ▮ PUSCH/PUCCH synchronous transmission
- ▮ Clustered PUSCH
- ▮ PUCCH format 3
- ▮ Generation of CSI reference signals¹⁾
- ▮ Eight-layer transmission (TX mode 9)¹⁾
- ▮ UL-MIMO¹⁾

¹⁾ In preparation; please check the Rohde&Schwarz website for availability.

LTE signal generation options

LTE Release 8	R&S®xxx-K55 R&S®xxx-K255
LTE closed-loop BS test	R&S®xxx-K69
LTE log file generation	R&S®xxx-K81
LTE Release 9 + enhanced features	R&S®xxx-K84 R&S®xxx-K284
LTE Release 10/LTE-Advanced	R&S®xxx-K85 R&S®xxx-K285

For supported instruments, see page 72/73.

R&S®SMx/AMU-K42/-K43/-K45/-K59 3GPP FDD/HSPA/HSPA+

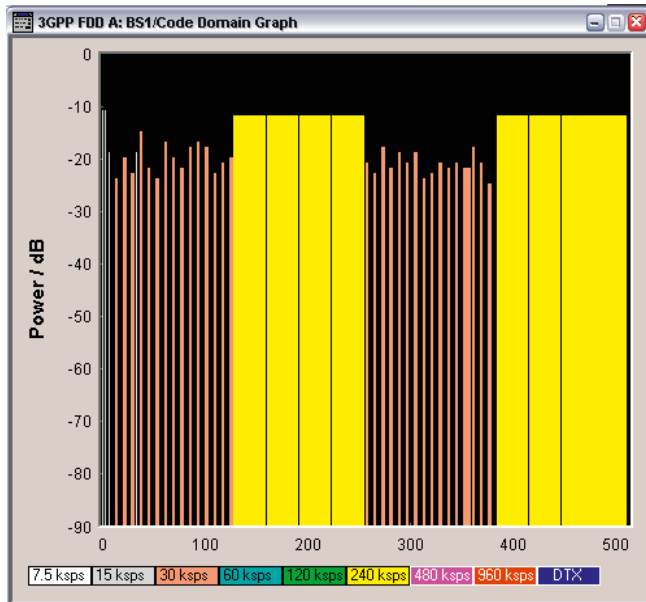

Example of 3GPP code domain display (downlink, test model 6).

3GPP signal generation

These options provide signal generation capabilities according to 3GPP FDD Release 9, including HSDPA, HSUPA and HSPA+.

The R&S®SMx/AMU-K42 option combines realtime operation and arbitrary waveform mode for realtime generation of the P-CCPCH and up to three DPCHs in the downlink, for example. In the uplink, one UE can be simulated in realtime; up to 128 UEs can be simulated via the ARB and added to the realtime signal.

The R&S®SMx/AMU-K43 option extends the R&S®SMx/AMU-K42 option to full HSDPA support and dynamic power control. It allows the simulation of HS-SCCH (high speed shared control channel) and HS-PDSCH (high speed physical downlink shared channel) in the downlink in line with TS25.211. Generation of HSDPA H-sets is also supported. In addition, it is possible to simulate a HS-DPCCH (high speed dedicated physical control channel) in realtime operation (UE1) and arbitrary waveform mode (UE2 to UE4).

The R&S®SMx/AMU-K45 option can generate all HSUPA physical channels. In the uplink, it supports simulation of one E-DPCCH and up to four E-DPDCHs with channel coding.

The R&S®SMx/AMU-K59 HSPA+ option supports higher-order modulation (64QAM) for higher data rates, multiple input multiple output (MIMO) for higher data throughput in the downlink, and continuous packet connectivity (CPC) for reduction of latency and control information overhead.

3GPP signal generation options

3GPP FDD	R&S®xxx-K42 R&S®xxx-K242
3GPP FDD enhanced BS/MS tests incl. HSDPA	R&S®xxx-K43 R&S®xxx-K243
3GPP FDD HSUPA	R&S®xxx-K45 R&S®xxx-K245
HSPA+	R&S®xxx-K59 R&S®xxx-K259

For supported instruments, see page 72/73.

R&S®SMx/AMU-K40/-K41 GSM/EDGE/EDGE Evolution

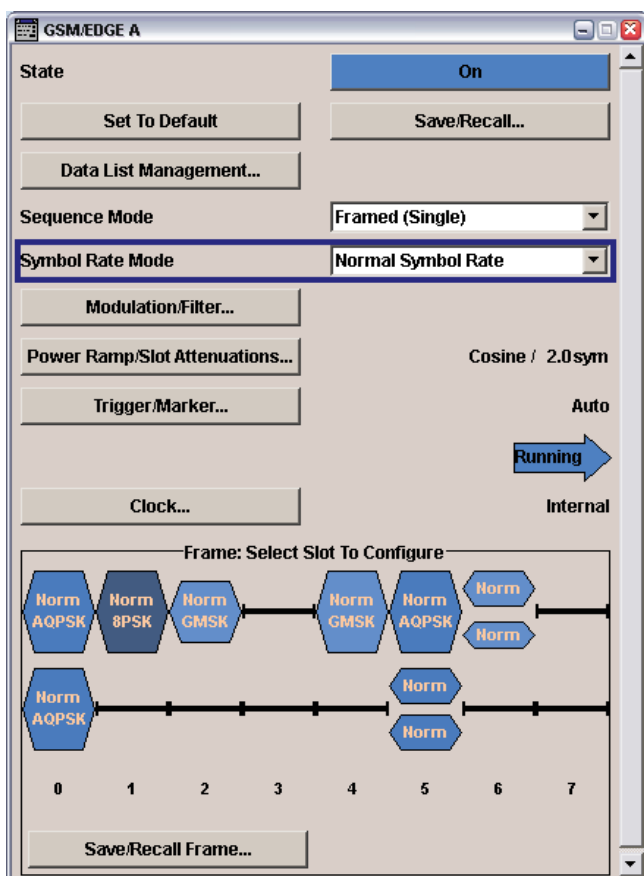

Main GSM/EDGE signal configuration menu.

GSM/EDGE signal generation

With the R&S®SMx/AMU-K40 option, GSM/EDGE signals can be generated in realtime, whereas the type of modulation can be changed from slot to slot. In addition, eight different power levels can be defined for the timeslots. All necessary burst types (e.g. Normal (full and half rate), EDGE, Synchronization, Access) are supported.

The R&S®SMx/AMU-K41 option adds EDGE Evolution and VAMOS features such as:

- Higher symbol rate (325 kHz)
- Higher-order modulation types: 16QAM, 32QAM
- Mixed frames with GSM, EDGE and EGPRS2 slots in one frame (with same symbol rate per frame)
- “Framed double” sequence mode for generation of realistic test scenarios with changing frame content
- Adaptive QPSK (AQPSK) modulation scheme

GSM/EDGE signal generation options

GSM/EDGE	R&S®xxx-K40 R&S®xxx-K240
EDGE Evolution	R&S®xxx-K41 R&S®xxx-K241

For supported instruments, see page 72/73.

R&S®SMx/AMU-K46/-K47 CDMA2000® incl. 1xEV-DV and 1xEV-DO

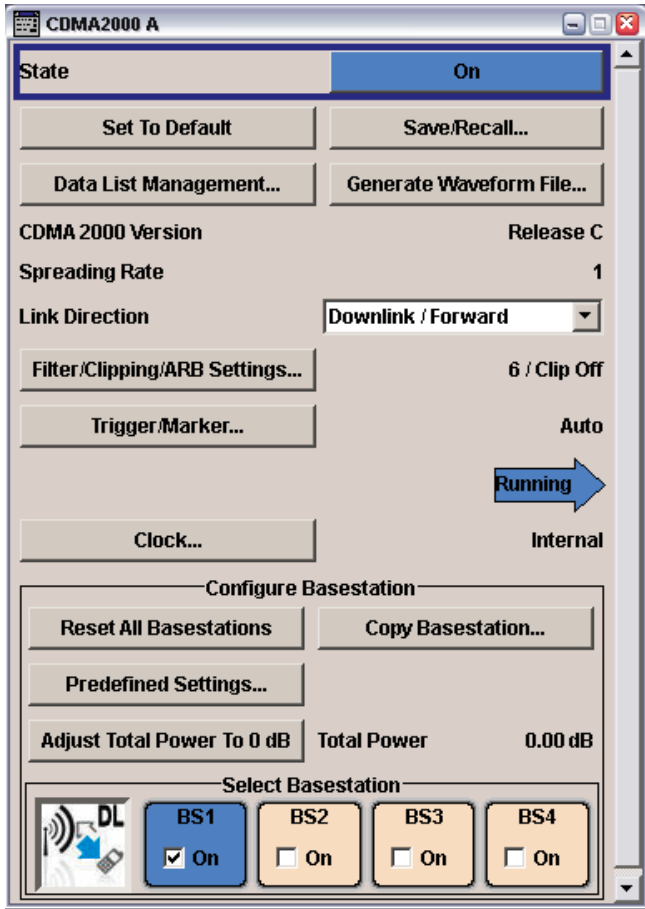

Start screen including basic settings for CDMA2000®.

CDMA2000®, 1xEV-DV and 1xEV-DO signal generation

The R&S®SMx/AMU-K46 option generates signals for CDMA2000®, the North American standard for the third mobile radio generation including IS-95 as a subset. Even signals for 1xEV-DV can be generated using R&S®SMx/AMU-K46.

R&S®SMx/AMU-K46 option for generating CDMA2000® signals

- ▮ Configuration of up to four base stations or four mobile stations
- ▮ All special channels and up to 78 channels in the downlink (depending on radio configuration)
- ▮ Packet channel in line with 1xEV-DV in the downlink
- ▮ Operating modes "Traffic", "Access", "Enhanced Access" and "Common Control" in the uplink
- ▮ Simulation of up to 64 additional mobile stations
- ▮ All channel coding modes included in IS-2000 (Frame Quality Indicator, Convolutional Encoder, Turbo Encoder, Symbol Puncture, Interleaver etc.)

R&S®SMx/AMU-K47 option for generating signals for 1xEV-DO (Rev. A)

- ▮ Simulation of up to four users in the downlink and up to four terminals in the uplink
- ▮ Physical layer subtypes 0 and 1 or 2 selectable
- ▮ Downlink data rate selectable through rate index and packet size
- ▮ Matrix for reverse power control (RPC) allowing flexible testing of power control
- ▮ Traffic and access mode in the uplink; automatic setting of different data rates and modulations by selected payload size

CDMA2000® signal generation options

CDMA2000®	R&S®xxx-K46 R&S®xxx-K246
1xEV-DO Rev. A	R&S®xxx-K47 R&S®xxx-K247

For supported instruments, see page 72/73.

R&S®SMx/AMU-K50/-K51 TD-SCDMA Signal Generation

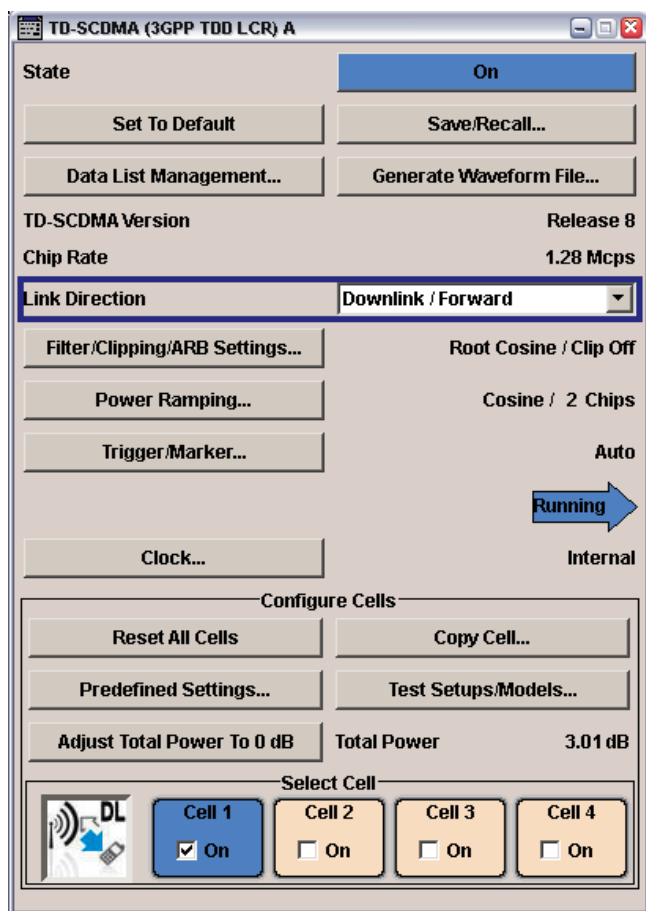

Main TD-SCDMA configuration menu.

TD-SCDMA signal generation

The combination of the R&S®SMx/AMU-K50 and R&S®SMx/AMU-K51 options offers easy, flexible configuration of realtime, fully coded (transport and physical layer) TD-SCDMA (3GPP TDD LCR) test signals for evaluating components, power amplifiers, digital baseband receiver chips and RF receivers in user equipment and base stations. The TD-SCDMA signal generation is in accordance with 3GPP TDD LCR with a chip rate of 1.28 Mcps (Low Chip Rate mode) and contains the HSDPA and HSUPA functionality for TD-SCDMA.

R&S®SMx/AMU-K50 TD-SCDMA functionality

- Simulation of up to four TD-SCDMA cells with variable switching point of uplink and downlink
- User-configurable channel table for each slot and simulation of downlink and uplink pilot timeslot
- PRACH can be generated in the uplink

R&S®SMx/AMU-K51 TD-SCDMA enhanced functionality

- Enhancing R&S®SMx/AMU-K50 to support full channel coding in fixed coding schemes and user-defined coding schemes, HSDPA and HSUPA
- Simulation of up to four TD-SCDMA cells with generation of the coded P-CCPCH (BCH with running SFN) in the downlink
- Fixed reference measurement channels RMC 12.2 kbps up to RMC 384 kbps in both uplink and downlink; user configuration supported
- Simulation of HSDPA channels HS-SCCH, HS-PDSCH, HS-SICH and H-RMC 0.5 Mbps, 1.1 Mbps, 1.6 Mbps, 2.2 Mbps, 2.8 Mbps (QPSK and 16QAM), H-RMC 64QAM; user configuration supported
- Simulation of HSUPA channels E-DCH FRC from 1 to 4 (QPSK and 16QAM); user configuration supported

TD-SCDMA signal generation options

TD-SCDMA	R&S®xxx-K50 R&S®xxx-K250
TD-SCDMA enhanced BS/MS tests	R&S®xxx-K51 R&S®xxx-K251

For supported instruments, see page 72/73.

R&S®SMBV-K44/-K65/-K66/-K91/-K92/-K93/-K94 GNSS Simulation with GPS (C/A code and P code), GLONASS and Galileo

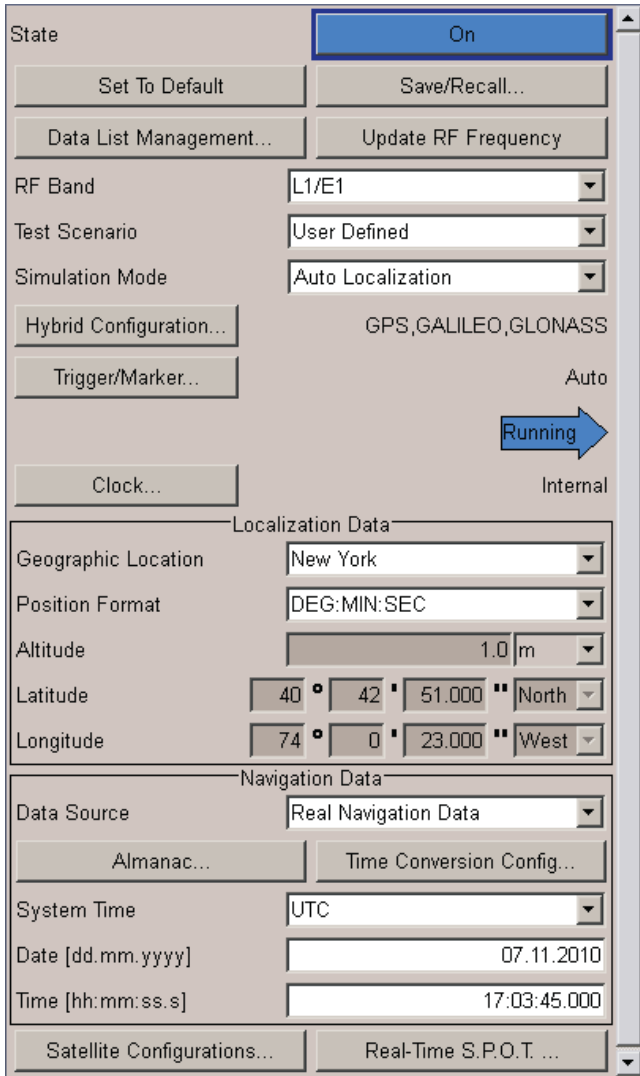

Start screen with simulation mode selection for the different applications, hybrid setup for selecting the used GNSS and signal parameters as the time and location.

The Real-Time S.P.O.T. (satellites and position online tracker) view is a dynamic display of the current satellite constellation and provides dynamic realtime information about parameters such as HDOP, PDOP, receiver's location and current simulation time.

GNSS simulation with GPS, GLONASS and Galileo

Whether in the R&D lab or in production, the global navigation satellite system (GNSS) solution for the R&S®SMBV100A sets new standards in the field of satellite simulation. It supports all possible scenarios, from simple setups with individual, static satellites all the way to flexible scenarios generated in realtime with up to 12 dynamic GPS, GLONASS and Galileo satellites.

- Support of GPS L1/L2 with C/A code and P code, GLONASS L1 and Galileo E1, including hybrid constellations
- Simulation of realistic constellations with up to 12 satellites in realtime (no precalculated waveforms)
- Flexible scenario generation including moving scenarios (import of NMEA waypoints), multipath, dynamic power control and atmospheric modeling without the need for additional software tools
- Unlimited simulation time with automatic, on-the-fly exchange of satellites
- User mode for full flexibility to select the satellites and to define the navigation data (import of RINEX files)
- Support of predefined as well as user-defined Assisted GPS (A-GPS) test scenarios, including generation of assistance data

GNSS receiver tests made easy

With the GNSS simulator, the R&S®SMBV100A allows quick and easy characterization of receivers, including TTFB, location accuracy, reacquisition time and sensitivity.

- Flexible scenario generation for easy receiver testing
- Faster testing with GNSS signal generation in realtime
- Unlimited simulation time with automatic, on-the-fly exchange of satellites
- Receiver testing under real-world conditions
- Support of Assisted GPS (A-GPS) test cases

Customized solutions through flexible options

- Instrument configuration tailored to customer needs
- Ready for other GNSS standards
- Ideal for production and R&D

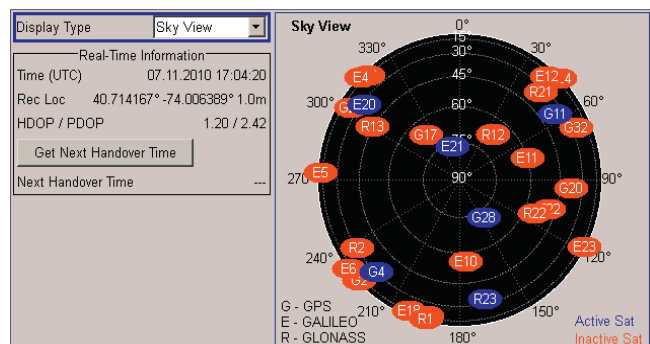

R&S®SMx/AMU-K48/-K54/-K86 IEEE 802.11a/b/g/n/ac

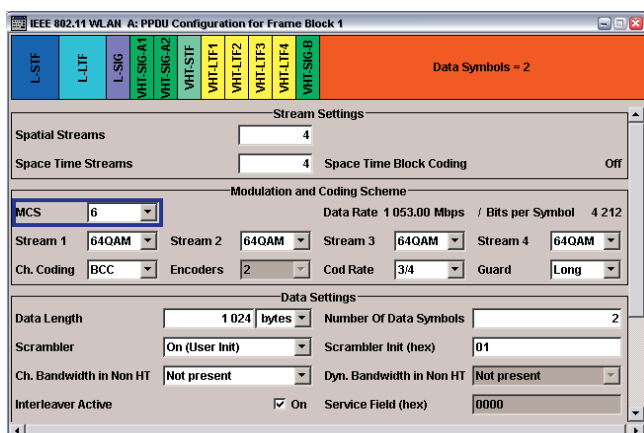

IEEE 802.11n/ac PPDU configuration menu.

WLAN signal generation

The R&S®SMx/AMU-K48 option allows the generation of signals in line with the IEEE 802.11a, b and g wireless LAN standards.

The R&S®SMx/AMU-K54 option makes it possible to generate signals in line with the IEEE 802.11n wireless LAN standard. Channel bandwidths of 20 MHz and 40 MHz are supported. The high throughput (HT) mode allows high data rate 802.11n signals to be generated. Furthermore, this option includes MIMO capabilities (generation of one to four spatial streams; one to four TX antennas).

R&S®SMx/AMU-K86 (together with R&S®SMx/AMU-K54) for IEEE 802.11ac

- Support of all mandatory physical layer modes
- Very high throughput (VHT) frames with 20 MHz, 40 MHz, 80 MHz and 160 MHz transmission bandwidth
- VHT preambles and signal fields
- Frame block sequencer for alternating legacy (11a/b/g), 11n or 11ac frames within one ARB waveform
- MIMO modes with 4 transmit antennas
- BPSK, QPSK, 16QAM, 64QAM and 256QAM modulation

WLAN signal generation options

IEEE 802.11a/b/g	R&S®xxx-K48 R&S®xxx-K248
IEEE 802.11n	R&S®xxx-K54 R&S®xxx-K254
IEEE 802.11ac	R&S®xxx-K86 R&S®xxx-K286

For supported instruments, see page 72/73.

R&S®SMx/AMU-K49 WiMAX™ Signal Generation

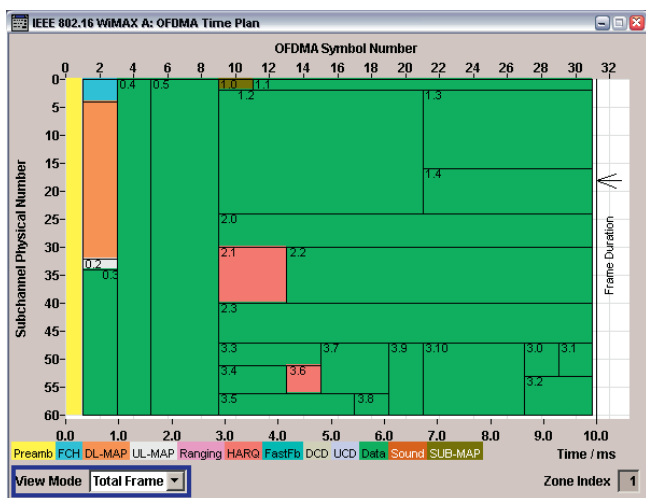

The signal generator graphically displays the configured WiMAX™ signal. The time plan shows the different WiMAX™ zones, segments and burst types.

WiMAX™ signal generation

The R&S®SMx/AMU-K49 option allows convenient generation of OFDM and OFDMA signals in line with WiMAX™ IEEE 802.16 Rev. 2 (incl. WiBro) as well as WiMAX™ IEEE 802.16-2004 and IEEE 802.16e-2005 standards. It covers uplink and downlink as well as SISO and MIMO signal generation.

- Full CC and CTC channel coding
- FCH, DL-MAP and UL-MAP, either automatic or user-defined
- DCD, UCD, sub-maps
- HARQ, ranging and fast feedback bursts
- Optional generic MAC headers and CRC for each burst
- Predefined frames for receiver tests
- Subchannelization modes
- Space time coding for up to four antennas (matrix A, B, C, collaborative spatial multiplexing, CSTD)
- Multiple zones and segments

WiMAX™ signal generation options

IEEE 802.16	R&S®xxx-K49 R&S®xxx-K249
-------------	-----------------------------

For supported instruments, see page 72/73.

R&S®SMx/AMU-K60 Bluetooth® V 4.0 and EDR

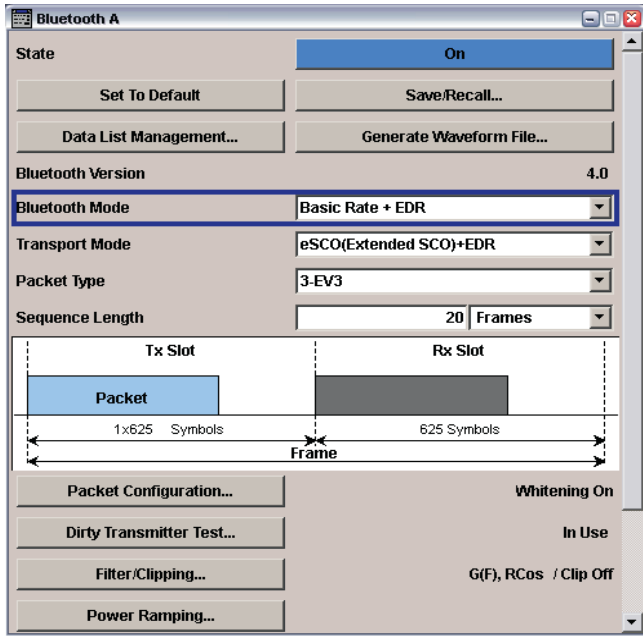

Main Bluetooth® signal configuration menu.

Bluetooth® V 4.0 and EDR signal generation

The R&S®SMx/AMU-K60 option enables Rohde&Schwarz signal generators to generate Bluetooth® signals in line with version 4.0 including EDR and Bluetooth® low energy. The solution allows straightforward testing of Bluetooth® receivers and chipsets. Standard-compliant packets as well as packets with user-defined content – e.g. for intensive R&D tests – can easily be generated.

- | Bluetooth® 4.0, basic rate + EDR
- | Bluetooth® low energy
- | ACL+EDR, SCO and eSCO+EDR transport modes
- | Support of all packet types
- | Up to 5238 frames (depending on signal generator)
- | Intuitive packed editor
- | Optional data whitening
- | Support of dirty transmitter test
- | Power ramp control including ramp time, rise and fall offset
- | Setting of clipping, filter and modulation parameters

Bluetooth® signal generation options	
Bluetooth® V 4.0 and EDR	R&S®xxx-K60 R&S®xxx-K260

R&S®SMx/AMU-K68 TETRA Release 2 Signal Generation

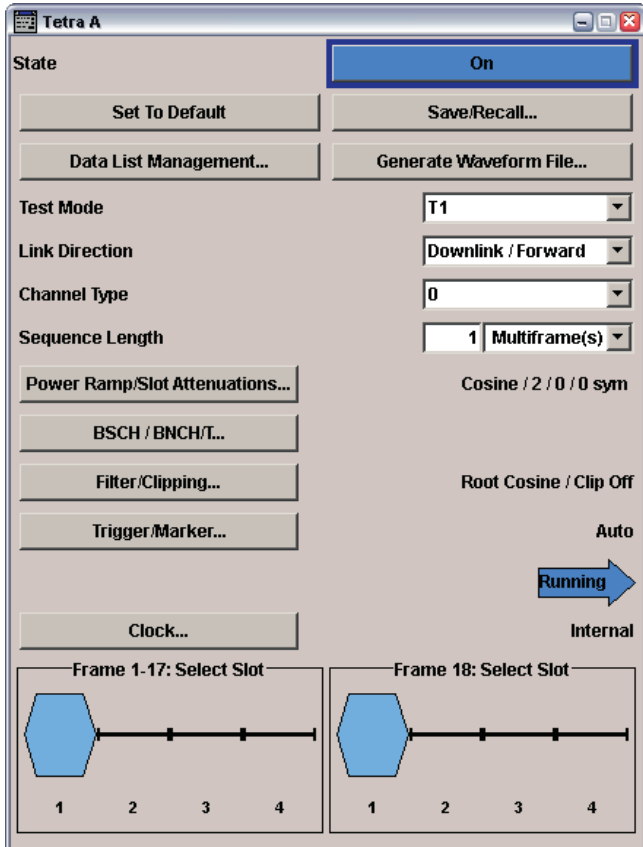

TETRA Release 2 main menu.

TETRA Release 2 digital standard

- | In line with ETSI EN 300 392-2 digital standard (V3.2.1) and TETRA conformance testing specification ETSI EN 300 394-1 (V3.1.1)
- | Link direction: downlink and uplink (not for T3)
- | T1 downlink channels 0, 1, 2, 3, 4, 21, 22, 24
- | T1 uplink channels 7, 8, 9, 10, 11, 21, 23, 24
- | T2 TETRA interferer phase modulation, QAM
- | T3 CW interferer
- | T4 downlink channel 27
- | T4 uplink channels 25, 26

TETRA signal generation options	
TETRA Release 2	R&S®xxx-K68 R&S®xxx-K268

For supported instruments, see page 72/73.

R&S®SMx/AMU-K52/-K53/-K56/-K57/ -K58/-K256/-K352

DVB-H/DVB-T, DAB/T-DMB, XM Radio™, FM Stereo/RDS, Sirius, HD Radio™

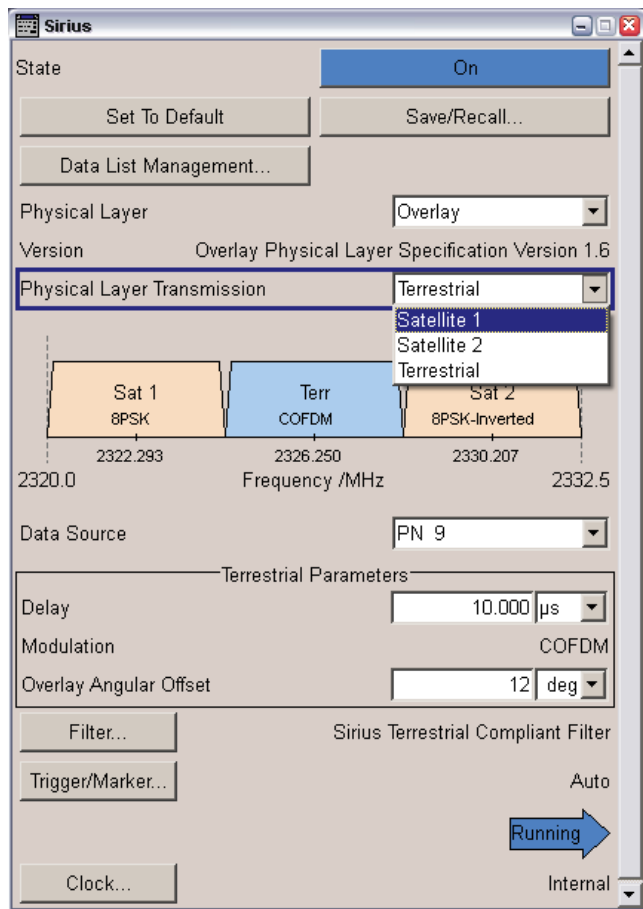

Sirius main menu

Signal generation options for radio and video standards

- Testing mobile communications standards (such as WCDMA 3GPP FDD, TD-SCDMA, GSM/EDGE) and video standards with only one signal generator
- Realtime signal generation for the XM Radio™ and Sirius standards
- Solution tested and approved by Sirius for software testing as well as for manufacturing
- R&S®SMx/AMU-K352 option for playback of all test vectors as given by iBiquity (iBiquity license required)
- Realtime generation of FM stereo signals; closed-loop testing with R&S®UPV or R&S®UPP audio analyzers possible

Signal generation options for radio/video standards

DVB-H/DVB-T	R&S®xxx-K52 R&S®xxx-K252
DAB/T-DMB	R&S®xxx-K53 R&S®xxx-K253
XM Radio™	R&S®xxx-K56 R&S®xxx-K256
FM stereo	R&S®xxx-K57
Sirius	R&S®xxx-K58
HD Radio™ test waveforms (iBiquity license required; HD Radio™ is a trademark of iBiquity Digital Corp.)	R&S®xxx-K352

For supported instruments, see page 72/73.

R&S®WinIQSIM2™ Simulation Software

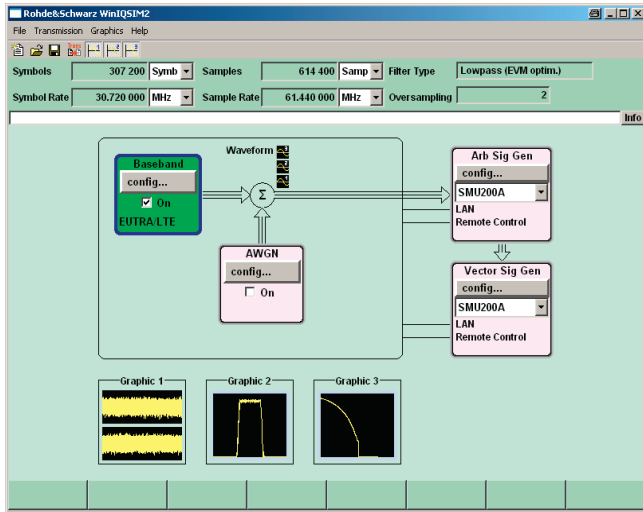

Ideal for the generation of digitally modulated signals

R&S®WinIQSIM2™ was especially developed for the generation of digitally modulated signals. Complex signals can easily be generated. The graphical user interface allows intuitive operation, supported by context-sensitive help. The convenient way of creating any standard-conforming waveform with all the included standards and the generation of multicarrier signals and multisegment waveforms make R&S®WinIQSIM2™ suitable for a wide range of applications.

The signals generated with the aid of R&S®WinIQSIM2™ can be output by the R&S®AFQ100A and R&S®AFQ100B arbitrary waveform generators, the R&S®SMU200A, R&S®SMJ100A and R&S®SMBV100A vector signal generators as well as by the R&S®AMU200A baseband signal generator and fading simulator.

Some standards also work for the R&S®CMW500 wide-band radio communication tester and the R&S®CMW270 wireless connectivity tester as well as for the R&S®EX-IQ-BOX digital signal interface module (together with CPRI™). R&S®WinIQSIM2™ is delivered with these arbitrary waveform generators free of charge; it can also be downloaded from www.rohde-schwarz.com – search term: WinIQSIM2.

Large variety of digital standards

- ▮ EUTRA/LTE
- ▮ GSM/EDGE, EDGE Evolution, VAMOS
- ▮ 3GPP FDD with HSDPA, HSUPA and HSPA+
- ▮ CDMA2000® with 1xEV-DV
- ▮ 1xEV-DO Release A
- ▮ TD-SCDMA
- ▮ IEEE 802.11(a/b/g/n/ac) WLAN
- ▮ IEEE 802.16 WiMAX™ supporting OFDM and OFDMA
- ▮ DVB-H/DVB-T, DAB/T-DMB
- ▮ UWB (ECMA-368)
- ▮ Bluetooth®
- ▮ TETRA, TETRA Release 2

Additional systems in R&S®WinIQSIM2™

- ▮ Custom digital waveforms for generating user-definable digital signals while offering user-selectable modulation parameters
- ▮ Multicarrier CW signal generation
- ▮ Multicarrier generation allowing several digital signals to be combined into one waveform with different frequency offsets
- ▮ Multisegment waveform function for multiple different waveforms in an arbitrary waveform generator's memory, ensuring minimum transition times and seamless transitions
- ▮ AWGN generation and addition to the signal
- ▮ Import function for importing I/Q samples via a server connection into the R&S®WinIQSIM2™ signal generation chain where filtering can be applied and AWGN can be added

Extended graphics

- ▮ I and Q versus time
- ▮ Absolute value and phase versus time
- ▮ Vector diagram
- ▮ Constellation diagram
- ▮ FFT magnitude showing the spectrum of the signal
- ▮ Eye diagram of I and Q
- ▮ CCDF (complementary cumulative distribution function)

Convenient connections

- ▮ Waveform transmission via GPIB, USB and LAN
- ▮ Local storing of waveforms on PC; data transmission with USB memory stick
- ▮ Control of instruments by means of Remote Desktop connection via LAN
- ▮ Remote control of R&S®WinIQSIM2™

R&S®SMx/AMU/AFQ-K6 Pulse Sequencer

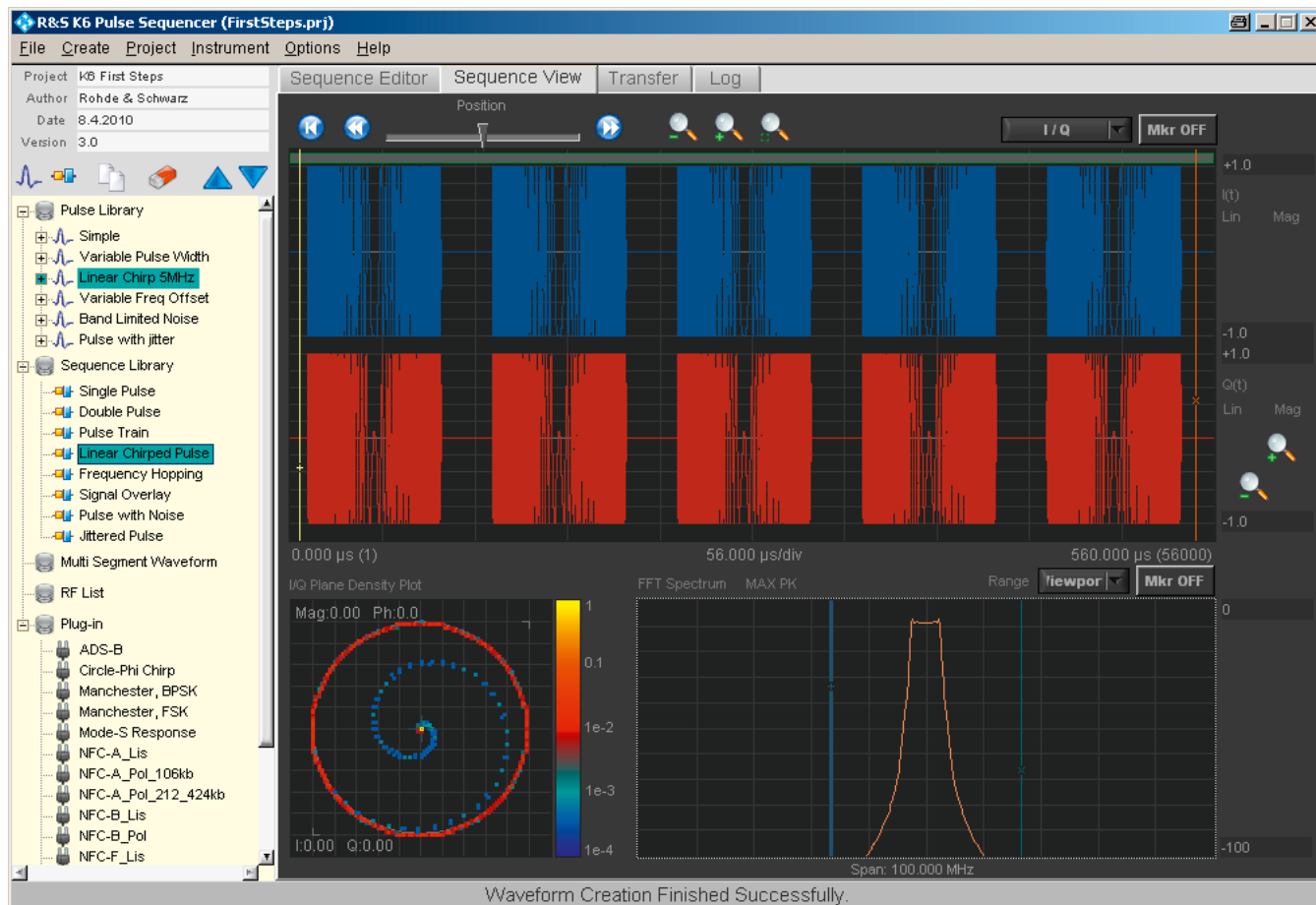

User interface of the pulse sequencer software (FM chirp signal example).

Generation of complex pulsed signals

The pulse sequencer software generates complex pulses and bursts for playback via the waveform memory of the baseband and vector signal generators from Rohde&Schwarz. This software is a standalone, PC-based application that creates waveform files. The pulse sequencer software is available for free download from the Rohde&Schwarz website. For uploading waveforms to a Rohde&Schwarz generator, the R&S®SMx/AMU/AFQ-K6 option must be installed on the instrument.

- Generation of DFS pulses in line with FCC standard
- Radar signals for receiver tests
- RFID signals in line with standard
- Intuitive user interface with graphical display of time plan
- Modulated pulses possible (with ASK, FSK, BPSK, QPSK, FM chirp, FM, AM)
- User-defined modulation mode via user plug-in (e.g. for military customers)
- Graphical display of signal (e.g. I/Q versus time, spectrum, I/Q density)

Chapter 6

Network Analyzers

Vector network analysis (VNA) is one of the most essential RF/microwave measurement techniques. As a leading manufacturer of T&M equipment, Rohde & Schwarz offers a wide range of high-performance network analyzers.



Type	Designation	Frequency range	Description	Page
Vector network analyzers				
R&S®ZNB	Vector Network Analyzer	9 kHz to 4.5/8.5 GHz	Leading in speed, dynamic range and ease of operation	87
R&S®ZNC	Vector Network Analyzer	9 kHz to 3 GHz	Solid performance on a future-oriented platform	88
R&S®ZVA	Vector Network Analyzer	300 kHz to 8 GHz 10 MHz to 24/40/50/67 GHz	High-end VNA with up to four sources for sophisticated measurements up to 67 GHz	89
R&S®ZVT	Multiport Vector Network Analyzer	300 kHz to 8 GHz 10 MHz to 20 GHz	Network analysis with up to eight test ports	90
R&S®ZVB	Vector Network Analyzer	300 kHz to 4/8 GHz 10 MHz to 14/20 GHz	High measurement speed with two or four test ports	91
R&S®ZVL	Vector Network Analyzer	9 kHz to 3/6/13.6 GHz	Cost-efficient compact class (two test ports)	92
Converters				
R&S®ZVA-Z75/-Z90E/ -Z110/-Z110E/-Z140/ -Z170/-Z220/ -Z325/-Z500	Millimeter-Wave Converters	50 GHz to 500 GHz, depending on converter model	Millimeter-wave measurements in the V, E, W, F, D, G, J and Y bands – network analysis in frequency ranges from 50 GHz to 500 GHz depending on converter model	93
Accessories for network analysis				
R&S®ZVAX24	Extension Unit	10 MHz to 24 GHz	Measurements on active devices made easy	94
R&S®ZV-Z81/-Z82	Switch Matrix	50 MHz to 24 GHz	Two or four VNA ports, up to 16 test ports	94
R&S®ZV-Z5x	Automatic Calibration Units	300 kHz to 50 GHz	Automatic calibration of vector network analyzers (two, four, six, eight ports)	95
R&S®ZCAN	Calibration Kit	0 Hz to 3 GHz	Manual calibration kit (coaxial)	95
R&S®ZV-WRxx	Manual Waveguide Calibration Kits	50 GHz up to 500 GHz	Manual calibration kits (coaxial)	94
R&S®ZV-Z121/-Z132	Manual Calibration Kits	0 Hz to 8 GHz/13 GHz	Manual calibration of vector network analyzers (economy)	95
R&S®ZV-Z2xx	Manual Calibration Kits	0 Hz to 67 GHz	Manual calibration of vector network analyzers (precision)	95

R&S®ZNB Vector Network Analyzer



Leading in speed, dynamic range and ease of operation

With frequency ranges of 9 kHz to 4.5 GHz and 9 kHz to 8.5 GHz, the new R&S®ZNB vector network analyzers are primarily targeted at applications in the mobile radio and electronic goods industries. The R&S®ZNB is the right choice when it comes to developing, producing and servicing RF components such as amplifiers, mixers, filters and cables.

The R&S®ZNB vector network analyzers feature a wide dynamic range of up to 140 dB (at 10 Hz IF bandwidth), low trace noise of less than 0.004 dB RMS (at 10 kHz IF bandwidth) and high output power of up to +13 dBm, which can be adjusted electronically in a range of more than 95 dB.

The new analyzers combine excellent measurement accuracy with exceptional speed – better than 10 μs per point. They feature excellent temperature and long-term stability,

which ensures reliable measurements over several days without having to recalibrate the units.

These short-depth, compact two-port and four-port analyzers leave plenty of space on the workbench for the measurement application. They feature low operating noise thanks to low power consumption and a sophisticated cooling concept. The low power consumption also reduces operating costs and protects the environment.

- ▮ Wide dynamic range of up to 140 dB
- ▮ Short sweep times of 4 ms for 401 points
- ▮ High temperature stability of typ. 0.01 dB/°C
- ▮ Wide power sweep range of 98 dB
- ▮ Wide range of IF bandwidths from 1 Hz to 10 MHz
- ▮ Manual and automatic calibration
- ▮ Large, high-resolution 12.1" screen
- ▮ Touchscreen user interface
- ▮ Two or four test ports

Models

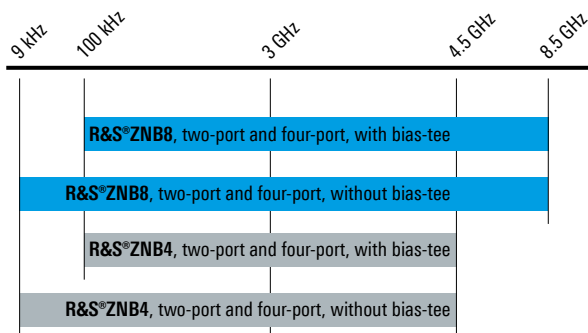

R&S®ZNB phase noise

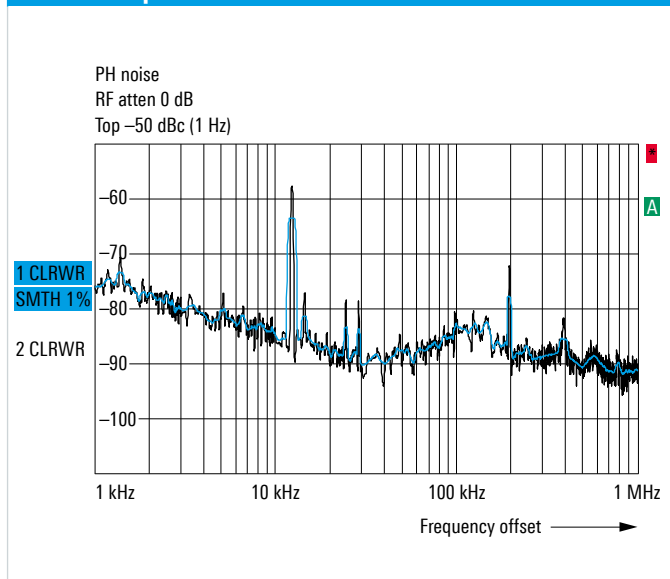

Typical effective system data of the R&S®ZNB

	9 kHz to 100 kHz	100 kHz to 4.5 GHz	4.5 GHz to 8.5 GHz
Directivity	46	45	40
Source match	41	40	36
Load match	44	45	40
Reflection tracking	0.02	0.02	0.05
Transmission tracking	0.028	0.018	0.09

R&S®ZNB measurement speed

Sweep 401 points, normalized, 800 MHz to 1 GHz, 1 MHz IFBW	4 ms
Data transfer 201 points, via Rohde & Schwarz RSIB protocol and 1 Gbit/s LAN	typ. 1.0 ms
Switching between channels Up to 2001 points	< 5 ms
Switching between instrument setups Up to 2001 points	< 5 ms

R&S®ZNC Vector Network Analyzer

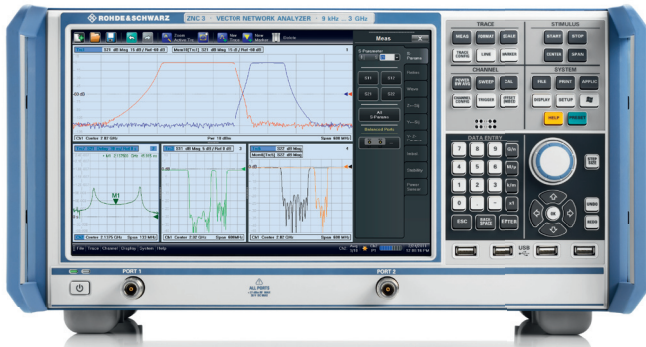

Solid performance on a future-oriented platform

High reliability, outstanding ease of operation, maximum precision and a wide dynamic range – this is what customers expect from a network analyzer. Using state-of-the-art technology and a user-friendly operating concept, Rohde & Schwarz has implemented all these features in its R&S®ZNC vector network analyzer.

Operating in a range from 9 kHz to 3 GHz, the network analyzer is targeted at applications in the mobile radio and electronic goods industries. The R&S®ZNC is the right choice when it comes to developing, producing and servicing RF components such as filters and cables.

The R&S®ZNC has a bidirectional test set for measuring all four S-parameters of active and passive DUTs. Plus, it offers calibration methods suitable for a wide range of T&M environments in development and production. The analyzer features excellent temperature and long-term stability, which ensures reliable measurements over several days without having to recalibrate the unit.

This short-depth, compact two-port analyzer leaves plenty of space on the workbench for the measurement application. It features low operating noise thanks to low power consumption and a sophisticated cooling concept. The low power consumption also reduces operating costs and protects the environment.

- Frequency range from 9 kHz to 3 GHz
- Dynamic range of up to 130 dB
- Short sweep times of 11 ms for 401 points
- High temperature stability of typ. 0.01 dB/°C
- Wide power sweep range from -50 dBm to +13 dBm
- IF bandwidths from 1 Hz to 300 kHz
- Manual and automatic calibration
- Low trace noise of 0.004 dB RMS at 10 kHz IF bandwidth
- Large, high-resolution 12.1" screen
- Touchscreen user interface

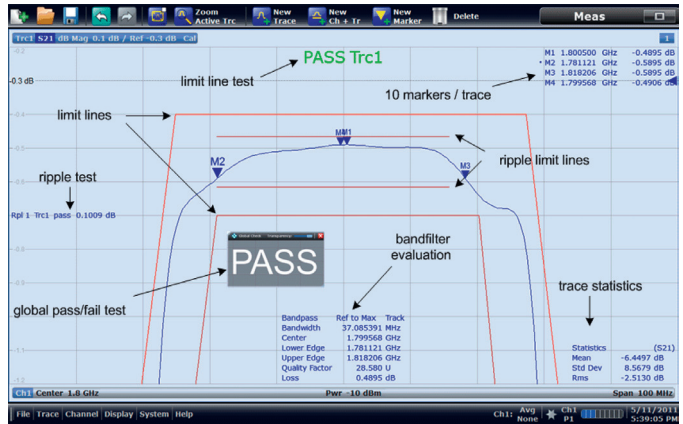

Wide range of analysis functions, e.g. for filter adjustment.

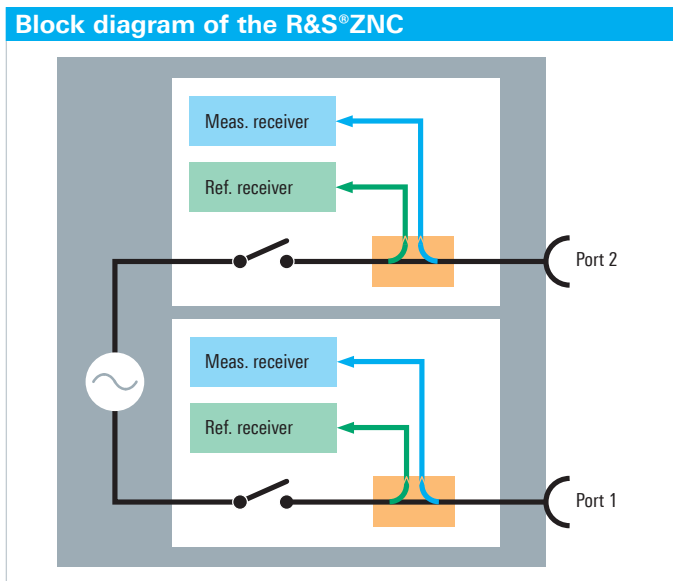

Typical effective system data of the R&S®ZNC		
	9 kHz to 100 kHz	100 kHz to 3 GHz
Directivity	46	45
Source match	41	40
Load match	44	45
Reflection tracking	0.02	0.02
Transmission tracking	0.028	0.018

R&S®ZNC measurement speed	
Measurement time 201 points, 200 MHz span, 300 kHz measurement bandwidth with 900 MHz center frequency	< 8 ms
Measurement time per point 300 kHz measurement bandwidth, CW mode	< 4 μs
Time for measurement and data transfer 201 points, 800 MHz start frequency, 1 GHz stop frequency, 300 kHz measurement bandwidth	typ. 8 ms
Switching between channels Up to 2001 points	< 5 ms
Switching between instrument setups Up to 2001 points	< 5 ms

R&S®ZVA Vector Network Analyzer

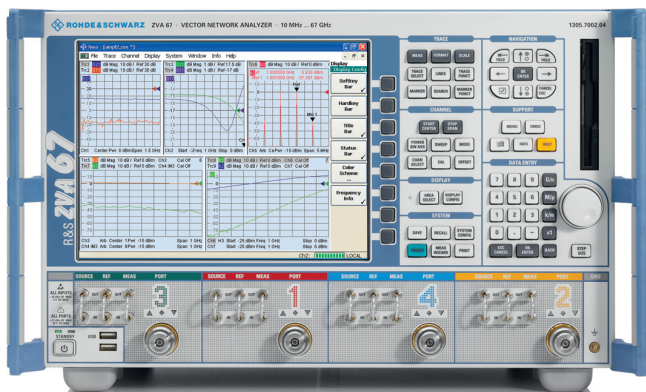

High-end VNA with up to four sources for sophisticated measurements up to 67 GHz

The R&S®ZVA series is an ideal choice for demanding measurements on active and passive components and modules, which require high performance and wide versatility. All instruments support scalar and vector measurements on mixers and converters (linear and nonlinear) and noise measurements on amplifiers as well as pulsed measurements for aerospace and defense applications. The frequency range of the high-frequency models can be extended to more than 0.3 THz.

- First VNA
 - With four internal sources up to 67 GHz for fast two-tone measurements on amplifiers and mixers
 - Up to 67 GHz and generating phase-coherent signals
 - With IF bandwidths up to 30 MHz for pulsed measurements on amplifiers and mixers
- Phase and group delay measurements of conversion loss on mixers with and without LO access
- Harmonic, compression, intermodulation and hot S_{22} measurements on amplifiers and mixers
- New method for noise figure definition without noise source
- Point-in-pulse, average pulse and pulse profile measurements
- Two internal pulse generators
- Internal pulse modulators and combiner by means of the R&S®ZVAX24
- Embedding/deembedding for impedance matching using virtual networks
- True differential measurements to characterize nonlinear effects of balanced devices
- Versatile calibration techniques: TOSM, TRL/LRL, TOM, TRM, TNA, UOSM and AutoCal

Specifications in brief

Number of test ports	2 or 4
Frequency range	
R&S®ZVA8	300 kHz to 8 GHz
R&S®ZVA24/40/50/67	10 MHz to 24/40/50/67 (70) GHz
Measurement time per test point	< 3.5 μ s
Measurement time, 201 test points	4.7 ms
Data transfer time, 201 test points	
Via IEC/IEEE bus	< 2.9 ms
Via VX11 over 100 Mbit/s LAN	< 1.3 ms
Via RSIB over 100 Mbit/s LAN	< 0.7 ms
Switching time	
Between channels	< 1 ms
Between instrument setups	< 10 ms
Max. dynamic range at 10 Hz measurement bandwidth	
Between test ports	
R&S®ZVA8	130 dB, typ. > 140 dB
R&S®ZVA24	130 dB, typ. > 135 dB
R&S®ZVA40	130 dB, typ. > 140 dB
R&S®ZVA50	130 dB, typ. > 140 dB
R&S®ZVA67	125 dB, typ. > 135 dB
With direct receiver access	
R&S®ZVA8	typ. > 150 dB
R&S®ZVA24	typ. > 150 dB
R&S®ZVA40	typ. > 150 dB
R&S®ZVA50	typ. > 150 dB
R&S®ZVA67	typ. > 145 dB
Output power at test port	
R&S®ZVA8	> 13 dBm, typ. 15 dBm
R&S®ZVA24	> 13 dBm, typ. 18 dBm
R&S®ZVA40	> 13 dBm, typ. 18 dBm
R&S®ZVA50	> 13 dBm, typ. 18 dBm
R&S®ZVA67	> 13 dBm, typ. 18 dBm
Power sweep range	> 40 dB, typ. 50 dB
IF bandwidths	1 Hz to 30 MHz
Channels, diagrams, traces	> 100
Test points per trace	1 to 60001
Operating system	Windows XP Embedded

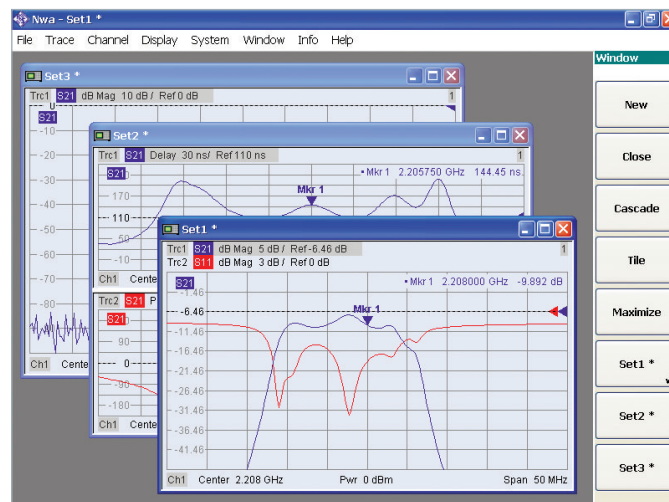

Switching between setups at the click of a mouse.

R&S®ZVT Multiport Vector Network Analyzer



Network analysis with up to eight test ports from 300 kHz to 20 GHz

The R&S®ZVT8 contains up to four internal generators and up to 16 receivers. The R&S®ZVT20 includes up to three internal generators and up to 12 receivers. This unique concept with one generator per two test ports makes the R&S®ZVT ideal for intermodulation measurements, even on mixers, (true) differential balanced measurements, multi-receiver measurements with antennas or high throughput and efficiency in production.

Hardware options such as direct generator/receiver access for the individual ports enable versatile test set configuration. Based on this concept, the R&S®ZVT multiport vector network analyzers provide solutions for even the most demanding measurement tasks.

The R&S®ZVT provides all functions of the R&S®ZVA, plus features based on multichannel and multi-receiver capability

- ▀ Arbitrary frequency conversion measurements
- ▀ Multiport measurements, avoiding any time loss due to matrix control
- ▀ Flexible configuration of test ports for balanced and single-ended measurements
- ▀ True differential measurements, coherence mode
- ▀ Multiple-signal measurements, e.g. intermodulation measurements on mixers or double-converting DUTs, requiring only a single unit and extremely short run times
- ▀ Enhanced performance by parallel measurements on several DUTs
- ▀ Multichannel receiver with simultaneous sampling of channels, e.g. for phase measurements on antenna arrays
- ▀ Automatic calibration units
- ▀ Point-in-pulse and pulse profile measurements with up to 16 receivers

R&S®ZVT with direct generator/receiver access

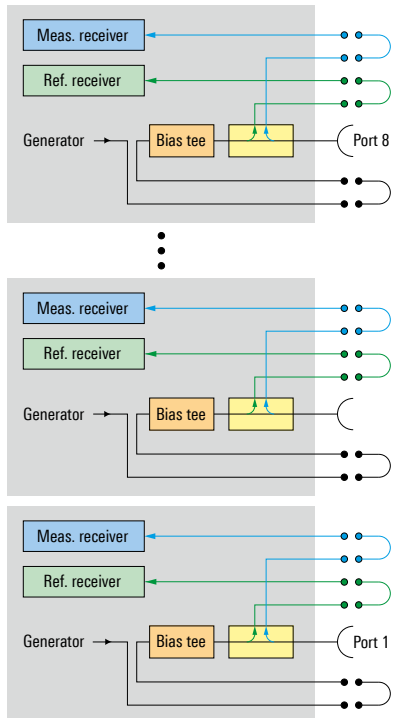

Specifications in brief

	R&S®ZVT8	R&S®ZVT20
Number of test ports ¹⁾	2 to 8	2 to 6
Frequency range	300 kHz to 8 GHz	10 MHz to 20 GHz
Measurement time (201 points)	5 ms	
Data transfer time (201 points)		
Via IEC/IEEE bus	< 2.9 ms	
Via VX11 (100 Mbit/s LAN)	< 1.3 ms	
Via RSIB (100 Mbit/s LAN)	< 0.7 ms	
Switching time		
Between channels	< 1 ms	
Between instrument setups of up to 2001 points	< 10 ms	
Electronic power sweep range	> 50 dB	> 40 dB
Dynamic range (at test ports)	120 dB	
Output level	+13 dBm	+10 dBm
Sensitivity at 10 Hz measurement bandwidth	-110 dBm	-105 dBm
IF bandwidths	1 Hz to 1 MHz ²⁾	
Number of channels and traces	> 100 ³⁾	
Number of points per trace	60001	
Operating system	Windows XP Embedded	

¹⁾ Depending on installed options.

²⁾ With options up to 30 MHz.

³⁾ Limited by available RAM capacity.

R&S®ZVB Vector Network Analyzer



High measurement speed up to 20 GHz with two or four test ports

The R&S®ZVB combines excellent performance with low weight and compact design. Intelligent and user-friendly functions offer maximum ease of operation. They allow the large number of measured quantities involved in multipoint and balanced measurements to be handled easily, and also offer a variety of ways to optimize production sequences – a smart solution that satisfies even the most challenging demands.

High-speed parallel measurements can be performed because the generator signal can be output to multiple test ports simultaneously, plus data can be captured at multiple ports simultaneously and all displayed at the same time. For example, the R&S®ZVB four-port version makes it possible to measure two two-port DUTs simultaneously, which doubles performance.

It is also possible to measure and display the four reflection parameters S_{11} to S_{44} simultaneously on a four-port DUT (provided that DUT ports are uncoupled). This reduces measurement time by a factor of 4 compared with instruments featuring just one generator and a conventional switching technique.

- Multipoint measurements
- Balanced measurements
- Mixer and harmonics measurements
- Response power calibration and power measurements
- Filter measurements and adjustments
- Measurements on active components
- Integrated embedding/deembedding function
- Integrated PC with Windows XP for automated procedures and data management
- Optimization of test and production sequences

Specifications in brief

Frequency range (R&S®ZVB4/8)	300 kHz to 4 GHz/8 GHz
Frequency range (R&S®ZVB14/20)	10 MHz to 14 GHz/20 GHz
Measurement time per point (CW mode, at 500 kHz IF bandwidth)	< 4.5 μ s
Measurement time (including any data transfer time) ¹⁾	< 4.5 ms
Data transfer time	data transfer simultaneous with measurement
Dynamic range (at 10 Hz IF bandwidth)	> 123 dB
Inherent noise	< -110 dBm
Power sweep range ²⁾	-40 dBm to +13 dBm
IF bandwidths	1 Hz to 500 kHz
Number of measurement points per trace	1 to 60 001
Number of test ports	2 or 4
Number of measurement and reference receivers	one measurement and one reference receiver per test port
Number of integrated generators	one generator per test port pair
Calibration techniques	TOSM, UOSM, TRL/LRL, TOM, TRM, TNA, automatic calibration unit
Operating system and internal PC	Windows XP
Number of traces, diagrams, independent channels, setups that can be simultaneously loaded into RAM	> 100 ³⁾ , traces can be assigned to diagrams as required

¹⁾ Specification valid for 201 measurement points, 500 kHz measurement bandwidth, display OFF, ALC OFF, at 5 GHz, narrow span.

²⁾ Power level that can be electronically swept.

³⁾ Number limited only by internal memory.

R&S®ZVL Vector Network Analyzer



The cost-efficient compact class in network analysis

- Network analyzer, spectrum analyzer and power meter in a single box
- Digital communications standards
- Bidirectional test set for displaying all four S-parameters
- R&S®ZVL3-75: 75 Ω vector network analyzer for TV and CATV measurements
- Multitrace display for displaying all relevant parameters
- Distance-to-fault measurement for detecting cable faults
- Time domain analysis
- Operation with mouse or hardkeys/softkeys; convenient user interface with wizards and context menus
- Undo/Redo softkey for reversing up to six preceding operating steps
- USB connector for R&S®NRP-Zxx power sensors for precise power measurements
- DVI-D connector for external monitor
- Internal battery and 12 V DC operation
- Small, compact, lightweight and portable (< 7 kg)

Specifications in brief

Frequency range	
R&S®ZVL3/6/13, specified	9 kHz to 3 GHz/6 GHz/13.6 GHz
R&S®ZVL3/6/13, unspecified	5 kHz to 3 GHz/6 GHz/15 GHz
Network analysis	
Measurement time (201 measurement points, full two-port-calibrated)	< 75 ms
Data transfer (201 measurement points)	1.5 ms (via RSIB over 100 Mbit/s LAN)
Dynamic range at 10 Hz measurement bandwidth	> 115 dB, typ. 123 dB
Output power	> 0 dBm, typ. +10 dBm
Measurement bandwidths	10 Hz to 500 kHz in 1/2/5 steps
Weight (without battery)	< 7 kg (15.43 lb)
Channels, diagrams and traces	> 100
Measurement points per trace	2 to 4001
Operating system	Windows XP
Spectrum analysis	
Resolution bandwidths	
Standard	300 Hz to 10 MHz in 1/3 steps, 20 MHz at zero span
With R&S®FSL-B7 option	(1 Hz) 10 Hz to 10 MHz in 1/3 steps
Video bandwidths	10 Hz to 10 MHz
I/Q demodulation bandwidth	20 MHz
SSB phase noise at 500 MHz	typ. -103 dBc (1 Hz), 10 kHz carrier offset
Displayed average noise level	
Without preamplifier at 1 GHz	< -140 dBm (1 Hz)
With preamplifier at 1 GHz	< -156 dBm (1 Hz), typ. -163 dBm
TOI	> +5 dBm, typ. +12 dBm
Detectors	Max/Min Peak, Auto Peak, RMS, Quasi Peak, Average, Sample
Level measurement uncertainty (95% confidence level)	< 0.5 dB

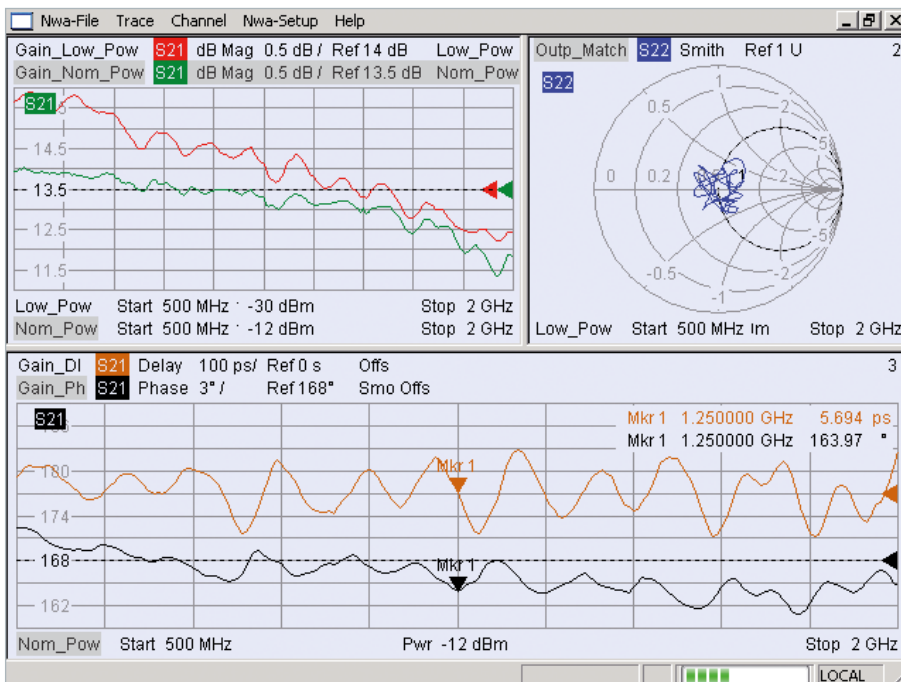

Multitrace display for faster DUT characterization.

R&S®ZVA-Zxx Millimeter-Wave Converters



Network analysis up to 500 GHz

Featuring a wide dynamic range, the Rohde & Schwarz converters offer high operating convenience and allow fast measurements.

Two-port measurements can be performed using a four-port network analyzer and two converters; no external generator is required. When using a two-port network analyzer, an external generator is needed to supply the LO signals.

The wide dynamic range is particularly important for high-blocking filters, for example, but it also speeds up measurements in general, as it enables the use of wider bandwidths while maintaining the same excellent performance.

- ▮ Variable output power
- ▮ Electronic power control (R&S®ZVA-Z90E, R&S®ZVA-Z110E)
- ▮ Automatic parameter setting
- ▮ Convenient handling
- ▮ Multipoint and true differential measurements
- ▮ Pulsed measurements
- ▮ Calibration
- ▮ Applications
 - On-wafer measurements
 - True differential measurements

Specifications in brief					
	R&S®ZVA-Z75	R&S®ZVA-Z90E	R&S®ZVA-Z110	R&S®ZVA-Z110E	R&S®ZVA-Z140
Waveguide designation					
Electronic Industries Alliance (EIA)	WR15	WR12	WR10	WR10	WR08
Connector type					
Anti-cocking flange	precision waveguide flange compatible with UG387/U-M				
Frequency range	50 GHz to 75 GHz	60 GHz to 90 GHz	75 GHz to 110 GHz	75 GHz to 110 GHz	90 GHz to 140 GHz
Output power					
	at +7 dBm input power from the R&S®ZVA/R&S®ZVT				
	+4 dBm	+2 dBm	+3 dBm	+1 dBm	typ. +2 dBm
Output power attenuation	manually adjustable by variable attenuator	electronic power control	manually adjustable by variable attenuator	electronic power control	manually adjustable by variable attenuator
Range	0 dB to 25 dB	0 dB to 20 dB	0 dB to 25 dB	0 dB to 25 dB	0 dB to 20 dB
Dynamic range	> 90 dB, typ. > 110 dB	> 90 dB, typ. > 110 dB	> 95 dB, typ. > 110 dB	> 95 dB, typ. > 110 dB	> 85 dB, typ. > 100 dB
Specifications in brief					
	R&S®ZVA-Z170	R&S®ZVA-Z220	R&S®ZVA-Z325	R&S®ZVA-Z500	
Waveguide designation					
Electronic Industries Alliance (EIA)	WR06	WR05	WR03	WR02	
Connector type					
Anti-cocking flange	precision waveguide flange compatible with UG387/U-M				
Frequency range	110 GHz to 170 GHz	140 GHz to 220 GHz	220 GHz to 325 GHz	325 GHz to 500 GHz	
Output power					
	at +7 dBm input power from the R&S®ZVA/R&S®ZVT				
	typ. -5 dBm	typ. -12 dBm	typ. -17 dBm	typ. -24 dBm	
Output power attenuation	manually adjustable by variable attenuator	manually adjustable by variable attenuator	manually adjustable by variable attenuator	manually adjustable by variable attenuator	
Range	0 dB to 25 dB	0 dB to 20 dB	0 dB to 20 dB	0 dB to 20 dB	
Dynamic range	> 75 dB, typ. > 90 dB	> 75 dB, typ. > 90 dB	> 60 dB, typ. > 70 dB	> 50 dB, typ. > 65 dB	

Accessories for network analysis

R&S®ZVAX24 Extension Unit



Measurements on active devices made easy
 The R&S®ZVAX24 extension unit for the R&S®ZVA simplifies harmonic, intermodulation, high-power and pulsed measurements on active devices such as amplifiers. Depending on the measurement tasks, it can be configured with combiners, harmonic filters, pulse modulators or high-power couplers.

It is directly controlled by the R&S®ZVA via a graphical user interface. The combination of an R&S®ZVA and the R&S®ZVAX24 behaves like a fully integrated single box. However, if multiple R&S®ZVA analyzers are being used in a lab, they can share the extension unit. This helps ensure optimum investment utilization.

R&S®ZV-Z81/-Z82 Switch Matrix



Two or four VNA ports, up to 16 test ports

- ▮ Frequency range: 50 MHz to 24 GHz
- ▮ Impedance: 50 Ω
- ▮ Port connector: type K (2.92 mm), female
- ▮ Damage level: +23 dBm
- ▮ Damage DC voltage: 12 V
- ▮ Isolation
 - 50 MHz to 8 GHz: > 90 dB
 - 8 GHz to 24 GHz: > 80 dB

- ▮ Switching time
 - USB: 10 ms, nominal
 - LAN: 12 ms, nominal
 - RS-232-C: 8 ms, nominal
- ▮ Remote control: USB, LAN, RS-232-C

R&S®ZV-WRxx Manual Waveguide Calibration Kits

Designation

- ▮ Calibration kit WR02
- ▮ Calibration kit WR03
- ▮ Calibration kit WR05
- ▮ Calibration kit WR06
- ▮ Calibration kit WR08
- ▮ Calibration kit WR10
- ▮ Calibration kit WR12
- ▮ Calibration kit WR15

Type (models with/without sliding match)

- ▮ R&S®ZV-WR02
- ▮ R&S®ZV-WR03
- ▮ R&S®ZV-WR05
- ▮ R&S®ZV-WR06
- ▮ R&S®ZV-WR08
- ▮ R&S®ZV-WR10
- ▮ R&S®ZV-WR12
- ▮ R&S®ZV-WR15

Frequency range

- ▮ 325 GHz to 500 GHz
- ▮ 220 GHz to 325 GHz
- ▮ 140 GHz to 220 GHz
- ▮ 110 GHz to 170 GHz
- ▮ 90 GHz to 140 GHz
- ▮ 75 GHz to 110 GHz
- ▮ 60 GHz to 90 GHz
- ▮ 50 GHz to 75 GHz

Accessories for network analysis

R&S®ZCAN/ZV-Z121/-Z132/-Z2xx Manual Calibration Kits (coaxial)

**Type, connector**

- R&S®ZCAN, type N, 75 Ω
- R&S®ZCAN, type N, 50 Ω
- R&S®ZV-Z121, type N, male/female
- R&S®ZV-Z270, 3.5 mm, male/female
- R&S®ZV-Z132, 3.5 mm, male/female
- R&S®ZV-Z235, 3.5 mm
- R&S®ZV-Z229, 2.92 mm, male/female
- R&S®ZV-Z224, 2.4 mm, male/female
- R&S®ZV-Z218, 1.85 mm, male/female
- R&S®ZV-Z210, 1 mm, male/female

Description

- TOSM, 3 GHz
- TOSM, 3 GHz
- Combination, 8 GHz
- TOSM, fixed matches, 18 GHz
- Combination, 13 GHz
- TOSM, fixed matches, 26 GHz
- TOSM, fixed matches, 40 GHz
- TOSM, fixed matches, 50 GHz
- TOSM, fixed matches, 67 GHz
- TOSM, fixed matches, 110 GHz

R&S®ZV-Z5x Automatic Calibration Units

**Type, connector**

- R&S®ZV-Z53, N female
- R&S®ZV-Z53, N female
- R&S®ZV-Z51, N female
- R&S®ZV-Z58, N female
- R&S®ZV-Z53, 3.5 mm female
- R&S®ZV-Z51, 3.5 mm female
- R&S®ZV-Z52, 3.5 mm female
- R&S®ZV-Z58, 3.5 mm female
- R&S®ZV-Z59, 3.5 mm female
- R&S®ZV-Z54, 2.92 mm female
- R&S®ZV-Z55, 2.4 mm female

Frequency range, ports

- 300 kHz to 3 GHz, 2 ports, 75 Ω
- 300 kHz to 18 GHz, 2 ports, 50 Ω
- 300 kHz to 8 GHz, 4 ports
- 300 kHz to 8 GHz, 8 ports
- 300 kHz to 24 GHz, 2 ports
- 300 kHz to 8 GHz, 4 ports
- 10 MHz to 24 GHz, 4 ports
- 300 kHz to 8 GHz, 8 ports
- 10 MHz to 20 GHz, 6 ports
- 10 MHz to 40 GHz, 2 ports
- 10 MHz to 50 GHz, 2 ports

Chapter 7

Drive Test Tools

The number of mobile networks and new technologies are steadily increasing. Rohde & Schwarz drive test systems are available in various designs that are always tailored to meet your specific needs and optimize your benefits.



Type	Designation	Description	Page
Hardware			
R&S®TSMW	Universal Radio Network Analyzer	Scanner for drive tests and I/Q streaming	97
R&S®TSMQ	Radio Network Analyzer	Just one drive test covers all standards	97
R&S®TSMU	Radio Network Analyzer	Flexible drive test solution	97
R&S®TSML	Radio Network Analyzer	Technology-specific drive test solution	97
R&S®TSMX-PPS	GPS Module	GPS receiver module with PPS output	98
Software			
R&S®ROMES4	Drive Test Software	Mobile coverage and QoS measurements in wireless communications	99
R&S®ROMES4NPA	Network Problem Analyzer	Advanced network problem analysis	100
R&S®ROMES2GO	3GPP Walk Test Solution	QoS assurance made simple	101
Systems			
R&S®TS51GA30	Coverage Suitcase System	Compact case system for outdoor measurements	101
R&S®TS9955	High-Performance Drive Test System	Drive test platform for accurate and fast coverage measurements in mobile radio and broadcasting networks	102
R&S®TSMU-Z3	Coverage Backpack	Lightweight backpack solution for indoor and outdoor coverage measurements	103

R&S®TSMW Universal Radio Network Analyzer



Scanner for drive tests and I/Q streaming

The R&S®TSMW universal radio network analyzer is a high-end platform for optimizing all conventional mobile radio networks. Two highly sensitive frontends for any input frequency from 30 MHz to 6 GHz, a preselection and a software-defined architecture offer unsurpassed perfor-

mance while providing maximum flexibility and operational readiness. In addition to functioning as a scanner for wireless communications networks, the R&S®TSMW is also an ideal digital I/Q baseband receiver for customer-specific applications.

- User-definable input frequency range from 30 MHz to 6 GHz
- Two independent RF and signal processing paths, each with a bandwidth of 20 MHz
- Integrated preselection for high intermodulation suppression with wide dynamic range
- Support of LTE FDD and TD-LTE measurements together with the R&S®ROMES drive test software
- Parallel measurements in GSM, WCDMA, CDMA2000® 1xEV-DO, WiMAX™, TETRA and LTE (FDD and TD-LTE) networks in all bands
- I/Q baseband streaming to a state-of-the-art PC or the R&S®IQR I/Q data recorder
- Integrated GPS

R&S®TSMx Radio Network Analyzers



Simultaneous or single measurement possible.

Powerful scanner family for mobile applications

The R&S®TSML, R&S®TSMU and R&S®TSMQ form a family of radio network analyzers with scanner functionality. Their compact size and low power consumption make them ideal for mobile applications. Even a fully equipped backpack solution can easily be implemented in order to perform indoor measurements, for example.

When combined with the R&S®ROMES4 drive test software, the scanners provide their full-range functionality and maximum performance. Interference measurements, automatic neighborhood measurements or fast spectrum measurements can be performed in virtually no time. The software has been designed for multicore CPUs to enable simultaneous multiple measurements.

- No band limiting – support of all frequencies from 80 MHz to 3 GHz or 6 GHz (R&S®TSML-CW)
- Decoding of all broadcast information
- Small weight and low power consumption
- Suitable for GSM, WCDMA, CDMA2000® 1xEV-DO, spectrum, CW
- High measurement speed in all technologies

Device	GSM	WCDMA	CDMA2000® 1xEV-DO	CW
R&S®TSML-G	•	–	–	–
R&S®TSML-W	–	•	–	–
R&S®TSML-C	–	–	•	–
R&S®TSML-CW	–	–	–	•
R&S®TSML-GW	•	•	–	–
R&S®TSMU	•	•	•	•
R&S®TSMQ	•	•	•	•

R&S®TSMX-PPS GPS Module



GPS receiver module with PPS output

- SuperSense GPS receiver
- Pulses per second (PPS) output
- 16 channels
- 4 Hz activation interval
- Compact, light and versatile

High sensitivity

- Suitable for use in buildings
- High accuracy

PPS output

- Precise synchronization of an R&S®TSMx scanner

Fast update rate

- Local resolution higher than with conventional GPS receivers

Supported instruments

The R&S®TSMX-PPS with PPS pulses can be used in combination with one of the following instruments:

- R&S®TSMQ
- R&S®TSML-C
- R&S®TSML-G
- R&S®TSML-W
- R&S®TSML-GW
- R&S®TSML-CW
- R&S®TSMU

R&S®ROMES4 Drive Test Software

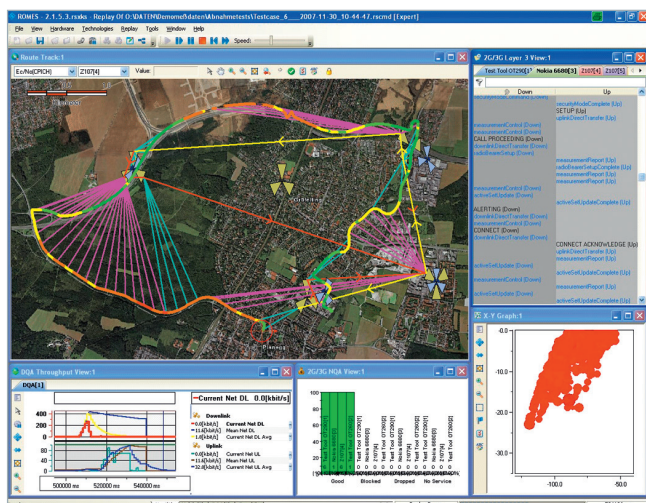

Mobile coverage and QoS measurements

R&S®ROMES4 is a test platform for mobile measurements in all modern radio networks. In combination with scanners and test mobile phones, it forms a complete system for coverage and quality of service (QoS) measurements. Besides pure recording and visualization of test parameters, data is processed instantly and statistics are calculated in realtime.

Currently, the following technologies are supported: GSM/EDGE, WCDMA/HSPA+, CDMA2000® 1xEV-DO Rev. A, WLAN (IEEE 802.11b, g), WiMAX™ (IEEE 802.16e), TETRA, LTE, DVB-T and DVB-H. Standard-compliant RF level measurements can be time- and route-triggered over a very wide frequency range (9 kHz to 7 GHz).

- One software solution for all technologies: “all under one roof”
- Flexible handling of licenses reduces startup costs
- Parallel measurements with up to 12 mobile phones per software license; this saves time, allowing existing resources to be utilized more effectively: reduction of operating expenses (OPEX)
- Use of highly accurate, fast RF test and measurement equipment (Rohde & Schwarz scanners): many reliable measured values and results
- Automatic evaluation after completion of measurement by means of the integrated replay function or R&S®ROMES4NPA network problem analyzer, which considerably reduces OPEX
- Automatic identification of GSM interferences: considerable OPEX reduction
- Unique scanner support for six technologies (GSM, WCDMA, CDMA2000® 1xEV-DO, WiMAX™, LTE and TETRA)

R&S®ROMES4NPA Network Problem Analyzer

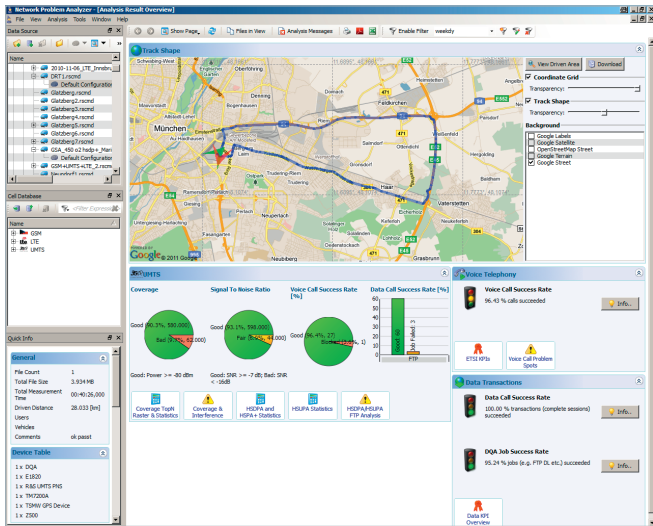

Advanced network problem analysis

The sheer volume of recorded data makes individual and manual analysis of drive test data impossible. The data is therefore analyzed by R&S®ROMES4NPA, which then outputs a list of all detected trouble spots and displays them on a map using Google Maps or OpenStreetMap. Maps loaded earlier are available offline from the hard disk. In addition, R&S®ROMES4NPA indicates the cause of the problem.

The easy-to-use interface guides the user through the process, from reading in the measured data (from one or more drive tests) and selecting the analysis criteria to retrieving the automatically generated list of trouble spots. This list can be processed in different ways:

- Right-clicking a problem automatically opens R&S®ROMES4 and positions the replay of the measurement file just ahead of the trouble spot in question so that the user can perform a detailed check if required
- Automatic generation of an HTML report that provides a clear overview of the result and that can be printed
- Export to Excel with customizing of report

The measurement data is analyzed according to specific criteria that depend on the selected modules. In all modules, the analysis criteria can be adapted to user-specific limit values and settings.

The following modules are available:

- R&S®ROMES4N11: NQA for GSM/WCDMA/TETRA voice call and problem spot detection. Analysis of voice calls for network problems, which can be selected from more than 140 different problem categories; listing of the problem spots together with type and cause of problem
- R&S®ROMES4N20: data module for EDGE, HSPA+ and LTE including problem spot detection. Specific analysis of high-speed data links for achievable data rates and analysis of possible problems as well as IP data analyzer for analyzing IP-based data traffic and associated problems
- R&S®ROMES4N15: coverage module with display of coverage data on a raster map. Coverage data (GSM, WCDMA, CDMA2000® 1xEV-DO, TETRA, LTE) measured with the Rohde&Schwarz scanners is rasterized and displayed on the map. This makes the generation of coverage plots easy. Likewise, optimizations can be checked by means of a before-and-after comparison
- R&S®ROMES4N17: neighborhood analyzer module for automatically allocating neighborhoods to one of the following categories:

- (Potentially) missing neighbor: A cell has been measured with high power level and good quality (both thresholds can be adjusted), but is not included in the currently defined neighborhood list
- Unused neighbor: A cell is configured as neighbor, but has not been detected during measurement
- Confirmed neighbor: A cell has been classified as (potentially) missing neighbor and is included in the neighborhood list

Advanced filtering options enable the user to quickly analyze the log files in detail, make comparisons (e.g. different providers in the same area, same provider at different times or weekdays) and draw conclusions.

R&S®ROMES4NPA considerably helps to save time and reduce costs by automatically analyzing the measured data. Optimizing the results no longer requires time-consuming, manual checking and analysis of data that may not even contain any problems.

Its sophisticated algorithms make R&S®ROMES4NPA a very effective tool for finding the causes of existing problems. More in-depth analyses can be performed at any time.

A large amount of measured data can be automatically processed in minimum time and on an identical basis; reports – for management and for general documentation – are generated without the user having to take action.

R&S®ROMES2GO 3GPP Walk Test Solution



QoS assurance made simple

The R&S®ROMES2GO autonomous walk test solution records and stores quality of service (QoS) and performance data in 3GPP mobile radio networks. The measurement results are displayed both alphanumerically and graphically. All of them, including past error events such as dropped calls, are saved to the memory card in the test mobile phone.

The scanner mode provides a quick overview of network activities. The results are based on the Nokia C5 mobile phone.

- ▀ Autonomous 3GPP walk test solution for indoor and outdoor applications
- ▀ Use of indoor floor plans for walk tests
- ▀ With external (Bluetooth®) or built-in GPS
- ▀ Low investment costs (CAPEX); additional control software for standard test mobile phones
- ▀ Easy operation (measurement ON, measurement OFF)
- ▀ Available in different languages: German, English, Spanish, Chinese
- ▀ Flexible handling of task files (GSM, GPRS, EDGE, WCDMA, HSDPA, HSUPA and scanning)
- ▀ Storage of measurement data on the test mobile phone as well as data transmission to an FTP server or via USB
- ▀ Tooltips inform the user about the most important parameters
- ▀ Measurement files can be downloaded and converted to the *.rscmd R&S®ROMES data format for further evaluation using the R&S®ROMES replay function
- ▀ Files can be analyzed by means of compatible planning and analysis programs

R&S®TS51GA30 Coverage Suitcase System



Compact case system for outdoor measurements

The R&S®TS51GA30 coverage suitcase system integrates the latest drive test technology in a compact, portable suitcase. Four test mobile phones allow measurements using different standards at the same time so that measurements can be carried out on several networks simultaneously. This solution is ideal for portable coverage measurements and offers maximum flexibility.

- ▀ High-end R&S®TSMx radio network analyzer
- ▀ Up to four mobile phones
- ▀ Supported mobile phones (Nokia, Qualcomm)
- ▀ GPS receiver with PPS output
- ▀ High-performance notebook with Windows XP and R&S®ROMES software
- ▀ Battery buffer for the R&S®TSMx
- ▀ Ruggedized suitcase with connectors for external antennas and power supply

R&S®TS9955 High-Performance Drive Test System



Drive test platform for accurate and fast coverage measurements in mobile radio and broadcasting networks

The R&S®TS9955 provides high-performance measurement data needed for the planning, installation, optimization and quality monitoring of radio networks. This custom-designed system supports high-precision, fast field strength measurements.

In the appropriate configuration, the drive test system can deliver immediate results from comprehensive realtime interference analysis. Further time-consuming post-processing is not required. This is a unique system design offered only by Rohde&Schwarz.

- Extremely flexible system concept for perfectly customized solution
- Numerous types of high-quality Rohde&Schwarz receivers available for various applications, including
 - CW measurements from 9 kHz to 7 GHz
 - GSM, GPRS, EDGE, WCDMA, CDMA2000® 1xEV-DO, WiMAX™, LTE, TETRA
 - EMC
- Easy means of competitive analysis (benchmarking), e.g. for four or more network operators in one drive
- Measurements in accordance with the Lee criterion (distance-triggered)
- Quality of service (QoS) measurement
- Interference and pilot pollution analysis
- Realtime handover analysis
- Missing neighbor analysis
- Channel impulse response analysis

R&S®TSMU-Z3 Coverage Backpack



Lightweight backpack solution for indoor and outdoor coverage measurements

The R&S®TSMU-Z3 coverage backpack is a compact, lightweight solution for GSM, WCDMA, CDMA2000® 1xEV-DO and CW parameter- and network-specific quality measurements. The R&S®TSMU-Z3 is ideal for portable indoor and outdoor coverage measurements (e.g. in shopping malls, railway stations, airports and pedestrian zones).

- Up to two mobile phones
- Supported mobile phones (Nokia, Qualcomm)
- Portable size: 43 cm × 30 cm × 12 cm (16.93 in × 11.81 in × 4.72 in)
- Backpack > 6 kg (13.2 lb, including battery pack)
- Approximately 4 h continuous operation with battery pack
- Spare battery pack
- AC charger included

Chapter 8

EMC and Field Strength Test Solutions

EMI and EMS test equipment and systems from Rohde & Schwarz determine the causes and effects of electromagnetic interference. Decades of experience in the field of EMC measurements has made us the world market leader.



Type	Designation	Description	Page
EMI precompliance/compliance			
R&S®ESU	EMI Test Receiver, 20 Hz to 8/26.5/40 GHz	Maximum-precision, standard-compliant EMI measurements at high speed	110
R&S®ESCI	EMI Test Receiver, 9 kHz to 3/7 GHz	For compliance tests meeting all commercial standards	111
R&S®ESPI	Test Receiver, 9 kHz to 3/7 GHz	The reference in the EMI precompliance class	112
R&S®ESL	EMI Test Receiver, 9 kHz to 3/6 GHz	The EMC expert for every lab bench	113
R&S®TS9975	EMI Test System	Tests in line with commercial, wireless, automotive and MIL standards	114
EMS measurements			
R&S®TS9980	EMS Test System for Audio and Video and TV Monitoring	EMS measurements on sound and TV broadcast receivers, satellite receivers and DVB receivers	115
R&S®TS9982	EMS Test System	Radiated and conducted EMS measurements in line with commercial, wireless, automotive and MIL standards	116
EMF measurements			
R&S®TS-EMF	Portable EMF Measurement System	Simple, frequency-selective measurement of EMF emissions	117
R&S®EMF-M	EMF Monitor Station	Autonomous test station for automated EMF long-term measurements	118
EMC software			
R&S®ES-SCAN	EMI Measurement Software	User-friendly software for EMI measurements	119
R&S®EMC32	EMC Measurement Software Platform	For use in development, for compliance and batch testing	120

Type	Designation	Description	Page
Broadband amplifiers			
R&S®BBA100	Broadband Amplifier	Family of modular, flexible, state-of-the-art broadband amplifiers	122
RF test chamber			
R&S®R-Line	Compact Test Chamber	Measurement accuracy as high as that of an anechoic chamber	123
EMC accessories			
Disturbance voltage measurements			
R&S®ENV216/4200, R&S®ESH2-Z5, R&S®ESH3-Z6		V-networks for EMC measurements on power supply networks	124
R&S®ENY21/ENY41/ENY81, R&S®ENY81-CA6		Coupling networks for EMC measurements on telecommunications ports	125
R&S®EZ-12, R&S®EZ-25		Antenna impedance converter, 150 kHz highpass filter	126
R&S®ESH2-Z2/-Z3, R&S®ESH2-Z31, R&S®ESH3-Z2		Voltage probes, attenuator, pulse limiter	126
Disturbance current measurements			
R&S®EZ-17, R&S®ESV-Z1		Current probes for disturbance current measurements on cables	127
Disturbance power measurements			
R&S®EZ-24, R&S®MDS-21		Absorbing clamps for EMC measurements on cables	128
Field strength measurements			
R&S®HZ-10, R&S®HZ-14/-15/-16		Pickup coil, E and H near-field probe sets	129
R&S®HFH2-Z2, R&S®HFH2-Z6, R&S®HZ-9		Loop antenna, rod antenna, power supply	130
R&S®HL033/HL040/HL046(E)/HL050/HL223		Log-periodic antennas	131
R&S®HM020, R&S®HK5000		Triple-loop antenna, EMS broadband dipole	132
R&S®HK116, R&S®HF907, R&S®HL562, R&S®HE202/HE302		Biconical antenna, double-ridged waveguide horn antenna, ULTRALOG, active receiving dipoles	133

Introduction

EMC = EMI + EMS

Electromagnetic compatibility (EMC) is the capability of an electrical device or system to operate in its electromagnetic environment without disturbing it or being disturbed by it. EMC is an important criterion of product quality. To ensure EMC of a product in the most economical way, appropriate measures should be taken early in the design phase. In line with the definition, EMC is subdivided into electromagnetic interference (EMI) and electromagnetic susceptibility (EMS). Legislation prescribes compliance with maximum values for EMI and minimum values for EMS. The applicable limits, the measurement methods and instruments to be employed are specified in the relevant standards.

Conformity mark

To show their conformity to the EMC requirements prescribed by law, all electrical devices have to be marked accordingly, e.g. by the CE conformity mark required in the entire European Economic Area.

EMI measurements

For measuring electromagnetic disturbance, the disturbance sink, which in the commercial sector is the radio listener or TV viewer, is replaced by the measuring instrument. As a result, all test receivers for commercial EMI measurements should have human-like response built in: They must have a quasi-peak-weighting detector to show the human perception of disturbance as a measured value. Disturbance measurements higher than 1 GHz use peak, CISPR-average and RMS-average weighting.

In the military sector, the disturbance sink is assumed to be a technical device that responds to the maximum disturbance level. Therefore, the peak level of disturbance is measured.

Disturbance is emitted by the equipment under test in various ways of coupling. Therefore, the EMC standards contain procedures for coupling the test receiver to the equipment under test, as well as for the environment of the EUT and its operation.

EMS measurements

For measuring electromagnetic susceptibility, the different disturbance sources occurring in practice are replaced by appropriate generators, the interfering signals of which are applied to the EUT via suitable coupling/decoupling networks.

For monitoring the proper functioning of the EUT, suitable monitoring equipment can be provided, which so far has not been defined in the relevant EMC standards. In many cases, highly shielded video cameras with a monitor are used for this purpose.

EMC measurement software

Reproducible EMC measurements are only possible if a number of rules and standards for the measuring instruments used and for the measurement methods adopted are complied with.

For computer-controlled EMC measurements, two different software tools are available: The R&S®ES-SCAN EMI diagnostics software is used to quickly and easily collect, evaluate and document RFI voltage, power and field strength data. The R&S®EMC32 software platform includes various modules for electromagnetic interference (EMI) and electromagnetic susceptibility (EMS) measurements. Due to its flexible structure the software can be optimally adapted to the requirements of almost any commercial or military EMC application.

These tools relieve the user of routine settings and offer every convenience from automatic consideration of frequency-dependent transducer factors of the coupling/decoupling networks, automatic selection of the applicable limit lines, display of the results in graphical or tabular form through to the generation of test reports. Similar convenience is provided by the automatic EMI test routines implemented in the test receivers of the R&S®ESU, R&S®ESCI, R&S®ESPI and R&S®ESL series. They allow fully automatic time-saving measurements without an external controller, so that very compact test setups can be implemented.

EMC test systems

Planning and implementation of practice-oriented EMC test systems requires a great deal of specialized knowledge and experience. This is what Rohde&Schwarz specialists have. All their expertise goes into turnkey EMC test systems, which are the fastest means for obtaining correct EMC measurements.

These systems are always tailored to the specific needs of the customer to provide the optimum solution to the tasks at hand. We can offer everything from small systems to complete test houses with shielded anechoic chamber and the required infrastructure, covering all major standards in the commercial, automotive, wireless and military range.

EMC standards in the European Economic Area

The number of standards published in the Official Journals are steadily increasing. The different types of standards include generic standards, which can be applied in all cases not covered by specific product or product family standards. The product (family) standards are divided into standards limiting low-frequency and high-frequency emission (radio disturbance suppression) and standards defining the requirements of immunity to electromagnetic emission. Besides, there is a series of specific product standards defining EMC requirements.

Generic standards – emission

- ▮ **EN 61000-6-3:** Residential, commercial and light industry environment
- ▮ **EN 61000-6-4:** Industrial environment

Generic standards – immunity

- ▮ **EN 61000-6-1:** Residential, commercial and light industry environment
- ▮ **EN 61000-6-2:** Industrial environment

Product family standards and product standards for low-frequency emission

- ▮ **EN 61000-3-2:** Limits for harmonic currents up to 16 A per phase
- ▮ **EN 61000-3-3:** Limits for voltage fluctuations and flicker up to 16 A per phase
- ▮ **EN 61000-3-11:** Limits for voltage fluctuations and flicker up to 75 A per phase
- ▮ **EN 61000-3-12:** Limits for harmonic currents up to 75 A per phase

Product family standards for high-frequency emission

- ▮ **EN 55011:** ISM equipment
- ▮ **EN 55012:** Automotive equipment – protection of off-board receivers
- ▮ **EN 55013:** Sound and TV broadcast receivers
- ▮ **EN 55014-1:** Household appliances and electric tools
- ▮ **EN 55015:** Lighting equipment
- ▮ **EN 55022:** Information technology equipment
- ▮ **EN 55025:** Automotive equipment – protection of on-board receivers
- ▮ **EN 55103-1:** Audio and video equipment for professional use

Product standards for immunity

- ▮ **EN 55014-2:** Household appliances, tools and similar apparatus
- ▮ **EN 61547:** Lighting equipment
- ▮ **EN 55020:** Sound and TV broadcast receivers
- ▮ **EN 55024:** Information technology equipment
- ▮ **EN 55103-2:** Audio and video equipment for professional use

Special standards for signal transmission in low-voltage installations

- ▮ **EN 50065-1:** Signaling on low-voltage electrical installations, Part 1: General requirements, frequency bands and electromagnetic disturbances
- ▮ **EN 50065-2-x:** Immunity

Product standards containing EMC requirements

- ▮ **EN 50083-2:** Cabled networks for TV and sound signals
- ▮ **EN 50090-2-2:** Electronic systems for home and buildings
- ▮ **EN 62040-2:** Uninterruptible power systems
- ▮ **EN 50130-4:** Alarm systems
- ▮ **EN 50148:** Electronic taximeters
- ▮ **EN 60974-10:** Arc welding equipment
- ▮ **EN 50263:** Measuring relays and protection equipment
- ▮ **EN 50270:** Gas sensors
- ▮ **EN 50293:** Road traffic signal systems
- ▮ **EN 50295, EN 60439-1, EN 60947-x-x:** Low-voltage switchgear and control gear
- ▮ **EN 50370-1, -2:** Machine tools
- ▮ **EN 60034-1:** Rotating electrical machines
- ▮ **EN 60204-31:** Sewing machines
- ▮ **EN 62052-x, EN 62053-x, EN 62054-x:** Several AC watt-hour meters, tariff and load control equipment
- ▮ **EN 60601-1-2:** Medical electrical equipment
- ▮ **EN 50428, EN 60669-2-x:** Switches for household and similar fixed electrical installations
- ▮ **EN 60730-x-x:** Automatic electric controls for household and similar use
- ▮ **EN 60870-2-1:** Telecontrol equipment and systems
- ▮ **EN 60945:** Maritime navigational equipment
- ▮ **EN 61008-1, EN 61009-1, EN 61543:** Residual current circuit breakers
- ▮ **EN 61037:** Electronic ripple control receivers for tariff and load control
- ▮ **EN 61204-3:** Low-voltage power supplies
- ▮ **EN 61131-2:** Programmable controllers
- ▮ **EN 61326-x:** Electrical equipment for measurement, control and laboratory use
- ▮ **EN 61800-3:** Adjustable speed electrical power drive systems
- ▮ **EN 61812-1:** Time relays for industrial and residential use
- ▮ **EN 617, EN 618, EN 619, EN 620:** Continuous handling equipment
- ▮ **EN 12015, EN 12016:** Elevators and escalators
- ▮ **EN 12895:** Industrial trucks
- ▮ **EN 13241:** Doors and gates
- ▮ **EN 13309:** Construction machinery with internal power supply
- ▮ **EN 14010:** Power driven parking equipment for vehicles
- ▮ **EN ISO 14982:** Agricultural and forestry machines

Group of equipment		Standards																				
Frequency range	Test receivers	Accessories and extras	International Europe and Germany	Japan	USA	Industrial, scientific and medical equipment	Vehicles with combustion engines, remote/built-in radio reception	Sound and TV broadcast receivers	Electrical devices, household appliances and tools	Fluorescent lamps and luminaires	Information technology and telecommunications equipment (ITE)	Military equipment and systems	Generic emission standards	Means signaling equipment	Cabled distribution systems TV/sound	Uninterruptible power systems (UPS)	Professional audio/video equipment	Electric railways	Medical electrical apparatus	Maritime navigation equipment	Low-voltage switchgear and control gear	
From 20 Hz	R&S®ESU	R&S®EZ-17 current probe R&S®HZ-10 H-field pickup coil																				
From 9 kHz	R&S®ESCI R&S®ESPI ¹⁾ R&S®ESU R&S®ESL ¹⁾	R&S®EZ-17 current probe R&S®EZ-25 150 kHz highpass R&S®HZ-10 H-field pickup coil R&S®HFU-Z tripod R&S®HFH2-Z2 loop antenna R&S®HZ-1 tripod R&S®HFH2-Z6 rod antenna R&S®ESH2-Z5 V-network R&S®ESH3-Z6 V-network R&S®ENV216 V-network R&S®ENV4200 V-network R&S®ENY21 coupling network R&S®ENY41 coupling network R&S®ENV81 coupling network R&S®ESH2-Z2 voltage probe R&S®ESH2-Z3 voltage probe R&S®EZ-12 antenna imp. converter R&S®HZ-14 probe set R&S®HM020 triple-loop antenna R&S®HZ-3/HZ-4 RF cable R&S®HZ-9 power supply																				
From 30 MHz	R&S®ESCI R&S®ESPI ¹⁾ R&S®ESU R&S®ESL ¹⁾	R&S®EZ-17 current probe R&S®ESV-Z1 current probe R&S®MDS-21 absorbing clamp R&S®HZ-14 probe set R&S®HZ-15 probe set R&S®HK116 biconical antenna R&S®HL223 log-periodic antenna R&S®HL562 ULTRALOG antenna R&S®HZ-1 tripod R&S®HFU2-Z4/-Z5 RF cable																				
From 1 GHz	R&S®ESCI R&S®ESPI ¹⁾ R&S®ESL ¹⁾ R&S®ESU	R&S®HL050, R&S®HF907 antennas Further antennas on request																				
From 3 GHz	R&S®ESCI7 R&S®ESL6 ¹⁾ R&S®ESPI7 R&S®ESU	R&S®HL050, R&S®HF907 antennas Further antennas on request																				
From 6 GHz	R&S®ESU	R&S®HL050, R&S®HF907 antennas Further antennas on request																				
From 18 GHz to 40 GHz	R&S®ESU40	Accessories Further antennas on request																				

R&S®ESU EMI Test Receiver



Maximum-precision, standard-compliant EMI measurements at unparalleled measurement speed

The R&S®ESU family of CISPR 16-1-1-compliant EMI test receivers meets all commercial and military standards for electromagnetic interference measurements. The R&S®ESU-K53 FFT-based time-domain scan option allows users to perform overview measurements up to 1000 times faster than with previous EMI test receivers. The R&S®ESU also features automatic and interactive measurement functions, parallel IF analysis and up to three detectors in parallel, including the average detector with meter time constant (CISPR-average), the new RMS-average detector and the amplitude probability distribution function (APD).

- ▀ Combination of standard-compliant EMI test receiver and high-end spectrum analyzer
- ▀ Excellent RF characteristics
- ▀ Very low measurement uncertainty
- ▀ Full compliance with CISPR 16-1-1 basic standard
- ▀ High-speed time-domain scan (FFT) option

- ▀ Receiver mode with parallel IF analysis
- ▀ All commercial and military standards met
- ▀ Internal preselection (can be switched off in analyzer mode)
- ▀ Integrated 20 dB preamplifier up to 3.6 GHz as standard
- ▀ Wide choice of detectors incl. CISPR-average and RMS-average
- ▀ CISPR- and MIL-STD-compliant measurement bandwidths
- ▀ User-programmable scan tables (max. 10 subranges)
- ▀ Frequency scan with max. three detectors in parallel (max. 2 million test points/trace)
- ▀ Second RF input (max. 1 GHz, pulse-protected)
- ▀ Time-domain analysis for evaluation of timing behavior of disturbances (e.g. click-rate analysis)
- ▀ Fully and partially automatic measurements (preview measurement, data reduction, final measurement)
- ▀ Automatic consideration of coupling devices such as line impedance stabilization networks, probes, cables and antennas using transducer factors and sets
- ▀ Simultaneous measurement of multiple traces for parallel evaluation
- ▀ Continuous bargraph display and marker functions for precise measurements
- ▀ Automatic disturbance voltage measurements using remote-controllable line impedance stabilization networks (LISN) from Rohde & Schwarz
- ▀ Predefined transducer factors
- ▀ Library of limit lines for commercial standards
- ▀ Integrated report generator
- ▀ Optional low-noise preamplifiers up to 8/26.5/40 GHz (R&S®ESU-B24)

Specifications in brief

	R&S®ESU8	R&S®ESU26	R&S®ESU40
Frequency			
Frequency range, RF input 1	20 Hz to 8 GHz	20 Hz to 26.5 GHz	20 Hz to 40 GHz
Frequency range, RF input 2	20 Hz to 1 GHz	20 Hz to 1 GHz	20 Hz to 1 GHz
Reference frequency	aging 1×10^{-7} /year, optionally 2×10^{-6} /year (R&S®FSU-B4)		
Spectral purity	< -128 dBc (1 Hz), typ. -133 dBc (1 Hz) at 10 kHz		
Preselection	12 preselection filters from 20 Hz to 3.6 GHz, can be switched off in analyzer mode		
Preamplifier (standard)	can be switched between preselection and 1st mixer, 20 dB gain, 1 kHz to 3.6 GHz frequency range		
Resolution bandwidth			
3 dB bandwidths	10 Hz to 10 MHz in steps of 1/2/3/5		
6 dB bandwidths (EMI)	10/100/200 Hz, 1/9/10/100/120 kHz, 1 MHz		
FFT filters (-3 dB, analyzer mode)	1 Hz to 30 kHz in 1/3 sequence		
Channel filters	44 bandwidths, 100 Hz to 5 MHz		
Detectors (receiver mode)	Max Peak, Min Peak, RMS, Average, Quasi Peak, CISPR-average, RMS-average		
Display range	DANL up to +30 dBm		
Intermodulation			
Third-order intercept (TOI), without preselection/preamplifier (< 3.6 GHz)	$> +17$ dBm	$> +17$ dBm	$> +17$ dBm
1 dB compression of input mixer (< 3.6 GHz)	+13 dBm, nominal		

R&S®ESCI EMI Test Receiver



For compliance tests meeting all commercial standards from 9 kHz to 3/7 GHz

The R&S®ESCI/ESCI7 EMI test receivers are standard-compliant measuring receivers for EMC certification measurements in line with commercial standards in the frequency range from 9 kHz to 3/7 GHz. The receivers conform to the latest version of the CISPR 16-1-1 basic standard. At the same time, they function as full-featured and powerful spectrum analyzers for lab applications.

- Combination of standard-compliant EMI test receiver and high-quality spectrum analyzer
- Integrated preselection with selectable 20 dB preamplifier
- Frequency range from 9 kHz to 3/7 GHz; usable for all commercial EMC standards
- Effective analysis of the disturbance spectrum through simultaneous graphical presentation of the disturbance level and emission spectrum around the receive frequency ("mixed-mode")
- Time-domain analysis for evaluation of timing behavior of disturbances (e.g. click-rate analysis)
- Automatic consideration of coupling devices such as line impedance stabilization networks, probes, cables and antennas using transducer factors and sets
- SCAN settings in tabular format (max. 10 subranges)
- Simultaneous measurement of multiple traces for parallel evaluation
- Fast, reliable measurements using automatic and interactive test routines
- Continuous bargraph display and marker functions for precise measurements
- Automatic disturbance voltage measurements using remote-controllable line impedance stabilization networks (LISN) from Rohde & Schwarz
- Predefined transducer factors
- Library of limit lines for commercial standards

Specifications in brief

Frequency

Frequency range	
R&S®ESCI	9 kHz to 3 GHz
R&S®ESCI7	9 kHz to 7 GHz
Frequency resolution	0.01 Hz
Frequency accuracy	
Standard	1×10^{-6}
With R&S®FSP-B4 (OCXO) option	1×10^{-7}
External reference frequency	10 MHz

Measurement time

Receiver mode/scan (per frequency step)	selectable from 33 μ s to 100 s
Analyzer mode/sweep time	selectable from 2.5 ms to 16000 s, zero span from 1 μ s to 16000 s

Resolution bandwidths

3 dB bandwidths	10 Hz to 3 MHz in steps of 1/3/10
6 dB bandwidths (EMI)	200 Hz, 9 kHz, 120 kHz (–6 dB), 1 MHz (impulse bandwidth)
Video bandwidth (analyzer mode)	1 Hz to 10 MHz in steps of 1/3/10
Preselection	can be turned off in analyzer mode
R&S®ESCI	11 fixed/continuously tunable filters up to 3 GHz
R&S®ESCI7	12 fixed/continuously tunable filters up to 7 GHz

Level

Max. RF level (CW), input attenuation ≥ 10 dB	137 dB μ V (= 1 W)
Max. pulse energy, input attenuation ≥ 10 dB	
R&S®ESCI	10 mWs (20 μ s)
R&S®ESCI7	1 mWs (10 μ s)
Max. pulse voltage, input attenuation ≥ 10 dB, 10 μ s	150 V
Preamplifier	can be switched on/off, 20 dB gain
Third-order intercept (TOI)	
Without preselection/preamplifier	
From 200 MHz to 3 GHz	> 7 dBm, typ. 10 dBm
From 3 GHz to 7 GHz	> 10 dBm, typ. 15 dBm (R&S®ESCI7)
With preselection/without preamplifier, from 200 MHz to 3 GHz	> 2 dBm, typ. 5 dBm
1 dB compression, $f > 200$ MHz, RF attenuation 0 dB, without preselection/preamplifier	5 dBm, nominal
Total measurement uncertainty, 95% confidence level, < 3 GHz	
Without preselection/preamplifier	0.5 dB
With preselection/preamplifier	1.0 dB

Displayed average noise level (DANL),

receiver mode, nominal, 0 dB input attenuation, 50 Ω termination

Without preamplifier, 1 MHz, BW = 9 kHz	< –4 dB μ V
Without preamplifier, 30 MHz to 1 GHz, BW = 120 kHz	< 6 dB μ V
With preamplifier, 1 MHz, BW = 9 kHz	< –14 dB μ V
With preamplifier, 30 MHz to 1 GHz, BW = 120 kHz	< –4 dB μ V

Detectors (receiver mode)

	Max/Min Peak, Quasi Peak, RMS, Average, average with meter time constant (CISPR-average), RMS-average
--	---

Number of measurement points

Analyzer mode	125 to 8001 (default: 501)
Receiver mode	
Frequency domain	max. 1 million
Time domain	max. 1.44 million

R&S®ESPI Test Receiver



The reference in the EMI precompliance class

The R&S®ESPI test receivers are especially designed to meet all EMC testing demands during product development and for EMC precertification. Equipped with the R&S®ESPI-B2 preselector/preamplifier option, all R&S®ESPI models feature an excellent dynamic range and are therefore able to perform precise interference measurements for pulse repetition frequencies ≥ 10 Hz in line with CISPR 16-1-1.

- Combination of precertification EMI test receiver and high-quality spectrum analyzer
- Frequency ranges
 - R&S®ESPI3: 9 kHz to 3 GHz
 - R&S®ESPI7: 9 kHz to 7 GHz
- Integrated preselection with selectable 20 dB preamplifier (R&S®ESPI-B2 option)
- Weighting detectors in line with the latest version of CISPR 16-1-1 incl. CISPR-average and RMS-average
- SCAN settings in tabular format (max. 10 subranges)
- Simultaneous measurement of multiple traces for parallel evaluation
- Fast, reliable measurements using automatic and interactive test routines
- Continuous bargraph display and marker functions for precise measurements
- Automatic disturbance voltage measurements using remote-controllable line impedance stabilization networks (LISN) from Rohde&Schwarz
- Predefined transducer factors
- Library of limit lines for commercial standards
- Measurement of the coverage field strength of communications or broadcast networks at very high measurement rates (R&S®ESPI-K50 option)
- Additional channel filters with various bandwidths between 5.6 MHz and 8 MHz matching terrestrial DVB networks including DVB-T2 (R&S®ESPI-K50 option)

Specifications in brief

Frequency

Frequency range	
R&S®ESPI3	9 kHz to 3 GHz
R&S®ESPI7	9 kHz to 7 GHz
Frequency resolution	0.01 Hz
Frequency accuracy	
Standard	1×10^{-6}
With R&S®FSP-B4 (OCXO) option	1×10^{-7}
External reference frequency	10 MHz

Measurement time

Receiver mode/scan (per frequency step)	selectable from 100 μ s to 100 s
Analyzer mode/sweep time	selectable from 2.5 ms to 16000 s, zero span from 1 μ s to 16000 s

Resolution bandwidths

3 dB bandwidths	10 Hz to 10 MHz in steps of 1/3/10
6 dB bandwidths (EMI)	200 Hz, 9 kHz, 120 kHz (–6 dB), 1 MHz (impulse bandwidth)
Video bandwidth, analyzer mode	1 Hz to 10 MHz in steps of 1/3/10
Preselection (R&S®ESPI-B2 option)	can be turned off in analyzer mode, 11 fixed/continuously tunable filters up to 3 GHz

Level

Max. RF level (CW), input attenuation ≥ 10 dB	137 dB μ V (= 1 W)
Max. pulse energy, input attenuation ≥ 10 dB	1 mWs (10 μ s)
Max. pulse voltage, input attenuation ≥ 10 dB, 10 μ s	150 V
Preamplifier (R&S®ESPI-B2 option)	can be switched on/off, 20 dB gain up to 3 GHz
Third-order intercept (TOI)	
Without preselection/preamplifier	
From 200 MHz to 3 GHz	> 7 dBm, typ. 10 dBm
From 3 GHz to 7 GHz	> 2 dBm, typ. 5 dBm (R&S®ESPI7)
With preselection/without preamplifier	
From 200 MHz to 3 GHz	> 2 dBm, typ. 5 dBm
1 dB compression, $f > 200$ MHz, 0 dB RF attenuation, without preselection/preamplifier	0 dBm, nominal
Total measurement uncertainty, 95% confidence level, < 3 GHz	
Without preselection/preamplifier	0.5 dB
With preselection/preamplifier	1.5 dB

Displayed average noise level (DANL),

receiver mode, nominal, 0 dB input attenuation, 50 Ω termination

Without preamplifier, 1 MHz, BW = 9 kHz	< 17 dB μ V
Without preamplifier, 30 MHz to 1 GHz, BW = 120 kHz	< 6 dB μ V
With preamplifier, 1 MHz, BW = 9 kHz	< 7 dB μ V
With preamplifier, 30 MHz to 1 GHz, BW = 120 kHz	< –4 dB μ V

Detectors (receiver mode)

Max/Min Peak, Quasi Peak, RMS, Average, average with meter time constant (CAV), RMS-average (CRMS)

Number of measurement points

Analyzer mode	125 to 8001 (default: 501)
Receiver mode	max. 1 million (frequency domain)

R&S®ESL EMI Test Receiver



Compact, cost-effective measuring receiver

The R&S®ESL EMI test receiver combines two instruments in one, measuring EMC disturbances in accordance with the latest standards and also serving as a full-featured spectrum analyzer for diverse lab applications. The R&S®ESL is designed to meet the needs of cost-conscious users who want to perform diagnostic and precompliance EMI measurements up to 3 GHz or 6 GHz.

The combination of very good RF characteristics and all of the important functions needed for fast, precise measurement and evaluation of the EMC of a device under test in accordance with commercial standards is unmatched in this instrument class. The diverse analysis capabilities, high measurement speed and time-saving automated test routines make the R&S®ESL the obvious choice for any development lab that needs to prepare for EMC certification tests.

- First-ever combination of an EMI test receiver and spectrum analyzer in the entry-level class
- All major functions of an advanced EMI test receiver, including fully automated test sequences
- Weighting detectors: Min/Max Peak, Average, RMS, Quasi Peak as well as average with meter time constant (CISPR-average) and RMS-average
- Predefined transducer factors
- Library of limit lines for commercial standards
- Compact, lightweight instrument, can be battery-powered for mobile applications

Specifications in brief				
	R&S®ESL3	R&S®ESL3	R&S®ESL6	R&S®ESL6
Frequency range	9 kHz to 3 GHz	9 kHz to 3 GHz	9 kHz to 6 GHz	9 kHz to 6 GHz
Frequency accuracy (standard)	1 × 10 ⁻⁶			
With R&S®FSL-B4 (OCXO)	1 × 10 ⁻⁷			
Measurement time				
Receiver mode/scan (per frequency step)	selectable from 100 μs to 100 s			
Analyzer mode/sweep time	selectable from 2.5 ms to 16000 s, zero span from 1 μs to 16000 s			
Resolution bandwidths				
3 dB bandwidths	10 Hz to 10 MHz in 1/3 sequence			
6 dB bandwidths (EMI)	200 Hz, 9 kHz, 120 kHz, 1 MHz (impulse)			
Video bandwidth, analyzer mode	1 Hz to 10 MHz in 1/3 sequence			
Level				
Max. RF level (input attenuation ≥ 10 dB)	+30 dBm (= 1 W)			
Max. pulse energy (10 μs pulse width)	10 mWs			
Max. pulse voltage	150 V			
Third-order intercept (f ≥ 30 MHz)	typ. +18 dBm			
1 dB compression (0 dB RF attenuation, preamplifier = OFF, f > 200 MHz)	+ 5 dBm			
Displayed average noise level (0 dB RF attenuation, 50 Ω termination, RBW = 1 kHz, VBW = 1 Hz, Sample detector, log scaling, normalized to 1 Hz, R&S®FSL-B22 preamplifier option ON)				
9 kHz < f < 3 MHz	typ. -130 dBm			
f = 500 MHz	typ. -162 dBm			
f = 3 GHz	typ. -158 dBm			
Detectors	Pos/Neg Peak, Auto Peak, Quasi Peak, RMS, Average, sample, average with meter time constant (CISPR-average), RMS-average			
Level measurement uncertainty (95% confidence level, +20°C to +30°C, S/N >16 dB, 0 dB to -50 dB from reference level)	10 MHz < f ≤ 3 GHz: < 0.5 dB 3 GHz < f ≤ 6 GHz: < 0.8 dB			
Tracking generator	no	yes	no	yes
Frequency range	-	1 MHz to 3 GHz	-	1 MHz to 6 GHz
Output level	-	-20 dBm to 0 dBm	-	-20 dBm to 0 dBm

R&S®TS9975 EMI Test System

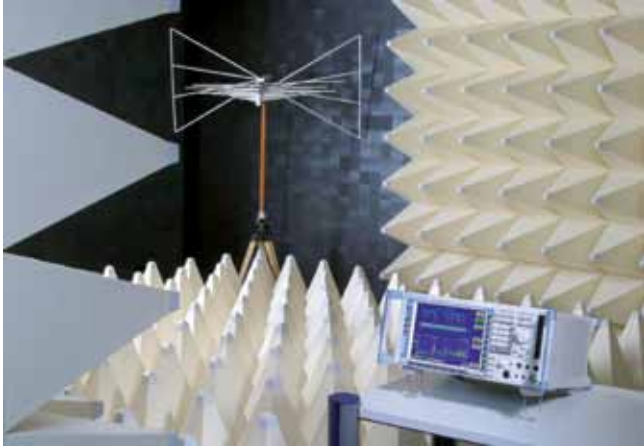

Tests in line with commercial, wireless, automotive and MIL standards

The R&S®TS9975 is the base system for conducted and radiated EMI measurements. Due to its modular design, it covers a wide range of applications and can be very easily adapted to the measurement task at hand. Any configuration is possible – from conducted measurements and a small precompliance system with compact test cell to an accredited test system for complete motor vehicles. Combinations of different applications or incremental expansion can also be implemented without any problem.

All test systems are controlled by the R&S®EMC32 EMC test software.

The test receiver forms the core of the system. It evaluates and displays emissions in line with the relevant standards. From system design and implementation to installation and training, these turnkey systems and our EMC experts provide everything from a single source, enabling the customer to concentrate on testing. A design only for conducted or radiated measurements is possible.

Covered standards (examples)

This test system covers the main standards for EMI measurements for the different ranges of applications.

Commercial tests

- ▮ CISPR 11-22
- ▮ EN 55011-55022
- ▮ VDE 0872-0879
- ▮ ANSI-C63.4
- ▮ CFR47 FCC part 15, 18
- ▮ 3GPP TS51.010
- ▮ ETSI EN301908-1
- ▮ ETSI EN300328-1

Wireless tests

- ▮ ETSI EN301489 for all major technologies (e.g. CDMA, GSM, UMTS, LTE, WLAN, WiMAX™)

Automotive tests

- ▮ CISPR 12
- ▮ CISPR 25
- ▮ Customer-specific requirements

MIL tests

- ▮ VG 95370-95377
- ▮ DEF-STAN 49-41
- ▮ GAM-EG 13
- ▮ MIL-STD-461E/F
- ▮ Customer-specific requirements

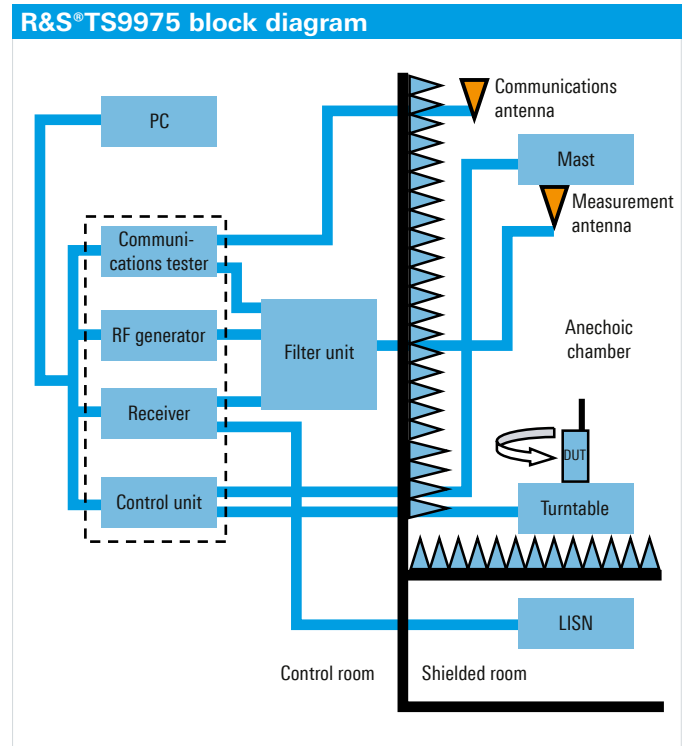

R&S®TS9980 EMS Test System for Audio and Video and TV Monitoring



Measuring the electromagnetic susceptibility (EMS) of sound and TV broadcast receivers, satellite receivers and DVB/DAB receivers

Automatic measurements in line with

- EN 55020:2001
- CISPR 20:2002, edition 5

The growth in communications via terrestrial and satellite links and the frequency crowding in cable networks may affect reception quality. Comprehensive EMS tests are used to verify the capability of receivers to operate satisfactorily even under adverse conditions. These tests cover the following measurements:

- Immunity to input interference (S1)
- Immunity to RFI voltages (S2a)
- Immunity to RFI currents (S2b)
- Immunity to radiated interference (S3)
- Shielding effectiveness (S4)
- Keyed carrier (S5)
- Immunity to radiated RFI for large EUTs (S6)

Since these tests are highly complex and involve a large number of single measurements, they are carried out with automatic test systems. The R&S®TS9980 test system is available in three versions to cater for different products and applications:

■ R&S®TS9980 audio

- FM: VHF (mono/stereo)
- AM: LF/MF/HF (mono)

■ R&S®TS9980 AV multistandard

- PAL: B/G, I, D/K
- SECAM: D/K, L/L'
- NTSC: M/N

■ R&S®TS9980 DVB multistandard

- DVB-C QAM (quadrature amplitude modulation) in line with ETS300429
- DVB-S QPSK (quadrature phase shift keying) in line with ETS300421
- DVB-T OFDM (orthogonal frequency division multiplex) in line with ETS 300744
- ATSC 8VSB (vestigial sideband) in line with ATSC Doc. A/53
- DAB OFDM in line with ETS300401

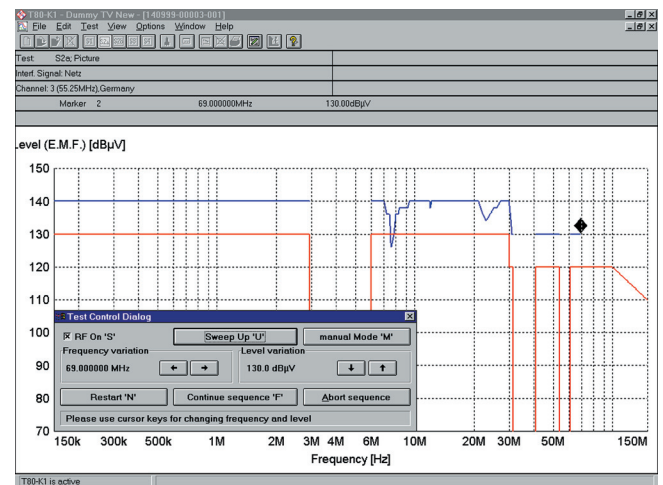

R&S®T80-K1 system software

The powerful R&S®T80-K1 software package is the basis for automatic control and monitoring of the R&S®TS9980 test system as well as for data collection and analysis. The effective and economical use of the R&S®TS9980 test system is only possible through automation.

Further benefits

- Improved reproducibility and higher accuracy of measurement results
- Automatic generation of comprehensive test reports
- Permanent system monitoring
- Improved data management through integrated database
- Automatic calibration and correction of frequency-dependent parameters

Software options

- R&S®T80-K5 (video upgrade)
- R&S®T80-K6 (audio upgrade)
- R&S®T80-K7 (DVB upgrade)
- R&S®T80-K8 (DAB upgrade)
- R&S®T80-K13 (S4 option)
- R&S®T80-K14 (S5 option)
- R&S®T80-K15 (S6 option)

R&S®TS9982 EMS Test System



Radiated and conducted EMS measurements in line with commercial, wireless, automotive and MIL standards

The R&S®TS9982 is the base system for conducted and radiated EMS measurements. Due to its modular design, it covers a wide range of applications and can be very easily adapted to the measurement task at hand. Any configuration is possible – from conducted measurements and a small precompliance system with compact test cell to an accredited test system for complete motor vehicles with 200 V/m. Combinations of different applications or incremental expansion can also be implemented without any problem. All test systems are controlled by the R&S®EMC32 EMC test software with its various capabilities such as extensive EUT and system monitoring. From system design and implementation to installation and training, these turnkey systems and our EMC experts provide everything from a single source, enabling the customer to concentrate on testing. A design only for conducted or radiated measurements is possible.

Covered standards (examples)

This test system covers all relevant standards for radiated and conducted commercial measurements for the different ranges of applications.

Commercial tests

- ▮ IEC/EN 61000-4-3 and -6
- ▮ IEC/EN 61000-4-20
- ▮ EN 61000-6-1
- ▮ EN 61000-6-2
- ▮ CISPR 24/EN 55024
- ▮ EN 60601-1-2

Wireless tests

- ▮ ETSI EN 301489 for all major technologies (e.g. CDMA, GSM, UMTS, LTE, WLAN, WiMAX™)

Automotive tests – components

- ▮ ISO 11452-2
- ▮ ISO 11452-3
- ▮ ISO 11452-4
- ▮ ISO 11452-5
- ▮ 2004/104/EC

Automotive tests – vehicles

- ▮ ISO 11451
- ▮ 2004/104/EC
- ▮ Customer-specific requirements

MIL tests

- ▮ MIL-STD-461E/F
- ▮ Customer-specific requirements

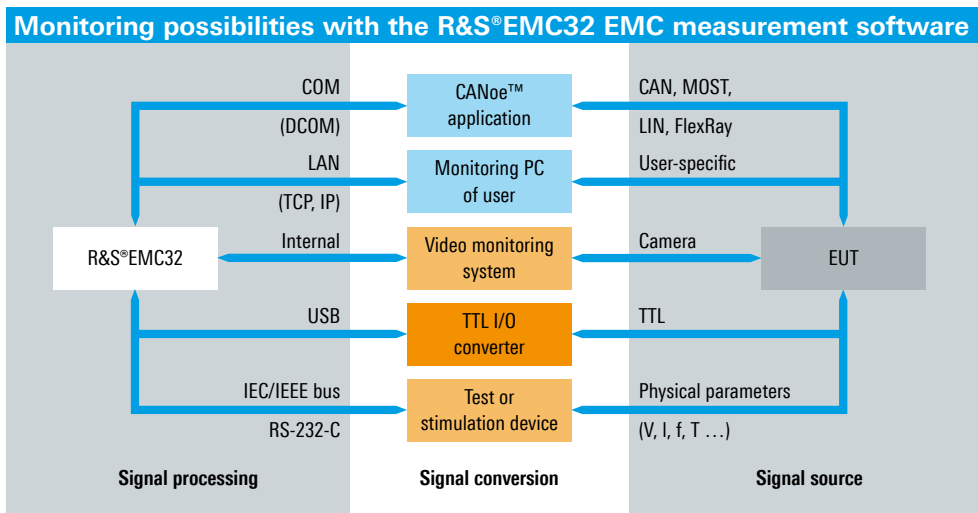

R&S®TS-EMF Portable EMF Measurement System



Simple, frequency-selective measurement of EMF emissions

In combination with Rohde&Schwarz spectrum analyzers, the R&S®TS-EMF measurement system detects high-frequency electromagnetic fields (EMF). The isotropic antenna, together with the software, which has been specifically designed for EMF measurements, allows simple and precise on-site evaluation of total and individual emissions.

- ▀ Automated EMF measurements
- ▀ Precise measurements of even complex scenarios and RF signals
- ▀ Wide frequency range from 9 kHz to 6 GHz using isotropic antennas
- ▀ Isotropic antenna for detecting fields independent of direction and polarization
- ▀ Combined use possible with various Rohde&Schwarz spectrum analyzers and test receivers

Safety based on exact measurements for reproducible and reliable results

- ▀ Evaluation of total emissions, individual radio services or individual frequencies
- ▀ Measurements in line with all common EMF standards and measurement methods
- ▀ Correct evaluation even of complex scenarios or RF signals
- ▀ Excellent reproducibility using automated measurements

Efficient on-site measurements

- ▀ Fast, simple measurements owing to predefined test routines
- ▀ On-site interpretation of results using integrated report generation
- ▀ Easy adaptation to local conditions
- ▀ Versatile use due to the compact one-box solution with the R&S®FSL spectrum analyzer

Suitable for a wide range of applications

- ▀ Investigation of specific problems or radio signals by directly setting individual measurement parameters
- ▀ Additional manual measurements using a full-featured spectrum analyzer
- ▀ Optional storage of raw measurement data for further in-depth result evaluation
- ▀ Precise extrapolation for WCDMA using CPICH demodulation
- ▀ Support for LTE measurements by decoding and frequency-selective procedure

Future-oriented

- ▀ Coverage of the complete frequency range from 9 kHz to 6 GHz, extendable up to 40 GHz, using additional antennas
- ▀ Measurements of advanced radio services with wide bandwidths and high crest factors

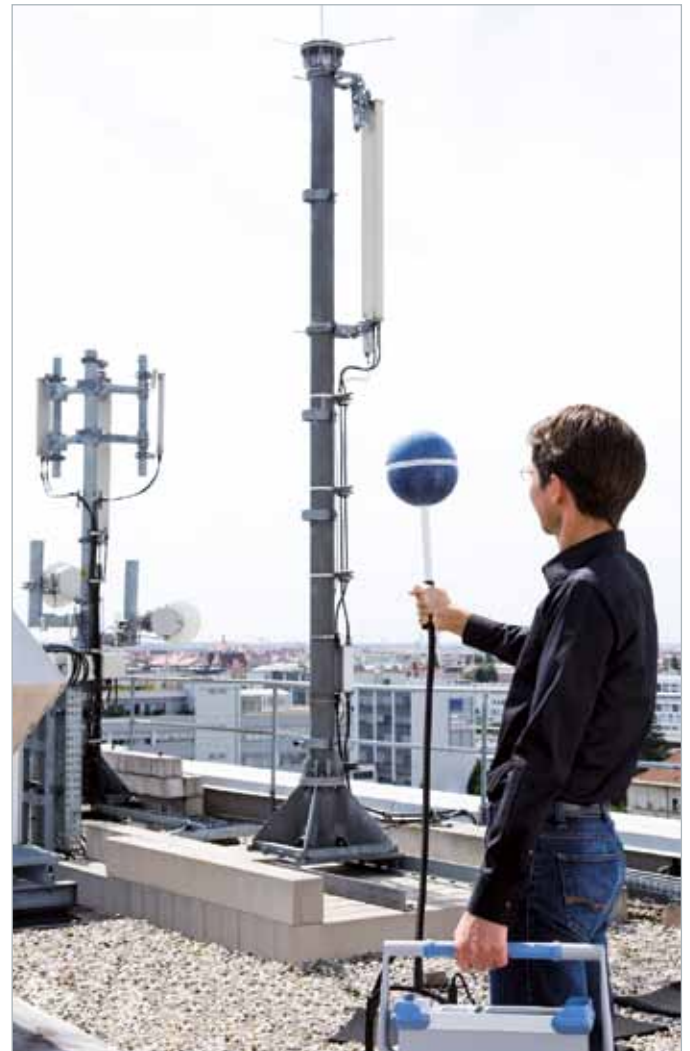

R&S®EMF-M EMF Monitor Station



Fully automatic EMF measurement station

Automated EMF long-term measurements expand snapshot measurements associated with risk communications

Conventional on-site measurements only cover the situation at the moment. Signal weighting is also difficult because some radio signals are only transmitted for a short time and because advanced technologies make use of adaptive power and radiation pattern control.

Such problems are solved by automatically and continuously monitoring typical or critical measurement points, which yields conclusive results. This approach involves standard-compliant monitoring over the entire frequency range, where the individual electromagnetic emissions are allocated to exact frequencies. This solution allows the evaluation of both short-term and long-term fluctuations, e.g. due to new technologies, and provides reliable data for risk communications and research.

- ▮ Automated EMF long-term measurements
- ▮ Frequency range from 9 kHz to 3 GHz, optionally 6 GHz
- ▮ Accurate and reliable detection of each emission
- ▮ Automatic wireless data transmission and remote configuration via GSM
- ▮ Ruggedized design for outdoor use
- ▮ Easy transport

Main components of the R&S®EMF-M

- ▮ Radome with measurement antennas, thermo/hygro sensor and GPRS antenna
- ▮ Protective cover (housing GPS antenna)
- ▮ R&S®ESPI test receiver
- ▮ System controller with measurement software and watchdog
- ▮ Temperature management with display
- ▮ Interface for external monitor for local configuration
- ▮ Foldable, detachable base

As an autonomous test station, the R&S®EMF-M precisely and seamlessly detects electromagnetic emissions in the frequency range from 9 kHz to 3 GHz or 6 GHz specified by many EMF standards.

The wide dynamic range covers both strong and weak signals. The frequency-selective field strength measurement is not dependent on the angle of incidence and polarization and covers everything from analog modulated signals to digital, pulsed wideband or radar signals.

Measurement and signal analysis are controlled by the tried-and-tested R&S®RFEX EMF measurement software. This software allows the exact detection, allocation and evaluation of electromagnetic emissions. The measurement results are automatically transmitted to a server and – in Germany, for example – made available to the public via the Internet.



R&S®ES-SCAN EMI Software

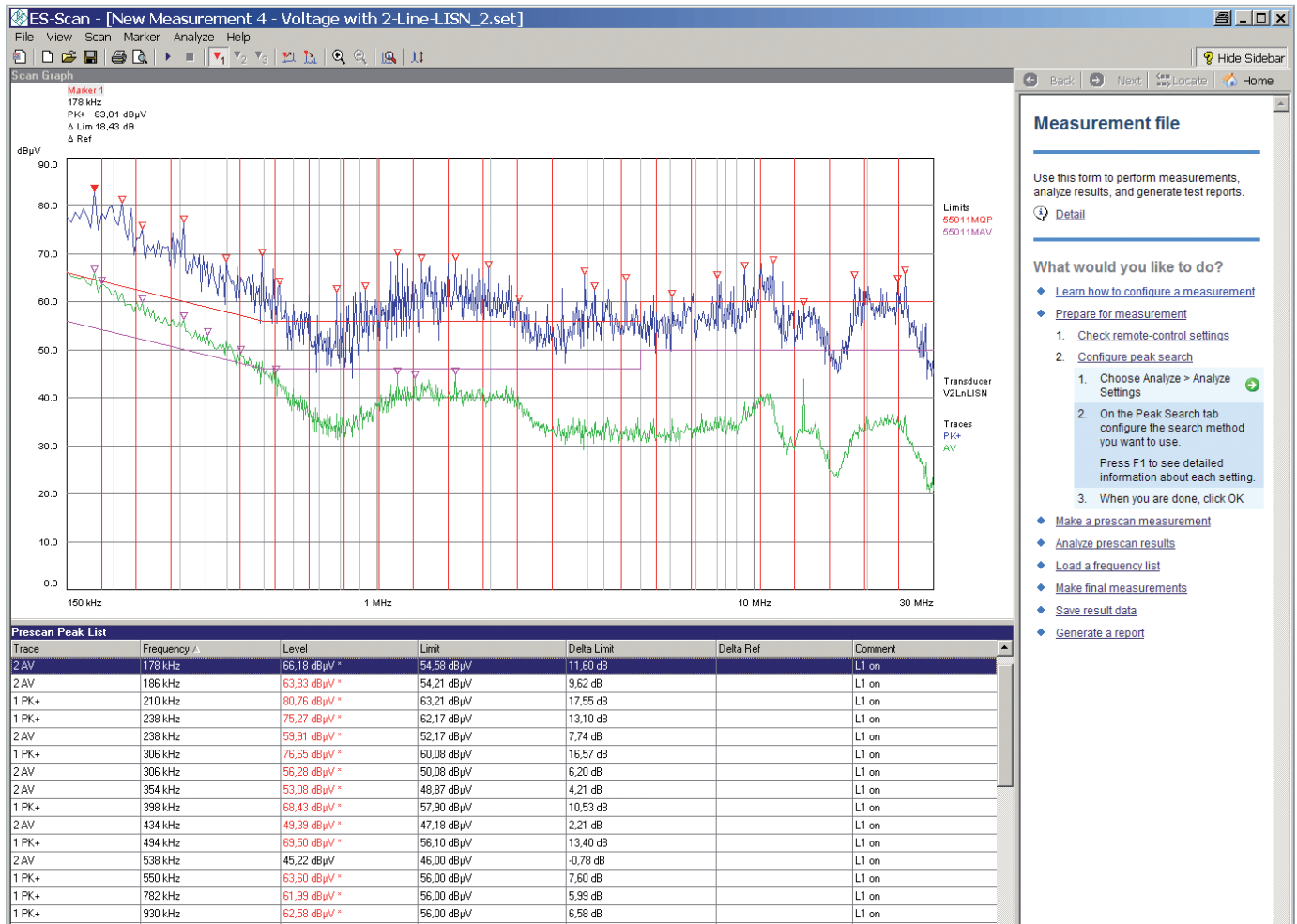

User-friendly software for EMI measurements

R&S®ES-SCAN is a cost-efficient and user-friendly Windows software application that has been developed for Rohde&Schwarz test receivers and spectrum analyzers. The main requirements of EMI measurements in accordance with commercial standards have been combined in an easy-to-use application: measurement settings and storage, scan data acquisition and display with automatic data reduction, peak search with acceptance limit and selection of subranges, final measurement with worst-case selection, report generation, and measurement data storage.

R&S®ES-SCAN offers all the advantages of a state-of-the-art software tool, including operation via keyboard and mouse, table editor, configurable report generation, and printout of reports on any Windows printer. An assistant supports the user of the R&S®ES-SCAN EMI software at any stage of operation. Online help texts explain all software functions; an operating manual is therefore not required.

- Menu-controlled configuration of test receivers and spectrum analyzers and storage of settings on controller, including limit lines and transducer factors
- Reliable acquisition, evaluation and documentation of measurement data
- Graphical display of scan data with automatic data reduction
- Marker function, including Marker to Peak and Tune Receiver to Marker Frequency
- Automatic peak search with selectable acceptance limit and selectable subranges
- Editable frequency list for semi-automatic or interactive final measurements
- Fine Tuning function for fast detection of local maxima
- Flexible configuration of report generation for different report layouts
- For use with the R&S®ESCI, R&S®ESPI and R&S®ESL EMI test receivers, the R&S®FSP and R&S®FSL spectrum analyzers, the R&S®FSV signal and spectrum analyzer and the R&S®FSVR real-time spectrum analyzer

R&S®EMC32 EMC Measurement Software Platform

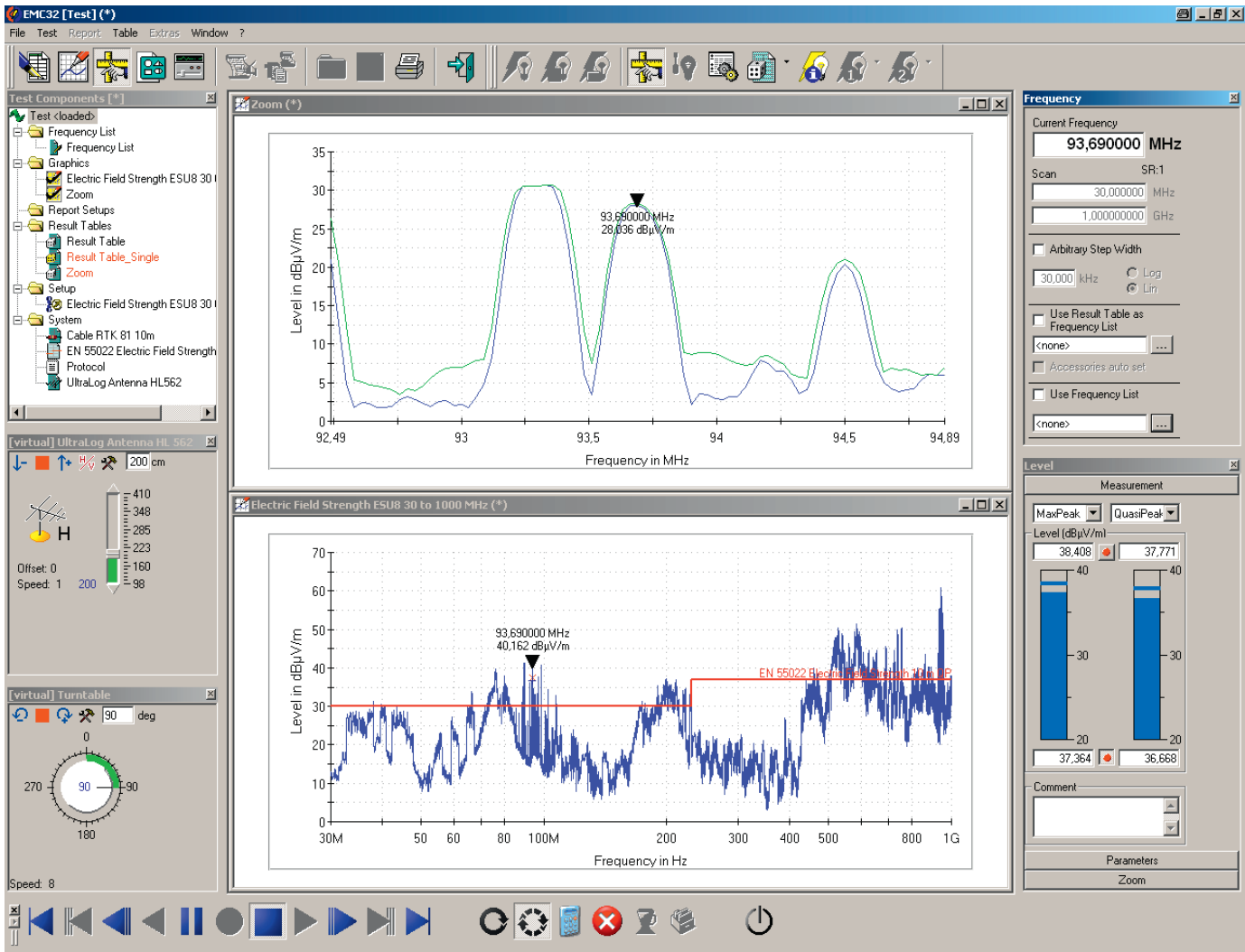

R&S®EMC32 as virtual instrument: e.g. user interface for manual measurement of disturbance field strength.

For use in development, for compliance and batch testing

The R&S®EMC32 EMC measurement software can be used for all electromagnetic interference (EMI) and electromagnetic susceptibility (EMS) measurements. The software is a modern and powerful tool for controlling and monitoring Rohde & Schwarz devices as well as third party equipment. Its comprehensive and modular configuration capabilities and its open software structure ensure reliable collection, evaluation and documentation of measurement results.

- ▮ Cost-efficient
- ▮ Flexible and scalable
- ▮ Future-ready
- ▮ Modular concept allowing flexible adaptation to customer needs
- ▮ Predefined hardware setups to support easy generation of test setups
- ▮ Support of measurements in line with all major standards in the commercial, wireless, automotive and military range
- ▮ Manual and automatic EMI and EMS measurements
- ▮ Fully automatic and interactive sequences
- ▮ Customer- or EUT-specific data handling
- ▮ Extensive EUT monitoring capabilities and user-specific actions
- ▮ Interface to lab management system
- ▮ User administration for managing different user profiles

Options	
R&S®EMC32-EB	Basic EMI measurement software
R&S®EMC32-S	Basic EMS measurement software
R&S®EMC32-K1	EMS measurements in line with automotive standards and MIL-STD-461
R&S®EMC32-K2	EMC measurements in line with wireless standards
R&S®EMC32-K3	EMS measurements in reverberation chambers
R&S®EMC32-K4	Automatic EMS test sequences
R&S®EMC32-K6	EMS measurements in line with MIL-STD-461E, CS 103,104,105
R&S®EMC32-K7	Generic driver for generators, power meters and oscilloscopes
R&S®EMC32-K8	Database interface for lab management system
R&S®EMC32-K10	EMI auto test
R&S®EMC32-K11	Sequencer for EMC measurements
R&S®EMC32-K21	Application interface for customer-specific RF measurements
R&S®EMC32-K22	Measurement of antenna characteristic (azimuth chart)
R&S®EMC32-K33	EMI measurements in mode-tuned chambers (reverberation chambers)
R&S®EMC32-K51	EMI measurement reports in line with GMW3091/3097
R&S®EMC32-K56	EMI measurements in line with MIL-STD-461E/F

Application overview (examples)		
Application	Standards (examples) EMS	Standards (examples) EMI
Industrial and household products (commercial)	IEC/EN61000-4-3, -6	CISPR 11/EN 55011, CISPR 14-1/EN 55014-1, ANSI-C 63.4 FCC 15, 18
Information technology (commercial)	CISPR 24/EN 55024, IEC/EN61000-4-3, -6	CISPR 22/EN 55022, ANSI-C 63.4 FCC 15, 18
Medical devices (commercial)	EN 60601-1-2, EN 60601-2-x	EN 60601-1-2, CISPR 11/EN 55011
Wireless devices (commercial)	ETSI EN 301498-x, ETSI EN 300826	ETSI EN 301489-x, 3GPP TS 51.010, ETSI EN 301908-1, ETSI EN 300328-1, FCC part 15
Automotive	ISO 11451, ISO 11452, SAE J1113, SAE J551, 2004/104 EC reverberation chamber (mode-tuned)	2004/104/EC CISPR 12, SAE J551/2 CISPR 25, SAE J1113/41 reverberation chamber (mode-tuned)
Military/avionics	MIL-STD-461E/F, CS 114 and RS 103, MIL-STD-461E/F, CS 103, CS 104, CS 105, RTCA/DO-160, MIL-STD-464	MIL-STD-461E/F, CE 101, CE 102, CE 106, RE 101, RE 102, RE 103, RTCA/DO-160, VG 95370-95377, DEF-STAN 49-41, GAM-EG 13
Consumer products, radio/TV receivers (commercial)		CISPR 13/EN 55013

R&S® BBA100 Broadband Amplifier



Family of modular, flexible, state-of-the-art broadband amplifiers

The monitoring and control options allow the setup of very compact EMC systems. The R&S® BBA100 “grows” with the requirements. The instrument can be upgraded and therefore provides maximum investment protection and readiness for the future.

The R&S® BBA100 broadband amplifiers are suitable for a variety of applications in EMC environments, communications, research and physical engineering. They are optimally scalable and configurable.

Due to their modular design, the amplifiers can be tailored to meet specific requirements with regard to output power and frequency range.

Even in its basic version, the 19" base unit (5 HU) includes a powerful system controller that controls the installed frequency bands (RF paths), switches the associated components (such as input switch, preamplifier and power amplifier) and monitors the system.

The user interface (both on the instrument and via web browser) allows efficient operation, and different remote control interfaces make it possible to integrate the amplifier into automated environments and systems. Extension units accommodate additional amplifier units, allowing the R&S® BBA100 to be expanded into a system featuring higher power and/or additional frequency bands.

- ▀ Frequency ranges from 9 kHz to 1 GHz
- ▀ Output power up to 500 W
- ▀ Tolerant to 100% mismatch
- ▀ Suitable for amplitude, frequency, phase and pulse modulation, depending on input signal
- ▀ Software-updatable system controller with versatile control and configuration options
- ▀ 19" housing of 5 HU, suitable for rack installation
- ▀ Wide-range AC power supplies (90 V to 264 V AC)
- ▀ Three-year warranty

Specifications in brief

RF specifications

Frequency ranges		9 kHz to 250 MHz instantaneously, 80 MHz to 400 MHz instantaneously, 250 MHz to 1 GHz instantaneously
Nominal power	9 kHz to 250 MHz	125/250/500 W
	80 MHz to 400 MHz	125/250/500 W
	250 MHz to 1 GHz	70/125 W
Nominal power gain without RF input switch module	9 kHz to 250 MHz	54.5/57.5/60.5 dB
	80 MHz to 400 MHz	54.5/57.5/60.5 dB
	250 MHz to 1 GHz	52.0/54.5 dB
Nominal power gain with RF input switch module	9 kHz to 250 MHz	51.0/54.0/57.0 dB
	80 MHz to 400 MHz	51.0/54.0/57.0 dB
	250 MHz to 1 GHz	48.5/51.0 dB
Gain flatness	at 1 dB compression and +25°C	< 4.5 dB (or better, see data sheet)
	at 1 dB compression and temperature range from 0°C to +45°C	< 5.5 dB (or better, see data sheet)
Gain adjustment range		> 20 dB
Spurious		typ. -80 dBc, max. -70 dBc
Modulation capability	no multicarrier operation at VSWR > 2:1 and no operation with peak input power of more than 3 dB above nominal input power	AM, FM, φM, PM
Input level for nominal output power	without RF input switch	-3.5 dBm
	with RF input switch	0 dBm
Output mismatch tolerance		100%

R&S®R-Line Compact Test Chamber



Measurement accuracy as high as that of an anechoic chamber

The R&S®R-Line compact test chamber is used to eliminate emission problems and optimize the overall RF performance of wireless terminals already in the initial phases of product development. This helps to avoid costly and time-consuming modifications to a large number of prototypes at a later stage, optimizing time to market and return on investment.

The R&S®R-Line compact RF chamber performs measurements in the critical frequency range from 800 MHz to 18 GHz with an accuracy as high as that of an anechoic chamber ten times larger. It easily fits into any R&D lab, which reduces investments for infrastructure and instrumentation.

The SVSWR validation requirements in line with CISPR 16-1-4:2007 are not only met but even considerably exceeded.

The high measurement accuracy is obtained through an optimized measurement geometry and absorber layout combined with a 3D positioner made of low-permittivity material throughout.

Optimum utilization of resources through comprehensive, automated test systems

Optimizing radiated spurious emissions and over-the-air (OTA) performance poses a permanent challenge. These two R&S®R-Line applications are automatically performed by the R&S®AMS32 or R&S®EMC32 test software together with Rohde & Schwarz turnkey test system solutions:

- R&S®TS8991 over-the-air (OTA) performance test system
- R&S®TS8996 radiated spurious emissions (RSE) test system

The R&S®R-Line identifies radiated harmonics and spurious emissions at an early stage – i.e. during development. This avoids complex and costly reengineering during the final conformance tests. As a result, time to market and related costs are reduced.

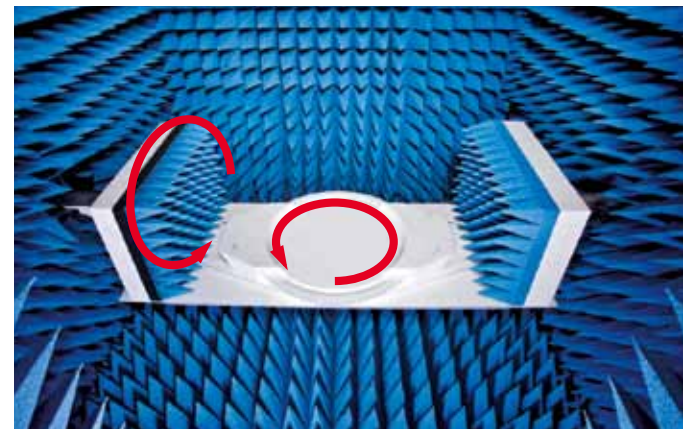

Internal 3D positioner.

Specifications in brief

RF specifications/measurement range	
Frequency range	800 MHz to 18 GHz
Polarization	horizontal and vertical through R&S®HL024A1 crossed log-periodic antenna
Field uniformity of site	VSWR, typ. 2 dB in line with CISPR 16-1-4:2007
Communications antenna	800 MHz to 6 GHz, circularly polarized
Shielding effectiveness	> 95 dB, 800 MHz to 6 GHz; > 70 dB, 6 GHz to 18 GHz
Mechanical data	
Dimensions (W × H × D)	1700 mm × 2250 mm × 1640 mm (66.93 in × 88.58 in × 64.57 in)
Door size (W × H)	500 mm × 1000 mm (19.68 in × 39.37 in)
Size of EUT (∅ × H)	max. 330 mm × 240 mm (max. 12.99 in × 9.45 in)
Weight	562 kg (1239 lb)
Weight of EUT	max. 1 kg (max. 2.2 lb)
RF feedthroughs for calibrating or connecting the EUT	2 × N (female), 2 × SMA (female)

EMC accessories for disturbance voltage/current/power and field strength measurements

EMC accessories for disturbance voltage measurements

R&S®ENV216 Two-Line V-Network

**Disturbance voltage measurements on single-phase EUTs**

- ▮ Several models for Germany, United Kingdom, France, China/Australia, USA
- ▮ Air-core design and artificial hand
- ▮ Switch-selectable highpass filter of 150 kHz
- ▮ Built-in 10 dB attenuator pad
- ▮ Built-in pulse limiter (can be switched off)
- ▮ Remote control with TTL levels (compatible with Rohde & Schwarz EMI test receivers)
- ▮ Compact, lightweight

Specifications in brief

- ▮ Frequency range: 9 kHz to 30 MHz
- ▮ Continuous current up to 16 A (depending on model)
- ▮ Simulated impedance: $(50 \mu\text{H} + 5 \Omega) \parallel 50 \Omega$ in line with CISPR 16-1-2 Amd. 2:2006
- ▮ V-network in line with CISPR, EN, VDE, ANSI, FCC Part 15 and MIL-STD-461D, E and F
- ▮ Calibrated in line with CISPR 16-1-2 and ANSI C63.4

R&S®ENV4200 200 A Four-Line V-Network

**RFI voltage measurements at high currents**

The R&S®ENV4200 V-network meets the requirements of CISPR 16-1-2, EN55016-1-2 and ANSI C63.4 for V-networks with impedance in the frequency range from 150 kHz to 30 MHz. The maximum attainable current of the V-network is limited by the voltage drop at the standardized inductances (CISPR 16-1-2 limits the voltage drop to 5% of the AC supply voltage) and by unavoidable heat losses.

Specifications in brief

- ▮ Frequency range: 150 kHz to 30 MHz
- ▮ Impedance: $50 \mu\text{H} \parallel 50 \Omega$, magnitude and phase in line with CISPR 16-1-2 Amd. 2:2006
- ▮ Artificial hand
- ▮ Continuous current up to $4 \times 200 \text{ A}$
- ▮ Air-core design
- ▮ Built-in pulse limiter (can be switched off)
- ▮ Remote control with TTL levels (compatible with Rohde & Schwarz EMI test receivers)

R&S®ESH2-Z5 25 A Four-Line V-Network

**Disturbance measurements on DC- or AC-powered loads**

The R&S®ESH2-Z5 four-line V-network is used to measure RFI voltages on supply connections of EUTs and is based on air-core inductances. It contains an artificial hand as well as a PE simulating network that can be bypassed.

Specifications in brief

- ▮ Frequency range: 9 kHz to 30 MHz
- ▮ V-network in line with CISPR, EN, VDE, ANSI
- ▮ Impedance: $(50 \mu\text{H} + 5 \Omega) \parallel 50 \Omega$, magnitude and phase in line with CISPR 16-1-2:2006
- ▮ Continuous current up to $4 \times 25 \text{ A}$
- ▮ Short-time current (max. 2 min) up to $4 \times 50 \text{ A}$
- ▮ Artificial hand and PE simulation network
- ▮ Air-core design
- ▮ Remote control via TTL levels (compatible with the Rohde & Schwarz EMI test receivers)
- ▮ Calibrated in line with CISPR 16-1-2 and ANSI C63.4

R&S®ESH3-Z6 150 A Single-Line V-Network

**For measurements of RFI voltage and immunity to RFI in low-impedance power supply networks**

The R&S®ESH3-Z6 is a single-phase V-network with an equivalent circuit of $(5 \mu\text{H} + 1 \Omega) \parallel 50 \Omega$ for the frequency range from 100 kHz to 200 MHz. The R&S®ESH3-Z6 is rated for a continuous current of up to 150 A and can handle surges of up to 500 A for a maximum time of 30 s. Its screw terminals ensure a low-impedance connection of the test device and the power supply.

Specifications in brief

- ▮ Frequency range: 0.1 MHz to 200 MHz
- ▮ Continuous current up to 150 A
- ▮ Impedance: $(5 \mu\text{H} + 1 \Omega) \parallel 50 \Omega$
- ▮ In line with
 - CISPR 25 (on-board power supply systems)
 - CISPR 16-1-2 and EN55016-1-2 (low-impedance power supplies)
 - MIL-I-6181D, MIL-I-16910C, MIL-E-55301
 - DEF-STAN 59-411 and DO-160

EMC accessories for disturbance voltage measurements

R&S®ENY21 Two-Wire Coupling Network

Radio disturbance and immunity measurements on unshielded, symmetrical telecommunications ports

- ▮ Radio disturbance measurements in line with CISPR 22:2005 and EN 55022:2006 (150 kHz to 30 MHz)
- ▮ Immunity measurements in line with CISPR 24 and EN 55024 (150 kHz to 80 MHz)
- ▮ CISPR 16-1-2 complied with
- ▮ Adapter sets to meet standardized LCL requirements (55 dB and 65 dB) and to accommodate various telecommunications interfaces
- ▮ High transmission bandwidth for wanted signal (100 MHz)

Specifications in brief

- ▮ Frequency range
 - Radio disturbance: 150 kHz to 30 MHz
 - Immunity: 150 kHz to 80 MHz
- ▮ Asymmetrical impedance
 - Imped. (0.15 MHz to 30 MHz): $150 \Omega \pm 20 \Omega$
 - Phase angle (0.15 MHz to 30 MHz): $0^\circ \pm 20^\circ$
 - Imped. (> 30 MHz to 80 MHz): $150 \Omega \pm 40 \Omega$
- ▮ Voltage division factor in asymmetrical circuit
 - 150 kHz to 30 MHz: typ. $10 \text{ dB} \pm 1 \text{ dB}$
- ▮ Maximum permissible values
 - Max. RF input voltage: < 15 V
 - Max. DC voltage between line/ground: 100 V
 - Max. AC voltage between line/ground: 63 V
 - Max. DC current: 400 mA (current on each individual wire of one pair or on different pairs)

R&S®ENY41 Four-Wire Coupling Network

Radio disturbance and immunity measurements on unshielded, symmetrical telecommunications ports

- ▮ Radio disturbance measurements in line with CISPR 22:2005 and EN 55022:2006 (150 kHz to 30 MHz)
- ▮ Immunity measurements in line with CISPR 24 and EN 55024 (150 kHz to 80 MHz)
- ▮ CISPR 16-1-2 complied with
- ▮ Adapter sets to meet standardized LCL requirements (55 dB and 65 dB) and to accommodate various telecommunications interfaces
- ▮ High transmission bandwidth for wanted signal (100 MHz)

Specifications in brief

- ▮ Frequency range
 - Radio disturbance: 150 kHz to 30 MHz
 - Immunity: 150 kHz to 80 MHz
- ▮ Asymmetrical impedance
 - Imped. (0.15 MHz to 30 MHz): $150 \Omega \pm 20 \Omega$
 - Phase angle (0.15 MHz to 30 MHz): $0^\circ \pm 20^\circ$
 - Imped. (> 30 MHz to 80 MHz): $150 \Omega \pm 40 \Omega$
- ▮ Voltage division factor in asymmetrical circuit
 - 150 kHz to 30 MHz: typ. $10 \text{ dB} \pm 1 \text{ dB}$
- ▮ Maximum permissible values
 - Max. RF input voltage: < 15 V
 - Max. DC voltage between line/ground: 100 V
 - Max. AC voltage between line/ground: 63 V
 - Max. DC current: 400 mA (current on each individual wire of one pair or on different pairs)

R&S®ENY81 Eight-Wire Coupling Network

Radio disturbance measurements on unshielded, symmetrical telecommunications ports

- ▮ Radio disturbance measurements in line with CISPR 22:2005 and EN 55022:2006 (150 kHz to 30 MHz)
- ▮ CISPR 16-1-2 complied with
- ▮ Adapter sets to meet standardized LCL requirements (55 dB and 65 dB) and to accommodate various telecommunications interfaces
- ▮ High transmission bandwidth for wanted signal (100 MHz)

Specifications in brief

- ▮ Frequency range: 150 kHz to 30 MHz
- ▮ Asymmetrical impedance
 - Imped. (0.15 MHz to 30 MHz): $150 \Omega \pm 20 \Omega$
 - Phase angle (0.15 MHz to 30 MHz): $0^\circ \pm 20^\circ$
- ▮ Voltage division factor in asymmetrical circuit
 - 150 kHz to 30 MHz: typ. $10 \text{ dB} \pm 1 \text{ dB}$
- ▮ Maximum permissible values
 - Max. RF input voltage: < 15 V
 - Max. DC voltage between line/ground: 100 V
 - Max. AC voltage between line/ground: 63 V
 - Max. DC current: 400 mA (current on each individual wire of one pair or on different pairs)

R&S®ENY81-CA6 Eight-Wire Coupling Network for cable category CAT 6

Radio disturbance measurements on unshielded, symmetrical telecommunications ports

- ▮ Radio disturbance measurements in line with CISPR 22:2005 and EN 55022:2006
- ▮ Immunity measurements in line with CISPR 24 and EN 55024 (150 kHz to 80 MHz)
- ▮ CISPR 16-1-2 complied with
- ▮ 75 dB longitudinal conversion loss (LCL)
- ▮ High transmission bandwidth for wanted signal (250 MHz)

Specifications in brief

- ▮ Frequency range
 - Radio disturbance: 150 kHz to 30 MHz
 - Immunity: 150 kHz to 80 MHz
- ▮ Asymmetrical impedance
 - Imped. (0.15 MHz to 30 MHz): $150 \Omega \pm 20 \Omega$
 - Phase angle (0.15 MHz to 30 MHz): $0^\circ \pm 20^\circ$
 - Imped. (> 30 MHz to 80 MHz): $150 \Omega \pm 40 \Omega$
- ▮ Voltage division factor in asymmetrical circuit
 - 150 kHz to 30 MHz: typ. $9.5 \text{ dB} \pm 1 \text{ dB}$
- ▮ Maximum permissible values
 - Max. RF input voltage: < 15 V
 - Max. DC voltage between line/ground: 100 V
 - Max. AC voltage between line/ground: 63 V
 - Max. DC current: 400 mA (current on each individual wire of one pair or on different pairs)

EMC accessories for disturbance voltage measurements

R&S®EZ-12 Antenna Impedance Converter



Broadband matching unit for test receivers and spectrum analyzers with low-impedance inputs

The R&S®EZ-12 is used for high-impedance measurements of disturbance voltage at the feed-point of a vehicle-mounted antenna in the long-, medium-, shortwave and FM bands in line with VDE 0879 Part 2 and CISPR 25. For measurements in the VHF FM range, the antenna signal can be switched to a separate 50-Ω input.

- ▮ Flat frequency response
- ▮ High sensitivity and overload capacity
- ▮ Calibration in line with CISPR 25:2008
- ▮ Remote-controlled FM range switch

Specifications in brief

- ▮ Frequency range: 150 kHz to 30 MHz (120 MHz)
- ▮ RF input: SO 10599-1
- ▮ Input impedance: > 100 kΩ, < 10 pF (at 1 MHz)
- ▮ Gain factor for direct input to antenna connector: +11.2 dB ±1 dB
- ▮ Correction factor (nom. gain in line with CISPR 25 is 10 dB): 10 dB
- ▮ VSWR: ≤ 1.4
- ▮ Noise voltage at output (input terminated with antenna simulator; AVG, BW = 10 kHz)
 - f > 150 kHz: < -5 dBμV
 - f > 500 kHz: < -7 dBμV
- ▮ 1 dB compression point: > 107 dBμV

R&S®EZ-25 150 kHz Highpass



Conducted emission measurements in the presence of longwave mains disturbance signals

For the measurement of equipment that requires higher selectivity at the transition between 130 kHz and 150 kHz as shown in figure 2 of CISPR 16-1-1 (e.g. signaling equipment as defined in EN 50065-1), a highpass filter may be added in front of the measuring receiver to improve the selectivity and achieve the values stipulated in EN 50065 Part 1 without impairing the passband of the measuring receiver.

- ▮ Conducted emission measurements in line with EN 50065 Part 1
- ▮ Very steep slope in line with CISPR 16-1-1
- ▮ Suitable for any CISPR measuring receiver
- ▮ Relative attenuation > 50 dB below 130 kHz
- ▮ Built-in 10 dB attenuation pad for exact 50 Ω termination of LISN
- ▮ High pulse energy capability (50 mWs)
- ▮ Calibrated response

Specifications in brief

- ▮ Passband: 150 kHz to 30 MHz
- ▮ Insertion loss in passband: 9.5 dB to 11.5 dB
- ▮ VSWR in passband: < 1.2
- ▮ Stopband: below 130 kHz
- ▮ Minimum attenuation in stopband: 60 dB
- ▮ Attenuation in transition region
 - 146 kHz: < 12 dB
 - 145 kHz: > 12 dB
 - 140 kHz: > 24 dB
 - 130 kHz: > 60 dB
- ▮ Max. input voltage (continuous): 137 dBμV
- ▮ Max. impulse energy (50 μs): 50 mWs
- ▮ Dimensions (L × W × H): 145 mm × 95 mm × 52 mm (5.7 in × 3.74 in × 2.05 in)
- ▮ Weight: 500 g (1.1 lb)

R&S®ESH2-Z2/-Z3 Voltage Probes, R&S®ESH2-Z31 Attenuator



R&S®ESH2-Z2 active voltage probe

The active voltage probe is used for measuring RFI voltages on lines that do not carry AC supply voltage.

R&S®ESH2-Z3 passive voltage probe

The passive voltage probe is suitable for measuring RFI voltages (on AC supply lines) in line with CISPR 16-2-1 and EN 55016-2-1.

R&S®ESH2-Z31 attenuator

For checking the interference source impedance in line with EN 55016-2-1 and CISPR 16-2-1

Specifications in brief (R&S®ESH2-Z2/Z3)

- ▮ Frequency range: 9 kHz to 30 MHz
- ▮ Measurement range (AVG, 200 Hz IF bandwidth with Rohde & Schwarz test receivers): -20 dBμV to +120 dBμV/+10 dBμV to +150 dBμV
- ▮ Attenuation, uncertainty of calibration: 10 dB, 0.5 dB/30 dB, 0.5 dB
- ▮ Input impedance: 118 kΩ ± 5% || 8 pF/1.5 kΩ ± 5% || 8 pF
- ▮ Max. input voltage
 - f < 63 Hz: 100 V/250 V
 - f < 500 Hz: 5 V/250 V
 - 9 kHz to 30 MHz: 3 V/30 V

R&S®ESH3-Z2 Pulse Limiter



High RF input levels and high-energy interfering pulses generated on artificial mains networks when the DUT is switched on and off can damage the RF input circuits of test receivers. The R&S®ESH3-Z2 pulse limiter limits and reduces the interference level.

Specifications in brief

- ▮ Frequency range: 0 Hz to 30 MHz
- ▮ Insertion loss: 10 dB ± 0.3 dB
- ▮ Frequency response: ≤ ±0.3 dB
- ▮ SWR with 50 Ω termination, input/output: ≤ 1.06/≤ 1.25
- ▮ Power-handling capacity in continuous mode: 1 W
- ▮ Pulse power-handling capacity: E = 0.1 Ws (6 ms)
- ▮ Dimensions (L × W × H): 94 mm × 25 mm × 25 mm (3.70 in × 0.98 in × 0.98 in)
- ▮ Weight: 120 g (0.26 lb)

EMC accessories for disturbance current measurements

R&S®EZ-17 Current Probe

**Emission and susceptibility measurements**

The R&S®EZ-17 model .02 with its extremely flat frequency response is optimal for current measurements and for measuring shielding effectiveness. Due to its high load capacity, model .03 is recommended for EMS measurements (bulk current injection).

- Model .02 for emission measurements
- Model .03 for emission and susceptibility measurements
- High sensitivity and overload capability
- Wide frequency range
- High load capacity for DC and AC current
- Small dimensions in spite of large inner diameter (30 mm)
- Simple clamping thanks to spring-loaded mechanism

Specifications in brief

- Frequency range: 20 Hz to 100 MHz
- Range with constant transducer factor (–3 dB): 1 MHz/2 MHz to 100 MHz
- Transducer factor reduced by 20 dB/decade in range from 20 Hz to 1 MHz/2 MHz
- Source impedance: $\leq 0.8 \Omega / \leq 1 \Omega$
- Transfer impedance Z_t in range with constant transducer factor: $3.16 \Omega / 7.1 \Omega$
- Transducer factor k in range with flat frequency response: –10 dB/–17 dB
- Load capacity (RF current measurement)
 - Max. DC current or peak, AC current: 300 A ($f < 1$ kHz)
 - Max. RF current (RMS): 2 A ($f > 1$ MHz)/1 A ($f > 1$ MHz)
- Load capacity of model .03 (EMS measurement)
 - Max. power at RF connector: 10 W ($f > 1$ MHz)

R&S®ESV-Z1 VHF Current Probe



The R&S®ESV-Z1 current probe is used for selective or broadband measurements of very small or very large RF currents in electric lines. It is shielded against electrostatic effects and complies with CISPR 16-1-2 and VDE 0876.

Specifications in brief

- Frequency range: 9 kHz to 600 MHz
- Measurement range (AVG, 7.5 kHz IF bandwidth): –33 dB μ A to +117 dB μ A
- Transfer admittance ($Y_t = I_{in}/V_{out}$): 0.1 S (20 MHz to 600 MHz)
- Transducer factor ($k = 20 \log(Y_t/s)$): –20 dB (20 MHz to 600 MHz)
- Max. current (superimposed on RF current or peak AC current): 50 A
- Max. diameter of conductor: 13.5 mm (0.53 in)
- Dimensions (dia./height): 55 mm/20 mm (2.17 in/0.79 in)
- Weight: 130 g (0.29 lb)

EMC accessories for disturbance power measurements

R&S®EZ-24 Ferrite Clamp

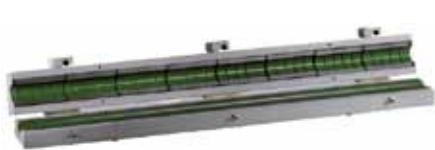

The R&S®EZ-24 ferrite clamp is used to improve the reproducibility of disturbance field strength measurements and of disturbance power and screening effectiveness measurements.

In a 50 Ω circuit, the clamp produces decoupling attenuation of more than 15 dB in the range from 30 MHz to 1 GHz. The ferrite clamp can be opened to insert the cable to be loaded.

Drafts on the measurement of radiated emission call for ferrite absorbers to load cables in order to improve the reproducibility of disturbance field strength measurements. Ferrite absorbers also help to improve the quality of disturbance power and screening effectiveness measurements.

Specifications in brief

- Frequency range: 1 MHz to 1 GHz
- High reproducibility of disturbance field strength measurements
- Calibrated in line with CISPR 16-1-3
- Maximum diameter of cable: 22 mm (0.87 in)

R&S®MDS-21 Absorbing Clamp



The R&S®MDS-21 absorbing clamp can be used together with EMI test receivers to measure the disturbance power of cables in line with CISPR 13 or EN 55013, CISPR 14-1 or EN 55014-1, as well as EN 50083-2. When used with two-port measurement devices, the clamp makes it possible to measure the shielding effectiveness of cables in line with DIN 47250 Part 6, IEC 96-1 and EN 50083-2.

It can also be used for measuring the efficiency of disturbance suppression devices for high-voltage ignition systems in line with CISPR 12 or EN 55012.

High-energy pulses are coupled out and taken to the measuring receiver. This means that measuring receiver inputs must be thoroughly protected.

The clamps are also suitable for use as coupling clamps in order to test the immunity of electronic devices.

Specifications in brief

- Frequency range: 30 MHz to 1000 MHz
- Calibrated in line with CISPR 16-1-3
- Ball bearing rollers for continuous use in automatic measurements
- Maximum diameter of cable: 20 mm (0.79 in)

EMC accessories for field strength measurements

R&S®HZ-10 Shielded, Calibrated Magnetic Field Pickup Coil (MIL)

**Measurement of magnetic field strengths in line with relevant standards**

The R&S®HZ-10 shielded, individually calibrated magnetic field pickup coil allows magnetic field strengths in the frequency range from 20 Hz to 200 kHz to be measured in line with commercial and military standards (MIL-STD-461/462, DEF-STAN 59-61, GAM-EG 13, VG95377 Part 13 and EN55103-1). These standards specify limits for the magnetic flux density in the frequency range from 30 Hz to 50 kHz or 200 kHz and prescribe an electrostatically shielded coil with a defined number of turns for measuring the magnetic flux density. The coil comes with a calibration certificate for the range from 5 Hz to 10 MHz.

Specifications in brief

- ▮ Frequency range: 5 Hz to 10 MHz
- ▮ Antenna factor: calibration certificate supplied with coil
- ▮ Coil
 - Diameter: 133 mm (5.23 in)
 - Number of turns: 36
 - Type of wire: 7-41, litz wire
 - Resistance: 10 Ω
 - Inductance: 415 μH
- ▮ Connector: Twinax female
- ▮ Dimensions (W × H × D): 142 mm × 178 mm × 29 mm (5.59 in × 7.01 in × 1.14 in)
- ▮ Weight: 260 g (0.57 lb)

R&S®HZ-14 H Near-Field Probe Set

**Diagnostic tools for detecting EMC trouble spots**

The R&S®HZ-14 near-field probe set can be used together with test receivers, spectrum analyzers or oscilloscopes to determine electromagnetic emissions of any type. The main application is the diagnosis of emissions from printed boards, cables and leakage spots in shielded enclosures. The two passive H-field probes can be used for a local susceptibility test. The R&S®HZ-14 probe set allows quantitative analysis. It comes in a handy transit case.

Equipment supplied

- ▮ Two passive H-field probes (9 kHz to 30 MHz and 30 MHz to 1 GHz)
- ▮ One active E-field probe (9 kHz to 1 GHz)
- ▮ One 30 dB preamplifier for the H-field probe (can be powered from all Rohde&Schwarz test receivers and spectrum analyzers)
- ▮ Test jig for functional testing of H-field probes and simplified normalization of H-field measurements with the aid of a tracking generator and normalization functions provided in spectrum analyzers

Specifications in brief

- ▮ H-field probes
 - Max. input power:
 - ≤ 30 MHz: 0.5 W; > 30 MHz: 0.25 W
 - VSWR (f > 30 MHz): < 2
- ▮ E-field probe
 - Frequency response: ±3 dB
 - Sensitivity: 13 mV/V
- ▮ Connectors: SMA female
- ▮ Preamplifier
 - Frequency range: 9 kHz to 1 GHz
 - Gain: 30 dB ± 2 dB (typ. ±1 dB)
 - Noise figure: < 4 dB (at +25 °C, 100 MHz), typ. < 3 dB
 - Max. output level (1 dB compression): 8 dBm
 - Input/output: BNC female/N male
 - Impedance: 50 Ω
 - VSWR: < 1.5
 - DC powering: 10/15 V ± 0.1 V, < 100 mA
 - DC connector: LEMO

R&S®HZ-15 Probe Set for E and H Near-Field Emission Measurements



The R&S®HZ-15 probe set contains special probes from 30 MHz to 3 GHz for near-field emission measurements on electronic modules and can be used together with test receivers and spectrum analyzers. Inserting the R&S®HZ-16 preamplifier between the near-field probe and the spectrum analyzer makes it easier to measure very weak high-frequency fields of up to 3 GHz.

- ▮ Five probes for easy diagnostic measurements
- ▮ Special, electrically shielded magnetic field probes
- ▮ Probe tips adapted to near-field measurement
- ▮ High-resolution measurements
- ▮ Easy-to-determine magnetic field orientation
- ▮ Easy operation and handling

Specifications in brief (R&S®HZ-16)

- ▮ Frequency range: 100 kHz to 3 GHz
- ▮ Gain: 20 dB (from 1.5 GHz decreasing to 17 dB)
- ▮ Noise figure: 4.5 dB
- ▮ Max. input power: +13 dBm
- ▮ Operating voltage: 12 V
- ▮ Plug-in power supply: 100 V to 240 V, 50 Hz/60 Hz, Euro connector (2 mm × 4 mm), adapter for USA and Japan

EMC accessories for field strength measurements

R&S®HFH2-Z2 Loop Antenna

**Broadband active loop antenna for measuring the magnetic field-strength**

- ▮ Frequency range: 9 kHz to 30 MHz
- ▮ Antenna factor k, referred to 1/m: 20 dB (E-field)
- ▮ Accuracy: 1 dB
- ▮ Measurement range (200 Hz IF bandwidth, AV ind.)
 - Lower limit, frequency-dependent, 9 kHz to 1 MHz: +40 dB(μV/m) to +10 dB(μV/m)
 - Lower limit, frequency-dependent, 1 MHz to 30 MHz: +10 dB(μV/m) to +5 dB(μV/m)
 - Upper limit: 140 dB(μV/m)
- ▮ Connectors
 - RF: BNC female, 50 Ω
 - Supply and coding (antenna factor): 12-contact Tuchel female
 - Length of connecting cables: 10 m (393.70 in)
- ▮ Current drain (±10 V): < 40 mA
- ▮ Dimensions (loop diameter): 590 mm (23.23 in)
- ▮ Weight in transit case, without cable: 12 kg (26.46 lb)

R&S®HFH2-Z6 Rod Antenna

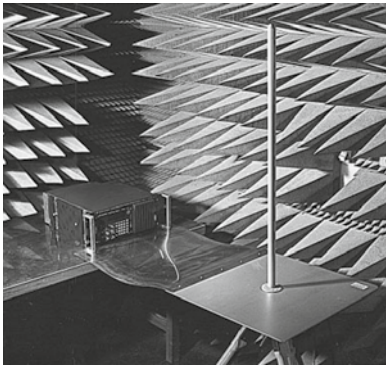
**Broadband active rod antenna for measuring the electrical component of radiated EMI in test setups in line with MIL-STD-461/462, similar MIL standards and CISPR25**

- ▮ Frequency range: 9 kHz to 30 MHz
- ▮ Antenna factor k, referred to 1/m: 10/20 dB, selectable
- ▮ Accuracy: 1 dB
- ▮ Measurement range (200 Hz IF bandwidth, AV ind.)
 - Lower limit, frequency-dependent: +15 dB(μV/m) to -18 dB(μV/m)
 - Upper limit: 140 dB(μV/m), 130 dB(μV/m) with k = 10 dB
- ▮ Connectors
 - RF: BNC female, 50 Ω
 - Supply and coding (antenna factor): 12-contact Tuchel female
 - Length of connecting cables: 10 m (393.70 in)
- ▮ Current drain (±10 V): < 45 mA
- ▮ Dimensions
 - Counterpoise: 600 mm × 600 mm (23.62 in × 23.62 in)
 - Rod height: 1000 mm (39.37 in)
- ▮ Weight without cable: 5 kg (11.02 lb)

R&S®HZ-9 Power Supply

Power supply for feeding the active R&S®HFH2-Z2/-Z6 antennas, if these antennas cannot be powered from the test receiver

- ▮ Output voltages: ±10 V ± 0.5%
- ▮ Max. current load: 100 mA
- ▮ DC connector: 12-contact Tuchel female
- ▮ AC supply: 100 V to 120 V/220 V to 240 V, ±10%
- ▮ Dimensions (W × H × D): 128 mm × 66 mm × 203 mm (5.04 in × 2.60 in × 7.99 in)
- ▮ Weight: 1.7 kg (3.75 lb)

EMC accessories for field strength measurements

R&S®HL033 Log-Periodic Broadband Antenna

**Detection and measurement of RF signals**

- ▮ Extremely broadband
- ▮ Only one antenna required to cover a wide frequency range
- ▮ Low frequency dependence of radiation patterns and input impedance
- ▮ Can be used as transmit antenna
- ▮ Metal parts electrically connected to mast flange for protection against electric charges and lightning
- ▮ Highly weatherproof
- ▮ Stable installation due to optional center bracket
- ▮ Individual calibration in line with ANSI C63.5

Specifications in brief

- ▮ Frequency range: 80 MHz to 2 GHz
- ▮ Polarization: linear
- ▮ Input impedance: 50 Ω
- ▮ VSWR: ≤ 2
- ▮ Max. input power ($T_{amb} = +30^{\circ}\text{C}$)
 - 80 MHz: 460 W + 100% AM
 - 2 GHz: 120 W + 100% AM
- ▮ Gain: typ. 6.5 dBi
- ▮ Max. wind speed (without ice deposit): 150 km/h
- ▮ Dimensions (L x W): approx. 1800 mm x 1960 mm (70.87 in x 77.17 in)
- ▮ Weight: approx. 5 kg (11.02 lb)

R&S®HL040 Log-Periodic Broadband Antenna

**For broadband transmission and reception under open-area and laboratory conditions**

- ▮ Wide bandwidth
- ▮ High symmetry and low frequency dependence of radiation patterns
- ▮ Coverage of various mobile radio frequency ranges
- ▮ Suitable for field strength and EMC measurements due to high precision
- ▮ Individual calibration in line with ANSI C63.5/ DIN 45003
- ▮ Compact and sturdy design
- ▮ Can be used in the lab and for open-area applications
- ▮ Individual calibration certificate

Specifications in brief

- ▮ Frequency range: 400 MHz to 3 GHz
- ▮ Polarization: linear
- ▮ Input impedance: 50 Ω
- ▮ VSWR: < 2.5 , typ. < 2.0
- ▮ Max. input power: 150 W to 50 W CW
- ▮ Gain: 5 dBi to 7 dBi
- ▮ Front-to-back ratio
 - 400 MHz to 450 MHz: > 10 dB
 - 450 MHz to 3 GHz: > 15 dB
- ▮ Polarization isolation: > 20 dB
- ▮ Max. wind speed (without ice deposit): 200 km/h
- ▮ Dimensions (H x W x L): approx. 130 mm x 300 mm x 680 mm (5.1 in x 11.8 in x 26.8 in)
- ▮ Weight: approx. 2.8 kg (6.17 lb)

R&S®HL046 Log-Periodic Broadband Antenna

**Antenna for EMS measurements**

- ▮ Consists of two log-periodic antennas arranged in a V-shape and connected in parallel
- ▮ Almost rotation-symmetrical radiation patterns
- ▮ High antenna gain, i.e. low amplifier power required
- ▮ Wide frequency range
- ▮ High selectivity in H plane
- ▮ Uniform object irradiation due to optimized radiation patterns
- ▮ Reduced influence of test chamber
- ▮ Wall mounting possible
- ▮ Small size, suitable for use in test chambers

Specifications in brief

- ▮ Frequency range: 80 MHz to 1.3 GHz
- ▮ Gain: typ. > 7 dBi
- ▮ Max. input power
 - 80 MHz: 1000 W + 100% AM
 - 1 GHz: 300 W + 100% AM
- ▮ Front-to-back ratio: typ. > 20 dB
- ▮ Input impedance: 50 Ω
- ▮ VSWR: < 2
- ▮ Polarization: linear
- ▮ Optional trolley
 - Height continuously adjustable between approx. 1 m and 1.75 m above ground
 - Optional pneumatic actuators

R&S®HL046E High Gain Log-Periodic Antenna

**Antenna for EMS measurements**

- ▮ High antenna gain, i.e. low amplifier power required
- ▮ No change of antennas needed over wide frequency range
- ▮ Uniform object irradiation due to optimized radiation patterns
- ▮ Small size, suitable for use in test chambers
- ▮ Reduced influence of test chamber
- ▮ Antenna gain approximately constant over the entire frequency range
- ▮ Wall mounting possible

Specifications in brief

- ▮ Frequency range: 80 MHz to 3 GHz
- ▮ Polarization: linear
- ▮ Input impedance: 50 Ω
- ▮ VSWR: < 2 (< 2.5 GHz); < 2.5 (≥ 2.5 GHz)
- ▮ Practical gain: typ. > 8 dBi
- ▮ Max. input power
 - 80 MHz: 1400 W + 100% AM
 - 3 GHz: 250 W + 100% AM
- ▮ Optional trolley
 - Height continuously adjustable between approx. 1 m and 1.75 m above ground
 - Optional pneumatic actuators

EMC accessories for field strength measurements

<p>R&S®HL050 Log-Periodic Antenna</p> 	<p>Log-periodic directional antenna for linear polarization</p> <ul style="list-style-type: none"> ▮ Extremely wide frequency range ▮ Rotation-symmetrical radiation patterns ▮ High gain due to V-shaped configuration of antenna elements ▮ Can be used in the lab and for open-area applications ▮ Can be used as a separate antenna or as a feed for microwave directional antennas 	<p>Specifications in brief</p> <ul style="list-style-type: none"> ▮ Frequency range: 850 MHz to 26.5 GHz ▮ Polarization: linear ▮ Input impedance: 50 Ω ▮ VSWR: ≤ 2.5 ▮ Max. input power: 10 W to 2 W ▮ Gain: typ. 8.5 dBi ▮ Max. wind speed (without ice deposit): 180 km/h ▮ Dimensions (∅ × H, with radome): approx. 210 mm × 300 mm (8.27 in × 11.81 in) ▮ Weight: approx. 0.7 kg (1.54 lb)
<p>R&S®HL223 Log-Periodic Antenna</p> 	<p>For measurement, monitoring and transmission</p> <p>Owing to its broadband characteristics and the virtually frequency-independent radiation patterns, the R&S®HL223 covers a very wide frequency range. The sturdy construction makes the antenna suitable for stationary and mobile applications. Each antenna is supplied with an individual calibration certificate so that measurements can be performed in addition to monitoring and transmitting.</p>	<p>Specifications in brief</p> <ul style="list-style-type: none"> ▮ Frequency range: 200 MHz to 1.3 GHz ▮ Polarization: linear ▮ Input impedance: 50 Ω ▮ VSWR: ≤ 2 (typ. 1.6) ▮ Max. input power: 1500 W to 600 W CW ▮ Gain: > 6 dBi ▮ Max. wind speed (without ice deposit): 200 km/h ▮ Dimensions (L × W): approx. 710 mm × 765 mm (27.95 in × 30.12 in) ▮ Weight: approx. 2 kg (4.41 lb)
<p>R&S®HM020 Triple-Loop Antenna</p> 	<p>Large loop antenna system</p> <p>The R&S®HM020 is a large loop antenna system in line with CISPR 16-1-4, for electric lighting equipment in line with CISPR 15 and for induction sources in line with CISPR 11.</p> <ul style="list-style-type: none"> ▮ Frequency range: 9 kHz to 30 MHz ▮ Loops switchable between X, Y and Z planes ▮ Transducer factor of current probe: 0 dB, referred to 1 S ▮ RF connector: N female, 50 Ω 	<p>Dimensions (W × H × D); weight</p> <ul style="list-style-type: none"> ▮ Loops set up, normal mode: 2.49 m × 2.57 m × 2.07 m; 45 kg (98.03 in × 101.18 in × 81.50 in; 99.21 lb) ▮ Loops set up, reduced height: 2.49 m × 2.09 m × 2.07 m (98.03 in × 82.28 in × 81.50 in) ▮ Transport crate: 2.68 m × 2.32 m × 0.57 m (105.51 in × 91.34 in × 22.44 in) ▮ R&S®HM020Z1 basic pedestal: 0.9 m × 1 m × 0.9 m; 40 kg (35.43 in × 39.37 in × 35.43 in; 88.18 lb) ▮ R&S®HM020Z2 adapter pedestal: 0.9 m × max. 0.5 m × 0.9 m; 30 kg (35.43 in × max. 19.69 in × 35.43 in; 66.14 lb)
<p>R&S®HK5000 EMS Broadband Dipole</p> 	<p>High-power transmitting antenna specially designed for EMS operation in test chambers</p> <ul style="list-style-type: none"> ▮ Generation of high field strength ▮ High power capability ▮ No tuning necessary ▮ Compact size ▮ Easy mounting and dismounting 	<p>Specifications in brief</p> <ul style="list-style-type: none"> ▮ Frequency range: 20 MHz to 100 MHz ▮ Polarization: linear ▮ Input impedance: 50 Ω ▮ VSWR: < 2 (under free-space conditions) ▮ Gain: > 2 dBi (under free-space conditions) ▮ Max. input power <ul style="list-style-type: none"> ▪ With EIA 1 5/8" connector: 10 kW CW ▪ With 13-30 connector (in line with IEC 169-5): 5 kW CW ▮ Generated field strength: > 200 V/m RMS at a distance of 1 m and 5 kW CW input power ▮ Dimensions (L × W × H) <ul style="list-style-type: none"> ▪ Vertically polarized: approx. 1.8 m × 2.95 m × 2.2 m (70.9 in × 116.1 in × 86.6 in) ▪ Horizontally polarized: approx. 2.9 m × 2.4 m × 2.2 m (114.2 in × 94.5 in × 86.6 in) ▮ Weight <ul style="list-style-type: none"> ▪ Antenna: approx. 150 kg (330.7 lb) ▪ Holder with motor: approx. 120 kg (264.6 lb)

EMC accessories for field strength measurements

R&S®HK116 Biconical Antenna

**For radiated emission measurements**

- ▮ Wide frequency range
- ▮ Radiation patterns virtually independent of frequency
- ▮ Individual calibration in line with ANSI C63.5 (free-space calibration) and ARP958
- ▮ Low weight

Specifications in brief

- ▮ Frequency range: 20 MHz to 300 MHz
- ▮ Polarization: linear
- ▮ Input impedance: 50 Ω
- ▮ VSWR: typ. 2.5
- ▮ Permissible input power: 75 W CW
- ▮ Dimensions (L × W × H): approx. 1380 mm × 530 mm × 720 mm (54.3 in × 20.9 in × 28.3 in)
- ▮ Weight: approx. 3 kg (6.61 lb)

R&S®HF907 Double-Ridged Waveguide Horn Antenna

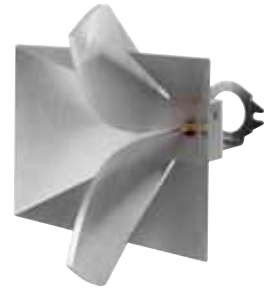
**Broadband directional antenna, ideal for EMC measurements**

- ▮ Wide frequency range
- ▮ High gain and low VSWR for measurement of weak signals and generation of high field strengths without any significant return loss
- ▮ Radiation pattern contains only one main lobe over the entire frequency range
- ▮ Ideal for use in EMC laboratories
- ▮ Compact size, low weight
- ▮ Each antenna is calibrated individually in line with ANSI C63.5 and SAE ARP958

Specifications in brief

- ▮ Frequency range: 800 MHz to 18 GHz
- ▮ Polarization: linear
- ▮ Polarization decoupling: > 25 dB (typ. > 30 dB)
- ▮ Input impedance: 50 Ω
- ▮ VSWR: ≤ 3.0 (f < 1.5 GHz); < 2.0 (f ≥ 1.5 GHz)
- ▮ Max. input power: 300 W CW/500 W PEP
- ▮ Gain: 5 dBi to 14 dBi (typ.)
- ▮ Dimensions (L × W × H): approx. 305 mm × 280 mm × 226 mm (12.0 in × 11.0 in × 8.9 in)
- ▮ Weight: approx. 1.9 kg (4.2 lb)

R&S®HL562 ULTRALOG

**EMI and EMS measurements in an extremely wide frequency range**

- ▮ Combines the characteristics of a biconical and a log-periodic antenna
- ▮ Only one antenna required to cover a wide frequency range
- ▮ Selectable polarization plane
- ▮ V-shaped log-periodic part of the antenna for high system sensitivity
- ▮ Suitable for EMS measurements with high field strengths (10 V/m or higher)
- ▮ Gain increase at high frequencies
- ▮ Compact size
- ▮ Individual calibration (ANSI C63.5 and DIN 45003)

Specifications in brief

- ▮ Frequency range: 30 MHz to 3 GHz
- ▮ Polarization: linear
- ▮ Cross-polar suppression: > 20 dB (in line with CISPR 16-1-4)
- ▮ Nominal impedance: 50 Ω
- ▮ VSWR: typ. < 2
- ▮ Max. input power ($T_{amb} = +40^{\circ}\text{C}$)
 - 30 MHz: 150 W + 100% AM
 - 80 MHz: 300 W + 100% AM
 - 250 MHz: 500 W + 100% AM
 - 1000 MHz: 280 W + 100% AM
 - 3000 MHz: 180 W + 100% AM
- ▮ Gain: typ. 8 dBi from 200 MHz

R&S®HE202 Active Receiving Dipole

**Optimized for very small dimensions**

- ▮ Extremely small size
- ▮ High sensitivity
- ▮ Wide frequency range
- ▮ High immunity to nonlinear distortion, comparable to passive antennas in conjunction with high-grade preamplifier
- ▮ High immunity to nearby lightning strikes
- ▮ Shock- and vibration-resistant
- ▮ Linear polarization

Specifications in brief

- ▮ Frequency range: 200 MHz to 1 GHz
- ▮ VSWR: < 2.5
- ▮ Electronic gain: 5 dB to 9 dB
- ▮ Practical gain: 7 dB to 11 dB
- ▮ Directivity: 2 dB average
- ▮ Noise figure: 6 dB (200 MHz); 7 dB (1 GHz)
- ▮ Second-order intercept: > 55 dBm
- ▮ Third-order intercept: > 30 dBm
- ▮ Dimensions (L × H): approx. 512 mm × 238 mm (20.16 in × 9.37 in)
- ▮ Weight: 2.1 kg (4.63 lb)

R&S®HE302 Active Receiving Dipole

**Optimized for very small dimensions**

- ▮ Extremely small size
- ▮ High sensitivity
- ▮ Wide frequency range
- ▮ High immunity to nonlinear distortion, comparable to passive antennas in conjunction with high-grade preamplifier
- ▮ High immunity to nearby lightning strikes
- ▮ Shock- and vibration-resistant
- ▮ Linear polarization

Specifications in brief

- ▮ Frequency range: 20 MHz to 500 MHz
- ▮ VSWR: < 2.5
- ▮ Electronic gain: -11 dB to +8 dB
- ▮ Practical gain: -9 dB to +10 dB
- ▮ Directivity: 2 dB average
- ▮ Noise figure: 28 dB (20 MHz); 9 dB (500 MHz)
- ▮ Second-order intercept: > 60 dBm
- ▮ Third-order intercept: > 30 dBm
- ▮ Dimensions (L × H): approx. 1 m × 240 mm (39.37 in × 9.45 in)
- ▮ Weight: 2.5 kg (5.51 lb)

Chapter 9

Power Meters and Voltmeters

Power meters, directional power meters, voltmeters and sensors from Rohde & Schwarz provide extremely high versatility. Rohde & Schwarz power sensors are intelligent standalone instruments specially designed for use with the company's signal generators and spectrum analyzers.



Type	Designation	Description	Page
R&S®NRP2	Power Meter	The ultimate solution for power measurements	135
R&S®NRP-Zxx	Power Sensors	USB power sensors for power measurements with a base unit or standalone on a PC	135
R&S®NRPV	Virtual Power Meter	Easy RF power measurements with R&S®NRP-Zxx power sensors on a PC	138
R&S®NRP-Z5	Sensor Hub	Connecting up to four R&S®NRP-Zxx power sensors	138
R&S®NRT	Power Reflection Meter	Power measurement on transmitters, amplifiers, industrial RF and microwave generators	139
R&S®NRT-Zxx	Power Sensors	Intelligent sensors: simply plug in and measure	139
R&S®NRVD	Dual-Channel Power Meter	Power, level and voltage measurements from DC to 40 GHz	140
R&S®NRV-Zxx	Power Sensors	Thermal sensors and diode sensors for high-precision power measurements	140
R&S®NRVC	Calibration Kit	Power calibration up to 18 GHz	141
R&S®URE3	RMS/Peak Voltmeter	At the peak of speed and precision	141

R&S®NRP2 Power Meter



The ultimate solution for power measurements

Accurate determination of RF power is one of the most challenging tasks in the field of electrical test and measurement. The R&S®NRP2 power meter is ideal for a vast number of applications in R&D, production and maintenance as well as in calibration laboratories. In addition to the R&S®NRP2 base unit, there are a number of sensors available to perform diverse measurements. Complex signals with digital modulation (e.g. as required by advanced mobile radio standards such as WCDMA and WiMAX™) are handled as easily as are CW signals, carriers with analog modulation (e.g. AM, FM) and pulsed RF.

Each R&S®NRP-Zxx sensor is an independent test instrument and can be operated directly via USB. The sensors are typically connected using the R&S®NRP-Z4 passive USB adapter. Regardless of the type, no calibration is required prior to making measurements, since calibration data is stored directly in the sensor at the factory.

- ▮ Power measurements with a base unit or with cost-efficient USB power sensors alone
- ▮ Average, peak and peak-to-average power measurements from DC to 67 GHz
- ▮ Versatile USB power sensors with superior performance
- ▮ Accurate measurements for GSM/EDGE, 3G, WLAN, WiMAX™, LTE and beyond
- ▮ Solutions for radar and EMC applications
- ▮ Ultrafast statistical analysis
- ▮ Flexible use with signal generators, signal analyzers and network analyzers from Rohde&Schwarz

R&S®NRP2 base unit

- ▮ Small, lightweight and ruggedized base unit for production, laboratory and mobile applications
- ▮ Simple operation due to window-based graphical user interface
- ▮ Presets for fast, standard-compliant measurements
- ▮ Simultaneous operation of up to four sensors (with the R&S®NRP-B2 and R&S®NRP-B5 options)
- ▮ Remote operation via Ethernet, GPIB or USB
- ▮ Sensor check source (R&S®NRP-B1 option)

R&S®NRP-Z11/-Z2x/-Z31 universal power sensors

- ▮ True universal power sensors for a vast number of applications
- ▮ Innovative three-path diode power sensor with enhanced inter-range performance
- ▮ 90 dB dynamic range for CW und modulated signals
- ▮ Continuous average, burst average, timeslot average, time gating and trace mode supported (100 kHz video bandwidth)
- ▮ Automatic burst detection and acquisition
- ▮ Up to 1500 measurements/s (buffered mode)
- ▮ Low sensitivity to harmonics

R&S®NRP-Z211/-Z221 two-path diode power sensors

- ▮ Excellent price/performance ratio
- ▮ 80 dB dynamic range for CW and modulated signals
- ▮ Two-path diode power sensor with enhanced inter-range performance
- ▮ Continuous average, burst average, timeslot average, time gating and trace mode supported (50 kHz video bandwidth)
- ▮ Automatic burst detection and acquisition

R&S®NRP-Z27/-Z37 power sensor modules (for use with the R&S®FSMR)

- ▮ Power sensor with additional RF signal output
- ▮ Developed for use with the R&S®FSMR measuring receiver
- ▮ For precise calibration of T&M equipment
- ▮ DC to 18 GHz (R&S®NRP-Z27)
- ▮ DC to 26.5 GHz (R&S®NRP-Z37)
- ▮ Level range from -24 dBm to +26 dBm



R&S®NRP-Z23 sensor.



R&S®NRP-Z22 sensor.



R&S®NRP-Z28 sensor.



R&S®NRP-Z81 sensor.

R&S®NRP-Z5x thermal power sensors

- ▮ Suitable for very demanding reference applications
- ▮ Industry-proven DC-coupled thermoelectric test cell
- ▮ Highly accurate continuous average power measurements
- ▮ Linearity uncertainty < 0.007 dB

R&S®NRP-Z8x wideband power sensors

- ▮ Peak power measurements of radar and mobile communications signals with up to 30 MHz RF video bandwidth; sensor rise time < 13 ns
- ▮ Automatic burst detection and acquisition
- ▮ Ultrafast statistical analysis (one-million point CCDF within < 25 ms)
- ▮ Accurate continuous power measurements on modulated and unmodulated signals in the range from -60 dBm to +20 dBm
- ▮ High measurement repeatability due to very low zero drift of < 150 nW for single-shot events and statistics, < 2 nW for repetitive measurements

R&S®NRP-Z9x average power sensors

- ▮ Specially designed for EMC applications
- ▮ Measurement of continuous average power
- ▮ 90 dB dynamic range for CW and modulated signals
- ▮ Low sensitivity to harmonics

R&S®NRP-Z28/-Z98 level control sensors

The sensors are used where high-precision RF power is required as a reference source over a high dynamic range.

- ▮ Integrated one-box solution for classic power splitter/power sensor combination
- ▮ Special directional power sensor with integrated power splitter
- ▮ For applications requiring a precisely known level to be fed in (e.g. calibration of measuring receivers)
- ▮ 10 MHz to 18 GHz (R&S®NRP-Z28)
- ▮ 9 kHz to 6 GHz (R&S®NRP-Z98)
- ▮ Improvement of the absolute level accuracy of signal generators

Recommended extras	
R&S®NRP-Z2	Extension cable
R&S®NRP-Z3	Active USB adapter
R&S®NRP-Z4	Passive USB adapter
R&S®NRP-Z5	Sensor hub for up to 4 R&S®NRP-Zxx sensors
R&S®NRPZ-K1	Option key for R&S®NRPV virtual power meter PC application

R&S®NRP-Zxx sensor overview					
Sensor connector	Frequency range	Power range; max. average power/peak envelope power	Impedance matching (SWR)	Rise time, video BW	Accuracy
Universal power sensors					
R&S®NRP-Z11 N connector	10 MHz to 8 GHz	200 pW to 200 mW (-67 dBm to +23 dBm); max. 400 mW (AVG), 1 W (PK, 10 µs)	< 1.13 (10 MHz to 2.4 GHz) < 1.20 (> 2.4 GHz to 8.0 GHz)	< 8 µs, > 50 kHz	0.058 dB
R&S®NRP-Z21 N connector	10 MHz to 18 GHz	200 pW to 200 mW (-67 dBm to +23 dBm); max. 400 mW (AVG), 1 W (PK, 10 µs)	< 1.13 (10 MHz to 2.4 GHz) < 1.20 (> 2.4 GHz to 8.0 GHz) < 1.25 (> 8.0 GHz to 18.0 GHz)	< 8 µs, > 50 kHz	0.058 dB
R&S®NRP-Z31 3.5 mm connector	10 MHz to 33 GHz	200 pW to 200 mW (-67 dBm to +23 dBm); max. 400 mW (AVG), 1 W (PK, 10 µs)	< 1.13 (10 MHz to 2.4 GHz) < 1.20 (> 2.4 GHz to 8.0 GHz) < 1.25 (> 8.0 GHz to 18.0 GHz) < 1.30 (> 18.0 GHz to 26.5 GHz) < 1.35 (> 26.5 GHz to 33.0 GHz)	< 8 µs, > 50 kHz	0.149 dB
R&S®NRP-Z22 N connector	10 MHz to 18 GHz	2 nW to 2 W (-57 dBm to +33 dBm); max. 3 W (AVG), 10 W (PK, 10 µs)	< 1.14 (10 MHz to 2.4 GHz) < 1.20 (> 2.4 GHz to 8.0 GHz) < 1.25 (> 8.0 GHz to 12.4 GHz) < 1.30 (> 12.4 GHz to 18.0 GHz)	< 8 µs, > 50 kHz	0.085 dB
R&S®NRP-Z23 N connector	10 MHz to 18 GHz	20 nW to 15 W (-47 dBm to +42 dBm); max. 18 W (AVG), 100 W (PK, 10 µs)	< 1.14 (10 MHz to 2.4 GHz) < 1.25 (> 2.4 GHz to 8.0 GHz) < 1.30 (> 8.0 GHz to 12.4 GHz) < 1.41 (> 12.4 GHz to 18.0 GHz)	< 8 µs, > 50 kHz	0.087 dB
R&S®NRP-Z24 N connector	10 MHz to 18 GHz	60 nW to 30 W (-42 dBm to +45 dBm); max. 36 W (AVG), 300 W (PK, 10 µs)	< 1.14 (10 MHz to 2.4 GHz) < 1.25 (> 2.4 GHz to 8.0 GHz) < 1.30 (> 8.0 GHz to 12.4 GHz) < 1.41 (> 12.4 GHz to 18.0 GHz)	< 8 µs, > 50 kHz	0.088 dB
Two-path diode power sensors					
R&S®NRP-Z211 N connector	10 MHz to 8 GHz	1 µW to 100 mW (-60 dBm to +20 dBm); max. 400 mW (AVG), 2W (PK, 10 µs)	< 1.13 (10 MHz to 2.4 GHz) < 1.20 (> 2.4 GHz to 8.0 GHz)	< 10 µs, > 40 kHz	0.075 dB
R&S®NRP-Z221 N connector	10 MHz to 18 GHz	1 µW to 100 mW (-60 dBm to +20 dBm); max. 400 mW (AVG), 2W (PK, 10 µs)	< 1.13 (10 MHz to 2.4 GHz) < 1.20 (> 2.4 GHz to 8.0 GHz) < 1.25 (> 8.0 GHz to 18.0 GHz)	< 10 µs, > 40 kHz	0.075 dB

R&S®NRP-Zxx sensor overview					
Sensor connector	Frequency range	Power range; max. average power/peak envelope power	Impedance matching (SWR)	Rise time, video BW	Accuracy
Thermal power sensors					
R&S®NRP-Z51 N connector	DC to 18 GHz	1 µW to 100 mW (–30 dBm to +20 dBm); max. 300 mW (AVG), 10 W (PK, 1 µs)	< 1.10 (DC to 2.4 GHz) < 1.15 (> 2.4 GHz to 12.4 GHz) < 1.20 (> 12.4 GHz to 18.0 GHz)	–	0.061 dB
R&S®NRP-Z52 3.5 mm connector	DC to 18 GHz	1 µW to 100 mW (–30 dBm to +20 dBm); max. 300 mW (AVG), 10 W (PK, 1 µs)	< 1.10 (DC to 2.4 GHz) < 1.15 (> 2.4 GHz to 12.4 GHz) < 1.20 (> 12.4 GHz to 18.0 GHz)	–	0.068 dB
R&S®NRP-Z55 2.92 mm connector	DC to 40 GHz	1 µW to 100 mW (–30 dBm to +20 dBm); max. 300 mW (AVG), 10 W (PK, 1 µs)	< 1.10 (DC to 2.4 GHz) < 1.15 (> 2.4 GHz to 12.4 GHz) < 1.20 (> 12.4 GHz to 18.0 GHz) < 1.25 (> 18.0 GHz to 26.5 GHz) < 1.30 (> 26.5 GHz to 40.0 GHz)	–	0.068 dB
R&S®NRP-Z56 2.40 mm connector	DC to 50 GHz	300 nW to 100 mW (–35 dBm to +20 dBm); max. 300 mW (AVG), 10 W (PK, 1 µs)	< 1.03 (DC to 100 MHz) < 1.06 (> 100 MHz to 2.4 GHz) < 1.13 (> 2.4 GHz to 12.4 GHz) < 1.16 (> 12.4 GHz to 18.0 GHz) < 1.22 (> 18.0 GHz to 26.5 GHz) < 1.28 (> 26.5 GHz to 40.0 GHz) < 1.30 (> 40.0 GHz to 50.0 GHz)	–	0.055 dB
R&S®NRP-Z57 1.85 mm connector	DC to 67 GHz	300 nW to 100 mW (–35 dBm to +20 dBm); max. 300 mW (AVG), 10 W (PK, 1 µs)	< 1.03 (DC to 100 MHz) < 1.06 (> 100 MHz to 2.4 GHz) < 1.13 (> 2.4 GHz to 12.4 GHz) < 1.16 (> 12.4 GHz to 18.0 GHz) < 1.22 (> 18.0 GHz to 26.5 GHz) < 1.28 (> 26.5 GHz to 40.0 GHz) < 1.30 (> 40.0 GHz to 50.0 GHz) < 1.35 (> 50.0 GHz to 67.5 GHz)	–	0.055 dB
Wideband power sensors					
R&S®NRP-Z81 N connector	50 MHz to 18 GHz	1 nW to 100 mW (–60 dBm to +20 dBm); max. 200 mW (AVG), 1 W (PK, 1 µs)	< 1.16 (50 MHz to 2.4 GHz) < 1.20 (> 2.4 GHz to 8.0 GHz) < 1.25 (> 8.0 GHz to 18.0 GHz)	< 13 ns, up to 30 MHz	0.13 dB
R&S®NRP-Z85 2.92 mm connector	50 MHz to 40 GHz	1 nW to 100 mW (–60 dBm to +20 dBm); max. 200 mW (AVG), 1 W (PK, 1 µs)	< 1.16 (50 MHz to 2.4 GHz) < 1.20 (> 2.4 GHz to 8.0 GHz) < 1.25 (> 8.0 GHz to 18.0 GHz) < 1.30 (> 18.0 GHz to 26.5 GHz) < 1.35 (> 26.5 GHz to 40.0 GHz)	< 13 ns, up to 30 MHz	0.13 dB
R&S®NRP-Z86 2.40 mm connector	50 MHz to 40 GHz	1 nW to 100 mW (–60 dBm to +20 dBm); max. 200 mW (AVG), 1 W (PK, 1 µs)	< 1.16 (50 MHz to 2.4 GHz) < 1.20 (> 2.4 GHz to 8.0 GHz) < 1.25 (> 8.0 GHz to 18.0 GHz) < 1.30 (> 18.0 GHz to 26.5 GHz) < 1.35 (> 26.5 GHz to 40.0 GHz)	< 13 ns, up to 30 MHz	0.13 dB
Average power sensors					
R&S®NRP-Z91 N connector	9 kHz to 6 GHz	200 pW to 200 mW (–67 dBm to +23 dBm); max. 400 mW (AVG), 1 W (PK, 10 µs)	< 1.13 (9 kHz to 2.4 GHz) < 1.20 (> 2.4 GHz to 6.0 GHz)	–	0.058 dB
R&S®NRP-Z92 N connector	9 kHz to 6 GHz	2 nW to 2 W (–57 dBm to +33 dBm); max. 3 W (AVG), 10 W (PK, 10 µs)	< 1.14 (9 kHz to 2.4 GHz) < 1.20 (> 2.4 GHz to 6.0 GHz)	–	0.085 dB
Level control sensors					
R&S®NRP-Z28 N connector	10 MHz to 18 GHz	200 pW to 100 mW (–67 dBm to +20 dBm); max. 700 mW (AVG), > 4 W (PK, 10 µs)	< 1.11 (10 MHz to 2.4 GHz) < 1.15 (> 2.4 GHz to 4.0 GHz) < 1.22 (> 4.0 GHz to 8.0 GHz) < 1.30 (> 8.0 GHz to 18.0 GHz)	< 8 µs, > 50 kHz	0.058 dB
R&S®NRP-Z98 N connector	9 kHz to 6 GHz	200 pW to 100 mW (–67 dBm to +20 dBm); max. 700 mW (AVG), > 4 W (PK, 10 µs)	< 1.11 (9 kHz to 2.4 GHz) < 1.15 (> 2.4 GHz to 4.0 GHz) < 1.22 (> 4.0 GHz to 6.0 GHz)	–	0.058 dB
Power sensor modules (for use with the R&S®FSMR)					
R&S®NRP-Z27 N connector	DC to 18 GHz	4 µW to 400 mW (–24 dBm to +26 dBm); max. 500 mW (AVG), 30 W (PK, 1 µs)	< 1.15 (DC to 2.0 GHz) < 1.18 (> 2.0 GHz to 4.2 GHz) < 1.23 (> 4.3 GHz to 8.0 GHz) < 1.25 (> 8.0 GHz to 12.4 GHz) < 1.35 (> 12.4 GHz to 18 GHz)	–	0.075 dB
R&S®NRP-Z37 3.5 mm connector	DC to 26.5 GHz	4 µW to 400 mW (–24 dBm to +26 dBm); 500 mW (AVG), 30 W (PK, 1 µs)	< 1.15 (DC to 2.0 GHz) < 1.18 (> 2.0 GHz to 4.2 GHz) < 1.23 (> 4.3 GHz to 8.0 GHz) < 1.25 (> 8.0 GHz to 12.4 GHz) < 1.30 (> 12.4 GHz to 18.0 GHz) < 1.45 (> 18.0 GHz to 26.5 GHz)	–	0.075 dB

R&S®NRPV Virtual Power Meter



Easy RF power measurements with R&S®NRP-Zxx power sensors on a PC

The R&S®NRPV virtual power meter is a sophisticated, user-friendly PC software for power measurements. It supports all R&S®NRP-Zxx power sensors and the sensor-specific measurement modes.

- ▮ Simultaneous operation of up to four R&S®NRP-Zxx power sensors
- ▮ Multiple traces in one window
- ▮ Flexible marker functionality
- ▮ Sensor-based licensing concept (R&S®NRPZ-K1)

Specifications in brief

Measurement modes	continuous average (numeric), timegate (numeric), timeslot (bargraph), burst average (numeric), trace (graphical), statistics (graphical)
Number of power sensors to be used simultaneously (= number of channels)	1 to 4
Continuous average	
Max. number of measurements per measurement window	4
Measurand	average, peak, random
Timeslot	
Max. number of timeslots	16
Nominal width	0 s to 999.999 s
Exclude areas at start and end of slot	0 to nominal width
Fences	1 (valid for all slots), length: 0 to nominal width
Timegate	
Max. number of gates	4
Gate length	0 s to 999.999 s
Fences	1 per gate, length: 0 to gate length
Trace	
Max. number of traces per measurement window	8 (4 physical plus 4 math)
Measurand	average, peak, random
Math functions	ratio, difference, SWR
Statistics	
Max. number of traces per measurement window	5 (4 physical plus AWGN reference trace)
Aperture	10 ns to 1 s
Distribution function	CCDF (lin), CCDF (log), CDF (lin), CDF (log), PDF (lin)

R&S®NRP-Z5 Sensor Hub



Connecting up to four R&S®NRP-Zxx power sensors

The R&S®NRP-Z5 can host up to four R&S®NRP-Zxx sensors. A professional trigger solution allows simultaneous internal and external triggering of all connected sensors.

- ▮ Connection of up to four R&S®NRP-Zxx power sensors
- ▮ Internal triggering, individual for each sensor
- ▮ Bidirectional trigger bus for external and synchronous triggering
- ▮ Trigger master mode (with R&S®NRP-Z8x)

R&S®NRT Power Reflection Meter



Power measurement on transmitters, amplifiers, industrial RF and microwave generators

- ▮ Simultaneous display of power and reflection
- ▮ Measurement of average power irrespective of modulation mode
- ▮ Measurement of peak power, crest factor and average burst power
- ▮ Compatible with all main digital standards, such as GSM/EDGE, WCDMA, cdmaOne, CDMA2000®, PHS, NADC, PDC, TETRA, DECT, DAB, DVB-T
- ▮ Intelligent sensors: simply plug in and measure
- ▮ Digital interface between sensor and base unit
- ▮ Direct connection of sensor to a PC

Specifications in brief (base unit)

Frequency range	200 kHz to 4 GHz (sensor-dependent)
Power measurement range	0.7 mW to 2 kW (sensor-dependent)
Measurement inputs	1 to 3 (4), one active
For R&S®NRT-Zxx sensors	one input on front panel, two additional inputs on rear panel (R&S®NRT-B2 option)
For R&S®NAP-Zx sensors	one input on rear panel (R&S®NRT-B1 option)
Measurement functions	
Power	forward power and power absorbed by load in W, dBm, dB or % (dB and % referenced to measured value or reference value)
Power parameters	average power, average burst power, peak envelope power, peak-to-average ratio (crest factor), complementary cumulative distribution function
Reflection	SWR, return loss, reflection coefficient, reverse-to-forward power ratio in %, reverse power



R&S®NRT-Z44 directional power sensor.

Specifications in brief (directional power sensors)

	R&S®NRT-Z14	R&S®NRT-Z43	R&S®NRT-Z44
Power measurement range	0.006 W to 120 W (average), 300 W (peak)	0.0007 W to 30 W (average), 75 W (peak)	0.003 W to 120 W (average), 300 W (peak)
Frequency range	25 MHz to 1 GHz	400 MHz to 4 GHz	200 MHz to 4 GHz
SWR (referenced to 50 Ω)	max. 1.06	max. 1.07 (from 0.4 GHz to 3 GHz), max. 1.12 (from 3 GHz to 4 GHz)	max. 1.07 (from 0.2 GHz to 3 GHz), max. 1.12 (from 3 GHz to 4 GHz)
Insertion loss	max. 0.06 dB	max. 0.06 dB (from 0.4 GHz to 1.5 GHz), max. 0.09 dB (from 1.5 GHz to 4 GHz)	max. 0.06 dB (from 0.2 GHz to 1.5 GHz), max. 0.09 dB (from 1.5 GHz to 4 GHz)
Directivity	min. 30 dB	min. 30 dB (from 0.4 GHz to 3 GHz), min. 26 dB (from 3 GHz to 4 GHz)	min. 30 dB (from 0.2 GHz to 3 GHz), min. 26 dB (from 3 GHz to 4 GHz)
	R&S®NAP-Z6	R&S®NAP-Z7	R&S®NAP-Z8
Power measurement range	0.3 W to 1.1 kW	0.05 W to 200 W	0.5 W to 2 kW
Frequency range	25 MHz to 1 GHz	0.4 MHz to 80 MHz	0.2 (0.4) MHz to 80 MHz
SWR (referenced to 50 Ω)	max. 1.07	max. 1.03 (max. 1.02 from 1.5 MHz to 30 MHz)	
Insertion loss			
Up to 0.3 GHz	max. 0.05 dB	–	–
Up to 0.5 GHz	max. 0.10 dB	–	–
Entire frequency range	max. 0.15 dB	max. 0.015 dB	max. 0.015 dB
Directivity	min. 25 dB	min. 35 dB (from 1.5 MHz to 30 MHz)	

R&S®NRVD Dual-Channel Power Meter



Power, level and voltage measurements from DC to 40 GHz

The R&S®NRVD operates like two independent power meters in one instrument, performing simultaneous measurements and exchanging data with each other. The two channels can be set separately so that two completely dif-

ferent measurements can be carried out at the same time. The two measured values can also be related to each other for readout of reflection coefficient, SWR or return loss, for instance.

- ▀ Accurate, general-purpose, easy-to-use
- ▀ Attenuation and reflection measurements
- ▀ Two independent channels measuring simultaneously
- ▀ Operating modes: average power, reflection, pulse power, AM, DC
- ▀ Manual or automatic range selection
- ▀ Intelligent sensors – simply plug in and measure
- ▀ Remote control of all functions via IEC/IEEE (SCPI)

Specifications in brief

Measurement functions	unmodulated and modulated power (average power, pulse power, peak envelope power, AM), reflection, DC and AC voltage (depending on sensor)
Frequency and level range	DC to 40 GHz, 100 pW to 30 W (depending on sensor)
Sensors	all R&S®NRV-Zxx and R&S®URV5-Zx voltage and power sensors

R&S®NRV-Zxx Power Sensors



Thermal sensors and diode sensors for high-precision power measurements

- ▀ Compatible with the R&S®NRVS and R&S®NRVD base units
- ▀ Standards: GSM900/1800/1900, DECT, cdmaOne, CDMA2000®, WCDMA, NADC, PDC, DAB, DVB, etc.
- ▀ Absolute calibration – simply plug in and measure
- ▀ Calibration data memory for sensor-specific parameters
- ▀ High long-term stability
- ▀ Excellent temperature response

Specifications in brief

Model Connector Impedance	Frequency range	Power measurement range, max. power	Max. SWR (reflection coefficient)		Zero offset	Display noise	Linearity uncertainty	Power coefficient
R&S®NRV-Z4 N connector 50 Ω	100 kHz to 6 GHz	100 pW to 20 mW, 100 mW (AVG), 100 mW (PK)	0.1 MHz to 100 MHz	1.05 (0.024)	±50 pW	20 pW	0.03 dB (0.7%)	0
R&S®NRV-Z6 PC-3.5 connector 50 Ω	50 MHz to 26.5 GHz	400 pW to 20 mW, 100 mW (AVG), 100 mW (PK)	> 0.1 GHz to 2 GHz	1.10 (0.048)	±200 pW	80 pW	0.04 dB (1%)	0
R&S®NRV-Z15 K connector (2.92 mm), 50 Ω	50 MHz to 40 GHz	400 pW to 20 mW, 100 mW (AVG), 100 mW (PK)	> 2 GHz to 4 GHz	1.20 (0.09)	±200 pW	80 pW	0.04 dB (1%)	0
R&S®NRV-Z5 N connector 50 Ω	100 kHz to 6 GHz	10 nW to 500 mW, 2 W (AVG), 10 W (PK)	> 4 GHz to 6 GHz	1.35 (0.15)	±5 nW	2 nW	0.03 dB (0.7%)	0
R&S®NRV-Z31 N connector 50 Ω	30 MHz to 6 GHz	1 μW to 20 mW, 100 mW (AVG), 100 mW (PK)	0.03 GHz to 0.1 GHz	1.05 (0.024)	±30 nW	3 nW	included in calibration uncertainty	0
			> 0.1 GHz to 2 GHz	1.10 (0.048)				
			> 2 GHz to 4 GHz	1.20 (0.09)				
			> 4 GHz to 6 GHz	1.35 (0.15)				

R&S®NRVC Calibration Kit



Power calibration up to 18 GHz

The R&S®NRVC calibration kit is used for fast, program-controlled calibration of the R&S®NRV-Zxx and R&S®URV5-Zx sensors. The calibration kit comprises three sets:

- R&S®NRVC for absolute calibration
- R&S®NRVC-B1 option for verification
- R&S®NRVC-B2 option for linearity checking

The core of the absolute calibration set is a broadband power standard consisting of a power splitter and thermocouple power sensor. The power standard, operated on the R&S®NRVD dual-channel power meter, enables exact determination of the measurement accuracy of power and voltage sensors throughout their frequency range and at the relevant reference level.

R&S®URE3 RMS/Peak Voltmeter



At the peak of speed and precision

- True RMS measurement for AC and AC+DC
- Peak-value measurement (pos., neg., peak-to-peak)
- Frequency measurement up to 30 MHz
- DC voltage measurement
- Unmatched measuring accuracy through automatic frequency response error correction
- More than 30 measurements/s
- Highpass and lowpass filters
- Digital and analog displays
- Relative measurements, maxima/minima
- Convenient menu operation
- IN/OUT option with dual-channel analog output, ready output, trigger input, TTL frequency counter input
- IEC/IEEE bus for all functions

Specifications in brief

Measurement functions	RMS value, peak value, AC and DC voltage, frequency
Frequency range	
RMS	0.02 Hz to 30 MHz
Peak	10 Hz to 10 MHz
Voltage measurement range	
DC	0 V to ± 300 V
AC, AC+DC	50 mV to 300 V
Range selection	AUTO, HOLD, FIX
Ranges and resolution	10 mV to 1000 V, 20 dB steps, max. reading: 12000 digits, max. resolution: 1 mV
RMS measurement	
Voltage meas. range	50 mV to 300 V
Ranges and resolution	1 mV to 300 V, 10 dB steps, max. reading: 3800 or 12000 digits, max. resolution: 1 mV
Peak measurement	
Voltage meas. range	0.1 mV to 500 V
Ranges and resolution	3 mV to 1000 V, 10 dB steps, max. reading: 1200 or 3800 digits, max. resolution: 1 mV

Chapter 10

Audio Analyzers

Rohde & Schwarz audio test equipment enjoys an excellent reputation. Versatile audio analyzers and audio switchers enable audio measurements on a large variety of digital and analog interfaces.



Type	Designation	Description	Page
R&S®UPV	Audio Analyzer	Compact instrument for all audio measurements	143
R&S®UPP	Audio Analyzer	Audio analyzer for use in the lab and in production	144
R&S®UPZ	Audio Switcher	Multichannel switcher for audio channel inputs and outputs	145

R&S®UPV Audio Analyzer



Compact instrument for all audio measurements

The R&S®UPV enables users to perform virtually all measurements that are necessary in the audio world: frequency response measurement, total harmonic distortion (THD) displays, spectral displays, analysis of digital interfaces and much more. The generator is just as versatile. It can be used to create any conceivable signal from sine-wave and noise signals up to multi-sine-wave signals.

- ▮ Suitable for all interfaces: analog, digital and combined
- ▮ Simultaneous display of multiple measurement functions
- ▮ Sampling rate up to 400 kHz
- ▮ User-programmable filters for analyzer and generator
- ▮ Compact all-in-one instrument with integrated PC
- ▮ Slots for future options

All test signals/measurement functions in a single box

- ▮ Wide variety of analog and digital (optional) test signals
- ▮ Extensive measurement capabilities, on analog and digital (optional) interfaces
- ▮ Efficient as well as multichannel FFT analysis with a resolution down to the mHz range
- ▮ User-programmable filters can be adapted to the measurement task at hand in only a few seconds
- ▮ Everything included; no peripherals required

Largest variety of interfaces in a single instrument

- ▮ Analog generator outputs as standard
- ▮ Dual-channel analyzer with analog inputs as standard
- ▮ Expansion up to 16 measurement channels
- ▮ Digital audio interfaces (optional)
- ▮ Digital protocol analysis and generation (optional)
- ▮ Jitter and interface test (optional)
- ▮ Test of audio ICs with I²S interfaces (optional)
- ▮ The universal serial interface allows virtually any audio circuit to be adapted (optional)

Options for other applications

- ▮ The PESQ^{® 1)} measurement option analyzes speech signals in line with psycho-acoustic methods
- ▮ The PEAQ^{® 1)} measurement option analyzes broadband audio signals in line with psycho-acoustic methods
- ▮ The POLQA^{® 1)} measurement option analyzes broadband speech quality in line with psycho-acoustic methods
- ▮ Standard-compliant measurements of hearing aids
- ▮ Acoustic measurements on mobile phones

¹⁾ PESQ[®], PEAQ[®] and POLQA[®] are registered trademarks of OPTICOM Dipl.-Ing. M. Keyhl GmbH, Germany.

Specifications in brief	
Dual-channel analog analyzer	
Frequency range	DC/10 Hz to 21.76 kHz/40 kHz/80 kHz/250 kHz
Voltage range	0.1 µV to 110 V
Measurement functions (base unit and options)	RMS wideband, RMS selective, peak, quasi-peak, S/N, DC, FFT, THD, THD+N, SINAD, Mod Dist, DFD, DIM, polarity, waveform, frequency, phase, group delay, rub&buzz, 1/n octave analysis, undersample FFT, PESQ [®] , PEAQ [®] , POLQA [®]
Analog generator	
Voltage (balanced, RMS, sine, open circuit)	0.1 mV to 20 V
Output signals (base unit and options)	sine, multi-sine, sine burst, sine ² burst, Mod Dist, DFD, noise, arbitrary waveform, polarity, FM, AM, DC, play WAV files, stereo sine, DIM, square
Digital analyzer/generator	
Digital audio interfaces (optional)	
Audio bits	8 bit to 24 bit
Clock rate	30 kHz to 200 kHz
Format	professional and consumer format in line with AES3 and IEC60958
I²S interface (optional)	
Audio bits	8 bit to 32 bit
Clock rate	6.75 kHz to 400 kHz
Universal serial interface (optional)	
Data lines	1 to 4
Audio bits	8 bit to 32 bit
Clock rate	0.85 kHz to 400 kHz

R&S®UPP Audio Analyzer



Audio analyzer for use in the lab and in production

High measurement speed, parallel signal processing in multichannel applications, and high reliability in continuous operation are vital requirements to be met by audio analyzers that are used in production. If, on top of that, a cost-efficient instrument is what you need, the solution is the R&S®UPP audio analyzer.

Depending on the model, two, four or eight channels are processed in parallel; by cascading multiple instruments, users can simultaneously trigger up to 48 measurement channels.

The R&S®UPP audio analyzer is a compact instrument of low height and comes without front-panel control elements or integrated display. In combination with an external monitor, mouse and keyboard, it becomes a full-featured, manually operable measuring instrument. It has an integrated controller, and the required software is already installed. Users can start taking measurements right away.

When used in test systems, the R&S®UPP can be remote-controlled via LAN, USB or IEC/IEEE bus. Here too, the integrated controller is advantageous: Since the analyses are performed on the instrument's computer, the test system's controller does not have to provide any additional performance. Featuring the same operating philosophy and remote-control commands, the R&S®UPV and R&S®UPP audio analyzers support convenient teamwork – for example, when R&D and production use both Rohde&Schwarz audio analyzer types.

All test signals and measurement functions in a single box

- Generation of a wide variety of analog and – optionally – also digital test signals
- Broad scope of measurements on both analog and – optionally – digital interfaces
- Powerful, multichannel FFT analysis with resolution down to the mHz range
- User-programmable filters that take only seconds to adapt to the individual measurement task
- Integrated controller; manual operation requires only an external monitor, a mouse and a keyboard

Large variety of interfaces in a single instrument

- Analog generator outputs (two-channel)
- Two-, four- or eight-channel analyzer with analog inputs
- Digital audio interfaces for professional studio operation and for consumer electronics (R&S®UPP-B2 option)
- I²S interfaces for testing audio ICs (R&S®UPP-B2 option)
- HDMI device testing (R&S®UPP-B4 option)

Convenient operation throughout

- State-of-the-art, intuitive user interface makes operation quick and easy to learn
- All measurement results at a glance
- Effective online help

Options for other applications

- R&S®UPP-B2 option providing digital audio interfaces in line with AES/EBU and S/P DIF as well as I²S interfaces
- R&S®UPP-B4 HDMI and digital audio interfaces (for details, see below)
- R&S®UPP-K800 cascading software for combining multiple R&S®UPP audio analyzers for parallel measurement of more than eight channels

HDMI device testing (R&S®UPP-B4 option)

High-definition multimedia interface (HDMI) is used to digitally transmit high-definition video signals and up to eight audio channels in maximum quality via a single common cable. The R&S®UPP-B4 option provides the R&S®UPP audio analyzer with HDMI functionality in version 1.4a.

The R&S®UPP-B4 option features two RJ-45 female connectors for connecting the HEC signals as well as the following four HDMI plug-in connectors:

■ SOURCE

All audio test signals available in the R&S®UPP audio analyzer can be transmitted to the DUT via HDMI; video data and info frames are also generated; E-EDID is read

■ AUX IN

An external video source (e.g. a video test generator) can be connected; the source's unchanged video signal plus the audio data generated in the R&S®UPP are transferred to the DUT via SOURCE

■ SINK

Connection of an HDMI DUT to the analyzer section of the R&S®UPP

■ AUX OUT

A TV monitor, for example, can be connected here in order to audiovisually assess the transmitted test signals or to operate the DUT by means of an on screen dialog (OSD)

Decoding of Dolby-coded data streams (R&S®UPP-K41 option)

The R&S®UPP-K41 option allows realtime decoding of compressed audio data streams in line with the Dolby Digital®¹⁾ and Dolby Digital Plus®¹⁾ methods on the S/P DIF and HDMI inputs of the R&S®UPP-B4 option.

Extended audio/video measurements (R&S®UPP-K45 option)

This option extends the functionality of the R&S®UPP-B4 option to include generator signals and measurements that go beyond purely audio operation.

The lip sync function measures the time offset between the video and audio signal. The pattern generator function generates a large number of multichrome video test patterns. Bit error rate testing (BERT) and measurements of pixel clock, Hsync and Vsync frequencies and the timing parameters of the measured video signal are also included.

¹⁾ Dolby Digital® and Dolby Digital Plus® are registered trademarks of Dolby Laboratories.

Specifications in brief

Analog analyzer	
Frequency range (bandwidth 22/40/80 kHz)	DC/10 Hz to 21.76/40/80 kHz
Voltage range (RMS, sine)	1 µV to 50 V
Measurement functions: RMS wideband, RMS selective, peak, S/N, DC, FFT, THD, THD+N, SINAD, Mod Dist, DFD, polarity, waveform, frequency, phase, group delay	
Analog generator	
Voltage (balanced, RMS, sine, open circuit)	0.2 mV to 14 V
Output signals: sine, stereo sine, multi-sine, sine burst, Mod Dist, DFD, noise, arbitrary waveform, polarity, DC, play WAV files	
Digital analyzers/generators	
Digital audio interfaces (optional)	
Audio bits	8 bit to 24 bit
Clock rate	30 kHz to 200 kHz
Format	professional and consumer format in line with AES3 or IEC 60958
I ² S interface (optional)	
Audio bits	8 bit to 32 bit
Word clock rate	6.75 kHz to 200 kHz
HDMI interface (optional)	
Channels	1 to 8
Audio bits	8 bit to 24 bit
Clock rate	32 kHz to 192 kHz

R&S®UPZ Audio Switcher



Multichannel switcher for audio channel inputs and outputs

As an add-on unit to the Rohde & Schwarz audio analyzers, the R&S®UPZ audio switcher can be used whenever input or output signals have to be switched over to multiple channels or DUTs. Users can directly operate the switcher from the graphical user interface of the R&S®UPV and R&S®UPP audio analyzers.

Control via any PC is also possible. Up to 16 input switchers plus 16 output switchers can be cascaded, allowing up to 128 input or output channels to be switched.

Specifications in brief

Signal amplitude ¹⁾	33 V (RMS)/2 A (46.7 V (peak))
Crosstalk (balanced 600 Ω load) ²⁾	
20 kHz	typ. -140 dB
100 kHz	typ. -126 dB
Series resistance (per signal pin)	typ. < 0.3 Ω
Shunt capacitance (each signal pin to ground)	typ. < 90 pF

¹⁾ For max. relay life: max. 5 W or 0.2 A.

²⁾ Between any two channels into 600 Ω.

Chapter 11

Modular Instruments



Production testing is performed in various industries. Testing departments want to flexibly configure required functions in compact units so that future requirements can be covered without large additional investments.

Type	Designation	Description	Page
R&S®CompactTSVP Open Test Platform			
R&S®TS-PCA3	CompactTSVP Test and Measurement Chassis	Open test platform based on CompactPCI and PXI	148
R&S®TS-PWA3	PowerTSVP Switching Application Chassis	Open test platform based on CAN bus	148
System controllers			
R&S®TS-PSC5	System Controller	CompactPCI embedded system controller	149
R&S®TS-PSC4C	System Controller	CompactPCI embedded system controller with enhanced speed and memory	149
R&S®TS-PSC0	System Controller	CompactPCI PCI remote system controller	149
Digital multimeter and in-circuit test			
R&S®TS-PSAM	Analog Source and Measurement Module	Scanning multimeter and data acquisition unit	149
R&S®TS-PICT	In-Circuit Test Extension	Analog ICT in conjunction with the R&S®TS-PSAM	150
Signal routing and switching			
R&S®TS-PMB	Switch Matrix Module	High-density, 90-channel, full matrix relay-multiplexer module	150
R&S®TS-PSM1	Power Switching Module	High-power multiplexer and multiple DUT power switching module	150
R&S®TS-PSM2	Multiplex and Switch Module	Medium-power multiplexer and switching module	150
Communications, digital I/O and mixed signal acquisition			
R&S®TS-PDFT	Digital Functional Test Module	Programmable 32-bit digital pattern I/O and serial communications interfaces	151
R&S®TS-PHDT	High-Speed Digital Test Module	Programmable 32-bit digital high-speed I/O and realtime comparison	151
R&S®TS-PIO3B and R&S®TS-PTRF	Digital I/O Module and Signal Port and Transmission Module	Digital control and coil driver with power outputs	151
R&S®TS-PIO2	Analog and Digital I/O Module	Analog and digital 16-channel stimulus and measurement unit for mixed-signal DUT testing	151
Arbitrary waveform generator and signal analyzer			
R&S®TS-PFG	Function Generator Module	Dual-channel arbitrary waveform generator with isolated outputs	152
R&S®TS-PAM	Signal Analyzer Module	Eight-channel digitizer and waveform analyzer	152
Power supplies			
R&S®TS-PSU	Power Supply and Load Module	Four-quadrant source with integrated measurement unit	152
R&S®TS-PSU12	Power Supply and Load Module	Four-quadrant source with integrated measurement unit	152
In-system calibration			
R&S®TS-ISC	In-System Calibration Kit	On-site calibration solution for the R&S®CompactTSVP	153
R&S®TS-PCAL2	Calibration Module	On-site calibration module for chassis rear I/O	153



Type	Designation	Description	Page
R&S®ATSI100 Infotainment Test System			
R&S®ATSI100	Infotainment Test System	Fast, comprehensive tests in automobile production	154
Housing			
R&S®ATSI-MF	Module Frame	19" housing	155
RF generators			
R&S®ATSI-AM	AM Generator	For AM radio tests	155
R&S®ATSI-FM	FM Generator	For FM radio tests	155
R&S®ATSI-ISM	ISM Generator	For tests in ISM bands	155
R&S®ATSI-ATV	Analog TV Generator	For analog TV receiver tests	155
RF repeaters			
R&S®ATSI-GPS1	GPS Repeater	For GPS receiver tests	156
R&S®ATSI-DAB1	DAB Repeater	For digital audio broadcasting tests	156
R&S®ATSI-DVBT1	DVB-T Repeater	For digital TV tests	156
Monitor module			
R&S®ATSI-MON1	Monitor Module	Accurate monitoring of transmitted signals	156
Software options			
R&S®ATSI-K1	Sequence Controller	Easy generation of test cases	157
R&S®ATSI-K2	Remote Interface	Command exchange with master process control system	157
R&S®ATSI-K4	Loudspeaker Test	Testing the correct installation of loudspeakers	157
R&S®ATSI-K5	Audio Analysis	Identification of loudspeaker installation errors	157
R&S®ATSI-K7	System Configuration 1	Easy system overview	157
R&S®ATSI-K8	System Configuration 2	Closed-loop control of all levels (with monitor module installed)	157
R&S®ATSI-K9	Database Interface	Interface for parameter database	157
R&S®ATSI-K10	R&S®SFE100 DAB Interface	Integration of the R&S®SFE100 as a digital radio signal source	157
R&S®ATSI-K11	R&S®SFE100 DVB-T Interface	Integration of the R&S®SFE100 as a digital TV signal source	157
R&S®ATSI-K12	ISM Interface	Testing of keyless entry, auxiliary heater or other customized ISM/SRD applications	157

R&S®TS-PCA3 CompactTSVP Test and Measurement Chassis



Open test platform based on CompactPCI and PXI

The R&S®CompactTSVP family of products has been developed for high-performance ATE applications. The chassis contains a mechanical frame, digital backplane, analog backplane, mains switching and filtering, power supply and diagnostic extensions.

For cost-effective peripheral control via CAN bus, the R&S®TS-PSYS1 CAN controller interface is included as a rear I/O module.

The R&S®CompactTSVP is offered as a test and measurement platform (R&S®TS-PCA3) and as a switching application platform (R&S®TS-PWA3). Various measurement modules for industrial use in research, development and production are available.

Specifications in brief

Modular instrument chassis for CompactPCI and PXI modules

Enclosure	standard 19" rackmount, 4 HU, suitable for 3 HU CompactPCI
-----------	--

Peripheral slots	14
------------------	----

Control backplane

Bus systems	<ul style="list-style-type: none"> ■ CompactPCI/PXI, 32 bit, 33 MHz in line with PICMG 2.0 Rev. 3.0 ■ Rear I/O support IEEE 1101.11-1998 ■ CAN 2.0b, 1 Mbit ■ PXI trigger bus, 8 signals
-------------	--

R&S®TS-PWA3 PowerTSVP Switching Application Chassis



Open test platform based on CAN bus

The R&S®TS-PWA3 PowerTSVP chassis was created as a cost-efficient subsystem for switching applications. It can be used to build systems ranging from dedicated switching instruments to complex switching applications in test and measurement systems.

The chassis contains a mechanical frame, digital backplane, analog backplane, mains switching and filtering, power supply and diagnostic extensions. For cost-effective peripheral control via CAN bus, the R&S®TS-PSYS2 slave interface is included as a rear I/O module.

Various switching and measurement modules controlled by the CAN bus interface from Rohde&Schwarz can be deployed in this chassis.

Specifications in brief

Modular instrument chassis for dedicated Rohde & Schwarz modules with CAN bus control

Enclosure	standard 19" rackmount, 4 HU, suitable for 3 HU CompactPCI
-----------	--

Peripheral slots	16
------------------	----

Control backplane

Bus systems	<ul style="list-style-type: none"> ■ CAN 2.0b, 1 Mbit ■ Slots 1 to 16, peripheral slots for CAN-bus-controlled modules
-------------	--

Modules of the R&S® CompactTSVP family: system controllers

R&S®TS-PSC5 System Controller



CompactPCI embedded system controller

Test and measurement computing platform for R&S® CompactTSVP instruments.

The CompactPCI system controller board combines the performance of Intel's Core™2 Duo 2.26 GHz CPU with the high integration of the GS45 Express chipset. Legacy interfaces can be accessed on the R&S® CompactTSVP instrument rear panel via the additional rear I/O module, which is included.

Specifications in brief

- ▮ Packaging: 3 U dual-slot CompactPCI CPU board
- ▮ Processor: Intel® Core™2 Duo 2.26 GHz
- ▮ RAM: 4 Gbyte DDR3 SO-DIMM
- ▮ HDD: 250 Gbyte, enhanced availability type (around-the-clock access)
- ▮ Legacy interfaces
 - 5 × USB 2.0
 - 3 × 1 Gbit Ethernet
 - 1 × PS/2
 - 1 × RS-232-C
 - 1 × DVI-I
- ▮ Operating system: Windows XP Professional, multilingual

R&S®TS-PSC4C System Controller



CompactPCI embedded system controller with enhanced speed and memory

Test and measurement computing platform for R&S® CompactTSVP instruments.

The CompactPCI system controller board combines the performance of Intel's Mobile Pentium® processor with the high integration of the 855GME chipset and the ICH4 I/O controller hub. Legacy interfaces can be accessed on the R&S® CompactTSVP instrument rear panel via the additional rear I/O module, which is included.

Specifications in brief

- ▮ Packaging: 3 U dual-slot processor card
- ▮ Processor: Intel Mobile Pentium® 1.8 GHz
- ▮ RAM: 1 Gbyte
- ▮ HDD: ≥ 55.8 Gbyte
- ▮ Legacy interfaces
 - 4 × USB
 - 2 × LAN
 - 2 × RS-232-C
 - 1 × VGA
- ▮ Operating system: Windows XP Professional

R&S®TS-PSC0 System Controller



CompactPCI PCI remote system controller

External PC can be used as R&S® CompactTSVP system controller for the R&S® CompactTSVP chassis (R&S®TS-PCA3).

Ideal for solutions where the system design requires the PCI-bus-based hardware to be integrated in the system. The transparent, serial StarFabric interface is ready to run without any software installation and has nearly no influence on the system performance compared to the embedded controller solution.

Specifications in brief

- ▮ Remote interface: StarFabric
- ▮ External host PC: PCI bus
- ▮ Implementation: transparent PCI bridge, serial PCI to CompactPCI link
- ▮ Interface location: rear panel of R&S® CompactTSVP chassis, at controller slot 1

Modules of the R&S® CompactTSVP family: digital multimeter and in-circuit test

R&S®TS-PSAM Analog Source and Measurement Module



Scanning multimeter and data acquisition unit

- ▮ Floating measurement of voltage, current (AC/DC) and resistance in 2- and 4-wire mode
- ▮ Analog in-circuit test with short, contact and continuity test
- ▮ Test of resistors, diodes, bipolar transistors, jumpers/switches and discharge of capacitors
- ▮ Measurement synchronization via PXI clock and trigger



Specifications in brief

- ▮ Voltage ranges
 - DC: ±10 mV to ±125 V
 - AC: ±20 mV to ±90 V (V_{RMS})
- ▮ Current ranges
 - DC: ±1 μA to ±1 A
 - AC: ±100 μA to ±1 A
- ▮ Resistance ranges: 1 Ω to 10 MΩ
- ▮ Sample rate: 0.01 sample/s to 200 ksamples/s
- ▮ DC source: ±5 V, 100 mA, 4-quadrant
- ▮ Discharge unit: max. 125 V (DC), 400 mA
- ▮ Bus interface: CompactPCI/PXI

Modules of the R&S®CompactTSVP family: digital multimeter and in-circuit test

R&S®TS-PICT In-Circuit Test Extension		
	<p>Analog ICT in conjunction with the R&S®TS-PSAM</p> <ul style="list-style-type: none"> ▮ For guarded measurements in 3-, 4-, 6-wire technology ▮ Measurement of inductors, capacitors and impedances 	<p>Specifications in brief</p> <ul style="list-style-type: none"> ▮ AC source: referenced to GND ▮ Voltage: 0.1 V, 0.2 V, 1.0 V ▮ Voltage offset: OFF, POS, NEG ▮ Impedance: 1 Ω, 10 Ω, 1 kΩ, 10 kΩ ▮ Frequency: DC, 100 Hz, 1 kHz, 10 kHz ▮ Measurement unit: referenced to GND ▮ Current ranges: 1 μA to 200 mA ▮ Sample rate: max. 200 ksample/s ▮ Working voltage: max. 60 V (DC) ▮ Bus interface: CompactPCI/PXI

Modules of the R&S®CompactTSVP family: signal routing and switching

R&S®TS-PMB Switch Matrix Module		
	<p>High-density, 90-channel, full matrix relay-multiplexer module</p> <p>The R&S®TS-PMB establishes test channels for functional and in-circuit tests. It provides all routing of signals between DUT and measurement modules via the R&S®CompactTSVP analog bus.</p> <p>The general-purpose switch matrix module can handle input signals up to 125 V and up to 1 A. It provides self-test capability and fast switching of signal paths.</p>	<p>Specifications in brief</p> <ul style="list-style-type: none"> ▮ Switching: relay, full matrix ▮ Configuration: 90 channels to 2 × 4 buses ▮ Deployed as <ul style="list-style-type: none"> ▪ Single matrix: 90 pins to 4 bus lines ▪ Single matrix: 45 pins to 8 bus lines ▪ Dual matrix: 45 pins to 4 bus lines ▮ Analog measurement bus access to 8 bus lines ▮ Voltage: max. 125 V (DC) ▮ Current: max. 1 A ▮ Power: max. 10 W ▮ Switch time: 0.5 ms (incl. bouncing) ▮ Bus interface: CAN
R&S®TS-PSM1 Power Switching Module		
	<p>High-power multiplexer and multiple DUT power switching module</p> <ul style="list-style-type: none"> ▮ Power switching module for supplies and loads ▮ Can handle voltages up to 60 V with <ul style="list-style-type: none"> ▪ 8 high-power channels with max. 16 A ▪ 10 power channels with max. 2 A ▪ 4 high-power 4-to-1 multiplexer channels with max. 16 A ▮ Indirect high-current measurements on high-power channels via shunt resistors; routing of corresponding voltage via analog measurement bus ▮ Self-test of all relays via analog measurement bus and R&S®TS-PSAM 	<p>Specifications in brief</p> <ul style="list-style-type: none"> ▮ Switching: high- and medium-power relays ▮ Configuration MP: 10 × SPST front – front/rear ▮ Configuration HP <ul style="list-style-type: none"> ▪ 8 × SPST rear – front, shunt ▪ 2 × SP 4:1 MUX front – front ▪ 2 × SP 4:1 MUX rear – rear ▮ Voltage: max. 60 V (DC) ▮ Current MP/HP: max. 2 A/16 A ▮ Power MP/HP: max. 150 W/480 W ▮ Switch time MP: 5 ms (incl. bouncing) ▮ Switch time HP: 10 ms (incl. bouncing) ▮ Bus interface: CAN
R&S®TS-PSM2 Multiplex and Switch Module		
	<p>Medium-power multiplexer and switching module</p> <ul style="list-style-type: none"> ▮ Medium-power switching module for voltages up to 125 V and 2 A ▮ Eight independent groups of 3 SPST/1 SPDT relay channels or 4-to-1 DPST relay multiplexers ▮ Relay multiplexers can be cascaded via local power buses ▮ Indirect current measurements on each SPxT channel via shunt resistors ▮ Direct current measurements up to 1 A on all channels via R&S®CompactTSVP analog measurement bus and R&S®TS-PSAM 	<p>Specifications in brief</p> <ul style="list-style-type: none"> ▮ Switching: 8 independent relay groups ▮ Configuration <ul style="list-style-type: none"> ▪ 3 × SPST + SPDT, shunt or ▪ DP 4:1 MUX ▮ Voltage: max. 125 V (DC) ▮ Current: max. 2 A ▮ Power: max. 60 W ▮ Switch time: 5 ms (incl. bouncing) ▮ Bus interface: CAN

Modules of the R&S® CompactTSVP family: communications, digital I/O and mixed signal acquisition

R&S®TS-PDFT Digital Functional Test Module

**Programmable 32-bit digital pattern I/O and serial communications interfaces**

- ▮ 32 digital output channels with pattern acquisition rate up to 20 MHz
- ▮ One programmable output level per group
- ▮ High output current and short-circuit protection
- ▮ Four high-power open drain channels, fully protected and capable of pulse width modulation
- ▮ Five relay channels SPST
- ▮ 32 digital input channels with two programmable input threshold levels per group for hysteresis or level monitoring

Specifications in brief

- ▮ Output channels: 32, in 4 groups
- ▮ Voltage/group: -3 V to +10 V, tristate
- ▮ Current/channel: 80 mA
- ▮ Sample rate: 0.01 sample/s to 20 Msample/s
- ▮ Input channels: 32, in 4 groups
- ▮ Threshold/group: 0 V to 9.5 V
- ▮ Data buffer: 128/64/32 kbyte at 8/16/32 bit
- ▮ DUT interfaces: CAN, K-line, RS-232-C, SPI, I²C
- ▮ Bus interface: CompactPCI/PXI

R&S®TS-PHDT High-Speed Digital Test Module

**Programmable 32-bit digital high-speed I/O and realtime comparison**

- ▮ High pattern rate up to 40 MHz
- ▮ HIGH and LOW programmable, two thresholds
- ▮ Large memory capacity of 1.5 Gbyte
- ▮ Independent pattern sets, selectively executable and reusable without new download
- ▮ Tristate at full speed, RTZ clock formatting
- ▮ Forbidden-zone detection
- ▮ Realtime comparison and results: pass/fail, failed channels, failed pattern
- ▮ Timing resolution down to 12.5 ns
- ▮ Triggering/synchronization with analog PXI measurement cards

Specifications in brief

- ▮ Output channels: 32, in 4 groups
- ▮ Voltage/group: -3 V to +10 V, tristate
- ▮ Tristate control: bitwise
- ▮ Current/channel: 80 mA
- ▮ Sample rate: 0.01 sample/s to 40 Msample/s
- ▮ Input channels: 32, in 4 groups
- ▮ Threshold/group: 0 V to 9.5 V
- ▮ Data buffer: 3 × 64 Msample × 64 bit
- ▮ Bus interface: CompactPCI/PXI

R&S®TS-PIO3B Digital I/O Module and R&S®TS-PTRF Signal Port and Transmission Module

**Digital control and coil driver with power outputs**

The R&S®TS-PIO3B is a versatile digital I/O module with 64 channels. It offers eight ports with eight digital I/O lines each that have MOSFET output drivers. The circuitry is designed to drive RF relays with all common control voltages. The high current-carrying capacity makes the module a universal coil driver.

For easily measuring voltages, there are eight analog inputs that can be monitored via a 10-bit A/D converter. An SPI interface offers the capability to control external SPI modules.

Specifications in brief

- ▮ Digital I/O channels: 64, in 8 groups
- ▮ Voltage: 0 V to 35 V
- ▮ Current output: max. 200 mA per bit, 1 A per port
- ▮ Analog inputs: 8
- ▮ Level range : 0 V to 5 V
- ▮ Resolution: 10 bit
- ▮ Accuracy: ±(100 mV + 5%)
- ▮ SPI interface: SPI SCLK MOSI 5 V TTL output with 300 Ω series MISO 5 V TTL input
- ▮ Bus interface: CAN

R&S®TS-PIO2 Analog and Digital I/O Module



**Analog and digital 16-channel stimulus and measurement unit for mixed-signal DUT testing**

- ▮ Analog and digital signal acquisition with high measurement resolution of 24 bit for level ranges up to ±27 V
- ▮ Sampling rate of up to 5 ksamples/s for inputs and outputs
- ▮ Autocorrection feature for all input and output channels
- ▮ Analog and digital stimulus outputs, offering static and dynamic signal outputs
- ▮ 16-bit resolution, high output level up to ±27 V
- ▮ Versatile signal switching and DUT interconnection
- ▮ Stimulus and acquisition channels providing floating operation

Specifications in brief

- ▮ Output channels: 16, in 4 groups, floating high/low voltage: ±27 V/±27 V (L per group)
- ▮ Current/channel: 12 × 15 mA, 4 × 100 mA
- ▮ Modes: analog, digital, frequency
- ▮ Input channels: 16, in 4 groups, floating
- ▮ High/low threshold: ±27 V/±27 V (both per group)
- ▮ Data buffer: 4 × 5 ksamples (A_{out}/D_{out}/A_{in}/D_{in})
- ▮ Sample rate: 0.01 sample/s to 5 ksamples/s
- ▮ Bus interface: CAN

Modules of the R&S®CompactTSVP family: arbitrary waveform generator and signal analyzer

R&S®TS-PFG Function Generator Module		
	<p>Dual-channel arbitrary waveform generator with isolated outputs</p> <ul style="list-style-type: none"> ▮ Arbitrary waveform generator module featuring two floating signal outputs with independent channel isolation ▮ High output level range up to 40 V (V_{pp}) ▮ High sampling rate of 25 Msample/s per channel ▮ Output of standard waveforms up to 1 MHz sine, square, triangle, arbitrary waveform ▮ Sequencing of multiple memory sections and multiple repetitions 	<p>Specifications in brief</p> <ul style="list-style-type: none"> ▮ Channels: 2, fully independent, floating, cascadable ▮ Voltage ranges: ± 1 V, ± 5 V, ± 10 V, ± 20 V ▮ Voltage resolution: 16 bit ▮ Output current: max. 250 mA ▮ Data buffer: 1 Msample per channel ▮ Sample rate: 0.01 sample/s to 25 Msample/s ▮ Standard waveforms: sine wave, triangle, square wave (1 Hz to 1 MHz), DC static ▮ Pulse: min. 500 ns (1% to 99%) ▮ Output ranges: ± 1 V to ± 20 V, max. 40 V (V_{pp}) ▮ Output current: max. ± 250 mA ▮ Bus interface: CompactPCI/PXI
R&S®TS-PAM Signal Analyzer Module		
	<p>Eight-channel digitizer and waveform analyzer</p> <ul style="list-style-type: none"> ▮ Digitizer module featuring two fully independent, floating acquisition units ▮ Acquisition modes with up to eight single-ended or four differential channels ▮ High sampling rate of 20 Msample/s for each acquisition unit ▮ Multichannel signal recording for up to eight channels at 5 Msample/s ▮ Synchronous acquisition of eight programmable comparator signals and PXI trigger ▮ Wide dynamic range with 14-bit resolution 	<p>Specifications in brief</p> <ul style="list-style-type: none"> ▮ Acquisition units: 2, fully independent and floating ▮ Data buffer: 1 Msample per acquisition unit ▮ Channels per unit: 4 ▮ Voltage ranges: ± 0.2 V to 100 V (per channel) ▮ Resolution: 14 bit ▮ Sample rate: 0.02 sample/s to 20 Msample/s ▮ Relay multiplexer: 3:1 per channel ▮ Bus interface: CompactPCI/PXI

Modules of the R&S®CompactTSVP family: power supplies

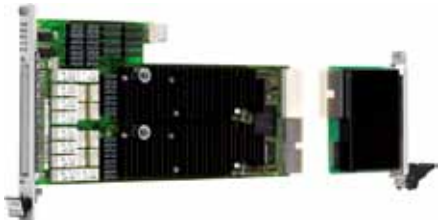
R&S®TS-PSU Power Supply and Load Module		
	<p>Four-quadrant source with integrated measurement unit</p> <ul style="list-style-type: none"> ▮ Two independent, floating channels of four-quadrant sources with separate sensing per channel ▮ Programmable current and voltage limiting ▮ Integrated voltage and current measurement unit per channel ▮ Electronic load simulation of 20 W per channel ▮ Output and recording of voltage and current profiles ▮ Protection against overvoltage, overcurrent, overtemperature and short-circuits ▮ 4-to-1 relay multiplexer for force and sense lines of each channel 	<p>Specifications in brief</p> <ul style="list-style-type: none"> ▮ Output channels: 2, floating, fully independent, 4 quadrants, cascadable ▮ Voltage ranges: ± 15 V, ± 50 V (16 bit) ▮ Current ranges: 10 mA, 100 mA, 3 A (16 bit) ▮ Data buffer: 2×10 ksampl (V_{OUT}/I_{OUT}) ▮ Measurement unit: voltage or current ▮ Data buffer: 10 ksampl ▮ Sample rate: 0.01 sample/s to 10 ksampl/s ▮ Bus interface: CAN
R&S®TS-PSU12 Power Supply and Load Module		
	<p>Four-quadrant source with integrated measurement unit</p> <ul style="list-style-type: none"> ▮ Two independent, floating channels of four-quadrant sources with separate sensing per channel ▮ Programmable current and voltage limiting ▮ Same feature set as the R&S®TS-PSU but with R&S®TS-PDC internal primary power supply 	<p>Specifications in brief</p> <ul style="list-style-type: none"> ▮ Output channels: 2, floating, fully independent, 4 quadrants, cascadable ▮ Voltage ranges: ± 12 V (16 bit) ▮ Current ranges: 10/100/500 mA (16 bit) ▮ Data buffer: 2×10 ksampl (V_{OUT}/I_{OUT}) ▮ Measurement unit: voltage or current ▮ Data buffer: 10 ksampl ▮ Sample rate: 0.01 sample/s to 10 ksampl/s ▮ Bus interface: CAN

Modules of the R&S® CompactTSVP family: in-system calibration

R&S®TS-ISC In-System Calibration Kit



On-site calibration solution for the R&S® CompactTSVP

The R&S®TS-ISC in-system calibration kit contains the fundamental tools for calibrating all modular instruments available for the R&S® CompactTSVP product family.

The most important benefit for systems deployed on the factory floor is that all modules that must be calibrated may remain in the instrument chassis slots. Additionally, a dedicated type of highly accurate multimeter is required to achieve a corresponding measuring accuracy during calibration.

Specifications in brief

The R&S®TS-ISC in-system calibration kit consists of the following components:

- R&S®TS-PCAL2 calibration module
 - Calibration adapters
 - R&S®TS-PCALA
 - R&S®TS-PCALB
 - R&S®TS-PCALC
 - R&S®TS-PKL cable for connecting the adapters to the external multimeter
 - R&S®TS-LISC: one software license for in-system calibration; additional licenses are required for each system controller hosting the calibration software

R&S®TS-PCAL2 Calibration Module



On-site calibration module for chassis rear I/O

The R&S®TS-PCAL2 calibration module is used to provide traceable calibration signals. It can be integrated into multiple chassis on the factory floor to prepare each R&S® CompactTSVP instrument for on-site calibration without changing the module configuration.

An on-board relay multiplexer connects the components to the analog bus lines on an R&S®TS-PMB module which has to be installed in front of the R&S®TS-PCAL2 module.

Specifications in brief

The R&S®TS-PCAL2 provides the following functionalities:

- Floating 5 V reference source
- Three reference resistors for resistance measurements
- Ground-referenced current source, adjustable up to 1 A current measurements
- Floating signal generator for dynamic measurements of
 - DC: -40 V to +40 V
 - AC sinusoidal:
 - 2 V to 80 V (V_{pp}) in frequency range from 20 Hz to 50 kHz
 - 0.2 V to 2 V (V_{pp}) in frequency range from 50 kHz to 1 MHz

R&S® ATSI100 Infotainment Test System



Fast, comprehensive tests in automobile production

The R&S® ATSI100 system generates every test signal separately in application-specific modules. Each module contains all components needed for signal generation and amplification.

Due to the robust design, the modules meet the rigorous standards in automobile production. The R&S® ATSI100 module frames provide easy slot-in installation and power supply for up to two and up to eleven modules.

The modular concept allows the installation of the modules close to the test environment (e.g. test cabin, production line). This largely avoids time-consuming and fault-prone laying of RF cables in the production area.

Configuration and control via powerful software application

For easy integration of the R&S® ATSI100 system into the production process control system, the R&S® ATSI-K1 to R&S® ATSI-K12 options offer the appropriate interfaces. These options make it easy for the user to do the following:

- Program automatic test sequences
- Interface the master production computer system in customer-specific versions
- Get a detailed representation of the entire system that is installed in the production facility
- Evaluate the modules' self-test and monitoring signals, allowing errors to be instantly located
- Notify the system administrator by e-mail if an error occurs
- Analyze complex test scenarios (e.g. loudspeaker tests and audio analysis)
- Configure data management for test scenarios and test parameters depending on different vehicle variants
- Connect to a common database for extremely flexible test parameter handling

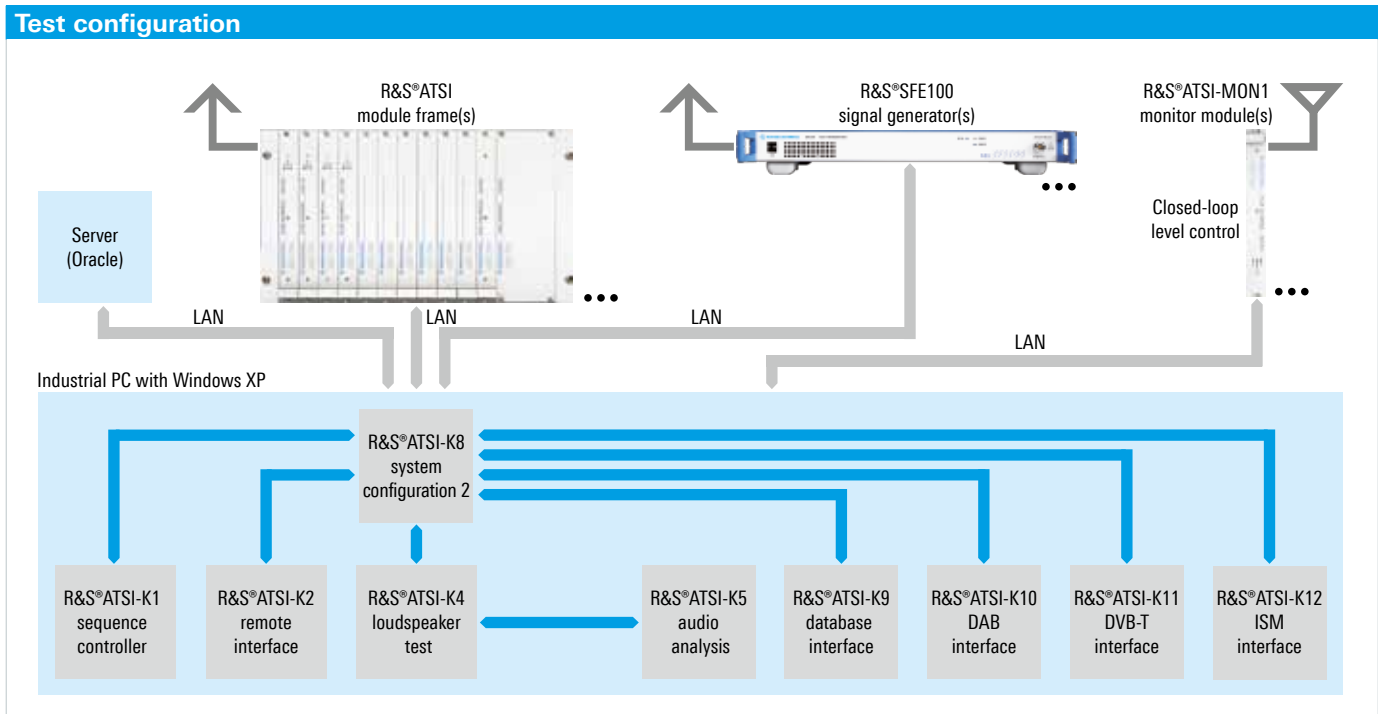

Modules of the R&S® ATSI100 infotainment test system: housing

R&S® ATSI-MF Module Frame



19" housing

19" housing with six vertical units for holding the circuit power pack and backplane as well as a variable arrangement for holding a maximum of eleven R&S® ATSI modules.

Specifications in brief

- Circuit power pack for power supply
 - Primary: 100 V to 240 V AC, 50 Hz to 60 Hz
 - Secondary: +5 V, +12 V, -12 V DC
- Backplane for distributing the power supply voltages (+5 V, +12 V, -12 V) to the individual R&S® ATSI modules
- 2 HU, 2-slot model available

Modules of the R&S® ATSI100 infotainment test system: RF generators

R&S® ATSI-AM AM Generator



For AM radio tests

The R&S® ATSI-AM generator enhances the R&S® ATSI100 infotainment test system with the capability to perform AM radio tests. The generator module is simply plugged into the system rack. It is controlled via an Ethernet LAN.

Specifications in brief

- Frequency range: 50 kHz to 30 MHz
- Frequency resolution: 1 Hz
- Level range: -30 dBm to +23 dBm
- Level accuracy better than 1 dB
- Integrated modulation generator: 20 Hz to 20 kHz
- External modulation input

R&S® ATSI-FM FM Generator



For FM radio tests

The R&S® ATSI-FM generator enhances the R&S® ATSI100 infotainment test system with the capability to perform FM radio tests. The generator module is simply plugged into the system rack. It is controlled via an Ethernet LAN.

Specifications in brief

- Frequency range: 76 MHz to 108 MHz
- Output level: -80 dBm to +20 dBm
- Internal modulation generator: 20 Hz to 15 kHz
- External modulation input
- Stereo option
- RDS option

R&S® ATSI-ISM ISM Generator



For tests in ISM bands

The R&S® ATSI-ISM generator enhances the R&S® ATSI100 infotainment test system with the capability to perform tests for different applications in ISM/SRD bands (e.g. centralized door locking, auxiliary heating). The generator module is simply plugged into the system rack. It is controlled via an Ethernet LAN.

Specifications in brief

- Frequency ranges
 - 310 MHz to 320 MHz
 - 431 MHz to 470 MHz
 - 862 MHz to 920 MHz
- Output power: -60 dBm to +20 dBm
- Modulation and coding: customizable

R&S® ATSI-ATV Analog TV Generator



For analog TV receiver tests

The R&S® ATSI-ATV generator enhances the R&S® ATSI100 infotainment test system with the capability to perform analog TV receiver tests. The generator module is simply plugged into the system rack. It is controlled via an Ethernet LAN.

Specifications in brief

- Frequency range
 - 174 MHz to 225 MHz
 - 470 MHz to 860 MHz
- Level range: -60 dBm to +20 dBm
- TV standards: PAL B/G, NTSC M
- Internal video generator (color bar)
- External video input
- Internal audio generator
- External audio input
- SD card slot for selectable video patterns

Modules of the R&S® ATSI100 infotainment test system: RF repeaters

R&S® ATSI-GPS1 GPS Repeater

**For GPS receiver tests**

The R&S® ATSI-GPS1 repeater enhances the R&S® ATSI100 infotainment test system with the capability to perform GPS receiver tests inside buildings by repeating the GPS signal from an outside reference antenna. The repeater module is simply plugged into the system rack. It is controlled via an Ethernet LAN.

Specifications in brief

- Output frequency: 1575.42 MHz
- Overall gain (selectable): up to 80 dB
- Supply voltage for reference antenna (can be switched on/off): 5 V DC
- Overvoltage protection at antenna input

R&S® ATSI-DAB1 DAB Repeater

**For digital audio broadcasting tests**

The R&S® ATSI-DAB1 repeater enhances the R&S® ATSI100 infotainment test system with the capability to perform digital audio broadcasting tests. The repeater module is simply plugged into the system rack. It is controlled via an Ethernet LAN.

Specifications in brief

- Frequency range
 - 174 MHz to 240 MHz (band III)
 - 1452 MHz to 1491 MHz (L band)
- Maximum conversion gain: > 90 dB
- Input sensitivity: better than -70 dBm
- Output level range: -30 dBm to +20 dBm
- Level accuracy: typ. better than 2 dB

R&S® ATSI-DVBT1 DVB-T Repeater

**For digital TV tests**

The R&S® ATSI-DVBT1 repeater enhances the R&S® ATSI100 infotainment test system with the capability to perform digital TV tests. The repeater module is simply plugged into the system rack. It is controlled via an Ethernet LAN.

Specifications in brief

- Frequency range
 - 177.5 MHz to 226.5 MHz
 - 474 MHz to 858 MHz
- Input sensitivity: better than -80 dBm
- Output level range: -80 dBm to +20 dBm

Modules of the R&S® ATSI100 infotainment test system: monitor module

R&S® ATSI-MON1 Monitor Module

**Accurate monitoring of transmitted signals**

The R&S® ATSI-MON1 monitor module enhances the R&S® ATSI100 infotainment test system with the capability to accurately monitor different transmitted signals. The monitor antennas and the monitor module are installed in the vicinity of the transmit antenna(s). The monitor module is controlled via an Ethernet LAN.

If multiple module frames are to be monitored, one monitor module per module frame is required.

Specifications in brief

- Frequency range
 - 50 kHz to 1650 kHz
 - 76 MHz to 108 MHz
 - 170 MHz to 240 MHz
 - 470 MHz to 870 MHz
 - 1.45 GHz to 1.5 GHz
- Resolution bandwidth: adjustable
- Measurement duration: adjustable
- Level range: -90 dBm to +13 dBm
- Level accuracy: better than 1 dB
- 6 RF ports

Modules of the R&S® ATSI100 infotainment test system: software options

R&S® ATSI-K1 Sequence Controller

Easy generation of test cases

- Scheduling of different test cases (e.g. start a GPS test in parallel with an FM test, followed by an AM test)
- Repeatable tests

R&S® ATSI-K2 Remote Interface

Command exchange with master process control system

- Remote commands of major process control system suppliers are interpreted
- Complete integration into customer's control system (as a slave) by means of R&S® ATSI-K2

R&S® ATSI-K4 Loudspeaker Test

Testing the correct installation of loudspeakers

- Frequency-selective measurement of sound pressure level (SPL)
- Generation of a multi-sine test signal

R&S® ATSI-K5 Audio Analysis

Identification of loudspeaker installation errors

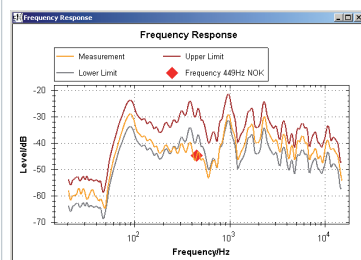

- Detection of mechanical defects in acoustic transducers (rub and buzz detection)
- Check of the sound system's frequency response
- Comparison with reference measurements

R&S® ATSI-K7 System Configuration 1

Easy system overview

- Shortcuts for launching the configuration software of each installed module
- Polling and display of the modules' status information
- E-mail notification in case of malfunction (configurable)
- Handling of up to three parameters per module

R&S® ATSI-K8 System Configuration 2

Closed-loop control of all levels
(with monitor module installed)

- Programmable by R&S® ATSI-K1 (sequence controller)
- Controllable by R&S® ATSI-K2 (remote interface)
- Handles up to 32 modules and unlimited parameters

R&S® ATSI-K9 Database Interface

Interface for parameter database

- Transfer of test parameters to the customer's database (Oracle)

R&S® ATSI-K10 R&S® SFE100 DAB Interface

Integration of the R&S® SFE100 as a digital radio signal source

- Integration of the R&S® SFE100 test transmitter with the R&S® SFE100-K11 T-DMB/DAB option
- Digital audio broadcasting signal source

R&S® ATSI-K11 R&S® SFE100 DVB-T Interface

Integration of the R&S® SFE100 as a digital TV signal source

- Integration of the R&S® SFE100 test transmitter with the R&S® SFE100-K1 DVB-T/DVB-H option
- Digital video broadcasting signal source

R&S® ATSI-K12 ISM Interface

Testing of keyless entry, auxiliary heater or other customized ISM/SRD applications

- Programmable RF data telegram including header, user data and CRC block
- Selectable modulation (FSK, GFSK, ASK, OOK), coding and data bit rate
- Programmable telegram timings (pre- and post-delay), telegram repetition

Chapter 12

Broadcasting Test and Measurement Solutions

Broadcasting systems have different capabilities for distributing audio and/or video signals. Rohde & Schwarz supplies instruments for digital and analog baseband generation, modulation, demodulation and analysis, as well as baseband analysis.



Type	Designation	Description	Page
Video and MPEG TS generation			
R&S®DVSG	Digital Video Signal Generator	Development and quality assurance of 2D/3D TV displays	159
R&S®Stream Libraries		Test signal libraries for development, production and testing of TV components	160
RF broadcasting signal generation			
R&S®SFU	Broadcast Test System	Multistandard reference signal generator for R&D	161
R&S®SFE	Broadcast Tester	Compact signal generator for digital and analog TV and audio broadcasting standards	162
R&S®SFE100	Test Transmitter	Powerful broadcast signal generator for production test systems	163
R&S®SFC	Compact Modulator	Test signals for TV and audio broadcasting – compact and cost-effective	164
TV analysis			
R&S®ETH	Handheld TV Analyzer	Portable DVB-T/DVB-H signal analysis up to 3.6 GHz/8 GHz	165
R&S®FSH3-TV	Handheld TV Analyzer	Universal combined TV and spectrum analyzer from 100 kHz to 3 GHz	166
R&S®ETL	TV Analyzer	Universal multistandard platform for the analysis of TV, mobile TV and FM radio signals	167
R&S®EFL240 R&S®EFL340	Portable TV Test Receiver	Professional installation of cable and satellite TV systems and antennas	168
R&S®EFA	TV Test Receiver Family	Comprehensive analysis/demodulation/monitoring of digital/analog TV signals	169
R&S®EFA-K1	EFA-SCAN Measurement Software	Fast recording and documentation of measurement values for the R&S®EFA digital test receivers	169
R&S®BCDRIVE	Broadcast Drive Test Software	Efficient coverage analysis for terrestrial broadcast signals	170
R&S®TVSCAN	Automatic TV Channel Scan Software	Quality assessment of multichannel TV signals at cable TV headends or in the field	171
Video and MPEG TS analysis			
R&S®DVMS	Digital TV Monitoring System	Ensuring high quality of digital TV network operation	172
R&S®DVM	Digital Video Measurement System	DTV monitoring and analysis	173
R&S®VEGA Suite	Software	Detailed media file analysis	175
R&S®VSA	Video Measurement System	Video and FFT analyzer, vectorscope and oscilloscope in one unit	176

R&S®DVSG Digital Video Signal Generator



Development and quality assurance of 2D/3D TV displays

The R&S®DVSG digital video signal generator supports the development and quality assurance of latest-generation TV sets and projectors. It is a cost-efficient, one-box solution that generates the audio and video signals required for these tasks.

- Configurable digital and analog video and audio output
- HDTV, SDTV and 3D formats up to 1080p according to HDMI 1.4a
- PC formats up to WUXGA
- Reference source for moving sequences
- Preinstalled Konica Minolta analysis software
- MPEG-2 transport stream recording and playback

Uncompressed, high-precision video and audio signals

The R&S®DVSG-K10 AV signal generator option makes it possible to test displays with up to 12-bit color depth. The AV signal generator outputs uncompressed 2D and 3D video content with a maximum resolution of 1080p in line with HDMI 1.4a, and PC resolutions of up to 1920 × 1200 (WUXGA). In addition, Multi-Motion test sequences help enhance picture quality by checking motion blur, deinterlacing and film detection, for example. Comprehensive audio functionalities have been added to the AV signal generator to allow the assessment of sound quality.

Output of compressed live signals

The R&S®DVSG-B30 AV signal player option provides exactly the type of signals that a display must be able to handle when operated by an end user. The AV signals are generated on the basis of MPEG-2 transport streams. In addition to the large set of signals supplied with the option, users can also use their own recordings of 2D and 3D transport streams. This feature makes it possible to easily simulate any live scenario in the lab.

Recording and playing of transport streams

The R&S®DVSG-K20 TS player and recorder option can record and play MPEG-2 transport streams. The numerous transport streams supplied with the option are played in a seamless loop. It is also possible to play transport stream recordings of other devices with no problem.

Specifications in brief

R&S®DVSG-K10 AV signal generator

Interfaces	HDMI 1.4a/DVI, component, composite, SCART, VGA, TS
TV resolutions (SD/HD)	480i, 576i, 480p, 576p, 720p, 1080i, 1080p, 1470p (3D), 2228p (3D) with flexible timings
VESA resolutions	VGA, SVGA, XGA, WXGA, SXGA, HD Ready 1, WXGA+, UXGA, WSXGA, WUXGA
Supported color spaces	ITU601/709, sRGB, xvYCC etc. (customizable)
Color depth	up to 12 bit
Audio standards and interfaces	HDMI, AUDIO DIG OUT with PCM audio for up to 8 channels (customizable)
Signal libraries	uncompressed 2D and 3D patterns and sequences for luminance and chromaticity, motion blur, deinterlacing and EMC measurements; support of EBU, ITU, ANSI, SMPTE standards; import software for customized signals

R&S®DVSG-K20 TS player and recorder

Interfaces	ASI, SMPTE, SPI
Supported standards	DVB, ATSC (Mobile DTV), ISDB-T(B), DTMB, CMMB, MediaFLO™

R&S®Stream Libraries

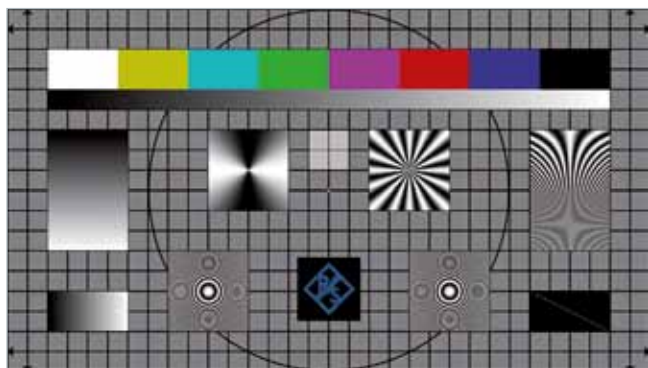

Test signal libraries for development, production and testing of TV components

Whenever the development, production and testing of TV components or devices is involved, suitable test signals are needed. To meet this need, Rohde&Schwarz offers not only the generators and modulators that are required but also an extensive collection of stream libraries.

Large variety of applications

- ▮ Testing of TV sets, set-top boxes and mobile TV handsets
- ▮ EMC testing of TV sets
- ▮ Testing of decoders and encoders
- ▮ Testing of analog/digital TV networks and transmitters
- ▮ Testing of radio receivers

Extensive collection of libraries

- ▮ SDTV stream library for DVB and ATSC
- ▮ HDTV stream library for DVB and ATSC
- ▮ H.264 stream library for DVB and ATSC
- ▮ TCM stream library for DVB and ATSC
- ▮ DVB-H stream library
- ▮ ISDB-T stream libraries for Japanese and Brazilian ISDB-T
- ▮ MediaFLO™ stream library
- ▮ CMMB stream library
- ▮ T-DMB and DAB stream library
- ▮ DAB+ stream library
- ▮ Analog video signal library
- ▮ ATSC Mobile DTV stream library
- ▮ T2-MI stream library
- ▮ French DMB stream library

Easy generation of transport streams by the user

- ▮ Generation of customer-specific transport streams with the R&S®DV-ASC advanced stream combiner software

Rohde&Schwarz customizes baseband streams

- ▮ Rohde&Schwarz offers the generation of customer-specific transport streams or analog CCVS signals as a service

Support of numerous transmission standards

- ▮ Digital TV
- ▮ Mobile TV
- ▮ Audio broadcasting
- ▮ Analog TV

High-quality video contents

- ▮ High-quality video sequences
- ▮ Precise test patterns
- ▮ Numerous resolutions, including full HD
- ▮ MPEG-2 and H.264 coding

High-quality audio contents

- ▮ Detailed audio signals
- ▮ Precise test tones
- ▮ Surround/multichannel sound
- ▮ Various coding methods, including MPEG-4 HE-AAC v2

Efficient use

- ▮ Standard-compliant, reliable operation worldwide
- ▮ Available at the push of a button
- ▮ Clear and simple property rights
- ▮ Comprehensive documentation



R&S®SFU Broadcast Test System



Multistandard reference signal generator for R&D

RF signals for a variety of broadcasting transmission standards can be transmitted by the integrated broadcast signal generator over a wide, user-variable frequency range. All the different standards – for terrestrial, satellite or cable transmission – can be easily loaded into the multistandard broadcast signal generator via software, and an extremely pure spectrum can be generated.

- Multistandard platform
- Realtime digital TV, analog TV and audio broadcasting signal generation
- Digital and analog transmission standards

Specifications in brief	
Frequency	
Frequency range	100 kHz to 3 GHz
Frequency sweep	digital sweep in discrete steps
Operating modes	automatic, single shot, manual or external trigger, linear or logarithmic
Sweep range, step width (lin)	full range
Step width (log)	0.01% to 100%
Level	
Maximum level	+13 dBm (PEP), -120 dBm to +20 dBm
With R&S®SFU-B90 option	+19 dBm (PEP), -120 dBm to +30 dBm
Level accuracy	< 0.5 dB
VSWR (f ≤ 3 GHz, ALC ON)	typ. < 1.4
Spectral purity	
Harmonics	< -30 dBc
Nonharmonics (CW, offset > 10 kHz, 200 MHz < f ≤ 1.5 GHz)	< -80 dBc
Subharmonics (f > 1.5 GHz to 3.0 GHz)	< -74 dBc
Wideband noise (offset > 5 MHz, 1 Hz CW, 200 MHz < f ≤ 1.5 GHz)	< -150 dBc
I/Q modulator	external wideband I/Q, internal baseband I/Q
Transmission standards	
Digital TV	DVB-T2, DVB-S2, DVB-C2, DVB-T, DVB-S, DVB-C, ATSC/8VSB, J.83/B (DOCSIS), DIRECTV, ISDB-T, ISDB-S, ISDB-C, DTMB (GB 20600-2006)

- Wide output frequency range from 100 kHz to 3 GHz
- Digital/analog interferer and digital dividend simulation
- Realtime transmission simulations
- Bit error ratio (BER) measurement
- TS generator, TRP and ETI player, recorder
- 1 Gsample I/Q arbitrary waveform generator
- Fully digital baseband signal processing

Outstanding signal quality

- I/Q modulator with 180 MHz RF bandwidth
- Very low SSB phase noise of typ. -135 dBc at 1 GHz (20 kHz carrier offset, 1 Hz measurement bandwidth)
- High-stability reference oscillator as standard

I/Q signal generator

Customer I/Q waveforms or Rohde & Schwarz waveform libraries for different transmission standards can be re-played with the arbitrary waveform generator.

Channel simulator

Integrated transmission simulators for AWGN, phase noise, impulsive noise and fading, as well as adjacent channel simulations (ACI and CCI) are available for simulating real and, above all, reproducible environmental conditions in the lab.

Specifications in brief	
Analog TV	B/G, D/K, M/N, L, I, with PAL, SECAM, NTSC
Mobile TV	DVB-H, DVB-SH, ATSC-M/H, MediaFLO™, ISDB-T (1 seg), T-DMB, CMMB
Audio broadcasting	DAB, DAB+, French DMB, HD Radio™, DRM, ISDB-T _{SB}
Modulation frequency range	100 MHz (I/Q wideband ON)
Transmission simulations	
Interferer management	R&S®SFU-K37 option
Interferers	analog TV, digital TV, cable, satellite, mobile communication standards (digital dividend)
AWGN	R&S®SFU-K40 option
Phase noise	R&S®SFU-K41 option
Impulsive noise	R&S®SFU-K42 option
Fading simulator	R&S®SFU-B30 option
Number of paths	20 (40 with R&S®SFU-K31 option)
BER measurements	R&S®SFU-K60 option
Baseband generator	
ARB waveform generator	R&S®SFU-K35 option
TS generator	R&S®SFU-K20 option
TS player	R&S®SFU-K22 option
TS recorder	R&S®SFU-K21 option
Video signal generator	included in R&S®SFU-K190 to R&S®SFU-K194 options
Video signals (ATV video basic)	COLORBARS_75 (PAL, NTSC, SECAM), FUBK (PAL)
ATV video	libraries with analog video test signals

R&S®SFE Broadcast Tester



Compact signal generator for digital and analog TV and audio broadcasting standards

The R&S®SFE is a multistandard signal generator that supports all common TV standards and a number of audio

broadcasting standards. Whether analog or digital terrestrial TV, cable, satellite or mobile TV, or sound broadcasting – the R&S®SFE modulates all these signals in realtime. For this purpose, it combines a high-quality RF modulator, a universal realtime coder and diverse baseband signal sources in a single unit.

- Versatile multistandard signal generator with realtime coding
- High-precision signal generation over wide frequency and level range
- Integrated transport stream generator and audio/video generator
- Flexible signal generation with ARB waveform generator
- Simulation of multipath propagation and single-frequency networks
- Receiver tests with noise source and BER tester
- Compact design and convenient graphical user interface

Specifications in brief		
RF signal		
Frequency range		100 kHz to 2.7 GHz
Frequency resolution		1 Hz
Level		-110 dBm to +15 dBm
Level accuracy		< 1.0 dB
Spectral purity		
SSB phase noise	at 300 MHz and 20 kHz carrier offset	< -115 dBc (1 Hz)
Broadband noise	> 10 MHz	< -135 dBc (1 Hz)
Digital realtime modulation systems		
Terrestrial TV		DVB-T2, DVB-T, DTMB, ISDB-T, ISDB-T _B , ATSC/8VSB
Cable TV		DVB-C2 ¹⁾ , DVB-C, J.83/B, ISDB-C
Satellite TV		DVB-S, DVB-S2, DIRECTV
Mobile TV		DVB-H, T-DMB, ISDB-T 1 seg., MediaFLO™, CMMB, ATSC-M/H
Digital audio broadcasting		DAB, DAB+, ISDB-T _{SB}
Analog realtime modulation systems		
Analog TV		B/G, D/K, I, M/N, L
Analog audio broadcasting		AM, FM mono, FM stereo with RDS
ARB-based modulation systems		
Digital audio broadcasting		HD Radio™, DRM, DRM+ ¹⁾
Digital TV		DVB-T2, CMMB, MediaFLO™
Baseband signal sources		
Transport stream generator	file format	GTS, Rohde&Schwarz proprietary
	data rate (including null packets)	100 kbit/s to 214 Mbit/s
Transport stream player	file format	TRP, T10, ETI, FLO, MFS, PMS, BIN
	data rate	100 kbit/s to 90 Mbit/s
ARB waveform generator	memory	256 Msample
	sample rate	up to 100 Msample/s
Simulation and analysis functions		
AWGN generator	signal-to-noise ratio (SNR)	-30 dB to +60 dB
Fading simulator	number of paths	12
	fading profiles	Static, Constant Phase, Pure Doppler, Rayleigh, Rice
BER measurement	PRBS measurement	clock, data, enable inputs
	MPEG-2 transport stream measurement	ASI input

¹⁾ In preparation.

R&S®SFE100 Test Transmitter



Powerful broadcast signal generator for production test systems

The R&S®SFE100 is a multistandard test transmitter providing realtime coding for broadcast signals. It supports all common digital and analog TV standards and a number of audio broadcasting standards. Its flexible customization options make the R&S®SFE100 suitable for a wide variety of applications – from production and quality assurance to simple development applications.

Versatile multistandard test transmitter with realtime coding

- ▮ Digital and analog TV standards for cable, satellite and terrestrial transmission
- ▮ Digital and analog audio broadcasting standards
- ▮ Realtime signal generation with selectable modulation and coding parameters
- ▮ Standards available as software options

High-precision signal generation over wide frequency and level range

- ▮ Frequency range from 100 kHz to 2.7 GHz
- ▮ Level range from –110 dBm to +15 dBm

- ▮ Output power up to 27 dBm with integrated power amplifier
- ▮ Extremely short switching times
- ▮ Low phase noise and high MER
- ▮ High-precision modulator (MER typ. +43 dB)
- ▮ Integrated noise generator

Integrated baseband signal sources

- ▮ Transport stream generator, transport stream player and comprehensive test signal libraries
- ▮ Audio/video generator with test pattern library for analog TV
- ▮ ARB waveform generator with waveform libraries
- ▮ Digital I/Q input

User-friendly control elements and convenient remote operation

- ▮ Control keys and LC display on front panel
- ▮ Local control via USB mouse, USB keyboard and monitor
- ▮ Remote control and remote operation via LAN

Economical models without local controls

- ▮ For all digital or analog standards
- ▮ Full remote control capability

Optimized for use in production test systems

- ▮ Integrated power amplifier for high output levels
- ▮ Optional RF output on rear
- ▮ Compatible with Rohde&Schwarz system control software
- ▮ Low power consumption

Specifications in brief	
RF signal	
Frequency range	
Without power amplifier	100 kHz to 2.7 GHz
With power amplifier	47 MHz to 862 MHz
Frequency resolution	1 Hz
Level	
Without power amplifier	–110 dBm to +15 dBm
With power amplifier	+27 dBm, adjustable from 0 dB to 30 dB
Spectral purity	
SSB phase noise (at 300 MHz and 20 kHz carrier offset)	< –115 dBc (1 Hz)
Broadband noise (> 10 MHz)	< –135 dBc (1 Hz)
Digital realtime modulation systems	
Terrestrial TV	DVB-T2, DVB-T, DTMB, ISDB-T, ISDB-T _B , ATSC/8VSB
Cable TV	DVB-C2 ¹⁾ , DVB-C, J.83/B, ISDB-C
Satellite TV	DVB-S, DVB-S2, DIRECTV
Mobile TV	DVB-H, T-DMB, ISDB-T 1 segment, MediaFLO™, CMMB, ATSC-M/H
Digital audio broadcasting	DAB, DAB+, ISDB-T _{SB}

Specifications in brief	
Analog realtime modulation systems	
Analog TV	B/G, D/K, I, M/N, L
Analog audio broadcasting	AM, FM mono, FM stereo with RDS
ARB-based modulation systems	
Digital audio broadcasting	HD Radio™, DRM, DRM+ ¹⁾
Digital TV	DVB-T2, CMMB, MediaFLO™
Baseband signal sources	
Transport stream generator	
File format	Rohde&Schwarz proprietary
Data rate (including null packets)	100 kbit/s to 214 Mbit/s
Transport stream player	
File format	TRP, T10, ETI, FLO, MFS, PMS, BIN
Data rate	100 kbit/s to 90 Mbit/s
ARB waveform generator	
Memory	256 Msample
Sample rate	up to 100 Msample/s
Noise generator	
AWGN, signal-to-noise ratio (SNR)	–30 dB to +60 dB

¹⁾ In preparation.

R&S®SFC Compact Modulator



Test signals for TV and audio broadcasting – compact and cost-effective

The R&S®SFC compact modulator is an economical multistandard signal source offering realtime coding for all established digital and analog TV and audio broadcasting standards.

The 1 HU, ½ 19" instrument is extremely compact and therefore ideal for rack installation in production test systems. Though small in size, the modulator is a full-featured signal generator with integrated transport stream player, audio/video generator and optional noise source, making it very useful for simple applications in development. The R&S®SFC is controlled using a USB mouse, keyboard and monitor, or via LAN using Remote Desktop. It has the same, well-known graphical user interface as the R&S®SFU and R&S®SFE. Remote control via SCPI commands is also possible.

Multistandard signal generator with realtime coding

- ▀ Digital and analog standards for cable, satellite and terrestrial TV
- ▀ Digital and analog audio broadcasting standards
- ▀ Realtime signal generation and coding
- ▀ Additional standards available as software options

Integrated baseband signal sources

- ▀ Transport stream player
- ▀ Transport stream libraries for digital TV standards
- ▀ Analog audio/video generator
- ▀ Test pattern library for analog TV

Simple and convenient remote operation

- ▀ Local operation using USB mouse, keyboard and monitor
- ▀ Remote control and remote operation via LAN

Optimized for use in production test systems

- ▀ Extremely compact housing, ideal for rack installation
- ▀ Low power consumption for reduced operating costs
- ▀ Compatible with Rohde&Schwarz system control software
- ▀ Standalone operation without PC possible

Additional functions for professional applications

- ▀ Integrated AWGN generator
- ▀ ASI transport stream input
- ▀ Digital I/Q input
- ▀ 10 MHz reference input

Specifications in brief		
RF characteristics		
Frequency range	R&S®SFC base unit	30 MHz to 900 MHz
	with R&S®SFC-K83 option	30 MHz to 3000 MHz
Frequency setting resolution		1 Hz
Level setting range	R&S®SFC base unit	-31.5 dBm to 0 dBm RMS for DVB-T
	with R&S®SFC-K84 option	-110 dBm to 0 dBm RMS for DVB-T
Modulation systems		
Terrestrial TV and mobile TV		DVB-T2, DVB-T, DVB-H, DTMB, CMMB, T-DMB, ISDB-T, ISDB-T _B , ISDB-T 1 seg., ATSC/8VSB, ATSC-M/H, MediaFLO™
Cable TV		DVB-C2 ¹⁾ , DVB-C, ISDB-C, J.83/B
Satellite TV		DVB-S2, DVB-S, DIRECTV
Analog TV		B/G, D/K, I, M/N, L
Digital audio broadcasting		DAB, DAB+, ISDB-T _{SB}
Analog audio broadcasting		AM, FM mono, FM stereo with RDS
Additional functionality		
Transport stream player	file format	TRP, T10, ETI, FLO, MFS, PMS, BIN
Audio/video generator	file format	Rohde&Schwarz proprietary
AWGN	signal-to-noise ratio (SNR)	-30 dB to +60 dB

¹⁾ In preparation.

R&S®ETH Handheld TV Analyzer



Portable digital TV signal analysis up to 3.6 GHz/8 GHz

The R&S®ETH handheld TV analyzer was specially developed for coverage measurements as well as for service and maintenance work on DVB-T, DVB-H and ISDB-T gap-filler and low-power transmitters. The universal capabilities of the R&S®ETH also make it useful in the repair and development of TV components. The R&S®ETH handheld TV analyzer is the compact combination of a TV analyzer, spectrum analyzer and network analyzer.

Comprehensive TV, spectrum and network analysis functionality

- ▮ Measurement of DVB-T, DVB-H and ISDB-T signal parameters
- ▮ Display of constellation diagram, channel impulse response, OFDM spectrum with shoulder distance and MER(k)
- ▮ Wide input level range due to integrated preselection and preamplifier
- ▮ Full-featured spectrum analyzer
- ▮ Network analysis and distance-to-fault measurement by means of integrated tracking generator (option)

Fast and precise measurement due to realtime demodulation

- ▮ Reliable detection of short-time interference
- ▮ BER measurement and ASI transport stream output

Optimized for field use

- ▮ Compact, lightweight instrument with rugged housing
- ▮ Splash-proof and dust-proof
- ▮ Easy-to-replace lithium-ion battery for long battery operating time
- ▮ Frequency correction and positioning via GPS

Easy operation and convenient data exchange with PC

- ▮ Reproducible measurements using user-specific measurement profiles, transducers and cable models
- ▮ Storage of measurement data in internal memory, on SD card or USB memory stick
- ▮ R&S®ETHView PC software for configuring channel tables, limit tables and measurement profiles and for transferring measured data to PC via LAN or USB

Specifications in brief

DVB-T/DVB-H receiver (R&S®ETH-K140 option) and ISDB-T receiver (R&S®ETH-K160 option)

Quasi-error-free input level range	RF = 500 MHz, RF preselection ON	typ. -76 dBm to +10 dBm
Inherent modulation error ratio (MER)	RF = 500 MHz, RF preselection OFF, level = -30 dBm	> 43 dB, typ. 46 dB
	RF = 500 MHz, RF preselection ON, level = -45 dBm	> 41 dB, typ. 44 dB
Phase noise	RF = 500 MHz, $\Delta f = 30$ kHz	< 98 dBc (1 Hz)
	RF = 500 MHz, $\Delta f = 100$ kHz	< 100 dBc (1 Hz)
	RF = 500 MHz, $\Delta f = 1$ MHz	< 125 dBc (1 Hz)
Third-order intermodulation (TOI)	0 dB RF attenuation, RF preselection OFF	typ. +7 dBm
	0 dB RF attenuation, RF preselection ON	typ. -6 dBm

Spectrum analysis

Displayed average noise level (DANL)	10 MHz < RF < 2 GHz, 0 dB RF attenuation	
	RF preselection OFF	typ. -156 dBm (1 Hz)
	RF preselection ON	typ. -165 dBm (1 Hz)
Resolution bandwidths		100 Hz to 3 MHz in 1/3 sequence
Video bandwidths		10 Hz to 3 MHz in 1/3 sequence

Network analysis

Tracking generator output level		-40 dBm to 0 dBm in 1 dB steps
Data points		631
Dynamic range for transmission measurements	300 kHz to 3.6 GHz	> 70 dB, typ. 90 dB

R&S®FSH3-TV Handheld TV Analyzer



Universal combined TV and spectrum analyzer from 100 kHz to 3 GHz

The R&S®FSH 3-TV handheld TV analyzer combines the functions and features of a complete spectrum analyzer with those of a TV test receiver in a single measurement instrument. It can be taken wherever needed and is ideal for technicians who perform measurements on site, e.g. during new installations or maintenance/repair on components of TV cable networks and transmitters.

- Measurement functions for analog and digital TV signals
- Full-featured spectrum analyzer
- Combined video/ASI output

- Compact and robust housing
- Four hours operating time on battery power
- Wide selection of accessories for diverse measurement tasks
- Preselector option with 75 Ω RF input

Robust and portable

The instrument's compact housing is designed for portable use. Its robust edge protection and RF connector covers safeguard the R&S®FSH3-TV against mechanical and weather-related conditions. The R&S®FSH3-TV weighs only 2.8 kg. The powerful, built-in NiMH battery can power the instrument for up to four hours, providing reliable operation even at remote locations.

Well-equipped

The R&S®FSH3-TV comes equipped with a TV board, a pre-amplifier and a tracking generator. The TV board permits the measurement and demodulation of analog TV signals. The demodulated video signal, which is made available at an output that can be used either as a CCVS (analog TV) or as a TS-ASI (digital TV) output, can be routed to an external monitor or an MPEG decoder. The supplied headphones can be used to listen to the sound of the analog TV signal.

Optional accessories

Numerous accessories that add a wide variety of capabilities to the R&S®FSH3-TV are available, e.g. options for performing distance-to-fault measurements and measurements on digital TV signals. With the vector transmission measurement option, the R&S®FSH3-TV can also be used in development and service.

Specifications in brief	
Spectrum analyzer	
Frequency range	100 kHz to 3 GHz
Resolution bandwidths	100 Hz to 1 MHz
Video bandwidths	10 Hz to 1 MHz
Displayed average noise level (DANL)	typ. -135 dBm (100 Hz)
Third-order intermodulation (TOI)	typ. 13 dBm
SSB phase noise	< -100 dBc (1 Hz) at 100 kHz from carrier
Sweep at span = 0 Hz	100 μs to 100 s
Detectors	Sample, Max/Min Peak, Auto Peak, RMS
Level measurement uncertainty	< 1.5 dB, typ. 0.5 dB
Reference level	-80 dBm to +20 dBm
Digital TV receiver (R&S®FSHTV-K21 for QAM, R&S®FSHTV-K22 for 8VSB)	
Modulation methods	4, 16, 32, 64, 128 and 256QAM, 8VSB
Bandwidths, depending on standard	6 MHz, 7 MHz and 8 MHz
Symbol rate	2 MHz to 6.999 MHz/10.762238 MHz
Inherent MER (equalizer ON)	> 35 dB
Analog TV receiver	
Standards	B, G, H, D, K, I, L, M, N
Sound standards	IRT-A2, NICAM, BTSC, EIA-J
Video bandwidths	depending on standard
Inherent S/N video, weighted in line with ITU-R Rec. 567	> 50 dB

R&S®ETL TV Analyzer



Universal multistandard platform for the analysis of TV, mobile TV, DAB and FM radio signals

The R&S®ETL TV analyzer stands for all-in-one. It combines the functionality of a TV and FM (radio) signal analyzer, a video and MPEG TS analyzer and a spectrum analyzer in a single instrument. The R&S®ETL also contains generators to create analog video signals, audio signals and MPEG-2 transport streams.

- ▮ Frequency range from 500 kHz to 3 GHz
- ▮ TV, FM (radio), video, audio, MPEG-2 transport stream and spectrum analysis in a single box
- ▮ FPGA and chip-based realtime demodulators for analog TV, DVB-T, DVB-H, ATSC/8VSB, ATSC Mobile DTV, ISDB-T_(B), DVB-T2, J.83/A/C, DVB-C, J.83/B, DTMB, T-DMB/DAB and FM (radio)
- ▮ Baseband outputs
- ▮ Preselection with additional 75 Ω RF input
- ▮ Video signal generator
- ▮ Audio signal generator
- ▮ MPEG-2 transport stream generator/recorder
- ▮ Support of power sensors
- ▮ DC input and rechargeable Li-ion battery

Main applications

Acceptance testing, maintenance and servicing of TV, mobile TV, DAB and FM transmitters

- ▮ Precise analysis of signal quality at transmitter output
- ▮ Measurements to optimize transmitter operating parameters
- ▮ Measurement of spurious emissions
- ▮ Detection of faults
- ▮ Documentation of signal parameters
- ▮ Remote maintenance via IP networks with Remote Desktop function

Quality assurance during the production of modulators and TV, DAB and FM transmitters

- ▮ Reproducible analysis of signal quality of modulators and transmitters

Optimization of TV, mobile TV, DAB and FM transmitter networks

- ▮ Measurement of receive levels and signal quality at reception site
- ▮ Checking and optimization of digital single-frequency networks (SFN)
- ▮ Systematic determination of receive quality in transmission area (coverage measurement)

Specifications in brief

Frequency range		500 kHz to 3 GHz
Displayed average noise level (DANL)	FM (radio)	75 MHz to 110 MHz
	50 MHz to 3 GHz, preamplifier OFF	≤ -140 dBm (1 Hz)
	500 MHz, preamplifier ON, preselector ON	typ. -166 dBm (1 Hz)
Level	3 GHz, preamplifier ON, preselector ON	typ. -161 dBm (1 Hz)
	quasi-error-free for digital standards depending on transmission modes	-90 dBm to +10 dBm
Inherent modulation error ratio (MER)	T-DMB/DAB with R&S®ETL-B203 preselector, preamplifier ON	-92 dBm
	signal level ≥ -30 dBm, f ≤ 1.3 GHz	≥ 40 dB, typ. 46 dB
Video S/N	DTMB	≥ 34 dB
	analog TV mode	≥ 60 dB
General data		
Dimensions	W × H × D with handle	409 mm × 158 mm × 465 mm (16.1 in × 6.2 in × 18.3 in)
Weight	without options	< 9 kg (< 19.8 lb)

R&S®EFL240/R&S®EFL340 Portable TV Test Receiver



Professional installation of cable and satellite TV systems and antennas

The R&S®EFL240/R&S®EFL340 is a compact, portable TV test receiver for satellite, cable and terrestrial television. Its versatile measurement functions and its operating convenience are ideal for the installation of cable TV systems, satellite receiver systems, in-building distribution systems and antennas. Its favorable price makes the test receiver extremely attractive for these applications.

Measurements during the installation of cable and satellite systems must be fast and simple. The R&S®EFL240/R&S®EFL340 supports these measurements in various ways: Its clear-cut ergonomic keypad allows intuitive operation. The Scan&Log function and the Macro Measurement function largely automate frequent measurement tasks. Pre-installed channel tables and transponder lists save the user valuable time when entering parameters.

- ▮ Frequency range from 5 MHz to 2500 MHz
- ▮ Digital TV level range from 15 dBμV to 130 dBμV
- ▮ MPEG-2 and MPEG-4 decoding
- ▮ Common Interface for encrypted programs
- ▮ LNB and antenna control
 - DC via RF socket: 5 V, 13 V, 18 V, 24 V, extra burst of 14 V and 19.5 V
 - 22 kHz tone, DiSEqC, SCR
- ▮ 5.7" TFT color display for SD and HD video output
- ▮ Battery operation > 4 hours

Extensive measurement functions for cable, satellite and antenna

- ▮ Multistandard test receiver
 - Analysis of DVB-T2, DVB-T, DVB-H, DVB-C, DVB-S and DVB-S2
 - Measurement of constellation, MER(f) and echoes
- ▮ MPEG decoding and video output
 - MPEG-2 and MPEG-4
 - SD and HD
- ▮ Analog TV and FM sound broadcasting
 - PAL and SECAM
 - Videoscope functionality
- ▮ Spectrum measurement with zoom function and Combo mode
 - Spectrum analysis up to 2500 MHz
 - Spectrum, results and TV picture – all at a glance

Optimized operating concept for mobile use

- ▮ Ergonomic design and easy operation
- ▮ Independent work in the field
- ▮ Automated measurements simplify routine work
 - Automatic program search
 - User-defined measurement sequences
 - R&S®EFL-Suite software for transferring measurement results to a PC

Wide range of accessories supplied

- ▮ Carrying bag
- ▮ Two carrying straps
- ▮ Rechargeable battery
- ▮ Battery charger
- ▮ Power cable
- ▮ 12 V car adapter
- ▮ RF adapter set
- ▮ SD card
- ▮ USB cable
- ▮ Software and operating manual on CD

Model overview		
	R&S®EFL240	R&S®EFL340
DVB-T, DVB-H, DVB-C, DVB-S, DVB-S2	•	•
DVB-T2	–	•
Analog TV and FM sound broadcasting	•	•
MPEG-2 decoding	•	•
MPEG-4 decoding	–	•

R&S®EFA TV Test Receiver Family



Comprehensive analysis/demodulation/monitoring of digital and analog TV signals

- High-end test receiver
- High-end demodulator
- Models for DVB-T/DVB-H, DVB-C, ATSC, J.83/B and analog TV
- Comprehensive measurement and monitoring functions
- Simple, user-friendly operation

- Modular design for easy retrofitting of options
- IEC/IEEE bus and RS-232-C interface

Specifications in brief		
Frequency range	high-end test receiver	5 MHz to 1000 MHz
	high-end demodulator	45 MHz to 1000 MHz
Level	quasi-error-free for digital standards depending on transmission modes and TV standards	-88 dBm to +20 dBm
Inherent modulation error ratio (MER)	signal level ≥ -40 dBm	
	high-end test receiver	≥ 41 dB
	high-end demodulator	≥ 42 dB
Video S/N _w	analog TV mode	
	high-end test receiver	≥ 64 dB (typ. 66 dB)
	high-end demodulator	≥ 67 dB (typ. 70 dB)
Dimensions	W x H x D	435 mm x 147 mm x 460 mm (17.1 in x 5.8 in x 18.1 in)
Weight	depending on options	approx. 12 kg (26.5 lb)

R&S®EFA-K1 EFA-SCAN Measurement Software

User Field	Channel 32	Channel 33	Channel 34	Channel 35	Channel 36	Channel 37
Center Frequency (MHz)	394.000000	402.000000	410.000000	418.000000	426.000000	434.000000
Symbol Rate (MSymb/s)	6.900000	6.900000	6.900000	6.900000	6.900000	6.900000
Status	Done	Done	Done	Done	Done	Done
Time Stamp	24.06.2003 15:40:27	24.06.2003 15:42:52	24.06.2003 15:45:18	24.06.2003 15:47:34	24.06.2003 15:50:00	24.06.2003 15:52:24
RF Level (dBm)	-56.6	-57.3	-57.4	-51.1	-57.6	-57.7
Frequency Offset (Hz)	-421.6	926.5	-475.8	---	-935.9	277.8
Symbol Rate Offset (Hz)	5	0.8	3	---	12.1	3.2
BER before FIS	0.00E+00 (391/1000)	1.40E-09 (390/1000)	0.00E+00 (392/1000)	---	0.00E+00 (388/1000)	0.00E+00 (386/1000)
BER after FIS	0.00E+00 (401/1000)	0.00E+00 (399/1000)	0.00E+00 (402/1000)	---	0.00E+00 (397/1000)	0.00E+00 (395/1000)
Packet Err Ratio	0.00E+00 (401/1000)	0.00E+00 (403/1000)	0.00E+00 (402/1000)	---	0.00E+00 (401/1000)	0.00E+00 (395/1000)
Packet Err / s	0	0	0	---	0	0
TS Bitrate (Mbit/s)	38.153	38.153	38.153	---	38.153	38.153
10 MHz Ref Sync	OK	OK	OK	OK	OK	OK
Carrier Loop Sync	OK	OK	OK	UNSYNC	OK	OK
MPEG TS Sync	OK	OK	OK	UNSYNC	OK	OK
Ampl. Response (dB)	1.03	1.5	1.41	---	0.83	1.05
Phase Response (°)	9.5	9.4	8.9	---	8.9	8.5
Group Delay (µs)	0.0765	0.0709	0.0708	---	0.0573	0.0668
Shoulder Lower (dB)	---	---	---	---	---	---
Shoulder Upper (dB)	---	---	---	---	---	---
Crest Factor - Margin (dB)	12.8	12.8	12.8	12.2	12.8	12.8
Crest Factor - Max (dB)	11.2	11.2	11.2	11	11.3	11.3
Crest Factor - Current (dB)	11.2	11.2	11.2	11	11.3	11.3
Echo Pattern Att. 1 (dB)	-36.7	---	---	---	---	---
Echo Pattern Delay 1 (µs)	0.59	---	---	---	---	---
Echo Pattern Att. 2 (dB)	---	---	---	---	---	---
Echo Pattern Delay 2 (µs)	---	---	---	---	---	---
I/Q Ampl. Imbal. (°)	0.01	0.01	0	---	0	0
I/Q Quad. Error (°)	0	0	0	---	0	0
Carrier Suppression (dB)	>60	>60	>60	---	>60	>60
Phase Jitter (° RMS)	0.17	0.16	0.12	---	0.22	0.15
S/N (dB)	33.9	33.4	33.8	---	30.5	33.5
MER (dB RMS)	33.6	33.1	33.4	---	30.2	33.2
Sync Errors (%)	0.0	0.0	0.0	100.0	0.0	0.0

Fast recording and documentation of measurement values for the R&S®EFA digital test receivers

- Repeated measurements in any number of loops
- Use for R&S®EFA .2x/4x/5x/6x/7x models
- PC connection via RS-232-C, IEC/IEEE bus, TCP/IP
- Runs on any PC under Windows

Easy operation

- A sequence of registers in the entry dialog specifies the steps that need to be carried out one after the other
- Clearly arranged dialog window helps users to define the measurement task at hand
- User-defined measurement parameter handling:
 - Only to be displayed
 - Only stored to a file
 - Displayed and stored

Two measurement modes

- Measurements are started at a keystroke
- Snapshot mode
 - Snapshot mode processes previously defined frequency list just once
- Run mode
 - Run mode is cyclically performed until the measurements are explicitly stopped
 - Measurement values obtained in this way are displayed in tables for each frequency

Convenient data storage

- Easy storage of measurement values in CSV format (comma-separated values)
- Commonly used CSV file format enables data to be ported to Excel or a database, for example

R&S®BCDRIVE Broadcast Drive Test Software

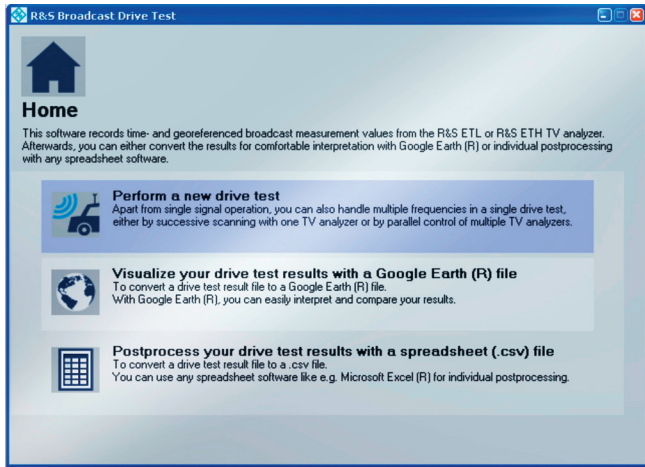

Efficient coverage analysis for terrestrial broadcast signals

Reliable coverage of specific regions is of central importance for terrestrial broadcast network operators. A series of real field measurements are needed after commis-

sioning to verify that the planned network coverage was achieved.

The R&S®BCDRIVE broadcast drive test software manages this task quickly with a minimum of resources. Depending on the number of frequencies to be measured in parallel, the program can control one or more R&S®ETL or R&S®ETH TV analyzers to quickly and accurately perform the measurements needed for quality assessment and root cause analysis in accordance with a variety of terrestrial broadcast standards. The R&S®ETL can run the software directly, avoiding the need for an additional control computer. All that is needed are a USB GPS receiver and the corresponding antennas.

- Support of all relevant measurements in accordance with a variety of terrestrial broadcast standards
- Highly informative output through precise signal quality recording every second using the R&S®ETL or R&S®ETH TV analyzer
- Efficient drive tests through intuitive program operation and measurement of multiple frequencies in parallel
- Effective conversion of test results for Google Earth, or alternatively in CSV format for maximum flexibility

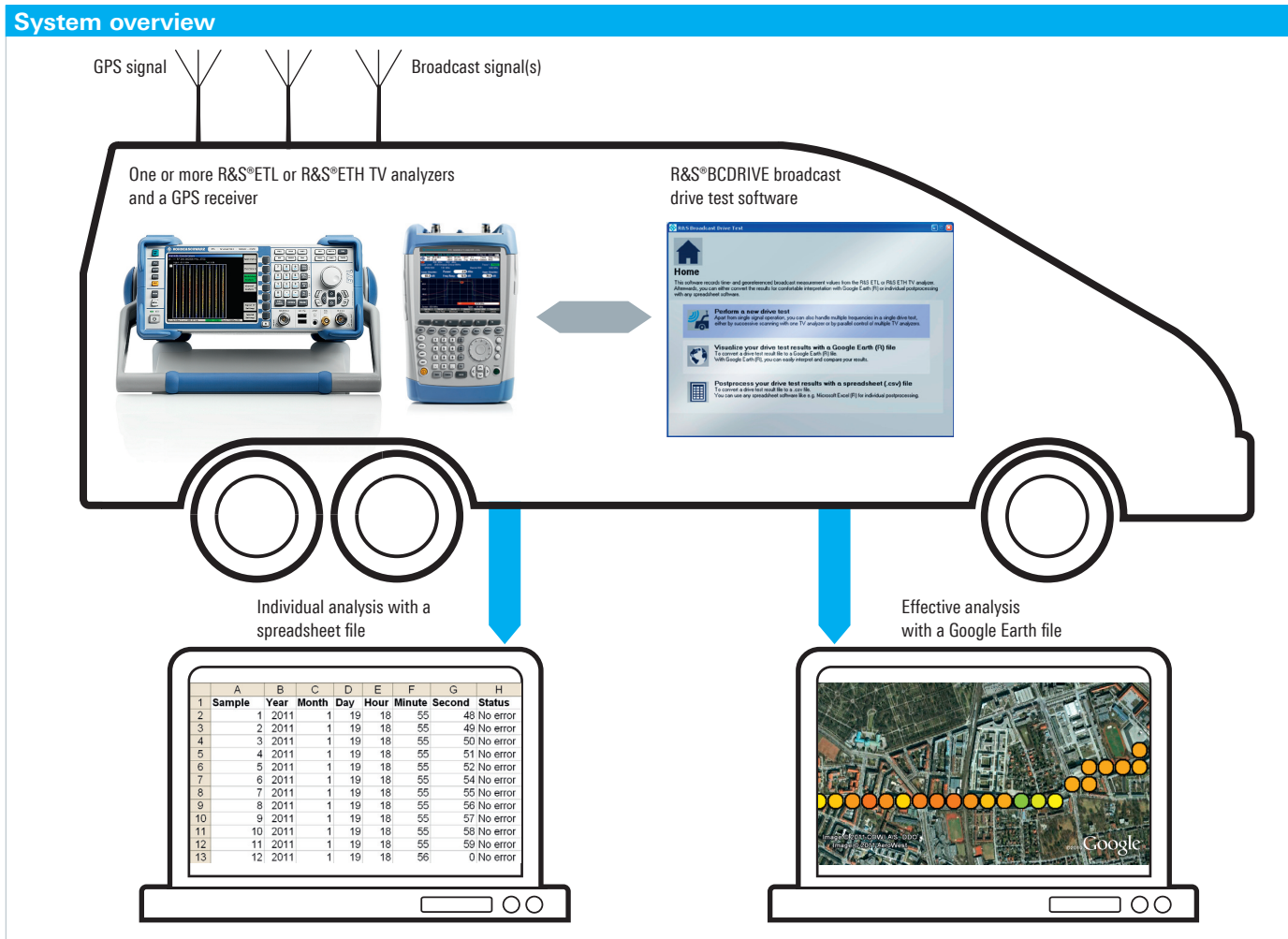

R&S®TVSCAN Automatic TV Channel Scan Software

The screenshot displays the R&S TVSCAN software interface. At the top, there's a menu bar (File, Edit, View, Scan, Tools, Help) and a toolbar. Below that is a channel list with 21 channels selected. The main area is divided into 'Settings' and 'Readings' sections. The 'Settings' section includes a 'General' tab with a grid of parameters for each channel, such as Digital Standard, Payload, Center Frequency, and Symbol Rate. The 'Readings' section shows a grid of measurement results for the same 21 channels, with parameters like Status, Time Stamp, Hardware, Reference Level, Preamp State, Dynamic Range, Attenuation, and Presetlock. The MER (ms) row is highlighted in red, indicating critical results. At the bottom, there's a status bar showing 'Channel List: Europe6G digital (01.02.2011 11:18:05) 1* Profile: All Digital 630 MHz' and a 'Ready' indicator.

Quality assessment of multichannel TV signals at cable TV headends or in the field

The R&S®TVSCAN automatic TV channel scan software allows fast acquisition of quality parameters of multichannel TV signals such as used at cable TV headends. The software can also effectively measure the transmission parameters of terrestrial TV signals, allowing users to assess their quality. R&S®TVSCAN can be used with the R&S®ETL TV analyzer, the R&S®FSH3-TV TV analyzer and the R&S®EFA TV test receiver.

R&S®TVSCAN performs sequential measurements on multiple TV channels. For these measurements, the software relies on channel tables and suitable measurement profiles, both of which can easily be created and changed by the user.

The results of a measurement sequence are clearly presented in a matrix. Critical results are highlighted in color.

Predefined channel tables, measurement profiles and automated measurement sequences save time and deliver reproducible results at all times.

- Automated measurements on multichannel TV signals
- Quick overview of measured quality parameters
- Comparison of current and previous measurement values
- Measurements for analog TV, DVB-C, J.83/A, J.83/B, DVB-T and DVB-T2
- Usable with the R&S®ETL, R&S®FSH3-TV and R&S®EFA

R&S®DVMS Digital TV Monitoring System



R&S®DVMS1.



R&S®DVMS4.

Ensuring high quality of digital TV network operation

The R&S®DVMS family is a professional, attractively priced and compact solution for monitoring digital TV networks. It includes the R&S®DVMS1 and the R&S®DVMS4. Typical fields of applications for the R&S®DVMS family are signal monitoring at the transmitter site, the satellite uplink or the headend.

The R&S®DVMS1 (1 HU, ½ rack width) makes it possible to simultaneously monitor an RF signal and a transport stream. The R&S®DVMS4 (1 HU) allows simultaneous monitoring of up to four RF/TS signals. Interface modules for DVB-T/DVB-H, DVB-T2 and DVB-S/DVB-S2 as well as exclusively for transport streams are available.

All relevant errors at the RF and TS level are recognized and reported immediately. Thumbnail display and electronic program guide (EPG) simplify visual monitoring of the transmitted contents. Remote access is supported via an integrated web server allowing independent, simultaneous access from different locations. SNMP and SNMP traps are supported for integration into central network management systems.

High-quality analysis functions and easy-to-understand displays complement the system's extensive array of monitoring functions. The analysis functions include program clock reference (PCR) analysis and buffer analysis as well as functions for multimedia home platform (MHP), system software update (SSU) and DVB-H, including the electronic service guide (ESG). As a result, the R&S®DVMS is also ideal for troubleshooting, for example at a multiplex center or headend. Due to its small size, the R&S®DVMS1 in particular is a versatile and valuable tool for development.

- Simultaneous monitoring of up to four signals
- RF modules for DVB-T/DVB-H, DVB-T2 and DVB-S/DVB-S2
- Support for DVB/T2-MI, ATSC and ISDB-T/ISDB-T_B specific TS characteristics
- Optional functions for detailed analysis
- Modular and extremely compact design (1 HU)
- IP module for optical and electric networks

Comparison of models		
	R&S®DVMS1	R&S®DVMS4
Number of module slots	1	4
Maximum number of simultaneously monitored inputs	2 (1 × TS and 1 × RF input)	4 (TS and RF inputs in any combination)
TS interfaces integrated in base unit	–	4
Total maximum bit rates of all inputs used	82 Mbit/s	360 Mbit/s
Integrated display	–	yes
Width	½ rack	1 rack

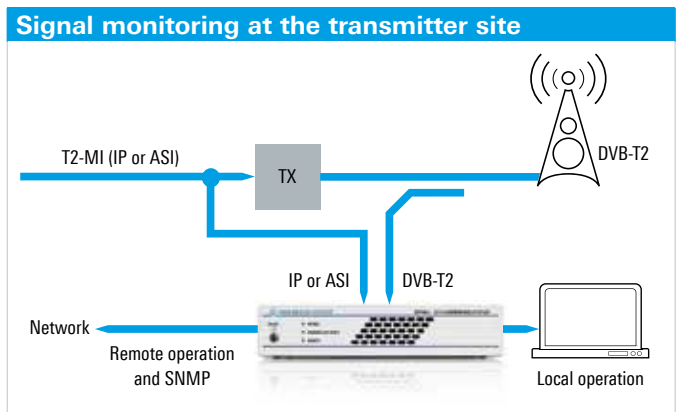

R&S®DVM Family



DTV monitoring and analysis

The R&S®DVM family of instruments combines the tools needed for all monitoring and analysis applications in the area of digital television signal generation and distribution. An extensive range of analysis tools is available to support the development and testing of digital television equipment such as multiplexers, encoders, modulators and associated components.

- Minimal installation effort due to low space requirements and combination of various functions in one instrument
- Minimal training required due to intuitive operating concept
- Cost-effective and future-ready modular design
- Portable and simple operation due to small, lightweight design and integrated display (R&S®DVM400)



The R&S®DVM family consists of four base units and one expansion unit, all of which have extremely compact designs. All four base units can be configured in accordance with customer requirements and expanded whenever necessary.

Multiple RF, IP and transport stream signals can be monitored and analyzed simultaneously. For example, up to four RF signals can be monitored in a single height unit at the same time.

Extensive testing can be carried out on a variety of data services such as videotext, subtitles, system software updates (SSU) and DVB-H signals including electronic service guide (ESG). Video and audio elementary streams (MPEG-2, MPEG-4/AVC/H.264, AAC and AC-3) are analyzed using special software tools.

A hardware decoder processes SD and HD signals coded with either MPEG-2 or MPEG-4/AVC/H.264 to enable the fast and simple analysis of various video formats. Using the qPSNR analysis, the encoding quality of these video signals is also tested and visualized in realtime.

R&S®DVM400 Digital Video Measurement System Universal and portable

- Broadest scope of functions – ideal for development and maintenance
- Monitoring/analysis of transport streams and contents
- Monitoring, analysis and demodulation of RF signals of various standards
- Monitoring, analysis and transcoding of IPTV signals (Gigabit Ethernet)
- Powerful generator and recorder options with extensive TS libraries and TS multiplexer software
- Simultaneous operation of multiple functions
- Small and lightweight, therefore ideal for portable applications

R&S®DVM100L MPEG-2 Monitoring System

The space saver

- Ideal for network operators and program providers
- Monitoring/analysis of transport streams and contents
- Monitoring, analysis and demodulation of RF signals of various standards
- Monitoring of up to 20 signals in one system when expanded with the R&S®DVM120



R&S®DVM50 MPEG-2 Monitoring System

The starter package





- ▮ Particularly cost-effective solution for all monitoring and analysis tasks, including in the lab, for service applications or unattended in the field
- ▮ Monitoring/analysis of transport streams and contents
- ▮ Monitoring, analysis and demodulation of RF signals of various standards
- ▮ Operation via external PC



R&S®DVM120 MPEG-2 Monitoring System

The expansion unit

- ▮ Add-on to the R&S®DVM100L and R&S®DVM400 for simultaneous monitoring of more than four signals in one system
- ▮ Integration into the base unit user interface

Base units	R&S®DVM50 ¹⁾	R&S®DVM100L	R&S®DVM400	Expansion unit R&S®DVM120
				
Height	1 HU	1 HU	4 HU	1 HU
Number of transport streams that can be monitored in parallel	1 to 4	1 to 4	1 to 4	1 to 4 (with RF inputs), 1 to 8 (without RF inputs)
Number of RF signals that can be demodulated and monitored in parallel	1 to 4	1 to 2	1 to 4	1 to 4
Expansion by the R&S®DVM120 for a total of:	–	20 TS and 18 RF inputs	20 TS and 20 RF inputs	–
Local operation	PC required	via external monitor, external keyboard and mouse	integrated color display, keys and rotary knob; if necessary, external mouse and keyboard	via base units
Remote operation via web server	•	•	•	via base units
SNMP (incl. traps)	•	•	•	via base units
Alarm relays	–	•	•	via base units
TS monitoring and analysis including TS capture	•	•	•	•
ES and data service analysis	•	•	•	•
Streaming function	via PC interface	•	•	via base units
Software decoder	•	•	•	•
Hardware decoder with various interfaces	•	•	•	•
Recorder and generator options	–	–	•	–
Gigabit Ethernet/IP interface, monitoring functions and transcoding	–	–	•	–
Reference clock input	–	–	•	–
SPI input and output	–	–	•	–

¹⁾ The operation of the R&S®DVM50 requires a PC. Some of the functions specified are only available via the PC.

R&S®VEGA Suite Software

Detailed media file analysis

R&S®VEGA Suite contains software tools for in-depth off-line analysis of media files on a PC. Since it supports the latest standards and technologies, it is ideal for developers of DTV components and devices who can use it to check that their products are standard-compliant, for quality assurance testing and to improve performance. Broadcast operators and service providers can use this software to find deep-lying signal errors and optimize content. Many video formats can be analyzed, including H.264, H.264 SVC, H.264 MVC and VC-1. Supported audio formats include MPEG and a number of Dolby standards. Data streams such as teletext, DVB subtitling, closed captioning and EPG can also be analyzed.

R&S®VEGA Suite consists of three products. R&S®VEGA-H264 is for detailed analysis of video and audio signals. R&S®VEGA-TSA is for analyzing MPEG-2 transport streams and MXF files. R&S®VEGA-SYNC is for checking audio-video synchronization.

- Support of the latest standards and technologies
- Detailed analysis capabilities
- Comprehensive visualization functions
- Batch mode for checking multiple files (R&S®VEGA-K11 option)

In-depth audio and video analysis – R&S®VEGA-H264

- Support of broad range of DTV standards
- Extensive video analysis functions
- Extensive audio analysis functions
- Support of several data applications
- Automated analysis of multiple files – batch mode (R&S®VEGA-K11)
- Comparison of two video signals – video comparator (R&S®VEGA-K13)

Comprehensive MPEG-2 transport stream analysis – R&S®VEGA-TSA

- Extensive analysis functions (MPEG-2 transport streams)
- Support of characteristics specific to various digital TV standards
- Special analysis features for data services
- Comprehensive analysis of MXF streams
- Support of PCAP files

Precise audio-video synchronization analysis – R&S®VEGA-SYNC

- Support of numerous standards
- Extensive analysis functions

R&S®VSA Video Measurement System

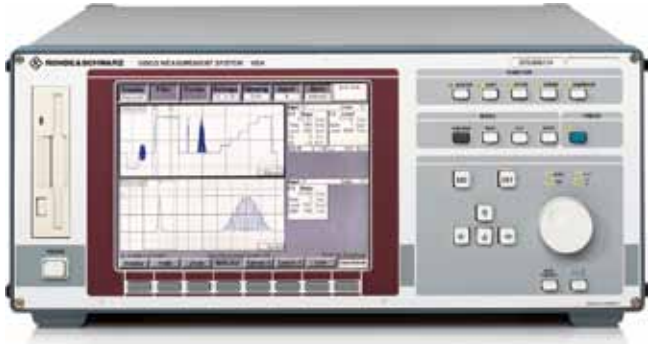

Video and FFT analyzer, vectorscope and oscilloscope in one unit

The great versatility of the R&S®VSA video measurement system makes it suitable for a wide range of applications. Users in both laboratory and service environments will value the comprehensive measurement capabilities as well as the operating convenience of the integrated instruments.

The integrated PC makes the R&S®VSA ideal for use as an automatic test and monitoring system, e.g. for TV transmitters or cable networks. No external controller is required for system control. An integrated hard disk allows a large number of measurement results and graphics to be stored for later evaluation.

For the production of video equipment, the R&S®VSA offers unrivaled measurement speed. Results are computed virtually in realtime even if long test reports are called for, and this considerably reduces time and costs.

The R&S®VSA video measurement system provides several functions in a minimum of space:

- ▮ Video and FFT analyzer
- ▮ Three-channel oscilloscope
- ▮ Vectorscope
- ▮ Monitor
- ▮ System controller

The R&S®VSA is suitable for a wide variety of applications:

- ▮ In labs and service centers
- ▮ In automatic measuring and monitoring systems
- ▮ In production and quality assurance of video equipment

The R&S®VSA also offers the following features:

- ▮ Four loop-through video signal inputs with analog 9 MHz bandwidth
- ▮ Convenient menu-driven user interface
- ▮ IEC/IEEE bus controller
- ▮ Two serial interfaces (RS-232-C)
- ▮ SCPI remote control via IEC/IEEE bus or serial interface
- ▮ Hard disk for storing results and application programs

Available functions for different signal types				
	Video and FFT analyzer	3-channel oscilloscope	Vectorscope	Control monitor
CCVS	•	•	•	•
R/G/B ¹⁾	• ¹⁾	• ²⁾		
Y/Cb/Cr	• ¹⁾	• ²⁾		• ³⁾
Y/U/V	• ¹⁾	• ²⁾		• ³⁾
S-VHS ¹⁾	same as CCVS (signals added) or RGB (signals separated)			

¹⁾ Only one component at a time.

²⁾ Requires sync pulse in the signal or via an additional sync signal.

³⁾ Only for Y component.

Specifications in brief

Frequency range	0 Hz to 9 MHz
Standard	B/G, I, D/K, PAL, SECAM ⁴⁾ , NTSC (R&S®VSA-B1 option)
Signal inputs	
Video inputs	75 Ω loop-through filters
Level	1 V ± 6 dB
Return loss up to 6 MHz	> 40 dB
Return loss up to 10 MHz	> 36 dB
Decoupling of inputs up to 10 MHz	> 85 dB
DC input	1 MΩ
Level	±5 V
Signal outputs	
Zero-reference control pulse, 75 Ω	
Level	1.4 V
Line position and duration	adjustable
Interfaces	
Remote control	IEC 625-2/IEEE 488.2, 2 × RS-232-C (9-contact)
Printer	parallel interface (Centronics)
External monitor	640 × 480 pixel, VGA color monitor
External keyboard	PC AT keyboard
Display	640 × 480 pixel, color TFT

⁴⁾ SECAM without color subcarrier measurements.

Chapter 13

System Components

For demanding computational tasks, Rohde & Schwarz offers system controllers, switch units and test chambers that are versatile and flexible in everyday use. Excellent EMC shielding, reliable test results and modular solutions are core benefits of these instruments.



Type	Designation	Description	Page
R&S°OSP	Open Switch and Control Platform	Modular solution for RF switch and control tasks	178
R&S°IQOR	I/Q Data Recorder	Realtime recording and streaming of digital I/Q data	180
R&S°RSC	Step Attenuator	Precise signal levels and high repeatability	181

R&S®OSP Open Switch and Control Platform



Modular solution for RF switch and control tasks

The R&S®OSP open switch and control platform is a modular platform designed to handle RF switch and control tasks. A number of optional modules make the R&S®OSP ideal for a wide range of applications from simple RF switch functions to automatic path switchover in complex RF test systems such as EMC systems.

The R&S®OSP120 and R&S®OSP130 base units can be controlled via Ethernet. The R&S®OSP130 has a display with a control panel. The individual switch and control modules of the R&S®OSP130 and of all connected R&S®OSP150 extension units can be manually operated using the control panel.

Modular, reliable, cost-efficient

The modularity provided by the R&S®OSP family helps ensure the fast setup of test and measurement configurations for applications in production, test labs and development departments. The ability to implement complex wiring by means of a single switch and control platform is an essential prerequisite for reliable and reproducible measurements that can be automated to enable cost-efficient test sequences.

Compact and flexible

The R&S®OSP units are accommodated in a compact 19" wide cabinet of two height units. The sophisticated CPU control functionality provides maximum flexibility for

controlling switch and control modules and makes high-performance external interfaces available.

Powerful control and RF relay modules

The switch and control modules are inserted into the three rear module slots. The versatile 18 GHz or 40 GHz RF relay modules, 6 GHz semiconductor relay modules and digital input/output modules as well as modules with terminated relays can be combined as required, allowing users to configure the R&S®OSP cost-efficiently according to the application.

Special modules make it easier to implement different switch, input and output functions such as control of external power relays.

Expandability

Up to four R&S®OSP150 extension units can be connected via the CAN bus port of the base units. This allows the range of functions of the base units to be considerably expanded while also making it possible to economically meet increasing requirements at a later point in time.

Easy control and system integration

All base units of the platform can be controlled via the Ethernet interface. This interface makes it possible to connect the platform directly to a PC, integrate it into test systems or remotely operate it via a corporate network.

Compared to the R&S®OSP120, the R&S®OSP130 also has a control panel with a keyboard for direct manual operation of the R&S®OSP130 and any extension units that are connected. Manual operation of the R&S®OSP120 is possible by connecting an external keyboard and a monitor. The supplied operating software or a web GUI can be used to control the switch and control modules easily and directly without special software knowledge.

Of course, it is also possible to control the platform from application programs such as LabVIEW, LabWindows/CVI, Agilent VEE, C++, C#, Visual Basic, Visual Basic .NET.

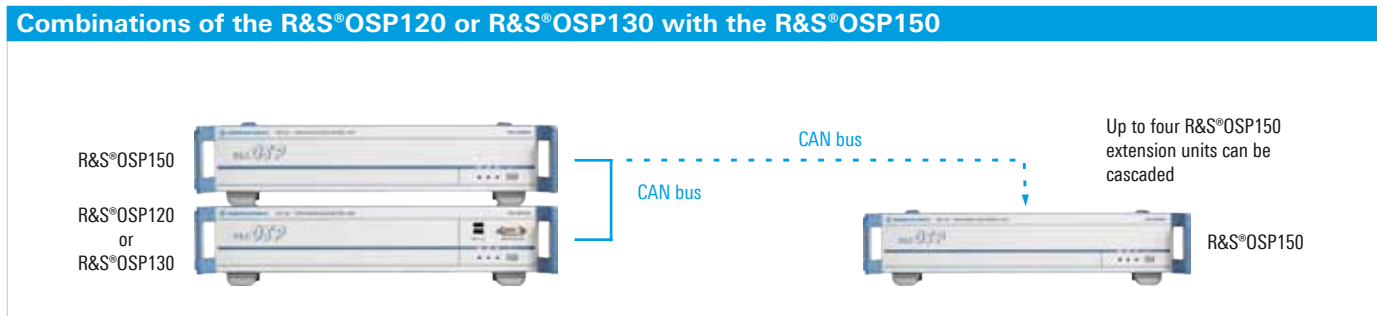

Overview of modules

Type	Designation of module, characteristics	Module width
Universal RF switch modules (with SMA plug)		
R&S®OSP-B101	RF switch module, 6 × coaxial changeover relays (SPDT), 0 Hz to 18 GHz, non-terminated	standard
R&S®OSP-B111	RF switch module, 6 × coaxial changeover relays (SPDT), 0 Hz to 40 GHz, non-terminated	standard
R&S®OSP-B102	RF switch module, 2 × coaxial multiposition relays (SP6T), 0 Hz to 18 GHz, non-terminated	standard
R&S®OSP-B112	RF switch module, 2 × coaxial multiposition relays (SP6T), 0 Hz to 40 GHz, non-terminated	standard
R&S®OSP-B107	RF switch module, 6 × coaxial changeover relays (SPDT), SSR, 0 Hz to 6 GHz, non-terminated	standard
R&S®OSP-B121	RF switch module, 3 × coaxial changeover relays (SPDT), 0 Hz to 18 GHz, terminated	standard
R&S®OSP-B122	RF switch module, 1 × coaxial multiposition relays (SP6T), 0 Hz to 18 GHz, terminated	standard
R&S®OSP-B123 ¹⁾	RF switch module, 6 × coaxial changeover relays (SPDT), 1 × coaxial multiposition relay (SP6T), 0 Hz to 18 GHz, terminated	double
R&S®OSP-B124 ¹⁾	RF switch module, 3 × coaxial changeover relays (SPDT), 2 × coaxial multiposition relays (SP6T), 0 Hz to 18 GHz, terminated	double
R&S®OSP-B125 ¹⁾	RF switch module, 6 × coaxial changeover relays (SPDT), 3 × coaxial multiposition relays (SP6T), 0 Hz to 18 GHz, terminated	triple
R&S®OSP-B126 ¹⁾	RF switch module, 3 × coaxial multiposition relays (SP6T), 0 Hz to 18 GHz, terminated	triple
Special switch modules		
R&S®OSP-B106	RF switch module, 3 × coaxial changeover relays (SPDT), N connector (f), 0 Hz to 12 GHz, 3 × changeover relays (SPDT), BNC connector (f), 0 Hz to 900 MHz	double
R&S®OSP-B104	Relay driver module, control of four external RF power relays, additional digital inputs/outputs, interlock	standard
R&S®OSP-B103	Digital I/O module, 16 × digital inputs, 16 × digital outputs	standard
R&S®OSP-B108	Multiplexer module, 6-channel, 4-wire multiplexer, 0 V to 60 V, 30 VA	standard

¹⁾ The R&S®OSP-B122 to R&S®OSP-B126 relay modules can be built in or retrofitted in the R&S®OSP120/130/150 models produced in May 2010 or later.



Rear view of the R&S®OSP

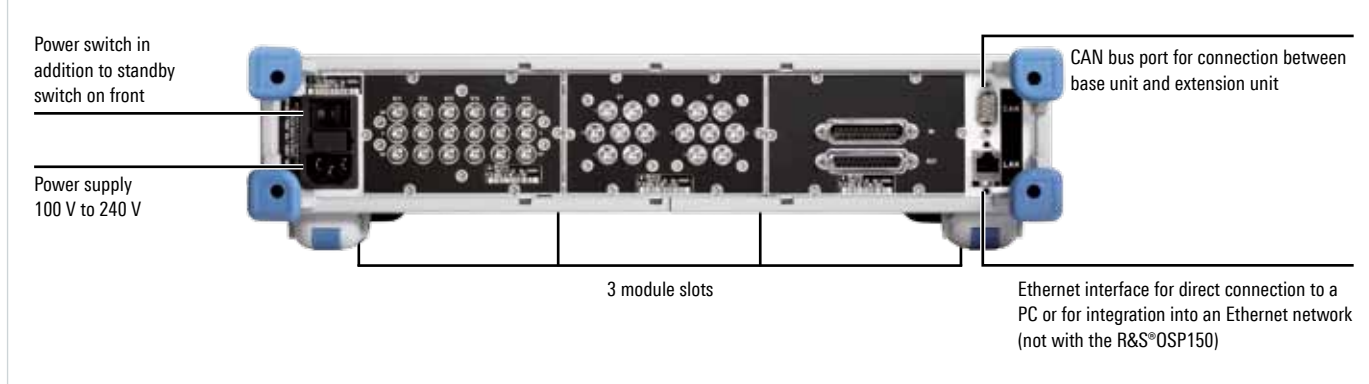

R&S® IQR I/Q Data Recorder



Realtime recording and streaming of digital I/Q data

The R&S® IQR is a high-speed recorder for recording and playing digital I/Q data streams. When used in combination with one of the many Rohde & Schwarz instruments that have the R&S® Digital I/Q Interface, the R&S® IQR can store and play data in realtime. The real and imaginary parts of digital I/Q data make it possible to completely describe RF signals.

The R&S® IQR is an ideal storage medium for applications such as providing interference or test signals, drive tests, realtime storage of data when archiving RF signals, and for playing recorded I/Q signals. The I/Q data recorder is well suited for research and development applications, for drive tests when measuring wireless communications and broadcast signals, and for military applications.

- Recording and playing of digital I/Q data with a sample rate of up to 66.6 Msample/s or up to 270 Mbyte/s
- 2 × 16 bit I/Q data width
- Touchscreen for easy manual operation
- Two models for various requirements: R&S® IQR20 with up to 20 Msample/s and R&S® IQR100 with up to 100 Msample/s depending on the memory packs used
- Easily removable memory packs with hard disk drives (HDDs) for stationary use and with solid state drives (SSDs) for higher data rates and mobile use
- More than 3 hours recording of I/Q data with a bandwidth of 20 MHz (e.g. FM radio) when using the R&S® IQR-B110 memory pack (1 Tbyte)
- Very robust in combination with the R&S® IQR-B110 memory pack (SSD, no moving parts as with HDD)
- Very compact combination of devices for receiving (R&S® TSMW) and recording (R&S® IQR)
- R&S® IQR-K101 option allowing I/Q data recorded with the R&S® FSx or R&S® TSMW to be exported for further processing, e.g. to MATLAB®
- R&S® IQR-K102 option for GPS meta data recording, e.g. when performing drive tests with a combination of the R&S® TSMW and R&S® IQR
- Extensive internal and external trigger modes for controlling recording and playing
- Data generator function for generating various data streams (sinewave, squarewave)

Specifications in brief

Data interfaces		
DIGITAL I/Q IN/OUT (R&S® Digital I/Q Interface)	no simultaneous data transfer	1 × I/Q input, 1 × I/Q output
I/O 1 to I/O 8	input clock rate	66 MHz to 100 MHz
	output clock rate	100 MHz
	trigger signals	8 × BNC sockets for I/O signals, including max. two for trigger signals
Reference clock	programmable I/O signals (future release)	2 × 4 programmable I/O
	input socket, BNC	10 MHz
	output socket, BNC	10 MHz
I/Q data		
I/Q word size		16 bit per channel
Sample rate	R&S® IQR20	1 ksample/s to 20 Msample/s
	R&S® IQR100	1 ksample/s to 66 Msample/s ¹⁾
Data rate	R&S® IQR20	up to 80 Mbyte/s
	R&S® IQR100	up to 270 Mbyte/s ¹⁾

¹⁾ Depending on the memory pack used.

R&S®RSC Step Attenuator



Precise signal levels and high repeatability

The R&S®RSC is a switchable, mechanical step attenuator. It is available in various models with different upper frequency limits (6 GHz or 18 GHz), maximum attenuation ranges and minimum settable step sizes. The R&S®RSC can also control external step attenuators with frequency ranges from DC to 40 GHz or 67 GHz.

The R&S®RSC step attenuator is an ideal choice in all applications that call for precise signal levels. Operation is intuitive, and all settings are visible at a glance. Featuring high attenuation accuracy and high linearity, the R&S®RSC delivers reliable results and ensures stable conditions for the test setup. This simplifies work for developers of RF components.

In automated test systems, the R&S®RSC stands out for its high repeatability of 0.02 dB, long life and high reliability with specified 10 million switching cycles. Various frequency ranges from DC to 6 GHz, 18 GHz, 40 GHz and

67 GHz are available to meet the requirements of wireless communications, electronic products and aerospace and defense. The R&S®RSC is available with one internal step attenuator and allows up to four additional external step attenuators to be controlled.

The R&S®RSC offers a wide scope of functions, including frequency response correction and display of attenuation deviation relative to a nominal value. Moreover, it can display an overall attenuation value, taking into account further test setup components such as high-power attenuators. The R&S®RSC covers a broad range of applications from power measurements to high-precision calibration.

Its low weight and compact dimensions make the R&S®RSC ideal for flexible applications in the lab. The step attenuator can be manually operated via its front-panel keypad. The built-in screen shows current device settings at a glance. The R&S®RSC takes up just half a rack width (½ 19"). It can be delivered with RF connectors optionally on the front or rear panel. Various interfaces (IEC/IEEE, LAN and USB) are available for remote control. These features make the device ideal for system applications as well.

- Step attenuators with frequency ranges up to 6 GHz, 18 GHz, 40 GHz and 67 GHz
- Maximum attenuation ranges up to 139.9 dB, 115 dB and 75 dB
- Minimum step sizes of 0.1 dB, 1 dB and 5 dB
- Control of one internal plus up to four external step attenuators by a single R&S®RSC
- Outstanding accuracy due to frequency response correction and user calibration

Specifications in brief		R&S®RSC model .03/.13 ¹⁾	R&S®RSC model .04/.14 ¹⁾	R&S®RSC model .05/.15 ¹⁾	R&S®RSC-Z405 external step attenuator	R&S®RSC-Z675 external step attenuator
Frequency range		DC to 6 GHz		DC to 18 GHz	DC to 40 GHz	DC to 67 GHz
Attenuation range		0 dB to 139 dB	0 dB to 139.9 dB	0 dB to 115 dB	0 dB to 75 dB	0 dB to 75 dB
Connectors		type N (f)			2.92 mm (f)	1.85 mm (f)
Minimum attenuation step size		1 dB	0.1 dB	5 dB		
Matching	up to	> 20 dB				
Attenuation uncertainty (relative to attenuation at 0 dB)	up to	< 0.2 dB + 1% of attenuation value	< 0.07 dB + 0.5% of attenuation value (corrected)	< 0.6 dB + 1% of attenuation value	< 0.5 dB	
Repeatability		typ. 0.02 dB				
Maximum power-handling capability	CW	1 W				
	pulse < 10 µs	200 W				
Maximum voltage	pulse < 10 µs	150 V				
Operating life		> 10 × 10 ⁶ switching cycles		> 1 × 10 ⁶ switching cycles		
Switching speed		< 25 ms		< 30 ms		

¹⁾ Model .0x: RF connectors on front panel; model .1x: RF connectors on rear panel.

Appendix

Service and Support

We are here to assist you – live with real experts.
At Rohde & Schwarz you talk to people.



Description	Page
Rohde & Schwarz worldwide	183
Service you can rely on	184
Training and application support	186
The future lies with systems	188
Service for systems	190
Global sales and service locations, trademarks	191
Index by type	192

Rohde & Schwarz

worldwide

Headquarters

At company headquarters in Munich, around 2000 employees work in research and development, central sales and service, marketing and administration.

Rohde & Schwarz GmbH & Co. KG

Mühlendorfstraße 15
D-81671 München
Phone +49 89 41 29 0
Fax +49 89 41 29 121 64
info.rs@rohde-schwarz.com
www.rohde-schwarz.com

Contact

Sales

For the addresses of the local sales companies in more than 70 countries, visit www.sales.rohde-schwarz.com

Customer support – worldwide live support

Whatever problem you have, our support center is there to help you. Your question will be dealt with fast and in detail. There are three support centers in three different time zones: Munich, Washington and Singapore. Support is available 24 hours a day, Monday through Friday excluding public holidays. The staff of our support center is optimally trained to assist you in solving your problems. Our regional support centers will be glad to answer any questions regarding our products and service:

Europe, Africa, Middle East

Phone +49 89 4129 12345
customersupport@rohde-schwarz.com

North America

Phone 1 888 TEST RSA (1 888 837 87 72)
customer.support@rsa.rohde-schwarz.com

Latin America

Phone +1 410 910 79 88
customersupport.la@rohde-schwarz.com

Asia/Pacific

Phone +65 65 13 04 88
customersupport.asia@rohde-schwarz.com

China

Phone +86 800 810 8228/+86 400 650 5896
customersupport.china@rohde-schwarz.com

Plants

Memmingen plant

info.rsmb@rohde-schwarz.com

Teisnach plant

info.rsdt@rohde-schwarz.com

Vimperk plant

info.vimperk@rohde-schwarz.com

Subsidiaries

Arpege SAS

arpege@arpege-defense.com

DVS Digital Video Systems GmbH

info@dvs.de

GEDIS GmbH

sales.gedis@rohde-schwarz.com

HAMEG Instruments GmbH

info@hameg.com

Ipoque GmbH

info@ipoque.com

R&S Systems GmbH

info.rssys@rohde-schwarz.com

Rohde & Schwarz SIT GmbH

info.sit@rohde-schwarz.com

RPG Radiometer Physics GmbH

info@radiometer-physics.de

S.C. Rohde & Schwarz Topex S.A.

topex@topex.ro

Service you can rely on

Dear Customer,

At first glance, tradition and high-tech don't really seem to fit together. Rohde&Schwarz, however, has shown that these two concepts can make a perfect match: For nearly 80 years, it has been the company's tradition to explore the limits of what is physically feasible in generating and measuring electronic signals. As a manufacturer, we have always proved that our products comply with the relevant specifications. We provide this proof with the calibration certificate issued by our service centers. As a matter of course, we apply the same high technological and quality standards that we demand of our products. We know that low calibration costs are the crucial factor when it comes to total cost of ownership. And we are also aware of the high demands placed on our equipment and the necessary scope of measurements. Moreover, we will not accept compromises on quality for the sake of costs. This is why we offer efficient, favorably priced calibration solutions to our customers. These solutions are implemented in the test procedures running on our automatic test systems worldwide. Our driving force is your satisfaction over the complete life cycle of our products. This is yet another tradition at Rohde&Schwarz.

Dr. Klaas Hoekstein
Director of International Service

Contractually assured services

Rohde&Schwarz offers full-range service at your command. You can mix and match our services according to your technical and budgetary requirements.

Service contracts

As the original equipment manufacturer (OEM), we provide the most qualified, responsive and thorough service available. Customer care is especially important to us. We support you with services tailored to your needs:

- Short and reliable turnaround times
- Efficient logistics for pickup and return of your equipment
- High spare-part availability
- Flexible adjustment of terms during the contract period
- Services tailored to your needs

Service options

Service options are powerful service contracts that are offered exclusively when you purchase a new product. Taking advantage of a service option ensures optimum performance and availability of your Rohde&Schwarz product at low, predictable operating costs.

Asset management

Our service portal allows you to manage all your measurement instruments serviced by Rohde&Schwarz. Register for your secure account at http://www.rohde-schwarz.com/service_portal and request access to the service portal. Once your request is processed, you can access the key data of your instruments and check the status of current service jobs



Calibration Repair			
<p>Factory standard calibration</p> <ul style="list-style-type: none"> Full calibration (ISO 17025 conformant), returning the instrument to the same state as when it originally left the factory Traceability to national/international standards Certificate and test report Software updates and hardware modifications included Instrument adjustment 	<p>Accredited calibration</p> <ul style="list-style-type: none"> Same features as factory standard calibration Directly traceable calibration in accordance with ISO 17025 Controlled by national accreditation authority (NIST, DKD/DakkS) Certificate and test report Software updates and hardware modifications included Instrument adjustment 	<p>Performance calibration (only available under service contract)</p> <ul style="list-style-type: none"> Competitive price Complete measurement of all specifications as with factory standard calibration Certificate and test report Quality-related software updates and hardware modifications No instrument adjustments 	<p>Adjustment</p> <ul style="list-style-type: none"> Includes adjustment and incoming equipment test report Can only be ordered in connection with performance calibration
<p>Standard price repair</p> <ul style="list-style-type: none"> Fixed repair price which covers the cost of materials and work performed Twelve-month service warranty on the entire equipment (does not apply in case of improper handling or alteration of the equipment) Calibration in line with ISO 9001 including documentation of test results Latest hardware and software updates 	<ul style="list-style-type: none"> Pickup and return of the equipment (only for shipping by a Rohde & Schwarz logistics partner in the country of the Rohde & Schwarz service organization) If it turns out that only little work and material are needed to eliminate the fault, you pay merely a small lump sum instead of the standard price 	<p>Time and material repair</p> <ul style="list-style-type: none"> Repair based on the amount of material and work required to repair the equipment Twelve-month service warranty on the work performed 	

Rohde & Schwarz service offers you further advantages

Service request

Service from the start – higher efficiency, smooth handling and greater visibility through on-line tracking. Just call or visit our website at <http://rohde-schwarz.com/RMA> to register your instrument. You will immediately receive shipping instructions, the service reference number, preliminary service pricing options and the estimated turnaround time via e-mail.

Service for TPM (third party maintenance) products

Rohde & Schwarz also offers the services mentioned here for TPM products.

On-site calibration

You can opt for on-site calibration of your Rohde & Schwarz equipment and TPM products. On-site calibration is convenient and reduces downtime to the absolute minimum. Various calibrations and minor repairs can be performed at your company; minimum quantities apply.

Pickup service

On request we pick up your equipment at your company. We can also arrange for the packaging.

Loan equipment

Your local service center can offer a loaner to bridge the repair time – subject to availability.

Service order tracking

The www.servicestatus.rohde-schwarz.com portal allows you to verify the repair or calibration status of your instrument. Service order tracking provides effective transparency. You only need the service reference number and the serial number of your equipment to track its status.



Training and application support

The product portfolio of Rohde & Schwarz is accompanied by a comprehensive choice of training seminars and detailed application notes. By offering comprehensive application notes and practice-oriented training, we want to show you how to use our products most effectively. This ranges from first-time users who can choose from detailed introductory courses and practical T&M examples up to seasoned users who can gain deep insight into the numerous – and very special – ways to use the high-performance solutions from Rohde & Schwarz.

Training

The extensive choice of seminars includes everything from standard training classes on numerous topics in radio engineering and test and measurement to practice-oriented product training for Rohde & Schwarz solutions.



If needed, customer-specific training programs designed specially for your wishes and requirements are held in order to achieve optimum benefit for the participants. Skilled trainers convey concise, practice-oriented knowledge at our state-of-the-art, fully equipped training center in Munich. Alternatively, training can also be held on the customer's premises or at any other location of choice.

Comprehensive choice of training seminars

Standard seminars

Detailed seminars are offered on numerous topics in radio engineering and T&M such as RF and EMC testing, as well as classes covering the fields of wireless communications, television and antennas from the basics up to workshop level.

Customized seminars

Optimum benefit for customers and their participants is the focal point of customer-specific seminars. The training content is tailored specifically to the customer's wishes and requirements.

Hands-on experience

Practical exercises are an essential part of all seminars to help ensure that the material just learned can be tried out immediately using state-of-the-art test setups. This is crucial for understanding and clarifying the training content in detail.

Small groups

The number of participants is intentionally kept small so that everyone has sufficient time for questions as well as the opportunity to try out the class content in a hands-on environment.

Trainers/training staff

The trainers continuously keep their technical knowledge up to date. They possess not only technical expertise but also the ability to convey it in an understandable and lasting manner.

Location

Classes may be held at the state-of-the-art training center at company headquarters in Munich. Optionally, seminars can take place on the customer's premises or at any other suitable location.

Timetable

Standard training classes are scheduled twice a year. The dates can be viewed on the Rohde & Schwarz homepage. The schedule for customized seminars is drawn up together with the individual customer.

Languages

The seminars are conducted either in German or English. If needed, special training classes can be held in other languages.

Registration and organization

All detailed information regarding the seminars – including class descriptions, registration, cost, procedure and content – is provided on the Rohde & Schwarz homepage under Service & Support/Training.

Limiting the number of participants helps to ensure better communications between participant and trainer. Knowledge is conveyed more intensely, and extra time is available for questions so that the participants can put their newly gained knowledge and skills into practice immediately after the seminar.

Skill and up-to-date knowledge are top priority in all our seminars. The company's intensive participation in relevant bodies – such as in the standardization of state-of-the-art wireless communications – is reflected in training classes, which are always cutting-edge both in theory and in T&M expertise. Our customers also benefit from this.

Application support

Rohde&Schwarz offers you support for your measurement task no matter which application and which category of industry it involves. We look forward to sharing the knowledge and the experience of our worldwide network of experts with you:

- Local application engineers help you to successfully implement your specific application on site by using Rohde&Schwarz T&M solutions, and provide guidance services for all T&M matters
- A large number of application notes, often combined with helpful application programs or T&M examples, can be downloaded from www.rohde-schwarz.com/appnote

Abstracts of some popular application notes

Download application notes from: www.rohde-schwarz.com/appnote

Development hints and best practices for using instrument drivers (1MA153)

To make the programming of your own T&M applications efficient, the Rohde&Schwarz website offers the required device drivers as free-of-charge downloads. Application note 1MA153 provides important hints on how to use these drivers in various development environments and also answers frequently asked questions on how to control the T&M equipment. Therefore, it offers valuable support for application engineers and software developers alike.

RSCCommander – versatile software tool for Rohde & Schwarz instruments (1MA74)

RSCCommander is a popular software tool that makes your daily business easier when operating Rohde&Schwarz T&M instruments, and especially when using them via remote control. In addition to many other useful functions, screenshots from T&M instruments can be generated or trace data can be output in order to process it on your computer. The tool also provides convenient access to the T&M equipment's file management system.

RSCCommander is available for a large number of Rohde&Schwarz T&M instruments, including signal generators, signal and spectrum analyzers, as well as network analyzers.

LTE base station tests in accordance with TS36.141 (1MA154 and 1MA162)

Wireless communications networks worldwide are currently being equipped with long term evolution (LTE) technology, which is the follow-up development to the existing UMTS networks and promises even higher data rates for the end customer. These two application notes support developers of LTE base stations with a free-of-charge example program that facilitates the settings of the T&M equipment for all tests required by the standard.

Transmitter and receiver tests in line with the 3GPP TS36.141 specification are addressed in application note 1MA154, and performance tests in 1MA162.

VoIP measurements for WiMAX™ (1MA149)

Voice quality is a key performance indicator for wireless communications systems and therefore also for the testing of terminal equipment. In the packet-oriented, next-generation wireless communications technologies such as WiMAX™ and LTE, voice over IP is used to transfer speech.

A combination of the R&S®UPV audio analyzer and the R&S®CMW270 wireless connectivity tester allows the voice and audio quality of a WiMAX™ mobile station to be determined. Application note 1MA149 describes the steps required for performing the measurement and for configuring the T&M equipment.

The future lies with systems

Customer-specific solutions are implemented to an increasing extent by integrating measuring instruments and specially developed devices into overall systems. Rohde&Schwarz has many years of experience implementing turnkey EMC test centers, conformance test systems for mobile phones, mobile test systems for coverage measurements and mobile phone production lines.

System applications

In numerous branches of industry, measurements and tests often have to be carried out repeatedly on a series of DUTs, e.g. in:

- Incoming inspection: component or module tests
- Production: automatic alignment
- Quality assurance: testing at the various stages of production and final testing
- Research and development: series measurements on prototypes
- Service: long-time measurements (e.g. of temperature) at defined test intervals

Project handling by Rohde&Schwarz

A high-performance measurement system requires extensive development and design efforts. The choice of the right instruments and components as well as their careful installation are essential for the high performance and availability of a system.

System design at Rohde&Schwarz ensures full utilization of a large variety of measuring instruments of advanced technology and highest precision from both Rohde&Schwarz and other manufacturers. System responsibility lies always with Rohde&Schwarz, irrespective of the origin of the measuring equipment and individual system components.

Rohde&Schwarz has experienced and optimally trained staff to implement a project from the initial planning through to the operational system.

Rohde&Schwarz test systems

- Production test systems, board testers
- Conformance test systems for mobile phones
- Coverage measurement systems for all modern radio networks
- EMC test systems and test centers

Production test systems, board testers – a strong concept

A development and production chain is only as strong as its weakest links, which used to be highly complex measurement systems and time-consuming final testing. Market launch of the products was often subject to delays. Today, to reduce test time, production test systems and conformance systems from Rohde&Schwarz can be used wherever electronic equipment is produced. Efficient solutions in this field range from precompliance test equipment through to complete production lines.

The unique Rohde&Schwarz modular hardware and software concept supports a large variety of test combinations for alignment, RF test, optical check, board test, etc.

Our production test systems are tailored to the needs of the customers and provide overall solutions: measurements with DUT adaptation also in the RF range via test prods; with conveyor belts; networking within user-specific computer networks; logistics; consulting and advice regarding the selection of suitable tests for optimizing measurement times and test depth.

Conformance test systems for mobile phones and devices of digital radio networks

Rohde&Schwarz test systems, especially for conformance testing, are at the leading edge in their field. Our customers benefit from this high innovation potential. Specialists at Rohde&Schwarz implemented the latest requirements for conformance measurements in the appropriate test systems using ultramodern measuring equipment from our production.



This synergy of available equipment and new system applications yields optimum results. For instance, it is possible to achieve maximum test depth while ensuring the highest degree of ergonomics and operational reliability. And another great advantage is self-calibration. Customers can utilize all these benefits to make their products fit for both present-day and future markets.

Coverage measurement systems for all modern radio networks

Rohde&Schwarz test systems are not only used where electronics is produced but also where it is made to "work": in mobile radio networks, for instance. Our range of mobile coverage measurement systems ensures full monitoring of analog and digital radio networks as well as smooth, optimal operation.

EMC test systems

Rohde&Schwarz offers complete EMC test systems that can handle all the complex aspects in this field. No matter whether it is about precompliance tests at the manufacturer, acceptance tests in accredited test houses or market monitoring by government authorities, Rohde&Schwarz always provides an appropriate solution ranging from the compact system based on a test cell to the complete test center.

Applications

- Commercial
- Wireless
- Automotive components
- Automotive vehicles
- MIL
- Medical

Rohde&Schwarz also offers test systems for over-the-air (OTA) performance measurements for characterizing DUTs with built-in antenna as well as systems for measuring ambient electromagnetic fields (EMF).

Future-oriented design

Rohde&Schwarz measurement and test systems feature extremely flexible hardware and software concepts that allow adaptation to modified requirements at any time.

Support

Rohde&Schwarz test stations are powerful instruments for increasing productivity in automated production. Rohde&Schwarz products include a complete service package, which allows the full performance of the system to be utilized from the very first day. This package includes training, application support, maintenance, fixture design, 24-hour spare parts service and a telephone support line.

References

Rohde&Schwarz measurement and test systems are successfully used all over the world: Tailored to the needs of the customers, the test systems can be found at renowned industrial companies, test houses and government institutes – the impressive list of references can be supplied on request.

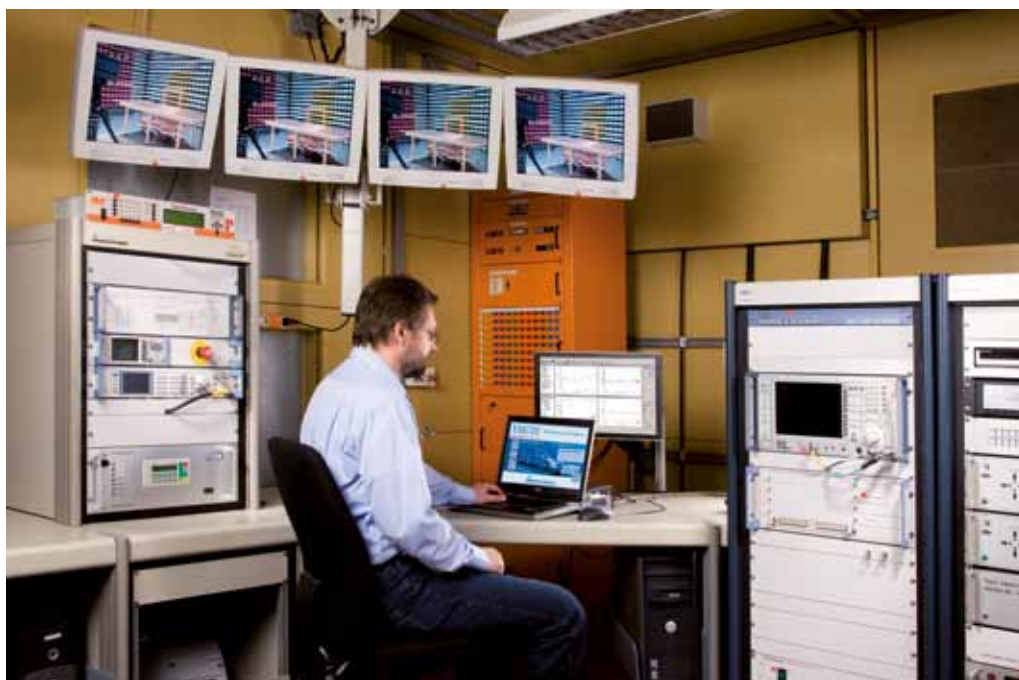

Service for systems

First-hand service

Rohde&Schwarz systems combine the latest achievements in hardware and software with the know-how and experience gained over many decades. In line with the Rohde&Schwarz system philosophy, the high level of expertise does not stop with system development but is maintained during the operational life of the systems by means of the services offered.

Telephone support, continuous updating of system software, fast replacement and repair of equipment and modules in case of a fault are essential prerequisites for the high availability of an operational system.

Rohde&Schwarz offers complete packages and solutions for servicing the systems. The service concept is of modular structure and consists of unit blocks providing an entire series of services for hardware and software.

Services available during warranty period

- Enhanced warranty service
 - Problem report service
 - Telephone support line service
 - Access to a pool of spare modules
- Calibration service

Services available after warranty period

- After-warranty service
 - Problem report service
 - Telephone support line service
 - Access to a pool of spare modules
- Software service
- Calibration service



Enhanced warranty service

The enhanced warranty service supplements the standard warranty services of Rohde&Schwarz to satisfy – even during the warranty period – the high demands placed on system availability and offers a service time of eight hours and defined response time.

- Database-supported information system with direct customer access
- Telephone support line service
- Access to a pool of spare modules
- On-site repair, if necessary
- Escalation procedure

After-warranty service

The after-warranty service contains all the unit blocks of the enhanced warranty service plus the following:

- Repair of faults
- Supply of software updates

Calibration service

The calibration service assures you that the parameters of your system will be checked at regular intervals and corrected if necessary.

- Calibration by an accredited calibration laboratory in line with EN ISO/IEC 17025
- Calibration at specified calibration intervals in line with DIN EN ISO 9001
- Traceability of calibration to national or international standards
- Calibration reports and certificates
- On-site calibration possible

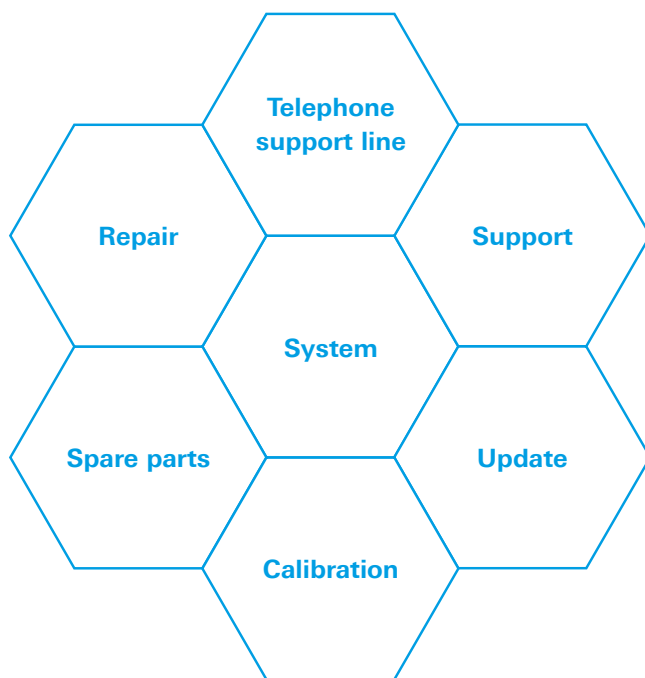

Rohde & Schwarz worldwide

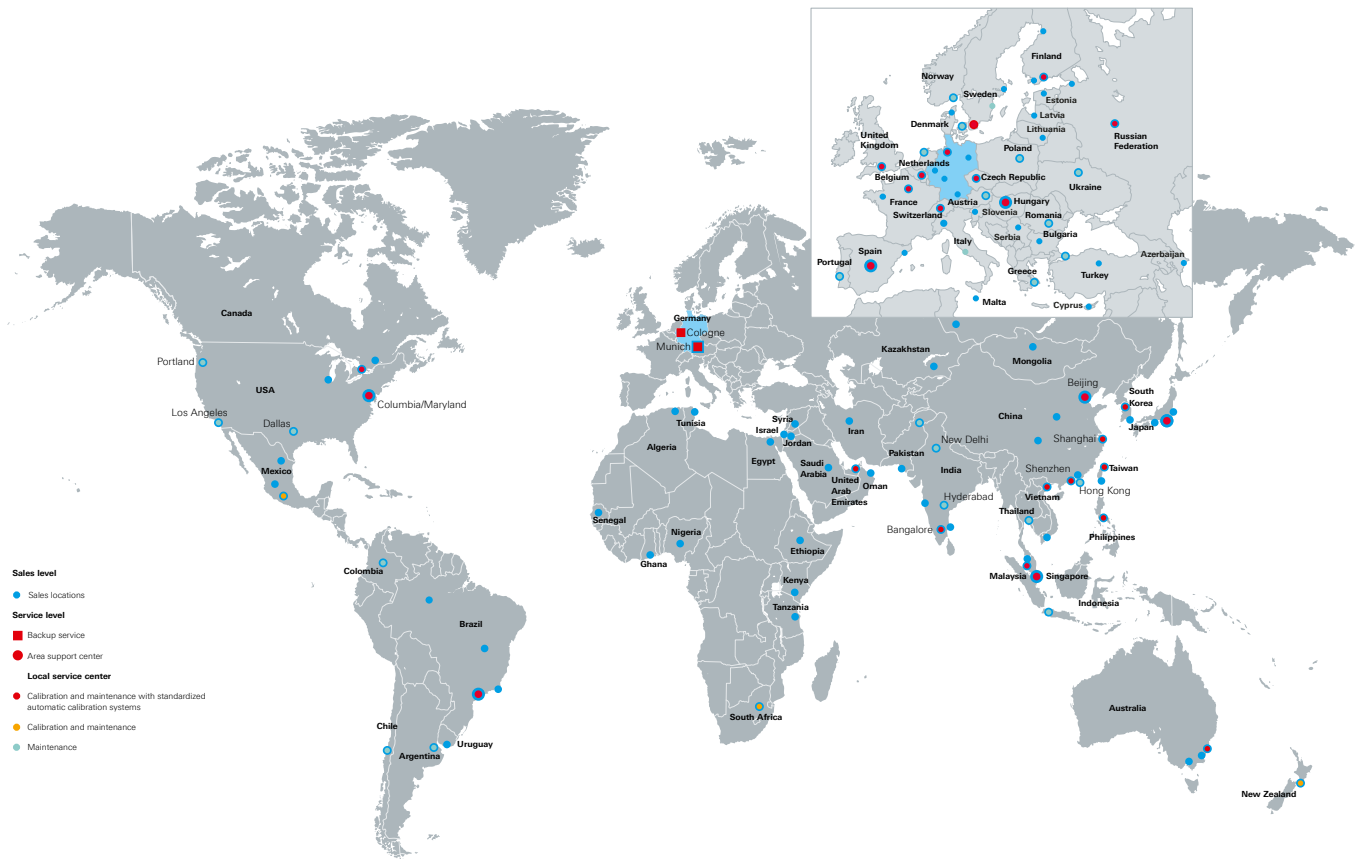

Trademarks

Trade names are trademarks of the owners

- R&S® is a registered trademark of Rohde & Schwarz GmbH & Co. KG. Example: R&S®FSU spectrum analyzer
- Windows is a registered trademark of Microsoft Corp., USA
- CORBA is a registered trademark of the Object Management Group, Inc.
- “WiMAX Forum” is a registered trademark of the WiMAX Forum. “WiMAX”, the WiMAX Forum logo, “WiMAX Forum Certified” and the WiMAX Forum Certified logo are trademarks of the WiMAX Forum
- The Bluetooth® word mark and logos are registered trademarks owned by Bluetooth SIG, Inc. and any use of such marks by Rohde & Schwarz is under license
- CDMA2000® is a registered trademark of the Telecommunications Industry Association (TIA - USA)

Index by type

Type	Designation	Data sheet	News from Rohde & Schwarz	Page
A				
R&S® AFQ100A	I/Q Modulation Generator	PD 5214.0799	189, 194, 199	70
R&S® AFQ100B	UWB Signal and I/Q Modulation Generator	PD 5214.0799	199	70
R&S® AFQ-Kxx	Application Firmware Packages for R&S® AFQ generators	–	–	72
R&S® AMU200A	Baseband Signal Generator and Fading Simulator	PD 5213.7954	192, 193, 199, 200, 201, 204	69
R&S® AMU-Kxx	Application Firmware Packages for the R&S® AMU200A	–	204	72
R&S® ATSI100	Infotainment Test System	PD 5213.8909	189	154
R&S® ATSI-AM	AM Generator	PD 5213.9328	–	155
R&S® ATSI-ATV	Analog TV Generator	PD 5213.9334	–	155
R&S® ATSI-DAB1	DAB Repeater	PD 5214.2804	–	156
R&S® ATSI-DVBT1	DVB-T Repeater	–	–	156
R&S® ATSI-FM	FM Generator	PD 5214.0553	–	155
R&S® ATSI-GPS1	GPS Repeater	PD 5214.1072	–	156
R&S® ATSI-ISM	ISM Generator	–	–	155
R&S® ATSI-K1	Sequence Controller	–	189	157
R&S® ATSI-K10	R&S® SFE100 DAB Interface	–	–	157
R&S® ATSI-K11	R&S® SFE100 DVB-T Interface	–	–	157
R&S® ATSI-K12	ISM Interface	–	–	157
R&S® ATSI-K2	Remote Interface	–	189	157
R&S® ATSI-K4	Loudspeaker Test	–	–	157
R&S® ATSI-K5	Audio Analysis	–	–	157
R&S® ATSI-K7	System Configuration 1	–	189	157
R&S® ATSI-K8	System Configuration 2	–	–	157
R&S® ATSI-K9	Database Interface	–	–	157
R&S® ATSI-MF	Module Frame	–	–	155
R&S® ATSI-MON1	Monitor Module	–	–	156
B				
R&S® BBA100	Broadband Amplifier	PD 5214.0753	201	122
R&S® BCDRIVE	Broadcast Drive Test Software	PD 5214.5761	–	170
C				
R&S® CBT/CBT32	Bluetooth® Testers	PD 0758.1287	182, 188, 196, 198	16
R&S® CMS54/57	Radiocommunication Service Monitors	PD 5213.8996	158	14
R&S® CMU200	Universal Radio Communication Tester	PD 0758.0039	165, 167, 168, 169, 170, 171, 173, 174, 175, 177, 179, 182, 186, 187, 188, 189, 190, 191, 193,	13
R&S® CMW-Z10/-Z11	RF Shielding Box and Antenna Coupler	PD 5214.0601	–	23
R&S® CMW270	Wireless Connectivity Tester	PD 5213.8880	195, 197, 199, 200, 201, 202, 203, 204	11
R&S® CMW500	Wideband Radio Communication Tester	PD 5213.9211 PD 5214.2833	195, 197, 199, 201, 202, 203, 204	12
R&S® CMW500-PT	HSPA+ and LTE Protocol Tester	PD 5213.9363	196, 199, 203	18
R&S® CompactTSVP	Open Test Platform	PD 5214.2204	180, 186	148
R&S® CRTU-W/G	Protocol Test Platform	PD 5213.5574	176, 178, 179, 181, 182, 184, 185, 187, 188, 190, 191, 193, 194, 195, 196, 199	17
R&S® CTH	Portable Radio Test Set	PD 5214.4671	–	15
D				
R&S® DST200	RF Diagnostic Chamber	PD 5214.3600	201	23
R&S® DVM	Digital Video Measurement System	PD 5213.5274	179, 182, 183, 184, 186, 188, 192, 194, 195, 196, 199	173
R&S® DVM100L	MPEG-2 Monitoring System	PD 5213.5274	199	173
R&S® DVM120	MPEG-2 Monitoring System	PD 5213.5274	179, 199	174
R&S® DVM400	Digital Video Measurement System	PD 5213.5274	182, 194, 199	173
R&S® DVM50	MPEG-2 Monitoring System	PD 5213.5274	183, 199	174
R&S® DVMS	Digital TV Monitoring System	PD 5214.4788	202, 203, 204	172
R&S® DVSG	Digital Video Signal Generator	PD 5213.9892	197, 201	159

Type	Designation	Data sheet	News from Rohde & Schwarz	Page
E				
R&S® EFA	TV Test Receiver Family	PD 0758.2254 PD 5213.6835 PD 5214.4836	152, 157, 160, 164, 167, 170, 172, 173, 174, 175, 178, 179, 184, 185, 189, 199	169
R&S® EFA-K1	EFA-SCAN Measurement Software	PD 0758.0416	179	169
R&S® EFL240/EFL340	Portable TV Test Receiver	PD 5214.6000	–	168
R&S® EMC32	EMC Measurement Software Platform	PD 5214.0147	172, 178, 179, 184, 186, 191, 198, 201	120
R&S® EMF-M	EMF Monitor Station	PD 5213.8715	–	118
R&S® ENV216	Two-Line V-Network	PD 5214.0299	197	124
R&S® ENV4200	200 A Four-Line V-Network	PD 5213.7977	197	124
R&S® ENY21	Two-Wire Coupling Network	PD 5213.9286	–	125
R&S® ENY41	Four-Wire Coupling Network	PD 5213.9286	–	125
R&S® ENY81	Eight-Wire Coupling Network	PD 5213.9386	197	125
R&S® ENY81-CA6	Eight-Wire Coupling Network for cable category CAT 6	PD 5214.1772	–	125
R&S® ES-SCAN	EMI Software	–	194, 197	119
R&S® ESCI	EMI Test Receiver	PD 0758.1558 PD 5214.2762	182, 185, 195, 200	111
R&S® ESH2-Z2/-Z3	Voltage Probes	–	178	126
R&S® ESH2-Z31	Attenuator	–	–	126
R&S® ESH2-Z5	25 A Four-Line V-Network	–	158	124
R&S® ESH3-Z2	Pulse Limiter	–	175	126
R&S® ESH3-Z6	150 A Single-Line V-Network	PD 0758.1535	158	124
R&S® ESL	EMI Test Receiver	PD 5214.0430	197	113
R&S® ESPI	Test Receiver	PD 0758.0745	170, 171, 175, 181, 185, 189, 194, 195	112
R&S® ESU	EMI Test Receiver	PD 5213.6693	190, 192, 193, 195	110
R&S® ESV-Z1	VHF Current Probe	–	178	127
R&S® ETH	Handheld TV Analyzer	PD 5213.9592	199	165
R&S® ETL	TV Analyzer	PD 5213.7748	193, 195, 196, 198, 199, 200, 202, 203	167
R&S® EVS300	VOR/ILS Analyzer	PD 5213.6070	188, 194, 195, 196, 203	56
R&S® EX-IQ-BOX	Digital Signal Interface Module	PD 5213.9511	196, 198, 202	71
R&S® EXBOX-Kxx	Application Firmware Packages for the R&S®EX-IQ-BOX	–	202	72
R&S® EZ-12	Antenna Impedance Converter	PD 0757.5289	–	126
R&S® EZ-17	Current Probe	PD 0758.2531	178	127
R&S® EZ-24	Ferrite Clamp	PD 5213.7919	–	128
R&S® EZ-25	150 kHz Highpass	PD 5213.8144	–	126
F				
R&S® FMAx	Modulation Analyzers	PD 0756.9300 PD 0758.0797 PD 0757.0912 PD 0758.1987	196	57
R&S® FMU36	Baseband Signal Analyzer	PD 5213.7025	193, 196	41
R&S® FS-K10	GSM/EDGE/EDGE Evolution Analysis Firmware	PD 5213.0982	–	46
R&S® FS-K110	TETRA Release 2 Analysis Firmware	PD 5214.1095	–	53
R&S® FS-K130PC	Distortion Analysis Software	PD 5214.4113	201	54
R&S® FS-K15	VOR/ILS Demodulation Firmware	PD 5214.0182	196	55
R&S® FS-K30	Noise Figure and Gain Measurement Firmware	PD 0758.0839	182	47
R&S® FS-K40	Phase Noise Measurement Firmware	PD 0758.2631	186, 190, 194	48
R&S® FS-K7	AM/FM/φM Measurement Demodulation Firmware	PD 0758.2331	186, 191, 194	45
R&S® FS-K72/-K73/ -K73+/-K74/-K74+	WCDMA 3GPP Measurement Firmware	PD 0758.2260	174, 175, 181, 182, 190, 191	49
R&S® FS-K76/-K77	TD-SCDMA Test Firmware	PD 0758.0880	181, 182, 191	50
R&S® FS-K8	Transmitter Measurements for Bluetooth® V2.0 and EDR	PD 0757.7730	182	46
R&S® FS-K82/-K84	Base Station Test Firmware	PD 0758.1712	175, 181, 182, 191	50
R&S® FS-K83/-K85	Mobile Station Test Firmware	PD 0758.1729	181, 182, 191	51
R&S® FS-K96/-K96PC	OFDM Vector Signal Analysis Software	PD 5214.4820	203	52
R&S® FS-Z10	Coherence Unit	PD 5214.2285	–	43
R&S® FS-Zxx	External Mixers	PD 5213.5868	182, 194	43
R&S® FSC	Spectrum Analyzer	PD 5214.3330 PD 5214.3830	–	32
R&S® FSG	Spectrum Analyzer	PD 5213.8721	196, 203	38

Appendix

Type	Designation	Data sheet	News from Rohde & Schwarz	Page
R&S® FSH3-TV	Handheld TV Analyzer	PD 0758.2648	186, 190	166
R&S® FSH3/18	Handheld Spectrum Analyzer	PD 0758.1593 PD 0758.1735	175, 177, 181, 182, 189, 190, 193	29
R&S® FSH4/8	Handheld Spectrum Analyzer	PD 5214.0482	198, 199	30
R&S® FSL	Spectrum Analyzer	PD 0758.2790	186, 189, 190, 193, 195	33
R&S® FSL-K14	Spectrogram Measurement Firmware	–	–	47
R&S® FSL-K30	Noise Figure and Gain Measurement Firmware	PD 0758.0839	–	47
R&S® FSL-K7	AM/FM/φM Measurement Demodulation Firmware	PD 0758.2331	195	45
R&S® FSL-K8	Transmitter Measurements for Bluetooth® V2.0 and EDR	PD 0757.7730	–	46
R&S® FSMR	Measuring Receiver	PD 0758.2319	185, 190, 191, 196	42
R&S® FSQ	Signal Analyzer	PD 0758.0945	174, 178, 180, 181, 182, 183, 184, 185, 186, 187, 190, 191, 193, 196, 203	39
R&S® FSQ-K100/-K101/ -K102/-K103/ -K104/-K105	EUTRA/LTE Signal Analysis Firmware	PD 5213.8521 PD 5213.9186 PD 5214.3281	193, 198	53
R&S® FSQ-K70	Vector Signal Analysis Firmware	PD 0758.1706	178, 181, 182, 183, 184, 185, 191, 199	49
R&S® FSQ-K94	WiMAX™ MIMO TX Measurement Firmware	PD 5213.8550 PD 5214.1289	–	52
R&S® FSU	Spectrum Analyzer	PD 0758.0016	170, 171, 174, 175, 181, 182, 183, 184, 185, 186, 187, 189, 190, 191, 194, 196	37
R&S® FSUP	Signal Source Analyzer	PD 5213.6729	190, 192, 199	40
R&S® FSV	Signal and Spectrum Analyzer	PD 5214.0499	197, 198, 200, 203	34
R&S® FSVR	Real-Time Spectrum Analyzer	PD 5214.3381	202, 203, 204	35
R&S® FSV-K10	GSM/EDGE/EDGE Evolution Analysis Firmware	PD 5214.0447	–	46
R&S® FSV-K100/-K101/ -K102/-K103/ -K104/-K105	EUTRA/LTE Signal Analysis Firmware	PD 5213.8521 PD 5213.9186 PD 5214.3281	193, 198	53
R&S® FSV-K14	Spectrogram Measurement Firmware	–	–	47
R&S® FSV-K30	Noise Figure and Gain Measurement Firmware	PD 5214.1837	–	47
R&S® FSV-K40	Phase Noise Measurement Firmware	PD 5213.9705	–	48
R&S® FSV-K54	EMI Measurement Application	PD 5214.5661	–	54
R&S® FSV-K7	AM/FM/φM Measurement Demodulation Firmware	PD 5214.0530	–	45
R&S® FSV-K70	Vector Signal Analysis Firmware	PD 5214.0599	200, 203	48
R&S® FSV-K7S	FM Stereo Measurement Firmware	PD 5214.0530	–	45
R&S® FSV-K8	Transmitter Measurements for Bluetooth® V2.0 and EDR	PD 0757.7730	–	46
R&S® FSV-K83/-K85	Mobile Station Test Firmware	PD 0758.1729	181, 182, 191	51
R&S® FSW	Signal and Spectrum Analyzer	PD 5214.5984	204	36
R&S® FSx-K91/-K91n/ -K91ac	WLAN TX Measurement Firmware	PD 5214.1450 PD 5214.1989	–	51
R&S® FSx-K92/-K93	WiMAX™ TX Measurement Firmware	PD 5213.8550 PD 5214.1466	–	52
H				
R&S® HE202	Active Receiving Dipole	–	–	133
R&S® HE302	Active Receiving Dipole	–	160	133
R&S® HF907	Double-Ridged Waveguide Horn Antenna	–	199, 200	133
R&S® HFH2-Z2	Loop Antenna	–	154, 178, 181	130
R&S® HFH2-Z6	Rod Antenna	–	178	130
R&S® HK116	Biconical Antenna	–	178	133
R&S® HK5000	EMS Broadband Dipole	–	197	132
R&S® HL033	Log-Periodic Broadband Antenna	–	–	131
R&S® HL040	Log-Periodic Broadband Antenna	–	178	131
R&S® HL046	Log-Periodic Broadband Antenna	–	–	131
R&S® HL046E	High Gain Log-Periodic Antenna	–	–	131
R&S® HL050	Log-Periodic Antenna	–	181, 200	132
R&S® HL223	Log-Periodic Antenna	–	178	132
R&S® HL562	ULTRALOG	–	165, 178	133
R&S® HM020	Triple-Loop Antenna	PD 5213.6658	–	132
R&S® HZ-10	Shielded, Calibrated Magnetic Field Pickup Coil (MIL)	PD 0757.0458	156, 162, 178	129
R&S® HZ-14	H Near-Field Probe Set	PD 5213.7883	156, 197	129
R&S® HZ-15	Probe Set for E and H Near-Field Emission Measurements	PD 5213.6687	197, 198	129

Type	Designation	Data sheet	News from Rohde & Schwarz	Page
R&S®HZ-16	Preamplifier	PD 5213.6687	–	129
R&S®HZ-9	Power Supply	–	–	130
I				
R&S®IQR	I/Q Data Recorder	PD 5214.4394	202, 204	180
M				
R&S®MDS-21	Absorbing Clamp	PD 5213.7919	160	128
N				
R&S®NRP2	Power Meter	PD 5213.5539	174, 180, 183, 184, 185, 186, 188, 189, 192, 195, 197, 198, 199, 200	135
R&S®NRP-Zxx	Power Sensors	PD 5213.5539	174, 180, 183, 184, 185, 186, 190, 192, 195, 197, 198, 199, 200, 202	135
R&S®NRP-Z5	Sensor Hub	PD 5213.5539	202	138
R&S®NRPV	Virtual Power Meter	PD 5214.0018	204	138
R&S®NRT	Power Reflection Meter	PD 0758.2202	153, 159, 161, 166, 183, 189	139
R&S®NRT-Zxx	Power Sensors	PD 0758.2202	161	139
R&S®NRV-Zxx	Power Sensors	PD 0758.2248	150, 152, 153, 157, 162, 165, 166, 168, 177, 199	140
R&S®NRVC	Calibration Kit	–	157	141
R&S®NRVD	Dual-Channel Power Meter	PD 5213.5551	150, 151, 152, 153, 156, 157, 162, 165, 166, 168, 172, 177	140
O				
R&S®OSP	Open Switch and Control Platform	PD 5213.9928 PD 5214.1437	195, 197, 202, 203	178
R				
R&S®R-Line	Compact Test Chamber	PD 5214.0253	197	123
R&S®ROMES2GO	3GPP Walk Test Solution	PD 5214.1789	198, 199, 200	101
R&S®ROMES4	Drive Test Software	PD 5214.2062	192, 193, 194, 195, 197, 198, 199, 200	99
R&S®ROMES4NPA	Network Problem Analyzer	PD 5214.2062	200	100
R&S®RSC	Step Attenuator	PD 5214.4413	–	181
R&S®RTM	Digital Oscilloscope	PD 5214.0276	201	26
R&S®RTO	Digital Oscilloscope	PD 5214.2327	201, 202, 204	25
S				
R&S®SFC	Compact Modulator	PD 5214.5910	–	164
R&S®SFE	Broadcast Tester	PD 5213.8596	194, 197, 198, 199	162
R&S®SFE100	Test Transmitter	PD 5213.9234	197, 198, 199	163
R&S®SFU	Broadcast Test System	PD 0758.1658	183, 185, 190, 194, 198, 199, 200, 201	161
R&S®SGS100A	SGMA RF Source	PD 5214.5703	204	63
R&S®SMA100A	Signal Generator	PD 5213.6412	189, 191, 192, 195, 197, 198, 199, 200	64
R&S®SMATE200A	Vector Signal Generator	PD 0758.1893	186, 189, 190, 193, 195, 198, 199, 204	60
R&S®SMB100A	RF and Microwave Signal Generator	PD 5213.8396	194, 195, 197, 198, 199, 203, 204	65
R&S®SMBV100A	Vector Signal Generator	PD 5214.1114	198, 199, 203, 204	62
R&S®SMC100A	Signal Generator	PD 5214.1143	198	66
R&S®SMF100A	Microwave Signal Generator	PD 5213.7660	192, 194, 197, 199	67
R&S®SMJ100A	Vector Signal Generator	PD 5213.5074	186, 187, 188, 189, 190, 193, 194, 195, 196, 198, 199, 204	61
R&S®SMU200A	Vector Signal Generator	PD 0758.0197	180, 182, 183, 184, 185, 187, 188, 189, 190, 193, 194, 195, 196, 198, 199, 204	59
R&S®SMx-Kxx	Application Firmware Packages for R&S®SMx generators	–	199, 204	72
R&S®SMZ	Frequency Multiplier	PD 5214.4336	204	68
R&S® Stream Libraries	Test Signal Libraries	PD 5213.7202	173, 177, 188, 190, 198	160
T				
R&S®T80-K1	System Software	PD 0757.1525	–	115
R&S®TS-EMF	Portable EMF Measurement System	PD 0758.2777	177, 180, 181, 204	117
R&S®TS-ISC	In-System Calibration Kit	PD 5214.1972	–	153
R&S®TS-PAM	Signal Analyzer Module	PD 0758.0668	180, 186	152
R&S®TS-PCA3	CompactTSVP Test and Measurement Chassis	PD 0758.0597	180	148
R&S®TS-PCAL2	Calibration Module	–	–	153
R&S®TS-PDFT	Digital Functional Test Module	PD 0758.0645	180, 193	151
R&S®TS-PFG	Function Generator Module	PD 0758.0639	180	152
R&S®TS-PHDT	High-Speed Digital Test Module	–	193	151

Type	Designation	Data sheet	News from Rohde & Schwarz	Page
R&S® TS-PICT	In-Circuit Test Extension	–	180	150
R&S® TS-PIO2	Analog and Digital I/O Module	PD 5213.8009	193	151
R&S® TS-PIO3B	Digital I/O Module	PD 5214.2204	–	151
R&S® TS-PMB	Switch Matrix Module	PD 0758.0600	180	150
R&S® TS-PSAM	Analog Source and Measurement Module	PD 0758.0580	180	149
R&S® TS-PSC0	System Controller	–	–	149
R&S® TS-PSC4C	System Controller	–	–	149
R&S® TS-PSC5	System Controller	–	–	149
R&S® TS-PSM1	Power Switching Module	–	180	150
R&S® TS-PSM2	Multiplex and Switch Module	–	–	150
R&S® TS-PSU	Power Supply and Load Module	PD 5213.6558	–	152
R&S® TS-PSU12	Power Supply and Load Module	PD 5214.0201	–	152
R&S® TS-PTRF	Signal Port and Transmission Module	PD 5214.2204	–	151
R&S® TS-PWA3	PowerTSVP Switching Application Chassis	PD 0758.0622	180	148
R&S® TS51GA30	Coverage Suitcase System	–	–	101
R&S® TS6300	ILS Test System	PD 5214.4342	203	8
R&S® TS6600	Radar Test Generator	–	–	9
R&S® TS6710	TRM Radar Test System	PD 5214.5078	–	7
R&S® TS712x	Shielded RF Test Chambers	PD 5213.6058	187, 189	23
R&S® TS895xG/W/GW	GSM/GPRS/EDGE/WCDMA RF Test System Family	PD 0757.6956	174, 178, 181, 187, 194, 196	19
R&S® TS8980	RF Test System for LTE and WCDMA	PD 5214.1150	200, 202, 203	20
R&S® TS8991	OTA Performance Test System	PD 5213.8796	192, 197, 203	21
R&S® TS8996	RSE Test System	–	197	22
R&S® TS9955	High-Performance Drive Test System	–	158, 166	102
R&S® TS9975	EMI Test System	–	152	114
R&S® TS9980	EMS Test System for Audio and Video and TV Monitoring	PD 0757.1525	173, 176, 187	115
R&S® TS9982	EMS Test System	–	–	116
R&S® TSMU-Z3	Coverage Backpack	–	186	103
R&S® TSMW	Universal Radio Network Analyzer	PD 5213.9934	197, 200	97
R&S® TSMx	Radio Network Analyzers	PD 5214.3246	189, 190, 192, 193, 194, 195, 197, 199	97
R&S® TSMX-PPS	GPS Module	PD 5214.0930	–	98
R&S® TVSCAN	Automatic TV Channel Scan Software	PD 5214.5484	–	171
U				
R&S® UPP	Audio Analyzer	PD 5214.3846	201	144
R&S® UPV	Audio Analyzer	PD 0758.1306	183, 185, 186, 187, 193, 196, 197	143
R&S® UPZ	Audio Switcher	PD 0758.1170	175, 196	145
R&S® URE3	RMS/Peak Voltmeter	PD 0756.8326	–	141
V				
R&S® VEGA Suite	Media File Analysis Software	PD 5214.5490	–	175
R&S® VSA	Video Measurement System	PD 5213.5697	150	176
W				
R&S® WinIQSIM2™	Simulation Software	PD 5213.7460	159, 168, 171, 173, 204	84
Z				
R&S® ZCAN	Manual Calibration Kits	PD 5214.1950	–	95
R&S® ZNB	Vector Network Analyzer	PD 5214.5384	203	87
R&S® ZNC	Vector Network Analyzer	PD 5214.5610	203	88
R&S® ZV-WRxx	Manual Waveguide Calibration Kits	PD 5214.0476	–	94
R&S® ZV-Z121/-Z132	Manual Calibration Kits	PD 5214.0801	–	95
R&S® ZV-Z2xx	Manual Calibration Kits	–	–	95
R&S® ZV-Z5x	Automatic Calibration Units	PD 0758.2554	188, 189	95
R&S® ZV-Z81	Switch Matrix	PD 5213.6864	–	94
R&S® ZV-Z82	Switch Matrix	PD 5213.6870	–	94
R&S® ZVA	Vector Network Analyzer	PD 5213.5680	188, 192, 194, 198, 200, 203	89
R&S® ZVA-Zxx	Millimeter-Wave Converters	PD 5213.8273 PD 5214.2033	194	93
R&S® ZVAX24	Extension Unit	PD 5214.2291	200	94
R&S® ZVB	Vector Network Analyzer	PD 0758.1529	183	91
R&S® ZVH	Cable and Antenna Analyzer	PD 5214.4588	203	31
R&S® ZVL	Vector Network Analyzer	PD 5213.8150	193, 200	92
R&S® ZVT	Multiport Vector Network Analyzer	PD 0758.0651	189, 192, 194, 200	90

