

electronics

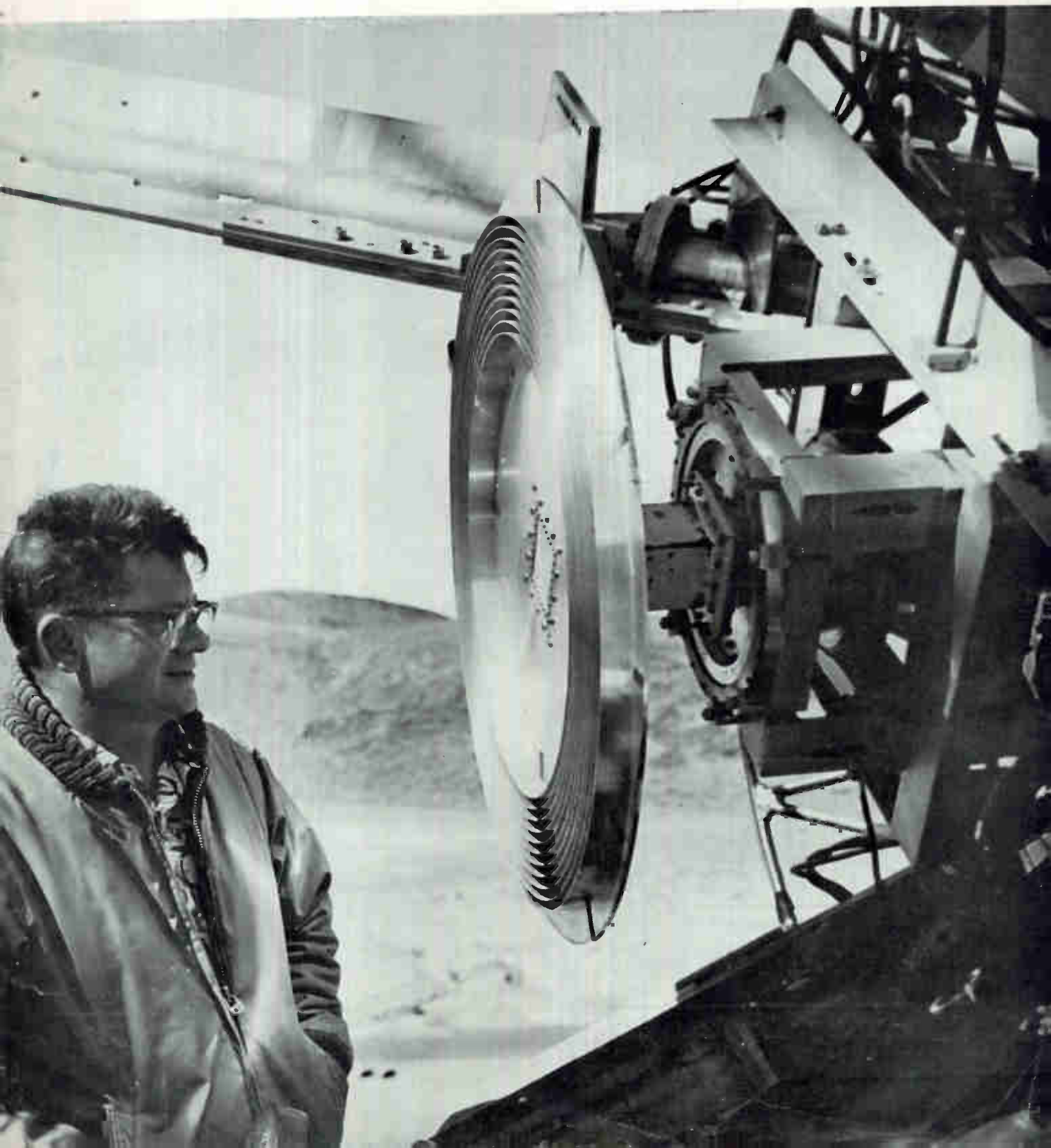

SPECIAL *Venus-bounce experiment using shaped-beam feed (below) with maser preamplifier is one of many recent West Coast technical achievements. For others, see p 141*

A McGraw-Hill Publication 75 Cents





Inductance...



General Radio offers a wide line of fixed and variable standard inductors. Toroidal air-cored inductors, such as the Type 1482 Standard Inductor, approach the ideal; stability is high, effects of external magnetic fields are negligible, temperature coefficient is low, and inductance changes with current are minimized.

Greater economy in coil construction can be obtained using "iron" (special ferromagnetic alloys) as the core material. Although there is some sacrifice in stability, properly designed iron-cored inductors exhibit a higher Q than air-cored types, and are excellent secondary standards.



**Type 1482
Standard Inductors**
17 models
from 50 μ h to 10 h in 1-2-5 sequence.

Primary standard for measurements at low audio frequencies featuring high stability, high adjustment accuracy, and high certification accuracy. Uniformly wound toroid on ceramic core — negligible external magnetic field and practically no pickup. Thermal aging equalizes winding strains. May be used for either two- or three-terminal measurements — 50- μ h, 100- μ h, and 200- μ h values have six terminals for minimizing connection errors. Low temperature coefficient of 30 ppm/°C. Adjustment accuracy is $\pm 0.1\%$ for values between 500 μ h to 10 h; $\pm 0.25\%$ for 100 μ h and 200 μ h; and $\pm 0.5\%$ for 50 μ h. Typical certification of actual value given to better than $\pm(0.025\% + 0.1\mu\text{h})$ — long-term stability better than 0.01% per year. Prices from \$110 to \$225.



Type 1481 Inductors
16 models
from 100 μ h to 10 h
in 1-2-5 sequence.

Extremely useful secondary standards for two-terminal measurements — toroidal winding on molybdenum-permalloy dust core; higher low-frequency Q values than 1482 models . . . electrostatically shielded. Adjustment accuracy is $\pm 0.4\%$ for 100-mh through 10-h values; $\pm 0.6\%$ for 10-mh through 50-mh values; $\pm 1.0\%$ for 500- μ h through 5-mh values; and $\pm 2.0\%$ for 100 and 200- μ h values. Stability better than 0.25% per year. Prices from \$37.50 to \$50.00.

Type 940 Decade-Inductor Units

Assemblies of four Type 1481 Inductors which are combined by switching to give eleven successive values from 0 to 10. High Q values for all models. Wax impregnation keeps out moisture — aluminum covers provide electrostatic shielding.



Type	Range	Accuracy	Price
940-DD	1 mh, total, in 100- μ h Steps	$\pm 2\%$	\$110
940-E	0.01 h, total, in 1-mh Steps	$\pm 2\%$	\$110
940-F	0.1 h, total, in 0.01-h Steps	$\pm 1\%$	\$110
940-G	1 h, total, in 0.1-h Steps	$\pm 0.5\%$	\$110
940-H	10 h, total, in 1-h Steps	$\pm 0.25\%$	\$120



**Type 1490
Decade Inductors**

Assemblies of Type 940 Decade-Inductor Units in shielded metal cases — for 2- or 3-terminal measurements.

Type	Range	Price
1490-C	1.11 h, total, in 1-mh Steps	\$360
1490-D	11.11 h, total, in 1-mh Steps	\$460
1490-F	1.111 h, total, in 100- μ h Steps	\$490

Type 107 Variable Inductors

Two concentrically-mounted coils are used as stator and rotor to provide continuous adjustment of self and mutual inductance. May be connected in series or parallel. Basic calibration accuracy is $\pm 1.0\%$ of full scale. Five models available with following series-connected values: 9-50 μ h; 90-500 μ h; 0.9-5 mh; 9-50 mh; 90-500 mh. When connected in parallel, inductance is $\frac{1}{4}$ of series-connected values. Prices range from \$95 to \$110.

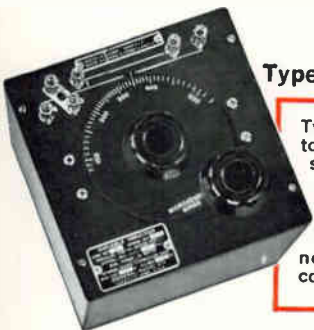

Write For
Complete Information

GENERAL RADIO COMPANY

WEST CONCORD, MASSACHUSETTS

See us at WESCON
Booths 2202-2204

NEW YORK, WOrth 4-2722
District Office in Ridgefield, N. J.
WHiney 3-3140

CHICAGO
Ook Park
Village 8-9400

PHILADELPHIA
Abington
HAncock 4-7419

WASHINGTON, D.C.
Silver Spring
JUniper 5-1088

SAN FRANCISCO
Los Altos
WHitecliff 8-8233

LOS ANGELES
Los Angeles
HOLlywood 9-6201

IN CANADA
Toronto
CHerry 6-2171

electronics

A McGraw-Hill Publication 75 Cents



W. W. MacDONALD, Editor

J. M. CARROLL, Managing Editor
SENIOR ASSOCIATE EDITORS: Samuel Weber, Roland J. Charest. **ASSOCIATE EDITORS:** Michael F. Tomaino, George Sideris, Sylvester P. Carter, William P. O'Brien, John F. Mason, William E. Bushor, Thomas Emma, Sy Vogel, Leslie Solomon, M. M. Perugini, George J. Flynn.
ASSISTANT EDITORS: Michael F. Wolff, Nilo Lindgren, Stanley Froud, Stephen B. Gray, Roy J. Bruun, George V. Novotny, Leon H. Dulberger.
REGIONAL EDITORS: Harold C. Hood (Pacific Coast, Los Angeles), Thomas Maguire (New England, Boston), Cletus M. Wiley (Midwest, Chicago).
ART DIRECTOR: Harry Phillips; Howard R. Berry. **PRODUCTION EDITOR:** John C. Wright, Jr. **EDITORIAL ASSISTANTS:** Gloria J. Meurer, Bernice Duffy, Lorraine Rossi, Virginia T. Bastian, Lynn Emery, Avis Pomeranz, Florence Hajaistran, Laura W. Smith, Bette H. Snyder.

JAMES GIRDWOOD, Publisher

	Radar system that bounced signals off Venus used antenna with shaped r-f feed and maser preamplifier. See p 141	COVER
	Industry Attention Centers on WESCON Show. This year: 1,180 exhibits, 41 technical sessions, 127 papers	44
	What WESCON Exhibitors Are Saying. Timely, important opinions	46
	Quantum Research and Arms Control Share Spotlight at Sessions	48
	"From Diversity . . . New Ideas". Exclusive interview with IRE President Lloyd V. Berkner	52
	Technical Preview of 1961 WESCON. Survey of some new developments to be shown. By H. C. Hood	141
	TRANSIT NAVIGATIONAL SATELLITES Instrumentation and Telemetry. Intricate electronics are needed to produce reliable, accurate information. By J. W. Hamblen and J. B. Oakes	148
	TUNNEL DIODES Increase Digital-Circuit Switching Speeds. Tunnel diodes are combined with transistors. By W. V. Harrison and R. S. Foote	154
	Designing Hybrid D-C Amplifiers to Withstand Missile Environments. Reliable performance under severe conditions. By R. L. Konigsberg	157
	R-F Spot Welder Reattaches Retina of Human Eye. Electronic timing key to better eye repair. By O. Rich, Jr. and R. V. Hill	160
	Lightweight Transmitter Provides Data and Beacon Signal. By R. W. Frykman and A. R. Moore	164



San Francisco Aug. 22-25

	Crosstalk	4		Production Techniques	174
	Comment	6		New on the Market	178
	Electronics Newsletter	11		Other New Products	210
	Washington Outlook	14		Literature of the Week	222
	Financial Roundup	34		New Books	224
	Meetings Ahead	56		People and Plants	226
	Research and Development	166		List of Exhibitors	228
	Components and Materials	170		Index to Advertisers	252

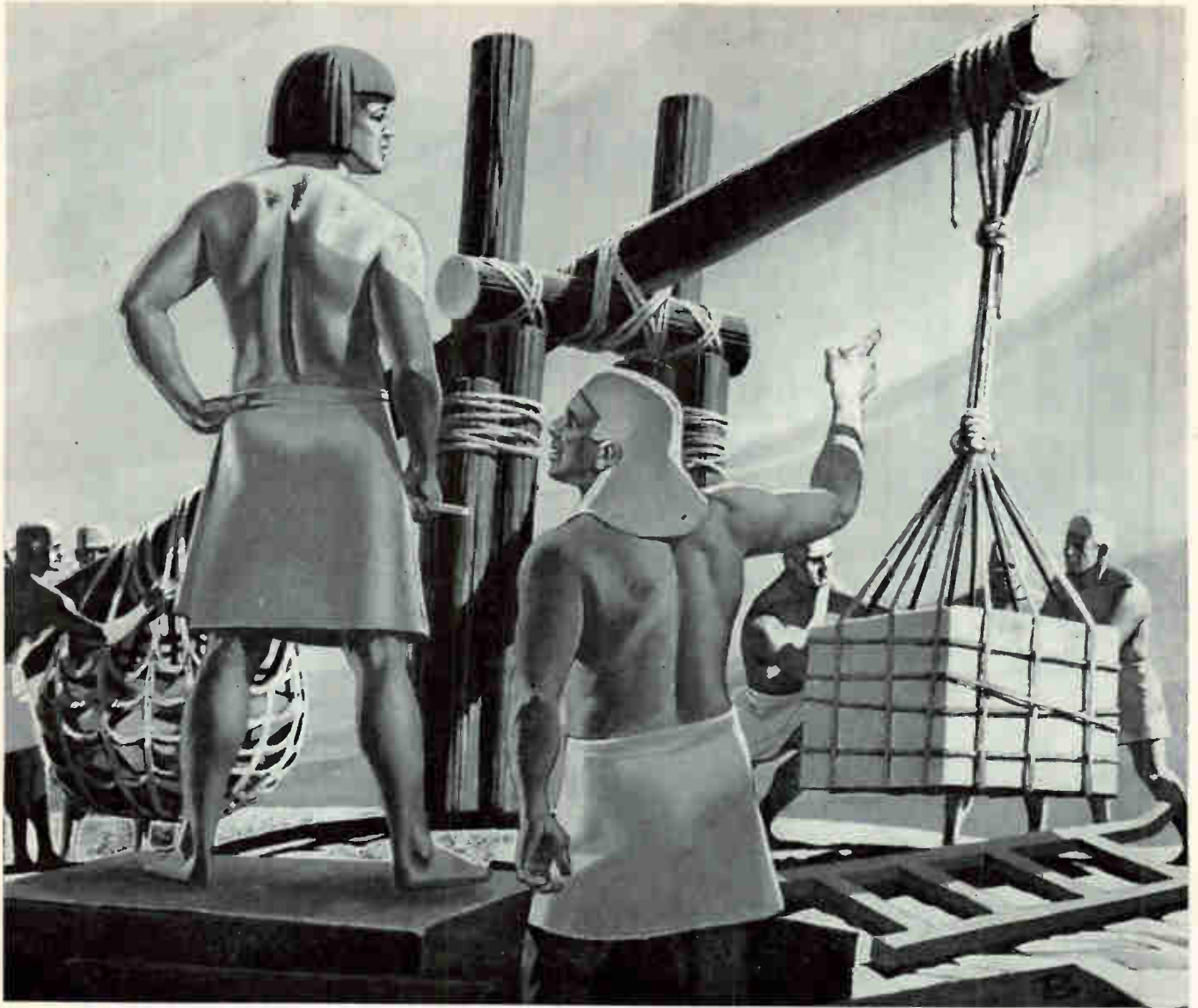

Milestones in Engineering

As life became more complex, man found that his muscle alone could not accomplish all the tasks that evolved upon him.

Becoming a "builder" made it necessary to lift weights beyond human strength alone. Man found that a pole, supported at a point along its length, could be used to lift or move objects far heavier than he alone could lift or move. The principle of the lever was applied in many ways—versatility of application is a characteristic of all engineering principles.

Similarly, it is characteristic of soundly engineered equipment that its versatility is unlimited to the extent of man's imaginative application.

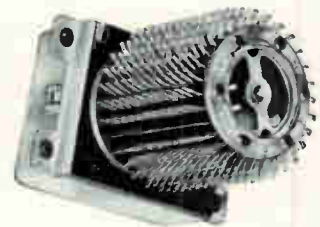

The North Electric Rotary Stepping Switch is a versatile tool in the hands of the imaginative design engineer, giving him a new flexibility in circuit approach.

Reliable service, long life and positive action are prime characteristics of this unique Switch.

Selection, sequential operation, scanning and totalizing are but a few of the tasks this Switch is handling—where can it help you?

For detailed specifications, write

VISIT OUR BOOTHS 2502-4
AT THE WESCON SHOW

NORTH ELECTRIC COMPANY

148 S. MARKET ST., GALION, OHIO



electronics

DELAY LINES, INDUCTORS, FILTERS AND CHOKES... ARNOLD IRON POWDER CORES CUT COSTS

Iron powder cores are commonly specified for such applications as delay lines (illustrated below), inductors, filters and filter chokes because of their inherent low cost. And Arnold cores are your logical choice, for the principal reasons of superior dependability and the wide selection available to you.

Arnold's overall magnetic knowledge, and unequalled facilities for manufacture and test, are of prime importance in assuring you a source of

cores that are highly uniform, shipment after shipment. You'll find them dependable, not only in permeability and resultant inductance at high frequencies, but in high mechanical strength and dimensional accuracy as well.

The Arnold line also offers a wider range of shapes and sizes of iron powder cores for your selection than any other one brand on the market. It includes bobbin cores, cups, toroids, plain, sleeve and hollow cores, threaded cores and

insert cores, etc. Facilities for special cores to your order. Ask for new Bulletin PC-109A. • Write *The Arnold Engineering Company, Main Office and Plant, Marengo, Illinois.*

ADDRESS DEPT. E-8



ARNOLD

SPECIALISTS in MAGNETIC MATERIALS

BRANCH OFFICES and REPRESENTATIVES in PRINCIPAL CITIES • Find them FAST in the YELLOW PAGES

2284

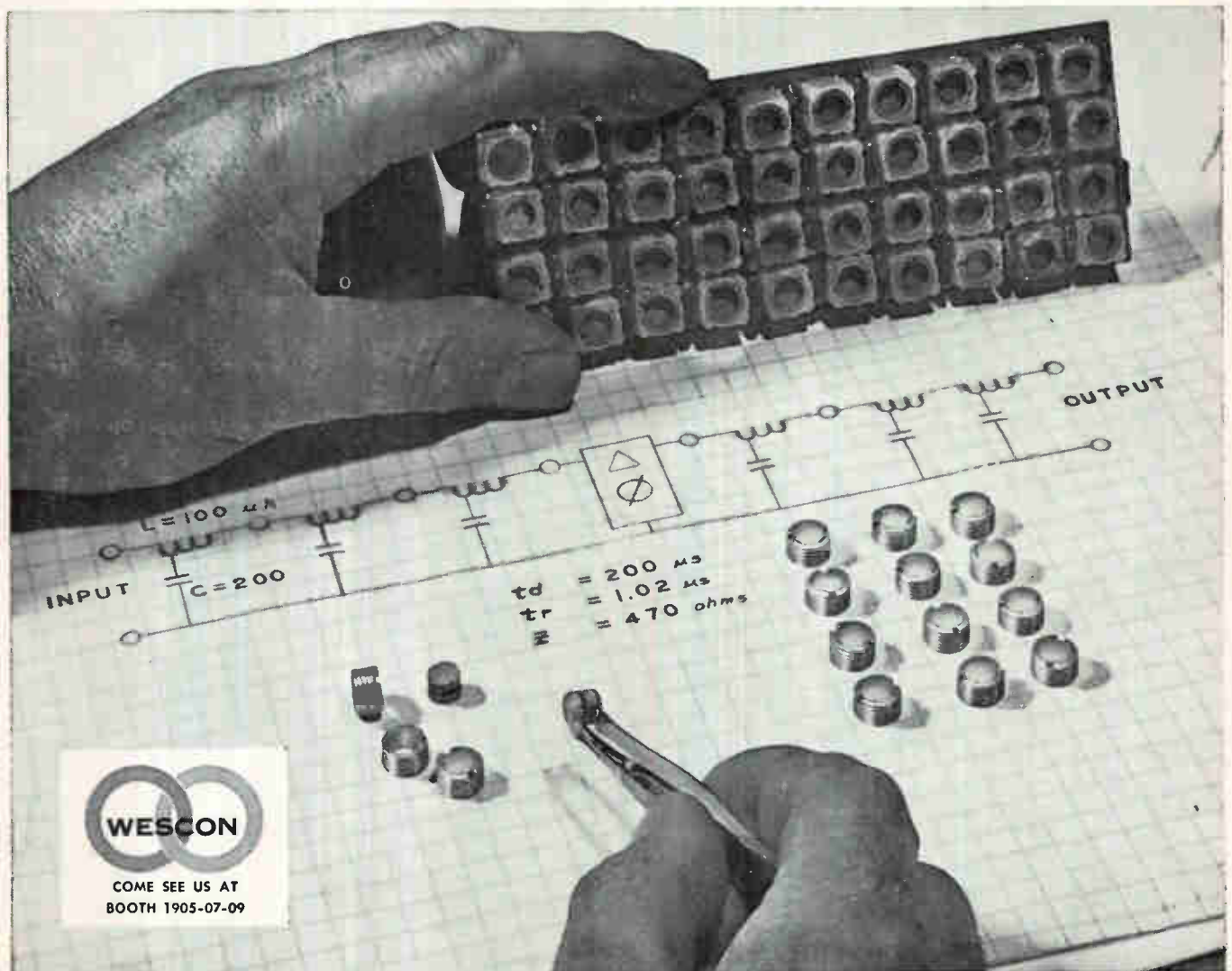

COME SEE US AT
BOOTH 1905-07-09

Published weekly, with Electronics Buyers' Guide and Reference Issue, as part of the subscription, by McGraw-Hill Publishing Company, Inc. Founder: James H. McGraw (1860-1948).

Title © registered U.S. Patent Office; Copyrighted © 1961, McGraw-Hill Publishing Company, Inc. All rights reserved, including the right to reproduce the contents of this publication, in whole or in part.

Executive, editorial, circulation and advertising offices McGraw-Hill Building, 330 West 42nd Street, New York 36, N. Y. Telephone Longacre 4-3000. Teletype TWX N.Y. 1-1636. Cable McGrawhill, N. Y. PRINTED IN ALBANY, N. Y.; second class postage paid.

OFFICERS OF THE PUBLICATIONS DIVISION: Nelson L. Bond, President; Shelton Fisher, Wallace F. Traendly, Senior Vice Presidents; John R. Callahan, Vice President and Editorial Director; Joseph H. Allen, Vice President and Director of Advertising Sales; A. R. Venezian, Vice President and Circulation Coordinator; Daniel F. Crowley, Vice President and Controller.

OFFICERS OF THE CORPORATION: Donald C. McGraw, President; Hugh J. Kelly, Harry L. Waddell, Executive Vice Presidents; L. Keith Goodrich, Executive Vice President and Treasurer; John J. Cooke, Vice President and Secretary.

Subscriptions are solicited only from those actively engaged in the field of the publication. Position and company connection must be indicated on orders. Subscription rates: United States and Possessions, \$6.00 one year; \$9.00 two years; \$12.00 three years. Canada, \$10.00 one year. All other countries \$20.00 one year. Single Copies, United States and Possessions and Canada 75¢; Buyers' Guide \$3.00; Single copies all other countries \$1.50; Buyers' Guide \$10.00.

THE PUBLISHER, UPON WRITTEN REQUEST FROM ANY SUBSCRIBER TO OUR NEW YORK OFFICE, AGREES TO REFUND THAT PART OF THE SUBSCRIPTION PRICE APPLYING TO COPIES NOT YET MAILED.

Subscribers: Please address all correspondence, change of address notices, subscription orders or complaints to Fulfillment Manager, Electronics, at above address. Change of address notices should provide old as well as new address, including postal zone number if any. If possible, attach address label from recent issue. Allow one month for change to become effective.

Postmaster: Please send Form 3579 to Fulfillment Manager, Electronics, 330 West 42nd Street, New York 36, New York.



Audited Paid Circulation



CROSSTALK

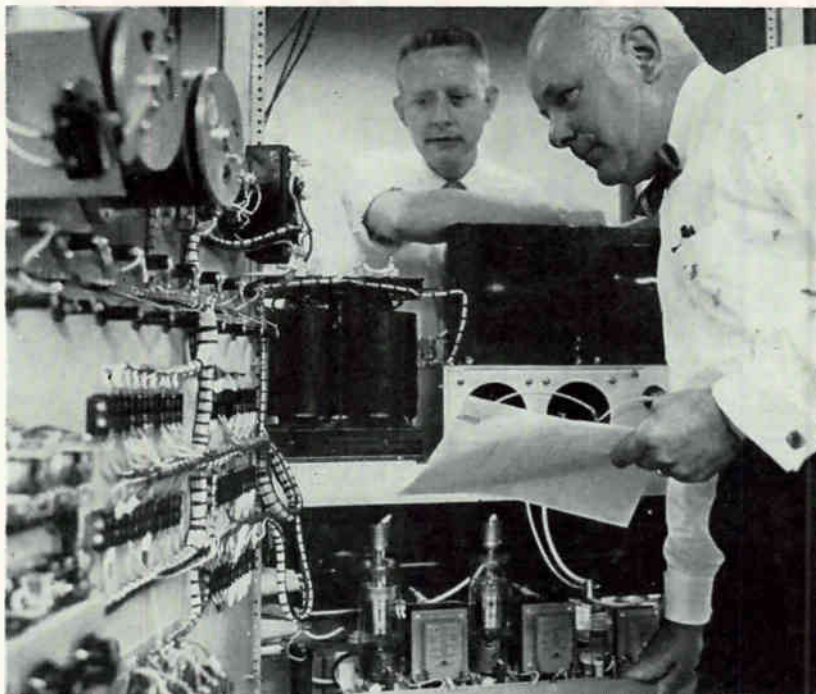

THE THIRTEENTH WESCON CONVENTION 11 days from now will attract 35,000 to San Francisco's Cow Palace. ELECTRONICS wants to help you get the most out of your trip, so we suggest you preview the show by absorbing some of the material in this issue's special features.

The photo above, for instance, shows final inspection being given a Granger Associates ionosphere sounder. System can be used for realtime observation of skip distance versus frequency for h-f communications, or for detection and observation of perturbations in the ionosphere. For details on other developments in the western electronics industry, special convention events and outstanding sessions to take in, turn to Pacific Coast Editor Hood's article on p 44. Then there's an exclusive interview with IRE President Lloyd V. Berkner on p 52. What WESCON exhibitors are saying appears on p 46.

We told you last week about some developments our staff feels have been outstanding achievements in the west over the past few months. There may well be some helpful hints for your engineers in the lead feature article starting on p 141. The technical program committee has hinted that certain papers to be presented will be particularly significant. We've abstracted these for you on p 48. And, for a profile on one of the prime movers behind this year's show, turn to p 226 and meet Al Morris, dynamic convention chairman.

Coming In Our August 18 Issue

FEATURE MATERIAL to appear next week includes: multiplex adapters for compatible f-m stereo reception by Associate Editor Solomon; an air traffic control simulator by E. B. Boyle, Jr., R. L. Edwards, Jr., and R. E. Nicht of Aircraft Armaments Inc; a wideband K-band omni-directional antenna by G. J. Monser and E. D. Botkin of American Electronic Laboratories Inc; nanosecond photography with Kerr cell cameras by S. M. Hauser and H. Quan of Electro-Optical Instruments Inc; generating random forcing functions for control-system simulation by N. D. Diamantides and C. E. McCray of Goodyear Aircraft Corp; and a narrow pass-band amplifier that uses a parallel-T network by R. F. Hobson and L. Calcagno of Rheem Semiconductor Corp.

HIGH PERFORMANCE!

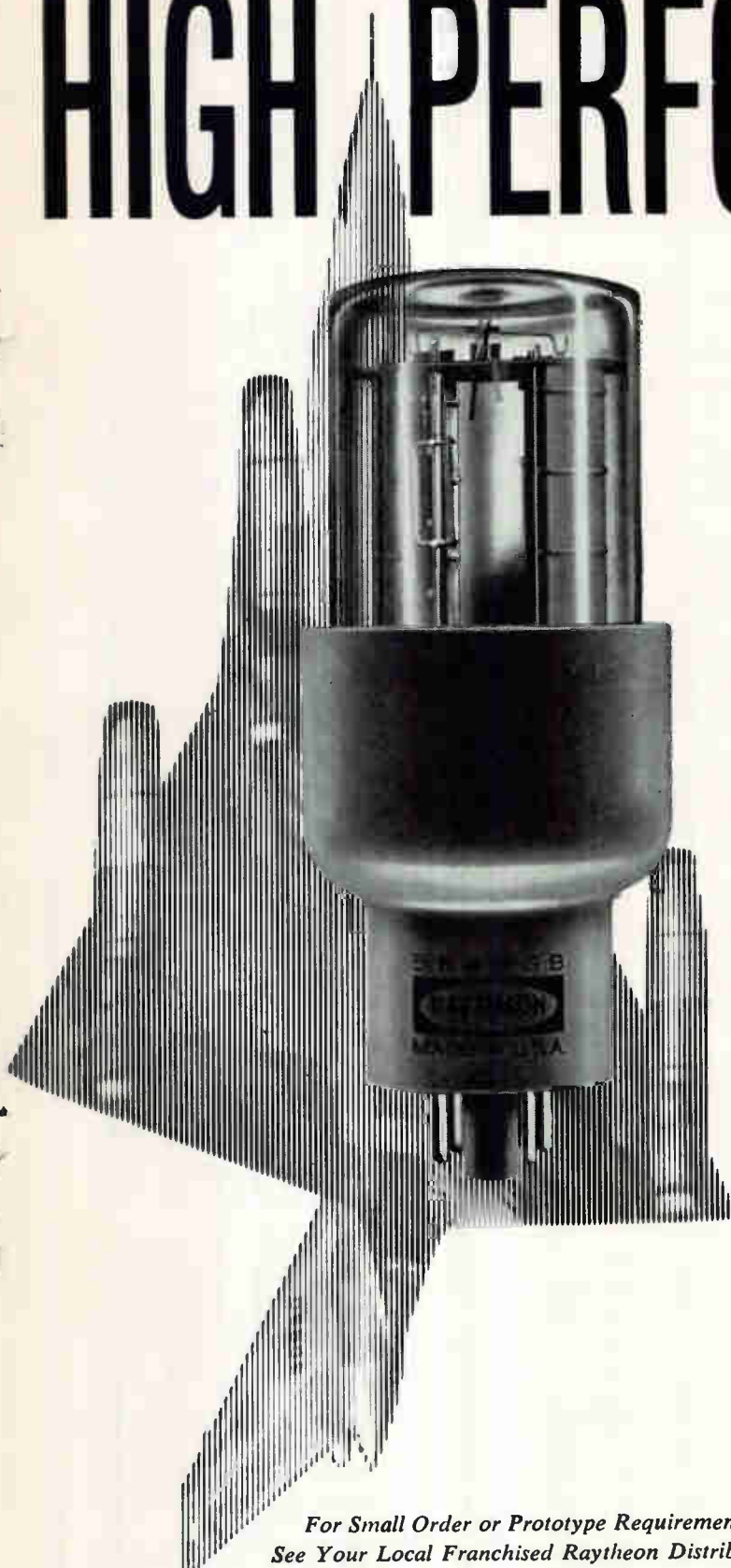

Raytheon now offers
the 5R4WGB full-wave rectifier —
ideal for high-current,
high-PIV power supply requirements
in rugged environments.

The reliability of Raytheon 5R4WGB rectifiers is the result of exceptional care in their design and manufacture . . . with no compromise in quality control. Rubber lined bases and hard glass 'T-14 bulbs protect against severe shock and vibration. Raytheon 5R4WGB rectifiers are specifically designed for rugged industrial and military applications and fully conform to all applicable military specifications.

If you design power supplies or communications equipment, you will be interested in receiving full technical data on the 5R4WGB . . . and other types in Raytheon's expanding line of diode rectifiers.

Please write to: Raytheon, Industrial Components Division, 55 Chapel Street, Newton 58, Massachusetts.

*For Small Order or Prototype Requirements
See Your Local Franchised Raytheon Distributor.*

RAYTHEON DIODE RECTIFIERS						
TYPE	SERVICE	HEATER		MAX. PLATE RATINGS		
		VOLTS	AMPS.	PEAK INVERSE (VOLTS)	PEAK CURRENT (AMPERES)	AVERAGE CURRENT (AMPERES)
5R4WGB*	FULL WAVE RECTIFIER	5.0	2.075	2,800	.7	0.165
				2,900		0.190
				2,300		0.275
				2,150		0.275
583*	H.W. RECT. (to 36,000 ft.) CLIPPER DIODE (to 36,000 ft.)	2.5	4.9	17,000	0.250	0.065
		2.5	4.9	15,000	8.0	0.240
3824W 3824WA*	H.W. RECT. (HALF FIL.) (FULL FIL.)	2.5	3.0	20,000	0.150	0.030
		5.0	3.0	20,000	0.300	0.060
3826	CLIPPER DIODE	2.5	4.75	15,000	8.0	0.020
3829	H.V. RECT. (OP. 1) (OP. 2) (OP. 3) CLIPPER DIODE	2.5	4.9	16,000	0.250	0.065
				7,700	0.300	0.080
				5,000	0.300	0.095
4831*	H.W. RECT. CLIPPER DIODE	5.0	5.0	16,000	0.470	0.150
		5.0	5.0	16,000	12.0	0.060

*MII-Std-200E Preferred Type

RAYTHEON COMPANY

INDUSTRIAL COMPONENTS DIVISION



CIRCLE 5 ON READER SERVICE CARD

You decide...

W

I

T

H

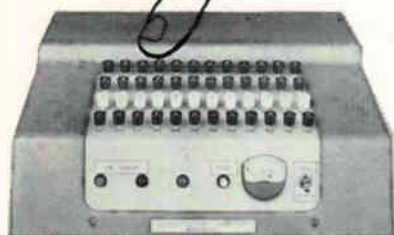

SELECTIVE SIGNALING

Yes, YOU make the decisions, selectively . . . to activate or alert over 11,000 individual groups of decoder equipped units. The 12 tone 4 pulse sequential transmission eliminates the need for continuous receiver monitoring.

Although designed primarily to operate in conjunction with decoders, the versatile encoder is ideally suited for use in almost any encoding system.

The ET12-4 Encoder employs our highly stable "Resonator" Resonant Reed Oscillator controls as frequency determining devices. The infinite life characteristic and low power consumption of Resonators coupled with transistors as active elements, provide years of economical trouble-free service.



Complete specifications and application data on request.

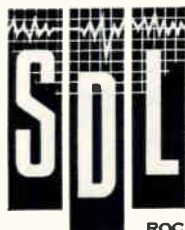

SECURITY
DEVICES
LABORATORY

ROCHESTER 21, NEW YORK

COMMENT

Medical Electronics

Your article on "Prosthetics—Hearing Aids and Blind Guidance Devices" appearing in the June 23, 1961 issue was very interesting to our engineering group. In fact, the entire series on Medical Electronics is the subject of many discussions among us and, I am sure, contains subjects that would stimulate engineering association meetings.

As Program Chairman for the Northern Vermont Sub-Section I.R.E., I am planning our fall 1961 technical sessions and would like to include a meeting on "Prosthetics."

It might be difficult to obtain a speaker who is familiar with two, three, or more aspects of the subject and, here, I would appreciate your help. Could you advise of contacts I might make to obtain such a person?

G. L. LA PORTE
GENERAL PRODUCTS DIVISION, IBM
ESSEX JUNCTION, VT.

Contact information has been forwarded.

... My congratulations on the very excellent Medical Electronics Part IV appearing in the June 23rd issue of ELECTRONICS.

This article on an extremely important subject is most interesting and stimulating to those involved with audio and visual problems. As a former active member of the Lions Club of Ann Arbor, Michigan, I worked with several people at the University of Michigan in the early development of such a device as mentioned in your article to aid the blind. This was in the early 40's and of course the devices at that time were quite crude and rather ineffective. I have been away from any activity in this area for a number of years and I enjoyed reading your article. Certainly tremendous progress has been made over the past decade.

ALAN D. MEACHAM
GILLE ASSOCIATES INC.
DETROIT, MICH.

Microwave Filters

In my article "Graphical Design Procedures for Maximally Flat Microwave Filters" on page 94 of the June 30, 1961 issue, I had an error in Fig. 1B: on the "attenuation-in-db" side of the graph the number 1 should be midway between 0 and 2. An editorial error also was made in the graph: on the "bandwidth" side, the values should be 0.1, 0.2, etc, instead of 1, 2, etc. On page 98, in the text, in the center column 13 lines from the top, the value of multiplier $Q_{u/s}$ should be 10^{-2} .

MARC CHOMET
AIRBORNE INSTRUMENTS
LABORATORY
DEER PARK, N. Y.

Author Chomet informed us that the errors in the graph do not affect calculations but should be corrected because of background considerations.

Electromagnetic Acoustic Probe

We have noted an error in an *Electronics Newsletter* item in the ELECTRONICS issue of July 7. The electromagnetic-acoustic (EMAC) probe is not being used at Carnegie Institute of Technology for the measurement of air speed. However, Dr. Paul L. Smith, Jr., Assistant Professor of Electrical Engineering at Carnegie Tech has made significant contributions to the development of the probe during summer employment at Midwest Research Institute.

The EMAC probe was conceived several years ago at Midwest Research Institute as a means for remotely sensing and measuring air speed, and its feasibility was demonstrated experimentally. More recently, we have conducted studies showing the applicability of the EMAC probe to the remote measurement of wind profiles through ranges up to 1,000 ft or more. Research is continuing on systems to meet the requirements of numerous applications — missile launching, aircraft carrier operations, airport operations, and general meteorological investigations.

HAROLD L. STOUT
MIDWEST RESEARCH INSTITUTE

STOP

eyeletting or thru-plating
printed circuit boards!

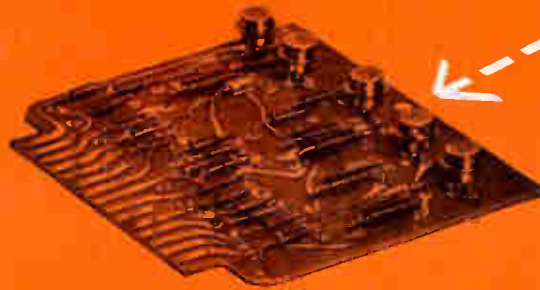
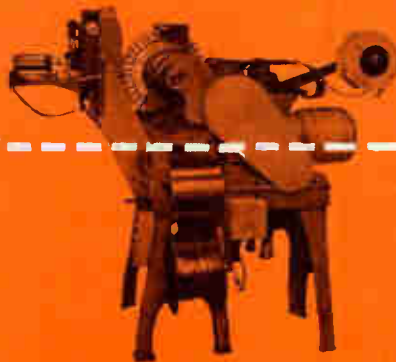

Use AMP
CIRCUITIP* Terminals

... AMP's tapered terminal, crimped to electronic component leads with precision-engineered, high-speed, automatic application machines.

CIRCUITIP Terminals give you quick, secure mounting of components at lowest installed costs anywhere.

ADDITIONAL FEATURES: • Mechanical retention of components prior to soldering • crimp configuration to aid capillary action of solder • standardization of hole size • bridging and offsetting of components for air circulation • heat sink in tip to help dissipate heat and protect costly components • uniform solder fillets • automatic trimming and bending of component leads • absence of radial wire protection ideal for increased board density. **Send for complete information today.**

Visit us at
the Wescon Show
Booths 517-521,
August 22-25, 1961

*TRADEMARK OF AMP INC.

AMP INCORPORATED

GENERAL OFFICES: HARRISBURG, PENNSYLVANIA

AMP products and engineering assistance are available through subsidiary companies in: Australia • Canada • England • France • Holland • Italy • Japan • Mexico • West Germany

August 11, 1961

CIRCLE 7 ON READER SERVICE CARD 7

High quality, high reliability plus

PLUG-IN VERSATILITY

**hp 170A MILITARIZED
SCOPE — TO 30 MC!**



**hp 160B MILITARIZED
15 MC SCOPE**



Seven horizontal, vertical plug-ins give

Ⓢ 166A Plug-in (*Time-Axis*) furnished with the Ⓢ 160B and 170A Oscilloscopes (as pictured above), provides standard input connections for Z-axis modulation and single-sweep arming.



Ⓢ 166B Time Mark Generator (*Time-Axis plug-in*) makes precise time measurements simple, provides intensity-modulated time markers on the oscilloscope trace of either Ⓢ 160B or 170A. Markers, at 0.1, 1 and 10 usec intervals, speed, simplify photographs, calibration of fast oscilloscope sweeps and operation between calibrated sweep ranges with sweep vernier. Markers may also be used as triggers or for calibration of other devices. Accuracy is $\pm 0.2\%$, 10° to 30° C. Ⓢ 166B, \$130.00.

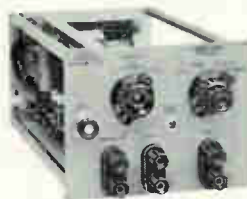

Ⓢ 166C Display Scanner (*Time-Axis plug-in*) provides output to duplicate, on an X-Y recorder, any repetitive waveform appearing on CRT trace. Resolution with permanent, large-scale records is higher than either scope CRT or photograph, and you can observe the scope trace while records are made. Unit converts high speed signals to slower signals having the same waveshape; scanning speed is arranged to keep Y output within the bandwidth of conventional recorders. Ⓢ 166C, \$300.00.

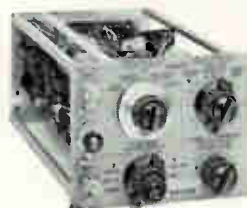

Ⓢ 166D Sweep Delay Generator (*Time-Axis plug-in*) delays the main sweep of the 160B and 170A Scopes for detailed examination of a complex signal or pulse train. In addition, it offers a unique mixed sweep feature to show an expanded segment of a delayed waveform while still retaining a presentation of earlier portions of the waveform. Delay time 1 usec to 10 sec. Delaying sweep, 18 ranges. Delayed length 0 to 10 cm. Delay functions: trigger main sweep, arm main sweep, mixed sweep. Ⓢ 166D, \$325.00.

in these OSCILLOSCOPES

Vertical or horizontal plug-ins make possible

Dual trace amplification

Fast pulse amplification

High gain amplification

X-Y records of repetitive waveforms

New sweep delay convenience

Time markers for photos, calibration

Both oscilloscopes are highly ruggedized; both have conventional controls for simple, swift operation

Built to exacting military specifications, these  oscilloscopes offer instantly expandable measurement capability—when you need it. It's easy! Just add a moderately priced plug-in unit!



Both  160B and 170A employ the same vertical and time-axis plug-ins providing the widest range of application with minimum investment.

New  160B and 170A meet MIL specifications for shock, vibration, humidity and temperature. Important features include high stability tube/transistor circuits, regulated dc filament voltages and premium components throughout.

Etched circuits on translucent epoxy glass provide great mechanical stability and simplify circuit tracing. Improved preset triggering insures optimum operation for almost all conditions with just one adjustment—even on signals down to 2 mm deflection. A push-button beam finder automatically locates an off-screen beam or trace, especially important during operation by inexperienced personnel.

SPECIFICATIONS— 160B and 170A with 166A Plug-in

VERTICAL

Bandwidth:  160B, > 15 MC;  170A, > 30 MC
Voltage Calibrator: 18 calibrated ranges $\pm 3\%$, 0.2 mv to 100 v peak to peak



HORIZONTAL

Bandwidth: DC to 1 MC
Sensitivity: 7 ranges 0.1 v/cm to 10 v/cm. Vernier extends minimum sensitivity to 25 v/cm
Input Impedance: 1 megohm shunted by 30 pf

SWEEP GENERATOR

Internal Sweep: 24 ranges, 0.1 μ sec/cm to 5 sec/cm, $\pm 3\%$. Vernier extends slowest sweep to 15 sec/cm
Magnification: 7 ranges, X1, X2, X5, X10, X20, X50 and X100. Increases fastest sweep to 0.02 μ sec/cm
Triggering: Internal, power line or vertical input signal (2 mm or more vertical deflection); external ($\frac{1}{2}$ v peak to peak or more). Trigger level of external sync signal adjustable -30 to +30 volts

PRICE:

 160B, \$1,850.00 (cabinet or rack mount)
 170A, \$2,150.00 (cabinet or rack mount)

160B, 170A unmatched usefulness

162A Dual Trace Amplifier



plug-in (vertical) gives maximum sensitivity to 20 mv/cm, permits viewing of two phenomena simultaneously, offers differential input for common mode rejection. Electronic chopping extends simultaneous viewing of 2 signals to lower frequencies without flicker.  162A, \$350.00.



162D High Gain Vertical Amplifier



increases sensitivity to 5 mv/cm. 12 calibrated ranges, 5 mv/cm to 20 v/cm in 1, 2, 5, 10 sequence, accuracy $\pm 5\%$. Continuous vernier extends min. sensitivity to 50 v/cm. Differential input with at least 40 db common mode rejection included for ranges 5 mv/cm through 50 mv/cm. AC or dc coupling of either of two inputs.  162D, \$225.00.

162F Fast Rise preamplifier



Vertical plug-in allows full utilization of the excellent transient response of the 160B and 170A main vertical amplifiers. Rise time with  170A is 12 nsec, dc to 30 MC; with  160B is 23 nsec, dc to 15 MC. Sensitivity is 0.05 v/cm to 50 v/cm, covered in 9 ranges; input impedance 1 megohm with 25 pf shunt.  162F, \$145.

Data subject to change without notice. Prices f.o.b. factory.

HEWLETT-PACKARD COMPANY

1086A Page Mill Road Palo Alto, California, U.S.A.
Cable "HEWPACK" Davenport 6-7000

Sales representatives in all principal areas

HEWLETT-PACKARD S. A.

Rue du Vieux Billard No. 1 Geneva, Switzerland
Cable "HEWPACKSA" Tel. No. (022) 26. 43. 36

FOR
THE
FIRST
TIME...
AT
WESCON!

Sierra introduces 3 versatile new instruments:

Model 126A Two-Band Frequency Selective Voltmeter

Here's new broad frequency coverage, 5 to 1,620 kc in two bands, in a continuously tuneable frequency selective voltmeter that offers



- Dual selectivity, 250 or 2,500 cps
- Level ranges, -90 to +32 dbm
- Three bridging inputs, 75, 135 and 600 ohms
- Two-speed dial drive for extra convenience
- Crystal Controlled calibration oscillator
- Sierra reliability and rugged, modular construction

Plus REAL convenience with the new Model 127A Solid State Frequency Selective VM!

You can see it at WESCON: The new solid state Model 127A Frequency Selective Voltmeter, 2 to 350 kc, — only 7¾" x 7¾" x 13"! It weighs less than 15 lbs.! It's completely portable with rechargeable battery pack! 250 cycle selectivity with audio monitoring capability, measures -80 to +22 dbm. You have to see it to believe it!

Model 160-1200 Coaxial Load

There's remarkable versatility in this new three-way coaxial termination . . . Sierra Model 160-1200. Power capacity to 1200 watts in standard form, to 2000 watts with accessory air cooler, to 3000 watts with accessory water cooler. Both accessories are easily attached, can be delivered with the termination . . . or order the power capacity you need now, expand it later. 0 to 1000 mc, low VSWR, may be ordered with Type N, HN or LC connectors.



ALSO TO BE
SEEN AT
WESCON:

Sierra Model 186B 50-ohm Coaxial Water Load, dc to 4000 mc, 1000 W av., 10,000 W peak
Sierra Model 125B-CR Frequency Selective VM, with provision for carrier reinsertion
Sierra Model 125B-Y with front-panel 20-pin connector, expanded input circuitry for carrier rack fast patch

Don't miss the Sierra Instrumentation at Wescon! Booth 2006-8, Main Floor

Sierra **SIERRA ELECTRONIC CORPORATION**
A Division of Philco Corporation
7306A BOHANNON DRIVE • DAVENPORT 6-2060 • AREA CODE 415 • MENLO PARK, CALIF., U. S. A.

Sales representatives in all major areas
Canada: Atlas Instrument Corporation, Ltd., Montreal, Ottawa, Toronto, Vancouver
Export: Frazer & Hansen, Ltd., San Francisco

7306

ELECTRONICS NEWSLETTER

Converter Camera 'Stops' Light In Flight

THE 186,000-mile-per-second flight of a light beam has been "stopped" at several points along its path and photographed by scientists of Space Technology Laboratories in Los Angeles. The STL image converter camera took light flight pictures last week by an image-sweeping technique. The technique may be used for advanced light velocity measurements when further refined.

The photos presented show a flash of light reflected into the image converter camera by a series of mirrors placed before it at successively greater distances from the source of the flash. The camera, adjusted to "sweep" the image being photographed across the film from top to bottom, recorded the reflected light from each mirror as it reached the lens.

With the shortest distance to travel, light from the nearest mirror appeared at the top of the film, at the beginning of the camera's "sweep". As it streaks down the film, light from each of the farther mirrors reaches the camera in succession and joins the sweep to form parallel, but increasingly shorter, streaks. The camera and light source are triggered simultaneously.

An optical image received by the camera is converted to an electronic image for high speed transmission and amplified 50 times in intensity. The electronic image is then reconverted to an optical image for recording on film. The equipment involved in the demonstration was the light source, a row of mirrors mounted on sawhorses, and the camera.

GE Develops Resonator For 2-Way Car Radios

A "RASER" which reportedly improves the distance covered by transistorized two-way radio sets in cars up to 43 percent, and provides clear, sharp, distinct messages, was announced last week by GE.

The raser—range and sensitivity extending resonator—will be added without cost to all high-band GE transistorized Progress Line mobile radios shipped after Sept. 4, firm says. All equipment containing the new circuit will have sensitivity better than 0.5 microvolt, company adds.

Report 'Blinding' By Optical Maser

A WORD OF CAUTION to engineers working with optical masers:

It has been reported that an optical maser "blinding" incident occurred recently. A group of personnel from a large company was setting up maser equipment in the field when an engineer, standing

a half mile away, looked in the direction of the unit when it accidentally began operating. He was temporarily blinded for several days, but has regained his sight.

Gets Contract for Atomic Thermoelectric Generator

GENERAL INSTRUMENT CORP. this week received a contract from the Atomic Energy Commission to develop thermoelectric generator to produce electricity directly from the heat of Mixed Fission Products (MFP), the unrefined waste of nuclear reactors.

The contract represents the second stage in a development program for such generators, which could be used to power underseas sonar devices, communications equipment, automatic weather stations, navigational beacons and other equipment in remote areas of the world.

The first-stage contract, recently completed by the General Instrument Thermoelectric division, called for an investigation and report on the heat characteristics of MFP as

they could be used to power such a generator. The firm is now building a working generator model, in which the heat from MFP fuel would be simulated.

Gold-Silicon Detector To Measure Cosmic Rays

SOLID-STATE gold-silicon detector and double cluster of triple-coincidence cosmic ray telescopes will measure cosmic rays, protons from solar explosions and electrons trapped in Van Allen belt, in experiment piggy-backed onto Ranger I when it is launched to perfect technology of future unmanned moon and planet explorations.

Laboratory for Applied Sciences at University of Chicago developed successive layers of millionths-inch thick protective coating which extends range of detector down to extremely low energies. An impinging cosmic ray pelts shower of electrons through successive layers of gold and silicon, revealing energy of particle through penetration power of shower. Each of two cylindrical telescope bundles of seven high-energy counter tubes is shielded with different amounts of lead to make it responsive to a distinct energy range within cosmic spectrum.

Enrico Fermi Institute for Nuclear Studies worked with the laboratory in developing experiments to study natural mechanisms for modulating and accelerating galactic and solar particles and for stoking and depleting belts of trapped radiation. These experiments form third stage in continuing series begun as hitch-hike experiments on Explorer VI and Pioneer V flights.

Transistor 'Fish' Camera Uses 200-Kc Transducer

ELECTRONICS-ORIENTED visitors to Chicago's 16-day International Trade Fair which closed yesterday found little that was new or unique. Conventional transistor portables and home receivers fitted with short wave were most plentiful among exhibits by 60 nations.

Visitors thought Polish Elektrim set up a technically interesting dis-

play, ranging over X-band radar vehicle speedometer, ferrite circulator and isolator, Q-band measuring instruments, phase shifter, pocket radio indicator radiometer and counter wavemeter covering 20 cps to 2.2 Mc, alongside home receivers.

The Japanese display featured transistor portables from several companies and family stereo center from Toshiba. Nippon Electric offered transistor fish "camera" using 200-Kc transducer locator of fish out to depths of 200 feet, tracing findings on traveling strip of moist paper.

Coney Onkyo, Ltd., Kobe, offered automatic calibration of transistorized direction finder and Kanda Tsushin Kogyo a pony autophone with memory unit storing 30 most frequently called numbers for push-button choice. Pony periodically and automatically re-calls busy number until connection is made. Austria's Wolfgang von Karakan, Salzburg, featured an 11-lb ekg fitting small briefcase. Second portable incorporates most features of console models.

European Computer Firms Organize Association

LONDON—An association including every major data processing manufacturer in Europe has been formed to ensure inter-company cooperation throughout the European computer industry so manufacturers can offer better products and service. Its name: the European Computer Manufacturers' Association (ECMA).

At its recent inaugural meeting in Geneva its first president, C. G. Holland-Martin, research director of a British firm, International Computers and Tabulators (ICT), said ECMA's main aims were getting system and equipment compatibility, and the development of common systems languages throughout European equipment.

Three technical committees are working on character coding for computer inputs and outputs, common programming languages and symbolic process representation. Another committee is to be formed to deal with character recognition.

Congress Votes \$5 Million For Device Experiments

CONGRESS has voted \$5 million to be used for electronic instrumentation experiments to be conducted by the National Institutes of Health in fiscal 1962. The money will go to establish "special resource centers" at universities selected by NIH.

The legislators turned down a bid by Senator Hubert H. Humphrey (D.-Minn.) to get \$3 million of the money earmarked specifically to create two regional medical instrumentation centers devoted to farthing efforts to electronically measure the physiological reactions of the human body. As it stands, NIH has wide latitude in using the money, including such things as data processing.

Computer Typewriter Uses Six-Bit Code

ELECTRIC TYPEWRITING mechanism using a spherical print element instead of the conventional 44 type bars will replace present input-output units in IBM data processing equipment. Though unveiled only last week, the typewriter has been installed in several computing systems in recent months.

Heart of the device is a truncated spherical section measuring 1-3/8 in. in diameter that has the conventional 88 characters molded in four lines of latitude, with 22 characters per line. This element is mounted on a head and rocker assembly which in turn is fixed to a small carriage. The carriage moves from left to right along the paper during typing; the platen and paper holder is fixed to the frame. Maximum rate of operation is 930 characters per second.

Typewriter is designed in two major sections: the printer, and the keyboard. Keyboard can be removed and replaced by solenoidal actuators to make an automatic printer. System is directly adaptable to digital use as character selection is accomplished with a six-bit binary code instead of 45-bit code found in present machines.

In Brief . . .

MILITARY ELECTRONICS contracts of more than \$40 million have been awarded by the Department of Defense to the Magnavox Co. during the past 90 days. The largest single contract (\$20 million) involves systems and equipment for submarine detection.

BENDIX CORP. gets a \$10.4-million Army contract for Pershing missile components.

HALLICRAFTERS CO. receives \$3-million Air Force prime contract for classified airborne electronic warfare penetration systems.

RCA gets a \$6.6-million Air Force contract for continued development of a ballistic missile early warning system.

A CONTRACT for \$28.5 million for follow-on production of the FPS-26 height-finding radar has been received from the Air Force by AVCO's Electronics and Ordnance division.

RYAN ELECTRONICS gets Navy contracts totaling over \$8.3 million for airborne navigation systems, spares and support material.

ITT receives a \$9.7-million Air Force contract to develop a Strategic Air Command control network.

PAY TELEVISION for Little Rock, Ark., was approved by the Arkansas Public Service Commission last week. It will be the second in the United States. Bell Telephone will provide lines to Midwest Video Corp.

TRANSDUCER division of Consolidated Electrodynamics Corp. gets a \$1.9-million contract from the Bureau of Naval Weapons for pressure detectors, hydrophones, and depth compensators.

ELECTRONIC REPRESENTATIVES ASSOCIATION is stepping up its educational program for reps on five fronts: management development, sales training, audio dealer and distributor seminars, ERA chapter development, and publication of member-manuals.

Nowhere is this closeness more apparent than at Lockheed. Here, with each passing day, new technological advances help bring nearer the exploration of Mars, the Moon and Venus.

As the time grows shorter, the pace grows faster. New designs in Spacecraft and Aircraft are rapidly being developed—and the number continues to mount. Included are: Missiles; satellites; hypersonic and supersonic aircraft; V/STOL; and manned spacecraft.

For Lockheed, this accelerated program creates pressing need for additional Scientists and Engineers. For those who qualify, it spells unprecedented opportunity. Notable among current openings are: Aerodynamics engineers; thermody-

namics engineers; dynamics engineers; electronic research engineers; servosystem engineers; electronic systems engineers; theoretical physicists; infrared physicists; hydrodynamicists; ocean systems scientists; physio-psychological research specialists; electrical—electronic design engineers; stress engineers; and instrumentation engineers.

Scientists and Engineers are cordially invited to write: Mr. E. W. Des Lauriers, Manager Professional Placement Staff, Dept. 1505, 2408 N. Hollywood Way, Burbank, California. All qualified applicants will receive consideration for employment without regard to race, creed, color, or national origin. U.S. citizenship or existing Department of Defense industrial security clearance required.

LOCKHEED
CALIFORNIA DIVISION

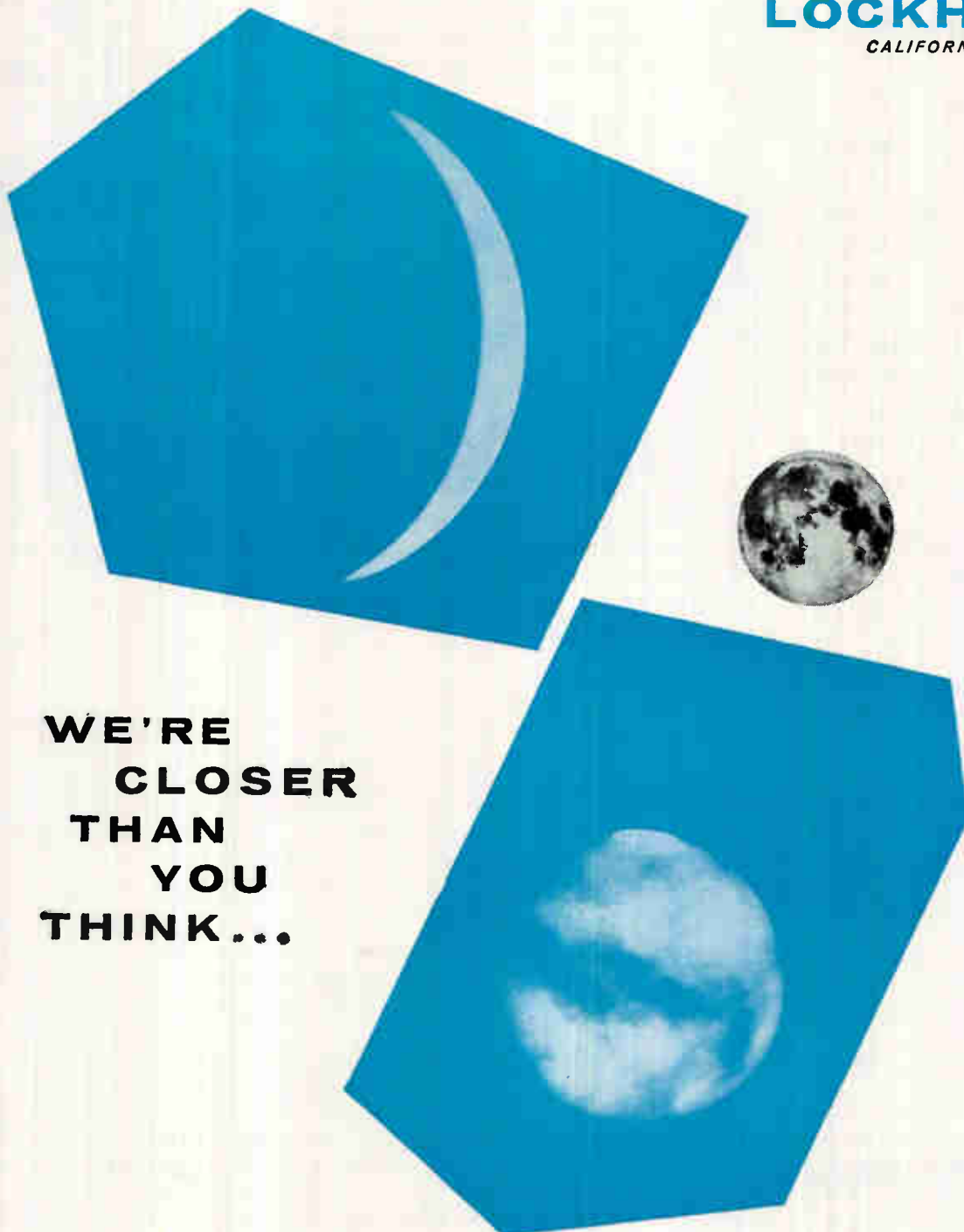

**WE'RE
CLOSER
THAN
YOU
THINK...**

Reading clockwise: Venus, Moon, Mars. Approximate distance from Venus to Earth, 25,000,000 miles; from Moon, 240,000 miles; from Mars, 50,000,000 miles.

Photos courtesy of Mount Wilson and Palomar Observatories.

WASHINGTON OUTLOOK

SPRAGUE PIEZO- ELECTRIC CERAMIC ELEMENTS



**ELEMENTS
FOR ALL
APPLICATIONS
AS WELL AS
COMPLETE**

**TRANSDUCER ASSEMBLIES
FOR MOST APPLICATIONS,
SUCH AS UNDERWATER
SOUND AND
VARIOUS ORDNANCE AND
MISSILE DEVICES.**



Sprague-developed mass production and quality-control techniques assure lowest possible cost consistent with utmost quality and reliability. Here too, complete fabrication facilities permit prompt production in a full, wide range of sizes and shapes.

Look to Sprague for today's most advanced ceramic elements—where continuing intensive research promises new material with many properties extended beyond present limits.



**YOUR INQUIRIES
ARE INVITED**

**WRITE FOR
LITERATURE**

SPRAGUE ELECTRIC COMPANY
35 Marshall Street, North Adams, Mass.

SPRAGUE[®]
THE MARK OF RELIABILITY

NASA'S COMMUNICATIONS SATELLITE CONTRACT with AT&T provides that the company will develop and build the satellites with its own money and pay about \$6 million to the government to cover launching and tracking services. Up to four experimental communications satellites will be launched during 1962. (Photo: Bell Lab engineers study satellite structure problems.)

AT&T agreed to make public all data acquired from the tests and to give the government royalty-free rights—and the right to grant these to other firms—to any inventions made in the field of space communications within one year after the last satellite is launched.



CONGRESS, meanwhile, is showing growing concern that AT&T will end up dominating any joint ownership venture worked out for the commercial satellite communication system. The House Commerce Committee has told FCC chairman Newton N. Minow that the ad hoc committee representing 10 international communications companies, set up by FCC to make ownership proposals for the system, should be enlarged to include domestic communications companies and electronic manufacturers.

NASA'S AT&T CONTRACT represents one of the most far-reaching patent claims the government has ever demanded from industry. The company will turn over all rights resulting from 100 percent industry-financed research, not only coming directly from the satellite experiment, but from "any other AT&T-sponsored research and development project which has as one of its purposes advancement of the state of the art in communications satellite systems, equipment, components, or ground tracking, transmitting, or receiving facilities."

Admittedly, the agreement is unique since only the government can launch satellites into orbit and the experiments are being made in an area where the government's stated policy is to prevent any single company from dominating the field.

AFTER THREE YEARS development work, the Army has authorized The Martin Co. to begin production of operational-type Pershing missiles. The company has been awarded two letter contracts totaling \$70.7 million for completion of the test program, now in the advanced phase, and for subsequent production of missiles for delivery to combat units.

Bendix Eclipse-Pioneer div. is subcontractor on Pershing's inertial guidance system; Collins Radio, on a portable tropospheric scatter communication terminal system.

THE PENTAGON has decided to stress multiple-shift operations for contractors producing items on its new \$1.7-billion shopping list rather than tool-up new contractors. There may be exceptions to the rule, of course, but defense officials feel orders for multiple-shift work would be more economical and would assure faster delivery. Just about all the extra arms and equipment procurement resulting from Kennedy's new defense buildup is made up of off-the-shelf items, including electronics.

DEVELOPED

This 16 channel redundant magnetic head for one inch tape was developed by **iem** for a critical system requirement.

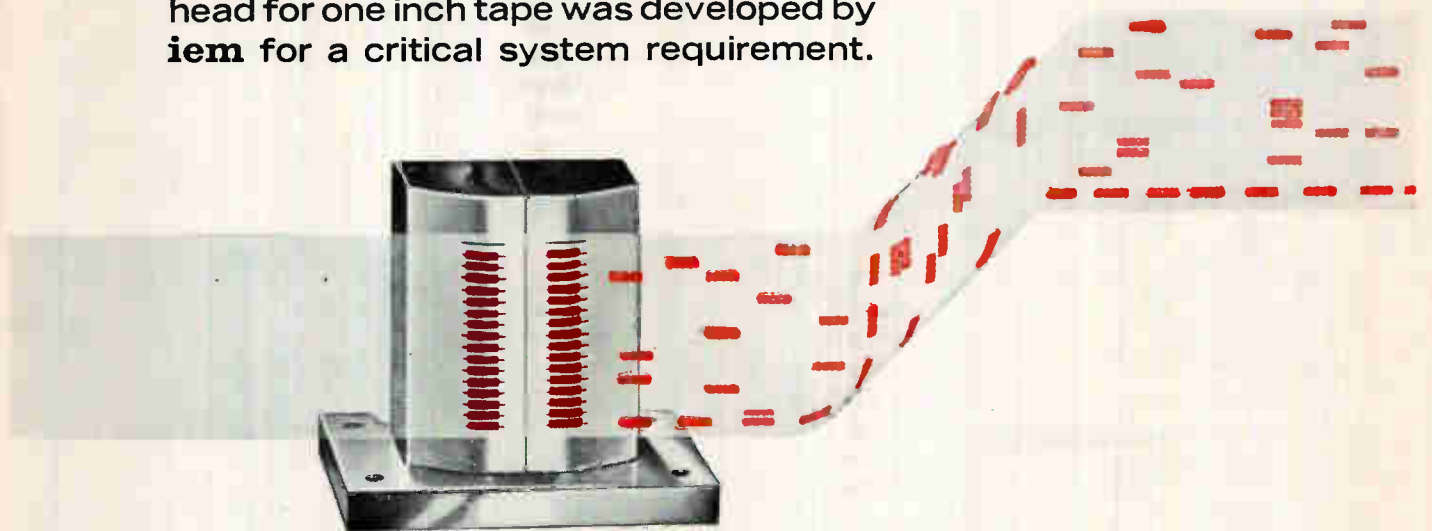

Your magnetic head requirements can be developed and produced by **iem** with no compromise to your specifications. This at no more cost; at no more time than required of the so-called standard head.

- Devoted exclusively to the manufacture of magnetic heads
- Complete production facilities
- Thorough testing and documentation of data
- Proven design
- Entire range of magnetic heads

For further information call or write:

iem

international electro-magnetics, inc.
Box 7, North Chicago, Illinois DEXter 6-1440

DC POWER SUPPLIES FROM STOCK

MODULAR SUPPLIES

Hundreds of modules with outputs over the range of up to 500 volts and up to 6 amperes.

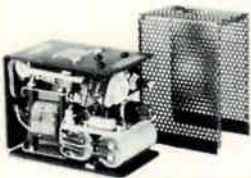

KITTED MODULAR SUPPLIES

Over 1,000,000 combinations of modular supplies are available in rack mounting kits.

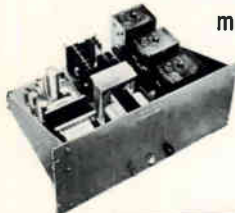

LABORATORY SUPPLIES

Includes voltage ranges of up to 1000 volts and current ranges up to 15 amps.



Also available in modularized kits for multiple outputs at specific ranges.

SPECIAL DEVELOPMENTS

R & D facilities are available for special developments like this supply for a solar panel simulator also developed by D/B.



SEE US AT **WESCON**
Booth 2101 & 2102

DRESSEN-BARNES



**Electronics
Corporation**

250 N. Vinedo Ave.
Pasadena, California

SEEN THE NEW

IDEA
INDEX
IN
EBG
?

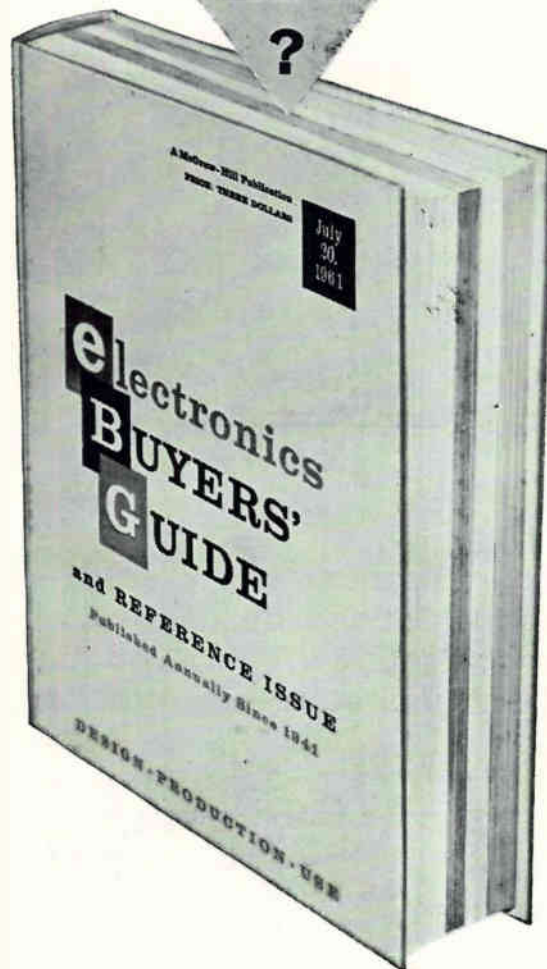

The INDEX to the editorial articles in electronics magazine, previously published annually in a December issue, now appears ONLY in the EBG. Another original EBG idea that saves time and trouble for users! Keep your EBG copy on your desk!

EXTRA!

Also in the EBG are condensed ABSTRACTS of all the editorial feature articles which have appeared to date in 1961. Another reason why EBG is used more by all four — men in research, design, production and management.

What was Bell Telephone Laboratories doing ON FRIDAY, JUNE 30, 1961?

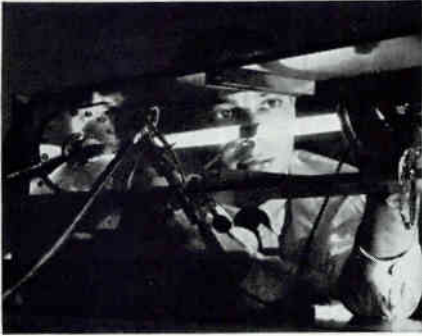

It was exploring the communications possibilities of the gaseous optical maser — a device which generates continuous coherent infrared radiation in a narrow beam.

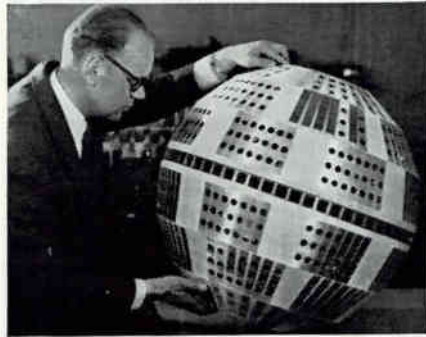

It was preparing an experiment in worldwide communications using "active" satellites powered by the solar battery, a Bell Laboratories invention.



It was completing the development of a new "heavy route" Long Distance microwave system capable of handling over 11,000 two-way conversations at once.



It was developing an anti-missile defense system designed to detect, track, intercept and destroy an enemy ICBM — in a matter of minutes.



It was demonstrating the potentialities of the superconducting compound of niobium and tin for generating, with little power, magnetic fields of great strength.

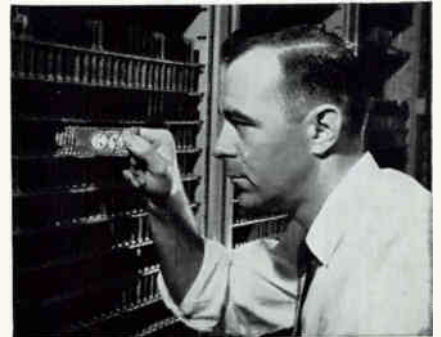

It was experimenting with an electronic central office at Morris, Ill., which is capable of providing a wide range of new telephone services.



It was perfecting the card dialer which permits, through insertion of a punched card into a slot, automatic dialing of frequently used numbers.



It was developing improved repeaters or "amplifiers" to increase greatly the capacity and economy of undersea telephone cable systems.



It was continuing its endless search for new knowledge under the leadership of scientists and engineers with world-wide reputations in their chosen fields.

Bell Laboratories scientists and engineers work with every art and science that can benefit communications. Their inquiries range from the ocean floor to outer space, from atomic physics to the design of new telephone sets, from the tiny transistor to massive transcontinental radio systems. The goal is constant—ever-improving Bell System communications services.

BELL TELEPHONE LABORATORIES

World center of communications research and development



New individually calibrated meters • New

MICROWAVE POWER, SWR METERS, POWER SUPPLIES



⊕ 431A Power Meter

⊕ 431A Power Meter, easy to use, ends zero chasing due to time-temperature drift; no zero change when switching ranges. Quickly, accurately measures to 1 μw to 10 mw with ⊕ 478A Thermistor Mount (coaxial), ⊕ X486A X-Band Thermistor Mount, truly temperature compensated mounts (neither pictured). ⊕ 431A is solid state, compact, modular; ac or rechargeable battery operated. ⊕ 431A, \$345.00. ⊕ 478A or X486A, \$145.00.

⊕ 415C Standing Wave Ratio Meter, solid state, incorporates revolutionary *four-times expansion of readings at any scale point*. Special circuitry protects bolometers. Recorder output, bolometer checker, ac or rechargeable battery operation. \$325.00.

⊕ 716A Klystron Power Supply provides up to —800 v beam voltage at 100 ma, has excellently regulated dc filament voltage. Reflector voltage settable to 0.5% accuracy up to —800 v from beam. Reflector ripple < 500 μv . Internal square wave modulation, can be externally modulated; output can be automatically scanned on oscilloscope. Price on request.

SEE AT WESCON—NEW, SPACE SAVING MODULAR INSTRUMENTS



Only from \odot these trim, compact new modular instruments that rest neatly on your bench, mount precisely in EIA racks either directly or using new \odot pressure-actuated tilt-slides. Depending on size, they install one, two or three per rack width. Here's real economy of bench or rack space, light weight and easy access, plus traditional \odot accuracy, dependability and long service life. This remarkable new packaging is yours in a wide array of \odot instruments appearing for the first time at WESCON.



HEWLETT-PACKARD COMPANY

1088A Page Mill Road • Palo Alto, California, U.S.A.
Cable "HEWPACK" • DAVenport 6-7000

Sales representatives in all principal areas

no-parallax CRT's • Plus 20 new compacts
in the  modular
cabinet concept for

Rack 'em up or stack 'em up

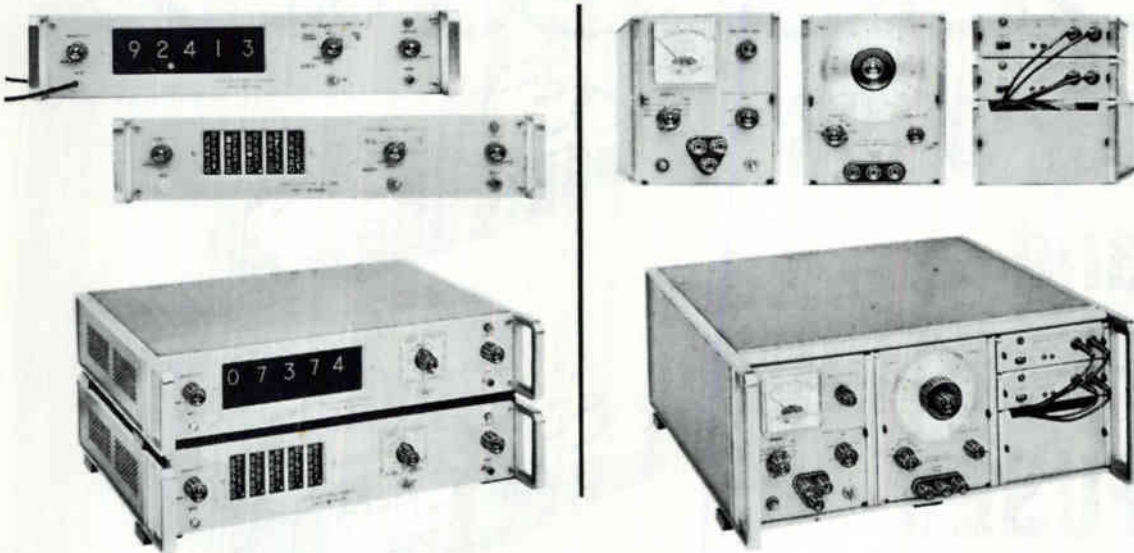

See them all at  **WESCON**
end of center aisle, main arena

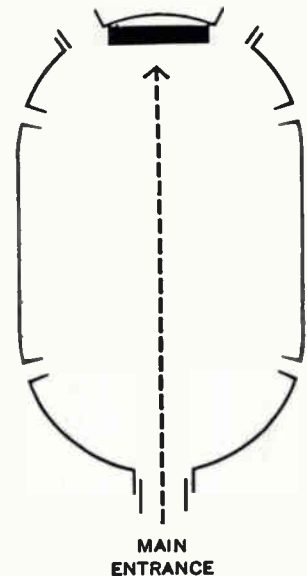

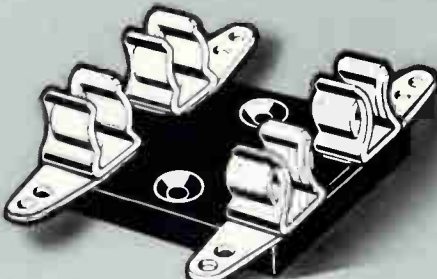

BLOCKS

**for BUSS
and
FUSETRON
FUSES**

*All types
available
for every
application*

**BUSS
and FUSETRON
FUSES: One source
for all your
fuse needs.**

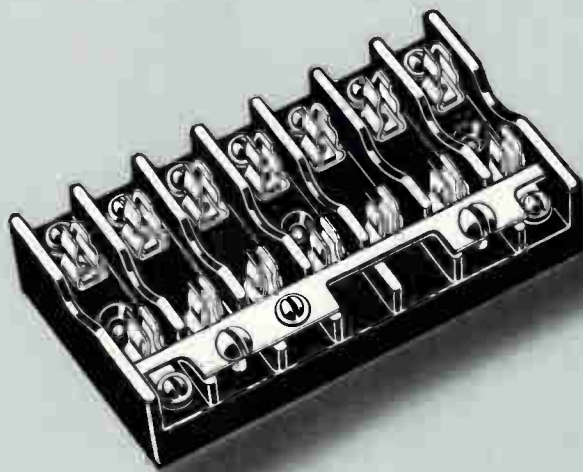

Get full data for your files, write for BUSS
bulletin, Form SFB—it gives a comprehensive picture
of the complete line of fuses and fuse mountings of
unquestioned high quality.

BUSSMANN MFG. DIVISION, McGraw-Edison Co., UNIVERSITY AT JEFFERSON, ST. LOUIS 7, MO.

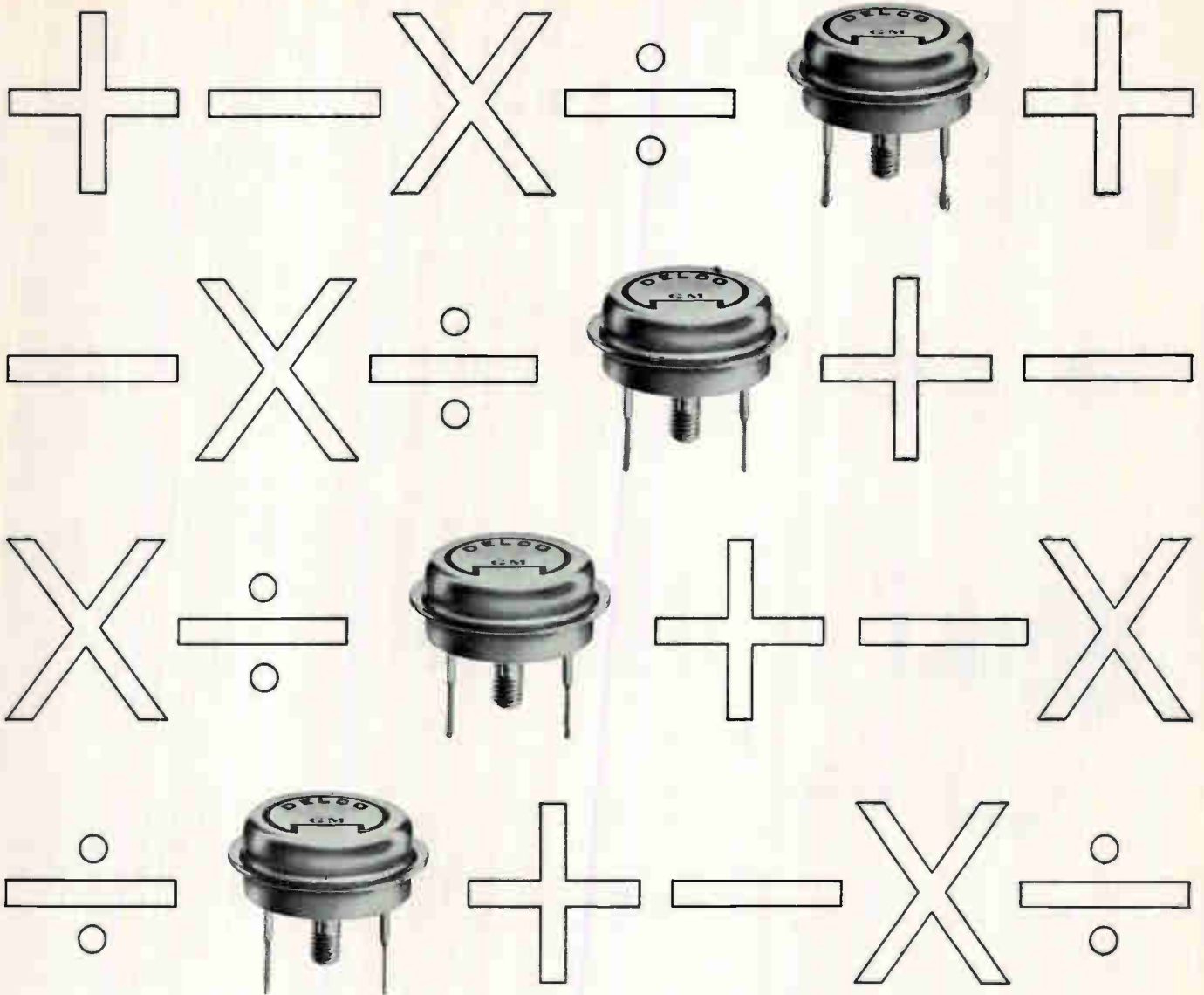

DELCO POWER TRANSISTORS PROVED IN COMPUTERS by IBM, UNIVAC®, BURROUGHS, NATIONAL CASH REGISTER

Since Delco Radio produced its first power transistors over five years ago, no transistors have undergone a more intensive testing program to assure reliability—which accounts for their popular acceptance in hundreds of industrial and military uses. Before leaving our laboratories, Delco transistors must pass numerous electrical and environmental tests both before and after aging. This double testing, combined with five years of manufacturing refinements, enables us to mass produce any type of power transistors with consistent uniformity. And we can supply them to you quickly in any quantity at a low price. For complete information or technical assistance on our versatile application-proved family of transistors, just write or call our nearest sales office or distributor.

Union, New Jersey
324 Chestnut Street
MUrdock 7-3770

Santa Monica, California
726 Santa Monica Blvd.
UPTon 0-8807

Chicago, Illinois
5750 West 51st Street
PORtsmouth 7-3500

Detroit, Michigan
57 Harper Avenue
TRinity 3-6560

DELCO
RELIABILITY
RADIO
RELIABILITY

Division of
General Motors
Kokomo, Indiana

See you at the WESCON Show, Booths 2518 & 2520

August 11, 1961

CIRCLE 33 ON READER SERVICE CARD 33

SPRAGUE®

MODEL 500

INTERFERENCE LOCATOR



This versatile instrument is a highly sensitive interference locator—with the widest frequency range of any standard available unit! Model 500 tunes across the entire standard and FM broadcast, shortwave, and VHF-TV spectrums from 550 kc. to 220 mc. in 6 bands.

It's a compact, portable, rugged, versatile instrument—engineered and designed for most efficient operation in practical field use. It features a transistorized power supply, meter indications proportional to carrier strength as well as sensitivity of 5 microvolts minimum for 5% meter deflection over entire tuning range.

For full details, send for brochure IL-106.

SPRAGUE ELECTRIC COMPANY
35 Marshall Street, North Adams, Mass.

SPRAGUE®
THE MARK OF RELIABILITY

IBM Half-Year Earnings Rise

FOR THE SIX MONTHS ended June 30, 1961, net earnings of International Business Machines were \$100,859,439 after estimated Federal income taxes. This is equivalent to \$3.67 per share on the 27,515,575 shares outstanding at the end of the period and compares with net earnings for the corresponding 1960 period of \$76,616,285 or \$2.79 a share on 27,435,974 shares then outstanding. Net earnings for this year's six-month period before tax deductions amounted to \$203,659,439 as against \$156,341,285 a year before. Gross income for the six months was \$811,163,397 in the 1961 period and \$694,626,974 in the corresponding 1960 interval. T. J. Watson, IBM president, said that while the company's main income continues to be derived predominantly from equipment rentals, outright sales of data processing gear were substantially higher this year than in 1960.

VARO INC., Garland, Tex., reports sales for the fiscal year ended April 30, 1961 amounted to \$5,581,000, an increase of 54 percent over the preceding year. Profits rose 51 percent to a total of \$146,800. Capital assets of the company during the fiscal period rose 75 percent to \$1,396,000, while working capital of \$2,276,000 was up 62 percent. The company produces conversion and control systems, infrared gear, frequency standards and semiconductor components.

ENTRON, INC., Bladensburg, Md., manufacturer of community antenna and closed circuit tv systems, reports net sales of \$1,844,221 for the fiscal year ended Feb. 28. This represents a 30 percent gain over the previous year when the net sales were \$1,409,976. Net earnings declined to \$4,009 compared to \$56,002 the year before. H. M. Diambra, president, attributes the drop to construction delays due to unduly severe weather and to protest proceedings before Federal Communications Commission involving Entron's subsidiary, Southern Trans-

mission. He adds that company backlog will exceed \$3.5 million as compared with \$1.2 million at the end of the 1960 fiscal period and predicts an improved financial situation during the current period.

P. R. MALLORY & CO., Indianapolis, reports second quarter sales of \$21,615,000, nine percent higher than first quarter sales this year and 1.5 percent above those of the second quarter of 1960. G. B. Mallory, company president, says net earnings of \$1,058,176 were the highest for any second quarter in company history, exceeding 1961 first quarter earnings by 35 percent and topping 1960 earnings for the same period by 12 percent.

DATATROL CORP., Silver Springs, Md., has announced a 60,000-share stock offering with a par value of 50 cents a share. The initial offering price was \$4.25 a share. First Investment Planning Co. of Washington and Jones, Kreeger & Co. were underwriters. The company, which is in the field of data processing consulting, is authorized to issue an additional 240,000 shares. Net proceeds of the 60,000-share sale of approximately \$219,500 after underwriting commissions and corporate expenses will be used to develop data processing programs for applying computers to record-keeping in small and medium-sized businesses. Approximately \$120,000 will be used for general corporate purposes, recruiting and debt retirement.

GENERAL INSTRUMENT CORP., Newark, N. J., reports for the first fiscal quarter ended May 31 this year that its net profits rose and sales hit a record of \$19,220,342, rising 13 percent over the \$16,983,282 reported in the equivalent 1960 period. Net earnings for this year's three-month interval were \$663,076 or 27 cents per common share on 2,488,700 shares outstanding. This compares with \$642,727 or 26 cents a share a year ago. Company back-

Special Engineering Section Maintained for Design and Development of Pulse-forming Networks

log was \$53,540,000, up from \$44,600,000 at the end of the 1960 first quarter. The figures disclosed include those of General Transistor and Pyramid Electric Co., merged with General Instrument in 1960 and 1961 respectively.

BURNELL & CO., Pelham, N. Y., manufacturers of specialized filters and other electronic components reports sales of \$3,505,567 for the year ended March 31, 1961. In the 1960 fiscal period, sales were \$3,223,303. Net income, \$122,092 or 18 cents a share in fiscal 1960, was \$134,178 or 20 cents a share in fiscal 1961 computed on 670,000 shares outstanding.

INVESTMENT of \$100,000 has been made in RLC Electronics, Inc., Mamaroneck, N. Y., by Payson & Trask, New York venture capital firm. RLC manufacturers precision coaxial microwave components and subsystems. The company, in its second year of operation, has named W. Hardie Shepard, a partner of Payson & Trask, as a director.

25 MOST ACTIVE STOCKS

	WEEK ENDING JULY 28, 1961			
	SHARES (IN 100's)	HIGH	LOW	CLOSE
Avco Corp	2,685	25¼	22½	25¼
Lockheed Aircraft	1,824	50¼	46¾	49¾
Gen Tel & Elec	1,649	26¾	25	25¾
Gen Electric	1,172	66¾	62¼	66¾
Gen Dynamics	951	37¾	34¾	37½
Sperry Rand	858	28¾	26¾	28¾
Avnet Elec	838	43½	36¼	42
Martin Co	834	36¾	34½	35½
Ampex Corp	833	21¾	18¾	21¼
Dynamics Corp of Am	734	167½	14¾	15½
Republic Aviation	697	50½	47½	49¾
Raytheon	674	40¾	36¾	40¾
Westinghouse	667	44¾	40½	44
Hycon Mfg	644	57½	49½	5½
Elec & Mus Ind	594	5¼	47½	5
Standard Kollsman	572	48¾	44¼	47¾
US Ind	555	17¾	16¾	17½
Transitron	522	26¾	23½	26
I T & T	498	57¾	54¼	57½
Ling Temco Elec	488	36¾	33¾	35½
Gen Inst Corp	479	44¼	38	43½
Burroughs Corp	473	32½	30¾	32½
Lear Inc	472	26¼	23¼	25¼
Univ Control	455	11	10¼	10¾
Varian Assoc	384	57¾	51	57

The above figures represent sales of electronics stocks on the New York and American Stock Exchanges. Listings are prepared exclusively for ELECTRONICS by Ira Haupt & Co., investment bankers.

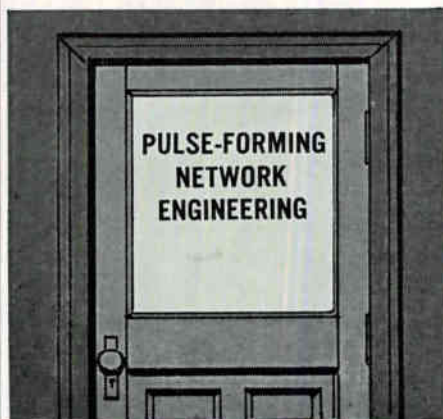

BEHIND this door, the Sprague Electric Company, North Adams, Massachusetts, maintains a highly-technical special engineering section devoted exclusively to the design, development, and manufacture of pulse capacitors and pulse-forming networks. The many complexities of these highly-specialized units demand that they be handled by a highly-specialized organization. For this reason, Sprague has been, from the very beginning, a major supplier of pulse capacitors and networks for radar equipment (ground, marine, aircraft, missile), tube testing, and similar pulse circuit applications.

This special engineering section performs four important functions: One group *designs* custom units in accordance with required parameters. Another group *builds* pulse capacitors and networks to these precise specifications. In another area, a group of specially-trained field engineers *provides application assistance* wherever needed. And yet another independent group *works toward the future* developing new materials, new design concepts, and new techniques for manufacture, enabling Sprague to introduce product improvements such as heliarc sealing of cases, rugged alumina bushing assemblies, Fabmika® dielectric, and improved hermetic sealing of closures.

Save time and money by working with Sprague from the start. Application engineering services are available to you without obligation.

Write for Engineering Bulletin No. 10,001 to Technical Literature Section, Sprague Electric Co., 35 Marshall Street, North Adams, Massachusetts.

CIRCLE 150 ON READER SERVICE CARD

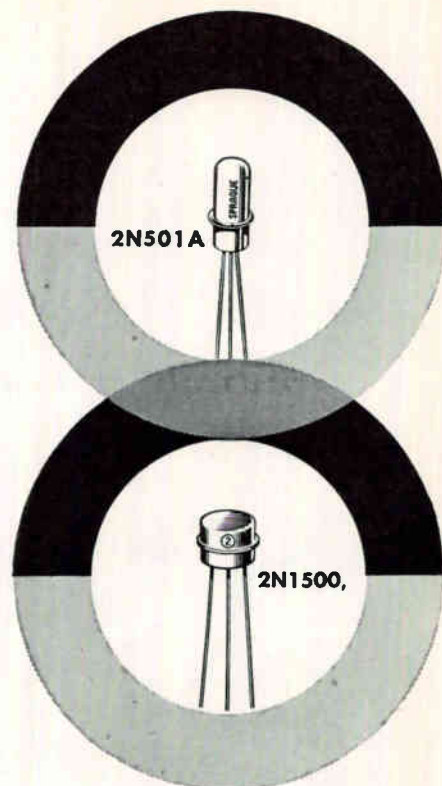

PROVEN ULTRA-HIGH-SPEED TRANSISTORS BY SPRAGUE

The well known slim-line Type 2N501A Micro-Alloy Diffused-Base Transistor, extensively used in critical military, industrial, and commercial applications, is now joined by the 2N1500, in its low-height case.

The electrical characteristics of both of these "Precision-Etch" transistors are identical. They will operate reliably at switching speeds up to 20 mc. They also feature excellent frequency response at very low collector voltages.

Manufactured with cadmium junctions, Sprague MADT* Transistors provide an extra safety margin. Effects of high temperature, the major destructive factor with transistors, are minimized by the super-conductivity of cadmium, assuring cooler operation and greater reliability.

Write for engineering data sheets to Technical Literature Section, Sprague Electric Company, 35 Marshall Street, North Adams, Massachusetts.

*Trademark of Philco Corporation

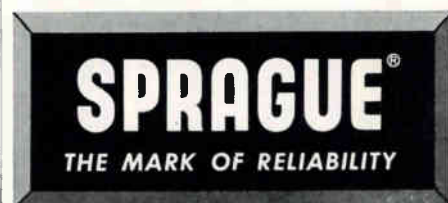

CIRCLE 35 ON READER SERVICE CARD 35

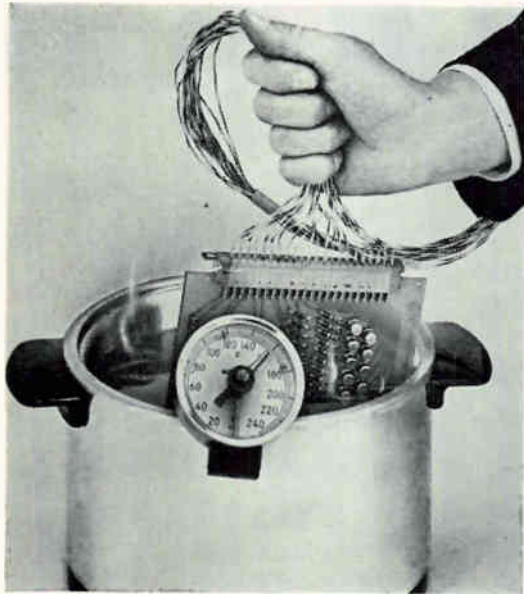
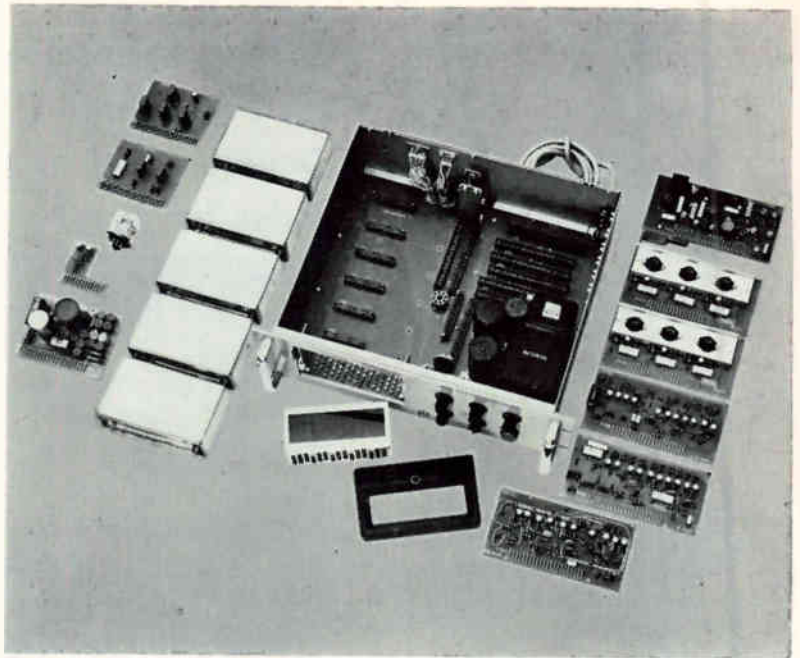

Point 1 — PREVENTIVE MAINTENANCE DESIGN. These two photos illustrate a fundamental NLS policy: "Build reliability into instruments to keep malfunctions to a minimum . . . and design them so that, when malfunctions do occur, the user can spot them and fix 99% of them within a few minutes." On the left, a circuit board is boiled in oil at 158°F to assure operation at elevated temperatures. Above, 99% plug-in modular construction of a Series 30 instrument is graphically shown. Results: fast troubleshooting by substitution of modules . . . easy servicing by simply replacing modules. Even lowest cost industrial instruments incorporate such exclusive servicing features as plug-in stepping switches.

FOLLOW-THROUGH...

Point 2 — PROMPT PARTS SERVICE.

All NLS offices (starred) stock spare parts and plug-in modules. In practically all cases, a phone call to an NLS office brings immediate delivery of a module to keep your DVM in action while the faulty module undergoes repair. Many NLS reps (circled) also maintain stocks of plug-in modules. Delivery of replacement parts is fast and sure.

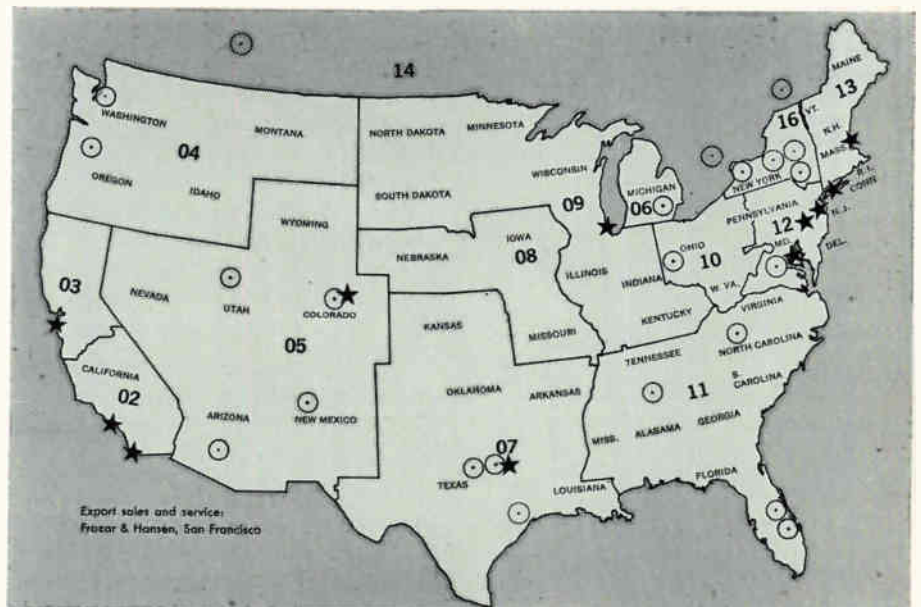

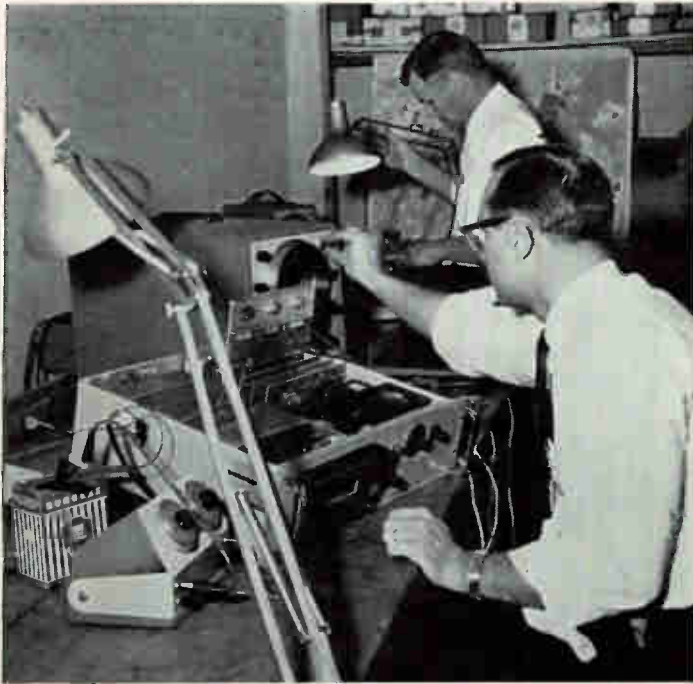

Point 3 — FAST REPAIR SERVICE. Servicing of NLS instruments is normally performed by NLS regional office facilities (such as pictured at Nutley, N.J.) for faster, more personalized service in your area. Many NLS reps also offer servicing.



Point 4 — CUSTOMER TRAINING. NLS conducts special courses several times a year for customer servicing personnel at no charge other than room and board. NLS engineers and servicing experts cover basic theory of each type of instrument, troubleshooting techniques, calibration, and so forth. Contact your nearest NLS office for details.

to protect your digital voltmeter investment

“What happens after the sale?”

Here is the NLS answer — a comprehensive four-point program designed to keep your digital voltmeter in action ... to protect your important investment in this basic measuring and data logging tool. This is the type of program that answers the very serious need for servicing follow-through.

In establishing the four-point program outlined here, Non-Linear Systems, Inc., fully recognizes these basic facts concerning the touchy subject of servicing.

- Digital voltmeters do not last forever — nor do any other electronic instruments. Like all things made by man, they require attention from time to time.

- Normally when a malfunction occurs in a digital voltmeter, *every minute* counts in returning it to operation.
- Because of the important jobs performed by DVMs, an ounce of prevention is worth *much more* than a pound of cure.
- Providing complete information on servicing to DVM users can pay big dividends to user and manufacturer.

Here is a servicing program that meets the servicing needs of digital voltmeter users head on. For more information on NLS servicing or any instrument in the complete line of NLS digital voltmeters, contact your nearest NLS office or sales representative.

Visit us at WESCON (Booth 1518-1520) and the Los Angeles ISA SHOW (Booth 105)



non-linear systems, inc. *Originator of the Digital Voltmeter*
DEL MAR, CALIFORNIA

electronics REPRINT SERVICE

All electronics Editorial Matter Can Be Made Available in Reprint Form

The Reprint Service Department offers 4 types of reprints for sale: 1—Reprints of Special Reports as they appear with definite costs for varying quantities; 2—Reprints of Special Reports that have appeared in past issues; 3—Reprints of other editorial material in the current issues (minimum order is 100); and 4—Reprints of editorial that has appeared in past issues (minimum order is 100). On other than Special Reports we cannot publish prices because the order may involve any number of editorial pages depending upon the length of the article.

For Single Reprints

Single copies of articles from the very first issue of electronics, to the very latest issue may be obtained. (If available as tearsheets they are free.) Photostatic copies are offered at cost. Write today for a copy of any article you desire. Please write to Reprints Service Dept., electronics, 330 West 42nd St., New York 36, N.Y. or telephone LO 4-3000 Ext. 3140 for all information pertaining to reprints.

Reprints Available on Past Special Reports and Feature Articles

Order by Key Number. Use REPRINT ORDER FORM BELOW.

KEY NO.	TITLE OF REPRINT	NO. OF PAGES	ISSUE DATE	PRICE
Key No. R-5	Electronic Markets Special Report	18	Jan. 1, 1960	*
Key No. R-7	Electronics Research and Development Around the World	24	Feb. 12, 1960	*
Key No. R-8	Graphical Extensions of Transform Techniques	6	Apr. 1, 1960	10¢ each
Key No. R-12	1960 Semi-Annual Index	24	Jan.-June issues	50¢ each
Key No. R-15	Microminiaturization	32	Nov. 25, 1960	*
Key No. R-16	1960 Semi-Annual Index	16	July-Dec. Issues	50¢ each
Key No. R-17	Reference Section of The 1960-61 Electronics Buyers' Guide	64	July 20, 1960	50¢ each
Medical Electronics				
Key No. R-19a	Part I: Diagnostic Measurements	8	Jan. 20, 1961	25¢ each
Key No. R-19b	Part II: Diagnostic Systems and Visualization	6	Feb. 3, 1961	25¢ each
Key No. R-19c	Part III: Therapeutic Devices	7	Feb. 24, 1961	25¢ each
Key No. R-19d	Part IV: Prosthetics-Hearing Aids and Blind Guidance Devices	7	June 23, 1961	25¢ each
Key No. R-19e	Part V: Prosthetics-Substitute Organs and Limbs	7	July 21, 1961	25¢ each
Key No. R-20	Computers Today	32	April 28, 1961	*
Key No. R-21	Electronics in Europe	32	June 9, 1961	*
Key No. R-22a	Plasma Engineering—Part I: Generating and Heating Plasma	7	July 14, 1961	25¢ each
Key No. R-22b	Plasma Engineering—Part II: Measuring Parameters	7	August 4, 1961	25¢ each

* Price: Reprints on items above are 1-10 copies, 75¢ each; 11-24 copies, 60¢ each, 25 copies or more, 50¢ each unless otherwise noted.

REPRINT ORDER FORM

For Reprints of PLASMA ENGINEERING, Part II Measuring Parameters (August 4, 1961)

Send me.....Reprints of Key No. R-22b at 25¢ each.

For Reprints of past SPECIAL REPORTS or FEATURE ARTICLES fill in below:

Send me.....Reprints of Key No. @¢ each.

* For Reprints of other editorial articles in this issue, fill in below:

Send me.....reprints of article entitled.....
..... on page(s) (Minimum order 100 copies)

* For Reprints of other editorial articles in past issues, fill in below:

Send me.....reprints of article entitled.....
..... on page(s) of issue dated..... (Minimum order 100 copies)

Check one box *First advise me of costs

Mail immediately and bill me later.

Name

Number and Street.....

City, Zone No., State.....

Fill in,
Clip Out
coupon,
insert
into
envelope
and
mail to
electronics
READER SERVICE
330 W. 42nd Street
New York 36, N. Y.

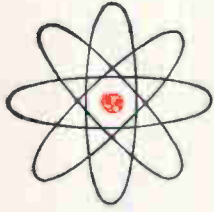

Model of the crystal structure of yttrium-iron garnet which is used as a basic composition into which ions of samarium, gadolinium, chromium, aluminum, or gallium, or combinations of these ions, can be substituted to produce desired microwave properties.

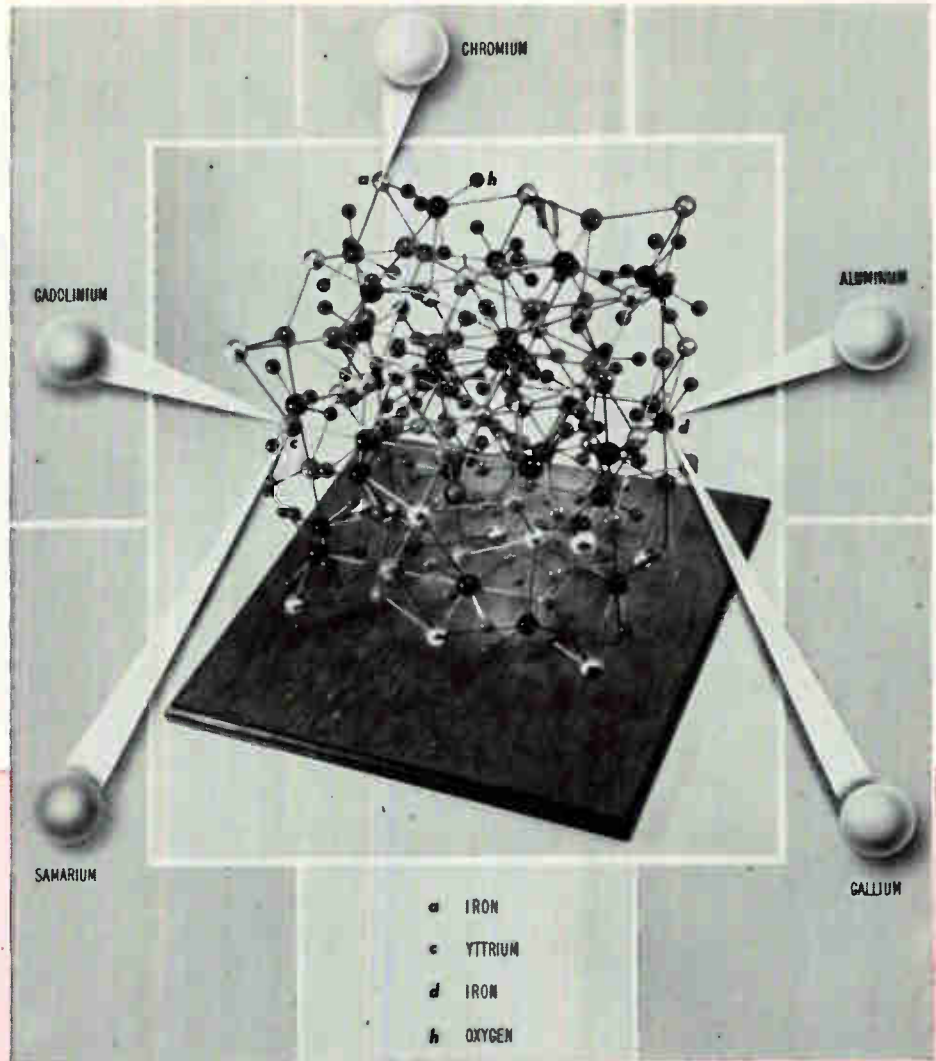

**Backed
by
Years of
Materials
Research...**

SPERRY Ferrimagnetic GARNETS

● What are the microwave properties of ferrimagnetic garnet materials? That WAS the question. Years of intensive study by scientists at Sperry Microwave Electronics Company have provided the answers needed to satisfy many of your most exacting requirements. Today Sperry's ferrimagnetic garnets have no peer for microwave applications. We intend to maintain this position through a never-ending search for advanced materials, superior compositions, and new applications.

Exotic, Sperry-developed hybrid garnet compositions display many unique microwave properties. For example, some compositions possess stabilized properties as a function of

temperature; others exhibit independently controlled properties; still others possess unique high power handling capabilities.

The Sperry Solid State Materials Laboratory maintains exacting formation procedures. Quality control is rigid. Laboratory equipment and manufacturing methods are unexcelled. And most important of all, technical know-how at Sperry is a proven claim.

Sperry's extensive background of materials experience is reflected in the development of many advanced solid state devices. Your inquiries for development and production of new materials and devices are invited.

SPERRY

SPERRY MICROWAVE ELECTRONICS COMPANY, CLEARWATER, FLORIDA • DIVISION OF SPERRY RAND CORPORATION
Microline Instruments • Radar Test Sets • Systems Instrumentation • Solid State Devices and Materials • Microwave Components and Antennas

Engineer for Value

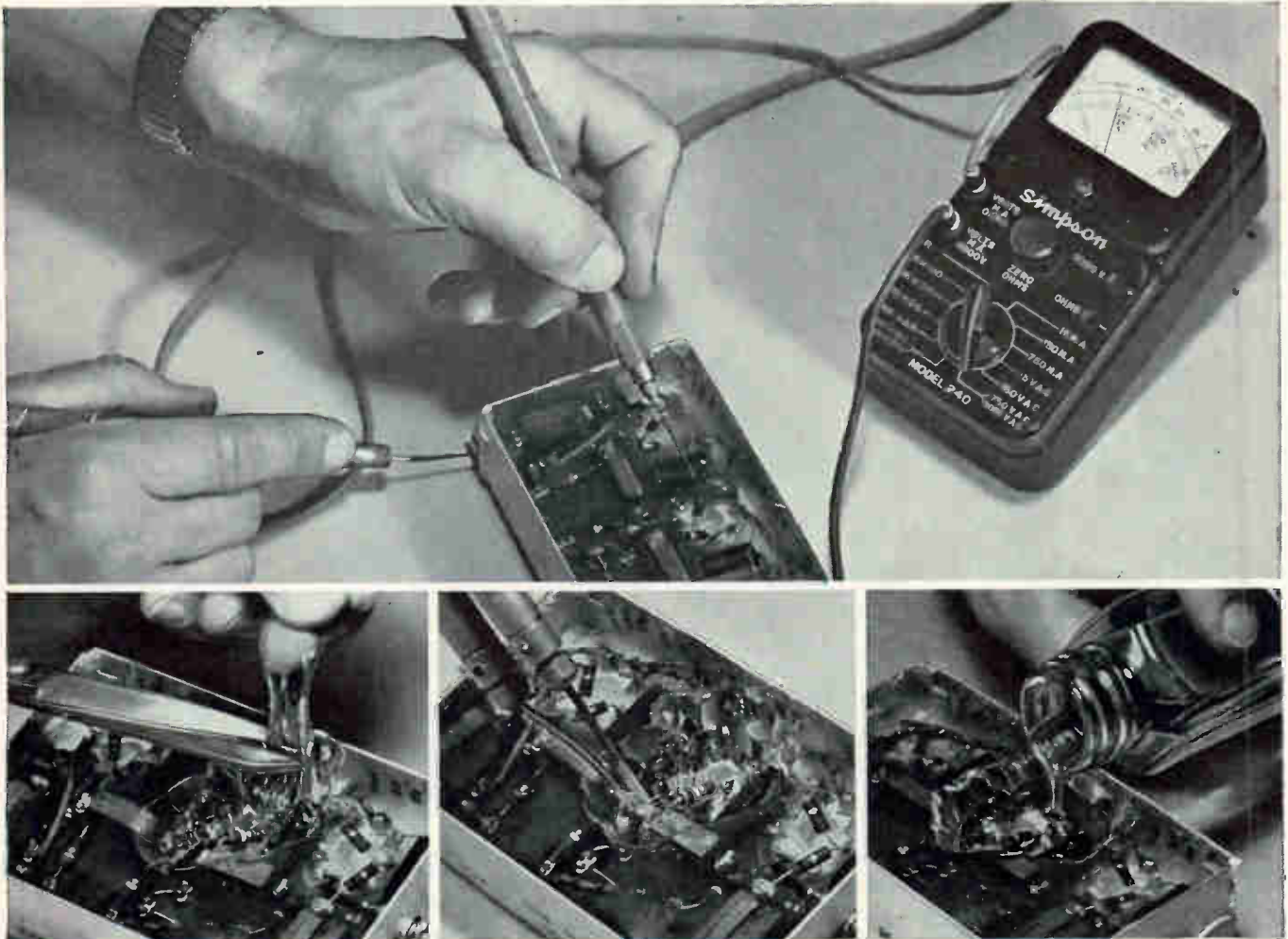

New Dielectric Gel Assures Protection Plus Easy Repairs

If value engineering is important to you, so is Dielectric Gel. This new "see-through" potting material offers all the advantages of other materials *plus* visual inspection and instrument testing . . . plus easy repair . . . plus fool-proof *repotting*.

A water white, medium viscosity liquid, Dielectric Gel readily surrounds components. It cures in place, forming a resilient mass with outstanding dielectric properties, good thermal stability and moisture resistance. No significant stresses are developed during or after cure. Serviceable from -60 to 200 C, Dielectric Gel protects potted components and circuits from

shock and vibration, other environmental extremes . . . is excellent for filling and impregnating capacitors, magnetic amplifiers, similar components and devices.

Circuits and components potted in Dielectric Gel can be checked both visually and by instrument. When probes are removed, Dielectric Gel heals itself. To replace a defective part you simply cut away the Dielectric Gel with a knife or scissors, replace the defective component and pour fresh Gel around the part. Result: Original high quality protection!

CIRCLE 289 ON READER SERVICE CARD

For 12-page manual, "Silicones for the Electronic Engineer", Write Dept. 4220A.



Dow Corning

...Specify Silicones

No Heat-loosened Terminals Here

Repeated soldering does not loosen terminals mounted on silicone-glass laminate made with Dow Corning resins. Lightweight and rugged, silicone-glass laminates provide greater strength at elevated temperatures than many metals . . . keep their excellent dielectric properties despite storage, environmental aging, rapidly changing ambients, vibratory shock and high humidity. These are the reasons why Lear, Inc., Grand Rapids, Michigan selected silicone-glass laminate for the capacitor mounting board in their Stable Platform Model 2013J.

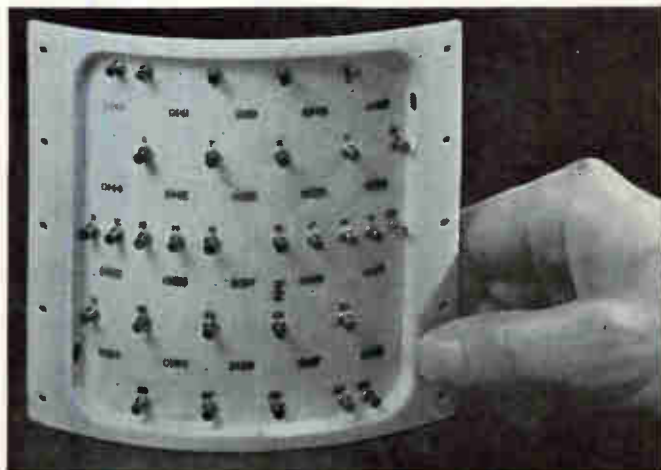

CIRCLE 290 ON READER SERVICE CARD

Easy Way to Repair Encapsulations

It's easy to replace defective parts encapsulated in Silastic® RTV, the fluid silicone rubber that cures without heat. First, you cut a slit in the Silastic RTV jacket; second, replace the component; third, patch the cut by pouring fresh Silastic RTV over the repair . . . there's no measurable loss in dielectric properties or physical strength. Encapsulation with Silastic RTV offers these advantages, too: resistance to moisture, fungus, corrosive atmospheres, corona and ozone, excellent dielectric properties, good heat dissipation and an operating temperature range of -60 to 250 C. Silastic RTV assures top value protection.

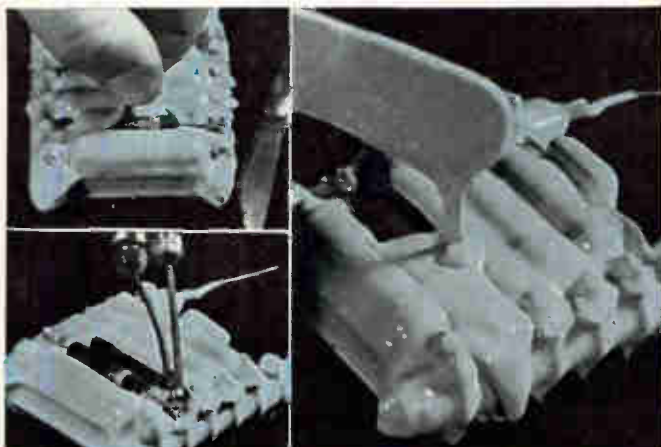

CIRCLE 291 ON READER SERVICE CARD

Heat-sink Sealant Ups Performance

When transistors and diodes are mounted with Dow Corning compound as the heat-sink sealant, heat dissipation improves up to 50%. That's because this grease-like silicone compound doesn't dry out, harden, melt or lose its initial properties from -70 to 200 C . . . even after long time exposure. Dow Corning silicone compound has excellent thermal conductivity and increases the heat transfer between diode-and-washer and washer-and-chassis . . . improves device performance. Applied to lead terminals and connector pins after soldering, Dow Corning compound protects against corrosion, corona and shorts.



CIRCLE 292 ON READER SERVICE CARD

Visit Our Booth 5102-06 at Wescon Show

CORPORATION MIDLAND, MICHIGAN

branches: ATLANTA BOSTON CHICAGO CLEVELAND DALLAS LOS ANGELES NEW YORK WASHINGTON, D.C.



THE SIZE DIMINISHES; THE POWER REMAINS AS HIGH

**Tiny New 3/8" (0.375") Squaretrim®
Potentiometer Dissipates One Full
Watt In Still Air!**



The performance of this new Daystrom subminiature Squaretrim is as great as its half-inch cousins. Further, the one-watt rating is based on *still-air tests*...typical of our conservative specifications. Contained in a stackable package only 3/8" square and just 1/8" thick, the new Series 200 Squaretrims permit great circuit density (27 per cubic inch) and the 144 different models offered give wide design latitude. The Series 200 Squaretrims range from 10 ohms to 35K, operate from -55 to +150°C, and need no mounting brackets for stacking. A true precision instrument with all the exclusive features of the Daystrom line, this new potentiometer is designed to meet MIL R-27208 and MIL R-22097. Write for detailed information.

 **DAYSTROM, INCORPORATED**
POTENTIOMETER DIVISION
ARCHBALD, PENNSYLVANIA • LOS ANGELES, CALIFORNIA

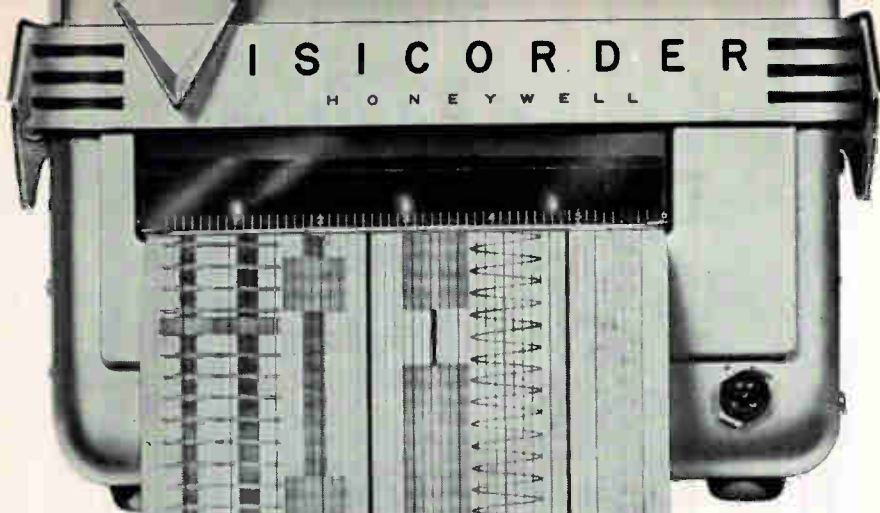

Visicorder and
record shown
approx. 1/2
actual size.

"MASTER CLOCK"

for the missile range uses 15

Honeywell Visicorder oscillographs

The Timing Operations Center designed and built by Epsco-West for the Navy's Pacific Missile Range is now in use at Point Mugu, California. It makes use of 15 Honeywell Visicorders to read out (as shown on the unretouched record at left) the modulated timing codes distributed as balanced outputs to the Center's "customers."

The solid-state Epsco-West TOC generates up to 11 separate timing signals, one or all of which may be delivered to any of 36 users.

The 906B Visicorder also performs a supplementary function as a monitor on the timing and test-patch panel, and as permanent "record-keeper" for the built-in indicators and test oscilloscopes. Visicorders were selected for their jobs with the TOC because of their versatility, reliability, low cost, and compact size (10" x 10" x 15 1/2"; weight, 37 lbs.).

Pioneer and acknowledged standard in the field of high frequency direct-recording oscillography, the Visicorder is available in several models, from 6 to 36 channels, DC to 5000 cps response, up to 50,000" sec writing speed. Honeywell engineering is at your service through 120 field offices for help in applying one Visicorder or a full system to your data acquisition program; or a quantity of Visicorders for OEM application in your products.

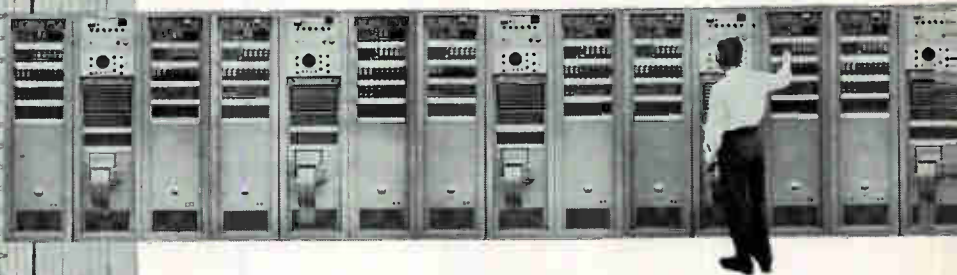

Record speed
changed
during
recording.

Call your local Honeywell office now or write today for Catalogs HC906B, 1012, 1108, and 1406 to Minneapolis-Honeywell, Heiland Division, 5200 East Evans Avenue, Denver 22, Colorado. Our telephone is SKyline 6-3681, Area Code 303.

Honeywell

 First in Control
SINCE 1885



INDUSTRY ATTENTION

FOCAL POINT of electronics industry interest this month will be San Francisco, where 35,000 convention-goers will converge on the Cow Palace to view 1,180 exhibits, sit in on 41 technical sessions featuring 127 papers, and participate in many special events at WESCON '61. Several things are peculiar to this year's convention:

- An astronomical flavor, due in large part to the concurrent meeting of the International Astronomical Union.

- This year a "credit card" system will be used to streamline distribution of exhibitor product hand-outs.

- A major revision of exhibitor rules, assuring better equity among large and small manufacturers.

- Emphasis in the technical program on coherent light generators and quantum electronics.

A preponderance of high-quality papers in the fields of information theory (3 sessions) and computers (4 sessions) will be noted. One of these 21 papers which promises to draw a full house describes Iliac, a large computer which instructs in its own operation and use.

Devotees of basic science and those interested in recent particle accelerator progress will want to attend the August 25th session in

which details of three giant machines will be discussed. These three are presently being completed at Princetown, Brookhaven National Laboratory, and Argonne Laboratories.

One paper of particular interest to missile people will detail a new industrial radiographic apparatus which reduces from several hours to a few minutes the time required for checking solid-fuel missiles.

A departure from the practice of publishing a complete convention record has been announced. Pre-prints of individual papers will be available at a nominal charge before presentation.

Wescon chairman Albert J. Morris reports a continuation of last year's "gentleman's agreement" de-emphasizing recruiting activities.

Special events this year include the Distributor-Rep-Manufacturers conference to be held at the Jack Tar Hotel.

Several field trips, within a radius of ten miles of the Stanford University Campus, have been scheduled.

Featured speaker at the all-industry banquet on Thursday will be IRE President Lloyd V. Berkner. The WEMA Luncheon address will be given by Arnold Beckman.

Many notable new products will

be seen. A sampling follows:

Pulse Engineering will show its ramp/pulse generator which makes possible definitive measurement of pulse inductance in blocking oscillator transformers and coupling circuits.

Bourns will mark its entry into the strain gage field by showing its new transducer having a linearity and hysteresis error of ± 0.25 per cent. Temperature range is -100 F. to 275 F. Also shown will be its 50G-variable reluctance dc-dc transducer with input voltage regulation of ± 1.5 percent zero shift of ± 0.003 percent, linearity of ± 0.5 percent, and hysteresis of ± 2 percent.

Hughes Aircraft will introduce a random access, card programmed automatic circuit tester for checking wiring harnesses and electrical assemblies.

Bendix-Pacific will announce a new research and development tool combining telemetry and sonar transmitting equipment. The system can provide test data for torpedo development programs, for testing of submarine models, and oceanographic studies.

Litton Tube Division will unveil a precision resistance network analogue having an overall accuracy of better than one part per 10,000.

Litton's Westrex division will un-

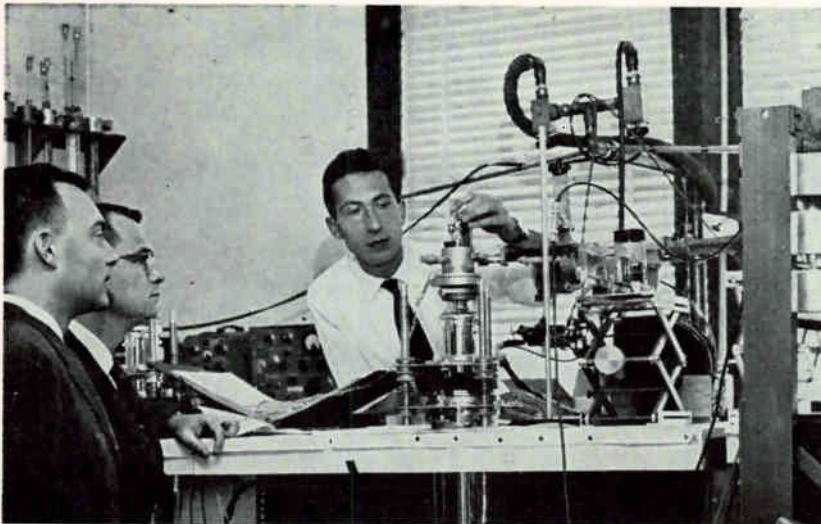

New instrumentation for testing harmonically-pumped ruby maser is demonstrated at Stanford University Electronics lab



Varian Associates' Louis T. Zitelli and VA-849 klystron amplifier for which he is receiving 1961 Seventh Region IRE Electronic Achievement Award

CENTERS ON WESCON SHOW

veil a 13-lb magnetic tape recorder system that records 14 tracks of data with laboratory accuracy in airborne or missile environments.

Gertsch Products will introduce a low-cost general purpose ratio transformer operating from 50 cycles to 10 Kc. The device is accurate to 0.001 percent. Other new instruments to be shown by the company include a 90-deg phase shift standard, an isolation amplifier, a militarized solid state complex ratio bridge, and a line voltage stabilizer.

Babcock Electronics will preview a solid-state 10-channel receiver for radio control of high altitude unmanned aircraft. Using a carrier-operated control relay for reliability, the crystal controlled unit operates in the 406 to 549.5 Mc range. Six or fewer channels may be energized simultaneously with a deviation of ± 20 Kc per channel, resulting in a total bandwidth spread of ± 120 Kc for the six channel.

Tally Register will introduce a detachable read head paper tape reader. The head may be detached for servicing and a new head inserted, thereby eliminating downtime of the system.

Automation Development will show an automated anodizing controller which maintains desired voltage across deposition tanks for high quality, uniform coatings.

Eitel-McCullough will show its new line of compact power triodes for use as zero-bias Class-B linear amplifiers in audio or r-f applications. Peak envelope powers range from 500 to 20,000 watts. Also shown will be two new travelling-wave tubes, produced for commercial point-to-point communications at 4 and 6 Gc bands, and featuring ppm stacks with full plug-in interchangeability and power output of 10 watts.

Non-Linear Systems will debut a transistorized full five-digit voltmeter-ohmmeter. Voltage and resistance accuracies are ± 0.01 percent of reading ± 1 digit in range of $\pm 9.9999/99.999/999.99$ volts and kilohms respectively. Digital output is printed, tape, or punched card.

Transdata will unveil a new character generator, positioning amplifier, and digital-to-analog converter with which output of computers can be printed on crt's in excess of 1,000,000 characters per second.

Varian's new products will be highlighted with several new microwave tubes, an atomic frequency standard and two automatic high vacuum systems. One of the latter, designed for thin film deposition, vacuum firing and brazing, and space-environmental testing, fea-

tures an ultimate pressure of 10^{-9} torr. The frequency standard uses optical pumping and has a rated stability of two parts in 10^{10} .

Acoustica Associates will introduce the smallest and the largest transistorized ultrasonic cleaners in its catalog line. The former is a one-gallon system with 100-watt generator and the latter a 25-gallon model with 2,500-watt generator.

Birtcher will show its new line of double-ended transistor radiator/retainers featuring quick mounting in flip-flop and push-pull circuits.

The aluminum alloy multifin units are designed to reduce heat up to 27 per cent.

Orbitec will unveil a transistor beta tester which produces either linear or log sweep of collector current for specialized testing. Resettable high-speed circuit breakers protect transistor on loads from 15 ma to 150 ma with 10 microsecond trip time.

Kin Tel will present a precision d-c voltage standard providing full seven-digit resolution in three ranges from zero to more than 1,000 volts, positive or negative. Output voltage is accurate to 0.01 percent of dial setting and stable within 50 parts per million. Output currents up to ± 25 ma are available.

Western Companies, Employment and Sales

Total Eleven Western States:		1960	1961 (projected)
Number of Firms	NF	914	987
Employees	E	190,000	215,000
Sales	S	\$2,465,000,000	\$2,815,000,000
<hr/>			
Portland-Seattle:	NF	51	55
	E	7,800	9,400
	S	\$130,000,000	\$140,000,000
<hr/>			
San Francisco-Peninsula	NF	156	167
	E	40,000	45,500
	S	\$570,000,000	\$675,000,000
<hr/>			
Los Angeles-Orange	NF	556	595
	E	115,000	128,000
	S	\$1,415,000,000	\$1,550,000,000
<hr/>			
San Diego County	NF	46	58
	E	9,500	10,800
	S	\$130,000,000	\$160,000,000
<hr/>			
Phoenix-Tucson	NF	38	42
	E	8,500	11,000
	S	\$120,000,000	\$165,000,000
<hr/>			
Balance of 11 Western States	NF	67	70
	E	9,200	10,300
	S	\$120,000,000	\$135,000,000

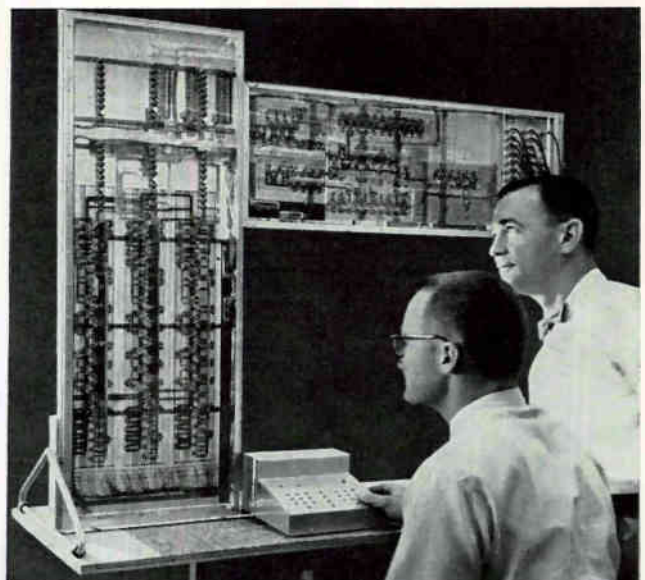

All-magnetic computer developed under Air Force sponsorship at Stanford Research Institute's Computer lab



What WESCON Exhibitors Are Saying

"Invaluable Showcase . . ."

WESCON'S IMPORTANCE to our company, to industry and to science can best be demonstrated by measuring its contribution in 3 dimensions.

First, it is an invaluable showcase. Exhibitors can display new devices and materials that enable the design engineer to improve his product technically or economically. Secondly, it provides manufacturers an opportunity to survey competitive lines, triggering the development of new or improved products and accelerating the industry's technical growth.

The third is the total effect WESCON has upon the scientific community of our western states. Already strongly represented in the inventive thinking, western scientists find further inspiration through the interchange of thought in personal contact and technical sessions. —*Eric Lidow, President, International Rectifier Corp.*

"Search for Markets . . ."

NEW TREND in the complex data processing field will be in evidence at the 1961 WESCON show. New standards of efficiency, advances in production techniques and application of engineering know-how will mark the road to standardization

—a revolution in an industry that up to now carried an expensive "custom-made" label.—*L. H. Orpin, General Manager — Information Technology Div., General Dynamics/Electronics*

"Cooperation, Fellowship . . ."

WE WELCOME this annual opportunity to show the latest fruits of our labors. We find the show even more valuable in supplying contact with customers, giving us an opportunity to discuss new applications of our products, special problems and specific requirements.

Each show teaches us important lessons.

WESCON provides a unique opportunity to see in one vast sampling the general state of our industry. From visiting exhibits and talking with others, we gain a fresh insight into the size, complexity and health of our industry. We pick up ideas about subtle shifts in our markets, technical innovations and industry-wide problems. In an industry changing as rapidly as ours, this yearly summing up is vitally important.

The various experiences help build a spirit of cooperation and fellowship throughout the industry. —*H. Myrl Stearns, President, Varian Associates.*



Norman H. Moore, Litton Industries

"Another Banner Year . . ."

WESCON GROWS in stature year after year as an industry showcase and market place. Here capabilities are demonstrated and products sold. Here ideas are shared and today's technology projected into the future. Here the West dramatizes annually its historic leadership in electronic science. All indications point to another banner year for the electronics industry in 1961. We confidently expect that this continued growth will be reflected in the most constructive and best-attended WESCON in history.—*Robert S. Bell, President, Packard-Bell Electronics Corp.*

"Vision, Imagination . . ."

WESCON FOCUSES on the energy and technical and scientific progress that has marked the West in the electronics industry. All trade shows are largely regional, and the



IRC's Eric Lidow, Robert S. Bell of Packard-Bell, C. Lester Hogan of Motorola and Varian Associates' H. Myrl Stearns



L. H. Orpin, General Dynamics

activity of the area has a dominating influence on the success of the show from the exhibitor's standpoint. In its growth Western electronics has not only been a leader in technological advancement, but an important market for all phases of electronics. This evolution makes the event a significant sales facet in an industry that is becoming more marketing conscious. In turn, WESCON management has shown vision and imagination in making this show an attractive balance of market emphasis, industry information and technological exchange.—Norman H. Moore, Vice President and General Manager, Litton Industries Electron Tube Div.

"Increasing Scope . . ."

WE HAVE BECOME increasingly aware of the importance of the West in the electronics industry. We feel the show is not so much a place for direct sales as it is an opportunity to acquaint customers with our capabilities, to answer their questions and to help solve applications problems.

Of course we will introduce new products, but this is secondary to meeting and exchanging ideas with equipment engineers. WESCON, due to its ever increasing scope and influence, affords us the opportunity to accomplish both our immediate and long-range goals in this area.—C. Lester Hogan, Vice President and General Manager, Motorola Inc., Semiconductor Products Div.



For Small Space Printed Circuit Applications

NEW SUBMINIATURE SINGLE TURN COMMERCIAL TRIMMER POTENTIOMETER

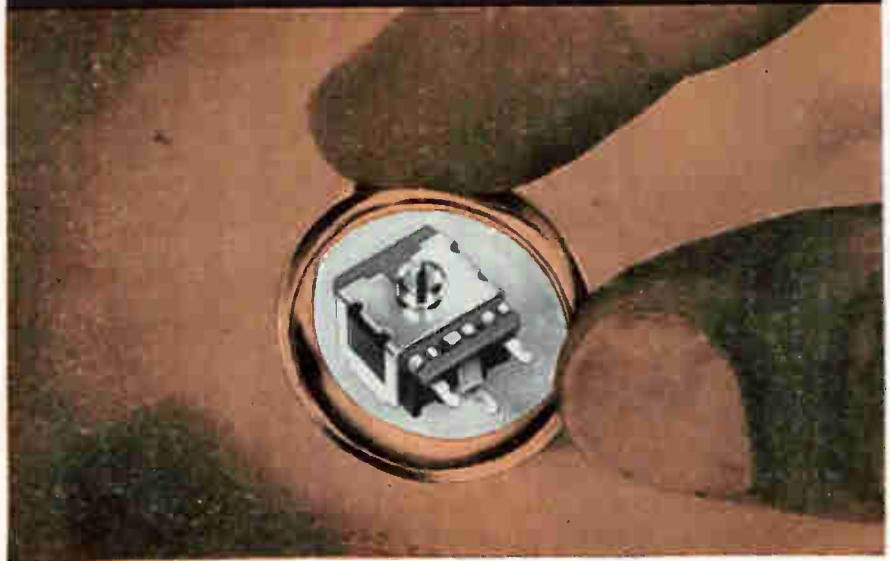

7/16" x 5/16" x 1/2"

- An economically priced unit containing the same composition element, double wiper contactor construction and all other performance-proven quality features of CTS miniature composition variable resistors.
- Requires only 7/16" x 5/16" p. c. board area. Extends only 1/2" above board surface. Plugs directly into board and is self-supporting. Can be used in applications where multiple boards are stacked on 5/8" centers.
- Designed for communications, computers, instrumentation, electro-medical and other small space printed circuit equipment applications.

SPECIFICATIONS for SERIES 220

Resistance Range: 250 ohms thru 2.5 megohms, linear taper. Other tapers available.

Wattage & Temperature Rating: 1/8 watt at 55°C derated linearly to no load at 85°C with control mounted on p. c. board.

Voltage Rating:

Shaft to Terminals: 750 VAC for 1 minute high pot test, 500 VDC operating maximum.

Across End Terminals: 350 VDC. Load not to exceed wattage rating.

Angle of Rotation: 300° ± 5°.

Request Data Sheet 184 containing complete technical description.

For your military, industrial and commercial applications, CTS manufactures the world's greatest variety of variable resistors . . . both composition and wire wound. Draw upon the expert knowledge and willing help offered by CTS variable resistor specialists.



CTS CORPORATION
ELKHART, INDIANA

Factories in Elkhart & Berne, Indiana; South Pasadena, California; Asheville, No. Carolina and Streetsville, Ontario, Canada. Sales offices and Representatives conveniently located throughout the world to help solve your variable resistor problems.

Quantum Research and Arms Control

Sharing Spotlight At Sessions



TWO PARTICULARLY TIMELY, and not completely dissociated subjects, will be highlighted by WESCON technical sessions week after next—quantum electronics and arms control.

The former, which by popular usage has come to refer generally to various types of masers, will be the topic of nine papers. Technical program chairman Edward W. Herold, says "Now, with the advent of coherent light generators, or lasers, we are entering a completely new era in quantum electronics."

Prof. J. R. Singer, chairman of the sessions on coherent optical emission points out that efforts to obtain optical maser operation at a great many frequencies are being stimulated by the possibilities for new communications channels, catalyzing of chemical reactions by intense photoexcitation of molecules, and by basic physical investigations.

In addition to catalyzing entirely new reactions and compounds, photoexcitation might be used to change the excitation states of molecules and also to cause ionization of molecules, he feels.

At the University of California

at Berkeley, his group is doing research on lasers, microwave masers, new materials such as paramagnetic impurities in barium sulfate and calcite, and is studying zero-field splitting of these materials. Investigations are being made of mercury vapor and various inert gases for use in optical masers.

Recent advances in Hughes Colidar system will be reported by Eric Woodbury. The most obvious advance is the successful range measurement of seven miles in full sunlight. Accurate power measurements have been made and beam power is now known to be about one Kw for the peak of the laser output spikes. This is a threefold increase over the actual transmitted power previously obtained. Substantially greater power has been obtained in the laboratory, but these have not yet been used in the Colidar system.

Hughes' M. L. Stitch will report on a method for obtaining single sharp pulses from the laser instead of the usual chain of pulses, also resulting in a considerable increase in peak power. It makes use of a multiple pumping arrangement, and will soon be incorporated into the Colidar system.

A method for detecting the error in tuning of the resonant cavity of an ammonia beam maser, developed by the National Bureau of Standards, will also be outlined. To observe the frequency shift with the application of a magnetic field, an oscillatory magnetic field was applied to the double beam maser and a low noise phase demodulator was constructed to detect any phase modulation present in the maser signal. A servo loop was completed to continually-control the tuning of the resonant cavity so that elimination of the most critical parameter of the maser's frequency dependence resulted.

Departing somewhat from the maser theme, one paper in the quantum devices session will report results of an extensive study made of the use of solid state paramagnetic crystals as spin echo storage materials for a microwave digital computer.

The arms control session has been organized and will be led by L. C. Van Atta, recently a special assistant for arms control in the office of the Director of Defense, Research and Engineering. Among authorities to address the session will be W. H. K. Panofsky, professor of physics at Stanford University and deputy director of the two-mile accelerator program on the campus.

Remarks on military aspects will be made by Rear Admiral P. L. Dudley, special assistant to the joint chiefs of staff for disarmament affairs. Politico economic aspects will be covered by Harry Rowen, deputy assistant secretary in the office of the Assistant Secretary of Defense.

Various technical areas will be covered by Donald G. Brennan of MIT's Lincoln Laboratory. Psychological problems will be reviewed by Charles E. Osgood, director of the Institute of Communications Research, University of Illinois.

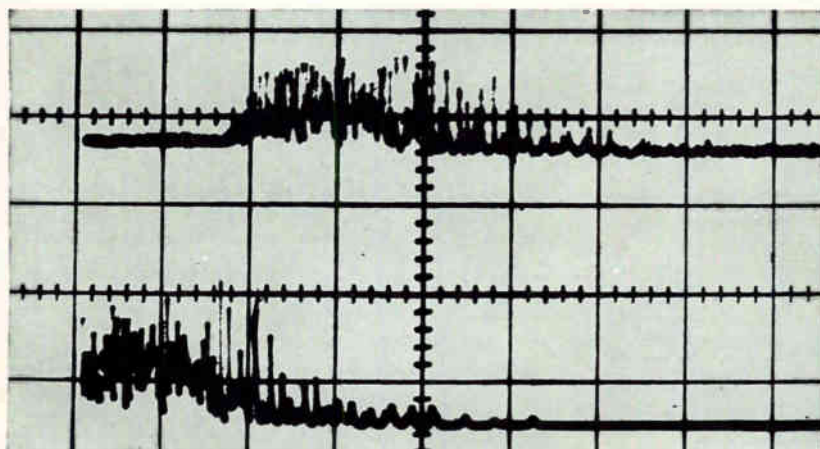

Trace of a 3.7-mile range from a concrete wall in bright daylight. Hughes says lower trace is the transmitted signal; upper trace is the return. Scale is 20 μ sec/division

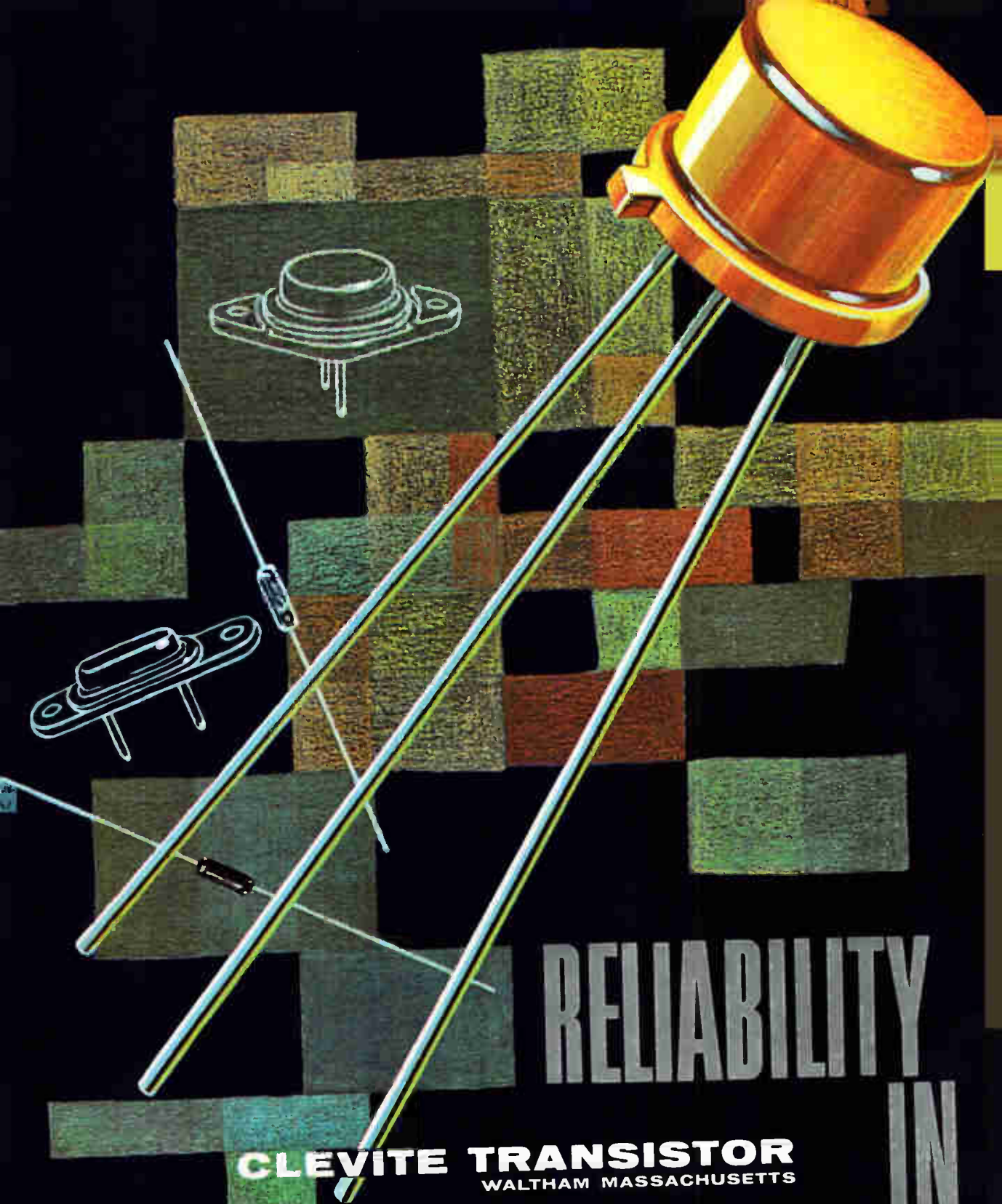

CLEVITE TRANSISTOR
WALTHAM MASSACHUSETTS

RELIABILITY

**IN
VOLUME...**

Factors to consider in silicon diode selection

by DAVID E. HUMEZ

Technical Advisor to the Manager of Operations
Clevite Transistor, Waltham, Mass.

If your circuit does not require the superior forward conductivity characteristics of germanium diodes or you require extremely low reverse currents or must operate at temperatures above 50°C, you will probably select a silicon diode.

Of the bewildering array of silicon diode types available, some will almost certainly suit your circuit better than others. Current silicon diode types fall into four main categories with many sub-categories. The first category historically was the general purpose alloy junction silicon diode. These diodes are principally useful in the applications in which good high voltage characteristics, very low leakage currents, even at high temperatures, are necessary. They are available with comparatively high forward conduction and over a wide range of voltages up to several hundred volts.

The next category is that of computing application silicon diodes. These differ from the general purpose types in that the material from which they are made is doped or otherwise treated in such a way as to reduce its bulk lifetime. Reduction of the lifetime of the material makes possible much faster operation, that is, faster recovery when switched from the forward conduction to the reverse condition. Such diodes have found wide application in military and commercial computing circuits which is expected to operate at high temperatures. A price is paid, however, for higher speed in reducing the lifetime of the material results in an increase of the reverse current and a decrease in the forward conduction.

TYPICAL REVERSE CHARACTERISTICS

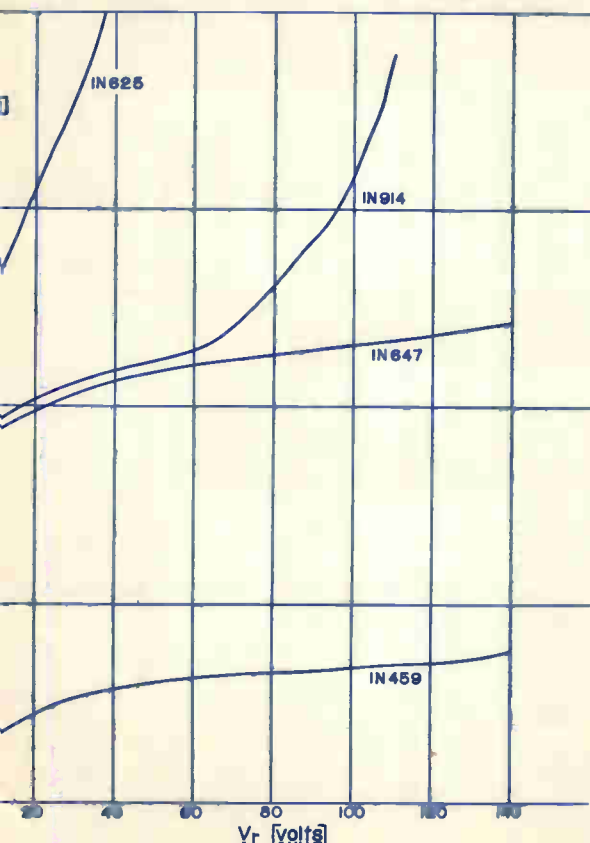

TYPICAL FORWARD CHARACTERISTICS

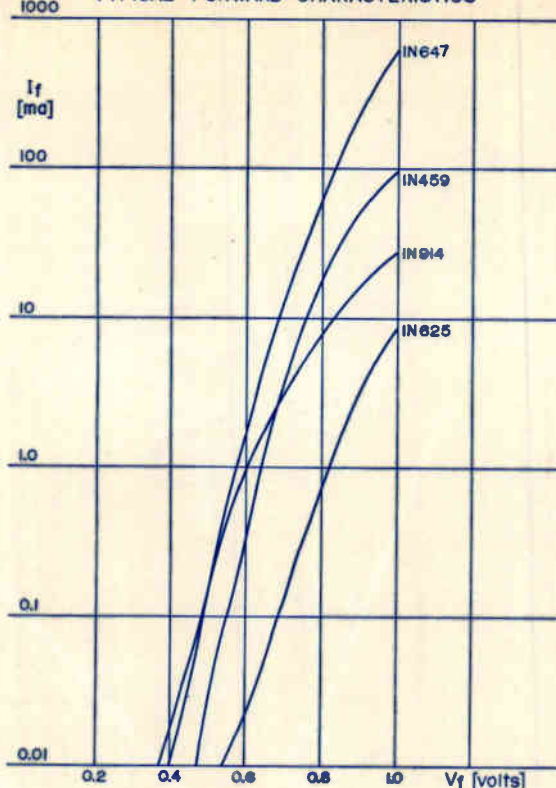

The third and fourth groups are the most recent and employ a different method, namely, solid state diffusion for producing the PN junction. The third group, sometimes called rectifiers, are devices fabricated in either the same subminiature glass package familiar in other diode types or this glass package modified by the inclusion of a larger diameter stud at one electrode for improved heat conduction. They are large area devices compared to the diodes in categories one and two and are designed for conduction of as much as 400 milliamperes at a volt. Since their area is substantially larger, their capacitance is also larger though not as large as would be expected by the ratio of areas, since the method of producing the junction results in less capacitance per unit area than is characteristic of alloyed junctions.

SWITCHING SPEED — REVERSE RECOVERY

Units switched by mercury wetted chopper from 15 ma forward current to 1.2 volts reverse in series with a 100 ohm load resistor. Recovery to 1 ma.

Unit	Time μ sec.	Types
1N914	2.5	silicon mesa diode.
1N625	60.	high speed silicon alloy diode.
1N459	1500.	general purpose silicon diode.
1N647	8000.	silicon diffused rectifier.

The fourth and newest category is that of extremely small area devices made by the newer techniques of the mesa or planar constructions. These types are also manufactured by a diffusion process. They are designed primarily for applications in which the very fastest switching speeds are required. For this additional speed, compared to conventional computing alloyed junction types, a further price must also be paid. Because they are tiny, they are also less rugged. Because their area is smaller, both the resistance of the connecting wires and the spreading resistance are larger. Consequently, these devices as a group are characterized by somewhat poorer forward conduction than is true of the larger area computing diodes.

Ask for Silicon Diode Bulletins
CLEVITE TRANSISTOR
Waltham, Massachusetts



Look for new, time-saving IDEA INDEX in your new 1961 EBG!

NEW! Complete INDEX OF EDITORIAL ARTICLES, broken down by subject matter, that have appeared for a full year in *electronics*, published in EBG for the first time ... available nowhere else.

NEW! ABSTRACTS of all 1961 Feature Articles published to date in *electronics*, appears in EBG only. This makes the Index of articles fully meaningful for users and provides a quick summary of the editorial highlights of an entire year's effort.

4 MORE IDEAS THAT MAKE EBG THE MOST USED CATALOG-DIRECTORY IN THE INDUSTRY!

- **Specific Product Listing!** No matter how many products a company makes, each is listed under its specific heading, more than 3,000 are cross indexed. Listings are ACCU-

RATE, COMPLETE, AUTHENTIC. *Specially Edited Reference Section!* 64 pages of Data — an invaluable source of buying information about military electronic procurement, subcontracting, materials information centers, listing of industry organizations, government services, design data, extensive symbols dictionary. *Registered Trade Name Index!* If a product is known by trade name only, EBG quickly tells who makes it and where to buy it! *Local Sales Office Listing!* The nearest manufacturer's sales office, address, phone number is easily available.

These ideas make EBG the *most used* directory in the industry, make it the *most valuable catalog-directory medium* for electronic advertisers. Makes your advertising in *electronics* pay off 12 months a year, whenever your customers and prospects are ready to buy.

electronics BUYERS' GUIDE and Reference Issue



A McGraw-Hill Publication, 330 West 42nd Street, New York 36, N. Y.

← CIRCLE 50 ON READER SERVICE CARD



The Basic Buying Book in Electronics

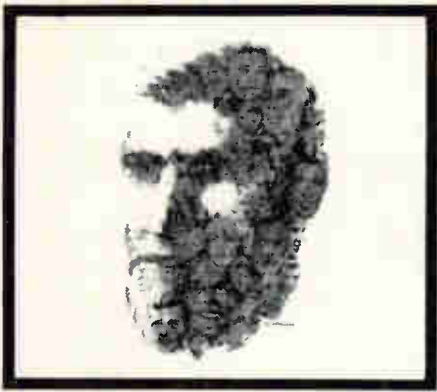

An Interview With Berkner . . .

“From Diversity...New Ideas”

NEW! CRYSTAL CASE ELECTRONIC TIMERS

Feature advanced solid state design with no moving parts.

A new series of microminiature Crystal Case Timers is the latest addition to Tempo's growing line of high precision electronic timing devices. These new all-electronic timers provide fixed or adjustable time delays previously available only in larger or less versatile units. Fixed-time delay periods may be specified from .050 to 60.0 seconds. In adjustable-time units, time delay periods may be set by users to any point within a 20 to 1 range; minimum range is .050 to 1.00 seconds; maximum range is 3.0 to 60.0 seconds.



GUARANTEED ACCURACY

Tempo's new Crystal Case Timers are designed for use wherever high accuracy and reliability, plus reduced weight and volume, are important considerations, including such applications as rockets, missiles and satellites. The accuracy rating is $\pm 10\%$ of nominal time delay, guaranteed under any combination of environmental conditions including:

Temperature	-55°C to +125°C
Vibration	20 g's, 2,000 cps
Shock	100 g's, 11 milliseconds
Acceleration	100 g's, steady state

COMPACT SOLID STATE DESIGN

The hermetically sealed timer packages weigh only 0.8 ounces and measure 1.0 x 0.8 x 0.4 inches. They employ a solid-state multi-stage silicon transistor timing circuit. The reliability and long life necessary for ruggedized timers are achieved through careful component selection plus maximum package density.

TIMING ACTION

Standard models are designed for 28 vdc input, with time delay occurring between application of voltage and "turn-on." The timers provide a solid state switch closure to ground. They may be used to excite and control a variety of loads such as relays, solenoids, digital logic elements and stepping switches.

DESIGN VARIATIONS

Special-order types are available with variations including: time delays longer than 60 seconds, higher accuracy ratings, special supply voltages and reverse switching action.

WRITE FOR COMPLETE
TECHNICAL LITERATURE



TEMPO INSTRUMENT INCORPORATED
Box 338, Hicksville, N. Y. OVerbrook 1-2280



DR. LLOYD V. BERKNER, president of the IRE and featured speaker at WESCON's All-Industry banquet (Fairmont Hotel, San Francisco, August 24), has been traveling the world on scientific missions since 1928. His numerous contributions to science, starting with participation in the first Byrd expedition to Antarctica and extending to his present position as chairman of the Space Science Board of the National Academy of Sciences, were outlined in *ELECTRONICS*, p 274, March 10, 1961. He is often referred to as the intellectual father of the Geophysical Year.

His continuing concern with the larger problems of technology is indicated by this recent statement in a *Saturday Review* article: "As the new technological industry takes over, the technological unemployment will become chronic and endemic in those geographical regions where education fails to provide the brain power to develop new technological opportunities for employment. Regions which fail intellectually will fail economically and become poor and colonial to intellectually advanced regions."

Dr. Berkner currently is president of the Graduate Research Center of the Southwest, in Dallas. The

center is being developed under a 15-year plan to boost engineering and scientific graduate programs in the area to a level equal to or above those in the rest of the country.

At WESCON, he will talk on *Electronics in the Universe*, discussing various aspects of space science, electronics' role in space projects, scientific data reduction and transmission and communications problems.

Q. Last year's extension to international status by the IRE was done to form a closer link between the technologies and scientific groups of the free-world countries. What has been accomplished and what is yet to be done?

A. An ad hoc committee, comprised of four past presidents and one past vice president of the IRE, has been appointed by the president with the authority of the board of directors. These men are making a country-by-country study of England, France, Germany, Switzerland and other free-world nations and are looking at the specific relationships that must be established to advance the professional interest of the countries and IRE jointly. We expect to have their report in the Fall.

Q. You have indicated that extension of U. S. standards activity internationally, such as the recently formed IRE/EIA technical committee is attempting to accomplish, would boost U. S. export of equipment. What are some accomplishments of this program?

A. It's too early to mention any specific accomplishments, since these international mills grind slowly. The main accomplishment to date is that the machinery is set up and we will have our first reports from representatives at meetings this Fall. There will be a va-

riety of standards considered at that time and just what will be decided is not yet known. But I think the goal of having solid U. S. representation in the consideration of international standards in radio and electronics is now an accomplished fact.

Q. You recently made the comment, "If we had two electronic engineers for every one we have now, our economy would be in world-beating shape." This will take some time. Meanwhile is more efficient use of engineers and scientists, and extension of their capabilities by computers feasible?

A. I'm sure that we will always multiply our scientific engineering capabilities by means of computers and other advanced technological tools, but this depends largely upon the field in which they're working. And I have the feeling that most of industry, in the interest of efficiency, is working hard on the highest development of the capabilities of their engineers.

I think, on the other hand, that we are far from the required quota of men who are capable of leadership in the electronics field. Consequently, during the next decade,



great emphasis must be given to the motivation of high school and college students so that they will be encouraged to enter this fruitful and exciting field. My post at the Graduate Research Center of the Southwest, as you might guess, is not unrelated to this matter.

Further, I believe that in the undergraduate colleges and universities, improved teaching methods will be introduced to relieve the burden

Another in a series of thoughtful observations on the topic of Time

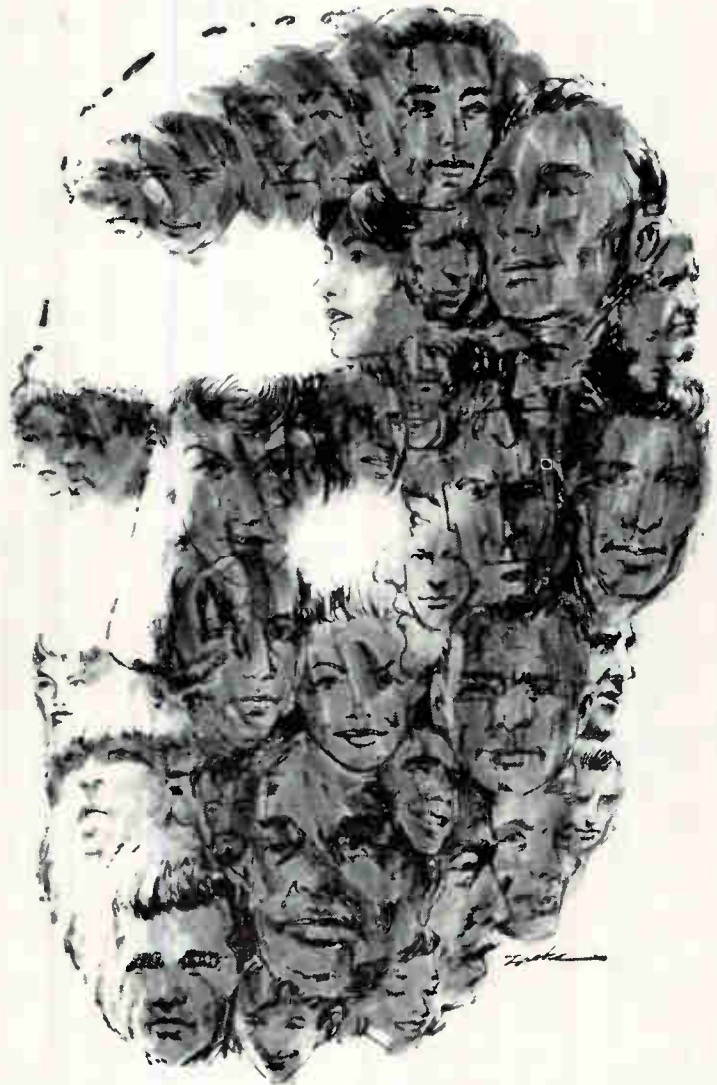

*"Ordinary people
think merely how they
will spend their Time —
a man of intellect
tries to use it."*

ARTHUR SCHOPENHAUER, Philosopher, 1788-1860

TEMPO INSTRUMENT INCORPORATED, HICKSVILLE, L.I., NEW YORK
DESIGN AND MANUFACTURE OF PRECISION ELECTRONIC TIMING DEVICES AND CONTROLS

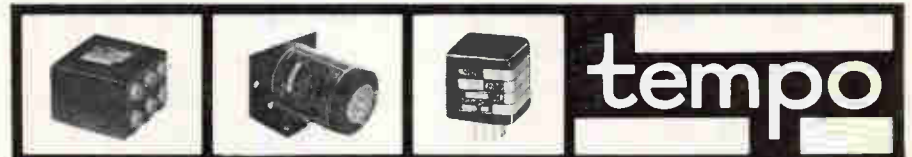



**SOLVE 5
CRITICAL
DESIGN
PROBLEMS
WITH
TURBOTEMP[®]
Teflon FEP/Nylon
WIRE**

Until Turbotemp Teflon* FEP/Nylon wire was developed, no single wire ever solved so many combined heat and electrical problems. This new wire provides these advantages:

1. Overcomes the "short length" problem inherent in extruded Teflon TFE. Get the long continuous lengths (up to 6,000 ft.) that until now were available only in lower temperature wires or in those having less stable electrical properties.
2. Gives complete freedom to circuit designers when optimum performance demands low capacitance. The low dielectric constant of FEP/nylon shows minimum change over a wide range of frequency and temperature.
3. Provides utmost reliability to automatic wire wrap terminations. Of all conventional plastics or combinations tested, FEP/nylon has the best cut through resistance on wire wrap pins.
4. Is suitable for continuous operation up to 120°C, an important consideration if computers are for military use.
5. Meets flammability requirements of both MIL-W-16878 and U.L. Appliance Wire.

* DUPONT REG. T. M.



DIVISION OF

American ENKA Corporation

DEPT. W, 39 SUDBURY ROAD, CONCORD, MASSACHUSETTS
TELEPHONE: EMERSON 9-9630

WRITE FOR COMPLETE DATA!

New MICROWAVE
insulation medium
opens new concepts
for design!

REXOLITE®

family of
dielectrics
continues
to grow...

Breaking old design barriers, REXOLITE is today's "hottest" microwave insulation material for design engineers. A growing family of dielectrics, you should know about these thermosetting cast plastics — you should feel and see samples! Here are the highlights... complete information is yours for the asking!

Rexolite 1422 — Available in rod, and plain or copper clad sheet — can be machined into just about any mechanical shape with precision. Dielectric properties include low dielectric constant, low dissipation factor over a wide frequency range, and of increasing importance, exceptional resistance to radiation! Under loads up to 2000 psi at temperatures to 200°C, REXOLITE shows no permanent deformation.

Rexolite 2200 — Copper Clad, it is ideal for strip lines, directional couplers, duplexers and slot arrays. In addition it offers all the other dielectric strength and radiation resistance of REXOLITE 1422.

Complete, Up-To-The Minute Information and Samples Are Available. Qualified Technical Service is yours, too!



American ENKA Corporation
31 Sudbury Road, Concord, Massachusetts
TELEPHONE: EMERSON 9-9630

Berkner . . .

on our teachers during the coming ten years, and that this will result in a better job of handling the repetitive information in the teaching process, relieving more of the teachers' time for counseling and guidance.

Q. What about the educational race between U.S. and Russia?

A. It's extremely difficult to make comparisons either in quantity or quality at this time. I think we have to look at our own needs in this respect and our own needs indicate that we are very short.

Q. The Graduate Research Center of the Southwest is designed to sparkplug an intellectual and technological renaissance of the area. What was the philosophy behind it?

A. The greatest growth in the electronics industry has been on the New York-Boston-Washington axis and on the San Francisco-Stanford-Los Angeles axis. This growth is directly traceable to the availability of large-scale graduate research facilities. The biggest developments in electronics are occurring where large numbers of graduates and consultants are available to the industry. Because electronics is the nerve fiber of our new industry, skills related to its various segments must be more generally developed throughout the country.

Q. During your recent visit to Los Angeles you stated that magnetohydrodynamics is an example of a new science that promises to touch off a segment of our current technological revolution. Do any other areas come to mind?

A. The outstanding development in MHD, of course, is the high probability of the generation of electric power in the future with much higher efficiencies than we can possibly get by the ancient ideas of rotating machinery.

Another outstanding example that can be mentioned is the development of circuits of infinite complexity based on modern solid-state physics, which give sufficient reliability so that we no longer worry about complexity. A third area to watch is inexpensive long-distance communications.



Q. The Russians have been bragging that Communist and government-controlled methods of advancing scientific and engineering achievement are more effective than democratic or free-enterprise methods. Do you have any comments?

A. In the long run I would seriously question whether the Russians could operate very successfully with a controlled science if it weren't for the presence of a good democratic science. My point is that creativeness is not something that you can direct. The basic characteristic of our American system is diversity—diversity in university research, in experimental research and applied research, in which the direction is rather finely subdivided so that a whole variety of different approaches is made possible. I would suppose it to be almost self evident that out of this diversity would always emerge the most advanced ideas.

Q. How does the growth of WESCON, as a trade show and technical conference, parallel and relate to the growth of the electronics industry as a whole?

A. Electronics is so dynamic that it is becoming the nerve system of most modern industry. Consequently, the growth of electronics is representative of the growth of a whole new industry in the U.S.—industry that goes far beyond electronics but basically employs electronics to make it possible. Therefore, one would anticipate that this growth has not reached a limit, but will certainly continue for some time to come.

General Atomic Provides

PULSED RADIATION FACILITIES

An unusual combination of pulsed radiation facilities is now available on a scheduled basis to industry and military organizations for conducting transient radiation effects testing. These facilities include, at a single location, the TRIGA Mark-I and Mark-F reactors and the high-energy Electron Linear Accelerator.

In addition to the skilled personnel who operate the facilities, scientific and engineering staff members with extensive experience in transient radiation effects testing programs are available to assist in planning and executing specific research programs.

Testing can range from fundamental studies of transient radiation effects to the environmental testing of specific components and systems. The TRIGA reactors developed by General Atomic are designed to yield reproducible, pulses of neutrons and gamma rays up to a peak fast neutron flux of 4.0×10^{16} nv. The powerful 45 Mev L-band Electron Linear Accelerator provides extremely short pulses of high energy electrons, gamma rays or both.

Write now for complete information on these facilities to: Applications Group-FS, General Atomic, P.O. Box 608, San Diego 12, California.

**GENERAL DYNAMICS
GENERAL ATOMIC
DIVISION**

MEETINGS AHEAD

Aug. 13-18: Magneto-hydrodynamics Seminar; Penn State Univ., University Park, Pa.

Aug. 16-18: Electronic Circuit Packaging Symposium; Univ. of Colorado, Boulder, Colorado.

Aug. 22-25: WESCON, L. A. & S. F. Sections of IRE, WEMA; Cow Palace, San Francisco.

Aug. 23-Sept. 2: National Radio & TV Exhibition, 1961 British Radio Show; Earls Court, London.

Aug. 23-25: Gas Dynamics Symposium, ARS; Northwestern Univ., Evanston, Ill.

Aug. 28-Sept. 1: Heat Transfer Conf., International; Univ. of Colorado, Boulder, Colorado.

Aug. 30-Sept. 1: Semiconductor Conf., AIME; Ambassador Hotel, Los Angeles.

Sept. 4-9: Analog Computation, International Conf., International Association for Analog Comp., and Yugoslav Nat. Comm. for ETAN; Belgrade, Yugoslavia.

Sept. 6-8: Computing Machinery, National Conf., ACM; Statler-Hilton Hotel, Los Angeles.

Sept. 6-8: Nuclear Instrumentation Symposium, PGNA of IRE, AIEE, ISA; N. C. State College, Raleigh, N. C.

Sept. 6-8: Space Elec. & Telemetry, PGSET of IRE; Univ. of New Mexico, Albuquerque, N. M.

Sept. 6-13: Electrical Engineering Education, International Conf., ASEE, AIEE, PGE, of IRE; Sagamore Conf. Center, Syracuse Univ., Adirondack, N. Y.

Sept. 8-10: High-Fidelity and Home Entertainment Show; Crystal Ballroom, Palmer House, Chicago.

Sept. 11-15: Instrument-Automation Conf. and Exhibit, ISA; Sports Arena, Los Angeles.

Oct. 9-11: National Electronics Conf., IRE, AIEE, EIA, SMPTE; Int. Amphitheatre, Chicago.

Nov. 14-16: Northeast Research & Engineering Meeting, NEREM; Commonwealth Armory and Somerset Hotel, Boston.

*first
choice of
all 4*

research

design

production

management

Because the BUYERS' GUIDE satisfies the buying and specifying needs of all four segments of the industry! Gives more information in less space. Easier to use. Only the BUYERS' GUIDE has been screened for usefulness over a 20 year period... comes to you compact, complete and accurate.

gives more to all 4!

**electronics
BUYERS' GUIDE
and REFERENCE ISSUE**

If it interests this special engineering mind...

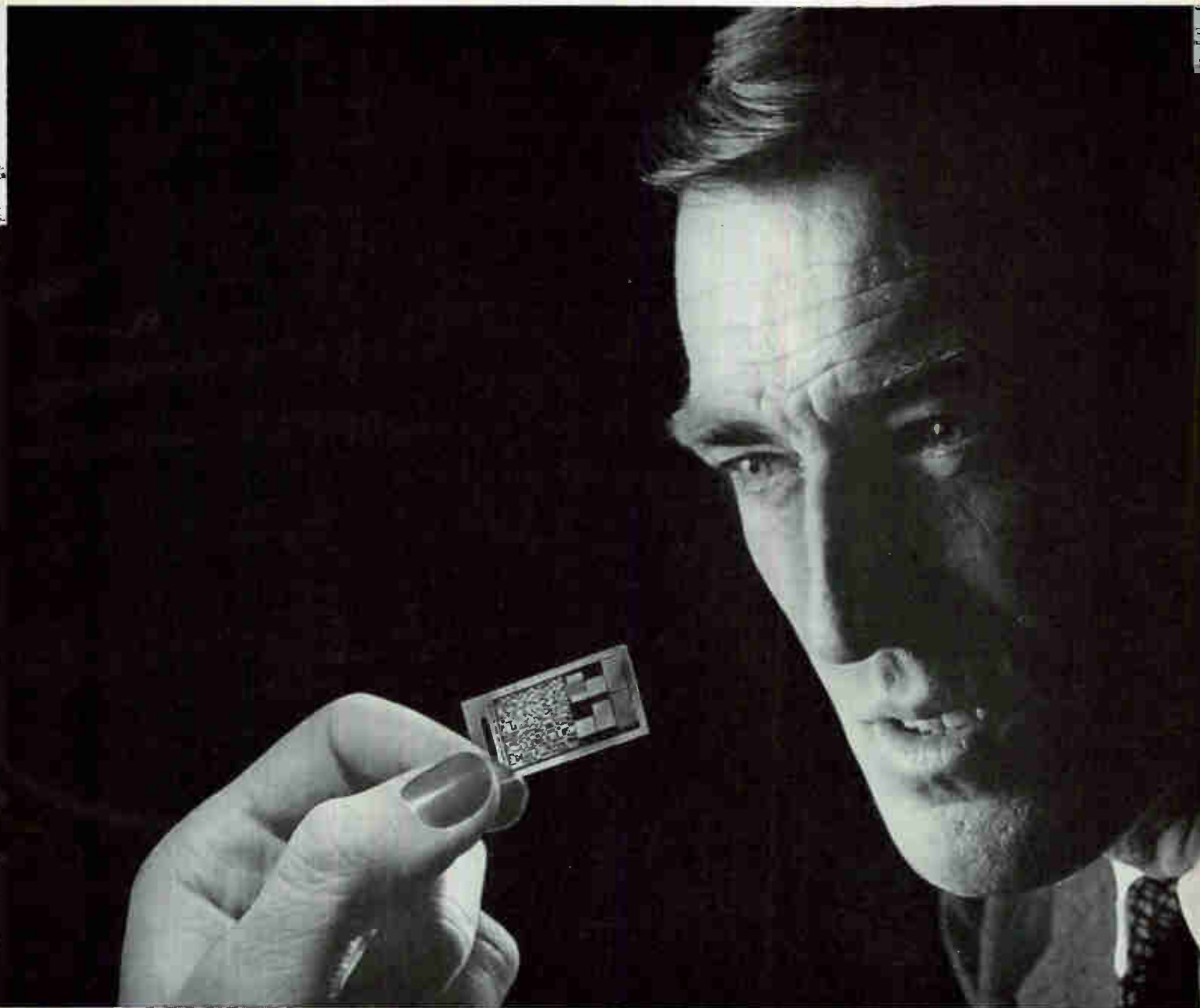

Eastman-Kodak Minicard record with 6 legal-length documents, coded index data

it's in electronics:

To sell the electronics engineer, you must contact a fast-moving, highly curious and constantly probing mind. In a single day, an electronics man may face problems in research, design, production or management; he may work in any one or all four areas. You must reach a mind which never gets its fill of information. Only **electronics** magazine has an editorial staff that constantly scours the nation and the globe to report and interpret authoritative information in all four areas. That's why **electronics'** readers are uniquely loyal. That's why this OEM engineering audience forms the major advertising and sales target for the nation's leading electronics manufacturers. Take a look at a recent issue and see!

1.13



A MCGRAW-HILL PUBLICATION, 330 West 42nd Street, New York 36, N.Y.

CIRCLE 58 ON READER SERVICE CARD →



BOEING *selects*

FOR

**MINUTEMAN
SYSTEM
COMPONENTS**

Power Transformers

Reactors

Magnetic Amplifiers

will be made by

HST Division

under a **Reliability**

Production Contract.

Dresser Electronics



HST DIVISION

Choose Dresser Electronics and be assured of . . .

- *Engineering* skill to help solve your problem.
- *Production Facilities* adequate to meet the most exacting schedule—and on time!
- *Environmental Testing* that assures *Reliability* to specification—in one of the nation's most complete laboratories.
- *Availability* of standard components through distributors everywhere.
- *Field Service* from engineers experienced in the application of electronic components and subsystems.

Iron core components and subsystem assemblies built for use under severe and varied environments are the specialty of Dresser Electronics. We welcome the opportunity to tackle your most difficult problem.

Dresser Electronics



HST DIVISION

555 North Fifth Street • Garland, Texas • Dallas Phone BRoadway 6-5141

DRESSER ELECTRONICS IS A SUBSIDIARY OF
DRESSER INDUSTRIES, INC.

DALLAS, TEXAS



Dresser Industries is a team of 14 progressive companies supplying equipment and technical services throughout the world to the electronic, defense, chemical, gas, oil and general industries.

24-HOUR DELIVERY OF HST STANDARD STOCK COMPONENTS AVAILABLE NATIONALLY THROUGH ARCO ELECTRONICS

TYPICAL MAGNETIC COMPONENTS AND SUBSYSTEMS BY DRESSER ELECTRONICS:



HERMETICALLY SEALED TRANSFORMERS
Mil-T-27A Specifications



MINIATURIZED TRANSISTOR TRANSFORMERS
55 Standard Models



WAVE FILTERS
Band Pass, High Pass, Low Pass



SPACE SAVER AUDIO TRANSFORMERS
High Fidelity Frequency Response



SPECIAL POWER TRANSFORMERS
Up To 150,000 Volts Test



COMMERCIAL GRADE TRANSFORMERS
Stocked Nationally by Leading Distributors



VOLTAGE REGULATORS
Single- or Three-Phase



DELAY LINES
Custom Designed



CONVERTERS
Airborne Applications



POWER SUPPLIES
Solid State Throughout

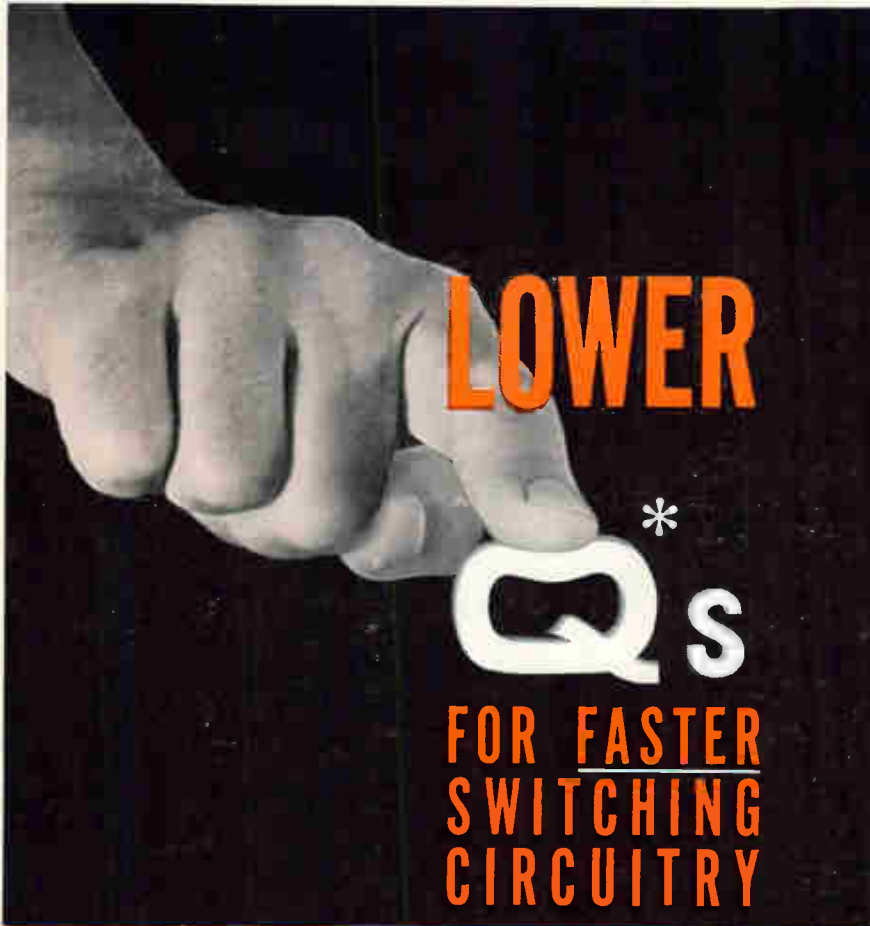

LOWER

Q_s

FOR FASTER SWITCHING CIRCUITRY

TOTAL BASE CONTROL CHARGE @ 25°C

- 2N706 Silicon Non-Epitaxial
- Motorola Silicon Epitaxial 2N834 and 2N706 (All Motorola Silicon Mesa Transistors are Epitaxial)

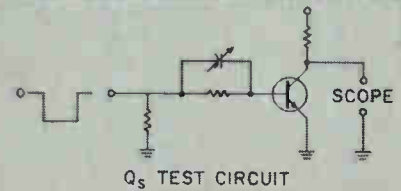
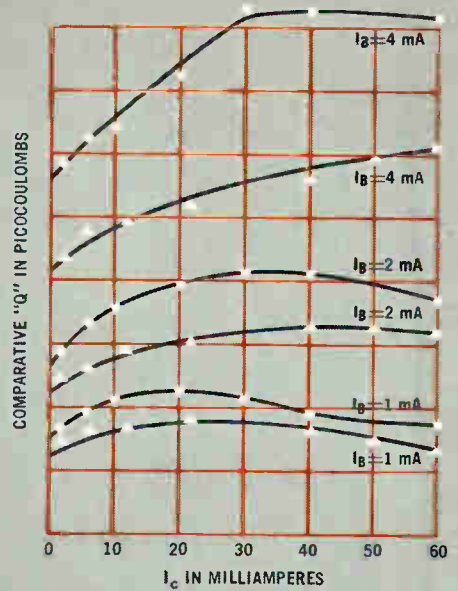

WITH MOTOROLA SILICON EPITAXIAL MESA TRANSISTORS

* Total Base Control Charge = base stored charge, collector stored charge and linear control charge

The smaller the speed-up capacitor . . . the faster usable clock rate!

Since the Motorola 2N834 has a lower Total Base Control Charge (Q_s) than previous switching transistors, smaller capacitors are required for a momentary overdrive. The result: a faster overall switching circuit.

Key to this low Q_s factor is Motorola's highly-refined epitaxial technique . . . now employed in the fabrication of all Motorola Silicon Mesa transistors. The Motorola epitaxial process results in a lower Total Base Control Charge for all devices . . . permitting improved switching circuitry even with older EIA devices such as the now-epitaxial Motorola 2N706.

The low Q_s factor is only one of many improved switching characteristics offered by all Motorola Mesa transistors . . . including higher f_T , lower $V_{CE(sat)}$, and higher breakdown voltages.

So, if you are working with switching/computer circuits, investigate the performance and price advantages of Motorola's Silicon Epitaxial, Germanium Epitaxial and Germanium Mesas.

FOR MORE COMPLETE INFORMATION on Total Base Control Charge for Motorola silicon epitaxial Mesa transistors write Motorola Semiconductor Products Inc., Technical Information Center, 5005 East McDowell, Phoenix 8, Arizona. For information on individual devices, request by "type number".

MOTOROLA MESA SWITCHING TRANSISTORS

EPITAXIAL SILICON SWITCHES	V_{ce} max volts	h_{FE} @ I_c		$V_{CE(sat)}$ typical volts	f_T typical mc
		typical	mA		
2N706*	25	40	10	.3	300
2N706	25	40	10	.18	450
2N706B	25	40	10	.18	450
2N753	25	75	10	.18	450
2N835	25	35	10	.18	450
2N834	40	40	10	.15	500

*Non-epitaxial unit shown for comparison

MOTOROLA DISTRICT OFFICES:

BELMONT, MASS., IVanhoe 4-5070/BURLINGAME, CAL., Diamond 2-3228
 CHICAGO, ILL., Avenue 2-4300/CLIFTON, N. J., GREGORY 2-5300
 DALLAS, TEX., Lakeside 6-8931/OAYTON, OHIO, Axminster 3-4164
 DETROIT, MICH., Broadway 3-7171/GLENSIDE, PA., Turner 7-7020
 HOLLYWOOD, CAL., Hollywood 2-0821/MINNEAPOLIS, MINN., Liberty 5-2198
 NEW YORK, N. Y., Wisconsin 7-2980/PHILADELPHIA, PA., Waverly 7-6144
 PHOENIX, ARIZ., 273-6364/SILVER SPRINGS, MD., Juniper 5-4485
 SYRACUSE, N. Y., Granite 4-3321/WINTER PARK, FLA., Midway 7-2507
 TORONTO, ONT., Plymouth 9-2222

VISIT WESCON BOOTH #914-916



MOTOROLA
Semiconductor Products Inc.

A SUBSIDIARY OF MOTOROLA, INC.

5005 EAST McDOWELL ROAD • PHOENIX 8, ARIZONA

LOOK TO MOTOROLA FOR ALL YOUR SEMICONDUCTOR REQUIREMENTS
 POWER TRANSISTORS • MESA SWITCHING & AMPLIFIER TRANSISTORS • MILLIWATT TRANSISTORS • SILICON RECTIFIERS • ZENER DIODES

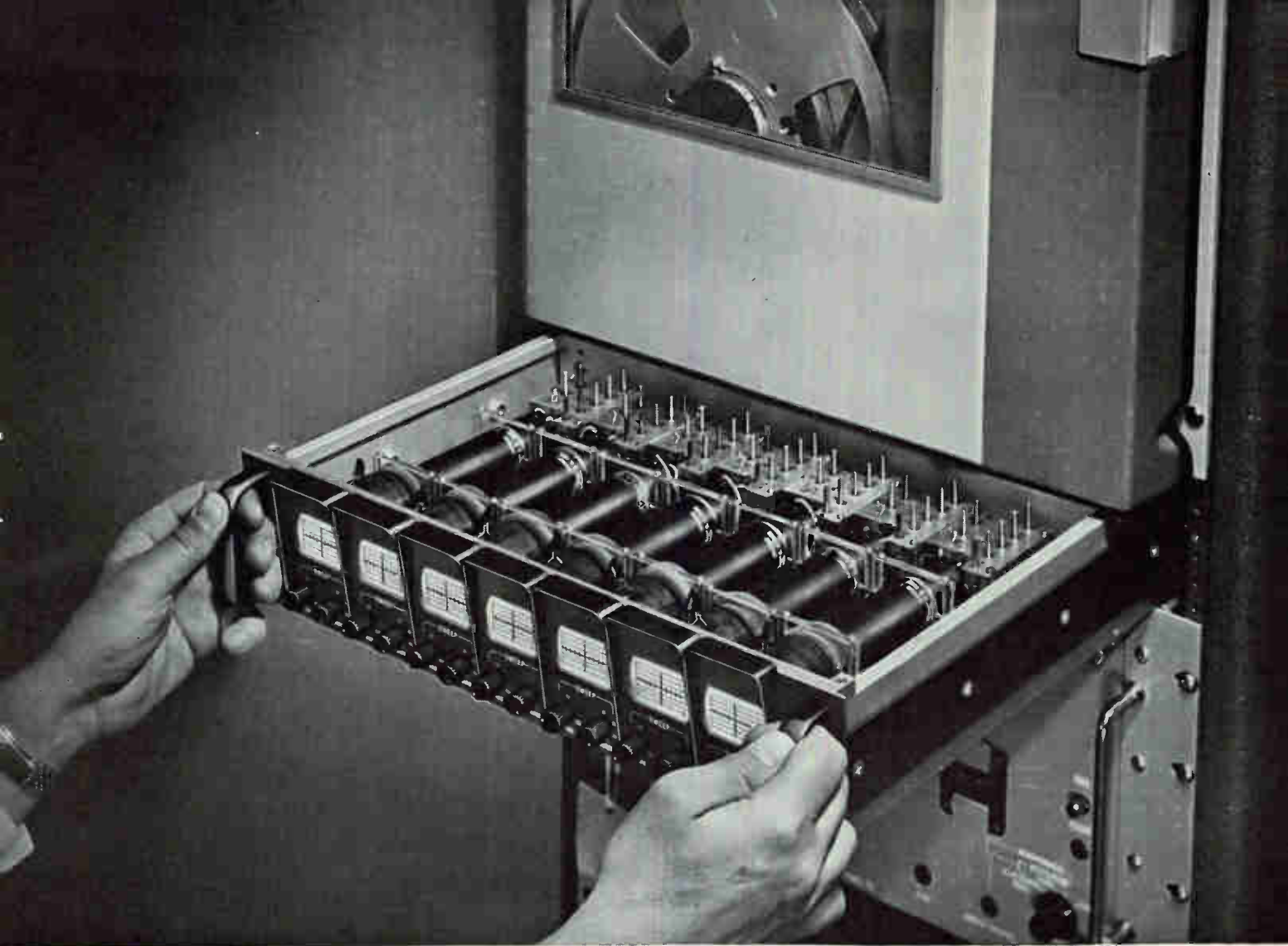

Seven 2" Scopes in 3½" of Rack Space!

New EI solid state scopes combine small size with exceptionally high performance to provide the ideal instrumentation scopes for displaying multi-channel electrical phenomena.

High performance—Each Model 260M incorporates its own independent sweep and vertical circuits. The vertical amplifier provides a bandwidth of from DC to 1 megacycle with horizontal sweep rates of from 10 cps to 100 kc. Use of a 2", flat-faced CRT provides a bright, precision display.

Compact size—Each individual scope requires no more front panel area than a needle movement meter and only 16" behind the panel. The compactness saves at least 45 inches of panel space when compared with the same number of conventional instruments.

Solid state reliability—Totally transistorized circuits eliminate the ever present problem of heat flow to adjacent equipment, and the operational aging so often associated with vacuum tube amplifiers.

Simple, rugged construction—All components are mounted on plug-in printed circuit boards. The controls required most frequently—sweep range and sweep vernier—are positioned on the front panel for operational adjustment, while all others are easily accessible at the top rear of the scope chassis. Individual scopes plug into a separate power supply rack capable of accommodating seven units.

Maximum versatility—The plug-in nature of each individual scope makes it possible to obtain only the number of units required for the specific task, with adequate provisions for future additions as the need arises. For applications involving the use of the Model 260 with multi-channel tape recorders, an additional record-reproduce switch is incorporated on the front panel. Use of this switch allows the connection of the scope to two separate inputs. Versatility is further extended by the use of DC coupling, a feature normally found only in laboratory instruments.

*Ask your EI field engineer
for complete specifications*



Engineers: Challenging opportunities now available. Contact Mr. Harvey Fleming.

Electro Instruments, Inc. / B611 BALBOA AVENUE,
SAN DIEGO 11, CALIFORNIA

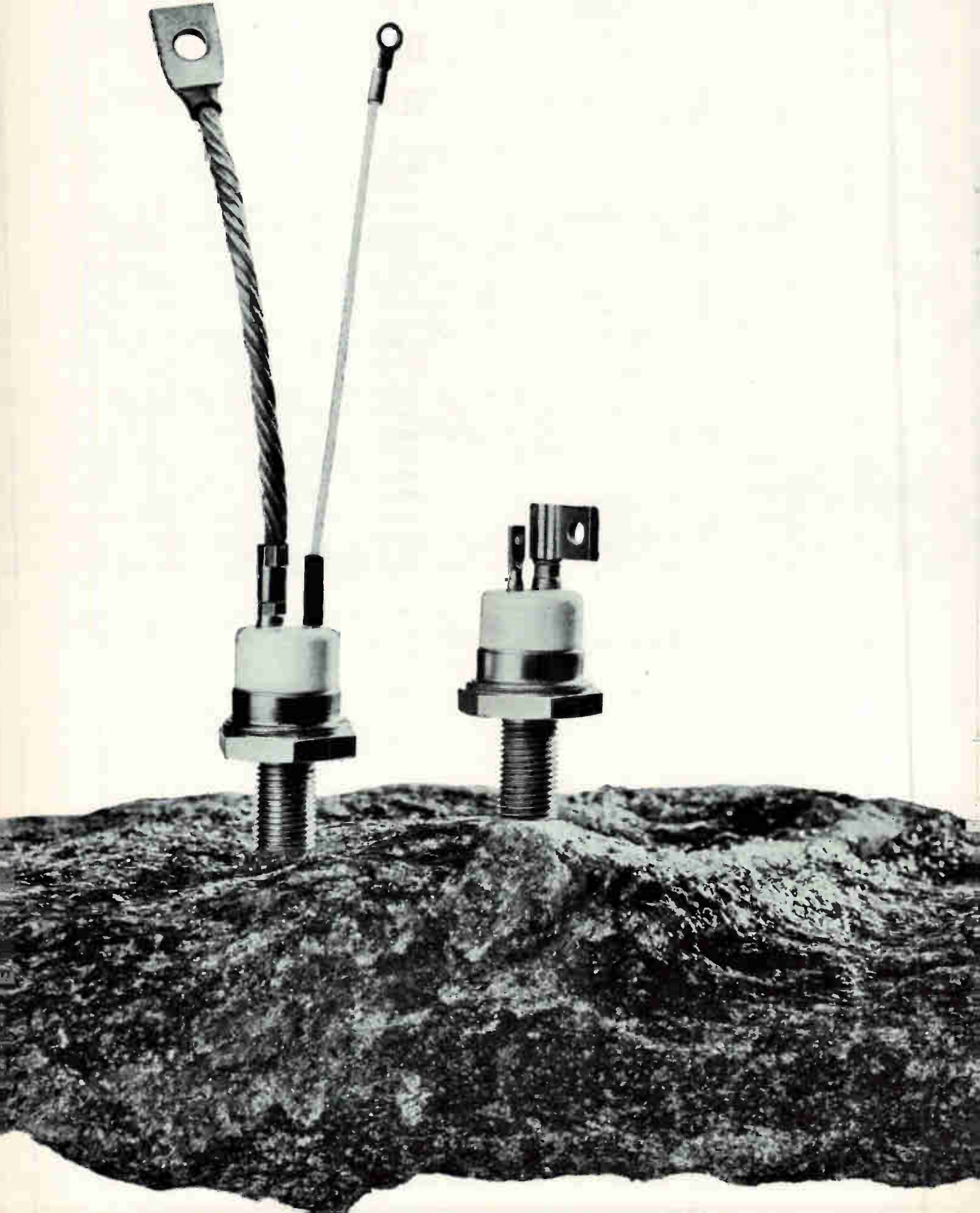

Westinghouse announces new 70-amp ratings in "Rock-Top" Trinistor[®] controlled rectifiers

Highest rated flag type in the industry. Type 809 Trinistor controlled rectifier series, in both flag terminal and flexible lead types, now immediately available in production quantities at 70-amp ratings! Exclusive Westinghouse "Rock-Top" construction offers superior electrical and mechanical characteristics for greater performance reliability under all operating conditions. Provides positive protection against arcing at highest voltages. Exclusive new flag terminal design has lower weight . . . requires less headroom. Outstanding parameters include: ■ 600 nano-second switching time ■ efficiencies in excess of 98% ■ minimum noise level ■ peak reverse voltages to 480 volts ■ ideal parameters for high-speed static switch functions.

Industrial, commercial, and military applications include: high-frequency power generation; variable frequency controls; pulse generation; ignitron firing; welding control. Trinistors also replace thyatrons, contactors, magnetic amplifiers, relays.

For more information, or technical assistance, contact your nearest Westinghouse representative, or write: Westinghouse Electric Corporation, Semiconductor Department, Youngwood, Penna. *You can be sure... if it's Westinghouse.* SC-1046

For Immediate "Off-The-Shelf" Delivery, Order From These Westinghouse Distributors:

EASTERN ACK SEMICONDUCTOR, INC. Birmingham 5, Ala./FA 2-0588 Pittsburgh, Pa./EX 1-4000 CAMERADIO CRAMER ELECTRONICS, INC. Boston, Mass./CO 7-4700 ELECTRONIC WHOLESALERS, INC. Melbourne, Florida/PA 3-1441 GENERAL RADIO SUPPLY CO., INC. Camden, N. J./WO 4-8560 GENESEE RADIO PARTS CO. Buffalo, N. Y./TR 3-9661 KANN-ELLERT ELECTRONICS, INC. Baltimore, Md./TU 9-4242 MILGRAY ELECTRONICS New York, N. Y./RE 2-4400 RADIO & ELECTRONIC PARTS CORP. Cleveland, Ohio/UT 1-6060 SCHWEBER ELECTRONICS Long Island, N. Y./PI 6-6520 Silver Spring, Md./JU 5-7023	HALLMARK INSTRUMENTS CORP. Dallas, Texas/RI 7-8933 INTER-STATE RADIO & SUPPLY CO. Denver 4, Colo./TA 5-8257 LENERT CO. Houston, Texas/CA 4-2663 MIDLAND SPECIALTY CO. El Paso, Texas/KE 3-9555 Phoenix, Ariz./AL 8-8254 Albuquerque, N. M./CH 7-0236 RADIO DISTRIB. CO. Indianapolis, Ind./ME 7-5711 SEMICONDUCTOR SPEC., INC. Chicago, Ill./NA 2-8860 S. STERLING CO. Detroit, Mich./BR 3-2900 UNITED RADIO, INC. Cincinnati, Ohio/MA 1-6530
MIDWESTERN E.C.I. SEMICONDUCTORS, INC. Kansas City, Mo./WE 1-0829 ELECTRONIC COMPONENTS FOR INDUSTRY CO. St. Louis, Mo./WO 2-9916	WESTERN ALMAC ELECTRONICS CORP. Seattle, Wash./PA 3-7310 Oakland, Cal./TE 4-3311 ELMAR ELECTRONICS HAMILTON ELECTRO SLS. Los Angeles, Cal./BR 2-9154 Palo Alto, Cal./DA 1-7541 NEWARK ELECTRONICS, CO. Inglewood, Cal./OR 4-8440

Westinghouse



SIMPLE



NEW MINCOM SERIES G-100 RECORDER/REPRODUCER

Building-block construction; card system record/reproduce modules; just twelve moving parts with four easy adjustments; complete plug-in modular design—everything about this new and outstanding **Mincom**

Series G-100 emphasizes its reliable simplicity. Here's an all-purpose

magnetic tape system for better performance with improved dynamic range. It's planned for easier operation and maintenance with automatic bias and power supply protection; built-in calibration, plus built-in monitor switching; dynamic braking; all-transistorized electronics; fourteen tracks (analog or FM) in one rack. Covering the bandwidths listed at right, G-100 fills the gap between Mincom's Series CA-100 (125 kc-60 ips) and the Series CM-100 (1.2 mc-120 ips). To discover more of this new system's extra capabilities, write today for complete specifications. See us at **WESCON, Booth 1806.**

Series G-100 Frequency Response

Direct: 200 cps to 300 kc at 60 ips
FM (extended): DC to 20 kc at 60 ips
FM (standard): DC to 10 kc at 60 ips



... WHERE RESEARCH IS THE KEY TO TOMORROW

MINCOM DIVISION **MINNESOTA MINING AND MANUFACTURING COMPANY**

2049 SO. BARRINGTON AVE., LOS ANGELES 25, CALIFORNIA • 529 PENN BLDG., 425 13th STREET N.W., WASHINGTON 4, D. C.

a New and superior latching P&B relay



LIES FLAT FOR GREATER PACKAGE DENSITY, HIGHER PERFORMANCE

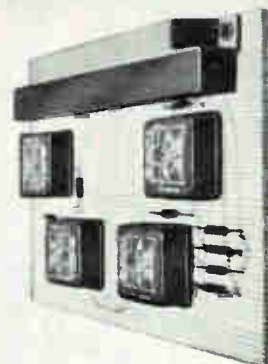

This DPDT, permanent magnet, latching relay is superior on these counts: (1) shorter height for maximum compactness between stacked circuit boards; (2) greater sensitivity (80 milliwatts); (3) better vibration resistance (30 g to 2000 cps); (4) better shock resistance (100 g).

Designated the FL Series, this relay meets all applicable sections of MIL-R-5757D, MIL-R-6106C and ABMA #PD-R-187.

Call your nearest P&B representative today for complete information about the whole P&B family of microminiature relays.

FL SERIES SPECIFICATIONS

Contact Arrangement: DPDT

Shock: 100 g for 11 milliseconds with no contact openings.

Vibration: .195; max. excursions, 10 to 55 cps. 30 g from 55 to 2000 cps. No contact openings.

Linear Acceleration: 400 g minimum with no contact openings.

Pull-In: 150 milliwatts, approx. (standard) at 25°C. coil temperature.

80 milliwatts, approx. (sensitive) at 25°C. coil temperature.

Operate Time: 3 milliseconds max. at nominal voltage at 25°C. coil temperature.

Dimensions: .485" high, 1.100" long, .925" wide

Printed circuit board using 4 FL relays was designed by the Martin Company, Orlando, as part of ground support equipment for a major missile project.

THERE'S A **P&B**
CRYSTAL CASE RELAY
FOR YOUR PROJECT

Diode in relay case is used for arc suppression in special applications. Four diodes form full-wave bridge rectifier for 400 cycles.

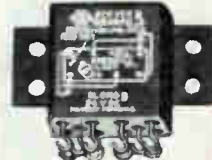

Non-latching or latching relays in conventional crystal cases with or without shoulder brackets, studs or mounting plates. All types of terminals are available.

Terminals spaced on .200" grids are available on all P&B microminiature relays. These carry a "G" suffix (SCG and SLG) and are .890" high, .800" wide, .400" deep, max.

These 3 relays are shown slightly reduced in size.

P&B STANDARD RELAYS ARE AVAILABLE AT YOUR LOCAL ELECTRONICS PARTS DISTRIBUTOR



POTTER & BRUMFIELD

DIVISION OF AMERICAN MACHINE & FOUNDRY COMPANY • PRINCETON, INDIANA
IN CANADA: POTTER & BRUMFIELD, DIVISION OF AMF CANADA LIMITED, GUELPH, ONTARIO

McCoy

CRYSTALS & CRYSTAL FILTERS

Regardless of its size,
type, or frequency
any crystal
bearing the name
McCoy
can be relied upon to
deliver the ultimate
in frequency control
despite wide temperature
variations and
extreme conditions
of shock
and vibration.



M-1 (HC-6/U)

The crystals that made the name of McCoy a synonym for quality. Metal encased, HC-6/U size is available in frequencies from 500.0 kc to 200.00 mc.

METAL ENCASED STANDARD SIZE AND MINIATURE CRYSTAL UNITS

shown actual size



M-20 (HC-18/U)

M-21 (HC-18/U w/pins)

Fills the need for miniature crystals in frequencies from 2.5 mc to 200.0 mc. Meets specs MIL-C-3098B and ARINC No. 401.



G-1 (Military HC-27/U)

This vacuum sealed, hard glass crystal unit possesses all of the quality features for which the McCoy M-1 is so famous. It has long term frequency stability five times better than the conventional metal types. Available in frequencies from 500 kc to 200 mc.

ALL GLASS STANDARD SIZE AND MINIATURE CRYSTAL UNITS

shown actual size



G-20 (Military HC-26/U)

G-21 (Military HC-29/U)

This vacuum sealed, hard glass crystal unit meets the new CR-73/U and CR-74/U specifications. It has long term frequency stability five times better than the conventional metal type. Available in frequencies from 5000 kc to 200 mc.

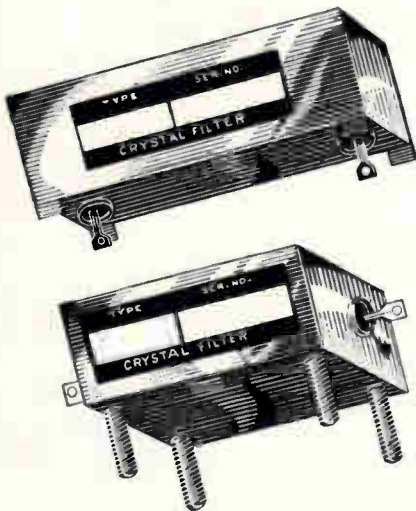

CRYSTAL FILTERS

Our many years experience in designing and producing top quality oscillator crystals have enabled us to develop and produce filters of equal desirability. Current production includes filters in the 1.0 mc to 30 mc range, with bandwidths of .01% to 4.0% of center frequency. A number are available without costly design and prototype charges.

Actual Size for Series 3 Types

SELECTIVITY CURVES

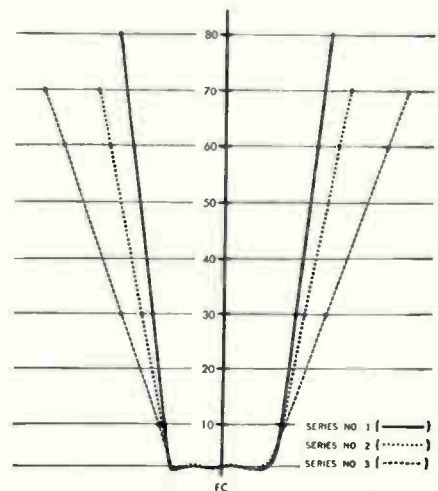

See the **New!** MICRO MODULE CRYSTALS (GLASS)



AT THE WESCON SHOW
COW PALACE • SAN FRANCISCO, CAL.
AUGUST 22 thru 25 BOOTH NO. 1402

.28" square x .110" thick
frequency range: 7000 kc to 200 mc
Now available in limited quantities

Write today for our free illustrated catalogs which include complete listing of military specifications. For specific needs, write, wire or phone us. Our research section is anxious to assist you.

McCoy

ELECTRONICS CO.
Dept. E-8
MT. HOLLY SPRINGS, PA.
Phone: HUnter 6-3411

ELECTRON TUBE NEWS from SYLVANIA

Strap Frame Grid Performance & Gold Brand Reliability

Now in 5 New Sylvania
Subminiature Tubes!

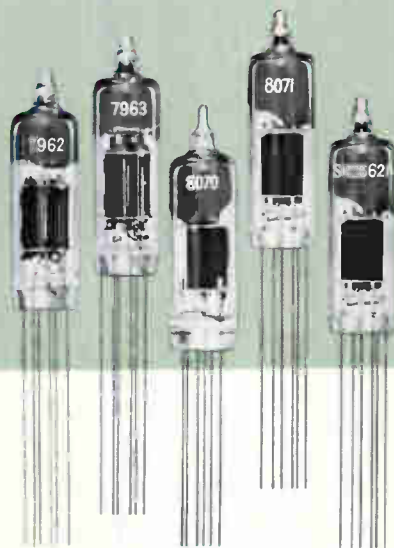

If you've been seeking tubes with an optimum combination of high performance, resistance to environmental stresses, genuine interchangeability, small size/weight, assured reliability... let Sylvania shorten your search.

Few devices can fill those requirements so impressively as these five new Gold Brand Subminiature Tubes featuring Strap Frame Grids... Sylvania-7962, 7963, 8070, 8071, SR-262A. Here's why—

HIGH PERFORMANCE—Sylvania Strap Frame Grid design significantly improves tube characteristics for Gm, Gm:Ib, gain, bandwidth, and noise. (Fig. 1)

ELECTRICAL STABILITY—rugged Strap Frame Grids retain precise physical dimensions and, therefore, electrical stability, over an exceedingly long, useful life. Specially designed heaters tolerate wide voltage variations of $\pm 10\%$ of specified ratings. Too, Gold Brand Subminiature types exhibit an inherent resiliency to plate and screen voltage surges.

DURABILITY

Shock—Sylvania Gold Brand Subminiature Tubes are designed to withstand impact acceleration tests of 500g and fatigue tests of 2.5g for periods of 96 hours.

Radiation—they demonstrate remarkable resistance to radiation effects, tolerate dose rates of 10^{12} nv, total dosage of 10^{16} nvt.

Temperature—not susceptible to thermal runaway, they perform at ambient bulb temperatures of as high

as 220°C, withstand prolonged storage temperatures.

INTERCHANGEABILITY — exceptionally low dispersion of characteristics (electrical uniformity) from tube to tube within a given type offers genuine interchangeability without costly preselection and testing.

RELIABILITY — several authoritative, documented examples of reliability under field and laboratory conditions are cited on the following page.

NEW DESIGN SYLVANIA SUBMINIATURE TUBES FEATURE STRAP FRAME GRIDS

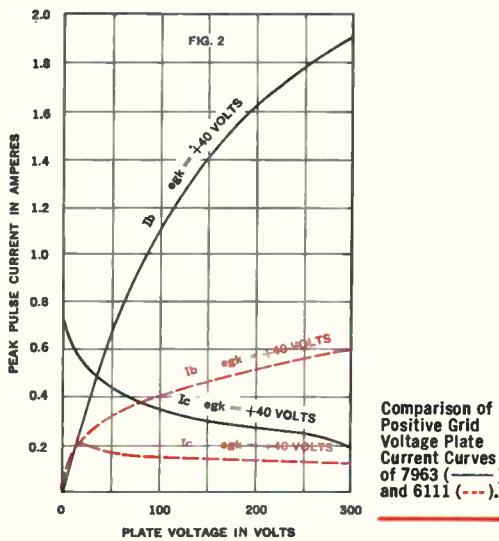
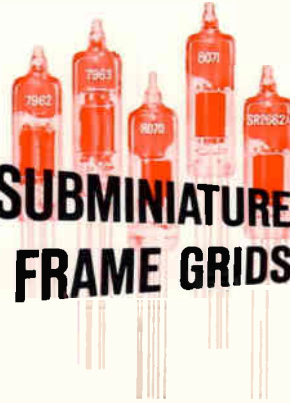

Sylvania-7963, medium-mu double triode . . .

For use as an RF or pre-IF amplifier in missiles, radar, radiosonde and beacon receivers, telemetering equipment or as a blocking tube oscillator. It's a high-performance version of the general-purpose 6021 with higher heater power and huskier cathode. Per section: Gm is 13,000 μ mhos, Gm:Ib is 1,730.

Sylvania-7962, medium-mu double triode . . .

Featuring very low heater power of 0.7W per section, low Eb of 30V per section. It's designed for application as an RF or pre-IF amplifier or multivibrator in conjunction with low B+ supplies. Per section: Gm is 9,500 μ mhos (80% higher than conventional prototypes), Gm:Ib is 1,055.

Sylvania-8070, high-mu triode . . .

Draws only 125mA @ 6.3V heater power. It's used as an RF amplifier in communication equipment, pre-IF amplifier in navigational radar and beacon receivers, telemetering receivers. Gm is 11,000 μ mhos, Gm:Ib is 1,222. 8070 provides 2.5 db better gain than usually encountered in present high-performance types.

Sylvania-8071, high-mu VHF triode . . .

Is the industry's first subminiature tube for grounded grid amplifier applications. It offers very low heater power of 125mA @ 6.3V, as much as 50% less than types with comparable Gm and Ib. Gm is 13,000 μ mhos. 8071 exhibits a 2.5 to 7 db gain improvement, 1.5 to 4 db noise improvement at 480mc than normally encountered with popular grounded-grid RF amplifier types.

Sylvania SR-2662A, medium-mu VHF double triode . . .

Features 26.5V heater and plate operation. Designed for use as a cathode-follower or RF amplifier-mixer in hybrid systems. In airborne or mobile equipment using a 26.5V energy source, SR-2662A eliminates the need for special plate and heater supply circuits, enhancing equipment compactness and reliability. Per section, Gm is 9,000 μ mhos.

Examine the extraordinary performance advantages of Sylvania Strap Frame Grid Subminiature Tubes for your design. Ask your Sylvania Sales Engineer for full information, or write for technical data to Electronic Tubes Division, Sylvania Electric Products Inc., 1100 Main St., Buffalo 9, N. Y.

FIG. 1 AVERAGE CHARACTERISTICS

	7962 double triode	7963 double triode	8070 triode	8071 triode	SR-2662A double triode	Units
Ef	6.3	6.3	6.3	6.3	26.5	V
If	235	350	125	125	90	mA
Eb	60	100	110	150	55	V
Rk	220*	270*	—	100	—	Ohms
Ib	9.0*	7.5*	9.0	13.0	5.0*	mA
Gm	9,500*	13,000*	11,000	13,000	9,000*	μ mhos
Gm:Ib	1,055*	1,730*	1,222	1,000	1,800*	μ mhos:mA
Mu	20*	40*	58	55.2	20*	

Noise-matched Conditions

	Grounded Cathode Circuit (200mc)			Grounded Grid (480mc)	RF Cascode Amp. (213mc)	
Gain	14.8*	15.1*	17.5	14.0	21*	db
BW	8.0*	9.5*	11.8	9.5	8.5*	mc
NF	4.0*	4.0*	4.4	7.2	6.4*	db

*SINGLE SECTION VALUES

How to predict reliability of end-equipment!

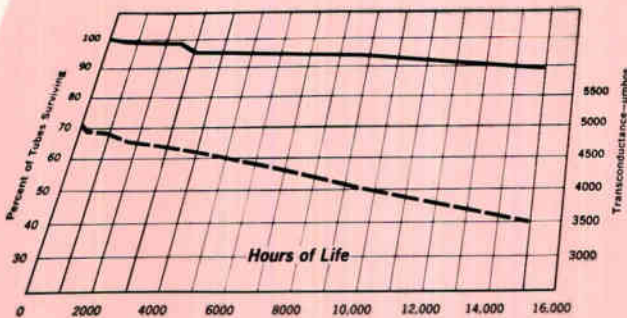
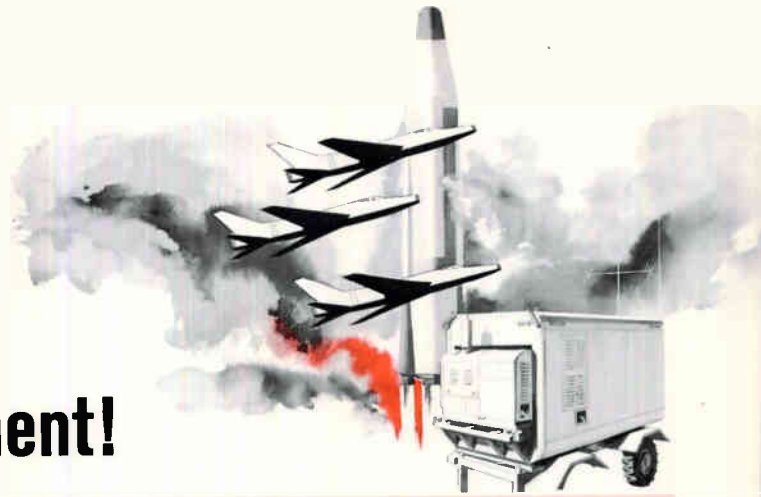

FIG. 4

6111 Survival curve for inoperatives through 15,000 hours (—). Median for Gm through 15,000 hours (---).

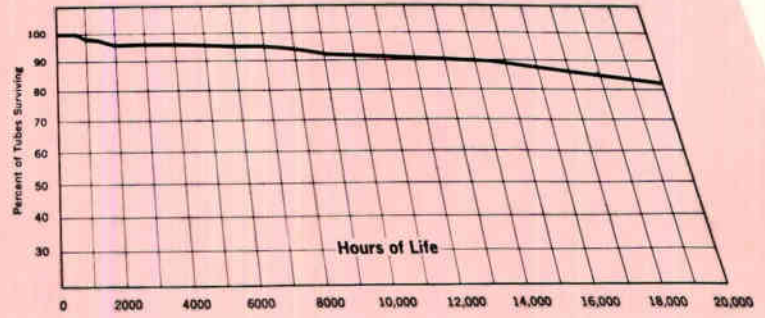

FIG. 3

5718 Survival curve for inoperatives through 20,000 hours.

A laboratory-proven design transferred to production line—then to actual field-use—may sometimes perform in an unexpected, erratic manner. Yet Management and Military are demanding increased assurances of reliability. How do you solve the dilemma for your design? One way: specify components offering documented, field-proven reliability.

Take the case for tubes. Tests by ARINC Research Corp.† illustrate the dramatic improvements in tube reliability since 1954. The results of tests conducted aboard naval vessels show a combined tube removal rate of 15% per 1000 hours in 1954. By 1960 this figure dropped to 1.2% for miniature tubes and a remarkable 0.19% for subminiature tubes. All the controlled subminiature types were *Sylvania* tubes.*

Survival tests by Sylvania (Figs. 3 & 4) on Gold Brand Subminiature types 5718 and 6111 demonstrate similar outstanding results. Sylvania-5718, UHF medium-mu triode, shows better than 90% survival at 12,000 hours. Sylvania-6111, medium-mu double triode, shows an average decline in Gm of only 2.4% per 1000 hours and better than 90% tube survival at 12,000 hours.

Further quantitative measure of reliability is provided by Sylvania acceptance criteria for Gold Brand Subminiature Tubes. Based on the average number of cumulative failures per 1000 hours for a 5-lot moving average, instead of the customary 1-lot, it offers a stringent control over an exceptionally wide range of production. And, it provides a highly accurate basis for statistical prediction of % failure rate in 1000 tube hours.

If you're being asked to predict reliability of your military or industrial design, call upon the expert assistance of Sylvania. Your Sylvania Sales Engineer will gladly supply detailed documentation of Gold Brand Subminiature Tube reliability.

*Sylvania-5636, 5644, 5647, 5718, 5719, 5840, 5899, 5902

The subminiature tubes were use-tested in SRR-13A receivers.

†Courtesy ARINC Research Corp. as published in publication #101-28-166, #101-26-160

MICROWAVE DEVICE NEWS from SYLVANIA

**50%
SMALLER!**
**75%
LIGHTER!**



Low Cost, High Performance

PPM- FOCUSED TWT's

for operation from 1 to 12Gc

Now available from Sylvania -- a new family of traveling wave tubes designed for high-performance microwave amplifier applications where economy, compactness, light weight are vital design considerations.

Less than 4 lbs. in weight and 2¼" in maximum diameter, these TWT's present unusual opportunities for compact design of such end-products as microwave test equipment. No electrical performance is sacrificed in attaining these advantages over bulky, 12-16 lb. solenoid types. In addition, they are priced at less than \$1,000 each in quantity.

For further information contact your nearest Sylvania Sales Engineering Office, or write Electronic Tubes Division, Sylvania Electric Products Inc., 1100 Main St., Buffalo 9, N. Y.

Frequency Range (Gc)	Sylvania Type	Power Output	Min. Gain (db)
1-2	TW-4267	15mW	35**
1-2	TW-4268	1W	30*
2-4	TW-4261	10mW	35**
2-4	TW-4260	1W	30*
4-8	TW-4281	10mW	35**
4-8	TW-4278	1W	30*
8-12	TW-4282	5mW	35**
8-12	TW-4273	1W	30*

**small signal gain *at saturation



Hewlett-Packard specified Sylvania TWT in the new versatile 1-Watt amplifiers, Models 489A (1 to 2 Gc) and 491C (2 to 4 Gc).

AT WESCON -- see the Sylvania exhibit, Booth #3201, 3, 5, 7, 9, 11, 12, 3302, 4, 6, 8,

EQUIPMENT SALES OFFICES

CHICAGO: 2001 N. Cornell Ave., Melrose Park, Ill., Esterbrook 9-2525; CINCINNATI: 411 Oak St., Plaza 1-8454; DALLAS: 100 Fordyce St., Riverside 1-4836; DAYTON: 333 W. First St., Baldwin 3-6227; FORT WAYNE, IND.: 4740 Coldwater Rd., T3 1145; LOS ANGELES: 6505 E. Gayhart St., Raymond 3-5371; NEW YORK CITY: 1000 Huyler St., Teterboro, N. J., ATias 8-9884; N. Y.-UPSTATE: Seneca Falls, Logan 8-5881; ORLANDO: Suite C, 1520 Edgewater Dr., P.O. Box 7248, Orlando, Fla., Garden 4-8245; SAN FRANCISCO: 1811 Adrian Rd., Burlingame, Calif., OXford 7-3500; WASHINGTON, D.C.: 1120 Connecticut, N.W., Federal 7-6600; WILMINGTON, MASS.: 281 Main St., OLiver 8-3357.

SYLVANIA

SUBSIDIARY OF

GENERAL TELEPHONE & ELECTRONICS



New reading checklist from McGraw-Hill

1 ANTENNA ENGINEERING HANDBOOK

Contains information on all areas of antenna engineering to help you solve problems in the design and use of antenna systems. Edited by Henry Jasik, Jasik Laboratories. Prepared by a staff of specialists. 1013 pp., 993 illus. & charts, \$22.00

2 PROGRAMMING COMPUTERS FOR BUSINESS APPLICATIONS

Provides a sound basis for programming computers geared to business applications. Offers a guide to what a programmer must do, including a series of didactic programming examples. By Ned Chapin, Stanford Research Inst. 275 pp., 91 illus., \$7.50

3 ELECTROMECHANICAL COMPONENTS FOR SERVOMECHANISMS

Clearly explains how to choose and apply rotating components for best system operation. By Sidney A. Davis, Consulting Electrical Engineer; and Byron K. Ledgerwood, Editor, Control Engineering. 342 pp., 315 illus. & tables, \$11.50

4 DESIGN MANUAL FOR TRANSISTOR CIRCUITS

Provides quick answers to your daily design problems on transistor and other semiconductor circuits. Edited by John M. Carroll, Managing Editor, Electronics. 390 pp., over 600 illus., \$9.50

5 PROCEEDINGS OF THE SIXTH SYMPOSIUM ON MAGNETISM AND MAGNETIC MATERIALS

Presents the latest survey of current research in magnetism and magnetic materials—covering the work of 260 specialists. Sponsored by the American Institute of Electrical Engineers and the American Institute of Physics. 399 pp., 309 illus., \$10.00

6 ELECTRONIC PACKAGING WITH RESINS

Describes modern resin-packaging techniques developed for electrical and electronic components and systems. By Charles A. Harper, Westinghouse Electric Corp., 339 pp., 139 illus., 125 tables, \$11.00

7 MATHEMATICAL HANDBOOK FOR SCIENTISTS AND ENGINEERS

Gives fast, accurate reference to mathematical facts and data essential in engineering and scientific applications. By Granino A. Korn, Univ. of Arizona; and Theresa M. Korn. 943 pp., \$20.00

8 MISSILE CONFIGURATION DESIGN

Brings together in one source the essential factors in configuration design of guided missiles. By S. S. Chin, The Martin Co. 270 pp., 159 illus. & tables, \$11.00

9 NUCLEAR PULSE SPECTROMETRY

Explains electronic techniques, physical principles, and applications of nuclear pulse spectrometers. By Robert L. Chase, Brookhaven National Laboratory. 226 pp., 119 illus. & tables, \$8.50

10 MAGNETIC TAPE INSTRUMENTATION

Explains how to specify, purchase, and use magnetic tape equipment. By Gomer L. Davies, Consulting Engineer. 257 pp., 86 illus., \$8.50

11 ELECTRONIC MEASURING INSTRUMENTS

Thoroughly covers how basic components work . . . what they do . . . how they are used in measurement and control systems. By Harold E. Soisson, Knolls Atomic Power Laboratory. 352 pp., 328 illus., \$7.50

12 GROUND SUPPORT SYSTEMS FOR MISSILES AND SPACE VEHICLES

Presents a complete picture of the weapon systems which form the ground support systems for modern missiles. By Kenneth Brown, Univ. of Calif., L.A.; and Peter B. Welsler, Space Technology Laboratories, 608 pp., over 200 illus. in Press

13 ELECTROMECHANICAL SYSTEM THEORY

Brings you facts on the applications of the unique engineering discipline of lumped-parameter system analysis. By Herman E. Koenig, Michigan State Univ.; and William A. Blackwell, Southern Methodist Univ. 520 pp., 367 illus., \$14.50

14 ELECTRONIC AMPLIFIER CIRCUITS

Gives facts on both vacuum tube and transistor amplifying devices—discusses practical design results. By Joseph M. Pettit and Malcolm M. McWhorter, both of Stanford Univ. 336 pp., 255 illus., in Press

15 ELECTRICITY AND ELECTRONICS FOR AEROSPACE VEHICLES

Shows how theory is applied to systems in modern aircraft and rocket-propelled vehicles. Northrop Institute of Technology. 330 pp., 500 illus., \$13.95

16 TRANSISTORS AND ACTIVE CIRCUITS

Helps you solve basic transistor circuit problems. By John G. Linvill and James F. Gibbons, both of Stanford Univ. 511 pp., 403 illus., charts, & tables, \$14.50

17 METEOR SCIENCE AND ENGINEERING

Gives engineering results of today's meteor science and research. By D. W. R. McKinley, National Research Council, Ottawa, Canada. 309 pp., 124 illus., \$12.50

18 AN INTRODUCTION TO INFORMATION THEORY

Explains probability theory and introduces information and coding theory. By Fazlollah M. Reza, Syracuse Univ., 500 pp., over 200 illus., \$13.50

19 SEMICONDUCTOR DEVICES AND APPLICATIONS

Gives full information on how diodes and transistors function and how they can be used effectively in circuits. By Richard A. Greiner, Univ. of Wisconsin. 500 pp., 441 illus., \$12.50

20 THE PHYSICAL THEORY OF TRANSISTORS

Tells how to use the theory determining operation of semiconductor diodes and transistors. By Leopoldo B. Valdes, Rheem Semiconductor Corp. 366 pp., 180 illus., \$10.95

21 INTRODUCTORY SYSTEM ANALYSIS

Outlines practical techniques of linear system analysis. By William A. Lynch, and John G. Truxal, both of Polytechnic Inst. of Brooklyn. 450 pp., 481 illus., \$7.50

22 ELECTRONICS

Fully explains the physical basis and equivalent circuit representation of modern electronic devices. By Paul M. Chirlan, Stevens Inst. of Tech.; and Armen H. Zemanian, NYU. 335 pp., 246 illus., \$8.75

23 AN INTRODUCTION TO THE PRINCIPLES OF COMMUNICATION THEORY

Covers the principles of modern communication theory and its applications in electrical engineering. By John C. Hancock, Purdue Univ. 253 pp., 200 illus., \$9.50

24 PRINCIPLES OF INERTIAL NAVIGATION

A basic guide to inertial navigation—its concepts . . . problems . . . systems . . . and components. By C. Savant, Jr., Hughes Tool Co.; R. Howard, Giannini Controls Corp.; C. Solloway, Jet Propulsion Lab.; and C. Savant, Northrop Corp. 249 pp., 166 illus., \$9.75

VISIT McGRAW-HILL
AT THE WESCON SHOW
BOOTHS P6—7—8—9

USE THESE BOOKS 10 DAYS FREE

McGraw-Hill Book Co., Dept. L-8-11 — 327 W. 41st St., New York 36, N. Y.
Send me book(s) whose numbers I have circled below for 10 days' examination on approval. In 10 days I will remit for book(s) I keep, plus few cents for delivery costs, and return unwanted book(s) postpaid. (We pay delivery costs if you remit with this coupon—same return privilege.)

1 2 3 4 5 6 7 8 9 10 11 12
13 14 15 16 17 18 19 20 21 22 23 24

Name _____ Address _____

City _____ Zone _____ State _____

Position _____ Company _____

For price and terms outside U. S., write McGraw-Hill Int'l, N.Y.C. L-8-11



COLD CATHODE TUBES

- count
- readout
- store
- compute
- sort
- control
- time
- switch



GCA10G



GS10H



TWO NEW TUBES

GCA10G — A recently developed tube for the direct coupling of a readout tube to a Dekatron without the need of any additional amplifiers.

GS10H — New, low cost, miniature selector with access to all cathodes. Seated height — $1\frac{1}{2}$ ".



Dekatron Tubes — Full line of twelve types for totalizing, sorting, programming or controlling. High speed (up to 20,000 cps). Reliable up to 100,000 hours — low current.



Voltage Reference Tube — Useful in high-level stages of DC amplifiers. No jump in characteristic. Constant internal resistance.



Computer Trigger Tube — Inexpensive subminiature tubes especially designed for computer application. Widely used for slow-speed storage applications.



Tetrode Trigger Tube — Designed for Dekatron coupling, readout circuits and bi-directional counting. Reliable in self-quench circuits. Drift-free operation.

Baird-Atomic has more different types of cold cathode counting tubes than anyone! All have been field proven... all feature rugged construction, low power requirements and simple circuitry. And B/A tubes are backed by extensive applications engineering service and a network of distributors in the U. S. and Canada.

For more information on Baird-Atomic tubes and services, send today for **HANDBOOK OF COUNTING TUBES**. Price \$1.00.



BAIRD-ATOMIC, INC.

33 University Road · Cambridge 38, Mass.

Engineers and scientists: Investigate challenging opportunities with Baird-Atomic. Write Industrial Relations Director. All qualified applicants will receive consideration for employment without regard to race, creed, color or national origin.

ADVANCED OPTICS AND ELECTRONICS...SERVING SCIENCE

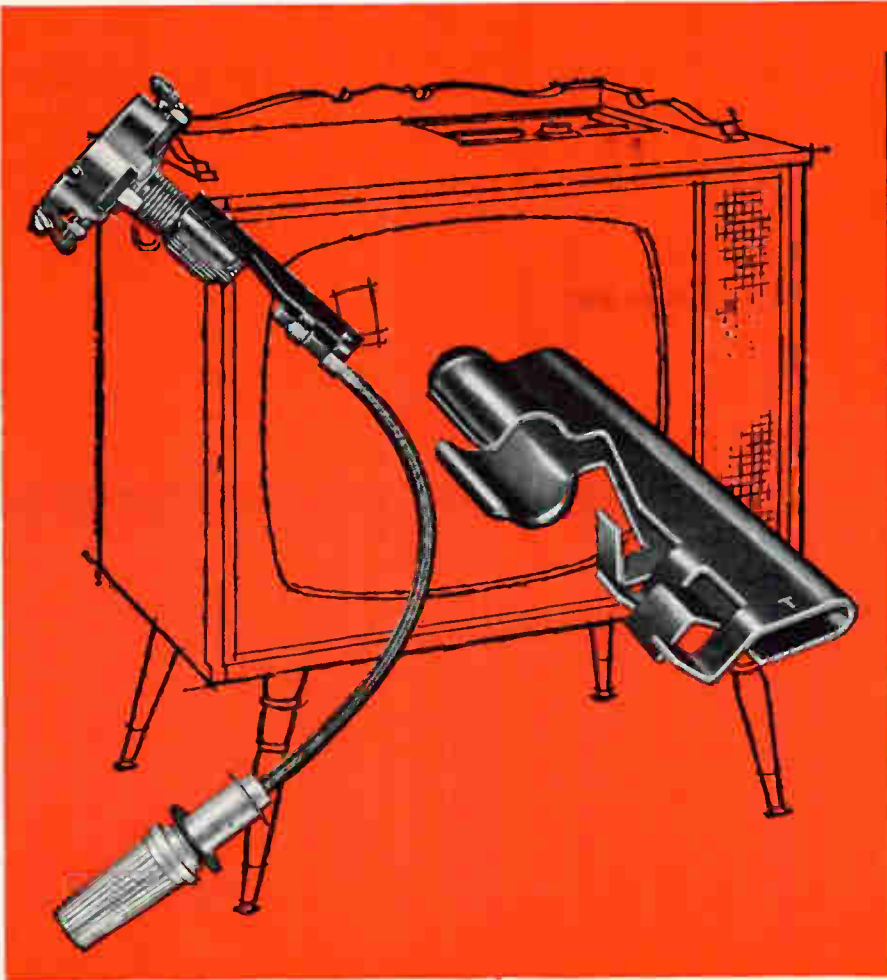

A Tinnerman T-Marked Original...

SPEED CLIP[®] gives Sylvania easier, more reliable, more flexible assembly

This new Tinnerman-engineered SPEED CLIP fastener provides a faster, more flexible connection between control "pots" and knobs on a TV manufactured by Sylvania Electric Products, Inc. The fastener can be applied wherever similar components are mounted and space limitations pose an assembly problem.

Several advantages are offered over methods previously used. Assembly is easier and faster... mating parts are simply pressed together and secured under live spring tension. Built-in ratcheting action permits overload slippage to protect the control from over-adjustment. Designed for use with a flexible cable, mounting of the control is completely independent of the knob location. They can be perpendicular to each other anywhere within 360°. Finally, this fastener is stamped with the Tinnerman T-mark, as are all SPEED NUT[®] brand fasteners. This is your assurance that Tinnerman quality and total reliability are going into your products wherever these fasteners are specified.

For samples, literature, prices, call your Tinnerman sales office... listed in the "Yellow Pages" under "Fasteners." Or write to: Tinnerman Products, Inc., Department 12, P. O. Box 6688, Cleveland 1, Ohio.



TINNERMAN
Speed Nuts[®]
Look for the Tinnerman "T"

August 11, 1961

T-MARK ENGINEERED SPECIALS

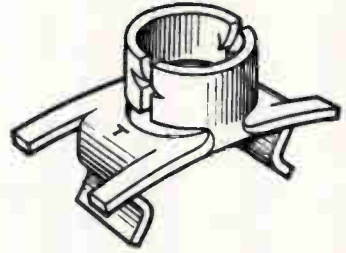

TRANSISTOR CLIP saves weight and space, snaps quickly into panel... no screws, rivets. Designed for coil form retention, this SPEED CLIP fastener proved ideal for fastening transistors. Tubular retaining collar has excellent heat sink properties, openings at sides and bottom allow air circulation.

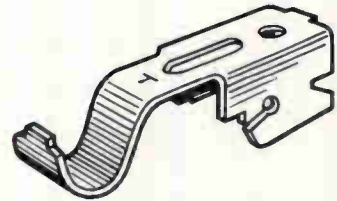

FRONT MOUNTING SPEED CLIP FASTENER cuts front panel assembly costs on popular washer-dryer. Unique self-retaining SPEED CLIP fastener permits simplified front mounting for easier, faster, lower cost assembly of front panel. No welding, staking, screw driving... ends scrap hazard. Four fasteners engage panel mounting flange as it slips in place over curved spring fingers. Assures firm vibration resistant assembly, yet easy removal for servicing.

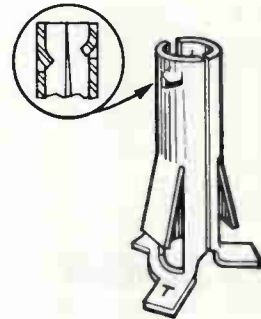

BOWDEN CABLE CLIP is one of many Tinnerman designs to fasten armored cable. Designed for car instrument panels, it's the perfect answer to through-panel cable fastening problems. No welding, staking, clinching, no special mounting brackets or clamps. Live spring tension prohibits vibration... prevents loosening.

CANADA: Dominion Fasteners Ltd., Hamilton, Ontario.
GREAT BRITAIN: Simmonds Aerocessories Ltd., Treforest, Wales. FRANCE: Simmonds S.A., 3 rue Salomon de Rothschild, Suresnes (Seine). GERMANY: Mecano Simmonds GMBH, Heidelberg.

CIRCLE 73 ON READER SERVICE CARD

73

ULTRAMICROWAVE®



Size Designation Frequency Band in KMC Waveguide Nomenclature	DBW 90-140 RG-138/U	DBA 60-90 RG-99/U	DBB 50-75 RG-98/U	DBC 33-50 RG-97/U	DBD 26.5-40 RG-96/U	DBE 18-26.5 RG-93/U	DBF 12.4-18 RG-91/U	DBG 8.2-12.4 RG-52/U	DBH 7.05-10.0 RG-51/U	DBJ 5.85-8.2 RG-50/U	DBK 3.95-5.85 RG-49/U	DBL 2.6-3.95 RG-48/U												
	Cat. No.	Price	Cat. No.	Price	Cat. No.	Price	Cat. No.	Price	Cat. No.	Price	Cat. No.	Price												
Tube Mounts Nylatron Tube Mount Nose Tube Mount with Tube					DBC-140-T	\$395	DBD-140-T	\$278	DBE-111-T	\$219	DBF-140-T	\$209	DBG-111-T	\$219	DBH-111-T	\$209	DBJ-111-T	\$209	DBK-111-T	\$209	DBL-111-T	\$209		
Transmission Line Components Adaptors, Check to Cover Tapered Transitions Rect to Cylindrical Transitions N to Waveguide Transformers *Straight Sections 90° E-Plane Elbows 90° H-Plane Elbows Rotating Joints 90-90 Rotating Joints 90-Col Rotating Joints Col-90 90° Twisted Sections Bulkhead Flanges Bulkhead Flanges with Seals Pressurizing Units	DBWB-018	\$1.25	DBAB-018	\$1.00	DBBC-018	\$90	DBCD-018	\$90	DBD-010	\$30	DBE-010	\$28	DBF-010	\$28	DBG-010	\$28	DBH-010	\$27	DBJ-010	\$27	DBK-010	\$26	DBL-010	\$25
Crystal Mounts & Multipliers Crystal Mounts Crystal Mts. thru Guide w/Xtal Crystal Mounts, Movable Short Tunable Crystal Mounts Crystal Multipliers	DBW-312	\$27.2	DBA-312	\$27.2	DBB-312	\$27.2	DBC-312	\$27.2	DBD-312	\$27.2	DBE-310	\$26	DBF-310	\$26	DBG-310	\$26	DBH-310	\$26	DBJ-310	\$25	DBK-310	\$24	DBL-310	\$23
Power Absorbing Units Precision Attenuators Variable Attenuators Variable Attenuators, Calibrated Fixed Attenuators Low Power Terminations Movable Low Power Terminations Movable Term with Extension Movable Term with Ext. & Vermer Tunable Low Power Terminations High Power Terminations	DBW-410	\$337	DBA-410	\$358	DBB-410	\$358	DBC-410	\$358	DBD-410	\$358	DBE-410	\$358	DBF-410	\$270	DBG-410	\$250	DBH-410	\$250	DBJ-410	\$250	DBK-410	\$250	DBL-410	\$250
Horns Pickup Horns Standard Gain Horns, 10 DB, 15 DB Standard Gain Horns, 20 DB Conical Horns	DBW-520	\$149	DBA-510	\$83	DBB-510	\$83	DBC-510	\$83	DBD-510	\$83	DBE-510	\$83	DBF-510	\$72	DBG-510	\$71	DBH-510	\$70	DBJ-510	\$69	DBK-510	\$69	DBL-510	\$69
Tees, Junctions and Mixers E-Plane Tees Waveguide Switches, 2 Way Waveguide Switches, 4 Way H-Plane Tees Basic Directional Couplers Directional Couplers, Fig to Term Directional Couplers, Coax to Term Directional Couplers, Xtal to Fig Directional Couplers, Xtal to Term Magic Tees Matched Magic Tees Balanced Crystal Mixers	DBW-610	\$150	DBA-610	\$65	DBB-610	\$60	DBC-610	\$58	DBD-610	\$58	DBE-610	\$51	DBF-610	\$41	DBG-610	\$38	DBH-610	\$38	DBJ-610	\$37	DBK-610	\$36	DBL-610	\$35

MANUFACTURERS OF:
Microwave Products,
Educational, Medical,
Laboratory Instruments

For precise quantitative analysis of:
 • Dielectric properties of solids and liquids
 • Ferromagnetic effects
 • Paramagnetic relaxation and resonance effects

• Absorption spectra of gases
 • Molecular beam resonance
 • Superconductivity phenomena
 • Microwave accelerated particles

• Radiometry
 • Velocity and phase by interferometry
 • Transmission and absorption spectrometry
 • Plasma diagnostics

DE MORNAY

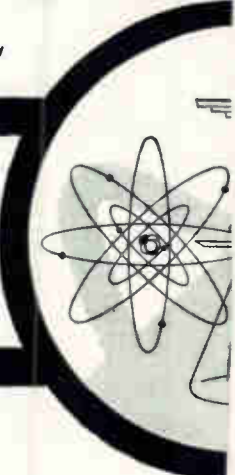

EQUIPMENT

Precision Cavity Wavemeter



Variable Stub Tuner

Rotating Joint



Waveguide Sw



IMPORTANT NEW DEVELOPMENT!
 - on display at the WESCON show
 SEE US AT BOOTH
1414-16

Ultramicrowave Cavity Wavemeter

Standing Wave Detector

Ferrite Isolator

Size Designation Frequency Band in KMC Waveguide Nomenclature	DBW 90-140 RG-138/U	DBA 60-90 RG-99/U	DBB 50-75 RG-98/U	DBC 33-50 RG-97/U	DBD 26.5-40 RG-96/U	DBE 18-26.5 RG-53/U	DBF 12-18 RG-91/U	DBG 8.2-12.4 RG-52/U	DBH 7.05-10.0 RG-51/U	DBJ 5.85-8.2 RG-50/U	DBK 3.95-5.85 RG-49/U	DBL 2.6-3.95 RG-48/U
	Cat No. Price	Cat No. Price	Cat No. Price	Cat No. Price	Cat No. Price	Cat No. Price	Cat No. Price	Cat No. Price	Cat No. Price	Cat No. Price	Cat No. Price	Cat No. Price
Frequency Meters												
Precision Cavity Wavemeters												
Reaction Type	DBW-715-1 \$1,100	DBA-715-1 \$647	DBB-715-1 \$647	DBC-715-1 \$647	DBD-715-1 \$647	DBE-715-1 \$647	DBF-715-1 \$647	DBG-715-1 \$647	DBH-715-1 \$647	DBJ-715-1 \$647	DBK-715-1 \$647	DBL-715-1 \$647
Absorption Type	DBW-715-2 \$1,200	DBA-715-2 \$675	DBB-715-2 \$675	DBC-715-2 \$675	DBD-715-2 \$675	DBE-715-2 \$675	DBF-715-2 \$675	DBG-715-2 \$675	DBH-715-2 \$675	DBJ-715-2 \$675	DBK-715-2 \$675	DBL-715-2 \$675
Transmission Type		DBA-715-3 \$590	DBB-715-3 \$590	DBC-715-3 \$590	DBD-715-3 \$590	DBE-715-3 \$590	DBF-715-3 \$590	DBG-715-3 \$590	DBH-715-3 \$590	DBJ-715-3 \$590	DBK-715-3 \$590	DBL-715-3 \$590
Reference Cavity Reaction Type		DBA-715-1A \$625	DBB-715-1A \$625	DBC-715-1A \$625	DBD-715-1A \$625	DBE-715-1A \$625	DBF-715-1A \$625	DBG-715-1A \$625	DBH-715-1A \$625	DBJ-715-1A \$625	DBK-715-1A \$625	DBL-715-1A \$625
Reference Cavity Absorption		DBA-715-2A \$560	DBB-715-2A \$560	DBC-715-2A \$560	DBD-715-2A \$560	DBE-715-2A \$560	DBF-715-2A \$560	DBG-715-2A \$560	DBH-715-2A \$560	DBJ-715-2A \$560	DBK-715-2A \$560	DBL-715-2A \$560
Reference Cavity Transmission		DBA-715-3A \$605	DBB-715-3A \$605	DBC-715-3A \$605	DBD-715-3A \$605	DBE-715-3A \$605	DBF-715-3A \$605	DBG-715-3A \$605	DBH-715-3A \$605	DBJ-715-3A \$605	DBK-715-3A \$605	DBL-715-3A \$605
Impedance Meters												
Precision Standing Wave Detectors Complete	DBW-825 \$265	DBA-825 \$610	DBB-825 \$610	DBC-825 \$610	DBD-825 \$610	DBE-825 \$610	DBF-825 \$610	DBG-825 \$610	DBH-825 \$610	DBJ-825 \$610	DBK-825 \$610	DBL-825 \$610
Cannage Units Only	DB-820 \$247	DBA-820 \$147	DBB-820 \$147	DBC-820 \$147	DBD-820 \$147	DBE-820 \$147	DBF-820 \$147	DBG-820 \$147	DBH-820 \$147	DBJ-820 \$147	DBK-820 \$147	DBL-820 \$147
Waveguide Sections	DBW-821 \$250	DBA-821 \$140	DBB-821 \$140	DBC-821 \$140	DBD-821 \$140	DBE-821 \$140	DBF-821 \$140	DBG-821 \$140	DBH-821 \$140	DBJ-821 \$140	DBK-821 \$140	DBL-821 \$140
Broadband Probes	DBW-822 \$250	DBA-822 \$140	DBB-822 \$140	DBC-822 \$140	DBD-822 \$140	DBE-822 \$140	DBF-822 \$140	DBG-822 \$140	DBH-822 \$140	DBJ-822 \$140	DBK-822 \$140	DBL-822 \$140
Phase Shifters, Tuners & Shorts												
Phase Shifters	DBW-915 \$275	DBA-915 \$150	DBB-915 \$150	DBC-915 \$150	DBD-915 \$150	DBE-915 \$150	DBF-915 \$150	DBG-915 \$150	DBH-915 \$150	DBJ-915 \$150	DBK-915 \$150	DBL-915 \$150
Calibrated Phase Shifters	DBW-915-1 \$300	DBA-915-1 \$180	DBB-915-1 \$180	DBC-915-1 \$180	DBD-915-1 \$180	DBE-915-1 \$180	DBF-915-1 \$180	DBG-915-1 \$180	DBH-915-1 \$180	DBJ-915-1 \$180	DBK-915-1 \$180	DBL-915-1 \$180
Variable Stub Tuners		DBA-919 \$125	DBB-919 \$125	DBC-919 \$125	DBD-919 \$125	DBE-919 \$125	DBF-919 \$125	DBG-919 \$125	DBH-919 \$125	DBJ-919 \$125	DBK-919 \$125	DBL-919 \$125
Cylindrical Phase Shifters		DBA-930 \$165	DBB-930 \$165	DBC-930 \$165	DBD-930 \$165	DBE-930 \$165	DBF-930 \$165	DBG-930 \$165	DBH-930 \$165	DBJ-930 \$165	DBK-930 \$165	DBL-930 \$165
Fixed Shorts		DBA-960 \$80	DBB-960 \$80	DBC-960 \$80	DBD-960 \$80	DBE-960 \$80	DBF-960 \$80	DBG-960 \$80	DBH-960 \$80	DBJ-960 \$80	DBK-960 \$80	DBL-960 \$80
Movable Shorts	DBW-969A \$150	DBA-969A \$75	DBB-969A \$75	DBC-969A \$75	DBD-969A \$75	DBE-969A \$75	DBF-969A \$75	DBG-969A \$75	DBH-969A \$75	DBJ-969A \$75	DBK-969A \$75	DBL-969A \$75
Movable Shorts with Vernier	DBW-969A-1 \$217	DBA-969A-1 \$97	DBB-969A-1 \$97	DBC-969A-1 \$97	DBD-969A-1 \$97	DBE-969A-1 \$97	DBF-969A-1 \$97	DBG-969A-1 \$97	DBH-969A-1 \$97	DBJ-969A-1 \$97	DBK-969A-1 \$97	DBL-969A-1 \$97
Movable Shorts with Extension		DBA-969 \$80	DBB-969 \$80	DBC-969 \$80	DBD-969 \$80	DBE-969 \$80	DBF-969 \$80	DBG-969 \$80	DBH-969 \$80	DBJ-969 \$80	DBK-969 \$80	DBL-969 \$80
Movable Shorts with Ext & Vernier		DBA-969-1 \$107	DBB-969-1 \$107	DBC-969-1 \$107	DBD-969-1 \$107	DBE-969-1 \$107	DBF-969-1 \$107	DBG-969-1 \$107	DBH-969-1 \$107	DBJ-969-1 \$107	DBK-969-1 \$107	DBL-969-1 \$107
E.H. Plane Tuners	DBW-979 \$200	DBA-979 \$120	DBB-979 \$120	DBC-979 \$120	DBD-979 \$120	DBE-979 \$120	DBF-979 \$120	DBG-979 \$120	DBH-979 \$120	DBJ-979 \$120	DBK-979 \$120	DBL-979 \$120
E.H. Plane Tuners with Vernier	DBW-979-1 \$230	DBA-979-1 \$120	DBB-979-1 \$120	DBC-979-1 \$120	DBD-979-1 \$120	DBE-979-1 \$120	DBF-979-1 \$120	DBG-979-1 \$120	DBH-979-1 \$120	DBJ-979-1 \$120	DBK-979-1 \$120	DBL-979-1 \$120
Accessories												
Adjustable Waveguide Supports, Ultramicrowave	DBW-1010 \$6	DBA-1010 \$6	DBB-1010 \$6	DBC-1010 \$6	DBD-1010 \$6	DBE-1010 \$6	DBF-1010 \$6	DBG-1010 \$6	DBH-1010 \$6	DBJ-1010 \$6	DBK-1010 \$6	DBL-1010 \$6
Adjustable Waveguide Supports, Microwave					DB-1010-1 \$14	DB-1010-1 \$14	DB-1010-1 \$14	DB-1010-1 \$14	DB-1010-1 \$14	DB-1010-1 \$14	DB-1010-1 \$14	DB-1010-1 \$14
Waveguide Chassis Mounting Stands	DBW-1012 \$10	DBA-1012 \$10	DBB-1012 \$10	DBC-1012 \$10	DBD-1012 \$10	DBE-1012 \$10	DBF-1012 \$10	DBG-1012 \$10	DBH-1012 \$10	DBJ-1012 \$10	DBK-1012 \$10	DBL-1012 \$10
Waveguide Fastening Screws, Pr	DBW-1020 \$1.10	DBA-1020 \$1.10	DBB-1020 \$1.10	DBC-1020 \$1.10	DBD-1020 \$1.10	DBE-1020 \$1.10	DBF-1020 \$1.10	DBG-1020 \$1.10	DBH-1020 \$1.10	DBJ-1020 \$1.10	DBK-1020 \$1.10	DBL-1020 \$1.10
Waveguide Window Seals		DBA-1100 \$34	DBB-1100 \$34	DBC-1100 \$34	DBD-1100 \$34	DBE-1100 \$34	DBF-1100 \$34	DBG-1100 \$34	DBH-1100 \$34	DBJ-1100 \$34	DBK-1100 \$34	DBL-1100 \$34
Electronic Equipment												
1 F Transformer Box						DB-1502 \$125						
Remote Control Box						DB-2016 \$650						
Noise Diode Power Supply						DB-2140 \$300						

Prices subject to change without notice

Deliveries: 2 weeks to 30 days on most items. New 1961 catalog on request.

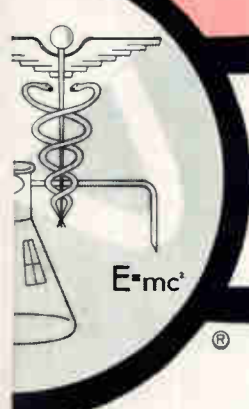

BONARDI

DE MORNAY-BONARDI
 780 South Arroyo Parkway, Pasadena, California

"See us at Wescon Show Booth No. 1414-16"

NEW FLEXIBLE PRINTED CIRCUITRY

from Garlock

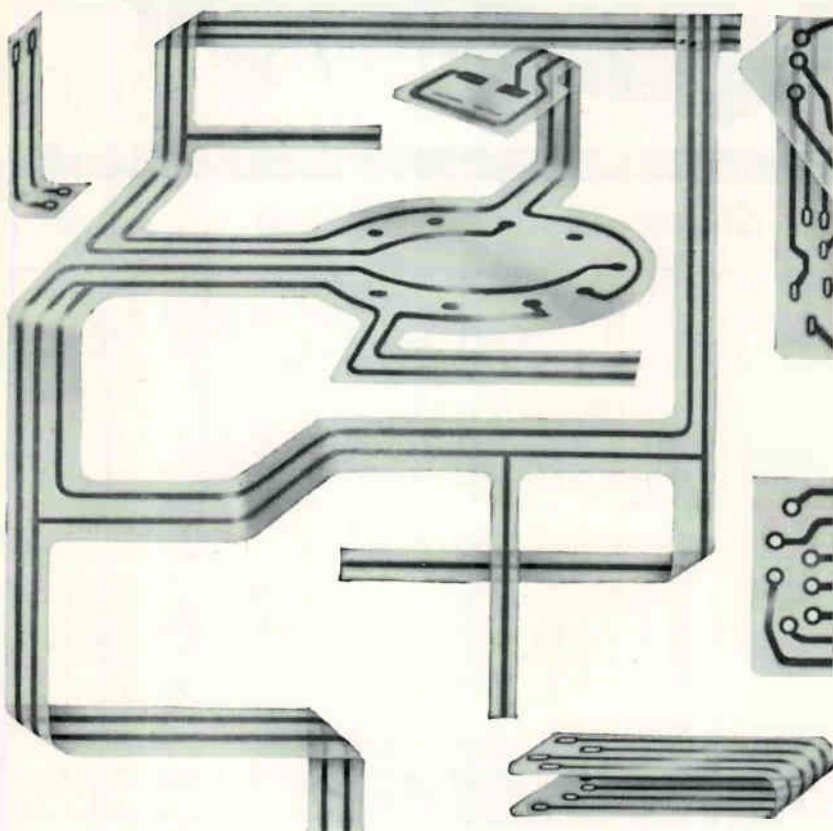

Garlock flexible printed circuitry can be economically induction soldered due to high temperature resistance of Teflon FEP.

Teflon FEP*—and its outstanding electrical, physical and thermal properties—has been incorporated by Garlock into an advanced circuit design that offers many distinct advantages over conventional wiring or rigid printed wiring boards.

Greater design freedom. Garlock Flexible Printed Circuitry can be bent or twisted into any desired shape to allow design freedom without compromise to overall reliability. It can be designed to conform exactly to package contours and component parts. Garlock offers terminations adaptable to common industry standards.

Maximum reliability. Garlock Flexible Printed Circuitry is made of etched copper completely encapsulated between two layers of Teflon FEP. Permanently bonded under pressure, this encapsulation affords both line-to-line and line-to-ground protection, and will resist penetration of harmful moisture and gases. No adhesive is used to effect the bond, eliminating any possibility of breakdown through aging.

Reduced size and weight. Garlock Flexible Printed Circuitry can often cut overall package dimensions by as much as 50%. Being extremely flexible, it will hug curves, go around corners, conform to the most eccentric layout. And, because of excellent electrical properties a thinner gauge of Teflon FEP can handle the same job that requires thick gauges of other insulating materials. This, combined with the use of less copper, greatly reduces package weight.

For more information, call your nearest Garlock Electronic Products representative for more data, or write Garlock Electronic Products, Garlock Inc., Camden 1, New Jersey.

GARLOCK

ELECTRONIC PRODUCTS

Canadian Div.: Garlock of Canada Ltd.
Plastics Div.: United States Gasket Company.

Order from the Garlock 2,000 . . . two thousand different styles of Packings, Gaskets, Seals, Molded and Extruded Rubber, Plastic Products.

*DuPont Trademark

Yes, they are available...from

OHMITE

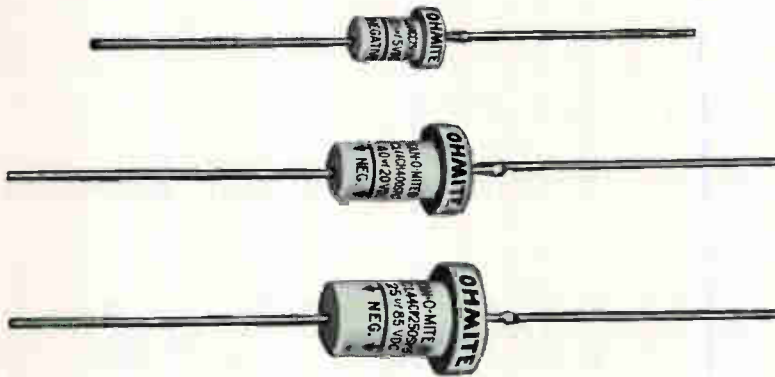

Tan-O-Mite® Series TS Capacitors Meet All Requirements of CHAR. "C" MIL-C-3965B

125°C

TANTALUM SLUG CAPACITORS

Ohmite can supply *all three* sizes of "hat shape" capacitors for use in equipment requiring MIL-C-3965B units. The 29 *basic* stock values as listed at right are the uninsulated type, CL44, with an "S" tolerance of $-15 + 20\%$.* They are available also from stock as insulated units, CL45, with plastic sleeves. A "T" tolerance of $-15 + 50\%$ can be supplied on both types.

Standard tolerance "K," $\pm 10\%$, is offered on commercial units. Special closer tolerances also furnished.

Ohmite manufactures a big, full line of tantalum slug, foil, and wire capacitors for all pertinent MIL specifications as well as commercial applications. Complete details are covered in Bulletins 148, 152, and 159. *Why not write for a set now?*

*"S" tolerance, as furnished by Ohmite, is closer than the MIL "S" tolerance of $-15 + 30\%$.

BASIC STOCK MIL VALUES

Mfd	DC Rated Volts	Case Size	MIL Designation
30	4	T1	CL44CB300SP3
140	4	T2	CL44CB141SP3
330	4	T3	CL44CB331SP3
25	5	T1	CL44CC250SP3
20	7	T1	CL44CD200SP3
100	7	T2	CL44CD101SP3
250	7	T3	CL44CD251SP3
15	10	T1	CL44CE150SP3
70	10	T2	CL44CE700SP3
170	10	T3	CL44CE171SP3
10	17	T1	CL44CG100SP3
8	20	T1	CL44CH080SP3
40	20	T2	CL44CH400SP3
100	20	T3	CL44CH101SP3
5	33	T1	CL44CJ050SP3
25	33	T2	CL44CJ250SP3
60	33	T3	CL44CJ600SP3
4	40	T1	CL44CK040SP3
20	40	T2	CL44CK200SP3
50	40	T3	CL44CK500SP3
3.5	50	T1	CL44CL3R5SP3
15	50	T2	CL44CL150SP3
40	50	T3	CL44CL400SP3
2.5	70	T1	CL44CN2R5SP3
11	70	T2	CL44CN110SP3
30	70	T3	CL44CN300SP3
1.7	85	T1	CL44CP1R7SP3
9	85	T2	CL44CP090SP3
25	85	T3	CL44CP250SP3



OHMITE MANUFACTURING COMPANY
3610 Howard Street, Skokie, Illinois

Rheostats Power Resistors Precision Resistors
Variable Transformers Tantalum Capacitors
Tap Switches Relays R. F. Chokes
Germanium Diodes Micromodules

TANTALUM SLUG

TANTALUM FOIL— ETCHED AND PLAIN

TANTALUM WIRE



... OUTPUT CONSTANT

±1 db

with MELABS new Swept Frequency Signal Generator

Available . . . a new series of swept frequency signal generators covering L, S, C and X band frequencies. These generators use a BWO tube as signal source, incorporate the exclusive MELABS Power Regulator as a built-in feature. This regulator operates solely upon BWO tube output—permits amplitude modulation without incidental frequency modulation—provides swept output at 10 mw that is maintained constant within ± 1 db throughout the entire range. Sweep width is continuously adjustable from full frequency range to less than 10 mcs. Units can be switched to manual tuning for use as a signal generator, have linearly calibrated dials accurate to $\pm 1\%$. The built-in variable attenuator also operates on BWO tube output and provides continuous control of unregulated output over a 40 db range without causing a change in frequency.

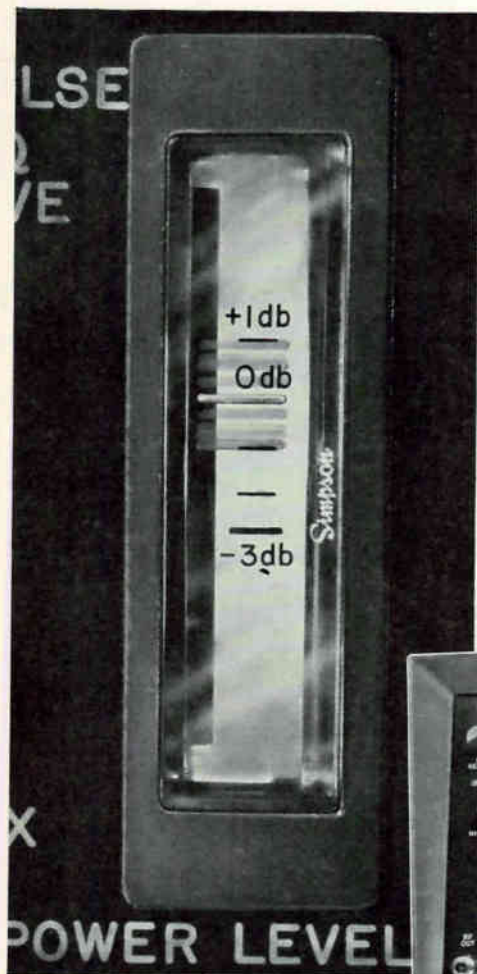

The generator "package" is broken down into two units to reduce weight, facilitate easy carrying by one man. The same power supply/sweep unit can be used with any of the MELABS electronically tuned generators.

The many built-in features of these generators tend to reduce materially the amount of external equipment necessary for accurate visual presentation of equipment characteristics. Operation is simple, straightforward.

SPECIFICATIONS (Similar for all units)

POWER OUTPUT: Regulated, 10 mw ± 1 db. Unregulated, continuously adjustable over 40 db range.

INTERNAL MODULATION: For regulated power: Pulse, 1-10 usec. width, prf, 100-5000 cps. Square wave, repetition rate 1000 cps with $\pm 10\%$ front panel adjustment.

EXTERNAL MODULATION: Any type, unregulated only.

SWEEP: .03 to 30 cps with sweep widths continuously adjustable to 100% of Frequency Range.

DIMENSIONS: 11"H, 8"W, 21¼"D, each unit.

WEIGHT: Power supply, approx. 65 lbs. RF heads, approx. 35 lbs.

AVAILABLE MODELS: RF heads,
Model SGL-2, 1-2 kmc.2600.00
Model SCS-2, 2-4 kmc.2300.00
Model SGC-2, 4-8 kmc.2400.00
Model SGX-2, 8-12 kmc.2600.00

POWER SUPPLY/SWEEP UNIT (required for each RF head)
Model SGO-2900.00
will operate with any of the listed RF heads.

DATA AND PRICES SUBJECT TO CHANGE WITHOUT NOTICE. PRICES F.O.B. FACTORY.

Employment opportunities at Melabs are exceptional for ambitious engineers and physicists; write in confidence.



We will be at the WESCON Show in San Francisco, Booth 1122.

3300 Hillview Avenue, Palo Alto, California Dept. B-2 DA 6-9500 Area Code 415

GET THE FULL STORY...

BEHIND THE *Beam-X*[®] SWITCH

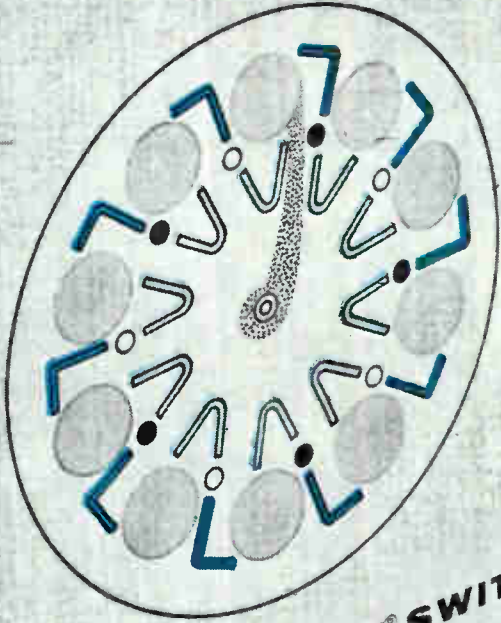

NOW THE BEAM-X[®] SWITCH GIVES YOU

- FLEXIBILITY** — The only device with two outputs in each of ten positions due to 4th electrode construction
- SIMPLICITY** — Drives NIXIE[®] Indicator Tubes directly
- VERSATILITY** — Performs almost every digital function
- RELIABILITY** — 50,000 hour life • High temperature operation • Rugged construction
- ECONOMY** — Replaces 18-30 transistors



TYPICAL APPLICATIONS

MULTI-POSITION DISTRIBUTION

DECADE COUNTING

DATA CONVERSION

CODE GENERATION

Book 10 Position Beam-X Switch Circuit
Fig. 22

Decade Counting
Fig. 23

Code Generation
Fig. 24

Write today . . .

NEW 28 page Technical Brochure. This fully illustrated brochure contains over 50 diagrams, and covers the entire line of Beam-X switches. Includes: Theory • Design Information & Characteristic Curves • Applications •

ANOTHER ELECTRONIC CONTRIBUTION BY
Burroughs Corporation

ELECTRONIC COMPONENTS DIVISION,
PLAINFIELD, NEW JERSEY
Formerly Electronic Tube Division

NEW MINIATURIZED LONG-LIFE COMMUTATION SWITCH

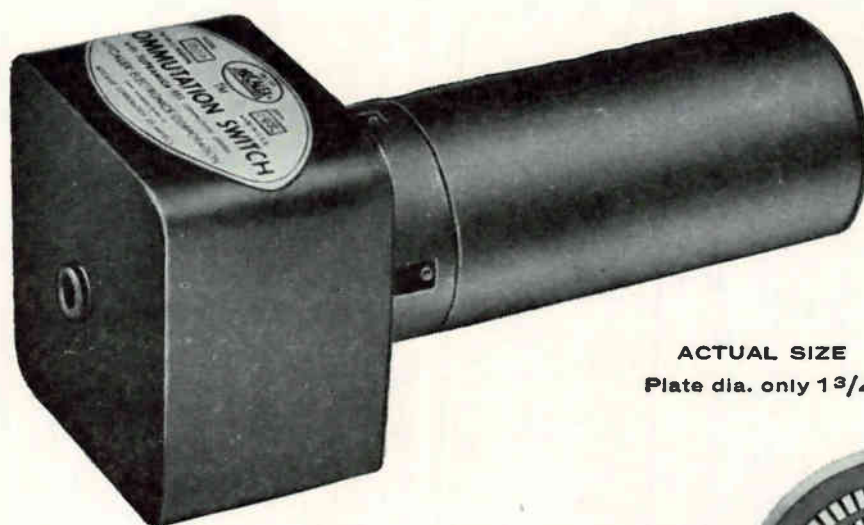

ACTUAL SIZE
Plate dia. only 1³/₄"

... but 1³/₄" plate diameter and 50% space savings* in a 180-channel switch are only the start of the story. This new electromechanical switch also gives the other advantages that have made MYCALEX® units the industry standard. Noise level of less than 1 millivolt when switching 5 volts into a 150-ohm load. Up-to-a 1000 megohm resistance between rectangular contacts. Speeds as high as 1800 RPM. Metal-to-metal wiping action that prevents graphite build-up. Super-hard, gold-plated contacts. SUPRAMICA® 555 ceramoplastic plate that withstands operating temperatures to 650° F., has total dimensional stability, locks contacts in place. Plus nylon-brush mountings of new design that eliminate bounce and deliver sharp, clean signal edges.

Whether you're looking for commutation plates or complete switches, it'll pay you to investigate both of these compact, new components which give you an additional degree of design latitude. (For example, other MYCALEX switches offer up to 540 contacts on a 3"-diameter plate.) Write today for our new, comprehensive technical bulletin.

*When compared with conventional Inter-Range Instrumentation Group Telemetering Switches.

General Offices and Plant: 120 Clifton Boulevard, Clifton, N. J.
Executive Offices: 30 Rockefeller Plaza, New York 20, N. Y.

EXCLUSIVE LICENSEE OF MYCALEX CORPORATION OF AMERICA

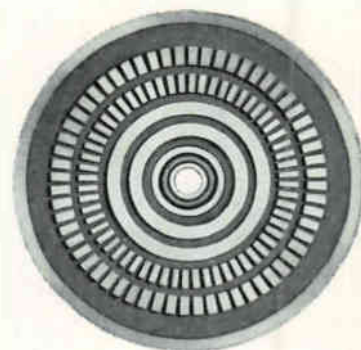

"See us at booth 902-904,
WESCON Show,
August 22-25, 1961"

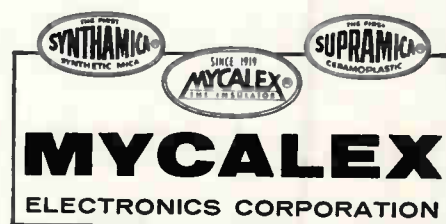

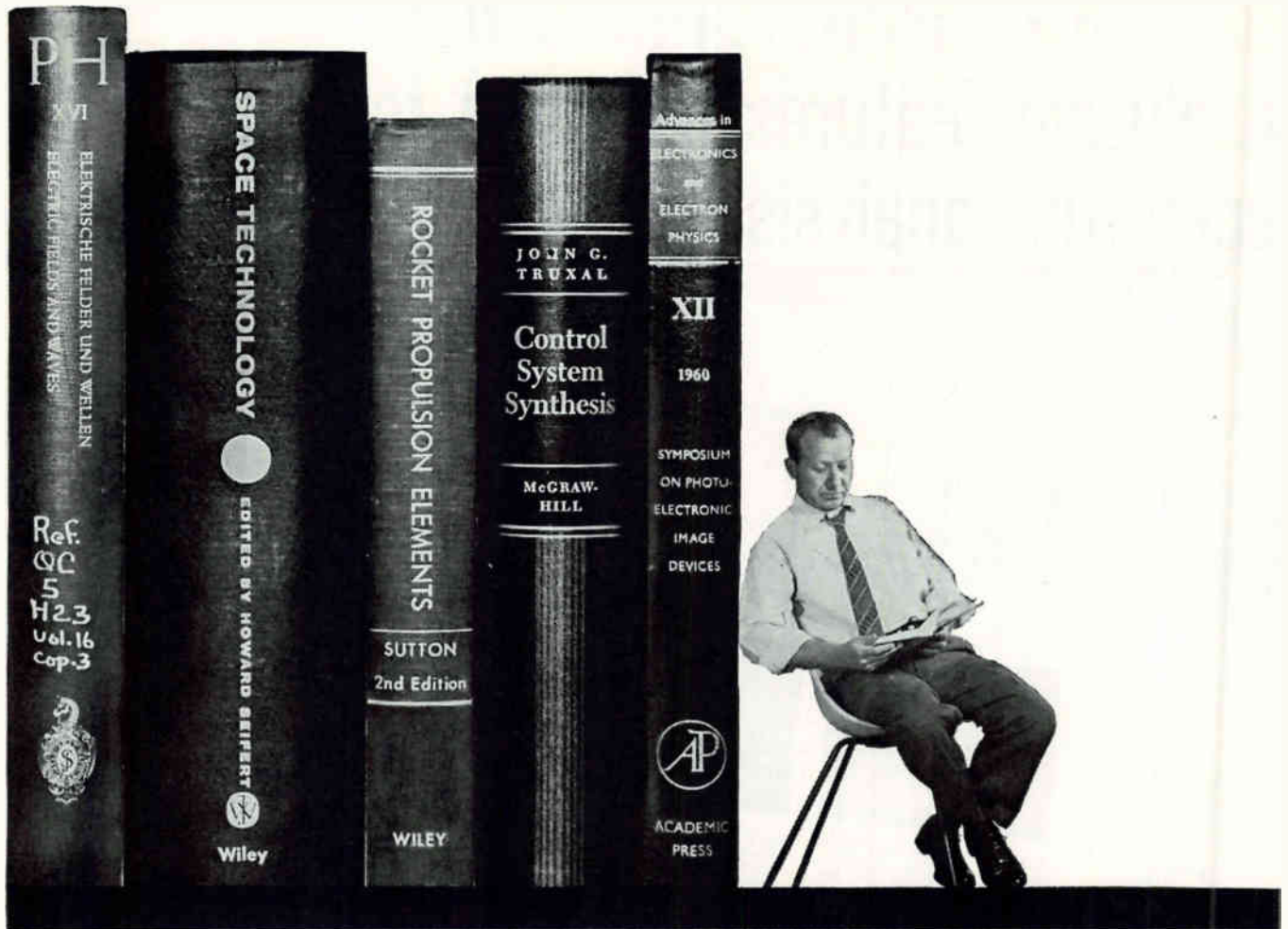

electronic and electromechanical engineers in a unique role

The engineers and scientists of Aerospace Corporation are in the forefront of a rapidly advancing state-of-the-art in sensing and information systems. Their unique role: a critical civilian link uniting government and the scientific-industrial team responsible for development of space systems and advanced ballistic missiles. In providing scientific and technical leadership to every element of this team, they are engaged in a broad spectrum of activities, from formulation of new concepts to technical review and supervision of hardware development by industry. Specific areas of interest include inertial and radio guidance, automatic control, communications, instrumentation, space- and ground-based computing, telemetering, tracking, auxiliary power, infrared, television, optics, and photography. Now more men of superior ability are needed; highly motivated engineers and scientists with demonstrated achievement, maturity, and judgment, beyond the norm. Such men are urged to write Mr. George Herndon, Aerospace Corporation, Room 110, P. O. Box 95081, Los Angeles 45, California.

Organized in the public interest and dedicated to providing objective leadership in the advancement and application of space science and technology for the United States Government.

AEROSPACE CORPORATION

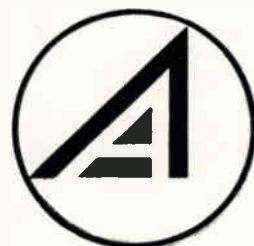

FROM ELECTRONIC MEASUREMENTS

0-1500 V DC POWER SUPPLIES

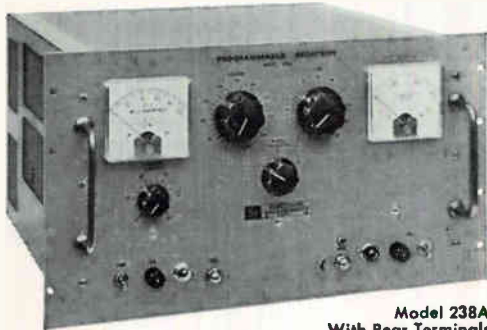

Model 238A
With Rear Terminals

CONSTANT-VOLTAGE

In addition to covering a complete voltage range—0 to 1500 V—this programmable, regulated power supply can deliver rated current of 100 ma at any output voltage . . . even at less than a volt.

But an even more useful feature is its continuously variable current-limiting control. Here's a feature that's finding more application with every passing day.

When it comes to regulation, the Model 238A is truly flexible. Standard regulation is 0.1% line or load. However, 0.01% regulation is available by means of an optional plug-in chopper unit.

The chart below lists just a few of the many Electronic Measurements off-the-shelf, constant-voltage power supplies. For complete information request Catalog BR1961.

MODEL	VOLTS DC	RANGE	
		CURRENT	
238A	0-1500 V DC	0-100 MA	
239A	0-600 V DC	0-1 AMP	
235A	0-600 V DC	0-500 MA	
234A	0-300 V DC	0-500 MA	
230A	0-200 V DC	0-1 AMP	
228A	0-150 V DC	0-1 AMP	
229A	0-150 V DC	0-300 MA	
218A	0-100 V DC	0-3 AMP	
221A	0-100 V DC	0-500 MA	
225A	0-75 V DC	0-2 AMP	
215A	0-50 V DC	0-3 AMP	



Model C638A
With Rear Terminals

CONSTANT-CURRENT

Here's the newest in Electronic Measurements' line of Constant Current Power Supplies . . . a full 1500 V compliance at constant current outputs from less than a ma to 100 ma. Like all Electronic Measurements Power Supplies, the Model C638A has a lot of built-in extras too. For example, there's a modulation input . . . there are also provisions for remote programming . . . and an adjustable voltage compliance control that in effect provides for voltage-limiting.

Specifications include a high output impedance of 10^4 megohms at $0.5 \mu\text{a}$ to 0.5 megohm at 100 ma. Above $2.2 \mu\text{a}$, regulation is better than 0.15%, line or load. Ripple is less than 0.01% + $1 \mu\text{a}$.

The following listing shows some of the constant current models available. For complete information, request Specification Sheet 3072B.

MODEL	RANGE		VOLTAGE COMPLIANCE (MINIMUM)
	MIN.	MAX.	
C614A	10 μa	1 AMP	100 V
C613A	10 μa	1 AMP	50 V
C621A	5 μa	500 MA	100 V
C620A	5 μa	500 MA	50 V
C633A	2.2 μa	300 MA	300 V
C629A	2.2 μa	300 MA	50 V
C632A	2.2 μa	220 MA	300 V
C624A	2.2 μa	220 MA	100 V
C638A	1 μa	100 MA	1500 V
C631A	1 μa	100 MA	300 V
C612A	1 μa	100 MA	100 V

SEE THEM AT WESCON • BOOTHS 1324 AND 1325



ELECTRONIC
MEASUREMENTS
COMPANY, INCORPORATED
EATONTOWN • NEW JERSEY

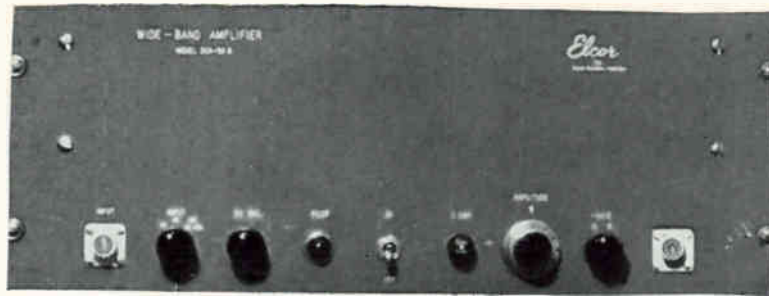

Elcor Amplifiers . . . are far advanced . . . use Isoplys for more dependable, stable circuitry.

The same engineer-minded company that pioneered the use of Isoplys (Isolated Power Supplies) in many of today's most up-to-date electronic circuits, use the same advanced circuit technique in their own quality DC amplifiers. Elcor's DC Amplifier features a variety of feedback arrangements to give it the ability to perform such jobs as integration, differentiation, stabilized gain, summing, gating, wave form generation, and wave shaping. The Wide-Band DC Amplifier by Elcor is ideal for lab use, or in applications needing signal simplification over a very wide band with low phase, or amplitude distortion. Elcor's High-Voltage Amplifier is a wide-band DC amplifier capable of 800 volts peak-to-peak output . . . especially applicable where large signal voltages are applied to a predominately capacitive load. The details and specifications on these fine instruments are concisely and graphically contained in a special Elcor Amplifier Catalog. Write or call, and this information will be on the way to you by fast return mail.



Write for full information: ELCOR Incorporated

*Subsidiary of Welx Electronics Corporation
Sales / R & D Laboratory / Manufacturing
1225 W. Broad Street / Falls Church, Virginia
JEfferson 2-8850*

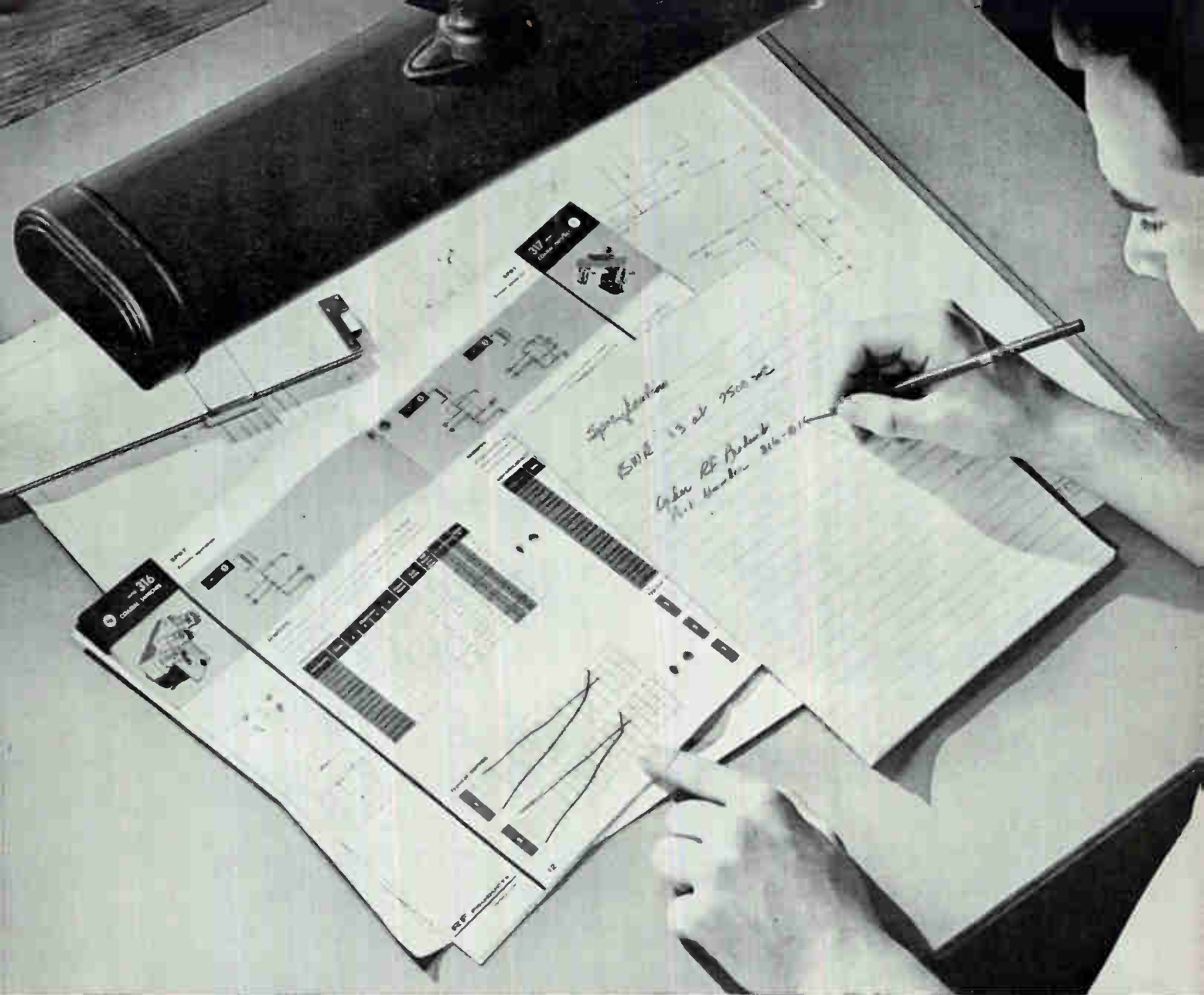

Now, you can save time and insure reliability... by specifying DK Coaxial switches in your design

It's easy. DK Coaxial switches are available in scores of shapes, sizes, and functions *from factory stock*. RF Products' new DK Coaxial switch catalog lists over 130 variations of 16 basic coax switch designs, covering a proven 90% of all known applications. All the facts and figures on the industry's most complete line of coaxial switches are at your finger tips.

You'll also find that these switches successfully combine ruggedness with the highest standards of precision: spring-leaf switching blades, gold-plated silver contacts and impedance matched connectors keep insertion loss and VSWR (1.3 @ 4,000 MCs) low, Crosstalk high (in

decibels down); electro-mechanically actuated models operate and release in 8 to 20 milliseconds, depending on type and function, with a proven mechanical life of 1,000,000 cycles minimum when operated under 10 cps.

And, don't forget that RF Products, pioneers in the development of the coaxial switch, will continue to offer you design and engineering services whenever you need them. Whether you order a switch from the catalog or a switch designed to meet your exact specifications, you can be assured of the same high quality and service.

For details on our new line of standard switches, write for catalog DK 61.

RF PRODUCTS | **DK** **ipc** **AMPHENOL**
DIVISION OF AMPHENOL-BORG ELECTRONICS CORPORATION • 33 EAST FRANKLIN ST., DANBURY, CONN.

For Long Life and Power Economy

Specify *the* **NEW**

CLARE LATCHING
SUBMINIATURE
crystal can
RELAY

The new CLARE Type LF, magnetic latching subminiature relay offers designers simplified circuitry in small space by providing latching effect without transistors. Magnetic latching results in power economy.

The Type LF is available with either 2-coil or 1-coil configuration. The 2-coil relay allows complete control of the latching operation within the relay and provides an extremely compact operating unit. The 1-coil relay is somewhat more sensitive; it is adaptable to existing circuits where outside control is provided. (See opposite page for specifications and circuit diagrams.) The Type LF provides the same wide range of mounting arrangements and terminals as the CLARE Type F relay.

**FOR NON-LATCHING
OPERATION**

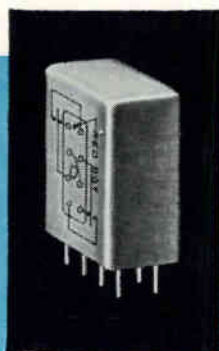

**CLARE Type F Subminiature
Crystal Can Relay**

The CLARE Type F relay is extremely fast and more than moderately sensitive. It is built to withstand temperature extremes, heavy shock and extreme vibration. Contacts, rated at 3 amperes, are excellent for low-level circuit operations. Send for Design Manual 203.



TYPE LF

relay shown (cover removed) is the 2-coil design which controls the entire latching operation within the relay. Shown twice actual size.



2-Coil Circuit Diagram



1-Coil Circuit Diagram

PHYSICAL FEATURES

Life Expectancy

Wet Circuit:

- 3.0 amperes, 28VDC resistive—100,000 operations
- 2.0 amperes, 28VDC resistive—250,000 operations
- 1.0 ampere, 28VDC resistive—1,000,000 operations
- 1.0 ampere, 28VDC inductive (100 millihenry)—100,000 operations

- 1.0 ampere, 115 VAC resistive—100,000 operations

Dry Circuit:

- 1,000,000 miss free operations when subject to conventional dry circuit requirements.

Temperature—+125° C to -65° C

Shock—100g's for 1/2 sine wave 11 ± 1 MS pulse

Linear Acceleration—100g's minimum

Vibration—.250" DA or 30 g's, 5-2000 cps.

Humidity & Salt Spray—MIL-R-5757D

Enclosures: Tinned brass cover with fungus-resistant finish. Hermetically sealed and filled with dry nitrogen at atmospheric pressure.

Contact Arrangement—2PDT latching

Terminals—Plug-in (3/16" straight), solder hook, 3" straight

Wiring—Two coils (as shown on drawing above)
One coil (as shown on drawing above)

Weights—.54 oz. for plug-in
.62 oz. for 2 studs, 3" leads

ELECTRICAL FEATURES

Operate Time—Two coil: When applying—for a minimum of 5 milliseconds—a voltage of at least two times the must operate voltage, the operate time including bounce will not exceed 5 milliseconds. One Coil: operate time will not exceed 8 milliseconds.

Sensitivity—Two coil, approximately 150 milliwatts
One coil, approximately 75 milliwatts

Dielectric Strength

- Sea level: 1000 volts rms—all terminals to case
- 1000 volts rms—between contact sets
- 600 volts rms—between open contacts of a set
- 70,000 ft: 350 volts rms—all terminals to case

Insulation Resistance—1000 megohms minimum at +125° C between any two terminals and between all terminals and case.

Maximum Interelectrode Capacitance—

- Closed contacts to case 3.7 picofarads
- Open contacts to case 2.0 picofarads
- Between contacts of a set 2.0 picofarads
- Between adjacent contact sets 3.5 picofarads

Maximum Coil Dissipation

- Two Coil: .50 watts at +125° C
- .75 watts at +25° C
- One Coil: 1.25 watts at +125° C
- 2.0 watts at +25° C

Standard Adjustment—Relay will operate and hold when the must operate voltage is applied

Contact Resistance:

- Maximum: 50 milliohms at 6 volts, 100 milliamperes.
- Typical: 25 milliohms at 6 volts, 100 milliamperes.

For coil and mounting data on CLARE Type LF relay send for CPC-12. Address: C. P. Clare & Co., 3101 Pratt Blvd., Chicago 45, Illinois. In Canada: C. P. Clare Canada Ltd., 840 Caledonia Road, Toronto 19, Ontario. Cable Address: CLARELAY.



C. P. CLARE & CO. Relays and related control components

I-V plots were made every 250 hours on each device.** Certified tests were performed in accordance with MIL-S-19500B shock, vibration, and angular acceleration requirements.

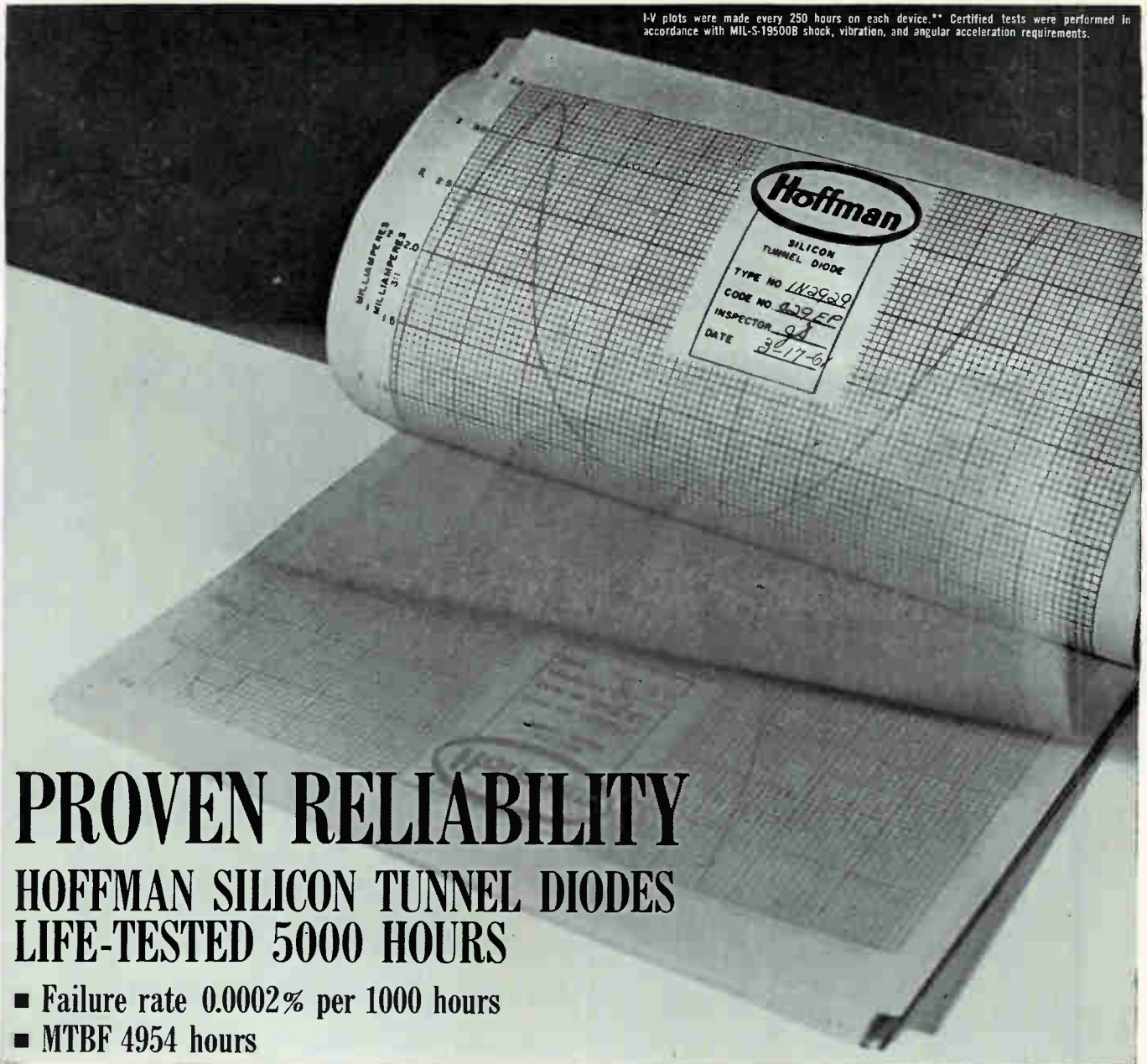

PROVEN RELIABILITY

HOFFMAN SILICON TUNNEL DIODES

LIFE-TESTED 5000 HOURS

- Failure rate 0.0002% per 1000 hours
- MTBF 4954 hours

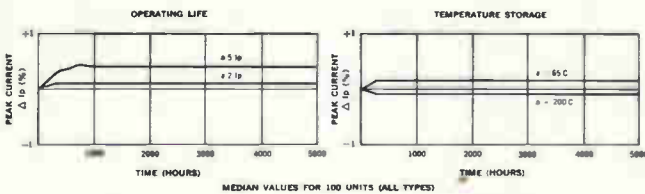

HERE'S WHAT MAKES THE RELIABILITY RECORD POSSIBLE

Hoffman silicon tunnel diodes:

- Are protected by a stable silicon oxide coating against contamination of the junction surface.
- Are made with junction-forming materials which have very high melting points for stability in high-temperature and high-current-density applications.
- Utilize impurities with low diffusivities for stability under high forward voltages.
- Have high V_f (.8V) values inherent in silicon devices, a protective characteristic against voltage transients.
- Undergo stringent quality control. Each unit is temperature-cycled from -85°C to $+200^\circ\text{C}$ for five cycles and baked for 8 hours at 250°C before capping. Hermetically sealed in an inert atmosphere.

USES AND AVAILABILITY

Excellent for all your applications, including low-level switching circuits, oscillators, amplifiers, and other small-signal applications requiring temperature stability, uniformity, reliability, and wide voltage swing. Your distributor has Hoffman silicon tunnel diodes, in the widest range available today, as well as complementary Uni-Tunnel diode types.

Electrical Characteristics (25°C)

EIA Type No.	Peak Current I_p (mA)	Minimum Peak-to-Valley Current Ratio I_p/I_v	Typical Valley-to-Peak Voltage Ratio V_v/V_p	Typical Negative Resistance $-R$ (Ohms)	Maximum Series Resistance R_s (Ohms)	Typical Series Inductance L_s (mH)	Typical Forward Voltage (mV)
1N2928	.47	3.5	6.8	470	1	4	800
1N2929	1.0	3.5	6.8	220	1	4	800
1N2930	4.7	3.5	6.8	47	1	4	800
1N2931	10.0	3.5	6.8	22	1	4	800
1N2932	22.0	3.5	6.8	10	1	4	800
1N2933	47.0	3.5	6.8	4.7	1	4	800
1N2934	100.0	3.5	6.8	2.2	1	4	800

NOTES: 1. Standard units have a peak current tolerance of $\pm 10\%$. Units with $\pm 2\%$ tolerance are available and are designated with a suffix "A" (such as 1N2928A).

Units from 100 microamperes to 5 amperes are available on request.

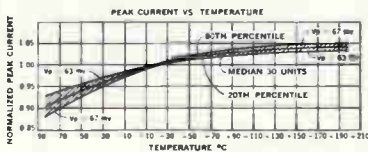

TO-18 CASE

**Send for your copy of Span magazine, May-June, 1961 issue, which describes monitoring program. Data Sheet No. 137-1060TD-R covers silicon tunnel diodes Types 1N2928 through 1N2934.

Hoffman / ELECTRONICS CORPORATION

Semiconductor Division
 1001 Arden Drive, El Monte, California
 TWX: El Monte 9735, Evanston 398
 Plants: El Monte, California and Evanston, Illinois

VISIT BOOTHS 1615-17-19-21-33 DURING WESCON.

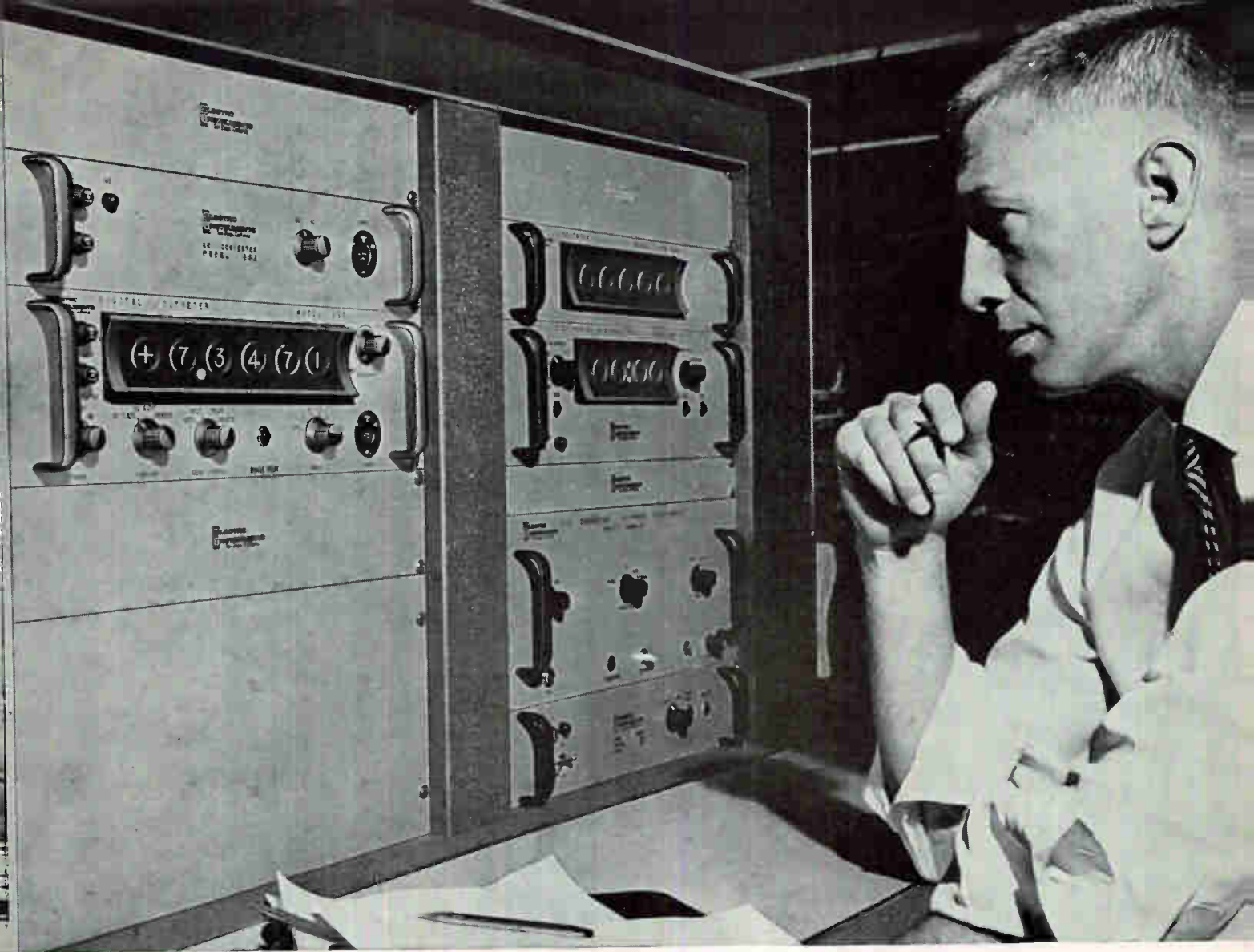

New all-electronic, full-five-digit voltmeter

20 readings per second, 0.01% accuracy, silent, clatter-free operation

Consider what you get with the new EItronic 880. Twenty readings per second. True, absolute 0.01% accuracy. Solid state reliability and coolness. Silent operation. Only the EItronic 880 can give you these advantages.

Switching is accomplished electronically. There are no moving parts. No contacts to clatter and wear. Hence, no noise. Exclusive "conductance adder" logic tracks varying voltages, permitting *exact* values to be read instantly.

For operator convenience, measurements are digitally displayed on a unique readout which tilts to three different positions. Measurements can be easily and accurately read

whether the 880 is used on a bench, at eye level or high in a rack. Clear, bright, digital indicators have 10,000-hour life, eliminating troublesome bulb changing.

Reliability too, is exceptional. Each component, circuit board and sub-assembly is rigorously "pyramid" tested. Each completed 880 is subjected to a program of accelerated aging, simulating 100 hours of actual use. Questionable components are discovered *before* delivery, sharply increasing field reliability.

The EItronic 880 is available now. Its cost is surprisingly low, so why settle for less? Get in touch with your nearest EI field office today.

Another significant breakthrough in digital instrumentation from

Electro Instruments, Inc.

8611 BALBOA AVENUE,  SAN DIEGO 11, CALIFORNIA

Engineers: Challenging opportunities now available. Contact Mr. Harvey Fleming.

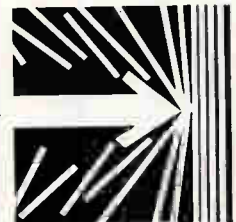

TANTALUM CAPACITORS

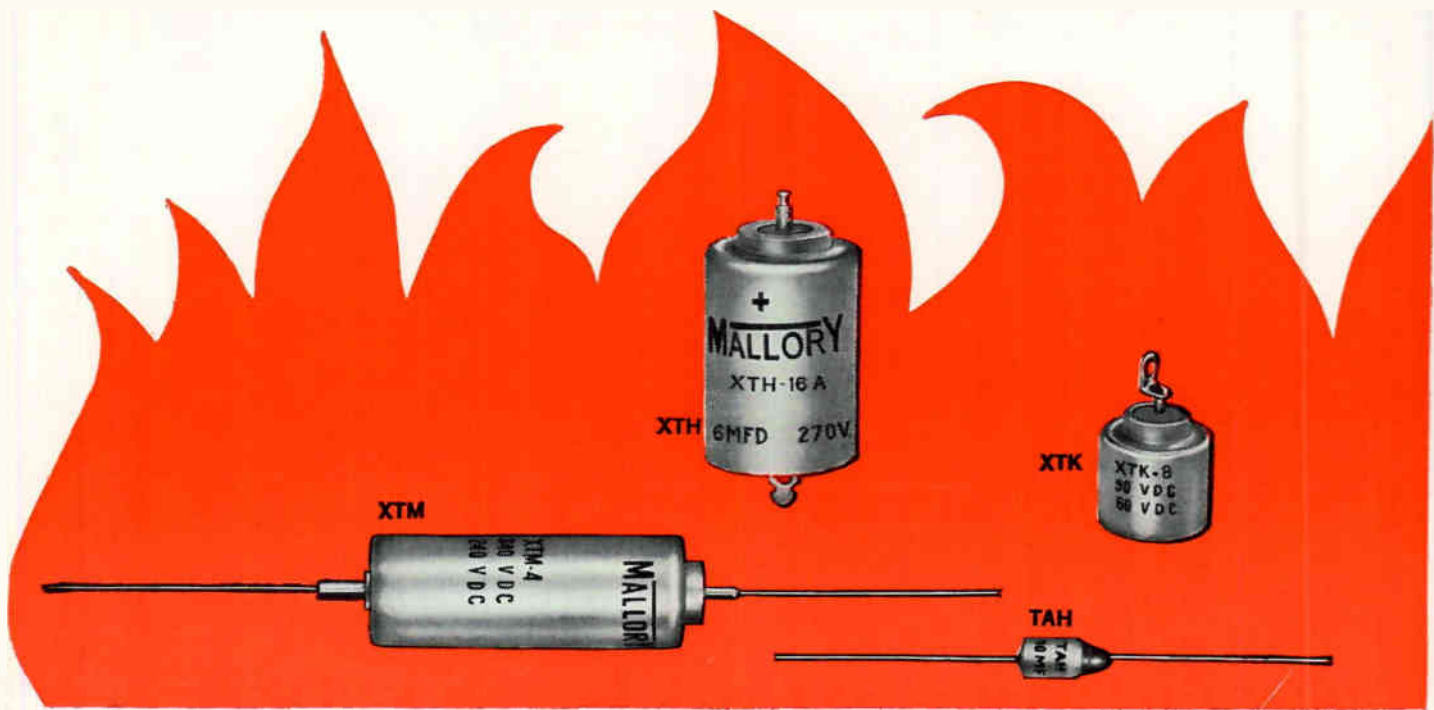

from the industry's widest selection...

the highest temperatures—up to 200°C . . . the highest capacitances—up to 2250 microfarads . . . the smallest sizes—new 125°C miniature TAH . . . many terminal arrangements are available in the XT series.

seven different high temperature types . . . with the

sintered pellet anode pioneered by Mallory for extreme environments.

. . . plus seven other tantalum capacitor types—including foil, solid electrolyte, encapsulated, miniature, microminiature. Write for catalog and consultation. Mallory Capacitor Company, Indianapolis 6, Indiana.

FOR THE HOTTEST JOBS

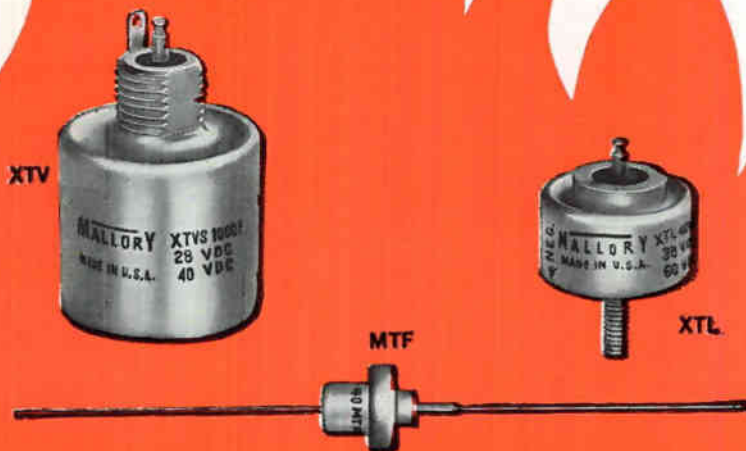

P. R. MALLORY & CO. Inc.
MALLORY

Mallory Tantalum Capacitors Stocked by these distributors

- Arlington, Va.
Rucker Electronic Products
- Baltimore, Md.
Radio Electric Service
- Binghamton, N.Y.
Federal Electronics
- Boston, Mass.
Cramer Electronics, Inc.
DeMambro Radio Supply Co.
Lafayette Radio
- Bridgeport, Conn.
Westconn Electronics
- Buffalo, N.Y.
Wehle Electronics
- Chicago, Ill.
Allied Radio Corp.
Newark Electronics Corp.
- Cincinnati, Ohio
United Radio
- Cleveland, Ohio
Pioneer Electronics
- Dallas, Texas
Engineering Supply Co.
- Dayton, Ohio
Allied Supply Co.
- Denver, Colo.
Denver Electronics
- Houston, Texas
Harrison Equipment Co., Inc.
Lenert Company
- Indianapolis, Ind.
Graham Electronics
- Los Angeles, Calif.
California Electronics
Kierulff Electronics, Inc.
Electronic Supply Corp.
Radio Product Sales
- Minneapolis, Minn.
Northwest Radio
- Montreal, Que.
Canadian Electrical Supply Co.
- Mountainside, N.J.
Federated Purchaser, Inc.
- Nashville, Tenn.
Electra Dist. Co.
- Newark, N.J.
Lafayette Radio
- New York, N.Y.
Harrison Radio Corp.
Harvey Radio Co., Inc.
Lafayette Radio
Milo Electronics
Terminal Hudson Electronics
- Oakland, Calif.
Elmar Electronics, Inc.
- Orlando, Fla.
East Coast Radio
- Ottawa, Ont.
Wackid Radio-TV Lab.
- Palo Alto, Calif.
Zack Electronics
- Perth Amboy, N.J.
Atlas Electronics
- Philadelphia, Pa.
Herbach & Rademan
Philadelphia Electronics
- Pittsburgh, Pa.
Radio Parts Co.
- St. Louis, Mo.
Olive Electronics
- Seattle, Wash.
F. B. Connelly Co.
- Tampa, Florida
Thurow Distributors, Inc.
- Toronto, Ont.
Alpha Aracon Radio Co.
Electro Sonic Supply
Wholesale Radio & Electronics
- Tucson, Ariz.
Standard Radio Parts
- Tulsa, Okla.
Engineering Supply Co.
- Washington, D.C.
Capitol Radio Wholesalers
Electronic Industrial Sales
- White Plains, N.Y.
Westchester Electronic Supply Co., Inc.
- Winston-Salem, N.C.
Dalton-Hege Radio



A complete line of aluminum and tantalum electrolytics, motor start and run capacitors.

Shallcross

precision
circuit
news

Standard 'Specials' in Shallcross Miniature Switches

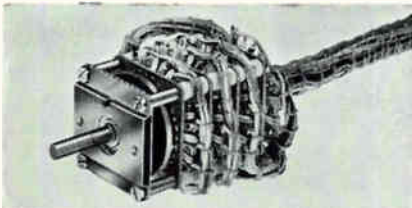

PRE-WIRED & HARNESED SWITCHES—Decks pre-wired before gonging to reduce your production costs and time.

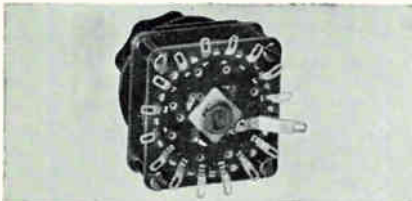

GOLD PLATED CONTACTS & TERMINALS—for the ultimate in maintaining low, stable contact resistance under corrosive conditions.

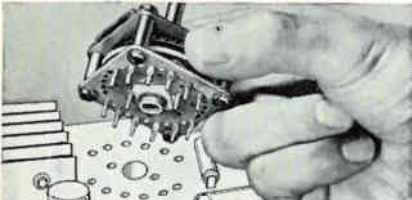

PRINTED CIRCUIT TERMINALS—available on single-deck or lost deck of multi-deck switches.

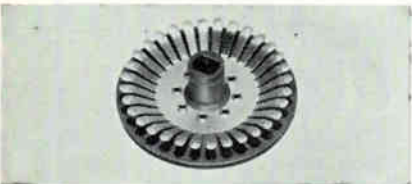

CLUSTER ARM ROTORS—for progressive-shortening or progressive-making circuits.

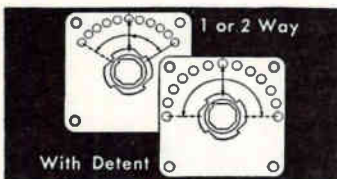

SPRING RETURN ROTORS—an either or both directions of rotor travel.

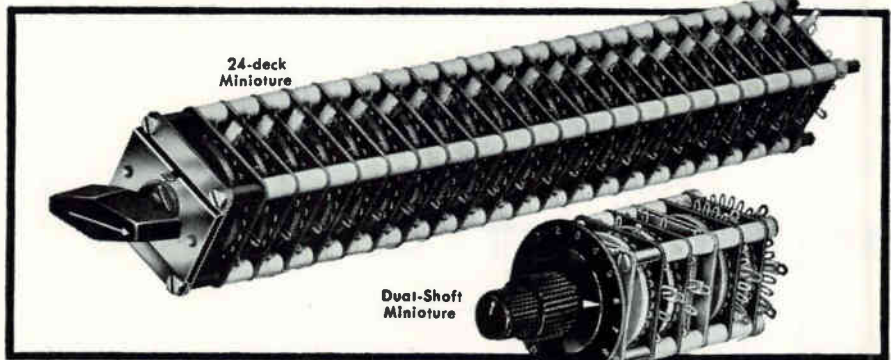

MAXIMUM CIRCUIT SWITCHING IN MINIMUM SPACE

Here's a positive approach to miniaturization—a way to handle more circuits per cubic inch! Conservatively estimated, over 650 circuits may be switched in only 38 cubic inches by a Shallcross Miniature Series switch . . . and with the quality and reliability only a button-contact, multi-leaf wiper arm switch can provide. In one recent application, the single 24-deck Shallcross Miniature switch shown above replaced four "subminiature" units.

Equally impressive space advantages are possible with dual concentric shaft versions of the Shallcross Miniature Series. Either shaft may

operate up to five of a total of ten decks. The inner shaft may also control a rheostat, variable capacitor, or other device.

If, in addition to size, switch quality is also your concern, the following highlights substantiate why Shallcross Miniature Switch users repeatedly specify these switches, and no others, for critical airborne, missile control, and computer applications.

Low initial contact resistance—less than 0.002 ohm.

Stable contact resistance—0.5 milliohm for 10,000 operations.

Highly immune to vibration damage—exceeds MIL-S-3786 requirements.

Uncompromised material quality—silver button contacts; silver alloy, multi-leaf, self-cleaning wipers; diallyl phthalate rotors; epoxy-laminate decks (filament woven with glass fiber).

Designed to applicable MIL-S-3786 Specifications.

Minimum thermocouple effects—similar materials for all current-carrying parts.

Excellent RF characteristics.

Minimum depth—1" first deck, 5/8" each additional deck.

Maximum Versatility—up to 32 positions, 1 to 4 poles, shorting or non-shorting in the same switch, 1 to 24 decks, ball detents, many special modifications.

For complete details, write for Shallcross Switch Bulletin

Solenoid-Operated Switches

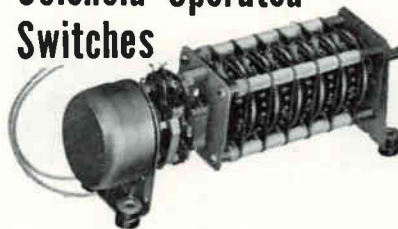

For indirect switching of complex circuits, or to avoid "over stepping" positions in critical circuits, most Shallcross Miniature Switches can be furnished with solenoid operation. Outline your circuit requirements for a prompt recommendation by Shallcross engineers.

Shallcross Manufacturing Co. Selma, North Carolina

Precision wirewound resistors. Switches. Instruments. Delay lines. Resistance networks. Audio attenuators.

RAYTHEON TRANSFORMER TALK

Facts about transformers that have solved equipment design problems • No. 4 in a series.

Look at what epoxy encapsulation

has done for high-voltage plate transformers

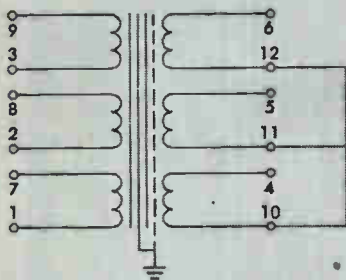
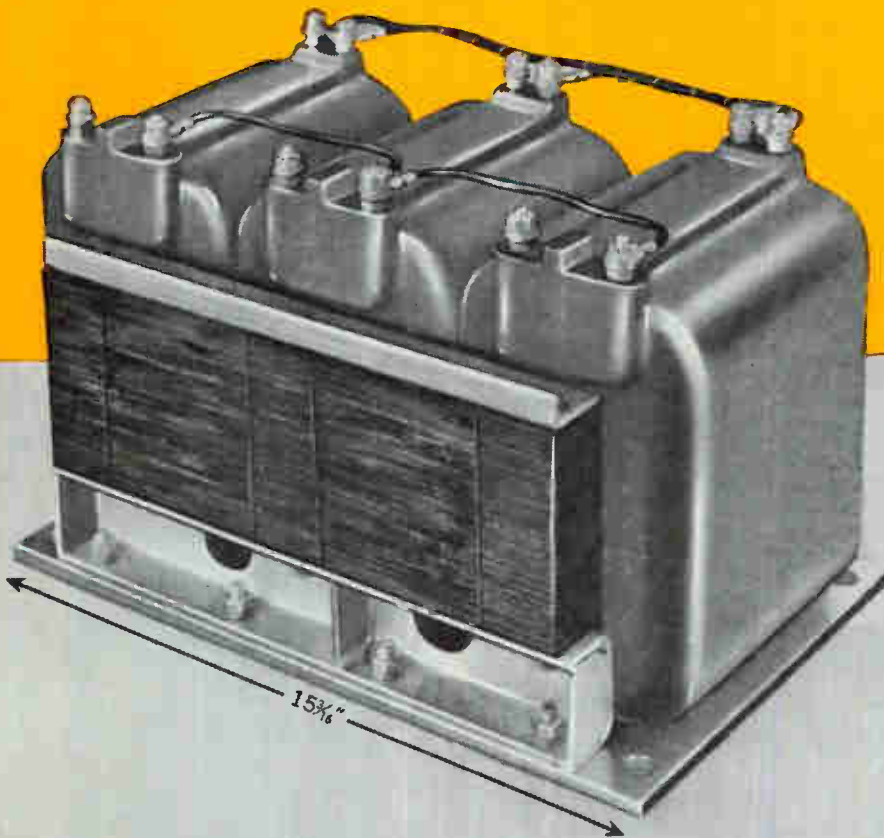

50% SMALLER, 30% LIGHTER than its predecessors, this 3.25 KVA plate transformer has proven itself in continued performance under actual environmental conditions.

Raytheon encapsulation techniques are successfully applied to 3.25 KVA units for startling reductions in size and weight.

The transformer illustrated at left measures just $9\frac{9}{16}$ x $15\frac{3}{16}$ x $9\frac{11}{16}$ in. Yet, it will deliver 11,750 dc volts at 0.275 dc amperes in a full-wave bridge rectifier circuit.

Reliability? Raytheon produced over 500 units of this design for military applications without a single reported failure.

Epoxy encapsulation, now commonly used in small transformers, had never before been successfully applied to large high-voltage power transformers. Now, with newly developed techniques in casting and curing epoxy, Raytheon has solved one of the toughest encapsulation problems known.

This same kind of engineering experience and skill is being applied to a wide range of transformer design and production problems from small silicone rubber impregnated units for high-temperature application to high-voltage designs like the one described here.

Write today for descriptive folder and technical article describing Raytheon encapsulated transformers. Address Magnetics Operation, Microwave and Power Tube Division, Raytheon Company, Foundry Avenue, Waltham 54, Massachusetts.

RAYTHEON

RAYTHEON COMPANY

MICROWAVE AND POWER TUBE DIVISION



NEFF INSTRUMENT CORPORATION, WITH MANY PROVEN CONTRIBUTIONS TO INSTRUMENTATION, INVITES YOUR INSPECTION AND EVALUATION OF THESE RECENTLY INTRODUCED AMPLIFIERS. THEY HAVE BEEN DESIGNED TO SATISFY TODAY'S MORE CRITICAL APPLICATIONS. NEFF CUSTOMERS KNOW THAT EACH AMPLIFIER WILL MEET ITS PUBLISHED SPECIFICATIONS. FOR YOUR CRITICAL AMPLIFIER APPLICATIONS — LOOK TO NEFF.

NEFF
INSTRUMENT CORPORATION

1088 East Hamilton Road Duarte, California

TYPE 101B AN EXTREMELY RELIABLE SOLID STATE DIFFERENTIAL DC AMPLIFIER COMBINING HIGH GAIN, LOW NOISE, HIGH INPUT IMPEDANCE AND LOW OUTPUT IMPEDANCE WITH INTERCHANGEABLE PLUG-IN FILTERS. THIS AMPLIFIER IS IDEAL FOR NARROW BAND REQUIREMENTS WHERE NOISE OR GROUND CURRENTS CREATE PROBLEMS.

TYPE 106 A SOLID STATE BROAD BAND, SINGLE ENDED LOW GAIN DC AMPLIFIER PARTICULARLY APPLICABLE AS A GALVANOMETER DRIVER OR LINE DRIVER. THE AMPLIFIER FEATURES HIGH OUTPUT CURRENT, LOW OUTPUT IMPEDANCE, AND OPTIMUM ISOLATION. A DUAL OUTPUT IS PROVIDED — DIRECT OR THROUGH A PLUG-IN DAMPING NETWORK WHICH ACCOMMODATES THE RESISTANCE NECESSARY TO MATCH ANY GALVANOMETER.

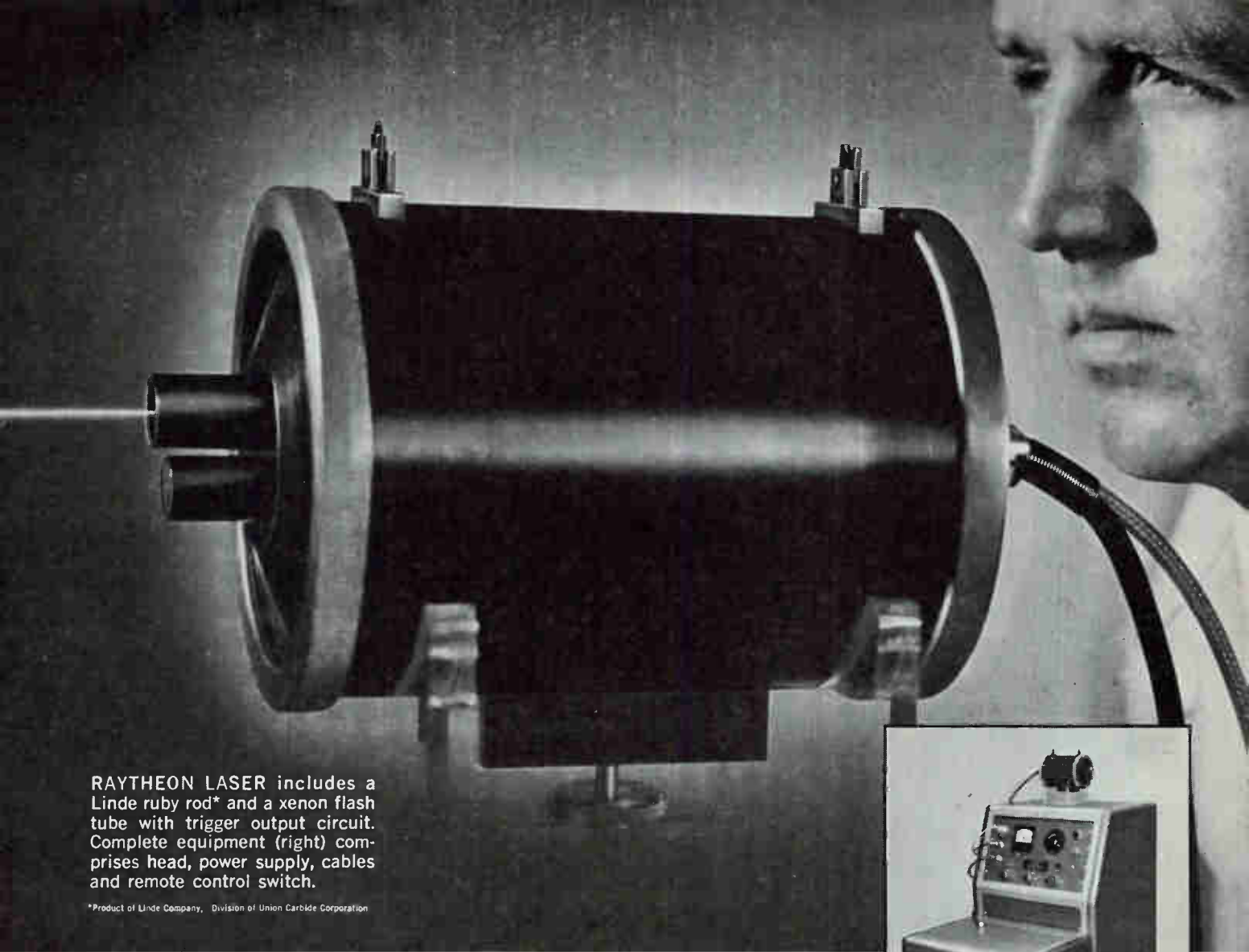

RAYTHEON LASER includes a Linde ruby rod* and a xenon flash tube with trigger output circuit. Complete equipment (right) comprises head, power supply, cables and remote control switch.

*Product of Linde Company, Division of Union Carbide Corporation



Raytheon ruby laser now available for laboratory investigations

Complete equipment as shown is ready for use and priced at \$5,850.

Raytheon's low-cost pulsed ruby laser complete with power supply is stocked for immediate delivery.

This new laboratory set-up is similar to the one recently exhibited at technical sessions and described in national scientific journals. The \$5,850 price is possible because of an improved Raytheon optical design that permits laser action to be obtained with approximately one-tenth the flash tube energy previously required.

The laser head is constructed for convenient interchangeability of ruby rods and replacement of flash tube. The heavy-duty power supply is designed to permit precise adjustment of flash tube firing voltage for investigation of laser action at various power levels.

For complete technical proposal LTP-100, write to Special Microwave Devices Operation, Raytheon Company, Waltham Industrial Park, Waltham 54, Massachusetts.

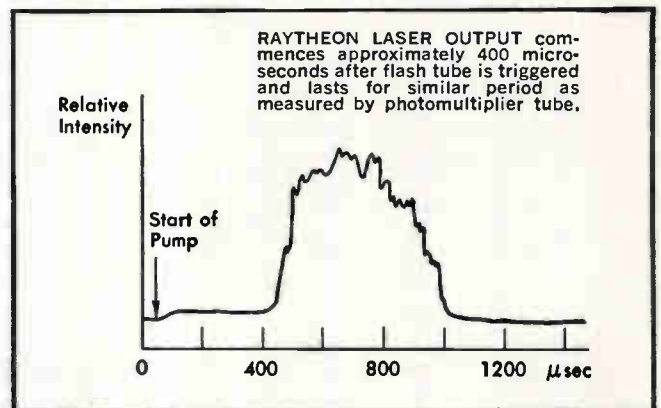

RAYTHEON COMPANY

SPECIAL MICROWAVE DEVICES OPERATION



CIRCLE 95 ON READER SERVICE CARD

FREQ. STDS.

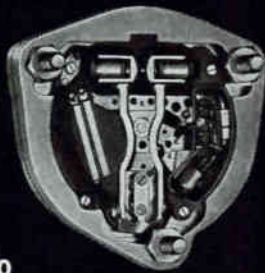

TYPE 10
1 3/8" x 1 3/8" x 3/8"

This frequency standard (360 or 400 cycles) is accurate to ± 50 parts per million at 10° to 35°C. Aging has been greatly minimized.

External power of 1.4 volts at 6 microamperes powers the unit.

TYPE 2007-6



TYPE 25



TYPE 2001-2



AND PRECISION FORK UNITS 1 TO 40,000 CYCLES

TYPE 2007-6 FREQUENCY STANDARD

Transistorized, Silicon type
Size, 1 1/2" dia., x 3 1/2" H., Wt., 7 oz.
Frequencies: 360 to 1000 cy.

Accuracies:

2007-6 $\pm 0.2\%$ (-50° to +85°C)

R2007-6 $\pm .002\%$ (+15° to +35°C)

W2007-6 $\pm .005\%$ (-65° to +85°C)

Input: 10 to 30V DC at 6 ma.

Output: Multitap, 75 to 100,000 ohms

TYPE 2001-2 FREQUENCY STANDARD

Size, 3 3/4" x 4 1/2" x 6" H., Wt., 26 oz.

Frequencies: 200 to 3000 cycles

Accuracy: $\pm .001\%$ at +20° to +30°C

Output: 5V at 250,000 ohms

Input: Heater voltage, 6.3 - 12 - 28

B voltage, 100 to 300 V, at 5 to 10 ma.

Accessory Modular units are available to divide, multiply, amplify and power this unit.

TYPE K-5A FREQUENCY STANDARD

Size, 3 1/2" x 3" x 1 3/4"

Weight, 1 1/2 lbs.

Frequency: 400 cycles

Accuracy: .03%, -55° to +71°C

Input: 28V DC $\pm 10\%$

Output: 400 cy. approx. sq. wave
at 115V into 4000 ohm load (approx. 4W)

TYPE 25 PRECISION FORK

Size, 5/8" dia. x 2 1/4"

Weight: 2 ounces

Frequencies: 200 to 1000 cy.

Accuracies:

R-25T and R-25V $\pm .002\%$ (15° to 35°C)

25T and 25V $\pm .02\%$ (-65° to 85°C)

For use with tubes or transistors.

INQUIRIES INVITED

For over 20 years we have made frequency standards and precision fork units for applications where consistent accuracy and rugged dependability are vital. Shown are just a few typical examples.

Some users integrate our products with instruments of their own manufacture. In other cases we develop complete assemblies to meet special needs.

You are invited to submit any problems within the area of our activity for study by our engineering staff.



AMERICAN TIME PRODUCTS

DIV. OF BULOVA WATCH COMPANY, INC.

61-20 Woodside Ave., Woodside 77, L. I., N. Y.

WESTERN OFFICE, 234 N. LAKE AVE., PASADENA, CALIF.

General Instrument Planar Transistors

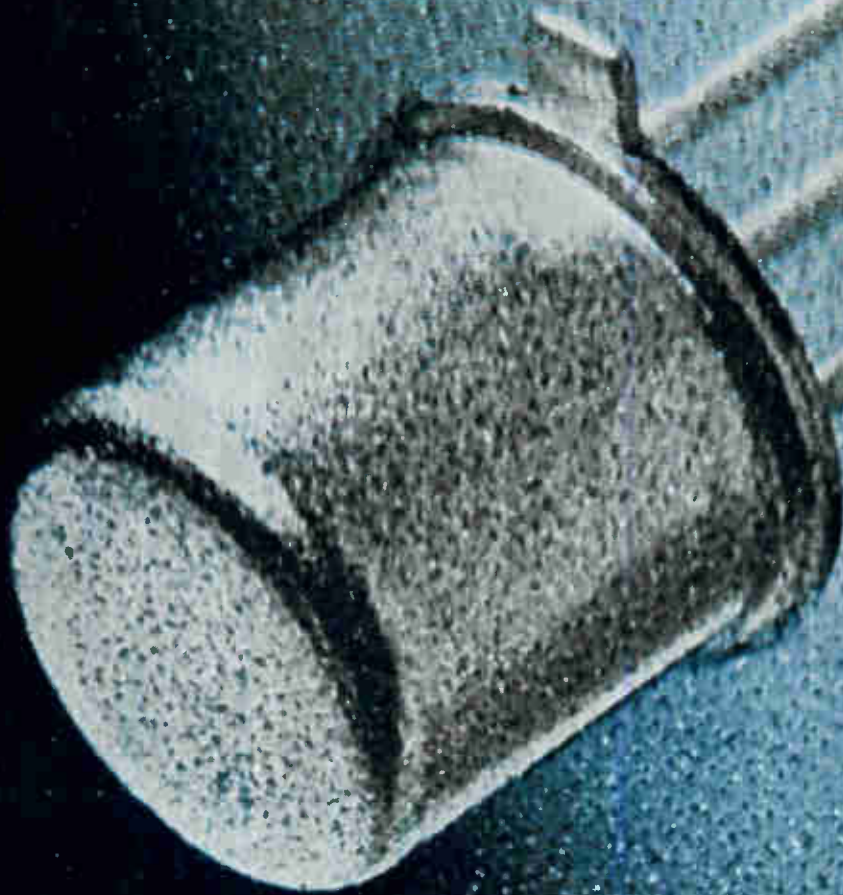

At last! A truly passivated planar! New 2N708 silicon switch

For high speed logic switching with assured reliability, the General Instrument 2N708 npn silicon planar switch features the unique Molecular Shield™ surface-passivation process. ■ Here's a planar that is stable, reliable and uniform...lot by lot...with excellent gain characteristics as well as extremely low leakage current. Designed for switching applications, this type, as well as others in the popular 2N706 class, utilizes the latest planar techniques. ■ Extensive tests have proved that this type of transistor construction offers definite circuit advantages. Life tests, for example, indicate little degradation as a result of operation and storage at high temperatures. ■ The immediate availability of the 2N706 series in production quantities should be of interest to designers now using our silicon mesa transistors. The 2N708 is also available in limited quantities. For microtransistors, pancake-package transistors...for all your silicon planar and mesa transistors, call the sales office or franchised distributor nearest you. Or write for complete details to General Instrument Semiconductor Division, 65 Gouverneur St., Newark 4, N.J.

Abbreviated Specifications—General Instrument NPN Silicon Planar Transistors

Type	V _{CB0}	V _{CER}	h _{FE}	T _S
2N706	25v	20v	20	60 nsec
2N706A	25v	20v	20	25 nsec
2N706B	25v	20v	20	25 nsec
2N708	40v	20v	30	25 nsec

GENERAL INSTRUMENT SEMICONDUCTOR DIVISION
GENERAL INSTRUMENT CORPORATION



JEDEC TO-18 CASE ACTUAL SIZE

GENERAL INSTRUMENT

a major new source for

CAPACITORS

The GENERAL INSTRUMENT CAPACITOR DIVISION enters the electronics world with 60 years of experience. Formed by a consolidation of Pyramid and Micamold, the new GENERAL INSTRUMENT CAPACITOR DIVISION combines Pyramid's 23 years of experience and Micamold's 37 years under one, new corporate roof.

What does this mean to you? ■ You now have a major new source for capacitors...with a product line that meets almost 100% of your capacitor requirements. **(You'll be especially interested in our Tantalums — Dipped Micas — Subminiature Electrolytics and Film Capacitors)**... with modern manufacturing and research facilities capable of handling everything from special high-reliability capacitors to high-quality, large production runs...with experienced and imaginative designers, engineers and technicians approaching each assignment from one point of view — yours!...with a nationwide staff of trained and experienced sales engineers ready to sit down at a moment's notice to help you work out your capacitor problems...with marketing and financial resources that insure a sound pricing policy, and prompt, reliable deliveries, not some of the time, not most of the time, but all the time. ■ Find out how this new "60-year old" source of capacitors can work for you. **Come see us at the WESCON Show, Booth 1912.** Write for engineering bulletins to GENERAL INSTRUMENT CAPACITOR DIVISION, Darlington, S.C.

Order the reliable capacitor from

GENERAL INSTRUMENT CAPACITOR DIVISION
GENERAL INSTRUMENT CORPORATION

Visit our booth
No. 3718
WESCON

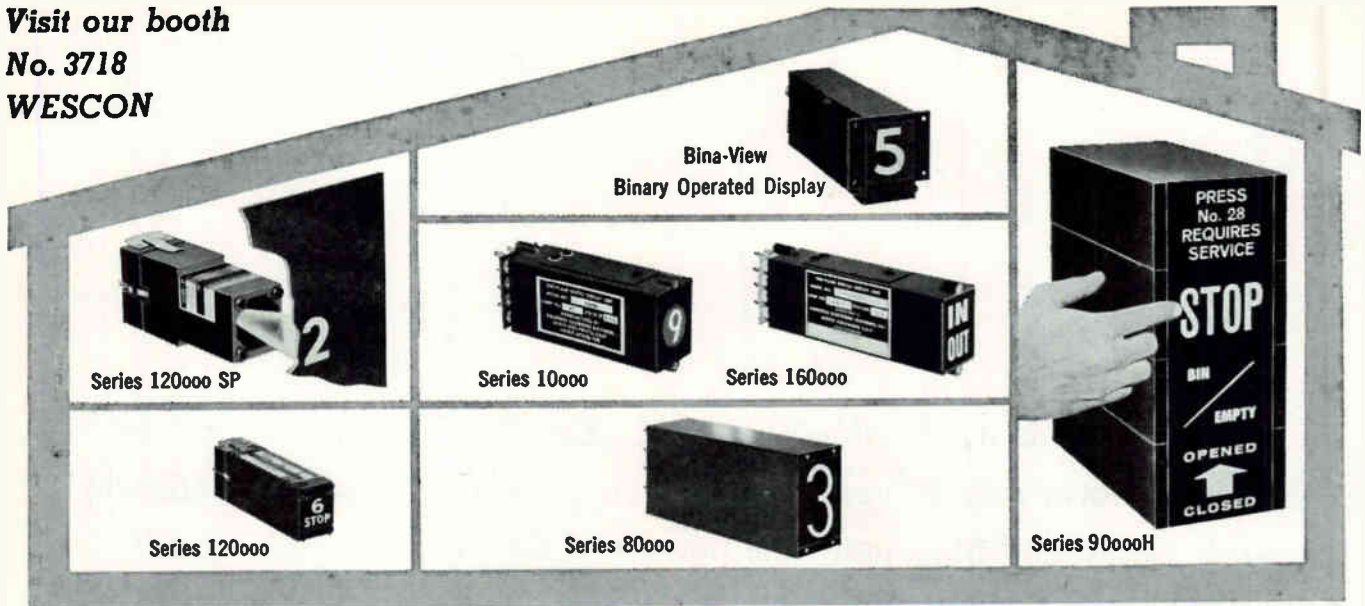

READOUTS THAT DO MORE THAN DISPLAY NUMBERS

I.E.E.'s complete line of rear-projection readouts display words, numbers, symbols, and color. The alpha-numeric Bina-View readout is self-decoding and operates direct from binary output. And all can satisfy human factors requirements!

The engineering staff and facilities of Industrial Electronic Engineers, Inc. have approached the problem of readouts as one of visual communications, the case in point being that

complete!
under
the

roof

numbers are only one form in a host of methods in visual communications. The engineering talent at I.E.E. work under the formula that the more forms of visual communications that are available the less chance there is for communicative breakdown. *In a word; complete.*

Your inquiry to complete readout visual communications is invited.



INDUSTRIAL ELECTRONIC ENGINEERS, Inc.
.5528 Vineland Avenue, North Hollywood, California

CIRCLE 256 ON READER SERVICE CARD

UNIQUE

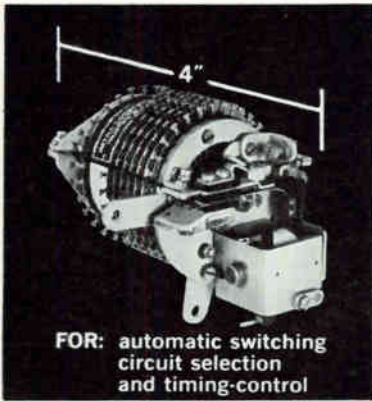

FOR: automatic switching
circuit selection
and timing-control

The
Genalex
Miniature
High-Speed
Stepping Switch

FEATURING: 80 steps per second on impulse drive **30** contacts per bank **12** banks maximum **17 oz.** light-weight **7** levels sequence switching.

Over 5,000,000 Steps Without Replacements

Write today for complete data — Also, data available on Genalex one-way and two-way stepping switches.



11 UNIVERSITY ROAD, CAMBRIDGE 38, MASS.

U. S. AGENTS FOR THE GENERAL ELECTRIC COMPANY, LTD. OF ENGLAND

KEW
Around the world, it's **KEW**

KYORITSU ELECTRICAL INST. WORKS, LTD.
No. 120, Nokone-cho, Meguro-ku, Tokyo, Japan
Cable Address: "KYORITSUKEIKI TOKYO"
Tel: (717) 0131-5

CIRCLE 257 ON READER SERVICE CARD

electronics

Transitron
ANNOUNCES
NEW DEVELOPMENTS
IN ITS
ADVANCED LINE OF...

SILICON POWER TRANSISTORS

IN THE HIGH POWER RANGE, THE TRANSITRON UNITS FEATURE:



- the widely accepted stud-mounted package, pioneered by Transitron
- low saturation resistances
- voltages to 100 volts
- reliability-tested specifications

Write for Bulletin TE-1355-1210

Type	Maximum Power Dissipation at 100°C Case (Watts)	Maximum Collector Voltage V_{ce} (Volts)	Minimum DC Common Emitter Current Gain at 2 Amps β	Typical Collector Saturation Resistance (Ohms at 2 Amps)
2N1616	30	60	15	0.7
2N1617	30	80	15	0.7
2N1618	30	100	15	0.7
2N1210	30	60	15	0.7
2N1211	30	80	15	0.7
2N1620	30	100	15	0.7

CIRCLE 258 ON READER SERVICE CARD

IN THE INTERMEDIATE POWER RANGE, THE NEW TRANSITRON UNITS FEATURE:



- $\frac{1}{16}$ " hex base stud-mounted package
- saturation resistances under 3 ohms (2N1647-50 series)
- guaranteed Betas over normal operating range
- voltage ratings as high as 200 volts (2N2018-21 series)
- true intermediate power capability

Write for Bulletins TE-1355S and TE-1355-2018

Type	Maximum Collector Voltage V_{ce} (Volts)	Maximum Power Dissipation at 100°C Case (Watts)	Minimum DC Common Emitter Current Gain at 500 mA β	Minimum Collector Breakdown Voltage at 50 mA V_{ce0} (Volts)	Typical Saturation Resistance (Ohms)
2N2018	150	20	20	125	3.5
2N2019	200	20	20	140	3.5
2N2020	150	20	40	125	3.5
2N2021	200	20	40	140	3.5
2N1647	80	20	15	60	1.9
2N1648	120	20	15	80	1.9
2N1649	80	20	30	60	1.9
2N1650	120	20	30	80	1.9

CIRCLE 259 ON READER SERVICE CARD

MEET US AT WESCON • BOOTHS 3502-3504

The widest range of silicon power transistors is now available as the result of Transitron's development of an advanced line of competitively priced silicon transistors in the intermediate and high power ranges.

Electrical and mechanical advantages of the Transitron devices include low saturation resistances, voltages up to 200 volts, and solutions to heat dissipation problems that have long plagued designers. Included in this broad line are a number of silicon power transistors that Transitron is marketing at prices geared to the budget of the industrial designer!



ALSO AVAILABLE 2N1047-50 and 2N1047A-50A SERIES OF INTERMEDIATE POWER SILICON TRANSISTORS ... for applications which require the single-ended, stud package.

Write for Bulletin TE-1355-1047

CIRCLE 260 ON READER SERVICE CARD

ANOTHER
TRANSITRON
EXCLUSIVE:

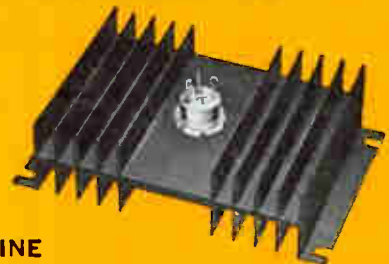

NEW STANDARD LINE OF NATURAL CONVECTION COOLERS

Transitron has recently canvassed the market for the best available natural convection coolers. Under laboratory conditions, research engineers conducted a series of unbiased tests to determine which coolers possess the best heat dissipation capabilities for Transitron power semiconductors.

As a result, Transitron now offers a new standard line of four natural convection coolers, backed by extensive applications know-how. Transitron is thereby the first company to offer its customers a systematic and continuing program of service for the solution of annoying heat dissipation problems.

For further information, write for Application Notes AN-1355C and Bulletin TE-1355-1. CIRCLE 261 ON READER SERVICE CARD

Transitron



electronic corporation
wakefield, melrose, boston, mass.

SALES OFFICES IN PRINCIPAL CITIES THROUGHOUT THE U.S.A. AND EUROPE • CABLE ADDRESS: TRELCO

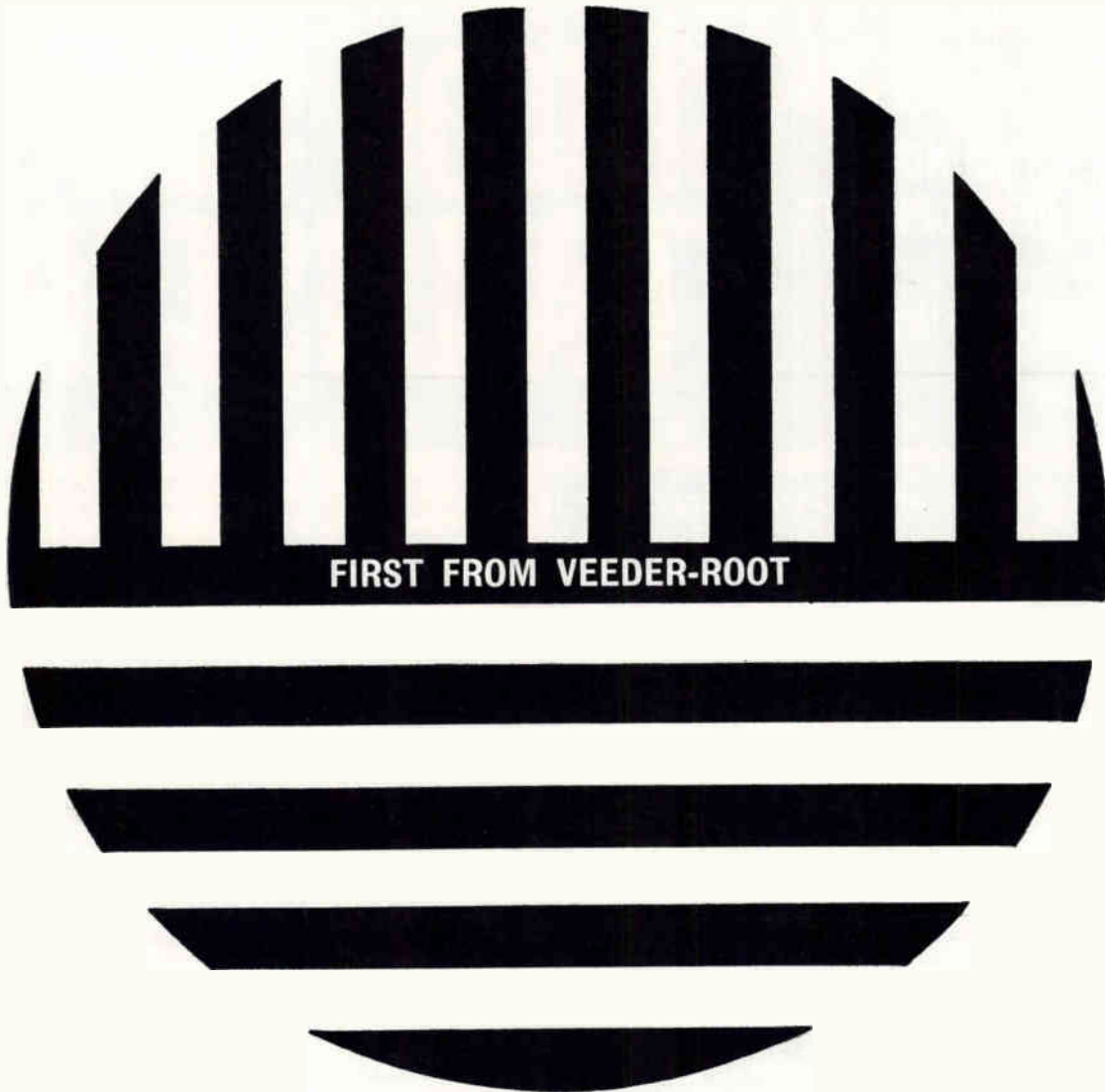

an electronic high-speed bi-directional counter that's easy to attach, easy to use, easy to maintain. It adds, subtracts, counts up to 5000 per second, recycles instantly. Moderate in cost, it's ideal for a wide range of displacement measurement jobs... on lathes, drill presses, boring mills... on linear or rotary optical comparators. And this is only the beginning of its usefulness. To see what it can do for you write Electronic Controls Division, Veeder-Root Incorporated, Danvers, Mass.

count on... VEEDER-ROOT

Visit Booth (No. 3617-3619)
at the Wescon Show
San Francisco Cow Palace
August 22-25

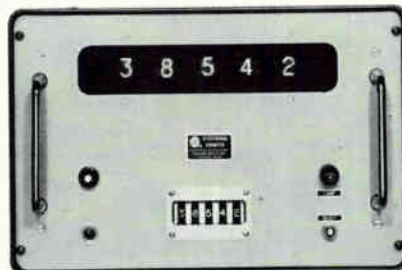

Numerical readout tubes—in five or six digits make the Series A-1805 Electronic Counter easy to read up to 40' away. Transistors and printed circuits assure trouble-free operation. Controls include selector switches, power switch, reset button, pilot light.

COPYRIGHT 1961

BRUSH INSTRUMENTS

DIVISION OF CLEVITE CORPORATION

CLEVELAND, OHIO

**unmatched
peak in
penmanship...**

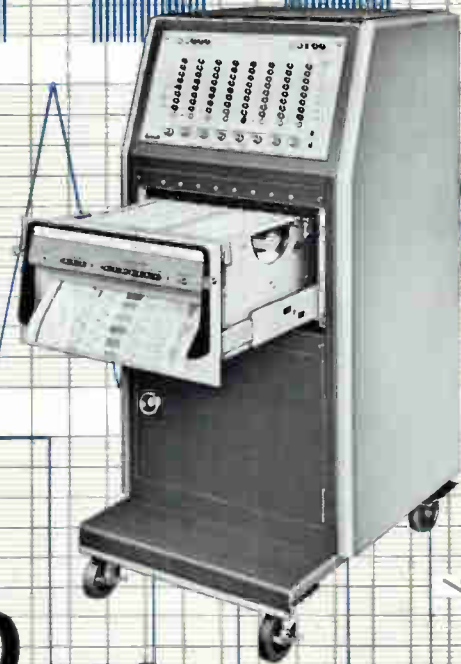

The totally new **Brush Recorder Mark 200** made these incredibly crisp tracings. No other recorder in existence can match them. Note the line width. It never varies . . . regardless of writing velocity, regardless of chart speed. The writing mechanism is electrically signaled by the position-seeking "Metrisite" transducer . . . no parts to wear, infinite resolution, verifiable dynamic $\frac{1}{2}\%$ accuracy. Traces are permanent, high-contrast, reproducible . . . on low cost chart paper. The Mark 200 has but three standard controls . . . attenuator, pen position, chart speed. Such fidelity, simplicity and economy are possible with no other direct writing recorder. Write for details . . . they'll speak for themselves.

brush INSTRUMENTS
DIVISION OF
37TH AND PERKINS **CLEVITE** CORPORATION CLEVELAND 14, OHIO



Model FC-14 J & L Optical Comparator

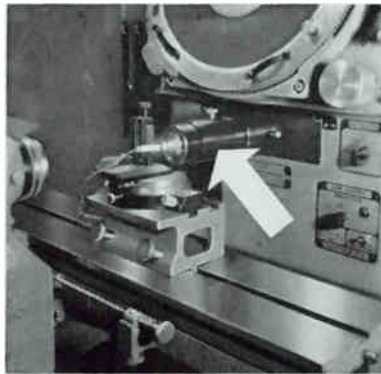

CENTRALITE image of read/record head clearly shows two magnetic poles separated by aluminum foil insulator at 31.25 magnifications.

CENTRALITE adapter (arrow) slips easily into place on J & L Optical Comparator — used here to inspect tiny read/record head.

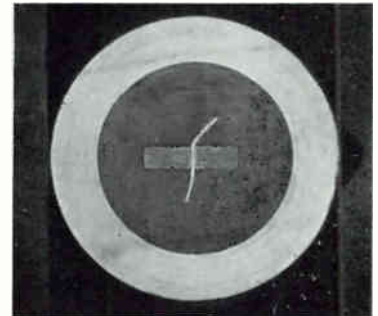

NOW...closer inspection of micro-assemblies ...with CENTRALITE and PARABOLITE

Simply slip on a CENTRALITE or PARABOLITE adapter, and your J & L TC-14 or FC-14 Optical Comparator becomes even *more* versatile. You'll use it for critical inspection jobs that may have previously seemed impossible.

For example, CENTRALITE provides a highly concentrated light which now permits the projection of a precise image of a tiny read/record head used in a computer component. Light is concentrated intensely on the part and reflected back through the J & L projection system onto the Comparator screen. CENTRALITE is also used for micro-inspection of a mesa diode assembly.

PARABOLITE permits detailed examination of a tiny tunnel diode assembly by surrounding it with concentrated light. Simply by rotating the diode, you can take a close look at seal, bubble configuration at fusion points, gold contact to wafer, and other critical details.

Solve *your* inspection problems with J & L Optical Inspection Equipment. Send for Catalog LO-6013 now.

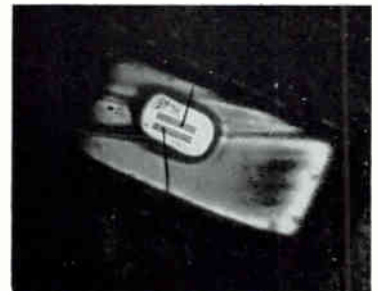

Micro inspection of this mesa diode assembly at 100 magnifications is clearly detailed with CENTRALITE.

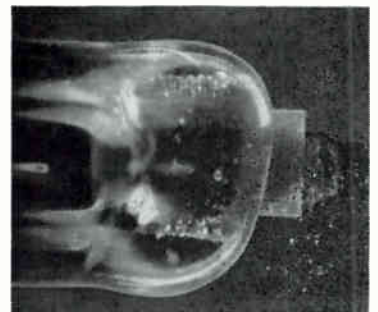

PARABOLITE makes possible a sharp close-up of bubble configuration at the fusion point of this tunnel diode (50 magnifications).



JONES & LAMSON MACHINE COMPANY

539 Clinton Street, Springfield, Vermont

Turret Lathes • Automatic Lathes • Tape Controlled Machines • Thread & Form Grinders • Optical Comparators • Thread Tools

104 CIRCLE 104 ON READER SERVICE CARD

electronics

NEW...FROM SORENSEN

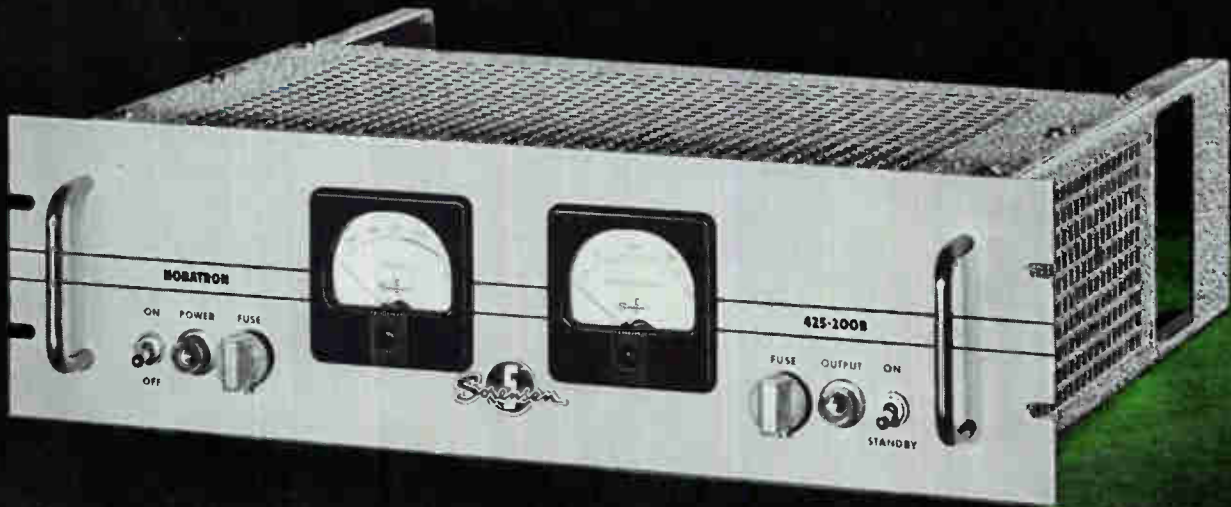

Regulated, variable-output

B SUPPLIES

2 voltage ranges at 200, 400 and 800 MA

TRANSISTORIZED SINE WAVE INVERTER -

The QISB, a rugged, low-cost, compact inverter, provides up to 60 VA of 115V AC at 60 or 400 cycles from a DC source. Output will not vary more than $\pm 3\%$ with load variations. The QISB is easy to install and starts instantly. It has no moving parts and is not damaged by momentary overloads or output shorts.



3-PHASE FREQUENCY CHANGER -The FCR 3P300 variable frequency power source supplies 0-130 volts line to neutral; 300 VA 3-phase, 200 VA 2-phase, or 300

VA single phase with $\pm 1\%$ regulation for both output frequency and voltage. Frequency may be varied from 45 to 2000 cps in two ranges. Suitable for many laboratory and industrial applications.



Close regulation, maximum dependability and relatively low cost distinguish these versatile new B Supplies. Available with 125-325 VDC or 325-525 VDC output, they also provide 6.5 VAC for powering external tube filaments. Mechanically designed for easy access to tubes and circuits, all models are designed for standard 19" rack mounting and include front-panel output voltmeters and ammeters. These compact new plate and filament supplies are ideal for use in a broad variety of industrial and laboratory electronic equipment. Ask for complete specifications and literature.

SPECIFICATIONS

INPUT VOLTS:	105-125 volts AC 60-400 Cycles All Models
DC OUTPUT VOLTS:	125-325 V DC or 325-525 V DC
DC OUTPUT CURRENT (MA):	200 400 800
LINE & LOAD REGULATION COMBINED:	$\pm (0.1\% + .1 \text{ V})$
RIPPLE:	3 millivolts RMS
AC OUTPUT VOLTS (unregulated):	6.5 V (at full load, 115 V AC Input)

See us in the Raytheon Exhibit at the Wescon Show:
Booths 3404, 3406

A UNIT OF RAYTHEON COMPANY



RICHARDS AVENUE • SOUTH NORWALK • CONNECTICUT

FOR FILTER NETWORKS —
 DELAY LINES

0°C 10°C 20°C 30°C 40°C 50°C

+1.0					
+0.5					
0					
-0.5					
-1.0					

% Delta Mu
Mu

Typical Curve for a TC-1-03-250 Cup Core

FERRAMIC® Cup Core Assemblies with Unmatched Stability 0° C to 50° C (International Series)

FEATURES THAT PAY OFF IN PERFORMANCE AND COST

- Seven sizes from stock .599" to 1.425" O.D.
- Frequencies — 1KC to 1MC
- "Q" values to 750
- Standard Gapped Inductance Values 40 to 1000 MH/1000 turns
- Extreme temperature stability
- Trimmer for minimum of 12% adjustment
- Complete assembly available

Now, a complete line of in-stock cup core assemblies designed for electronic coil applications requiring inductance and permeability having exacting temperature stability and linearity.

The high "Q" factor exhibited by these temperature compensated cup cores is engineered to meet the most rigid coil design requirements.

TC permeability stable units combine optimum operating performance in the smallest possible space providing complete design flexibility at low cost.

For exact recommendations and fast off-the-shelf deliveries, write, wire or phone today — ask for Bulletin 28, Dept. A-8.



GENERAL CERAMICS

Phone VALley 6-5100 • Direct Distance Dialing Code 201

KEASBEY, NEW JERSEY, U. S. A.

TECHNICAL CERAMICS, FERRITES AND MEMORY PRODUCTS

NEW DIMENSIONS IN MEASURING RFI

with the **STODDART
NM-62A**

1 gc to 10 gc
(1 kmc to 10 kmc)

Even our benign Sun is often a nuisance to missile guidance systems. A successful count-down and launching can occur only after a "path" is cleared through a limitless sky filled with interference. And STODDART—leader in the field of radio interference control—now adds the needed new dimensions to RFI measurement techniques with the NM-62A Interference Measuring Instrumentation.

The NM-62A is designed and manufactured to rigid military equipment specifications for use by all government services, as well as industry. This completely self-contained, compact unit cuts operating time and cost, and advances the state of the art by providing:

- **AUTOMATIC FREQUENCY SCANNING** over entire range of 1 to 10 gc
- **AUTOMATIC TUNER SELECTION**
- **AUTOMATIC RECORDING** of amplitude vs. frequency
- **MOTORIZED TUNER SCANNING**

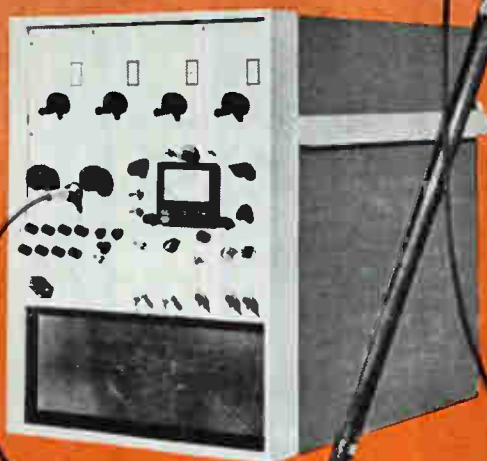

See this new and revolutionary instrument at the Wescon Show Booth 205. We invite your immediate request for complete details and specifications.

STODDART

AIRCRAFT RADIO CO., INC.
6644 SANTA MONICA BLVD.
HOLLYWOOD 38, CALIFORNIA
HOLLYWOOD 4-9292

serving 33 countries in Radio Interference control



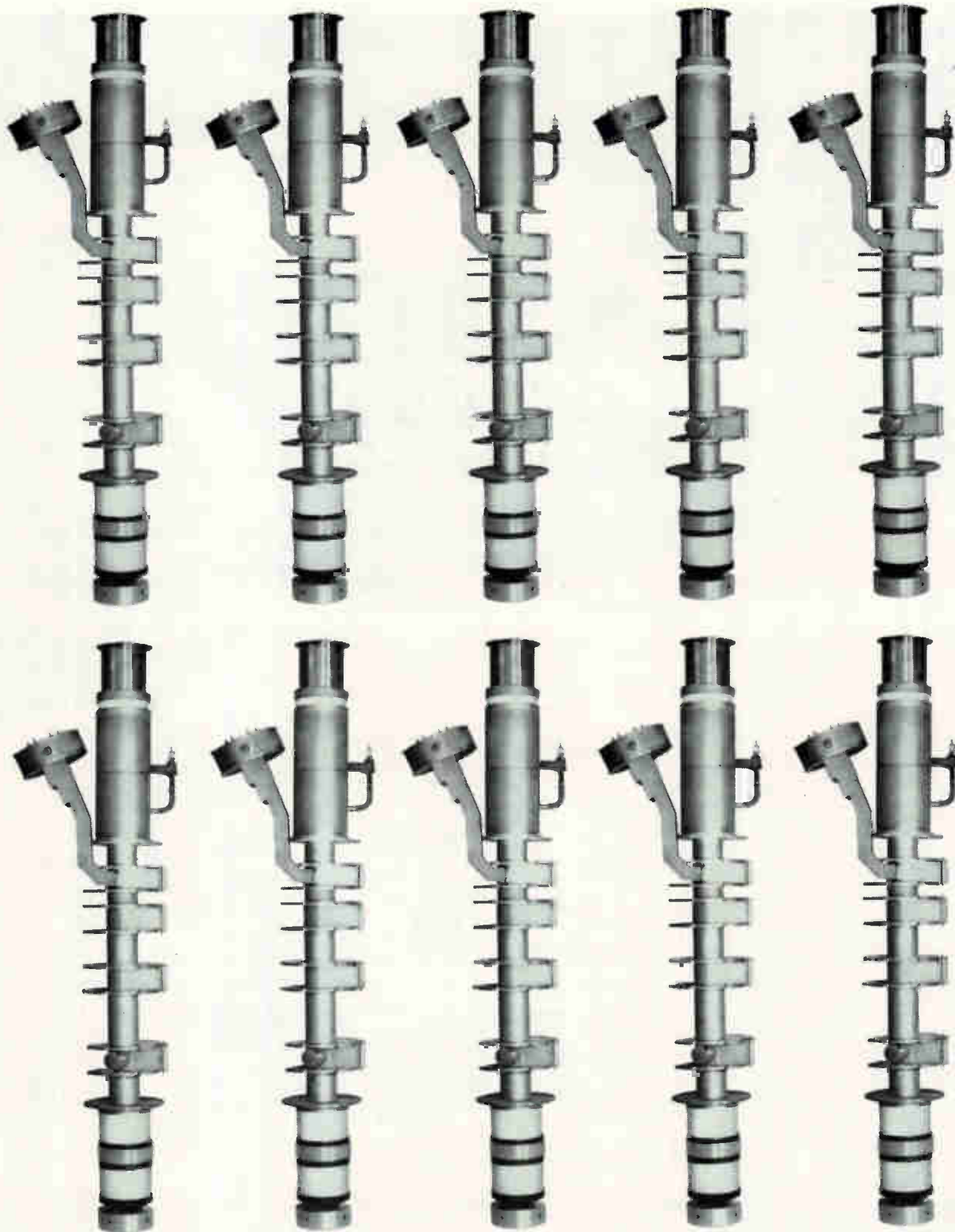

Today it would take ten super-klystrons to generate more than a megawatt of average power. But now Eimac is ready to do it

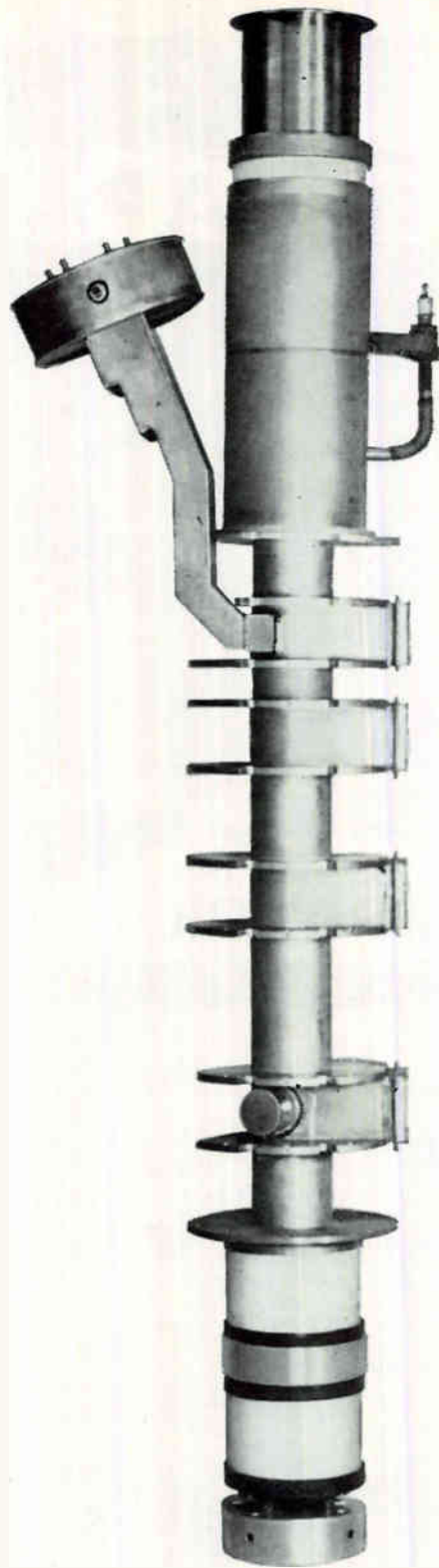

with one.

Today, the most powerful klystron available can produce 100KW of average power. But now Eimac is ready to develop a klystron with *ten times* this capability...a klystron that can generate more than one megawatt of average power!

Impossible? Not for the company that's designed, financed and built the world's largest high voltage

DC power supply (325,000 volts at 10 amps steady current). Not for the company that's made more high power klystrons than any other manufacturer. Not, in short, for *Eimac*. Write for information about this super-klystron capability to: Power Klystron Marketing, Eitel-McCullough, Inc., San Carlos, California.



A NEW LOOK AT SEMCOR'S CAPABILITIES

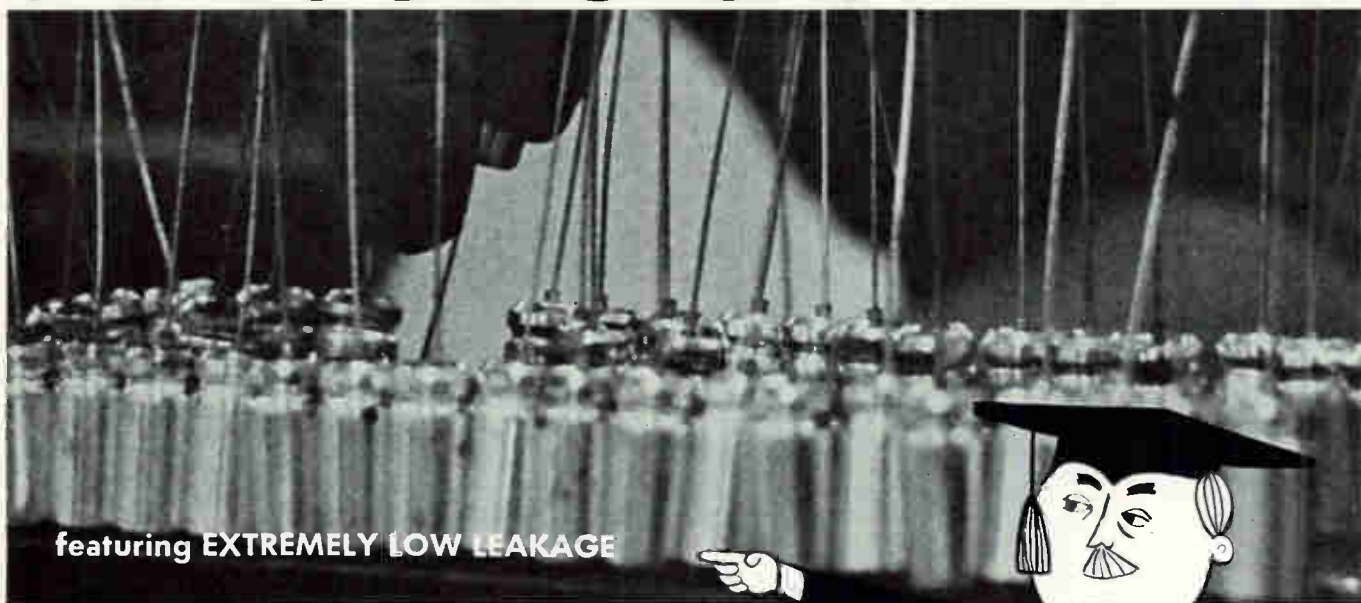

featuring **EXTREMELY LOW LEAKAGE**

as low as $.002 \mu\text{A}/\text{MFD}/\text{VOLTS}$

WET TANTALUM CAPACITORS

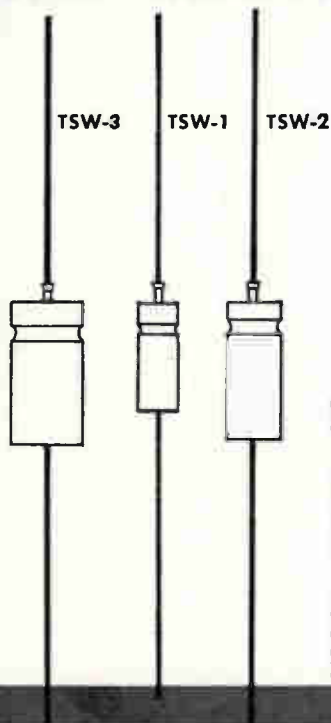

Jelled Electrolyte . . .
insures against physical leakage common in liquid type capacitors.

Internal Nickel Weld — Hermetic Glass Seal
The internal tantalum to nickel weld with glass hermetic seal eliminates lead breakage common with external welds. Devices have unique shoulderless tubular configuration which displays unusual mechanical strength due to special internal weld and compression bond.

Reliability
Long term shelf life tests demonstrate no significant changes in performance characteristics. You can count on Semcor for high reliability.

Capacitance ratings from 4.7 mfd to 680 mfd with working voltages from 3 to 100 volts.

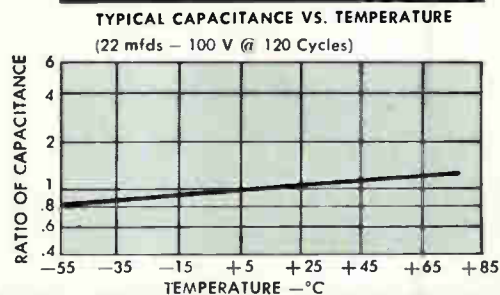
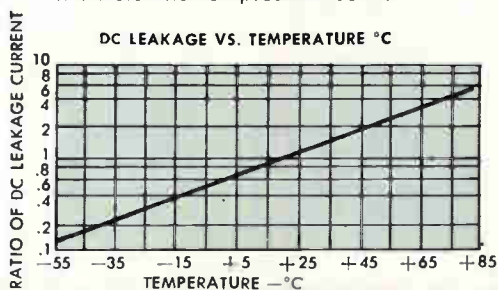

**SOLID STATE DIVISION
of NUCLEAR CORPORATION OF AMERICA**

3 5 4 0 WEST OSBORN ROAD, PHOENIX, ARIZONA

Divisions of Nuclear Corporation of America: Electron Tube Division • Nucleonics Service Corp. • Nucor, Instrument and Controls Division
Research Chemicals, Advanced Materials Development Division • U. S. Semcor, Solid State Division

VISIT OUR BOOTH AT WESCON AND ASK ABOUT THERMA **BOND**

35G

VIBRATION

A SENSITIVE
RELAY WITH
0.2 INCH GRID
SPACED TERMINALS

RELAY

SPECIFICATIONS:

Contact Arrangement: DPDT (2C)
Contact Rating: 3 amps resistive at 28VDC

Operating Power: 250 MW standard, 100 MW special

Vibration: 35G's to 3000 CPS

Shock: 100G's standard, 150G's special

Dielectric Strength: 1000V RMS, 750V RMS between open contacts
Ambient Temperature Range: -65°C to +125°C

Terminals: plug-in pins, solder hooks, 3-inch leads

Mounting: a variety of popular bracket and stud arrangements

Dimensions: 0.875 inches high, by 0.800 inches wide, by 0.396 inches thick

Weight: 0.6 ounces maximum



VR SERIES
RELAY

ELGIN advance RELAYS

THE ELECTRONICS DIVISION OF ELGIN NATIONAL WATCH COMPANY
2435 NORTH NAOMI STREET, BURBANK, CALIFORNIA



SEND FOR LATEST DATA

SEE THIS AND OTHER NEW PRODUCTS AT

WESCON BOOTH
1802-04

Highly Reliable

HITACHI "SEMI-CONDUCTORS"

For Industrial Use
Switching Transistors and Diodes

2SA18
2SA41
2SA42
2SA86
2SA208
2SA209
2SA210
2SB66
2SB67
2SB68
2SB81
2SB82
2SC89
2SC90
2SC91

Hitachi semi-conductors provide the basis for the excellent capacity of the Hitachi Electronic Computer HITAC 103.

1N34A
1N35
1N38A
1N56A
1N60
1S77
1S78
1S79
1S84

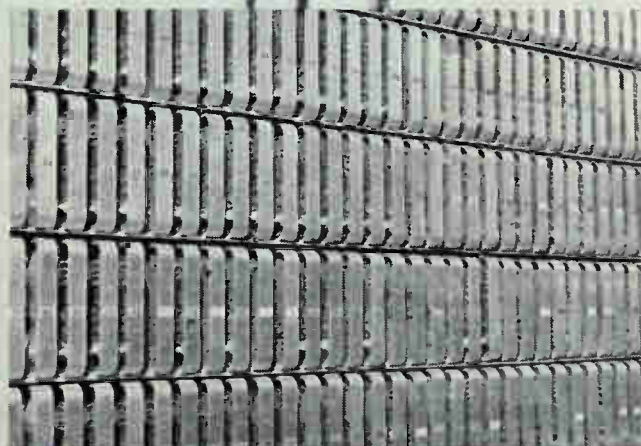

Back of HITAC 103.



Hitachi, Ltd.

Tokyo Japan

Cable Address "HITACHY" TOKYO

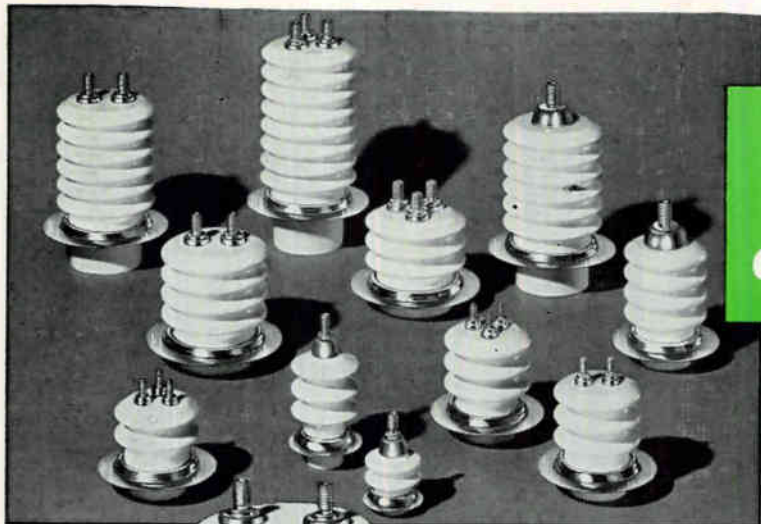

ALITE[®]
CERAMIC-TO-METAL SEALS

*Standard Bushings
 or Special Designs*

FROM ONE COMPLETELY INTEGRATED SOURCE



ALITE — with its completely equipped facilities for producing high quality, vacuum-tight, ceramic-to-metal seals — is geared to meet all your requirements for high alumina ceramic-metal components. From design to finished assembly, every manufacturing step — including formulating, firing, metalizing and testing — is carefully supervised in our own plant. Result: effective quality control and utmost reliability.

Hermetic seals and bushings made of high alumina Alite are recommended for electromechanical applications where service conditions are extremely severe or critical. Alite has high mechanical strength and thermal shock resistance. It maintains low-loss characteristics through a wide frequency and temperature range. It resists corrosion, abrasion and nuclear radiation. Its extra-smooth, hard, high-fired glaze assures high surface resistivity.

To simplify design problems and speed delivery, Alite high voltage terminals, feed-throughs and cable end seals are available in over 100 standard sizes. However, when specifications call for special units for unusual applications, you can rely on expert assistance from Alite engineers to help you take full advantage of Alite's superior properties.

Write us about your specific requirements today.

WRITE FOR HELPFUL FREE BULLETINS

Bulletin A-7R gives useful comparative data. Bulletin A-40 describes Alite facilities and complete line of Alite Standard Bushings.



ALITE DIVISION

U. S. STONEWARE

BOX 119

ORRVILLE, OHIO

FOR PRECISION WELDING OF TRANSISTORS AND COMPONENTS

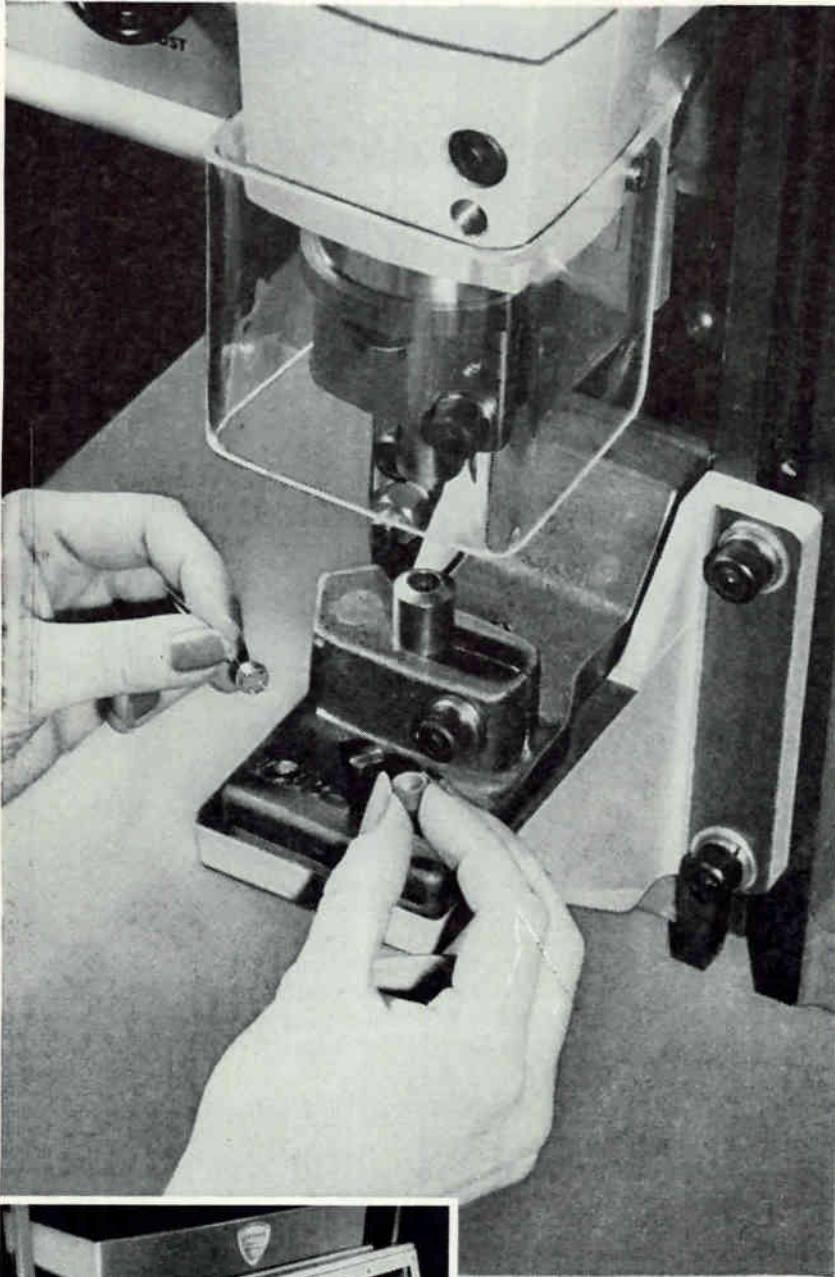

RAYTHEON'S MODEL "M" WELDING HEAD

**Newest
development
in precision
welding
of miniature
parts.**

The "M" head—Raytheon's completely new precision welding device—assures consistent welding performance even when joining miniature parts. The secret is the advanced design that achieves relatively low welding currents and electrode pressures.

The new head has extremely fast action and a new low-impact anti-hammer arrangement that extends electrode life many times. It has an air chamber that provides for a deflection of less than .003 inch under full pressure.

The "M" head—thoroughly tested in transistor production—can be mounted horizontally or vertically and is adaptable to dial feed or in-line feed for automated production.

THE UNIQUE ADVANTAGES of an "M" head installation will be obvious to you after reading the latest technical bulletins. Write for them today to Raytheon Company, Commercial Apparatus & Systems Division, Production Equipment Department, 225 Crescent Street, Waltham 54, Massachusetts. In Canada, Raytheon Canada, Waterloo, Ontario.

FEATURES

- Can be used with any welder
- Horizontal or vertical operation
- Adaptable to dry box installations
- Quick, easy servicing, electrode changing
- Adjustable linear bushing and electrode alignment
- Long electrode life
- Minimum deflection

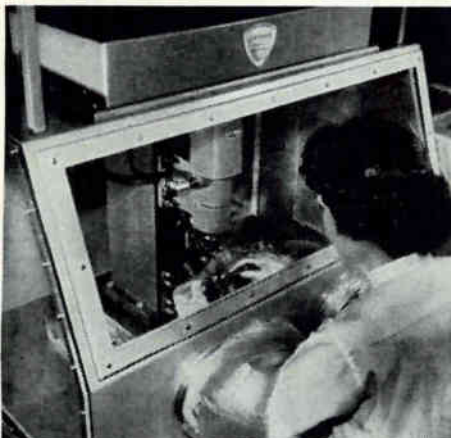

A complete line of precision welding equipment for the electronics industry

RAYTHEON
**RAYTHEON
COMPANY**
COMMERCIAL APPARATUS
& SYSTEMS DIVISION

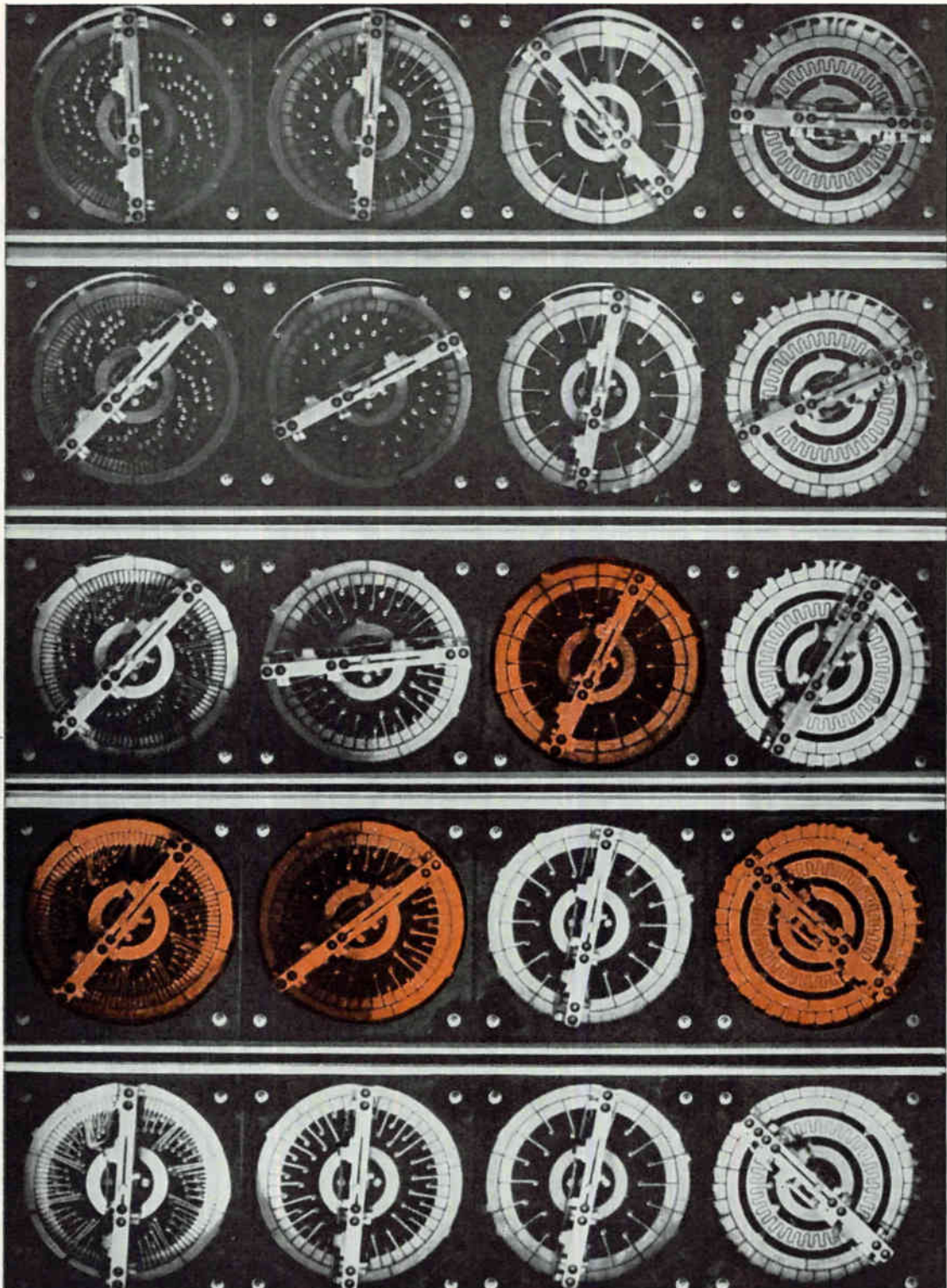

UNUSUAL CAREER OPPORTUNITIES FOR QUALIFIED SCIENTISTS AND ENGINEERS... REGARDLESS OF RACE, CREED, COLOR OR NATIONAL ORIGIN... WRITE AVCO TODAY.

Component panel in Avco's automated Air Traffic Control Central

Teaching new tricks to electronics. From Avco come systems that use electronics in new ways. In super-selective receiver-decoders for satellites. In automated systems to control air traffic. In fail-safe fuzing for ballistic missiles . . . command communications units for Polaris submarines . . . infrared scanners to detect jet aircraft or missile attack. Highly specialized, all of them—and illustrative of Avco capabilities in electronics research and product development.

Avco

AVCO CORPORATION, 750 THIRD AVENUE, NEW YORK 17, NEW YORK

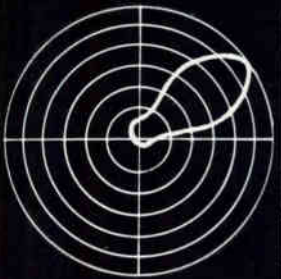
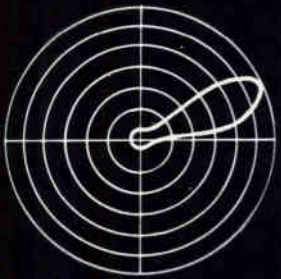
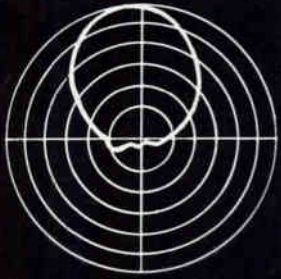
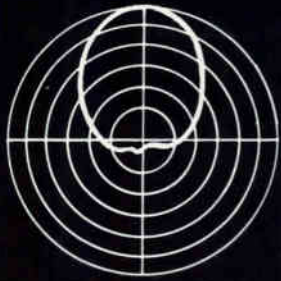

Hy-gain
antenna products

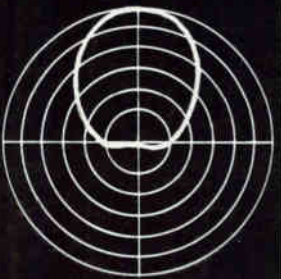

*Hy-Gain Antenna
Products Corporation
announces the new
departmental status
of their Special
Products Division
for the design and
production of antenna
systems for specific
applications.*

*Write:
Hy-Gain Antenna
Products Corporation,
Special Products
Division,
22nd and Y Streets,
Lincoln, Nebraska*

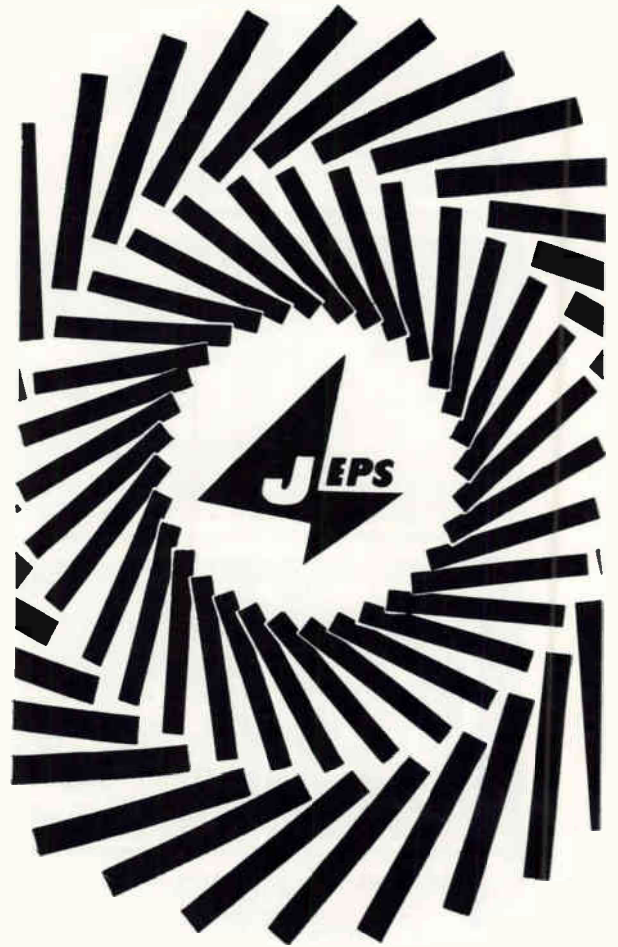

4th Annual JAPAN ELECTRONIC PARTS SHOW

You Are Cordially Invited To
THE ONLY AND LARGEST EXHIBITION
OF JAPANESE ELECTRONIC COMPONENTS

OCTOBER 17-22, 1961

AT TOKYO TRADE CENTER

See the Latest Developments in Quality Products
including Semi-Conductors and Micro-Modules

**ELECTRONIC INDUSTRIES ASSOCIATION
OF JAPAN**

TOSHO BLDG., 14, MARUNOUCHI 3-CHOME, TOKYO, JAPAN
CABLE ADDRESS: "ELINDASO" TOKYO
TELEPHONE: TOKYO 211-2765

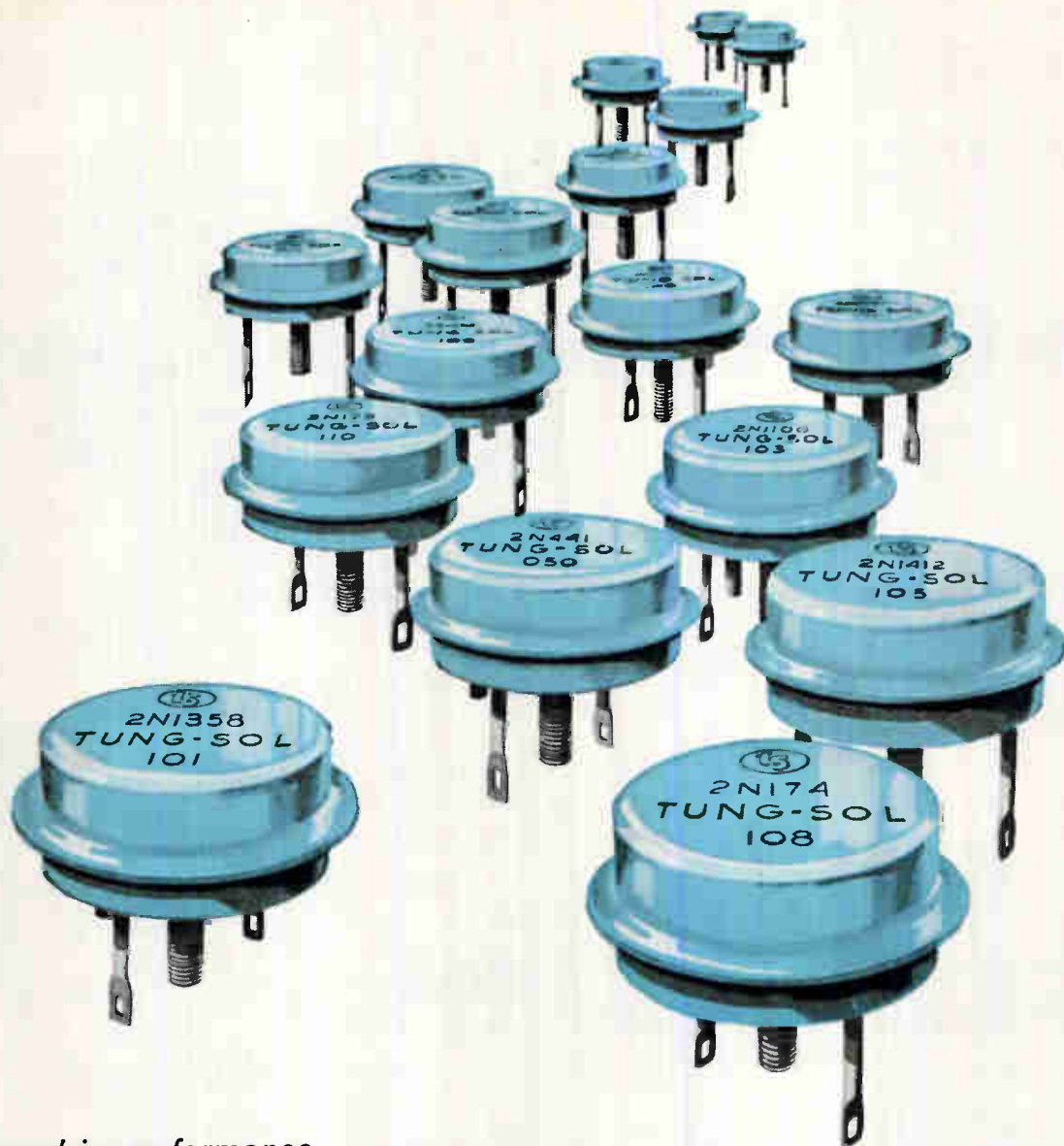

Proved in performance

THE TUNG-SOL LINE OF HIGH-POWER GERMANIUM TRANSISTORS

■ WIDELY INTERCHANGEABLE ■ MORE FLEXIBLE IN APPLICATION ■ UNIFORMLY RELIABLE

For several years Tung-Sol has been manufacturing high-power germanium transistors to the industry's most exacting standards of electrical and mechanical reliability.

They have proved themselves efficient and fully reliable in countless installations, providing rugged, long-life performance for equipment in commercial and military use.

As further proof of peak performance, the fact may be cited that Tung-Sol's complete line of high-power transistors includes the JAN 2N174 and USA 2N1358, fully inspected and guaranteed to their respective MIL specifications.

The Tung-Sol line offers widest applicability in high-power amplifiers. DC-to-AC converters, DC-to-AC inverters, regulated power supplies, motor controls, servo amplifiers, relay drivers and high-power switches.

Designed for wide interchangeability, they may be specified for new, improved equipment. Their features of vacuum-tight, copper-to-copper "Cold-Welded" sealing increase design flexibility and make them more reliable. Stud-mounted, single-end construction, with solid-lug terminals, simplifies

installation in all chassis and allows sufficient heat-sink design.

Ask your Tung-Sol representative for full technical details, or write: Tung-Sol Electric Inc., Newark 4, N.J. TWX:NK 193.

TUNG-SOL HIGH-POWER GERMANIUM TRANSISTORS

TYPE	MAXIMUM RATINGS (25°C)				TYPICAL VALUES (25°C)			
	V _{ce} Volts	V _{cb} Volts	I _c A	T _J °C	I _{ceo} Ma	h _{FE}	f _{ce} kc	MAX. T _R °C/W
2N173	-50	-80	15	100	8	52	10	.5
2N174*	-70	-80	15	100	8	37	10	.5
2N174A	-70	-80	15	100	8	37	10	.5
2N277	-40	-40	15	100	8	52	10	.5
2N278	-45	-60	15	100	8	52	10	.5
2N441	-40	-40	15	100	8	30	10	.5
2N442	-45	-60	15	100	8	30	10	.5
2N443	-60	-80	15	100	8	52	10	.5
2N1088	-70	-80	15	100	8	37	10	.5
2N1100	-80	-100	15	100	8	37	10	.5
2N1368*	-70	-80	15	100	8	37	10	.5
2N1412	-80	-100	15	100	8	37	10	.5
2N1870	-60 (1)	-100	15	100	4	20	10	.5

(1) BV_{CEO}

TECHNICAL ASSISTANCE IS AVAILABLE THROUGH THE FOLLOWING SALES OFFICES: Atlanta, Ga.; Columbus, Ohio; Culver City, Calif.; Dallas, Tex.; Denver, Colo.; Detroit, Mich.; Irvington, N.J.; Melrose Park, Ill.; Newark, N.J.; Philadelphia, Pa.; Seattle, Wash. In Canada: Abbey Electronics, Toronto, Ont.

*Also available in military versions.

TUNG-SOL

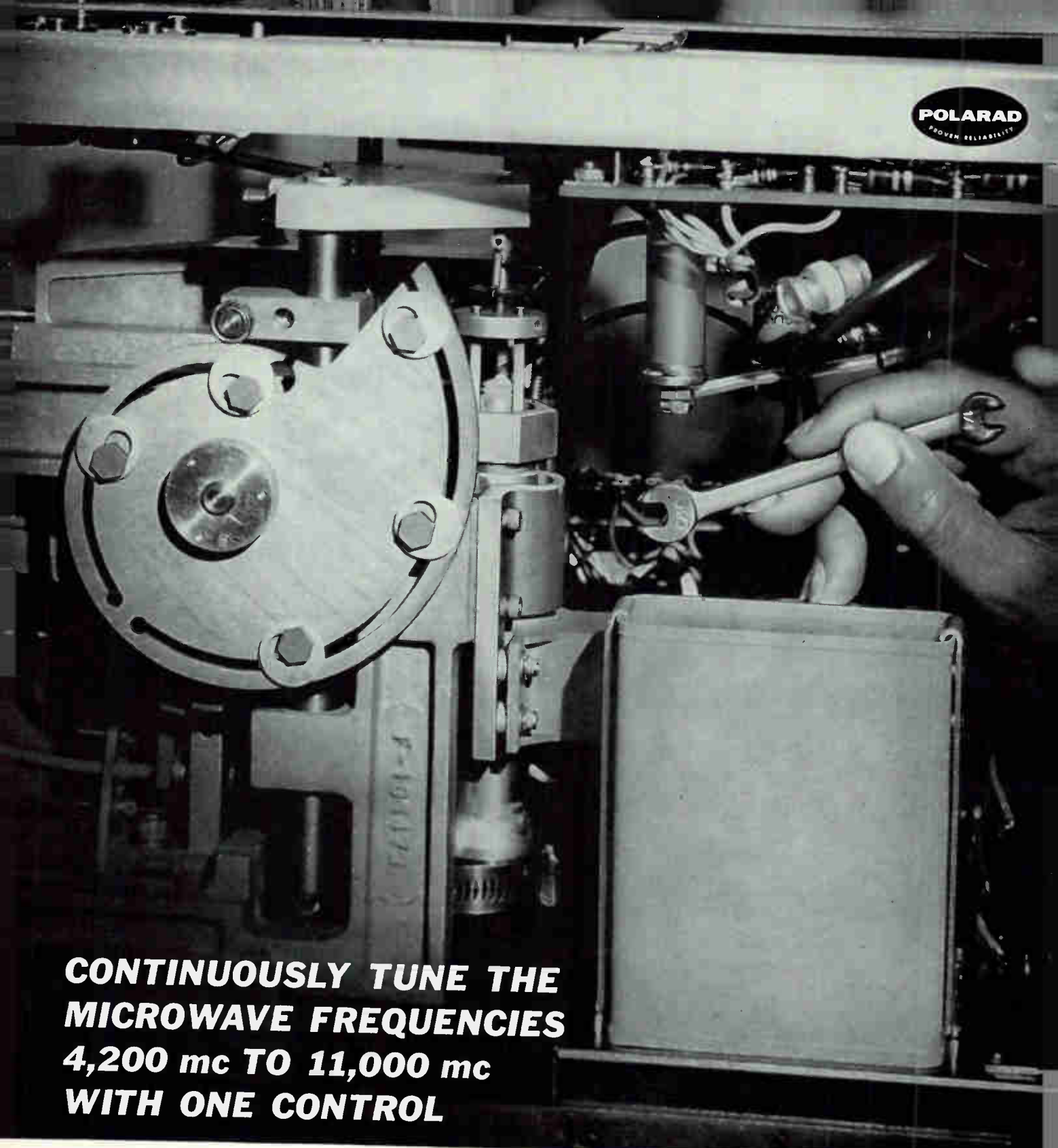

**CONTINUOUSLY TUNE THE
MICROWAVE FREQUENCIES
4,200 mc TO 11,000 mc
WITH ONE CONTROL**

Model MSG-34

Because of its unique electro-mechanical design, only the MSG-34 Microwave Signal Generator offers such a wide frequency range in one unit—with 1 mw calibrated power output from 4,200 mc to 11,000 mc.

The printed circuit modulator is important, too. A single unit offers 10 to 10,000 cps rates for pulse, FM and square wave rf outputs. All with the shortest pulse width available—0.2 μ sec.

SPECIFICATIONS

Frequency Range	4,200 mc to 11,000 mc
Frequency Accuracy	$\pm 1\%$
Power Output	1 milliwatt (0 dbm) calibrated
Attenuator Output Accuracy	± 2 db from 0 to -127 dbm
Modulation	Internal or external pulse, square wave or internal FM

Internal Pulse Modulation:

Width	0.2 to 10 microseconds
Repetition Rate	10 to 10,000 pps
Delay	2 to 2,000 microseconds

POLARAD MICROWAVE SIGNAL GENERATORS

500 to 50,000 mc

Because each of these fine test instruments has something special about it, a feature or capability that can suit your test requirements exactly, check through the chart—then get full and complete specifications from your local Polarad representative.

SELECT YOUR GENERATOR FROM THIS CHART



Model PMR
500 to 1,000 mc

Interchangeable FM or pulse modulators. FM modulator provides low distortion wide-range, sine-wave deviation. Pulse modulator provides pulse, square wave and saw-tooth FM. (10-10,000 pps). Calibrated power output: 1 mw



Model MSG 950 to 4,600 mc

	Frequency	Calibrated Power Output	Internal Pulse Modulation				
			Internal Square Wave	Width in μ sec.	Pulse Repetition Rate in pps	Delay in μ sec.	FM deviation in mc minimum
MSG-1	950-2,400 mc	1 mw (0 dbm)	40- 4,000 pps	0.5-10	40- 4,000	2.5-300	± 2.5
MSG-1P*	950-2,400 mc	10 mw (+10 dbm)	10-10,000 pps	0.3-10	10-10,000	2-2,000	± 2.5
MSG-1R	950-2,400 mc	1 mw (0 dbm)	10-10,000 pps	0.3-10	10-10,000	2-2,000	± 2.5
MSG-2A	2,000-4,600 mc	1 mw (0 dbm)	40- 4,000 pps	0.5-10	40- 4,000	2.5-300	± 2.5
MSG-2R	2,000-4,600 mc	1 mw (0 dbm)	10-10,000 pps	0.3-10	10-10,000	2-2,000	± 2.5
MSG-2P*	2,000-4,600 mc	10mw (+10 dbm)	10-10,000 pps	0.3-10	10-10,000	2-2,000	± 2.5

*Attenuator Accuracy: ± 3 db between 0 and +10 dbm.
 ± 2 db below 0 dbm.



Model PMX
4,450 to 8,000 mc
6,950 to 11,000 mc

Two interchangeable r-f generator units.

Internal pulse and square wave modulation (10-10,000 pps); 0 to -127 dbm power output.



Model MSG-34
4,200 to 11,000 mc
in one instrument

Internal pulse and square wave modulation (10-10,000 pps); 0 to -127 dbm power output; DIGITAL frequency indicator.



Model PMK
10,000 to 21,000 mc
in 2 tuning units

Two interchangeable generator units.

Calibrated power output: +10 dbm (10 mw); internal pulse and square wave modulation (10-10,000 pps); DIGITAL frequency indicator.



Model KSS
GENERATOR SOURCE
1,050 to 11,000 mc
in 4 tuning units

Power output: 14 to 400 mw, depending upon frequency; internal square wave 10-10,000 pps; external pulse, square wave or FM modulation; adjustable attenuator.



Model CSG
SWEEP GENERATOR
1,000 to 16,000 mc
in 5 interchangeable tuning units

Provides high-power microwave signal adjustable from single frequency to 2:1 frequency range; .001 to 100 cps sweep rate; internal modulation: 1,000 cps and 456 kc square wave; external modulation: square wave, FM and pulse.



EHF SIGNAL GENERATOR AND SOURCE
12,400 to 50,000 mc

Units in this range provide cw signals, 1,000 cps internal square wave, external modulation provisions, accurate frequency calibration. EHF SIGNAL GENERATOR 18,000 to 39,700 mc, 7 plug-in units. Accurate power calibration. EHF SIGNAL SOURCE 18,000 to 50,000 mc, 9 plug-in units. High power output.

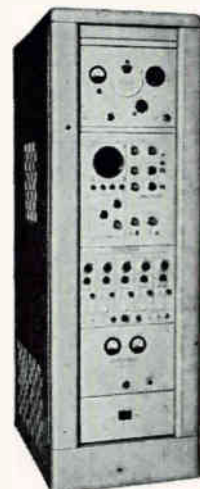

Model B
CODE MODULATOR
MULTI-PULSE GENERATOR
950 to 10,750 mc
in 4 interchangeable tuning units.

Provides 5 independently adjustable pulse channels, each with variable pulse width and delay. Built-in precision oscilloscope.

All Polarad Signal Generators (500 to 21,000 mc) offer:

Continuously variable attenuators calibrated directly in $-$ dbm.

Internal pulse, FM and square wave modulation, external pulse and multi-pulse modulation.

Delayed and undelayed sync outputs.

UNI-DIAL[®] tuning with direct-reading frequency dials accurate to $\pm 1\%$.

High stability non-contacting klystron cavity chokes for noiseless tuning and accurate calibration.

POLARAD

ELECTRONICS CORPORATION

43-20 34th Street • Long Island City 1, New York

FREE LIFETIME
SERVICE

DURING WESCON
VISIT US AT BOOTH
1911-1913

CIRCLE 119 ON READER SERVICE CARD

largest selection of adjustment potentiometers...

More engineers specify Trimpot because:

Trimpot line is complete

Bourns offers you the largest selection of leadscrew actuated potentiometers... 23 basic models—4 terminal types—three mounting methods.

Trimpot is small

Space saving size and rectangular shape permit the installation of 12 to 17 units in one square inch of panel area.

Trimpot is accurate

Multi-turn screwdriver adjustment provides up to 9000° of rotation...you can make and repeat the finest adjustments.

Trimpot is stable

Adjustment shaft is self-locking...settings are virtually immune to severe acceleration, vibration and shock.

Trimpot is fully tested

All instruments are 100% inspected before shipment to assure you of reliable performance.

Trimpot is proved

It is used in more military and commercial equipment than any other leadscrew actuated potentiometer.

Trimpot®

See these products and more at WESCON—Booth 3102-3104.

Only Trimpot potentiometers give you all of these outstanding features.

TERMINATION—Alloyed with multiple turns of the resistance wire, the exclusive Bourns Silverweld® termination is virtually indestructible under thermal or mechanical stress.

TERMINALS—Three terminals are Teflon-insulated stranded leads. (Most Trimpot potentiometers available with leads, pins or solder lugs.)

CONTACT—Precious-metal wiper provides constant, positive contact under extreme environmental conditions.

BODY—High-temperature, thermosetting plastic body is sealed, enabling potentiometer to meet Mil Specs for humidity, sand, dust, fungus, salt spray, etc.

ELEMENT—Special metal mandrel is precision wound with low-temperature-coefficient resistance wire.

WIPER PICK-OFF—Spring pick-off provides positive electrical contact with wiper to improve potentiometer performance, reliability.

"O" RINGS—Two high-temperature silicone rubber "O" rings provide effective double seal against humidity.

ADJUSTMENT SCREW—Stainless steel leadscrew accommodates standard screwdriver, meets military requirements for salt spray.

CLUTCH ASSEMBLY—Exclusive clutch design and positive stop at ends of wiper travel prevent internal mechanical damage.

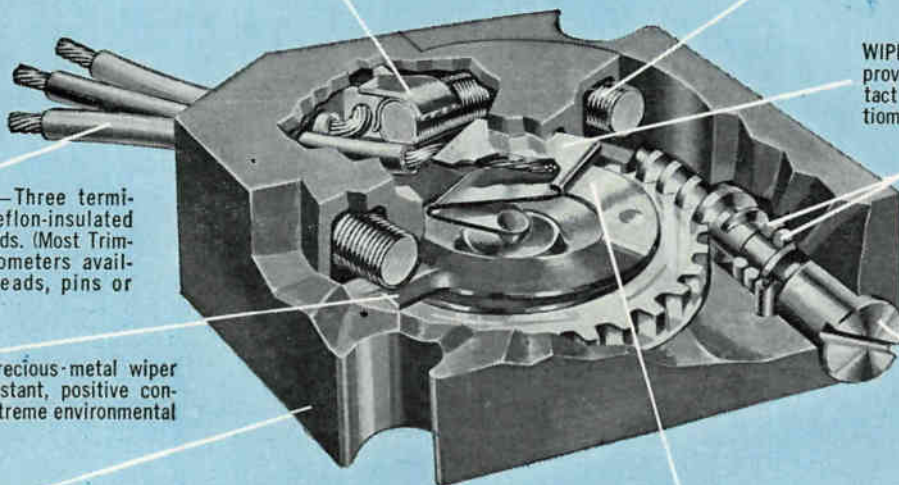

This cutaway of Model 3250 is typical of the design of all Bourns Trimpot potentiometers though some features may vary from model to model.

longest record of reliability

NUMBER — 17 PRODUCT SERIES

Potentiometers



High-Temperature, Humidity-Proof Wirewound Trimpot—Model 3010. Operates at 175°C / L, P terminals / 1 watt / 10 ohms to 100K. Meets Mil Specs for humidity. Available in carbon as Model 3011 / 20K to 1 Meg.



Low-Cost Commercial Wirewound E-Z Trim—Model 3067. Operates at 85°C / L, S terminals / 0.5 watt / 100 ohms to 20K. Meets steady state humidity. Available in Resiston carbon as Model 3068 / 20K to 1 Meg. Priced under \$1 in production quantities.



Subminiature Humidity-Proof Wirewound Trimpot—Model 3250. Operates at 175°C / L, 3 types of P terminals / 1 watt / 100 ohms to 50K. Meets Mil Specs for humidity.



1/2" Wirewound Single-Turn Potentiometer—Model 3367. Operates at 105°C / P, S terminals with panel mount collar / 0.5 watt / 100 ohms to 20K. Meets steady state humidity.



General-Purpose Wirewound Trimpot—Model 200. Operates at 105°C / L, S, P terminals / 0.25 watt / 10 ohms to 100K. Available as a rheostat, Model 201.



Humidity-Proof Wirewound Trimpot—Model 236. Operates at 135°C / L, S, P terminals / 0.8 watt / 10 ohms to 100K. Meets Mil Specs for humidity.



High-Power Wirewound Trimpot—Model 3030. 15 watts. Operates at 265°C / L terminals / 10 ohms to 10K.



General-Purpose Resiston® Carbon Trimpot—Model 215. Operates at 125°C / L, S, P terminals / 0.25 watt / 20K to 1 Meg.



High-Temperature Wirewound Trimpot—Model 260. Operates at 175°C / L, S, P terminals / 1 watt / 10 ohms to 100K.



PANEL MOUNTED UNITS—All models except 3250 are now available with panel mounting. Unique design permits quick factory assembly to "on-the-shelf" units. In addition, mounting screws, mounting brackets and clip brackets are available from factory or distributor stock to meet virtually any mounting situation.



Subminiature Wirewound Trimpot—Model 220. Operates at 175°C / L, W, terminals / 1 watt / 100 ohms to 30K. Meets Mil Specs for humidity.



High-Quality Commercial Wirewound Trimit®—Models 271, 273, 275. Operate at 85°C / L, S, P terminals / 0.25 watt / 100 ohms to 10K. Resiston carbon versions also available, Models 272, 274, 276 / 20K to 1 Meg.



High-Temperature, Humidity-Proof Wirewound Trimpot—Model 224. Operates at 175°C / L, S, P terminals / 1 watt / 10 ohms to 100K. Meets Mil Specs for humidity. Also available in Resiston carbon as Model 3051 / 20K to 1 Meg.



Subminiature High-Temperature Wirewound Trimpot—Model 3000. Operates at 175°C / tapered pin terminals / 0.5 watt / 50 ohms to 20K. Resiston carbon version available, Model 3001 / 20K to 1 Meg. Only 3/4" long.



General-Purpose Resiston Carbon Humidity-Proof Trimpot—Model 235. Operates at 125°C / L, S, P terminals / 0.25 watt / 20K to 1 Meg. Meets Mil Specs for humidity.

Key to terminal types:
L = Insulated stranded leads
S = Solder lugs (includes 3367S, panel mount bushing only)
P = Printed circuit pins
W = Uninsulated wires

The following resistances are standard if they fall within the limits listed: 10 20 50 100 200 500 1K 2K 5K 10K 20K 25K (wirewound only) 50K 100K 200K 500K 750K 1 Meg. Other resistances available on special order.

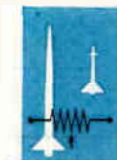

BOURNS

BOURNS, INC., TRIMPOT DIVISION
6135 MAGNOLIA AVE., RIVERSIDE, CALIF.
PHONE: OVERLAND 4-1700 • TWX: RZ9222
CABLE: BOURNSINC.

Manufacturer: Trimpot® potentiometers; transducers for position, pressure, acceleration. Plants: Riverside, California; Ames, Iowa; and Toronto, Canada

PULSE POINTERS

Popular E-P 3450D pulse generator quickly converts to 6 standard pulse instruments*

Modular flexibility, simplicity of operation expand versatility, cut pulse costs

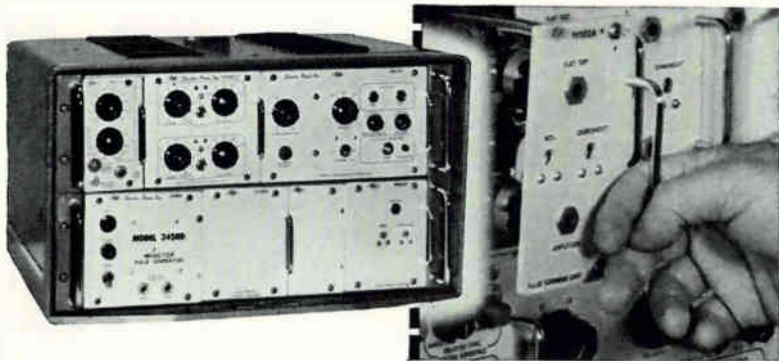

Modular concept extends instrument versatility, guards against obsolescence, cuts costs. Standard modules, designed to accomplish specific instrument and system functions, quickly plug into both front and rear of rack frames. Simplicity of operation is highlighted throughout.

Can one general-purpose pulse generator handle such common laboratory and production applications as the design and test of radar, navigation and fire control systems, digital computers... then quickly convert to transistor and diode delay line testing, production line testing, quality control, high-voltage drive of strain gages, system transient testing, and other pulse applications?

Yes, the *Electro-Pulse* Model 3450D. This popular general-purpose pulse generator is winning plaudits from both production and the lab.

The secret: modular plug-in construction and adjustable pulse-forming controls—standard with all *Electro-Pulse* instruments.

Interchangeable plug-in printed circuit modules quickly and economically extend instrument performance to meet changing requirements. Integral front panels and controls achieve both electrical and mechanical standardization.

Add the 3450D's fully regulated output amplitude; stable, jitter-free repetition rate and delay; reliable output overload protection; and high resolution controls.

The result is a single versatile source of high power; very fast rise time; single or recurrent pulses...controllable in repetition rate, delay from trigger, duration, rise time, and top slope.

Take these basic specifications:

- Positive and negative polarity
- 2 mc-2 cps rep. rate
- 0-10,000 μ s delays
- .05-10,000 μ s widths
- \pm 50 volts into 50 ohms
- 15 nanosec. continuous rise time

Modify with these standard modules:

- Y** Simultaneous complementary output.
- X** Twin pulse and pulse train capability.
- T** .05-5,000 cps rep. rate.
- I** 1 volt input trigger sensitivity.
- G** ON-OFF gated output.

In effect, you end up with 6 different instruments.

Model 3450D is just one of 33 cataloged instruments in the broad *Electro-Pulse* line, which includes as many as 200 standard pulse and digital circuit modules (both tube and transistor types). Advanced pulse techniques and circuitry, coupled with traditional Servo Corp. instrument quality and reliability, make E-P the wisest buy.

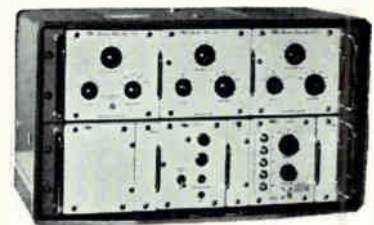

4500 Series 10-Megacycle Pulse Generators

7 standard models • solid state reliability and circuits • variable delay and width • optional output characteristics •

For reliable generation of variable parameter pulses at very high repetition rates. Wide application in development and testing of components, logic circuitry, and high clock rate digital systems.

Servo Corporation of America
111 New South Road
Hicksville, L. I., N. Y.

Gentlemen:

- Please send detailed catalog.
- Please contact me for demonstration.
- Please send me a free SERVO slide rule.

(name)

(title)

(organization)

(address)

(city, zone, state)

Electro-Pulse Products



SERVO CORPORATION OF AMERICA

111 New South Road • Hicksville, L. I., N. Y. • WElls 8-9700

Sales & service offices coast-to-coast • Representatives in major cities

single pulse generators • double pulse generators • word generators • pulse train and pulse code generators • time delay and gate generators • current generators and core testers • modules

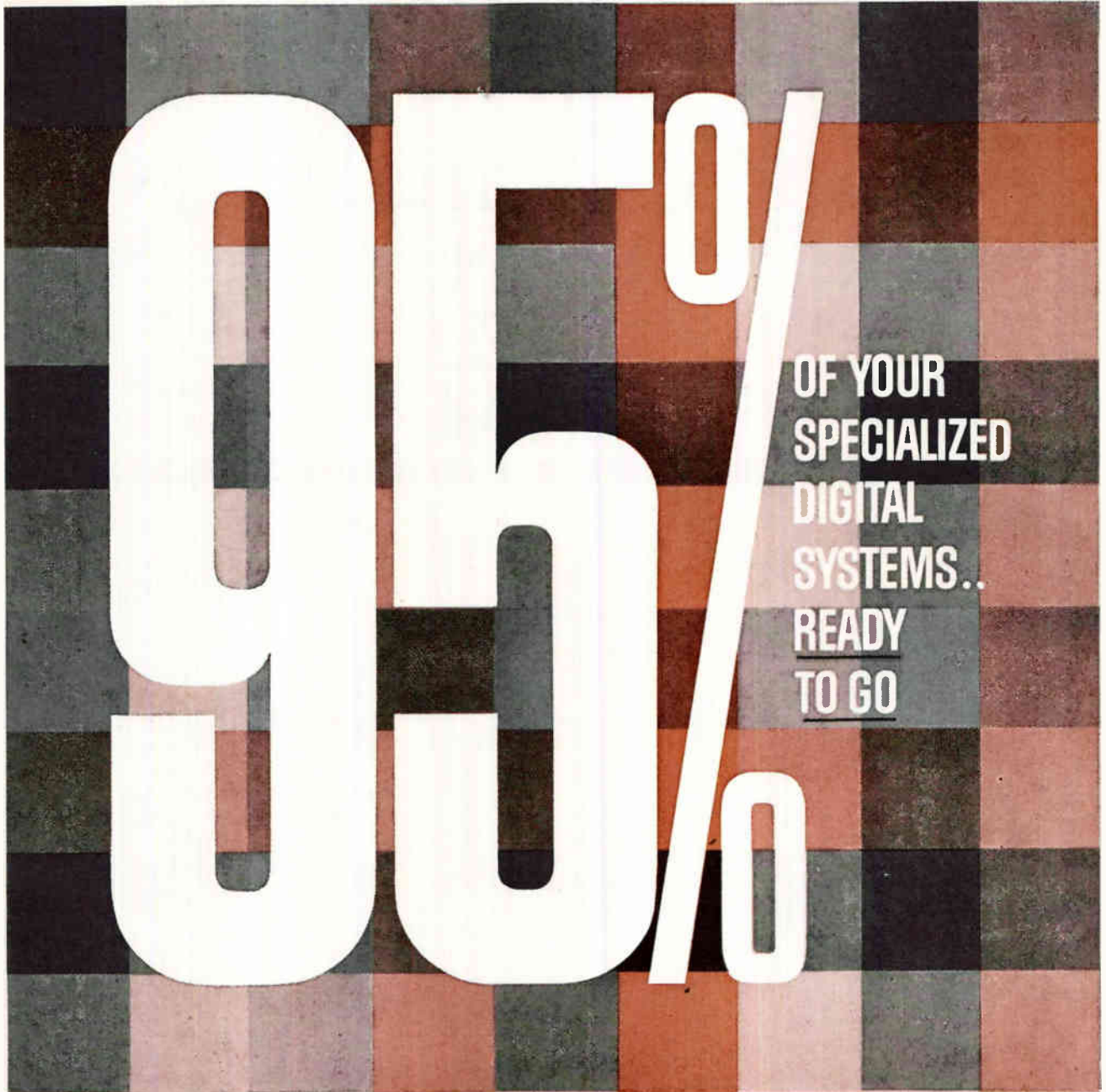

If you have special requirements in digital data handling equipment, format conversion, special purpose computers or airborne and ground timing systems . . . Temco Electronics can deliver any part or all of the system with speed and economy. ■ The digital equipment design section of Temco Electronics has already developed printed circuit cards that meet 95% of all standard digital requirements. Remaining circuits can be provided with a minimum of design effort and time. All of these logic modules are designed and tested to meet or exceed MIL-E-5272 specifications, through a temperature range of from 71°C to -55°C. ■ Use of these pre-engineered, off-the-shelf "building blocks" . . . plus quick reaction capabilities, wide range of experience and talent . . . gives Temco a significant head-start in producing equipment for your special needs. For quick action on your inquiries, write or call Temco Electronics today.

See us at WESCON Booths 4121 & 4123



LING-TEMCO ELECTRONICS, INC.

TEMCO ELECTRONICS DIVISION • DEPT. 221N • P. O. BOX 6191 • DALLAS 22, TEXAS

Opportunities for:

Aerospace Vehicles Engineers

The Aerospace Vehicles Laboratory of the Space Systems Division has openings for nearly one hundred engineers who have experience in stress, structures, propulsion, mechanisms, control systems, equipment installation or heat transfer which can be applied to advanced aerospace weapons systems or vehicles. The Aerospace Laboratory is concerned, as a result of SURVEYOR and other contracts, with lunar and space exploration, air to air missiles and ICBM defense systems. The openings are for both junior and senior mechanical engineers, electronic engineers, physicists and aeronautical engineers. Some of the openings are described below:

Structures

Senior Dynamicist. Must be capable of performing advanced analysis in structural mechanics. Will be required to calculate response of complex elastic systems to various dynamic inputs including random excitation. Must be capable of original work in developing advanced analytical techniques.

Loads Analyst. To establish structural design criteria for advanced missiles and spacecraft. Should be capable of determining external airload and inertial force distributions.

Reliability Analyst. To perform statistical analysis of structural loads and strength properties for the purpose of establishing structural reliability criteria on a probability basis.

Stress Analyst. To perform advanced stress analysis of complex and redundant missile and spacecraft structures. Will be required to solve special problems in elasticity, plasticity, short time creep and structural stability.

Design. Experience is required in preliminary and final structural engineering and design, including preliminary stress analysis. A knowledge of the effects of extreme temperature environ-

ment and hand vacuum, plus a background in materials is desired.

Heat Transfer

Space Vehicle Heat Transfer. Basic knowledge of radiation conduction and convection heat transfer with application to thermal control of space vehicles is required. Knowledge of spectrally-selective radiation coating, super-insulations and thermal vacuum testing is of particular value.

Aerothermodynamicist. Experience in hypersonic real gas dynamics, heat transfer, ablation; re-entry vehicle design, detection; shock layer, wake and rocket exhaust ionization; and anti-missile system requirements will be most useful.

Equipment Installation

Packaging and Installation Engineer. To perform optimum packaging and installation design for missile and or spacecraft units, considering amount and geometric shape of space available as well as weight and center of gravity distribution requirements. Must be capable of analyzing structural adequacy of unit under extreme environmental conditions.

Controls

Optical Devices. Design, development, procurement and test operations are involved. Considerable experience in the field of optical devices for space applications such as star, horizon, sun and moon trackers.

System Test. To plan and supervise the operations of a flight control system laboratory. Air bearing tables and a wide variety of optical mechanical and electrical equipment are involved.

Control System Analysis. Requires engineers at various levels of experience including senior men capable of taking over-all project responsibility in the synthesis and analysis of control systems.

Circuit Design and Development. Experience in design and development of transistorized control system circuits, including various types of electronic switching and modulation techniques is required.

If you are a graduate mechanical engineer, electronic engineer, physicist or aeronautical engineer, with experience applicable to the above openings, please airmail your resume to: **Dr. F. P. Adler**, Manager, Space Systems Division, Hughes Aircraft Company, 11940 W. Jefferson Blvd., Culver City 72, California.

WE PROMISE YOU A REPLY WITHIN ONE WEEK

All qualified applicants will receive consideration for employment without regard to race, creed, color or national origin.

Creating a new world with Electronics

HUGHES

HUGHES AIRCRAFT COMPANY
SPACE SYSTEMS DIVISION

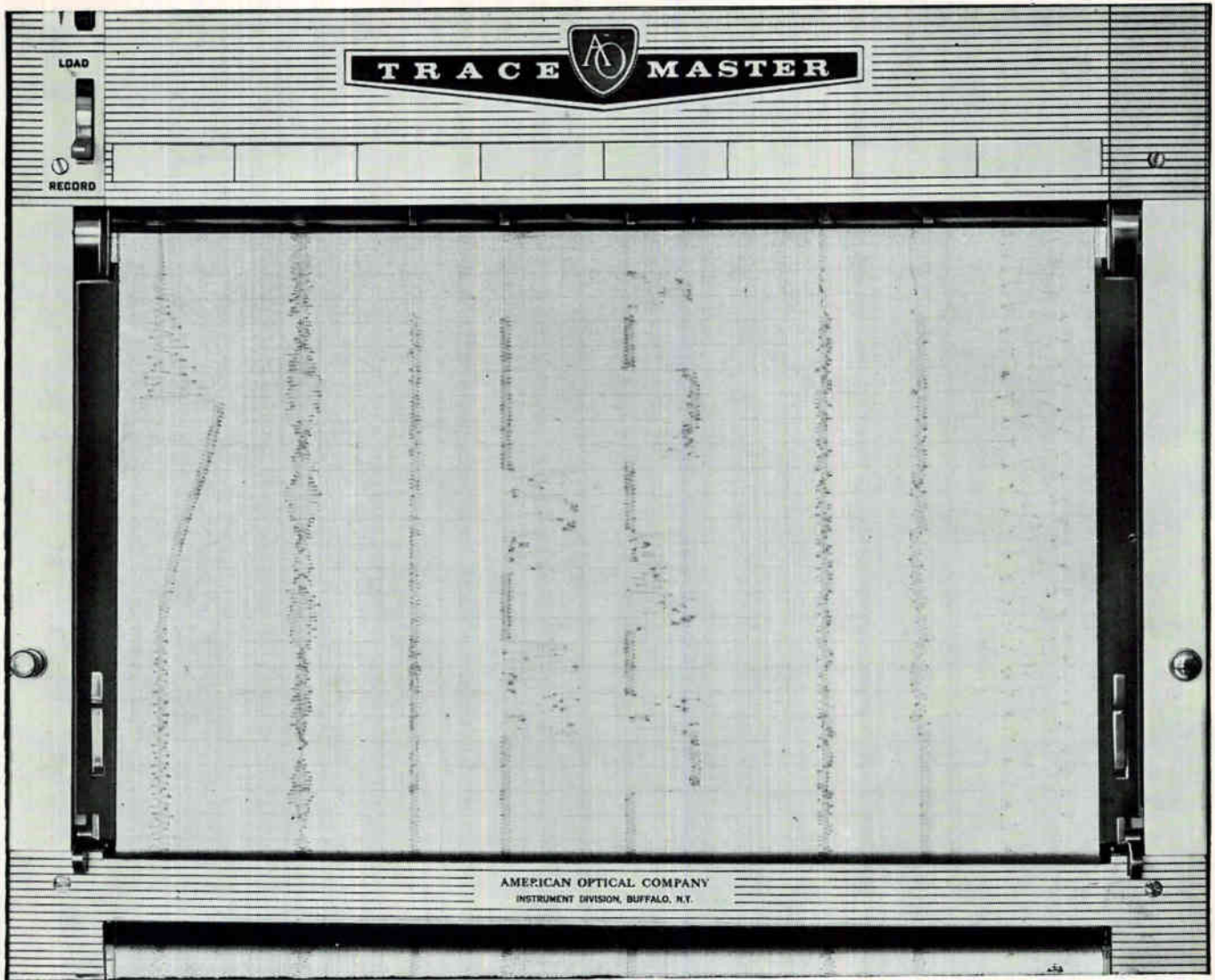

AO Trace-master
provides twice the
definition of any
other direct
writing technique

SEE IT AT WESCON...

Booths 3707, 3709, 3711, 3713

The unique direct-carbon-transfer writing method produces a trace from 2 to 3 times finer than any other direct-writing technique. This allows twice as many lines per millimeter... twice the definition! Resolution is unsurpassed... each line is uniform in width and contrast, revealing the most minute variations in the phenomena measured with utmost fidelity. This writing technique combined with the advanced pen-motor design produces a wider frequency response at larger amplitudes. Continuous recording of data can be displayed simultaneously on 8 channels... up to 8 independent event markers can be added. Ten chart speeds—0.1 to 500 mm/sec—provide a 5000:1 chart speed ratio. The AO Tracemaster has become the new standard of performance for these and many other reasons... write now for the full story!

American  **Optical**
COMPANY

INSTRUMENT DIVISION, BUFFALO 15, NEW YORK

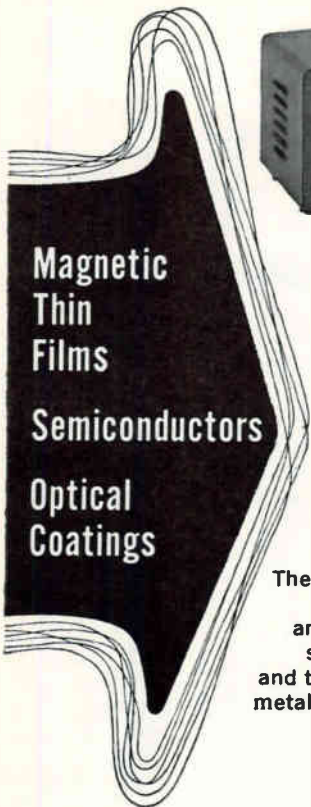

Now you can
CONTINUOUSLY MEASURE THIN FILM THICKNESS
DURING VACUUM DEPOSITION

using optical techniques in the
simplest, most versatile system yet devised!

Precise thickness control of metallic or dielectric materials during deposition can be made with the new Optics Technology Monitoring System, which permits high precision both in production and lab setups.

The optical measurements are made from a monitor disk which is simultaneously coated with the substrate. The position of the disk can be controlled from outside the chamber, and with this system you can deposit up to 20 different layers or coatings without breaking the vacuum. The system may be used to control thickness to $\pm 0.25\%$. Accuracy is not affected by changes in filament or ambient light.

Installation and initial calibration are simple, as is operation, and the system monitors metal or dielectric coatings for either reflection or transmission.

The system is supplied complete with in-chamber fittings, light source, detector unit, solid state amplifier, and optical components. A meter or a strip chart recorder may be used as a readout, and the system may be used with glass bell jars or metal chambers with inspection ports. System cost, \$2,275.00, f.o.b. Belmont.

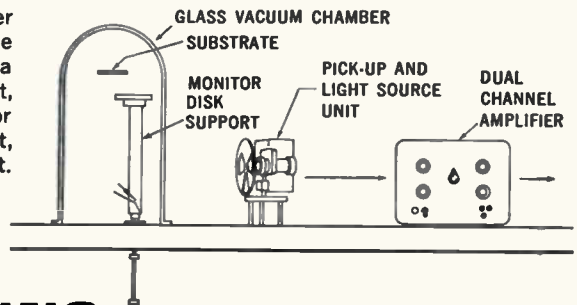

Write or call today for full information.
Data subject to change without notice.



OPTICS TECHNOLOGY, INC

Dept. E-8, 248 Harbor Blvd., Belmont, California • LYtell 1-0358 • (Area Code 415)

Representative inquiries invited.

7310

CIRCLE 271 ON READER SERVICE CARD

+500°F TO -100°F
in SIX minutes

With **NEW DELTA TEMPERATURE CHAMBER**



MODEL 1060F

Rapid temperature cycling without sacrificing precise control ($\pm \frac{1}{2}^\circ \text{F}$) is achieved with the Delta 1060F temperature chamber.

This convenient bench model can make the complete cycle between -100°F and $+500^\circ \text{F}$ in less than twelve minutes.

An auxiliary timer Delta MR-1 is available for use in test work where automatic cycling is desired.

For further information on the 1060F and other Delta temperature chambers, contact your local Delta representative or write



3163 Adams Ave.
San Diego 16, Calif.
ATwater 3-3193
TWX: SD 6488U
Cable: DELTA

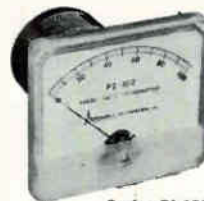

Series PI-100

Frequency indicators and frequency deviation indicators



Series PI-300

Precision frequency-to-dc converters for telemetry and other aircraft and missile uses.



Series PI-400

Precision plug-in module frequency-to-dc converter and indicator. Six may be mounted in 19" rack.

For Frequency Measurement
PULSE RATE INTEGRATORS

by *Anadex*

Designed For Use With

- Turbine Flow Sensors
- Tachometers
- Rotating Machinery
- Repetition Rate Pick-ups
- Radiation Detectors and other frequency generating devices

Here is a complete, all new line of versatile, reliable Pulse Rate Integrators especially designed for accurately converting a frequency or pulse rate to an analog output of dc voltage or current, or to a visual meter indication. Featuring many different models for the widest range of applications, these Anadex instruments represent the ultimate in dependability and operating performance.

Write today for complete detailed specifications.

Anadex INSTRUMENTS INC.

14734 Arminta St., Van Nuys, Calif.

CIRCLE 272 ON READER SERVICE CARD

CHRISTIE

Specialists in Power Supplies for over 30 Years

D-C POWER

SILICON CONTROLLED RECTIFIER REGULATED



2 TO 36 VOLT D-C • 30 AMPERE

Laboratory Power
General Purpose Power
Automatic Battery Charging

- Wide Range
- All Silicon
- Overload Capability
- Mil-Type Available
- Local or Remote Sensing

Write for Complete Information

CHRISTIE ELECTRIC CORP.

3400 West 67th Street, Los Angeles 43, California

SCR POWER SUPPLY MODEL BC236-30

VOLTAGE ADJUSTMENT RANGE:
2 to 36 v. d-c (two ranges)

OUTPUT CURRENT RATING:
30 ampere continuous
50 ampere intermittent

VOLTAGE REGULATION:
 $\pm 0.5\%$ or ± 140 millivolt
(whichever is greater)

RMS RIPPLE:
1% from 12 to 36 vdc; 2% below

TIME CONSTANT (12-36 v.):
full load on: 50 millisecc
full load off: 150 millisecc

A-C INPUT:
115 v. $\pm 10\%$, 1-Ph., 60 cps.

AMBIENT TEMPERATURE RANGE:
 -20°C to $+45^{\circ}\text{C}$

PARALLEL OPERATION:
Includes load sharing provision

VOLTAGE SENSING:
Local or remote

VOLTMETER & AMMETER:
2% accuracy, $3\frac{1}{2}$ " square

ON-OFF CONTROL:
A-C Switch

PROTECTION:
Magnetic Circuit Breaker

INPUT-OUTPUT ISOLATION:
"+" or "-" may be grounded

COOLING:
Convection (no fan)

AUTOMATIC REGULATOR:
Silicon Controlled Rectifiers

SIZE & WEIGHT:
 $13\frac{3}{8}$ " H x $17\frac{5}{8}$ " W x $15\frac{1}{4}$ " D
100 lbs.

Optional Extras:

AUTOMATIC BATTERY CHARGING &
CURRENT LIMITING PROVISION:
Specify Suffix "B"

MILITARIZING:
Built to MIL-E-4970A for humidity,
salt spray, sand, dust, fungus,
rain, sunshine & low pressure.
Also shock & vibration category D.
Specify Suffix "P"

RACK STYLE:
 $12\frac{1}{4}$ " H x 19" W x 13" D
Specify Suffix "R"

Over 200 other Power Supplies and Battery Chargers

TRANSISTOR-
MAGNETIC
AMPLIFIER
REGULATED



MAGNETIC
AMPLIFIER
REGULATED
(STAVOLT)



UNREGULATED &
SEMI-REGULATED
(RECTODYNE)



TRANSISTOR
REGULATED



AUTOMATIC
BATTERY
CHARGERS
FOR EVERY
TYPE OF
BATTERY



See us at the Wescon Show Booth No. 2901

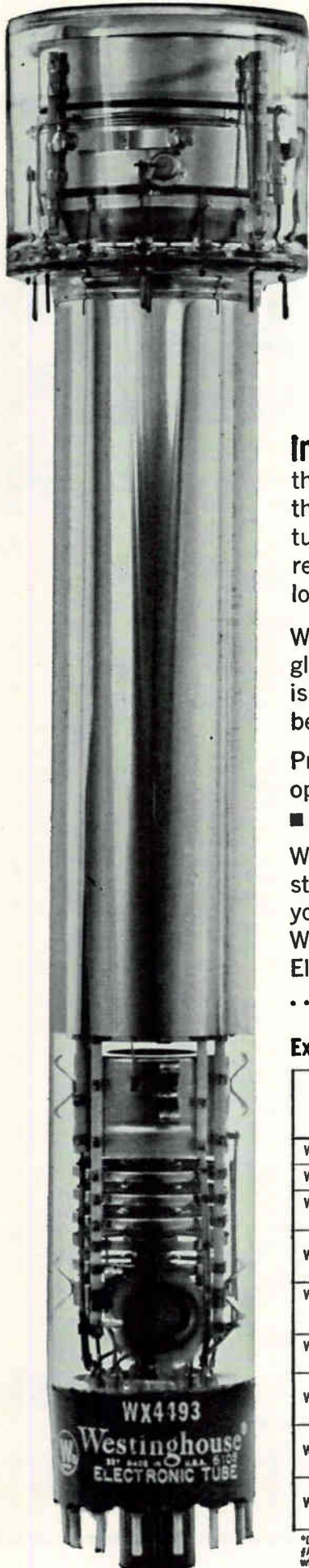

In ruggedized and long-life image orthicons Westinghouse leads the industry. Development contract work, continuous since 1953, resulted in the first truly ruggedized orthicon WL 7198. The latest version of this same tube, WX 4493, provides a special S-20 photo cathode that extends the red response, and a rugged thin film storage target that enhances sensitivity for low-light level applications.

Westinghouse also developed the WL 7611—the first image orthicon with a glass target that minimizes sticking and increases life expectancy. This tube is the first in the industry to be warranted for 1000 hours, and tubes have been recorded operating satisfactorily after 7000 hours in field applications.

Present development work includes: ■ image intensifier orthicons. ■ fiber optic inputs. ■ ultraviolet and infrared sensitive tubes. ■ field mesh tubes. ■ higher resolution capabilities.

Whether your application is standard or special, write on your Company letterhead to: Westinghouse Electric Corp., Elmira, N.Y. You can be sure . . . if it's Westinghouse.

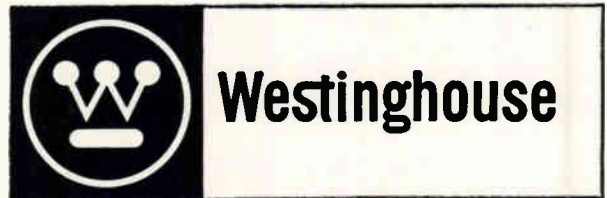

Examples of Westinghouse image orthicon design capabilities

TUBE TYPE	MAXIMUM VOLTAGE RATINGS [‡]		MAXIMUM ILLUMINATION FOR		SPECTRAL RESPONSE		SPECIAL FEATURES AND COMMENTS [▲]
	ANODE VOLTS	PHOTOCATHODE VOLTS	200 TV LINES	400 TV LINES	PEAK A [*]	1% A [*]	
WL-5820	1350	—550	7 x 10 ⁻⁵	5 x 10 ⁻⁴	4500	7500	Standard I.O. used for TV broadcast.
WL-6849	1350	—550	3 x 10 ⁻⁵	5 x 10 ⁻⁴	4500	7500	Wide spaced 5820
WL-7198	1350	—550	3 x 10 ⁻⁵	5 x 10 ⁻⁴	4500	7500	Ruggedized 5820 (will meet environmental conditions per MIL-5272A).
WL-7611	1350	—550	7 x 10 ⁻⁵	5 x 10 ⁻⁴	4500	7500	Direct replacement for 5820 with long-life target essentially free of image retention and target burn throughout life.
WX-4299	2200	1st. —20,000 2nd. —800	5 x 10 ^{-8*}	2.8 x 10 ^{-7*}	4250	8250	Ruggedized image intensifier I.O. 6 Dynodes—factor of 700 more sensitive at low-light level than 5820.
WX-4322	1350	—550	2.5 x 10 ⁻⁶	1.3 x 10 ⁻⁵	4500	7500	Thin film target—factor of 10-15 more sensitive than 5820 at low-light levels.
WX-4323	1350	—550	7 x 10 ⁻⁷	4 x 10 ⁻⁶	4250	8250	Thin film target—S-20 (tri-alkali) photosurface-factor of 50 more sensitive than 5820 at low-light levels.
WX-4476	1850	—650	2.5 x 10 ⁻⁶	1.3 x 10 ⁻⁵	4500	7500	Ruggedized (capable of meeting WL-7198 specs)—thin film target-factor of 10-15 more sensitive than 5820 at low-light levels.
WX-4493	1850	—650	7 x 10 ⁻⁷	4 x 10 ⁻⁶	4250	8250	Ruggedized (capable of meeting WL-7198 specs)—thin film target-factor of 50 more sensitive than 5820 at low-light levels.

^{*}Design objectives. [‡]All cathodes 6.3 volts, 0.6 amps. [▲]Max. usable image diagonal 1.8 inches except WX-4299, which is 1.6 inches. Max. over-all length 157/16 inches except WX-4299 which is 23 3/4 inches. Max. tube diameter 3 1/16 inches except WX-4299, which is 3 3/4 inches.

BUILT FOR ROUGH DUTY IN TIGHT SPACES



MODEL MM5-22 SCREWLOCK CONNECTOR
SHOWN ACTUAL SIZE

Continental's Series 22 Micro-Miniature Connectors are designed expressly for jobs that demand the ultimate in miniaturization without sacrifice of performance. Their ruggedness is service-proven daily in hundreds of aircraft, missile, computer and other applications where severe shock and vibration are normal environments.

Series 22 Connectors are available in a range of 14 sizes, providing 5 to 104 contacts, to meet virtually every requirement for high density connection in minimum space. All feature glass-filled Diallyl Phthalate moldings, self-aligning phosphor bronze contacts, gold plated over silver, and can

be supplied with beryllium contacts on order. Reversed guide pins and sockets assure positive polarization, and all sizes are available with screwlocks, protective shells and hoods.



DESIGNERS' DATA FILE

To help you select the micro-miniature connector that best meets your design requirements, Continental's Con-Dex File MM provides complete electrical, mechanical and dimensional data on the Series 22 Micro-Miniature Connectors. Write for your copy to: Electronic Sales Division, DeJur-Amsco Corporation, Northern Boulevard at 45th St., Long Island City 1, New York (Exclusive Sales Agent) RAvenswood 1-8000.

MICRO-MINIATURE • SUB-MINIATURE • MINIATURE • PRINTED CIRCUIT • RIGHT ANGLE PIN & SOCKET • CENTER SCREWLOCK

CONTINENTAL CONNECTORS

CONTINENTAL CONNECTOR CORPORATION • WOODSIDE 77, NEW YORK
VISIT US AT WESCON SHOW • BOOTHS 1919-1921

A VARACTOR FOR EVERY PURPOSE

220 new epitaxial silicon high power varactors in four package styles — subminiature glass case • double-ended cartridge • “pill” case • new “coaxial pill” case — all hermetically sealed, make *this* kind of harmonic generation possible now.

A WIDE VARIETY of PIV ratings and capacitance values allows selection of the optimum diode in each case style for your circuit application.

The data reported below was obtained by the Waveguide Systems Division of Microwave Associates* in a tandem chain of three doubler stages, each using a selected single Microwave Associates' epitaxial silicon high power varactor.

This high power output and remarkable harmonic efficiency was achieved without boosters, without power supply, in passive circuits.

Since the initial introduction of varactors on a commercial basis by Microwave Associates, we have continued to lead the way in varactor technology.

Microwave Associates' unsurpassed varactor circuit capabilities are your assurance of varactors tested to meet specific harmonic generation requirements.

The Waveguide Systems Division of Microwave Associates offers capabilities for the design and delivery of complete harmonic generator circuits.

Write for a copy of “SELECTION OF VARACTORS FOR POWER HARMONIC GENERATION” and for the 1961 Semiconductor Division Short Form Catalog.

* Support received by (USAF) ETL Aeronautical Systems Division Contract #AF33 (616) — 7232.

3 WATTS at 1120 Mc from 7 WATTS at 140 Mc

with MICROWAVE ASSOCIATES
EPITAXIAL SILICON
HIGH-POWERED VARACTORS



MICROWAVE ASSOCIATES, INC.
SEMICONDUCTOR DIVISION

Burlington, Massachusetts • Browning 2-3000
Western Union Fax • TWX: Burlington, Mass. 942



Immediate Minuteman and Dyna-Soar openings for Electronic and Electrical Engineers

Electronics is one of the fastest growing areas of engineering at Boeing. Electronic and electrical engineers interested in the advancement of space-age technologies will find challenging and deeply rewarding opportunities in advanced Boeing programs, including the Dyna-Soar manned space glider and the solid-fuel Minuteman ICBM. Assignments exist in your particular area of interest and at the level you require for career satisfaction and advancement. For your convenience, a professional application form appears at the right, and continues on the following page.



RETURN TO: MR. W. B. EVANS
THE BOEING COMPANY
P. O. BOX 3707-ENK
SEATTLE 24, WASHINGTON

PROFESSIONAL POSITION APPLICATION
(All replies held in strict confidence)

Date of this Application _____

Name _____
LAST FIRST MIDDLE (USE NO INITIALS)

Social Security No. _____

Present Address _____
NO. STREET

CITY ZONE STATE

Telephone No. _____

Ht. _____ Wt. _____ Age _____ U.S. Citizen _____

Male _____ Female _____ Marital Status _____

No. of Children _____ Other Dependents _____

U.S. Veteran _____ Entry Date _____

Discharge Date _____

Type of Discharge _____

Spouse's Maiden Name _____

Employer _____

Previous Boeing Employee? _____

If the answer to following three questions is "yes," explain on supplementary sheet:

1) Have you any physical defects? _____

2) Have you ever been arrested (except traffic and juvenile)? _____

3) Have you ever received disability or accident _____

compensation? _____

TURN PAGE ➔

HIGHER EDUCATION

College and Location	Dates Attended	Degree and Major
1. _____		
2. _____		

EMPLOYMENT HISTORY (Attach Resume)

Firm Name and Address	Base Pay 40 hr/Wk	Dates Employed Month/Year
1. _____ Position & Duties _____		
2. _____ Position & Duties _____		
3. _____ Position & Duties _____		
4. _____ Position & Duties _____		

REFERENCES. Give full names, occupations and addresses. Professional (previous supervisor preferred):

1. _____
2. _____

Character (other than relatives or former employers):

1. _____
2. _____

LIST TYPE OF WORK PREFERRED UPON EMPLOYMENT:

Have you ever been cleared for classified military information? _____. If yes, give date, level and company.

May we contact your former and present employer prior to completion of employment negotiations? Yes ____ No ____
If "yes," I authorize, without liability, the release of all employment and personal information.

SIGN YOUR NAME HERE

All qualified applicants will receive consideration for employment without regard to race, creed, color or national origin.

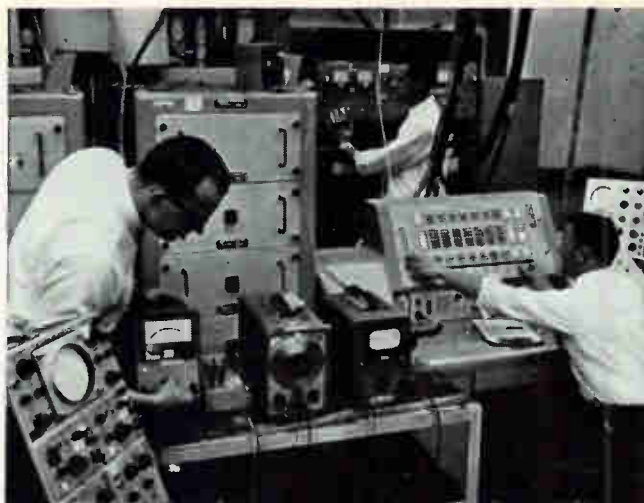

Boeing-developed command control console in Minuteman Subsystem Test Laboratory, Boeing Developmental Center.

Electronic and electrical engineers will find unique opportunities at Boeing. Activities in research, design and test are making significant contributions to the state-of-the-art as well as to the development, manufacture and installation of systems associated with Dyna-Soar, Minuteman, Bomarc, advanced aircraft, and orbital vehicle programs.

Assignments encompass broad areas of electronics activities including surveillance, communications, guidance and control, systems engineering, systems integration, antennas, cabling, circuit design, electromagnetic warfare, electronic packaging, electronics ground support, instrumentation, radio frequency interference control, reliability, systems test, solid state circuit design and many others.

Exceptional opportunities exist for logical designers and for specialists in systems design; in data processing associated with telemetry, and in digital design techniques embracing circuit and systems design, miniaturization, test and evaluation of airborne computers and supporting ground electronics.

You'll find space in the application at the left to indicate your special interests. Fill in and mail today.

* * *



Sailing on 23-mile Lake Washington in Seattle.

**RETURN TO: MR. W. B. EVANS
THE BOEING COMPANY
P. O. BOX 3707-ENK
SEATTLE 24, WASHINGTON**

**Form
begins
on
previous
page**

Matching the career advantages at Boeing are the family living advantages of the Pacific Northwest. This uncongested, evergreen area is famous for mild, year-round climate, unexcelled recreational facilities, fine modern homes, excellent educational and cultural institutions and healthful outdoor Western living for the entire family.

BOEING

NEW
from Belden
for the
WESCON
SHOW



Frank Timmons

See us in
Booth 4612-4614

Frank Timmons, Belden Electronic Standards Engineer, will again be available for consultation and to help you with your specifications.



NEW!

COILED RETRACTILE CABLES
Microphone-Telephone

A variety of new types and lengths for most applications. Microphone cables offered with 1, 3, and 4 conductors in vinyl and neoprene—telephone cords with 3 and 4 conductors, vinyl only.



NEW! HOOK-UP WIRE

Complete Range of New Mil-Spec Numbers

new!

Mil-W-76B-Plastic
MW-Vinyl-1000V-80C
MW-Shielded-1000V-80C
MW-Shielded-Nylon Jacket-1000V-80C
MW-Glass Braid-1000V-80C
MW-Glass Braid-Shielded-1000V-80C
MW-Nylon Jacket-1000V-90C
HW-Vinyl-Gauges 16-22 2500V
Gauges 6-14 -600V-80C
HW-Glass Braid-600V-80C
LW-Vinyl-300V-80C
LW-Nylon Jacket-300V-90C

new!

Mil-W-16878D-Plastic
B-Vinyl-600V-105C
B-Vinyl-Nylon Jacket-600V-115C
C-Vinyl-1000V-105C
C-Vinyl-Nylon Jacket-1000V-115C
D-Vinyl-3000V-105C

new!

Mil-W-5086A & Mil-C-7078A
Aircraft Power and Lighting Cables
Mil-W-5086A-Types 1 & 2-600V
Mil-C-7078A-Type 1-600V



Just published—new electronic catalog—4000 new items! Available at the Wescon Show. Request your copy.

One wire source for everything electronic and electrical



magnet wire • lead wire • electronic wire • control cables • power supply cords • welding cable • automotive and aircraft wire & cable

NEW

4-TRACE

PREAMPLIFIER

for Tektronix
Oscilloscopes that
accept
letter-series
plug-in units

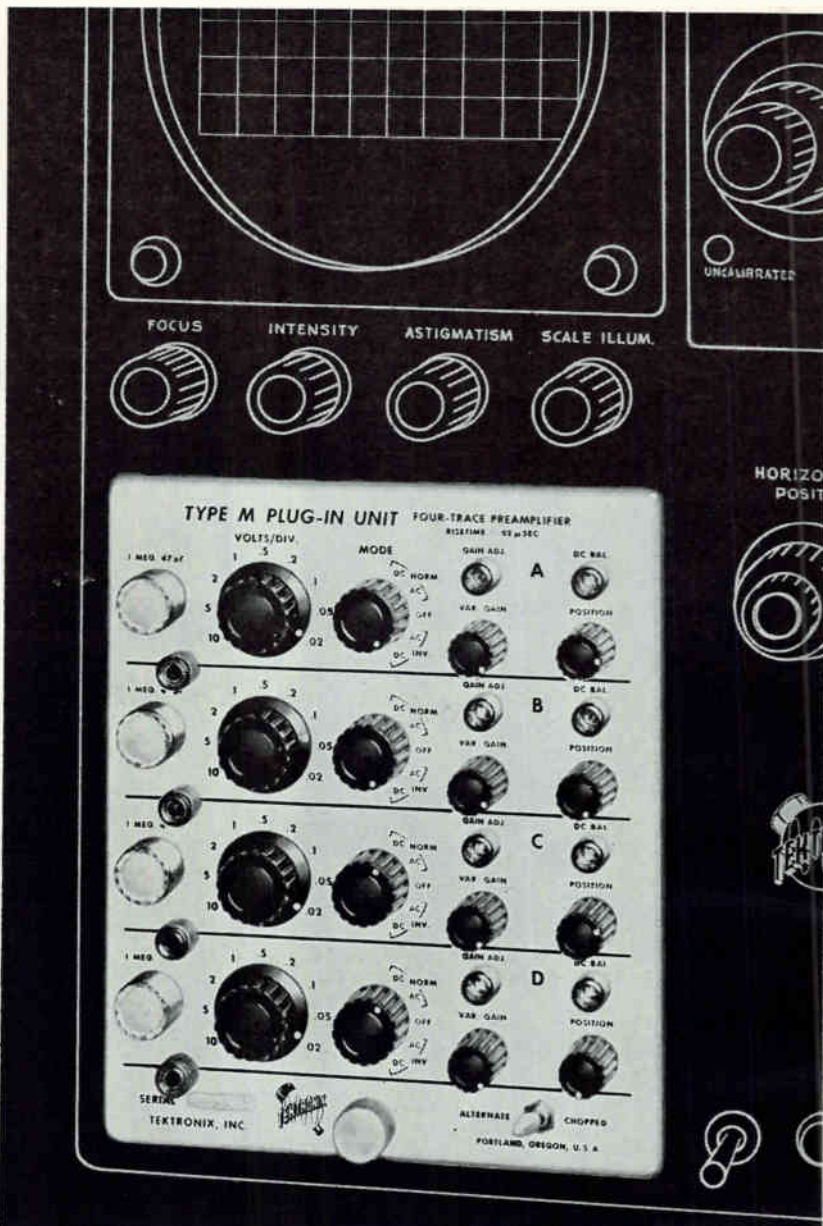
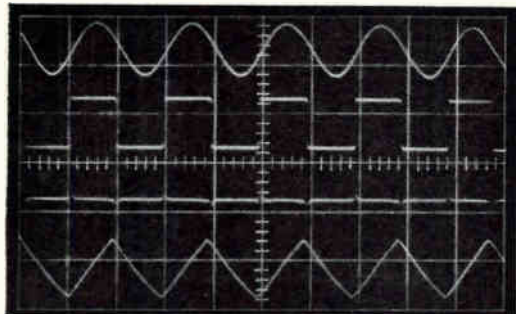

TYPE M UNIT Seventeenth in the letter-series of plug-in units, the new Type M Unit adds multiple-trace displays to the wide range of applications possible with your Tektronix oscilloscope.

With a Type M Unit, you can observe up to four signals—either separately, or in any combination.

Independent controls for each amplifier channel permit you to position, attenuate, invert input signals as desired.

Other convenient preamplifier features—such as triggered or free-running electronic switching . . . ac-coupling or dc-coupling . . . and, after initial hookup, little or no cable switching—ideally suit the new Type M Unit for multiple-trace presentations in the laboratory or in the field.

For more information about this new 4-Trace Preamplifier, please call your Tektronix Field Engineer.

CHARACTERISTICS

Operating Modes—Any combination of one to four channels electronically switched—at the end of each sweep or at a free-running rate of about 500 kc. Or each channel separately. **Channel Sensitivity**—20 mv/cm to 10 v/cm in 9 calibrated steps. Continuously variable uncalibrated between steps, and to 25 v/cm. **Channel A Signal**—available on front panel for optimum triggering in some applications. **Frequency Response and Risetime**—With Type 540-Series and Type 550-Series Oscilloscopes dc to 15 mc, 23 nsec. With Type 531A, 533A, 535A Oscilloscopes dc to 12 mc, 30 nsec. **Constant Input Impedance**—at all attenuator settings.

Type M Plug-in Unit \$455.00
f.o.b. factory

Tektronix, Inc. P. O. BOX 500 • BEAVERTON, OREGON / Mitchell 4-0161 • TWX-BEAV 311 • Cable: TEKTRONIX

TEKTRONIX FIELD OFFICES: Albuquerque, N. Mex. • Atlanta, Ga. • Baltimore (Towson) Md. • Boston (Lexington) Mass. • Buffalo, N.Y. • Chicago (Park Ridge) Ill. • Cleveland, Ohio • Dallas, Texas • Dayton, Ohio • Denver, Colo. • Detroit (Lathrup Village) Mich. • Endicott (Endwell) N.Y. • Greensboro, N.C. • Houston, Texas • Indianapolis, Ind. • Kansas City (Mission) Kan. • Los Angeles, Calif. Area (East Los Angeles, Encino • West Los Angeles) • Minneapolis, Minn. • Montreal, Quebec, Canada • New York City Area (Albertson, L.I., N.Y. • Stamford, Conn. • Union, N.J.) • Orlando, Fla. • Philadelphia, Pa. • Phoenix (Scottsdale) Ariz. • Poughkeepsie, N.Y. • San Diego, Calif. • San Francisco, Calif. Area (Lafayette, Palo Alto) • St. Petersburg, Fla. • Syracuse, N.Y. • Toronto (Willowdale) Ont., Canada • Washington, D.C. (Annandale, Va.).

TEKTRONIX ENGINEERING REPRESENTATIVES: Hawthorne Electronics; Portland, Oregon; Seattle, Washington • Keron Hawaii Ltd., Honolulu, Hawaii. Tektronix is represented in twenty overseas countries by qualified engineering organizations.

In Europe please contact Tektronix International A.G., Terrassenweg 1A, Zug, Switzerland, Phone (042) 4-91-92, for the address of the Tektronix Representative in your country.

SEE THE M UNIT AND OTHER NEW TEKTRONIX INSTRUMENTS AT WESCON BOOTH 1726

General Electric Industrial Silicon Transistors

famous "fixed-bed"
mounting at low
industrial prices

Featuring . . .

Excellent performance up to
125°C

For applications in . . .

- Linear amplifiers
- Switching circuits requiring low leakage currents
- "Starvation" circuits



RATINGS AND CHARACTERISTICS

G-E Type Numbers	I_{CBO} @ 25°C (Max.)	V_{CBO} ($I_C=100\mu A$) (Min.)	V_{CEO} ($I_C=100\mu A$) (Min.)	V_{EBO} ($I_E=100\mu A$) (Max.)	h_{FE} ($V_C=5V$ $I_C=1mA$ $F=1Kc$)	$V_{CE(SAT)}$ ($V_C=5V$ $I_B=2.2mA$) (Max.)	h_{FE} (pulsed) ($V_C=5V$ $I_C=10mA$)
	@ 30V						
4C28	5 μA	40V	20V	1V	9-22	1.5V	
4C29	5 μA	40V	20V	1V	18-44	1.5V	
4C30	5 μA	40V	20V	1V	37-90	1.5V	
4C31	5 μA	40V	20V	1V	76-333	1.5V	
	@ 20V						
4D20	5 μA	40V	20V	1V		1.5V	15-50
4D21	5 μA	40V	20V	1V		1.5V	40-135
4D22	5 μA	40V	20V	1V		1.5V	120-250
	@ 15V						
4D24	1 μA		15V	1V			15-50
4D25	1 μA		15V	1V			40-135
4D26	1 μA		15V	1V			120-250

General Electric's famous "Fixed-Bed" mounting design for extremely high mechanical reliability under severe environmental conditions, plus unusually stable operation at high temperature (125°C) make these new, low cost industrial silicon transistors ideal for high performance industrial applications. Derived from the popular G-E 2N332 series now being used in ultra-reliable missile applications, these economy units offer inherently reliable operation and high dissipation ability

for your most critical industrial designs.

For complete technical information and test data, call your Semiconductor Products District Sales Manager. Or write Semiconductor Products Department, Section 25H102, General Electric Company, Electronics Park, Syracuse, New York. In Canada: Canadian General Electric, 189 Dufferin Street, Toronto, Ont. Export: International General Electric, 150 E. 42nd Street, New York 17, New York.

FOR FAST DELIVERY OF INDUSTRIAL SILICON TRANSISTORS AT FACTORY-LOW PRICES, CALL YOUR G-E SEMICONDUCTOR DISTRIBUTOR

GENERAL  ELECTRIC

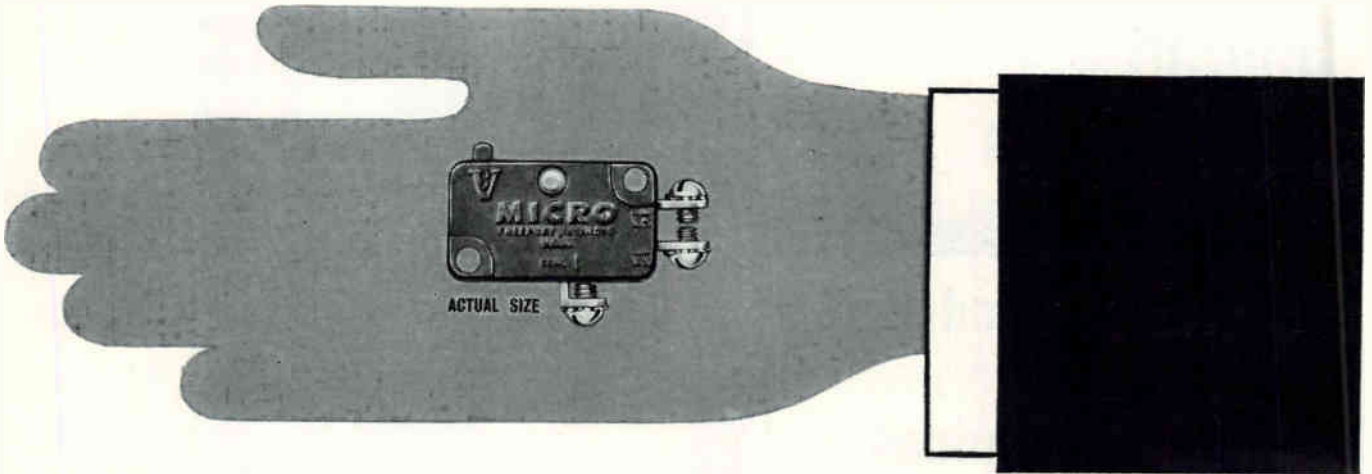

Your choice of
many auxiliary actuator designs



Single-pole double-throw
(With quick-connect terminals)



Single-pole double-throw



Single-pole double-throw
(Extra-long life, mushroom head plunger)

MINIATURE BUT MIGHTY

... WITH NEW, HIGHER CAPACITIES! This versatile series of basic switches combines miniature size with new, higher electrical capacities. Switch cases and plungers are available in different plastic materials to meet varying requirements. Special high-temperature versions with synthetic mica cases withstand temperatures up to 600°F. Contact arrangements include double-throw, normally-open or normally-closed, with a choice of terminals. Models are available which conform to applicable requirements of Military Specification MIL-S-6743. "V3" Series basic switches are especially adaptable to multiple cam-operated gang-mounted systems and are also used as switching elements in many of our enclosures and assemblies. See the Yellow Pages for the nearby MICRO SWITCH Branch Office or write for Catalog 63.

MICRO SWITCH . . . FREEPORT, ILLINOIS

A division of Honeywell

In Canada: Honeywell Controls, Limited, Toronto 17, Ontario



Honeywell

MICRO SWITCH Precision Switches

Choice of engineers everywhere!

JOHNSON Air Variables

NEW! Type "U" and "UB" Sub-miniatures . . . available in Single-Section or Butterfly Types.

- 3 Mounting Methods
- Unique machined design for exceptional uniformity and outstanding mechanical stability!
- High "Q"—greater than 1500 at 1 mc.! High torque-to-mass ratio—2 to 7 inch ounces! Exceptionally low temperature coefficient—approximately 35 PPM/°C positive!

These low cost, tiny Type "U" and "UB" capacitors require less than 0.2 and 0.3 square inch respectively for chassis or panel mounting. Rotors and stators machined from one piece of solid brass—provide exceptionally uniform delta C and voltage characteristics. All metal parts silver-plated—ceramic is steatite Grade L-4 or better. Provides freedom from moisture entrapment found in trimmer capacitors of enclosed or solid dielectric type. Voltage breakdown ratings to 1,300 volts DC. Extra heavy end rotor plate—slotted for screwdriver adjustment.



"LOCTAB" MOUNTING

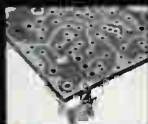

PRINTED CIRCUIT MOUNTING



2-HOLE MOUNTING

TYPE "R" CAPACITORS

This popular variable has extra-heavy steatite stator support insulators and soldered .023" thick brass plates. Metal parts heavily nickel-plated. Sturdy brass end frames—double bearing construction—silver-plated beryllium copper wiping contacts—peak voltage rating 1200 volts. Available in a number of plate spacings as well as special platings, shaft lengths and without mounting feet for panel mounting applications. Bearing threaded $\frac{3}{8}$ "-32.

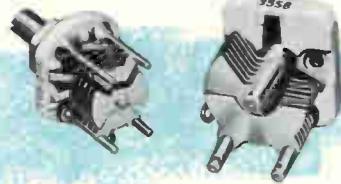

TYPE "M" AND "S" CAPACITORS

Excellent for use in compact equipment. DC-200 treated steatite insulators. Soldered plate construction and heavily anchored stator supports provide extreme rigidity. Plates are nickel-plated brass. Single section, butterfly and differential types with straight, locking, and screw-driver shafts.

TYPE "M"—Requires only $\frac{3}{8}$ " x $\frac{3}{4}$ " panel area. Peak voltage rating 1250 volts on .017" spaced units; 850 volts on 160-130, spaced .013". Mounting bushing, $\frac{1}{4}$ "-32.

TYPE "S"—Slightly larger than the Type "M". Peak voltage rating 850 volts—plate spacing .013", other spacings available on special order. Mounting studs tapped 4-40 on 17/32" centers.

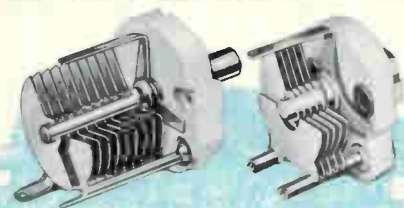

TYPE "J" AND "K" CAPACITORS

TYPE "J"—This heavy duty miniature has wider spacing (.025") than most small air variables, yet occupies little more space. Ideal for small space tank circuits in low power stages. DC-200 treated insulator—soldered plate construction. Peak voltage rating 1200 volts. Mounting brackets and 6-32 screws provided.

TYPE "K"—Widely used for military and commercial applications. DC-200 treated insulator—slotted stator contacts—extra-rigid soldered plate construction. Peak voltage rating 1000 volts. Plate spacing .015". Available in production quantities to meet MIL-C092A specifications—other capacities and variations available.



Ceramic-soldered for greater strength!

TYPE "L" CAPACITORS

Ideal for applications requiring extreme stability and strength. Rotor bearings and stator support rods soldered directly to heavy 3/16" thick steatite. Split-sleeve bearing and silver-plated beryllium copper contact provide constant torque and smooth capacity variation. Plate spacing .030". Peak voltage rating 1500 volts. Available in a number of plate spacings, as well as special platings, shaft lengths and stator terminal locations. Bearings threaded $\frac{3}{8}$ "-32. Single section, dual, butterfly and differential types.

Free Catalog

Johnson also manufactures a line of heavy duty and special purpose capacitors in addition to the types described above. For complete specifications and current prices on all Johnson electronic components, write for our newest components catalog.



Tube Sockets



Plugs Jacks



Insulators



Knobs Dials



Pilot Lights



Inductors



E. F. JOHNSON COMPANY

WASECA, MINNESOTA

Extra quality at no extra cost with Bendix Semiconductors

Bendix Bulletin

MIL-TYPE UNITS SET PACE FOR FULL LINE RELIABILITY

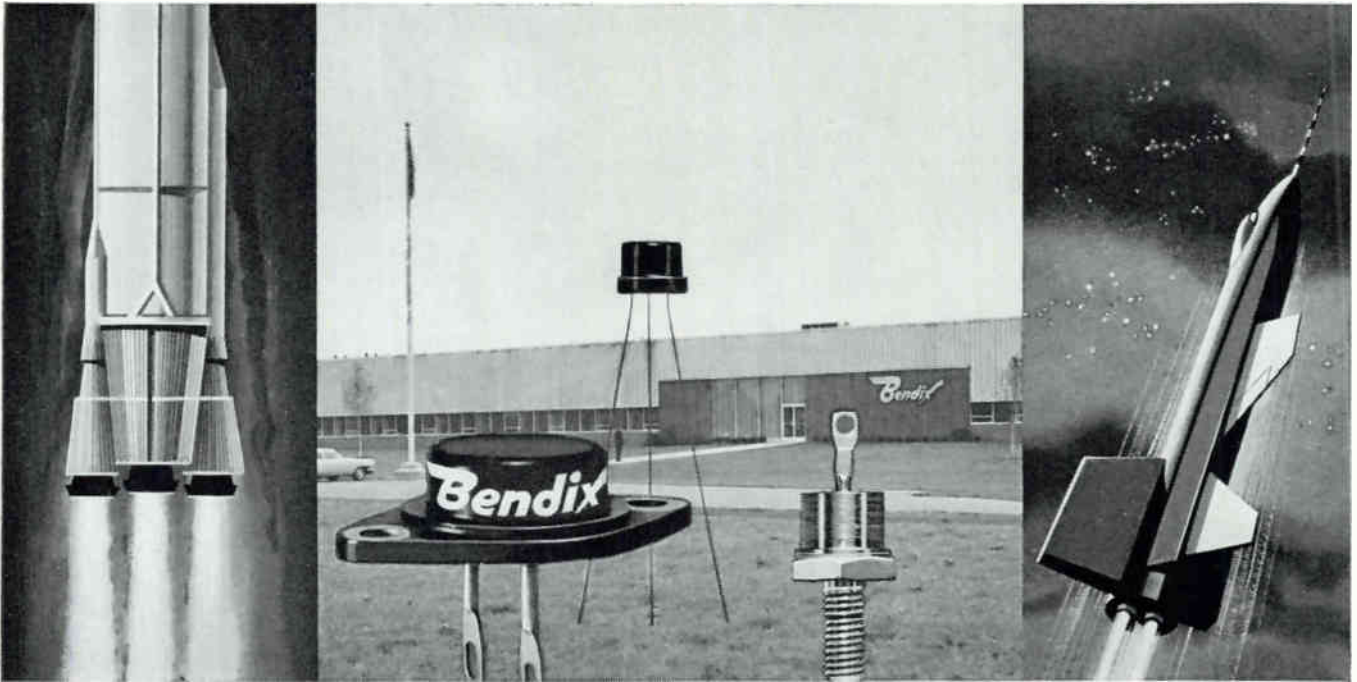

“Dynamic testing” part of everyday quality story at new Bendix plant

Bendix mil-type power transistors and rectifiers give engineers unusually wide design freedom on military equipment applications. And these units are well suited to both electrical and environmental conditions because of their rugged dependability.

As a matter of fact, high reliability characterizes our entire semiconductor line. For, at Bendix, we apply extra precautions—such as “dynamic testing”—across-the-board daily. Thus, you get “an extra measure of value” *no matter what Bendix type you buy.*

Specially suited to high-current switching, audio amplification, small motor and servo drive applications, our mil-type transistors feature rugged reliability to meet electrical and environmental conditions. The three rectifiers are characterized by low forward drop and low reverse leakage current. Besides power rectification, they're ideal for magnetic amplifier and DC blocking circuits.

Be sure to see our MIL-TYPE line of semiconductors at the WESCON Show, Booth No. 2605

Main Office: South Street, Holmdel, New Jersey—Phone: SHadyside 7-5400—TWX HOLM 1388 • New England Office: 114 Waltham St., Lexington, Mass.—Phone: VOlunteer 2-7650 • Detroit Office: 12950 West 8 Mile Road, Detroit 37, Mich.—Phone: JOrdan 6-1420 • Midwest Office: 2N565 York Road, Elmhurst, Ill.—Phone: BRowing 9-5050—TWX ELM 393 • West Coast Office: 117 E. Providencia Avenue, Burbank, California—Phone: VICTorio 9-3961—TWX BRB 9808 • Canadian Affiliate: Computing Devices of Canada, P.O. Box 508, Ottawa 4, Ontario • Export Office: Bendix International, 205 E. 42nd Street, New York 17, N.Y.—Phone: MUrrroy Hill 3-1100—TWX NY 1-4800. Stocking Distributors—Contact nearest sales office for name of local distributor.

MAXIMUM RATINGS AND TYPICAL OPERATION OF MILITARY POWER TRANSISTORS

TYPE NUMBER	MIL-T-19500/	MAXIMUM RATINGS						TYPICAL OPERATION	
		V _{cb} Vdc	V _{ce} Vdc	I _c Adc	P _c W	T _j °C	T storage °C	h _{FE}	at I _c Adc
2N297A	36A (SigC)	-60	-50	5	35	95	-65 to +95	70	0.5
2N331	4A	-30	-12	0.2	0.075	85	-65 to +85	50	0.001
2N1008B	196 (SigC)	-60	-55	0.3	0.4	100	-65 to +100	80	0.01
2N1011	67 (SigC)	-80	-70	5	35	95	-65 to +95	55	3.0
2N1120	68 (SigC)	-80	-70	15	45	95	-65 to +95	35	10.0
2N1430	SCL7002/25A	-100	-80	10	50	100	-65 to +100	70	5

Ideal for such applications as: HIGH CURRENT SWITCHING • AUDIO AMPLIFICATION • SMALL MOTOR AND SERVO DRIVERS

MAXIMUM RATINGS OF MILITARY POWER RECTIFIERS

TYPE NUMBER	*MIL-T-19500/	I _o at 150°C	PRV Vdc	I _{ib} at 25°C	E _{pp} Vrms	I _{ib} at 150°C
1N1614	162 (SigC)	5 Adc	200	50 μAdc	140	500 μAdc
1N1615	162 (SigC)	5 Adc	400	50 μAdc	280	500 μAdc
1N1616	162 (SigC)	5 Adc	600	50 μAdc	420	500 μAdc

*These were MIL-E-1/1240, 1241 and 1242 respectively.

Ideal for such applications as: MAGNETIC AMPLIFIERS DC BLOCKING CIRCUITS • POWER RECTIFICATION

Bendix
Semiconductor Division

HOLMDEL, NEW JERSEY



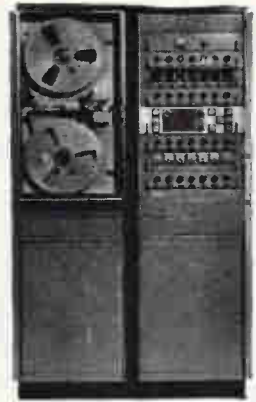

Ampex's Advanced Recorder/Reproducer, the FR-600 used for missile check-out work.

**A Quality Product
requires
ALLEN-BRADLEY
Electronic Components**

This shows a few of the A-B components in one of the Ampex recorder's modules.

In the design of the highly sophisticated circuitry for this advanced recorder, engineers at Ampex selected Allen-Bradley quality electronic components to meet the critical requirements for reliability, long life, and quiet operation. For example, the use of Allen-Bradley potentiometers—with their exclusive solid, hot molded resistance element—assures smooth control at all times. There are never any abrupt changes in resistance during adjustment as in wire-wound resistors. Also the "noise" factor is extremely low initially, and it decreases with use.

Allen-Bradley composition fixed resistors—also made by an *exclusive* hot molding process—are fantastically uniform. Their electrical characteristics are so consistent from resistor to resistor that performance over long periods of time can be accurately predicted. *And catastrophic failure is unheard of*—when you use Allen-Bradley composition resistors.

For the ultimate in reliability and performance, insist on Allen-Bradley *quality* electronic components. Send for Publication 6024 today.

Allen-Bradley Co., 110 W. Greenfield Ave., Milwaukee 4, Wis. In Canada: Allen-Bradley Canada Ltd., Galt, Ont.

Portion of one of 14 CRT monitors, each containing 8 A-B Type G Potentiometers.

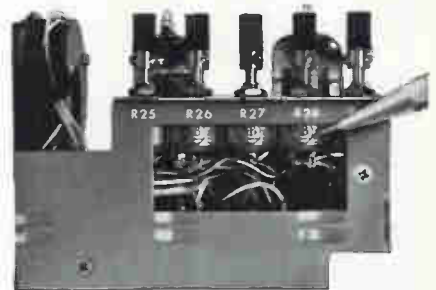

**A-B QUALITY ELECTRONIC COMPONENTS
USED IN AMPLEX WIDE-RANGE RECORDER**



ALLEN - BRADLEY

**QUALITY
ELECTRONIC
COMPONENTS**

**NOW!
30 DAY
DELIVERY**

SIZE 8 & 10 INTEGRAL GEARHEAD MOTORS

3 Times Torque Load Capacity*
of comparable size 8 gearheads

*Will sustain 20 in-oz torque load for 1,000 hours operation and 100 in-oz momentary overload at the maximum ratios.

CPPC one-piece gearhead housing eliminates separate gear plates and fastening posts, improves and maintains accuracy through exact alignment of gear clusters, assures smoother operation and more expedient inspection and servicing.



Gearhead and motor are selectable, individual parts enclosed in the same common motor housing.

Clifton Precision, pioneers in postless gearhead construction, introduces the finest in gearhead design—cage-type, one-piece gearhead housing machined from a single block of metal. In these units, exact duplication of gear centers is accomplished through simultaneous boring of permanently integrated bearing plates (patent pending). Positive and permanent alignment of gear clusters composed of AGMA precision Classes II and III hardened-steel gears integral with shafts journaled at both ends in ABEC class 5 bearings, minimize deflection and backlash, maximize torque load capacity, insure smoother operation and continued reliability of performance beyond normal endurance life requirements. Cage-type construction facilitates inspection and lubrication while gearhead is mounted simply by removing motor. CPPC motors will stand greater heat than ever before due to the use of new materials. See box at lower right.

Write for our free pamphlet which gives detailed specifications of our entire gearhead motor and motor-tachometer line, sizes 8, 10 and 11.

PERFORMANCE CHARACTERISTICS

SIZE 8 INTEGRAL GEARHEAD MOTOR
SERVO MOTOR TYPE ALC-8-□-1

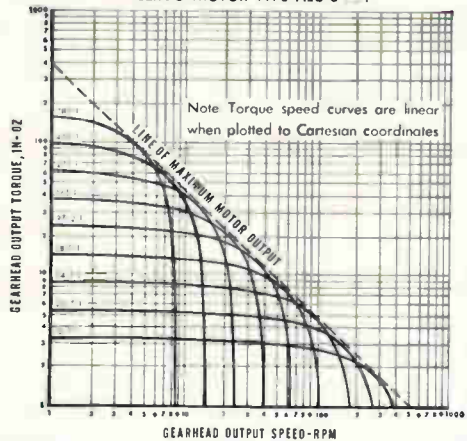

MOTORS

The following CPPC standard motors, electrical characteristics of which can be found in the current CPPC Rotary Components catalog, are offered with our gearheads:

- | | | | |
|---------------|-----------|----------------|------------|
| SIZE 8 | | SIZE 10 | |
| ACH-8-□-1 | AMH-8-□-3 | ACH-10-□-1 | ALH-10-□-1 |
| ACH-8-□-4 | ALC-8-□-1 | ACH-10-□-4 | ALH-10-□-5 |
| AMH-8-□-1 | ALC-8-□-4 | | |

CURRENT LEAKAGE

VARIAION WITH TEMPERATURE OF LEAKAGE CURRENT BETWEEN PHASES OF SERVO MOTORS

Superiority of insulation in CPPC motors is illustrated by actual comparative curves shown at the right.

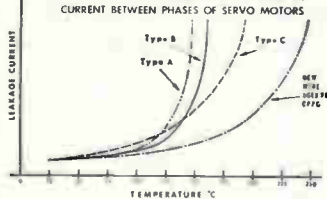

STANDARD TYPES

RATIOS		No. of Clusters	Dir. of Rotation
Size 8	Size 10		
12.09	19.98	2 (3 pass)	reverse
20.63	32.19	3 (4 pass)	direct
34.26	58.28	3 (4 pass)	direct
58.44	93.89	4 (5 pass)	reverse
97.07	169.97	4 (5 pass)	reverse
165.58	273.84	5 (6 pass)	direct
275.02	495.74	5 (6 pass)	direct
469.15	798.70	6 (7 pass)	reverse
779.22	1445.92	6 (7 pass)	reverse

Notes: 1. Any ratio (±3%) is available within the limits of the ratio range at additional cost and may require longer delivery time. 2. Max. backlash = 30 minutes at 2 in-oz reverse gauge load in above units. Inquire if special tolerance is required.

CLIFTON PRECISION PRODUCTS CO., INC.
CLIFTON HEIGHTS, PENNSYLVANIA



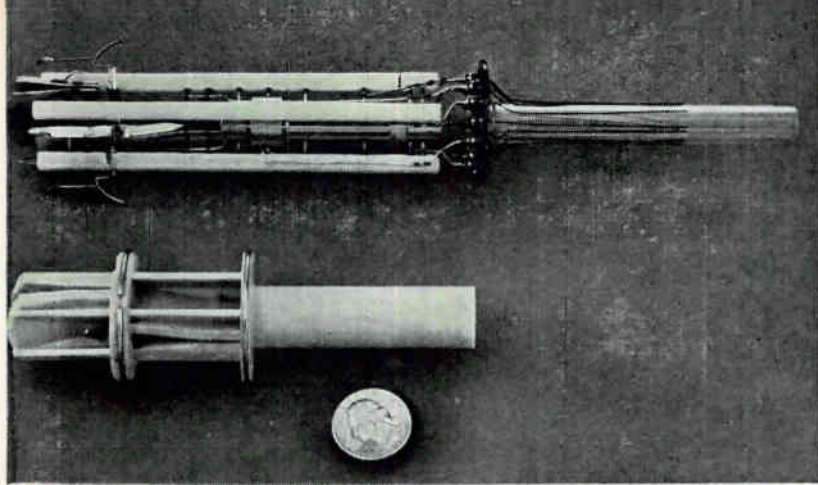

FIG. 1—Comparison of ceramic crt electrogun (bottom) with ordinary crt



electronics
August 11, 1961

Technical Preview of 1961 WESCON

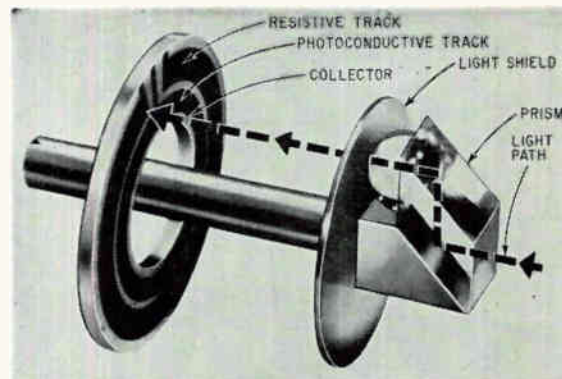

FIG. 2—Electro-optical potentiometer has frictionless pickoff and infinite resolution

Sampling of this year's show includes a new approach to making crt guns, contactless potentiometers, solid-state X-band limiter, an X-band klystron with 20 Kw c-w power and a core memory having a 2- μ sec read-restore, clear-write cycle

By HAROLD C. HOOD,
Pacific Coast Editor

AS USUAL, the annual WESCON show will be symptomatic of the dynamic growth of the Western segment of our industry. This will be evident on the exhibit floors and in the quality of the technical presentations to be made at the Cow Palace in San Francisco.

As in the electronics industry nationally, R&D expenditures in the West are reported to be significantly higher this year, and the effect is made evident by a number of outstanding new developments that have occurred in this region over the past few months.

A two-year research program at General Dynamics Electronics has spawned a new critical-tolerance crt formed gun that reportedly is much more rugged than conventional guns. Estimates place the labor in fabricating crt's employ-

ing formed guns at 25 percent of that required for conventional-gun crt fabrication.

The new one-piece gun is precision molded and machined in symmetrical halves from one of the family of glass-bonded mica formulations. Gun elements, including electron lenses and deflection plates, are produced by firing conductive coatings such as silver paint that adheres well to the glass-bonded mica, onto internal surfaces of the gun (See Fig. 1). Electrode connections are made through wires imbedded in the ceramic that act as conductors from the fired-on elements to the base assembly. A rugged assembly supports the molded gun in the crt neck. Conventional sealing and exhaust procedures complete the process.

The molded gun development program, initiated by GD/E in 1958, resulted in the evaluation of many ceramic materials for high-temper-

ature characteristics, moldability, outgassing under vacuum and dimensional stability. The process, was first applied to a commonly used radar-tube gun, the 5AQP, and is presently being adapted to multi-gun designs where uniformity, orientation and alignment are critical. Cathode-ray tubes incorporating formed guns are said to withstand shock and vibration better than electrically equivalent conventional tubes. Other advantages claimed for the formed gun include ease of production, reproducibility, flexibility of design and improved environmental stability.

While initial material costs are high, GD/E reports mass production methods make the unit cost of formed guns competitive with conventional glass-rodged electron guns. Initial tooling costs for producing formed guns are equivalent to tooling cost presently encountered in conventional crt manufac-

turing. Since tooling for hand-assembly operations is not required for production of the new device, long-term tooling costs will be lower. The practice of boresighting to line up component parts has been eliminated.

An electro-optical precision potentiometer, developed jointly by Duncan Electronics and Electro Radiation, Inc., in Southern California, reportedly will minimize mechanical wear, undesirable torque and electrical noise caused by variation in contact resistance. The device has no contact point between the wiper and the resistance element.

A prototype of the Duncan device, shown in Fig. 2, is claimed to have extremely fine resolution and has endured life tests of tens of millions of revolutions at fast rotational speeds. Resistive element is a deposited metallic film, and a beam of light focused on a photoconductive material takes the place of the conventional wiper.

Three concentric rings are applied to a glass base. The outer, resistive ring is tin oxide, the inner ring of low-resistance metal forms the collector, and the connecting ring is cadmium sulphide, a material that is highly conductive when exposed to light and nonconductive when in darkness. Light-to-dark conductivity ratio has been controlled to as high as 10^7 -to-1 for only a few footcandles of illumination. Rise and decay times of as little as one millisecond have been attained and the possibility of reducing this to only ten microseconds is indicated. Response times on this order would permit rotational speeds as high as 10,000

rpm in a 2-in. diameter potentiometer.

Light source is a small lamp contained in the rear lid of the assembly. It is focused on the photoconductive track through a lens and a small hole in the disk connected to the operating shaft. The lens and hole concentrate the light on only a small area of semiconductive surface. At this point only, the current flows between the resistive element and the connector ring, and the position of this point is controlled by the operating shaft as is the sliding contact in a conventional potentiometer.

Further refinements of the development may include the use of a radioluminescent light source to replace the lamp and its need for electrical power in the present device. Other uses for this transducer include applications as high-speed signal generators and telemetering switches with long life and low torques such as are required by both industrial and military control and computing systems.

Typical of contributions from the West to the fields of space communication and astronomy is Jet Propulsion Laboratory's recent Venus radar bounce using the setup shown in Fig. 3. A step-up in efficiency of NASA's Goldstone Deep Space Instrumentation Facility installation in California was largely responsible for success of the experiment, which produced a significant refinement of the Astronomical Unit (93 million miles, the mean distance between the sun and earth used for measuring distances in the universe) and proved feasible communication between Venus-bound spacecraft and the earth.

The 2,388-Mc signal from the 85-ft Goldstone transmitter dish took $6\frac{1}{2}$ minutes to make the round trip between earth and Venus. Design of the Venus radar receiver maser and antenna-feed system provided high antenna aperture efficiency and low operating system noise temperature, a combination resulting in the most sensitive receiver.

A ruby-crystal three-level cavity maser was used for a preamplifier. To minimize the noise following the maser, a JPL-designed semiconductor parametric amplifier was adapted as the second stage of amplification. This combination of solid-state low-noise amplifiers produced an equivalent noise temperature of approximately 29 K at the maser input. A maser gain of 20 db \pm 0.5 db was maintained by manual adjustment of pump power and magnet current. A bandwidth of 2.5 Mc was obtained at the 2,388 Mc operating frequency. The maser was mounted on one of the antenna feed support booms near the antenna focal point to minimize the length of transmission line required. Parts of the feed system are shown on the cover and in Fig. 3.

Using a shaped-beam feed, optimized for minimum reflector spill-over and back radiation effects, a minimum antenna temperature of approximately 15 K was obtained at a gain of 53.6 db over that of an isotropic radiator. A minimum-length transmission line from feed to maser was constructed of large low-loss waveguide and contributed an additional 14 K. This included a directional coupler and waveguide switch that were necessary for monitoring gain and noise figure of the system. Noise temperature

FIG. 3—Venus radar with nonsynchronous closed-loop ranging system (left) and details of feed (right)

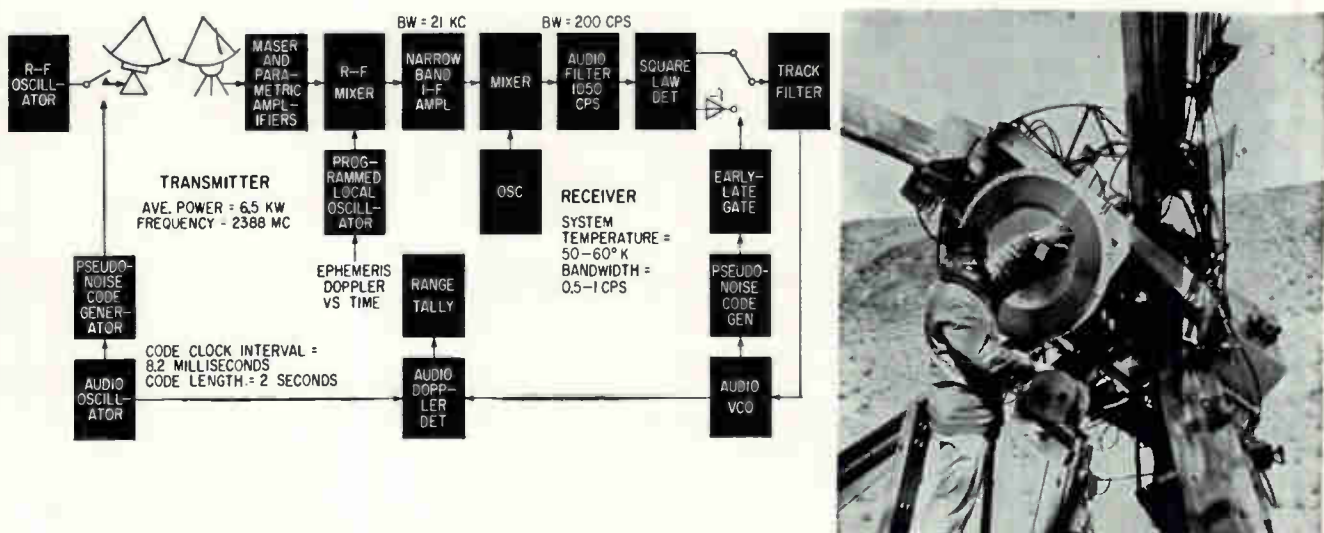

measurement instrumentation injected about 1 K of noise when off. Total calculated system noise temperature was approximately 59 K.

Quantitative measurements of received signal strength required calibration of receiver gain and noise temperature. These measurements were simplified by a reference load maintained at liquid helium temperature.

Wiley Electronics Company, a subsidiary of Giannini Scientific Corporation, has developed a simple and effective system for transmission of strain gage and thermocouple data from the rotors of high-speed machinery. Telemetry of low-level signals without the use of slip rings to provide noise-free data was initially accomplished by a complete fm-fm, r-f carrier telemetry system. However, the r-f carrier system required special antenna installations, relatively complex receiving equipment and special modulators for subcarrier oscillator frequencies with ± 40 -percent deviation. To simplify the system, the carrier was omitted and the f-m subcarrier oscillator frequencies transmitted directly through a capacitively coupled, non-contacting slipring arrangement. Problems of r-f carrier frequency stability and of obtaining permission to radiate r-f energy in the 30 Mc to 100 Mc band were also eliminated.

The unit, shown in Fig. 4, has three separate bridge-controlled oscillators and a 100-hour life battery pack. The rectangular transmitter was installed in a cylindrical power shaft and terminal board assembly. The terminal board meshed with a flexible coupling, and provided terminals for strain gage, antenna and power-switch connections. The block diagram shows the system using only two bridge-controlled oscillators. The output of the amplifier feeds conventional f-m data handling, recording, indication and transmission equipment.

Heart of the new system is the shaft-mounted bridge-controlled oscillators, and the low-noise power amplifier in the capacitively coupled antenna output. The oscillator uses six silicon transistors and has a power consumption of 0.1 w. The oscillators are temperature com-

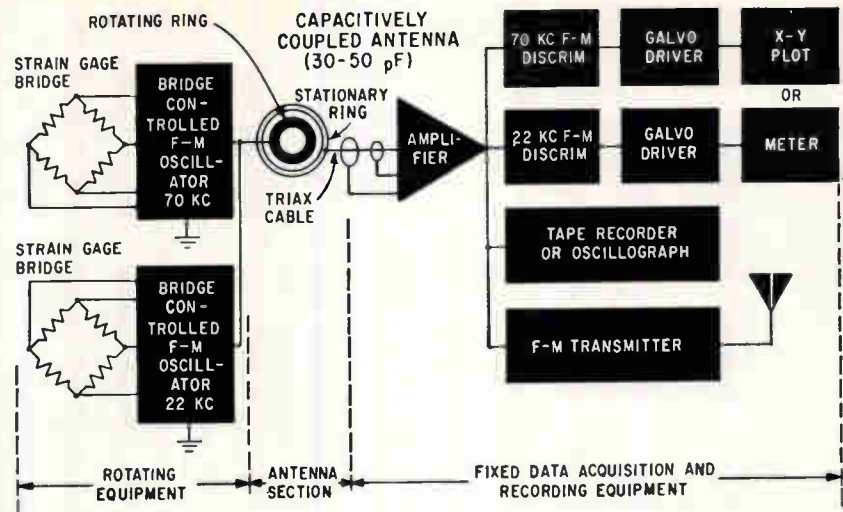

FIG. 4—Wiley telemetry system for instrumentation of rotating parts

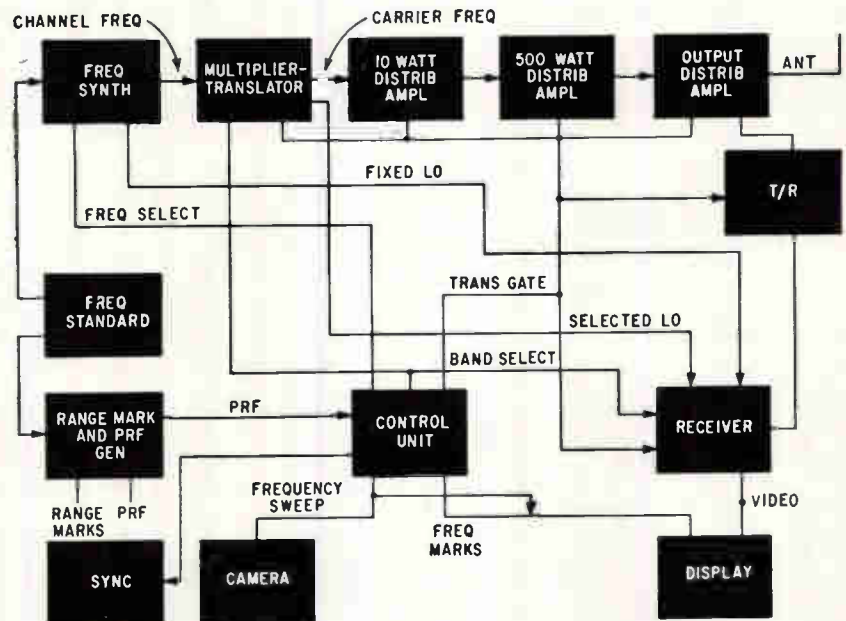

FIG. 5—Electronically tuned 160-channel h-f radar covers 4 to 64 Mc

GROWTH of electronics in the West is highlighted this year by the fact that the electronics industry has finally unseated the air-frame industry as number one employer in the Southern California area. Western Electronic Manufacturers Association statistics just released show that the Los Angeles—Orange County complex, which accounts for 55 percent of the total electronics business in the eleven Western states, now employs 128,000 people contrasted with 125,000 employed by aircraft companies.

The portion of the electronic industry sales total claimed by the West for 1961 is 24.9 percent, or \$2,815 million. Hottest area for growth is the Phoenix-Tucson area. Boasting twice the number of companies it supported two years ago, this

section shows a sales gain of 37 percent this year over last. Recognizing the potential in this area, which now accounts for 5.9 percent of total Western business, WEMA recently established a fifth area council (Arizona Council).

Runner-up growth percentage figures were turned in by the San Diego section with a 23 percent increase noted over last year. The Los Angeles area showed a 9.6 percent increase over the past year, or somewhat less than the 14 percent figure for the entire eleven states. The San Francisco Bay area, which showed big gains between '59 and '60, has continued to spurt with a gain of 18.4 percent this year. Specific segments of industry have shown marked increases the past year in microwaves, semiconductors and space communications.

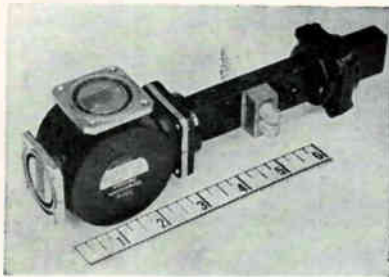

FIG. 6—Circulator type diode limiter uses two MA450F diodes

pensated over a wide temperature range. Stable operation has been obtained reliably at over 100-c vibration, 5,000-g acceleration and over 33,000-rpm. The bridge-controlled oscillators have been packaged in both rectangular and cylindrical form and are about 1.5 cubic inches volume. Circuits are encapsulated in a dense epoxy foam to prevent damage from thermal shock. 2,000 microinches per inch strain in strain gages with a gage factor of two will produce $\pm 7\frac{1}{2}$ -

percent deviation of the subcarrier center frequency. Four active arm gages can produce full ± 40 -percent center frequency deviation when higher overall system frequency response is desired. Battery power packs, the limiting factor in past operation, are being replaced with thermoelectric or photoelectric power converters that will increase the operational limits of presently available equipment.

To insure low noise operation, an amplifier has been developed to handle the output of the capacitively coupled antenna. This amplifier can be operated with over 100 feet of double shielded cable in its input. The outer shield of the cable is at system ground, and the inner shield driven by a portion of the amplifier output. Stray noise pickup is essentially eliminated although the amplifier input impedance is five megohms. The amplifier is capable of driving up to twelve subcarrier oscillator discrimina-

tors, any commercial tape recorder, or the modulator of f-m telemetering transmitters.

This low noise data transmission system is useful only when transmission distances are small. To date, application has been limited to high-speed turbines and machinery. The bridge-controlled oscillators are sufficiently rugged to enable them to operate reliably even when mounted on large-diameter shafts and pneumatic tire rims. Elimination of the r-f carrier by capacitively fed rings or disks makes possible a relatively simple, noise-free data-transmission system.

Granger Associates reports a redesigned version of its ionosphere sounder system that it claims represents the most advanced tool available for real-time observation of skip distance versus frequency for h-f communications, or for detection and observation of natural or man-made perturbations in the

Forty-one sessions and 127 papers make up the technical program for Wescon 1961. Technical program chairman Edward H. Herold reports that papers are of high caliber, and that the tie-in with the International Astronomical Union, meeting concurrently in Berkeley and drawing top astronomers from around the world, should add interest to the sessions. One timely session will be an evening meeting on the subject of Technical Aspects of Arms Control, chaired by Hughes' L. C. Van Atta, just back from a 15-month stint in the office of the Director of Defense Research and Engineering in Washington.

The abstracts are of representative papers to be delivered in San Francisco that the technical program committee has singled out to ELECTRONICS as being of high technical significance and wide industry interest:

Current and Future Radio Astronomy and Its Techniques. (Session 6—a joint session with the International Astronomical Union). Developments in Antenna Technique in Radio Astronomy, Emile-Jacques Blum, Observatory of Paris, Mendon, France.

From the first radio astronomy antennas, borrowed from radar, the author traces the development to modern antenna types designed to meet the problems of radio astronomy.

In the measurement of weak noise signals the sensitivity and stability of the radio telescope are of importance, and they are not independent of the type of antenna. Here the radio astronomers have made a substantial contribution. A number of instruments representative of trends are described and their performances compared with other, more classic instruments. The probable evolution of several techniques in the near future is discussed.

Computer Applications (Session 8). Plato: An Automated Teaching Device, D. Bitzer, P. G. Braunfeld and W. Lichtenberger, University of Illinois, Urbana, Ill.

Described is a teaching machine, developed during the past nine months, for individually teaching a number of students by means of a single, central, high-speed, gen-

eral purpose digital computer. Each student is provided with his own keyset and television display. The student controls the sequence of materials to him from the machine and transmits to the machine answers to its questions.

Communication between the computer and each student is by closed-circuit tv. The computer selects slides, and writes or erases sentences and diagrams on a storage tube. These two outputs are superimposed and displayed on the student's tv screen. Detailed records of each student's progress are kept by the machine. The system has been used to present subject matter ranging from mathematics to French grammar. In one experiment, a student located 20 miles from the computer was successfully tutored.

Signal Selection (Session 9). A criterion for Signal Selection Based Upon Comparison of Experiments, T. L. Grettenberg, Stanford University, Stanford, California.

A unique approach is taken in investigating methods of comparing statistical experiments as possible criteria for comparing codes in a communications system. The author points out that one method of comparing codes (the divergence criterion) is implied by each of the comparison criteria considered when the receiver is of the maximum likelihood ratio type. While the divergence criteria is thus less stringent than the other criteria for comparing codes, it has the property that its application does not require a choice of loss function or a knowledge of the a-priori probability distribution of the message source.

Stereophonic F-M Broadcasting (Session 12). Conversion of F-M Broadcast Stations to F-M Multiplex Stereo, James Gabbert, KPEN, San Francisco, California.

The recent FCC approval of a set of standards for f-m stereophonic multiplex broadcasting is hailed by the author as one of the greatest events since the advent of television. His broadcast station, he reports, will be one of the first stations to have completed a typical conversion, probably by early summer.

There are, at present, over 1,000 f-m broadcast stations

ionosphere. The system enables communicators to measure accurately the muf (maximum usable frequency) for point-to-point and broadcast applications. Groups working on missile and nuclear detection activities are investigating its effectiveness in observing recently discovered ionization phenomena connected with these military activities.

Dubbed Skipfinder, the system is a high-speed electronically tuned 160-channel h-f radar. Coverage is from 4 to 64 Mc or from 2 to 32 Mc. The 160 frequencies are derived from a single stable reference as shown in Fig. 5 and are electronically selected at rates up to 50 frequency changes a second.

A programmed frequency synthesizer generates a spectrum of related carrier and oscillator frequencies. Various frequency stepping programs are available with standard equipment, and pseudo-random programs are possible with

auxiliary equipment.

Four octave-band triple-conversion superheterodyne receivers are fed from a high-performance wide-band multicoupler. Receiver tuning is accomplished by injecting oscillator frequencies from the frequency synthesizer. The carrier frequency pulses are derived from the local oscillator frequencies in the translator, and are amplified to 30 or 100 Kw by wide-band distributed amplifiers.

During recent months, several X-band developments have resulted from microwave R&D efforts in the West. Two examples of these are the Hughes solid-state X-band limiter and Varian's VA-849 c-w amplifier klystron.

The former is said to provide radar systems with a passive device capable of providing protection for receiver crystals from high-power microwave pulses. Many present-day gaseous t-r tubes perform adequately in low average-power appli-

cations, but may exhibit slow recovery time, present reliability problems and deliver relatively poor performance under high average-power conditions.

Hughes asserts that a limiter should pass low-level signals essentially unattenuated and attenuate high-power signals so that no more than half an erg of spike energy and a half-watt maximum of flat leakage reach the crystals. Quick recovery time, high power handling capability, broad band operation and reasonable size are also important. The study of nonlinear properties of ferrites and diodes has resulted in a power limiter that combines features of each nonlinear element.

This ferrite limiter uses the subsidiary absorption phenomena wherein microwave power that is above a certain critical threshold is heavily attenuated by the device, while that below this threshold is passed unattenuated. The ferrite

authorized by the FCC. Within the next twelve months most of these stations will be making the decision whether or not to begin stereo broadcasting, and if so, how best to do it. This paper covers the various alternatives available to the country's f-m broadcasters, the steps the author's station chose to convert its facilities to f-m, and the problems it experienced. Suggestions and necessary information for conversion of other stations are submitted.

High-Density Tape Recording (Session 13). Pulse Resolutions From Magnetic and Hall Reproduce Heads, Irving Stein, Ampex Corp., Redwood City, California.

Determination of the resolutions of pulses stored on a magnetic medium, either tape or drum, by both magnetic and Hall reproduce heads is explained. Comparison is made for different size magnetic gaps and varying thickness of Hall heads. The relative resolutions as a function of medium-to-head spacing for both types of heads is also determined. It is found that the Hall head resolution is theoretically capable of better resolution than magnetic heads, but that practical considerations prevent the full use of the better Hall head resolution.

Industrial Electronics (Session 17). Radiography of Large Missiles with a Linear Electron Accelerator, J. Haimson, Varian Associates, Palo Alto, California.

In the past, inspection of a solid propellant missile by means of high-voltage X-ray machines, Cobalt 60 sources, or Betatrons required from three to fifteen hours. Tiny cracks, as small as 0.005 inch must be located to prevent uneven burning and possible explosion of the missile.

The author describes a linear accelerator (8-10 mev range) that does the job in five to ten minutes. The description covers a variety of concepts relating to the injection system, the accelerator waveguide and associated r-f equipment, electron beam bending system and finite rotating gold target. The X-ray performance curves are shown, and the method of calibrating the X-ray output and determining the focal source size are described.

Point-to-Point Communications Via Satellite Relays (Session 21). Twelve Advantages of Stationary Satellite for Point-to-Point Communication, S. G. Lutz, Hughes Research Lab., Malibu, California.

The author, a proponent of the large-orbit satellite, points out why stationary systems should become the backbone of future global communications. Seven of his reasons are based on economic and system advantages, while the remaining five arise from interference coordination advantages in frequency sharing among satellite systems and with surface services.

Stationary satellites present space technology and propagation delay problems, but these, he reports, are rapidly becoming overcome. He recommends that more planning and regulatory emphasis be focused on stationary satellite communications systems, since nonstationary, nonmilitary systems will be only interim or supplementary systems.

Computer Theory (Session 38). A Decision Theoretic Approach to Machine Learning and Pattern Recognition, D. Braverman, Stanford University, Stanford, California.

A method of formulating and investigating a decision theoretic model of machine learning and pattern recognition when patterns in each class possess a common property which is unknown to the recognition system is described. The author points out that Bayes decision rules for recognition of the class of a pattern are obtained as functions of the measurement of a set of characteristics of the pattern and the measurements of the characteristics of a finite number of learning patterns from each class. The role of the learning measurements is defined and examples of recognition systems for minimization of the probability of misrecognition of unknown signals in additive gaussian noise and unknown binary signals in multiplicative geometric noise are presented.

Other Sessions. For additional information and coverage consult COMPONENTS AND MATERIALS, p 170. Sessions 2, 7, 15, 25, 30, 27, 32, and 40 dealing with microwave, solid-state, and optical devices are previewed.

limiter by itself, has the advantage of high power capacity, and the disadvantages of high amplitude spike leakage and a power threshold that is not low enough for crystal protection.

To overcome the disadvantages of the ferrite limiter, a diode limiter of the type shown in Fig. 6 can be inserted after the ferrite limiter. This device uses the change of r-f admittance of a diode with r-f power level. At low power, the diodes placed across the waveguide reflect the incident r-f energy. At high power, the r-f energy is transmitted to a load.

The characteristics of one model of the limiter are:

Insertion loss = 1.6 db total
(includes noise figure)

Bandwidth = 500 Mc

Peak power = 10 Kw

Recovery time \leq 10 nsec

$f_c = 9,300$ Mc

High power isolation = 50 db

Pulse width = 1.0 μ sec

Spike energy leakage \leq 0.5 erg

Power leakage = 400 mw max.

Duty cycle = 0.001

Specific advantages claimed for the limiter are long life, high reliability and passive operation adding little noise to the system.

The Varian klystron delivers in c-w power at X-band. It is a water-cooled, electromagnetically focused, four-cavity X-band tube that produces a c-w power output in excess of 20 Kw, with a maximum input r-f drive power requirement of one watt. Each tube is capable of tuning over a range of 60 Mc within a frequency band of 7.125 to 8.5 Gc. Typical tubes will produce output powers of 20 to 24 Kw at beam efficiencies of 36 to 40 percent while operating within tube ratings. However, one experimental model of this tube has achieved a power output of 51.5 Kw c-w with an efficiency of 42 percent while being operated under laboratory conditions.

The tube showed stability at this power level without degradation of subsequent performance. The results achieved can be largely attributed to the beam optics. A typical tube will exhibit approximately 1 to 2 percent beam interception with full r-f output.

Varian points out that as late as Dec. 1960, some leaders in the microwave field adhered to the for-

mula for microwave tubes

$$\frac{\text{power (Kw)} \times \text{frequency}^2}{(\text{Gc})} = 100$$

to determine the maximum attainable power at a given frequency. According to this, the maximum power possible at 8.5 Gc should have been slightly less than 2 Kw.

Most applications of the tube are classified, but it is known that earth-to-satellite communications and radio astronomy will benefit from the increased power. Orbital-scatter communication, such as proposed with the West Ford Project, is one likely application. Myriads of tiny dipole antennas would form metallic bands around the earth from which X-band signals could be bounced more easily than from a single satellite.

A step forward in medical electronics is reported in progress by General Data Corp., developers of a three-unit transistor hearing-aid. One unit, made from special materials selected to give an expected life of 50 years, is surgically implanted in the patients head approximately one-half inch beneath the skin and in the vicinity of the middle ear. It is magnetically coupled with a second unit worn externally behind the outer ear. This unit, in turn, is connected by a pair of fine wires to a $1\frac{1}{2} \times 3 \times 6$ -in. receiver worn at the patients side and containing 50 diodes and 28 transistors.

Anticipated application of microminiaturization techniques should reduce the size of this unit to that of a cigarette pack. Future refinements of the system also

call for a radio link between the two external units.

The implanted unit contains a coil of fine platinum wire wound around magnetic-core material and tapped at six points for direct connection to fiber groups of the eighth nerve that connects the ear with the brain. A company spokesman states that future units will have a greater number of taps with a resulting better resolution of hearing.

The company points out that this device is an analog-to-digital unit and is designed for partial restoration of hearing in totally deaf ears. The company is also currently engaged in the initial studies for an electronic eye to help restore sight to the blind.

Rapid set-up and use in both stationary and mobile applications are features of a new portable flash X-ray unit developed by Field Emission Corp. of McMinnville, Ore. Complete system weighs only 40 lb and occupies 1.4 cu ft. The X-ray tube is in a small flashlight-size gun (Fig. 7) and is adaptable to use on cables up to 50 ft long. Battlefield use, medical X-rays, non-destructive testing of small electronic components, hypervelocity and exploding wire studies and radiation damage studies are some of the fields of application reported by the company.

The unit operates at 100,000 v, 1,400 amp for a pulse duration of 30 nanoseconds. The X-ray tube has an effective source size of 1 mm diameter with a resolution of 2 mils on small components, and dosage rate is 10^6 R per second. Penetration in opaque media is 1 inch of aluminum or the equivalent.

The high-voltage power supply has an output voltage of 35 Kv d-c. This power supply charges a modified square-wave pulser.

The pulser storage elements are lumped constant type and are charged in parallel and discharged in series through a spark gap. Discharge of the pulser is initiated by externally discharging the first module of the pulser and in turn starting a cascade discharge of the remaining modules.

The pulser has a square-wave discharge of a constant potential throughout the pulse duration and the voltage and current are in phase. The X-ray tube used in the system is a cold-cathode field-emis-



FIG. 7—Flash X-ray unit radiographs 1-in. aluminum in 0.3 μ sec

sion tube that receives the discharge of the square-wave pulser at the anode. The electron beam to the target is triggered by the electrical field created around the cold cathode at the time of the pulser discharge.

Litton Systems, Inc., has developed a linear-selected, random-access core memory (shown in Fig. 8) designed to operate in severe airborne environments and having a read-restore or clear-write cycle time of only 2 μ sec. Access time for the new unit is 1 μ sec.

Used as a high-speed scratch-pad storage to supplement a drum storage, or as a main storage, the core memory is expected by Litton to greatly speed the operation of any computer. All digital electronic circuits are equipped with silicon epitaxial transistors, primarily of the 2N744 and 2N1959 variety for low saturation resistance and fast response time.

Circuit design also reportedly contributes to rapid cycling time. Switching is accomplished with partial current impulses. The number of wires entering and leaving the ferrite-core matrix is reduced by a common line to apply the read-write currents through the selected word lines. Data transfer to and from the core memory is in parallel.

In microcircuits, Delta Semiconductors has announced a multiple diode in a computer logic gate configuration that plugs into a Cannon microconnector eliminating the printed-circuit board in certain computer logic applications.

The typical unit shown in Fig. 9, is under development for a computer manufacturer, is said to result in a 90-percent space reduction over previously used printed circuit boards with the convenience of plug-in serviceability. This application uses 256 quad polydiodes (designated the PD 400) with four diode junctions formed on a single silicon slice with a common cathode. The unit is glass encapsulated with pins welded 0.050 inch apart.

Eight PD 400 units plug into the microconnector that measures 0.160 \times 1.5 in. and thirty-two connectors are assembled into a matrix measuring 2.75 \times 3.25 in. This results in the installation of 1,024 diodes in less than nine square inches.

The polydiode is presently being used to achieve space reduction in other computer circuits and is available in three, four and five-diode units with minimum parameters of 50 v piv., 10 ma forward current at 1 v, 0.2 μ a reverse current at 35 v and a maximum of 50 nanoseconds reverse recovery time, measured with a sampling scope in a typical test circuit.

In materials, Atomics International division of North American Aviation recently reported development of a new superconductor that offers essentially no resistance to electrical current at temperatures near absolute zero. This cold-worked material consisting of three parts niobium to one part zirconium has the characteristics shown in Fig. 10. Prime usage will be for air-core magnets where light weight or magnetic fields many times higher than obtainable with conventional electromagnets are required.

At liquid helium temperatures (-452 F) the wire conducts 20,000 amp per sq cm in a high magnetic field (80 kilogauss). For one suggested configuration of a thermonuclear fusion reactor, a magnet wound with copper wire establishing the required field of 80 kilogauss and measuring two meters in diameter by 100 meters in length would require a power input of 8 billion watts. Its superconducting counterpart, once the magnetic field was established, would require no magnetizing power. A refrigeration load would be needed with the latter, but this would be only one megawatt, even if the refrigeration efficiency were only one-tenth of one percent.

Another possible application of the material is with masers. Where size and weight are critical, as in space use, conventional electromagnets or permanent magnets might be replaced by a compact, light superconductor magnet to provide the field that splits electronic energy levels. The same liquid helium that refrigerates the ruby crystal would cool the magnet.

Other applications hinted at by Atomics International are for high-energy particle accelerators, and possibly as energy storage units for spacecraft where larger conventional capacitors are found impractical.

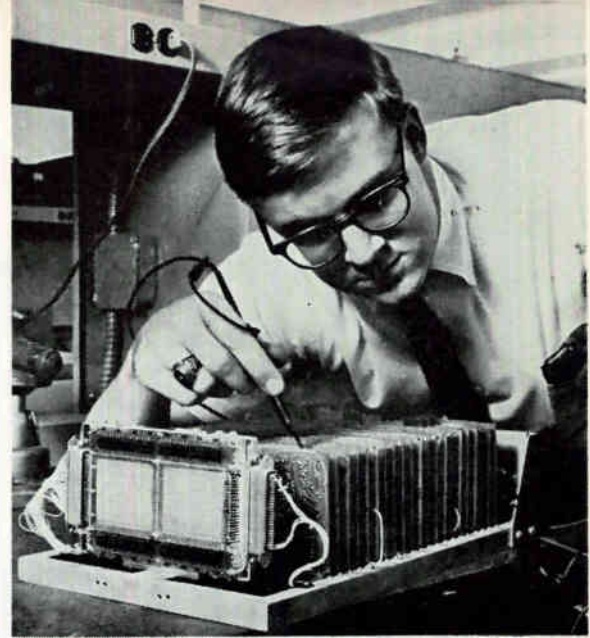

FIG. 8—Engineer checks out 2- μ sec core memory

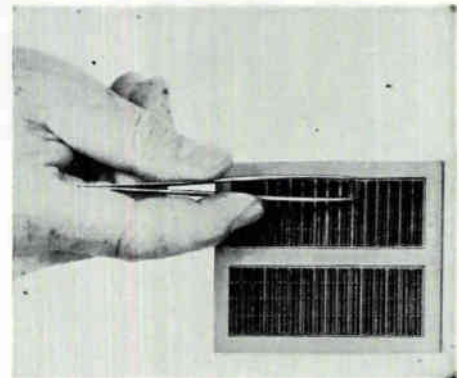

FIG. 9—This 9-sq in. matrix holds 1,024 diodes

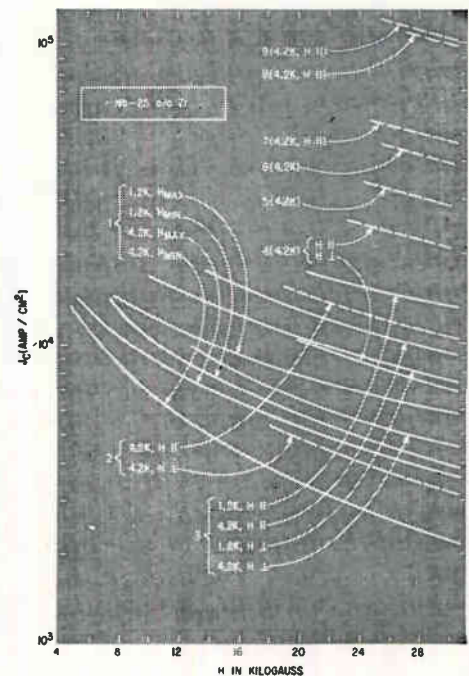

FIG. 10—Characteristics of some niobium zirconium samples to be used as superconductors

Instrumentation and Telemetry of

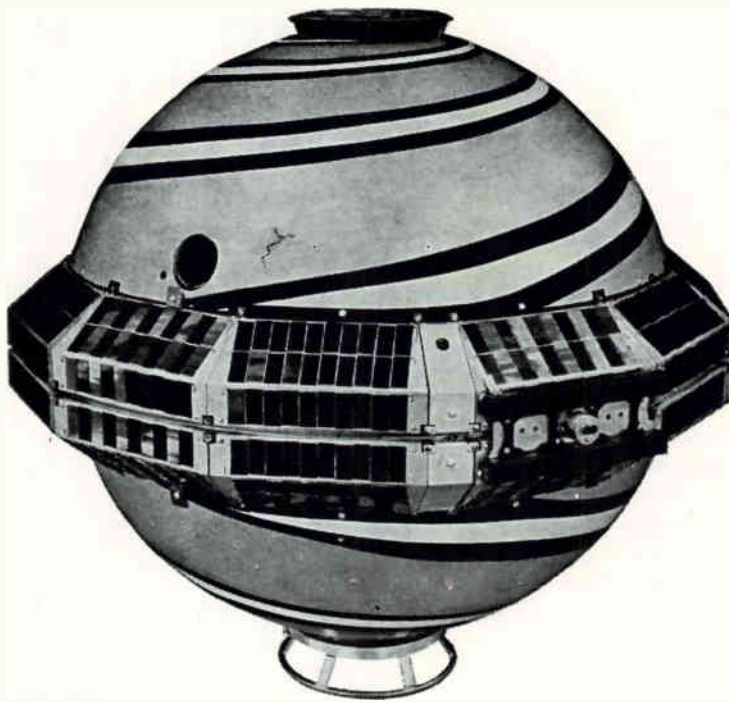

FIG. 1—Overall view of Transit 2-A satellite. A 10-inch glass fiber tube, passing from pole to pole, strengthens the mechanical structure

Project Transit, an all-weather global navigation system, largely depends on its electronic equipment for its accuracy. Its oscillator is accurate to several parts in 10^{10}

By J. W. HAMBLEN

J. B. OAKES,

Applied Physics Laboratory,
the Johns Hopkins University,
Silver Springs, Md.

PROJECT TRANSIT will ultimately provide a global means of fixing the position of ships, submarines and aircraft more precisely than has heretofore been possible. A series of experimental Transit satellites is planned that will supply data for: (1) a basis for navigation trials and demonstration in elementary form; (2) an improved understanding of the effects of ionospheric refraction of radio waves; (3) increased accuracy in geodetic measurements; and (4) improved orbital tracking.

The experimental Transit satellites have consisted of an instrument structure and two hemispheres. The instrument structure is a 10-inch-thick cylindrical section having an outside diameter of about 35 in., thermally isolated from the exterior shell. The hemispheres are molded from a glass fiber and phenolic resin honeycombed sandwich material and are attached to the instrument structure to form a sphere approximately 36 in. in diameter. The glass fiber shells provide both a mounting surface for spiral-slot antennas and a symmetrical skin that can be treated for thermal balance. The cavities

formed by the hemispheres and the instrument package are kept free of metallic objects that could produce undesirable reflections within the cavities. A photograph of the Transit 2-A payload is shown in Fig. 1.

The Transit navigation system is based upon the ability to extract accurate positional information from the measured doppler shift of a satellite's transmitter during a single passage of the satellite within range of a single tracking station. Ionospheric refraction enters directly into the accuracy with which this information can be obtained. To investigate this effect over a broad frequency region, each experimental Transit satellite contains four transmitters operating between 54 and 324 Mc. These transmitters are arranged in pairs, as indicated in the Transit 2-A block diagram, Fig. 2, and each pair is driven from a single stable frequency source. This allows for a two-frequency real-time refraction correction by phase comparison, in addition to the four-frequency refraction investigation. Wherever possible, the two systems are kept electrically separate to improve the

overall system reliability, for if one system should fail, the remaining one would still provide useful information. The output of each transmitter is fed to an isolation network consisting of shorted quarter-wave stubs, and then to the spherical spiral slot antenna on the outer skin of the satellite. A telemetering transmitter gathers thermal and solar environmental data. A command receiver is on board for switching subsystems. A digital clock provides timing. The electronic system is powered by a nickel-cadmium battery system recharged by silicon solar cells.

Each satellite contains two crystal-controlled oscillators operating at 3 Mc. The circuit is indicated in Fig. 3. The crystal operates at series resonance in the feedback path between the emitter of Q_1 and the tank circuit tap point. A silicon diode shunted across the tank circuit inductance provides limiting to keep the crystal drive level constant. Voltage from the emitter of Q_1 is fed through a small load-isolating buffer capacitor to a two-stage feedback amplifier. This amplifier (Q_2 and Q_3) provides an output impedance of about 150 ohms when re-

multiplication ratios. The two B-system power amplifiers are shown in Fig. 5A. The 162-Mc unit at the left contains a common-base class-B power tripler driving a common-emitter output amplifier. The output power is about 140 milliwatts, and the collector efficiency of the output stage is 43 percent. All harmonics are more than 27 db below the desired frequency. The 216-Mc unit at the right has four stages. The first two stages are class B common-base power doublers; the last two stages are class AB common-emitter amplifiers. An output power of 150 milliwatts is achieved, and harmonics are more than 24 db below the desired frequency.

The C system transmitter diagram is indicated in Fig. 5B. The 54-Mc transmitter consists of a single class AB common-emitter stage. When driven with 25 milliwatts, an output power of 200 milliwatts is obtained. The collector efficiency is about 55 percent. The 324-Mc transmitter consists of three stages. Two class B common-base stages, a tripler and a doubler, drive the class AB common-base output amplifier to a power level of 50 milliwatts. A collector efficiency of 17 percent is obtained at this drive level.

Figure 5C indicates typical construction of these units. A 3-Mc input cable feeds the oscillator output to the frequency multiplier mounted on top. Short leads then carry the 54-Mc signals to the printed-circuit power amplifier board. The power efficiency of the B system including oscillator, multipliers, and power amplifiers, is 15 percent, while that of the C system is 17 percent.

A telemetering system to gather thermal and solar environmental data was included in both Transit satellites orbited to date. Transit 1B employs the 162-Mc doppler carrier to transmit telemetering information, while Transit 2-A has a separate telemetering carrier.

Requirements for Transit 1B call for a multichannel telemetering system to measure satellite temperature (accuracy ± 5 percent), requiring a minimum of power and space, and so using a doppler carrier that telemetering would not conflict with doppler measurements. Three electronic boards constitute

the system; total power consumed is 4 milliwatts. Many of the system concepts and circuit techniques employed were influenced by work on Project Vanguard.

The Transit 1B telemetering system uses the r-f transmitter common to the doppler transmission system. Its transducer array consists of seven thermistors having variable resistive outputs connected to a multiplexer. The time-division multiplexer produces a series of pulses whose widths are a function of the corresponding sensor. The pulse-width coded output of the multiplexer is applied to the modulator input of the doppler transmitter. The absence of a pulse produces full power output and the presence of a pulse produces zero output. The multiplexer output and corresponding transmitted r-f envelope are shown in Fig. 7. Both the absence of a carrier (t_2, t_4, t_6) and the presence of a carrier (t_3, t_5, t_7) represent a data channel. Period t_2 is a calibration pulse that removes temperature and voltage variation effects, and data reduction employs the ratio between this reference channel and the active data channels. Since the primary function of the 162-Mc carrier is for doppler measurements, telemetering transmissions are kept to a minimum. Therefore, the period t_Σ is approximately 400 milliseconds, while t_0 is of the order of 94 seconds. Data pulses vary in width from 4 to 30 milliseconds as a function of the temperature.

The heart of the Transit 1B PDM/AM telemetering system is the four magnetic coupled multi-vibrators (MCMV) shown in Fig. 6A along with a block diagram of the control circuits. A single square loop magnetic core is employed for

the four MCMV's. Thus, the primary winding plus all of the base feedback windings are on a common core. The circuit is similar to that devised by Royer' except that the circuits operate from nominally constant supply voltage with temperature sensors connected in the collector circuit of all but one of the transistors. One collector circuit employs a fixed resistance that provides a calibration channel for removing voltage and temperature effects. Consequently, the duration of both negative and positive excursions of each MCMV is controlled by the resistance value of its sensor.

Since the MCMV is a free-running device, control circuits are necessary that allow one cycle of operation from each MCMV in time sequence for data readout. This is done by connecting the base and collector circuits of the MCMV's in sequence to the negative supply voltage buses. The control circuits are conventional².

The telemetering requirements for the Transit 2-A satellite include three continuous channels in addition to the commutated temperature measurements employed in 1-B. Also, it is necessary to transmit an extra timing pulse with precisely fixed repetition rate. Therefore, the system shown in Fig. 6B was developed. Four voltage-controlled subcarrier oscillators are employed (IRIG bands 7, 9, 10, 12) to modulate the transmitter which operates on 108.06 Mc. The eight-channel pdm temperature telemeter output is fed to the input of the 10.5-Kc subcarrier oscillator. The clock timing pulses trigger the monostable multivibrator in the pdm telemeter; thus, the first pulse of each pdm telemetering burst ap-

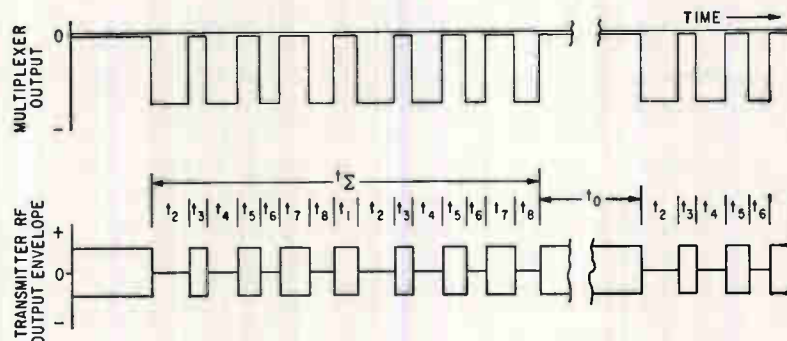

FIG. 7—Multiplexer and transmitter output waveforms, showing how multiplex information is transmitted by r-f output envelope

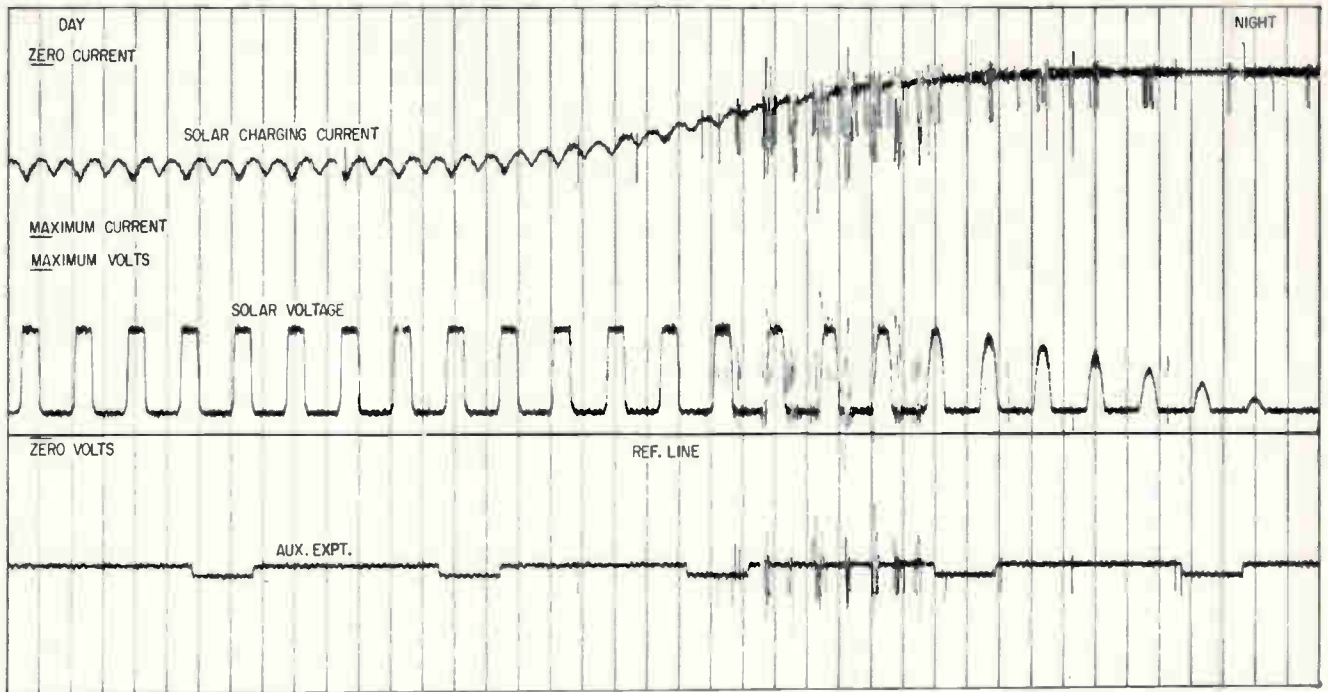

FIG. 8—Transit 2A telemetering record showing the solar charging current and voltage, as satellite passes from daylight to darkness. The satellite spinning on its axis produced variations in current and in voltage

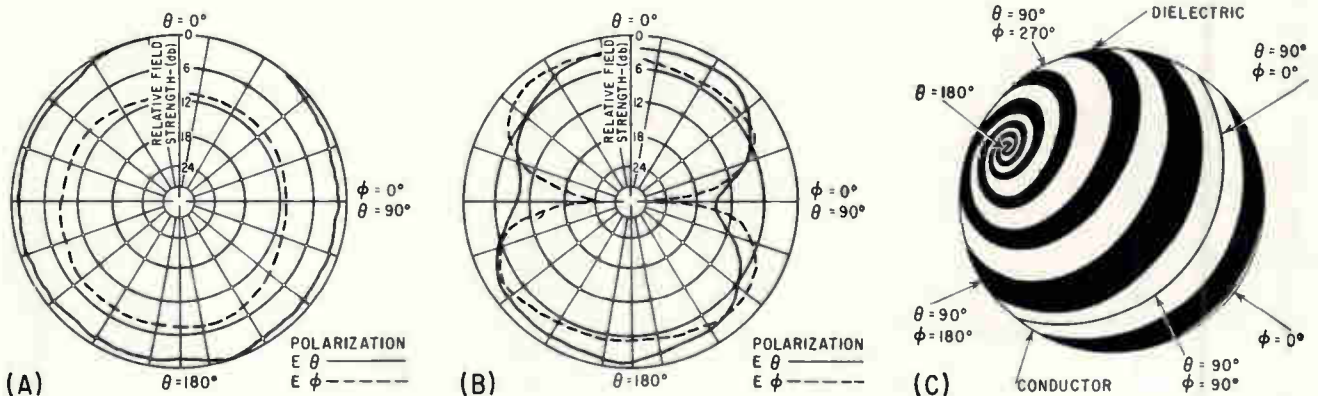

FIG. 9—Radiation patterns for the spiral antenna of the Transit, plotted for frequencies 54 Mc (A); for 216 Mc (B); the spherical coordinate radiation pattern reference system, (C)

pearing on the 10.5-Kc subcarrier is synchronized with the timing signal from the satellite clock. The pdm telemetry is read out every 11.2 seconds.

The ground receiving equipment employed with the Transit 2-A telemetering system uses four pulse-averaging discriminators, a narrow band phase lock receiver (i-f bandwidth 50 Kc) and the conventional oscillograph recorder. Threshold values of $0.3 \mu\text{v}$ were obtained with β values of 1.5 on the two lower subcarrier bands, and 1.0 on the two higher bands.

The overall dimensions of the subcarrier oscillators are $\frac{7}{8}$ by $1\frac{1}{2}$ by $1\frac{3}{8}$ in. Each requires 6 volts at 8 ma, while the transmitter is $2\frac{1}{2}$

in. in diameter and $1\frac{1}{2}$ in. high and requires 65 ma at 22 volts and has a power output of 300 milliwatts. Voltage regulation to ± 0.01 percent was required for the subcarrier oscillators. This was provided by a separate regulator employing four transistors and two Zener diodes that consumed less than 400 milliwatts.

Figure 8 is a section of a Transit 2-A telemetering record obtained during a pass of the Transit 2-A satellite from daylight to dark. The top trace is the 2.3-Kc channel metering solar charging current, and the second trace is the 3.9-Kc channel carrying the voltage output of one solar window. The charging current goes to zero followed a few

seconds later by the solar voltage. The lag between the two channels occurs because enough ambient light exists to produce a voltage output from the solar test panel after the current from the heavily loaded battery charging panels has decreased to zero. The current variation on the 2.3-Kc record is produced by satellite spin since despin weights cover two solar panels. Voltage output variation occurs on the 3.9-Kc channel when the single solar panel moves from direct illumination to shadow during each revolution of the satellite. The third trace is the 5.4-Kc channel metering the output of an auxiliary experiment.

A single broadband antenna is

employed on Transit^a and is made by projecting two sets of double spiral slots on the surface of each hemisphere so that the feed points (poles) are diametrically opposed. Since the two hemispheres are isolated by the instrument structure, radiation in the polar directions from each hemisphere is independent and mutual coupling is minimized. The hemispheres are fed in such a way that the fields from common meridian points on the equator are in phase. This configuration gives a nearly uniform field distribution. The opposing screw sense of the spirals causes left circular polarization from one pole and right circular polarization from the other pole. In progressing from the pole areas toward the equator, the radiation experiences an evolution from circular polarization through elliptical to linear polarization at the equator.

Figures 9A and 9B are typical radiation patterns for both horizontal (θ) and vertical (ϕ) polarization for frequencies of 54 Mc and 216 Mc. The coordinate system is shown in Fig. 9C. The gain of the spiral antenna is a function of operating frequency. The efficiency is a few db lower than that of a resonant dipole for frequencies where the circumference of the sphere is less than one and one-half wave lengths. Above the cutoff frequency, however, the gain was comparable to that of a half-wave dipole. Below cutoff frequency, the impedance goes through sharp resonances but exhibits nearly flat reactive and resistive characteristics above cutoff. Because the antenna impedance is not the same as the characteristic impedance of the transmission line, a normal vswr (voltage standing wave ratio) exists on the line, and since the filter stubs add to this mismatch, the line impedance is corrected to 50 ohms by matching stubs at the transmitter or receiver end of the line. The insertion loss at each frequency due to the isolation network does not exceed 1 db.

The antennas were applied to the hemispheres by first plotting on the exterior of the hemispheres the radial dimensions of the spiral slot as measured from a spiral plotted on a plane surface. Although this method distorts the true logarithmic spiral, the slightly higher

degree of accuracy that could be obtained by more complex techniques proved unnecessary. After the plotting the slot is masked. The hemisphere is then sprayed with a conducting silver paint containing an epoxy binder. The conducting portions of the spiral become solid bands around the equator, electrically connected to a continuous metal band to insure adequate electrical continuity between hemispheres. The conducting surface has a resistivity of a fraction of an ohm, as measured between the feed terminals at a pole.

The Transit 1-B satellite has two different power supply systems. The C system transmitters and stable oscillator are powered by a nonrechargeable silver-zinc battery, providing about 60 days of power. The B system transmitters and oscillator, and the telemetering system, are powered by nickel-cadmium batteries that are charged by a double ring of solar cells circling the equator of the satellite. The command receivers have a separate nickel-cadmium source that is also recharged by the solar rings. On command, the C system can be switched over to the B system supply after the silver-zinc cells are exhausted.

The Transit 2-A power supply represents an advancement over that of the 1-B. A single nickel-cadmium battery, consisting of twelve F size cells, is recharged by solar cells. To allow optimization of design of the power system and still

achieve complete flexibility in circuit design, a series of d-c/d-c converters is used. These converters are fed from a battery-boosting type regulator that provides ± 2 percent regulation over the complete range of battery voltage changes caused by thermal and charging-rate variations. A total of 3,600 1-by 2-cm solar cells are shingled into 24 panels arranged in a polyhedral ring of trapezoidal cross-section, surrounding satellite equator. Blocking diodes between panels prevent loading by nonilluminated panels. At a battery voltage of 18 volts, each solar cell operates at 0.36 volt; this cell voltage was chosen to maximize the available solar power over the expected temperature range.

The solar-generator charging current varies with satellite orientation with respect to the sun. The maximum charging rate of 1,150 ma (at 18 volts) occurs when a pole of the satellite faces the sun, and a minimum rate of 940 ma occurs when the equator faces the sun. For the latter orientation, assuming a 65 percent sunlight orbit (the worst situation of Transit 2-A), a total power capability of 8.5 watts is achieved. A graph of this behavior is indicated in Fig. 10.

Overcharge protection is provided by a thermostatic switch in the insulated battery compartment. At high ambient temperatures, this switch protects the cells from high charge rates, a set of conditions known to cause permanent battery degradation. Provision is made to command of bypass of this thermostat in case of improper operation.

The authors acknowledge the cooperation of S. A. Warren, R. F. Sloan and J. W. Keibler, who designed the frequency multipliers and power amplifiers, C. A. Blackburn and F. K. Preikschat, who designed the telemetering encoder, H. B. Riblet and R. M. Knight, designers of the antenna and isolation networks, and W. C. Scott, L. F. Collins and R. L. Weitzel, who designed the power supply system.

REFERENCES

- (1) G. H. Royer, A Switching Transistor DC-to-AC Converter having an Output Frequency Proportional to the DC Input Voltage, *Trans AIEE*, Part I, 74, p 322, July 1955.
- (2) R. W. Rochell, Earth Satellite Telemetering Coding Systems, *Electrical Engineering*, 76, No. 12, p 1,062, Dec. 1957.
- (3) H. B. Riblet, A Broad Band Spherical Satellite Antenna, *Proc IRE*, 48, No. 4, p 631, April 1960.

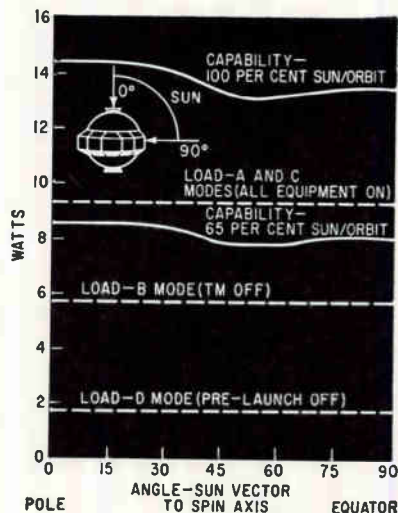

FIG. 10—Plot of electrical power capability of the Transit 2A satellite shows how the satellite's orbit affects capability

Tunnel Diodes Increase Digital-Circuit

Gallium arsenide tunnel diodes are used with transistors in high-speed switching circuits

By W. V. HARRISON

Industrial Products Group,
Texas Instruments Inc.,
Houston, Texas

R. S. FOOTE,

Information and Components Research
Laboratory,
Texas Instruments Inc.,
Dallas, Texas

IN DESIGNING FOR high-speed digital circuit operation, there are advantages to be gained by incorporating tunnel diodes into transistor circuits, because of the fast rate of change of voltage and the bistable capabilities of the tunnel diode. Development has been mainly centered on the application of the GaAs tunnel diode because of its high output voltage.

The use of transistors with the tunnel diode has several advantages which overshadow the main disadvantages, namely slower maximum circuit speed and added power consumption. Some advantages obtained are input-output isolation, ability to obtain direct pulse inversion, ability to prevent bidirectional flow of information, easier stage-to-stage coupling, and widening of the peak current tolerance. Circuits using transistors as emitter followers accomplish pulse steering and impedance transformation, while nanosecond pulse transformers and transistor amplifiers provide signal inversion and amplification. A combination of these techniques makes possible higher digital circuit operating speeds.

Since in all the circuits to be discussed it was advantageous to use the GaAs tunnel diode, an evaluation was made of its drift characteristics. The results indicated that for the power levels used (< 5 mw), the peak current drift as a function of time did not constitute a problem. Switching times for the tunnel diode can be shown^{1,2} to be approximately

$$\tau \cong C_V (V_f - V_p) / (I_p - I_v)$$

where $\tau \cong$ time to 90 percent; V_f , the voltage of the intercept of the horizontal load line with the diode diffusion region; V_p , the voltage at the peak tunneling current; I_p , the peak tunneling current; I_v , the

valley current; and C_v , the valley capacitance. For a 10-ma current peak unit having 10 pf capacitance, τ is about 1 nanosecond. Emitter followers directly following the tunnel diode will add about 0.5 nanosecond to the switching time and provide output-pulse risetimes of between 1 and 2 nanoseconds, thus removing loading or fan-out problems normally associated with direct tunnel-diode logic.

One of the problems in tunnel-diode circuits is pulse coupling. The transformer provides one answer. Nanosecond pulse transformers can be made, using ferrite beads,³ which are capable of transforming pulses of 1 to 2 nanosecond risetime. Key to the success of such a transformer is the bifilar winding.

Transistor amplifiers operating both in the grounded-base and grounded-emitter modes can provide current gains with delays of as little as 3 nanoseconds.

Using a combination of these techniques, it is possible to build circuits such as generators that can provide variable amplitude pulses of nearly constant base width with repetition rates greater than 140 Mc. The pulser circuit of Fig. 1A incorporates a tunnel diode whose switching voltage change is differentiated and amplified by a grounded-base amplifier. Tunnel diodes with peak currents from 5 to 10 ma are satisfactory for pulse generation. Nominal pulse base width are 10 nsec with 4 nsec rise and fall times. With a $B+$ of 8 volts, pulse amplitudes of 5 volts can be obtained into 91 ohms.

Figure 1B indicates pulse shapes for a 65, 100 and 140-Mc clock rate.

The tunnel diode is an excellent bistable device. Using a near horizontal load line on the tunnel diode I-V plot, a bistable flip-flop can be made. Control of such a stage would be by successive positive and negative pulses. It is desirable to use a tunnel diode with a similar load line for a binary stage driven by either a series of positive or negative pulses. A binary stage of

this type is shown in Fig. 2A. The tunnel diode is steered by the action of a fast rising input to transformer T_1 . This transformer transforms and amplifies the input pulse giving less than 10 nsec pulse base widths to emitter followers Q_1 and Q_2 . Depending on the position of the tunnel diode, either Q_1 or Q_2 will be back-biased so that the forward-biased transistor will transfer current to or away from the tunnel diode, allowing it to switch. The binary can operate with an input voltage spread of approximately a factor of two. The stage has been made to operate with input repetition rates as high as 200 Mc, but would not supply sufficient output to operate successive stages. However, with readily available components, pulse inputs up to 140 Mc can provide output pulses capable of triggering successive stages. The remainder of the circuit of Fig. 2A is a pulse amplifier for triggering the next stage. Resistor R_1 can be replaced with a second tunnel diode. However, voltage levels then become more critical than in the single tunnel diode circuit.

The waveforms at the emitter of tunnel diode emitter follower Q_2 for three stages in cascade are indicated in Fig. 2B for a 120-Mc pulse clock rate. Stage-to-stage switching delay times are from 7 to 10 nsec. A combination of four stages can be arranged in a decade code to count randomly spaced pulses with a minimum pulse separation of less than 10 nsec, thus providing an input to a scaler capable of operation beyond 100 Mc. The same stage can be driven from independent driving sources as a flip-flop and produce a variable width square wave function. Waveforms from such a generator are indicated in Fig. 3A. Multiple outputs can be combined to one output as indicated in Fig. 3B. Output rise and fall times are 3 to 5 nanoseconds.

Tunnel diode controlled shift registers are possible for shift speeds approaching 50 Mc. Such a

Switching Speeds

suitable for pulse-generator application

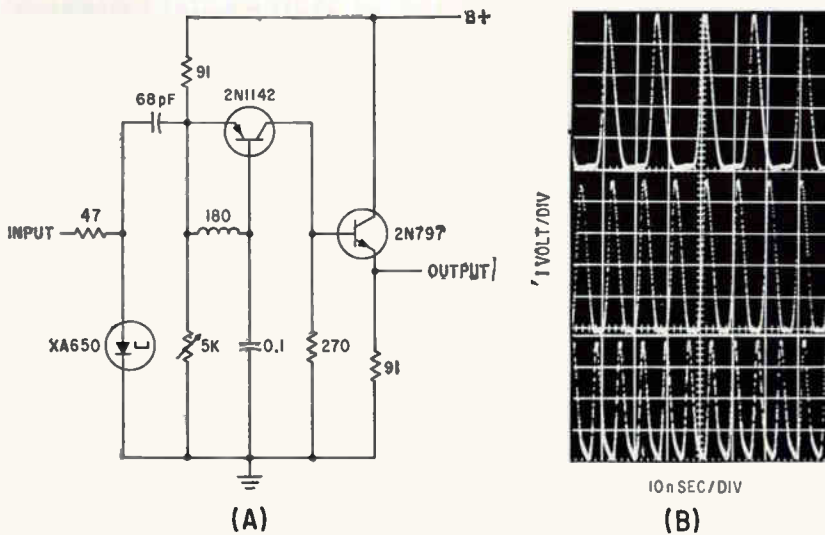

FIG. 1—Circuit of basic pulse generator, (A); oscilloscope shows 65, 100 and 140-Mc clock pulses, (B)

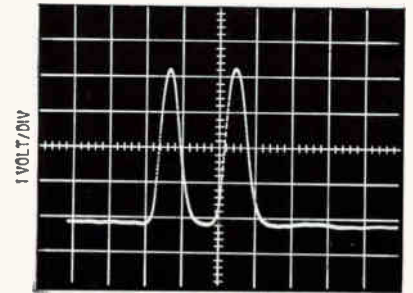
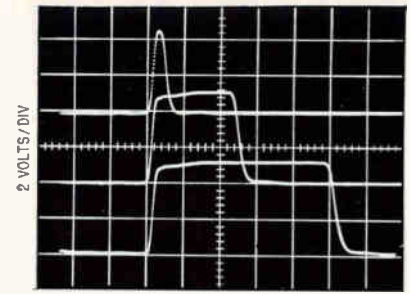

FIG. 3—Oscilloscope shows outputs from a variable-width square wave generator, (A); and double pulse generator indicating combined outputs, (B)

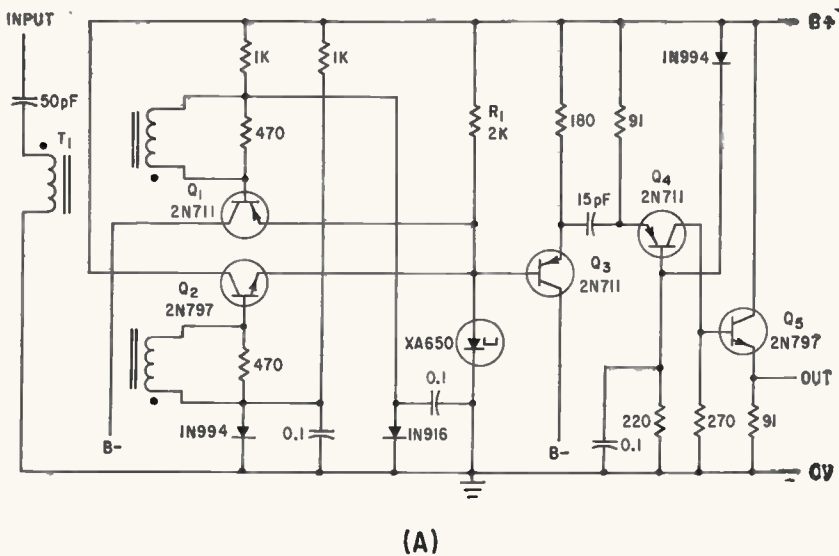

FIG. 2—High-speed binary stage with tunnel diode, (A); waveshapes of 120-Mc sine wave input to three cascaded binary stages, (B)

shift register can be placed into rings of as many stages as desired. A typical shift register stage is indicated in Fig. 4A and B. This stage incorporates tunnel diode steering by transistor Q_1 and diode D_1 . Load line R_L indicates the slope of the load line created by resistor R_1 . Transformer T_1 provides the necessary phase reversal. A ring counter composed of eight stages is indicated in Fig. 4C.

By incorporating OR-gates and an envelope generator, any number of ring shifts can be programmed together, creating a program pulse generator. A program pulse generator incorporating a ring of four stages diode matrixed with a ring of three stages providing twelve-bit words has been operated at more than a 30-Mc clock rate using printed-circuit techniques and nominal speed diodes. The OR-circuit

and envelope generators associated with this program generator of 12 stages is indicated in Fig. 5.

In this schematic, C_0 and R_2 are a-c terminations for the coaxial line from the output of the ring counter. The anode of D_1 is connected to a control switch that ties this point to approximately 1.5 volts and ground. Components D_1 , D_2 and R_1 comprise an AND gate such that when D_1 is switched to 1.5 volts

then the junction of D_1 and D_2 is clamped thereby prohibiting the negative pulse from the ring counter from affecting the base of Q_1 . If D_1 is switched to ground then the negative pulse is propagated through D_2 to the base of Q_1 . Resistor D_3 is the load for all Q_i transistors thereby forming a multi-input OR-gate. If the base of any Q_i receives a negative signal from its ring counter output, then this signal is transmitted through Q_i and appears at the junction of R_3 , C_1 and R_1 . The levels for this junction are approximately 1.4 volts for no signal through any Q_i . If the junction of R_3 , C_1 and R_1 is at 1.4 volts, Q_2 should be turned on almost to saturation thus holding the base of Q_3 at approximately 0.3 to 0.4 volt and clamping the emitter of Q_3 at 0.5 to 0.6 volt. In this condition no signal transmitted through C_2 from the delayed clock pulse emitter-follower, Q_{12} , can be propagated through Q_1 into the transformer T_1 . If amplifier Q_2 is cut off, the clock pulse is transmit-

ted through Q_4 and amplified by T_1 . In this condition a positive pulse is transmitted through C_3 and D_3 to force the tunnel diode flip-flop to its operating point B on its I-V curve of Fig. 4A. When the junction of R_3 , C_1 and R_1 is at 1.4 volts preventing a positive pulse from appearing at D_3 , then the OR gate comprised of Q_6 and Q_{10} transmits a clock pulse through T_2 where it is inverted and supplied to the base of Q_5 . Resistors R_7 and R_8 form a voltage divider. This divider provides bias for the base of Q_5 so that the transistor is normally cut off until the negative signal is supplied from T_2 . When this negative signal occurs, it forces the tunnel diode to operating point A on its I-V curve.

Transistor Q_8 is an emitter follower to prevent loading of the tunnel diode circuit and Q_7 is an amplifier inverter, with Q_6 being a clamp circuit operating as an amplitude control for Q_7 . Transistor Q_{11} is the final emitter-follower output circuit.

Shift register shift speeds are believed to be possible up to at least 100 Mc. Components in all circuits were readily available. To preserve risetimes, transistors should have $f_t > 500$ Mc with current gains preserved beyond 20 ma.

In summary, clock pulse generators capable of speeds beyond 100 Mc, dual variable delay square pulse generators capable of 50-Mc operation, programmable pulse generators capable of operating with clock rates to 50 Mc and cascaded binary stages capable of countdown from inputs of 140 Mc have been developed. Commercial transistors, diodes and transformers have been used with tunnel diodes to allow high digital operating speeds with the limitation on speed being the quality of the transistors and not the tunnel diode switching speed.

REFERENCES

- (1) TI Technical Report 08-60-24-P9002-30, "Negative-Resistance Devices in Inductive or Capacitive Circuits."
- (2) TI Technical Report 08-60-24-P9002-36, "Comparison of Tunnel diode Predicted Switch Time to Measured Switch Time."
- (3) Ferroxcube #56-590-65/4A.

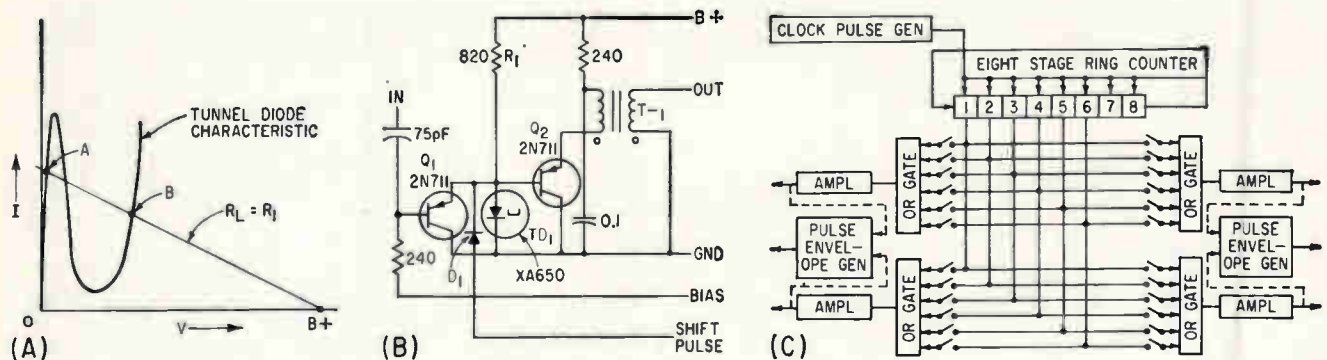

FIG. 4—Tunnel diode characteristic with load line (A); diagram of tunnel diode shift register circuit, (B); block diagram of program pulse generator built from an 8-stage ring counter, (C)

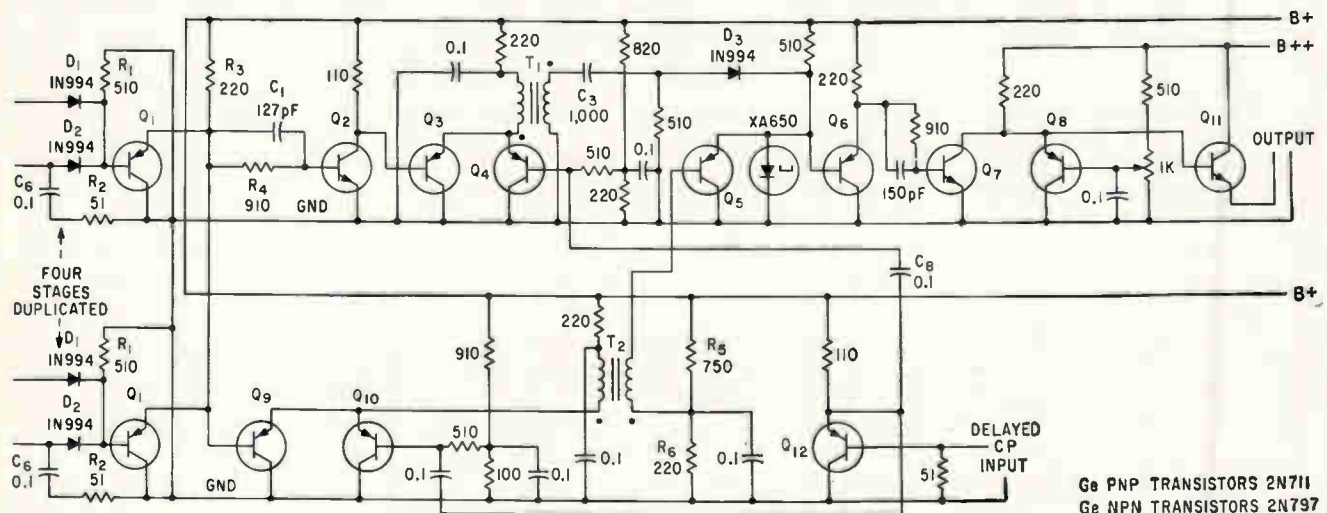

FIG. 5—Diagram showing OR circuit and an envelope generator

Ge PNP TRANSISTORS 2N711
Ge NPN TRANSISTORS 2N797

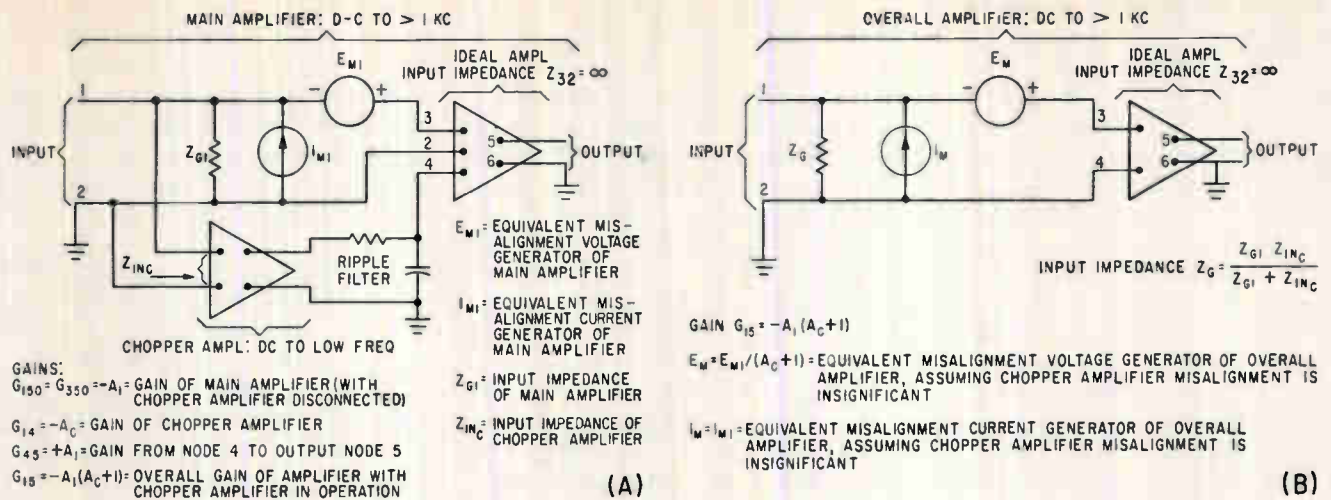

FIG. 1—Overall amplifier showing misalignment generators E_{m1} and I_{m1} (A). Equivalent circuit showing effective misalignment generators (B)

Hybrid D-C Designing Amplifiers To Withstand Missile Environments

Where severe environmental conditions are encountered, this hybrid d-c operational amplifier uses one vacuum tube, silicon transistors and the Goldberg principle for d-c drift correction

By R. L. KONIGSBERG,
 Applied Physics Laboratory,
 Johns Hopkins University,
 Silver Springs, Maryland

COMPONENTS intended for missile control system applications often encounter severe environments. The hybrid d-c operational amplifier described here has reliable performance in ambient temperatures between 0 and 100 C, ± 10 -percent power supply variations and has short circuit stability (in Nyquist sense). Electrically, it has a d-c gain of 900,000, an input impedance of 230,000 ohms, an output impedance of 1,000 ohms and generates -20 to $+20$ v across a 10,000-ohm load at frequencies between 0 and 800 cps. The equivalent input misalignment voltage and current generators are less than 1 mv and 1 millimicroampere respectively.

Figure 1A shows an equivalent block diagram of a chopper-stabilized d-c amplifier consisting of the main d-c amplifier, chopper amplifier used for drift correction in the Goldberg¹ arrangement and low-frequency ripple filter. Also shown is the equivalent input circuit for the main amplifier with its equivalent input voltage and current d-c misalignment (drift or offset) generators E_{m1} and I_{m1} . These offset generators are independent of the signal source and load impedances and represent the main amplifier misalignment characteristics. The validity of this representation has been shown elsewhere^{2,3}.

Offset generator E_{m1} may be determined by short circuiting the main amplifier input terminals and measuring (or calculating) the amplifier d-c output voltage. Divide the latter voltage by the amplifier d-c gain to obtain E_{m1} . Similarly,

offset generator I_{m1} may be determined by measuring (or calculating) the d-c current in a short circuit placed across the main amplifier input terminals; this current flowing towards the amplifier ground node is I_{m1} .

Contributions to E_{m1} result from variations in component values from their nominal values due to aging and ambient temperature changes. Circuit potential changes, caused by power supply potential changes, also contribute to E_{m1} .

Contributions to I_{m1} result from input current variations in the main amplifier. Sources of these variations are the changes in the characteristics of components at and near the amplifier input node resulting from aging, temperature changes and power supply variations. Stray leakage currents to the input node from relatively high-potential nodes

within the amplifier also contribute to I_{m1} .

After determining E_{m1} and I_{m1} , the circuit appears as shown in Fig. 1B. This represents the block diagram equivalent input circuit for the overall amplifier with its equivalent input misalignment generators. The E_m generator of the overall amplifier is that of the main amplifier divided by $(A_c + 1)$, while I_{m1} ($=I_m$) remains untouched by the Goldberg compensation circuit. If the amplifier is to be used in the operational mode, as shown in Fig. 2, with relatively high source (Z_1, Z_2) and feedback (Z_f) impedances, the misalignment term with I_m ($-I_m Z_f$ in Fig. 2) can be significant. In missile control systems, impedance levels in the 100,000 ohms to 5 megohm range are frequently used. These levels are sufficiently high such that I_m values exceeding 10×10^{-9} ampere are unacceptable. If a silicon transistor were used as the main amplifier input stage of the d-c amplifier, changes in I_m considerably in excess of 10×10^{-9} ampere may be experienced when the amplifier is operated over a 0 C to 100 C ambient temperature environment. The alternatives to a transistor input stage are a vacuum tube input stage having grid and leakage currents normally below 1×10^{-9} ampere, and blocking the d-c path to the main amplifier input node by a high-quality high-leakage resistance capacitor and using the Goldberg compensating amplifier alone to provide the d-c path through the overall amplifier.

Once the input stage problem has been solved, the remaining amplifier stages can use transistors to reduce size and power dissipation. The amplifier's input stage consists of a vacuum tube to hold I_m below 1.0×10^{-9} amp. All the remaining stages, including the chopper amplifier stages, use transistors as suggested by R. W. Cole of APL/JHU.

Figure 3 shows the amplifier circuit. One section of V_1 is a cathode follower input. The other section of this tube, also a cathode follower, provides for mixing the rectified and filtered signal from the chopper amplifier with that from the main amplifier in the following differential amplifier stage formed by transistors Q_1 and Q_2 . This stage has sufficient voltage gain (approx-

imately 150) to reduce misalignment contributions to E_{m1} occurring after this stage to insignificance. Within the main amplifier, the major contributor to E_{m1} is the difference between the grid-cathode potentials of the two sections of the tube. This difference may range between 0 and ± 0.5 v and, by selecting tubes, the difference may be held to less than 0.3 volts. If an additional 0.3 volts is allowed for all other misalignment sources contributing to E_{m1} , then the chopper amplifier d-c gain should be approximately 600. This will insure that the overall amplifier E_m value will not exceed one millivolt, the design limit, under all missile environmental stresses.

Assuming certain design precautions are observed, the major contributors to I_m are the grid and leakage currents of V_1 at the amplifier input node. Measurements indicate that over 50 percent of production type tubes will have grid and leakage currents less than 1.0×10^{-9} amperes for all missile environments. By selection therefore, I_m will never exceed the latter design limit.

The signal from Q_2 collector is coupled to Q_3 emitter follower stage through a resistance voltage divider network having a loss factor of about $\frac{1}{4}$. Stage Q_3 then couples the signal to gain stage Q_4 . The emitter resistance of Q_4 is sufficiently high that the stage gain (about 35) is the ratio of its effective collector load impedance to this emitter resistance. Stage Q_4 provides an electronic ground for the emitter resistance of Q_4 while maintaining the actual Q_4 d-c emitter potential around -30 volts. The biasing potential permits amplifier output potential swings down to -20 volts (the negative design limit) since the d-c collector potential of Q_4 must also swing down to -20 volts. Stage Q_5 is an emitter follower output stage capable of driving a 10,000-ohm load with a ± 20 volt swing. Transistor Q_5 collector resistance protects it from burnout in case the output node (Q_5 emitter) is grounded while testing the amplifier.

High-frequency compensation of the amplifier is provided by the resistance-capacitance network connected between collectors of Q_1 and Q_2 , and by the capacitor connected

between Q_4 collector and ground.

Design of the a-c coupled chopper amplifier is straightforward. It uses a miniature chopper operating at 400 cps. As required for an E_m value below one millivolt, its d-c gain magnitude is approximately 600. The ripple filter (R_1 - C_1) time constant is set at approximately 2 seconds. Of importance is the leakage resistance at high temperatures of the input coupling capacitance connected to the base of Q_5 . Any leakage current in this resistance results in contributions to both E_m and I_m . These contributions can be reduced to insignificance if the leakage resistance exceeds 5,000 Megohms at the highest operating temperature (100C).

Noise in the 10 cps to 100 cps range is primarily due to Q_5 and selection of this transistor for low noise will keep the equivalent input noise (analogous to offset E_m in the Fig. 2 circuit) below one mv rms.

To insure that stray leakage currents do not enter the overall amplifier input node (and hence do not contribute to I_m), a guard circuit is provided around input node leads. Significant 400 cps noise and d-c misalignment are coupled into the amplifier if the heater of V_1 is supplied by a 6.3 v a-c, 400 cps source. The tube is fed from a 6.3 v d-c supply. When operating with E_m and I_m values as low as described, it is important to pay attention to the routing of signal ground leads in, and from, the amplifier.

To insure that the drifts in d-c collector potentials of Q_2 and Q_4 at 100C do not become excessive (causing saturation of each stage), it is necessary to select Q_2 and Q_4 for $I_{c0} \leq 2$ microamperes at 100C junction temperature for $V_{c0} = 30$ v. This requirement is met by approximately 75 percent of production type transistors. To insure a full +20 v swing at the amplifier output node, it is necessary to select Q_4 for $BV_{c0} \geq 60$ v. Roughly 50 percent of production 2N335's will meet this requirement.

Figure 4 shows the ideal open loop gain-frequency characteristic of the amplifier. For several amplifiers constructed and tested, gain cross-over frequency ranged between 40 and 65 Kc while the phase margin ranged between 50 and 60 degrees. The amplifier is thus short circuit stable and will

not oscillate if output is shorted to input. Increased d-c and low-frequency gain, required when greater operational accuracy is called for, may be obtained by reducing the emitter resistance of Q_1 to 237 ohms and shunting the 196,000-ohm resistance connected to Q_2 collector with a 0.1 μ F capacitor. Figure 4 also shows the modified gain characteristic for the increased gain condition. By increasing the gain, short circuit stability is sacrificed; to insure high frequency stability the signal source and feedback impedances in Fig. 2 must be chosen carefully.

Both E_m and I_m may be conveniently measured by choosing particular values of Z_1, Z_2, \dots, Z_n and Z_f in Fig. 2. To measure E_m , let: $Z_1, Z_2, \dots, Z_n = \infty$; $E_1, E_2, \dots, E_n = 0$ and $Z_f = 0$. If E_{om1} is the amplifier output potential with respect to ground, $E_m = -E_{om1}$.

To determine I_m indirectly choose $Z_1, Z_2, \dots, Z_n = \infty$; $E_1, E_2, \dots, E_n = 0$ and $Z_f = 10$ megohms (resistive).

If E_{om2} is the amplifier output potential with respect to ground, then from Fig. 2

$$I_m = -\frac{1}{Z_f} \left[E_{om2} + E_m \left(1 + \frac{Z_f}{Z_o} \right) \right]$$

where E_m is given above and Z_o is the amplifier input impedance—approximately 230,000 ohms.

In actual measurements of E_m and I_m at room temperature (25C) with 0C to 100C temperature changes and ± 10 percent power supply changes, many amplifiers consistently yielded overall E_m and I_m values within the design limits of one millivolt and 1.0×10^{-9} ampere, respectively. Printed circuit amplifiers, when subjected to the design environmental stresses, showed similar results.

The writer acknowledges the help of E. R. Thompson and R. W. Caruthers of APL/JHU and B. Thornsen of Bendix-Mishawaka.

REFERENCES

- (1) E. A. Goldberg, Stabilization of Wide-Band Direct Current Amplifiers for Zero and Gain, *RCA Review*, 11, p 296, June 1950.
- (2) R. L. Konigsberg, Equivalent Input Circuit Representation of DC Misalignment in DC Amplifiers, APL/JHU Internal Report BBC-4-101, 1959, Applied Physics Lab., Johns Hopkins Univ., Silver Springs, Md.
- (3) R. L. Konigsberg, DC Amplifier Misalignment in Computing Systems, *IRE Transactions on Electronic Computers*, EC-9, 3, Sept. 1960.

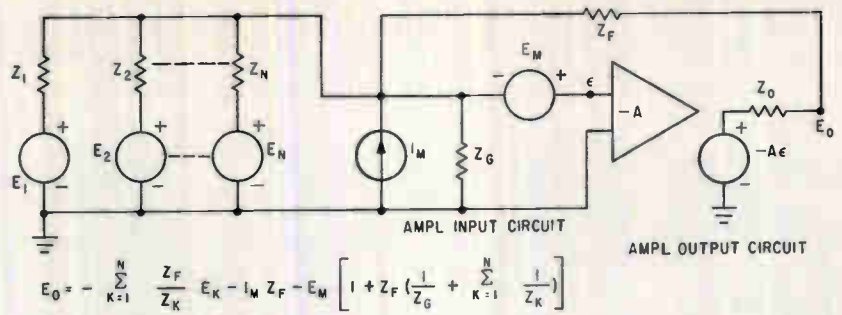

FIG. 2—D-c amplifier connected as operational amplifier

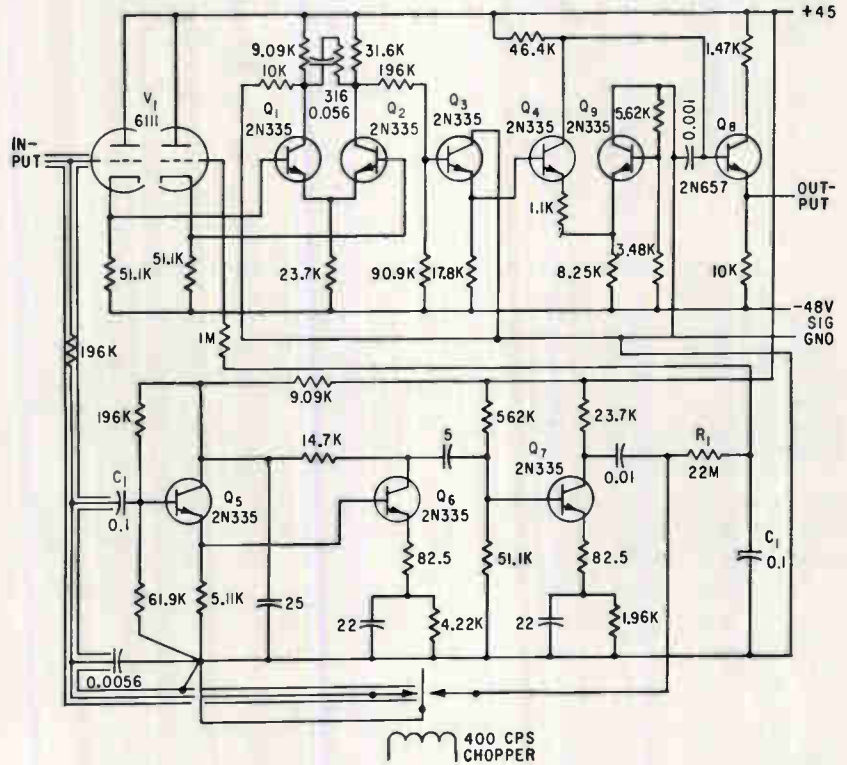

FIG. 3—Final amplifier circuit. Vacuum tube is used as two cathode followers

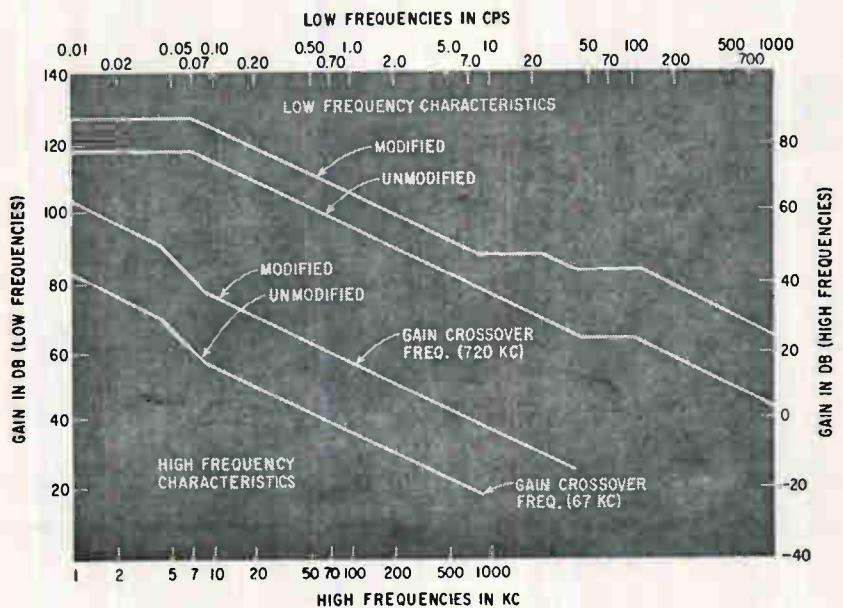

FIG. 4—Gain-frequency characteristics of unmodified and modified d-c operational amplifiers

of Human Eye *Special spot welder allows making large*

number of welds with little tissue destruction and with high reliability.

High frequency and electronic timing help eliminate errors during use

of spot-welding it to the choroid. This is accomplished by creating many focal areas of scar tissue between the choroid and retina by diathermy or r-f burns (Fig. 1B).

The application electrode burns a small hole through the relatively thick, tough, fibrous coat of the eye (sclera) before reaching the choroid for each such burn. After a number of these burns are applied to the choroid in the detachment area, the fluid that has accumulated underneath the retina is removed, allowing the retina to regain its normal apposition with the outer coats of eye. Air, saline or vitreous space if necessary to push the retina back to its original position. Gradually, over a period of weeks, firm scar tissue adhesions between the retina and choroid occur at each site of diathermy or r-f application, closing the retinal break and fixing the retina in place.

This has been a successful procedure in most instances over the past 15 to 20 years and surgical techniques have improved considerably during that period. Unfortunately the electronic instruments have not improved proportionately and most failures are now attributed to lack of precise instrument control. Two main types of failures occur. First is insufficient diathermy application, giving scars too tiny or nebulous to create a firm adhesion. Second is excessive diathermy application, resulting in excessive scarring and in traction bands in the vitreous gel (Fig. 1C). These traction bands often pull the retina away from the choroid in areas removed from the original detachment. Perforation of the retina by the electrode and severe heat damage to the sclera are also complications of excessive diathermy application. This is not usually the fault of the surgeon but rather that of the instrument, which allows current surge in the presence of low tissue impedance.

Lack of accurate electronic timing of diathermy application may result in too little or too much burn, even though other parameters are constant.

Since it virtually eliminates both human and instrument error, the new instrument promises to supplant diathermy instruments for retina reattachment presently used. Human error exists because the surgeon only estimates the length of application time of diathermy burning of the tissue. This error is further exaggerated by variation in thickness of the sclera. Instrument errors exist because use of low-frequency (1 – 5 Mc) and broad electrodes and the absence of feedback control means great variation in the amount of r-f energy delivered to the eye tissues. This occurs because of wide variations in tissue impedance and variable skin effect. In addition, accurate timing of the r-f application and accurate metering of r-f energy delivered is not provided in these instruments.

The instrument now in use at the Univ. of Oregon Medical School overcomes these deficiencies by providing accurate electronic timing of the r-f energy at the exact desired site of application (the choroid). By using a higher frequency (27.12 Mc), a finer needle-like electrode and feedback voltage control, identical bursts of r-f energy can be repeatedly applied to the selected site without fear of human or instrument error. The finer electrode and the high-frequency provide a greater localization of the electrostatic r-f field, and a smaller hole in the wall of the eye, as well as better localization of the burn area in the choroid. Thus, greater numbers of the burns may be made with less tissue destruction and with greater reliability of desired effect (Fig. 1D). Excessive scars with disastrous traction bands can be avoided.

One of the instrument's features providing excellent repeatability is

the electronic timing. This timing starts with a feedback pulse that occurs when the electrode passes from the high impedance in the wall (sclera) to the low impedance of the choroid. Thus, accurate timing of r-f energy delivery occurs at the desired site of application and eliminates errors that would otherwise be caused by variations in the thickness of the sclera and therefore total burning time as well as variations in speed of penetration of the sclera by differences in pressure on the electrode held by the surgeon.

Radio-frequency burns in tissues may be current burns or voltage burns. In current burns, the current from the instrument actually enters the tissue (d-c coupling). These burns are little, if any, different than thermal burns. Third degree thermal burns with complete tissue destruction occur if the current surge is high. This is likely to happen when there is a sudden drop in tissue impedance, especially with larger electrodes and no feedback regulation.

Voltage burns coagulate tissue proteins by electrostatic or electromagnetic fields. No current from the instrument enters the tissue (a-c coupling). In this case, as with the new instrument, a high resistance (15-20 megohms) is very rapidly developed by the electrode with its highly localized electrostatic field as it burns a hole down to the choroid. Capacitance is high (1-2 μf) however, and abruptly increases (3-5 μf) as the electrode approaches the highly vascular choroid. This capacitive change occurs because there is relatively little ionizable tissue fluid and few cells in the sclera as compared to the choroid which has much highly ionizable tissue fluid (blood plasma) and many more cells (blood cells and tissue cells). Thus, voltage burns occur primarily because of tissue cell breakdown from rapid alterations in cell polarity by the

r-f electrostatic field. The heat produced is smaller and secondary as compared to that in current burns. For these reasons the new instrument has a high d-c impedance (15-20 megohms) and the a-c impedance at the frequency used (27.12 megacycles) is low. For the average capacitance of $3 \mu\text{f}$, $X_c = 1/2\pi fC = 1/(6.28)(27.12)(3) \approx 0.002$ ohms.

Now, because of the high d-c resistance, no electrons flow from the instrument into the tissues. On the other hand, this wall of high resistance created by the fine electrode serves as the dielectric for capacitive coupling to the tissues. Because of the low X_c and the relatively high internal impedance of the instruments, large changes in tissue reactance have a negligible loading effect on the instrument. No undesirable and uncontrollable variations in tissue reaction occur as the application electrode passes through the coats of the eye.

Figure 2 shows the functional relationships in the instrument; an r-f voltage is generated and accurately controlled to any preset value from 50 to 500 v peak-to-peak. This is accomplished by sampling the output and controlling the power amplifier through a direct coupled amplifier and clamp tube. Output voltage is metered by a compensated electronic voltmeter having a linear reading scale.

The device may be operated in one of three modes. One mode is to have continuous output while maintaining the regulation of the output voltage. In this position, the timing and shutdown circuits are disabled and will maintain the output voltage as long as the foot switch (Fig. 3) is operated. A second mode provides a method of operation whereby the instrument will remain on for a predetermined length of time after operation of the foot switch. In third mode operation the instrument is on until a sudden increase in loading on the output starts the timing circuit, such as might occur when the probe reaches the choroid. After the interval determined by the time dial setting the instrument shuts down.

There are two timing ranges in each of the timed modes. One range is 0 to 100 msec in 0.1 msec increments. The other range is 0 to 1,000 msec in 1 msec increments. The maximum time setting is within 3 percent of the specified value. The sensitivity control and the meter zero calibration control are on the front panel.

The crystal-controlled electron-coupled oscillator (Fig. 3) drives the power amplifier as a straight through class-C amplifier. The oscillator (V_1) screen voltage is derived from the regulating source to control its output level and adjust the drive to power amplifier

V_2 , which has its grid bias derived from both fixed and self bias. The bias automatically adjusts to the required value, depending on the amount of drive, yet reduces the plate current to a low value during lack of excitation.

Capacitor C_1 , rated at 20,000 v, and choke L_1 insure against accident should high voltage d-c get to the probe. Should this happen, L_1 would short the power supply, blowing the fuse before doing any other damage.

A sample of the output is taken through C_2 and detected in voltage coupler, V_3 . D-c output of V_3 is filtered and applied to the grid of d-c amplifier V_4 . Tube V_4 amplifies any change in the output and applies this change to the grid of clamp tube V_5 . This action causes output tube V_2 to restore the output to the desired or established level. Output level is established by the setting of the R-F LEVEL control that sets the static bias on the grid of V_2 .

A portion of the d-c voltage from V_3 is fed to V_6 through the meter calibration potentiometer. Tube V_6 is an electronic voltmeter forming a bridge with the voltmeter between its cathodes. Tube V_6 balances the Edison effect in V_7 .

When the foot switch S_1 is operated, relay K_1 operates, establishing the operating bias for V_2 and sending a positive pulse to the timing circuits if the pretimed posi-

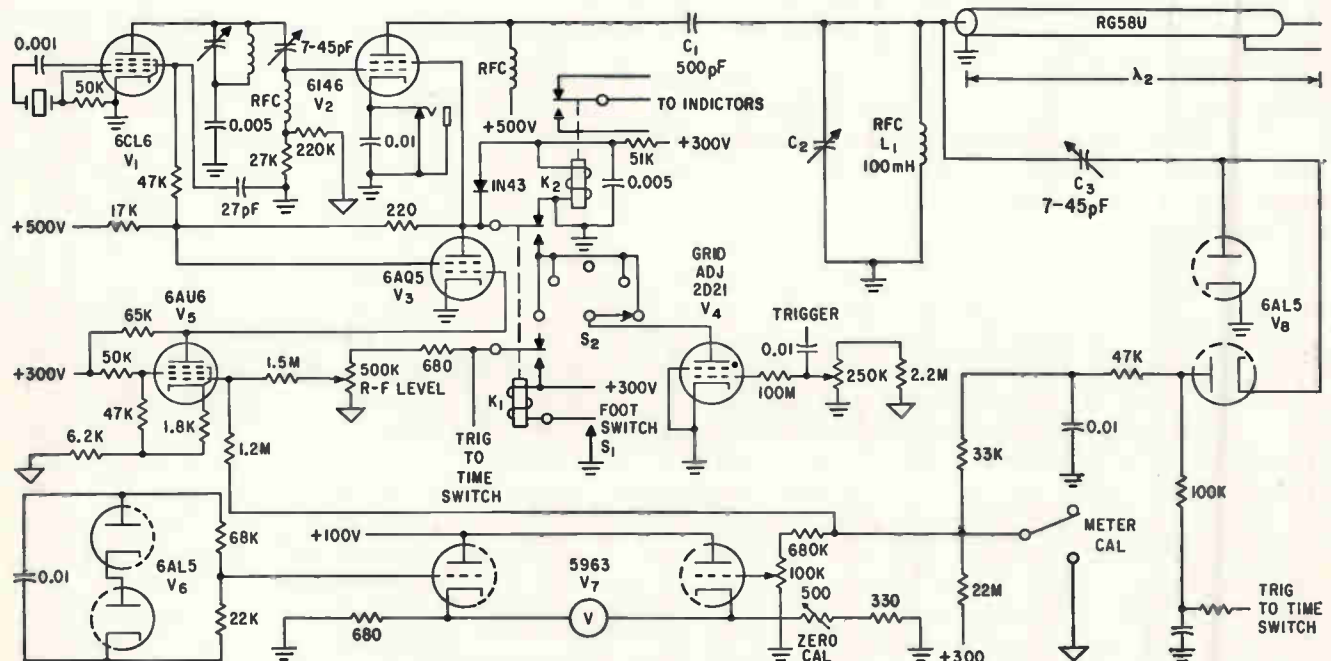

FIG. 3—Output is applied to probe through coaxial cable that is tuned by C_1 to half wave length

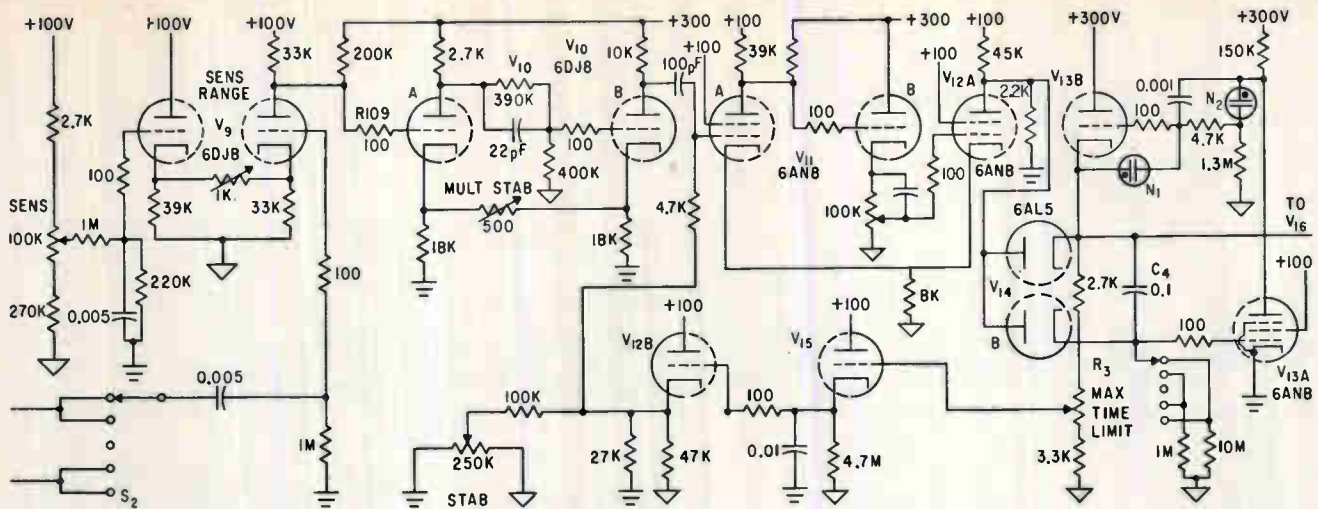

FIG. 4—Comparator circuit uses V_{10} to shape pulse for reliable operation of multivibrator

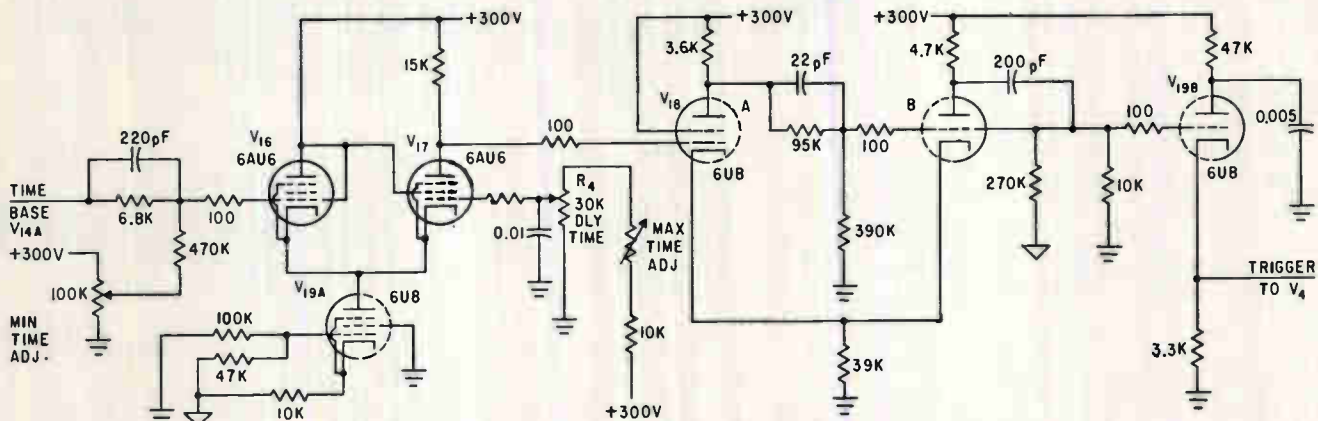

FIG. 5—Delay time resistor R_4 controls timing interval of radio-frequency output

tion has been selected. At the same time, ground is removed from the plate of the thyatron V_1 which is biased to cutoff, causing the output stage to start delivering energy and at the same time preparing for the shutdown. After the desired interval, the delayed pulse is applied to the grid of V_1 , causing it to conduct. This reduces the screen voltage of the output tube V_2 to nearly zero causing it to reduce its output almost to zero. Due to the small voltage remaining, there would be some output; however, screen potential of the oscillator is also reduced, completely cutting off any output.

When V_1 conducts, it also lowers the voltage available to operate the relay K_2 , causing K_2 to release operating indicators that show whether the machine is on and idle or delivering power. When S_2 is switched to the continuous output position, V_1 is disconnected, insuring that the instrument runs continuously.

When using the automatic shutdown, a trigger pulse is taken from the output of the sampling diodes V_8 to start the timing circuits. The timing circuits are activated by the trigger pulse that is derived from the loading on the output or from K_1 . This pulse is selected by S_2 and compared to a fixed bias on one half of comparator tube V_9 (Fig. 4). This fixed bias is controlled by the sensitivity control that determines the amplitude of the triggering pulse that activates the timing circuits. Trigger shaping by V_{10} provides a strong, sharp pulse for the gating multivibrator V_{11} and V_{12A} . The gating multivibrator causes diodes V_{14} to turn off allowing the Miller runup circuit to start a time base runup. The runup consists of the Miller integrator tube V_{13A} and cathode follower V_{13B} that drives charging capacitor C_4 .

After C_4 arrives at the desired value of 150 v, the circuit reverts to normal through the maximum time limit potentiometer R_3 , V_{15} , and

V_{12B} . The gating multivibrator reverts to its off state, diodes V_{14} turn on and the charging capacitors are discharged. The time base ramp voltage is fed to the trigger pick-off circuit composed of V_{16} , V_{17} and V_{19A} (Fig. 5). The delay time potentiometer R_4 determines the voltage at which the tube will conduct. The ramp voltage is linear with respect to time, so the voltage setting of R_4 corresponds to a time interval beginning with the start of the ramp voltage. The delayed pulse is fed to the trigger shaping multivibrator V_{18} . This multivibrator provides a strong, fast pulse for the cathode follower V_{19B} that drives the grid of thyatron V_1 (Fig. 2), causing it to fire and shut down the circuit.

BIBLIOGRAPHY

- K. C. Swan, and L. E. Christensen, Scleral Changes Induced by Diathermy in the Treatment of Retinal Detachment, *Trans Amer Ophthal Soc* 52, p 65, 1954.
- R. V. Hill, O. Rich, Jr., K. C. Swan, and D. Weeks, A New Electronic Instrument for Precision Surgery for Retinal Detachment, *Archives of Ophthal* 65, p 680, May, 1961.

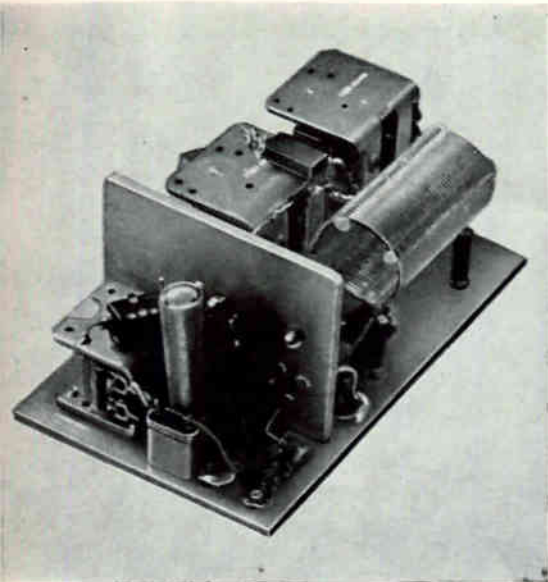

Construction details of prototype model shows component placement

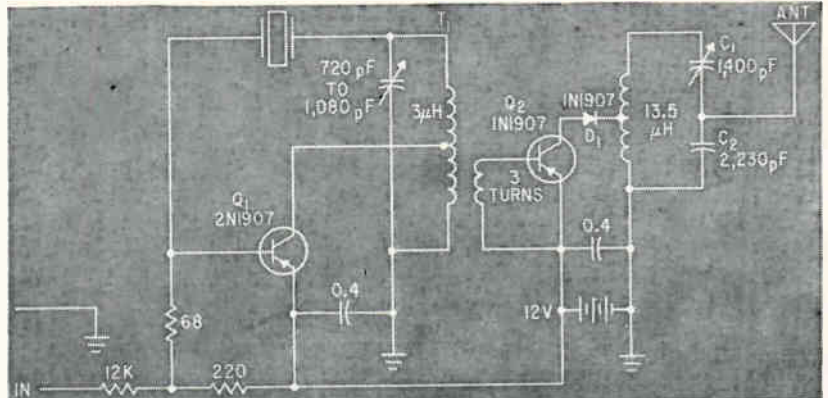

Crystal and tank of transmitter can be changed to provide different frequency

Lightweight Transmitter Provides Flight Data and Beacon Signal

Ten-watt device for high-altitude balloons is crystal controlled and can operate up to 7 Mc. Beacon signal for aircraft radio compass is provided

By R. W. FRYKMAN
A. R. MOORE,
G. T. Schjeldahl Company,
Northfield, Minnesota

ON HIGH-ALTITUDE balloon flights, a lightweight transmitter relays flight information and provides radio beacon signals. The transmitter (see figure) replaces a 2-w tube device. It uses a 1,686-Kc signal to transmit altitude information and provides a beacon signal for a 1-f aircraft radio compass.

The 2N1907 high-power switching transistors used in the oscillator and amplifier were selected for their high power dissipation, high beta and a 20-Mc alpha cut-off frequency. Selectivity of the coupling circuit,

gives a virtually distortionless output. The amplifier delivers 10 w at 1,686 Kc into 72 ohms at 60-percent efficiency. This circuit operates at 7 Mc by changing the crystal and tank circuit. At 7 Mc, efficiency is slightly lower.

An altitude transducer provides Morse-code keying of the oscillator bias. The oscillator tank is tuned to the crystal frequency and operates only when a keying signal is present. The three-turn winding of T_1 provides loose coupling to the amplifier stage. Because diode D_1 acts as a limiting resistor to any reverse voltage caused by load changes, the load can become intermittent without

adversely effecting the transistor.

The matching network matches the amplifier output (14 ohms) to the antenna load (72 ohms). The network is an autotransformer with the capacitors cancelling the inductive reactance at the crystal frequency (f_c). Value of the coil inductance is arbitrary, but the turns ratio is approximately $N_2/N_1 = [(R_{OUT})/2R_{IN}]^{1/2}$. Degree of flux linkage will determine the accuracy of this relation. For maximum output, C_1 should be equal to $1/2R_{OUT} f_c$, while capacitor C_2 can be varied without adverse effects on the output.

A tube transmitter of equivalent output is five times heavier.



LOOK HERE FOR ANSWERS TO YOUR RELAY PROBLEMS

IT'S WHAT'S INSIDE THAT COUNTS IN TIME DELAY RELAYS



Especially when milliseconds count! Note the printed circuit construction of Leach's optional output time delay relays. This economical line of off-the-shelf electronic units includes time delays on release and time delays on operate—in a timing range of 100 milliseconds to 60 seconds. These standard components are available with fixed or adjustable timing to meet your most critical requirements. And they're all 100% inspected during manufacture for highest reliability!

Bulletin TD-200.

WE'RE LOADED WITH LITERATURE...

Write for bulletins, write for information, write for details and specifications. Or mail your request on the Reader-Service Card!

BLOCK THAT SHOCK!

Leach balanced-armature relays provide high resistance to shock (50 G's) and vibration (15 G's to 2000 cps). They meet or exceed MIL-R-25018, MIL-R-5757C and MIL-R-6106C. Choose from 4,000 variations of 20 basic types!



Bulletin BA-859.

NOT A SQUARE IN THE WHOLE FAMILY!



2 PDT, 3 AMP

4 PDT, 5 AMP

6 PDT, 5 AMP

2 PDT, 10 AMP

4 PDT, 10 AMP

When only a round can relay will fit your need, Leach offers this family group in contact configurations of 2, 4 and 6 PDT and in contact ratings ranging from dry circuit to 10 amps.

Bulletin RC-300.

SUBMINIATURE CRYSTAL CANS, TOO!

Want big performance, compact size? Get both in a wide range of standard relay configurations. Dual coils... balanced rotary armature for 2 amp, 2 PDT switching in aerospace and electronic control applications. *Bulletin CC-M200 and M101.*

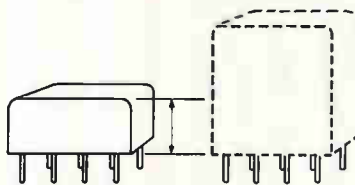

WHAT'S HALF OF A SUBMINIATURE?

Answer: The new Leach Half-Size Crystal Can Relay. Half the height of a subminiature but boasting the same base dimensions, the same performance! Amazing.

Bulletin CC-M250.

NEED RELAYS FAST?

When you need immediate delivery on prototype or small quantities of relays, look to Leach for standard stocks—available to you locally at factory prices. Each of these relays is backed by 41 years of Leach experience in meeting the high performance requirements of the aerospace and electronic industries.

DISTRIBUTORS:

Inglewood, California
Flight Electronics Supply Corp.
423 South Hindry
ORegon 8-5122

San Jose, California
Weatherbie Industrial Electronics, Inc.
333 Prevost Street
CYpress 7-9550

San Diego, California
Atlas Electronic
4618 Santa Fe
BRowning 4-3131

LEACH DISTRICT SALES OFFICES:

Seattle 8, Washington
South Annex Bldg., Room 201
King County Airport
Boeing Field
PARkway 5-6978

Palo Alto, California
814 San Antonio Road
YORKshire 8-4408

Los Angeles 17, California
1101 Wilshire Blvd.
HUNTley 2-0790

Dayton 2, Ohio
333 West First Street, Room 250
BALDwin 2-8652

New York, New York
405 Lexington Avenue, Suite 3204
YUKon 6-2520

Washington, D.C.
Suite 307
1700 K Street, N.W.
STERling 3-1147

LEACH CORPORATION, 18435 Susana Road, Compton, California • District offices and field representatives in principal cities of U.S. • Export: Leach International, S. A. Forty-one years of serving the control needs of the aircraft, missile and electronic industries



LOOK TO LEACH

LOOK TO LEACH

LEACH CORPORATION,
18435 SUSANA ROAD,
COMPTON, CALIFORNIA

EXPORT: LEACH INTERNATIONAL, S.A.



Magnetron Modulator Is Also Load Isolator

FERRITE device will be described at the 1961 Wescon Show that modulates either frequency or amplitude of a microwave oscillator while simultaneously isolating it from load variations. Details of theory, design and operation of the unit, called an isomodulator, will be given in a paper by H. Scharfman, Special Microwave Device Operations, Raytheon, Waltham, Mass.

The isomodulator can be used for such applications as frequency modulating c-w radar, which is now accomplished by varying magnetron voltage. However, the present method requires special driving equipment; and erratic tube operation, increased noise and amplitude modulation can result. Also, load variations can pull magnetron frequency. Although this problem can be helped by ferrite load isolators, the isomodulator both modulates and isolates the magnetron.

A four-port circulator can be used as a basis for understanding isomodulator operation. Two ports are assumed terminated in dummy loads so that the circulator acts like an isolator. Polarized energy entering port 1 in the figure is rotated 45 degrees and emerges from port 2, energy entering port 2 emerges from port 3, continuing in typical circulator fashion. If absorbing loads are at ports 3 and 4, a two-port isolator is formed.

With exactly 45 degrees rotation and a perfect match into port 3, no energy reaches port 4, which can be replaced by a short circuit. If the magnetic field of a three-port isolator is perturbed so that rotation is 45 degrees + $\Delta\theta$, the field at the output in the plane cross polarized to port 2 is $E_2 = E_1 \sin \Delta\theta$.

This field is reflected back through the rotator so that the field entering the load at port 3 is $E_3 = E_1 \sin^2 \Delta\theta$ and the field returning to port 1 is $E_1' = E_1 \sin \Delta\theta \cos \Delta\theta$. When $\Delta\theta$ is small, $\Delta\theta \cong \sin \Delta\theta$ and $\cos \Delta\theta \cong 1$. Thus $E_2 \cong E_1 \Delta\theta$, $E_3 \cong E_1 \Delta\theta^2$ and $E_1' \cong E_1 \Delta\theta$. The last equation indicates that a re-

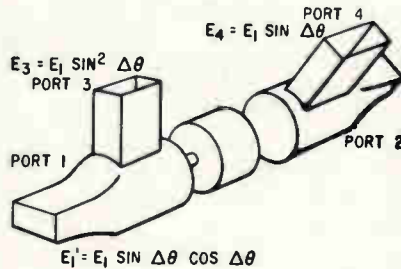

Impedance into port 1 of isomodulator is a function of perturbation angle added to 45-degree ferrite rotation

flected field proportional to $\Delta\theta$ can be introduced at the input, which implies that impedance looking into port 1 is a function of $\Delta\theta$.

With a perfect match, voltage reflection coefficient at port 1 is $\Gamma \cong E_1 \Delta\theta \angle \phi / E_1 = \Delta\theta \angle \phi$, where ϕ is phase angle and a function of reference plane location. The corresponding vswr is $\gamma = (1 + |\Gamma|) / (1 - |\Gamma|) = (1 + \Delta\theta) / (1 - \Delta\theta) \cong 1 + 2\Delta\theta$, and admittance relative to characteristic admittance is $Y^{-1} = Y/Y_0 = (1 - \Gamma) / (1 + \Gamma) = (1 - \Delta\theta \angle \phi) / (1 + \Delta\theta \angle \phi)$.

If reference plane location is chosen so that $\phi = 0$, $Y^{-1} = (1 - \Delta\theta) / (1 + \Delta\theta) \cong 1 - 2\Delta\theta$. If $\phi = 90$ degrees, $Y^{-1} = (1 - j\Delta\theta) / (1 + j\Delta\theta) \cong 1 - 2j\Delta\theta$, and variation in admittance is purely susceptive and proportional to $\Delta\theta$.

If a magnetron were operating into a matched load but then susceptance was varied, frequency would change but power output would be substantially constant. However, if the real part of the load were changed, power output would vary but frequency would not. Thus varying load susceptance modulates frequency and varying resistance modulates amplitude. Whether frequency or amplitude is modulated is determined by line length between magnetron and isomodulator.

When variable susceptance is introduced to modulate frequency, perturbation angle of the quiescent 45-degree ferrite rotator controls

deviation. Required angle is a function of the particular magnetron, modulation index and modulation frequency.

An X-band isomodulator has been designed that provides 20 db isolation and has an insertion loss of 0.25 db. It can withstand 200 watts average transmitter power at a temperature of 80 C working into a 3:1 mismatch. It requires 0.4 watt d-c and 0.1 watt modulation power. The 1.65-lb unit is 3.3 by 3 by 1½ inches.

Multivibrator for Low Frequencies Uses Relays

By RONALD L. IVES,
Palo Alto, Calif.

MULTIVIBRATOR using only relays consumes no steady-state power. It can provide bistable, monostable or astable operation at frequencies from a few operations an hour to a few a second. More than 10 million operations can be expected if maximum frequency is limited to about 3 cps.

The circuit was originally designed to switch integrating capacitors in a field meteorological recorder, although it also worked well in driving a sealed solenoid for

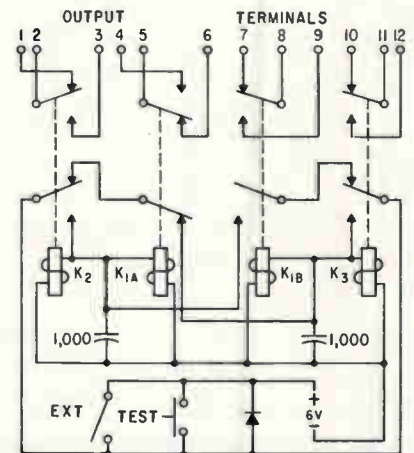

FIG. 1—Basic bistable multivibrator consumes power only during switching



the
Slant
on this
Power
Supply
is
0-325 vdc
@800 ma,
Stabilized to
0.01%
(even at the angle shown)

HB GROUP Optional 0.1% or 0.01% regulation:

PRICE	0.1% MODELS	DC OUTPUT RANGE		0.01% MODELS	PRICE
		VOLTS	MA		
\$295.00	HB 2M	0-325	0-200	HB 20M	\$495.00
\$350.00	HB 4M	0-325	0-400	HB 40M	\$550.00
\$395.00	HB 6M	0-325	0-600	HB 60M	\$595.00
\$415.00	HB 8M	0-325	0-800	HB 80M	\$615.00

FOR COMPLETE SPECIFICATIONS, WRITE FOR CATALOG B-611

PACKAGED: 3½" HIGH x 19" W x 14⅜" D:
EQUIPPED FOR REMOTE PROGRAMMING
AND CURRENT REGULATED OPERATION.

This remarkably compact capability derives from a unique hybrid design which employs semi-conductor components in the reference amplifier for optimum regulation characteristics, and vacuum tubes in the power stage of the series regulator for high voltage reliability.

kepcO
inc.

131-34 SANFORD AVENUE • FLUSHING 52, N. Y. • IN 1-7000 • TWX # NY 4-5196

Visit us at WESCON Booths 501-503

calculated advantage

New SOLA "CVDR" d-c supply simplifies missile-age circuit design, reduces costs.

It's a natural for computers, communications equipment, and similarly sophisticated electronic gear. Made for today's stringent operating parameters. Ends costly dependence on over-engineered d-c power sources.

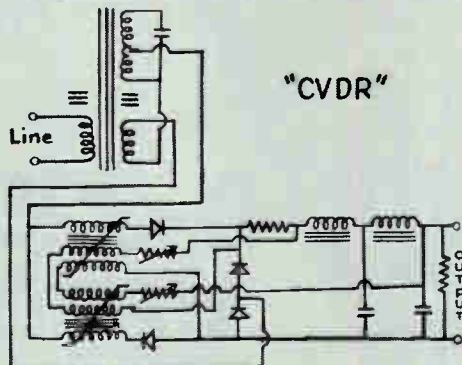

CVDR provides both line and load regulation without tubes or transistors. Line regulation $\pm 1\%$, for $\pm 15\%$ line voltage changes; 1% load regulation from zero to full load; 1% peak to peak ripple. Fits 19" relay racks, and measures only $3\frac{1}{2}$ " high. Custom configurations and power ratings available on special order.

Line voltage stabilization is by means of the Sola "CV" self-regulating transformer. Load voltage stabilization is accomplished by the series "IX" voltage drop in the saturable reactor (see schematic). This voltage drop is controlled by the load current itself.

CVDR is ready right now, off-the-shelf, in units rated 6-volts, 10-amps . . . and 12, 18 or 24 volts, 5-amps. For outstanding reliability in a-c and d-c power supplies tailored to every application, see your SOLA representative . . . or write to address below.

SOLA ELECTRIC CO., 1717 Busse Road, Elk Grove Village, Ill. HEMPstead 9-2800
IN CANADA, Sola-Basic Products Ltd., 377 Evans Ave., Toronto 18, Ontario

SOLA



Division of Basic Products Corporation

For all your a-c and d-c power supply requirements or special engineering, contact your nearest SOLA representative:

CALIFORNIA, San Francisco: Sola Electric Co., Three W. 37 Ave., San Mateo, Fireside 1-6538
 • Los Angeles: Sola Electric Co., 2907 West Vernon Avenue, AKminster 2-0166

COLORADO, Denver: Slaybaugh & Thompson 100 W. 13th Avenue; AComa 2-5826

FLORIDA, Winter Park: James Millar Assoc., P. O. Box 1603; Midway 7-7407

GEORGIA, Atlanta: James Millar Assoc., 1036 Peachtree Street N. E., TRinity 6-0919

INDIANA, Indianapolis: R. O. Whitesell & Assoc., 6620 E. Washington Street; FLeetwood 9-5374

IOWA, Des Moines: McDowell-Redlingshafer Sales Co., 3615 Olive St.; JEFFerson 3-3277

KENTUCKY, Louisville: R. O. Whitesell & Assoc., 400 N. 38 Street; SPring 6-2024

MASSACHUSETTS, Newton: Sola Electric Co., 272 Centre Street; Blgelow 4-3354

MICHIGAN, Detroit: R. C. Merchant & Co., Inc., 18411 W. McNichols Rd.; KEnwood 5-6000

MINNESOTA, Minneapolis: Helmann Co., 1711 Hawthorne Avenue; FEderal 2-5457

MISSOURI, Kansas City: McDowell-Redlingshafer Sales Co., 1103 E. Armour; WEstport 1-5622

• St. Louis: McDowell-Redlingshafer Sales Co., 3615 Olive Street; JEFFerson 3-3277

NEW JERSEY, Little Ferry: Sola Electric Co., 84 Industrial Avenue; HUBbard 9-1060

NEW YORK, Buffalo: R. W. Mitscher Co., 487 Ellicott Square Building; TL 4-2517

NORTH CAROLINA, Charlotte: Ranson, Wallace & Co., 116½ E. 4th St.; EDison 4-4244

OHIO, Cleveland: Sola Electric Co., 14235 Detroit Avenue; LAkewood 1-8038

PENNSYLVANIA, Philadelphia: Sola Electric Co., (Philadelphia answering service — WALnut 2-5340); or 210 North 6 Street, Camden 2, N. J.; EMerson 5-7744

• Pittsburgh: R. G. Sidnell & Co., 675 Princeton Blvd.; CHurhill 2-1476

TEXAS, Dallas: Robert E. Nesbitt Co., 1925 Cedar Springs; RIVERSide 7-4145

WASHINGTON, Seattle: Northwestern Agencies, Inc., 4130 First Ave. So.; MAine 3-8882

WASHINGTON, D. C.: Sola Electric Co., contact 8719 Colesville Rd., Silver Spring, Md.; JUNiper 5-0331

viscous fluids. Its flexibility and economical use of power make it suitable for other low-frequency applications.

At higher frequencies, vacuum-tube and transistor bistable multivibrators of various configurations are satisfactory for frequency division by factors and combinations of two. At very low frequencies, particularly if a between pulse condition is required like maintaining a power contact, high standby power is needed. In field installations where batteries are used, power costs can become prohibitive.

Availability of improved components has made possible the

the energized position. Opening the external circuit again de-energizes K_3 .

If the external circuit is now closed, K_{1A} and K_2 are energized through contacts of K_{1B} and K_3 . Energizing K_{1A} releases K_{1B} , which then locks K_{1A} at its energized position. Opening the external circuit de-energizes K_3 , making the circuit ready for the next cycle.

After the external circuit has been opened, the 1,000- μ f capacitors slightly delay armature release, preventing chatter. The diode fly-back absorber is desirable to extend switch life and is essential if a transistor driver is used.

Highly satisfactory a-c operation was obtained when the circuit was modified as in Fig. 2 with a symmetrical a-c latching relay and operation of K_2 and K_3 with rectified a-c. The circuit was immune to 20 percent voltage and frequency changes and operated reliably with any waveform from square to triangular, assuring satisfactory performance with a field generator.

Either the d-c or a-c circuit can be made a free-running multivibrator by opening the circuit of the normally open contact of K_2 and K_3 . Opening this circuit in only one relay makes a one-shot multivibrator.

Approximate cycle time is $T = 2 \times 2.303 RC \log_{10} (E_b/E_d)$, where E_b is supply voltage, E_d is drop-out voltage of K_2 and K_3 , and R and C are circuit resistance in ohms and capacitance in farads for one side of the circuit only. This equation does not account for relay coil inductance or relay response lag, which are important at high but negligible at low frequencies.

With two relay coils shunted across each capacitor, required capacitance at low frequencies would be quite large. It can be greatly reduced by using diode isolation as in Fig. 3 and high-resistance relays for K_2 and K_3 , which also appreciably lowers initial costs.

Using the indicated constants and suitable components, more than 10 million operations can be expected if frequency is limited to 3 cps. Maximum operating speed of the multivibrator is about 9 cps. However, when operating at this speed, fewer than 500,000 operations can be expected from the relay multivibrator.

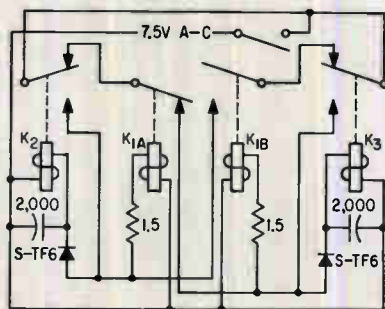

FIG. 2—Use of a-c latching relay and rectifier diodes permits operation from a-c source

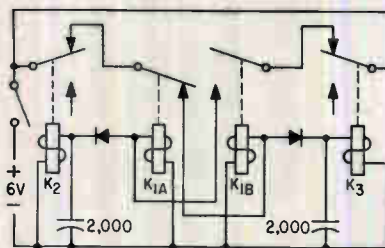

FIG. 3—Using diodes to isolate capacitors reduces capacitance requirements for low frequencies

operational all-relay multivibrator in Fig. 1, which is connected as a scale-of-two divider. Relay coils K_{1A} and K_{1B} are from a symmetrical latching relay and are constructed so that one armature is locked at its energized position by the other armature when the other armature is at its de-energized position. Relays K_2 and K_3 are mechanically independent.

With K_{1A} initially locked at its energized position, K_{1B} , K_2 and K_3 are at their de-energized positions. Closing the external circuit energizes K_{1B} and K_3 through contacts of K_{1A} and K_2 . Energizing K_{1B} releases K_{1A} , which then locks K_{1B} at



Microwave, Solid State, and Optical Devices

DUE FOR WIDESPREAD ATTENTION AT WESCON FORUM

By MICHAEL F. TOMAINO,
Associate Editor

THIS YEAR at Wescon, device engineers will learn about recent developments in three areas: microwaves, solid state devices, and what is happening in the optical spectrum. And since a preview of the Wescon papers indicates that there will be a great interest in these talks, we have organized a planned schedule for these events (see table).

The only overlapping sessions here are sessions 27 and sessions 30. But a choice can be made for your particular field of interest.

We commend the work done by the committeemen who organized these sessions, and of course to the authors of the papers.

One of the most interesting sessions in this group, the one on coherent optical emission, was planned by two professional groups of the IRE: the Electron Device Group, and the Microwave Theory and Techniques Group.

In addition, the Electron Device Group is responsible for the sessions on new microwave electron devices; two sessions on solid-state devices; and a session on microwave tubes and parameter measurements.

The Microwave Theory and Techniques Group set up the sessions on microwave components and techniques; quantum devices; and microwave solid-state devices.

What new information will electronics men who attend these sessions pick up about fundamental aspects, potentialities, and operation of new devices for these important areas?

Quite a bit. Engineers new to these areas will get good basic information on which to build their knowledge of these fields. And the more seasoned engineers will have the opportunity to corner the experts for clarification of many

SCHEDULE FOR MICROWAVES, SOLID STATE, AND OPTICS

Subject	Wescon Session	Date	Held at Cow Palace
New Microwave Electron Devices	2	Aug. 22, am	Rm B
Solid State Devices (I)	7	Aug. 22, pm	Rm B
Microwave Components and Techniques	15	Aug. 23, am	Rm E
Coherent Optical Emission	25	Aug. 24, am	Rm E
Quantum Devices	30	Aug. 24, pm	Rm E
Microwave Tubes, and Parameters	27	Aug. 24, pm	Rm B
Solid State Devices (II)	32	Aug. 25, am	Rm B
Microwave Solid State Devices	40	Aug. 25, pm	Rm E

all a.m. sessions, 10 a.m. to 12:30 p.m.; all p.m. sessions, 2 p.m. to 4:30 p.m.

technical points. For the top men in the country will be there, either on the lectern, or in the audience. So use this schedule to plan your time for your own needs.

At session 25 on coherent optical emission, papers will be presented by J. R. Singer of the University of California, B. M. Oliver of Hewlett-Packard, P. P. Kisliuk and W. S. Boyle of Bell, H. A. Bostick of Lincoln Labs, H. Cummins of Columbia, and M. L. Stitch, E. J. Woodbury and J. H. Morse of Hughes. These men are all well known for their work with coherent light generators, and they will wrap up present knowledge in this important area.

The Bell paper on the ruby maser as a light amplifier will be of particular interest. This paper presents a pulsed ruby maser that has been operated as a light amplifier using a ruby maser oscillator as a source. A net gain of a factor of two was observed. Theory, apparatus and the results will be discussed.

Session 2, on new microwave devices, will present information on a superior microwave power source developed at Bell. This design yields a higher power output, greater frequency stability, and a

higher efficiency tuning range—important to radar performance. H. M. Olson and L. H. Von Ohlson of Bell are the authors.

At this same session, G. E. Dombrowski and W. C. Brown of Raytheon will discuss a cross-field waveguide amplifier that shows promise for generation of large amounts of high frequency power, especially at millimeter wavelengths.

The first session on solid state devices, session 7, includes material on superconductor solenoids by R. W. Boom and R. S. Livingston of Oak Ridge. Another paper in this session by C. H. Becker of Westinghouse describes construction of a parametric quartz amplifier that is completely free of electronic noise.

In the second session on solid state devices, session 32, J. L. Moll of Stanford will describe the design theory for a new class of *pn* junction charge storage diodes useful for generating nanosecond pulses, harmonic generation and wave shaping. Also in this session, C. T. Sah of Fairchild will introduce a new semiconductor tetrode that has the planar geometry. By varying the potential applied between the field electrode and either the emitter or base, the beta may be varied

The Untouchables

Specify Crucible Charges of Deposited Hyper-Pure Silicon



Pre-packaged single piece crucible charges . . . in sizes and weights to meet the exact requirements of your Czochralski crystal growing equipment . . . are now available from Dow Corning.

Accurately Pre-weighed, these single piece crucible charges assure easy handling . . . smallest surface area . . . highest purity . . . an exceptionally clean melt and a savings in crucible costs.

High Quality is inherent in Dow Corning crucible charges. The *deposited* polycrystalline silicon in these charges has never touched a mold. Result — highest purity.

This High Purity means consistently higher quality crystals — simplifies doping procedures — increases device yield. Typical resistivity of N-type crystals grown from Dow Corning pre-packaged crucible charges is greater than 100-ohms centimeter for 80% of the crystal; maximum boron content, 0.3 parts per billion atoms; maximum donor impurity, 2.0 parts per billion.

Now You Specify the Weight and Diameter, up to 38 mm (about 1½"), best suited for each crucible of your Czochralski crystal growing machines. Your crucible charges will be supplied in the appropriate length to provide the exact weight you require in just one piece.

Protective Packaging guards initial *deposited* purity right through crucible charging. Charges are individually wrapped in special cellophane, and sealed in airtight polyethylene envelopes to assure untouchable purity.

Whatever your need — deposited silicon crucible charges; polycrystalline rod or chunk; high resistivity P-type single crystal rod; single crystal rod doped to your specifications — Dow Corning should lead your list of sources.

Profile of Crystal Grown from Pre-Packaged Charge

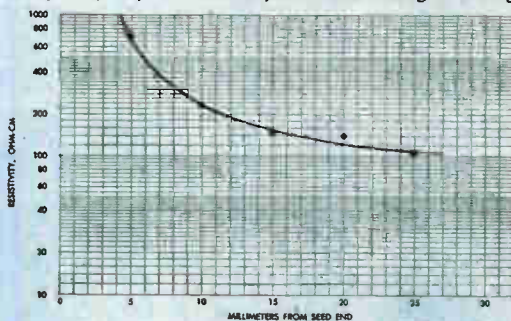

Free brochure — "Hyper-Pure Silicon for Semiconductor Devices." Write Dept. 4220.

VISIT OUR
BOOTH 5102-06 AT
WESCON SHOW

Dow Corning CORPORATION

MIDLAND, MICHIGAN

ATLANTA BOSTON CHICAGO CLEVELAND DALLAS LOS ANGELES NEW YORK WASHINGTON, D. C.

HYPER-PURE SILICON DIVISION
Address: HEMLOCK, MICHIGAN

IERC

**COOLS
POWER
TRANSISTORS
BEST-FOR LESS!***



*** LESS WEIGHT! LESS SPACE! LESS COST!
MORE VERSATILE! MORE EFFICIENT!**

The unique design of IERC's UP Series Transistor Heat Dissipators give amazing cooling performance in natural and forced-air installations. Technical data covering the unusual performance benefits of Universal Power Series Transistor Heat Dissipators is available now — *write TODAY!*

IERC  **DIVISION**

**International Electronic Research Corporation
135 West Magnolia Boulevard, Burbank, California**

Foreign Manufacturers: Europelec, Paris, France. Garrard Mfg. & Eng. Co., Ltd., Swindon, England

over as much as five orders of magnitude at low currents.

Another solid state device in session 32 is an experimental *pnp* double diffused germanium switch developed by Texas Instruments. This work indicates that low switching times and high gain bandwidth products may be interrelated. J. Brixey and W. Jaeger will present this unit.

The session for microwave tube men, session 27, includes four papers: a method of increasing the bandwidth of a klystron with fixed output cavity, by C. Romiguere of Compagnie Francaise Thomson-Houston; a method of checking cold broad-band klystron circuits by M. Lakits, also of Thomson-Houston; techniques developed at Microwave Electronics Corp. by W. Raub, in achieving wide-band matches to metal-ceramic traveling wave tubes without requiring direct connection to the helix through the vacuum envelope; and Bell work on a 50 milliwatt bwo and a 0.5 watt twt for cw operation over the 50,000 Mc to 60,000 Mc band, by D. O. Melroy.

New microwave components and techniques discussed in session 15 include: experimental microwave attenuators built in frequency ranges from 1 to 12,000 Mc, by J. K. Hunton and A. G. Ryals of Hewlett-Packard; a new microwave ferrite device which modulates a microwave oscillator while simultaneously isolating the oscillator from load variations—designed for X band operation in a cw system at the 200-watt level—by H. Scharfman of Raytheon; and a practical approach to the design of parametric frequency amplifiers, by G. Luetgenau and J. Williams of Pacific Semiconductors.

At the quantum device session, 30, Hughes men will demonstrate the experimental Colidar (coherent light detecting and ranging) featured in **ELECTRONICS** last April 21, p 51. This session also includes discussion of a solid state memory system coming out of University of California; and the feasibility of considering the use of the ammonia beam maser as a frequency standard, by National Bureau of Standards men.

In addition, components men interested in electroluminescent and

radio luminescent light sources will follow the Electro-Optical Components session (20), held Aug. 22 am in Room E of Cow Palace. Three papers will be given: a new precision potentiometer developed at Electro-Radiation Inc. that uses an optical-electronic contact made with CdS and CdSe; a frequency-sensitive control that uses a photosensor, developed at Midwest Research for J. B. T. Instruments Inc., of New Haven; and the Sylvania approach to digital displays using electro-luminescence.

Air Cooled Columns



THE ASSEMBLY above, to be seen at WESCON, is one of two three-phase bridge rectifiers supplied by International Rectifier Corporation for a radar beam supply. Each bridge is rated at 35,000-v d-c at 110 amperes continuous when connected in parallel. In series they will produce 70,000 volts at 55 amperes.

Built to do a job that couldn't be done by tubes, these columns operate in a fraction of the space required by conventional components. They withstand a 1,000 ampere d-c short circuit current for 10 cycles or 1/6 sec., and provide a voltage breakdown safety factor of 4 to 1 over normal voltage.

Engineer at left holds standard module consisting of silicon rectifier cell, a resistor and capacitor mounted on a heat exchanger. These modules, which can incorporate either 150 or 250 amp rated rectifier cells, are mounted in a helix on fiberglass cores of varying length, depending on the rating required.

size problem:

Package a power supply for the B-52G electrical system within stringent space requirements. Compensate for the bulky core insulation of conventional transformers. Clad the cores with epoxy potting capable of withstanding -65°C to 150°C .

solution:

Westinghouse solved the problem for Bendix Aviation Corporation, Red Bank, N.J., by developing a polyclad coating technique for potting cores with epoxy material. Formerly, pressure from the epoxy pushed the wires through the taping into the core, causing shorts. Westinghouse developed a very thin layer of polyclad material that (1) came within the allotted space requirements, (2) withstood the pressure from the epoxy of the potted unit, (3) withstood extreme temperature variations and (4) was capable of even application over the entire core. To shed some helpful light on your aerospace problems, contact your Westinghouse sales engineer. Or write: Westinghouse Electric Corporation, P.O. Box 868, Pittsburgh 30, Pennsylvania. *You can be sure . . . if it's Westinghouse.*

J-92513

Westinghouse

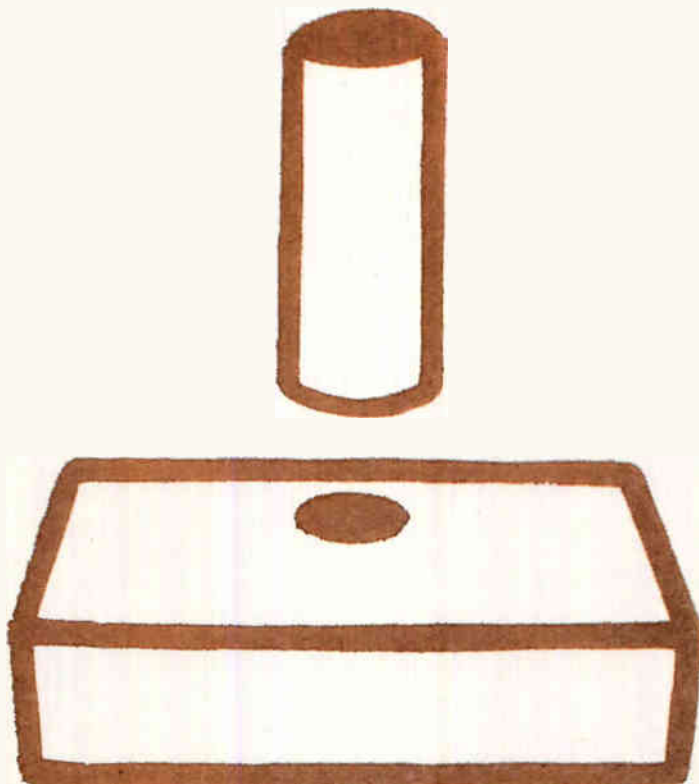



Tape Programs Miniature Component Welder

AMONG NEW PRODUCTION equipment to be shown at Wescon is a punched tape-programmed automatic welding system (PAWS-1) by Unitek's Weldmatic Division, Monrovia, Calif. The machine is designed for welding microminiature modules, vacuum tube assemblies and other precision applications.

All force and heat settings are automatically selected by the program tape. The operator need only insert the part and actuate the head. Up to 10 weld conditions may be sequenced.

The system operates as follows (see block diagram): the paper tape control, located at the top of the cabinet, reads the programmed condition. The binary output is converted to a decimal equivalent and is fed to the weld condition selector. The selector commands weld condition setup components, which in turn control force transducer and welding energy power supplies. Both supplies are powered by the regulated source. The actuator is moved by the operator to fire the welder. Upon discharge of the welding energy supply, the tape advances to the next weld sequence.

If the operator tries to make a weld before the power supply has sufficiently recharged, no weld will be made, the weld will be disallowed and a misfire lamp will light. The operator can skip or repeat a weld sequence by using jog buttons.

Lighted control buttons indicate selected weld conditions and the sequence number is displayed, correlating each of the operator's assembly instructions with the corresponding weld condition. By preventing operator error, the machine improves weld rate and reliability, Unitek reports.

The welding head is a standard unit (Weldmatic Model 1032) mounted horizontally on a riser for better visibility and use of space. The electrodes are mounted at a 70-degree angle, to make it easier to weld dense packages, and are coated to prevent accidental shunting of current through module com-

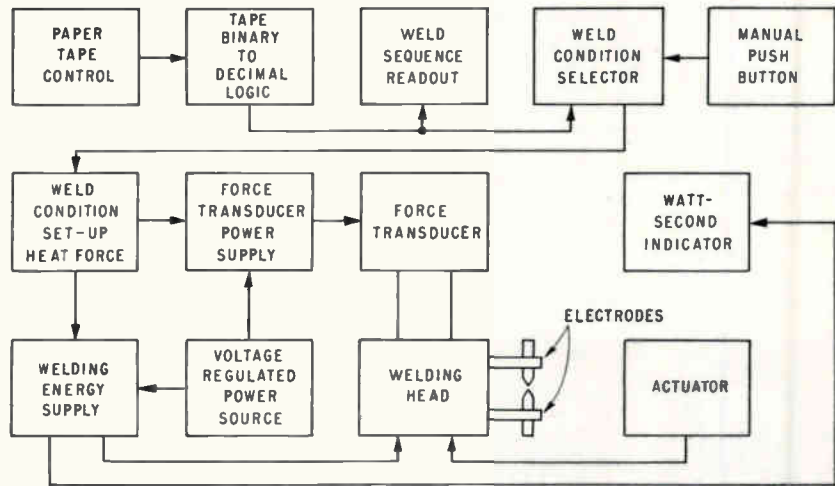

Block diagram of programmed welding system



Machine is used to weld modules

ponents. The force transducer is actuated by the operator through a foot pedal.

Force and heat controls, located in a locked compartment, are ad-

justed in advance by the leadman. The 10 knobs for weld heat are set according to desired watt-second energy storages as determined by a weld schedule. Weld force is set on a parallel row of selectors.

At the lower right of the panel are 10 manual push buttons, forward and reverse jog buttons and the sequence number display.

For manual operation, toggle switches are placed in manual control and weld positions. A weld condition selector button corresponding to the setup desired is pushed. The selected force and heat will be repeated until another condition button is pushed.

Egg Crate Tools Encapsulate Parts

WEST COAST mold manufacturer has introduced a tooling system for component and module encapsulation with epoxies or other thermosetting compounds. As many as 200 individual parts can be encapsulated in a batch, using molding tools shaped like egg crates.

Basic equipments are a mold base and a hydraulic hand press used to remove the molding tool from the base and also to eject the molded parts from the tool. The base and press will accept a variety of mold-



Components are placed in base plate



ANALOG CIRCUIT DESIGN

The strictly realistic art of analog circuit design relates directly to our projects in inertial guidance. If you have fine-line experience in the design and development of transistorized circuits for servo and analog computer applications used in I.G. systems, write to Mr. Donald E. Krause.

Qualified applicants will be considered regardless of race, creed, color or national origin.



LITTON SYSTEMS, INC. Guidance & Control Systems Div.
Woodland Hills, California

If you live in the
EAST or MIDWEST
write or phone
the LITTON
Research & Engineering
Staff Representative
nearest you:

Mr. Harry Laur,
221 Crescent Street,
Waltham, Mass.
TWinbrook 9-2200.

Mr. Garrett Sanderson,
375 Park Ave.,
New York City, New York.
PLaza 3-6060.

Mr. Robert L. Baker,
360 No. Michigan Ave.,
Chicago, Ill. ANdover 3-3131

BIG NEWS FOR USERS OF INSTRUMENT LATHES

LEVIN® LATHES

PRODUCE SMALL INSTRUMENT
PARTS MUCH BETTER

We present the latest in the series of Levin Instrument Lathes, a new model with a half inch collet capacity but with the same sensitivity and precision for which Levin Lathes are so well known.

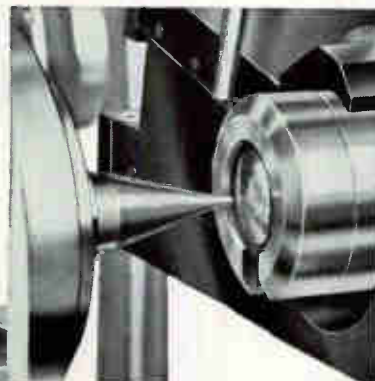
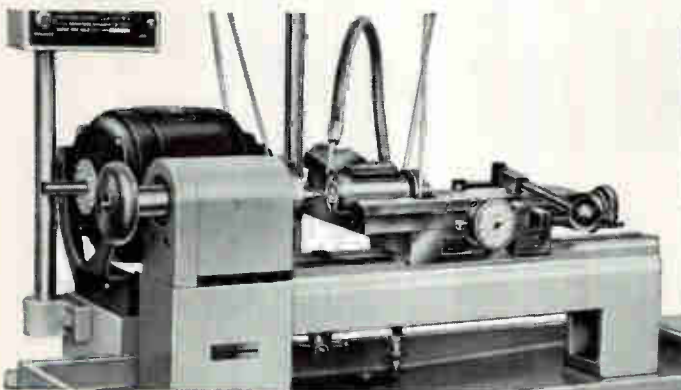
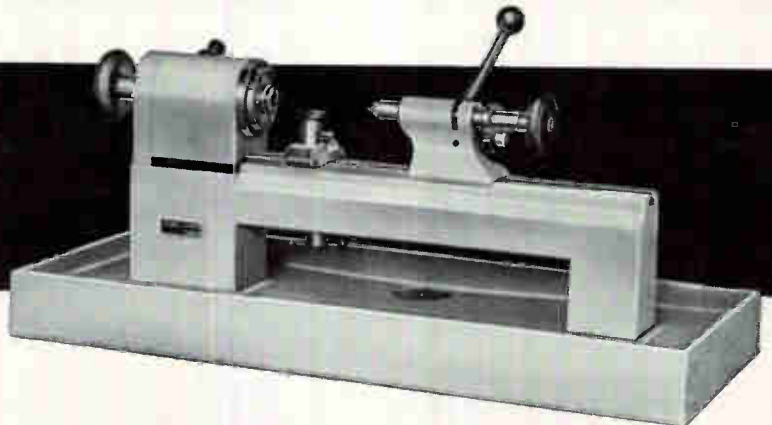

Here is a typical example of work which can be done in the new Levin $\frac{1}{2}$ " capacity lathe. A hole .002" in diameter is being drilled in a nozzle.

Send for literature describing the $\frac{1}{2}$ " capacity instrument lathe and accessories.

LOUIS LEVIN & SON, INC., 3573 HAYDEN AVE., CULVER CITY, CALIF.

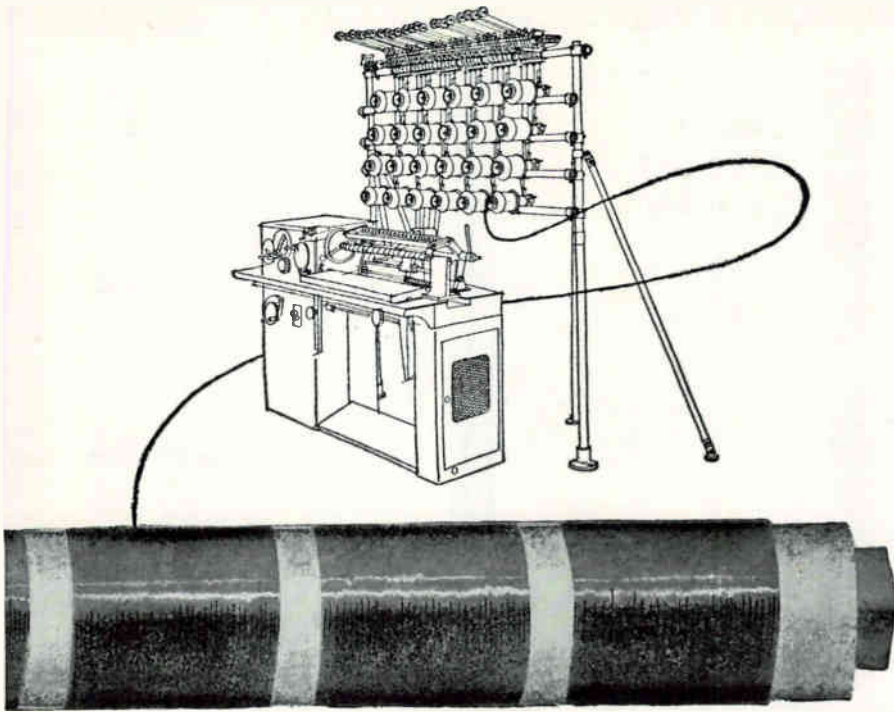

Produces more...more accurately The No. 108 Coil Winder

Quick set ups...30-coil simultaneous winding capacity (short or long runs)...finger tip control...make the LEESONA No. 108 today's most productive semi-automatic coil winder. Versatile — handles wire from No. 19 to No. 44 (B & S) and finer. Modern design eliminates operator fatigue. Write LEESONA CORPORATION, P.O. Box 6088, Providence 4, Rhode Island.

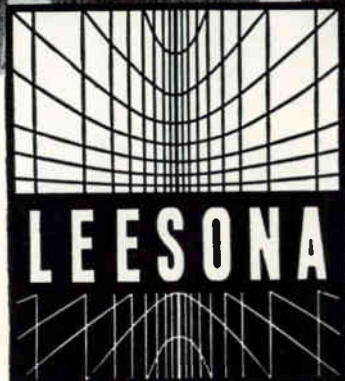
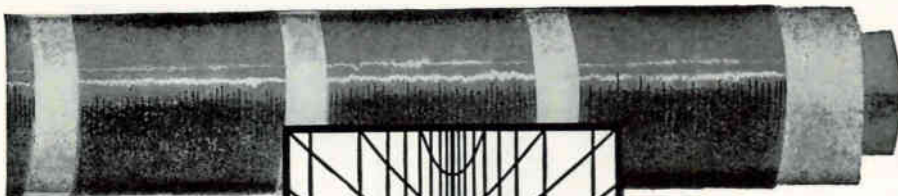

238.14

ing and ejector tools, supplied in standard or special forms.

Standard tooling includes the egg crate style, for cube-shaped encapsulations, a modified egg crate called the gateway, for modules with side leads, and molds with cylindrical cavities.

The equipment is manufactured by Mason Mold Corp., Covina, Calif., a subsidiary of Technical Systems, Inc. The photos, taken at the Pasadena, Calif., plant of United Electrodynamics, Inc., illustrate use of an egg crate with 100 cavities.

After component leads are inserted into the Teflon-covered base plate, the molding tool is fastened to the plate. Epoxy is poured over the egg crate, filling the cavities, and the epoxy is hardened. Holding screws are removed from the tool. The tool and plate are inverted and the tool is slipped into grooves in the side walls of the press. Pumping the press handle raises the two

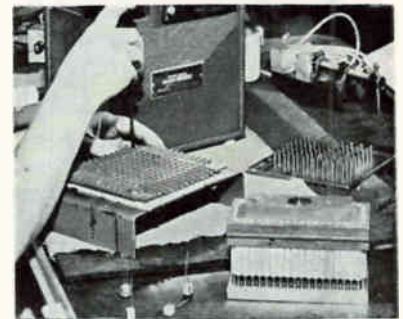

Molding tool is fastened to base

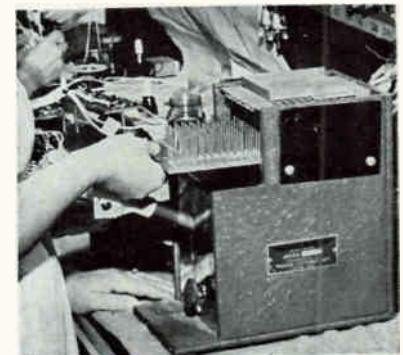

Ejector tool is inserted in press

side plates of the press, which lift the base plate off the tool. As the Teflon plate rises free of the component leads, the leads are straightened.

Then an ejector is placed in the

press, on a lift under the molding tool. The ejector is raised until each of the upright rods is under a cavity. As the operator continues pumping the press handle, the rods push the parts from the cavities.

In the gateway tools, cavity sides

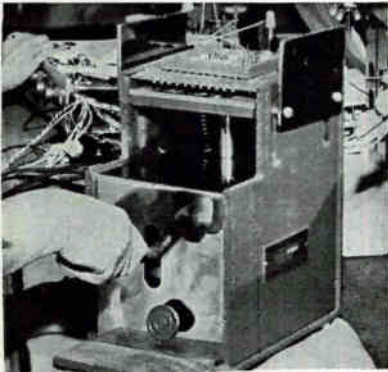

Rising ejector tool releases parts

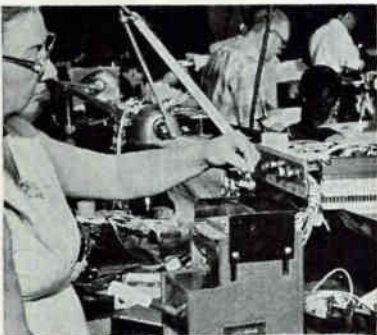

Freed components are lifted from mold

are pierced Teflon plates, which fit into the tool slots. Module leads are inserted into the plates before the molding tool is fastened to the base. Room is allowed between cavities for the leads. Leads can project from top and bottom, as well as sides. During ejection, the plates come off with the modules. The plates are slipped off the leads, straightening the leads as they are removed.

Chief production advantage of the system, according to Mason Mold, is that tooling is interchangeable, readily available and less costly than conventional molds. Also, the use of Teflon and other nonsticking materials on surfaces contacting epoxy makes it unnecessary to add release agents which might prevent positive bonding of epoxy and component leads.

machinability problem:

Minimize complicated machining of inner-magnet phase for a control system hysteresis clutch. Meet close casting tolerances without machining from bar stock. Find materials method that cuts costs most significantly.

solution:

A Westinghouse precision investment casting eliminated a complicated machinability problem for missile manufacturer Hughes Aircraft Company, Tucson, Arizona. Hughes is prime contractor to the USAF on the Falcon air-to-air missile. Materials competence at Westinghouse solves many aerospace problems. For example: Nivco high damping alloys minimize fatigue in turbine metallurgy . . . thin gauge Hiperco magnetic alloy strip simplifies missile generator design . . . Hipernik special alloy performs well in missile control systems and torque motors. For data on magnets, magnetic alloys, refractory metals, non-fuel nuclear materials, investment and shell castings and conversion of your special material, contact the Westinghouse sales engineer. Or write, Westinghouse Electric Corporation, P.O. Box 868, Pittsburgh 30, Pennsylvania. *You can be sure . . . if it's Westinghouse.*

J-92514

Westinghouse

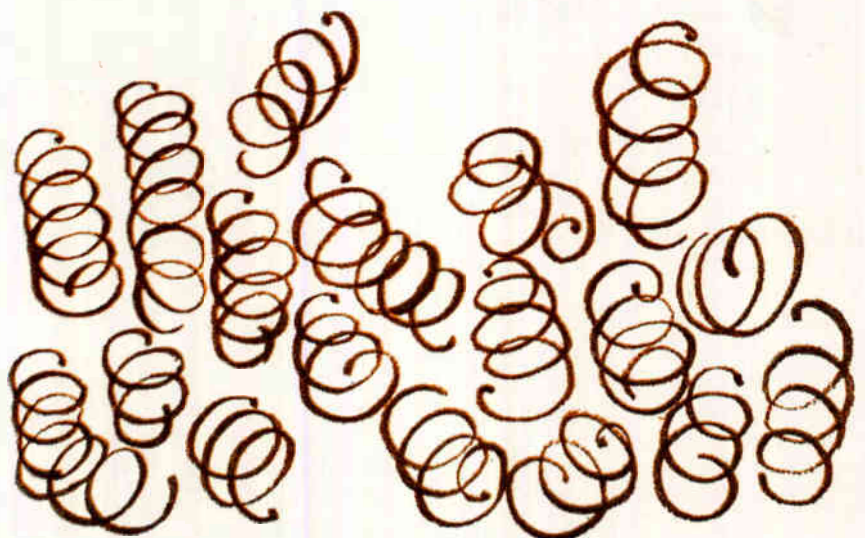

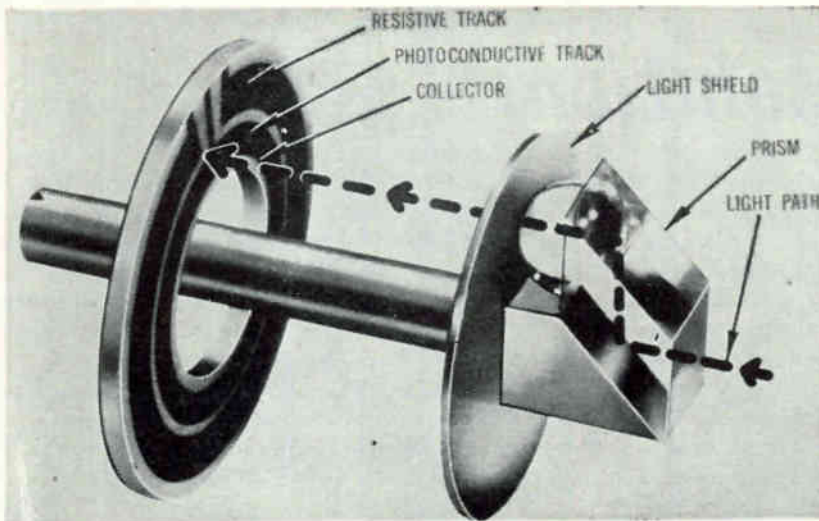

ential unit has ranges from 0 to 10 and 0 to 10,000 psid or ± 10 to $\pm 10,000$ psid. Outputs are 50 mv, 250 mv, and 5 v d-c. Temperature compensation from zero to 150 F is standard; compensation from -65 to 250 F is available.

Infinite resolution transducer has self-contained calibration and high repeatability. Combined linearity and hysteresis is ± 0.25 percent; linearity is ± 0.25 percent terminal; hysteresis 0.30 percent; output at zero applied pressure is ± 3 percent. Manufacturer is Fairchild Controls Corp., 219 Park Ave., Hicksville, L. I., N. Y.

CIRCLE 403 ON READER SERVICE CARD

Potentiometer

INFINITE RESOLUTION, LOW NOISE

POTENTIOMETER USES a light beam for pick-off, giving frictionless action. Absence of torque normally associated with mechanical wiping action makes it suited for applications requiring negligible drift. Since the resistive element need not be wire wound, infinite resolution and absence of contact noise are possible.

Betapot beams a stream of photons through a thin film of photo-

conductive semiconductor material. Normally passive, the semiconductor reacts to light by becoming highly conductive. The movable light beam thus bridges the gap between the annular collector and resistive elements, giving the same effect as the wiper of a conventional pot. Manufacturer is Duncan Electronics Inc., 2865 Fairview Rd., Costa Mesa, Calif.

CIRCLE 401 ON READER SERVICE CARD

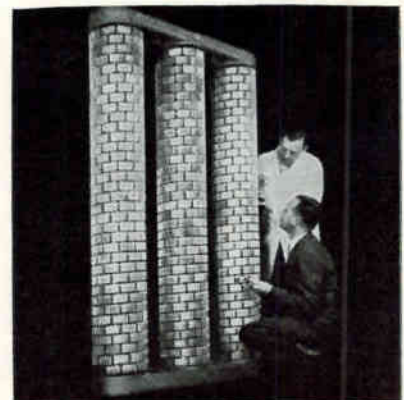

Rectifier Columns

HIGH POWER

RECTIFIER COLUMNS for outputs to 100,000 volts, 250 amperes and d-c surge current to 2,500 amperes are available for radar beam power supplies, plasma research, electron beam furnaces, high yield accelerators, high power transmitters, and similar uses. Manufactured by International Rectifier Corp., 233 Kansas St., El Segundo, California, the compact rectifiers consist of air-cooled semiconductor columns which may be assembled in any configuration—from single phase $\frac{1}{2}$ -wave to 3-phase bridge.

The assembly shown is one of two 3-phase bridge rectifiers for a radar beam power supply. Each bridge is rated at 35,000 volts d-c at 55 amperes continuous when connected in parallel.

Each of the 3 columns in the as-



Noiseless Relays

PRINTED CIRCUIT BOARDS

LINE OF Raysistors (noiseless relays and potentiometers) for back-to-back-mounted circuit boards, is announced by Raytheon Co. Industrial Components Div., 55 Chapel St., Newton 58, Mass. CK1101P and CK1111P are for chopper and relay applications. The CK1111P switches up to 300 volts with an on resistance of 13,000 ohms; CK1101P will switch up to 60 volts with an on resistance of 600 ohms.

CK1102P, CK1103P, CK1104P, and CK1112P are for use as vari-

able resistances or slow switching elements and have control voltages, respectively, of 0 to 1, 0 to 5, 0 to 25, and 0 to 10 volts. Price of the printed circuit units are \$10.75 (less in quantity), and are immediately available.

CIRCLE 402 ON READER SERVICE CARD



Pressure Transducers

SILICON STRAIN GAGE

FAMILY OF silicon-semiconductor strain-gage pressure transducers includes high-line, low-differential models for both corrosive and non-corrosive media. The 3S-G differ-

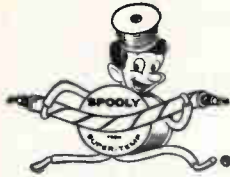

HOTTEST NEWS

in the industry

Super-Temps new versatile wire and cable with an operating temperature of 1000°F... flexibility... moisture resistant properties is bringing a new high standard of quality to today's most demanding industries.

New design potentials with MGT are literally unlimited and new economies and more efficient operations are being obtained in present equipment.

MGT wires are ideally suited for incorporation in cables of single or multi-conductor constructions. Braided wide shielding of various metals including stainless steel can be used. Jackets of Glass Fiber Braids or other materials compatible with high temperature usage are obtainable.

Below is a test chart showing results from our own and other laboratories.

MGT WIRE AND CABLE

Specimen #1-#24 (AWG) 7/32 N.P.C. Specimen #2-#20 (AWG) 7/28 N.P.C.

TEST	SPECIMEN #1	SPECIMEN #2
Dielectric 1.5 KV 1 Min. 5% Salt Solution Test #1	Passed	Passed
1000°F. for 30 Minutes Dielectric	1500 for 20 sec.	1500 for 60 sec. 1550 Breakdown
Insul. Res.	6000 Megohms	12,000 Megohms
Cycle Test		
4.1 800°F. for 30 Minutes Cool to Room Temp. Insul. Res.	infinite	infinite
4.2 Saltwater Bath 1 Hr. Insul. Res.	infinite	infinite
4.3 800°F. for 30 Minutes Cool to Room Temp. Insul. Res.	infinite	infinite
4.4 Hi-Pot 1 KV for 1 Min	Passed	Passed
4.5 Breakdown	4.8 KV	2.7 KV
Cycle Test (conducted on single specimen)		
5.1 1000°F. for 30 Minutes Cool to Room Temp. Insul. Res.	infinite	infinite
5.3 1000°F. for 30 Minutes Insul. Res.	infinite	infinite
5.4 Hi-Pot 1 KV for 1 Min	Passed	Passed
5.5 Insul. Resist.	300,000 Megohms	infinite
5.6 Breakdown	2 KV	2.2 KV

INSULATION RESISTANCE CHECKED AT 500 VOLTS D.C. EXCEPT WHERE NOTED ABRASION TEST—(JANCO) Specimen #1—39.8 Inches; Specimen #2—61.3 Inches.

Super-Temp has the largest line of wire and cable, the best production facilities, and a nationwide network of engineering representatives ready to serve you at a moment's notice... good reasons to always specify Super-Temp.

For information on availability and prices of amazing new MGT wire and cable write, wire or phone... your inquiry will receive prompt attention.

Super-Temp

AMERICAN SUPER-TEMPERATURE WIRES, INC.

A Subsidiary of Haveg Industries, Inc.

8 West Canal Street, Winooski, Vermont—UNiversity 2-9636
General Sales Office: 195 Nassau St., Princeton, N. J.—WAlnut 4-4450



FIRST IN *Engineered* PLASTICS

Super-Temp is a specialist in Teflon* and Silicone Rubber Insulations. Products include: Magnet Wire, Airframe Wire, Hook-up Wire, Coaxial Cables, Miniature & Jumbo Cables and Tapes.

*Dupont's TFE FEP Resins

sembly contains 360 rectifier modules. The modules may consist of either 150 or 250 ampere silicon rectifier cells. Price depends on as-

sembly required; delivery is 4 to 10 weeks.

CIRCLE 404 ON READER SERVICE CARD

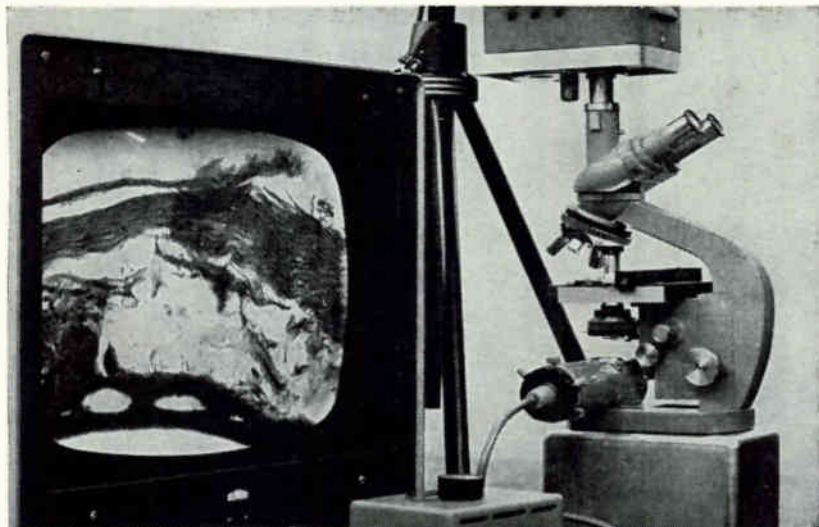

TV Microscope CLOSED CIRCUIT

A MICROSCOPE, closed-circuit tv combination allows enlarged displays of microscopic phenomena without the need of intermediary amplifiers. The camera is a single, self-contained unit powered by 110 volts a-c. The camera and monitor have 600 line horizontal resolution, giving better pictures than home tv

sets. The Micro-Vue system is primarily for multiple enlarged displays in classrooms, lecture halls, even allowing identical displays in two or more buildings simultaneously. Manufacturer is Allen B. Du Mont Labs., 750 Bloomfield Ave., Clifton, N. J.

CIRCLE 405 ON READER SERVICE CARD

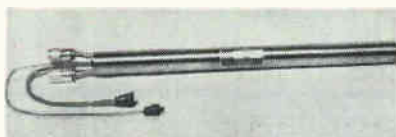

Low Noise TWT 10 mW SATURATED POWER

TWT EXHIBITS less than 5 db noise across selected 400 Mc portions of the S-band, while attaining greater than 25 db small-signal gain and 10 mw saturation power output. Operated broadband, 2.0 to 4.0 Gc, the HA-89 achieves 8 db max noise figure, 20 db min small-signal gain. Relatively high output power reduces troubles associated with inter- and cross modulation effects when simultaneous reception of large and small signals is desired. Tube is 19½ in long, including connectors, by 1½ in. o-d and weighs 2 lb 7 oz; Huggins Labs., 999 E. Arques Ave., Sunnyvale, Calif.

CIRCLE 406 ON READER SERVICE CARD

Smith Chart Display REFLECTION COEFFICIENT

LINE OF waveguide resolvers provides simultaneous instantaneous crt Smith Chart display of reflection coefficient as a continuous function of frequency from 350 to

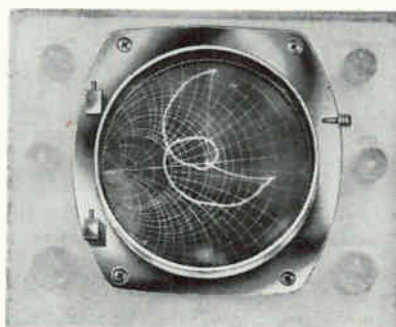

12,000 Mc. Equipment measures impedance and admittance of antennas, filters, load resistors, transformers, and other r-f networks. It eliminates procedures required by

the slotted line technique by giving immediate display of load changes during network adjustments.

The resolver, in conjunction with an oscilloscope and swept signal generator, provides an oscilloscope trace on a Smith Chart faceplate, which can be photographed or recorded; vswr uncertainty is 1.01. The impedance plot can be referred to any point along the transmission line. Manufacturer is Dielectric Products Co., Raymond, Maine.

CIRCLE 407 ON READER SERVICE CARD

Cable Carrier TELESCOPIC ACTION

CABLE-CARRYING mechanism by Jonathan Manufacturing Co., 720 E. Walnut Ave., Fullerton, Calif., firmly secures cable, prevents entanglement with other stored chassis, eliminates vibration problems, and stores cable in minimum depth when chassis drawer is closed. Two telescopic action supporting arms, mounted to opposing sides of the

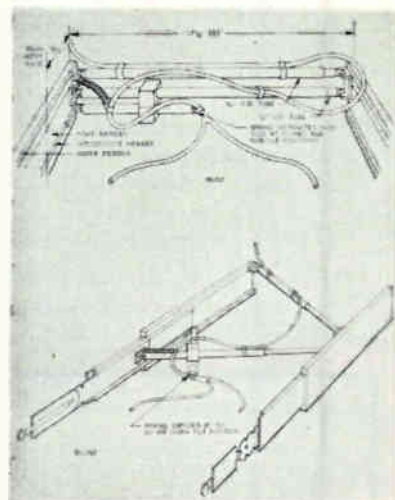

3-member chassis slides, automatically provide uniform cable support throughout drawer traverse. The Power-Track cable carrier occupies approximately 1 inch of storage space when retracted, meets applicable military specifications. Price is approximately \$15 to \$30; availability is 30 days.

CIRCLE 408 ON READER SERVICE CARD

Bar Solder CUTS REJECTS

ALPHA METALS, INC., 56 Water St., Jersey City 4, N. J., has available

That's a strong statement to make. Yet if you've used an old-fashioned voltmeter, you may have been disappointed . . . the mechanical stepping switches . . . the marginal reliability . . . the great amount of time required between successive readings . . . the inconvenient operating techniques.

Let's take a look at the new Franklin Model 550. First off, here's a fast-reading digital voltmeter that's 100% electronic . . . and a voltmeter that's as easy to use as any moving-pointer voltmeter. More important, the Model 550 is one of the most stable and reliable instruments you'll ever use. That's because the Model 550 utilizes techniques and materials never before available to the digital voltmeter manufacturer.

For example, it utilizes the new Burroughs Corp. ®Beam-X Switching Tubes plus the new Burroughs Corp. Long-Life ®Nixie Indicators. This means one-quarter the number of parts of previous counters and a service life that is well over 50,000 hours. But there's more.

The use of up-to-date components in an advanced circuit design means freedom from instability owing to normal changes in circuit parameters. It means an order of

You can't know what a digital voltmeter is . . . unless you've used a FRANKLIN MODEL 550

reliability and ruggedness never before possible.

Finally, there's no denying it, you can buy a less expensive digital voltmeter than the Franklin Model 550. On the other hand, if you need a substantial digital voltmeter . . . a digital voltmeter that must stand up under day-in and day-out abuse . . . then you'll do well to consider the superior performance of a Franklin Model 550.

Bulletin 311 contains a complete description, illustrations of the individual plug-in components, comparative data, specifications, and other useful data. Ask for it.



Franklin Model 550 Digital Voltmeter; ± 0.0001 to ± 1200 V dc; ± 1 count accuracy; effectively infinite input impedance; automatic polarity indication; all-electronic, modular, plug-in construction.

SEE IT AT WESCON BOOTH 3510

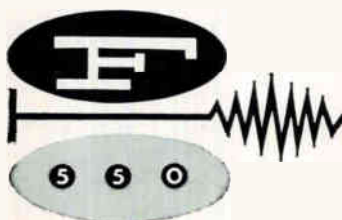

FRANKLIN

electronics, inc.
BRIDGEPORT • PENNSYLVANIA

®Beam-X and Nixie are trademarks of the Burroughs Corp.



ENGINEERING
REPORT
ON BENDIX COMPONENTS

SELECTED FOR



PROJECT ADVENT!

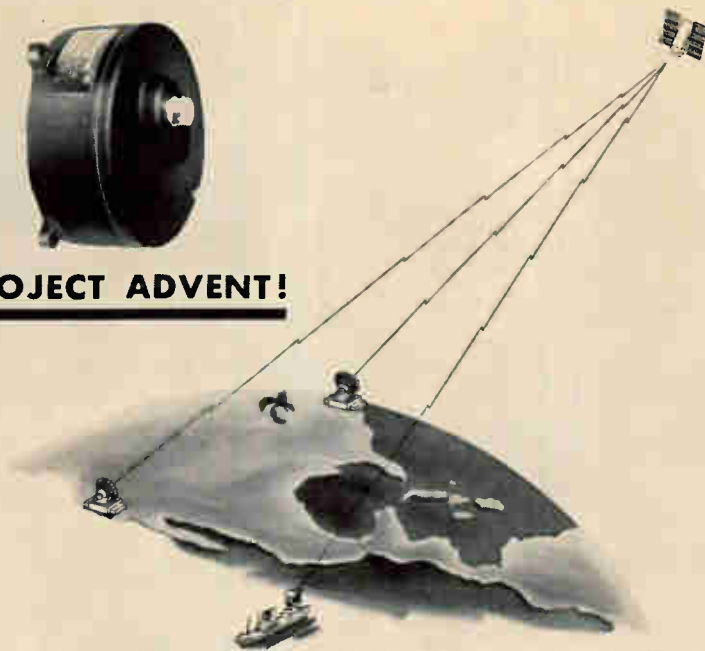

BENDIX REACTION WHEEL FOR SATELLITE CONTROL AND STABILIZATION

Precision reaction wheels developed at Bendix meet requirements for attitude control of space vehicles and satellites. For example, these wheels will be used for Project ADVENT—advanced Army research program which will use satellites as relay stations for global communications.

Since reaction torque is directly proportional to applied voltage, the reaction wheel provides a means for proportional control of vehicle attitude. An integral tachometer senses wheel speed and direction of rotation.

Several wheel configurations are now available, and the basic design concept offers flexibility to meet still broader requirements. Individual wheels can be tailored to specific voltage, torque, inertia, and momentum storage requirements.

- ADVANTAGES AND FEATURES:** Minimum weight and power
- Brushless motor and tachometer • Low friction • Flexible design
 - Consistent performance over environmental range

*PREVIEW LATEST SENSING, STABILIZATION, AND CONTROL DEVICES
FOR SPACE SYSTEMS AT OUR WESCON BOOTH 2801-03.*

Eclipse-Pioneer Division

Teterboro, N. J.



District Offices: Burbank, and San Francisco, Calif.; Seattle, Wash.; Dayton, Ohio; and Washington, D.C.
Export Sales & Service: Bendix International, 205 E. 42nd St., New York 17, N.Y.

a bar solder that cuts rejects from 8 in 400 to 1 in 5,000. Alpha AAA solder cuts dross, increases bath life, reduces inherent inclusions, improves wetting and produces brighter joints. It is said to provide more finished units per lb. The solder is available from stock in most of the common tin-lead alloys.

CIRCLE 409 ON READER SERVICE CARD



Transistor Inserter & LEAD STRAIGHTENER

UNIVERSAL INSTRUMENTS CORP., 139 E. Frederick St., Binghamton, N.Y. The TO-5 is a combination transistor inserter and lead straightener. Transistors placed in the vibrating bowl are oriented and fed to the lead positioning unit which in turn feeds the transistor lead straightener. From this point oriented transistors with straight leads may be transferred automatically to any subsequent operation.

CIRCLE 410 ON READER SERVICE CARD

Laminated Plastic FLAME-RETARDANT

SYNTHANE CORP., Oaks, Pa. Grade FR-2 laminate is recommended for use in electronic and electrical components, tv transformer parts, terminal boards, arc barriers, printed circuits, and computer components. A paper-base laminate with flame-retardant phenolic resin binder, it has outstanding electrical properties, and may be punched at room temperature.

CIRCLE 411 ON READER SERVICE CARD

Voltmeter FREQUENCY SELECTIVE

SIERRA ELECTRONIC DIV., Philco Corp., 3885 Bohannon Drive, Menlo Park, Calif. Model 127A solid state

frequency selective voltmeter is a portable unit powered by a rechargeable battery pack. It weighs less than 15 lb including batteries, and measures 7½ by 7½ by 13 in. Unit covers the range from 2 to 350 Kc, offers 250 cycle selectivity with audio monitoring capability, and measures -80 to +22 dbm.

CIRCLE 412 ON READER SERVICE CARD

Transistor Fault Counters

OPTIMIZED DEVICES, INC., 864 Franklin Ave., Thornwood, N. Y. Units display fault count distribution of transistors under test.

CIRCLE 413 ON READER SERVICE CARD



Anti-Static Fluid FOR PLASTIC SURFACES

DAYSTROM, INC., Weston Instruments Division, Newark, N. J., announces Statnol, an anti-static fluid that prevents build-up of static charges on plastic-faced instruments. It provides a thin transparent coating which drains off static electricity, even under extremely dry conditions. It is being marketed in plastic squeeze bottles and impregnated cloths.

CIRCLE 414 ON READER SERVICE CARD

Pressure-Sensitive Tapes SILICON ADHESIVES

MYSTIK ADHESIVE PRODUCTS, INC., 2635 No. Kildare Ave., Chicago 39, Ill., announces three new pressure-sensitive tapes. One is a thin glass cloth that saves space. Another is an aluminum foil-glass cloth laminate with unusual heat-reflective properties. The third is a thermo-setting Mylar with a special coating which bonds securely to encapsulating resins. All have silicone

adhesives for dependable high-low temperature performance.

CIRCLE 415 ON READER SERVICE CARD



Milliwattmeter SIX STANDARD RANGES

BIRD ELECTRONIC CORP., 30303 Aurora Road, Cleveland 39 (Solon), O. Model 6254 Termaline milliwattmeter is designed to measure power output and to terminate low power 50-ohm systems. Power is direct reading over the range of 30 to 500 Mc with less than 1.15 vswr. Any one of six standard ranges may be specified. Full scale readings are: 25, 50, 100, 250, 500, or 1,000 mw.

CIRCLE 416 ON READER SERVICE CARD

Power Generator

ROHDE & SCHWARZ, 111 Lexington Ave., Passaic, N. J. Power signal generator features 275 to 3000 Mc frequency range, 20 w maximum output.

CIRCLE 417 ON READER SERVICE CARD

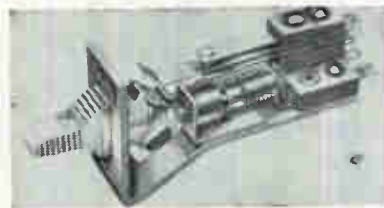

Lever Switch ILLUMINATED

SWITCHCRAFT, INC., 5555 N. Elston Ave., Chicago 30, Ill. The Lever-Lite is designed to color code switching positions and functions. It replaces an ordinary switch and up to three indicator lamps. It is available in series 25000, 2 and 3 position, non-locking types; and series 25000L, 2 and 3 position, locking types. Unit adds greater

ENGINEERING
REPORT
ON OTHER BENDIX
COMPONENT PACKAGES

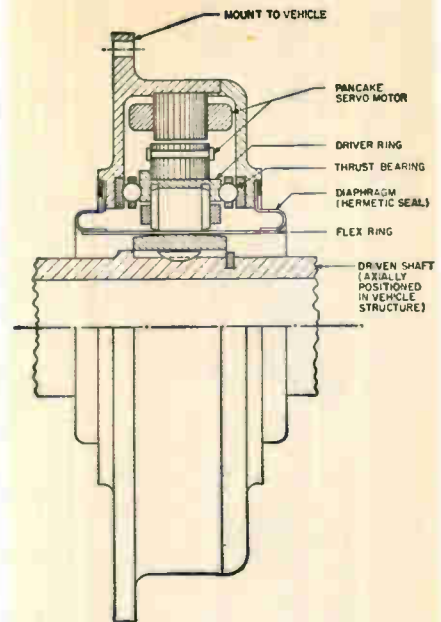

CYCLO-SINE

Hermetically-sealed drive
for space applications

The Bendix® Cyclo-Sine Drive provides an absolute, hermetically-sealed actuator for varied space applications. Operating through a flexible ring, the drive offers infinite resolution and irreversibility for general-purpose and precision servo devices.

OUTSTANDING CHARACTERISTICS:

5:1 weight advantage over conventional drives • Up to 20,000:1 speed differential • No backlash • Infinite resolution

Manufacturers of

GYROS • ROTATING COMPONENTS
RADAR DEVICES • INSTRUMENTATION
PACKAGED COMPONENTS

Eclipse-Pioneer Division



Teterboro, N. J.

METOX

TYPE
F-20

MINIATURE MOLDED OXIDE RESISTORS

Alloed in
**ONE
RESISTOR**
for the
FIRST TIME

- RELIABILITY
- RUGGEDNESS
- STABILITY
- SMALL SIZE
- ECONOMY
IN PRICE



RELIABILITY — Failure rate is better than one per ten million hours.

STABILITY — Under full load, the stability is better than 2% after 10,000 hours. Subsequent rate of change will not exceed 0.1% per thousand hours.

TEMP. COEF. — Will not exceed $\pm 0.05\%$ per $^{\circ}\text{C}$.

NOISE — Less than 0.5 $\mu\text{V}/\text{V}$ applied.

TOLERANCE — All MIL - R - 11C values at $\pm 5\%$.

SIZE — Same as the Mil Type RC20.

SPECIFICATION — Exceeds materially Mil - R - 11C.

PRICE as compelling as the performance and related to 5% carbon composition resistors.

Type	Rating @ 70 $^{\circ}\text{C}$ Ambient	Mil Type	Rated Voltage	Minimum Resistance	Maximum Resistance	Dialectric Strength
F20	1/2 Watt	RC20	350V	10 Ohms	500 K	1000 Volts



For complete data and specifications write to

Welwyn INTERNATIONAL INC.

For further information write for data sheet W-1014.
3355 EDGECLIFFE TERRACE, CLEVELAND 11, OHIO
Factories in Canada and England

latitude in control panel design because of its compact size, variety of colors and low cost.

CIRCLE 418 ON READER SERVICE CARD

Logic Cards

ONE MEGACYCLE

NAVIGATION COMPUTER CORP., Valley Forge Industrial Park, Norristown, Pa. The M series, a complete line of 1 Mc logic cards, includes the following solid state plug-in modules: gated clock, flip-flop storage, binary counters, shift register, parallel adder, universal NAND, and others.

CIRCLE 419 ON READER SERVICE CARD

Voltmeter-Ohmmeter

NON-LINEAR SYSTEMS INC., Box 728, Del Mar, Calif. Transistorized voltmeter-ohmmeter reads to five digits.

CIRCLE 420 ON READER SERVICE CARD

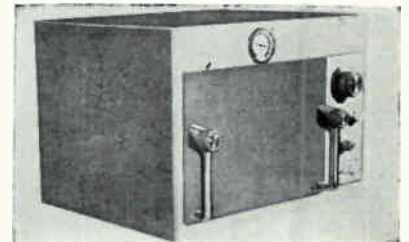

Temperature Chamber MINIATURIZED

WYLE LABORATORIES, El Segundo, Calif., has designed a liquid CO_2 -cooled miniature high-low temperature chamber, model C-106, for use in environmental simulation tests of electronic, missile and aerospace components. Test volume is 640 cu. in. Weight is 55 lb. Temperature range is from -100 F to $+500\text{ F}$ with an accuracy of control of $\pm 0.5\text{ F}$.

CIRCLE 421 ON READER SERVICE CARD

Direct Drive Counters LOW TORQUE

VEEDER-ROOT INC., 70 Sargeant St., Hartford 2, Conn., offers a line of high performance, low torque, direct drive counters for digital read-out applications where plus and minus, right and left, or directional readings are required. They are

designed for applications in navigation instruments, missile ground support equipment, ground approach systems, machine tool indicators, gaging instruments and tracking equipment.

CIRCLE 422 ON READER SERVICE CARD

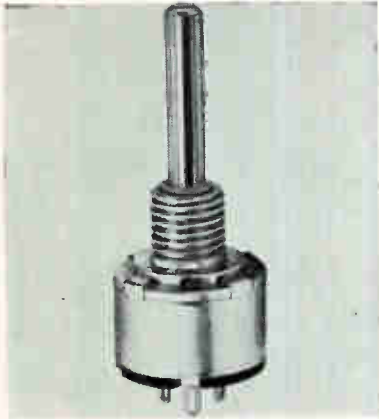

Potentiometer
MOLDED CARBON

CLAROSTAT MFG. CO., INC., Dover, N. H. Series 63M is a $\frac{1}{2}$ in. molded carbon potentiometer designed to fill the need for reliability and electrical quietness required in better grades of commercial equipment. It is available in a wide range of resistance values.

CIRCLE 423 ON READER SERVICE CARD

Ratio Box

NORTH ATLANTIC INDUSTRIES, INC., Plainview, N. Y. Miniature, auto tapped transformer offers a ratio range of 0.000 to 1.1110 at 50 cps to 3000 cps.

CIRCLE 424 ON READER SERVICE CARD



P-C Card Enclosure
ALUMINUM CONSTRUCTION

ELCO CORP., "M" St. below Erie Ave., Philadelphia 24, Pa. Varipak II printed circuit card enclosure is designed to be adapted to any packaging technique utilizing printed or etched circuitry, and to provide

CIRCLE 185 ON READER SERVICE CARD →

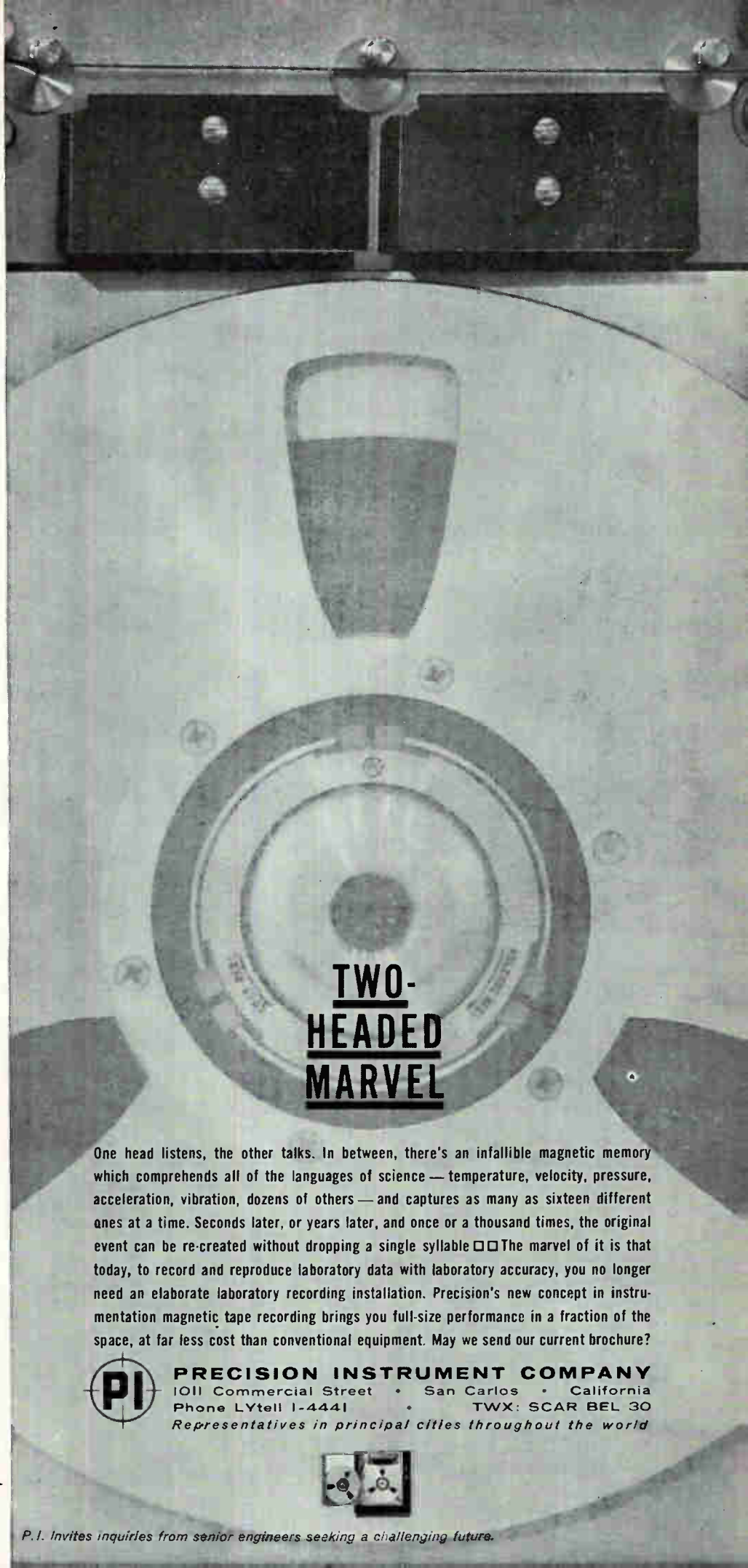

**TWO-
HEADED
MARVEL**

One head listens, the other talks. In between, there's an infallible magnetic memory which comprehends all of the languages of science — temperature, velocity, pressure, acceleration, vibration, dozens of others — and captures as many as sixteen different ones at a time. Seconds later, or years later, and once or a thousand times, the original event can be re-created without dropping a single syllable □□ The marvel of it is that today, to record and reproduce laboratory data with laboratory accuracy, you no longer need an elaborate laboratory recording installation. Precision's new concept in instrumentation magnetic tape recording brings you full-size performance in a fraction of the space, at far less cost than conventional equipment. May we send our current brochure?



PRECISION INSTRUMENT COMPANY
1011 Commercial Street • San Carlos • California
Phone LYtell 1-4441 • TWX: SCAR BEL 30
Representatives in principal cities throughout the world



P.I. invites inquiries from senior engineers seeking a challenging future.

MULTIPLE BANDWIDTH TELEMETRY RECEIVER NEMS-CLARKE 1455



(1) PCM or any other conventional IRIG telemetry signal in the 215-280 mc band may be received and demodulated with traditional Nems-Clark reliability.

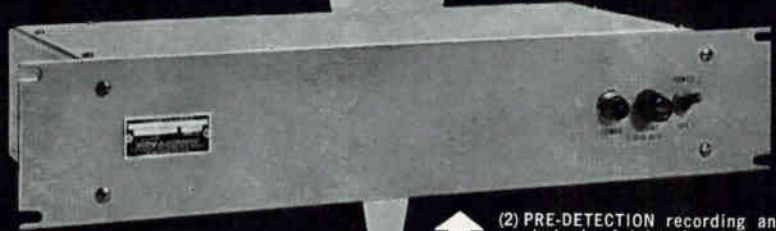

(2) PRE-DETECTION recording and playback of telemetry data are standard features of the 1455 receiver when used with Type IFC-1400 Pre-Detection Converter shown above, and a suitable wide-band tape recorder.

The ease and speed of changes in IF bandwidth, and interchangeability of modules, makes this receiver the most versatile of Nems-Clarke 1400 series telemetry receivers.

This receiver is unique because it offers a variety of plug-in IF demodulator modules which plug into front panel to determine operating IF bandwidth of receiver. Each module is interchangeable with the others without disturbing the level adjustments of receiver, since each module provides output voltages and meter deflections of essentially the same percentage of bandwidth. Thus, one basic receiver chassis serves to cover bandwidth ranges from 30 kc to 1.5 mc in nine separate bandwidths.

Pre-Detection Feature—In addition to the usual standard outputs for connection to auxiliary equipments (such as signal strength, video frequency response, frequency monitor and spectrum display), this receiver has a 5 mc pre-detection recording output and playback input. When the output is connected to a Pre-Detection Converter, Nems-Clarke Type IFC-1400, and a recorder, telemetry data can be recorded prior to demodulation and stored for subsequent playback and demodulation.

Modules for the receiver may be obtainable separately as required in the following IF bandwidths: 30, 50, 100, 200, 300, 500, 750 kc; 1.0 and 1.5 mc.

Vitro ELECTRONICS A DIVISION OF VITRO CORPORATION OF AMERICA
PRODUCERS OF **NEMS-CLARKE** EQUIPMENT
819 JESUP-BLAIR DRIVE, SILVER SPRING, MARYLAND / 2301 PONTIUS AVENUE, LOS ANGELES 64, CALIFORNIA

maximum density. It holds the p-c boards and p-c connectors in correct alignment; and company says its adaptability to any packaging program is universal.

CIRCLE 425 ON READER SERVICE CARD

DPDT Chopper

MINIATURIZED

THE BRISTOL CO., Waterbury 20, Conn. Miniature dpdt chopper operates at 400 cps. Action is "make before-break after". Tracking is excellent; the maximum difference in phase lag is 3 deg. Vibration limit is 30 g, 0-2,000 cps.

CIRCLE 426 ON READER SERVICE CARD

Transducer

SERVONIC INSTRUMENTS INC., 1644 Whittier Ave., Costa Mesa, Calif. A 1.7 oz potentiometer transducer for severe environments withstands 100g acceleration.

CIRCLE 427 ON READER SERVICE CARD



Muffin Fan

LOW-COST

ROTRON MFG. CO., INC., Woodstock, N. Y. The Gold Seal muffin fan moves 100 cfm under free delivery conditions, operates on 110 v a-c, and is available as a skeleton, venturi, grilled, or filtered fan. A new grille, featuring an aerodynamic design, significantly reduces noise level, and eliminates dust collecting.

CIRCLE 428 ON READER SERVICE CARD

Hydrogen Diodes

CERAMIC-METAL

EDGERTON, GERMESHAUSEN & GRIER, INC., 160 Brookline Ave., Boston, Mass. High-power, high-voltage diodes for use as grid-controlled

rectifiers, hold-off diodes, inverse clippers and back-swing clippers. Compact, light, rugged. Will withstand severe shock, vibration and temperature extremes.

CIRCLE 429 ON READER SERVICE CARD

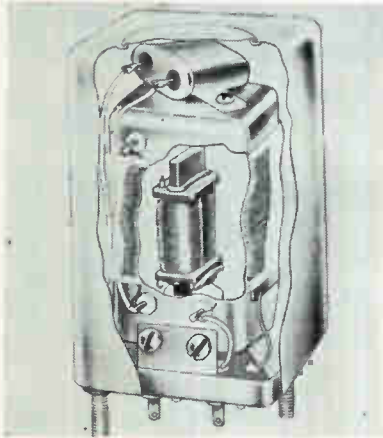

Variable Inductor OVENIZED

VARI-L CO., INC., 207 Greenwich Ave., Stamford, Conn. Model OM-101 has a built-in heater that holds frequency drift to less than 1 percent over a wide range of ambient temperatures. Based on 1-w control power, it has a range of 10 Mc to 20 Mc minimum, and 40 Mc to 80 Mc maximum. Maximum inductance is 1.6 μ henries, with 0.4 μ henry inductance at saturation.

CIRCLE 430 ON READER SERVICE CARD

Counter Module

BURROUGHS CORP., P. O. Box 1226, Plainfield, N. J. Transistorized, 1 Mc counter module features 10 electrical outputs, few active components.

CIRCLE 431 ON READER SERVICE CARD



Coaxial Connectors MINIATURIZED

GENERAL RF FITTINGS, INC., 702 Beacon St., Boston 16, Mass., offers weather-proof, 3-pin, bayonet coup-

noise problem:

Silence the switching action of a 7½-hp refrigeration compressor motor starter aboard the submarine U.S.S. *Ethan Allen*. Design a small, lightweight motor starter that's noiseless, operationally infallible, unaffected by shock, vibration and corrosion.

solution:

Westinghouse designed and built a static motor controller for Electric Boat Division, General Dynamics Corporation, Groton, Conn. Completely silent. No moving parts. Oscillograms at impact show no evidence of distortion or interruption of the a-c power to the motor. Unit is quickly and easily interchangeable with its conventional electromechanical counterpart. Response: ½ cycle, faster than any controller available today. Retains original electrical characteristics without attention, even after 3¼ million operations. All parts hermetically sealed or encapsulated. To meet your specific electronic requirements, contact your Westinghouse sales engineer. Or write: Westinghouse Electric Corporation, P.O. Box 868, Pittsburgh 30, Pa. *You can be sure . . . if it's Westinghouse.*

J-92515

Westinghouse

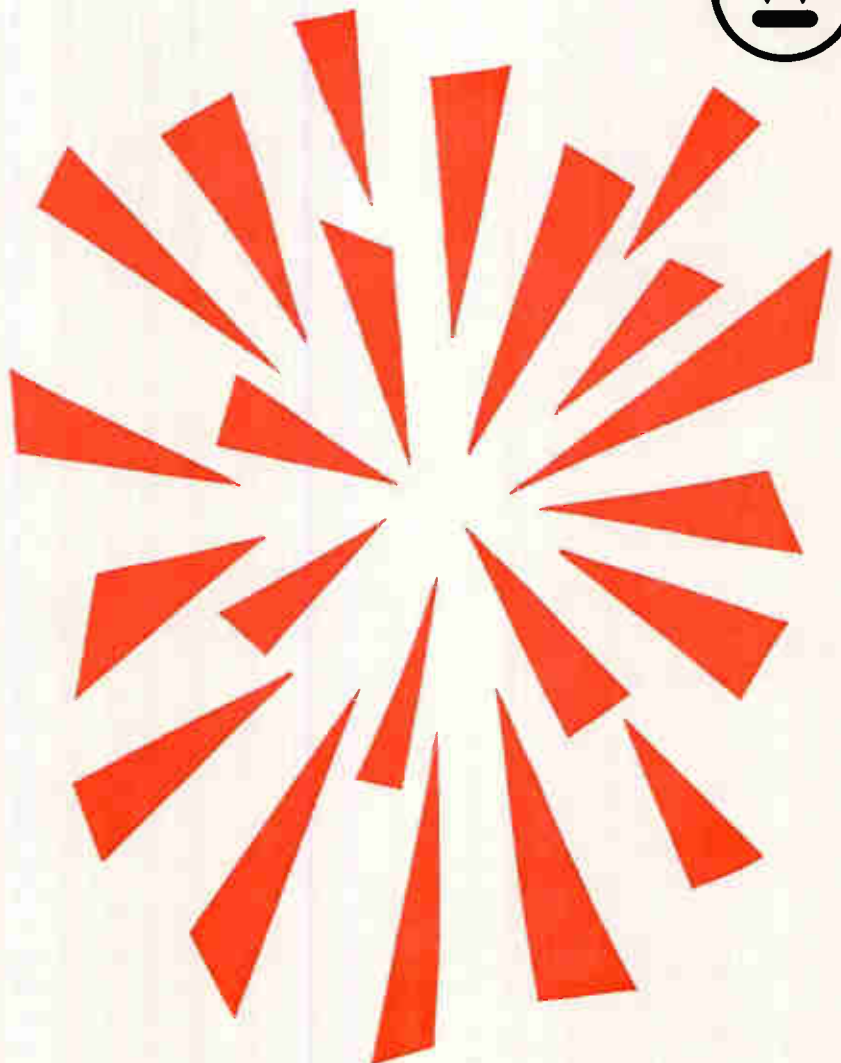



AT WESCON
BOOTH 4415

is

UNDERWATER

If you want to discuss the latest technical innovations or problems in ASW and underwater engineering, members of Integron's technical staff will be available for confabs, conversations, conferences and consultations at Wescon Booth 4415.

Over the last ten years Integron, Inc., a subsidiary of Tang Industries, has devised, developed and delivered a wide range of ASW equipment to industry and government.

A list of these projects and devices would include electromagnetic and acoustic flowmeters, underwater sound detection devices, ASW engineering services and prototype manufacture of numerous classified equipment.

If your interests are more in the solid state, other technical personnel will be glad to discuss Integron's capability in producing semiconductor strain gages, semiconductor materials and special purpose computers.

Other areas of proven Integron expertness include technical publications, molecular electronics and prototype manufacture.

Members of the technical staff from two Tang Industries, Inc. subsidiaries—Integron, Inc. and Tang Semiconductor Materials—invite you to discuss your problems with them.

If you do not plan to attend WESCON, contact:

N. A. PAGANI
Sales Manager
409 Main Street
Waltham, Massachusetts

ling, quick-connect/disconnect TPS series miniature coaxial connectors. They are designed to produce minimum electrical discontinuities in a solid dielectric coaxial cable of characteristic impedance 50 ohms up to a frequency of 10,000 Mc and rated at 500 v rms at sea level. Operating temperature is from -65 F to +260 F.

CIRCLE 432 ON READER SERVICE CARD

Industrial Laminates

GENERAL ELECTRIC CO., Laminated Products Dept., Coshocton, Ohio. Five grades include a self-extinguishing epoxy-glass laminate for application requiring cyanide plating.

CIRCLE 433 ON READER SERVICE CARD

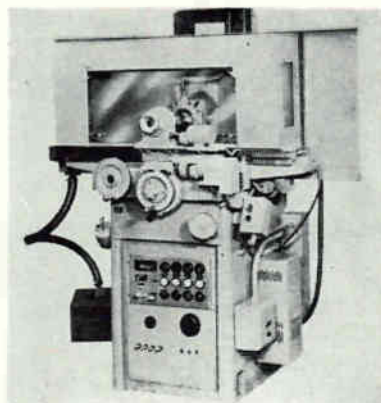

Slicer

VARIABLE SPEEDS

REID BROTHERS CO., INC., 140 Elliott St., Beverly, Mass. Model 612 slicer eliminates machine variables in slicing silicon, germanium or many other types of semiconductor material. It has a cross-feed index within ± 0.0001 . Application of the Post electronic counter controls the repeatability accuracy of the cross-feed increment. Features include variable speed, faster "slug set-up" and easy to read dial settings.

CIRCLE 434 ON READER SERVICE CARD

Resistance Wire

FOR POTS, RESISTORS

DRIVER-HARRIS CO., Harrison, N. J., introduces improved Karma resistance wire with greater long term stability. Principal use of Karma wire is in the manufacture of precision pots and resistors. It has

ERIE
Instrumentation
MODEL 925
... the counter that remembers!!



SOLID STATE
20 MC
UNIVERSAL COUNTER-TIMER

All new . . . the rugged, compact Model 925 is designed to offer the ultimate in reliable counting of periodic or random electrical events and precise measurement of Frequency, Period and Time Intervals. Built-in memory provides readout storage, continuous display while counting, more frequent sampling and less operator eye fatigue. Modular construction.

OUTSTANDING FEATURES:

- IN-LINE NIXIE READOUT
- 8 DIGIT MEMORY — No Blinking
- SENSITIVITY — .1V RMS — All 3 Channels
- THREE DC AMPLIFIERS
- HIGH INPUT IMPEDANCE
- AUTOMATIC DECIMAL POINT
- ONLY 3 1/2" RACK SPACE (Model 925-R)
- DECADE TIME BASE — No Adjustments
- STABILITY — 1 Part In 10⁸/Day; 5 Parts In 10⁸/Week



ONE HAND PORTABILITY

Write today for complete specifications on the Model 925 or Model 925-R (Rack Model) — the ideal instrument for laboratory or industrial applications.

Quality Where It Counts
ERIE
Instrumentation
ERIE-PACIFIC, DIV. OF ERIE RESISTOR CORP.
12932 South Weber Way, Hawthorne, Calif.
ORegon 8-5418 • TWX HAW CAL 4006

CIRCLE 288 ON READER SERVICE CARD
electronics

new standard limits for temperature coefficient of resistance of ± 5 parts per million per deg C. Other benefits are (1) negligible change in temperature coefficient after winding and processing, (2) extremely high linearity, and (3) greater tensile strength.

CIRCLE 435 ON READER SERVICE CARD



Ultrasonic Cleaners FULLY TRANSISTORIZED

ACOUSTICA ASSOCIATES INC., 10400 Aviation Blvd., Los Angeles 45, Calif. The SC (semiconductor) line of ultrasonic cleaning systems operate on 20 Kc frequency. Tank sizes range from 1 to 25 gallons, with generator powers rated at from 100 to 2,500 w, in the standard off-the-shelf line. The light-weight systems offer a choice of selectable power levels, provide automatic compensation for load and liquid levels, and require no warm-up time, limited maintenance.

CIRCLE 436 ON READER SERVICE CARD

Data Acquisition

DATEX CORP., Monrovia, Calif. System collects accounting and production facts as they occur, connects up to 50 input stations.

CIRCLE 437 ON READER SERVICE CARD

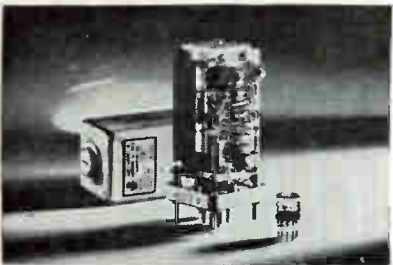

Frequency Standard ULTRASTABLE

JAMES KNIGHTS CO., Sandwich, Ill. The JKTO-42 frequency standard is an ultrastable, compact, plug-in transistorized oscillator with a stability of 5×10^{-9} /day. Unit is a low-drive-level, current limiting os-

BALLANTINE Battery-Powered Vacuum Tube VOLTMETER

model
302C

Price: \$255



**MEASURES
VOLTAGES
100 μ V
to 1000V at**

Frequencies from 2 cps to 150 kc

This is a vacuum tube voltmeter capable of measuring 100 microvolts to 1000 volts in seven decade ranges with an accuracy better than 3% at any point on the scale. No other battery-operated instrument on the market meets this performance. It may be used as a hum-free amplifier with a maximum gain of 60 db, a high input impedance and an equivalent short-circuit input noise of less than 10 microvolts, which is considerably better than a transistorized amplifier with similar input impedance and band-pass. Panel controls are available to vary the preamplifier gain continuously or to select the more appropriate of two meter damping positions. Excellent as a null detector. Battery life exceeds 100 hours of normal operation.

SPECIFICATIONS

Voltage Range..... 100 μ V-1000 V Input Impedance..... 2 M Ω shunted by
Frequency Range..... 2 cps-150 kc 10 pF or 25 pF
Accuracy 3% 5 cps-100 kc Noise Level..... Less than 10 μ V referred to
and 5% elsewhere ANY POINT ON SCALE shorted input circuit

Scales... Logarithmic voltage scale from 1-10;
linear decibel scale from 0 to 20

Write for brochure giving many more details

— Since 1932 —

B BALLANTINE LABORATORIES INC.

Boonton, New Jersey

CHECK WITH BALLANTINE FIRST FOR LABORATORY AC VACUUM TUBE VOLTMETERS, REGARDLESS OF YOUR REQUIREMENTS FOR AMPLITUDE, FREQUENCY, OR WAVEFORM. WE HAVE A LARGE LINE, WITH ADDITIONS EACH YEAR. ALSO AC-DC AND DC-AC INVERTERS, CALIBRATORS, CALIBRATED WIDE BAND AF AMPLIFIER, DIRECT-READING CAPACITANCE METER, OTHER ACCESSORIES. ASK ABOUT OUR LABORATORY VOLTAGE STANDARDS TO 1,000 MC.

*Why Varian's
G-10 Potentiometer Recorder
is the*



PRACTICAL RECORDING CHOICE

This recorder has gained an enviable reputation over the years for performing reliably in every recording chore within its capabilities. It owes nothing to styling but the dictates of practicality and delivers performance to match — 10 to 100 mv d.c. full scale; sixteen chart speeds from 1"/hr. to 16"/min.; 1% accuracy and 1/4%-of-span sensitivity; 1 or 2 1/2 second full scale balance time; economical 5" charts with a flat platen for easy note-making. Prices — from \$385.00. Fast delivery; parts and service — world-wide.

Consider the rightness of the G-10 — a potentiometer recorder that has stood the test of time, use and acceptance.

For details, write Instrument Division:

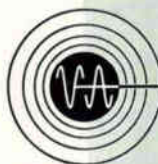

VARIAN associates
PALO ALTO 1, CALIFORNIA

NMR & EPR SPECTROMETERS, MAGNETS, FLUXMETERS, GRAPHIC RECORDERS, MAGNETOMETERS, MICROWAVE TUBES,
MICROWAVE SYSTEM COMPONENTS, HIGH VACUUM EQUIPMENT, LINEAR ACCELERATORS, RESEARCH AND DEVELOPMENT SERVICES

cillator designed for laboratory or plant environment. It is available on special order in frequencies up to 5 Mc.

CIRCLE 438 ON READER SERVICE CARD



Planetary Lappers PRECISION MACHINES

DALLONS LABORATORIES, INC., 5066 Santa Monica Blvd., Los Angeles, Calif. Two precision planetary lappers for semiconductor crystal processing feature parallelism within five millionths of an inch and a high degree of flatness. One model will lap 10 slices, up to a maximum size of 1 1/4 in. in diameter, or 60 smaller slices, to a thickness of 0.008 in. The other can lap 17 slices up to 1 in. in diameter or 51 smaller slices to a thickness of 0.003 in.

CIRCLE 439 ON READER SERVICE CARD

Latching Relay

C. P. CLARE & CO., 3101 Pratt Blvd., Chicago 45, Ill. Subminiature magnetic latching relay, two coil, is sensitive to 150 mw per coil.

CIRCLE 440 ON READER SERVICE CARD

Receiver/Decoder COMMAND-DESTRUCT

RS ELECTRONICS CORP., P.O. Box 11368, Station A, Palo Alto, Calif. Command-destroy receiver/decoder package for missiles is contained in a watertight assembly, designed to operate in severe missile environments (-55 C to +72 C, 20 g vibration, 100 g acceleration, 100 g shock) with a minimum sen-

sitivity of -90 dbm. Receiver frequency range is 406-549 Mc. Interlocked decoder provides a destruct signal when 3 tones are received in a predetermined combination and sequence.

CIRCLE 441 ON READER SERVICE CARD

Counter-Timer

ERIE-PACIFIC, Div. of Erie Resistor Corp., 12932 S. Weber Way, Hawthorne, Calif. Solid state, 20 Mc counter has built-in memory, 8 digit inline readout.

CIRCLE 442 ON READER SERVICE CARD

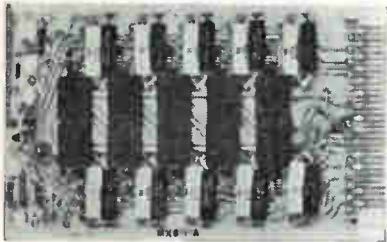

Multiplexer

50-CHANNEL

ADAGE INC., 292 Main St., Cambridge 42, Mass. The MXV5 is a 50-channel version of the Adage series of high-speed all solid state, precision multiplexers. This series is capable of switching rates of over 20,000 independent samples per sec. Illustrated is a 10 channel multiplexer 5 in. by 8 in. p-c card. Five such cards comprise the MXV5.

CIRCLE 443 ON READER SERVICE CARD

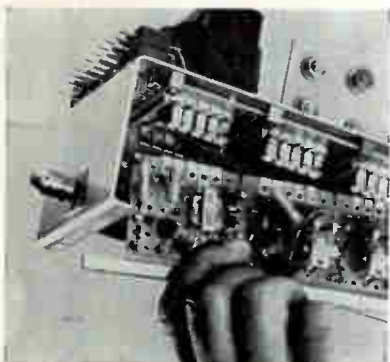

Crossover System

MODULAR CONCEPT

ALDEN PRODUCTS CO., 117 N. Main St., Brockton, Mass. Crossover system permits solderless interconnections between chassis and terminal card modules, providing true plug-

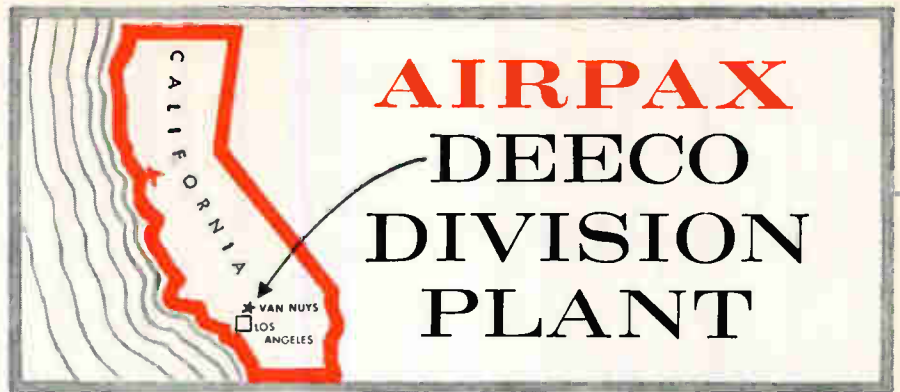

AIRPAX DEECO DIVISION PLANT

The new Airpax Deeco Division, formerly Deeco Instruments, Inc., manufactures a complete line of magnetic components and telemetry discriminator systems, both bandswitching and single channel types. Products include high-pass, low-pass and band-pass filters; toroidal chokes and transformers; standard and custom power transformers and frequency discriminators.



TOROIDS

Subminiature, Miniature and Standard Sizes



FILTERS

High-Pass, Low-Pass and Band-Pass Types



TELEMETRY EQUIPMENT

Telemetry Signal Analyzers and Discriminators

Displaying at WESCON and ISA



OC31

AIRPAX ELECTRONICS, INC. OF CALIFORNIA
DEECO DIVISION, 14737 ARMINTA STREET, VAN NUYS, CALIFORNIA

JUST OUT

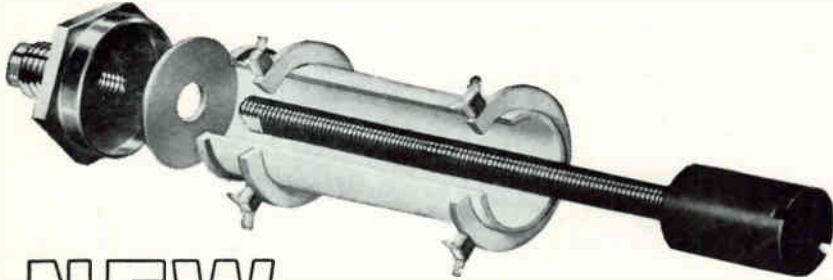

NEW TERMINAL

DESIGN ON ALL THE

Delevan Deleforms

THE INDUSTRY'S FINEST

VARIABLE INDUCTOR COIL FORMS

"Y" type terminal tabs



- Each terminal has two rigid tabs for circuit connections.
- Completely safe as terminal is insulated from coil form by a fiberglass collar.
- Coil winding connections are made to base of terminal leaving tabs clean and free for attachments.
- Solder connections are easily made on the "Y" type terminal tabs.

ALSO Introducing



SERIES 200
TAPER-LOCK



SERIES 220
TORK-TITE

Two New Series to the Industry's Widest Range of Standard Molded Coils

Series 200 and 220

MOLDED VARIABLE COILS

These Variable Coils are completely molded for maximum protection and reliability. Series 200 has a small taper nut for positively locking the insert core. Series 220, the Tork-Tite, has a split coupling of unique design which guarantees optimum torque yet cannot bind or freeze. The case design of either Series permits use for chassis mounting or for printed circuit applications. Standard values from .15uh to 36MH.

DELEVAN ELECTRONICS CORPORATION



77E-1 OLEAN ROAD • EAST AURORA, NEW YORK

in/snap-out circuit planes. Cross-over connector blocks mount to underside of chassis and hold circuit cards which carry all interconnections between terminal cards and chassis-mounted components to single point for input/output at back connectors.

CIRCLE 444 ON READER SERVICE CARD

Speed Control

INSTRUMENT DEVELOPMENT LABORATORIES, INC., 67 Mechanic St., Attleboro, Mass. D-c motor speed control, 28 v, holds speed to 2 percent regulation.

CIRCLE 445 ON READER SERVICE CARD

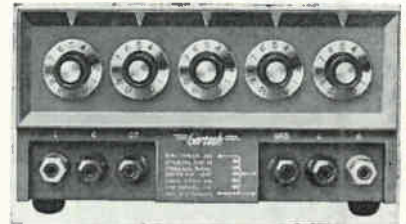

Ratio Transformer

GENERAL PURPOSE

GERTSCH PRODUCTS, INC., 3211 S. La Cienega Blvd., Los Angeles 16, Calif. The RT-60 bench model general purpose ratio transformer is a precision inductive a-c voltage divider featuring: high input impedance, low effective series impedance, and very low phase shift. Accuracy is 0.001 percent, and is traceable to the National Bureau of Standards. Operating range is 50 cps to 10 Kc; price, \$275.

CIRCLE 446 ON READER SERVICE CARD



Delay Line

VARIABLE TYPE

PCA ELECTRONICS, INC., 16799 Schoenborn St., Sepulveda, Calif. Straight variable delay line meets Mil-Standard 202 specs covering shock, vibration, moisture resistance and salt spray. It operates over a temperature range from -55 C to +105 C. Production models have an impedance range of

from 500 to 1,000 ohms, coupled with a delay range of from 0.2 μ sec min to a max of 1 μ sec.

CIRCLE 447 ON READER SERVICE CARD



Receiver-Decoder

INTERLOCK CHANNEL

BABCOCK ELECTRONICS CORP., 1640 Monrovia Ave., Costa Mesa, Calif. Compact BRC-47A receiver-decoder for unmanned aircraft offers f-m crystal controlled operation in 406 to 549.5 Mc range with 10 audio control channels. Unit features solid state/printed circuit design and carrier operated relay.

CIRCLE 448 ON READER SERVICE CARD

Nuvistor Tube

RCA, 30 Rockefeller Plaza, New York 20, N. Y. High- μ triode tube has semiremote cutoff characteristic.

CIRCLE 449 ON READER SERVICE CARD



Coil Winder

WITH DIGITAL READ-OUT

UNIVERSAL MFG. CO., INC., 1168 Grove St., Irvington, N. J., announces a toroidal winding machine which a fully transistorized in-line digital read-out counter which operates on a simple photocell principle minimizing maintenance. Number of turns applied to the coil flash onto the screen above. The 1C-601 inductance comparator monitors the winding of a coil directly to preset inductances at high

air density problem:

Design light, compact ionization gages to measure atmospheric pressure and density 125 miles up. Gages must withstand acceleration and vibration during initial launch, yet be sensitive enough to measure thousandths of millimeters of mercury.

solution:

Westinghouse built several ionization gages for NASA's Aerobee-Hi Sounding rocket. One of these gages, tested at Wallops Island, Va., gained direct measurements of pressures and densities at 70 to 125 miles up. With a sensitivity range of 1×10^{-3} to 1×10^{-10} mm of mercury, the gages are expected to record data in the thin atmospheres of near space. To achieve this, Westinghouse developed tube elements of extremely low mass, as well as new techniques for mounting them. For help in resolving your avionic problems, contact your Westinghouse sales engineer. Or write: Westinghouse Electric Corporation, P.O. Box 868, Pittsburgh 30, Pennsylvania. *You can be sure . . . if it's Westinghouse.*

J-92517

Westinghouse

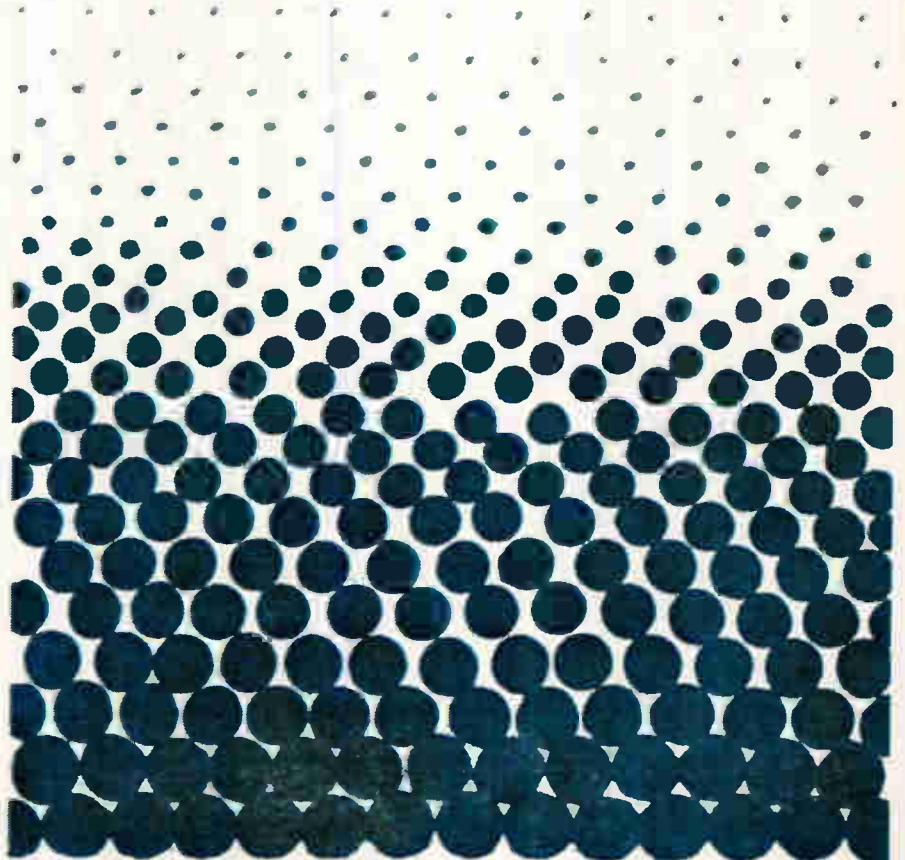

reliability...



METAL FILM POTENTIOMETERS

Compare your requirements with the performance of Mechatrol's precision metal film potentiometers. These vacuum deposited film potentiometers provide characteristics that are outstanding when compared with other types of rotary potentiometers. Resolution is better than .005% with reliability an order of magnitude better than achieved in conventional units. Mechatrol's metal film potentiometers provide superior wear and rotational life under conditions of high ambient temperature and severe vibration and shock.

THESE UNITS ARE IN CURRENT PRODUCTION.

Standard units measure 1.062 inches in diameter and are available for servo or panel mounted application. They may also be supplied as single or multiple ganged assemblies.

FEATURES:

- **Resolution** ... Better than .005%
- **Temperature** ... -55°C to $+200^{\circ}\text{C}$.
- **Linearity** 1.0% (to tighter tolerances available for special applications)
- **Vibration** 10 g's, 10 - 2000 C.P.S.
- **Rotational Life** ... 2,000,000 cycles @ speeds up to 90 R.P.M.

Write for full details.

SM/I

SERVOMECHANISMS/INC.

MECHATROL DIVISION

1200 Prospect Avenue, Westbury, New York

MECHATROL OF CALIFORNIA, 200 North Aviation Blvd., El Segundo, California

volume on powdered permalloy or ferrite cores.

CIRCLE 450 ON READER SERVICE CARD



Digital Voltmeter

INSTANT READING

FRANKLIN ELECTRONICS INC., Bridgeport, Pa. Model 550 digital voltmeter features a range of 0.0001 to $\pm 1,200$ v at an accuracy of ± 1 count. Other specifications include automatic polarity indication, effectively infinite input impedance, instantaneous reading. Modular plug-in construction is used throughout. Price is \$1,370.

CIRCLE 451 ON READER SERVICE CARD

Voltage Calibrator

ELECTRO SCIENTIFIC INDUSTRIES, 7524 S. W. Macadam Ave., Portland 19, Ore. Two dial test instrument checks calibration adjustments of d-c voltmeters.

CIRCLE 452 ON READER SERVICE CARD



Latching Relays

MICROMINIATURE

FILTERS, INC., Port Washington, N. Y. Type PL Microlatch is a dual-coil, rotary-motor relay with the standard S-type header configuration. Relay will maintain its switch position, without consuming power, under vibration forces of 20 g to 2,000 cps and shock forces of 50 g (for 11 milliseconds). Units are 2 pdt, are hermetically sealed and can be supplied with contacts

rated for 2 amperes resistive or for dry-circuit use.

CIRCLE 453 ON READER SERVICE CARD

Oscilloscope Camera

BEATTIE-COLEMAN, INC., 1004 N. Olive St., Anaheim, Calif. Camera system for oscilloscope photography selects any object-to-image ratio from 1:1 through 1:0.5 without extra lenses.

CIRCLE 454 ON READER SERVICE CARD

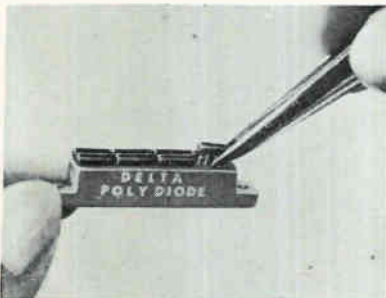

Multiple Diode

REDUCES CIRCUIT SIZE

DELTA SEMICONDUCTORS, INC., 835 Production Place, Newport Beach, Calif. The plug-in Poly-Diode consists of up to five separate diode junctions, each with an individual lead, formed on a single silicon slice in a computer gate configuration. The entire circuit is glass encapsulated in a package about the size as an ordinary single diode. Eight Poly-Diodes can be plugged into a special micro plug. Each micro plug with 8 quad Poly-Diodes contains 32 diode junctions and measures 0.160 by 1.5 in.

CIRCLE 455 ON READER SERVICE CARD



Hermetic Connectors

WITH SOCKET CONTACTS

THE DEUTSCH CO., Banning, Calif., has developed a quick-disconnect hermetic receptacle with socket contact insert configurations. This connector features a full compression

This Tape Recording shows the actual deviations in Linearity of Resistance present in a representative length of .0014" Chromel-R wire having a total of 105,750 ohms. Note that greatest change recorded was 6 ohms—which is well within Hoskins Guarantee of .012% maximum deviation in any 250 feet.

How close linearity of wire resistance improves Potentiometer performance

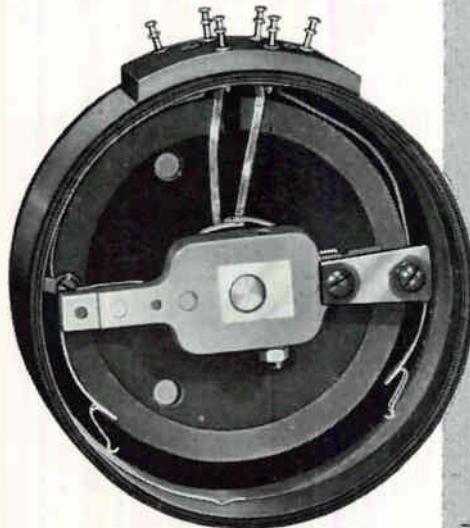

Basic Function of a potentiometer is to control voltage in a circuit by varying electrical resistance. Thus use of wire which possesses superior controlled Linearity of Resistance assures finer accuracy and reliability of operation proportional to shaft rotation.

Three reasons why you should specify

Hoskins Chromel-R

Premium Potentiometer Grade 800-Ohm Wire

First, its fine linearity of resistance is controlled to the closest standard of uniformity ever established for potentiometer wire as specified above. Second, it is unconditionally guaranteed to have less than 40 ohms of equivalent noise resistance when received at your plant. And third, it possesses the superior wire roundness required for more uniform winding of mandrels.

Sample spools of Chromel-R with detailed technical data are now available to potentiometer manufacturers for evaluation. Requests on company letterhead will receive prompt attention.

HOSKINS MANUFACTURING CO.

4445 Lawton Avenue • Detroit 8, Michigan • Tyler 5-2860

In Canada: Hoskins Alloys of Canada, Ltd., Toronto, Ontario

Producers of Custom-Quality Electrical Resistance, Resistor and Thermoelectric Alloys Since 1908

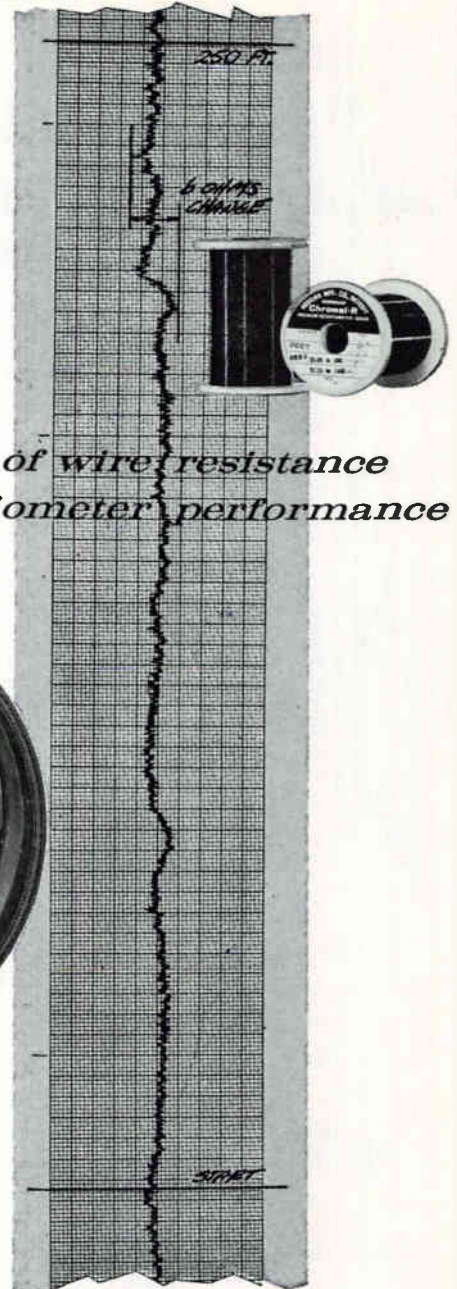
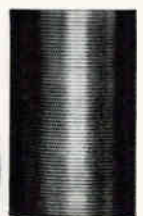

...variations
on a
theme

POWER



BR-12P (case removed)

In one versatile new BR-12 micro-miniature series, Babcock offers relay types suitable to a wide range of novel uses in extreme environments. The BR-12P is an especial boon to those designing for both sides of the component card due to low profile and side header mounting arrangement. A second type, the BR-12K, provides sensitivity down to 20 mw. Both types have contacts rated at dry circuit through 3 amps resistive. Performance characteristics are generally shared with other types in the BR-12 Series. All are available with activated getter material, providing lifetime prevention of contamination effects at dry circuit to rated current on contacts.

You are invited to request complete technical data.



BR-12

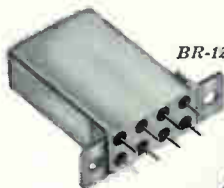

BR-12K

SENSITIVE

PERFORMANCE CHARACTERISTICS - BR-12 SERIES

Contact Rating: 3 amps resistive @ 32 VDC Standard

Vibration: Minimum 30g to 3000 cps, to 50g on special units.

Shock: Standard, 75g or special, 125g.

Temperature: -65°C to +125°C

Note: All Babcock Relays are checked out for leakage rate of 10⁻⁹cc per second on mass spectrometer

BABCOCK RELAYS, INC.

1645 Babcock Avenue
Costa Mesa, California

glass insert on the rear and a resilient silicone insert, front. The coupling mechanism is of the push-pull, ball-lock type. The DM5600 series connector is available in six different shell sizes and in a wide choice of insert configurations.

CIRCLE 456 ON READER SERVICE CARD

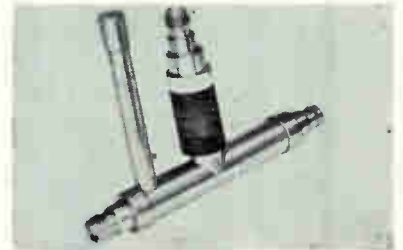

**Coax Crystal Mixers
LIGHTWEIGHT**

MICROLAB, 570 W. Mt. Pleasant Ave., Livingston, N. J. The XR series single-ended coaxial crystal mixers are designed to cover the 225 to 6,000 Mc region in seven overlapping frequency ranges. They are fixed tuned and require no r-f adjustment over the specified frequency bands. They feature a low noise figure, optimum conversion loss and a compact, lightweight design suited for airborne and other military applications.

CIRCLE 457 ON READER SERVICE CARD

Resistors

INTERNATIONAL RESISTANCE CO., 401 N. Broad St., Philadelphia 8, Pa. DM and EM 1/10 w resistors make available RN55 precision film units in RCO7 size.

CIRCLE 458 ON READER SERVICE CARD



**Silver-Zinc Battery
ACTIVATES IN 1 SEC**

POWER SOURCES, division of Telecomputing Corp., 3850 Olive St., Denver, Colo. Auxiliary power for an ICBM decoy system is available

with an automatically activated primary silver-zinc battery model P134A. Highly reliable piston-tank mechanism activates the battery in less than 1 sec. Battery measures 2½ by 4 by 6 in. and weighs 3 lb. It exceeds environmental requirements of MIL-E-5272.

CIRCLE 459 ON READER SERVICE CARD

Power Supply

SORENSEN PRODUCTS, Richards Ave., South Norwalk, Conn. Power supply output ranges to 36 v, features regulation of ± (0.01 percent plus 1 mv), and ripple of 0.5 mv rms maximum.

CIRCLE 460 ON READER SERVICE CARD



Frequency Comparator FOR PROCESS CONTROL

DAYSTROM - WIANCKO ENGINEERING CO., 255 N. Halstead Ave., Pasadena, Calif., has designed an all solid-state frequency comparator, type 35-2001, to control a function in process systems where the parameter to be controlled can be expressed as a frequency. A wide range of parameters, including rpm, flow rate, temperature, pressure, force, and acceleration can be accommodated. Input frequency range, 1 cps to 50 Kc.

CIRCLE 461 ON READER SERVICE CARD

Hook-Up Wire TEFLON INSULATED

TENSOLITE INSULATED WIRE CO., INC., Tarrytown, N. Y. Extruded Teflon insulated hook-up wire, for continuous operation at 260 C is available. It meets all requirements

CUSTOMIZE EFFICIENCY & ACCURACY WITH **trio/lab** BUILD-IN INSTRUMENTS...

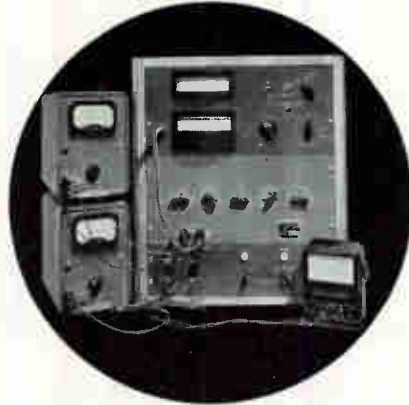

BEFORE . . . 3 external instruments were used to measure AC and DC voltages . . . cluttered, tedious, wasteful, subject to error.



AFTER . . . 3 trio/lab miniature VTVMs integrally built-in now are always on hand to measure just the parameters you designate.

the industry's pioneer complete line of Miniaturized Electronic Instruments

MILITARY

COMMERCIAL

<p>Model 102 (formerly B series) ruggedized single-range AC VTVMs \$160.</p>	<p>for MIL-T-21200B & MIL-T-945A applications.</p> 		<p>Model 104 (formerly E series) Single-range AC VTVMs \$99.50</p>
<p>Model 103 (formerly C series) ruggedized multi-range AC VTVMs \$272.</p>			<p>Model 109-1 low-level multi-range DC VTVM \$199.</p>
<p>Model 106 (formerly G series) ruggedized single or multi-range DC VTVMs from \$136.</p>			<p>Model 105 (formerly F series) single or multi-range DC VTVMs from \$84.50</p>
<p>Model 107 (formerly J series) ruggedized low-level multi-range DC VTVMs \$450.</p>			<p>Model 130-1 1% accuracy AC VTVM \$150.</p>

By building-in trio/lab panel-mounting instruments you . . . customize test systems, set-ups and instruments; save space (average model is 4" x 4" x 4"); save time with at-a-glance monitoring; save money; make monitoring foolproof ("go/no-go"); improve system reliability; increase overall design freedom. Choose from many "standard" or "special" models — or consult us for new designs for your needs. Write for free "how to" Engineering Guide.

trio/lab

TRIO LABORATORIES, INC.,
Plainview, Long Island, N. Y. • TWX HKVL 1166
Overbrook 1-0400 Area Code 516
Export: EMEC, 127 Grace St., Plainview, N. Y.

See Trio at Wescon Booth 917

ANELEX®

In data processing installations, where quality and volume of document production are critical, Anelex High Speed Printing Systems have consistently demonstrated unequalled speed and reliability.



The National Defense Communications Control Center, which was designed by Philco Corporation, includes three special Anelex High Speed Printing Systems.



Further information available upon request
ANELEX CORPORATION
156 Causeway Street, Boston 14, Massachusetts.

of MIL-W27300 (USAF). Nickel plated copper conductors, manufactured to extremely close dimensional and resistance tolerances, are used. And, the insulation is subjected to a rigid abrasion test. Sizes from Awg 26 to 12 are available.

CIRCLE 462 ON READER SERVICE CARD

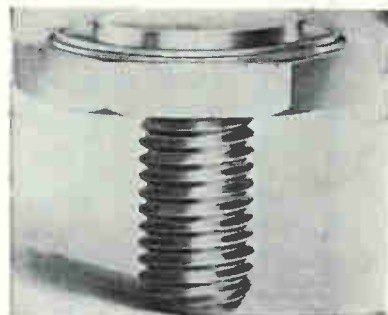

Semiconductor Bases READY-TO-WELD

STANDARD PRESSED STEEL CO., Box 775, Jenkintown, Pa. Copper semiconductor bases, with integral steel weld rings already brazed in place, are being supplied in the full-hard condition. Integral steel weld-ring simplifies subsequent joining of steel cap. They are offered with an annular projection for welding performed on the ring. The base lets semiconductor makers use less complicated and less costly drawn caps for their assemblies.

CIRCLE 463 ON READER SERVICE CARD

Frequency Standard

VARIAN ASSOCIATES, 611 Hansen Way, Palo Alto, Calif. Rubidium vapor frequency standard uses optical pumping principle. Long term stability is two parts in 10^{10} .

CIRCLE 464 ON READER SERVICE CARD



VLF Timing Receiver AND CORRELATOR

INTERSTATE ELECTRONICS CORP., 707 E. Vermont, Anaheim, Calif. Model

400 solid state unit may be used, through front panel selection, at 16, 18, or 20 Kc for reception of stations GBR, Rugby, England; NBA, Balboa, Canal Zone; and WWVL, Sunset, Colo. The signal selected is automatically correlated with a signal derived from a local standard by means of the internal regenerative divider circuitry, giving an output of approximately 1 cycle each 50 sec for 1 part in 1 million frequency difference.

CIRCLE 465 ON READER SERVICE CARD

Resistors

FILMOHM CORP., 48 W. 25th St., New York 10, N. Y. Coaxial termination resistors achieve a vswr of 1.05 from d-c to 4,000 Mc when mounted in $\frac{3}{8}$ in. line.

CIRCLE 466 ON READER SERVICE CARD



Trimming Pots

ONE-HALF IN. SQUARE

DUNCAN ELECTRONICS, INC., 2865 Fairview Road, Costa Mesa, Calif. Measuring $\frac{1}{2}$ in. sq, the 0.18 oz series 150 trimming pots are suitable for severe environmental usage where stability and reliability are critical. Series is designed with a 30:1 mechanical ratio for simple screw driver adjustment. Standard resistance range is 10,000 to 50,000 ohms, and power rating 1 w at 60 C.

CIRCLE 467 ON READER SERVICE CARD

SPDT H-F Chopper

MINIATURIZED

COLLINS ELECTRONICS, INC., Stevensville, Md. Miniature chopper is designed for operation at 6.3 v, 1,000 cps. It features lack of resonance or phase inversion points throughout a range of 0 to 1,050 cps. Dwell time is constant within ± 5 deg over a 60 to 1,050 cps range. Available in break-before-make (model 2C-10) or make-before-break (2C-10M) configurations, the units are

navigation problem:

Prevent loss of directional and positional information by providing ultra-reliable, closely regulated power supply for SINS (Ships Inertial Navigation System) for nuclear submarines.

solution:

Westinghouse is delivering static inverters to the Navy to take the place of motor generator sets previously used in SINS. Since SINS could conceivably swing out of calibration, all direction and position reference could be lost. The submarine would have to surface to recalibrate. So the Navy turned to Westinghouse for solid state inverters, used for the first time in the operation phase of SINS. These unique inverters have no moving parts. They permit lower noise operations and reduce maintenance while helping SINS equipment maintain stable and absolute directional accuracy. Contact your Westinghouse sales engineer on your challenging electronic component problems. Or write: Westinghouse Electric Corporation, P.O. Box 868, Pittsburgh 30, Pennsylvania. *You can be sure . . . if it's Westinghouse.*

J-92518

Westinghouse

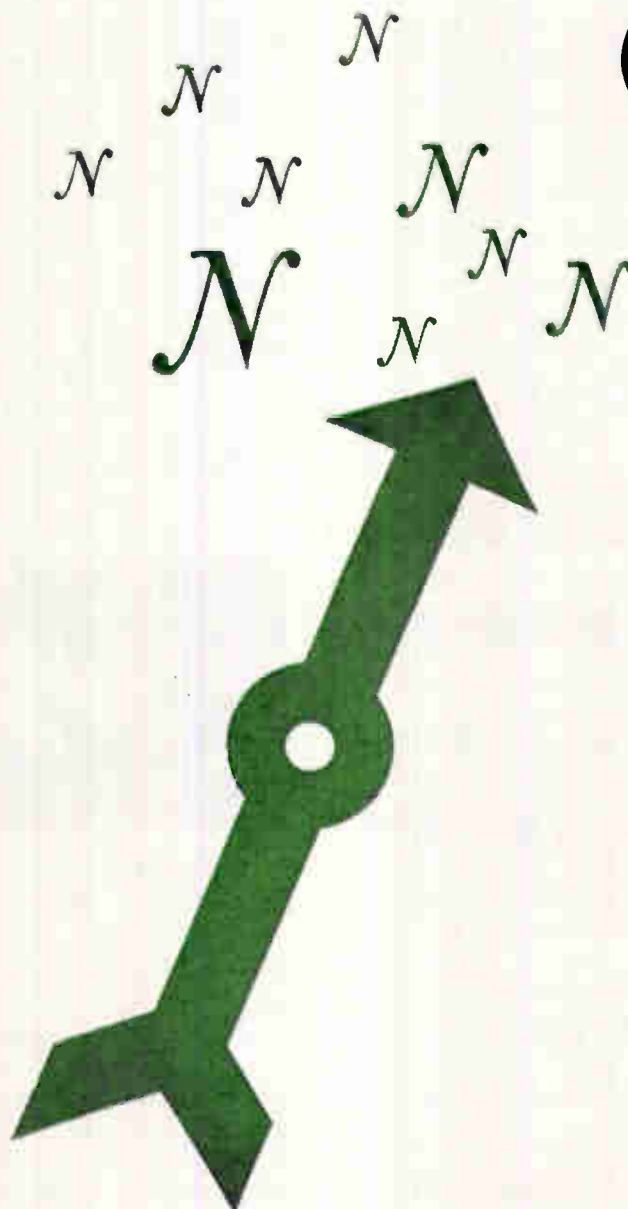

Reliability assured!

H-H "Gray Line"
RHEOSTATS
and
RESISTORS



Ruggedized Components for
All Types of Commercial and
Military Applications

"Gray Line" precision-built components feature special H-H design and construction advantages that assure the engineer/designer maximum dependability in the most severe environments. Standard types are available to meet a wide range of electrical and mechanical requirements; "specials" can be custom designed for unusual applications.

"GRAY LINE" RHEOSTATS



Standard types from 5 to 1000 watts. MIL types and customs to 'specs.'

"GRAY LINE" RESISTORS



• Wide Range of Fixed Resistors



• Flat and Stack Mounting Power Resistors



• Axial-lead Types from 2 to 10 Watts



• Adjustable-Resistors from 10 to 200 Watts

"Gray Line" ... Stocked by Authorized H-H Distributors Nationwide!



HARDWICK
HINDLE • INC

40 Hermon Street
Newark 5, New Jersey



The Mark of Quality since 1924

contained in a compact $\frac{3}{4}$ in. diameter by $1\frac{1}{4}$ in. high housing.

CIRCLE 468 ON READER SERVICE CARD

Test Set

WILTRON CO., 717 Loma Verde Ave., Palo Alto, Calif. Switching time test set, covering 1 nsec to $1\mu\text{sec}$, includes an 800-Mc bandwidth oscilloscope.

CIRCLE 469 ON READER SERVICE CARD

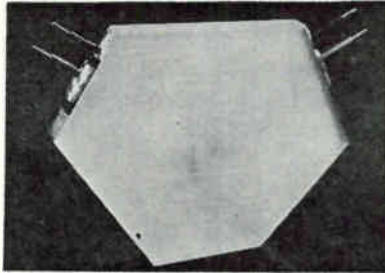

Ultrasonic Delay Lines

FOR DIGITAL MEMORIES

CORNING GLASS WORKS, Bradford, Pa., has developed glass ultrasonic delay lines that serve as high-speed digital memories for computers and data processing equipment. Serial memories have been built that exhibit information rates of 3 to 20 megabits per sec, comparable to rates of thin film, cryogenic and tunnel diode memory devices. Delay times as high as $150\mu\text{sec}$ have been achieved with the product.

CIRCLE 470 ON READER SERVICE CARD

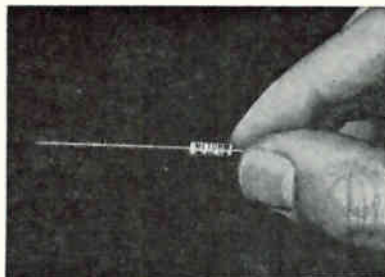

Precision Resistor

MOLDED METAL FILM

WARD LEONARD ELECTRIC CO., Mount Vernon, N. Y., announces Metohm resistors for use in missile guidance systems, computers, radar equipment and instruments. Available in $\frac{1}{8}$, $\frac{1}{4}$ and $\frac{1}{2}$ w sizes. They feature high stability, accuracy and reliability; temperature coefficient as low as $\pm 25\text{ ppm/deg C}$;

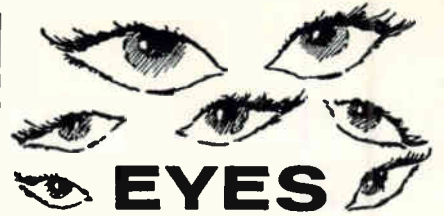

EYES

THAT NEVER SLEEP

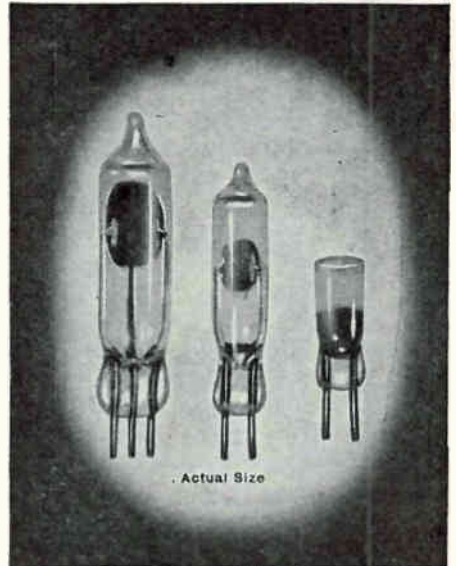

NEW! CETRON

LEAD SULFIDE

PHOTO CELLS

WITH INFRA-RED SENSITIVITY

FOR USE IN:

- Electronic Computers
- Sound Projectors
- Temperature Measurement
- Infra-Red Communications
- Missile Guidance Systems
- Fire Detection
- Computing Solar Temperatures

These new developments in the semiconductor field are especially sensitive to infra-red radiation. Cetron's careful production control insures reliable performance characteristics in all of your photo cell requirements.

Cetron engineers are always available to help in your tube requirements—just write, wire or phone.

YOUR DEPENDABLE SOURCE FOR RECTIFIER, THYRATRON AND PHOTO TUBES

CETRON
ELECTRONIC
CORPORATION



715 Hamilton Street • Geneva, Illinois

low noise level; resistance tolerances ± 1 percent and below.

CIRCLE 471 ON READER SERVICE CARD

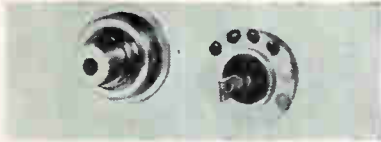

Button Capacitor WELDED SEAL

SANGAMO ELECTRIC CO., Springfield, Ill., announces a welded seal button mica capacitor. Solder-free design eliminates the restrictions imposed by relatively low-melting point-soft solder seals and thus permits operation at higher ambients. Each unit is fully liquid impregnated for protection against corona. Capacitance values up to 1,500 pf are available at 500 wvdc in a variety of mounting configurations.

CIRCLE 472 ON READER SERVICE CARD

Shielding Assemblies

TECHNICAL WIRE PRODUCTS INC., 129 Dermody St., Cranford, N. J. Honeycomb structure with r-f gasketing combines cooling air flow and r-f shielding.

CIRCLE 473 ON READER SERVICE CARD



Transformers HERMETICALLY SEALED

COMMUNICATION ACCESSORIES CO., a subsidiary of Collins Radio Co., Lee's Summit, Mo., has developed a line of miniature hermetically sealed transformers. Shown is an impedance matching transformer designed to work between transistor stages. Similar CAC transformers are available for a wide range of impedance matching requirements and are designed for loading on p-c

New *QC-SERIES

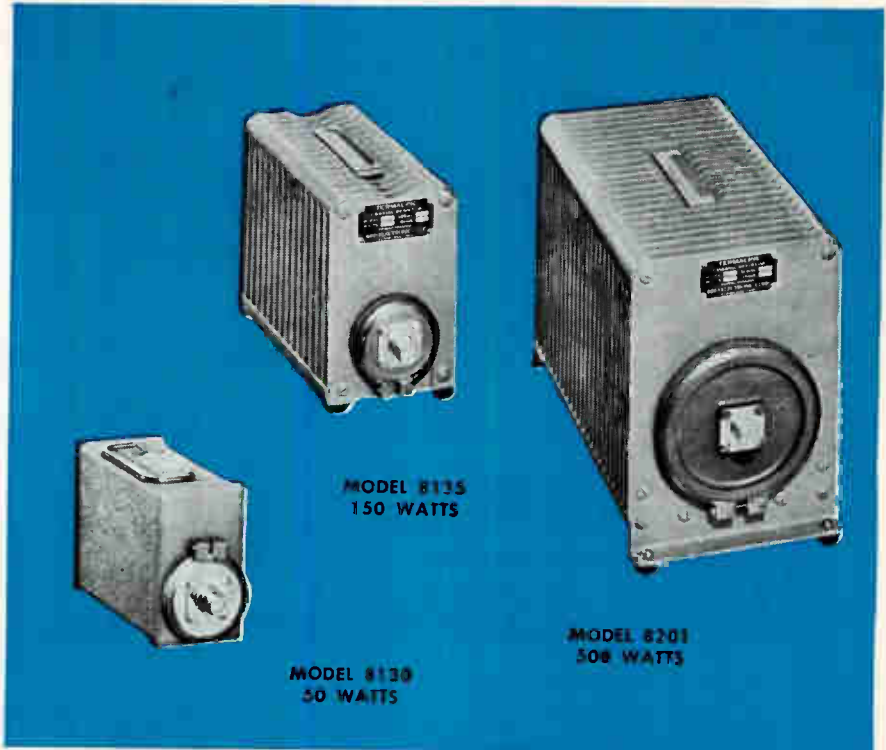

TERMALINE COAXIAL LOAD RESISTORS

A new series of Loads with QUICK-CHANGE CONNECTORS

This new series of TERMALINE Load Resistors are portable, general purpose, 50-ohm coaxial terminations. Their low VSWR, freedom from radiation and ruggedized construction, make them ideally suited as loads during the adjustment and testing of transmitters. All models in this series utilize the Bird Quick-Change Connectors (QC), which are available to accommodate any standard series of coaxial line fittings. VSWR specifications are 1.1 max. to 1000 mc, and less than 1.25 to 4000 mc.

Higher power loads with QC feature are available.

*QUICK CHANGE CONNECTORS

Eliminate connector-adapter problems. Any connector may be readily changed. QC connectors of the most popular types are illustrated below. For complete specifications request Bulletin R-QC-1.



Male "HN" Female "HN" Male "C" Female "C" Male "N" Female "N" Female UHF (SO-239)



BIRD

ELECTRONIC CORPORATION

30303 Aurora Rd., Cleveland 39 (Solon), Ohio
Churchill 8-1200 TWX CGN FS 679

Western Representative:

VAN GROOS COMPANY, Woodland Hills, Calif.

"See us at Wescon Show Booth Nos. 1922-1924"

WRAP-AROUND MAGNETIC SHIELDS

... APPLIED IN SECONDS

Economical
CO-NETIC & NETIC
Magnetic Shielding Foils
For Any Size or Shape Components



Netic and Co-Netic foils are universally used as an evaluation tool; ultimately, as a production solution. Available in continuous lengths on rolls up to 15" wide... for human production line or to fit automated existing reels of your tape serving machinery. Furnished in final annealed state ready for your operation.

HOW YOU SAVE SPACE, WEIGHT, TIME, MONEY

Minimum weight and displacement shielding designs are possible due to the magnetic shielding effectiveness of Co-Netic and Netic foils... foils can be supplied FROM .002", even thinner if you desire. Ordinary scissors cut foil easily to exact contour and size required. Foil can be wrapped quickly around hard-to-get-at components, saving valuable time, minimizing tooling costs.

HOW TO INCREASE RELIABILITY

Guard against performance degradation from unpredictable magnetic field conditions to which your equipment may be exposed. Eliminate such failure or erratic performance possibilities with dependable Co-Netic and Netic protection... assuring *performance repeatability* for your device over a *wider range* of magnetic field conditions.

Co-Netic and Netic alloys are not affected significantly by dropping, vibration or shock. They are characterized by low magnetic retention and do not require periodic annealing. When grounded, they effectively shield electrostatic as well as magnetic fields over a wide range of intensities.

Every satellite and virtually all guidance devices increase reliability with Netic and Co-Netic magnetic shielding alloys. Use these highly adaptable foils for saving valuable space, weight, time and money... in solving your magnetic shielding problems for military, commercial and laboratory applications.

PHONE YOUR NEAREST SALES OFFICE TODAY:

BALTIMORE, MARYLAND, HOplins 7-3766
UNION CITY, NEW JERSEY, UNion 4-9577
MERIDEN, CONNECTICUT, BEverly 7-9232
MIAMI, FLORIDA, HIghland 4-1118
DALLAS, TEXAS, FLeetwood 1-1615
ALBUQUERQUE, NEW MEXICO, AMherst 8-6797
LOS ANGELES, CALIFORNIA, WEbster 1-1041

PALO ALTO, CALIFORNIA, DAvenport 1-5064
SAN DIEGO, CALIFORNIA, ACAcademy 4-1717
SEATTLE, WASHINGTON, EAst 3-8545
PHOENIX, ARIZONA, AMhurst 4-4934
HOUSTON, TEXAS, HOmestead 5-7780
WESTMOUNT, MONTREAL, QUEBEC
WELlington 7-1167

MAGNETIC SHIELD DIVISION

Perfection Mica Company

1322 N. ELSTON AVENUE, CHICAGO 22, ILLINOIS

ORIGINATORS OF PERMANENTLY EFFECTIVE NETIC CO-NETIC MAGNETIC SHIELDING

boards. These transformers will find application in radar and communication systems.

CIRCLE 474 ON READER SERVICE CARD

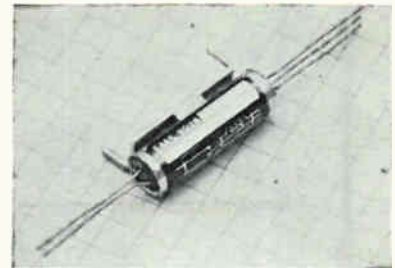

Subminiature Relay HIGH SPEED

ELECTRO-MECHANICAL SPECIALTIES CO., INC., Whittier, Calif. The Micro-Mite spdt 2 amp hermetically sealed military relay weighs under 0.17 oz, is housed in a 0.275 in. diameter tube and is under 0.900 in. long. Contact low level rating is under 8 μ a at 16 mv. Specifications include shock 30 g and vibration of 20 g from 5-1,000 cps and 10 g from 1,000-2,000 cps. Insulation resistance 10,000 megohms min between leads.

CIRCLE 475 ON READER SERVICE CARD

Delay Line

ESC ELECTRONICS CORP., 534 Bergen Blvd., Palisades Park, N. J. Transponder delay lines for air traffic controls and airborne equipment feature 40 to 1 delay rise time ratio in a 6 cu. in. case.

CIRCLE 476 ON READER SERVICE CARD

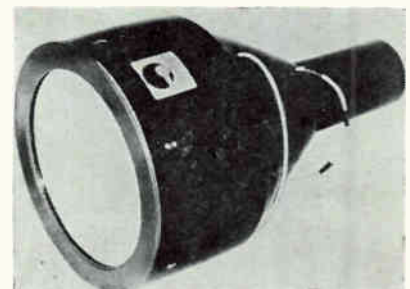

Storage Tubes 10-IN. SCREENS

HUGHES AIRCRAFT CO., VTP Division, 2020 Short St., Oceanside Calif., offers multi-mode Tonotron tubes with 10-in. flat view screens. They are direct viewing storage tubes having selective erasure, high

resolution and write-through capabilities in addition to the brightness and controllable persistence features of conventional storage tubes. Type H-1059 has two writing guns, electrostatic focus and deflection and is supplied potted and magnetically shielded in a Netic-Conetic laminated metal shield.

CIRCLE 477 ON READER SERVICE CARD

Character Generator

TRANSDATA, INC., P. O. Box 1369, San Diego 12, Calif. Character generator has 64 plug-in characters and codes, and displays up to 100,000 characters per second.

CIRCLE 478 ON READER SERVICE CARD



Silver-Zinc Battery

LONG-LIFE

YARDNEY ELECTRIC CORP., 40-50 Leonard St., New York, N. Y., announces a Silvercel battery that can provide up to six times more energy output than an ordinary battery of equal size. It has achieved more than 440 cycles during 30 months' application.

CIRCLE 479 ON READER SERVICE CARD

Microfilm Televiser

REMOTE POSITIONING

GPL DIVISION, General Precision, Inc., 63 Bedford Road, Pleasantville, N. Y., announces a microfilm readout device tied to closed-circuit television. It eliminates duplication of files by transmitting to one or more remote positions tv images of microfilm or other records retained at a central filing station. Any particular area of a film can be

reliability problem:

Drastically reduce downtime of T-R units in aircraft. Achieve a high degree of reliability. Increase operating time by reducing unscheduled removals for maintenance. Keep cost of equipment comparable to conventional unit.

solution:

Westinghouse furnished silicon power rectifier cells for use in new transformer-rectifier units. These units have had only one recorded removal in 100,000 hours operating time. Best operating performance by previous units was 20,000 hours between unscheduled shutdowns. The Westinghouse T-R units are used in the C130A and B aircraft manufactured for the Air Force by the Lockheed Aircraft Corporation, Marietta, Ga. Each unit converts 115-volt, 17.5-ampere, 400-cycle power to direct current at 27 volts and 200 amps. Compare this record with a motor-generator set that performs the same function. The use of the static transformer-rectifier eliminates moving parts that would otherwise require changing of brushes and bearings seventy times, changing the rotor thirty times, in a comparable 100,000-hour life period. Ideas and products like this one can save you man-hours and maintenance time while hiking your reliability results. Contact the Westinghouse sales engineer. Or write: Westinghouse Electric Corporation, P.O. Box 868, Pittsburgh 30, Pennsylvania. *You can be sure . . . if it's Westinghouse.*

J-92519

Westinghouse



Handwritten-style blue lines forming a series of horizontal, rounded rectangular shapes, likely for a reader to write in.



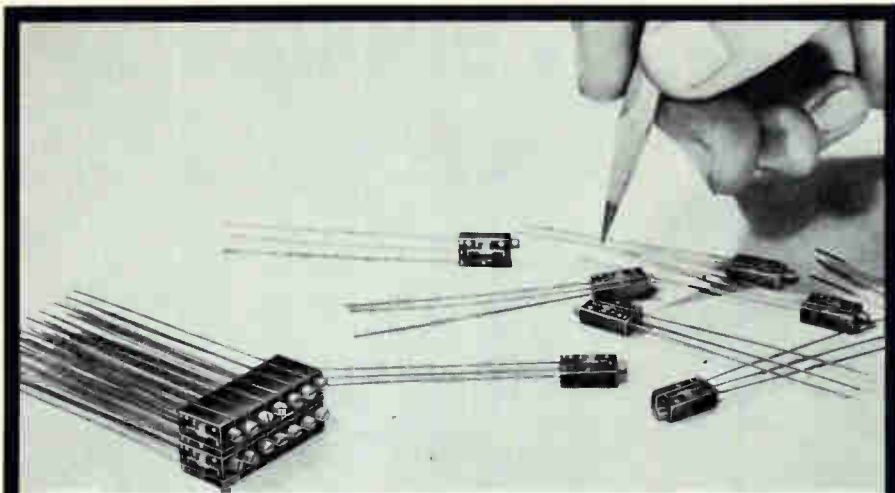

52 linear, wirewound pots in 1 cubic inch!

You may never use 52 pots in such a small space, but you could with the new Atohm Series 320. It's a precision, trimmer pot measuring only .250" x .435" x .150", but providing resistances from 5 ohms to 50K ohms. Its simple, linear mechanism provides a more uniform winding, more ohms per linear length, and better mechanical distribution of the resistant material. Unique, clip-type mounting. Write for complete data.

ATOHM ELECTRONICS
7648 San Fernando Road, Sun Valley, California



CIRCLE 263 ON READER SERVICE CARD

selected and magnified under the control of the remote viewer. Variable magnification up to 300 X or more.

CIRCLE 480 ON READER SERVICE CARD

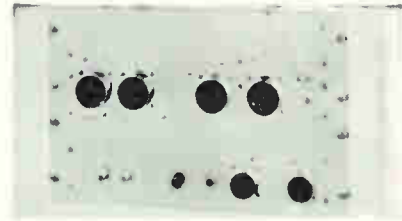

Pulse Generator

REMOTELY PROGRAMMABLE

RUTHERFORD ELECTRONICS Co., 8944 Lindblade St., Culver City, Calif., announces model B-11 remotely programmable pulse generator for automated checkout systems. It may be programmed to give an output pulse featuring repetition rates from 20 pps to 2 million pps, pulse delays from 0 to 10,000 μ sec, pulse widths from 0.05 to 10,000 μ sec, pulse amplitudes from 50 v to 60 db below 50 v, pulse rise times from 0.015 to 1 μ sec, and either positive or negative polarity.

CIRCLE 481 ON READER SERVICE CARD



micro-miniature toggle switches

Shown actual size **DESIGNED FOR
"LIMITED SPACE" PROBLEMS**

5 AMPS @ 115 VAC — and capable of carrying a 100% overload!

SOLID SILVER — contacts, terminals and moving parts! Not just plated!

LONG LIFE RATINGS — over 80,000 operations for this tiny switch!

MICRO-MINIATURE — S.P.D.T. is subminiaturized to only 1/2" x 3/8" x 1/4"!

Quantity	S.P.D.T.	D.P.D.T.
1-24	\$1.65	\$2.15
25-90	1.12	1.43
100-499	.99	1.29
500 over	.83	1.08

**LARGER QUANTITY PRICES
AVAILABLE ON REQUEST**

In use by over
1000 manufacturers

**ALCO ELECTRONIC
PRODUCTS INC.**
3 Wolcott Ave., Lawrence 31, Mass.

**COMING
SOON**

- Color-Coded Handle Inserts
- Weather-Proof Rubber Seals
- Momentary Toggle Switches
- Center-Off Toggle Switches

GRC tiny parts

die cast
ZINC ALLOY

molded
PLASTICS

Coil Bobbins
Gears & Pinions

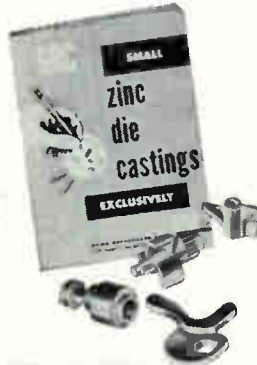

"SMALL ZINC
DIE CASTINGS"

Get GRC's fact filled brochures. GRC's methods give you quality and accuracy in small parts of die cast zinc alloy, Nylon, Delrin, other engineering thermoplastics. Exclusive single cavity, automatic techniques allow new designs, new production and assembly shortcuts. Write, wire, phone for samples and bulletins. Send prints for quotations.

NO MINIMUM SIZE! Maximum sizes:
Zinc Alloy—
2" long, 1/2
oz. Plastic—
1 3/4" long,
.05 oz.

GRIES

GRIES REPRODUCER CORP.

World's Foremost Producer of Small Die Castings
151 Beechwood Avenue, New Rochelle, New York
NEW Rochelle 3-8600

CIRCLE 264 ON READER SERVICE CARD

Pulse Magnetron

BOMAC LABORATORIES INC., Salem Rd., Beverly, Mass. K_a band pulse magnetron for airborne radar is a fixed frequency tube, rated at 100 Kw peak power, 0.001 duty cycle.

CIRCLE 482 ON READER SERVICE CARD

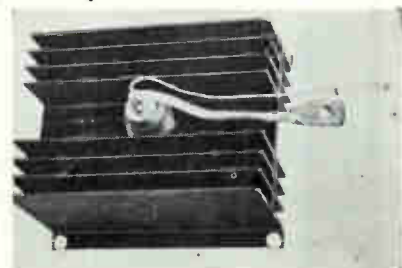

Rectifier Cooler DUAL PURPOSE

WAKEFIELD ENGINEERING, INC., 414 Main St., Wakefield, Mass. The Delta-T model NC-423 dual purpose semiconductor cooler offers extremely low thermal resistance per unit volume; with stock models affording 0.8C/w with natural convection and as low as 0.3C/w with

AXIAL LEAD COMPONENT USERS



Universal Component
Processing Equipment

NOW
INSPECT ...
COUNT ...
PACKAGE ...



Incoming Components
Automatically!

Regardless of component type and size

- REDUCE COST OF INCOMING INSPECTION—Insure reliability through rapid practical 100% inspection of components.
- REDUCE COST OF INVENTORY CONTROL—Count and package at receiving. Eliminate subsequent handling and identification problems.
- REDUCE COST OF PRODUCTION—Step up efficiency by issuing components to assemblers in convenient ready to go-to-work form.
- REDUCE COST OF REWORK—Assembly manufacturing error and installation of faulty components minimized.

Universal Component Processing Equipment is the standard for lead straightening and taping of axial lead components for automatic assembly. Virtually every component manufacturer is using it today. Experience proves that the equipment will pay for itself in a few months!

DEMONSTRATION EASILY ARRANGED
See it at the WESCON SHOW,
Booths 4932-4934, or write

UNIVERSAL
INSTRUMENTS CORPORATION

137 E. Frederick St., Binghamton, N. Y.
Phone RAymond 2-1244

CIRCLE 265 ON READER SERVICE CARD

August 11, 1961

NEW GENERAL ELECTRIC "PENLINE-120" SOLDERING IRON

Now you can get all the *electronic industry* proved features of General Electric's 6-volt Midget iron, plus the convenience of 120-volt design. "Penline-120" irons are available in 30- and 50-watt ratings.

Check these features:

LOW COST. G-E "Penline-120" irons are competitively priced.

LOW OPERATING COST—due to longer tip and heater life and low-cost replacement.

HIGHEST OPERATING EFFICIENCY. Calrod® heater built right in the tip assures fastest heatup and tip temperature recovery, rapid void-free solder connections.

OPERATOR COMFORT ASSURED. G-E Lexan® plastic handle is shaped to fit the hand. It stays cool during full shift operation.

PEN-LIKE SHAPE EASY TO MANEUVER—important for miniaturization designs. Solder in congested areas with little danger of damage to adjacent joints and wiring.

GET ALL THE FACTS on General Electric's complete line of proved industrial soldering irons from your local G-E sales office or authorized distributor. Or write Section 758-05, General Electric Co., Schenectady 5, N. Y.

ACTUAL SIZE

Progress Is Our Most Important Product

GENERAL ELECTRIC

See the NEW "PENLINE-120" in operation at WESCON Show—G-E Booth 709.

CIRCLE 205 ON READER SERVICE CARD

205

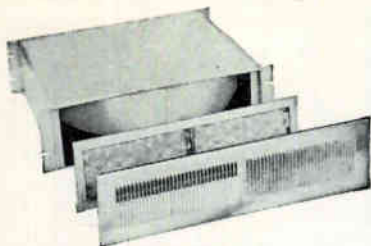

TRANS-AIRE BLOWERS

Ideal for use where excessive heat is generated by equipment in an enclosed rack, cabinet or console. They have thermal overload protection and automatic re-set. These blowers occupy less area, and a smaller panel space than others having similar air displacement capability. They are the lowest priced units of equal capacity and performance. Available in three sizes with air displacement from 100 cfm to 700 cfm.

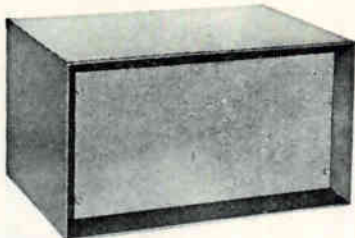

SHADOW CABINETS

An extremely versatile housing since both front and rear panels as well as bottom may be removed for installation or servicing purposes. Unusually attractive appearance is created by recessing the front panel one inch as well as by beveling the front. The two piece body is made of 18 gauge steel and the panels of 16 gauge steel. Four sizes available. Finished in light gray hamertone.

CREATE THE IDEAL ENVIRONMENT FOR YOUR ELECTRONIC EQUIPMENT WITH THESE BUD PRODUCTS

COWL-TYPE MINIBOXES

A projecting cover reduces glare from overhead lighting, and provides protection for controls and dials. Cover has two box braces to which the bottom is attached by means of sheet metal screws. This type of construction results in a sturdy, rigid housing. Fabricated of .040 aluminum and furnished natural or with light gray hamertone finish. Four sizes available.



See these new Bud Products at your Authorized Bud Distributor or write us for literature.

CONTOUR UTILITY CABINETS

Rounded contour corners and the flanged panels combine to create an eye-catching design. Fabricated from 20 gauge steel to provide strength and rigidity. Front and rear panels are removable, the front panel being solid while the rear panel is louvred to provide ventilation. Body is finished in smooth dark gray enamel and the panels in light gray enamel. Six sizes available.

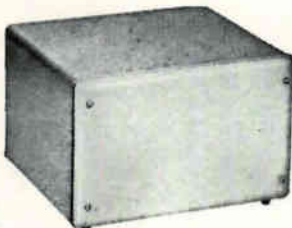

BUD RADIO, INC.

CLEVELAND 3, OHIO

CIRCLE 206 ON READER SERVICE CARD

Is your advertising selling the same four key buyers your salesmen call on? Competition demands it! Only advertising in electronics reaches and sells the electronics man *wherever* he is: in *Research,*

Design, Production, and Management. Put your advertising where it works *hardest...*

in electronics

forced air. Optimum spacing of fins, plus high base conductivity, maximizes efficiency. Available with or without mounting provisions.

CIRCLE 483 ON READER SERVICE CARD

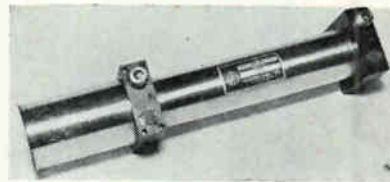

PPM Focused TWT

LOW-NOISE

HUGGINS LABORATORIES, INC., 999 E. Arques Ave., Sunnyvale, Calif. The HA-60 periodic magnet focused twt exhibits these characteristics across the 8 to 11 Gc frequency range: 17 db max noise figure, 25 db min small-signal gain, and 10 mw min saturation power output. When operated more broadband, from 7 to 11 Gc, it achieves 30 db min small-signal gain and 20 db max noise figure, with 10 mw min saturation power output.

CIRCLE 484 ON READER SERVICE CARD

Modulator

FXR, Div. of Amphenol-Borg Electronics Corp., 25-26 50th St., Woodside, N. Y. Ferrite a-m modulator covers entire X-band, 8.2 to 12.4 Gc.

CIRCLE 485 ON READER SERVICE CARD



Oscilloscope

MODULAR PACKAGE

HEWLETT-PACKARD CO., 1501 Page Mill Road, Palo Alto, Calif. Model 120B is a 200 Kc triggered oscilloscope that incorporates modular package and new crt with internal graticule to eliminate parallax error. It features direct reading calibration, automatic trigger, auto-

TODAY YOU MUST SELL ALL FOUR!

matic baseline and push-button beam finder. It also provides a times -5 sweep expander and a linear integrator for accurate sweeps.

CIRCLE 486 ON READER SERVICE CARD

Measuring Instrument

RADIO FREQUENCY LABORATORIES, INC., Powerville Rd., Boonton, N. J. A-c to d-c calibration/transfer standard has a direct reading error limit of ± 0.06 percent for a-c and ± 0.05 percent for d-c.

CIRCLE 487 ON READER SERVICE CARD



Portable Oscilloscope WIDE-BAND

THE SCOPES CO. INC., P.O. Box 56, Monsey, N. Y. Model S32 is designed around a new crt with post deflection acceleration and operating at 3.5 Kv giving a bright, sharp trace. The balanced d-c coupled amplifier has 7.5 Mc bandwidth with sensitivity of 100 mv/cm and rise time of 50 nsec. A X10 gain facility increases sensitivity to 10 mv/cm, d-c to 200 Kc. Unit has time and voltage calibration.

CIRCLE 488 ON READER SERVICE CARD

Recorder/Reproducer VIDEO BAND

MINCOM DIVISION, Minnesota Mining and Mfg. Co., 2049 S. Barrington Ave., Los Angeles 25, Calif., announces the CM-100 video band recorder/reproducer with frequencies to 1.2 Mc. Bandwidth has been increased proportionately by 20 percent at all six speeds, ranging from 75 Kc at 7½ ips to 1.2 Mc at

August 11, 1961

FOR SUPERFINE CUTTING OF HARD, BRITTLE MATERIALS

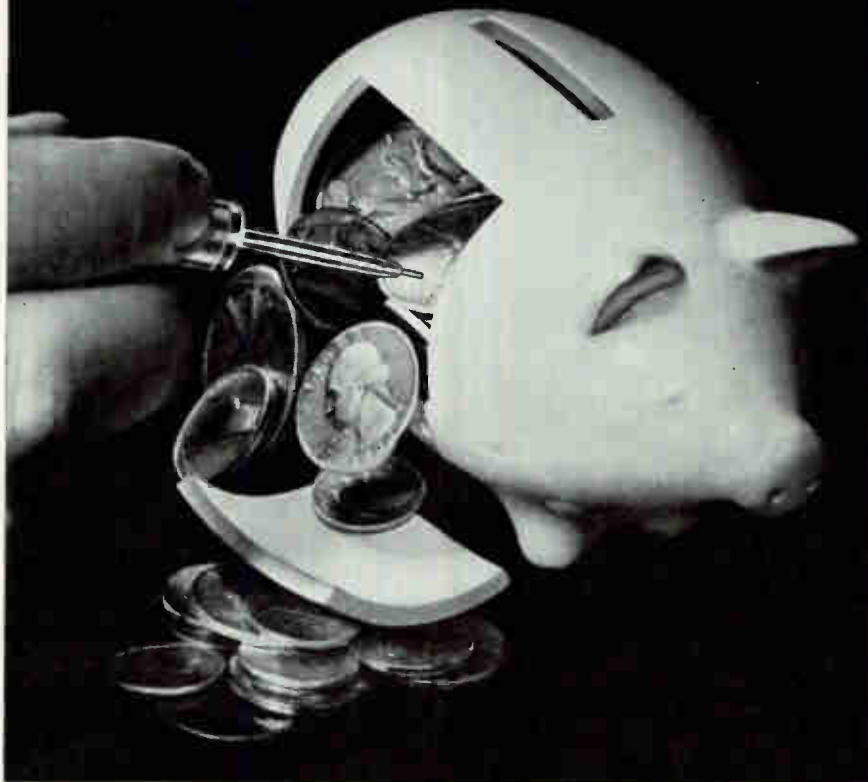

THE *S. White* Industrial Airbrasive® Unit

There may be easier ways to tap junior's piggy bank...but none that could craftily slice a piece out of a fragile ceramic part the way Industrial Airbrasive can.

The secret of the Airbrasive's ability to cut hard, brittle materials is its accurate stream of gas-propelled abrasive. The cutting action is cool and completely shockless. Highly flexible in use, the same tool will make a cut as fine as 0.003" or it will frost, abrade or clean a large area.

Every day new uses are being found for the Airbrasive in production lines and in the laboratory... deburring small parts... shaping, drilling or cleaning germanium and other crystals... wirestripping potentiometers... removing fine films... printed circuits... micromodules... and many others!

Important too: the cost is low... for under \$1,000 you can set up your own Airbrasive cutting unit!

Send us your most difficult samples and we will test them for you at no cost.



SEND FOR
BULLETIN 6006
... complete information.

**WESCON
Booth 5128**

S. White

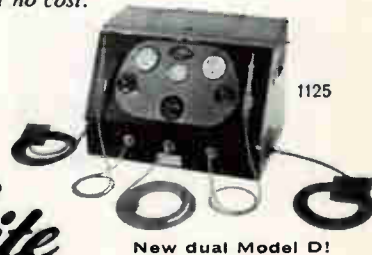

1125
New dual Model D!

S. S. White Industrial Division Dept. EU, 10 East 40th Street, New York 16, N. Y.

CIRCLE 207 ON READER SERVICE CARD 207

reliability

...based
on
experience



ultra-high precision capacitors

Southern Electronics high-precision capacitors are demonstrating their proven reliability today in twelve different missiles, analog computers, and many radar and communications applications.

SEC high-precision capacitors utilize polystyrene, providing .01% tolerances, and mylar and teflon to meet .5% requirements. They show excellent stability characteristics over an extended temperature range, and tolerances are unaffected even at extreme high altitudes. The unusual accuracy, stability and reliability of SEC capacitors are the result of engineering experience concentrated on the design and manufacture of precision capacitors only, plus rigid quality control standards subjecting each capacitor to seven inspections during manufacture, plus final inspection.

Our engineering experience enables us to meet your size requirements, while holding to exact capacitance and tolerance specifications.

SEC capacitors are manufactured in a wide range of capacitance to meet your needs from 100 mmfd. to any higher value, and meet or exceed the most rigid MIL-SPECS.

See our new sub-miniature polystyrene capacitor at the Wescon show, Booth 1723



SOUTHERN ELECTRONICS Corporation

150 WEST CYPRESS AVENUE
BURBANK, CALIFORNIA

120 ips. The standard 7-track single-rack unit can be converted to 14 tracks simply by plugging in an additional rack of electronics and changing the tape transport to accommodate one-inch tape.

CIRCLE 489 ON READER SERVICE CARD



Ceramic Capacitor

THREE SIZES

DALE ELECTRONICS, INC., Columbus, Neb., announces a ceramic capacitor with a capacitance range from 0.05 μ f to 0.15 μ f. Maximum working voltage is 600 v d-c. Three sizes from 1 in. long by $\frac{1}{2}$ in. diameter to 2.2 in. long by $\frac{1}{2}$ in. diameter are said to be considerably smaller than respective values in paper style. Produced by an extrusion process, the thin wall design provides a capacitor with the utmost inherent reliability, company says.

CIRCLE 490 ON READER SERVICE CARD

Coaxial Relays

JENNINGS RADIO MFG. CORP., P. O. Box 1278, San Jose, Calif. Vacuum relays for remote switching of 6 in. coaxial lines handle 300 Kw c-w power at 30 Mc.

CIRCLE 491 ON READER SERVICE CARD

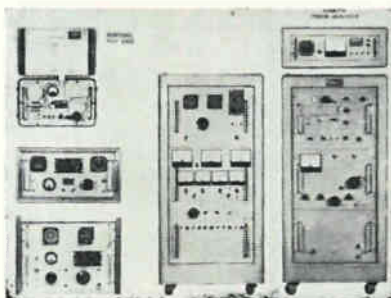

Test Equipment

FOR TACAN SYSTEMS

HOFFMAN ELECTRONICS CORP., 3740 S. Grand Ave., Los Angeles 7, Calif., has developed a line of test equipment that permits AN/ARN-21 and ARN-65 (V) Tacan gear to be tested on the bench or in the cockpit. Seven models comprise the

AUGAT CRYSTAL SOCKET ASSEMBLIES

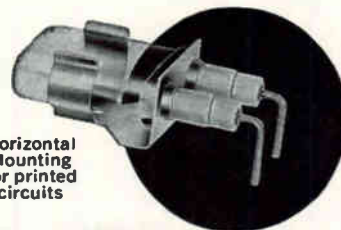

Horizontal
Mounting
for printed
circuits

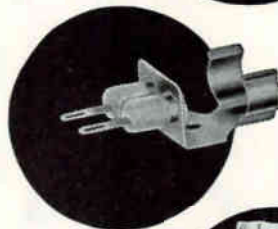

Horizontal
Mounting
for sub-
miniature
crystal

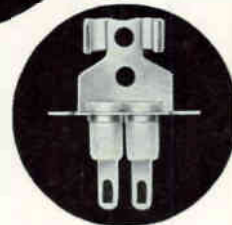

Vertical
Mounting
for sub-
miniature
crystal

Augat Crystal Socket Assemblies are especially designed to reduce overall package size and weight. They combine modern packaging techniques with top quality materials to assure dependable mechanical and electrical life.

Once the crystal is installed, it will never shake loose... even under the most severe conditions.

Available for horizontal or vertical mounting, for use with hook up wire or printed circuits.

SOCKET SPECIFICATIONS

FOR USE WITH THE FOLLOWING CRYSTAL CASE SIZES:

HC-6/U & HC-13/U.

HC-18/U with .040 diameter pins or .018 wire leads.

McCoy M-25 or equivalent.

CONTACT MATERIALS:

Phosphor bronze and beryllium copper.
FINISHES: silver plate with gold flash; cadmium or tin plated.

INSULATION:

DuPont's Teflon or Blue Nylon

HOLDING CLIP:

Beryllium copper or steel, cadmium plated.

For detailed specifications, write for Data Sheets.

AUGAT BROS., INC:

30 Perry Avenue, Attleboro, Mass.

See us at Booth 1021, Wescon Aug. 22-25

CIRCLE 266 ON READER SERVICE CARD

electronics

line: HLI-119A (AN/ARM-25A) portable ramp test unit; HLI-103B Tacan beacon simulator; HLD-129 azimuth error analyzer; HLI-116A peak power calibrator; HLD-141, HLD-144 and HLD-146 instrument and power panels.

CIRCLE 492 ON READER SERVICE CARD

Data Display Console INSTANT READOUT

A. B. DICK CO., 5700 W. Touhy Ave., Chicago 48, Ill. Model 9801 Videograph digital display console converts coded electrical signals from any random access-type memory unit into readable letters, numbers, and symbols and displays them on a 14-in. tv tube. An inquiry may be initiated from a keyboard on the display console, from a Flexowriter, or a punched card reader. Up to 190 characters can be displayed on the tv screen per inquiry.

CIRCLE 493 ON READER SERVICE CARD

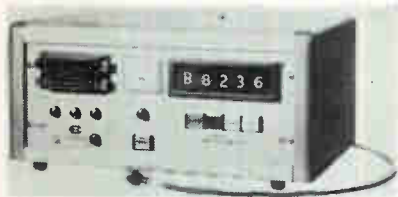

Fluxmeter EXTREMELY ACCURATE

THE J. C. CARTER CO., 671 W. 17th St., Costa Mesa, Calif. Model 611 is an extremely accurate fluxmeter, featuring digital readout and remote control provision. Company says it can also be used as a field control unit to regulate a magnetic field. At present there are four standard probes covering the 500 to 30,000 gauss range.

CIRCLE 494 ON READER SERVICE CARD

H-V Silicon Rectifiers SUBMINIATURE

MOTOROLA SEMICONDUCTOR PRODUCTS INC., 5005 E. McDowell Rd., Phoenix, Ariz. Silicon rectifiers, only 0.27 in. long and less than 0.1 in. in diameter, can withstand piv up to 3,000 v and handle currents on the order of 100 ma. Utilizing only

any size panels

engraved in your own plant

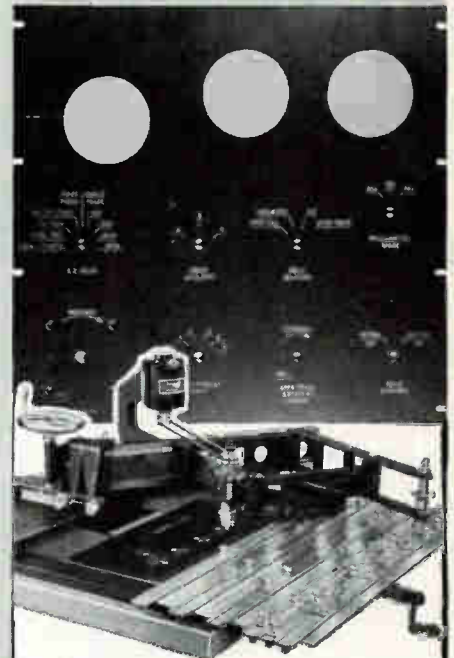

Engrave 1-inch nameplates or 6-foot panels by unskilled labor.

Spindle covers 18¼" x 6" in one set-up — more than any other machine of its kind.

Bench type model I-R — \$685.

Send for complete catalog ZR-4
VISIT BOOTH 5007, WESCON SHOW

new hermes ENGRAVING MACHINE CORP.

154 WEST 14th STREET, NEW YORK 11, N. Y. IN CANADA: 359 St. James Street West, Montreal, P. Q.

CIRCLE 267 ON READER SERVICE CARD

from the Frontier digital module line

COMPACT MULTI-PURPOSE SCALER

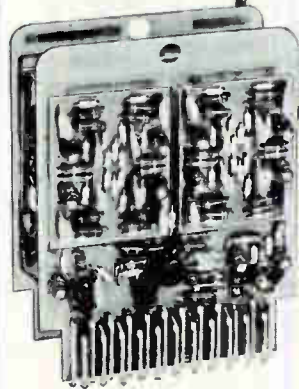

provides parallel output of binary equivalents and scales at 2, 3, 6, 10 or 16 with only a connection change

- High-Density, Piggy-Back Construction
- Silicon Mesa Transistors
- Complimentary Transistor-Diode Logic
- Pulse Rate to 1.5 Megacycle
- Easily Maintainable
- Inter-Scaler Simultaneous Drive
- "Glass" Circuit Boards, Gold Plated Circuits

Modules meet MIL requirements and package into minimum size with reliability equipment. Designers can go right from "bread board" or model stage into operational equipment without wasting time in repackaging.

Absolute reliability, "advanced-art" fully solid state packaging

For details write Dept. E-8

Frontier

ELECTRONICS CO.
4600 Memphis Avenue • Cleveland 9, Ohio

© 1961 Frontier Electronics Co.

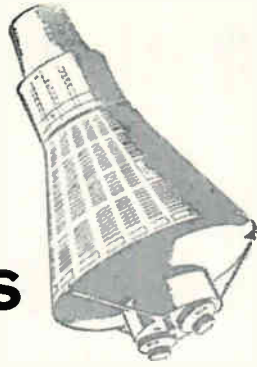

Bristol choppers help first U.S. Astronaut maneuver space capsule

Four Bristol Syncroverter* choppers formed a vital part of the infrared horizon sensors manufactured by Barnes Engineering Company, Stamford, Conn., and carried aloft in NASA's MERCURY capsule by the first U.S. astronaut to reach outer space.

The Bristol choppers function as sensitive phase detectors in the sensors as they establish a horizontal reference plane for the vehicle.

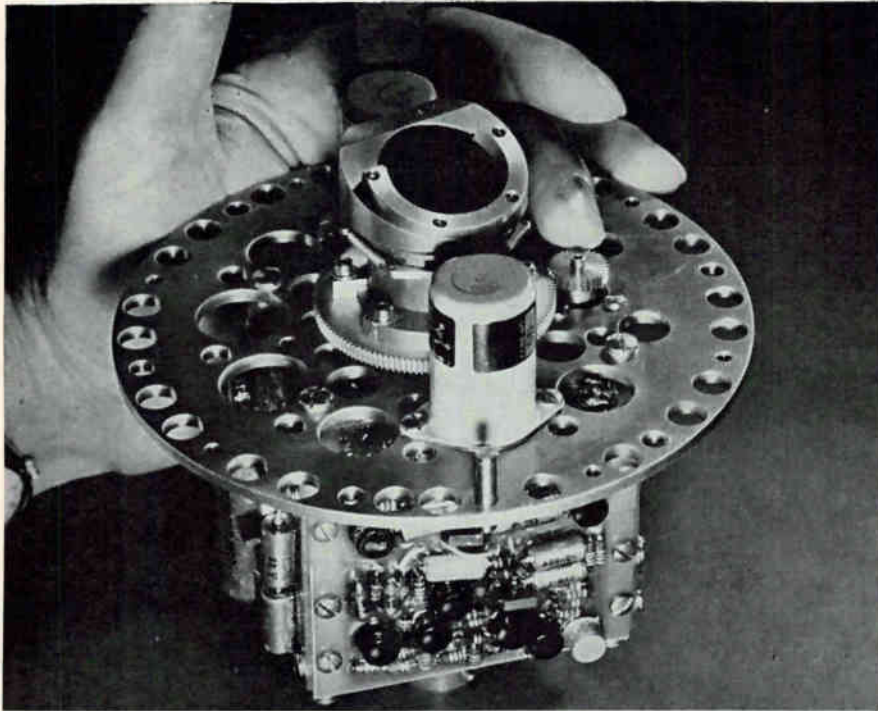

Infrared Horizon Sensor undergoes rigorous optical, mechanical, and electrical checks at Barnes Engineering Co. One Bristol chopper is located in foreground, in front of gear.

Bristol Syncroverter* choppers, noted for low noise, long life and high reliability, are finding a vital place in more and more missile guidance systems, as well as in analog computers, d-c amplifiers, and test equipment for industrial applications. More than 200 models available. Write for complete details.

**The Bristol Company, Aircraft Equipment Division,
152 Bristol Road, Waterbury 20, Conn.**

A Subsidiary of American Chain & Cable Company, Inc.

*T.M. Reg. U.S. Pat. Off. 1.4

BRISTOL ... engineers for precision, builds for reliability
Visit us at Booths 3316-3318 at the Wescon Show



three junctions in a hermetically sealed glass enclosure, the units have a low forward voltage drop on the order of 2.5 v at 100 ma, thus assuring excellent regulation in power supply applications.

CIRCLE 495 ON READER SERVICE CARD

Comparator

NORTH AMERICAN AVIATION, INC., Autonetics Div., 9150 E. Imperial Highway, Downey, Calif. Comparator features built-in cathode ray tube and voltmeter for measuring phase shifts and voltage ratios.

CIRCLE 496 ON READER SERVICE CARD

Other New Products

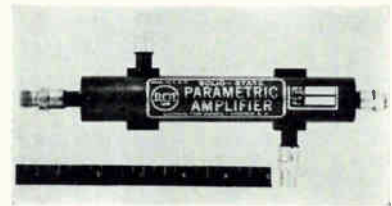

Microwave Circuits

PACKAGED UNITS

RADIO CORP. OF AMERICA, Harrison, N. J., announces a family of packaged microwave circuits for satellite communications systems, military radar, L- and S-band communications. They incorporate the company's latest tunnel diodes and varactor diodes. The SS-1000 helix parametric amplifier, 2200-2300 Mc, 15 db gain (min), noise factor 7.5 db (max) across the range, power output 1 mw.

CIRCLE 497 ON READER SERVICE CARD



Vector Analyzer

PRECISION UNIT

AD-YU ELECTRONICS LAB., INC., 249 Terhune Ave., Passaic, N. J. Type 202 precision vector analyzer features: (1) Accuracy better than

0.02 deg or 2 percent. (2) Resolution: 0.005 deg deviations can be read. (3) Full scale sensitivity is 1 deg or 0.01 v rms. (4) Frequency range from 20 cps to 40 Kc.

CIRCLE 498 ON READER SERVICE CARD

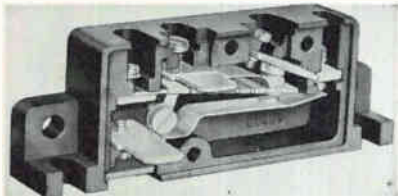

Time Delay Relay

LOW COST

E-T-A PRODUCTS CO., 6285 N. Cicero Ave., Chicago 46, Ill. Only 90 cents each in lots of 100, these time delay relays are available with spst—n-c or n-o contacts, two independent circuits or spdt. Unit features totally enclosed Bakelite housing, two mounting variations, and terminals to accept either solder or standard quick connect wiring. Rated: 100 ma to 10 amp, up to 115 v a-c.

CIRCLE 499 ON READER SERVICE CARD

Solar Sensor

BALL BROTHERS RESEARCH CORP., Boulder Industrial Park, Boulder, Colo. Photoelectric sensors provide servo control of rocket and satellite-borne sun trackers.

CIRCLE 500 ON READER SERVICE CARD

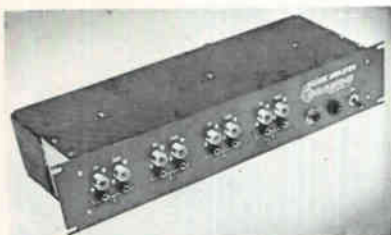

Decade Amplifier

FOUR-IN-ONE

PRENCO, INC., 246 Park Ave., Garden City Park, L. I., N. Y. Decade amplifier consists of 4 completely independent amplifiers in one compact package. Two-stage feedback circuits with 20 db gain are employed, allowing the amplifiers to be used separately or in cascaded combinations providing gains of 40, 60, or 80 db. Push-pull operation may be used, either as two single 20 db

shock problem:

Supply sensitive, ultra-reliable switchboard instruments for Nike-Zeus control panels. Make them absolutely precise, yet rugged enough to withstand extreme shock. Eliminate the degrading friction of the standard pivot.

solution:

Westinghouse furnished Continental Electronics Manufacturing Company, Dallas, Texas, with "Taut Band Suspension" switchboard instruments for the Nike-Zeus control system. "Taut Band Suspension" is a tough metal band about one-tenth the thickness of a human hair. It eliminates conventional pivots and bearings, makes possible an extremely rugged unit with almost infallible repeatability. They bear overloads up to 150 times the full-scale deflection and withstand extreme vibration and shock without influencing accuracy. Appearance is attractive, conducive to quick legibility. If you need this kind of resourcefulness in your current projects, call your Westinghouse sales engineer. Or write: Westinghouse Electric Corporation, P.O. Box 868, Pittsburgh 30, Pennsylvania. *You can be sure . . . if it's Westinghouse.*

J-92516

Westinghouse

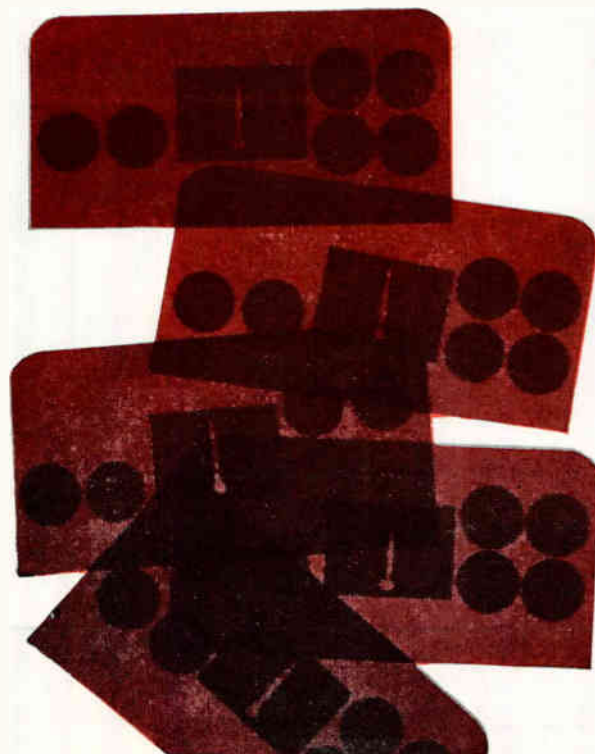

THE SPECIALIST IN



FREQUENCY COUNTERS

DEPENDABLE — proven on major missile programs, under most severe environments.

MAINTAINABLE — simplified, clean design; fewer tubes and diodes — more accessible — easier check-out.

DELIVERED from factory stock — no waiting.

PRICED right; low lease terms available.

THE MODEL 14-20AN (nixie)

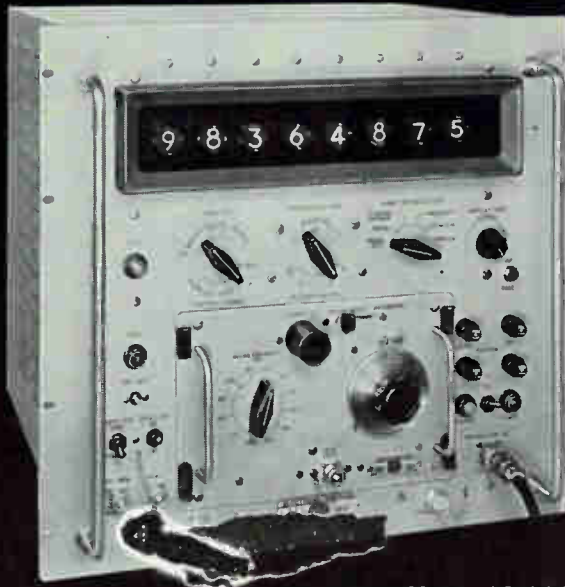

IS LESS THAN \$2,000 !

Reps in Principal Cities
TWX: MAN NH 370-U

Telephone —
NAtional 2-6485

NORTHEASTERN ENGINEERING

An Affiliate of Atlantic Research Corp.

MANCHESTER • NEW HAMPSHIRE

stages, or cascaded to provide a gain of 40 db.

CIRCLE 501 ON READER SERVICE CARD

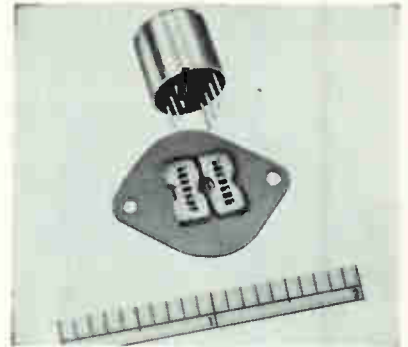

Tiny Transformers PLUG IN-SOLDER IN

JAMES ELECTRONICS, INC., 4050 N. Rockwell St., Chicago 18, Ill., has microminiature transformers with 0.030 in. diameter brass pin leads spaced 0.100 in. apart, to plug in to a standard 5 pin subminiature socket or to facilitate soldering-in for permanent installations. The $\frac{1}{2}$ in. diameter metal cases are sealed and potted to meet MIL-T-27A, grade 5. Impedance ranges available from 10 ohms to 300,000 ohms.

CIRCLE 502 ON READER SERVICE CARD

Subminiature Switch

FANSTEEL METALLURGICAL CORP., North Chicago, Ill. "Cricket" action in contact-carrying leaf spring distributes stress uniformly, reducing metal fatigue.

CIRCLE 503 ON READER SERVICE CARD



Power Rectifier MAGNETIC STARTER

GATES ELECTRONICS CO., 2243 White Plains Road, Bronx 67, N. Y. Model G50-50R silicon power rectifier uses 220 v a-c, 60 cycle,

Do you know?



11 Cerafil capacitors can fit under a dime... we tried it. Hi-Q Cerafil capacitors are the smallest ceramic units available anywhere! Unique design makes it possible to obtain extremely high capacities per unit volume. Want complete technical specifications? Write today to...



AEROVOX CORPORATION 1007 SENECA ST.,
OLEAN, NEW YORK

CIRCLE 268 ON READER SERVICE CARD

Type 405 Series: 1 cps to 500 kc. Direct reading in degrees; no amplitude adjustment, no frequency adjustment. Accuracy 0.25° or 2%. Price — \$548.00 and up.

Type 202: 20 cps to 500 mc. Accuracy 0.05° or 2%. 1° full scale sensitivity. Price — \$588.00.

Type 205-A1-A2: 100 kc to 15 mc. Accuracy 0.05° or 1%. Sensitivity 0.04 volt full scale. Price—\$625.00 and up.



Type 205B1 Series: 15 mc to 1500 mc. Accuracy 0.05° or 1%. Measures down to millivolt. Price — \$1193.00 and up.

Type 208 Phase Shifter: 0 to 360°, continuously adjustable. Accuracy 0.1°. Price — \$445.00 and up.

PHASE METERS

1 CPS TO 1500 MC
ACCURACY 1% or 0.05°

AD-YU
Formerly Advance
ELECTRONICS LAB., INC.
249 Terhune Avenue
Passaic, New Jersey

CIRCLE 269 ON READER SERVICE CARD

Very Low Noise Antenna Preamplifier

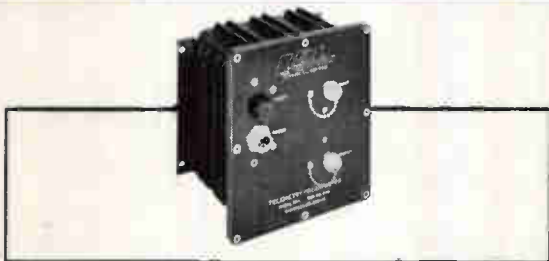

Newest in the LEL Antenna Preamplifier series, the TP-6 provides very low noise figures over 10mc bandwidths at frequencies up to 1200mc. Self contained power supply and weatherproofed packaging make the unit ideal for mounting at a receiving antenna.

SPECIFICATIONS

Gain	26db
Noise figure	1.5db at 136mc
	3.5db at 400mc
Weight	8-1/2 lbs.
Size	7" x 8" x 4-3/4"
Power	115v; 50 to 400cps

Send for 48 page Microwave RF/IF Equipment Catalog

LEL INC.

Akron Street
Copiague, L. I., N. Y.
A Mityville 4-2200

CIRCLE 270 ON READER SERVICE CARD

BLOCK VACUUM VALVES

BELLOWS SEALED

Maximum Flow...
Minimum Space... Low Cost

NRC Equipment Corp.'s block valves assure you:

- Porosity-free body... machined from sulphur-free solid brass.
- Freedom from stem leakage... positive bellows seal.
- Full opening... sizes from 1/4" to 1 1/2".
- Easy mounting... available in angle or in-line types — for soldered or screwed connections.
- Low-cost maintenance... bellows removable without removing valve from line.
- Neoprene disc gasket... teflon, viton or other materials available on request.



Write for data sheet on NRC Block Valves,

160 Charlemont Street, Dept. 4-H
Newton 61, Massachusetts
DEcatur 2-5800

A Subsidiary of National Research Corporation



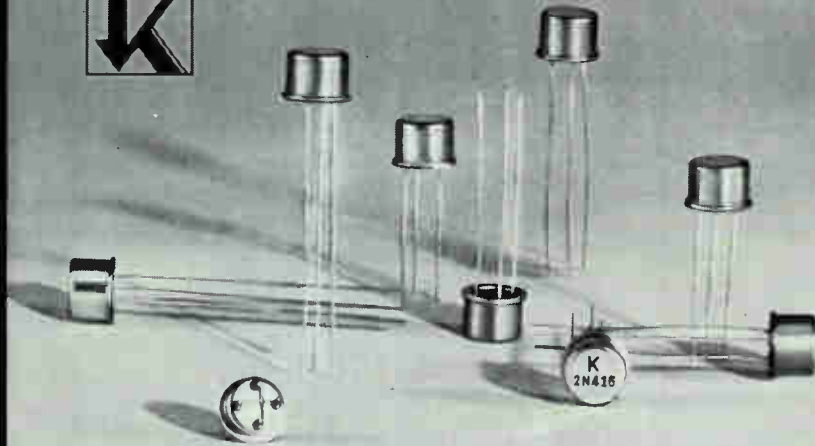

KEARFOTT TRANSISTORS PROVIDE HIGH RELIABILITY- CONSISTENT PERFORMANCE

HIGHEST POWER DISSIPATION OF ALL AVAILABLE GERMANIUM-ALLOY JUNCTION TRANSISTORS

Kearfott now offers a complete off-the-shelf series of TO-5 germanium-alloy PNP junction transistors. Their unexcelled electrical and mechanical reliability, precise electrical characteristics, and virtual insensitivity to temperature changes derive from Kearfott's intensive materials-and-methods control, plus complete, 100% functional testing. These factors add up to the consistent reliability, uniformity, extended service life, and repeatability of product performance which typify Kearfott semiconductors.

DESIGNED AND PRODUCED BY KEARFOTT SEMICONDUCTOR CORP. WEST NEWTON, MASS.

CHARACTERISTICS

Designed to meet or exceed requirements of NAVORD OS9669B (R-212 Series) and MIL-S-19500B

All transistors tabulated below are available with maximum collector power dissipation of 200 mw.

2N123	2N404	2N520A	2N653
2N315	2N404A	2N521	2N658
2N315A	2N413	2N521A	2N659
2N316	2N414	2N522	2N660
2N316A	2N414A	2N522A	2N661
2N317	2N416	2N523	2N662
2N317A	2N425	2N523A	2N1017
2N394	2N426	2N578	2N1303
2N395	2N427	2N579	2N1305
2N396	2N428	2N580	2N1307
2N396A	2N519	2N581	2N1309
2N397	2N520	2N582	

Write for complete data



KEARFOTT DIVISION
GENERAL PRECISION, INC.

Little Falls, New Jersey

3 phase input. It produces an output of 0.50 v d-c, 0-50 amp d-c with continuous duty over the entire range. Features: 0.5 percent ripple rms, 8 percent regulation no load to full load, 2 percent accuracy, thermal overload protection.

CIRCLE 504 ON READER SERVICE CARD

Axial Flow Fans

BORG-WARNER CORP., Pesco Products Div., 24700 N. Miles Blvd., Bedford, Ohio. Heating fans raise the air temperature 30F, while providing a flow of 40 cubic feet per minute.

CIRCLE 505 ON READER SERVICE CARD



Silicon Rectifier

LOW COST

MOTOROLA SEMICONDUCTOR PRODUCTS INC., 5005 E. McDowell Rd., Phoenix, Ariz., announces a fifty-eight cent 18-ampere silicon rectifier. The MR322 is housed in a welded, hermetically-sealed $\frac{3}{8}$ in. diameter knurled case with an $\frac{1}{4}$ in. long axial-lead top terminal, and is designed for press-fitted mounting into a heat sink. Rated for operation at case temperature ranging from - 65 C to 175 C.

CIRCLE 506 ON READER SERVICE CARD

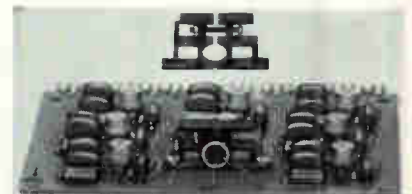

Transistor Heat Sinks

NATURAL CONVECTION

ASTRO DYNAMICS, INC., 200 Sixth St., Cambridge, Mass. Developed to satisfy the needs for the reduction of space and weight in the design of component boards for

computers, the model 2700 series heat sinks substantially increase transistor performance by optimizing the effect of the heat transfer coefficient available in free convection.

CIRCLE 507 ON READER SERVICE CARD



Coaxial Switch

MODULATOR, ATTENUATOR

SOMERSET RADIATION LABORATORY, INC., 192 Central Ave., Stirling, N. J., announces two series SMA coaxial switch/modulator/attenuators that feature low insertion loss, wide dynamic range, relatively high power handling capability (up to 7 w) over close to an octave range at microwave frequencies.

CIRCLE 508 ON READER SERVICE CARD

Power Recorder

RUSTRAK INSTRUMENT CO., 130 Silver St., Manchester, N. H. Records expanded scale a-c voltage simultaneously with a-c current by two galvanometers. Price is \$149.50.

CIRCLE 509 ON READER SERVICE CARD

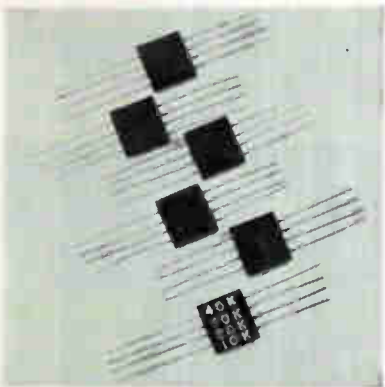

Resistor Packages

WAFER-THIN

GENERAL RESISTANCE, INC., 430 Southern Blvd., New York 55, N. Y. Wafer-thin Resist-O-Stats contain four subminiature precision resistors in each unit with relative resistance values of 1, 2, 4, and 4. Linking these resistors in various series produces relative values from

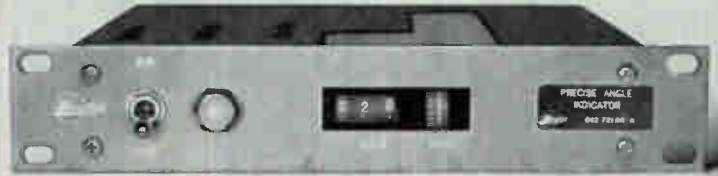

HIGH-ACCURACY PRECISE ANGLE INDICATOR

NEW KEARFOTT UNIT ACCURATE TO ± 6 MINUTES

The new CO 2721011 Precise Angle Indicator features an accuracy of ± 6 minutes. Latest addition to the Kearfott line of standard test equipment, the unit is designed to meet a wide range of applications. Typical Applications

- Indication of gyro angle of pitch, roll, or yaw and relaying of signal to any preselected impedance or voltage level.
- Indication of shaft position of remote synchro or resolver, and transmission of this information to any impedance or voltage level.
- Display of difference between two shafts when driven by transmitter and differential synchros.

In addition to high accuracy the instrument combines a number of other prominent advantages: it requires only a single power source; it has good sensitivity; it is designed for modular application; and it offers direct automatic read-out. The unit is of extremely compact construction and is built for maximal ease of maintenance.

The low-cost CO 2721011 Precise Angle Indicator is available with a single sensor, auxiliary dual-input sensor, or an auxiliary retransmitter. For additional information on this new test instrument, write for the brochure which describes its operation and capabilities in detail.

SPECIFICATIONS

Repeatability ± 1.2 min	Slewing Speed	7 sec/180°
Readability 0.5 min	Power (single source)	115 v, 1 ϕ , 400 cps
Input Power 30 va	Size	1 $\frac{3}{4}$ x 9 $\frac{1}{2}$ x 9 $\frac{1}{8}$ in.
Sensitivity 1.0 min	Weight	4 lbs.

Write for complete data



**KEARFOTT DIVISION
GENERAL PRECISION, INC.**

Little Falls, New Jersey

NEW! 10-AMPERE RELAY

**Dunco
FC-215**

Weight 3 oz. Size
 $\frac{5}{8}$ " x $1\frac{1}{32}$ "
x $1\frac{1}{4}$ " high.

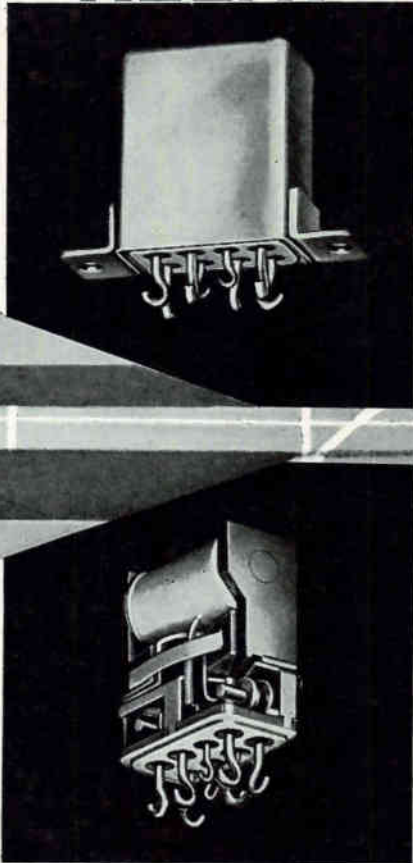

**ALL-WELDED
INTERNAL
CONSTRUCTION!**

for missile and aircraft uses

Conservatively rated for 10 ampere DC operation, these solidly built little DPDT units fill a long standing need for dependable heavy duty power relay service under temperature, vibration and shock extremes.

Constructed throughout to meet or surpass MIL-R-575C and MIL-R-25018 requirements. No internal

soldered joints. Withstand 30G vibration to 2000 cycles and 50G shock. Standard coils rated 26.5 Volts DC nominal with 400 ohms coil resistance. Other coils available. Designed for 125° C. operation

Header terminals are 0.2" grid-spaced and can be furnished with hook, long or short wire lead terminals.

WRITE FOR DUNCO BULLETIN FC-215
STRUTHERS-DUNN

World's largest selection of relay types

STRUTHERS-DUNN, Inc., Pitman, N. J.

Member, National Association of Relay Manufacturers



Sales Engineering offices in: Atlanta • Boston • Buffalo • Charlotte • Chicago • Cincinnati • Cleveland • Dallas • Dayton • Detroit • Kansas City • Los Angeles • Montreal • New Orleans • New York • Pittsburgh • St. Louis • San Francisco • Seattle • Toronto

216 CIRCLE 216 ON READER SERVICE CARD

1 through 11 within a Resist-O-Stat. When combined with other Resist-O-Stats (up to six) they provide any desired resistance value between 1 ohm and 1,222,221 ohms in 1 ohm steps.

CIRCLE 510 ON READER SERVICE CARD

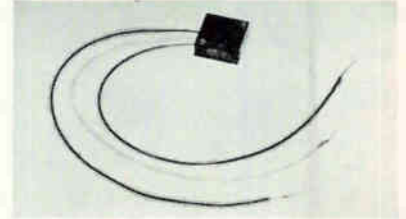

Trimming Pot SUBMINIATURE

DAYSTROM INC., Potentiometer Division, Archbald, Pa. The Squaretrim model 355 provides a precision trimming pot in a high-density package $\frac{1}{2}$ by $\frac{1}{2}$ by 0.2 in. Resistance values run from 10 ohms to 50,000 ohms over an operating range from -55 C to +200 C. Three 4 in., 30 Awg, Teflon-insulated wire leads are positioned at the narrow end.

CIRCLE 511 ON READER SERVICE CARD

Radar Test Set

REPUBLIC ELECTRONIC INDUSTRIES CORP., 111 Gazza Blvd., Farmingdale, L. I., N. Y. Unit provides ground checkout of airborne radar, without physical connection to the aircraft, in 30 minutes.

CIRCLE 512 ON READER SERVICE CARD

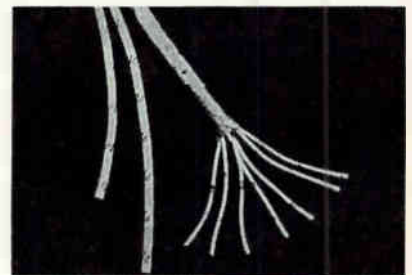

Multiconductor Cable PRINTED, NUMBERED

AMERICAN SUPER-TEMPERATURE WIRES, INC., Winooski, Vt., has a process for printing code numbers or letters on multiconductor cable. Major advantage of the process is the elimination of color coding of multiconductor cabling. Compli-

electronics

cated color stripping is replaced by easy-to-read numbers which all but eliminate the possibility of hook-up error and make for easy identification of the electronic circuits.

CIRCLE 513 ON READER SERVICE CARD

Voltage Indicator

TROTT ELECTRONICS, INC., 412 Smith St., Rochester 8, N. Y. Fully transistorized, battery operated device indicates presence of voltage transients in circuitry.

CIRCLE 514 ON READER SERVICE CARD



Video Crystal Tester RAPID AND ACCURATE

AIRBORNE INSTRUMENTS LABORATORY, Deer Park, L. I., N. Y. Type 393 is used to measure the tangential sensitivity of video crystals. Using a d-c technique, the tester does not require the operator's familiarity with microwave measurements to obtain accurate readings. Unit is completely portable and battery operated for field as well as lab operation.

CIRCLE 515 ON READER SERVICE CARD



Solid State Converter ANALOG-DIGITAL-ANALOG

TEXAS INSTRUMENTS INC., P. O. Box 6027, Houston 6, Texas. Model

fault protection problem:

Protect electrical circuits in case of overloads. Replace large conventional devices with smaller, more compact tripping units offering greater fault protection for a given size, thus eliminating costly and unnecessary downtime.

solution:

Westinghouse supplied Raytheon Company, Waltham, Massachusetts, with Type 550 (hydraulic-magnetic) circuit breakers for use in FAA air route surveillance radar consoles. These fail-safe breakers are ideal in ground or airborne electrical and electronic equipment where fractional amperage is required. Sturdy, compact design assures protection of electrical equipment under wide ranges of operating temperatures and stringent environmental conditions. Available in a variety of tripping characteristics: standard time delay, short time delay, instantaneous trip. Available from 20 milliamps to 50 amperes with maximum voltage range 250 volts a-c or 50 volts d-c. For helpful data bulletin or a demonstration on the hydraulic-magnetic tripping principle, contact your Westinghouse sales engineer. Or write: Westinghouse Electric Corporation, P.O. Box 868, Pittsburgh 30, Pennsylvania. *You can be sure . . . if it's Westinghouse.*

J-92511

Westinghouse

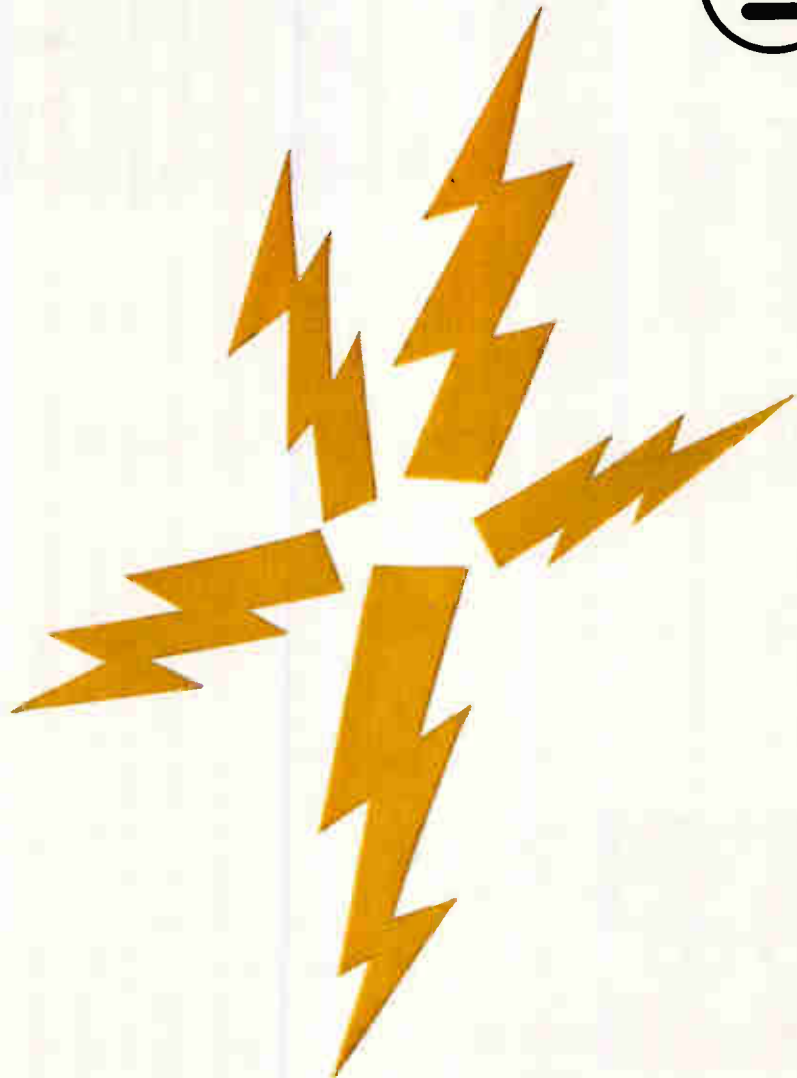

PRODUCT APPLICATION

HANSEN
SYNCHRON
TIMING MOTORS

Schulmerich
electro-mechanical

CARILLONIC BELL

systems . . .



Hansen
SYNCHRON
motors,
the "heart"
controlling
the split-second
timing of
Schulmerich
Carillonic
Bells

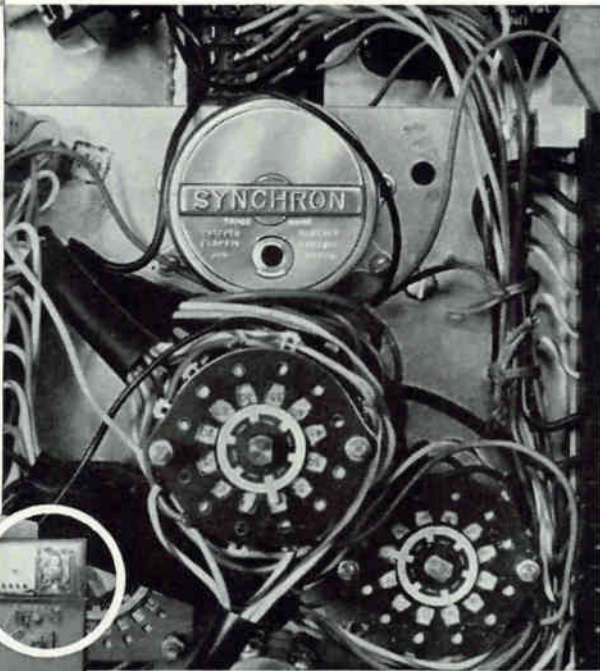

SCHULMERICH CARILLONS, INC., world's largest manufacturer of electro-mechanical carillons, uses Hansen SYNCHRON Timing Motors to drive the program clock governing the all-automatic operation of these precision, perfect-tone instruments. Clock programming is offered at 15-minute intervals, 24 hours a day, 7 days a week. Scheduled to play at specified times, exactly to the minute — there is no allowance for plus or minus variation.

HANSEN SYNCHRON TIMING MOTORS were selected as an integral part of Schulmerich Carillonic Bells because they outperformed all other motors tested. Carefully controlled testing was based on four specifications: (1) instantaneous starting, (2) no time loss or gain, (3) absence of malfunction, and, (4) reliable, continuous operation for periods of a year or more. Depending on installation, motors operate at either 110 or 220 volts — 50 or 60 cycles.

SEND TODAY for informative folder containing specifications and technical data on all Hansen SYNCHRON motors and clock movements.

HANSEN REPRESENTATIVES:

THE FROMM COMPANY
5150 W. Madison, Chicago, Illinois
H. C. JOHNSON AGENCIES, INC.
Rochester, N. Y. — Buffalo, N. Y. — Syracuse, N. Y.
Binghamton, N. Y. — Schenectady, N. Y.
ELECTRIC MOTOR ENGINEERING, INC.
Los Angeles, Calif. — (Olive 1-3220)
Oakland, California
WINSLOW ELECTRIC CO.
New York, N.Y. — Essex, Conn. (SOuth 7-8229)
Philadelphia, Penn. — Cleveland, Ohio

Sweet's Product
Design File



430 converter includes a sample and hold facility and is a successive approximation type of feedback voltage encoder operating in true binary code. Fourteen bit conversions are made at rates up to 35 Kc. Instrument is equipped for remote switching between analog-digital and digital-analog modes. Basic speed (analog-to-digital) is 1.5 μ sec per bit plus 4.5 μ sec per conversion.

CIRCLE 516 ON READER SERVICE CARD



R-F Inductors SLUG-TUNED

NORTH HILLS ELECTRONICS, INC., Glen Cove, N. Y. Series 1500 slug-tuned, shielded r-f inductors are designed for military and high quality commercial applications. They cover a range of inductance from 100 μ h to 7.5 mh in 9 steps and are most useful over the 0.1 to 1.0 Mc spectrum where the average Q is 60. Units can be used in telemetering, radar, and communications equipment.

CIRCLE 517 ON READER SERVICE CARD



Spectral Lamp FOR RESEARCHERS

VARIAN ASSOCIATES, 611 Hansen Way, Palo Alto, Calif. Model X49-609 research rubidium spectral lamp is designed to provide the researcher with a stable, high-intensity light source for use in optically pumped resonance systems. It provides a high-photon flux at a correspondingly high signal-to-noise ratio. Price is \$275.

CIRCLE 518 ON READER SERVICE CARD



PRODUCT BRIEFS

MICA CAPACITORS resin-encapsulated. Cornell-Dubilier Electronics Division, 50 Paris St., Newark, N. J. (551)

INDUCTION MOTORS fractional h-p. Kearfott Division, General Precision, Inc., 1150 McBride Ave., Little Falls, N. J. (552)

DECOMMUTATOR pam/nrz/pdm. The Ralph M. Parsons Co., 151 S. DeLacey Ave., Pasadena, Calif. (553)

ELECTRONIC CHOPPERS solid state. Solid State Electronics Co., 15321 Rayen St., Sepulveda, Calif. (554)

ENCAPSULATED RESISTORS in hard glass. Texas Instruments Inc., P. O. Box 5012, Dallas 22, Texas. (555)

POWER SUPPLY high regulation. Perkin Electronics Corp., 345 Kansas St., El Segundo, Calif. (556)

MAGNETIC AMPLIFIER fast-response. Lumen, Inc., P. O. Box 905, Joliet, Ill. (557)

TIME CODE GENERATORS for field or lab. Abacus, Inc., 1718 21st St., Santa Monica, Calif. (558)

SYNCHRONOUS MOTOR with 1,000 oz-in. torque rating. The Superior Electric Co., Bristol, Conn. (559)

BINARY COUNTER fully transistorized. Digital Design Corp., Box 21, Clay, N. Y. (560)

MODULAR RACKS square cornered. Premier Metal Products Co., 337 Manida St., N. Y. 59, N. Y. (561)

NANOSECOND DELAY LINE variable step. Lumatron Electronics, Inc., 116 County Courthouse Road, New Hyde Park, L. I., N. Y. (562)

SWITCHES, ATTENUATORS for microwave receiver. Microwave Associates, Inc., Burlington, Mass. (563)

SHAFT POSITION ENCODER uses U-scan technique. Datex Corp., 1307 South Myrtle Ave., Monrovia, Calif. (564)

GENERAL PURPOSE RELAYS low cost. Ohmite Mfg. Co., 3672 Howard St., Skokie, Ill. (565)



IN PARIS

PORTE DE VERSAILLES

FROM 16th TO 20th

FEBRUARY 1962

5th INTERNATIONAL EXHIBITION OF ELECTRONIC COMPONENTS

The greatest world meeting
in the field of electronics

**FÉDÉRATION NATIONALE
DES INDUSTRIES
ÉLECTRONIQUES**

23 rue de Lubeck, Paris 16^e
phone: PASsy 01.16

Published by Chart-Pak, Inc., originator of the tape method of drafting

PRINTED-CIRCUIT DRAFTSMEN GET "INSTANT" SYMBOLS WITH CHART-PAK

It's a lot less work to make fast, accurate master drawings with Chart-Pak printed circuit symbols and tapes.

Chart-Pak offers circles, ovals, fillets and a variety of common shapes die-cut out of pressure-sensitive black crepe paper — available on handy backing rolls. You just press them down!

Chart-Pak circuit symbols are low in cost; accurate; reproducible; easily "correctable". Available in popular decimal sizes.

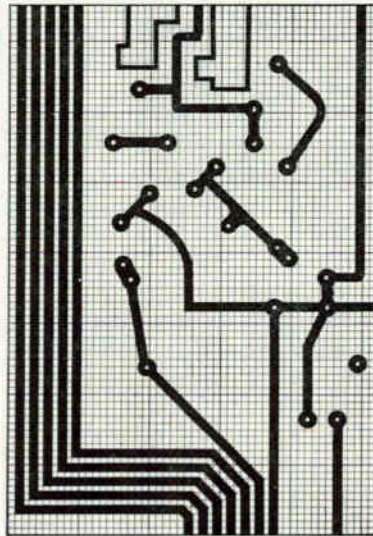

Conductor Paths "Tape" On—A Yard at a Time!

Draftsmen put down conductor paths in seconds, with Chart-Pak circuit tapes . . . Lines have unusual uniformity (width held within .002") Chart-Pak's precision-slit tapes come in sizes down to 1/4" . . . in all-black or white-backed type (handy for registering circuits back-to-back.)



WRITE FOR NEW CHART-PAK CATALOG. It helps you take the drudgery out of drafting!

Chart-Pak Grids Pin-Point Location within .002"

Precise printed-circuit drawings are a foregone conclusion when they're "taped-up" with Chart-Pak, on a Chart-Pak Precision Grid. The distance between any two lines is guaranteed accurate within .005".

The sheet, tough, stable DuPont "Mylar"® is a pleasure to work on — can be used over and over again.

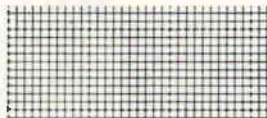

New! "Tape-Saver" Package

CHART-PAK, INC.

ORIGINATOR OF THE TAPE METHOD OF DRAFTING

16B1 River Road, Leeds, Mass.

Dealers in principal cities in U. S. and Canada

CIRCLE 222 ON READER SERVICE CARD

Is your advertising selling the same four key buyers your salesmen call on? Competition demands it! Only advertising in electronics reaches and sells the electronics man wherever he is: in *Research,*

TODAY YOU MUST SELL ALL FOUR!

Design, Production, and Management. Put your advertising where it works *hardest...*

in **electronics**

AMMETERS & VOLTMETERS General Electric Co., Schenectady 5, N.Y. Bulletin describes rectifier-type ammeters and voltmeters with Big Look design features. (566)

STRAIN GAGE Microdot Inc., 220 Pasadena Ave., S. Pasadena, Calif. Bulletin SG-1 covers a weldable strain gage that is capable of continuous operation at 750 F and dynamic test to 1,500 F. (567)

SOLID STATE CIRCUITS Owen Laboratories, Inc., 55 Beacon Place, Pasadena, Calif. A handbook discusses the use of semiconductor test equipment in the development of solid state circuitry. (568)

POWER TRANSISTOR STABILITY Delco Radio Division, General Motors Corp., Kokomo, Ind. Application Note 15-A contains information on the stability of electrical parameters of the company's power transistors under high temperature storage conditions. (569)

INDICATOR TUBES Burroughs Corp., P. O. Box 1226, Plainfield, N. J., has published a Nixie indicator tube catalog that describes new wide viewing angle series of Nixie tubes. (570)

POTS & DIALS Borg Equipment Division, Amphenol-Borg Electronics Corp., 120 S. Main St., Janesville, Wisc. Short form brochure covers more than 9 Micropot potentiometers and 6 Microdial turns-counting dials. (571)

CONNECTORS Hermetic Seal Corp., 4232 Temple City Blvd., Rosemead, Calif. Four-page brochure describes representative models of the Atlas line of high reliability plastic molded rack and panel connectors. (572)

CHEMICALS Fidelity Chemical Products Corp., 470-474 Frelinghuysen Ave., Newark 14, N. J. Bulletin describes various chemicals available for the specialized needs of the electronics industry, particularly in the area of semiconductors. (573)

SHAFT POSITION ENCODERS AR & T Electronics, Inc., 1101 McAlmont St., Little Rock, Ark., announces a bulletin covering the series 1000 shaft position encoders for conversion of angular shaft displacement

the Week

into electrical form for digital read-out in cyclic binary code. (574)

PHASE-LOCKED-LOOP DISCRIMINATOR Electro-Mechanical Research, Inc., Sarasota, Fla. An 8-page brochure describes phase-locked-loop discriminators for telemetry ground instrumentation. (575)

DIGITAL INSTRUMENTS KinTel, a division of Cohu Electronics, Inc., Box 623, San Diego 12, Calif., has issued a catalog with details and specifications on d-c a-c/d-c digital voltmeters, preamplifiers, scanners and readouts. (576)

BERYLLIUM COPPER ALLOYS The Brush Beryllium Co., 5209 Euclid Ave., Cleveland 3, Ohio, offers four data sheets on beryllium copper alloys with tensile strength up to 215,000 psi. (577)

SYNCHRONOUS MOTOR Kearfott Division, General Precision, Inc., Little Falls, N. J. Catalog sheet covers a size 15 synchronous motor for use in such applications as ground support equipment, timing devices and recorders. (578)

TAPE REWIND UNIT Electronic Engineering Co. of California, 1601 E. Chestnut Ave., Santa Ana, Calif. Model TR-300 high-speed magnetic tape rewind unit is the subject of a recent data sheet. (579)

COOLING FAN Rotron Mfg. Co., Inc., Woodstock, N. Y. Catalog No. E-2800 describes the Gold Seal Muffin fan for cooling electronic equipment. (580)

PRINTED CIRCUITS U. S. Engineering Co., 13536 Saticoy St., Van Nuys, Calif. Specifications for all types of printed circuits available from the company are contained in a technical bulletin entitled "Depth in Circuitry." (581)

MICROWAVE TEST EQUIPMENT PRD Electronics, Inc., 202 Tillary St., Brooklyn 1, N. Y. Bulletin 800 categorizes hundreds of products by frequency ranges, waveguide sizes, prices, etc. (582)

STRAIN GAGES Micro Systems Inc., 319 Agostino Road, San Gabriel, Calif., has available a catalog on 29 new Micro-Sensor semiconductor strain gages. (583)

ANOTHER AEROVOX FIRST!

NOW

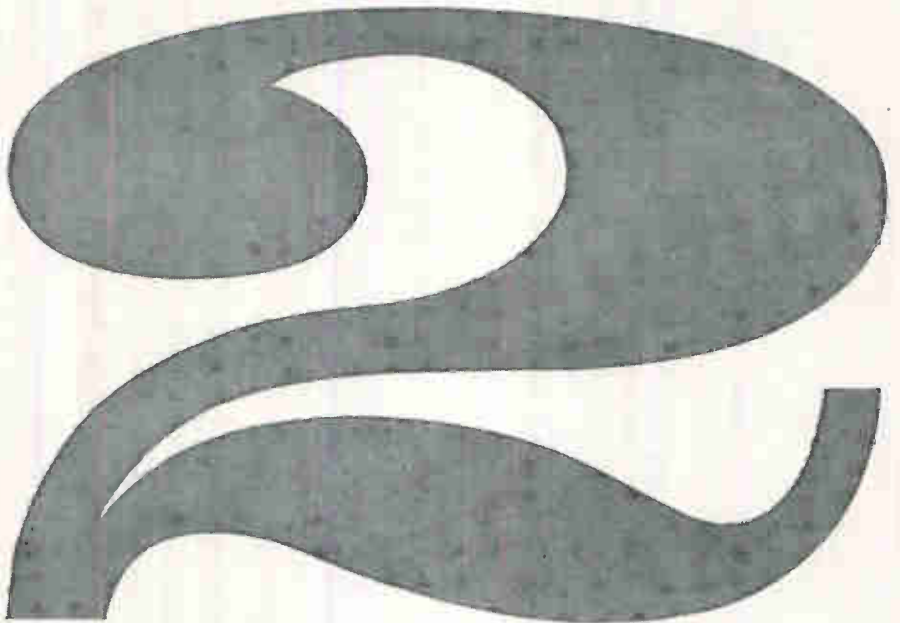

2 YEAR WARRANTY

ON ALL
**AEROVOX CAPACITORS
& RESISTORS**

In answer to the industry's stringent requirements for increased quality and reliability in capacitors and resistors for military, industrial, and commercial applications, Aerovox has placed a high priority on research and development, in addition to a rigorous program of application engineering and manufacturing modernization. New laboratory facilities, production tools and machinery, manufacturing techniques, and quality control have all contributed to the significant advancements made in the design and production of Aerovox components. As a result, Aerovox proudly announces another industry first...

A 2-Year Warranty is now in effect on all Aerovox capacitors and resistors! This reflects the willingness of Aerovox to take positive action as a pioneer and leader in the electronics industry. While it costs more to be able to build-in this added customer value, there will be no immediate across-the-board price increase. For full details please see your local Aerovox representative... He stands ready at all times to serve your needs.



AEROVOX CORPORATION
NEW BEDFORD DIVISION NEW BEDFORD, MASS.

Technical Leadership - Manufacturing Excellence

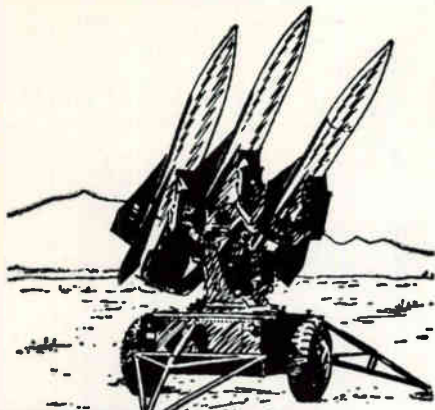

HAWK PROVEN CONNECTORS

LIONEL

Series S-20

Extra Reliability With—

- Shell-Enclosed, Die-Cast Housings
- Diallyl Phthalate Moldings
- Positive Alignment & Polarization
- Minimum Depth in Mated Position
- Beryllium Copper Contacts for Extended
- Insertion/Withdrawal Life

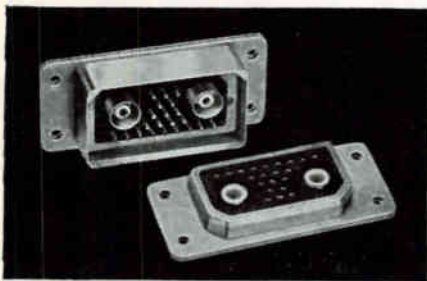

4 sizes: 13 to 41 high voltage contacts, 2 and 4 coaxial contacts; Meet applicable MIL specs; Materials & specifications modified to meet your special needs.

■ Write Dept. 28-HW for Series S-20 Dimensional Data Sheets

 **Lionel**
Electronic
Laboratories

(Formerly Anton Electronic Laboratories)

1226 Flushing Ave.
Brooklyn 37, N. Y.

NEW BOOKS

Coupled Mode and Parametric Electronics

By WILLIAM H. LOUISELL
John Wiley and Sons, Inc., New York, 268 p, \$11.50.

THIS BOOK presents the theory of coupled modes in an integrated fashion with emphasis on applications to traveling wave tubes, backward wave oscillators, parametric amplifiers, and related devices. The method of coupled modes as described in the book is an application of perturbation theory to solve oscillating and propagating systems as encountered in microwave electronic devices. The book will be of value to both graduate students and researchers.

The first chapter expounds the theory of coupled modes and the remainder of the book is dedicated to applications of the theory to electron beams, space charged waves, parametric amplifiers, and ferrite amplifiers. A comprehensive list of references is available at the end of each chapter.—*H. HODARA, Head of Space Communications, Research and Development Div., The Hallcrafters Co., Chicago, Ill.*

Electrons and Phonons

By J. M. ZIMAN

Oxford University Press, New York, 554 p, \$13.45.

THIS is an excellent book. Many readers will welcome the appearance of this volume from a number of points of view. Graduate students in solid state physics will find the material covered invaluable, as will physicists now directing their efforts in areas requiring knowledge of transport phenomena. Also, in today's world of new devices for future applications in electrical and electronic equipments, the need exists for a thorough understanding of the transport phenomena in solids. Device engineers developing thermoelectric converters, amplifiers based on phonon-phonon coupling, devices depending upon the propagation and control of acoustic energy in the kilomegacycle range, and other devices will find the text useful in a supplementary way, even though these subjects

are not treated explicitly.

As the author states, this is a book of theory. Still, he is able to establish an active rapport with the reader, making the subject matter come alive. Very few books on theory establish such an active interaction. The result is, without question, a most readable book, reflecting erudition as well as utility for the working theorist.

The subject matter is developed in an orderly manner, and emphasizes physical interpretation rather than mathematical rigor. Ziman states in his preface: "It is easier to pretend that the subject can be studied *a priori*, and to develop the argument logically from plausible premises than it is to follow the steps backwards and forwards, from experiment to phenomenology, to further experiment, to a final fundamental explanation. In the exposition of scientific knowledge, history is often the enemy of logic and lucidity." This principle is followed throughout the book.

The text begins by presenting the formalism for representing the behavior of lattice vibrations (phonons) and a corresponding discussion for electrons in solids. There then follows treatment of the possible mutual interactions: phonon-phonon, electron-electron, and electron-phonon. Finally, the effects of lattice imperfections are introduced to complete the basic treatment of interaction mechanisms. The scattering of electrons and phonons by the many possible lattice imperfections is kept orderly by classifying the types of imperfections according to their dimensionality. Thus, point imperfections are taken to be zero dimension; dislocations are treated as one dimensional, grain boundaries and stacking faults as two dimensional, and volume disorder as three dimensional.

To establish the framework for applications of the theory, formal transport is then developed. The theory is based on the Boltzmann equation, with a thoroughly readable account of variational methods, including the thermodynamic formulation of the principle.

The second half of the book is devoted to areas of application. Here the treatment of lattice conduction in metals and insulators and of electronic conduction in met-

als is relatively complete and highly recommended. The treatment of semiconductors is not as complete, but the compromise effected is a good one, that accomplished by playing down items of possibly greater technological than academic interest. A short chapter on size and surface effects is included and contains information not usually found in a text of this sort. The need to appreciate size and surface effects has become increasingly important over the past few years, during which emphasis has been placed on behavior of thin geometrics and microparticles. The book is concluded with a discussion of selected transport phenomena in a magnetic field.

Considering the author's ability for presenting difficult concepts and abstract matter in lucid exposition, it is the reader's misfortune that the author decided against including superconductivity, even though superconductivity is not closely related to general transport phenomena. But we are warned right at the beginning where Ziman states: "Originally it was planned to say something about superconductivity, but . . ." Perhaps this area will be included in a subsequent volume. *N. Schwartz, General Electric Electronics Laboratory, Syracuse, New York.*

The Modern Aspect of Mathematics

By LUCIENNE FELIX (translated by J.H. and F.H. Hlavaty)
Basic Books, Inc., New York, 194 p, \$5.

DESIGNED to be read by mathematician and teacher as a humanistic explanation of the new theories of mathematics, this book perhaps loses in translation, for its style makes reading rather tedious. Based on the work and aims of a society of French mathematicians who have been doing monumental work in the field of mathematics under the fictitious name of Nicolas Bourbaki, the book fails to impress the reader with the truly great importance of the subject matter. Probably this volume would not have too much appeal to either professional or amateur mathematicians.—W. E. B.

ELECTRICAL & ELECTRONIC CONTACT PARTS AND ASSEMBLIES

SEE US AT
WESCON
BOOTH 4809

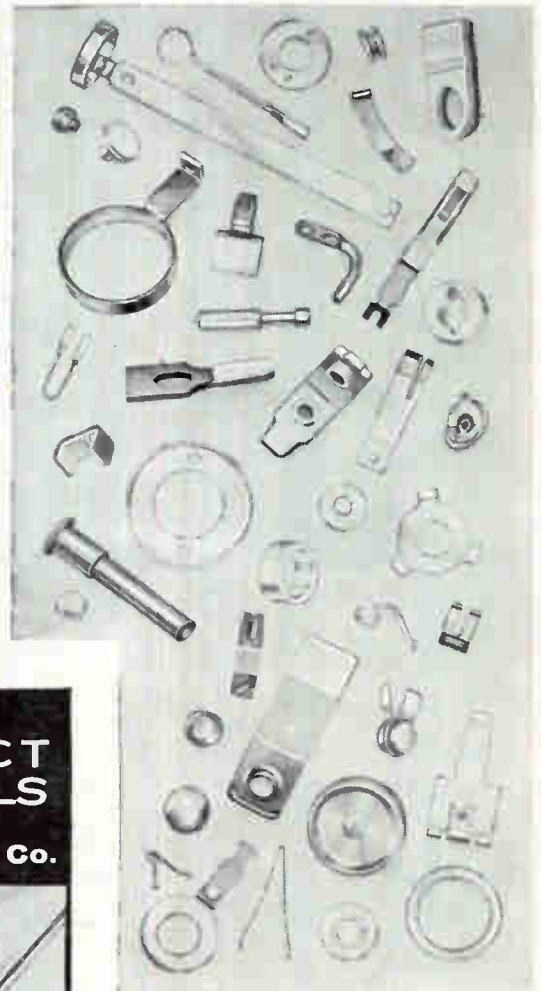

AND
CONTACT MATERIALS
BY OUR AFFILIATE
Leach & Garner Co.

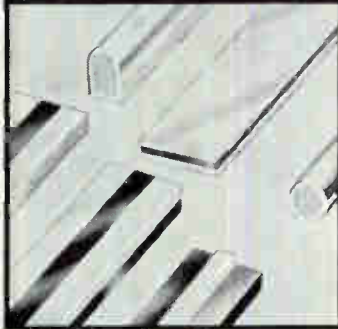

All standard and special alloys of Gold, Silver, Platinum and Palladium clad forms: Toplay, Overlay, Inlay, Edgelay and Thru-lay. Also Silver Solders • Waveguide Tubing Rolled Formed Shapes.

INDUSTRIAL DIVISION
LEACH & GARNER CO.
52 Pearl St., Attleboro, Mass.

Among our many specialties is the custom manufacture of intricate and precise miniature contacts and assemblies.

For our Southern California Customers . . . contact our West Coast Plant
GENERAL FINDINGS INC.—7327 Lankershim Blvd.
North Hollywood, California



INDUSTRIAL DIVISION
GENERAL FINDINGS INC.

Leach & Garner Bldg., Attleboro, Mass.



Morris: Exponent of Gamesmanship

"YOU MIGHT SAY he's a foremost exponent of gamesmanship. Whatever he undertakes, whether in sports or business, he plays to win—and usually does!" This characterization of Wescon's board chairman for '61 by a close business associate is probably as accurate as any. Most people who have dealt even briefly with Albert J. Morris, president and general manager of Radiation at Stanford, are impressed with his seemingly inexhaustible energy, imagination and ability to get the job done ahead of schedule.

An old-timer in Bay Area industry affairs, he is past chairman of IRE's San Francisco section, founded its chapter of the Professional Group on Medical Electronics, and was Wescon's convention director in 1959. Born 42 years ago in New York, Morris holds a BS degree from University of California (EE and ME) and received his MS and Degree of Engineer in EE from Stanford.

After serving as an electronics officer with the Navy, (he's now a USNR commander) during World War II, he held the spot of scientific research coordinator with

the San Francisco branch office of Office of Naval Research. Morris joined Levinthal Electronic Products, Inc., of Palo Alto in 1953. His initial contributions to the company were the Morris Pacemaker and Defibrillator, operating room devices credited with saving many lives. Rising through the positions of vice president and chief engineer, and later senior vice president, engineering, Morris became president in November, 1960, at the time of Levinthal's corporate reorganization and name change.

Morris, who early in life developed a philosophy that nothing is impossible, will tackle problems of any magnitude. He is proud of the several significant changes which have taken place in Wescon format during his four years on the board and says of this largest of Western trade shows, "It is a dynamic organization, and members of the board find a real challenge each year in trying to outdo their predecessors. I believe that the policy of rotating jobs and the injection of new blood into the organization each year are largely responsible for the show's attaining

its place of eminence in such a short time."

His recreational interests run from bridge-playing and dancing through golf. He admits to being a "pretty fair" tennis player, but his only adjective for his efforts in his latest sport, water skiing, is "tenacious". Wife Barbara, his college sweetheart from Berkeley, reports that his tenacity carries over into everything he does, including reading science fiction.

They both collect Oriental art objects with a passion, and take pride in the colorful Japanese garden adjacent to their Los Altos Hills home. Youngest of their three children, Lisa Ann, is three. Lee Ellen, 13, seems to be patterned in her father's mold, and Peter Alan, 16, is already showing a great interest in electronics.



MacLeod Instrument Elects Hull

MACLEOD INSTRUMENT CORP., Fort Lauderdale, Fla., announces the election of David R. Hull to the company's board of directors.

Hull joined Hoffman Electronics Corp. in 1960 as executive vice president. He served as president of the Electronic Industries Association from 1958 to 1960, and was recipient of the 1960 EIA medal of honor.

Vitro Electronics Names Schutz V-P

GERALD C. SCHUTZ has been named vice president of Vitro Electronics, a division of Vitro Corp. of America, New York, N. Y. He will be in charge of engineering and sales ac-

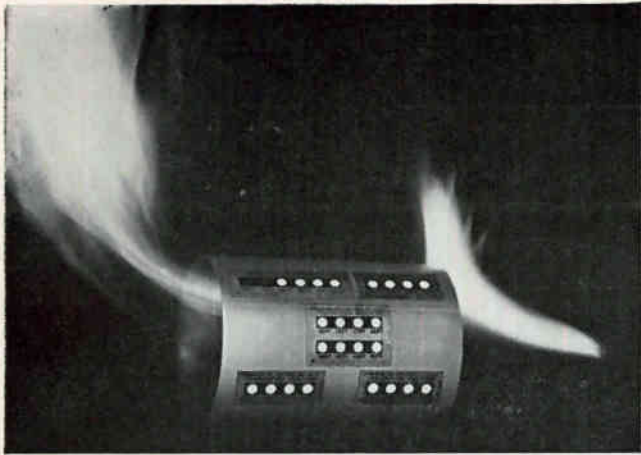

TEMP-PLATE® TEMPERATURE INDICATING STICKER

Temp-Plates detect overheating of electronic components, vital airborne parts, industrial equipment, in a positive, direct manner. Simple, easy to use, irreversible, Temp-Plate is the thin little tab that sticks to the component, turns black when the temperature reaches any desired value between 100° and 1100°F. Impervious to ambient atmosphere and production line handling, Temp-Plate is accurate to $\pm 1\%$, provides for absolute indication of heat damage. Write now for literature.

TEMP-PLATE/Pyrodyne, Inc.

11973 San Vicente Blvd.

Los Angeles 49, California



Actual Size

CIRCLE 274 ON READER SERVICE CARD

New... LOW COST PRODUCTION EYELET MACHINES

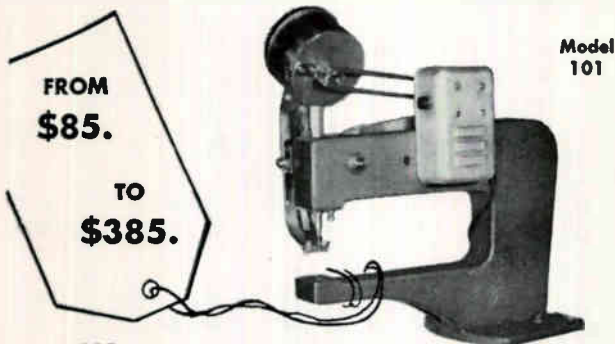

Model 101

We specialize in production machines for electrical and electronic needs. Used by leading makers of PW boards for setting funnel flange, standardized, and special eyelets, from smallest sizes to $\frac{3}{8}$ ". Best value on the market.

Model 101 air-operated machine automatically adjusts to various thicknesses. Cuts damage when setting plastics, ceramics, PW boards, glass, leather, etc.

FREE BULLETIN NO. AE100

Solve your eyelet machine problems fast — Write today.



EYELET TOOL CO.
INCORPORATED

31 Carleton Street, Cambridge, Mass.

CIRCLE 275 ON READER SERVICE CARD

August 11, 1961

ONE CUSTOMER REPORTS ACME ELECTRIC TRANSFORMERS HAVE A RELIABILITY FACTOR OF 99.4%*

* The six-tenths of one-percent failure rate includes secondary failures caused by initial failures of one or more other components or external arcing.

Engineering "know-how" and manufacturing facilities are available at Acme Electric to produce high reliability transformers in prototype or production runs for applications with operating temperatures up to 350°C.

We invite your inquiry for transformers to be supplied

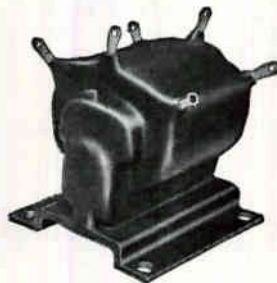

✓ ENCAPSULATED

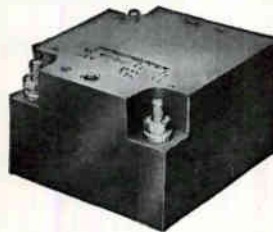

✓ MOLDED



✓ HERMETICALLY SEALED

SAA3502/1958

ACME ELECTRIC CORPORATION

318 Water Street

Cuba, N. Y.

In Canada: Acme Electric Corp. Ltd., 50 Northline Rd., Toronto, Ontario



CIRCLE 227 ON READER SERVICE CARD 227

ONE SOURCE FOR ALL YOUR METAL HOUSINGS

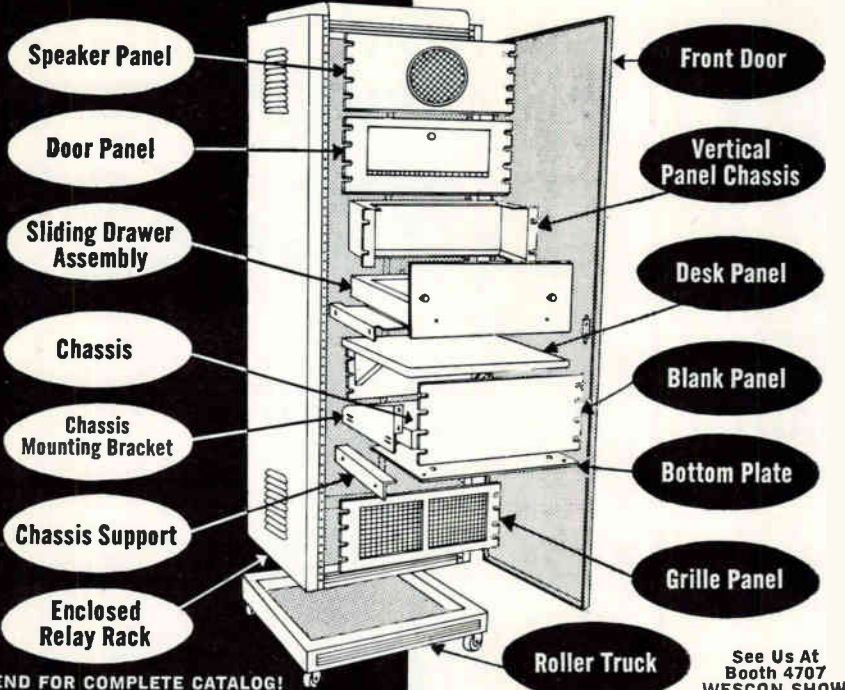

SEND FOR COMPLETE CATALOG!

See Us At Booth 4707 WESCON SHOW

PREMIER METAL PRODUCTS CO.

337 MANIDA STREET, NEW YORK 59, N. Y.



WESTERN SALES OFFICE: 1667 Laurel St., San Carlos, California
 EXPORT DEPARTMENT: EMEC, 127 Grace Street, Plainview, New York
 MFD. IN CANADA by PREMIER METAL HOUSINGS, Ltd., 5810 Smart Ave., Montreal

CIRCLE 276 ON READER SERVICE CARD

REMOTE DATA RETRIEVERS, EVENT AND DATA RECORDERS

1-1000+
EVENTS RECORDED
SIMULTANEOUSLY

HOGAN FAXimile recorders are available with up to 2000 individual styli for simultaneous recording. A wide range of stylus spacings is offered—up to 100 to the inch for high-speed facsimile, television and radar recorders and high resolution printers and plotters. Chart widths to 30" and feed rates to 50" per second.

Hogan specializes in electrolytic techniques for event, spectrum analysis, oscillograph and facsimile recording, frequency time analysis and special purpose binary and gray scale record applications. Hogan electrolytic faxpapers provide a permanent high contrast black on white record which is reproducible on most conventional office duplicators.

Whatever your recording problem may be—contact HOGAN FAXimile, a subsidiary of TELautograph Corporation, 635 Greenwich Street, New York 14, N. Y.

HOGAN FAXimile Corporation • 635 Greenwich St., New York 14, N. Y.
 A SUBSIDIARY OF TELAUTOGRAPH CORPORATION

OPERATION MONITORS, PRINTER PLOTTERS, TIME QUANTIZERS

SPECTRUM ANALYSIS, DENSITOMETERS, FACSIMILE RECORDERS

tivities for this precision electronics manufacturer.

Schutz was formerly with Bendix Systems Division, Ann Arbor, Mich., where he was associate technical director.

Vogue Instrument Moves Plant

VOGUE INSTRUMENT CORP. has announced that its plant and office have completed their move to a new building in Brooklyn, N. Y.

The thirteen-year old company started as a contract manufacturer of precision metal products and electronic components for the computer, electronic, aircraft and missile industries. The firm then developed proprietary products that included those items for which there had been a demand in the past on a contract basis such as instrument gears and gear train assemblies.

What To See At The Show

THIS YEAR there will be nearly 1,200 booths at Wescon featuring the wares and capabilities of 744 companies. Last year there were 989 booths of 805 companies.

The exhibits will be on the lower level of the Los Angeles Sports Arena and in a specially erected annex.

A

ACDC Electronics, Inc.	105
ACF Electronics Division	2820-2822
ADC Inc.	4218
AEL, Inc.	1209
AMP Inc.	417-517-519-521
A. P. M. Corp.	2614
Ace Electronics Associates, Inc.	3110
Ace Engineering & Machine Co., Inc.	1311
Acoustica Associates, Inc.	1407-1409
Adage, Inc.	3610
Aero Bolt & Screw Co., Inc.	5130
Airborne Instruments Lab.	2118-2119
Airpax Electronics Inc.	1716-1718
Aladdin Electronics	2615
Alden Electronic & Impulse Recording Equipment Co. Inc.	4314
Alden Products Co.	4219
Alford Manufacturing	1005-1007
Alfred Electronics	1412
Alite Div. of U. S. Stoneware Co.	1202-1204
Allen-Bradley Co.	1515-1516
Allen-Jones, Inc.	1216
Allied Chemical Corp.	4706

Alpha Metals, Inc.4924
 Alpha Wire Corp.4732-4734
 Amco Engineering Co.4731-4733
 American Bosch Arma Corp. 4126-4128
 American Electrical Heater Co. 5131
 American-Marietta Co.4523
 American Optical Co.
 3707-3709-3711-3713
 American Super-Temperature
 Wires Inc.4928-4930
 American Systems Inc.4403
 Ampex Electronic Corp. 3301-3303
 Ampex Computer Products
 Co.1101-1103-1105
 Ampex Instrumentation
 Products Co. .1107-1109-1111-1113
 Amphenol-Borg Electronics
 Corp. 3411-3413-3415-3417-3419-3421
 Anaconda Wire & Cable Co.4720
 Analab Instrument Corp.1218
 Anchor Plating & Tinning Co.,
 Inc.5015
 Andrew Corp.1821
 Anetsberger Brothers, Inc.4829
 Antenna & Radome Research
 Associates4221
 Antlab, Inc.4116
 Applied Development Corp.4507
 Applied Physics Corp.4308
 Arco Electronics, Inc.2610
 The Arnold Engineering
 Co.1905-1907-1909
 Artos Engineering Co.4721
 Assembly Products, Inc.3401-3403
 Associated American Winding
 Machinery, Inc.4628
 Astrodata, Inc.2417-2419
 Astro Dynamics, Inc.712
 Astron Corp.3221
 Astro-Science Corp.121
 Atlantis Electronics Corp.4508
 Atohm Electronics3506-3508
 Augat Bros, Inc.1021
 Auto Data1118
 Automatic Electric Sales
 Corp.2201-2203
 Automatic Metal Products Corp. 2514
 Automation Development Corp. 1805
 Autonetics1418-1420
 Autronics, Inc.204
 Aveco Corp.1326-1327-1328
 Aviel Electronics, Inc.319
 Avnet Corp.403-405

B

B & K Manufacturing Co.4122
 Babcock Electronics Corp.310
 Babcock Relays, Inc.312
 Baird-Atomic, Inc.3720-3722
 Ballantine Laboratories, Inc.2501
 Barber-Colman Co.3601-3603
 Barnes Engineering Co.1308-1309
 Beattie-Coleman, Inc.2426-2428
 Beckman Instruments,
 Inc.2001-2002-2003-2004
 Behlman Engineering Co.3114-3116
 Belden Manufacturing Co. 4612-4614
 Arvin Bell Co.4516
 The Bendix Corp.2902-4-6-8
 2605-6 2891-3-5-7
 Bird Electronic Corp.1922-1924
 The Bircher Corp.1910
 Blaw-Knox Co.4226-4228
 Bliley Electric Co.1914
 Blue M Electric Co.5112-5114
 Boesch Manufacturing Division. 4616
 Bomac Laboratories, Inc.2015-2017

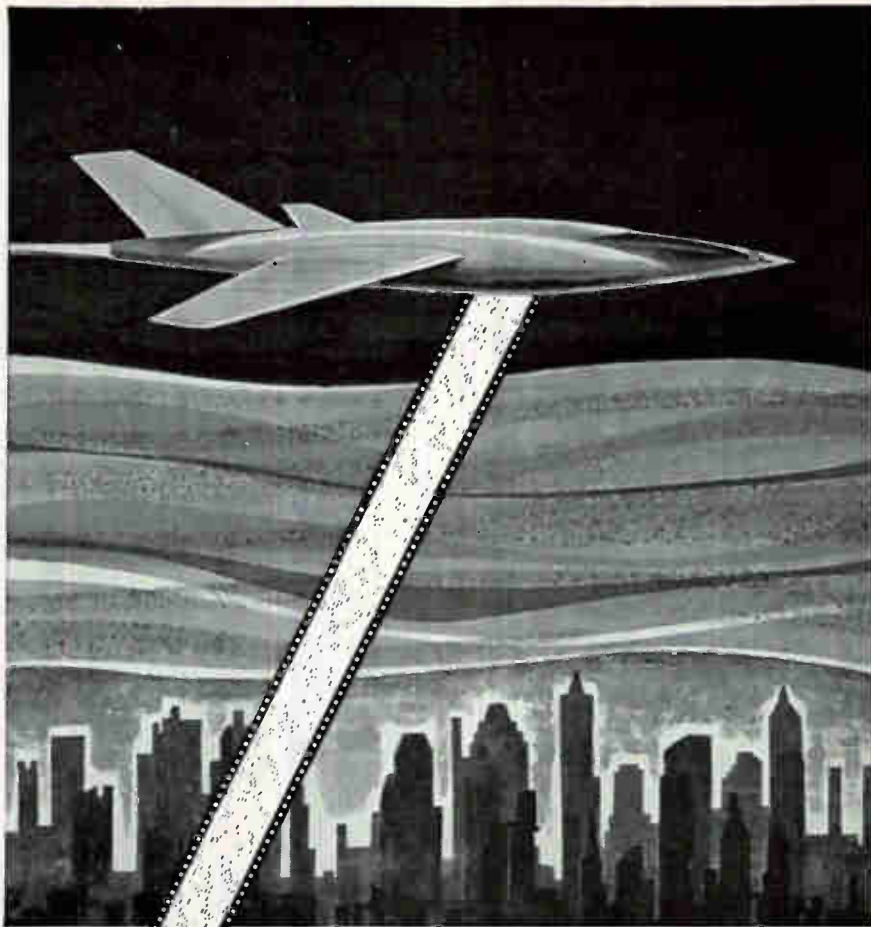

Sees through Weather and Night

Bausch & Lomb capabilities

turn blips into pictures

The "Processor" as manufactured by Bausch & Lomb takes a mass of unintelligible blips and rearranges them into a picture that is the equivalent of an aerial photograph.

In this way, B&L integrated skills help the Army and Air Force carry out precision reconnaissance in any weather, day or night.

The same B&L skills can help you with your contract work, too—providing the design, development, and production of precision systems to meet your specific needs. Write us for full details.

Bausch & Lomb Incorporated, Military Products Division,
 61420 Bausch Street, Rochester 2, New York.



METERS

You can SEE and READ

by
HOYT

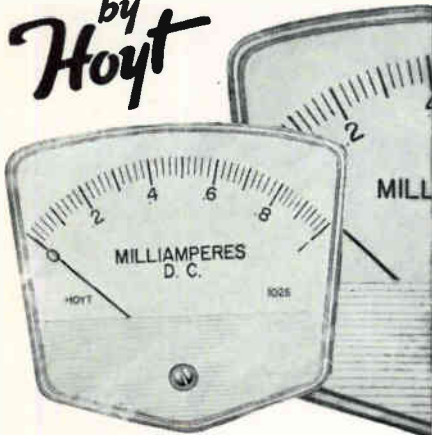

New

Series 1025-1026 Interchangeable with Round Bakelite Case Type

Brilliantly new in their high visibility polystyrene cases are these modern type Meters by HOYT which give a true reading at a glance! Here longer scale length and the elimination of shadows plus clean design add up to a top-notch combination to incorporate in any panel.

The Famous HOYT high torque movement with precise and rugged craftsmanship gives you what you've been looking for in Meters. These models are directly interchangeable with all round Bakelite meters, and are available in all AC and DC ranges as Ammeters, Milliammeters, Microammeters, Voltmeters and Millivoltmeters. Similar styles #1037 3 1/2" and #1060 6" meters are also available for any modern panel meter application.

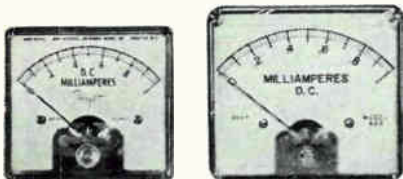

The HOYT square plastic case series (#649 and #653 shown) is available in 2 1/2", 3 1/2" and 4 1/2" types. Just right for use where equipment needs to be revised to meet modern design requirements. These instruments are interchangeable with square Bakelite meters and can be supplied with a frosted or colored band on the case front in any AC and DC range. Extra long scales in shadow free cases give you the most value and quality for your money.

Write us for the NEW HOYT PANEL METER Brochure showing a complete line of plastic and Bakelite models.

VISIT US AT THE WESCON SHOW



BURTON-ROGERS COMPANY

Sales Division, Dept. E-8
42 Carleton Street, Cambridge 42, Mass.

Boonton Electronics Corp...2412-2414
Boonton Radio Corp.....2018-2020
Borg-Warner Corp...2717-2719-2721
Bourns, Inc.3102-3104
Bowmar Instrument Corp....2922
Bradley Semiconductor Corp...1305
W. H. Brady Co.....4831-4833
William Brand-Rex Division...4604
Branson Corp.1018
Branson Instruments, Inc.....4920
The Bristol Co.....3316-3318
Buchanan Electrical Products Corp.421
Buckbee Mears Co.....4728
Bud Radio, Inc.....304
Budd-Stanley Co. Inc.....1217
Burgess Battery Co.....1719
Burndy Corp.2601-2602-2603
Burr-Brown Research Corp....3320
Burrhoughs Corp.2507-2509
Bussmann Mfg. Division.....1813

C

CBS Electronics2903-2905
CI Industries4729
C & K Components, Inc.....2916
Cadre Industries Corp.....1207
Cain & Co.....108
Calibration Standards Corp...4124
California Magnetic Control Corp. 106
California Technical Industries303-305
Camblock Corp.4412
Cambridge Thermionic Corp...1715
Camloc Fastener Corp....4812-4814
Cannon Electric Co...2302-2304-2306
Capitol Radio Engineering InstituteP-4
The J. C. Carter Co.....111
Centralab, Electronic Div. of Globe-Union920-922
Ceramaseal, Inc.4227
Chalco Engineering Corp.....2703
Chemprint Corp.4225
Chicago Dynamic Industries, Inc.1112
Chicago Standard Transformer Corp.1517
Chicago Telephone of California, Inc.3706
Chilton Co.P-17-P-11
Christie Electric Corp.....2901
Cinch Manufacturing Co.404-406-408-410
C. P. Clare & Co.....1009-1011
Clarostat Mfg Co., Inc.....1714
Clevite Corp.809-811-813-815
Coast Pro-Seal Mfg. Co.....5014
Cobehn, Inc.4824
Sigmund Cohn Corp.....4715
Coil Winding Equipment Co.5005-5006
Coleman Electronics, Inc. 2418-2424
Collins Electronics, Inc.....1110
Collins Radio Co.....1301-1302
Comar Electric Co.....3010
Cominco Products, Inc.....4530
Communications Control Corp...4517
Computer Control Co. Inc....819-821
Computer-Measurements Co.1524-1525
Conrad, Inc.912
Consolidated Avionics Corp.....1120
Consolidated Electrodynamics Corp.3708-3710
Control Switch Division1819-1820-1821

WIDE RANGE

MODEL

105TA



WITH



ROBOTEC
overload and
short protection
and



HEATRAN
electronic
dissipation
control

\$239⁵⁰

FOB FACTORY
**WESCON
BOOTH
2 7 0 5**

**SEMICONDUCTORIZED
POWER SUPPLY
1-100 VDC
0-0.5 AMP**

High efficiency,
stabilized solid state
DC power supply with
.05% regulation,
1 millivolt ripple,
.025 ohm source im-
pedance, 50 micro-
second response time,
55-440 cycle input.

IMMEDIATE DELIVERY

Power Designs inc.

1700 SHAMES DRIVE, WESTBURY, NEW YORK
Edgewood 3-6200 (LD Area Code 516)

CIRCLE 277 ON READER SERVICE CARD

'On PW Boards'

**DYNASERT
COMPONENT
INSERTING
MACHINE
CAN PAY
FOR ITSELF**

**IN A YEAR
or less!**



BY DYNASERT
BY HAND



With only a few hundred PW boards a week, when Dynasert automatically feeds, prepares and inserts components, direct labor is cut to a fraction. Insertion rates go up to ten times faster, model changeovers made in seconds, boards are neater, more dependable, easier to solder tightly. Result: Savings that can return the cost of Dynasert in six months' to a year's time, plus more accurate and uniform insertions.

Send for the facts and figures. Dynasert Dept., United Shoe Machinery Corp., Boston, Mass.



**United
DYNASERT**

See us at Booth 4722 or 4724

CIRCLE 278 ON READER SERVICE CARD
electronics

Cool Fin Corp. 414
 Coors Porcelain Co. 4832-4834
 Cornell-Dubilier
 Electronics 3405-3407-3409
 Corning Glass Works 1820-1822
 Costello & Co. 1307
 Craig Corp. 1315
 Cramer Controls Corp. 4419
 Crystalonics, Inc. 3725
 Cubic Corp. 3001-3003
 Curtiss-Wright Corp. 210-212-214

D

Dage Electric Co., Inc. 2918
 Dale Electronics, Inc. 2122-2123
 Dalmo Victor Co. 4234
 Data-Stor Division, Cook Electric
 Co. 4223
 Datex Corp. 1015
 The Daven Co. 3002
 Daystrom, Inc. 2907-2909
 2911-2913-2915-2917-2919-2921
 The Decker Corp. 4522-4524
 DeJur-Amsco Corp. 1919-1921
 Delco Radio Division. 2518-2520
 Delevan Electronics Corp. 4310
 Delta Design, Inc. 1304
 Delta-f, Inc. 4503
 Delta Semiconductors, Inc. 4512
 Delttime Inc. 714
 Demornay-Bonardi 1414-1416
 Dempa Shinbun, Inc. 4102-4104-4106
 Denki Kogyo Shinbun. 4114
 Design Tool Co. 5018
 The Deutsch Co. 2619
 Develop-Amatic Engineering ... 4725
 Device Seals, Inc. 3715
 Dialight Corp. 2519-2521
 Di/An Controls, Inc. 4316
 A. B. Dick Co. 117
 Dielectric Products Engineering
 Co., Inc. 4411
 Digital Equipment Corp. 1211
 Dit-Mco, Inc. 2625-2626
 The DoAll Co. 5012
 Douglas Microwave Co., Inc. ... 202
 Dow Corning Corp. ... 5102-5104-5106
 Drake Manufacturing Co. 318
 Dressen-Barnes Corp. 2101-2102
 Driver-Harris Co. 4421
 Wilbur B. Driver Co. 4714
 Allen B. Du Mont
 Laboratories ... 1614-1616-1618-1620
 Duncan Electronics, Inc. 808
 E. I. duPont de Nemours &
 Co., Inc. 4030-4032-4330-4332
 Dynacor, Inc. 3122
 Dynamic Gear Co., Inc. 1322

E

E-H Research Laboratories,
 Inc. 3613-3615
 EMI/US Ltd. 4304
 ESC Electronic Corp. 2609
 Eastern Industries, Inc. ... 3514-3516
 Edgerton, Germeshausen &
 Grier, Inc. 3518-3520
 Thomas A. Edison Industries. 718-720
 Eitel-McCullough, Inc. 1720-1722-1724
 Elco Corp. 2124-2125
 Eldorado Electronics 4217
 Electra Manufacturing Co. ... 2317-2319
 Electralab Printed Electronics
 Corp. 109
 The Electric Autolite Co. ... 2620-2621



**Fred
 Jones
 can
 show
 you...**

**how to measure in-phase
 and quadrature with
 0.1% accuracy—in milliseconds**

Previously unobtainable accuracy and millisecond response are only two of the reasons why NAI's Phase Sensitive AC-to-DC Converters meet the most critical requirements in computer, recording, automatic test and digital display systems.

Unlike conventional converters, these all solid state modules measure not only total signal—but quadrature, in-phase and fundamental components as well. DC output is proportional to selected input component, yet unaffected by harmonics. A wide range of manual and relay-actuated models permits selection and programming of function, range and frequency to suit test or system requirements.

Specifications of relay-programmed models are given in the table. Data on manually switched models PSC-415 and -416 upon request.

	PSC-410/411	PSC-420/421
Voltage Range	(410 & 420)	1 v f.s. to 300 v f.s., 4 ranges
	(411 & 421)	10 mv f.s. to 300 v f.s., 6 ranges
Frequency Range	(phase sens.)	1 frequency ²
	(total volts)	3 frequencies*
Linearity	0.1% f.s.	0.1% f.s.
Functions	E _t , E _f , E _{in} and E _q	
Output Voltage	0-10 v dc, into 10 k load, for all functions	
Input Impedance	1 megohm	1 megohm
Response Time	0.1 sec	

²any frequency between 60cps and 10kc.

The North Atlantic man in your area can quickly show you how the PSC-410 and -420 simplify AC measurement jobs from GSE to production test of transducers, networks and amplifiers. Call today for his name, or request Bulletin PSC-1.



NORTH ATLANTIC industries, inc.
 TERMINAL DRIVE, PLAINVIEW, L. I., NEW YORK • Overbrook 1-8600

See us at Wescon—Booth 2812-2814

DAGE CUB series

SUBMINIATURE RF CONNECTORS

proven
reliability
in miniature

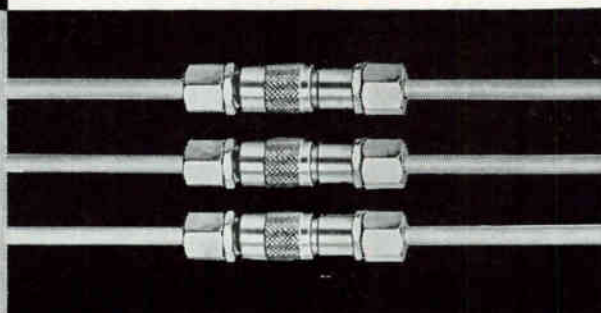

BOOTH
2918
AT
WESCON
SHOW

DAGE "CUB" Series is designed to meet the toughest commercial and military requirements for small, lightweight connectors, Less than *half the size* of standard BNCs.

- Impedance Matched
- Excellent Insulation
- Positive Electrical Contact
- Weather-Proof
- Superior Mechanical Strength
- All Standard Fittings

Write for Detailed Specifications.

DAGE

DAGE ELECTRIC COMPANY, INC.
67 NORTH SECOND STREET
BEECH GROVE, INDIANA

CIRCLE 279 ON READER SERVICE CARD

GUDELACE
TAKES THE
SLIPS
OUT OF
LACING

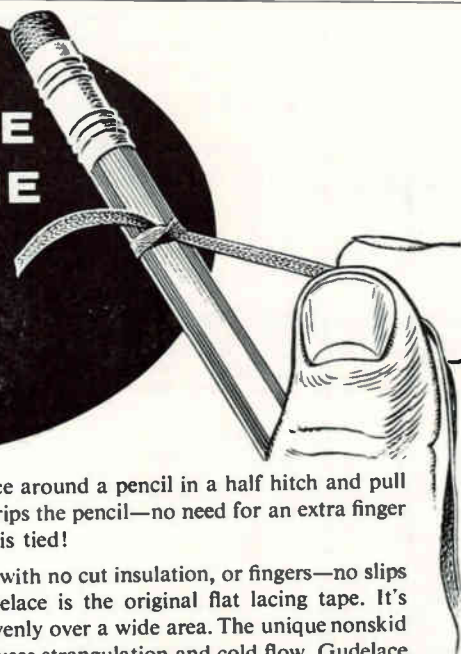

Try this simple test. Tie a piece of Gudelace around a pencil in a half hitch and pull one end. Gudelace's flat, nonskid surface grips the pencil—no need for an extra finger to hold Gudelace in place while the knot is tied!

Gudelace makes lacing easier and faster, with no cut insulation, or fingers—no slips or rejects—and that's *real* economy. Gudelace is the original flat lacing tape. It's engineered to *stay* flat, distributing stress evenly over a wide area. The unique nonskid surface eliminates the too-tight pull that causes strangulation and cold flow. Gudelace is made of sturdy nylon mesh, combined with special microcrystalline wax, for outstanding strength, toughness, and stability.

Write for a free sample and test it yourself. See how Gudelace takes the slips—and the problems—out of lacing.

GUDEBROD

BROS. SILK CO., INC.

Electronic Division
225 West 34th Street
New York 1, N.Y.

Executive Offices
12 South 12th Street
Philadelphia 7, Pa.

Visit Gudebrod Booth 4718 at the Wescon Show

232 CIRCLE 232 ON READER SERVICE CARD

The Electric Hotpack Co., Inc.5023
Electrical Industries3005
Electro Devices, Inc.5110
Electro Engineering Works2301
Electro Instruments, Inc.2103-2104
Electro-Mechanical Specialties
Co., Inc.1422
Electro-Optical Instruments, Inc. 3714
Electro Scientific Industries,
Inc.1928-1929
Electro Switch Corp.4401
Electron Products Division1016
Electronic Associates, Inc.2303-2305
Electronic Enclosures, Inc.4632-4634
Electronic Engineering Co. of
Calif.2320-2322-2324-2326
Electronic Equipment
EngineeringP18
Electronic Instrument Co.413
Electronic Measurements
Company, Inc.1324-1325
Electronic NewsP-5
Electronic Research Associates,
Inc.3217-3219
Electronics MagazineP-6—P-9
Electronic/SourcesP-3
Elgin National Watch
Company1802-1804
Electropot, Inc.1203
Emerson & Cuming, Inc.810-812
Engelhard Industries, Inc.2530-2532
Epsco, Inc.1413-1415
Equipto Electronics Corp.4527
Erie Pacific1710-1712
Eubanks Engineering Co.4620
Evra, Inc.4723
Exact Engineering & Manufac-
turing Inc.115

F

FXR, Inc.220-222
Fairchild Camera and
Instrument Corp.818
Fairchild Controls Corp.820-822
Fairchild Semiconductor Corp. 814-816
Fanon Transistor Corporation.4409
Fansteel Metallurgical
Corp.606-608-610
Faradyne Electronics Corp.4103
Fenwal Electronics, Inc.3512
Ferranti Electric, Inc.3013-3015
Ferro Magnetic Co.1117
Ferroxcube Corporation of
America107
Fidelitone Microwave, Inc.2515
Field Emission Corp.118
Filmohm Corp.1006
Filters, Inc.513-515
Filtron Company, Inc.1622
Flight Electronics Corp.1222
Flite Electronic Wire &
Components, Inc.5028
Flotron Industries, Inc.4626
John Fluke Manufacturing
Co., Inc.2105-2106
Food Machinery and Chemical
Corporation5126
Foto-Video Electronics, Inc.1206
Franklin Electronics Inc.3510
Furane Plastics Inc.4806

G

GB Components, Inc.1323
G. C. Electronics301
G-L Electronics Co. Inc.322

electronics

...IT GLOWS when
the FUSE BLOWS!

NEW INDICATING 3AG FUSE POSTS

EXAMINE THESE FEATURES



ACTUAL
SIZE



- 1 New patented knob design to assure high degree of illumination for instant blown fuse indication.
- 2 Positive finger grip for knob extraction.
- 3 Quick service bayonet lock.
- 4 Constant tension beryllium copper coil & leaf spring for positive contact & lower millivolt drop.
- 5 Optional—at extra cost—neoprene "O" ring to assure splash-proof feature.
- 6 New high degree vacuum neon lamp for greater brilliance & visibility.
- 7 Impact black phenolic material in accordance with MIL-M-14E type CFG.
- 8 One piece brass hot tin dipped non-turning bottom terminal.
- 9 Double flats on body to permit mounting versatility.

SPECIFICATIONS:



PART #	VOLTAGE RANGE
344006	2 1/2 - 7 volts
344012	7 - 16 volts
344024	16 - 32 volts
344125	90 - 125 volts
344250	200 - 250 volts

Maximum current rating 20 amps.

PHYSICAL CHARACTERISTICS—Overall length 2 3/8" with fuse inserted • Front of panel length 1 3/16" • Back of panel length 1 1/16" • Panel area front 1 1/16" dia. • Panel area back 1 1/16" dia. • Mounting hole size (D hole) 5/8" dia. flat at one side.

TERMINAL—Side—one piece, .025 brass—electro-tin plated • Bottom—one piece, lead free brass, hot tin dipped.

KNOB—High temperature styrene (amber with incandescent bulbs—2 1/2 thru 32 volts—and clear with high degree vacuum neon bulbs—90 thru 250 volts) • Extractor Method—Bayonet, spring grip in cap.

HARDWARE—Hexagon nut—steel, zinc cronak or zinc iridite finish • Interlock lock washer—steel, cadmium plated • Oil resistant rubber washer.

MILITARY SPECIFICATIONS—MIL-M-14E type CFG. Fungus treatment available upon request per Jan-T-152 & Jan-C-173.

TORQUE—Unit will withstand 15 inch lbs. mounting torque.

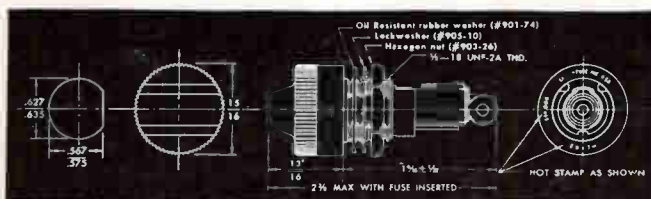

LITTELFUSE

DES PLAINES, ILLINOIS

CIRCLE 280 ON READER SERVICE CARD

August 11, 1961

MEET THE N. E. I. POTENTIOMETER FAMILY



Their reliability assures your products performance N.E.I. precision potentiometers, both Conductive Plastic and Wire Wound, embody every desirable design and engineering feature known to potentiometer manufacture. Because we manufacture both types, our engineers can analyze your specific requirements from both sides and produce the proper solution. Remember, N.E.I. precision potentiometers are unsurpassed for reliability.

Conductive Plastics

- Infinite resolution
- Unsurpassed reliability
- Negligible noise level
- Standard resistance values 1K, 2K, 5K, 10K, and 20K, 0.5 linearity.
- Specials from 500 ohms to 1 megohm -0.1% linearity

Wire Wound

- Meet performance specs of MIL5272A, NAS710 and applicable portions of JANR-19
- Maintain excellent characteristics from -55° to 150°C
- Available from 1/2" single and 10 turn types to 3"
- Standard resistances from 1K to 100K, special designs from 25 ohm to 250K



Send for complete catalog

New England Instrument Company
39 Green Street, Waltham, Massachusetts

CIRCLE 233 ON READER SERVICE CARD 233

Select the transistorized DYNA-EMPIRE GAUSSMETER best suited to your needs

Completely transistorized Dyna-Empire gaussmeters accurately measure flux density and determine "flow" direction. Ideal for measuring and locating stray fields, plotting variations in strength and performing rapid comparisons of production lots against a standard. Easy-to-operate,—no jerk, pull, ballistic readings or circuit breaking required.



NEW TRANSISTORIZED GAUSSMETER MODEL D-874

This precision instrument reads from 300 to 30,000 gauss full scale, with an accuracy of $\pm 3.5\%$. It fulfills all needs of a quality gaussmeter at a modest price.

Special Features:

FIVE RANGES: 300 gauss full scale, 1,000 gauss full scale, 3,000 gauss full scale, 10,000 gauss full scale, 30,000 gauss full scale.

LINEAR OVER ENTIRE OPERATING RANGE
PORTABLE, OPERATES FROM OWN SELF-CONTAINED BATTERIES

BATTERY LIFE—1,000 HOURS
REQUIRES NO EXTERNAL POWER SOURCE
INTERNAL CALIBRATION STANDARD
WEIGHT—4 LBS.

UNIVERSAL PROBE SUPPLIED IS 0.025" THICK BY 0.200" WIDE. ACTIVE AREA IS ONLY 0.0079 SQUARE INCHES LOCATED NEAR THE TIP OF THE PROBE.

Complete with Universal probe \$195.

TRANSISTORIZED GAUSSMETER MODEL D-855

This quality precision built Gaussmeter reads flux densities to 30,000 Gauss full scale $\pm 2.5\%$. It is a highly sensitive instrument and provides tremendous flexibility. Complete with two linear probes—one high sensitivity probe for measurement of low density fields and one probe for measurement of high density fields. Special probe available for reading 3 gauss full scale.

Write to

Dyna-Empire, Inc.
1075 Stewart Avenue, Garden City, N. Y.



GPS Instrument Co. Inc.....	4417
The Gamewell Company.....	4407
Garlock Electronic Products....	4118
Gamma Research Laboratory Corp.	4719
Garlynn Engineering	4534
Garrett Corp.	4402-4404
Gates Radio Co.	514
W. K. Geist Co.	3305-3307
General Communication Co.	4302
General Controls Co.	1114
General Dynamics Astronautics	2607-2608
General Dynamics Electronics (Convair)	201-203-208
General Electric Co.	4811-701 thru 710-2214-2216
General Findings, Inc.	4809
General Instrument Corp.	1912
General Plastics Corp.	5025
General Precision, Inc.	3309-3311 3313-3315-3317-3319-3321
General Radio Co.	2202-2204
General Time Corp.	613
Genisco, Inc.	3702-3704
Gertsch Products, Inc.	1602-1604-1606
Giannini Controls Corp.	1417-1419
Globe Industries, Inc.	1812
Goe Engineering Co.	4610
The B. F. Goodrich Co.	1215
B. F. Goodrich.....	5026
Gorman Machine Corp.	5119
Gould-National Batteries, Inc.	102-104
Granger Associates	3012
Grant Pulley & Hardware Corp.	4711
Grayhill, Inc.	422
Greman Manufacturing Co., Inc.	1512
Guardian Electric Manufacturing Co.	4408-4410
Gudebrod Bros. Silk Co., Inc.	4718
W. & L. E. Gurley.....	2604

H

Halliburton Enterprises, Inc.	4912-4914
Harman-Kardon, Inc.	4129
Harowe Servo Controls, Inc.	4510
Harrison Laboratories, Inc.	1008-1010
The Hartwell Corp.	4826
Hastings-Raydist, Inc.	2821
Hathaway Denver	1608-1610
Hayden Publishing Co., Inc.	P-1—P-2
The A. W. Haydon Co.	2802-2804
Heinemann Electric Co.	3701-3703
Hermetic Pacific Corp.	1707-1709
Carl Herrmann Associates	611
Hevi-Duty Electric Co.	5027
Hewlett-Packard Co.	2313-2314-2315 2316-2318
Hexacon Electric Co.	5033
The Hickok Electrical Instrument Co.	3220-3222
Hi-G, Inc.	3009-3011
J. T. Hill Co.	1612
Hill Magnetic Products.....	218
Carl Hirschmann Co., Inc.	5108
Hitemp Wires Co.	4805
Hoffman Electronics Corp.	1615-1617-1619-1621-1623
The Hoover Co.	1106
Hopkins Engineering Co.	3109
Houston Instrument Corp.	407
Hudson Tool & Die Co., Inc.	5034
Huggins Laboratories, Inc.	2308-2310

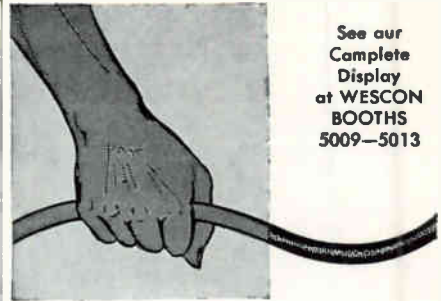

See our
Complete
Display
at WESCON
BOOTHS
5009-5013

A HIDDEN HELPER

Protects your tubes and components from damage by sagging cable.

—eliminates the old bugaboo of cable entanglement which damages tubes and components in lower chassis each time the one above is withdrawn for service and returned to position.

Our new Cable Retractor's double action maintains constant tension and correct suspension of cable at all times—permits ample cable length for full extension and tilting of chassis without hazard of snagging.

For use with all types of chassis or drawer slides, adjustable to fit varying chassis lengths, simple to install, inexpensive, proven thoroughly reliable in operation.

Mounts on rear support rails on standard 1 3/4" hole increments. Cadmium plated CRS.

Write for Bulletin CR-100A

ORegion 8-7827

Western Devices, Inc.
600 W. FLORENCE AVE., INGLEWOOD, CAL.
CIRCLE 281 ON READER SERVICE CARD



WHO DROPPED THE BINOCULARS?

With everybody watching each other along the DEW line and the Iron Curtain these days, electronics has replaced binoculars.

What's happening in the giant markets for missile controls, radar and communications equipment?

electronics tells how things are going, keeps you informed of developments as they occur. This is a good time to subscribe or renew your subscription. Just fill in box on Reader Service Card. Easy to use. Postage free.

FIND WHAT YOU NEED IN... electronics

Hughes Aircraft
Co. 2421-2423-2425-2427
3106-3108
R. N. Hunter Sales Co., Inc. 4730
Hy-Gain Antenna Co. 415
Hysol of California. 4821

Iconix Inc. 4521
Ideal Precision Meter, Co., Inc. 213
Illumitronic Engineering Corp. 116
Indiana General Corp. 2107-2108
Industrial Electronic Engineers,
Inc. 3718
Industrial Test Equipment Co. 2415
Ingersoll Products 4916-4918
Inland Motor Corporation of Va. 1306
Inso Electronic Products, Inc. 4529
The Institute of Radio Engineers. P-12
Instrument Development
Laboratories, Inc. 1310
Instruments Publishing Co., Inc. P-19
International Communications
Corp. 1220
International Eastern Co. 5115
International Electronic
Industries, Inc. 4201-4203
International Electronic
Research Corp. 1504-1505
International Rectifier
Corp. 1701-1702-1703
International Resistance
Co. 2307-2309-2311
International Telephone
and Telegraph
Corp. 801-802-803-804-805-806
Interstate Electronic Corp. 2817
Iron Fireman Manufacturing
Co. 1316-1317
Isi-Computer Products 1208
Isotronics, Inc. 1713

J

J-B-T Instruments, Inc. 2527
JFD Electronics Corp. 621
J Omega Co. 4514
Japan Electric
Industry 4108-4110-4112
Jennings Radio Manufacturing
Corp. 1901-1902
Jerrold Electronics Corp. 1002-1004
Jewett Co. 2920
Jonathan Manufacturing
Co. 1013-4830
Joy Manufacturing Co. 4229

K

Kay Electric Co. 3105-3107
Kaynar Mfg. Co., Inc. 5124
Keithley Instruments, Inc. 3019-3021
J. S. Kempf Co. 4505
Keeco, Inc. 501-503
Kester Solder Co. 5017-5019
Kewaunee Scientific Equipment. 5129
Key Resistor Corp. 3210
Kinetics Corp. 4230
King Engineering Co. 910
Kingsley Machine Co. 4820
Kinney Vacuum Division 4926
Kin Tel 2019-2021
Kittleson Co. 1801-1803

NEW Powertron

AC ELECTRONIC GENERATOR

MODEL 150
\$52500

**PRECISION
AC POWER
SUPPLY FOR
LABORATORY &
PRODUCTION USE**



SPECIFICATIONS

Power Output	160 V.A.	Total Distortion	Less than 1%
Fixed Frequency 400 CPS (other freq. avail.)		Regulation	Less than 1%
Variable Frequency	350-450 CPS	Operates with load of any power factor	
External Frequency	50-4000 CPS	Small size	8 3/4" x 19" Panel

Also Available — Model 250 — 250 VA Power Output

Representatives in Principal Cities



INDUSTRIAL TEST EQUIPMENT CO.
55 EAST 11th STREET • NEW YORK 3, N. Y.

Visit us at Booth 2415, WESCON 1961

CIRCLE 283 ON READER SERVICE CARD



8-13 Digits • Direct Reading
Incremental • Photoelectric

Programmer • Special
Encoders

Airborne Incremental
Minimum Weight

14-17 Digits • Direct Reading
Incremental • Sine/Cosine



the complete line ...

DIGISYN® DIGITAL POSITION TRANSDUCERS

(Non Contacting)

- Direct Reading Cyclic Codes: Binary; Sine/Cosine; BCD; Special.
- Incremental Counts per rev: 1000 thru 65,000. Many counts standard.
- Qualified to Military Specifications.
- Integral Power Supplies, many models.
- Remote Go-No-Go test provisions.
- Output Counters and Decimal Displays available.

Send for Engineering Data or call
(Boston) COpley 7-8425



WAYNE-GEORGE

CORPORATION
(ADCON DIVISION)

588 COMMONWEALTH AVENUE • BOSTON 15, MASS.



you'll need help!

If you earnestly feel the only way to get the kind of pots you need is to build 'em yourself — a word of caution. Don't start off alone — gather a few choice friends around to assist with the problems you might run into. There's the little matter of metals engineering, plastics, contact engineering, chemical, metallurgy and other assorted engineering areas. Otherwise, you might *never* get through all these little details!

But don't waste time putting your friends through engineering school — Ace has a staff of specialists and consultants all recruited for just such design problems! They save us — and in turn — our customers, needless concern over the stumbling blocks which may arise. So if a unique design solution to your pot requirements is what you're after, don't hesitate! See your ACErep!

Here's a typical bit of ACE collaboration: Our A.I.A. 1-1/16" size ACEPOT®, servo-mount.



ACE ELECTRONICS ASSOCIATES, INC.
99 Dover Street, Somerville 44, Mass.
SOMerset 6-5130 TMX SMVL 181 West. Union WUX

Acepot® Acetrim® Accetol® Aceohm® *Reg. Appl. for

Mathias Klein & Sons, Inc. 5116
Knight Electronics Corp. 906-908
The James Knights Co. 1509
Krohn-Hite Corp. 219
Kurman Electric Co. 320

L

Laboratory for Electronics. 2408-2410
Lambda Electronics Corp. 3602-3604
Land-Air Inc. 3612
Leach Corp. 1605-1607-1609
Lel Inc. 4322
Lenkurt Electric Co. Inc. 1521
Licon Division 619
Lindberg Engineering Co. 4427
Ling-Temco Electronics,
Inc. .4121-4123-4125-4127-4022-4024
4026-4028
Littelfuse, Inc. 302
Litton Industries ... 601-603-605-607
502-504-506-508
Lockheed Aircraft
Corp. 2711-2713-2715
Lord Manufacturing Co. 907-909
Lumatron Electronics, Inc. 1017-1019
Luxo Lamp Corp. 308

M

MB Electronics 307-309
McMillan Industrial Corp. 2413
MM Enclosures, Inc. 5024
MacDonald & Co. 4429
Mac Panel Co. 4215
Magnasyn Corp. 2811
Magnecraft Electric Co. 3017
Magnetic Metals Co. 4413
Magnetic Shield Division. 4606
Magnetics Inc. 1915-1917
Magtrol, Inc. 317
P. R. Mallory & Company,
Inc. 1923-1925
Manufacturing Associates 3705
Marco Industries Co. 4130
Marconi Instruments 1408-1410
Marshall Industries 1814-1816
Master Specialties Co. 1303
Mechtronics Corp. 3719
Melabs 1122
Adolf Meller Co. 5133
Melpar, Inc. 4120
Menlo Park Engineering. 2411
Mepco, Inc. 1121
Mesa Plastics Co. 5021
Metcom, Inc. 1201
Methode Electronic, Inc. 4318
Claude Michael, Inc. 5020-5022
Micon Electronics, Inc. 216
Micro Electronics Corp. 321
Microdot Inc. 1916-1918
Micro Gee Products Inc. 2506-2508
Microlab 4306
Microtran Company, Inc. 411
Microwave Associates, Inc. 3118-3120
Microwave Development Labora-
tories, Inc. 3621
Microwave Electronics Corp. 1108
Midwestern Instruments ... 1522-1523
James Millen Manufacturing Co. 1717
J. W. Miller Co. 401
Millivac Instruments, Inc. 911
Mincom Division,
Minnesota Mining and
Manufacturing Co. 1806-1808
Minneapolis-Honeywell
Regulator Co. .3501-3503-3505-3507

C. H. Mitchell Co.....306
 Mitronics Inc.4519
 Modular Electronics Inc.....4416
 Moletronics Corp.2622
 Molecu-Wire Corp.4428
 Monitor Products Co.1711
 Mosley Electronics, Inc.....2517
 F. L. Moseley Co.2010-2012
 Motorola Communications &
 Electronics, Inc.1116
 Motorola Semiconductor Products
 Inc.914-916
 Moxon Electronics Corp.....1503
 Mucon Corp.4513
 Mycalex Corp. of America...902-904
 Mystik Adhesive Products, Inc..5016
 McCoy Electronics Co.....1402
 McGraw-Hill Publishing Co.
 Inc.P6-P7-P8-P9
 McLean Engineering Labora-
 tories217

N

The Narda Microwave
 Corp.2407-2409
 National Beryllia Corp.....4624
 The National Cash Register
 Co.1012-1014
 National Connector Corp.....4213
 National Radio Co. Inc.....1810
 National Semiconductor Corp....4212
 National Vulcanized Fibre
 Co.5123-5125
 Nationwide Engineering Service,
 Inc.4424
 Navigation Computer Corp.....4515
 New Hermes Engraving Machine
 Corp.5007
 J. M. Ney Co.....2210-2212
 Nippon Electric Co. Ltd.....4109
 Non-Linear Systems,
 Inc.1518-1519-1520
 North American Electronics, Inc..3509
 North Atlantic Industries,
 Inc.2812-2814
 North Electric Co.....2502-2504
 Nuclear Corp. of America...2120-2121
 Paul Nurches Co.....2707
 Nylok Western4426

O

Offner Electronics Inc.....1513-1514
 O'Halloran Associates2416
 Ohmite Manufacturing Co.1601-1603
 Omtronics Manufacturing, Inc..4216
 Optical Coating Laboratory....4908
 Optimized Devices, Inc.....1210
 John Oster Manufacturing Co...3004

P

P C A Electronics Inc.....1423
 PRD Electronics, Inc.....2109-2110
 Pacific Coast Electronics Corp..1226
 Pacific Resistor Co.....4206
 Pacific Scientific Co.....311
 Pacific Semiconductors, Inc..2111-2112
 Packard Bell Computer
 Corp.2617-2618
 Packard Bell Electronics Corp...4202
 Palo Alto Engineering Co.....512
 Panduit Corp.817
 Panoramic Electronics, Inc..3202-3204
 Parker Seal Co.....4828
 Loren Patrick Associates, Inc....5127

MicroMatch[®]

**RF LOAD RESISTORS
 COVER THE RANGE:**

TO 6000 WATTS AND 3000 MCS.

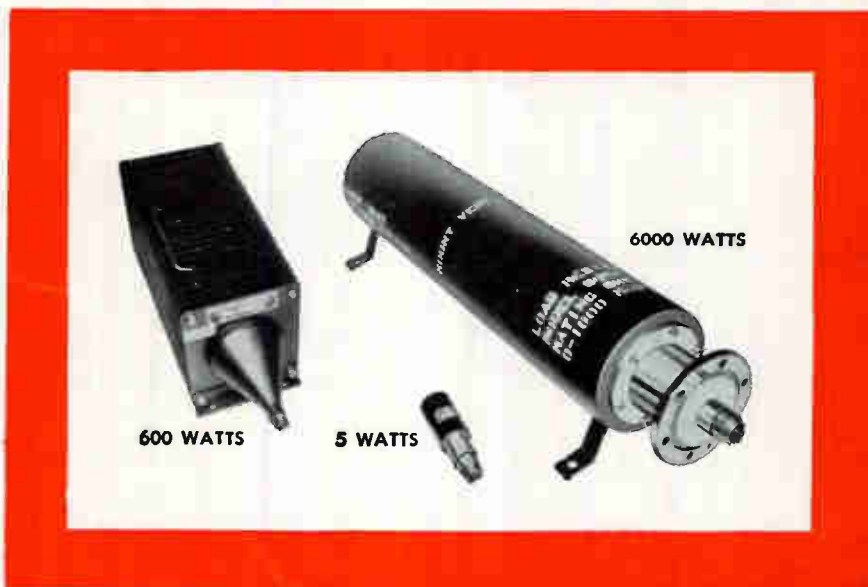

MicroMatch

RF Load Resistors provide the virtually reflectionless terminations needed for accurate RF power measurement. They serve many useful purposes as non-radiating RF power absorbers, particularly in lieu of antenna systems during the measurement and alignment phase of transmitter operation.

Other useful functions are in conjunction with feed-through wattmeters to form excellent absorption-type wattmeters, and as a load for side-band elimination filters or high power directional couplers.

SPECIFICATIONS		RF LOAD RESISTORS	
MODEL NO.	FREQUENCY RANGE (mcs)	RF POWER DISSIPATION (watts)	RF CONNECTORS
601	0-3000	5	N, C or BNC
603	0-3000	20	N, C or BNC
633	0-3000	50	N, C or HN
634	0-3000	150	N, C or HN
635	0-3000	200	N, C or HN
636	0-3000	600	N, C or HN
638	0-2000	6000	3/8" flange

Many other special models have been designed and manufactured to meet your particular space and input connection requirements.

For more information on RF Loads, Directional Couplers, Tuners, and RF Wattmeters, write:



M. C. JONES ELECTRONICS CO., INC.

185 N. MAIN STREET, BRISTOL, CONN.
 SUBSIDIARY OF



MUCON

SUBminiature CERAMIC CAPACITORS

designed for your
SMALL SPACE

THINLINE

Any value, SQUARE or RECTANGULAR, made from any one of the following CERAMIC bodies. As small as .100" square maximum

SUPER-K for MAX. CAPACITANCE

HIGH-K for BETTER TEMP. CURVE

STABLE-K . . . FLAT within ±10%

LOW-VAR . . . FLAT WITHIN ±8%

9 ADDITIONAL CERAMICS for TEMPERATURE COMPENSATION or LOWER CAPACITANCE VALUES

**N2400 N450 N150
N1400 N330 N080
N750 N220 NPO**

NARROW-CAPS

NARROW DESIGN TO FIT 1/10" MODULAR SPACING Intermediate values quickly obtainable.

19 STOCK VALUES below

Part No.	Capacitance mmf.	Tolerance	Working Volts D. C.
NC-5	5	±15%	50
NC-7.5	7.5	±15%	50
NC-10	10	±15%	50
NC-15	15	±15%	50
NC-22	22	±15%	50
NC-33	33	±15%	50
NC-47	47	±15%	50
NC-68	68	±15%	50
NC-82	82	±15%	50
NC-100	100	±20%	50
NC-250	250	±20%	50
NC-500	500	±20%	50
NC-750	750	±20%	50
NC-1000	1000	±20%	50
NC-1500	1500	±25%	25
NC-2000	2000	±25%	25
NC-3000	3000	±30%	25
NC-4000	4000	±30%	25
NC-01	10000	±30%	10

Depth 4513 WESCON SHOW

RIBBON LEADS

FOR HIGHER SELF-RESONANT FREQUENCY and Q

STANDOFFS

EXTREMELY LOW SERIES INDUCTANCE

SPECIALS

RIBBON, WIRE, TAB LEADS POSITIONED AS REQUIRED.

MUCON CORPORATION MITCHELL 2-1476
9 ST. FRANCIS ST., NEWARK 5, N. J.

- Penta Laboratories, Inc. 1115
- Perfect Gear & Instrument Corp. . 316
- Perkins Electronics Corp. 516-518
- The Perkin-Elmer Corp. 119
- Perlmuth Electronic Associates, Inc. 2211
- Phaestron Instrument & Electronic Co. 1401-1403-1405
- George A. Philbrick Researches, Inc. 4204
- Philco Corp. 919-921
- Phillips Control Co. 419
- Photo Chemical Products of Calif., Inc. 4705
- Photocircuits Corp. 2624
- Pic Design Corp. 1404
- Piddington & Associates Limited. 5029
- Plastic Capacitors Inc. 615
- Plastic Products Division, International Resistance Co. 1421
- Plastoid Corp. 4727
- Polarad Electronics Corp. . 1911-1913
- Pomona Electronics Co., Inc. . . . 2709
- Potter Aeronautical Corp. 4506
- The Potter Co. 1205
- Potter & Brumfield. 2206-2208
- Potter Instrument Co., Inc. . . 101-103
- Power Designs, Inc. 2705
- Power Sources, Inc. 2816-2818
- Powertron Ultrasonics Corp. . . . 5111
- Precision Instrument Co. 913-915
- Precision Scientific Co. 4504
- Premier Metal Products Co. 4707-4709
- Price Electric Corp. 2806
- Prodelin, Inc. 2701
- Prudential Industries, Inc. 3606-3608
- Pulse Engineering, Inc. 2808
- The Pyle-National Co. 1213
- Pyrofilm Resistor Co., Inc. 2810

Q

- Quan-Tech Laboratories, Inc. 1020-1022

R

- R S Electronics Corp. 3322
- Radiation Inc. 4209
- Radiation at Stanford. . . . 4205-4207
- Radiation Materials, Inc. 4713
- Radio Corporation of America . . 715-717-719-721-616-618 620-622
- Radio Frequency Laboratories, Inc. 2912-2914
- Ransom Research, Inc. 4211
- Rantec Corp. 2510-2512
- Raychem Corp. 5008-5010
- Raytheon Co. 3404-3406-3408-3410 3412-3414-3416-3418-3420-3422
- Raytheon Company Production Equipment 4823
- Reed Instrument Bearing Co. . . . 4525
- Reeves Instrument Corp. 3214-3216-3218
- Reeves Soundcraft Corp. 2312
- Reid Brothers Co., Inc. 4425
- Rese Engineering, Inc. 3721
- Rheem Manufacturing Corp. 901-903-905
- M. W. Riedel & Co. 4113-4115
- Rimak Electronics Inc. 4813
- Robinson & Middy Associates. . 4105
- Rockbestos Wire & Cable Co. . . . 4326
- Rogers Publishing Co. P-14
- Rohde & Schwarz Sales Co. (USA) Inc. 2526-2528

WHAT
do
you need to know
about...



Since final quality of your production of ferrites, electronic cores, and magnetic recording media depends on proper use of 3 specialized groups of magnetic materials . . . you'll find it mighty helpful to have all the latest, authoritative technical data describing the physical and chemical characteristics of each. This information is available to you just for the asking. Meanwhile, here are highlights of each product group.

PURE FERRIC OXIDES—For the production of ferrite bodies, we manufacture a complete range of high purity ferric oxide powders. These are available in both the spheroidal and acicular shapes, with average particle diameters from 0.2 to 0.8 microns. Impurities such as soluble salts, silica, alumina and calcium are at a minimum.

MAGNETIC IRON OXIDES—For magnetic recording—audio, video, instrumentation etc.—we produce a group of special magnetic oxides with a range of controlled magnetic properties. Both the black ferrous-ferric and brown gamma ferric oxides are available.

MAGNETIC IRON POWDERS—For the fabrication of magnetic cores in high-frequency, tele-communication, and other magnetic applications, we make a series of high purity iron powders.

If you have problems involving any of these materials, please let us go to work for you. We maintain fully equipped laboratories for the development of new and better inorganic materials. Write . . . stating your problem . . . to C. K. Williams & Co., Dept. 25, 640 N. 13th St., Easton, Penna.

WILLIAMS
COLORS & PIGMENTS

C. K. WILLIAMS & CO.
EAST ST. LOUIS, ILL. • EASTON, PA.
EMERYVILLE, CAL.

Rosan Inc.4906
 The Milton Ross Co.4528
 Rototest Laboratories, Inc.315
 Rotron Manufacturing Co.,
 Inc.3006-3008
 Rowan Controller Co.221
 Royal McBee Corp.4520
 Royco Instruments, Inc.110
 Rush and Key Electronics,
 Inc.1721 & 1411
 Rutherford Electronics Co. 1501-1502

S

Sage Laboratories, Inc.4232
 St. Regis Paper Co.5121
 Howard W. Sams & Co., Inc.P-13
 Sanborn Co.2014-2016
 Sanders Associates, Inc.2523-2525
 San Fernando Electric
 Manufacturing Co.1903
 Sangamo Electric Co.2207-2209
 Sarkes Tarzian, Inc.505-507
 Scientific-Atlanta, Inc.3522
 Scientific Engineering Labs5132
 The Scopes Co., Inc.207
 Sealectro Corp.716
 Selectrons Ltd.4827
 Sensitive Research Instrument
 Corp.2113-2114
 Servo Corp. of America.4509-4511
 Servonic Instruments, Inc.4107
 Shelton Division4722-4724
 Sherold Crystals, Inc.2819
 Shielding, Inc.2511-2513
 H. M. Shoemaker & Associates.711
 The Sibley Co.4430
 Sierra Electronic Corp.2006-2008
 Sigma Instruments, Inc.520 & 522
 Silicon Transistor Corp.1224
 Simplex Wire & Cable Co.4423
 Simpson Electric Co.1704-1706
 The Sippican Corp.4422
 Skydyne, Inc.4817-4819
 Sliding Mechanisms, Inc.4910
 Slip Ring Co. of America.206
 Smith-Florence, Inc.1102-1104
 Herman H. Smith, Inc.1611
 T. Louis Snitzer Co.3112
 Sola Electric Co.2321-2323
 Solid State Products, Inc.1119
 Southco Division4804
 Southern Electronics Corp.1723
 Space Age NewsP-20
 Space Technology Laboratories,
 Inc.209-211
 Spaulding Fibre Company, Inc.5134
 Spectra-Strip Wire and Cable
 Corp.4726
 Spectrol Electronics Corp.602-604
 Spectrolab313
 Sperry Rand
 Corp. 3111-3113-3115-3117-3119-3121
 Sprague Electric Co.1904-1906-1908
 Standard Pressed Steel Co.4717
 Standard Wire and Cable Co.4630
 Sterling Precision Corp.918
 Stevens-Arnold, Inc.2522-2524
 George Stevens Manufacturing
 Co., Inc.4618
 Stewart Engineering Co.123
 Stewart Stamping Co.4708
 Stoddart Aircraft Radio Co., Inc.205
 Stone & Smith, Inc.5107-5109
 Sunbank Electronics, Inc.4203
 The Superior Electric
 Co.1312-1313-1314

METALS for ELECTRONIC APPLICATION

rolled ULTRA THIN

by **OUR SPECIAL ROLLING
 TECHNIQUE**

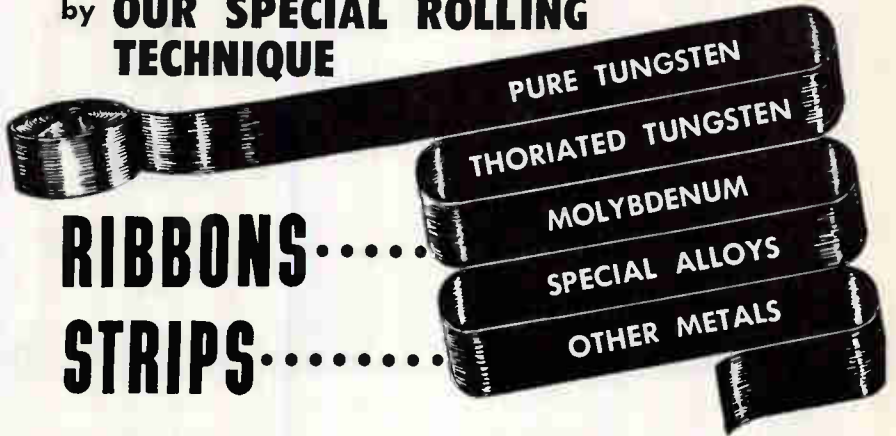

RIBBONS..... STRIPS.....

TOLERANCES CLOSER THAN COMMERCIAL STANDARDS

Note: for highly engineered applications—strips of TUNGSTEN and some other metals can be supplied

rolled down to .0003 thickness

- Finish: Roll Finish—Black or Cleaned
- Ribbons may be supplied in Mg. weights if required

Developed and Manufactured by

H.CROSS CO.

3229 BERGENLINE AVE., UNION CITY, NEW JERSEY
 Tele: Union City, N. J.: UN. 3-1134
 N. Y. C., N. Y.: BR 9-4425

CIRCLE 285 ON READER SERVICE CARD

ELECTRONIC ENGINEER

For design and construction of:

- HIGH VOLTAGE POWER SUPPLIES
- HIGH POWER PULSE MODULATORS
- RADAR TRANSMITTERS

We are a small closely knit and steadily growing organization and specialize in building precision engineered equipment to meet specific applications.

Successful candidates should have a BS or MS in Electrical Engineering or Physics and possess experience in development or use of equipment designed for testing high power vacuum tubes, microwave components, or systems.

Salary commensurate with experience. U. S. Citizenship not required. To arrange a discussion of your future with us, write in confidence to

Mr. R. Walter, Personnel Director.

MANSON LABORATORIES, Inc.

375 Fairfield Ave.
 Stamford, Conn.

DAvis 5-1391





KITS AND WIRED

STEREO
 AND MONO
 HIGH FIDELITY
 TEST INSTRUMENTS
 HAM EQUIPMENT
 CITIZENS' TRANSCEIVERS
 RADIOS

LABORATORY PRECISION AT LOWEST COST
Easy trouble-free set-up

Send for **FREE** **New 1961 EICO Electronics Catalog**

EICO, 3300 N. Blvd., L.I.C. 1, N. Y. E-7B
 Send free 32-page catalog & dealer's name
 Send new 36-page Guidebook to HI-FI for which I enclose 25¢ for postage & handling.

Name
 Address
 City Zone State

EICO 3300 N. Blvd., L.I.C. 1, N. Y.
 ...praised by the experts
 as BEST BUYS IN ELECTRONICS

See us at the WESCON Show Booth No. 413

CIRCLE 241 ON READER SERVICE CARD 241

WIDE BAND FM DEVIATION...



... is measured to 3% accuracy with 928 and 928/2. Like all Marconi FM Deviation Meters they have direct readout, xtal standardization and ease of use. They include demodulated output for transmitter noise and distortion measurements.

Most Missile Makers Measure Modulation with Marconi Meters.

	Model 928	Model 928/2
Carrier Freq.	10-500Mc.	215-265Mc
Deviation	to 400 kc	to 150kc
Modulation	50cps-120kc	50cps-120kc
Construction	Shock Resistant, ruggedized, waterproof.	
Price	\$1450	\$1600

- Surprenant Manufacturing**
 Co.4816-4818
 Switchcraft, Inc.1510
 Sylvania Electric Products,
 Inc.. 3302-3304-3306-3308-3310-3312
 3201-3203-3205-3207-3209-3211
 Synthane Corp.4716
 Systron-Donner Corp. 2611-2612-2613

T

- Tally Register Corp.2516
 Tang Industries, Inc.4415
 Technical Appliance Corp.409
 Technical Devices Co.4802
 Technical Products Co.617
 Technical Sales Corp.3716
 Technical Wire Products, Inc.215
 Technology Instrument Corp. of
 Calif.1560-1507-1508
 Tech-Ohm Electronics, Inc.4405
 Tech-Ser Inc.2213-2215
 Tektronix, Inc. ..1726-1727-1728-1823
 Telecomputing Corp.2022-2024
 Telerad Division of the Lionel
 Corp.3605-3607
 Teletype Corp.4418-4420
 Telex Inc.2503-2505
 Telonic Industries, Inc.2813-2815
 Temperature Engineering Corp..4922
 Tenney Engineering Inc.4222
 Tensolite Insulated Wire Co.,
 Inc.4608
 Texas Instruments
 Inc.3014-3016-3018-3020-3022
 Thermador Electric
 Manufacturing Co.1811
 Thermal Wire of America.....4622
 The Thomas & Betts Co.418-420
 Thomas Electronics, Inc.4406
 Thomas & Skinner, Inc.1819
 Thompson Ramo Wooldridge, Inc. 3215
 F. D. Thompson Publications,
 Inc.P-10
 The Thorson Co.4224
 Timsley Laboratories, Inc.4501
 Topatron, Inc.2616
 The Torrington Manufacturing
 Co.4117
 Transdata, Inc.114
 Transformer Engineers1705
 Transistor Specialties, Inc.....4101
 Transitron Electronic Corp..3502-3504
 Trans-Sonics, Inc.4414
 Tri Metal Works, Inc.5117
 Trio Laboratories, Inc.917
 Triplett Electrical Instrument Co. 511
 Tri-State Supply Corp.5105
 Tru-Connector Corp.4328
 Tru-Ohm Products Division1511
 Trygon Electronics Inc.4119
 Tung-Sol Electric Inc.1807-1809
 Tur-Bo Jet Products Co., Inc.3007



MARCONI
INSTRUMENTS



111 CEDAR LANE • ENGLEWOOD, NEW JERSEY
 CIRCLE 286 ON READER SERVICE CARD

Reliable products depend on reliable parts

The worldwide success of Japan's transistor radios is a tribute to their highly efficient yet minute components, of which the ultra-small Mitsumi IFT Poly-vari-con is typical. With other superb Mitsumi parts, it is being extensively used by leading radio manufacturers.

For Transistor Radio parts



IFT
Intermediate
Frequency
Transformer



POLY-VARI-CON
Variable
Capacitor

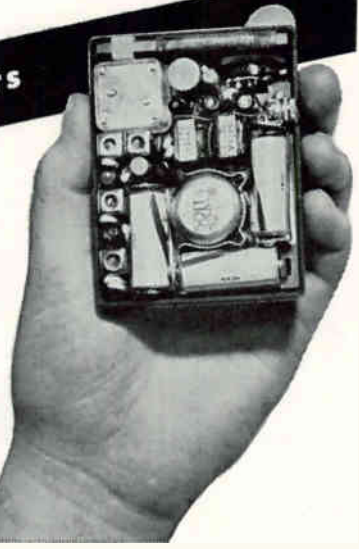

Mitsumi Parts

MITSUMI ELECTRIC CO., LTD.
 1056-1, Koadachi, Komae-cho, Kitatama-gun, Tokyo, Japan

U

- Ultek Corp.4320
 Ultrasonic Industries Inc.4526
 Ultronix, Inc.3206
 Ungar Electric Tools4815
 Unholtz-Dickie Corp.4324
 Union Switch & Signal....3101-3103
 United Catalog Publishers, Inc...P-22
 United Transformer Corp.1613
 Unitek Corp.4808-4810
 Universal Electronics Co.807

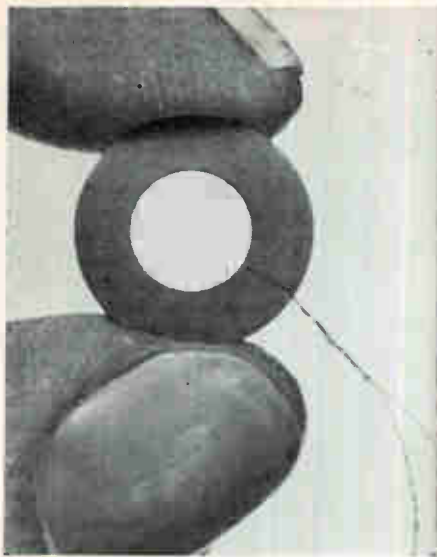

In the Remington Rand Univac physics laboratory, 5 mil. diameter holes are ultrasonically drilled in ferrite cores, then threaded with fine wire in the examination of domain structure. Such experiments prove that a series of alternate-polarity pulses of diminishing amplitude result in concentric rings of alternately directed magnetization. Much smaller cores (80 mil. o.d.) were then studied by means of residual magnetization curves for flux distribution under various modes of partial switching.

Opportunity for personal progress has never been greater than it is today at Remington Rand Univac.

In addition to an attractive salary, you will work with engineers and scientists who have made significant advances in solid state development and computer reliability. Immediate openings include:

RESEARCH ENGINEERS

Attractive positions are now available for Research Engineers. These permanent assignments include circuit development work and the logical design of high speed computer elements.

- TRANSISTOR CIRCUIT DESIGNERS
- ELECTRONIC PACKAGING ENGINEERS
- SERVO-ENGINEERS
- ELECTROMECHANICAL ENGINEERS
- QUALITY CONTROL ENGINEERS
- PRODUCTION ENGINEERS
- RELIABILITY ENGINEERS
- STANDARDS & SPECIFICATIONS ENGINEERS

Send resume of education and experience to:

R. K. PATTERSON, DEPT. T-8

Remington Rand

Univac

DIVISION OF SPERRY RAND CORPORATION
2750 West Seventh St., St. Paul 16, Minn.

There are also immediate openings in all areas of digital computer development at our other laboratories. Inquiries should be addressed to:



F. E. NAGLE, Dept. T-8
REMINGTON RAND UNIVAC
P. O. Box 500
Blue Bell, Pa.

D. CLAVELoux, Dept. T-8
REMINGTON RAND UNIVAC
Wilson Avenue
South Norwalk, Conn.

(All qualified applicants will be considered regardless of race, creed, color or national origin.)

Universal Instruments Corp.4932-4934
Universal Manufacturing Co., Inc.4532
Utica Drop Forge & Tool Division5031

V

Vaco Products Co.412
Vacuum Apparatus Co.113
Vacuum-Electronics Corp....120-122
Vacuum Technology Inc.1214
Van Groos Co.1920
Varian Associates2009-2011-2013
2015-2017
Vari-L Company, Inc.4312
Varo Inc.3609-3611
Vector Electronic Co., Inc..1824-1927
Veeder-Root Inc.3617-3619
Verco, Inc.4210
Victor Adding Machine Co.3208
Vidar Corp.112
Viking Industries, Inc.1815-1817
Vitramon Inc.1818
Vitro Electronics1219-1221
Vogue Instrument Corp.4202

W

L. Wagner5030
Wales Strippit, Inc.....5120-5122
Walkirt Co.1725
Ward Leonard Electric Co.509
Waterman Products Co., Inc.1406
Wave Particle4214
A. W. Weart Brothers.....4208
Weckesser Company Inc.....4822
Weightman & Associates1708
Weller Electric Corp.5118
Wesrep Corp.1318
Western Devices, Inc..5009-5011-5013
Western Gear Corp.1001-1003
Western Gold & Platinum Co. ...4712
Western Transistor Corp.4220
Westinghouse Electric Corp. ...3515
3517-3519-3521-3616-3618-3620-3622
Westline Products Division of
Western Lithograph Company.4807
Westron Sales & Engineering ..3511
S. S. White Industrial Division...5128
John Wiley & Sons, Inc.P-16
The Wilkinson Co.4825
Wiltron Co.1212
Winchester Electronics, Inc.2205
Wire Company of America.....4710
Wright Engineering Co.2115-2116-2117
Wright Machinery Co.3717
Wyle Laboratories4518

X

Xcelite Inc.402

Y

Yardney Electric Corp.3402
Yokogawa Electric Works, Inc. ..4111

Z

The Zero-Max Co.416
Ziff-Davis Publishing Co.P-21
W. E. Zimmerman Co.314
The Zippertubing Co.5113

STANDING AT THE TOP

Westran TRANSISTORS

QUALITY - RELIABILITY

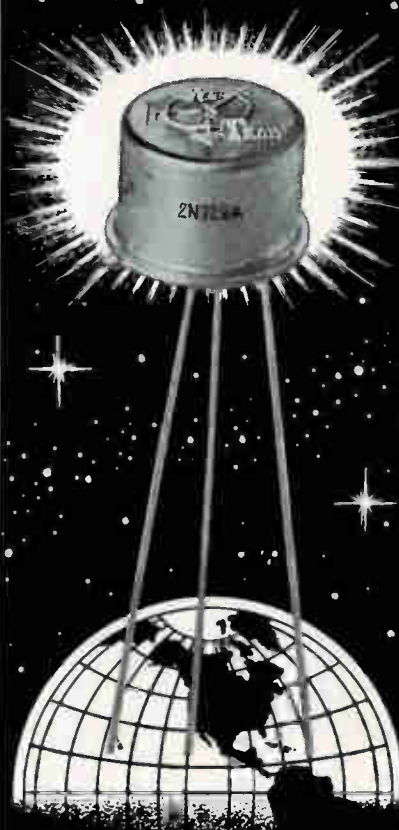

Westran PNP SILICON ALLOY JUNCTION TRANSISTORS

TYPES - 2N327A - 28A - 29A
2N1228-29-30-31-32-33-34

PROMPT DELIVERY ON ANY ORDER
24 HOUR DELIVERY ON SMALL QUANTITIES
CUSTOM DESIGN ENGINEERING SERVICES
AVAILABLE

Westran WESTERN TRANSISTOR CORP.

13021 South Budlong Avenue
Gardena, California
Facuity 1-5741
EXPORT DEPT: Minthorne International Co.,
15 Moore St., New York 4, N.Y.

Wescon Booth No. 4220

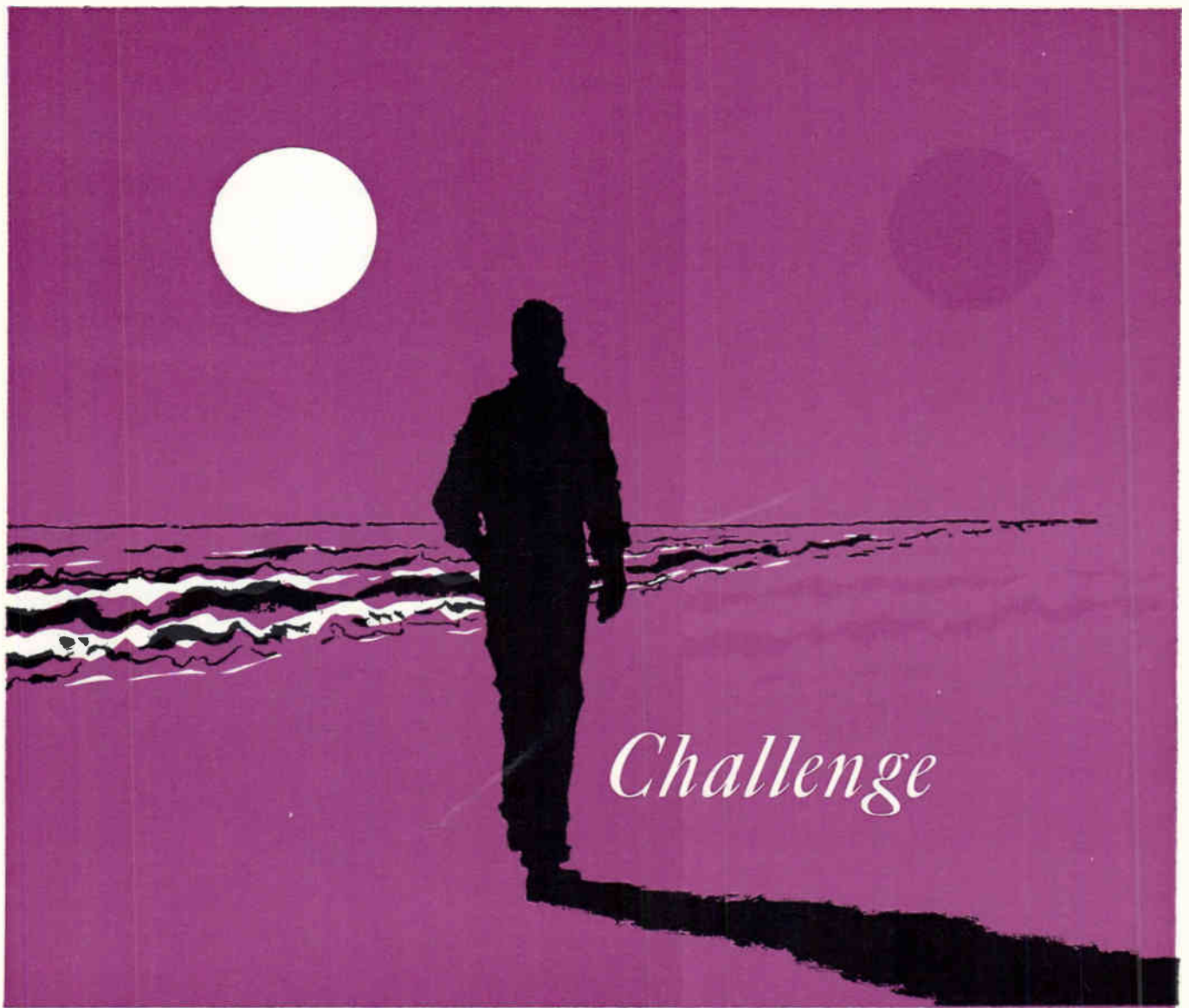

Bring me men to match my mountains . . . Foss

Guided Missiles Range Division needs men of vision, men of ability, men of dedication for challenging career positions.

Much has been done. Great strides have been taken. Yet the tasks that lie ahead are even more demanding. Fully qualified men are invited to join with GMRD in doing the job that must be done.

Guided Missiles Range Division of Pan American World Airways, Inc., as prime contractor to the U. S. Air Force at Cape Canaveral for planning, engineering and operation of the Atlantic Missile Range, has successfully supported over 600 missile launchings, including manned sub-orbital space explorations.

Now new career positions are available in planning, engineering and operation. Physicists, engineers and mathematicians with B.S., M.S. and Ph.D. degrees having interest and experience in range instrumentation systems determination are invited to submit résumés in confidence. Address Professional Employment Manager, Guided Missiles Range Division, PAN AMERICAN WORLD AIRWAYS, INC., Dept. W41, P. O. Box 4336, MU 113, Patrick Air Force Base, Florida. Inquiries will receive prompt replies and all qualified applicants will be considered for employment without regard to race, creed, color or national origin.



GUIDED MISSILES RANGE DIVISION
PATRICK AIR FORCE BASE, FLORIDA

electronics

WEEKLY QUALIFICATION FORM FOR POSITIONS AVAILABLE

ATTENTION: ENGINEERS, SCIENTISTS, PHYSICISTS

This Qualification Form is designed to help you advance in the electronics industry. It is unique and compact. Designed with the assistance of professional personnel management, it isolates specific experience in electronics and deals only in essential background information.

The advertisers listed here are seeking professional experience. Fill in the Qualification Form below.

STRICTLY CONFIDENTIAL

Your Qualification form will be handled as "Strictly Confidential" by ELECTRONICS. Our processing system is such that your form will be forwarded within 24 hours to the proper executives in the companies you select. You will be contacted at your home by the interested companies.

WHAT TO DO

1. Review the positions in the advertisements.
2. Select those for which you qualify.
3. Notice the key numbers.
4. Circle the corresponding key number below the Qualification Form.
5. Fill out the form completely. Please print clearly.
6. Mail to: D. Hawksby, Classified Advertising Div., ELECTRONICS, Box 12, New York 36, N. Y. (No charge, of course).

COMPANY	SEE PAGE	KEY #
AMERICAN MACHINE & FOUNDRY CO. Springdale, Connecticut	84*	1
THE BOEING COMPANY Seattle, Washington	131-132	2
BRENTON EMPLOYMENT AGENCY Newark, New Jersey	248	3
CENTRAL RESISTOR CORP. Addison, Illinois	248	4
CORNELL ASSOCIATES, INC. Chicago, Illinois	84*	5
COWIN ASSOCIATES Garden City, New York	248	6
ERIE ELECTRONICS DIV. Erie Resistor Corp. Erie, Pa.	248	7
ESQUIRE PERSONNEL Chicago, Illinois	246	8
GYRODYNE CO. OF AMERICA INC. St. James, L. I., N. Y.	246	9
INSTRUMENTS FOR INDUSTRY INC. Hicksville, L. I., New York	246	10
LITTON SYSTEMS INC. Guidance & Control Systems Division Woodland Hills, California	175	11
LOCKHEED CALIFORNIA DIV. Burbank, California	13	12
MANSON LABORATORIES, INC. Stamford, Conn.	241	13

Continued on page 246

(cut here)

(cut here)

electronics WEEKLY QUALIFICATION FORM FOR POSITIONS AVAILABLE

Personal Background

NAME

HOME ADDRESS.....

CITY..... ZONE..... STATE.....

HOME TELEPHONE.....

Education

PROFESSIONAL DEGREE(S).....

MAJOR(S)

UNIVERSITY

DATE(S)

FIELDS OF EXPERIENCE (Please Check)

8111

- | | | |
|--|--|---------------------------------------|
| <input type="checkbox"/> Aerospace | <input type="checkbox"/> Fire Control | <input type="checkbox"/> Radar |
| <input type="checkbox"/> Antennas | <input type="checkbox"/> Human Factors | <input type="checkbox"/> Radio—TV |
| <input type="checkbox"/> ASW | <input type="checkbox"/> Infrared | <input type="checkbox"/> Simulators |
| <input type="checkbox"/> Circuits | <input type="checkbox"/> Instrumentation | <input type="checkbox"/> Solid State |
| <input type="checkbox"/> Communications | <input type="checkbox"/> Medicine | <input type="checkbox"/> Telemetry |
| <input type="checkbox"/> Components | <input type="checkbox"/> Microwave | <input type="checkbox"/> Transformers |
| <input type="checkbox"/> Computers | <input type="checkbox"/> Navigation | <input type="checkbox"/> Other |
| <input type="checkbox"/> ECM | <input type="checkbox"/> Operations Research | <input type="checkbox"/> |
| <input type="checkbox"/> Electron Tubes | <input type="checkbox"/> Optics | <input type="checkbox"/> |
| <input type="checkbox"/> Engineering Writing | <input type="checkbox"/> Packaging | <input type="checkbox"/> |

CATEGORY OF SPECIALIZATION

Please indicate number of months
experience on proper lines.

	Technical Experience (Months)	Supervisory Experience (Months)
RESEARCH (pure, fundamental, basic)
RESEARCH (Applied)
SYSTEMS (New Concepts)
DEVELOPMENT (Model)
DESIGN (Product)
MANUFACTURING (Product)
FIELD (Service)
SALES (Proposals & Products)

CIRCLE KEY NUMBERS OF ABOVE COMPANIES' POSITIONS THAT INTEREST YOU

1 2 3 4 5 6 7 8 9 10 11 12 13 14 15 16 17 18 19 20 21 22 23 24 25

★ INTERNATIONAL AIR SHOW ★
LE BOURGET
PARIS, FRANCE



GRAND PRIX JUNE 1, 1961

ENGINEERS:

Join the team that developed and designed the ROTORCYCLE—the coaxial one-man helicopter awarded the Grand

Prix for its competitive performance on June 1, 1961 at the International Air Show, Le Bourget, Paris, France.

It is this kind of pioneer engineering that has resulted in Gyrodyne's Drone—the DSN pilotless, remotely controlled, weapons carrying helicopter having been selected by the U. S. Navy for the ASW DASH program. DASH consists of Gyrodyne Drones and Navy Destroyers with the necessary ship-board equipment to launch, control, guide, and retrieve the Drone. This combination gives the Navy a new long-range striking force against enemy submarines.

These types of projects are creating career openings at various levels, for graduate engineers experienced in the following fields:

DESIGNERS

- Transmission
- Airframe
- Powerplant Installation
- Equipment Installation
- Electrical

ANALYTICAL

- Aerodynamicists
- Stress Analysts
- Helicopter
- Stability and Performance

DRAFTSMEN

- Layout
- Detailers
- Mechanical Design Checkers

TEST ENGINEERS

- Flight Test
- Structural Test
- Static and Dynamic

Applicants interested in the possibility of becoming associated with a progressive organization located in one of the most beautiful suburban residential areas on Long Island, are requested to submit confidential resumes to our Personnel Director, Dept. E, Gyrodyne Company of America, Inc., St. James, L. I., N. Y.

Gyrodyne
COMPANY OF AMERICA, INC.
An equal opportunity employer.

MANUFACTURING ENGINEERS

- Tool Design
- Tool Design Checkers
- Shop Liaison
- Vendor Liaison

AVIONIC SYSTEMS ENGINEERS

- Autopilot
- Digital Data Link
- Radar Tracking
- Ground Control Equipment

CONTRACT ADMINISTRATION ENGINEERS

- Electronic Systems
- Electronic Components
- Electronic Support Equipment

PRODUCT SUPPORT ENGINEERS

- Publications
- Electronic Equipment
- Field Service
- Training

**ENGINEERS
RESEARCH & DEVELOPMENT**

Now is the time to investigate job opportunities with IFI if you feel the need to reach out for a more promising and rewarding career.

Expansion of our Research and Development facilities offers challenging opportunities to creative Engineers in the field of Military and Commercial VHF and UHF electronic systems.

PROJECT ENGINEERS

B.S. in E.E. or Physics. Prefer M.S. Minimum 7 years work background in UHF and VHF circuit development and extensive amplifier experience in the 50 to 1,000 MC range. Ability to provide technical direction and effective group management for all phases of prototype development, fabrication, testing, delivery and customer liaison.

SENIOR ENGINEERS

B.S. in E.E. or Physics. Prefer M.S. Minimum 4 years broad technical background in circuit design and development in the 50 to 1,000 MC range.

- Salaries Commensurate With Ability
- Many Benefits Including
- Profit Sharing Retirement Plan

Please submit resume in confidence to:
Mr. J. V. Hicks, Personnel Manager



All qualified applicants considered regardless of race, creed, color or national origin.

**INSTRUMENTS FOR
INDUSTRY, INC.**

101 New South Road, Hicksville, L. I.,
New York

ASST. CHIEF ENGINEER . . . \$19,000

Needed NOW to head up Navigational Lab. of a major corporation. You will be in complete charge of the design and development of Navigational guidance equipment and systems. Location and working conditions are among the best in the country. Client assumes employment cost and moving expenses.

ESQUIRE PERSONNEL
202 S. State St. Chicago 4, Ill.

electronics

**WEEKLY QUALIFICATIONS FORM
FOR POSITIONS AVAILABLE**

(Continued from page 245)

COMPANY	SEE PAGE	KEY #
MED-SCIENCE ELECTRONICS INC. St. Louis, Missouri	84*	14
MERONEY & ASSOC., A. H. Chicago, Illinois	248	15
THE MITRE CORPORATION Bedford, Mass.	249	16
PAN AMERICAN WORLD AIRWAYS INC. Guided Missiles Range Div. Patrick AFB, Fla.	244	17
PAN AMERICAN WORLD AIRWAYS, INC. Tucson, Arizona	248	18
PERKIN-ELMER CORP. Norwalk, Connecticut	84*	19
PHILCO WESTERN DEVELOPMENT LABS. Palo Alto, California	247	20
REMINGTON RAND UNIVAC Div. of Sperry Rand Corp. St. Paul, Minnesota	243	21
SIKORSKY AIRCRAFT Div. of United Aircraft Corp. Stratford, Connecticut	83*	22
UNITED ELECTRODYNAMICS INC. Pasadena, California	84*	23
P-7078	248	24
P-7177	248	25

* These advertisements appeared in the 8/4/61 issue.

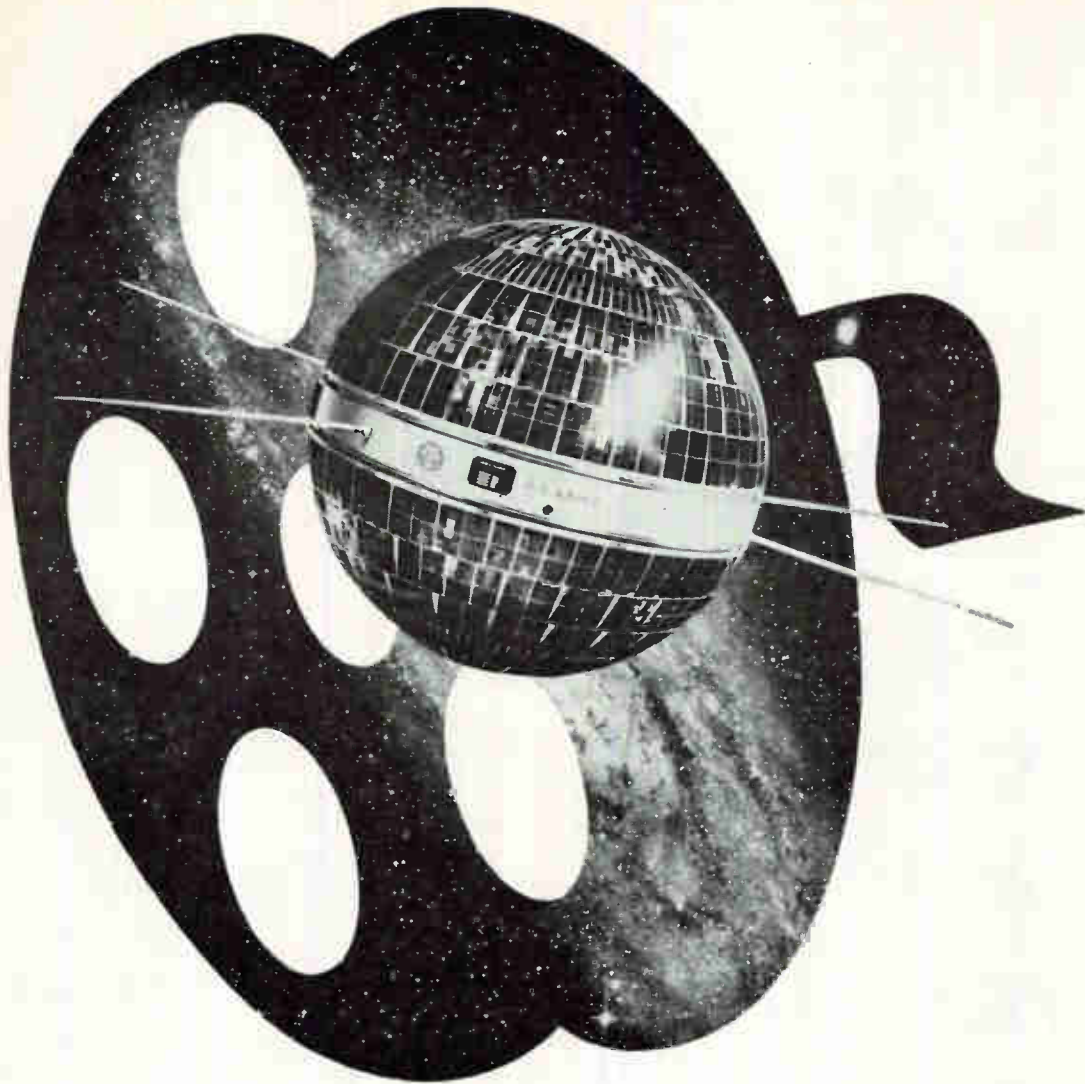

LP Record—Stellar Style

The message from Courier is just one of the challenges offered to you at PHILCO Western Development Laboratories, whose long record in space communications achievement merely presages the adventure ahead.

From the earliest plans to invade space, PHILCO Western Development Laboratories has played a vital role in satellite vehicle instrumentation, still but *part* of its contribution to space communications. From this newest electronics center on the San Francisco Peninsula comes a continuing flow of advanced missile tracking, range and data processing instrumentation.

Added research projects and growing programs assure *you* a long and rewarding career as a member of the PHILCO Western Development Laboratories. What you think and what you do can be unhampered and uninhibited. Personal recognition and advancement promptly follow performance, with monetary rewards to match. Northern California provides an affluent climate for living, as PHILCO Western Development Laboratories provides a stimulating climate for working. For information on careers in electronic engineering, please write Mr. W. E. Daly, Dept. E-8.

All qualified applicants will receive consideration for employment without regard to race, creed, color or national origin; U. S. citizenship or current transferable Department of Defense clearance required.

PHILCO
 Famous for Quality the World Over[®]

WESTERN DEVELOPMENT LABORATORIES

3875 Fabian Way, Palo Alto, California

6317

ELECTRONIC ENGINEERS

- Career Opportunities
- Challenging Assignments
- Top Earnings

Leading, independent research organization has positions available for men with BS and MS degrees in Electronic Engineering. Men with experience in the development of vacuum tubes, transistor or relay circuits, or recent outstanding college graduates will qualify. Interesting, unusual work in data transmission and retrieval and digital computing.

- Non-military work
- Individual effort recognized
- Good job security
- Ideal working conditions
- Excellent employee benefit program
- Long-established firm

Comfortable living in Suburban areas only minutes away.

FORWARD YOUR RESUME IN CONFIDENCE

P-7177 Electronics, 645 N. Michigan Ave., Chicago 11, Ill.

EAST COAST OPPORTUNITIES IN SPACE ELECTRONICS

NOW is the time to apply your engineering talent to the challenge of space.

Openings exist for engineers and managers in the following fields:

- Communications
- TV Camera
- Video Systems
- Applied Math
- Data Systems
- Propulsion
- Space Systems

For further information and personal interview, please forward detailed resume including salary to Mr. D. M. Cowin.

West Coast interviews can be arranged August 21 through 24.

COWIN ASSOCIATES

600 OLD COUNTRY ROAD • GARDEN CITY, N.Y.

Management Search Specialists

TRANSFORMER ENGINEER

With experience in the design and development of Hi-Frequency and Pulse transformers for commercial and military applications.

Ideal opportunity for ambitious man to develop full potential of present small department. Salary—open. Location—Erie, Pa. Call or send resume to Chief Engineer

Erie Electronics Division

Erie Resistor Corporation

645 West 12th Street Erie, Pa.
GL 6-8592

SCIENTISTS PHD's NEW JERSEY

All \$13-20,000 Fee Paid by Co.

(1) INFORMATION & SYSTEMS THEORIST. As applied to transmission, conversion or storage (eg. Pulse code telemetry; computer organization) etc.

(1) S.S. PHYSICIST—Quantum mechanics & imperfection of solids; semiconductors.

(2) ADVANCED CIRCUIT SYNTHESIS & ANALYSIS—Analog orientation—calculus of variations, matrix & fourier analysis etc. Write, call collect J. Albert (N.J. Market 2-0915.)

Engineers Manage Our Unique Service

BRENTEN Emp Agcy

786 Broad St., Newark 2, N. J.

PAN AMERICAN WORLD AIRWAYS, INC.

Electronic Environmental Test Facility Headquarters in Tucson, Arizona, Heart of the Desert Southwest has a continuing interest in Electronic Engineers.

Those with experience in Radar Engineering are invited to send resumes to:

Box 5894, Tucson, Arizona

SYSTEMS SALES ENGINEER

Challenging interesting opportunity for exp. electronic sales engr. as eastern repr. of a growing Chicago area firm specializing in remote control systems for industry. Prefer EE with servo audio and circuitry backgr. Salary approximately \$10,000 to start plus expense and bonus arrangement. Interviews about Aug. 12-15 in NYC.

A. H. MERONEY & ASSOCIATES
5 N. WABASH AVE. CHICAGO 2, ILL.

ENGINEERS

Continued expansion of research and development departments of Midwest electronic manufacturer provides excellent opportunities for qualified engineers.

Present openings include opportunities for a project group leader who has a minimum of three years experience in supervising group projects in electronic tubes, and for a filament engineer experienced in winding and coating of tungsten filaments.

For further information write in confidence to

P-7078, Electronics
645 N. Michigan Ave., Chicago 11, Ill

RESISTOR ENGINEER

Progressive manufacturer of Metal Film Resistors located near Chicago needs an experienced engineer to take charge of their precision resistor line. Must be experienced on Mil type resistors. Excellent opportunity for the right person to manage this division.

CENTRAL RESISTOR CORP.

507 Factory Road Addison, Illinois
National 5-9332

POSITION VACANT

Medical Electronic Sales Manager or Consultant—Rare opportunity for the right man in New York City. Write about your background and experience to the President of the Interstate Mfg. Corp., 190 Boston Post Road, Orange, Connecticut.

Your Inquiries to Advertisers Will Have Special Value . . .

—for you—the advertiser—and the publisher, if you mention this publication. Advertisers value highly this evidence of the publication you read. Satisfied advertisers enable the publisher to secure more advertisers and —more advertisers mean more information on more products or better service—more value—to YOU.

FOR INFORMATION

About Classified Advertising

Contact

*The McGraw-Hill
Office Nearest You.*

ATLANTA, 9
1375 Peachtree St. N. E.
TRinity 5-0523
R. JOHNSON

BOSTON, 16
Copley Square
COngress 2-1160

CHICAGO, 11
645 No. Michigan Ave.
MOhawk 4-5800
W. J. HIGGENS - W. SONZSKI

CLEVELAND, 13
1164 Illuminating Bldg.
SUperior 1-7000

DALLAS, 2-1712 Commerce St.,
Vaughn Bldg., RIVERSIDE 7-9721
J. GRANT

DENVER, 2
1700 Broadway, Tower Bldg.
ALpine 5-2981
J. PATTEN

DETROIT, 26
856 Penobscot Bldg.
WOodward 2-1793
P. HAMMOND

HOUSTON, 25
Prudential Bldg.,
Holcombe Blvd., Rm. W-724
JACKSON 6-1281
GENE HOLLAND

LOS ANGELES, 17
1125 W. 6th St.
HUntley 2-5450
W. C. GRIES

NEW YORK, 36
500 Fifth Ave.
OXford 5-5959
H. T. BUCHANAN - R. P. LAWLESS
T. W. BENDER

PHILADELPHIA, 3
Six Penn Center Plaza
LOcust 8-4330
P. PASCHALL - W. B. SULLIVAN

PITTSBURGH, 22
4 Gateway Center
EXpress 1-1314

ST. LOUIS, 8
3615 Olive St.
JEFFerson 5-4867
R. BOWMAN

SAN FRANCISCO, 11
255 California St.
DOuglas 2-4600
J. A. HARTLEY

ENGINEERS • SCIENTISTS

a technical adviser's seat at the conference table

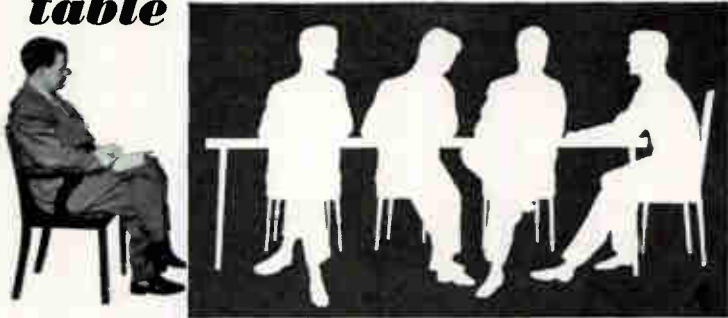

**... where the requirements of the
aerospace control environment
are defined—decisions implemented**

This seat is reserved for MITRE, Technical Adviser to the Air Force for command and control systems.

Electronic Systems must meet the challenge to command posed by present and future weapons, aerospace vehicles and widely dispersed forces.

MITRE works with the Air Force in planning and developing these systems. The job demands application of the most advanced command and control technology.

Many technical disciplines are pursued with a scientific objectivity engendered by the corporation's nonprofit status and the clearly defined programs established bilaterally with the Air Force Electronics Systems Division.

Specifically, MITRE engages in:

- ... Advance conceptual planning
- ... Specification of individual system requirements
- ... Intersystem engineering
- ... Research and experimentation to generate new command and control techniques

Engineers and scientists interested in the new field of command and control technology are invited to inquire about openings in:

- Operations Research
- Radar Systems and Techniques
- System Analysis
- Advanced System Design
- Communications
- Air Traffic Control System Development
- Econometrics
- Computer Technology
- Human Factors
- Mathematics
- Antenna Design — Microwave Components

Write in confidence to: VICE PRESIDENT — TECHNICAL OPERATIONS

THE
MITRE
CORPORATION

Post Office Box 208, 17-WU — Bedford, Massachusetts

*All qualified applicants will receive consideration for employment
without regard to race, creed, color or national origin.*

**ANTENNA PEDESTAL
SCR 584—MP 61B**

Full azimuth and elevation sweeps 360 degrees in azimuth. 210 degrees in elevation. Accurate to 1 mil. or better over system. Complete for full tracking response. Angle acceleration rate: AZ, 9 degrees per second squared EL, 4 degrees per second squared. Angle slewing rate: AZ 20 degrees per sec. EL 10 degrees per sec. Can mount up to a 20 ft. dish. Angle tracking rate: 10 degrees per sec. Includes pedestal drives, selsyns, potentiometers, drive motors, control amplifiers. Excellent condition. Quantity in stock for immediate shipment. Ideal for missile & satellite tracking, antenna pattern ranges, radar systems, radio astronomy, any project requiring accurate response in elevation and azimuth. Complete description in McGraw-Hill Radiation Laboratory Series, Volume 1, page 284 and page 209, and Volume 26, page 233.

**MIT MODEL 9 PULSER
1 MEGAWATT-HARD TUBE**

Output pulse power 25 KV at 40 amp. Max duty ratio: .002. Uses 6C21 pulse tube. Pulse duration .25 to 2 microsec. Input 115 volts 60 cycle AC. Includes power supply in separate cabinet and driver. Fully guaranteed as new condition. Full Desc. MIT. Rad. Lab. series "Pulse Generators."

MIT MODEL 3 PULSER

Output: 144kw (12kv at 12 amp). Duty ratio: .001 max. Pulse duration: .5 1 and 2 micro sec. Input: 115V 400 to 2000 cps and 24rds. \$325 ea. Full desc. Vol. 5 MIT Rad. Lab. series pg. 140.

AN/TPS—10D HEIGHT FINDER

250 KW X-Band. 60 & 120 mile ranges to 60,000 feet. Complete.

500 KW PULSER

5C22 Hydrogen Thyatron Modulator. 22KV at 28 Amps. W/HV & Fil supplies. 3 pulse length rep rates: 2.25 μ sec 300 pps. 1.75 μ sec 550 pps. .4 μ sec 2500 pps. 115V 60cy AC input.

60 MC I.F. STRIP

-95 DBM sensitivity. 130 DB gain. 1 MC & 5 MC band widths. Mfg. Texas Instruments. \$125 each w/tubes.

AN/TPS-1D RADAR

500kw. 1220-1359mes. 160 nautical mile search range P.P.I. and A Scopes. MTI. thyatron mod. 5J26 magnetron. Like new. Complete system incl. spare parts and gas generator field supply.

225 KW X-BAND RF

4J50 Magnetron RF Generator with dummy load & Dir. Cplr. Variable rep rates. Variable power output. 115V 60-cycle AC input. New. \$2400 complete.

WESTINGHOUSE 3CM RADAR

Complete X band system over. from 115v 60cy ac with 40 kw power output 2J55 magnetron. Ranges 0-1.5, 4, 16, 40 miles. Includes installation warequide. An ideal system for lab school, demonstration or shipboard. \$1800. New with spares.

10 CM. WEATHER RADAR SYSTEM

US Navy Raytheon. 275 KW peak output S band. Rotating yoke Plan position Indicator. Magnetron supplied for any S band frequency specified. Incl. Weather Band. 4, 20 and 80 mile range. 360 degree azimuth scan. Sensitive rev using 2K28 707B and 1N21B. Supplied brand new complete with instruction books and installation drawings. Can be supplied to operate from 32VDC or 115 volts. Price \$975. Ideal for weather work. Has picked up clouds at 50 miles. Weight 488 lbs.

10KW 3 CM. X BAND RADAR

Complete RF head including transmitter, receiver, modulator. Uses 2J42 magnetron. Fully described in MIT Rad. Lab. Series Vol. I, pps. 616-625 and Vol. II, pps. 171-185, \$375. Complete X band radar system also avail. Incl. 360-deg antenna, PPI, syn pwr supply. Similar to \$17,000 weather radar now in use by airlines, \$750 complete.

AN/APS-15B 3 CM RADAR

Alborno radar. 40kw output using 725A magnetron. Model 3 pulser. 30 in. parabola stabilized antenna. PPI scope. Complete system. \$1200 each. new.

SCR 584 RADARS

AUTOMATIC TRACKING RADAR

Our 584s in like new condition, ready to go, and in stock for immediate delivery. Ideal for research and development, airway control, (GCA, missile tracking, balloon tracking, weather forecasting, antiaircraft defense tactical air support. Write us. Fully Desc. MIT Rad. Lab. Series. Vol. 1, pps. 207-210, 228, 284-288.

**RADIO RESEARCH
INSTRUMENT CO.**

550
FIFTH AVE.
NEW YORK
JUDSON
6-4691

CIRCLE 631 ON READER SERVICE CARD

Wilgreen

can deliver **Amphenol
Bendix
Cannon
CONNECTORS
FITTINGS & CLAMPS**

We stock more than 5,000,000 MS/AN CONNECTORS . . . of 50,000 variations! In PRODUCTION QUANTITIES . . . we sell BELOW "O.E.M." PRICE . . . and offer IMMEDIATE "OFF-THE-SHELF" DELIVERY!

FREE . . . Send for latest brochure and list price chart

WILGREEN INDUSTRIES, Inc.
100 Warren Street, New York 7, N. Y.
WOrth 4-2490-1-2 Wire: FXX

CIRCLE 632 ON READER SERVICE CARD

**PRACTICALLY NEW
7 Precision
Potentiometer Card Winders**
For Information Contact
R & H MACHINERY INC.
799 W. Boylston St. Worcester, Mass.
Phone PLeasant 7-2741

CIRCLE 635 ON READER SERVICE CARD

**LIFSCHULTZ
FASTEST TO BOTH COASTS**



Over 62 years of dependable ON-TIME Freight Forwarding Service.

We welcome your inquiry.



PROMPT DAILY PICKUP and DELIVERY

**LIFSCHULTZ
FAST FREIGHT**

CIRCLE 633 ON READER SERVICE CARD

lab grade **TEST EQUIPMENT** for sale
standard brands—military surplus
(new or professionally reconditioned)
experienced problem solvers and budget-cutters

ENGINEERING ASSOCIATES
434 Patterson Road Dayton 19, Ohio

CIRCLE 636 ON READER SERVICE CARD

RT181/APG30 X-Band freq. conv. Xcvrs. N.W. GTEED, all 19 orig. tubes (2J42 & 2K25 Raytheon, TR, ATR, DHT, etc. Has 10-level IF, AFC, bal. mfr. limited. \$79.50 fob Bk.
RT100A/APS19, dual bal.-mfr. X-Band Xcvr. compl. w/24 tubes (Two 2K25's, 2J55-Raytheon, thy. TR, ATR, 3B26, etc.) Has 30 mc IF 3 mc w. 1023 cav., etc., used, exc., GTEED, Ltd. \$59.50 fob B.
D-K CS-300 SPDT rotary CO-AX Switches. 26 vdc coil. (RF #319-01131-3), BNC conn's. 1.5VS WR @ 2 Kmc. NEW. GTEED. \$19.50 ea. fob Berk. Electronics Supplies, Box 161, Sta. A, Berkeley 2, Calif.

CIRCLE 637 ON READER SERVICE CARD

**SEARCHLIGHT
Equipment
Locating Service**

NO COST OR OBLIGATION

This service is aimed at helping you, the reader of "SEARCHLIGHT", to locate Surplus new and used electronic equipment and components *not currently advertised.* (This service is for USER-BUYERS only).

How to use: Check the dealer ads to see if what you want is not currently advertised. If not, send us the specifications of the equipment wanted on the coupon below, or on your own company letterhead to:

**Searchlight Equipment
Locating Service
c/o ELECTRONICS**

P. O. Box 12, N. Y. 36, N. Y.

Your requirements will be brought promptly to the attention of the equipment dealers advertising in this section. You will receive replies directly from them.

Searchlight Equipment Locating Service
c/o ELECTRONICS

P. O. Box 12, N. Y. 36, N. Y.

Please help us locate the following equipment components.

NAME

TITLE

COMPANY

STREET

CITY 8/11/61

IT'S ARRIVED . . .



and
it's
yours
for
the
asking . . .

. . . the NEW 1961 FALL edition of the BARRY *GREENSHEET CATALOG

A complete catalog of specialized industrial ELECTRONIC TUBES and COMPONENTS . . . featuring BARRY ELECTRONICS savings to industry. WRITE or CIRCLE READER SERVICE CARD NO. 634 FOR YOUR COPY.

BARRY ELECTRONICS

CORPORATION

512 BROADWAY Walker 5-7000
NEW YORK 12, N. Y. TWX: NY 1-3731

CIRCLE 634 ON READER SERVICE CARD

RADAR and MICROWAVE TEST EQUIPMENT NEW and AS NEW

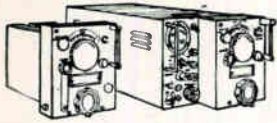

Checked Out TEST EQUIPMENT for your Laboratory and Radar needs

PIB I	Pulse Impedance Bridge, Class Labs.	400.00
608 A	Hewlett Packard Signal Generator	750.00
608 B	Hewlett Packard Signal Generator	750.00
400 A	Hewlett Packard VTVM	125.00
400 C	Hewlett Packard VTVM	135.00
400	Sylvania Oscilloscope	280.00
402 A	Sylvania Synchroscope	245.00
416 A	Hewlett Packard Signal Generator	1,250.00
TS10	Calibrator	95.00
TS12	Standing Wave Amplifier	195.00
TS15A	Gauss Meter	75.00
TS16	Calibrator	45.00
TS19	Calibrator	95.00
TS28	Synchroscope	150.00
TS32	X Band Frequency Meter	95.00
TS34	WE Synchroscope	100.00
TS34A	WE Synchroscope	150.00
TS35	WE X Band Signal Generator	150.00
TS36	WE X Band Signal Generator	90.00
TS45	X Band Signal Source	90.00
TS46	S Band Frequency Meter	45.00
TS47	40-400 MC Oscillator	145.00
TS58	L Band Signal Generator	95.00
TS61	Echo Box S Band	90.00
TS62	Echo Box S Band	125.00
TS68	Calibrator 400-1000 MCS	95.00
TS76	Test Meter	35.00
TS89	Meter Voltage Drop	95.00
TS100	Oscilloscope	125.00
TS102A	Calibrator	95.00
TS108	Lead X Band	90.00
TS110	Echo Box	35.00
TS117GP	S Band Frequency Meter	325.00
TS125	S Band Power Meter	195.00
TS126	Oscilloscope	195.00
TS147	Wide Band X-Band Signal Generator	695.00
TS147B	Wide Band X-Band Signal Generator	795.00
TS147D	Wide Band X-Band Signal Generator	1,695.00
TS148	X-Band Spectrum Analyzer	1,695.00
TS155	S Band Signal Generator	125.00
TS155C	S Band Signal Generator	195.00
TS173	Frequency Meter	225.00
TS174	Frequency Meter	225.00
TS175	Frequency Meter	295.00
TS182	VHF Oscillator & Power Meter	45.00
TS183	Battery Tester	125.00
BC221	Frequency Meter	45.00
TS226	Frequency Meter	175.00
TS229	Oscilloscope	175.00
TS232	Range Calibrator	175.00
TS270	Echo Box	175.00
TS270A	Echo Box	175.00
TS270B	Echo Box	175.00
TS403	S Band Signal Generator	1,250.00
TS435	L Band Signal Generator	895.00
TS492A	Echo Box X Band-New	95.00
TS545	L Band Echo Box	95.00
TS577	Telephone Test Set	125.00
TS666	Range Calibrator	750.00
EPUT554	Berkley Instruments Frequency Meter	395.00
RCAMI-7519C	Distortion & Noise Analyzer	350.00
UPM 7, 10, 11, 11A, 30, 33, 42	URM 12, 23, 25, 27, 33, 34	
Radar Test Sets Prices on Request		
Tektronix Oscilloscope Model 511A		450.00
Tektronix Oscilloscope 511AD		375.00
Tektronix Oscilloscope 514B		425.00
Tektronix Oscilloscope 524D		475.00
Measurement signal generator Model 80		450.00
General Radio Signal Generator G05A		295.00
Power Supplies		
Radar Pulsers to test Magnetrons		695.00 up

KLYSTRONS		
726 B. C.	\$15.00	2K50 572.00
5721	12.50	2K54 15.00
6116	50.00	2K55 75.00
6116	75.00	2K56 50.00
6390	175.00	7K21 15.00
2K22	22.50	QK185 35.00
2K23	22.50	QK290 350.00
2K25	9.00	QK291 350.00
2K28	27.00	QK292 350.00
2K29	27.50	QK293 350.00
2K33A	200.00	QK294 350.00
2K33B	150.00	QK295 450.00
2K39	170.00	V23 450.00
2K41	75.00	V27 600.00
2K42	150.00	V28 975.00
2K43	144.00	V45 450.00
2K44	100.00	V270 125.00
2K45	2.00	V094 35.00
2K48	50.00	X12 475.00
		and others

MAGNETRONS		
Sorenson Power Supplies	Selenium Rectifiers	
Furst Power Supplies	Various Semiconductors.	
Inverters	Transistors.	
Thermistors 167332	Diodes X Band Wave Guides, Misc.	
J221	12.50	Microwave Plumbing etc.
J230	37.50	
J231	12.50	2J56A 110.00
J232-34	17.50	2J61-62 35.00
J236	17.50	2J61A-62A 75.00
J237/39	22.50	3J11 60.00
J242	90.00	4J11/39 135.00
J248/50	25.00	4J57-59 135.00
J51	95.00	4J60-62 135.00
J51A	180.00	4J60-62 radar. 27.50
J55A	145.00	and others

STANDARD LABORATORY RECEIVERS		
APR4	\$195.00	APT5 5180.00
APR4 (w/5 tuning units)	895.00	APS4 228.00
APR5	180.00	APS16 695.00
APR5A	180.00	APS22 (trans) 395.00
APR10	180.00	APS32 K band radar. 875.00
APT2	75.00	APS31 PARTS

SPECIAL PURPOSE TUBES

OA2	.80	4-1000A	80.00	242C	10.00	807WA	5.00	5841	3.25
OA2WA	2.00	4AP10	10.00	244A	1.25	808	.75	5844	.60
OA3	.85	4B31	12.50	245A	2.50	810	12.50	5845	4.50
OB2	.60	4C35	12.50	249B	10.00	811	2.50	5852	2.25
OB2WA	2.00	4D32	15.00	249C	5.00	811A	3.50	5854	1.00
OB3	.70	4E27	7.50	250R	10.00	813	12.50	5876	8.50
OC3	.50	4J30-61	PUR	251A	50.00	814	3.50	5879	1.00
OD3	.30	4J52	25.00	252A	4.75	815	1.50	5881/6L6WGB.	2.00
C1A	6.50	4PR60A	60.00	254A	2.00	816	1.85	5886	3.00
1AD4	1.50	4X150A	15.00	257A	2.50	828	8.50	5896	.75
C18 A	10.00	4X150D	15.00	FG-258A	75.00	829B	9.50	5902	2.50
1B24A	8.50	4X250B	20.00	259A	2.50	832	2.00	5915	.85
1B35	1.85	4X250F	30.00	262B	2.50	832A	6.75	5948/2A3W.	2.00
1B35A	3.00	5BP1A	9.50	FP-265	5.00	833A	35.00	5932/6L6WGA.	2.00
1B59/R113	7.50	5C22	12.50	267	5.00	836	1.00	5933/807W.	1.75
1B63A OB	10.00	5CP1	3.50	271A	9.00	837	.80	5933WA	5.00
1C/3B22	3.50	5J26	25.00	272A	2.75	838	1.00	5948/1754.	75.00
C1K	5.00	5I1P	7.50	274A	2.00	842	5.00	5949/1907.	50.00
IP21	30.00	5R4GY	1.00	275A	3.00	845	7.50	5956/3E6A.	9.00
IP22	8.00	5R4WGB.	5.00	276A	4.00	850	12.50	5962/BS101.	3.00
IP25	8.00	5R4WGY	2.75	283A	2.50	866A	1.75	5963	1.10
IP29	2.25	5R1PA	9.50	287A	1.85	869B	50.00	5964	.85
2-01C	12.50	5R11A	25.00	293A	2.50	872A	3.50	5965	.85
2AP1A	5.00	55P1	25.00	HF-300	25.00	884	1.25	5977/6K4.	1.25
2B73	25.00	55P7	25.00	300B	5.00	885	.65	5979/BS1.	4.00
2BP1	7.50	6AC7W	.35	304TH	30.00	913	8.50	5980/BS2.	6.00
2C36	22.50	6AG7Y	.75	304TL	40.00	918	.65	5987	7.70
2C39	4.25	6AK5W	.90	309A	2.50	920	2.50	5992	2.00
2C39A	8.50	6AN5	1.75	310A	2.50	927	1.00	5993	4.00
2C39B	18.75	6AR6	.75	311A	2.25	931A	3.00	6005/6AQ5W.	1.00
2C40	7.00	6A56	.85	313C	1.50	959	.50	6012	3.50
2C42	3.00	6A57G	2.50	323A	5.00	1000T	80.00	6021A	2.00
2C43	7.50	6B4G	2.85	328A	2.25	CK-1006	2.00	6032	10.00
2C50	4.00	6B16	30.00	336A	2.00	1737	2.00	6037/QK-243.	15.00
2C51	1.50	6B86	30.00	337A	2.25	1500T	125.00	6044	3.00
2C52	1.50	6B86A	30.00	347A	1.00	1614	2.75	6045	1.15
2D21	2.50	6C4W	2.50	348A	3.00	1616	.50	6050	1.00
2D21W	1.00	6C21	15.00	349A	1.50	1419	.20	6072	1.50
2E22	2.50	6C1J	10.00	350A	3.50	1620	3.50	6073	.75
2E24	2.50	6C1A	15.00	350B	1.00	1624	.75	6074	1.50
2E26	2.50	6C1K	20.00	352A	6.00	1846	50.00	6080A	2.50
2E30	3.00	6J4WA	1.00	354A	7.50	1904	7.50	6080WA	5.00
2J21-50	PUR	6J6W	.75	355A	7.50	2050	1.25	6080WB.	10.00
2J42	60.00	6C1	2.00	393A	5.00	2050W	1.50	6082	3.00
2J51	40.00	6L6GAY	.75	394A	2.50	5'45	10.00	6087/5Y3WGTB	3.00
2K22	20.00	6L6WGB	2.00	395A	2.00	5550	30.00	6098	5.00
2K25	8.50	6L6WGB	2.00	396A/2C51	1.50	5586	100.00	6099	.75
2K26	30.00	6O5G	2.50	398A/5603	3.00	5641	1.75	6100/6C4WA.	1.00
2K28	25.00	65C7GY	1.00	401A/5590	1.00	5642	2.00	6101/6J6WA.	.85
2K29	25.00	65J7WGT	1.25	403B/6AK5.	.65	5643	3.00	6108/BS213.	2.50
2K30	50.00	65L7WGT	1.25	403B/5591.	2.75	5644	2.50	6109/BS404.	1.00
2K34	75.00	65N7W	.50	404A/5847	7.50	5647	3.50	6111A	2.00
2K35	250.00	65N7WGT	.75	407A	3.50	5651	.75	6112	2.00
2K41	25.00	65N7WGT.	2.50	408A/6028	3.25	5654/6AK5W.	1.00	6115/QK-351.	40.00
2K42	125.00	65U7WGT.	.85	409A/6A56	1.00	5654/6AK5W/		6130/3C45.	5.00
2K43	150.00	6V6GTY	.75	416B/6280	30.00	6096	1.25	6135	1.50
2K44	125.00	6X4W	.75	WL-417A	2.50	5656	2.50	6136/6AU6WA.	1.35
2K45	20.00	6X5WGT	1.00	417A/5842	8.25	5663	.75	6137/6SK7WA.	1.50
2K47	125.00	7AK7	2.50	418A	10.00	5670	1.00	6146	3.35
2K48	50.00	7BP7A	5.00	420A/5755	3.75	5672	1.75	6147	2.25
2K50	70.00	7MP7	22.50	421A/5998	7.50	5675	8.50	6161	50.00
2K54	10.00	10KP7	15.00	429A	6.50	5678	1.25	6186/6AQ5WA.	1.50
2K55	15.00	12A17WA	1.25	GL-434A	5.00	5686	1.85	6189/12A7WA	1.50
2P21	30.00	12A17	1.50	450TH	40.00	5687	1.50	6197	1.50
2X2A	.80	12DP7	7.00	450TL	40.00	5691	5.00	6198	75.00
3AP1	2.00	12GP7	12.50	CK-503AX.	.75	5692	2.50	6201/12A7WA	1.75
3B23/RK-22	2.00	16F	10.00	CK-510AX.	1.00				

Julius Knapp
of the
SCHERING
CORPORATION
called
for . . .

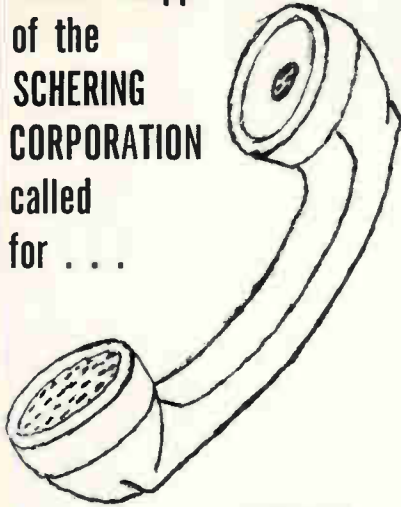

STEPPING SWITCHES



"This is a letter of appreciation. I needed 50 stepping switches in a hurry, called you and got them in four days. This is not the first time that we have called you with a rush order and have been serviced promptly. I would like to thank you and say that this kind of service is an extremely wonderful thing to encounter."

Julius Knapp, Instrumentation Engineer
Schering Corporation, Bloomfield, N. J.

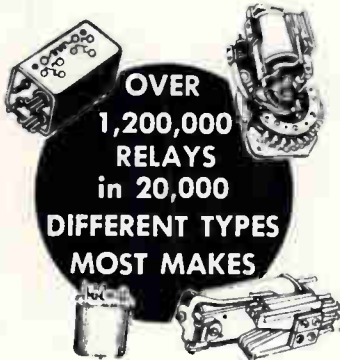

**OVER
1,200,000
RELAYS
in 20,000
DIFFERENT TYPES
MOST MAKES**

- PRODUCTION QUANTITIES IN STOCK
- DELIVERY ON OFF-THE-SHELF ITEMS WITHIN 48 HOURS. DELIVERY WITHIN ONE WEEK ON RELAYS REQUIRING ASSEMBLY AND/OR ADJUSTMENT.

**WE DELIVER RELAYS
NOT PROMISES**



FREE...

Send
for
NEW
catalog
"E"

Universal RELAY CORP.

42A White St., N. Y. 13, N. Y. Walker 5-9257
CIRCLE 642 ON READER SERVICE CARD

INDEX TO ADVERTISERS



Audited Paid Circulation

• AMP Incorporated 7	• Continental Connector Corp. 129
ACE Electronics Associates, Inc. 236	• Cross Co., II 241
• Acme Electric Transformers 227	• CTS Corporation 47
• Ad-Yu Electronics 213	
Aerospace Corporation 82	• Dage Electric Company, Inc. 232
Aerovox Corporation 213, 223	• Daystrom Incorporated, Potentiometer Division 42
• Airpax Electronics, Inc. 191	• DeJur-Amsco Corporation 129
Alco Electronics Mfg. Co. 204	Delco Radio 23
Allen-Bradley Co. 139	Delevan Electronics Corp. 192
American Machine & Foundry Co. Potter & Brumfield Div. 65	Delta Design, Inc. 126
• American Optical Co. 125	• DeMornay-Bonardi 74, 75
• American Time Products Inc. 96	Dow Corning Corp. 40, 41, 171
• Anadex Instruments Inc. 126	Dressen-Barnes Electronic Corp. 16
Anelex Corporation 198	Dresser Industries, Inc. 58, 59
• Arnold Engineering Co., The 3	• Dyna Empire Inc. 234
Atom Electronics 204	
• Angut Bros., Inc. 208	
Avco Corp. 116	• Eitel-McCullough, Inc. 108, 109
	Elcor, Inc. 84
Babcock Relays, Inc. 196	Electro Instruments Inc. 61, 89
Baird-Atomic, Inc. 72	Electronic Industries Association of Japan 116
• Ballantine Laboratories, Inc. 189	• Electronic Instrument Co., Inc. (EICO) 241
Bausch & Lomb, Inc. 229	Electronic Measurements Co., Inc. 83
• Belden Manufacturing Co. 133	Elgin National Watch Co., Elgin-Advance Relays 111
Bell Telephone Laboratories. 17	• Erie Resistor Corp., Erie-Pacific Div. . 188
• Bendix Corporation	• Eyelet Tool Co. 227
Ellipse Pioneer Division 182, 183	
Semiconductor Division 138	
• Bird Electronic Corporation. 201	
Boeing Co., The 131, 132	Federation Nationale Des Industries Electroniques 221
Bourns Laboratories, Inc. 120, 121	Franklin Electronics Inc. 181
Brand Rex, Division American Enka Corp. 54, 55	• Frontier Electronics Co. 209
Bristol Company, The 210	
• Brush Instruments, Div. of Clevite Corp. 103	Garlock Electronics Products, Inc. 76
• Bud Radio, Inc. 206	General Atomic, Div. of General Dynamics 56
Burroughs Corporation	• General Electric Co. 205
Electronic Components Division 79	Semiconductor Pmts. Dept. 135
• Bussmann Mfg. Div., McGraw-Edison Co. 32	• General Findings, Inc. 225
	• General Instrument Corp. 97, 98, 99
• Cetron Electronic Corp. 200	General Radio Co. 2nd Cover
• Chart-Pak, Inc. 222	Gries Reproducer Corp. 204
• Christie Electric Corp. 127	• Gudebrod Bros. Silk Co., Inc. 232
Clare & Co., C. P. 86, 87	
• Clevite Transistor	
A Div. of Clevite Corp. 49, 50	• See Advertisement in the July 20, 1961 issue of Electronics Buyers' Guide for complete line of products or services.
• Clifton Precision Products Co., Inc. 140	

Hansen Mfg. Co., Inc.	218
• Hardwick-Hindle, Inc.	200
Haveg Industries, Inc.	179
Holland Division, Minneapolis-Honeywell Regulator Co.	43
• Hewlett-Packard Company	8, 9, 18-31
• Hitachi, Ltd.	112
Hoffmann Electronics Corp.	
Semiconductor Div.	88
Hogan Faximile Corp.	228
• Hoskins Mfg. Co.	195
• Hoyt Electrical Instruments	230
Hughes Aircraft Co.	124
Hy-Gain Antenna Products	116
Imtra Corp.	100
• Inham General Corp.	106
Industrial Electronic Engineers, Inc.	100
• Industrial Test Equipment Co.	235
International Electronic Research Corporation	172
International Electro-Magnetics Inc.	15
Johnson Company, E. F.	137
• Jones Electronics Co., Inc., M. C.	239
Jones & Lamson Machine Co.	104
• Kearfott Div. General Precision Inc.	214, 215
• Kepeco, Inc.	167
Kingsley Machine Co.	254
• Kintel, A Division of Colu Electronics Inc.	3rd Cover
• Kyoritsu Electrical Instruments Works, Ltd.	100
Leach Corp.	165
Leesona Corp.	176
• LEL, Inc.	213
Levin and Son, Inc. Louis.	175
• Ling Temeo Electronics Inc.	123
Lionel Electronic Laboratories	224
Littlefuse	233
Litton Systems, Inc.	175
Lockheed	
California Division	13
Mallory and Co., Inc. P. R.	90, 91
Manson Laboratories, Inc.	241
• Marconi Instruments, Ltd.	242
• McCoy Electronics Co.	66
• McGraw-Hill Book Co.	71
Melabs	78
• Microswitch, Div. of Minneapolis-Honeywell Reg. Co.	136
Microwave Associates, Inc.	130
Minnesota Mining & Mfg. Co.	
Mincom Division	64
• Mitsumi Electric Co., Ltd.	242
Motorola, Inc.	60
• Mueon Corp.	240
• Mycalex Corp. of America	80

National Research Corporation	213
Neff Instrument Corp.	94
New England Instrument Co.	233
• New Hermes Engraving Machine Corp.	209
• Non-Linear Systems, Inc.	36, 37
• North Atlantic Industries, Inc.	231
North Electric Co.	2
• Northeastern Engineering, Inc.	212
• Ohmite Mfg. Co.	77
Optics Technology Inc.	126
Pan American World Airways Inc.	
Guided Missiles Range Div.	244
• Panoramic Electronics, Inc.	81
• Perfection Mica Co.	
Magnetic Shield Div.	202
• Polarad Electronics Corporation	118, 119
Potter and Brumfield	
Div. American Machine & Foundry Co.	65
• Power Designs, Inc.	230
Precision Instrument Co.	185
• Premier Metal Products Co.	228
Pyrodyne Inc.	227
• R F Products	
Div. of Amphenol-Borg Electronics Corp.	85
• Radio Corporation of America	4th Cover
• Raytheon Company	5, 93, 95, 114
Remington Rand Univac, Div. of Sperry Rand Corp.	243
Security Devices Laboratory	6
• Servo Corporation of America	122
Servomechanisms, Inc.	194
Shallcross	92
• Sierra Electronic Corp.	10
• Sola Electric Co.	168, 169
• Sorensen & Co.	105
• Southern Electronic Corp.	208
Sperry Microwave Electronics Co., Div. of Sperry Rand Corp.	39
Sprague Electric Co.	14, 34, 35
• Stoddart Aircraft Radio Co., Inc.	107
Struthers-Dunn, Inc.	216
Sylvania Electric Products, Inc.	
Electron Tube Div.	67, 68, 69, 70
• Syntronic Instruments, Inc.	253
Tang Industries, Inc.	188
Tektronix, Inc.	134
• Tempo Instrument, Inc.	52, 53
Tinnerman Products, Inc.	73
• Transatron Electronic Corp.	101
• Trio Laboratories, Inc.	197
• Tung-Sol Electric, Inc.	117
* See Advertisement in the July 20, 1961 issue of Electronics Buyers' Guide for complete line of products or services.	

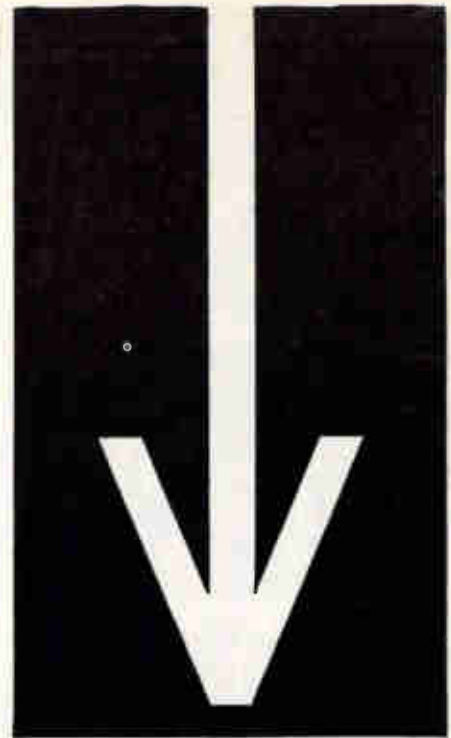

WHY

MAJOR C. R. TUBE MFGRS. RECOMMEND SYNTRONIC YOKES

Syntronic yoke procedure originated the industry standard for specification correlation between yoke, c. r. tube and circuitry. For a helpful, time-saving checklist covering all physical and electrical yoke parameters and their determining conditions, request ELECTRONICS reprint #12-59. Thorough correlation enables Syntronic to guarantee accepted specifications.

Call your nearest SYNTRONIC REP today

Boston-New Eng.: NORwood 7-3164
New York Area: OXFord 5-0255
Phila. Area: MOhawk 4-4200
Wash.-Balt. Area: APpleton 7-1023
Indianapolis: VICTor 6-0359
Los Angeles: CUMberland 3-1201

Syntronic

INSTRUMENTS, INC.

100 Industrial Road, Addison, Illinois
 Phone: Kingswood 3-6444

The industry's broadest yoke line... already tooled for quantity production. Or, yokes can be custom designed to your precise requirement.

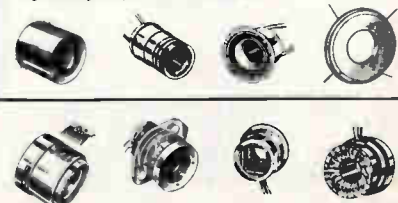



Simplify
**WIRE
ASSEMBLY**

with a
KINGSLEY
Wire & Tube
Marking Machine

Now you can mark each wire or piece of plastic tubing with its own circuit number...quickly...economically, right in your own plant!

You reduce wire inventories because you need only one color of wire for as many circuits as necessary.

Simplify your assembly methods and speed production with the same machine that has proven so successful in the aircraft and missile field. Write for details.

KINGSLEY MACHINES
850 Cahuenga • Hollywood 38, Calif.

United Shoe Machinery Corp.....	280	Electronic Supplies	250
U. S. Semiconductor Corp.....	110	Engineering Associates	250
U. S. Stoneware.....	118	Erie Electronics Division.....	248
Universal Instruments Corp.....	305	Esquire Personnel	246
		Gyrodyne Co. of America Inc.....	246
Varian Associates	190	Instruments for Industry Inc.....	246
Veeder-Root, Inc.	102	Liberty Electronics Inc.....	251
• Vitro Electronics	186	Lifschultz Fast Freight.....	250
		Maroney & Associates, A. H.....	248
Wayne-George Corp.	235	Mitre Corp., The.....	249
Welwyn International, Inc.....	184	Pan American World Airways Inc.....	248
• Western Devices, Inc.....	234	Philco Western Development Labs.....	247
Westinghouse Electric Corp.....	62, 63, 128 173, 177, 187, 193, 199 203, 211, 217, 219, 220	R & H Machinery Inc.....	250
White S. S.....	207	Radio Research	250
Western Transistors Corp.	243	Tropical Radio	250
• Williams & Co., C. K.	240	Universal Relay Corp.....	252
		Western Engineers	251
		Wilgreen Industries	250

■
CLASSIFIED ADVERTISING
F. J. Eberle, Business Mgr.

EMPLOYMENT OPPORTUNITIES 246-249

EQUIPMENT
(Used or Surplus New)
For Sale250-252

INDEX TO CLASSIFIED ADVERTISERS

Barry Electronics Corp.....	250
Brenten Emp. Agy.....	248
Central Resistor Corp.....	248
Cowin & Associates.....	248

• See Advertisement in the July 20, 1961 issue of Electronics Buyers' Guide for complete line of products or services.

This index and our Reader Service Numbers are published as a service. Every precaution is taken to make them accurate, but ELECTRONICS assumes no responsibilities for errors or omissions.

electronics



Audit Bureau
of Circulations



Associated Business
Publications

Audited Paid Circulation

JAMES T. HAUPTLI
Advertising Sales Manager

R. S. QUINT, Assistant Publisher Buyers' Guide and Business Manager; FRED STEWART, Promotion Manager; B. ANELLO, Marketing Service Manager; RICHARD J. TOMLINSON, Production Manager; GEORGE E. POMEROY, Classified Manager; HUGH J. QUINN, Circulation Manager.

ADVERTISING REPRESENTATIVES: NEW YORK (36) Donald H. Miller, Henry M. Shaw, George F. Werner, 500 Fifth Avenue, OXFORD 5-5959; **BOSTON** (16) William S. Hodgkinson, Donald R. Furth, McGraw-Hill Building, Copley Square, Congress 2-1160; **PITTSBURGH** (22) David M. Watson, Four Gateway Center, Express 1-1314; **PHILADELPHIA** (3) Warren H. Gardner, William J. Boyle, 6 Penn Center Plaza, LOcust 8-4330; **CHICAGO** (11) Harvey

W. Wernecke, Martin J. Gallay, 645 North Michigan Avenue, Mohawk 4-5800; **CLEVELAND** (13) P. T. Fegley, 55 Public Square, Superior 1-7000; **SAN FRANCISCO** (11) T. H. Carmody, R. C. Alcorn, 255 California Street, Douglas 2-4600; **LOS ANGELES** (17) Marshall Freeman, Peter S. Carberry, 1125 W. 6th St., Huntley 2-5450; **DENVER** (2) J. W. Patten, Tower Building, 1700 Broadway, Alpine 5-2981; **ATLANTA** (9) M. H. Miller, 1375 Peachtree St. N.E., Trinity 5-0523; **HOUSTON** (25) Joseph C. Page, Jr., Prudential Bldg., Holcombe Blvd., Jackson 6-1281; **DALLAS** (1) Frank Le Beau, The Vaughn Bldg., 1712 Commerce St., Riverside 7-9721; **LONDON** W1, Edward E. Schrimmer, 34 Dover St.; **FRANKFURT/Main**, Stanley R. Kimes, 85 Westendstrasse; **GENEVA**, Michael R. Zeynel, 2 Place du Port.

BRIEF SPECIFICATIONS

OUTPUT VOLTAGE 1.000 to 502.110 volts, variable in 100-, 10-, 1-, 0.1-, 0.01-, and 0.001-volt steps

OUTPUT CURRENT Up to 20 ma

STABILITY $\pm 0.0025\%$

OUTPUT VOLTAGE CALIBRATION 0.01% of setting $\pm 0.0002V$

LOAD REGULATION 0.002% or $\pm 100 \mu V$, no load to full load

LINE REGULATION 0.002%, 10% change in line voltage

METER ACCURACY 4% of full scale

OUTPUT Z < 0.01 ohm, DC

FLOATING OUTPUT > 1000 megohms resistance between chassis and either output terminal; current between either output terminal and chassis $< 0.5 \mu$ ampere DC, $< 4 \mu$ ampere at 60 cps

RESPONSE TIME 0.2 millisecond

PRICE \$1280.00



KIN TEL's Model 302 DC Voltage Standard and Null Voltmeter is an extremely stable, accurate, and compact source of variable voltage low-impedance DC.

Standard cell stability is obtained by using KIN TEL's chopper circuit which constantly compares the Model 302 output against an internal unsaturated mercury-cadmium cell. Short-term stability is better than 25 parts per million, and stability over a 30-day period is better than 50 parts per million. Both load and line regulation are maintained better than 0.002%, and ripple is less than 0.0001 volt.

Precision voltage adjustment is easy with six detented dials. Up to 20 milliamperes of current are available at any dialed output from 1.000 to 502.110 volts. Output voltage accuracy is within 0.01% of setting ± 0.0002 volt.



now!
supply and
measure
1 to 502 volts
with 0.01%
accuracy!

Laboratory-accurate measurements are made by the self-contained null voltmeter which shows the difference between the 302 output and an unknown input voltage. The meter has four decades ranges from 50 volts to 0.05 volt, full scale, and permits rapid measurement of DC voltage—with up to 6 digit resolution—to an absolute accuracy within 0.01% of the reading ± 0.001 volt. The meter can also be used to indicate either the 302 voltage or an unknown input to a standard accuracy of 4% of full scale.

The floating output is isolated from chassis ground; resistance between chassis and either output lead is greater than 1000 megohms. The effective output impedance is less than 0.01 ohm for DC, less than 0.2 ohm at 1000 cps.

Write today for detailed technical literature or demonstration.

Representatives in all major cities,

5725 Kearny Villa Road, San Diego 11, California • Phone: BRowning 7-6700



RCA Combines Two Major Advances in a Single Tube



New

NOVAR
Design

New RCA
DARK HEATER

in RCA-6BH3, 17BH3, and 22BH3 half-wave vacuum rectifiers for TV damper service

Design your new TV horizontal-deflection damper circuits around one of these new novar rectifiers, and you'll get better performance at less cost, thanks to economical novar design and the revolutionary RCA Dark Heater.

High performance, low-cost novar construction—These BH3 types are stellar members of RCA's new novar line of large, all-glass, integral-base receiving tubes that outperform at less cost other high-dissipation receiving tubes of any base configuration and T9 or T12 envelope. BH3's are rated to withstand a maximum peak-inverse plate voltage of 5500 volts; they can supply maximum peak plate current of 1100 ma and maximum dc plate current of 180 ma.

These tubes embody the advantages of novar design, the only all-glass, integral-base receiving tube design featuring:
Larger internal lead diameter—for strong cage support and high thermal conductivity for highly effective heat dissipation.

Wider pin spacing (0.172")—minimizes chance of voltage breakdown; hence greater reliability.

Pin length of 0.335"—for firm retention of tube in socket.

Pin-circle diameter of 0.687"—allows use of both T9 and T12 envelope.

RCA Dark Heater—additional assurance of high reliability.

REVOLUTIONARY RCA DARK HEATER—Each of these tubes features the new RCA Dark Heater...one of the most significant contributions to tube technology in years. The Dark Heater operates at greatly reduced temperature, as much as 350°K below the 1500 to 1700°K of conventional heaters. The required cathode temperature is reached with the heater operating at approximately 1350°K. Result: longer heater life; reduced chance of heater failure; heater-current stability on life; reduced ac H-K leakage and hum; improved mechanical stability; greater safety factor in established H-K voltage ratings.

For additional information on novar types, see your RCA Field Representative or write Commercial Engineering, Section H-19-DE-2, RCA Electron Tube Division, Harrison, N. J.



The Most Trusted Name in Electronics

RCA ELECTRON TUBE DIVISION FIELD OFFICES

EAST: 744 Broad Street, Newark 2, New Jersey, HUmboldt 5-3900 · MIDWEST: Suite 1154, Merchandise Mart Plaza, Chicago 54, Illinois, WHitehall 4-2900 · WEST: 6801 E. Washington Boulevard, Los Angeles 22, California, RAymond 3-8361.