

MES-3528

Layer 2+ Metro Ethernet Switch

User's Guide



Default Login Details

IP Address	http://192.168.1.1
User Name	admin
Password	1234

Firmware Version 3.90
Edition 2, 7/2009

www.zyxel.com

ZyXEL

About This User's Guide

Intended Audience

This manual is intended for people who want to configure the Switch using the web configurator.

Related Documentation

- Command Line Interface (CLI) Reference Guide
The Command Reference Guide explains how to use the Command-Line Interface (CLI) and CLI commands to configure the Switch.
- Web Configurator Online Help
The embedded Web Help contains descriptions of individual screens and supplementary information.

Note: It is recommended you use the web configurator to configure the Switch.

- Support Disc
Refer to the included CD for support documents.

Documentation Feedback

Send your comments, questions or suggestions to: techwriters@zyxel.com.tw

Thank you!

The Technical Writing Team, ZyXEL Communications Corp.,
6 Innovation Road II, Science-Based Industrial Park, Hsinchu, 30099, Taiwan.

Need More Help?

More help is available at www.zyxel.com.

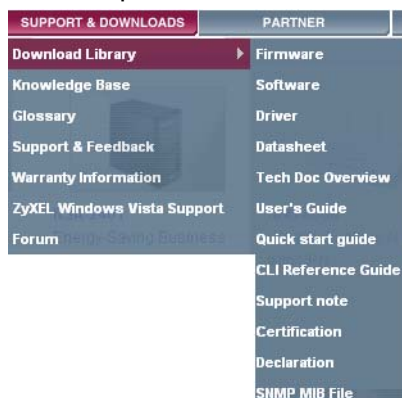

- Download Library

Search for the latest product updates and documentation from this link. Read the Tech Doc Overview to find out how to efficiently use the User Guide, Quick Start Guide and Command Line Interface Reference Guide in order to better understand how to use your product.

- Knowledge Base

If you have a specific question about your product, the answer may be here. This is a collection of answers to previously asked questions about ZyXEL products.

- Forum

This contains discussions on ZyXEL products. Learn from others who use ZyXEL products and share your experiences as well.

Customer Support

Should problems arise that cannot be solved by the methods listed above, you should contact your vendor. If you cannot contact your vendor, then contact a ZyXEL office for the region in which you bought the device.

See http://www.zyxel.com/web/contact_us.php for contact information. Please have the following information ready when you contact an office.

- Product model and serial number.
- Warranty Information.
- Date that you received your device.
- Brief description of the problem and the steps you took to solve it.

Document Conventions

Warnings and Notes

These are how warnings and notes are shown in this User's Guide.

Warnings tell you about things that could harm you or your device.









Note: Notes tell you other important information (for example, other things you may need to configure or helpful tips) or recommendations.

Syntax Conventions

- The MES-3528 may be referred to as the "Switch", the "device", the "system" or the "product" in this User's Guide.
- Product labels, screen names, field labels and field choices are all in **bold** font.
- A key stroke is denoted by square brackets and uppercase text, for example, [ENTER] means the "enter" or "return" key on your keyboard.
- "Enter" means for you to type one or more characters and then press the [ENTER] key. "Select" or "choose" means for you to use one of the predefined choices.
- A right angle bracket (>) within a screen name denotes a mouse click. For example, **Maintenance > Log > Log Setting** means you first click **Maintenance** in the navigation panel, then the **Log** sub menu and finally the **Log Setting** tab to get to that screen.
- Units of measurement may denote the "metric" value or the "scientific" value. For example, "k" for kilo may denote "1000" or "1024", "M" for mega may denote "1000000" or "1048576" and so on.
- "e.g.," is a shorthand for "for instance", and "i.e.," means "that is" or "in other words".

Icons Used in Figures

Figures in this User's Guide may use the following generic icons. The Switch icon is not an exact representation of your device.

The Switch 	Computer 	Notebook computer 
Server 	DSLAM 	Firewall 
Telephone 	Router 	

Safety Warnings

- Do NOT use this product near water, for example, in a wet basement or near a swimming pool.
- Do NOT expose your device to dampness, dust or corrosive liquids.
- Do NOT store things on the device.
- Do NOT install, use, or service this device during a thunderstorm. There is a remote risk of electric shock from lightning.
- Do not obstruct the device ventilation slots as insufficient airflow may harm your device.
- Connect ONLY suitable accessories to the device.
- Do NOT open the device or unit. Opening or removing covers can expose you to dangerous high voltage points or other risks. ONLY qualified service personnel should service or disassemble this device. Please contact your vendor for further information.
- Make sure to connect the cables to the correct ports.
- Place connecting cables carefully so that no one will step on them or stumble over them.
- Always disconnect all cables from this device before servicing or disassembling.
- Use ONLY an appropriate power adaptor or cord for your device. Connect it to the right supply voltage (for example, 110V AC in North America or 230V AC in Europe).
- Use ONLY power wires of the appropriate wire gauge (see [Chapter 40 on page 325](#) for details) for your device. Connect it to a power supply of the correct voltage (see [Chapter 40 on page 325](#) for details).
- Do NOT allow anything to rest on the power adaptor or cord and do NOT place the product where anyone can walk on the power adaptor or cord.
- Do NOT use the device if the power adaptor or cord is damaged as it might cause electrocution.
- If the power adaptor or cord is damaged, remove it from the device and the power source.
- Do NOT attempt to repair the power adaptor or cord. Contact your local vendor to order a new one.
- Fuse Warning! Replace a fuse only with a fuse of the same type and rating.
- The length of exposed (bare) power wire should not exceed 7 mm.

Your product is marked with this symbol, which is known as the WEEE mark. WEEE stands for Waste Electronics and Electrical Equipment. It means that used electrical and electronic products should not be mixed with general waste. Used electrical and electronic equipment should be treated separately.



Contents Overview

Introduction and Hardware	21
Getting to Know Your Switch	23
Hardware Installation and Connection	29
Hardware Overview	33
Basic Configuration	41
The Web Configurator	43
Initial Setup Example	53
Tutorials	59
System Status and Port Statistics	69
Basic Setting	75
Advanced	87
VLAN	89
Static MAC Forward Setup	109
Static Multicast Forward Setup	113
Filtering	117
Spanning Tree Protocol	119
Bandwidth Control	141
Broadcast Storm Control	145
Mirroring	147
Link Aggregation	149
Port Authentication	159
Port Security	163
Classifier	167
Policy Rule	173
Queuing Method	179
Multicast	183
AAA	199
IP Source Guard	213
Loop Guard	239
Layer 2 Protocol Tunneling	243
IP Application	247
Static Route	249
Differentiated Services	253
DHCP	257

Management	265
Maintenance	267
Access Control	275
Diagnostic	297
Syslog	299
Cluster Management	303
MAC Table	311
ARP Table	315
Configure Clone	317
Troubleshooting & Product Specifications	319
Troubleshooting	321
Product Specifications	325
Appendices and Index	333

Table of Contents

About This User's Guide	3
Document Conventions.....	5
Safety Warnings.....	7
Contents Overview	9
Table of Contents.....	11
Part I: Introduction and Hardware	21
Chapter 1	
Getting to Know Your Switch	23
1.1 Introduction	23
1.1.1 Backbone Application	23
1.1.2 Bridging Example	24
1.1.3 High Performance Switching Example	25
1.1.4 IEEE 802.1Q VLAN Application Examples	25
1.1.5 Metro Ethernet	26
1.2 Ways to Manage the Switch	27
1.3 Good Habits for Managing the Switch	28
Chapter 2	
Hardware Installation and Connection	29
2.1 Installation Scenarios	29
2.2 Desktop Installation Procedure	29
2.3 Mounting the Switch on a Rack	29
2.3.1 Rack-mounted Installation Requirements	30
2.3.2 Attaching the Mounting Brackets to the Switch	30
2.3.3 Mounting the Switch on a Rack	31
Chapter 3	
Hardware Overview.....	33
3.1 Front Panel	33
3.1.1 Console Port	34
3.1.2 Gigabit Ethernet Ports	35
3.1.3 Mini-GBIC Slots	36

3.1.4 Power Connector (DC)	38
3.1.5 Procedure to Turn on the Switch Power	38
3.1.6 Power Connector (AC)	38
3.1.7 Signal Slot	38
3.2 LEDs	39
Part II: Basic Configuration.....	41
Chapter 4	
The Web Configurator	43
4.1 Introduction	43
4.2 System Login	43
4.3 The Status Screen	44
4.3.1 Change Your Password	49
4.4 Saving Your Configuration	49
4.5 Switch Lockout	50
4.6 Resetting the Switch	50
4.6.1 Reload the Configuration File	50
4.7 Logging Out of the Web Configurator	51
4.8 Help	52
Chapter 5	
Initial Setup Example.....	53
5.1 Overview	53
5.1.1 Creating a VLAN	53
5.1.2 Setting Port VID	55
5.2 Configuring Switch Management IP Address	56
Chapter 6	
Tutorials.....	59
6.1 How to Use DHCP Snooping on the Switch	59
6.2 How to Use DHCP Relay on the Switch	63
6.2.1 DHCP Relay Tutorial Introduction	63
6.2.2 Creating a VLAN	64
6.2.3 Configuring DHCP Relay	67
6.2.4 Troubleshooting	67
Chapter 7	
System Status and Port Statistics.....	69
7.1 Overview	69
7.2 Port Status Summary	70

7.2.1 Status: Port Details	71
Chapter 8	
Basic Setting	75
8.1 Overview	75
8.2 System Information	75
8.3 General Setup	76
8.4 Introduction to VLANs	78
8.5 Switch Setup Screen	79
8.6 IP Setup	80
8.6.1 Management IP Addresses	81
8.7 Port Setup	83
Part III: Advanced.....	87
Chapter 9	
VLAN	89
9.1 Introduction to IEEE 802.1Q Tagged VLANs	89
9.1.1 Forwarding Tagged and Untagged Frames	89
9.2 Automatic VLAN Registration	90
9.2.1 GARP	90
9.2.2 GVRP	90
9.3 Port VLAN Trunking	91
9.4 Select the VLAN Type	92
9.5 Static VLAN	92
9.5.1 VLAN Status	93
9.5.2 VLAN Details	94
9.5.3 Configure a Static VLAN	95
9.5.4 Configure VLAN Port Settings	97
9.6 Subnet Based VLANs	98
9.7 Configuring Subnet Based VLAN	99
9.8 Protocol Based VLANs	101
9.9 Configuring Protocol Based VLAN	102
9.10 Create an IP-based VLAN Example	104
9.11 Port-based VLAN Setup	105
9.11.1 Configure a Port-based VLAN	106
Chapter 10	
Static MAC Forward Setup.....	109
10.1 Overview	109
10.2 Configuring Static MAC Forwarding	109

Chapter 11	
Static Multicast Forward Setup	113
11.1 Static Multicast Forwarding Overview	113
11.2 Configuring Static Multicast Forwarding	114
Chapter 12	
Filtering.....	117
12.1 Configure a Filtering Rule	117
Chapter 13	
Spanning Tree Protocol	119
13.1 STP/RSTP Overview	119
13.1.1 STP Terminology	119
13.1.2 How STP Works	120
13.1.3 STP Port States	121
13.1.4 Multiple RSTP	121
13.1.5 Multiple STP	122
13.2 Spanning Tree Protocol Status Screen	125
13.3 Spanning Tree Configuration	126
13.4 Configure Rapid Spanning Tree Protocol	127
13.5 Rapid Spanning Tree Protocol Status	129
13.6 Configure Multiple Rapid Spanning Tree Protocol	131
13.7 Multiple Rapid Spanning Tree Protocol Status	133
13.8 Configure Multiple Spanning Tree Protocol	135
13.9 Multiple Spanning Tree Protocol Status	138
Chapter 14	
Bandwidth Control.....	141
14.1 Bandwidth Control Overview	141
14.2 Bandwidth Control Setup	142
Chapter 15	
Broadcast Storm Control	145
15.1 Broadcast Storm Control Setup	145
Chapter 16	
Mirroring	147
16.1 Port Mirroring Setup	147
Chapter 17	
Link Aggregation	149
17.1 Link Aggregation Overview	149
17.2 Dynamic Link Aggregation	149

17.2.1 Link Aggregation ID	150
17.3 Link Aggregation Status	151
17.4 Link Aggregation Setting	153
17.5 Link Aggregation Control Protocol	155
17.6 Static Trunking Example	156
Chapter 18	
Port Authentication.....	159
18.1 Port Authentication Overview	159
18.1.1 IEEE 802.1x Authentication	159
18.2 Port Authentication Configuration	160
18.2.1 Activate IEEE 802.1x Security	161
Chapter 19	
Port Security.....	163
19.1 About Port Security	163
19.2 Port Security Setup	164
Chapter 20	
Classifier.....	167
20.1 About the Classifier and QoS	167
20.2 Configuring the Classifier	167
20.3 Viewing and Editing Classifier Configuration	170
20.4 Classifier Example	171
Chapter 21	
Policy Rule.....	173
21.1 Policy Rules Overview	173
21.2 Configuring Policy Rules	173
21.3 Viewing and Editing Policy Configuration	176
21.4 Policy Example	177
Chapter 22	
Queuing Method.....	179
22.1 Queuing Method Overview	179
22.1.1 Strictly Priority Queuing	179
22.1.2 Weighted Fair Queuing	179
22.1.3 Weighted Round Robin Scheduling (WRR)	180
22.2 Configuring Queuing	181
Chapter 23	
Multicast	183
23.1 Overview	183

23.1.1 IP Multicast Addresses	183
23.1.2 IGMP Filtering	183
23.1.3 IGMP Snooping	184
23.1.4 IGMP Snooping and VLANs	184
23.2 Multicast Status	184
23.3 Multicast Setting	185
23.4 IGMP Snooping VLAN	188
23.5 IGMP Filtering Profile	189
23.6 MVR Overview	191
23.6.1 Types of MVR Ports	191
23.6.2 MVR Modes	192
23.6.3 How MVR Works	192
23.7 General MVR Configuration	193
23.8 MVR Group Configuration	195
23.8.1 MVR Configuration Example	196
Chapter 24	
AAA	199
24.1 Authentication, Authorization and Accounting (AAA)	199
24.1.1 Local User Accounts	200
24.1.2 RADIUS and TACACS+	200
24.2 AAA Screens	200
24.2.1 RADIUS Server Setup	201
24.2.2 TACACS+ Server Setup	203
24.2.3 AAA Setup	205
24.2.4 Vendor Specific Attribute	208
24.3 Supported RADIUS Attributes	209
24.3.1 Attributes Used for Authentication	210
24.3.2 Attributes Used for Accounting	211
Chapter 25	
IP Source Guard.....	213
25.1 IP Source Guard Overview	213
25.1.1 DHCP Snooping Overview	214
25.1.2 ARP Inspection Overview	216
25.2 IP Source Guard	217
25.3 IP Source Guard Static Binding	218
25.4 DHCP Snooping	220
25.5 DHCP Snooping Configure	224
25.5.1 DHCP Snooping Port Configure	226
25.5.2 DHCP Snooping VLAN Configure	227
25.6 ARP Inspection Status	229
25.6.1 ARP Inspection VLAN Status	230

25.6.2 ARP Inspection Log Status	231
25.7 ARP Inspection Configure	232
25.7.1 ARP Inspection Port Configure	234
25.7.2 ARP Inspection VLAN Configure	236
Chapter 26	
Loop Guard.....	239
26.1 Loop Guard Overview	239
26.2 Loop Guard Setup	241
Chapter 27	
Layer 2 Protocol Tunneling.....	243
27.1 Layer 2 Protocol Tunneling Overview	243
27.1.1 Layer 2 Protocol Tunneling Mode	244
27.2 Configuring Layer 2 Protocol Tunneling	245
Part IV: IP Application	247
Chapter 28	
Static Route.....	249
28.1 Static Routing Overview	249
28.2 Configuring Static Routing	250
Chapter 29	
Differentiated Services.....	253
29.1 DiffServ Overview	253
29.1.1 DSCP and Per-Hop Behavior	253
29.1.2 DiffServ Network Example	254
29.2 Activating DiffServ	254
29.3 DSCP-to-IEEE 802.1p Priority Settings	255
29.3.1 Configuring DSCP Settings	256
Chapter 30	
DHCP.....	257
30.1 DHCP Overview	257
30.1.1 DHCP Modes	257
30.1.2 DHCP Configuration Options	257
30.2 DHCP Status	258
30.3 DHCP Relay	258
30.3.1 DHCP Relay Agent Information	258
30.3.2 Configuring DHCP Global Relay	259

30.3.3 Global DHCP Relay Configuration Example 260

30.4 Configuring DHCP VLAN Settings 261

 30.4.1 Example: DHCP Relay for Two VLANs 263

Part V: Management 265

**Chapter 31
Maintenance 267**

31.1 The Maintenance Screen 267

31.2 Load Factory Default 268

31.3 Save Configuration 269

31.4 Reboot System 269

31.5 Firmware Upgrade 269

31.6 Restore a Configuration File 270

31.7 Backup a Configuration File 271

31.8 FTP Command Line 271

 31.8.1 Filename Conventions 271

 31.8.2 FTP Command Line Procedure 272

 31.8.3 GUI-based FTP Clients 273

 31.8.4 FTP Restrictions 273

**Chapter 32
Access Control..... 275**

32.1 Access Control Overview 275

32.2 The Access Control Main Screen 275

32.3 About SNMP 276

 32.3.1 SNMP v3 and Security 277

 32.3.2 Supported MIBs 277

 32.3.3 SNMP Traps 278

 32.3.4 Configuring SNMP 282

 32.3.5 Configuring SNMP Trap Group 284

 32.3.6 Setting Up Login Accounts 285

32.4 SSH Overview 287

32.5 How SSH works 288

32.6 SSH Implementation on the Switch 289

 32.6.1 Requirements for Using SSH 289

32.7 Introduction to HTTPS 289

32.8 HTTPS Example 290

 32.8.1 Internet Explorer Warning Messages 290

 32.8.2 Netscape Navigator Warning Messages 291

 32.8.3 The Main Screen 293

32.9 Service Port Access Control	293
32.10 Remote Management	294
Chapter 33	
Diagnostic.....	297
33.1 Diagnostic	297
Chapter 34	
Syslog	299
34.1 Syslog Overview	299
34.2 Syslog Setup	300
34.3 Syslog Server Setup	301
Chapter 35	
Cluster Management.....	303
35.1 Cluster Management Status Overview	303
35.2 Cluster Management Status	304
35.2.1 Cluster Member Switch Management	305
35.3 Clustering Management Configuration	308
Chapter 36	
MAC Table	311
36.1 MAC Table Overview	311
36.2 Viewing the MAC Table	312
Chapter 37	
ARP Table	315
37.1 ARP Table Overview	315
37.1.1 How ARP Works	315
37.2 Viewing the ARP Table	316
Chapter 38	
Configure Clone	317
38.1 Configure Clone	317
Part VI: Troubleshooting & Product Specifications	319
Chapter 39	
Troubleshooting.....	321
39.1 Power, Hardware Connections, and LEDs	321
39.2 Switch Access and Login	322

39.3 Switch Configuration 324

Chapter 40

Product Specifications 325

Part VII: Appendices and Index 333

Appendix A Changing a Fuse 335

Appendix B Common Services..... 337

Appendix C Legal Information 341

Index..... 345

PART I

Introduction and Hardware

Getting to Know Your Switch (23)

Hardware Installation and Connection
(29)

Hardware Overview (33)

Getting to Know Your Switch

1.1 Introduction

This chapter introduces the main features and applications of the Switch.

The Switch is a layer-2 standalone Ethernet switch with additional layer-2, layer-3, and layer-4 features suitable for metro ethernets. The Switch has twenty-four 10/100 Mbps Ethernet ports. It also has four GbE dual personality interfaces with each interface comprising one mini-GBIC slot and one 100/1000 Mbps RJ-45 port, with either port or slot active at a time.

With its built-in web configurator, managing and configuring the Switch is easy. In addition, the Switch can also be managed via Telnet, any terminal emulator program on the console port, or third-party SNMP management.

See [Chapter 40 on page 325](#) for a full list of software features available on the Switch.

This section shows a few examples of using the Switch in various network environments.

1.1.1 Backbone Application

The Switch is an ideal solution for small networks where rapid growth can be expected in the near future. The Switch can be used standalone for a group of heavy traffic users. You can connect computers and servers directly to the Switch's port or connect other switches to the Switch.

In this example, all computers can share high-speed applications on the server. To expand the network, simply add more networking devices such as switches, routers, computers, print servers etc.

Figure 1 Backbone Application

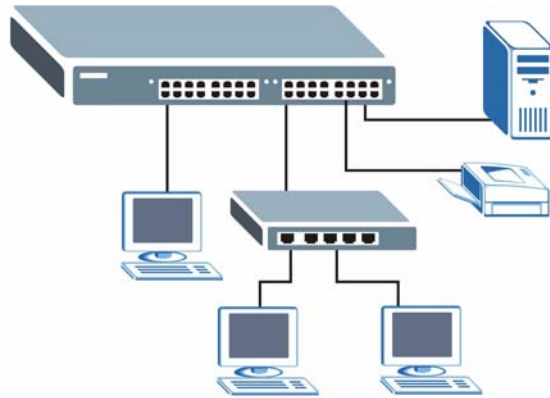

1.1.2 Bridging Example

In this example, the Switch connects different company departments (**RD** and **Sales**) to the corporate backbone. It can alleviate bandwidth contention and eliminate server and network bottlenecks. All users that need high bandwidth can connect to high-speed department servers via the Switch. You can provide a super-fast uplink connection by using a Gigabit Ethernet/mini-GBIC port on the Switch.

Moreover, the Switch eases supervision and maintenance by allowing network managers to centralize multiple servers at a single location.

Figure 2 Bridging Application

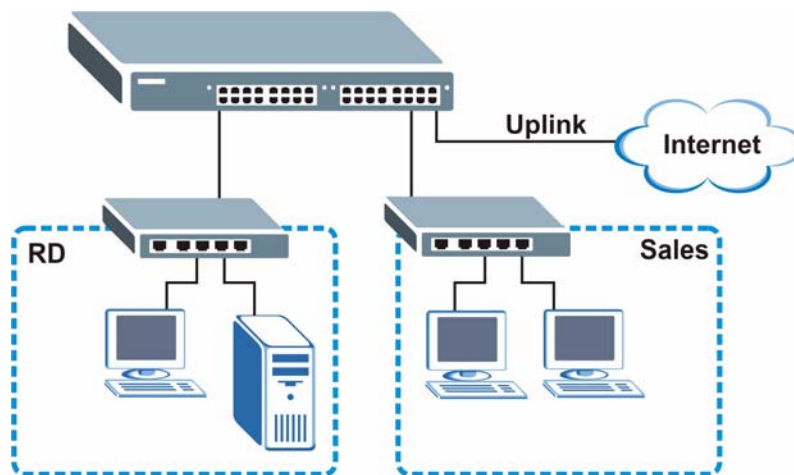

1.1.3 High Performance Switching Example

The Switch is ideal for connecting two networks that need high bandwidth. In the following example, use trunking to connect these two networks.

Switching to higher-speed LANs such as ATM (Asynchronous Transmission Mode) is not feasible for most people due to the expense of replacing all existing Ethernet cables and adapter cards, restructuring your network and complex maintenance. The Switch can provide the same bandwidth as ATM at much lower cost while still being able to use existing adapters and switches. Moreover, the current LAN structure can be retained as all ports can freely communicate with each other.

Figure 3 High Performance Switched Workgroup Application

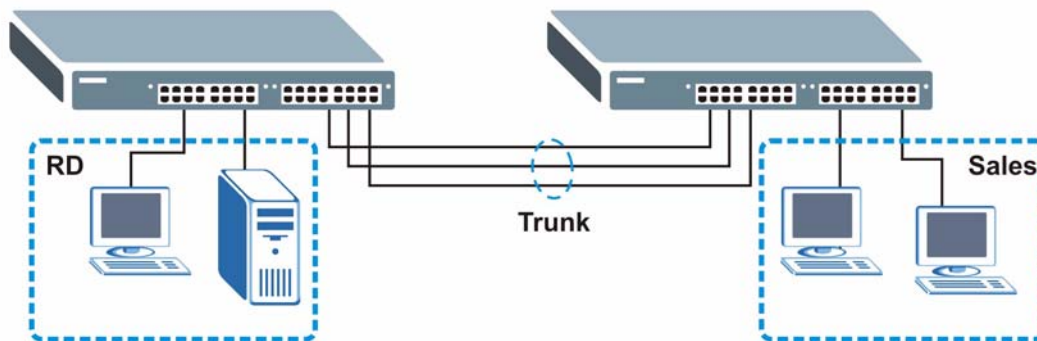

1.1.4 IEEE 802.1Q VLAN Application Examples

A VLAN (Virtual Local Area Network) allows a physical network to be partitioned into multiple logical networks. Stations on a logical network belong to one group. A station can belong to more than one group. With VLAN, a station cannot directly talk to or hear from stations that are not in the same group(s) unless such traffic first goes through a router.

For more information on VLANs, refer to [Chapter 9 on page 89](#).

1.1.4.1 Tag-based VLAN Example

Ports in the same VLAN group share the same frame broadcast domain thus increase network performance through reduced broadcast traffic. VLAN groups can be modified at any time by adding, moving or changing ports without any re-cabling.

Shared resources such as a server can be used by all ports in the same VLAN as the server. In the following figure only ports that need access to the server need to be part of VLAN 1. Ports can belong to other VLAN groups too.

Figure 4 Shared Server Using VLAN Example

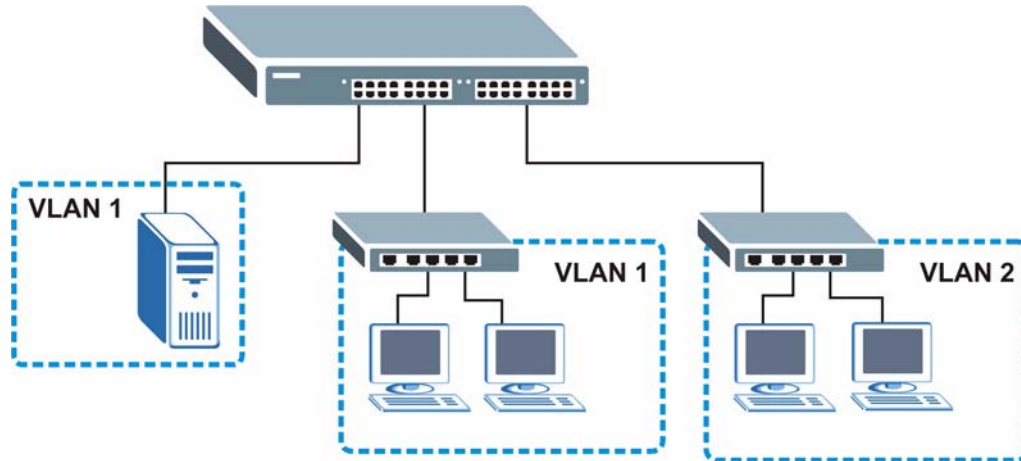

1.1.5 Metro Ethernet

The Switch is ideal for connecting users to an Ethernet network that spans a metropolitan area.

In the following example, the Switch is one of many switches that connect users in the metropolitan area to the Internet. The metro ethernet is based on a star (or hub-and-spoke) topology, though other topologies, such as ring or mesh, are also

possible. The Switch is connected to the backbone and the metropolitan servers over an optical network that provides higher bandwidth than copper.

Figure 5 Metro Ethernet

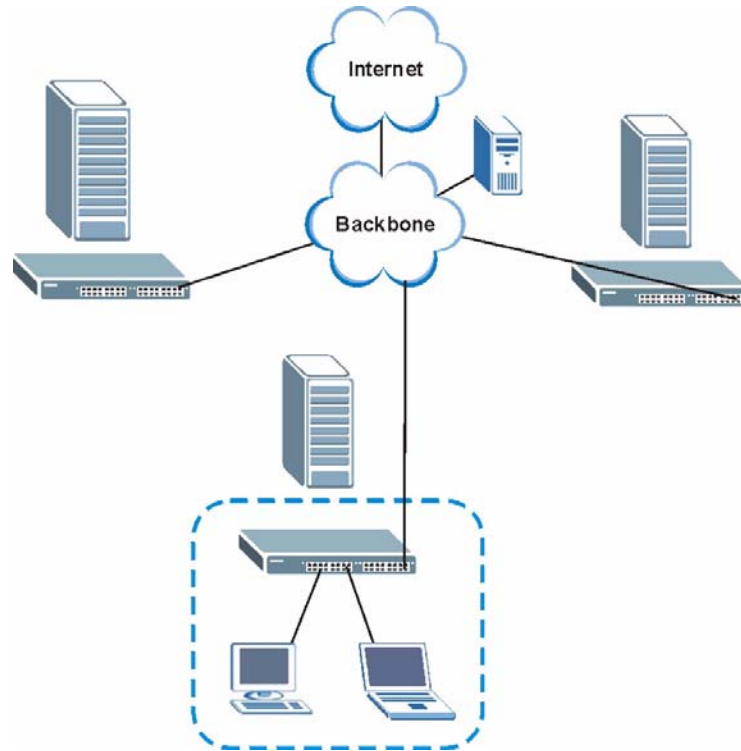

1.2 Ways to Manage the Switch

Use any of the following methods to manage the Switch.

- **Web Configurator.** This is recommended for everyday management of the Switch using a (supported) web browser. See [Chapter 4 on page 43](#).
- **Command Line Interface.** Line commands offer an alternative to the web configurator and in some cases are necessary to configure advanced features. See the CLI Reference Guide.
- **FTP.** Use FTP for firmware upgrades and configuration backup/restore. See [Section 31.8 on page 271](#).
- **SNMP.** The Switch can be monitored by an SNMP manager. See [Section 32.3 on page 276](#).
- **Cluster Management.** Cluster Management allows you to manage multiple switches through one switch, called the cluster manager. See [Chapter 35 on page 303](#).

1.3 Good Habits for Managing the Switch

Do the following things regularly to make the Switch more secure and to manage the Switch more effectively.

- Change the password. Use a password that's not easy to guess and that consists of different types of characters, such as numbers and letters.
- Write down the password and put it in a safe place.
- Back up the configuration (and make sure you know how to restore it). Restoring an earlier working configuration may be useful if the device becomes unstable or even crashes. If you forget your password, you will have to reset the Switch to its factory default settings. If you backed up an earlier configuration file, you would not have to totally re-configure the Switch. You could simply restore your last configuration.

Hardware Installation and Connection

This chapter shows you how to install and connect the Switch.

2.1 Installation Scenarios

The Switch can be placed on a desktop or rack-mounted on a standard EIA rack. Use the rubber feet in a desktop installation and the brackets in a rack-mounted installation.

Note: For proper ventilation, allow at least 4 inches (10 cm) of clearance at the front and 3.4 inches (8 cm) at the back of the Switch. This is especially important for enclosed rack installations.

2.2 Desktop Installation Procedure

- 1 Make sure the Switch is clean and dry.
- 2 Set the Switch on a smooth, level surface strong enough to support the weight of the Switch and the connected cables. Make sure there is a power outlet nearby.
- 3 Make sure there is enough clearance around the Switch to allow air circulation and the attachment of cables and the power cord.

2.3 Mounting the Switch on a Rack

The Switch can be mounted on an EIA standard size, 19-inch rack or in a wiring closet with other equipment. Follow the steps below to mount your Switch on a standard EIA rack using a rack-mounting kit.

2.3.1 Rack-mounted Installation Requirements

- Two mounting brackets.
- Eight M3 flat head screws and a #2 Philips screwdriver.
- Four M5 flat head screws and a #2 Philips screwdriver.

Failure to use the proper screws may damage the unit.

2.3.1.1 Precautions

- Make sure the rack will safely support the combined weight of all the equipment it contains.
- Make sure the position of the Switch does not make the rack unstable or top-heavy. Take all necessary precautions to anchor the rack securely before installing the unit.

2.3.2 Attaching the Mounting Brackets to the Switch

- 1 Position a mounting bracket on one side of the Switch, lining up the four screw holes on the bracket with the screw holes on the side of the Switch.

Figure 6 Attaching the Mounting Brackets

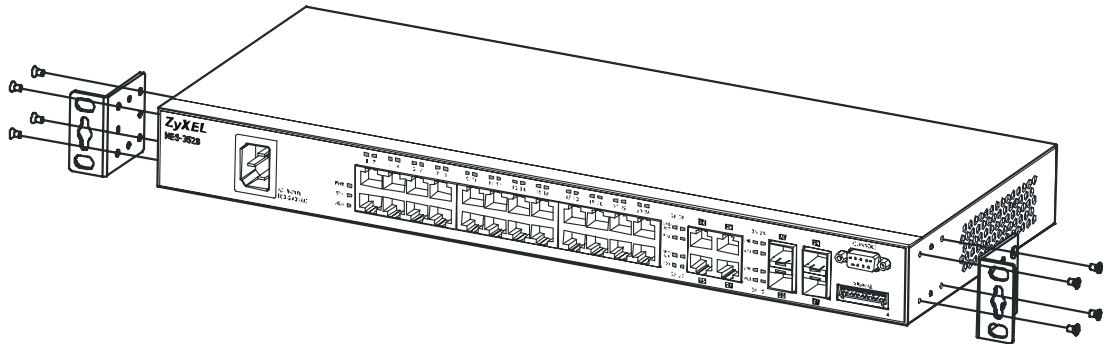

Figure 7 Using a #2 Philips screwdriver, install the M3 flat head screws through the mounting bracket holes into the Switch.

- 2 Repeat steps 1 and 7 to install the second mounting bracket on the other side of the Switch.
- 3 You may now mount the Switch on a rack. Proceed to the next section.

2.3.3 Mounting the Switch on a Rack

- 1 Position a mounting bracket (that is already attached to the Switch) on one side of the rack, lining up the two screw holes on the bracket with the screw holes on the side of the rack.

Figure 8 Mounting the Switch on a Rack

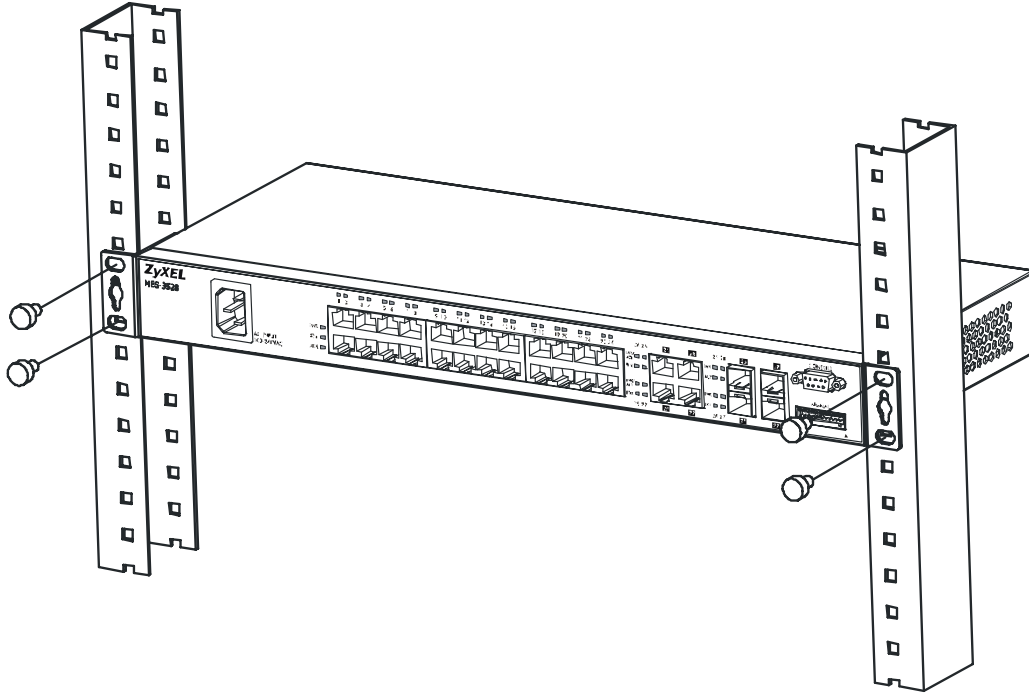

Figure 9

- 2 Using a #2 Philips screwdriver, install the M5 flat head screws through the mounting bracket holes into the rack.
- 3 Repeat steps 1 and 2 to attach the second mounting bracket on the other side of the rack.

Hardware Overview

This chapter describes the front panel and rear panel of the Switch and shows you how to make the hardware connections.

3.1 Front Panel

The following figure shows the front panel of the Switch.

Figure 10 Front Panel (DC)

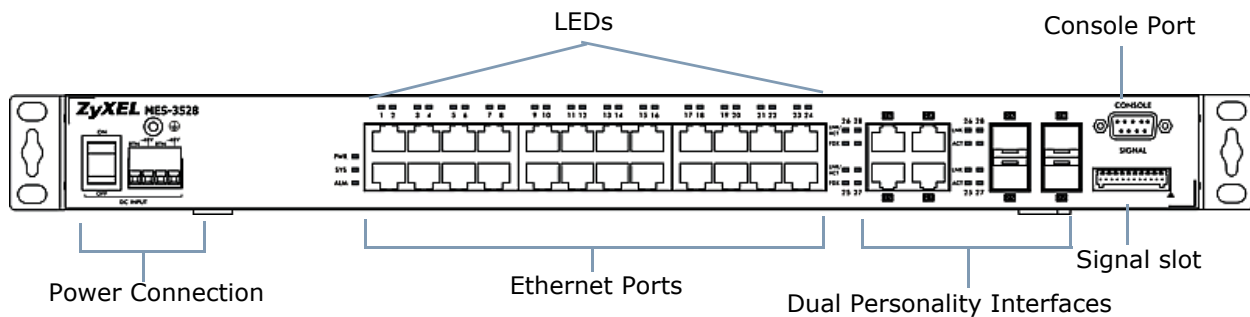

The following figure shows the front panel of the Switch.

Figure 11 Front Panel (AC)

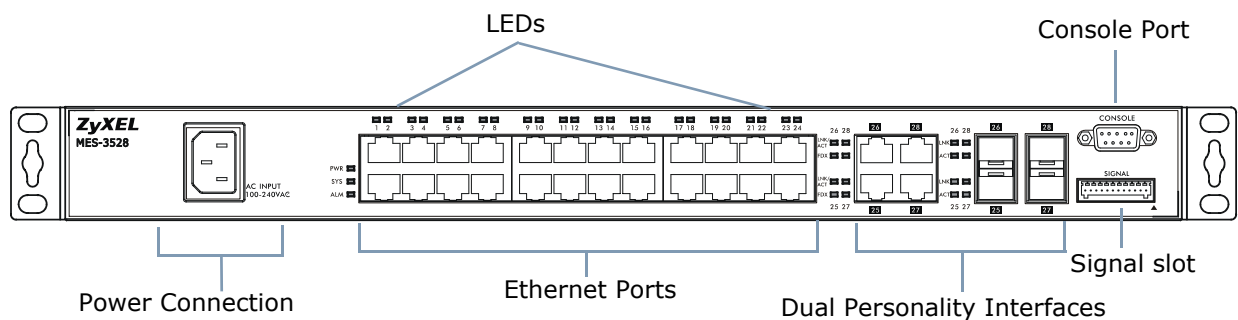

The following table describes the port labels on the front panel.

Table 1 Front Panel Connections

LABEL	DESCRIPTION
Power Connection	Connect an appropriate power supply to this port. For DC, Turn the device on or off using the switch.
24 10/100 Mbps RJ-45 Ethernet Ports	Connect these ports to a computer, a hub, an Ethernet switch or router.
Four Dual Personality Interfaces	Each interface has one 1000BASE-T RJ-45 port and one Small Form-Factor Pluggable (SFP) slot (also called a mini-GBIC slot), with one port or transceiver active at a time.
	<ul style="list-style-type: none"> • Four 100/1000 Mbps RJ-45 Ports: Connect these ports to high-bandwidth backbone network Ethernet switches using 1000BASE-T compatible Category 5/5e/6 copper cables. • Four Mini-GBIC Slots: Use mini-GBIC transceivers in these slots for connections to backbone Ethernet switches.
Console Port	The console port is for local configuration of the Switch.
SIGNAL	<p>Connect the signal input pins to signal output terminals on other pieces of equipment.</p> <p>Connect the signal output pins to an signal input terminal on another piece of equipment.</p> <p>See Chapter 40 on page 325 for details on the pin assignments required.</p>

3.1.1 Console Port

For local management, you can use a computer with terminal emulation software configured to the following parameters:

- VT100
- Terminal emulation
- 9600 bps
- No parity, 8 data bits, 1 stop bit
- No flow control

Connect the male 9-pin end of the console cable to the console port of the Switch. Connect the female end to a serial port (COM1, COM2 or other COM port) of your computer.

3.1.2 Gigabit Ethernet Ports

The Switch has 1000Base-T auto-negotiating, auto-crossover Ethernet ports. In 10/100/1000 Mbps Fast Ethernet, the speed can be 10 Mbps, 100 Mbps or 1000 Mbps and the duplex mode can be half duplex or full duplex.

An auto-negotiating port can detect and adjust to the optimum Ethernet speed (10/100/1000 Mbps) and duplex mode (full duplex or half duplex) of the connected device.

An auto-crossover (auto-MDI/MDI-X) port automatically works with a straight-through or crossover Ethernet cable.

Four 1000Base-T Ethernet ports are paired with a mini-GBIC slot to create a dual personality interface. The Switch uses up to one connection for each mini-GBIC and 1000Base-T Ethernet pair. The mini-GBIC slots have priority over the Gigabit ports. This means that if a mini-GBIC slot and the corresponding GbE port are connected at the same time, the GbE port will be disabled.

When auto-negotiation is turned on, an Ethernet port negotiates with the peer automatically to determine the connection speed and duplex mode. If the peer Ethernet port does not support auto-negotiation or turns off this feature, the Switch determines the connection speed by detecting the signal on the cable and using half duplex mode. When the Switch's auto-negotiation is turned off, an Ethernet port uses the pre-configured speed and duplex mode when making a connection, thus requiring you to make sure that the settings of the peer Ethernet port are the same in order to connect.

3.1.2.1 Default Ethernet Negotiation Settings

The factory default negotiation settings for the Gigabit ports on the Switch are:

- Speed: Auto
- Duplex: Auto
- Flow control: Off
- Link Aggregation: Disabled

3.1.2.2 Auto-crossover

All ports are auto-crossover, that is auto-MDIX ports (Media Dependent Interface Crossover), so you may use either a straight-through Ethernet cable or crossover Ethernet cable for all Gigabit port connections. Auto-crossover ports automatically sense whether they need to function as crossover or straight ports, so crossover cables can connect both computers and switches/hubs.

3.1.3 Mini-GBIC Slots

These are slots for mini-GBIC (Gigabit Interface Converter) transceivers. A transceiver is a single unit that houses a transmitter and a receiver. The Switch does not come with transceivers. You must use transceivers that comply with the Small Form-factor Pluggable (SFP) Transceiver MultiSource Agreement (MSA). See the SFF committee's INF-8074i specification Rev 1.0 for details.

You can change transceivers while the Switch is operating. You can use different transceivers to connect to Ethernet switches with different types of fiber-optic or even copper cable connectors.

To avoid possible eye injury, do not look into an operating fiber-optic module's connectors.

- Type: SFP connection interface
- Connection speed: 1 Gigabit per second (Gbps)

3.1.3.1 Transceiver Installation

Use the following steps to install a mini-GBIC transceiver (SFP module).

- 1 Insert the transceiver into the slot with the exposed section of PCB board facing down.
- 2 Press the transceiver firmly until it clicks into place.
- 3 The Switch automatically detects the installed transceiver. Check the LEDs to verify that it is functioning properly.
- 4 Close the transceiver's latch (latch styles vary).

- 5 Connect the fiber optic cables to the transceiver.

Figure 12 Transceiver Installation Example

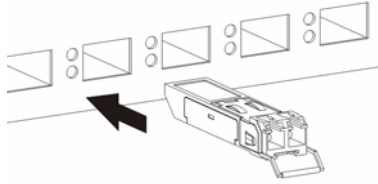
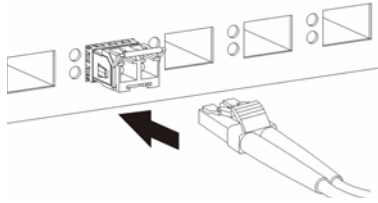

Figure 13 Connecting the Fiber Optic Cables



3.1.3.2 Transceiver Removal

Use the following steps to remove a mini-GBIC transceiver (SFP module).

- 1 Remove the fiber optic cables from the transceiver.
- 2 Open the transceiver's latch (latch styles vary).
- 3 Pull the transceiver out of the slot.

Figure 14 Removing the Fiber Optic Cables

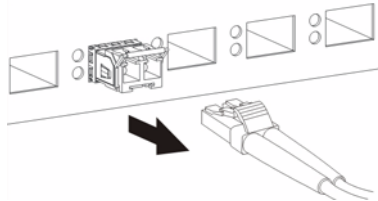

Figure 15 Opening the Transceiver's Latch Example

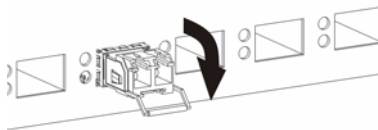
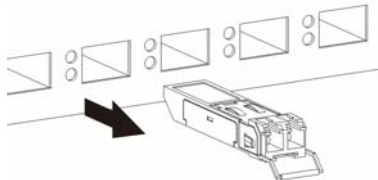

Figure 16 Transceiver Removal Example



3.1.4 Power Connector (DC)

Note: When installing the Switch power wire, push the wire firmly into the terminal as deep as possible and make sure that no exposed (bare) wire can be seen or touched.

- 1 Connect one end of a power wire to the '-' power terminal on the front panel of your Switch and tighten the terminal screw.
- 2 Connect the external power adapter to the -36 to -48 VDC terminal on the power supply.
- 3 Repeat the previous step for the terminal labeled '+

See [Chapter 40 on page 325](#) for information on the Switch's power supply requirements.

3.1.5 Procedure to Turn on the Switch Power

- 1 Turn on the power supply.
- 2 Move the Switch power switch to the **ON** position.

3.1.6 Power Connector (AC)

Note: Make sure you are using the correct power source as shown on the panel.

To connect power to the Switch, insert the female end of the power cord to the AC power receptacle on the front panel. Connect the other end of the supplied power cord to a power outlet. Make sure that no objects obstruct the airflow of the fans (located on the side of the unit).

See [Chapter 41 on page 331](#) for information on the Switch's power supply requirements.

3.1.7 Signal Slot

The **SIGNAL** slot (fitted with the signal connector) allows you to connect devices to the Switch. This feature is in addition to the system alarm, which detects abnormal temperatures, voltage levels and fan speeds on the Switch.

- The Switch can be configured to send an SNMP trap to the SNMP server. See [Section 32.3 on page 276](#) for more information on using SNMP.
- The Switch can be configured to create an error log of the alarm. See [Section 34.1 on page 299](#) for more information on using the system log.

3.2 LEDs

After you connect the power to the Switch, view the LEDs to ensure proper functioning of the Switch and as an aid in troubleshooting.

Table 2 LED Descriptions

LED	COLOR	STATUS	DESCRIPTION
PWR	Green	On	The system is turned on.
		Off	The system is off.
SYS	Green	On	The system is on and functioning properly.
		Blinking	The system is rebooting and performing self-diagnostic tests.
	Off	The power is off or the system is not ready/malfunctioning.	
ALM	Red	On	A hardware failure is detected, or an external alarm is active.
		Off	The system is functioning normally.
Ethernet Ports			
1 ~ 24	Green	Blinking	The system is transmitting/receiving to/from a 10 Mbps Ethernet network.
		on	The link to a 10 Mbps Ethernet network is up.
	Amber	Blinking	The system is transmitting/receiving to/from a 100 Mbps Ethernet network.
		On	The link to a 100 Mbps Ethernet network is up.
	Off	The link to an Ethernet network is down.	
Mini-GBIC Slots			
LNK	Green	On	The link to this port is up.
		Off	The link to this port is not connected.
ACT	Green	Blinking	This port is receiving or transmitting data.
1000Base-T Ethernet Ports (in Dual Personality Interface)			
LNK/ACT	Green	Blinking	The system is transmitting/receiving to/from a 10 Mbps or a 1000 Mbps Ethernet network.
		On	The link to a 10 Mbps or a 1000 Mbps Ethernet network is up.
	Amber	Blinking	The system is transmitting/receiving to/from a 100 Mbps Ethernet network.
		On	The link to a 100 Mbps Ethernet network is up.
	Off	The link to an Ethernet network is down.	
FDX	Amber	On	The Gigabit port is negotiating in full-duplex mode.
		Off	The Gigabit port is negotiating in half-duplex mode.

PART II

Basic Configuration

The Web Configurator (43)

Initial Setup Example (53)

System Status and Port Statistics (69)

Basic Setting (75)

The Web Configurator

This section introduces the configuration and functions of the web configurator.

4.1 Introduction

The web configurator is an HTML-based management interface that allows easy Switch setup and management via Internet browser. Use Internet Explorer 6.0 and later or Netscape Navigator 7.0 and later versions. The recommended screen resolution is 1024 by 768 pixels.

In order to use the web configurator you need to allow:

- Web browser pop-up windows from your device. Web pop-up blocking is enabled by default in Windows XP SP (Service Pack) 2.
- JavaScript (enabled by default).
- Java permissions (enabled by default).

4.2 System Login

- 1 Start your web browser.
- 2 Type "http://" and the IP address of the Switch (for example, the default management IP address is 192.168.1.1) in the **Location** or **Address** field. Press [ENTER].

- 3 The login screen appears. The default username is **admin** and associated default password is **1234**. The date and time display as shown if you have not configured a time server nor manually entered a time and date in the **General Setup** screen.

Figure 17 Web Configurator: Login



- 4 Click **OK** to view the first web configurator screen.

4.3 The Status Screen

The **Status** screen is the first screen that displays when you access the web configurator.

The following figure shows the navigating components of a web configurator screen.

Figure 18 Web Configurator Home Screen (Status)

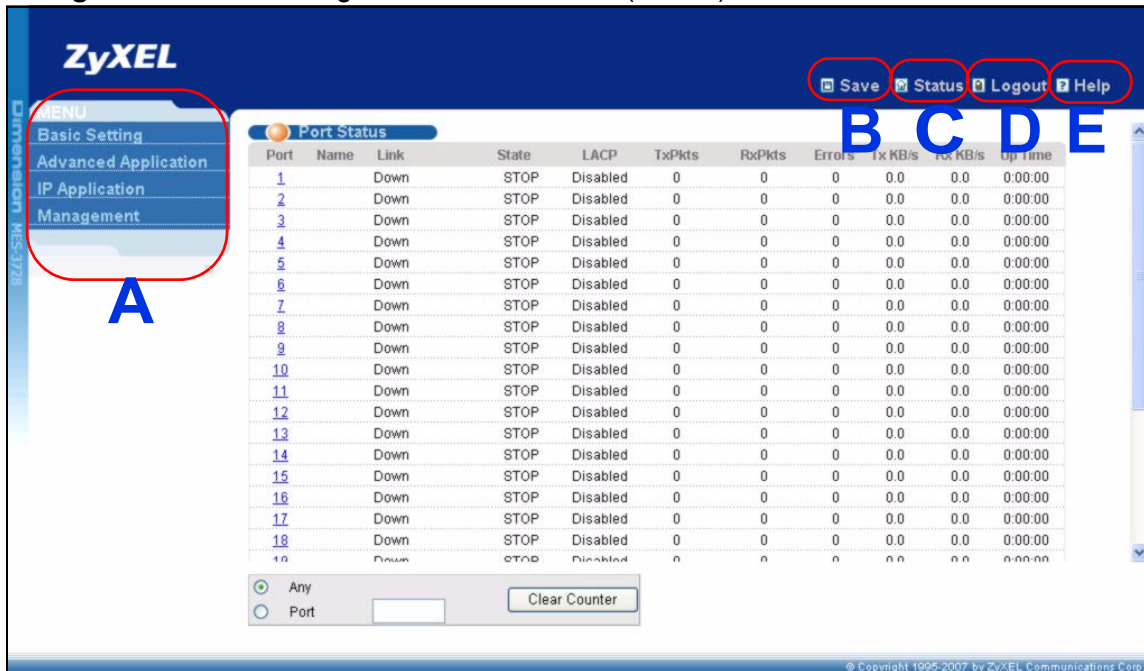

A - Click the menu items to open submenu links, and then click on a submenu link to open the screen in the main window.

B, C, D, E - These are quick links which allow you to perform certain tasks no matter which screen you are currently working in.

B - Click this link to save your configuration into the Switch's nonvolatile memory. Nonvolatile memory is the configuration of your Switch that stays the same even if the Switch's power is turned off.





C - Click this link to go to the status page of the Switch.

D - Click this link to logout of the web configurator.

E - Click this link to display web help pages. The help pages provide descriptions for all of the configuration screens.

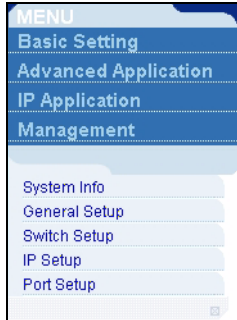
In the navigation panel, click a main link to reveal a list of submenu links.

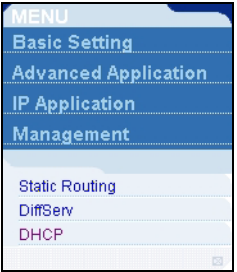
Table 3 Navigation Panel Sub-links Overview

BASIC SETTING	ADVANCED APPLICATION	IP APPLICATION	MANAGEMENT
			

The following table describes the links in the navigation panel.

Table 4 Navigation Panel Links

LINK	DESCRIPTION
Basic Settings	
System Info	This link takes you to a screen that displays general system information.
General Setup	This link takes you to a screen where you can configure general identification information about the Switch.
Switch Setup	This link takes you to a screen where you can set up global Switch parameters such as VLAN type, GARP and priority queues.
IP Setup	This link takes you to a screen where you can configure the IP address, subnet mask (necessary for Switch management) and DNS (domain name server) and set up to 64 IP routing domains.
Port Setup	This link takes you to a screen where you can configure settings for individual Switch ports.
Advanced Application	
VLAN	This link takes you to screens where you can configure port-based or 802.1Q VLAN (depending on what you configured in the Switch Setup menu). You can also configure a protocol based VLAN or a subnet based VLAN in these screens.
Static MAC Forwarding	This link takes you to a screen where you can configure static MAC addresses for a port. These static MAC addresses do not age out.

Table 4 Navigation Panel Links (continued)

LINK	DESCRIPTION
Static Multicast Forwarding	This link takes you to a screen where you can configure static multicast MAC addresses for port(s). These static multicast MAC addresses do not age out.
Filtering	This link takes you to a screen to set up filtering rules.
Spanning Tree Protocol	This link takes you to screens where you can configure the RSTP/MRSTP/MSTP to prevent network loops.
Bandwidth Control	This link takes you to a screen where you can configure bandwidth limits on the Switch.
Broadcast Storm Control	This link takes you to a screen to set up broadcast filters.
Mirroring	This link takes you to screens where you can copy traffic from one port or ports to another port in order that you can examine the traffic from the first port without interference.
Link Aggregation	This link takes you to screens where you can logically aggregate physical links to form one logical, higher-bandwidth link.
Port Authentication	This link takes you to a screen where you can configure IEEE 802.1x port authentication for clients communicating via the Switch.
Port Security	This link takes you to screens where you can activate MAC address learning and set the maximum number of MAC addresses to learn on a port.
Classifier	This link takes you to a screen where you can configure the Switch to group packets based on the specified criteria.
Policy Rule	This link takes you to a screen where you can configure the Switch to perform special treatment on the grouped packets.
Queuing Method	This link takes you to a screen where you can configure queuing with associated queue weights for each port.
Multicast	This link takes you to screens where you can configure various multicast features, IGMP snooping and create multicast VLANs.
AAA	This link takes you to a screen where you can configure authentication, authorization and accounting services via external servers. The external servers can be either RADIUS (Remote Authentication Dial-In User Service) or TACACS+ (Terminal Access Controller Access-Control System Plus).
IP Source Guard	This link takes you to screens where you can configure filtering of unauthorized DHCP and ARP packets in your network.
Loop Guard	This link takes you to a screen where you can configure protection against network loops that occur on the edge of your network.
Layer 2 Protocol Tunneling	This link takes you to a screen where you can configure L2PT (Layer 2 Protocol Tunneling) settings on the Switch.
IP Application	
Static Routing	This link takes you to a screen where you can configure static routes. A static route defines how the Switch should forward traffic by configuring the TCP/IP parameters manually.
DiffServ	This link takes you to screens where you can enable DiffServ, configure marking rules and set DSCP-to-IEEE802.1p mappings.

Table 4 Navigation Panel Links (continued)

LINK	DESCRIPTION
DHCP	This link takes you to screens where you can configure the DHCP settings.
Management	
Maintenance	This link takes you to screens where you can perform firmware and configuration file maintenance as well as reboot the system.
Access Control	This link takes you to screens where you can change the system login password and configure SNMP and remote management.
Diagnostic	This link takes you to a screen where you can view system logs and test port(s).
Syslog	This link takes you to screens where you can setup system logs and a system log server.
Cluster Management	This link takes you to screens where you can configure clustering management and view its status.
MAC Table	This link takes you to a screen where you can view the MAC addresses (and types) of devices attached to what ports and VLAN IDs.
ARP Table	This link takes you to a screen where you can view the MAC addresses – IP address resolution table.
Configure Clone	This link takes you to a screen where you can copy attributes of one port to other ports.

4.3.1 Change Your Password

After you log in for the first time, it is recommended you change the default administrator password. Click **Management** > **Access Control** > **Logins** to display the next screen.

Figure 19 Change Administrator Login Password

Logins [Access Control](#)

Administrator

Old Password

New Password

Retype to confirm

Please record your new password whenever you change it. The system will lock you out if you have forgotten your password.

Edit Logins

Login	User Name	Password	Retype to confirm
1	<input type="text"/>	<input type="text"/>	<input type="text"/>
2	<input type="text"/>	<input type="text"/>	<input type="text"/>
3	<input type="text"/>	<input type="text"/>	<input type="text"/>
4	<input type="text"/>	<input type="text"/>	<input type="text"/>

4.4 Saving Your Configuration

When you are done modifying the settings in a screen, click **Apply** to save your changes back to the run-time memory. Settings in the run-time memory are lost when the Switch's power is turned off.

Click the **Save** link in the upper right hand corner of the web configurator to save your configuration to nonvolatile memory. Nonvolatile memory refers to the Switch's storage that remains even if the Switch's power is turned off.

Note: Use the **Save** link when you are done with a configuration session.

4.5 Switch Lockout

You could block yourself (and all others) from managing the Switch if you do one of the following:

- 1 Delete the management VLAN (default is VLAN 1).
- 2 Delete all port-based VLANs with the CPU port as a member. The "CPU port" is the management port of the Switch.
- 3 Filter all traffic to the CPU port.
- 4 Disable all ports.
- 5 Misconfigure the text configuration file.
- 6 Forget the password and/or IP address.
- 7 Prevent all services from accessing the Switch.
- 8 Change a service port number but forget it.

Note: Be careful not to lock yourself and others out of the Switch.

4.6 Resetting the Switch

If you lock yourself (and others) from the Switch or forget the administrator password, you will need to reload the factory-default configuration file or reset the Switch back to the factory defaults.

4.6.1 Reload the Configuration File

Uploading the factory-default configuration file replaces the current configuration file with the factory-default configuration file. This means that you will lose all previous configurations and the speed of the console port will be reset to the default of 9600 bps with 8 data bits, no parity, one stop bit and flow control set to none. The password will also be reset to "1234" and the IP address to 192.168.1.1.

To upload the configuration file, do the following:

- 1 Connect to the console port using a computer with terminal emulation software.

- 2 Disconnect and reconnect the Switch's power to begin a session. When you reconnect the Switch's power, you will see the initial screen.
- 3 When you see the message "Press any key to enter Debug Mode within 3 seconds ..." press any key to enter debug mode.
- 4 Type `atlc` after the "Enter Debug Mode" message.
- 5 Wait for the "Starting XMODEM upload" message before activating XMODEM upload on your terminal.
- 6 After a configuration file upload, type `atgo` to restart the Switch.

Figure 20 Resetting the Switch: Via the Console Port

```

Bootbase Version: V1.04 | 12/15/2008 15:42:13
RAM: Size = 65536 Kbytes
DRAM POST: Testing: 65536K
OK
FLASH: AMD 64M *2

ZyNOS Version: V3.90(BHR.0)b0 | 12/24/2008 21:56:57

Press any key to enter debug mode within 3 seconds.
ras> atlc
Starting XMODEM upload (CRC mode)....
CCCCCCCCCCCCCCCC
Total 573440 bytes received.
Erasing..
.....
OK
ras> atgo

```

The Switch is now reinitialized with a default configuration file including the default password of "1234".

4.7 Logging Out of the Web Configurator

Click **Logout** in a screen to exit the web configurator. You have to log in with your password again after you log out. This is recommended after you finish a management session for security reasons.

Figure 21 Web Configurator: Logout Screen



4.8 Help

The web configurator's online help has descriptions of individual screens and some supplementary information.

Click the **Help** link from a web configurator screen to view an online help description of that screen.

Initial Setup Example

This chapter shows how to set up the Switch for an example network.

5.1 Overview

The following lists the configuration steps for the initial setup:

- Create a VLAN
- Set port VLAN ID
- Configure the Switch IP management address

5.1.1 Creating a VLAN

VLANs confine broadcast frames to the VLAN group in which the port(s) belongs. You can do this with port-based VLAN or tagged static VLAN with fixed port members.

In this example, you want to configure port 1 as a member of VLAN 2.

Figure 22 Initial Setup Network Example: VLAN

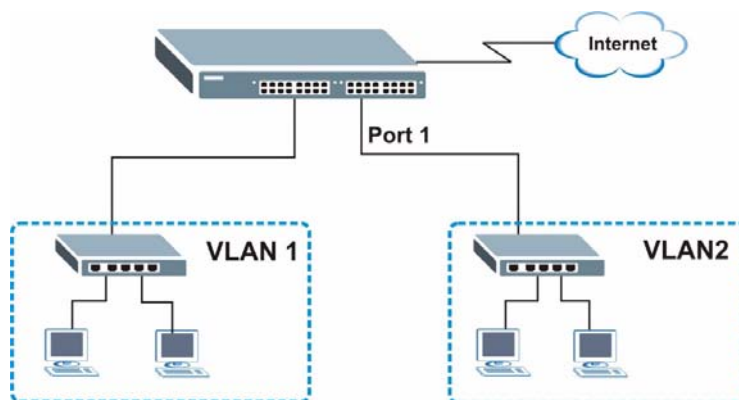

- 1 Click **Advanced Application** > **VLAN** in the navigation panel and click the **Static VLAN** link.

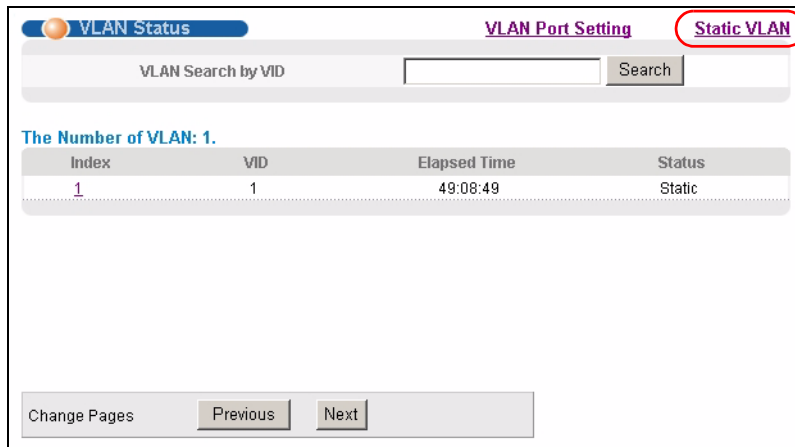

- 2 In the **Static VLAN** screen, select **ACTIVE**, enter a descriptive name in the **Name** field and enter 2 in the **VLAN Group ID** field for the **VLAN2** network.

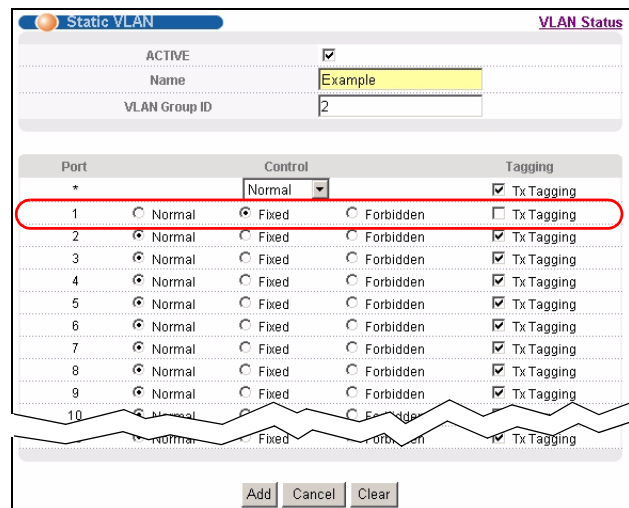

Note: The **VLAN Group ID** field in this screen and the **VID** field in the **IP Setup** screen refer to the same VLAN ID.

- 3 Since the **VLAN2** network is connected to port 1 on the Switch, select **Fixed** to configure port 1 to be a permanent member of the VLAN only.
- 4 To ensure that VLAN-unaware devices (such as computers and hubs) can receive frames properly, clear the **TX Tagging** check box to set the Switch to remove VLAN tags before sending.
- 5 Click **Add** to save the settings to the run-time memory. Settings in the run-time memory are lost when the Switch's power is turned off.

5.1.2 Setting Port VID

Use PVID to add a tag to incoming untagged frames received on that port so that the frames are forwarded to the VLAN group that the tag defines.

In the example network, configure 2 as the port VID on port 1 so that any untagged frames received on that port get sent to VLAN 2.

Figure 23 Initial Setup Network Example: Port VID

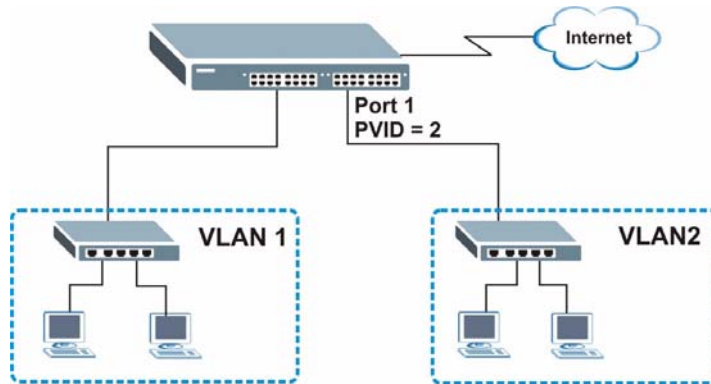

- 1 Click **Advanced Applications > VLAN** in the navigation panel. Then click the **VLAN Port Setting** link.
- 2 Enter 2 in the **PVID** field for port 1 and click **Apply** to save your changes back to the run-time memory. Settings in the run-time memory are lost when the Switch's power is turned off.

VLAN Port Setting Subnet Based Vlan Protocol Based Vlan VLAN Status

GVRP

Ingress Check

Port	PVID	GVRP	Acceptable Frame Type	VLAN Trunking	Isolation
*		<input type="checkbox"/>	All	<input type="checkbox"/>	<input type="checkbox"/>
1	1	<input type="checkbox"/>	All	<input type="checkbox"/>	<input type="checkbox"/>
2	2	<input type="checkbox"/>	All	<input type="checkbox"/>	<input type="checkbox"/>
3	1	<input type="checkbox"/>	All	<input type="checkbox"/>	<input type="checkbox"/>
4	1	<input type="checkbox"/>	All	<input type="checkbox"/>	<input type="checkbox"/>
5	1	<input type="checkbox"/>	All	<input type="checkbox"/>	<input type="checkbox"/>
6	1	<input type="checkbox"/>	All	<input type="checkbox"/>	<input type="checkbox"/>
7	1	<input type="checkbox"/>	All	<input type="checkbox"/>	<input type="checkbox"/>
8	1	<input type="checkbox"/>	All	<input type="checkbox"/>	<input type="checkbox"/>
9	1	<input type="checkbox"/>	All	<input type="checkbox"/>	<input type="checkbox"/>
10	1	<input type="checkbox"/>	All	<input type="checkbox"/>	<input type="checkbox"/>
11	1	<input type="checkbox"/>	All	<input type="checkbox"/>	<input type="checkbox"/>

Apply Cancel

5.2 Configuring Switch Management IP Address

The default management IP address of the Switch is 192.168.1.1. You can configure another IP address in a different subnet for management purposes. The following figure shows an example.

Figure 24 Initial Setup Example: Management IP Address

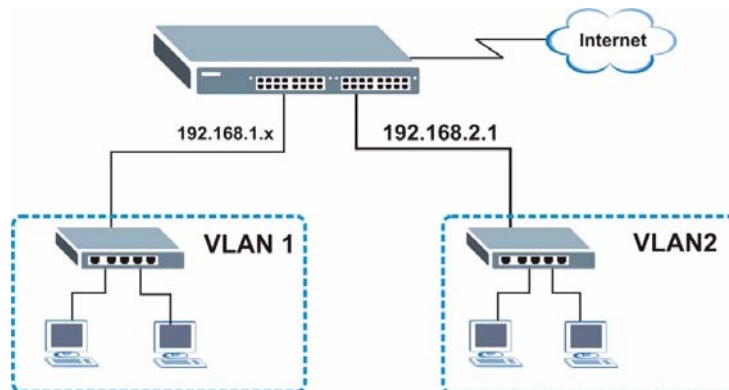

- 1 Connect your computer to any Ethernet port on the Switch. Make sure your computer is in the same subnet as the Switch.
- 2 Open your web browser and enter 192.168.1.1 (the default IP address) in the address bar to access the web configurator. See [Section 4.2 on page 43](#) for more information.
- 3 Click **Basic Setting > IP Setup** in the navigation panel.
- 4 Configure the related fields in the **IP Setup** screen.
- 5 For the **VLAN2** network, enter 192.168.2.1 as the IP address and 255.255.255.0 as the subnet mask.
- 6 In the **VID** field, enter the ID of the VLAN group to which you want this management IP address to belong. This is the same as the VLAN ID you configure in the **Static VLAN** screen.

Index	IP Address	IP Subnet Mask	VID	Default Gateway	Delete
	192.168.2.1	255.255.255.0	2	0.0.0.0	

- 7 Click **Add** to save your changes back to the run-time memory. Settings in the run-time memory are lost when the Switch's power is turned off.

Tutorials

This chapter provides some examples of using the web configurator to set up and use the Switch. The tutorials include:

- [How to Use DHCP Snooping on the Switch](#)
- [How to Use DHCP Relay on the Switch](#)

6.1 How to Use DHCP Snooping on the Switch

You only want DHCP server **A** connected to port 5 to assign IP addresses to all devices in VLAN network (**V**). Create a VLAN containing ports 5, 6 and 7. Connect a computer **M** to the Switch for management.

Figure 25 Tutorial: DHCP Snooping Tutorial Overview

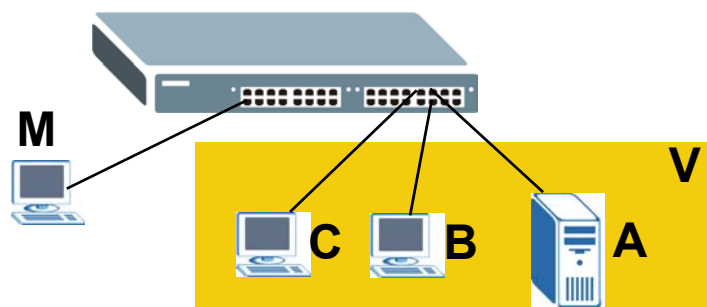

Note: For related information about DHCP snooping, see [Section 25.1 on page 213](#).

The settings in this tutorial are as the following.

Table 5 Tutorial: Settings in this Tutorial

HOST	PORT CONNECTED	VLAN	PVID	DHCP SNOOPING PORT TRUSTED
DHCP Server (A)	5	1 and 100	100	Yes
DHCP Client (B)	6	1 and 100	100	No
DHCP Client (C)	7	1 and 100	100	No

- 1 Access the Switch through **http://192.168.1.1** by default. Log into the Switch by entering the username (default: **admin**) and password (default: **1234**).
- 2 Go to **Advanced Application > VLAN > Static VLAN**, and create a VLAN with ID of 100. Add ports 5, 6 and 7 in the VLAN by selecting **Fixed** in the **Control** field as shown.

Deselect **Tx Tagging** because you don't want outgoing traffic to contain this VLAN tag.

Click **Add**.

Figure 26 Tutorial: Create a VLAN and Add Ports to It

Static VLAN VLAN Status

ACTIVE

Name

VLAN Group ID

Port	Control			Tagging
*	Normal			<input checked="" type="checkbox"/> Tx Tagging
1	<input checked="" type="radio"/> Normal	<input type="radio"/> Fixed	<input type="radio"/> Forbidden	<input checked="" type="checkbox"/> Tx Tagging
2	<input checked="" type="radio"/> Normal	<input type="radio"/> Fixed	<input type="radio"/> Forbidden	<input checked="" type="checkbox"/> Tx Tagging
3	<input checked="" type="radio"/> Normal	<input type="radio"/> Fixed	<input type="radio"/> Forbidden	<input checked="" type="checkbox"/> Tx Tagging
4	<input checked="" type="radio"/> Normal	<input type="radio"/> Fixed	<input type="radio"/> Forbidden	<input checked="" type="checkbox"/> Tx Tagging
5	<input type="radio"/> Normal	<input checked="" type="radio"/> Fixed	<input type="radio"/> Forbidden	<input type="checkbox"/> Tx Tagging
6	<input type="radio"/> Normal	<input checked="" type="radio"/> Fixed	<input type="radio"/> Forbidden	<input type="checkbox"/> Tx Tagging
7	<input type="radio"/> Normal	<input checked="" type="radio"/> Fixed	<input type="radio"/> Forbidden	<input type="checkbox"/> Tx Tagging
8	<input checked="" type="radio"/> Normal	<input type="radio"/> Fixed	<input type="radio"/> Forbidden	<input checked="" type="checkbox"/> Tx Tagging

- Go to **Advanced Application > VLAN > VLAN Port Setting**, and set the PVID of the ports 5, 6 and 7 to 100. This tags untagged incoming frames on ports 5, 6 and 7 with the tag 100.

Figure 27 Tutorial: Tag Untagged Frames

Port	PVID	GVRP	Acceptable Frame Type	VLAN Trunking	Isolation
*		<input type="checkbox"/>	All	<input type="checkbox"/>	<input type="checkbox"/>
1	1	<input type="checkbox"/>	All	<input type="checkbox"/>	<input type="checkbox"/>
2	1	<input type="checkbox"/>	All	<input type="checkbox"/>	<input type="checkbox"/>
3	1	<input type="checkbox"/>	All	<input type="checkbox"/>	<input type="checkbox"/>
4	1	<input type="checkbox"/>	All	<input type="checkbox"/>	<input type="checkbox"/>
5	100	<input type="checkbox"/>	All	<input type="checkbox"/>	<input type="checkbox"/>
6	100	<input type="checkbox"/>	All	<input type="checkbox"/>	<input type="checkbox"/>
7	100	<input type="checkbox"/>	All	<input type="checkbox"/>	<input type="checkbox"/>
8	1	<input type="checkbox"/>	All	<input type="checkbox"/>	<input type="checkbox"/>
9		<input type="checkbox"/>	All	<input type="checkbox"/>	<input type="checkbox"/>

- Go to **Advanced Application > IP Source Guard > DHCP snooping > Configure**, activate and specify VLAN 100 as the DHCP VLAN as shown. Click **Apply**.

Figure 28 Tutorial: Specify DHCP VLAN

Active
 Disable
 DHCP Vlan: 100

Database
 Agent URL:
 Timeout interval: 300 seconds
 Write delay interval: 300 seconds

Renew DHCP Snooping URL:

- 5 Click the **Port** link at the top right corner.



- 6 The **DHCP Snooping Port Configure** screen appears. Select **Trusted** in the **Server Trusted state** field for port 5 because the DHCP server is connected to port 5. Keep ports 6 and 7 **Untrusted** because they are connected to DHCP clients. Click **Apply**.

Figure 29 Tutorial: Set the DHCP Server Port to Trusted

 The screenshot shows the 'DHCP Snooping Port Configure' interface. It features a table with columns for 'Port', 'Server Trusted state', and 'Rate (pps)'. The 'Server Trusted state' column has dropdown menus for each port. Port 5 is highlighted with a green circle, and its dropdown menu is open, showing 'Trusted' selected. Below the table, the 'Apply' button is also highlighted with a green circle.

Port	Server Trusted state	Rate (pps)
*	Untrusted	
1	Untrusted	0
2	Untrusted	0
3	Untrusted	0
4	Untrusted	0
5	Trusted	0
6	Untrusted	0
7	Untrusted	0
8	Untrusted	0
9	Untrusted	0

- 7 Go to **Advanced Application > IP Source Guard > DHCP snooping > Configure > VLAN**, show VLAN 100 by entering 100 in the **Start VID** and **End VID** fields and click **Apply**. Then select **Yes** in the **Enabled** field of the VLAN 100 entry shown at the bottom section of the screen.

If you want to add more information in the DHCP request packets such as source VLAN ID or system name, you can also select the **Option82** and **Information** fields in the entry. See [Section 25.1.1.3 on page 215](#).

Figure 30 Tutorial: Enable DHCP Snooping on this VLAN

 The screenshot shows the 'DHCP Snooping VLAN Configure' interface. At the top, there are input fields for 'Start VID' and 'End VID', both containing the value '100'. Below these fields is an 'Apply' button. Further down is a table with columns for 'VID', 'Enabled', 'Option82', and 'Information'. The 'Enabled' column has dropdown menus. For VID 100, the 'Enabled' dropdown is open, showing 'Yes' selected. Below the table, there are 'Apply' and 'Cancel' buttons. Green arrows and circles highlight the 'Start VID' and 'End VID' fields, the 'Apply' button below them, the 'Enabled' dropdown for VID 100, and the 'Apply' button at the bottom.

VID	Enabled	Option82	Information
*	No	<input type="checkbox"/>	<input type="checkbox"/>
100	Yes	<input type="checkbox"/>	<input type="checkbox"/>

- 8 Click **Save** at the top right corner of the web configurator to save the configuration permanently. 
- 9 Connect your DHCP server to port 5 and a computer (as DHCP client) to either port 6 or 7. The computer should be able to get an IP address from the DHCP server. If you put the DHCP server on port 6 or 7, the computer will not be able to get an IP address.
- 10 To check if DHCP snooping works, go to **Advanced Application > IP Source Guard**, you should see an IP assignment with the type **dhcp-snooping** as shown.

Figure 31 Tutorial: Check the Binding If DHCP Snooping Works



Index	MAC Address	IP Address	Lease	Type	VID	Port
1	00:02:00:00:00:1c	10.10.1.16	6d23h17m 0s	dhcp-snooping	100	7

You can also telnet or log into the Switch's console. Use the command "show dhcp snooping binding" to see the DHCP snooping binding table as shown next.

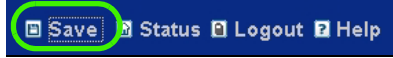
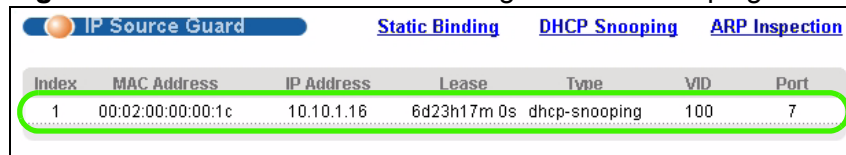
```

sysname# show dhcp snooping binding
      MacAddress      IpAddress      Lease      Type      VLAN      Port
-----
00:02:00:00:00:1c    10.10.1.16    6d23h59m20s  dhcp-snooping  100      7
Total number of bindings: 1

```

6.2 How to Use DHCP Relay on the Switch

This tutorial describes how to configure your Switch to forward DHCP client requests to a specific DHCP server. The DHCP server can then assign a specific IP address based on the information in the DHCP requests.

6.2.1 DHCP Relay Tutorial Introduction

In this example, you have configured your DHCP server (192.168.2.3) and want to have it assign a specific IP address (say 172.16.1.18) to DHCP client **A** based

on the system name, VLAN ID and port number in the DHCP request. Client **A** connects to the Switch's port 2 in VLAN 102.

Figure 32 Tutorial: DHCP Relay Scenario

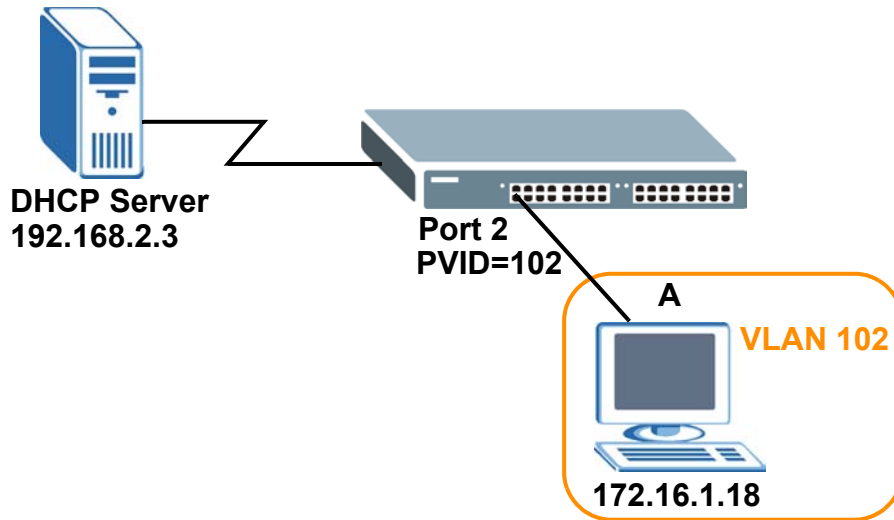

6.2.2 Creating a VLAN

Follow the steps below to configure port 2 as a member of VLAN 102.

- 1 Access the web configurator through the Switch's management port.
- 2 Go to **Basic Setting > Switch Setup** and set the VLAN type to **802.1Q**. Click **Apply** to save the settings to the run-time memory.

Figure 33 Tutorial: Set VLAN Type to 802.1Q

The screenshot shows the "Switch Setup" configuration page. The "VLAN Type" section has two radio buttons: "802.1Q" (selected) and "Port Based". Below this are sections for "GARP Timer" and "Priority Queue Assignment".

GARP Timer	
Join Timer	200 milliseconds
Leave Timer	600 milliseconds
Leave All Timer	10000 milliseconds

Priority Queue Assignment	
Level7	7
Level6	6
Level5	5
Level4	4
Level3	3
Level2	1
Level1	0
Level0	2

At the bottom of the page are "Apply" and "Cancel" buttons.

- 3 Click **Advanced Application > VLAN > Static VLAN**.
- 4 In the **Static VLAN** screen, select **ACTIVE**, enter a descriptive name (VLAN 102 for example) in the **Name** field and enter 102 in the **VLAN Group ID** field.
- 5 Select **Fixed** to configure port 2 to be a permanent member of this VLAN.
- 6 Clear the **TX Tagging** check box to set the Switch to remove VLAN tags before sending.
- 7 Click **Add** to save the settings to the run-time memory. Settings in the run-time memory are lost when the Switch's power is turned off.

Figure 34 Tutorial: Create a Static VLAN

Static VLAN VLAN Status

ACTIVE

Name

VLAN Group ID

Port	Control			Tagging
*	Normal			<input checked="" type="checkbox"/> Tx Tagging
1	<input checked="" type="radio"/> Normal	<input type="radio"/> Fixed	<input type="radio"/> Forbidden	<input checked="" type="checkbox"/> Tx Tagging
2	<input type="radio"/> Normal	<input checked="" type="radio"/> Fixed	<input type="radio"/> Forbidden	<input type="checkbox"/> Tx Tagging
3	<input checked="" type="radio"/> Normal	<input type="radio"/> Fixed	<input type="radio"/> Forbidden	<input checked="" type="checkbox"/> Tx Tagging
4	<input checked="" type="radio"/> Normal	<input type="radio"/> Fixed	<input type="radio"/> Forbidden	<input checked="" type="checkbox"/> Tx Tagging
5	<input checked="" type="radio"/> Normal	<input type="radio"/> Fixed	<input type="radio"/> Forbidden	<input checked="" type="checkbox"/> Tx Tagging
24	<input checked="" type="radio"/> Normal	<input type="radio"/> Fixed	<input type="radio"/> Forbidden	<input checked="" type="checkbox"/> Tx Tagging
25	<input checked="" type="radio"/> Normal	<input type="radio"/> Fixed	<input type="radio"/> Forbidden	<input checked="" type="checkbox"/> Tx Tagging
26	<input checked="" type="radio"/> Normal	<input type="radio"/> Fixed	<input type="radio"/> Forbidden	<input checked="" type="checkbox"/> Tx Tagging
27	<input checked="" type="radio"/> Normal	<input type="radio"/> Fixed	<input type="radio"/> Forbidden	<input checked="" type="checkbox"/> Tx Tagging
28	<input checked="" type="radio"/> Normal	<input type="radio"/> Fixed	<input type="radio"/> Forbidden	<input checked="" type="checkbox"/> Tx Tagging

- 8 Click the **VLAN Status** link in the **Static VLAN** screen and then the **VLAN Port Setting** link in the **VLAN Status** screen.

Figure 35 Tutorial: Click the VLAN Port Setting Link

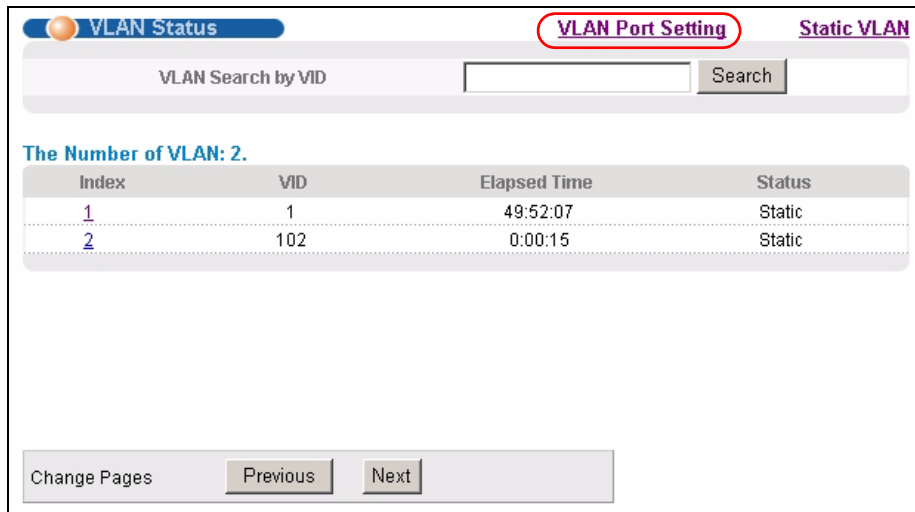

- 9 Enter 102 in the **PVID** field for port 2 to add a tag to incoming untagged frames received on that port so that the frames are forwarded to the VLAN group that the tag defines.
- 10 Click **Apply** to save your changes back to the run-time memory.

Figure 36 Tutorial: Add Tag for Frames Received on Port 2

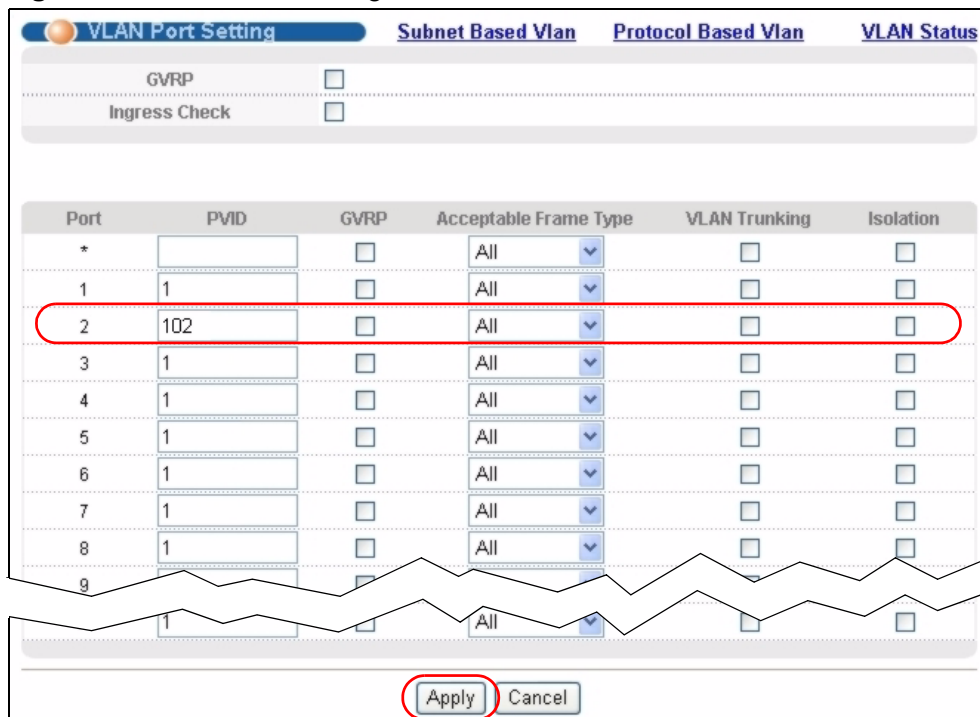

- 11 Click the **Save** link in the upper right corner of the web configurator to save your configuration permanently.

6.2.3 Configuring DHCP Relay

Follow the steps below to enable DHCP relay on the Switch and allow the Switch to add relay agent information (such as the VLAN ID) to DHCP requests.

- 1 Click **IP Application > DHCP** and then the **Global** link to open the **DHCP Relay** screen.
- 2 Select the **Active** check box.
- 3 Enter the DHCP server's IP address (192.168.2.3 in this example) in the **Remote DHCP Server 1** field.
- 4 Select the **Option 82** and the **Information** check boxes.
- 5 Click **Apply** to save your changes back to the run-time memory.

Figure 37 Tutorial: Set DHCP Server and Relay Information

DHCP Relay		Status
Active	<input checked="" type="checkbox"/>	
Remote DHCP Server 1	<input type="text" value="192.168.2.3"/>	
Remote DHCP Server 2	<input type="text" value="0.0.0.0"/>	
Remote DHCP Server 3	<input type="text" value="0.0.0.0"/>	
Relay Agent Information	<input checked="" type="checkbox"/> Option 82	
Information	<input checked="" type="checkbox"/> <input type="text" value="MES"/>	

- 6 Click the **Save** link in the upper right corner of the web configurator to save your configuration permanently.
- 7 The DHCP server can then assign a specific IP address based on the DHCP request.

6.2.4 Troubleshooting

Check the client **A**'s IP address. If it did not receive the IP address 172.16.1.18, make sure:

- 1 Client **A** is connected to the Switch's port 2 in VLAN 102.
- 2 You configured the correct VLAN ID, port number and system name for DHCP relay on both the DHCP server and the Switch.
- 3 You clicked the **Save** link on the Switch to have your settings take effect.

System Status and Port Statistics

This chapter describes the system status (web configurator home page) and port details screens.

7.1 Overview

The home screen of the web configurator displays a port statistical summary with links to each port showing statistical details.

7.2 Port Status Summary

To view the port statistics, click **Status** in all web configurator screens to display the **Status** screen as shown next.

Figure 38 Status

Port	Name	Link	State	LACP	TxPkts	RxPkts	Errors	Tx KB/s	Rx KB/s	Up Time
1		Down	STOP	Disabled	0	0	0	0.0	0.0	0:00:00
2		Down	STOP	Disabled	0	0	0	0.0	0.0	0:00:00
3		Down	STOP	Disabled	0	0	0	0.0	0.0	0:00:00
4		Down	STOP	Disabled	0	0	0	0.0	0.0	0:00:00
5		Down	STOP	Disabled	0	0	0	0.0	0.0	0:00:00
6		Down	STOP	Disabled	0	0	0	0.0	0.0	0:00:00
7		Down	STOP	Disabled	0	0	0	0.0	0.0	0:00:00
8		Down	STOP	Disabled	0	0	0	0.0	0.0	0:00:00
9		Down	STOP	Disabled	0	0	0	0.0	0.0	0:00:00
10		Down	STOP	Disabled	0	0	0	0.0	0.0	0:00:00
11		Down	STOP	Disabled	0	0	0	0.0	0.0	0:00:00
12		Down	STOP	Disabled	0	0	0	0.0	0.0	0:00:00
13		Down	STOP	Disabled	0	0	0	0.0	0.0	0:00:00
14		Down	STOP	Disabled	0	0	0	0.0	0.0	0:00:00
15		Down	STOP	Disabled	0	0	0	0.0	0.0	0:00:00
16		Down	STOP	Disabled	0	0	0	0.0	0.0	0:00:00

Control Panel:

Any
 Port

The following table describes the labels in this screen.

Table 6 Status

LABEL	DESCRIPTION
Port	This identifies the Ethernet port. Click a port number to display the Port Details screen (refer to Figure 39 on page 71).
Name	This is the name you assigned to this port in the Basic Setting > Port Setup screen.
Link	This field displays the speed (either 10M for 10Mbps, 100M for 100Mbps or 1000M for 1000Mbps) and the duplex (F for full duplex or H for half). It also shows the cable type (Copper or Fiber) for the combo ports.
State	If STP (Spanning Tree Protocol) is enabled, this field displays the STP state of the port (see Section 13.1 on page 119 for more information). If STP is disabled, this field displays FORWARDING if the link is up, otherwise, it displays STOP .
LACP	This field displays whether LACP (Link Aggregation Control Protocol) has been enabled on the port.
TxPkts	This field shows the number of transmitted frames on this port.
RxPkts	This field shows the number of received frames on this port.
Errors	This field shows the number of received errors on this port.
Tx KB/s	This field shows the number of kilobytes per second transmitted on this port.

Table 6 Status (continued)

LABEL	DESCRIPTION
Rx KB/s	This field shows the number of kilobytes per second received on this port.
Up Time	This field shows the total amount of time in hours, minutes and seconds the port has been up.
Clear Counter	Enter a port number and then click Clear Counter to erase the recorded statistical information for that port, or select Any to clear statistics for all ports.

7.2.1 Status: Port Details

Click a number in the **Port** column in the **Status** screen to display individual port statistics. Use this screen to check status and detailed performance data about an individual port on the Switch.

Figure 39 Status > Port Details

Port Details		Port Status
Port Info	Port NO.	1
	Name	
	Link	Down
	Status	STOP
	LACP	Disabled
	TxPkts	0
	RxPkts	0
	Errors	0
	Tx KBs/s	0.0
	Rx KBs/s	0.0
	Up Time	0:00:00
TX Packet	TX Packets	0
	Multicast	0
	Broadcast	0
	Pause	0
RX Packet	RX Packets	0
	Multicast	0
	Broadcast	0
	Pause	0
TX Collision	Single	0
	Multiple	0
	Excessive	0
	Late	0
Error Packet	RX CRC	0
	Runt	0
Distribution	64	0
	65 to 127	0
	128 to 255	0
	256 to 511	0
	512 to 1023	0
	1024 to 1518	0
	Giant	0

The following table describes the labels in this screen.

Table 7 Status: Port Details

LABEL	DESCRIPTION
Port Info	
Port NO.	This field displays the port number you are viewing.
Name	This field displays the name of the port.
Link	This field displays the speed (either 10M for 10Mbps, 100M for 100Mbps or 1000M for 1000Mbps) and the duplex (F for full duplex or H for half duplex). It also shows the cable type (Copper or Fiber).
Status	If STP (Spanning Tree Protocol) is enabled, this field displays the STP state of the port (see Section 13.1 on page 119 for more information). If STP is disabled, this field displays FORWARDING if the link is up, otherwise, it displays STOP .
LACP	This field shows if LACP is enabled on this port or not.
TxPkts	This field shows the number of transmitted frames on this port
RxPkts	This field shows the number of received frames on this port
Errors	This field shows the number of received errors on this port.
Tx KB/s	This field shows the number kilobytes per second transmitted on this port.
Rx KB/s	This field shows the number of kilobytes per second received on this port.
Up Time	This field shows the total amount of time the connection has been up.
Tx Packet	
The following fields display detailed information about packets transmitted.	
TX Packet	This field shows the number of good packets (unicast, multicast and broadcast) transmitted.
Multicast	This field shows the number of good multicast packets transmitted.
Broadcast	This field shows the number of good broadcast packets transmitted.
Pause	This field shows the number of 802.3x Pause packets transmitted.
Rx Packet	
The following fields display detailed information about packets received.	
RX Packet	This field shows the number of good packets (unicast, multicast and broadcast) received.
Multicast	This field shows the number of good multicast packets received.
Broadcast	This field shows the number of good broadcast packets received.
Pause	This field shows the number of 802.3x Pause packets received.
TX Collision	
The following fields display information on collisions while transmitting.	
Single	This is a count of successfully transmitted packets for which transmission is inhibited by exactly one collision.
Multiple	This is a count of successfully transmitted packets for which transmission was inhibited by more than one collision.

Table 7 Status: Port Details (continued)

LABEL	DESCRIPTION
Excessive	This is a count of packets for which transmission failed due to excessive collisions. Excessive collision is defined as the number of maximum collisions before the retransmission count is reset.
Late	This is the number of times a late collision is detected, that is, after 512 bits of the packets have already been transmitted.
Error Packet	The following fields display detailed information about packets received that were in error.
RX CRC	This field shows the number of packets received with CRC (Cyclic Redundant Check) error(s).
Runt	This field shows the number of packets received that were too short (shorter than 64 octets), including the ones with CRC errors.
Distribution	
64	This field shows the number of packets (including bad packets) received that were 64 octets in length.
65-127	This field shows the number of packets (including bad packets) received that were between 65 and 127 octets in length.
128-255	This field shows the number of packets (including bad packets) received that were between 128 and 255 octets in length.
256-511	This field shows the number of packets (including bad packets) received that were between 256 and 511 octets in length.
512-1023	This field shows the number of packets (including bad packets) received that were between 512 and 1023 octets in length.
1024-1518	This field shows the number of packets (including bad packets) received that were between 1024 and 1518 octets in length.
Giant	This field shows the number of packets (including bad packets) received that were between 1519 octets and the maximum frame size. The maximum frame size varies depending on your switch model. See Chapter 40 on page 325 .

Basic Setting

This chapter describes how to configure the **System Info**, **General Setup**, **Switch Setup**, **IP Setup** and **Port Setup** screens.

8.1 Overview

The **System Info** screen displays general Switch information (such as firmware version number). The **General Setup** screen allows you to configure general Switch identification information. The **General Setup** screen also allows you to set the system time manually or get the current time and date from an external server when you turn on your Switch. The real time is then displayed in the Switch logs. The **Switch Setup** screen allows you to set up and configure global Switch features. The **IP Setup** screen allows you to configure a Switch IP address in each routing domain, subnet mask(s) and DNS (domain name server) for management purposes.

8.2 System Information

In the navigation panel, click **Basic Setting** > **System Info** to display the screen as shown. You can check the firmware version number.

Figure 40 Basic Setting > System Info



System Info	
System Name	MES-3528
ZyNOS FW Version	V3.90(BHR.0) b0 12/24/2008
Ethernet Address	00:19:cb:00:00:01

The following table describes the labels in this screen.

Table 8 Basic Setting > System Info

LABEL	DESCRIPTION
System Name	This field displays the descriptive name of the Switch for identification purposes.
ZyNOS F/W Version	This field displays the version number of the Switch 's current firmware including the date created.
Ethernet Address	This field refers to the Ethernet MAC (Media Access Control) address of the Switch.

8.3 General Setup

Use this screen to configure general settings such as the system name and time. Click **Basic Setting** > **General Setup** in the navigation panel to display the screen as shown.

Figure 41 Basic Setting > General Setup

The following table describes the labels in this screen.

Table 9 Basic Setting > General Setup

LABEL	DESCRIPTION
System Name	Choose a descriptive name for identification purposes. This name consists of up to 64 printable characters; spaces are allowed.
Location	Enter the geographic location of your Switch. You can use up to 32 printable ASCII characters; spaces are allowed.

Table 9 Basic Setting > General Setup (continued)

LABEL	DESCRIPTION
Contact Person's Name	Enter the name of the person in charge of this Switch. You can use up to 32 printable ASCII characters; spaces are allowed.
Use Time Server when Bootup	<p>Enter the time service protocol that your timeserver uses. Not all time servers support all protocols, so you may have to use trial and error to find a protocol that works. The main differences between them are the time format.</p> <p>When you select the Daytime (RFC 867) format, the Switch displays the day, month, year and time with no time zone adjustment. When you use this format it is recommended that you use a Daytime timeserver within your geographical time zone.</p> <p>Time (RFC-868) format displays a 4-byte integer giving the total number of seconds since 1970/1/1 at 0:0:0.</p> <p>NTP (RFC-1305) is similar to Time (RFC-868).</p> <p>None is the default value. Enter the time manually. Each time you turn on the Switch, the time and date will be reset to 1970-1-1 0:0:0.</p>
Time Server IP Address	Enter the IP address of your timeserver. The Switch searches for the timeserver for up to 60 seconds. If you select a timeserver that is unreachable, then this screen will appear locked for 60 seconds. Please wait.
Current Time	This field displays the time you open this menu (or refresh the menu).
New Time (hh:min:ss)	Enter the new time in hour, minute and second format. The new time then appears in the Current Time field after you click Apply .
Current Date	This field displays the date you open this menu.
New Date (yyyy-mm-dd)	Enter the new date in year, month and day format. The new date then appears in the Current Date field after you click Apply .
Time Zone	Select the time difference between UTC (Universal Time Coordinated, formerly known as GMT, Greenwich Mean Time) and your time zone from the drop-down list box.
Daylight Saving Time	<p>Daylight saving is a period from late spring to early fall when many countries set their clocks ahead of normal local time by one hour to give more daytime light in the evening.</p> <p>Select this option if you use Daylight Saving Time.</p>
Start Date	<p>Configure the day and time when Daylight Saving Time starts if you selected Daylight Saving Time. The time is displayed in the 24 hour format. Here are a couple of examples:</p> <p>Daylight Saving Time starts in most parts of the United States on the second Sunday of March. Each time zone in the United States starts using Daylight Saving Time at 2 A.M. local time. So in the United States you would select Second, Sunday, March and 2:00.</p> <p>Daylight Saving Time starts in the European Union on the last Sunday of March. All of the time zones in the European Union start using Daylight Saving Time at the same moment (1 A.M. GMT or UTC). So in the European Union you would select Last, Sunday, March and the last field depends on your time zone. In Germany for instance, you would select 2:00 because Germany's time zone is one hour ahead of GMT or UTC (GMT+1).</p>

Table 9 Basic Setting > General Setup (continued)

LABEL	DESCRIPTION
End Date	<p>Configure the day and time when Daylight Saving Time ends if you selected Daylight Saving Time. The time field uses the 24 hour format. Here are a couple of examples:</p> <p>Daylight Saving Time ends in the United States on the first Sunday of November. Each time zone in the United States stops using Daylight Saving Time at 2 A.M. local time. So in the United States you would select First, Sunday, November and 2:00.</p> <p>Daylight Saving Time ends in the European Union on the last Sunday of October. All of the time zones in the European Union stop using Daylight Saving Time at the same moment (1 A.M. GMT or UTC). So in the European Union you would select Last, Sunday, October and the last field depends on your time zone. In Germany for instance, you would select 2:00 because Germany's time zone is one hour ahead of GMT or UTC (GMT+1).</p>
Apply	Click Apply to save your changes to the Switch's run-time memory. The Switch loses these changes if it is turned off or loses power, so use the Save link on the top navigation panel to save your changes to the non-volatile memory when you are done configuring.
Cancel	Click Cancel to begin configuring this screen afresh.

8.4 Introduction to VLANs

A VLAN (Virtual Local Area Network) allows a physical network to be partitioned into multiple logical networks. Devices on a logical network belong to one group. A device can belong to more than one group. With VLAN, a device cannot directly talk to or hear from devices that are not in the same group(s); the traffic must first go through a router.

In MTU (Multi-Tenant Unit) applications, VLAN is vital in providing isolation and security among the subscribers. When properly configured, VLAN prevents one subscriber from accessing the network resources of another on the same LAN, thus a user will not see the printers and hard disks of another user in the same building.

VLAN also increases network performance by limiting broadcasts to a smaller and more manageable logical broadcast domain. In traditional switched environments, all broadcast packets go to each and every individual port. With VLAN, all broadcasts are confined to a specific broadcast domain.

Note: VLAN is unidirectional; it only governs outgoing traffic.

See [Chapter 9 on page 89](#) for information on port-based and 802.1Q tagged VLANs.

8.5 Switch Setup Screen

Click **Basic Setting** > **Switch Setup** in the navigation panel to display the screen as shown. The VLAN setup screens change depending on whether you choose **802.1Q** or **Port Based** in the **VLAN Type** field in this screen. Refer to the chapter on VLAN.

Figure 42 Basic Setting > Switch Setup

The following table describes the labels in this screen.

Table 10 Basic Setting > Switch Setup

LABEL	DESCRIPTION
VLAN Type	Choose 802.1Q or Port Based . The VLAN Setup screen changes depending on whether you choose 802.1Q VLAN type or Port Based VLAN type in this screen. See Chapter 9 on page 89 for more information.
GARP Timer: Switches join VLANs by making a declaration. A declaration is made by issuing a Join message using GARP. Declarations are withdrawn by issuing a Leave message. A Leave All message terminates all registrations. GARP timers set declaration timeout values. See the chapter on VLAN setup for more background information.	
Join Timer	Join Timer sets the duration of the Join Period timer for GVRP in milliseconds. Each port has a Join Period timer. The allowed Join Time range is between 100 and 65535 milliseconds; the default is 200 milliseconds. See the chapter on VLAN setup for more background information.
Leave Timer	Leave Time sets the duration of the Leave Period timer for GVRP in milliseconds. Each port has a single Leave Period timer. Leave Time must be two times larger than Join Timer ; the default is 600 milliseconds.

Table 10 Basic Setting > Switch Setup (continued)

LABEL	DESCRIPTION
Leave All Timer	Leave All Timer sets the duration of the Leave All Period timer for GVRP in milliseconds. Each port has a single Leave All Period timer. Leave All Timer must be larger than Leave Timer.
<p>Priority Queue Assignment</p> <p>IEEE 802.1p defines up to eight separate traffic types by inserting a tag into a MAC-layer frame that contains bits to define class of service. Frames without an explicit priority tag are given the default priority of the ingress port. Use the next fields to configure the priority level-to-physical queue mapping.</p> <p>The Switch has eight physical queues that you can map to the 8 priority levels. On the Switch, traffic assigned to higher index queues gets through faster while traffic in lower index queues is dropped if the network is congested.</p>	
Priority Level (The following descriptions are based on the traffic types defined in the IEEE 802.1d standard (which incorporates the 802.1p).	
Level 7	Typically used for network control traffic such as router configuration messages.
Level 6	Typically used for voice traffic that is especially sensitive to jitter (jitter is the variations in delay).
Level 5	Typically used for video that consumes high bandwidth and is sensitive to jitter.
Level 4	Typically used for controlled load, latency-sensitive traffic such as SNA (Systems Network Architecture) transactions.
Level 3	Typically used for "excellent effort" or better than best effort and would include important business traffic that can tolerate some delay.
Level 2	This is for "spare bandwidth".
Level 1	This is typically used for non-critical "background" traffic such as bulk transfers that are allowed but that should not affect other applications and users.
Level 0	Typically used for best-effort traffic.
Apply	Click Apply to save your changes to the Switch's run-time memory. The Switch loses these changes if it is turned off or loses power, so use the Save link on the top navigation panel to save your changes to the non-volatile memory when you are done configuring.
Cancel	Click Cancel to reset the fields.

8.6 IP Setup

Use the **IP Setup** screen to configure the Switch IP address, default gateway device, the default domain name server and the management VLAN ID. The default gateway specifies the IP address of the default gateway (next hop) for outgoing traffic.

8.6.1 Management IP Addresses

The Switch needs an IP address for it to be managed over the network. The factory default IP address is 192.168.1.1. The subnet mask specifies the network number portion of an IP address. The factory default subnet mask is 255.255.255.0.

You can configure up to 64 IP addresses which are used to access and manage the Switch from the ports belonging to the pre-defined VLAN(s).

Note: You must configure a VLAN first.

Figure 43 Basic Setting > IP Setup

The screenshot shows the 'IP Setup' configuration page. At the top, there is a 'Domain Name Server' field with the value '0.0.0.0'. Below this, the 'Default Management IP Address' section has two radio buttons: 'DHCP Client' (unselected) and 'Static IP Address' (selected). Under 'Static IP Address', there are three input fields: 'IP Address' (192.168.1.1), 'IP Subnet Mask' (255.255.255.0), and 'Default Gateway' (0.0.0.0). A 'VID' field below these contains the value '1'. There are 'Apply' and 'Cancel' buttons. Below this is the 'Management IP Addresses' section, which has a form with four rows: 'IP Address' (0.0.0.0), 'IP Subnet Mask' (0.0.0.0), 'VID' (empty), and 'Default Gateway' (0.0.0.0). There are 'Add' and 'Cancel' buttons. At the bottom, there is a table with the following data:

Index	IP Address	IP Subnet Mask	VID	Default Gateway	Delete
1	192.168.2.1	255.255.255.0	2	0.0.0.0	<input type="checkbox"/>

Below the table are 'Delete' and 'Cancel' buttons.

The following table describes the labels in this screen.

Table 11 Basic Setting > IP Setup

LABEL	DESCRIPTION
Domain Name Server	DNS (Domain Name System) is for mapping a domain name to its corresponding IP address and vice versa. Enter a domain name server IP address in order to be able to use a domain name instead of an IP address.
Default Management IP Address	
DHCP Client	Select this option if you have a DHCP server that can assign the Switch an IP address, subnet mask, a default gateway IP address and a domain name server IP address automatically.
Static IP Address	Select this option if you don't have a DHCP server or if you wish to assign static IP address information to the Switch. You need to fill in the following fields when you select this option.
IP Address	Enter the IP address of your Switch in dotted decimal notation for example 192.168.1.1.
IP Subnet Mask	Enter the IP subnet mask of your Switch in dotted decimal notation for example 255.255.255.0.
Default Gateway	Enter the IP address of the default outgoing gateway in dotted decimal notation, for example 192.168.1.254.
VID	Enter the VLAN identification number associated with the Switch IP address. This is the VLAN ID of the CPU and is used for management only. The default is "1". All ports, by default, are fixed members of this "management VLAN" in order to manage the device from any port. If a port is not a member of this VLAN, then users on that port cannot access the device. To access the Switch make sure the port that you are connected to is a member of Management VLAN.
Management IP Addresses	
You can create up to 64 IP addresses, which are used to access and manage the Switch from the ports belonging to the pre-defined VLAN(s). You must configure a VLAN first.	
IP Address	Enter the IP address for managing the Switch by the members of the VLAN specified in the VID field below.
IP Subnet Mask	Enter the IP subnet mask in dotted decimal notation.
VID	Type the VLAN group identification number.
Default Gateway	Enter the IP address of the default outgoing gateway in dotted decimal notation.
Add	Click Add to insert the entry to the summary table below and save your changes to the Switch's run-time memory. The Switch loses these changes if it is turned off or loses power, so use the Save link on the top navigation panel to save your changes to the non-volatile memory when you are done configuring.
Cancel	Click Cancel to reset the fields to your previous configuration.
Index	This field displays the index number of the rule. Click an index number to edit the rule.
IP Address	This field displays the IP address.
IP Subnet Mask	This field displays the subnet mask.
VID	This field displays the ID number of the VLAN group.

Table 11 Basic Setting > IP Setup (continued)

LABEL	DESCRIPTION
Default Gateway	This field displays the IP address of the default gateway.
Delete	Check the management IP addresses that you want to remove in the Delete column, then click the Delete button.
Cancel	Click Cancel to clear the selected check boxes in the Delete column.

8.7 Port Setup

Use this screen to configure Switch port settings. Click **Basic Setting** > **Port Setup** in the navigation panel to display the configuration screen.

Figure 44 Basic Setting > Port Setup

Port	Active	Name	Type	Speed / Duplex	Flow Control	802.1p Priority
*	<input type="checkbox"/>		-	Auto	<input type="checkbox"/>	0
1	<input checked="" type="checkbox"/>		10/100M	Auto	<input type="checkbox"/>	0
2	<input checked="" type="checkbox"/>		10/100M	Auto	<input type="checkbox"/>	0
3	<input checked="" type="checkbox"/>		10/100M	Auto	<input type="checkbox"/>	0
4	<input checked="" type="checkbox"/>		10/100M	Auto	<input type="checkbox"/>	0
5	<input checked="" type="checkbox"/>		10/100M	Auto	<input type="checkbox"/>	0
6	<input checked="" type="checkbox"/>		10/100M	Auto	<input type="checkbox"/>	0
7	<input checked="" type="checkbox"/>		10/100M	Auto	<input type="checkbox"/>	0
8	<input checked="" type="checkbox"/>		10/100M	Auto	<input type="checkbox"/>	0
9	<input checked="" type="checkbox"/>		10/100M	Auto	<input type="checkbox"/>	0
10	<input checked="" type="checkbox"/>		10/100M	Auto	<input type="checkbox"/>	0
24	<input checked="" type="checkbox"/>		10/100M	Auto	<input type="checkbox"/>	0
25	<input checked="" type="checkbox"/>		10/100/1000M	Auto	<input type="checkbox"/>	0
26	<input checked="" type="checkbox"/>		10/100/1000M	Auto	<input type="checkbox"/>	0
27	<input checked="" type="checkbox"/>		10/100/1000M	Auto	<input type="checkbox"/>	0
28	<input checked="" type="checkbox"/>		10/100/1000M	Auto	<input type="checkbox"/>	0

Apply Cancel

The following table describes the labels in this screen.

Table 12 Basic Setting > Port Setup

LABEL	DESCRIPTION
Port	This is the port index number.
*	<p>Settings in this row apply to all ports.</p> <p>Use this row only if you want to make some settings the same for all ports. Use this row first to set the common settings and then make adjustments on a port-by-port basis.</p> <p>Note: Changes in this row are copied to all the ports as soon as you make them.</p>
Active	Select this check box to enable a port. The factory default for all ports is enabled. A port must be enabled for data transmission to occur.
Name	<p>Enter a descriptive name that identifies this port. You can enter up to 64 alpha-numerical characters.</p> <p>Note: Due to space limitation, the port name may be truncated in some web configurator screens.</p>
Type	This field displays 10/100M for Fast Ethernet connections and 10/100/1000M for Gigabit connections.
Speed/ Duplex	<p>Select the speed and the duplex mode of the Ethernet connection on this port. Choices are Auto, 10M/Half Duplex, 10M/Full Duplex, 100M/Half Duplex, 100M/Full Duplex and 1000M/Full Duplex (Gigabit connections only).</p> <p>Selecting Auto (auto-negotiation) allows one port to negotiate with a peer port automatically to obtain the connection speed and duplex mode that both ends support. When auto-negotiation is turned on, a port on the Switch negotiates with the peer automatically to determine the connection speed and duplex mode. If the peer port does not support auto-negotiation or turns off this feature, the Switch determines the connection speed by detecting the signal on the cable and using half duplex mode. When the Switch's auto-negotiation is turned off, a port uses the pre-configured speed and duplex mode when making a connection, thus requiring you to make sure that the settings of the peer port are the same in order to connect.</p>
Flow Control	<p>A concentration of traffic on a port decreases port bandwidth and overflows buffer memory causing packet discards and frame losses. Flow Control is used to regulate transmission of signals to match the bandwidth of the receiving port.</p> <p>The Switch uses IEEE802.3x flow control in full duplex mode and backpressure flow control in half duplex mode.</p> <p>IEEE802.3x flow control is used in full duplex mode to send a pause signal to the sending port, causing it to temporarily stop sending signals when the receiving port memory buffers fill.</p> <p>Back Pressure flow control is typically used in half duplex mode to send a "collision" signal to the sending port (mimicking a state of packet collision) causing the sending port to temporarily stop sending signals and resend later. Select Flow Control to enable it.</p>

Table 12 Basic Setting > Port Setup (continued)

LABEL	DESCRIPTION
802.1p Priority	This priority value is added to incoming frames without a (802.1p) priority queue tag. See Priority Queue Assignment in Table 10 on page 79 for more information.
Apply	Click Apply to save your changes to the Switch's run-time memory. The Switch loses these changes if it is turned off or loses power, so use the Save link on the top navigation panel to save your changes to the non-volatile memory when you are done configuring.
Cancel	Click Cancel to begin configuring this screen afresh.

PART III

Advanced

VLAN (89)

Static MAC Forward Setup (109)

Filtering (117)

Spanning Tree Protocol (119)

Bandwidth Control (141)

Broadcast Storm Control (145)

Mirroring (147)

Link Aggregation (149)

Port Authentication (159)

Port Security (163)

Classifier (167)

Policy Rule (173)

Queuing Method (179)

Multicast (183)

AAA (199)

IP Source Guard (213)

Loop Guard (239)

Layer 2 Protocol Tunneling (243)

The type of screen you see here depends on the **VLAN Type** you selected in the **Switch Setup** screen. This chapter shows you how to configure 802.1Q tagged and port-based VLANs.

9.1 Introduction to IEEE 802.1Q Tagged VLANs

A tagged VLAN uses an explicit tag (VLAN ID) in the MAC header to identify the VLAN membership of a frame across bridges - they are not confined to the switch on which they were created. The VLANs can be created statically by hand or dynamically through GVRP. The VLAN ID associates a frame with a specific VLAN and provides the information that switches need to process the frame across the network. A tagged frame is four bytes longer than an untagged frame and contains two bytes of TPID (Tag Protocol Identifier, residing within the type/length field of the Ethernet frame) and two bytes of TCI (Tag Control Information, starts after the source address field of the Ethernet frame).

The CFI (Canonical Format Indicator) is a single-bit flag, always set to zero for Ethernet switches. If a frame received at an Ethernet port has a CFI set to 1, then that frame should not be forwarded as it is to an untagged port. The remaining twelve bits define the VLAN ID, giving a possible maximum number of 4,096 VLANs. Note that user priority and VLAN ID are independent of each other. A frame with VID (VLAN Identifier) of null (0) is called a priority frame, meaning that only the priority level is significant and the default VID of the ingress port is given as the VID of the frame. Of the 4096 possible VIDs, a VID of 0 is used to identify priority frames and value 4095 (FFF) is reserved, so the maximum possible VLAN configurations are 4,094.

TPID	User Priority	CFI	VLAN ID
2 Bytes	3 Bits	1 Bit	12 bits

9.1.1 Forwarding Tagged and Untagged Frames

Each port on the Switch is capable of passing tagged or untagged frames. To forward a frame from an 802.1Q VLAN-aware switch to an 802.1Q VLAN-unaware

switch, the Switch first decides where to forward the frame and then strips off the VLAN tag. To forward a frame from an 802.1Q VLAN-unaware switch to an 802.1Q VLAN-aware switch, the Switch first decides where to forward the frame, and then inserts a VLAN tag reflecting the ingress port's default VID. The default PVID is VLAN 1 for all ports, but this can be changed.

A broadcast frame (or a multicast frame for a multicast group that is known by the system) is duplicated only on ports that are members of the VID (except the ingress port itself), thus confining the broadcast to a specific domain.

9.2 Automatic VLAN Registration

GARP and GVRP are the protocols used to automatically register VLAN membership across switches.

9.2.1 GARP

GARP (Generic Attribute Registration Protocol) allows network switches to register and de-register attribute values with other GARP participants within a bridged LAN. GARP is a protocol that provides a generic mechanism for protocols that serve a more specific application, for example, GVRP.

9.2.1.1 GARP Timers

Switches join VLANs by making a declaration. A declaration is made by issuing a Join message using GARP. Declarations are withdrawn by issuing a Leave message. A Leave All message terminates all registrations. GARP timers set declaration timeout values.

9.2.2 GVRP

GVRP (GARP VLAN Registration Protocol) is a registration protocol that defines a way for switches to register necessary VLAN members on ports across the network. Enable this function to permit VLAN groups beyond the local Switch.

Please refer to the following table for common IEEE 802.1Q VLAN terminology.

Table 13 IEEE 802.1Q VLAN Terminology

VLAN PARAMETER	TERM	DESCRIPTION
VLAN Type	Permanent VLAN	This is a static VLAN created manually.
	Dynamic VLAN	This is a VLAN configured by a GVRP registration/deregistration process.

Table 13 IEEE 802.1Q VLAN Terminology (continued)

VLAN PARAMETER	TERM	DESCRIPTION
VLAN Administrative Control	Registration Fixed	Fixed registration ports are permanent VLAN members.
	Registration Forbidden	Ports with registration forbidden are forbidden to join the specified VLAN.
	Normal Registration	Ports dynamically join a VLAN using GVRP.
VLAN Tag Control	Tagged	Ports belonging to the specified VLAN tag all outgoing frames transmitted.
	Untagged	Ports belonging to the specified VLAN don't tag all outgoing frames transmitted.
VLAN Port	Port VID	This is the VLAN ID assigned to untagged frames that this port received.
	Acceptable Frame Type	You may choose to accept both tagged and untagged incoming frames, just tagged incoming frames or just untagged incoming frames on a port.
	Ingress filtering	If set, the Switch discards incoming frames for VLANs that do not have this port as a member

9.3 Port VLAN Trunking

Enable **VLAN Trunking** on a port to allow frames belonging to unknown VLAN groups to pass through that port. This is useful if you want to set up VLAN groups on end devices without having to configure the same VLAN groups on intermediary devices.

Refer to the following figure. Suppose you want to create VLAN groups 1 and 2 (V1 and V2) on devices A and B. Without **VLAN Trunking**, you must configure VLAN groups 1 and 2 on all intermediary switches C, D and E; otherwise they will drop frames with unknown VLAN group tags. However, with **VLAN Trunking** enabled on a port(s) in each intermediary switch you only need to create VLAN groups in the end devices (A and B). C, D and E automatically allow frames with

VLAN group tags 1 and 2 (VLAN groups that are unknown to those switches) to pass through their VLAN trunking port(s).

Figure 45 Port VLAN Trunking

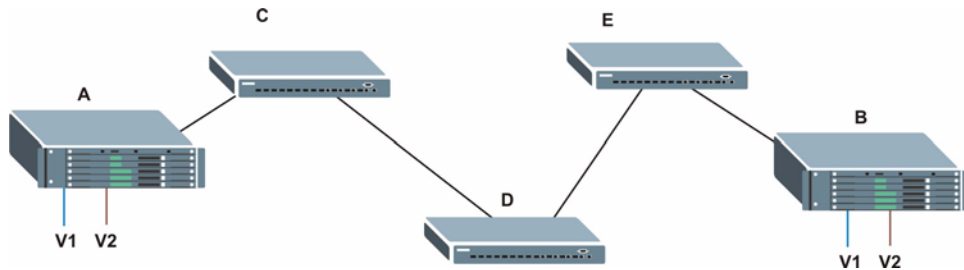

9.4 Select the VLAN Type

Select a VLAN type in the **Basic Setting > Switch Setup** screen.

Figure 46 Switch Setup > Select VLAN Type



9.5 Static VLAN

Use a static VLAN to decide whether an incoming frame on a port should be

- sent to a VLAN group as normal depending on its VLAN tag.
- sent to a group whether it has a VLAN tag or not.
- blocked from a VLAN group regardless of its VLAN tag.

You can also tag all outgoing frames (that were previously untagged) from a port with the specified VID.

9.5.1 VLAN Status

See [Section 9.1 on page 89](#) for more information on Static VLAN. Click **Advanced Application** > **VLAN** from the navigation panel to display the **VLAN Status** screen as shown next.

Figure 47 Advanced Application > VLAN: VLAN Status

Index	VID	Elapsed Time	Status
1	1	0:52:21	Static

The following table describes the labels in this screen.

Table 14 Advanced Application > VLAN: VLAN Status

LABEL	DESCRIPTION
VLAN Search by VID	Enter an existing VLAN ID number(s) (separated by a comma) and click Search to display only the specified VLAN(s) in the list below. Leave this field blank and click Search to display all VLANs configured on the Switch.
The Number of VLAN	This is the number of VLANs configured on the Switch.
The Number of Search Results	This is the number of VLANs that match the searching criteria and display in the list below. This field displays only when you use the Search button to look for certain VLANs.
Index	This is the VLAN index number. Click on an index number to view more VLAN details.
VID	This is the VLAN identification number that was configured in the Static VLAN screen.
Elapsed Time	This field shows how long it has been since a normal VLAN was registered or a static VLAN was set up.

Table 14 Advanced Application > VLAN: VLAN Status (continued)

LABEL	DESCRIPTION
Status	This field shows how this VLAN was added to the Switch. dynamic: using GVRP static: added as a permanent entry other: added in another way such as via Multicast VLAN Registration (MVR)
Change Pages	Click Previous or Next to show the previous/next screen if all status information cannot be seen in one screen.

9.5.2 VLAN Details

Use this screen to view detailed port settings and status of the VLAN group. See [Section 9.1 on page 89](#) for more information on static VLAN. Click on an index number in the **VLAN Status** screen to display VLAN details.

Figure 48 Advanced Application > VLAN > VLAN Detail

The screenshot shows the 'VLAN Detail' screen with a 'VLAN Status' link in the top right. The main content is a table with the following structure:

VID	Port Number														Elapsed Time	Status
	2	4	6	8	10	12	14	16	18	20	22	24	26	28		
1	U	U	U	U	U	U	U	U	U	U	U	U	U	U	142:09:00	Static

The following table describes the labels in this screen.

Table 15 Advanced Application > VLAN > VLAN Detail

LABEL	DESCRIPTION
VLAN Status	Click this to go to the VLAN Status screen.
VID	This is the VLAN identification number that was configured in the Static VLAN screen.
Port Number	This column displays the ports that are participating in a VLAN. A tagged port is marked as T , an untagged port is marked as U and ports not participating in a VLAN are marked as "-".
Elapsed Time	This field shows how long it has been since a normal VLAN was registered or a static VLAN was set up.
Status	This field shows how this VLAN was added to the Switch. dynamic: using GVRP static: added as a permanent entry other: added in another way such as via Multicast VLAN Registration (MVR)

9.5.3 Configure a Static VLAN

Use this screen to configure and view 802.1Q VLAN parameters for the Switch. See [Section 9.1 on page 89](#) for more information on static VLAN. To configure a static VLAN, click **Static VLAN** in the **VLAN Status** screen to display the screen as shown next.

Figure 49 Advanced Application > VLAN > Static VLAN

The screenshot shows the 'Static VLAN' configuration interface. At the top, there is a title bar with 'Static VLAN' and a 'VLAN Status' link. Below the title bar, there is an 'ACTIVE' checkbox, a 'Name' text input field, and a 'VLAN Group ID' text input field. The main part of the screen is a table with three columns: 'Port', 'Control', and 'Tagging'. The 'Control' column has a dropdown menu set to 'Normal'. The 'Tagging' column has a 'Tx Tagging' checkbox checked for each row. Below the table, there are 'Add', 'Cancel', and 'Clear' buttons. At the bottom, there is a table with four columns: 'VID', 'Active', 'Name', and 'Delete'.

Port	Control	Tagging
*	Normal	<input checked="" type="checkbox"/> Tx Tagging
1	<input checked="" type="radio"/> Normal <input type="radio"/> Fixed <input type="radio"/> Forbidden	<input checked="" type="checkbox"/> Tx Tagging
2	<input checked="" type="radio"/> Normal <input type="radio"/> Fixed <input type="radio"/> Forbidden	<input checked="" type="checkbox"/> Tx Tagging
3	<input checked="" type="radio"/> Normal <input type="radio"/> Fixed <input type="radio"/> Forbidden	<input checked="" type="checkbox"/> Tx Tagging
4	<input checked="" type="radio"/> Normal <input type="radio"/> Fixed <input type="radio"/> Forbidden	<input checked="" type="checkbox"/> Tx Tagging
5	<input checked="" type="radio"/> Normal <input type="radio"/> Fixed <input type="radio"/> Forbidden	<input checked="" type="checkbox"/> Tx Tagging
6	<input checked="" type="radio"/> Normal <input type="radio"/> Fixed <input type="radio"/> Forbidden	<input checked="" type="checkbox"/> Tx Tagging
7	<input checked="" type="radio"/> Normal <input type="radio"/> Fixed <input type="radio"/> Forbidden	<input checked="" type="checkbox"/> Tx Tagging
8	<input checked="" type="radio"/> Normal <input type="radio"/> Fixed <input type="radio"/> Forbidden	<input checked="" type="checkbox"/> Tx Tagging
9	<input checked="" type="radio"/> Normal <input type="radio"/> Fixed <input type="radio"/> Forbidden	<input checked="" type="checkbox"/> Tx Tagging
10	<input checked="" type="radio"/> Normal <input type="radio"/> Fixed <input type="radio"/> Forbidden	<input checked="" type="checkbox"/> Tx Tagging
11	<input checked="" type="radio"/> Normal <input type="radio"/> Fixed <input type="radio"/> Forbidden	<input checked="" type="checkbox"/> Tx Tagging

VID	Active	Name	Delete
1	Yes	1	<input type="checkbox"/>

The following table describes the related labels in this screen.

Table 16 Advanced Application > VLAN > Static VLAN

LABEL	DESCRIPTION
ACTIVE	Select this check box to activate the VLAN settings.
Name	Enter a descriptive name for the VLAN group for identification purposes. This name consists of up to 64 printable characters.
VLAN Group ID	Enter the VLAN ID for this static entry; the valid range is between 1 and 4094.
Port	The port number identifies the port you are configuring.

Table 16 Advanced Application > VLAN > Static VLAN (continued)

LABEL	DESCRIPTION
*	<p>Settings in this row apply to all ports.</p> <p>Use this row only if you want to make some settings the same for all ports. Use this row first to set the common settings and then make adjustments on a port-by-port basis.</p> <p>Note: Changes in this row are copied to all the ports as soon as you make them.</p>
Control	<p>Select Normal for the port to dynamically join this VLAN group using GVRP. This is the default selection.</p> <p>Select Fixed for the port to be a permanent member of this VLAN group.</p> <p>Select Forbidden if you want to prohibit the port from joining this VLAN group.</p>
Tagging	<p>Select TX Tagging if you want the port to tag all outgoing frames transmitted with this VLAN Group ID.</p>
Add	<p>Click Add to save your changes to the Switch's run-time memory. The Switch loses these changes if it is turned off or loses power, so use the Save link on the top navigation panel to save your changes to the non-volatile memory when you are done configuring.</p>
Cancel	<p>Click Cancel to change the fields back to their last saved values.</p>
Clear	<p>Click Clear to start configuring the screen again.</p>
VID	<p>This field displays the ID number of the VLAN group. Click the number to edit the VLAN settings.</p>
Active	<p>This field indicates whether the VLAN settings are enabled (Yes) or disabled (No).</p>
Name	<p>This field displays the descriptive name for this VLAN group.</p>
Delete	<p>Click Delete to remove the selected entry from the summary table.</p>
Cancel	<p>Click Cancel to clear the Delete check boxes.</p>

9.5.4 Configure VLAN Port Settings

Use the VLAN Port Setting screen to configure the static VLAN (IEEE 802.1Q) settings on a port. See [Section 9.1 on page 89](#) for more information on static VLAN. Click the **VLAN Port Setting** link in the **VLAN Status** screen.

Figure 50 Advanced Application > VLAN > VLAN Port Setting

Port	PVID	GVRP	Acceptable Frame Type	VLAN Trunking	Isolation
+		<input type="checkbox"/>	All	<input type="checkbox"/>	<input type="checkbox"/>
1	1	<input type="checkbox"/>	All	<input type="checkbox"/>	<input type="checkbox"/>
2	1	<input type="checkbox"/>	All	<input type="checkbox"/>	<input type="checkbox"/>
3	1	<input type="checkbox"/>	All	<input type="checkbox"/>	<input type="checkbox"/>
4	1	<input type="checkbox"/>	All	<input type="checkbox"/>	<input type="checkbox"/>
5	1	<input type="checkbox"/>	All	<input type="checkbox"/>	<input type="checkbox"/>
6	1	<input type="checkbox"/>	All	<input type="checkbox"/>	<input type="checkbox"/>
7	1	<input type="checkbox"/>	All	<input type="checkbox"/>	<input type="checkbox"/>
8	1	<input type="checkbox"/>	All	<input type="checkbox"/>	<input type="checkbox"/>
9	1	<input type="checkbox"/>	All	<input type="checkbox"/>	<input type="checkbox"/>
10	1	<input type="checkbox"/>	All	<input type="checkbox"/>	<input type="checkbox"/>
26	1	<input type="checkbox"/>	All	<input type="checkbox"/>	<input type="checkbox"/>

The following table describes the labels in this screen.

Table 17 Advanced Application > VLAN > VLAN Port Setting

LABEL	DESCRIPTION
GVRP	GVRP (GARP VLAN Registration Protocol) is a registration protocol that defines a way for switches to register necessary VLAN members on ports across the network. Select this check box to permit VLAN groups beyond the local Switch.
Ingress Check	If this check box is selected, the Switch discards incoming frames on a port for VLANs that do not include this port in its member set. Clear this check box to disable ingress filtering.
Port	This field displays the port number.

Table 17 Advanced Application > VLAN > VLAN Port Setting (continued)

LABEL	DESCRIPTION
*	<p>Settings in this row apply to all ports.</p> <p>Use this row only if you want to make some settings the same for all ports. Use this row first to set the common settings and then make adjustments on a port-by-port basis.</p> <p>Note: Changes in this row are copied to all the ports as soon as you make them.</p>
PVID	<p>A PVID (Port VLAN ID) is a tag that adds to incoming untagged frames received on a port so that the frames are forwarded to the VLAN group that the tag defines.</p> <p>Enter a number between 1 and 4094 as the port VLAN ID.</p>
GVRP	<p>Select this check box to allow GVRP on this port.</p>
Acceptable Frame Type	<p>Specify the type of frames allowed on a port. Choices are All, Tag Only and Untag Only.</p> <p>Select All from the drop-down list box to accept all untagged or tagged frames on this port. This is the default setting.</p> <p>Select Tag Only to accept only tagged frames on this port. All untagged frames will be dropped.</p> <p>Select Untag Only to accept only untagged frames on this port. All tagged frames will be dropped.</p>
VLAN Trunking	<p>Enable VLAN Trunking on ports connected to other switches or routers (but not ports directly connected to end users) to allow frames belonging to unknown VLAN groups to pass through the Switch.</p>
Isolation	<p>Select this to allow this port to communicate only with the CPU management port and the ports on which the isolation feature is not enabled.</p>
Apply	<p>Click Apply to save your changes to the Switch's run-time memory. The Switch loses these changes if it is turned off or loses power, so use the Save link on the top navigation panel to save your changes to the non-volatile memory when you are done configuring.</p>
Cancel	<p>Click Cancel to begin configuring this screen afresh.</p>

9.6 Subnet Based VLANs

Subnet based VLANs allow you to group traffic into logical VLANs based on the source IP subnet you specify. When a frame is received on a port, the Switch checks if a tag is added already and the IP subnet it came from. The untagged packets from the same IP subnet are then placed in the same subnet based VLAN. One advantage of using subnet based VLANs is that priority can be assigned to traffic from the same IP subnet.

For example, an ISP (Internet Services Provider) may divide different types of services it provides to customers into different IP subnets. Traffic for voice services is designated for IP subnet 172.16.1.0/24, video for 192.168.1.0/24 and data for 10.1.1.0/24. The Switch can then be configured to group incoming traffic based on the source IP subnet of incoming frames.

You configure a subnet based VLAN with priority 6 and VID of 100 for traffic received from IP subnet 172.16.1.0/24 (voice services). You also have a subnet based VLAN with priority 5 and VID of 200 for traffic received from IP subnet 192.168.1.0/24 (video services). Lastly, you configure VLAN with priority 3 and VID of 300 for traffic received from IP subnet 10.1.1.0/24 (data services). All untagged incoming frames will be classified based on their source IP subnet and prioritized accordingly. That is video services receive the highest priority and data the lowest.

Figure 51 Subnet Based VLAN Application Example

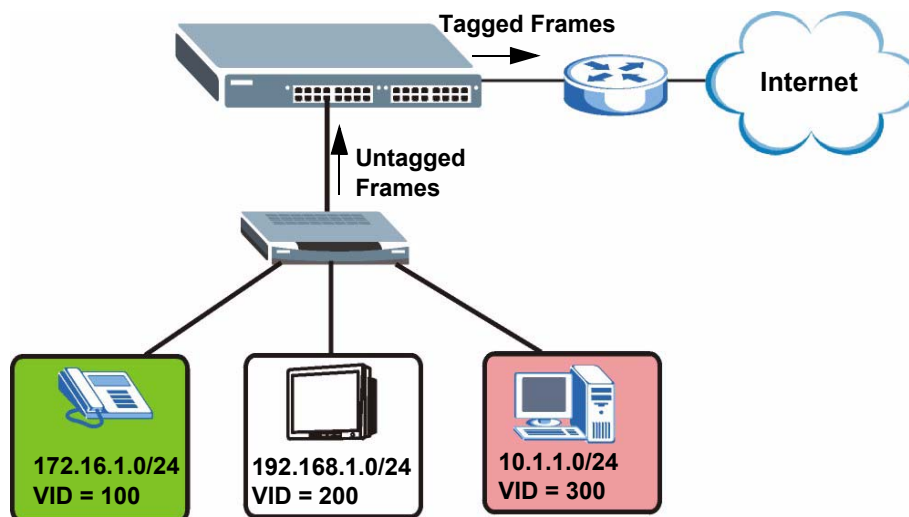

9.7 Configuring Subnet Based VLAN

Click **Subnet Based VLAN** in the **VLAN Port Setting** screen to display the configuration screen as shown.

Note: Subnet based VLAN applies to un-tagged packets and is applicable only when you use IEEE 802.1Q tagged VLAN.

Figure 52 Advanced Application > VLAN > VLAN Port Setting > Subnet Based VLAN

The following table describes the labels in this screen.

Table 18 Advanced Application > VLAN > VLAN Port Setting > Subnet Based VLAN Setup

LABEL	DESCRIPTION
Active	Check this box to activate this subnet based VLANs on the Switch.
DHCP-Vlan Override	When DHCP snooping is enabled DHCP clients can renew their IP address through the DHCP VLAN or via another DHCP server on the subnet based VLAN. Select this checkbox to force the DHCP clients in this IP subnet to obtain their IP addresses through the DHCP VLAN.
Apply	Click Apply to save your changes to the Switch's run-time memory. The Switch loses these changes if it is turned off or loses power, so use the Save link on the top navigation panel to save your changes to the non-volatile memory when you are done configuring.
Active	Check this box to activate the IP subnet VLAN you are creating or editing.
Name	Enter up to 32 alpha numeric characters to identify this subnet based VLAN.
IP	Enter the IP address of the subnet for which you want to configure this subnet based VLAN.
Mask-Bits	Enter the bit number of the subnet mask. To find the bit number, convert the subnet mask to binary format and add all the 1's together. Take "255.255.255.0" for example. 255 converts to eight 1s in binary. There are three 255s, so add three eights together and you get the bit number (24).

Table 18 Advanced Application > VLAN > VLAN Port Setting > Subnet Based VLAN Setup (continued)

LABEL	DESCRIPTION
VID	Enter the ID of a VLAN with which the untagged frames from the IP subnet specified in this subnet based VLAN are tagged. This must be an existing VLAN which you defined in the Advanced Applications > VLAN screens.
Priority	Select the priority level that the Switch assigns to frames belonging to this VLAN.
Add	Click Add to save your changes to the Switch's run-time memory. The Switch loses these changes if it is turned off or loses power, so use the Save link on the top navigation panel to save your changes to the non-volatile memory when you are done configuring.
Cancel	Click Cancel to begin configuring this screen afresh.
Index	This is the index number identifying this subnet based VLAN. Click on any of these numbers to edit an existing subnet based VLAN.
Active	This field shows whether the subnet based VLAN is active or not.
Name	This field shows the name the subnet based VLAN.
IP	This field shows the IP address of the subnet for this subnet based VLAN.
Mask-Bits	This field shows the subnet mask in bit number format for this subnet based VLAN.
VID	This field shows the VLAN ID of the frames which belong to this subnet based VLAN.
Priority	This field shows the priority which is assigned to frames belonging to this subnet based VLAN.
Delete	Click this to delete the subnet based VLANs which you marked for deletion.
Cancel	Click Cancel to begin configuring this screen afresh.

9.8 Protocol Based VLANs

Protocol based VLANs allow you to group traffic into logical VLANs based on the protocol you specify. When an upstream frame is received on a port (configured for a protocol based VLAN), the Switch checks if a tag is added already and its protocol. The untagged packets of the same protocol are then placed in the same protocol based VLAN. One advantage of using protocol based VLANs is that priority can be assigned to traffic of the same protocol.

Note: Protocol based VLAN applies to un-tagged packets and is applicable only when you use IEEE 802.1Q tagged VLAN.

For example, port 1, 2, 3 and 4 belong to static VLAN 100, and port 4, 5, 6, 7 belong to static VLAN 120. You configure a protocol based VLAN A with priority 3 for ARP traffic received on port 1, 2 and 3. You also have a protocol based VLAN B with priority 2 for Apple Talk traffic received on port 6 and 7. All upstream ARP traffic from port 1, 2 and 3 will be grouped together, and all upstream Apple Talk

traffic from port 6 and 7 will be in another group and have higher priority than ARP traffic, when they go through the uplink port to a backbone switch C.

Figure 53 Protocol Based VLAN Application Example

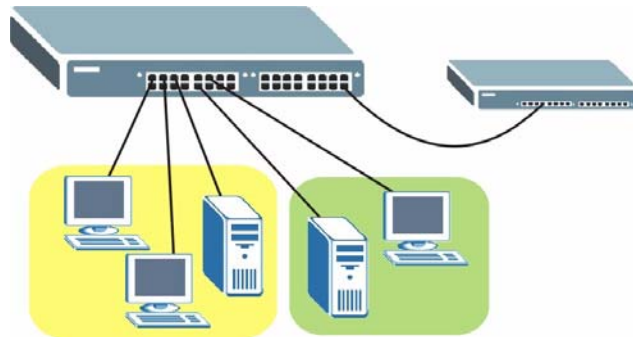

9.9 Configuring Protocol Based VLAN

Click **Protocol Based VLAN** in the **VLAN Port Setting** screen to display the configuration screen as shown.

Note: Protocol-based VLAN applies to un-tagged packets and is applicable only when you use IEEE 802.1Q tagged VLAN.

Figure 54 Advanced Application > VLAN > VLAN Port Setting > Protocol Based VLAN

Protocol Based VLAN
Vlan Port Setting

Active

Port

Name

Ethernet-type IP
 Others (Hex)

VID

Priority

Index	Active	Port	Name	Ethernet-type	VID	Priority	Delete
<input type="button" value="Delete"/> <input type="button" value="Cancel"/>							

The following table describes the labels in this screen.

Table 19 Advanced Application > VLAN > VLAN Port Setting > Protocol Based VLAN Setup

LABEL	DESCRIPTION
Active	Check this box to activate this protocol based VLAN.
Port	Type a port to be included in this protocol based VLAN. This port must belong to a static VLAN in order to participate in a protocol based VLAN. See Chapter 9 on page 89 for more details on setting up VLANs.
Name	Enter up to 32 alpha numeric characters to identify this protocol based VLAN.
Ethernet-type	Use the drop down list box to select a predefined protocol to be included in this protocol based VLAN or select Others and type the protocol number in hexadecimal notation. For example the IP protocol in hexadecimal notation is 0800, and Novell IPX protocol is 8137. Note: Protocols in the hexadecimal number range of 0x0000 to 0x05ff are not allowed to be used for protocol based VLANs.
VID	Enter the ID of a VLAN to which the port belongs. This must be an existing VLAN which you defined in the Advanced Applications > VLAN screens.
Priority	Select the priority level that the Switch will assign to frames belonging to this VLAN.
Add	Click Add to save your changes to the Switch's run-time memory. The Switch loses these changes if it is turned off or loses power, so use the Save link on the top navigation panel to save your changes to the non-volatile memory when you are done configuring.
Cancel	Click Cancel to begin configuring this screen afresh.
Index	This is the index number identifying this protocol based VLAN. Click on any of these numbers to edit an existing protocol based VLAN.
Active	This field shows whether the protocol based VLAN is active or not.
Port	This field shows which port belongs to this protocol based VLAN.
Name	This field shows the name the protocol based VLAN.
Ethernet Type	This field shows which Ethernet protocol is part of this protocol based VLAN.
VID	This field shows the VLAN ID of the port.
Priority	This field shows the priority which is assigned to frames belonging to this protocol based VLAN.
Delete	Click this to delete the protocol based VLANs which you marked for deletion.
Cancel	Click Cancel to begin configuring this screen afresh.

9.10 Create an IP-based VLAN Example

This example shows you how to create an IP VLAN which includes ports 1, 4 and 8. Follow these steps:

- 1 Activate this protocol based VLAN.
- 2 Type the port number you want to include in this protocol based VLAN. Type **1**.
- 3 Give this protocol-based VLAN a descriptive name. Type **IP-VLAN**.
- 4 Select the protocol. Leave the default value **IP**.
- 5 Type the VLAN ID of an existing VLAN. In our example we already created a static VLAN with an ID of 5. Type **5**.
- 6 Leave the priority set to **0** and click **Add**.

Figure 55 Protocol Based VLAN Configuration Example

The screenshot shows a configuration window for a Protocol Based VLAN. The form has the following fields and values:

- Active:**
- Port:** 1
- Name:** IP-VLAN
- Ethernet-type:** IP, Others (Hex)
- VID:** 5
- Priority:** 0

Buttons: Add, Cancel

Index	Active	Port	Name	Ethernet-type	VID	Priority	Delete
-------	--------	------	------	---------------	-----	----------	--------

Buttons: Delete, Cancel

To add more ports to this protocol based VLAN.

- 1 Click the index number of the protocol based VLAN entry. Click **1**
- 2 Change the value in the **Port** field to the next port you want to add.
- 3 Click **Add**.

9.11 Port-based VLAN Setup

Port-based VLANs are VLANs where the packet forwarding decision is based on the destination MAC address and its associated port.

Port-based VLANs require allowed outgoing ports to be defined for each port. Therefore, if you wish to allow two subscriber ports to talk to each other, for example, between conference rooms in a hotel, you must define the egress (an egress port is an outgoing port, that is, a port through which a data packet leaves) for both ports.

Port-based VLANs are specific only to the Switch on which they were created.

Note: When you activate port-based VLAN, the Switch uses a default VLAN ID of 1. You cannot change it.

Note: In screens (such as **IP Setup** and **Filtering**) that require a VID, you must enter 1 as the VID.

The port-based VLAN setup screen is shown next. The **CPU** management port forms a VLAN with all Ethernet ports.

9.11.1 Configure a Port-based VLAN

Select **Port Based** as the **VLAN Type** in the **Basic Setting > Switch Setup** screen and then click **Advanced Application > VLAN** from the navigation panel to display the next screen.

Figure 56 Port Based VLAN Setup (All Connected)

Port Based VLAN Setup

Setting Wizard: All connected [v] Apply

		Incoming																													
		1	2	3	4	5	6	7	8	9	10	11	12	13	14	15	16	17	18	19	20	21	22	23	24	25	26	27	28		
Outgoing	1	✓	✓	✓	✓	✓	✓	✓	✓	✓	✓	✓	✓	✓	✓	✓	✓	✓	✓	✓	✓	✓	✓	✓	✓	✓	✓	✓	✓	1	
	2	✓	✓	✓	✓	✓	✓	✓	✓	✓	✓	✓	✓	✓	✓	✓	✓	✓	✓	✓	✓	✓	✓	✓	✓	✓	✓	✓	✓	✓	2
	3	✓	✓	✓	✓	✓	✓	✓	✓	✓	✓	✓	✓	✓	✓	✓	✓	✓	✓	✓	✓	✓	✓	✓	✓	✓	✓	✓	✓	✓	3
	4	✓	✓	✓	✓	✓	✓	✓	✓	✓	✓	✓	✓	✓	✓	✓	✓	✓	✓	✓	✓	✓	✓	✓	✓	✓	✓	✓	✓	✓	4
	5	✓	✓	✓	✓	✓	✓	✓	✓	✓	✓	✓	✓	✓	✓	✓	✓	✓	✓	✓	✓	✓	✓	✓	✓	✓	✓	✓	✓	✓	5
	6	✓	✓	✓	✓	✓	✓	✓	✓	✓	✓	✓	✓	✓	✓	✓	✓	✓	✓	✓	✓	✓	✓	✓	✓	✓	✓	✓	✓	✓	6
	7	✓	✓	✓	✓	✓	✓	✓	✓	✓	✓	✓	✓	✓	✓	✓	✓	✓	✓	✓	✓	✓	✓	✓	✓	✓	✓	✓	✓	✓	7
	8	✓	✓	✓	✓	✓	✓	✓	✓	✓	✓	✓	✓	✓	✓	✓	✓	✓	✓	✓	✓	✓	✓	✓	✓	✓	✓	✓	✓	✓	8
	9	✓	✓	✓	✓	✓	✓	✓	✓	✓	✓	✓	✓	✓	✓	✓	✓	✓	✓	✓	✓	✓	✓	✓	✓	✓	✓	✓	✓	✓	9
	10	✓	✓	✓	✓	✓	✓	✓	✓	✓	✓	✓	✓	✓	✓	✓	✓	✓	✓	✓	✓	✓	✓	✓	✓	✓	✓	✓	✓	✓	10
	11	✓	✓	✓	✓	✓	✓	✓	✓	✓	✓	✓	✓	✓	✓	✓	✓	✓	✓	✓	✓	✓	✓	✓	✓	✓	✓	✓	✓	✓	11
	12	✓	✓	✓	✓	✓	✓	✓	✓	✓	✓	✓	✓	✓	✓	✓	✓	✓	✓	✓	✓	✓	✓	✓	✓	✓	✓	✓	✓	✓	12
	13	✓	✓	✓	✓	✓	✓	✓	✓	✓	✓	✓	✓	✓	✓	✓	✓	✓	✓	✓	✓	✓	✓	✓	✓	✓	✓	✓	✓	✓	13
	14	✓	✓	✓	✓	✓	✓	✓	✓	✓	✓	✓	✓	✓	✓	✓	✓	✓	✓	✓	✓	✓	✓	✓	✓	✓	✓	✓	✓	✓	14
	15	✓	✓	✓	✓	✓	✓	✓	✓	✓	✓	✓	✓	✓	✓	✓	✓	✓	✓	✓	✓	✓	✓	✓	✓	✓	✓	✓	✓	✓	15
	16	✓	✓	✓	✓	✓	✓	✓	✓	✓	✓	✓	✓	✓	✓	✓	✓	✓	✓	✓	✓	✓	✓	✓	✓	✓	✓	✓	✓	✓	16
	17	✓	✓	✓	✓	✓	✓	✓	✓	✓	✓	✓	✓	✓	✓	✓	✓	✓	✓	✓	✓	✓	✓	✓	✓	✓	✓	✓	✓	✓	17
	18	✓	✓	✓	✓	✓	✓	✓	✓	✓	✓	✓	✓	✓	✓	✓	✓	✓	✓	✓	✓	✓	✓	✓	✓	✓	✓	✓	✓	✓	18
	19	✓	✓	✓	✓	✓	✓	✓	✓	✓	✓	✓	✓	✓	✓	✓	✓	✓	✓	✓	✓	✓	✓	✓	✓	✓	✓	✓	✓	✓	19
	20	✓	✓	✓	✓	✓	✓	✓	✓	✓	✓	✓	✓	✓	✓	✓	✓	✓	✓	✓	✓	✓	✓	✓	✓	✓	✓	✓	✓	✓	20
	21	✓	✓	✓	✓	✓	✓	✓	✓	✓	✓	✓	✓	✓	✓	✓	✓	✓	✓	✓	✓	✓	✓	✓	✓	✓	✓	✓	✓	✓	21
	22	✓	✓	✓	✓	✓	✓	✓	✓	✓	✓	✓	✓	✓	✓	✓	✓	✓	✓	✓	✓	✓	✓	✓	✓	✓	✓	✓	✓	✓	22
	23	✓	✓	✓	✓	✓	✓	✓	✓	✓	✓	✓	✓	✓	✓	✓	✓	✓	✓	✓	✓	✓	✓	✓	✓	✓	✓	✓	✓	✓	23
	24	✓	✓	✓	✓	✓	✓	✓	✓	✓	✓	✓	✓	✓	✓	✓	✓	✓	✓	✓	✓	✓	✓	✓	✓	✓	✓	✓	✓	✓	24
	25	✓	✓	✓	✓	✓	✓	✓	✓	✓	✓	✓	✓	✓	✓	✓	✓	✓	✓	✓	✓	✓	✓	✓	✓	✓	✓	✓	✓	✓	25
	26	✓	✓	✓	✓	✓	✓	✓	✓	✓	✓	✓	✓	✓	✓	✓	✓	✓	✓	✓	✓	✓	✓	✓	✓	✓	✓	✓	✓	✓	26
	27	✓	✓	✓	✓	✓	✓	✓	✓	✓	✓	✓	✓	✓	✓	✓	✓	✓	✓	✓	✓	✓	✓	✓	✓	✓	✓	✓	✓	✓	27
	28	✓	✓	✓	✓	✓	✓	✓	✓	✓	✓	✓	✓	✓	✓	✓	✓	✓	✓	✓	✓	✓	✓	✓	✓	✓	✓	✓	✓	✓	28
CPU	✓	✓	✓	✓	✓	✓	✓	✓	✓	✓	✓	✓	✓	✓	✓	✓	✓	✓	✓	✓	✓	✓	✓	✓	✓	✓	✓	✓	✓	CPU	

Apply Cancel

Figure 57 Port Based VLAN Setup (Port Isolation)

Setting Wizard Port isolation Apply

Incoming

	1	2	3	4	5	6	7	8	9	10	11	12	13	14	15	16	17	18	19	20	21	22	23	24	25	26	27	28	
1	<input checked="" type="checkbox"/>	<input type="checkbox"/>	<input type="checkbox"/>	<input type="checkbox"/>	<input type="checkbox"/>	<input type="checkbox"/>	<input type="checkbox"/>	<input type="checkbox"/>	<input type="checkbox"/>	<input type="checkbox"/>	<input type="checkbox"/>	<input type="checkbox"/>	<input type="checkbox"/>	<input type="checkbox"/>	<input type="checkbox"/>	<input type="checkbox"/>	<input type="checkbox"/>	<input type="checkbox"/>	<input type="checkbox"/>	<input type="checkbox"/>	<input type="checkbox"/>	<input type="checkbox"/>	<input type="checkbox"/>	<input type="checkbox"/>	<input type="checkbox"/>	<input type="checkbox"/>	<input type="checkbox"/>	<input type="checkbox"/>	1
2	<input type="checkbox"/>	<input checked="" type="checkbox"/>	<input type="checkbox"/>	<input type="checkbox"/>	<input type="checkbox"/>	<input type="checkbox"/>	<input type="checkbox"/>	<input type="checkbox"/>	<input type="checkbox"/>	<input type="checkbox"/>	<input type="checkbox"/>	<input type="checkbox"/>	<input type="checkbox"/>	<input type="checkbox"/>	<input type="checkbox"/>	<input type="checkbox"/>	<input type="checkbox"/>	<input type="checkbox"/>	<input type="checkbox"/>	<input type="checkbox"/>	<input type="checkbox"/>	<input type="checkbox"/>	<input type="checkbox"/>	<input type="checkbox"/>	<input type="checkbox"/>	<input type="checkbox"/>	<input type="checkbox"/>	<input type="checkbox"/>	2
3	<input type="checkbox"/>	<input type="checkbox"/>	<input checked="" type="checkbox"/>	<input type="checkbox"/>	<input type="checkbox"/>	<input type="checkbox"/>	<input type="checkbox"/>	<input type="checkbox"/>	<input type="checkbox"/>	<input type="checkbox"/>	<input type="checkbox"/>	<input type="checkbox"/>	<input type="checkbox"/>	<input type="checkbox"/>	<input type="checkbox"/>	<input type="checkbox"/>	<input type="checkbox"/>	<input type="checkbox"/>	<input type="checkbox"/>	<input type="checkbox"/>	<input type="checkbox"/>	<input type="checkbox"/>	<input type="checkbox"/>	<input type="checkbox"/>	<input type="checkbox"/>	<input type="checkbox"/>	<input type="checkbox"/>	<input type="checkbox"/>	3
4	<input type="checkbox"/>	<input type="checkbox"/>	<input type="checkbox"/>	<input checked="" type="checkbox"/>	<input type="checkbox"/>	<input type="checkbox"/>	<input type="checkbox"/>	<input type="checkbox"/>	<input type="checkbox"/>	<input type="checkbox"/>	<input type="checkbox"/>	<input type="checkbox"/>	<input type="checkbox"/>	<input type="checkbox"/>	<input type="checkbox"/>	<input type="checkbox"/>	<input type="checkbox"/>	<input type="checkbox"/>	<input type="checkbox"/>	<input type="checkbox"/>	<input type="checkbox"/>	<input type="checkbox"/>	<input type="checkbox"/>	<input type="checkbox"/>	<input type="checkbox"/>	<input type="checkbox"/>	<input type="checkbox"/>	<input type="checkbox"/>	4
5	<input type="checkbox"/>	<input type="checkbox"/>	<input type="checkbox"/>	<input type="checkbox"/>	<input checked="" type="checkbox"/>	<input type="checkbox"/>	<input type="checkbox"/>	<input type="checkbox"/>	<input type="checkbox"/>	<input type="checkbox"/>	<input type="checkbox"/>	<input type="checkbox"/>	<input type="checkbox"/>	<input type="checkbox"/>	<input type="checkbox"/>	<input type="checkbox"/>	<input type="checkbox"/>	<input type="checkbox"/>	<input type="checkbox"/>	<input type="checkbox"/>	<input type="checkbox"/>	<input type="checkbox"/>	<input type="checkbox"/>	<input type="checkbox"/>	<input type="checkbox"/>	<input type="checkbox"/>	<input type="checkbox"/>	<input type="checkbox"/>	5
6	<input type="checkbox"/>	<input type="checkbox"/>	<input type="checkbox"/>	<input type="checkbox"/>	<input type="checkbox"/>	<input checked="" type="checkbox"/>	<input type="checkbox"/>	<input type="checkbox"/>	<input type="checkbox"/>	<input type="checkbox"/>	<input type="checkbox"/>	<input type="checkbox"/>	<input type="checkbox"/>	<input type="checkbox"/>	<input type="checkbox"/>	<input type="checkbox"/>	<input type="checkbox"/>	<input type="checkbox"/>	<input type="checkbox"/>	<input type="checkbox"/>	<input type="checkbox"/>	<input type="checkbox"/>	<input type="checkbox"/>	<input type="checkbox"/>	<input type="checkbox"/>	<input type="checkbox"/>	<input type="checkbox"/>	<input type="checkbox"/>	6
7	<input type="checkbox"/>	<input type="checkbox"/>	<input type="checkbox"/>	<input type="checkbox"/>	<input type="checkbox"/>	<input type="checkbox"/>	<input checked="" type="checkbox"/>	<input type="checkbox"/>	<input type="checkbox"/>	<input type="checkbox"/>	<input type="checkbox"/>	<input type="checkbox"/>	<input type="checkbox"/>	<input type="checkbox"/>	<input type="checkbox"/>	<input type="checkbox"/>	<input type="checkbox"/>	<input type="checkbox"/>	<input type="checkbox"/>	<input type="checkbox"/>	<input type="checkbox"/>	<input type="checkbox"/>	<input type="checkbox"/>	<input type="checkbox"/>	<input type="checkbox"/>	<input type="checkbox"/>	<input type="checkbox"/>	<input type="checkbox"/>	7
8	<input type="checkbox"/>	<input type="checkbox"/>	<input type="checkbox"/>	<input type="checkbox"/>	<input type="checkbox"/>	<input type="checkbox"/>	<input type="checkbox"/>	<input checked="" type="checkbox"/>	<input type="checkbox"/>	<input type="checkbox"/>	<input type="checkbox"/>	<input type="checkbox"/>	<input type="checkbox"/>	<input type="checkbox"/>	<input type="checkbox"/>	<input type="checkbox"/>	<input type="checkbox"/>	<input type="checkbox"/>	<input type="checkbox"/>	<input type="checkbox"/>	<input type="checkbox"/>	<input type="checkbox"/>	<input type="checkbox"/>	<input type="checkbox"/>	<input type="checkbox"/>	<input type="checkbox"/>	<input type="checkbox"/>	<input type="checkbox"/>	8
9	<input type="checkbox"/>	<input type="checkbox"/>	<input type="checkbox"/>	<input type="checkbox"/>	<input type="checkbox"/>	<input type="checkbox"/>	<input type="checkbox"/>	<input type="checkbox"/>	<input checked="" type="checkbox"/>	<input type="checkbox"/>	<input type="checkbox"/>	<input type="checkbox"/>	<input type="checkbox"/>	<input type="checkbox"/>	<input type="checkbox"/>	<input type="checkbox"/>	<input type="checkbox"/>	<input type="checkbox"/>	<input type="checkbox"/>	<input type="checkbox"/>	<input type="checkbox"/>	<input type="checkbox"/>	<input type="checkbox"/>	<input type="checkbox"/>	<input type="checkbox"/>	<input type="checkbox"/>	<input type="checkbox"/>	<input type="checkbox"/>	9
10	<input type="checkbox"/>	<input type="checkbox"/>	<input type="checkbox"/>	<input type="checkbox"/>	<input type="checkbox"/>	<input type="checkbox"/>	<input type="checkbox"/>	<input type="checkbox"/>	<input type="checkbox"/>	<input checked="" type="checkbox"/>	<input type="checkbox"/>	<input type="checkbox"/>	<input type="checkbox"/>	<input type="checkbox"/>	<input type="checkbox"/>	<input type="checkbox"/>	<input type="checkbox"/>	<input type="checkbox"/>	<input type="checkbox"/>	<input type="checkbox"/>	<input type="checkbox"/>	<input type="checkbox"/>	<input type="checkbox"/>	<input type="checkbox"/>	<input type="checkbox"/>	<input type="checkbox"/>	<input type="checkbox"/>	<input type="checkbox"/>	10
11	<input type="checkbox"/>	<input type="checkbox"/>	<input type="checkbox"/>	<input type="checkbox"/>	<input type="checkbox"/>	<input type="checkbox"/>	<input type="checkbox"/>	<input type="checkbox"/>	<input type="checkbox"/>	<input type="checkbox"/>	<input checked="" type="checkbox"/>	<input type="checkbox"/>	<input type="checkbox"/>	<input type="checkbox"/>	<input type="checkbox"/>	<input type="checkbox"/>	<input type="checkbox"/>	<input type="checkbox"/>	<input type="checkbox"/>	<input type="checkbox"/>	<input type="checkbox"/>	<input type="checkbox"/>	<input type="checkbox"/>	<input type="checkbox"/>	<input type="checkbox"/>	<input type="checkbox"/>	<input type="checkbox"/>	<input type="checkbox"/>	11
12	<input type="checkbox"/>	<input type="checkbox"/>	<input type="checkbox"/>	<input type="checkbox"/>	<input type="checkbox"/>	<input type="checkbox"/>	<input type="checkbox"/>	<input type="checkbox"/>	<input type="checkbox"/>	<input type="checkbox"/>	<input type="checkbox"/>	<input checked="" type="checkbox"/>	<input type="checkbox"/>	<input type="checkbox"/>	<input type="checkbox"/>	<input type="checkbox"/>	<input type="checkbox"/>	<input type="checkbox"/>	<input type="checkbox"/>	<input type="checkbox"/>	<input type="checkbox"/>	<input type="checkbox"/>	<input type="checkbox"/>	<input type="checkbox"/>	<input type="checkbox"/>	<input type="checkbox"/>	<input type="checkbox"/>	<input type="checkbox"/>	12
13	<input type="checkbox"/>	<input type="checkbox"/>	<input type="checkbox"/>	<input type="checkbox"/>	<input type="checkbox"/>	<input type="checkbox"/>	<input type="checkbox"/>	<input type="checkbox"/>	<input type="checkbox"/>	<input type="checkbox"/>	<input type="checkbox"/>	<input type="checkbox"/>	<input checked="" type="checkbox"/>	<input type="checkbox"/>	<input type="checkbox"/>	<input type="checkbox"/>	<input type="checkbox"/>	<input type="checkbox"/>	<input type="checkbox"/>	<input type="checkbox"/>	<input type="checkbox"/>	<input type="checkbox"/>	<input type="checkbox"/>	<input type="checkbox"/>	<input type="checkbox"/>	<input type="checkbox"/>	<input type="checkbox"/>	<input type="checkbox"/>	13
14	<input type="checkbox"/>	<input type="checkbox"/>	<input type="checkbox"/>	<input type="checkbox"/>	<input type="checkbox"/>	<input type="checkbox"/>	<input type="checkbox"/>	<input type="checkbox"/>	<input type="checkbox"/>	<input type="checkbox"/>	<input type="checkbox"/>	<input type="checkbox"/>	<input type="checkbox"/>	<input checked="" type="checkbox"/>	<input type="checkbox"/>	<input type="checkbox"/>	<input type="checkbox"/>	<input type="checkbox"/>	<input type="checkbox"/>	<input type="checkbox"/>	<input type="checkbox"/>	<input type="checkbox"/>	<input type="checkbox"/>	<input type="checkbox"/>	<input type="checkbox"/>	<input type="checkbox"/>	<input type="checkbox"/>	<input type="checkbox"/>	14
15	<input type="checkbox"/>	<input type="checkbox"/>	<input type="checkbox"/>	<input type="checkbox"/>	<input type="checkbox"/>	<input type="checkbox"/>	<input type="checkbox"/>	<input type="checkbox"/>	<input type="checkbox"/>	<input type="checkbox"/>	<input type="checkbox"/>	<input type="checkbox"/>	<input type="checkbox"/>	<input type="checkbox"/>	<input checked="" type="checkbox"/>	<input type="checkbox"/>	<input type="checkbox"/>	<input type="checkbox"/>	<input type="checkbox"/>	<input type="checkbox"/>	<input type="checkbox"/>	<input type="checkbox"/>	<input type="checkbox"/>	<input type="checkbox"/>	<input type="checkbox"/>	<input type="checkbox"/>	<input type="checkbox"/>	<input type="checkbox"/>	15
16	<input type="checkbox"/>	<input type="checkbox"/>	<input type="checkbox"/>	<input type="checkbox"/>	<input type="checkbox"/>	<input type="checkbox"/>	<input type="checkbox"/>	<input type="checkbox"/>	<input type="checkbox"/>	<input type="checkbox"/>	<input type="checkbox"/>	<input type="checkbox"/>	<input type="checkbox"/>	<input type="checkbox"/>	<input type="checkbox"/>	<input checked="" type="checkbox"/>	<input type="checkbox"/>	<input type="checkbox"/>	<input type="checkbox"/>	<input type="checkbox"/>	<input type="checkbox"/>	<input type="checkbox"/>	<input type="checkbox"/>	<input type="checkbox"/>	<input type="checkbox"/>	<input type="checkbox"/>	<input type="checkbox"/>	<input type="checkbox"/>	16
17	<input type="checkbox"/>	<input type="checkbox"/>	<input type="checkbox"/>	<input type="checkbox"/>	<input type="checkbox"/>	<input type="checkbox"/>	<input type="checkbox"/>	<input type="checkbox"/>	<input type="checkbox"/>	<input type="checkbox"/>	<input type="checkbox"/>	<input type="checkbox"/>	<input type="checkbox"/>	<input type="checkbox"/>	<input type="checkbox"/>	<input type="checkbox"/>	<input checked="" type="checkbox"/>	<input type="checkbox"/>	<input type="checkbox"/>	<input type="checkbox"/>	<input type="checkbox"/>	<input type="checkbox"/>	<input type="checkbox"/>	<input type="checkbox"/>	<input type="checkbox"/>	<input type="checkbox"/>	<input type="checkbox"/>	<input type="checkbox"/>	17
18	<input type="checkbox"/>	<input type="checkbox"/>	<input type="checkbox"/>	<input type="checkbox"/>	<input type="checkbox"/>	<input type="checkbox"/>	<input type="checkbox"/>	<input type="checkbox"/>	<input type="checkbox"/>	<input type="checkbox"/>	<input type="checkbox"/>	<input type="checkbox"/>	<input type="checkbox"/>	<input type="checkbox"/>	<input type="checkbox"/>	<input type="checkbox"/>	<input type="checkbox"/>	<input checked="" type="checkbox"/>	<input type="checkbox"/>	<input type="checkbox"/>	<input type="checkbox"/>	<input type="checkbox"/>	<input type="checkbox"/>	<input type="checkbox"/>	<input type="checkbox"/>	<input type="checkbox"/>	<input type="checkbox"/>	<input type="checkbox"/>	18
19	<input type="checkbox"/>	<input type="checkbox"/>	<input type="checkbox"/>	<input type="checkbox"/>	<input type="checkbox"/>	<input type="checkbox"/>	<input type="checkbox"/>	<input type="checkbox"/>	<input type="checkbox"/>	<input type="checkbox"/>	<input type="checkbox"/>	<input type="checkbox"/>	<input type="checkbox"/>	<input type="checkbox"/>	<input type="checkbox"/>	<input type="checkbox"/>	<input type="checkbox"/>	<input type="checkbox"/>	<input checked="" type="checkbox"/>	<input type="checkbox"/>	<input type="checkbox"/>	<input type="checkbox"/>	<input type="checkbox"/>	<input type="checkbox"/>	<input type="checkbox"/>	<input type="checkbox"/>	<input type="checkbox"/>	<input type="checkbox"/>	19
20	<input type="checkbox"/>	<input type="checkbox"/>	<input type="checkbox"/>	<input type="checkbox"/>	<input type="checkbox"/>	<input type="checkbox"/>	<input type="checkbox"/>	<input type="checkbox"/>	<input type="checkbox"/>	<input type="checkbox"/>	<input type="checkbox"/>	<input type="checkbox"/>	<input type="checkbox"/>	<input type="checkbox"/>	<input type="checkbox"/>	<input type="checkbox"/>	<input type="checkbox"/>	<input type="checkbox"/>	<input type="checkbox"/>	<input checked="" type="checkbox"/>	<input type="checkbox"/>	<input type="checkbox"/>	<input type="checkbox"/>	<input type="checkbox"/>	<input type="checkbox"/>	<input type="checkbox"/>	<input type="checkbox"/>	<input type="checkbox"/>	20
21	<input type="checkbox"/>	<input type="checkbox"/>	<input type="checkbox"/>	<input type="checkbox"/>	<input type="checkbox"/>	<input type="checkbox"/>	<input type="checkbox"/>	<input type="checkbox"/>	<input type="checkbox"/>	<input type="checkbox"/>	<input type="checkbox"/>	<input type="checkbox"/>	<input type="checkbox"/>	<input type="checkbox"/>	<input type="checkbox"/>	<input type="checkbox"/>	<input type="checkbox"/>	<input type="checkbox"/>	<input type="checkbox"/>	<input type="checkbox"/>	<input checked="" type="checkbox"/>	<input type="checkbox"/>	<input type="checkbox"/>	<input type="checkbox"/>	<input type="checkbox"/>	<input type="checkbox"/>	<input type="checkbox"/>	<input type="checkbox"/>	21
22	<input type="checkbox"/>	<input type="checkbox"/>	<input type="checkbox"/>	<input type="checkbox"/>	<input type="checkbox"/>	<input type="checkbox"/>	<input type="checkbox"/>	<input type="checkbox"/>	<input type="checkbox"/>	<input type="checkbox"/>	<input type="checkbox"/>	<input type="checkbox"/>	<input type="checkbox"/>	<input type="checkbox"/>	<input type="checkbox"/>	<input type="checkbox"/>	<input type="checkbox"/>	<input type="checkbox"/>	<input type="checkbox"/>	<input type="checkbox"/>	<input type="checkbox"/>	<input checked="" type="checkbox"/>	<input type="checkbox"/>	<input type="checkbox"/>	<input type="checkbox"/>	<input type="checkbox"/>	<input type="checkbox"/>	<input type="checkbox"/>	22
23	<input type="checkbox"/>	<input type="checkbox"/>	<input type="checkbox"/>	<input type="checkbox"/>	<input type="checkbox"/>	<input type="checkbox"/>	<input type="checkbox"/>	<input type="checkbox"/>	<input type="checkbox"/>	<input type="checkbox"/>	<input type="checkbox"/>	<input type="checkbox"/>	<input type="checkbox"/>	<input type="checkbox"/>	<input type="checkbox"/>	<input type="checkbox"/>	<input type="checkbox"/>	<input type="checkbox"/>	<input type="checkbox"/>	<input type="checkbox"/>	<input type="checkbox"/>	<input type="checkbox"/>	<input checked="" type="checkbox"/>	<input type="checkbox"/>	<input type="checkbox"/>	<input type="checkbox"/>	<input type="checkbox"/>	<input type="checkbox"/>	23
24	<input type="checkbox"/>	<input type="checkbox"/>	<input type="checkbox"/>	<input type="checkbox"/>	<input type="checkbox"/>	<input type="checkbox"/>	<input type="checkbox"/>	<input type="checkbox"/>	<input type="checkbox"/>	<input type="checkbox"/>	<input type="checkbox"/>	<input type="checkbox"/>	<input type="checkbox"/>	<input type="checkbox"/>	<input type="checkbox"/>	<input type="checkbox"/>	<input type="checkbox"/>	<input type="checkbox"/>	<input type="checkbox"/>	<input type="checkbox"/>	<input type="checkbox"/>	<input type="checkbox"/>	<input type="checkbox"/>	<input checked="" type="checkbox"/>	<input type="checkbox"/>	<input type="checkbox"/>	<input type="checkbox"/>	<input type="checkbox"/>	24
25	<input type="checkbox"/>	<input type="checkbox"/>	<input type="checkbox"/>	<input type="checkbox"/>	<input type="checkbox"/>	<input type="checkbox"/>	<input type="checkbox"/>	<input type="checkbox"/>	<input type="checkbox"/>	<input type="checkbox"/>	<input type="checkbox"/>	<input type="checkbox"/>	<input type="checkbox"/>	<input type="checkbox"/>	<input type="checkbox"/>	<input type="checkbox"/>	<input type="checkbox"/>	<input type="checkbox"/>	<input type="checkbox"/>	<input type="checkbox"/>	<input type="checkbox"/>	<input type="checkbox"/>	<input type="checkbox"/>	<input type="checkbox"/>	<input checked="" type="checkbox"/>	<input type="checkbox"/>	<input type="checkbox"/>	<input type="checkbox"/>	25
26	<input type="checkbox"/>	<input type="checkbox"/>	<input type="checkbox"/>	<input type="checkbox"/>	<input type="checkbox"/>	<input type="checkbox"/>	<input type="checkbox"/>	<input type="checkbox"/>	<input type="checkbox"/>	<input type="checkbox"/>	<input type="checkbox"/>	<input type="checkbox"/>	<input type="checkbox"/>	<input type="checkbox"/>	<input type="checkbox"/>	<input type="checkbox"/>	<input type="checkbox"/>	<input type="checkbox"/>	<input type="checkbox"/>	<input type="checkbox"/>	<input type="checkbox"/>	<input type="checkbox"/>	<input type="checkbox"/>	<input type="checkbox"/>	<input type="checkbox"/>	<input checked="" type="checkbox"/>	<input type="checkbox"/>	<input type="checkbox"/>	26
27	<input type="checkbox"/>	<input type="checkbox"/>	<input type="checkbox"/>	<input type="checkbox"/>	<input type="checkbox"/>	<input type="checkbox"/>	<input type="checkbox"/>	<input type="checkbox"/>	<input type="checkbox"/>	<input type="checkbox"/>	<input type="checkbox"/>	<input type="checkbox"/>	<input type="checkbox"/>	<input type="checkbox"/>	<input type="checkbox"/>	<input type="checkbox"/>	<input type="checkbox"/>	<input type="checkbox"/>	<input type="checkbox"/>	<input type="checkbox"/>	<input type="checkbox"/>	<input type="checkbox"/>	<input type="checkbox"/>	<input type="checkbox"/>	<input type="checkbox"/>	<input type="checkbox"/>	<input checked="" type="checkbox"/>	<input type="checkbox"/>	27
28	<input type="checkbox"/>	<input type="checkbox"/>	<input type="checkbox"/>	<input type="checkbox"/>	<input type="checkbox"/>	<input type="checkbox"/>	<input type="checkbox"/>	<input type="checkbox"/>	<input type="checkbox"/>	<input type="checkbox"/>	<input type="checkbox"/>	<input type="checkbox"/>	<input type="checkbox"/>	<input type="checkbox"/>	<input type="checkbox"/>	<input type="checkbox"/>	<input type="checkbox"/>	<input type="checkbox"/>	<input type="checkbox"/>	<input type="checkbox"/>	<input type="checkbox"/>	<input type="checkbox"/>	<input type="checkbox"/>	<input type="checkbox"/>	<input type="checkbox"/>	<input type="checkbox"/>	<input type="checkbox"/>	<input checked="" type="checkbox"/>	28
CPU	<input checked="" type="checkbox"/>	<input checked="" type="checkbox"/>	<input checked="" type="checkbox"/>	<input checked="" type="checkbox"/>	<input checked="" type="checkbox"/>	<input checked="" type="checkbox"/>	<input checked="" type="checkbox"/>	<input checked="" type="checkbox"/>	<input checked="" type="checkbox"/>	<input checked="" type="checkbox"/>	<input checked="" type="checkbox"/>	<input checked="" type="checkbox"/>	<input checked="" type="checkbox"/>	<input checked="" type="checkbox"/>	<input checked="" type="checkbox"/>	<input checked="" type="checkbox"/>	<input checked="" type="checkbox"/>	<input checked="" type="checkbox"/>	<input checked="" type="checkbox"/>	<input checked="" type="checkbox"/>	<input checked="" type="checkbox"/>	<input checked="" type="checkbox"/>	<input checked="" type="checkbox"/>	<input checked="" type="checkbox"/>	<input checked="" type="checkbox"/>	<input checked="" type="checkbox"/>	<input checked="" type="checkbox"/>	<input checked="" type="checkbox"/>	CPU

Outgoing

Apply Cancel

The following table describes the labels in this screen.

Table 20 Port Based VLAN Setup

label	Description
Setting Wizard	<p>Choose All connected or Port isolation.</p> <p>All connected means all ports can communicate with each other, that is, there are no virtual LANs. All incoming and outgoing ports are selected. This option is the most flexible but also the least secure.</p> <p>Port isolation means that each port can only communicate with the CPU management port and cannot communicate with each other. All incoming ports are selected while only the CPU outgoing port is selected. This option is the most limiting but also the most secure.</p> <p>After you make your selection, click Apply (top right of screen) to display the screens as mentioned above. You can still customize these settings by adding/deleting incoming or outgoing ports, but you must also click Apply at the bottom of the screen.</p>
Incoming	<p>These are the ingress ports; an ingress port is an incoming port, that is, a port through which a data packet enters. If you wish to allow two subscriber ports to talk to each other, you must define the ingress port for both ports. The numbers in the top row denote the incoming port for the corresponding port listed on the left (its outgoing port). CPU refers to the Switch management port. By default it forms a VLAN with all Ethernet ports. If it does not form a VLAN with a particular port then the Switch cannot be managed from that port.</p>
Outgoing	<p>These are the egress ports; an egress port is an outgoing port, that is, a port through which a data packet leaves. If you wish to allow two subscriber ports to talk to each other, you must define the egress port for both ports. CPU refers to the Switch management port. By default it forms a VLAN with all Ethernet ports. If it does not form a VLAN with a particular port then the Switch cannot be managed from that port.</p>
Apply	<p>Click Apply to save your changes to the Switch's run-time memory. The Switch loses these changes if it is turned off or loses power, so use the Save link on the top navigation panel to save your changes to the non-volatile memory when you are done configuring.</p>
Cancel	<p>Click Cancel to begin configuring this screen afresh.</p>

Static MAC Forward Setup

Use these screens to configure static MAC address forwarding.

10.1 Overview

This chapter discusses how to configure forwarding rules based on MAC addresses of devices on your network.

10.2 Configuring Static MAC Forwarding

A static MAC address is an address that has been manually entered in the MAC address table. Static MAC addresses do not age out. When you set up static MAC address rules, you are setting static MAC addresses for a port. This may reduce the need for broadcasting.

Static MAC address forwarding together with port security allow only computers in the MAC address table on a port to access the Switch. See [Chapter 19 on page 163](#) for more information on port security.

Click **Advanced Application > Static MAC Forwarding** in the navigation panel to display the configuration screen as shown.

Figure 58 Advanced Application > Static MAC Forwarding

The following table describes the labels in this screen.

Table 21 Advanced Application > Static MAC Forwarding

LABEL	DESCRIPTION
Active	Select this check box to activate your rule. You may temporarily deactivate a rule without deleting it by clearing this check box.
Name	Enter a descriptive name for identification purposes for this static MAC address forwarding rule.
MAC Address	Enter the MAC address in valid MAC address format, that is, six hexadecimal character pairs. Note: Static MAC addresses do not age out.
VID	Enter the VLAN identification number.
Port	Enter the port where the MAC address entered in the previous field will be automatically forwarded.
Add	Click Add to save your rule to the Switch's run-time memory. The Switch loses this rule if it is turned off or loses power, so use the Save link on the top navigation panel to save your changes to the non-volatile memory when you are done configuring.
Cancel	Click Cancel to reset the fields to their last saved values.
Clear	Click Clear to begin configuring this screen afresh.
Index	Click an index number to modify a static MAC address rule for a port.
Active	This field displays whether this static MAC address forwarding rule is active (Yes) or not (No). You may temporarily deactivate a rule without deleting it.
Name	This field displays the descriptive name for identification purposes for this static MAC address-forwarding rule.
MAC Address	This field displays the MAC address that will be forwarded and the VLAN identification number to which the MAC address belongs.
VID	This field displays the ID number of the VLAN group.

Table 21 Advanced Application > Static MAC Forwarding (continued)

LABEL	DESCRIPTION
Port	This field displays the port where the MAC address shown in the next field will be forwarded.
Delete	Click Delete to remove the selected entry from the summary table.
Cancel	Click Cancel to clear the Delete check boxes.

Static Multicast Forward Setup

Use these screens to configure static multicast address forwarding.

11.1 Static Multicast Forwarding Overview

A multicast MAC address is the MAC address of a member of a multicast group. A static multicast address is a multicast MAC address that has been manually entered in the multicast table. Static multicast addresses do not age out. Static multicast forwarding allows you (the administrator) to forward multicast frames to a member without the member having to join the group first.

If a multicast group has no members, then the switch will either flood the multicast frames to all ports or drop them. You can configure this in the **Advanced Application > Multicast > Multicast Setting** screen (see [Section 23.3 on page 185](#)). [Figure 59](#) shows such unknown multicast frames flooded to all ports. With static multicast forwarding, you can forward these multicasts to port(s) within a VLAN group. [Figure 60](#) shows frames being forwarded to devices

connected to port 3. [Figure 61](#) shows frames being forwarded to ports 2 and 3 within VLAN group 4.

Figure 59 No Static Multicast Forwarding

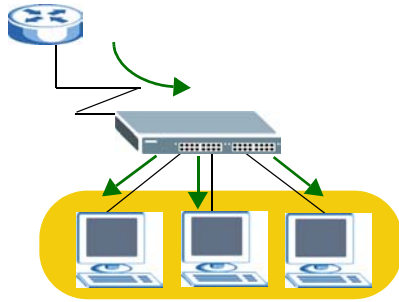

Figure 60 Static Multicast Forwarding to A Single Port

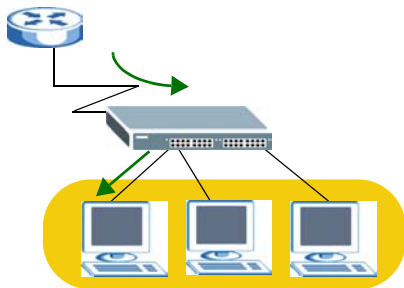
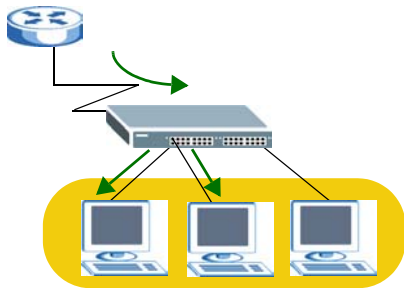

Figure 61 Static Multicast Forwarding to Multiple Ports



11.2 Configuring Static Multicast Forwarding

Use this screen to configure rules to forward specific multicast frames, such as streaming or control frames, to specific port(s).

Click **Advanced Application > Static Multicast Forwarding** to display the configuration screen as shown.

Figure 62 Advanced Application > Static Multicast Forwarding

The following table describes the labels in this screen.

Table 22 Advanced Application > Static Multicast Forwarding

LABEL	DESCRIPTION
Active	Select this check box to activate your rule. You may temporarily deactivate a rule without deleting it by clearing this check box.
Name	Type a descriptive name (up to 32 printable ASCII characters) for this static multicast MAC address forwarding rule. This is for identification only.
MAC Address	Enter a multicast MAC address which identifies the multicast group. The last binary bit of the first octet pair in a multicast MAC address must be 1. For example, the first octet pair 00000001 is 01 and 00000011 is 03 in hexadecimal, so 01:00:5e:00:00:0A and 03:00:5e:00:00:27 are valid multicast MAC addresses.
VID	You can forward frames with matching destination MAC address to port(s) within a VLAN group. Enter the ID that identifies the VLAN group here. If you don't have a specific target VLAN, enter 1.
Port	Enter the port(s) where frames with destination MAC address that matched the entry above are forwarded. You can enter multiple ports separated by (no space) comma (,) or hyphen (-). For example, enter "3-5" for ports 3, 4, and 5. Enter "3,5,7" for ports 3, 5, and 7.
Add	Click Add to save your rule to the Switch's run-time memory. The Switch loses this rule if it is turned off or loses power, so use the Save link on the top navigation panel to save your changes to the non-volatile memory when you are done configuring.
Cancel	Click Cancel to reset the fields to their last saved values.
Clear	Click Clear to begin configuring this screen afresh.
Index	Click an index number to modify a static multicast MAC address rule for port(s).

Table 22 Advanced Application > Static Multicast Forwarding (continued)

LABEL	DESCRIPTION
Active	This field displays whether a static multicast MAC address forwarding rule is active (Yes) or not (No). You may temporarily deactivate a rule without deleting it.
Name	This field displays the descriptive name for identification purposes for a static multicast MAC address-forwarding rule.
MAC Address	This field displays the multicast MAC address that identifies a multicast group.
VID	This field displays the ID number of a VLAN group to which frames containing the specified multicast MAC address will be forwarded.
Port	This field displays the port(s) within a identified VLAN group to which frames containing the specified multicast MAC address will be forwarded.
Delete	Click Delete to remove the selected entry from the summary table.
Cancel	Click Cancel to clear the Delete check boxes.

Filtering

This chapter discusses MAC address port filtering.

12.1 Configure a Filtering Rule

Filtering means sifting traffic going through the Switch based on the source and/or destination MAC addresses and VLAN group (ID).

Click **Advanced Application > Filtering** in the navigation panel to display the screen as shown next.

Figure 63 Advanced Application > Filtering

The following table describes the related labels in this screen.

Table 23 Advanced Application > Filtering

LABEL	DESCRIPTION
Active	Make sure to select this check box to activate your rule. You may temporarily deactivate a rule without deleting it by deselecting this check box.
Name	Type a descriptive name (up to 32 printable ASCII characters) for this rule. This is for identification only.

Table 23 Advanced Application > Filtering (continued)

LABEL	DESCRIPTION
Action	<p>Select Discard source to drop the frames from the source MAC address (specified in the MAC field). The Switch can still send frames to the MAC address.</p> <p>Select Discard destination to drop the frames to the destination MAC address (specified in the MAC address). The Switch can still receive frames originating from the MAC address.</p> <p>Select Discard source and Discard destination to block traffic to/from the MAC address specified in the MAC field.</p>
MAC	Type a MAC address in valid MAC address format, that is, six hexadecimal character pairs.
VID	Type the VLAN group identification number.
Add	Click Add to save your changes to the Switch's run-time memory. The Switch loses these changes if it is turned off or loses power, so use the Save link on the top navigation panel to save your changes to the non-volatile memory when you are done configuring.
Cancel	Click Cancel to reset the fields to your previous configuration.
Clear	Click Clear to clear the fields to the factory defaults.
Index	This field displays the index number of the rule. Click an index number to change the settings.
Active	This field displays Yes when the rule is activated and No when is it deactivated.
Name	This field displays the descriptive name for this rule. This is for identification purpose only.
MAC Address	This field displays the source/destination MAC address with the VLAN identification number to which the MAC address belongs.
VID	This field displays the VLAN group identification number.
Delete	Check the rule(s) that you want to remove in the Delete column and then click the Delete button.
Cancel	Click Cancel to clear the selected checkbox(es) in the Delete column.

Spanning Tree Protocol

The Switch supports Spanning Tree Protocol (STP), Rapid Spanning Tree Protocol (RSTP) and Multiple Spanning Tree Protocol (MSTP) as defined in the following standards.

- IEEE 802.1D Spanning Tree Protocol
- IEEE 802.1w Rapid Spanning Tree Protocol
- IEEE 802.1s Multiple Spanning Tree Protocol

The Switch also allows you to set up multiple STP configurations (or trees). Ports can then be assigned to the trees.

13.1 STP/RSTP Overview

(R)STP detects and breaks network loops and provides backup links between switches, bridges or routers. It allows a switch to interact with other (R)STP - compliant switches in your network to ensure that only one path exists between any two stations on the network.

The Switch uses IEEE 802.1w RSTP (Rapid Spanning Tree Protocol) that allows faster convergence of the spanning tree than STP (while also being backwards compatible with STP-only aware bridges). In RSTP, topology change information is directly propagated throughout the network from the device that generates the topology change. In STP, a longer delay is required as the device that causes a topology change first notifies the root bridge that then notifies the network. Both RSTP and STP flush unwanted learned addresses from the filtering database. In RSTP, the port states are Discarding, Learning, and Forwarding.

Note: In this user's guide, "STP" refers to both STP and RSTP.

13.1.1 STP Terminology

The root bridge is the base of the spanning tree.

Path cost is the cost of transmitting a frame onto a LAN through that port. The recommended cost is assigned according to the speed of the link to which a port is attached. The slower the media, the higher the cost.

Table 24 STP Path Costs

	LINK SPEED	RECOMMENDED VALUE	RECOMMENDED RANGE	ALLOWED RANGE
Path Cost	4Mbps	250	100 to 1000	1 to 65535
Path Cost	10Mbps	100	50 to 600	1 to 65535
Path Cost	16Mbps	62	40 to 400	1 to 65535
Path Cost	100Mbps	19	10 to 60	1 to 65535
Path Cost	1Gbps	4	3 to 10	1 to 65535
Path Cost	10Gbps	2	1 to 5	1 to 65535

On each bridge, the root port is the port through which this bridge communicates with the root. It is the port on this switch with the lowest path cost to the root (the root path cost). If there is no root port, then this switch has been accepted as the root bridge of the spanning tree network.

For each LAN segment, a designated bridge is selected. This bridge has the lowest cost to the root among the bridges connected to the LAN.

13.1.2 How STP Works

After a bridge determines the lowest cost-spanning tree with STP, it enables the root port and the ports that are the designated ports for connected LANs, and disables all other ports that participate in STP. Network packets are therefore only forwarded between enabled ports, eliminating any possible network loops.

STP-aware switches exchange Bridge Protocol Data Units (BPDUs) periodically. When the bridged LAN topology changes, a new spanning tree is constructed.

Once a stable network topology has been established, all bridges listen for Hello BPDUs (Bridge Protocol Data Units) transmitted from the root bridge. If a bridge does not get a Hello BPDU after a predefined interval (Max Age), the bridge assumes that the link to the root bridge is down. This bridge then initiates negotiations with other bridges to reconfigure the network to re-establish a valid network topology.

13.1.3 STP Port States

STP assigns five port states to eliminate packet looping. A bridge port is not allowed to go directly from blocking state to forwarding state so as to eliminate transient loops.

Table 25 STP Port States

PORT STATE	DESCRIPTION
Disabled	STP is disabled (default).
Blocking	Only configuration and management BPDUs are received and processed.
Listening	All BPDUs are received and processed. Note: The listening state does not exist in RSTP.
Learning	All BPDUs are received and processed. Information frames are submitted to the learning process but not forwarded.
Forwarding	All BPDUs are received and processed. All information frames are received and forwarded.

13.1.4 Multiple RSTP

MRSTP (Multiple RSTP) is ZyXEL's proprietary feature that is compatible with RSTP and STP. With MRSTP, you can have more than one spanning tree on your Switch and assign port(s) to each tree. Each spanning tree operates independently with its own bridge information.

In the following example, there are two RSTP instances (**MRSTP 1** and **MRSTP2**) on switch **A**.

To set up MRSTP, activate MRSTP on the Switch and specify which port(s) belong to which spanning tree.

Note: Each port can belong to one STP tree only.

Figure 64 MRSTP Network Example

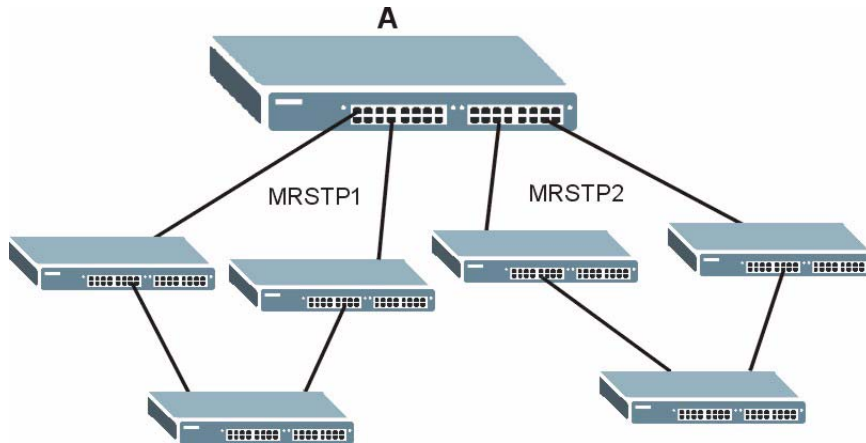

13.1.5 Multiple STP

Multiple Spanning Tree Protocol (IEEE 802.1s) is backward compatible with STP/RSTP and addresses the limitations of existing spanning tree protocols (STP and RSTP) in networks to include the following features:

- One Common and Internal Spanning Tree (CIST) that represents the entire network's connectivity.
- Grouping of multiple bridges (or switching devices) into regions that appear as one single bridge on the network.
- A VLAN can be mapped to a specific Multiple Spanning Tree Instance (MSTI). MSTI allows multiple VLANs to use the same spanning tree.
- Load-balancing is possible as traffic from different VLANs can use distinct paths in a region.

13.1.5.1 MSTP Network Example

The following figure shows a network example where two VLANs are configured on the two switches. If the switches are using STP or RSTP, the link for VLAN 2 will be

blocked as STP and RSTP allow only one link in the network and block the redundant link.

Figure 65 STP/RSTP Network Example

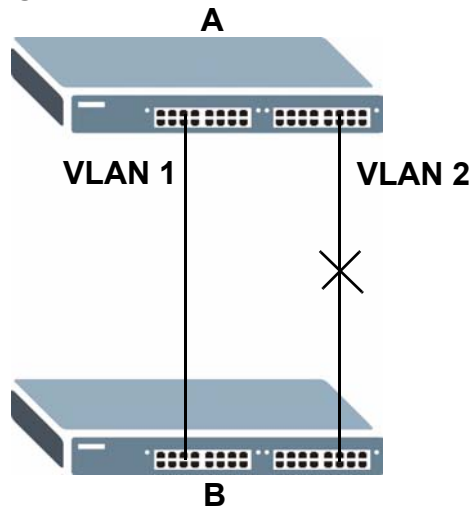

With MSTP, VLANs 1 and 2 are mapped to different spanning trees in the network. Thus traffic from the two VLANs travel on different paths. The following figure shows the network example using MSTP.

Figure 66 MSTP Network Example

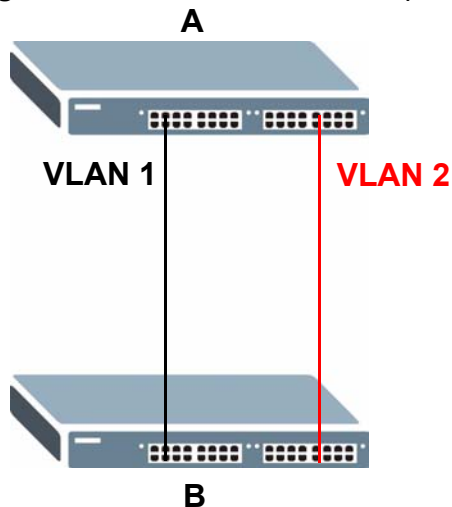

13.1.5.2 MST Region

An MST region is a logical grouping of multiple network devices that appears as a single device to the rest of the network. Each MSTP-enabled device can only belong to one MST region. When BPDUs enter an MST region, external path cost (of paths outside this region) is increased by one. Internal path cost (of paths within this region) is increased by one when BPDUs traverse the region.

Devices that belong to the same MST region are configured to have the same MSTP configuration identification settings. These include the following parameters:

- Name of the MST region
- Revision level as the unique number for the MST region
- VLAN-to-MST Instance mapping

13.1.5.3 MST Instance

An MST Instance (MSTI) is a spanning tree instance. VLANs can be configured to run on a specific MSTI. Each created MSTI is identified by a unique number (known as an MST ID) known internally to a region. Thus an MSTI does not span across MST regions.

The following figure shows an example where there are two MST regions. Regions 1 and 2 have 2 spanning tree instances.

Figure 67 MSTIs in Different Regions

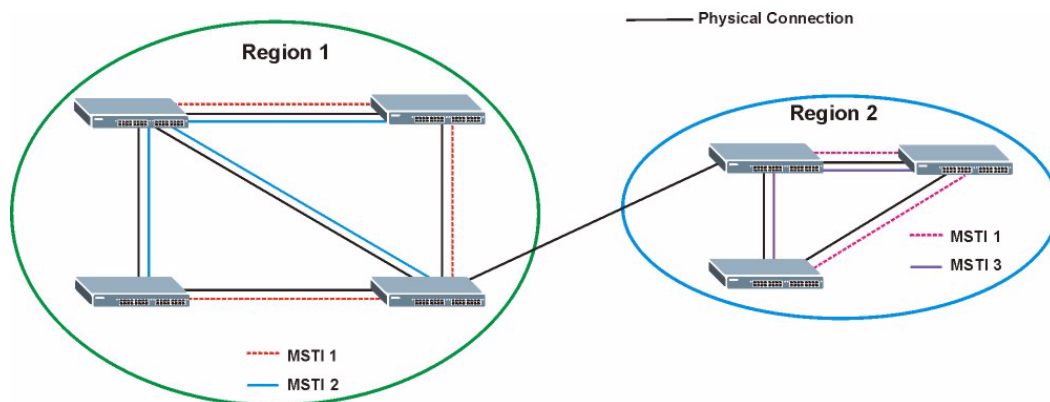

13.1.5.4 Common and Internal Spanning Tree (CIST)

A CIST represents the connectivity of the entire network and it is equivalent to a spanning tree in an STP/RSTP. The CIST is the default MST instance (MSTID 0). Any VLANs that are not members of an MST instance are members of the CIST. In an MSTP-enabled network, there is only one CIST that runs between MST regions

and single spanning tree devices. A network may contain multiple MST regions and other network segments running RSTP.

Figure 68 MSTP and Legacy RSTP Network Example

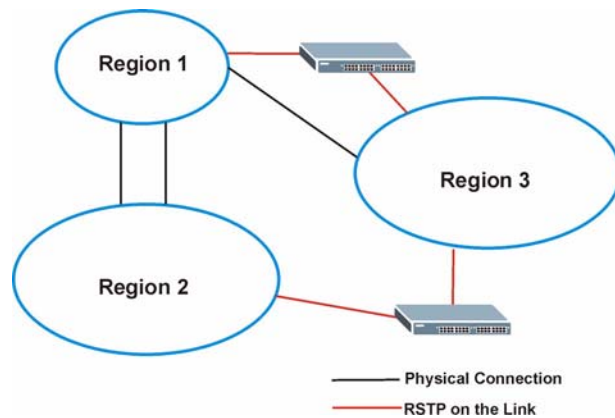

13.2 Spanning Tree Protocol Status Screen

The Spanning Tree Protocol status screen changes depending on what standard you choose to implement on your network. Click **Advanced Application > Spanning Tree Protocol** to see the screen as shown.

Figure 69 Advanced Application > Spanning Tree Protocol

Spanning Tree Protocol Status		
	Configuration	RSTP
	MRSTP	MSTP
Spanning Tree Protocol: RSTP		
Bridge	Root	Our Bridge
Bridge ID	0000-000000000000	0000-000000000000
Hello Time (second)	0	0
Max Age (second)	0	0
Forwarding Delay (second)	0	0
Cost to Bridge	0	
Port ID	0x0000	
Topology Changed Times		0
Time Since Last Change		0:00:00

This screen differs depending on which STP mode (RSTP, MRSTP or MSTP) you configure on the Switch. This screen is described in detail in the section that follows the configuration section for each STP mode. Click **Configuration** to activate one of the STP standards on the Switch.

13.3 Spanning Tree Configuration

Use the **Spanning Tree Configuration** screen to activate one of the STP modes on the Switch. Click **Configuration** in the **Advanced Application > Spanning Tree Protocol**.

Figure 70 Advanced Application > Spanning Tree Protocol > Configuration

The following table describes the labels in this screen.

Table 26 Advanced Application > Spanning Tree Protocol > Configuration

LABEL	DESCRIPTION
Spanning Tree Mode	You can activate one of the STP modes on the Switch. Select Rapid Spanning Tree , Multiple Rapid Spanning Tree or Multiple Spanning Tree . See Section 13.1 on page 119 for background information on STP.
Apply	Click Apply to save your changes to the Switch's run-time memory. The Switch loses these changes if it is turned off or loses power, so use the Save link on the top navigation panel to save your changes to the non-volatile memory when you are done configuring.
Cancel	Click Cancel to begin configuring this screen afresh.

13.4 Configure Rapid Spanning Tree Protocol

Use this screen to configure RSTP settings, see [Section 13.1 on page 119](#) for more information on RSTP. Click **RSTP** in the **Advanced Application > Spanning Tree Protocol** screen.

Figure 71 Advanced Application > Spanning Tree Protocol > RSTP

Port	Active	Priority	Path Cost
*	<input type="checkbox"/>		
1	<input type="checkbox"/>	128	4
2	<input type="checkbox"/>	128	4
3	<input type="checkbox"/>	128	4
4	<input type="checkbox"/>	128	4
5	<input type="checkbox"/>	128	4
6	<input type="checkbox"/>	128	4
7	<input type="checkbox"/>	128	4

The following table describes the labels in this screen.

Table 27 Advanced Application > Spanning Tree Protocol > RSTP

LABEL	DESCRIPTION
Status	Click Status to display the RSTP Status screen (see Figure 72 on page 129).
Active	Select this check box to activate RSTP. Clear this checkbox to disable RSTP. Note: You must also activate Rapid Spanning Tree in the Advanced Application > Spanning Tree Protocol > Configuration screen to enable RSTP on the Switch.

Table 27 Advanced Application > Spanning Tree Protocol > RSTP (continued)

LABEL	DESCRIPTION
Bridge Priority	<p>Bridge priority is used in determining the root switch, root port and designated port. The switch with the highest priority (lowest numeric value) becomes the STP root switch. If all switches have the same priority, the switch with the lowest MAC address will then become the root switch. Select a value from the drop-down list box.</p> <p>The lower the numeric value you assign, the higher the priority for this bridge.</p> <p>Bridge Priority determines the root bridge, which in turn determines Hello Time, Max Age and Forwarding Delay.</p>
Hello Time	<p>This is the time interval in seconds between BPDU (Bridge Protocol Data Units) configuration message generations by the root switch. The allowed range is 1 to 10 seconds.</p>
Max Age	<p>This is the maximum time (in seconds) the Switch can wait without receiving a BPDU before attempting to reconfigure. All Switch ports (except for designated ports) should receive BPDUs at regular intervals. Any port that ages out STP information (provided in the last BPDU) becomes the designated port for the attached LAN. If it is a root port, a new root port is selected from among the Switch ports attached to the network. The allowed range is 6 to 40 seconds.</p>
Forwarding Delay	<p>This is the maximum time (in seconds) the Switch will wait before changing states. This delay is required because every switch must receive information about topology changes before it starts to forward frames. In addition, each port needs time to listen for conflicting information that would make it return to a blocking state; otherwise, temporary data loops might result. The allowed range is 4 to 30 seconds.</p> <p>As a general rule:</p> <p>Note: $2 * (\text{Forward Delay} - 1) \geq \text{Max Age} \geq 2 * (\text{Hello Time} + 1)$</p>
Port	<p>This field displays the port number.</p>
*	<p>Settings in this row apply to all ports.</p> <p>Use this row only if you want to make some settings the same for all ports. Use this row first to set the common settings and then make adjustments on a port-by-port basis.</p> <p>Note: Changes in this row are copied to all the ports as soon as you make them.</p>
Active	<p>Select this check box to activate RSTP on this port.</p>
Priority	<p>Configure the priority for each port here.</p> <p>Priority decides which port should be disabled when more than one port forms a loop in a switch. Ports with a higher priority numeric value are disabled first. The allowed range is between 0 and 255 and the default value is 128.</p>
Path Cost	<p>Path cost is the cost of transmitting a frame on to a LAN through that port. It is recommended to assign this value according to the speed of the bridge. The slower the media, the higher the cost-see Table 24 on page 120 for more information.</p>

Table 27 Advanced Application > Spanning Tree Protocol > RSTP (continued)

LABEL	DESCRIPTION
Apply	Click Apply to save your changes to the Switch's run-time memory. The Switch loses these changes if it is turned off or loses power, so use the Save link on the top navigation panel to save your changes to the non-volatile memory when you are done configuring.
Cancel	Click Cancel to begin configuring this screen afresh.

13.5 Rapid Spanning Tree Protocol Status

Click **Advanced Application** > **Spanning Tree Protocol** in the navigation panel to display the status screen as shown next. See [Section 13.1 on page 119](#) for more information on RSTP.

Note: This screen is only available after you activate RSTP on the Switch.

Figure 72 Advanced Application > Spanning Tree Protocol > Status: RSTP

Bridge	Root	Our Bridge
Bridge ID	0000-000000000000	0000-000000000000
Hello Time (second)	0	0
Max Age (second)	0	0
Forwarding Delay (second)	0	0
Cost to Bridge	0	
Port ID	0x0000	
Topology Changed Times		0
Time Since Last Change		0:00:00

The following table describes the labels in this screen.

Table 28 Advanced Application > Spanning Tree Protocol > Status: RSTP

LABEL	DESCRIPTION
Configuration	Click Configuration to specify which STP mode you want to activate. Click RSTP to edit RSTP settings on the Switch.
Bridge	Root refers to the base of the spanning tree (the root bridge). Our Bridge is this switch. This Switch may also be the root bridge.
Bridge ID	This is the unique identifier for this bridge, consisting of bridge priority plus MAC address. This ID is the same for Root and Our Bridge if the Switch is the root switch.
Hello Time (second)	This is the time interval (in seconds) at which the root switch transmits a configuration message. The root bridge determines Hello Time, Max Age and Forwarding Delay.

Table 28 Advanced Application > Spanning Tree Protocol > Status: RSTP

LABEL	DESCRIPTION
Max Age (second)	This is the maximum time (in seconds) the Switch can wait without receiving a configuration message before attempting to reconfigure.
Forwarding Delay (second)	This is the time (in seconds) the root switch will wait before changing states (that is, listening to learning to forwarding). Note: The listening state does not exist in RSTP.
Cost to Bridge	This is the path cost from the root port on this Switch to the root switch.
Port ID	This is the priority and number of the port on the Switch through which this Switch must communicate with the root of the Spanning Tree.
Topology Changed Times	This is the number of times the spanning tree has been reconfigured.
Time Since Last Change	This is the time since the spanning tree was last reconfigured.

13.6 Configure Multiple Rapid Spanning Tree Protocol

To configure MRSTP, click **MRSTP** in the **Advanced Application > Spanning Tree Protocol** screen. See [Section 13.1 on page 119](#) for more information on MRSTP.

Figure 73 Advanced Application > Spanning Tree Protocol > MRSTP

Tree	Active	Bridge Priority	Hello Time	MAX Age	Forwarding Delay
1	<input type="checkbox"/>	32768	2 seconds	20 seconds	15
2	<input type="checkbox"/>	32768	2 seconds	20 seconds	15

Port	Active	Priority	Path Cost	Tree
*	<input type="checkbox"/>			1
1	<input type="checkbox"/>	128	19	1
2	<input type="checkbox"/>	128	19	1
3	<input type="checkbox"/>	128	19	1
4	<input type="checkbox"/>	128	19	1
5	<input type="checkbox"/>	128	19	1
26	<input type="checkbox"/>	128	4	1
27	<input type="checkbox"/>	128	4	1
28	<input type="checkbox"/>	128	4	1

Apply Cancel

The following table describes the labels in this screen.

Table 29 Advanced Application > Spanning Tree Protocol > MRSTP

LABEL	DESCRIPTION
Status	Click Status to display the MRSTP Status screen (see Figure 72 on page 129).
Tree	This is a read only index number of the STP trees.
Active	Select this check box to activate an STP tree. Clear this checkbox to disable an STP tree. Note: You must also activate Multiple Rapid Spanning Tree in the Advanced Application > Spanning Tree Protocol > Configuration screen to enable MRSTP on the Switch.

Table 29 Advanced Application > Spanning Tree Protocol > MRSTP (continued)

LABEL	DESCRIPTION
Bridge Priority	<p>Bridge priority is used in determining the root switch, root port and designated port. The switch with the highest priority (lowest numeric value) becomes the STP root switch. If all switches have the same priority, the switch with the lowest MAC address will then become the root switch. Select a value from the drop-down list box.</p> <p>The lower the numeric value you assign, the higher the priority for this bridge.</p> <p>Bridge Priority determines the root bridge, which in turn determines Hello Time, Max Age and Forwarding Delay.</p>
Hello Time	This is the time interval in seconds between BPDU (Bridge Protocol Data Units) configuration message generations by the root switch. The allowed range is 1 to 10 seconds.
Max Age	This is the maximum time (in seconds) the Switch can wait without receiving a BPDU before attempting to reconfigure. All Switch ports (except for designated ports) should receive BPDUs at regular intervals. Any port that ages out STP information (provided in the last BPDU) becomes the designated port for the attached LAN. If it is a root port, a new root port is selected from among the Switch ports attached to the network. The allowed range is 6 to 40 seconds.
Forwarding Delay	<p>This is the maximum time (in seconds) the Switch will wait before changing states. This delay is required because every switch must receive information about topology changes before it starts to forward frames. In addition, each port needs time to listen for conflicting information that would make it return to a blocking state; otherwise, temporary data loops might result. The allowed range is 4 to 30 seconds.</p> <p>As a general rule:</p> <p>Note: $2 * (\text{Forward Delay} - 1) \geq \text{Max Age} \geq 2 * (\text{Hello Time} + 1)$</p>
Port	This field displays the port number.
*	<p>Settings in this row apply to all ports.</p> <p>Use this row only if you want to make some settings the same for all ports. Use this row first to set the common settings and then make adjustments on a port-by-port basis.</p> <p>Note: Changes in this row are copied to all the ports as soon as you make them.</p>
Active	Select this check box to activate STP on this port.
Priority	<p>Configure the priority for each port here.</p> <p>Priority decides which port should be disabled when more than one port forms a loop in a switch. Ports with a higher priority numeric value are disabled first. The allowed range is between 0 and 255 and the default value is 128.</p>
Path Cost	Path cost is the cost of transmitting a frame on to a LAN through that port. It is recommended to assign this value according to the speed of the bridge. The slower the media, the higher the cost-see Table 24 on page 120 for more information.

Table 29 Advanced Application > Spanning Tree Protocol > MRSTP (continued)

LABEL	DESCRIPTION
Tree	Select which STP tree configuration this port should participate in.
Apply	Click Apply to save your changes to the Switch's run-time memory. The Switch loses these changes if it is turned off or loses power, so use the Save link on the top navigation panel to save your changes to the non-volatile memory when you are done configuring.
Cancel	Click Cancel to begin configuring this screen afresh.

13.7 Multiple Rapid Spanning Tree Protocol Status

Click **Advanced Application > Spanning Tree Protocol** in the navigation panel to display the status screen as shown next. See [Section 13.1 on page 119](#) for more information on MRSTP.

Note: This screen is only available after you activate MRSTP on the Switch.

Figure 74 Advanced Application > Spanning Tree Protocol > Status: MRSTP

Bridge	Root	Our Bridge
Bridge ID	8000-001349000002	8000-001349000002
Hello Time (second)	2	2
Max Age (second)	20	20
Forwarding Delay (second)	15	15
Cost to Bridge	0	
Port ID	0x0000	
Topology Changed Times	0	
Time Since Last Change	0:00:00	

The following table describes the labels in this screen.

Table 30 Advanced Application > Spanning Tree Protocol > Status: MRSTP

LABEL	DESCRIPTION
Configuration	Click Configuration to specify which STP mode you want to activate. Click MRSTP to edit MRSTP settings on the Switch.
Tree	Select which STP tree configuration you want to view.
Bridge	Root refers to the base of the spanning tree (the root bridge). Our Bridge is this switch. This Switch may also be the root bridge.
Bridge ID	This is the unique identifier for this bridge, consisting of bridge priority plus MAC address. This ID is the same for Root and Our Bridge if the Switch is the root switch.

Table 30 Advanced Application > Spanning Tree Protocol > Status: MRSTP

LABEL	DESCRIPTION
Hello Time (second)	This is the time interval (in seconds) at which the root switch transmits a configuration message. The root bridge determines Hello Time, Max Age and Forwarding Delay.
Max Age (second)	This is the maximum time (in seconds) the Switch can wait without receiving a configuration message before attempting to reconfigure.
Forwarding Delay (second)	This is the time (in seconds) the root switch will wait before changing states (that is, listening to learning to forwarding). Note: The listening state does not exist in RSTP.
Cost to Bridge	This is the path cost from the root port on this Switch to the root switch.
Port ID	This is the priority and number of the port on the Switch through which this Switch must communicate with the root of the Spanning Tree.
Topology Changed Times	This is the number of times the spanning tree has been reconfigured.
Time Since Last Change	This is the time since the spanning tree was last reconfigured.

13.8 Configure Multiple Spanning Tree Protocol

To configure MSTP, click **MSTP** in the **Advanced Application > Spanning Tree Protocol** screen. See [Section 13.1.5 on page 122](#) for more information on MSTP.

Figure 75 Advanced Application > Spanning Tree Protocol > MSTP

Multiple Spanning Tree Protocol
Status

Bridge:

Active	<input type="checkbox"/>
Hello Time	<input type="text" value="2"/> seconds
MAX Age	<input type="text" value="20"/> seconds
Forwarding Delay	<input type="text" value="15"/> seconds
Maximum hops	<input type="text" value="128"/>
Configuration Name	<input type="text" value="0019cb000002"/>
Revision Number	<input type="text" value="0"/>

Instance:

Instance	<input type="text"/>
Bridge Priority	<input type="text" value="32768"/> <input type="button" value="v"/>
VLAN Range	Start <input type="text"/> End <input type="text"/> <input type="button" value="Add"/> <input type="button" value="Remove"/> <input type="button" value="Clear"/>
Enabled VLAN(s)	<div style="border: 1px solid gray; height: 50px; width: 100%;"></div>

Port	Active	Priority	Path Cost
*	<input type="checkbox"/>	<input type="text"/>	<input type="text"/>
1	<input type="checkbox"/>	<input type="text" value="128"/>	<input type="text" value="4"/>
2	<input type="checkbox"/>	<input type="text" value="128"/>	<input type="text" value="4"/>
3	<input type="checkbox"/>	<input type="text" value="128"/>	<input type="text" value="4"/>
4	<input type="checkbox"/>	<input type="text" value="128"/>	<input type="text" value="4"/>
5	<input type="checkbox"/>	<input type="text" value="128"/>	<input type="text" value="4"/>
6	<input type="checkbox"/>	<input type="text" value="128"/>	<input type="text" value="4"/>

Instance	VLAN	Active Port	Delete
0	1-4094	-	<input type="button" value="Delete"/>

The following table describes the labels in this screen.

Table 31 Advanced Application > Spanning Tree Protocol > MSTP

LABEL	DESCRIPTION
Status	Click Status to display the MSTP Status screen (see Figure 76 on page 138).
Active	Select this to activate MSTP on the Switch. Clear this to disable MSTP on the Switch. Note: You must also activate Multiple Spanning Tree in the Advanced Application > Spanning Tree Protocol > Configuration screen to enable MSTP on the Switch.
Hello Time	This is the time interval in seconds between BPDU (Bridge Protocol Data Units) configuration message generations by the root switch. The allowed range is 1 to 10 seconds.
MaxAge	This is the maximum time (in seconds) the Switch can wait without receiving a BPDU before attempting to reconfigure. All Switch ports (except for designated ports) should receive BPDUs at regular intervals. Any port that ages out STP information (provided in the last BPDU) becomes the designated port for the attached LAN. If it is a root port, a new root port is selected from among the Switch ports attached to the network. The allowed range is 6 to 40 seconds.
Forwarding Delay	This is the maximum time (in seconds) the Switch will wait before changing states. This delay is required because every switch must receive information about topology changes before it starts to forward frames. In addition, each port needs time to listen for conflicting information that would make it return to a blocking state; otherwise, temporary data loops might result. The allowed range is 4 to 30 seconds. As a general rule: Note: $2 * (\text{Forward Delay} - 1) \geq \text{Max Age} \geq 2 * (\text{Hello Time} + 1)$
Maximum hops	Enter the number of hops (between 1 and 255) in an MSTP region before the BPDU is discarded and the port information is aged.
Configuration Name	Enter a descriptive name (up to 32 characters) of an MST region.
Revision Number	Enter a number to identify a region's configuration. Devices must have the same revision number to belong to the same region.
Apply	Click Apply to save your changes to the Switch's run-time memory. The Switch loses these changes if it is turned off or loses power, so use the Save link on the top navigation panel to save your changes to the non-volatile memory when you are done configuring.
Cancel	Click Cancel to begin configuring this screen afresh.
Instance	Use this section to configure MSTI (Multiple Spanning Tree Instance) settings.
Instance	Enter the number you want to use to identify this MST instance on the Switch. The Switch supports instance numbers 0-15.

Table 31 Advanced Application > Spanning Tree Protocol > MSTP (continued)

LABEL	DESCRIPTION
Bridge Priority	<p>Set the priority of the Switch for the specific spanning tree instance. The lower the number, the more likely the Switch will be chosen as the root bridge within the spanning tree instance.</p> <p>Enter priority values between 0 and 61440 in increments of 4096 (thus valid values are 4096, 8192, 12288, 16384, 20480, 24576, 28672, 32768, 36864, 40960, 45056, 49152, 53248, 57344 and 61440).</p>
VLAN Range	<p>Enter the start of the VLAN ID range that you want to add or remove from the VLAN range edit area in the Start field. Enter the end of the VLAN ID range that you want to add or remove from the VLAN range edit area in the End field.</p> <p>Next click:</p> <ul style="list-style-type: none"> • Add - to add this range of VLAN(s) to be mapped to the MST instance. • Remove - to remove this range of VLAN(s) from being mapped to the MST instance. • Clear - to remove all VLAN(s) from being mapped to this MST instance.
Enabled VLAN(s)	This field displays which VLAN(s) are mapped to this MST instance.
Port	This field displays the port number.
*	<p>Settings in this row apply to all ports.</p> <p>Use this row only if you want to make some settings the same for all ports. Use this row first to set the common settings and then make adjustments on a port-by-port basis.</p> <p>Note: Changes in this row are copied to all the ports as soon as you make them.</p>
Active	Select this check box to add this port to the MST instance.
Priority	<p>Configure the priority for each port here.</p> <p>Priority decides which port should be disabled when more than one port forms a loop in a switch. Ports with a higher priority numeric value are disabled first. The allowed range is between 0 and 255 and the default value is 128.</p>
Path Cost	<p>Path cost is the cost of transmitting a frame on to a LAN through that port. It is recommended to assign this value according to the speed of the bridge. The slower the media, the higher the cost-see Table 24 on page 120 for more information.</p>
Add	<p>Click Add to save this MST instance to the Switch's run-time memory. The Switch loses this change if it is turned off or loses power, so use the Save link on the top navigation panel to save your changes to the non-volatile memory when you are done configuring.</p>
Cancel	Click Cancel to begin configuring this screen afresh.
Instance	This field displays the ID of an MST instance.
VLAN	This field displays the VID (or VID ranges) to which the MST instance is mapped.
Active Port	This field display the ports configured to participate in the MST instance.

Table 31 Advanced Application > Spanning Tree Protocol > MSTP (continued)

LABEL	DESCRIPTION
Delete	Check the rule(s) that you want to remove in the Delete column and then click the Delete button.
Cancel	Click Cancel to begin configuring this screen afresh.

13.9 Multiple Spanning Tree Protocol Status

Click **Advanced Application** > **Spanning Tree Protocol** in the navigation panel to display the status screen as shown next. See [Section 13.1.5 on page 122](#) for more information on MSTP.

Note: This screen is only available after you activate MSTP on the Switch.

Figure 76 Advanced Application > Spanning Tree Protocol > Status: MSTP

Spanning Tree Protocol Status Configuration RSTP MRSTP MSTP

Spanning Tree Protocol: MSTP

CST

Bridge	Root	Our Bridge
Bridge ID	0000-000000000000	8000-000000000000
Hello Time (second)	0	2
Max Age (second)	0	20
Forwarding Delay (second)	0	15
Cost to Bridge	0	0
Port ID	0x0000	0x0000
Configuration Name	001349000002	
Revision Number	0	
Configuration Digest	A317523DB32DA2D62	
Topology Changed Times	0	
Time Since Last Change	0	

Instance:

Instance	VLAN
0	1-4093

MSTI 1

Bridge	Regional Root	Our Bridge
Bridge ID	0000-000000000000	8001-000000000000
Internal Cost	0	0
Port ID	0x0000	0x0000

The following table describes the labels in this screen.

Table 32 Advanced Application > Spanning Tree Protocol > Status: MSTP

LABEL	DESCRIPTION
Configuration	Click Configuration to specify which STP mode you want to activate. Click MSTP to edit MSTP settings on the Switch.
CST	This section describes the Common Spanning Tree settings.
Bridge	Root refers to the base of the spanning tree (the root bridge). Our Bridge is this switch. This Switch may also be the root bridge.
Bridge ID	This is the unique identifier for this bridge, consisting of bridge priority plus MAC address. This ID is the same for Root and Our Bridge if the Switch is the root switch.
Hello Time (second)	This is the time interval (in seconds) at which the root switch transmits a configuration message.
Max Age (second)	This is the maximum time (in seconds) the Switch can wait without receiving a configuration message before attempting to reconfigure.
Forwarding Delay (second)	This is the time (in seconds) the root switch will wait before changing states (that is, listening to learning to forwarding).
Cost to Bridge	This is the path cost from the root port on this Switch to the root switch.
Port ID	This is the priority and number of the port on the Switch through which this Switch must communicate with the root of the Spanning Tree.
Configuration Name	This field displays the configuration name for this MST region.
Revision Number	This field displays the revision number for this MST region.
Configuration Digest	A configuration digest is generated from the VLAN-MSTI mapping information. This field displays the 16-octet signature that is included in an MSTP BPDU. This field displays the digest when MSTP is activated on the system.
Topology Changed Times	This is the number of times the spanning tree has been reconfigured.
Time Since Last Change	This is the time since the spanning tree was last reconfigured.
Instance:	These fields display the MSTI to VLAN mapping. In other words, which VLANs run on each spanning tree instance.
Instance	This field displays the MSTI ID.
VLAN	This field displays which VLANs are mapped to an MSTI.
MSTI	Select the MST instance settings you want to view.
Bridge	Root refers to the base of the MST instance. Our Bridge is this switch. This Switch may also be the root bridge.
Bridge ID	This is the unique identifier for this bridge, consisting of bridge priority plus MAC address. This ID is the same for Root and Our Bridge if the Switch is the root switch.

Table 32 Advanced Application > Spanning Tree Protocol > Status: MSTP

LABEL	DESCRIPTION
Internal Cost	This is the path cost from the root port in this MST instance to the regional root switch.
Port ID	This is the priority and number of the port on the Switch through which this Switch must communicate with the root of the MST instance.

Bandwidth Control

This chapter shows you how you can cap the maximum bandwidth using the **Bandwidth Control** screen.

14.1 Bandwidth Control Overview

Bandwidth control means defining a maximum allowable bandwidth for incoming and/or out-going traffic flows on a port.

14.2 Bandwidth Control Setup

Click **Advanced Application > Bandwidth Control** in the navigation panel to bring up the screen as shown next.

Figure 77 Advanced Application > Bandwidth Control

Port	Active	Ingress Rate	Active	Egress Rate
*	<input type="checkbox"/>	<input type="text"/> Kbps	<input type="checkbox"/>	<input type="text"/> Kbps
1	<input type="checkbox"/>	64 Kbps	<input type="checkbox"/>	64 Kbps
2	<input type="checkbox"/>	64 Kbps	<input type="checkbox"/>	64 Kbps
3	<input type="checkbox"/>	64 Kbps	<input type="checkbox"/>	64 Kbps
4	<input type="checkbox"/>	64 Kbps	<input type="checkbox"/>	64 Kbps
5	<input type="checkbox"/>	64 Kbps	<input type="checkbox"/>	64 Kbps
6	<input type="checkbox"/>	64 Kbps	<input type="checkbox"/>	64 Kbps
7	<input type="checkbox"/>	64 Kbps	<input type="checkbox"/>	64 Kbps
8	<input type="checkbox"/>	64 Kbps	<input type="checkbox"/>	64 Kbps
9	<input type="checkbox"/>	64 Kbps	<input type="checkbox"/>	64 Kbps
10	<input type="checkbox"/>	64 Kbps	<input type="checkbox"/>	64 Kbps
11	<input type="checkbox"/>	64 Kbps	<input type="checkbox"/>	64 Kbps
28	<input type="checkbox"/>	64 Kbps	<input type="checkbox"/>	64 Kbps

Apply Cancel

The following table describes the related labels in this screen.

Table 33 Advanced Application > Bandwidth Control

LABEL	DESCRIPTION
Active	Select this check box to enable bandwidth control on the Switch.
Port	This field displays the port number.
*	Settings in this row apply to all ports. Use this row only if you want to make some settings the same for all ports. Use this row first to set the common settings and then make adjustments on a port-by-port basis. Note: Changes in this row are copied to all the ports as soon as you make them.
Active	Select this check box to activate ingress rate limits on this port.
Ingress Rate	
Active	Select this check box to activate egress rate limits on this port.
Egress Rate	Specify the maximum bandwidth allowed in kilobits per second (Kbps) for the out-going traffic flow on a port.

Table 33 Advanced Application > Bandwidth Control (continued)

LABEL	DESCRIPTION
Apply	Click Apply to save your changes to the Switch's run-time memory. The Switch loses these changes if it is turned off or loses power, so use the Save link on the top navigation panel to save your changes to the non-volatile memory when you are done configuring.
Cancel	Click Cancel to reset the fields.

Broadcast Storm Control

This chapter introduces and shows you how to configure the broadcast storm control feature.

15.1 Broadcast Storm Control Setup

Broadcast storm control limits the number of broadcast, multicast and destination lookup failure (DLF) packets the Switch receives per second on the ports. When the maximum number of allowable broadcast, multicast and/or DLF packets is reached per second, the subsequent packets are discarded. Enable this feature to reduce broadcast, multicast and/or DLF packets in your network. You can specify limits for each packet type on each port.

Click **Advanced Application** > **Broadcast Storm Control** in the navigation panel to display the screen as shown next.

Figure 78 Advanced Application > Broadcast Storm Control

Port	Broadcast (pkt/s)	Multicast (pkt/s)	DLF (pkt/s)
*	<input type="checkbox"/> []	<input type="checkbox"/> []	<input type="checkbox"/> []
1	<input type="checkbox"/> 0	<input type="checkbox"/> 0	<input type="checkbox"/> 0
2	<input type="checkbox"/> 0	<input type="checkbox"/> 0	<input type="checkbox"/> 0
3	<input type="checkbox"/> 0	<input type="checkbox"/> 0	<input type="checkbox"/> 0
4	<input type="checkbox"/> 0	<input type="checkbox"/> 0	<input type="checkbox"/> 0
5	<input type="checkbox"/> 0	<input type="checkbox"/> 0	<input type="checkbox"/> 0
6	<input type="checkbox"/> 0	<input type="checkbox"/> 0	<input type="checkbox"/> 0
7	<input type="checkbox"/> 0	<input type="checkbox"/> 0	<input type="checkbox"/> 0

Apply Cancel

The following table describes the labels in this screen.

Table 34 Advanced Application > Broadcast Storm Control

LABEL	DESCRIPTION
Active	Select this check box to enable traffic storm control on the Switch. Clear this check box to disable this feature.
Port	This field displays the port number.
*	<p>Settings in this row apply to all ports.</p> <p>Use this row only if you want to make some settings the same for all ports. Use this row first to set the common settings and then make adjustments on a port-by-port basis.</p> <p>Note: Changes in this row are copied to all the ports as soon as you make them.</p>
Broadcast (pkt/s)	Select this option and specify how many broadcast packets the port receives per second.
Multicast (pkt/s)	Select this option and specify how many multicast packets the port receives per second.
DLF (pkt/s)	Select this option and specify how many destination lookup failure (DLF) packets the port receives per second.
Apply	Click Apply to save your changes to the Switch's run-time memory. The Switch loses these changes if it is turned off or loses power, so use the Save link on the top navigation panel to save your changes to the non-volatile memory when you are done configuring.
Cancel	Click Cancel to reset the fields.

Mirroring

This chapter discusses port mirroring setup screens.

16.1 Port Mirroring Setup

Port mirroring allows you to copy a traffic flow to a monitor port (the port you copy the traffic to) in order that you can examine the traffic from the monitor port without interference.

Click **Advanced Application > Mirroring** in the navigation panel to display the **Mirroring** screen. Use this screen to select a monitor port and specify the traffic flow to be copied to the monitor port.

Figure 79 Advanced Application > Mirroring

Port	Mirrored	Direction
*	<input type="checkbox"/>	Ingress
1	<input type="checkbox"/>	Ingress
2	<input type="checkbox"/>	Ingress
3	<input type="checkbox"/>	Ingress
4	<input type="checkbox"/>	Ingress
5	<input type="checkbox"/>	Ingress
6	<input type="checkbox"/>	Ingress
7	<input type="checkbox"/>	Ingress
8	<input type="checkbox"/>	Ingress
9	<input type="checkbox"/>	Ingress
10	<input type="checkbox"/>	Ingress
11	<input type="checkbox"/>	Ingress

Apply Cancel

The following table describes the labels in this screen.

Table 35 Advanced Application > Mirroring

LABEL	DESCRIPTION
Active	Select this check box to activate port mirroring on the Switch. Clear this check box to disable the feature.
Monitor Port	The monitor port is the port you copy the traffic to in order to examine it in more detail without interfering with the traffic flow on the original port(s). Enter the port number of the monitor port.
Port	This field displays the port number.
*	<p>Settings in this row apply to all ports.</p> <p>Use this row only if you want to make some settings the same for all ports. Use this row first to set the common settings and then make adjustments on a port-by-port basis.</p> <p>Note: Changes in this row are copied to all the ports as soon as you make them.</p>
Mirrored	Select this option to mirror the traffic on a port.
Direction	Specify the direction of the traffic to mirror by selecting from the drop-down list box. Choices are Egress (outgoing), Ingress (incoming) and Both .
Apply	Click Apply to save your changes to the Switch's run-time memory. The Switch loses these changes if it is turned off or loses power, so use the Save link on the top navigation panel to save your changes to the non-volatile memory when you are done configuring.
Cancel	Click Cancel to reset the fields.

Link Aggregation

This chapter shows you how to logically aggregate physical links to form one logical, higher-bandwidth link.

17.1 Link Aggregation Overview

Link aggregation (trunking) is the grouping of physical ports into one logical higher-capacity link. You may want to trunk ports if for example, it is cheaper to use multiple lower-speed links than to under-utilize a high-speed, but more costly, single-port link.

However, the more ports you aggregate then the fewer available ports you have. A trunk group is one logical link containing multiple ports.

The beginning port of each trunk group must be physically connected to form a trunk group.

The Switch supports both static and dynamic link aggregation.

Note: In a properly planned network, it is recommended to implement static link aggregation only. This ensures increased network stability and control over the trunk groups on your Switch.

See [Section 17.6 on page 156](#) for a static port trunking example.

17.2 Dynamic Link Aggregation

The Switch adheres to the IEEE 802.3ad standard for static and dynamic (LACP) port trunking.

The IEEE 802.3ad standard describes the Link Aggregation Control Protocol (LACP) for dynamically creating and managing trunk groups.

When you enable LACP link aggregation on a port, the port can automatically negotiate with the ports at the remote end of a link to establish trunk groups.

LACP also allows port redundancy, that is, if an operational port fails, then one of the “standby” ports become operational without user intervention. Please note that:

- You must connect all ports point-to-point to the same Ethernet switch and configure the ports for LACP trunking.
- LACP only works on full-duplex links.
- All ports in the same trunk group must have the same media type, speed, duplex mode and flow control settings.

Configure trunk groups or LACP before you connect the Ethernet switch to avoid causing network topology loops.

17.2.1 Link Aggregation ID

LACP aggregation ID consists of the following information¹:

Table 36 Link Aggregation ID: Local Switch

SYSTEM PRIORITY	MAC ADDRESS	KEY	PORT PRIORITY	PORT NUMBER
0000	00-00-00-00-00-00	0000	00	0000

Table 37 Link Aggregation ID: Peer Switch

SYSTEM PRIORITY	MAC ADDRESS	KEY	PORT PRIORITY	PORT NUMBER
0000	00-00-00-00-00-00	0000	00	0000

1. Port Priority and Port Number are 0 as it is the aggregator ID for the trunk group, not the individual port.

17.3 Link Aggregation Status

Click **Advanced Application > Link Aggregation** in the navigation panel. The **Link Aggregation Status** screen displays by default. See [Section 17.1 on page 149](#) for more information.

Figure 80 Advanced Application > Link Aggregation Status

Link Aggregation Status				Link Aggregation Setting	
Group ID	Enabled Ports	Synchronized Ports	Aggregator ID	Criteria	Status
T1	3,6	-	[(0000,00-00-00-00-00-00,0000,00,0000)] [(0000,00-00-00-00-00-00,0000,00,0000)]	src-dst-mac	LACP
T2	7	-	-	src-dst-ip	Static
T3	-	-	-	src-dst-mac	-
T4	-	-	-	src-dst-mac	-
T5	-	-	-	src-dst-mac	-
T6	-	-	-	src-dst-mac	-

The following table describes the labels in this screen.

Table 38 Advanced Application > Link Aggregation Status

LABEL	DESCRIPTION
Group ID	This field displays the group ID to identify a trunk group, that is, one logical link containing multiple ports.
Enabled Ports	These are the ports you have configured in the Link Aggregation screen to be in the trunk group. The port number(s) displays only when this trunk group is activated and there is a port belonging to this group.
Synchronized Ports	These are the ports that are currently transmitting data as one logical link in this trunk group.
Aggregator ID	Link Aggregator ID consists of the following: system priority, MAC address, key, port priority and port number. Refer to Section 17.2.1 on page 150 for more information on this field. The ID displays only when there is a port belonging to this trunk group and LACP is also enabled for this group.

Table 38 Advanced Application > Link Aggregation Status (continued)

LABEL	DESCRIPTION
Criteria	<p>This shows the outgoing traffic distribution algorithm used in this trunk group. Packets from the same source and/or to the same destination are sent over the same link within the trunk.</p> <p>src-mac means the Switch distributes traffic based on the packet's source MAC address.</p> <p>dst-mac means the Switch distributes traffic based on the packet's destination MAC address.</p> <p>src-dst-mac means the Switch distributes traffic based on a combination of the packet's source and destination MAC addresses.</p> <p>src-ip means the Switch distributes traffic based on the packet's source IP address.</p> <p>dst-ip means the Switch distributes traffic based on the packet's destination IP address.</p> <p>src-dst-ip means the Switch distributes traffic based on a combination of the packet's source and destination IP addresses.</p>
Status	<p>This field displays how these ports were added to the trunk group. It displays:</p> <ul style="list-style-type: none"> • Static - if the ports are configured as static members of a trunk group. • LACP - if the ports are configured to join a trunk group via LACP.

17.4 Link Aggregation Setting

Click **Advanced Application > Link Aggregation > Link Aggregation Setting** to display the screen shown next. See [Section 17.1 on page 149](#) for more information on link aggregation.

Figure 81 Advanced Application > Link Aggregation > Link Aggregation Setting

Group ID	Active	Criteria
T1	<input checked="" type="checkbox"/>	src-dst-mac
T2	<input type="checkbox"/>	src-dst-ip
T3	<input checked="" type="checkbox"/>	src-ip
T4	<input checked="" type="checkbox"/>	src-dst-mac
T5	<input checked="" type="checkbox"/>	src-dst-mac
T6	<input type="checkbox"/>	src-dst-mac

Port	Group
1	T4
2	T4
3	T1
4	None
5	None
6	T1
7	T2
8	None

Apply Cancel

The following table describes the labels in this screen.

Table 39 Advanced Application > Link Aggregation > Link Aggregation Setting

LABEL	DESCRIPTION
Link Aggregation Setting	This is the only screen you need to configure to enable static link aggregation.
Group ID	The field identifies the link aggregation group, that is, one logical link containing multiple ports.
Active	Select this option to activate a trunk group.

Table 39 Advanced Application > Link Aggregation > Link Aggregation Setting

LABEL	DESCRIPTION
Criteria	<p>Select the outgoing traffic distribution type. Packets from the same source and/or to the same destination are sent over the same link within the trunk. By default, the Switch uses the src-dst-mac distribution type. If the Switch is behind a router, the packet's destination or source MAC address will be changed. In this case, set the Switch to distribute traffic based on its IP address to make sure port trunking can work properly.</p> <p>Select src-mac to distribute traffic based on the packet's source MAC address.</p> <p>Select dst-mac to distribute traffic based on the packet's destination MAC address.</p> <p>Select src-dst-mac to distribute traffic based on a combination of the packet's source and destination MAC addresses.</p> <p>Select src-ip to distribute traffic based on the packet's source IP address.</p> <p>Select dst-ip to distribute traffic based on the packet's destination IP address.</p> <p>Select src-dst-ip to distribute traffic based on a combination of the packet's source and destination IP addresses.</p>
Port	This field displays the port number.
Group	<p>Select the trunk group to which a port belongs.</p> <p>Note: When you enable the port security feature on the Switch and configure port security settings for a port, you cannot include the port in an active trunk group.</p>
Apply	Click Apply to save your changes to the Switch's run-time memory. The Switch loses these changes if it is turned off or loses power, so use the Save link on the top navigation panel to save your changes to the non-volatile memory when you are done configuring.
Cancel	Click Cancel to begin configuring this screen afresh.

17.5 Link Aggregation Control Protocol

Click **Advanced Application > Link Aggregation > Link Aggregation Setting > LACP** to display the screen shown next. See [Section 17.2 on page 149](#) for more information on dynamic link aggregation.

Figure 82 Advanced Application > Link Aggregation > Link Aggregation Setting > LACP

The screenshot shows the LACP configuration interface. At the top, there's a title bar with 'Link Aggregation Control Protocol' and 'Link Aggregation Setting'. Below that, there are two fields: 'Active' with an unchecked checkbox and 'System Priority' with a text box containing '65535'. A table follows with columns 'Group ID' and 'LACP Active', listing groups T1 through T6, all with unchecked checkboxes. Below this is another table with columns 'Port' and 'LACP Timeout', listing ports 1 through 7, all with a dropdown menu set to '30 seconds'. At the bottom, there are 'Apply' and 'Cancel' buttons.

The following table describes the labels in this screen.

Table 40 Advanced Application > Link Aggregation > Link Aggregation Setting > LACP

LABEL	DESCRIPTION
Link Aggregation Control Protocol	Note: Do not configure this screen unless you want to enable dynamic link aggregation.
Active	Select this checkbox to enable Link Aggregation Control Protocol (LACP).

Table 40 Advanced Application > Link Aggregation > Link Aggregation Setting > LACP (continued)

LABEL	DESCRIPTION
System Priority	LACP system priority is a number between 1 and 65,535. The switch with the lowest system priority (and lowest port number if system priority is the same) becomes the LACP "server". The LACP "server" controls the operation of LACP setup. Enter a number to set the priority of an active port using Link Aggregation Control Protocol (LACP). The smaller the number, the higher the priority level.
Group ID	The field identifies the link aggregation group, that is, one logical link containing multiple ports.
LACP Active	Select this option to enable LACP for a trunk.
Port	This field displays the port number.
*	<p>Settings in this row apply to all ports.</p> <p>Use this row only if you want to make some settings the same for all ports. Use this row first to set the common settings and then make adjustments on a port-by-port basis.</p> <p>Note: Changes in this row are copied to all the ports as soon as you make them.</p>
LACP Timeout	<p>Timeout is the time interval between the individual port exchanges of LACP packets in order to check that the peer port in the trunk group is still up. If a port does not respond after three tries, then it is deemed to be "down" and is removed from the trunk. Set a short timeout (one second) for busy trunked links to ensure that disabled ports are removed from the trunk group as soon as possible.</p> <p>Select either 1 second or 30 seconds.</p>
Apply	Click Apply to save your changes to the Switch's run-time memory. The Switch loses these changes if it is turned off or loses power, so use the Save link on the top navigation panel to save your changes to the non-volatile memory when you are done configuring.
Cancel	Click Cancel to begin configuring this screen afresh.

17.6 Static Trunking Example

This example shows you how to create a static port trunk group for ports 2-5.

- 1 **Make your physical connections** - make sure that the ports that you want to belong to the trunk group are connected to the same destination. The following figure shows ports 2-5 on switch **A** connected to switch **B**.

Figure 83 Trunking Example - Physical Connections



- 2 **Configure static trunking** - Click **Advanced Application > Link Aggregation > Link Aggregation Setting**. In this screen activate trunk group **T1**, select the traffic distribution algorithm used by this group and select the ports that should belong to this group as shown in the figure below. Click **Apply** when you are done.

Figure 84 Trunking Example - Configuration Screen

Link Aggregation Setting Status LACP

Group ID	Active	Criteria
T1	<input checked="" type="checkbox"/>	src-dst-mac
T2	<input type="checkbox"/>	src-dst-mac
T3	<input type="checkbox"/>	src-dst-mac
T4	<input type="checkbox"/>	src-dst-mac
T5	<input type="checkbox"/>	src-dst-mac
T6	<input type="checkbox"/>	src-dst-mac

Port	Group
1	None
2	T1
3	T1
4	T1
5	T1
6	None
7	None
8	None

Your trunk group 1 (**T1**) configuration is now complete.

Port Authentication

This chapter describes the IEEE 802.1x authentication method.

18.1 Port Authentication Overview

Port authentication is a way to validate access to ports on the Switch to clients based on an external server (authentication server). The Switch supports the following method for port authentication:

- **IEEE 802.1x²** - An authentication server validates access to a port based on a username and password provided by the user.

IEEE 802.1x authentication uses the RADIUS (Remote Authentication Dial In User Service, RFC 2138, 2139) protocol to validate users. See [Section 24.1.2 on page 200](#) for more information on configuring your RADIUS server settings.

18.1.1 IEEE 802.1x Authentication

The following figure illustrates how a client connecting to a IEEE 802.1x authentication enabled port goes through a validation process. The Switch prompts the client for login information in the form of a user name and password. When the client provides the login credentials, the Switch sends an authentication

2. At the time of writing, IEEE 802.1x is not supported by all operating systems. See your operating system documentation. If your operating system does not support 802.1x, then you may need to install 802.1x client software.

request to a RADIUS server. The RADIUS server validates whether this client is allowed access to the port.

Figure 85 IEEE 802.1x Authentication Process

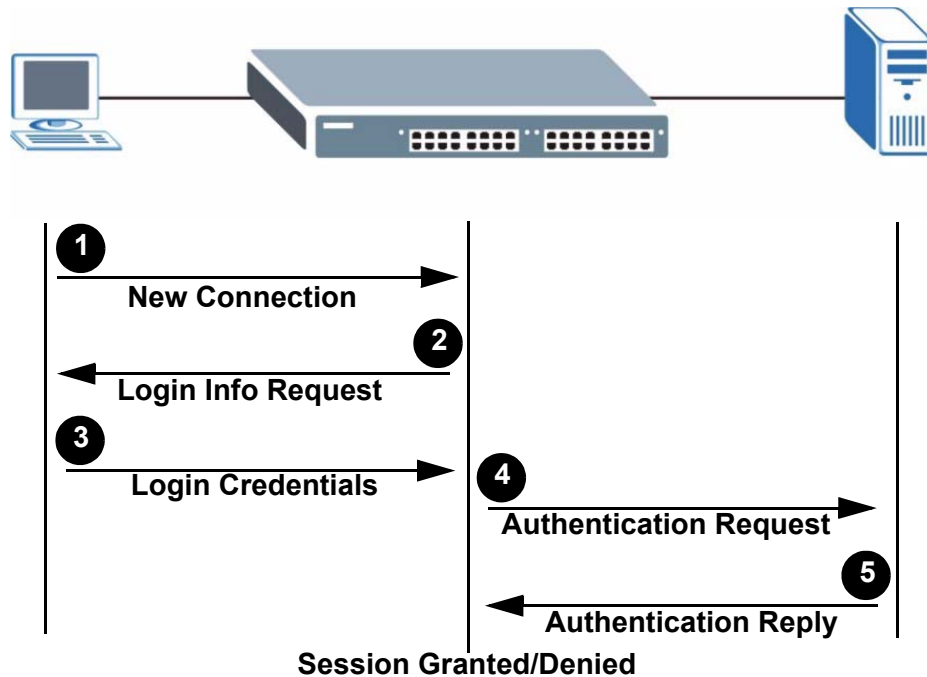

18.2 Port Authentication Configuration

To enable port authentication, first activate the port authentication method (both on the Switch and the port(s)) then configure the RADIUS server settings in the **Auth and Acct > Radius Server Setup** screen.

Click **Advanced Application > Port Authentication** in the navigation panel to display the screen as shown.

Figure 86 Advanced Application > Port Authentication

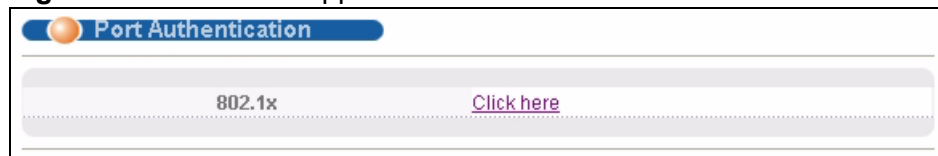

18.2.1 Activate IEEE 802.1x Security

Use this screen to activate IEEE 802.1x security. In the **Port Authentication** screen click **802.1x** to display the configuration screen as shown.

Figure 87 Advanced Application > Port Authentication > 802.1x

Port	Active	Reauthentication	Reauthentication Timer
*	<input type="checkbox"/>	On ▼	<input type="text"/> seconds
1	<input type="checkbox"/>	On ▼	3600 seconds
2	<input type="checkbox"/>	On ▼	3600 seconds
3	<input type="checkbox"/>	On ▼	3600 seconds
4	<input type="checkbox"/>	On ▼	3600 seconds
5	<input type="checkbox"/>	On ▼	3600 seconds
6	<input type="checkbox"/>	On ▼	3600 seconds
7	<input type="checkbox"/>	On ▼	3600 seconds
8	<input type="checkbox"/>	On ▼	3600 seconds
9	<input type="checkbox"/>	On ▼	3600 seconds
27	<input type="checkbox"/>	On ▼	3600 seconds
28	<input type="checkbox"/>	On ▼	3600 seconds

The following table describes the labels in this screen.

Table 41 Advanced Application > Port Authentication > 802.1x

LABEL	DESCRIPTION
Active	Select this check box to permit 802.1x authentication on the Switch. Note: You must first enable 802.1x authentication on the Switch before configuring it on each port.
Port	This field displays the port number.
*	Settings in this row apply to all ports. Use this row only if you want to make some settings the same for all ports. Use this row first to set the common settings and then make adjustments on a port-by-port basis. Note: Changes in this row are copied to all the ports as soon as you make them.

Table 41 Advanced Application > Port Authentication > 802.1x (continued)

LABEL	DESCRIPTION
Active	Select this to permit 802.1x authentication on this port. You must first allow 802.1x authentication on the Switch before configuring it on each port.
Reauthentication	Specify if a subscriber has to periodically re-enter his or her username and password to stay connected to the port.
Reauthentication Timer	Specify how often a client has to re-enter his or her username and password to stay connected to the port.
Apply	Click Apply to save your changes to the Switch's run-time memory. The Switch loses these changes if it is turned off or loses power, so use the Save link on the top navigation panel to save your changes to the non-volatile memory when you are done configuring.
Cancel	Click Cancel to begin configuring this screen afresh.

Port Security

This chapter shows you how to set up port security.

19.1 About Port Security

Port security allows only packets with dynamically learned MAC addresses and/or configured static MAC addresses to pass through a port on the Switch. The Switch can learn up to 16K MAC addresses in total with no limit on individual ports other than the sum cannot exceed 16K.

For maximum port security, enable this feature, disable MAC address learning and configure static MAC address(es) for a port. It is not recommended you disable port security together with MAC address learning as this will result in many broadcasts. By default, MAC address learning is still enabled even though the port security is not activated.

19.2 Port Security Setup

Click **Advanced Application > Port Security** in the navigation panel to display the screen as shown.

Figure 88 Advanced Application > Port Security

The screenshot shows the 'Port Security' configuration interface. It includes a 'MAC Freeze' section with a 'Port List' input field and a 'MAC freeze' button. Below this is the 'Port Security' section with an 'Active' checkbox. A table lists ports from 1 to 28, with columns for 'Active', 'Address Learning', and 'Limited Number of Learned MAC Address'. The 'Active' column has checkboxes, 'Address Learning' has green checkmarks, and 'Limited Number of Learned MAC Address' has input fields with '0'. At the bottom are 'Apply' and 'Cancel' buttons.

Port	Active	Address Learning	Limited Number of Learned MAC Address
*	<input type="checkbox"/>	<input checked="" type="checkbox"/>	<input type="text"/>
1	<input type="checkbox"/>	<input checked="" type="checkbox"/>	<input type="text" value="0"/>
2	<input type="checkbox"/>	<input checked="" type="checkbox"/>	<input type="text" value="0"/>
3	<input type="checkbox"/>	<input checked="" type="checkbox"/>	<input type="text" value="0"/>
4	<input type="checkbox"/>	<input checked="" type="checkbox"/>	<input type="text" value="0"/>
5	<input type="checkbox"/>	<input checked="" type="checkbox"/>	<input type="text" value="0"/>
6	<input type="checkbox"/>	<input checked="" type="checkbox"/>	<input type="text" value="0"/>
26	<input type="checkbox"/>	<input checked="" type="checkbox"/>	<input type="text" value="0"/>
27	<input type="checkbox"/>	<input checked="" type="checkbox"/>	<input type="text" value="0"/>
28	<input type="checkbox"/>	<input checked="" type="checkbox"/>	<input type="text" value="0"/>

The following table describes the labels in this screen.

Table 42 Advanced Application > Port Security

LABEL	DESCRIPTION
Port List	Enter the number of the port(s) (separated by a comma) on which you want to enable port security and disable MAC address learning. After you click MAC freeze , all previously learned MAC addresses on the specified port(s) will become static MAC addresses and display in the Static MAC Forwarding screen.
MAC freeze	Click MAC freeze to have the Switch automatically select the Active check boxes and clear the Address Learning check boxes only for the ports specified in the Port list .
Active	Select this option to enable port security on the Switch.
Port	This field displays the port number.

Table 42 Advanced Application > Port Security (continued)

LABEL	DESCRIPTION
*	<p>Settings in this row apply to all ports.</p> <p>Use this row only if you want to make some settings the same for all ports. Use this row first to set the common settings and then make adjustments on a port-by-port basis.</p> <p>Note: Changes in this row are copied to all the ports as soon as you make them.</p>
Active	<p>Select this check box to enable the port security feature on this port. The Switch forwards packets whose MAC address(es) is in the MAC address table on this port. Packets with no matching MAC address(es) are dropped.</p> <p>Clear this check box to disable the port security feature. The Switch forwards all packets on this port.</p>
Address Learning	<p>MAC address learning reduces outgoing broadcast traffic. For MAC address learning to occur on a port, the port itself must be active with address learning enabled.</p>
Limited Number of Learned MAC Address	<p>Use this field to limit the number of (dynamic) MAC addresses that may be learned on a port. For example, if you set this field to "5" on port 2, then only the devices with these five learned MAC addresses may access port 2 at any one time. A sixth device would have to wait until one of the five learned MAC addresses aged out. MAC address aging out time can be set in the Switch Setup screen. The valid range is from "0" to "16384". "0" means this feature is disabled.</p>
Apply	<p>Click Apply to save your changes to the Switch's run-time memory. The Switch loses these changes if it is turned off or loses power, so use the Save link on the top navigation panel to save your changes to the non-volatile memory when you are done configuring.</p>
Cancel	<p>Click Cancel to begin configuring this screen afresh.</p>

Classifier

This chapter introduces and shows you how to configure the packet classifier on the Switch.

20.1 About the Classifier and QoS

Quality of Service (QoS) refers to both a network's ability to deliver data with minimum delay, and the networking methods used to control the use of bandwidth. Without QoS, all traffic data is equally likely to be dropped when the network is congested. This can cause a reduction in network performance and make the network inadequate for time-critical application such as video-on-demand.

A classifier groups traffic into data flows according to specific criteria such as the source address, destination address, source port number, destination port number or incoming port number. For example, you can configure a classifier to select traffic from the same protocol port (such as Telnet) to form a flow.

Configure QoS on the Switch to group and prioritize application traffic and fine-tune network performance. Setting up QoS involves two separate steps:

- 1 Configure classifiers to sort traffic into different flows.
- 2 Configure policy rules to define actions to be performed on a classified traffic flow (refer to [Chapter 21 on page 173](#) to configure policy rules).

20.2 Configuring the Classifier

Use the **Classifier** screen to define the classifiers. After you define the classifier, you can specify actions (or policy) to act upon the traffic that matches the rules. To configure policy rules, refer to [Chapter 21 on page 173](#).

Click **Advanced Application > Classifier** in the navigation panel to display the configuration screen as shown.

Figure 89 Advanced Application > Classifier

The following table describes the labels in this screen.

Table 43 Advanced Application > Classifier

LABEL	DESCRIPTION
Active	Select this option to enable this rule.
Name	Enter a descriptive name for this rule for identifying purposes.
Layer 2	Specify the fields below to configure a layer 2 classifier.
Ethernet Type	Select an Ethernet type or select Other and enter the Ethernet type number in hexadecimal value. Refer to Table 45 on page 170 for information.
Source	
MAC Address	Select Any to apply the rule to all MAC addresses. To specify a source, select the second choice and type a MAC address in valid MAC address format (six hexadecimal character pairs).

Table 43 Advanced Application > Classifier (continued)

LABEL	DESCRIPTION
Port	Type the port number to which the rule should be applied. You may choose one port only or all ports (Any).
Destination	
MAC Address	Select Any to apply the rule to all MAC addresses. To specify a destination, select the second choice and type a MAC address in valid MAC address format (six hexadecimal character pairs).
Layer 3 Specify the fields below to configure a layer 3 classifier.	
IP Protocol	Select an IP protocol type or select Other and enter the protocol number in decimal value. Refer to Table 46 on page 171 for more information. You may select Establish Only for TCP protocol type. This means that the Switch will pick out the packets that are sent to establish TCP connections.
Source	
IP Address/ Address Prefix	Enter a source IP address in dotted decimal notation. Specify the address prefix by entering the number of ones in the subnet mask. A subnet mask can be represented in a 32-bit notation. For example, the subnet mask "255.255.255.0" can be represented as "11111111.11111111.11111111.00000000", and counting up the number of ones in this case results in 24.
Socket Number	Note: You must select either UDP or TCP in the IP Protocol field before you configure the socket numbers. Select Any to apply the rule to all TCP/UDP protocol port numbers or select the second option and enter a TCP/UDP protocol port number. Refer to Table 47 on page 171 for more information.
Destination	
IP Address/ Address Prefix	Enter a destination IP address in dotted decimal notation. Specify the address prefix by entering the number of ones in the subnet mask.
Socket Number	Note: You must select either UDP or TCP in the IP Protocol field before you configure the socket numbers. Select Any to apply the rule to all TCP/UDP protocol port numbers or select the second option and enter a TCP/UDP protocol port number. Refer to Table 47 on page 171 for more information.
Add	Click Add to insert the entry in the summary table below and save your changes to the Switch's run-time memory. The Switch loses these changes if it is turned off or loses power, so use the Save link on the top navigation panel to save your changes to the non-volatile memory when you are done configuring.
Cancel	Click Cancel to reset the fields back to your previous configuration.
Clear	Click Clear to set the above fields back to the factory defaults.

20.3 Viewing and Editing Classifier Configuration

To view a summary of the classifier configuration, scroll down to the summary table at the bottom of the **Classifier** screen. To change the settings of a rule, click a number in the **Index** field.

Note: When two rules conflict with each other, a higher layer rule has priority over lower layer rule.

Figure 90 Advanced Application > Classifier: Summary Table

Index	Active	Name	Rule	Delete
1	Yes	Example	EtherType = IP; SrcMac = 00:50:ba:ad:4f:81; SrcPort = port 2;	<input type="checkbox"/>

The following table describes the labels in this screen.

Table 44 Classifier: Summary Table

LABEL	DESCRIPTION
Index	This field displays the index number of the rule. Click an index number to edit the rule.
Active	This field displays Yes when the rule is activated and No when it is deactivated.
Name	This field displays the descriptive name for this rule. This is for identification purpose only.
Rule	This field displays a summary of the classifier rule's settings.
Delete	Click Delete to remove the selected entry from the summary table.
Cancel	Click Cancel to clear the Delete check boxes.

The following table shows some other common Ethernet types and the corresponding protocol number.

Table 45 Common Ethernet Types and Protocol Numbers

ETHERNET TYPE	PROTOCOL NUMBER
IP ETHII	0800
X.75 Internet	0801
NBS Internet	0802
ECMA Internet	0803
Chaosnet	0804
X.25 Level 3	0805
XNS Compat	0807
Banyan Systems	0BAD
BBN Simnet	5208

Table 45 Common Ethernet Types and Protocol Numbers

ETHERNET TYPE	PROTOCOL NUMBER
IBM SNA	80D5
AppleTalk AARP	80F3

In the Internet Protocol there is a field, called "Protocol", to identify the next level protocol. The following table shows some common protocol types and the corresponding protocol number. Refer to <http://www.iana.org/assignments/protocol-numbers> for a complete list.

Table 46 Common IP Protocol Types and Protocol Numbers

PROTOCOL TYPE	PROTOCOL NUMBER
ICMP	1
TCP	6
UDP	17
EGP	8
L2TP	115

Some of the most common TCP and UDP port numbers are:

Table 47 Common TCP and UDP Port Numbers

PROTOCOL NAME	TCP/UDP PORT NUMBER
FTP	21
Telnet	23
SMTP	25
DNS	53
HTTP	80
POP3	110

See [Appendix B on page 337](#) for information on commonly used port numbers.

20.4 Classifier Example

The following screen shows an example where you configure a classifier that identifies all traffic from MAC address 00:50:ba:ad:4f:81 on port 2.

After you have configured a classifier, you can configure a policy (in the **Policy** screen) to define action(s) on the classified traffic flow.

Figure 91 Classifier: Example

The screenshot shows the 'Classifier' configuration interface. At the top, there is a title bar with an orange circle and the word 'Classifier'. Below this, the 'Active' checkbox is checked. The 'Name' field contains 'Example'. The configuration is divided into two main sections: Layer 2 and Layer 3.

Layer 2 Configuration:

- Ethernet Type:** 'All' is selected in the dropdown menu. 'Others' is also an option with a text input field for '(Hex)'.
- Source:**
 - MAC Address:** 'Any' is selected. The 'MAC' option is also available with a text input field containing '00 : 50 : ba : ad : 4f : 81'. This field is circled in red.
 - Port:** 'Any' is selected. The 'Port' option is also available with a text input field containing '2'. This field is also circled in red.
- Destination:** 'Any' is selected. The 'MAC' option is also available with a text input field for MAC address.

Layer 3 Configuration:

- IP Protocol:** 'All' is selected in the dropdown menu. 'Establish Only' is a checkbox option. 'Others' is also an option with a text input field for '(Dec)'.
- Source:**
 - IP Address / Address Prefix:** '0.0.0.0' is entered in the first field, and an empty field is in the second.
 - Socket Number:** 'Any' is selected. The 'Socket Number' option is also available with a text input field.
- Destination:**
 - IP Address / Address Prefix:** '0.0.0.0' is entered in the first field, and an empty field is in the second.
 - Socket Number:** 'Any' is selected. The 'Socket Number' option is also available with a text input field.

At the bottom of the screen, there are three buttons: 'Add', 'Cancel', and 'Clear'.

Policy Rule

This chapter shows you how to configure policy rules.

21.1 Policy Rules Overview

A classifier distinguishes traffic into flows based on the configured criteria (refer to [Chapter 20 on page 167](#) for more information). A policy rule ensures that a traffic flow gets the requested treatment in the network.

21.2 Configuring Policy Rules

You must first configure a classifier in the **Classifier** screen. Refer to [Section 20.2 on page 167](#) for more information.

Click **Advanced Applications > Policy Rule** in the navigation panel to display the screen as shown.

Figure 92 Advanced Application > Policy Rule

The screenshot shows a web-based configuration interface for a Policy Rule. The interface is organized into several sections:

- Active:** A checkbox to enable or disable the policy.
- Name:** A text input field for naming the policy.
- Classifier(s):** A list box showing the classifier(s) associated with the policy, with 'Example' listed.
- Parameters:**
 - General:** Includes fields for 'VLAN ID', 'Egress Port' (set to 1), and 'Priority' (set to 0).
 - Rate Limit:** Includes a 'Bandwidth' field set to 64 Kbps.
- Action:**
 - Forwarding:** Radio buttons for 'No change' (selected) and 'Discard the packet'.
 - Priority:** Radio buttons for 'No change' (selected) and 'Set the packet's 802.1 priority'.
 - Outgoing:** Checkboxes for 'Send the packet to the egress port' and 'Set the packet's VLAN ID'.
 - Rate Limit:** A checkbox for 'Enable'.

At the bottom of the form are three buttons: 'Add', 'Cancel', and 'Clear'.

The following table describes the labels in this screen.

Table 48 Advanced Application > Policy Rule

LABEL	DESCRIPTION
Active	Select this option to enable the policy.
Name	Enter a descriptive name for identification purposes.
Classifier(s)	This field displays the active classifier(s) you configure in the Classifier screen. Select the classifier(s) to which this policy rule applies. To select more than one classifier, press [SHIFT] and select the choices at the same time.
Parameters	Set the fields below for this policy. You only have to set the field(s) that is related to the action(s) you configure in the Action field.
General	
VLAN ID	Specify a VLAN ID number.
Egress Port	Type the number of an outgoing port.
Priority	Specify a priority level.

Table 48 Advanced Application > Policy Rule (continued)

LABEL	DESCRIPTION
Rate Limit	You can configure the desired bandwidth available to a traffic flow. Traffic that exceeds the maximum bandwidth allocated (in cases where the network is congested) is dropped.
Bandwidth	Specify the bandwidth in kilobit per second (Kbps). Enter a number between 64 and 1000000.
Action	<p>Specify the action(s) the Switch takes on the associated classified traffic flow.</p> <p>Note: You can specify only one action (pair) in a policy rule. To have the Switch take multiple actions on the same traffic flow, you need to define multiple classifiers with the same criteria and apply different policy rules.</p> <p>Say you have several classifiers that identify the same traffic flow and you specify a different policy rule for each. If their policy actions conflict (Discard the packet, Send the packet to the egress port and Rate Limit), the Switch only applies the policy rules with the Discard the packet and Send the packet to the egress port actions depending on the classifier names. The longer the classifier name, the higher the classifier priority. If two classifier names are the same length, the bigger the character, the higher the classifier priority. The lowercase letters (such as a and b) have higher priority than the capitals (such as A and B) in the classifier name. For example, the classifier with the name of class 2, class a or class B takes priority over the classifier with the name of class 1 or class A.</p> <p>Let's say you set two classifiers (Class 1 and Class 2) and both identify all traffic from MAC address 11:22:33:44:55:66 on port 3.</p> <p>If Policy 1 applies to Class 1 and the action is to drop the packets, Policy 2 applies to Class 2 and the action is to forward the packets to the egress port, the Switch will forward the packets.</p> <p>If Policy 1 applies to Class 1 and the action is to drop the packets, Policy 2 applies to Class 2 and the action is to enable bandwidth limitation, the Switch will discard the packets immediately.</p> <p>If Policy 1 applies to Class 1 and the action is to forward the packets to the egress port, Policy 2 applies to Class 2 and the action is to enable bandwidth limitation, the Switch will forward the packets.</p>
Forwarding	<p>Select No change to forward the packets.</p> <p>Select Discard the packet to drop the packets.</p>
Priority	<p>Select No change to keep the priority setting of the frames.</p> <p>Select Set the packet's 802.1 priority to replace the packet's 802.1 priority field with the value you set in the Priority field.</p>
Outgoing	<p>Select Send the packet to the egress port to send the packet to the egress port.</p> <p>Select Set the packet's VLAN ID to replace the VLAN ID of the packets with the value you configure in the VLAN ID field.</p>
Rate Limit	Select Enable to activate bandwidth limitation on the traffic flow(s).
Add	Click Add to inset the entry to the summary table below and save your changes to the Switch's run-time memory. The Switch loses these changes if it is turned off or loses power, so use the Save link on the top navigation panel to save your changes to the non-volatile memory when you are done configuring.

Table 48 Advanced Application > Policy Rule (continued)

LABEL	DESCRIPTION
Cancel	Click Cancel to reset the fields back to your previous configuration.
Clear	Click Clear to set the above fields back to the factory defaults.

21.3 Viewing and Editing Policy Configuration

To view a summary of the classifier configuration, scroll down to the summary table at the bottom of the **Policy** screen. To change the settings of a rule, click a number in the **Index** field.

Figure 93 Advanced Application > Policy Rule: Summary Table

Index	Active	Name	Classifier(s)	Delete
1	Yes	Test	Example;	<input type="checkbox"/>

The following table describes the labels in this screen.

Table 49 Advanced Application > Policy Rule: Summary Table

LABEL	DESCRIPTION
Index	This field displays the policy index number. Click an index number to edit the policy.
Active	This field displays Yes when policy is activated and No when it is deactivated.
Name	This field displays the name you have assigned to this policy.
Classifier(s)	This field displays the name(s) of the classifier to which this policy applies.
Delete	Click Delete to remove the selected entry from the summary table.
Cancel	Click Cancel to clear the Delete check boxes.

21.4 Policy Example

The figure below shows an example **Policy** screen where you configure a policy to limit bandwidth on a traffic flow classified using the **Example** classifier (refer to [Section 20.4 on page 171](#)).

Figure 94 Policy Example

The screenshot displays the 'Policy' configuration interface. The 'Active' checkbox is checked. The 'Name' field contains 'Test'. The 'Classifier(s)' dropdown menu is set to 'Example'. In the 'Parameters' section, under the 'General' tab, the 'Bandwidth' field is set to '10000' Kbps. The 'Action' section has 'Rate Limit' checked and set to 'Enable'. At the bottom, there are 'Add', 'Cancel', and 'Clear' buttons.

Section	Field	Value
General	Active	<input checked="" type="checkbox"/>
General	Name	Test
General	Classifier(s)	Example
Parameters	VLAN ID	
	Egress Port	1
	Priority	0
	Bandwidth	10000 Kbps
Action	Forwarding	<input checked="" type="radio"/> No change
		<input type="radio"/> Discard the packet
	Priority	<input checked="" type="radio"/> No change
		<input type="radio"/> Set the packet's 802.1 priority
	Outgoing	<input type="checkbox"/> Send the packet to the egress port
		<input type="checkbox"/> Set the packet's VLAN ID
	Rate Limit	<input checked="" type="checkbox"/> Enable

Queuing Method

This chapter introduces the queuing methods supported.

22.1 Queuing Method Overview

Queuing is used to help solve performance degradation when there is network congestion. Use the **Queuing Method** screen to configure queuing algorithms for outgoing traffic. See also **Priority Queue Assignment** in **Switch Setup** and **802.1p Priority** in **Port Setup** for related information.

Queuing algorithms allow switches to maintain separate queues for packets from each individual source or flow and prevent a source from monopolizing the bandwidth.

22.1.1 Strictly Priority Queuing

Strictly Priority Queuing (SPQ) services queues based on priority only. As traffic comes into the Switch, traffic on the highest priority queue, Q7 is transmitted first. When that queue empties, traffic on the next highest-priority queue, Q6 is transmitted until Q6 empties, and then traffic is transmitted on Q5 and so on. If higher priority queues never empty, then traffic on lower priority queues never gets sent. SP does not automatically adapt to changing network requirements.

22.1.2 Weighted Fair Queuing

Weighted Fair Queuing is used to guarantee each queue's minimum bandwidth based on its bandwidth weight (portion) (the number you configure in the Weight field) when there is traffic congestion. WFQ is activated only when a port has more traffic than it can handle. Queues with larger weights get more guaranteed bandwidth than queues with smaller weights. This queuing mechanism is highly efficient in that it divides any available bandwidth across the different traffic queues. By default, the weight for Q0 is 1, for Q1 is 2, for Q2 is 3, and so on. Guaranteed quantum is calculated as Queue Weight x 2048 bytes.

22.1.3 Weighted Round Robin Scheduling (WRR)

Round Robin Scheduling services queues on a rotating basis and is activated only when a port has more traffic than it can handle. A queue is given an amount of bandwidth irrespective of the incoming traffic on that port. This queue then moves to the back of the list. The next queue is given an equal amount of bandwidth, and then moves to the end of the list; and so on, depending on the number of queues being used. This works in a looping fashion until a queue is empty.

Weighted Round Robin Scheduling (WRR) uses the same algorithm as round robin scheduling, but services queues based on their priority and queue weight (the number you configure in the queue **Weight** field) rather than a fixed amount of bandwidth. WRR is activated only when a port has more traffic than it can handle. Queues with larger weights get more service than queues with smaller weights. This queuing mechanism is highly efficient in that it divides any available bandwidth across the different traffic queues and returns to queues that have not yet emptied.

22.2 Configuring Queuing

Click **Advanced Application > Queuing Method** in the navigation panel.

Figure 95 Advanced Application > Queuing Method

Port	Method	Weight								Hybrid-SPQ Lowest-Queue
		Q0	Q1	Q2	Q3	Q4	Q5	Q6	Q7	
*	SPQ									None
1	SPQ	1	2	3	4	5	6	7	8	None
2	SPQ	1	2	3	4	5	6	7	8	None
3	SPQ	1	2	3	4	5	6	7	8	None
4	SPQ	1	2	3	4	5	6	7	8	None
5	SPQ	1	2	3	4	5	6	7	8	None
25	SPQ	1	2	3	4	5	6	7	8	None
26	SPQ	1	2	3	4	5	6	7	8	None
27	SPQ	1	2	3	4	5	6	7	8	None
28	SPQ	1	2	3	4	5	6	7	8	None

Apply Cancel

The following table describes the labels in this screen.

Table 50 Advanced Application > Queuing Method

LABEL	DESCRIPTION
Port	This label shows the port you are configuring.
*	Settings in this row apply to all ports. Use this row only if you want to make some settings the same for all ports. Use this row first to set the common settings and then make adjustments on a port-by-port basis. Note: Changes in this row are copied to all the ports as soon as you make them.

Table 50 Advanced Application > Queuing Method (continued)

LABEL	DESCRIPTION
Method	<p>Select SPQ (Strictly Priority Queuing), WFQ (Weighted Fair Queuing) or WRR (Weighted Round Robin).</p> <p>Strictly Priority Queuing services queues based on priority only. When the highest priority queue empties, traffic on the next highest-priority queue begins. Q7 has the highest priority and Q0 the lowest.</p> <p>Weighted Fair Queuing is used to guarantee each queue's minimum bandwidth based on their bandwidth portion (weight) (the number you configure in the Weight field). Queues with larger weights get more guaranteed bandwidth than queues with smaller weights.</p> <p>Weighted Round Robin Scheduling services queues on a rotating basis based on their queue weight (the number you configure in the queue Weight field). Queues with larger weights get more service than queues with smaller weights.</p>
Weight	<p>When you select WFQ or WRR enter the queue weight here. Bandwidth is divided across the different traffic queues according to their weights.</p>
Hybrid-SPQ Lowest-Queue	<p>This field is applicable only when you select WFQ or WRR.</p> <p>Select a queue (Q0 to Q7) to have the Switch use SPQ to service the subsequent queue(s) after and including the specified queue for the port. For example, if you select Q5, the Switch services traffic on Q5, Q6 and Q7 using SPQ.</p> <p>Select None to always use WFQ or WRR for the port.</p>
Apply	<p>Click Apply to save your changes to the Switch's run-time memory. The Switch loses these changes if it is turned off or loses power, so use the Save link on the top navigation panel to save your changes to the non-volatile memory when you are done configuring.</p>
Cancel	<p>Click Cancel to begin configuring this screen afresh.</p>

Multicast

23.1 Overview

This chapter shows you how to configure various multicast features.

Traditionally, IP packets are transmitted in one of either two ways - Unicast (1 sender to 1 recipient) or Broadcast (1 sender to everybody on the network). Multicast delivers IP packets to just a group of hosts on the network.

IGMP (Internet Group Management Protocol) is a network-layer protocol used to establish membership in a multicast group - it is not used to carry user data. Refer to RFC 1112, RFC 2236 and RFC 3376 for information on IGMP versions 1, 2 and 3 respectively.

23.1.1 IP Multicast Addresses

In IPv4, a multicast address allows a device to send packets to a specific group of hosts (multicast group) in a different subnetwork. A multicast IP address represents a traffic receiving group, not individual receiving devices. IP addresses in the Class D range (224.0.0.0 to 239.255.255.255) are used for IP multicasting. Certain IP multicast numbers are reserved by IANA for special purposes (see the IANA web site for more information).

23.1.2 IGMP Filtering

With the IGMP filtering feature, you can control which IGMP groups a subscriber on a port can join. This allows you to control the distribution of multicast services (such as content information distribution) based on service plans and types of subscription.

You can set the Switch to filter the multicast group join reports on a per-port basis by configuring an IGMP filtering profile and associating the profile to a port.

23.1.3 IGMP Snooping

A Switch can passively snoop on IGMP packets transferred between IP multicast routers/switches and IP multicast hosts to learn the IP multicast group membership. It checks IGMP packets passing through it, picks out the group registration information, and configures multicasting accordingly. IGMP snooping allows the Switch to learn multicast groups without you having to manually configure them.

The Switch forwards multicast traffic destined for multicast groups (that it has learned from IGMP snooping or that you have manually configured) to ports that are members of that group. IGMP snooping generates no additional network traffic, allowing you to significantly reduce multicast traffic passing through your Switch.

23.1.4 IGMP Snooping and VLANs

The Switch can perform IGMP snooping on up to 16 VLANs. You can configure the Switch to automatically learn multicast group membership of any VLANs. The Switch then performs IGMP snooping on the first 16 VLANs that send IGMP packets. This is referred to as auto mode. Alternatively, you can specify the VLANs that IGMP snooping should be performed on. This is referred to as fixed mode. In fixed mode the Switch does not learn multicast group membership of any VLANs other than those explicitly added as an IGMP snooping VLAN.

23.2 Multicast Status

Click **Advanced Applications > Multicast** to display the screen as shown. This screen shows the multicast group information. See [Section 23.1 on page 183](#) for more information on multicasting.

Figure 96 Advanced Application > Multicast

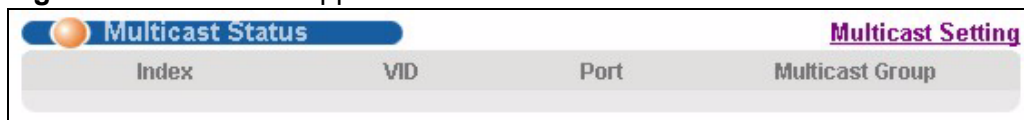

The following table describes the labels in this screen.

Table 51 Advanced Application > Multicast Status

LABEL	DESCRIPTION
Index	This is the index number of the entry.
VID	This field displays the multicast VLAN ID.

Table 51 Advanced Application > Multicast Status (continued)

LABEL	DESCRIPTION
Port	This field displays the port number that belongs to the multicast group.
Multicast Group	This field displays IP multicast group addresses.

23.3 Multicast Setting

Click **Advanced Applications > Multicast > Multicast Setting** link to display the screen as shown. See [Section 23.1 on page 183](#) for more information on multicasting.

Figure 97 Advanced Application > Multicast > Multicast Setting

Multicast Setting [Multicast Status](#) [IGMP Snooping VLAN](#) [IGMP Filtering Profile](#) [MVR](#)

IGMP Snooping

Active

Querier

Host Timeout

802.1p Priority

IGMP Filtering

Active

Unknown Multicast Frame Flooding Drop

Reserved Multicast Group Flooding Drop

Port	Immed. Leave	Normal Leave	Fast Leave	Group Limited	Max Group Num.	Throttling	IGMP Filtering Profile	IGMP Querier Mode
*	<input type="radio"/>	<input checked="" type="radio"/>	<input type="text"/>	<input type="radio"/>	<input type="text"/>	Deny	Default	Auto
1	<input type="radio"/>	<input checked="" type="radio"/>	<input type="text" value="4000"/>	<input type="radio"/>	<input type="text" value="200"/>	Deny	Default	Auto
2	<input type="radio"/>	<input checked="" type="radio"/>	<input type="text" value="4000"/>	<input type="radio"/>	<input type="text" value="200"/>	Deny	Default	Auto
3	<input type="radio"/>	<input checked="" type="radio"/>	<input type="text" value="4000"/>	<input type="radio"/>	<input type="text" value="200"/>	Deny	Default	Auto
4	<input type="radio"/>	<input checked="" type="radio"/>	<input type="text" value="4000"/>	<input type="radio"/>	<input type="text" value="200"/>	Deny	Default	Auto
5	<input type="radio"/>	<input checked="" type="radio"/>	<input type="text" value="4000"/>	<input type="radio"/>	<input type="text" value="200"/>	Deny	Default	Auto
6	<input type="radio"/>	<input checked="" type="radio"/>	<input type="text" value="4000"/>	<input type="radio"/>	<input type="text" value="200"/>	Deny	Default	Auto
7	<input type="radio"/>	<input checked="" type="radio"/>	<input type="text" value="4000"/>	<input type="radio"/>	<input type="text" value="200"/>	Deny	Default	Auto

Apply Cancel

The following table describes the labels in this screen.

Table 52 Advanced Application > Multicast > Multicast Setting

LABEL	DESCRIPTION
IGMP Snooping	Use these settings to configure IGMP Snooping.
Active	Select Active to enable IGMP Snooping to forward group multicast traffic only to ports that are members of that group.
Querier	Select this option to allow the Switch to send IGMP General Query messages to the VLANs with the multicast hosts attached.
Host Timeout	Specify the time (from 1 to 16,711,450) in seconds that elapses before the Switch removes an IGMP group membership entry if it does not receive report messages from the port.
802.1p Priority	Select a priority level (0-7) to which the Switch changes the priority in outgoing IGMP control packets. Otherwise, select No-Change to not replace the priority.
IGMP Filtering	<p>Select Active to enable IGMP filtering to control which IGMP groups a subscriber on a port can join.</p> <p>Note: If you enable IGMP filtering, you must create and assign IGMP filtering profiles for the ports that you want to allow to join multicast groups.</p>
Unknown Multicast Frame	Specify the action to perform when the Switch receives an unknown multicast frame. Select Drop to discard the frame(s). Select Flooding to send the frame(s) to all ports.
Reserved Multicast Group	<p>The IP address range of 224.0.0.0 to 224.0.0.255 are reserved for multicasting on the local network only. For example, 224.0.0.1 is for all hosts on a local network segment and 224.0.0.9 is used to send RIP routing information to all RIP v2 routers on the same network segment. A multicast router will not forward a packet with the destination IP address within this range to other networks. See the IANA web site for more information.</p> <p>The layer 2 multicast MAC addresses used by Cisco layer 2 protocols, 01:00:0C:CC:CC:CC and 01:00:0C:CC:CC:CD, are also included in this group.</p> <p>Specify the action to perform when the Switch receives a frame with a reserved multicast address. Select Drop to discard the frame(s). Select Flooding to send the frame(s) to all ports.</p>
Port	This field displays the port number.
*	<p>Settings in this row apply to all ports.</p> <p>Use this row only if you want to make some settings the same for all ports. Use this row first to set the common settings and then make adjustments on a port-by-port basis.</p> <p>Note: Changes in this row are copied to all the ports as soon as you make them.</p>
Immed. Leave	<p>Select this option to set the Switch to remove this port from the multicast tree when an IGMP version 2 leave message is received on this port.</p> <p>Select this option if there is only one host connected to this port.</p>

Table 52 Advanced Application > Multicast > Multicast Setting (continued)

LABEL	DESCRIPTION
Normal Leave	<p>Enter an IGMP normal leave timeout value (from 200 to 6,348,800) in milliseconds. Select this option to have the Switch use this timeout to update the forwarding table for the port.</p> <p>This defines how many seconds the Switch waits for an IGMP report before removing an IGMP snooping membership entry when an IGMP leave message is received on this port from a host.</p>
Fast Leave	<p>Enter an IGMP fast leave timeout value (from 200 to 6,348,800) in milliseconds. Select this option to have the Switch use this timeout to update the forwarding table for the port.</p> <p>This defines how many seconds the Switch waits for an IGMP report before removing an IGMP snooping membership entry when an IGMP leave message is received on this port from a host.</p>
Group Limited	<p>Select this option to limit the number of multicast groups this port is allowed to join.</p>
Max Group Num.	<p>Enter the number of multicast groups this port is allowed to join.</p>
Throttling	<p>IGMP throttling controls how the Switch deals with the IGMP reports when the maximum number of the IGMP groups a port can join is reached.</p> <p>Select Deny to drop any new IGMP join report received on this port until an existing multicast forwarding table entry is aged out.</p> <p>Select Replace to replace an existing entry in the multicast forwarding table with the new IGMP report(s) received on this port.</p>
IGMP Filtering Profile	<p>Select the name of the IGMP filtering profile to use for this port. Otherwise, select Default to prohibit the port from joining any multicast group.</p> <p>You can create IGMP filtering profiles in the Multicast > Multicast Setting > IGMP Filtering Profile screen.</p>
IGMP Querier Mode	<p>The Switch treats an IGMP query port as being connected to an IGMP multicast router (or server). The Switch forwards IGMP join or leave packets to an IGMP query port.</p> <p>Select Auto to have the Switch use the port as an IGMP query port if the port receives IGMP query packets.</p> <p>Select Fixed to have the Switch always use the port as an IGMP query port. Select this when you connect an IGMP multicast server to the port.</p> <p>Select Edge to stop the Switch from using the port as an IGMP query port. The Switch will not keep any record of an IGMP router being connected to this port. The Switch does not forward IGMP join or leave packets to this port.</p>
Apply	<p>Click Apply to save your changes to the Switch's run-time memory. The Switch loses these changes if it is turned off or loses power, so use the Save link on the top navigation panel to save your changes to the non-volatile memory when you are done configuring.</p>
Cancel	<p>Click Cancel to begin configuring this screen afresh.</p>

23.4 IGMP Snooping VLAN

Click **Advanced Applications > Multicast** in the navigation panel. Click the **Multicast Setting** link and then the **IGMP Snooping VLAN** link to display the screen as shown. See [Section 23.1.4 on page 184](#) for more information on IGMP Snooping VLAN.

Figure 98 Advanced Application > Multicast > Multicast Setting > IGMP Snooping VLAN

The following table describes the labels in this screen.

Table 53 Advanced Application > Multicast > Multicast Setting > IGMP Snooping VLAN

LABEL	DESCRIPTION
Mode	<p>Select auto to have the Switch learn multicast group membership information of any VLANs automatically.</p> <p>Select fixed to have the Switch only learn multicast group membership information of the VLAN(s) that you specify below.</p> <p>In either auto or fixed mode, the Switch can learn up to 16 VLANs (including up to five VLANs you configured in the MVR screen). For example, if you have configured one multicast VLAN in the MVR screen, you can only specify up to 15 VLANs in this screen.</p> <p>The Switch drops any IGMP control messages which do not belong to these 16 VLANs.</p> <p>Note: You must also enable IGMP snooping in the Multicast Setting screen first.</p>
Apply	<p>Click Apply to save your changes to the Switch's run-time memory. The Switch loses these changes if it is turned off or loses power, so use the Save link on the top navigation panel to save your changes to the non-volatile memory when you are done configuring.</p>

Table 53 Advanced Application > Multicast > Multicast Setting > IGMP Snooping VLAN (continued)

LABEL	DESCRIPTION
Cancel	Click Cancel to begin configuring this screen afresh.
VLAN	Use this section of the screen to add VLANs upon which the Switch is to perform IGMP snooping.
Name	Enter the descriptive name of the VLAN for identification purposes.
VID	Enter the ID of a static VLAN; the valid range is between 1 and 4094. Note: You cannot configure the same VLAN ID as in the MVR screen.
Add	Click Add to insert the entry in the summary table below and save your changes to the Switch's run-time memory. The Switch loses these changes if it is turned off or loses power, so use the Save link on the top navigation panel to save your changes to the non-volatile memory when you are done configuring.
Cancel	Click Cancel to reset the fields to your previous configuration.
Clear	Click this to clear the fields.
Index	This is the number of the IGMP snooping VLAN entry in the table.
Name	This field displays the descriptive name for this VLAN group.
VID	This field displays the ID number of the VLAN group.
Delete	Check the rule(s) that you want to remove in the Delete column, then click the Delete button.
Cancel	Click Cancel to clear the Delete check boxes.

23.5 IGMP Filtering Profile

An IGMP filtering profile specifies a range of multicast groups that clients connected to the Switch are able to join. A profile contains a range of multicast IP addresses which you want clients to be able to join. Profiles are assigned to ports (in the **Multicast Setting** screen). Clients connected to those ports are then able to join the multicast groups specified in the profile. Each port can be assigned a single profile. A profile can be assigned to multiple ports.

Click **Advanced Applications > Multicast > Multicast Setting > IGMP Filtering Profile** link to display the screen as shown.

Figure 99 Advanced Application > Multicast > Multicast Setting > IGMP Filtering Profile

Profile Name	Start Address	End Address
	224.0.0.0	224.0.0.0

Add Clear

Profile Name	Start Address	End Address	Delete Profile	Delete Rule
Default	0.0.0.0	0.0.0.0	<input type="checkbox"/>	<input type="checkbox"/>

Delete Cancel

The following table describes the labels in this screen.

Table 54 Advanced Application > Multicast > Multicast Setting > IGMP Filtering Profile

LABEL	DESCRIPTION
Profile Name	Enter a descriptive name for the profile for identification purposes. To configure additional rule(s) for a profile that you have already added, enter the profile name and specify a different IP multicast address range.
Start Address	Type the starting multicast IP address for a range of multicast IP addresses that you want to belong to the IGMP filter profile.
End Address	Type the ending multicast IP address for a range of IP addresses that you want to belong to the IGMP filter profile. If you want to add a single multicast IP address, enter it in both the Start Address and End Address fields.
Add	Click Add to save the profile to the Switch's run-time memory. The Switch loses these changes if it is turned off or loses power, so use the Save link on the top navigation panel to save your changes to the non-volatile memory when you are done configuring.
Clear	Click Clear to clear the fields to the factory defaults.
Profile Name	This field displays the descriptive name of the profile.
Start Address	This field displays the start of the multicast address range.
End Address	This field displays the end of the multicast address range.

Table 54 Advanced Application > Multicast > Multicast Setting > IGMP Filtering Profile (continued)

LABEL	DESCRIPTION
Delete	To delete the profile(s) and all the accompanying rules, select the profile(s) that you want to remove in the Delete Profile column, then click the Delete button. To delete a rule(s) from a profile, select the rule(s) that you want to remove in the Delete Rule column, then click the Delete button.
Cancel	Click Cancel to clear the Delete Profile/Delete Rule check boxes.

23.6 MVR Overview

Multicast VLAN Registration (MVR) is designed for applications (such as Media-on-Demand (MoD)) that use multicast traffic across an Ethernet ring-based service provider network.

MVR allows one single multicast VLAN to be shared among different subscriber VLANs on the network. While isolated in different subscriber VLANs, connected devices can subscribe to and unsubscribe from the multicast stream in the multicast VLAN. This improves bandwidth utilization with reduced multicast traffic in the subscriber VLANs and simplifies multicast group management.

MVR only responds to IGMP join and leave control messages from multicast groups that are configured under MVR. Join and leave reports from other multicast groups are managed by IGMP snooping.

The following figure shows a network example. The subscriber VLAN (**1**, **2** and **3**) information is hidden from the streaming media server, **S**. In addition, the multicast VLAN information is only visible to the Switch and **S**.

Figure 100 MVR Network Example

23.6.1 Types of MVR Ports

In MVR, a source port is a port on the Switch that can send and receive multicast traffic in a multicast VLAN while a receiver port can only receive multicast traffic. Once configured, the Switch maintains a forwarding table that matches the multicast stream to the associated multicast group.

23.6.2 MVR Modes

You can set your Switch to operate in either dynamic or compatible mode.

In dynamic mode, the Switch sends IGMP leave and join reports to the other multicast devices (such as multicast routers or servers) in the multicast VLAN. This allows the multicast devices to update the multicast forwarding table to forward or not forward multicast traffic to the receiver ports.

In compatible mode, the Switch does not send any IGMP reports. In this case, you must manually configure the forwarding settings on the multicast devices in the multicast VLAN.

23.6.3 How MVR Works

The following figure shows a multicast television example where a subscriber device (such as a computer) in VLAN 1 receives multicast traffic from the streaming media server, **S**, via the Switch. Multiple subscriber devices can connect through a port configured as the receiver on the Switch.

When the subscriber selects a television channel, computer **A** sends an IGMP report to the Switch to join the appropriate multicast group. If the IGMP report matches one of the configured MVR multicast group addresses on the Switch, an entry is created in the forwarding table on the Switch. This maps the subscriber VLAN to the list of forwarding destinations for the specified multicast traffic.

When the subscriber changes the channel or turns off the computer, an IGMP leave message is sent to the Switch to leave the multicast group. The Switch sends a query to VLAN 1 on the receiver port (in this case, a DSL port on the Switch). If there is another subscriber device connected to this port in the same subscriber VLAN, the receiving port will still be on the list of forwarding destination for the multicast traffic. Otherwise, the Switch removes the receiver port from the forwarding table.

Figure 101 MVR Multicast Television Example

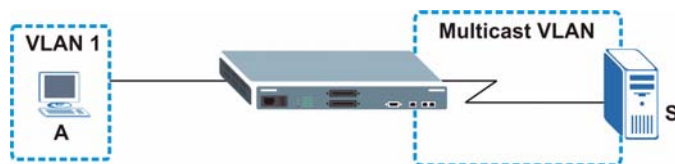

23.7 General MVR Configuration

Use the **MVR** screen to create multicast VLANs and select the receiver port(s) and a source port for each multicast VLAN. Click **Advanced Applications > Multicast > Multicast Setting > MVR** link to display the screen as shown next.

Note: You can create up to five multicast VLANs and up to 256 multicast rules on the Switch.

Note: Your Switch automatically creates a static VLAN (with the same VID) when you create a multicast VLAN in this screen.

Figure 102 Advanced Application > Multicast > Multicast Setting > MVR

The screenshot displays the MVR configuration interface. At the top, there are tabs for "MVR", "Multicast Setting", and "Group Configuration". Below the tabs are several configuration fields:

- Active:** A checkbox that is currently unchecked.
- Name:** A text input field.
- Multicast VLAN ID:** A text input field.
- 802.1p Priority:** A dropdown menu currently set to "0".
- Mode:** Two radio buttons: "Dynamic" (selected) and "Compatible".

Below these fields is a table for configuring ports. The table has five columns: "Port", "Source Port", "Receiver Port", "None", and "Tagging".

Port	Source Port	Receiver Port	None	Tagging
*		None		<input type="checkbox"/>
1	<input type="radio"/>	<input type="radio"/>	<input checked="" type="radio"/>	<input type="checkbox"/>
2	<input type="radio"/>	<input type="radio"/>	<input checked="" type="radio"/>	<input type="checkbox"/>
3	<input type="radio"/>	<input type="radio"/>	<input checked="" type="radio"/>	<input type="checkbox"/>
4	<input type="radio"/>	<input type="radio"/>	<input checked="" type="radio"/>	<input type="checkbox"/>
5	<input type="radio"/>	<input type="radio"/>	<input checked="" type="radio"/>	<input type="checkbox"/>
6	<input type="radio"/>	<input type="radio"/>	<input checked="" type="radio"/>	<input type="checkbox"/>
7	<input type="radio"/>	<input type="radio"/>	<input checked="" type="radio"/>	<input type="checkbox"/>
8	<input type="radio"/>	<input type="radio"/>	<input checked="" type="radio"/>	<input type="checkbox"/>
25	<input type="radio"/>	<input type="radio"/>	<input checked="" type="radio"/>	<input type="checkbox"/>
26	<input type="radio"/>	<input type="radio"/>	<input checked="" type="radio"/>	<input type="checkbox"/>
27	<input type="radio"/>	<input type="radio"/>	<input checked="" type="radio"/>	<input type="checkbox"/>
28	<input type="radio"/>	<input type="radio"/>	<input checked="" type="radio"/>	<input type="checkbox"/>

Below the table are "Add" and "Cancel" buttons. At the bottom of the interface is a table listing existing VLANs:

VLAN	Active	Name	Mode	Source Port	Receiver Port	802.1p	Delete

Below this table are "Delete" and "Cancel" buttons.

The following table describes the related labels in this screen.

Table 55 Advanced Application > Multicast > Multicast Setting > MVR

LABEL	DESCRIPTION
Active	Select this check box to enable MVR to allow one single multicast VLAN to be shared among different subscriber VLANs on the network.
Name	Enter a descriptive name (up to 32 printable ASCII characters) for identification purposes.
Multicast VLAN ID	Enter the VLAN ID (1 to 4094) of the multicast VLAN.
802.1p Priority	Select a priority level (0-7) with which the Switch replaces the priority in outgoing IGMP control packets (belonging to this multicast VLAN).
Mode	Specify the MVR mode on the Switch. Choices are Dynamic and Compatible . Select Dynamic to send IGMP reports to all MVR source ports in the multicast VLAN. Select Compatible to set the Switch not to send IGMP reports.
Port	This field displays the port number on the Switch.
*	Settings in this row apply to all ports. Use this row only if you want to make some settings the same for all ports. Use this row first to set the common settings and then make adjustments on a port-by-port basis. Note: Changes in this row are copied to all the ports as soon as you make them.
Source Port	Select this option to set this port as the MVR source port that sends and receives multicast traffic. All source ports must belong to a single multicast VLAN.
Receiver Port	Select this option to set this port as a receiver port that only receives multicast traffic.
None	Select this option to set the port not to participate in MVR. No MVR multicast traffic is sent or received on this port.
Tagging	Select this checkbox if you want the port to tag the VLAN ID in all outgoing frames transmitted.
Add	Click Add to save your changes to the Switch's run-time memory. The Switch loses these changes if it is turned off or loses power, so use the Save link on the top navigation panel to save your changes to the non-volatile memory when you are done configuring.
Cancel	Click Cancel to begin configuring this screen afresh.
VLAN	This field displays the multicast VLAN ID.
Active	This field displays whether the multicast group is enabled or not.
Name	This field displays the descriptive name for this setting.
Mode	This field displays the MVR mode.
Source Port	This field displays the source port number(s).
Receiver Port	This field displays the receiver port number(s).
802.1p	This field displays the priority level.

Table 55 Advanced Application > Multicast > Multicast Setting > MVR (continued)

LABEL	DESCRIPTION
Delete	To delete a multicast VLAN(s), select the rule(s) that you want to remove in the Delete column, then click the Delete button.
Cancel	Click Cancel to clear the Delete check boxes.

23.8 MVR Group Configuration

All source ports and receiver ports belonging to a multicast group can receive multicast data sent to this multicast group.

Configure MVR IP multicast group address(es) in the **Group Configuration** screen. Click **Group Configuration** in the **MVR** screen.

Note: A port can belong to more than one multicast VLAN. However, IP multicast group addresses in different multicast VLANs cannot overlap.

Figure 103 Advanced Application > Multicast > Multicast Setting > MVR: Group Configuration

The following table describes the labels in this screen.

Table 56 Advanced Application > Multicast > Multicast Setting > MVR: Group Configuration

LABEL	DESCRIPTION
Multicast VLAN ID	Select a multicast VLAN ID (that you configured in the MVR screen) from the drop-down list box.
Name	Enter a descriptive name for identification purposes.
Start Address	Enter the starting IP multicast address of the multicast group in dotted decimal notation. Refer to Section 23.1.1 on page 183 for more information on IP multicast addresses.

Table 56 Advanced Application > Multicast > Multicast Setting > MVR: Group Configuration

LABEL	DESCRIPTION
End Address	Enter the ending IP multicast address of the multicast group in dotted decimal notation. Enter the same IP address as the Start Address field if you want to configure only one IP address for a multicast group. Refer to Section 23.1.1 on page 183 for more information on IP multicast addresses.
Add	Click Add to save your changes to the Switch's run-time memory. The Switch loses these changes if it is turned off or loses power, so use the Save link on the top navigation panel to save your changes to the non-volatile memory when you are done configuring.
Cancel	Click Cancel to begin configuring this screen afresh.
MVLAN	This field displays the multicast VLAN ID.
Name	This field displays the descriptive name for this setting.
Start Address	This field displays the starting IP address of the multicast group.
End Address	This field displays the ending IP address of the multicast group.
Delete	Select Delete Group and click Delete to remove the selected entry(ies) from the table.
Cancel	Select Cancel to clear the checkbox(es) in the table.

23.8.1 MVR Configuration Example

The following figure shows a network example where ports 1, 2 and 3 on the Switch belong to VLAN 1. In addition, port 7 belongs to the multicast group with VID 200 to receive multicast traffic (the **News** and **Movie** channels) from the remote streaming media server, **S**. Computers A, B and C in VLAN are able to receive the traffic.

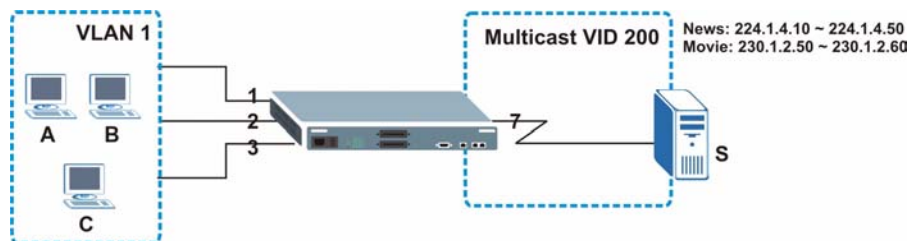
Figure 104 MVR Configuration Example

To configure the MVR settings on the Switch, create a multicast group in the **MVR** screen and set the receiver and source ports.

Figure 105 MVR Configuration Example

The screenshot shows the MVR configuration interface. The top navigation bar includes 'MVR', 'Multicast Setting', and 'Group Configuration'. The configuration fields are as follows:

- Active:
- Name: Premium
- Multicast VLAN ID: 200
- 802.1p Priority: 0
- Mode: Dynamic Compatible

Below the configuration fields is a table with the following columns: Port, Source Port, Receiver Port, None, and Tagging. The table contains 8 rows, with Port 7 highlighted by a red circle.

Port	Source Port	Receiver Port	None	Tagging
*		None		<input type="checkbox"/>
1	<input type="radio"/>	<input checked="" type="radio"/>	<input type="radio"/>	<input type="checkbox"/>
2	<input type="radio"/>	<input checked="" type="radio"/>	<input type="radio"/>	<input type="checkbox"/>
3	<input type="radio"/>	<input checked="" type="radio"/>	<input type="radio"/>	<input type="checkbox"/>
4	<input type="radio"/>	<input type="radio"/>	<input checked="" type="radio"/>	<input type="checkbox"/>
5	<input type="radio"/>	<input type="radio"/>	<input checked="" type="radio"/>	<input type="checkbox"/>
6	<input type="radio"/>	<input type="radio"/>	<input checked="" type="radio"/>	<input type="checkbox"/>
7	<input checked="" type="radio"/>	<input type="radio"/>	<input type="radio"/>	<input checked="" type="checkbox"/>
8	<input type="radio"/>	<input type="radio"/>	<input checked="" type="radio"/>	<input type="checkbox"/>

To set the Switch to forward the multicast group traffic to the subscribers, configure multicast group settings in the **Group Configuration** screen. The

following figure shows an example where two multicast groups (**News** and **Movie**) are configured for the multicast VLAN 200.

Figure 106 MVR Group Configuration Example

The screenshot shows the 'Group Configuration' interface for MVR. The 'Multicast VLAN ID' is set to 200. A red oval highlights the 'Add' form where the 'Name' is 'Movie', 'Start Address' is 230.1.2.50, and 'End Address' is 230.1.2.60. Below this is a table showing the 'News' group already configured for the same VLAN.

MVLAN	Name	Start Address	End Address	Delete All	Delete Group
200	News	224.1.4.10	224.1.4.50	<input type="checkbox"/>	<input type="checkbox"/>

Figure 107 MVR Group Configuration Example

The screenshot shows the 'Group Configuration' interface for MVR. The 'Multicast VLAN ID' is set to 200. A red oval highlights the 'Cancel' form where the 'Name' is empty, 'Start Address' is 0.0.0.0, and 'End Address' is 0.0.0.0. Below this is a table showing both 'Movie' and 'News' groups configured for the same VLAN.

MVLAN	Name	Start Address	End Address	Delete All	Delete Group
200	Movie	230.1.2.50	230.1.2.60	<input type="checkbox"/>	<input type="checkbox"/>
	News	224.1.4.10	224.1.4.50		<input type="checkbox"/>

This chapter describes how to configure authentication, authorization and accounting settings on the Switch.

24.1 Authentication, Authorization and Accounting (AAA)

Authentication is the process of determining who a user is and validating access to the Switch. The Switch can authenticate users who try to log in based on user accounts configured on the Switch itself. The Switch can also use an external authentication server to authenticate a large number of users

Authorization is the process of determining what a user is allowed to do. Different user accounts may have higher or lower privilege levels associated with them. For example, user A may have the right to create new login accounts on the Switch but user B cannot. The Switch can authorize users based on user accounts configured on the Switch itself or it can use an external server to authorize a large number of users.

Accounting is the process of recording what a user is doing. The Switch can use an external server to track when users log in, log out, execute commands and so on. Accounting can also record system related actions such as boot up and shut down times of the Switch.

The external servers that perform authentication, authorization and accounting functions are known as AAA servers. The Switch supports RADIUS (Remote Authentication Dial-In User Service, see [Section 24.1.2 on page 200](#)) and TACACS+ (Terminal Access Controller Access-Control System Plus, see [Section](#)

[24.1.2 on page 200](#)) as external authentication, authorization and accounting servers.

Figure 108 AAA Server

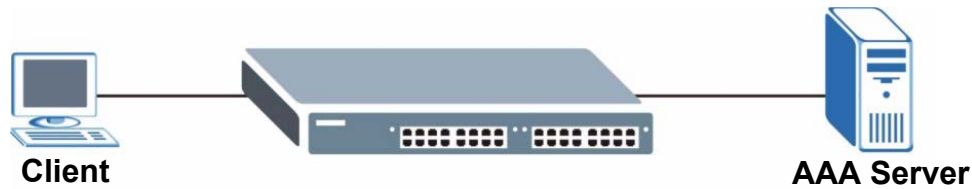

24.1.1 Local User Accounts

By storing user profiles locally on the Switch, your Switch is able to authenticate and authorize users without interacting with a network AAA server. However, there is a limit on the number of users you may authenticate in this way (See [Chapter 31 on page 267](#)).

24.1.2 RADIUS and TACACS+

RADIUS and TACACS+ are security protocols used to authenticate users by means of an external server instead of (or in addition to) an internal device user database that is limited to the memory capacity of the device. In essence, RADIUS and TACACS+ authentication both allow you to validate an unlimited number of users from a central location.

The following table describes some key differences between RADIUS and TACACS+.

Table 57 RADIUS vs. TACACS+

	RADIUS	TACACS+
Transport Protocol	UDP (User Datagram Protocol)	TCP (Transmission Control Protocol)
Encryption	Encrypts the password sent for authentication.	All communication between the client (the Switch) and the TACACS server is encrypted.

24.2 AAA Screens

The **AAA** screens allow you to enable authentication, authorization, accounting or all of them on the Switch. First, configure your authentication and accounting server settings (RADIUS, TACACS+ or both) and then set up the authentication priority, activate authorization and configure accounting settings.

Click **Advanced Application** > **AAA** in the navigation panel to display the screen as shown.

Figure 109 Advanced Application > AAA

The screenshot shows the AAA configuration page with a navigation bar at the top containing an orange circle icon and the text 'AAA'. Below the navigation bar, there are three rows of configuration options, each with a link to the right:

RADIUS Server Setup	Click Here
TACACS+ Server Setup	Click Here
AAA Setup	Click Here

24.2.1 RADIUS Server Setup

Use this screen to configure your RADIUS server settings. See [Section 24.1.2 on page 200](#) for more information on RADIUS servers and [Section 24.3 on page 209](#) for RADIUS attributes utilized by the authentication and accounting features on the Switch. Click on the **RADIUS Server Setup** link in the **AAA** screen to view the screen as shown.

Figure 110 Advanced Application > AAA > RADIUS Server Setup

The screenshot shows the RADIUS Server Setup configuration page. At the top, there is a navigation bar with an orange circle icon, the text 'RADIUS Server Setup', and a link to 'AAA'. The page is divided into two main sections: 'Authentication Server' and 'Accounting Server'.

Authentication Server

Mode:

Timeout: seconds

Index	IP Address	UDP Port	Shared Secret	Delete
1	<input type="text" value="0.0.0.0"/>	<input type="text" value="1812"/>	<input type="text"/>	<input type="checkbox"/>
2	<input type="text" value="0.0.0.0"/>	<input type="text" value="1812"/>	<input type="text"/>	<input type="checkbox"/>

Buttons:

Accounting Server

Timeout: seconds

Index	IP Address	UDP Port	Shared Secret	Delete
1	<input type="text" value="0.0.0.0"/>	<input type="text" value="1813"/>	<input type="text"/>	<input type="checkbox"/>
2	<input type="text" value="0.0.0.0"/>	<input type="text" value="1813"/>	<input type="text"/>	<input type="checkbox"/>

Buttons:

The following table describes the labels in this screen.

Table 58 Advanced Application > AAA > RADIUS Server Setup

LABEL	DESCRIPTION
Authentication Server	Use this section to configure your RADIUS authentication settings.
Mode	<p>This field is only valid if you configure multiple RADIUS servers.</p> <p>Select index-priority and the Switch tries to authenticate with the first configured RADIUS server, if the RADIUS server does not respond then the Switch tries to authenticate with the second RADIUS server.</p> <p>Select round-robin to alternate between the RADIUS servers that it sends authentication requests to.</p>
Timeout	<p>Specify the amount of time in seconds that the Switch waits for an authentication request response from the RADIUS server.</p> <p>If you are using index-priority for your authentication and you are using two RADIUS servers then the timeout value is divided between the two RADIUS servers. For example, if you set the timeout value to 30 seconds, then the Switch waits for a response from the first RADIUS server for 15 seconds and then tries the second RADIUS server.</p>
Index	This is a read-only number representing a RADIUS server entry.
IP Address	Enter the IP address of an external RADIUS server in dotted decimal notation.
UDP Port	The default port of a RADIUS server for authentication is 1812 . You need not change this value unless your network administrator instructs you to do so.
Shared Secret	Specify a password (up to 32 alphanumeric characters) as the key to be shared between the external RADIUS server and the Switch. This key is not sent over the network. This key must be the same on the external RADIUS server and the Switch.
Delete	Check this box if you want to remove an existing RADIUS server entry from the Switch. This entry is deleted when you click Apply .
Apply	Click Apply to save your changes to the Switch's run-time memory. The Switch loses these changes if it is turned off or loses power, so use the Save link on the top navigation panel to save your changes to the non-volatile memory when you are done configuring.
Cancel	Click Cancel to begin configuring this screen afresh.
Accounting Server	Use this section to configure your RADIUS accounting server settings.
Timeout	Specify the amount of time in seconds that the Switch waits for an accounting request response from the RADIUS accounting server.
Index	This is a read-only number representing a RADIUS accounting server entry.
IP Address	Enter the IP address of an external RADIUS accounting server in dotted decimal notation.
UDP Port	The default port of a RADIUS server for accounting is 1813 . You need not change this value unless your network administrator instructs you to do so.

Table 58 Advanced Application > AAA > RADIUS Server Setup (continued)

LABEL	DESCRIPTION
Shared Secret	Specify a password (up to 32 alphanumeric characters) as the key to be shared between the external RADIUS accounting server and the Switch. This key is not sent over the network. This key must be the same on the external RADIUS accounting server and the Switch.
Delete	Check this box if you want to remove an existing RADIUS accounting server entry from the Switch. This entry is deleted when you click Apply .
Apply	Click Apply to save your changes to the Switch's run-time memory. The Switch loses these changes if it is turned off or loses power, so use the Save link on the top navigation panel to save your changes to the non-volatile memory when you are done configuring.
Cancel	Click Cancel to begin configuring this screen afresh.

24.2.2 TACACS+ Server Setup

Use this screen to configure your TACACS+ server settings. See [Section 24.1.2 on page 200](#) for more information on TACACS+ servers. Click on the **TACACS+ Server Setup** link in the **AAA** screen to view the screen as shown.

Figure 111 Advanced Application > AAA > TACACS+ Server Setup

TACACS+ Server Setup AAA

Authentication Server

Mode: index-priority

Timeout: 30 seconds

Index	IP Address	TCP Port	Shared Secret	Delete
1	0.0.0.0	49		<input type="checkbox"/>
2	0.0.0.0	49		<input type="checkbox"/>

Apply Cancel

Accounting Server

Timeout: 30 seconds

Index	IP Address	TCP Port	Shared Secret	Delete
1	0.0.0.0	49		<input type="checkbox"/>
2	0.0.0.0	49		<input type="checkbox"/>

Apply Cancel

The following table describes the labels in this screen.

Table 59 Advanced Application > AAA > TACACS+ Server Setup

LABEL	DESCRIPTION
Authentication Server	Use this section to configure your TACACS+ authentication settings.
Mode	This field is only valid if you configure multiple TACACS+ servers. Select index-priority and the Switch tries to authenticate with the first configured TACACS+ server, if the TACACS+ server does not respond then the Switch tries to authenticate with the second TACACS+ server. Select round-robin to alternate between the TACACS+ servers that it sends authentication requests to.
Timeout	Specify the amount of time in seconds that the Switch waits for an authentication request response from the TACACS+ server. If you are using index-priority for your authentication and you are using two TACACS+ servers then the timeout value is divided between the two TACACS+ servers. For example, if you set the timeout value to 30 seconds, then the Switch waits for a response from the first TACACS+ server for 15 seconds and then tries the second TACACS+ server.
Index	This is a read-only number representing a TACACS+ server entry.
IP Address	Enter the IP address of an external TACACS+ server in dotted decimal notation.
TCP Port	The default port of a TACACS+ server for authentication is 49 . You need not change this value unless your network administrator instructs you to do so.
Shared Secret	Specify a password (up to 32 alphanumeric characters) as the key to be shared between the external TACACS+ server and the Switch. This key is not sent over the network. This key must be the same on the external TACACS+ server and the Switch.
Delete	Check this box if you want to remove an existing TACACS+ server entry from the Switch. This entry is deleted when you click Apply .
Apply	Click Apply to save your changes to the Switch's run-time memory. The Switch loses these changes if it is turned off or loses power, so use the Save link on the top navigation panel to save your changes to the non-volatile memory when you are done configuring.
Cancel	Click Cancel to begin configuring this screen afresh.
Accounting Server	Use this section to configure your TACACS+ accounting settings.
Timeout	Specify the amount of time in seconds that the Switch waits for an accounting request response from the TACACS+ server.
Index	This is a read-only number representing a TACACS+ accounting server entry.
IP Address	Enter the IP address of an external TACACS+ accounting server in dotted decimal notation.
TCP Port	The default port of a TACACS+ server for accounting is 49 . You need not change this value unless your network administrator instructs you to do so.

Table 59 Advanced Application > AAA > TACACS+ Server Setup (continued)

LABEL	DESCRIPTION
Shared Secret	Specify a password (up to 32 alphanumeric characters) as the key to be shared between the external TACACS+ accounting server and the Switch. This key is not sent over the network. This key must be the same on the external TACACS+ accounting server and the Switch.
Delete	Check this box if you want to remove an existing TACACS+ accounting server entry from the Switch. This entry is deleted when you click Apply .
Apply	Click Apply to save your changes to the Switch's run-time memory. The Switch loses these changes if it is turned off or loses power, so use the Save link on the top navigation panel to save your changes to the non-volatile memory when you are done configuring.
Cancel	Click Cancel to begin configuring this screen afresh.

24.2.3 AAA Setup

Use this screen to configure authentication, authorization and accounting settings on the Switch. Click on the **AAA Setup** link in the **AAA** screen to view the screen as shown.

Figure 112 Advanced Application > AAA > AAA Setup

AAA Setup AAA

Authentication

Type	Method 1	Method 2	Method 3
Privilege Enable	local	-	-
Login	local	-	-

Authorization

Type	Active	Method
Exec	<input type="checkbox"/>	radius
Dot1x	<input type="checkbox"/>	radius

Accounting

Update Period minutes

Type	Active	Broadcast	Mode	Method	Privilege
System	<input type="checkbox"/>	<input type="checkbox"/>	-	radius	-
Exec	<input type="checkbox"/>	<input type="checkbox"/>	start-stop	radius	-
Dot1x	<input type="checkbox"/>	<input type="checkbox"/>	start-stop	radius	-
Commands	<input type="checkbox"/>	<input type="checkbox"/>	stop-only	tacacs+	0

Apply Cancel

The following table describes the labels in this screen.

Table 60 Advanced Application > AAA > AAA Setup

LABEL	DESCRIPTION
Authentication	Use this section to specify the methods used to authenticate users accessing the Switch.
Privilege Enable	<p>These fields specify which database the Switch should use (first, second and third) to authenticate access privilege level for administrator accounts (users for Switch management).</p> <p>Configure the access privilege of accounts via commands (See the CLI Reference Guide) for local authentication. The TACACS+ and RADIUS are external servers. Before you specify the priority, make sure you have set up the corresponding database correctly first.</p> <p>You can specify up to three methods for the Switch to authenticate the access privilege level of administrators. The Switch checks the methods in the order you configure them (first Method 1, then Method 2 and finally Method 3). You must configure the settings in the Method 1 field. If you want the Switch to check other sources for access privilege level specify them in Method 2 and Method 3 fields.</p> <p>Select local to have the Switch check the access privilege configured for local authentication.</p> <p>Select radius or tacacs+ to have the Switch check the access privilege via the external servers.</p>
Login	<p>These fields specify which database the Switch should use (first, second and third) to authenticate administrator accounts (users for Switch management).</p> <p>Configure the local user accounts in the Access Control > Logins screen. The TACACS+ and RADIUS are external servers. Before you specify the priority, make sure you have set up the corresponding database correctly first.</p> <p>You can specify up to three methods for the Switch to authenticate administrator accounts. The Switch checks the methods in the order you configure them (first Method 1, then Method 2 and finally Method 3). You must configure the settings in the Method 1 field. If you want the Switch to check other sources for administrator accounts, specify them in Method 2 and Method 3 fields.</p> <p>Select local to have the Switch check the administrator accounts configured in the Access Control > Logins screen.</p> <p>Select radius to have the Switch check the administrator accounts configured via your RADIUS server.</p> <p>Select tacacs+ to have the Switch check the administrator accounts configured via your TACACS+ server.</p>
Authorization	Use this section to configure authorization settings on the Switch.
Type	<p>Set whether the Switch provides the following services to a user.</p> <ul style="list-style-type: none"> • Exec: Allow an administrator which logs in the Switch through Telnet or SSH to have different access privilege level assigned via the external server. • Dot1x: Allow an IEEE 802.1x client to have different bandwidth limit or VLAN ID assigned via the external server.

Table 60 Advanced Application > AAA > AAA Setup (continued)

LABEL	DESCRIPTION
Active	Select this to activate authorization for a specified event types.
Method	<p>Select whether you want to use RADIUS or TACACS+ for authorization of specific types of events.</p> <p>RADIUS is the only method for IEEE 802.1x authorization.</p>
Accounting	Use this section to configure accounting settings on the Switch.
Update Period	This is the amount of time in minutes before the Switch sends an update to the accounting server. This is only valid if you select the start-stop option for the Exec or Dot1x entries.
Type	<p>The Switch supports the following types of events to be sent to the accounting server(s):</p> <ul style="list-style-type: none"> • System: Configure the Switch to send information when the following system events occur: system boots up, system shuts down, system accounting is enabled, system accounting is disabled • Exec: Configure the Switch to send information when an administrator logs in and logs out via the console port, Telnet or SSH. • Dot1x: Configure the Switch to send information when an IEEE 802.1x client begins a session (authenticates via the Switch), ends a session as well as interim updates of a session. • Commands: Configure the Switch to send information when commands of specified privilege level and higher are executed on the Switch.
Active	Select this to activate accounting for a specified event types.
Broadcast	<p>Select this to have the Switch send accounting information to all configured accounting servers at the same time.</p> <p>If you don't select this and you have two accounting servers set up, then the Switch sends information to the first accounting server and if it doesn't get a response from the accounting server then it tries the second accounting server.</p>
Mode	<p>The Switch supports two modes of recording login events. Select:</p> <p>start-stop: to have the Switch send information to the accounting server when a user begins a session, during a user's session (if it lasts past the Update Period), and when a user ends a session.</p> <p>stop-only: to have the Switch send information to the accounting server only when a user ends a session.</p>
Method	<p>Select whether you want to use RADIUS or TACACS+ for accounting of specific types of events.</p> <p>TACACS+ is the only method for recording Commands type of event.</p>
Privilege	This field is only configurable for Commands type of event. Select the threshold command privilege level for which the Switch should send accounting information. The Switch will send accounting information when commands at the level you specify and higher are executed on the Switch.
Apply	Click Apply to save your changes to the Switch's run-time memory. The Switch loses these changes if it is turned off or loses power, so use the Save link on the top navigation panel to save your changes to the non-volatile memory when you are done configuring.
Cancel	Click Cancel to begin configuring this screen afresh.

24.2.4 Vendor Specific Attribute

RFC 2865 standard specifies a method for sending vendor-specific information between a RADIUS server and a network access device (for example, the Switch). A company can create Vendor Specific Attributes (VSAs) to expand the functionality of a RADIUS server.

The Switch supports VSAs that allow you to perform the following actions based on user authentication:

- Limit bandwidth on incoming or outgoing traffic for the port the user connects to.
- Assign account privilege levels (See the CLI Reference Guide for more information on account privilege levels) for the authenticated user.

The VSAs are composed of the following:

- **Vendor-ID:** An identification number assigned to the company by the IANA (Internet Assigned Numbers Authority). ZyXEL's vendor ID is 890.
- **Vendor-Type:** A vendor specified attribute, identifying the setting you want to modify.
- **Vendor-data:** A value you want to assign to the setting.

Note: Refer to the documentation that comes with your RADIUS server on how to configure VSAs for users authenticating via the RADIUS server.

The following table describes the VSAs supported on the Switch.

Table 61 Supported VSAs

FUNCTION	ATTRIBUTE
Ingress Bandwidth Assignment	Vendor-Id = 890 Vendor-Type = 1 Vendor-data = ingress rate (Kbps in decimal format)

Table 61 Supported VSAs

FUNCTION	ATTRIBUTE
Egress Bandwidth Assignment	Vendor-Id = 890 Vendor-Type = 2 Vendor-data = egress rate (Kbps in decimal format)
Privilege Assignment	Vendor-ID = 890 Vendor-Type = 3 Vendor-Data = " shell:priv-lvl=N " or Vendor-ID = 9 (CISCO) Vendor-Type = 1 (CISCO-AVPAIR) Vendor-Data = " shell:priv-lvl=N " where N is a privilege level (from 0 to 14). Note: If you set the privilege level of a login account differently on the RADIUS server(s) and the Switch, the user is assigned a privilege level from the database (RADIUS or local) the Switch uses first for user authentication.

24.2.4.1 Tunnel Protocol Attribute

You can configure tunnel protocol attributes on the RADIUS server (refer to your RADIUS server documentation) to assign a port on the Switch to a VLAN based on IEEE 802.1x authentication. The port VLAN settings are fixed and untagged. This will also set the port's VID. The following table describes the values you need to configure. Note that the bolded values in the table are fixed values as defined in RFC 3580.

Table 62 Supported Tunnel Protocol Attribute

FUNCTION	ATTRIBUTE
VLAN Assignment	Tunnel-Type = VLAN (13) Tunnel-Medium-Type = 802 (6) Tunnel-Private-Group-ID = VLAN ID Note: You must also create a VLAN with the specified VID on the Switch.

24.3 Supported RADIUS Attributes

Remote Authentication Dial-In User Service (RADIUS) attributes are data used to define specific authentication, and accounting elements in a user profile, which is stored on the RADIUS server. This appendix lists the RADIUS attributes supported by the Switch.

Refer to RFC 2865 for more information about RADIUS attributes used for authentication. Refer to RFC 2866 and RFC 2869 for RADIUS attributes used for accounting.

This section lists the attributes used by authentication and accounting functions on the Switch. In cases where the attribute has a specific format associated with it, the format is specified.

24.3.1 Attributes Used for Authentication

The following sections list the attributes sent from the Switch to the RADIUS server when performing authentication.

24.3.1.1 Attributes Used for Authenticating Privilege Access

User-Name

- The format of the User-Name attribute is **\$enab#\$**, where # is the privilege level (1-14).

User-Password

NAS-Identifier

NAS-IP-Address

24.3.1.2 Attributes Used to Login Users

User-Name

User-Password

NAS-Identifier

NAS-IP-Address

24.3.1.3 Attributes Used by the IEEE 802.1x Authentication

User-Name

NAS-Identifier

NAS-IP-Address

NAS-Port

NAS-Port-Type

- This value is set to **Ethernet(15)** on the Switch.

Calling-Station-Id

Frame-MTU

EAP-Message

State

Message-Authenticator

24.3.2 Attributes Used for Accounting

The following sections list the attributes sent from the Switch to the RADIUS server when performing authentication.

24.3.2.1 Attributes Used for Accounting System Events

NAS-IP-Address

NAS-Identifier

Acct-Status-Type

Acct-Session-ID

- The format of Acct-Session-Id is **date+time+8-digit sequential number**, for example, 2007041917210300000001. (date: 2007/04/19, time: 17:21:03, serial number: 00000001)

Acct-Delay-Time

24.3.2.2 Attributes Used for Accounting Exec Events

The attributes are listed in the following table along with the time that they are sent (the difference between Console and Telnet/SSH Exec events is that the Telnet/SSH events utilize the Calling-Station-Id attribute):

Table 63 RADIUS Attributes - Exec Events via Console

ATTRIBUTE	START	INTERIM-UPDATE	STOP
User-Name	Y	Y	Y
NAS-Identifier	Y	Y	Y
NAS-IP-Address	Y	Y	Y
Service-Type	Y	Y	Y
Acct-Status-Type	Y	Y	Y
Acct-Delay-Time	Y	Y	Y
Acct-Session-Id	Y	Y	Y
Acct-Authentic	Y	Y	Y
Acct-Session-Time		Y	Y
Acct-Terminate-Cause			Y

Table 64 RADIUS Attributes - Exec Events via Telnet/SSH

ATTRIBUTE	START	INTERIM-UPDATE	STOP
User-Name	Y	Y	Y
NAS-Identifier	Y	Y	Y
NAS-IP-Address	Y	Y	Y
Service-Type	Y	Y	Y
Calling-Station-Id	Y	Y	Y
Acct-Status-Type	Y	Y	Y
Acct-Delay-Time	Y	Y	Y

Table 64 RADIUS Attributes - Exec Events via Telnet/SSH

ATTRIBUTE	START	INTERIM-UPDATE	STOP
Acct-Session-Id	Y	Y	Y
Acct-Authentic	Y	Y	Y
Acct-Session-Time		Y	Y
Acct-Terminate-Cause			Y

24.3.2.3 Attributes Used for Accounting IEEE 802.1x Events

The attributes are listed in the following table along with the time of the session they are sent:

Table 65 RADIUS Attributes-Exec Events via 802.1x

ATTRIBUTE	START	INTERIM-UPDATE	STOP
User-Name	Y	Y	Y
NAS-IP-Address	Y	Y	Y
NAS-Port	Y	Y	Y
Class	Y	Y	Y
Called-Station-Id	Y	Y	Y
Calling-Station-Id	Y	Y	Y
NAS-Identifier	Y	Y	Y
NAS-Port-Type	Y	Y	Y
Acct-Status-Type	Y	Y	Y
Acct-Delay-Time	Y	Y	Y
Acct-Session-Id	Y	Y	Y
Acct-Authentic	Y	Y	Y
Acct-Input-Octets		Y	Y
Acct-Output-Octets		Y	Y
Acct-Session-Time		Y	Y
Acct-Input-Packets		Y	Y
Acct-Output-Packets		Y	Y
Acct-Terminate-Cause			Y
Acct-Input-Gigawords		Y	Y
Acct-Output-Gigawords		Y	Y

IP Source Guard

Use IP source guard to filter unauthorized DHCP and ARP packets in your network.

25.1 IP Source Guard Overview

IP source guard uses a binding table to distinguish between authorized and unauthorized DHCP and ARP packets in your network. A binding contains these key attributes:

- MAC address
- VLAN ID
- IP address
- Port number

When the Switch receives a DHCP or ARP packet, it looks up the appropriate MAC address, VLAN ID, IP address, and port number in the binding table. If there is a binding, the Switch forwards the packet. If there is not a binding, the Switch discards the packet.

The Switch builds the binding table by snooping DHCP packets (dynamic bindings) and from information provided manually by administrators (static bindings).

IP source guard consists of the following features:

- Static bindings. Use this to create static bindings in the binding table.
- DHCP snooping. Use this to filter unauthorized DHCP packets on the network and to build the binding table dynamically.
- ARP inspection. Use this to filter unauthorized ARP packets on the network.

If you want to use dynamic bindings to filter unauthorized ARP packets (typical implementation), you have to enable DHCP snooping before you enable ARP inspection.

25.1.1 DHCP Snooping Overview

Use DHCP snooping to filter unauthorized DHCP packets on the network and to build the binding table dynamically. This can prevent clients from getting IP addresses from unauthorized DHCP servers.

25.1.1.1 Trusted vs. Untrusted Ports

Every port is either a trusted port or an untrusted port for DHCP snooping. This setting is independent of the trusted/untrusted setting for ARP inspection. You can also specify the maximum number for DHCP packets that each port (trusted or untrusted) can receive each second.

Trusted ports are connected to DHCP servers or other switches. The Switch discards DHCP packets from trusted ports only if the rate at which DHCP packets arrive is too high. The Switch learns dynamic bindings from trusted ports.

Note: If DHCP is enabled and there are no trusted ports, DHCP requests will not succeed.

Untrusted ports are connected to subscribers. The Switch discards DHCP packets from untrusted ports in the following situations:

- The packet is a DHCP server packet (for example, OFFER, ACK, or NACK).
- The source MAC address and source IP address in the packet do not match any of the current bindings.
- The packet is a RELEASE or DECLINE packet, and the source MAC address and source port do not match any of the current bindings.
- The rate at which DHCP packets arrive is too high.

25.1.1.2 DHCP Snooping Database

The Switch stores the binding table in volatile memory. If the Switch restarts, it loads static bindings from permanent memory but loses the dynamic bindings, in which case the devices in the network have to send DHCP requests again. As a result, it is recommended you configure the DHCP snooping database.

The DHCP snooping database maintains the dynamic bindings for DHCP snooping and ARP inspection in a file on an external TFTP server. If you set up the DHCP snooping database, the Switch can reload the dynamic bindings from the DHCP snooping database after the Switch restarts.

You can configure the name and location of the file on the external TFTP server. The file has the following format:

Figure 113 DHCP Snooping Database File Format

```
<initial-checksum>
TYPE DHCP-SNOOPING
VERSION 1
BEGIN
<binding-1> <checksum-1>
<binding-2> <checksum-1-2>
...
...
<binding-n> <checksum-1-2-...-n>
END
```

The <initial-checksum> helps distinguish between the bindings in the latest update and the bindings from previous updates. Each binding consists of 72 bytes, a space, and another checksum that is used to validate the binding when it is read. If the calculated checksum is not equal to the checksum in the file, that binding and all others after it are ignored.

25.1.1.3 DHCP Relay Option 82 Information

The Switch can add information to DHCP requests that it does not discard. This provides the DHCP server more information about the source of the requests. The Switch can add the following information:

- Slot ID (1 byte), port ID (1 byte), and source VLAN ID (2 bytes)
- System name (up to 32 bytes)

This information is stored in an Agent Information field in the option 82 field of the DHCP headers of client DHCP request frames. See [Chapter 30 on page 257](#) for more information about DHCP relay option 82.

When the DHCP server responds, the Switch removes the information in the Agent Information field before forwarding the response to the original source.

You can configure this setting for each source VLAN. This setting is independent of the DHCP relay settings ([Chapter 30 on page 257](#)).

25.1.1.4 Configuring DHCP Snooping

Follow these steps to configure DHCP snooping on the Switch.

- 1 Enable DHCP snooping on the Switch.
- 2 Enable DHCP snooping on each VLAN, and configure DHCP relay option 82.

- 3 Configure trusted and untrusted ports, and specify the maximum number of DHCP packets that each port can receive per second.
- 4 Configure static bindings.

25.1.2 ARP Inspection Overview

Use ARP inspection to filter unauthorized ARP packets on the network. This can prevent many kinds of man-in-the-middle attacks, such as the one in the following example.

Figure 114 Example: Man-in-the-middle Attack

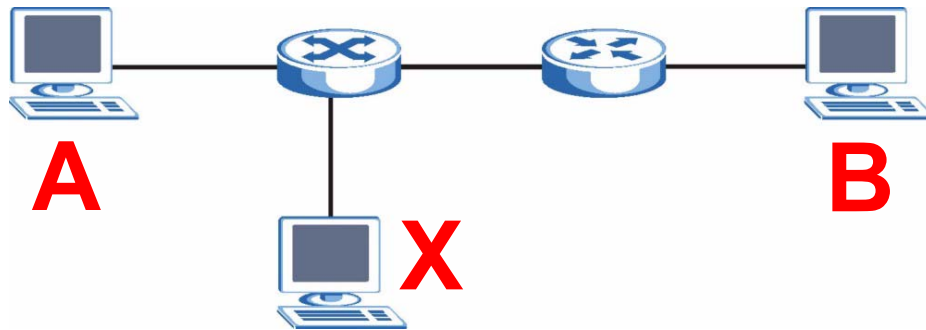

In this example, computer **B** tries to establish a connection with computer **A**. Computer **X** is in the same broadcast domain as computer **A** and intercepts the ARP request for computer **A**. Then, computer **X** does the following things:

- It pretends to be computer **A** and responds to computer **B**.
- It pretends to be computer **B** and sends a message to computer **A**.

As a result, all the communication between computer **A** and computer **B** passes through computer **X**. Computer **X** can read and alter the information passed between them.

25.1.2.1 ARP Inspection and MAC Address Filters

When the Switch identifies an unauthorized ARP packet, it automatically creates a MAC address filter to block traffic from the source MAC address and source VLAN ID of the unauthorized ARP packet. You can configure how long the MAC address filter remains in the Switch.

These MAC address filters are different than regular MAC address filters ([Chapter 12 on page 117](#)).

- They are stored only in volatile memory.
- They do not use the same space in memory that regular MAC address filters use.

- They appear only in the **ARP Inspection** screens and commands, not in the **MAC Address Filter** screens and commands.

25.1.2.2 Trusted vs. Untrusted Ports

Every port is either a trusted port or an untrusted port for ARP inspection. This setting is independent of the trusted/untrusted setting for DHCP snooping. You can also specify the maximum rate at which the Switch receives ARP packets on untrusted ports.

The Switch does not discard ARP packets on trusted ports for any reason.

The Switch discards ARP packets on untrusted ports in the following situations:

- The sender's information in the ARP packet does not match any of the current bindings.
- The rate at which ARP packets arrive is too high.

25.1.2.3 Syslog

The Switch can send syslog messages to the specified syslog server ([Chapter 34 on page 299](#)) when it forwards or discards ARP packets. The Switch can consolidate log messages and send log messages in batches to make this mechanism more efficient.

25.1.2.4 Configuring ARP Inspection

Follow these steps to configure ARP inspection on the Switch.

- 1 Configure DHCP snooping. See [Section 25.1.1.4 on page 215](#).

Note: It is recommended you enable DHCP snooping at least one day before you enable ARP inspection so that the Switch has enough time to build the binding table.

- 2 Enable ARP inspection on each VLAN.
- 3 Configure trusted and untrusted ports, and specify the maximum number of ARP packets that each port can receive per second.

25.2 IP Source Guard

Use this screen to look at the current bindings for DHCP snooping and ARP inspection. Bindings are used by DHCP snooping and ARP inspection to distinguish between authorized and unauthorized packets in the network. The Switch learns

the bindings by snooping DHCP packets (dynamic bindings) and from information provided manually by administrators (static bindings). To open this screen, click **Advanced Application > IP Source Guard**.

Figure 115 IP Source Guard



The following table describes the labels in this screen.

Table 66 IP Source Guard

LABEL	DESCRIPTION
Index	This field displays a sequential number for each binding.
MAC Address	This field displays the source MAC address in the binding.
IP Address	This field displays the IP address assigned to the MAC address in the binding.
Lease	This field displays how many days, hours, minutes, and seconds the binding is valid; for example, 2d3h4m5s means the binding is still valid for 2 days, 3 hours, 4 minutes, and 5 seconds. This field displays infinity if the binding is always valid (for example, a static binding).
Type	This field displays how the Switch learned the binding. static: This binding was learned from information provided manually by an administrator. dhcp-snooping: This binding was learned by snooping DHCP packets.
VID	This field displays the source VLAN ID in the binding.
Port	This field displays the port number in the binding. If this field is blank, the binding applies to all ports.

25.3 IP Source Guard Static Binding

Use this screen to manage static bindings for DHCP snooping and ARP inspection. Static bindings are uniquely identified by the MAC address and VLAN ID. Each MAC address and VLAN ID can only be in one static binding. If you try to create a static binding with the same MAC address and VLAN ID as an existing static binding, the

new static binding replaces the original one. To open this screen, click **Advanced Application > IP Source Guard > Static Binding**.

Figure 116 IP Source Guard Static Binding

The following table describes the labels in this screen.

Table 67 IP Source Guard Static Binding

LABEL	DESCRIPTION
MAC Address	Enter the source MAC address in the binding.
IP Address	Enter the IP address assigned to the MAC address in the binding.
VLAN	Enter the source VLAN ID in the binding.
Port	Specify the port(s) in the binding. If this binding has one port, select the first radio button and enter the port number in the field to the right. If this binding applies to all ports, select Any .
Add	Click this to create the specified static binding or to update an existing one.
Cancel	Click this to reset the values above based on the last selected static binding or, if not applicable, to clear the fields above.
Clear	Click this to clear the fields above.
Index	This field displays a sequential number for each binding.
MAC Address	This field displays the source MAC address in the binding.
IP Address	This field displays the IP address assigned to the MAC address in the binding.
Lease	This field displays how long the binding is valid.
Type	This field displays how the Switch learned the binding. static: This binding was learned from information provided manually by an administrator.
VLAN	This field displays the source VLAN ID in the binding.

Table 67 IP Source Guard Static Binding (continued)

LABEL	DESCRIPTION
Port	This field displays the port number in the binding. If this field is blank, the binding applies to all ports.
Delete	Select this, and click Delete to remove the specified entry.
Cancel	Click this to clear the Delete check boxes above.

25.4 DHCP Snooping

Use this screen to look at various statistics about the DHCP snooping database. To open this screen, click **Advanced Application > IP Source Guard > DHCP Snooping**.

Figure 117 DHCP Snooping

DHCP Snooping		Configure	IPSG
Database Status			
Description	Status		
Agent URL			
Write delay timer	300	seconds	
Abort timer	300	seconds	
Agent running	None		
Delay timer expiry	Not Running		
Abort timer expiry	Not Running		
Last succeeded time	None		
Last failed time	None		
Last failed reason	No failure recorded		
		Times	
Total attempts	0		
Startup failures	0		
Successful transfers	0		
Failed transfers	0		
Successful reads	0		
Failed reads	0		
Successful writes	0		
Failed writes	0		
Database detail			
Description	Status		
First successful access	None		
Last ignored bindings counters			
Binding collisions	0		
Invalid interfaces	0		
Parse failures	0		
Expired leases	0		
Unsupported vlans	0		
Last ignored time	None		
Total ignored bindings counters			
Binding collisions	0		
Invalid interfaces	0		
Parse failures	0		
Expired leases	0		
Unsupported vlans	0		

The following table describes the labels in this screen.

Table 68 DHCP Snooping

LABEL	DESCRIPTION
Database Status	This section displays the current settings for the DHCP snooping database. You can configure them in the DHCP Snooping Configure screen. See Section 25.5 on page 224 .
Agent URL	This field displays the location of the DHCP snooping database.
Write delay timer	This field displays how long (in seconds) the Switch tries to complete a specific update in the DHCP snooping database before it gives up.
Abort timer	This field displays how long (in seconds) the Switch waits to update the DHCP snooping database after the current bindings change.
	This section displays information about the current update and the next update of the DHCP snooping database.
Agent running	This field displays the status of the current update or access of the DHCP snooping database. none: The Switch is not accessing the DHCP snooping database. read: The Switch is loading dynamic bindings from the DHCP snooping database. write: The Switch is updating the DHCP snooping database.
Delay timer expiry	This field displays how much longer (in seconds) the Switch tries to complete the current update before it gives up. It displays Not Running if the Switch is not updating the DHCP snooping database right now.
Abort timer expiry	This field displays when (in seconds) the Switch is going to update the DHCP snooping database again. It displays Not Running if the current bindings have not changed since the last update.
	This section displays information about the last time the Switch updated the DHCP snooping database.
Last succeeded time	This field displays the last time the Switch updated the DHCP snooping database successfully.
Last failed time	This field displays the last time the Switch updated the DHCP snooping database unsuccessfully.
Last failed reason	This field displays the reason the Switch updated the DHCP snooping database unsuccessfully.
	This section displays historical information about the number of times the Switch successfully or unsuccessfully read or updated the DHCP snooping database.
Total attempts	This field displays the number of times the Switch has tried to access the DHCP snooping database for any reason.
Startup failures	This field displays the number of times the Switch could not create or read the DHCP snooping database when the Switch started up or a new URL is configured for the DHCP snooping database.

Table 68 DHCP Snooping (continued)

LABEL	DESCRIPTION
Successful transfers	This field displays the number of times the Switch read bindings from or updated the bindings in the DHCP snooping database successfully.
Failed transfers	This field displays the number of times the Switch was unable to read bindings from or update the bindings in the DHCP snooping database.
Successful reads	This field displays the number of times the Switch read bindings from the DHCP snooping database successfully.
Failed reads	This field displays the number of times the Switch was unable to read bindings from the DHCP snooping database.
Successful writes	This field displays the number of times the Switch updated the bindings in the DHCP snooping database successfully.
Failed writes	This field displays the number of times the Switch was unable to update the bindings in the DHCP snooping database.
Database detail	
First successful access	This field displays the first time the Switch accessed the DHCP snooping database for any reason.
Last ignored bindings counters	This section displays the number of times and the reasons the Switch ignored bindings the last time it read bindings from the DHCP binding database. You can clear these counters by restarting the Switch or using CLI commands. See the CLI Reference Guide.
Binding collisions	This field displays the number of bindings the Switch ignored because the Switch already had a binding with the same MAC address and VLAN ID.
Invalid interfaces	This field displays the number of bindings the Switch ignored because the port number was a trusted interface or does not exist anymore.
Parse failures	This field displays the number of bindings the Switch ignored because the Switch was unable to understand the binding in the DHCP binding database.
Expired leases	This field displays the number of bindings the Switch ignored because the lease time had already expired.
Unsupported vlans	This field displays the number of bindings the Switch ignored because the VLAN ID does not exist anymore.
Last ignored time	This field displays the last time the Switch ignored any bindings for any reason from the DHCP binding database.
Total ignored bindings counters	This section displays the reasons the Switch has ignored bindings any time it read bindings from the DHCP binding database. You can clear these counters by restarting the Switch or using CLI commands. See the CLI Reference Guide.
Binding collisions	This field displays the number of bindings the Switch has ignored because the Switch already had a binding with the same MAC address and VLAN ID.
Invalid interfaces	This field displays the number of bindings the Switch has ignored because the port number was a trusted interface or does not exist anymore.

Table 68 DHCP Snooping (continued)

LABEL	DESCRIPTION
Parse failures	This field displays the number of bindings the Switch has ignored because the Switch was unable to understand the binding in the DHCP binding database.
Expired leases	This field displays the number of bindings the Switch has ignored because the lease time had already expired.
Unsupported vlans	This field displays the number of bindings the Switch has ignored because the VLAN ID does not exist anymore.

25.5 DHCP Snooping Configure

Use this screen to enable DHCP snooping on the Switch (not on specific VLAN), specify the VLAN where the default DHCP server is located, and configure the DHCP snooping database. The DHCP snooping database stores the current bindings on a secure, external TFTP server so that they are still available after a restart. To open this screen, click **Advanced Application > IP Source Guard > DHCP Snooping > Configure**.

Figure 118 DHCP Snooping Configure

The screenshot shows the DHCP Snooping Configure interface. At the top, there are tabs for 'Port', 'VLAN', and 'DHCP Snooping'. The 'DHCP Snooping' tab is active. Below the tabs, there is a section for 'Active' with an unchecked checkbox. Below that, there is a 'DHCP Vlan' dropdown menu with 'Disable' selected. The 'Database' section contains three rows: 'Agent URL' with an empty text box, 'Timeout interval' with a value of 300 and the unit 'seconds', and 'Write delay interval' with a value of 300 and the unit 'seconds'. At the bottom, there is a 'Renew DHCP Snooping URL' field with an empty text box and a 'Renew' button. Below the 'Renew' button are 'Apply' and 'Cancel' buttons.

The following table describes the labels in this screen.

Table 69 DHCP Snooping Configure

LABEL	DESCRIPTION
Active	<p>Select this to enable DHCP snooping on the Switch. You still have to enable DHCP snooping on specific VLAN and specify trusted ports.</p> <p>Note: If DHCP is enabled and there are no trusted ports, DHCP requests will not succeed.</p>
DHCP Vlan	<p>Select a VLAN ID if you want the Switch to forward DHCP packets to DHCP servers on a specific VLAN.</p> <p>Note: You have to enable DHCP snooping on the DHCP VLAN too.</p> <p>You can enable Option82 in the DHCP Snooping VLAN Configure screen (Section 25.5.2 on page 227) to help the DHCP servers distinguish between DHCP requests from different VLAN.</p> <p>Select Disable if you do not want the Switch to forward DHCP packets to a specific VLAN.</p>
Database	<p>If Timeout interval is greater than Write delay interval, it is possible that the next update is scheduled to occur before the current update has finished successfully or timed out. In this case, the Switch waits to start the next update until it completes the current one.</p>
Agent URL	<p>Enter the location of the DHCP snooping database. The location should be expressed like this: tftp://{domain name or IP address}/directory, if applicable/file name; for example, tftp://192.168.10.1/database.txt.</p>
Timeout interval	<p>Enter how long (10-65535 seconds) the Switch tries to complete a specific update in the DHCP snooping database before it gives up.</p>
Write delay interval	<p>Enter how long (10-65535 seconds) the Switch waits to update the DHCP snooping database the first time the current bindings change after an update. Once the next update is scheduled, additional changes in current bindings are automatically included in the next update.</p>
Renew DHCP Snooping URL	<p>Enter the location of a DHCP snooping database, and click Renew if you want the Switch to load it. You can use this to load dynamic bindings from a different DHCP snooping database than the one specified in Agent URL.</p> <p>When the Switch loads dynamic bindings from a DHCP snooping database, it does not discard the current dynamic bindings first. If there is a conflict, the Switch keeps the dynamic binding in volatile memory and updates the Binding collisions counter in the DHCP Snooping screen (Section 25.4 on page 220).</p>

Table 69 DHCP Snooping Configure (continued)

LABEL	DESCRIPTION
Apply	Click Apply to save your changes to the Switch's run-time memory. The Switch loses these changes if it is turned off or loses power, so use the Save link on the top navigation panel to save your changes to the non-volatile memory when you are done configuring.
Cancel	Click this to reset the values in this screen to their last-saved values.

25.5.1 DHCP Snooping Port Configure

Use this screen to specify whether ports are trusted or untrusted ports for DHCP snooping.

Note: If DHCP snooping is enabled but there are no trusted ports, DHCP requests cannot reach the DHCP server.

You can also specify the maximum number for DHCP packets that each port (trusted or untrusted) can receive each second. To open this screen, click **Advanced Application > IP Source Guard > DHCP Snooping > Configure > Port**.

Figure 119 DHCP Snooping Port Configure

The screenshot shows the 'DHCP Snooping Port Configure' interface. At the top, there is a title bar with an orange circle icon, the text 'DHCP Snooping Port Configure', and a 'Configure' link. Below the title bar is a table with three columns: 'Port', 'Server Trusted state', and 'Rate (pps)'. The table has 12 rows, with the first row labeled '*' and the subsequent rows labeled 1 through 11. Each row has a dropdown menu for 'Server Trusted state' (all set to 'Untrusted') and a text input field for 'Rate (pps)' (all set to '0'). At the bottom of the screen, there are two buttons: 'Apply' and 'Cancel'.

Port	Server Trusted state	Rate (pps)
*	Untrusted	
1	Untrusted	0
2	Untrusted	0
3	Untrusted	0
4	Untrusted	0
5	Untrusted	0
6	Untrusted	0
7	Untrusted	0
8	Untrusted	0
9	Untrusted	0
10	Untrusted	0
11	Untrusted	0

The following table describes the labels in this screen.

Table 70 DHCP Snooping Port Configure

LABEL	DESCRIPTION
Port	This field displays the port number. If you configure the * port, the settings are applied to all of the ports.
Server Trusted state	<p>Select whether this port is a trusted port (Trusted) or an untrusted port (Untrusted).</p> <p>Trusted ports are connected to DHCP servers or other switches, and the Switch discards DHCP packets from trusted ports only if the rate at which DHCP packets arrive is too high.</p> <p>Untrusted ports are connected to subscribers, and the Switch discards DHCP packets from untrusted ports in the following situations:</p> <ul style="list-style-type: none"> • The packet is a DHCP server packet (for example, OFFER, ACK, or NACK). • The source MAC address and source IP address in the packet do not match any of the current bindings. • The packet is a RELEASE or DECLINE packet, and the source MAC address and source port do not match any of the current bindings. • The rate at which DHCP packets arrive is too high.
Rate (pps)	Specify the maximum number for DHCP packets (1-2048) that the Switch receives from each port each second. The Switch discards any additional DHCP packets. Enter 0 to disable this limit, which is recommended for trusted ports.
Apply	Click Apply to save your changes to the Switch's run-time memory. The Switch loses these changes if it is turned off or loses power, so use the Save link on the top navigation panel to save your changes to the non-volatile memory when you are done configuring.
Cancel	Click this to reset the values in this screen to their last-saved values.

25.5.2 DHCP Snooping VLAN Configure

Use this screen to enable DHCP snooping on each VLAN and to specify whether or not the Switch adds DHCP relay agent option 82 information ([Chapter 30 on page 257](#)) to DHCP requests that the Switch relays to a DHCP server for each VLAN. To

open this screen, click **Advanced Application > IP Source Guard > DHCP Snooping > Configure > VLAN**.

Figure 120 DHCP Snooping VLAN Configure

The following table describes the labels in this screen.

Table 71 DHCP Snooping VLAN Configure

LABEL	DESCRIPTION
Show VLAN	Use this section to specify the VLANs you want to manage in the section below.
Start VID	Enter the lowest VLAN ID you want to manage in the section below.
End VID	Enter the highest VLAN ID you want to manage in the section below.
Apply	Click this to display the specified range of VLANs in the section below.
VID	This field displays the VLAN ID of each VLAN in the range specified above. If you configure the * VLAN, the settings are applied to all VLANs.
Enabled	Select Yes to enable DHCP snooping on the VLAN. You still have to enable DHCP snooping on the Switch and specify trusted ports. Note: If DHCP is enabled and there are no trusted ports, DHCP requests will not succeed.
Option82	Select this to have the Switch add the slot number, port number and VLAN ID to DHCP requests that it broadcasts to the DHCP VLAN, if specified, or VLAN. You can specify the DHCP VLAN in the DHCP Snooping Configure screen. See Section 25.5 on page 224 .
Information	Select this to have the Switch add the system name to DHCP requests that it broadcasts to the DHCP VLAN, if specified, or VLAN. You can configure the system name in the General Setup screen. See Chapter 8 on page 75 . You can specify the DHCP VLAN in the DHCP Snooping Configure screen. See Section 25.5 on page 224 .
Apply	Click Apply to save your changes to the Switch's run-time memory. The Switch loses these changes if it is turned off or loses power, so use the Save link on the top navigation panel to save your changes to the non-volatile memory when you are done configuring.
Cancel	Click this to reset the values in this screen to their last-saved values.

25.6 ARP Inspection Status

Use this screen to look at the current list of MAC address filters that were created because the Switch identified an unauthorized ARP packet. When the Switch identifies an unauthorized ARP packet, it automatically creates a MAC address filter to block traffic from the source MAC address and source VLAN ID of the unauthorized ARP packet. To open this screen, click **Advanced Application > IP Source Guard > ARP Inspection**.

Figure 121 ARP Inspection Status

The screenshot shows the ARP Inspection Status interface. At the top, there is a navigation bar with 'ARP Inspection Status' selected, and links for 'VLAN Status', 'Log Status', 'Configure', and 'IPSG'. Below this, it states 'Total number of filters = 0'. A table with the following columns is displayed: Index, MAC Address, VID, Port, Expiry (sec), Reason, and Delete. The table contains one row with asterisks in the first six columns and a checkbox in the last. Below the table are 'Delete' and 'Cancel' buttons. At the bottom, there are 'Change Pages', 'Previous Page', and 'Next Page' buttons.

The following table describes the labels in this screen.

Table 72 ARP Inspection Status

LABEL	DESCRIPTION
Total number of filters	This field displays the current number of MAC address filters that were created because the Switch identified unauthorized ARP packets.
Index	This field displays a sequential number for each MAC address filter.
MAC Address	This field displays the source MAC address in the MAC address filter.
VID	This field displays the source VLAN ID in the MAC address filter.
Port	This field displays the source port of the discarded ARP packet.
Expiry (sec)	This field displays how long (in seconds) the MAC address filter remains in the Switch. You can also delete the record manually (Delete).
Reason	This field displays the reason the ARP packet was discarded. MAC+VLAN: The MAC address and VLAN ID were not in the binding table. IP: The MAC address and VLAN ID were in the binding table, but the IP address was not valid. Port: The MAC address, VLAN ID, and IP address were in the binding table, but the port number was not valid.
Delete	Select this, and click Delete to remove the specified entry.

Table 72 ARP Inspection Status (continued)

LABEL	DESCRIPTION
Cancel	Click this to clear the Delete check boxes above.
Change Pages	Click Previous or Next to show the previous/next screen if all status information cannot be seen in one screen.

25.6.1 ARP Inspection VLAN Status

Use this screen to look at various statistics about ARP packets in each VLAN. To open this screen, click **Advanced Application > IP Source Guard > ARP Inspection > VLAN Status**.

Figure 122 ARP Inspection VLAN Status

The following table describes the labels in this screen.

Table 73 ARP Inspection VLAN Status

LABEL	DESCRIPTION
Show VLAN range	Use this section to specify the VLANs you want to look at in the section below.
Enabled VLAN	Select this to look at all the VLANs on which ARP inspection is enabled in the section below.
Selected VLAN	Select this to look at all the VLANs in a specific range in the section below. Then, enter the lowest VLAN ID (Start VID) and the highest VLAN ID (End VID) you want to look at.
Apply	Click this to display the specified range of VLANs in the section below.
VID	This field displays the VLAN ID of each VLAN in the range specified above.
Received	This field displays the total number of ARP packets received from the VLAN since the Switch last restarted.
Request	This field displays the total number of ARP Request packets received from the VLAN since the Switch last restarted.
Reply	This field displays the total number of ARP Reply packets received from the VLAN since the Switch last restarted.

Table 73 ARP Inspection VLAN Status

LABEL	DESCRIPTION
Forwarded	This field displays the total number of ARP packets the Switch forwarded for the VLAN since the Switch last restarted.
Dropped	This field displays the total number of ARP packets the Switch discarded for the VLAN since the Switch last restarted.

25.6.2 ARP Inspection Log Status

Use this screen to look at log messages that were generated by ARP packets and that have not been sent to the syslog server yet. To open this screen, click **Advanced Application > IP Source Guard > ARP Inspection > Log Status**.

Figure 123 ARP Inspection Log Status

The following table describes the labels in this screen.

Table 74 ARP Inspection Log Status

LABEL	DESCRIPTION
Clearing log status table	Click Apply to remove all the log messages that were generated by ARP packets and that have not been sent to the syslog server yet.
Total number of logs	This field displays the number of log messages that were generated by ARP packets and that have not been sent to the syslog server yet. If one or more log messages are dropped due to unavailable buffer, there is an entry called overflow with the current number of dropped log messages.
Index	This field displays a sequential number for each log message.
Port	This field displays the source port of the ARP packet.
VID	This field displays the source VLAN ID of the ARP packet.
Sender MAC	This field displays the source MAC address of the ARP packet.
Sender IP	This field displays the source IP address of the ARP packet.
Num Pkts	This field displays the number of ARP packets that were consolidated into this log message. The Switch consolidates identical log messages generated by ARP packets in the log consolidation interval into one log message. You can configure this interval in the ARP Inspection Configure screen. See Section 25.7 on page 232 .

Table 74 ARP Inspection Log Status (continued)

LABEL	DESCRIPTION
Reason	<p>This field displays the reason the log message was generated.</p> <p>dhcp deny: An ARP packet was discarded because it violated a dynamic binding with the same MAC address and VLAN ID.</p> <p>static deny: An ARP packet was discarded because it violated a static binding with the same MAC address and VLAN ID.</p> <p>deny: An ARP packet was discarded because there were no bindings with the same MAC address and VLAN ID.</p> <p>dhcp permit: An ARP packet was forwarded because it matched a dynamic binding.</p> <p>static permit: An ARP packet was forwarded because it matched a static binding.</p> <p>In the ARP Inspection VLAN Configure screen, you can configure the Switch to generate log messages when ARP packets are discarded or forwarded based on the VLAN ID of the ARP packet. See Section 25.7.2 on page 236.</p>
Time	This field displays when the log message was generated.

25.7 ARP Inspection Configure

Use this screen to enable ARP inspection on the Switch. You can also configure the length of time the Switch stores records of discarded ARP packets and global

settings for the ARP inspection log. To open this screen, click **Advanced Application > IP Source Guard > ARP Inspection > Configure**.

Figure 124 ARP Inspection Configure

The following table describes the labels in this screen.

Table 75 ARP Inspection Configure

LABEL	DESCRIPTION
Active	Select this to enable ARP inspection on the Switch. You still have to enable ARP inspection on specific VLAN and specify trusted ports.
Filter Aging Time	
Filter aging time	This setting has no effect on existing MAC address filters. Enter how long (1~2147483647 seconds) the MAC address filter remains in the Switch after the Switch identifies an unauthorized ARP packet. The Switch automatically deletes the MAC address filter afterwards. Enter 0 if you want the MAC address filter to be permanent.
Log Profile	
Log buffer size	Enter the maximum number (1~1024) of log messages that were generated by ARP packets and have not been sent to the syslog server yet. Make sure this number is appropriate for the specified Syslog rate and Log interval . If the number of log messages in the Switch exceeds this number, the Switch stops recording log messages and simply starts counting the number of entries that were dropped due to unavailable buffer. Click Clearing log status table in the ARP Inspection Log Status screen to clear the log and reset this counter. See Section 25.6.2 on page 231 .

Table 75 ARP Inspection Configure (continued)

LABEL	DESCRIPTION
Syslog rate	<p>Enter the maximum number of syslog messages the Switch can send to the syslog server in one batch. This number is expressed as a rate because the batch frequency is determined by the Log Interval. You must configure the syslog server (Chapter 34 on page 299) to use this. Enter 0 if you do not want the Switch to send log messages generated by ARP packets to the syslog server.</p> <p>The relationship between Syslog rate and Log interval is illustrated in the following examples:</p> <ul style="list-style-type: none"> • 4 invalid ARP packets per second, Syslog rate is 5, Log interval is 1: the Switch sends 4 syslog messages every second. • 6 invalid ARP packets per second, Syslog rate is 5, Log interval is 2: the Switch sends 5 syslog messages every 2 seconds.
Log interval	<p>Enter how often (1-86400 seconds) the Switch sends a batch of syslog messages to the syslog server. Enter 0 if you want the Switch to send syslog messages immediately. See Syslog rate for an example of the relationship between Syslog rate and Log interval.</p>
Apply	<p>Click Apply to save your changes to the Switch's run-time memory. The Switch loses these changes if it is turned off or loses power, so use the Save link on the top navigation panel to save your changes to the non-volatile memory when you are done configuring.</p>
Cancel	<p>Click this to reset the values in this screen to their last-saved values.</p>

25.7.1 ARP Inspection Port Configure

Use this screen to specify whether ports are trusted or untrusted ports for ARP inspection. You can also specify the maximum rate at which the Switch receives

ARP packets on each untrusted port. To open this screen, click **Advanced Application > IP Source Guard > ARP Inspection > Configure > Port**.

Figure 125 ARP Inspection Port Configure

Port	Trusted State	Limit	
		Rate (pps)	Burst interval (seconds)
*	Untrusted		
1	Untrusted	15	1
2	Untrusted	15	1
3	Untrusted	15	1
4	Untrusted	15	1
5	Untrusted	15	1
6	Untrusted	15	1
7	Untrusted	15	1
8	Untrusted	15	1
9	Untrusted	15	1
10	Untrusted	15	1
11	Untrusted	15	1

The following table describes the labels in this screen.

Table 76 ARP Inspection Port Configure

LABEL	DESCRIPTION
Port	This field displays the port number. If you configure the * port, the settings are applied to all of the ports.
Trusted State	Select whether this port is a trusted port (Trusted) or an untrusted port (Untrusted). The Switch does not discard ARP packets on trusted ports for any reason. The Switch discards ARP packets on untrusted ports in the following situations: <ul style="list-style-type: none"> The sender's information in the ARP packet does not match any of the current bindings. The rate at which ARP packets arrive is too high. You can specify the maximum rate at which ARP packets can arrive on untrusted ports.
Limit	These settings have no effect on trusted ports.
Rate (pps)	Specify the maximum rate (1-2048 packets per second) at which the Switch receives ARP packets from each port. The Switch discards any additional ARP packets. Enter 0 to disable this limit.

Table 76 ARP Inspection Port Configure (continued)

LABEL	DESCRIPTION
Burst interval (seconds)	The burst interval is the length of time over which the rate of ARP packets is monitored for each port. For example, if the rate is 15 pps and the burst interval is 1 second, then the Switch accepts a maximum of 15 ARP packets in every one-second interval. If the burst interval is 5 seconds, then the Switch accepts a maximum of 75 ARP packets in every five-second interval. Enter the length (1-15 seconds) of the burst interval.
Apply	Click Apply to save your changes to the Switch's run-time memory. The Switch loses these changes if it is turned off or loses power, so use the Save link on the top navigation panel to save your changes to the non-volatile memory when you are done configuring.
Cancel	Click this to reset the values in this screen to their last-saved values.

25.7.2 ARP Inspection VLAN Configure

Use this screen to enable ARP inspection on each VLAN and to specify when the Switch generates log messages for receiving ARP packets from each VLAN. To open this screen, click **Advanced Application > IP Source Guard > ARP Inspection > Configure > VLAN**.

Figure 126 ARP Inspection VLAN Configure

The following table describes the labels in this screen.

Table 77 ARP Inspection VLAN Configure

LABEL	DESCRIPTION
VLAN	Use this section to specify the VLANs you want to manage in the section below.
Start VID	Enter the lowest VLAN ID you want to manage in the section below.
End VID	Enter the highest VLAN ID you want to manage in the section below.
Apply	Click this to display the specified range of VLANs in the section below.

Table 77 ARP Inspection VLAN Configure (continued)

LABEL	DESCRIPTION
VID	This field displays the VLAN ID of each VLAN in the range specified above. If you configure the * VLAN, the settings are applied to all VLANs.
Enabled	Select Yes to enable ARP inspection on the VLAN. Select No to disable ARP inspection on the VLAN.
Log	Specify when the Switch generates log messages for receiving ARP packets from the VLAN. None: The Switch does not generate any log messages when it receives an ARP packet from the VLAN. Deny: The Switch generates log messages when it discards an ARP packet from the VLAN. Permit: The Switch generates log messages when it forwards an ARP packet from the VLAN. All: The Switch generates log messages every time it receives an ARP packet from the VLAN.
Apply	Click Apply to save your changes to the Switch's run-time memory. The Switch loses these changes if it is turned off or loses power, so use the Save link on the top navigation panel to save your changes to the non-volatile memory when you are done configuring.
Cancel	Click this to reset the values in this screen to their last-saved values.

Loop Guard

This chapter shows you how to configure the Switch to guard against loops on the edge of your network.

26.1 Loop Guard Overview

Loop guard allows you to configure the Switch to shut down a port if it detects that packets sent out on that port loop back to the Switch. While you can use Spanning Tree Protocol (STP) to prevent loops in the core of your network. STP cannot prevent loops that occur on the edge of your network.

Figure 127 Loop Guard vs. STP

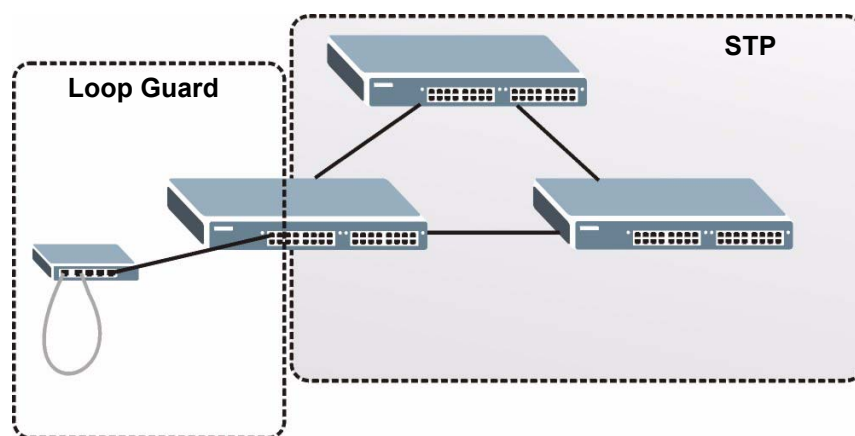

Loop guard is designed to handle loop problems on the edge of your network. This can occur when a port is connected to a Switch that is in a loop state. Loop state occurs as a result of human error. It happens when two ports on a switch are connected with the same cable. When a switch in loop state sends out broadcast messages the messages loop back to the switch and are re-broadcast again and again causing a broadcast storm.

If a switch (not in loop state) connects to a switch in loop state, then it will be affected by the switch in loop state in the following way:

- It will receive broadcast messages sent out from the switch in loop state.

- It will receive its own broadcast messages that it sends out as they loop back. It will then re-broadcast those messages again.

The following figure shows port **N** on switch **A** connected to switch **B**. Switch **B** is in loop state. When broadcast or multicast packets leave port **N** and reach switch **B**, they are sent back to port **N** on **A** as they are rebroadcast from B.

Figure 128 Switch in Loop State

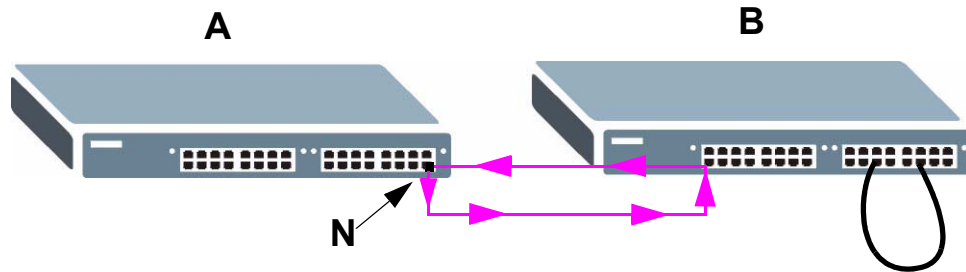

The loop guard feature checks to see if a loop guard enabled port is connected to a switch in loop state. This is accomplished by periodically sending a probe packet and seeing if the packet returns on the same port. If this is the case, the Switch will shut down the port connected to the switch in loop state.

The following figure shows a loop guard enabled port **N** on switch **A** sending a probe packet **P** to switch **B**. Since switch **B** is in loop state, the probe packet **P** returns to port **N** on **A**. The Switch then shuts down port **N** to ensure that the rest of the network is not affected by the switch in loop state.

Figure 129 Loop Guard - Probe Packet

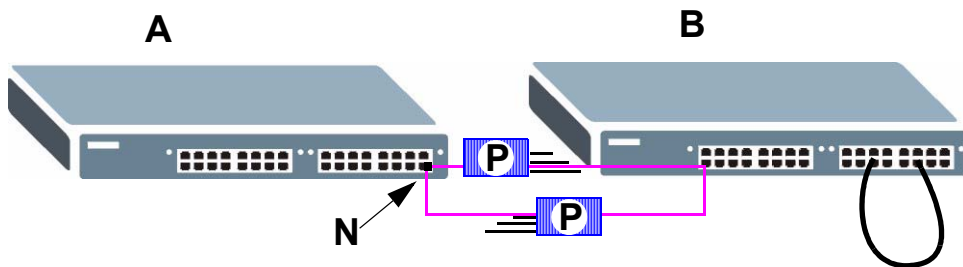

The Switch also shuts down port **N** if the probe packet returns to switch **A** on any other port. In other words loop guard also protects against standard network loops. The following figure illustrates three switches forming a loop. A sample path of the loop guard probe packet is also shown. In this example, the probe packet is sent from port **N** and returns on another port. As long as loop guard is enabled on

port **N**. The Switch will shut down port **N** if it detects that the probe packet has returned to the Switch.

Figure 130 Loop Guard - Network Loop

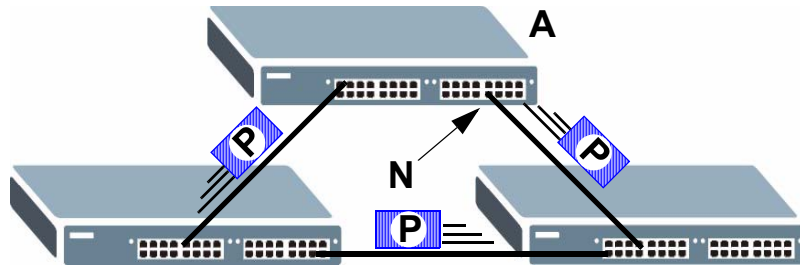

Note: After resolving the loop problem on your network you can re-activate the disabled port via the web configurator (see [Section 8.7 on page 83](#)) or via commands (See the CLI Reference Guide).

26.2 Loop Guard Setup

Click **Advanced Application** > **Loop Guard** in the navigation panel to display the screen as shown.

Note: The loop guard feature can not be enabled on the ports that have Spanning Tree Protocol (RSTP, MRSTP or MSTP) enabled.

Figure 131 Advanced Application > Loop Guard

Port	Active
*	<input type="checkbox"/>
1	<input type="checkbox"/>
2	<input type="checkbox"/>
3	<input type="checkbox"/>
4	<input type="checkbox"/>
5	<input type="checkbox"/>
6	<input type="checkbox"/>
7	<input type="checkbox"/>
8	<input type="checkbox"/>
9	<input type="checkbox"/>
10	<input type="checkbox"/>
11	<input type="checkbox"/>
12	<input type="checkbox"/>

The following table describes the labels in this screen.

Table 78 Advanced Application > Loop Guard

LABEL	DESCRIPTION
Active	<p>Select this option to enable loop guard on the Switch.</p> <p>The Switch generates syslog, internal log messages as well as SNMP traps when it shuts down a port via the loop guard feature.</p>
Port	This field displays the port number.
*	<p>Use this row to make the setting the same for all ports. Use this row first and then make adjustments on a port-by-port basis.</p> <p>Note: Changes in this row are copied to all the ports as soon as you make them.</p>
Active	<p>Select this check box to enable the loop guard feature on this port. The Switch sends probe packets from this port to check if the switch it is connected to is in loop state. If the switch that this port is connected is in loop state the Switch will shut down this port.</p> <p>Clear this check box to disable the loop guard feature.</p>
Apply	<p>Click Apply to save your changes to the Switch's run-time memory. The Switch loses these changes if it is turned off or loses power, so use the Save link on the top navigation panel to save your changes to the non-volatile memory when you are done configuring.</p>
Cancel	Click Cancel to begin configuring this screen afresh.

Layer 2 Protocol Tunneling

This chapter shows you how to configure layer 2 protocol tunneling on the Switch.

27.1 Layer 2 Protocol Tunneling Overview

Layer 2 protocol tunneling (L2PT) is used on the service provider's edge devices. L2PT allows edge switches (**1** and **2** in the following figure) to tunnel layer 2 STP (Spanning Tree Protocol), CDP (Cisco Discovery Protocol) and VTP (VLAN Trunking Protocol) packets between customer switches (**A**, **B** and **C** in the following figure) connected through the service provider's network. The edge switch encapsulates layer 2 protocol packets with a specific MAC address before sending them across the service provider's network to other edge switches.

Figure 132 Layer 2 Protocol Tunneling Network Scenario

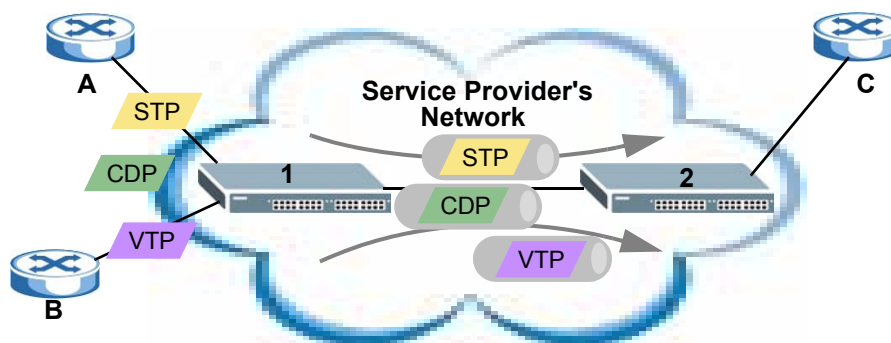

In the following example, if you enable L2PT for STP, you can have switches **A**, **B**, **C** and **D** in the same spanning tree, even though switch **A** is not directly connected to switches **B**, **C** and **D**. Topology change information can be propagated throughout the service provider's network.

To emulate a point-to-point topology between two customer switches at different sites, such as **A** and **B**, you can enable protocol tunneling on edge switches **1** and

2 for PAgP (Port Aggregation Protocol), LACP or UDLD (UniDirectional Link Detection).

Figure 133 L2PT Network Example

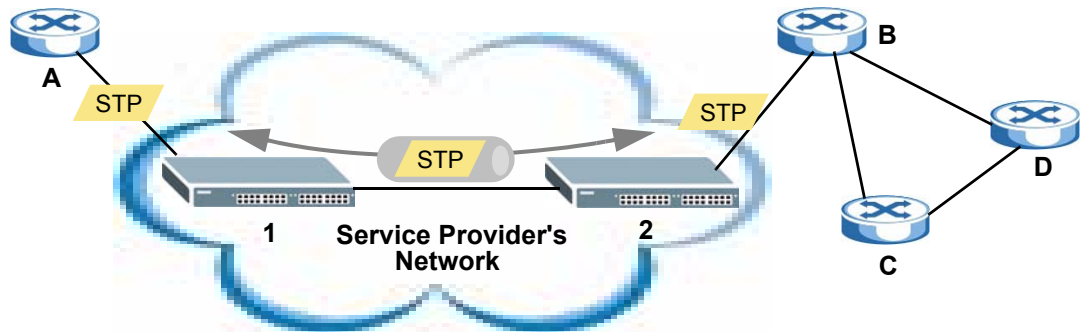

27.1.1 Layer 2 Protocol Tunneling Mode

Each port can have two layer 2 protocol tunneling modes, **Access** and **Tunnel**.

- The **Access** port is an ingress port on the service provider's edge device (**1** or **2** in [Figure 133 on page 244](#)) and connected to a customer switch (**A** or **B**). Incoming layer 2 protocol packets received on an access port are encapsulated and forwarded to the tunnel ports.
- The **Tunnel** port is an egress port at the edge of the service provider's network and connected to another service provider's switch. Incoming encapsulated layer 2 protocol packets received on a tunnel port are decapsulated and sent to an access port.

27.2 Configuring Layer 2 Protocol Tunneling

Click **Advanced Application > Layer 2 Protocol Tunneling** in the navigation panel to display the screen as shown.

Figure 134 Advanced Application > Layer 2 Protocol Tunneling

The screenshot shows the configuration interface for Layer 2 Protocol Tunneling. At the top, there is a title bar 'Layer 2 Protocol Tunnel' and an 'Active' checkbox. Below it is a 'Destination MAC Address' field with six octets, each containing '00'. A table lists ports from 1 to 13. Each port row has checkboxes for CDP, STP, VTP, and three Point-to-Point protocols: PAGP, LACP, and UDLD. The 'Mode' column for each port has a dropdown menu set to 'Access'. At the bottom, there are 'Apply' and 'Cancel' buttons.

The following table describes the labels in this screen.

Table 79 Advanced Application > Layer 2 Protocol Tunneling

LABEL	DESCRIPTION
Active	Select this to enable layer 2 protocol tunneling on the Switch.
Destination MAC Address	Specify an MAC address with which the Switch uses to encapsulate the layer 2 protocol packets by replacing the destination MAC address in the packets. Note: The MAC address can be either a unicast MAC address or multicast MAC address. If you use a unicast MAC address, make sure the MAC address does not exist in the address table of a switch on the service provider's network. Note: All the edge switches in the service provider's network should be set to use the same MAC address for encapsulation.

Table 79 Advanced Application > Layer 2 Protocol Tunneling (continued)

LABEL	DESCRIPTION
Port	This field displays the port number.
*	<p>Use this row to make the setting the same for all ports. Use this row first and then make adjustments on a port-by-port basis.</p> <p>Note: Changes in this row are copied to all the ports as soon as you make them.</p>
CDP	Select this option to have the Switch tunnel CDP (Cisco Discovery Protocol) packets so that other Cisco devices can be discovered through the service provider's network.
STP	Select this option to have the Switch tunnel STP (Spanning Tree Protocol) packets so that STP can run properly across the service provider's network and spanning trees can be set up based on bridge information from all (local and remote) networks.
VTP	Select this option to have the Switch tunnel VTP (VLAN Trunking Protocol) packets so that all customer switches can use consistent VLAN configuration through the service provider's network.
Point to Point	<p>The Switch supports PAGP (Port Aggregation Protocol), LACP (Link Aggregation Control Protocol) and UDLD (UniDirectional Link Detection) tunneling for a point-to-point topology.</p> <p>Both PAGP and UDLD are Cisco's proprietary data link layer protocols. PAGP is similar to LACP and used to set up a logical aggregation of Ethernet ports automatically. UDLD is to determine the link's physical status and detect a unidirectional link.</p>
PAGP	Select this option to have the Switch send PAGP packets to a peer to automatically negotiate and build a logical port aggregation.
LACP	Select this option to have the Switch send LACP packets to a peer to dynamically creates and manages trunk groups.
UDLD	Select this option to have the Switch send UDLD packets to a peer's port it connected to monitor the physical status of a link.
Mode	<p>Select Access to have the Switch encapsulate the incoming layer 2 protocol packets and forward them to the tunnel port(s). Select Access for ingress ports at the edge of the service provider's network.</p> <p>Note: You can enable L2PT services for STP, LACP, VTP, CDP, UDLD, and PAGP on the access port(s) only.</p> <p>Select Tunnel for egress ports at the edge of the service provider's network. The Switch decapsulates the encapsulated layer 2 protocol packets received on a tunnel port by changing the destination MAC address to the original one, and then forward them to an access port. If the service(s) is not enabled on an access port, the protocol packets are dropped.</p>
Apply	Click Apply to save your changes to the Switch's run-time memory. The Switch loses these changes if it is turned off or loses power, so use the Save link on the top navigation panel to save your changes to the non-volatile memory when you are done configuring.
Cancel	Click Cancel to begin configuring this screen afresh.

PART IV

IP Application

Static Route (249)

Differentiated Services (253)

DHCP (257)

Static Route

This chapter shows you how to configure static routes.

28.1 Static Routing Overview

The Switch uses IP for communication with management computers, for example using HTTP, Telnet, SSH, or SNMP. Use IP static routes to have the Switch respond to remote management stations that are not reachable through the default gateway. The Switch can also use static routes to send data to a server or device that is not reachable through the default gateway, for example when sending SNMP traps or using ping to test IP connectivity.

This figure shows a **Telnet** session coming in from network **N1**. The Switch sends reply traffic to default gateway **R1** which routes it back to the manager's computer. The Switch needs a static route to tell it to use router **R2** to send traffic to an SNMP trap server on network **N2**.

Figure 135 Static Routing Overview

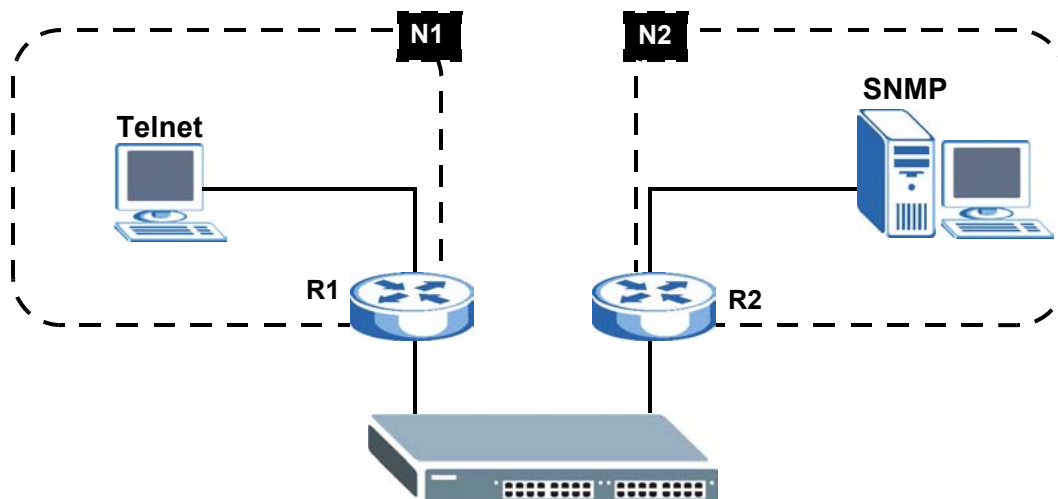

28.2 Configuring Static Routing

Click **IP Application > Static Routing** in the navigation panel to display the screen as shown.

Figure 136 IP Application > Static Routing

Index	Active	Name	Destination Address	Subnet Mask	Gateway Address	Metric	Delete
1	Yes	Example	172.21.1.1	255.255.0.0	192.168.1.2	2	<input type="checkbox"/>

The following table describes the related labels you use to create a static route.

Table 80 IP Application > Static Routing

LABEL	DESCRIPTION
Active	This field allows you to activate/deactivate this static route.
Name	Enter a descriptive name (up to 10 printable ASCII characters) for identification purposes.
Destination IP Address	This parameter specifies the IP network address of the final destination.
IP Subnet Mask	Enter the subnet mask for this destination. Routing is always based on network number. If you need to specify a route to a single host, use a subnet mask of 255.255.255.255 in the subnet mask field to force the network number to be identical to the host ID.
Gateway IP Address	Enter the IP address of the gateway. The gateway is an immediate neighbor of your Switch that will forward the packet to the destination. The gateway must be a router on the same segment as your Switch.
Metric	The metric represents the "cost" of transmission for routing purposes. IP routing uses hop count as the measurement of cost, with a minimum of 1 for directly connected networks. Enter a number that approximates the cost for this link. The number need not be precise, but it must be between 1 and 15. In practice, 2 or 3 is usually a good number.
Add	Click Add to insert a new static route to the Switch's run-time memory. The Switch loses these changes if it is turned off or loses power, so use the Save link on the top navigation panel to save your changes to the non-volatile memory when you are done configuring.

Table 80 IP Application > Static Routing (continued)

LABEL	DESCRIPTION
Cancel	Click Cancel to reset the above fields to your previous configuration.
Clear	Click Clear to set the above fields back to the factory defaults.
Index	This field displays the index number of the route. Click a number to edit the static route entry.
Active	This field displays Yes when the static route is activated and NO when it is deactivated.
Name	This field displays the descriptive name for this route. This is for identification purposes only.
Destination Address	This field displays the IP network address of the final destination.
Subnet Mask	This field displays the subnet mask for this destination.
Gateway Address	This field displays the IP address of the gateway. The gateway is an immediate neighbor of your Switch that will forward the packet to the destination.
Metric	This field displays the cost of transmission for routing purposes.
Delete	Click Delete to remove the selected entry from the summary table.
Cancel	Click Cancel to clear the Delete check boxes.

Differentiated Services

This chapter shows you how to configure Differentiated Services (DiffServ) on the Switch.

29.1 DiffServ Overview

Quality of Service (QoS) is used to prioritize source-to-destination traffic flows. All packets in the flow are given the same priority. You can use CoS (class of service) to give different priorities to different packet types.

DiffServ is a class of service (CoS) model that marks packets so that they receive specific per-hop treatment at DiffServ-compliant network devices along the route based on the application types and traffic flow. Packets are marked with DiffServ Code Points (DSCPs) indicating the level of service desired. This allows the intermediary DiffServ-compliant network devices to handle the packets differently depending on the code points without the need to negotiate paths or remember state information for every flow. In addition, applications do not have to request a particular service or give advanced notice of where the traffic is going.

29.1.1 DSCP and Per-Hop Behavior

DiffServ defines a new DS (Differentiated Services) field to replace the Type of Service (ToS) field in the IP header. The DS field contains a 6-bit DSCP field which can define up to 64 service levels and the remaining 2 bits are defined as currently unused (CU). The following figure illustrates the DS field.

Figure 137 DiffServ: Differentiated Service Field

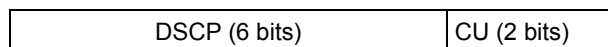

DSCP is backward compatible with the three precedence bits in the ToS octet so that non-DiffServ compliant, ToS-enabled network device will not conflict with the DSCP mapping.

The DSCP value determines the PHB (Per-Hop Behavior), that each packet gets as it is forwarded across the DiffServ network. Based on the marking rule different

kinds of traffic can be marked for different priorities of forwarding. Resources can then be allocated according to the DSCP values and the configured policies.

29.1.2 DiffServ Network Example

The following figure depicts a DiffServ network consisting of a group of directly connected DiffServ-compliant network devices. The boundary node (**A** in [Figure 138](#)) in a DiffServ network classifies (marks with a DSCP value) the incoming packets into different traffic flows (**Platinum, Gold, Silver, Bronze**) based on the configured marking rules. A network administrator can then apply various traffic policies to the traffic flows. An example traffic policy, is to give higher drop precedence to one traffic flow over others. In our example, packets in the **Bronze** traffic flow are more likely to be dropped when congestion occurs than the packets in the **Platinum** traffic flow as they move across the DiffServ network.

Figure 138 DiffServ Network

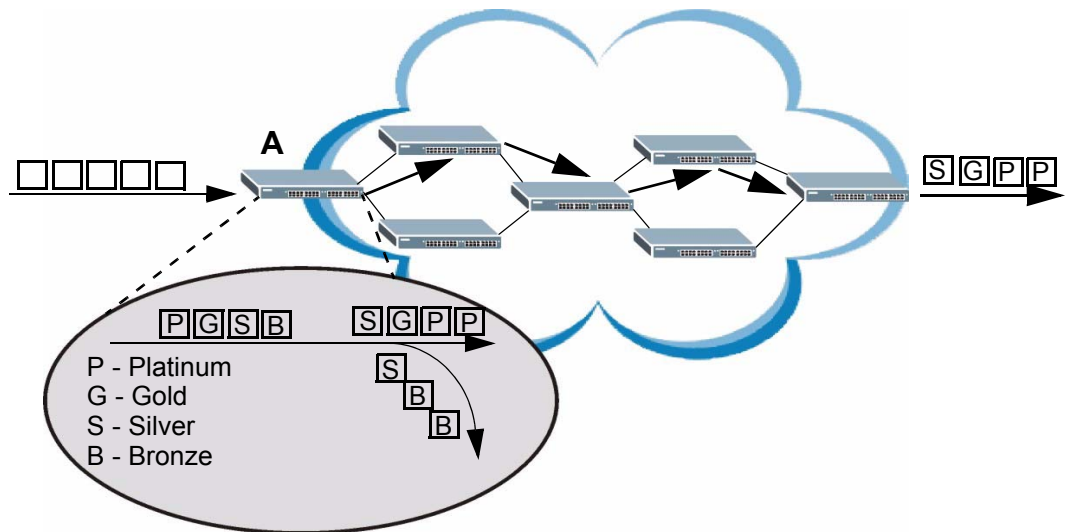

29.2 Activating DiffServ

Activate DiffServ to apply marking rules or IEEE 802.1p priority mapping on the Switch.

Click **IP Application** > **DiffServ** in the navigation panel to display the screen as shown.

Figure 139 IP Application > DiffServ

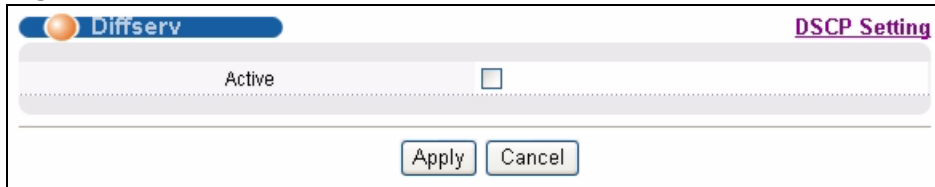

The following table describes the labels in this screen.

Table 81 IP Application > DiffServ

LABEL	DESCRIPTION
Active	Select this option to enable DiffServ on the Switch.
Apply	Click Apply to save your changes to the Switch's run-time memory. The Switch loses these changes if it is turned off or loses power, so use the Save link on the top navigation panel to save your changes to the non-volatile memory when you are done configuring.
Cancel	Click Cancel to begin configuring this screen afresh.

29.3 DSCP-to-IEEE 802.1p Priority Settings

You can configure the DSCP to IEEE 802.1p mapping to allow the Switch to prioritize all traffic based on the incoming DSCP value according to the DiffServ to IEEE 802.1p mapping table.

The following table shows the default DSCP-to-IEEE802.1p mapping.

Table 82 Default DSCP-IEEE 802.1p Mapping

DSCP VALUE	0 - 7	8 - 15	16 - 23	24 - 31	32 - 39	40 - 47	48 - 55	56 - 63
IEEE 802.1p	0	1	2	3	4	5	6	7

29.3.1 Configuring DSCP Settings

To change the DSCP-IEEE 802.1p mapping click the **DSCP Setting** link in the **DiffServ** screen to display the screen as shown next.

Figure 140 IP Application > DiffServ > DSCP Setting

DSCP Value	IEEE 802.1p Priority
0	0
1	0
2	0
3	0
4	0
5	0
6	0
7	0
8	1
9	1
10	1
11	1
12	1
13	1
14	1
15	1
16	2
17	2
18	2
19	2
20	2
21	2
22	2
23	2
24	3
25	3
26	3
27	3
28	3
29	3
30	3
31	3
32	4
33	4
34	4
35	4
36	4
37	4
38	4
39	4
40	5
41	5
42	5
43	5
44	5
45	5
46	5
47	5
48	6
49	6
50	6
51	6
52	6
53	6
54	6
55	6
56	7
57	7
58	7
59	7
60	7
61	7
62	7
63	7

The following table describes the labels in this screen.

Table 83 IP Application > DiffServ > DSCP Setting

LABEL	DESCRIPTION
0 ... 63	This is the DSCP classification identification number. To set the IEEE 802.1p priority mapping, select the priority level from the drop-down list box.
Apply	Click Apply to save your changes to the Switch's run-time memory. The Switch loses these changes if it is turned off or loses power, so use the Save link on the top navigation panel to save your changes to the non-volatile memory when you are done configuring.
Cancel	Click Cancel to begin configuring this screen afresh.

This chapter shows you how to configure the DHCP feature.

30.1 DHCP Overview

DHCP (Dynamic Host Configuration Protocol RFC 2131 and RFC 2132) allows individual computers to obtain TCP/IP configuration at start-up from a server. You can configure the Switch as a DHCP server or a DHCP relay agent. When configured as a server, the Switch provides the TCP/IP configuration for the clients. If you configure the Switch as a relay agent, then the Switch forwards DHCP requests to DHCP server on your network. If you don't configure the Switch as a DHCP server or relay agent then you must have a DHCP server in the broadcast domain of the client computers or else the client computers must be configured manually.

30.1.1 DHCP Modes

If there is already a DHCP server on your network, then you can configure the Switch as a DHCP relay agent. When the Switch receives a request from a computer on your network, it contacts the DHCP server for the necessary IP information, and then relays the assigned information back to the computer.

30.1.2 DHCP Configuration Options

The DHCP configuration on the Switch is divided into **Global** and **VLAN** screens. The screen you should use for configuration depends on the DHCP services you want to offer the DHCP clients on your network. Choose the configuration screen based on the following criteria:

- **Global:** The Switch forwards all DHCP requests to the same DHCP server.
- **VLAN:** The Switch is configured on a VLAN by VLAN basis. The Switch can be configured to relay DHCP requests to different DHCP servers for clients in different VLAN.

30.2 DHCP Status

Click **IP Application > DHCP** in the navigation panel. The **DHCP Status** screen displays.

Figure 141 IP Application > DHCP Status

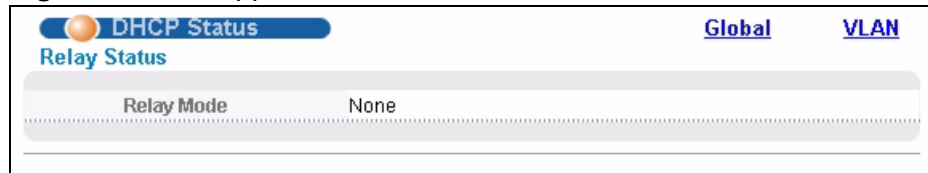

The following table describes the labels in this screen.

Table 84 IP Application > DHCP

LABEL	DESCRIPTION
Relay Mode	This field displays: <ul style="list-style-type: none"> • None: if the Switch is not configured as a DHCP relay agent. • Global: if the Switch is configured as a DHCP relay agent only. • VLAN: followed by a VLAN ID if it is configured as a relay agent for specific VLAN(s).

30.3 DHCP Relay

Configure DHCP relay on the Switch if the DHCP clients and the DHCP server are not in the same broadcast domain. During the initial IP address leasing, the Switch helps to relay network information (such as the IP address and subnet mask) between a DHCP client and a DHCP server. Once the DHCP client obtains an IP address and can connect to the network, network information renewal is done between the DHCP client and the DHCP server without the help of the Switch.

The Switch can be configured as a global DHCP relay. This means that the Switch forwards all DHCP requests from all domains to the same DHCP server. You can also configure the Switch to relay DHCP information based on the VLAN membership of the DHCP clients.

30.3.1 DHCP Relay Agent Information

The Switch can add information about the source of client DHCP requests that it relays to a DHCP server by adding **Relay Agent Information**. This helps provide authentication about the source of the requests. The DHCP server can then provide an IP address based on this information. Please refer to RFC 3046 for more details.

The DHCP **Relay Agent Information** feature adds an Agent Information field to the **Option 82** field. The **Option 82** field is in the DHCP headers of client DHCP request frames that the Switch relays to a DHCP server.

Relay Agent Information can include the **System Name** of the Switch if you select this option. You can change the **System Name** in **Basic Settings > General Setup**.

The following describes the DHCP relay information that the Switch sends to the DHCP server:

Table 85 Relay Agent Information

FIELD LABELS	DESCRIPTION
Slot ID	(1 byte) This value is always 0 for stand-alone switches.
Port ID	(1 byte) This is the port that the DHCP client is connected to.
VLAN ID	(2 bytes) This is the VLAN that the port belongs to.
Information	(up to 64 bytes) This optional, read-only field is set according to system name set in Basic Settings > General Setup .

30.3.2 Configuring DHCP Global Relay

Configure global DHCP relay in the **DHCP Relay** screen. Click **IP Application > DHCP** in the navigation panel and click the **Global** link to display the screen as shown.

Figure 142 IP Application > DHCP > Global

DHCP Relay		Status
Active	<input type="checkbox"/>	
Remote DHCP Server 1	<input type="text" value="0.0.0.0"/>	
Remote DHCP Server 2	<input type="text" value="0.0.0.0"/>	
Remote DHCP Server 3	<input type="text" value="0.0.0.0"/>	
Relay Agent Information	<input type="checkbox"/> Option 82	
Information	<input type="checkbox"/> <input type="text" value="MES-3528"/>	

The following table describes the labels in this screen.

Table 86 IP Application > DHCP > Global

LABEL	DESCRIPTION
Active	Select this check box to enable DHCP relay.
Remote DHCP Server 1 .. 3	Enter the IP address of a DHCP server in dotted decimal notation.
Relay Agent Information	Select the Option 82 check box to have the Switch add information (slot number, port number and VLAN ID) to client DHCP requests that it relays to a DHCP server.
Information	This read-only field displays the system name you configure in the General Setup screen. Select the check box for the Switch to add the system name to the client DHCP requests that it relays to a DHCP server.
Apply	Click Apply to save your changes to the Switch's run-time memory. The Switch loses these changes if it is turned off or loses power, so use the Save link on the top navigation panel to save your changes to the non-volatile memory when you are done configuring.
Cancel	Click Cancel to begin configuring this screen afresh.

30.3.3 Global DHCP Relay Configuration Example

The following figure shows a network example where the Switch is used to relay DHCP requests for the **VLAN1** and **VLAN2** domains. There is only one DHCP server that services the DHCP clients in both domains.

Figure 143 Global DHCP Relay Network Example

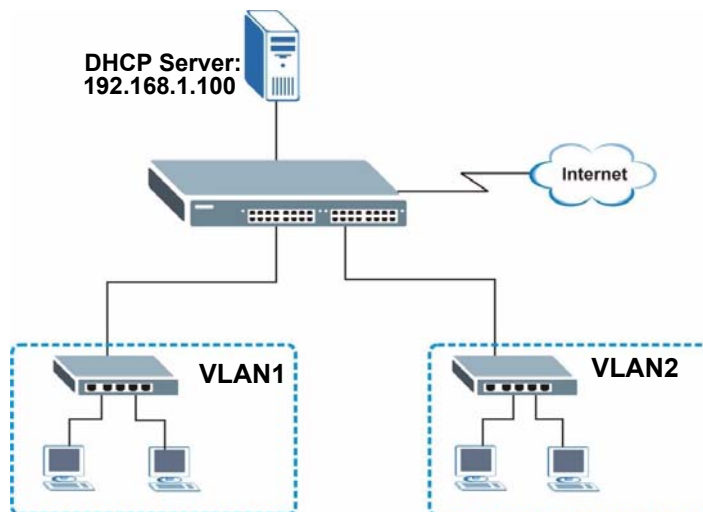

Configure the **DHCP Relay** screen as shown. Make sure you select the **Option 82** check box to set the Switch to send additional information (such as the VLAN ID)

together with the DHCP requests to the DHCP server. This allows the DHCP server to assign the appropriate IP address according to the VLAN ID.

Figure 144 DHCP Relay Configuration Example

DHCP Relay		Status
Active	<input checked="" type="checkbox"/>	
Remote DHCP Server 1	<input type="text" value="192.168.1.100"/>	
Remote DHCP Server 2	<input type="text" value="0.0.0.0"/>	
Remote DHCP Server 3	<input type="text" value="0.0.0.0"/>	
Relay Agent Information	<input checked="" type="checkbox"/> Option 82	
Information	<input type="checkbox"/> <input type="text" value="MES-3528"/>	

30.4 Configuring DHCP VLAN Settings

Use this screen to configure your DHCP settings based on the VLAN domain of the DHCP clients. Click **IP Application > DHCP** in the navigation panel, then click the **VLAN** link In the **DHCP Status** screen that displays.

Note: You must set up a management IP address for each VLAN that you want to configure DHCP settings for on the Switch.

See [Section 8.6 on page 80](#) for information on how to set up management IP addresses for VLANs.

Figure 145 IP Application > DHCP > VLAN

The following table describes the labels in this screen.

Table 87 IP Application > DHCP > VLAN

LABEL	DESCRIPTION
VID	Enter the ID number of the VLAN to which these DHCP settings apply.
Remote DHCP Server 1 .. 3	Enter the IP address of a DHCP server in dotted decimal notation.
Relay Agent Information	Select the Option 82 check box to have the Switch add information (slot number, port number and VLAN ID) to client DHCP requests that it relays to a DHCP server.
Information	This read-only field displays the system name you configure in the General Setup screen. Select the check box for the Switch to add the system name to the client DHCP requests that it relays to a DHCP server.
Add	Click Add to save your changes to the Switch's run-time memory. The Switch loses these changes if it is turned off or loses power, so use the Save link on the top navigation panel to save your changes to the non-volatile memory when you are done configuring.
Cancel	Click Cancel to begin configuring this screen afresh.
Clear	Click this to clear the fields above.
VID	This field displays the ID number of the VLAN group to which this DHCP settings apply.
Type	This field displays the DHCP mode (Relay).
DHCP Status	For DHCP relay configuration, this field displays the first remote DHCP server IP address.

Table 87 IP Application > DHCP > VLAN (continued)

LABEL	DESCRIPTION
Delete	Select the configuration entries you want to remove and click Delete to remove them.
Cancel	Click Cancel to clear the Delete check boxes.

30.4.1 Example: DHCP Relay for Two VLANs

The following example displays two VLANs (VIDs 1 and 2) for a campus network. Two DHCP servers are installed to serve each VLAN. The system is set up to forward DHCP requests from the dormitory rooms (VLAN 1) to the DHCP server with an IP address of 192.168.1.100. Requests from the academic buildings (VLAN 2) are sent to the other DHCP server with an IP address of 172.23.10.100.

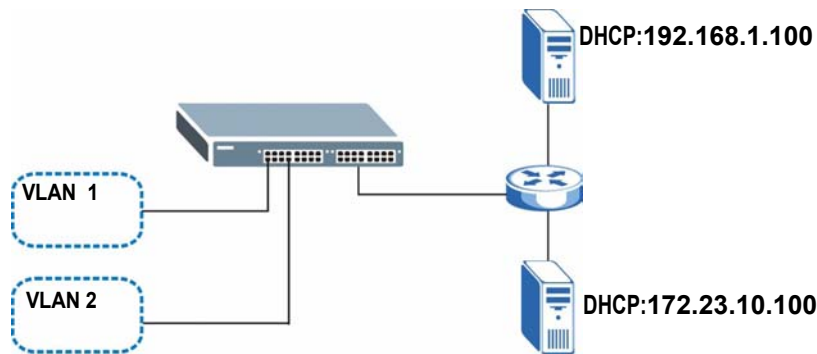
Figure 146 DHCP Relay for Two VLANs

For the example network, configure the **VLAN Setting** screen as shown.

Figure 147 DHCP Relay for Two VLANs Configuration Example

VLAN Setting
Status

VID	2
Remote DHCP Server 1	172.23.10.100
Remote DHCP Server 2	0.0.0.0
Remote DHCP Server 3	0.0.0.0
Relay Agent Information	<input type="checkbox"/> Option 82
Information	<input type="checkbox"/> MES-3528

Add Cancel Clear

VID	Type	DHCP Status	Delete
1	Relay	192.168.1.100	<input type="checkbox"/>

Delete Cancel

PART V

Management

Maintenance (267)

Access Control (275)

Diagnostic (297)

Syslog (299)

Cluster Management (303)

MAC Table (311)

ARP Table (315)

Configure Clone (317)

Maintenance

This chapter explains how to configure the screens that let you maintain the firmware and configuration files.

31.1 The Maintenance Screen

Use this screen to manage firmware and your configuration files. Click **Management > Maintenance** in the navigation panel to open the following screen.

Figure 148 Management > Maintenance

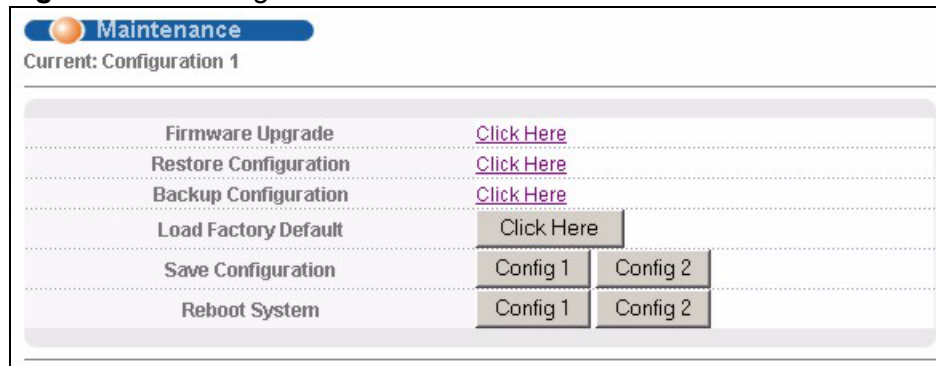

The following table describes the labels in this screen.

Table 88 Management > Maintenance

LABEL	DESCRIPTION
Current	This field displays which configuration (Configuration 1 or Configuration 2) is currently operating on the Switch.
Firmware Upgrade	Click Click Here to go to the Firmware Upgrade screen.
Restore Configuration	Click Click Here to go to the Restore Configuration screen.
Backup Configuration	Click Click Here to go to the Backup Configuration screen.

Table 88 Management > Maintenance (continued)

LABEL	DESCRIPTION
Load Factory Default	Click Click Here to reset the configuration to the factory default settings.
Save Configuration	Click Config 1 to save the current configuration settings to Configuration 1 on the Switch. Click Config 2 to save the current configuration settings to Configuration 2 on the Switch.
Reboot System	Click Config 1 to reboot the system and load Configuration 1 on the Switch. Click Config 2 to reboot the system and load Configuration 2 on the Switch. Note: Make sure to click the Save button in any screen to save your settings to the current configuration on the Switch.

31.2 Load Factory Default

Follow the steps below to reset the Switch back to the factory defaults.

- 1 In the **Maintenance** screen, click the **Click Here** button next to **Load Factory Default** to clear all Switch configuration information you configured and return to the factory defaults.
- 2 Click **OK** to reset all Switch configurations to the factory defaults.

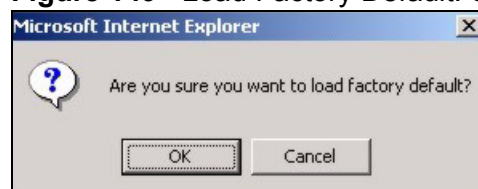
Figure 149 Load Factory Default: Start

- 3 In the web configurator, click the **Save** button in the top of the screen to make the changes take effect. If you want to access the Switch web configurator again, you may need to change the IP address of your computer to be in the same subnet as that of the default Switch IP address (192.168.1.1).

31.3 Save Configuration

Click **Config 1** to save the current configuration settings permanently to **Configuration 1** on the Switch.

Click **Config 2** to save the current configuration settings to **Configuration 2** on the Switch.

Alternatively, click Save on the top right-hand corner in any screen to save the configuration changes to the current configuration.

Note: Clicking the **Apply** or **Add** button does NOT save the changes permanently. All unsaved changes are erased after you reboot the Switch.

31.4 Reboot System

Reboot System allows you to restart the Switch without physically turning the power off. It also allows you to load configuration one (**Config 1**) or configuration two (**Config 2**) when you reboot. Follow the steps below to reboot the Switch.

- 1 In the **Maintenance** screen, click the **Config 1** button next to **Reboot System** to reboot and load configuration one. The following screen displays.

Figure 150 Reboot System: Confirmation



- 2 Click **OK** again and then wait for the Switch to restart. This takes up to two minutes. This does not affect the Switch's configuration.

Click **Config 2** and follow steps 1 to 2 to reboot and load configuration two on the Switch.

31.5 Firmware Upgrade

Make sure you have downloaded (and unzipped) the correct model firmware and version to your computer before uploading to the device.

Be sure to upload the correct model firmware as uploading the wrong model firmware may damage your device.

Click **Management > Maintenance > Firmware Upgrade** to view the screen as shown next.

Figure 151 Management > Maintenance > Firmware Upgrade

Type the path and file name of the firmware file you wish to upload to the Switch in the **File Path** text box or click **Browse** to locate it. Select the **Rebooting** check box if you want to reboot the Switch and apply the new firmware immediately. (Firmware upgrades are only applied after a reboot). Click **Upgrade** to load the new firmware.

After the firmware upgrade process is complete, see the **System Info** screen to verify your current firmware version number.

31.6 Restore a Configuration File

Restore a previously saved configuration from your computer to the Switch using the **Restore Configuration** screen.

Figure 152 Management > Maintenance > Restore Configuration

Type the path and file name of the configuration file you wish to restore in the **File Path** text box or click **Browse** to locate it. After you have specified the file, click **Restore**. "config" is the name of the configuration file on the Switch, so your backup configuration file is automatically renamed when you restore using this screen.

31.7 Backup a Configuration File

Backing up your Switch configurations allows you to create various “snap shots” of your device from which you may restore at a later date.

Back up your current Switch configuration to a computer using the **Backup Configuration** screen.

Figure 153 Management > Maintenance > Backup Configuration

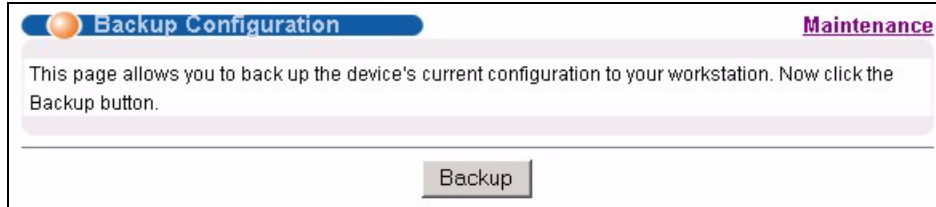

Follow the steps below to back up the current Switch configuration to your computer in this screen.

- 1 Click **Backup**.
- 2 Click **Save** to display the **Save As** screen.
- 3 Choose a location to save the file on your computer from the **Save in** drop-down list box and type a descriptive name for it in the **File name** list box. Click **Save** to save the configuration file to your computer.

31.8 FTP Command Line

This section shows some examples of uploading to or downloading files from the Switch using FTP commands. First, understand the filename conventions.

31.8.1 Filename Conventions

The configuration file (also known as the romfile or ROM) contains the factory default settings in the screens such as password, Switch setup, IP Setup, and so on. Once you have customized the Switch’s settings, they can be saved back to your computer under a filename of your choosing.

ZyNOS (ZyXEL Network Operating System sometimes referred to as the "ras" file) is the system firmware and has a "bin" filename extension.

Table 89 Filename Conventions

FILE TYPE	INTERNAL NAME	EXTERNAL NAME	DESCRIPTION
Configuration File	config	*.cfg	This is the configuration filename on the Switch. Uploading the config file replaces the specified configuration file system, including your Switch configurations, system-related data (including the default password), the error log and the trace log.
Firmware	ras	*.bin	This is the generic name for the ZyNOS firmware on the Switch.

31.8.1.1 Example FTP Commands

```
ftp> put firmware.bin ras
```

This is a sample FTP session showing the transfer of the computer file "firmware.bin" to the Switch.

```
ftp> get config config.cfg
```

This is a sample FTP session saving the current configuration to a file called "config.cfg" on your computer.

If your (T)FTP client does not allow you to have a destination filename different than the source, you will need to rename them as the Switch only recognizes "config" and "ras". Be sure you keep unaltered copies of all files for later use.

Be sure to upload the correct model firmware as uploading the wrong model firmware may damage your device.

31.8.2 FTP Command Line Procedure

- 1 Launch the FTP client on your computer.
- 2 Enter `open`, followed by a space and the IP address of your Switch.
- 3 Press [ENTER] when prompted for a username.
- 4 Enter your password as requested (the default is "1234").
- 5 Enter `bin` to set transfer mode to binary.

- 6 Use `put` to transfer files from the computer to the Switch, for example, `put firmware.bin ras` transfers the firmware on your computer (firmware.bin) to the Switch and renames it to "ras". Similarly, `put config.cfg config` transfers the configuration file on your computer (config.cfg) to the Switch and renames it to "config". Likewise `get config config.cfg` transfers the configuration file on the Switch to your computer and renames it to "config.cfg". See [Table 89 on page 272](#) for more information on filename conventions.
- 7 Enter `quit` to exit the ftp prompt.

31.8.3 GUI-based FTP Clients

The following table describes some of the commands that you may see in GUI-based FTP clients.

General Commands for GUI-based FTP Clients

COMMAND	DESCRIPTION
Host Address	Enter the address of the host server.
Login Type	Anonymous. This is when a user I.D. and password is automatically supplied to the server for anonymous access. Anonymous logins will work only if your ISP or service administrator has enabled this option. Normal. The server requires a unique User ID and Password to login.
Transfer Type	Transfer files in either ASCII (plain text format) or in binary mode. Configuration and firmware files should be transferred in binary mode.
Initial Remote Directory	Specify the default remote directory (path).
Initial Local Directory	Specify the default local directory (path).

31.8.4 FTP Restrictions

FTP will not work when:

- FTP service is disabled in the **Service Access Control** screen.
- The IP address(es) in the **Remote Management** screen does not match the client IP address. If it does not match, the Switch will disconnect the FTP session immediately.

Access Control

This chapter describes how to control access to the Switch.

32.1 Access Control Overview

A console port and FTP are allowed one session each, Telnet and SSH share nine sessions, up to five Web sessions (five different user names and passwords) and/or limitless SNMP access control sessions are allowed.

Table 90 Access Control Overview

Console Port	SSH	Telnet	FTP	Web	SNMP
One session	Share up to nine sessions		One session	Up to five accounts	No limit

A console port access control session and Telnet access control session cannot coexist when multi-login is disabled. See the CLI Reference Guide for more information on disabling multi-login.

32.2 The Access Control Main Screen

Click **Management** > **Access Control** in the navigation panel to display the main screen as shown.

Figure 154 Management > Access Control



32.3 About SNMP

Simple Network Management Protocol (SNMP) is an application layer protocol used to manage and monitor TCP/IP-based devices. SNMP is used to exchange management information between the network management system (NMS) and a network element (NE). A manager station can manage and monitor the Switch through the network via SNMP version one (SNMPv1), SNMP version 2c or SNMP version 3. The next figure illustrates an SNMP management operation. SNMP is only available if TCP/IP is configured.

Figure 155 SNMP Management Model

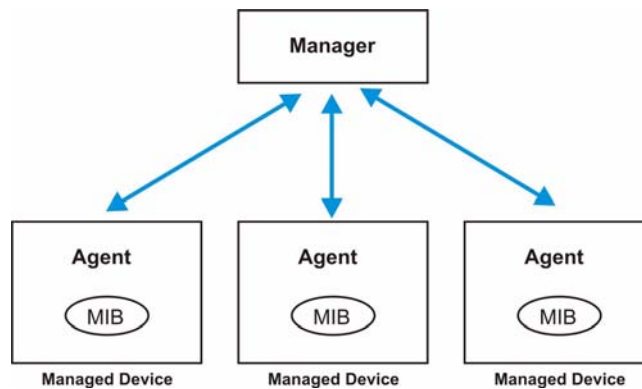

An SNMP managed network consists of two main components: agents and a manager.

An agent is a management software module that resides in a managed switch (the Switch). An agent translates the local management information from the managed switch into a form compatible with SNMP. The manager is the console through which network administrators perform network management functions. It executes applications that control and monitor managed devices.

The managed devices contain object variables/managed objects that define each piece of information to be collected about a switch. Examples of variables include number of packets received, node port status and so on. A Management Information Base (MIB) is a collection of managed objects. SNMP allows a manager and agents to communicate for the purpose of accessing these objects.

SNMP itself is a simple request/response protocol based on the manager/agent model. The manager issues a request and the agent returns responses using the following protocol operations:

Table 91 SNMP Commands

COMMAND	DESCRIPTION
Get	Allows the manager to retrieve an object variable from the agent.
GetNext	Allows the manager to retrieve the next object variable from a table or list within an agent. In SNMPv1, when a manager wants to retrieve all elements of a table from an agent, it initiates a Get operation, followed by a series of GetNext operations.
Set	Allows the manager to set values for object variables within an agent.
Trap	Used by the agent to inform the manager of some events.

32.3.1 SNMP v3 and Security

SNMP v3 enhances security for SNMP management. SNMP managers can be required to authenticate with agents before conducting SNMP management sessions.

Security can be further enhanced by encrypting the SNMP messages sent from the managers. Encryption protects the contents of the SNMP messages. When the contents of the SNMP messages are encrypted, only the intended recipients can read them.

32.3.2 Supported MIBs

MIBs let administrators collect statistics and monitor status and performance.

The Switch supports the following MIBs:

- SNMP MIB II (RFC 1213)
- RFC 1157 SNMP v1
- RFC 1493 Bridge MIBs
- RFC 1643 Ethernet MIBs
- RFC 1155 SMI
- RFC 2674 SNMPv2, SNMPv2c
- RFC 1757 RMON
- SNMPv2, SNMPv2c or later version, compliant with RFC 2011 SNMPv2 MIB for IP, RFC 2012 SNMPv2 MIB for TCP, RFC 2013 SNMPv2 MIB for UDP

32.3.3 SNMP Traps

The Switch sends traps to an SNMP manager when an event occurs. The following tables outline the SNMP traps by category.

An OID (Object ID) that begins with "1.3.6.1.4.1.890.1.5.8" is defined in private MIBs. Otherwise, it is a standard MIB OID.

Table 92 SNMP System Traps

OPTION	OBJECT LABEL	OBJECT ID	DESCRIPTION
coldstart	coldStart	1.3.6.1.6.3.1.1.5.1	This trap is sent when the Switch is turned on.
warmstart	warmStart	1.3.6.1.6.3.1.1.5.2	This trap is sent when the Switch restarts.
reset	UncontrolledResetEventOn	1.3.6.1.4.1.890.1.5.8.51.2 7.2.1	This trap is sent when the Switch automatically resets.
	ControlledResetEventOn	1.3.6.1.4.1.890.1.5.8.51.2 7.2.1	This trap is sent when the Switch resets by an administrator through a management interface.
	RebootEvent	1.3.6.1.4.1.890.1.5.0.1	This trap is sent when the Switch reboots by an administrator through a management interface.
timesync	RTCNotUpdatedEventOn	1.3.6.1.4.1.890.1.5.8.51.2 7.2.1	This trap is sent when the Switch fails to get the time and date from a time server.
	RTCNotUpdatedEventClear	1.3.6.1.4.1.890.1.5.8.51.2 7.2.2	This trap is sent when the Switch gets the time and date from a time server.
intrusionlock	IntrusionLockEventOn	1.3.6.1.4.1.890.1.5.8.51.2 7.2.1	This trap is sent when intrusion lock occurs on a port.
loopguard	LoopguardEventOn	1.3.6.1.4.1.890.1.5.8.51.2 7.2.2	This trap is sent when loopguard shuts down a port.
externalalarm	ExternalAlarmEventOn	1.3.6.1.4.1.890.1.5.8.51.2 7.2.1	This trap is sent when the external alarm is received.
	ExternalAlarmEventClear	1.3.6.1.4.1.890.1.5.8.51.2 7.2.2	This trap is sent when the external alarm stops sending an alert.

Table 93 SNMP Interface Traps

OPTION	OBJECT LABEL	OBJECT ID	DESCRIPTION
linkup	linkUp	1.3.6.1.6.3.1.1.5.4	This trap is sent when the Ethernet link is up.
	LinkDownEventClear	1.3.6.1.4.1.890.1.5.8.51.27 .2.2	This trap is sent when the Ethernet link is up.

Table 93 SNMP Interface Traps (continued)

OPTION	OBJECT LABEL	OBJECT ID	DESCRIPTION
linkdown	linkDown	1.3.6.1.6.3.1.1.5.3	This trap is sent when the Ethernet link is down.
	LinkDownEventOn	1.3.6.1.4.1.890.1.5.8.51.27.2.1	This trap is sent when the Ethernet link is down.
lldp	LLDPRemoteTopologyChange	1.0.8802.1.1.2.0.0.1	This trap is sent when the LLDP (Link Layer Discovery Protocol) remote topology changes.
transceiver-ddmi	transceiverddmiEventOn	1.3.6.1.4.1.890.1.5.8.51.27.2.1	This trap is sent when one of the device operating parameters (such as transceiver temperature, laser bias current, transmitted optical power, received optical power and transceiver supply voltage) is above or below a factory set normal range.
	transceiverddmiEventClear	1.3.6.1.4.1.890.1.5.8.51.27.2.2	This trap is sent when all device operating parameters return to the normal operating range.

Table 94 AAA Traps

OPTION	OBJECT LABEL	OBJECT ID	DESCRIPTION
authentication	authenticationFailure	1.3.6.1.6.3.1.1.5.5	This trap is sent when authentication fails due to incorrect user name and/or password.
	AuthenticationFailureEventOn	1.3.6.1.4.1.890.1.5.8.51.27.2.1	This trap is sent when authentication fails due to incorrect user name and/or password.
	RADIUSNotReachableEventOn	1.3.6.1.4.1.890.1.5.8.51.27.2.1	This trap is sent when there is no response message from the RADIUS server.
	RADIUSNotReachableEventClear	1.3.6.1.4.1.890.1.5.8.51.27.2.2	This trap is sent when the RADIUS server can be reached.
	TACACS+NotReachableEventOn	1.3.6.1.4.1.890.1.5.8.51.27.2.1	This trap is sent when there is no response message from the TACACS+ server.
	TACACS+NotReachableEventClear	1.3.6.1.4.1.890.1.5.8.51.27.2.2	This trap is sent when the TACACS+ server can be reached.

Table 94 AAA Traps (continued)

OPTION	OBJECT LABEL	OBJECT ID	DESCRIPTION
accounting	RADIUSNotReachableEventOn	1.3.6.1.4.1.890.1.5.8.51.2 7.2.1	This trap is sent when there is no response message from the RADIUS accounting server.
	RADIUSNotReachableEventClear	1.3.6.1.4.1.890.1.5.8.51.2 7.2.2	This trap is sent when the RADIUS accounting server can be reached.
	TACACS+NotReachableEventOn	1.3.6.1.4.1.890.1.5.8.51.2 7.2.1	This trap is sent when there is no response message from the TACACS+ accounting server.
	TACACS+NotReachableEventClear	1.3.6.1.4.1.890.1.5.8.51.2 7.2.2	This trap is sent when the TACACS+ accounting server can be reached.

Table 95 SNMP IP Traps

OPTION	OBJECT LABEL	OBJECT ID	DESCRIPTION
ping	pingProbeFailed	1.3.6.1.2.1.80.0. 1	This trap is sent when a single ping probe fails.
	pingTestFailed	1.3.6.1.2.1.80.0. 2	This trap is sent when a ping test (consisting of a series of ping probes) fails.
	pingTestCompleted	1.3.6.1.2.1.80.0. 3	This trap is sent when a ping test is completed.
traceroute	traceRoutePathChange	1.3.6.1.2.1.81.0. 1	This trap is sent when a path to a target changes.
	traceRouteTestFailed	1.3.6.1.2.1.81.0. 2	This trap is sent when a traceroute test fails.
	traceRouteTestCompleted	1.3.6.1.2.1.81.0. 3	This trap is sent when a traceroute test is completed.

Table 96 SNMP Switch Traps

OPTION	OBJECT LABEL	OBJECT ID	DESCRIPTION
stp	STPNewRoot	1.3.6.1.2.1.17.0.1	This trap is sent when the STP root switch changes.
	MRSTPNewRoot	1.3.6.1.4.1.890.1.5.8.51.36.2.1	This trap is sent when the MRSTP root switch changes.
	MSTPNewRoot	1.3.6.1.4.1.890.1.5.8.51.107.70.1	This trap is sent when the MSTP root switch changes.
	STPTopologyChange	1.3.6.1.2.1.17.0.2	This trap is sent when the STP topology changes.
	MRSTPTopologyChange	1.3.6.1.4.1.890.1.5.8.51.36.2.2	This trap is sent when the MRSTP topology changes.
	MSTPTopologyChange	1.3.6.1.4.1.890.1.5.8.51.107.70.2	This trap is sent when the MSTP root switch changes.
mactable	MacTableFullEventOn	1.3.6.1.4.1.890.1.5.8.51.27.2.1	This trap is sent when more than 99% of the MAC table is used.
	MacTableFullEventClear	1.3.6.1.4.1.890.1.5.8.51.27.2.2	This trap is sent when less than 95% of the MAC table is used.
rmon	RmonRisingAlarm	1.3.6.1.2.1.16.0.1	This trap is sent when a variable goes over the RMON "rising" threshold.
	RmonFallingAlarm	1.3.6.1.2.1.16.0.2	This trap is sent when the variable falls below the RMON "falling" threshold.
cfm	dot1agCfmFaultAlarm	1.3.111.2.802.1.1.8.0.1	The trap is sent when the Switch detects a connectivity fault.

32.3.4 Configuring SNMP

Click **Management > Access Control > SNMP** to view the screen as shown. Use this screen to configure your SNMP settings.

Figure 156 Management > Access Control > SNMP

The screenshot shows the SNMP configuration interface. At the top, there are tabs for 'SNMP', 'Access Control', and 'Trap Group'. The 'SNMP' tab is active, and the 'General Setting' section is expanded. Below this, there are three rows for 'Get Community', 'Set Community', and 'Trap Community', each with a text input field containing 'public'. The 'Version' dropdown is set to 'v2c'. The 'Trap Destination' section contains a table with four rows, each with a 'Version' dropdown set to 'v2c', an 'IP' field set to '0.0.0.0', and a 'Port' field set to '162'. The 'User Information' section contains a table with one row for 'Index' 1, 'Username' 'admin', 'Security Level' 'noauth', 'Authentication' 'MD5', and 'Privacy' 'DES'. At the bottom, there are 'Apply' and 'Cancel' buttons.

The following table describes the labels in this screen.

Table 97 Management > Access Control > SNMP

LABEL	DESCRIPTION
General Setting	Use this section to specify the SNMP version and community (password) values.
Version	Select the SNMP version for the Switch. The SNMP version on the Switch must match the version on the SNMP manager. Choose SNMP version 2c (v2c), SNMP version 3 (v3) or both (v3v2c). Note: SNMP version 2c is backwards compatible with SNMP version 1.
Get Community	Enter the Get Community string, which is the password for the incoming Get- and GetNext- requests from the management station. The Get Community string is only used by SNMP managers using SNMP version 2c or lower.

Table 97 Management > Access Control > SNMP (continued)

LABEL	DESCRIPTION
Set Community	Enter the Set Community , which is the password for incoming Set-requests from the management station. The Set Community string is only used by SNMP managers using SNMP version 2c or lower.
Trap Community	Enter the Trap Community string, which is the password sent with each trap to the SNMP manager. The Trap Community string is only used by SNMP managers using SNMP version 2c or lower.
Trap Destination	Use this section to configure where to send SNMP traps from the Switch.
Version	Specify the version of the SNMP trap messages.
IP	Enter the IP addresses of up to four managers to send your SNMP traps to.
Port	Enter the port number upon which the manager listens for SNMP traps.
Username	Enter the username to be sent to the SNMP manager along with the SNMP v3 trap. Note: This username must match an existing account on the Switch (configured in the Management > Access Control > Logins screen).
User Information	Use this section to configure users for authentication with managers using SNMP v3. Note: Use the username and password of the login accounts you specify in this section to create accounts on the SNMP v3 manager.
Index	This is a read-only number identifying a login account on the Switch.
Username	This field displays the username of a login account on the Switch.
Security Level	Select whether you want to implement authentication and/or encryption for SNMP communication from this user. Choose: <ul style="list-style-type: none"> • noauth: to use the username as the password string to send to the SNMP manager. This is equivalent to the Get, Set and Trap Community in SNMP v2c. This is the lowest security level. • auth: to implement an authentication algorithm for SNMP messages sent by this user. • priv: to implement authentication and encryption for SNMP messages sent by this user. This is the highest security level. Note: The settings on the SNMP manager must be set at the same security level or higher than the security level settings on the Switch.
Authentication	Select an authentication algorithm. MD5 (Message Digest 5) and SHA (Secure Hash Algorithm) are hash algorithms used to authenticate SNMP data. SHA authentication is generally considered stronger than MD5 , but is slower.

Table 97 Management > Access Control > SNMP (continued)

LABEL	DESCRIPTION
Privacy	Specify the encryption method for SNMP communication from this user. You can choose one of the following: <ul style="list-style-type: none"> • DES - Data Encryption Standard is a widely used (but breakable) method of data encryption. It applies a 56-bit key to each 64-bit block of data. • AES - Advanced Encryption Standard is another method for data encryption that also uses a secret key. AES applies a 128-bit key to 128-bit blocks of data.
Apply	Click Apply to save your changes to the Switch's run-time memory. The Switch loses these changes if it is turned off or loses power, so use the Save link on the top navigation panel to save your changes to the non-volatile memory when you are done configuring.
Cancel	Click Cancel to begin configuring this screen afresh.

32.3.5 Configuring SNMP Trap Group

Click **Management > Access Control > SNMP > Trap Group** to view the screen as shown. Use the **Trap Group** screen to specify the types of SNMP traps that should be sent to each SNMP manager.

Figure 157 Management > Access Control > SNMP > Trap Group

Type	Options
System <input type="checkbox"/> *	<input type="checkbox"/> coldstart <input type="checkbox"/> warmstart <input type="checkbox"/> reset <input type="checkbox"/> timesync <input type="checkbox"/> intrusionlock <input type="checkbox"/> loopguard <input type="checkbox"/> externalalarm
Interface <input type="checkbox"/> *	<input type="checkbox"/> linkup <input type="checkbox"/> linkdown <input type="checkbox"/> lldp <input type="checkbox"/> transceiver-ddm
AAA <input type="checkbox"/> *	<input type="checkbox"/> authentication <input type="checkbox"/> accounting
IP <input type="checkbox"/> *	<input type="checkbox"/> ping <input type="checkbox"/> traceroute
Switch <input type="checkbox"/> *	<input type="checkbox"/> stp <input type="checkbox"/> mactable <input type="checkbox"/> rmon <input type="checkbox"/> cfm

The following table describes the labels in this screen.

Table 98 Management > Access Control > SNMP > Trap Group

LABEL	DESCRIPTION
Trap Destination IP	Select one of your configured trap destination IP addresses. These are the IP addresses of the SNMP managers. You must first configure a trap destination IP address in the SNMP Setting screen. Use the rest of the screen to select which traps the Switch sends to that SNMP manager.
Type	Select the categories of SNMP traps that the Switch is to send to the SNMP manager.
Options	Select the individual SNMP traps that the Switch is to send to the SNMP station. See Section 32.3.3 on page 278 for individual trap descriptions. The traps are grouped by category. Selecting a category automatically selects all of the category's traps. Clear the check boxes for individual traps that you do not want the Switch to send to the SNMP station. Clearing a category's check box automatically clears all of the category's trap check boxes (the Switch only sends traps from selected categories).
Apply	Click Apply to save your changes to the Switch's run-time memory. The Switch loses these changes if it is turned off or loses power, so use the Save link on the top navigation panel to save your changes to the non-volatile memory when you are done configuring.
Cancel	Click Cancel to begin configuring this screen afresh.

32.3.6 Setting Up Login Accounts

Up to five people (one administrator and four non-administrators) may access the Switch via web configurator at any one time.

- An administrator is someone who can both view and configure Switch changes. The username for the Administrator is always **admin**. The default administrator password is **1234**.

Note: It is highly recommended that you change the default administrator password (**1234**).

- A non-administrator (username is something other than **admin**) is someone who can view but not configure Switch settings.

Click **Management > Access Control > Logins** to view the screen as shown next.

Figure 158 Management > Access Control > Logins

The screenshot shows a web interface for managing system logins. At the top, there's a header with 'Logins' and 'Access Control'. Below that, the 'Administrator' section has three password input fields. A red warning message is displayed below the password fields. The 'Edit Logins' section contains a table with four rows for user configuration. Each row has columns for 'Login', 'User Name', 'Password', and 'Retype to confirm'. At the bottom of the screen are 'Apply' and 'Cancel' buttons.

The following table describes the labels in this screen.

Table 99 Management > Access Control > Logins

LABEL	DESCRIPTION
Administrator	This is the default administrator account with the "admin" user name. You cannot change the default administrator user name. Only the administrator has read/write access.
Old Password	Type the existing system password (1234 is the default password when shipped).
New Password	Enter your new system password.
Retype to confirm	Retype your new system password for confirmation
Edit Logins	You may configure passwords for up to four users. These users have read-only access. You can give users higher privileges via the CLI. For more information on assigning privileges see the CLI Reference Guide.
User Name	Set a user name (up to 32 ASCII characters long).
Password	Enter your new system password.
Retype to confirm	Retype your new system password for confirmation

Table 99 Management > Access Control > Logins (continued)

LABEL	DESCRIPTION
Apply	Click Apply to save your changes to the Switch's run-time memory. The Switch loses these changes if it is turned off or loses power, so use the Save link on the top navigation panel to save your changes to the non-volatile memory when you are done configuring.
Cancel	Click Cancel to begin configuring this screen afresh.

32.4 SSH Overview

Unlike Telnet or FTP, which transmit data in clear text, SSH (Secure Shell) is a secure communication protocol that combines authentication and data encryption to provide secure encrypted communication between two hosts over an unsecured network.

Figure 159 SSH Communication Example

32.5 How SSH works

The following table summarizes how a secure connection is established between two remote hosts.

Figure 160 How SSH Works

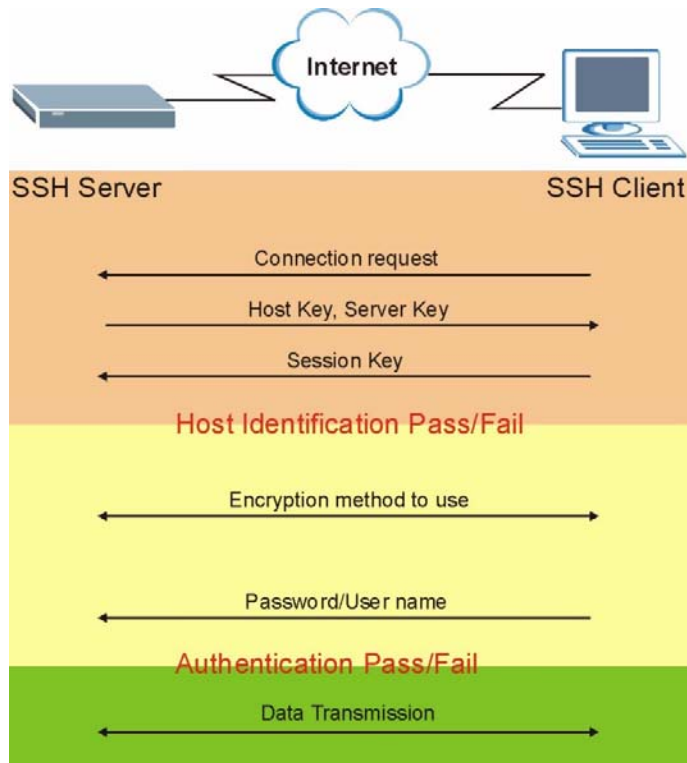

1 Host Identification

The SSH client sends a connection request to the SSH server. The server identifies itself with a host key. The client encrypts a randomly generated session key with the host key and server key and sends the result back to the server.

The client automatically saves any new server public keys. In subsequent connections, the server public key is checked against the saved version on the client computer.

2 Encryption Method

Once the identification is verified, both the client and server must agree on the type of encryption method to use.

3 Authentication and Data Transmission

After the identification is verified and data encryption activated, a secure tunnel is established between the client and the server. The client then sends its authentication information (user name and password) to the server to log in to the server.

32.6 SSH Implementation on the Switch

Your Switch supports SSH version 2 using RSA authentication and three encryption methods (DES, 3DES and Blowfish). The SSH server is implemented on the Switch for remote management and file transfer on port 22. Only one SSH connection is allowed at a time.

32.6.1 Requirements for Using SSH

You must install an SSH client program on a client computer (Windows or Linux operating system) that is used to connect to the Switch over SSH.

32.7 Introduction to HTTPS

HTTPS (HyperText Transfer Protocol over Secure Socket Layer, or HTTP over SSL) is a web protocol that encrypts and decrypts web pages. Secure Socket Layer (SSL) is an application-level protocol that enables secure transactions of data by ensuring confidentiality (an unauthorized party cannot read the transferred data), authentication (one party can identify the other party) and data integrity (you know if data has been changed).

It relies upon certificates, public keys, and private keys.

HTTPS on the Switch is used so that you may securely access the Switch using the web configurator. The SSL protocol specifies that the SSL server (the Switch) must always authenticate itself to the SSL client (the computer which requests the HTTPS connection with the Switch), whereas the SSL client only should authenticate itself when the SSL server requires it to do so. Authenticating client certificates is optional and if selected means the SSL-client must send the Switch a certificate. You must apply for a certificate for the browser from a CA that is a trusted CA on the Switch.

Please refer to the following figure.

- 1 HTTPS connection requests from an SSL-aware web browser go to port 443 (by default) on the Switch's WS (web server).
- 2 HTTP connection requests from a web browser go to port 80 (by default) on the Switch's WS (web server).

Figure 161 HTTPS Implementation

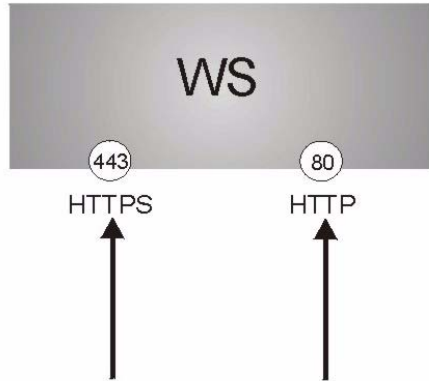

Note: If you disable **HTTP** in the **Service Access Control** screen, then the Switch blocks all HTTP connection attempts.

32.8 HTTPS Example

If you haven't changed the default HTTPS port on the Switch, then in your browser enter "https://Switch IP Address/" as the web site address where "Switch IP Address" is the IP address or domain name of the Switch you wish to access.

32.8.1 Internet Explorer Warning Messages

When you attempt to access the Switch HTTPS server, a Windows dialog box pops up asking if you trust the server certificate. Click **View Certificate** if you want to verify that the certificate is from the Switch.

You see the following **Security Alert** screen in Internet Explorer. Select **Yes** to proceed to the web configurator login screen; if you select **No**, then web configurator access is blocked.

Figure 162 Security Alert Dialog Box (Internet Explorer)



32.8.2 Netscape Navigator Warning Messages

When you attempt to access the Switch HTTPS server, a **Website Certified by an Unknown Authority** screen pops up asking if you trust the server certificate. Click **Examine Certificate** if you want to verify that the certificate is from the Switch.

If **Accept this certificate temporarily for this session** is selected, then click **OK** to continue in Netscape.

Select **Accept this certificate permanently** to import the Switch's certificate into the SSL client.

Figure 163 Security Certificate 1 (Netscape)

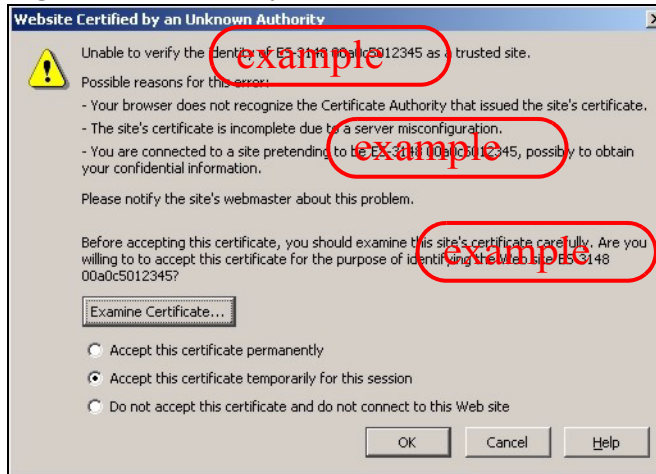
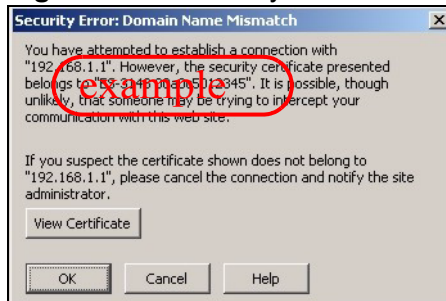

Figure 164 Security Certificate 2 (Netscape)



32.8.3 The Main Screen

After you accept the certificate and enter the login username and password, the Switch main screen appears. The lock displayed in the bottom right of the browser status bar denotes a secure connection.

Figure 165 Example: Lock Denoting a Secure Connection

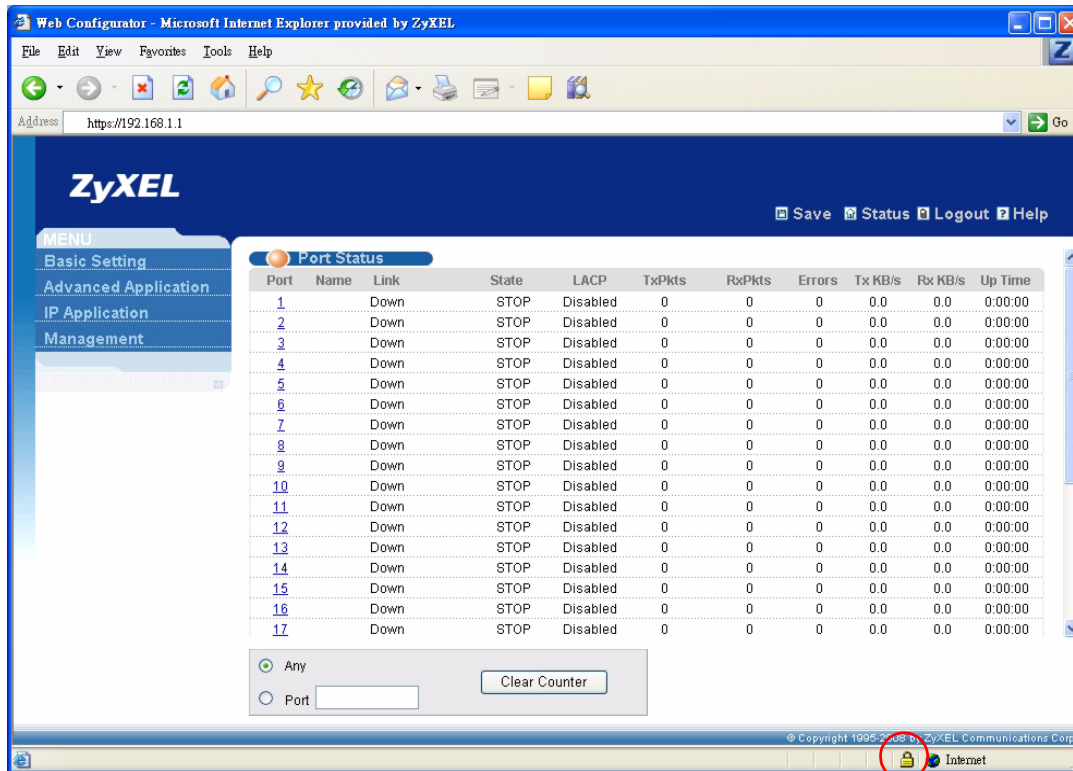

32.9 Service Port Access Control

Service Access Control allows you to decide what services you may use to access the Switch. You may also change the default service port and configure “trusted computer(s)” for each service in the **Remote Management** screen (discussed

later). Click **Management > Access Control > Service Access Control** to view the screen as shown.

Figure 166 Management > Access Control > Service Access Control

Services	Active	Service Port	Timeout
Telnet	<input checked="" type="checkbox"/>	23	
SSH	<input checked="" type="checkbox"/>	22	
FTP	<input checked="" type="checkbox"/>	21	
HTTP	<input checked="" type="checkbox"/>	80	3 Minutes
HTTPS	<input checked="" type="checkbox"/>	443	
ICMP	<input checked="" type="checkbox"/>		
SNMP	<input checked="" type="checkbox"/>		

Apply Cancel

The following table describes the fields in this screen.

Table 100 Management > Access Control > Service Access Control

LABEL	DESCRIPTION
Services	Services you may use to access the Switch are listed here.
Active	Select this option for the corresponding services that you want to allow to access the Switch.
Service Port	For Telnet, SSH, FTP, HTTP or HTTPS services, you may change the default service port by typing the new port number in the Server Port field. If you change the default port number then you will have to let people (who wish to use the service) know the new port number for that service.
Timeout	Type how many minutes a management session (via the web configurator) can be left idle before the session times out. After it times out you have to log in with your password again. Very long idle timeouts may have security risks.
Apply	Click Apply to save your changes to the Switch's run-time memory. The Switch loses these changes if it is turned off or loses power, so use the Save link on the top navigation panel to save your changes to the non-volatile memory when you are done configuring.
Cancel	Click Cancel to begin configuring this screen afresh.

32.10 Remote Management

Click **Management > Access Control > Remote Management** to view the screen as shown next.

You can specify a group of one or more “trusted computers” from which an administrator may use a service to manage the Switch. Click **Access Control** to return to the **Access Control** screen.

Figure 167 Management > Access Control > Remote Management

Entry	Active	Start Address	End Address	Telnet	FTP	HTTP	ICMP	SNMP	SSH	HTTPS
1	<input checked="" type="checkbox"/>	0.0.0.0	0.0.0.0	<input checked="" type="checkbox"/>	<input checked="" type="checkbox"/>	<input checked="" type="checkbox"/>	<input checked="" type="checkbox"/>	<input checked="" type="checkbox"/>	<input checked="" type="checkbox"/>	<input checked="" type="checkbox"/>
2	<input type="checkbox"/>	0.0.0.0	0.0.0.0	<input type="checkbox"/>	<input type="checkbox"/>	<input type="checkbox"/>	<input type="checkbox"/>	<input type="checkbox"/>	<input type="checkbox"/>	<input type="checkbox"/>
3	<input type="checkbox"/>	0.0.0.0	0.0.0.0	<input type="checkbox"/>	<input type="checkbox"/>	<input type="checkbox"/>	<input type="checkbox"/>	<input type="checkbox"/>	<input type="checkbox"/>	<input type="checkbox"/>
4	<input type="checkbox"/>	0.0.0.0	0.0.0.0	<input type="checkbox"/>	<input type="checkbox"/>	<input type="checkbox"/>	<input type="checkbox"/>	<input type="checkbox"/>	<input type="checkbox"/>	<input type="checkbox"/>

Apply Cancel

The following table describes the labels in this screen.

Table 101 Management > Access Control > Remote Management

LABEL	DESCRIPTION
Entry	This is the client set index number. A “client set” is a group of one or more “trusted computers” from which an administrator may use a service to manage the Switch.
Active	Select this check box to activate this secured client set. Clear the check box if you wish to temporarily disable the set without deleting it.
Start Address	Configure the IP address range of trusted computers from which you can manage this Switch.
End Address	The Switch checks if the client IP address of a computer requesting a service or protocol matches the range set here. The Switch immediately disconnects the session if it does not match.
Telnet/FTP/HTTP/ICMP/SNMP/SSH/HTTPS	Select services that may be used for managing the Switch from the specified trusted computers.
Apply	Click Apply to save your changes to the Switch’s run-time memory. The Switch loses these changes if it is turned off or loses power, so use the Save link on the top navigation panel to save your changes to the non-volatile memory when you are done configuring.
Cancel	Click Cancel to begin configuring this screen afresh.

Diagnostic

This chapter explains the **Diagnostic** screen.

33.1 Diagnostic

Click **Management > Diagnostic** in the navigation panel to open this screen. Use this screen to check system logs, ping IP addresses or perform port tests.

Figure 168 Management > Diagnostic

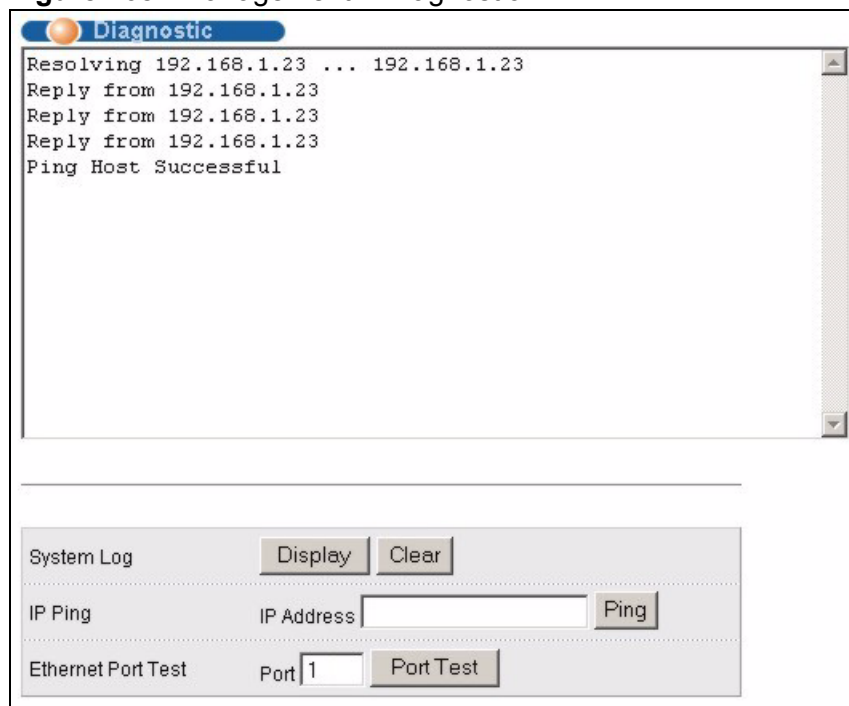

The screenshot shows the 'Diagnostic' screen with a terminal window displaying the results of a ping test. Below the terminal are three sections for system management: System Log, IP Ping, and Ethernet Port Test.

```
Resolving 192.168.1.23 ... 192.168.1.23
Reply from 192.168.1.23
Reply from 192.168.1.23
Reply from 192.168.1.23
Ping Host Successful
```

System Log

IP Ping IP Address

Ethernet Port Test Port

The following table describes the labels in this screen.

Table 102 Management > Diagnostic

LABEL	DESCRIPTION
System Log	Click Display to display a log of events in the multi-line text box. Click Clear to empty the text box and reset the syslog entry.
IP Ping	Type the IP address of a device that you want to ping in order to test a connection. Click Ping to have the Switch ping the IP address (in the field to the left).
Ethernet Port Test	Enter a port number and click Port Test to perform an internal loopback test.

This chapter explains the syslog screens.

34.1 Syslog Overview

The syslog protocol allows devices to send event notification messages across an IP network to syslog servers that collect the event messages. A syslog-enabled device can generate a syslog message and send it to a syslog server.

Syslog is defined in RFC 3164. The RFC defines the packet format, content and system log related information of syslog messages. Each syslog message has a facility and severity level. The syslog facility identifies a file in the syslog server. Refer to the documentation of your syslog program for details. The following table describes the syslog severity levels.

Table 103 Syslog Severity Levels

CODE	SEVERITY
0	Emergency: The system is unusable.
1	Alert: Action must be taken immediately.
2	Critical: The system condition is critical.
3	Error: There is an error condition on the system.
4	Warning: There is a warning condition on the system.
5	Notice: There is a normal but significant condition on the system.
6	Informational: The syslog contains an informational message.
7	Debug: The message is intended for debug-level purposes.

34.2 Syslog Setup

Click **Management** > **Syslog** in the navigation panel to display this screen. The syslog feature sends logs to an external syslog server. Use this screen to configure the device's system logging settings.

Figure 169 Management > Syslog

Logging type	Active	Facility
System	<input checked="" type="checkbox"/>	local use 0
Interface	<input checked="" type="checkbox"/>	local use 0
Switch	<input checked="" type="checkbox"/>	local use 0
AAA	<input checked="" type="checkbox"/>	local use 0
IP	<input checked="" type="checkbox"/>	local use 0

The following table describes the labels in this screen.

Table 104 Management > Syslog

LABEL	DESCRIPTION
Syslog	Select Active to turn on syslog (system logging) and then configure the syslog setting
Logging Type	This column displays the names of the categories of logs that the device can generate.
Active	Select this option to set the device to generate logs for the corresponding category.
Facility	The log facility allows you to send logs to different files in the syslog server. Refer to the documentation of your syslog program for more details.
Apply	Click Apply to save your changes to the Switch's run-time memory. The Switch loses these changes if it is turned off or loses power, so use the Save link on the top navigation panel to save your changes to the non-volatile memory when you are done configuring.
Cancel	Click Cancel to begin configuring this screen afresh.

34.3 Syslog Server Setup

Click **Management > Syslog > Syslog Server Setup** to view the screen as shown next. Use this screen to configure a list of external syslog servers.

Figure 170 Management > Syslog > Syslog Server Setup

The following table describes the labels in this screen.

Table 105 Management > Syslog > Syslog Server Setup

LABEL	DESCRIPTION
Active	Select this check box to have the device send logs to this syslog server. Clear the check box if you want to create a syslog server entry but not have the device send logs to it (you can edit the entry later).
Server Address	Enter the IP address of the syslog server.
Log Level	Select the severity level(s) of the logs that you want the device to send to this syslog server. The lower the number, the more critical the logs are.
Add	Click Add to save your changes to the Switch's run-time memory. The Switch loses these changes if it is turned off or loses power, so use the Save link on the top navigation panel to save your changes to the non-volatile memory when you are done configuring.
Cancel	Click Cancel to begin configuring this screen afresh.
Clear	Click Clear to return the fields to the factory defaults.
Index	This is the index number of a syslog server entry. Click this number to edit the entry.
Active	This field displays Yes if the device is to send logs to the syslog server. No displays if the device is not to send logs to the syslog server.
IP Address	This field displays the IP address of the syslog server.
Log Level	This field displays the severity level of the logs that the device is to send to this syslog server.
Delete	Select an entry's Delete check box and click Delete to remove the entry.
Cancel	Click Cancel to begin configuring this screen afresh.

Cluster Management

This chapter introduces cluster management.

35.1 Cluster Management Status Overview

Cluster Management allows you to manage switches through one Switch, called the cluster manager. The switches must be directly connected and be in the same VLAN group so as to be able to communicate with one another.

Table 106 Clustering Management Specifications

Maximum number of cluster members	24
Cluster Member Models	Must be compatible with ZyXEL cluster management implementation.
Cluster Manager	The switch through which you manage the cluster member switches.
Cluster Members	The switches being managed by the cluster manager switch.

In the following example, switch **A** in the basement is the cluster manager and the other switches on the upper floors of the building are cluster members.

Figure 171 Clustering Application Example

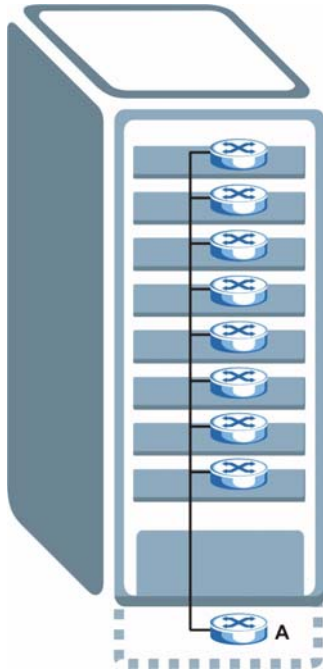

35.2 Cluster Management Status

Click **Management** > **Cluster Management** in the navigation panel to display the following screen.

Note: A cluster can only have one manager.

Figure 172 Management > Cluster Management: Status

Clustering Management Status		Configuration		
Status	Manager			
Manager	00:13:49:00:00:02			
The Number Of Member = 1				
Index	MacAddr	Name	Model	Status
1	00:a0:c5:01:23:46		GS-2024	Online

The following table describes the labels in this screen.

Table 107 Management > Cluster Management: Status

LABEL	DESCRIPTION
Status	This field displays the role of this Switch within the cluster. Manager Member (you see this if you access this screen in the cluster member switch directly and not via the cluster manager) None (neither a manager nor a member of a cluster)
Manager	This field displays the cluster manager switch's hardware MAC address.
The Number of Member	This field displays the number of switches that make up this cluster. The following fields describe the cluster member switches.
Index	You can manage cluster member switches via the cluster manager switch. Each number in the Index column is a hyperlink leading to the cluster member switch's web configurator (see Figure 173 on page 306).
MacAddr	This is the cluster member switch's hardware MAC address.
Name	This is the cluster member switch's System Name .
Model	This field displays the model name.
Status	This field displays: Online (the cluster member switch is accessible) Error (for example the cluster member switch password was changed or the switch was set as the manager and so left the member list, etc.) Offline (the switch is disconnected - Offline shows approximately 1.5 minutes after the link between cluster member and manager goes down)

35.2.1 Cluster Member Switch Management

Go to the **Clustering Management Status** screen of the cluster manager switch and then select an **Index** hyperlink from the list of members to go to that cluster member switch's web configurator home page. This cluster member web

configurator home page and the home page that you'd see if you accessed it directly are different.

Figure 173 Cluster Management: Cluster Member Web Configurator Screen

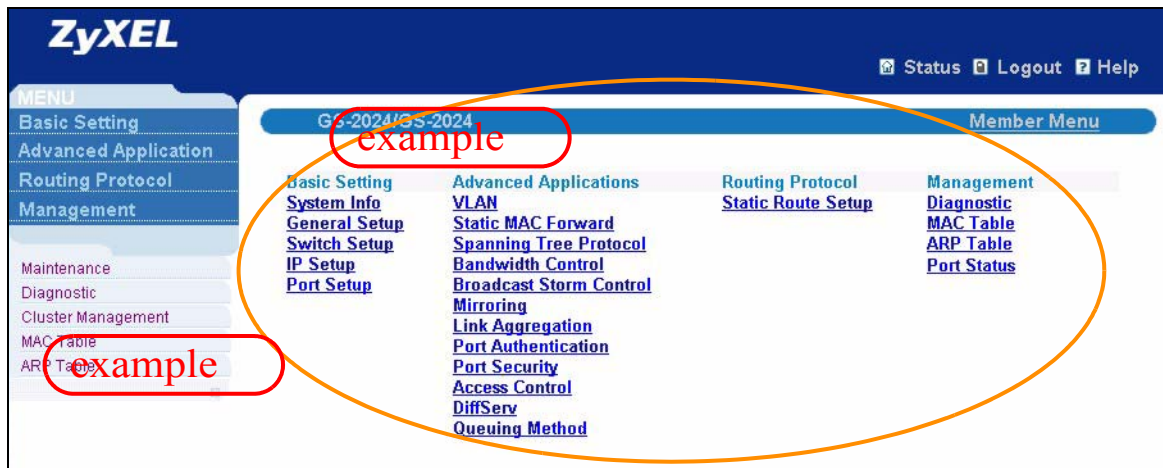

35.2.1.1 Uploading Firmware to a Cluster Member Switch

You can use FTP to upload firmware to a cluster member switch through the cluster manager switch as shown in the following example.

Figure 174 Example: Uploading Applications Firmware to a Cluster Member Switch

```
C:\>ftp 192.168.1.1
Connected to 192.168.1.1.
220 Switch FTP version 1.0 ready at Thu Jan  1 00:58:46 1970
User (192.168.0.1:(none)): admin
331 Enter PASS command
Password:
230 Logged in
ftp> ls
200 Port command okay
150 Opening data connection for LIST
--w--w--w-   1 owner   group      3042210 Jul  01 12:00 ras
-rw-rw-rw-   1 owner   group      393216 Jul  01 12:00 config
--w--w--w-   1 owner   group           0 Jul  01 12:00 fw-00-a0-c5-01-23-46
-rw-rw-rw-   1 owner   group           0 Jul  01 12:00 config-00-a0-c5-01-23-46
226 File sent OK
ftp: 297 bytes received in 0.00Seconds 297000.00Kbytes/sec.
ftp> bin
200 Type I OK
ftp> put 390BHR0.bin fw-00-a0-c5-01-23-46
200 Port command okay
150 Opening data connection for STOR fw-00-a0-c5-01-23-46
226 File received OK
ftp: 262144 bytes sent in 0.63Seconds 415.44Kbytes/sec.
ftp>
```

The following table explains some of the FTP parameters.

Table 108 FTP Upload to Cluster Member Example

FTP PARAMETER	DESCRIPTION
User	Enter "admin".
Password	The web configurator password default is 1234.
ls	Enter this command to list the name of cluster member switch's firmware and configuration file.
390BHR0.bin	This is the name of the firmware file you want to upload to the cluster member switch.
fw-00-a0-c5-01-23-46	This is the cluster member switch's firmware name as seen in the cluster manager switch.
config-00-a0-c5-01-23-46	This is the cluster member switch's configuration file name as seen in the cluster manager switch.

35.3 Clustering Management Configuration

Use this screen to configure clustering management. Click **Management > Cluster Management > Configuration** to display the next screen.

Figure 175 Management > Cluster Management > Configuration

The following table describes the labels in this screen.

Table 109 Management > Cluster Management > Configuration

LABEL	DESCRIPTION
Clustering Manager	
Active	Select Active to have this Switch become the cluster manager switch. A cluster can only have one manager. Other (directly connected) switches that are set to be cluster managers will not be visible in the Clustering Candidates list. If a switch that was previously a cluster member is later set to become a cluster manager, then its Status is displayed as Error in the Cluster Management Status screen and a warning icon (⚠) appears in the member summary list below.

Table 109 Management > Cluster Management > Configuration (continued)

LABEL	DESCRIPTION
Name	Type a name to identify the Clustering Manager . You may use up to 32 printable characters (spaces are allowed).
VID	This is the VLAN ID and is only applicable if the Switch is set to 802.1Q VLAN. All switches must be directly connected and in the same VLAN group to belong to the same cluster. Switches that are not in the same VLAN group are not visible in the Clustering Candidates list. This field is ignored if the Clustering Manager is using Port-based VLAN.
Apply	Click Apply to save your changes to the Switch's run-time memory. The Switch loses these changes if it is turned off or loses power, so use the Save link on the top navigation panel to save your changes to the non-volatile memory when you are done configuring.
Cancel	Click Cancel to begin configuring this screen afresh.
Clustering Candidate	The following fields relate to the switches that are potential cluster members.
List	A list of suitable candidates found by auto-discovery is shown here. The switches must be directly connected. Directly connected switches that are set to be cluster managers will not be visible in the Clustering Candidate list. Switches that are not in the same management VLAN group will not be visible in the Clustering Candidate list.
Password	Each cluster member's password is its web configurator password. Select a member in the Clustering Candidate list and then enter its web configurator password. If that switch administrator changes the web configurator password afterwards, then it cannot be managed from the Cluster Manager . Its Status is displayed as Error in the Cluster Management Status screen and a warning icon () appears in the member summary list below. If multiple devices have the same password then hold [SHIFT] and click those switches to select them. Then enter their common web configurator password.
Add	Click Add to save your changes to the Switch's run-time memory. The Switch loses these changes if it is turned off or loses power, so use the Save link on the top navigation panel to save your changes to the non-volatile memory when you are done configuring.
Cancel	Click Cancel to begin configuring this screen afresh.
Refresh	Click Refresh to perform auto-discovery again to list potential cluster members.
The next summary table shows the information for the clustering members configured.	
Index	This is the index number of a cluster member switch.
MacAddr	This is the cluster member switch's hardware MAC address.
Name	This is the cluster member switch's System Name .
Model	This is the cluster member switch's model name.
Remove	Select this checkbox and then click the Remove button to remove a cluster member switch from the cluster.
Cancel	Click Cancel to begin configuring this screen afresh.

MAC Table

This chapter introduces the **MAC Table** screen.

36.1 MAC Table Overview

The **MAC Table** screen (a MAC table is also known as a filtering database) shows how frames are forwarded or filtered across the Switch's ports. It shows what device MAC address, belonging to what VLAN group (if any) is forwarded to which port(s) and whether the MAC address is dynamic (learned by the Switch) or static (manually entered in the **Static MAC Forwarding** screen).

The Switch uses the MAC table to determine how to forward frames. See the following figure.

- 1 The Switch examines a received frame and learns the port on which this source MAC address came.
- 2 The Switch checks to see if the frame's destination MAC address matches a source MAC address already learned in the MAC table.
 - If the Switch has already learned the port for this MAC address, then it forwards the frame to that port.
 - If the Switch has not already learned the port for this MAC address, then the frame is flooded to all ports. Too much port flooding leads to network congestion.

- If the Switch has already learned the port for this MAC address, but the destination port is the same as the port it came in on, then it filters the frame.

Figure 176 MAC Table Flowchart

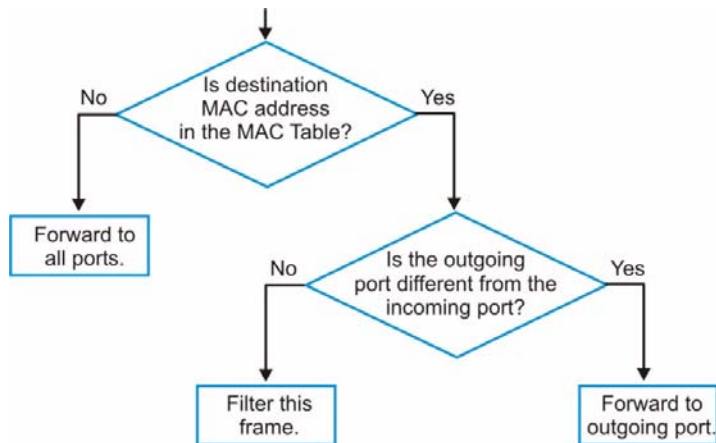

36.2 Viewing the MAC Table

Click **Management > MAC Table** in the navigation panel to display the following screen.

Figure 177 Management > MAC Table

The screenshot shows the "MAC table" configuration page. It includes a "Condition" section with radio buttons for "All", "Static", "MAC", "VID", and "Port". The "MAC" option is selected, with a corresponding input field for the MAC address. The "Sort by" dropdown is set to "MAC". The "Transfer Type" section has radio buttons for "Dynamic to MAC forwarding" (selected) and "Dynamic to MAC filtering". Below these are "Search", "Transfer", and "Cancel" buttons. A table displays the current MAC table entries.

Index	MAC Address	VID	Port	Type
1	00:00:aa:10:01:73	1	27	dynamic
2	00:00:e8:7c:14:80	1	28	dynamic
3	00:02:e3:56:16:9d	1	27	dynamic
4	00:02:e3:57:ea:1c	1	27	dynamic
5	00:04:80:9b:78:00	1	27	dynamic
6	00:0d:88:ca:af:b2	1	27	dynamic
7	00:0e:7b:e4:17:19	1	27	dynamic
8	00:0f:b0:80:e7:56	1	27	dynamic

The following table describes the labels in this screen.

Table 110 Management > MAC Table

LABEL	DESCRIPTION
Condition	<p>Select one of the buttons and click Search to only display the data which matches the criteria you specified.</p> <p>Select All to display any entry in the MAC table of the Switch.</p> <p>Select Static to display the MAC entries manually configured on the Switch.</p> <p>Select MAC and enter a MAC address in the field provided to display a specified MAC entry.</p> <p>Select VID and enter a VLAN ID in the field provided to display the MAC entries belonging to the specified VLAN.</p> <p>Select Port and enter a port number in the field provided to display the MAC addresses which are forwarded on the specified port.</p>
Sort by	<p>Define how the Switch displays and arranges the data in the summary table below.</p> <p>Select MAC to display and arrange the data according to MAC address.</p> <p>Select VID to display and arrange the data according to VLAN group.</p> <p>Select PORT to display and arrange the data according to port number.</p>
Transfer Type	<p>Select Dynamic to MAC forwarding and click the Transfer button to change all dynamically learned MAC address entries in the summary table below into static entries. They also display in the Static MAC Forwarding screen.</p> <p>Select Dynamic to MAC filtering and click the Transfer button to change all dynamically learned MAC address entries in the summary table below into MAC filtering entries. These entries will then display only in the Filtering screen and the default filtering action is Discard source.</p>
Cancel	Click Cancel to change the fields back to their last saved values.
Index	This is the incoming frame index number.
MAC Address	This is the MAC address of the device from which this incoming frame came.
VID	This is the VLAN group to which this frame belongs.
Port	This is the port where the above MAC address is forwarded.
Type	This shows whether the MAC address is dynamic (learned by the Switch) or static (manually entered in the Static MAC Forwarding screen).

ARP Table

This chapter introduces ARP Table.

37.1 ARP Table Overview

Address Resolution Protocol (ARP) is a protocol for mapping an Internet Protocol address (IP address) to a physical machine address, also known as a Media Access Control or MAC address, on the local area network.

An IP (version 4) address is 32 bits long. In an Ethernet LAN, MAC addresses are 48 bits long. The ARP Table maintains an association between each MAC address and its corresponding IP address.

37.1.1 How ARP Works

When an incoming packet destined for a host device on a local area network arrives at the Switch, the Switch's ARP program looks in the ARP Table and, if it finds the address, sends it to the device.

If no entry is found for the IP address, ARP broadcasts the request to all the devices on the LAN. The Switch fills in its own MAC and IP address in the sender address fields, and puts the known IP address of the target in the target IP address field. In addition, the Switch puts all ones in the target MAC field (FF.FF.FF.FF.FF.FF is the Ethernet broadcast address). The replying device (which is either the IP address of the device being sought or the router that knows the way) replaces the broadcast address with the target's MAC address, swaps the sender and target pairs, and unicasts the answer directly back to the requesting machine. ARP updates the ARP Table for future reference and then sends the packet to the MAC address that replied.

37.2 Viewing the ARP Table

Click **Management > ARP Table** in the navigation panel to open the following screen. Use the ARP table to view IP-to-MAC address mapping(s).

Figure 178 Management > ARP Table

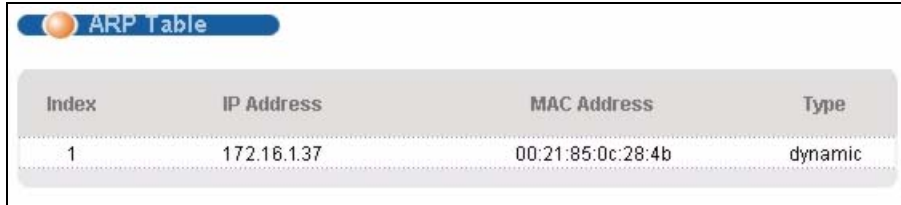

Index	IP Address	MAC Address	Type
1	172.16.1.37	00:21:85:0c:28:4b	dynamic

The following table describes the labels in this screen.

Table 111 Management > ARP Table

LABEL	DESCRIPTION
Index	This is the ARP Table entry number.
IP Address	This is the learned IP address of a device connected to a Switch port with corresponding MAC address below.
MAC Address	This is the MAC address of the device with corresponding IP address above.
Type	This shows whether the MAC address is dynamic (learned by the Switch) or static.

Configure Clone

This chapter shows you how you can copy the settings of one port onto other ports.

38.1 Configure Clone

Cloning allows you to copy the basic and advanced settings from a source port to a destination port or ports. Click **Management > Configure Clone** to open the following screen.

Figure 179 Management > Configure Clone

Configure Clone

Source: Port

Destination:

Port Features

Basic Setting	Advanced Application
<input type="checkbox"/> Active	<input type="checkbox"/> VLAN1 q
<input type="checkbox"/> Name	<input type="checkbox"/> VLAN1 q Member
<input type="checkbox"/> Speed / Duplex	<input type="checkbox"/> Bandwidth Control
<input type="checkbox"/> Flow Control	<input type="checkbox"/> Port Security
<input type="checkbox"/> Intrusion Lock	<input type="checkbox"/> Broadcast Storm Control
	<input type="checkbox"/> Mirroring
	<input type="checkbox"/> Port Authentication
	<input type="checkbox"/> Queuing Method
	<input type="checkbox"/> IGMP Filtering
	<input type="checkbox"/> Spanning Tree Protocol
	<input type="checkbox"/> Multiple Rapid Spanning Tree Protocol
	<input type="checkbox"/> Protocol-based VLAN
	<input type="checkbox"/> Port-based VLAN
	<input type="checkbox"/> Ethernet OAM
	<input type="checkbox"/> Loop Guard
	<input type="checkbox"/> ARP Inspection
	<input type="checkbox"/> DHCP Snooping
	<input type="checkbox"/> Layer 2 Protocol Tunneling
	<input type="checkbox"/> LLDP

Apply Cancel

The following table describes the labels in this screen.

Table 112 Management > Configure Clone

LABEL	DESCRIPTION
Source/ Destination Port	<p>Enter the source port under the Source label. This port's attributes are copied.</p> <p>Enter the destination port or ports under the Destination label. These are the ports which are going to have the same attributes as the source port. You can enter individual ports separated by a comma or a range of ports by using a dash.</p> <p>Example:</p> <ul style="list-style-type: none"> • 2, 4, 6 indicates that ports 2, 4 and 6 are the destination ports. • 2-6 indicates that ports 2 through 6 are the destination ports.
Basic Setting	Select which port settings (you configured in the Basic Setting menus) should be copied to the destination port(s).
Advanced Application	Select which port settings (you configured in the Advanced Application menus) should be copied to the destination ports.
Apply	Click Apply to save your changes to the Switch's run-time memory. The Switch loses these changes if it is turned off or loses power, so use the Save link on the top navigation panel to save your changes to the non-volatile memory when you are done configuring.
Cancel	Click Cancel to begin configuring this screen afresh.

PART VI

Troubleshooting & Product Specifications

Troubleshooting (321)

Product Specifications (325)

Troubleshooting

This chapter offers some suggestions to solve problems you might encounter. The potential problems are divided into the following categories.

- [Power, Hardware Connections, and LEDs](#)
- [Switch Access and Login](#)
- [Switch Configuration](#)

39.1 Power, Hardware Connections, and LEDs

The Switch does not turn on. None of the LEDs turn on.

- 1 Make sure you are using the power adaptor or cord included with the Switch.
- 2 Make sure the power adaptor or cord is connected to the Switch and plugged in to an appropriate power source. Make sure the power source is turned on.
- 3 Disconnect and re-connect the power adaptor or cord to the Switch.
- 4 If the problem continues, contact the vendor.

The **ALM** LED is on.

- 1 Disconnect and re-connect the power adaptor or cord to the Switch.
- 2 If the problem continues, contact the vendor.

One of the LEDs does not behave as expected.

- 1 Make sure you understand the normal behavior of the LED. See [Section 3.2 on page 39](#).
- 2 Check the hardware connections. See [Section 39.1 on page 321](#).
- 3 Inspect your cables for damage. Contact the vendor to replace any damaged cables.
- 4 Disconnect and re-connect the power adaptor or cord to the Switch.
- 5 If the problem continues, contact the vendor.

39.2 Switch Access and Login

I forgot the IP address for the Switch.

- 1 The default IP address is **192.168.1.1**.
- 2 Use the console port to log in to the Switch.
- 3 If this does not work, you have to reset the device to its factory defaults. See [Section 4.6 on page 50](#).

I forgot the username and/or password.

- 1 The default username is **admin** and the default password is **1234**.
- 2 If this does not work, you have to reset the device to its factory defaults. See [Section 4.6 on page 50](#).

I cannot see or access the **Login** screen in the web configurator.

- 1 Make sure you are using the correct IP address.
 - The default IP address is [192.168.1.1](#).
 - If you changed the IP address, use the new IP address.

- If you changed the IP address and have forgotten it, see the troubleshooting suggestions for [I forgot the IP address for the Switch](#).
- 2 Check the hardware connections, and make sure the LEDs are behaving as expected. See [Section 3.2 on page 39](#).
 - 3 Make sure your Internet browser does not block pop-up windows and has JavaScripts and Java enabled.
 - 4 Make sure your computer is in the same subnet as the Switch. (If you know that there are routers between your computer and the Switch, skip this step.)
 - 5 Reset the device to its factory defaults, and try to access the Switch with the default IP address. See [Section 4.6 on page 50](#).
 - 6 If the problem continues, contact the vendor, or try one of the advanced suggestions.

Advanced Suggestions

- Try to access the Switch using another service, such as Telnet. If you can access the Switch, check the remote management settings to find out why the Switch does not respond to HTTP.

I can see the [Login](#) screen, but I cannot log in to the Switch.

- 1 Make sure you have entered the user name and password correctly. The default user name is **admin**, and the default password is **1234**. These fields are case-sensitive, so make sure [Caps Lock] is not on.
- 2 You may have exceeded the maximum number of concurrent Telnet sessions. Close other Telnet session(s) or try connecting again later.

Check that you have enabled logins for HTTP or Telnet. If you have configured a secured client IP address, your computer's IP address must match it. Refer to the chapter on access control for details.
- 3 Disconnect and re-connect the cord to the Switch.
- 4 If this does not work, you have to reset the device to its factory defaults. See [Section 4.6 on page 50](#).

Pop-up Windows, JavaScripts and Java Permissions

In order to use the web configurator you need to allow:

- Web browser pop-up windows from your device.
- JavaScripts (enabled by default).
- Java permissions (enabled by default).

I cannot see some of **Advanced Application** submenus at the bottom of the navigation panel.

The recommended screen resolution is 1024 by 768 pixels. Adjust the value in your computer and then you should see the rest of **Advanced Application** submenus at the bottom of the navigation panel.

There is unauthorized access to my Switch via telnet, HTTP and SSH.

Click the **Display** button in the **System Log** field in the **Management > Diagnostic** screen to check for unauthorized access to your Switch. To avoid unauthorized access, configure the secured client setting in the **Management > Access Control > Remote Management** screen for telnet, HTTP and SSH (see [Section 32.10 on page 294](#)). Computers not belonging to the secured client set cannot get permission to access the Switch.

39.3 Switch Configuration

I lost my configuration settings after I restart the Switch.

Make sure you save your configuration into the Switch's nonvolatile memory each time you make changes. Click **Save** at the top right corner of the web configurator to save the configuration permanently. See also [Section 31.3 on page 269](#) for more information about how to save your configuration.

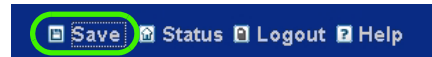

Product Specifications

The following tables summarize the Switch's hardware and firmware features.

Table 113 Hardware Specifications

SPECIFICATION	DESCRIPTION
Dimensions	Standard 19" rack mountable 438 mm (W) x 215 mm (D) x 44.45 mm (H)
Weight	3.4 kg
Power Specification	DC: -36VDC to -48VDC / 0.8A (max) AC: 100-240 V AC, 50/60 Hz, 0.34 A Max.
Power Consumption	20 W (maximum)
Interfaces	24 10/100 Base-Tx ports 4 GbE Dual Personality interfaces (Each interface has one 1000Base-T RJ-45 port and one Small Form-Factor Pluggable (SFP) slot, with one port active at a time.) Auto-negotiation Auto-MDIX One console port Compliant with IEEE 802.3ad/u/x Back pressure flow control for half duplex Flow control for full duplex (IEEE 802.3x) External signal jack
LEDs	Per switch: PWR, SYS, ALM Per Fast Ethernet RJ-45 10/100 port: LNK/ACT Per mini-GBIC slot: LNK, ACT Per 1000BASE-T RJ-45 port (in dual personality interface): LNK/ACT, FDX
Operating Environment	Temperature: 0° C ~ 50° C (32° F ~ 122° F) Humidity: 10 ~ 90% (non-condensing)
Storage Environment	Temperature: -10° C ~ 70° C (14° F ~ 158° F) Humidity: 10 ~ 90% (non-condensing)
Ground Wire Gauge	18 AWG or larger

Table 113 Hardware Specifications

Power Wire Gauge	18 AWG or larger
Fuse Specification	250 VAC, T2A
External Signal Jack	Supports input from four external alarms or other devices and output to one device.
External SIGNAL Connector	<p>Voltage rating</p> <ul style="list-style-type: none"> • Input: no power, dry contact; use open or short circuits without any external input power • Output: 20 V, 500 mA <p>Stranded Wire Gauge: 20 ~ 28 AWG</p> <p>Wire strip length: 6 ~7 mm</p>

Table 114 Firmware Specifications

FEATURE	DESCRIPTION
Default IP Address	192.168.1.1
Default Subnet Mask	255.255.255.0 (24 bits)
Administrator User Name	admin
Default Password	1234
Number of Login Accounts Configurable on the Switch	4 management accounts configured on the Switch. Authentication via RADIUS and TACACS+ also available.
Maximum Frame Size	9 K (9216 bytes)
VLAN	A VLAN (Virtual Local Area Network) allows a physical network to be partitioned into multiple logical networks. Devices on a logical network belong to one group. A device can belong to more than one group. With VLAN, a device cannot directly talk to or hear from devices that are not in the same group(s); the traffic must first go through a router.
MAC Address Filter	Filter traffic based on the source and/or destination MAC address and VLAN group (ID).
DHCP (Dynamic Host Configuration Protocol) Relay	Use this feature to have the Switch forward DHCP requests to DHCP servers on your network.
IGMP Snooping	The Switch supports IGMP snooping, enabling group multicast traffic to be only forwarded to ports that are members of that group; thus allowing you to significantly reduce multicast traffic passing through your Switch.
Differentiated Services (DiffServ)	With DiffServ, the Switch marks packets so that they receive specific per-hop treatment at DiffServ-compliant network devices along the route based on the application types and traffic flow.
Classifier and Policy	You can create a policy to define actions to be performed on a traffic flow grouped by a classifier according to specific criteria such as the IP address, port number or protocol type, etc.

Table 114 Firmware Specifications

FEATURE	DESCRIPTION
Queuing	Queuing is used to help solve performance degradation when there is network congestion. The following scheduling services are supported: Strict Priority Queuing (SPQ) Weighted Round Robin (WRR), and Weighted Fair Queuing (WFQ). This allows the Switch to maintain separate queues for packets from each individual source or flow and prevent a source from monopolizing the bandwidth.
Bandwidth Control	Bandwidth control means defining a maximum allowable bandwidth for incoming and/or out-going traffic flows on a port.
Broadcast Storm Control	Broadcast storm control limits the number of broadcast, multicast and destination lookup failure (DLF) packets the Switch receives per second on the ports.
Port Mirroring	Port mirroring allows you to copy traffic going from one or all ports to another or all ports in order that you can examine the traffic from the mirror port (the port you copy the traffic to) without interference.
Static Route	Static routes allow the Switch to communicate with management stations not reachable via the default gateway.
Multicast VLAN Registration (MVR)	Multicast VLAN Registration (MVR) is designed for applications (such as Media-on-Demand (MoD)) using multicast traffic across a network. MVR allows one single multicast VLAN to be shared among different subscriber VLANs on the network. This improves bandwidth utilization by reducing multicast traffic in the subscriber VLANs and simplifies multicast group management.
STP (Spanning Tree Protocol) / RSTP (Rapid STP)/MSTP (Multiple Spanning Tree Protocol)	(M)(R)STP detects and breaks network loops and provides backup links between switches, bridges or routers. It allows a Switch to interact with other (M)(R)STP-compliant switches in your network to ensure that only one path exists between any two stations on the network.
Loop Guard	Use the loop guard feature to protect against network loops on the edge of your network.
IP Source Guard	Use IP source guard to filter unauthorized DHCP and ARP packets in your network.
Link Aggregation	Link aggregation (trunking) is the grouping of physical ports into one logical higher-capacity link. You may want to trunk ports if for example, it is cheaper to use multiple lower-speed links than to under-utilize a high-speed, but more costly, single-port link.
Port Authentication and Security	For security, the Switch allows authentication using IEEE 802.1x with an external RADIUS server and port security that allows only packets with dynamically learned MAC addresses and/or configured static MAC addresses to pass through a port on the Switch.
Authentication, Authorization and Accounting	The Switch supports authentication, authorization and accounting services via RADIUS and TACACS+ AAA servers.
Device Management	Use the web configurator or commands to easily configure the rich range of features on the Switch.

Table 114 Firmware Specifications

FEATURE	DESCRIPTION
Port Cloning	Use the port cloning feature to copy the settings you configure on one port to another port or ports.
Syslog	The Switch can generate syslog messages and send it to a syslog server.
Firmware Upgrade	Download new firmware (when available) from the ZyXEL web site and use the web configurator, CLI or an FTP/TFTP tool to put it on the Switch. Note: Only upload firmware for your specific model!
Configuration Backup & Restoration	Make a copy of the Switch's configuration and put it back on the Switch later if you decide you want to revert back to an earlier configuration.
Cluster Management	Cluster management (also known as iStacking) allows you to manage switches through one switch, called the cluster manager. The switches must be directly connected and be in the same VLAN group so as to be able to communicate with one another.

Table 115 Feature Specifications

Layer 2 Features	Bridging	16K MAC addresses Static MAC address filtering by source/destination Broadcast storm control Static MAC address forwarding
	Switching	Switching fabric: 12.8 Gbps, non-blocking Max. Frame size: 9 K bytes Forwarding frame: IEEE 802.3, IEEE 802.1q, Ethernet II, PPPoE Prevent the forwarding of corrupted packets
	STP	IEEE 802.1w Rapid Spanning Tree Protocol (RSTP) Multiple Rapid Spanning Tree capability (2 configurable trees) IEEE 802.1s Multiple Spanning Tree Protocol
	QoS	IEEE 802.1p SPQ, WRR, WFQ, SPQ/WRR or SPQ/WFQ combination capable Eight priority queues per port Rule-based bandwidth control (ingress traffic metering/dropping 64Kb stepping) Port-based egress traffic shaping Rule-based traffic mirroring IGMP snooping

Table 115 Feature Specifications (continued)

	VLAN	Port-based VLAN 802.1Q tag-based VLAN number of VLAN: 4K, 1024 static maximum GVRP for dynamic registration Private VLAN for port isolation. Protocol-Based VLAN. IP subnet based VLAN
	Port Aggregation	IEEE 802.3ad LACP Six groups (up to eight ports each)
	Port mirroring	Port-based mirroring Support port mirroring per IP/TCP/UDP
	Bandwidth control	Supports rate limiting at 64 Kb increments
	Provider Bridge	Layer2 protocol tunneling
Layer 3 Features	IP Capability	IPv4 support 64 Management IPs
	Routing protocols	Static Routing
	IP services	DHCP client DHCP relay VLAN-based DHCP relay DHCP snooping
Filtering	Support L2 MAC filtering, L3 IP filtering, Layer 4 TCP/UDP socket	
Multicast	IGMP snooping (IGMP v1/v2/v3, 16 VLAN maximum-user configurable) IGMP filtering MVR IGMP timer Multicast reserve group Static multicast IGMP snooping fast-leave IGMP snooping statistics IGMP throttling	

Table 115 Feature Specifications (continued)

AAA	Support RADIUS and TACACS+
Security	Static MAC address filtering Static MAC address forwarding MAC Freeze IEEE 802.1x port-based authentication Limiting number of dynamic MAC addresses per port SSH v1/v2 SSL Intrusion Lock Multiple RADIUS servers Multiple TACACS+ servers 802.1X VLAN and bandwidth assignment. IP source guard Static IP/MAC binding DHCP snooping ARP Inspection

The following list, which is not exhaustive, illustrates the standards supported in the Switch.

Table 116 Standards Supported

STANDARD	DESCRIPTION
RFC 826	Address Resolution Protocol (ARP)
RFC 867	Daytime Protocol
RFC 868	Time Protocol
RFC 894	Ethernet II Encapsulation
RFC 1112	IGMP v1
RFC 1155	SMI
RFC 1157	SNMPv1: Simple Network Management Protocol version 1
RFC 1213	SNMP MIB II
RFC 1305	Network Time Protocol (NTP version 3)
RFC 1441	SNMPv2 Simple Network Management Protocol version 2
RFC 1493	Bridge MIBs
RFC 1643	Ethernet MIBs
RFC 1757	RMON
RFC 1901	SNMPv2c Simple Network Management Protocol version 2c
RFC 2138	RADIUS (Remote Authentication Dial In User Service)
RFC 2139	RADIUS Accounting
RFC 2236	Internet Group Management Protocol, Version 2.

Table 116 Standards Supported (continued)

STANDARD	DESCRIPTION
RFC 2865	RADIUS - Vendor Specific Attribute
RFC 2674	P-BRIDGE-MIB, Q-BRIDGE-MIB
RFC 3046	DHCP Relay
RFC 3164	Syslog
RFC 3376	Internet Group Management Protocol, Version 3
RFC 3414	User-based Security Model (USM) for version 3 of the Simple Network Management Protocol (SNMP v3)
RFC 3580	RADIUS - Tunnel Protocol Attribute
IEEE 802.1ab	Link Layer Discovery Protocol (LLDP)
IEEE 802.1ag	Connectivity Fault Management (CFM)
IEEE 802.1x	Port Based Network Access Control
IEEE 802.1D	MAC Bridges
IEEE 802.1p	Traffic Types - Packet Priority
IEEE 802.1Q	Tagged VLAN
IEEE 802.1w	Rapid Spanning Tree Protocol (RSTP)
IEEE 802.1s	Multiple Spanning Tree Protocol (MSTP)
IEEE 802.3	Packet Format
IEEE 802.3ad	Link Aggregation
IEEE 802.3ah	Ethernet OAM (Operations, Administration and Maintenance)
IEEE 802.3x	Flow Control
Safety	UL 60950-1 CSA 60950-1 EN 60950-1 IEC 60950-1
EMC	FCC Part 15 (Class A) CE EMC (Class A)

PART VII

Appendices and Index

Changing a Fuse (335)

Common Services (337)

Legal Information (341)

Index (345)

Changing a Fuse

This appendix shows you how to remove and install fuses for the Switch.

If you use a fuse other than an included fuse, make sure it matches the fuse specifications in the chapter on product specifications.

Removing a Fuse

Disconnect all power from the Switch before you begin this procedure.

- 1 Remove the power cord from the Switch.
- 2 See the product specifications for the location of the fuse. Use a small flat-head screwdriver to carefully pry out the fuse housing.
- 3 A burnt-out fuse is blackened, darkened or cloudy inside its glass casing. A working fuse has a completely clear glass casing. Pull gently, but firmly, to remove the burnt out fuse from the fuse housing. Dispose of the burnt-out fuse properly.

Installing a Fuse

- 1 The Switch is shipped from the factory with one spare fuse included in a box-like section of the fuse housing. Push the middle part of the box-like section to access the spare fuse. Put another spare fuse in its place in order to always have one on hand.
- 2 Push the replacement fuse into the fuse housing until you hear a click.
- 3 Push the fuse housing back into the Switch until you hear a click.
- 4 Plug the power cord back into the unit.

Common Services

The following table lists some commonly-used services and their associated protocols and port numbers. For a comprehensive list of port numbers, ICMP type/code numbers and services, visit the IANA (Internet Assigned Number Authority) web site.

- **Name:** This is a short, descriptive name for the service. You can use this one or create a different one, if you like.
- **Protocol:** This is the type of IP protocol used by the service. If this is **TCP/UDP**, then the service uses the same port number with TCP and UDP. If this is **User-Defined**, the **Port(s)** is the IP protocol number, not the port number.
- **Port(s):** This value depends on the **Protocol**. Please refer to RFC 1700 for further information about port numbers.
 - If the **Protocol** is **TCP, UDP, or TCP/UDP**, this is the IP port number.
 - If the **Protocol** is **USER**, this is the IP protocol number.
- **Description:** This is a brief explanation of the applications that use this service or the situations in which this service is used.

Table 117 Commonly Used Services

NAME	PROTOCOL	PORT(S)	DESCRIPTION
AH (IPSEC_TUNNEL)	User-Defined	51	The IPSEC AH (Authentication Header) tunneling protocol uses this service.
AIM/New-ICQ	TCP	5190	AOL's Internet Messenger service. It is also used as a listening port by ICQ.
AUTH	TCP	113	Authentication protocol used by some servers.
BGP	TCP	179	Border Gateway Protocol.
BOOTP_CLIENT	UDP	68	DHCP Client.
BOOTP_SERVER	UDP	67	DHCP Server.
CU-SEEME	TCP UDP	7648 24032	A popular videoconferencing solution from White Pines Software.
DNS	TCP/UDP	53	Domain Name Server, a service that matches web names (for example www.zyxel.com) to IP numbers.

Table 117 Commonly Used Services (continued)

NAME	PROTOCOL	PORT(S)	DESCRIPTION
ESP (IPSEC_TUNNEL)	User-Defined	50	The IPSEC ESP (Encapsulation Security Protocol) tunneling protocol uses this service.
FINGER	TCP	79	Finger is a UNIX or Internet related command that can be used to find out if a user is logged on.
FTP	TCP TCP	20 21	File Transfer Program, a program to enable fast transfer of files, including large files that may not be possible by e-mail.
H.323	TCP	1720	NetMeeting uses this protocol.
HTTP	TCP	80	Hyper Text Transfer Protocol - a client/server protocol for the world wide web.
HTTPS	TCP	443	HTTPS is a secured http session often used in e-commerce.
ICMP	User-Defined	1	Internet Control Message Protocol is often used for diagnostic or routing purposes.
ICQ	UDP	4000	This is a popular Internet chat program.
IGMP (MULTICAST)	User-Defined	2	Internet Group Multicast Protocol is used when sending packets to a specific group of hosts.
IKE	UDP	500	The Internet Key Exchange algorithm is used for key distribution and management.
IRC	TCP/UDP	6667	This is another popular Internet chat program.
MSN Messenger	TCP	1863	Microsoft Networks' messenger service uses this protocol.
NEW-ICQ	TCP	5190	An Internet chat program.
NEWS	TCP	144	A protocol for news groups.
NFS	UDP	2049	Network File System - NFS is a client/server distributed file service that provides transparent file sharing for network environments.
NNTP	TCP	119	Network News Transport Protocol is the delivery mechanism for the USENET newsgroup service.
PING	User-Defined	1	Packet Internet Groper is a protocol that sends out ICMP echo requests to test whether or not a remote host is reachable.

Table 117 Commonly Used Services (continued)

NAME	PROTOCOL	PORT(S)	DESCRIPTION
POP3	TCP	110	Post Office Protocol version 3 lets a client computer get e-mail from a POP3 server through a temporary connection (TCP/IP or other).
PPTP	TCP	1723	Point-to-Point Tunneling Protocol enables secure transfer of data over public networks. This is the control channel.
PPTP_TUNNEL (GRE)	User-Defined	47	PPTP (Point-to-Point Tunneling Protocol) enables secure transfer of data over public networks. This is the data channel.
RCMD	TCP	512	Remote Command Service.
REAL_AUDIO	TCP	7070	A streaming audio service that enables real time sound over the web.
REXEC	TCP	514	Remote Execution Daemon.
RLOGIN	TCP	513	Remote Login.
RTELNET	TCP	107	Remote Telnet.
RTSP	TCP/UDP	554	The Real Time Streaming (media control) Protocol (RTSP) is a remote control for multimedia on the Internet.
SFTP	TCP	115	Simple File Transfer Protocol.
SMTP	TCP	25	Simple Mail Transfer Protocol is the message-exchange standard for the Internet. SMTP enables you to move messages from one e-mail server to another.
SNMP	TCP/UDP	161	Simple Network Management Program.
SNMP-TRAPS	TCP/UDP	162	Traps for use with the SNMP (RFC:1215).
SQL-NET	TCP	1521	Structured Query Language is an interface to access data on many different types of database systems, including mainframes, midrange systems, UNIX systems and network servers.
SSH	TCP/UDP	22	Secure Shell Remote Login Program.
STRM WORKS	UDP	1558	Stream Works Protocol.
SYSLOG	UDP	514	Syslog allows you to send system logs to a UNIX server.
TACACS	UDP	49	Login Host Protocol used for (Terminal Access Controller Access Control System).

Table 117 Commonly Used Services (continued)

NAME	PROTOCOL	PORT(S)	DESCRIPTION
TELNET	TCP	23	Telnet is the login and terminal emulation protocol common on the Internet and in UNIX environments. It operates over TCP/IP networks. Its primary function is to allow users to log into remote host systems.
TFTP	UDP	69	Trivial File Transfer Protocol is an Internet file transfer protocol similar to FTP, but uses the UDP (User Datagram Protocol) rather than TCP (Transmission Control Protocol).
VDOLIVE	TCP	7000	Another videoconferencing solution.

Legal Information

Copyright

Copyright © 2009 by ZyXEL Communications Corporation.

The contents of this publication may not be reproduced in any part or as a whole, transcribed, stored in a retrieval system, translated into any language, or transmitted in any form or by any means, electronic, mechanical, magnetic, optical, chemical, photocopying, manual, or otherwise, without the prior written permission of ZyXEL Communications Corporation.

Published by ZyXEL Communications Corporation. All rights reserved.

Disclaimer

ZyXEL does not assume any liability arising out of the application or use of any products, or software described herein. Neither does it convey any license under its patent rights nor the patent rights of others. ZyXEL further reserves the right to make changes in any products described herein without notice. This publication is subject to change without notice.

Trademarks

ZyNOS (ZyXEL Network Operating System) is a registered trademark of ZyXEL Communications, Inc. Other trademarks mentioned in this publication are used for identification purposes only and may be properties of their respective owners.

Certifications

Federal Communications Commission (FCC) Interference Statement

This device complies with Part 15 of FCC rules. Operation is subject to the following two conditions:

- This device may not cause harmful interference.

- This device must accept any interference received, including interference that may cause undesired operations.

FCC Warning

This device has been tested and found to comply with the limits for a Class A digital switch, pursuant to Part 15 of the FCC Rules. These limits are designed to provide reasonable protection against harmful interference in a commercial environment. This device generates, uses, and can radiate radio frequency energy and, if not installed and used in accordance with the instruction manual, may cause harmful interference to radio communications. Operation of this device in a residential area is likely to cause harmful interference in which case the user will be required to correct the interference at his own expense.

CE Mark Warning:

This is a class A product. In a domestic environment this product may cause radio interference in which case the user may be required to take adequate measures.

Taiwanese BSMI (Bureau of Standards, Metrology and Inspection) A Warning:

警告使用者
這是甲類的資訊產品，在居住的環境使用時，
可能造成射頻干擾，在這種情況下，
使用者會被要求採取某些適當的對策。

Notices

Changes or modifications not expressly approved by the party responsible for compliance could void the user's authority to operate the equipment.

This Class A digital apparatus complies with Canadian ICES-003.

Cet appareil numérique de la classe A est conforme à la norme NMB-003 du Canada.

CLASS 1 LASER PRODUCT

APPAREIL A LASER DE CLASS 1

PRODUCT COMPLIES WITH 21 CFR 1040.10 AND 1040.11.

PRODUIT CONFORME SELON 21 CFR 1040.10 ET 1040.11.

Viewing Certifications

- 1 Go to <http://www.zyxel.com>.
- 2 Select your product on the ZyXEL home page to go to that product's page.
- 3 Select the certification you wish to view from this page.

ZyXEL Limited Warranty

ZyXEL warrants to the original end user (purchaser) that this product is free from any defects in materials or workmanship for a period of up to two years from the date of purchase. During the warranty period, and upon proof of purchase, should the product have indications of failure due to faulty workmanship and/or materials, ZyXEL will, at its discretion, repair or replace the defective products or components without charge for either parts or labor, and to whatever extent it shall deem necessary to restore the product or components to proper operating condition. Any replacement will consist of a new or re-manufactured functionally equivalent product of equal or higher value, and will be solely at the discretion of ZyXEL. This warranty shall not apply if the product has been modified, misused, tampered with, damaged by an act of God, or subjected to abnormal working conditions.

Note

Repair or replacement, as provided under this warranty, is the exclusive remedy of the purchaser. This warranty is in lieu of all other warranties, express or implied, including any implied warranty of merchantability or fitness for a particular use or purpose. ZyXEL shall in no event be held liable for indirect or consequential damages of any kind to the purchaser.

To obtain the services of this warranty, contact your vendor. You may also refer to the warranty policy for the region in which you bought the device at http://www.zyxel.com/web/support_warranty_info.php.

Registration

Register your product online to receive e-mail notices of firmware upgrades and information at www.zyxel.com for global products, or at www.us.zyxel.com for North American products.

Index

Numerics

802.1P priority [85](#)

A

AAA [199](#)

AAA (Authentication, Authorization and Accounting) [199](#)

access control

limitations [275](#)

login account [285](#)

remote management [294](#)

service port [293](#)

SNMP [276](#)

accounting [199](#)

setup [205](#)

address learning, MAC [99](#), [102](#)

Address Resolution Protocol (ARP) [315](#), [317](#), [318](#)

administrator password [286](#)

age [136](#)

aggregator ID [153](#), [155](#)

airflow [38](#)

applications

backbone [23](#)

bridging [24](#)

IEEE 802.1Q VLAN [25](#)

switched workgroup [25](#)

ARP

how it works [315](#)

viewing [316](#)

ARP (Address Resolution Protocol) [315](#)

ARP inspection [213](#), [216](#)

and MAC filter [216](#)

configuring [217](#)

syslog messages [217](#)

trusted ports [217](#)

authentication [199](#)

setup [205](#)

Authentication, Authorization and Accounting,
see AAA [199](#)

authorization [199](#)

privilege levels [206](#)

setup [205](#)

auto-crossover [35](#)

automatic VLAN registration [90](#)

B

back up, configuration file [271](#)

bandwidth control [141](#), [328](#)

egress rate [142](#)

ingress rate [142](#)

setup [142](#)

basic settings [75](#)

basic setup tutorial [59](#)

binding [213](#)

binding table [213](#)

building [213](#)

BPDUs (Bridge Protocol Data Units) [120](#)

Bridge Protocol Data Units (BPDUs) [120](#)

bridging [328](#)

broadcast storm control [145](#)

C

CDP [246](#)

certifications [341](#)

notices [342](#)

viewing [343](#)

CFI (Canonical Format Indicator) [89](#)

changing the password [49](#)

Cisco Discovery Protocol, see CDP

CIST [124](#)

Class of Service (CoS) [253](#)

classifier [167](#), [169](#)

and QoS [167](#)

- editing [170](#)
 - example [171](#)
 - overview [167](#)
 - setup [167](#), [169](#), [170](#)
 - viewing [170](#)
 - cloning a port See port cloning [318](#)
 - cluster management [303](#)
 - and switch passwords [309](#)
 - cluster manager [303](#), [308](#)
 - cluster member [303](#), [309](#)
 - cluster member firmware upgrade [306](#)
 - network example [304](#)
 - setup [308](#)
 - specification [303](#)
 - status [304](#)
 - switch models [303](#)
 - VID [309](#)
 - web configurator [305](#)
 - cluster manager [303](#)
 - cluster member [303](#)
 - Common and Internal Spanning Tree, See CIST [124](#)
 - configuration [251](#)
 - change running config [269](#)
 - file names [271](#)
 - configuration file [50](#)
 - backup [271](#)
 - restore [50](#), [270](#)
 - saving [269](#)
 - configuration, saving [49](#)
 - console port [34](#)
 - copying port settings, See port cloning [318](#)
 - copyright [341](#)
 - CPU management port [105](#)
 - current date [77](#)
 - current time [77](#)
- ## D
- daylight saving time [77](#)
 - default Ethernet settings [35](#)
 - DHCP [257](#)
 - configuration options [257](#)
 - modes [257](#)
 - Option 82 [259](#)
 - overview [257](#)
 - relay agent [257](#)
 - relay agent information [258](#)
 - relay example [263](#)
 - setup [261](#)
 - VLAN setting [261](#)
 - DHCP relay [258](#)
 - configuration [259](#)
 - example [260](#)
 - DHCP relay option 82 [215](#)
 - DHCP snooping [59](#), [213](#), [214](#)
 - configuring [215](#)
 - DHCP relay option 82 [215](#)
 - trusted ports [214](#)
 - untrusted ports [214](#)
 - DHCP snooping database [214](#)
 - diagnostics [297](#)
 - Ethernet port test [298](#)
 - ping [298](#)
 - system log [298](#)
 - Differentiated Service (DiffServ) [253](#)
 - DiffServ [253](#)
 - activate [254](#)
 - DS field [253](#)
 - DSCP [253](#)
 - network example [254](#)
 - PHB [253](#)
 - dimensions [325](#)
 - disclaimer [341](#)
 - DS (Differentiated Services) [253](#)
 - DSCP
 - service level [253](#)
 - what it does [253](#)
 - DSCP (DiffServ Code Point) [253](#)
 - Dynamic Host Configuration Protocol, see DHCP
 - dynamic link aggregation [149](#)
- ## E
- egress port [108](#)
 - egress rate, and bandwidth control [142](#)
 - Ethernet broadcast address [315](#)
 - Ethernet port test [298](#)
 - external authentication server [200](#)

F

- FCC interference statement [341](#)
- file transfer using FTP
 - command example [272](#)
- filename convention, configuration [271](#)
- filtering [117](#)
 - rules [117](#)
- filtering database, MAC table [311](#)
- firmware [76](#)
 - upgrade [269](#), [306](#)
- flow control [84](#)
 - back pressure [84](#)
 - IEEE802.3x [84](#)
- forwarding
 - delay [136](#)
- frames
 - tagged [98](#)
 - untagged [98](#)
- front panel [33](#)
- FTP [271](#)
 - file transfer procedure [272](#)
 - restrictions over WAN [273](#)
- fuse [335](#)
 - replacement [335](#)

G

- GARP [90](#)
- GARP (Generic Attribute Registration Protocol) [90](#)
- GARP terminology [90](#)
- GARP timer [79](#), [90](#)
- general features [328](#)
- general setup [76](#)
- getting help [52](#)
- Gigabit ports [35](#)
- GMT (Greenwich Mean Time) [77](#)
- GVRP [90](#), [97](#), [98](#)
 - and port assignment [98](#)
- GVRP (GARP VLAN Registration Protocol) [90](#)

H

- hardware installation [29](#)
- hardware overview [33](#)
- hello time [136](#)
- hops [136](#)
- HTTPS [289](#)
 - certificates [289](#)
 - implementation [289](#)
 - public keys, private keys [289](#)
- HTTPS example [290](#)
- humidity [325](#)

I

- IEEE 802.1p, priority [80](#)
- IEEE 802.1x
 - activate [161](#), [203](#)
 - port authentication [159](#)
 - reauthentication [162](#)
- IGMP
 - version [183](#)
- IGMP (Internet Group Management Protocol) [183](#)
- IGMP filtering [183](#)
 - profile [189](#)
 - profiles [186](#)
- IGMP leave timeout
 - fast [187](#)
 - normal [187](#)
- IGMP snooping [184](#)
 - and VLANs [184](#)
 - MVR [191](#)
 - setup [188](#)
- IGMP throttling [187](#)
- ingress port [108](#)
- ingress rate, and bandwidth control [142](#)
- install
 - fuse [335](#)
- installation
 - desktop [29](#)
 - precautions [30](#)
 - rack-mounting [29](#)
 - transceivers [36](#)
- installation scenarios [29](#)

- introduction [23](#)
- IP address [82](#)
- IP capability [329](#)
- IP interface [81](#)
- IP services [329](#)
- IP setup [80](#)
- IP source guard [213](#)
 - ARP inspection [213](#), [216](#)
 - DHCP snooping [213](#), [214](#)
 - static bindings [213](#)
- IP subnet mask [82](#)

L

- L2PT [243](#)
 - access port [244](#)
 - CDP [243](#)
 - configuration [245](#)
 - encapsulation [243](#)
 - LACP [243](#)
 - MAC address [243](#)
 - mode [244](#)
 - overview [243](#)
 - PAgP [243](#)
 - point to point [243](#)
 - STP [243](#)
 - tunnel port [244](#)
 - UDLD [243](#)
 - VTP [243](#)
- LACP [149](#), [246](#)
 - system priority [156](#)
 - timeout [156](#)
- layer 2 features [328](#)
- Layer 2 protocol tunneling, see L2PT
- layer 3 features [329](#)
- LEDs [39](#)
- limit MAC address learning [165](#)
- link aggregation [149](#)
 - dynamic [149](#)
 - ID information [150](#)
 - setup [153](#), [155](#)
 - status [151](#)
 - traffic distribution algorithm [152](#)
 - traffic distribution type [154](#)
 - trunk group [149](#)
- Link Aggregation Control Protocol (LACP) [149](#)

- Link Aggregation Control Protocol, see LACP [149](#)
- lockout [50](#)
- log [298](#)
- login [43](#)
 - password [49](#)
- login account
 - Administrator [285](#)
 - non-administrator [285](#)
- login accounts [285](#)
 - configuring via web configurator [285](#)
 - multiple [285](#)
 - number of [285](#)
- login password [286](#)
- loop guard [239](#)
 - examples [240](#)
 - port shut down [241](#)
 - setup [241](#)
 - vs. STP [239](#)

M

- MAC (Media Access Control) [76](#)
- MAC address [76](#), [315](#)
 - maximum number per port [165](#)
- MAC address learning [99](#), [102](#), [109](#), [165](#)
 - specify limit [165](#)
- MAC filter
 - and ARP inspection [216](#)
- MAC freeze [164](#)
- MAC table [311](#)
 - display criteria [313](#)
 - how it works [311](#)
 - sorting criteria [313](#)
 - transfer type [313](#)
 - viewing [312](#)
- maintenance [267](#)
 - configuration backup [271](#)
 - current configuration [267](#)
 - firmware [269](#)
 - main screen [267](#)
 - restoring configuration [270](#)
- Management Information Base (MIB) [276](#)
- management port [108](#)
- managing the device
 - good habits [28](#)

- using FTP. See FTP. [27](#)
 - using Telnet. See command interface. [27](#)
 - using the command interface. See command interface. [27](#)
 - man-in-the-middle attacks [216](#)
 - max
 - age [136](#)
 - hops [136](#)
 - MDIX (Media Dependent Interface Crossover) [35](#)
 - MIB
 - and SNMP [276](#)
 - supported MIBs [277](#)
 - MIB (Management Information Base) [276](#)
 - mirroring ports [147](#)
 - monitor port [147](#), [148](#)
 - mounting brackets [30](#)
 - MRSTP status [133](#)
 - MST ID [124](#)
 - MST Instance, See MSTI [124](#)
 - MST region [123](#)
 - MSTI [124](#)
 - MSTP [119](#), [122](#)
 - bridge ID [139](#)
 - configuration [135](#)
 - configuration digest [139](#)
 - forwarding delay [136](#)
 - Hello Time [139](#)
 - hello time [136](#)
 - Max Age [139](#)
 - max age [136](#)
 - max hops [136](#)
 - path cost [137](#)
 - port priority [137](#)
 - revision level [136](#)
 - status [138](#)
 - MTU (Multi-Tenant Unit) [78](#)
 - multicast [183](#)
 - 802.1 priority [186](#)
 - and IGMP [183](#)
 - IGMP throttling [187](#)
 - IP addresses [183](#)
 - overview [183](#)
 - setup [185](#), [186](#)
 - multicast group [189](#)
 - multicast VLAN [195](#)
 - Multiple Rapid Spanning Tree Protocol [121](#)
 - Multiple RSTP [121](#)
 - Multiple Spanning Tree Protocol, See MSTP [119](#), [122](#)
 - Multiple STP [122](#)
 - MVR [191](#)
 - configuration [193](#)
 - group configuration [195](#)
 - network example [191](#)
 - MVR (Multicast VLAN Registration) [191](#)
- ## N
- network applications [23](#)
 - network management system (NMS) [276](#)
 - NTP (RFC-1305) [77](#)
- ## P
- PAGP [246](#)
 - password [49](#)
 - administrator [286](#)
 - PHB (Per-Hop Behavior) [253](#)
 - ping, test connection [298](#)
 - policy [174](#), [176](#)
 - and classifier [174](#)
 - and DiffServ [173](#)
 - configuration [174](#)
 - example [177](#)
 - overview [173](#)
 - rules [173](#)
 - viewing [176](#)
 - policy configuration [176](#)
 - Port Aggregation Protocol, see PAgP
 - port authentication [159](#)
 - and RADIUS [200](#), [201](#)
 - IEEE802.1x [161](#), [203](#)
 - port based VLAN type [79](#)
 - port cloning [317](#), [318](#)
 - advanced settings [317](#), [318](#)
 - basic settings [317](#), [318](#)
 - port details [71](#)
 - port isolation [108](#)
 - port mirroring [147](#), [148](#), [328](#)

- direction [148](#)
- egress [148](#)
- ingress [148](#)
- port redundancy [150](#)
- port security [163](#)
 - limit MAC address learning [165](#)
 - MAC address learning [163](#)
 - overview [163](#)
 - setup [164](#), [241](#), [245](#)
- port setup [83](#)
- port status [70](#)
- port VLAN ID, see PVID [98](#)
- port VLAN trunking [91](#)
- port-based VLAN [105](#)
 - all connected [108](#)
 - port isolation [108](#)
 - settings wizard [108](#)
- ports
 - diagnostics [298](#)
 - mirroring [147](#)
 - speed/duplex [84](#)
 - standby [150](#)
- power connector [38](#)
- power consumption [325](#)
- power specification [325](#)
- priority level [80](#)
- priority, queue assignment [80](#)
- product registration [343](#)
- protocol based VLAN [101](#)
 - and IEEE 802.1Q tagging [101](#)
 - application example [101](#)
 - configuration example [104](#)
 - isolate traffic [101](#)
 - priority [103](#)
 - un-tagged packets [101](#)
- PVID [90](#)
- PVID (Priority Frame) [90](#)

Q

- QoS [328](#)
 - and classifier [167](#)
- queue weight [180](#)
- queuing [179](#)
 - SPQ [180](#)

- WRR [180](#)
- queuing method [179](#), [182](#)

R

- rack-mounting [29](#)
- RADIUS [199](#), [200](#)
 - advantages [200](#)
 - and port authentication [200](#)
 - and tunnel protocol attribute [209](#)
 - Network example [200](#)
 - server [200](#)
 - settings [201](#)
 - setup [201](#)
- Rapid Spanning Tree Protocol, See RSTP. [119](#)
- rear panel connections [38](#)
- reboot
 - load configuration [269](#)
- reboot system [269](#)
- registration
 - product [343](#)
- related documentation [3](#)
- remote management [294](#)
 - service [295](#)
 - trusted computers [295](#)
- removing fuses [335](#)
- resetting [50](#), [268](#)
 - to factory default settings [268](#)
- restoring configuration [50](#), [270](#)
- RFC 3164 [299](#)
- Round Robin Scheduling [180](#)
- routing protocols [329](#)
- RSTP [119](#)

S

- safety certifications [331](#)
- safety warnings [7](#)
- save configuration [49](#), [269](#)
- security [329](#)
- service access control [293](#)
 - service port [294](#)

- Simple Network Management Protocol, see SNMP [276](#)
 - Small Form-factor Pluggable (SFP) [36](#)
 - SNMP [276](#)
 - agent [276](#)
 - and MIB [276](#)
 - and security [277](#)
 - authentication [283](#)
 - communities [282](#)
 - management model [276](#)
 - manager [276](#)
 - MIB [277](#)
 - network components [276](#)
 - object variables [276](#)
 - protocol operations [277](#)
 - security [283](#)
 - setup [282](#), [284](#)
 - version 3 [277](#)
 - versions supported [276](#)
 - SNMP traps [278](#)
 - setup [284](#)
 - supported [278](#), [279](#), [281](#)
 - Spanning Tree Protocol, See STP. [119](#)
 - SPQ (Strict Priority Queuing) [180](#)
 - SSH
 - encryption methods [289](#)
 - how it works [288](#)
 - implementation [289](#)
 - SSH (Secure Shell) Secure Shell, See SSH [287](#)
 - SSL (Secure Socket Layer) [289](#)
 - standby ports [150](#)
 - static bindings [213](#)
 - static link aggregation example [156](#)
 - static MAC address [109](#)
 - static MAC forwarding [99](#), [102](#), [109](#)
 - static multicast address [113](#)
 - static multicast forwarding [113](#)
 - static routes [251](#)
 - static trunking example [156](#)
 - Static VLAN [95](#)
 - static VLAN
 - control [96](#)
 - tagging [96](#)
 - status [44](#), [70](#)
 - link aggregation [151](#)
 - MSTP [138](#)
 - port [70](#)
 - port details [71](#)
 - STP [129](#), [133](#)
 - VLAN [93](#)
 - STP [119](#), [246](#), [328](#)
 - bridge ID [129](#), [133](#)
 - bridge priority [128](#), [132](#)
 - configuration [127](#), [131](#)
 - designated bridge [120](#)
 - forwarding delay [128](#), [132](#)
 - Hello BPDU [120](#)
 - Hello Time [128](#), [129](#), [132](#), [134](#)
 - how it works [120](#)
 - Max Age [128](#), [130](#), [132](#), [134](#)
 - path cost [120](#), [128](#), [132](#)
 - port priority [128](#), [132](#)
 - port state [121](#)
 - root port [120](#)
 - status [129](#), [133](#)
 - terminology [119](#)
 - vs. loop guard [239](#)
 - subnet based VLAN [100](#)
 - and DHCP VLAN [100](#)
 - priority [100](#)
 - setup [99](#)
 - subnet based VLANs [98](#)
 - switch lockout [50](#)
 - switch reset [50](#)
 - switch setup [79](#)
 - switching [328](#)
 - syntax conventions [5](#)
 - syslog [217](#), [299](#)
 - protocol [299](#)
 - server setup [301](#)
 - settings [300](#)
 - setup [300](#)
 - severity levels [299](#)
 - system information [75](#)
 - system log [298](#)
 - system reboot [269](#)
- ## T
- TACACS+ [199](#), [200](#)
 - setup [203](#)
 - TACACS+ (Terminal Access Controller Access-Control System Plus) [199](#)

- tagged VLAN [89](#)
- temperature [325](#)
- terminal emulation [34](#)
- time
 - current [77](#)
 - time zone [77](#)
- Time (RFC-868) [77](#)
- time server [77](#)
- time service protocol [77](#)
 - format [77](#)
- trademarks [341](#)
- transceiver MultiSource Agreement (MSA) [36](#)
- transceivers [36](#)
 - installation [36](#)
 - removal [37](#)
- traps
 - destination [283](#)
- trunk group [149](#)
- trunking [149](#), [328](#)
 - example [156](#)
- trusted ports
 - ARP inspection [217](#)
 - DHCP snooping [214](#)
- tunnel protocol attribute, and RADIUS [209](#)
- tutorials [59](#)
 - DHCP snooping [59](#)
- Type of Service (ToS) [253](#)

U

- UDLD [246](#)
- UniDirectional Link Detection, see UDLD
- untrusted ports
 - ARP inspection [217](#)
 - DHCP snooping [214](#)
- user profiles [200](#)

V

- Vendor Specific Attribute, See VSA [208](#)
- ventilation [29](#)
- VID [93](#), [94](#)
 - number of possible VIDs [89](#)

- priority frame [89](#)
- VID (VLAN Identifier) [89](#)
- VLAN [78](#), [328](#)
 - acceptable frame type [98](#)
 - automatic registration [90](#)
 - ID [89](#)
 - IGMP snooping [184](#)
 - ingress filtering [97](#)
 - introduction [78](#), [89](#)
 - number of VLANs [93](#)
 - port number [94](#)
 - port settings [97](#)
 - port-based VLAN [105](#)
 - port-based, all connected [108](#)
 - port-based, isolation [108](#)
 - port-based, wizard [108](#)
 - PVID [98](#)
 - static VLAN [95](#)
 - status [93](#), [94](#)
 - subnet based [98](#)
 - tagged [89](#)
 - trunking [91](#), [98](#)
 - type [79](#), [92](#)
- VLAN (Virtual Local Area Network) [78](#)
- VLAN ID [82](#)
- VLAN Trunking Protocol, see VTP
- VLAN, protocol based, See protocol based VLAN [101](#)
- VSA [208](#)
- VT100 [34](#)
- VTP [246](#)

W

- warranty [343](#)
 - note [343](#)
- web configurator [43](#)
 - getting help [52](#)
 - home [44](#)
 - login [43](#)
 - logout [51](#)
 - navigation panel [46](#)
- weight, queuing [180](#)
- Weighted Round Robin Scheduling (WRR) [180](#)
- WRR (Weighted Round Robin Scheduling) [180](#)

Z

ZyNOS (ZyXEL Network Operating System) [272](#)

