

[STOP]

- 2** Press the **EMERGENCY OPERATION** switch again.

PRECAUTIONS FOR GROUP CONTROL SYSTEM OR TWO REMOTE CONTROLLER CONTROL SYSTEM

This system provides two other control systems beside individual control (one remote controller controls one indoor unit) system. Confirm the following if your unit is of the following control system type.

■ Group control system

One remote controller controls up to 16 indoor units.
All indoor units are equally set.

■ Two remote controller control system

Two remote controllers control one indoor unit. (In case of group control system, one group of indoor units)
The unit follows individual operation.

NOTES

- Cannot have two remote controller control system with only wireless remote controllers. (It will be a two remote controller control system having one wired and one wireless remote controllers.)
- Under two remote controller control system, wireless remote controller cannot control timer operation.
- Only the operating indicator lamp out of 3 other lamps on the indoor unit display functions.

NOTE

- Contact your Daikin dealer in case of changing the combination or setting of group control and two remote controller control systems.

6. NOT MALFUNCTION OF THE AIR CONDITIONER

The following symptoms do not indicate air conditioner malfunction

I. THE SYSTEM DOES NOT OPERATE

- **The system does not restart immediately after the ON/OFF button is pressed.**
If the OPERATION lamp lights, the system is in normal condition. It does not restart immediately because a safety device operates to prevent overload of the system. After 3 minutes, the system will turn on again automatically.
- **The system does not restart immediately when TEMPERATURE SETTING button is returned to the former position after pushing the button.**
It does not restart immediately because a safety device operates to prevent overload of the system. After 3 minutes, the system will turn on again automatically.
- **If the reception beep is rapidly repeated 3 times (It sounds only twice when operating normally.)**
Control is set to the optional controller for centralized control.
- **If the defrost lamp on the indoor unit's display is lit when heating is started.**
This indication is to warn against cold air being blown from the unit. There is nothing wrong with the equipment.

7. HOW TO DIAGNOSE TROUBLE SPOTS

I. EMERGENCY STOP

When the air conditioner stops in emergency, the run lamp on the indoor unit starts blinking. Take the following steps yourself to read the malfunction code that appears on the display. Contact your dealer with this code. It will help pinpoint the cause of the trouble, speeding up the repair.

3P107422-1F

2

2.8 BRC7E530W / BRC7E531W



Большая библиотека технической документации
<http://splitoff.ru/tehn-doc.html>
 каталоги, инструкции, сервисные мануалы, схемы.



Press the **INSPECTION/TEST** button to select the inspection mode “**U**”.

“**U**” appears on display and blinks. “UNIT” lights up.



Press **PROGRAMMING TIMER** **BUTTON** and change the unit number.

Press to change the unit number until the indoor unit beeps and perform the following operation according to the number of beeps.

Number of beeps

3 short beepsPerform all steps from **3** to **6**.

1 short beepPerform **3** and **6** steps.

1 long beepNormal state



Press **OPERATION MODE SELECTOR** **BUTTON**

“**U**” on the left-hand of the malfunction code blinks.



Press **PROGRAMMING TIMER** **BUTTON** and change the malfunction code.

Press until the indoor unit beeps twice.



Press **OPERATION MODE SELECTOR** **BUTTON**

“**U**” on the right-hand of the malfunction code blinks.



Press **PROGRAMMING TIMER** **BUTTON** and change the malfunction code.

Press until the indoor unit makes a long beep.

The malfunction code is fixed when the indoor unit makes a long beep.



Reset of the display

Press **OPERATION MODE SELECTOR** **BUTTON** to get the display back to the normal state.

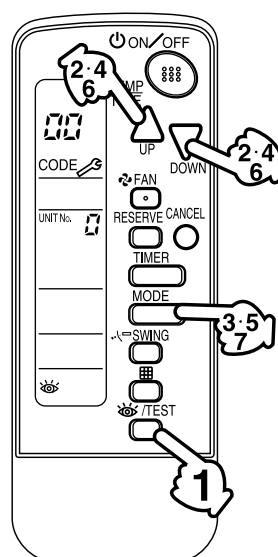

3P107422-1F

II. IN CASE BESIDES EMERGENCY STOP

1. The unit does not operate at all.

- Check if the receiver is exposed of sunlight or strong light. Keep receiver away from light.
- Check if there are batteries in the remote controller. Place the batteries.
- Check if the indoor unit number and wireless remote controller number are equal.

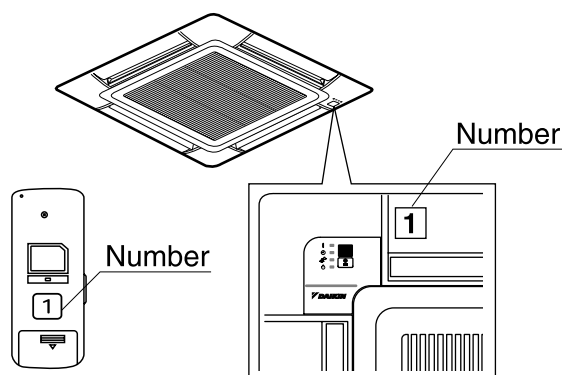

Operate the indoor unit with the remote controller of the same number.

Signal transmitted from a remote controller of a different number cannot be accepted. (If the number is not mentioned, it is considered as "1")

2. The system operates but it does not sufficiently cool or heat.

- If the set temperature is not proper.
- If the FAN SPEED is set to LOW SPEED.
- If the air flow angle is not proper.

Contact the place of purchase in the following case.

⚠ WARNING

When you detect a burning odor, shut OFF power immediately and contact the place of purchase. Using the equipment in anything but proper working condition can result in equipment damage, electric shock and/or fire.

[Trouble]

The RUN lamp of the indoor unit is flashing and the unit does not work at all.

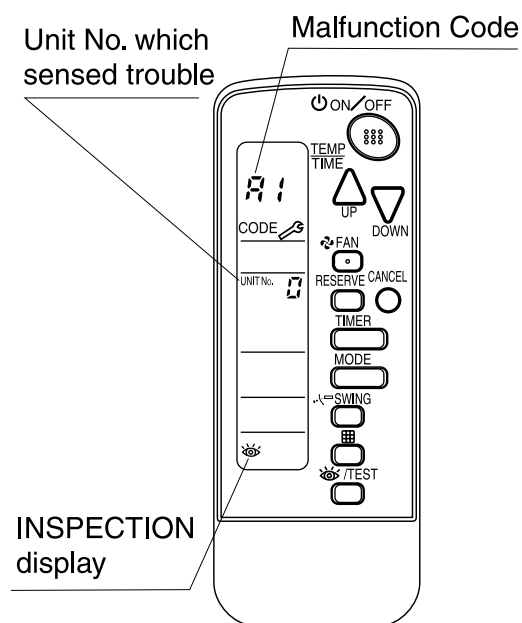

[Remedial action]

Check the malfunction code (A1 - UF) on the remote controller.

Notify and inform the model name and what the malfunction code indicates to your Daikin dealer.

2.8.2 Installation

1. SAFETY CONSIDERATIONS

Please read this "SAFETY CONSIDERATIONS" carefully before installing air conditioning equipment and be sure to install it correctly. After completing the installation, make sure at start up operation that the unit operates properly. Please instruct the customer how to operate the unit and keep maintenance.

Meaning of caution symbols

CAUTION If the caution is not observed, it may cause injury or damage to equipment.





NOTE These instructions will ensure proper use of the equipment.



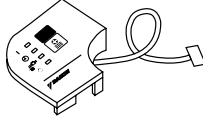
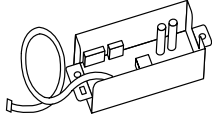

- CAUTION**
- Refer also to the installation manual attached to the indoor unit and the installation manual attached to the decoration panel.
 - Confirm that following conditions are satisfied prior to installation.
 - Ensure that nothing interrupts the operation of the wireless remote controller. (Ensure that there is neither a source of light nor fluorescent lamp near the receiver. Also, ensure that the receiver is not exposed of direct sunlight.)
 - Ensure that the operation display lamp and other indicators are easy to see.
 - The installation position of this kit is 1 position of the decoration panel. Therefore, confirm that its position is set so that the single form the wireless remote controller can be easily transmitted and its display can be easily seen.

2. BEFORE INSTALLATION

2-1 ACCESSORIES

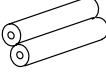
Check if the following accessories are included with your unit.

Name	Receiver	Transmitter board	Tapping screw for transmitter board	Wireless remote controller	Remote controller holder
Quantity	1 set.	1 pc.	2 pcs.	1 pc.	1 pc.
Shape					

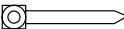
Name	Dry cell battery LR03 (AM4)	Unit No. label	Screw for installing remote controller holder	Operation manual	Clamp
Quantity	2 pcs.	1 pc.	2 pcs.	1 pc.	1 pc.
Shape					

2-2 NOTE TO THE INSTALLER

- Be sure to instruct the customer how to properly operate the system showing him/her the attached operation manual.

3P107423-1B

3. REMOTE CONTROLLER INSTALLATION

<Installing wireless remote controller>

- Do not throw the remote controller or impose large shocks. Also, do not store where it may be exposed to moisture or direct sunlight.
- When operating, point the transmitting part of the remote controller in the direction of the receiver.
- The direct transmitting distance of the remote controller is approximately 7 meters.
- The signal cannot be transmitted if something such as curtains blocks the receiver and the remote controller.

Installing to a wall or a pillar

(1) Fix the remote controller holder with the screws.

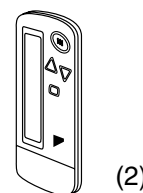

(2) Slide the remote controller into the remote controller holder from the top.

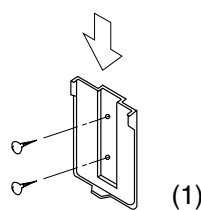

• How to insert the batteries

1. Open the back cover of the remote controller by sliding it in the direction of the arrow.

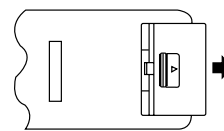

2. Insert the attached dry cell batteries. Properly insert, set the batteries by matching the (+) and (-) polarity marks as indicated. Then close the cover as before.

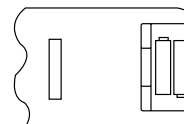

3P107423-1B

4. RECEIVER INSTALLATION

(1) Preparations before installation

1. Detach the brand name plate part of the decoration corner panel piece, before attaching the decoration panel. This part is not needed hereafter.
2. Next, remove the suction grille and the air filter according to the instructions in the installation manual attached to the decoration panel.
3. Remove the control box lid according to the instructions in the installation manual attached to the indoor unit. (Be sure to turn off power, before removing the control box lid.)

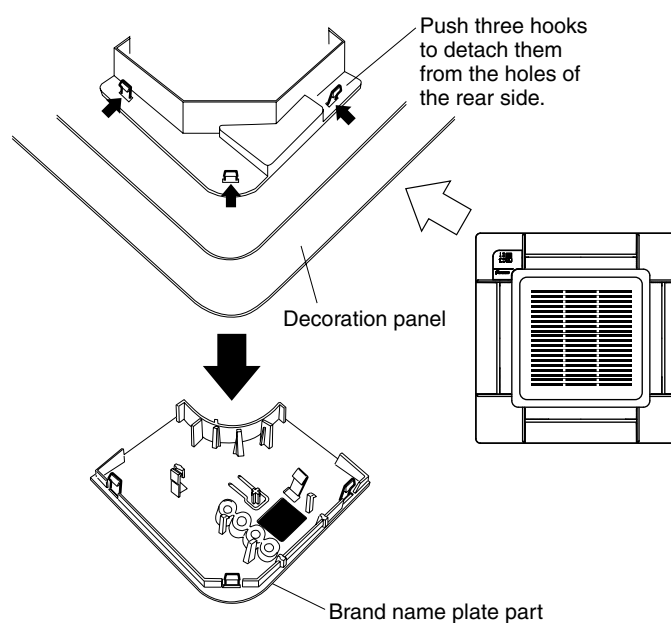

(2) Determination of address and MAIN/SUB remote controller.

If setting multiple wireless remote controllers to operate in one room, perform address setting for the receiver and the wireless remote controller.

If setting multiple wired remote controllers in one room, change the MAIN/SUB switch of the receiver.

SETTING PROCEDURE

1. Setting the receiver

Set the wireless address switch (SS2) on the transmitter board according to the table below.

Unit No.	No. 1	No. 2	No. 3
Wireless address switch (SS2)			

When using both a wired and a wireless remote controller for 1 indoor unit, the wired controller should be set to MAIN. Therefore, set the MAIN/SUB switch (SS1) of the transmitter board to SUB.



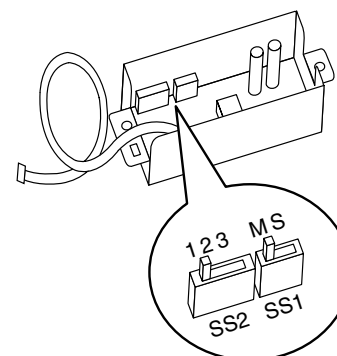

	MAIN	SUB
MAIN/SUB switch (SS1)		





3P107423-1B

2. Setting the address of wireless remote controller (It is factory set to "1")

Setting from the remote controller

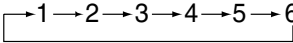
1. Hold down the  button and the  button for at least 4 seconds to get the Field Set mode. (Indicated in the display area in the figure at right.)
2. Press the  button and select a multiple setting (A/b). Each time the button is pressed the display switches between "A" and "b".
3. Press the "" button and "" button to set the address.



Address can be set from 1 to 6, but set it to 1 ~ 3 and to same address as the receiver. (The receiver does not work with address 4 ~ 6.)
4. Press the  button to enter the setting.
5. Hold down the  button for at least 1 second to quit the Field Set mode and return to the normal display.

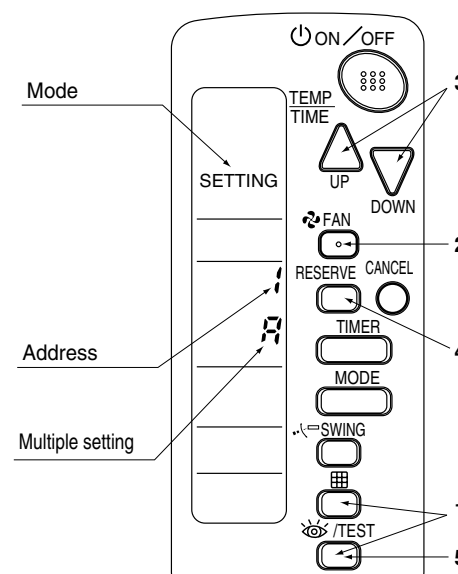

Multiple settings A/b

When the indoor unit is being operating by outside control (central remote controller, etc.), it sometimes does not respond to ON/OFF and temperature setting commands from this remote controller. Check what setting the customer wants and make the multiple setting as shown below.

Remote controller		Movement when the operation is controlled by the other air conditioners and equipment
Multiple setting	Remote controller display	
A: Standard	All items displayed.	When operation changeover, temperature setting or the like is carried out from the remote controller, the indoor unit rejects the instruction. (Signal receiving sound "peeh" or "pick-pick-pick") As a result, a discrepancy between the operation state of the indoor unit and the indication of the remote controller display occurs.
b: Multi System	Operations remain displayed shortly after execution.	Since the indication of the remote controller is turned off, no discrepancy such as mentioned above occurs.

3. Stick the Unit No. label on the air outlet of the decoration panel and the back of the wireless remote controller.

[PRECAUTIONS]

Set the Unit No. of the receiver and the wireless remote controller to be equal. If the settings differ, the signal from the remote controller cannot be transmitted.

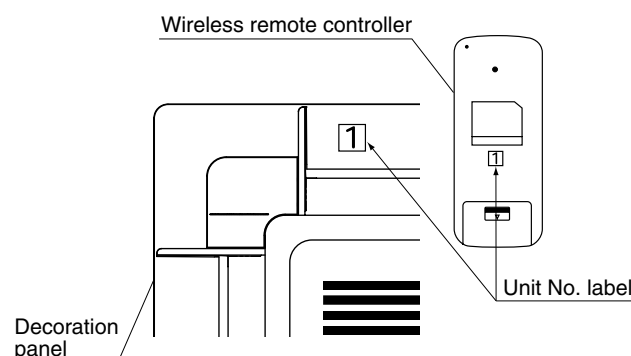

3P107423-1B

(3) Receiver installation

1. As shown at right, pass the harness from the receiver through the wiring hole of the decoration panel. Then, attach the receiver to the decoration panel.

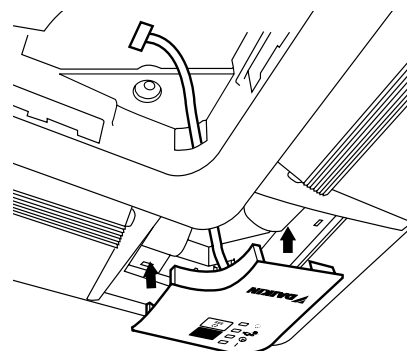

2. Hook the harness from the receiver on the upper part of the panel temporary suspension of the decoration panel. Be sure to push the harness to the groove.

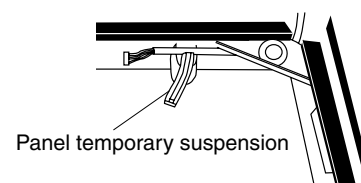

3. Attach the decoration panel to the indoor unit.
(Refer to the installation manual attached to the decoration panel.)
4. Connect the harness from the receiver to the connector X1A on the transmitter board.

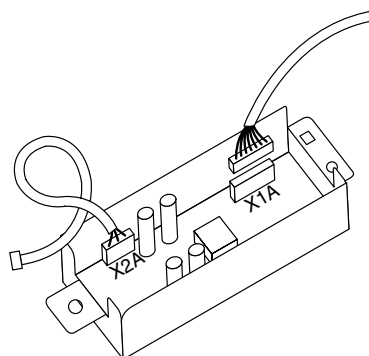

After connecting, use the attached clamp to fix the two harnesses to the transmitter board box.

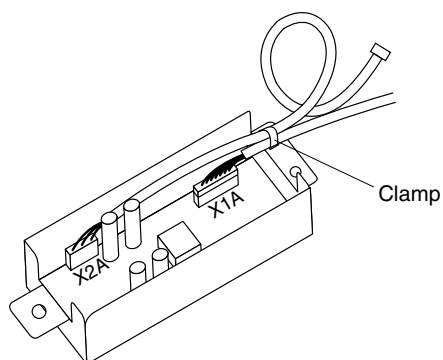

3P107423-1B

5. Use two tapping screws to attach the transmitter board to the indoor unit, as shown in the figure.

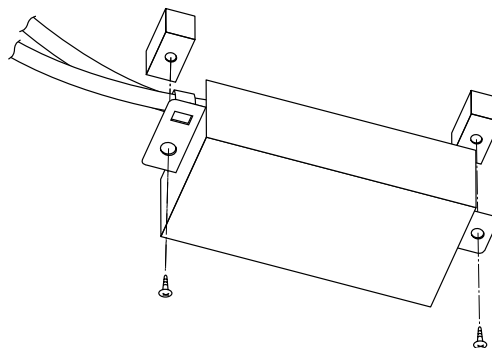

6. Connect the harness from the transmitter board to the connector X24 on the indoor unit PC board.

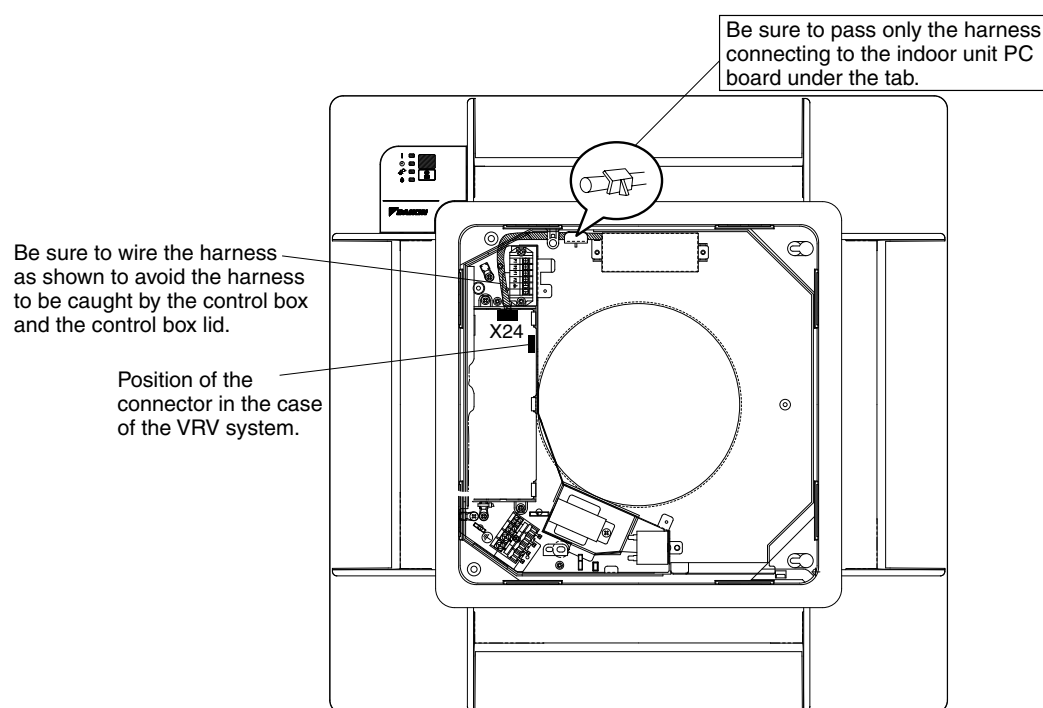

5. FIELD SETTING

If optional accessories are mounted on the indoor unit, the indoor unit setting may have to be changed. Refer to the instruction manual (optional hand book) for each optional accessory.

Procedure

1. When in the normal mode, press the button for a minimum of four seconds, and the FIELD SET MODE is entered.
2. Select the desired MODE NO. with the button.
3. Push the “” button and select the FIRST CODE NO.
4. Push the “” button and select the SECOND CODE NO.
5. Push the button and the present settings are SET.
6. Push the button to return to the NORMAL MODE.

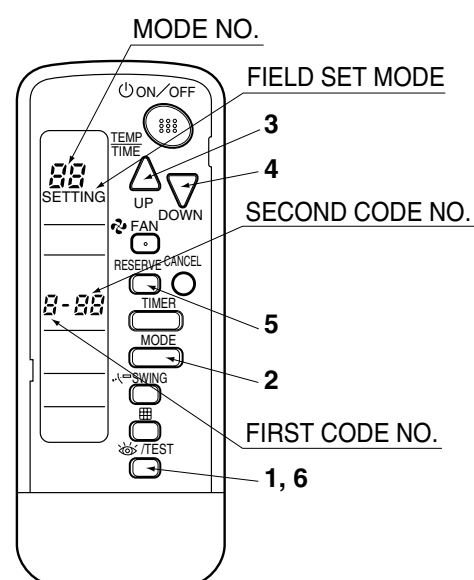

3P107423-1B

(Example)

If the time to clean air filter is set to "Filter Contamination-Heavy", set Mode No. to "10", FIRST CODE NO. to "0", and SECOND CODE NO. to "02".

MODE NO.	FIRST CODE NO.	DESCRIPTION OF SETTING	SECOND CODE NO. NOTE)			
			01	02	03	
10	0	Filter Contamination-Heavy/Light (Setting for spacing time of display time to clean air filter) (Setting for when filter contamination is heavy, and spacing time of display time to clean air filter is to be halved)	Long-life type	light approx. 2,500 hours	heavy approx. 1,250 hours	-
	3	Spacing time of display time to clean air filter count (Setting for when the filter sign is not to be displayed)		Display	Do not display	-
12 (VRV system)	1	ON/OFF input from outside (Set to enable starting/stopping from remote.)		Forced OFF input	ON/OFF	-
	2	Thermostat differential changeover (Set when using remote controller thermostat sensor.)		1°C	0.5°C	-
13	1	Selection of Air Flow Direction (Setting for when a sealing member of air discharge outlet kit has been installed)		F	T	W
	4	Air Flow Direction Range Setting		Upper	Normal	Lower

NOTE

- The SECOND CODE NO. is factory set to "01". However, for the following cases it is set to "02".
 - Air Flow Direction Range Setting

Do not use any settings not listed in the table.

For group control with a wireless remote controller, initial settings for all the indoor units of the group are equal.

(For group control, refer to the installation manual attached to the indoor unit for group control.)





3P107423-1B

6. TEST OPERATION

- Perform test operation according to the instructions in the installation manual attached to the indoor unit.
- After refrigerant piping, drain piping, and electric wiring, operate according to the table to protect the unit.

[PRECAUTIONS]

1. Refer to malfunction code of installation manual attached to the indoor unit, if it does not operate.
2. Refer to the installation manual attached to the outdoor unit for individual operation system types.

Order	Operation
(1)	Open gas side stop valve.
(2)	Open liquid side stop valve.
(3)	Electrify for 6 hours.
(4)	Set to cooling with the remote controller and push  button to start operation.
(5)	Push  button twice and operate in TEST OPERATION mode for 3 minutes.
(6)	Push  button and confirm its operation.
(7)	Push  button and operate normally.
(8)	Confirm its function according to the operation manual.

3P107423-1B

2.9 BRC7C528W / BRC7C529W (for FXUQ)

2.9.1 Operation

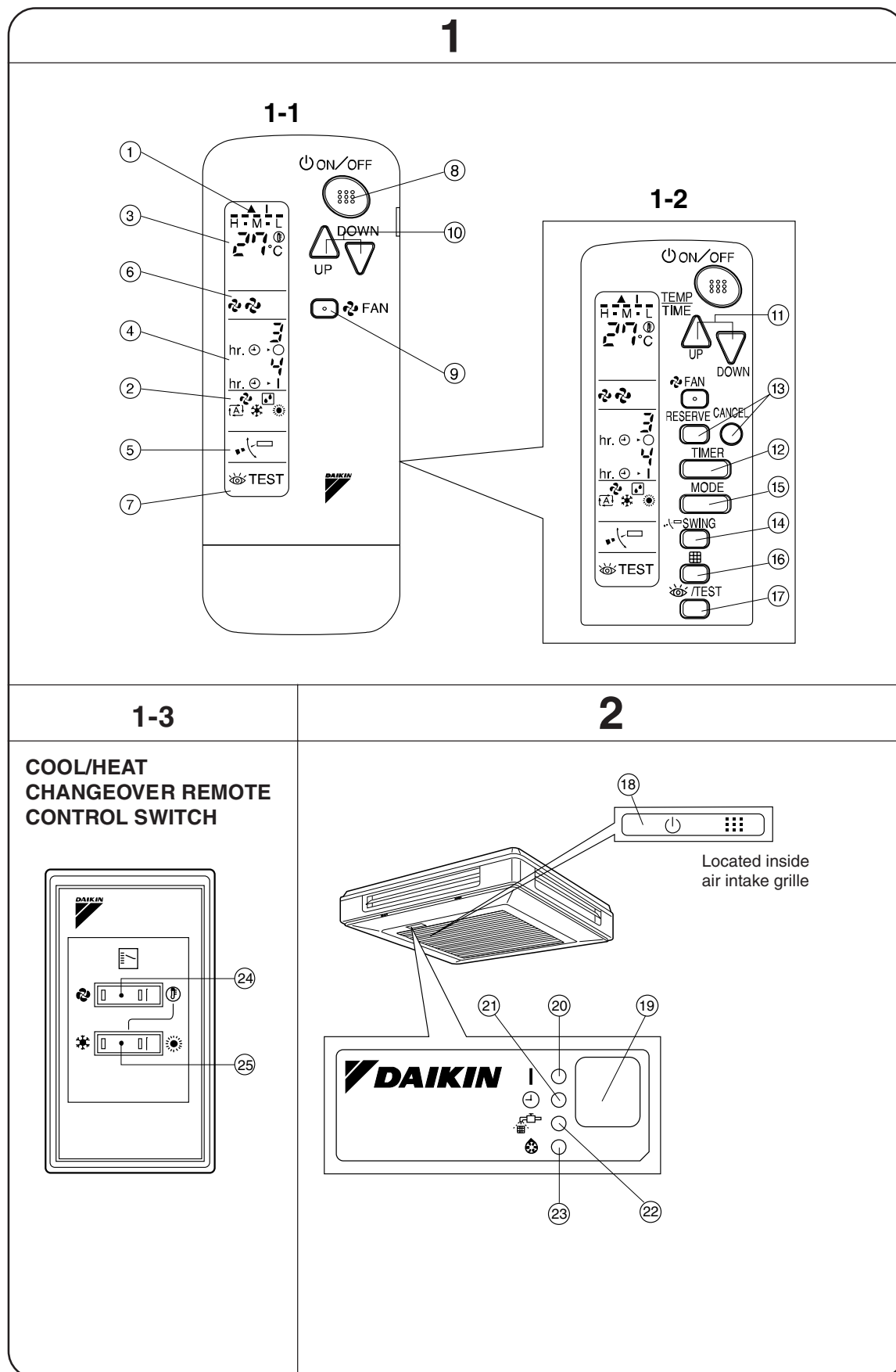

C: 3PA63363-19N

2
2.9 BRC7C528W / BRC7C529W

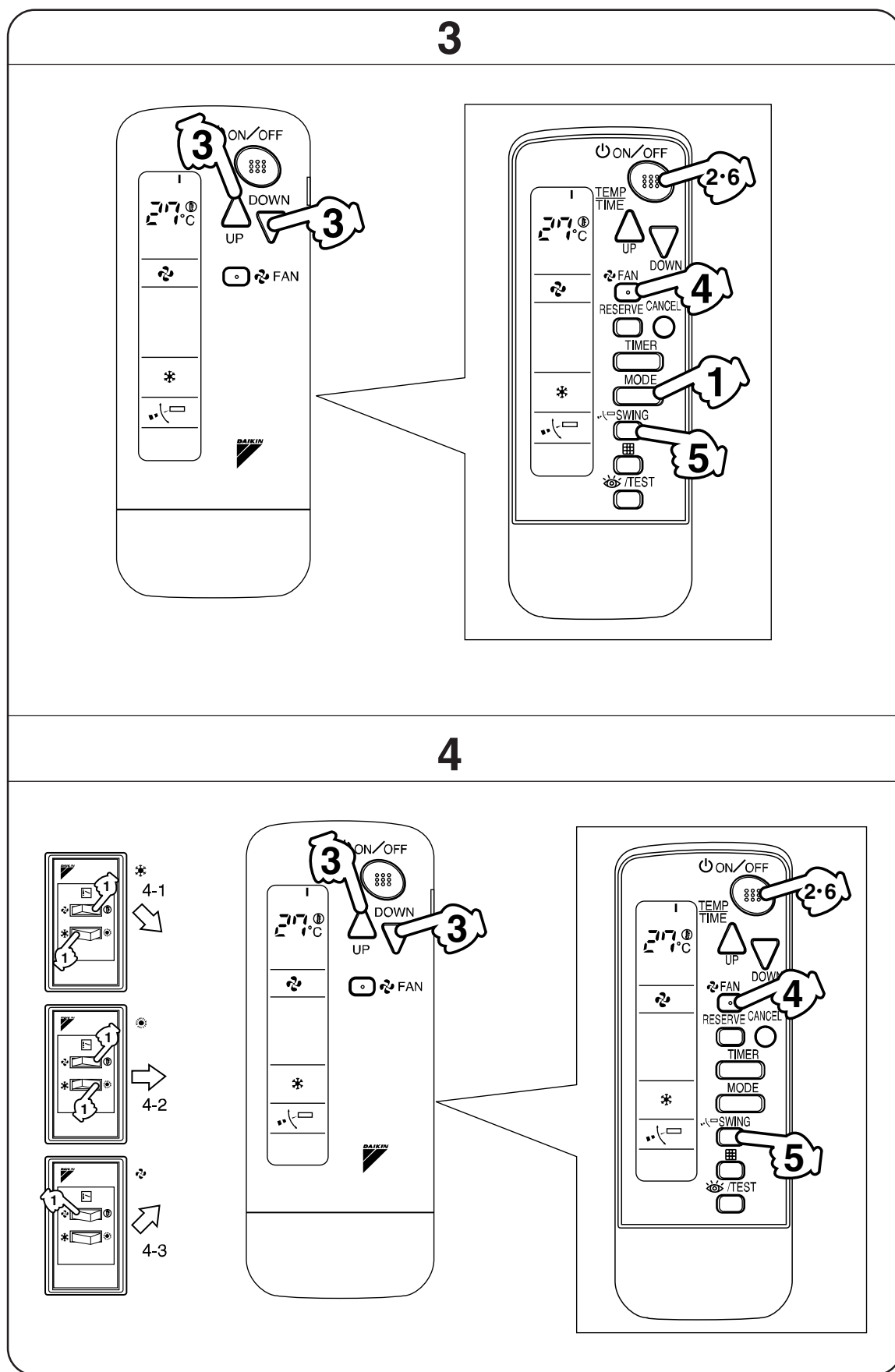

C: 3PA63363-19N

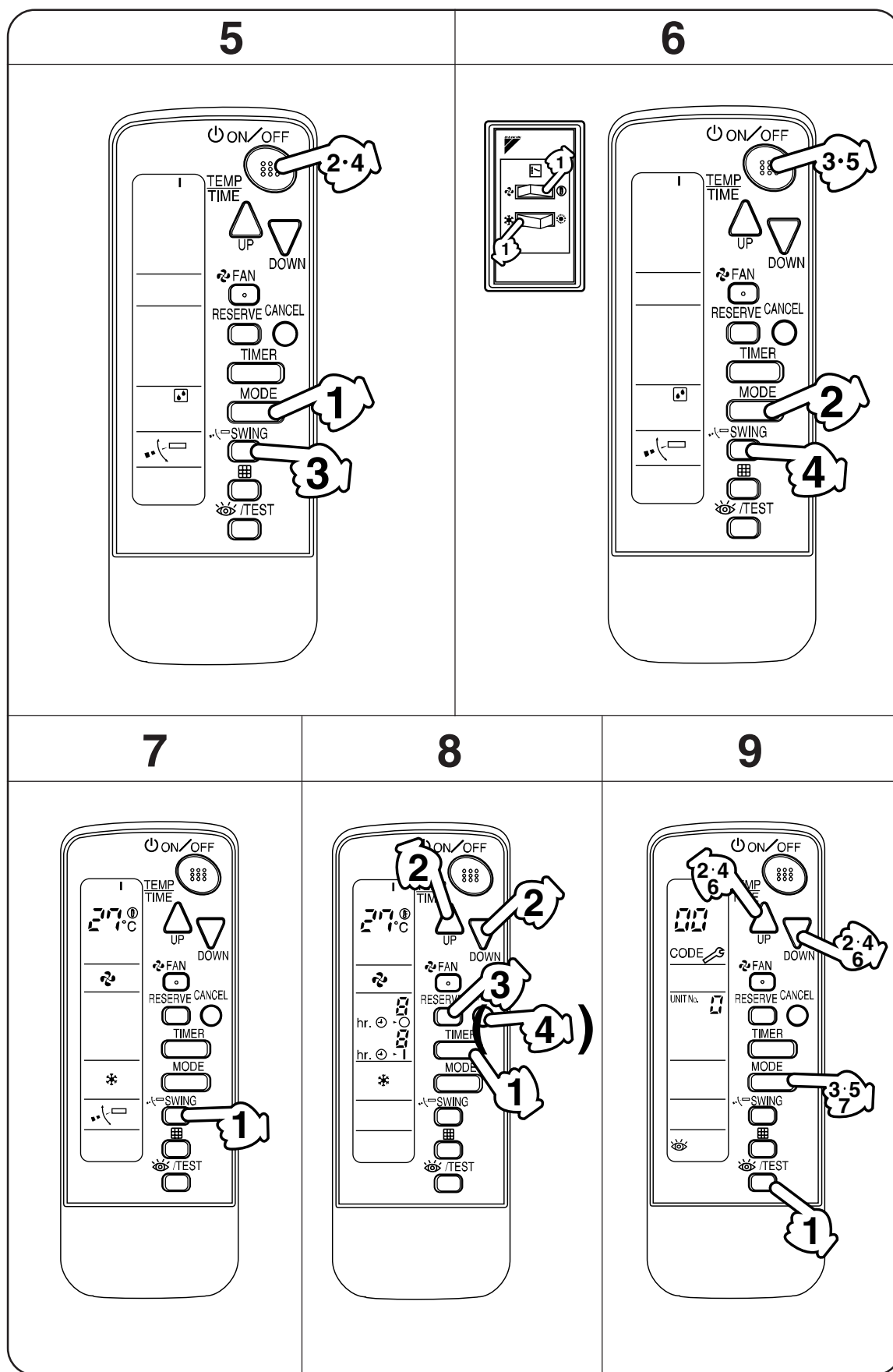



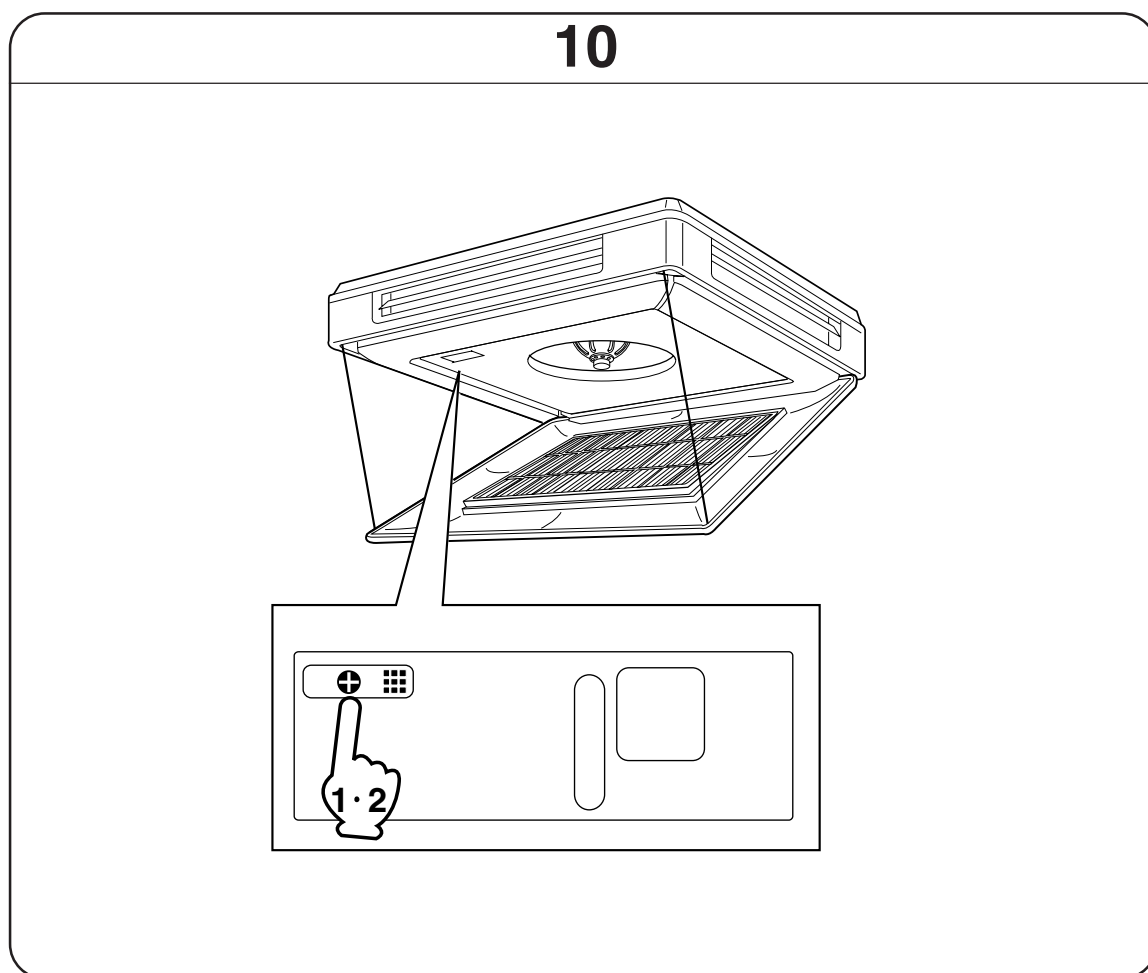















C: 3PA63363-19N



C: 3PA63363-19N

NAMES AND FUNCTIONS OF THE OPERATING SECTION (Fig. 1, 2)

①	DISPLAY “▲” (SIGNAL TRANSMISSION) This lights up when a signal is being transmitted.	⑭	AIR FLOW DIRECTION ADJUST BUTTON Refer to page 168.
②	DISPLAY “” “” “” “” “” (OPERATION MODE) This display shows the current OPERATION MODE. For straight cooling type, “  ” (Auto) and “  ” (Heating) are not installed.	⑮	OPERATION MODE SELECTOR BUTTON Press this button to select OPERATION MODE.
③	DISPLAY “” (SET TEMPERATURE) This display shows the set temperature.	⑯	FILTER SIGN RESET BUTTON Refer to the section of MAINTENANCE in the operation manual attached to the indoor unit.
④	DISPLAY “ hr” “ hr” (PROGRAMMED TIME) This display shows PROGRAMMED TIME of the system start or stop.	⑰	INSPECTION/TEST OPERATION BUTTON This button is used only by qualified service persons for maintenance purposes.
⑤	DISPLAY “” (AIR FLOW FLAP) Refer to page 168.	⑱	EMERGENCY OPERATION SWITCH (Located inside air intake grille) This button can be used to start the unit when the remote controller does not work.
⑥	DISPLAY “” “” (FAN SPEED) The display shows the set fan speed.	⑲	RECEIVER This receives the signals from the remote controller.
⑦	DISPLAY “ TEST” (INSPECTION/TEST OPERATION) When the INSPECTION/TEST OPERATION BUTTON is pressed, the display shows the system mode is in.	⑳	OPERATING INDICATOR LAMP (Red) This lamp stays lit while the air conditioner runs. It flashes when the unit is in trouble.
⑧	ON/OFF BUTTON Press the button and the system will start. Press the button again and the system will stop.	㉑	TIMER INDICATOR LAMP (Green) This lamp stays lit while the timer is set.
⑨	FAN SPEED CONTROL BUTTON Press this button to select the fan speed, HIGH or LOW, of your choice.	㉒	AIR FILTER CLEANING TIME INDICATOR LAMP (Red) Lights up when it is time to clean the air filter.
⑩	TEMPERATURE SETTING BUTTON Use this button for SETTING TEMPERATURE (Operates with the front cover of the remote controller closed.)	㉓	DEFROST LAMP (Orange) Lights up when the defrosting operation has started.
⑪	PROGRAMMING TIMER BUTTON Use this button for programming “START and/or STOP” time. (Operates with the front cover of the remote controller opened.)	㉔	FAN/AIR CONDITIONING SELECTOR SWITCH Set the switch to “  ” (FAN) for FAN and “  ” (A/C) for HEAT or COOL.
⑫	TIMER MODE START/STOP BUTTON Refer to page 169.	㉕	COOL/HEAT CHANGE OVER SWITCH Set the switch to “  ” (COOL) for COOL and “  ” (HEAT) for HEAT.
⑬	TIMER RESERVE/CANCEL BUTTON Refer to page 169.	<p>(NOTES)</p> <ul style="list-style-type: none"> For the sake of explanation, all indications are shown on the display in Figure 1 contrary to actual running situations. Fig. 1-2 shows the remote controller with the front cover opened. Fig. 1-3 shows this remote controller can be used in conjunction with the one provided with the VRV system. If the air filter cleaning time indicator lamp lights up, clean the air filter as explained in the operation manual provided with the indoor unit. <p>After cleaning and reinstalling the air filter, press the filter sign reset button on the remote controller. The air filter cleaning time indicator lamp on the receiver will go out.</p>	

C: 3PA63363-19N

HANDLING FOR WIRELESS REMOTE CONTROLLER

Precautions in handling remote controller

Direct the transmitting part of the remote controller to the receiving part of the air conditioner.

If something blocks the transmitting and receiving path of the indoor unit and the remote controller as curtains, it will not operate.

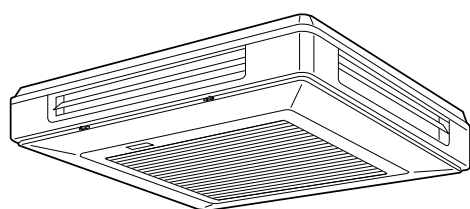

2 short beeps from the receiver indicates that the transmission is properly done.

Transmitting distance is approximately 7 m.

Do not drop or get it wet.

It may be damaged.

Never press the button of the remote controller with a hard, pointed object.

The remote controller may be damaged.

Installation site

- It is possible that signals will not be received in rooms that have electronic fluorescent lighting. Please consult with the salesman before buying new fluorescent lights.
- If the remote controller operated some other electrical apparatus, move that machine away or consult your dealer.

Placing the remote controller in the remote controller holder

Install the remote controller holder to a wall or a pillar with the attached screw. (Make sure it transmits)

Placing the remote controller

Slide from above

Removing the remote controller

Pull it upward

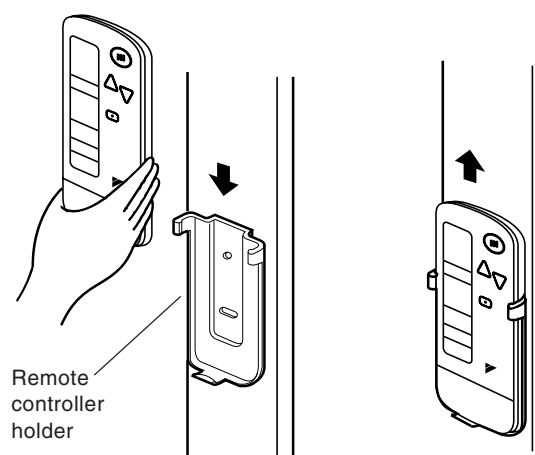

How to put the dry batteries

① Remove the back cover of the remote controller to the direction pointed by the arrow mark.

② Put the batteries
Use two LR03<IEC> dry cell batteries. Put dry batteries correctly to fit their (+) and (-).

③ Close the cover

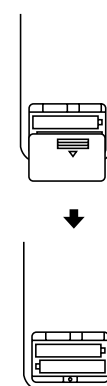

When to change batteries

Under normal use, batteries last about a year. However, change them whenever the indoor unit doesn't respond or responds slowly to commands, or if the display becomes dark.

CAUTIONS

- Replace all batteries at the same time, do not use new and old batteries intermixed.
- In case the remote controller is not used for a long time take out all batteries in order to prevent liquid leak of the battery.

2

2.9 BRC7C528W / BRC7C529W

C: 3PA63363-19N

OPERATION RANGE

Split System

If the temperature or the humidity is beyond the following conditions, safety devices may work and the air conditioner may not operate, or sometimes, water may drop from the indoor unit.

COOLING [°C]

	OUTDOOR UNIT	INDOOR		OUTDOOR TEMPERATURE		
		TEMPERATURE	HUMIDITY			
STRAIGHT COOLING TYPE	R71 • 100 • 125	D B	18 to 35	80% or below	D B	-15 to 46
		W B	12 to 25			
HEAT PUMP TYPE	RY71 • 100 • 125	D B	18 to 35	80% or below	D B	-5 to 46
		W B	12 to 25			

HEATING [°C]

	OUTDOOR UNIT	INDOOR TEMPERATURE	OUTDOOR TEMPERATURE		
HEAT PUMP TYPE	RY71 • 100 • 125	D B	15 to 27	D B	-9 to 21
				W B	-10 to 15.5

DB: Dry bulb temperature

WB: Wet bulb temperature

The setting temperature range of the remote controller is 16°C ~ 32°C.

For VRV systems, see the instruction manual provided with the air conditioner.

OPERATION PROCEDURE

- Operating procedure varies with heat pump type and straight cooling type. Contact your Daikin dealer to confirm your system types.
- To protect the unit, turn on the main power switch 6 hours before operation.
- If the main power supply is turned off during operation, operation will restart automatically after the power turns back on again.

COOLING, HEATING, AUTOMATIC AND FAN OPERATION (Fig. 3, 4)

- AUTOMATIC OPERATION can be selected only by RSEY series or split system.
- RSX series or split system cooling only type give selection of FAN or COOLING OPERATION only.

■ **FOR SYSTEMS WITHOUT COOL/HEAT CHANGEOVER REMOTE CONTROL SWITCH (Fig. 3)**

1 Press **OPERATION MODE SELECTOR** button several times and select the **OPERATION MODE** of your choice as follows.

COOLING OPERATION “❄️”
 HEATING OPERATION “🔥”
 AUTOMATIC OPERATION “⏸️”
 FAN OPERATION “🌀”

On AUTOMATIC OPERATION

In this operation mode, COOL/HEAT changeover is automatically conducted at a present indoor temperature.

2 Press **ON/OFF** button

OPERATION lamp lights up and the system starts OPERATION.

C: 3PA63363-19N

■ **FOR SYSTEMS WITH COOL/HEAT CHANGEOVER REMOTE CONTROL SWITCH (Fig. 4)**

1 Select OPERATION MODE with the COOL/HEAT CHANGEOVER REMOTE CONTROL SWITCH as follows.

COOLING OPERATION..... Refer to fig. 4-1

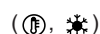

HEATING OPERATION... Refer to fig. 4-2

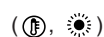

FAN OPERATION... Refer to fig. 4-3 ()

2 Press ON/OFF button

OPERATION lamp lights up and the system starts OPERATION.

Adjustment

For programming TEMPERATURE and FAN SPEED and AIR FLOW DIRECTION, follow the procedure shown below.

3 Press TEMPERATURE SETTING button and program the setting temperature.



UP

Each time this button is pressed, setting temperature rises 1°C.



DOWN

Each time this button is pressed, setting temperature lowers 1°C.

In case of automatic operation



UP

Each time this button is pressed, setting temperature shifts to "H" side.



DOWN

Each time this button is pressed, setting temperature shifts to "L" side.

[°C]

	H	•	M	•	L
Setting temperature	25	23	22	21	19

Note:

- The setting is impossible for fan operation.

4 Press FAN SPEED CONTROL button.

High or Low fan speed can be selected.

5 Press AIR FLOW DIRECTION button

Refer to "ADJUSTING THE AIR FLOW DIRECTION" (p. 168) for details.

STOPPING THE SYSTEM

6 Press ON/OFF button once again.

OPERATION lamp goes off, and the system stops OPERATION.

Note:

- Do not turn OFF power immediately after the unit stops. Then, wait no less than 5 minutes. Water is leaking or there is something else wrong with the unit.

EXPLANATION OF HEATING OPERATION

DEFROST OPERATION

- As the frost on the coil of an outdoor unit increase, heating effect decreases and the system goes into DEFROST OPERATION.
- The fan operation stops and the DEFROST lamp of the indoor unit goes on. After 6 to 8 minutes (maximum 10 minutes) of DEFROST OPERATION, the system returns to HEATING OPERATION.

Heating capacity & Outdoor air temperature

- Heating capacity drops as outdoor air temperature lowers. If feeling cold, use another heater at the same time as this air conditioner.
- Hot air is circulated to warm the room. It will take some time from when the air conditioner is first started until the entire room becomes warm. The internal fan automatically turns at low speed until the air conditioner reaches a certain temperature on the inside. In this situation, all you can do is wait.
- If hot air accumulates on the ceiling and feet are left feeling cold, it is recommended to use a circulator. For details, contact the place of purchase.

C: 3PA63363-19N

PROGRAM DRY OPERATION (Fig. 5, 6)

- The function of this program is to decrease the humidity in your room with the minimum temperature decrease.
- Micro computer automatically determines TEMPERATURE and FAN SPEED.
- This system does not go into operation if the room temperature is below 16°C.

■ FOR SYSTEMS WITHOUT COOL/HEAT CHANGEOVER REMOTE CONTROL SWITCH (Fig. 5)

1 Press OPERATION MODE SELECTOR button several times and select “” (PROGRAM DRY OPERATION)

2 Press ON/OFF button
OPERATION lamp lights up and system starts OPERATION.

Adjustment

3 Press AIR FLOW DIRECTION ADJUST button.
Refer to “ADJUSTING THE AIR FLOW DIRECTION” (p. 133) for details.

STOPPING THE SYSTEM

4 Press ON/OFF button again.
OPERATION lamp goes off and the system stops OPERATION.

■ FOR SYSTEMS WITH COOL/HEAT CHANGEOVER REMOTE CONTROL SWITCH (Fig. 6)

1 Select COOLING OPERATION MODE with the COOL/HEAT CHANGEOVER REMOTE CONTROL SWITCH.

2 Press OPERATION MODE SELECTOR button several times and select PROGRAM DRY “”.

3 Press ON/OFF button.
OPERATION lamp lights up and the system starts.

4 Press AIR FLOW DIRECTION ADJUST button.
Refer to “ADJUSTING THE AIR FLOW DIRECTION” for details.

STOPPING THE SYSTEM

5 Press ON/OFF button once again.
OPERATION lamp goes off, and the system stops OPERATION.
Note:

- Do not turn OFF power immediately after the unit stops. Then, wait no less than 5 minutes. Water is leaking or there is something else wrong with the unit.

ADJUSTING THE AIR FLOW DIRECTION (Fig. 7)

Press the AIR FLOW DIRECTION ADJUST button to adjust the air flow angle.

C: 3PA63363-19N

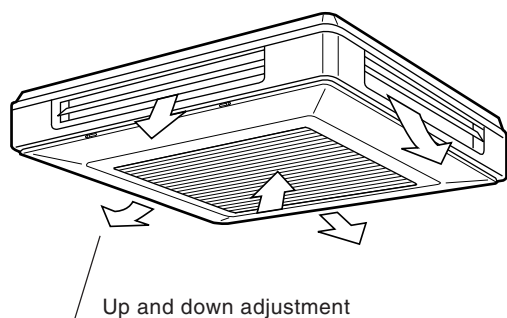

- The movable limit of the blade is changeable. Contact your Daikin dealer for details.

1 Press the **AIR FLOW DIRECTION ADJUST** button to select the air direction as shown below.

“” DISPLAY appears and the air flow direction continuously varies. (Automatic swing setting)



Press **AIR FLOW DIRECTION ADJUST** button to select the air direction of your choice.

“” DISPLAY vanishes and the desired air flow direction is fixed. (Fixed air flow setting)

MOVEMENT OF THE AIR FLOW FLAP

For the following conditions, micro computer controls the air flow direction so it may be different from the display.

Operation mode	Cooling	Heating
Operation conditions	<ul style="list-style-type: none"> When room temperature is lower than the set temperature 	<ul style="list-style-type: none"> When room temperature is higher than the set temperature At defrost operation
	<ul style="list-style-type: none"> When operating continuously at horizontal air flow direction 	

Operation mode includes automatic operation.

PROGRAM TIMER OPERATION (Fig. 8)

- The timer is operated in the following two ways. Programming the stop time (⊕ ▶ ○)... The system stops operating after the set time has elapsed. Programming the start time (⊕ ▶ |)... The system starts operating after the set time has elapsed.
- The timer can be programmed a maximum of 72 hours.
- The start and the stop time can be simultaneously programmed.

1 Press the **TIMER MODE START/STOP** button several times and select the mode on the display.

The display flashes.

For setting the timer stop (⊕ ▶ ○)

For setting the timer start (⊕ ▶ |)

2 Press the **PROGRAMMING TIMER** button and set the time for stopping or starting the system.



When this button is pressed, the time advances by 1 hour.



When this button is pressed, the time goes backward by 1 hour.

3 Press **RESERVE** button.

The timer setting procedure ends.

The display changes from flashing light to a constant light.

NOTE

- When setting the timer Off and On at the same time, repeat the above procedure from **1** to **3** once again.

For example.

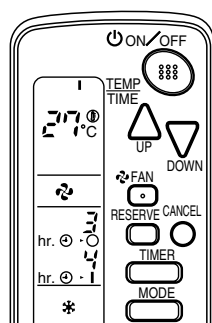

When the timer is programmed to stop the system after 3 hours and start the system after 4 hours, the system will stop after 3 hours and then 1 hour later the system will start.

- After the timer is programmed, the display shows the remaining time.
- Press the TIMER OFF button to cancel programming. The display vanishes. (4)

HOW TO SET MASTER REMOTE CONTROLLER (For RSXY and RSEY series)

- When the system is installed as shown below, it is necessary to designate the master remote controller.

■ For RSXY series

When one outdoor unit is connected with several indoor units.

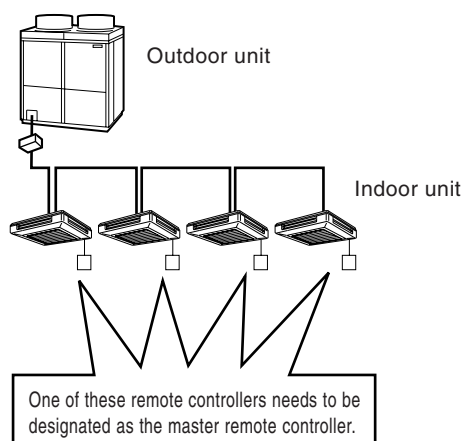

■ For RSEY series

When one BS unit is connected with several indoor units.

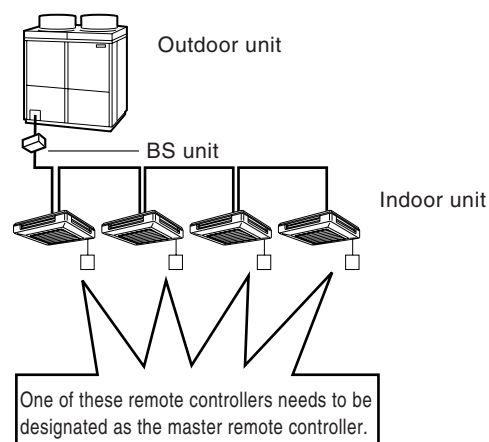

- Only the master remote controller can select HEATING, COOLING or AUTOMATIC (only RSEY series) OPERATION.

When the indoor unit with master remote controller is set to "COOL", you can switch over operation mode between "FAN", "DRY" and "COOL".

When the indoor unit with master remote controller is set to "HEAT", you can switch over operation mode between "FAN" and "HEAT".

When the indoor unit with master remote controller is set to "FAN", you cannot switch operation mode.

When attempting settings than that consented above, a "peep" is emitted as a warning.

Only with RSEY series, you can set the indoor unit to AUTOMATIC. Attempting to do so, a "peep" will be emitted as a warning.

How to designate the master remote controller

- 1 Continuously press the OPERATION MODE SELECTOR button for 4 seconds.

The displays showing "Ⓢ" of all slave indoor unit connected to the same outdoor unit or BS unit flash.

C: 3PA63363-19N

- 2 Press the **OPERATION MODE SELECTOR** button to the indoor unit that you wish to designate as the master remote controller. Then designation is completed. This indoor unit is designated as the master remote controller and the display showing “⊕” vanishes.

- To change settings, repeat steps 1 and 2.

EMERGENCY OPERATION (Fig. 10)

When the remote controller does not work due to dead batteries or it is missing, use this switch which is located beside the discharge grille on the main unit. When the remote controller does not work, but the battery low indicator on it is not lit, contact your dealer.

Local start button (Located inside air intake grille)

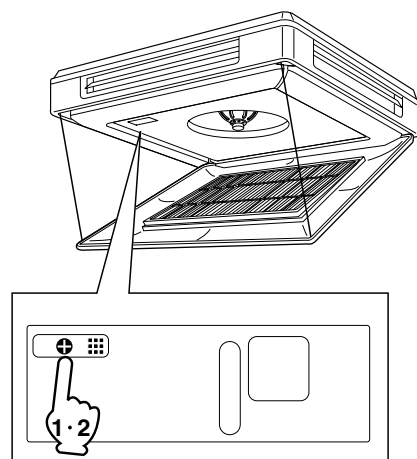

The local start button can be seen in the upper left-hand corner when the air intake grille is open.

START

- 1 Press the **EMERGENCY OPERATION** switch.

The machine runs in the previous mode.
The system operates with the previously set air flow direction.

STOP

- 2 Press the **EMERGENCY OPERATION** switch again.

PRECAUTIONS FOR GROUP CONTROL SYSTEM OR TWO REMOTE CONTROLLER CONTROL SYSTEM

This system provides two other control systems beside individual control (one remote controller controls one indoor unit) system. Confirm the following if your unit is of the following control system type.

■ Group control system

One remote controller controls up to 16 indoor units.
All indoor units are equally set.

■ Two remote controller control system

Two remote controllers control one indoor unit. (In case of group control system, one group of indoor units)
The unit follows individual operation.

NOTE:

- Cannot have two remote controller control system with only wireless remote controllers. (It will be a two remote controller control system having one wired and one wireless remote controllers.)
- Under two remote controller control system, wireless remote controller cannot control timer operation.
- Only the operating indicator lamp out of 3 other lamps on the indoor unit display functions.

NOTE:

Contact your Daikin dealer in case of changing the combination or setting of group control and two remote controller control systems.

NOT MALFUNCTION OF THE AIR CONDITIONER

The following symptoms do not indicate air conditioner malfunction

I. THE SYSTEM DOES NOT OPERATE

- The system does not restart immediately after the ON/OFF button is pressed.

If the OPERATION lamp lights, the system is in normal condition. It does not restart immediately because a safety device operates to prevent overload of the system. After 3 minutes, the system will turn on again automatically.

- The system does not restart immediately when TEMPERATURE SETTING button is returned to the former position after pushing the button.

It does not restart immediately because a safety device operates to prevent overload of the system. After 3 minutes, the system will turn on again automatically.

- If the reception beep is rapidly repeated 3 times (It sounds only twice when operating normally.)

Control is set to the optional controller for centralized control.

- If the defrost lamp on the indoor unit's display is lit when heating is started.

This indication is to warn against cold air being blown from the unit. There is nothing wrong with the equipment.

HOW TO DIAGNOSE TROUBLE SPOTS (Fig. 9)

I. EMERGENCY STOP

When the air conditioner stops in emergency, the run lamp on the indoor unit starts blinking. Take the following steps yourself to read the malfunction code that appears on the display. Contact your dealer with this code. It will help pinpoint the cause of the trouble, speeding up the repair.

- 1 Press the INSPECTION/TEST button to select the inspection mode "E".

"E" appears on display and blinks. "UNIT" lights up.

- 2 Press PROGRAMMING TIMER BUTTON and change the unit number.

Press to change the unit number until the indoor unit beeps and perform the following operation according to the number of beeps.

Number of beeps

3 short beeps Perform all steps from ③ to

⑥

1 short beep Perform ③ and ⑥ steps

1 long beep Normal state

- 3 Press OPERATION MODE SELECTOR BUTTON

"E" on the left-hand of the malfunction code blinks.

- 4 Press PROGRAMMING TIMER BUTTON and change the malfunction code.

Press until the indoor unit beeps twice.

- 5 Press OPERATION MODE SELECTOR BUTTON

"E" on the right-hand of the malfunction code blinks.

C: 3PA63363-19N

6 Press **PROGRAMMING TIMER BUTTON** and change the malfunction code.

Press until the indoor unit makes a long beep.
The malfunction code is fixed when the indoor unit makes a long beep.

7 **Reset of the display**

Press **OPERATION MODE SELECTOR BUTTON** to get the display back to the normal state.

II. IN CASE BESIDES EMERGENCY STOP

1. The unit does not operate at all.

- Check if the receiver is exposed of sunlight or strong light. Keep receiver away from light.
- Check if there are batteries in the remote controller. Place the batteries.
- Check if the indoor unit number and wireless remote controller number are equal.

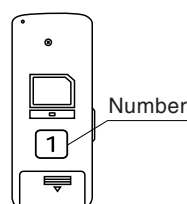
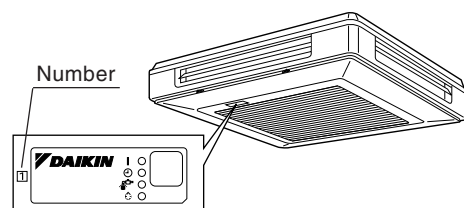

Operate the indoor unit with the remote controller of the same number.

Signal transmitted from a remote controller of a different number cannot be accepted. (If the number is not mentioned, it is considered as "1")

The receiver on the air intake grille is not positioned under the receiver on the indoor unit itself.

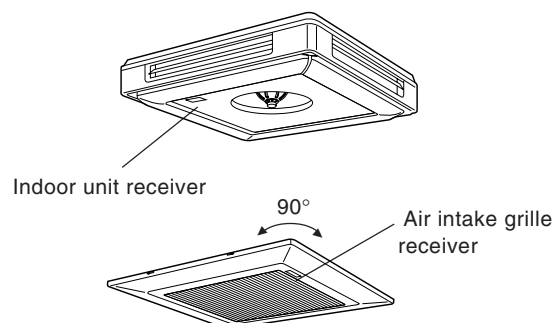

Turn the air intake grille 90° and attach to the indoor unit.

2. The system operates but it does not sufficiently cool or heat.

- If the set temperature is not proper.
- If the FAN SPEED is set to LOW SPEED.
- If the air flow angle is not proper.

Contact the place of purchase in the following case.

WARNING

- When you detect a burning odor, shut OFF power immediately and contact the place of purchase. Using the equipment in anything but proper working condition can result in equipment damage, electric shock and/or fire.

Trouble	Remedial action
<p>The RUN lamp of the indoor unit is flashing and the unit does not work at all.</p> <div style="text-align: center; margin-top: 20px;"> </div>	<p>Check the malfunction code (A1 ~ UF) on the remote control and contact the place of purchase.</p>

C: 3PA63363-19N



2.9.2 Installation





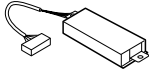
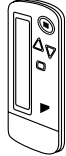
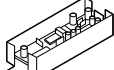
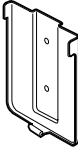

1. BEFORE INSTALLATION

- Install the wireless remote controller in the indoor unit before hanging the unit from the ceiling.
- When using the wireless remote controller, the air intake grille must be attached in a specific direction. Check which way the grille will open before selecting a location for the indoor unit.

1-1 ACCESSORIES

Check if the following accessories are included with your unit.

Name	Receiver	Wireless remote controller	Transmitter board	Remote controller holder	Faceplate for receiver
Quantity	1 set	1 pc.	1 pc.	1 pc.	1 pc.
Shape					

Name	Relay harness	Unit No. label	Drycell battery LR03 (AM4)	Screw for installing remote control holder	Tapping screw	Cable clamp	Operation manual
Quantity	1 pc.	1 pc.	2 pcs.	2 pcs.	4 pcs.	2 pcs.	1 pc.
Shape							

1-2 NOTE TO THE INSTALLER

- Be sure to instruct the customer how to properly operate the system showing him/her the attached operation manual.

2. REMOTE CONTROLLER INSTALLATION

(Installing wireless remote controller)

- Do not throw the remote controller or impose large shocks. Also, do not store where it may be exposed to moisture or direct sunlight.
- When operating, point the transmitting part of the remote controller in the direction of the receiver.
- The direct transmitting distance of the remote controller is approximately 7 meters.
- The signal cannot be transmitted if something such as curtains blocks the receiver and the remote controller.

C: 3PA59585-21Z

- Installing to a wall or a pillar

Slide the remote controller into the remote controller holder from the top.

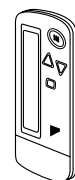

Fix the remote controller holder with the screws.

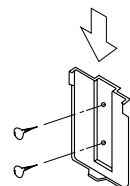

- How to insert the batteries

1. Open the back cover of the remote controller by sliding it in the direction of the arrow.

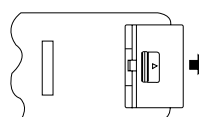

2. Insert the attached dry cell batteries. Properly insert, set the batteries by matching the (+) and (-) polarity marks as indicated. Then close the cover as before.

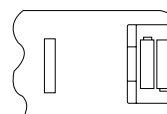

3. RECEIVER INSTALLATION

(1) Attaching the receiver faceplate.

- Remove the installation drawing from the indoor unit. The drawing is glued down and can be peeled off.
- Attach the included receiver faceplate so that it fits the receiver frame.

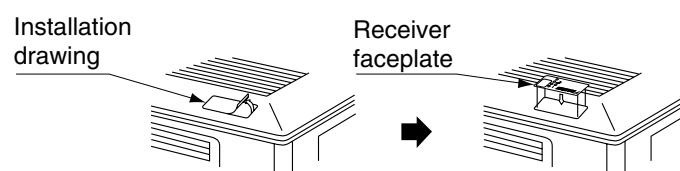

(2) Determination of address and MAIN/SUB remote controller.

If setting multiple wireless remote controllers to operate in one room, perform address setting for the receiver and the wireless remote controller.

If setting multiple wired remote controllers in one room, change the MAIN/SUB switch of the receiver.

C: 3PA59585-21Z

SETTING PROCEDURE

1. Setting the receiver

Through the small opening on the back of the receiver, set the wireless address switch (SS2) on the printed circuit board according to the table below.

Unit No.	No. 1	No. 2	No. 3
Wireless address switch (SS2)			

When using both a wired and a wireless remote controller for 1 indoor unit, the wired controller should be set to MAIN. Therefore, set the MAIN/SUB switch (SS1) of the receiver to SUB.

	MAIN	SUB
MAIN/SUB switch (SS1)		

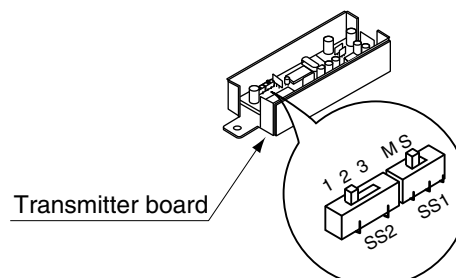

2. Setting the address of wireless remote controller (It is factory set to "1")

⟨Setting from the remote controller⟩

- Hold down the button and the button for at least 4 seconds to get the Field Set mode. (Indicated in the display area in the figure at right.)
- Press the button and select a multiple setting (A/b). Each time the button is pressed the display switches between "A" and "b".
- Press the "" button and "" button to set the address.

→ 1 → 2 → 3 → 4 → 5 → 6

Address can be set from 1 to 6, but set it to 1 ~ 3 and to same address as the receiver. (The receiver does not work with address 4 ~ 6.)

- Press the button to enter the setting.
- Hold down the button for at least 1 second to quit the Field Set mode and return to the normal display.

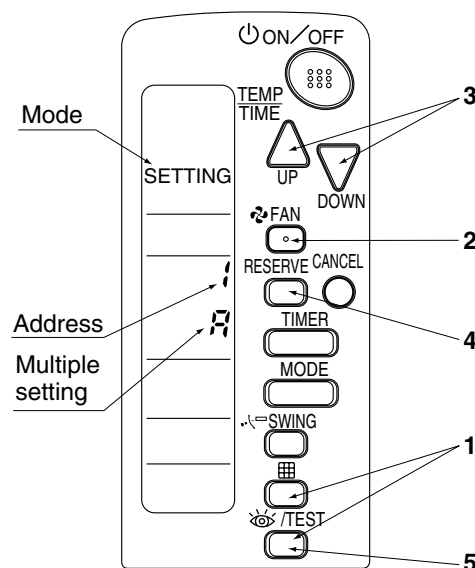

C: 3PA59585-21Z

Multiple settings A/b

When the indoor unit is being operating by outside control (central remote controller, etc.), it sometimes does not respond to ON/OFF and temperature setting commands from this remote controller. Check what setting the customer wants and make the multiple setting as shown below.

Remote controller		Indoor unit	
Multiple setting	Remote controller display	To control other air conditions and units	For other than on left
A: Standard	All items displayed.	Commands other than ON/OFF and temperature setting accepted. (1 LONG BEEP or 3 SHORT BEEPS emitted)	
b: Multi System	Operations remain displayed shortly after execution.	All commands accepted (2 SHORT BEEPS)	

3. Stick the Unit No. label to the indoor unit and the back of the wireless remote controller.

[PRECAUTIONS]

Set the Unit No. of the receiver and the wireless remote controller to be equal. If the settings differs, the signal from the remote controller cannot be transmitted.

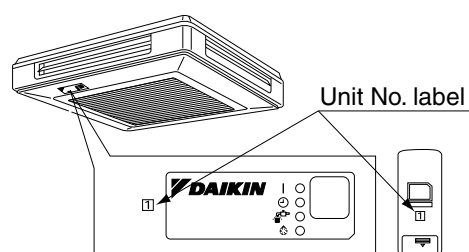
**(3) PC board installation.**

- Detach the air intake grille and switch box lid (screws × 2) as explained in the installation instructions of the indoor unit.
- Install the transmitter board and receiver in the locations indicated at right.

NOTE:

When using the wireless remote controller, the indoor unit must be opened/closed in the direction shown at right.

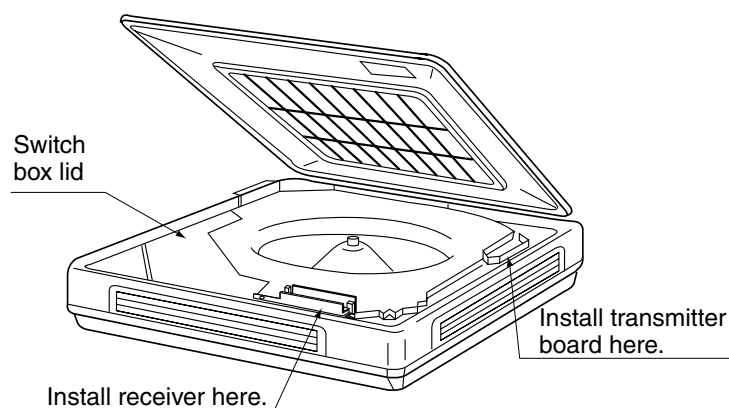







C: 3PA59585-21Z

4. FIELD SETTING

(If optional accessories are mounted on the indoor unit, the indoor unit setting may have to be changed. Refer to the instruction manual (optional hand book) for each optional accessory.)

Procedure

1. When in the normal mode, press the  /TEST button for a minimum of four seconds, and the FIELD SET MODE is entered.
2. Select the desired MODE NO. with the  button.
3. Push the “” button and select the FIRST CODE NO.
4. Push the “” button and select the SECOND CODE NO.
5. Push the  button and the present settings are SET.
6. Push the  button to return to the NORMAL MODE.

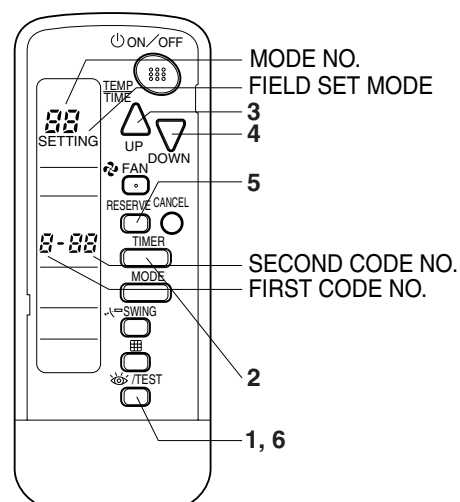

(Example)

If the time to clean air filter is set to “Filter Contamination-Heavy”, set Mode No. to “10”, FIRST CODE NO. to “0”, and SECOND CODE NO. to “02”.

MODE NO.	FIRST CODE NO.	DESCRIPTION OF SETTING	SECOND CODE NO. NOTE)				
			01	02	03		
10	0	Filter Contamination-Heavy/Light (Setting for spacing time of display time to clean air filter) (Setting for when filter contamination is heavy, and spacing time of display time to clean air filter is to be halved)	Light	Approx. 2,500 hrs.	Heavy	Approx. 1,250 hrs.	—
	3	Spacing time of display time to clean air filter count (Setting for when the filter sign is not to be displayed)	Display		Do not display		—
11 (Sprit system)	0	Setting the number of connected simultaneous operation system indoor units.	Pair	Twin	Triple		
12 (VRV system)	1	ON/OFF input from outside (Set to enable starting/stopping from remote.)	Forced OFF input	ON/OFF	—		
	2	Thermostat differential changeover (Set when using remote controller thermostat sensor.)	1°C	0.5°C	—		
13	0	High ceiling setting (Setting for when installed in a ceiling higher than 2.7 m)	Normal	High Ceiling 1	High Ceiling 2		
	1	Selection of Air Flow Direction (Setting for when a blocking pad kit has been installed)	F	T	W		

Do not use any settings not listed in the table.

For group control with a wireless remote controller, initial settings for all the indoor units of the group are equal. (For group control, refer to the installation manual attached to the indoor unit for group control.)

C: 3PA59585-21Z

5. TEST OPERATION

- Perform test operation according to the instructions in the installation manual attached to the indoor unit.
- After refrigerant piping, drain piping, and electric wiring, operate according to the table to protect the unit.

[PRECAUTIONS]

1. Refer to malfunction diagnosis label attached to the unit if it does not operate.
2. Refer to the installation manual attached to the outdoor unit for individual operation system types.

Order	Operation
(1)	Open gas side stop valve.
(2)	Open liquid side stop valve.
(3)	Electrify crank case heater for 6 hours. (Not necessary for cooling type units)
(4)	Set to cooling with the remote controller and push ON/OFF button to start operation.
(5)	Push TEST button twice and operate in TEST OPERATION mode for 3 minutes.
(6)	Push SWING button and confirm its operation.
(7)	Push TEST button and operate normally.
(8)	Confirm its function according to the operation manual.

C: 3PA59585-21Z

3. Simplified Remote Controller

3.1 BRC2C51

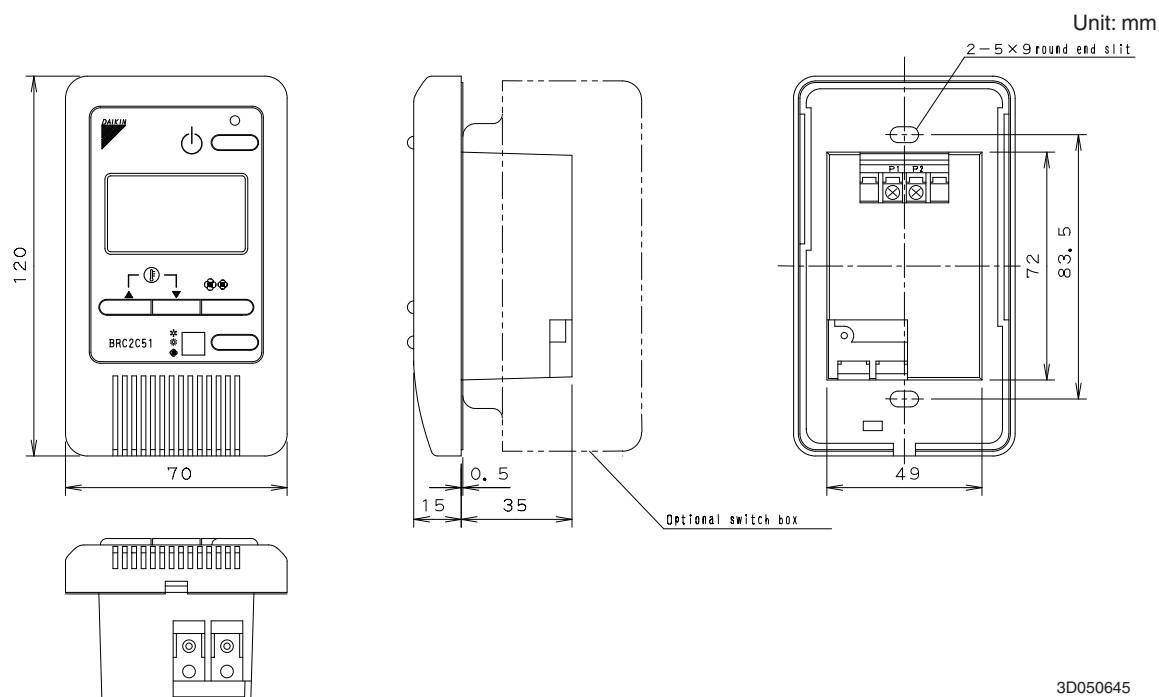

1. Remove the upper part of remote controller.

Insert minus screwdriver into the slots between the upper and the lower part of remote controller.

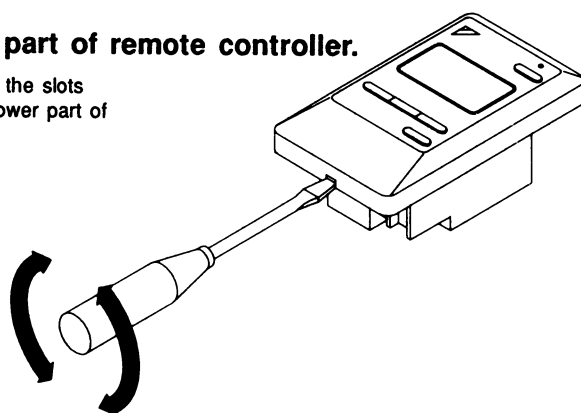

2. Wire the indoor unit.

Connect terminals P1 and P2 on the rear of the lower part of remote controller to terminals P1 and P2 on the indoor unit. (Terminals P1 and P2 have no polarity.)

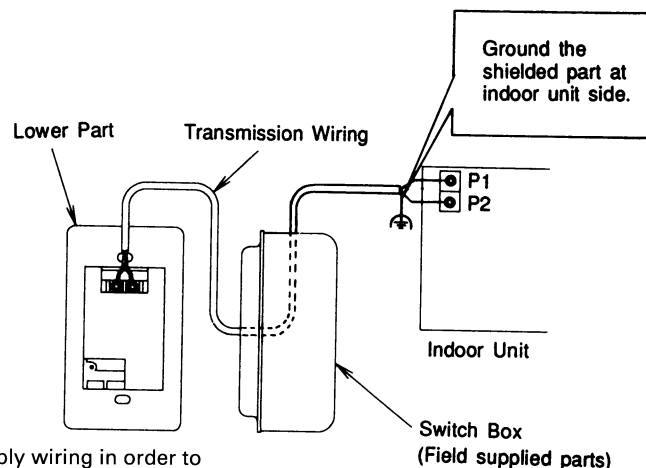

NOTE

- When wiring, run the wiring away from the power supply wiring in order to avoid receiving electric noise (external noise).
- When wiring, refer to the wiring diagram of indoor unit (attached to indoor unit) as well.

WIRING SPECIFICATION

Wiring type	Shield wire (2 wire) (See NOTE 2,3)
Size	0.75 – 1.25 mm ²

- NOTE)** 1. Treat the terminal for the wire to be connected to the remote controller so the shielded part does not touch any other part.
 2. Sheathed wire may be used for transmission wirings, but they do not comply with EMC (Electromagnetic Compatibility) (European Directive).
 When using sheathed wire, EMC must conform to Japanese standards stipulated in the Electric Appliance Regulatory Act. (If using a sheathed wire, the grounding shown the figure on the right is unnecessary.)

3PA52943C

3. Fasten the remote controller.

Attach the lower part of remote controller to the switch box (field supplied parts).

NOTE

Choose the flattest place possible for the mounting surface. Be careful not to distort the shape of the lower part of remote controller by over-tightening the mounting screws.

For the field supplied switch box, use optional accessories KJB111A.

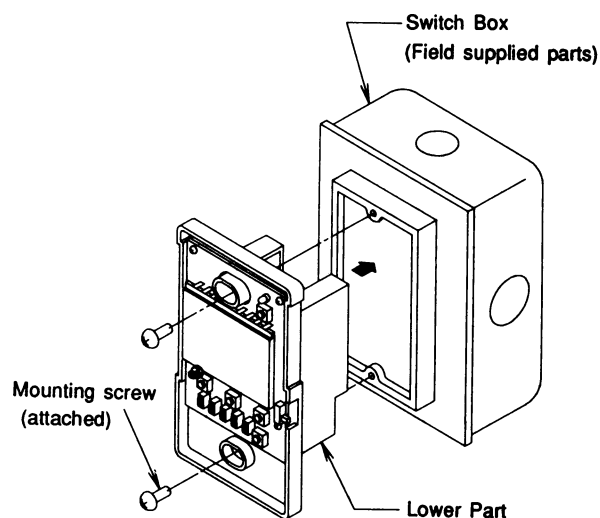

4. Initial setting

Change the MAIN/SUB changeover switch setting as described below.
If controlling one indoor unit with two remote controllers.
Set one remote controller to "main," and the other to "sub."



Main Remote Controller
(Factory Set)



Sub Remote Controller

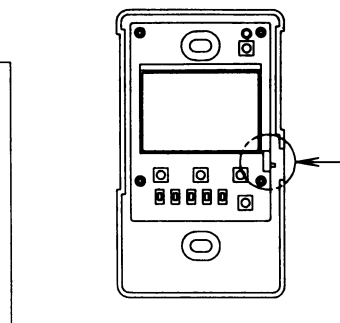

NOTE

- If controlling with one remote controller, be sure to set it to "main."
- Set the remote controller before turning power supply on.

"88" is displayed for about one minute when the power supply is turned on, and the remote controller cannot be operated in some cases.

5. Reattach the upper part of remote controller.

NOTE

1. The switch box and wiring for connection are not included.
2. Do not directly touch the PC board with your hand.

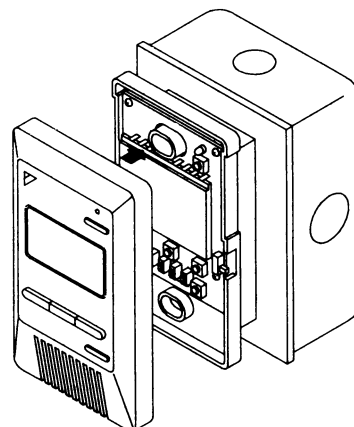

3PA52943C

FIELD SETTING

(If optional accessories are mounted on the indoor unit, the indoor unit setting may have to be changed. Refer to the instruction manual for each optional accessory.)

Procedure

- ① Remove the upper part of remote controller.
- ② When in the normal mode, press the **[BS6]** BUTTON (field set), and the FIELD SET MODE is entered.
- ③ Select the desired MODE No. with the **[BS2]** BUTTON (temperature setting ▲) and the **[BS3]** BUTTON (temperature setting ▼).
- ④ During group control, when setting by each indoor unit (mode No. 20, 22 and 23 have been selected), push the **[BS8]** BUTTON (unit no.) and select the INDOOR UNIT NO. to be set. (This operation is unnecessary when setting by group.)
- ⑤ Push the **[BS9]** BUTTON (set A) and select FIRST CODE NO.
- ⑥ Push the **[BS10]** BUTTON (set B) and select SECOND CODE NO.
- ⑦ Push the **[BS7]** BUTTON (set/cancel) once and the present settings are SET.
- ⑧ Push the **[BS6]** BUTTON (field set) to return to the NORMAL MODE.

(Example) If during group setting and the time to clean air filter is set to FILTER CONTAMINATION - HEAVY, SET MODE NO. to "10," FIRST CODE NO. to "0," and SECOND CODE NO. to "02."

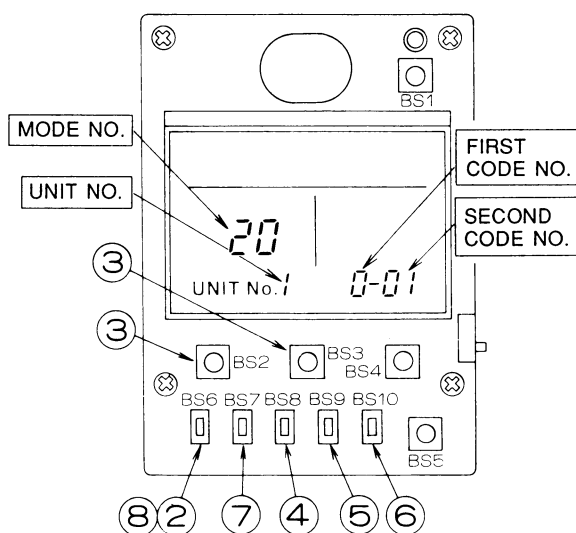

Mode No. Note) 1	FIRST CODE No.	Description of Setting	SECOND CODE No. Note) 2				
			01	02	03		
10(20) Note) 6	0	Filter Contamination - Heavy/Light (Setting for spacing time of display time to clean air filter) (Setting for when filter contamination is heavy, and spacing time of display time to clean air filter is to be halved)	Long Life Filter Light	Approx. 2,500 Hrs.	Heavy	Approx. 1,250 Hrs.	—
			Standard Filter	Approx. 200 Hrs.		Approx 100 Hrs.	
	3	Spacing Time of Display Time to Clean Air Filter Count (Setting for when the filter sign is not to be displayed)		Display		Do Not Display	—
12(22)	1	ON/OFF Input from Outside. (Setting for when forced ON/OFF is to be operated from outside.)		Forced OFF		ON/OFF Operation	
	2	Thermostat Differential Changeover (Setting for when using the remote sensor) FXYC, FXYF, FXYK or FXYH only		1°C		0.5 C	—
13(23)	0	High Air Outlet Velocity (Setting for when installed in a high ceiling) FXYF only		2.7 m or less		More than 2.7 m; 3.0 m or less	More than 3.0 m; 3.5 m or less
	1	Selection of Air Flow Direction (Setting for when a blocking pad kit has been installed) FXYF only		4-way flow		3-way flow	2-way flow
15(25)	1	Humidifying with thermostat OFF		Not equipped		Equipped	
	3	Drain pump operation with humidifying		Not equipped		Equipped	





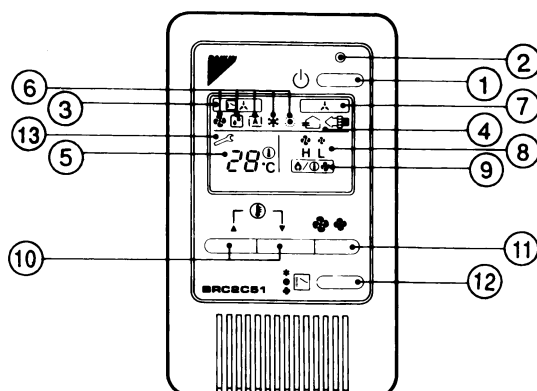



NOTE) 1. Setting is carried out in the group mode, however, if the mode number inside the parentheses is selected, indoor units can also be set individually.
2. The SECOND CODE number, is set to "01" when shipped from the factory.
3. Do not make any settings not given in the table on the left.
4. Not displayed if the indoor unit is not equipped with that function.
5. When returning to the normal mode, "88" may be displayed in the LCD in order for the remote controller to initialize itself.
6. This mode is used to set the time until the display time to clean air filter lights up when using central remote controller.

3PA52946A



2

3.1 BRC2C51

REMOTE CONTROLLER: NAME AND FUNCTION OF EACH SWITCH AND DISPLAY			DISPLAY "  " (UNDER CENTRALIZED CONTROL)
①	ON/OFF BUTTON Press the button and the system will start. Press the button again and the system will stop.	⑦	When this display shows, the system is UNDER CENTRALIZED CONTROL. (This is not a standard specification)
②	OPERATION LAMP (RED) The lamp lights up during operation. Blinks in case of stop due to malfunction.	⑧	DISPLAY "  " (FAN SPEED). The display shows the fan speed: "HIGH" or "LOW".
③	DISPLAY "  " (CHANGEOVER UNDER CONTROL) It is impossible to changeover heat/cool with the remote controller when it shows this display. (As for details, see "SETTING OF MASTER REMOTE CONTROLLER" in the operation manual attached to the indoor unit.)	⑨	DISPLAY "  " (DEFROST/ HOT START) Indicates that defrost or hot start (during which the fan is stopped till the temperature of air supply rises enough at the start of a heating run) is progress.
④	DISPLAY "  OPTION " (VENTILATION) This display shows that the total heat exchanger (HRV) are in operation.	⑩	TEMPERATURE SETTING BUTTON Use this button for SETTING TEMPERATURE of the thermostat. ▲ ; Each press raises the set temperature by 1°C. ▼ ; Each press lowers the set temperature by 1°C. The variable temperature range is 16°C to 32°C.
⑤	DISPLAY " 28.0°C " (SET TEMPERATURE) This display shows the set temperature. Only given during a cooling or heating operation.	⑪	FAN SPEED CONTROL BUTTON Press this button to select the fan speed, HIGH or LOW, of your choice.
⑥	DISPLAY "  " (OPERATION MODE) This display shows current OPERATION MODE. "  " is not available with outdoor units specially designed for cooling only. "  " is reserved only for outdoor units capable of heat recovery.	⑫	OPERATION MODE SELECTOR BUTTON Press this button to select OPERATION MODE.
		⑬	DISPLAY "  " (MALFUNCTION) Indicates malfunction and blinks if the unit stops operating due to malfunction. (As for details, see "TROUBLE SHOOTING" in the operation manual attached to the indoor unit.)
		For the sake of explanation, all indications are shown in the figure above contrary to actual running situations.	

C: 2PA52942

4. Remote Controller for Hotel Use

4.1 BRC3A61

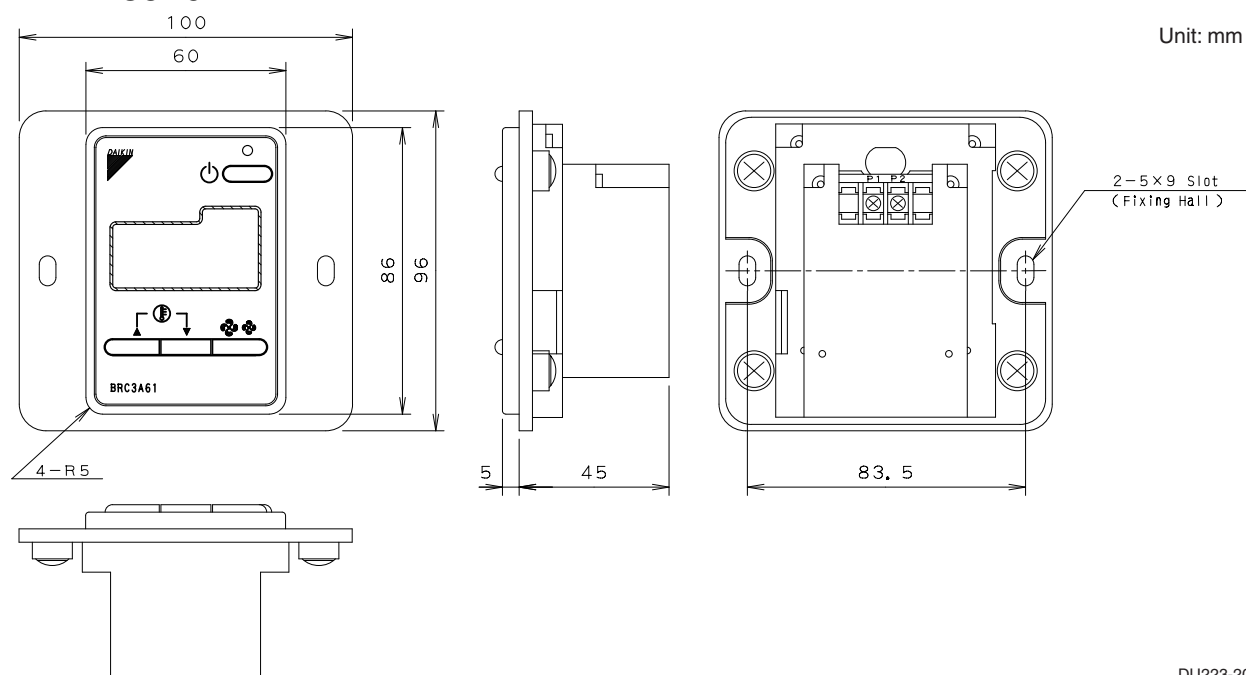

1, Prepare for the fixing panel

Open a hole in the panel and install two mounting bolt at below.

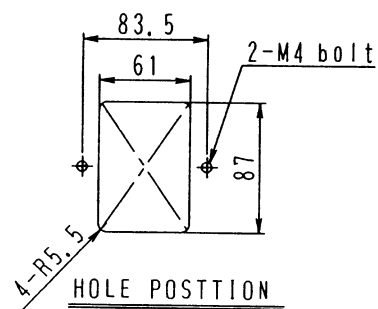

2, Attach the remote controller

Attach the remote controller to the hole.

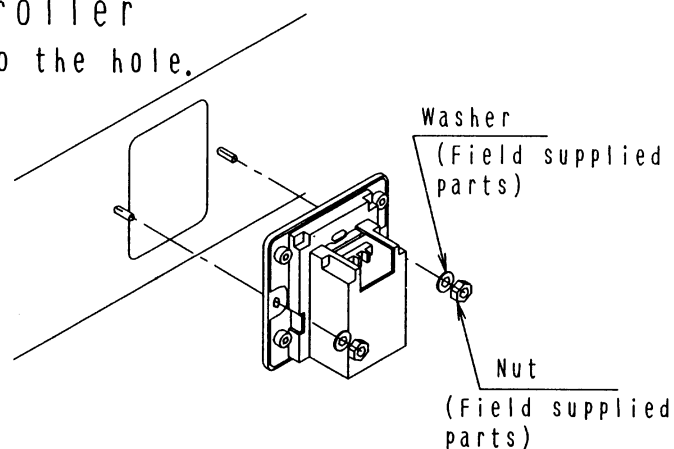

(Choose the flattest place possible for the mounting surface.
Be careful not to distort the shape of the casing of remote controller by over-lightening the nuts.)

《 PRECAUTION 》

1. The washers and nuts are not included.
2. Do not directly touch the PC board with your hand.

3PA61527

3, Wire the indoor unit.

Connect terminals P1 and P2 on the rear of the lower part of remote controller to terminals P1 and P2 on the indoor unit.
(Terminals P1 and P2 have no polarity)

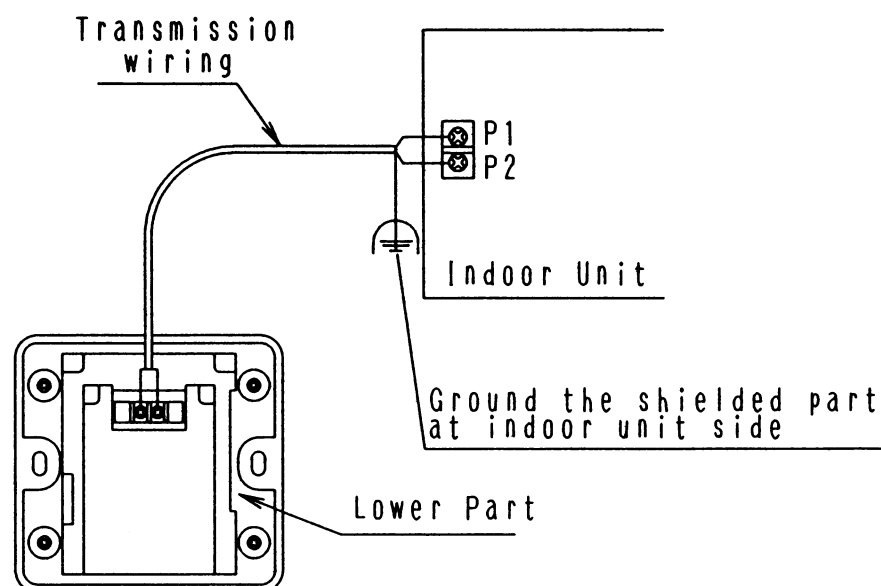

《 PRECAUTION 》

- ① When wiring, run the wiring away the power supply wiring in order to avoid receiving electric noise (external noise)
- ② When wiring, refer to the wiring diagram of indoor unit (attached to indoor unit) as well.

WIRING SPECIFICATION

Wiring type	Shield wire (2 wire)(See NOTE 2)
Size	0.75~1.25mm ²

NOTE)

1. Treat the terminal for the wire to be connected to the remote controller so the shielded part does not touch any other part.
2. Sheathed wire may be used for transmission wirings. If using a sheathed wire, as for Electromagnetic Compatibility the system must conform to the Electrical Appliance And Material Control Law Of Japan.

3PA61527

4, Initial setting

Remove the screws(×4) and remove the lower part of remote controller.

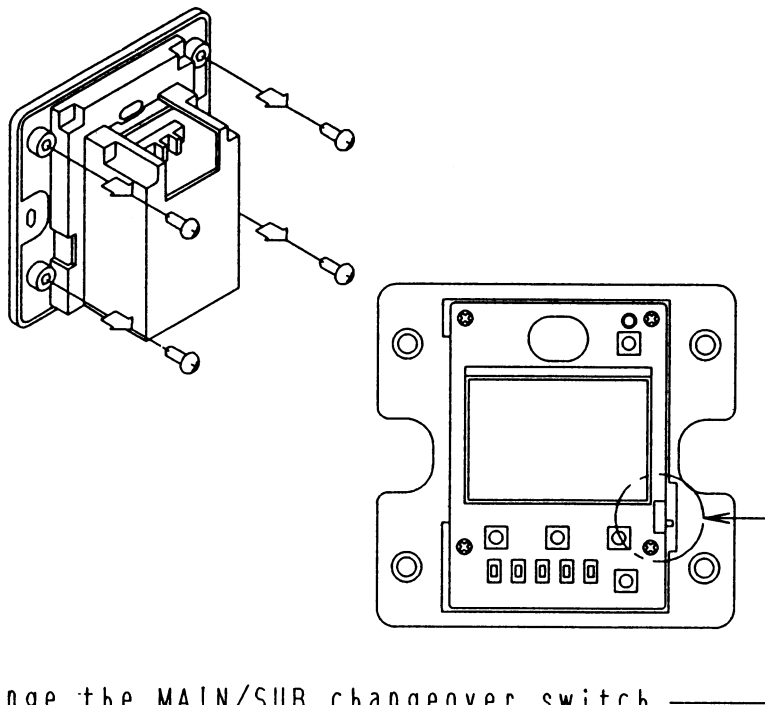

Change the MAIN/SUB changeover switch

If controlling one indoor unit with two remote controllers setting as described below. Set one remote controller to 'MAIN', and the other to 'SUB'



Main Remote
Controller
(Factory Set)



Sub Remote
Controller

« PRECAUTION »

- If controlling with one remote controller, be sure to set it to 'MAIN'
- Set the remote controller before turning power supply on.

'88' is displayed for about one minute when the power supply is turned on, and the remote controller cannot be operated in some cases.

3PA61527

FIELD SETTING

(If optional accessories are mounted on the indoor unit, the indoor unit setting may have to be changed. Refer to the instruction manual for each optional accessory.)

2

4.1 BRC3A61

Procedure

- ① Remove the upper part of remote controller.
- ② When in the normal mode, press the **[BS6]** BUTTON (field set), and the FIELD SET MODE is entered.
- ③ Select the desired MODE No. with the **[BS2]** BUTTON (temperature setting ▲) and the **[BS3]** BUTTON (temperature setting ▼).
- ④ During group control, when setting by each indoor unit (mode No. 20, 22 and 23 have been selected), push the **[BS8]** BUTTON (unit no.) and select the INDOOR UNIT NO. to be set. (This operation is unnecessary when setting by group.)
- ⑤ Push the **[BS9]** BUTTON (set A) and select FIRST CODE NO.
- ⑥ Push the **[BS10]** BUTTON (set B) and select SECOND CODE NO.
- ⑦ Push the **[BS7]** BUTTON (set/cancel) once and the present settings are SET.
- ⑧ Push the **[BS6]** BUTTON (field set) to return to the NORMAL MODE.

(Example) If during group setting and the time to clean air filter is set to FILTER CONTAMINATION - HEAVY, SET MODE NO. to "10," FIRST CODE NO. to "0," and SECOND CODE NO. to "02."

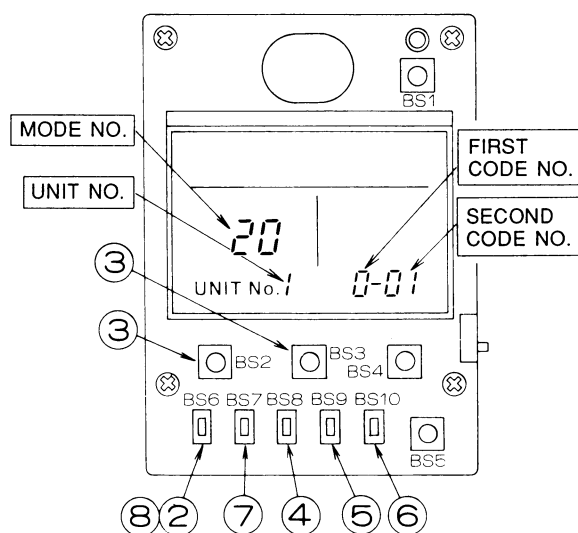

Mode No. Note) 1	FIRST CODE No.	Description of Setting	SECOND CODE No. Note) 2					
			01	02	03			
10(20) Note) 6	0	Filter Contamination - Heavy/Light (Setting for spacing time of display time to clean air filter) (Setting for when filter contamination is heavy, and spacing time of display time to clean air filter is to be halved)	Long Life Filter	Light	Approx. 2,500 Hrs.	Heavy	Approx. 1,250 Hrs.	—
		Standard Filter	Light	Approx. 200 Hrs.	Heavy	Approx. 100 Hrs.	—	
	3	Spacing Time of Display Time to Clean Air Filter Count (Setting for when the filter sign is not to be displayed)		Display		Do Not Display		—
12(22)	1	ON/OFF Input from Outside. (Setting for when forced ON/OFF is to be operated from outside.)		Forced OFF		ON/OFF Operation		—
	2	Thermostat Differential Changeover (Setting for when using the remote sensor) FXYC, FXYF, FXYK or FXYH only		1°C		0.5 C		—
13(23)	0	High Air Outlet Velocity (Setting for when installed in a high ceiling) FXYF only		2.7 m or less		More than 2.7 m; 3.0 m or less		More than 3.0 m; 3.5 m or less
	1	Selection of Air Flow Direction (Setting for when a blocking pad kit has been installed) FXYF only		4-way flow		3-way flow		2-way flow
15(25)	1	Humidifying with thermostat OFF		Not equipped		Equipped		—
	3	Drain pump operation with humidifying		Not equipped		Equipped		—

NOTE) 1. Setting is carried out in the group mode, however, if the mode number inside the parentheses is selected, indoor units can also be set individually.
2. The SECOND CODE number, is set to "01" when shipped from the factory.
3. Do not make any settings not given in the table on the left.
4. Not displayed if the indoor unit is not equipped with that function.
5. When returning to the normal mode, "88" may be displayed in the LCD in order for the remote controller to initialize itself.
6. This mode is used to set the time until the display time to clean air filter lights up when using central remote controller.

3PA52946A

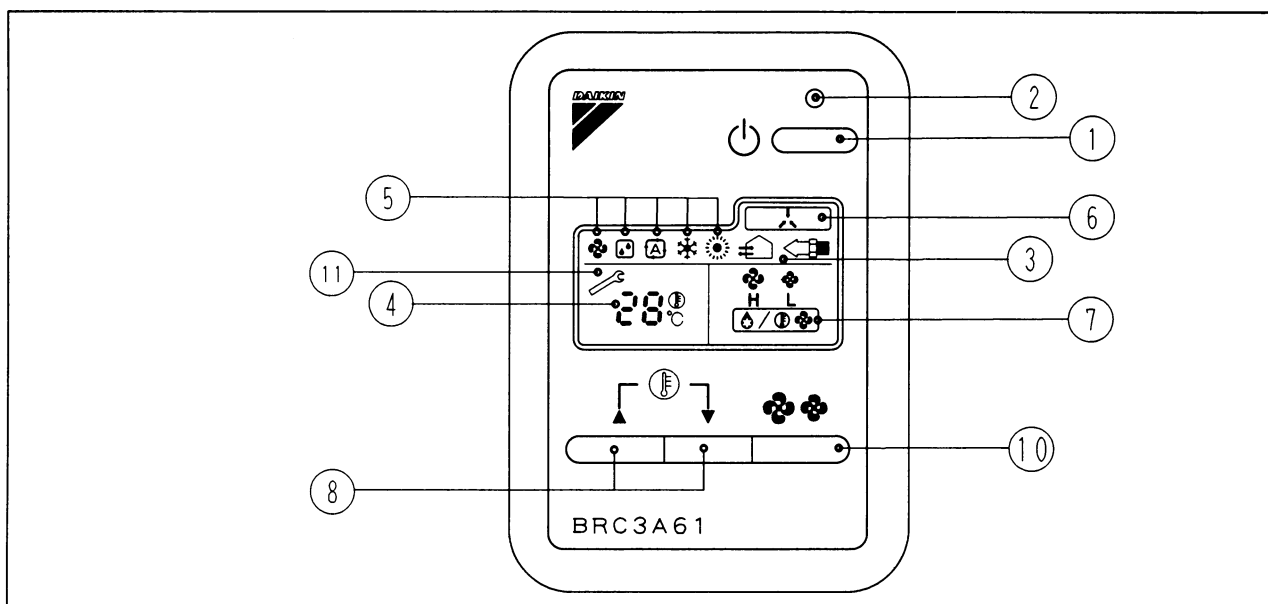

REMOTE CONTROLLER: NAME AND FUNCTION OF EACH SWITCH AND DISPLAY

①	ON/OFF BUTTON Press the button and the system will start. Press the button again and the system will stop.	⑦	DISPLAY' ' (FAN SPEED) The display shows the fan speed: 'HIGH' or 'LOW'.
②	OPERATION LAMP(RED) The lamp lights up during operation. Blinks in case of stop due to malfunction.	⑧	DISPLAY' ' (DEFROST/HOT START) Indicates that defrost or hot start (during which the fan is stopped till the temperature of air supply rises enough at the start of a heating run) is progress.
③	DISPLAY' ' OPTION' (VENTILATION/AIR CLEANING) This display shows that the total heat exchange are in operation. (This is optional accessory)	⑨	TEMPERATURE SETTING BUTTON Use this button for SETTING TEMPERATURE of the thermostat. ▲:Each press raises the set temperature by 1°C ▼:Each press lowers the set temperature by 1°C The variable temperature range is 16°C to 32°C.
④	DISPLAY' 28°C ' (SET TEMPERATURE) This display shows the set temperature. Only given during a cooling or heating operation.	⑩	FAN SPEED CONTROL BUTTON Press this button to select the fan speed, HIGHT or LOW, of your choice.
⑤	DISPLAY' ' (OPERATION MODE) This display shows current OPERATION MODE. is not available whis outdoor units specially designed for cooling only. 'A' is reserved only for outdoor units capable of heat recovery.	⑪	DISPLAY' ' (MALFUNCTION) Indicates malfunction and blinks if the unit stops operating due to malfunction. (As for details, see 'TROUBLE SHOOTING' in the operation manual attached to the indoor uint or the outdoor unit.)
⑥	DISPLAY' ' (UNDER CENTRALIZED CONTROL) When this display shows, the system is UNDER CENTRALIZED CONTROL (This is not a standard specification)		

(NOTE)

- For the sake of explanation, all indications are shown in the figure above contrary to actual running situations.
- This remote controller does not have "AIR FLOW DIRECTION ADJUST BUTTON." Don't operate the flap adjusting air flow direction by your hand. (FXYF, FXYC, FXYH, FXYA, FXYK)

3PA61137

5. Adaptor for Wiring

5.1 KRP1B61

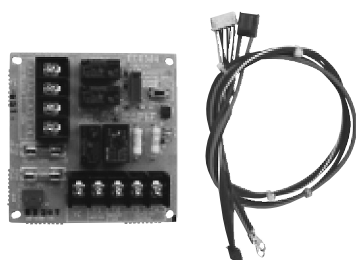

Item	Model	KRP1B61
Dimensions (mm)		100x100
Length of lead wire (mm)		400
Accessories		PC board support, Clamp, Installation manual

2
 4.1 BRC3A61 / 5.1 KRP1B61

Accessories Check if the following accessories are included in the kit.

Adaptor	x1
PC board support	x4
Clamp	x3
Installation manual	x1

Notes

- Kits vary according to applicable models.
- A special adaptor fixing plate and box are required for the following models.
 FXYC, FXCQ KRP1B96
 FXD (Installing two adaptors) . . . KRP4A91

1 NAMES OF PARTS

2 ELECTRIC WIRING

- Refer to the WIRING DIAGRAM attached to the indoor unit before attempting to wire. (Make sure wires to units do not pass over the PC board when wiring.)
- Wire the adaptor to the indoor unit as shown below.

1 Fetching the operation display signal

- Attaching an hour meter
- Fan ON display

Output is generated at the contact while the compressor is running.

Example: HM: Hour meter (Part to be procured in the field)

Output is generated at the contact while the fan is running.

Example: RL: Operation lamp (Part to be procured in the field)

2 If optional accessories are installed (auxiliary electric heater, humidifier)

- Wire correctly in accordance with the attached installation manual.
- Refer to the wiring diagram applied to the indoor unit when running electric wiring.

C: 2PA61563C

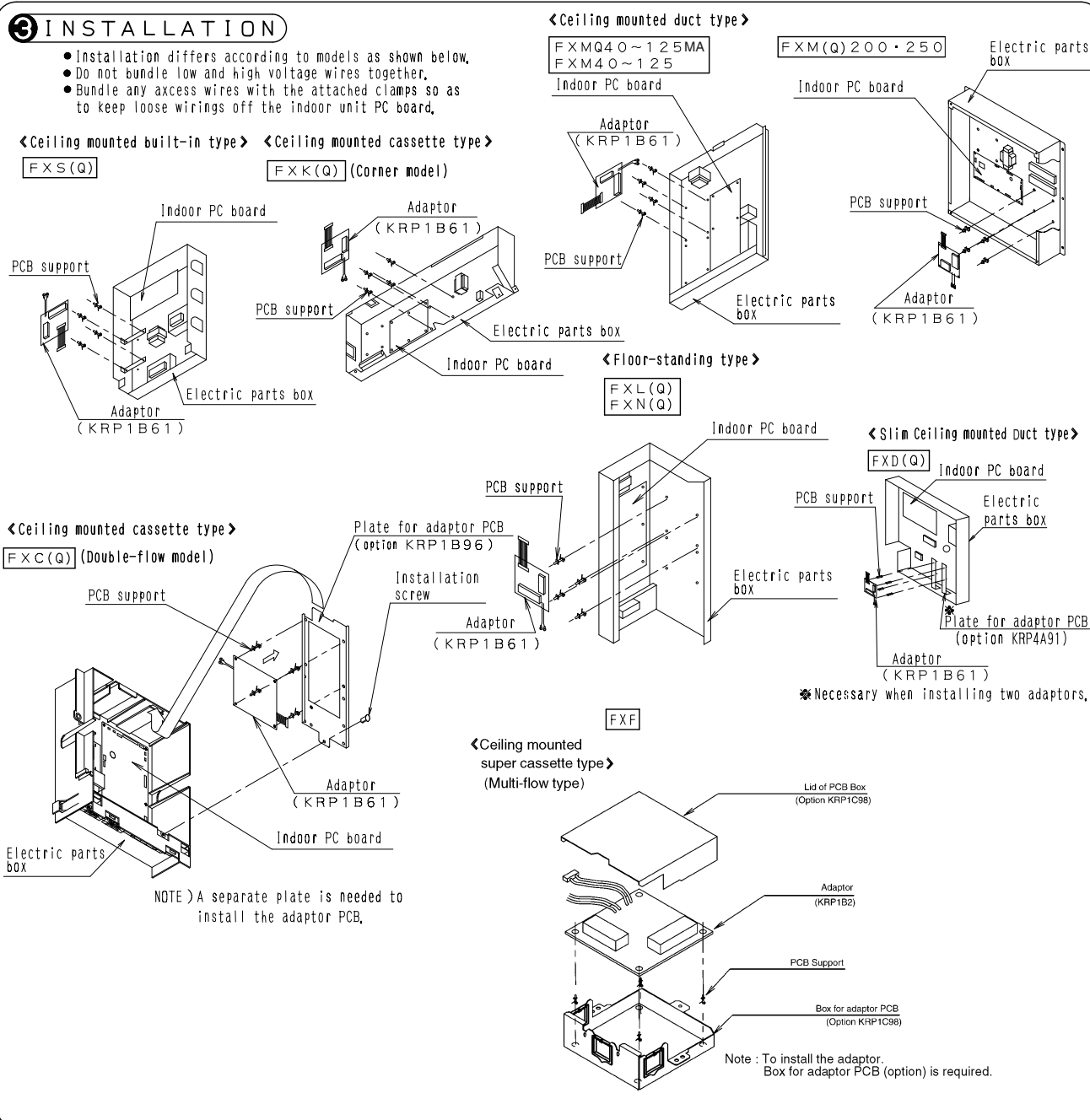

C: 2PA61563C

5.2 KRP1B56 / KRP1B57 / KRP1B59



Item	Model	KRP1B56	KRP1B57	KRP1B59
Dimensions (mm)		85x49		
Length of lead wire (mm)		2,000	1,500	500
Component parts		Wiring adaptor PCB, PCB support, clamp, Installation manual		

2
 5.1 KRP1B61 / 5.2 KRP1B56 / KRP1B57 / KRP1B59

Accessories Check if the following accessories are included in the kit.

Adaptor × 1	PCB support × 4
	Clamp × 3
	Installation manual × 1

NOTE

- Kits vary according to applicable models.
- A special adaptor fixing plate and box are required for the following models.

FHYCP-D, FXFQ-MA, FXF-L	KRP1D98
FXFQ-P	KRP1H98
FH(Y)C(P)-B	KRP1C98
FH(Y)C-K	KRP1B98
FH(Y)(P), FHQ, FXHQ	KRP1C93
FV(Y)	KRP4A95
FFQ, FXZQ, FXD(Q)	KRP1B101

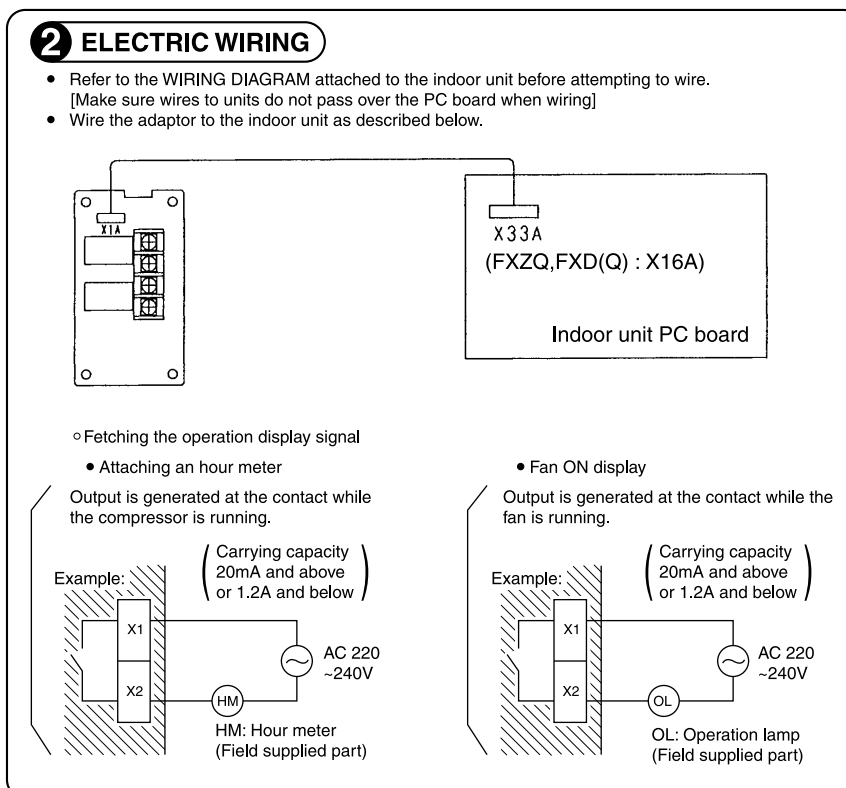
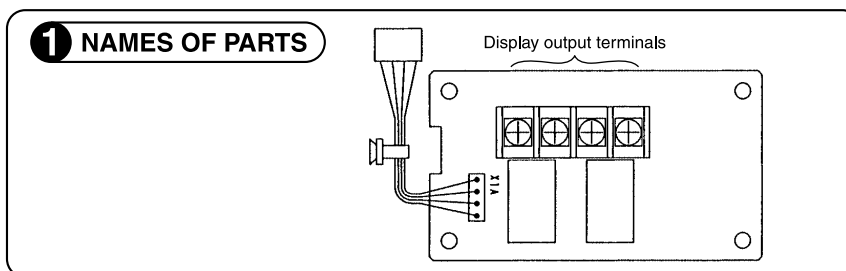

C: 1PA60037E

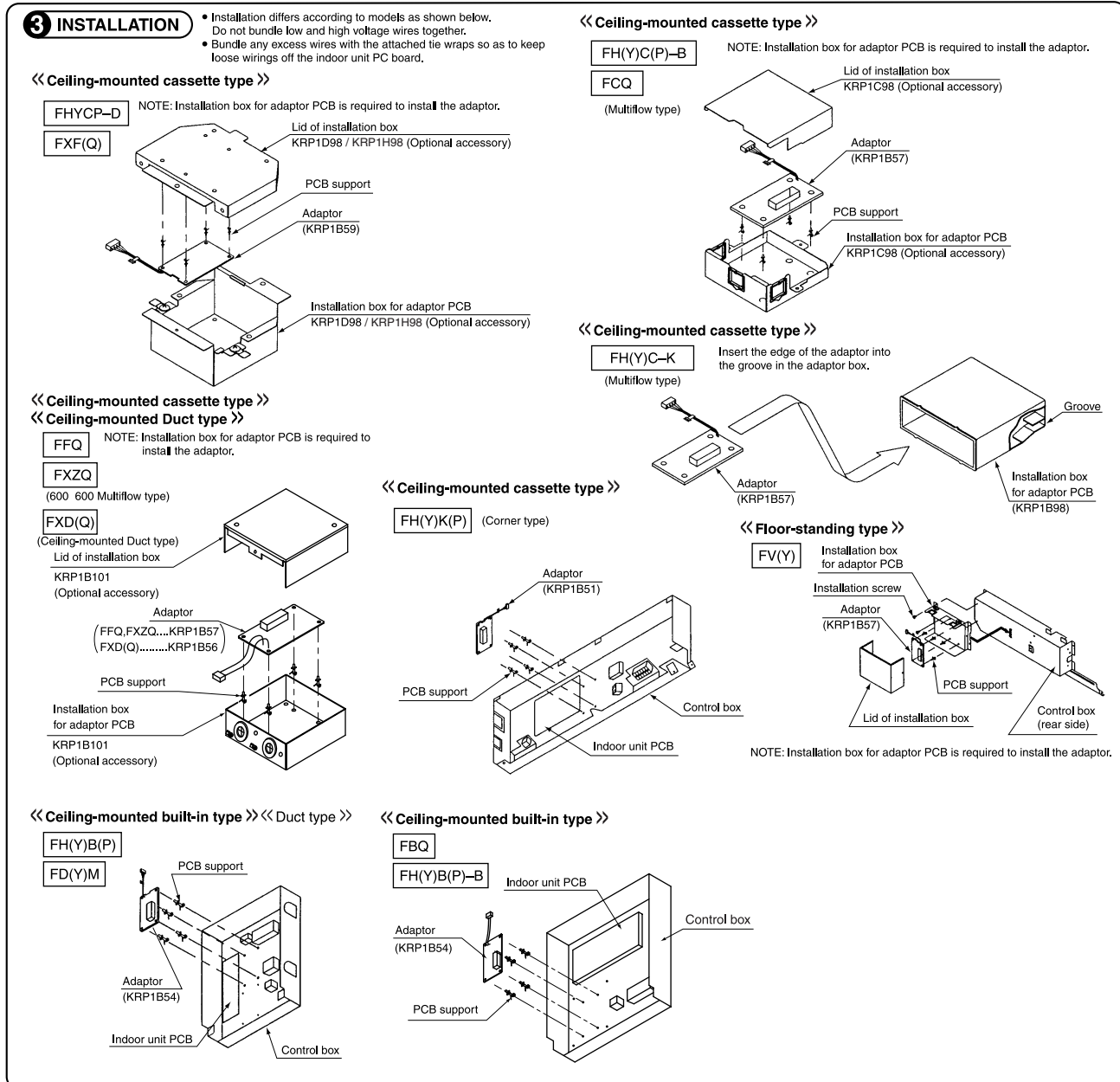

C: 1PA60037E

5.3 KRP1B3

Contents of kit

Prior to installation check whether you have the complete kit of parts as shown below including the installation manual.

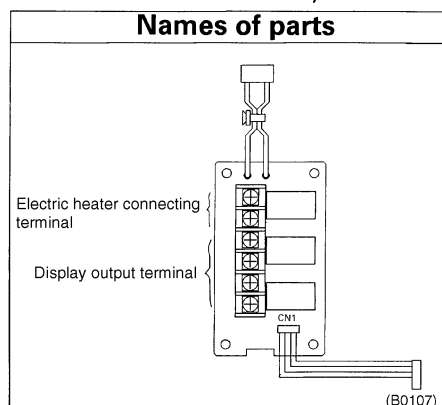

Item	Model	KRP1B3
Installation site		Interior of electric parts box
Dimensions (mm)		85×49
Length of lead wire (mm)		250/650
Component parts		Wiring adaptor PCB, Clamp, Installation Manual

1. Electrical wiring

- Refer to the wiring diagram of the indoor unit for its wiring connection. (Make sure all the wiring to the unit should not go over the PC board.)
- Connect the wiring to the indoor unit as shown below.

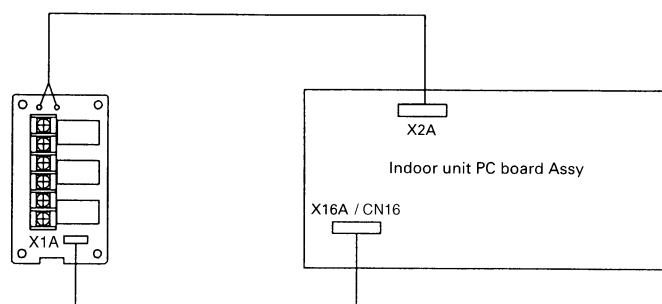

- ① To detect the operation display signal
- Installation of the watt-hour meter

Output signal to detect the operation of the compressor

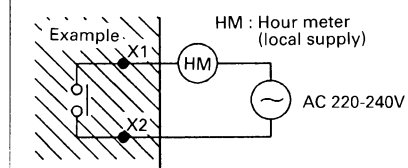

- The fan display signal

Output signal to detect the operation of the fan

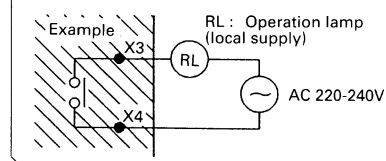

② In case the electric heater is installed

- Connect the wiring properly according to the installation manual included in the kit.
- Refer to the wiring diagram of the indoor unit for its wiring connection.

2. Installation

- Never bundle high and low voltage wiring together.
- Be sure to bundle the excess wiring with the attached plastic strap so as to keep the loose wiring off the indoor unit PC board.

< Ceiling Suspended Type >

FXH (Q)

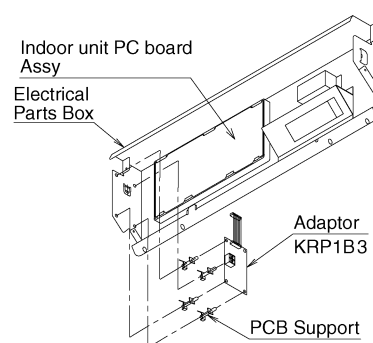







JC: 2PA58148A

2

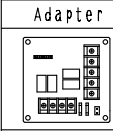
5.2 KRP1B56 / KRP1B57 / KRP1B59 / 5.3 KRP1B3

5.4 KRP1C63

Accessories Check if the following accessories are included in the kit,

Adapter	Wire harness 1	Wire harness 2	PCB support	Clamp	Installation manual
					
x 1	x 1	x 1	x 4	x 3	x 1

Note

- Keep in mind that a kit changes with application models,
- An adapter attachment box is required for the following model separately.
FXFQ-P KRP1H98

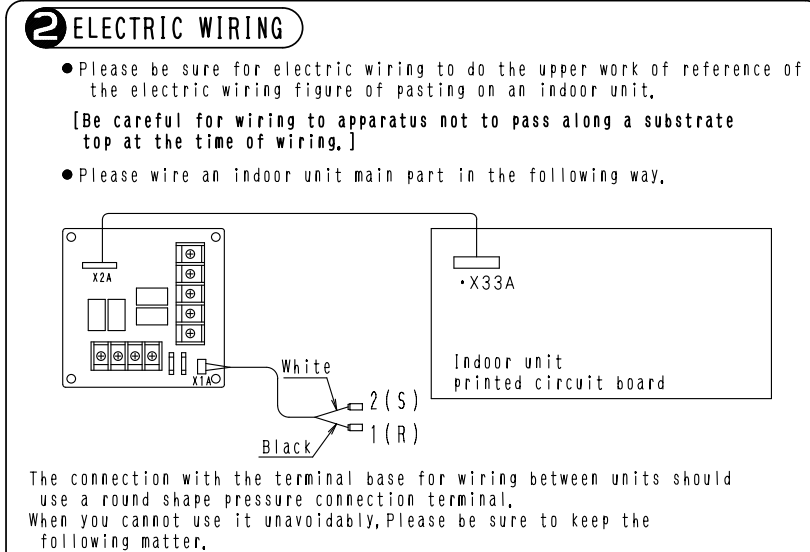
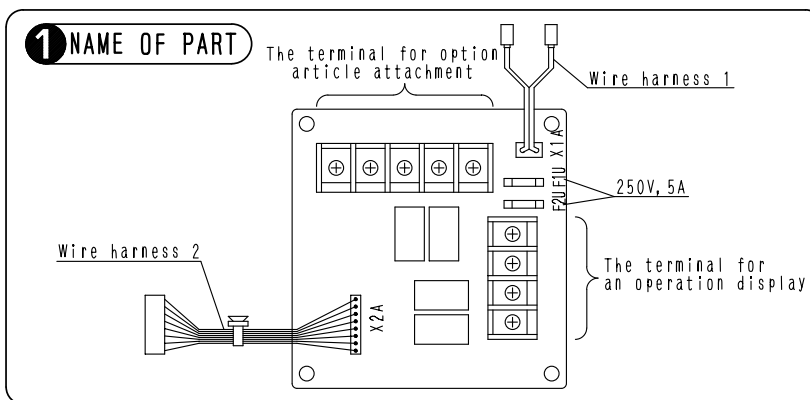

2P178844-1A

<Attention at the time of power-source wiring>

Round shape pressure terminal Electric wire

- Please do not connect two diameter electric wires of different to the terminal base for wiring between units, (There is fear of unusual generation of heat according to looseness of an electric wire etc.)
- It connects certainly using a predetermined electric wire, and external force wiring in a terminal part, Please fix not to be added,
- Please use a proper driver for bolting of a terminal screw thread, The driver of small size damages a screw-head part, and cannot perform proper bolting,
- A screw thread may be damaged if a terminal screw thread is bolted too much,
- Refer to the right table for the torque with a bundle of a terminal screw thread,

Torque with a bundle (N·m)	
The terminal base for wiring between units	1.18~1.44

- Fetching the operation display signal.
- Attaching the operation display signal ● Fan ON display

Output is generated at the contact while the compressor is running,

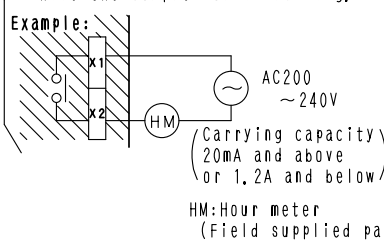

Output is generated at the contact while the fan is running,

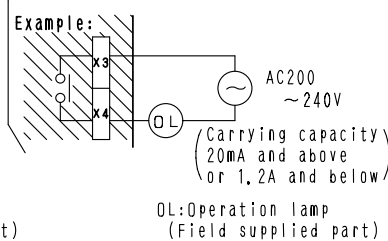

③ INSTALLATION

- Means of attachment are shown below, However, a strong electric wire and a weak-electric-current line should not band together simultaneously,
- Please remain so that wiring does not wire on the indoor PCB, and bundle wiring of a part by attached Thailand Rapp,

FXFQ-P

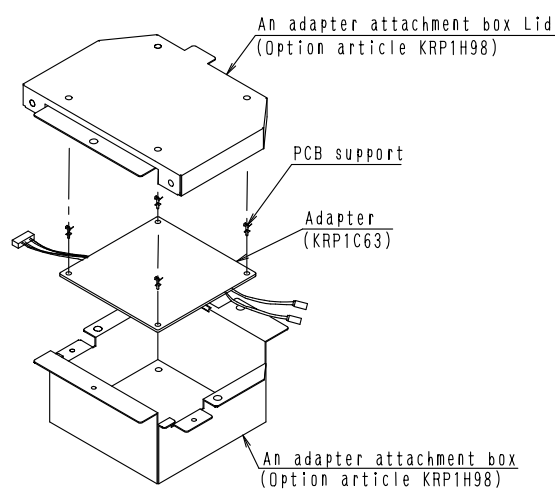

NOTE) An adapter attachment box is required for attachment separately.
• Please use substrate support of attachment by an adapter and attach in the adapter attachment box cover side,

2P178844-1A

5.5 KRP1C64

Caution

- This unit is wiring adaptor for indoor unit of ceiling-mounted duct type. Check the indoor unit model name, (As below mentioned table)
- This unit is needed to plate for adaptor PC separately.
- Refer to installation manual of plate for adaptor PC, while installing this unit,

Adaptor for wiring	Indoor unit	Plate for adaptor PC kit
KRP1C64	FBQ~DVET FXMQ~PVE	KRP4A96

Accessories

- Check if the following accessories are included in the kit,

< Remarks >

Don't throw away all parts until finished installation, because these parts are necessary for installation work,

Name	Adaptor for wiring	Harness 1	Harness 2	PC board support	Clamp	Installation manual
Shape						
Quantity	1	1	1	4	4	1

< Caution >

- All wiring must be performed by an authorized electrician.
- For electric wiring work, refer to also "Wiring diagram" attached to the control box lid and this manual.
- All wiring must be worked after shutting down power supply.
- All field supplied parts and materials and electric works must conform to local codes.
- A circuit breaker capable of shutting down power supply to the entire system must be installed,

1 NAMES OF PARTS

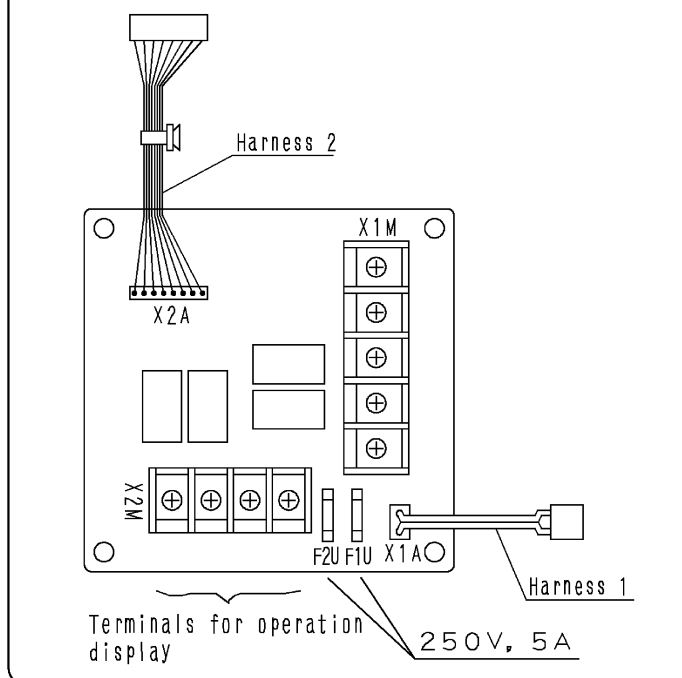

3P226298-1

2 ELECTRIC WIRING

- Refer to the WIRING DIAGRAM attached to the indoor unit before attempting to wire.
[Make sure wires to units do not pass over the PC board when wiring.]
- Wire the adaptor to the indoor unit as shown below.

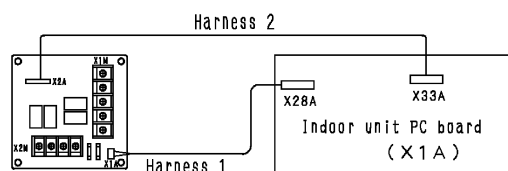

Fetching the operation display signal

- Attaching an hour meter
- Fan ON display

Output is generated at the contact while the compressor is running.

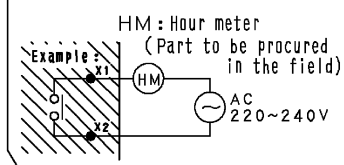

Output is generated at the contact while the fan is running.

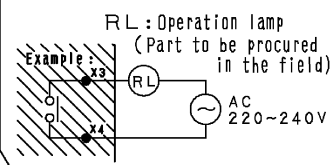
**3 INSTALLATION**

- Do not bundle low and high voltage wires together.
- Bundle any excess wires with the attached clamps so as to keep loose wirings off the indoor unit PC board.
- Set up adaptor to the plate refer to below figure direction.

Plate for adaptor PC

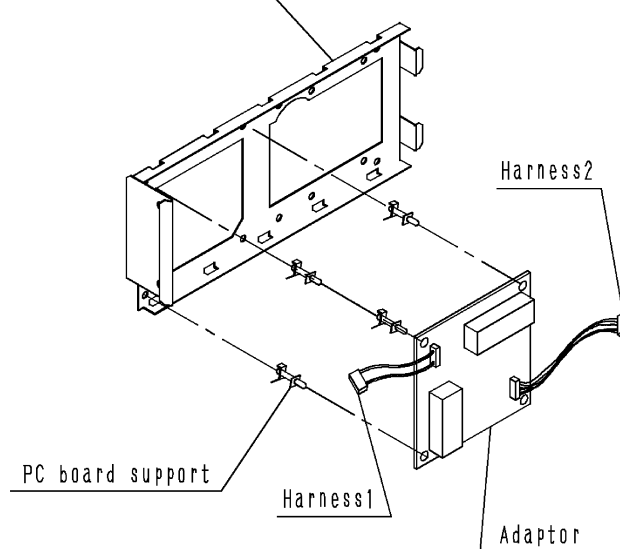

3P226298-1

6. Wiring Adaptor for Electrical Appendices (1) (2)

6.1 KRP2A61 / KRP2A62 / KRP2A53

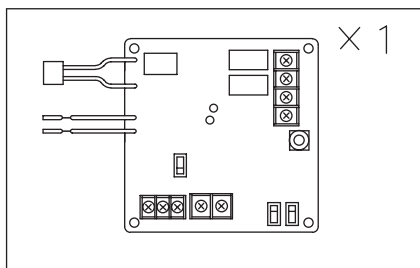

Item	Model	KRP2A53	KRP2A61	KRP2A62
Dimensions (mm)		100x100		
Length of lead wire (mm)		2,000	500	1,300
Component parts		Wiring adaptor PCB, PCB support, clamp, Installation manual		

System Configuration

The KRP2A61-62 enables operation by remote control (ON/OFF control, temperature setting, operation display, error display). With it, the following system can be built. Note however that the adaptor cannot be used with other optional controllers for centralized control.

1. Zone Control

(Unified control of a max. 64 groups of a max. 16 indoor units each. But, the max. of indoor units is 128.)

This system requires the following parts.

- Wiring Adaptor for Electrical Appendices (1)
... KRP2A61 or KRP1C62
- Remote controller switches (For control)

...BRC1C62
BRC2A51
BRC3A61 } Per group

(Ex.) Zone control for 8 FXYC63KVE units (control groups of 4, 3 and 1)

KRP2A61x1 kit
BRC1C62x3 kits } 1 set required for each group.

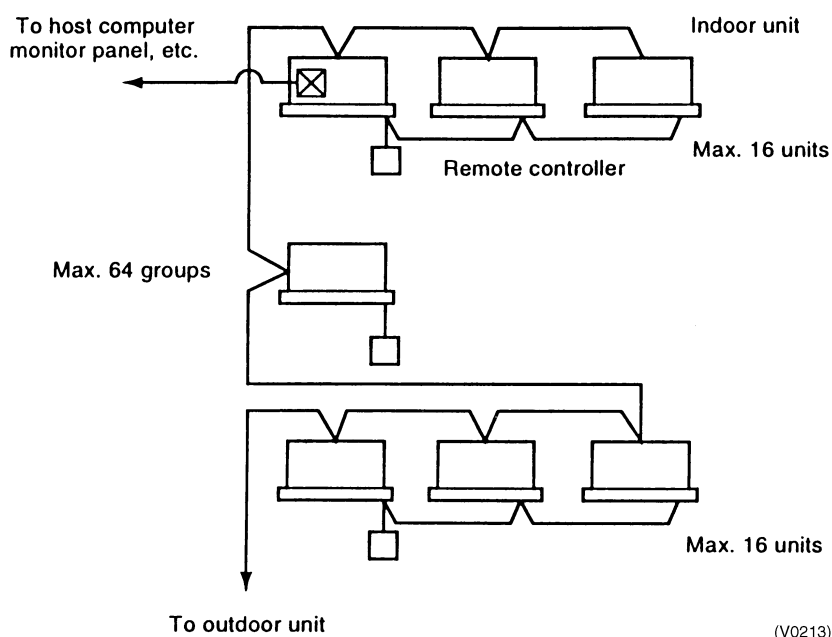

Note:

1. Individual indoor units connected to the centralized line cannot be displayed individually.
2. For wiring adaptor for electrical appendices (2) <KRP4AA51, KRP4AA52, KRP4AA53, KRP4A54>, refer to page 528.

C: 1PA63641H

Names of Parts and Functions

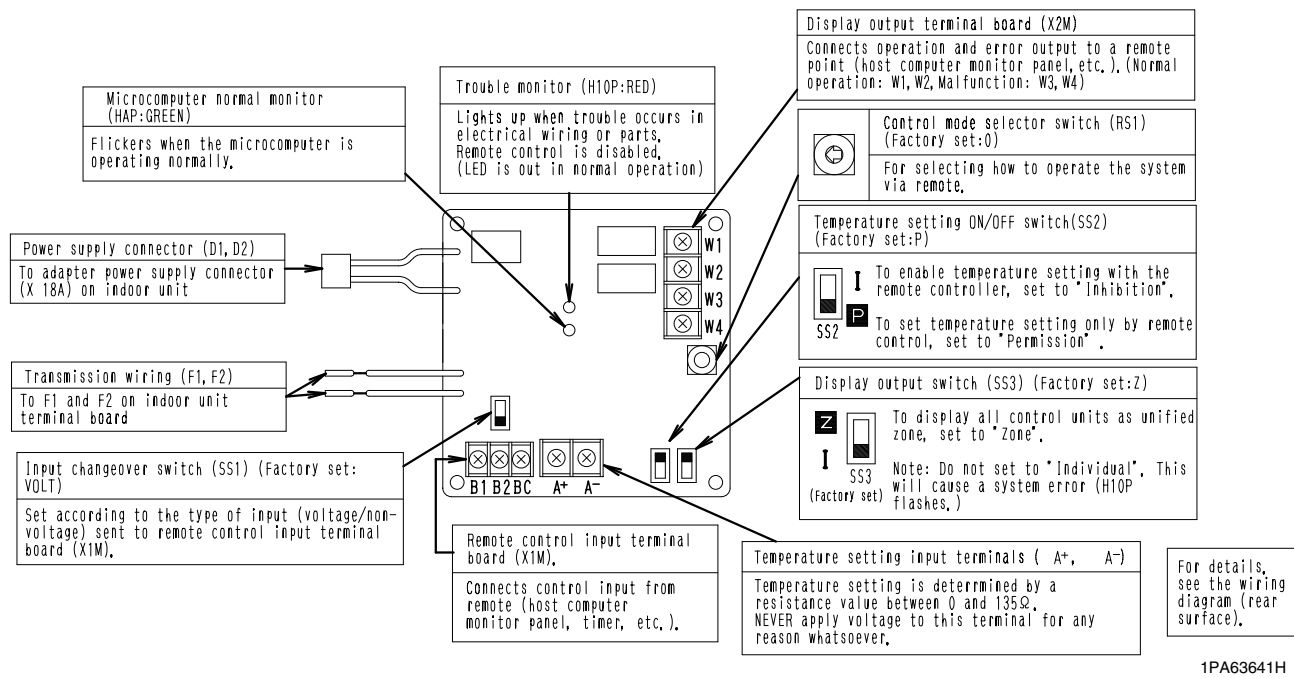

2
 6.1 KRP2A61 / KRP2A62 / KRP2A53

Installation

Ceiling Mounted Cassette Corner Type

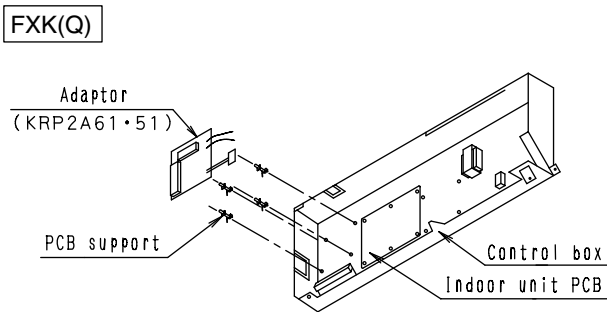

Ceiling Mounted Cassette Type (Double-Flow)

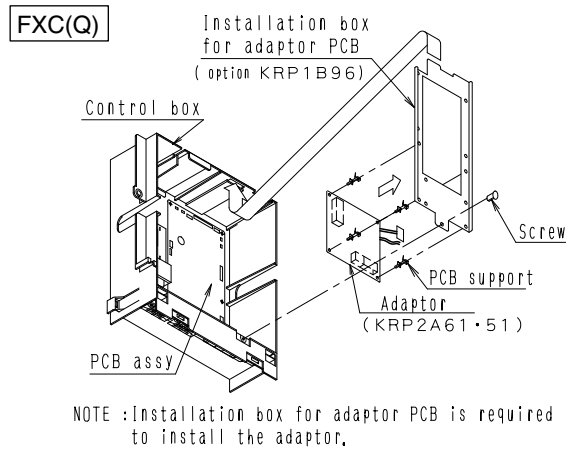

Ceiling Mounted Cassette Type

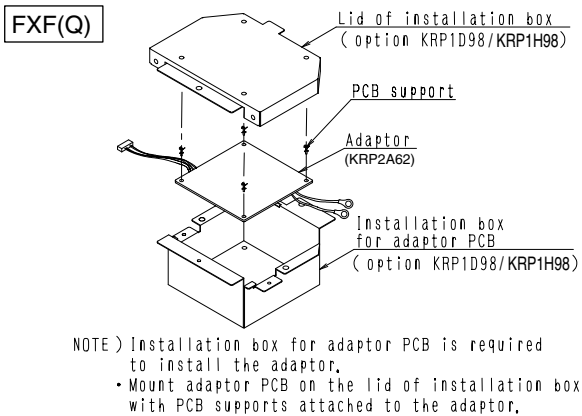

Ceiling Mounted Cassette Type (600x600 Multi-Flow)

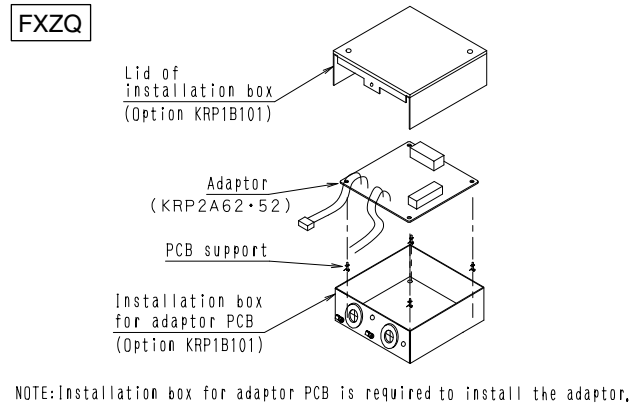

C: 1PA63641H

Ceiling Mounted Duct Type

FXM(Q)40~125

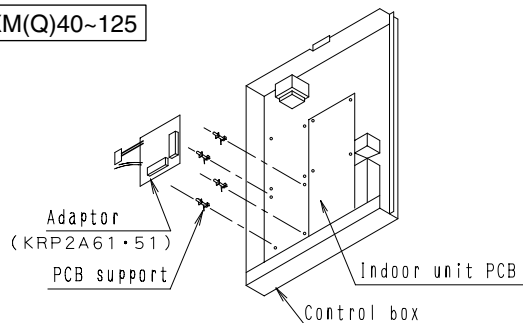

FXM(Q)200 · 250

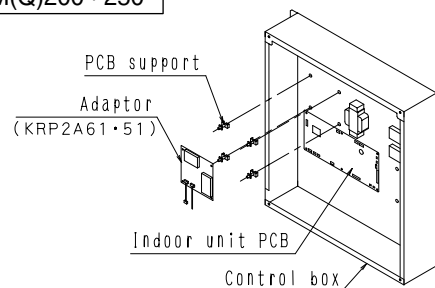

**Ceiling Mounted Built-In Type
Ceiling Mounted Built-In Type (Rear Suction)**

FXS(Q)
FXYS
FXYP
FXYS
FXYP

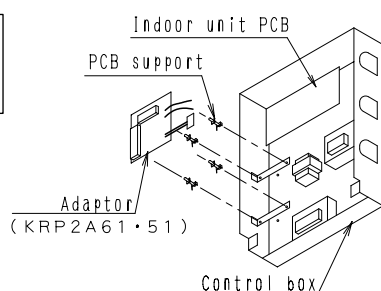

Note :
Installation box is necessary for second adaptor (FXS (Q)) .

Ceiling Suspended Type

FXH(Q)
FXYP

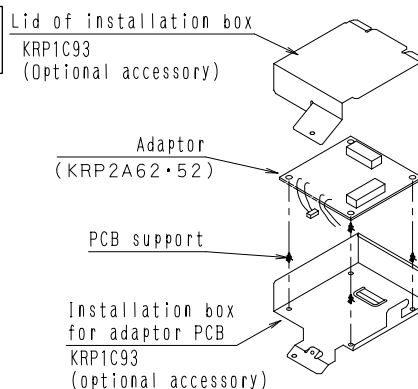

NOTE : Installation box for adaptor PCB is required to install the adaptor.

Floor Standing Type

FXL(Q), FXYLP
FXN(Q), FXYLMP

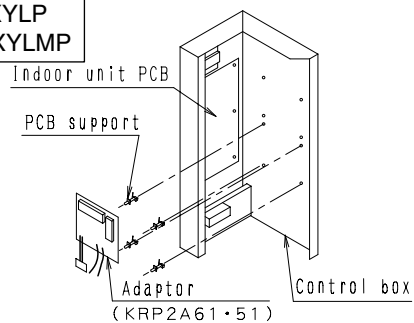

Wall Mounted Type

FXA(Q)

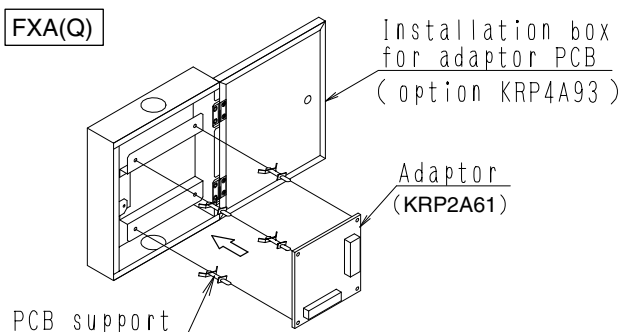

Slim Ceiling Mounted Duct Type

FXD(Q)

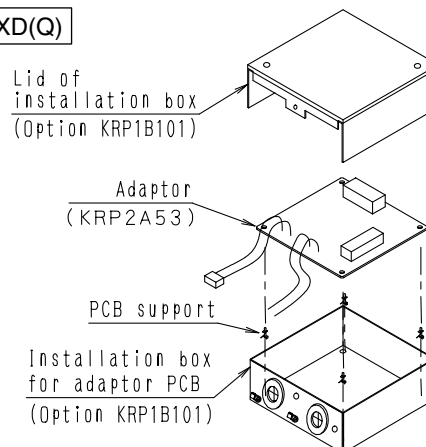

NOTE : Installation box for adaptor PCB is required to install the adaptor.

C : 1PA63641H

Electric Wiring Work

1. First, wire between the indoor and outdoor units, then to the separate power sources, and between the indoor units and the remote controllers. Then, check wiring is correct. (If wanting group control by remote controller, check transmission wiring.) For details, see the installation manual of the indoor and outdoor units.
2. Next, wire between the wiring adaptor for electrical appendices (1) and the indoor units. For details, see **Wiring to indoor units**.
3. Finally, wire between external units such as the host computer monitor panel, and make the necessary settings. For details, see **Wiring to external units (host computer monitor panel)**.

Note:

It is not necessary to set address No. for centralized control.
(Setting is automatic.)

2

6.1 KRP2A61 / KRP2A62 / KRP2A53

Wiring to Indoor Units

1. For Zone Control

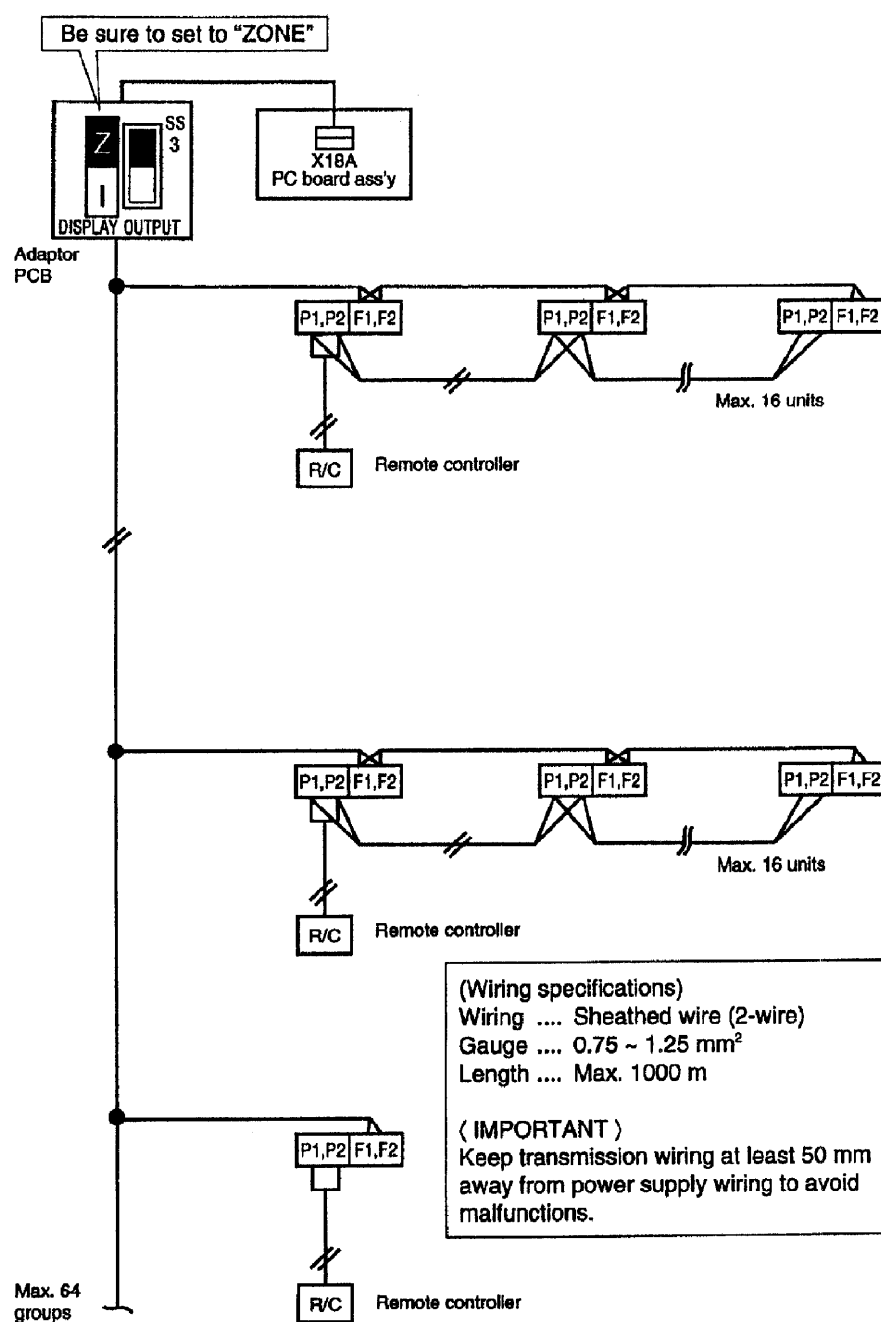

1PA63642B

4 Electrical wiring

- ① First, wire between the indoor and outdoor units, then to the separate power sources, and between the indoor units and the remote controllers. Then, check wiring is correct. (If wanting group control by remote controller, check transmission wiring.) For details, see the installation manual of the indoor and outdoor units.
- ② Next, wire between the wiring adaptor for electrical appendices (1) and the indoor units. For details, see Wiring to indoor units.
- ③ Finally, wire between external units such as the host computer monitor panel, and make the necessary settings. For details, see Wiring to external units (host computer monitor panel).

Note) It is not necessary to set address No. for centralized control.
(Setting is automatic.)

1PA63642B

Wiring to External Units (Host Computer Monitor Panel)

1. Remote Control Input (Operation Control)

Wire as described below. Wiring differs depending on whether using a voltage or non-voltage input.

■ For voltage input

■ For non-voltage input

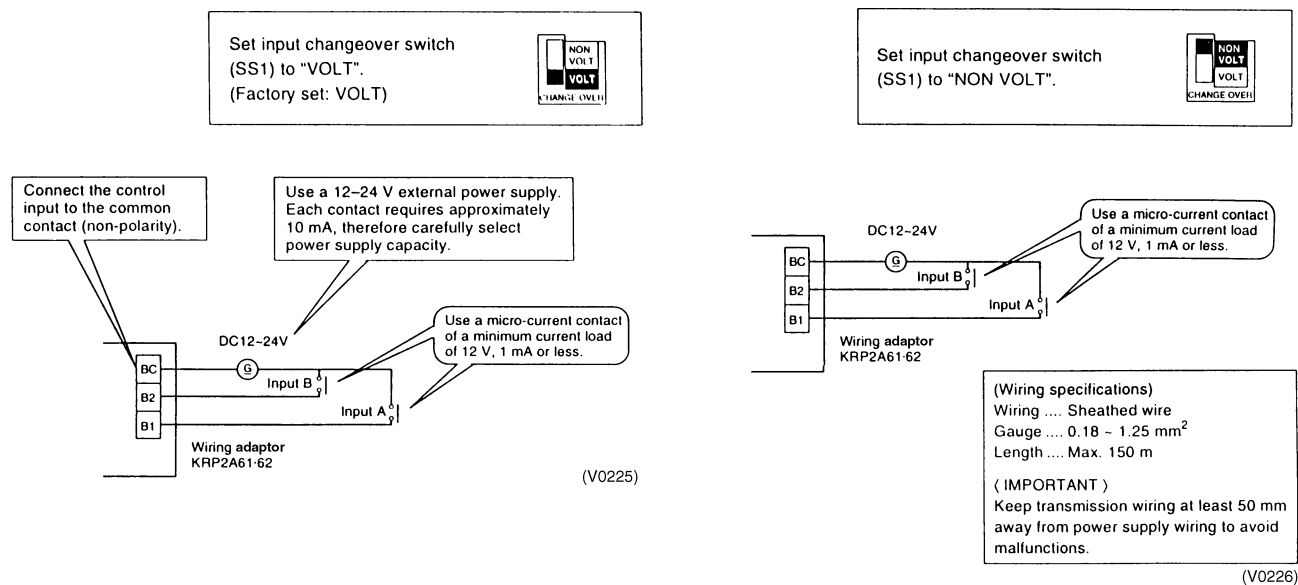

2. Setting Control Mode Selector Switch (RS1)

Using control mode selector switch (RS1), select the control mode as described below.

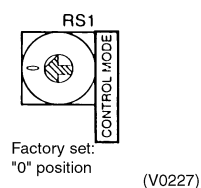

(1) When operating with only individual display function

Position	Function
0	Individual Display (Input Ignored)

(2) When operating with constant input from A

Position	Function	Contents when input A is ON	Contents when input A is OFF
1	Remote controller rejection	Operation (remote controller is normally rejected)	Stop + remote controller rejection
2	Central priority	Operation + remote controller accepted	
3	Stop by remote controller acceptable	Operation + stop by remote controller acceptable (No operation by the remote controller)	
4	Remote controller acceptance/rejection	Remote controller acceptance only (No operation by the remote location)	

Note:

- Input B is for forced-OFF. When ON, stop + remote controller is rejected, and input A is ignored. When OFF, even if A is ON, the contents of when input A is ON, are not achieved. Input A must therefore be re-input.

C : 1PA63642B

(3) When operating with momentary input from A
(Use a momentary input of ON time 200 milli-sec. or longer.)

Position	Function	Contents of Input A	Function of Input B
5	Remote Controller Rejected	Stop for ON while operating, Operate for ON while stopping	Input B will be forced stop function (When ON, stop + remote controller is rejected, input A is ignored.)
6	Last Command Priority	Stop for ON while operating, Operate for ON while stopping (Remote controller is normally accepted.)	

- For demand control from input B

Position	Function when input A is ON	Function when input B is ON
C	Remote controller rejected (Same as position "5")	Forced thermostat OFF command
D		Forced temperature shift command
E	Last command priority (Same as position "6")	Forced thermostat OFF command
F		Forced temperature shift command

- Forced thermostat OFF command
Forces indoor unit to operate the fan only.
- Forced temperature shift command
The indoor unit operates at 2°C higher (cooling) or 2°C lower (heating) than the set temperature.

Note:

- In zone control, operation is displayed as long as one indoor unit is running. When in the last command priority mode, some units are not operating while ON.
- In such case, even if input A is ON, the unit and all other units in the same zone will stop.

(4) When operating with dual momentary inputs from A and B (Use a momentary input of 200 milli-sec. or longer.)

Position	Function	Contents when Input A is ON	Contents when Input A is OFF
7	Remote Controller Rejection	Operation (remote controller is normally rejected)	Stop + remote controller rejection
8	Central Priority	Operation + remote controller accepted	
9	Stop by Remote Controller Acceptable	Operation + stop by remote controller acceptable (No operation by the remote controller)	
A	Remote Controller Acceptance/Rejection	Remote controller acceptance only (No operation by the remote location)	Stop (remote controller normally accepted)
B	Last Command Priority	Operation (remote controller is normally accepted)	

Note:

- Doing constant input A with position 7-A, it will be forced OFF function (input A is ignored).
- Constant input cannot use for input B with position B.

1PA63642B

3. Temperature Setting Input

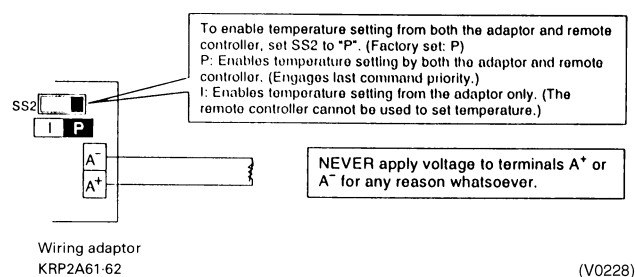

Temperature setting corresponds to resistance values in the range of 0 to 135Ω. Their relationship is as shown below.

Temperature Setting (°C)	16	17	18	19	20	21	22	23	24
Resistance (Ω)	0.0~3.4	5.0~11.6	13.8~20.0	22.4~28.4	31.0~36.4	39.4~44.8	48.2~52.8	56.6~61.2	65.2~69.4

Temperature Setting (°C)	25	26	27	28	29	30	31	32
Resistance (Ω)	73.8~77.8	82.4~85.8	91.0~94.0	99.4~102.2	108.6~110.4	117.2~119.2	125.8~127.4	134.2~140.0

Note:

Wiring resistance included in above figures.

(Wiring specifications)

Wiring ... Sheathed wire

Gauge ... 1.25~2.00 mm²

Length ... Max. 70 m

(IMPORTANT)

Keep transmission wiring at least 50 mm away from power supply wiring to avoid malfunctions.

4. Canceling Display Signals

Operation output terminals (W1 and W2) and malfunction output terminals (W3 and W4) are non-voltage constant contact output.

(Allowed electric current per contact is between 10 mA and 3 A.)

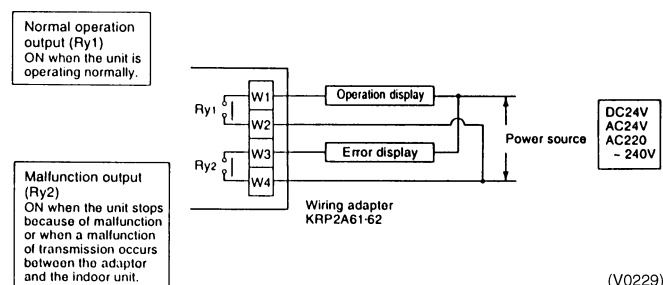

Note:

If using a 220~240V power supply, keep transmission wiring at least 50 mm away from incoming power supply wiring.

Output System	Both Ry1 and Ry2 OFF	Ry1 only ON	Ry2 only ON
Zone control	All zones OFF	At least one unit running normally, no malfunction	Even 1 unit stopped due to malfunction or malfunction of transmission between adaptor and indoor unit

Display output is described by system in the below table.

Note:

If rewiring F1 and F2 after running the system, turn ON power for 5 minutes, then turn it OFF and ON again. Changes to wiring can sometimes disable control from the wiring adaptor.

C: 1PA63642B

6.2 KRP4AA51 / KRP4AA52 / KRP4AA53 / KRP4A54

Outline / Features

This adaptor is an interface required to connect the indoor unit with the central monitoring panel. And by installing this adaptor in the indoor unit, it enables you to have various remote controls (ON/OFF, temperature setting, operation status display and malfunction display). One adaptor can control simultaneously the group of units (Max. 16 units) connected to the remote control wiring line (P1, P2).

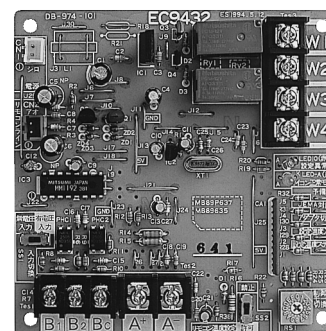

Note:

1. This adaptor cannot be used together with central control equipment and data station.
2. The model of adaptor differs according to the type of indoor unit to be installed.

Applied Model

Applied Model	Remark	Applied Model	Remark	Note
VRV Plus Series	○	SkyAir Series	○	
VRV Inverter "K(A)" "K(U)" Series	○	Room Air-Conditioner	×	
VRV Heat Recovery Series	○	Other Air-Conditioner	×	
VRV II Series	○	HRV Unit	○	BRC1B61, 62 etc. are required.

System Configuration

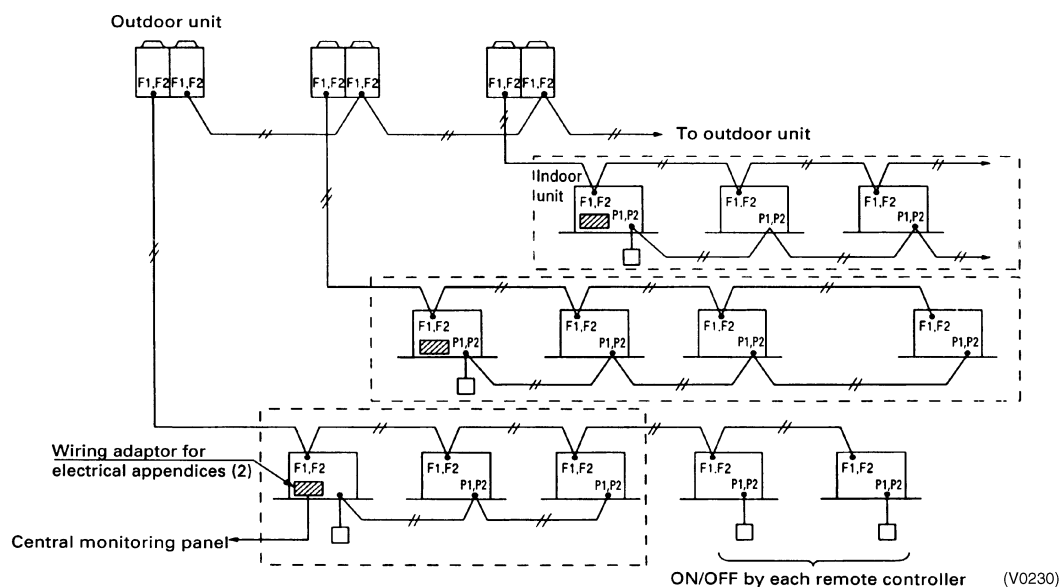

Note:

1. Marked shows wiring adaptor for electrical appendices.
2. Marked indicates the same control range.
3. The wiring adaptor for electrical appendices (2) can control simultaneously the group of the units (Max. 16 units) connected to the remote control wiring line (P1, P2). In another words, all the units connected between P1 and P2 terminal have the same control.

■ Point of wiring

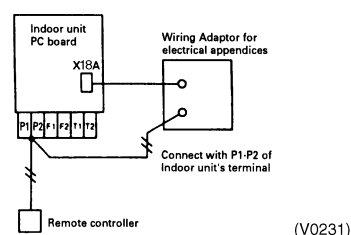

Names and Functions of Operating Part

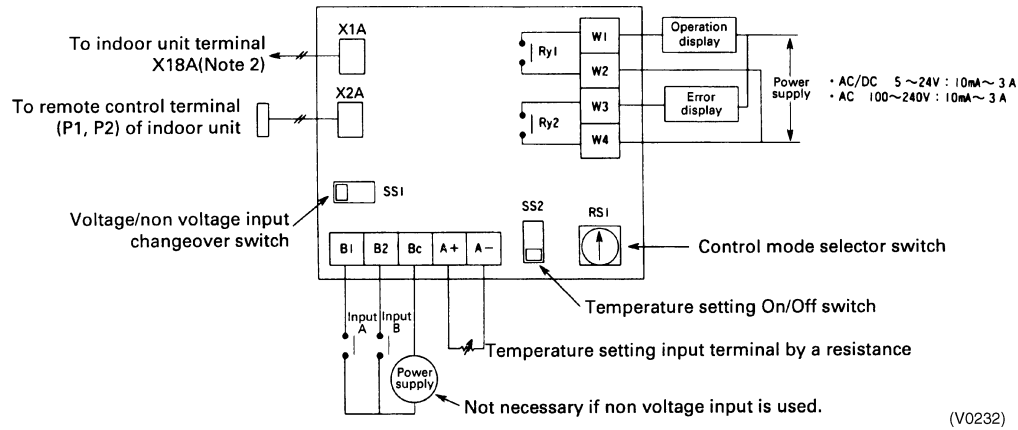

Note:

1. This is valid only for the indoor unit, which has a temperature setting function.
2. Terminal No. X18A is for the indoor unit of VRV system. For SkyAir series and other air-conditioner, connect to the relevant terminal for each units.

Input/Output for External Control

1. Depending on whether [voltage input] or [non voltage input], connect the wiring as shown below.

■ **Input with Voltage.**

Set the Voltage/Non voltage changeover switch (SS1) to VOLT.

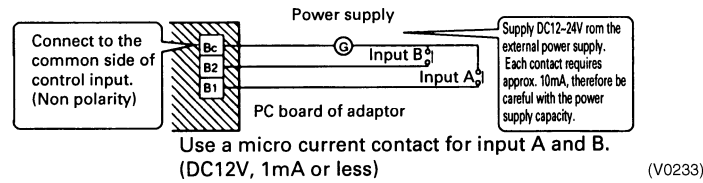

■ **Input with No Voltage.**

Set the Voltage/Non voltage changeover switch (SS1) to NON VOLT.

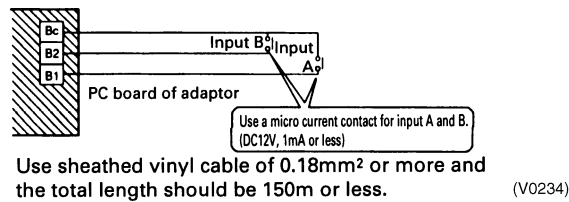

2. Display Signal Retrieval (Output)

The normal operation output terminals (W1, W2) and error output terminals (W3, W4) are non-voltage output contacts. (Permissible current is 10mA~3A per contact.)

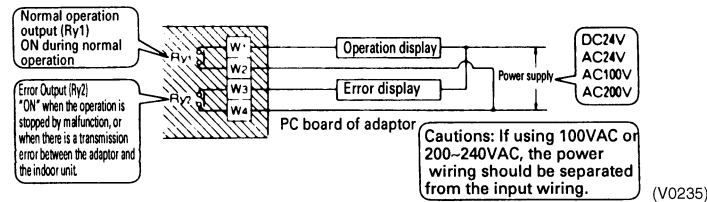

Output is as given below.

Output System	Both Ry1 and Ry2 is OFF.	Only Ry1 is ON.	Only Ry2 is ON.
Group control	OFF	All normal operation	At least one unit is stopped due to error or transmission error between the adaptor and the indoor unit.

3. Temperature Setting Input

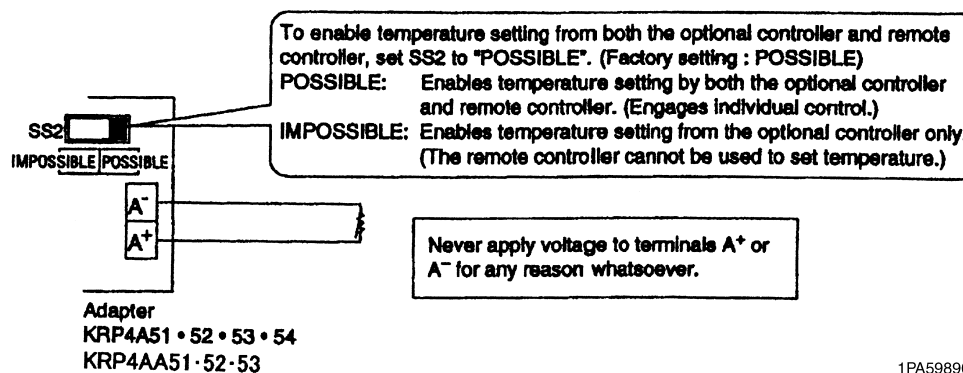

Temperature setting corresponds to resistance values in the range of 0 to 135Ω. Their relationship is as shown below.

Relation between the setting temperature and the resistance are as follows.

Setting temperature (°C)	16	17	18	19	20	21	22	23	24	25	26	27	28	29	30	31	32
Resistance (Ω)	0.0 ~ 3.4	5.0 ~ 11.6	13.8 ~ 20.0	22.4 ~ 28.4	31.0 ~ 36.4	39.4 ~ 44.8	48.2 ~ 52.8	56.6 ~ 61.2	65.2 ~ 69.4	73.8 ~ 77.8	82.4 ~ 85.8	91.0 ~ 94.0	99.4 ~ 102.2	108.6 ~ 110.4	117.2 ~ 119.2	125.8 ~ 127.4	134.2 ~ 140.0

Note:

- The value of resistance includes the resistance of wiring.
- The setting temperature is limited within the setting range of indoor unit. If you set the temperature outside of the range by the adaptor, it controls at the nearest setting range.

Setting of Control Mode Selector Switch (RS1)

Position	Functions	Description of Operation by Input Mode A and B	
		Input A (Between B1~Bc)	Input B (Between B2~Bc)
0	Input Ignored	—	—
1	Remote Control Rejection	Start at ON, and stop at OFF	Stop at ON (remote control rejection), Input A acceptance at OFF
2	Central Priority	Start at ON (remote control acceptance), stop at OFF (remote control rejection)	
3	Remote Control Acceptance/ Rejection	The same as position 1 (Only stop is accepted by remote controller)	
4	Remote Control Acceptance/ Rejection, OFF	Start at ON (remote control acceptance), stop at OFF (remote control rejection)	
5	Remote Control Rejection	Start/Stop (Repeats)	
6	Last Command Priority	The same as position 5 (remote control acceptance all the time)	Stop at ON remote control acceptance), start at OFF (remote control rejection)
7	Remote Control Rejection	Start at ON	Stop at ON.
8	Last Command Priority	Start at ON (remote control acceptance)	Stop at ON (remote control rejection)
9	Remote Control OFF Acceptance	The same as position 7 (Only stop is accepted by remote controller)	The same as position 7
A	Remote Control Acceptance/ Rejection, OFF	Start at ON (remote control acceptance)	Stop at ON (remote control rejection)
B	Last Command Priority	The same as position 7 (remote control acceptance all the time)	The same as position 7
C	Position 5 + Energy Saving Control	The same as position 5	Forced thermostat OFF at ON
D	Position 5 + Temperature Set-Back		Setting temperature shift command at ON
E	Position 6 + Energy Saving Control	The same as position 6	Forced thermostat OFF at ON
F	Position 6 + Temperature Set-Back		Setting temperature shift command at ON

Note:

1. When constant input is used for input B at position 7~A, the system is shut-down forcibly (Ignored input A). Constant input cannot be used for input B at position B.
2. Refer to the followings for the outline of above functions.

■ Description of Functions (Outline)

1. Remote Control Rejection..... For when you want to turn ON/OFF only by central remote controller. (ON/OFF cannot be controlled by remote controller for indoor unit.)
2. Remote controller OFF Only Accepted For when you want to turn ON only by the central remote controller, and turn OFF only by remote controller for indoor unit.
3. Central Priority For when you want to turn ON only by the central remote controller, and during the set time, turn ON/OFF freely by remote controller for indoor unit.
4. Individual Priority (Last command priority) For when you want to turn ON/OFF by both central remote controller and remote controller for indoor unit.
5. Remote Controller Permission Timer For when you want to turn ON/OFF by remote controller for indoor unit during set time, and you want to start the operation by remote controller for indoor unit at the programmed time of system start.

<Example when the control mode selector switch is set at position 6>

The following is the time chart for the command by remote controller and the indoor unit against input signal.

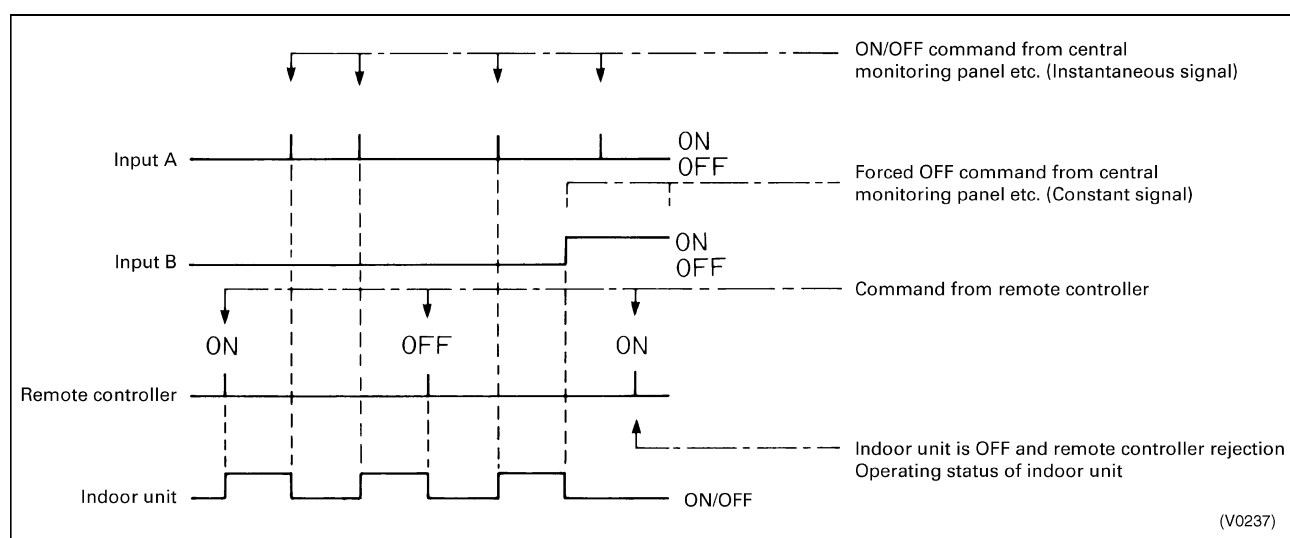

Instruction for Installation

Ceiling Mounted Cassette Type

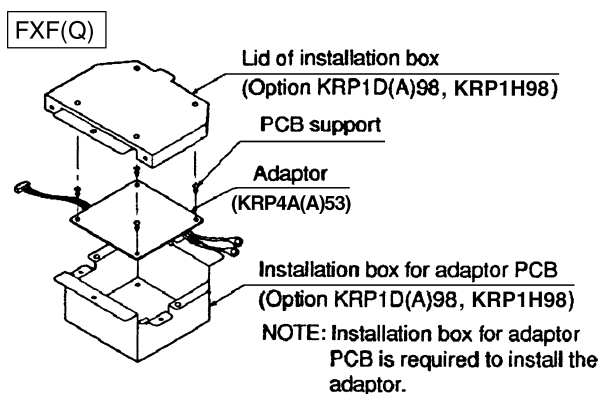

**Slim Ceiling Mounted Duct Type
Ceiling Mounted Cassette Type (Multi-Flow) 600x600**

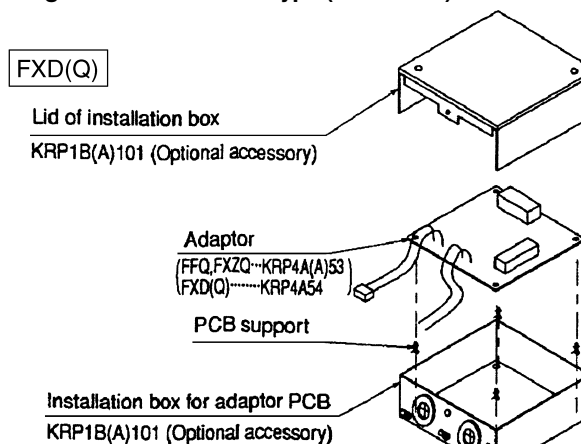

NOTE : Installation box for adaptor PCB is required to install the adaptor.

Ceiling Mounted Cassette Type (Double-Flow)

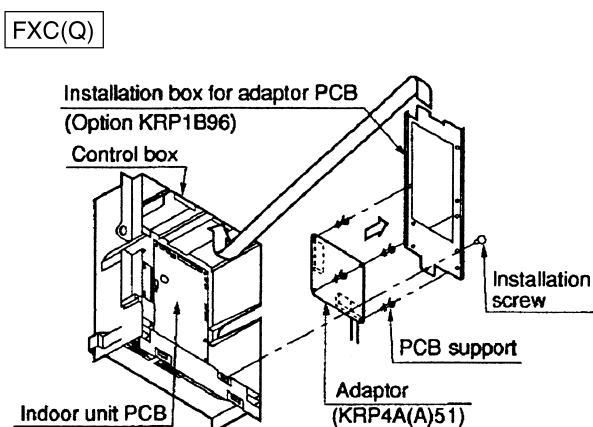

NOTE) A separate plate is needed to install the adaptor PCB.

Ceiling Mounted Cassette Corner Type

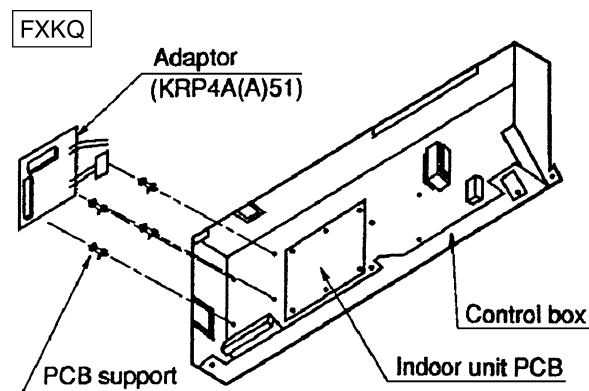

Ceiling Suspended Type

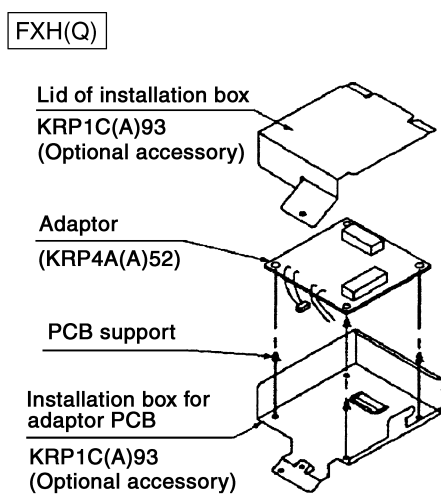

NOTE : Installation box for adaptor PCB is required to install the adaptor.

Note:

The above shows the installation for VRV indoor unit. For the SkyAir series and other air-conditioner, it may be different from the ones showed above and refer to its engineering data for the details.

Ceiling Mounted Built-In Type

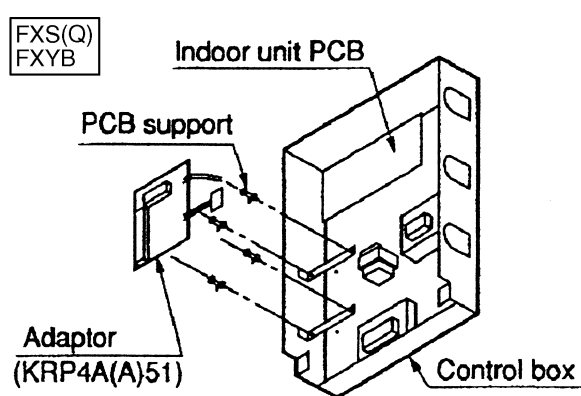

Note :

Installation box is necessary for second adaptor (FXS) .

C: 1PA59889H

Ceiling Mounted Duct Type

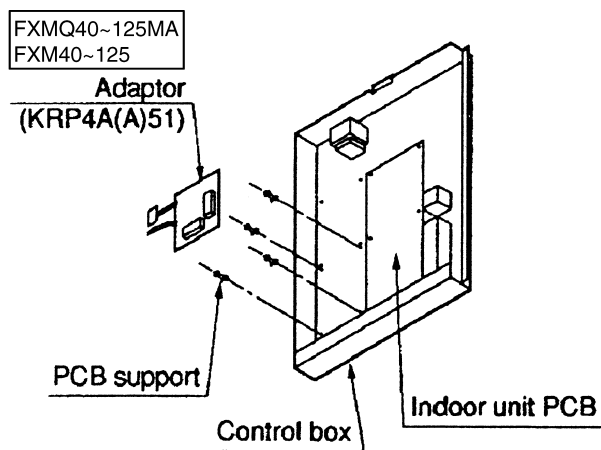

Floor Standing Type

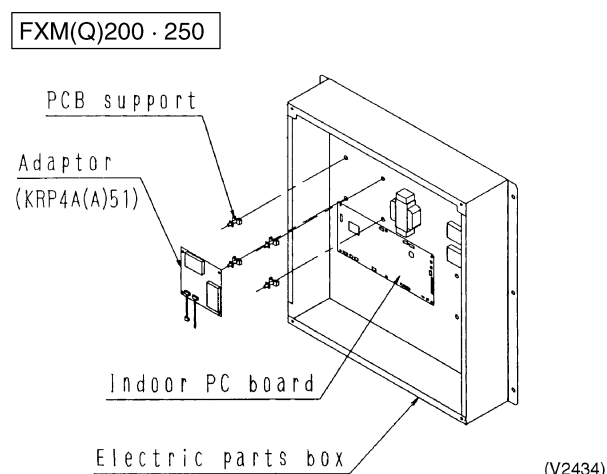
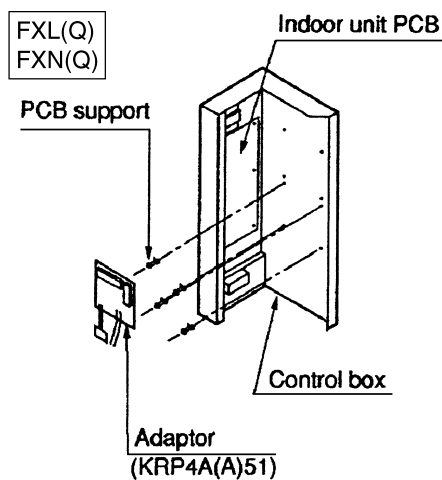

Wall Mounted Type

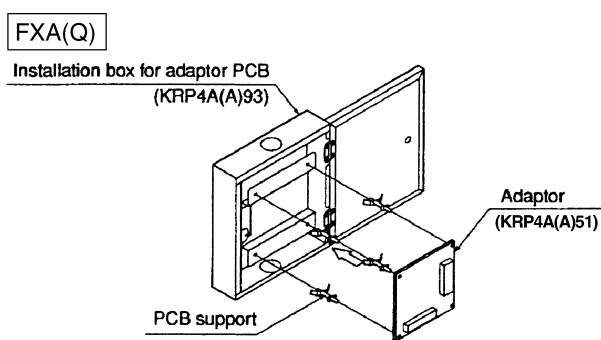
**Note:**

The above shows the installation for VRV indoor unit. For the SkyAir series and other air-conditioner, it may be different from the ones showed above and refer to its engineering data for the details.

C: 1PA59889H

2

6.2 KRP4AA51 / KRP4AA52 / KRP4AA53 / KRP4AA54

7. Installation box for adaptor PCB

7.1 KRP1B101



Notes

- One kit is required for each adaptor,
- Refer to the installation manual attached to the indoor unit and adaptor.

Kit name	Indoor unit
KRP1B101	FFQ25 • 35 • 50 • 60BV1B
	FXZQ20 • 25 • 32 • 40 • 50MVE
	FXD20 • 25 • 32 • 40 • 50 • 63MVE(5)
	FXDQ20 • 25 • 32 • 40 • 50 • 63NVE

Accessories Check the following accessories are included in this kit.

Name	Installation box	Lid of installation box	Clamp	Screws	Cord sticker	Installation manual	Screws
Quantity	x 1	x 1	x 3	x 3	x 3	x 1	x 2
Shape							

Applicable adaptor

(IN CASE OF FFQ, FXZQ TYPE)

Adaptor	Kit name
Adaptor for wiring	KRP1B57
Wiring adaptor for electrical appendices(1)	KRP2A52, KRP2A62
Wiring adaptor for electrical appendices(2)	KRP4A53
External control adaptor for outdoor units	DTA104A52

Applicable adaptor

(IN CASE OF FXD, FXDQ TYPE)

Adaptor	Kit name
Adaptor for wiring	KRP1B56
Wiring adaptor for electrical appendices(1)	KRP2A53
Wiring adaptor for electrical appendices(2)	KRP4A54
External control adaptor for outdoor units	DTA104A53

1 Method of attaching the adaptor

Attach the adaptor

Attach the adaptor in the Installation box ① by the PCB supports .
(PCB supports are accessories of adaptor.)

- Detach the aluminum tape of the Installation box ① to insert the PCB supports .
Adaptor : KRP1B57 --- Detach the aluminum tapes A,
KRP2A52, KRP2A62, KRP4A53, DTA104A52 --- Detach the aluminum tapes B.

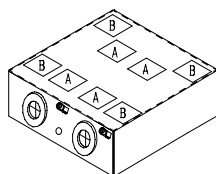

- Connect wires with the adaptor before attaching to the Installation box ①.
- Low voltage wires and high voltage wires should be kept space at least 50mm from each other.

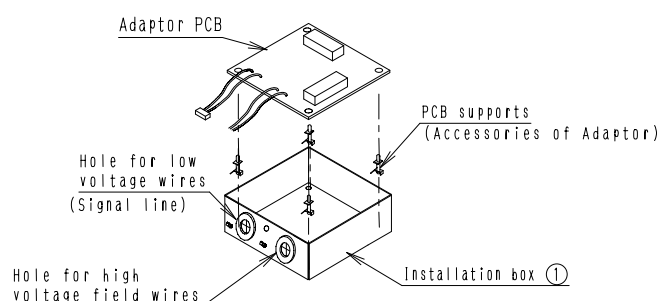

1P107687A

Attach the Lid of installation box

Attach the Lid of installation box ② to indoor unit with two screws.
If two adaptors are installed, the second adaptor is attached to side of first one.

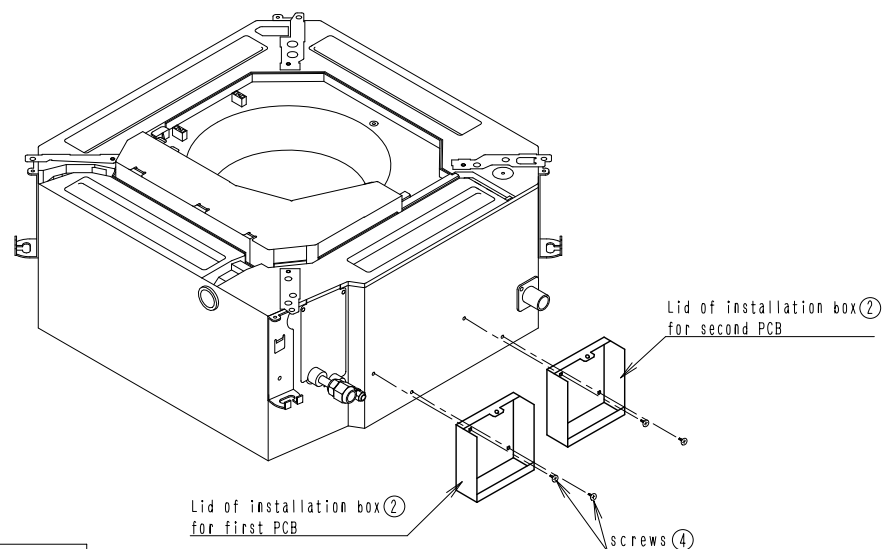

Attach the Installation box

Attach the Installation box ① into the Lid of installation box ② with the screw.

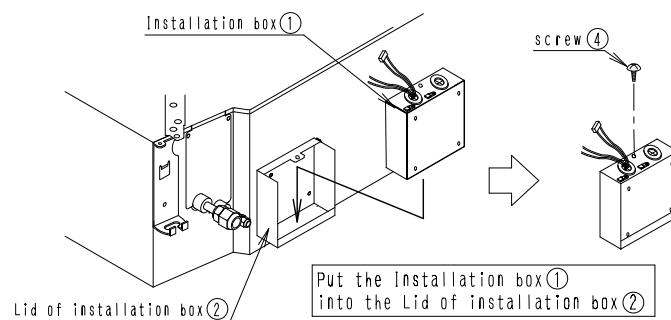

② Method of wiring processing

- Connect wires with control box. (Refer to the installation manual attached to the adaptor.)
- After connecting wires with the control box, clamp wires by using the cord stickers ⑤ and the clamps ③ as shown in the below drawing.

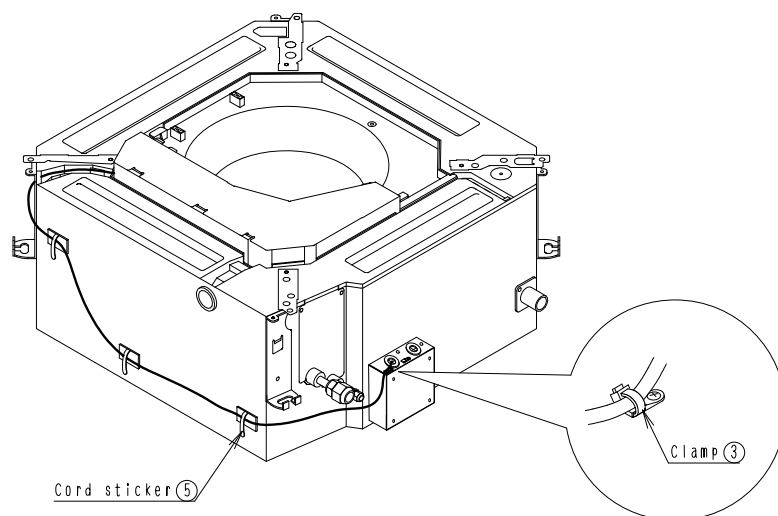

1P107687A

7.2 KRP1D98

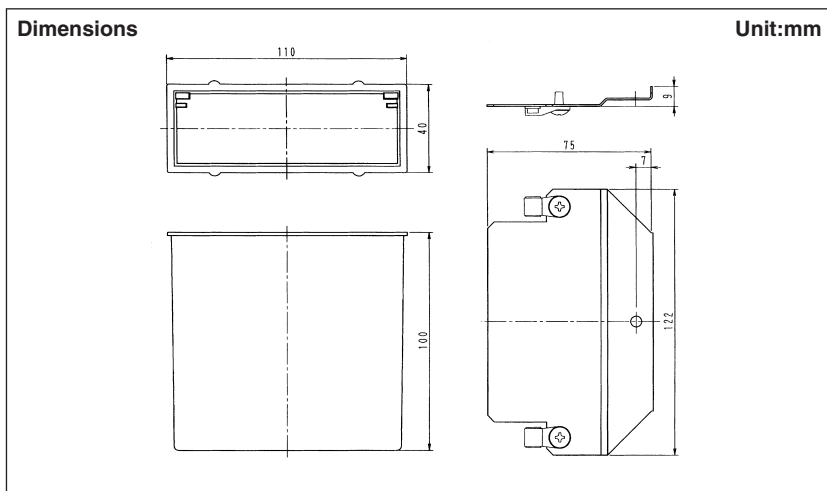
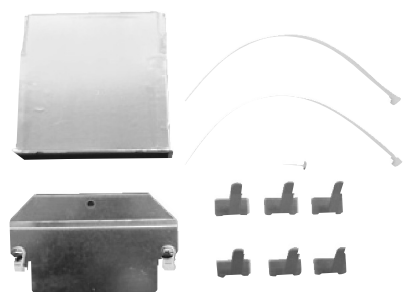

Caution

- This box is mountable on the ceiling mounted cassette type (multi-flow type) unit. After confirming the indoor unit model name, mount this box on the unit listed in the table shown right.
- When mounting the box, see also the indoor unit installation manual and the adapter PCB (Printed Circuit Board) mounting instruction.

Accessories

Check if the following accessories are included with your kit.

Kit name	Indoor unit model that party crowded is possible	
KRP1D98	SPLIT	FHYCP50 • 60 • 71 • 100 • 125DVE FHYCP71 • 100 • 125 • 140DVL FCQ 71 • 100 • 125 • 140D(A)V3B
	VRV	FXF25 • 32 • 40 • 50 • 63 • 80 • 100 • 125LVE FXF25 • 32 • 40 • 50 • 63 • 80 • 100 • 125LVEC FXFQ25 • 32 • 40 • 50 • 63 • 80 • 100 • 125MVE

Name	Adapter box	Adapter box cover	Clamp	Screw(1)	Screw(2)	Installation manual
Quantity	1PC.	1PC.	8PCS.	2PCS.	2PCS.	1PC.
Shape				 M4×12	 M4×8	

1 Mounting the adapter box

<Preparation before wiring>

- ① Remove the switch box cover and the terminal cover, (Fig.1)
- ② Open the switch box until it almost touches the bell mouth, (Fig.2)

<Mounting the adapter box>

- ① Fix the box with the attached fixing screws (1) at two places and the fixing screw (2) at one place, (Fig.3)

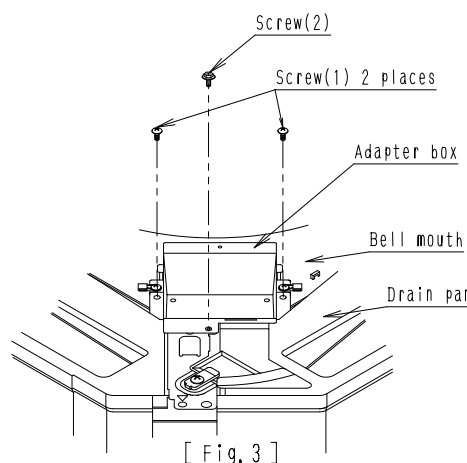
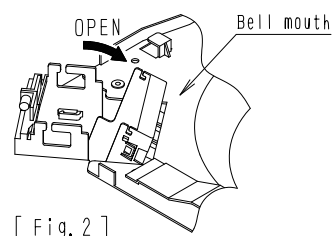
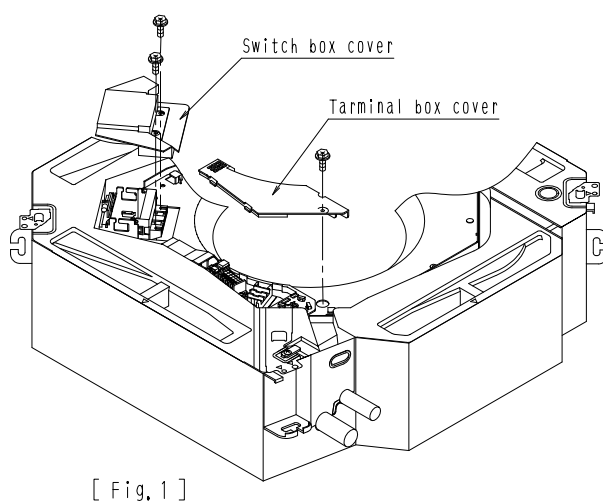

1P086302B

2 Mounting the adapter PCB

<How to mount the adapter PCB>

- ① Connect the wiring to the adapter PCB.
(The work is easier if the wiring is connected to the PCB first.)
- See the instruction attached to the adapter PCB for where to connect the wiring.
- ② Mount the adapter PCB on the adapter box and the adapter box cover.

Adapter PCB	Place where to mount
Adapter for wiring	The PCB to be mounted on the adapter box cover, (Fig.1)
Wiring adapter for electrical appendices(1)(2)	The PCB to be mounted on the adapter box, (Fig.2)

- For the mounting position of the adapter PCB, see the instruction attached to the adapter PCB.
- ③ Bind the wiring from the adapter PCB (signal wires, power supply wires) with the attached clamp. (Fig.1) (Fig.2)
- ④ After putting the claw of the cover into the hole of the box, fix them with the attached screw (2). (Fig.3)
- Take precautions to prevent the wires from getting caught.

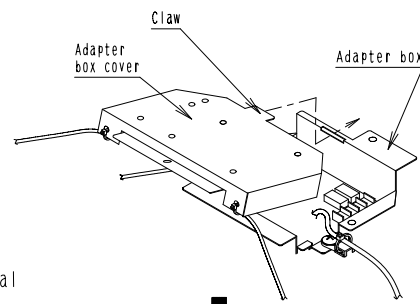

<Adapter for wiring>

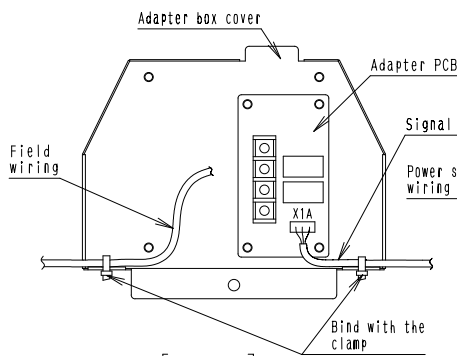

[Fig. 1]

<Wiring adapter for electrical appendices(1)(2)>

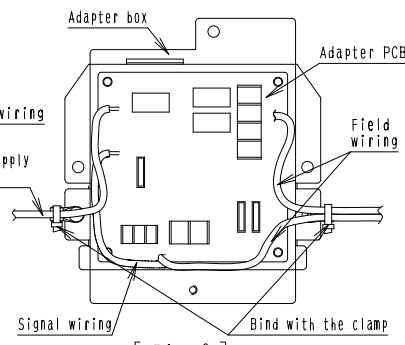

[Fig. 2]

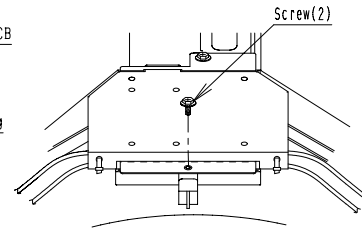

[Fig. 3]

3 How to handle the wiring

<Wiring to the indoor unit>

Connect the wiring from the adapter PCB to the indoor unit. (signal wires, power supply wires)

- See the instruction attached to the adapter PCB for the place where to connect the wires on the indoor unit.
- ① Fix the internal wirings.
- Bind the wiring from the adapter box to the indoor unit switch box and to the terminal box according to the drawing shown on the right with the attached clamp.
- Bind the the surplus wires and the other wiring together with the clamp.
- ② Shut the switch box and secure firmly the switch box cover and the terminal box cover in place in opposite order of removing.
- Take precautions to prevent the wires from getting caught.

Bind the signal wires and the remote control wiring together with the clamp, (2 places)

Bind the power supply wires and the wiring between the units together with the clamp, (2 places)

Let the clamp go through the bell mouth hole and bind the signal wires and the field wiring together with this clamp.

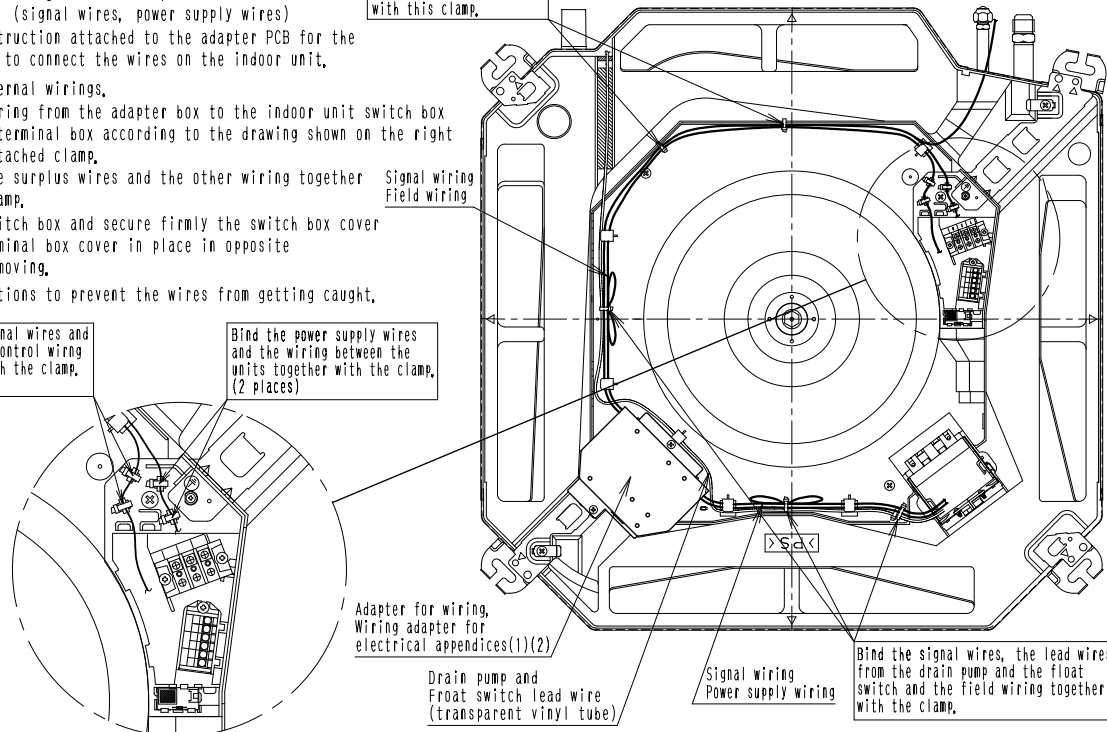

1P086302B

7.3 KRP4A93



Item		Model
		KRP4A93
Applicable Adaptor		KRP4A1.2.3.4
Installation		External
Material		Hot-dip zinc-coated steel sheet for painting
Dimensions	Width	160
	Height	180
	Thickness	50

REMARKS

- This box can be mounted on the small wall mounted type indoor unit.
One box is required for every adaptor.
- When mounting the box, see the installation manual of the indoor unit as well as the installation manual of the box.

Combination table

Kit model name	Model name of indoor unit which allows the box to be mounted	
KRP4A93	VRV	FXA 20 • 25 • 32 LVE(C) FXA 45 • 56 • 63 LVE FXAQ 20 • 25 • 32 • 45 • 56 • 63 MVE
	SPLIT	FAY71LVE(S), FAYP71LV1 FAQ71BUV1B

Parts included Make sure that the following parts are included.

Name	Installation box for adaptor PCB	Screw for fixing door	Plastic washer	Installation manual
Quantity	1 piece	1 piece	1 piece	1 sheet
Shape	①	②	③	④ (This sheet)

1 Selection of mounting location

- The location of the box must be near the indoor unit and where open/ close of the door can be handled smoothly.

Caution

- Make sure to select the flat area for mounting.

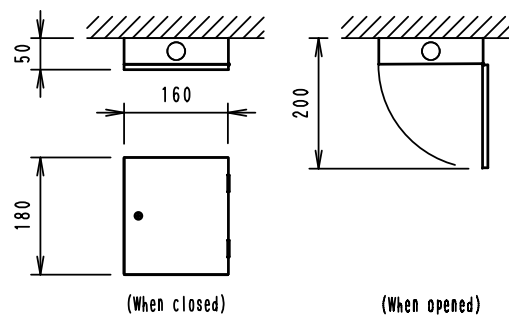

2 Mounting the box

- ① Determine the wiring outlet side and open the knockout hole on the box,
 - Three knockout holes for wiring outlet are located on the upper, the lower and the rear sides, (Shown right figs.)
- ② Determine the box mounting location properly so that it suits the wiring length and outlet location,
- ③ Fix the box with 4 screws (Field supplied)
 - The dimensions for mounting is shown right,

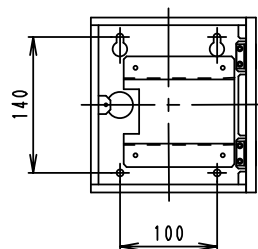
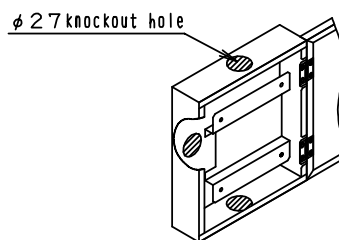

3 Mounting the adaptor

- Fix 4 pieces of substrate supports to the holes of the box. The substrate supports are attached to the adaptor.
- Match the adaptor to substrate supports and fix it.

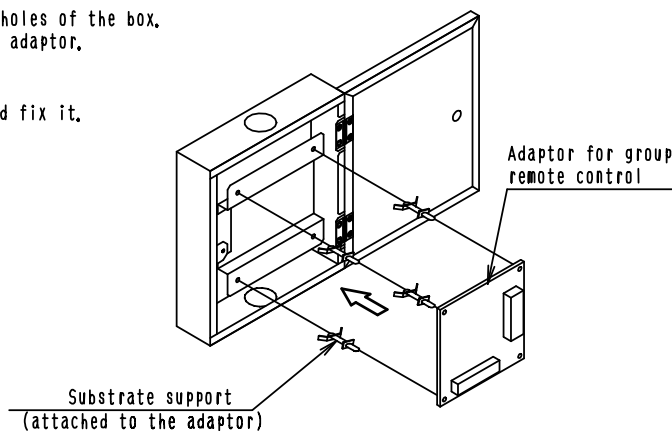

- For wiring, follow the installation manual attached to the adaptor.
- After checking the wiring, close the door and fix the door with the plastic washer and the fixing screws,

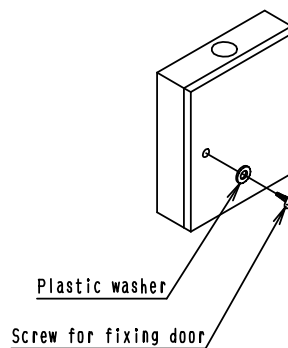

3K012186C

7.4 KRP1C93



Item		Model	KRP1C93
Installation			Interior of unit
Material			Hot-dip zinc-coated carbon steel sheet
Dimensions (mm)	Width		109
	Length		124
	Depth		38
Component parts			Installation box, Box cover, Clamp, Screws, Installation Manual

NOTE:

- This box can be installed to the ceiling-hang type unit.
- Each adapter plate requires one kit.

Parts included: Check the following parts are include with your unit.

Part name	Installation box main body	Installation box lid	Installation screw	Fixing screw for lid	Fixture	Installation manual	Clamp
Shape							
Quantity	1	1	2	2	2	1	4

Applicable adapter plate

Adapter plate name	Kit name
(Group) Remote control adapter	KRP2A62, KRP4AA52

1 Installation preparation

- ① Remove the electric parts box lid, (2 screws)
- ② Take out the electric parts box, (2 screws)
 - Before taking out the electric parts box, disconnect the internal wiring from the clamp.
- ③ For indoor unit class 90 or higher, remove the reinforcement bar, (2 screws)

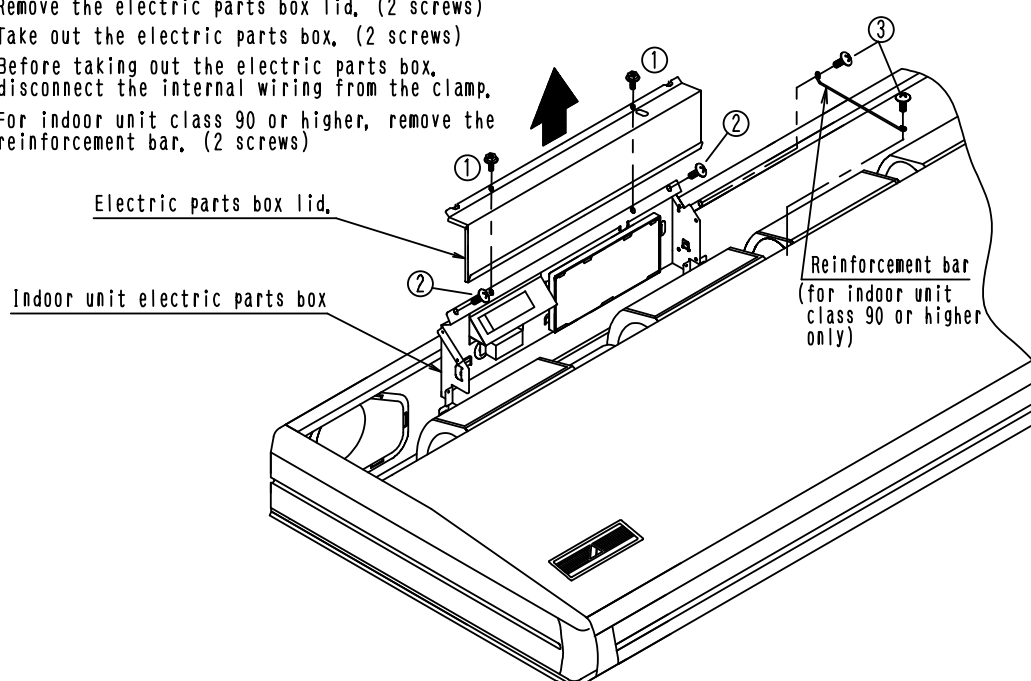

3K09595B

2 Installation of Adapter Plate

① Install the fixture included with the kit to the electric parts box, (2 locations)

② Install the adapter plate to the adapter installation box.

● For installation direction of the adapter plate, refer to the installation manual included with the adapter plate.

③ Temporarily hang the adapter installation box on the electric parts box of the indoor unit.

④ Connect wires to the adapter plate and the indoor unit.

● For wiring locations, refer to the manual included with the adapter plate.

● Separate power wires and signal wires. Refer to the figure below on how to wire inside the electric parts box.

● Bind the wires taken out of the adapter plate together with the fixture installed in ① using the included clamp material.

⑤ Fix the internal wiring.

● Refer to the figure below on how to fix the wires inside the electric parts box to the clamp material.

● Bind the remaining wires with the clamp material, and house them inside the electric parts box.

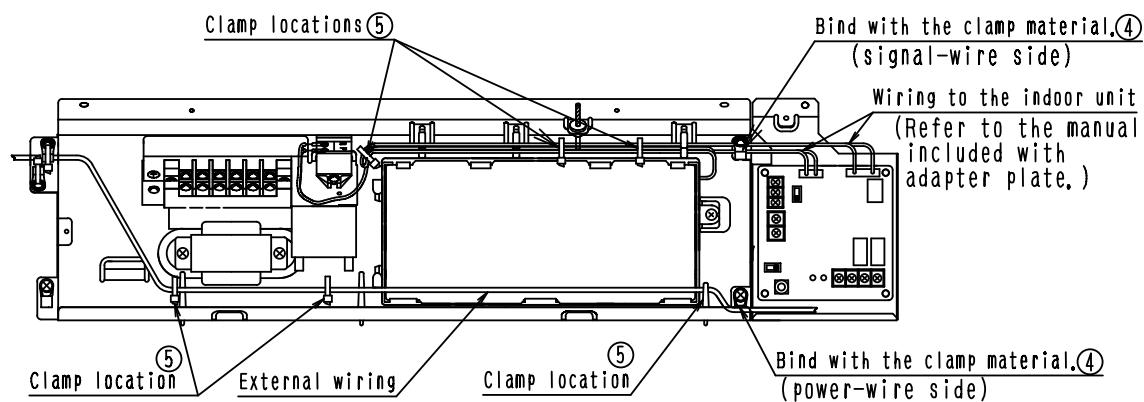
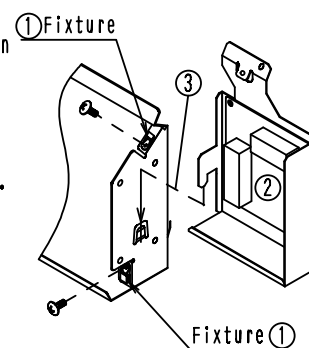

3 Installation to the Indoor Unit

① Install the electric parts box and the adapter installation box.

● Place the removed internal wiring clamp back in its original position.

② After installing the lid of the adapter installation box, install the lid of the electric parts box.

③ For indoor unit class 90 or higher, install the reinforcement bar to the indoor unit.

*When installing, be careful not to get wires caught by parts.

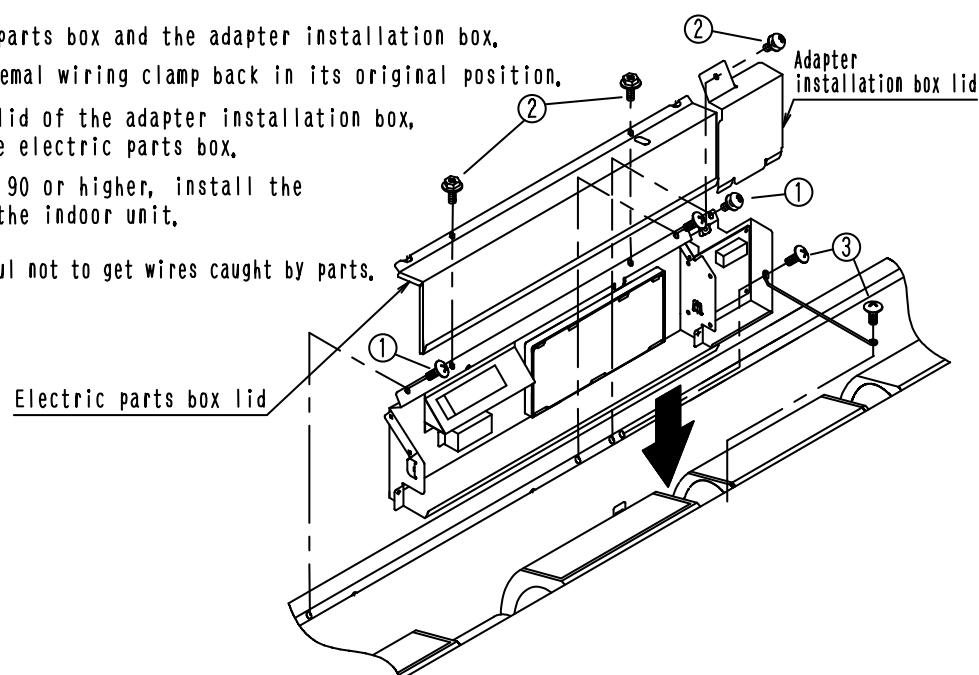

3K09595B

7.5 KRP1B97

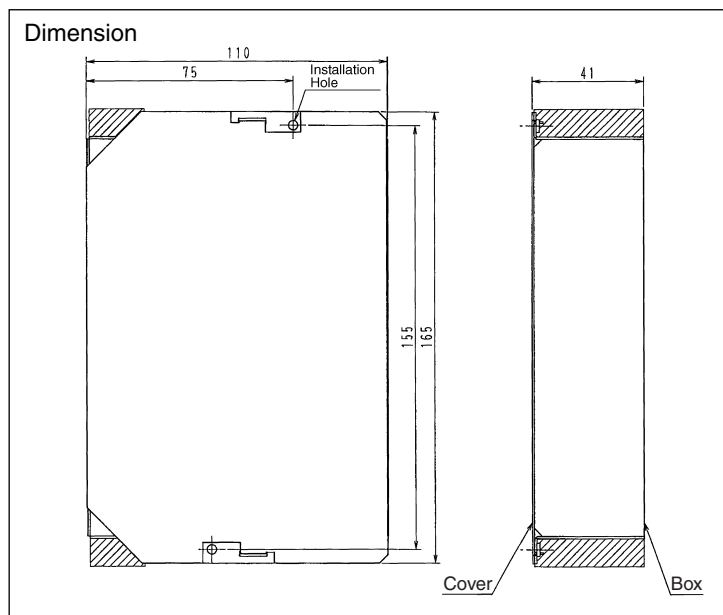





Model No.	KRP1B97
Item	
Adaptor for Wiring	KRP4A(A)53

Notes

- This kit is also attachable to the ceiling-suspended unit.
- Also refer to the indoor unit body installation manual before installation.

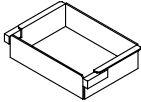
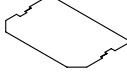
Description of Parts

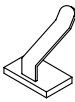
Make sure that the following parts are included.

Name	Installation box body	Installation box cover	Mounting screw	Cable Tie	Installation manual
Shape			 M4 × 12		
Quantity	1 unit	1 pc.	2 pcs.	2 pcs.	1 pc.

1. Preparation for mounting

- (1) Remove the suction grill and open the cover of the switch box. (2 screws)
- (2) Remove the lead wire of the swing motor and suction thermistor from the bell mouth (Fig. 1-1).
- (3) Remove the bell mouth from the indoor unit body (No. of screws: 3) (Fig. 1-2).
- (4) Use a nipper or cutter to cut two openings for bell mouth wiring (Fig. 1-3).
- (5) Drill two holes in the concave of the bell mouth for the mounting screws (Fig. 1-3).

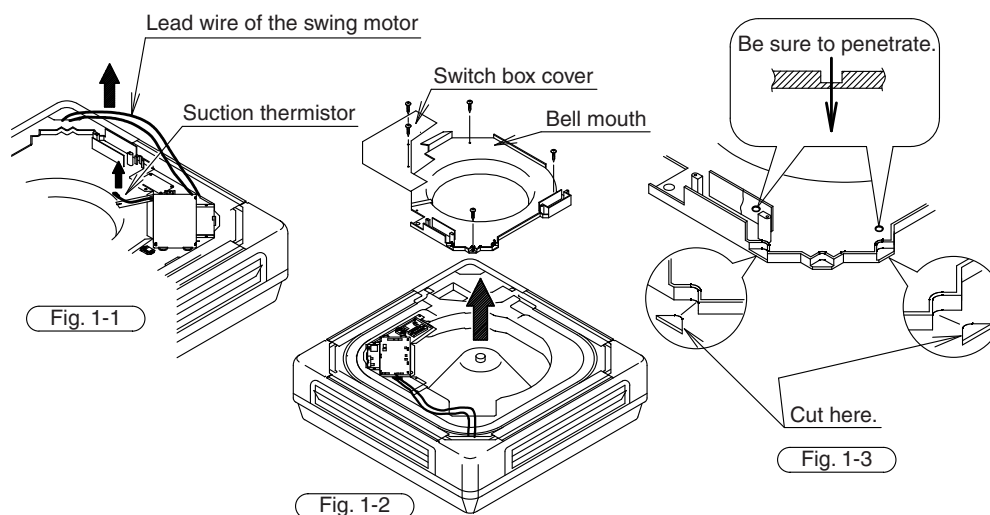

J: 2P002952C

2. Mounting the adapter (Also refer to the installation manual supplied with the adapter.)

- (1) Attach circuit board supports (4 pieces) to the holes of the installation box body (Fig. 2-1).
(Attach them before mounting the adapter.)
Circuit board supports are supplied with the adapter.
- (2) Mount the adapter according to the position of the circuit board supports.
Also connect the external wires to the adapter.
- (3) Attach the installation box body to the bell mouth with two screws supplied (Fig. 2-2).
- (4) Attach the bell mouth to the indoor unit body (Fig. 2-3).
- (5) Return the swing motor lead wire and the suction thermistor to the original positions and fix them.

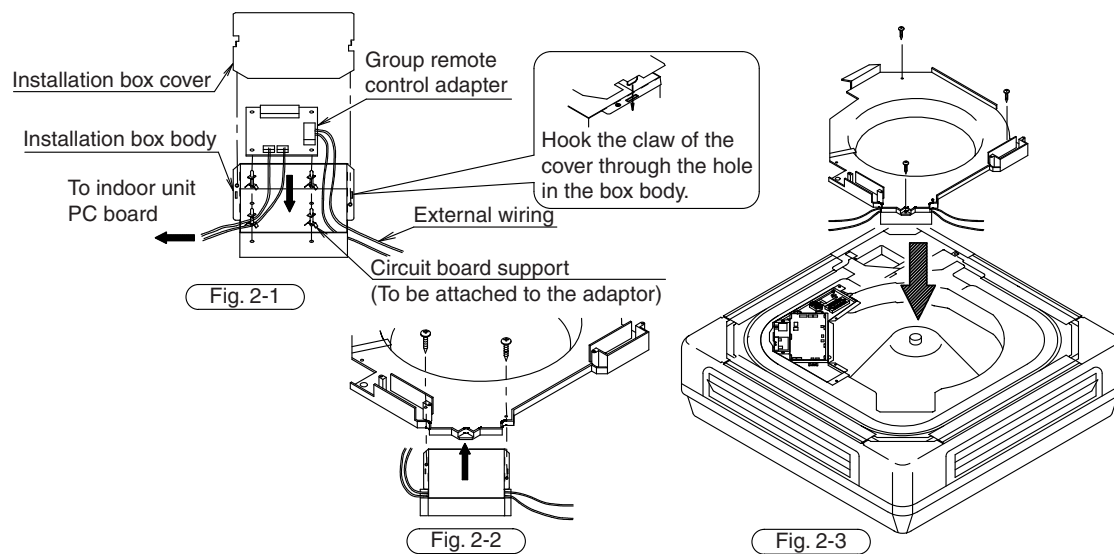

3. Wiring method

Refer to the installation manual supplied with the adapter for electric wiring.

- (1) After completing the installation work, attach the cable sticker supplied to fix the cable as shown in the figure below. Pay attention not to bend the cable.
- (2) Coil excess lead wire in the switch box and secure it with a tie wrap supplied with the adapter (Fig. 3-1).
- (3) Mount the switch box cover (Fig. 3-2).
- (4) Mount the suction grill.

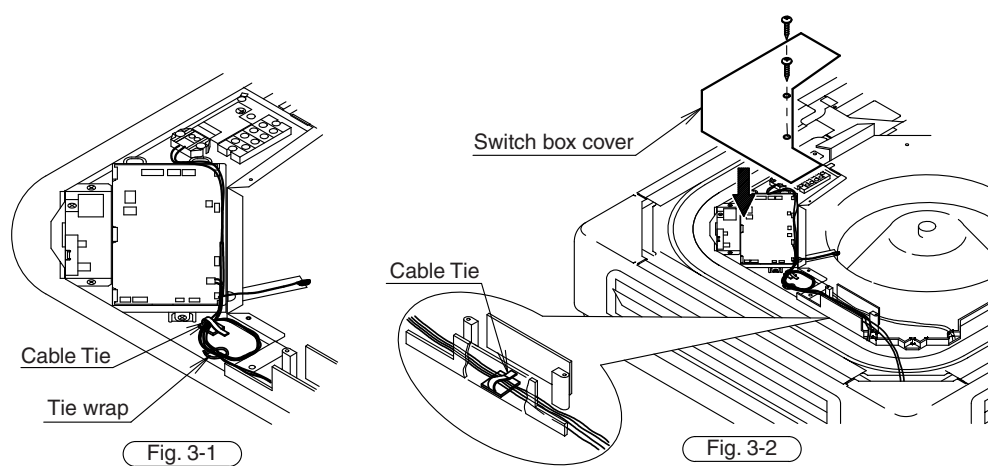

J: 2P002952C

8. Interface Adaptor for SkyAir Series

8.1 DTA102A52

Accessories

Check if the following accessories are included in the kit.

Adaptor	x 1	PC board support	x 4
Relay harness	x 1	Tie wrap	x 2
		Installation manual	x 1

1 SYSTEM OUTLINE

- By connecting this kit to an optional controller for centralized control, all units of the SKY AIR Series in the system can be controlled as a group from the optional controller.
- One kit must be installed onto the master unit of each group.

2 NAMES OF PARTS AND FUNCTION

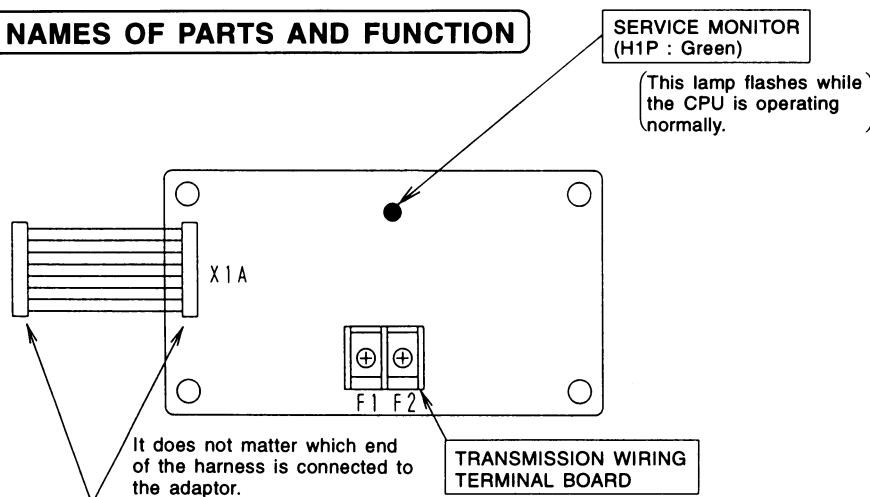

3 ELECTRIC WIRING

- Wire this kit as described below.
- Make sure wires to units do not pass over the PC board when wiring.

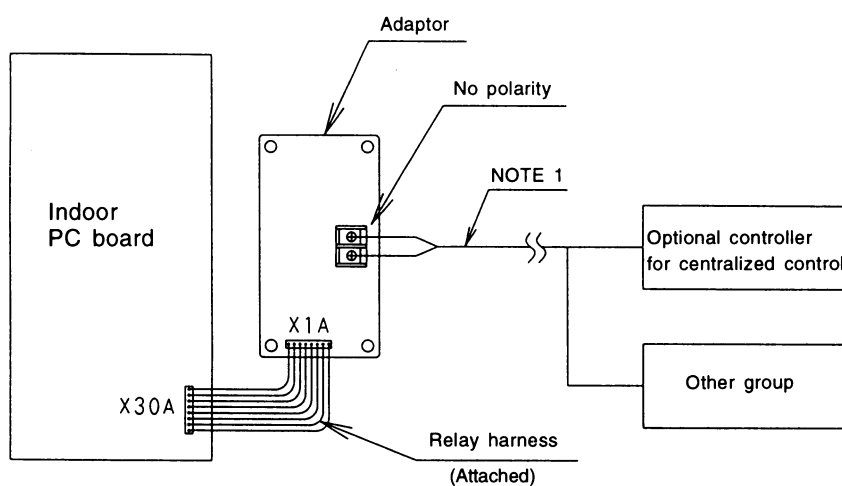

- NOTE 1. Wiring specifications . . . Use a 0.75 – 1.25 mm² sheathed vinyl cord or cable (2 wire).
 2. For details on compatible systems and how to connect to optional controllers, see the instruction manual of the optional controller and technical reference materials.

1PA59896

2

7.5 KRP1B97 / 8.1 DTA102A52

4 INSTALLATION

- Installation differs according to models as shown below.
- Do not bundle low and high voltage wires together.
- Bundle any excess wires with the attached tie wraps so as to keep loose wirings off the indoor unit PC board.

« Ceiling-mounted cassette type »

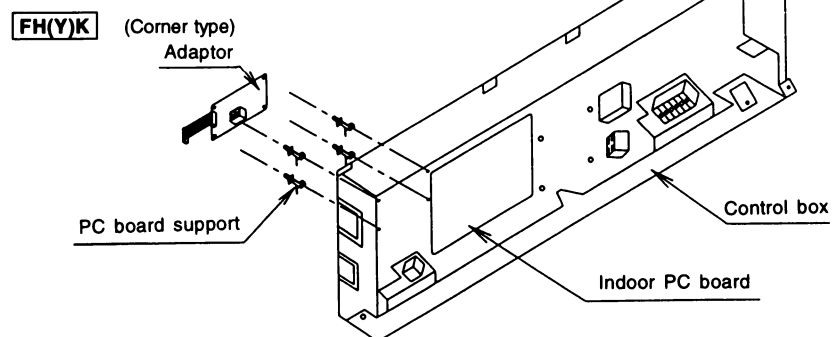

« Ceiling-mounted cassette type »

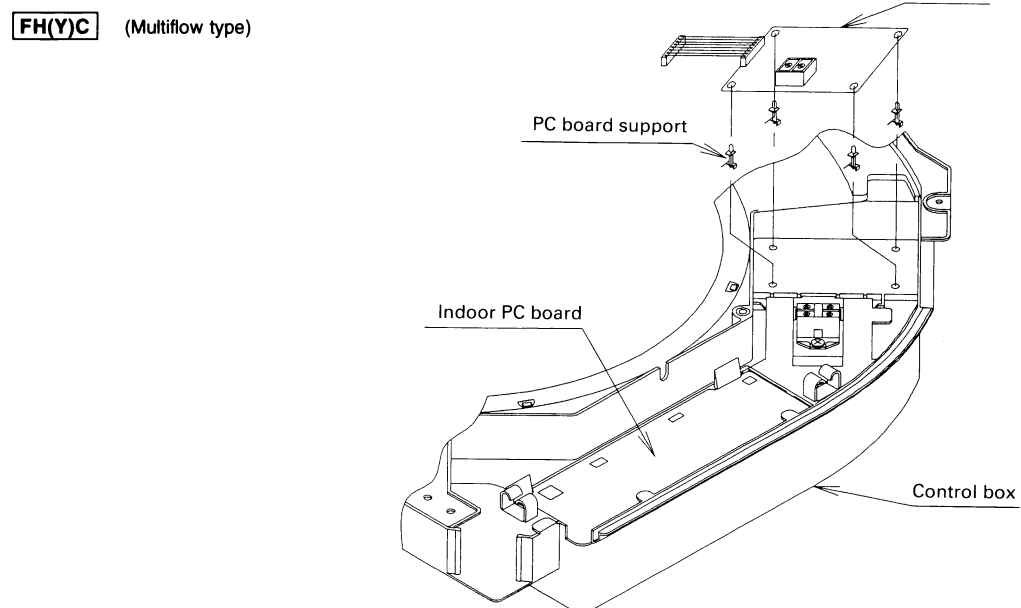

FH(Y)B (Built-in type)

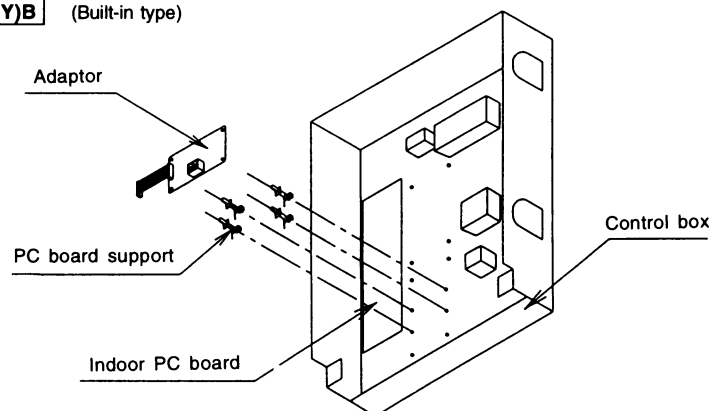

1PA59896

« Ceiling suspended type »

FH(Y), FXU(Q)

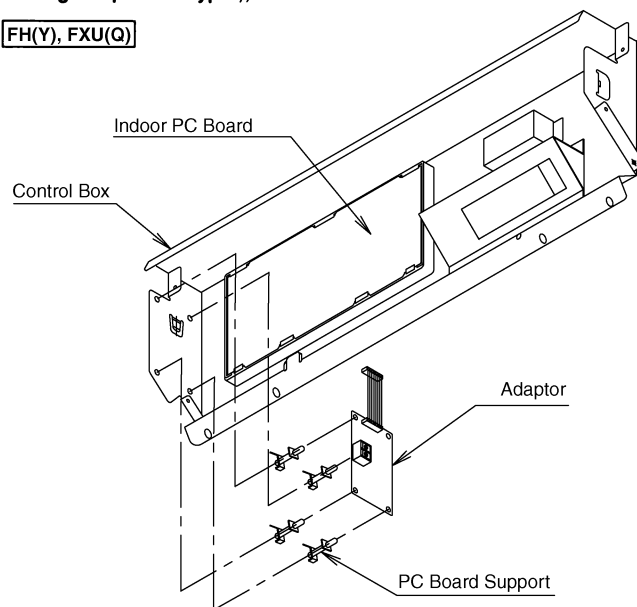

« Floor standing type »

FVY

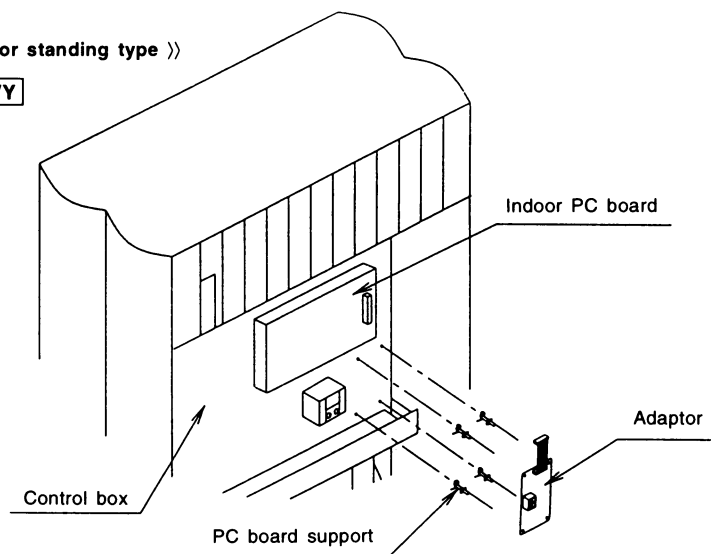

C: 1PA59896

9. External Control Adaptor for Outdoor Unit

9.1 DTA104A61 / DTA104A62 / DTA104A53

Accessories Check the following accessories are included in the kit before the installation.

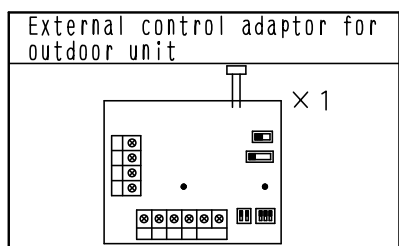

PCB support	× 4
Clamp	× 3
Installation manual	× 8

- NOTES**
- The kit type (DTA104A61 • 51 type, DTA104A62 • 52 type, DTA104A53 type) varies according to air conditioner model.
 - The installation box for adaptor PCB are required with the following air conditioner models.
- | | |
|-------------------|----------|
| FXC(Q) | KRP1B96 |
| FXFQ-P | KRP1H98 |
| FXF, FXFQ-M | KRP1D98 |
| FXH(Q) | KRP1C93 |
| FXA(Q) | KRP4A93 |
| FXD(Q) | KRP1B101 |
| FXMQ-P | KRP4A96 |

1 General description of system

With the external control adaptor, outdoor units are controlled as follows.

1. Operation mode (COOL/HEAT/FAN) is switched simultaneously for more than one outdoor unit.
 - If switching operation mode by indoor unit remote controller or COOL/HEAT selector.
 - Except RSEY(P)~KJ

External control adaptor for outdoor unit

Indoor unit remote controller

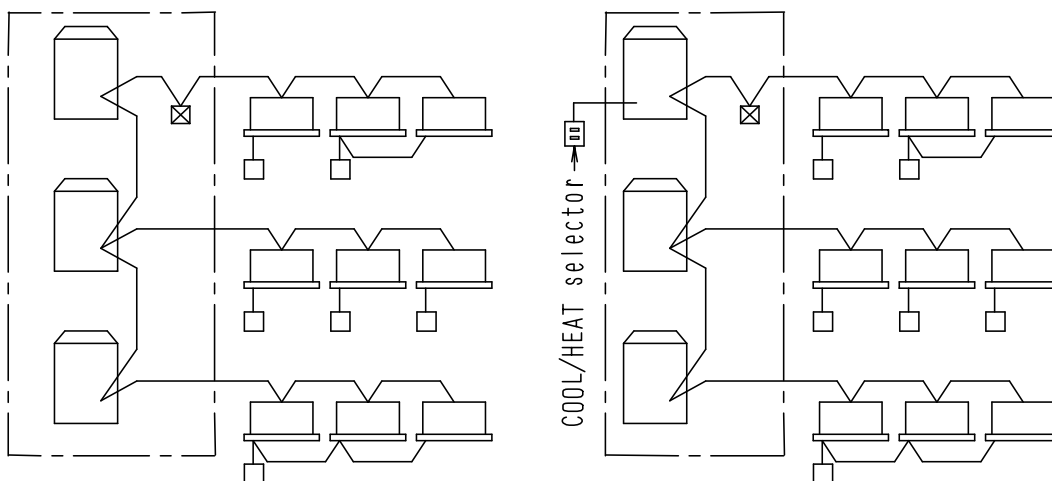

You can simultaneously switch operation mode for outdoor units in [---].

C: 1PA63164D

2. Demand control and low-noise control are executed simultaneously for more than one outdoor unit.

• Except RSEY(P)~KJ

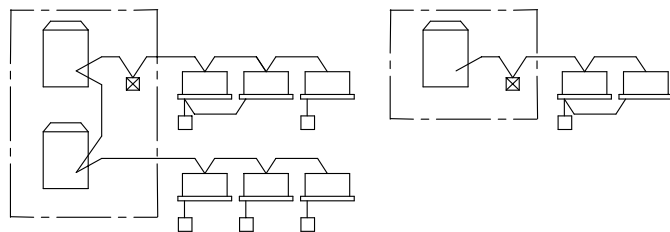

Demand control and low-noise control are executed simultaneously for outdoor units in []

2 Names of parts and functions

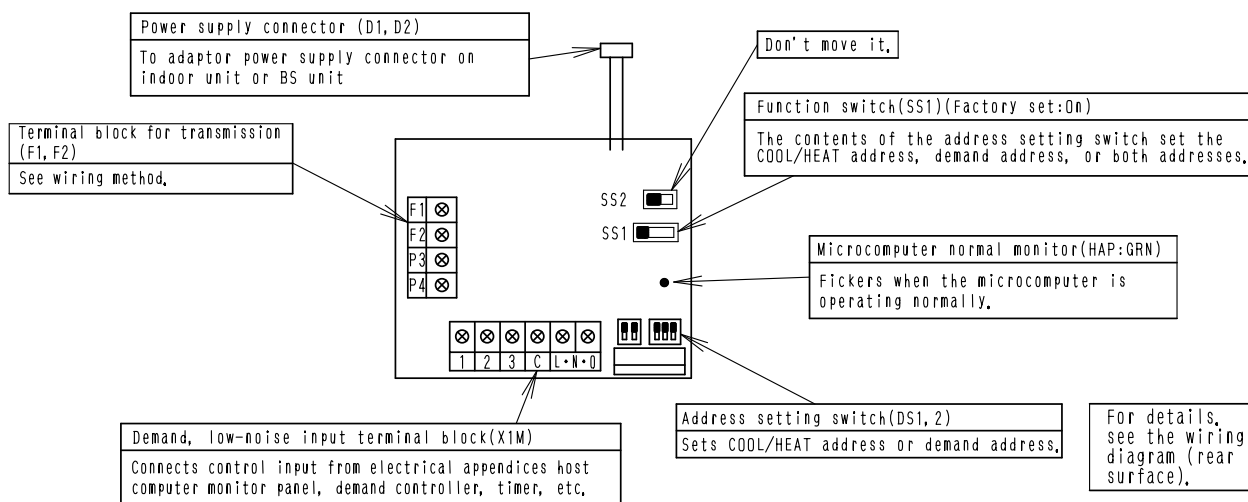

C: 1PA63164D

3 Installation

- Install the adaptor inside the electric parts box of indoor unit of same refrigerant circuit.
- If installing on a BS unit, install the adaptor inside the electric parts box of the BS unit.

< BS Unit >

BSV(Q)

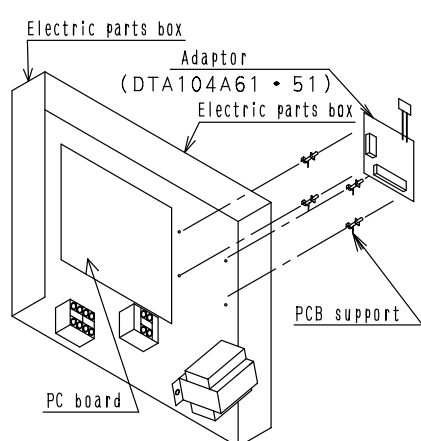

< Ceiling-mounted cassette type >

FXK(Q) (Corner model)

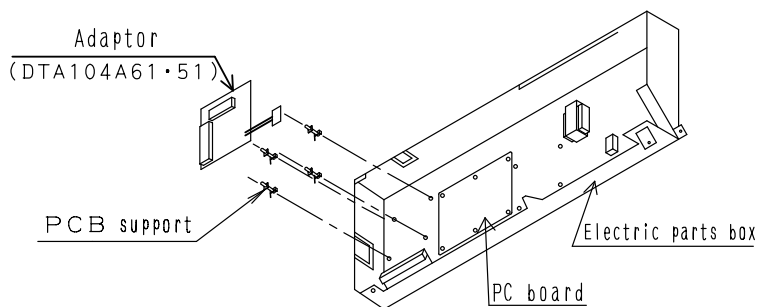

1PA63164B-3

< Ceiling-mounted cassette type >

FXC(Q) (Double-flow model)

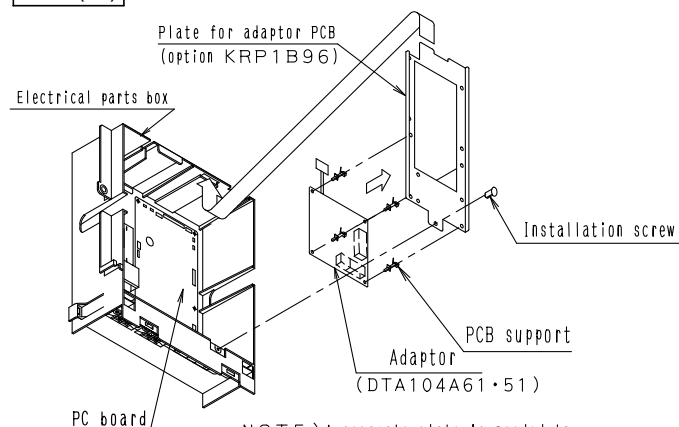

NOTE) A separate plate is needed to install the adaptor PCB.

< Ceiling-mounted Built-in type >

FXS(Q)
FXYB

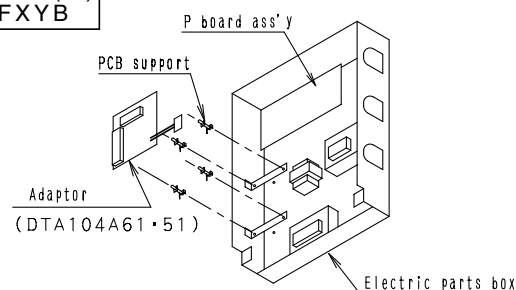

Note :
Installation box is necessary for second adaptor (FXS) .

< 600x600 Ceiling mounted cassette type > < Slim ceiling mounted duct type >

FXZQ

FXD(Q)

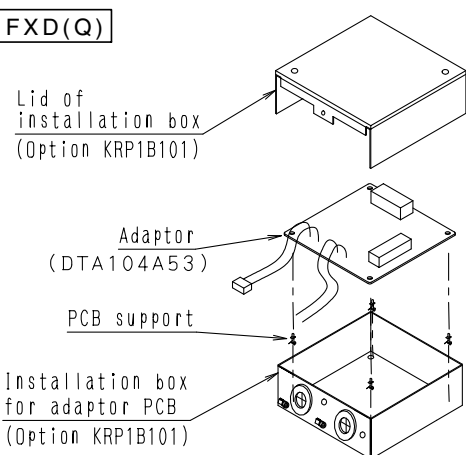

NOTE : Installation box for adaptor PCB is required to install the adaptor.

<< Ceiling Mounted Duct Type >>

FXYD-KA

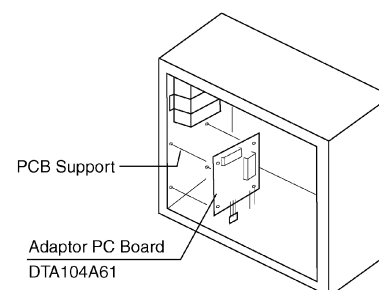

< Ceiling - mounted Duct type >

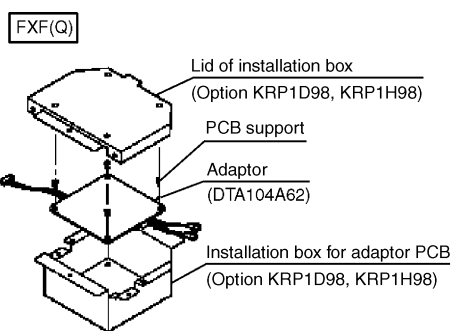
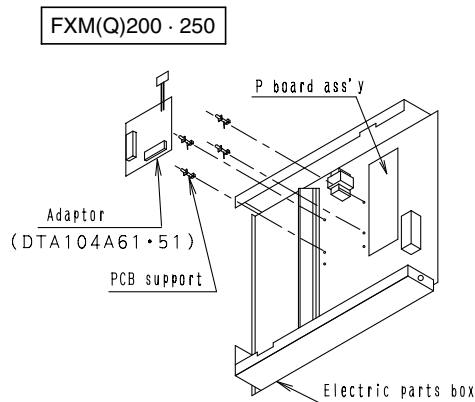
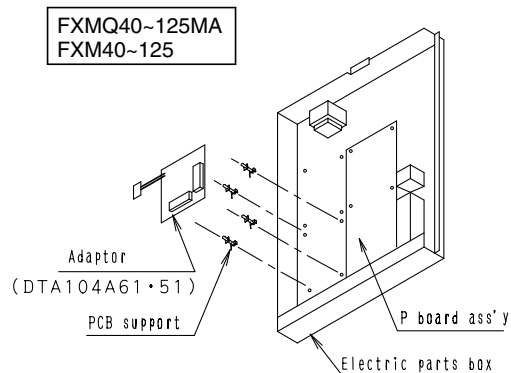

< Ceiling Suspended type >

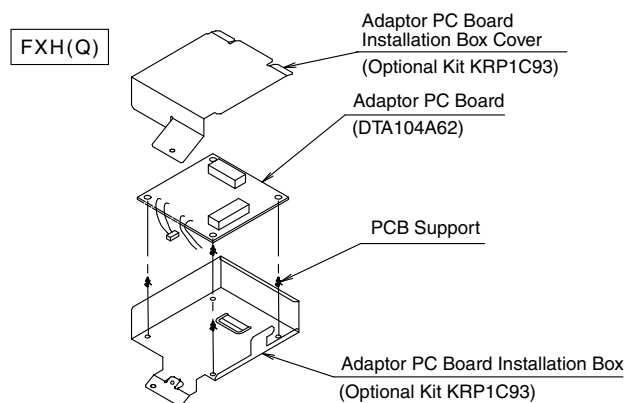

Note:
Installation box for adaptor PCB is required to install the adaptor.

Note:
For installation, the optional kit of adaptor PCB installation box is required.

< Wall mounted type >

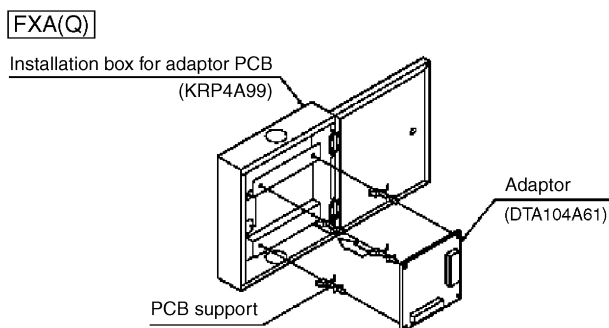

< Floor-standing type >

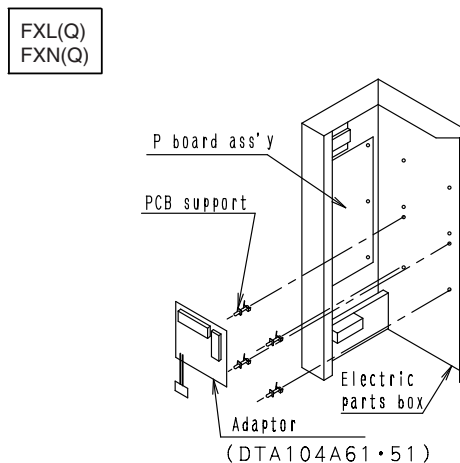

4 Electrical wiring

- ① Connect the power supply wiring from the adaptor to the adaptor power supply connector on the PCB of the Indoor unit or BS unit.
- ② Connect the transmission wiring to the various terminal blocks, and to the F1 and F2 terminals on the PCB. (Use double-core wiring with no polarity.)
- ③ Using the attached wiring ties, clamp the transmission wiring to weak field wiring, etc.

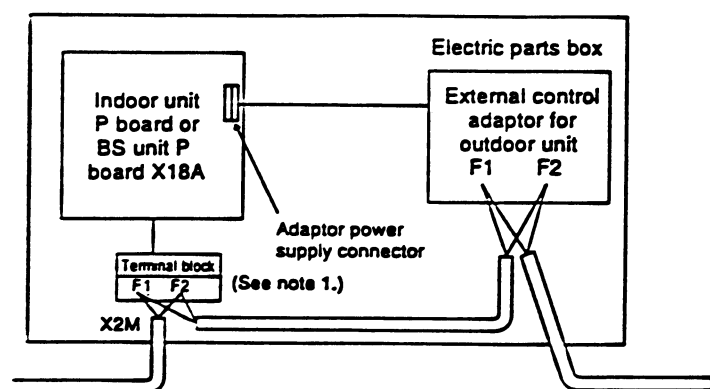

Note 1: If mounting on a BS unit, connect the BS unit's terminal block (F1 and F2, indoor unit side) with F1 and F2 of the adaptor.

NOTES

- (Transmission wiring specifications)

Sheathed wire
(2 wire)
0.75 - 1.25 mm²

- (Transmission wiring length)

Malfunction of transmission may occur if the following limits are exceeded.
(Total wiring length: Max. 1000 m)
(No. of branches: Max. 16)

- ④ If carrying out demand or low-noise input, connect the adaptor's terminals as shown below.

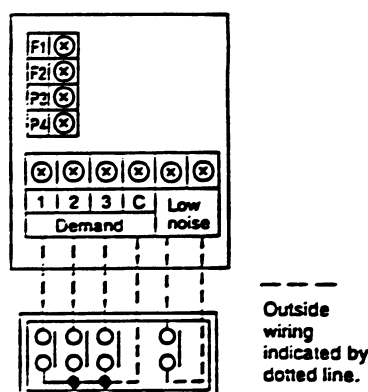

Host computer monitor panel or demand controller

(B0137)

[Input signal]

Constant a contact
 Input current is approx. 10 mA per contact.
 For the relay contact, use a weak current contact.

[Outside wiring specifications]

Recommended wiring: 0.75-2 mm² sheathed wire
 Wiring length: Within 150 m
 Keep a minimum 50 mm from power supply wiring to prevent malfunction.

Demand input terminal

Short circuit between (Demand 1) - (C)...As a guideline, demand should be about 70%.
 Short circuit between (Demand 2) - (C)...As a guideline, demand should be about 40%.
 Short circuit between (Demand 3) - (C)...Forced thermo OFF

Low-noise input terminal

When terminals are short-circuited during cooling, capacity save (outdoor unit fan low-speed turn, compressor frequency control) is carried out.
 use only at night when load is slight.

How to set demand control in the field

1. Outdoor unit field setting
 - Setting mode 1...Turn ON low noise control as explained in the outdoor unit's service manual.
 - Setting mode 2...Match low noise and demand addresses to the external control adaptor address.
2. External control adaptor settings
 - Function switch (SS1)
Set SS1 to either "BOTH" or "DE".
 - Address setting switch (DS1,DS2)
Match DS1 and DS2 to the low noise and demand addresses of the outdoor unit.

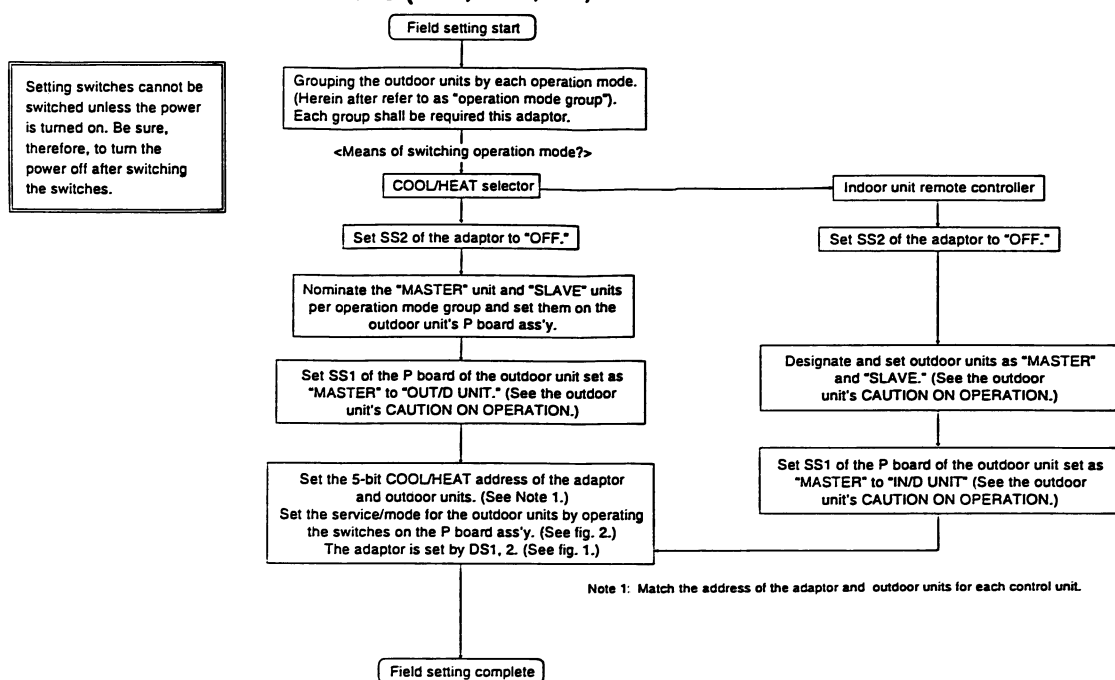
5 Field settings**1. The contents of the various settings for unified switching of the operation mode (cool, heat, fan) are as follows.**

(B0138)

2. The contents of the various settings for unified switching of demand and low noise operation are as follows.

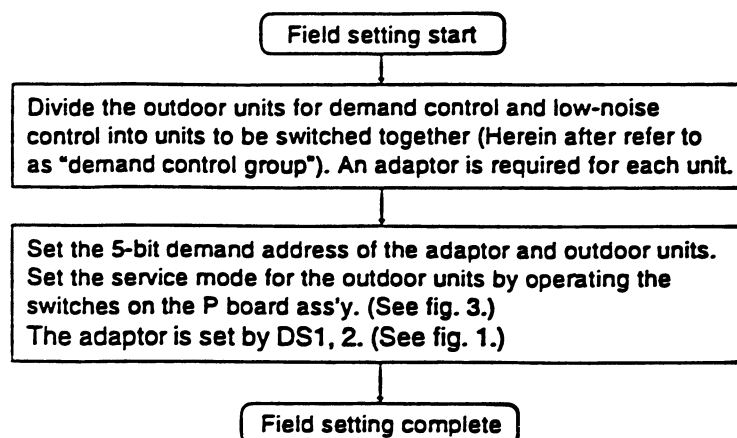

3. To carry out operation mode switching and demand control simultaneously

You can carry out operation mode switching and demand control simultaneously by setting function switch SS1 on the adaptor to "BOTH." Only one address, however, can be set on the adaptor, so the "operation mode switch unit" and "demand control unit" are the same.

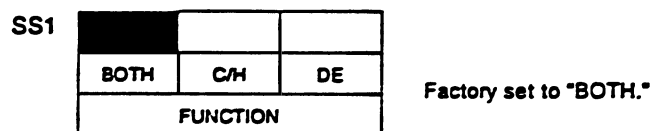

Set the COOL/HEAT address, demand address and low noise address, or both as needed.



Note 2: The outdoor unit can have an independent "COOL/HEAT address" and "demand address". You can therefore set the "operation mode group" and "demand control group" to different ranges.

(B0139)

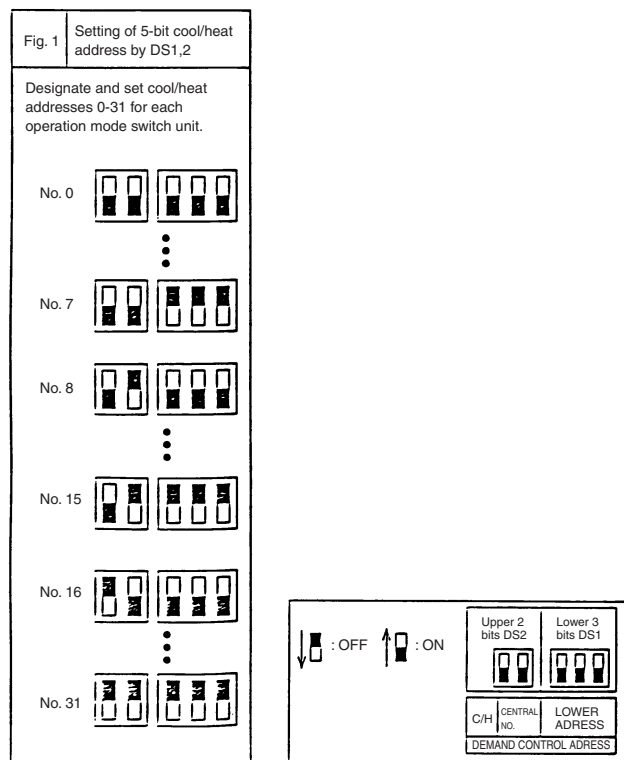

Fig. 2 (Ex.) To set the outdoor unit's cool/heat address to No. 15 :

●—Off ○—On ◐—Flicker

Procedure	Setting contents	MODE	TEST	5-bit				
				IND	MASTER	SLAVE	L.N.O.P.	SEQ. START
When power turned on	Setting mode (factory set)	● LED20	● LED21	○ LED22	● LED23	● LED24	● LED25	○ LED25
Hold down next page button for 5 secs.	Enters address setting.	○ LED20	● LED21	● LED22	● LED23	● LED24	● LED25	● LED25
Push operation button one time.	Enters cool/heat address setting.	○ LED20	● LED21	● LED22	● LED23	● LED24	● LED25	○ LED25
Push confirmation button one time.	Make sure cool/heat address has been entered.	○ LED20	● LED21	● LED22	● LED23	● LED24	● LED25	● LED25
Push operation button 15 times. (Address No. = Times pushed)	Sets cool/heat address.	○ LED20	● LED21	● LED22	◐ LED23	◐ LED24	◐ LED25	◐ LED25
Push confirmation button two times.	Check cool/heat address.	○ LED20	● LED21	● LED22	● LED23	● LED24	● LED25	● LED25
Push next page button one time.	Returns to set mode.	● LED20	● LED21	○ LED22	● LED23	● LED24	● LED25	○ LED25

Fig. 3 (Ex.) To set the outdoor unit's demand address to No. 7 :

●—Off ○—On ◐—Flicker

Procedure	Setting contents	MODE	TEST	5-bit				
				IND	MASTER	SLAVE	L.N.O.P.	SEQ. START
When power turned on	Setting mode (factory set)	● LED20	● LED21	○ LED22	● LED23	● LED24	● LED25	○ LED25
Hold down next page button for 5 secs.	Enters address setting.	○ LED20	● LED21	● LED22	● LED23	● LED24	● LED25	● LED25
Push operation button two times.	Enters demand address setting.	○ LED20	● LED21	● LED22	● LED23	● LED24	○ LED25	● LED25
Push confirmation button one time.	Make sure demand address has been entered.	○ LED20	● LED21	● LED22	● LED23	● LED24	● LED25	● LED25
Push operation button 7 times. (Address No. = Times pushed)	Sets demand address.	○ LED20	● LED21	● LED22	● LED23	◐ LED24	◐ LED25	◐ LED25
Push confirmation button two times.	Check demand address.	○ LED20	● LED21	● LED22	● LED23	● LED24	● LED25	● LED25
Push next page button one time.	Returns to set mode.	● LED20	● LED21	○ LED22	● LED23	● LED24	● LED25	○ LED25

10. Remote Sensor (For Indoor Temperature)

10.1 KRCS01-1B/KRCS01-4B

- Recommended for ceiling suspension and ceiling-embedded types which often result in a difference between set temperature and actual temperature.
- The sensor for detecting the temperature can be placed away from the indoor air conditioner. (Branch wiring is included in the kit.)



Item	Model	KRCS01-1B
Length of branch wiring (m)		12
Appearance		Light ivory (with the Daikin logo)
Box material		ABS resin
Weight (kg)		0.3

Component parts

Remote sensor · extension cord · screws · terminals · tie-wraps · two-sided tape
Installation Manual

Precautions for Use

- Select a location for the sensor where it can detect the average temperature. Avoid the following locations.
 1. Locations in direct sunlight.
 2. Locations where the outlet air from the air conditioner is directed.
 3. Locations close to other heat sources.
 4. Locations near doors which might be affected by air coming in.

Note

- The kit models vary according to the model of air conditioners as follows:

KRCS01-1B	Skyair, VRV, Other air-cooled package air conditioners, High efficiency year round cooling only air conditioners, Round-flow type is excluded.	Note 1)
KRCS01-4B	Skyair Round-flow type VRV Round-flow type Duct type, FBO~DYET, FXMQ~PVE	Note 2)

Note 1) If you are unsure if this kit can be used for your indoor unit, check if the type of the thermistor (for detection of inlet air temperature) is as same as the type in this kit (ST8601). The shape of the thermistor for detection of the indoor unit inlet air temperature is shown below.

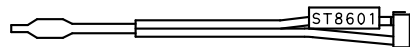

Note 2) When installed on these models, the dehumidification by detection of humidity does not operate.

Components

Check the following components.

Designation	Remote sensor (sensor box)	Extension cable (2-core, 12m)	Clamps	Installation manual (this drawing)	Sensor box mounting screws (M4X16)
shape					
Pieces	1 Piece	1 Piece	2 Pieces	1 sheet	2 Pieces

1) Mounting

1) Selecting the mounting location

The thermistor for temperature detection is incorporated into the remote sensor. Select the mounting location taking the following cautions into account.

- ① where the average temperature of an air conditioned room can be detected,
- ② where it is not exposed to the direct sunlight,
- ③ where it is not influenced by other heat sources,
- ④ where it is not exposed to the direct discharge air from the air conditioner,
- ⑤ where it is not exposed to the outdoor air infiltrated into the room by opening the door,

2) Mounting

- Remove the cover of the sensor box.

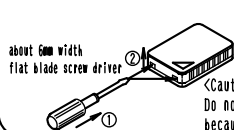

Insert a flat blade screw driver into the sensor box concave part (2 locations) and remove the cover pushing up the nail to the cover of the sensor box.

<Cautions>

Do not push the nail powerfully with a narrow flat blade screw driver, because you may break off the nail.

① When mounting on the wall

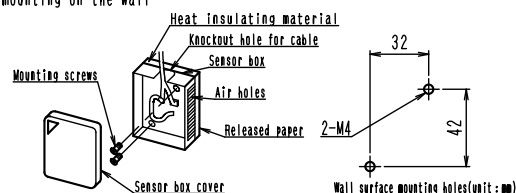

- Break open the knockout hole in the sensor box with a nipper or a similar tool. Pass the extension wires through the hole and fasten the wires to the terminals with screws.
- To avoid tensile force on the terminals, pass the attached clamp through the holes shown in the below right figure and tighten the extension cable with the attached clamp at the sheathed part. (The knot must come to the box inside.)

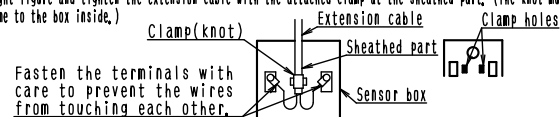

- Screw the sensor box securely to the wall surface with screws M4X16 (2 places). If the sensor box cannot be screwed to wall surface, tear off the released paper and mount it on the wall surface.

② For embedded wiring

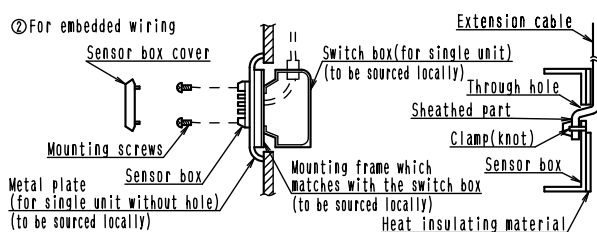

- Pass the extension cable through the switch box cable hole and carry out the wiring.

- Pass the attached clamp through the clamp holes and tighten the extension cable at the sheathed part as shown in the upper right drawing.

- Tap M4 screw holes in the metal plate (to be sourced locally) as shown in the right drawing and mount the switch box on the metal plate.

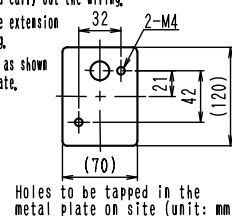

<Cautions>

- Give caution when wiring so that the air holes will not be blocked.
- When the extension cable is longer than necessary, cut it to the appropriate length, peel the insulation, attach the round crimp terminal for M3 (to be sourced locally) and carry out the wiring. The length of insulation to be peeled off is as shown. (Work carefully so that the connector side may not be cut.)



3K019189A

2 Wiring method

Connect the extension cable connector side to the indoor unit PCB (printed circuit board)
For connection to the indoor unit, follow the procedure shown below.

⚠ Caution

- 1) Make sure to turn off the power supply before starting the wiring work and do not turn on until all the work is completed.
Read also the wiring diagram of the indoor unit when carrying out the work.
- 2) When wiring the extension cable, do not pass where the extension cable may be affected by the power line or noise.
- 3) Make sure to securely connect the connectors.
Defective connection may result in incorrect detection of room temperature or malfunction.
- 4) Do not splice wires.
- 5) Since the connector marking of the thermistor for detection of inlet air temperature differ depending on the indoor unit type, make sure to check the indoor unit wiring diagram and follow it correctly.

<Procedure>

1. When wiring to the indoor unit PCB, remove the existing thermistor (for detection of inlet air temperature) and then connect the extension cable.
<For Skyair and VRV>

2. Lay and clamp the extension cable inside the indoor unit switch box just like the existing thermistor.
Provide protection of the existing cable for thermistor without affecting other components.
3. Fit the sensor box cover into the sensor box.

3 Operation test after mounting the sensor

Conduct cooling and heating operation test after the sensor is mounted and the wiring is completed.

3K019189A

11. DIII-NET Expander Adaptor

11.1 DTA109A51

Accessories Check the following accessories are included in the kit before the installation

Adaptor	× 1
PCB support	× 4
Clamp	× 3
Installation Manual	× 1

NOTE This adaptor does not apply to salt damage resistance.

1 General description of system

The adaptor allows easy system expansion as long as restrictions are observed.

1. The below systems can be controlled on the Super Wiring System when using the adaptor.

(1) Up to 1024 units can be centrally controlled in 64 different groups. (With 2 central remote controllers, up to 1024 units can be controlled in 128 groups.)

Restrictions on the number of units that can be connected to the Super Wiring System apply to each adaptor.

☑ The adaptor

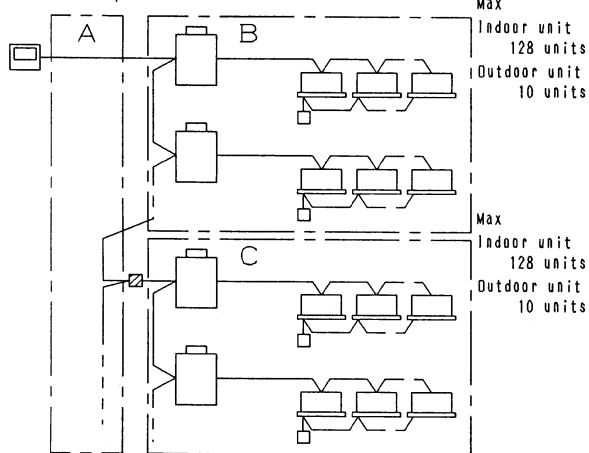

A maximum of 128 indoor units and 10 outdoor units can be connected in each group B and C.

(2) Wiring restrictions (max. length: 1000m, total wiring length: 2000m, max. number of branches: 16) apply to each adaptor.

☑ The adaptor

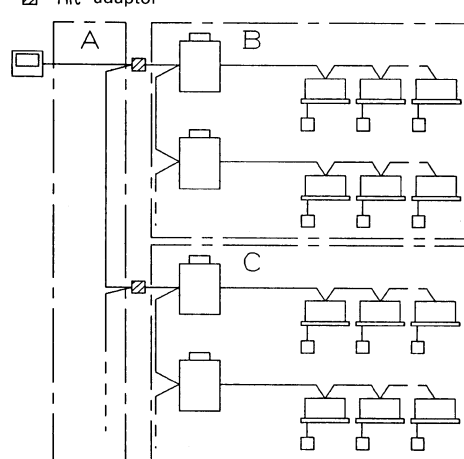

Each group A, B and C can have a maximum wiring length of 1000m, total wiring length of 2000m and a maximum 16 branches.

C: 1P013360

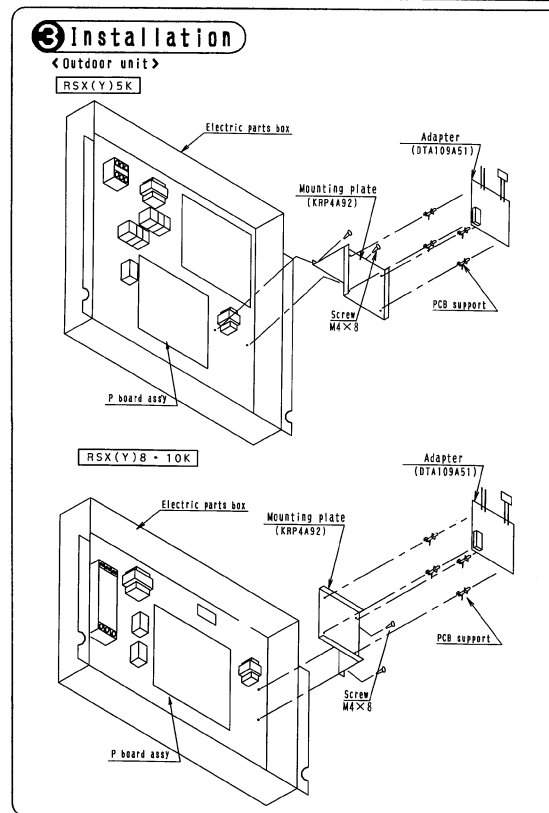
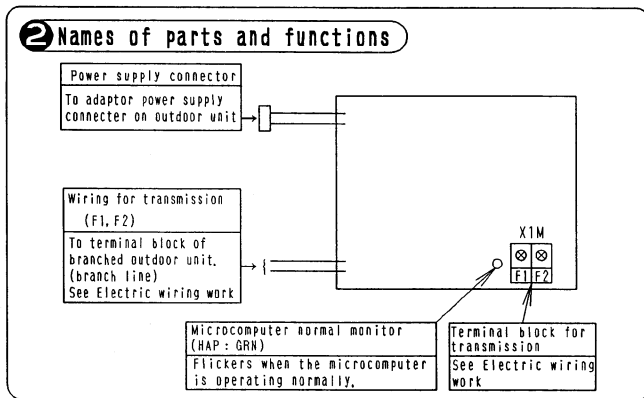
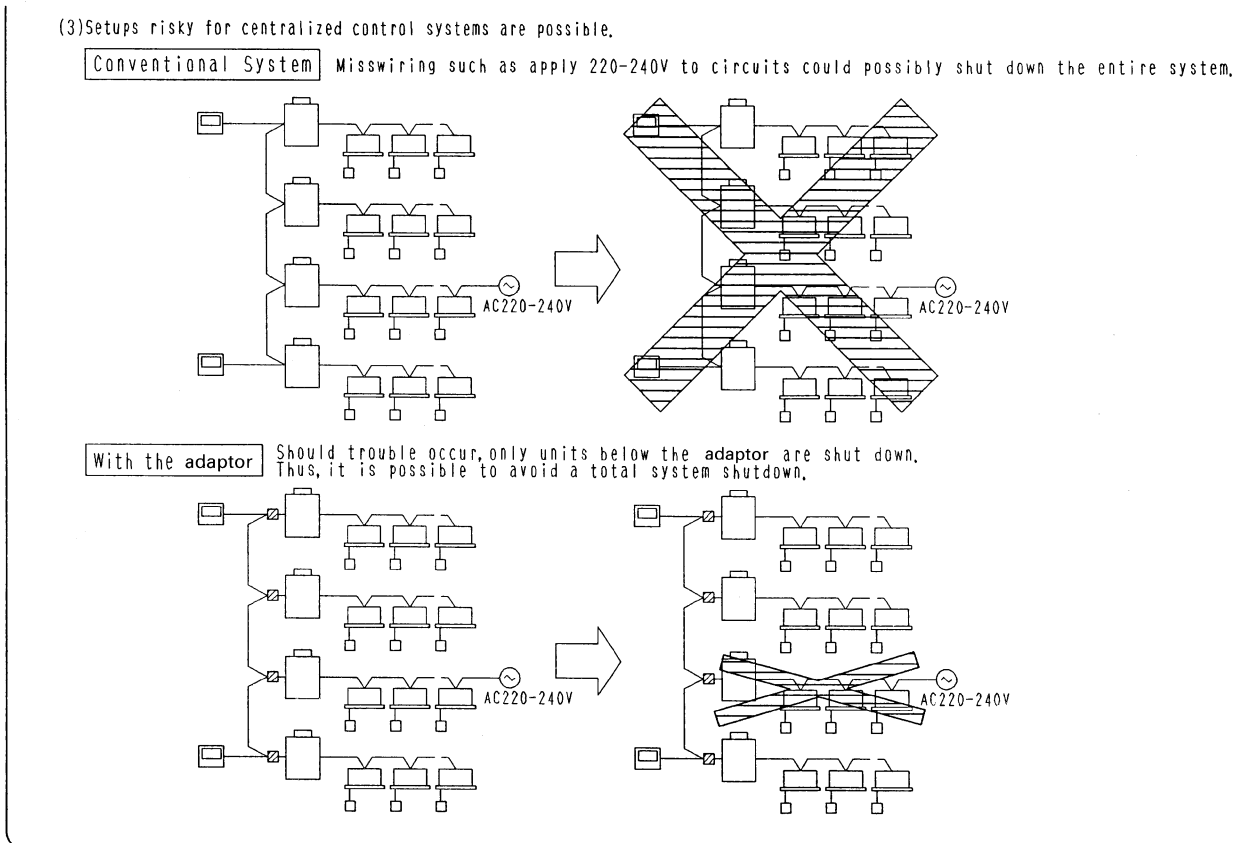

C: 1P013360

4 Electric wiring work

- (1) Connect the wire from the adaptor to the adaptor power connector on the outdoor unit's PC board.
(For connector Nos., see the electric wiring diagrams for the indoor and function units.)
- (2) Connect transmission wires between outdoor units (Outdoor-Outdoor terminal board).
- (3) Wire transmission wires to terminal boards as shown below.

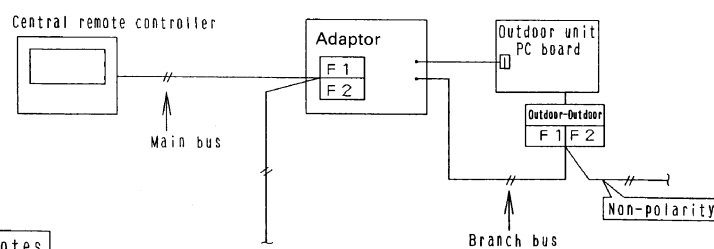

Notes

- (Transmission wiring specifications)
- 0.75~1.25mm² sheathed wire (2 wire).
- (Transmission wiring length)
- Observe the following limits on transmission wires. The limits apply to each adaptor. If you exceed the limits, it may cause malfunction.
 - (Total length : 2000m)
 - (Max. length --- 1000m)
 - (Max. number of branches : 16)
 - At least one outdoor unit and one optional controller for centralized control are required for every main bus and branch bus.
 - Up to 8 adaptors can be connected in one system.
 - Do not locate adaptors downstream of other adaptors (i.e. : on a branch bus).
 - If not used with a central control device, the expander adaptor cannot be used with the wiring adaptor for electrical appendices (KRP2A) or the schedule timer (DST301B51).
 - The external control adaptor for outdoor units controls group cooling and demand for each adaptor. (Anything beyond the expansion control falls outside the control domain.)
 - Do not turn the system ON/OFF rapidly from the optional controller for centralized control. This can cause temporary erroneous displays.
 - Sequential starts is controlled by each expander adaptor.

5 Wiring example

System with more than 10 outdoor units.

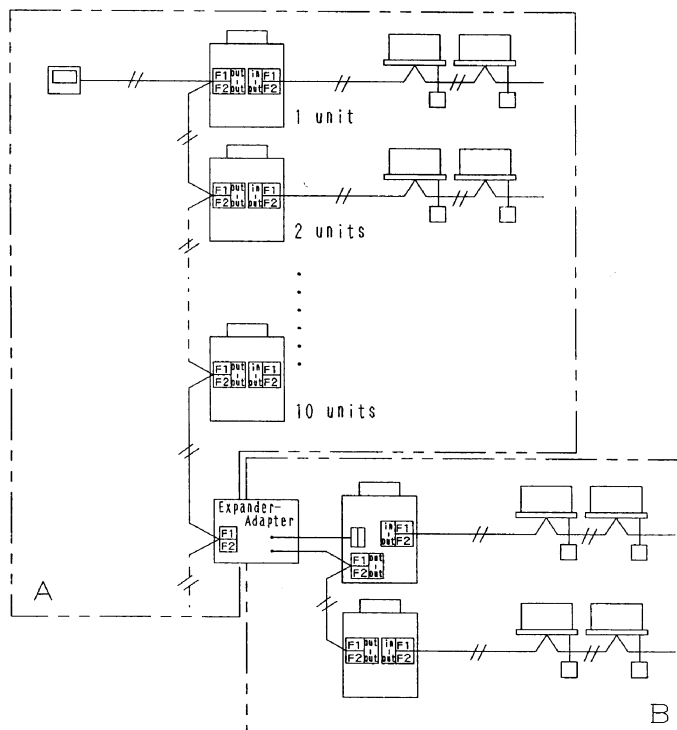

Note Wiring restrictions (see "Electric wiring work") apply to each group A and B.

KRP4A92 - Fixing Plate for DTA109A51

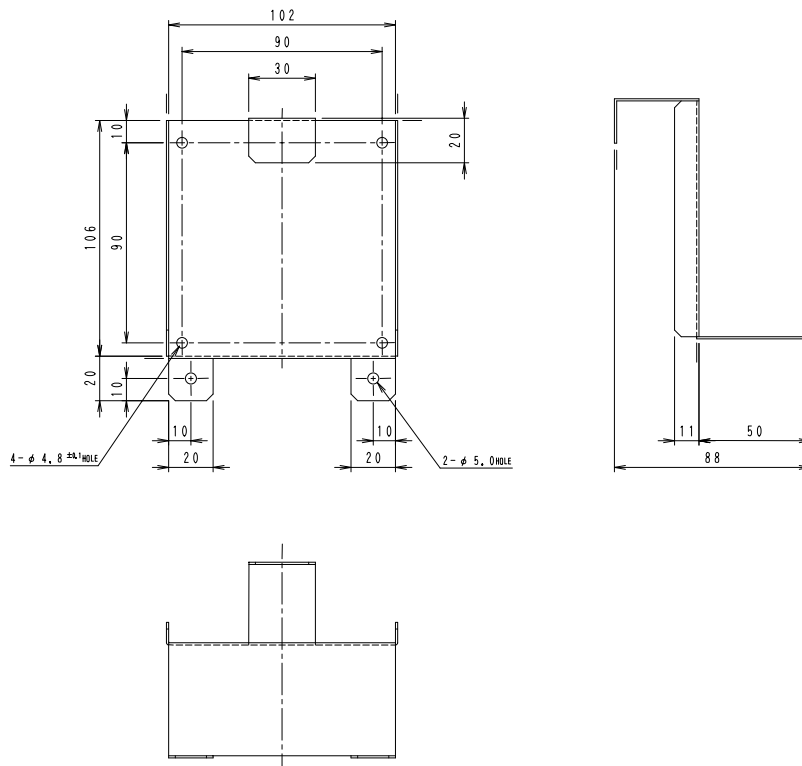

2
11.1 DTA109A51

NOTE) CHAMFERS OF CORNERS NOT SPECIFIED : C3. 3P022630A

12. Central Remote Controller

12.1 DCS302CA61

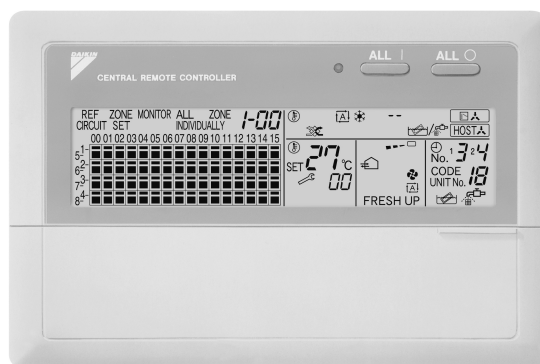

12.1.1 Specifications / Dimensions

Specifications

	DCS302CA61
Power supply voltage / frequency	AC100~240V ±10% 50/60Hz
Power consumption	Max. 8W
Setting data backup	Non-volatile memory (Data preserved semi-permanently)
Effects of instantaneous power failure	No effect for 20 milli-sec. or less
Forced OFF input Operation on the local side cannot be carried out during forced OFF input.	<ul style="list-style-type: none"> ■ No-voltage normal open contact ■ Micro-current contact capable of handling 16VDC and approx. 10mA. ■ Max. 150 m cable length
Power supply for schedule timer	Power can be supplied to schedule timer. (Max. 1 unit)
Operating ambient temperature /humidity condition	-5~40°C, 95% RH or less (no condensation)
Size (width x height x depth)	180x120x64.5 mm exposed portion of front panel : 16 mm
Weight (Mass)	Approx. 420 g

Dimensions

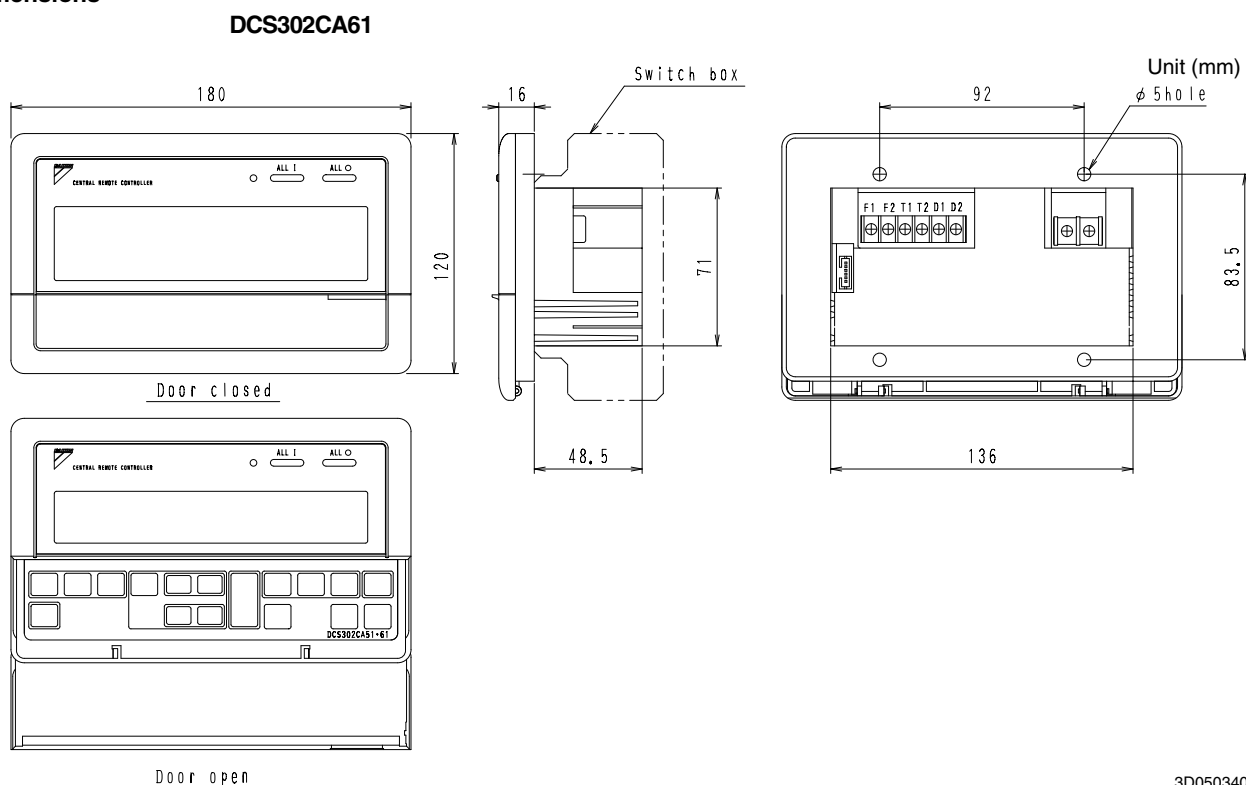

3D050340

12.1.2 Operation

■GENERAL DESCRIPTION OF SYSTEM

This central remote controller can monitor and control up to 64 indoor unit groups. Using two central remote controllers allows monitoring and controlling of up to 128 indoor unit groups.

Main Functions

1. Batch starting and stopping of indoor units connected to the central remote controller.
2. Handling of operation settings such as start/stop, timer operation, remote controller prohibition/permission, etc., and operation status settings such as temperature.
3. Operation status monitoring of operation mode, set temperature, etc.
4. Can be connected to an external central monitor panel and key system using the forced stop input (non-voltage a connector).

- When using 1 central remote controller

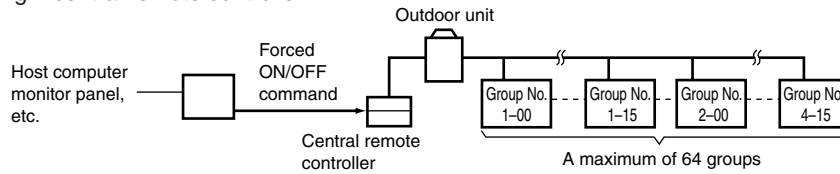

- When using 2 central remote controllers

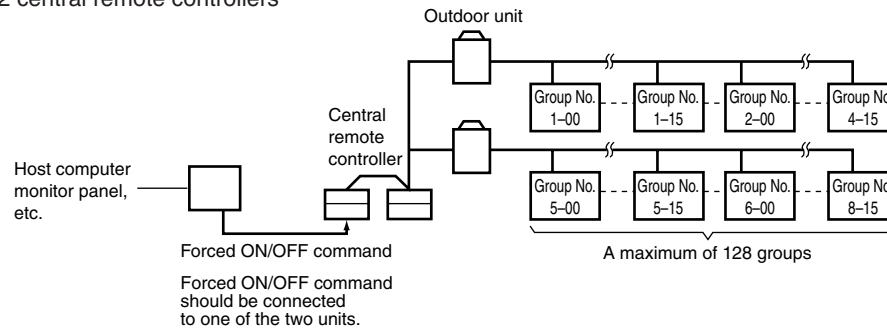

(The central remote controller and the separately sold remote control adapter circuit board or group remote control adapter cannot be used together.)

* GROUP OF INDOOR UNIT refers to the below.

1. A single indoor unit without remote controller

1. A single indoor unit without remote controller

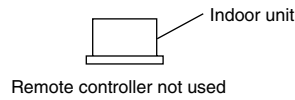

2. A single indoor unit controlled by one or two remote controllers

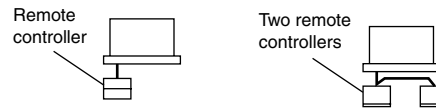

3. Maximum of 16 indoor units, group-controlled by one or two remote controllers

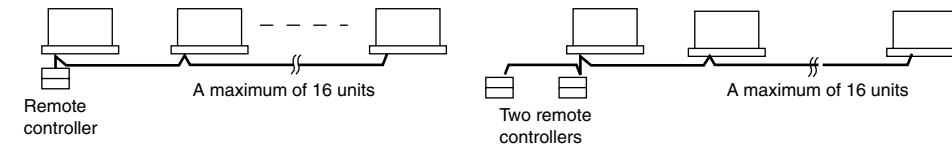

* Zone control from the central remote controller

Zone control is available from the central remote controller. With it, it is possible to make unified settings for multiple groups, so setting operations are greatly simplified.

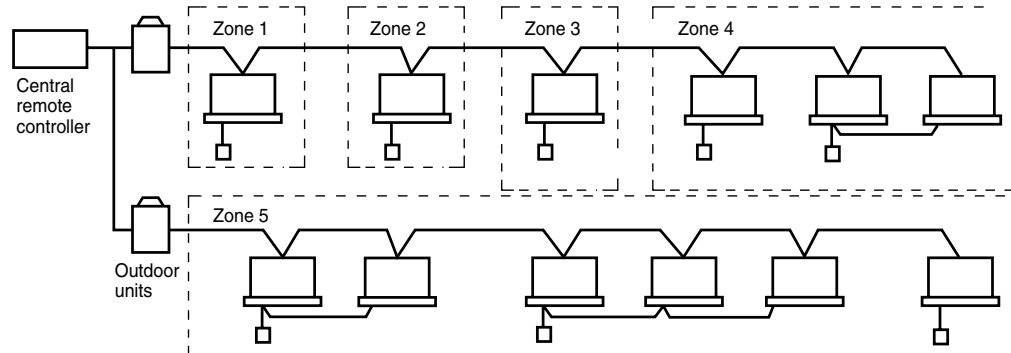

- Any setting you make within a given zone will apply to all groups in the said zone.
- A maximum of 64 zones can be set from a single central remote controller. (Each zone contains a maximum of 64 groups.)
- Zones can be set randomly from the central remote controller.

SAFETY CONSIDERATIONS

Please read these "SAFETY CONSIDERATIONS" carefully before installing air conditioning equipment and be sure to install it correctly.

After completing the installation, make sure that the unit operates properly during the start-up operation. Please instruct the customer on how to operate the unit and keep it maintained.

Also, inform customers that they should store this installation manual along with the operation manual for future reference. This air conditioner comes under the term "appliances not accessible to the general public".

Meaning of warning, caution and note symbols.

⚠ WARNING ... Indicates a potentially hazardous situation which, if not avoided, could result in death or serious injury.

⚠ CAUTION ... Indicates a potentially hazardous situation which, if not avoided, may result in minor or moderate injury. It may also be used to alert against unsafe practices.

⚠ NOTE Indicates situation that may result in equipment or property-damage-only accidents.

Keep these warning sheets handy so that you can refer to them if needed.

Also, if this equipment is transferred to a new user, make sure to hand over this operation manual to the new user.

⚠ WARNING

In order to avoid electric shock, fire or injury, or if you detect any abnormality such as smell of fire, turn off power and call your dealer for instructions.

Ask your dealer for installation of the air conditioner. Incomplete installation performed by yourself may result in a water leakage, electric shock, and fire.

Ask your dealer for improvement, repair, and maintenance. Incomplete improvement, repair, and maintenance may result in a water leakage, electric shock, and fire.

Improper installation or attachment of equipment or accessories could result in electric shock, short-circuit, leaks, fire or other damage to the equipment. Be sure only to use accessories made by Daikin which are specifically designed for use with the equipment and have them installed by a professional.

Ask your dealer to move and reinstall the air conditioner or the remote controller.

Incomplete installation may result in a water leakage, electric shock, and fire.

Never let the indoor unit or the remote controller get wet. It may cause an electric shock or a fire.

Never use flammable spray such as hair spray, lacquer or paint near the unit.

It may cause a fire.

Never replace a fuse with that of wrong ampere ratings or other wires when a fuse blows out.

Use of wire or copper wire may cause the unit to break down or cause a fire.

Never inspect or service the unit by yourself.

Ask a qualified service person to perform this work.

Cut off all electric waves before maintenance.

Do not wash the air conditioner or the remote controller with excessive water.

Electric shock or fire may result.

Do not install the air conditioner or the remote controller at any place where flammable gas may leak out.

If the gas leaks out and stays around the air conditioner, a fire may break out.

Do not touch the switch with wet fingers.

Touching a switch with wet fingers can cause electric shock.

CISPR 22 Class A Warning:

This is a class A product. In a domestic environment this product may cause radio interference in which case the user may be required to take adequate measures.

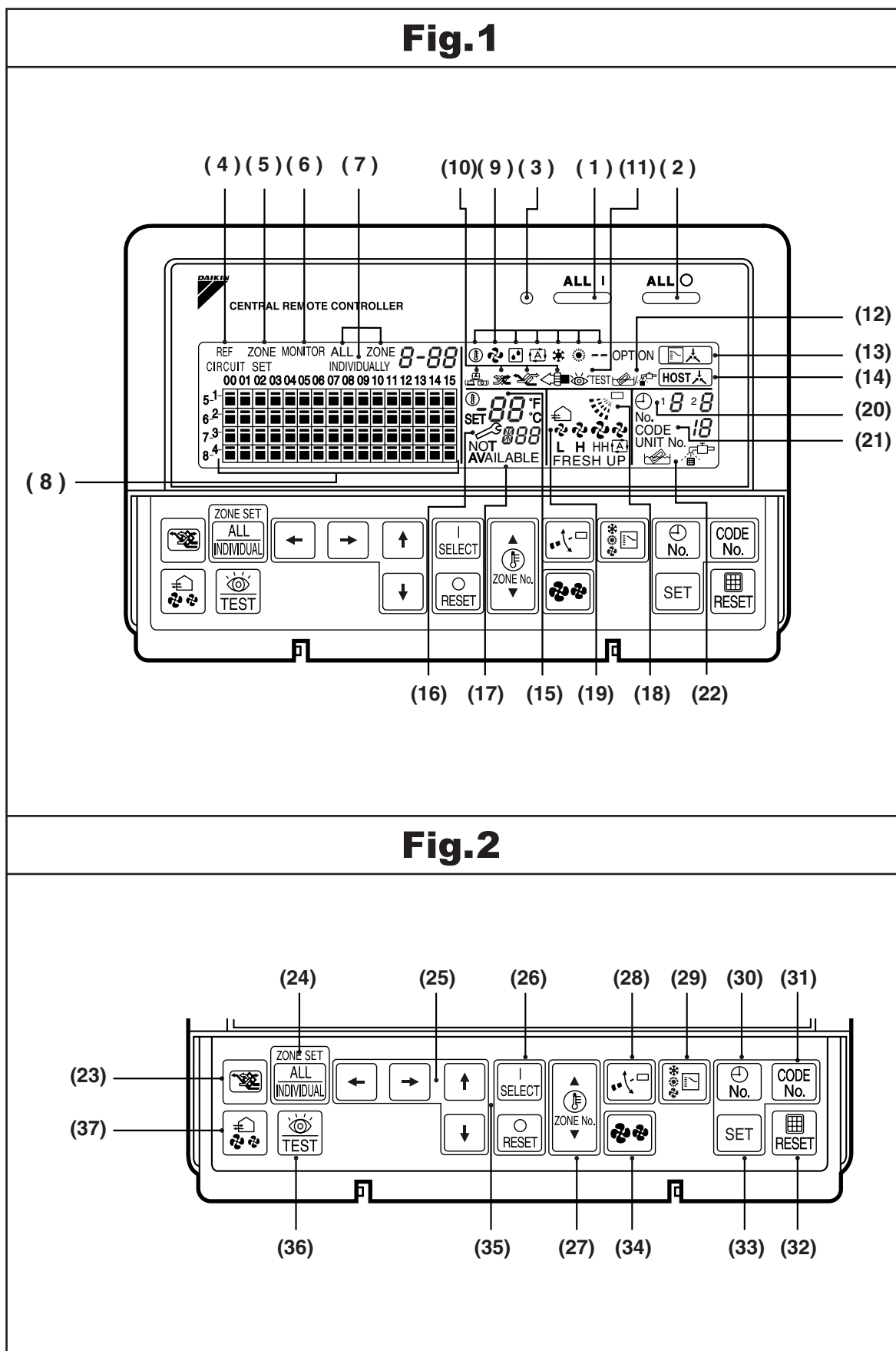

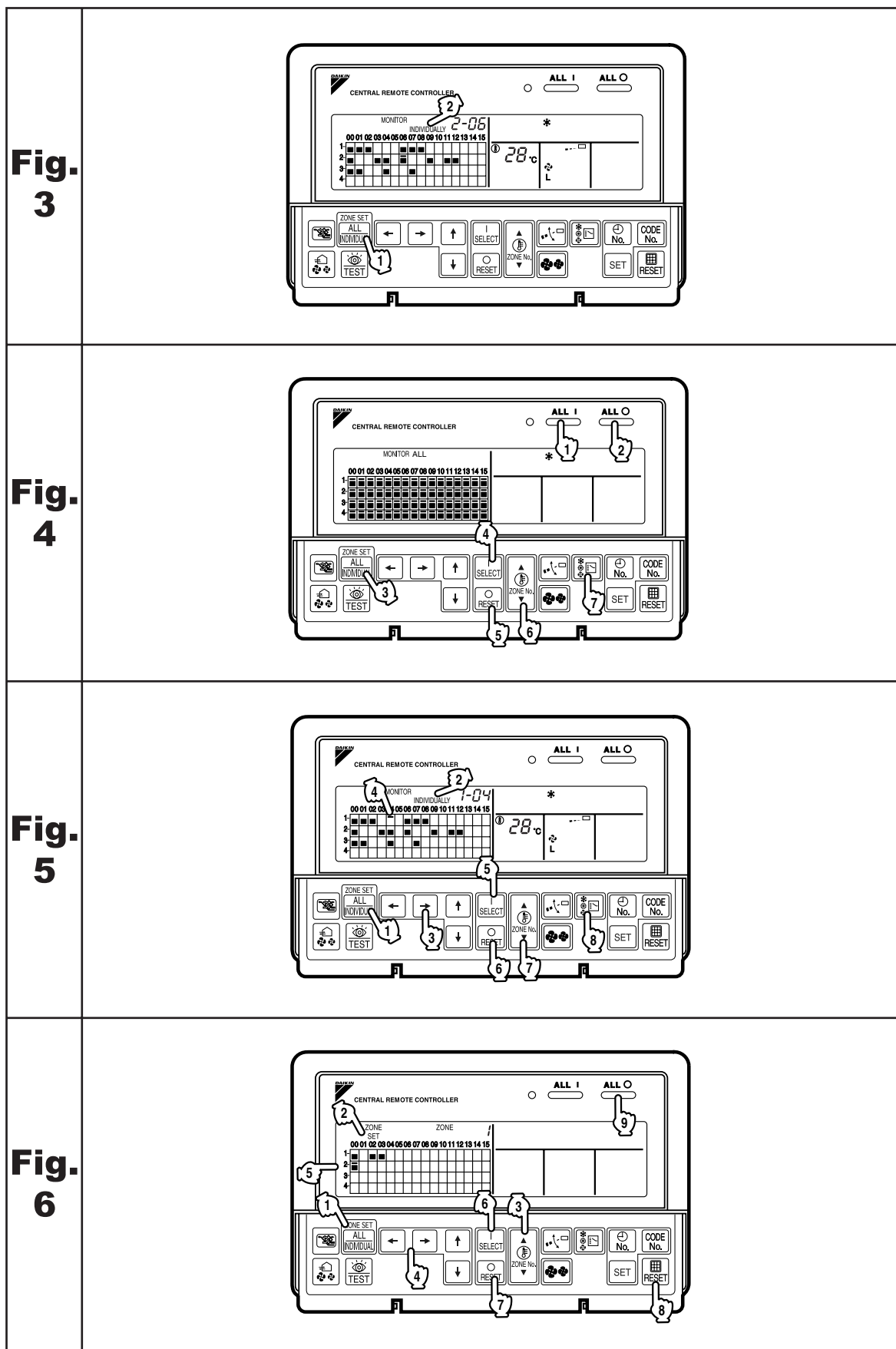

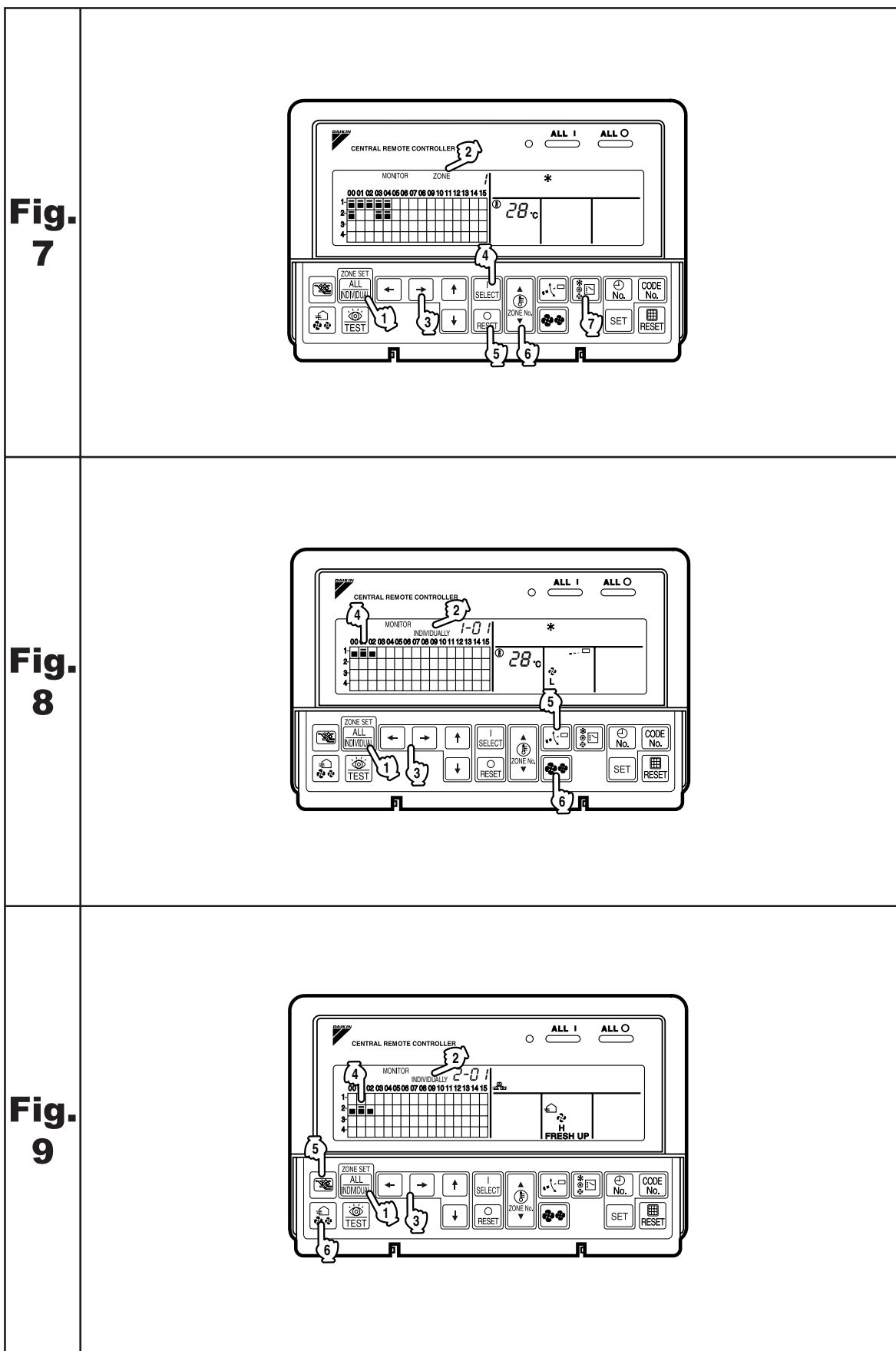

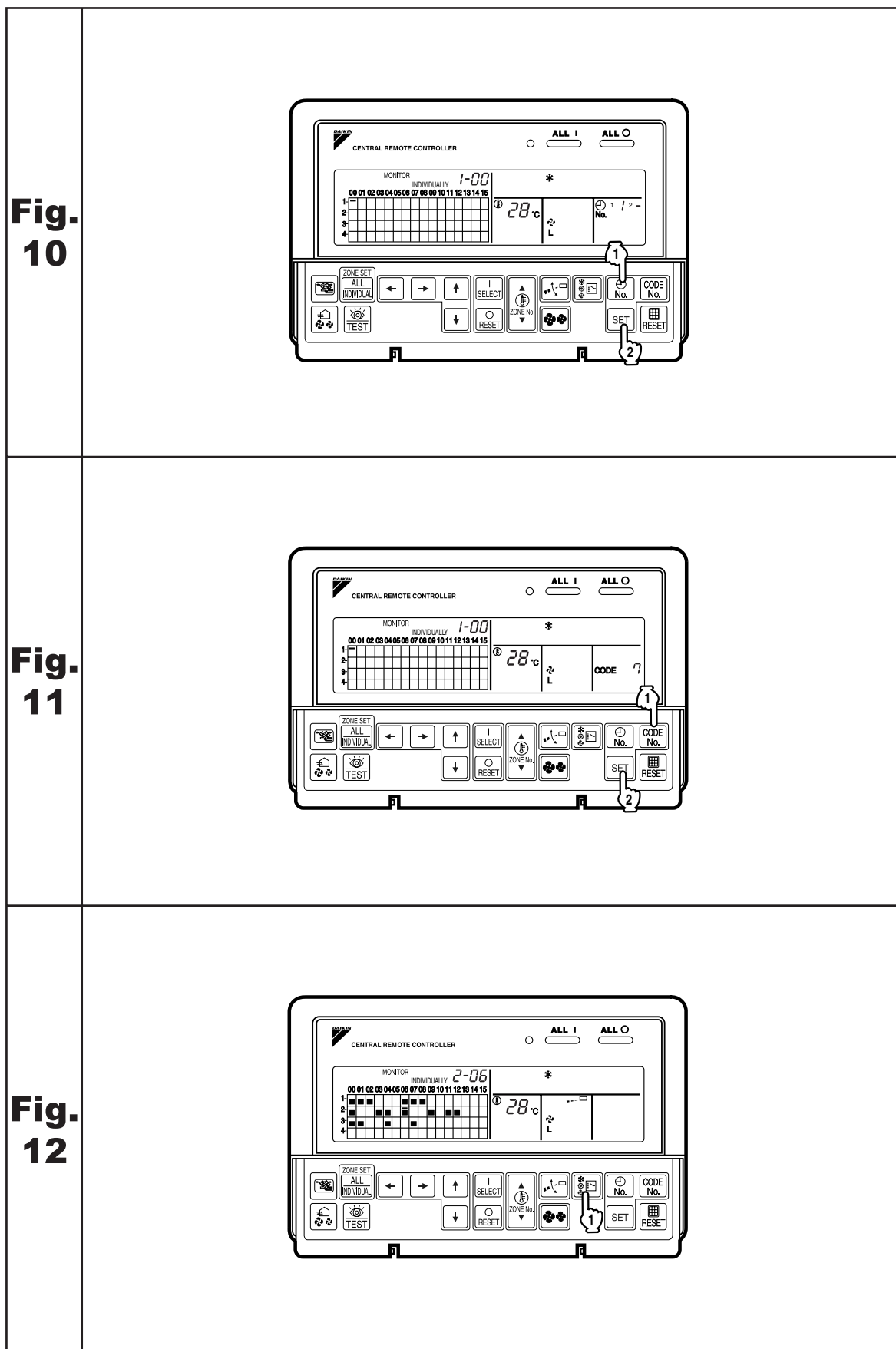

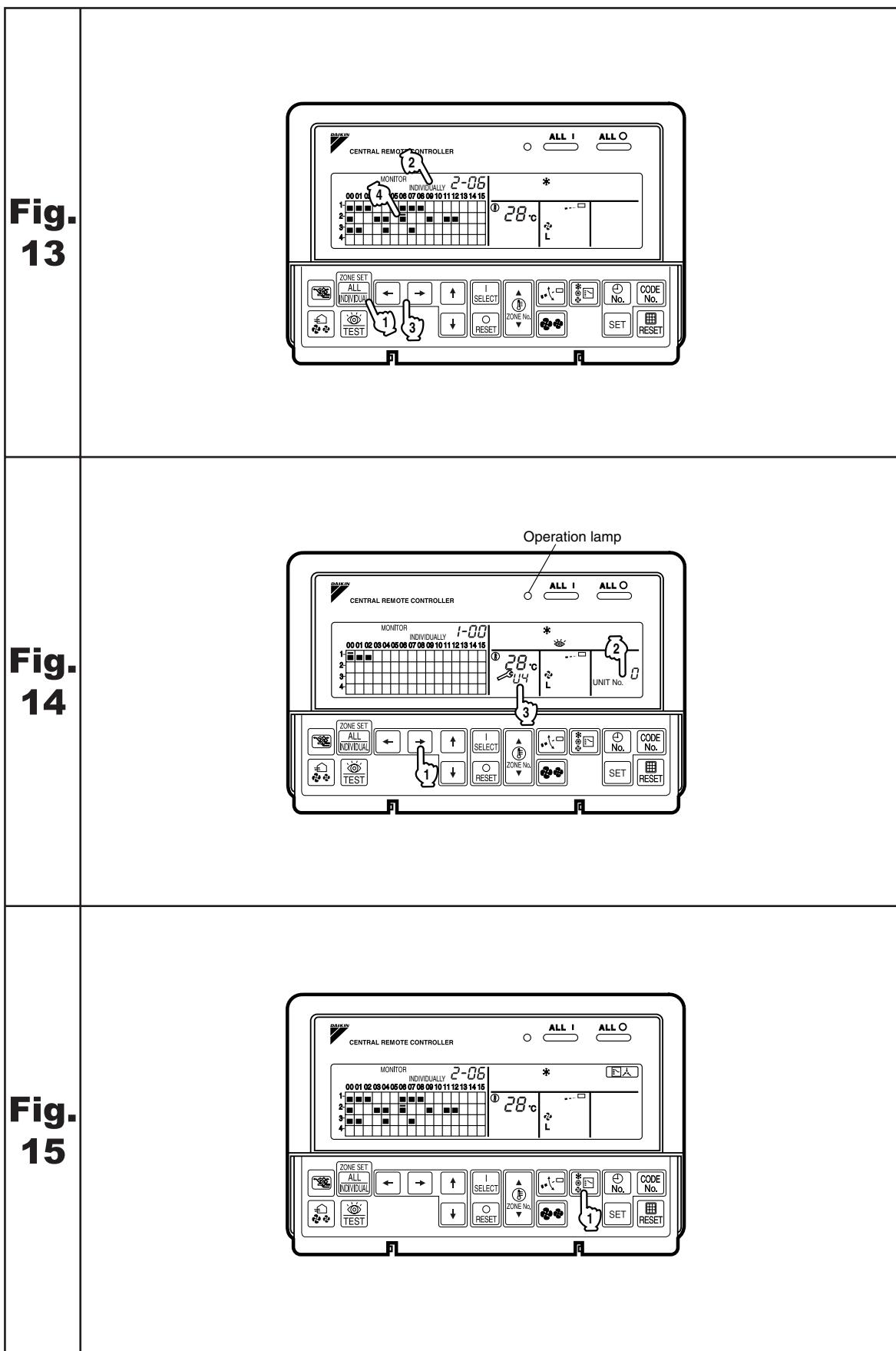

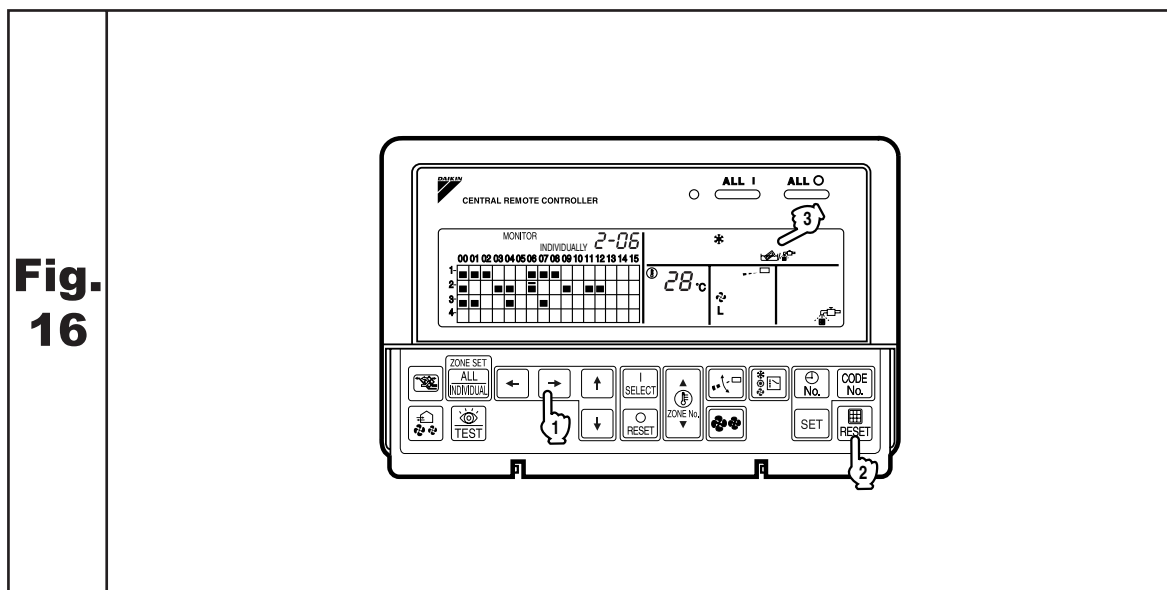

FEATURES AND FUNCTIONS

■ Operation menu

This central remote controller can operate and stop machines by either group or zone.
Batch operation and batch stop functions are also available. When used in combination with the schedule timer (optional accessory), timer operation and stop functions are available.



Note 1

■ Various operation modes.

You can operate the system from both this unit and the remote controller, so to enable various operation control patterns. Twenty different operation modes are available including five operation patterns:

1. Start/stop: remote controller prohibition, remote controller stop-only permission, central priority, after-press priority, remote controller permission timer
2. Operation modes: remote controller prohibition, remote controller permission
3. Set temperature: remote controller prohibition, remote controller permission



Note 2

■ Zone control for simpler setting procedures

You can control a maximum of 64 groups of indoor units by using this central remote controller. You don't have to repeat the same setting operations by group because you can make each of the following settings by zone.

A functions is available for setting all groups in one batch.

- Operation mode
- Control mode
- Setting temperature
- Programming time No. (Used in conjunction with the schedule timer)



Note 3

■ Monitoring all indoor unit information

The following information can be displayed by group.

- Operation information such as operation mode, set temperature, etc., for indoor units
- Maintenance information such as cleaning signs for filters or elements
- Error codes and other malfunction diagnosis information



Note 4

■ Function of refrigerant system display

This display helps you understand, at a glance, the indoor units sharing the same outdoor unit and the particular indoor unit among them that is set as the master remote controller.





























Note 5

- Room air conditioners and multi-purpose air conditioners may also be connected by using separately-sold adapter boards.
This may limit functionality, so consult the manuals that come with each adapter board.



Note 1 : page 253~257 , Note 2 : page 258~260 , Note 3 : page 253~261

Note 4 : page 261~266, Note 5 : page 265.

NAMES AND FUNCTIONS OF THE OPERATING SECTION (Fig. 1, 2)

1	UNIFIED OPERATION BUTTON Press to operate all indoor units.		
2	UNIFIED STOP BUTTON Press to stop all indoor units.		
3	OPERATION LAMP (RED) Lit white any of the indoor units under control is in operation.		
4	“^{REF} CIRCUIT” DISPLAY (REFRIGERANT SYSTEM DISPLAY) This indication in the square is lit while the refrigerant system is being displayed.		
5	“^{ZONE} SET” DISPLAY (ZONE SETTING) The lamp is lit while setting zones.		
6	“MONITOR” DISPLAY (OPERATION MONITOR) The lamp is lit while operation is being monitored.		
7	“ALL” “ZONE” “INDIVIDUALLY” DISPLAY The status displays indicates either batch functions or which zone or individual unit (or group) are being used.		
8	OPERATION MONITOR Each square displays the state corresponding to each group.		
9	“ “ “ “ “ “ “ “ “ “ “ “ “ “ “ “ “ “ “ “ “ “ “ “ “ “ “ “		

Names and Functions

21	“ CODE UNIT No. 18 ” DISPLAY (OPERATION CODE AND UNIT NUMBER DISPLAY)	The method of operation (remote controller prohibited, central operation priority after-press operation priority, etc.) is displayed by the corresponding code. This displays the numbers of any indoor units which have stopped due to an error.
22	“” “” DISPLAY (TIME TO CLEAN AIR CLEANER ELEMENT/ TIME TO CLEAN AIR FILTER)	Displayed to notify the user it is time to clean the air filter or air cleaner element of the group displayed.
23	VENTILATION MODE BUTTON	This is pressed to switch the ventilation mode of the total enthalpy heat exchanger.
24	ALL/INDIVIDUAL BUTTON	Pressing this button scrolls through the “all screen”, “zone screen”, and “individual screen”.
25	ARROW KEY BUTTON	This button is pressed when calling an individual indoor unit or a zone.
26	ON/OFF BUTTON	Starts and stops ALL, ZONE, and INDIVIDUAL units.
27	TEMPERATURE ADJUSTMENT BUTTON (ZONE NUMBER BUTTON)	This button is pressed when setting the temperature. Select the zone number if any zones have been registered.
28	FAN DIRECTION ADJUSTMENT BUTTON	This button is pressed when setting the fan direction to “fixed” or “swing”.
29	OPERATION MODE SELECTOR BUTTON	This sets the operation mode. The dry setting cannot be done.
30	TIME NO. BUTTON	Selects time No. (Use in conjunction with the schedule timer only).
31	CONTROL MODE BUTTON	Selects control mode.
32	FILTER SIGN RESET BUTTON	This button is pressed to erase the “clean filter” display after cleaning or replacement.
33	SET BUTTON	Sets control mode and time No.
34	FAN STRENGTH ADJUSTMENT BUTTON	Pressing this button scrolls through “weak”, “strong”, and “fast”.
35	ZONE SETTING BUTTON	Zone registration mode can be turned on and off by pressing the start and stop buttons simultaneously for at least four seconds.
36	INSPECTION/TEST RUN BUTTON (FOR SERVICE)	Pressing this button scrolls through “inspection”, “test run”, and “system display”. This button is not normally used.
37	VENTILATION STRENGTH ADJUSTMENT BUTTON	This button is pressed to switch the ventilation strength (“fresh up”) of the total enthalpy heat exchanger.
(Notes)		
1. Please note that all the displays in the figure appear for explanation purposes or when the cover is open.		
2. If the unit is used in conjunction with other optional central controllers, the OPERATION LAMP of the unit that is not under operation control may light up and go out a few minutes behind schedule. This shows that the signal is being exchanged, and does not indicate any failure.		

OPERATION

■ Individual screen, all screen, zone screen (Fig. 3)

This controller can perform operations in the individual screen, all screen, or zone screen.

- Individual screen The individual screen is used when performing group operations.
- All screen The all screen is used when performing operations for all units at once.
- Zone screen The zone screen is used when performing zone operations.

1.  Select the screen by pressing the “ALL/INDIVIDUAL” button.

 Every time the “ALL/INDIVIDUAL” button is pressed, the selection scrolls through INDIVIDUAL → ALL → ZONE.
If nothing is done in the all or zone screens for one minute, it automatically goes to the individual screen.

- If the zone number in the zone screen is displayed as "--," this indicates that no units are registered in a zone.
Please perform zone registration before proceeding in the zone screen. (Note 1)

■ Batch operation and stop method (Fig. 4)

This is for operating or stopping all connected units at once.

A. What to do when operating or stopping all connected units at once.

1. Press either "ALL I" or

 "ALL O".

- Operation can be performed from the individual screen, the all screen, or the zone screen.
- The "TEMPERATURE ADJUSTMENT" and "OPERATION MODE SELECTOR" buttons cannot be used.
To set the temperature and operation mode, use B. batch operation.

B. Batch Operation

1. Press the "ALL/INDIVIDUAL button" to enter the all screen.

The  display lights up on all registered units.

2. Press the "SELECT" button.

The  display lights up on all connected units.

 Press the "RESET" button.

The  display goes off on all connected units. Operation and stop in the batch screen are done the same as with the batch operation and batch stop buttons.

3. Press the "TEMPERATURE ADJUSTMENT" button.

The temperature rises 1° every time the (▲) button is pressed.
The temperature drops 1° every time the (▼) button is pressed.

Set to "--" when you do not wish to use batch setting for the temperature setting.
Setting to 1° above or below the temperature setting range displays "--".

4. Call up the desired mode by pressing the "OPERATION MODE SELECTOR" button.

Set to "--" when you do not wish to use batch setting for the operation setting.

Note 1 : page 254

■ Group operation and stop method (Fig. 5)

This is for operating or stopping connected units in groups.

[Group operation]

1. Press the "ALL/INDIVIDUAL button"

to enter the  individual screen.

The unit will enter the individual screen automatically if nothing is done for one minute.

2. Using the arrow keys, move the

 to select the units to operate or stop.

Keeping the button pressed down will move it rapidly.

The  in this screen has selected unit 1-04.

3. Press the "SELECT" button.

The  display lights up in the group.

 Press the "RESET" button.

The  display goes off in the group.

4. Press the "TEMPERATURE ADJUSTMENT" button.

The temperature rises 1° every time the (▲) button is pressed.

The temperature drops 1° every time the (▼) button is pressed.

Temperature adjustment cannot be done if the selected group's air conditioners are in fan mode.

5. Call up the desired mode by pressing the "OPERATION MODE SELECTOR" button.

■ Registering zones (Fig. 6)

It is possible to set multiple groups as one zone and control each zone separately.

No zones are registered when the unit is shipped from the factory.

Zone registration can be done in the individual screen, all screen, or zone screen.

[Registration]

1. Pressing the "ALL/INDIVIDUAL" button for four seconds. Displays ZONE SET.

Zone Number 1 will be displayed, and if there are any groups already registered in the displayed zone, a  will light up on the operation monitor.

2. Select the Zone Number to be registered using the “ZONE NUMBER” button. Keeping the button pressed down will move it rapidly.
3. “” to the group you wish to register using the arrow keys. Keeping the button pressed down will move it rapidly.
4. Press the “SELECT” button to register that group to the zone.

The “” display lights up on all the selected units.

Pressing the “RESET” button removes the group from that zone, and “” goes off.

Repeat steps 3 and 4 until all the units you wish to register to the zone have been added.

	ZONE SET															
	00	01	02	03	04	05	06	07	08	09	10	11	12	13	14	15
1-																
2-																
3-																
4-																

In this example, a screen is shown with units 1-00, 1-02, 1-03, and 2-00 registered to Zone Number 1.

5. Repeat steps 2 to 4 to register to the next zone.
6. Once zone registration is complete, press the “ALL/INDIVIDUAL” button to turn off “ZONE SET” display and return to the individual screen.

The display returns to the normal screen if nothing is done for one minute when in zone registration mode.

(NOTE)

- It is impossible to register one group to several different zones. If this is done, the last zone registered to will be valid.

[Batch deletion of zone registration]

1. Pressing the “ALL ○” for at least four seconds while pressing the “FILTER SIGN RESET” button when “ZONE SET” is displayed will delete all zone registrations. The zone registrations for all units will be lost.

■ Zone operation and stop method (Fig. 7)

This is for operating or stopping connected units in zones.

[Zone operation]

1. Press the “ALL/INDIVIDUAL button” to enter the zone screen.
2. Using the arrow keys, select the zone number to operate or stop. Pressing and reduces the zone number while and raise the number. Keeping the button pressed down will move it rapidly.
 - If the zone number is displayed as “---”, this indicates that no units are registered in a zone. Please perform zone registration before using a zone. (See page 261)

3. Press the “SELECT” button.

The “” display lights up in the group.

3. Press the “RESET” button.

The “” display goes off in the group.

4. Press the “TEMPERATURE ADJUSTMENT” button.

The temperature rises 1° every time the (▲) button is pressed.

The temperature drops 1° every time the (▼) button is pressed.

Set to “--” when you do not wish to use zone setting for the temperature setting.

Setting to 1° above or below the temperature setting range displays “--”.

5. Call up the desired mode by pressing the “OPERATION MODE SELECTOR” button.

Set to “--” when you do not wish to use zone setting for the operation mode.

■ Changing the fan direction and fan strength (Fig. 8)

This changes the fan direction and strength settings in the air conditioner.

Changing the fan direction and strength is done in the individual screen.

[Registration]

1. Press the “ALL/INDIVIDUAL button” to enter the individual screen.
The unit will enter the individual screen automatically if nothing is done for one minute.
2. Using the arrow keys, move the “” to select the units to fan direction adjustment or fan strength adjustment.
Keeping the button pressed down will move it rapidly.
3. Press the “FAN DIRECTION ADJUSTMENT” button.
This sets “fixed” or “swing” for the fan direction.
 Press the “FAN STRENGTH ADJUSTMENT” button.
Pressing this button scrolls through “”, “”, and “”.
Depending on the indoor unit, only “” and “” may be available.

The functions included in the indoor units may vary. Pressing a button for a function which is not available will cause “NOT AVAILABLE” to be displayed.

■ Changing the ventilation mode and ventilation strength (Fig. 9)

This changes the ventilation mode and strength settings in the total enthalpy heat exchanger. Changing the ventilation mode and strength is done in the individual screen.

[Registration]

1. Press the “ALL/INDIVIDUAL button” to enter the individual screen.
The unit will enter the individual screen automatically if nothing is done for one minute.
2. Using the arrow keys, move the “” to select the units to ventilation mode or ventilation strength adjustment.
Keeping the button pressed down will move it rapidly.

3. Press the “VENTILATION MODE” button.

It will scroll through “” → “” → “” → “”.

6. Press the “VENTILATION STRENGTH ADJUSTMENT” button.

It will scroll through “” → “” → “” →

“ FRESH UP” → “”.

The fresh up function may not be available depending on the connected unit model.

The functions included in the indoor units may vary. Pressing a button for a function which is not available will cause “NOT AVAILABLE” to be displayed.

• Ventilation Mode and Amount

If these are changed using the remote controller depending on the unit model, they cannot be displayed on the central remote controller. To monitor the ventilation mode and amount, check the values on the remote controller.

■ Timer Number Setting (Fig. 10)

(Only when used with the schedule timer)

Using this together with the schedule timer makes it possible to set on and off times four times a day.

[Registration]

1. Pressing the “TIMER NO.” button causes the number set for timer number 1 to blink.
If no timer setting has been made “-” will be displayed.
Select the desired timer number by pressing the “TIMER NO.” button.

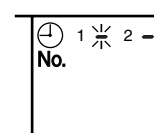

2. Once the desired timer number is displayed, press the “SET” button.

Press the “SET” button within 10 seconds after the timer number is displayed.
The display will return to how it was after 10 seconds.

The display for timer number 1 will stop blinking and then timer number 2 will start blinking.

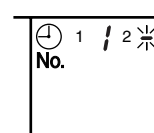

3. Select the desired timer number by pressing the “TIMER NO.” button.

Once the desired timer number is displayed,  press the “SET” button.
The display for timer number 2 will stop blinking.

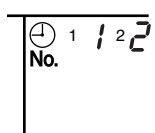

The “ No.” display will disappear after 3 seconds.

Select “-” in the timer number when you do not wish to set a timer number.
It is possible to set only one timer number.
(The times for turning the unit(s) on and off twice a day can be set with a single timer number.)

• Timer Number Setting

- Group control: select the unit in the individual screen and set the timer number.
- Batch control: set the timer numbers for all connected units.
- Zone control: set the timer numbers for all zone-registered units.
Call up the zones which you wish to set in the zone screen and set the timer numbers.

• Since the timer number will be set to after-press priority, the timer number in the last screen set will be valid for the connected units.

Example 1

Setting timer number 1 for unit 1-00 to “1” and timer number 2 to “2” in the individual screen and then setting timer number 1 to “3” and timer number 2 to “4” in the batch screen causes the timer numbers for all units to be set, so timer number 1 for unit 1-00 will be “3” and timer number 2 will be “4”.

Example 2

To prevent leaving units on, timer number 1 is set to “5” in the batch screen.

Setting timer number 1 in zone number 1 to “-” in the zone screen after that will change the timer number for zone number 1, so the setting to prevent leaving the units on will be lost for zone number 1 only.

If a timer number is set incorrectly by accident, redo the setting in the desired screen.

• What happens when the timer number on time and off time are set to the same time

When the on time and off time are set to the same time for the same timer number, operation does not change.

When the on time and off time are set to the same time for different timer numbers, the off time is given priority.

When using timer operation, make sure the times do not overlap when setting the program of the schedule timer.

■ Setting the Operation Code (Fig. 11)

[Registration]

1. Pressing the “CONTROL MODE” button causes the currently set operation code to blink.

Call up the desired code number by pressing the  “CONTROL MODE” button.
Scroll through the code numbers.

2. Once the code number is displayed, press the “SET” button.

The display will stop blinking.
The operation code display will disappear after 3 seconds.

[The Operation Code Setting]

Group control: select the unit in the individual screen and set the operation code.

Batch control: set the operation code for all connected units.

Zone control: set the operation code for all zone-registered units.
Call up the zones which you wish to set in the zone screen and set the operation code.

Since the operation code will be set for after-press priority, setting the operation code in the zone and individual screens after setting the operation code in the batch screen, will cause the operation codes set afterwards to be valid.

The following five operation control modes can be selected along with the temperature setting and operation mode by remote controller, for a total of twenty different modes. These twenty modes are set and displayed with control modes of 0 to 19. (For further details, see EXAMPLE OF OPERATION SCHEDULE on the next page.)

- ON/OFF control impossible by remote controller..... Use this mode when operating and stopping from the central remote controller only. (ON/OFF control by the remote controller is disabled.)
- Only OFF control possible by remote controller Use this mode when executing the operation only by the central remote controller, and executing only the stop by remote controller.
- Centralized..... Use this mode when executing the operation only by the central remote controller, and executing start/stop freely by remote controller during the preset hours.
- Individual Use this mode when executing start/stop both by central remote controller and remote controller.
- Timer operation possible by remote controller..... Use this mode when executing start/stop by remote controller during the preset hours, and not starting operation by the central remote controller at the programmed time of system start.

[HOW TO SELECT THE CONTROL MODE]

- Select whether to accept or to reject the operation from the remote controller regarding the operation, stop, temperature setting and operation mode setting, respectively, and determine the particular control mode from the rightmost column of the table below.

Example

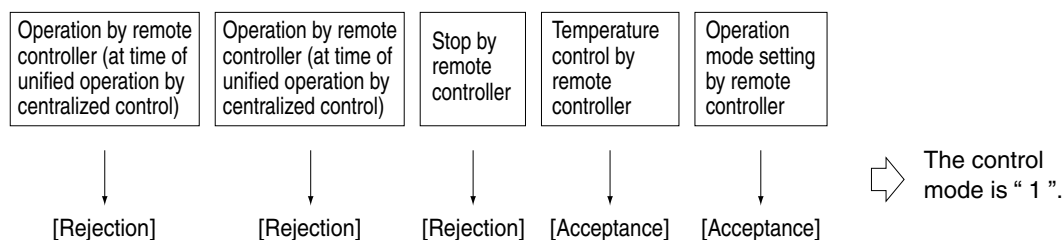

Operation mode	Control by remote controller					Control mode
	Operation		Stop	Temperature control	Operation mode setting	
	Unified operation, individual operation by central remote controller, or operation controlled by timer	Unified stop, individual stop by central remote controller, or timer stop				
ON/OFF control impossible by remote controller	Rejection (Example)	Rejection (Example)	Rejection (Example)	Rejection	Acceptance	0
Only OFF control possible by remote controller				Acceptance (Example)	Rejection	10
Centralized	Acceptance	Acceptance	Acceptance	Rejection	Acceptance (Example)	1 (Example)
				Acceptance	Rejection	11
Individual	Acceptance	Acceptance	Acceptance	Rejection	Acceptance	2
				Acceptance	Rejection	12
Timer operation possible by remote controller	Acceptance (During timer at ON position only)	Rejection (During timer at OFF position)	Acceptance	Rejection	Acceptance	3
				Acceptance	Rejection	13
				Rejection	Acceptance	4
				Acceptance	Rejection	14
				Rejection	Acceptance	5
				Acceptance	Rejection	15
				Rejection	Acceptance	6
				Acceptance	Rejection	16
				Rejection	Acceptance	7
				Acceptance	Rejection	17
				Rejection	Acceptance	8
				Acceptance	Rejection	18
				Rejection	Acceptance	9
				Acceptance	Rejection	19

Note) Do not select the timer operation possible without the remote controller. In this case, timer operation is disabled.

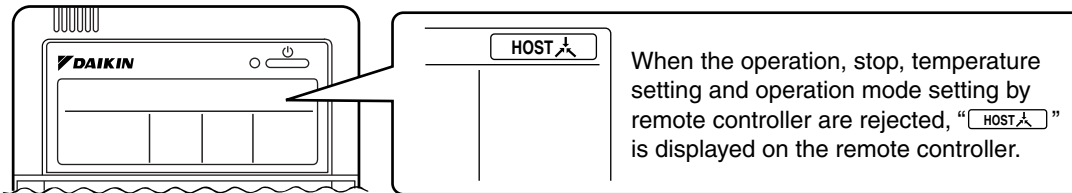

EXAMPLE OF OPERATION SCHEDULE

Operation schedule is possible only in conjunction with the schedule timer (optional accessory).

Liquid crystal display of schedule timer

ON/OFF control impossible by remote controller

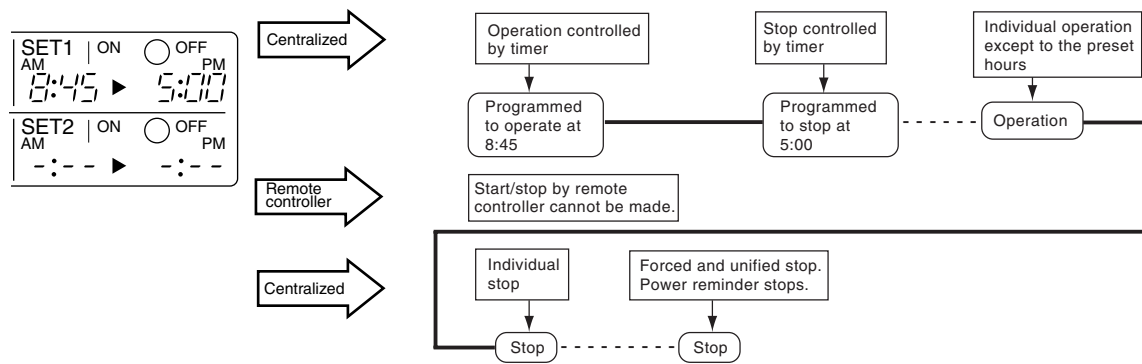

Only OFF control possible by remote controller

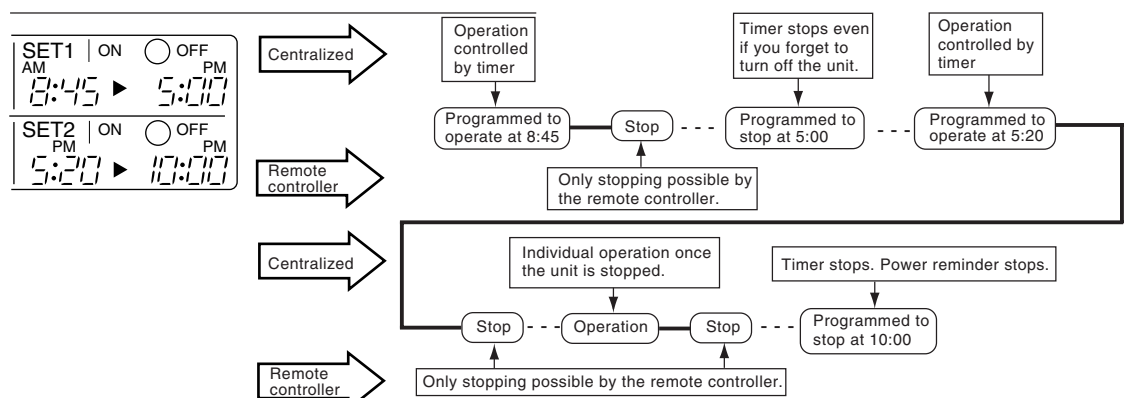

Centralized

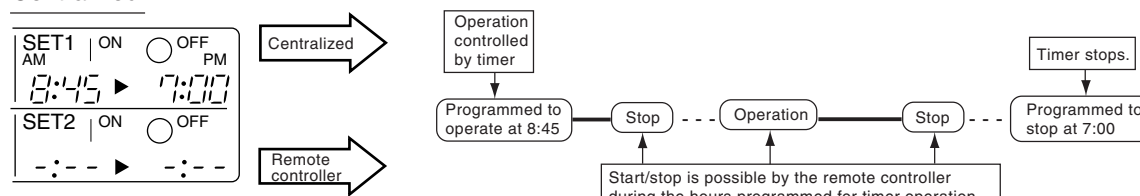

Individual

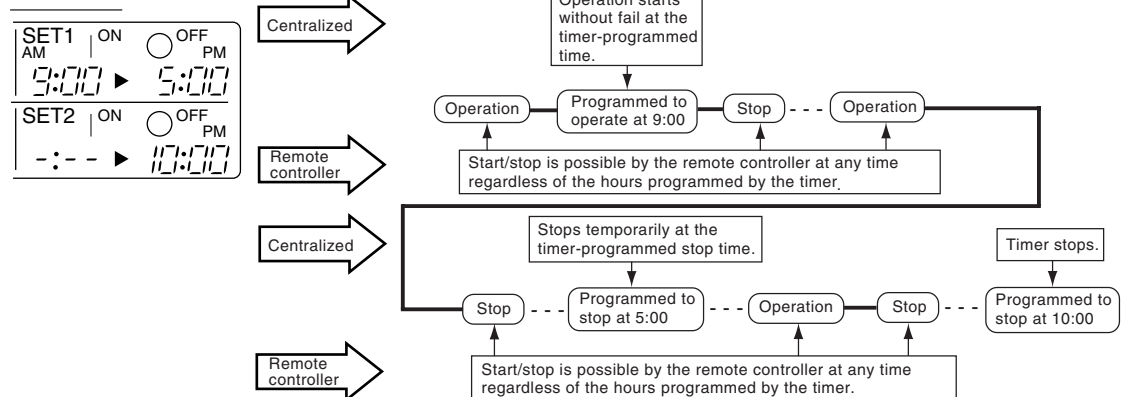

Timer operation possible by remote controller

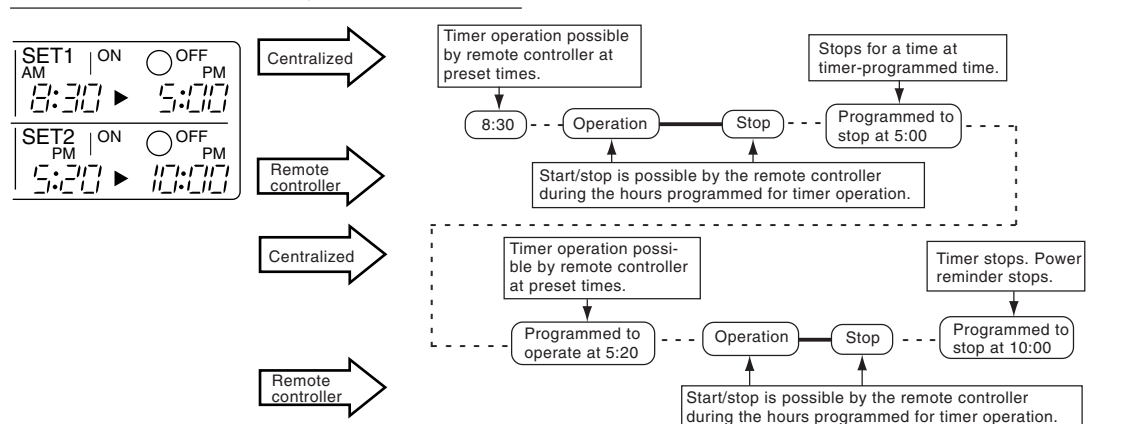

- Air conditioner now operating.
- - - - Air conditioner now stopping.
- ▭ Command by central remote controller
- Command by remote controller

■ Setting operation mode (Fig.12)

[Registration]

1. Press the OPERATION MODE SELECTOR BUTTON. Each time you press this button, the display rotates as shown on the below list.

• List of operations which can be set

In the below list, “ V ” refers to the acceptable setting, while “ x ” refers to the not acceptable setting.

Display	A: Zones and groups with no “” display.	
	Setting	Contents of setting
	x	
	○	Can be set in individual zones or groups
	○ * 1	Can be set in individual zones or groups
	○	Can be set in individual zones or groups
	○	Can be set in individual zones or groups
	○ * 1	Can be set in individual zones or groups 3
	○ * 1	Can be set in individual zones or groups
	○	Select this display if you don't wish to set by zone.

Display	B: Zones and groups with a “” display.	
	Setting	Contents of setting
	○	To be set by zone * 2
	○	Can be set in individual zones or groups
	x	
	x	The displays are shown by group * 4
	x	The displays are shown by group * 4
	○ * 1	Can be set in individual zones or groups * 3
	○ * 1	Can be set in individual zones or groups
	○	Select this display if you don't wish to set by zone.

Note 1 : page 265. Note 2 : page 266.

- *1: Setting may not be acceptable depending on the type of indoor unit with which this unit is connected.
- *2: In zone control, the units run in temperature adjustment mode (heating or cooling) for the outdoor system for the groups registered to those zones. Heating or cooling selection is not available.
- *3: or or Changing the ventilation mode cannot be done in the zone screen. Changing the ventilation mode should be done in the individual screen.
- *4: In group control, the units run in temperature adjustment mode (heating or cooling) for the group outdoor system. Heating or cooling selection is not available.

• The Zone consists of the following two cases.

A. Zone without display “”

The group with master remote controller setting exists in this zone.
Setting the master remote controller enables cool/heat selection.
Operations other than cool/heat operations can also be set for some operations. For further details, see the list on the left.

B. Zone with display “”

No group with master remote controller setting exists in this zone.
The cool/heat selection is not available because the master remote controller has not been set.
Some operations other than cool/heat operations can be set. For further details, see the list in the left.

See Note 1 if the display “” is flashing.

- Fan operation can be performed for each zone using the central remote controller even if there is no cooling/heating selection right during cooling or heating. Also, if a VentiAir is connected in the zone, ventilation and ventilation cleaning operation is possible. See the included operating manuals for details.
- When the indoor unit is in heat operation, change the setting to FAN operation through the central remote controller; then, you can switch the fan speed to the extremely low fan speed. Warm air may blow if any other indoor unit belonging to the same system is in heat operation.
- The indoor fan stops during defrost/hot start.
- DRY cannot be set from the central remote controller.

■ Group monitoring (Fig. 13)

Utilize the group monitor function in each of the following cases:

1. Check the malfunction code. (See the next page.)
2. Check the group that requires cleaning of the air filter and air cleaner element. (See Note 2.)
3. Change the setting of the master remote controller. (See Note 1.)
4. Check the group(s) sharing the same outdoor unit. Or, check the particular group(s) with the master remote controller setting. (See Note 1.)
5. Check the conditions of other individual groups.

When in zone screen

The zone screen will revert to the individual screen automatically if nothing is done in it for one minute.

[Registration]

1. Press the “ALL/INDIVIDUAL” button to switch to the “INDIVIDUAL” screen.

2. Using the arrow key, move the “ ” to select the unit to be monitored.

Keeping the button pressed down will move it rapidly.

The “ ” lights up and the status of that unit is displayed in the LCD. The cursor in the screen Fig. 13 has selected unit 2-06.

■ Error diagnosing function (Fig. 14)

This central remote controller is provided with a diagnosing function, for when an indoor unit stops due to malfunction. In case of actuation of a safety device, disconnection in transmission wiring for control or failure of some parts, the operation lamp, inspection display and unit No. start to flash; then, the malfunction

code is displayed. Check the contents of the display, and contact your DAIKIN dealer because the above signs can give you the idea on the trouble area.

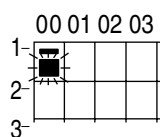

The display “ ” flashes under the group No. where the indoor unit that has stopped due to malfunction.

[Registration]

1. Press the ARROW KEY BUTTON to call up the group that has stopped due to malfunction.

The unit No. the malfunction code is flashing because of an error failure.

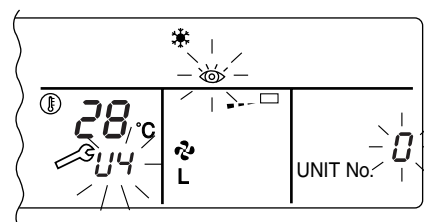

Operation lamp	Maintenance display	Unit No.	Malfunction code	Error content
☀	●	☾	64	Indoor air thermistor error
☀	●	☾	65	Outdoor air thermistor error
☀	●	☾	68	HVU error (Venti air dust-collecting unit)
☀	●	☾	6A	Dumper system error
☾	☾	☾	6A	Dumper system error + Thermistor error
☀	●	☾	6F	Simple remote controller error
☀	●	☾	6H	Door switch (Venti air dust-collecting unit), relay harness fault (Venti air dust-collecting/humidifier unit)
☾	☾	☾	94	Venti air internal transmission error (between total enthalpy – fan unit)
☾	☾	☾	A0	Indoor unit · external safety device error
☾	☾	☾	A1	Indoor unit · BEV unit (Sky-Air connection unit) PC board assembly fault
☀	●	☾	A1	Indoor unit · PC board assembly fault
☾	☾	☾	A3	Indoor unit · Drain level error (33H)
☾	☾	☾	A6	Indoor unit · Fan motor (51F) lock, overload
☀	●	☾	A7	Indoor unit · Fan direction adjustment motor (MA) error
☾	☾	☾	A9	Indoor unit · BEV unit, electric expansion valve motor (20E) error
☀	●	☾	AF	Indoor unit · Malfunctioning drain
☀	●	☾	AH	Indoor unit · Dust-collector error
☾	☾	☾	AJ	Indoor unit · Insufficient capacity setting, address setting fault

Operation lamp	Maintenance display	Unit No.	Malfunction code	Error content
☾	☾	☾	C4	Indoor unit · Liquid piping thermistor (Th2) Error (faulty connection, cut wire, short circuit, fault)
☾	☾	☾	C5	Indoor unit · BEV unit, gas piping thermistor (Th3) Error (faulty connection, cut wire, short circuit, fault)
☾	☾	☾	C9	Indoor unit · Intake air thermistor (Th1) Error (faulty connection, cut wire, short circuit, fault)
☾	☾	☾	CA	Indoor unit · Outlet air thermistor (Th4) Error (faulty connection, cut wire, short circuit, fault)
☼	●	☼	CJ	Indoor unit · remote controller sensor error
☾	☾	☾	E0	Outdoor unit · Safety device operation
☾	☾	☾	E1	Outdoor unit · PC board assembly fault
☼	●	☾	E1	Outdoor unit · PC board assembly fault
☾	☾	☾	E3	Outdoor unit · High-pressure switch fault
☾	☾	☾	E4	Outdoor unit · Low-pressure switch fault
☾	☾	☾	E9	Outdoor unit · Electric expansion valve motor (20E) error
☼	●	☾	EC	Heat source unit · Intake water temperature inter-lock operation (fan operation)
☾	☾	☾	EF	Outdoor unit · Ice thermal storage unit error
☾	☾	☾	F3	Outdoor unit · Discharge piping temperature error
☼	●	☾	H3	Outdoor unit · High-pressure switch operation
☾	☾	☾	H4	Outdoor unit · Low-pressure switch operation
☾	☾	☾	H9	Outdoor unit · Outdoor air thermistor (Th1) Error (faulty connection, cut wire, short circuit, fault)
☼	●	☾	H9	Outdoor unit · Outdoor air thermistor (Th1) Error (faulty connection, cut wire, short circuit, fault)
☼	●	☾	HC	Outdoor unit · Water temperature sensor system error
☼	●	☾	HF	Ice thermal storage unit error, ice thermal storage controller error, error in outdoor unit during ice thermal storage operation
☾	☾	☾	HJ	Outdoor unit · water system fault
☾	☾	☾	J1	Outdoor unit · pressure sensor error
☾	☾	☾	J3	Outdoor unit · Discharge piping thermistor (Th3) Error (faulty connection, cut wire, short circuit, fault)
☼	●	☾	J3	Outdoor unit · Discharge piping thermistor (Th3) Error (faulty connection, cut wire, short circuit, fault)
☾	☾	☾	J5	Outdoor unit · Intake piping thermistor (Th4) Error (faulty connection, cut wire, short circuit, fault)
☾	☾	☾	J6	Outdoor unit · Heat exchange thermistor (Th2) error
☼	●	☾	J6	Outdoor unit · Heat exchange thermistor (Th2) error Error (faulty connection, cut wire, short circuit, fault)
☾	☾	☾	J7	Outdoor unit · Header thermistor (Th6) error
☾	☾	☾	JA	Outdoor unit · Discharge piping pressure sensor error
☾	☾	☾	JC	Outdoor unit · Intake piping pressure sensor error
☾	☾	☾	JF	Outdoor unit · Oil temperature sensor (Th5) system error
☼	●	☾	JH	Outdoor unit · Oil temperature sensor (Th5) system error
☾	☾	☾	L0	Outdoor unit · Inverter system fault
☾	☾	☾	L4	Outdoor unit · Inverter cooler fault
☾	☾	☾	L5	Outdoor unit · Ground circuit for compressor motor, short circuit, or power unit short circuit

Operation lamp	Maintenance display	Unit No.	Malfunction code	Error content
☾	☾	☾	L6	Outdoor unit · Ground circuit for compressor motor, short circuit
☀	☾	☾	L8	Outdoor unit · Compressor overload, compressor motor wire disconnection
☾	☾	☾	L9	Outdoor unit · Compressor lock
☾	☾	☾	LA	Outdoor unit · Power unit error
☾	☾	☾	LC	Outdoor unit · Transmission error between inverter and outdoor control unit
☀ or ●	☾	☾	M1	Central controller: PC board fault
☀ or ●	☾	☾	M8	Transmission error between central controllers
☀ or ●	☾	☾	MA	Central controller: Incorrect combination
☀ or ●	☾	☾	MC	Central controller: Address setting fault
☾	●	☾	P0	Insufficient gas (thermal storage)
☾	☾	☾	P1	Outdoor unit · Power voltage imbalance, phase loss
☾	☾	☾	P4	Outdoor unit · Power unit temperature sensor error
☀	●	☾	U0	Pressure drop due to insufficient refrigerant, electric expansion valve fault, etc.
☾	☾	☾	U1	Reversed or lost phase
☾	☾	☾	U2	Power voltage error, momentary electrical stoppage
☾	☾	☾	U4	Transmission error between indoor unit/BEV unit and outdoor/BS unit, Transmission error between outdoor unit and BS unit
☾	☾	☾	U5	Transmission error between remote controller and indoor control unit
●	☀	●	U5	Remote controller board fault or remote controller setting fault
☾	☾	☾	U6	Transmission error between indoor units
☾	☾	☾	U7	Transmission error between outdoor units Transmission error between outdoor unit and ice thermal storage unit
☀	●	☾	U7	Transmission error between outdoor units (cooling/heating batch, low-noise operation)
☾	☾	●	U8	Transmission error between master remote controller and slave remote controller (slave remote controller error) Incorrect combination of indoor unit and remote controller within a single system (model)
☾	☾	☾	U9	Transmission error between indoor unit/BEV unit and outdoor unit within a single system Transmission error between BS unit and indoor unit/BEV unit and outdoor unit within a single system
☾	☾	☾	UA	Incorrect combination of indoor, BS, and outdoor units within a single system (model, number of units, etc.) Incorrect combination of indoor unit and remote controller (remote controller in question) BS unit connection position fault
☀	●	☀	UC	Central control group numbers overlap
☾	☾	☾	UE	Transmission error between indoor unit and central controller
☾	☾	☾	UF	Unset system, incorrect settings between BEV unit and indoor unit
☾	☾	☾	UH	System fault

■ error codes (in outline font) do not display “maintenance” and the system will run, but please check the content of the display and contact your dealer.

■ Setting master remote controller (Fig.15)

You must set the master remote controller of the operation mode for one of the indoor units, if two or more such indoor units with the remote controller are connected with the outdoor unit where the operation modes such as cool/heat operation and FAN operation can be set by remote controller and central remote controller.

1. Preparations

When you want to fix settings

- Check the particular group with the master remote controller setting for the refrigerant system you wish to reset. (See the below.)
- Call up the group without the display

“” (See page 261.)



☞ Hold the OPERATION MODE SELECTOR BUTTON down for about four seconds while the above group is being called up.

The display “” flashes on the liquid crystal display of the remote controller for all the groups sharing the same outdoor unit or BS unit.

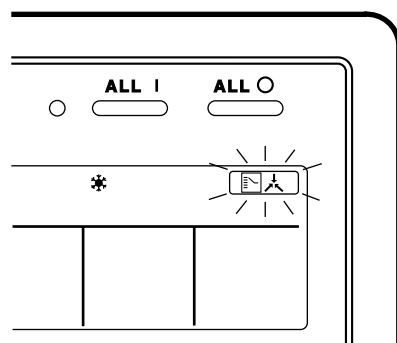
When you turn on the power switch for the first time, the display “” flashes.



2. Setting selection right

Call up the desired group to set the master remote controller, and ☞ press the OPERATION MODE SELECTOR BUTTON. The master remote controller is set for this group, and the display “” goes out. The display “” appears for the other groups. Setting is finished now.



When switching operation

- In case of operation switch



Call up the zone including the group with the setting of master remote controller.

(Zone without the display “”)

☞ Press the OPERATION MODE SELECTOR BUTTON several times, and switch to the desired operation mode.

Each time you press it, the display is switched to “” “” “” and “--” in sequence.

NOTE

- However, the displays “” “” and “VENTILATION MODE” may appear in some zones, depending on the type on indoor unit with which they are connected.

(VENTILATION MODE)

 or  or 

[System Display]

1. Test run mode is necessary to display the system display.
2. In order to turn on test run mode, select the appropriate air conditioner on the individual screen with the cursor and then set its operation mode to either cooling or heating. (The air conditioner does not need to be running. It doesn't matter if it is, though.)
3. Press the "inspection/test run" button twice to put it into test run mode.
4. Pressing the "inspection/test run" button for four or more seconds in test run mode will display  the "REF CIRCUIT."

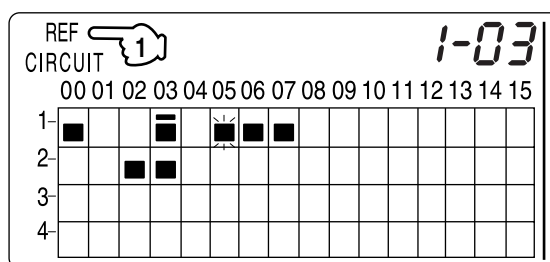

Call the unit whose system you wish to look up using the arrow keys.

The "■" on all groups in the same system as the displayed group will light up.

Of those, the "■" display in all groups which have cooling/heating selection privilege will blink.

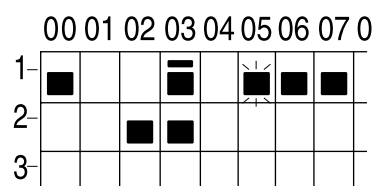

In this example, individual units 1-00, 1-03, 1-05, 1-06, 1-07, 2-02, and 2-03 are in the same system, and 1-05 has the cooling/heating selection privilege.



To look up other systems, call up all the units you wish to look up using the arrow keys.

Pressing the inspection/test run button one more time gets rid of the system display and ends it.

The unit will enter the individual screen automatically if nothing is done for one minute in the system display screen.



This function may not be available for all connected outdoor units, in which case "REF CIRCUIT" will blink. It will also not be correctly displayed if DIII-NET extension ADP is used.

■ Display of time to clean (Fig. 16)



This central remote controller displays the time to clean the air filter or air cleaner element for each group or any given group by utilizing two types of signs. The display "/ 

If a cleaning sign is displayed

A filter or element in some group is ready to be cleaned.



1.  Press the **ARROW KEY BUTTON**, and search the groups displaying "" or "" (The group may be plural.)

Clean or change the air filter or air cleaner element.

For further details, see the operation manual attached to each indoor unit. (Clean or change the air filter or air cleaner element of all the groups displaying "" or "".)

2.  Press the **FILTER SIGN RESET BUTTON**, and the display "/ " disappears. (Including all the groups where the air filter has been cleaned.)

NOTE

Be sure to check the display  "/ " has disappeared at this point. The appearance of the above display is a sign that the air filter or air cleaner element of some group still needs cleaning.





INSTALLATION TABLE

When installing the equipment, mark the zone No. of each group and installation location in the below table.

Setting group No.

(Setting is not possible unless power is activated to both the central remote controller and indoor unit.)

Operated by remote controller

1. Activate power to both the central remote controller and indoor unit.
2. While in the normal mode, hold down the “” button for a minimum of 4 seconds. The unified ON/OFF controller will enter the FIELD SET MODE.
3. Select the MODE No. “00” with the “” button.
4. Use the “” button to select the group No. for each group. (Group No. increases in the order of 1-00, 1-01 ... 1-15, 2-00, ... 8-15.)
5. Press “” to set the selected group No.
6. Press “” to return to the NORMAL MODE.

Operated by simplified remote controller

1. Activate power to both the central remote controller and indoor unit.
2. Remove the upper part of the remote controller.
3. Press the **BS6** BUTTON (field set) on the PC board. The controller will enter the FIELD SET MODE.
4. Select the MODE No. “00” with the **BS2** BUTTON and **BS3** BUTTON (temperature setting).
5. Use the **BS9** BUTTON (set A) and **BS10** BUTTON (set B) to select the group No. for each group. (Group No. increases in the order of 1-00, 1-01 ... 1-15, 2-00, ... 8-15.)
6. Press **BS7** BUTTON (set/cancel) to set the selected group No.
7. Press **BS6** BUTTON (field set) to return to the NORMAL MODE.

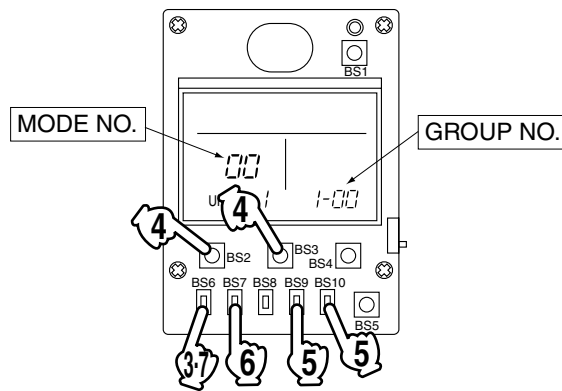
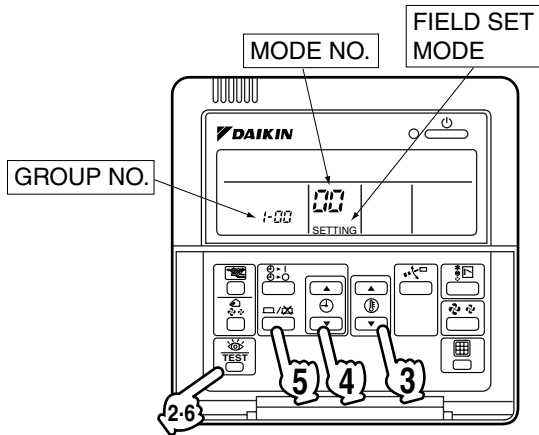

Zone No.																
Group No.	-00	-01	-02	-03	-04	-05	-06	-07	-08	-09	-10	-11	-12	-13	-14	-15
Indoor unit Quantity of units Controlled by																
Location																
Zone No.																
Group No.	-00	-01	-02	-03	-04	-05	-06	-07	-08	-09	-10	-11	-12	-13	-14	-15
Indoor unit Quantity of units Controlled by																
Location																

Zone No.																
Group No.	-00	-01	-02	-03	-04	-05	-06	-07	-08	-09	-10	-11	-12	-13	-14	-15
Indoor unit Quantity of units Controlled by																
Location																
Zone No.																
Group No.	-00	-01	-02	-03	-04	-05	-06	-07	-08	-09	-10	-11	-12	-13	-14	-15
Indoor unit Quantity of units Controlled by																
Location																

OPTIONAL ACCESSORIES

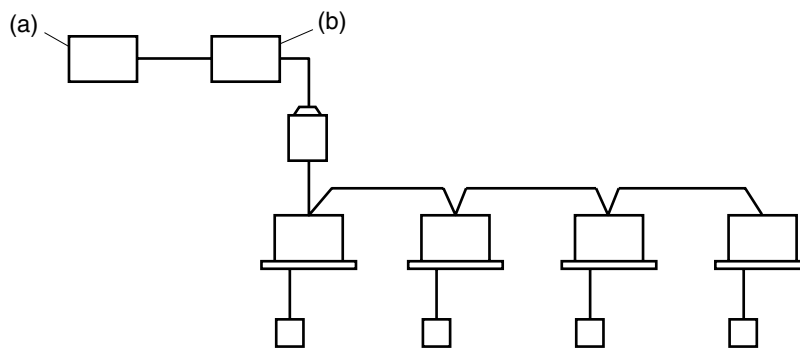

You can perform the normal operation, take off the malfunction contact point and unified start/stop by contact point, all by connecting this unit with the unification adaptor for computerized control. For further details, ask your DAIKIN dealer.

(a) Unification adaptor for computerized control (b) Central remote controller

DOUBLE CENTRAL REMOTE CONTROLLERS

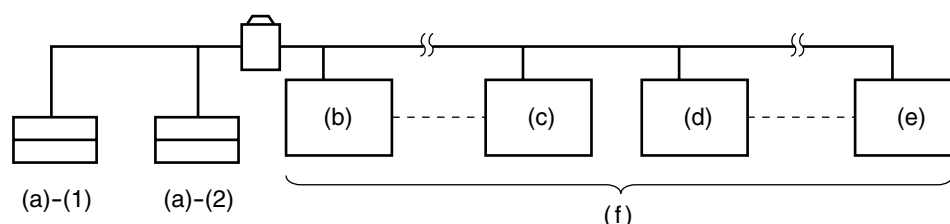

With two central remote controllers, centralized control (indoor units) is possible from different locations.

(a) Central remote controller (b) Group No. 1 - 00 (c) Group No. 1 - 15 (d) Group No. 2 - 00
 (e) Group No. 4 - 15 (f) A maximum of 64 groups

Note)

- For control alignment and settings for double central remote controllers, contact your dealer.

12.1.3 Installation

1 COMPONENTS

Check the following components are included in this optional accessory before installation.

Installation screw (M4 x 16)	4
Operation manual	1
Installation manual	1
Installation table	1

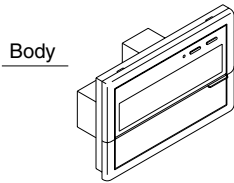

When using this optional accessory an electric parts box of KJB311A is required. For installation, a steel electric parts box to be embedded is necessary.

2

12.1 DCS302CA61

2 SYSTEM CONFIGURATION

With the central remote controller, unified operation/stop is possible with up to a maximum 64 groups of indoor units.
 When using 2 central remote controllers, unified operation is possible with up to a maximum 128 groups.
 With this optional accessory, setting of control modes including operation, stop, operation controlled by timer, and ON/OFF control possible/impossible by remote controller can be set individually by zones while it enables to control and display the operation state such as set temperature.
 It can be connected with the external key system, host computer monitor panel, etc., through forced OFF input (no-voltage normally open contactor).
 A zone is a one or more groups together. In general, the same settings are used throughout a zone.

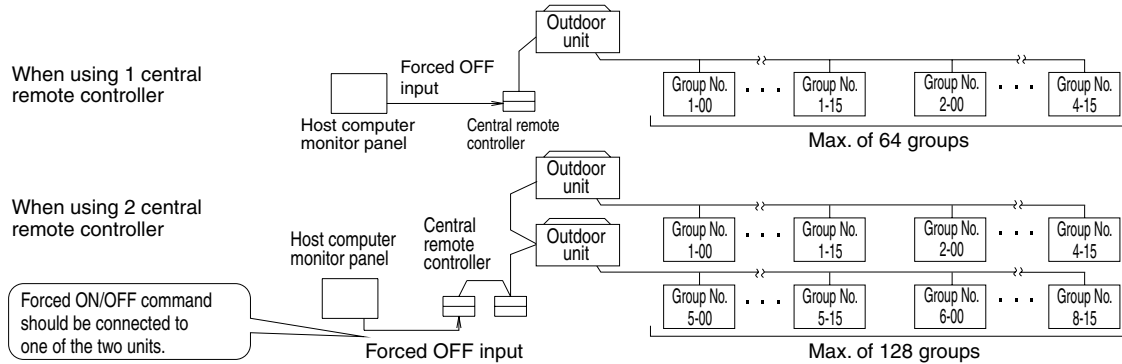

The central remote controller and the separately sold remote control adapter circuit board or group remote control adapter cannot be used together. See the D-BACS design guide for details.

3 INSTALLATION

(1) Open the upper part of remote controller. Insert a ⊖ screwdriver (2 locations) into the recess between the upper part and the lower part of remote controller and twist the screwdriver lightly.

PC board is attached with both the upper and lower part of remote controller. Do not damage the board with the screwdriver.

(2) Open the upper part of remote controller and install the Electric parts box with the attached installation screws (M4 x 16).

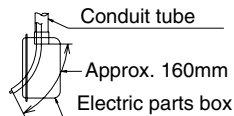

NOTE) Suitable length of the electric wire is about 160mm. (from electric parts box)
 If it is difficult to contain a long wiring, strip the sheathed part of the wiring.

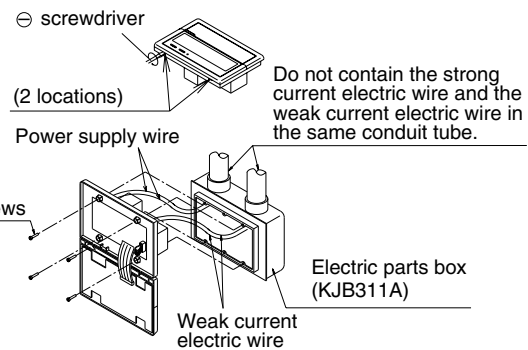

4 INITIAL SETTING

Setting (1) through (3) are initialized when power is turned ON, therefore complete settings BEFORE activating the power. (The positions of connectors and switches used for settings in this section are shown in Fig. 1.)

- (1) Connector for setting master controller (X1A) (Provided with connector at factory set)
- When using only 1 central remote controller, do not disconnect the connector for setting master controller. (Use the unit with the connector in the state in which it was delivered.)
 - When using multiple central remote controllers, or using the central remote controller in conjunction with the optional controllers for centralized control, makes settings as indicated in the below table.

Pattern of connection of optional controllers for centralized control			Connector for setting master controller (X1A) Setting, Removed		
Central remote controller	Unified ON/OFF controller	Schedule timer	Central remote controller	Unified ON/OFF controller	Schedule timer
1 to 4	1 to 16	1	Set one to "Used" and all the rest to "Not used"	Set all to "Not used"	"Not used"
		1			"Not used"

(Remove all the connectors for the central remote controller, the on/off controller, and the schedule timer when using the unit together with the Ve-UP controller, the master station II, the DMS interface, the payment management unit, or the parallel interface station.)

- (2) Address setting
Two central remote controllers can be used as shown in **2 SYSTEM CONFIGURATION**, to control anywhere up to a max. 128 groups of indoor units. In this case, group address must be set. This is done with the switch for setting each address (SS3).

SS3 setting	Indoor unit address	SS3 setting	Indoor unit address
SETTING EACH ADDRESS 5-00 ~ 8-15	To control indoor units from group Nos. 1-00 through 4-15	SETTING EACH ADDRESS 5-00 ~ 8-15	To control indoor units from group Nos. 5-00 through 8-15

- (3) MAIN/SUB changeover switch setting
With two central remote controllers, centralized control (indoor units) is possible from different locations. In this kind of set-up, it is necessary to set the MAIN/SUB changeover switch.

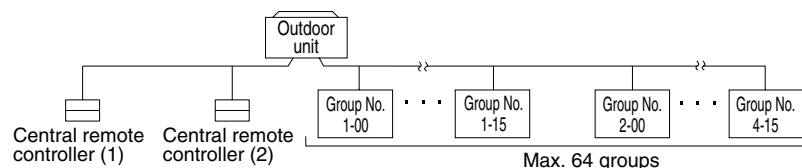

One of the two central remote controllers (1) · (2) is set to "MAIN" while the other is set to "SUB".

- (4) Setting of the sequential operation function
The central remote controller is equipped with a sequential operation function that sequentially turns indoor units on in 2-second intervals during unified operation. (Sequential operation is factory set to "ON.") To switch sequential operation ON or OFF, set as follows.

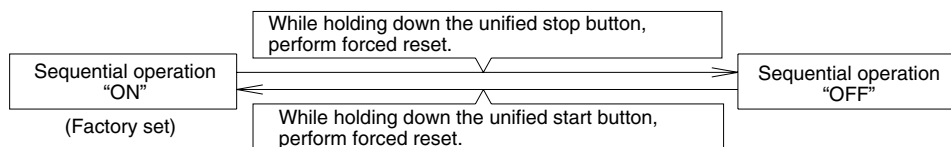

NOTE: The sequential operation function is designed to reduce the load on the power supply equipment, but does not guarantee that compressors will not be started simultaneously. You cannot therefore count on a capacity reduction effect by power supply equipment breaker selection.

- (5) Forced reset switch
When changing the setting of the connector for setting master controller, etc., you can reset simply by setting it to the reset side once and returning to the normal side, without turning the power OFF. (For normal operation, set the switch to the normal side.)

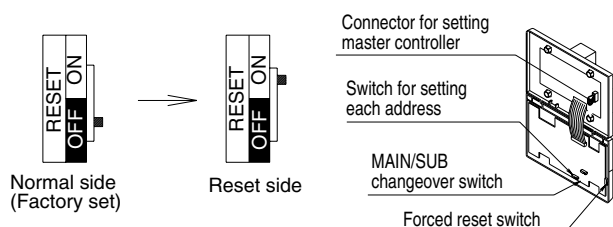

Fig. 1

5 ELECTRIC WIRING

WIRING OUTLINE

WIRING TO THE INDOOR UNIT AND OUTDOOR UNIT

See the installation manual which came with the air conditioner for details on its transmission wiring specifications.

Batch remote control adapter Connector (X2A)
 Separately sold batch remote control adapter.
 Used for DCS302A52 connections.
 See the instruction manual included with the batch remote control adapter for details.

Power terminal block
 Power supply (AC100V-240V)
 Between AC100V and 240V

Wiring specifications

Power supply wiring	2mm ²
Transmission wiring for control	0.75 – 1.25 mm ² sheathed vinyl cord or cable (balanced type) – maximum length 1000 m (total overall wiring length 2000 m)
Manual switch	10A or 15A

Wire the indoor units to the outdoor units and between all power, indoor units, and remote controllers. See the instruction manual included with the indoor and outdoor units for details.

CONTROL TERMINAL STRIP

*1 For connecting Indoor unit (F1, F2)
 *2 Forced OFF input (T1, T2)
 None of the indoor units connected to the forced OFF input contact (non-voltage contact with minimal current) will operate when it is shut off.
 Use only contactors which guarantee the minimum applicable load DC 16V, 10mA.
 T1 → | | DC16V NOTE) Use instantaneous contactor of over 200m sec. energizing time, when necessary.
 T2 → | |

*3 For schedule timer (D1, D2)
 Power can be supplied to the schedule timer (DST301B51-61) separately sold. For details, refer to the installation manual of the schedule timer.
 Wire *2 and *3 only when necessary.

(NOTE)
 Do not connect the power supply wiring (100 to 240V) to the control terminal strip. If connected by mistake, it may damage or burn electrical parts of optional controllers for centralized control and indoor unit. It may result in serious danger. Be sure to check wirings before turning the power ON.

6 SETTING GROUP NO. FOR CENTRALIZED CONTROL

Set the group number of each group of the indoor unit from the remote controller. (In case of no remote controller, also connect the remote controller and set the group No. Then, remove the remote controller.)

- (1) Turn ON the power of the indoor unit and central remote controller.
(Unless the power is ON, no setting can be made.)
Check that the installation and electrical wiring are correct before turning the power supply ON.
(When the power supply is turned ON, all LCD appear once and the unit may not accept the operation for about one minute with the display of "88".)
- (2) While in the normal mode, hold down the " " button for a minimum of 4 seconds.
The remote controller will enter the FIELD SET MODE.
- (3) Select the MODE No. " " with the " " button.
- (4) Use the " " button to select the group No. for each group.
(Group numbers increase in the order of 1-00, 1-01, ... 1-15, 2-00, ... 8-15.)
- (5) Press " " to set the selected group No.
- (6) Press " " to return to the NORMAL MODE.

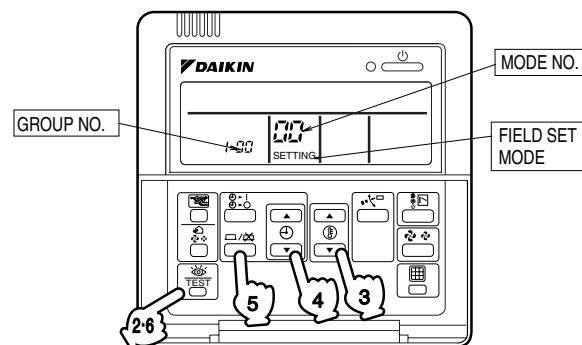

- NOTES
- For simplified remote controller, see the installation table.
 - See the instruction manuals which came with the VentiAir and adapters (i.e., multi-purpose adapters) for details on their Group No. settings.

NOTICE Enter the group No. and installation place of the indoor unit into the installation table in the operation manual. Be sure to keep the operation manual for maintenance.

7 TEST OPERATION (Perform a test operation in the individual screen before registering zones.)

Before starting test operation, check that the power is supplied to the indoor and outdoor units, and central remote controller.

- (1) Select the display "INDIVIDUALLY"
Press " " button to display "INDIVIDUALLY"
- (2) Select the group to be tested.
Select the group No. with " " " " " " " " button.
- (3) Press " " button to select the test operation mode.
"TEST" is displayed.
"HOST" is displayed on the remote controller.
- (4) Press " " button within 10 seconds after entering into the test operation mode.
Operation the unit for 30 minutes.
When pressing the " " button, the unit stops operating.
If the operation lamp flashes, it indicates a malfunction.
Call the group of flashing display, confirm malfunction code, and check the source of malfunction.
(The operation manual lists all error codes, so refer to it.)

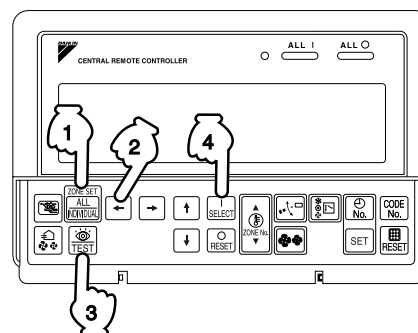

- NOTES
- For test operation, refer to the installation manual of the outdoor unit.
 - After turning the power supply ON, if the unit does not accept operation for two minutes or more with the display of "88", check the following points.
 - Check that setting of the connector for setting master controller is correct.
 - Check that the group No. for centralized control has been set.

13. Electrical Box with Earth Terminal

13.1 KJB212A / KJB311A / KJB411A

2

12.1 DCS302CA61 / 13.1 KJB212A / KJB311A / KJB411A



INSTALLATION POINT OF SWITCH BOX

PARTS • Check the parts according to the list shown below.

	NAME	SWITCH BOX	COVER	WOOD SCREW A (5.1×25)	CLAMP SCREW B (M4×16)	EARTH SCREW (M4×12)	C-CUP WASHER	LABEL FOR EARTH
QTY	KJB212A	1	1	4	4	3	2	1
	KJB311A	1	1	4	4	3	3	1
	KJB411A	1	1	4	4	—	—	—
SHAPE								

INSTALLATION

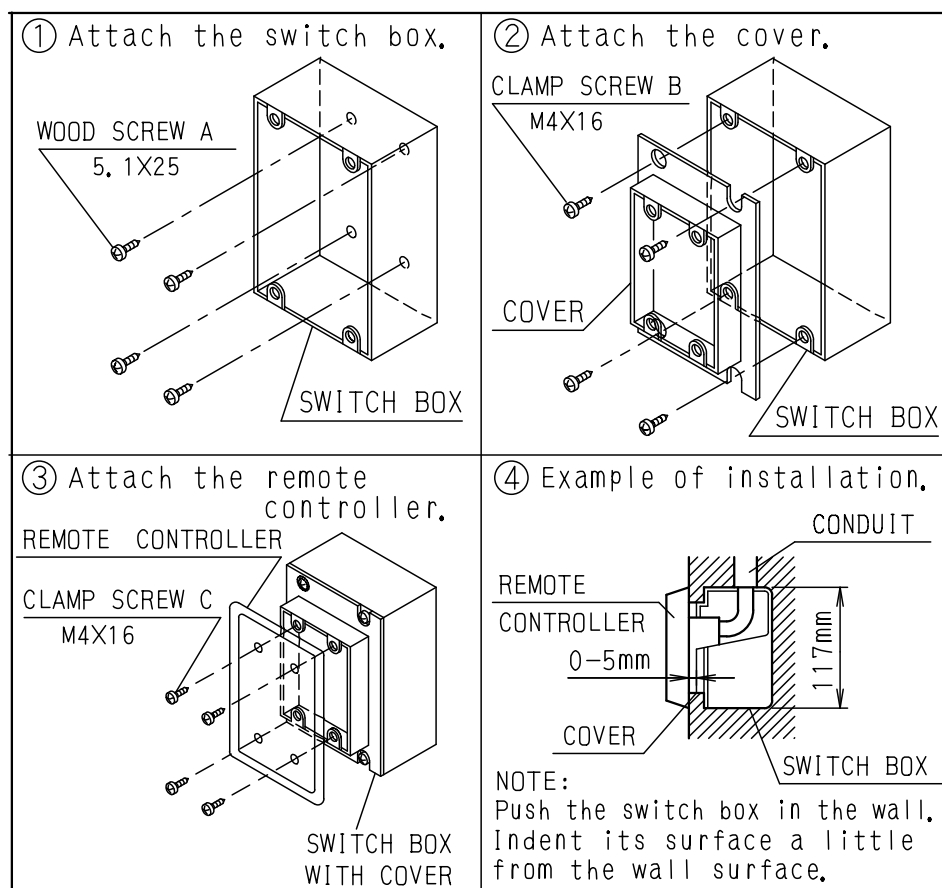

C: 3PA34878C

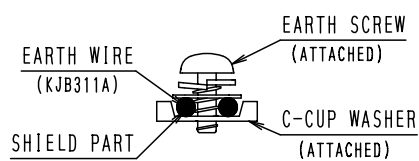
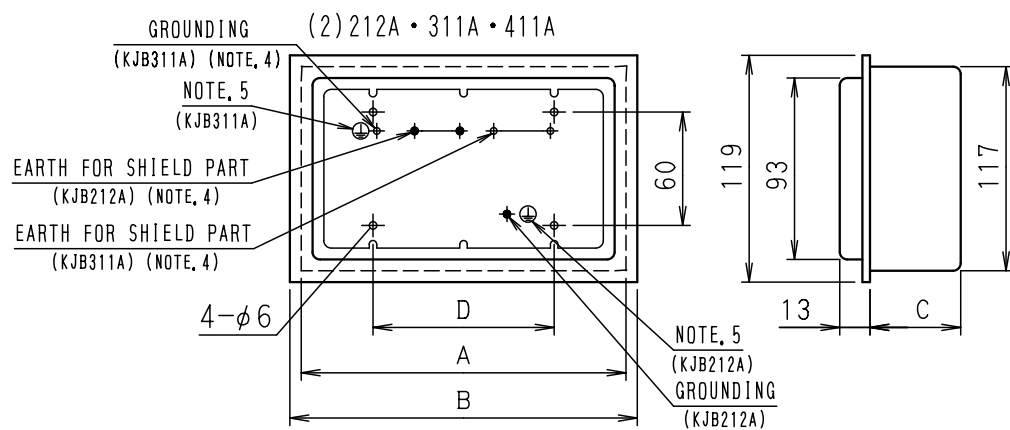

Fig. 1

MODEL	SIZE (mm)			
	A	B	C	D
KJB212A	136	138	44	70
KJB311A	182	184	44	110
KJB411A	228	230	54	155

- NOTES: 1. Refer to the installation of each remote controller.
 2. Do not bind the lead wires for switch box with the power cord and the link wiring. This may cause erratic operation.
 3. The remote controller and the clamp screw C are one kit. They are sold separately and attach to the switch box.
 4. Ground the shield part of shielded wire or earth wire (only KJB311A) as shown in the Fig. 1.
 5. Stick the label for earth attached to the equipment.

C: 3PA34878C

14. Unified ON/OFF Controller

14.1 DCS301BA61

Turns up to 16 groups of indoor units (max. 128 units) on/off (operation/stop) by individual group or all at once, and lets you check display of operation/malfunction at the same time.

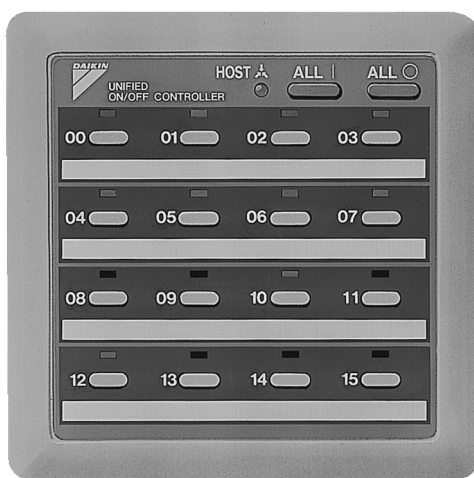

- For a maximum of 16 groups of indoor units (max. 128 units), unified operation/stop or individual operation/stop can be performed with this optional accessory. Also allows you check operation/error display at a glance.
- By combining with a central remote controller and schedule timer, you can construct a system that matches the size and use of the building.
- Up to 8 units connectable within 1 system.
Up to 16 units in the double central control mode.
- Features thin design of a mere 16mm in thickness. (Uses JIS recessed box for 2.)
- Wiring can be up to 1km in length. Applicable wiring methods include bus and star in addition to crossover type.
- Can be used in combination with other D-BACS equipment.

Dimensions

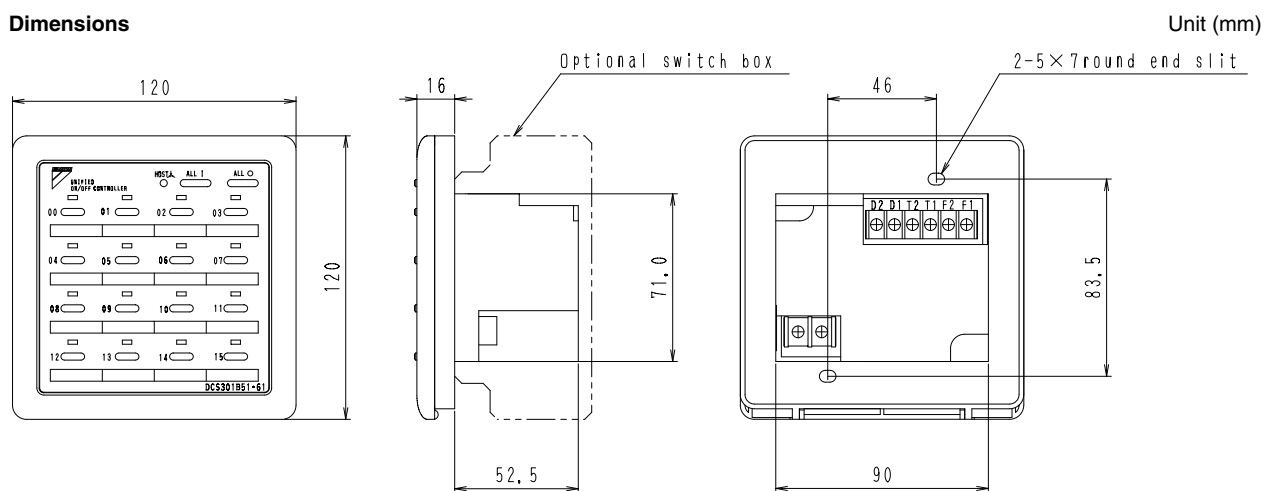

3D050339

2

13.1 KJVB212A / KJVB311A / KJVB411A / 14.1 DCS301BA61

14.1.1 Installation

1 COMPONENTS

Check the following components are included in this optional accessory before installation.

Body

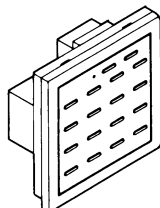

Installation screw (M4 x 16)	2
Operation manual	1
Installation manual	2
Installation table	2
Switch display sticker	1

For installation, a steel electrical box to be embedded is necessary.

2 SYSTEM CONFIGURATION

This unified ON/OFF controller enables individual and unified operation/stop for a maximum of 16 groups of indoor units. With 2 to 8 unified ON/OFF controllers, individual and unified control is possible with up to a maximum 128 groups of indoor units.

- When using 1 unified ON/OFF controller

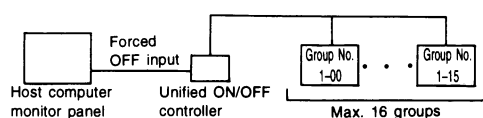

- When using 2 to 8 unified ON/OFF controllers

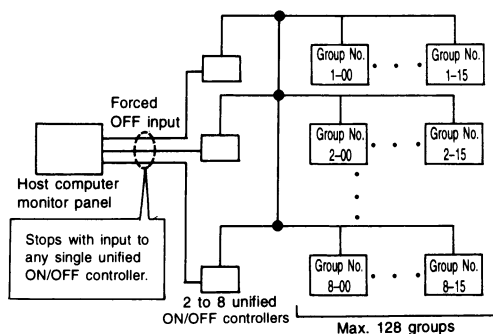

(This optional accessory can not be used in conjunction with wiring adaptor for electrical appendices (optional accessory).)

The groups of indoor units are as follows:

- ① One indoor unit without remote controller
- ② One indoor unit controlled by one or two remote controllers

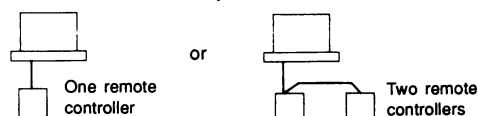

- ③ A maximum of 16 indoor units controlled in groups by one or two remote controllers

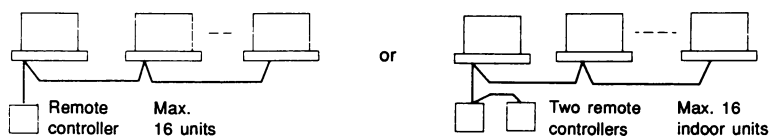

1P162827

3 ELECTRIC WIRING

GENERAL INSTRUCTIONS

- All wiring, components and materials to be procured on the site must comply with the applicable local and national codes.
- Use copper conductors only.
- All field wiring and components must be provided by licensed electrician.
- Unit shall be grounded in compliance with the applicable local and national codes.
- Fit the power supply wiring with a fuse and a switch.
- After wiring work, check power to the equipment shuts OFF when switch is shut OFF.

WIRING OUTLINE

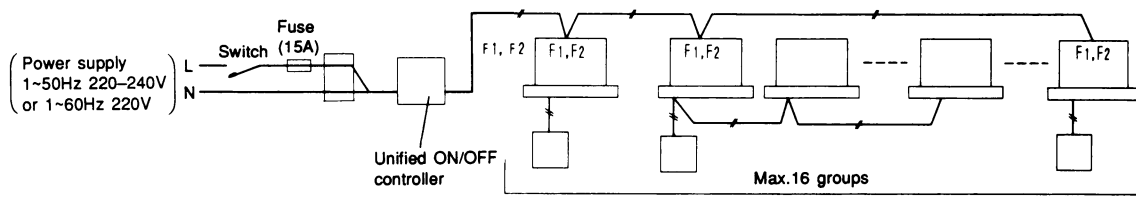

Wiring specification

	Type	Size
Power supply wiring	, H05VV-U3G	(NOTE 1)
Transmission wiring	Sheathed wire (2 wire) (NOTE 2)	0.75 – 1.25 mm ²

- NOTES) 1. The size of power supply wiring must comply with the applicable national and local codes.
 2. Allowable length of transmission wiring is as follows.
 Max. 1000m (Total wiring length: 2000m)

Connect the wiring between indoor and outdoor units, indoor/outdoor units and power supply, and indoor units and remote controllers.
 For details, refer to the installation manuals of indoor and outdoor units.

EXAMPLES OF WIRING FOR TRANSMISSION

① Series wiring

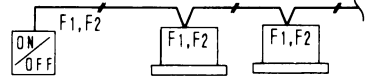

1P162827

② Bus type wiring (Can be branched up to 16 branchings)

Example of 3 branchings

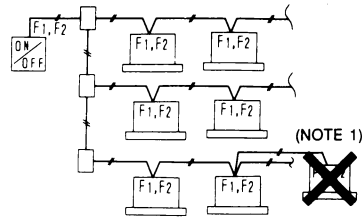

③ Star type wiring (Can be branched up to 16 branchings)

Example of 3 branchings

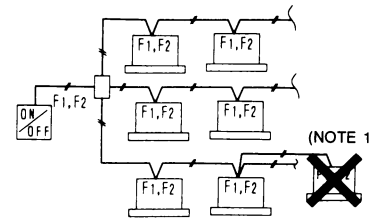

: Unified ON/OFF controller



: Terminal board
: (Part to be procured in the field)



: Indoor unit

NOTES) 1. No branching is allowed after branching.

2. Use a relay terminal board (part to be procured in the field) to branch more than 3 control wirings from the same terminal board.

WIRING TO THE INDOOR UNIT AND OUTDOOR UNIT

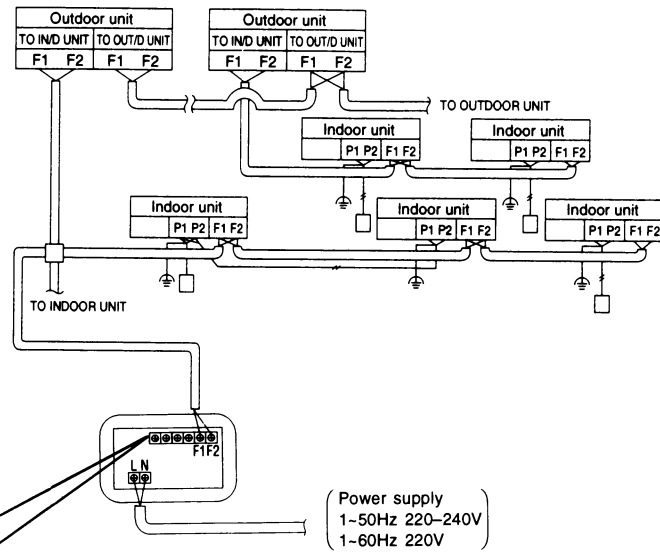

CONTROL TERMINAL STRIP

* 1 For connecting indoor unit (F1, F2)

* 2 Forced OFF input (T1, T2)

While the forced OFF input (no voltage contactor, for micro current) is ON (energized), all the connected indoor units are stopped and can not be operated. Use only contactors which guarantee the minimum applicable load ∼ 16V, 10mA.



NOTE) Use instantaneous contactor of over 200msec. energizing time, when necessary.

* 3 For schedule timer (D1, D2)

Power can be supplied to the schedule timer (DST301B61/optional accessory). For details, refer to the installation manual of the schedule timer.

Wire * 2 and * 3 only when necessary.

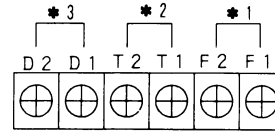

(NOTE)

Do not connect the power supply wiring (220 to 240V) to the control terminal strip. If connected by mistake, it may damage or burn electrical parts of optional controllers for centralized control and indoor unit. It may result in serious danger. Be sure to check wirings before turning the power ON.

1P162827

4 INSTALLATION

- ① Open the upper part of remote controller. Insert a ⊖ screwdriver (2 locations) into the recess between the upper part and the lower part of remote controller and twist the screwdriver lightly.

PC board is attached with both the upper and lower part of remote controller. Do not damage the board with the screwdriver.

- ② Open the upper part of remote controller and install the electrical box (part to be procured in the field) with the attached installation screws (M4 x 16).

NOTE) Suitable length of the electric wire is about 160mm from the inlet of the electrical box. If it is difficult to contain a long wiring, strip the sheathed part of the wiring.

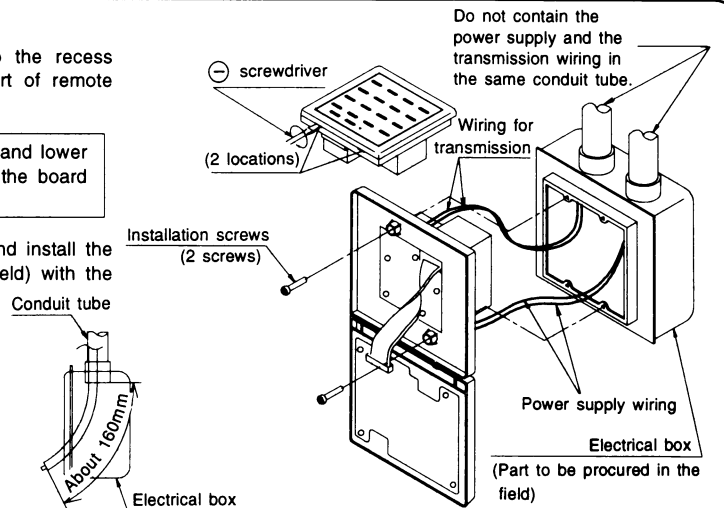

5 INITIAL SETTING

Setting ① through ③ are initialized when power is turned ON, therefore complete settings BEFORE activating the power.

- ① Connector for setting master controller (X1A) (Provided with connector at factory set)
- When using 1 unified ON/OFF controller, do not disconnect the connector for setting master controller. (Use the unit with the connector in the state in which it was delivered.)
 - When using multiple unified ON/OFF controllers, or using the unified ON/OFF controller in conjunction with other optional controllers for centralized control, makes settings as indicated in the right table.

2

14.1 DCSS301BA61

1P162827

Pattern of connection of optional controllers for centralized control			Connector for setting master controller (X1A) Settings		
Unified ON/OFF controller	Central remote controller	Schedule timer	Unified ON/OFF controller	Central remote controller	Schedule timer
1 to 16	1 to 4	1	Set one to "Used" and all the rest to "Not used".	(Note)	"Not used"
			Set all to "Not used".		
	1 to 4	1	Set one to "Used" and all the rest to "Not used".	(Note)	"Not used"
			Set all to "Not used".		

(Note) For instructions on how to set the connector for setting master controller on the central remote controller, see the installation manual provided with the central remote controller.

② Switch for setting each address (DS1)

These switches are used to set group control address.

Groups Nos. 1-00 through 1-15 are grouped in the same control group when the unit is shipped from the factory.

Each Address	1-00-1-15	2-00-2-15	3-00-3-15	4-00-4-15	5-00-5-15	6-00-6-15	7-00-7-15	8-00-8-15
DS1 setting								
	(Factory setting)							

After setting, attach the number seal applicable to respective control range of the attached switch display sticker, as shown in the diagram below.

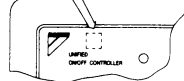

(Example)
In the case of 1-00 to 1-15, attach 1

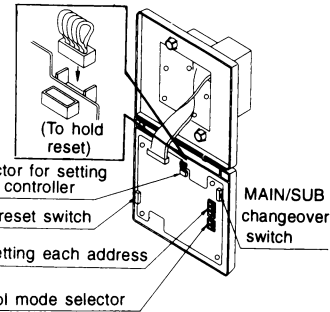

③ MAIN/SUB changeover switch setting

With two unified ON/OFF controllers, centralized control (indoor units) is possible from different locations. In this kind of set-up, it is necessary to set the MAIN/SUB changeover switch.

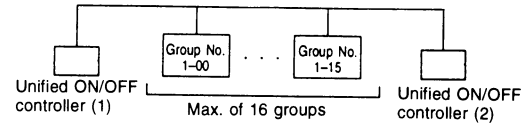

One of the two unified ON/OFF controllers (1)•(2) is set to "MAIN" while the other is set to "SUB".

④ Setting of the sequential operation function

The unified ON/OFF controller is equipped with a sequential operation function that sequentially turns indoor units on in 2-second intervals during unified operation. (Sequential operation is factory set to "ON.") To switch sequential operation ON or OFF, set as follows.

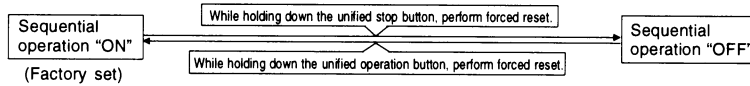

NOTE: The sequential operation function is designed to reduce the load on the power supply equipment, but does not guarantee that compressors will not be started simultaneously. You cannot therefore count on a capacity reduction effect by power supply equipment breaker selection.

⑤ Control mode selector (DS2)

The following four patterns of control mode can be set.

Control mode	Individual	Centralized	Timer operation possible by remote controller	ON/OFF control impossible by remote controller
Content	Operation/stop is controlled by both unified ON/OFF controller and remote controller.	After operated by unified ON/OFF controller, operation/stop is freely controlled by remote controller until stopped by unified ON/OFF controller.	When used in conjunction with schedule timer, operation/stop is controlled freely by remote controller during the set time but operation is not available when schedule timer is ON.	Operation/stop is controlled by unified ON/OFF controller only. (This unit can not be operated/stopped by remote controller.)
DS2 setting				
	(Factory set)			

- NOTES)
- indicates the position of switches.
 - Set control mode before turning power supply ON.
 - When used in conjunction with central remote controller, the control modes of the central remote controller has the priority.

⑥ Forced reset switch (SS1)

When changing the setting of the connector for setting master controller, etc., you can reset simply by setting it to the reset side once and returning to the normal side, without turning the power OFF. (For normal operation, set the switch to the normal side.)

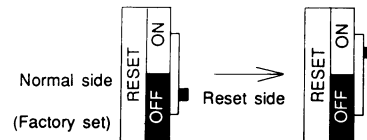

1P162827

6 SETTING GROUP NO. FOR CENTRALIZED CONTROL

Set the group number of each group of the indoor unit from the remote controller. (In case of no remote controller, also connect the remote controller and set the group No. Then, remove the remote controller.)

- ① Turn ON the power of the indoor unit and unified ON/OFF controller. (Unless the power is ON, no setting can be made.)
Check that the installation and electrical wiring are correct before turning the power supply ON.
When the power supply is turned ON, all LCD appear once and the unit may not accept the operation for about one minute with the display of "HOST" flashing (an interval of ON, ON, and OFF).
- ② While in the normal mode, hold down the "TEST" button for a minimum of 4 seconds.
The remote controller will enter the FIELD SET MODE.
- ③ Select the MODE No. "00" with the "MODE" button.
- ④ Use the "GROUP" button to select the group No. for each group.
(Group numbers increase in the order of 1-00, 1-01, ... 1-15, 2-00, ... 8-15.)
- ⑤ Press "SET" to set the selected group No.
- ⑥ Press "TEST" to return to the NORMAL MODE.

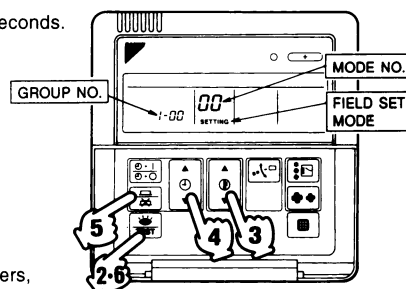

- NOTES)
- For simplified remote controller, see the installation table.
 - For setting group No. of HRV and wiring adaptor for other air conditioners, etc., refer to the instruction manual attached.

NOTICE Enter the group No. and installation place of the indoor unit into the attached installation table. Be sure to keep the installation table with the operation manual for maintenance.

7 CONFIRMING OPERATION

Before starting test operation, supply power to the indoor units, outdoor units, and unified ON/OFF controller and press the ON/OFF BUTTON.

If the operation lamp flashes, it indicates a malfunction in the indoor unit of the applicable group.

If the display of "HOST" flashes, it indicates a malfunction in the optional controllers for centralized control. Check for such malfunctions.

- NOTES**
- For test operation of indoor and outdoor units, refer to the installation manual attached with the outdoor unit.
 - After turning the power supply ON, if the unit does not accept operation for two minutes or more with the display of "HOST" flashing, check the following points.
 - Check that setting of the connector for setting master controller is correct.
 - Check that the group No. for centralized control has been set.

1P162827

15. Wired Remote Controller with Weekly Schedule Timer

15.1 BRC1D61

Adds new, advanced functions to those of the wired remote controller.



BRC1D61

- Includes ventilation mode and airflow rate switching, the main functions of HRV series.
- 24-hour clock function (1-hour backup for power failures).
- Programming function for each day of week.
- Scheduling possible of start/stop and temperature limit (5 settings/day).
- Programming can be enabled or disabled.
- Copy function for programmed schedules.

15.1.1 Dimensions

Unit (mm)

• REMOTE CONTROLLER DIMENSIONS

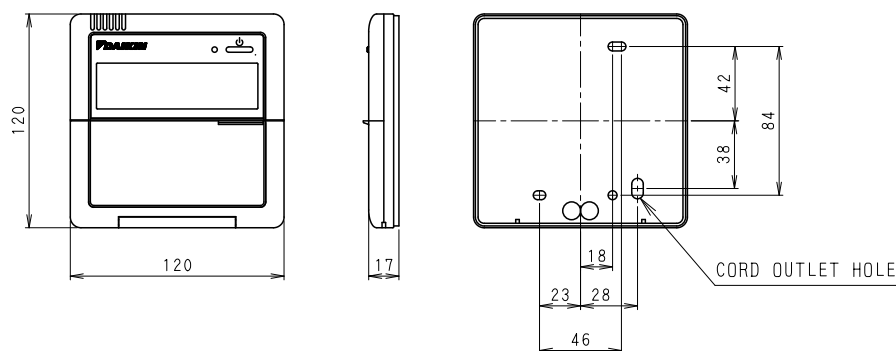

• INSTALLATION METHOD

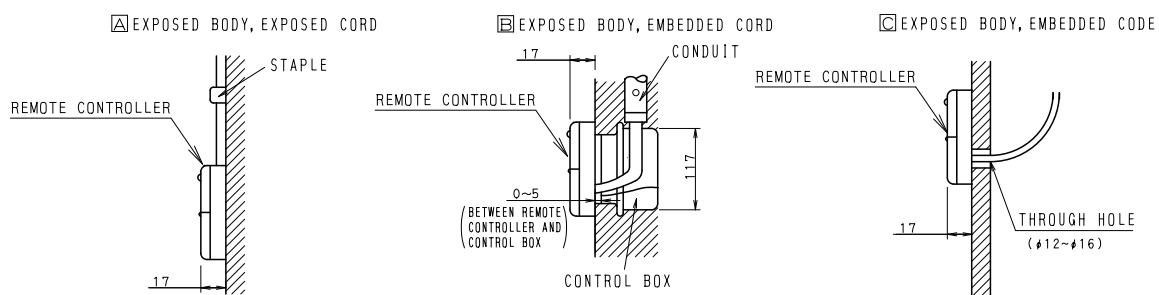

NOTE) 1. REMOTE CONTROLLER CORD AND STAPLE ARE NOT ATTACHED, THEY ARE FIELD SUPPLIED PARTS.

• SPECIFICATIONS OF CORD

	FOR AUSTRALIA	FOR OTHER COUNTRIES
TYPE	SHIELD WIRE (INSULATED THICKNESS: 1mm OR MORE)	VINYL CORD WITH SHEATH OR CABLE (INSULATED THICKNESS: 1mm OR MORE)
SIZE	0.75 ~ 1.25 mm ²	
TOTAL LENGTH	500m	

3D048117

15.1.2 Features and Functions

The BRC1D61 is a state of the art remote controller that offers full control over your installation.

1 BASIC REMOTE CONTROLLER

The basic remote controller functions are:

- ON/OFF,
- operation mode change-over,
- temperature adjustment,
- air volume adjustment
- air flow direction adjustment.

2 CLOCK FUNCTION

The clock functions are:

- 24 hours real time clock,
- day of the week indicator.

3 SCHEDULE TIMER FUNCTION

The schedule timer functions are:

- a maximum of 5 actions can be programmed for each day of the week (totalling 35 actions),
- schedule timer can be enabled/disabled at any time,
- linked to a set temperature or a LIMIT operation or an OFF operation,
- "last command" overrules previous command until next scheduled command.

4 LIMIT OPERATION

Limit operation provides thermostat control within the range of the set minimum and maximum temperature. The minimum temperature setting will trigger heating, the maximum temperature setting will trigger cooling.

5 LEAVE HOME

The leave home function prevents the room temperature from dropping when the occupants are out for a longer period. If the room temperature drops below 10°C, heating is started automatically. As soon as 15°C is reached, the controller returns to its original status.

6 BUTTON PERMISSION LEVEL

Three hierarchical permission levels can be set to limit the user action.

15.1.3 Names and Functions

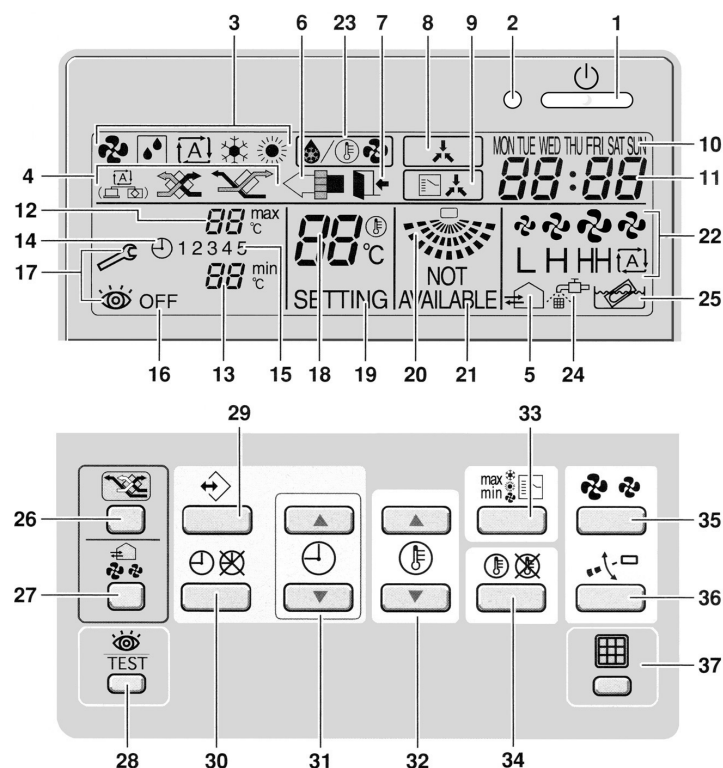

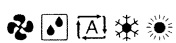







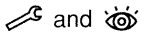

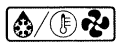





Figure 1

3P107422-3D

15.1.4 Name and Function of Switches and Icons (Refer to figure 1)

- 1 **ON/OFF BUTTON** 
Press the ON/OFF button to start or stop the system.
- 2 **OPERATION LAMP** 
The operation lamp lights up during operation or blinks if a malfunction occurs.
- 3 **OPERATION MODE ICON** 
These icons indicate the current operation mode (FAN, DRY, AUTOMATIC, COOLING, HEATING).
- 4 **VENTILATION MODE ICON**

These icons indicate the current ventilation mode (HRV only) (AUTOMATIC, HEAT EXCHANGE, BYPASS).
- 5 **VENTILATION ICON** 
The ventilation icon appears when the ventilation is adjusted with the ventilation amount button (HRV only). Simultaneously, the ventilation amount is indicated by the fan speed icon (see 22).
- 6 **AIR CLEANING ICON** 
This icon indicates that the air cleaning unit (option) is operational.
- 7 **LEAVE HOME ICON** 
The leave home icon shows the status of the leave home function.
- | | |
|----------|------------------------|
| ON | Leave home is enabled |
| FLASHING | Leave home is active |
| OFF | Leave home is disabled |
- 8 **EXTERNAL CONTROL ICON** 
This icon indicates that another controller with higher priority is controlling or disabling your installation.
- 9 **CHANGE-OVER UNDER CENTRALISED CONTROL ICON** 
This icon indicates that the change-over of the installation is under centralised control assigned to another indoor unit or optional cool/heat selector connected to the outdoor unit (= master remote controller).
- 10 **DAY OF THE WEEK INDICATOR**
MON TUE WED THU FRI SAT SUN
The day of the week indicator shows the current week day (or the set day when reading or programming the schedule timer).
- 11 **CLOCK DISPLAY** **88:88**
The clock display indicates the current time (or the action time when reading or programming the schedule timer).
- 12 **MAXIMUM SET TEMPERATURE** **88^{max} °C**
The maximum set temperature indicates the maximum set temperature when in limit operation.
- 13 **MINIMUM SET TEMPERATURE** **88^{min} °C**
The minimum set temperature indicates the minimum set temperature when in limit operation.
- 14 **SCHEDULE TIMER ICON** 
This icon indicates that the schedule timer is enabled.
- 15 **ACTION ICONS 1 2 3 4 5**
These icons indicate the actions for each day of the schedule timer.
- 16 **OFF ICON** **OFF**
This icon indicates that the OFF action is selected when programming the schedule timer.
- 17 **INSPECTION REQUIRED** 
These icons indicate that inspection is required. Consult your installer.
- 18 **SET TEMPERATURE DISPLAY** **88[°] °C**
This indicates the current set temperature of the installation (not shown in LIMIT operation or in FAN or DRY mode).
- 19 **SETTING** **SETTING**
Not used, for service purposes only.
- 20 **AIR FLOW DIRECTION ICON** 
This icon indicates the air flow direction (only for installations with motorised air flow flaps).
- 21 **NOT AVAILABLE** ^{NOT AVAILABLE}
^{NOT AVAILABLE} is displayed whenever a non-installed option is addressed or a function is not available.
- 22 **FAN SPEED ICON** 
This icon indicates the set fan speed.
- 23 **DEFROST/HOTSTART MODE ICON** 
This icon indicates that the defrost/hotstart mode is active.
- 24 **AIR FILTER CLEANING TIME ICON** 
This icon indicates the air filter must be cleaned. Refer to the manual of the indoor unit.
- 25 **ELEMENT CLEANING TIME ICON** 
This icon indicates the element must be cleaned (HRV only).
- 26 **VENTILATION MODE BUTTON** 
The ventilation mode button operates the HRV; refer to the HRV manual for more details.

3P107422-3D

27 VENTILATION AMOUNT BUTTON 

This button sets the ventilation amount; refer to the HRV manual for more details.

28 INSPECTION/TEST OPERATION BUTTON 

Not used, for service purposes only.

29 PROGRAMMING BUTTON 

This button is a multi-purpose button.

Depending on the previous manipulations of the user, the programming button can have various functions.

30 SCHEDULE TIMER BUTTON 

This button enables or disables the schedule timer.

31 TIME ADJUST BUTTON 

These buttons are used to adjust the clock or, when in programming mode, to adjust the programmed action time. Both buttons have an auto-repeat function.

32 TEMPERATURE ADJUST BUTTONS 

These buttons are used to adjust the current setpoint or, when in programming mode, to adjust the programmed setpoint temperature (step = 1°C). Both buttons are also used to adjust the day of the week.

33 OPERATION CHANGE/MIN-MAX BUTTON 

This button is a multi-purpose button. Depending on the previous manipulations of the user, it can have following functions:

- 1 select the operation mode of the installation (FAN, DRY, AUTOMATIC, COOLING, HEATING)
- 2 toggle between minimum temperature and maximum temperature when in limit operation

34 SETPOINT/LIMIT BUTTON 

This button toggles between setpoint, limit operation or **OFF** (programming mode only).

35 FAN SPEED BUTTON 

This button toggles between L (Low), H (High), HH (very High),  (Automatic).

36 AIR FLOW DIRECTION ADJUST BUTTON 

This button enables to adjust the air flow direction.

37 AIR FILTER CLEANING TIME ICON RESET BUTTON 

This button is used to reset the air filter cleaning time icon.

15.1.5 Installation

3P107422-3D

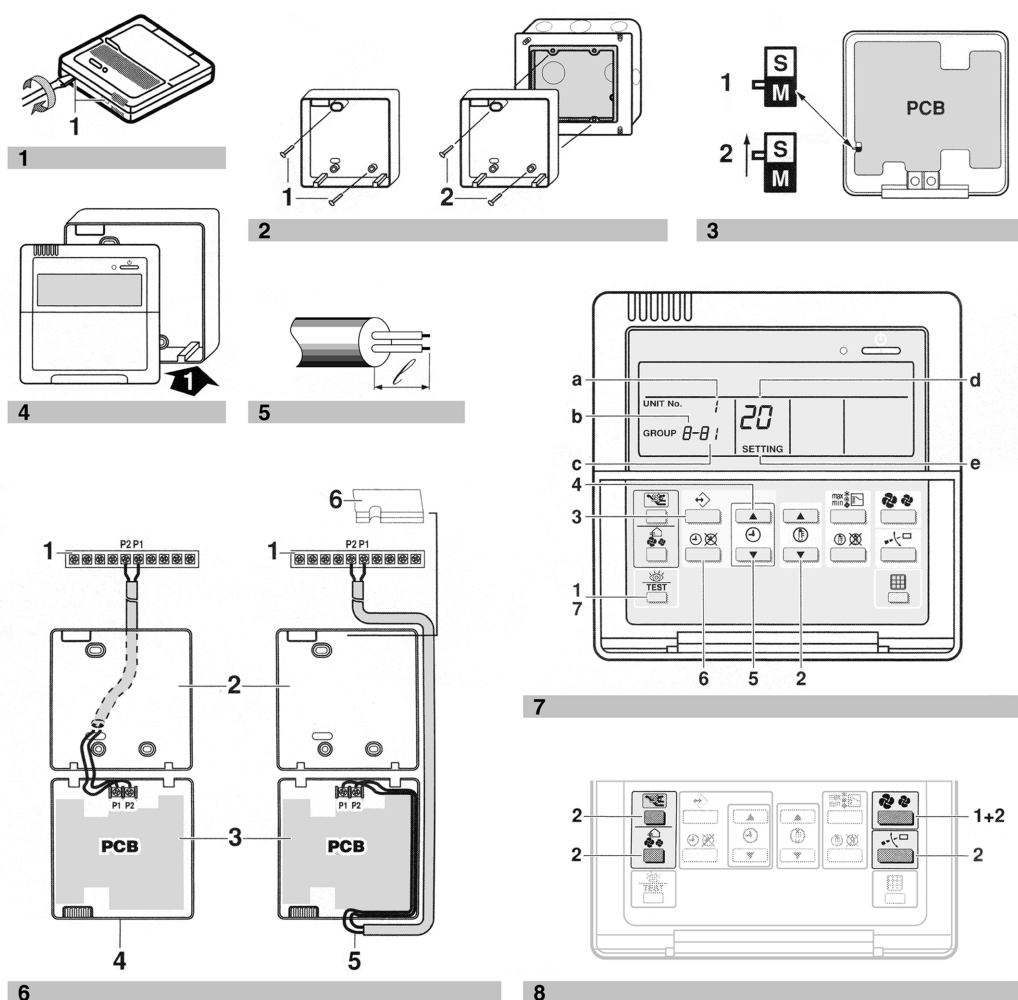

3P107422-4D

The kit includes the following parts:

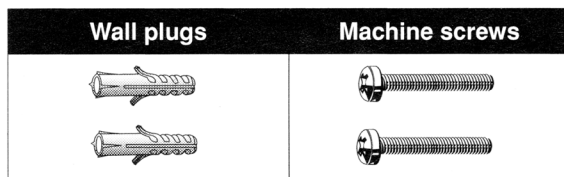
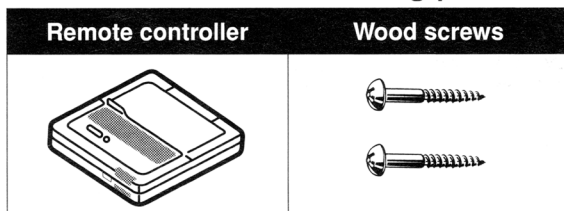

1. Remove the upper part of remote controller

(Refer to figure 1)

Insert a minus screwdriver into the slots (1) in the lower part of the remote controller (2 places), and remove the upper part of the remote controller.

 The PC board is mounted in the upper part of the remote controller. Be careful not to damage the board with the minus screwdriver.

2. Fasten the remote controller

(Refer to figure 2)

- 1 for exposed mounting, fasten with the two included wood screws (Ø4x30) and plugs.
- 2 for flush-mounting, fasten with the two included machine screws (M4x16).

For the field supplied switch box, use optional accessory KJB111A or KJB211A.

 **NOTE** Choose the flattest place possible for the mounting surface. Be careful not to distort the shape of the lower part of the remote controller by overtightening the mounting screws.

3. Wire the indoor unit

(Refer to figure 6)

- 1 indoor unit
- 2 lower part of the remote controller
- 3 upper part of the remote controller
- 4 wired from the rear
- 5 wired from the top
- 6 notch the part for the wiring to pass through with nippers, etc.

Connect the terminals on top of the upper part of the remote controller (P1, P2), and the terminals of the indoor unit (P1, P2). (P1 and P2 do not have polarity.)

 **NOTE** When wiring, run the wiring away from the power supply wiring in order to avoid receiving electric noise (external noise).

Wiring specifications

Wiring type	Size
2 wire	0.75–1.25 mm ²

 **NOTE** Peel the shield for the part that has to pass through the inside of the remote controller case (✓). Refer to figure 5.

4. Reattach the upper part of the remote controller

 Be careful not to pinch the wiring when attaching.

Refer to figure 4:

First begin fitting from the clips at the bottom.

 **NOTE**

1. The switch box and wiring for connection are not included.
2. Do not directly touch the PC board with your hand.

If controlling one indoor unit or one group of indoor units with two remote controllers

Change the MAIN/SUB changeover switch setting as described below (Refer to figure 3).

- 1 Main remote controller (factory set)
- 2 Sub remote controller

Set one remote controller to “main”, and the other to “sub”.

 **NOTE**

1. If controlling with one remote controller, be sure to set it to “main”.
2. Set the remote controller before turning the power supply on.

“88” is displayed for about one minute when the power supply is turned on. During this time the remote controller can not be operated.



3P107422-4D

5. Permission level function

- If required, you can limit the user action by restricting the number of operable buttons. Refer to the chapter "Field settings".

Level	Operable buttons
1	All
2	<ul style="list-style-type: none"> • on/off button • schedule timer button • temperature adjust button • operation change/MIN-MAX button • fan speed button • air flow direction adjust button
3	<ul style="list-style-type: none"> • on/off button • temperature adjust button • fan speed button

- For switching between level 1 permission and the selected level in service, proceed as follows:

- 1 Keep the fan speed button "  " pressed,
- 2 and press the 3 other indicated keys simultaneously while keeping the fan speed button "  " pressed.

Refer to figure 8.

- If you want to limit the user action on the remote controller to be defined as "sub", start with only connecting this controller to the unit. Make sure that this controller is set to "main" (factory set) first, change the permission level to the setting you prefer and only then set the remote controller to "sub".
You can now proceed with connecting the remote controller to be defined as "main".







6. Field settings

If optional accessories are mounted on the indoor unit, the indoor unit setting may have to be changed. Refer to the instruction manual for each optional accessory.

Refer to figure 7.

- a Unit NO
- b First Code NO
- c Second Code NO
- d Mode NO
- e Field set mode

Procedure (Refer to figure 7)

- 1 When in the normal mode, press the "  " button for a minimum of four seconds, and the FIELD SET MODE is entered.
- 2 Select the desired MODE NO. with the "  " button.
- 3 During group control, when setting by each indoor unit (mode No. 20, 21, 22 and 23 have been selected), push the "  " button and select the INDOOR UNIT NO. to be set. (This operation is unnecessary when setting by group.)
- 4 Push the "  " upper button and select FIRST CODE NO.
- 5 Push the "  " lower button and select the SECOND CODE NO.
- 6 Push the "  " button once and the present settings are SET.
- 7 Push the "  " button to return to the NORMAL MODE.

Example

If during group setting and the time to clean the air filter is set to FILTER CONTAMINATION - HEAVY, SET MODE NO. to "10", FIRST CODE NO. to "0", and SECOND CODE NO. to "02".

NOTE



1. Setting is carried out in the group mode, however, if the mode number inside the parentheses is selected, indoor units can also be set individually.
2. The SECOND CODE number is set to "01" when shipped from the factory.
3. Do not make any settings not given in the table.
4. Not displayed if the indoor unit is not equipped with that function.
5. When returning to the normal mode, "88" may be displayed in the LCD in order for the remote controller to initialize itself.
6. It is not possible to change field settings on the remote controller that is set to "sub".

3P107422-4D

Mode No. Note 1	FIRST CODE NO.	Description of setting	SECOND CODE NO. Note 2				
			01	02	03	04	
10(20)	0	Filter Contamination - Heavy/Light (Setting for spacing time of display time to clean air filter) (Setting for when filter contamination is heavy, and spacing time of display time to clean air filter is to be halved)	Ultra long life filter	Approx. 10.000 hrs.	Approx. 5.000 hrs.	—	—
			Long life filter	Approx. 2.500 hrs.	Approx. 1.250 hrs.		
			Standard filter	Approx. 200 hrs.	Approx. 100 hrs.		
	1	Long-life filter type (setting of filter sign indication time). (Change setting when ultra-long filter is installed)	Long-life filter	Ultra-long life filter	—	—	
2	Thermostat sensor in remote controller	Use	Not use	—	—		
3	Spacing time of display time to clean air filter count (setting for when the filter sign is not to be displayed)	Display	Do not display	—	—		
11(21)	0	Setting number of connected Sky Air simultaneous operation system indoor units (setting for simultaneous operations system)	Pair	Twin	Triple	Double twin	
12(22)	1	ON/OFF input from outside (setting for when forced ON/OFF is to be operated from outside).	Forced OFF	ON/OFF operation	—	—	
	2	Thermostat differential changeover (setting for when using remote sensor).	1°C	0.5°C	—	—	
13(23)	0	High air outlet velocity (for high ceiling applications).	≤2.7 m	>2.7≤3.0 m	>3.0≤3.5 m	—	
	1	Selection of air flow direction (setting for when a blocking pad kit has been installed).	4-way flow	3-way flow	2-way flow	—	
	3	Selection of air flow function (setting for when using a decoration panel for outlet).	Equipped	Not equipped	—	—	
	4	Air flow direction range setting.	Upper	Normal	Lower	—	
	6	Setting the external static pressure (setting according to the connected duct resistance) (for FHYK, follow the high ceiling setting)	Normal (Normal)	High static pressure (High ceiling)	Low static pressure —	—	
15(25)	3	Drain pump operation with humidifying.	Equipped	Not equipped	—	—	
1b	0	Permission level setting	Level 2	Level 3	—	—	
	1	Leave home function	Not permitted	Permitted	—	—	
	2	Thermostat sensor in remote controller (for limit operation and leave home function only)	Use	Not use	—	—	

3P107422-4D

16. Set Back Time Clock

16.1 BRC15A61

Connected to a wired remote controller, this timer can set 2 sets of on/off times in an increment of 30 minutes within a day. For each on/off setting a temperature setting is also possible.

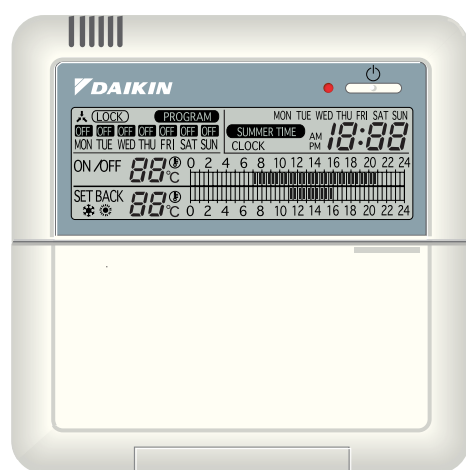

■ Operation Controlled By Programmed Time

Operation times of the air conditioner can be set for each day of the week to suit weekly schedules. Furthermore, up to two time schedules can be set per day.

■ Temperature Set Back

Temperatures can be "set back" when periods of precise cooling or heating is not necessary. This function reduces running costs.

■ Override (bypass) Function

The set back time clock can also be bypassed for periods when automatic start/stop and temperature set back is not required (such as extended vacations). By using this feature, programmed schedules are retained in the memory of the time clock for easy resumption of the schedules when required by simply pressing the ON/OFF button (1).

16.1.1 Dimensions

• DIMENSIONS

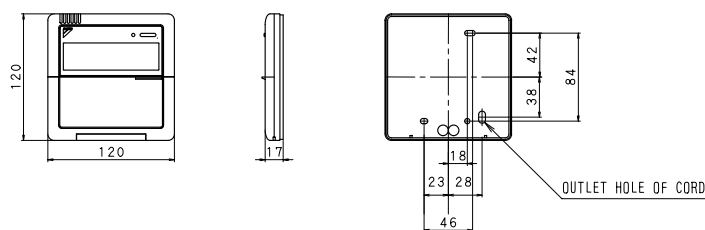

Unit (mm)

NOTE)1. CORDS AND STAPLES ARE NOT ATTACHED, THEY ARE FIELD SUPPLIED PARTS.

	CORD SPECIFICATIONS
TYPE	SHEATHED VINYL CORD OR CABLE (2 WIRES)
SIZE	0.75~1.25mm ²
LENGTH	500m

• INSTALLATION PROCEDURE

▲ EXPOSED BODY WITH EXPOSED CORD

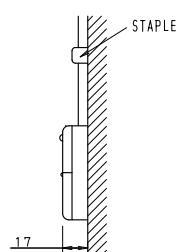

■ EXPOSED BODY WITH EMBEDDED CORD

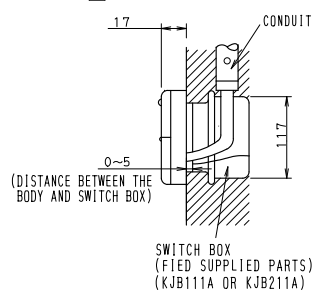

□ EXPOSED BODY WITH EMBEDDED CORD

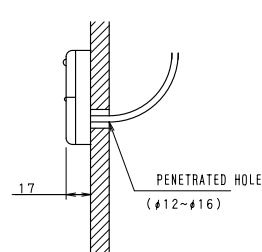

3D027674

SPECIFICATIONS

Display of time	12-hour digital display
Clock cycle type	Quartz clock type
Clock accuracy	Within ±30 sec./month (environmental temperature from 15°C to 35°C)
Timer programming	Two pairs of programmed time for both system start and system off can be set in units of 30 minutes.
Power failure compensation time	Approximately 1 hour for a single occurrence of power failure (clock with No. of programmed time)
Size	120(W) × 120(H) × 17(D) mm (Width/Height/Depth)

16.1.2 About the remote controller which can connect setback time clock (BRC15A61)

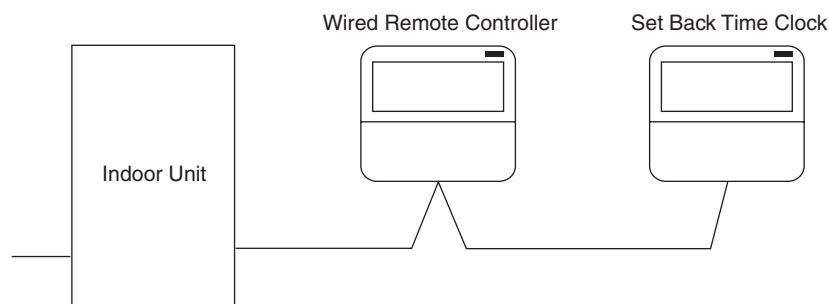

Although Set Back Time Clock is connected with Wired Remote Controller in parallel with Series Method, it does not applied to remote control of those other than the following.

Model	Remarks
BRC1A51 BRC1A52 BRC1A61 BRC1A62 BRC8A61 ARC11A52 ARC11A51	Only EC9721 the printed Circuit Board currently used for these remote control. (Refer to Note 1)
BRC1B51 BRC1B52 BRC1B61 BRC1B61	Applied for all printed circuit boards.
BRC1C61 BRC1C51	Applied for all printed circuit boards.

Note 1 : The check method of printed circuit board's model No.

The rear face of the remote control after removing a back cover.

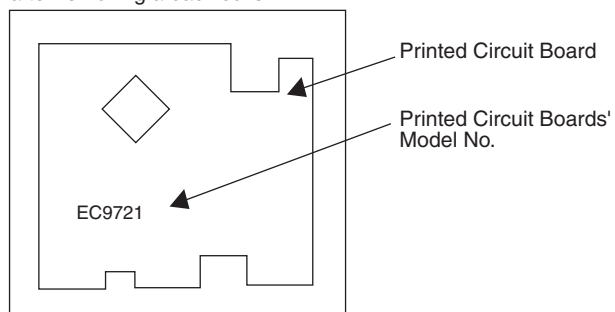







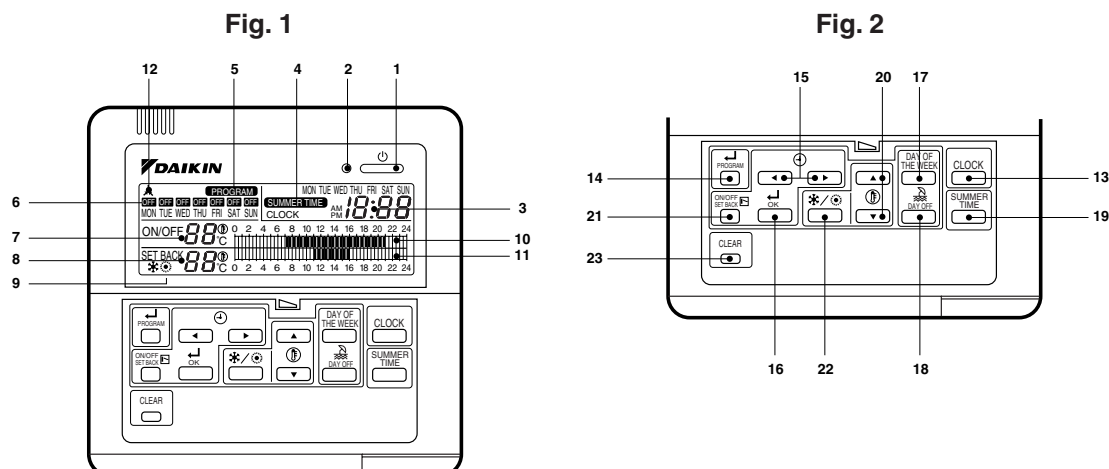

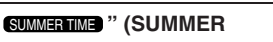
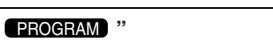

Printed circuit boards' model No. is indicated at the lower left of the PC board which can be locked at when the back cover of remote controller is removed.

The product start of EC9721 was carried out after 1997.

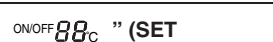
16.1.3 Names and Functions

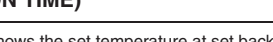
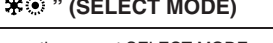

NAMES AND FNCTIONS OF OPERATING SECTION (Fig.1,2)

1	ON/OFF BUTTON	Press this button to make the program start/stop and the set back time schedule active. Press the button again to make them inactive.	11	DISPLAY “  ” (SET BACK TIME SCHEDULE)	This display shows the programmed set back operation time.
	OPERATION LAMP (RED)	The lamp turns on when the schedule function becomes active.		12	DISPLAY “  ” (UNDER CENTRALIZED CONTROL)
3	DISPLAY “  ” (PRESENT TIME)	Displays the present day of the week and time.	13	CLOCK ADJUST BUTTON	Press this button to set the present time.
	DISPLAY “  ” (SUMMER TIME)	This display shows the clock indicates summer time.		14	PROGRAMMING START BUTTON
5	DISPLAY “  ” (PROGRAMMING START)	The light turns on when the timer is programmed.	15		TIME ADJUST BUTTON
	DISPLAY “  ” (DAY OFF SETTING)	Lights above the day of the week set as day off. The operation controlled by timer is not available on that day.		16	SETTING FINISH BUTTON
7	DISPLAY “  ” (SET TEMPERATURE NORMAL OPERATION TIME)	This display shows the set temperature at normal operation time.	17		DAYS OF A WEEK SELECT BUTTON
	DISPLAY “  ” (SET TEMPERATURE SET BACK OPERATION TIME)	This display shows the set temperature at set back operation time.		18	DAYS OFF SET BUTTON
8	DISPLAY “  ” (SET TEMPERATURE SET BACK OPERATION TIME)	This display shows the set temperature at set back operation time.	19		SUMMER TIME SET BUTTON
	DISPLAY “  ” (SELECT MODE)	This display shows the current SELECT MODE (Cool/Heat) when setting temperature.		20	TEMPERATURE SET BUTTON
9	DISPLAY “  ” (OPERATION TIME SCHEDULE)	This display shows the programmed normal operation time.	21		ON/OFF OR SET BACK MODE SELECT BUTTON
	DISPLAY “  ” (OPERATION TIME SCHEDULE)	This display shows the programmed normal operation time.		22	COOL/HEAT SELECT BUTTON
10	DISPLAY “  ” (OPERATION TIME SCHEDULE)	This display shows the programmed normal operation time.	23		PROGRAM CLEAR BUTTON

16.1.4 Operation

SETTING THE PRESENT DAY AND TIME (Fig 3)(Note)

(Example in case of setting Friday 5:30pm)

The time needs to be set when the time clock is first switched on or after power supply to the unit is interrupted for over an hour.

- 1** Press the **CLOCK ADJUST BUTTON (13)**
The present time and day of the week flashes.

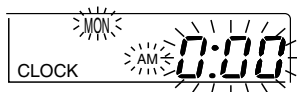

- 2** Press the **DAY OF THE WEEK BUTTON (17)**
Each time the button is pressed, the day display shifts to the right and advances by one day.

(Set the day to Friday)



- 3** Set the time with the **TIME ADJUST BUTTON (15)**
Each time the button is pressed, the displayed time increases or decreases by one minute. When the button is kept pressed the displayed time increases or decreases rapidly in increments of 10 minutes.

(set to 5:30pm)

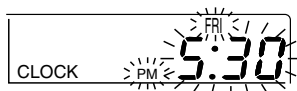

- 4** **PRESS THE PROGRAM REGISTER BUTTON (16)**
ONCE THIS BUTTON IS PRESSED, THE CLOCK STARTS AT THE SET TIME FROM 00 SECONDS. THEREFORE TO SYNCHRONISE

THE CLOCK TO THE SECOND, PRESS THE BUTTON WHEN THE SIGNAL FROM THE RADIO, TELEVISION, TELEPHONE MARKS 00 SECONDS.

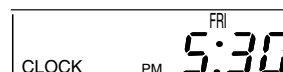

Notes)

- The time format used is 12 hour type
- When power supply is turned on, the system may display " 88 " for about one minute and not start to operate until after all the other displays appear.
- If the clock adjust button is pressed by mistake, press it again to return to the original state. As the clock does not stop, the time indicated by the clock is kept accurate.
- In case power is interrupted for less than one hour, the clock keeps operating by utilising an in built battery. This battery is self charging and does not need replacing.
- In case the time is incorrectly set, press the CLOCK ADJUST button (13) before pressing the PROGRAM REGISTER button (16). This will go back to the original time.
- Press the SUMMER TIME button (19) to change clock to summer time/daylight saving time (if applicable in your area). This advances the time by one hour. Pressing this button again changes the clock back to normal time.

SETTING TIME AND TEMPERATURE SET BACK SCHEDULES

(Example)

Monday to Friday
Operating Time
From 4:00am to 11:00am and
From 2:00pm to 11:00pm
Temperature Set Back Times
From 4:00am to 7:00am
From 9:00pm to 11:00pm
Normal operating temperatures
Cooling: 25°C
Heating: 20°C
Set Back Temperatures
Cooling: 27°C
Heating: 17°C

Saturday and Sunday
Days off (no time schedule)

Note : page 298

SETTING OPERATING TIME SCHEDULE (Fig 4)(Note)

1 Press the PROGRAMMING BUTTON (14) to enter the programming mode
The display “PROGRAM” appears and the current day of the week and the display ON/OFF starts flashing.

2 Press the DAY OF THE WEEK BUTTON (17)
Each time the button is pressed in the programming mode, the day of the week flashing advances

(set the day to Monday)



3 Press the TIME ADJUST BUTTON
Each time the button is pressed, the flashing cursor in the operating time schedule display (10) shifts in 30 minute increments.
Move the flashing cursor to the time that the air conditioning unit is required to turn on

(set it to 4:00am)

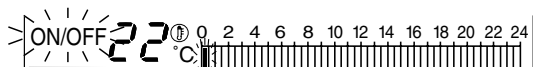

4 Press the PROGRAM REGISTER BUTTON (16)
The time to start the air conditioning unit is now registered in the memory of the time clock

(the time clock is set to turn the air conditioner on at 4:00am)

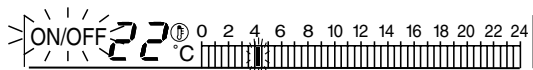

5 Press the TIME ADJUST BUTTON (15)
Each time the button is pressed, the flashing cursor shifts to the next

“cell” and the preceding cells are blacked out indicating the operation period. Move the flashing cursor to the time required to stop the air conditioner.

(set it to 11:00am)



6 Press the PROGRAM REGISTER BUTTON (16)
The cursor stops flashing and the first operation schedule is now displayed and set.

(in this example the first operation period is 4:00am to 11:00am)



7 Press the TIME ADJUST BUTTON (15)
Each time the button is pressed, the flashing cursor in the operating time schedule display (10) shifts in 30 minute increments to the start time for the second operating schedule.

(move it to 2:00pm)



8 Set the start time in the same manner as 4

(set to 2:00pm)

9 Set the second operation period in the same manner as 5 and 6

(set to operate from 2:00pm to 11:00pm)

10 Press DAY OF THE WEEK BUTTON (17)
Press this button to select the next day

11 Repeat steps 3 to 10 to set the operating schedules for other days of the week.

Note : page 298

- 12 Press the **PROGRAMMING BUTTON** to exit the programming mode.
The two operation schedules are now memorised and displayed.

- Notes)**
- If an error is made while programming, press the PROGRAM CLEAR button (23) to delete the time schedule(s) for that day.
 - Different operating schedules can be set for each day of the week if required.

SETTING DAYS OFF (fig 5)(Note)

- 1 Press the **PROGRAMMING BUTTON (14)**
Press this button to enter the programming mode. The display “PROGRAM” appears in the display and the current day of the week flashes.

- 2 Press the **DAY OF THE WEEK BUTTON (17)**
Each time the button is pressed in the programming mode, the day of the week advances. Select the day of the week required to be set as the day off.

(move it to Saturday)

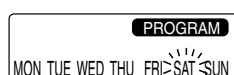

- 3 Press the **DAY OFF BUTTON (18)**
The display “OFF” appears above the day of the week flashing. If the DAY OFF button is pressed again, the day off is deselected.

(set to Saturday)



- 4 Press the **DAY OF THE WEEK BUTTON (17)** again to select an additional day required to be set as day off.

(move it to Sunday)

- 5 Press the **DAY OFF BUTTON** to set as day off.

(set to Sunday)

- 6 Additional day(s) off may be set as required by repeating steps 2 and 3.

- 7 Press **PROGRAMMING BUTTON (14)** to exit the programming mode.
The display “PROGRAM” disappears

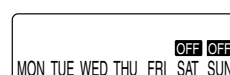

Notes)

- Although time schedules can be set on a day (or days) off, the schedules although displayed, remain inactive and the air conditioning unit will not stop or start automatically according to the schedules.

SETTING SET BACK TIME (fig 6)(Note)

- 1 Press the **PROGRAMMING BUTTON (14)** to enter the programming mode.
The display “PROGRAM” appears and the current day of the week and the display ON/OFF starts flashing.

- 2 Press the **ON/OFF OR SET BACK MODE SELECT BUTTON (21)**
The display SET BACK flashes. Each press of the button toggles between the ON/OFF setting mode or SET BACK mode.

- 3 Press the **DAY OF THE WEEK (17) BUTTON**
Each time the button is pressed in the programming mode, the day of the week advances.

(select Monday)



Note : page 298

- 4** Press the TIME ADJUST BUTTON (15)
Each time the button is pressed, the flashing cursor in the set back time schedule display (11) shifts in 30 minute increments.
Move the flashing cursor to the required start time for temperature set back

(set it to 4:00am)



- 5** Press the PROGRAM REGISTER BUTTON (16)
The time to start the first temperature set back period is now set and is registered in the memory of the set back time clock.

(the temperature set back start time is now set to 4:00am)

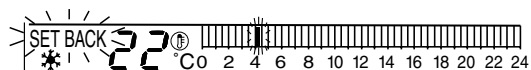

- 6** Press the TIME ADJUST BUTTON (15)
Each time the button is pressed, the flashing cursor shifts to the next "cell" and the preceding cells are blacked out indicating the first temperature set back period. Move the flashing cursor to the time required to end the temperature set back operation.

(set it to 7:00am)



- 7** Press the PROGRAM REGISTER BUTTON (16)
The blacked out cells stop flashing and the first temperature set back period is now set.

(set back period is set from 4:00am to 7:00am)



- 8** Press the TIME ADJUST BUTTON (15)
Each time the button is pressed, the flashing cursor in the set back time schedule display (11) shifts in 30 minute increments.
Move the flashing cursor to the required start time for the second temperature set back period

(set it to 9:00pm)



- 9** Press the PROGRAM REGISTER BUTTON (16)
The time to start the second temperature set back period is now set and is registered in the memory of the set back time clock.

(the temperature set back start time is now set to 9:00pm).

- 10** Press the TIME ADJUST BUTTON (15)
Each time the button is pressed, the flashing cursor shifts to the next "cell" and the cells are blacked out indicating the second temperature set back period. Move the flashing cursor to the time required to end the temperature set back operation.

(set it to 11:00pm).

- 11** Press the PROGRAM REGISTER BUTTON (16)
The blacked out cells stop flashing and the second temperature set back period is now set.

(the second temperature set back period is set from 9:00pm to 11:00pm).

- 12** Repeat steps 3 to 11 to set the set back periods for other days of the week.
In this example set back periods are as above for Monday to Friday)

- 13** Press PROGRAMMING BUTTON (14) to exit the programming mode.
The display "PROGRAM" disappears.

Notes)

- Different set back periods can be set for each day of the week if required.
- When the air conditioning unit is in the automatic cool/heat changeover, fan and dry mode, the set back timer function becomes inactive.

SETTING NORMAL SET TEMPERATURES (fig 7)(Note)

Normal set temperatures can be individually set for the cooling and heating modes. The operating temperature can be temporarily changed by using the air conditioning unit's controller. However, when the set back time clock starts or stops the air conditioning unit according to the programmed time schedules or initialises a set back period, the set temperature on the units controller reverts to the set back temperature.

1 Press the **PROGRAMMING BUTTON (14)**
The display “ **PROGRAM** ” appears and the current day of the week and the display **ON/OFF** starts flashing.

2 Press the **COOL/HEAT SELECT BUTTON (22)**
Each press of the button toggles between the cooling and heating settings.

3 Select **COOLING** to set the cooling normal set temperature

4 Press the **TEMPERATURE SET BUTTON (20)**
Set the required Normal set temperature for the cooling mode.

(set it to 25°C)



5 Press the **COOL/HEAT SELECT BUTTON (22)**
Select heating to set the Normal set temperature for the heating mode.

6 Press the **TEMPERATURE SET BUTTON (20)**
Set the required Normal set temperature for the heating mode.

(set it to 20°C)



7 If set back temperatures need to be set, then follow the instructions below, otherwise press the **PROGRAMMING BUTTON (14)** exit the programming mode.

SETTING SET BACK TEMPERATURES (fig 8)(Note)

Set back temperatures can be individually set for the cooling and heating modes. Cooling “set back” temperatures should be higher than the normal set temperatures and heating set back temperatures should be lower than the normal set temperatures.

When the air conditioning unit is in the automatic cool/heat changeover mode, the set back timer function becomes inactive.

1 If set back controller is not in the **PROGRAMMING** mode, follow steps 1 above. If continuing from above, follow steps below.

2 Press the **ON/OFF or SET BACK MODE BUTTON (21)**
The display **SET BACK** flashes. Each press of the button toggles **BETWEEN** the **ON/OFF** setting mode and **SET BACK** mode.

3 Press the **COOL/HEAT SELECT BUTTON (22)**
Select **COOLING** “  ” to set the cooling set back temperature

4 Press the **TEMPERATURE SET BUTTON (20)**
Set the required set back temperature for the cooling mode.

(set it to 27°C)



5 Press the **COOL/HEAT SELECT BUTTON (22)**
Select heating “  ” to set the set

Note : page 298

back temperature for the heating mode.

- 6** Press the TEMPERATURE SET BUTTON (20)
Set the required set back temperature for the heating mode.

(set it to 17°C)



- 7** Press the PROGRAMMING BUTTON (14) to exit the programming mode.
The display “PROGRAM” disappears.

CANCELLATION AND CHANGE OF PROGRAMMED ON/OFF SCHEDULES (fig 9)(Note)

Follow these instructions if any of the programmed schedules need to be changed or cancelled.

- 1** Press the PROGRAMMING BUTTON (14) to enter the programming mode.
The display “PROGRAM” appears and the current day of the week and the display ON/OFF starts flashing.
- 2** Press the DAY OF THE WEEK BUTTON (17) to select the day on which the programmed schedule needs to be cancelled or changed.
- 3** Press the PROGRAM CLEAR BUTTON (23) to delete the programmed schedule
The blacked out cells on the OPERATION TIME SCHEDULE display are cleared.
- 4** If an alternative time schedule needs to be set, then follow the steps 2 to 12 under “SETTING OPERATING TIME SCHEDULES”.

- 5** Press the PROGRAMMING BUTTON (14) to exit the programming mode.
The display “PROGRAM” disappears.

CANCELLATION AND CHANGE OF SET BACK TIME SCHEDULES (fig 10)(Note)

- 1** Press the PROGRAMMING BUTTON (14) to enter the programming mode.
The display “PROGRAM” appears and the current day of the week and the display ON/OFF starts flashing.

- 2** Press the ON/OFF OR SET BACK MODE SELECT BUTTON (21) to select the temperature SET BACK mode settings.

- 3** Follow steps 2 to 5 as above.

ACTIVATING OR DEACTIVATING THE TIME CLOCK

- 1** To activate the set back time clock press ON/OFF (BYPASS) BUTTON (1)
The red indicator light turns on.
This indicates that the time schedules and set back periods are now active.

- 2** To deactivate the set back time clock, press the ON/OFF BUTTON (1)
The red indicator light turns off. This indicates that the time schedules and set back periods are no inactive.

Note : page 298

Fig.3~10

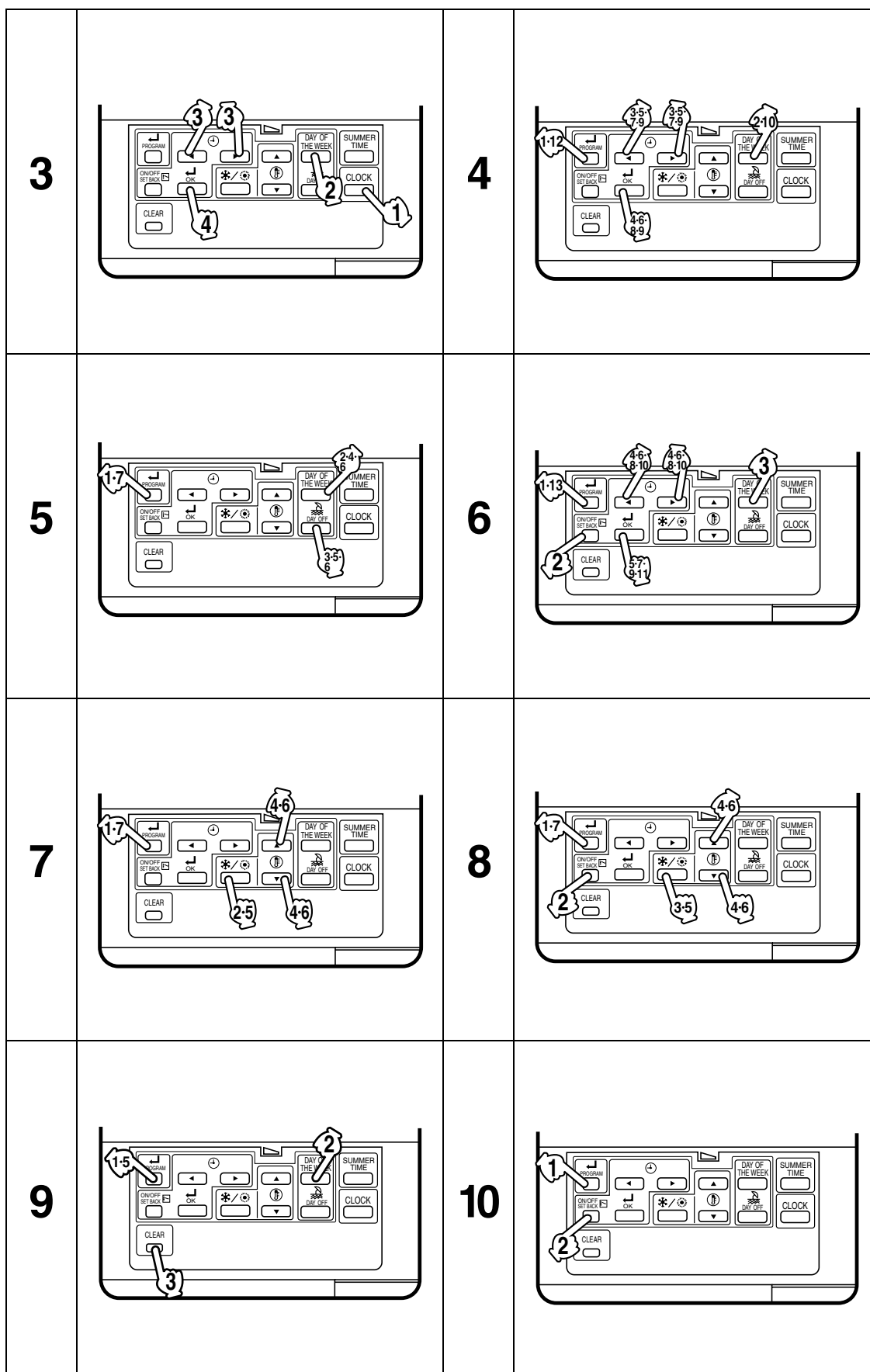

16.1.5 Installation

- Connected to a wired remote controller, this timer can set 2 sets of ON/OFF times in an increment of 30 minutes within a day. For each ON/OFF setting a temperature setting is also possible.

NOTE At least one Remote controller for indoor units are needed when installing and operating Set Back Time Clock.

1. Remove the upper part of Set back time clock.

Insert minus screwdriver into the slots in the lower part of Set back time clock (2 places), and remove the upper part of Set back time clock.

The PC board is mounted in the upper part of Set back time clock. Be careful not to damage the board with the minus screwdriver.

Minus screwdriver

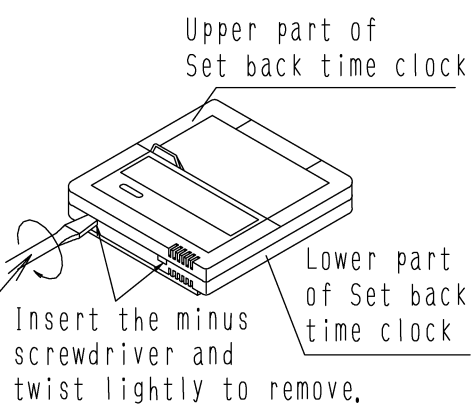

2. Fasten the Set back time clock.

- ① For exposed mounting, fasten with the included wood screws (2 pcs.)

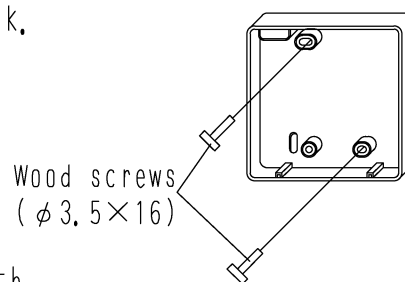

- ② For flush mounting, fasten with the included machine screws (2 pcs.).

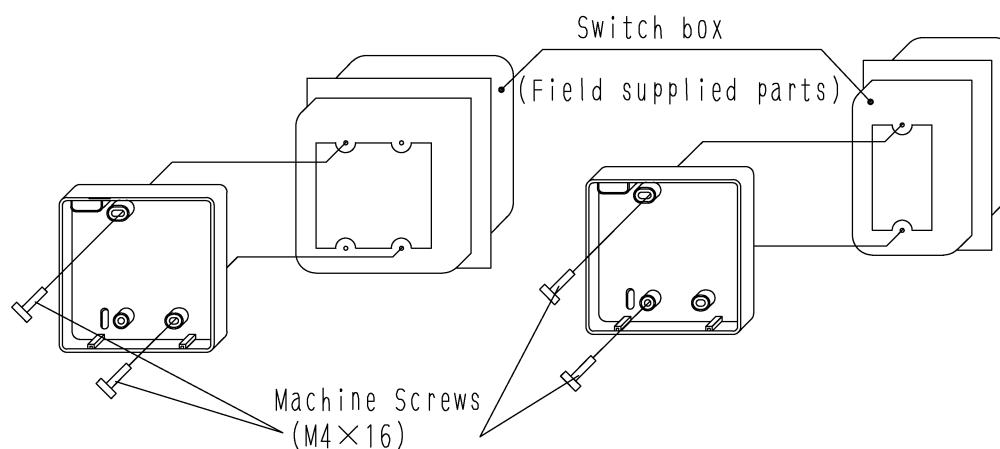

For the field supplied switch box, use optional accessories KJB111A or KJB211A.

3P063547-1B-1

NOTE Choose the flattest place possible for the mounting surface.
 Be careful not to distort the shape of the lower part of Set back time clock by over-tightening the mounting screws.

3. Wire the Set back time clock.

Connect the terminals on top of the upper part of Set back time clock (P1, P2) and the terminals of the indoor unit (P1, P2) or the terminals of the remote controller for the indoor unit. (P1 and P2 do not have polarity.)

NOTE) When wiring, run the wiring away from the power supply wiring in order to avoid receiving electric noise (external noise).

The terminals of the indoor unit (P1, P2)

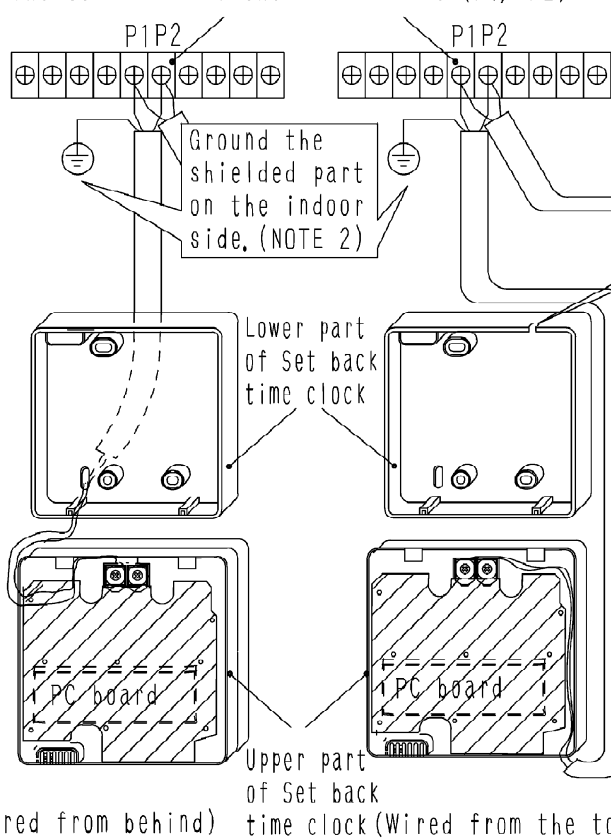

Notch the part for the wiring to pass through with nippers etc.

(NOTE 2)
Wiring specifications

Wiring type	Sheathed vinyl cord or cable (2 wires)
Size	0.75~1.25mm ²
Insulated thickness	1mm or more

NOTE)
 1. Peel the shield and sheath for the part that is to pass through the inside of the Set back time clock casing, as shown below.
 2. Shield wire (2wires) can be used for Set back time clock wiring, but it must conform to EMC, (Electromagnetic Compatibility)



4. Reattach the upper part of Set back time clock.

Do not put the lead wires between the upper part and the lower part of Set back time clock at installation.

NOTE

1. The switch box and wiring for connection are not included.
2. Do not directly touch the PC board with your hand.

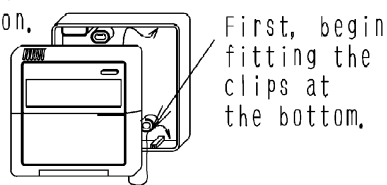

" 88 " is displayed for about one minute when the power supply is turned on, and the Set back time clock do not accept input during the time in some cases.

3P063547-B

3P063547-1B-2

17.Noise Filter (For Electromagnetic Interface Use only)

17.1 KEK26-1

1 COMPONENTS

- Check the following components are included in this optional accessory before installation.

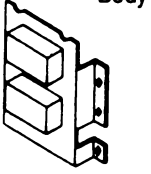
	Installation screw	4
	Clamp	2
	Relay harness	1
	Installation manual	2

- Store this optional accessory in the control box.
- When supplying a control box at site, prepare a control box whose dimensions are equal to or larger than the figures shown below.
Wide x Height x Depth = 136 x 117 x 44 mm

2 SYSTEM CONFIGURATION

- When connecting this optional accessory to the unified ON/OFF controller for VRV series, it is applicable to EMC (Electromagnetic Compatibility) (European Directive).

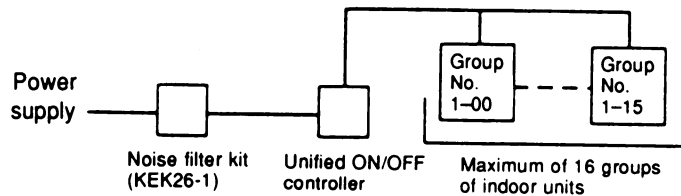

The groups of indoor units are as follows:

- ① One indoor unit without remote controller



Without remote controller

- ② One indoor unit controlled by one or two remote controllers



One remote controller

or



Two remote controllers

- ③ A maximum of 16 indoor units controlled in groups by one or two remote controllers



One remote controller
Max. 16 units

or

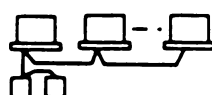

Two remote controllers
Max. 16 indoor units

2PA54937C

3 ELECTRIC WIRING

GENERAL INSTRUCTIONS

- All wiring, components and materials to be procured on the site must comply with the applicable local and national codes.
- Use copper conductors only.
- All wiring and components must be provided by licensed electrician.
- Unit shall be grounded in compliance with the applicable local and national codes.
- Fit the power supply wiring with a fuse and a switch.
- Before wiring work, turn the switch OFF and confirm that power to the equipment shuts OFF.

< Wiring specification >

	Type	Size
Power supply wiring	H05VV-U3G	(NOTE 1)
Transmission wiring	(NOTE 2)	0.75–1.25mm ²

NOTE) 1. The size of power supply wiring must comply with the applicable national and local codes.

2. Transmission wiring must comply with the condition as follows:

- ① When indoor unit is H series.
Use shield wire (2 wire).
- ② When indoor unit is G series.
Use sheathed wire (2 wire).

- You may also use the sheathed wire if the above condition ① is satisfied, but remember that the sheathed wire fails to comply with EMC (Electromagnetic Compatibility) (European Directive).
- When using sheathed wire, EMC conforms to Japanese standards stipulated in the Electric Appliance Regulatory act.
- The grounding of transmission line as shown in the figure 1 is not required if the sheathed wire is used.

WIRING SPECIFICATION

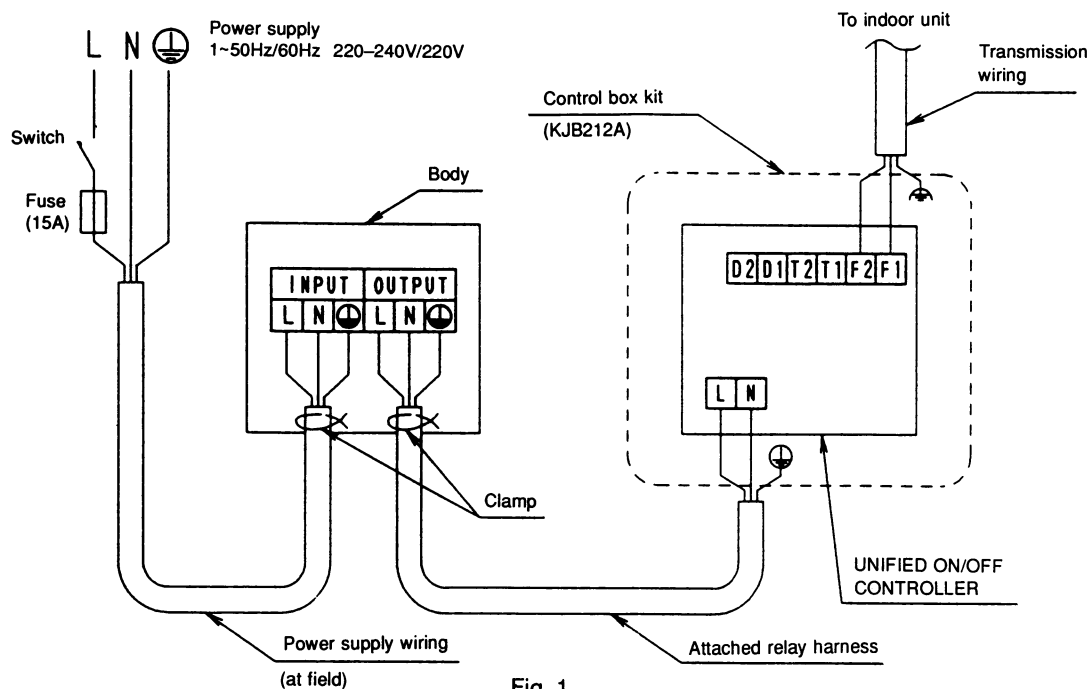

Fig. 1

NOTE

- Cramp the field supplied wirings with the body, using the attached tie wraps.

2PA54937C

4 INSTALLATION

Install this optional accessory on the control box (field supplied part) with the attached installation screws.

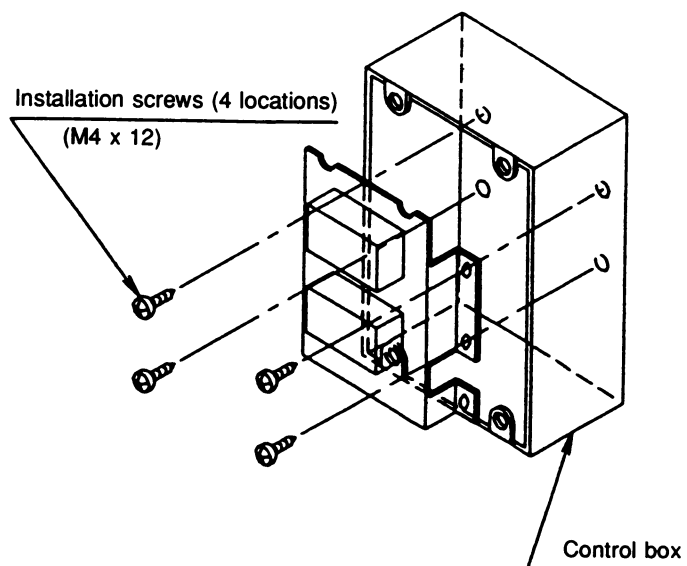

< Installation hole pitch >

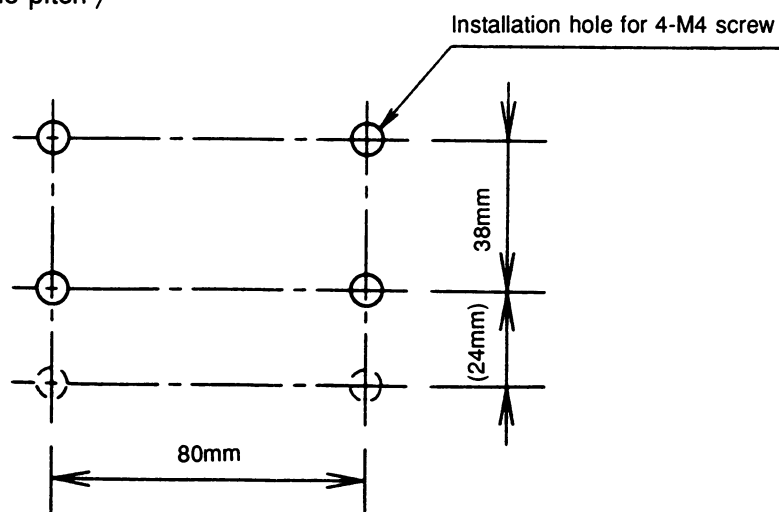

NOTE

- Lower two installation holes are reserves. Generally, use the upper 4 holes to install this optional accessory.

2PA54937C

18. Schedule Timer

18.1 DST301BA61

Enables you to connect and control weekly schedule for up to 128 indoor units all together.

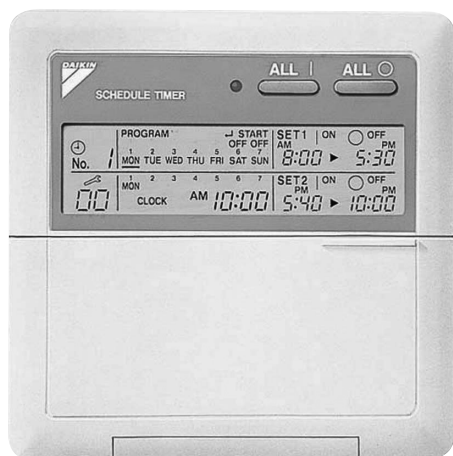

- Simultaneous control of up to 128 indoor units is managed by a week schedule.
- The start and stop time for twice a day can be set for the week in increments of 1 minute.
- By combining with a central remote controller and schedule timer, you can construct a system that matches the size and use of the building.
- If used together with a central remote controller, you can set up to 8 schedule patterns which can be distributed among zones as desired using the central remote controller.
- Is equipped with a compensation function for power failure up to 48 hours.
- Features thin design of a mere 16 mm in thickness. (Uses JIS recessed box for 2.)
- Wiring can be up to 1 km in length. Applicable wiring methods include bus and star in addition to crossover type.
- Can be used in combination with other D-BACS equipment.

18.1.1 Dimensions

Schedule Timer DST301BA61

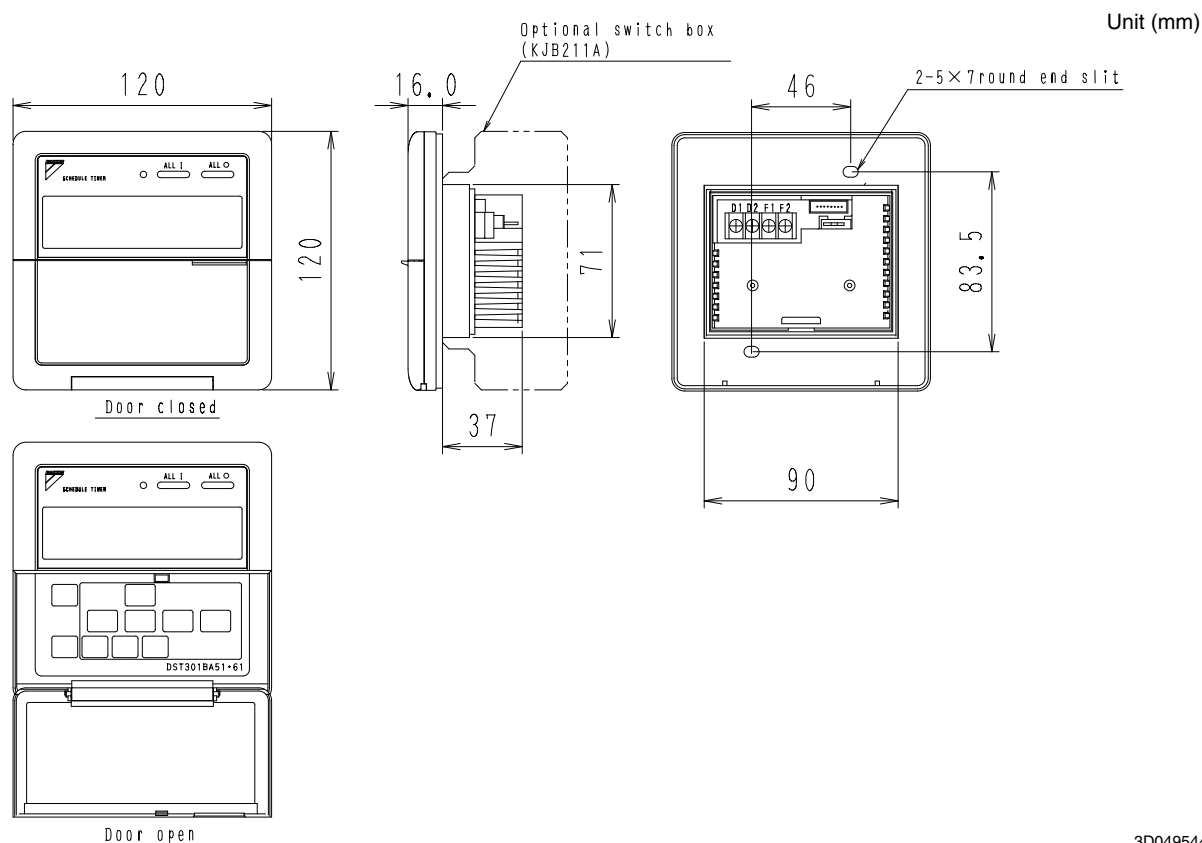

18.1.2 Names and Functions (DST301BA61)

2
18.1 DST301BA61

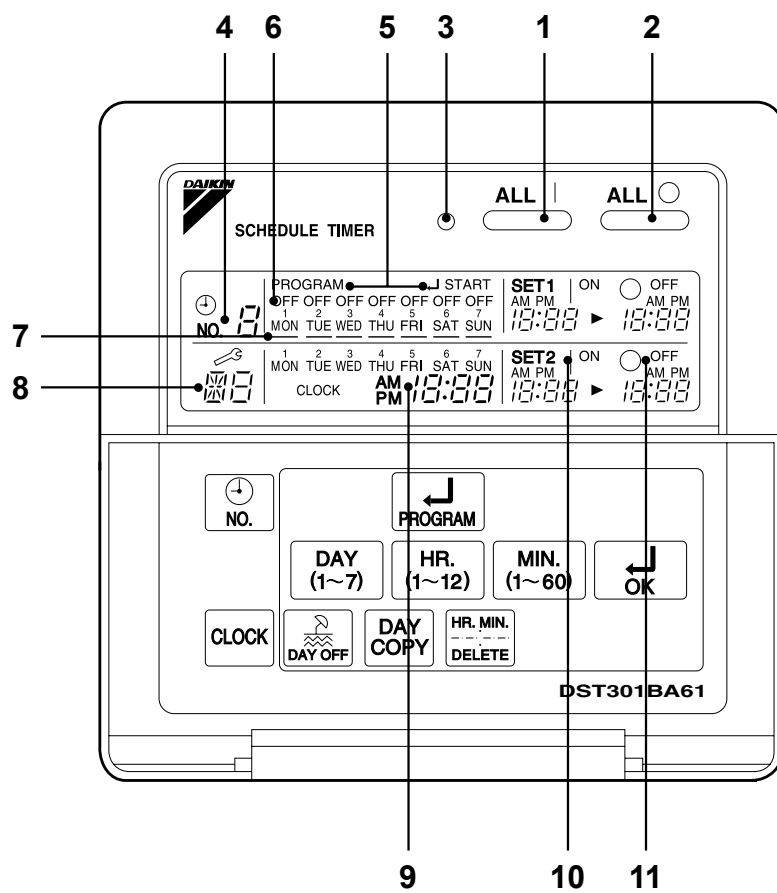

Fig. 1

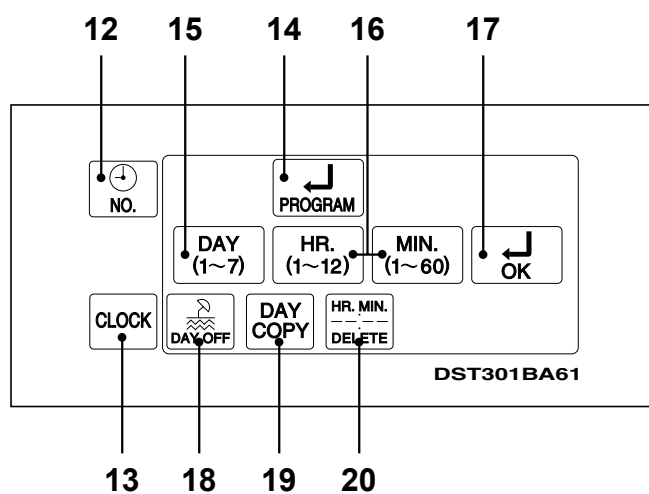

Fig. 2

3P124623-5C

18.1.3 Names and Functions of Operating Section (Fig. 1, 2)

1	UNIFIED OPERATION BUTTON “ ALL ”	Press this button to perform the unified operation regardless of the No. of programmed time.
	UNIFIED STOP BUTTON “ ALL ○ ”	
2	UNIFIED STOP BUTTON “ ALL ○ ”	Press this button to perform the unified stop regardless of the No. of programmed time.
	OPERATION LAMP (RED)	
3	OPERATION LAMP (RED)	The light turns on during the operation of the indoor unit.
	DISPLAY “ NO. 8 ” (TIME NO.)	
4	DISPLAY “ NO. 8 ” (TIME NO.)	Displays the time No. only when used in conjunction with the central remote controller.
	DISPLAY “PROGRAM ↵ START.” (PROGRAMMING START)	
5	DISPLAY “PROGRAM ↵ START.” (PROGRAMMING START)	The light turns on when the timer is programmed.
	DISPLAY “ OFF ” (HOLIDAY SETTING)	
6	DISPLAY “ OFF ” (HOLIDAY SETTING)	Lights above the day of the week set as holiday. The operation controlled by timer is not available on that day.
	DISPLAY “ — ” (SETTING OF DAYS OF A WEEK)	
7	DISPLAY “ — ” (SETTING OF DAYS OF A WEEK)	Flashes below the day of the week programmed.
	DISPLAY “ E8 ” (MALFUNCTION CODE)	
8	DISPLAY “ E8 ” (MALFUNCTION CODE)	Displays the contents of malfunction during the stop due to malfunction.
	DISPLAY “ MON TUE WED THU FRI SAT SUN ” (PRESENT TIME)	
9	DISPLAY “ MON TUE WED THU FRI SAT SUN ” (PRESENT TIME)	Displays the present day of the week and time.
	DISPLAY “ AM PM ON ” (PROGRAMMED TIME OF SYSTEM START)	
10	DISPLAY “ AM PM ON ” (PROGRAMMED TIME OF SYSTEM START)	Displays the time programmed to start.
	DISPLAY “ OFF AM PM ” (PROGRAMMED TIME OF SYSTEM OFF)	
11	DISPLAY “ OFF AM PM ” (PROGRAMMED TIME OF SYSTEM OFF)	Displays the time programmed to stop.
	TIME NO. BUTTON “ NO. ”	
12	TIME NO. BUTTON “ NO. ”	Press this button to select time No.
	CLOCK ADJUSTING BUTTON “ CLOCK ”	
13	CLOCK ADJUSTING BUTTON “ CLOCK ”	Press this button to set the present time.
	PROGRAMMING START BUTTON “ PROGRAM ”	
14	PROGRAMMING START BUTTON “ PROGRAM ”	Press this button to set or check the No. of programmed time. Press it again after you are through with the program.
	BUTTON FOR SELECTING DAYS OF A WEEK “ DAY (1~7) ”	
15	BUTTON FOR SELECTING DAYS OF A WEEK “ DAY (1~7) ”	Press this button to select the day of the week.
	HOUR/MINUTE BUTTON “ HR. (1~12) MIN. (1~60) ”	
16	HOUR/MINUTE BUTTON “ HR. (1~12) MIN. (1~60) ”	Press this button to adjust the present time and the programmed time.
	TIMER ON BUTTON “ OK ”	
17	TIMER ON BUTTON “ OK ”	Press this button to set the present time and the programmed time.
	HOLIDAY SETTING BUTTON “ DAY OFF ”	
18	HOLIDAY SETTING BUTTON “ DAY OFF ”	Press this button to set holidays.
	BUTTON FOR COPYING PROGRAM OF PREVIOUS DAY “ DAY COPY ”	
19	BUTTON FOR COPYING PROGRAM OF PREVIOUS DAY “ DAY COPY ”	Use this button to set the No. of programmed time same as that of the previous day.
	PROGRAM CANCELING BUTTON “ HR. MIN. DELETE ”	
20	PROGRAM CANCELING BUTTON “ HR. MIN. DELETE ”	Use this button to set the programmed time to cancel. The display shows “ - ; - - ”.
(Note)		
1. Please note that all the displays in the figure appear for explanation purpose or when the cover is open.		

3P124623-5C

18.1.4 System Configuration and Electric Wiring

With a schedule timer, you can set on/off time twice a day by units of 1 week for up to 128 indoor units.

■ System Configuration

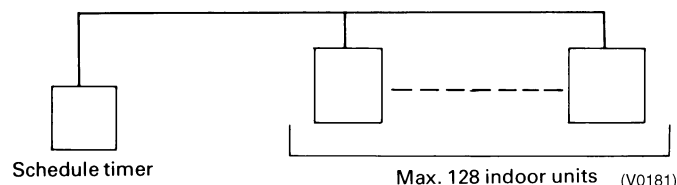

If using the schedule timer alone, you don't have to set the centralized control group No. for group control.

■ Transmission Wiring

<Indoor Unit Wiring>

1. If using the schedule timer alone:
 - For the schedule timer's power supply, connect the schedule timer (D1, D2) with the connector (X18A) on the indoor unit PC board by crimped style terminal with the attached electric wire.

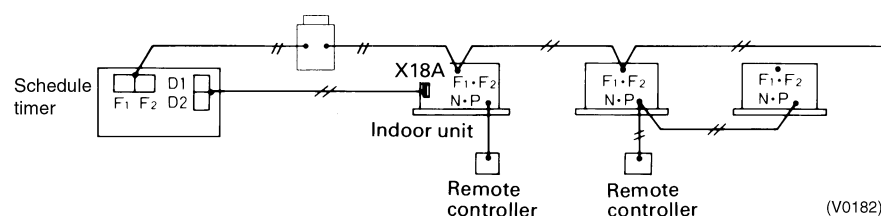

2. If using in combination with other optional controllers for centralized control:

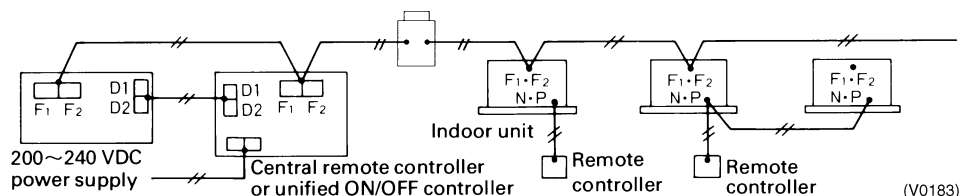

Transmission wiring for control: 0.75-1.25 mm² sheathed vinyl cord or cable (2 wire) Max. 1,000 m (Total Max. 2,000 m)

<Transmission Wiring Connection Example>

1 series wiring, 2 bus wiring, and 3 star wiring are the same as with the central remote controller.

18.1.5 Installation and Initial Setting

1. Remove the upper part of the remote controller.

- Insert a (-) screwdriver (2 locations) into the recess between the upper part and the lower part of the remote controller and twist the screwdriver lightly.

(The PC board is attached with the upper part of the remote controller. Do not damage electric parts with a screwdriver, etc.)

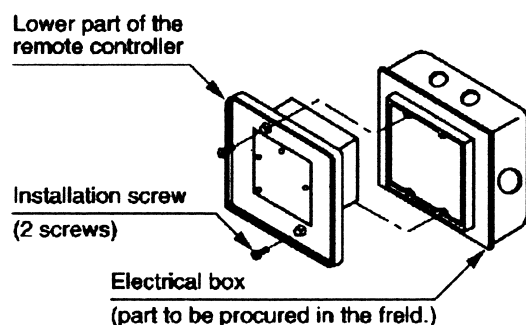
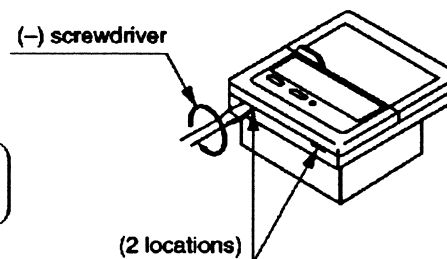

- Attach the lower part to the electrical box (part to be procured in the field) with the provided installation screws.

(Select a flat face as a installation place. Do not tighten the installation screws excessively not to damage the lower part of the remote controller.)

For part to be procured in the field electrical box, use KJB212AA (optional accessory).

2. Initial setting

① Setting connector for individual use (X1A) (Factory set : OFF) (Set for individual use only)

- For individual use of schedule timer
Insert the connector attached with the body case on the PC board.
- For combined use with other optional controllers for centralized control
Do not change the factory setting.

② Control mode selector (SS2) (Set for individual use only)

By changing the switch, setting mode of individual and centralized operation is available.

Note) When used with other optional controllers, control mode of central remote controller and unified ON/OFF controller have the priority.

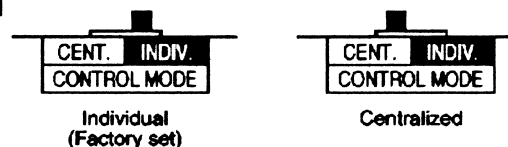

③ Setting of the sequential operation function

The schedule timer is equipped with a sequential operation function that sequentially turns indoor units on in 2-second intervals during unified operation.

(Sequential operation is factory set to "ON.")

To switch sequential operation ON or OFF, set as follows.

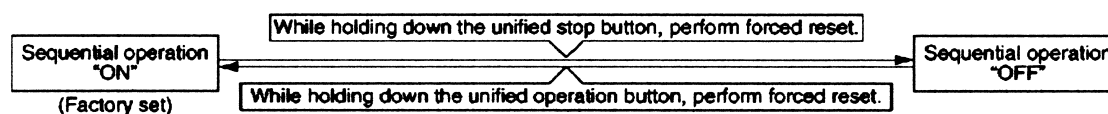

Note) The sequential operation function is designed to reduce the load on the power supply equipment, but does not guarantee that compressors will not be started simultaneously. You cannot therefore count on a capacity reduction effect by power supply equipment breaker selection.

④ Forced reset switch (SS1)

When changing the setting of the connector for individual use, etc., the switch can be reset simply by setting it to the reset side once and returning to the normal side. This procedure enables to reset without turning off the power. (Set the normal side at normal operation.)

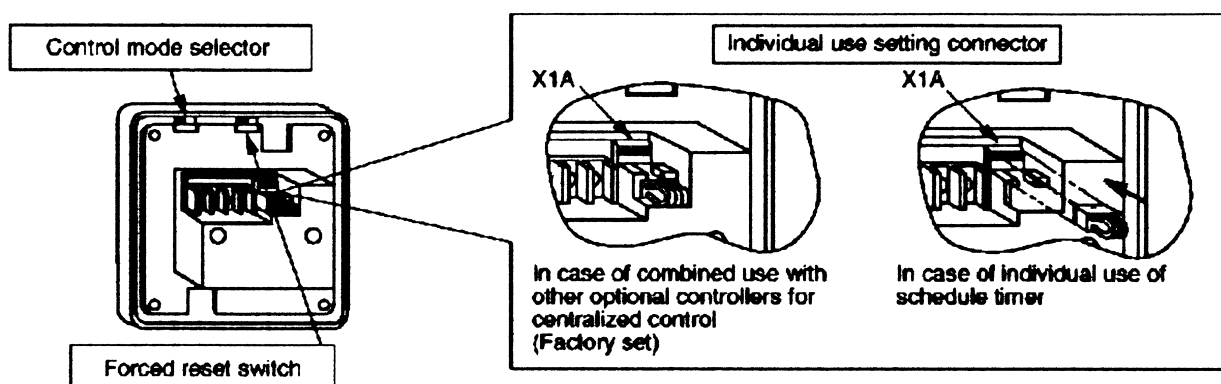
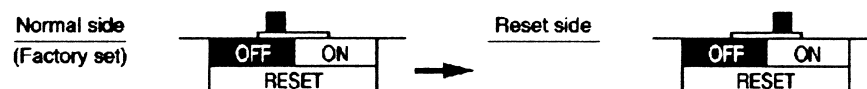

3P162015A

- ⑤ **Setting for special function**
 When you want to have a programmed operation of a part of indoor units by using only schedule timer, cut off J1 and supply the power again. You can have a programmed operation of the indoor units set the address for central control by local remote controller.

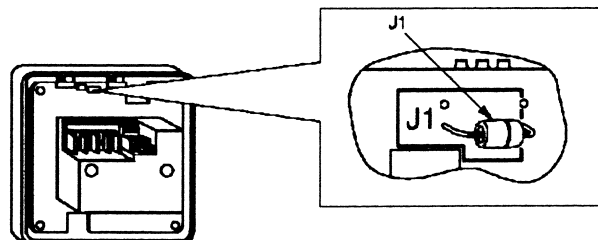

3. Transmission wiring

- **In case of individual use of schedule timer**
 Connect terminals of the schedule timer (F1, F2) with terminals of the indoor unit (F1, F2). Connect terminals of the schedule timer (D1, D2) and the connector on the indoor unit PC board, using the attached electric wire and crimp style terminals. Prevent the connection part of crimp style terminal from getting out of the electric parts box of indoor unit.
- **In case of combined use with other optional controllers for centralized control**
 Connect terminals of the schedule timer (F1, F2, D1, D2) and the terminals of the central remote controller (or unified ON/OFF controller).

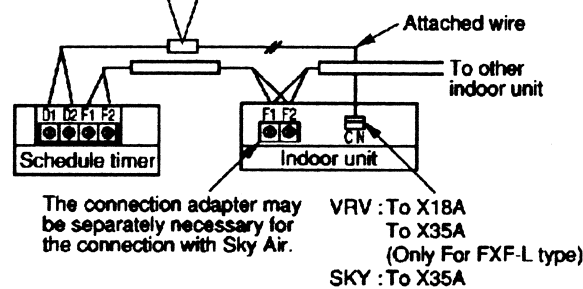
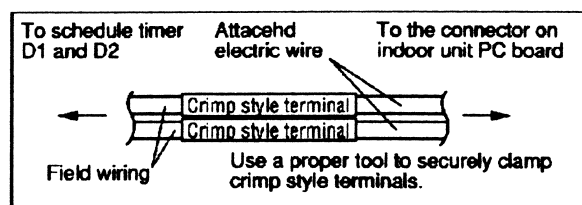

Wiring specifications

	F1, F2	D1, D2
Wiring	Sheathed wire (2-wire)	Sheathed wire (2-wire)
Gauge	0.75 ~ 1.25mm ²	0.75 ~ 1.25mm ²
Length	Max. 1000m	Max. 150m

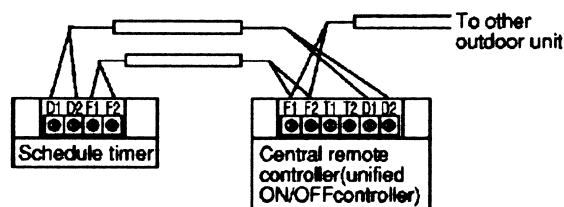

NOTES:

1. Electrical box and transmission wiring are not attached.
2. Do not touch the PC board with your hand.
3. Keep transmission wiring at least 50 mm away from power supply wiring to avoid malfunctions.



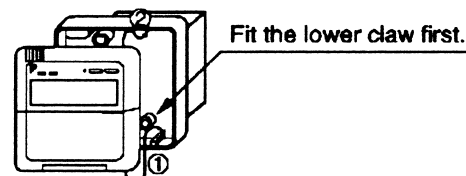

4. Install the upper part of the remote controller as before.



3P162015A

18.1.6 Setting Group No. for Centralized Control

In order to conduct the central remote control using the central remote controller and the unified ON/OFF controller, Group No. settings should be made by group using the operating remote controller. Make Group No. settings for central remote control using the operating remote controller.

1. While in normal mode, press and hold the  switch for a period of four seconds or more to set the system to "Field Setting Mode".
2. Select the MODE No. "00" with the  button.
3. Use the  button to select the group No. for each group. (Group numbers increase in the order of 1-00, 1-01, ... 1-15, 2-00, ... 4-15.)
4. Press  to set the selected group No.
5. Press  to return to the NORMAL MODE.

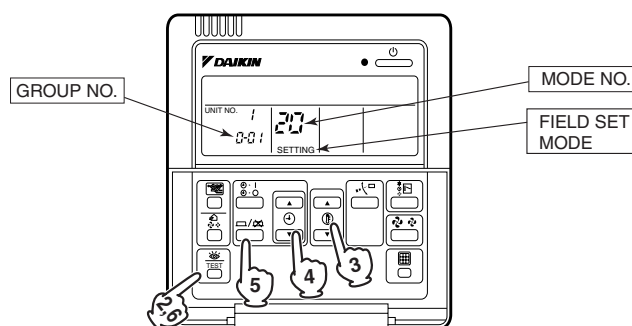

Note:

- For simplified remote controller, see the installation table.
- For setting group No. of HRV and wiring adaptor for other air conditioners, etc., refer to the instruction manual attached.

NOTICE

Enter the group No. and installation place of the indoor unit into the attached installation table. Be sure to keep the installation table with the operation manual for maintenance.

18.1.7 Error Diagnosing Function

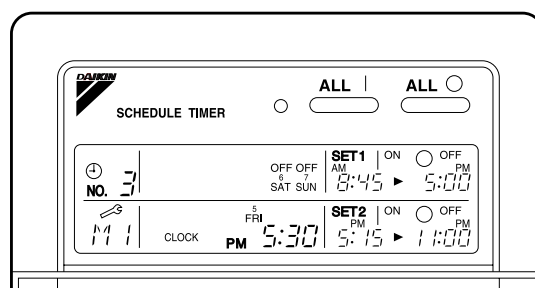

This schedule timer is provided with the malfunction diagnosing function. The malfunction code flashes if there occurs any malfunction in communication, etc. between and among the optional controllers for centralized control. In addition, the operation lamp also flashes if there occurs any malfunction in communication with the indoor unit. Check the contents of the display and contact your DAIKIN dealer because the signals give you the idea of the trouble area.

2

18.1 DST301BA61

Operation lamp	Malfunction code	Contents of malfunction
Turn off	M1	Failure of PC board of schedule timer. Fixes The following causes are possible. Check each one. 1. PC board problems
Turn on or off	M8	Malfunction of transmission between each optional controllers for centralized control. Fixes Check all central devices which are connected (e.g., power supply, transmission wiring, etc.).
Turn on or off	MA	Improper combination of optional controllers for centralized control. Fixes The following causes are possible. Check each one. 1. Are all central devices combined correctly? 2. Is the master central connector attached to two or more central devices? 3. Are there 128 or more indoor units connected?
Turn on or off	MC	Address failure of schedule timer. Fixes The following causes are possible. Check each one. 1. Do the control range addresses in the central remote controller overlap? 2. Do the control range addresses in the on/off controller overlap? 3. Are there 2 or more schedule timers connected?
Flash	UE	Malfunction of transmission between indoor unit and optional controllers for centralized control. Fixes Inspect all indoor units which are displaying an error (e.g., power supply, transmission wiring, etc.).
Flash	—	Malfunction in indoor unit (Refer to the malfunction codes of the indoor remote controller, while also read the "CAUTION FOR SERVICING" attached to the indoor unit.)

3P124623-5C

19. Residential Central Remote Controller

19.1 DCS303A51

19.1.1 Features

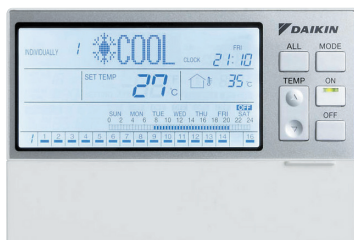

- Large, easy-to-read Liquid Crystal Display.
- Dot Matrix area shows which button to press next.
- Backlight equipped for easy operation.
- Each unit is identified for easier operation by individual group selection buttons.
- Frequently used functions are easily operated without opening the lid.

* Limit connection to the VRV system to household use.

19.1.2 Function

			Residential Central Remote Controller	Schedule Timer	Central Remote Controller
			DCS303A51	DST301BA61	DCS302CA61
Number of Management Groups			16	128	64
Monitoring	Command, State Monitoring	Start/Stop	○	△	○
		Operation Mode	○	×	○
		Set Temperature	○	×	○
		Inhibition / Permission by Remote Controller	○	×	○
		Room Temp. (Suction Temp.)	○	×	×
		Outside Temp.	○	×	×
		Malfunction Monitoring	○	△	○
		Air Filter, Element Monitoring	○	×	○
Setting and Control	Individual Control	Start/Stop	○	×	○
		Operation Mode	○	×	○
		Set Temperature	○	×	○
		Inhibition / Permission by Remote Controller	○	×	○
	All Start/Stop		○	○	○
	Schedule Control	Weekly schedule	○	○	×
	Emergency stop in case of fire		○	×	○

○ : OK

△ : There are some restrictions about each function.

× : NG

19.1.3 Specifications

Model		DCS303A51/61/61D
Power Supply		Externally supplied 200~240V AC, 50/60Hz
Installation Method		Japanese Industrial Standard triple plug socket switchbox embedded in indoor wall
Conditions for use	Ambient temperature/ Humidity	0- 40°C, less than 85% RH
Dimensions	Panel Size	180 mm (W) x 122 mm (H) x 20 mm (D)
Overseas Compatibility Certification	Safety	EN60335-2-40
	EMC(EMI, EMS)	EN50022 (CISPR22 Class-B) EN50024 (CISPR24)
LCD Panel	Size/Backlight color	120.4 mm (W) x 60.5 mm (H)/White light
Input	Buttons	6 buttons on the front panel and 24 buttons in the lid
Communication Line	DIII-NET	1 line of A/C equipment DIII-NET for communication use
Input terminals	Contact	Forced Shutdown input
Clock Accuracy		Within +/- 30 sec./month
Power consumption		Max. 3 W

19.1.4 Dimensions

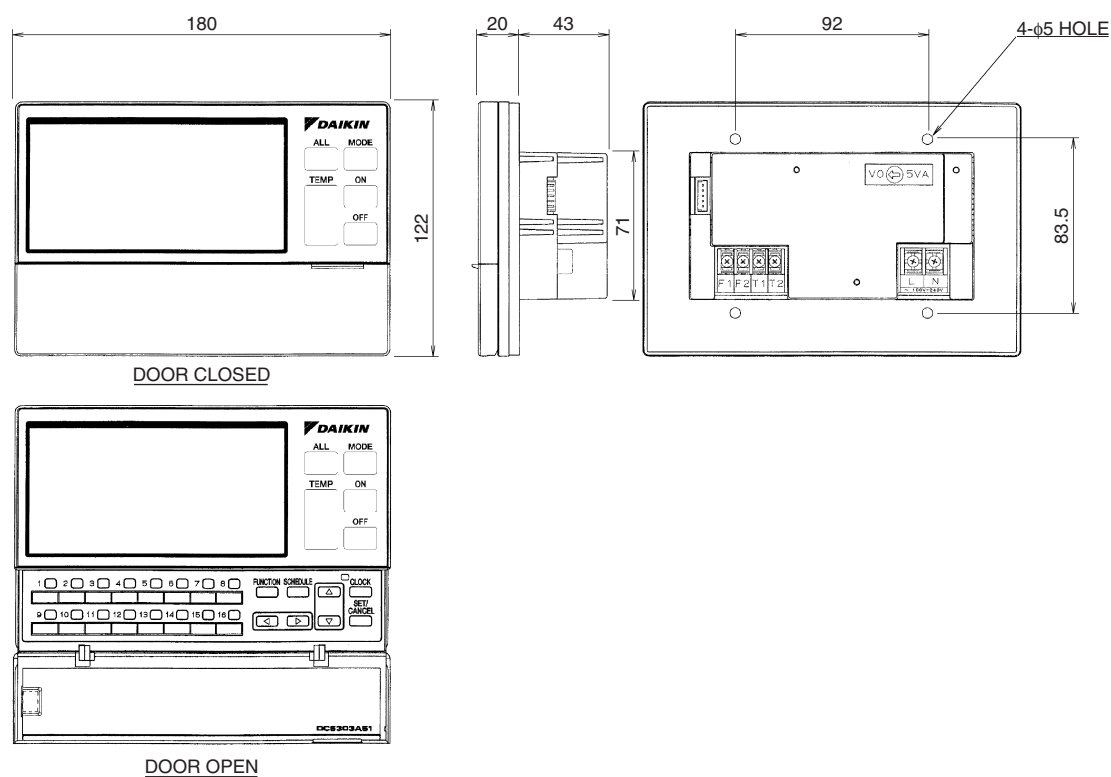

3D059845

19.1.5 System Overview

This central remote controller can monitor and control up to 16 “indoor unit groups”.
By using eight units of this central remote controller, maximum of 128 “indoor unit groups” can be monitored and controlled.

Main Functions

1. Simultaneous ON/OFF control of all indoor units connected to the central remote controller.
2. Setting of operating conditions (such as ON/OFF and set temperature) of indoor units individually by “group”.
3. Monitoring of operating conditions such as operation mode and set temperature.
4. Connection of an external key system, central monitoring panel, etc. via Forced OFF input (T1, T2).

■ When using one central remote controller unit

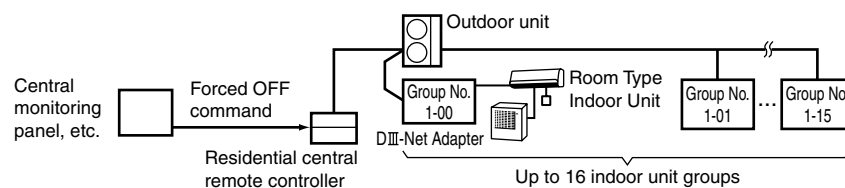

■ When using eight central remote controller units

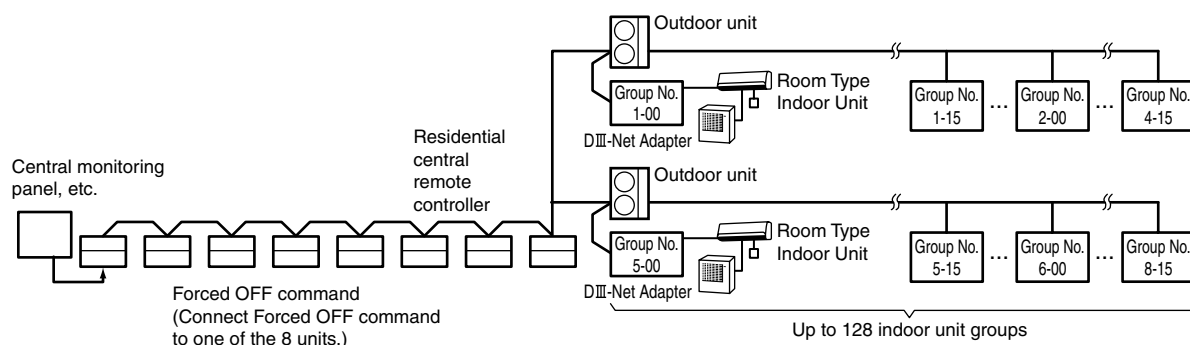

(The central remote controller cannot be used together with the optional remote control adaptor PCB or group remote control adaptor.)

* An “indoor unit group” refers to one of the following:

1. One indoor unit without remote controller

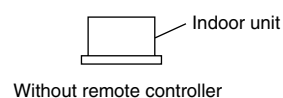

2. One indoor unit controlled by one or two remote controllers

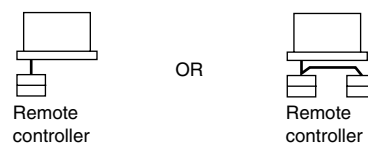

3. Up to 16 indoor units group-controlled by one or two remote controllers

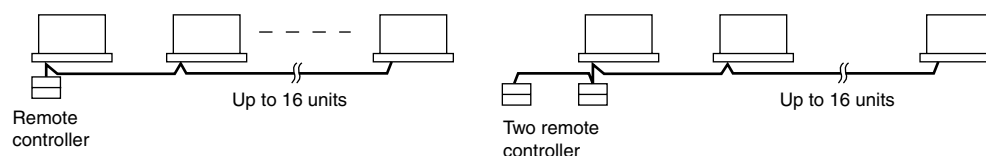

* “Group control” is a setting which enables simultaneous control of multiple indoor units from a single remote controller.

19.1.6 Names and Functions of the Operating Section

■ External View

(All indications are displayed in the following diagram of screen for the explanation purpose. Actual indications displayed during operation will vary.)

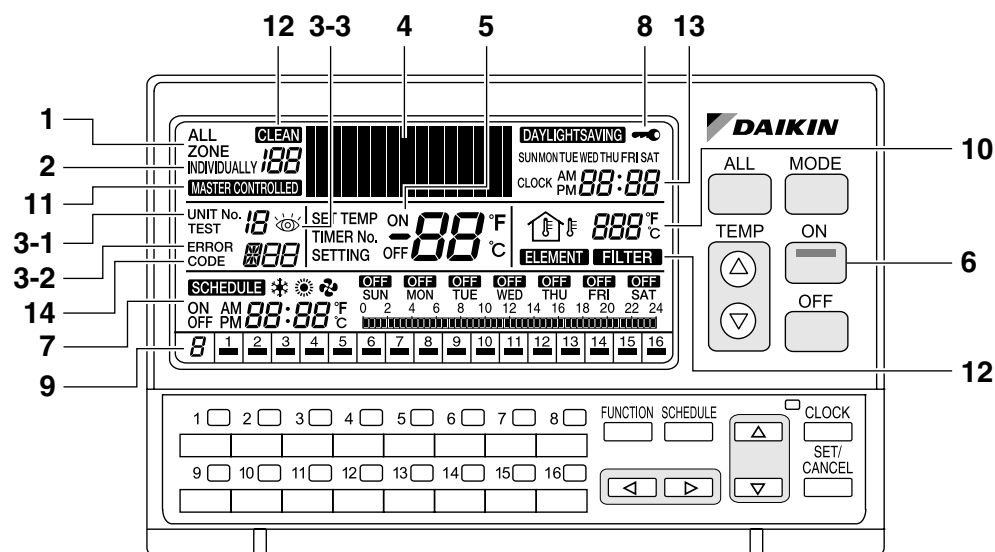

1	ALL This indicates that the display shows the ALL screen.
2	INDIVIDUALLY This indicates that the display shows the INDIVIDUALLY screen for the currently selected air conditioner No.
3	ERROR CODE DISPLAY When an equipment malfunction occurs, the malfunction UNIT No. (3-1), ERROR CODE (3-2) and (3-3) indications blink.
4	OPERATION MODE DISPLAY (Dot Matrix) This section displays the operation status.
5	SET TEMP DISPLAY This section displays the set temperature.
6	ON LAMP This lamp lights when one or more indoor units under control are operating.
7	SCHEDULE SETTING DISPLAY This section displays the programmed operation details.
8	KEY LOCK DISPLAY This symbol appears when the key lock has been activated.
9	OPERATION MONITOR Each box shows the No. of connected air conditioner (group) and its operation status.
10	OUTDOOR TEMP DISPLAY In the ALL screen, this displays the outside temperature detected by the outdoor unit connected to the air conditioner (group) with a cooling/heating selection privilege(*) that has the smallest unit No. In the INDIVIDUALLY screen, this displays the outside temperature detected by the outdoor unit connected to the selected air conditioner (group). If Total Heat Exchanger is selected, outdoor temperature is not displayed. (*An air conditioner (group) with a cooling/heating selection privilege is a unit which allows switching of the operation mode between cooling and heating.)
11	MASTER-CONTROLLED DISPLAY This indication appears when the selected air conditioner (group) does not have a cooling/heating selection privilege.
12	CLEAN SIGN The FILTER and ELEMENT indications appear when the filter and element need to be cleaned.
13	CLOCK DISPLAY This shows the current time.
14	OPERATION CODE DISPLAY This displays the operation code (prohibit remote controller, central control priority, last button priority, etc.) during the setting of operation details.

19.1.7 Names and Functions of the Operating Section

■ Names of Operation Buttons

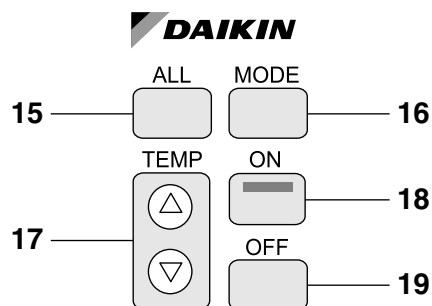

15	ALL BUTTON Changes the display to the ALL screen.
16	MODE BUTTON Used to select the operation mode.
17	TEMP BUTTONS Used to set the temperature.
18	ON BUTTON Turns on all indoor units or individual unit (group).
19	OFF BUTTON Stops all indoor units or individual unit (group).

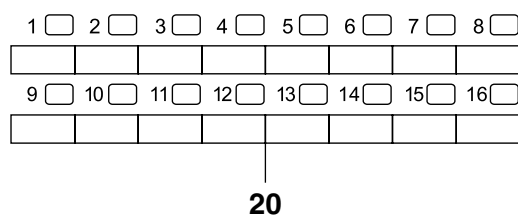

20	INDIVIDUAL UNIT (GROUP) SELECTION BUTTONS Changes the display to the INDIVIDUALLY screen for monitoring or setting the air conditioner (group) of the indicated No.
----	---

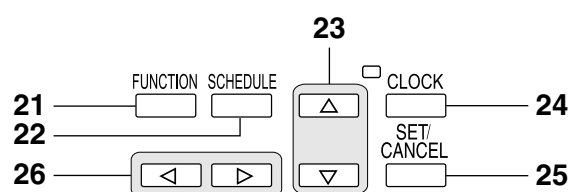

21	FUNCTION BUTTON Changes the display to the Function Menu setting screen.
22	SCHEDULE BUTTON Changes the display to the SCHEDULE setting screen.
23	△▽ BUTTONS Used to select a menu.
24	CLOCK BUTTON Changes the display to the current time setting screen.
25	SET/CANCEL BUTTON Enters or cancels settings.
26	◁▷ BUTTONS Used to set an operation schedule or current time.

19.1.8 Installation

■ Components

Check the following components are included in this optional accessory before installation.

Body

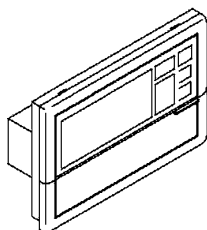

Installation screw (M4 × 16)	4 pcs.
Operation manual	1 pc.
Installation manual	1 pc.
Indoor label	1 pc.
Clamp	2 pcs.

When installing, 1 electric parts box is necessary.

■ System Configuration

With the central remote controller, unified operation/stop is possible with up to a maximum 16 groups of indoor units.

When using 8 central remote controllers, unified operation is possible with up to a maximum 128 groups of indoor units.

The remote controller can be set individually by group while it enables to display the operation state such as operation mode or set temperature. It can be connected with the external central monitoring panel, etc., through Forced OFF input (T1, T2).

■ When using 1 central remote controller

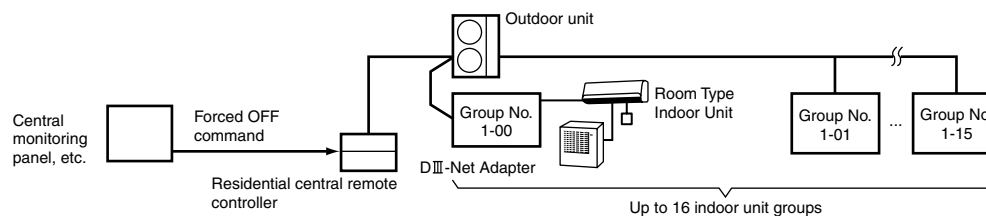

■ When using 8 central remote controllers

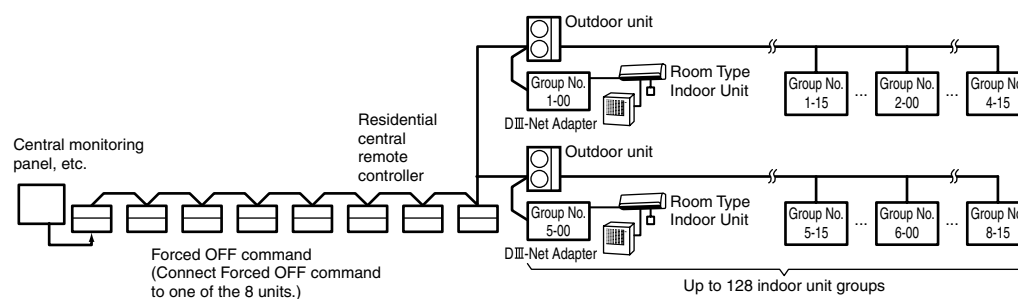

(The central remote controller and the separately sold remote control adapter or group remote control adapter cannot be used together.)

The combination of indoor units includes 3 modes specified here below:

- (1) One indoor unit, without remote controller



Without remote controller

- (2) One indoor unit controlled by 1 or 2 remote controllers

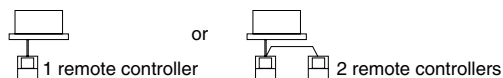

- (3) A maximum of 16 indoor units controlled by 1 or 2 remote controllers

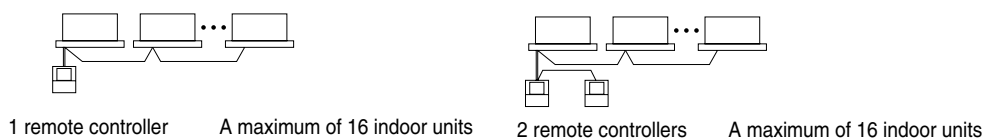

■ Installation

- (1) Open the upper part of remote controller.

Insert a ⊖ screwdriver (3 locations) into the recess between the upper part and the lower part of remote controller and twist the screwdriver lightly.

PC board is attached with both the upper and lower part of remote controller. Do not damage the board with the screwdriver.

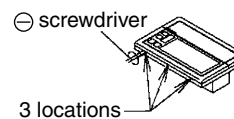

- (2) Open the upper part of remote controller and install the electric parts box (field supply) with the attached installation screws (M4 × 16).

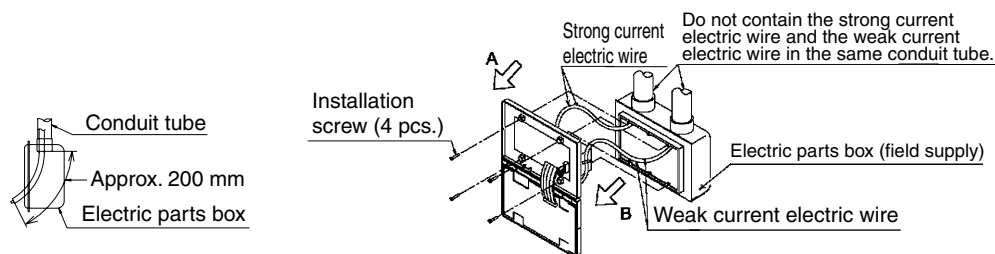

NOTE

Suitable length of the electric wire is about 200 mm (from electric parts box).

- (3) Please refer to A-direction view and B-direction view to configure and fix wires for strong current and weak current respectively.

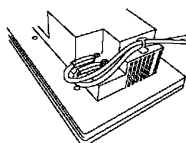

A direction view

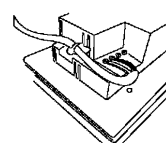

B direction view

■ Initial Setting

Settings (1) and (2) are initialized when power is turned ON, therefore complete settings BEFORE activating the power.

(1) Connector for setting master controller (X1A) (Provided with connector at factory set)

- When using only 1 central remote controller, do not disconnect the connector for setting master controller. (Use the unit with the connector in the state in which it was delivered.)
- When using multiple central remote controllers, make settings as indicated in the below table. It is not allowed to be used along with other centralized units.

	Connector for setting master controller (X1A)
1 to 16 units	Set 1 to "Used" and all the rest to "Not used".

(2) MAIN/SUB changeover switch setting

With 2 central remote controllers, centralized control (indoor units) is possible from different locations. In this kind of set-up, it is necessary to set the MAIN/SUB changeover switch.

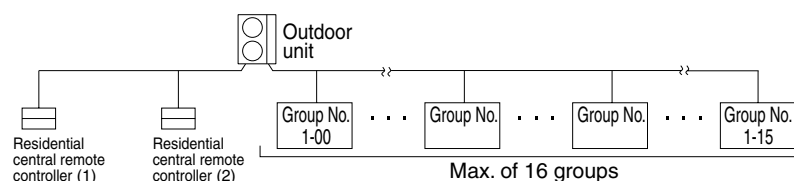

One of the 2 central remote controllers (1) to (2) is set to "MAIN" while the other is set to "SUB".

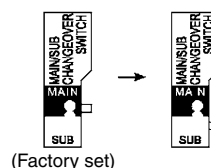

NOTE

- When using 1 central remote controller, it is necessary to set to "MAIN".
- Be sure to set before turning the power ON.

(3) Setting of the sequential operation function

The central remote controller is equipped with a sequential operation function that sequentially turns indoor units on in about 2-second intervals during unified operation. (Sequential operation is factory set to "ON".)

To switch sequential operation ON or OFF, set as follows:

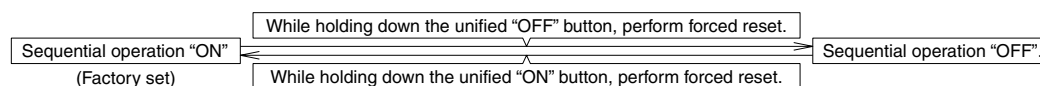

NOTE

The sequential operation function is designed to reduce the load on the power supply equipment, but does not guarantee that compressors will not be started simultaneously.

You cannot therefore count on a capacity reduction effect by power supply equipment breaker selection.

(4) Forced reset switch

When changing the setting of the connector for setting master controller, you can reset simply by setting it to the reset side and returning to the normal side, without turning the power OFF.

(For normal operation, set the switch to the normal side.)

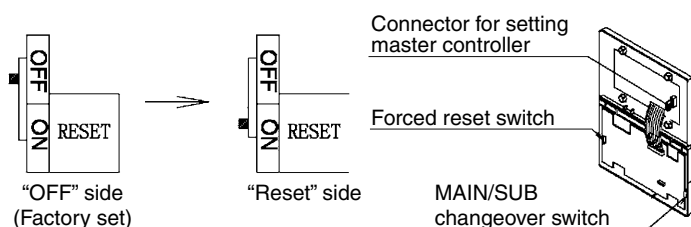

■ Electric Wiring

WIRING OUTLINE

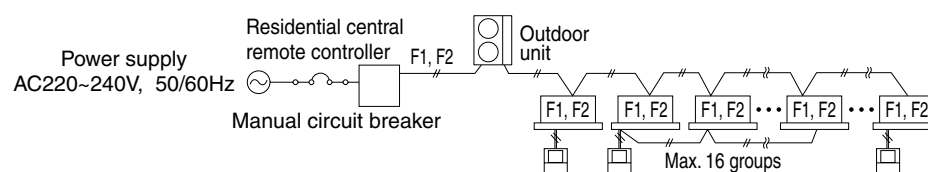

WIRING TO THE INDOOR UNIT AND OUTDOOR UNIT

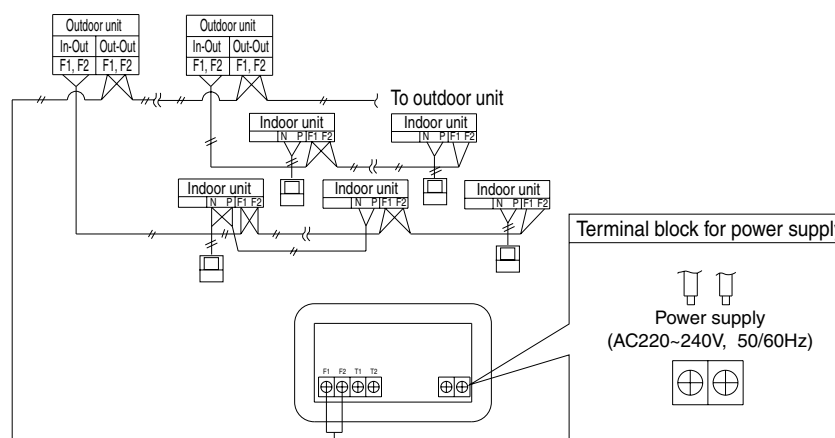

Wiring specifications

Power supply wiring	2mm ²
Transmission wiring for control	0.75 - 1.25 mm ² sheathed vinyl cord or cable (balanced type) - maximum length 1000 m (total overall wiring length 2000 m)
Manual circuit breaker	15 A or 10 A

Check the wiring of the indoor units to the outdoor units and between all power, indoor units, and remote controllers. See the installation manual included with the indoor and outdoor units for details.

CONTROL TERMINAL BLOCK

*1 For connecting indoor unit (F1, F2)

*2 Forced OFF input (T1, T2)

When the Forced OFF input (T1, T2) is "ON", all indoor units connected will stop running. Use only contactors which guarantee the minimum applicable load DC16 V, 10 mA.

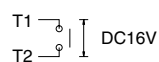

NOTE

Use instantaneous contactor of over 200 m sec energizing time, when necessary.

Wire Forced OFF input only when necessary.

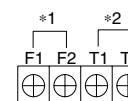

NOTE

Do not connect the power supply wiring (AC220 V, 50 Hz) to the control terminal block. If connected by mistake, it may damage or burn electrical parts of central remote controller and indoor unit. It may result in serious damage. Be sure to check wirings before turning the power ON.

■ Setting Language and Group No. for Centralized Control (When the Power Supply is Turned On)

The initial language for the central remote controller is "ENGLISH".

The initial value of centralized the group No. for the central remote controller is "1".

(the controlling scope of centralized Group No.: 1-00~1-15)

Please set in accordance with the items specified here below while switching the initial language and initial values of the centralized group No. from "1".

(1) Turn ON the power of the indoor unit and central remote controller. (Unless the power is ON, no setting can be made.)

* Check that the installation and electrical wiring are correct before turning the power supply ON again.

(2) When the power supply is turned ON, all LCD will be displayed once, and switch to language setting mode.

Select language with < or > button and set language with "SET/CANCEL" button.

(↔ ENGLISH ↔ FRENCH ↔ GERMAN ↔ ITALIAN ↔ SPANISH ↔ PORTUGUESE ↔)

After "SET CANCEL" button is pressed, "88" will appear in about 1 minute.

(3) When the "88" appears, hold down the "MODE" button and the single air conditioner selecting button "16" for a minimum of 4 seconds.

(4) When the "88" disappears, switch to Centralized Group No. Setting mode.

The centralized group No. setting appears, and the display of centralized group No. at the left below switches from light-on to light-off.

(5) Select the centralized group No. through buttons "1" to "8" of single air conditioner, and the selected No. will be displayed at left below (refer to Table 1).

The operation will be null in the case the buttons "9" to "16" are hold downed, and the centralized group No. displayed on the left of operation monitoring side will not be changed.

(6) Press the "OFF" button to determine the group No.

The display of the group No. at the left below will be switched from flash to light. After the set operation is completed, the "88" will appear on the central part.

* Please make sure that the "OFF" button has been hold downed. If the set of Group is uncertain, it will not be ended.

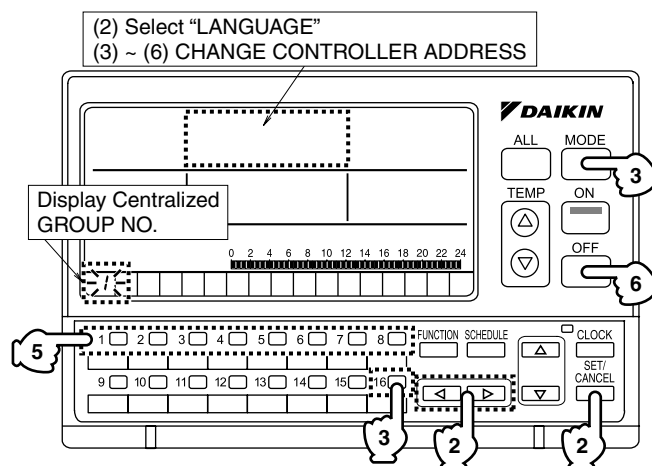

Table 1

Group No. for centralized control	Control range
1	1-00~1-15
2	2-00~2-15
3	3-00~3-15
4	4-00~4-15
5	5-00~5-15
6	6-00~6-15
7	7-00~7-15
8	8-00~8-15

■ Setting the Group No.

Set the group No. of indoor units by remote controller. (In the case that the remote control is absent, the group No. shall also be set by connecting to a remote controller, which shall be removed after the set operation.)

- (1) Turn ON the power of the indoor unit and central remote controller.
(Unless the power is ON, no setting can be made.)
Check that the installation and electrical wiring are correct before turning the power supply ON again.
(When the power supply is turned ON, all LCD appear once. Then, the unit may not accept the operation for about 1 minute with the display of "88".)
- (2) Enter into set mode
Hold down the "TEST" button for a minimum of 4 seconds and the remote controller will enter into Field set mode.
- (3) Select mode No.
Press "MODE NO." up and down button to select mode No. "00".
- (4) Select the group No.
Press "GROUP NO." up and down button to select the group No.
(Group No. increase in the order of 1-00, 1-01, ... 1-15, 2-00, ... 8-15.)
Please refer to Table 2 for the relation between the centralized group No. of remote controller and central remote controller.
- (5) Setting the group No.
Press the "FIELD SET MODE" button to select the group No. for each group.
- (6) Return to normal mode.
Press "TEST" button.

NOTES

- For simplified remote controller, see the installation table.
- See the manuals which came with the all heat exchangers and each adapter (i.e., multi-purpose adapters) for details on their Group No. settings.

NOTICE

Enter the group No. and installation place of the indoor unit into the installation table in the operation manual. Be sure to store the installation manual along with the operation manual for maintenance.

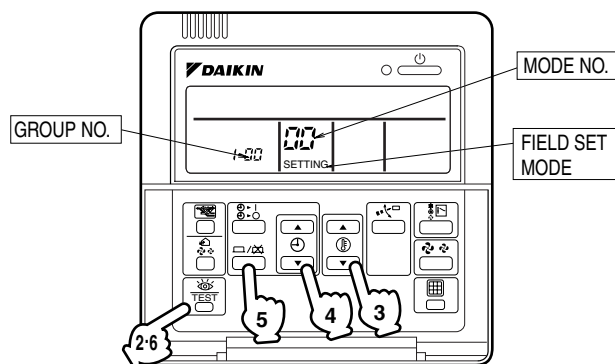

Table 2 Cross Reference List for Centralized Group No. of Remote Controller and Central Remote Controller

Display of the remote controller of air conditioner	Display of the centralized Group No. of central remote controller	Display of the remote controller of air conditioner	Display of the centralized Group No. of central remote controller
1-00	1	1-08	9
1-01	2	1-09	10
1-02	3	1-10	11
1-03	4	1-11	12
1-04	5	1-12	13
1-05	6	1-13	14
1-06	7	1-14	15
1-07	8	1-15	16

*In the case that the Group No. is "2" to "8", please replace the part "1-" of Table 2.

■ Test Operation

Before starting test operation, check that the power is supplied to the indoor and outdoor units, and central remote controller.

Press "ON" button on the remote controller within 10 seconds after entering into the test operation mode.

Operate the unit for 30 minutes.

Press "OFF" button to stop operating. If the operation lamp flashes, it indicates a malfunction.

Call the group of flashing display, confirm malfunction code, and check the source of malfunction.

(The operation manual lists all error codes, so refer to it.)

NOTICE

- For test operation, refer to the installation manual of the outdoor unit.
- After turning the power supply ON, if the unit does not accept operation for 2 minutes or more with the display of "88", check the following points.
 - Check that setting of the connector for setting master controller is correct.
 - Check that the group No. for centralized control has been set.

2P219071-1A