

Global server management solutions with KVM access over IP from anywhere around the world



**CyberView**<sup>™</sup>  
dedicated KVM switch and  
rackmount screen technology



### Austin Hughes

Founded in 1995, we are dynamic rapidly expanding, design and manufacturing company that offers various electro mechanical technologies and solutions. Our portfolio includes data centre server rack enclosures, SmartCard locking and monitoring solutions, rack mount LCD keyboard drawers, a complete range of KVM switch and serial console solutions, a wide range of industrial LCD display solutions and from early 2009 a range of intelligent metered and monitored power solutions. During early 2009, we are relocating into our new purpose built 30,000 square metre factory facilities, large scale investment in this facility is providing an increase in our in house processes and plant flexibility as well as a large upscale in our available manufacturing capacity.



### Regulatory Approvals for Quality Solutions

In 2007, the UL (US) and CCC (China) authorities audited and approved our China based manufacturing facilities to produce UL and CCC certified solutions.



### ISO 9001 Quality Approvals & Manufacturing Efficiency

Total customer satisfaction and quality management are of utmost importance to Austin Hughes. In 2001 we formerly announced the achievement of BS EN ISO 9001 for our electronics and metal enclosure manufacturing facilities in China. All our manufacturing processes are conducted in accordance with ISO 9001 ensuring maximum operating efficiency for our manufacturing and assembly facilities.



### ISO 14001 Environmentally Friendly Manufacturing

Austin Hughes is committed to manufacturing plants and processes that reduce energy consumption and the use of hazardous materials throughout the entire manufacturing / product life cycle. Since 2001 from our design processed through material sourcing, manufacturing, dispatch, usage and disposal we adhere to our ISO 14001 quality achievement.



### PFOS / RoHS Compliance

Due to environmental protection and health concerns, PFOS and RoHS compliance are now two major factors for global organisations potentially procuring or supplying solutions worldwide, Austin Hughes achieves stringent PFOS and RoHS standards and guarantees its manufacturing processes and solutions are 100% lead free.



### Leading Edge Design & Product Development

With a wealth of experience over many years in the electro mechanical industries, Austin Hughes design and development teams are focussed to rapidly transform customer requirements and market trends into saleable solutions. We have proven over many years that these services keep us well ahead of our competition and most important keep our customers ahead of their competition.



### OEM / ODM

Austin Hughes offers OEM / ODM services to meet the specific requirements of each customer's applications. In line with our sophisticated design and manufacturing facilities, we offer a 30 day prototyping service enabling our customers to be first to market with flexible up to date market driven solutions.



### Customer Service Commitment

Our expertly trained sales and technical staff are committed to respond immediately, orders are processed on receipt and delivery schedules are kept to a minimum. We have experienced export teams based in country in China, Hong Kong, the United States of America and Europe providing a truly global support structure.



### Global Distribution and Support Network

As well as our own global locations in the United States of America, the United Kingdom, China, Hong Kong, the United Arab Emirates and South Africa, to meet the needs of our customers daily procurement demands, we have built a world class network of authorised distributors who provide excellent support and service throughout the USA, Europe, the Middle East and Asia.



## **New** Product Highlights - 1U 20" LCD Keyboard Drawer

Further advancing the design boundaries for 1U rack mount LCD keyboard drawer solutions, Austin Hughes launches its new 20" LCD keyboard drawer with optional integrated KVM switch - the "L" series.

The "L" series offers its users and the largest available 4:3 ratio 20"  grade A industrial TFT LCD panel providing an ultra high resolution of 1600 x 1200. To compliment the "L" series, the "LS" series rack mount LCD keyboard drawer solution has been specifically designed to provide direct compatibility with SUN servers - the default LCD resolution is 1152 x 900 and the keyboard incorporates full SUN function keys as standard.

### **L-120 series**

1U 20" LCD keyboard drawer



- **The largest LCD**
- **20" LCD High**
- **Full range Cat6**
- **SUN server**
- **Modular design**

#### ① LCD module kit

-  20" Grade A LCD panel, ultra high resolution 1600 x 1200
- "LS" series provides direct support for SUN native 1152 x 900 resolution
- BNC + S-Video, DVI-D, DC power and audio options
- Enhanced aesthetics with new moulded front panel and two point lock

#### ② KVM interchangeable module kit

- All KVM models are interchangeable in the same chassis
- Multi-user Matrix Cat6 KVM with either 16 or 32 ports in 1U of rack space
- Cost efficient Combo KVM integration with either 8, 16 or 32 ports in 1U of rack space
- Mix PS/2, USB and SUN with multi-platform switch capability

## Introducing the New **CyberView™** 1U 20" LCD keyboard drawer - " L " series

Whether used on a day to day basis, for installation, maintenance or for disaster recovery, Austin Hughes solutions are designed to provide maximum life cycle, functionality and flexibility to the user whilst using the minimum amount of critical rack space and power requirement within the equipment closet. All our solutions are designed using a modular construction with interchangeable LCD panels, keyboards and KVM switches and are fully supported in country by local service and warranty programs with extended warranty programs available on request.

**LS-120 series**  **SOLARIS®**  
SUN-compatible 1U 20" LCD keyboard drawer

**in 1U KB drawer  
resolution 1600 x 1200  
& DB-15 KVM integration  
compatible**



- ③ Keyboard interchangeable module kit
- Combo interface either PS/2 or USB input to the LCD drawer / keyboard
  - Multiple keyboard language selections with touchpad
  - 104 key notepad keyboard with full numerical pad

## **New** Product Highlights - 19" widescreen LCD in 1U KB Drawer

Further advancing the design boundaries for 1U rack mount LCD keyboard drawer solutions, Austin Hughes launches its new 19" Widescreen LCD keyboard drawer with optional integrated KVM switch - the "W" series.

The "W" series offers its users Widescreen technology using only  grade A industrial panels, we have introduced enhanced aesthetics to the "W" units with our new molded front panel and two point locking system, as you would expect our "W" series offers a full range of integrated KVM solutions up to 32 ports of Matrix Cat6 KVM.

### **W-119 series**

1U 19" widescreen LCD keyboard drawer



- **The widest LCD**
- **19" widescreen**
- **Full range Cat6**
- **SUN server**
- **Modular design**

#### ① LCD module kit

-  Wide 19" Grade A LCD panel, ultra high resolution 1440 x 900
- "WS" series provides direct support for SUN native 1152 x 900 resolution
- BNC + S-Video, DVI-D, DC power and audio options
- Enhanced aesthetics with new moulded front panel and two point lock

#### ② KVM interchangeable module kit

- All KVM models are interchangeable in the same chassis
- Multi-user Matrix Cat6 KVM with either 16 or 32 ports in 1U of rack space
- Cost efficient Combo KVM integration with either 8, 16 or 32 ports in 1U of rack space
- Mix PS/2, USB and SUN with multi-platform switch capability

## Introducing the New **CyberView™** 1U 19" widescreen LCD keyboard drawer - **" W " series**

The **" WS "** series rack mount LCD keyboard drawer solution has been specifically designed to provide direct compatibility with SUN servers - the default LCD resolution is 1152 x 900 and the keyboard incorporates full SUN function keys including Stop, Cut, Paste, Compose, Copy and Help as standard. The "WS" series is available with our cost efficient DB-15 Combo KVM or our high density multi user Matrix Cat6 KVM with either 16 or 32 ports in 1U.

**WS-119 series**  **SOLARIS®**

SUN-compatible 1U 19" widescreen LCD KB drawer

**in 1U KB drawer**  
**LCD High resolution 1440 x 900**  
**& DB-15 KVM integration**  
**compatible**



- ③ Keyboard interchangeable module kit
  - Combo interface either PS/2 or USB input to the LCD drawer / keyboard
  - Multiple keyboard language selections with either touchpad or trackball
  - 104 key notepad keyboard with full numerical pad
  
- ④ Mouse module kit
  - 3 button Glidepoint™ touchpad or trackball interchangeable in same chassis
  - Combo interface either PS/2 or USB input to the LCD drawer / keyboard

## **New** Product Highlights - 1U Dual Slide LCD KB Drawer



Further advancing the design boundaries for 1U Dual Slide rack mount LCD keyboard drawer solutions, Austin Hughes launches its new 17" and 19" Dual Slide LCD keyboard drawer with optional integrated KVM switch - the "D" series.

The "D" series offers its users Dual Slide technology allowing the LCD to be left up / open when the rack door is closed, we have introduced enhanced aesthetics to the "D" units with our new molded front panel and two point locking system, as you would expect our "D" series offers a full range of integrated KVM solutions up to 32 ports of Matrix Cat6 KVM.

### **D-117 / D-119 series**

1U 17", 19" dual slide LCD keyboard drawer



- **Dual slide LCD**
- **17", 19" LCD**
- **Full range Cat6**
- **SUN server**
- **Modular design**

#### ① LCD interchangeable module kit

- 17" and 19" LCD panel interchangeable in same chassis
- **SAMSUNG** Grade A LCD panel
- "DS" series provides direct support for SUN native 1152 x 900 resolution
- BNC + S-Video, DVI-D, DC power and audio options
- Enhanced aesthetics with new moulded front panel and two point lock

#### ② KVM interchangeable module kit

- All KVM models are interchangeable in the same chassis
- Multi-user Matrix Cat6 KVM with either 16 or 32 ports in 1U of rack space
- Cost efficient Combo KVM integration with either 8, 16 or 32 ports in 1U of rack space
- Mix PS/2, USB and SUN with multi-platform switch capability



## Introducing the New **CyberView™** 1U dual slide LCD keyboard drawer - " **D** " series

The " **DS** " series Dual Slide rack mount LCD keyboard drawer solution has been specifically designed to provide direct compatibility with SUN servers - the default LCD resolution is 1152 x 900 and the keyboard incorporates full SUN function keys including Stop, Cut, Paste, Compose, Copy and Help as standard. The "DS" series is available with our cost efficient DB-15 Combo KVM or our high density multi user Matrix Cat6 KVM with either 16 or 32 ports in 1U.

### **DS-117 / 119 series**



SUN-compatible 1U dual slide LCD KB drawer

**in 1U KB drawer  
resolution 1280 x 1024  
& DB-15 KVM integration  
compatible**



- ③ Keyboard interchangeable module kit
  - Combo interface either PS/2 or USB input to the LCD drawer / keyboard
  - Multiple keyboard language selections with touchpad
  - 104 key notepad keyboard with full numerical pad
  
- ④ Mouse module kit
  - 3 button Glidepoint™ touchpad interchangeable in same chassis
  - Combo interface either PS/2 or USB input to the LCD drawer / keyboard

**New**

## Product Highlights - RKP Series Enhanced Version

Further advancing the design boundaries for cost efficient 1U rack mount LCD keyboard drawer solutions, Austin Hughes launches its enhanced 17" and 19" LCD keyboard drawer with optional integrated KVM switch - the " **RKP** " series.

The enhanced "RKP" series offers its users increased functionality with a full keyboard and numerical pad with centralised mouse and either touchpad or trackball as standard, new enhanced aesthetics with our moulded front panel and two point locking system, one-man installation slides, and as you would expect our "RKP" series offers a full range of integrated KVM solutions up to 32 ports of Matrix Cat6 KVM.

### RKP-117 / 119 series

1U 17", 19" LCD keyboard drawer



- **104 key notepad**
- **One man installation**
- **New moulded front**
- **SAMSUNG 17", 19"**
- **Full range Cat6 &**
- **SUN server**
- **Modular design**

#### ① LCD module kit

- **SAMSUNG** 17", 19" Grade A LCD panel, resolution 1280 x 1024
- "S" series provides direct support for SUN native 1152 x 900 resolution
- BNC + S-Video, DVI-D, DC power, audio and touchscreen options
- Enhanced aesthetics with new moulded front panel and two point lock

#### ② KVM interchangeable module kit

- All KVM models are interchangeable in the same chassis
- Multi-user Matrix Cat6 KVM with either 16 or 32 ports in 1U of rack space
- Cost efficient Combo KVM integration with either 8, 16 or 32 ports in 1U of rack space
- Mix PS/2, USB and SUN with multi-platform switch capability

## Introducing the **CyberView™** LCD keyboard drawer - " **RKP** " series

**RKP-117 / RKP-119 series** 1U 17", 19" LCD keyboard drawer

**S-117 / S-119 series**  **SOLARIS®** SUN-compatible 1U LCD keyboard drawer

The " **S** " series rack mount LCD keyboard drawer solution has been specifically designed to provide direct compatibility with SUN servers - the default LCD resolution is 1152 x 900 and the keyboard incorporates full SUN function keys including Stop, Cut, Paste, Compose, Copy and Help as standard. The "S" series is available with our cost efficient DB-15 Combo KVM or our high density multi user Matrix Cat6 KVM with either 16 or 32 ports in 1U.

**S-117 / 119 series**  **SOLARIS®**  
SUN-compatible 1U 17", 19" LCD KB drawer

*keyboard with full numerical pad  
slides included  
panel & two point lock  
grade A LCD panel  
DB-15 KVM integration  
compatible*

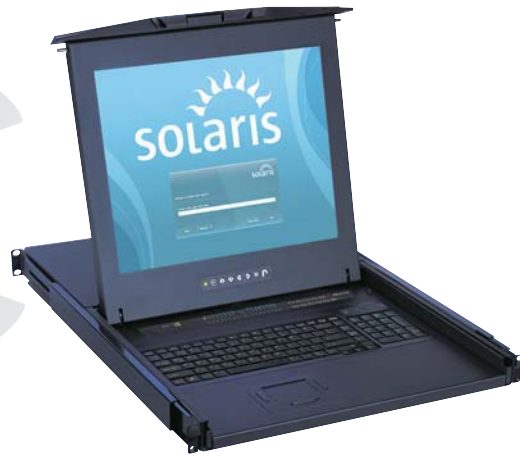

### ③ Keyboard interchangeable module kit

- Combo interface either PS/2 or USB input to the LCD drawer / keyboard
- Multiple keyboard language selections with either touchpad or trackball
- 104 key notepad keyboard with full numerical pad

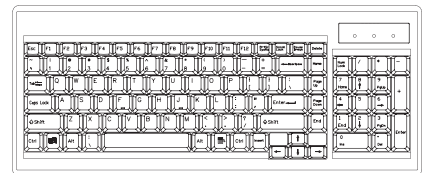

### ④ Mouse module kit

- 3 button Glidepoint™ touchpad or trackball interchangeable in same chassis
- Combo interface either PS/2 or USB input to the LCD drawer / keyboard



or



New

## Product Highlights - Matrix Cat6 KVM



Introducing the latest editions to the CyberView™ range - the MU-IP and MU series



The Matrix Cat6 KVM switch provides multi-users (maximum 4) local access, remote access up to 1000 feet away via Cat6 cable, and IP-based remote access to control the servers from anywhere in the world over the internet.

A scalable solution is provided not only for the VGA-USB and VGA-PS/2 interface, but also DVI-USB interface at the server end of the installation up to 40 meters away. This allows the user to specify the switch and match the exact server configuration on a cost effectiveness basis.

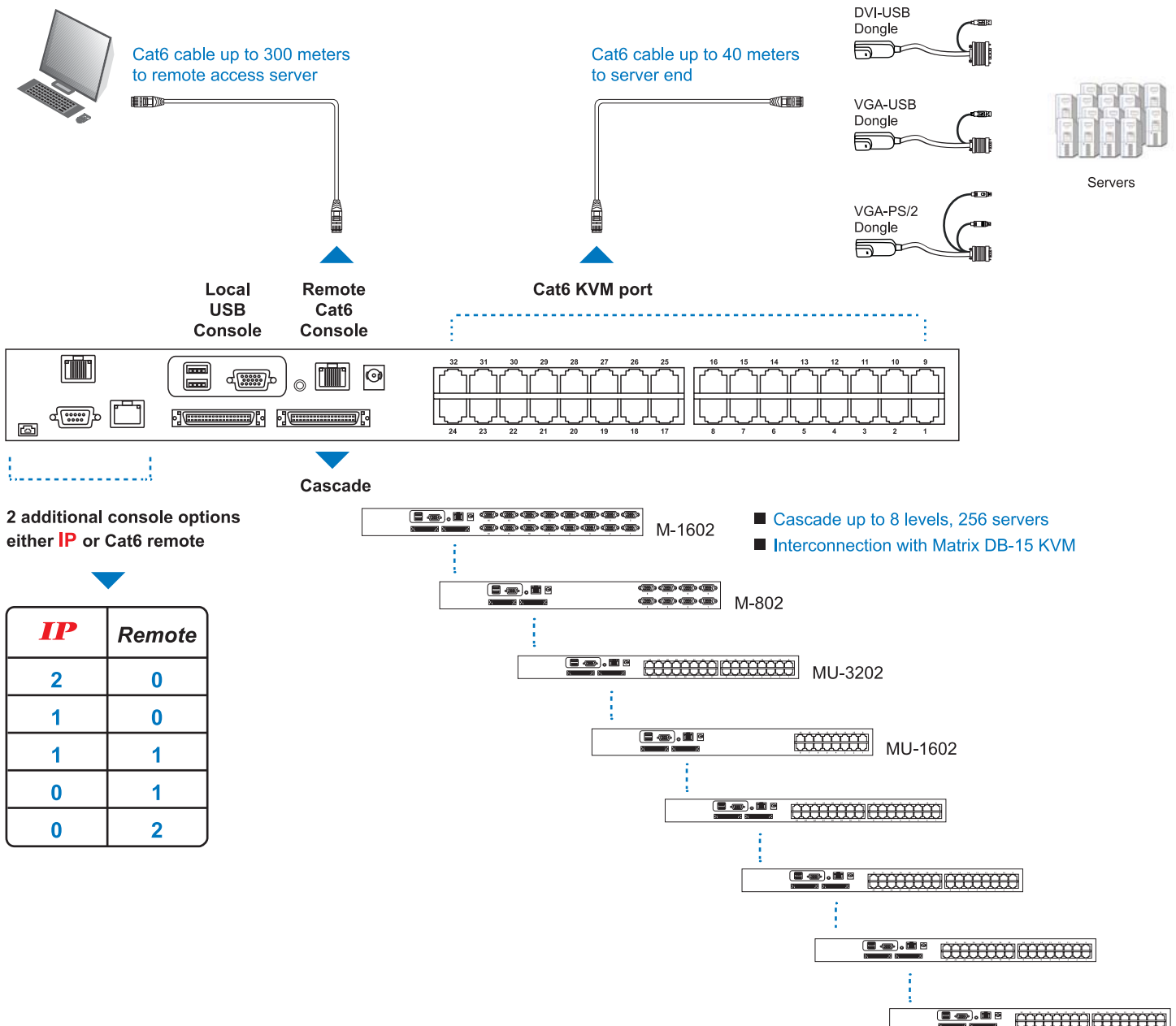

## New Product Highlights - Matrix DB-15 KVM KVM

Introducing the latest editions to the CyberView™ range - the M-IP and M series



The Matrix DB-15 KVM switch provides multi-users (maximum 4) for local access, remote access up to 1000 feet away via Cat6 cable, and IP-based remote access allows the user to control the servers from anywhere in the world over the internet.

The new design Combo (USB-PS/2) KVM support both USB or PS/2 interface server with a single cable in 6, 10 or 15 feet which allows a user to specify the switch and match the exact server configuration on a cost effectiveness basis.

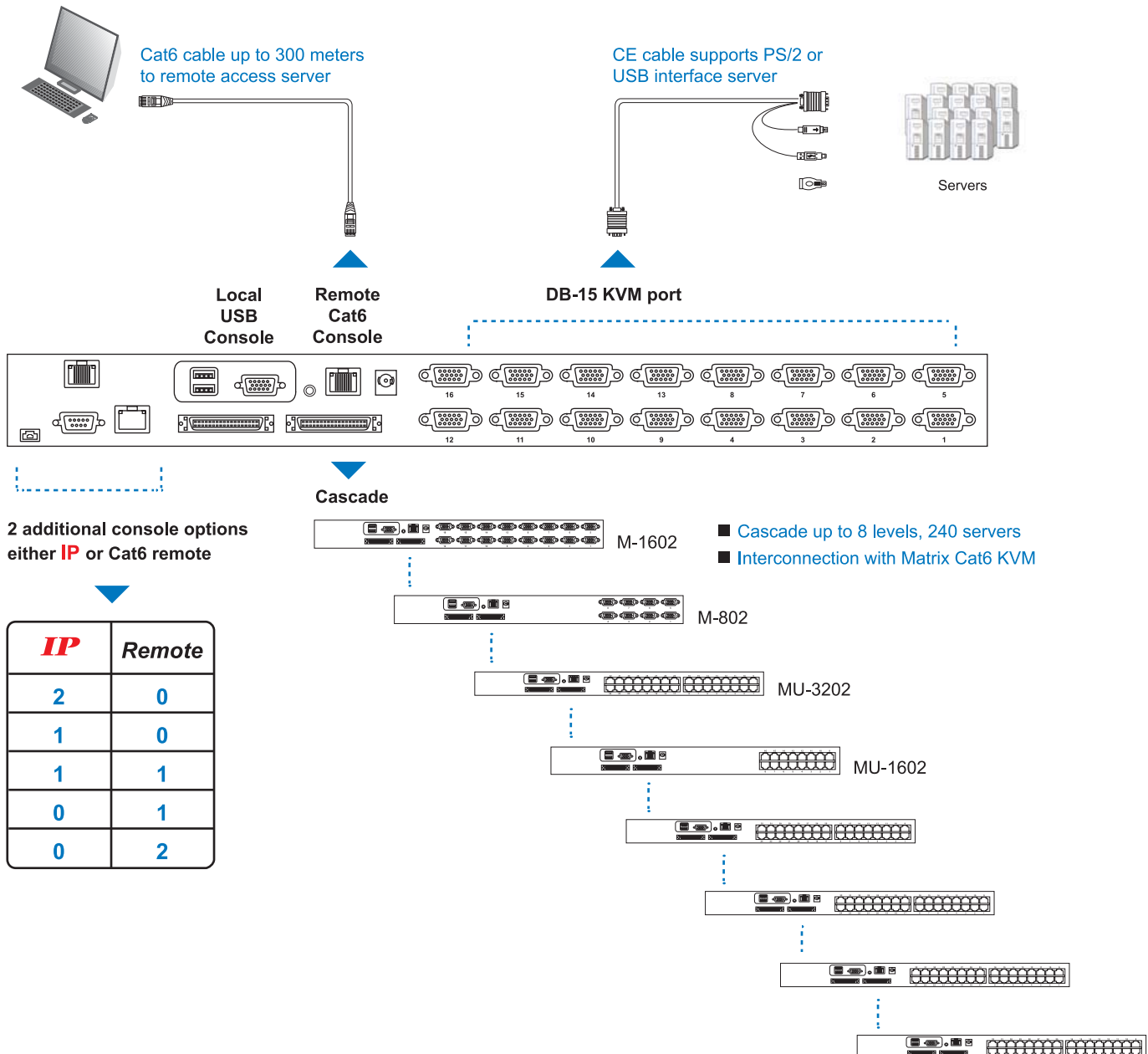

**New**

## Product Highlights - **Combo Cat6** **KVM**

Introducing the latest editions to the **CyberView™** range - the **U** series



Capable of connecting 32, 16, 8 servers per device, the new U series Cat6 KVM switch support multi-platform servers and multi-operating system. It also provides a scalable solution not only for the VGA-USB and VGA-PS/2 interface, but also DVI-USB interface at the server end of the installation up to 40 meters away. This allows the user to specify the switch and match the exact server configuration on a cost effectiveness basis.

The new U series Cat6 KVM switch provides an extra console for - either remote access up to 1000 feet away via Cat6 cable, or IP-based remote access which allows the user to control the servers from anywhere in the world over the internet.

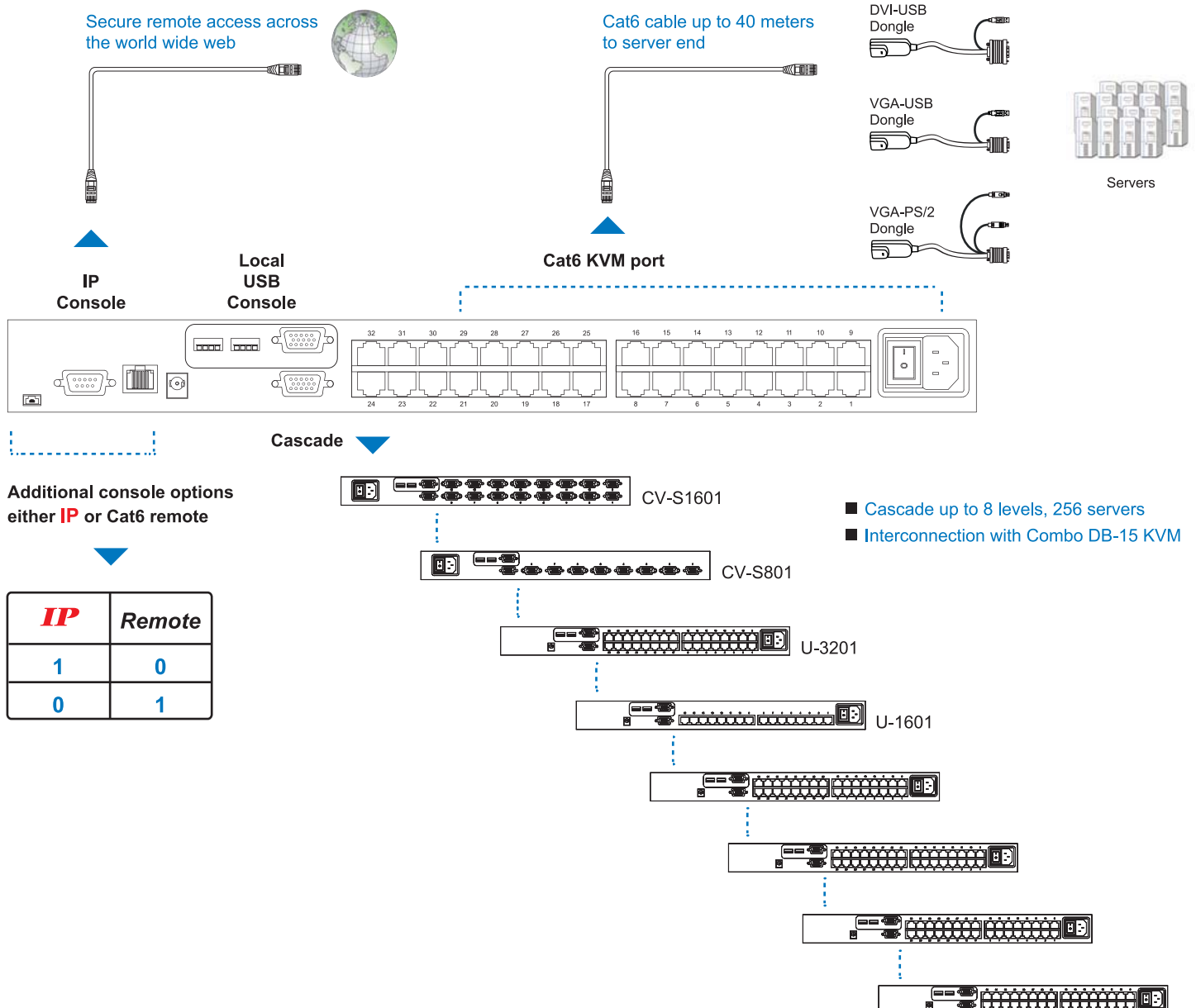

## New Product Highlights - Combo DB-15 KVM

Introducing the latest editions to the CyberView™ range - the CV series



Capable of connecting 16 or 8 servers per device, the new CV series Combo DB-15 KVM supports multi-platform servers and multi-operating system. It also provides an extra console for - either remote access up to 1000 feet away via Cat6 cable, or IP-based remote access which allows the user to control the servers from anywhere in the world over the internet.

The newly designed Combo (USB-PS/2) KVM supports both USB or PS/2 interface server with a single cable in 6, 10 & 15 feet which allows a user to specify the switch and match the exact server configuration on a cost effectiveness basis.

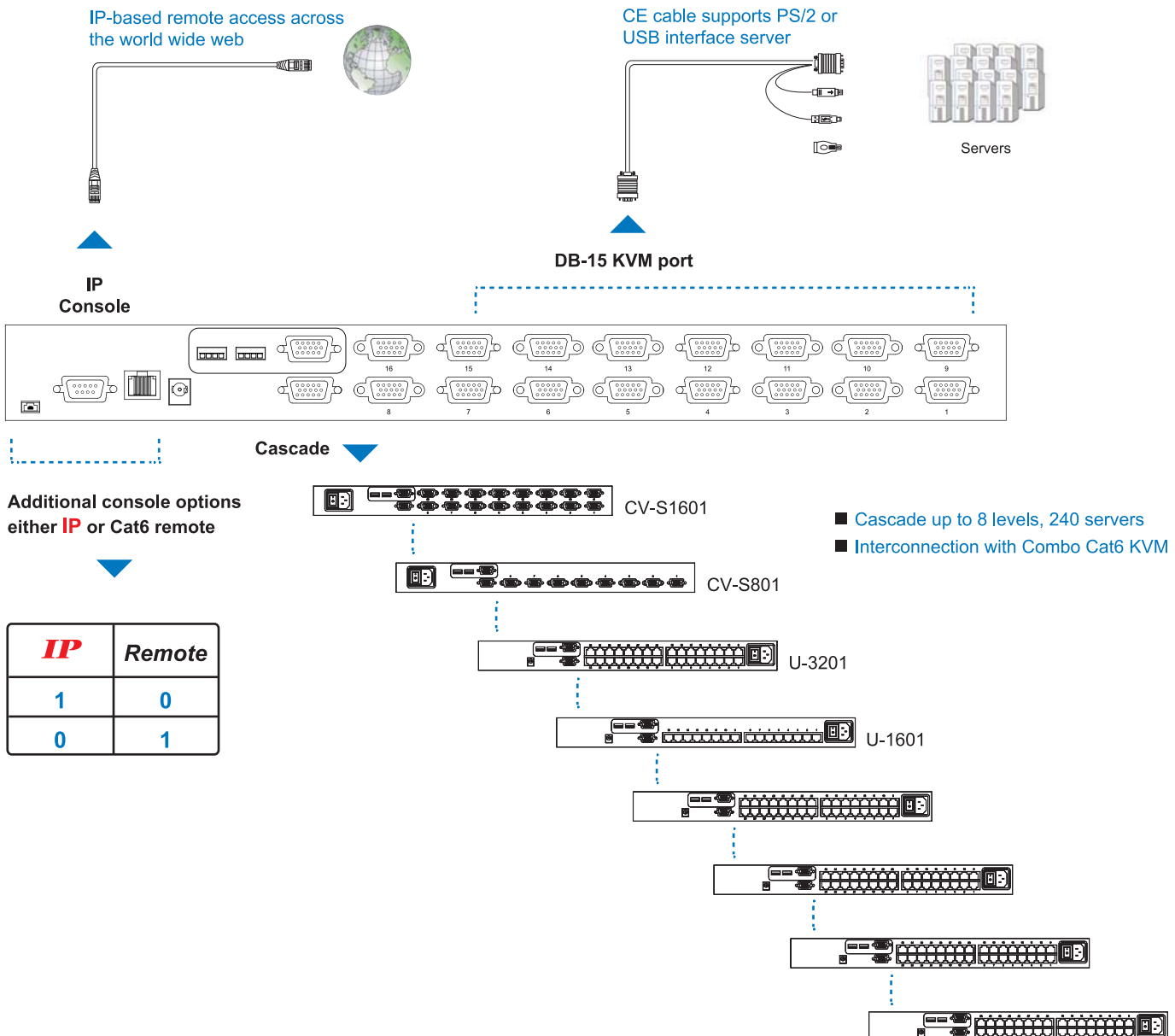

## New Product Highlights - Widescreen LCD Display

Austin Hughes has many years of electro mechanical design experience in industrial LCD display solutions, now we are advancing design boundaries to offer LCD widescreen technology using only **SAMSUNG** grade A industrial panels that support a greater range of applications on our hardware solutions listed below:

### 19" Widescreen



#### **SAMSUNG** Grade A industrial TFT LCD Panel

Native resolution : 1440 x 900

Viewing angle ( H x V ) : 160 / 160

Brightness : 300 cd/m2

Contrast ratio : 1000 : 1

Display colour : 16.7M

### 22" Widescreen



#### **SAMSUNG** Grade A industrial TFT LCD Panel

Native resolution : 1680 x 1050

Viewing angle ( H x V ) : 170 / 160

Brightness : 300 cd/m2

Contrast ratio : 1000 : 1

Display colour : 16.7M

## CyberView™ Model Coverage



**W-119 / WS-119**  
Widescreen LCD Keyboard Drawer



**RP-W719 / RP-W822**  
Widescreen Display Panel



**RP-W119**  
Widescreen Display Drawer

page 43~46, 79~81 for full product details



**New** Product Highlights - e-Capacitive Touchscreen

**Benefits**

- ▶ Anti-glare surface finish
- ▶ 99% touch accuracy
- ▶ 93% (± 2%) light transmission
- ▶ 9H surface hardness
- ▶ 25ms response time
- ▶ Over 300 million touches
- ▶ 2048 x 2048 resolution

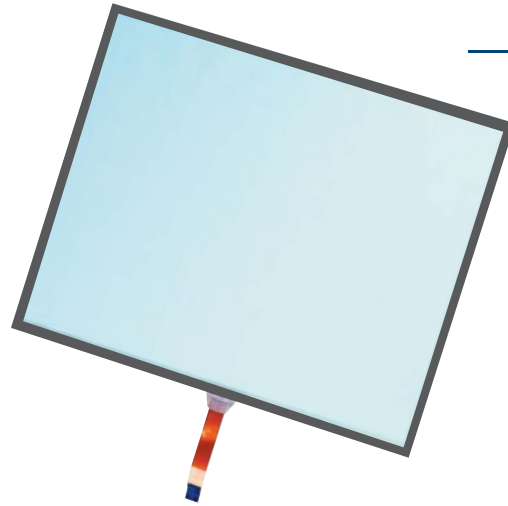

**Model Coverage Examples**



**RP-W822-TCB  
RP-W719-TCS**

Widescreen 19" & 22" Display Panel



**RP-819-TCB  
RP-717-TCS**

17" & 19" Display Panel



**RP-119-TCB  
RP-117-TCS**

1U 17" & 19" Display Drawer



**RKP-119-TCB  
RKP-117-TCS**

1U 17" & 19" LCD Keyboard Drawer

page 104 for full touchscreen specifications

## New Product Highlights - Quad Display (QD)

Introducing the advanced **CyberView™** video display technology - the Quad Display

Austin Hughes has successfully developed the Quad Screen Splitter option on all 17", 19", 20" and 22" LCD display panels and drawers. It allows the users to display and monitor the video signals from four different computers or video sources simultaneously on one single screen, resolution up to 1600 x 1200.

### Applications

- ▶ Mission critical monitoring and surveillance
- ▶ Industrial process control
- ▶ Large-scale operation centres
- ▶ Data centres
- ▶ Television control rooms

### Model Coverage



**RP-W819QD**  
**RP-W922QD**

Widescreen LCD Quad Display



**RP-817QD**  
**RP-919QD**  
**RP-1020QD**

4 : 3 LCD Quad Display



**RP-W119QD**

Widescreen Quad Display Drawer

*page 82~84, 92~93 for full product details*



**RP-117QD**  
**RP-119QD**

4 : 3 Quad Display Drawer

### Quad Display Features

- ▶ Four camera outputs can be combined into one video signal for simultaneous display & recording
- ▶ User selected video display mode including Quad Display mode (cameras 1-4) & full screen sequential switching
- ▶ On screen TIME, TITLE display for each channel & on-screen setup menu
- ▶ Alarm detection for sensor contact closure & video loss in camera inputs
- ▶ Built-in buzzer for alarm detection acknowledgement
- ▶ Freeze of last picture before video loss

### Quad Display Panel Button



*page 103 for full Quad Display specifications*

## New Product Highlights - New Generation High Bright LCD

### Benefits

- ▶ LED technology
- ▶ Low power consumption
- ▶ Long lifetime up to 70,000 hours
- ▶ Minimum EMI emissions
- ▶ Operation temperature at -20°C
- ▶ High shock & vibration resistance
- ▶ Mercury free
- ▶ Slim size



- 17", 800 cd/m2
- 19", 800 cd/m2
- Wide 19", 800 cd/m2
- Wide 22", 600 cd/m2

### Option

#### Optical Bonding



- 1mm thick optically clear adhesive for touchscreen or 4mm temper glass
- No air gap between the cover glass & LCD panel
- Increased LCD durability under vibration
- Eliminate residual and ghost images

#### Anti-Reflective Film (AR Film)



- 0.1mm thick optical interference coating film
- Designed to provide visual enhancement
- Cost effective vacuum laminated technology
- Greatly reduced specular & diffuse reflection
- Increased contrast for improved readability
- Easy clean surface

### Model Coverage



High Bright Widescreen Display Panel



High Bright 4 : 3 Display Panel



High Bright Display Drawer



High Bright LCD Keyboard Drawer

page 94-98 for full product details

**Part I**  
**KVM Switch**

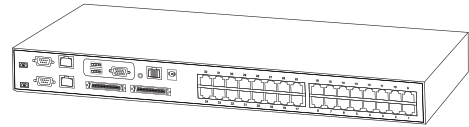

**Matrix Cat6**  **KVM**

Matrix Cat6 KVM	..... MU series	..... P.23 - 24
Matrix Cat6 IP KVM	..... MU-IP series	..... P.25 - 26

**Matrix DB-15**  **KVM**

Matrix DB-15 KVM	..... M series	..... P.27 - 28
Matrix DB-15 IP KVM	..... M-IP series	..... P.29 - 30

**Combo Cat6**  **KVM**

Combo Cat6 KVM	..... U series	..... P.31 - 32
Combo Cat6 IP KVM	..... U-IP series	..... P.33

**Combo DB-15**  **KVM**

Combo DB-15 KVM	..... CV Combo series	..... P.34 - 35
Combo DB-15 IP KVM	..... IP series	..... P.36

**PS/2 DB-15**  **KVM**

PS/2 DB-15 KVM	..... CV PS/2 series	..... P.37
----------------	----------------------	------------

**KVM Extender**

Combo KVM Extender	..... CV-S101	..... P.38
IP KVM Extender	..... IP-101	..... P.38



## **Part II**

### **LCD Keyboard Drawer**

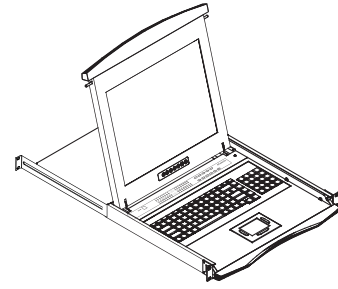

L-120	1U 20" LCD keyboard drawer	P.39 - 40
LS-120	1U 20" SUN solution LCD keyboard drawer	P.41 - 42
W-119	1U 19" widescreen LCD keyboard drawer	P.43 - 44
WS-119	1U 19" widescreen SUN solution LCD keyboard drawer	P.45 - 46
D-117 / D-119	1U 17", 19" dual slide LCD keyboard drawer	P.47 - 48
DS-117 / DS-119	1U 17", 19" dual slide SUN solution LCD keyboard drawer	P.49 - 50
N-117 / N-119	1U 17", 19" LCD keyboard drawer	P.51 - 52
N-1417 / N-1419	1U short depth 17", 19" LCD keyboard drawer	P.53 - 54
NS-117 / NS-119	1U 17", 19" SUN solution LCD keyboard drawer	P.55 - 56
RKP-115 / RKP-117 / RKP-119	1U 15", 17", 19" LCD keyboard drawer	P.57 - 58
RKP-1415 / RKP-1417 / RKP-1419	1U short depth 15", 17", 19" LCD keyboard drawer	P.59 - 60
S-117 / S-119	1U 17", 19" SUN solution LCD keyboard drawer	P.61 - 62
RKP-217 / RKP-219	2U 17", 19" LCD keyboard drawer	P.63 - 64
RKP-2415 / RKP-2417 / RKP-2419	2U short depth 15", 17", 19" LCD keyboard drawer	P.65 - 66
S-217 / S-219	2U 17", 19" SUN solution LCD keyboard drawer	P.67 - 68
RKP-7 / RKP-9	1U 17", 19" LCD keyboard drawer with true optical mouse	P.69 - 70
RKP-1617 / RKP-1619	1U 17", 19" LCD keyboard drawer with compact keyboard	P.71 - 72

**Part III**  
**Serial Console Server &**  
**Serial Console LCD Drawer**

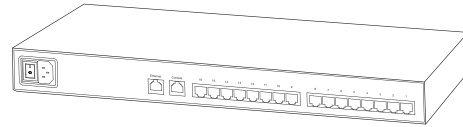

CS-116 .....	1U serial console server .....	P.73 - 74
NCP-1701 .....	1U 17" single port serial console LCD drawer .....	P.75 - 76
NCP-1716 .....	1U 17" 16-port serial console LCD drawer .....	P.77 - 78

**Part IV**  
**Rackmount LCD Display Panel &**  
**Display Drawer**

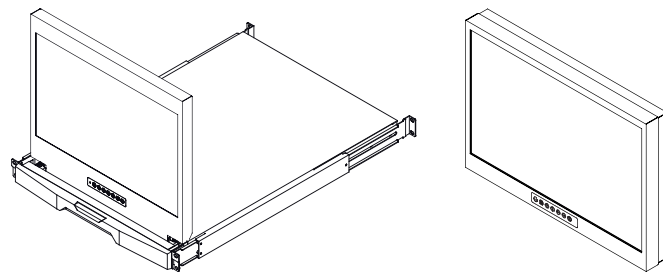

**Widescreen LCD Display**

RP-W822 .....	8U 22" widescreen LCD display .....	P.79
RP-W719 .....	7U 19" widescreen LCD display .....	P.80
RP-W119 .....	1U 19" widescreen LCD drawer .....	P.81

**Widescreen LCD Quad Display**

RP-W922QD .....	9U 22" widescreen LCD quad display .....	P.82
RP-W819QD .....	8U 19" widescreen LCD quad display .....	P.83
RP-W119QD .....	1U 19" widescreen quad display drawer .....	P.84

**4 : 3 LCD Display**

RP-120 .....	1U 20" LCD drawer .....	P.85
SP-120 .....	1U 20" SUN solution LCD drawer .....	P.86
RP-117 / RP-119 .....	1U 17", 19" LCD drawer .....	P.87
SP-117 / SP-119 .....	1U 17", 19" SUN solution LCD drawer .....	P.88
RP-1417 / RP-1419 .....	1U short depth 17", 19" LCD drawer .....	P.89
RP-717 / RP-819 / RP-920 .....	7U~9U 17", 19", 20" LCD display panel .....	P.90
SP-717 / SP-819 / SP-920 .....	7U~9U 17", 19", 20" SUN solution LCD display panel .....	P.91

**4 : 3 LCD Quad Display**

RP-117QD / RP-119QD / RP-120QD .....	1U 17", 19", 20" quad display drawer .....	P.92
RP-817QD / RP-919QD / RP-1020QD .....	8U~10U 17", 19", 20" LCD quad display .....	P.93



**Part V**  
**High Brightness Solution**

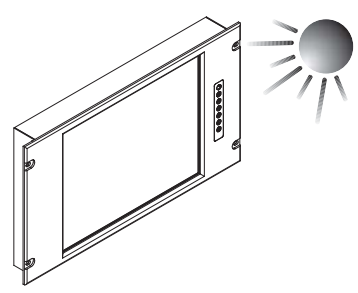

RP-H717 / RP-H819 ..... 7U~8U 17", 19" LCD display ..... P.94

RP-HW719 / RP-HW822 ..... 7U~8U 19", 22" widescreen LCD display ..... P.95

RP-H117 / RP-H119 ..... 1U 17", 19" LCD drawer ..... P.96

H-117 / H119 ..... 1U 17", 19" LCD keyboard drawer ..... P.97 - 98

**Part VI**  
**Rackmount Keyboard Drawer**

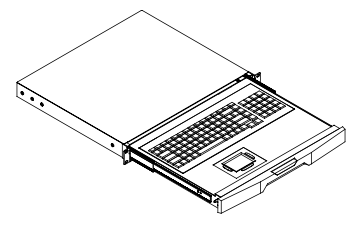

RK-1 ..... 1U keyboard drawer with KVM option ..... P.99 - 100

RK-2 ..... 1U short depth keyboard drawer ..... P.101

**Part VII**  
**Specifications & Accessories**

Accessories ..... P.102

Quad Display Specifications ..... P.103

DC Power Input & Touchscreen Specifications ..... P.104

LCD Specifications ..... P.105

Keyboard Specifications ..... P.106

KVM Rear I/O Windows for N-117 series, W-119 series, RKP-117 series, RKP-217 series ..... P.107 - 108

KVM Rear I/O Windows for L-120 series, D-117 series, RKP-7 series, H-117 series, RKP-2415 series --- P.109 - 110

MU-1602 / 3202

MU-1603 / 3203 *New*

MU-1604 / 3204



### Matrix Multi-User Cat6 KVM Benefits

- ▶ Efficient system management with simultaneous multi-user access
- ▶ Capable of connecting 32 or 16 servers per device in 1U
- ▶ Support DVI-USB, VGA-USB & VGA-PS/2 server interface
- ▶ Increased distance of 40m between your server & KVM switch
- ▶ Enhanced Cat6 cable management with remote access over 300m

### Switch Features & Options

- Provide a diversity of consoles to access servers independently and simultaneously
- Use of the RJ45 Cat6 interface allows for a higher number of ports in smaller density
- Greater distances between your switch and servers allow enhanced data centre rack layouts
- Multi lingual on screen display menu
- Advanced user profiles and configurable OSD hot key combinations



12V, 24V and 48V DC Power options

### Designed for:



### Accessories

DG-100SD

DVI-USB dongle

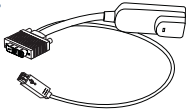

DG-100S

VGA-USB dongle



DG-100

VGA-PS/2 dongle



CMC-3

3ft Matrix KVM cascade cable



CU-3 CU-10

CU-6 CU-15 CU-33

Cat6 cable - 3, 6, 10, 15 & 33 ft



### Technical Specification

- **KVM Port :** 32 / 16 x RJ45 connector
- **KVM Dongle :** DVI-D / VGA connector dongle up to 40 meters (132 feet) Cat6 / Cat5 cable
- **Simultaneous Console Access**
  - Local : 1 x DB-15 VGA (up to 1600 x 1200), 2 x USB for KB & MS
  - Remote (1, 2 or 3) : 1 x RJ45, up to 300 meters (1000 feet) Cat6 cable
- **Remote Receiver (1, 2 or 3) :**
  - 1 x DB-15 VGA (up to 1600 x 1200), 2 x USB for KB & MS
  - 1 x KVM port for connecting an extra PC
- **Expansion :** Support mixed DB-15 or RJ45 Matrix KVM, up to 256 servers
- **Compatibility :** Mix PCs, SUNs, MACs, IBMs, HPs, DELLs server  
Windows Vista / 2003 / XP / 2000, Linux, Netware, Unix
- **Power :** 100~240VAC, 50 / 60Hz 0.5A via AC / DC cord
- **Regulatory Approval :** FCC, CE
- **Environmental**
  - Operating / Storage : 0 to 50°C / -5 to 60°C
  - Relative humidity : 90%, non-condensing
  - Shock : 50G peak acceleration (11 ms, half-sine wave)
  - Vibration : 58~100Hz / 0.98G (11ms / cycle)

### Dimensions

Model	Product Dimension (W x D x H)	Packing Dimension (W x D x H)	Net Weight	Gross Weight
MU-1602 / 1603 / 1604 MU-3202 / 3203 / 3204	448 x 180 x 44 mm 17.6 x 7.1 x 1.73 inch	510 x 400 x 77 mm 20.1 x 15.7 x 3 inch	4 kg / 9 lbs	7 kg / 15 lbs



# CyberView™ — Connect your *Matrix* Multi-User Cat6 KVM

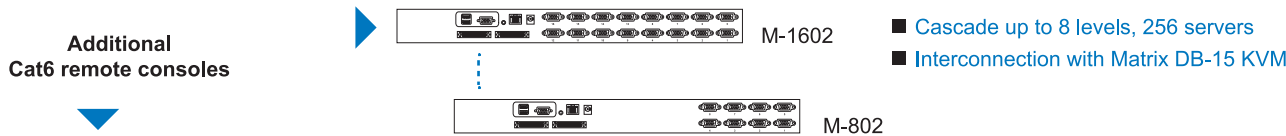
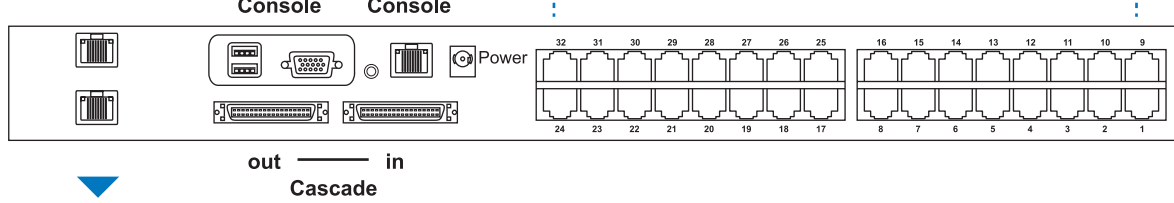
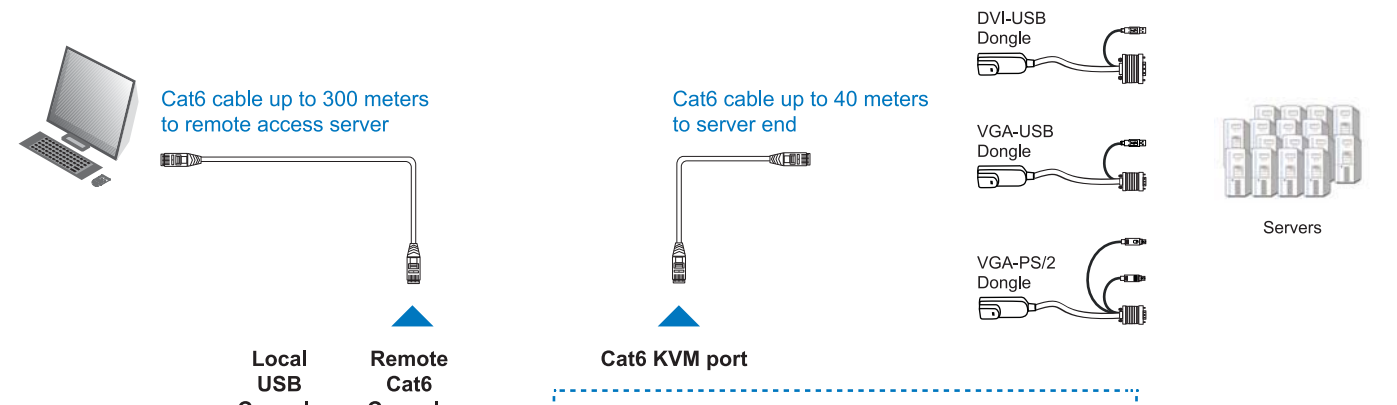
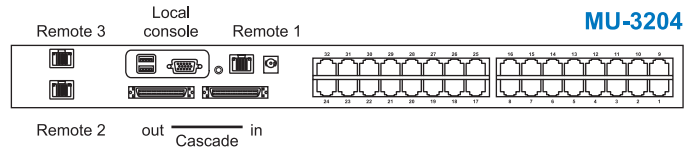
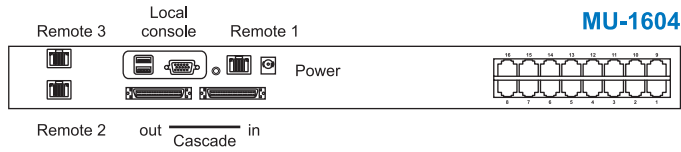
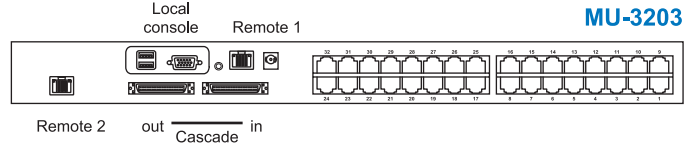
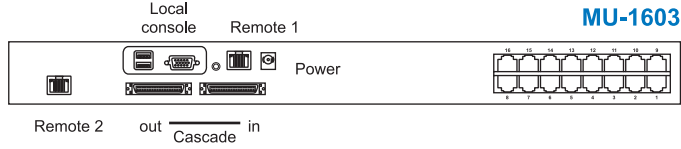
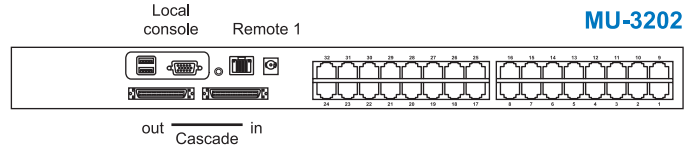
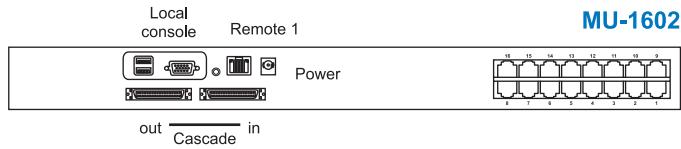

Model	Additional Cat6 Remote
<b>MU-1602</b>	<b>0</b>
<b>MU-3202</b>	<b>0</b>
<b>MU-1603</b>	<b>1</b>
<b>MU-3203</b>	<b>1</b>
<b>MU-1604</b>	<b>2</b>
<b>MU-3204</b>	<b>2</b>

**MU-IP1613 / 3213**  
**MU-IP1614 / 3214**  
**MU-IP1624 / 3224**

*New*



### Designed for:



### Matrix Multi-User Cat6 IP KVM Benefits

- ▶ Secure IP remote user access across the world wide web
- ▶ Efficient system management with simultaneous multi-user access
- ▶ Capable of connecting 32 or 16 servers per device in 1U
- ▶ Support DVI-USB, VGA-USB & VGA-PS/2 server interface
- ▶ Up to 40 meters between your server & KVM switch
- ▶ Enhanced Cat6 cable management with remote access over 300m

### Switch Features & Options

- Provide a diversity of consoles to access servers independently and simultaneously
- Use of the RJ45 Cat6 interface allows for a higher number of ports in smaller density
- Greater distances between your switch and servers allow enhanced data centre rack layouts
- Multi lingual on screen display menu
- Advanced user profiles and configurable OSD hot key combinations

**DC** 12V, 24V and 48V DC Power options

### Accessories

**DG-100SD**  
DVI-USB dongle

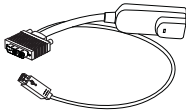

**DG-100S**  
VGA-USB dongle



**DG-100**  
VGA-PS/2 dongle



**CMC-3**  
3ft Matrix KVM cascade cable



**CU-3 CU-10**  
**CU-6 CU-15 CU-33**  
Cat6 cable - 3, 6, 10, 15 & 33 ft



### Technical Specification

- **KVM Port :** 32 / 16 x RJ45 connector
- **KVM Dongle :** DVI-D / VGA connector dongle up to 40 meters (132 feet) Cat6 / Cat5 cable
- **Simultaneous Console Access**
  - Local : 1 x DB-15 VGA (up to 1600 x 1200), 2 x USB for KB & MS
  - Remote (1 or 2) : 1 x RJ45, up to 300 meters (1000 feet) Cat6 / Cat5 cable
  - IP Access (1 or 2) : 1 x RJ45 Ethernet, 1 x DB-9 serial & 1 x USB port
  - IP Security : SSL v3, RSA, AES, CSR, http & https internet access  
15-user login (1 x active user)
- **Remote Receiver (1 or 2) :** 1 x DB-15 VGA (up to 1600 x 1200), 2 x USB for KB & MS  
1 x KVM port for connecting an extra PC
- **Expansion :** Support mixed DB-15 or RJ45 Matrix KVM, up to 256 servers
- **Compatibility :** Mix PCs, SUNs, MACs, IBMs, HPs, DELLs server  
Windows Vista / 2003 / XP / 2000, Linux, Netware, Unix
- **Power :** 100~240VAC, 50 / 60Hz 0.5A via AC / DC cord
- **Regulatory Approval :** FCC, CE
- **Environmental**
  - Operating / Storage : 0 to 50°C / -5 to 60°C
  - Relative humidity : 90%, non-condensing
  - Shock : 50G peak acceleration (11 ms, half-sine wave)
  - Vibration : 58~100Hz / 0.98G (11ms / cycle)

### Dimensions

Model	Product Dimension (W x D x H)	Packing Dimension (W x D x H)	Net Weight	Gross Weight
MU-IP1613 / 1614 / 1624 MU-IP3213 / 3214 / 3224	448 x 180 x 44 mm 17.6 x 7.1 x 1.73 inch	510 x 400 x 77 mm 20.1 x 15.7 x 3 inch	4 kg / 9 lbs	7 kg / 15 lbs

# CyberView™ — Connect your *Matrix* Multi-User Cat6 *IP* KVM

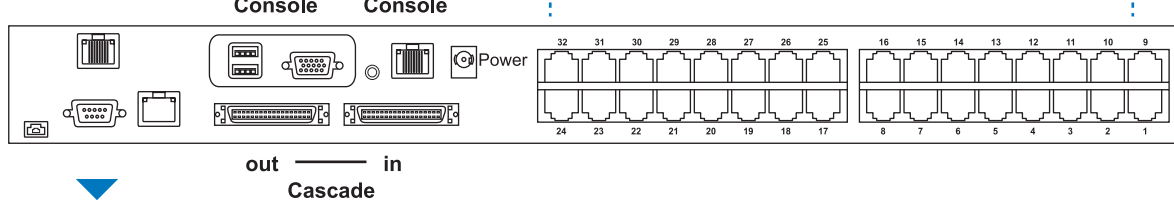
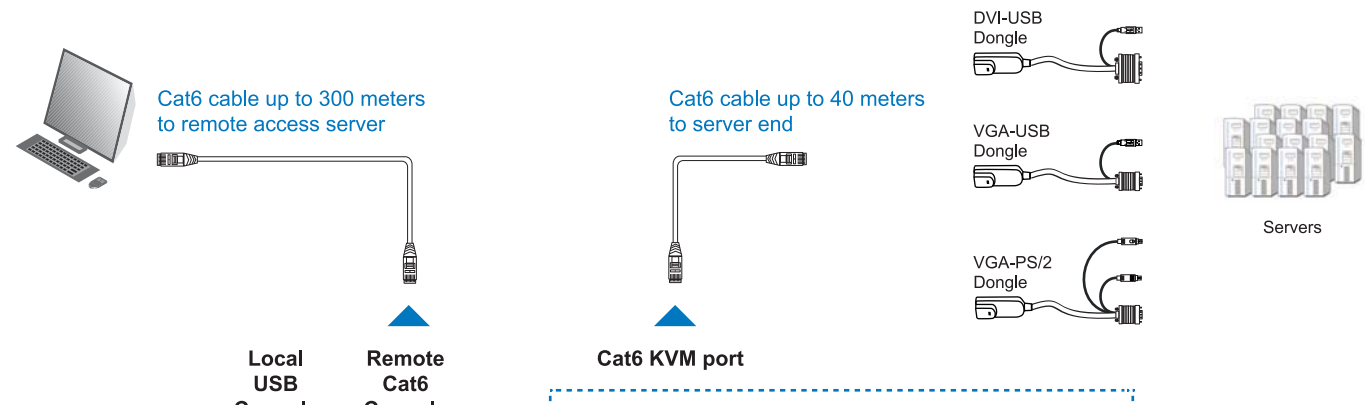
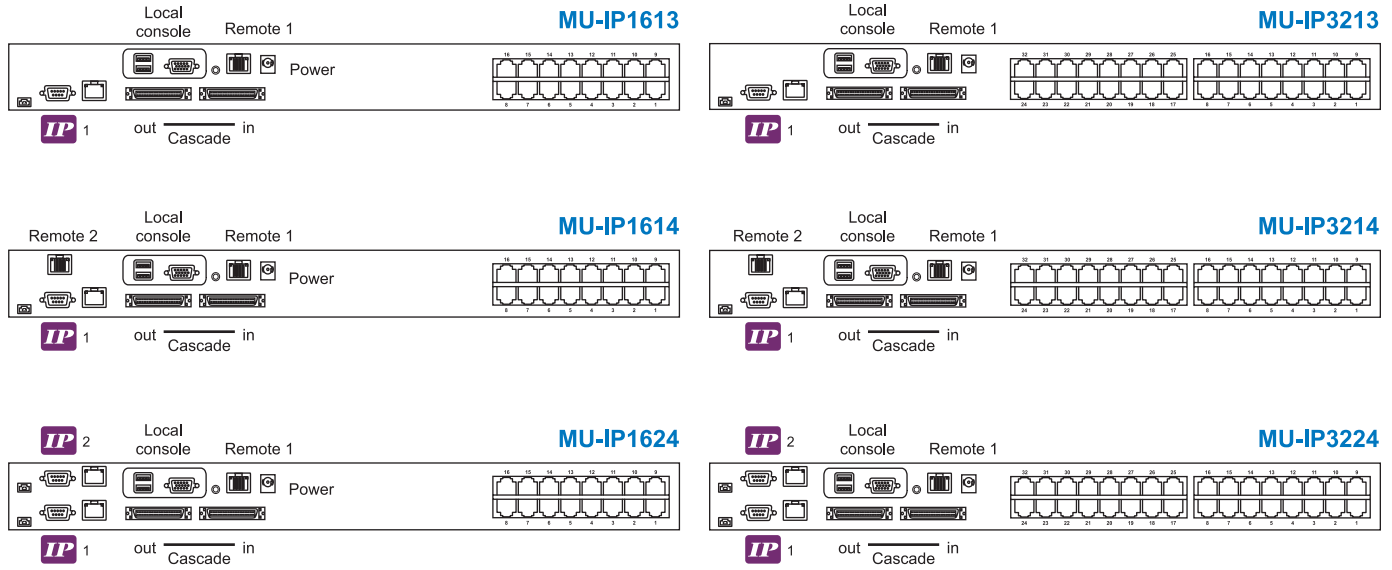

Additional IP or remote consoles

■ Cascade up to 8 levels, 256 servers  
■ Interconnection with Matrix DB-15 KVM

Model	Additional	
	IP	Remote
MU-IP1613	1	0
MU-IP3213	1	0
MU-IP1614	1	1
MU-IP3214	1	1
MU-IP1624	2	0
MU-IP3224	2	0

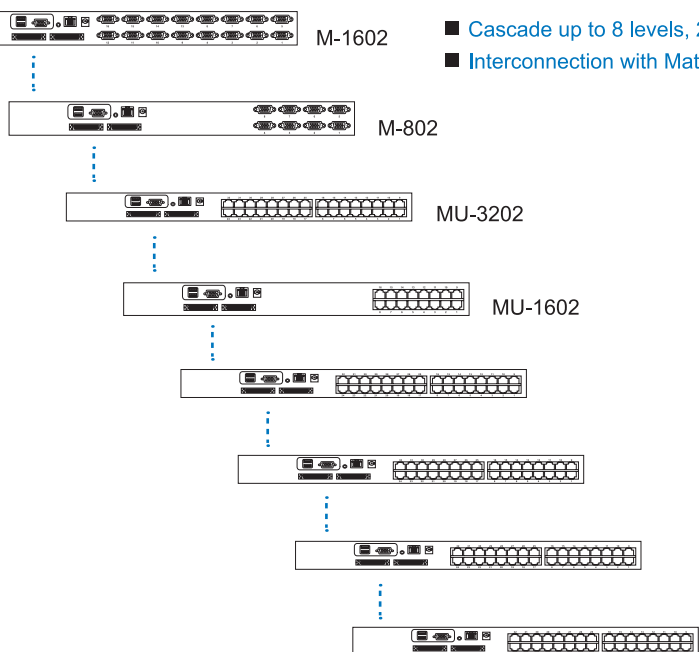

M-802 / 1602

M-803 / 1603 *New*

M-804 / 1604



### Designed for:



### Matrix Multi-User DB-15 KVM Benefits

- ▶ Efficient system management with simultaneous multi-user access
- ▶ Capable of connecting 8 or 16 servers per device in 1U
- ▶ Multi-platform servers shared by different consoles in cascade connection
- ▶ Mix PS/2, USB & SUN with Multi-Platform switch capability
- ▶ Extended Cat6 cord remote access over 300M
- ▶ Provide a diversity of consoles to access servers independently & simultaneously

### Switch Features & Options

- Mix Legacy PS/2 servers with newer USB and SUN solutions
- Greater distances between your switch and servers allow enhanced data centre rack layouts
- Multi lingual on screen display menu
- Advanced user profiles and configurable OSD hot key combinations

**DC** 12V, 24V and 48V DC Power options

### Accessories

CE-6  
CE-10  
CE-15  
Combo 4-in-1 KVM cable - 6, 10 & 15 ft



CMC-3  
3ft Matrix KVM cascade cable



### Technical Specification

- **KVM Port :** 16 / 8 x DB-15 combo connector
- **KVM cable :** Combo 4-in-1 KVM cable up to 6, 10 & 15 feet
- **Simultaneous Console Access**
  - Local : 1 x DB-15 VGA (up to 1600 x 1200), 2 x USB for KB & MS
  - Remote (1, 2 or 3) : 1 x RJ45, up to 300 meters (1000 feet) Cat6 / Cat5 cable
- **Remote Receiver (1, 2 or 3) :**
  - 1 x DB-15 VGA (up to 1600 x 1200), 2 x USB for KB & MS
  - 1 x KVM port for connecting an extra PC
- **Expansion :** Support mixed DB-15 or RJ45 Matrix KVM, up to 240 servers
- **Compatibility :** Mix PCs, SUNs, MACs, IBMs, HPs, DELLs server Windows Vista / 2003 / XP / 2000, Linux, Netware, Unix
- **Power :** 100~240VAC, 50 / 60Hz 0.5A via AC / DC cord
- **Regulatory Approval :** FCC, CE
- **Environmental**
  - Operating / Storage : 0 to 50°C / -5 to 60°C
  - Relative humidity : 90%, non-condensing
  - Shock : 50G peak acceleration (11 ms, half-sine wave)
  - Vibration : 58~100Hz / 0.98G (11ms / cycle)

### Dimensions

Model	Product Dimension (W x D x H)	Packing Dimension (W x D x H)	Net Weight	Gross Weight
M-802 / 803 / 804 M-1602 / 1603 / 1604	448 x 180 x 44 mm 17.6 x 7.1 x 1.73 inch	510 x 400 x 77 mm 20.1 x 15.7 x 3 inch	4 kg / 9 lbs	7 kg / 15 lbs

# CyberView™ — Connect your *Matrix* Multi-User DB-15 KVM

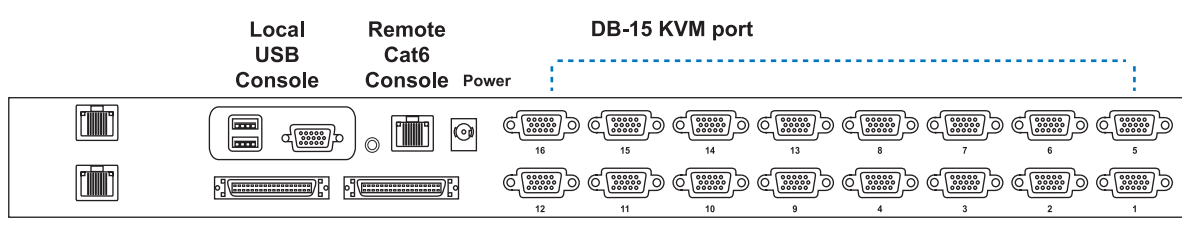
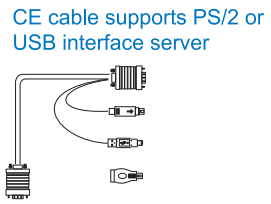
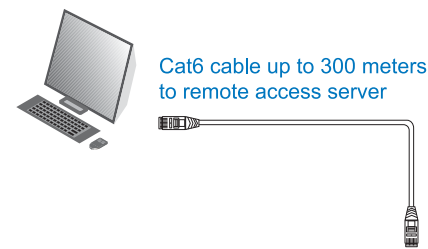
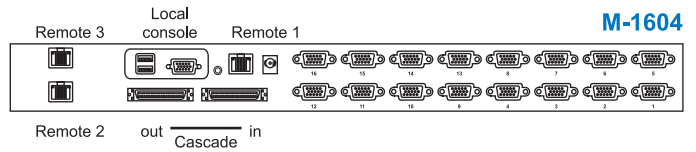
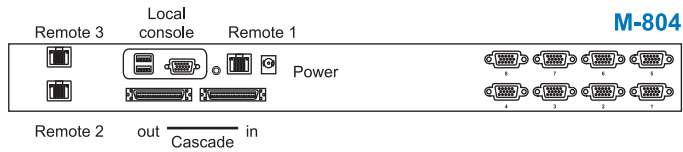
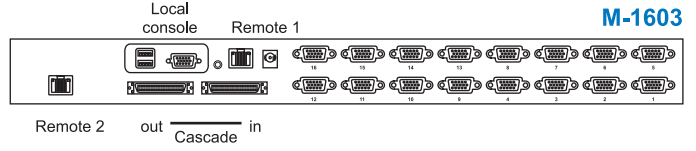
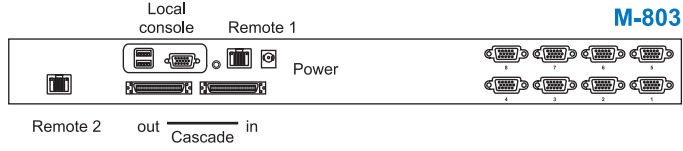
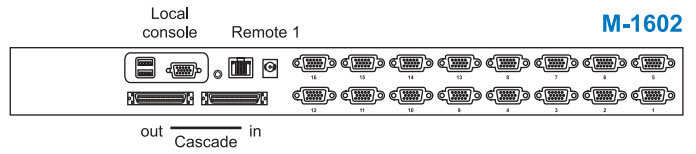
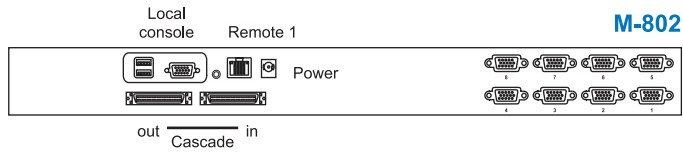

Additional Cat6 remote consoles

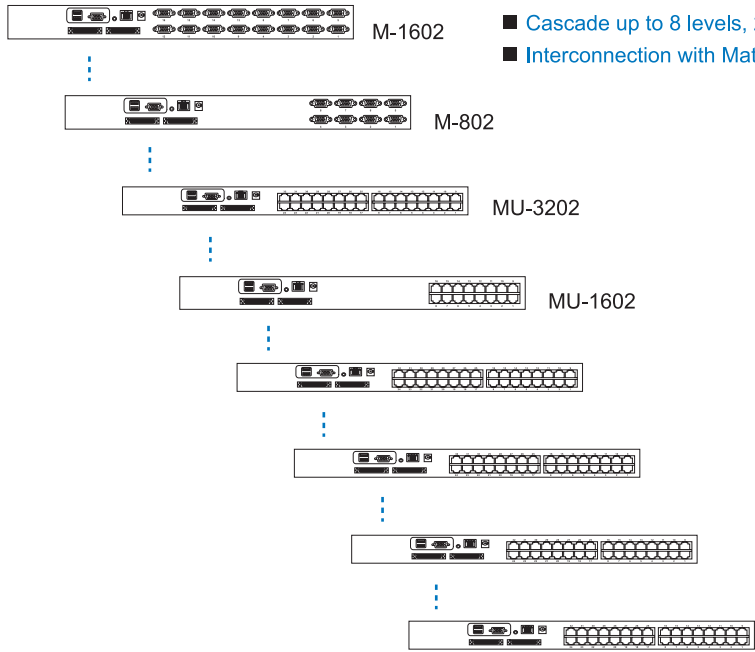

- Cascade up to 8 levels, 240 servers
- Interconnection with Matrix Cat6 KVM

Model	Additional Cat6 Remote
M-802	0
M-1602	0
M-803	1
M-1603	1
M-804	2
M-1604	2

M-IP813 / 1613

M-IP814 / 1614 *New*

M-IP824 / 1624



### Designed for:



### Matrix Multi-User DB-15 IP KVM Benefits

- ▶ Secure IP remote user access across the world wide web
- ▶ Efficient system management with simultaneous multi-user access
- ▶ Capable of connecting 8 or 16 servers per device in 1U
- ▶ Multi-platform servers shared by different consoles in cascade connection
- ▶ Mix PS/2, USB & SUN with Multi-Platform switch capability
- ▶ Extended Cat6 cord remote access over 300M
- ▶ Provide a diversity of consoles to access servers independently & simultaneously

### Switch Features & Options

- Mix Legacy PS/2 servers with newer USB and SUN solutions
- Greater distances between your switch and servers allow enhanced data centre rack layouts
- Multi lingual on screen display menu
- Advanced user profiles and configurable OSD hot key combinations

**DC** 12V, 24V and 48V DC Power options

### Accessories

CE-6

CE-10

CE-15

Combo 4-in-1 KVM cable - 6, 10 & 15 ft



CMC-3

3ft Matrix KVM cascade cable



### Technical Specification

- **KVM Port :** 16 / 8 x DB-15 combo connector
- **KVM cable :** Combo 4-in-1 KVM cable up to 6, 10 & 15 feet
- **Simultaneous Console Access**
  - Local : 1 x DB-15 VGA (up to 1600 x 1200), 2 x USB for KB & MS
  - Remote (1 or 2) : 1 x RJ45, up to 300 meters (1000 feet) Cat6 / Cat5 cable
  - IP Access (1 or 2) : 1 x RJ45 Ethernet, 1 x DB-9 serial & 1 x USB port
  - IP Security : SSL v3, RSA, AES, CSR, http & https internet access  
15-user login (1 x active user)
- **Remote Receiver (1 or 2) :**
  - 1 x DB-15 VGA (up to 1600 x 1200), 2 x USB for KB & MS
  - 1 x KVM port for connecting an extra PC
- **Expansion :** Support mixed DB-15 or RJ45 Matrix KVM, up to 240 servers
- **Compatibility :** Mix PCs, SUNs, MACs, IBMs, HPs, DELLs server  
Windows Vista / 2003 / XP / 2000, Linux, Netware, Unix
- **Power :** 100~240VAC, 50 / 60Hz 0.5A via AC / DC cord
- **Regulatory Approval :** FCC, CE
- **Environmental**
  - Operating / Storage : 0 to 50°C / -5 to 60°C
  - Relative humidity : 90%, non-condensing
  - Shock : 50G peak acceleration (11 ms, half-sine wave)
  - Vibration : 58~100Hz / 0.98G (11ms / cycle)

### Dimensions

Model	Product Dimension (W x D x H)	Packing Dimension (W x D x H)	Net Weight	Gross Weight
M-IP813 / 814 / 824 M-IP1613 / 1614 / 1624	448 x 180 x 44 mm 17.6 x 7.1 x 1.73 inch	510 x 400 x 77 mm 20.1 x 15.7 x 3 inch	4 kg / 9 lbs	7 kg / 15 lbs

# CyberView™ — Connect your *Matrix* Multi-User DB-15 IP KVM

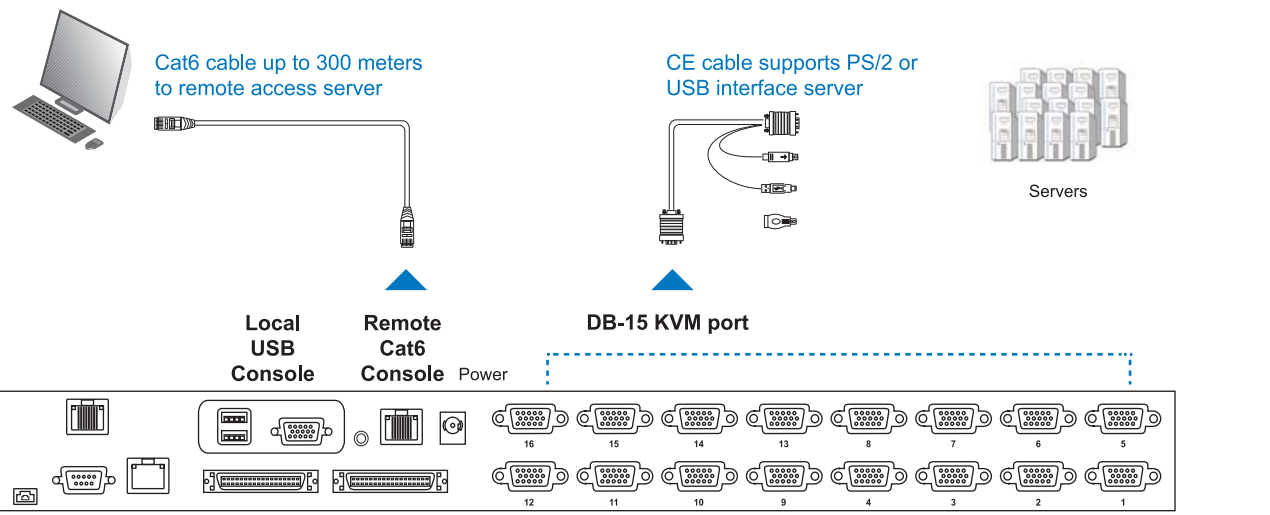
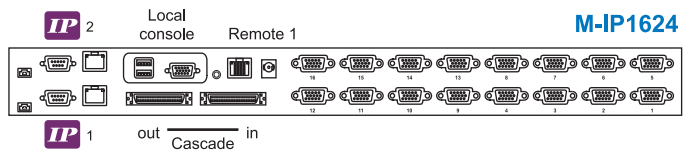
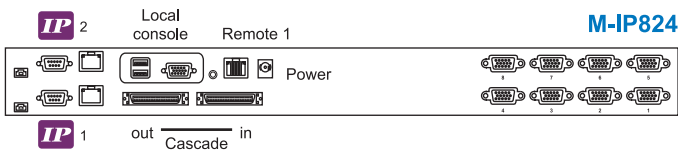
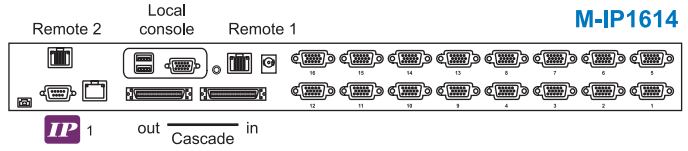
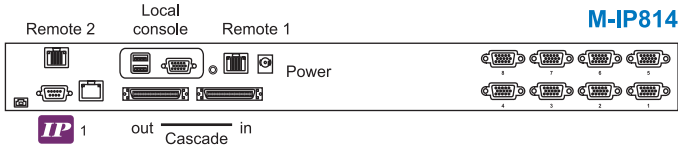
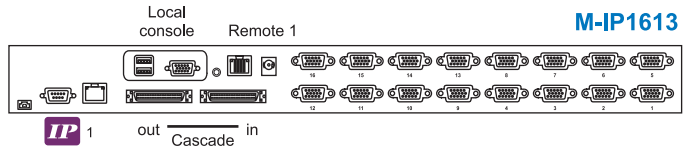
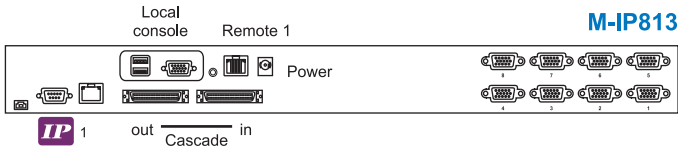

Additional IP or remote consoles

Model	Additional	
	IP	Remote
<b>M-IP813</b>	1	0
<b>M-IP1613</b>	1	0
<b>M-IP814</b>	1	1
<b>M-IP1614</b>	1	1
<b>M-IP824</b>	2	0
<b>M-IP1624</b>	2	0

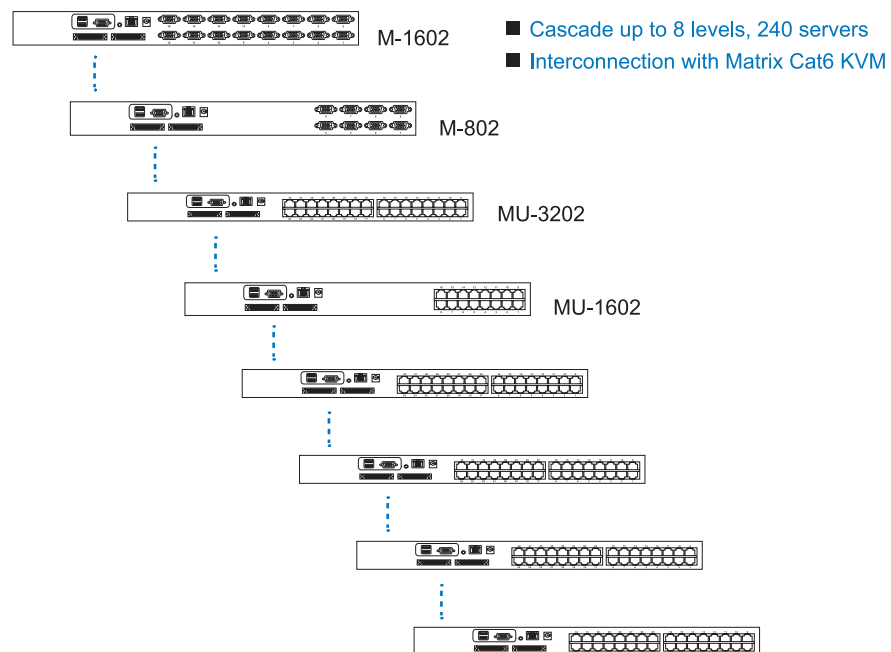

### U-801 / U-1601 / U-3201



#### Designed for:



#### Combo Cat6 KVM Benefits

- ▶ Combo Cat6 KVM with either 8, 16 or 32 ports in 1U
- ▶ Up to 40 meters between your servers & KVM ports
- ▶ Cascade switches up to 8 levels & Mix switches between Cat6 & Combo DB-15 KVM
- ▶ Support DVI-USB, VGA-USB & VGA-PS/2 server interface
- ▶ Mix PS/2, USB & SUN with Multi-Platform switch capability

#### Switch Features & Options

- Multi lingual on screen display menu
- Advanced user profiles and configurable OSD hot key combinations
- Dual power with failover

**DC** 12V, 24V and 48V DC Power options

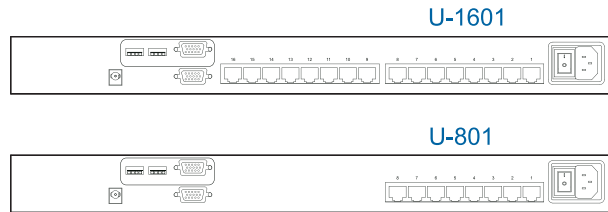
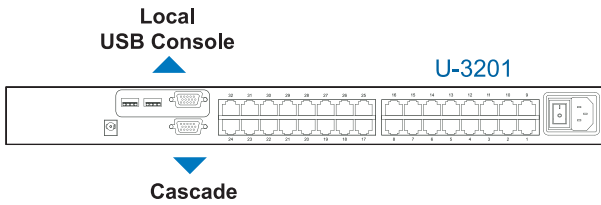

#### Technical Specification

- **KVM Port :** 32 / 16 / 8 x RJ45 connector
- **KVM Dongle :** DVI-D / VGA connector dongle up to 40 meters (132 feet) Cat6 / Cat5 cable
- **Local Console :** 1 x DB-15 VGA (up to 1600 x 1200), 2 x USB for KB & MS
- **Expansion :** Support mixed Combo Cat6 or Combo DB-15 KVM, up to 256 servers
- **Compatibility :** Mix PCs, SUNs, MACs, IBMs, HPs, DELLs server  
Windows Vista / 2003 / XP / 2000, Linux, Netware, Unix
- **Power :** 100~240VAC, 50 / 60Hz 0.3A via IEC type cord (12V / 24V / 48V DC input option)
- **Regulatory Approval :** FCC, CE
- **Environmental**  
Operating / Storage : 0 to 50°C / -5 to 60°C  
Relative humidity : 90%, non-condensing  
Shock : 50G peak acceleration (11 ms, half-sine wave)  
Vibration : 58~100Hz / 0.98G (11ms / cycle)

#### Accessories

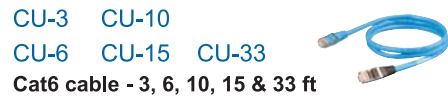

#### Dimensions

Model	Product Dimension (W x D x H)	Packing Dimension (W x D x H)	Net Weight	Gross Weight
U-801 U-1601 U-3201	446 x 180 x 44 mm 17.6 x 7.1 x 1.73 inch	510 x 400 x 77 mm 20.1 x 15.7 x 3 inch	4 kg / 9 lbs	7 kg / 15 lbs



### U-802 / U-1602 / U-3202



#### Designed for:



#### Combo Cat6 Two Console KVM Benefits

- ▶ Combo Cat6 KVM with either 8, 16 or 32 ports in 1U
- ▶ Up to 40 meters between your servers & KVM ports
- ▶ Remote access up to 300 meters
- ▶ Cascade switches up to 8 levels & Mix switches between Cat6 & Combo DB-15 KVM
- ▶ Support DVI-USB, VGA-USB & VGA-PS/2 server interface
- ▶ Mix PS/2, USB & SUN with Multi-Platform switch capability

#### Switch Features & Options

- Multi lingual on screen display menu
- Advanced user profiles and configurable OSD hot key combinations
- Dual power with failover

**DC** 12V, 24V and 48V DC Power options

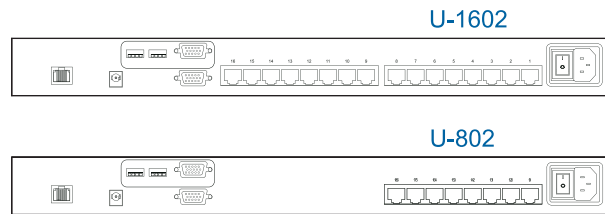
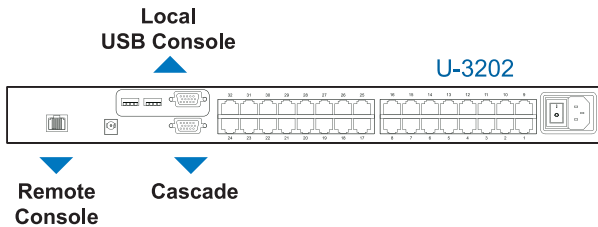

#### Technical Specification

- **KVM Port :** 32 / 16 / 8 x RJ45 connector
- **KVM Dongle :** DVI-D / VGA connector dongle up to 40 meters (132 feet) Cat6 / Cat5 cable
- **Console**  
Local : 1 x DB-15 VGA (up to 1600 x 1200), 2 x USB for KB & MS  
Remote : 1 x RJ45, up to 300 meters (1000 feet) Cat6 / Cat5 cable
- **Remote Receiver :** 1 x VGA port (up to 1600 x 1200), 2 x USB for KB & MS 1 x KVM port for connecting an extra PC
- **Expansion :** Support mixed Combo Cat6 or Combo DB-15 KVM, up to 256 servers
- **Compatibility :** Mix PCs, SUNs, MACs, IBMs, HPs, DELLs server Windows Vista / 2003 / XP / 2000, Linux, Netware, Unix
- **Power :** 100~240VAC, 50 / 60Hz 0.3A via IEC type cord (12V / 24V / 48V DC input option)
- **Regulatory Approval :** FCC, CE
- **Environmental**  
Operating / Storage : 0 to 50°C / -5 to 60°C  
Relative humidity : 90%, non-condensing  
Shock : 50G peak acceleration (11 ms, half-sine wave)  
Vibration : 58~100Hz / 0.98G (11ms / cycle)

#### Accessories

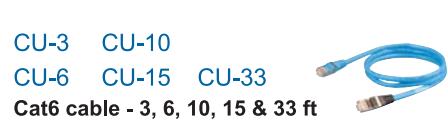

#### Dimensions

Model	Product Dimension (W x D x H)	Packing Dimension (W x D x H)	Net Weight	Gross Weight
U-802 U-1602 U-3202	446 x 180 x 44 mm 17.6 x 7.1 x 1.73 inch	510 x 400 x 77 mm 20.1 x 15.7 x 3 inch	4 kg / 9 lbs	7 kg / 15 lbs

### U-IP802 / U-IP1602 / U-IP3202



#### Combo Cat6 IP KVM Benefits

- ▶ Combo Cat6 KVM with either 8, 16 or 32 ports in 1U
- ▶ Up to 40 meters between your servers & KVM ports
- ▶ IP remote access across the world wide web
- ▶ Cascade switches up to 8 levels & Mix switches between Cat6 & Combo DB-15 KVM
- ▶ Support DVI-USB, VGA-USB & VGA-PS/2 server interface
- ▶ Mix PS/2, USB & SUN with Multi-Platform switch capability

#### Designed for:



#### Switch Features & Options

- Multi lingual on screen display menu
- Advanced user profiles and configurable OSD hot key combinations
- Dual power with failover

**DC** 12V, 24V and 48V DC Power options

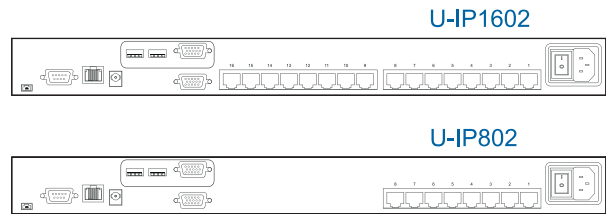
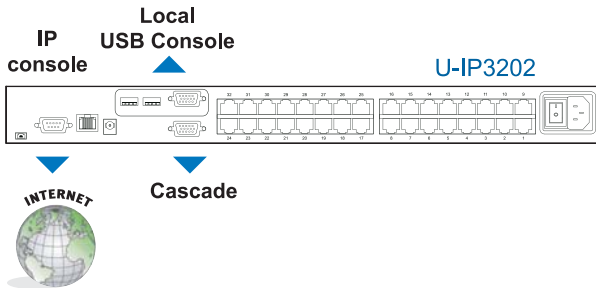

#### Technical Specification

- **KVM Port :** 32 / 16 / 8 x RJ45 connector
- **KVM Dongle :** DVI-D / VGA connector dongle up to 40 meters (132 feet) Cat6 / Cat5 cable
- **Console**
  - Local : 1 x DB-15 VGA (up to 1600 x 1200), 2 x USB for KB & MS
  - IP Access : 1 x RJ45 Ethernet, 1 x DB-9 serial & 1 x USB port
  - IP Security : SSL v3, RSA, AES, CSR, http & https internet access  
15-user login (1 x active user)
- **Expansion :** Support mixed Combo Cat6 or Combo DB-15 KVM, up to 256 servers
- **Compatibility :** Mix PCs, SUNs, MACs, IBMs, HPs, DELLs server  
Windows Vista / 2003 / XP / 2000, Linux, Netware, Unix
- **Power :** 100~240VAC, 50 / 60Hz 0.3A via IEC type cord (12V / 24V / 48V DC input option)
- **Regulatory Approval :** FCC, CE
- **Environmental**
  - Operating / Storage : 0 to 50°C / -5 to 60°C
  - Relative humidity : 90%, non-condensing
  - Shock : 50G peak acceleration (11 ms, half-sine wave)
  - Vibration : 58~100Hz / 0.98G (11ms / cycle)

#### Accessories

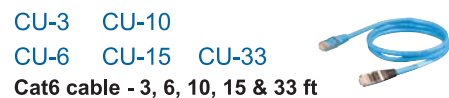

#### Dimensions

Model	Product Dimension (W x D x H)	Packing Dimension (W x D x H)	Net Weight	Gross Weight
U-IP802 U-IP1602 U-IP3202	446 x 180 x 44 mm 17.6 x 7.1 x 1.73 inch	510 x 400 x 77 mm 20.1 x 15.7 x 3 inch	4 kg / 9 lbs	7 kg / 15 lbs

### CV-S801 / CV-S1601



#### Designed for:



#### Combo DB-15 KVM Benefits

- ▶ Combo DB-15 KVM with either 8 or 16 ports in 1U
- ▶ Cascade switches up to 8 levels & Mix switches between Cat6 & Combo DB-15 KVM
- ▶ Mix PS/2, USB & SUN with Multi-Platform switch capability
- ▶ Support native SUN 1152 x 900 resolution
- ▶ Hot pluggable, no software or drivers required
- ▶ Easy & quick installation

#### Switch Features & Options

- Multi lingual on screen display menu
- Advanced user profiles and configurable OSD hot key combinations
- Dual power with failover

**DC** 12V, 24V and 48V DC Power options

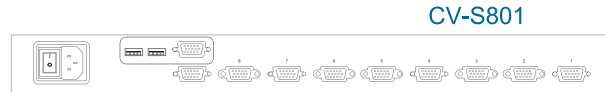
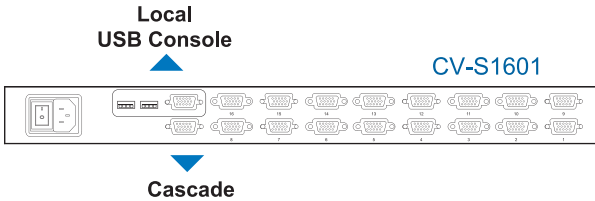

#### Technical Specification

- **KVM Port :** 16 / 8 x DB-15 combo connector
- **KVM Cable :** Combo 4-in-1 KVM cable, up to 6, 10 & 15 feet
- **Local Console :** 1 x DB-15 VGA (up to 1600 x 1200), 2 x USB for KB & MS
- **Expansion :** Support mixed Combo Cat6 or Combo DB-15 KVM, up to 240 servers
- **Compatibility :** Mix PCs, SUNs, MACs, IBMs, HPs, DELLs server  
Windows Vista / 2003 / XP / 2000, Linux, Netware, Unix
- **Power :** 100~240VAC, 50 / 60Hz 0.3A via IEC type cord (12V / 24V / 48V DC input option)
- **Regulatory Approval :** FCC, CE
- **Environmental**
  - Operating / Storage : 0 to 50°C / -5 to 60°C
  - Relative humidity : 90%, non-condensing
  - Shock : 50G peak acceleration (11 ms, half-sine wave)
  - Vibration : 58~100Hz / 0.98G (11ms / cycle)

#### Accessories



#### Dimensions

Model	Product Dimension (W x D x H)	Packing Dimension (W x D x H)	Net Weight	Gross Weight
CV-S801 CV-S1601	446 x 180 x 44 mm 17.6 x 7.1 x 1.73 inch	510 x 400 x 77 mm 20.1 x 15.7 x 3 inch	4 kg / 9 lbs	4.5 kg / 10 lbs

### CV-802 / CV-1602



#### Designed for:



#### Combo DB-15 Two Console KVM Benefits

- ▶ Combo DB-15 KVM with either 8 or 16 ports in 1U
- ▶ Remote access up to 300 meters
- ▶ Cascade switches up to 8 levels & Mix switches between Cat6 & Combo DB-15 KVM
- ▶ Mix PS/2, USB & SUN with Multi-Platform switch capability
- ▶ Cost efficient remote server management between user & equipment rooms within the building

#### Switch Features & Options

- Multi lingual on screen display menu
- Advanced user profiles and configurable OSD hot key combinations
- Dual power with failover

**DC** 12V, 24V and 48V DC Power options

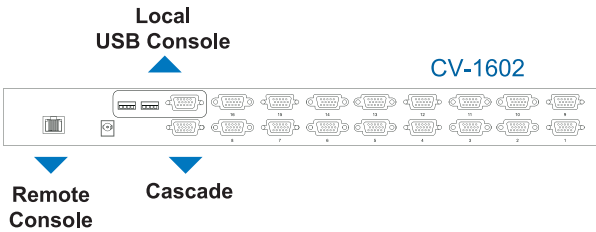

#### Technical Specification

- **KVM Port :** 16 / 8 x DB-15 connector
- **KVM Cable :** Combo 4-in-1 KVM cable, up to 6, 10 & 15 feet
- **Console**  
Local : 1 x DB-15 VGA (up to 1600 x 1200), 2 x USB for KB & MS  
Remote : 1 x RJ45, up to 300 meters (1000 feet) Cat6 / Cat5 cable
- **Remote Receiver :**  
1 x VGA port (up to 1600 x 1200), 2 x USB for KB & MS  
1 x KVM port for connecting an extra PC
- **Expansion :** Support mixed Combo Cat6 or Combo DB-15 KVM, up to 240 servers
- **Compatibility :** Mix PCs, SUNs, MACs, IBMs, HPs, DELLs server  
Windows Vista / 2003 / XP / 2000, Linux, Netware, Unix
- **Power :** 100~240VAC, 50 / 60Hz 0.3A via IEC type cord (12V / 24V / 48V DC input option)
- **Regulatory Approval :** FCC, CE
- **Environmental**  
Operating / Storage : 0 to 50°C / -5 to 60°C  
Relative humidity : 90%, non-condensing  
Shock : 50G peak acceleration (11 ms, half-sine wave)  
Vibration : 58~100Hz / 0.98G (11ms / cycle)

#### Accessories



#### Dimensions

Model	Product Dimension (W x D x H)	Packing Dimension (W x D x H)	Net Weight	Gross Weight
CV-802 CV-1602	446 x 180 x 44 mm 17.6 x 7.1 x 1.73 inch	510 x 400 x 77 mm 20.1 x 15.7 x 3 inch	4 kg / 9 lbs	4.5 kg / 10 lbs

### IP-802 / IP-1602



#### Designed for:



#### Combo DB-15 IP KVM Benefits

- ▶ Combo DB-15 KVM with either 8 or 16 ports in 1U
- ▶ IP remote access across the world wide web
- ▶ Cascade switches up to 8 levels & Mix switches between Cat6 & Combo DB-15 KVM
- ▶ Mix PS/2, USB & SUN with Multi-Platform switch capability
- ▶ Cost efficient remote server management between national / global sites

#### Switch Features & Options

- Multi lingual on screen display menu
- Advanced user profiles and configurable OSD hot key combinations
- Dual power with failover

**DC** 12V, 24V and 48V DC Power options

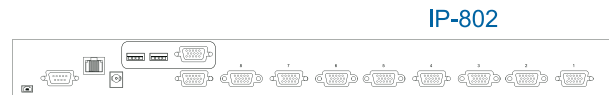
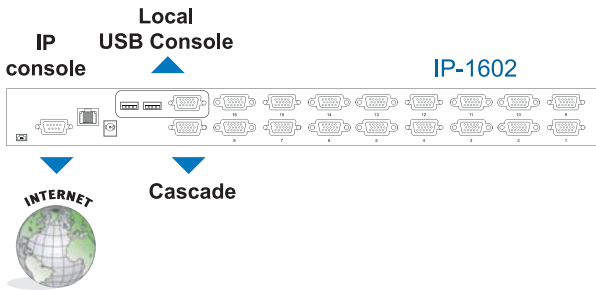

#### Technical Specification

- **KVM Port :** 16 / 8 x DB-15 combo connector
- **KVM Cable :** Combo 4-in-1 KVM cable, up to 6, 10 & 15 feet
- **Console**
  - Local : 1 x DB-15 VGA (up to 1600 x 1200), 2 x USB for KB & MS
  - IP Access : 1 x RJ45 Ethernet, 1 x DB-9 serial & 1 x USB port
  - IP Security : SSL v3, RSA, AES, CSR, http & https internet access  
15-user login (1 x active user)
- **Expansion :** Support mixed Combo Cat6 or Combo DB-15 KVM, up to 240 servers
- **Compatibility :** Mix PCs, SUNs, MACs, IBMs, HPs, DELLs server  
Windows Vista / 2003 / XP / 2000, Linux, Netware, Unix
- **Power :** 100~240VAC, 50 / 60Hz 0.3A via IEC type cord  
(12V / 24V / 48V DC input option)
- **Regulatory Approval :** FCC, CE
- **Environmental**
  - Operating / Storage : 0 to 50°C / -5 to 60°C
  - Relative humidity : 90%, non-condensing
  - Shock : 50G peak acceleration (11 ms, half-sine wave)
  - Vibration : 58~100Hz / 0.98G (11ms / cycle)

#### Accessories



#### Dimensions

Model	Product Dimension (W x D x H)	Packing Dimension (W x D x H)	Net Weight	Gross Weight
IP-802	446 x 180 x 44 mm 17.6 x 7.1 x 1.73 inch	510 x 400 x 77 mm 20.1 x 15.7 x 3 inch	4.5 kg / 10 lbs	5.5 kg / 12 lbs
IP-1602	446 x 180 x 44 mm 17.6 x 7.1 x 1.73 inch	510 x 400 x 77 mm 20.1 x 15.7 x 3 inch	5 kg / 11 lbs	6 kg / 13 lbs

### CV-401 / CV-801 / CV-1601



#### Designed for:



#### PS/2 DB-15 KVM Benefits

- ▶ PS/2 DB-15 KVM with either 4, 8 or 16 ports in 1U
- ▶ Mix PS/2, USB & SUN with Multi-Platform switch capability
- ▶ Low cost reliable PS/2 based server management
- ▶ No software or drivers required
- ▶ Easy & quick installation

#### Switch Features & Options

- Multi lingual on screen display menu
- Advanced user profiles and configurable OSD hot key combinations
- Dual power with failover

**DC** 12V, 24V and 48V DC Power options

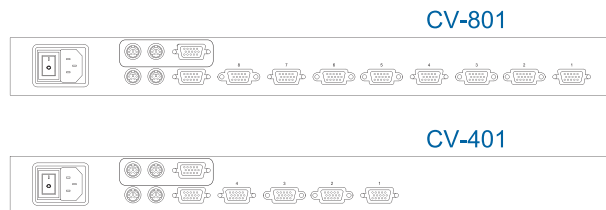
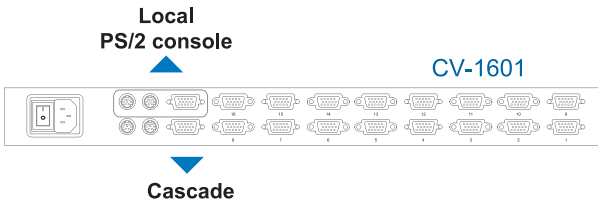

#### Technical Specification

- **KVM Port :** 16 / 8 / 4 x DB-15 connector
- **KVM Cable :** PS/2 3-in-1 KVM cable, up to 6, 10, 15 & 33 feet
- **Local Console :** 1 x DB-15 VGA (up to 1600 x 1200), 2 x PS/2 for KB & MS
- **Expansion :** Up to 128 servers by 8-level cascade
- **Compatibility :** Mix PCs, SUNs, MACs, IBMs, HPs, DELLs server  
Windows Vista / 2003 / XP / 2000, Linux, Netware, Unix
- **Power :** 100~240VAC, 50 / 60Hz 0.3A via IEC type cord  
(12V / 24V / 48V DC input option)
- **Regulatory Approval :** FCC, CE
- **Environmental**
  - Operating / Storage : 0 to 50°C / -5 to 60°C
  - Relative humidity : 90%, non-condensing
  - Shock : 50G peak acceleration (11 ms, half-sine wave)
  - Vibration : 58~100Hz / 0.98G (11ms / cycle)

#### Accessories



#### Dimensions

Model	Product Dimension (W x D x H)	Packing Dimension (W x D x H)	Net Weight	Gross Weight
CV-401	446 x 200 x 44 mm 17.6 x 7.9 x 1.73 inch	510 x 400 x 77 mm 20.1 x 15.7 x 3 inch	3.5 kg / 8 lbs	4 kg / 9 lbs
CV-801 / 1601	446 x 180 x 44 mm 17.6 x 7.1 x 1.73 inch	510 x 400 x 77 mm 20.1 x 15.7 x 3 inch	4 kg / 9 lbs	4.5 kg / 10 lbs

### CV-S101 Combo KVM Extender

New



- ▶ Remote console up to 300M (1000 feet)
- ▶ Dual user access at remote site
- ▶ Pure hardware solution makes network independent
- ▶ No software required



- **Console port**  
Graphic connector : HDDB 15-pin VGA  
Resolution : Up to 1600 x 1200  
Input device : 2 x USB type A for KB & MS
- **Remote port** Cat6 / Cat5 cable up to 300m
- **Receiver Power** 100~240VAC via AC adapter
- **LED indicator & control**  
Transmitter LED : Power & access LED  
Receiver Control : Front panel push button for switching local & remote port
- **PC port** VGA & Combo keyboard mouse
- **Dimensions** Receiver - 158 x 71 x 30 mm  
Transmitter - 158 x 71 x 30 mm

#### Connection I KVM port to Servers

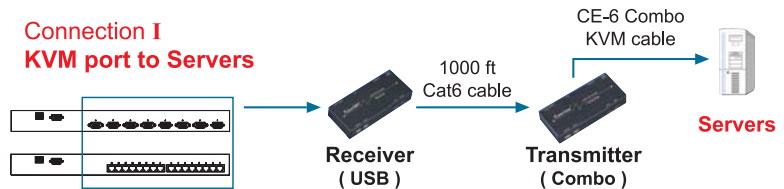

#### Connection II Console port to Remote console

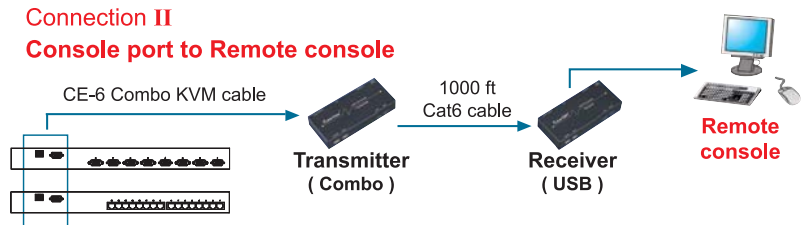

### IP-101 IP KVM Extender

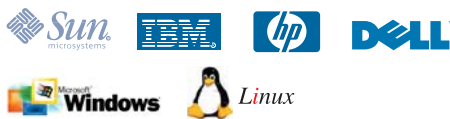

- ▶ Compatible with all branded KVM switches
- ▶ IP Remote access from any location via web browser
- ▶ Maintaining servers across the world up to BIOS level

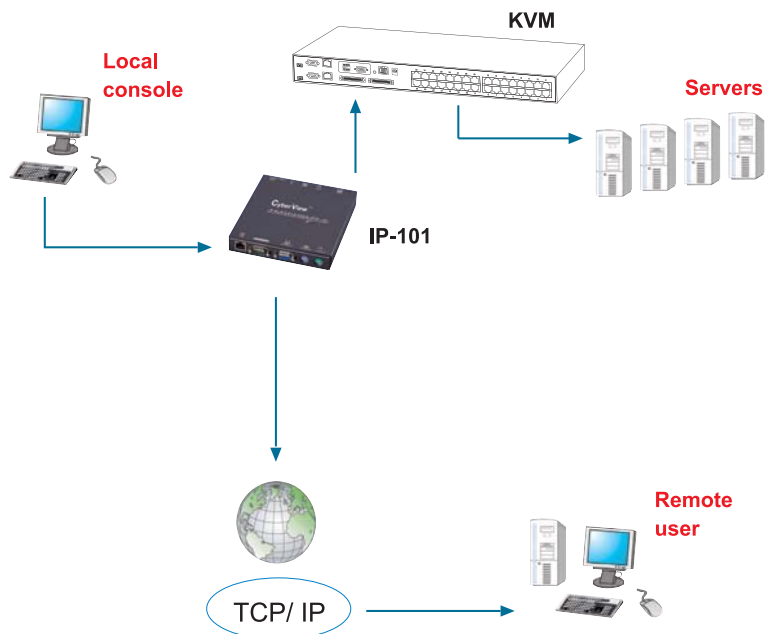

- **KVM Port**  
Graphic connector : HDDB 15-pin VGA  
Input device : 2 x PS/2 for KB & MS
- **Console**  
Graphic connector : HDDB 15-pin VGA  
Input device : 2 x PS/2 for KB & MS
- **IP Remote Console**  
Connector : RJ45 Ethernet  
User management : 15-user login, 1 x active user  
Network protocol : DHCP / BOOTP / DNS  
Security : SSL v3, RSA, AES, HTTP / HTTPS, CSR  
Resolution : 1600 x 1200  
Browser : IE, Firefox, Safari, Netscape  
Others : Serial port, virtual media via USB
- **Power** 100~240VAC via AC adapter
- **Dimensions** 143 x 156 x 28 mm

### L-120



#### LCD Drawer & KVM Benefits

- ▶ Multi-user Matrix KVM with either 16 or 32 ports in 1U
- ▶ Cost efficient Combo KVM integration
- ▶ Ultra high resolution 1600 x 1200
- ▶ Mix PS/2, USB & SUN with Multi-Platform switch capability

#### Drawer Features & Options

- 1U rackmount drawer with 20" LCD
- Combo interface either PS/2 or USB input to the LCD drawer
- Multiple keyboard language selections with 2 button touchpad
- Enhanced aesthetics with new molded front panel and two point lock



**Options** page 103~104 for full details



BNC + S-Video



DVI-D



DC Power



Audio

BNC + S-Video

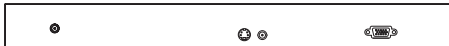

DC Power

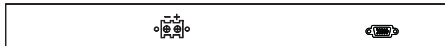

DVI-D



Audio



Diagram

Unit : mm

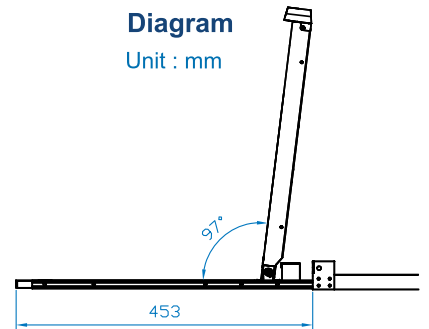

**Monitor** Grade A 20" industrial TFT LCD panel page 105 for full monitor details

#### Dimensions

Model	Product Dimension (W x D x H)	Packing Dimension (W x D x H)	Net Weight	Gross Weight
L-120 Series	442 x 650 x 44 mm 17.4 x 25.6 x 1.73 inch	589 x 856 x 168 mm 23.2 x 33.7 x 6.6 inch	20 kg / 44 lbs	26 kg / 57 lbs

#### Keyboard Selection

Supporting layouts



**N** N keyboard with full numerical pad

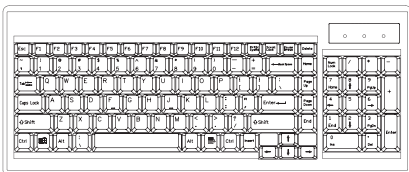

page 106 for full keyboard details



back



# KVM Selection















Base Model

20" LCD Series















<ul style="list-style-type: none"> <li>• Single port w/o KVM</li> <li>• Combo interface</li> </ul>	<h2>L-120</h2>
--	----------------

## Matrix Cat6 KVM









page 23~38 for KVM specifications, page 107~110 for KVM rear I/O

	2 consoles	<b>Matrix</b> Cat6 16 port	L120 - MU 1602
	3 consoles		L120 - MU 1603
	4 consoles		L120 - MU 1604
	3 consoles	<b>Matrix</b>  Cat6 16 port	L120 - MU IP 1613
	4 consoles		L120 - MU IP 1614
	4 consoles		L120 - MU IP 1624
	2 consoles	<b>Matrix</b> Cat6 32 port	L120 - MU 3202
	3 consoles		L120 - MU 3203
	4 consoles		L120 - MU 3204
	3 consoles	<b>Matrix</b>  Cat6 32 port	L120 - MU IP 3213
	4 consoles		L120 - MU IP 3214
	4 consoles		L120 - MU IP 3224







## Matrix DB-15 KVM

	2 consoles	<b>Matrix</b> DB-15 8 port	L120 - M 802
	3 consoles		L120 - M 803
	4 consoles		L120 - M 804
	3 consoles	<b>Matrix</b>  DB-15 8 port	L120 - M IP 813
	4 consoles		L120 - M IP 814
	4 consoles		L120 - M IP 824
	2 consoles	<b>Matrix</b> DB-15 16 port	L120 - M 1602
	3 consoles		L120 - M 1603
	4 consoles		L120 - M 1604
	3 consoles	<b>Matrix</b>  DB-15 16 port	L120 - M IP 1613
	4 consoles		L120 - M IP 1614
	4 consoles		L120 - M IP 1624



## Combo Cat6 KVM

	1 console	<b>Combo</b> Cat6 8 port	L120 - U 801
	2 consoles		L120 - U 802
	2 consoles		L120 - U IP 802
	1 console	<b>Combo</b> Cat6 16 port	L120 - U 1601
	2 consoles		L120 - U 1602
	2 consoles		L120 - U IP 1602
	1 console	<b>Combo</b> Cat6 32 port	L120 - U 3201
	2 consoles		L120 - U 3202
	2 consoles		L120 - U IP 3202

## Combo DB-15 KVM

	1 console	<b>Combo</b> DB-15 8 port	L120 - S 801
	2 consoles		L120 - 802
	2 consoles		L120 - IP 802
	1 console	<b>Combo</b> DB-15 16 port	L120 - S 1601
	2 consoles		L120 - 1602
	2 consoles		L120 - IP 1602

## PS/2 DB-15 KVM

	1 console	 DB-15 8 port 16 port	L120 - 801
			L120 - 1601

### LS-120



#### LCD Drawer & KVM Benefits

- ▶ Multi-user Matrix KVM with either 16 or 32 ports in 1U
- ▶ Cost efficient Combo KVM integration
- ▶ Direct support for SUN Micro 1152 x 900 native resolution
- ▶ Ultra high resolution 1600 x 1200
- ▶ Mix PS/2, USB & SUN with Multi-Platform switch capability
- ▶ Secure remote user access across the world wide web

#### Drawer Features & Options

- 1U rackmount drawer with 20" LCD
- Combo interface either PS/2 or USB input to the LCD drawer
- SUN key support including Stop, Cut, Paste, Compose etc
- US and UK keyboard language selections with touchpad
- Enhanced aesthetics with new molded front panel and two point lock

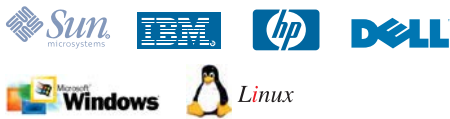

**Options** page 103~104 for full details



DVI-D



DC Power

DVI-D



DC Power

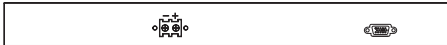

**Diagram**  
Unit : mm

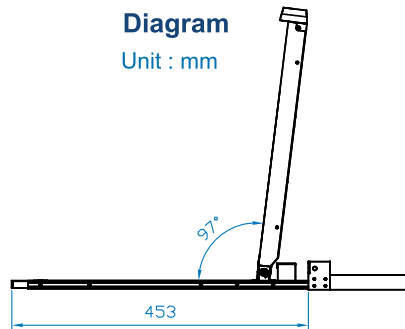

**Monitor** Grade A 20" industrial TFT LCD panel page 105 for full monitor details

#### Dimensions

Model	Product Dimension (W x D x H)	Packing Dimension (W x D x H)	Net Weight	Gross Weight
LS-120 Series	442 x 650 x 44 mm 17.4 x 25.6 x 1.73 inch	589 x 856 x 168 mm 23.2 x 33.7 x 6.6 inch	20 kg / 44 lbs	26 kg / 57 lbs

#### Keyboard Selection

Supporting layouts USB interface, Incorporates SUN keys

**NS** NS keyboard with full numerical pad and SUN function

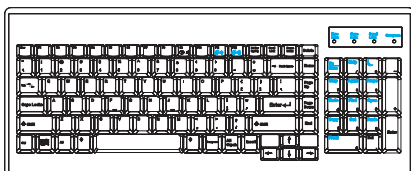

page 106 for full keyboard details



## KVM Selection















Base Model

20" LCD Series















<ul style="list-style-type: none"> <li>• Single port w/o KVM</li> <li>• USB interface</li> </ul>	<b>LS-120</b>
--	---------------

### Matrix Cat6 KVM









page 23~38 for KVM specifications, page 107~110 for KVM rear I/O

	2 consoles	<b>Matrix</b> Cat6 16 port	LS120 - MU 1602
	3 consoles		LS120 - MU 1603
	4 consoles		LS120 - MU 1604
	3 consoles	<b>Matrix</b>  Cat6 16 port	LS120 - MU IP 1613
	4 consoles		LS120 - MU IP 1614
	4 consoles		LS120 - MU IP 1624
	2 consoles	<b>Matrix</b> Cat6 32 port	LS120 - MU 3202
	3 consoles		LS120 - MU 3203
	4 consoles		LS120 - MU 3204
	3 consoles	<b>Matrix</b>  Cat6 32 port	LS120 - MU IP 3213
	4 consoles		LS120 - MU IP 3214
	4 consoles		LS120 - MU IP 3224







### Matrix DB-15 KVM

	2 consoles	<b>Matrix</b> DB-15 8 port	LS120 - M 802
	3 consoles		LS120 - M 803
	4 consoles		LS120 - M 804
	3 consoles	<b>Matrix</b>  DB-15 8 port	LS120 - M IP 813
	4 consoles		LS120 - M IP 814
	4 consoles		LS120 - M IP 824
	2 consoles	<b>Matrix</b> DB-15 16 port	LS120 - M 1602
	3 consoles		LS120 - M 1603
	4 consoles		LS120 - M 1604
	3 consoles	<b>Matrix</b>  DB-15 16 port	LS120 - M IP 1613
	4 consoles		LS120 - M IP 1614
	4 consoles		LS120 - M IP 1624

### Combo Cat6 KVM

	1 console	<b>Combo</b> Cat6 8 port	LS120 - U 801
	2 consoles		LS120 - U 802
	2 consoles		LS120 - U IP 802
	1 console	<b>Combo</b> Cat6 16 port	LS120 - U 1601
	2 consoles		LS120 - U 1602
	2 consoles		LS120 - U IP 1602
	1 console	<b>Combo</b> Cat6 32 port	LS120 - U 3201
	2 consoles		LS120 - U 3202
	2 consoles		LS120 - U IP 3202

### Combo DB-15 KVM

	1 console	<b>Combo</b> DB-15 8 port	LS120 - S 801
	2 consoles		LS120 - 802
	2 consoles		LS120 - IP 802
	1 console	<b>Combo</b> DB-15 16 port	LS120 - S 1601
	2 consoles		LS120 - 1602
	2 consoles		LS120 - IP 1602

### W-119



#### LCD Drawer & KVM Benefits

- ▶ Multi-user Matrix KVM with either 16 or 32 ports in 1U
- ▶ Cost efficient Combo KVM integration
- ▶ 19" widescreen LCD with high resolution 1440 x 900
- ▶ Mix PS/2, USB & SUN with Multi-Platform switch capability

#### Drawer Features & Options

- 1U rackmount drawer with 19" widescreen LCD
- Combo interface either PS/2 or USB input to the LCD drawer
- Multiple keyboard language selections with either touchpad or trackball
- Enhanced aesthetics with new molded front panel and two point lock



**Options** page 103~104 for full details



BNC + S-Video



DVI-D



DC Power



Audio

BNC + S-Video



DC Power



DVI-D



Audio



Diagram  
Unit : mm

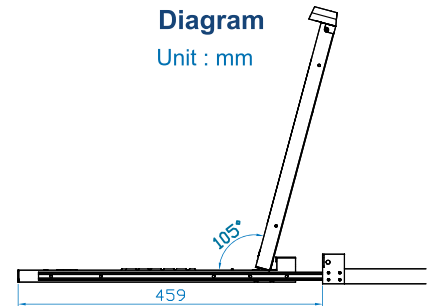

**Monitor** Grade A Wide 19" industrial TFT LCD panel page 105 for full monitor details

#### Dimensions

Model	Product Dimension (W x D x H)	Packing Dimension (W x D x H)	Net Weight	Gross Weight
W-119 Series	442 x 600 x 44 mm 17.4 x 23.6 x 1.73 inch	581 x 755 x 172 mm 22.9 x 29.7 x 6.8 inch	18 kg / 40 lbs	24 kg / 53 lbs

#### Keyboard Selection

Supporting layouts



**Ne** N keyboard integrated with touchpad

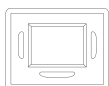
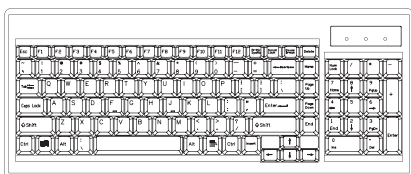

**Nb** N keyboard integrated with trackball

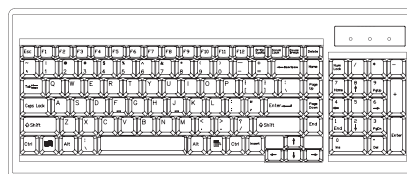

page 106 for full keyboard details



# KVM Selection

Base Model

Wide 19" LCD Series

<ul style="list-style-type: none"> <li>• Single port w/o KVM</li> <li>• Combo interface</li> </ul>	<p><b>W-119</b> </p>
--	----------------------

■ W-119 series in single console, with Combo Cat6 KVM or Combo DB-15 KVM integration is UL approved.

## Matrix Cat6 KVM

page 23~38 for KVM specifications, page 107~110 for KVM rear I/O

	2 consoles	<b>Matrix</b> Cat6 16 port	W119 - MU 1602
	3 consoles		W119 - MU 1603
	4 consoles		W119 - MU 1604
	3 consoles	<b>Matrix</b> Cat6 16 port	W119 - MU IP 1613
	4 consoles		W119 - MU IP 1614
	4 consoles		W119 - MU IP 1624
	2 consoles	<b>Matrix</b> Cat6 32 port	W119 - MU 3202
	3 consoles		W119 - MU 3203
	4 consoles		W119 - MU 3204
	3 consoles	<b>Matrix</b> Cat6 32 port	W119 - MU IP 3213
	4 consoles		W119 - MU IP 3214
	4 consoles		W119 - MU IP 3224

## Matrix DB-15 KVM

	2 consoles	<b>Matrix</b> DB-15 8 port	W119 - M 802
	3 consoles		W119 - M 803
	4 consoles		W119 - M 804
	3 consoles	<b>Matrix</b> DB-15 8 port	W119 - M IP 813
	4 consoles		W119 - M IP 814
	4 consoles		W119 - M IP 824
	2 consoles	<b>Matrix</b> DB-15 16 port	W119 - M 1602
	3 consoles		W119 - M 1603
	4 consoles		W119 - M 1604
	3 consoles	<b>Matrix</b> DB-15 16 port	W119 - M IP 1613
	4 consoles		W119 - M IP 1614
	4 consoles		W119 - M IP 1624

## Combo Cat6 KVM

	1 console	<b>Combo</b> Cat6 8 port	W119 - U 801
	2 consoles		W119 - U 802
	2 consoles		W119 - U IP 802
	1 console	<b>Combo</b> Cat6 16 port	W119 - U 1601
	2 consoles		W119 - U 1602
	2 consoles		W119 - U IP 1602
	1 console	<b>Combo</b> Cat6 32 port	W119 - U 3201
	2 consoles		W119 - U 3202
	2 consoles		W119 - U IP 3202

## Combo DB-15 KVM

	1 console	<b>Combo</b> DB-15 8 port	W119 - S 801
	2 consoles		W119 - 802
	2 consoles		W119 - IP 802
	1 console	<b>Combo</b> DB-15 16 port	W119 - S 1601
	2 consoles		W119 - 1602
	2 consoles		W119 - IP 1602

## PS/2 DB-15 KVM

	1 console	DB-15 8 port 16 port	W119 - 801
			W119 - 1601

### WS-119



#### LCD Drawer & KVM Benefits

- ▶ Multi-user Matrix KVM with either 16 or 32 ports in 1U
- ▶ Cost efficient Combo KVM integration
- ▶ Direct support for SUN Micro 1152 x 900 native resolution
- ▶ 19" widescreen LCD with high resolution 1440 x 900
- ▶ Mix PS/2, USB & SUN with Multi-Platform switch capability
- ▶ Secure remote user access across the world wide web

#### Drawer Features & Options

- 1U rackmount drawer with 19" widescreen LCD
- Combo interface either PS/2 or USB input to the LCD drawer
- SUN key support including Stop, Cut, Paste, Compose etc
- US and UK keyboard language selections with either touchpad or trackball
- Enhanced aesthetics with new molded front panel and two point lock

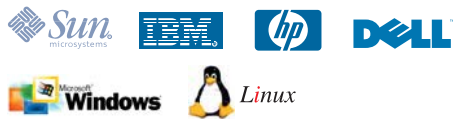

**Options** page 103~104 for full details

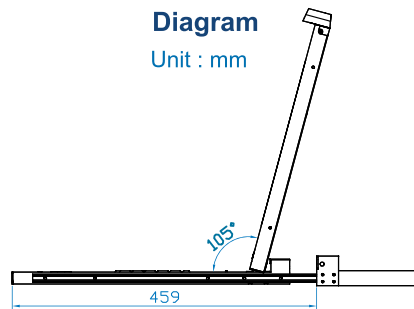
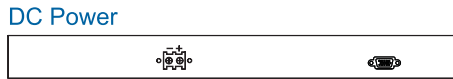

**Monitor** Grade A Wide 19" industrial TFT LCD panel page 105 for full monitor details

#### Dimensions

Model	Product Dimension (W x D x H)	Packing Dimension (W x D x H)	Net Weight	Gross Weight
WS-119 Series	442 x 600 x 44 mm 17.4 x 23.6 x 1.73 inch	581 x 755 x 172 mm 22.9 x 29.7 x 6.8 inch	18 kg / 40 lbs	24 kg / 53 lbs

**Keyboard Selection** Supporting layouts USB interface, Incorporates SUN keys

**Se** NS keyboard integrated with touchpad

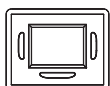
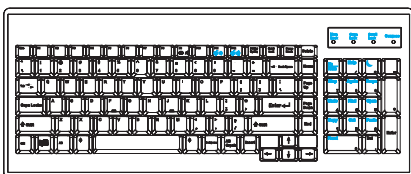

**Sb** NS keyboard integrated with trackball

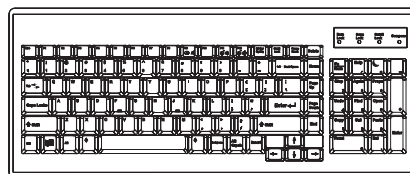

page 106 for full keyboard details



# KVM Selection

## Base Model

## Wide 19" LCD Series

<ul style="list-style-type: none"> <li>• Single port w/o KVM</li> <li>• USB interface</li> </ul>	<b>WS-119</b>
--	---------------

■ WS-119 series in single console, with Combo Cat6 KVM or Combo DB-15 KVM integration is UL approved.

### Matrix Cat6 KVM

page 23~38 for KVM specifications, page 107~110 for KVM rear I/O

	2 consoles	<b>Matrix</b> Cat6 16 port	WS119 - MU 1602
	3 consoles		WS119 - MU 1603
	4 consoles		WS119 - MU 1604
	3 consoles	<b>Matrix</b> Cat6 16 port	WS119 - MU IP 1613
	4 consoles		WS119 - MU IP 1614
	4 consoles		WS119 - MU IP 1624
	2 consoles	<b>Matrix</b> Cat6 32 port	WS119 - MU 3202
	3 consoles		WS119 - MU 3203
	4 consoles		WS119 - MU 3204
	3 consoles	<b>Matrix</b> Cat6 32 port	WS119 - MU IP 3213
	4 consoles		WS119 - MU IP 3214
	4 consoles		WS119 - MU IP 3224

### Matrix DB-15 KVM

	2 consoles	<b>Matrix</b> DB-15 8 port	WS119 - M 802
	3 consoles		WS119 - M 803
	4 consoles		WS119 - M 804
	3 consoles	<b>Matrix</b> DB-15 8 port	WS119 - M IP 813
	4 consoles		WS119 - M IP 814
	4 consoles		WS119 - M IP 824
	2 consoles	<b>Matrix</b> DB-15 16 port	WS119 - M 1602
	3 consoles		WS119 - M 1603
	4 consoles		WS119 - M 1604
	3 consoles	<b>Matrix</b> DB-15 16 port	WS119 - M IP 1613
	4 consoles		WS119 - M IP 1614
	4 consoles		WS119 - M IP 1624

### Combo Cat6 KVM

	1 console	<b>Combo</b> Cat6 8 port	WS119 - U 801
	2 consoles		WS119 - U 802
	2 consoles		WS119 - U IP 802
	1 console	<b>Combo</b> Cat6 16 port	WS119 - U 1601
	2 consoles		WS119 - U 1602
	2 consoles		WS119 - U IP 1602
	1 console	<b>Combo</b> Cat6 32 port	WS119 - U 3201
	2 consoles		WS119 - U 3202
	2 consoles		WS119 - U IP 3202

### Combo DB-15 KVM

	1 console	<b>Combo</b> DB-15 8 port	WS119 - S 801
	2 consoles		WS119 - 802
	2 consoles		WS119 - IP 802
	1 console	<b>Combo</b> DB-15 16 port	WS119 - S 1601
	2 consoles		WS119 - 1602
	2 consoles		WS119 - IP 1602

D-117  
D-119



### LCD Drawer & KVM Benefits

- ▶ 1U dual slide rackmount drawer with either 17" or 19" LCD
- ▶ Multi-user Matrix KVM with either 16 or 32 ports in 1U
- ▶ Cost efficient Combo KVM integration
- ▶ Mix PS/2, USB & SUN with Multi-Platform switch capability

### Drawer Features & Options

- Combo interface either PS/2 or USB input to the LCD Drawer
- Multiple keyboard language selections with touchpad
- Enhanced aesthetics with new molded front panel and two point lock



Options page 103~104 for full details



BNC + S-Video



DC Power



DVI-D



Audio



Diagram

Unit : mm

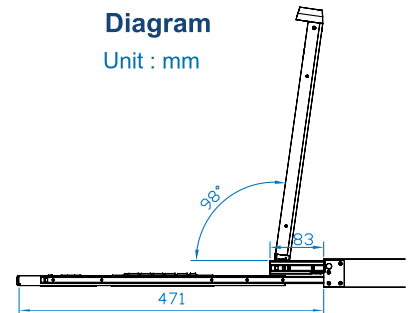

Monitor Grade A 17", 19" industrial TFT LCD panel page 105 for full monitor details

### Dimensions

Model	Product Dimension (W x D x H)	Packing Dimension (W x D x H)	Net Weight	Gross Weight
D-117 Series	442 x 650 x 44 mm 17.4 x 25.6 x 1.73 inch	589 x 856 x 168 mm 23.2 x 33.7 x 6.6 inch	16 kg / 35 lbs	22 kg / 48 lbs
D-119 Series	442 x 650 x 44 mm 17.4 x 25.6 x 1.73 inch	589 x 856 x 168 mm 23.2 x 33.7 x 6.6 inch	17 kg / 37 lbs	23 kg / 51 lbs

### Keyboard Selection

Supporting layouts



**N** keyboard integrated with touchpad

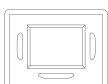
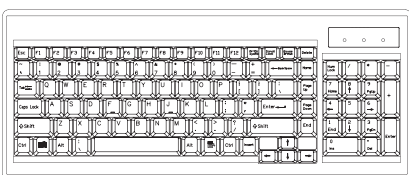

page 106 for full keyboard details



















# KVM Selection















Base Model	17" LCD Series	19" LCD Series
<ul style="list-style-type: none"> <li>* Single port w/o KVM</li> <li>* Combo interface</li> </ul>	D-117	D-119

## Matrix Cat6 KVM









page 23~38 for KVM specifications, page 107~110 for KVM rear I/O

	2 consoles	<b>Matrix</b> Cat6 16 port	D117 - MU 1602	D119 - MU 1602
	3 consoles		D117 - MU 1603	D119 - MU 1603
	4 consoles		D117 - MU 1604	D119 - MU 1604
	3 consoles	<b>Matrix</b>  Cat6 16 port	D117 - MU IP 1613	D119 - MU IP 1613
	4 consoles		D117 - MU IP 1614	D119 - MU IP 1614
	4 consoles		D117 - MU IP 1624	D119 - MU IP 1624
	2 consoles	<b>Matrix</b> Cat6 32 port	D117 - MU 3202	D119 - MU 3202
	3 consoles		D117 - MU 3203	D119 - MU 3203
	4 consoles		D117 - MU 3204	D119 - MU 3204
	3 consoles	<b>Matrix</b>  Cat6 32 port	D117 - MU IP 3213	D119 - MU IP 3213
	4 consoles		D117 - MU IP 3214	D119 - MU IP 3214
	4 consoles		D117 - MU IP 3224	D119 - MU IP 3224







## Matrix DB-15 KVM

	2 consoles	<b>Matrix</b> DB-15 8 port	D117 - M 802	D119 - M 802
	3 consoles		D117 - M 803	D119 - M 803
	4 consoles		D117 - M 804	D119 - M 804
	3 consoles	<b>Matrix</b>  DB-15 8 port	D117 - M IP 813	D119 - M IP 813
	4 consoles		D117 - M IP 814	D119 - M IP 814
	4 consoles		D117 - M IP 824	D119 - M IP 824
	2 consoles	<b>Matrix</b> DB-15 16 port	D117 - M 1602	D119 - M 1602
	3 consoles		D117 - M 1603	D119 - M 1603
	4 consoles		D117 - M 1604	D119 - M 1604
	3 consoles	<b>Matrix</b>  DB-15 16 port	D117 - M IP 1613	D119 - M IP 1613
	4 consoles		D117 - M IP 1614	D119 - M IP 1614
	4 consoles		D117 - M IP 1624	D119 - M IP 1624



## Combo Cat6 KVM

	1 console	<b>Combo</b> Cat6 8 port	D117 - U 801	D119 - U 801
	2 consoles		D117 - U 802	D119 - U 802
	2 consoles		D117 - U IP 802	D119 - U IP 802
	1 console	<b>Combo</b> Cat6 16 port	D117 - U 1601	D119 - U 1601
	2 consoles		D117 - U 1602	D119 - U 1602
	2 consoles		D117 - U IP 1602	D119 - U IP 1602
	1 console	<b>Combo</b> Cat6 32 port	D117 - U 3201	D119 - U 3201
	2 consoles		D117 - U 3202	D119 - U 3202
	2 consoles		D117 - U IP 3202	D119 - U IP 3202

## Combo DB-15 KVM

	1 console	<b>Combo</b> DB-15 8 port	D117 - S 801	D119 - S 801
	2 consoles		D117 - 802	D119 - 802
	2 consoles		D117 - IP 802	D119 - IP 802
	1 console	<b>Combo</b> DB-15 16 port	D117 - S 1601	D119 - S 1601
	2 consoles		D117 - 1602	D119 - 1602
	2 consoles		D117 - IP 1602	D119 - IP 1602

## PS/2 DB-15 KVM

	1 console	 DB-15 8 port 16 port	D117 - 801	D119 - 801
			D117 - 1601	D119 - 1601

**DS-117**  
**DS-119**



New



### LCD Drawer & KVM Benefits

- ▶ 1U dual slide rackmount drawer with either 17" or 19" LCD
- ▶ Multi-user Matrix KVM with either 16 or 32 ports in 1U
- ▶ Cost efficient Combo KVM integration
- ▶ Direct support for SUN Micro 1152 x 900 native resolution
- ▶ Mix PS/2, USB & SUN with Multi-Platform switch capability
- ▶ Secure remote user access across the world wide web

### Drawer Features & Options

- Combo interface either PS/2 or USB input to the LCD drawer
- SUN key support including Stop, Cut, Paste, Compose etc
- US and UK keyboard language selections with touchpad
- Enhanced aesthetics with new molded front panel and two point lock

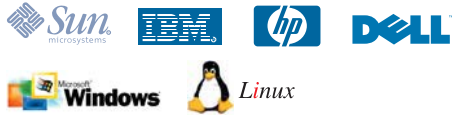

**Options** page 103~104 for full details



DVI-D



DC Power

DVI-D



DC Power



**Diagram**

Unit : mm

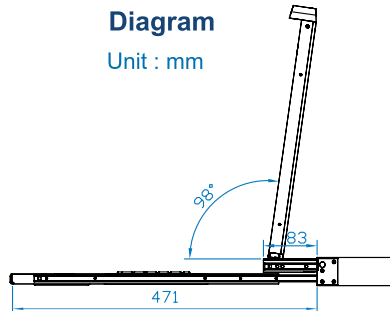

**Monitor** Grade A 17", 19" industrial TFT LCD panel page 105 for full monitor details

### Dimensions

Model	Product Dimension (W x D x H)	Packing Dimension (W x D x H)	Net Weight	Gross Weight
DS-117 Series	442 x 650 x 44 mm 17.4 x 25.6 x 1.73 inch	589 x 856 x 168 mm 23.2 x 33.7 x 6.6 inch	16 kg / 35 lbs	22 kg / 48 lbs
DS-119 Series	442 x 650 x 44 mm 17.4 x 25.6 x 1.73 inch	589 x 856 x 168 mm 23.2 x 33.7 x 6.6 inch	17 kg / 37 lbs	23 kg / 51 lbs

### Keyboard Selection

Supporting layouts USB interface, Incorporates SUN keys

**Se** NS keyboard integrated with touchpad

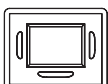
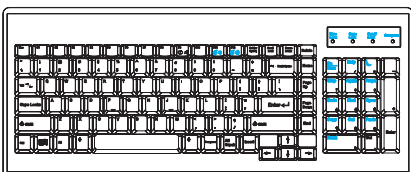

page 106 for full keyboard details

















# KVM Selection















Base Model	17" LCD Series	19" LCD Series
<ul style="list-style-type: none"> <li>* Single port w/o KVM</li> <li>* USB interface</li> </ul>	DS-117	DS-119

## Matrix Cat6 KVM









page 23~38 for KVM specifications, page 107~110 for KVM rear I/O

	2 consoles	<b>Matrix</b> Cat6 16 port	DS117 - MU 1602	DS119 - MU 1602
	3 consoles		DS117 - MU 1603	DS119 - MU 1603
	4 consoles		DS117 - MU 1604	DS119 - MU 1604
	3 consoles	<b>Matrix</b>  Cat6 16 port	DS117 - MU IP 1613	DS119 - MU IP 1613
	4 consoles		DS117 - MU IP 1614	DS119 - MU IP 1614
	4 consoles		DS117 - MU IP 1624	DS119 - MU IP 1624
	2 consoles	<b>Matrix</b> Cat6 32 port	DS117 - MU 3202	DS119 - MU 3202
	3 consoles		DS117 - MU 3203	DS119 - MU 3203
	4 consoles		DS117 - MU 3204	DS119 - MU 3204
	3 consoles	<b>Matrix</b>  Cat6 32 port	DS117 - MU IP 3213	DS119 - MU IP 3213
	4 consoles		DS117 - MU IP 3214	DS119 - MU IP 3214
	4 consoles		DS117 - MU IP 3224	DS119 - MU IP 3224







## Matrix DB-15 KVM

	2 consoles	<b>Matrix</b> DB-15 8 port	DS117 - M 802	DS119 - M 802
	3 consoles		DS117 - M 803	DS119 - M 803
	4 consoles		DS117 - M 804	DS119 - M 804
	3 consoles	<b>Matrix</b>  DB-15 8 port	DS117 - M IP 813	DS119 - M IP 813
	4 consoles		DS117 - M IP 814	DS119 - M IP 814
	4 consoles		DS117 - M IP 824	DS119 - M IP 824
	2 consoles	<b>Matrix</b> DB-15 16 port	DS117 - M 1602	DS119 - M 1602
	3 consoles		DS117 - M 1603	DS119 - M 1603
	4 consoles		DS117 - M 1604	DS119 - M 1604
	3 consoles	<b>Matrix</b>  DB-15 16 port	DS117 - M IP 1613	DS119 - M IP 1613
	4 consoles		DS117 - M IP 1614	DS119 - M IP 1614
	4 consoles		DS117 - M IP 1624	DS119 - M IP 1624

## Combo Cat6 KVM

	1 console	<b>Combo</b> Cat6 8 port	DS117 - U 801	DS119 - U 801
	2 consoles		DS117 - U 802	DS119 - U 802
	2 consoles		DS117 - U IP 802	DS119 - U IP 802
	1 console	<b>Combo</b> Cat6 16 port	DS117 - U 1601	DS119 - U 1601
	2 consoles		DS117 - U 1602	DS119 - U 1602
	2 consoles		DS117 - U IP 1602	DS119 - U IP 1602
	1 console	<b>Combo</b> Cat6 32 port	DS117 - U 3201	DS119 - U 3201
	2 consoles		DS117 - U 3202	DS119 - U 3202
	2 consoles		DS117 - U IP 3202	DS119 - U IP 3202

## Combo DB-15 KVM

	1 console	<b>Combo</b> DB-15 8 port	DS117 - S 801	DS119 - S 801
	2 consoles		DS117 - 802	DS119 - 802
	2 consoles		DS117 - IP 802	DS119 - IP 802
	1 console	<b>Combo</b> DB-15 16 port	DS117 - S 1601	DS119 - S 1601
	2 consoles		DS117 - 1602	DS119 - 1602
	2 consoles		DS117 - IP 1602	DS119 - IP 1602

N-117  
N-119



### LCD Drawer & KVM Benefits

- ▶ Multi-user Matrix KVM with either 16 or 32 ports in 1U
- ▶ Cost efficient Combo KVM integration
- ▶ "One Man" installation slides for easy, quick installation
- ▶ Mix PS/2, USB & SUN with Multi-Platform switch capability
- ▶ Secure remote user access across the world wide web

### Drawer Features & Options

- 1U rackmount drawer with either 17" or 19" LCD
- Combo interface either PS/2 or USB input to the LCD drawer
- Multiple keyboard language selections with either touchpad or trackball
- Slide rails with fixed positions to prevent drawer movement when typing
- An aesthetically enhanced latching front panel to release the two point lock



**Options** *page 103~104 for full details*

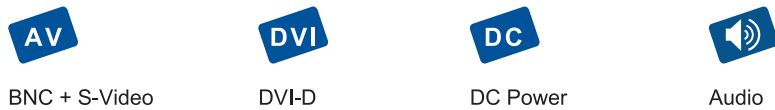

S-Video + BNC

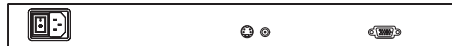

DC Power

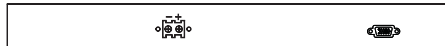

DVI-D



Audio



**Diagram**  
Unit : mm

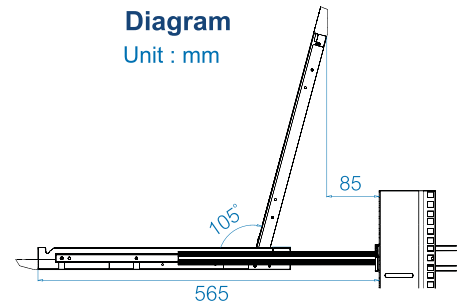

**Monitor** Grade A 17" or 19" industrial TFT LCD panel *page 105 for full monitor details*

### Dimensions

Model	Product Dimension (W x D x H)	Packing Dimension (W x D x H)	Net Weight	Gross Weight
N-117 Series	442 x 650 x 44 mm 17.4 x 25.6 x 1.73 inch	589 x 856 x 168 mm 23.2 x 33.7 x 6.6 inch	16 kg / 35 lbs	22 kg / 48 lbs
N-119 Series	442 x 650 x 44 mm 17.4 x 25.6 x 1.73 inch	589 x 856 x 168 mm 23.2 x 33.7 x 6.6 inch	17 kg / 37 lbs	23 kg / 51 lbs

### Keyboard Selection

Supporting layouts



**Ne** N keyboard integrated with touchpad

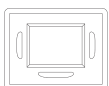
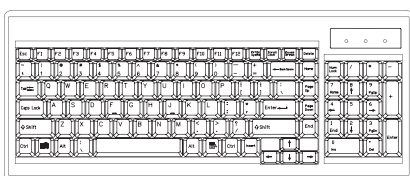

**Nb** N keyboard integrated with trackball

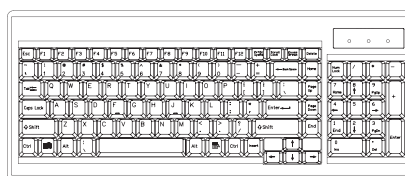

*page 106 for full keyboard details*

back

















# KVM Selection















Base Model	17" LCD Series	19" LCD Series
<ul style="list-style-type: none"> <li>* Single port w/o KVM</li> <li>* Combo interface</li> </ul>	N-117	N-119

## Matrix Cat6 KVM









page 23~38 for KVM specifications, page 107~110 for KVM rear I/O

	2 consoles	<b>Matrix</b> Cat6 16 port	N117 - MU 1602	N119 - MU 1602
	3 consoles		N117 - MU 1603	N119 - MU 1603
	4 consoles		N117 - MU 1604	N119 - MU 1604
	3 consoles	<b>Matrix</b>  Cat6 16 port	N117 - MU IP 1613	N119 - MU IP 1613
	4 consoles		N117 - MU IP 1614	N119 - MU IP 1614
	4 consoles		N117 - MU IP 1624	N119 - MU IP 1624
	2 consoles	<b>Matrix</b> Cat6 32 port	N117 - MU 3202	N119 - MU 3202
	3 consoles		N117 - MU 3203	N119 - MU 3203
	4 consoles		N117 - MU 3204	N119 - MU 3204
	3 consoles	<b>Matrix</b>  Cat6 32 port	N117 - MU IP 3213	N119 - MU IP 3213
	4 consoles		N117 - MU IP 3214	N119 - MU IP 3214
	4 consoles		N117 - MU IP 3224	N119 - MU IP 3224







## Matrix DB-15 KVM

	2 consoles	<b>Matrix</b> DB-15 8 port	N117 - M 802	N119 - M 802
	3 consoles		N117 - M 803	N119 - M 803
	4 consoles		N117 - M 804	N119 - M 804
	3 consoles	<b>Matrix</b>  DB-15 8 port	N117 - M IP 813	N119 - M IP 813
	4 consoles		N117 - M IP 814	N119 - M IP 814
	4 consoles		N117 - M IP 824	N119 - M IP 824
	2 consoles	<b>Matrix</b> DB-15 16 port	N117 - M 1602	N119 - M 1602
	3 consoles		N117 - M 1603	N119 - M 1603
	4 consoles		N117 - M 1604	N119 - M 1604
	3 consoles	<b>Matrix</b>  DB-15 16 port	N117 - M IP 1613	N119 - M IP 1613
	4 consoles		N117 - M IP 1614	N119 - M IP 1614
	4 consoles		N117 - M IP 1624	N119 - M IP 1624



## Combo Cat6 KVM

	1 console	<b>Combo</b> Cat6 8 port	N117 - U 801	N119 - U 801
	2 consoles		N117 - U 802	N119 - U 802
	2 consoles		N117 - U IP 802	N119 - U IP 802
	1 console	<b>Combo</b> Cat6 16 port	N117 - U 1601	N119 - U 1601
	2 consoles		N117 - U 1602	N119 - U 1602
	2 consoles		N117 - U IP 1602	N119 - U IP 1602
	1 console	<b>Combo</b> Cat6 32 port	N117 - U 3201	N119 - U 3201
	2 consoles		N117 - U 3202	N119 - U 3202
	2 consoles		N117 - U IP 3202	N119 - U IP 3202

## Combo DB-15 KVM

	1 console	<b>Combo</b> DB-15 8 port	N117 - S 801	N119 - S 801
	2 consoles		N117 - 802	N119 - 802
	2 consoles		N117 - IP 802	N119 - IP 802
	1 console	<b>Combo</b> DB-15 16 port	N117 - S 1601	N119 - S 1601
	2 consoles		N117 - 1602	N119 - 1602
	2 consoles		N117 - IP 1602	N119 - IP 1602

## PS/2 DB-15 KVM

	1 console	 DB-15 8 port 16 port	N117 - 801	N119 - 801
			N117 - 1601	N119 - 1601

**N-1417**  
**N-1419**



### LCD Drawer Benefits

- ▶ Short depth design of 480mm (18.9") only
- ▶ Depth will suit a 600mm rack application
- ▶ "One Man" installation slides for easy, quick installation
- ▶ 104 key notepad keyboard with full numerical pad

### Drawer Features & Options

- 1U rackmount drawer with either 17" or 19" LCD
- Combo interface either PS/2 or USB input to the LCD drawer
- Multiple keyboard language selections with either touchpad or trackball
- Slide rails with fixed positions to prevent drawer movement when typing
- An aesthetically enhanced latching front panel to release the two point lock

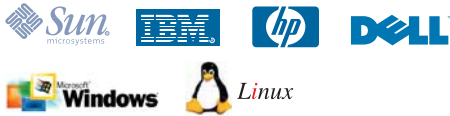

**Options** page 103~104 for full details



**S-Video + BNC**



**DC Power**



**DVI-D**

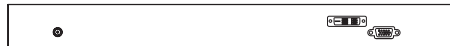

**Audio**



**\*\*With DVI-D or DC power option, the depth of N-1417 / N-1419 will be extended from 480mm ( 18.9" ) to 530mm ( 20.9" )**

### Diagram

Unit : mm

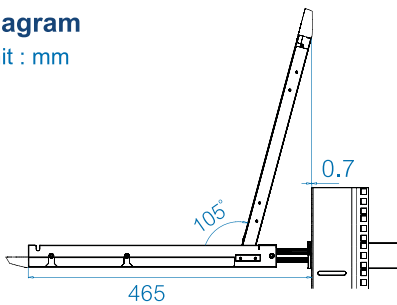

**Monitor**  Grade A 17" or 19" industrial TFT LCD panel page 105 for full monitor details

### Dimensions

Model	Product Dimension (W x D x H)	Packing Dimension (W x D x H)	Net Weight	Gross Weight
N-1417 Series	442 x 480 x 44 mm 17.4 x 18.9 x 1.73 inch	581 x 705 x 175 mm 22.9 x 27.8 x 6.9 inch	15 kg / 33 lbs	19 kg / 42 lbs
N-1419 Series	442 x 480 x 44 mm 17.4 x 18.9 x 1.73 inch	581 x 705 x 175 mm 22.9 x 27.8 x 6.9 inch	16 kg / 35 lbs	20 kg / 44 lbs

back



# Model Selection

Base Model	17" LCD Series	19" LCD Series
<ul style="list-style-type: none"> <li>• Single port w/o KVM</li> <li>• Combo interface</li> </ul>	N-1417	N-1419

## Keyboard Selection

Supporting layouts



### Ne N keyboard integrated with touchpad

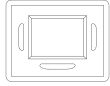
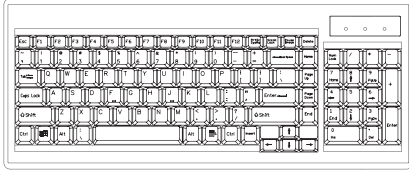

### Nb N keyboard integrated with trackball

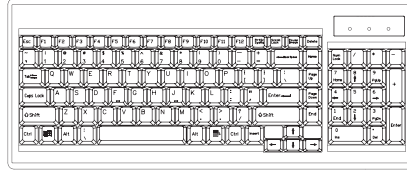

page 106 for full keyboard details

NS-117  
NS-119



### LCD Drawer & KVM Benefits

- ▶ Multi-user Matrix KVM with either 16 or 32 ports in 1U
- ▶ Cost efficient Combo KVM integration
- ▶ Direct support for SUN Micro 1152 x 900 native resolution
- ▶ "One Man" installation slides for easy, quick installation
- ▶ Mix PS/2, USB & SUN with Multi-Platform switch capability
- ▶ Secure remote user access across the world wide web

### Drawer Features & Options

- 1U rackmount drawer with either 17" or 19" LCD
- Combo interface either PS/2 or USB input to the LCD drawer
- SUN key support including Stop, Cut, Paste, Compose etc
- US and UK keyboard language selections with either touchpad or trackball
- Slide rails with fixed positions to prevent drawer movement when typing
- An aesthetically enhanced latching front panel to release the two point lock

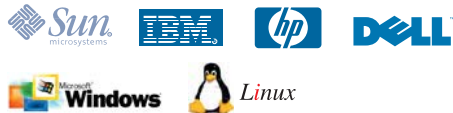

**Options** page 103~104 for full details

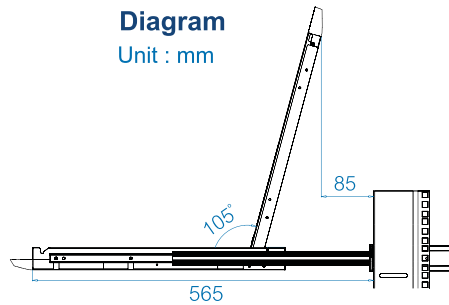
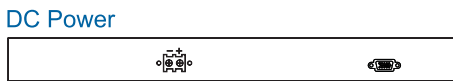
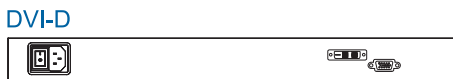
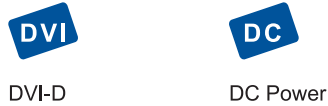

**Monitor** Grade A 17" or 19" industrial TFT LCD panel page 105 for full monitor details

### Dimensions

Model	Product Dimension (W x D x H)	Packing Dimension (W x D x H)	Net Weight	Gross Weight
NS-117 Series	442 x 650 x 44 mm 17.4 x 25.6 x 1.73 inch	589 x 856 x 168 mm 23.2 x 33.7 x 6.6 inch	16 kg / 35 lbs	22 kg / 48 lbs
NS-119 Series	442 x 650 x 44 mm 17.4 x 25.6 x 1.73 inch	589 x 856 x 168 mm 23.2 x 33.7 x 6.6 inch	17 kg / 37 lbs	23 kg / 51 lbs

**Keyboard Selection** Supporting layouts USB interface, Incorporates SUN keys

**Se** NS keyboard integrated with touchpad

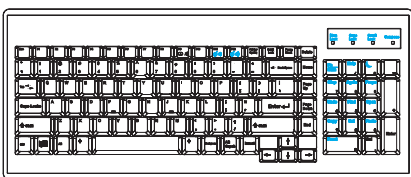

**Sb** NS keyboard integrated with trackball

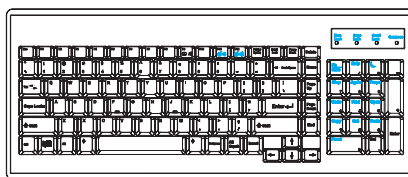

page 106 for full keyboard details



















# KVM Selection















Base Model	17" LCD Series	19" LCD Series
<ul style="list-style-type: none"> <li>* Single port w/o KVM</li> <li>* USB interface</li> </ul>	NS-117	NS-119

## Matrix Cat6 KVM









page 23~38 for KVM specifications, page 107~110 for KVM rear I/O

	2 consoles	<b>Matrix</b> Cat6 16 port	NS117 - MU 1602	NS119 - MU 1602
	3 consoles		NS117 - MU 1603	NS119 - MU 1603
	4 consoles		NS117 - MU 1604	NS119 - MU 1604
	3 consoles	<b>Matrix</b>  Cat6 16 port	NS117 - MU IP 1613	NS119 - MU IP 1613
	4 consoles		NS117 - MU IP 1614	NS119 - MU IP 1614
	4 consoles		NS117 - MU IP 1624	NS119 - MU IP 1624
	2 consoles	<b>Matrix</b> Cat6 32 port	NS117 - MU 3202	NS119 - MU 3202
	3 consoles		NS117 - MU 3203	NS119 - MU 3203
	4 consoles		NS117 - MU 3204	NS119 - MU 3204
	3 consoles	<b>Matrix</b>  Cat6 32 port	NS117 - MU IP 3213	NS119 - MU IP 3213
	4 consoles		NS117 - MU IP 3214	NS119 - MU IP 3214
	4 consoles		NS117 - MU IP 3224	NS119 - MU IP 3224







## Matrix DB-15 KVM

	2 consoles	<b>Matrix</b> DB-15 8 port	NS117 - M 802	NS119 - M 802
	3 consoles		NS117 - M 803	NS119 - M 803
	4 consoles		NS117 - M 804	NS119 - M 804
	3 consoles	<b>Matrix</b>  DB-15 8 port	NS117 - M IP 813	NS119 - M IP 813
	4 consoles		NS117 - M IP 814	NS119 - M IP 814
	4 consoles		NS117 - M IP 824	NS119 - M IP 824
	2 consoles	<b>Matrix</b> DB-15 16 port	NS117 - M 1602	NS119 - M 1602
	3 consoles		NS117 - M 1603	NS119 - M 1603
	4 consoles		NS117 - M 1604	NS119 - M 1604
	3 consoles	<b>Matrix</b>  DB-15 16 port	NS117 - M IP 1613	NS119 - M IP 1613
	4 consoles		NS117 - M IP 1614	NS119 - M IP 1614
	4 consoles		NS117 - M IP 1624	NS119 - M IP 1624

## Combo Cat6 KVM

	1 console	<b>Combo</b> Cat6 8 port	NS117 - U 801	NS119 - U 801
	2 consoles		NS117 - U 802	NS119 - U 802
	2 consoles		NS117 - U IP 802	NS119 - U IP 802
	1 console	<b>Combo</b> Cat6 16 port	NS117 - U 1601	NS119 - U 1601
	2 consoles		NS117 - U 1602	NS119 - U 1602
	2 consoles		NS117 - U IP 1602	NS119 - U IP 1602
	1 console	<b>Combo</b> Cat6 32 port	NS117 - U 3201	NS119 - U 3201
	2 consoles		NS117 - U 3202	NS119 - U 3202
	2 consoles		NS117 - U IP 3202	NS119 - U IP 3202

## Combo DB-15 KVM

	1 console	<b>Combo</b> DB-15 8 port	NS117 - S 801	NS119 - S 801
	2 consoles		NS117 - 802	NS119 - 802
	2 consoles		NS117 - IP 802	NS119 - IP 802
	1 console	<b>Combo</b> DB-15 16 port	NS117 - S 1601	NS119 - S 1601
	2 consoles		NS117 - 1602	NS119 - 1602
	2 consoles		NS117 - IP 1602	NS119 - IP 1602

RKP-115  
RKP-117  
RKP-119



### LCD Drawer & KVM Benefits

- ▶ Multi-user Matrix KVM with either 16 or 32 ports in 1U
- ▶ Cost efficient Combo KVM integration
- ▶ "One Man" installation slides for easy, quick installation
- ▶ Mix PS/2, USB & SUN with Multi-Platform switch capability
- ▶ Secure remote user access across the world wide web

### Drawer Features & Options

- 1U rackmount drawer with either 15", 17" or 19" LCD
- Combo interface either PS/2 or USB input to the LCD drawer
- Multiple keyboard language selections with either touchpad or trackball
- Slide rails with fixed positions to prevent drawer movement when typing
- Enhanced aesthetics with new molded front panel and two point lock

### Options

page 103~104 for full details



BNC + S-Video



DVI-D



DC Power



Touch Screen



Audio

### BNC + S-Video

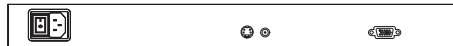

### Touchscreen - USB

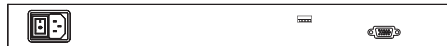

### DVI-D

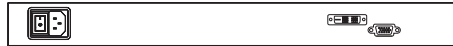

### Touchscreen - Serial

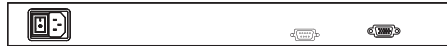

### DC Power



### Audio



### Diagram

Unit : mm

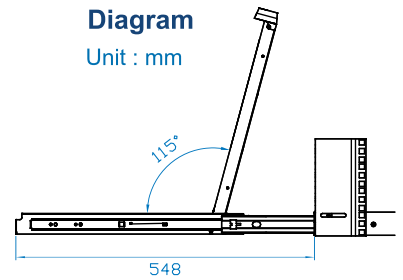

\*\*With touchscreen option, the height of RKP-117 / RKP-119 will be changed from 1U to 1.5U

### Monitor



Grade A 15", 17", 19" industrial TFT LCD panel page 105 for full monitor details

### Dimensions

Model	Product Dimension (W x D x H)	Packing Dimension (W x D x H)	Net Weight	Gross Weight
RKP-115 / RKP-117	442 x 650 x 44 mm 17.4 x 25.6 x 1.73 inch	589 x 856 x 168 mm 23.2 x 33.7 x 6.6 inch	15 kg / 33 lbs	21 kg / 46 lbs
RKP-119	442 x 650 x 44 mm 17.4 x 25.6 x 1.73 inch	589 x 856 x 168 mm 23.2 x 33.7 x 6.6 inch	17 kg / 37 lbs	23 kg / 51 lbs

### Keyboard Selection

Supporting layouts



**Ne** N keyboard integrated with touchpad

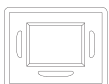
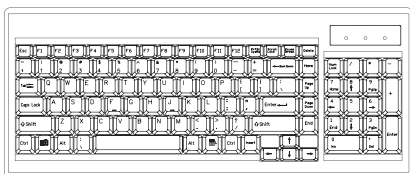

**Nb** N keyboard integrated with trackball

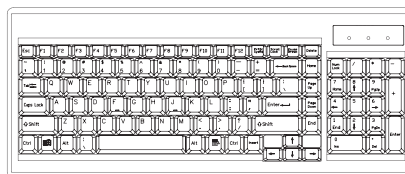

page 106 for full keyboard details

back



# KVM Selection

Base Model

15" LCD Series

17" LCD Series

19" LCD Series

<ul style="list-style-type: none"> <li>• Single port w/o KVM</li> <li>• Combo interface</li> </ul>	<b>RKP-115</b>	<b>RKP-117</b>	<b>RKP-119</b>
--	----------------	----------------	----------------

■ RKP-117 series in single console, with Combo Cat6 KVM or Combo DB-15 KVM integration is UL approved.

## Matrix Cat6 KVM

page 23~38 for KVM specifications, page 107~110 for KVM rear I/O

	2 consoles	<b>Matrix</b> Cat6	16 port	RKP115 - MU 1602	RKP117 - MU 1602	RKP119 - MU 1602
	3 consoles			RKP115 - MU 1603	RKP117 - MU 1603	RKP119 - MU 1603
	4 consoles			RKP115 - MU 1604	RKP117 - MU 1604	RKP119 - MU 1604
	3 consoles	<b>Matrix</b>	16 port	RKP115 - MU IP 1613	RKP117 - MU IP 1613	RKP119 - MU IP 1613
	4 consoles			RKP115 - MU IP 1614	RKP117 - MU IP 1614	RKP119 - MU IP 1614
	4 consoles			RKP115 - MU IP 1624	RKP117 - MU IP 1624	RKP119 - MU IP 1624
	2 consoles	<b>Matrix</b> Cat6	32 port	RKP115 - MU 3202	RKP117 - MU 3202	RKP119 - MU 3202
	3 consoles			RKP115 - MU 3203	RKP117 - MU 3203	RKP119 - MU 3203
	4 consoles			RKP115 - MU 3204	RKP117 - MU 3204	RKP119 - MU 3204
	3 consoles	<b>Matrix</b>	32 port	RKP115 - MU IP 3213	RKP117 - MU IP 3213	RKP119 - MU IP 3213
	4 consoles			RKP115 - MU IP 3214	RKP117 - MU IP 3214	RKP119 - MU IP 3214
	4 consoles			RKP115 - MU IP 3224	RKP117 - MU IP 3224	RKP119 - MU IP 3224

## Matrix DB-15 KVM

	2 consoles	<b>Matrix</b> DB-15	8 port	RKP115 - M 802	RKP117 - M 802	RKP119 - M 802
	3 consoles			RKP115 - M 803	RKP117 - M 803	RKP119 - M 803
	4 consoles			RKP115 - M 804	RKP117 - M 804	RKP119 - M 804
	3 consoles	<b>Matrix</b>	8 port	RKP115 - M IP 813	RKP117 - M IP 813	RKP119 - M IP 813
	4 consoles			RKP115 - M IP 814	RKP117 - M IP 814	RKP119 - M IP 814
	4 consoles			RKP115 - M IP 824	RKP117 - M IP 824	RKP119 - M IP 824
	2 consoles	<b>Matrix</b> DB-15	16 port	RKP115 - M 1602	RKP117 - M 1602	RKP119 - M 1602
	3 consoles			RKP115 - M 1603	RKP117 - M 1603	RKP119 - M 1603
	4 consoles			RKP115 - M 1604	RKP117 - M 1604	RKP119 - M 1604
	3 consoles	<b>Matrix</b>	16 port	RKP115 - M IP 1613	RKP117 - M IP 1613	RKP119 - M IP 1613
	4 consoles			RKP115 - M IP 1614	RKP117 - M IP 1614	RKP119 - M IP 1614
	4 consoles			RKP115 - M IP 1624	RKP117 - M IP 1624	RKP119 - M IP 1624

## Combo Cat6 KVM

	1 console	<b>Combo</b> Cat6	8 port	RKP115 - U 801	RKP117 - U 801	RKP119 - U 801
	2 consoles			RKP115 - U 802	RKP117 - U 802	RKP119 - U 802
	2 consoles			RKP115 - U IP 802	RKP117 - U IP 802	RKP119 - U IP 802
	1 console	<b>Combo</b> Cat6	16 port	RKP115 - U 1601	RKP117 - U 1601	RKP119 - U 1601
	2 consoles			RKP115 - U 1602	RKP117 - U 1602	RKP119 - U 1602
	2 consoles			RKP115 - U IP 1602	RKP117 - U IP 1602	RKP119 - U IP 1602
	1 console	<b>Combo</b> Cat6	32 port	RKP115 - U 3201	RKP117 - U 3201	RKP119 - U 3201
	2 consoles			RKP115 - U 3202	RKP117 - U 3202	RKP119 - U 3202
	2 consoles			RKP115 - U IP 3202	RKP117 - U IP 3202	RKP119 - U IP 3202

## Combo DB-15 KVM

	1 console	<b>Combo</b> DB-15	8 port	RKP115 - S 801	RKP117 - S 801	RKP119 - S 801
	2 consoles			RKP115 - 802	RKP117 - 802	RKP119 - 802
	2 consoles			RKP115 - IP 802	RKP117 - IP 802	RKP119 - IP 802
	1 console	<b>Combo</b> DB-15	16 port	RKP115 - S 1601	RKP117 - S 1601	RKP119 - S 1601
	2 consoles			RKP115 - 1602	RKP117 - 1602	RKP119 - 1602
	2 consoles			RKP115 - IP 1602	RKP117 - IP 1602	RKP119 - IP 1602

## PS/2 DB-15 KVM

	1 console		8 port	RKP115 - 801	RKP117 - 801	RKP119 - 801
			16 port	RKP115 - 1601	RKP117 - 1601	RKP119 - 1601

RKP-1415  
RKP-1417  
RKP-1419



### LCD Drawer Benefits

- ▶ Short depth design of 480mm (18.9") only
- ▶ Depth will suit a 600mm rack application
- ▶ "One Man" installation slides for easy, quick installation
- ▶ 104 key notepad keyboard with full numerical pad

### Drawer Features & Options

- 1U rackmount drawer with either 15", 17" or 19" LCD
- Combo interface either PS/2 or USB input to the LCD drawer
- Multiple keyboard language selections with either touchpad or trackball
- Slide rails with fixed positions to prevent drawer movement when typing
- Enhanced aesthetics with new molded front panel and two point lock

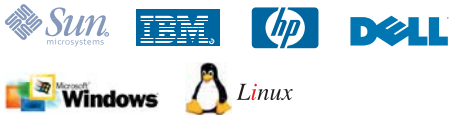

Options page 103~104 for full details



BNC + S-Video



DVI-D



DC Power



Touch Screen



Audio

#### BNC + S-Video



#### Touchscreen - USB



#### DVI-D



#### Touchscreen - Serial



#### DC Power

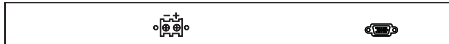

#### Audio

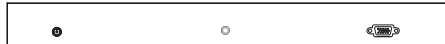

\*\*With DVI-D or DC power option, the depth of RKP-1415 / RKP-1417 / RKP-1419 will be extended from 480mm ( 18.9" ) to 530mm ( 20.9" )

\*\*With touchscreen option, the height of RKP-1417 / RKP-1419 will be changed from 1U to 1.5U

### Diagram

Unit : mm

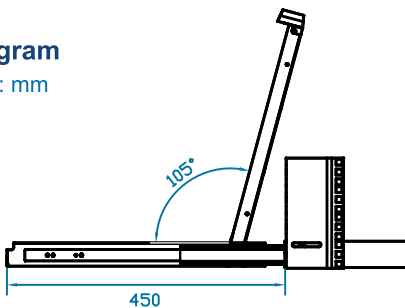

Monitor Grade A 15", 17", 19" industrial TFT LCD panel page 105 for full monitor details

### Dimensions

Model	Product Dimension ( W x D x H )	Packing Dimension ( W x D x H )	Net Weight	Gross Weight
RKP-1415 Series	442 x 480 x 44 mm 17.4 x 18.9 x 1.73 inch	581 x 705 x 175 mm 22.9 x 27.8 x 6.9 inch	15 kg / 33 lbs	21 kg / 46 lbs
RKP-1417 Series	442 x 480 x 44 mm 17.4 x 18.9 x 1.73 inch	581 x 705 x 175 mm 22.9 x 27.8 x 6.9 inch	16 kg / 35 lbs	22 kg / 48 lbs
RKP-1419 Series	442 x 480 x 44 mm 17.4 x 18.9 x 1.73 inch	581 x 705 x 175 mm 22.9 x 27.8 x 6.9 inch	17 kg / 37 lbs	23 kg / 51 lbs

# Model Selection



Base Model	15" LCD Series	17" LCD Series	19" LCD Series
<ul style="list-style-type: none"> <li>* Single port w/o KVM</li> <li>* Combo interface</li> </ul>	RKP-1415	RKP-1417	RKP-1419

## Keyboard Selection

Supporting layouts



### Ne N keyboard integrated with touchpad

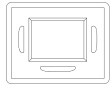
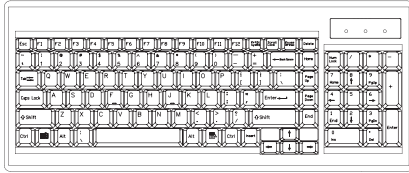

### Nb N keyboard integrated with trackball

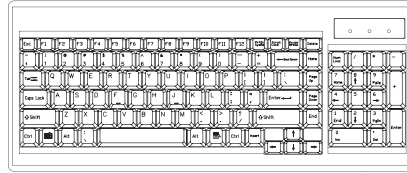

page 106 for full keyboard details

S-117  
S-119



### LCD Drawer & KVM Benefits

- ▶ Multi-user Matrix KVM with either 16 or 32 ports in 1U
- ▶ Cost efficient Combo KVM integration
- ▶ Direct support for SUN Micro 1152 x 900 native resolution
- ▶ "One Man" installation slides for easy, quick installation
- ▶ Mix PS/2, USB & SUN with Multi-Platform switch capability
- ▶ Secure remote user access across the world wide web

### Drawer Features & Options

- 1U rackmount drawer with either 17" or 19" LCD
- Combo interface either PS/2 or USB input to the LCD drawer
- SUN key support including Stop, Cut, Paste, Compose etc
- US and UK keyboard language selections with either touchpad or trackball
- Slide rails with fixed positions to prevent drawer movement when typing
- Enhanced aesthetics with new molded front panel and two point lock

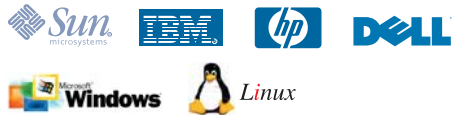

**Options** page 103~104 for full details

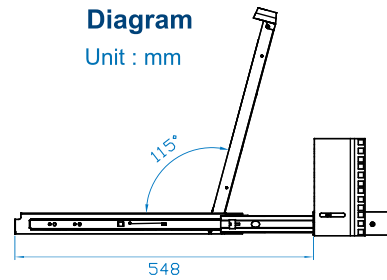
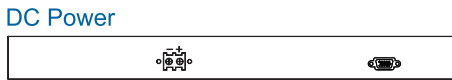

**Monitor** Grade A 17" or 19" industrial TFT LCD panel page 105 for full monitor details

### Dimensions

Model	Product Dimension (W x D x H)	Packing Dimension (W x D x H)	Net Weight	Gross Weight
S-117 series	442 x 650 x 44 mm 17.4 x 25.6 x 1.73 inch	589 x 856 x 168 mm 23.2 x 33.7 x 6.6 inch	15 kg / 33 lbs	21 kg / 46 lbs
S-119 Series	442 x 650 x 44 mm 17.4 x 25.6 x 1.73 inch	589 x 856 x 168 mm 23.2 x 33.7 x 6.6 inch	17 kg / 37 lbs	23 kg / 51 lbs

**Keyboard Selection** Supporting layouts USB interface, Incorporates SUN keys

**Se** NS keyboard integrated with touchpad

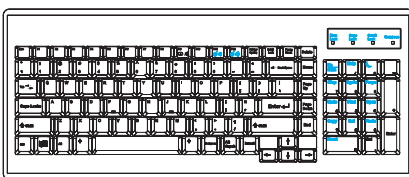

**Sb** NS keyboard integrated with trackball

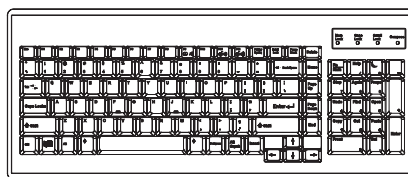

page 106 for full keyboard details



# KVM Selection

Base Model	17" LCD Series	19" LCD Series
<ul style="list-style-type: none"> <li>• Single port w/o KVM</li> <li>• USB interface</li> </ul>	<b>S-117</b>	<b>S-119</b>

■ S-117 series in single console, with Combo Cat6 KVM or Combo DB-15 KVM integration is UL approved.

## Matrix Cat6 KVM

page 23~38 for KVM specifications, page 107~110 for KVM rear I/O

	2 consoles	<b>Matrix</b> Cat6 16 port	S117 - MU 1602	S119 - MU 1602
	3 consoles		S117 - MU 1603	S119 - MU 1603
	4 consoles		S117 - MU 1604	S119 - MU 1604
	3 consoles	<b>Matrix</b> Cat6 16 port	S117 - MU IP 1613	S119 - MU IP 1613
	4 consoles		S117 - MU IP 1614	S119 - MU IP 1614
	4 consoles		S117 - MU IP 1624	S119 - MU IP 1624
	2 consoles	<b>Matrix</b> Cat6 32 port	S117 - MU 3202	S119 - MU 3202
	3 consoles		S117 - MU 3203	S119 - MU 3203
	4 consoles		S117 - MU 3204	S119 - MU 3204
	3 consoles	<b>Matrix</b> Cat6 32 port	S117 - MU IP 3213	S119 - MU IP 3213
	4 consoles		S117 - MU IP 3214	S119 - MU IP 3214
	4 consoles		S117 - MU IP 3224	S119 - MU IP 3224

## Matrix DB-15 KVM

	2 consoles	<b>Matrix</b> DB-15 8 port	S117 - M 802	S119 - M 802
	3 consoles		S117 - M 803	S119 - M 803
	4 consoles		S117 - M 804	S119 - M 804
	3 consoles	<b>Matrix</b> DB-15 8 port	S117 - M IP 813	S119 - M IP 813
	4 consoles		S117 - M IP 814	S119 - M IP 814
	4 consoles		S117 - M IP 824	S119 - M IP 824
	2 consoles	<b>Matrix</b> DB-15 16 port	S117 - M 1602	S119 - M 1602
	3 consoles		S117 - M 1603	S119 - M 1603
	4 consoles		S117 - M 1604	S119 - M 1604
	3 consoles	<b>Matrix</b> DB-15 16 port	S117 - M IP 1613	S119 - M IP 1613
	4 consoles		S117 - M IP 1614	S119 - M IP 1614
	4 consoles		S117 - M IP 1624	S119 - M IP 1624

## Combo Cat6 KVM

	1 console	<b>Combo</b> Cat6 8 port	S117 - U 801	S119 - U 801
	2 consoles		S117 - U 802	S119 - U 802
	2 consoles		S117 - U IP 802	S119 - U IP 802
	1 console	<b>Combo</b> Cat6 16 port	S117 - U 1601	S119 - U 1601
	2 consoles		S117 - U 1602	S119 - U 1602
	2 consoles		S117 - U IP 1602	S119 - U IP 1602
	1 console	<b>Combo</b> Cat6 32 port	S117 - U 3201	S119 - U 3201
	2 consoles		S117 - U 3202	S119 - U 3202
	2 consoles		S117 - U IP 3202	S119 - U IP 3202

## Combo DB-15 KVM

	1 console	<b>Combo</b> DB-15 8 port	S117 - S 801	S119 - S 801
	2 consoles		S117 - 802	S119 - 802
	2 consoles		S117 - IP 802	S119 - IP 802
	1 console	<b>Combo</b> DB-15 16 port	S117 - S 1601	S119 - S 1601
	2 consoles		S117 - 1602	S119 - 1602
	2 consoles		S117 - IP 1602	S119 - IP 1602

### RKP-217 RKP-219



#### LCD Drawer & KVM Benefits

- ▶ 2U dual slide rackmount drawer with either 17" or 19" LCD
- ▶ Multi-user Matrix KVM with either 16 or 32 ports in 2U
- ▶ Cost efficient Combo KVM integration
- ▶ Mix PS/2, USB & SUN with Multi-Platform switch capability
- ▶ Secure remote user access across the world wide web
- ▶ "One Man" installation slides for easy, quick installation

#### Drawer Features & Options

- Combo interface either PS/2 or USB input to the LCD drawer
- Multiple keyboard language selections with either touchpad or trackball
- Slide rails with fixed positions to prevent drawer movement when typing
- Enhanced aesthetics with new molded front panel and two point lock



**Options** page 103~104 for full details



BNC + S-Video



DVI-D



DC Power



Touch Screen



Audio

#### BNC + S-Video



#### Touchscreen - USB



#### DVI-D



#### Touchscreen - Serial



#### DC Power



#### Audio

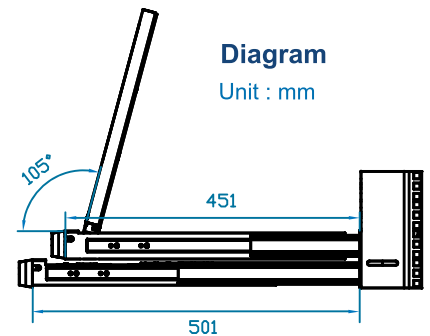

**Monitor** Grade A 17", 19" industrial TFT LCD panel page 105 for full monitor details

#### Dimensions

Model	Product Dimension (W x D x H)	Packing Dimension (W x D x H)	Net Weight	Gross Weight
RKP-217 / RKP-219	442 x 600 x 88 mm 17.4 x 23.6 x 3.5 inch	581 x 753 x 216 mm 22.9 x 29.6 x 8.5 inch	18 kg / 40 lbs	24 kg / 53 lbs

#### Keyboard Selection



**Ne** N keyboard integrated with touchpad

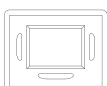
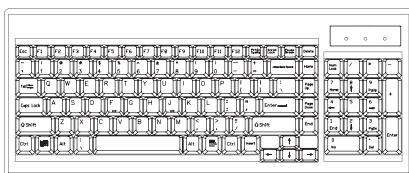

**Nb** N keyboard integrated with trackball

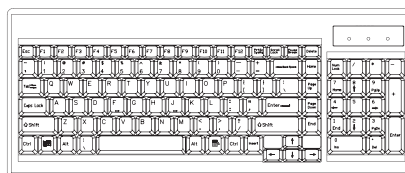

page 106 for full keyboard details



back

















# KVM Selection















Base Model	17" LCD Series	19" LCD Series
* Single port w/o KVM * Combo interface	RKP-217	RKP-219

## Matrix Cat6 KVM









page 23~38 for KVM specifications, page 107~110 for KVM rear I/O

	2 consoles	<b>Matrix</b> Cat6 16 port	RKP217 - MU 1602	RKP219 - MU 1602
	3 consoles		RKP217 - MU 1603	RKP219 - MU 1603
	4 consoles		RKP217 - MU 1604	RKP219 - MU 1604
	3 consoles	<b>Matrix</b>  Cat6 16 port	RKP217 - MU IP 1613	RKP219 - MU IP 1613
	4 consoles		RKP217 - MU IP 1614	RKP219 - MU IP 1614
	4 consoles		RKP217 - MU IP 1624	RKP219 - MU IP 1624
	2 consoles	<b>Matrix</b> Cat6 32 port	RKP217 - MU 3202	RKP219 - MU 3202
	3 consoles		RKP217 - MU 3203	RKP219 - MU 3203
	4 consoles		RKP217 - MU 3204	RKP219 - MU 3204
	3 consoles	<b>Matrix</b>  Cat6 32 port	RKP217 - MU IP 3213	RKP219 - MU IP 3213
	4 consoles		RKP217 - MU IP 3214	RKP219 - MU IP 3214
	4 consoles		RKP217 - MU IP 3224	RKP219 - MU IP 3224







## Matrix DB-15 KVM

	2 consoles	<b>Matrix</b> DB-15 8 port	RKP217 - M 802	RKP219 - M 802
	3 consoles		RKP217 - M 803	RKP219 - M 803
	4 consoles		RKP217 - M 804	RKP219 - M 804
	3 consoles	<b>Matrix</b>  DB-15 8 port	RKP217 - M IP 813	RKP219 - M IP 813
	4 consoles		RKP217 - M IP 814	RKP219 - M IP 814
	4 consoles		RKP217 - M IP 824	RKP219 - M IP 824
	2 consoles	<b>Matrix</b> DB-15 16 port	RKP217 - M 1602	RKP219 - M 1602
	3 consoles		RKP217 - M 1603	RKP219 - M 1603
	4 consoles		RKP217 - M 1604	RKP219 - M 1604
	3 consoles	<b>Matrix</b>  DB-15 16 port	RKP217 - M IP 1613	RKP219 - M IP 1613
	4 consoles		RKP217 - M IP 1614	RKP219 - M IP 1614
	4 consoles		RKP217 - M IP 1624	RKP219 - M IP 1624



## Combo Cat6 KVM

	1 console	<b>Combo</b> Cat6 8 port	RKP217 - U 801	RKP219 - U 801
	2 consoles		RKP217 - U 802	RKP219 - U 802
	2 consoles		RKP217 - U IP 802	RKP219 - U IP 802
	1 console	<b>Combo</b> Cat6 16 port	RKP217 - U 1601	RKP219 - U 1601
	2 consoles		RKP217 - U 1602	RKP219 - U 1602
	2 consoles		RKP217 - U IP 1602	RKP219 - U IP 1602
	1 console	<b>Combo</b> Cat6 32 port	RKP217 - U 3201	RKP219 - U 3201
	2 consoles		RKP217 - U 3202	RKP219 - U 3202
	2 consoles		RKP217 - U IP 3202	RKP219 - U IP 3202

## Combo DB-15 KVM

	1 console	<b>Combo</b> DB-15 8 port	RKP217 - S 801	RKP219 - S 801
	2 consoles		RKP217 - 802	RKP219 - 802
	2 consoles		RKP217 - IP 802	RKP219 - IP 802
	1 console	<b>Combo</b> DB-15 16 port	RKP217 - S 1601	RKP219 - S 1601
	2 consoles		RKP217 - 1602	RKP219 - 1602
	2 consoles		RKP217 - IP 1602	RKP219 - IP 1602

## PS/2 DB-15 KVM

	1 console	 DB-15 8 port	RKP217 - 801	RKP219 - 801
			RKP217 - 1601	RKP219 - 1601

**RKP-2415**  
**RKP-2417**  
**RKP-2419**



### LCD Drawer & KVM Benefits

- ▶ 2U dual slide rackmount drawer with either 15", 17" or 19" LCD
- ▶ Short depth design of 480mm (18.9") only
- ▶ Depth will suit a 600mm rack application
- ▶ Multi-user Matrix KVM with either 16 or 32 ports in 2U
- ▶ Cost efficient Combo KVM integration
- ▶ Secure remote user access across the world wide web
- ▶ "One Man" installation slides for easy, quick installation

### Drawer Features & Options

- Combo interface either PS/2 or USB input to the LCD drawer
- Multiple keyboard language selections with either touchpad or trackball
- Slide rails with fixed positions to prevent drawer movement when typing
- Enhanced aesthetics with new molded front panel and two point lock



**Options** page 103~104 for full details



BNC + S-Video



DVI-D



DC Power



Touch Screen



Audio

#### BNC + S-Video



#### Touchscreen - USB



#### DVI-D

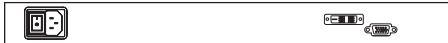

#### Touchscreen - Serial

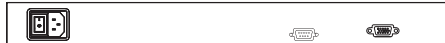

#### DC Power



#### Audio

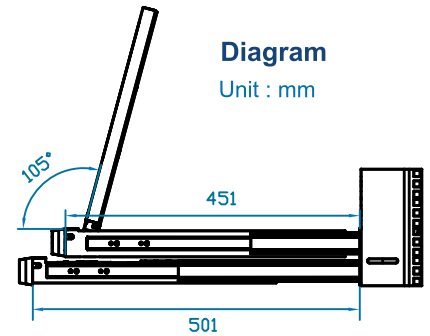

\*\*With DC power option, the depth of RKP-2415 / RKP-2417 / RKP-2419 will be extended from 480mm ( 18.9" ) to 530mm ( 20.9" )

**Monitor** Grade A 15", 17" or 19" industrial TFT LCD panel page 105 for full monitor details

### Dimensions

Model	Product Dimension ( W x D x H )	Packing Dimension ( W x D x H )	Net Weight	Gross Weight
RKP-2415 / RKP-2417	442 x 480 x 88 mm 17.4 x 18.9 x 3.5 inch	584 x 616 x 216 mm 23 x 24.3 x 8.5 inch	17 kg / 37 lbs	23 kg / 51 lbs
RKP-2419	442 x 480 x 88 mm 17.4 x 18.9 x 3.5 inch	584 x 616 x 216 mm 23 x 24.3 x 8.5 inch	18 kg / 40 lbs	24 kg / 53 lbs

### Keyboard Selection

Supporting layouts



**Ne** N keyboard integrated with touchpad

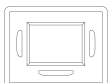
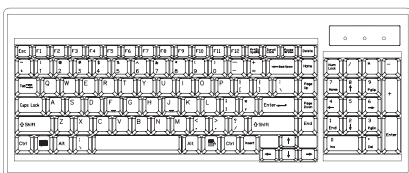

**Nb** N keyboard integrated with trackball

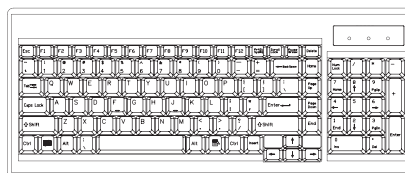

page 106 for full keyboard details



# KVM Selection

Base Model	15" LCD Series	17" LCD Series	19" LCD Series
<ul style="list-style-type: none"> <li>• Single port w/o KVM</li> <li>• Combo interface</li> </ul>	RKP-2415	RKP-2417	RKP-2419

No KVM membrane button will be provided for all models  
 page 23~38 for KVM specifications, page 107~110 for KVM rear I/O

## Matrix Cat6 KVM

	2 consoles	<b>Matrix</b> Cat6 16 port	RKP2415 - MU 1602	RKP2417 - MU 1602	RKP2419 - MU 1602
	3 consoles		RKP2415 - MU 1603	RKP2417 - MU 1603	RKP2419 - MU 1603
	4 consoles		RKP2415 - MU 1604	RKP2417 - MU 1604	RKP2419 - MU 1604
	3 consoles	<b>Matrix</b> Cat6 16 port	RKP2415 - MU IP 1613	RKP2417 - MU IP 1613	RKP2419 - MU IP 1613
	4 consoles		RKP2415 - MU IP 1614	RKP2417 - MU IP 1614	RKP2419 - MU IP 1614
	4 consoles		RKP2415 - MU IP 1624	RKP2417 - MU IP 1624	RKP2419 - MU IP 1624
	2 consoles	<b>Matrix</b> Cat6 32 port	RKP2415 - MU 3202	RKP2417 - MU 3202	RKP2419 - MU 3202
	3 consoles		RKP2415 - MU 3203	RKP2417 - MU 3203	RKP2419 - MU 3203
	4 consoles		RKP2415 - MU 3204	RKP2417 - MU 3204	RKP2419 - MU 3204
	3 consoles	<b>Matrix</b> Cat6 32 port	RKP2415 - MU IP 3213	RKP2417 - MU IP 3213	RKP2419 - MU IP 3213
	4 consoles		RKP2415 - MU IP 3214	RKP2417 - MU IP 3214	RKP2419 - MU IP 3214
	4 consoles		RKP2415 - MU IP 3224	RKP2417 - MU IP 3224	RKP2419 - MU IP 3224

## Matrix DB-15 KVM

	2 consoles	<b>Matrix</b> DB-15 8 port	RKP2415 - M 802	RKP2417 - M 802	RKP2419 - M 802
	3 consoles		RKP2415 - M 803	RKP2417 - M 803	RKP2419 - M 803
	4 consoles		RKP2415 - M 804	RKP2417 - M 804	RKP2419 - M 804
	3 consoles	<b>Matrix</b> DB-15 8 port	RKP2415 - M IP 813	RKP2417 - M IP 813	RKP2419 - M IP 813
	4 consoles		RKP2415 - M IP 814	RKP2417 - M IP 814	RKP2419 - M IP 814
	4 consoles		RKP2415 - M IP 824	RKP2417 - M IP 824	RKP2419 - M IP 824
	2 consoles	<b>Matrix</b> DB-15 16 port	RKP2415 - M 1602	RKP2417 - M 1602	RKP2419 - M 1602
	3 consoles		RKP2415 - M 1603	RKP2417 - M 1603	RKP2419 - M 1603
	4 consoles		RKP2415 - M 1604	RKP2417 - M 1604	RKP2419 - M 1604
	3 consoles	<b>Matrix</b> DB-15 16 port	RKP2415 - M IP 1613	RKP2417 - M IP 1613	RKP2419 - M IP 1613
	4 consoles		RKP2415 - M IP 1614	RKP2417 - M IP 1614	RKP2419 - M IP 1614
	4 consoles		RKP2415 - M IP 1624	RKP2417 - M IP 1624	RKP2419 - M IP 1624

## Combo Cat6 KVM

	1 console	<b>Combo</b> Cat6 8 port	RKP2415 - U 801	RKP2417 - U 801	RKP2419 - U 801
	2 consoles		RKP2415 - U 802	RKP2417 - U 802	RKP2419 - U 802
	2 consoles		RKP2415 - U IP 802	RKP2417 - U IP 802	RKP2419 - U IP 802
	1 console	<b>Combo</b> Cat6 16 port	RKP2415 - U 1601	RKP2417 - U 1601	RKP2419 - U 1601
	2 consoles		RKP2415 - U 1602	RKP2417 - U 1602	RKP2419 - U 1602
	2 consoles		RKP2415 - U IP 1602	RKP2417 - U IP 1602	RKP2419 - U IP 1602
	1 console	<b>Combo</b> Cat6 32 port	RKP2415 - U 3201	RKP2417 - U 3201	RKP2419 - U 3201
	2 consoles		RKP2415 - U 3202	RKP2417 - U 3202	RKP2419 - U 3202
	2 consoles		RKP2415 - U IP 3202	RKP2417 - U IP 3202	RKP2419 - U IP 3202

## Combo DB-15 KVM

	1 consoles	<b>Combo</b> DB-15 8 port	RKP2415 - S 801	RKP2417 - S 801	RKP2419 - S 801
	2 consoles		RKP2415 - 802	RKP2417 - 802	RKP2419 - 802
	2 consoles		RKP2415 - IP 802	RKP2417 - IP 802	RKP2419 - IP 802
	1 console	<b>Combo</b> DB-15 16 port	RKP2415 - S 1601	RKP2417 - S 1601	RKP2419 - S 1601
	2 consoles		RKP2415 - 1602	RKP2417 - 1602	RKP2419 - 1602
	2 consoles		RKP2415 - IP 1602	RKP2417 - IP 1602	RKP2419 - IP 1602

## PS/2 DB-15 KVM

	1 console	8 port DB-15 16 port	RKP2415 - 801	RKP2417 - 801	RKP2419 - 801
			RKP2415 - 1601	RKP2417 - 1601	RKP2419 - 1601

S-217  
S-219



### LCD Drawer & KVM Benefits

- ▶ 2U dual slide rackmount drawer with either 17" or 19" LCD
- ▶ Direct support for SUN Micro 1152 x 900 native resolution
- ▶ Multi-user Matrix KVM with either 16 or 32 ports in 2U
- ▶ Cost efficient Combo KVM integration
- ▶ Mix PS/2, USB & SUN with Multi-Platform switch capability
- ▶ Secure remote user access across the world wide web
- ▶ "One Man" installation slides for easy, quick installation

### Drawer Features & Options

- Combo interface either PS/2 or USB input to the LCD drawer
- SUN key support including Stop, Cut, Paste, Compose etc
- US and UK keyboard language selections with either touchpad or trackball
- Slide rails with fixed positions to prevent drawer movement when typing
- Enhanced aesthetics with new molded front panel and two point lock



Options page 103~104 for full details



DVI-D



DC Power

DVI-D

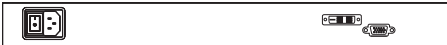

DC Power

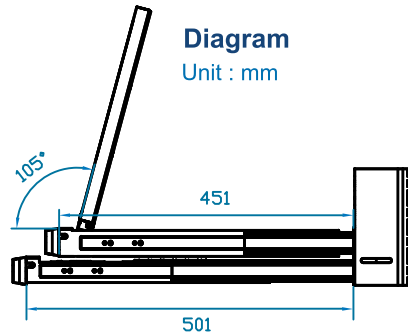

Monitor Grade A 17", 19" industrial TFT LCD panel page 105 for full monitor details

### Dimensions

Model	Product Dimension (W x D x H)	Packing Dimension (W x D x H)	Net Weight	Gross Weight
S-217 / S-219	442 x 600 x 88 mm 17.4 x 23.6 x 3.5 inch	581 x 753 x 216 mm 22.9 x 29.6 x 8.5 inch	18 kg / 40 lbs	24 kg / 53 lbs

### Keyboard Selection

Supporting layouts USB interface, Incorporates SUN keys

**Se** NS keyboard integrated with touchpad

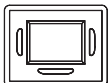
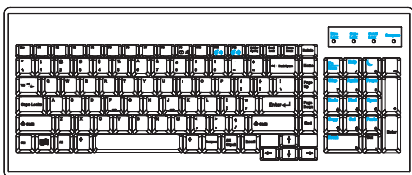

**Sb** NS keyboard integrated with trackball

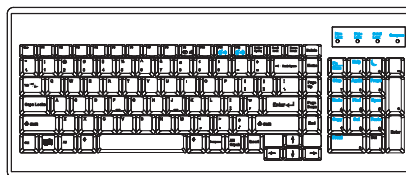

page 106 for full keyboard details

back

















## KVM Selection















Base Model	17" LCD Series	19" LCD Series
<ul style="list-style-type: none"> <li>• Single port w/o KVM</li> <li>• USB interface</li> </ul>	S-217	S-219

### Matrix Cat6 KVM









page 23~38 for KVM specifications, page 107~110 for KVM rear I/O

	2 consoles	<b>Matrix</b> Cat6 16 port	S217 - MU 1602	S219 - MU 1602
	3 consoles		S217 - MU 1603	S219 - MU 1603
	4 consoles		S217 - MU 1604	S219 - MU 1604
	3 consoles	<b>Matrix</b>  Cat6 16 port	S217 - MU IP 1613	S219 - MU IP 1613
	4 consoles		S217 - MU IP 1614	S219 - MU IP 1614
	4 consoles		S217 - MU IP 1624	S219 - MU IP 1624
	2 consoles	<b>Matrix</b> Cat6 32 port	S217 - MU 3202	S219 - MU 3202
	3 consoles		S217 - MU 3203	S219 - MU 3203
	4 consoles		S217 - MU 3204	S219 - MU 3204
	3 consoles	<b>Matrix</b>  Cat6 32 port	S217 - MU IP 3213	S219 - MU IP 3213
	4 consoles		S217 - MU IP 3214	S219 - MU IP 3214
	4 consoles		S217 - MU IP 3224	S219 - MU IP 3224







### Matrix DB-15 KVM

	2 consoles	<b>Matrix</b> DB-15 8 port	S217 - M 802	S219 - M 802
	3 consoles		S217 - M 803	S219 - M 803
	4 consoles		S217 - M 804	S219 - M 804
	3 consoles	<b>Matrix</b>  DB-15 8 port	S217 - M IP 813	S219 - M IP 813
	4 consoles		S217 - M IP 814	S219 - M IP 814
	4 consoles		S217 - M IP 824	S219 - M IP 824
	2 consoles	<b>Matrix</b> DB-15 16 port	S217 - M 1602	S219 - M 1602
	3 consoles		S217 - M 1603	S219 - M 1603
	4 consoles		S217 - M 1604	S219 - M 1604
	3 consoles	<b>Matrix</b>  DB-15 16 port	S217 - M IP 1613	S219 - M IP 1613
	4 consoles		S217 - M IP 1614	S219 - M IP 1614
	4 consoles		S217 - M IP 1624	S219 - M IP 1624

### Combo Cat6 KVM

	1 console	<b>Combo</b> Cat6 8 port	S217 - U 801	S219 - U 801
	2 consoles		S217 - U 802	S219 - U 802
	2 consoles		S217 - U IP 802	S219 - U IP 802
	1 console	<b>Combo</b> Cat6 16 port	S217 - U 1601	S219 - U 1601
	2 consoles		S217 - U 1602	S219 - U 1602
	2 consoles		S217 - U IP 1602	S219 - U IP 1602
	1 console	<b>Combo</b> Cat6 32 port	S217 - U 3201	S219 - U 3201
	2 consoles		S217 - U 3202	S219 - U 3202
	2 consoles		S217 - U IP 3202	S219 - U IP 3202

### Combo DB-15 KVM

	1 console	<b>Combo</b> DB-15 8 port	S217 - S 801	S219 - S 801
	2 consoles		S217 - 802	S219 - 802
	2 consoles		S217 - IP 802	S219 - IP 802
	1 console	<b>Combo</b> DB-15 16 port	S217 - S 1601	S219 - S 1601
	2 consoles		S217 - 1602	S219 - 1602
	2 consoles		S217 - IP 1602	S219 - IP 1602

### RKP-7 RKP-9



#### LCD Drawer & KVM Benefits

- ▶ Use of a true optical mouse
- ▶ Multi-user Matrix KVM with either 16 or 32 ports in 1U
- ▶ Cost efficient Combo KVM integration
- ▶ "One Man" installation slides for easy, quick installation
- ▶ Mix PS/2, USB & SUN with Multi-Platform switch capability
- ▶ Secure remote user access across the world wide web

#### Drawer Features & Options

- 1U rackmount drawer with either 17" or 19" LCD
- Combo interface either PS/2 or USB input to the LCD drawer
- Multiple keyboard language selections with a true optical mouse
- Slide rails with fixed positions to prevent drawer movement when typing
- Enhanced aesthetics with new molded front panel and two point lock



Options page 103~104 for full details



BNC + S-Video



DVI-D



DC Power



Touch Screen



Audio

#### BNC + S-Video



#### Touchscreen - USB



#### DVI-D



#### Touchscreen - Serial



#### DC Power



#### Audio



#### Diagram

Unit : mm

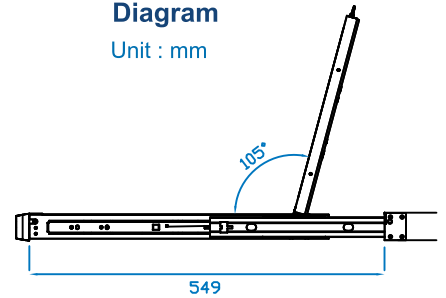

\*\*With touchscreen option, the height of RKP-7 / RKP-9 will be changed from 1U to 1.5U

Monitor Grade A 17", 19" industrial TFT LCD panel page 105 for full monitor details

#### Dimensions

Model	Product Dimension (W x D x H)	Packing Dimension (W x D x H)	Net Weight	Gross Weight
RKP-7 Series	442 x 650 x 44 mm 17.4 x 25.6 x 1.73 inch	589 x 826 x 168 mm 23.2 x 32.5 x 6.6 inch	17 kg / 37 lbs	23 kg / 51 lbs
RKP-9 Series	442 x 700 x 44 mm 17.4 x 27.6 x 1.73 inch	589 x 856 x 168 mm 23.2 x 33.7 x 6.6 inch	18 kg / 40 lbs	24 kg / 53 lbs

#### Keyboard Selection

Supporting layouts



**N** N keyboard with full numerical pad

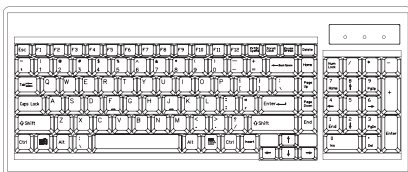

Option - Wireless optical mouse

page 106 for full keyboard details

















# KVM Selection















Base Model	17" LCD Series	19" LCD Series
* Single port w/o KVM * Combo interface	RKP-7	RKP-9

## Matrix Cat6 KVM









page 23~38 for KVM specifications, page 107~110 for KVM rear I/O

	2 consoles	<b>Matrix</b> Cat6 16 port	RKP7 - MU 1602	RKP9 - MU 1602
	3 consoles		RKP7 - MU 1603	RKP9 - MU 1603
	4 consoles		RKP7 - MU 1604	RKP9 - MU 1604
	3 consoles	<b>Matrix</b>  Cat6 16 port	RKP7 - MU IP 1613	RKP9 - MU IP 1613
	4 consoles		RKP7 - MU IP 1614	RKP9 - MU IP 1614
	4 consoles		RKP7 - MU IP 1624	RKP9 - MU IP 1624
	2 consoles	<b>Matrix</b> Cat6 32 port	RKP7 - MU 3202	RKP9 - MU 3202
	3 consoles		RKP7 - MU 3203	RKP9 - MU 3203
	4 consoles		RKP7 - MU 3204	RKP9 - MU 3204
	3 consoles	<b>Matrix</b>  Cat6 32 port	RKP7 - MU IP 3213	RKP9 - MU IP 3213
	4 consoles		RKP7 - MU IP 3214	RKP9 - MU IP 3214
	4 consoles		RKP7 - MU IP 3224	RKP9 - MU IP 3224







## Matrix DB-15 KVM

	2 consoles	<b>Matrix</b> DB-15 8 port	RKP7 - M 802	RKP9 - M 802
	3 consoles		RKP7 - M 803	RKP9 - M 803
	4 consoles		RKP7 - M 804	RKP9 - M 804
	3 consoles	<b>Matrix</b>  DB-15 8 port	RKP7 - M IP 813	RKP9 - M IP 813
	4 consoles		RKP7 - M IP 814	RKP9 - M IP 814
	4 consoles		RKP7 - M IP 824	RKP9 - M IP 824
	2 consoles	<b>Matrix</b> DB-15 16 port	RKP7 - M 1602	RKP9 - M 1602
	3 consoles		RKP7 - M 1603	RKP9 - M 1603
	4 consoles		RKP7 - M 1604	RKP9 - M 1604
	3 consoles	<b>Matrix</b>  DB-15 16 port	RKP7 - M IP 1613	RKP9 - M IP 1613
	4 consoles		RKP7 - M IP 1614	RKP9 - M IP 1614
	4 consoles		RKP7 - M IP 1624	RKP9 - M IP 1624



## Combo Cat6 KVM

	1 console	<b>Combo</b> Cat6 8 port	RKP7 - U 801	RKP9 - U 801
	2 consoles		RKP7 - U 802	RKP9 - U 802
	2 consoles		RKP7 - U IP 802	RKP9 - U IP 802
	1 console	<b>Combo</b> Cat6 16 port	RKP7 - U 1601	RKP9 - U 1601
	2 consoles		RKP7 - U 1602	RKP9 - U 1602
	2 consoles		RKP7 - U IP 1602	RKP9 - U IP 1602
	1 console	<b>Combo</b> Cat6 32 port	RKP7 - U 3201	RKP9 - U 3201
	2 consoles		RKP7 - U 3202	RKP9 - U 3202
	2 consoles		RKP7 - U IP 3202	RKP9 - U IP 3202

## Combo DB-15 KVM

	1 console	<b>Combo</b> DB-15 8 port	RKP7 - S 801	RKP9 - S 801
	2 consoles		RKP7 - 802	RKP9 - 802
	2 consoles		RKP7 - IP 802	RKP9 - IP 802
	1 console	<b>Combo</b> DB-15 16 port	RKP7 - S 1601	RKP9 - S 1601
	2 consoles		RKP7 - 1602	RKP9 - 1602
	2 consoles		RKP7 - IP 1602	RKP9 - IP 1602

## PS/2 DB-15 KVM

	1 console	 DB-15 8 port 16 port	RKP7 - 801	RKP9 - 801
			RKP7 - 1601	RKP9 - 1601

### RKP-1617 / 1619



#### LCD Drawer Benefits

- ▶ 1U rackmount drawer with either 17" or 19" LCD
- ▶ Combo interface either PS/2 or USB input to the LCD drawer
- ▶ US keyboard layout with either trackball or touchpad selection
- ▶ "One Man" installation slides for easy, quick installation
- ▶ Slide rails with fixed positions to prevent drawer movement when typing
- ▶ Enhanced aesthetics with new molded front panel and two point lock



**Options** page 103~104 for full details



BNC + S-Video



DVI-D



DC Power



Touch Screen



Audio

#### BNC + S-Video



#### Touchscreen - USB

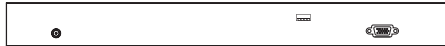

#### DVI-D



#### Touchscreen - Serial



#### DC Power



#### Audio



**\*\*With DVI-D or DC power option, the depth of RKP-1617 / RKP-1619 will be extended from 700mm ( 27.6" ) to 750mm ( 29.5" )**

#### Diagram

Unit : mm

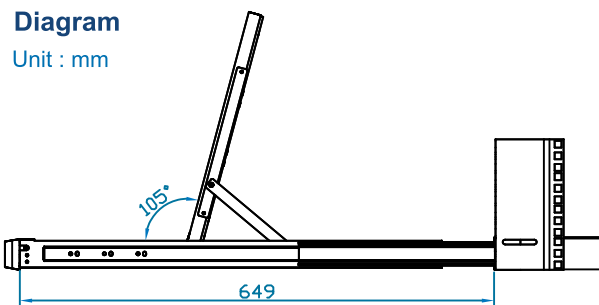

#### Monitor



Grade A 17" or 19" industrial TFT LCD panel page 105 for full monitor details

#### Dimensions

Model	Product Dimension ( W x D x H )	Packing Dimension ( W x D x H )	Net Weight	Gross Weight
RKP-1617 Series	442 x 700 x 44 mm 17.4 x 27.6 x 1.73 inch	589 x 856 x 168 mm 23.2 x 33.7 x 6.6 inch	18 kg / 40 lbs	24 kg / 53 lbs
RKP-1619 Series	442 x 700 x 44 mm 17.4 x 27.6 x 1.73 inch	589 x 856 x 168 mm 23.2 x 33.7 x 6.6 inch	19 kg / 42 lbs	25 kg / 55 lbs



# Model Selection



Base Model	17" LCD Series	19" LCD Series
<ul style="list-style-type: none"><li>• Single port w/o KVM</li><li>• Combo interface</li></ul>	RKP-1617	RKP-1619

## Keyboard Selection

Supporting layouts  only



**d** Compact keyboard integrated with trackball



**t** Compact keyboard integrated with touchpad mouse

page 106 for full keyboard details

### CS-116



**DC** 12V, 24V and 48V DC Power options

#### Serial Console Server Benefits

- ▶ Designed for SUN Solaris or other headless servers
- ▶ Supports all rackmount serial equipment including hubs, routers, modems, UPs & PDU
- ▶ Supports all common O/S including Linux, Solaris, Windows Server 2003

#### Switch Features & Options

- Near real time console performance allows remote server / device management
- Independent support for multi servers and different operating system
- Utilizes Cat6 cables allow field termination of cable length
- Multi level authentication via local database security
- SMTP e-mail alert functions for critical events

#### Designed for Branded Headless Servers :



- SUN** Sun Fire / Netra / Blade series  
Sun SPARC Enterprise Series
- IBM** IBM BladeCenter S / H / E / T / HT  
IBM System x / P / i series  
IBM Remote Supervisor Adapter II
- HP** HP ProLiant DL / ML  
HP ProLiant BL blades  
HP 9000 servers

Others

#### Designed for Branded Serial Devices :

- |                   |                 |                                 |
|-------------------|-----------------|---------------------------------|
| <b>APC</b>        | <b>PDU's</b>    | Metered & Switched              |
| <b>ServerTech</b> | <b>PDU's</b>    | Sentry Smart                    |
| <b>Cisco</b>      | <b>Routers</b>  | 800 / 1800 / 2800 / 3800 series |
| <b>Juniper</b>    | <b>Routers</b>  | E / J / m-series Services       |
| <b>Cisco</b>      | <b>Switches</b> | Catalyst series                 |
| <b>Juniper</b>    | <b>Switches</b> | EX-series Ethernet              |
| <b>Others</b>     |                 |                                 |

\*\* All brand names, logo and registered trademarks are properties of their respective owners.

#### Technical Specification

- **Serial Port :** 16 x RJ45 RS-232, 300 to 115.2K bps
- **Ethernet Port** 1 x RJ45 10BaseT
- **Security :** SSH v2, IP filtering, https, SSL, password access
- **Authentication :** Radius, SSH, Telnet & user database
- **Protocol :** RCP, UDP, IP, ARP, ICMP, http / https, telnet, PPP, DHCP / BOOTP, SMTP, DNS, NTP, Dynamic DNS
- **Compatibility :** Console server, PC-based headless server, any serially managed device IBM blade center
- **Power :** 100~240VAC, 50/ 60Hz 0.5A via IEC cable
- **Regulatory Approval :** FCC, CE
- **Environmental**
  - Operating : 0 to 50°C
  - Storage : -5 to 60°C
  - Relative humidity : 90%, non-condensing
  - Shock : 50G peak acceleration (11 ms, half-sine wave)
  - Vibration : 58~100Hz / 0.98G (11 ms / cycle)

#### Dimensions

Model	Product Dimension (W x D x H)	Packing Dimension (W x D x H)	Net Weight	Gross Weight
CS-116	446 x 180 x 44 mm 17.6 x 7.1 x 1.73 inch	510 x 400 x 77 mm 20.1 x 15.7 x 3 inch	3.5 kg / 8 lbs	4.5 kg / 10 lbs

# CyberView™ — Connect your 1U IP 16-port Serial Console Server

## I Connection with headless servers

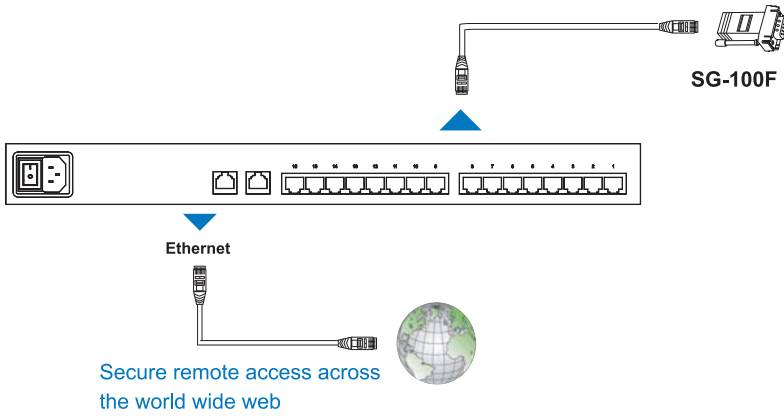

- SUN** Sun Fire / Netra / Blade series  
Sun SPARC Enterprise Series
- IBM** IBM BladeCenter S / H / E / T / HT  
IBM System x / P / i series  
IBM Remote Supervisor Adapter II
- HP** HP ProLiant DL / ML  
HP ProLiant BL blades  
HP 9000 servers

### Others



## II Connection with serial device equipment

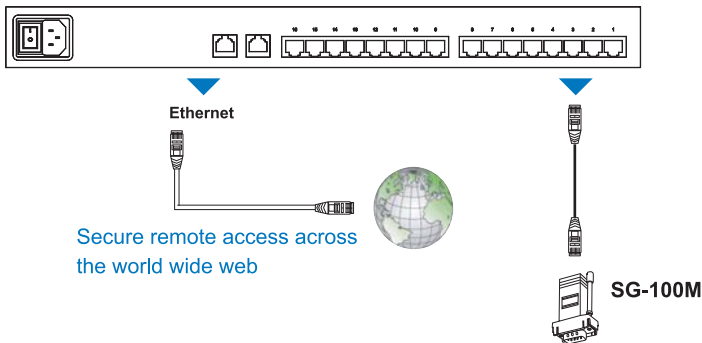

- |                   |                 |                                 |
|-------------------|-----------------|---------------------------------|
| <b>APC</b>        | <b>PDU's</b>    | Metered & Switched              |
| <b>ServerTech</b> | <b>PDU's</b>    | Sentry Smart                    |
| <b>Cisco</b>      | <b>Routers</b>  | 800 / 1800 / 2800 / 3800 series |
| <b>Juniper</b>    | <b>Routers</b>  | E / J / m-series Services       |
| <b>Cisco</b>      | <b>Switches</b> | Catalyst series                 |
| <b>Juniper</b>    | <b>Switches</b> | EX-series Ethernet              |
| <b>Others</b>     |                 |                                 |

### Accessories

SG-100M  
RJ45-DB9 male adapter

SG-100F  
RJ45-DB9 female adapter

CU-3 CU-10  
CU-6 CU-15 CU-33  
Cat6 cable - 3, 6, 10, 15 & 33 ft



\*\* All brand names, logo and registered trademarks are properties of their respective owners.

### NCP-1701



**DC** 12V, 24V and 48V DC Power options

#### Serial Console LCD Drawer Benefits

- ▶ Designed to connect brand name console server switches
- ▶ Fully compatible with SUN & all other branded headless servers
- ▶ Large range of ASCII serial terminal emulations
- ▶ Up to 12 multi-sessions, multiple log-in
- ▶ No hard drive or memory inside for secure environment

#### Drawer Features & Options



- 1U rackmount drawer with 17" LCD
- "One Man" installation slides for easy, quick installation
- Optional mounting hardware for two post telco style racks
- Slide rails with fixed positions to prevent drawer movement when typing
- An aesthetically enhanced latching front panel to release the two point lock

#### Designed for Branded Multi-Port Console Servers :

<b>Avocent</b>	CCM4850 / 1650 / 850 series
<b>Cyclades</b>	SC60xx, ATP00xx, CCS40xx series
<b>Digi</b>	CM 8 / 16 / 32 / 48 series
<b>MRV</b>	LX 1000X / 1000T / 4000T / 8000S
<b>Perle</b>	CS9000 / SCS / STS / SDS series
<b>Rose</b>	UltraConsole 8 / 16 series
<b>Raritan</b>	DSX / DSXA series
<b>Thinklogical</b>	SCS / SCS-R / Sentinel series
<b>Others</b>	

\*\* All brand names, logo and registered trademarks are properties of their respective owners.

#### Designed for Branded Headless Servers :

		
<b>SUN</b>	Sun Fire / Netra / Blade series Sun SPARC Enterprise Series	
<b>IBM</b>	IBM BladeCenter S / H / E / T / HT IBM System x / P / i series IBM Remote Supervisor Adapter II	
<b>HP</b>	HP ProLiant DL / ML HP ProLiant BL blades HP 9000 servers	
<b>Others</b>		

#### Technical Specification

<ul style="list-style-type: none"> <li>• <b>Console</b> Screen : 17" Grade A LCD, 800 x 600 Input : 104-key keyboard</li> <li>• <b>Serial Port</b> : 1 x DB-9 RS-232, 50 to 115.2K bps</li> <li>• <b>Terminal Emulations</b> WY-50+, WY-60, WY-120, WY-325, ADDS A2, PCG Alpha, TV1910+, TV1925, PC Term, VT52, VT100, VT220, Console ANSI</li> <li>• <b>Ethernet Port</b> 1 x RJ45 10BaseT Up to 12 telnet session to multiple servers</li> <li>• <b>Printer Port</b> : 1 x DB-9 serial and 1 x DB-25 parallel</li> </ul>	<ul style="list-style-type: none"> <li>• <b>Compatibility</b> : Console server, PC-based headless server, any serially managed device IBM blade center</li> <li>• <b>Power</b> : 100~240VAC, 50/ 60Hz 0.5A via IEC cable</li> <li>• <b>Regulatory Approval</b> : FCC, CE</li> <li>• <b>Environmental</b> Operating : 0 to 50°C Storage : -5 to 60°C Relative humidity : 90%, non-condensing Shock : 50G peak acceleration (11 ms, half-sine wave) Vibration : 58~100Hz / 0.98G (11 ms / cycle)</li> </ul>
--	---

#### Dimensions

Model	Product Dimension (W x D x H)	Packing Dimension (W x D x H)	Net Weight	Gross Weight
NCP-1701	442 x 650 x 44 mm 17.4 x 25.6 x 1.73 inch	589 x 856 x 168 mm 23.2 x 33.7 x 6.6 inch	16 kg / 35 lbs	22 kg / 48 lbs

# CyberView™ — Connect your Serial Console LCD Drawer

## I Connection with headless servers

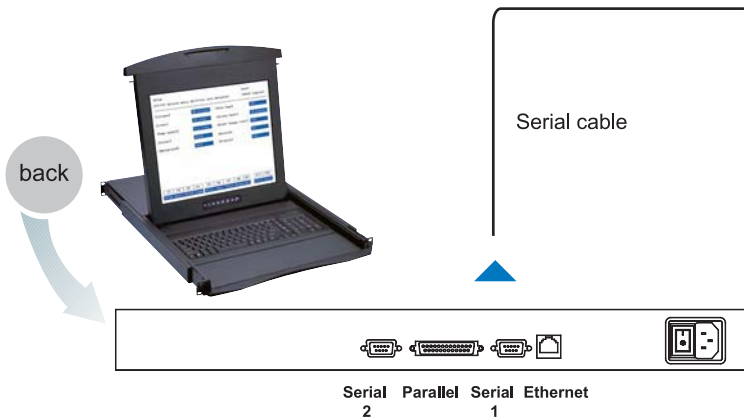

- SUN** Sun Fire / Netra / Blade series  
Sun SPARC Enterprise Series
- IBM** IBM BladeCenter S / H / E / T / HT  
IBM System x / P / i series  
IBM Remote Supervisor Adapter II
- HP** HP ProLiant DL / ML  
HP ProLiant BL blades  
HP 9000 servers

### Others



## II Connection with serial consoles

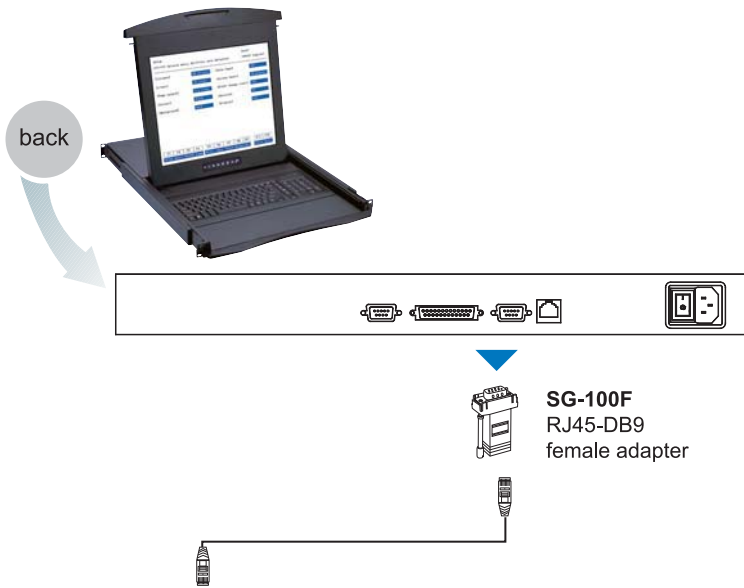

### Branded Multi-Port Serial Console Servers

<b>Avocent</b>	CCM4850 / 1650 / 850 series
<b>Cyclades</b>	SC60xx, ATP00xx, CCS40xx series
<b>Digi</b>	CM 8 / 16 / 32 / 48 series
<b>MRV</b>	LX 1000X / 1000T / 4000T / 8000S
<b>Perle</b>	CS9000 / SCS / STS / SDS series
<b>Rose</b>	UltraConsole 8 / 16 series
<b>Raritan</b>	DSX / DSXA series
<b>Thinklogical</b>	SCS / SCS-R / Sentinel series

\*\* All brand names, logo and registered trademarks are properties of their respective owners.

## NCP-1716



**DC** 12V, 24V and 48V DC Power options

### Serial Console LCD Drawer Benefits

- ▶ Designed for SUN Solaris or other branded headless servers
- ▶ Supports all common O/S including Linux, Solaris, Windows Server 2003
- ▶ Port buffering / logging for detailed troubleshooting
- ▶ Supports SSH secure communications between computer platforms
- ▶ Secure remote IP access using SSH or telnet clients

### Drawer Features & Options

- 1U rackmount drawer with 17" LCD
- "One Man" installation slides for easy, quick installation
- Near real time console performance allows of remote server / device management
- Utilizes Cat6 cables allow for field termination of cable length
- Optional mounting hardware for two post telco style racks
- Slide rails with fixed positions to prevent drawer movement when typing
- An aesthetically enhanced latching front panel to release the two point lock

### Designed for Branded Headless Servers :



- SUN** Sun Fire / Netra / Blade series  
Sun SPARC Enterprise Series
- IBM** IBM BladeCenter S / H / E / T / HT  
IBM System x / P / i series  
IBM Remote Supervisor Adapter II
- HP** HP ProLiant DL / ML  
HP ProLiant BL blades  
HP 9000 servers

Others

### Designed for Branded Serial Devices :

- |                   |                 |                                 |
|-------------------|-----------------|---------------------------------|
| <b>APC</b>        | <b>PDU's</b>    | Metered & Switched              |
| <b>ServerTech</b> | <b>PDU's</b>    | Sentry Smart                    |
| <b>Cisco</b>      | <b>Routers</b>  | 800 / 1800 / 2800 / 3800 series |
| <b>Juniper</b>    | <b>Routers</b>  | E / J / m-series Services       |
| <b>Cisco</b>      | <b>Switches</b> | Catalyst series                 |
| <b>Juniper</b>    | <b>Switches</b> | EX-series Ethernet              |
| <b>Others</b>     |                 |                                 |

**\*\* All brand names, logo and registered trademarks are properties of their respective owners.**

### Technical Specification

- **Console**
  - Screen : 17" Grade A LCD, 800 x 600
  - Input : 104-key keyboard
- **Serial Port :** 16 x RJ45 RS-232, 300 to 115.2K bps
- **Ethernet Port** 1 x RJ45 10BaseT
- **Security :** SSH v2, IP filtering, https, SSL, password access
- **Authentication :** Radius, SSH, Telnet & user database
- **Protocol :** RCP, UDP, IP, ARP, ICMP, http / https, telnet, PPP, DHCP / BOOTP, SMTP, DNS, NTP, Dynamic DNS
- **Compatibility :** Console server, PC-based headless server, any serially managed device IBM blade center
- **Power :** 100~240VAC, 50/ 60Hz 0.5A via IEC cable
- **Regulatory Approval :** FCC, CE
- **Environmental**
  - Operating : 0 to 50°C
  - Storage : -5 to 60°C
  - Relative humidity : 90%, non-condensing
  - Shock : 50G peak acceleration (11 ms, half-sine wave)
  - Vibration : 58~100Hz / 0.98G (11ms / cycle)

### Dimensions

Model	Product Dimension (W x D x H)	Packing Dimension (W x D x H)	Net Weight	Gross Weight
NCP-1716	442 x 650 x 44 mm 17.4 x 25.6 x 1.73 inch	589 x 856 x 168 mm 23.2 x 33.7 x 6.6 inch	16 kg / 35 lbs	22 kg / 48 lbs

# CyberView™ — Connect your 16-port IP Serial Console LCD Drawer

## I Connection with headless servers

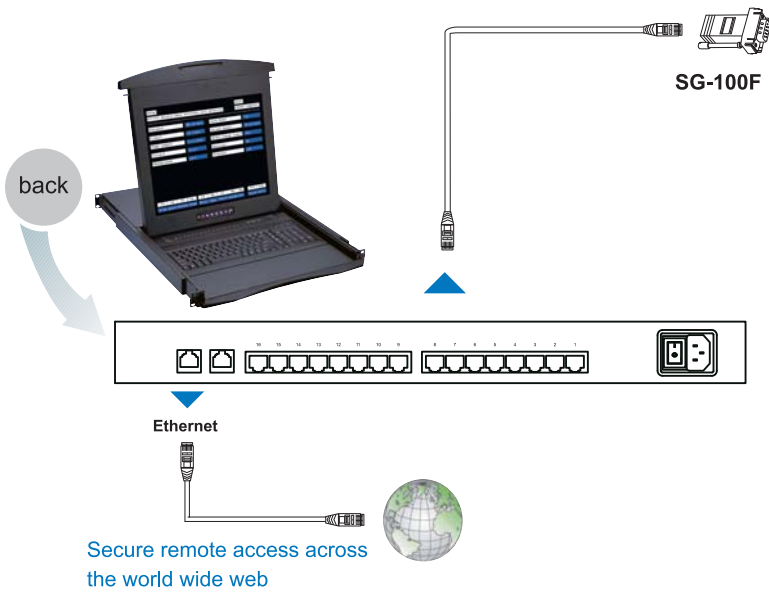

**SUN** Sun Fire / Netra / Blade series  
Sun SPARC Enterprise Series

**IBM** IBM BladeCenter S / H / E / T / HT  
IBM System x / P / i series  
IBM Remote Supervisor Adapter II

**HP** HP ProLiant DL / ML  
HP ProLiant BL blades  
HP 9000 servers

### Others



## II Connection with serial device equipment

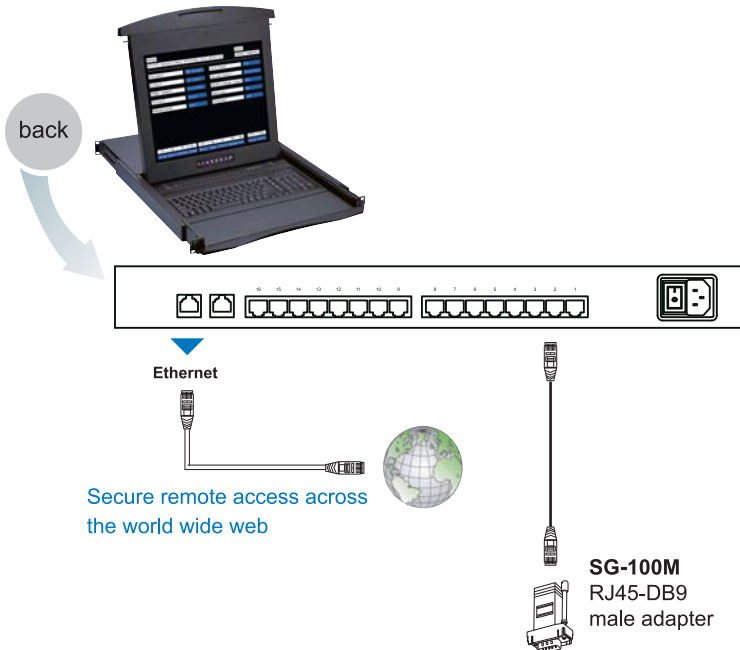

<b>APC</b>	<b>PDU's</b>	Metered & Switched
<b>ServerTech</b>	<b>PDU's</b>	Sentry Smart
<b>Cisco</b>	<b>Routers</b>	800 / 1800 / 2800 / 3800 series
<b>Juniper</b>	<b>Routers</b>	E / J / m-series Services
<b>Cisco</b>	<b>Switches</b>	Catalyst series
<b>Juniper</b>	<b>Switches</b>	EX-series Ethernet
<b>Others</b>		

\*\* All brand names, logo and registered trademarks are properties of their respective owners.

RP-W822

New



LCD Display Benefits

- ▶ 22" widescreen LCD with high resolution 1680 x 1050
- ▶ Ideal for CCTV security & industrial control

Display Features & Options

- 8U LCD display with 22" widescreen LCD
- Quad display option
- Touchscreen option
- 12V, 24V and 48V DC power options
- AV + BNC, Audio and DVI-D options
- NEMA 4 and IP65 options for front protection

Options page 103~104 for full details

 <b>AV</b>	 <b>DVI</b>	 <b>DC</b>	 <b>Touch Screen</b>	 <b>Audio</b>	 <b>QD</b>	 <b>IP65</b>
BNC + S-Video	DVI-D	DC Power	Touch Screen	Audio	Quad Display	NEMA 4

S-Video + BNC



Touchscreen - USB



DVI-D



Touchscreen - Serial



DC Power



Audio



Monitor  Grade A Wide 22" industrial TFT LCD panel

page 105 for full monitor details

Diagram  
Unit : mm

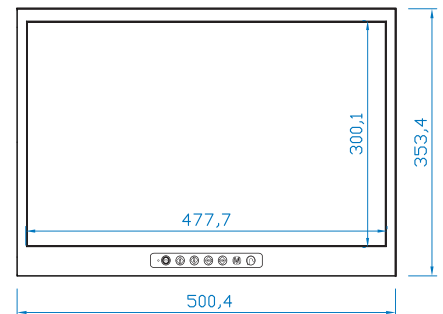

Ordering Information

Model	RP-W822
-------	---------

Dimensions

Model	Product Dimension (W x D x H)	Packing Dimension (W x D x H)	Net Weight	Gross Weight
RP-W822 Series	500.4 x 59.1 x 353.4 mm 19.7 x 2.3 x 13.9 inch	565 x 539 x 156 mm 22.2 x 21.2 x 6.1 inch	12 kg / 26 lbs	15 kg / 33 lbs

The rackmount width will be increased under RP widescreen series.  
With Quad Display option, 1U height will be increased on the casing. Page 82 for RP-W922QD specifications.



RP-W719

New



LCD Display Benefits

- ▶ 19" widescreen LCD with high resolution 1440 x 900
- ▶ Ideal for CCTV security & industrial control

Display Features & Options

- 7U LCD display with 19" widescreen LCD
- Quad display option
- Touchscreen option
- 12V, 24V and 48V DC power options
- AV + BNC, Audio and DVI-D options
- NEMA 4 and IP65 options for front protection

Options page 103-104 for full details

 AV BNC + S-Video	 DVI DVI-D	 DC DC Power	 Touch Screen	 Audio	 QD Quad Display	 IP65 NEMA 4
---	---	---	---	--	---	---

S-Video + BNC



Touchscreen - USB



DVI-D



Touchscreen - Serial



DC Power



Audio



Monitor  Grade A Wide 19" industrial TFT LCD panel

page 105 for full monitor details

Diagram  
Unit : mm

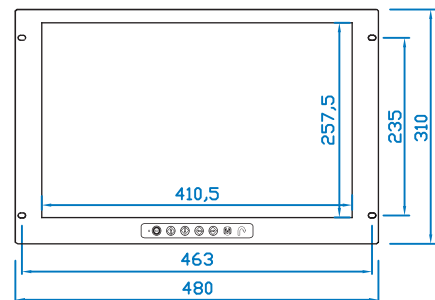

Ordering Information

Model	RP-W719
-------	---------

Dimensions

Model	Product Dimension (W x D x H)	Packing Dimension (W x D x H)	Net Weight	Gross Weight
RP-W719 Series	480 x 57.5 x 310 mm 18.9 x 2.3 x 12.2 inch	565 x 495 x 156 mm 22.2 x 19.5 x 6.1 inch	8 kg / 18 lbs	10 kg / 22 lbs

The rackmount width will be increased under RP widescreen series.  
With Quad Display option, 1U height will be increased on the casing. Page 83 for RP-W819QD specifications.

RP-W119

New



LCD Drawer Benefits

- ▶ 19" widescreen LCD with 1440 x 900 high resolution
- ▶ Sliding LCD allowing LCD to remain open when the rack door is closed
- ▶ Enhanced aesthetics with new molded front panel and two point lock

Drawer Features & Options

- 1U rackmount LCD drawer with 19" widescreen LCD
- Quad display option
- 12V, 24V and 48V DC power options
- AV + BNC, Audio and DVI-D options

Options page 103~104 for full details

 AV BNC + S-Video	 DVI DVI-D	 DC DC Power	 Audio	 QD Quad Display
--	--	--	---	--

S-Video + BNC



DC Power



DVI-D



Audio

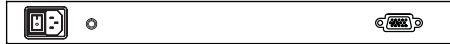

Monitor  Grade A Wide 19" industrial TFT LCD panel

page 105 for full monitor details

Diagram  
Unit : mm

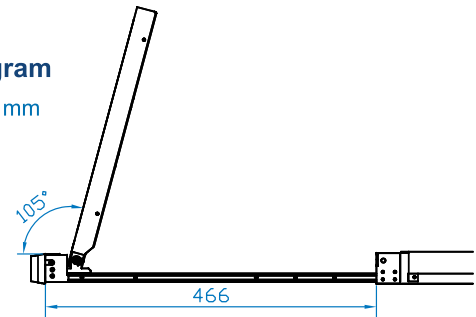

Ordering Information

Model	RP-W119
-------	---------

Dimensions

Model	Product Dimension (W x D x H)	Packing Dimension (W x D x H)	Net Weight	Gross Weight
RP-W119 Series	442 x 650 x 44 mm 17.4 x 25.6 x 1.73 inch	581 x 755 x 172 mm 22.9 x 29.7 x 6.8 inch	13 kg / 29 lbs	18 kg / 40 lbs

Page 84 for RP-W119QD specifications.

**RP-W922QD** *New*

**LCD Display Benefits**

- ▶ Built-in Quad Display
- ▶ Ideal for CCTV security & industrial control
- ▶ High resolution 1680 x 1050, 22" widescreen LCD

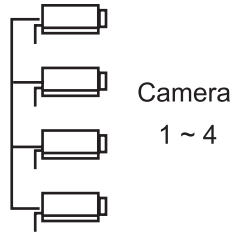

**Display Features & Options**

- 22" widescreen LCD in 9U
- **DC** 12, 24 and 48 volt DC power options

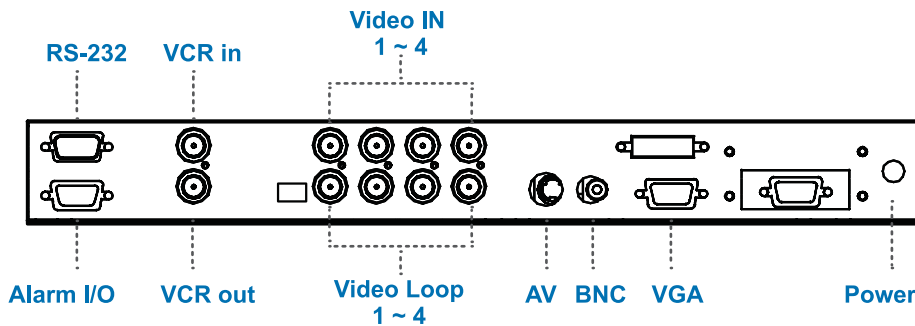

**Front QD membrane button**



**Monitor** Grade A Wide 22" industrial TFT LCD panel

page 105 for full monitor details

**Diagram** Unit : mm

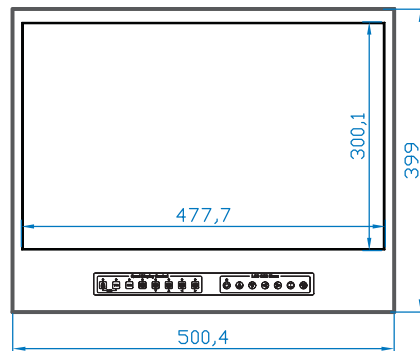

**Ordering Information**

Model	RP-W922QD
-------	-----------

**Dimensions**

Model	Product Dimension (W x D x H)	Packing Dimension (W x D x H)	Net Weight	Gross Weight
RP-W922QD Series	500.4 x 70.5 x 399 mm 19.7 x 2.8 x 15.7 inch	565 x 539 x 156 mm 22.2 x 21.2 x 6.1 inch	12 kg / 26 lbs	15 kg / 33 lbs

The rackmount width will be increased under RP widescreen series.  
With Quad Display option, the front panel should be 2.0mm steel one.

RP-W819QD

New

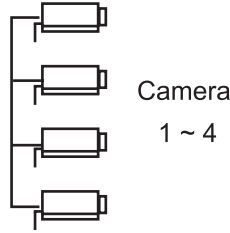

LCD Display Benefits

- ▶ Built-in Quad Display
- ▶ Ideal for CCTV security & industrial control
- ▶ High resolution 1440 x 900, 19" widescreen LCD

Display Features & Options

- 19" widescreen LCD in 8U
- **DC** 12V, 24V and 48V DC Power options

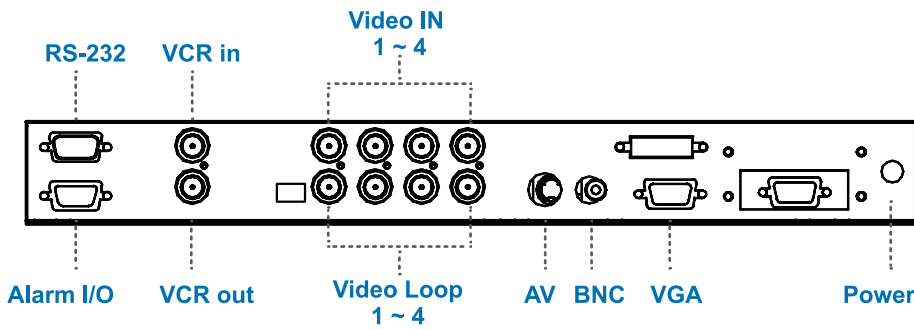

Front QD membrane button



Monitor **SAMSUNG** Grade A Wide 19" industrial TFT LCD panel

page 105 for full monitor details

Diagram Unit : mm

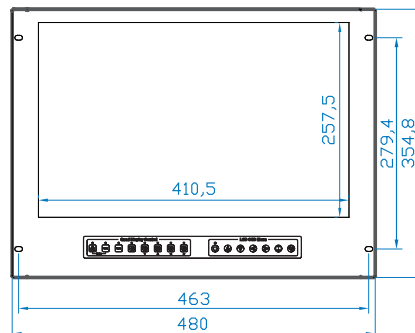

Ordering Information

Model	RP-W819QD
-------	-----------

Dimensions

Model	Product Dimension (W x D x H)	Packing Dimension (W x D x H)	Net Weight	Gross Weight
RP-W819QD Series	480 x 71.5 x 354.8 mm 18.9 x 2.8 x 14 inch	565 x 495 x 156 mm 22.2 x 19.5 x 6.1 inch	8 kg / 18 lbs	10 kg / 22 lbs

The rackmount width will be increased under RP widescreen series.  
With Quad Display option, the front panel should be 2.0mm steel one.

RP-W119QD *New*

LCD Drawer Benefits

- ▶ Built-in Quad Display
- ▶ Ideal for CCTV security & industrial control
- ▶ High resolution 1440 x 900, 19" widescreen LCD
- ▶ Sliding LCD allowing LCD to remain open when the rack door is closed

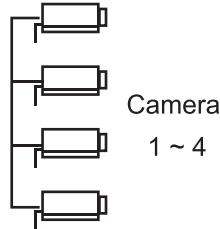

Drawer Features & Options

- 1U LCD drawer 19" widescreen LCD
- **DC** 12V, 24V and 48V DC Power options

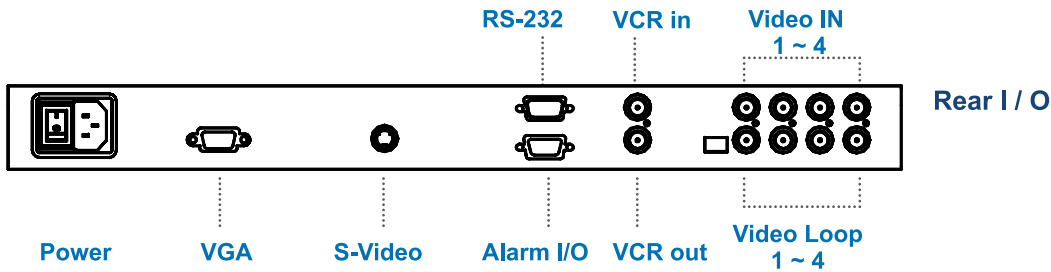

Front QD membrane button



Monitor **SAMSUNG** Grade A Wide 19" industrial TFT LCD panel

page 105 for full monitor details

Ordering Information

Model	RP-W119QD
-------	-----------

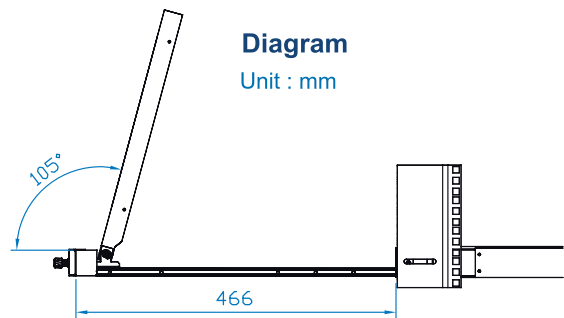

Dimensions

Model	Product Dimension (W x D x H)	Packing Dimension (W x D x H)	Net Weight	Gross Weight
RP-W119QD Series	445 x 650 x 44 mm 17.5 x 25.6 x 1.73 inch	581 x 755 x 172 mm 22.9 x 29.7 x 6.8 inch	13 kg / 29 lbs	18 kg / 40 lbs

### RP-120

*New*



#### LCD Drawer Benefits

- ▶ 20" LCD in 1U with 1600 x 1200 high resolution
- ▶ Sliding LCD allowing LCD to remain open when the rack door is closed
- ▶ Enhanced aesthetics with new molded front panel and two point lock

#### Drawer Features & Options

- 1U rackmount LCD drawer with 20" LCD
- Quad display option
- Touchscreen option
- 12V, 24V and 48V DC Power options
- AV + BNC, Audio and DVI-D options

**Options** *page 103~104 for full details*

 BNC + S-Video	 DVI-D	 DC Power	 Touch Screen	 Audio	 Quad Display
---	--	---	---	--	---

#### S-Video + BNC



#### Touchscreen - USB

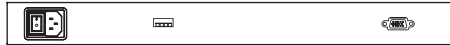

#### DVI-D



#### Touchscreen - Serial



#### DC Power



#### Audio



**Monitor**  Grade A 20" industrial TFT LCD panel

*page 105 for full monitor details*

#### Diagram

Unit : mm

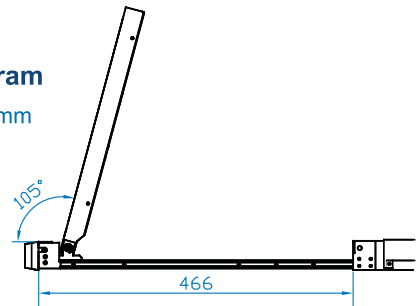

#### Ordering Information

Model	RP-120
-------	--------

#### Dimensions

Model	Product Dimension (W x D x H)	Packing Dimension (W x D x H)	Net Weight	Gross Weight
RP-120 Series	442 x 650 x 44 mm 17.4 x 25.6 x 1.73 inch	581 x 755 x 172 mm 22.9 x 29.7 x 6.8 inch	14 kg / 31 lbs	19 kg / 42 lbs

*Page 92 for RP-120QD specifications.*

SP-120

New



LCD Drawer Benefits

- ▶ 20" LCD in 1U with 1600 x 1200 high resolution
- ▶ Direct Support for SUN Micro 1152 x 900 native resolution
- ▶ Sliding LCD allowing LCD to remain open when the rack door is closed
- ▶ Enhanced aesthetics with new molded front panel and two point lock

Drawer Features & Options

- 1U rackmount LCD drawer with 20" LCD
- DVI-D option
- 12V, 24V and 48V DC Power options

Options page 103~104 for full details



DVI-D



DC Power

DVI-D



DC Power



Monitor Grade A 20" industrial TFT LCD panel

page 105 for full monitor details

Diagram

Unit : mm

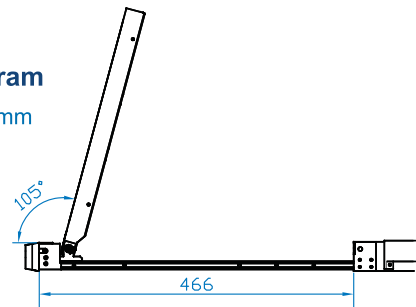

Ordering Information

Model	SP-120
-------	--------

Dimensions

Model	Product Dimension (W x D x H)	Packing Dimension (W x D x H)	Net Weight	Gross Weight
SP-120 Series	442 x 650 x 44 mm 17.4 x 25.6 x 1.73 inch	581 x 755 x 172 mm 22.9 x 29.7 x 6.8 inch	14 kg / 31 lbs	19 kg / 42 lbs

### RP-117 RP-119



#### LCD Drawer Benefits

- ▶ Sliding LCD allowing LCD to remain open when the rack door is closed
- ▶ "One Man" installation slides for easy, quick installation
- ▶ Enhanced aesthetics with new molded front panel and two point lock

#### Drawer Features & Options

- 1U rackmount LCD drawer with either 17" or 19" LCD
- Quad display option
- Touchscreen option
- 12V, 24V and 48V DC Power options
- AV + BNC, Audio and DVI-D options

Options page 103~104 for full details



BNC + S-Video



DVI-D



DC Power



Touch Screen



Audio



Quad Display

S-Video + BNC



Touchscreen - USB



DVI-D



Touchscreen - Serial



DC Power



Audio



Monitor Grade A 17" or 19" industrial TFT LCD panel

page 105 for full monitor details

Diagram

Unit : mm

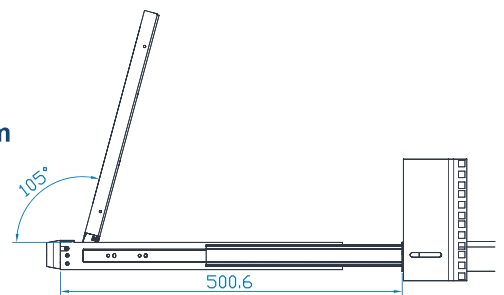

#### Ordering Information

17" LCD Series

19" LCD Series

Model	17" LCD Series	19" LCD Series
	<b>RP-117</b>	<b>RP-119</b>

#### Dimensions

Model	Product Dimension (W x D x H)	Packing Dimension (W x D x H)	Net Weight	Gross Weight
RP-117 Series	446 x 600 x 44 mm 17.6 x 23.6 x 1.73 inch	581 x 755 x 172 mm 22.9 x 29.7 x 6.8 inch	12 kg / 26 lbs	17 kg / 37 lbs
RP-119 Series	446 x 600 x 44 mm 17.6 x 23.6 x 1.73 inch	581 x 755 x 172 mm 22.9 x 29.7 x 6.8 inch	13 kg / 29 lbs	18 kg / 40 lbs

Page 92 for RP-117QD / RP-119QD specifications.



### SP-117 SP-119



#### LCD Drawer Benefits

- ▶ Sliding LCD allowing LCD to remain open when the rack door is closed
- ▶ Direct Support for SUN Micro 1152 x 900 native resolution
- ▶ "One Man" installation slides for easy, quick installation
- ▶ Enhanced aesthetics with new molded front panel and two point lock

#### Drawer Features & Options

- 1U rackmount LCD drawer with either 17" or 19" LCD
- DVI-D option
- 12V, 24V and 48V DC Power options

**Options** page 103~104 for full details



DVI-D



DC Power

DVI-D



DC Power

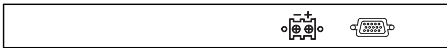

**Monitor** Grade A 17 or 19" industrial TFT LCD panel

page 105 for full monitor details

**Diagram**

Unit : mm

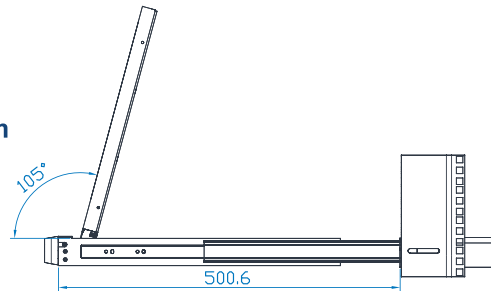

#### Ordering Information

17" LCD Series

19" LCD Series

Model	17" LCD Series	19" LCD Series
	SP-117	SP-119

#### Dimensions

Model	Product Dimension (W x D x H)	Packing Dimension (W x D x H)	Net Weight	Gross Weight
SP-117 Series	442 x 600 x 44 mm 17.4 x 23.6 x 1.73 inch	581 x 755 x 172 mm 22.9 x 29.7 x 6.8 inch	12 kg / 26 lbs	17 kg / 37 lbs
SP-119 Series	442 x 600 x 44 mm 17.4 x 23.6 x 1.73 inch	581 x 755 x 172 mm 22.9 x 29.7 x 6.8 inch	13 kg / 29 lbs	18 kg / 40 lbs

### RP-1417 RP-1419



#### LCD Drawer Benefits

- ▶ Short depth design of 480mm (18.9") only
- ▶ Depth will suit a 600mm rack application
- ▶ Sliding LCD allowing LCD to remain open when the rack door is closed
- ▶ "One Man" installation slides for easy, quick installation
- ▶ Enhanced aesthetics with new molded front panel and two point lock

#### Drawer Features & Options

- 1U rackmount LCD drawer with either 17" or 19" LCD
- Quad display option
- Touchscreen options
- 12V, 24V and 48V DC Power options
- AV + BNC, Audio and DVI-D options

Options page 103~104 for full details

 AV BNC + S-Video	 DVI DVI-D	 DC DC Power	 Touch Screen	 Audio	 QD Quad Display
---	---	---	---	--	---

#### S-Video + BNC



#### Touchscreen - USB



#### DVI-D



#### Touchscreen - Serial



#### DC Power

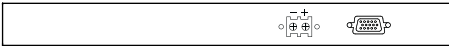

#### Audio

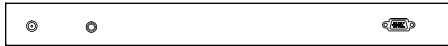

**\*\*With DVI-D or DC power option, the depth of RP-1417 / RP-1419 will be extended from 480mm ( 18.9" ) to 530mm ( 20.9" )**

Monitor  Grade A 17 or 19" industrial TFT LCD panel

page 105 for full monitor details

#### Diagram

Unit : mm

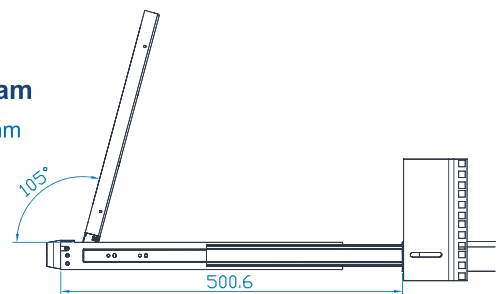

#### Ordering Information

17" LCD Series

19" LCD Series

Model	<b>RP-1417</b>	<b>RP-1419</b>
-------	----------------	----------------

#### Dimensions

Model	Product Dimension ( W x D x H )	Packing Dimension ( W x D x H )	Net Weight	Gross Weight
RP-1417 Series	446 x 480 x 44 mm 17.6 x 18.9 x 1.73 inch	584 x 641 x 169 mm 23 x 25.2 x 6.7 inch	12 kg / 26 lbs	17 kg / 37 lbs
RP-1419 Series	446 x 480 x 44 mm 17.6 x 18.9 x 1.73 inch	584 x 641 x 169 mm 23 x 25.2 x 6.7 inch	13 kg / 29 lbs	18 kg / 40 lbs

**RP-717**  
**RP-819**  
**RP-920**



### LCD Display Benefits

- ▶ Ultra high resolution 1600 x 1200 for RP-920
- ▶ Ideal for CCTV security & industrial control
- ▶ Stylish 6mm cast aluminum front panel

### Display Features & Options

- 17" LCD in 7U, 19" LCD in 8U or 20" LCD in 9U
- Quad display option
- Touchscreen option
- 12V, 24V and 48V DC Power options
- AV + BNC, Audio and DVI-D options
- NEMA 4 and IP65 options for front protection

**Options** page 103~104 for full details



BNC + S-Video



DVI-D



DC Power



Touch Screen



Audio



Quad Display



NEMA 4

#### S-Video + BNC



#### Touchscreen - USB



#### DVI-D



#### Touchscreen - Serial



#### DC Power

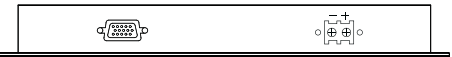

#### Audio



### Diagram

Unit : mm

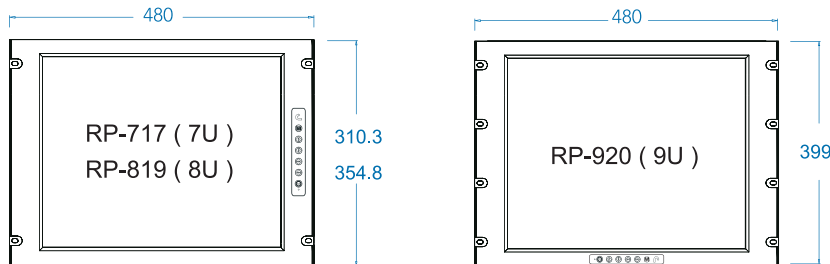

**Monitor** Grade A 17", 19" or 20" industrial TFT LCD panel page 105 for full monitor details

### Ordering Information

17" LCD Series

19" LCD Series

20" LCD Series

Model	<b>RP-717</b>	<b>RP-819</b>	<b>RP-920</b>
-------	---------------	---------------	---------------

### Dimensions

Model	Product Dimension (W x D x H)	Packing Dimension (W x D x H)	Net Weight	Gross Weight
RP-717 Series	480 x 57 x 310.3 mm 18.9 x 2.2 x 12.2 inch	565 x 450 x 156 mm 22.2 x 17.7 x 6.1 inch	7 kg / 15 lbs	8.5 kg / 19 lbs
RP-819 Series	480 x 57 x 354.8 mm 18.9 x 2.2 x 14 inch	565 x 495 x 156 mm 22.2 x 19.5 x 6.1 inch	8 kg / 18 lbs	10 kg / 22 lbs
RP-920 Series	480 x 67 x 399 mm 18.9 x 2.6 x 15.7 inch	565 x 539 x 156 mm 22.2 x 21.2 x 6.1 inch	12 kg / 26 lbs	15 kg / 33 lbs

**SP-717**  
**SP-819**  
**SP-920**

*New*



### LCD Display Benefits

- ▶ Ultra high resolution 1600 x 1200 for SP-920
- ▶ Direct Support for SUN Micro 1152 x 900 native resolution
- ▶ Stylish 6mm cast aluminum front panel

### Display Features & Options

- 17" LCD in 7U, 19" LCD in 8U or 20" LCD in 9U
- DVI-D option
- 12V, 24V and 48V DC Power options

**Options** *page 103~104 for full details*



DVI-D



DC Power

#### DVI-D



#### DC Power



**Diagram**  
Unit : mm

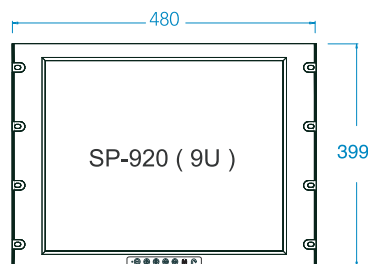
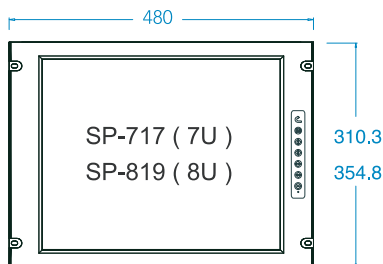

**Monitor** Grade A 17", 19" or 20" industrial TFT LCD panel

*page 105 for full monitor details*

### Ordering Information

17" LCD Series

19" LCD Series

20" LCD Series

Model	SP-717	SP-819	SP-920
-------	--------	--------	--------

### Dimensions

Model	Product Dimension (W x D x H)	Packing Dimension (W x D x H)	Net Weight	Gross Weight
SP-717 Series	480 x 57 x 310.3 mm 18.9 x 2.2 x 12.2 inch	565 x 450 x 156 mm 22.2 x 17.7 x 6.1 inch	7 kg / 15 lbs	8.5 kg / 19 lbs
SP-819 Series	480 x 57 x 354.8 mm 18.9 x 2.2 x 14 inch	565 x 495 x 156 mm 22.2 x 19.5 x 6.1 inch	8 kg / 18 lbs	10 kg / 22 lbs
SP-920 Series	480 x 67 x 399 mm 18.9 x 2.6 x 15.7 inch	565 x 539 x 156 mm 22.2 x 21.2 x 6.1 inch	12 kg / 26 lbs	15 kg / 33 lbs

RP-117QD  
RP-119QD  
RP-120QD

New



### LCD Drawer Benefits

- ▶ Built-in Quad Display
- ▶ Ideal for CCTV security & industrial control
- ▶ "One Man" installation slides included except 20" LCD model
- ▶ Sliding LCD allowing LCD to remain open when the rack door is closed

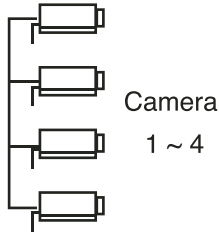

### Drawer Features & Options

- 1U LCD drawer with either 4 : 3, 17", 19" or 20" LCD
- **DC** 12V, 24V and 48V DC Power options

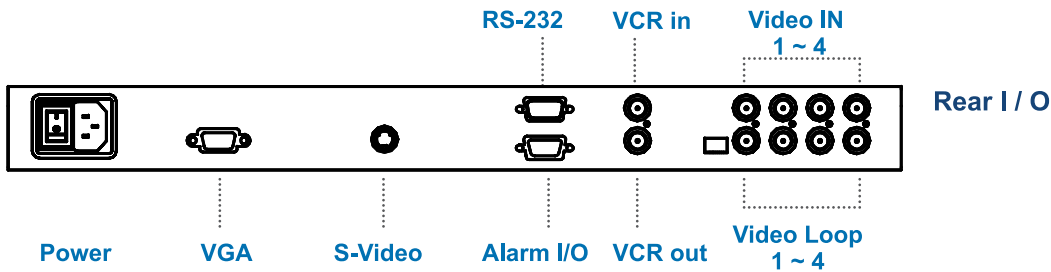

### Diagram

Unit : mm

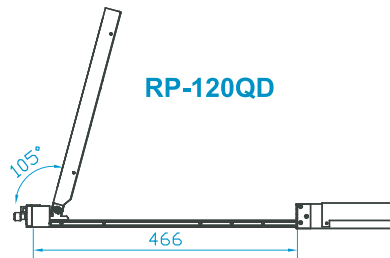
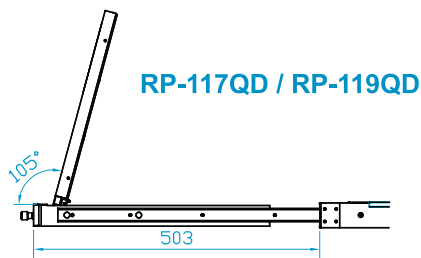

**Monitor** Grade A 17", 19" or 20" industrial TFT LCD panel *page 105 for full monitor details*

### Ordering Information

17" LCD Series

19" LCD Series

20" LCD Series

Model	RP-117QD	RP-119QD	RP-120QD
-------	----------	----------	----------

### Dimensions

Model	Product Dimension (W x D x H)	Packing Dimension (W x D x H)	Net Weight	Gross Weight
RP-117QD Series	442 x 600 x 44 mm 17.4 x 23.6 x 1.73 inch	581 x 755 x 172 mm 22.9 x 29.7 x 6.8 inch	12 kg / 26 lbs	17 kg / 37 lbs
RP-119QD Series	442 x 600 x 44 mm 17.4 x 23.6 x 1.73 inch	581 x 755 x 172 mm 22.9 x 29.7 x 6.8 inch	13 kg / 29 lbs	18 kg / 40 lbs
RP-120QD Series	442 x 650 x 44 mm 17.4 x 25.6 x 1.73 inch	581 x 755 x 172 mm 22.9 x 29.7 x 6.8 inch	14 kg / 31 lbs	19 kg / 42 lbs

### RP-817QD RP-919QD RP-1020QD

New

#### LCD Display Benefits

- ▶ Built-in Quad Display
- ▶ Ideal for CCTV security & industrial control

#### Display Features & Options

- 4 : 3, 17" in 8U, 19" in 9U or 20" in 10U
- **DC** 12V, 24V and 48V DC Power options

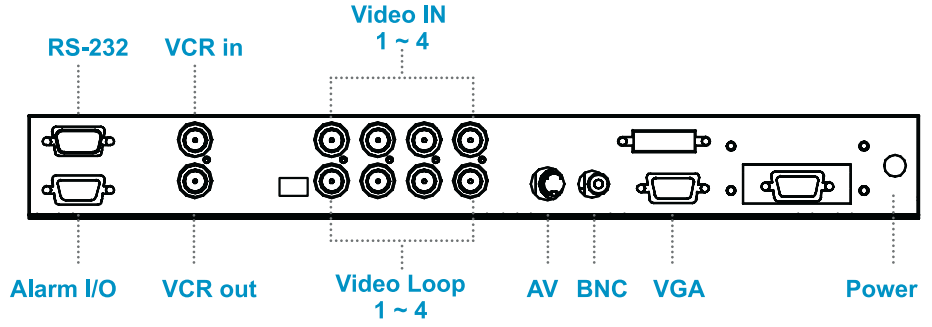
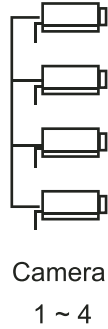

Front QD membrane button

#### Diagram Unit : mm

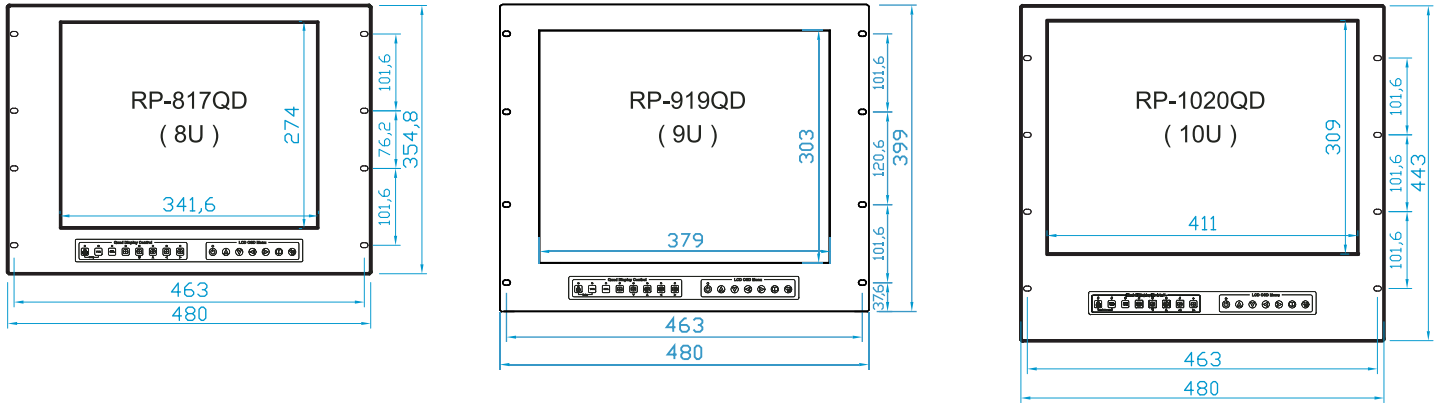

Monitor Grade A 17", 19" or 20" industrial TFT LCD panel *page 105 for full monitor details*

#### Ordering Information

17" LCD Series

19" LCD Series

20" LCD Series

Model	RP-817QD	RP-919QD	RP-1020QD
-------	----------	----------	-----------

#### Dimensions

Model	Product Dimension (W x D x H)	Packing Dimension (W x D x H)	Net Weight	Gross Weight
RP-817QD Series	480 x 71.5 x 354.8 mm 18.9 x 2.8 x 14 inch	565 x 450 x 156 mm 22.2 x 17.7 x 6.1 inch	7 kg / 15 lbs	8.5 kg / 19 lbs
RP-919QD Series	480 x 68.5 x 399 mm 18.9 x 2.7 x 15.7 inch	565 x 495 x 156 mm 22.2 x 19.5 x 6.1 inch	8 kg / 18 lbs	10 kg / 22 lbs
RP-1020QD Series	480 x 71.5 x 443 mm 18.9 x 2.8 x 17.4 inch	565 x 539 x 156 mm 22.2 x 21.2 x 6.1 inch	12 kg / 26 lbs	15 kg / 33 lbs

### RP-H717 / RP-H819

New



#### LCD Display Benefits page 105 for high bright LCD specifications

- ▶ LED technology
- ▶ 800 cd/m2 for 17", 19" LCD
- ▶ Low power consumption
- ▶ Long lifetime up to 70,000 hours
- ▶ Minimum EMI emissions
- ▶ Operation temperature at -20°C
- ▶ High shock & vibration resistance
- ▶ Mercury free
- ▶ Slim size

#### Options



BNC + S-Video



Touch Screen



Quad Display



DC Power



NEMA 4



DVI-D



Audio

#### Optical Bonding Option



- 1mm thick optically clear adhesive for touchscreen or 4mm temper glass
- No air gap between the cover glass & LCD panel
- Increased LCD durability under vibration
- Eliminate residual and ghost images

#### Anti-Reflective Film Option



- 0.1mm thick optical interference coating film
- Designed to provide visual enhancement
- Cost effective vacuum laminated technology
- Greatly reduced specular & diffuse reflection
- Increased contrast for improved readability
- Easy clean surface

Diagram  
Unit : mm

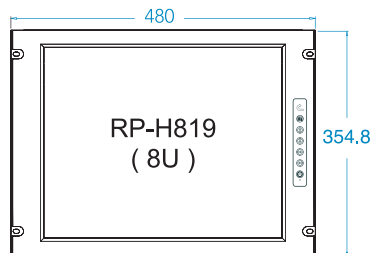
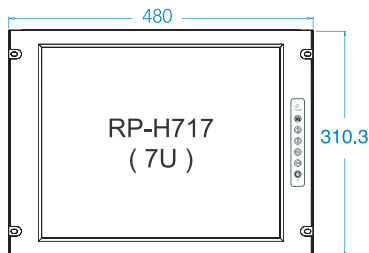

#### Ordering Information

17" LCD Series

19" LCD Series

Model	RP-H717	RP-H819
-------	---------	---------

#### Dimensions

Model	Product Dimension (W x D x H)	Packing Dimension (W x D x H)	Net Weight	Gross Weight
RP-H717 Series	480 x 57 x 310.3 mm 18.9 x 2.2 x 12.2 inch	565 x 450 x 156 mm 22.2 x 17.7 x 6.1 inch	7 kg / 15 lbs	8.5 kg / 19 lbs
RP-H819 Series	480 x 57 x 354.8 mm 18.9 x 2.2 x 14 inch	565 x 495 x 156 mm 22.2 x 19.5 x 6.1 inch	8 kg / 18 lbs	10 kg / 22 lbs

### RP-HW719 / RP-HW822

New



#### LCD Display Benefits page 105 for high bright LCD specifications

- ▶ LED technology
- ▶ 800 cd/m2 for 19" LCD, 800 cd/m2 for 22" LCD
- ▶ Low power consumption
- ▶ Long lifetime up to 70,000 hours
- ▶ Minimum EMI emissions
- ▶ Operation temperature at -20°C
- ▶ High shock & vibration resistance
- ▶ Mercury free
- ▶ Slim size

#### Options



BNC + S-Video



Touch Screen



Quad Display



DC Power



NEMA 4



DVI-D



Audio

#### Optical Bonding Option



- 1mm thick optically clear adhesive for touchscreen or 4mm temper glass
- No air gap between the cover glass & LCD panel
- Increased LCD durability under vibration
- Eliminate residual and ghost images

#### Anti-Reflective Film Option



- 0.1mm thick optical interference coating film
- Designed to provide visual enhancement
- Cost effective vacuum laminated technology
- Greatly reduced specular & diffuse reflection
- Increased contrast for improved readability
- Easy clean surface

Diagram  
Unit : mm

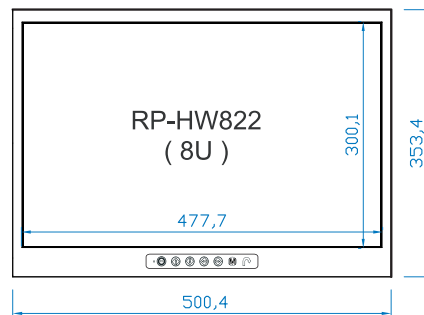
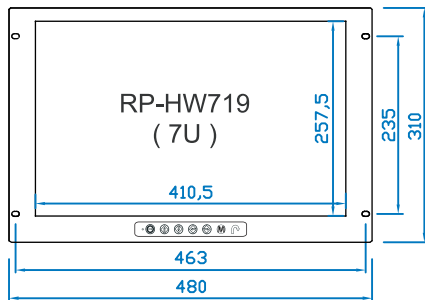

#### Ordering Information

Wide 19" LCD Series

Wide 22" LCD Series

Model	RP-HW719	RP-HW822
-------	----------	----------

#### Dimensions

Model	Product Dimension (W x D x H)	Packing Dimension (W x D x H)	Net Weight	Gross Weight
RP-HW719 Series	480 x 57.5 x 310 mm 18.9 x 2.3 x 12.2 inch	565 x 495 x 156 mm 22.2 x 19.5 x 6.1 inch	8 kg / 18 lbs	10 kg / 22 lbs
RP-HW822 Series	500.4 x 59.1 x 353.4 mm 19.7 x 2.3 x 13.9 inch	565 x 539 x 156 mm 22.2 x 21.2 x 6.1 inch	12 kg / 26 lbs	15 kg / 33 lbs



### RP-H117 New RP-H119



#### LCD Drawer Benefits page 105 for high bright LCD specifications

- ▶ 800 cd/m2 for 17", 19" LCD
- ▶ Low power consumption
- ▶ Long lifetime up to 70,000 hours
- ▶ Operation temperature at -20°C
- ▶ High shock & vibration resistance
- ▶ LED technology
- ▶ Minimum EMI emissions
- ▶ Mercury free
- ▶ Slim size

#### Drawer Features

- 1U rackmount LCD drawer with either 17" or 19" LCD
- "One Man" installation slides for easy, quick installation
- Enhanced aesthetics with new molded front panel and two point lock

#### Options



BNC + S-Video



Touch Screen



Quad Display



DC Power



DVI-D



Audio

#### Optical Bonding Option



- 1mm thick optically clear adhesive for touchscreen or 4mm temper glass
- No air gap between the cover glass & LCD panel
- Increased LCD durability under vibration
- Eliminate residual and ghost images

#### Anti-Reflective Film Option



- 0.1mm thick optical interference coating film
- Designed to provide visual enhancement
- Cost effective vacuum laminated technology
- Greatly reduced specular & diffuse reflection
- Increased contrast for improved readability
- Easy clean surface

#### Ordering Information

	17" LCD	19" LCD
Model	RP-H117	RP-H119

#### Diagram

Unit : mm

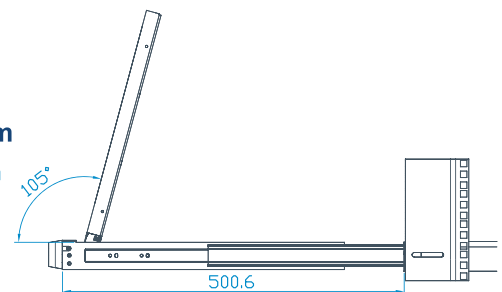

#### Dimensions

Model	Product Dimension (W x D x H)	Packing Dimension (W x D x H)	Net Weight	Gross Weight
RP-H117 Series	442 x 600 x 44 mm 17.4 x 23.6 x 1.73 inch	581 x 755 x 172 mm 22.9 x 29.7 x 6.8 inch	12 kg / 26 lbs	17 kg / 37 lbs
RP-H119 Series	442 x 600 x 44 mm 17.4 x 23.6 x 1.73 inch	581 x 755 x 172 mm 22.9 x 29.7 x 6.8 inch	13 kg / 29 lbs	18 kg / 40 lbs

H-117  
H-119



### LCD Drawer Benefits page 105 for high bright LCD specifications

- ▶ 800 cd/m<sup>2</sup> for 17", 19" LCD
- ▶ Low power consumption
- ▶ Long lifetime up to 70,000 hours
- ▶ Operation temperature at -20°C
- ▶ High shock & vibration resistance
- ▶ LED technology
- ▶ Minimum EMI emissions
- ▶ Mercury free
- ▶ Slim size

### Drawer & KVM Features

- 1U keyboard LCD drawer with either 17" or 19" LCD
- Combo interface either PS/2 or USB input to the LCD drawer
- Mix PS/2, USB & SUN with Multi-Platform switch capability
- "One Man" installation slides for easy, quick installation
- Slide rails with fixed positions to prevent drawer movement when typing
- Enhanced aesthetics with new molded front panel and two point lock

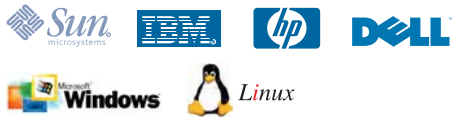

### Options page 103-104 for full details

- AV**  
BNC + S-Video
- DVI**  
DVI-D
- DC**  
DC Power
- Audio**
- Touch Screen** ( *the height changed from 1U to 1.5U* )

### Optical Bonding Option



- 1mm thick optically clear adhesive for touchscreen or 4mm temper glass
- No air gap between the cover glass & LCD panel
- Increased LCD durability under vibration
- Eliminate residual and ghost images

### Anti-Reflective Film Option



- 0.1mm thick optical interference coating film
- Designed to provide visual enhancement
- Cost effective vacuum laminated technology
- Greatly reduced specular & diffuse reflection
- Increased contrast for improved readability
- Easy clean surface

### Diagram

Unit : mm

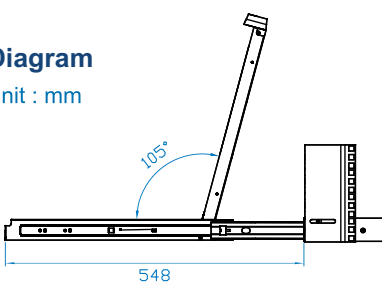



# KVM Selection

Base Model	17" LCD Series	19" LCD Series
* Single port w/o KVM * Combo interface	<b>H-117</b>	<b>H-119</b>

## Combo Cat6 KVM

page 23~38 for KVM specifications, page 107~110 for KVM rear I/O

Configuration	Ports	Model	17" LCD Series	19" LCD Series
1 console	<b>Combo</b> Cat6 8 port		H117 - U 801	H119 - U 801
2 consoles			H117 - U 802	H119 - U 802
2 consoles (IP)			H117 - U IP 802	H119 - U IP 802
1 console	<b>Combo</b> Cat6 16 port		H117 - U 1601	H119 - U 1601
2 consoles			H117 - U 1602	H119 - U 1602
2 consoles (IP)			H117 - U IP 1602	H119 - U IP 1602
1 console	<b>Combo</b> Cat6 32 port		H117 - U 3201	H119 - U 3201
2 consoles			H117 - U 3202	H119 - U 3202
2 consoles (IP)			H117 - U IP 3202	H119 - U IP 3202

## Combo DB-15 KVM

Configuration	Ports	Model	17" LCD Series	19" LCD Series
1 console	<b>Combo</b> DB-15 8 port		H117 - S 801	H119 - S 801
2 consoles			H117 - 802	H119 - 802
2 consoles (IP)			H117 - IP 802	H119 - IP 802
1 console	<b>Combo</b> DB-15 16 port		H117 - S 1601	H119 - S 1601
2 consoles			H117 - 1602	H119 - 1602
2 consoles (IP)			H117 - IP 1602	H119 - IP 1602

## PS/2 DB-15 KVM

Configuration	Ports	Model	17" LCD Series	19" LCD Series
1 console	DB-15 8 port DB-15 16 port		H117 - 801	H119 - 801
			H117 - 1601	H119 - 1601

## Keyboard Selection

Supporting layouts



### **Ne** N keyboard integrated with touchpad

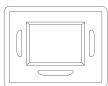
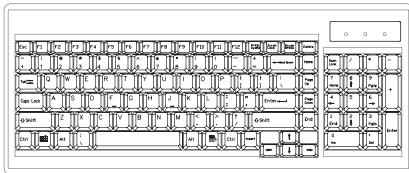

### **Nb** N keyboard integrated with trackball

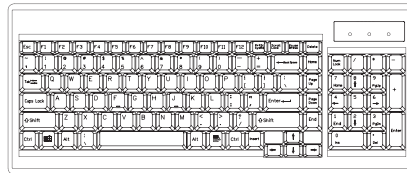

page 106 for full keyboard details

## Dimensions

Model	Product Dimension (W x D x H)	Packing Dimension (W x D x H)	Net Weight	Gross Weight
H-117 / H-119	442 x 650 x 44 mm 17.4 x 25.6 x 1.73 inch	589 x 856 x 168 mm 23.2 x 33.7 x 6.6 inch	16 kg / 35 lbs	22 kg / 48 lbs

### RK-1



### Keyboard Drawer Benefits

- ▶ Enhanced aesthetics with new molded front panel and two point lock
- ▶ Combo interface either PS/2 or USB input
- ▶ Multiple keyboard language selections with touchpad or trackball

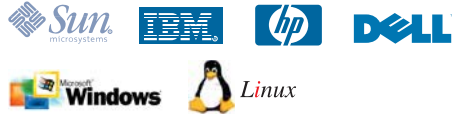

### KVM Options

- Multi-user Matrix Cat6 KVM with either 16 or 32 ports in 1U
- Cost efficient Combo KVM integration
- Mix PS/2 & USB with multi-platform switch capability
- Secure remote user access across the world wide web

### Matrix KVM 8, 16, 32 port button

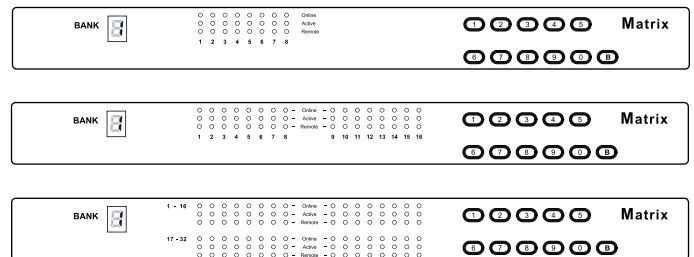

### PS/2 KVM 4, 8, 16 port button

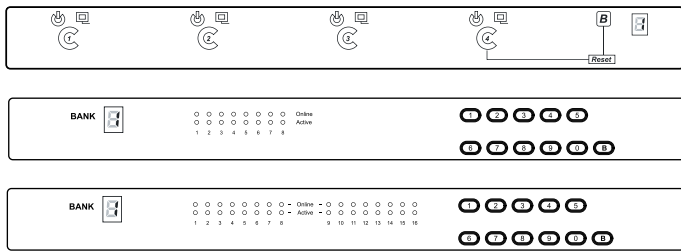

### Combo KVM 8, 16, 32 port button

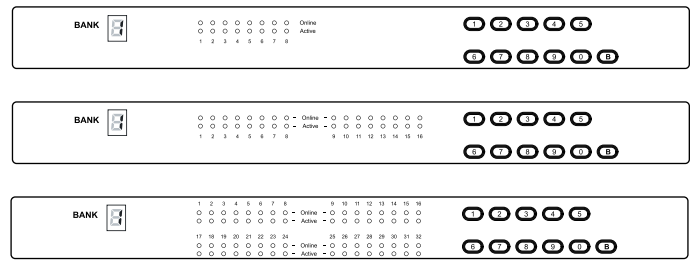

### Dimensions

Model	Product Dimension (W x D x H)	Packing Dimension (W x D x H)	Net Weight	Gross Weight
RK-1 Series	442 x 550 x 44 mm 17.4 x 21.6 x 1.73 inch	581 x 705 x 175 mm 22.9 x 27.8 x 6.9 inch	8 kg / 18 lbs	12 kg / 26 lbs

### Keyboard Selection

Supporting layouts



**Ne** N keyboard with touchpad



**Nb** N keyboard with trackball



US layout only

**d** Compact keyboard with trackball



US layout only

**t** Compact keyboard with touchpad mouse

page 106 for full details

back

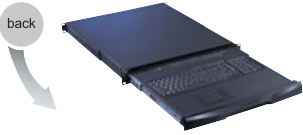

# KVM Selection

## Base Model















## RK1 Keyboard Drawer Series

- \* Single port w/o KVM
- \* Combo interface















**RK-1**

### Matrix Cat6 KVM









page 23~38 for KVM specifications, page 107~110 for KVM rear I/O

	2 consoles	<b>Matrix</b> Cat6 16 port	RK1 - MU 1602
	3 consoles		RK1 - MU 1603
	4 consoles		RK1 - MU 1604
	3 consoles	<b>Matrix</b>  Cat6 16 port	RK1 - MU IP 1613
	4 consoles		RK1 - MU IP 1614
	4 consoles		RK1 - MU IP 1624
	2 consoles	<b>Matrix</b> Cat6 32 port	RK1 - MU 3202
	3 consoles		RK1 - MU 3203
	4 consoles		RK1 - MU 3204
	3 consoles	<b>Matrix</b>  Cat6 32 port	RK1 - MU IP 3213
	4 consoles		RK1 - MU IP 3214
	4 consoles		RK1 - MU IP 3224







### Matrix DB-15 KVM

	2 consoles	<b>Matrix</b> DB-15 8 port	RK1 - M 802
	3 consoles		RK1 - M 803
	4 consoles		RK1 - M 804
	3 consoles	<b>Matrix</b>  DB-15 8 port	RK1 - M IP 813
	4 consoles		RK1 - M IP 814
	4 consoles		RK1 - M IP 824
	2 consoles	<b>Matrix</b> DB-15 16 port	RK1 - M 1602
	3 consoles		RK1 - M 1603
	4 consoles		RK1 - M 1604
	3 consoles	<b>Matrix</b>  DB-15 16 port	RK1 - M IP 1613
	4 consoles		RK1 - M IP 1614
	4 consoles		RK1 - M IP 1624



### Combo Cat6 KVM

	1 console	<b>Combo</b> Cat6 8 port	RK1 - U 801
	2 consoles		RK1 - U 802
	2 consoles		RK1 - U IP 802
	1 console	<b>Combo</b> Cat6 16 port	RK1 - U 1601
	2 consoles		RK1 - U 1602
	2 consoles		RK1 - U IP 1602
	1 console	<b>Combo</b> Cat6 32 port	RK1 - U 3201
	2 consoles		RK1 - U 3202
	2 consoles		RK1 - U IP 3202

### Combo DB-15 KVM

	1 console	<b>Combo</b> DB-15 8 port	RK1 - S 801
	2 consoles		RK1 - 802
	2 consoles		RK1 - IP 802
	1 console	<b>Combo</b> DB-15 16 port	RK1 - S 1601
	2 consoles		RK1 - 1602
	2 consoles		RK1 - IP 1602

### PS/2 DB-15 KVM

	1 console	 DB-15 4 port	RK1 - 401
		8 port	RK1 - 801
		16 port	RK1 - 1601

RK-2 Series



Keyboard Drawer Benefits

- ▶ Short depth design of 400mm (15.7")
- ▶ Light weight & low shipping cost
- ▶ Lockable drawer to secure keyboard & mouse access

Drawer Features

- Combo interface either PS/2 or USB input to the keyboard drawer
- Multiple keyboard language selections with either touchpad or trackball
- Slide rails with fixed positions to prevent drawer movement when typing
- Enhanced aesthetics with new molded front panel and two point lock



Model Selection



Basic Model	RK2 Keyboard Drawer Series
* Combo interface	RK-2

Diagram

Unit : mm

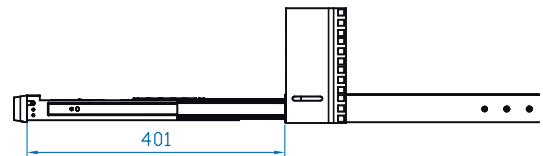
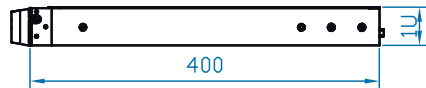
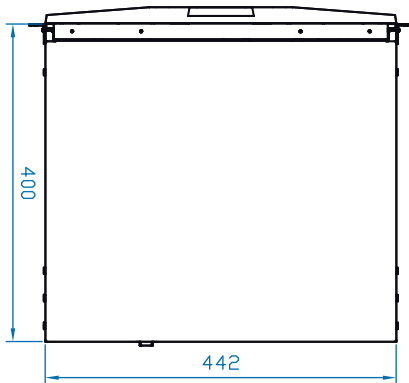

Dimensions

Model	Product Dimension (W x D x H)	Packing Dimension (W x D x H)	Net Weight	Gross Weight
RK-2 Series	442 x 400 x 44 mm 17.4 x 15.7 x 1.73 inch	500 x 582 x 100 mm 19.7 x 22.9 x 3.9 inch	6 kg / 13 lbs	8 kg / 18 lbs

Keyboard Selection

Supporting layouts



**Ne** N keyboard with touchpad



**Nb** N keyboard with trackball



**d** Compact keyboard with trackball



**t** Compact keyboard with touchpad mouse

page 106 for full details

**Cat6 KVM Dongle**

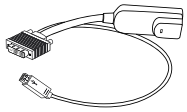

DG-100SD

DVI USB dongle



DG-100S

USB dongle



DG-100

PS/2 dongle

**KVM Cable**



CU-3  
CU-6  
CU-10  
CU-15  
CU-33

"CU" Cat6 cable  
3ft, 6ft, 10ft, 15ft & 33ft available



CE-6  
CE-10  
CE-15

"CE" Combo 4-in-1 KVM cable  
6ft, 10ft & 15ft available



CB-6  
CB-10  
CB-15

"CB" USB 2-in-1 KVM cable  
6ft, 10ft & 15ft available



CD-6  
CD-10  
CD-15  
CD-33

"CD" PS/2 3-in-1 KVM cable  
6ft, 10ft, 15ft & 33ft available

**Cascade Cable**



CMC-3

Matrix KVM cascade cable  
3ft available



CA-6

PS/2 KVM cascade cable  
6ft available



CBC-6

Combo KVM cascade cable  
6ft available

**Serial Adapter**



SG-100F  
RJ45-DB9  
female adapter



SG-100M  
RJ45-DB9  
male adapter

**USB to PS/2 Adapter**



SUN-31kit

**Optical Mouse**



WOM-01

Quad Display Connection

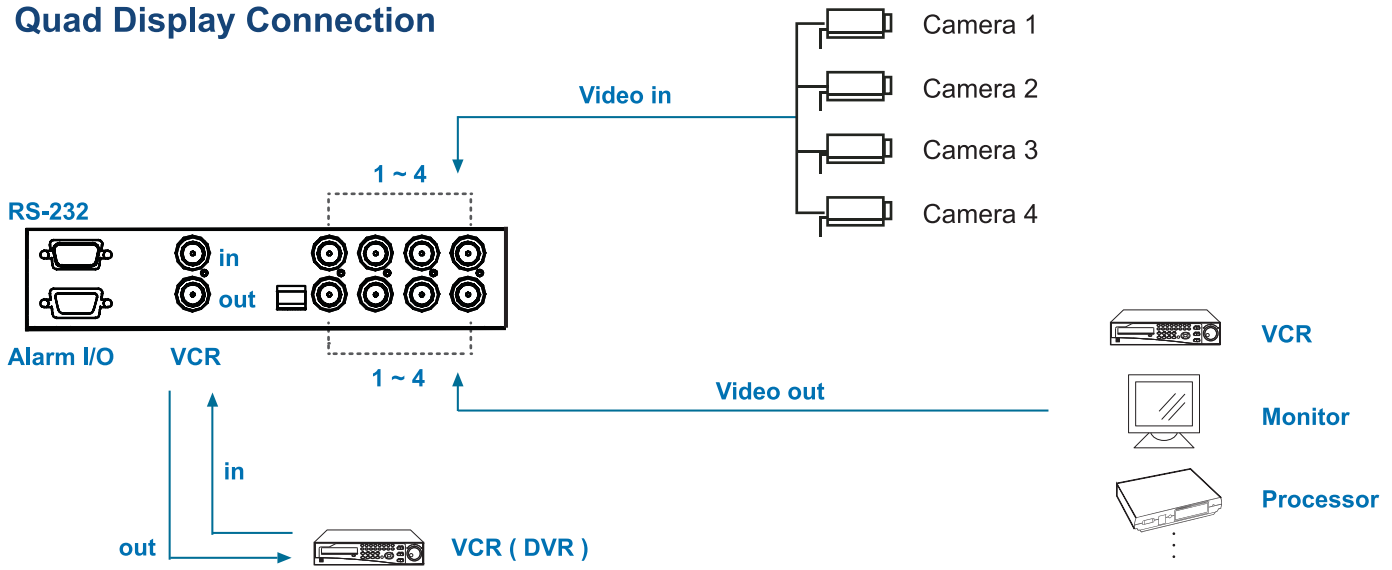

QD Membrane Button



- On-screen menu setup in Quad mode
- LCD on-screen menu setup

Specifications

Item		Description
Model Number		QD (NTSC)   QD (PAL)
Number of Colour		16.7 Mil.   16.7 Mil.
Imaging System		NTSC   PAL
Resolution		1024 x 525   1024 x 625
Refresh Rate		60   50
Video Input	Camera Input	1.0 Vpp, 75 Ohm x 4
	VCR Input	1.0 Vpp, 75 Ohm x 1
Video Output	Live Monitor	1.0 Vpp, 75 Ohm x 1
	Loop Through Out	1.0 Vpp, 75 Ohm x 4
	VCR Output	1.0 Vpp, 75 Ohm x 1
Auto Gain Control		Yes
Time / Date		Yes
On Screen Display		Yes
Camera Title		8 Character Title
Display Format	2 x Zoom On Playback	Yes
	QUAD	Yes
	FULL	Yes
	SEQUENCY	Yes
Dwell Time		0 to 99 Sec Adjustable
Built-in Buzzer		Yes
Key Lock		Yes



**DC power input** 

Model	-12V	-24V	-48V
<b>Input rating</b>			
Input voltage :	12-Volt	24-Volt	48-Volt
Input range :	9 ~ 18V	18 ~ 36V	36 ~ 75V
Input current			
- No load	50 mA	50 mA	50 mA
- Full load	4950 mA	2450 mA	1220 mA
<b>Output rating</b>			
Output voltage :	12-Volt	12-Volt	12-Volt
Output current :	4.16 A	4.16 A	4.16 A
<b>Efficiency :</b>	84%	85%	85%

**Touchscreen** 

**e-Capacitive**

Model	-15TCB/-15TCS	-17TCB/-17TCS	-19TCB/-19TCS
Screen size	15"	17"	19"
Interface :	USB / serial	USB / serial	USB / serial
Optical transmittance :	93% ± 2%	93% ± 2%	93% ± 2%
Surface hardness	9H		
Operating system :	Windows 98/2000/ME/XP/NT, DOS, Linux		

Model	-19WTCB/-19WTCS	-22WTCB/-22WTCS
Screen size	19" wide	22" wide
Interface :	USB / serial	USB / serial
Optical transmittance :	93% ± 2%	93% ± 2%
Surface hardness	9H	
Operating system :	Windows 98/2000/ME/XP/NT, DOS, Linux	

**e-Resistive**

Model	-15TRB/-15TRS	-17TRB/-17TRS	-19TRB/-19TRS	-20TRB/-20TRS
Screen size	15"	17"	19"	20"
Interface :	USB / serial	USB / serial	USB / serial	USB / serial
Optical transmittance :	80% ± 3%	80% ± 3%	80% ± 3%	80% ± 3%
Surface hardness	≥3H (JIS K5400)			
Operating system :	Windows 98/2000/ME/XP/NT, DOS, Linux			

Model	-19WTRB/-19WTRS	-22WTRB/-22WTRS
Screen size	19" wide	22" wide
Interface :	USB / serial	USB / serial
Optical transmittance :	80% ± 3%	80% ± 3%
Surface hardness	≥3H (JIS K5400)	
Operating system :	Windows 98/2000/ME/XP/NT, DOS, Linux	

 **LCD Specifications**

<b>4 : 3 Screen size</b>	<b>15"</b>	<b>17"</b>	<b>19"</b>	<b>20"</b>
Display type	Active Matrix TFT	Active Matrix TFT	Active Matrix TFT	Active Matrix TFT
Native resolution	1024 x 768	1280 x 1024	1280 x 1024	1600 x 1200
Brightness (cd/m2)	250	300	300	300
Contrast ratio	700 : 1	1000 : 1	1000 : 1	800 : 1
Viewing angle (H x V)	150 / 135	160 / 160	160 / 160	160 / 160
Display colour	16.2M	16.7M	16.7M	16.7M
Response time	Tr=2 / Tf=6	Tr=1.3 / Tf=3.7	Tr=1.3 / Tf=3.7	Tr=1 / Tf=4
Pixel Pitch (mm)	0.297 x 0.297	0.264 x 0.264	0.294 x 0.294	0.255 x 0.255

<b>WideScreen size</b>	<b>W19"</b>	<b>W22"</b>
Display type	Active Matrix TFT	Active Matrix TFT
Native resolution	1440 x 900	1680 x 1050
Brightness (cd/m2)	300	300
Contrast ratio	1000 : 1	1000 : 1
Viewing angle (H x V)	160 / 160	160 / 160
Display colour	16.7M	16.7M
Response time	Tr=1.3 / Tf=3.7	Tr=3.6 / Tf=1.4
Pixel Pitch (mm)	0.284 x 0.284	0.282 x 0.282



**High Brightness LCD Specifications**

<b>Screen size</b>	<b>17"</b>	<b>19"</b>	<b>W19"</b>	<b>W22"</b>
Display type	Active Matrix TFT	Active Matrix TFT	Active Matrix TFT	Active Matrix TFT
Native resolution	1280 x 1024	1280 x 1024	1440 x 900	1680 x 1050
Brightness (cd/m2)	800	800	800	800
Contrast ratio	800 : 1	800 : 1	900 : 1	900 : 1
Viewing angle (H x V)	170 / 160	160 / 160	160 / 160	160 / 160
Display colour	16.7M	16.7M	16.7M	16.7M
Response time	Tr=3.5 / Tf=1.5	Tr=1.3 / Tf=3.7	Tr=1.3 / Tf=3.7	Tr=3.6 / Tf=1.4
Pixel Pitch (mm)	0.264 x 0.264	0.294 x 0.294	0.284 x 0.284	0.282 x 0.282

Ne



**N keyboard integrated with touchpad**

- 104 keys (US / European / Chinese / Korean layout)
- 106 keys (Japanese layout)
- PS/2 or USB connection



**Dimensions** Keyboard 395 x 156 x 15 (mm)  
**(W x L x H)** Touchpad 107 x 82 x 15 (mm)

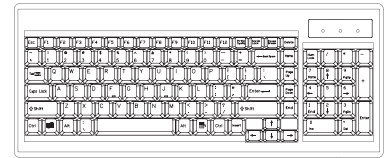

Nb



**N keyboard integrated with trackball**

- 104 keys (US / European / Chinese / Korean layout)
- 106 keys (Japanese layout)
- PS/2 or USB connection



**Dimensions** Keyboard 395 x 156 x 15 (mm)  
**(W x L x H)** Trackball 107 x 82 x 18 (mm)

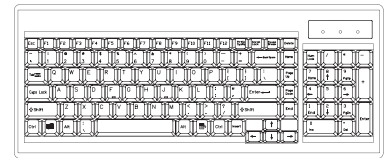

Se



**NS keyboard integrated with touchpad**

- Incorporates SUN keys, including Stop, Cut, Paste, Compose, Copy and Help
- 104 keys (US / UK layout)
- USB connection

**Dimensions** Keyboard 395 x 156 x 15 (mm)  
**(W x L x H)** Touchpad 107 x 82 x 15 (mm)

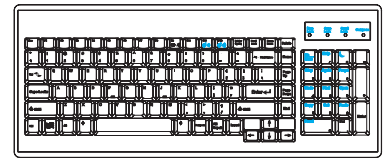

Sb



**NS keyboard integrated with trackball**

- Incorporates SUN keys, including Stop, Cut, Paste, Compose, Copy and Help
- 104 keys (US / UK layout)
- USB connection

**Dimensions** Keyboard 395 x 156 x 15 (mm)  
**(W x L x H)** Trackball 107 x 82 x 18 (mm)

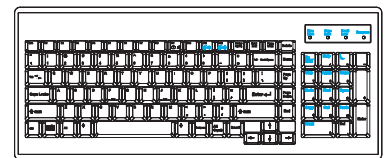

d



**Compact keyboard with trackball**

- Integrated 19mm trackball plus 3 mouse key
- Cursor key & numeric keys included
- 95 keys (US layout only)
- PS/2 or USB connection

**Dimensions** 412 x 175 x 38 (mm)

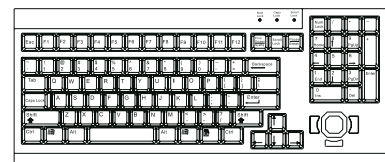

t



**Compact keyboard with touchpad**

- Integrated GlidePoint™ touchpad
- Cursor key & numeric keys included
- 95 keys (US layout only)
- PS/2 or USB connection

**Dimensions** 412 x 195 x 38 (mm)

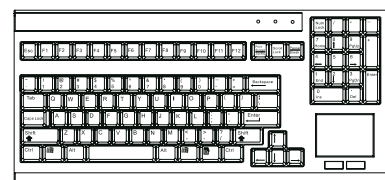

Coverage: N117 series, W119 series, RKP117 series, RKP217 series

**Matrix**  
**Cat6**  
16 port

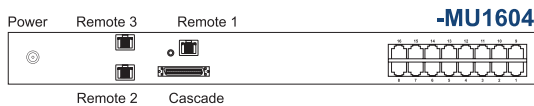
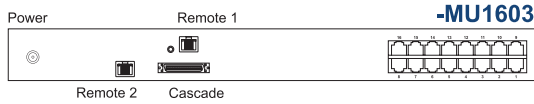
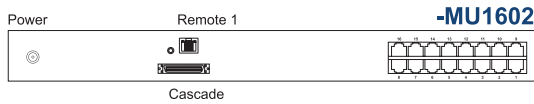

**Matrix**  
**DB-15**  
8 port

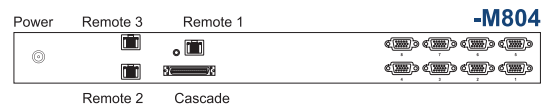
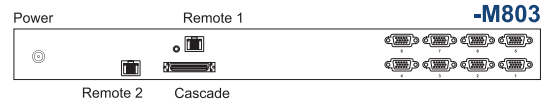
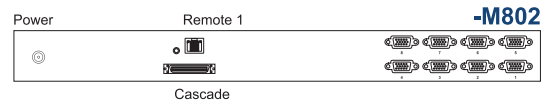

**Matrix**  
**Cat6**  
**IP**  
16 port

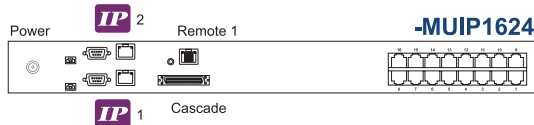
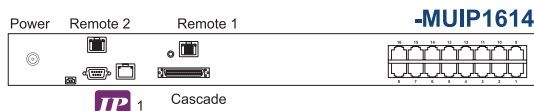
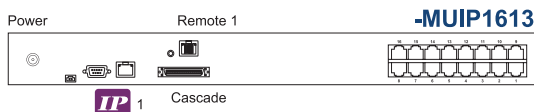

**Matrix**  
**DB-15**  
**IP**  
8 port

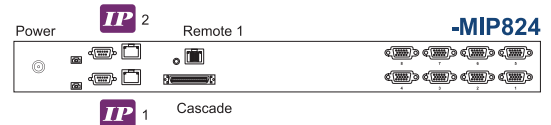
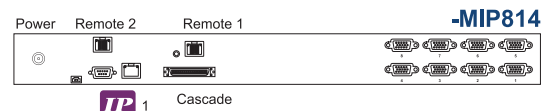
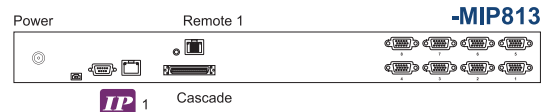

**Matrix**  
**Cat6**  
32 port

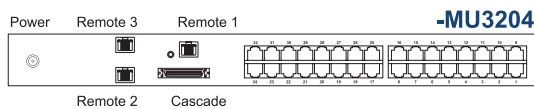
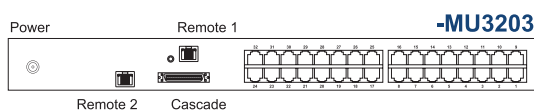
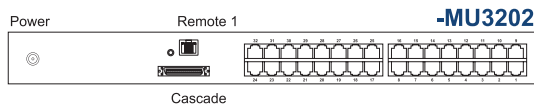

**Matrix**  
**DB-15**  
16 port

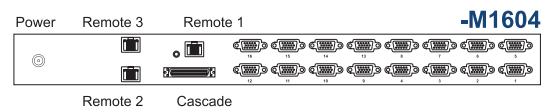
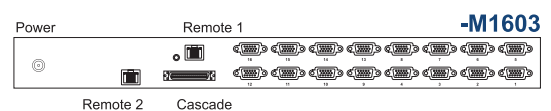
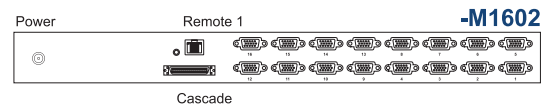

**Matrix**  
**Cat6**  
**IP**  
32 port

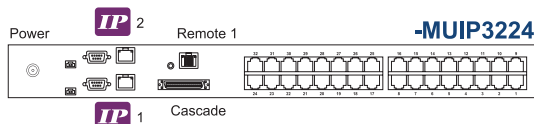
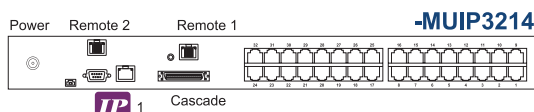
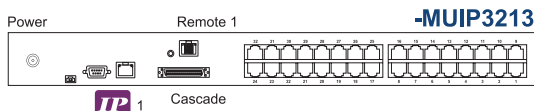

**Matrix**  
**DB-15**  
**IP**  
16 port

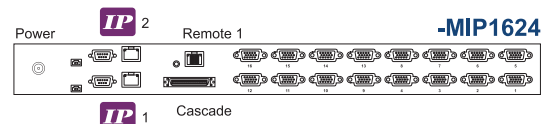
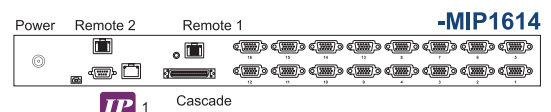
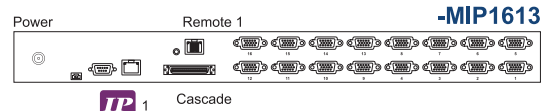

Coverage: **N117** series, **W119** series, **RKP117** series, **RKP217** series

**Combo**

**Cat6**

8 port

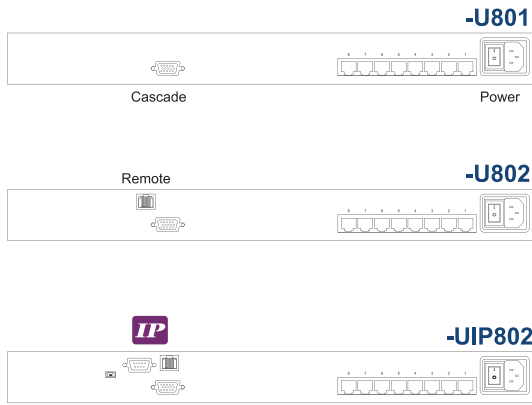

**Combo**

**DB-15**

8 port

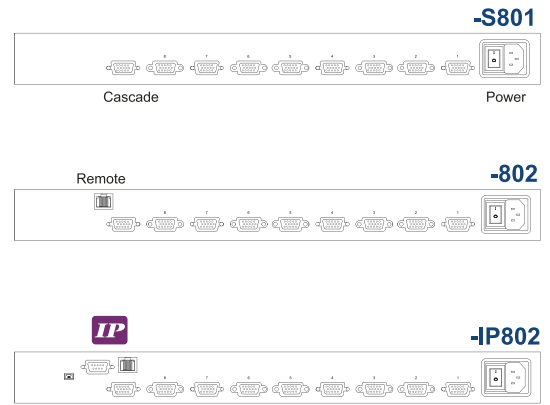

**Combo**

**Cat6**

16 port

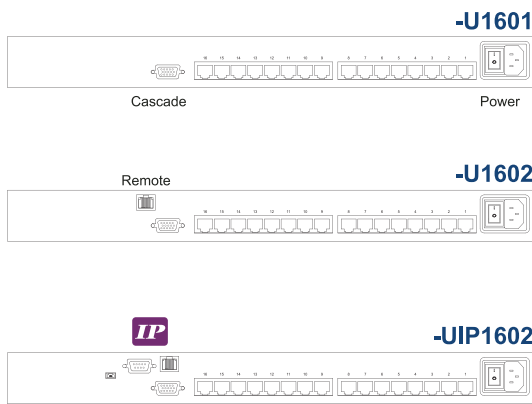

**Combo**

**DB-15**

16 port

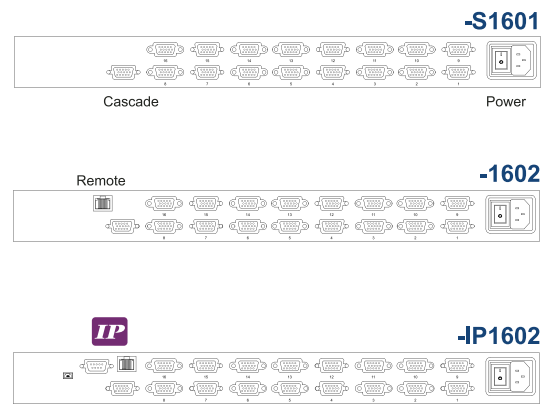

**Combo**

**Cat6**

32 port

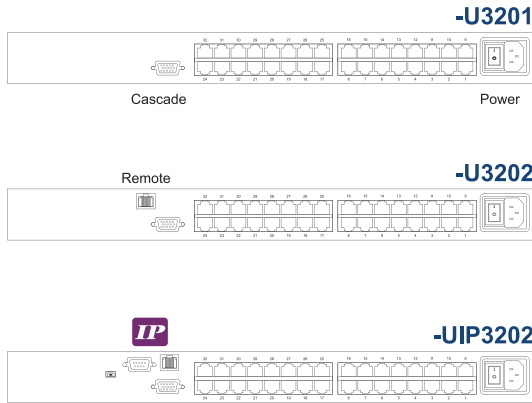

**PS/2**

**DB-15**

8 port

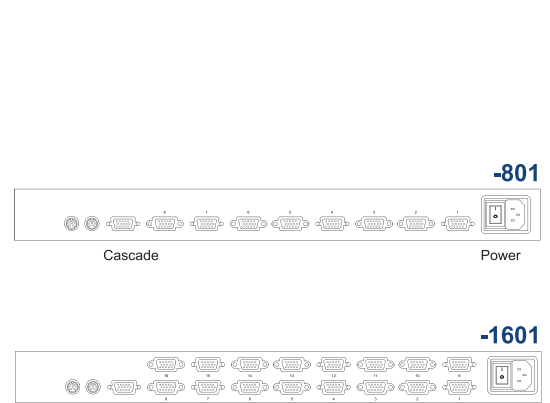

Coverage: L120 series, D117 series, RKP7 series, RKP2415 series

<p><b>Matrix</b> <b>Cat6</b> 16 port</p>	<p style="text-align: right;"><b>-MU1602</b></p>	<p><b>Matrix</b> <b>DB-15</b> 8 port</p>	<p style="text-align: right;"><b>-M802</b></p>
	<p style="text-align: right;"><b>-MU1603</b></p>		<p style="text-align: right;"><b>-M803</b></p>
	<p style="text-align: right;"><b>-MU1604</b></p>		<p style="text-align: right;"><b>-M804</b></p>
<p><b>Matrix</b> <b>Cat6</b> <b>IP</b> 16 port</p>	<p style="text-align: right;"><b>-MUIP1613</b></p>	<p><b>Matrix</b> <b>DB-15</b> <b>IP</b> 8 port</p>	<p style="text-align: right;"><b>-MIP813</b></p>
	<p style="text-align: right;"><b>-MUIP1614</b></p>		<p style="text-align: right;"><b>-MIP814</b></p>
	<p style="text-align: right;"><b>-MUIP1624</b></p>		<p style="text-align: right;"><b>-MIP824</b></p>
<p><b>Matrix</b> <b>Cat6</b> 32 port</p>	<p style="text-align: right;"><b>-MU3202</b></p>	<p><b>Matrix</b> <b>DB-15</b> 16 port</p>	<p style="text-align: right;"><b>-M1602</b></p>
	<p style="text-align: right;"><b>-MU3203</b></p>		<p style="text-align: right;"><b>-M1603</b></p>
	<p style="text-align: right;"><b>-MU3204</b></p>		<p style="text-align: right;"><b>-M1604</b></p>
<p><b>Matrix</b> <b>Cat6</b> <b>IP</b> 32 port</p>	<p style="text-align: right;"><b>-MUIP3213</b></p>	<p><b>Matrix</b> <b>DB-15</b> <b>IP</b> 16 port</p>	<p style="text-align: right;"><b>-MIP1613</b></p>
	<p style="text-align: right;"><b>-MUIP3214</b></p>		<p style="text-align: right;"><b>-MIP1614</b></p>
	<p style="text-align: right;"><b>-MUIP3224</b></p>		<p style="text-align: right;"><b>-MIP1624</b></p>

Coverage: L120 series, D117 series, RKP7 series, H117 series, RKP2415 series

Combo

Cat6

8 port

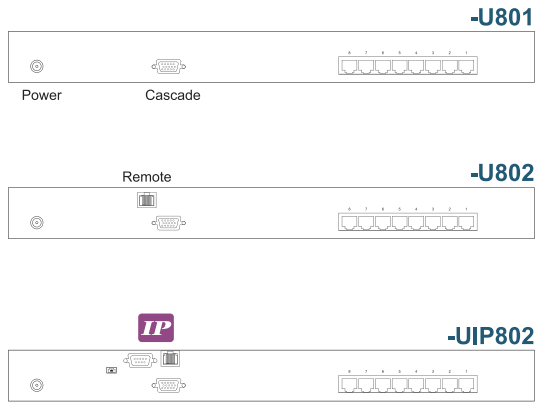

Combo

DB-15

8 port

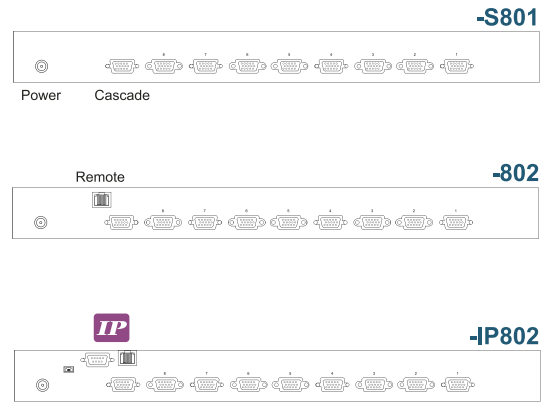

Combo

Cat6

16 port

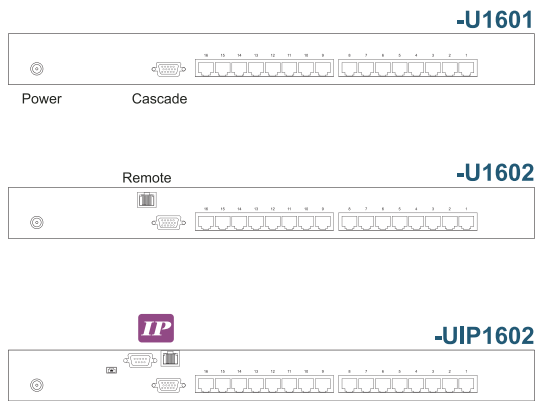

Combo

DB-15

16 port

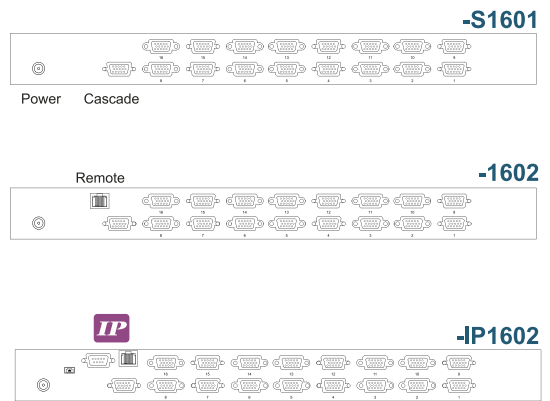

Combo

Cat6

32 port

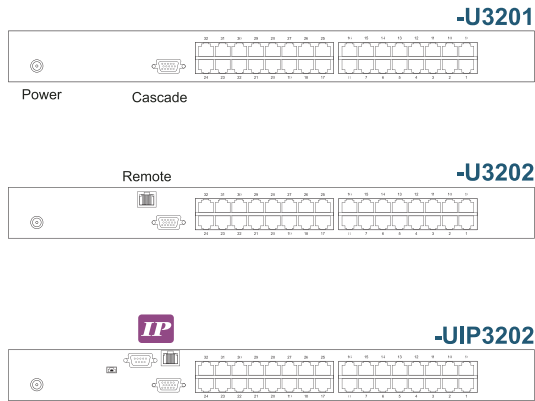

PS/2

DB-15

8 port

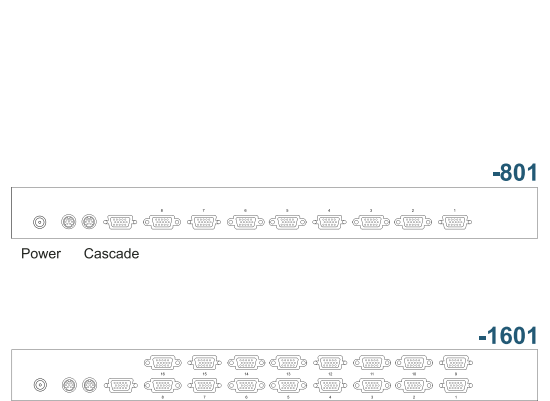

**Austin Hughes Electronics Ltd.**

Unit 3608-3612, Cable TV Tower  
9 Hoi Shing Road, Tsuen Wan  
Hong Kong

**Tel:** (852) 2415 2121

**Email:** cyberview-sales@austin-hughes.com

**Factory****Austin Hughes Electronics (China) Ltd.**

Hexi Road No.2, Jinxia Industrial Area  
Changan Town, Dongguan City  
Guangdong Province 523850  
China

**Austin Hughes Solutions Inc.**

8668 Thornton Ave, Newark  
CA 94560  
USA

**Tel:** (1) 510 794-2888

**Email:** cyberview-sales@austin-hughes.com

**Austin Hughes Europe Ltd**

Unit 1, Chancery Gate Business Centre  
Manor House Avenue  
Southampton, SO15 0AE  
United Kingdom

**Tel:** +44 (0) 2380 529303

**Email:** info@austin-hughes.eu

**Austin Hughes Middle East**

P.O. Box 43425  
Dubai

United Arab Emirates

**Tel:** (971) 50 4532127

**Email:** info@austin-hughes.eu

**Austin Hughes SA**

**Austin Hughes** has extensive distribution network, including Europe,  
the United States, the Middle East, Africa and Asia Pacific  
Contact your nearest sales office for details of local representation

**[www.austin-hughes.com](http://www.austin-hughes.com)**

Please ask for details of other products from Austin Hughes. Every effort has been made to ensure that the information contained herein is correct. The company reserves the right to modify product specifications without prior notice and assumes no responsibility for any error which may appear in this publication.

All brand names, logo and registered trademarks are properties of their respective owners.

Copyright 2008 Austin Hughes Electronics Ltd. All rights reserved.

**Distributed by:**

**Distributor by country on application**

CV-C08