

Service Manual

Inverter Pair Wall Mounted Type C-Series



[Applied Models]
●Inverter Pair : Heat Pump

Inverter Pair C-Series

●Heat Pump

Indoor Unit

FTXG25CVMAW	FTXG35CVMAW
FTXG25CVMAS	FTXG35CVMAS
FTXG25CVMBW	FTXG35CVMBW
FTXG25CVMBS	FTXG35CVMBS
ATXG25CVMB	ATXG35CVMB

Outdoor Unit

RXG25CVMA	RXG35CVMA
RXG25CVMB	RXG35CVMB
ARXG25CVMB	ARXG35CVMB

1. Introduction	V
1.1 Safety Cautions	V
Part 1 List of Functions	1
1. List of Functions	2
Part 2 Specifications	3
1. Specifications	4
Part 3 Printed Circuit Board	
Connector Wiring Diagram	9
1. Printed Circuit Board Connector Wiring Diagram.....	10
1.1 Indoor Unit.....	10
1.2 Outdoor Unit.....	12
Part 4 Function and Control.....	15
1. Main Functions.....	16
1.1 Frequency Principle.....	16
1.2 Power-Airflow Flap, Wide-Angle Louvres and Auto-Swing	18
1.3 Operation Starting Control.....	19
1.4 Fan Speed Control for Indoor Units.....	20
1.5 Programme Dry Function	21
1.6 Automatic Operation.....	22
1.7 NIGHT SET Mode	23
1.8 INTELLIGENT EYE	24
1.9 Inverter Powerful Operation	25
1.10 Other Functions.....	26
2. Function of Thermistor	27
2.1 Heat Pump Model.....	27
3. Control Specification	28
3.1 Mode Hierarchy	28
3.2 Frequency Control.....	29
3.3 Controls at Mode Changing / Start-up.....	30
3.4 Discharge Pipe Control	32
3.5 Input Current Control.....	32
3.6 Freeze-up Protection Control	33
3.7 Heating Peak-cut Control	33
3.8 Fan Control.....	34
3.9 Liquid Compression Protection Function 2.....	34
3.10 Defrost Control	35
3.11 Electronic Expansion Valve Control	36
3.12 Malfunctions	39
3.13 Forced Operation Mode	40
3.14 Additional Function.....	40

Part 5 System Configuration..... 41

1. System Configuration.....	42
2. Instruction.....	43
2.1 Safety Precautions	43
2.2 Names of Parts.....	45
2.3 Preparation before Operation.....	48
2.4 AUTO · DRY · COOL · HEAT · FAN Operation	51
2.5 Adjusting the Air Flow Direction	53
2.6 POWERFUL Operation	55
2.7 OUTDOOR UNIT SILENT Operation	56
2.8 INTELLIGENT EYE Operation	57
2.9 TIMER Operation	59
2.10 Care and Cleaning	61
2.11 Troubleshooting.....	64

Part 6 Service Diagnosis..... 67





1. Caution for Diagnosis.....	68
2. Problem Symptoms and Measures	69
3. Service Check Function	70
4. Troubleshooting	73
4.1 Error Codes and Description	73
4.2 Indoor Unit PCB Abnormality	74
4.3 Freeze-up Protection Control or High Pressure Control.....	75
4.4 Fan Motor (DC Motor) or Related Abnormality.....	77
4.5 Thermistor or Related Abnormality (Indoor Unit).....	79
4.6 Front Panel Open / Close Fault.....	80
4.7 Signal Transmission Error (between Indoor and Outdoor Unit)	81
4.8 Signal Transmission Error (between Indoor Unit and Wired Remote Controller)	82
4.9 Unspecified Voltage (between Indoor and Outdoor Unit).....	83
4.10 Outdoor Unit PCB Abnormality.....	84
4.11 OL Activation (Compressor Overload)	85
4.12 Compressor Lock	86
4.13 DC Fan Lock	87
4.14 Input Over Current Detection	88
4.15 Four Way Valve Abnormality	89
4.16 Discharge Pipe Temperature Control.....	91
4.17 High Pressure Control in Cooling	92
4.18 Sensor Abnormality around Compressor System	94
4.19 Position Sensor Abnormality	95
4.20 DC Voltage / Current Sensor Abnormality.....	96
4.21 Thermistor or Related Abnormality (Outdoor Unit).....	97
4.22 Output Over Current Detection.....	99
4.23 Insufficient Gas.....	101
4.24 Over-voltage Detection.....	103
5. Check.....	104
5.1 How to Check.....	104

Part 7 Removal Procedure	111
1. Indoor Unit.....	112
1.1 Removal of Air Filter.....	112
1.2 Removal of Front Grille	114
1.3 Removal of Assembly of Front Panel Mechanism.....	120
1.4 Removal of Lamp Cover.....	124
1.5 Removal of Horizontal Blade.....	125
1.6 Removal of Reduction Motor.....	126
1.7 Removal of Outlet Grille	129
1.8 Removal of Vertical Blades and Swing Motor	130
1.9 Removal of Electrical Box	134
1.10 Removal of PCB.....	140
1.11 Removal of Heat Exchanger	146
1.12 Removal of Fan Rotor and Fan Motor.....	149
2. Outdoor Unit.....	152
2.1 Removal of Panels and Fan Motor.....	152
2.2 Removal of Electrical Box	159
2.3 Removal of Reactor and Partition Plate	161
2.4 Removal of Sound Blanket.....	163
2.5 Removal of Four Way Valve.....	165
2.6 Removal of Compressor.....	167
2.7 Removal of PCB.....	169
Part 8 Others	173
1. Others	174
1.1 Test Run from the Remote Controller	174
1.2 Jumper Settings	175
Part 9 Appendix.....	177
1. Piping Diagrams.....	178
2. Wiring Diagrams.....	179
Index	i
Drawings & Flow Charts	v







1. Introduction







1.1 Safety Cautions

Cautions and Warnings

- Be sure to read the following safety cautions before conducting repair work.
- The caution items are classified into “ **Warning**” and “ **Caution**”. The “ **Warning**” items are especially important since they can lead to death or serious injury if they are not followed closely. The “ **Caution**” items can also lead to serious accidents under some conditions if they are not followed. Therefore, be sure to observe all the safety caution items described below.
- About the pictograms
 - △ This symbol indicates an item for which caution must be exercised.
The pictogram shows the item to which attention must be paid.
 - This symbol indicates a prohibited action.
The prohibited item or action is shown inside or near the symbol.
 - This symbol indicates an action that must be taken, or an instruction.
The instruction is shown inside or near the symbol.
- After the repair work is complete, be sure to conduct a test operation to ensure that the equipment operates normally, and explain the cautions for operating the product to the customer.



1.1.1 Caution in Repair



 Warning	
<p>Be sure to disconnect the power cable plug from the plug socket before disassembling the equipment for a repair. Working on the equipment that is connected to a power supply can cause an electrical shock. If it is necessary to supply power to the equipment to conduct the repair or inspecting the circuits, do not touch any electrically charged sections of the equipment.</p>	
<p>If the refrigerant gas discharges during the repair work, do not touch the discharging refrigerant gas. The refrigerant gas can cause frostbite.</p>	
<p>When disconnecting the suction or discharge pipe of the compressor at the welded section, release the refrigerant gas completely at a well-ventilated place first. If there is a gas remaining inside the compressor, the refrigerant gas or refrigerating machine oil discharges when the pipe is disconnected, and it can cause injury.</p>	
<p>If the refrigerant gas leaks during the repair work, ventilate the area. The refrigerant gas can generate toxic gases when it contacts flames.</p>	
<p>The step-up capacitor supplies high-voltage electricity to the electrical components of the outdoor unit. Be sure to discharge the capacitor completely before conducting repair work. A charged capacitor can cause an electrical shock.</p>	
<p>Do not start or stop the air conditioner operation by plugging or unplugging the power cable plug. Plugging or unplugging the power cable plug to operate the equipment can cause an electrical shock or fire.</p>	

 Warning	
Do not repair the electrical components with wet hands. Working on the equipment with wet hands can cause an electrical shock.	
Do not clean the air conditioner by splashing water. Washing the unit with water can cause an electrical shock.	
Be sure to provide the grounding when repairing the equipment in a humid or wet place, to avoid electrical shocks.	
Be sure to turn off the power switch and unplug the power cable when cleaning the equipment. The internal fan rotates at a high speed, and cause injury.	
Do not tilt the unit when removing it. The water inside the unit can spill and wet the furniture and floor.	
Be sure to check that the refrigerating cycle section has cooled down sufficiently before conducting repair work. Working on the unit when the refrigerating cycle section is hot can cause burns.	
Use the welder in a well-ventilated place. Using the welder in an enclosed room can cause oxygen deficiency.	



1.1.2 Cautions Regarding Products after Repair



 Warning	
Be sure to use parts listed in the service parts list of the applicable model and appropriate tools to conduct repair work. Never attempt to modify the equipment. The use of inappropriate parts or tools can cause an electrical shock, excessive heat generation or fire.	
When relocating the equipment, make sure that the new installation site has sufficient strength to withstand the weight of the equipment. If the installation site does not have sufficient strength and if the installation work is not conducted securely, the equipment can fall and cause injury.	
Be sure to install the product correctly by using the provided standard installation frame. Incorrect use of the installation frame and improper installation can cause the equipment to fall, resulting in injury.	For integral units only
Be sure to install the product securely in the installation frame mounted on a window frame. If the unit is not securely mounted, it can fall and cause injury.	For integral units only



 Warning	
Be sure to use an exclusive power circuit for the equipment, and follow the technical standards related to the electrical equipment, the internal wiring regulations and the instruction manual for installation when conducting electrical work. Insufficient power circuit capacity and improper electrical work can cause an electrical shock or fire.	
Be sure to use the specified cable to connect between the indoor and outdoor units. Make the connections securely and route the cable properly so that there is no force pulling the cable at the connection terminals. Improper connections can cause excessive heat generation or fire.	
When connecting the cable between the indoor and outdoor units, make sure that the terminal cover does not lift off or dismount because of the cable. If the cover is not mounted properly, the terminal connection section can cause an electrical shock, excessive heat generation or fire.	
Do not damage or modify the power cable. Damaged or modified power cable can cause an electrical shock or fire. Placing heavy items on the power cable, and heating or pulling the power cable can damage the cable.	
Do not mix air or gas other than the specified refrigerant (R410A / R22) in the refrigerant system. If air enters the refrigerating system, an excessively high pressure results, causing equipment damage and injury.	
If the refrigerant gas leaks, be sure to locate the leak and repair it before charging the refrigerant. After charging refrigerant, make sure that there is no refrigerant leak. If the leak cannot be located and the repair work must be stopped, be sure to perform pump-down and close the service valve, to prevent the refrigerant gas from leaking into the room. The refrigerant gas itself is harmless, but it can generate toxic gases when it contacts flames, such as fan and other heaters, stoves and ranges.	
When replacing the coin battery in the remote controller, be sure to disposed of the old battery to prevent children from swallowing it. If a child swallows the coin battery, see a doctor immediately.	

 Caution	
Installation of a leakage breaker is necessary in some cases depending on the conditions of the installation site, to prevent electrical shocks.	
Do not install the equipment in a place where there is a possibility of combustible gas leaks. If a combustible gas leaks and remains around the unit, it can cause a fire.	
Be sure to install the packing and seal on the installation frame properly. If the packing and seal are not installed properly, water can enter the room and wet the furniture and floor.	For integral units only

1.1.3 Inspection after Repair

 Warning	
Check to make sure that the power cable plug is not dirty or loose, then insert the plug into a power outlet all the way. If the plug has dust or loose connection, it can cause an electrical shock or fire.	
If the power cable and lead wires have scratches or deteriorated, be sure to replace them. Damaged cable and wires can cause an electrical shock, excessive heat generation or fire.	





 Warning	
Do not use a joined power cable or extension cable, or share the same power outlet with other electrical appliances, since it can cause an electrical shock, excessive heat generation or fire.	

 Caution	
Check to see if the parts and wires are mounted and connected properly, and if the connections at the soldered or crimped terminals are secure. Improper installation and connections can cause excessive heat generation, fire or an electrical shock.	
If the installation platform or frame has corroded, replace it. Corroded installation platform or frame can cause the unit to fall, resulting in injury.	
Check the grounding, and repair it if the equipment is not properly grounded. Improper grounding can cause an electrical shock.	
Be sure to measure the insulation resistance after the repair, and make sure that the resistance is 1 Mohm or higher. Faulty insulation can cause an electrical shock.	
Be sure to check the drainage of the indoor unit after the repair. Faulty drainage can cause the water to enter the room and wet the furniture and floor.	

1.1.4 Using Icons

Icons are used to attract the attention of the reader to specific information. The meaning of each icon is described in the table below:

1.1.5 Using Icons List

Icon	Type of Information	Description
 Note:	Note	A “note” provides information that is not indispensable, but may nevertheless be valuable to the reader, such as tips and tricks.
 Caution	Caution	A “caution” is used when there is danger that the reader, through incorrect manipulation, may damage equipment, lose data, get an unexpected result or has to restart (part of) a procedure.
 Warning	Warning	A “warning” is used when there is danger of personal injury.
	Reference	A “reference” guides the reader to other places in this binder or in this manual, where he/she will find additional information on a specific topic.

Part 1

List of Functions

1. List of Functions2

1. List of Functions

Category	Functions	FTXG25/35CVMAW(S) FTXG25/35CVMBW(S) RXG25/35CVMA(B)	ATXG25/35CVMBW(S) ARXG25/35CVMB	Category	Functions	FTXG25/35CVMAW(S) FTXG25/35CVMBW(S) RXG25/35CVMA(B)	ATXG25/35CVMBW(S) ARXG25/35CVMB	
Basic Function	Inverter (with Inverter Power Control)	○	○	Health & Clean	Air Purifying Filter with Bacteriostatic, Virustatic Functions	—	—	
	Operation Limit for Cooling (°CDB)	10 ~46	10 ~46		Photocatalytic Deodorizing Filter	—	—	
	Operation Limit for Heating (°CWB)	-15 ~20	-15 ~20		Air Purifying Filter with Photocatalytic Deodorizing Function	—	—	
	PAM Control	○	○		Titanium Apatite Photocatalytic Air-Purifying Filter	○	○	
Compressor	Oval Scroll Compressor	—	—	Mold Proof Air Filter	○	○		
	Swing Compressor	○	○	Wipe-clean Flat Panel	○	○		
	Rotary Compressor	—	—	Washable Grille	—	—		
	Reluctance DC Motor	○	○	Filter Cleaning Indicator	—	—		
Comfortable Airflow	Power-Airflow Flap	○	○	Good-Sleep Cooling Operation	—	—		
	Power-Airflow Dual Flaps	—	—	Timer	24-Hour On/Off Timer	○	○	
	Power-Airflow Diffuser	—	—		Night Set Mode	○	○	
	Wide-Angle Louvers	○	○	Worry Free "Reliability & Durability"	Auto-Restart (after Power Failure)	○	○	
	Vertical Auto-Swing (Up and Down)	○	○		Self-Diagnosis (Digital, LED) Display	○	○	
	Horizontal Auto-Swing (Right and Left)	○	○		Wiring Error Check	—	—	
	3-D Airflow	○	○		Anticorrosion Treatment of Outdoor Heat Exchanger	○	○	
	Comfort Airflow Mode	○	○		Flexibility	Multi-Split / Split Type Compatible Indoor Unit	—	—
3-Step Airflow (H/P Only)	—	—	Flexible Voltage Correspondence			○	○	
Comfort Control	Auto Fan Speed	○	○	High Ceiling Application		—	—	
	Indoor Unit Silent Operation	○	○	Chargeless		10m	10m	
	Night Quiet Mode (Automatic)	—	—	Either Side Drain (Right or Left)		○	○	
	Outdoor Unit Silent Operation (Manual)	○	○	Power Selection		—	—	
	Intelligent Eye	○	○	Remote Control		5-Rooms Centralized Controller (Option)	○	○
	Quick Warming Function	○	○			Remote Control Adaptor (Normal Open-Pulse Contact)(Option)	○	○
	Hot-Start Function	○	○		Remote Control Adaptor (Normal Open Contact)(Option)	○	○	
	Automatic Defrosting	○	○		DIII-NET Compatible (Adaptor)(Option)	○	○	
Operation	Automatic Operation	○	○	Remote Controller	Wireless	○	○	
	Programme Dry Function	○	○		Wired	—	—	
	Fan Only	○	○					
Lifestyle Convenience	New Powerful Operation (Non-Inverter)	—	—					
	Inverter Powerful Operation	○	○					
	Priority-Room Setting	—	—					
	Cooling / Heating Mode Lock	—	—					
	Home Leave Operation	—	—					
	Indoor Unit On/Off Switch	○	○					
	Signal Reception Indicator	○	○					
	Temperature Display	—	—					
Another Room Operation	—	—						

Note: ○ : Holding Functions
— : No Functions

Part 2 Specifications

1. Specifications4

1. Specifications

230V, 50Hz

Model	Indoor Units		FTXG25CVMAW		FTXG25CVMAS	
	Outdoor Units		RXG25CVMA		RXG25CVMA	
			Cooling	Heating	Cooling	Heating
Capacity Rated (Min.-Max.)	kW		2.5 (1.3-3.0)	3.4 (1.3-4.5)	2.5 (1.3-3.0)	3.4 (1.3-4.5)
	Btu/h		8,550 (4,450-10,250)	11,600 (4,450-15,350)	8,550 (4,450-10,250)	11,600 (4,450-15,350)
	kcal/h		2,150 (1,120-2,580)	2,920 (1,120-3,870)	2,150 (1,120-2,580)	2,920 (1,120-3,870)
Moisture Removal	L/h		1.2	—	1.2	—
Running Current (Rated)	A		3.4	4.5	3.4	4.5
Power Consumption Rated (Min.-Max.)	W		620 (300-950)	825 (290-1,420)	620 (300-950)	825 (290-1,420)
Power Factor	%		79.3	79.7	79.3	79.7
COP	W/W		4.03	4.12	4.03	4.12
Piping Connections	Liquid	mm	φ 6.4		φ 6.4	
	Gas	mm	φ 9.5		φ 9.5	
	Drain	mm	φ 18.0		φ 18.0	
Heat Insulation			Both Liquid and Gas Pipes		Both Liquid and Gas Pipes	
Indoor Unit			FTXG25CVMAW		FTXG25CVMAS	
Front Panel Color			Mat Crystal White		Mat Crystal Silver	
Air Flow Rate	m ³ /min (cfm)	H	7.9 (278)	8.2 (289)	7.9 (278)	8.2 (289)
		M	6.7 (236)	7.3 (257)	6.7 (236)	7.3 (257)
		L	5.4 (190)	6.3 (222)	5.4 (190)	6.3 (222)
		SL	4.7 (165)	5.4 (190)	4.7 (165)	5.4 (190)
Fan	Type		Cross Flow Fan		Cross Flow Fan	
	Motor Output	W	40		40	
	Speed	Steps	5 Steps, Silent and Auto		5 Steps, Silent and Auto	
Air Direction Control			Right, Left, Horizontal and Downward		Right, Left, Horizontal and Downward	
Air Filter			Removable / Washable / Mildew Proof		Removable / Washable / Mildew Proof	
Running Current (Rated)	A		0.14	0.14	0.14	0.14
Power Consumption (Rated)	W		30	30	30	30
Power Factor	%		93.2	93.2	93.2	93.2
Temperature Control			Microcomputer Control		Microcomputer Control	
Dimensions (HxWxD)	mm		275x840x150		275x840x150	
Packaged Dimensions (HxWxD)	mm		222x894x345		222x894x345	
Weight	kg		9		9	
Gross Weight	kg		13		13	
Operation Sound	H/M/L/SL	dBA	38/34/30/27	38/34/30/27	38/34/30/27	38/34/30/27
Sound Power	H	dBA	56	56	56	56
Outdoor Unit			RXG25CVMA		RXG25CVMA	
Casing Color			Ivory White		Ivory White	
Compressor	Type		Hermetically Sealed Swing Type		Hermetically Sealed Swing Type	
	Model		1YC23NXD#A		1YC23NXD#A	
Refrigerant Oil	Motor Output	W	600		600	
	Model		FVC50K		FVC50K	
Refrigerant	Charge	L	0.375		0.375	
	Model		R410A		R410A	
Air Flow Rate (H/L)	Charge	kg	1.00		1.00	
	m ³ /min (cfm)		31.3/22.4 (1,105/791)	28.1/22.4 (992/791)	31.3/22.4 (1,105/791)	28.1/22.4 (992/791)
Fan	Type		Propeller		Propeller	
	Motor Output	W	35		35	
Running Current (Rated)	A		3.26	4.36	3.26	4.36
Power Consumption (Rated)	W		590	795	590	795
Power Factor	%		78.7	79.3	78.7	79.3
Starting Current	A		4.5		4.5	
Dimensions (HxWxD)	mm		550x765x285		550x765x285	
Packaged Dimensions (HxWxD)	mm		589x882x363		589x882x363	
Weight	kg		32		32	
Gross Weight	kg		38		38	
Operation Sound	H/L	dBA	46/43	47/44	46/43	47/44
Sound Power	H	dBA	61	62	61	62
Drawing No.			3D046343A		3D046344A	

Notes:

- MAX. interunit piping length: 20m
- MAX. interunit height difference: 15m
- Amount of additional charge of refrigerant 20g/m for piping length exceeding 10m
- The data are based on the conditions shown in the table below.

Cooling	Heating	Piping Length
Indoor ; 27°CDB/19°CWB Outdoor ; 35°CDB/24°CWB	Indoor ; 20°CDB Outdoor ; 7°CDB/6°CWB	7.5m

Conversion Formulae
kcal/h=kWx860 Btu/h=kWx3414 cfm=m ³ /minx35.3

230V, 50Hz

Model	Indoor Units		FTXG25CVMBW		FTXG25CVMBS	
	Outdoor Units		RXG25CVMB		RXG25CVMB	
			Cooling	Heating	Cooling	Heating
Capacity Rated (Min.-Max.)	kW		2.5 (1.3-3.0)	3.4 (1.3-4.5)	2.5 (1.3-3.0)	3.4 (1.3-4.5)
	Btu/h		8,550 (4,450-10,250)	11,600 (4,450-15,350)	8,550 (4,450-10,250)	11,600 (4,450-15,350)
	kcal/h		2,150 (1,120-2,580)	2,920 (1,120-3,870)	2,150 (1,120-2,580)	2,920 (1,120-3,870)
Moisture Removal	L/h		1.2	—	1.2	—
Running Current (Rated)	A		3.4	4.5	3.4	4.5
Power Consumption Rated (Min.-Max.)	W		620 (300-950)	825 (290-1,420)	620 (300-950)	825 (290-1,420)
Power Factor	%		79.3	79.7	79.3	79.7
COP	W/W		4.03	4.12	4.03	4.12
Piping Connections	Liquid	mm	φ 6.4		φ 6.4	
	Gas	mm	φ 9.5		φ 9.5	
	Drain	mm	φ 18.0		φ 18.0	
Heat Insulation	Both Liquid and Gas Pipes				Both Liquid and Gas Pipes	
Indoor Unit	FTXG25CVMBW				FTXG25CVMBS	
Front Panel Color	Mat Crystal White				Mat Crystal Silver	
Air Flow Rate	m³/min (cfm)	H	7.4 (260)	7.7 (271)	7.4 (260)	7.7 (271)
		M	6.0 (211)	6.9 (243)	6.0 (211)	6.9 (243)
		L	4.4 (155)	6.0 (211)	4.4 (155)	6.0 (211)
		SL	3.7 (130)	5.0 (176)	3.7 (130)	5.0 (176)
Fan	Type		Cross Flow Fan		Cross Flow Fan	
	Motor Output	W	40		40	
	Speed	Steps	5 Steps, Silent and Auto		5 Steps, Silent and Auto	
Air Direction Control	Right, Left, Horizontal and Downward				Right, Left, Horizontal and Downward	
Air Filter	Removable / Washable / Mildew Proof				Removable / Washable / Mildew Proof	
Running Current (Rated)	A		0.14	0.14	0.14	0.14
Power Consumption (Rated)	W		30	30	30	30
Power Factor	%		93.2	93.2	93.2	93.2
Temperature Control	Microcomputer Control				Microcomputer Control	
Dimensions (HxWxD)	mm		275x840x150		275x840x150	
Packaged Dimensions (HxWxD)	mm		222x894x345		222x894x345	
Weight	kg		9		9	
Gross Weight	kg		13		13	
Operation Sound	H/M/L/SL	dBA	38/32/25/22	38/33/28/25	38/32/25/22	38/33/28/25
Sound Power	H	dBA	56	—	56	—
Outdoor Unit	RXG25CVMB				RXG25CVMB	
Casing Color	Ivory White				Ivory White	
Compressor	Type		Hermetically Sealed Swing Type		Hermetically Sealed Swing Type	
	Model		1YC23NXD#A		1YC23NXD#A	
Refrigerant Oil	Motor Output	W	600		600	
	Model		FVC50K		FVC50K	
Refrigerant	Charge	L	0.375		0.375	
	Model		R410A		R410A	
Air Flow Rate (H/L)	Charge	kg	1.00		1.00	
	m³/min		31.3/22.4	28.1/22.4	31.3/22.4	28.1/22.4
Fan	cfm		1,105/791	992/791	1,105/791	992/791
	Type		Propeller		Propeller	
Running Current (Rated)	Motor Output	W	35		35	
	A		3.26	4.36	3.26	4.36
Power Consumption (Rated)	W		590	795	590	795
Power Factor	%		78.7	79.3	78.7	79.3
Starting Current	A		4.5		4.5	
Dimensions (HxWxD)	mm		550x765x285		550x765x285	
Packaged Dimensions (HxWxD)	mm		589x882x363		589x882x363	
Weight	kg		32		32	
Gross Weight	kg		38		38	
Operation Sound	H/L	dBA	46/43	47/44	46/43	47/44
Sound Power	H	dBA	61	—	61	—
Drawing No.	3D045212				3D045213	

Notes:

- MAX. interunit piping length: 20m
- MAX. interunit height difference: 15m
- Amount of additional charge of refrigerant 20g/m for piping length exceeding 10m
- The data are based on the conditions shown in the table below.

Cooling	Heating	Piping Length
Indoor ; 27°CDB/19°CWB Outdoor ; 35°CDB/24°CWB	Indoor ; 20°CDB Outdoor ; 7°CDB/6°CWB	7.5m

Conversion Formulae
kcal/h=kWx860 Btu/h=kWx3414 cfm=m³/minx35.3

230V, 50Hz

Model	Indoor Units		FTXG35CVMAW		FTXG35CVMAS	
	Outdoor Units		RXG35CVMA		RXG35CVMA	
			Cooling	Heating	Cooling	Heating
Capacity Rated (Min.-Max.)	kW		3.5 (1.4-3.8)	4.2 (1.4-5.0)	3.5 (1.4-3.8)	4.2 (1.4-5.0)
	Btu/h		11,950 (4,750-12,950)	14,300 (4,750-17,050)	11,950 (4,750-12,950)	14,300 (4,750-17,050)
	kcal/h		3,010 (1,200-3,270)	3,610 (1,200-4,300)	3,010 (1,200-3,270)	3,610 (1,200-4,300)
Moisture Removal	L/h		1.9	—	1.9	—
Running Current (Rated)	A		4.9	5.2	4.9	5.2
Power Consumption Rated (Min.-Max.)	W		1,060 (300-1,290)	1,135 (310-1,560)	1,060 (300-1,290)	1,135 (310-1,560)
Power Factor	%		94.0	94.9	94.0	94.9
COP	W/W		3.30	3.70	3.30	3.70
Piping Connections	Liquid	mm	φ 6.4		φ 6.4	
	Gas	mm	φ 9.5		φ 9.5	
	Drain	mm	φ 18.0		φ 18.0	
Heat Insulation			Both Liquid and Gas Pipes		Both Liquid and Gas Pipes	
Indoor Unit			FTXG35CVMAW		FTXG35CVMAS	
Front Panel Color			Mat Crystal White		Mat Crystal Silver	
Air Flow Rate	m³/min (cfm)	H	8.2 (289)	8.4 (296)	8.2 (289)	8.4 (296)
		M	7.1 (250)	7.5 (264)	7.1 (250)	7.5 (264)
		L	5.8 (204)	6.3 (222)	5.8 (204)	6.3 (222)
		SL	4.9 (172)	5.5 (194)	4.9 (172)	5.5 (194)
Fan	Type		Cross Flow Fan		Cross Flow Fan	
	Motor Output	W	40		40	
	Speed	Steps	5 Steps, Silent and Auto		5 Steps, Silent and Auto	
Air Direction Control			Right, Left, Horizontal and Downward		Right, Left, Horizontal and Downward	
Air Filter			Removable / Washable / Mildew Proof		Removable / Washable / Mildew Proof	
Running Current (Rated)	A		0.14	0.14	0.14	0.14
Power Consumption (Rated)	W		30	30	30	30
Power Factor	%		93.2	93.2	93.2	93.2
Temperature Control			Microcomputer Control		Microcomputer Control	
Dimensions (HxWxD)	mm		275x840x150		275x840x150	
Packaged Dimensions (HxWxD)	mm		222x894x345		222x894x345	
Weight	kg		9		9	
Gross Weight	kg		13		13	
Operation Sound	H/M/L/SL	dBA	39/35/32/29	39/35/31/28	39/35/32/29	39/35/31/28
Sound Power	H	dBA	57	57	57	57
Outdoor Unit			RXG35CVMA		RXG35CVMA	
Casing Color			Ivory White		Ivory White	
Compressor	Type		Hermetically Sealed Swing Type		Hermetically Sealed Swing Type	
	Model		1YC23NXD#A		1YC23NXD#A	
	Motor Output	W	600		600	
Refrigerant Oil	Model		FVC50K		FVC50K	
	Charge	L	0.375		0.375	
Refrigerant	Model		R410A		R410A	
	Charge	kg	1.00		1.00	
Air Flow Rate (H/L)	m³/min		31.3/22.4	28.1/22.4	31.3/22.4	28.1/22.4
	cfm		1,105/791	992/791	1,105/791	992/791
Fan	Type		Propeller		Propeller	
	Motor Output	W	35		35	
Running Current (Rated)	A		4.76	5.06	4.76	5.06
Power Consumption (Rated)	W		1,030	1,105	1,030	1,105
Power Factor	%		94.1	94.9	94.1	94.9
Starting Current	A		5.2		5.2	
Dimensions (HxWxD)	mm		550x765x285		550x765x285	
Packaged Dimensions (HxWxD)	mm		589x882x363		589x882x363	
Weight	kg		32		32	
Gross Weight	kg		38		38	
Operation Sound	H/L	dBA	47/44	48/45	47/44	48/45
Sound Power	H	dBA	62	63	62	63
Drawing No.			3D046345A		3D046346A	

Notes:

- MAX. interunit piping length: 20m
- MAX. interunit height difference: 15m
- Amount of additional charge of refrigerant 20g/m for piping length exceeding 10m
- The data are based on the conditions shown in the table below.

Cooling	Heating	Piping Length
Indoor ; 27°CDB/19°CWB Outdoor ; 35°CDB/24°CWB	Indoor ; 20°CDB Outdoor ; 7°CDB/6°CWB	7.5m

Conversion Formulae
kcal/h=kWx860 Btu/h=kWx3414 cfm=m³/minx35.3

230V, 50Hz

Model	Indoor Units		FTXG35CVMBW		FTXG35CVMBS	
	Outdoor Units		RXG35CVMB		RXG35CVMB	
			Cooling	Heating	Cooling	Heating
Capacity Rated (Min.-Max.)	kW		3.5 (1.4-3.8)	4.2 (1.4-5.0)	3.5 (1.4-3.8)	4.2 (1.4-5.0)
	Btu/h		11,950 (4,750-12,950)	14,300 (4,750-17,050)	11,950 (4,750-12,950)	14,300 (4,750-17,050)
	kcal/h		3,010 (1,200-3,270)	3,610 (1,200-4,300)	3,010 (1,200-3,270)	3,610 (1,200-4,300)
Moisture Removal	L/h		1.9	—	1.9	—
Running Current (Rated)	A		4.9	5.2	4.9	5.2
Power Consumption Rated (Min.-Max.)	W		1,060 (300-1,290)	1135 (310-1,560)	1,060 (300-1,290)	1135 (310-1,560)
Power Factor	%		94.0	94.9	94.0	94.9
COP	W/W		3.30	3.70	3.30	3.70
Piping Connections	Liquid	mm	φ 6.4		φ 6.4	
	Gas	mm	φ 9.5		φ 9.5	
	Drain	mm	φ 18.0		φ 18.0	
Heat Insulation	Both Liquid and Gas Pipes				Both Liquid and Gas Pipes	
Indoor Unit	FTXG35CVMBW				FTXG35CVMBS	
Front Panel Color	Mat Crystal White				Mat Crystal Silver	
Air Flow Rate	m ³ /min (cfm)	H	7.9 (278)	7.9 (278)	7.9 (278)	7.9 (278)
		M	6.3 (222)	7.1 (250)	6.3 (222)	7.1 (250)
		L	4.7 (165)	6.0 (211)	4.7 (165)	6.0 (211)
		SL	4.1 (144)	5.1 (180)	4.1 (144)	5.1 (180)
Fan	Type		Cross Flow Fan		Cross Flow Fan	
	Motor Output	W	40		40	
	Speed	Steps	5 Steps, Silent and Auto		5 Steps, Silent and Auto	
Air Direction Control	Right, Left, Horizontal and Downward				Right, Left, Horizontal and Downward	
Air Filter	Removable / Washable / Mildew Proof				Removable / Washable / Mildew Proof	
Running Current (Rated)	A		0.14	0.14	0.14	0.14
Power Consumption (Rated)	W		30	30	30	30
Power Factor	%		93.2	93.2	93.2	93.2
Temperature Control	Microcomputer Control				Microcomputer Control	
Dimensions (HxWxD)	mm		275x840x150		275x840x150	
Packaged Dimensions (HxWxD)	mm		222x894x345		222x894x345	
Weight	kg		9		9	
Gross Weight	kg		13		13	
Operation Sound	H/M/L/SL	dBA	39/33/26/23	39/34/29/26	39/33/26/23	39/34/29/26
Sound Power	H	dBA	57	—	57	—
Outdoor Unit	RXG35CVMB				RXG35CVMB	
Casing Color	Ivory White				Ivory White	
Compressor	Type		Hermetically Sealed Swing Type		Hermetically Sealed Swing Type	
	Model		1YC23NXD#A		1YC23NXD#A	
	Motor Output	W	600		600	
Refrigerant Oil	Model		FVC50K		FVC50K	
	Charge	L	0.375		0.375	
Refrigerant	Model		R410A		R410A	
	Charge	kg	1.00		1.00	
Air Flow Rate (H/L)	m ³ /min		31.3/22.4	28.1/22.4	31.3/22.4	28.1/22.4
	cfm		1,105/791	992/791	1,105/791	992/791
Fan	Type		Propeller		Propeller	
	Motor Output	W	35		35	
Running Current (Rated)	A		4.76	5.06	4.76	5.06
Power Consumption (Rated)	W		1,030	1,105	1,030	1,105
Power Factor	%		94.1	94.9	94.1	94.9
Starting Current	A		5.2		5.2	
Dimensions (HxWxD)	mm		550x765x285		550x765x285	
Packaged Dimensions (HxWxD)	mm		589x882x363		589x882x363	
Weight	kg		32		32	
Gross Weight	kg		38		38	
Operation Sound	H/L	dBA	47/44	48/45	47/44	48/45
Sound Power	H	dBA	62	—	62	—
Drawing No.	3D045215				3D045216	

Notes:

- MAX. interunit piping length: 20m
- MAX. interunit height difference: 15m
- Amount of additional charge of refrigerant 20g/m for piping length exceeding 10m
- The data are based on the conditions shown in the table below.

Cooling	Heating	Piping Length
Indoor ; 27°CDB/19°CWB Outdoor ; 35°CDB/24°CWB	Indoor ; 20°CDB Outdoor ; 7°CDB/6°CWB	7.5m

Conversion Formulae

kcal/h=kW×860
Btu/h=kW×3414
cfm=m³/min×35.3

230V, 50Hz

Model	Indoor Units		ATXG25CVMB ARXG25CVMB		ATXG35CVMB ARXG35CVMB			
	Outdoor Units		Cooling	Heating	Cooling	Heating		
	Capacity Rated	kW	2.5 (1.3-3.0)	3.4 (1.3-4.5)	3.5 (1.4-3.8)	4.2 (1.4-5.0)		
	Btu/h	8,550 (4,450~10,250)	11,600 (4,450~15,350)	11,950 (4,750~12,950)	14,300 (4,750~17,050)			
	kcal/h	2,150 (1,120~2,580)	2,920 (1,120~3,870)	3,010 (1,200~3,270)	3,610 (1,200~4,300)			
Moisture Removal	L/h	1.2	—	1.9	—			
Running Current (Rated)	A	3.4	4.5	4.9	5.2			
Power Consumption Rated	W	620 (300-950)	825 (290~1,420)	1,060 (300~1,290)	1,135 (310~1,560)			
Power Factor	%	79.3	79.7	94.0	94.9			
COP	W/W	4.03	4.12	3.30	3.70			
Piping Connections	Liquid	mm	φ 6.4		φ 6.4			
	Gas	mm	φ 9.5		φ 9.5			
	Drain	mm	φ 18.0		φ 18.0			
Heat Insulation	Both Liquid and Gas Pipes				Both Liquid and Gas Pipes			
Indoor Unit	ATXG25CVMB				ATXG35CVMB			
Front Panel Color	Crystal Silver				Crystal Silver			
Air Flow Rate	m³/min (cfm)	H	7.4 (260)	7.7 (271)	7.9 (278)	7.9 (278)		
		M	6.0 (211)	6.9 (243)	6.3 (222)	7.1 (250)		
		L	4.4 (155)	6.0 (211)	4.7 (165)	6.0 (211)		
		SL	3.7 (130)	5.0 (176)	4.1 (144)	5.1 (180)		
Fan	Type	Cross Flow Fan				Cross Flow Fan		
	Motor Output	W	40				40	
	Speed	Steps	5 Steps, Silent and Auto				5 Steps, Silent and Auto	
Air Direction Control	Right, Left, Horizontal and Downward				Right, Left, Horizontal and Downward			
Air Filter	Removable / Washable / Mildew Proof				Removable / Washable / Mildew Proof			
Running Current (Rated)	A	0.14	0.14	0.14	0.14			
Power Consumption (Rated)	W	30	30	30	30			
Power Factor	%	93.2	93.2	93.2	93.2			
Temperature Control	Microcomputer Control				Microcomputer Control			
Dimensions (HxWxD)	mm	275x840x150				275x840x150		
Packaged Dimensions (HxWxD)	mm	222x894x345				222x894x345		
Weight	kg	9				9		
Gross Weight	kg	13				13		
Operation Sound	H/L	dBA	38/32/25/22	38/33/28/25	39/33/26/23	39/34/29/26		
Sound Power	H	dBA	56	—	57	—		
Outdoor Unit	ARXG25CVMB				ARXG35CVMB			
Casing Color	Ivory White				Ivory White			
Compressor	Type	Hermetically Sealed Swing Type				Hermetically Sealed Swing Type		
	Model	1YC23NXD#A				1YC23NXD#A		
Refrigerant Oil	Motor Output	W	600				600	
	Model	FVC50K				FVC50K		
Refrigerant	Charge	L	0.375				0.375	
	Model	R410A				R410A		
Air Flow Rate (H/L)	Charge	kg	1.00				1.00	
	m³/min	31.3/22.4		28.1/22.4		31.3/22.4		
Fan	cfm	1,105/791		992/791		1,105/791		
	Type	Propeller				Propeller		
Running Current (Rated)	Motor Output	W	35				35	
	A	3.26	4.36	4.76	5.06			
Power Consumption (Rated)	W	590	795	1,030	1,105			
Power Factor	%	78.7	79.3	94.1	94.9			
Starting Current	A	4.5				5.2		
Dimensions (HxWxD)	mm	550x765x285				550x765x285		
Packaged Dimensions (HxWxD)	mm	589x882x363				589x882x363		
Weight	kg	32				32		
Gross Weight	kg	38				38		
Operation Sound	H	dBA	46/43	47/44	47/44	48/45		
Sound Power	H	dBA	61	—	62	—		
Drawing No.	3D045214				3D045217			

Notes:

- MAX. interunit piping length: 20m
- MAX. interunit height difference: 15m
- Amount of additional charge of refrigerant 20g/m for piping length exceeding 10m
- The data are based on the conditions shown in the table below.

Cooling	Heating	Piping Length
Indoor ; 27°CDB/19°CWB Outdoor ; 35°CDB/24°CWB	Indoor ; 20°CDB Outdoor ; 7°CDB/6°CWB	7.5m

Conversion Formulae
kcal/h=kWx860 Btu/h=kWx3414 cfm=m³/minx35.3

Part 3

Printed Circuit Board

Connector Wiring Diagram

1. Printed Circuit Board Connector Wiring Diagram.....	10
1.1 Indoor Unit.....	10
1.2 Outdoor Unit.....	12

1. Printed Circuit Board Connector Wiring Diagram

1.1 Indoor Unit

Connectors

- | | |
|--------|--|
| 1) S1 | Connector for fan motor |
| 2) S21 | Connector for centralized control (HA) |
| 3) S32 | Connector for heat exchanger thermistor |
| 4) S36 | Connector for INTELLIGENT EYE sensor PCB and control PCB |
| 5) S41 | Connector for swing motor |
| 6) S46 | Connector for signal receiver PCB |
| 7) S47 | Connector for control PCB |
| 8) S49 | Connector for reduction motor (front panel mechanism) |
| 9) S51 | Connector for front panel limit switch |



Note: Other designations

- | | |
|---------|--|
| 1) V1 | Varistor |
| 2) JA | Address setting jumper |
| JB | Fan speed setting when compressor is OFF on thermostat |
| JC | Power failure recovery function (auto-restart) |
| | * Refer to page 175 for detail. |
| 3) SW1 | Forced operation ON / OFF switch |
| 4) LED2 | LED for INTELLIGENT EYE (green) |
| 5) LED3 | LED for timer (yellow) |
| 6) LED4 | LED for operation (green) |
| 7) FU1 | Fuse (3.15A) |
| 8) RTH1 | Room temperature thermistor |

1.2 Outdoor Unit

Connectors

- | | |
|-----------------------|--|
| 1) S10 | Connector for filter PCB |
| 2) S11 | Connector for control PCB |
| 3) S20 | Connector for electronic expansion valve coil |
| 4) S30 | Connector for compressor motor |
| 5) S40 | Connector for overload protector |
| 6) S70 | Connector for fan motor |
| 7) S80 | Connector for four way valve coil |
| 8) S90 | Connector for thermistors
(outdoor air, heat exchanger, discharge pipe) |
| 9) HC3, HC4, HL3, HN3 | Connector for filter PCB |



Note: Other Designations

- | | |
|---------------|---------------------|
| 1) FU1, FU2 | Fuse (3.15A) |
| 2) FU3 | Fuse (20A) |
| 3) LEDA | Service monitor LED |
| 4) V1, V2, V3 | Varistor |

PCB Detail

PCB(1): Control PCB (outdoor unit)

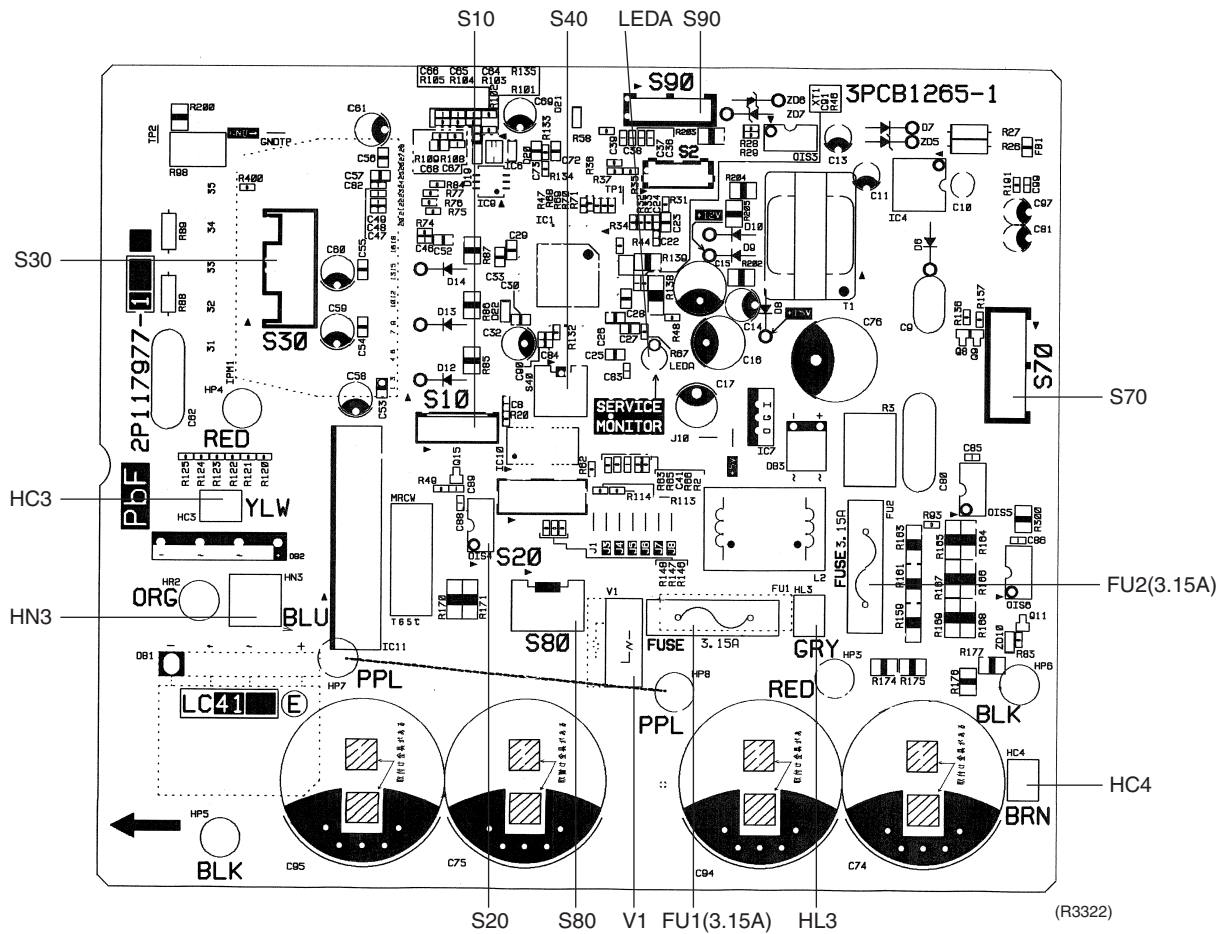

PCB(2): Filter PCB

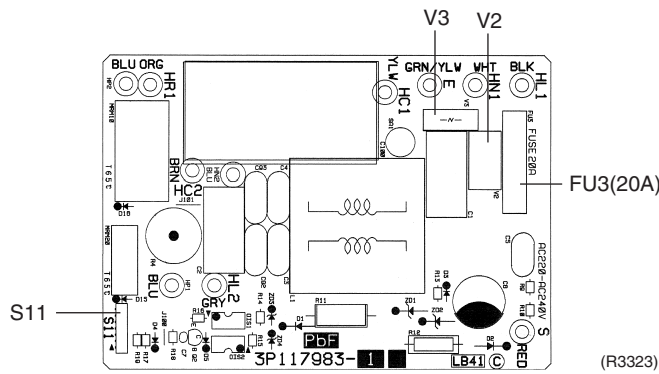

Part 4

Function and Control

1. Main Functions.....	16
1.1 Frequency Principle.....	16
1.2 Power-Airflow Flap, Wide-Angle Louvres and Auto-Swing	18
1.3 Operation Starting Control.....	19
1.4 Fan Speed Control for Indoor Units.....	20
1.5 Programme Dry Function	21
1.6 Automatic Operation.....	22
1.7 NIGHT SET Mode	23
1.8 INTELLIGENT EYE	24
1.9 Inverter Powerful Operation	25
1.10 Other Functions.....	26
2. Function of Thermistor	27
2.1 Heat Pump Model.....	27
3. Control Specification	28
3.1 Mode Hierarchy	28
3.2 Frequency Control.....	29
3.3 Controls at Mode Changing / Start-up.....	30
3.4 Discharge Pipe Control	32
3.5 Input Current Control.....	32
3.6 Freeze-up Protection Control	33
3.7 Heating Peak-cut Control	33
3.8 Fan Control.....	34
3.9 Liquid Compression Protection Function 2.....	34
3.10 Defrost Control	35
3.11 Electronic Expansion Valve Control	36
3.12 Malfunctions	39
3.13 Forced Operation Mode	40
3.14 Additional Function.....	40

1. Main Functions

i Note: See the list of functions for the functions applicable to different models.

1.1 Frequency Principle

Main Control Parameters

The compressor is frequency-controlled during normal operation. The target frequency is set by the following 2 parameters coming from the operating indoor unit:

- The load condition of the operating indoor unit
- The difference between the room temperature and the set temperature

Additional Control Parameters

The target frequency is adapted by additional parameters in the following cases:

- Frequency restrictions
- Initial settings
- Forced cooling operation

Inverter Principle

To regulate the capacity, a frequency control is needed. The inverter makes it possible to vary the rotation speed of the compressor. The following table explains the conversion principle:

Phase	Description
1	The supplied AC power source is converted into the DC power source for the present.
2	The DC power source is reconverted into the three phase AC power source with variable frequency. <ul style="list-style-type: none"> ■ When the frequency increases, the rotation speed of the compressor increases resulting in an increased refrigerant circulation. This leads to a higher amount of the heat exchange per unit. ■ When the frequency decreases, the rotation speed of the compressor decreases resulting in a decreased refrigerant circulation. This leads to a lower amount of the heat exchange per unit.

Drawing of Inverter

The following drawing shows a schematic view of the inverter principle:

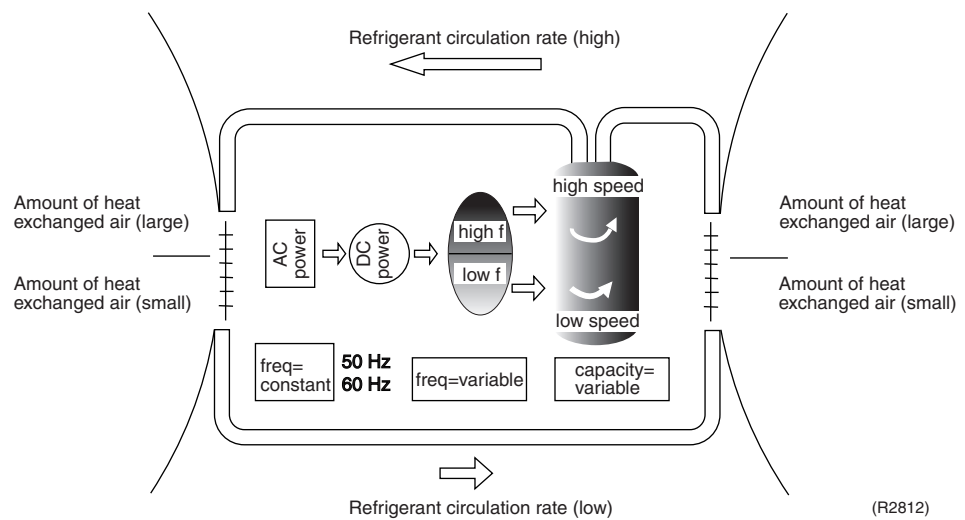

Inverter Features

The inverter provides the following features:

- The regulating capacity can be changed according to the changes in the outside temperature and cooling/heating load.
- Quick heating and quick cooling
The compressor rotational speed is increased when starting the heating (or cooling). This enables a quick set temperature.

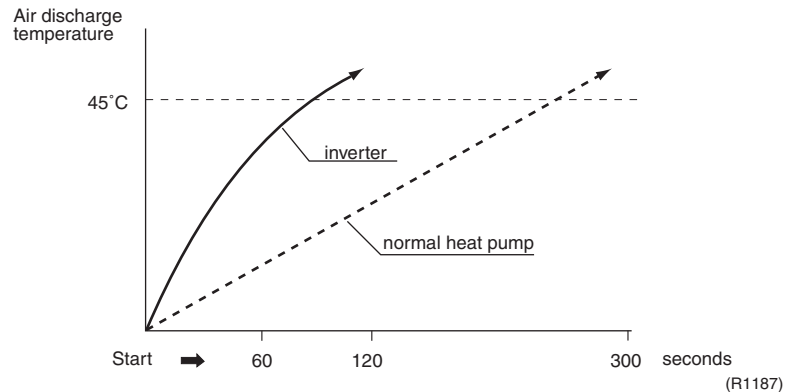

- Even during extreme cold weather, the high capacity is achieved. It is maintained even when the outside temperature is 2°C.
- Comfortable air conditioning
A detailed adjustment is integrated to ensure a fixed room temperature. It is possible to air condition with a small room temperature variation.
- Energy saving heating and cooling
Once the set temperature is reached, the energy saving operation enables to maintain the room temperature at low power.

Frequency Limits

The following table shows the functions that define the minimum and maximum frequency:

Frequency limits	Limited during the activation of following functions
Low	<ul style="list-style-type: none"> ■ Four way valve operation compensation. Refer to page 31.
High	<ul style="list-style-type: none"> ■ Input current control. Refer to page 32. ■ Compressor protection function. Refer to page 31. ■ Heating peak-cut control. Refer to page 33. ■ Freeze-up protection control. Refer to page 33. ■ Defrost control. Refer to page 35.

Forced Cooling Operation

For more information, refer to "Forced operation mode" on page 40.

1.2 Power-Airflow Flap, Wide-Angle Louvres and Auto-Swing

Power-airflow Flap

The large flap sends a large volume of air downwards to the floor. The flap provides an optimum control area in cooling, heating and dry mode.

Heating Mode

During heating mode, the large flap enables direct warm air straight downwards. The flap presses the warm air above the floor to reach the entire room.

Cooling Mode

During cooling mode, the flap retracts into the indoor unit. Then, cool air can be blown far and pervaded all over the room.

Wide-Angle Louvres

The louvres, made of elastic synthetic resin, provide a wide range of airflow that guarantees a comfortable air distribution.

Auto-Swing

The following table explains the auto-swing process for heating, cooling, dry and fan :

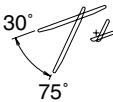
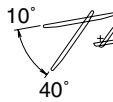
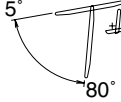
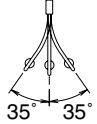
Vertical Swing (up and down)			Horizontal Swing (right and left)
Heating	Cooling, Dry	Fan	
 <p>(R3293)</p>	 <p>(R3294)</p>	 <p>(R3295)</p>	 <p>(R3296)</p>

Outline of 3-D Airflow

Alternative repetition of vertical and horizontal swing motions enables uniform air-conditioning of the entire room. This function is effective for starting the air conditioner.

Detail of the Action

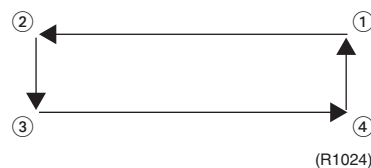

When the horizontal swing and vertical swing are both set to auto mode, the airflow become 3-D airflow and the horizontal swing and vertical swing motions are alternated. The order of swing motion is such that it turns counterclockwise, starting from the right upper point as viewed to the front side of the indoor unit.



COMFORT AIRFLOW Mode

The vertical swing flap is controlled not to blow the air directly on the person in the room.

- The airflow rate is set to AUTOMATIC.
- The airflow rate has the upper limit (M tap) in heating mode.
- The latest command has the priority between POWERFUL and COMFORT AIRFLOW.

Heating	Cooling, Dry
 <p>(R3297)</p>	 <p>(R3298)</p>

1.3 Operation Starting Control

The system carries out the following control at the beginning to conduct every functional parts properly.

1. Opening the front panel fully
2. Output of the ΔD signal after the front panel starts moving
3. Opening the flap fully after the front panel opens fully
4. Making the fan rotate when the flap passes over the fan-banned area

Control Flow

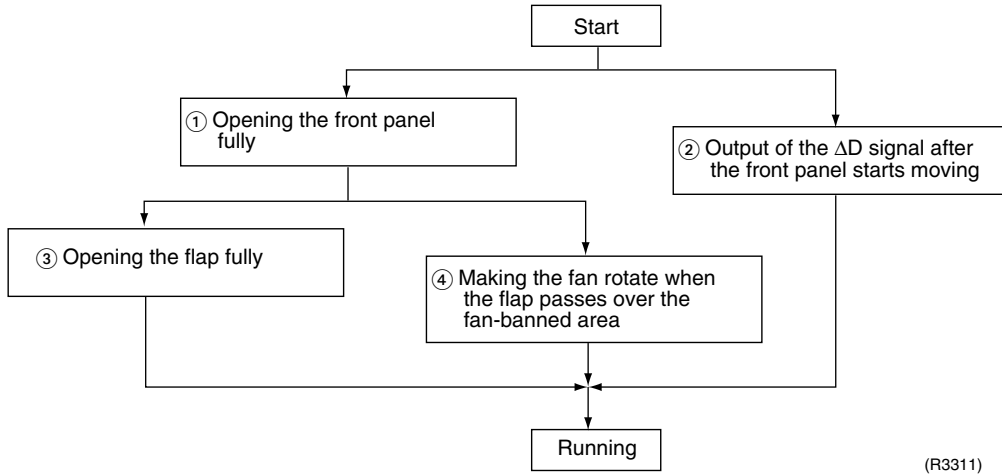

Timing Chart

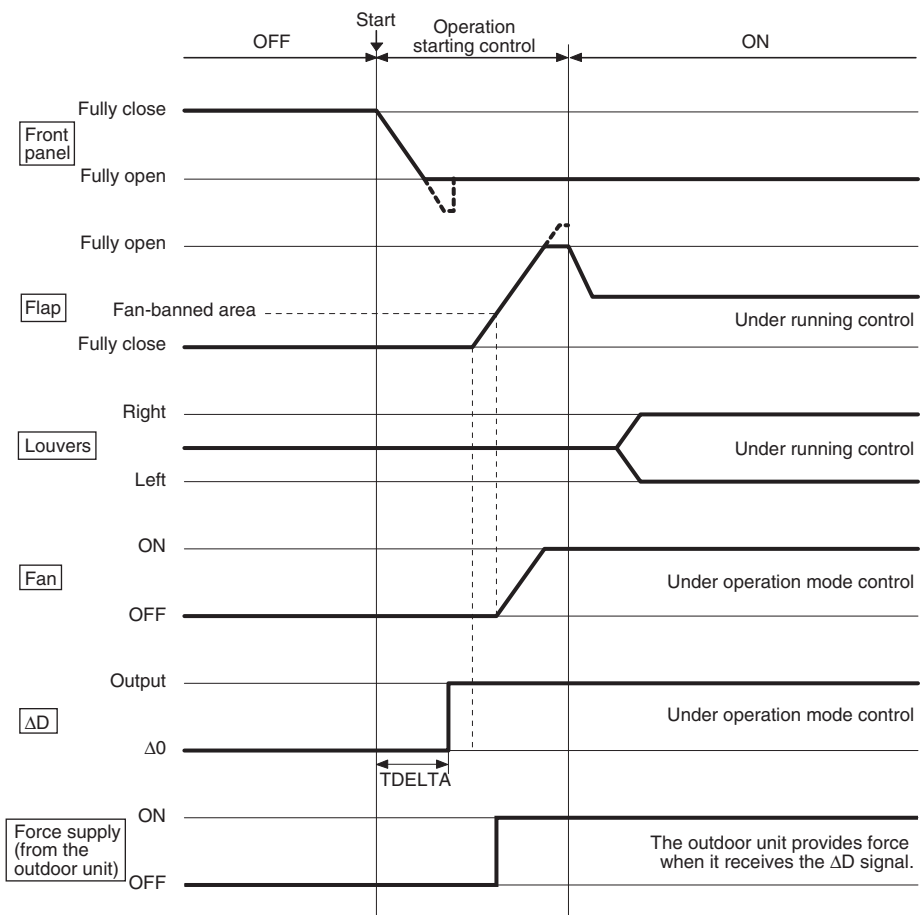

1.4 Fan Speed Control for Indoor Units

Control Mode

The airflow rate can be automatically controlled depending on the difference between the set temperature and the room temperature. This is done through phase control and hall IC control.



For more information about Hall IC, refer to the troubleshooting for fan motor on page 77.

Phase Steps

Phase control and fan speed control contains 9 steps: LLL, LL, SL, L, ML, M, MH, H and HH.

Step	Cooling	Heating	Dry mode
LLL (Heating thermostat OFF)	 (R4085)	 (R4085)	25/35kW class : 830 - 980 rpm (During powerful operation : 1030 rpm)
LL (Cooling thermostat OFF)			
SL (Silent)			
L			
ML			
M			
MH			
H			
HH (Powerful)			

= Within this range the airflow rate is automatically controlled when the FAN setting button is set to automatic.



Note:

1. During powerful operation, fan operates H tap + 50 - 70 rpm.
2. Fan stops during defrost operation.

Automatic Air Flow Control for Heating

The following drawing explains the principle for fan speed control for heating:

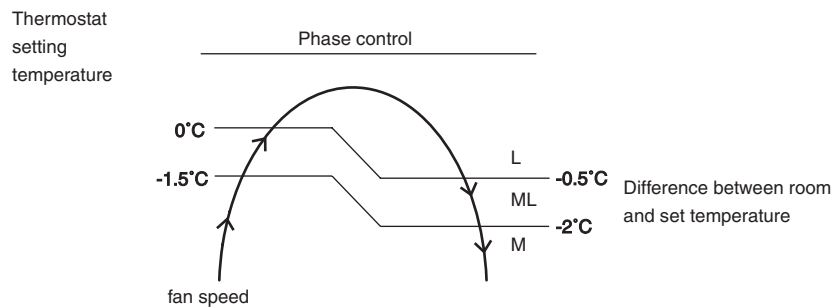

Automatic Air Flow Control for Cooling

The following drawing explains the principle of fan speed control for cooling:

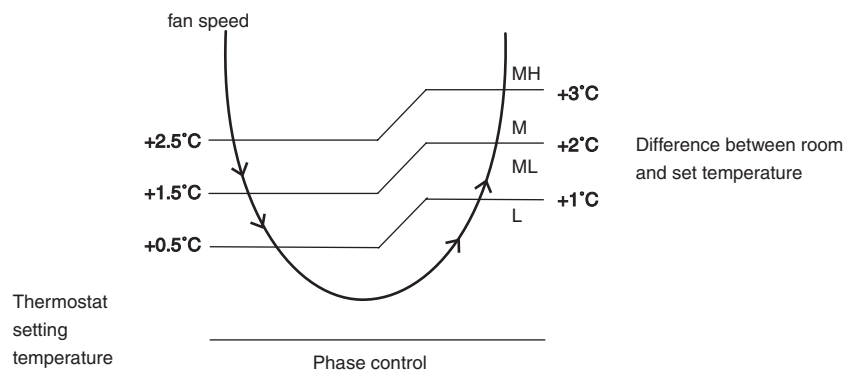

1.5 Programme Dry Function

Programme dry function removes humidity while preventing the room temperature from lowering.

Since the microcomputer controls both the temperature and air flow volume, the temperature adjustment and fan adjustment buttons are inoperable in this mode.

In Case of Inverter Units

The microcomputer automatically sets the temperature and fan settings. The difference between the room temperature at startup and the temperature set by the microcomputer is divided into two zones. Then, the unit operates in the dry mode with an appropriate capacity for each zone to maintain the temperature and humidity at a comfortable level.

Room temperature at startup	Temperature (ON point) at which operation starts	Frequency switching point	Temperature difference for operation stop
24°C	Room temperature at startup	1.0°C	2.5°C
18°C	18°C		2.0°C
17°C		—	

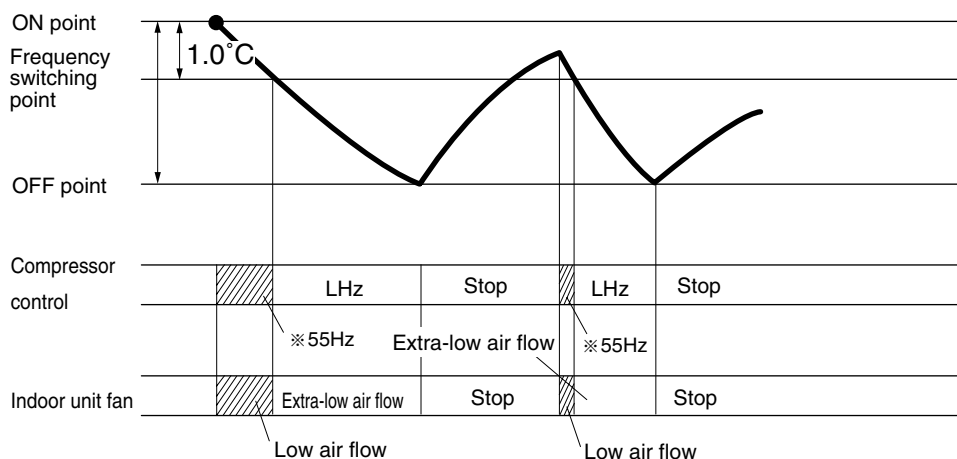

LHz indicates low frequency. Item marked with varies depending on models.

(R3301)

1.6 Automatic Operation

Automatic Cooling / Heating Function (Heat Pump Only)

When the AUTO mode is selected with the remote controller, the microcomputer automatically determines the operation mode from cooling and heating according to the room temperature and setting temperature at the time of the operation startup, and automatically operates in that mode.

The unit automatically switches the operation mode to cooling or heating to maintain the room temperature at the main unit setting temperature.

Detailed Explanation of the Function

1. Remote controller setting temperature is set as automatic cooling / heating setting temperature (18 to 30°C).
2. Main unit setting temperature equals remote controller setting temperature plus correction value (correction value: 0 deg).
3. Operation ON / OFF point and mode switching point are as follows.
 - ① Heating → Cooling switching point:
Room temperature \geq Main unit setting temperature +2.5 deg.
 - ② Cooling → Heating switching point:
Room temperature $<$ Main unit setting temperature -2.5 deg.
 - ③ Thermostat ON / OFF point is the same as the ON / OFF point of cooling or heating operation.
4. During initial operation
 Room temperature \geq Remote controller setting temperature: Cooling operation
 Room temperature $<$ Remote controller setting temperature: Heating operation

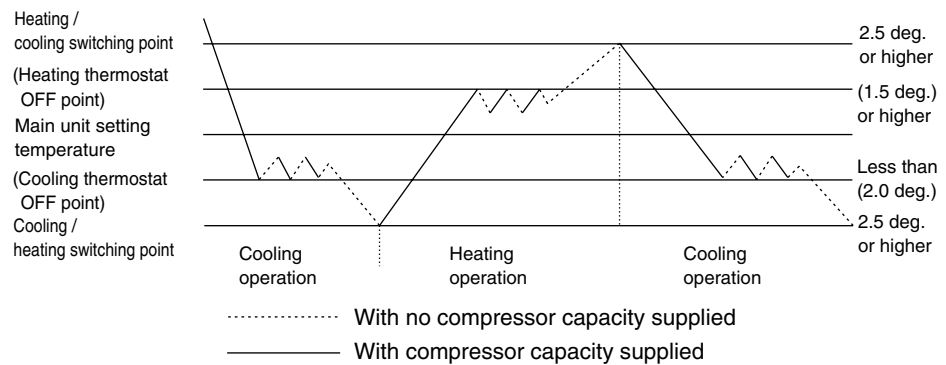

(R3302)

1.7 NIGHT SET Mode

When the OFF timer is set, the NIGHT SET circuit automatically activates. The NIGHT SET circuit maintains the airflow setting made by users.

NIGHT SET Circuit

The NIGHT SET circuit continues heating or cooling the room at the set temperature for the first one hour, then automatically lowers the temperature setting slightly in the case of cooling, or raises it slightly in the case of heating, for economical operations. This prevents excessive heating in winter and excessive cooling in summer to ensure comfortable sleeping conditions, and also conserves electricity.

Cooling Operation

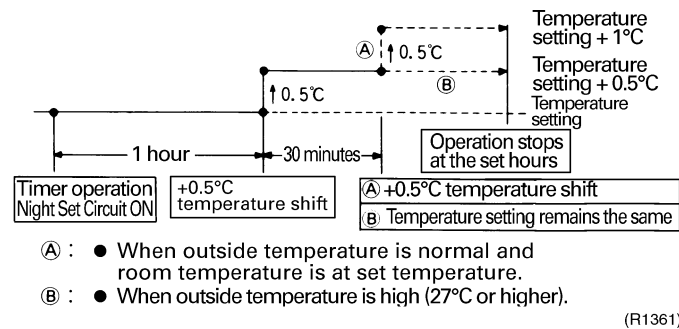

Heating Operation

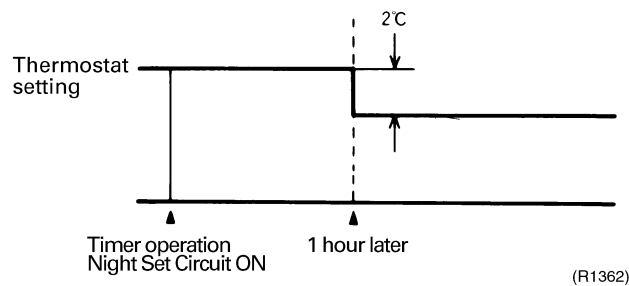

1.8 INTELLIGENT EYE

This is the function that detects existence of humans in the room by a human motion sensor (INTELLIGENT EYE) and reduces the capacity when there is no human in the room in order to save electricity.

Processing

1. Detection method by INTELLIGENT EYE

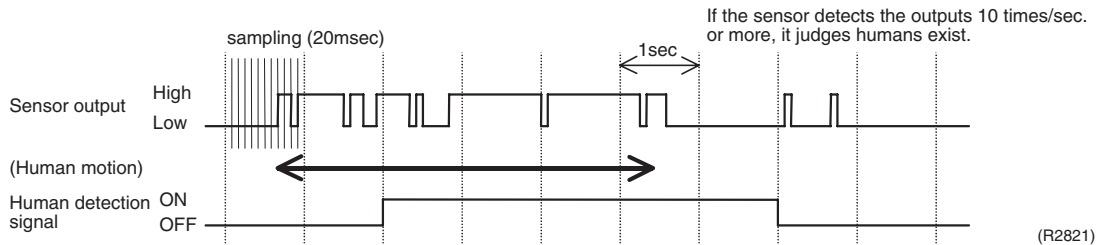

- This sensor detects human motion by receiving infrared rays and displays the pulse wave output.
- A microcomputer in an indoor unit carries out a sampling every 20 msec. and if it detects 10 cycles of the wave in one second in total (corresponding to $20\text{msec.} \times 10 = 100\text{msec.}$), it judges human is in the room as the motion signal is ON.

2. The motions (for example: in cooling)

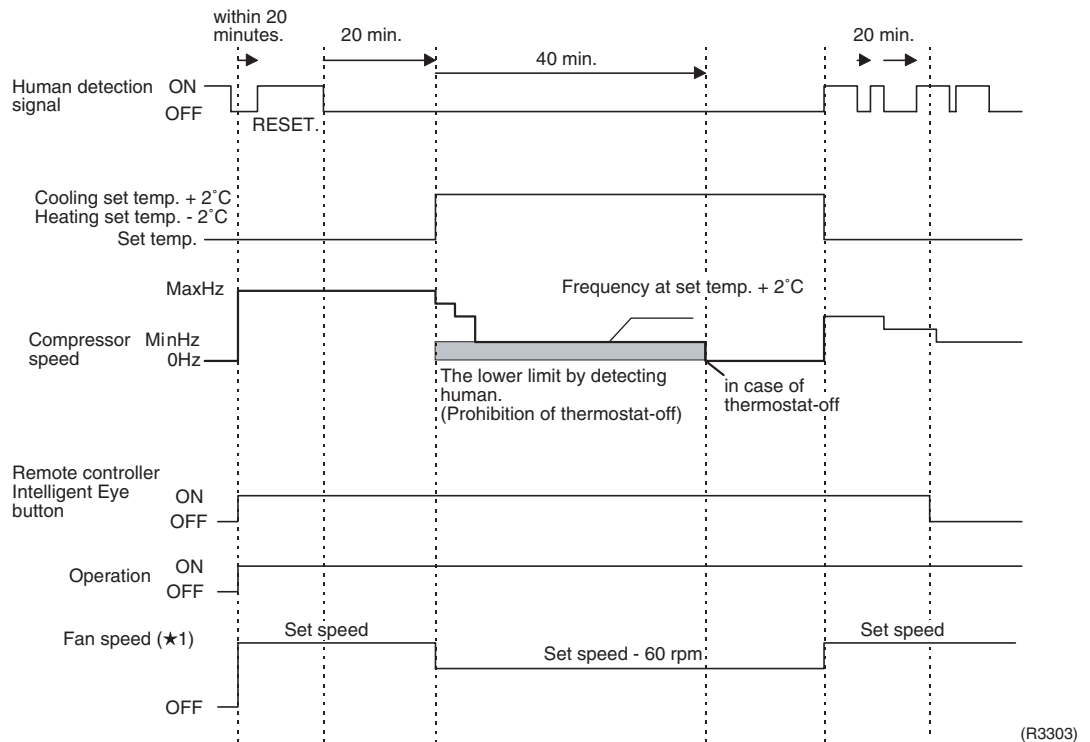

- When a microcomputer doesn't have a signal from the sensor in 20 minutes, it judges that nobody is in the room and operates the unit in temperature sifted 2°C from the set temperature. (COOL· DRY : 2°C higher, HEAT : 2°C lower, AUTO : according to the operation mode at that time.)
- ★1 In case of FAN mode, the fan speed reduces by 60 rpm.

- Since the set temperature is shifted by 2°C higher for 40 minutes, compressor speed becomes low and can realize energy saving operation. But as thermostat is prone to be off by the fact that the set temperature has been shifted, the thermostat-off action is prohibited in 40 minutes so as to prevent this phenomena. After this 40 minutes, the prohibition of the thermostat-off is cancelled and it can realize the conditions to conduct thermostat-off depending on the room temperature. In or after this forty minutes, if the sensor detects human motion detection signal, it let the set temperature and the fan speed return to the original set point, keeping a normal operation.

Others

- The dry operation can't command the setting temperature with a remote controller, but internally the set temperature is shifted by 1°C.

1.9 Inverter Powerful Operation

Outline

In order to exploit the cooling and heating capacity to full extent, operate the air conditioner by increasing the indoor fan rotating speed and the compressor frequency.

Details of the Control

When POWERFUL button is pushed in each operation mode, the fan speed/setting temperature will be converted to the following states in a period of twenty minutes.

Operation mode	Fan speed	Target set temperature
COOL	H tap + 70 rpm	18°C
DRY	Dry rotating speed + 70 rpm	Normally targeted temperature in dry operation; Approx. -2.5°C
HEAT	H tap + 50 rpm	30°C
FAN	H tap + 50 rpm	—
AUTO	Same as cooling / heating in POWERFUL operation	The target is kept unchanged

Ex.) : POWERFUL operation in cooling mode.

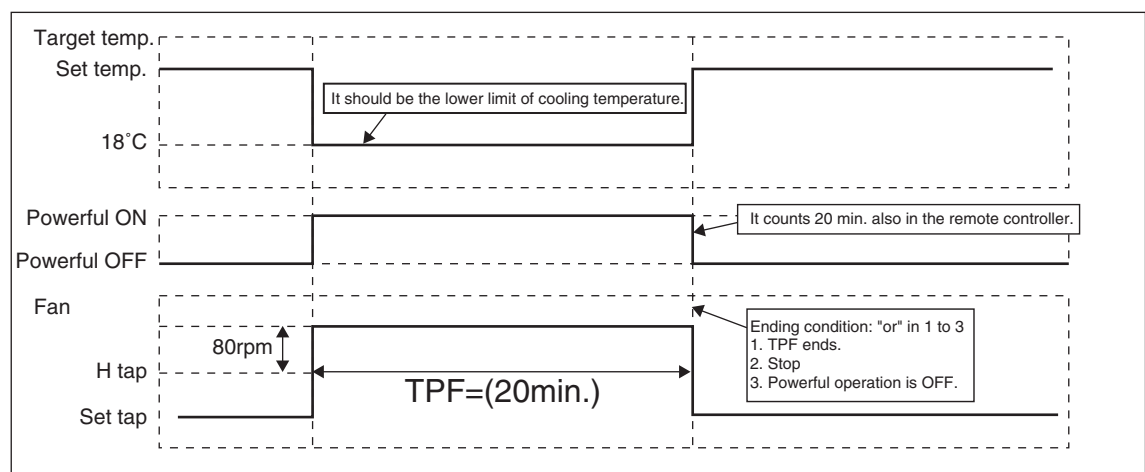

(R2823)

1.10 Other Functions

1.10.1 Hot Start Function

Heat Pump Only

In order to prevent the cold air blast that normally comes when heating is started, the temperature of the heat exchanger of the indoor unit is detected, and either the air flow is stopped or is made very weak thereby carrying out comfortable heating of the room.

*The cold air blast is also prevented using a similar control when the defrosting operation is started or when the thermostat gets turned ON.

1.10.2 Signal Receiving Sign

When the indoor unit receives a signal from the remote controller, the unit emits a signal receiving sound.

1.10.3 ON/OFF Button on Indoor Unit

An ON/OFF switch is provided on the front panel of the unit. Use this switch when the remote controller is missing or if its battery has run out.

Every press of the switch changes from Operation to Stop or from Stop to Operation

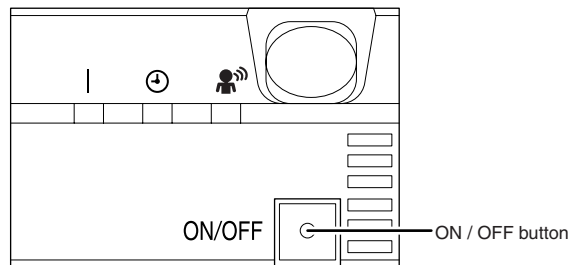

(R3304)

- Push this button once to start operation. Push once again to stop it.
- This button is useful when the remote controller is missing.
- The operation mode refers to the following table.

	Mode	Temperature setting	Air flow rate
Cooling Only	COOL	22°C	AUTO
Heat Pump	AUTO	25°C	AUTO

- In the case of multi system operation, there are times when the unit does not activate with this button.

1.10.4 Titanium Apatite Photocatalytic Air-Purifying Filter

This filter combines the Air Purifying Filter and Titanium Apatite Photocatalytic Deodorizing Filter in a single highly effective unit. The filter traps microscopic particles, decompose odours and even deactivates bacteria and viruses. It lasts for three years without replacement if washed about once every six months.

1.10.5 Mold Proof Air Filter

The air filter net is impregnated with a safe, odourless mould preventative to make the filter virtually immune to mould.

1.10.6 Self-Diagnosis Digital Display

The microcomputer continuously monitors main operating conditions of the indoor unit, outdoor unit and the entire system. When an abnormality occur, the LCD remote controller displays error code. These indications allow prompt maintenance operations.

1.10.7 Auto-restart Function

Even if a power failure (including one for just a moment) occurs during the operation, the operation restarts in the condition before power failure automatically when power is restored.

(Note) It takes 3 minutes to restart the operation because the 3-minutes standby function is activated.

2. Function of Thermistor

2.1 Heat Pump Model

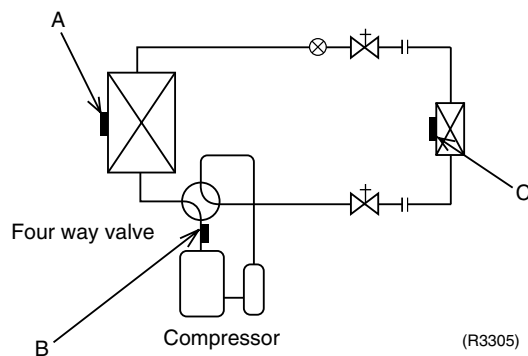

A Outdoor Heat Exchanger Thermistor (DCB)

1. The outdoor heat exchanger thermistor is used for controlling target discharge temperature. Set a target discharge temperature depending on the outdoor and indoor heat exchanger temperature. Control the electronic expansion valve opening so that the target discharge temperature can be obtained.
2. The outdoor heat exchanger thermistor is used for detecting the discharge thermistor disconnected when cooling. When the temperature of the discharge piping is lower than the temperature of outdoor heat exchanger, a disconnected discharge thermistor can be detected.
3. The outdoor heat exchanger thermistor is used for high pressure protection during cooling operation.

B Discharge Pipe Thermistor (DOT)

1. The discharge pipe thermistor is used to control the discharge pipe. If the temperature of discharge pipe (used in place of the inner temperature of the compressor) rises abnormally, the operating frequency drops or the operation must be halted.
2. The discharge pipe thermistor is used for detecting the discharge thermistor disconnected.

C Indoor Heat Exchanger Thermistor (DCN)

1. The indoor heat exchanger thermistor is used for controlling target discharge pipe temperature. Set a target discharge pipe temperature according to the outdoor and indoor heat exchanger temperature. Control the electronic expansion valve so that the target discharge pipe temperature can be obtained.
2. The indoor heat exchanger thermistor is used to prevent freezing. During the cooling operation, if the temperature drops abnormally, the operating frequency becomes lower, then the operation must be halted.
3. The indoor heat exchanger thermistor is used for anti-icing control. During the cooling operation, if the heat exchanger temperature in the room where operation is halted becomes -1°C , it is assumed as icing.
4. During heating: the indoor heat exchanger thermistor is used for detecting the discharge pipe thermistor disconnected. When the discharge pipe temperature become lower than an indoor heat exchanger temperature, a disconnected discharge pipe thermistor can be detected.

3. Control Specification

3.1 Mode Hierarchy

Outline

There are two modes; the mode selected in user's place (normal air conditioning mode) and forced operation mode for installation and providing service.

Detail

1. For heat pump model

There are following modes; stop, cooling (includes drying), heating (include defrosting)

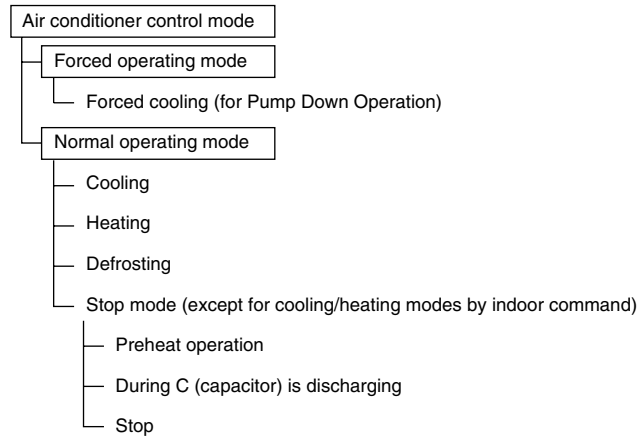

(R2829)



Note: Unless specified otherwise, an indoor dry operation command must be regarded as cooling operation.

3.2 Frequency Control

Outline

Frequency will be determined according to the difference between room and set temperature. The function is explained as follows.

1. How to determine frequency.
2. Frequency command from an indoor unit. (The difference between a room temperature and the temperature set by the remote controller.)
3. Frequency command from an indoor unit.
4. Frequency initial setting.
5. PI control.

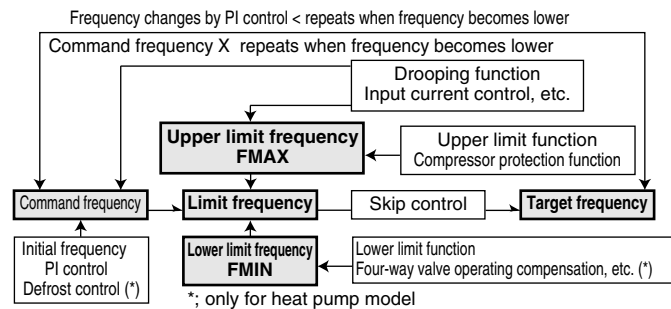

(R2831)

Detail

How to Determine Frequency

The compressor's frequency will finally be determined by taking the following steps.

For Heat Pump Model

1. Determine command frequency
 - Command frequency will be determined in the following order of priority.
 - 1.1 Limiting frequency by drooping function
 - Input current, discharge pipes, peak cutting, freeze-up protection, dew prevention, fin thermistor temperature.
 - 1.2 Limiting defrost control time
 - 1.3 Forced cooling
 - 1.4 Indoor frequency command
2. Determine upper limit frequency
 - Set a minimum value as an upper limit frequency among the frequency upper limits of the following functions:
 - Compressor protection, input current, discharge pipes, peak cutting, freeze-up protection, defrost.
3. Determine lower limit frequency
 - Set a maximum value as an lower limit frequency among the frequency lower limits of the following functions:
 - Four way valve operating compensation, draft prevention, pressure difference upkeep.
4. Determine prohibited frequency
 - There is a certain prohibited frequency such as a power supply frequency.

Indoor Frequency Command (ΔD signal)

The difference between a room temperature and the temperature set by the remote controller will be taken as the " ΔD signal" and is used for frequency command.

Temperature difference	ΔD signal	Temperature difference	ΔD signal	Temperature difference	ΔD signal	Temperature difference	ΔD signal
0	*Th OFF	2.0	4	4.0	8	6.0	C
0.5	1	2.5	5	4.5	9	6.5	D
1.0	2	3.0	6	5.0	A	7.0	E
1.5	3	3.5	7	5.5	B	7.5	F

*Th OFF = Thermostat OFF

Frequency Initial Setting

- Outline

When starting the compressor, or when conditions are varied due to the change of the room, the frequency must be initialized according to the ΔD value of the indoor unit and the Q value of the indoor unit.

Q value: Indoor unit output determined from indoor unit volume, air flow rate and other factors.

PI Control (Determine Frequency Up / Down by ΔD Signal)

1. P control

Calculate ΔD value in each sampling time (20 seconds), and adjust the frequency according to its difference from the frequency previously calculated.

2. I control

If the operating frequency is not change more than a certain fixed time, adjust the frequency up and down according to the ΔD value, obtaining the fixed ΔD value.

When the ΔD value is small...lower the frequency.

When the ΔD value is large...increase the frequency.

3. Frequency management when other controls are functioning

- When frequency is drooping;

Frequency management is carried out only when the frequency droops.

- For limiting lower limit

Frequency management is carried out only when the frequency rises.

4. Upper and lower limit of frequency by PI control

The frequency upper and lower limits are set depending on indoor unit.

When low noise commands come from the indoor unit or when outdoor unit low noise or quiet commands come from indoor unit, the upper limit frequency must be lowered than the usual setting.

3.3 Controls at Mode Changing / Start-up

3.3.1 Preheating Operation

Outline

Operate the inverter in the open phase operation with the conditions including the preheating command (only for heat pump model) from the discharge pipe temperature.

Detail**Preheating ON Condition**

- When the discharge pipe temperature is below 10°C, inverter in open phase operation starts.

OFF Condition

- When the discharge pipe temperature is higher than 12°C, inverter in open phase operation stops.

3.3.2 Four Way Valve Switching

Outline of Heating Operation

Heat Pump Only

During the heating operation current must be conducted and during cooling and defrosting current must not be conducted. In order to eliminate the switching sound (as the four way valve coil switches from ON to OFF) when the heating is stopped, the delay switch of the four way valve must be carried out after the operation stopped.

Detail

The OFF delay of four way valve
Energize the coil for 160 sec after unit operation is stopped.

3.3.3 Four Way Valve Operation Compensation

Outline

Heat Pump Only

At the beginning of the operation as the four way valve is switched, acquire the differential pressure required for activating the four way valve by having output the operating frequency, which is more than a certain fixed frequency, for a certain fixed time.

Detail

Starting Conditions

1. When starting compressor for heating.
 2. When the operating mode changes to cooling from heating.
 3. When starting compressor for rushing defrosting or resetting.
 4. When starting compressor for the first time after the reset with the power is ON.
 5. When starting compressor for heating next to the suspension of defrosting.
 6. When starting compressor next to the fault of switching over cooling / heating.
- Set the lower limit frequency to 68 (model by model) Hz for 45 seconds with any conditions 1 through 6 above.

3.3.4 3-minutes Standby

Prohibit to turn ON the compressor for 3 minutes after turning it off.
(Except when defrosting. (Only for Heat Pump Model).)

3.3.5 Compressor Protection Function

When turning the compressor from OFF to ON, the upper limit of frequency must be set as follows. (The function must not be used when defrosting (only for heat pump model).)

FCG 3	88
FCG 2	64
FCG 1	48
TCG 1	240
TCG 2	360
TCG 3	180

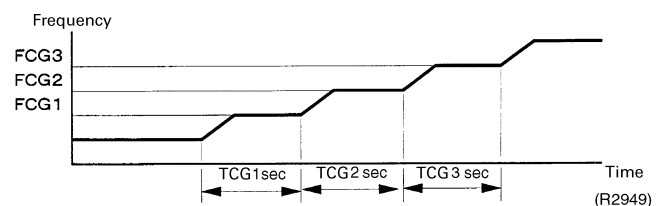

3.4 Discharge Pipe Control

Outline The discharge pipe temperature is used as the compressor's internal temperature. If the discharge pipe temperature rises above a certain level, the operating frequency upper limit is set to keep this temperature from going up further.

Detail **Divide the Zone**

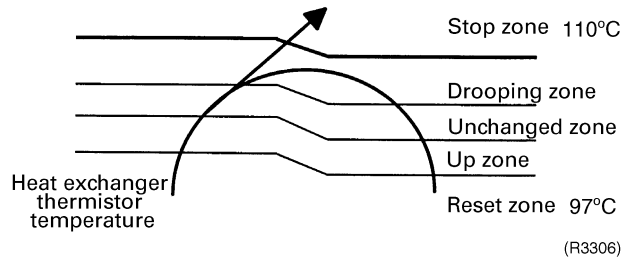

Management within the Zones

Zone	Control contents
Stop zone	When the temperature reaches the stop zone, stop the compressor and correct abnormality.
Drooping zone	Start the timer, and the frequency will be drooping.
Unchanged zone	Keep the upper limit of frequency.
Return / Reset zone	Cancel the upper limit of frequency.

3.5 Input Current Control

Outline Detect an input current by the CT during the compressor is running, and set the frequency upper limit from such input current. In case of heat pump model, this control is the upper limit control function of the frequency which takes priority of the lower limit of four way valve activating compensation.

Detail The frequency control will be made within the following zones.

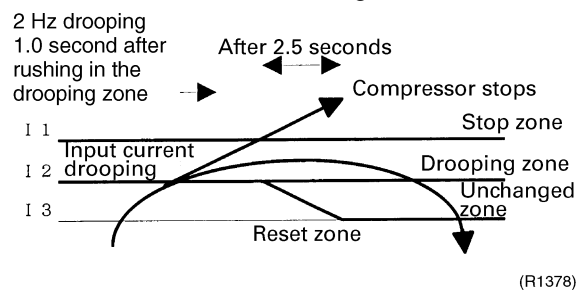

When a "stop current" continues for 2.5 seconds after rushing on the stop zone, the compressor operation stops.

If a "drooping current" is continues for 1.0 second after rushing on the drooping zone, the frequency will be 2 Hz drooping.

Repeating the above drooping continues until the current rushes on the drooping zone without change.

In the unchanged zone, the frequency limit will remain.

In the return / reset zone, the frequency limit will be cancelled.

Limitation of current drooping and stop value according to the outdoor air temperature

- In case the operation mode is cooling
 - The current droops when outdoor air temperature becomes higher than a certain level (model by model).
- In case the operation mode is heating (only for heat pump model)
 - The current droops when outdoor air temperature becomes higher than a certain level (model by model).

3.6 Freeze-up Protection Control

Outline During cooling operation, the signals being sent from the indoor unit allow the operating frequency limitation and then prevent freezing of the indoor heat exchanger. (The signal from the indoor unit must be divided into the zones as the followings.)

Detail

Conditions for Start Controlling

Judge the controlling start with the indoor heat exchanger temperature after 2 sec from operation start.

Control in Each Zone

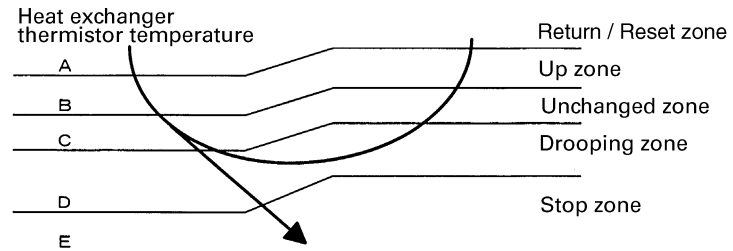

(R1379)

3.7 Heating Peak-cut Control

Outline

Heat Pump Only

During heating operation, the signals being sent from the indoor unit allow the operating frequency limitation and prevent abnormal high pressure. (The signal from the indoor unit must be divided as follows.)

Detail

Conditions for Start Controlling

Judge the controlling start with the indoor heat exchanger temperature after 2 sec. from operation start.

Control in Each Zone

The heat exchange intermediate temperature of indoor unit controls the following.

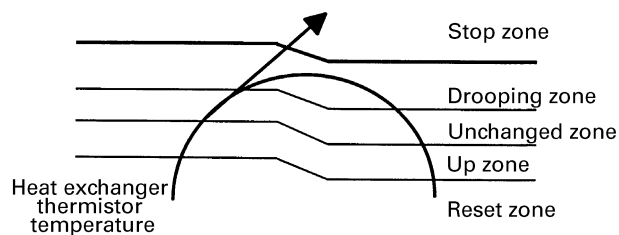

(R1380)

3.8 Fan Control

- Outline** Fan control is carried out according to the following priority.
1. Fan control when defrosting
 2. Fan OFF delay when stopped
 3. ON/OFF control when cooling operation
 4. Fan control when forced operation
 5. Fan control in low noise mode
 6. Fan control during heating operation
 7. Fan control in the quiet mode
 8. Fan control in the powerful mode
-

- Detail** **Fan OFF Control when Stopped**
- Fan OFF delay for 60 seconds must be made when the compressor is stopped.
-

3.9 Liquid Compression Protection Function 2

- Outline** In order to obtain the dependability of the compressor, the compressor must be stopped according to the conditions of the temperature of the outdoor air and outdoor heat exchanger.
-

- Detail**
- Operation stop depending on the outdoor air temperature
Compressor operation turns OFF under the conditions that the system is in cooling operation and outdoor air temperature is below 0°C.

3.10 Defrost Control

Outline

Heat Pump Only

Defrosting is carried out by the cooling cycle (reverse cycle). The defrosting time or outdoor heat exchanger temperature must be more than its fixed value when finishing.

Detail

Conditions for Starting Defrost

The starting conditions must be made with the outdoor air temperature and heat exchanger temperature. Under the conditions that the system is in heating operation, 6 minutes after the compressor is started and more than 44 minutes of accumulated time pass since the start of the operation or ending the defrosting.

Conditions for Canceling Defrost

The judgment must be made with heat exchanger temperature. (4°C~22°C)

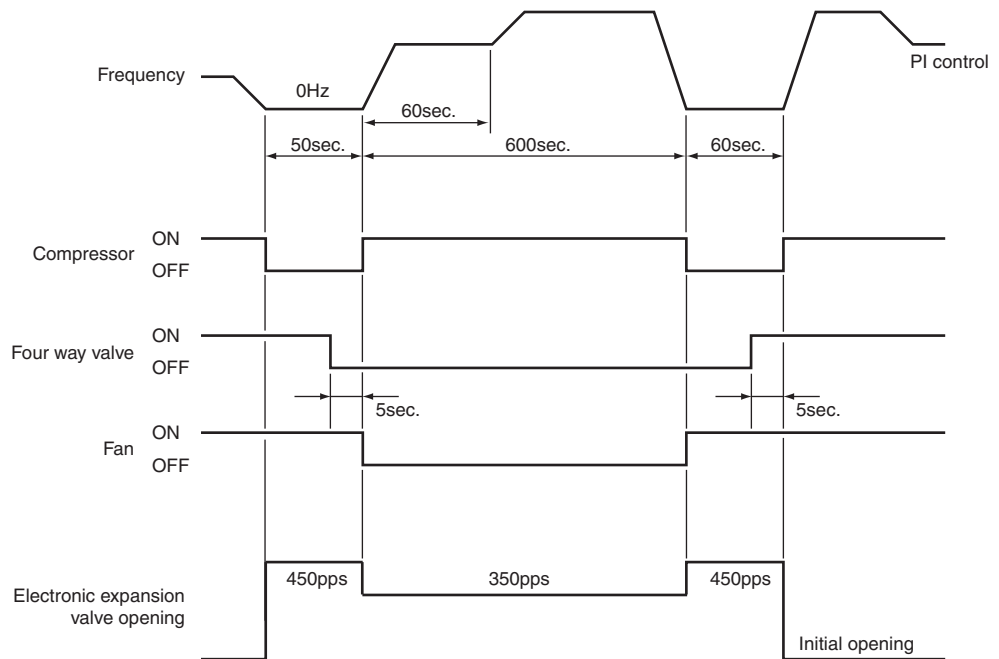

(R4084)

3.11 Electronic Expansion Valve Control

Outline

The following items are included in the electronic expansion valve control.

Electronic expansion valve is fully closed

1. Electronic expansion valve is fully closed when turning on the power.
2. Pressure equalizing control

Open Control

1. Electronic expansion valve control when starting operation
2. Control when frequency changed
3. Control for defrosting (only for heat pump model)
4. Control when a discharge pipe temperature is abnormally high
5. Control when the discharge pipe thermistor is disconnected

Feedback Control

1. Discharge pipe temperature control

Detail

The followings are the examples of control which function in each mode by the electronic expansion valve control.

Operation pattern		Control when frequency changed	Control for abnormally high discharge pipe temperature	
When power is turned ON	○ : function × : not function			
↓		Fully closed when power is turned ON	×	×
Cooling operation		Open control when starting	×	○
↓		(Control of target discharge pipe temperature)	○	○
Stop		Pressure equalizing control	×	×
Heating operation (only for heat pump model)		Open control when starting	×	○
↓		(Control of target discharge pipe temperature)	○	○
Stop		(Defrost control FD=1) (only for heat pump model)	×	×
Heating operation (only for heat pump model)		Pressure equalizing control	×	×
↓		Open control when starting	×	○
Control of discharge pipe thermistor disconnection		Continue	×	×
↓		Pressure equalizing control	×	×
Stop				

(R2833)

3.11.1 Fully Closing with Power ON

Initialize the electronic expansion valve when turning on the power, set the opening position and develop pressure equalizing.

3.11.2 Pressure Equalization Control

When the compressor is stopped, open and close the electronic expansion valve and develop pressure equalization.

3.11.3 Opening Limit

Outline

Limit a maximum and minimum opening of the electronic expansion valve.

Detail

- A maximum electronic expansion valve opening : 450 pulses
 - A minimum electronic expansion valve opening : 52 pulses
- The electronic expansion valve is fully closed in the room where cooling is stopped and is opened with fixed opening during defrosting.

3.11.4 Starting Operation Control

Control the electronic expansion valve opening when the system is starting, and prevent the system to be super heated or moistened.

3.11.5 High Temperature of the Discharge Pipe

When the compressor is operating, if the discharge pipe temperature exceeds a certain value, open the electronic expansion valve and remove the refrigerant to the low pressure side and lower discharge temperature.

3.11.6 Disconnection of the Discharge Pipe Thermistor

Outline

Detect a disconnected discharge pipe thermistor by comparing the discharge pipe temperature with the condensation temperature. If any is disconnected, open the electronic expansion valve according to the outdoor air temperature and the operating frequency and operate for a specified time, and then stop.

After 3 minutes of waiting, restart the unit and check if any is disconnected. If any is disconnected stop the system after operating for a specified time. If the disconnection is detected 4 times in succession, then the system will be down.

Detail

Detect Disconnection

If the timer for open control (cooling : 12min., heating : 15min.) becomes over, and the 9-minute timer for the compressor operation continuation is not counting time, the following adjustment must be made.

1. When the operation mode is cooling
When the discharge pipe temperature is lower than the outdoor heat exchanger temperature, the discharge pipe thermistor disconnection must be ascertained.
2. When the operation mode is heating (only for heat pump model)
When the discharge pipe temperature is lower than the max temperature of indoor unit heat exchanger, the discharge pipe thermistor disconnection must be ascertained.

Adjustment when the thermistor is disconnected

When compressor stop repeats specified time, the system should be down.

3.11.7 Control when frequency is changed

When the target discharge pipe temperature control is active, if the target frequency is changed for a specified value in a certain time period, cancel the target discharge pipe temperature control and change the target opening of the electronic expansion valve according to the shift.

3.11.8 Target Discharge Pipe Temperature Control

Obtain the target discharge pipe temperature from the indoor and outdoor heat exchanger temperature, and adjust the electronic expansion valve opening so that the actual discharge pipe temperature become close to that temperature. (Indirect SH control using the discharge pipe temperature)

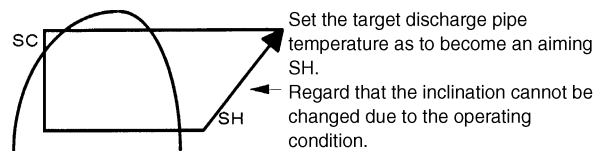

(R1389)

Determine a correction value of the electronic expansion valve compensation and drive it according to the deflection of the target discharge temperature and actual discharge temperature, and the discharge temperature variation by the 20 sec.

3.12 Malfunctions

3.12.1 Sensor Malfunction Detection

Sensor malfunction may occur in the thermistor.

Relating to Thermistor Malfunction

1. Outdoor heat exchanger thermistor
2. Discharge pipe thermistor
3. Fin thermistor
4. Outdoor air thermistor

3.12.2 Detection of Overload and Over Current

Outline

In order to protect the inverter, detect an excessive output current, and for protecting compressor, monitor the OL operation.

Detail

- If the OL (compressor head) temperature exceeds 120°C (depending on the model), the compressor gets interrupted.
- If the inverter current exceeds 22 A, the compressor gets interrupted too.

3.12.3 Insufficient Gas Control

Outline

There are three ways of control to detect insufficient gas.

I Detecting by power consumption

If the power consumption is below the specified value and the frequency is higher than the specified frequency, it is regarded as insufficient gas.

The power consumption is weak comparing with that in the normal operation when gas is insufficient, and gas insufficiency is detected by checking a power consumption.

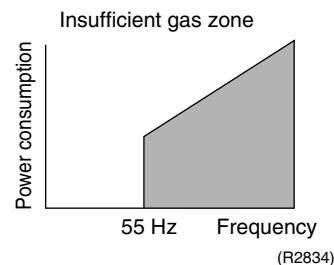

II Detecting by discharge pipe temperature

If the discharge temperature is higher than the target discharge pipe temperature, and the electronic expansion valve is fully open (450 pulses) more than the specified time, it is regarded as insufficient gas.

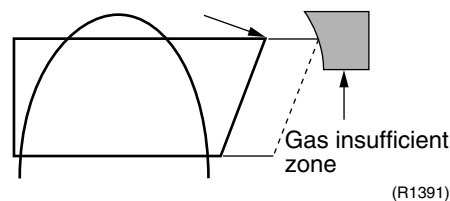

III Detecting by the difference of temperature

If the difference between inhale and exhale temperature is smaller than the specified value, it is regarded as insufficient gas.

Detail**I Judgment by power consumption**

When an output frequency is exceeds 55 Hz and the input current is less than specified value, the adjustment is made for insufficient gas.

II Judgment by discharge pipe temperature

When discharge pipe temperature is 20°C higher than target value and the electronic expansion valve opening is 450 pulses (max.), the adjustment is made for insufficient gas.

III Judgment by the difference of temperature

When the difference of the temperature is smaller than Δ , it is regarded as insufficient gas.

		Δ
Cooling	room temperature – indoor heat exchanger temperature	4.0°C
	outdoor heat exchanger temperature – outdoor temperature	4.0°C
Heating	indoor heat exchanger temperature – room temperature	4.0°C
	outdoor temperature – outdoor heat exchanger temperature	3.0°C

3.13 Forced Operation Mode

Outline

Forced operating mode includes only forced cooling.

Detail**Forced Cooling**

Item	Forced Cooling
Forced operation allowing conditions	1) The outdoor unit is not abnormal and not in the 3-minute stand-by mode. 2) The operating mode of the outdoor unit is the stop mode. 3) The forced operation is ON. The forced operation is allowed when the above “and” conditions are met.
Starting/adjustment	If the forced operation switch is pressed as the above conditions are met.
1) Command frequency	■ 68 Hz
2) Electronic expansion valve opening	■ Depending on the capacity of the indoor unit.
3) Outdoor unit adjustment	■ Compressor is in operation
4) Indoor unit adjustment	■ Transmit the command of forced draft to the indoor unit.
End	1) When the forced operation switch is pressed again. 2) The operation is to end automatically after 15 min.
Others	The protect functions are prior to all others in the forced operation.

3.14 Additional Function

3.14.1 Powerful Operation Mode

Compressor operating frequency is increased to P1 Max. (Max. Hz of operating room) and outdoor unit airflow rate is increased.

3.14.2 Voltage Detection Function

Power supply voltage is detected each time equipment operation starts.

Part 5

System Configuration

1. System Configuration.....	42
2. Instruction.....	43
2.1 Safety Precautions	43
2.2 Names of Parts.....	45
2.3 Preparation before Operation.....	48
2.4 AUTO · DRY · COOL · HEAT · FAN Operation	51
2.5 Adjusting the Air Flow Direction	53
2.6 POWERFUL Operation	55
2.7 OUTDOOR UNIT SILENT Operation	56
2.8 INTELLIGENT EYE Operation	57
2.9 TIMER Operation	59
2.10 Care and Cleaning	61
2.11 Troubleshooting.....	64

1. System Configuration



After the installation and test operation of the room air conditioner have been completed, it should be operated and handled as described below. Every user would like to know the correct method of operation of the room air conditioner, to check if it is capable of cooling (or heating) well, and to know a clever method of using it.

In order to meet this expectation of the users, giving sufficient explanations taking enough time can be said to reduce about 80% of the requests for servicing. However good the installation work is and however good the functions are, the customer may blame either the room air conditioner or its installation work because of improper handling. The installation work and handing over of the unit can only be considered to have been completed when its handling has been explained to the user without using technical terms but giving full knowledge of the equipment.

2. Instruction

2.1 Safety Precautions

- Keep this manual where the operator can easily find them.
- Read this manual attentively before starting up the unit.
- For safety reason the operator must read the following cautions carefully.
- This manual classifies precautions into WARNINGS and CAUTIONS. Be sure to follow all precautions below: they are all important for ensuring safety.

 WARNING If you do not follow these instructions exactly, the unit may cause property damage, personal injury or loss of life.	 CAUTION If you do not follow these instructions exactly, the unit may cause minor or moderate property damage or personal injury.
---	--



Never do.



Be sure to follow the instructions.



Be sure to earth the air conditioner.





Never cause the air conditioner (including the remote controller) to get wet.



Never touch the air conditioner (including the remote controller) with a wet hand.





WARNING

- In order to avoid fire, explosion or injury, do not operate the unit when harmful, among which flammable or corrosive gases, are detected near the unit. 
 - It is not good for health to expose your body to the air flow for a long time.
 - Do not put a finger, a rod or other objects into the air outlet or inlet. As the fan is rotating at a high speed, it will cause injury.
 - Do not attempt to repair, relocate, modify or reinstall the air conditioner by yourself. Incorrect work will cause electric shocks, fire etc.
For repairs and reinstallation, consult your Daikin dealer for advice and information.
 - Do not insert fingers, poles, or other objects into the moving parts of the top front panel or the bottom front panel.
-
- The refrigerant used in the air conditioner is safe. Although leaks should not occur, if for some reason any refrigerant happens to leak into the room, make sure it does not come in contact with any flame as of gas heaters, kerosene heaters or gas range. 
 - If the air conditioner is not cooling (heating) properly, the refrigerant may be leaking, so call your dealer. When carrying out repairs accompanying adding refrigerant, check the content of the repairs with our service staff.
 - Do not attempt to install the air conditioner by your self. Incorrect work will result in water leakage, electric shocks or fire. For installation, consult the dealer or a qualified technician.
 - In order to avoid electric shock, fire or injury, if you detect any abnormally such as smell of fire, stop the operation and turn off the breaker. And call your dealer for instructions.



CAUTION

- The air conditioner must be earthed. Incomplete earthing may result in electric shocks. Do not connect the earth line to a gas pipe, water pipe, lightning rod, or a telephone earth line. 
-
- In order to avoid any quality deterioration, do not use the unit for cooling precision instruments, food, plants, animals or works of art. 
 - Never expose little children, plants or animals directly to the air flow.
 - Do not place appliances which produce open fire in places exposed to the air flow from the unit or under the indoor unit. It may cause incomplete combustion or deformation of the unit due to the heat.

- Do not block air inlets nor outlets. Impaired air flow may result in insufficient performance or trouble.
- Do not stand or sit on the outdoor unit. Do not place any object on the unit to avoid injury, do not remove the fan guard.
- Do not place anything under the indoor or outdoor unit that must be kept away from moisture. In certain conditions, moisture in the air may condense and drip.
- After a long use, check the unit stand and fittings for damage.
- Do not touch the air inlet and aluminum fins of outdoor unit. It may cause injury.
- The appliance is not intended for use by young children or infirm persons without supervision.
- Young children should be supervised to ensure that they do not play with the appliance.

-
- To avoid oxygen deficiency, ventilate the room sufficiently if equipment with burner is used together with the air conditioner. 
 - Before cleaning, be sure to stop the operation, turn the breaker off or pull out the supply cord.
 - Do not connect the air conditioner to a power supply different from the one as specified. It may cause trouble or fire.
 - Depending on the environment, an earth leakage breaker must be installed. Lack of an earth leakage breaker may result in electric shocks.
 - Arrange the drain hose to ensure smooth drainage. Incomplete draining may cause wetting of the building, furniture etc.

-
- Do not operate the air conditioner with wet hands. 

-
- Do not wash the indoor unit with excessive water, only use a slightly wet cloth.
 - Do not place things such as vessels containing water or anything else on top of the unit. Water may penetrate into the unit and degrade electrical insulations, resulting in an electric shock. 

Installation site

- To install the air conditioner in the following types of environments, consult the dealer.
 - Places with an oily ambient or where steam or soot occurs.
 - Salty environment such as coastal areas.
 - Places where sulfide gas occurs such as hot springs.
 - Places where snow may block the outdoor unit.

The drain from the outdoor unit must be discharged to a place of good drainage.

Consider nuisance to your neighbours from noises

- For installation, choose a place as described below.
 - A place solid enough to bear the weight of the unit which does not amplify the operation noise or vibration.
 - A place from where the air discharged from the outdoor unit or the operation noise will not annoy your neighbours.

Electrical work

- For power supply, be sure to use a separate power circuit dedicated to the air conditioner.

System relocation

- Relocating the air conditioner requires specialized knowledge and skills. Please consult the dealer if relocation is necessary for moving or remodeling

2.2 Names of Parts

■ Indoor Unit

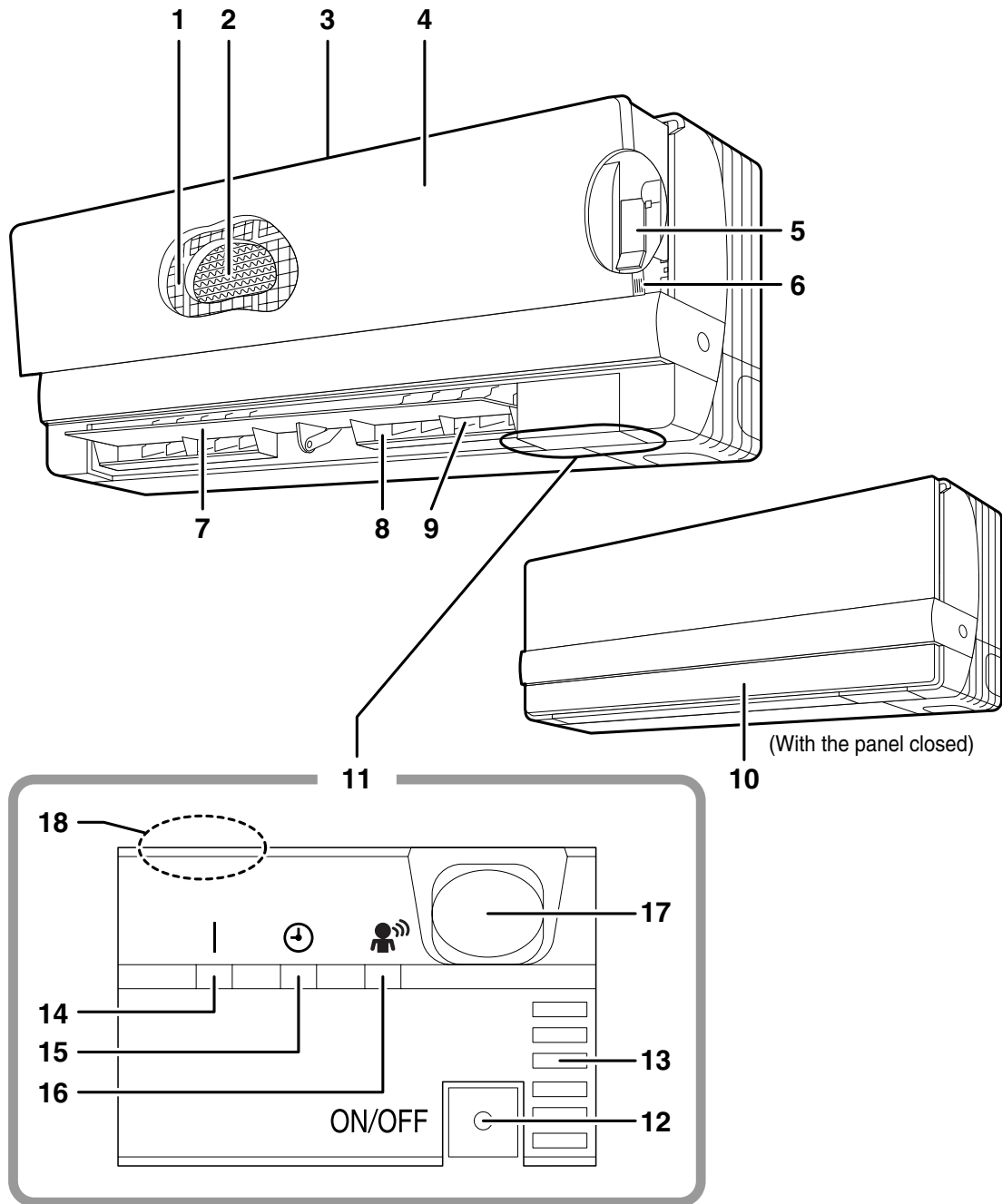

Outdoor Unit

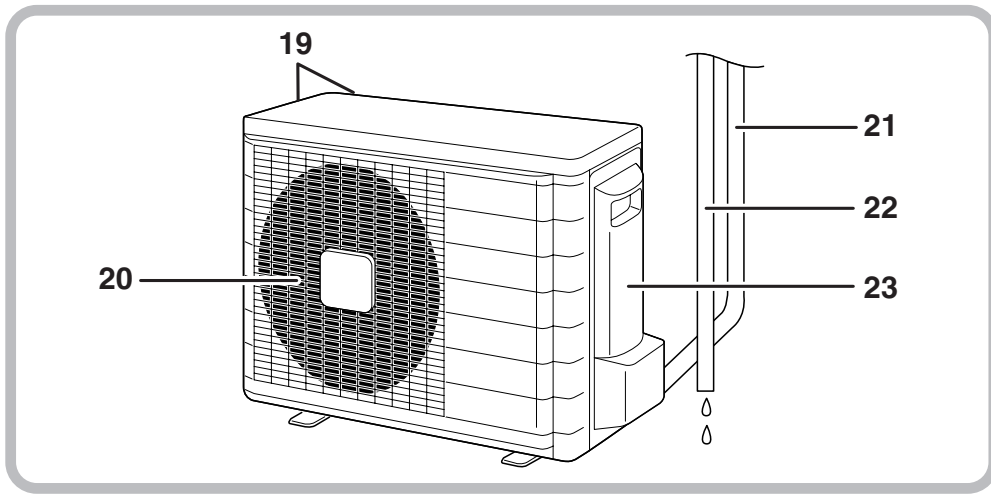

Indoor Unit

1. **Air filter**
2. **Titanium Apatite Photocatalytic Air-Purifying Filter:**
 - These filters are attached to the inside of the air filters.
3. **Air inlet**
4. **Top front panel**
5. **Supporting plate:**
 - The supporting plate is used to support the front panel during maintenance.
6. **Panel tab**
7. **Flap (horizontal blade):** (page 12.)
8. **Air outlet**
9. **Louvers (vertical blades):**
 - The louvers are inside of the air outlet. (page 12.)
10. **Bottom front panel**
11. **Display**
12. **Indoor Unit ON/OFF switch:** (page 10.)
 - Push this switch once to start operation. Push once again to stop it.

- The operation mode refers to the following table.

	Mode	Temperature setting	Air flow rate
FTXG	AUTO	25°C	AUTO

- This switch is useful when the remote controller is missing.
13. **Room temperature sensor:**
 - It senses the air temperature around the unit.
 14. **Operation lamp (green)**
 15. **TIMER lamp (yellow):** (page 18.)
 16. **INTELLIGENT EYE lamp (green):** (page 16.)
 17. **INTELLIGENT EYE sensor:**
 - It detects the movements of people and automatically switches between normal operation and energy saving operation. (page 16.)
 18. **Signal receiver:**
 - It receives signals from the remote controller.
 - When the unit receives a signal, you will hear a short beep.
 - Operation startbeep-beep
 - Settings changed.....beep
 - Operation stopbeeeeeeep

Outdoor Unit

19. **Air inlet:** (Back and side)
20. **Air outlet**
21. **Refrigerant piping and inter-unit cable**
22. **Drain hose**
23. **Earth terminal:**
 - It is inside of this cover.

Appearance of the outdoor unit may differ from some models.

■ Remote Controller

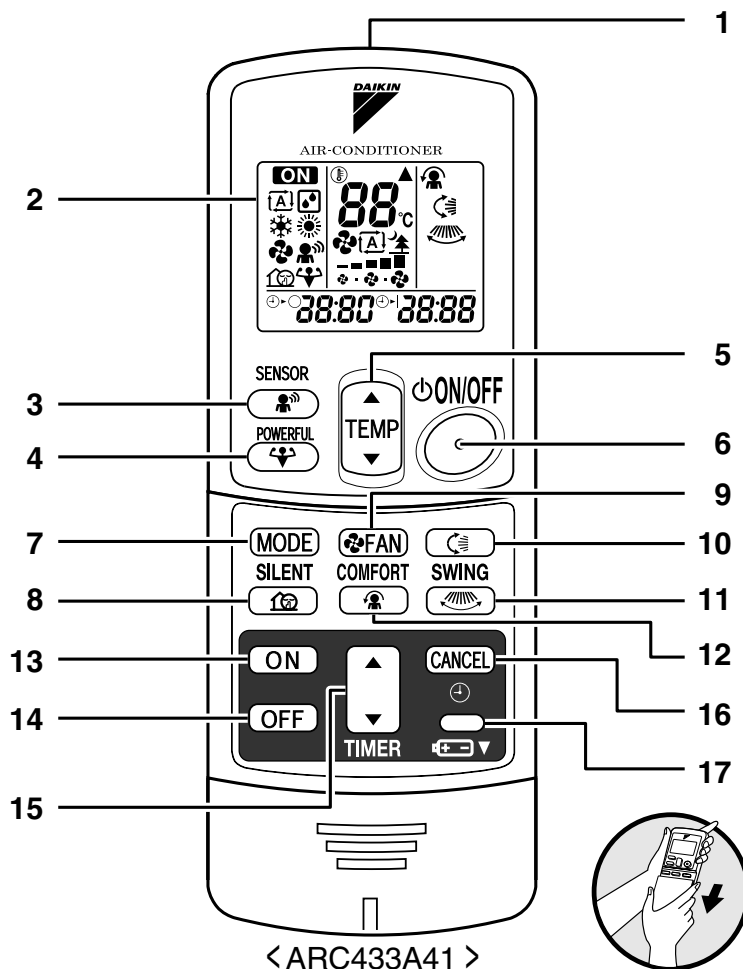

<ARC433A41 >

- 1. Signal transmitter:**
 - It sends signals to the indoor unit.
- 2. Display:**
 - It displays the current settings.
(In this illustration, each section is shown with all its displays ON for the purpose of explanation.)
- 3. SENSOR button:** for INTELLIGENT EYE operation (page 16.)
- 4. POWERFUL button:** for POWERFUL operation (page 14.)
- 5. TEMPERATURE adjustment buttons:**
 - It changes the temperature setting.
- 6. ON/OFF button:**
 - Press this button once to start operation.
Press once again to stop it.
- 7. MODE selector button:**
 - It selects the operation mode.
(AUTO/DRY/COOL/HEAT/FAN) (page 10.)
- 8. SILENT button:** for OUTDOOR UNIT SILENT operation (page 15.)
- 9. FAN setting button:**
 - It selects the air flow rate setting.
- 10. SWING button:** (page 12.)
 - Flap (Horizontal blade)
- 11. SWING button:** (page 12.)
 - Louvers (Vertical blades)
- 12. COMFORT AIRFLOW mode button:** (page 13.)
- 13. ON TIMER button:** (page 19.)
- 14. OFF TIMER button:** (page 18.)
- 15. TIMER Setting button:**
 - It changes the time setting.
- 16. TIMER CANCEL button:**
 - It cancels the timer setting.
- 17. CLOCK button:** (page 9.)

2.3 Preparation before Operation

■ To set the batteries

1. Press  with a finger and slide the front cover to take it off.
2. Set two dry batteries (AAA).
3. Set the front cover as before.

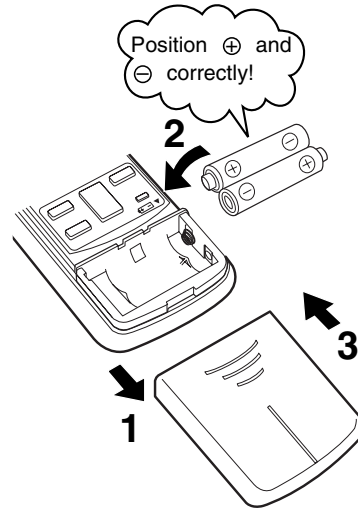

ATTENTION

■ About batteries

- When replacing the batteries, use batteries of the same type, and replace the two old batteries together.
- When the system is not used for a long time, take the batteries out.
- We recommend replacing once a year, although if the remote controller display begins to fade or if reception deteriorates, please replace with new alkali batteries. Using manganese batteries reduces the lifespan.
- The attached batteries are provided for the initial use of the system.
The usable period of the batteries may be short depending on the manufactured date of the air conditioner.

■ To operate the remote controller

- To use the remote controller, aim the transmitter at the indoor unit. If there is anything to block signals between the unit and the remote controller, such as a curtain, the unit will not operate.
- Do not drop the remote controller. Do not get it wet.
- The maximum distance for communication is about 7 m.

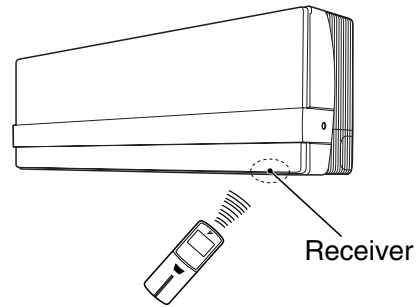

■ To fix the remote controller holder on the wall

1. Choose a place from where the signals reach the unit.
2. Fix the holder to a wall, a pillar, or similar location with the screws procured locally.
3. Place the remote controller in the remote controller holder.

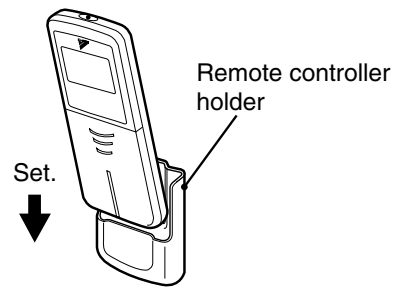

- To remove, pull it upwards.

■ Turn on the power breaker

- Turning on the power breaker will cause the panel and flap to open once and then close again. (This is a normal procedure.)

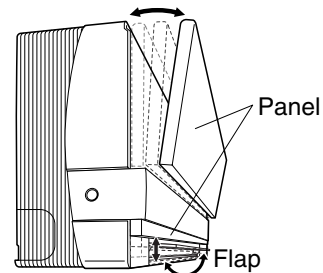

⚠ CAUTION

- During operation (i.e. when the panel is open or being opened or closed), do not touch the panel with your hands.

ATTENTION

■ About remote controller

- Never expose the remote controller to direct sunlight.
- Dust on the signal transmitter or receiver will reduce the sensitivity. Wipe off dust with soft cloth.
- Signal communication may be disabled if an electronic-starter-type fluorescent lamp (such as inverter-type lamps) is in the room. Consult the shop if that is the case.
- If the remote controller signals happen to operate another appliance, move that appliance to somewhere else, or consult the shop.

■ To set the clock

1. Press “CLOCK button”.

0:00 is displayed.

⌚ blinks.

2. Press “TIMER setting button” to set the clock to the present time.

Holding down “▲” or “▼” button rapidly increases or decreases the time display.

3. Press “CLOCK button”.

⌚ blinks.

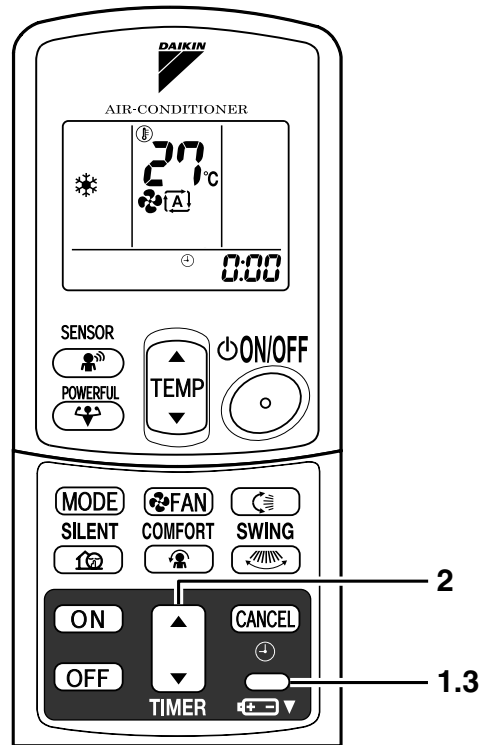

NOTE

■ Tips for saving energy

- Be careful not to cool (heat) the room too much. Keeping the temperature setting at a moderate level helps save energy.
- Cover windows with a blind or a curtain. Blocking sunlight and air from outdoors increases the cooling (heating) effect.
- Clogged air filters cause inefficient operation and waste energy. Clean them once in about every two weeks.

Recommended temperature setting

For cooling: 26°C – 28°C
For heating: 20°C – 24°C

■ Please note

- The air conditioner always consumes 15-35 watts of electricity even while it is not operating.
- If you are not going to use the air conditioner for a long period, for example in spring or autumn, turn the breaker OFF.
- Use the air conditioner in the following conditions.

Mode	Operating conditions	If operation is continued out of this range
COOL	Outdoor temperature: 10 to 46 °C Indoor temperature: 18 to 32 °C Indoor humidity: 80% max.	<ul style="list-style-type: none"> • A safety device may work to stop the operation. • Condensation may occur on the indoor unit and drip.
HEAT	Outdoor temperature: -15 to 21 °C Indoor temperature: 10 to 30 °C	<ul style="list-style-type: none"> • A safety device may work to stop the operation.
DRY	Outdoor temperature: 10 to 46 °C Indoor temperature: 18 to 32 °C Indoor humidity: 80% max.	<ul style="list-style-type: none"> • A safety device may work to stop the operation. • Condensation may occur on the indoor unit and drip.

- Operation outside this humidity or temperature range may cause a safety device to disable the system.

2.4 AUTO · DRY · COOL · HEAT · FAN Operation

The air conditioner operates with the operation mode of your choice.
 From the next time on, the air conditioner will operate with the same operation mode.

■ To start operation

1. Press “MODE selector button” and select a operation mode.

- Each pressing of the button advances the mode setting in sequence.

: AUTO

: DRY

: COOL

: HEAT

: FAN



2. Press “ON/OFF button” .

- The operation lamp will light up and the panel will open.

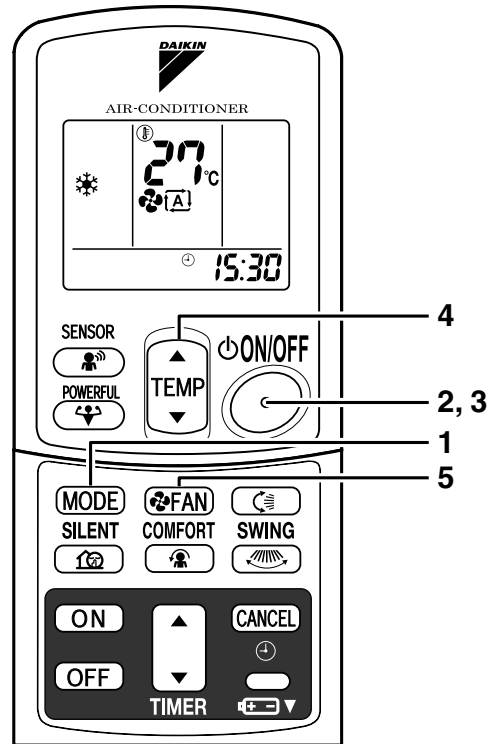
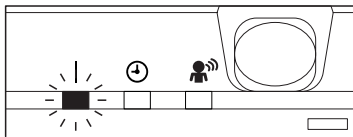

■ To stop operation

3. Press “ON/OFF button” again.

- The operation lamp will go off and the panel will close.





■ To change the temperature setting

4. Press “TEMPERATURE adjustment button”

DRY or FAN mode	AUTO or COOL or HEAT mode
The temperature setting is not variable.	Press “▲” to raise the temperature and press “▼” to lower the temperature.
	Set to the temperature you like.

■ To change the air flow rate setting

5. Press “FAN setting button”.

DRY mode	AUTO or COOL or HEAT or FAN mode
The air flow rate setting is not variable.	Five levels of air flow rate setting from “  ” to “  ” plus “  ” “  ” are available. 

- Indoor unit quiet operation

When the air flow is set to “”, the noise from the indoor unit will become quieter. Use this when making the noise quieter.

The unit might lose capacity when the air flow rate is set to a weak level.

NOTE

■ Note on HEAT operation

- Since this air conditioner heats the room by taking heat from outdoor air to indoors, the heating capacity becomes smaller in lower outdoor temperatures. If the heating effect is insufficient, it is recommended to use another heating appliance in combination with the air conditioner.
- The heat pump system heats the room by circulating hot air around all parts of the room. After the start of heating operation, it takes some time before the room gets warmer.
- In heating operation, frost may occur on the outdoor unit and lower the heating capacity. In that case, the system switches into defrosting operation to take away the frost.
- During defrosting operation, hot air does not flow out of indoor unit.

■ Note on DRY operation

- The computer chip works to rid the room of humidity while maintaining the temperature as much as possible. It automatically controls temperature and air flow rate, so manual adjustment of these functions is unavailable.

■ Note on AUTO operation

- In AUTO operation, the system selects an appropriate operation mode (COOL or HEAT) based on the room temperature at the start of the operation.
- The system automatically reselects setting at a regular interval to bring the room temperature to user-setting level.
- If you do not like AUTO operation, you can manually select the operation mode and setting you like.



■ Note on air flow rate setting

- At smaller air flow rates, the cooling (heating) effect is also smaller.

2.5 Adjusting the Air Flow Direction



You can adjust the air flow direction to increase your comfort.

■ To adjust the horizontal blade (flap)

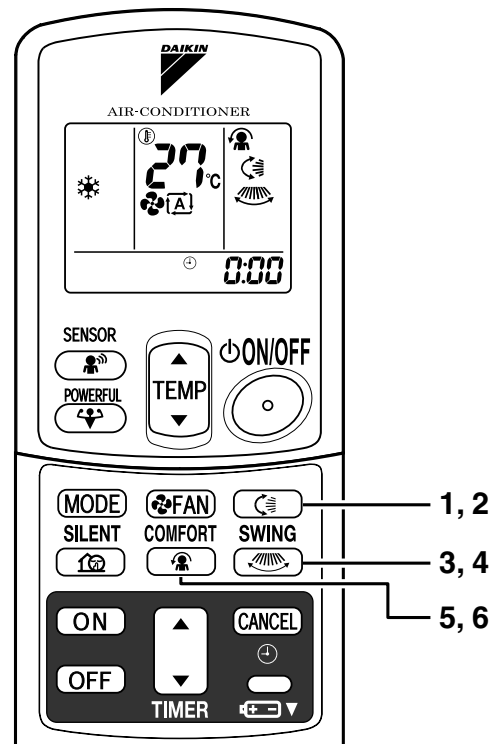
1. Press “SWING button - “- The flap will stop moving.



■ To adjust the vertical blades (louvers)

3. Press “SWING button - “- The louvers will stop moving.

■ To 3-D Airflow

1. 3. Press the “SWING button 

■ To cancel 3-D Airflow

2. 4. Press either the “SWING button 12

■ To start COMFORT AIRFLOW operation

5. Press “COMFORT AIRFLOW button”.

The flap orientation will change, preventing air from blowing directly on the occupants of the room.

- “” is displayed on the LCD.

〈COOL/DRY〉 The flap will go up.

〈HEAT〉 The flap will go down.

■ To cancel COMFORT AIRFLOW operation

6. Press “COMFORT AIRFLOW button” again.

Note

- When “**SWING button** ” is selected, the flap swinging range depends on the operation mode. (See the figure.)

Three-Dimensional (3-D) Airflow

- Using three-dimensional airflow circulates cold air, which tends to be collected at the bottom of the room, and hot air, which tends to collect near the ceiling, throughout the room, preventing areas of cold and hot developing.

Comfort Airflow

- The air flow is set automatically.
- The air direction is as shown in the figure at right.

■ ATTENTION

- Always use a remote controller to adjust the flap angle. If you attempt to move it forcibly with hand when it is swinging, the mechanism may be broken.
- Always use a remote controller to adjust the louvers angles.

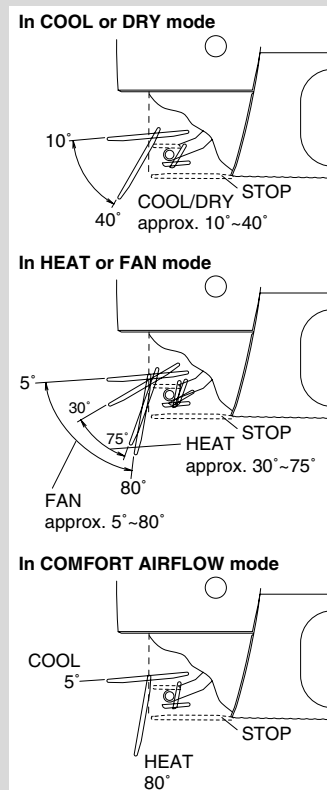

2.6 POWERFUL Operation

POWERFUL operation quickly maximizes the cooling (heating) effect in any operation mode. You can get the maximum capacity .

■ To start POWERFUL operation

1. Press “POWERFUL button”.
 - POWERFUL operation ends in 20 minutes. Then the system automatically operates again with the settings which were used before POWERFUL operation.
 - When using POWERFUL operation, there are some functions which are not available.
 - “” is displayed on the LCD.

■ To cancel POWERFUL operation

2. Press “POWERFUL button” again.

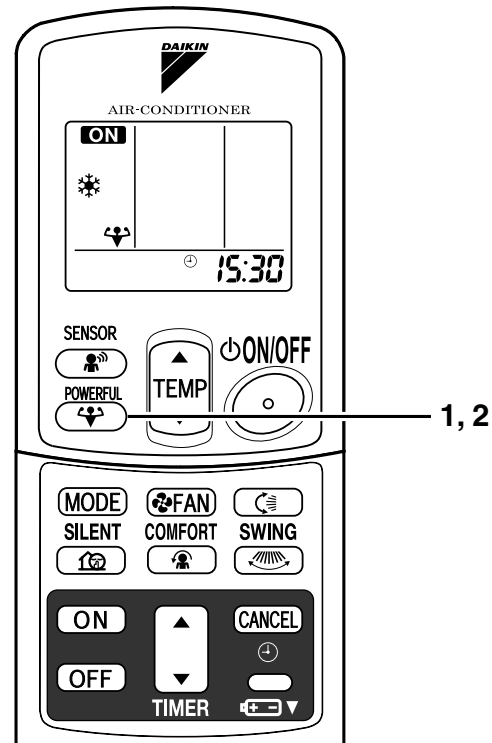

NOTE

■ Notes on POWERFUL operation

- **In COOL and HEAT mode**
To maximize the cooling (heating) effect, the capacity of outdoor unit must be increased and the air flow rate be fixed to the maximum setting. The temperature and air flow settings are not variable.
- **In DRY mode**
The temperature setting is lowered by 2.5°C and the air flow rate is slightly increased.
- **In FAN mode**
The air flow rate is fixed to the maximum setting.
- POWERFUL operation and COMFORT AIR FLOW cannot be used at the same time. The operation selected last is given priority.

2.7 OUTDOOR UNIT SILENT Operation

OUTDOOR UNIT SILENT operation lowers the noise level of the outdoor unit by changing the frequency and fan speed on the outdoor unit. This function is convenient during night.

■ To start OUTDOOR UNIT SILENT operation

1. Press “SILENT button”.
 - “” is displayed on the LCD.

■ To cancel OUTDOOR UNIT SILENT operation

2. Press “SILENT button” again.

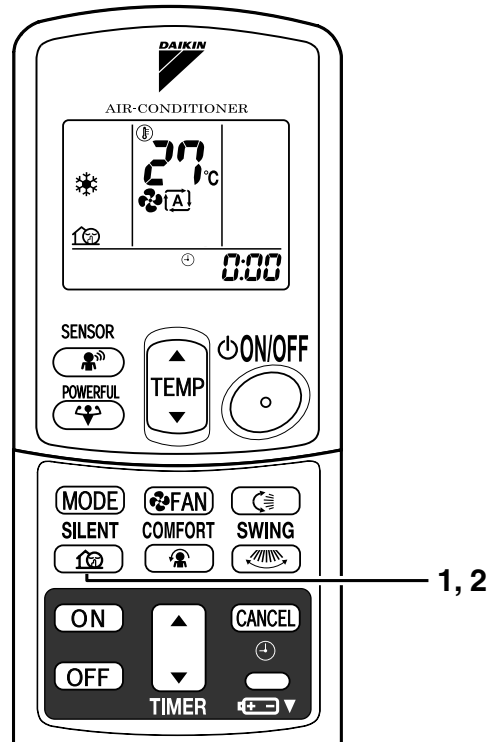

NOTE

■ Note on OUTDOOR UNIT SILENT operation

- This function is available in COOL, HEAT, and AUTO modes. (This is not available in FAN and DRY mode.)
- POWERFUL operation and OUTDOOR UNIT SILENT operation cannot be used at the same time. Priority is given to POWERFUL operation.
- If operation is stopped using the remote controller or the main unit ON/OFF switch when using OUTDOOR UNIT SILENT operation, “” will remain on the remote controller display.

2.8 INTELLIGENT EYE Operation

“INTELLIGENT EYE” is the infrared sensor which detects the human movement.

■ To start INTELLIGENT EYE operation

1. Press “SENSOR button”.
 - “” is displayed on the LCD.

■ To cancel the INTELLIGENT EYE operation

2. Press “SENSOR button” again.

[EX.]

When somebody in the room

- Normal operation.
- The INTELLIGENT EYE lamp lights up.

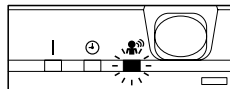

When nobody in the room

- 20 min. after, start energy saving operation.
- The INTELLIGENT EYE lamp goes off.

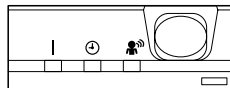

Somebody back in the room

- Back to normal operation.
- The INTELLIGENT EYE lamp lights up.

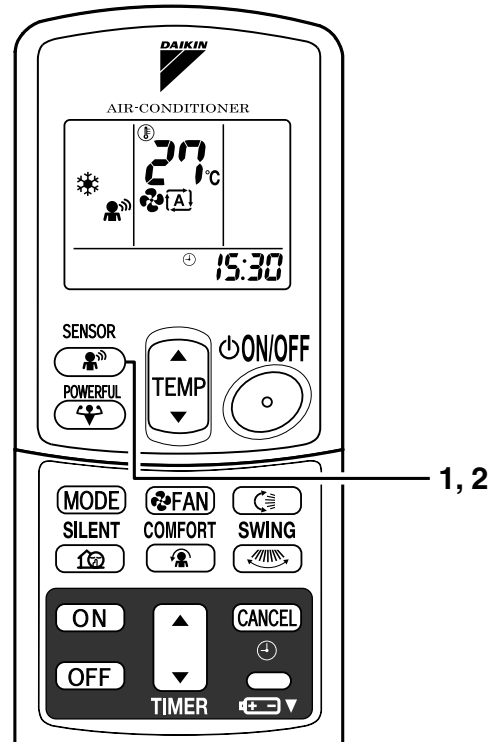
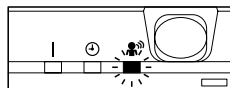

“INTELLIGENT EYE” is useful for Energy Saving

■ Energy saving operation

- Change the temperature -2°C in heating / $+2^{\circ}\text{C}$ in cooling / $+2^{\circ}\text{C}$ in dry mode from set temperature.
- Decrease the air flow rate slightly in fan operation. (In FAN mode only)

Notes on “INTELLIGENT EYE”

- Application range is as follows.

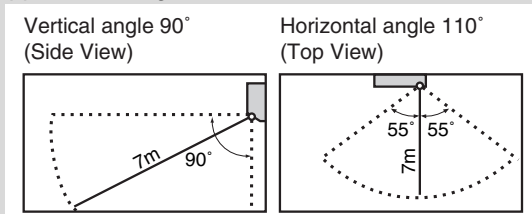

- Sensor may not detect moving objects further than 7m away. (Check the application range)
- Sensor detection sensitivity changes according to indoor unit location, the speed of passersby, temperature range, etc.
- The sensor also mistakenly detects pets, sunlight, fluttering curtains and light reflected off of mirrors as passersby.
- INTELLIGENT EYE operation will not go on during powerful operation.
- Night set mode (page 18.) will not go on during you use INTELLIGENT EYE operation.

CAUTION

- Do not place large objects near the sensor.
Also keep heating units or humidifiers outside the sensor's detection area. This sensor can detect objects it shouldn't as well as not detect objects it should.
- Do not hit or violently push the INTELLIGENT EYE sensor. This can lead to damage and malfunction.

2.9 TIMER Operation

Timer functions are useful for automatically switching the air conditioner on or off at night or in the morning. You can also use OFF TIMER and ON TIMER in combination.

■ To use OFF TIMER operation

- Check that the clock is correct. If not, set the clock to the present time. (page 9.)

1. Press “OFF TIMER button”.

0:00 is displayed.

⊕-⊖ blinks.

2. Press “TIMER Setting button” until the time setting reaches the point you like.

- Every pressing of either button increases or decreases the time setting by 10 minutes. Holding down either button changes the setting rapidly.

3. Press “OFF TIMER button” again.

- The TIMER lamp lights up.

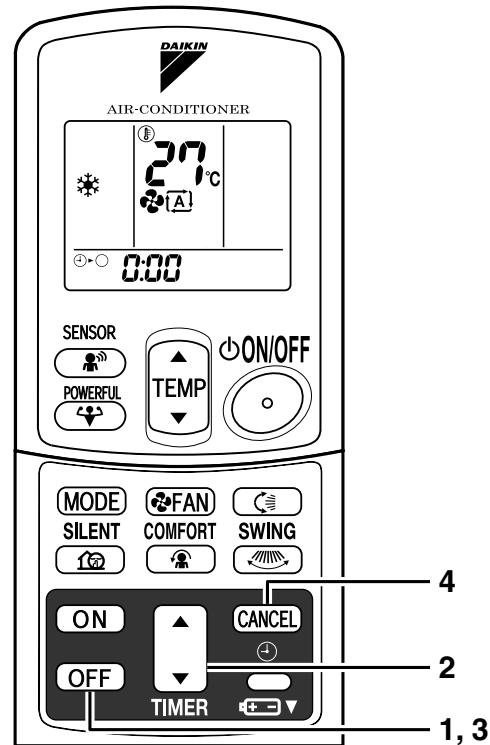
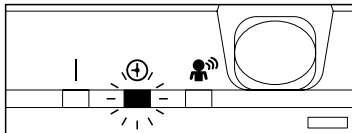

■ To cancel the OFF TIMER operation

4. Press “CANCEL button”.

- The TIMER lamp goes off.

Notes

- When TIMER is set, the present time is not displayed.
- Once you set ON, OFF TIMER, the time setting is kept in the memory. (The memory is canceled when remote controller batteries are replaced.)
- When operating the unit via the ON/OFF Timer, the actual length of operation may vary from the time entered by the user.

■ NIGHT SET MODE

When the OFF TIMER is set, the air conditioner automatically adjusts the temperature setting (0.5°C up in COOL, 2.0°C down in HEAT) to prevent excessive cooling (heating) for your pleasant sleep.

■ To use ON TIMER operation

- Check that the clock is correct. If not, set the clock to the present time (page 9.).

1. Press “ON TIMER button”.

6:00 is displayed.

⊕ blinks.

2. Press “TIMER Setting button” until the time setting reaches the point you like.

- Every pressing of either button increases or decreases the time setting by 10 minutes. Holding down either button changes the setting rapidly.

3. Press “ON TIMER button” again.

- The TIMER lamp lights up.

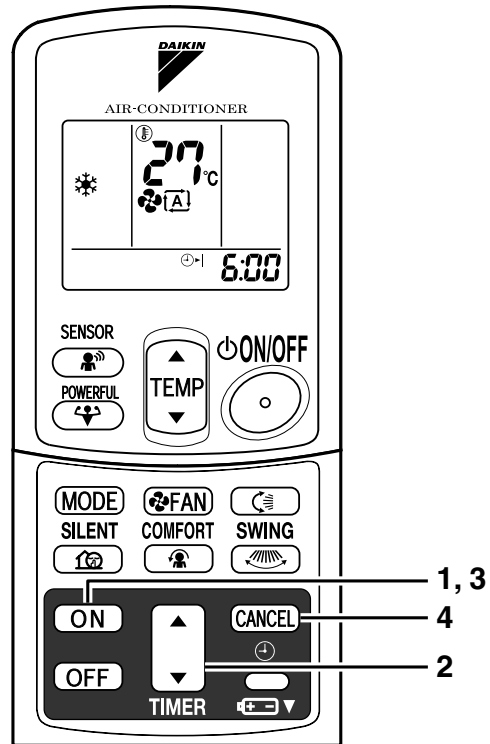
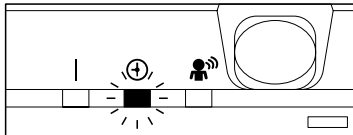

■ To cancel ON TIMER operation

4. Press “CANCEL button”.

- The TIMER lamp goes off.

■ To combine ON TIMER and OFF TIMER

- A sample setting for combining the two timers is shown below.

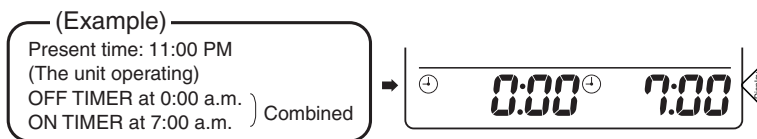

ATTENTION

■ In the following cases, set the timer again.

- After a breaker has turned OFF.
- After a power failure.
- After replacing batteries in the remote controller.

2.10 Care and Cleaning



CAUTION

- Before cleaning, be sure to stop the operation and turn the breaker OFF.
- Always shut down the unit (and close the panel) before doing any work. Opening the panel during operation may cause the panel to fall off.

Units

■ Indoor unit, Outdoor unit and Remote controller

1. Wipe them with dry soft cloth.

■ Top front panel

1. Open the top front panel.

- Open the top front panel by placing a finger on the panel tab on either side of the top front panel.

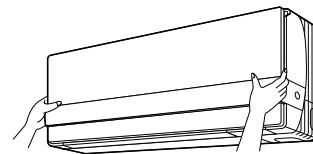

2. Remove the top front panel.

- With the top front panel open so that it is almost horizontal, slide it to the right. The revolving axis on the left will come off. The revolving axis on the right can be removed by sliding the top front panel to the left.

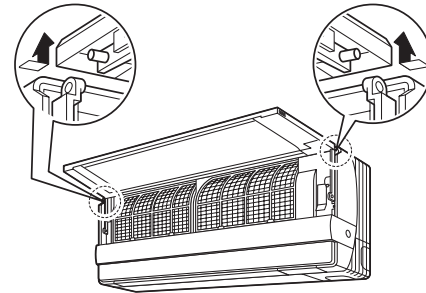

3. Clean the top front panel

- Wipe it with a soft cloth soaked in water.
- Only neutral detergent may be used.
- In case of washing the top front panel with water, dry it with cloth, dry it up in the shade after washing.

4. Attach the top front panel

- Place the revolving axes on either side of the top front panel into the holes and slowly close. (Press either side of the top front panel.)

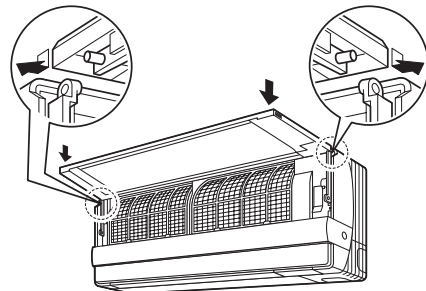

CAUTION

- Don't touch the metal parts of the indoor unit. If you touch those parts, this may cause an injury.
- When removing or attaching the top front panel, use a robust and stable stool and watch your steps carefully.
- When removing or attaching the top front panel, support the top front panel securely with hand to prevent it from falling.
- For cleaning, do not use hot water above 40 °C, benzene, gasoline, thinner, nor other volatile oils, polishing compound, scrubbing brushes, nor other hand stuff.
- After cleaning, make sure that the top front panel is securely fixed.

Filters

1. Open the top front panel.

- Open the top front panel by placing a finger on the panel tab on either side of the top front panel and then secure it using the supporting plate on the right.

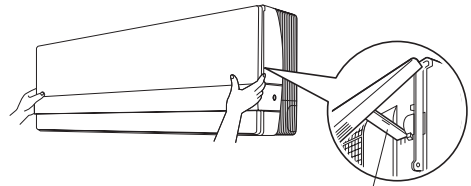

Supporting plate

2. Pull out the air filters.

- Push a little upwards the tab at the center of each air filter, then pull it down.

3. Take off the Titanium Apatite Photocatalytic Air-Purifying Filter.

- Hold the recessed parts of the frame and unhook the four claws.

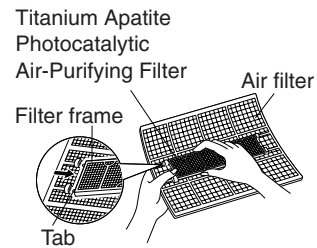
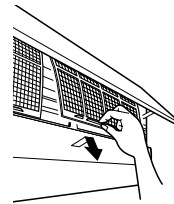

4. Clean or replace each filter.

See below.

5. Set the air filter and the Titanium Apatite Photocatalytic Air-Purifying Filter as they were and close the front grille.

- Be sure to insert the two tabs below.
- Return the supporting plate to its previous position.
- Press either side of the top front panel.

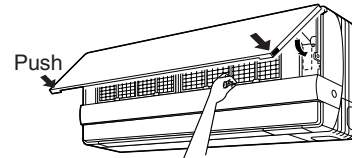

■ Air Filter

1. Wash the air filters with water or clean them with vacuum cleaner.

- If the dust does not come off easily, wash them with neutral detergent thinned with lukewarm water, then dry them up in the shade.
- It is recommended to clean the air filters every two weeks.

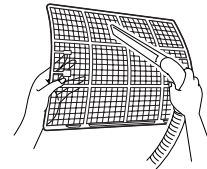

■ Titanium Apatite Photocatalytic Air-Purifying Filter. (gray)

The Titanium Apatite Photocatalytic Air-Purifying Filter can be renewed by washing it with water once every 6 months. We recommend replacing it once every 3 years.

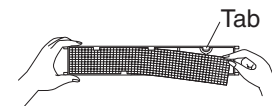

[Maintenance]

1. Remove dust with a vacuum cleaner and wash lightly with water.
2. If it is very dirty, soak it for 10 to 15 minutes in water mixed with a neutral cleaning agent.
3. Do not remove filter from frame when washing with water.
4. After washing, shake off remaining water and dry in the shade.
5. Since the material is made out of paper, do not wring out the filter when removing water from it.

[Replacement]

1. Remove the tabs on the filter frame and replace with a new filter.
 - Dispose of the old filter as flammable waste.

Check

Check that the base, stand and other fittings of the outdoor unit are not decayed or corroded.
Check that nothing blocks the air inlets and the outlets of the indoor unit and the outdoor unit.
Check that the drain comes smoothly out of the drain hose during COOL or DRY operation. <ul style="list-style-type: none"> If no drain water is seen, water may be leaking from the indoor unit. Stop operation and consult the service shop if this is the case.

■ Before a long idle period

- Operate the “FAN only” for several hours on a fine day to dry out the inside.**
 - Press “MODE” button and select “FAN” operation.
 - Press “ON/OFF” button and start operation.
- After operation stops, turn off the breaker for the room air conditioner.**
- Clean the air filters and set them again.**
- Take out batteries from the remote controller.**

NOTE

- Operation with dirty filters:
 - (1) cannot deodorize the air. (2) cannot clean the air.
 - (3) results in poor heating or cooling. (4) may cause odour.
- To order Titanium Apatite Photocatalytic Air-Purifying Filter contact to the service shop there you bought the air conditioner.
- Dispose of old filters as burnable waste.

Item	Part No.
Titanium Apatite Photocatalytic Air-Purifying Filter. (with frame) 1 set	KAF952B41
Titanium Apatite Photocatalytic Air-Purifying Filter. (without frame) 1 set	KAF952B42

2.11 Troubleshooting

These cases are not troubles.

The following cases are not air conditioner troubles but have some reasons. You may just continue using it.

Case	Explanation
<p>Operation does not start soon.</p> <ul style="list-style-type: none"> • When ON/OFF button was pressed soon after operation was stopped. • When the mode was reselected. 	<ul style="list-style-type: none"> • This is to protect the air conditioner. You should wait for about 3 minutes.
<p>Hot air does not flow out soon after the start of heating operation.</p>	<ul style="list-style-type: none"> • The air conditioner is warming up. You should wait for 1 to 4 minutes. (The system is designed to start discharging air only after it has reached a certain temperature.)
<p>The heating operation stops suddenly and a flowing sound is heard.</p>	<ul style="list-style-type: none"> • The system is taking away the frost on the outdoor unit. You should wait for about 3 to 8 minutes.
<p>The outdoor unit emits water or steam.</p>	<ul style="list-style-type: none"> ■ In HEAT mode <ul style="list-style-type: none"> • The frost on the outdoor unit melts into water or steam when the air conditioner is in defrost operation. ■ In COOL or DRY mode <ul style="list-style-type: none"> • Moisture in the air condenses into water on the cool surface of outdoor unit piping and drips.
<p>Mists come out of the indoor unit.</p>	<ul style="list-style-type: none"> ■ This happens when the air in the room is cooled into mist by the cold air flow during cooling operation.
<p>The indoor unit gives out odour.</p>	<ul style="list-style-type: none"> ■ This happens when smells of the room, furniture, or cigarettes are absorbed into the unit and discharged with the air flow. (If this happens, we recommend you to have the indoor unit washed by a technician. Consult the service shop where you bought the air conditioner.)
<p>The outdoor fan rotates while the air conditioner is not in operation.</p>	<ul style="list-style-type: none"> ■ After operation is stopped: <ul style="list-style-type: none"> • The outdoor fan continues rotating for another 60 seconds for system protection. ■ While the air conditioner is not in operation: <ul style="list-style-type: none"> • When the outdoor temperature is very high, the out door fan starts rotating for system protection.
<p>The operation stopped suddenly. (OPERATION lamp is on)</p>	<ul style="list-style-type: none"> ■ For system protection, the air conditioner may stop operating on a sudden large voltage fluctuation. It automatically resumes operation in about 3 minutes.

Check again.

Please check again before calling a repair person.

Case	Check
The air conditioner does not operate. (OPERATION lamp is off)	<ul style="list-style-type: none"> • Hasn't a breaker turned OFF or a fuse blown? • Isn't it a power failure? • Are batteries set in the remote controller? • Is the timer setting correct?
Cooling (Heating) effect is poor.	<ul style="list-style-type: none"> • Are the air filters clean? • Is there anything to block the air inlet or the outlet of the indoor and the outdoor units? • Is the temperature setting appropriate? • Are the windows and doors closed? • Are the air flow rate and the air direction set appropriately? • Is the unit set to the INTELLIGENT EYE mode? (page 16.)
Operation stops suddenly. (OPERATION lamp flashes.)	<ul style="list-style-type: none"> • Are the air filters clean? • Is there anything to block the air inlet or the outlet of the indoor and the outdoor units? Clean the air filters or take all obstacles away and turn the breaker OFF. Then turn it ON again and try operating the air conditioner with the remote controller. If the lamp still flashes, call the service shop where you bought the air conditioner.
An abnormal functioning happens during operation.	<ul style="list-style-type: none"> • The air conditioner may malfunction with lightning or radio waves. Turn the breaker OFF, turn it ON again and try operating the air conditioner with the remote controller.
The top front panel and bottom front panel will not open. (OPERATION lamp flashes.)	<ul style="list-style-type: none"> • Is there something caught in the panel? • Remove the object and attempt operation again using the remote control. If the panel still does not open, contact your dealer if the operation lamp is still flashing.

Call the service shop immediately.

 **WARNING**

- When an abnormality (such as a burning smell) occurs, stop operation and turn the breaker OFF.
Continued operation in an abnormal condition may result in troubles, electric shocks or fire.
Consult the service shop where you bought the air conditioner.
- Do not attempt to repair or modify the air conditioner by yourself.
Incorrect work may result in electric shocks or fire.
Consult the service shop where you bought the air conditioner.

If one of the following symptoms takes place, call the service shop immediately.

<ul style="list-style-type: none"> ■ The power cord is abnormally hot or damaged. ■ An abnormal sound is heard during operation. ■ The safety breaker, a fuse, or the earth leakage breaker cuts off the operation frequently. ■ A switch or a button often fails to work properly. ■ There is a burning smell. ■ Water leaks from the indoor unit. 		<p>Turn the breaker OFF and call the service shop.</p>
---	--	--

<ul style="list-style-type: none"> ■ After a power failure The air conditioner automatically resumes operation in about 3 minutes. You should just wait for a while. 	<ul style="list-style-type: none"> ■ Lightning If lightning may strike the neighbouring area, stop operation and turn the breaker OFF for system protection.
--	--

Disposal requirements

Dismantling of the unit, treatment of the refrigerant, oil and eventual other parts, should be done in accordance with the relevant local and national regulations.

We recommend periodical maintenance

In certain operating conditions, the inside of the air conditioner may get foul after several seasons of use, resulting in poor performance. It is recommended to have periodical maintenance by a specialist aside from regular cleaning by the user. For specialist maintenance, contact the service shop where you bought the air conditioner.

The maintenance cost must be born by the user.

Part 6

Service Diagnosis

1. Caution for Diagnosis.....	68
2. Problem Symptoms and Measures	69
3. Service Check Function	70
4. Troubleshooting	73
4.1 Error Codes and Description	73
4.2 Indoor Unit PCB Abnormality	74
4.3 Freeze-up Protection Control or High Pressure Control.....	75
4.4 Fan Motor (DC Motor) or Related Abnormality.....	77
4.5 Thermistor or Related Abnormality (Indoor Unit).....	79
4.6 Front Panel Open / Close Fault.....	80
4.7 Signal Transmission Error (between Indoor and Outdoor Unit)	81
4.8 Signal Transmission Error (between Indoor Unit and Wired Remote Controller)	82
4.9 Unspecified Voltage (between Indoor and Outdoor Unit).....	83
4.10 Outdoor Unit PCB Abnormality.....	84
4.11 OL Activation (Compressor Overload)	85
4.12 Compressor Lock	86
4.13 DC Fan Lock	87
4.14 Input Over Current Detection	88
4.15 Four Way Valve Abnormality	89
4.16 Discharge Pipe Temperature Control.....	91
4.17 High Pressure Control in Cooling	92
4.18 Sensor Abnormality around Compressor System	94
4.19 Position Sensor Abnormality	95
4.20 DC Voltage / Current Sensor Abnormality.....	96
4.21 Thermistor or Related Abnormality (Outdoor Unit).....	97
4.22 Output Over Current Detection.....	99
4.23 Insufficient Gas.....	101
4.24 Over-voltage Detection.....	103
5. Check.....	104
5.1 How to Check.....	104

1. Caution for Diagnosis

The operation lamp flashes when any of the following errors is detected.

1. When a protection device of the indoor or outdoor unit is activated or when the thermistor malfunctions, disabling equipment operation.
 2. When a signal transmission error occurs between the indoor and outdoor units.
- In either case, conduct the diagnostic procedure described in the following pages.

Location of Operation Lamp

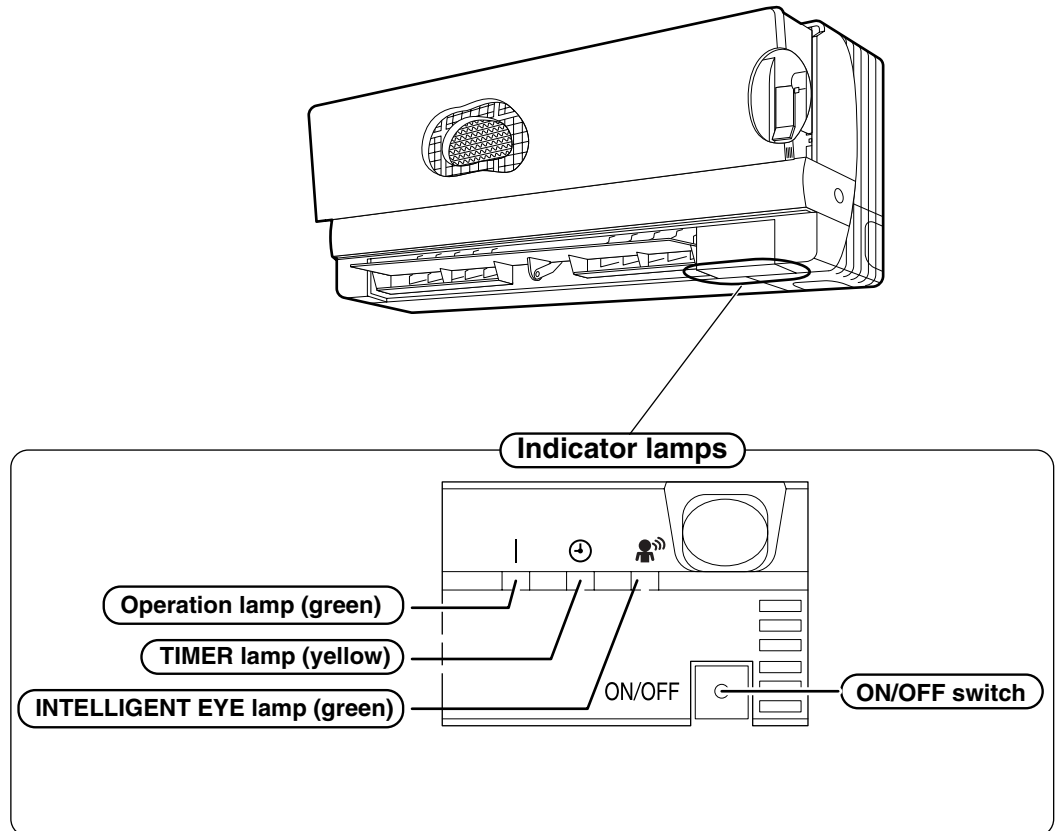

Troubleshooting with LED Indication

The outdoor unit has one green LED (LED A) on the PCB. The flashing green LED indicates normal condition of microcomputer operation.

2. Problem Symptoms and Measures

Symptom	Check Item	Details of Measure	Reference Page
None of the units operates.	Check the power supply.	Check to make sure that the rated voltage is supplied.	—
	Check the type of the indoor units.	Check to make sure that the indoor unit type is compatible with the outdoor unit.	—
	Check the outdoor air temperature.	Heating operation cannot be used when the outdoor air temperature is 21°C or higher (only for heat pump model), and cooling operation cannot be used when the outside temperature is below 10°C.	—
	Diagnosis with remote controller indication	—	73
	Check the remote controller addresses.	Check to make sure that address settings for the remote controller and indoor unit are correct.	—
Operation sometimes stops.	Check the power supply.	A power failure of 2 to 10 cycles can stop air conditioner operation. (Operation lamp OFF)	—
	Check the outdoor air temperature.	Heating operation cannot be used when the outdoor air temperature is 21°C or higher (only for heat pump model), and cooling operation cannot be used when the outside temperature is below 10°C.	—
	Diagnosis with remote controller indication	—	73
Equipment operates but does not cool, or does not heat (only for heat pump model).	Check for wiring and piping errors in the indoor and outdoor units connection wires and pipes.	Conduct the wiring/piping error check described on the product diagnosis nameplate.	—
	Check for thermistor detection errors.	Check to make sure that the main unit's thermistor has not dismantled from the pipe holder.	—
	Check for faulty operation of the electronic expansion valve.	Set the units to cooling operation, and compare the temperatures of the liquid side connection pipes of the connection section among rooms to check the opening and closing operation of the electronic expansion valves of the individual units.	—
	Diagnosis with remote controller indication	—	73
	Diagnosis by service port pressure and operating current	Check for insufficient gas.	109
Large operating noise and vibrations	Check the output voltage of the power transistor.	—	110
	Check the power transistor.	—	—
	Check the installation condition.	Check to make sure that the required spaces for installation (specified in the Technical Guide, etc.) are provided.	—

3. Service Check Function

In the **ARC433A** series remote controller, the temperature display sections on the main unit indicate corresponding codes.

Check Method 1

1. When the timer cancel button is held down for 5 seconds, a “00” indication flashes on the temperature display section.

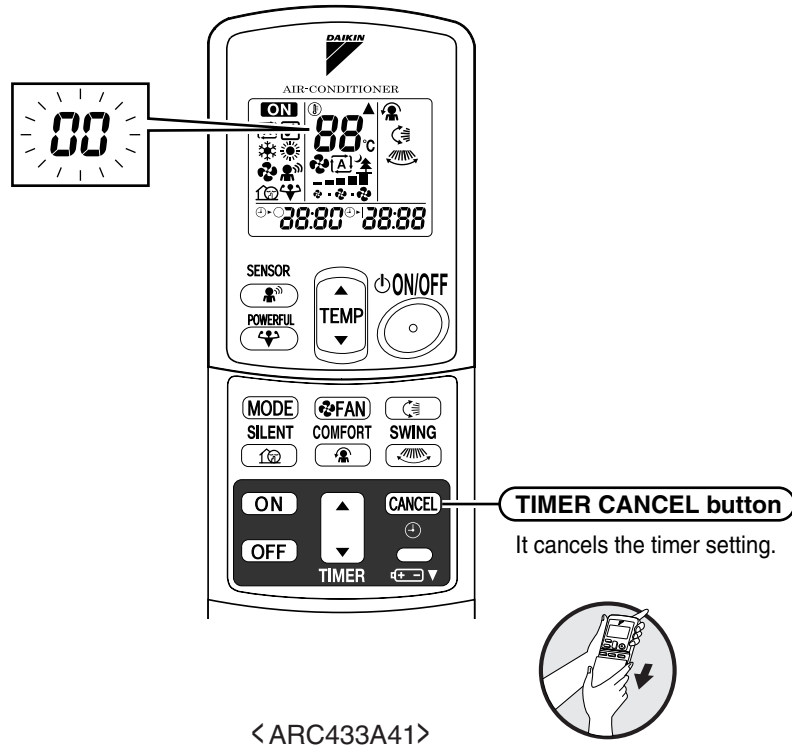

(R3309)

2. Press the timer cancel button repeatedly until a continuous beep is produced.
 - The code indication changes in the sequence shown below, and notifies with a long beep.

No.	Code	No.	Code	No.	Code
1	00	12	F6	23	A1
2	U4	13	C7	24	E1
3	L5	14	A3	25	UR
4	E6	15	H8	26	UH
5	H6	16	H9	27	P4
6	H0	17	C9	28	L3
7	A6	18	C4	29	L4
8	E7	19	C5	30	H7
9	U0	20	J3	31	U2
10	F3	21	J6	32	ER
11	A5	22	E5	33	AH



Note:

1. A short beep and two consecutive beeps indicate non-corresponding codes.
2. To cancel the code display, hold the timer cancel button down for 5 seconds. The code display also cancels itself if the button is not pressed for 1 minute.

Check Method 2

1. Enter the diagnosis mode.
Press the 3 buttons (TEMP▲,TEMP▼, MODE) simultaneously.

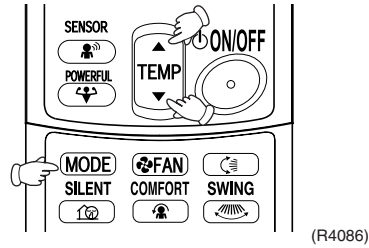

- The digit of the number of tens blinks.
- ★Try again from the start when the digit does not blink.

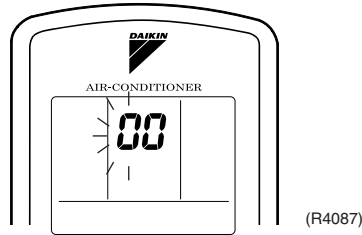

2. Press the TEMP button.
Press TEMP▲ or TEMP▼ and change the digit until you hear the sound of “beep” or “pi pi”.

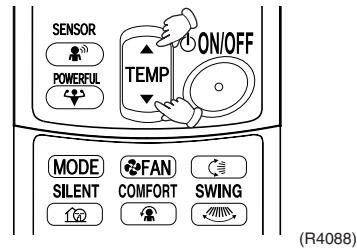

3. Diagnose by the sound.
 - ★“ pi ” : The number of tens does not accord with the error code.
 - ★“ pi pi ” : The number of tens accords with the error code.
 - ★“ beep ” : The both numbers of tens and units accord with the error code. (→See 7.)
4. Enter the diagnosis mode again.
Press the MODE button.

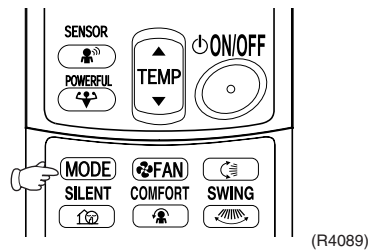

- The digit of the number of units blinks.

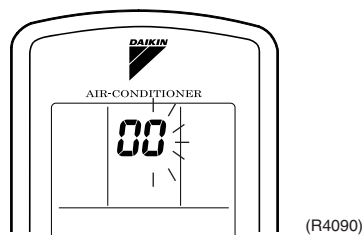

5. Press the TEMP button.
Press TEMP▲ or TEMP▼ and change the digit until you hear the sound of “beep”.

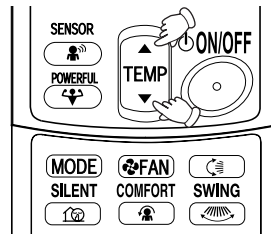

(R4088)

6. Diagnose by the sound.
 ★“ pi ” : The both numbers of tens and units do not accord with the error code.
 ★“ pi pi ” : The number of tens accords with the error code.
 ★“ beep ” : The both numbers of tens and units accord with the error code.
7. Determine the error code.
The digits indicated when you hear the “beep” sound are error code.
(Error codes and description → Refer to page 73.)
8. Exit from the diagnosis mode.
Press the MODE button.

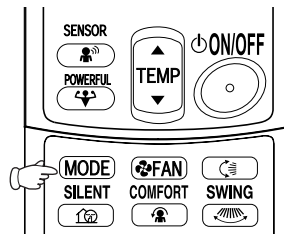

(R4089)

4. Troubleshooting

4.1 Error Codes and Description

	Code Indication	Description	Reference Page
System	<i>00</i>	Normal	—
	<i>U0</i> ★	Insufficient gas	101
	<i>U2</i>	Over-voltage detection	103
	<i>U4</i>	Signal transmission error (between indoor and outdoor unit)	81
	<i>U5</i>	Signal transmission error (between indoor unit and wired remote controller)	82
	<i>UR</i>	Unspecified voltage (between indoor and outdoor unit)	83
Indoor Unit	<i>R1</i>	Indoor unit PCB abnormality	74
	<i>R5</i>	Freeze-up protection control or high pressure control	75
	<i>R6</i>	Fan motor or related abnormality	77
	<i>C4</i>	Heat exchanger thermistor abnormality	79
	<i>C7</i>	Front panel open / close fault	80
	<i>C9</i>	Room temperature thermistor abnormality	79
Outdoor Unit	<i>E1</i>	Outdoor unit PCB abnormality	84
	<i>E5</i> ★	OL activation (compressor overload)	85
	<i>E6</i> ★	Compressor lock	86
	<i>E7</i>	DC fan lock	87
	<i>E8</i>	Input over current detection	88
	<i>ER</i>	Four way valve abnormality	89
	<i>F3</i>	Discharge pipe temperature control	91
	<i>F6</i>	High pressure control in cooling	92
	<i>HD</i>	Sensor abnormality around compressor system	94
	<i>H6</i>	Position sensor abnormality	95
	<i>H8</i>	DC voltage / current sensor abnormality	96
	<i>H9</i>	Outdoor air thermistor or related abnormality	97
	<i>J3</i>	Discharge pipe thermistor or related abnormality	97
	<i>J6</i>	Heat exchanger thermistor or related abnormality	97
	<i>L5</i>	Output over current detection	99

★: Displayed only when system-down occurs.

4.2 Indoor Unit PCB Abnormality

Remote
Controller
Display

A1

Method of
Malfunction
Detection

Evaluation of zero-cross detection of power supply by indoor unit.

Malfunction
Decision
Conditions

When there is no zero-cross detection in approximately 10 continuous seconds.

Supposed
Causes

- Faulty indoor unit PCB
- Faulty connector connection
- Faulty terminal strip of indoor unit

Troubleshooting



Caution

Be sure to turn off power switch before connect or disconnect connector, or parts damage may be occurred.

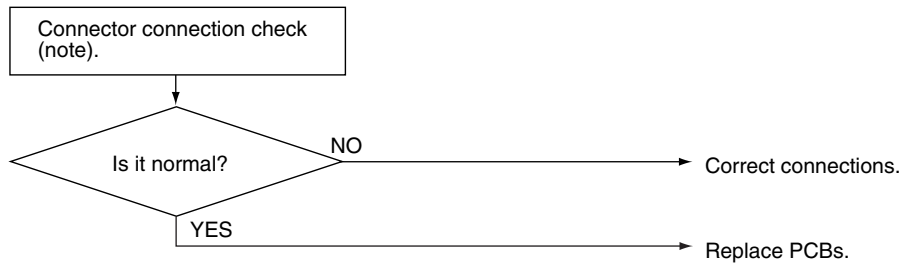

(R1400)



Note: Connector Nos. vary depending on models.

Model Type	Connector No.
Wall Mounted Type 25 / 35 class	Terminal strip~Control PCB (indoor unit)

4.3 Freeze-up Protection Control or High Pressure Control

Remote
Controller
Display

AS

Method of
Malfunction
Detection

- High pressure control (heat pump model only)
During heating operations, the temperature detected by the indoor heat exchanger thermistor is used for the high pressure control (stop, outdoor fan stop, etc.)
- The freeze-up protection control (operation halt) is activated during cooling operation according to the temperature detected by the indoor unit heat exchanger thermistor.

Malfunction
Decision
Conditions

- High pressure control
During heating operations, the temperature detected by the indoor heat exchanger thermistor is above 65°C
- Freeze-up protection
When the indoor unit heat exchanger temperature is below 0°C during cooling operation.

Supposed
Causes

- Operation halt due to clogged air filter of the indoor unit.
- Operation halt due to dust accumulation on the indoor unit heat exchanger.
- Operation halt due to short-circuit.
- Detection error due to faulty indoor unit heat exchanger thermistor.
- Detection error due to faulty indoor unit PCB.

Troubleshooting



Check No.6
Refer to P.106



Caution Be sure to turn off power switch before connect or disconnect connector, or parts damage may be occurred.

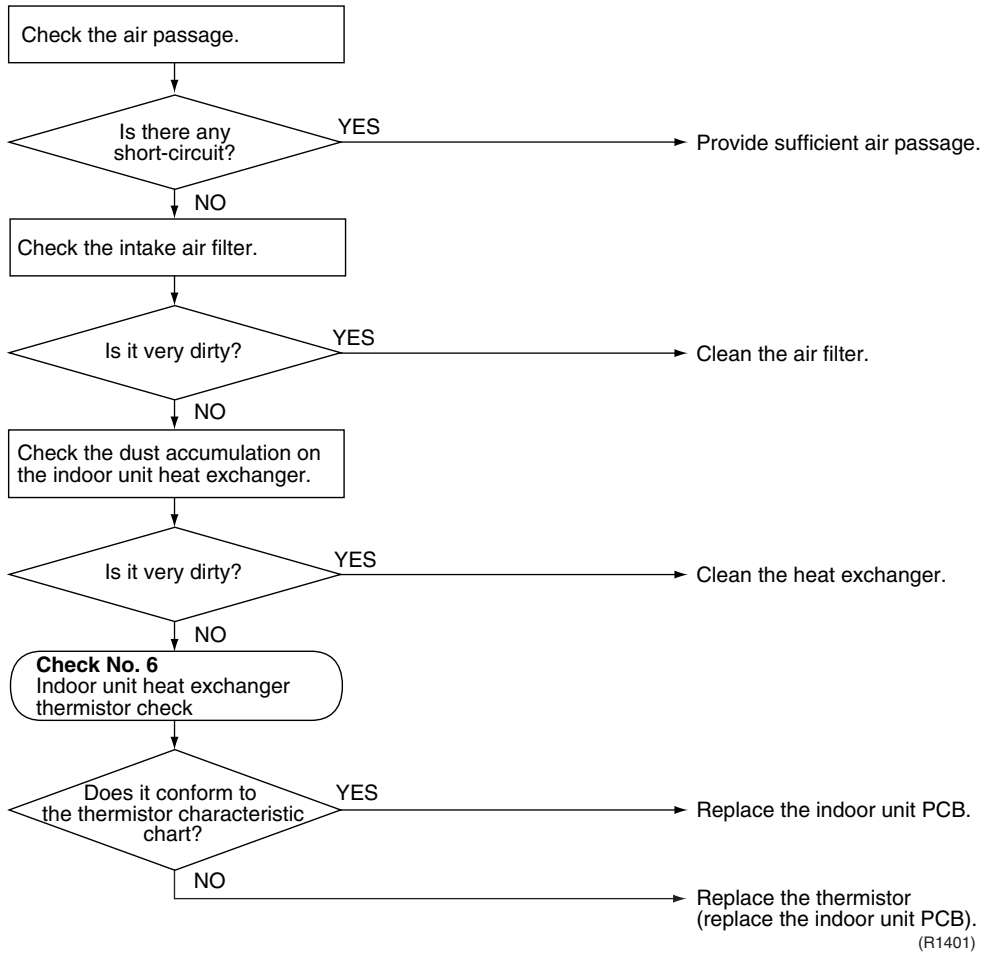

4.4 Fan Motor (DC Motor) or Related Abnormality

Remote
Controller
Display

AB

Method of
Malfunction
Detection

The rotation speed detected by the [Hall IC](#) during fan motor operation is used to determine abnormal fan motor operation.

Malfunction
Decision
Conditions

When the detected rotation speed is less than 50% of the HH tap under maximum fan motor rotation demand.

Supposed
Causes

- Operation halt due to short circuit inside the fan motor winding.
- Operation halt due to breaking of wire inside the fan motor.
- Operation halt due to breaking of the fan motor lead wires.
- Detection error due to faulty indoor unit PCB.

Troubleshooting

Check No.01
 Refer to P.104

 **Caution** Be sure to turn off power switch before connect or disconnect connector, or parts damage may be occurred.

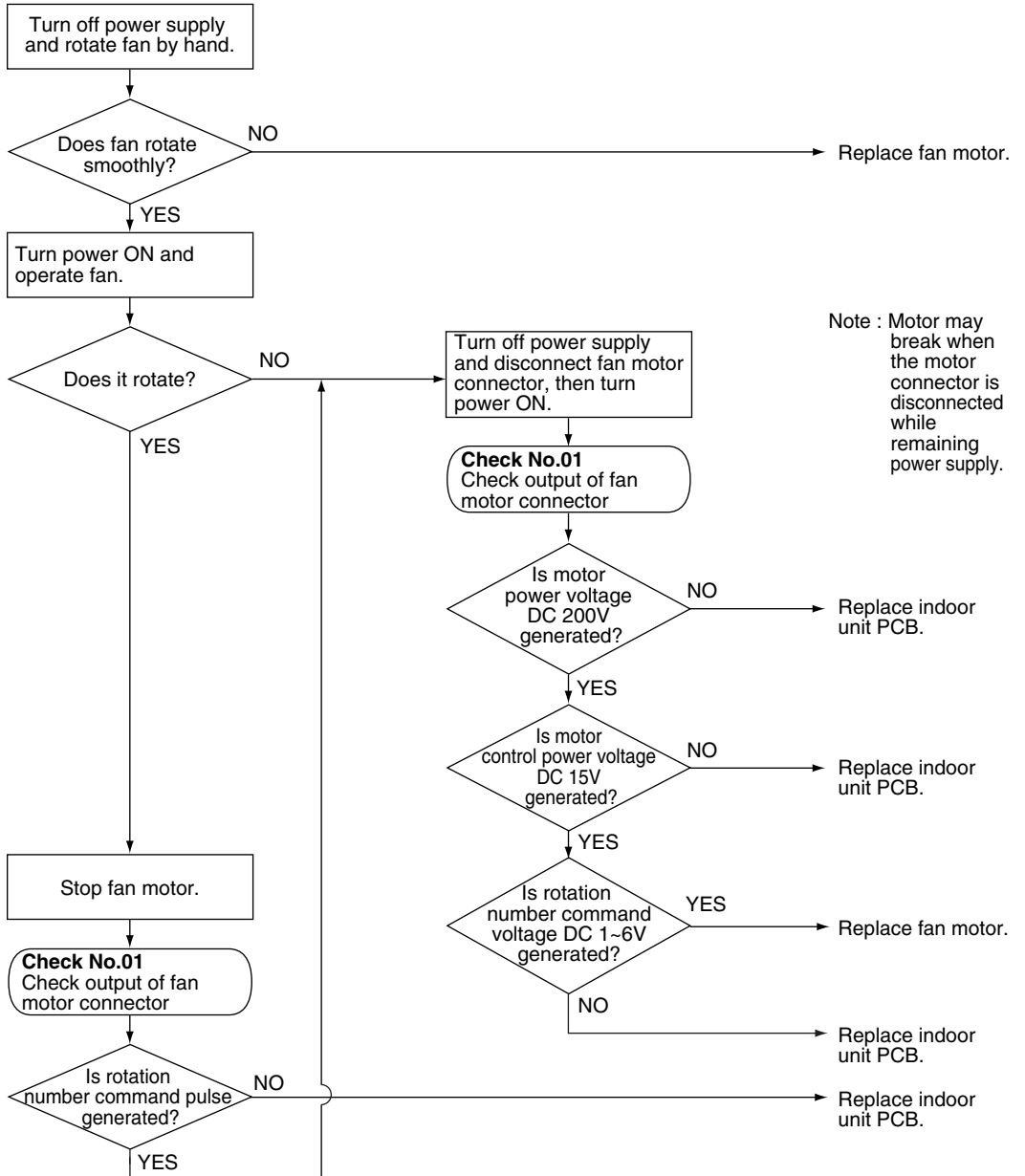

Note : Motor may break when the motor connector is disconnected while remaining power supply.

(R3310)

4.5 Thermistor or Related Abnormality (Indoor Unit)

Remote
Controller
Display

Ⓒ4, Ⓒ9

Method of
Malfunction
Detection

The temperatures detected by the thermistors are used to determine thermistor errors.

Malfunction
Decision
Conditions

When the thermistor input is more than 4.96 V or less than 0.04 V during compressor operation*.

* (reference)

When above about 212°C (less than 120 ohms) or below about -50°C (more than 1,860 kohms).



Note: The values vary slightly in some models.

Supposed
Causes

- Faulty connector connection
- Faulty thermistor
- Faulty PCB

Troubleshooting

Check No.6
Refer to P.106



Caution

Be sure to turn off power switch before connect or disconnect connector, or parts damage may be occurred.

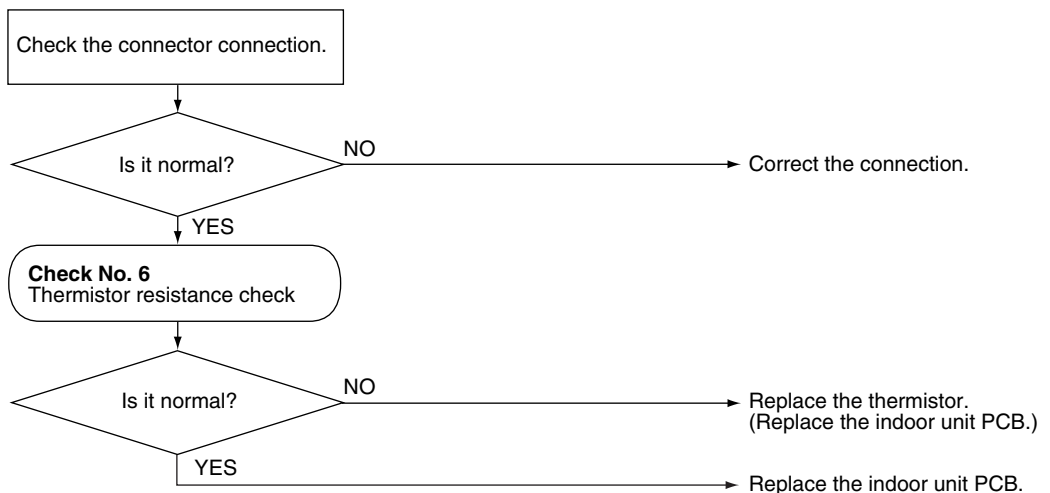

(R1403)

Ⓒ4 : Indoor heat exchanger thermistor

Ⓒ9 : Room temperature thermistor

4.6 Front Panel Open / Close Fault

Remote
Controller
Display



Method of
Malfunction
Detection

Malfunction
Decision
Conditions

- The system will be shut down when the error occurs twice.

Supposed
Causes

- Malfunction of the reduction motor
- Malfunction or deterioration of the front panel mechanism
- Malfunction of the limit switch

Troubleshooting

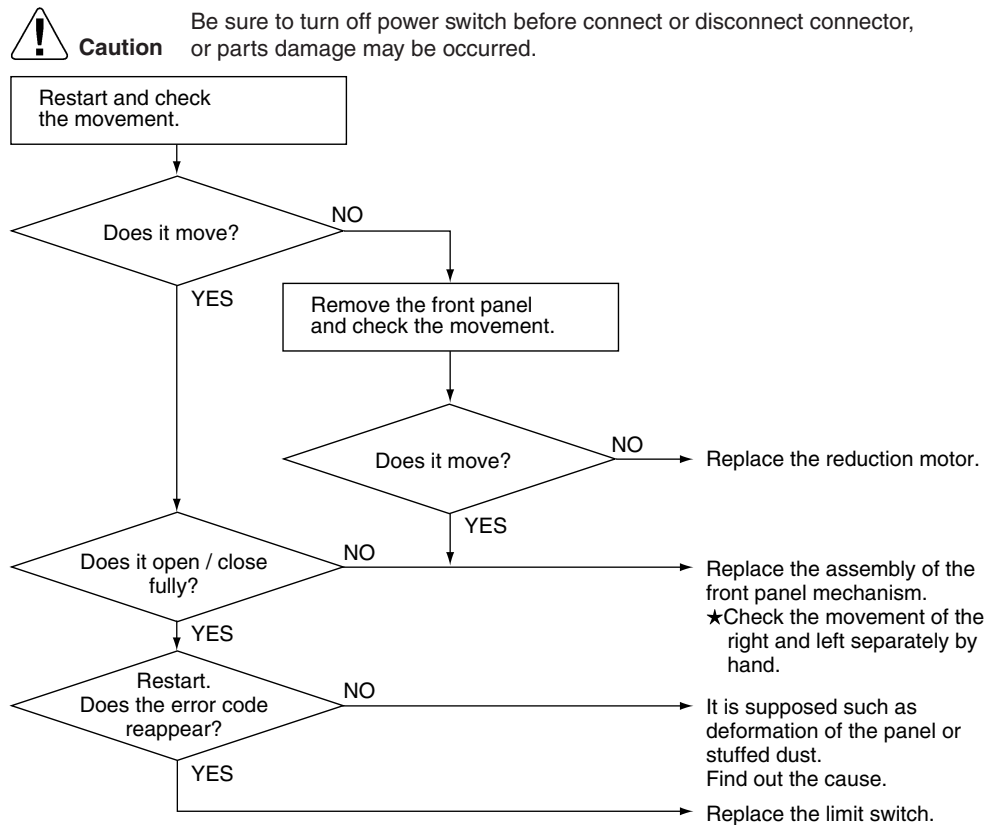

(R3313)



Note: You cannot operate the unit by the remote controller when the front panel mechanism breaks down.

<To the dealers: temporary measure before repair>

1. Pull the plug out or turn the breaker off.
2. Remove the decorative plate.
3. Remove the slot-in panel.
4. Put the plug in or turn the breaker on.
(Wait until the initialization finishes.)
5. Operate the unit by the indoor unit ON/OFF switch.

4.7 Signal Transmission Error (between Indoor and Outdoor Unit)

Remote
Controller
Display

U4

Method of
Malfunction
Detection

The data received from the outdoor unit in indoor unit-outdoor unit signal transmission is checked whether it is normal.

Malfunction
Decision
Conditions

When the data sent from the outdoor unit cannot be received normally, or when the content of the data is abnormal.

Supposed
Causes

- Faulty outdoor unit PCB.
- Faulty indoor unit PCB.
- Indoor unit-outdoor unit signal transmission error due to wiring error.
- Indoor unit-outdoor unit signal transmission error due to disturbed power supply waveform.
- Indoor unit-outdoor unit signal transmission error due to breaking of wire in the connection wires between the indoor and outdoor units (wire No. 2).

Troubleshooting



Check No.10
Refer to P.109

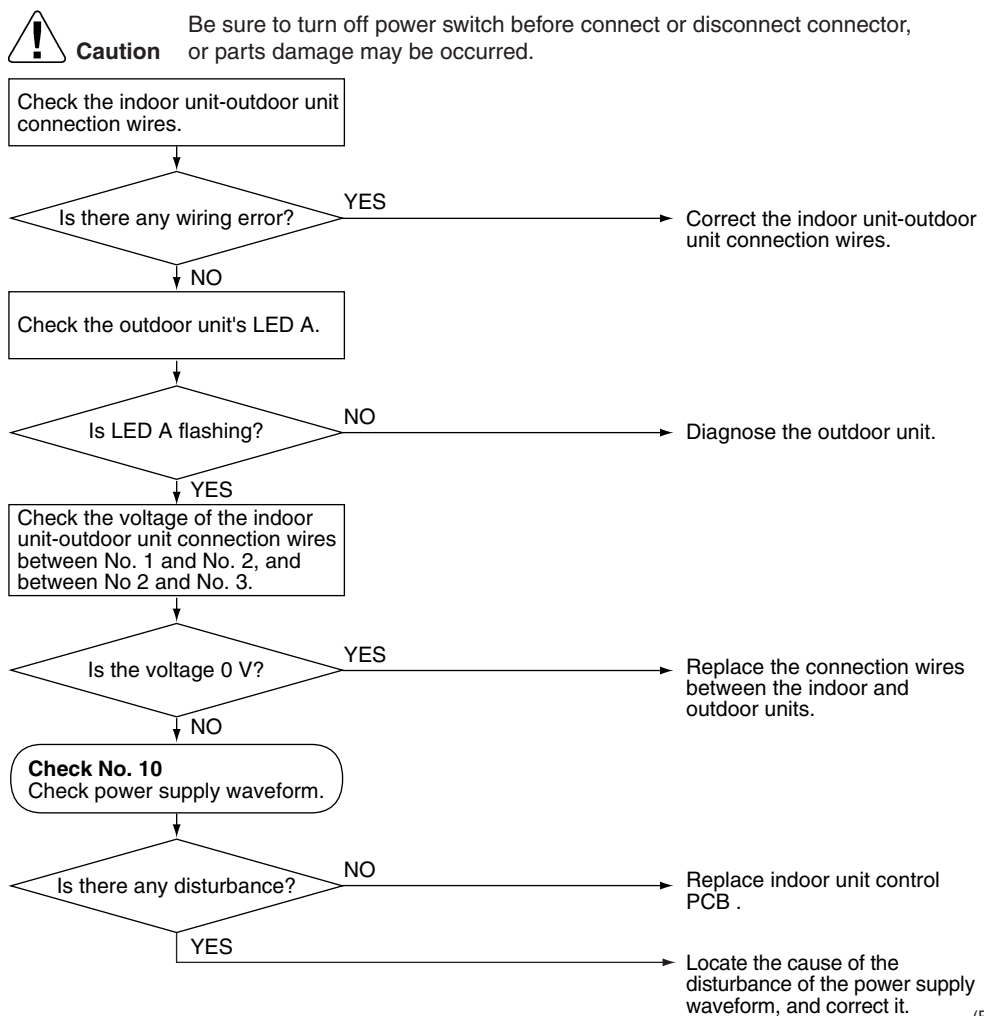

(R2840)

4.8 Signal Transmission Error (between Indoor Unit and Wired Remote Controller)

Remote Controller Display

U5

Method of Malfunction Detection

The data received from the indoor unit in indoor unit-wired remote controller signal transmission is checked whether it is normal.

Malfunction Decision Conditions

When the data sent from the indoor unit cannot be received normally, or when the content of the data is abnormal.

Supposed Causes

- Faulty remote controller cable
- Faulty remote controller

Troubleshooting

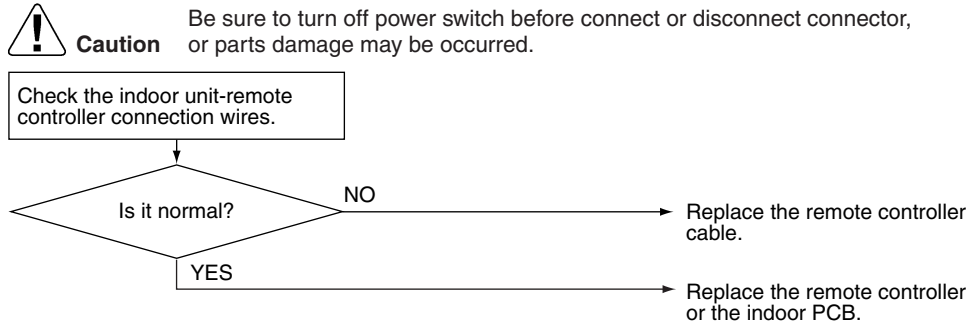

(R3314)

4.9 Unspecified Voltage (between Indoor and Outdoor Unit)

Remote
Controller
Display

UR

Method of
Malfunction
Detection

The supply power is detected for its requirements (different from separate type and multi type) by the indoor / outdoor transmission signal.

Malfunction
Decision
Conditions

The separate type and multi type are interconnected.

Supposed
Causes

- Wrong models interconnected
- Wrong indoor unit PCB mounted
- Indoor unit PCB defective
- Wrong outdoor unit PCB mounted or defective

Troubleshooting



Caution

Be sure to turn off power switch before connect or disconnect connector, or parts damage may be occurred.

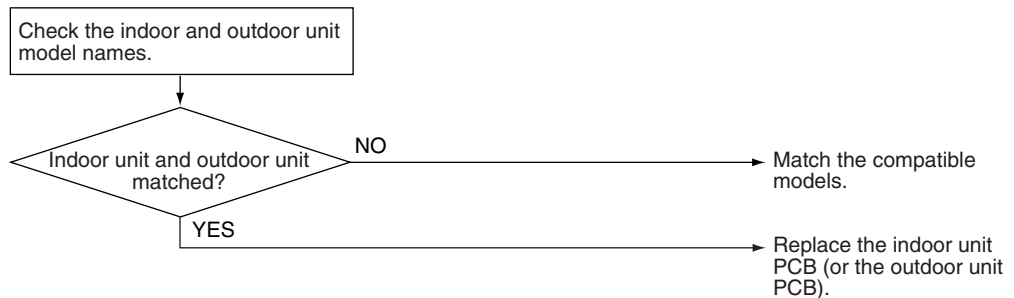

(R3315)

4.10 Outdoor Unit PCB Abnormality

Remote
Controller
Display

E1

Method of
Malfunction
Detection

- The proper programme operation of the microcomputer is checked by the programme.
- Checking whether the EEPROM data have the information of the outdoor unit

Malfunction
Decision
Conditions

- When the microcomputer programme does not function properly
- When the information of the outdoor unit (the type of the electronic expansion valve) is unidentified in the EEPROM data

Supposed
Causes

- Microcomputer programme run-away due to an external factor.
 - *Noise
 - *Momentary voltage drop
 - *Momentary power failure, etc.
- Unidentified information of the outdoor unit
 - *Damage of the EEPROM
- Faulty outdoor unit PCB.

Troubleshooting

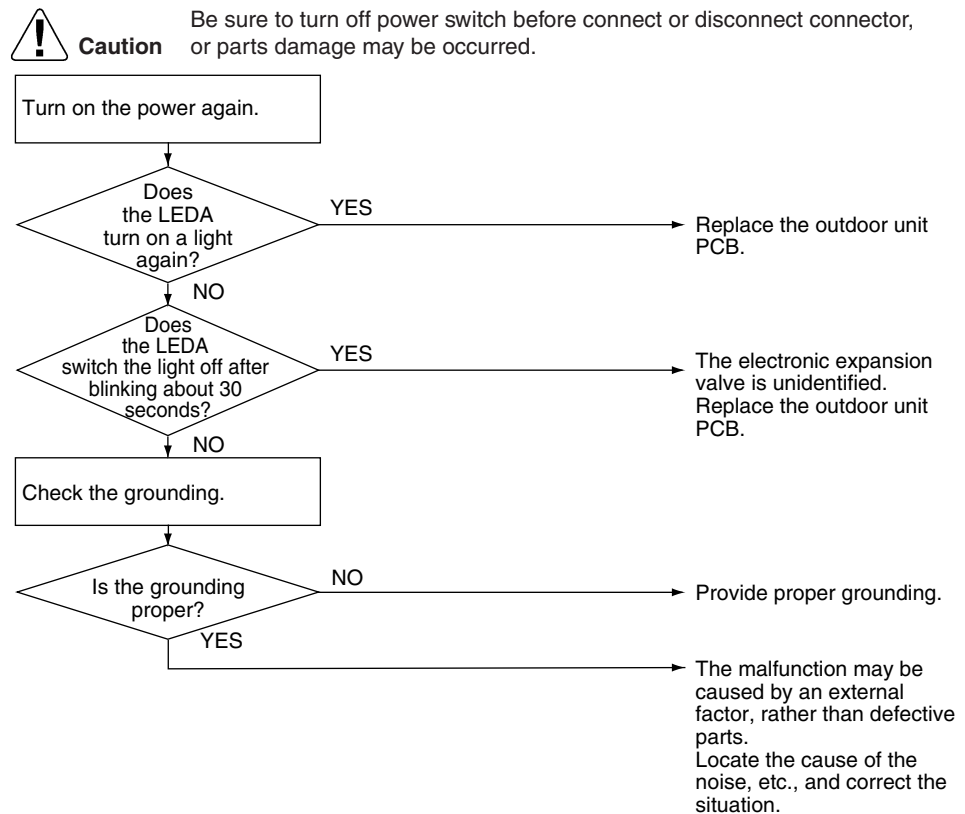

(R4000)

4.11 OL Activation (Compressor Overload)

Remote
Controller
Display

ES

Method of
Malfunction
Detection

A compressor overload is detected through compressor OL.

Malfunction
Decision
Conditions

- If the compressor OL is activated twice, the system will be shut down.
 - The error counter will reset itself if this or any other error does not occur during the following 60-minute compressor running time (total time).
- * The operating temperature condition is not specified.

Supposed
Causes

- Refrigerant shortage
- Four way valve malfunctioning
- Outdoor unit PCB defective
- Water mixed in the local piping
- Electronic expansion valve defective
- Stop valve defective

Troubleshooting

Check No.4
Refer to P.104

Check No.5
Refer to P.105

Check No.6
Refer to P.106

Check No.11
Refer to P.109

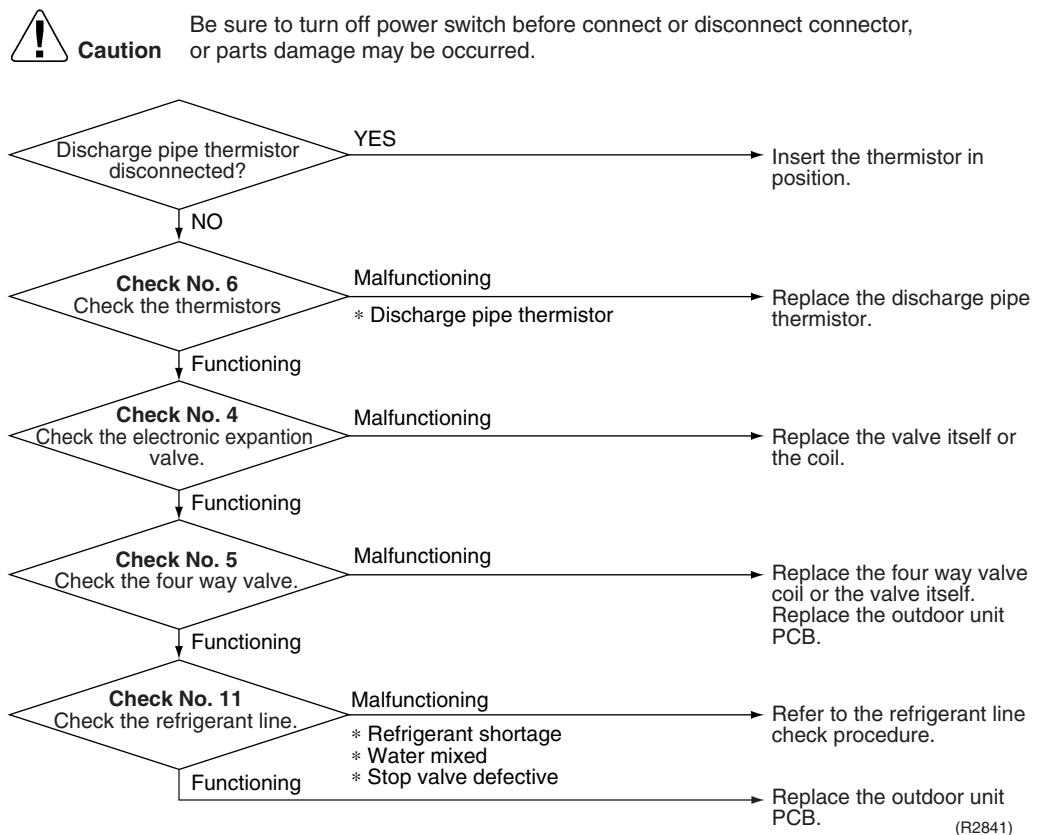

4.12 Compressor Lock

Remote
Controller
Display

EG

Method of
Malfunction
Detection

A compressor lock is detected by checking the compressor running condition through the position detection circuit.

Malfunction
Decision
Conditions

- The system judges the compressor lock, and stops due to over current.
- The system judges the compressor lock, and cannot operation with position detection within 15 seconds after start up.
- The system will be shut down if the error occurs 16 times.
- Clearing condition: Continuous run for about 10 minutes (normal)

Supposed
Causes

- Compressor locked
- Compressor harness disconnected

Troubleshooting

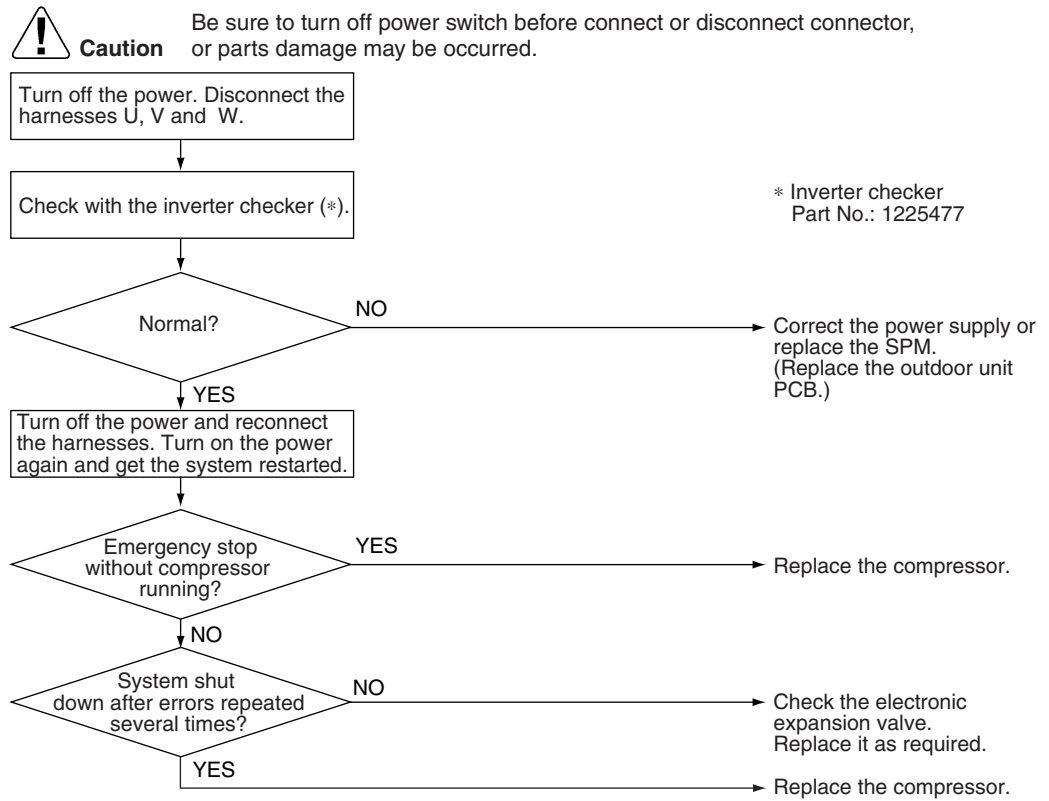

Note: If the model doesn't have SPM, replace the outdoor unit PCB.

(R2842)

4.13 DC Fan Lock

Remote
Controller
Display

E7

Method of
Malfunction
Detection

A fan motor or related error is detected by checking the high-voltage fan motor rpm being detected by the Hall IC.

Malfunction
Decision
Conditions

- The fan does not start in 30 seconds even when the fan motor is running.
- The system will be shut down if the error occurs 16 times.
- Clearing condition: Continuous run for about 5 minutes (normal)

Supposed
Causes

- Fan motor breakdown
- Harness or connector disconnected between fan motor and PCB or in poor contact
- Foreign matters stuck in the fan

Troubleshooting



Check No.15
Refer to P.110

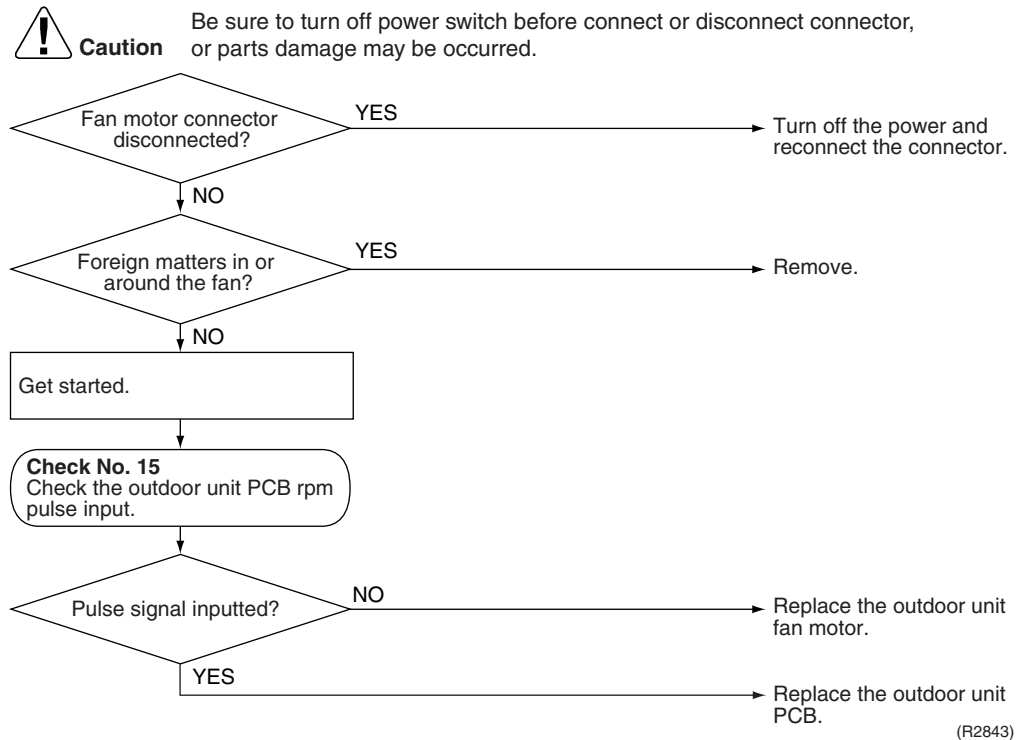

4.14 Input Over Current Detection

Remote
Controller
Display



Method of
Malfunction
Detection

An input over-current is detected by checking the input current value with the compressor running.

Malfunction
Decision
Conditions

- The following current with the compressor running continues for 2.5 seconds.
Cooling: Heating: Above 12A

Supposed
Causes

- Over-current due to compressor failure
- Over-current due to defective power transistor
- Over-current due to defective outdoor unit PCB
- Error detection due to outdoor unit PCB
- Over-current due to short-circuit

Troubleshooting

Check No.7
Refer to P.107

Check No.8
Refer to P.108



Caution Be sure to turn off power switch before connect or disconnect connector, or parts damage may be occurred.

* An input over-current may result from wrong internal wiring. If the wires have been disconnected and reconnected for part replacement, for example, and the system is interrupted by an input over-current, take the following procedure.

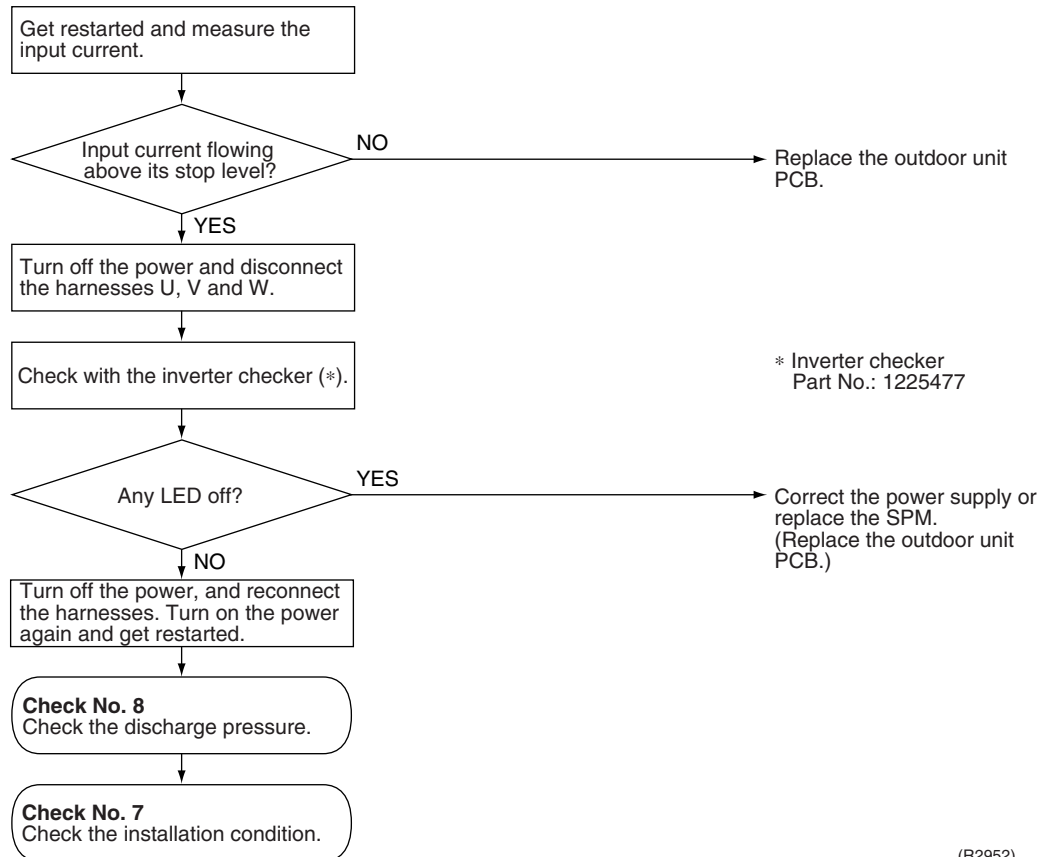

(R2952)



Note: If the model doesn't have SPM, replace the outdoor unit PCB.

4.15 Four Way Valve Abnormality

Remote
Controller
Display

EA

**Method of
Malfunction
Detection**

The indoor air temperature thermistor, the indoor unit heat exchanger thermistor, the outdoor temperature thermistor and the outdoor unit heat exchanger thermistor are checked to see if they function within their normal ranges in the operating mode.

**Malfunction
Decision
Conditions**

A following condition continues over 10 minute after operating 5 minutes.

- Cooling / dry operation
(room temp. – indoor heat exchanger temp.) < –5°C
- Heating
(indoor unit heat exchanger temp. – room temp.) < –5°C

**Supposed
Causes**

- Connector in poor contact
- Thermistor defective
- Outdoor unit PCB defective
- Four way valve coil or harness defective
- Four way valve defective
- Foreign substance mixed in refrigerant
- Insufficient gas

Troubleshooting

Check No.5
 Refer to P.105

Check No.6
 Refer to P.106

Check No.11
 Refer to P.109

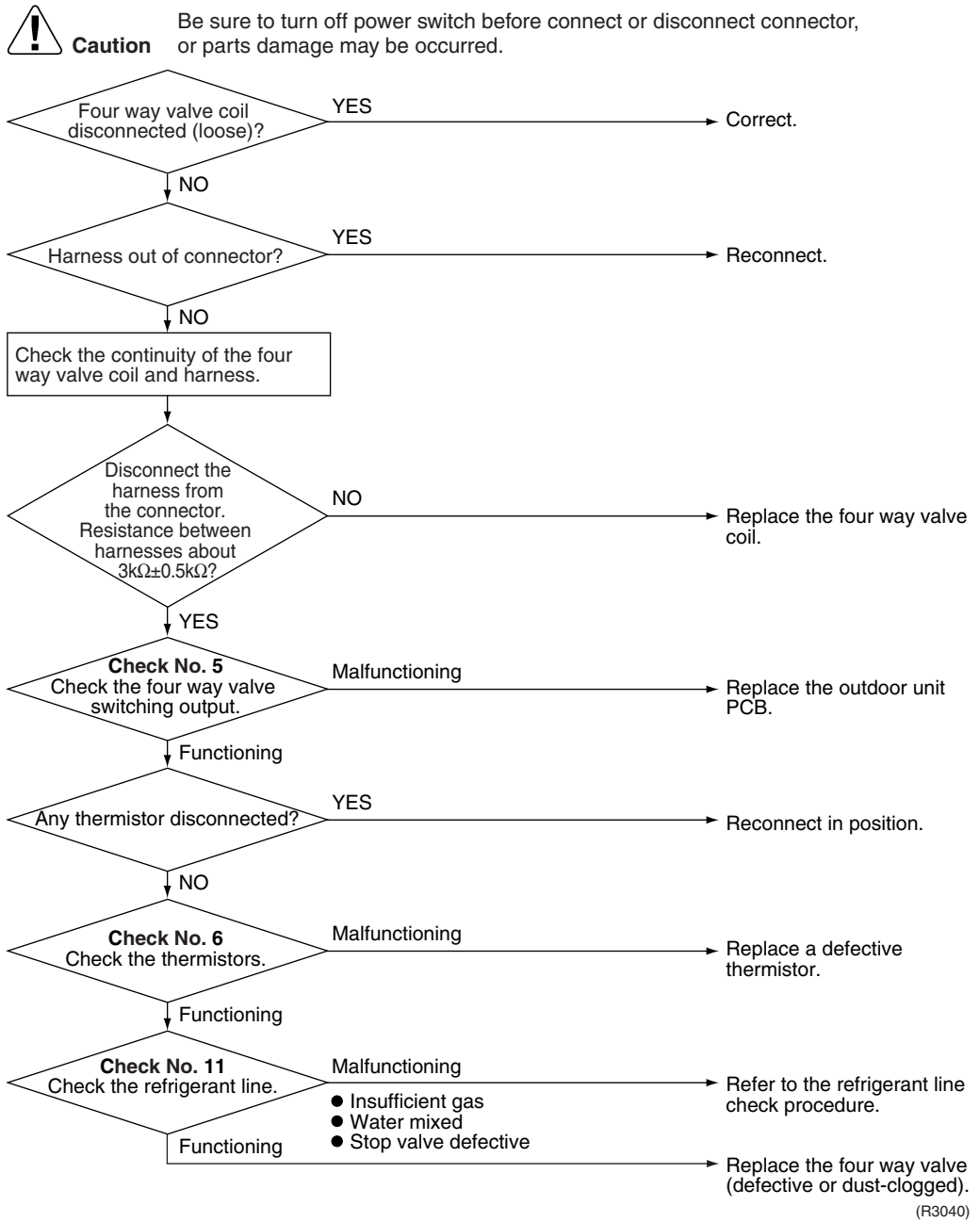

(R3040)

4.16 Discharge Pipe Temperature Control

Remote
Controller
Display

F3

Method of
Malfunction
Detection

The discharge pipe temperature control (stop, frequency drooping, etc.) is checked with the temperature being detected by the discharge pipe thermistor.

Malfunction
Decision
Conditions

- If a stop takes place 4 times successively due to abnormal discharge pipe temperature, the system will be shut down.
- If the temperature being detected by the discharge pipe thermistor rises above Δ °C, the compressor will stop. (The error is cleared when the temperature has dropped below B °C.)

Stop temperatures	Δ	B
(1) above 45Hz (rising), above 40Hz (dropping)	110	97
(2) 30~45Hz (rising), 25~40Hz (dropping)	105	92
(3) below 30Hz (rising), below 25Hz (dropping)	99	86

- The error counter will reset itself if this or any other error does not occur during the following 60-minute compressor running time (total time).

Supposed
Causes

- Refrigerant shortage
- Four way valve malfunctioning
- Discharge pipe thermistor defective
(heat exchanger or outdoor air temperature thermistor defective)
- Outdoor unit PCB defective
- Water mixed in the local piping
- Electronic expansion valve defective
- Stop valve defective

Troubleshooting

Check No.4
Refer to P.104

Check No.6
Refer to P.106

Check No.11
Refer to P.109

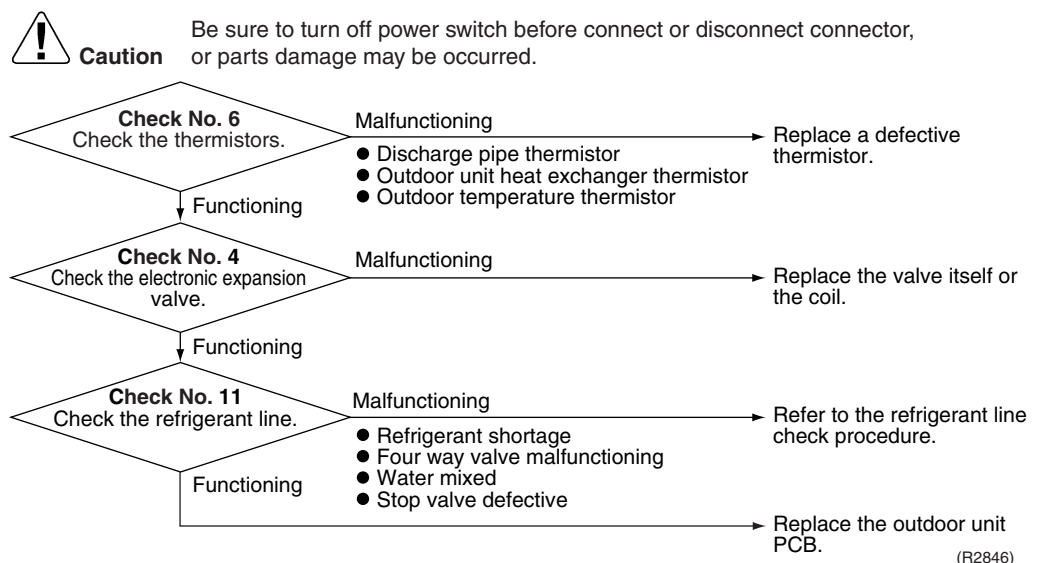

4.17 High Pressure Control in Cooling

Remote
Controller
Display

FB

Method of
Malfunction
Detection

High-pressure control (stop, frequency drop, etc.) is activated in the cooling mode if the temperature being sensed by the heat exchanger thermistor exceeds the limit.

Malfunction
Decision
Conditions

Activated when the temperature being sensed by the heat exchanger thermistor rises above 65°C. (The error is cleared when the temperature drops below 54°C.)

Supposed
Causes

- The installation space is not large enough.
- Faulty outdoor unit fan
- Faulty electronic expansion valve
- Faulty defrost thermistor
- Faulty outdoor unit PCB
- Faulty stop valve
- Dirty heat exchanger

Troubleshooting

Check No.4
 Refer to P.104



Check No.6
 Refer to P.106

Check No.7
 Refer to P.107

Check No.9
 Refer to P.108

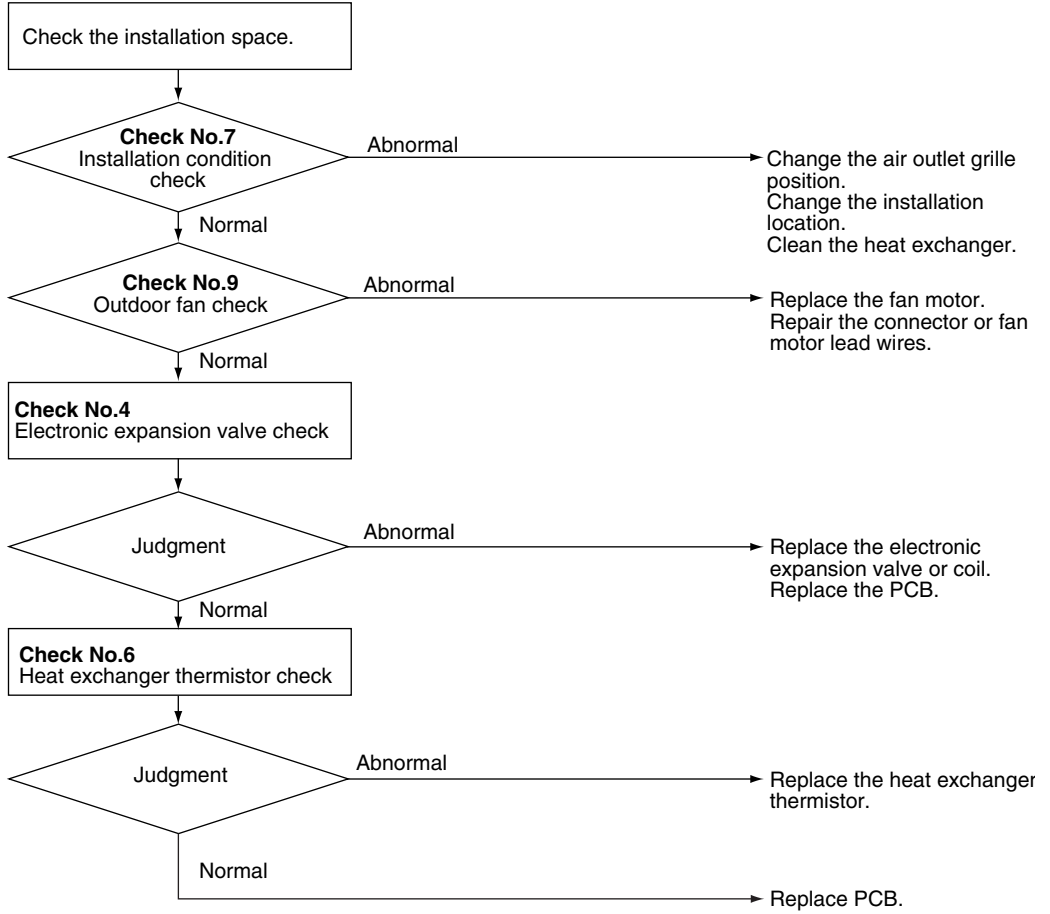

Caution Be sure to turn off power switch before connect or disconnect connector, or parts damage may be occurred.



(R2855)

4.18 Sensor Abnormality around Compressor System

Remote
Controller
Display

HO

Method of
Malfunction
Detection

Detecting by the value of direct current before the compressor starts up.

Malfunction
Decision
Conditions

- When the value of direct current before the compressor starts up is not within 0.5~4.5V (Sensor output is converted into voltage.)
- When the value of direct voltage before the compressor starts up is under 50V.

Supposed
Causes

- Faulty outdoor unit PCB
- Broken harness or imperfect connection

Troubleshooting

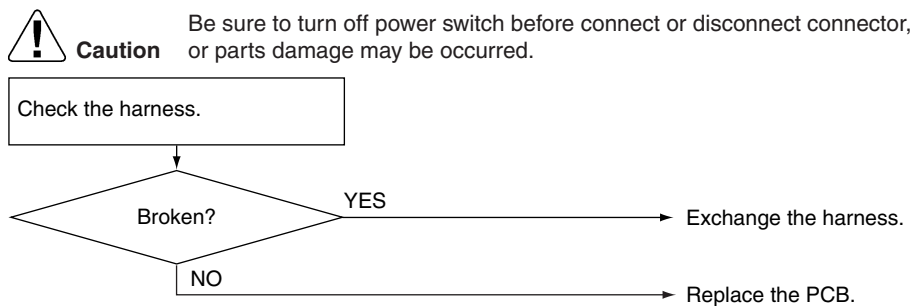

(R4001)

4.19 Position Sensor Abnormality

Remote
Controller
Display

H6

Method of
Malfunction
Detection

A compressor startup failure is detected by checking the compressor running condition through the position detection circuit.

Malfunction
Decision
Conditions

- The compressor fails to start in about 15 seconds after the compressor run command signal is sent.
- Clearing condition: Continuous run for about 10 minutes (normal)
- The system will be shut down if the error occurs 16 times.

Supposed
Causes

- Compressor relay cable disconnected
- Compressor itself defective
- Outdoor unit PCB defective
- Stop valve closed
- Input voltage out of specification

Troubleshooting

Check No.13
Refer to P.110

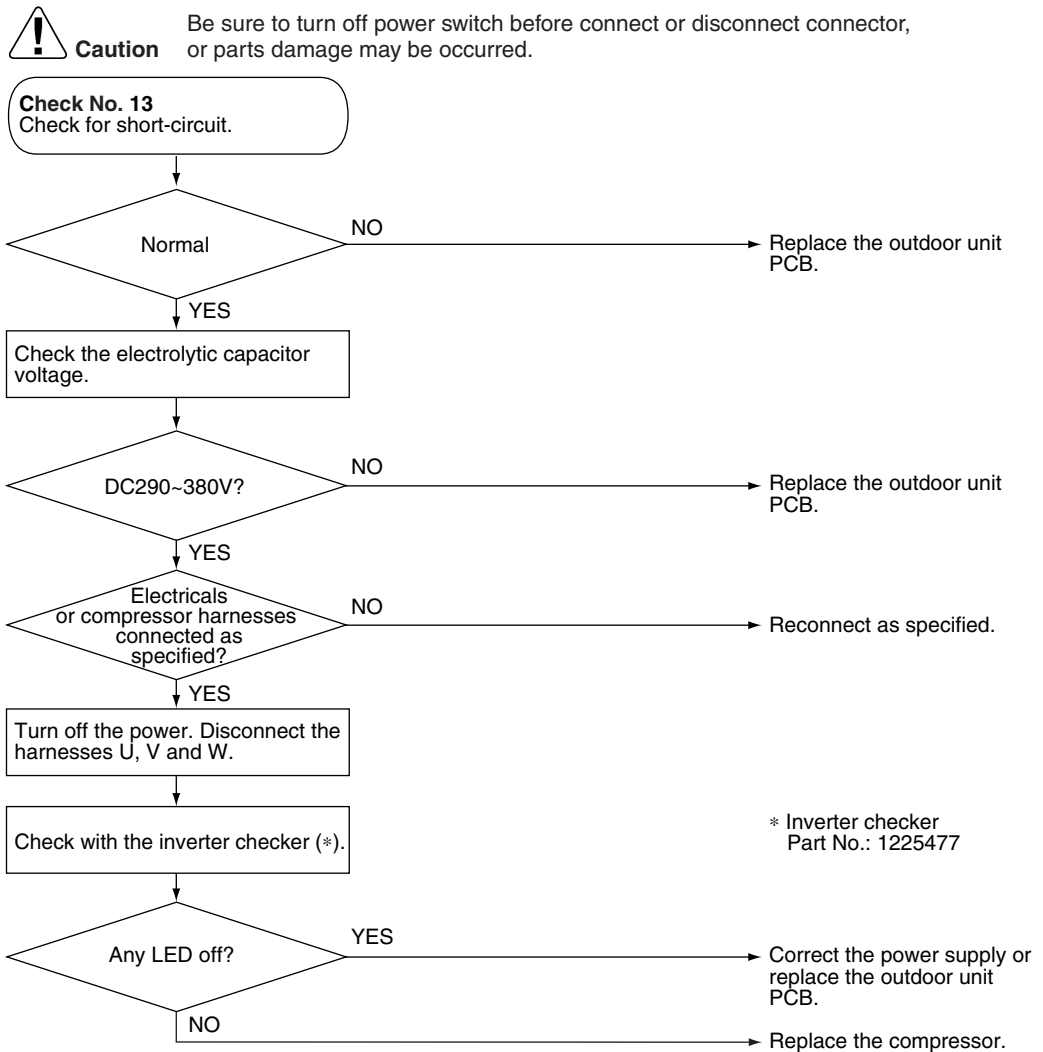

(R3041)

4.20 DC Voltage / Current Sensor Abnormality

Remote
Controller
Display

H8

Method of
Malfunction
Detection

Detecting abnormality of the DC sensor by the running frequency of compressor and by the input current multiplied DC voltage and current.

Malfunction
Decision
Conditions

The compressor running frequency is below 52 Hz.
(The input current is also below 0.5 A.)

- If this error repeats 4 times, the system will be shut down.
- The error counter will reset itself if this or any other error does not occur during the following 60-minute compressor running time (total time).

Supposed
Causes

- Outdoor unit PCB defective

Troubleshooting



Caution

Be sure to turn off power switch before connect or disconnect connector, or parts damage may be occurred.

Replace the outdoor unit PCB.

4.21 Thermistor or Related Abnormality (Outdoor Unit)

Remote
Controller
Display

J3, J6, H9

Method of
Malfunction
Detection

This type of error is detected by checking the thermistor input voltage to the microcomputer.
[A thermistor error is detected by checking the temperature.]

Malfunction
Decision
Conditions

The thermistor input is above 4.96 V or below 0.04 V with the power on.
Error *J3* is judged if the discharge pipe thermistor temperature is smaller than the condenser thermistor temperature.

Supposed
Causes

- Connector in poor contact
- Thermistor defective
- Outdoor unit PCB defective
- Indoor unit PCB defective
- Condenser thermistor defective in the case of *J3* error (outdoor unit heat exchanger thermistor in the cooling mode, or indoor unit heat exchanger thermistor in the heating mode)

Troubleshooting

Check No.6
 Refer to P.106

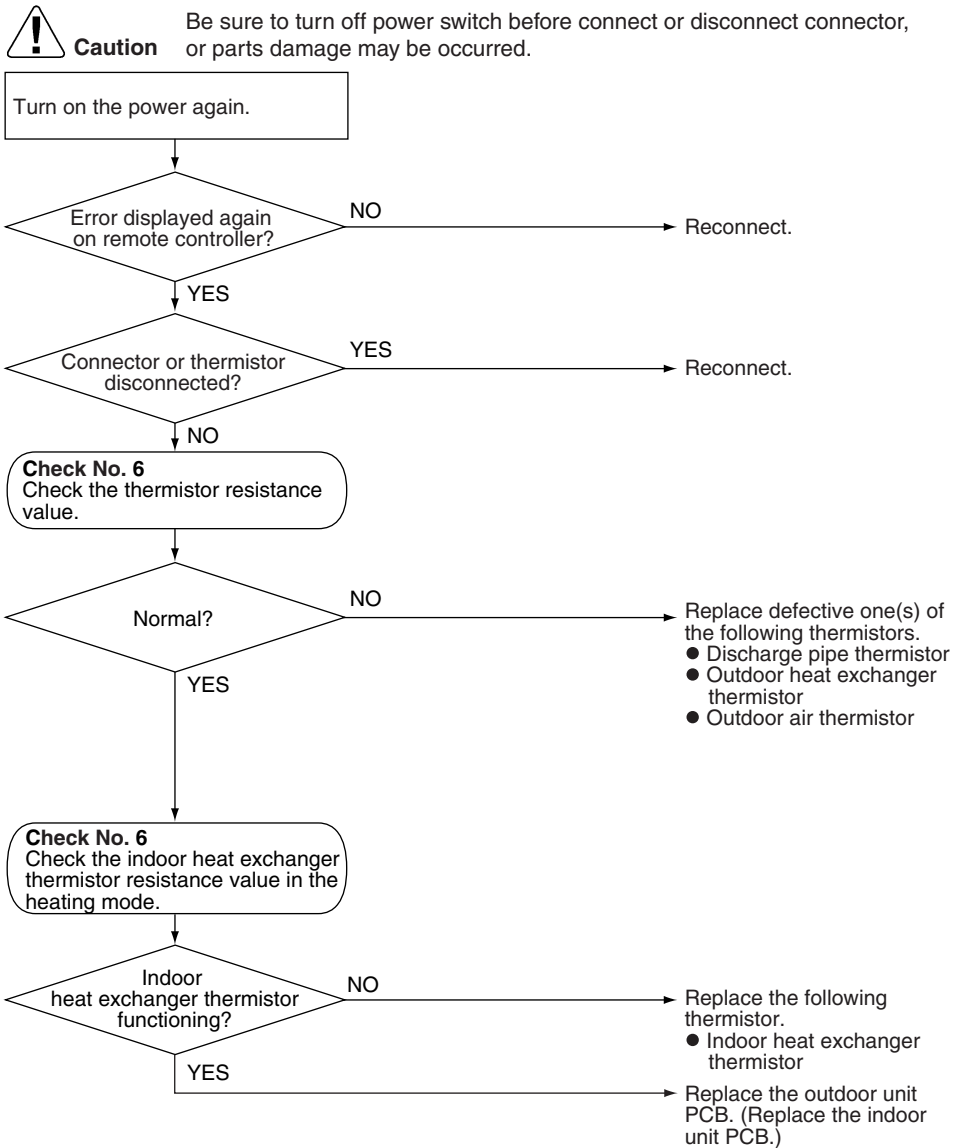

(R4093)

- J3 : Discharge pipe thermistor
- J5 : Outdoor heat exchanger thermistor
- H3 : Outdoor air temperature thermistor

4.22 Output Over Current Detection

Remote
Controller
Display

L5

Method of
Malfunction
Detection

An output over-current is detected by checking the current that flows in the inverter DC section.

Malfunction
Decision
Conditions

- A position signal error occurs while the compressor is running.
- A speed error occurs while the compressor is running.
- An output over-current input is fed from the output over-current detection circuit to the microcomputer.
- The system will be shut down if the error occurs 255 times.
- Clearing condition: Continuous run for about 10 minutes (normal)

Supposed
Causes

- Over-current due to defective power transistor
- Over-current due to wrong internal wiring
- Over-current due to abnormal supply voltage
- Over-current due to defective PCB
- Error detection due to defective PCB
- Over-current due to closed stop valve
- Over-current due to compressor failure
- Over-current due to poor installation condition

Troubleshooting

Check No.7
 Refer to P.107

Check No.8
 Refer to P.108

Check No.13
 Refer to P.110

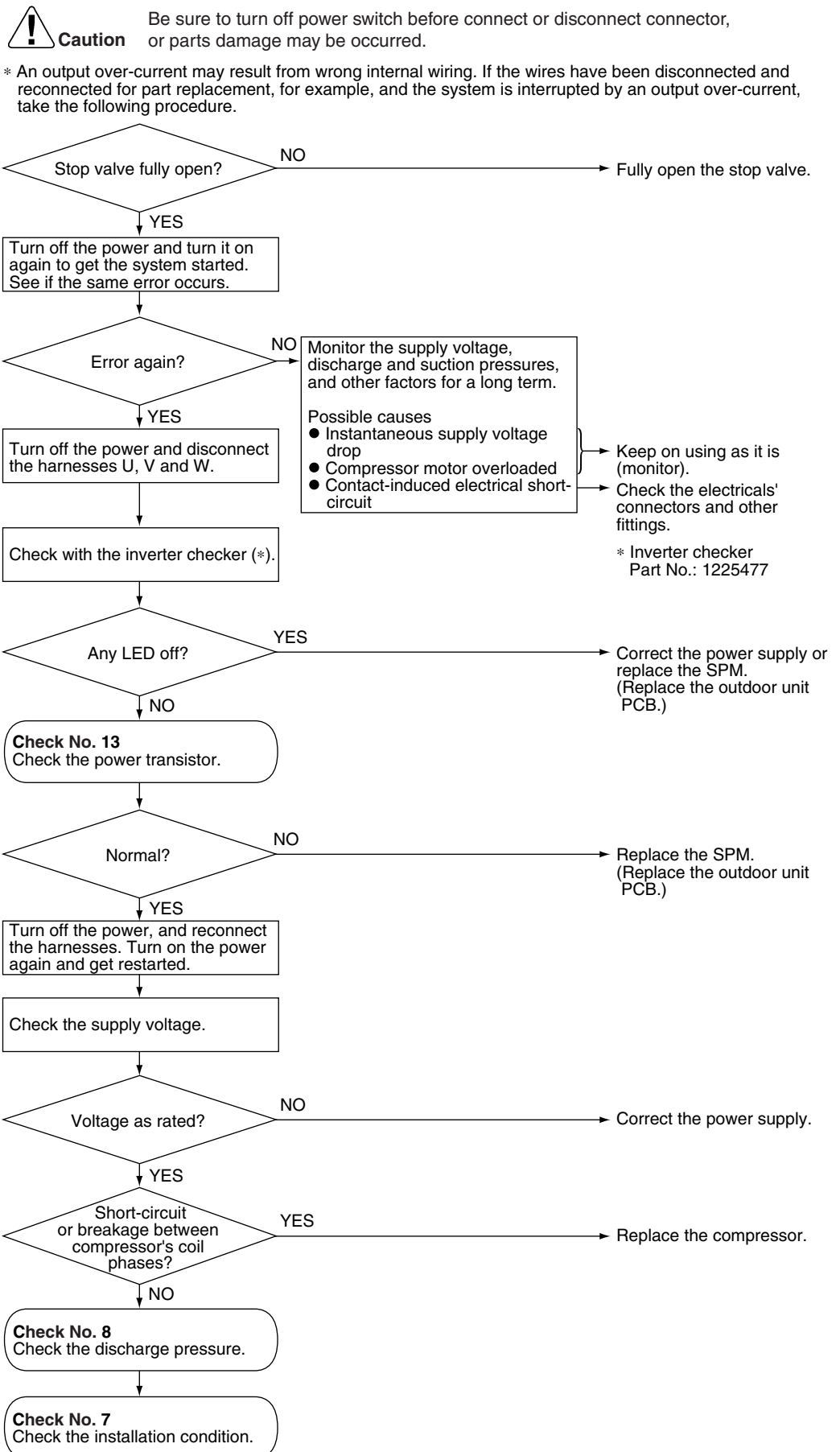

 **Note:** If the model doesn't have SPM, replace the outdoor unit PCB.

(R2852)

4.23 Insufficient Gas

Remote
Controller
Display

U0

Method of
Malfunction
Detection

Gas shortage detection I : A gas shortage is detected by checking the compressor running frequency.

Gas shortage detection II : A gas shortage is detected by checking the difference between indoor unit heat exchanger temperature and room temperature as well as the difference between outdoor unit heat exchanger temperature and room temperature.

Gas shortage detection III : A gas shortage is detected by checking the difference between inhale and exhale temperature.

Malfunction
Decision
Conditions

Gas shortage detection I :

Input current < Δ (A/Hz) x Compressor running frequency x Voltage + B

However, when the status of running frequency > C (Hz) is kept on for a certain time.

Note : The values are different from model to model.

Δ	B	C
640 / 256	0	55

Gas shortage detection II :

If a gas shortage error takes place 4 times successively, the system will be shut down. The error counter will reset itself if this or any other error does not occur during the following 60-minute compressor running time (total time).

Gas shortage detection III :

When the difference of the temperature is smaller than Δ , it is regarded as insufficient gas.

		Δ
Cooling	room temperature – indoor heat exchanger temperature	4.0°C
	outdoor heat exchanger temperature – outdoor temperature	4.0°C
Heating	indoor heat exchanger temperature – room temperature	4.0°C
	outdoor temperature – outdoor heat exchanger temperature	3.0°C

Supposed
Causes

- Refrigerant shortage (refrigerant leakage)
- Poor compression performance of compressor
- Discharge pipe thermistor disconnected, or indoor unit or outdoor unit heat exchanger thermistor disconnected, room or outdoor air temperature thermistor disconnected
- Stop valve closed
- Electronic expansion valve defective

Troubleshooting



Check No.4
Refer to P.104



Check No.6
Refer to P.106



Caution Be sure to turn off power switch before connect or disconnect connector, or parts damage may be occurred.

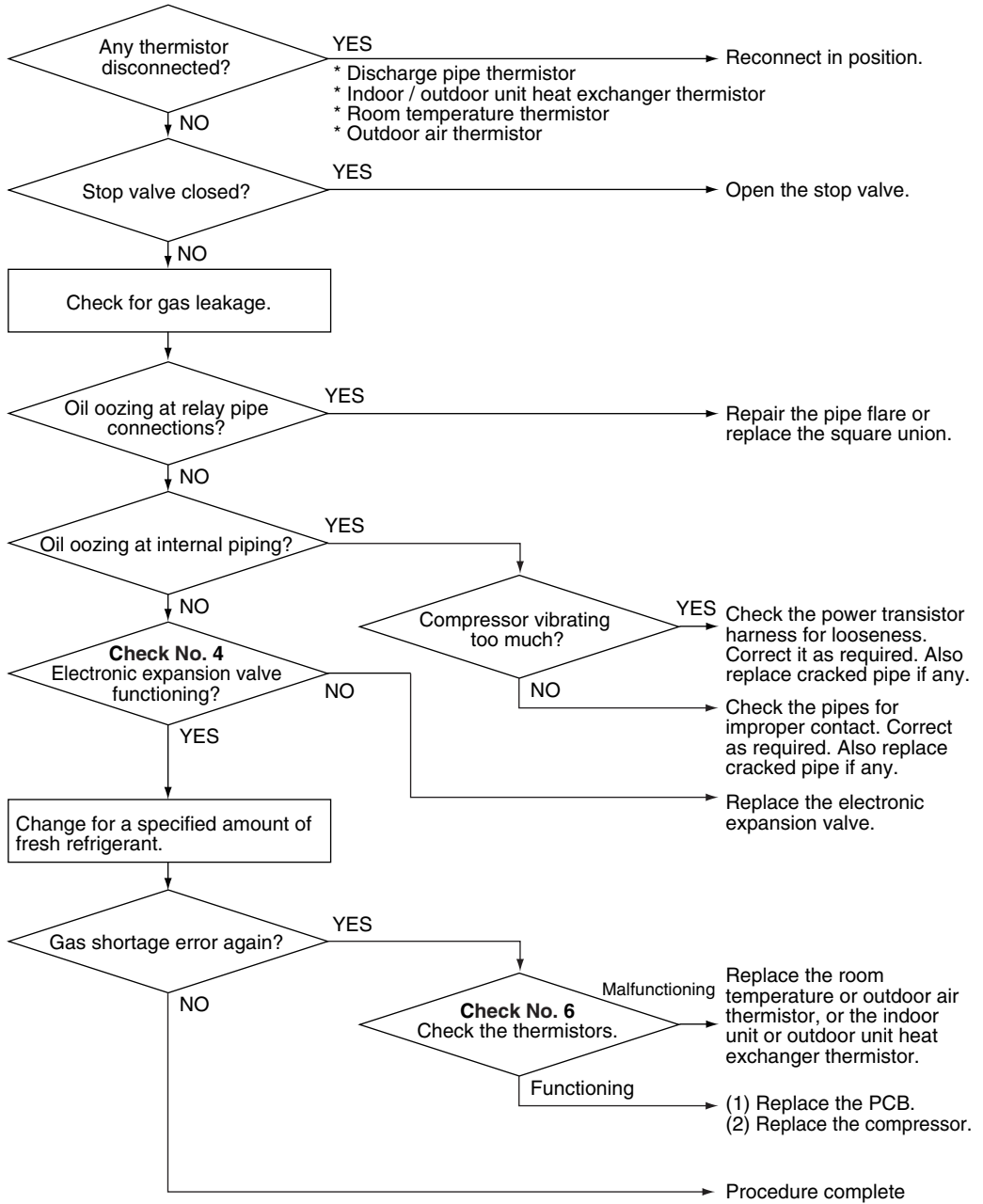

(R3318)

4.24 Over-voltage Detection

Remote
Controller
Display

U2

Method of
Malfunction
Detection

An abnormal voltage rise is detected by checking the specified over-voltage detection circuit.

Malfunction
Decision
Conditions

- An over-voltage signal is fed from the over-voltage detection circuit to the microcomputer (The voltage is over 400V).
- The system will be shut down if the error occurs 255 times.
- Clearing condition: Continuous run for about 10 minutes (normal)

Supposed
Causes

- Supply voltage not as specified
- Over-voltage detection circuit defective
- PAM control part(s) defective

Troubleshooting

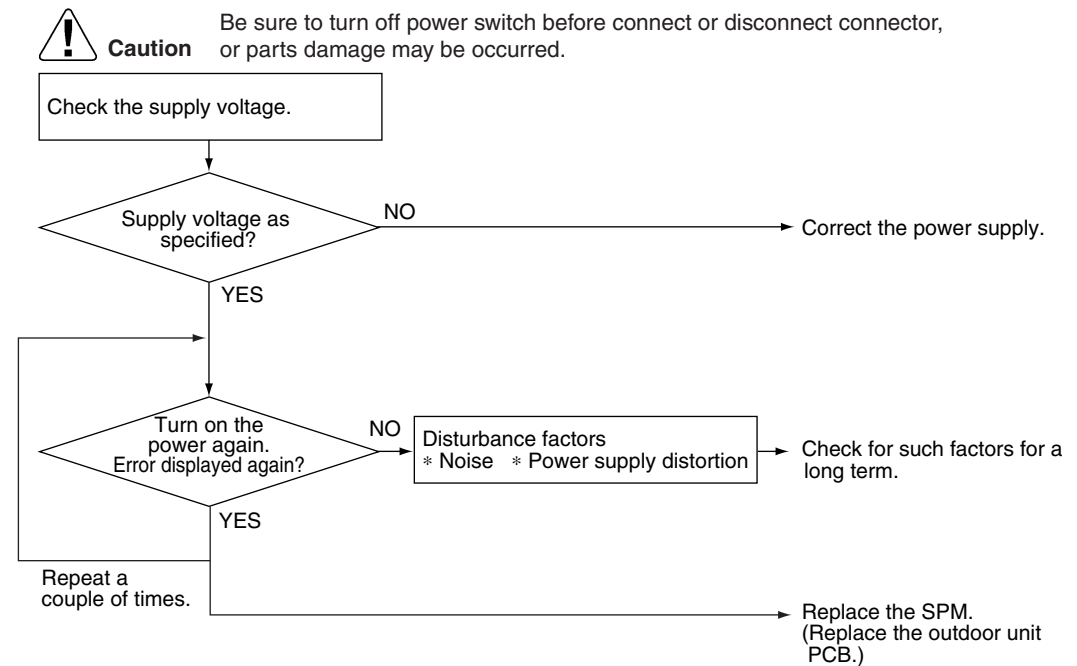

(R2957)



Note: If the model doesn't have SPM, replace the outdoor unit PCB.

5. Check

5.1 How to Check

5.1.1 Fan Motor Connector Output Check

Check No.01

1. Check connector connection.
2. Check motor power supply voltage output (pins 4-7).
3. Check motor control voltage (pins 4-3).
4. Check rotation command voltage output (pins 4-2).
5. Check rotation pulse input (pins 4-1).

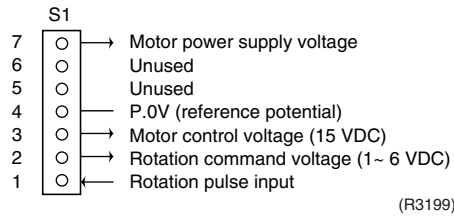

5.1.2 Electronic Expansion Valve Check

Check No.4

Conduct the followings to check the electronic expansion valve (EV).

1. Check to see if the EV connector is correctly inserted in the PCB. Compare the EV unit and the connector number.
2. Turn the power off and back on again, and check to see if all the EVs generate latching sound.
3. If any of the EVs does not generate latching noise in the above step 2, disconnect that connector and check the conductivity using a tester.
Check the conductivity between pins 1, 3 and 6, and between pins 2, 4 and 5. If there is no conductivity between the pins, the EV coil is faulty.

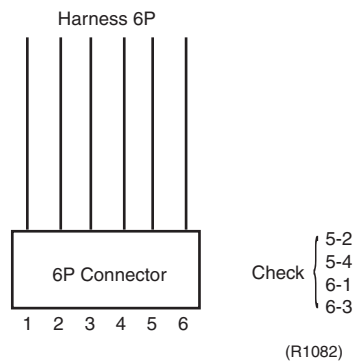

4. If no EV generates latching sound in the above step 2, the outdoor unit PCB is faulty.
5. If the conductivity is confirmed in the above step 2, mount a good coil (which generated latching sound) in the EV unit that did not generate latching sound, and check to see if that EV generates latching sound.
*If latching sound is generated, the outdoor unit PCB is faulty.
*If latching sound is not generated, the EV unit is faulty.



Note: Please note that the latching sound varies depending on the valve type.

5.1.3 Four Way Valve Performance Check

Check No.5

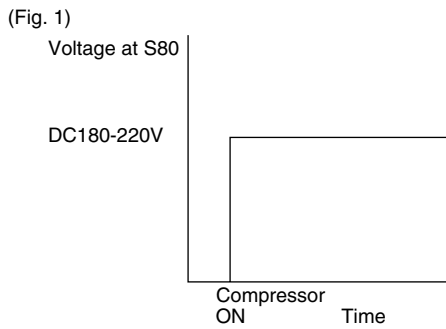
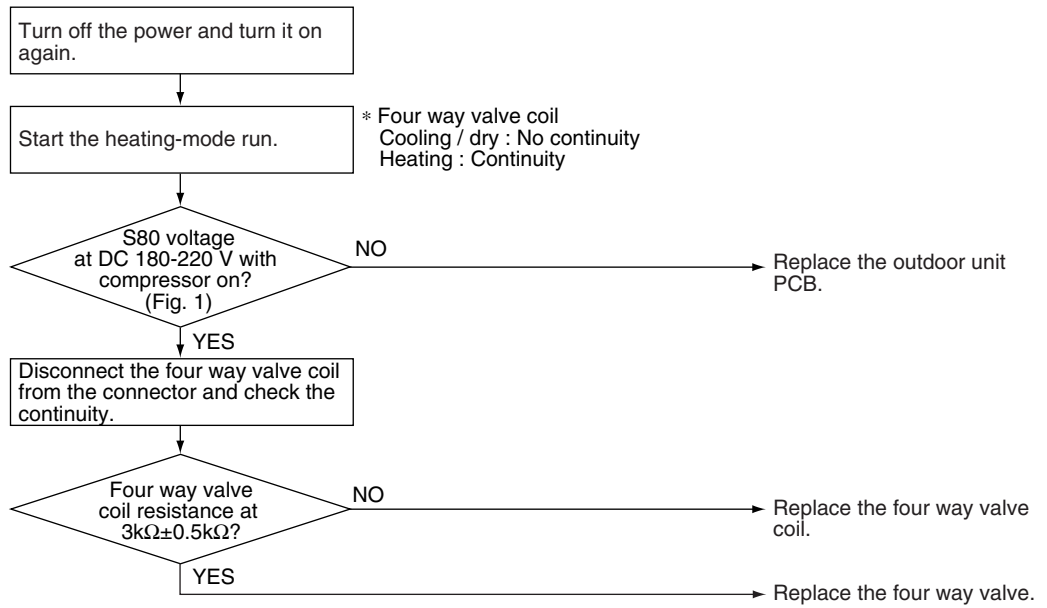

(R3047)

5.1.4 Thermistor Resistance Check

Check No.6

Remove the connectors of the thermistors on the PCB, and measure the resistance of each thermistor using tester.

The relationship between normal temperature and resistance is shown in the graph and the table below.

Temperature (°C)	Thermistor R25°C=20kΩ B=3950
-20	211.0 (kΩ)
-15	150
-10	116.5
-5	88
0	67.2
5	51.9
10	40
15	31.8
20	25
25	20
30	16
35	13
40	10.6
45	8.7
50	7.2

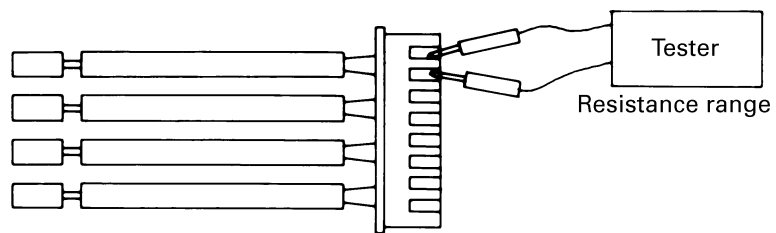

(R25 = 20k Ω 、 B = 3950)

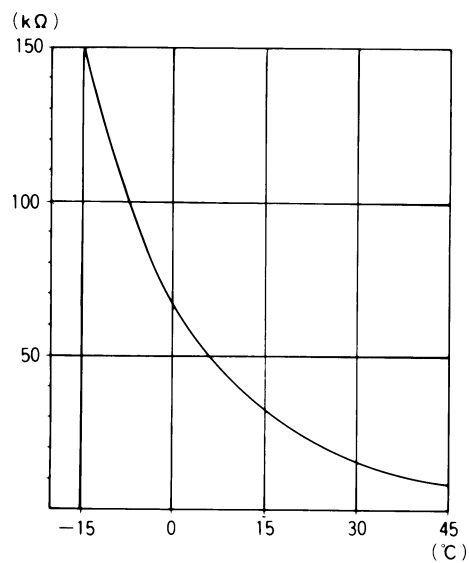

(R1437)

5.1.5 Installation Condition Check

Check No.7

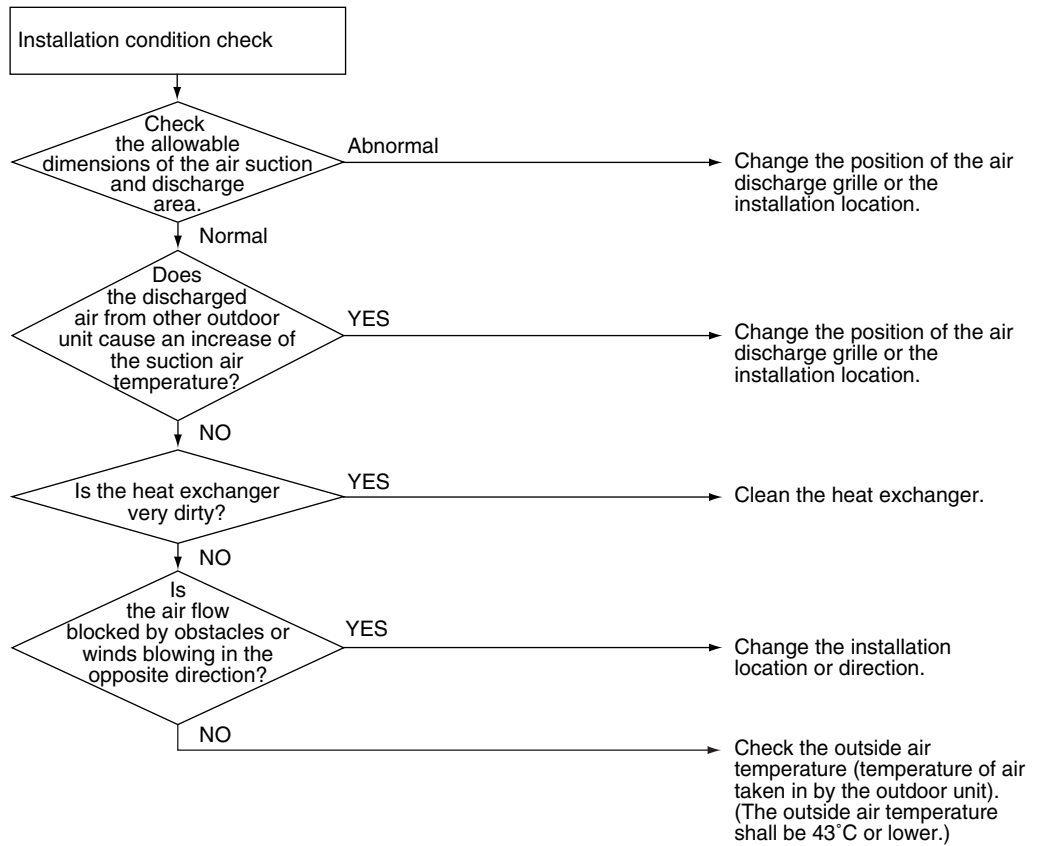

(R1438)

5.1.6 Discharge Pressure Check

Check No.8

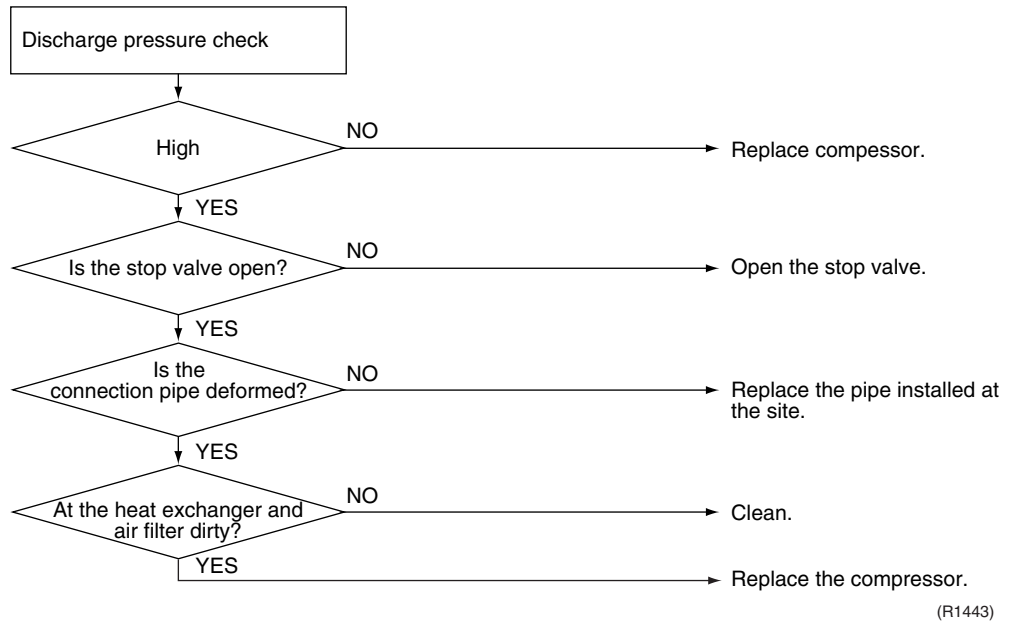

5.1.7 Outdoor Unit Fan System Check (With DC Motor)

Check No.9

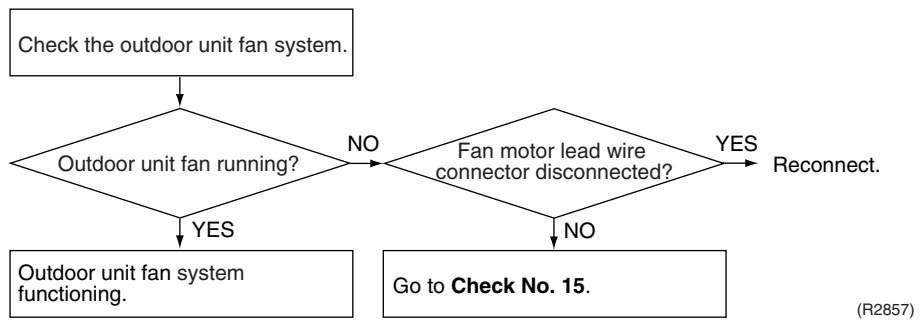

5.1.8 Power Supply Waveforms Check

Check No.10

Measure the power supply waveform between pins 1 and 3 on the terminal board, and check the waveform disturbance.

- Check to see if the power supply waveform is a sine wave (Fig.1).
- Check to see if there is waveform disturbance near the zero cross (sections circled in Fig.2)

[Fig.1]

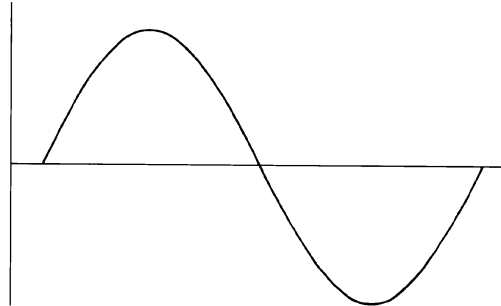

(R1736)

[Fig.2]

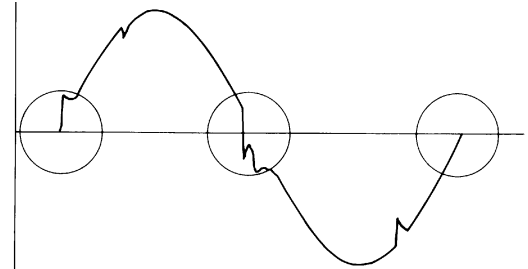

(R1444)

5.1.9 Inverter Units Refrigerant System Check

Check No.11

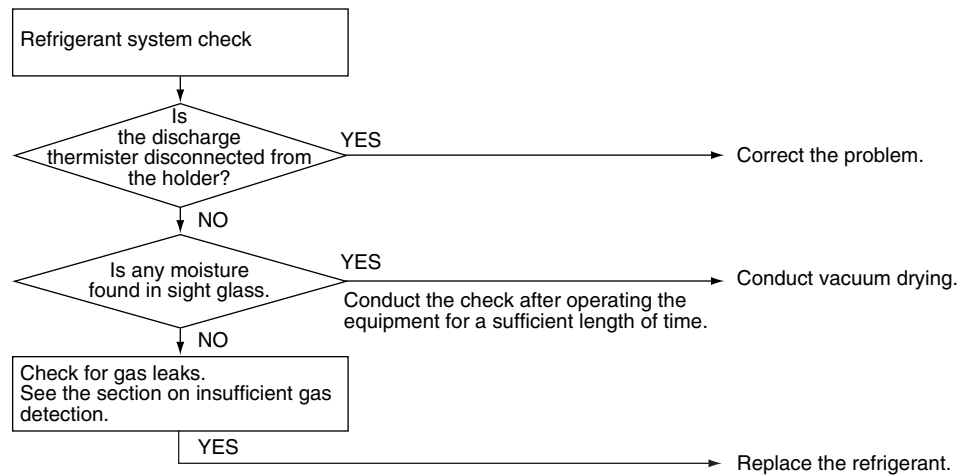

(R1445)

5.1.10 Power Transistor Check

Check No.13



Note: Check to make sure that the voltage between the terminal of Power transistor (+) and (-) is approx. 0 volt before checking power transistor.

< Measuring method >

Disconnect the compressor harness connector from the outdoor unit PCB. To disengage the connector, press the protrusion on the connector.

Then, follow the procedure below to measure resistance between power transistor (+) and (-) and the U, V and W terminals of the compressor connector with a multi-tester. Evaluate the measurement results for a pass/fail judgment.

<Power transistor check>

Negative (-) terminal of tester (positive terminal (+) for digital tester)	Power transistor (+)	UVW	Power transistor (-)	UVW
Positive (+) terminal of tester (negative terminal (-) for digital tester)	UVW	Power transistor (+)	UVW	Power transistor (-)
Normal resistance	Several kΩ to several MΩ (*)			
Unacceptable resistance	Short (0 Ω) or open			

5.1.11 Turning Speed Pulse Input on the Outdoor Unit PCB Check

Check No.15

<Propeller fan motor>

Make sure the voltage of 270±30V is being applied.

- (1) Stop the operation first and then the power off, and disconnect the connector S70.
- (2) Make sure there is about DC 270 V between pins 4 and 7.
- (3) With the system and the power still off, reconnect the connector S70.
- (4) Make a turn of the fan motor with a hand, and make sure the pulse (0-15 V) appears twice at pins 1 and 4.

If the fuse is blown out, the outdoor-unit fan may also be in trouble. Check the fan too.

If the voltage in Step (2) is not applied, it means the PCB is defective. Replace the PCB.

If the pulse in Step (4) is not available, it means the Hall IC is defective. Replace the DC fan motor. If there are both the voltage (2) and the pulse (4), replace the PCB.

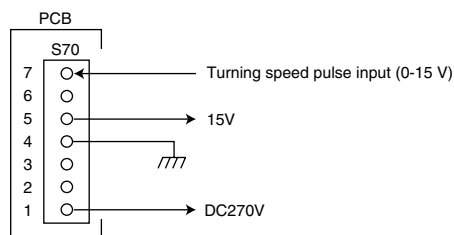

(R2859)

* Propeller fan motor : S70

Part 7

Removal Procedure

1. Indoor Unit.....	112
1.1 Removal of Air Filter.....	112
1.2 Removal of Front Grille	114
1.3 Removal of Assembly of Front Panel Mechanism.....	120
1.4 Removal of Lamp Cover.....	124
1.5 Removal of Horizontal Blade.....	125
1.6 Removal of Reduction Motor.....	126
1.7 Removal of Outlet Grille	129
1.8 Removal of Vertical Blades and Swing Motor	130
1.9 Removal of Electrical Box	134
1.10 Removal of PCB.....	140
1.11 Removal of Heat Exchanger	146
1.12 Removal of Fan Rotor and Fan Motor.....	149
2. Outdoor Unit.....	152
2.1 Removal of Panels and Fan Motor.....	152
2.2 Removal of Electrical Box	159
2.3 Removal of Reactor and Partition Plate	161
2.4 Removal of Sound Blanket.....	163
2.5 Removal of Four Way Valve.....	165
2.6 Removal of Compressor.....	167
2.7 Removal of PCB.....	169

1. Indoor Unit

1.1 Removal of Air Filter

Procedure

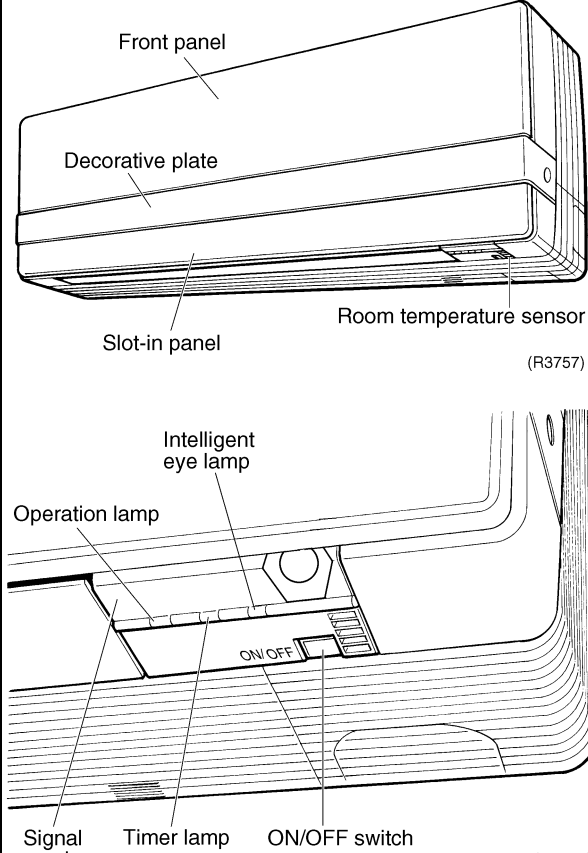
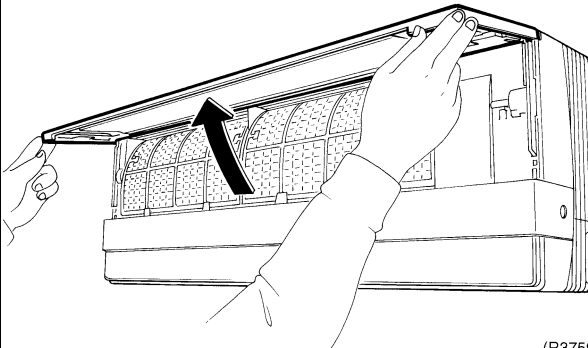
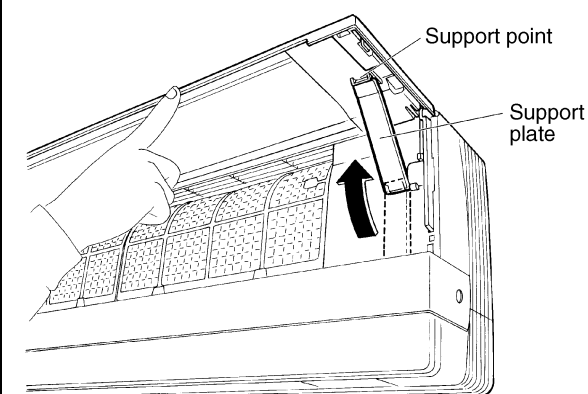

Warning Be sure to wait 10 minutes or more after turning off all power supplies before disassembling work.

Step	Procedure	Points
<p>1. Features</p>		<ul style="list-style-type: none"> When the signal receiver catches a signal from the remote controller, it produces beep sound and the operation lamp blinks.
<p>2. Remove the air filters.</p>	<p>1 Hold the front panel by the tabs on the both sides and lift it until it stops with a click.</p>  <p>(R3759)</p> <p>2 Keep the front panel open with the support plate.</p>  <p>(R3760)</p>	

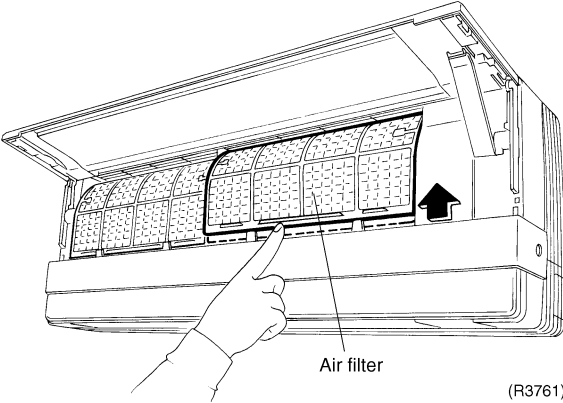
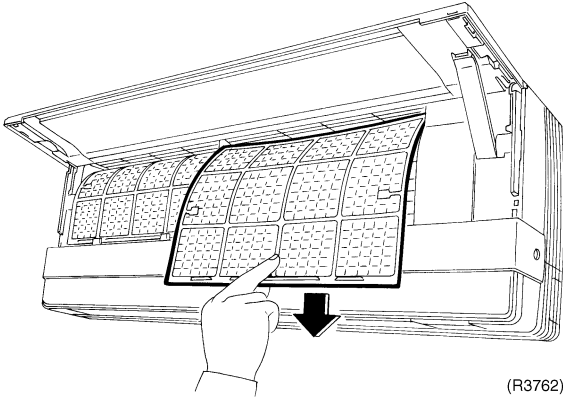
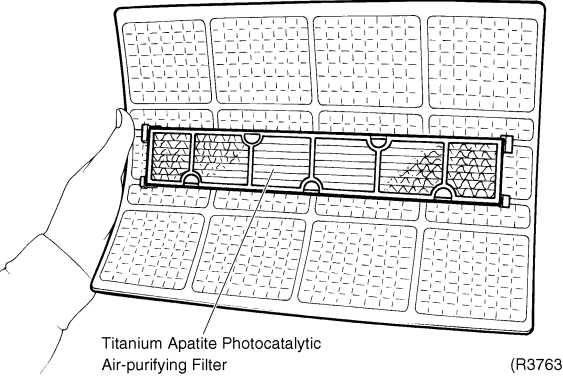
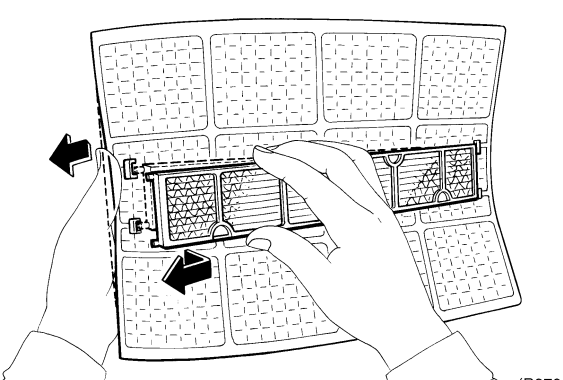
Step	Procedure	Points
3	<p>Lift an air filter upwards slightly and then pull it out downwards.</p>  <p>Air filter</p> <p>(R3761)</p>  <p>(R3762)</p>	<ul style="list-style-type: none"> ■ The right and left air filters are interchangeable. ■ Insert the air filters along grooves when installing. ■ When installing, insert 2 hooks of the air filter completely.
3. Remove the air-purifying filter.	<p>1 Titanium Apatite Photocatalytic Air-purifying Filter is fixed on the rear of the air filter.</p>  <p>Titanium Apatite Photocatalytic Air-purifying Filter</p> <p>(R3763)</p> <p>2 Bend the air filter to release the protrusions and remove the Titanium Apatite Photocatalytic Air-Purifying filter.</p>  <p>(R3764)</p>	<ul style="list-style-type: none"> ■ The right and left air-purifying filters are interchangeable.

1.2 Removal of Front Grille

Procedure



Warning Be sure to wait 10 minutes or more after turning off all power supplies before disassembling work.

Step	Procedure	Points
<p>1. Remove the front panel.</p> <p>1 Open the front panel to the horizontal position. Release the both sides pivots and remove the front panel.</p>	<p>(R3765)</p> <p>(R3766)</p>	<ul style="list-style-type: none"> ■ Start the removal procedure of front grille when the panels are closed. ■ Slide the front panel side to side to release each axis. ■ Align the right and left axes with grooves in turn and insert them to the end when installing.
<p>2. Remove the decorative plate.</p> <p>1 Lift and pull out the decorative plate while pushing the both sides hooks through the holes.</p>	<p>Decorative plate</p> <p>(R3767)</p> <p>(R3768)</p> <p>(R3769)</p>	<ul style="list-style-type: none"> ■ The decorative plate has hooks (3 for each side) on the back side.

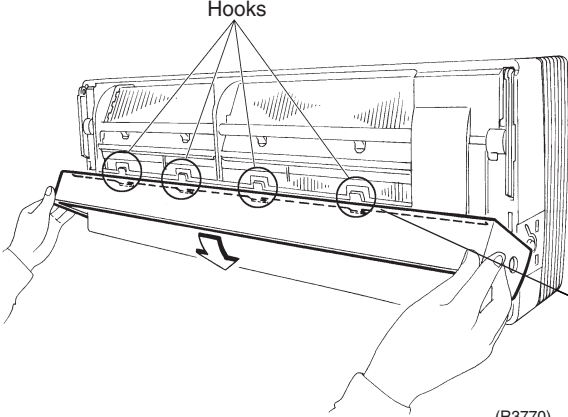
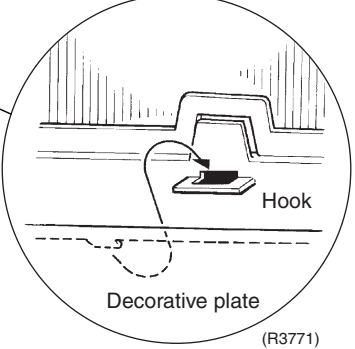
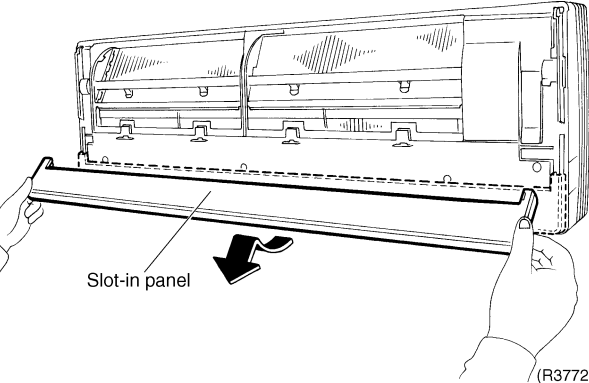
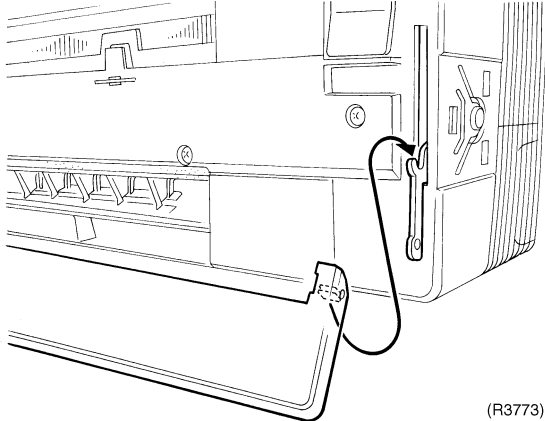
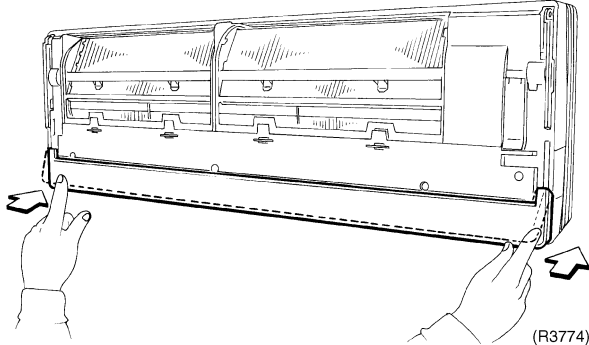
Step	Procedure	Points
2	When reassembling, fit the 4 hooks on the upper side and insert the both sides hooks while rotating the decorative plate.	<p> Caution Fit the hooks securely, or the slot-in panel gets caught in the decorative plate and the mechanism may break down.</p>  <p>(R3770)</p>  <p>(R3771)</p>
3	Lift and remove the slot-in panel.	 <p>(R3772)</p>
4	When reassembling, fit the axes of the slot-in panel from above.	 <p>(R3773)</p>
5	Push the lower part of the slot-in panel and attach to the running gear.	 <p>(R3774)</p>

Step	Procedure	Points	
3.	Remove the service cover.		
1	Bend the service cover inside and release the hooks.	<ul style="list-style-type: none"> ■ The service cover has no screw. 	
2	The service cover has 2 hooks on the right side and 4 hooks on the lower side.		<ul style="list-style-type: none"> ■ When reassembling, fit the right side hooks and insert the lower hooks while bending the service cover.
3	Loosen the screw on the service cover of electrical box.		

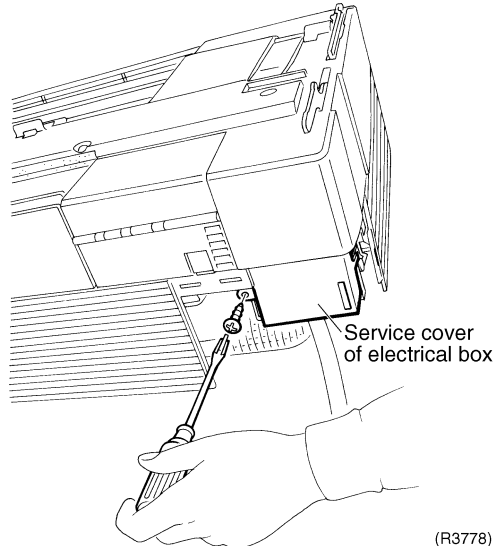
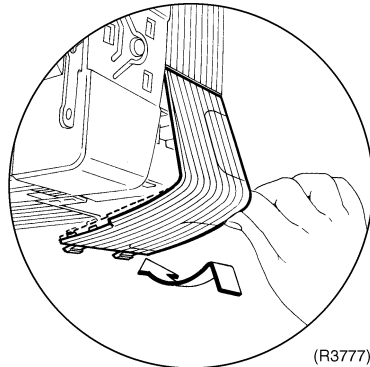
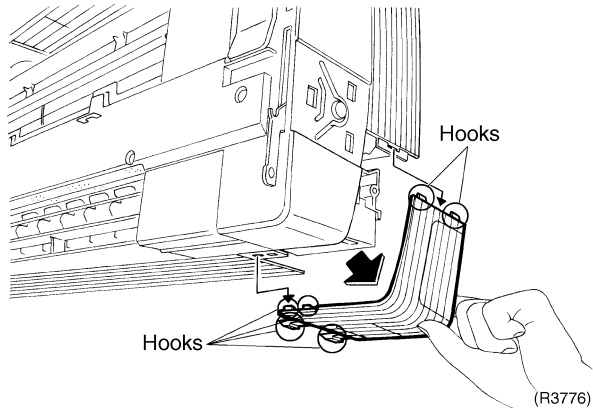
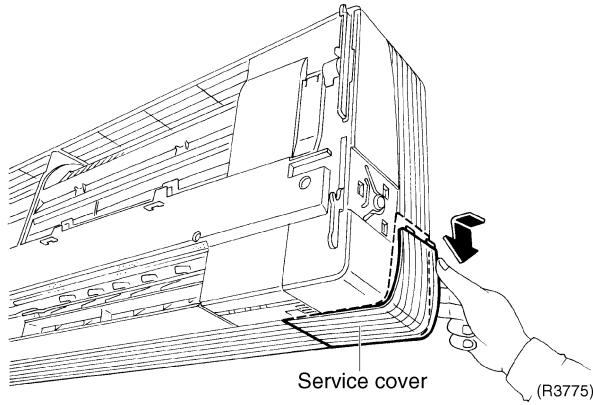

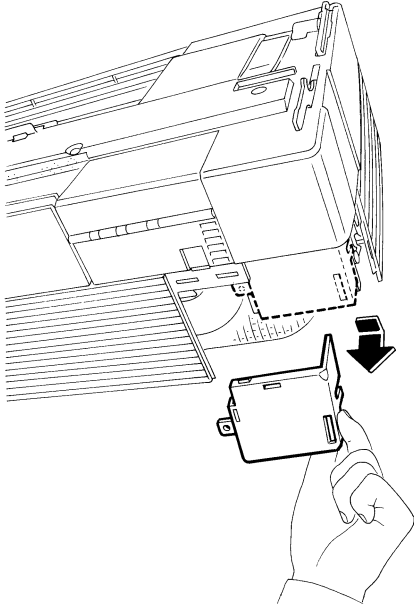
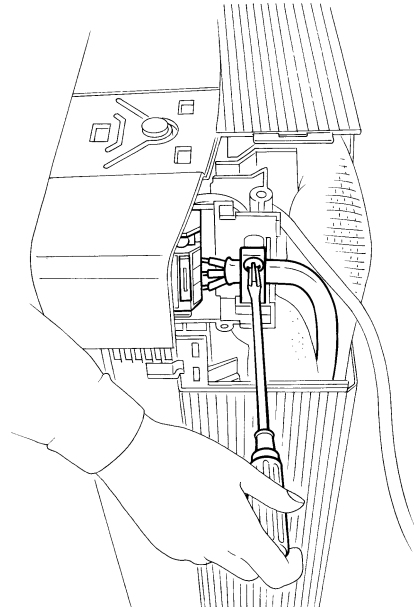
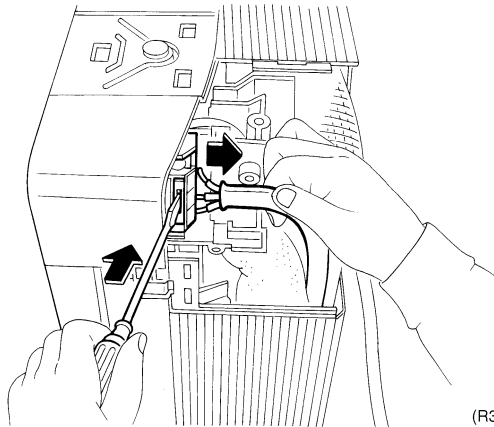
Step	Procedure	Points
4	<p>Pull down and remove the service cover of electrical box.</p>  <p>(R3779)</p>	
5	<p>Loosen the screw on the fixing plate.</p>  <p>(R3780)</p>	
6	<p>Push the white section on the terminal board and release the relay wires.</p>  <p>(R3781)</p>	

Step	Procedure	Points
<p>4. Remove the front grille.</p> <p>1 Loosen the 5 screws.</p> <p>2 The front grille has 3 hooks on the upper side.</p>		<ul style="list-style-type: none"> ■ The front grille has no screw inside flaps.

Step	Procedure	Points
3	Lift the upper part of the front grille and release the hooks. Release the center hook first.	<ul style="list-style-type: none"> ■ Be careful not to cut your finger by the fins of the heat exchanger. ■ As for the horizontal blades, fully opened position is easy to reassemble and remove.
4	Release the both sides hooks.	
5	Pull the front grille out horizontally and remove it.	<ul style="list-style-type: none"> ■ When reassembling, install the front grille horizontally so as not to stuff the flap inside.

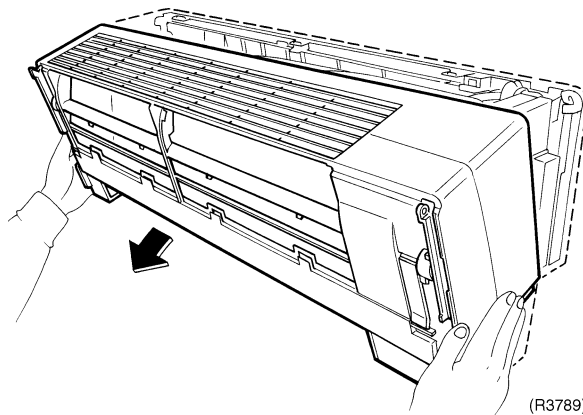
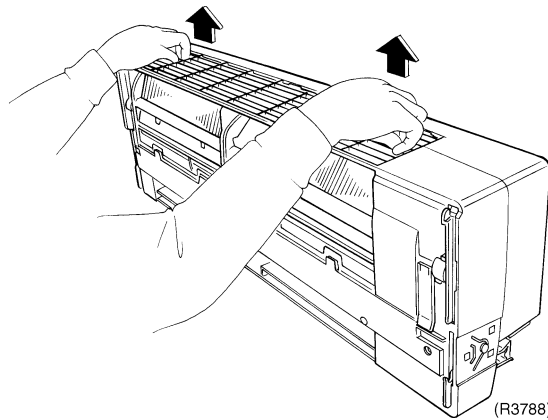
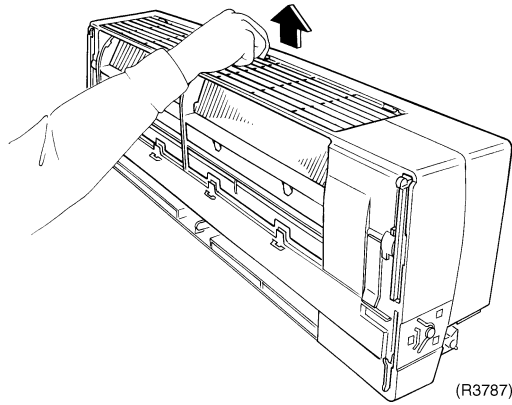

1.3 Removal of Assembly of Front Panel Mechanism

Procedure



Warning Be sure to wait 10 minutes or more after turning off all power supplies before disassembling work.

Step	Procedure	Points
<p>■ Remove the front grille.</p> <p>1. Remove the assembly of front panel mechanism.</p>	<p>Assy. of front panel mechanism (right)</p> <p>Assy. of front panel mechanism (left)</p> <p>(R3790)</p>	<p>■ When reassembling, insert the lower rack plate first.</p> <p>■ Pay attention so as not to lose the drive gear.</p> <div data-bbox="1139 1697 1410 1966" data-label="Image"> <p>Drive gear</p> <p>(R3794)</p> </div>
<p>1 The back of the front grilles</p>	<p>(R3791)</p>	
<p>2 Loosen the 2 screws of the assembly (left).</p>	<p>Lower rack plate</p> <p>(R3792)</p>	
<p>3 Remove the assembly.</p>	<p>Shaft</p> <p>(R3793)</p>	

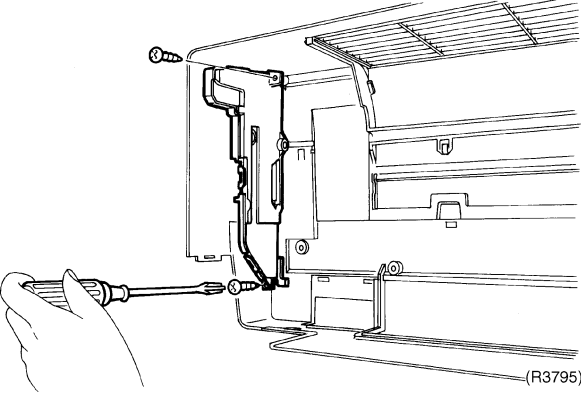
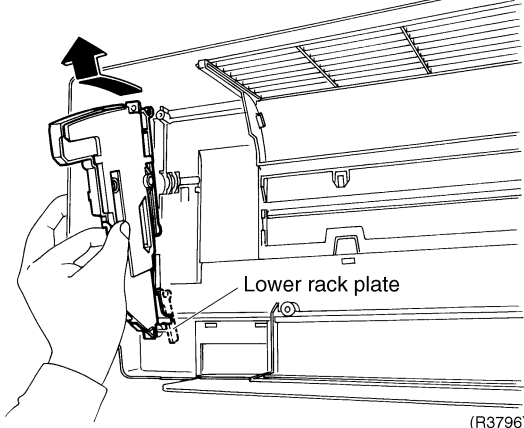
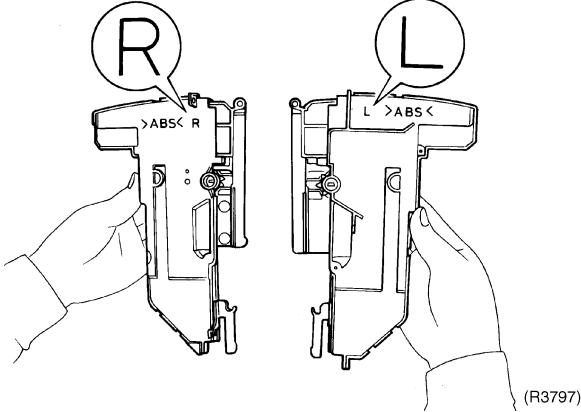
Step	Procedure	Points
5	<p>Loosen the 2 screws of the assembly (right).</p>  <p>(R3795)</p>	
6	<p>Remove the assembly.</p>  <p>(R3796)</p>  <p>(R3797)</p>	<ul style="list-style-type: none"> ■ When reassembling, insert the lower rack plate first. ■ The assembly has marks for right or left. R..... Right L Left

Step	Procedure	Points
2.	Remove the lower rack plate.	
1	Loosen the 2 screws of the left assembly cover.	
2	Hold the assembly horizontally and release the hook.	<ul style="list-style-type: none"> ■ When you demand small parts like cogs and rollers, order a set of assembly.
3	Remove the running gear.	<ul style="list-style-type: none"> ■ Pay attention so as not to lose the rollers.

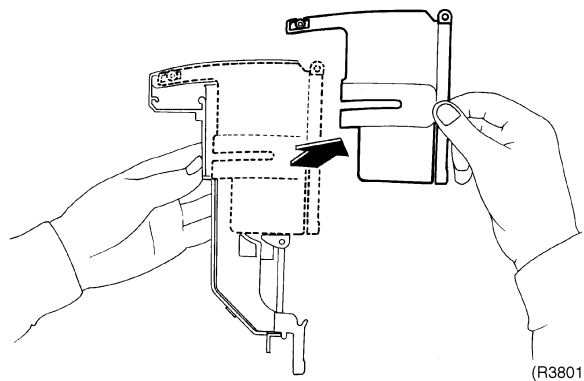
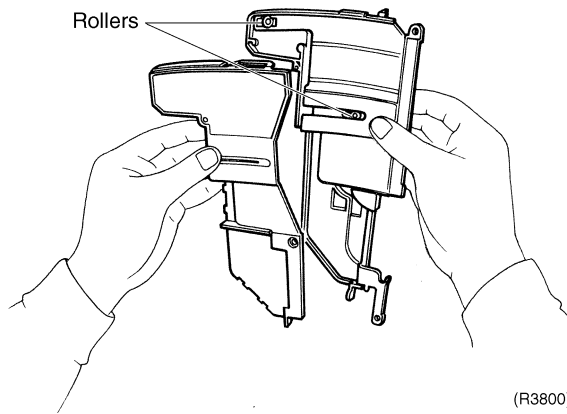
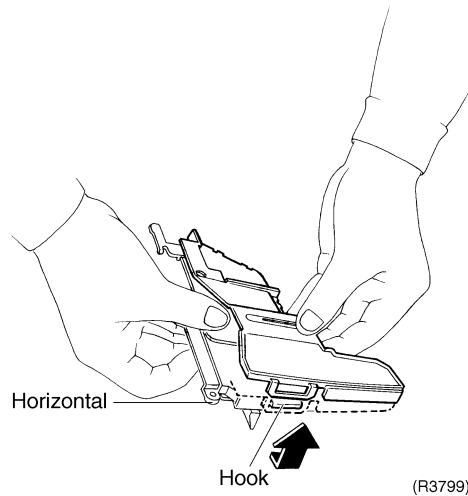
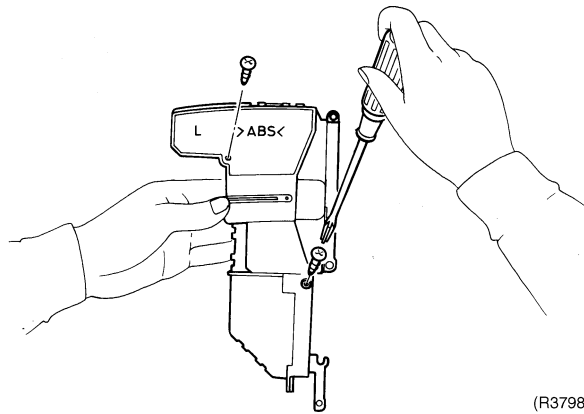

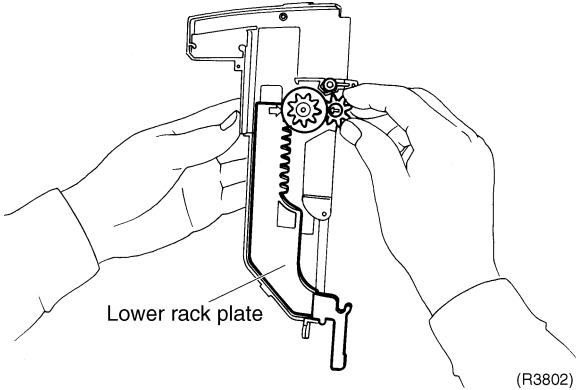
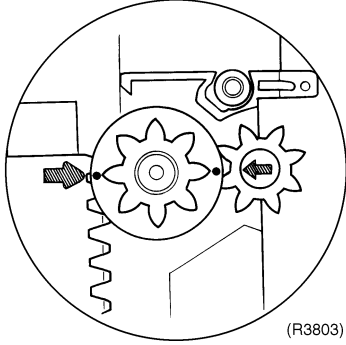
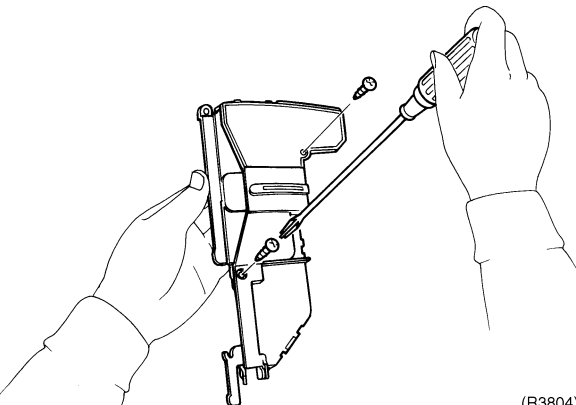
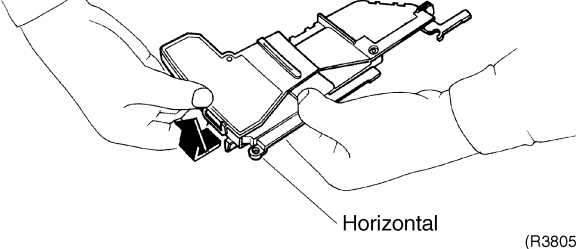
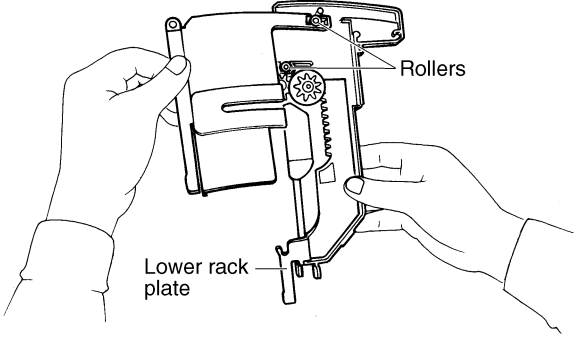
Step		Procedure	Points
4	Lift and remove the cog.	 <p>Lower rack plate</p> <p>(R3802)</p>	<ul style="list-style-type: none"> ■ When reassembling align the arrow with the mark • of the center cog.  <p>(R3803)</p>
5	Loosen the 2 screws of the right assembly cover.	 <p>(R3804)</p>	
6	Hold the assembly horizontally and release the hook.	 <p>Horizontal</p> <p>(R3805)</p>  <p>Rollers</p> <p>Lower rack plate</p> <p>(R3806)</p>	<ul style="list-style-type: none"> ■ When you demand small parts like cogs and rollers, order a set of assembly. ■ Pay attention so as not to lose the rollers. ■ The point for reassembling is the same as for the left.

1.4 Removal of Lamp Cover

Procedure



Warning Be sure to wait 10 minutes or more after turning off all power supplies before disassembling work.

Step	Procedure	Points
<p>■ Remove the front grille.</p>		
<p>1. Remove the lamp cover.</p>		
<p>1 Release the 2 hooks carefully.</p>	<p>(R3807)</p>	
	<p>(R3808)</p>	
<p>2 Release the 3 hooks while rotating the lamp cover and remove.</p>	<p>Lamp cover</p> <p>(R3809)</p>	
	<p>ON/OFF button</p> <p>Film</p> <p>Hooks</p> <p>(R3810)</p>	

1.5 Removal of Horizontal Blade

Procedure

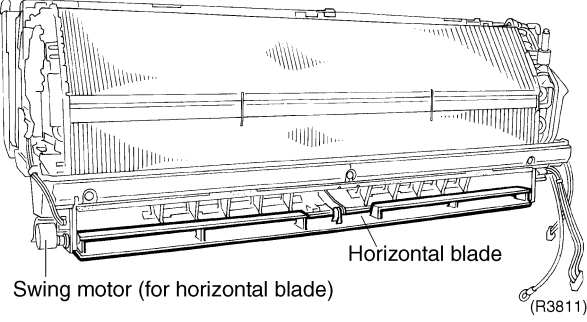
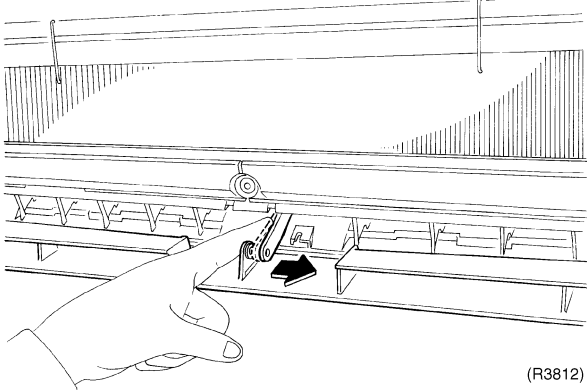
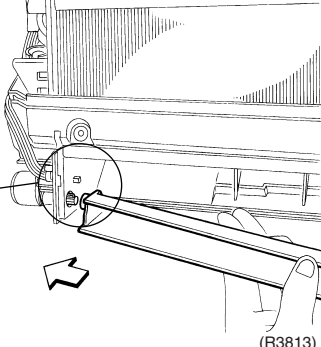
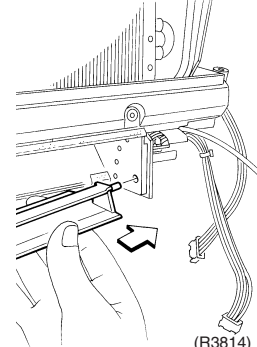
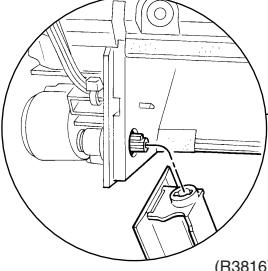
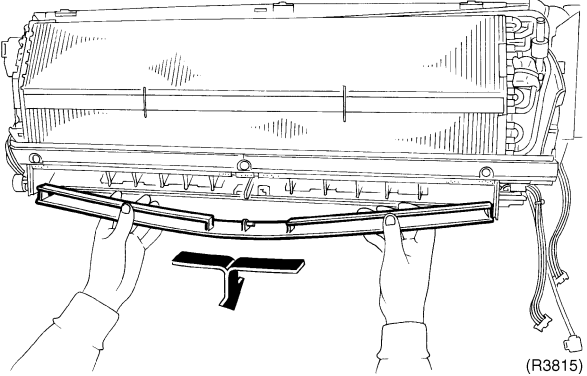

Warning Be sure to wait 10 minutes or more after turning off all power supplies before disassembling work.

Step	Procedure	Points
1. Remove the horizontal blade. 1 Release the center pivot.	    	<ul style="list-style-type: none"> ■ The horizontal blade is single.
2 Bend the horizontal blade slightly and remove it.		<ul style="list-style-type: none"> ■ Installation procedure <ol style="list-style-type: none"> 1. Since key pattern hook is provided, rotate the blade and fit it to the left pivot first. 2. Fit the blade to the right pivot. 3. Fit the blade to the center pivot.

1.6 Removal of Reduction Motor

Procedure



Warning Be sure to wait 10 minutes or more after turning off all power supplies before disassembling work.

Step	Procedure	Points
<p>■ Remove the front grille.</p>	<p>Assy. of reduction motor</p> <p>(R3817)</p>	
<p>1. Remove the assembly of reduction motor.</p>	<p>(R3818)</p>	
<p>1 Loosen the screw.</p>	<p>(R3819)</p>	
<p>2 Release the 2 hooks and remove the assembly.</p>		

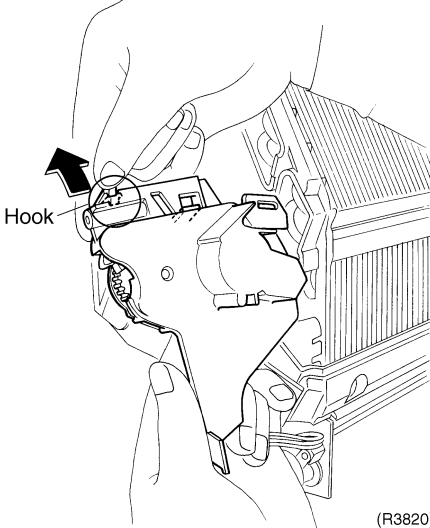
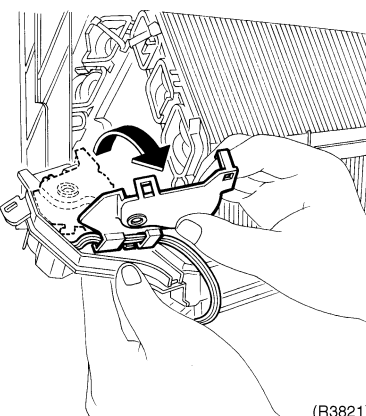
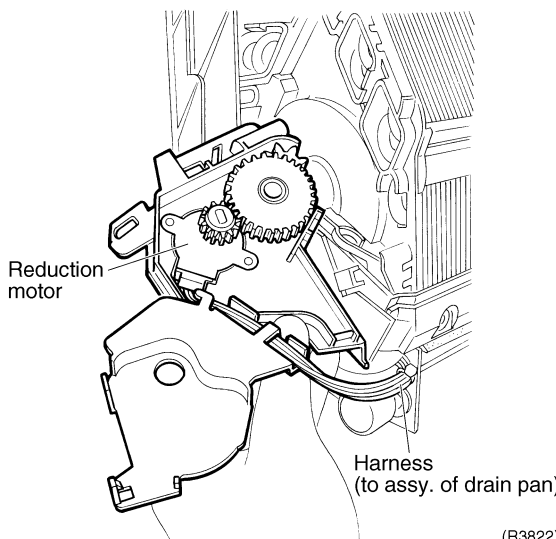
Step	Procedure	Points
2.	Remove the reduction motor.	
1	Release the hook and open the assembly.  <p style="text-align: right;">(R3820)</p>  <p style="text-align: right;">(R3821)</p>	
2	Layout of the harness of the motor  <p style="text-align: right;">(R3822)</p>	

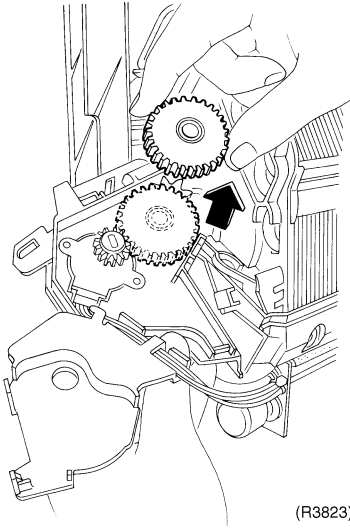
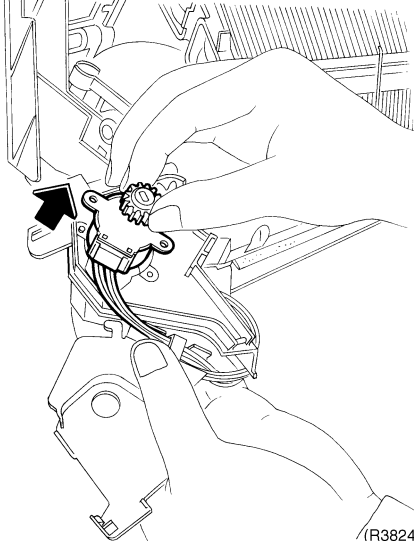
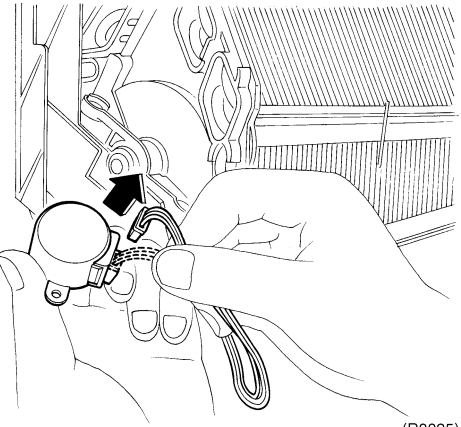
Step	Procedure	Procedure	Points
3	Remove the cog (large).	 <p>(R3823)</p>	
4	Lift and remove the reduction motor.	 <p>(R3824)</p>	
5	Pull and disconnect the connector for the motor.	 <p>(R3825)</p>	

1.7 Removal of Outlet Grille

Procedure

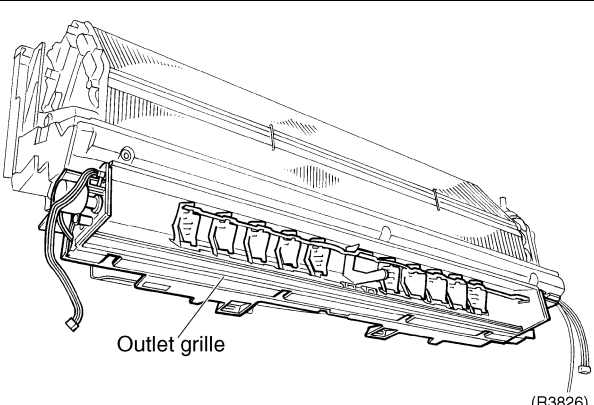
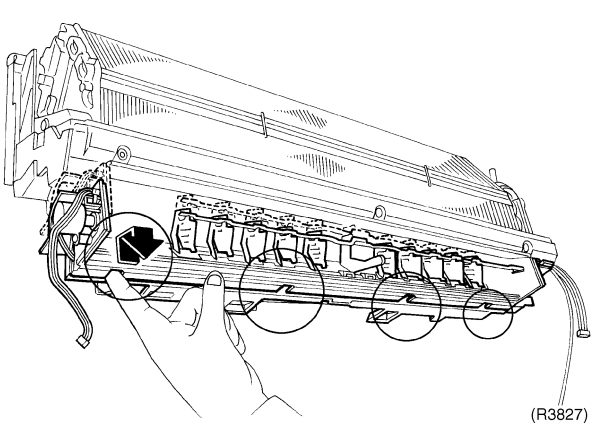
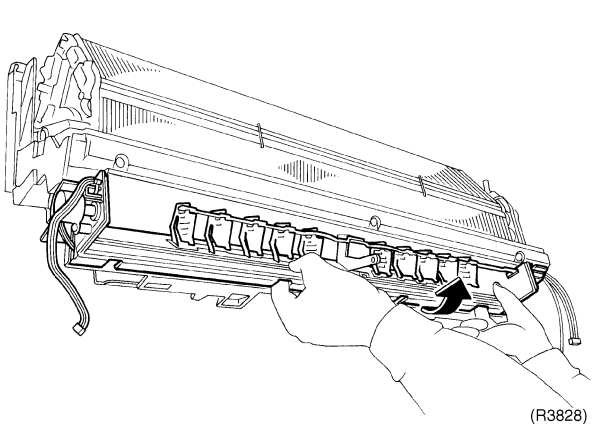
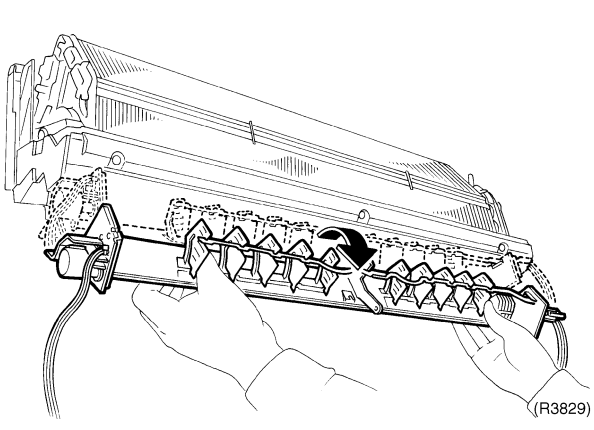

Warning Be sure to wait 10 minutes or more after turning off all power supplies before disassembling work.

Step	Procedure	Points
<ul style="list-style-type: none"> ■ Remove the front grille. ■ Remove the assembly of the reduction motor. 	 <p style="text-align: right;">(R3826)</p>	
1. Remove the outlet grille.	<p>1 Insert your finger into the hole and push up the hook to release it. The outlet grille has 4 holes.</p>	 <p style="text-align: right;">(R3827)</p>
2	<p>2 Lift up the lower part of the grille to release the hook on the upper backside.</p>	 <p style="text-align: right;">(R3828)</p>
3	<p>3 Rotate the upper part of the grille to release the hook on the lower backside. Pull out the grille.</p>	 <p style="text-align: right;">(R3829)</p>

1.8 Removal of Vertical Blades and Swing Motor

Procedure



Warning Be sure to wait 10 minutes or more after turning off all power supplies before disassembling work.

Step	Procedure	Points
<p>■ Remove the assembly of the outlet grille.</p> <p>1. Remove the vertical blades.</p>	<p style="text-align: center;">Vertical blades</p> <p style="text-align: right;">(R3830)</p>	
<p>1 Release the 4 hooks and remove the thermal insulation.</p>	<p style="text-align: right;">(R3831)</p> <p style="text-align: center;">Moisture condensation proof stuff</p> <p style="text-align: right;">(R3832)</p>	
<p>2 Release the 4 hooks and remove the thermal insulation.</p>	<p style="text-align: right;">(R3833)</p>	

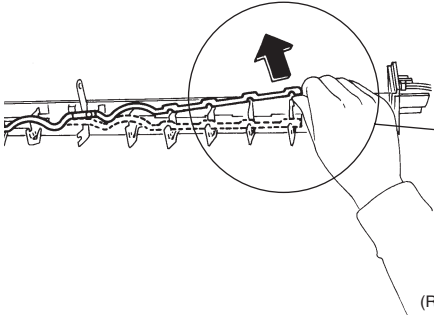
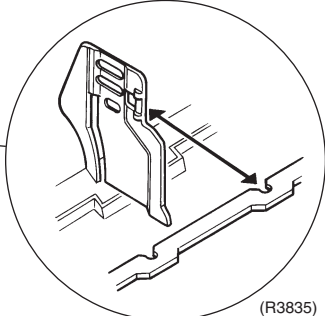
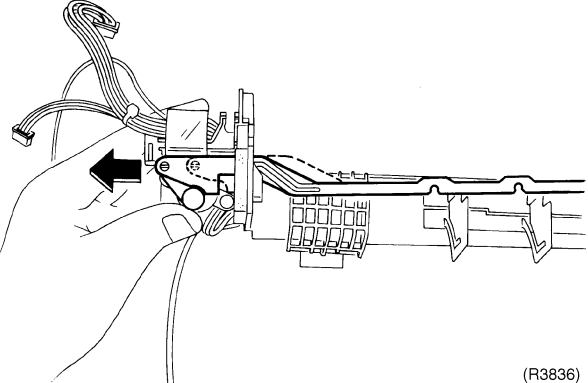
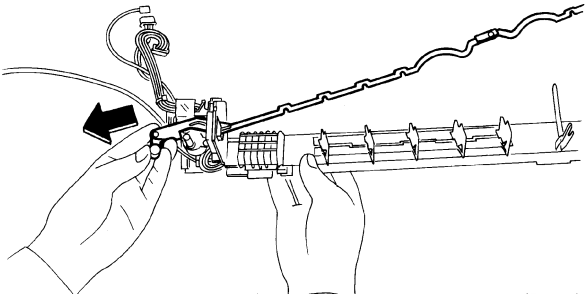
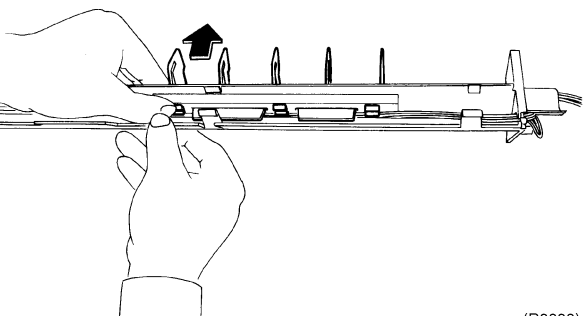
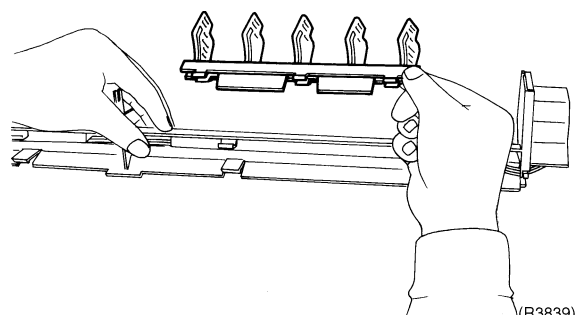
Step	Procedure	Points
3	<p>Remove the interlock rod from the vertical blades.</p>  <p>(R3834)</p>	 <p>(R3835)</p>
4	<p>Pull out the interlock rod from the swing motor side.</p>  <p>(R3836)</p>  <p>(R3837)</p>	<ul style="list-style-type: none"> ■ You cannot dismantle the caulking section.
5	<p>Push the hooks on the back of the vertical blades and remove.</p>  <p>(R3838)</p>  <p>(R3839)</p>	<ul style="list-style-type: none"> ■ One piece has 5 blades.

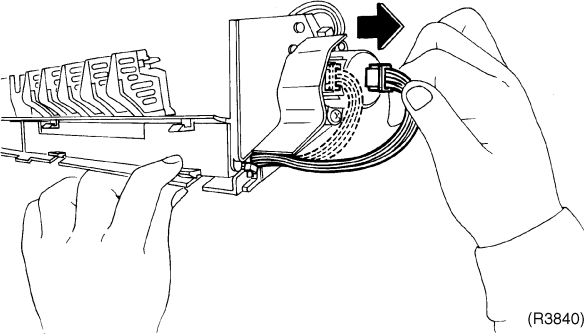
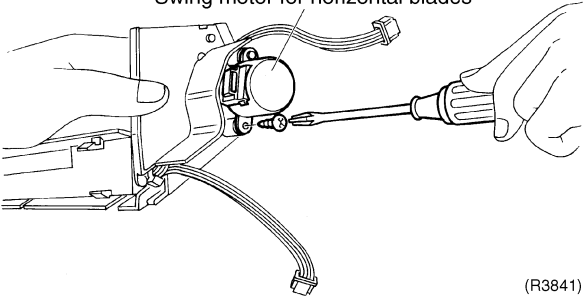
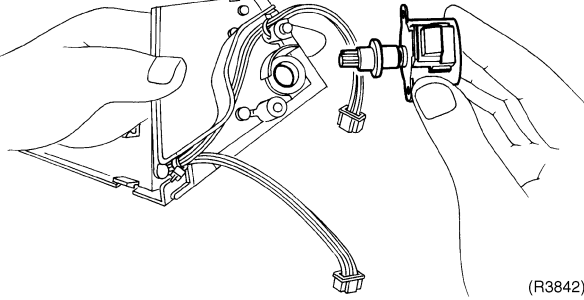
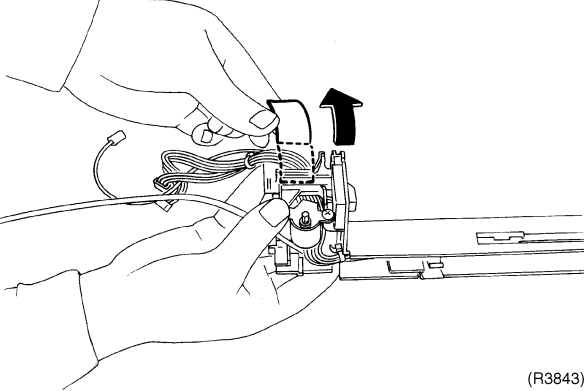
Step	Procedure	Points
<p>2. Remove the swing motor.</p>	<p>1 Disconnect the connector for the swing motor.</p>  <p>(R3840)</p> <p>2 Loosen the screw and remove the swing motor.</p> <p>Swing motor for horizontal blades</p>  <p>(R3841)</p>  <p>(R3842)</p> <p>3 Strip the fixing tape.</p>  <p>(R3843)</p>	

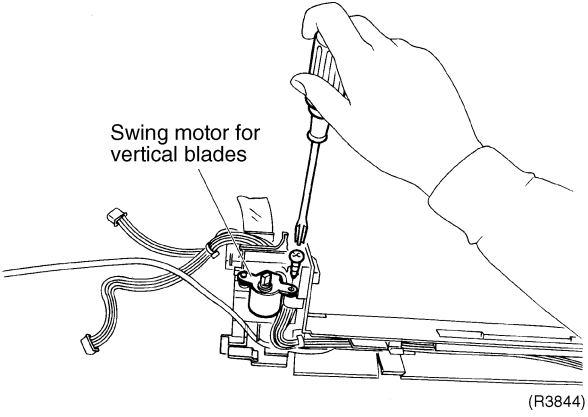
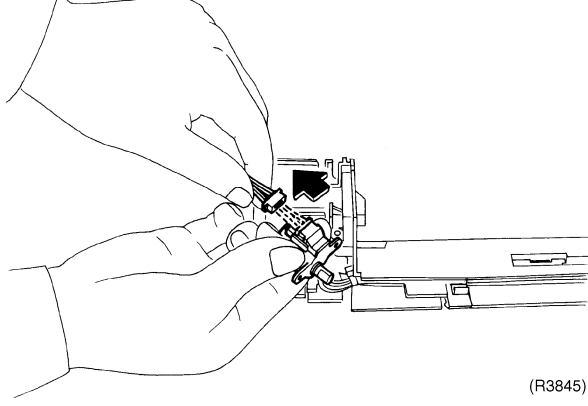
Step	Procedure	Points
4	<p data-bbox="199 217 454 309">Loosen the screw and pull out the swing motor.</p>  <p data-bbox="592 349 746 398">Swing motor for vertical blades</p> <p data-bbox="1015 622 1077 645">(R3844)</p>	
5	<p data-bbox="199 676 464 768">Disconnect the connector for the swing motor.</p>  <p data-bbox="1015 1070 1077 1093">(R3845)</p>	

1.9 Removal of Electrical Box

Procedure



Warning Be sure to wait 10 minutes or more after turning off all power supplies before disassembling work.

Step	Procedure	Points
<p>■ Remove the front grille. 1. Remove the electrical box.</p>	<p>Drip proof plate</p> <p>Electrical box</p> <p>(R3846)</p>	<p>■ Discharge the static electricity from your body before touching the electrical parts like signal receiver PCB. It may cause malfunction of PCB.</p>
<p>1 Loosen the screw of the earth.</p>	<p>Earth</p> <p>Limit switch</p> <p>Signal receiver PCB</p> <p>(R3847)</p>	
<p>2 Loosen the screw of the drip proof plate.</p>	<p>(R3848)</p> <p>(R3849)</p>	

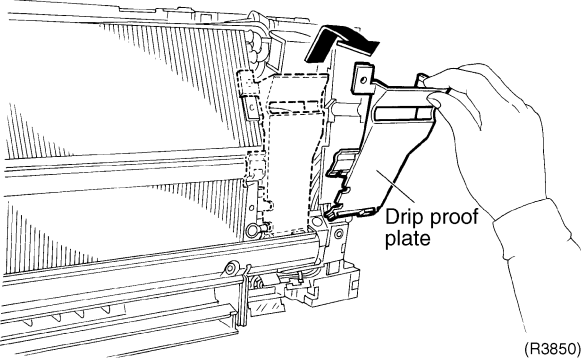
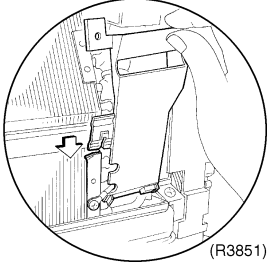
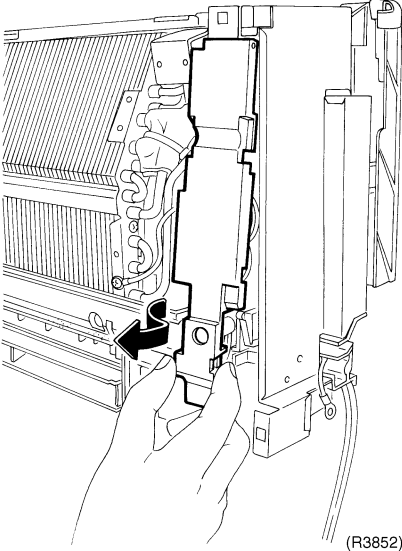
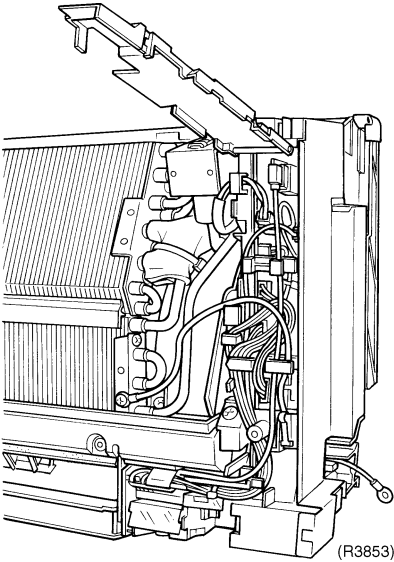
Step	Procedure	Points
3	<p>Lift and remove the drip proof plate.</p>  <p>(R3850)</p>	<p>■ When reassembling, insert the left hook of the drip proof plate into the hem plate of the heat exchanger.</p>  <p>(R3851)</p>
4	<p>Twist the electrical box cover to the right slightly to release the lower hook. Lift up and open the cover.</p>  <p>(R3852)</p>	
5	<p>Layout of the wiring</p>  <p>(R3853)</p>	

Step	Procedure	Points
6	Loosen the screw of the earth.	
7	Disconnect the connector for the swing motors for horizontal and vertical blades (S41).	<p>■ The harnesses for the horizontal swing motor and the vertical swing motor are united.</p>
8	Release the harness from the hook.	
9	Disconnect the connector for the fan motor (S1).	

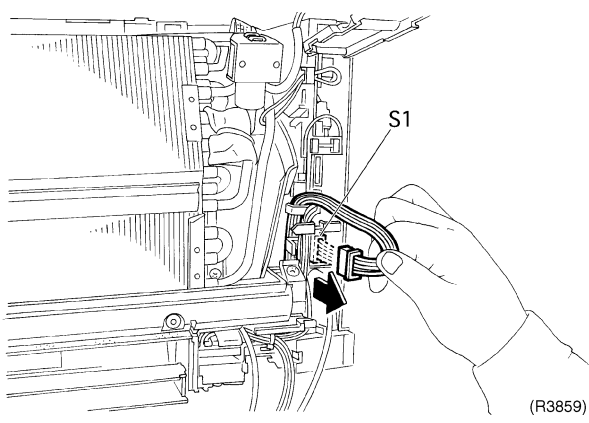
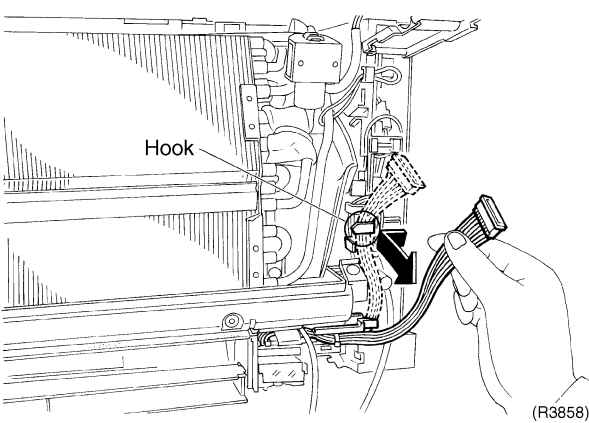
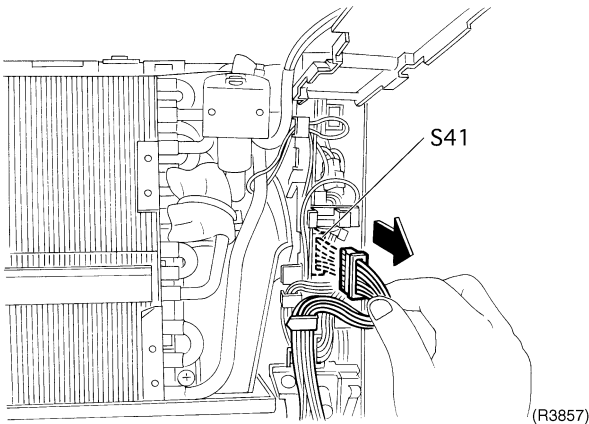
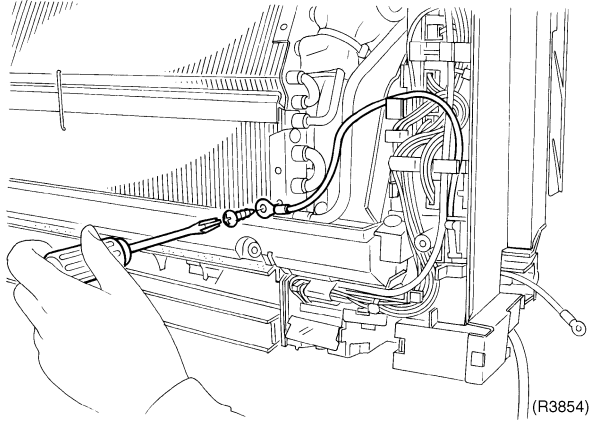

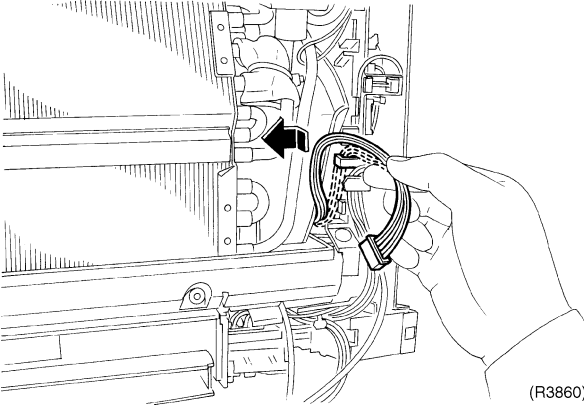
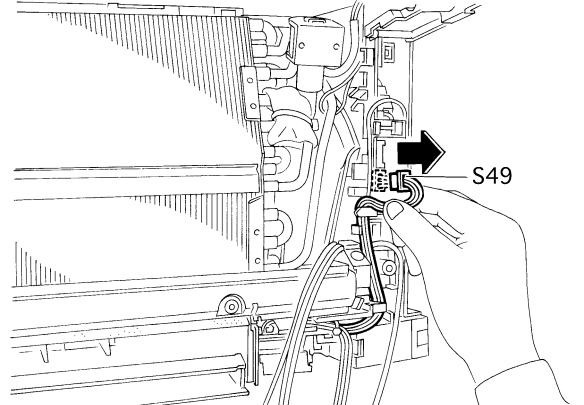
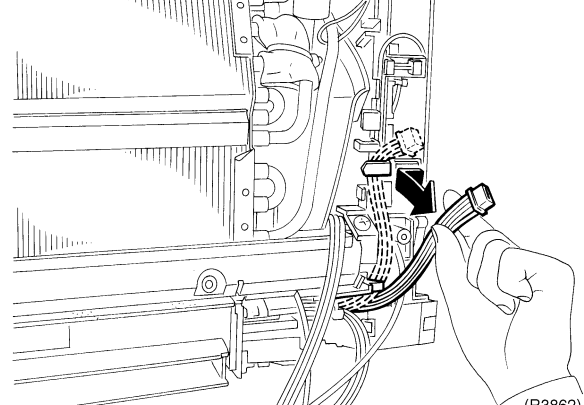
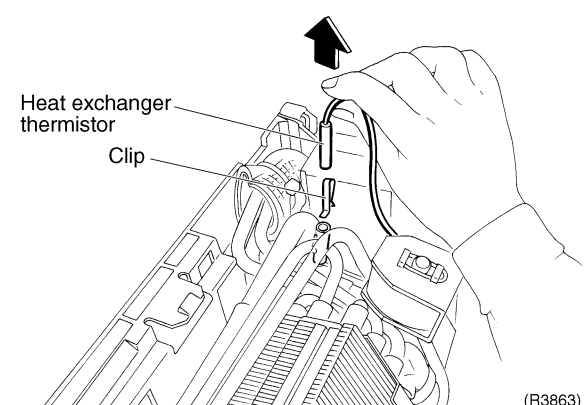
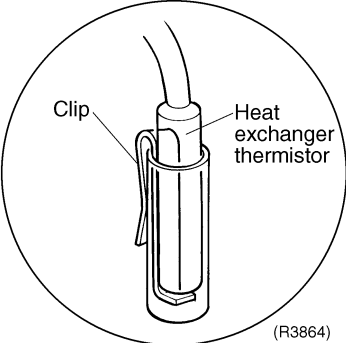
Step	Procedure	Points
10	<p>Release the harness from the hook.</p>  <p>(R3860)</p>	
11	<p>Disconnect the connector for the reduction motor (front panel mechanism) (S49).</p>  <p>(R3861)</p>	
12	<p>Release the harness from the hook.</p>  <p>(R3862)</p>	
13	<p>Release the heat exchanger thermistor.</p>  <p>(R3863)</p>	<p>■ Pay attention so as not to lose the clip.</p>  <p>(R3864)</p>

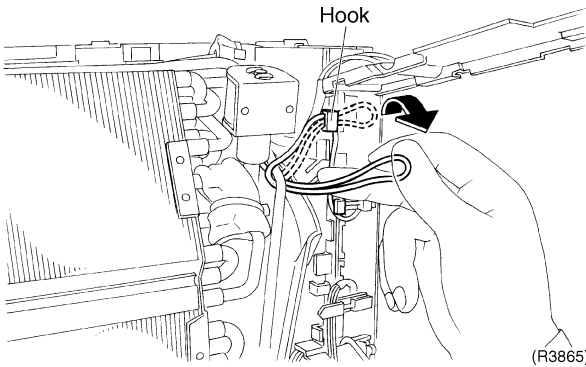
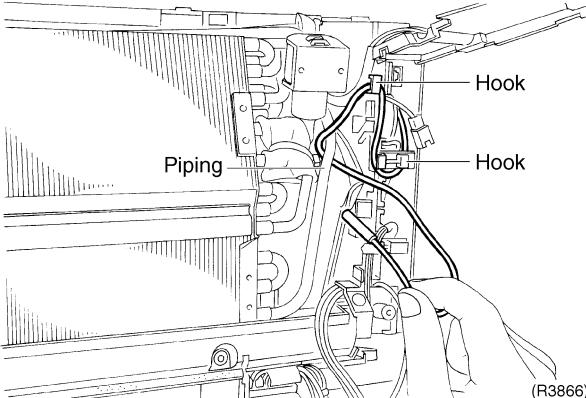
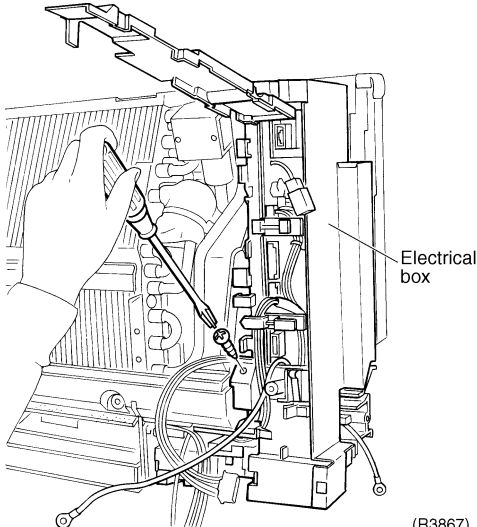
Step	Procedure	Points
14	<p>Release the thermistor lead wire from the hook.</p>  <p>(R3865)</p>	<ul style="list-style-type: none"> ■ When reassembling, hang the excessive lead wire of the heat exchanger thermistor on the hook.
15	<p>Layout of the lead wire for the heat exchanger thermistor</p>  <p>(R3866)</p>	
16	<p>Loosen the screw of the electrical box.</p>  <p>(R3867)</p>	

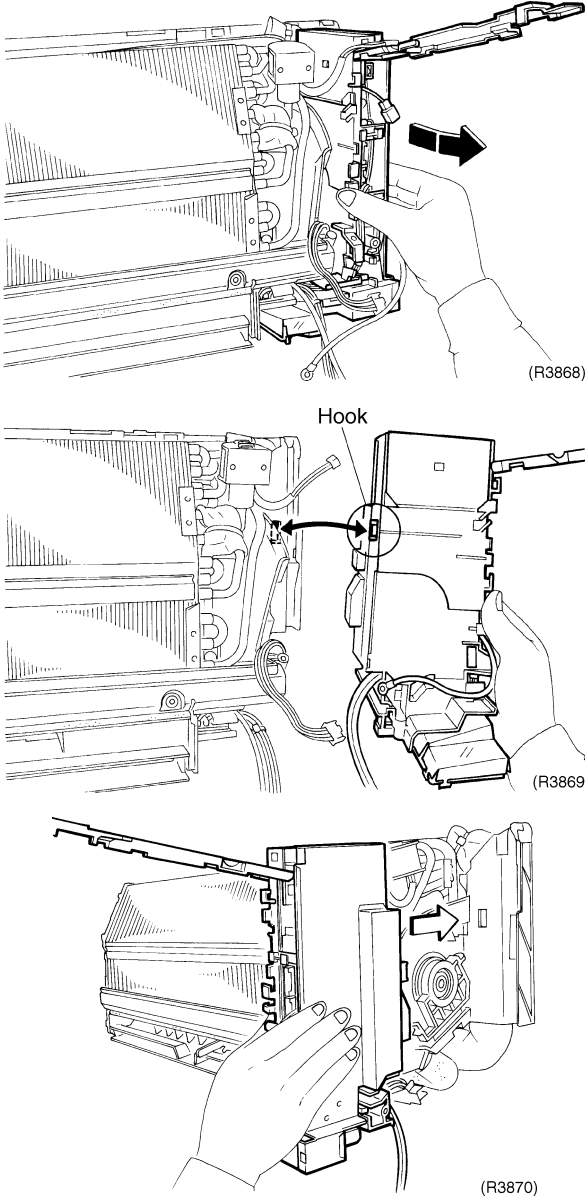
Step	Procedure	Points
17	<p data-bbox="199 215 459 338">Tilt the front part of the electrical box to the right slightly and pull it out.</p>  <p data-bbox="802 633 858 656">Hook</p>	<ul style="list-style-type: none"> <li data-bbox="1093 1048 1455 1171">■ When reassembling, push the electrical box upright and make sure to fit the hook on the backside.

1.10 Removal of PCB

Procedure



Warning Be sure to wait 10 minutes or more after turning off all power supplies before disassembling work.

Step	Procedure	Points
<p>■ Remove the electrical box.</p>	<p>(R3871)</p>	
<p>1. Remove the control PCB.</p>	<p>(R3872)</p>	
<p>1 Lift up the cover of the electrical box and open it.</p>		
<p>2 Release the right hook and remove the cover.</p>		

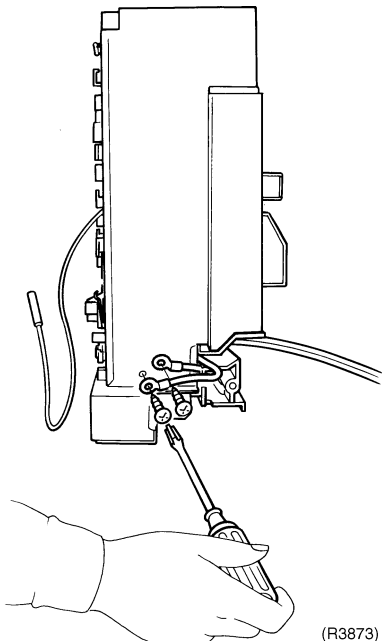
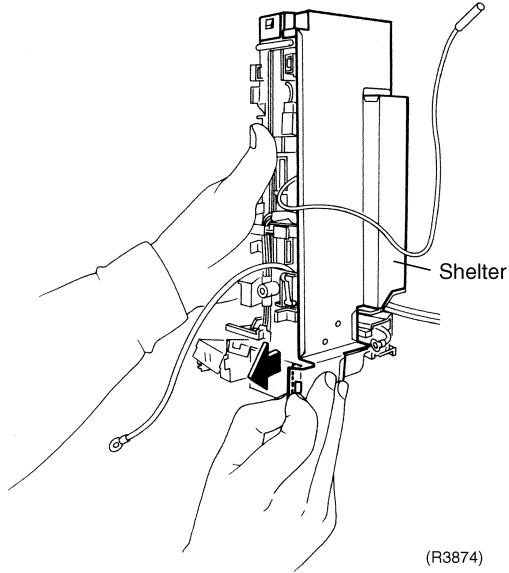
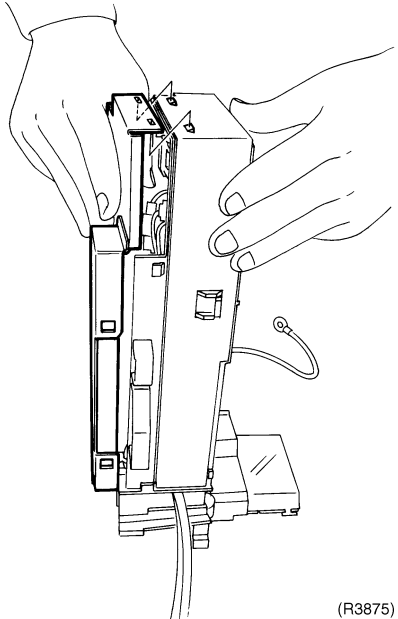
Step	Procedure	Points
3	<p data-bbox="199 219 446 280">Loosen the screws of the earth.</p>  <p data-bbox="909 840 973 862">(R3873)</p>	
4	<p data-bbox="199 878 470 974">Release the front hook and the 2 upper hooks, and remove the shelter.</p>  <p data-bbox="965 1153 1045 1176">Shelter</p> <p data-bbox="957 1433 1021 1456">(R3874)</p>  <p data-bbox="917 2083 981 2105">(R3875)</p>	

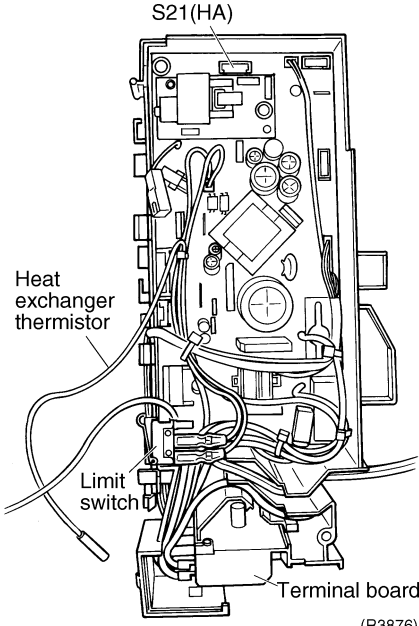
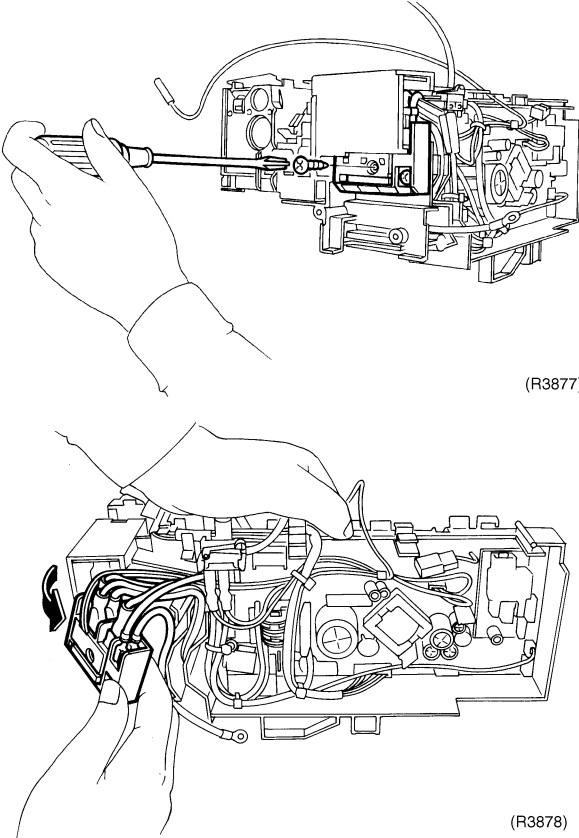
Step		Procedure	Points
5	Layout of the wiring	 <p>The diagram shows the internal wiring of the indoor unit. Labels include: S21(HA) at the top; Heat exchanger thermistor on the left; Limit switch at the bottom left; and Terminal board at the bottom right. The reference code (R3876) is located at the bottom right of the diagram.</p>	
6	Loosen the screw and pull out the terminal board.	 <p>The top diagram shows a hand using a screwdriver to loosen a screw on the terminal board. The bottom diagram shows the terminal board being pulled out of the unit. The reference code (R3877) is located to the right of the top diagram, and (R3878) is located to the right of the bottom diagram.</p>	

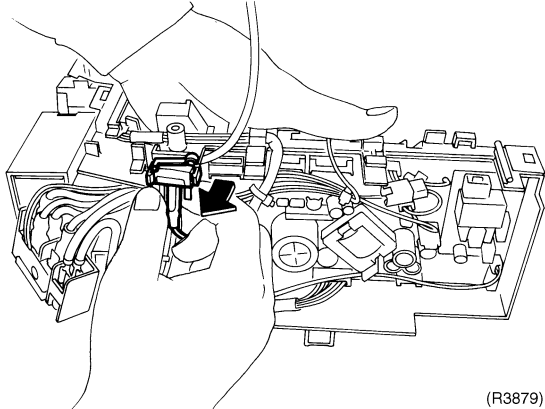
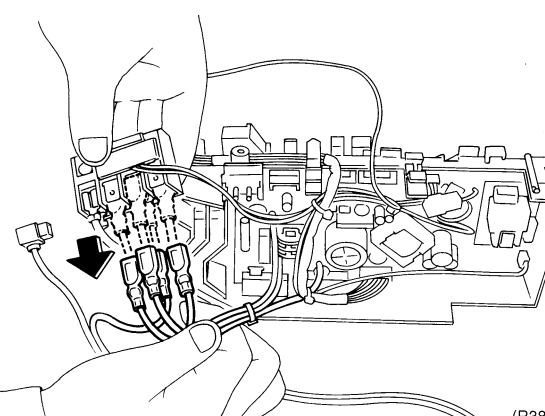
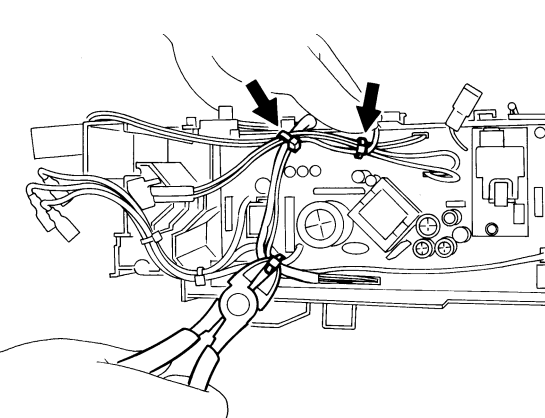
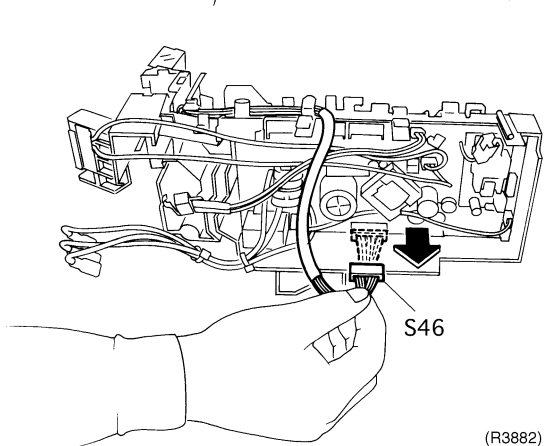
Step	Procedure	Procedure	Points
7	Pull out the limit switch.	 <p>(R3879)</p>	
8	Disconnect the terminals from the board.	 <p>(R3880)</p>	<p>■ Pb free soldering is adopted for PCB. When replacing PCB, use the particular solder and iron.</p> <p>Black.....(1) White.....(2) Red(3)</p>
9	Cut the clamps.	 <p>(R3881)</p>	<p>■ Clamps should be used all the time. Fix it as it was before.</p>
10	Disconnect the connector for the signal receiver PCB (S46).	 <p>(R3882)</p>	

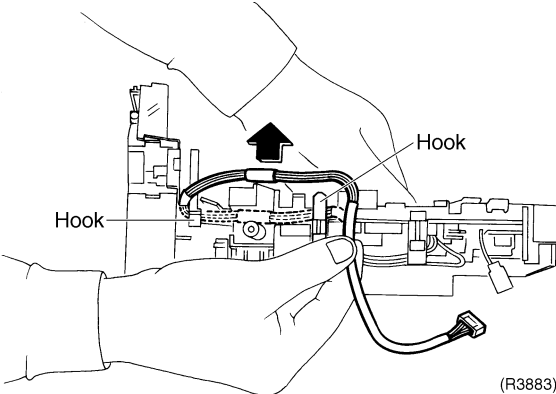
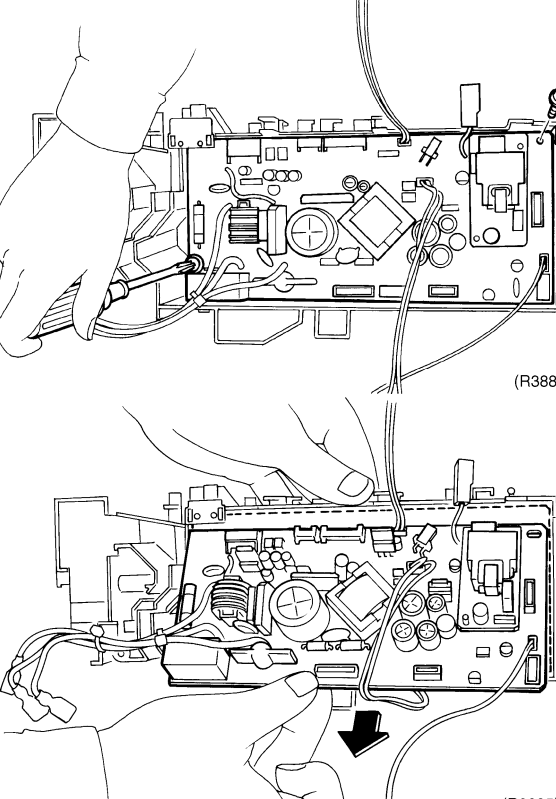
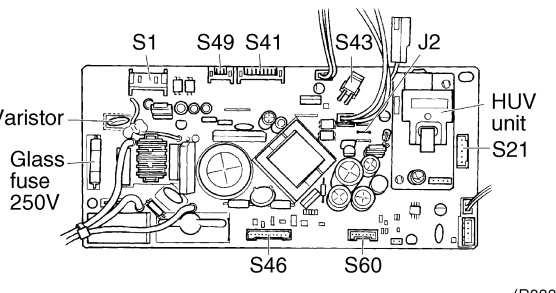
Step	Procedure	Procedure	Points
11	Release the hooks and draw out the harness from the ditch.	 <p>(R3883)</p>	
12	Loosen the 2 screws and remove the PCB.	 <p>(R3884)</p> <p>(R3885)</p>	
13	Control PCB	 <p>(R3886)</p>	

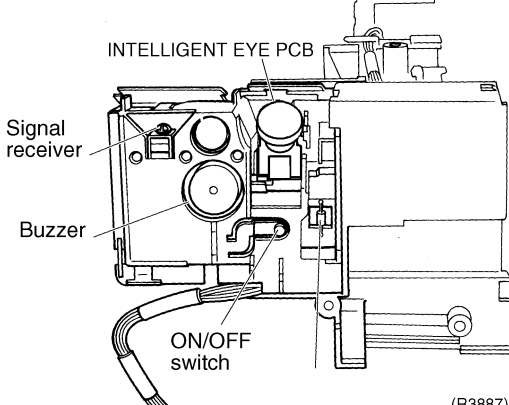
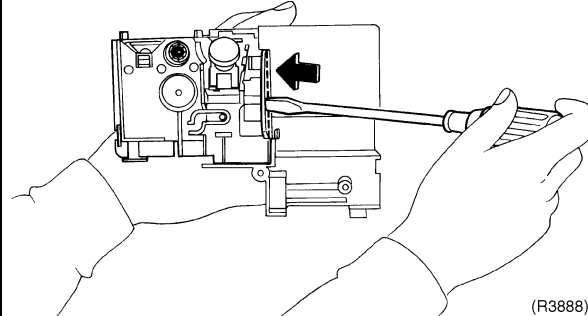
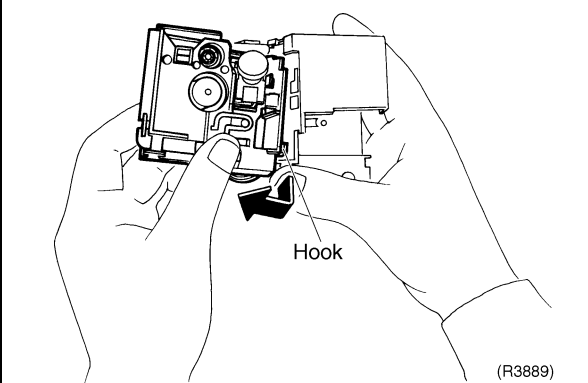
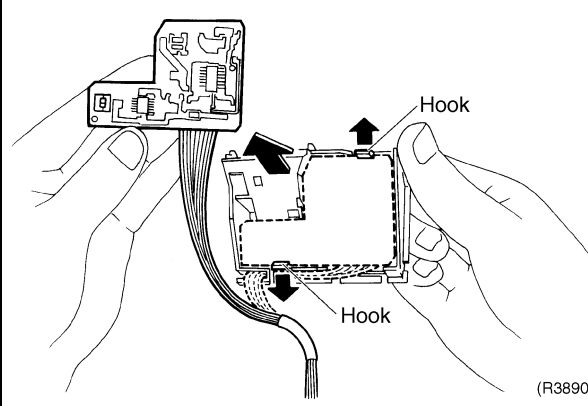
Step	Procedure	Points
2. Remove the signal receiver PCB.		
1	<p>Release the hook with a flat screwdriver.</p>  <p>(R3887)</p>	
2	<p>Release the hook and remove the receiver unit.</p>  <p>(R3888)</p>	
3	<p>Release the 2 hooks and remove the signal receiver PCB.</p>  <p>(R3889)</p>	
	 <p>(R3890)</p>	

1.11 Removal of Heat Exchanger

Procedure

Warning Be sure to wait 10 minutes or more after turning off all power supplies before disassembling work.

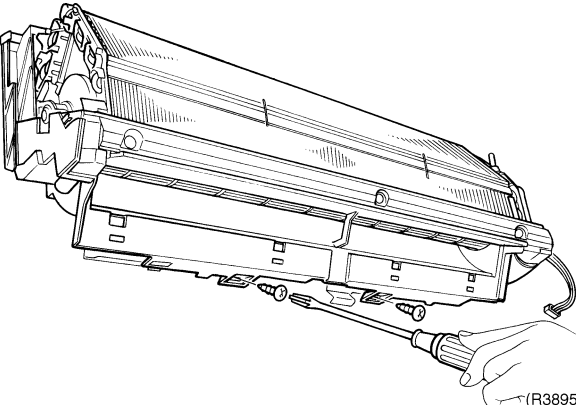
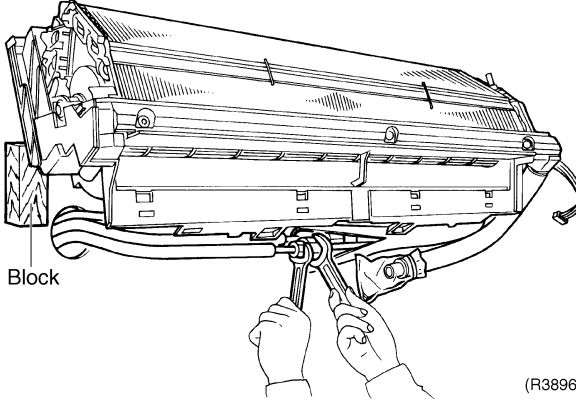
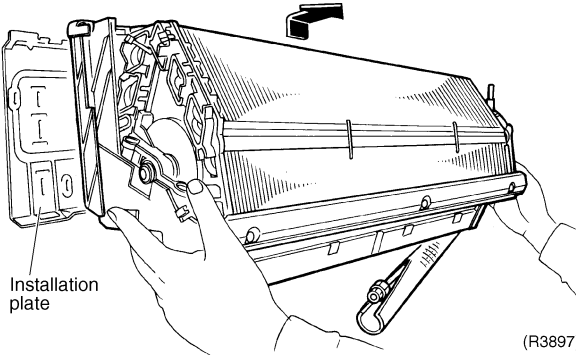
Step	Procedure	Points
<p>■ Remove the electrical box.</p> <p>1. Disconnect the refrigerant piping.</p> <p>1 Loosen the screws fixed to the installation plate.</p> <p>2 Hold the indoor unit up by a block. Unscrew the flare nut for piping by two wrenches.</p>	 <p>(R3895)</p>  <p>Block</p> <p>(R3896)</p>	<p>■ You can detach the indoor unit without removing the assembly of the outlet grille.</p> <p>Caution If gas leaks, repair the spot of leaking, then collect all refrigerant from the unit. After conducting vacuum drying, recharge proper amount of refrigerant.</p> <p>Caution Do not contaminate any gas (including air) other than the specified refrigerant (R410A), into refrigerant cycle. (Contaminating of air or other gas causes abnormal high pressure in refrigerating cycle, and this results in pipe breakage or personal injuries.)</p>
<p>2. Remove the indoor unit.</p> <p>1 Detach the indoor unit from the installation plate.</p>	 <p>Installation plate</p> <p>(R3897)</p>	<p>■ Pay attention so that the residual water in the drain will not make the floor wet.</p> <p>■ In case that a drain hose is buried inside a wall, remove it after the drain hose in the wall is pulled out.</p> <p>■ Use two wrenches to disconnect pipes.</p> <p>■ When disconnecting pipes, cover every nozzle with caps so as not to let dust and moisture in.</p>

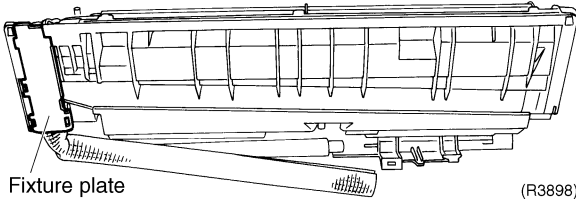
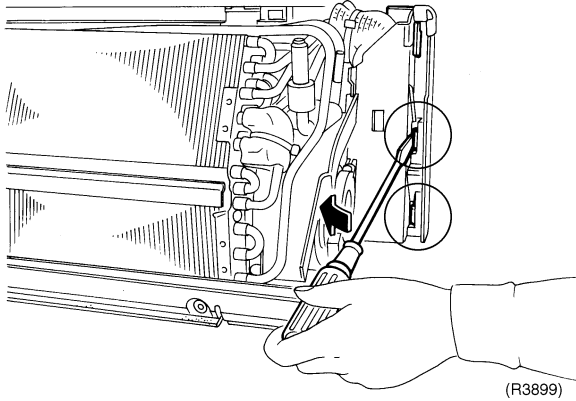
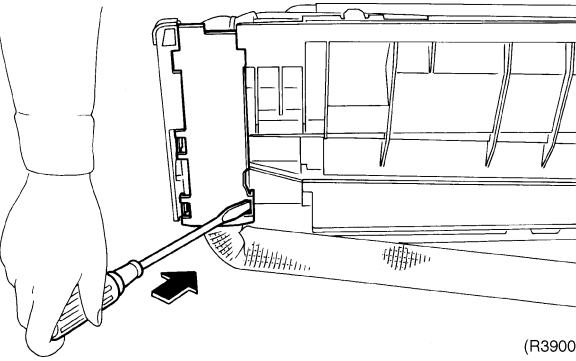
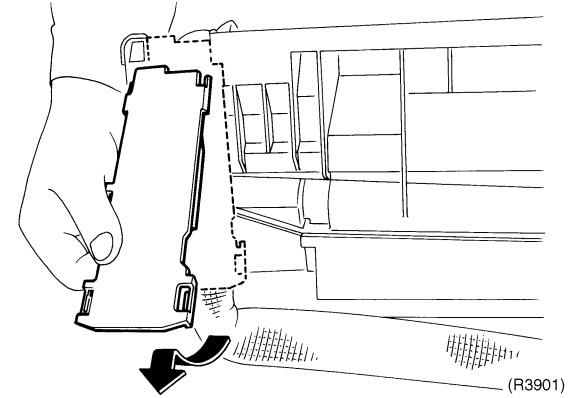
Step	Procedure	Points
3. Remove the piping fixture plate.	<div data-bbox="491 232 1070 432">  </div> <div data-bbox="153 472 448 566"> <p>1 Release the 2 hooks with a flat screwdriver from the front side.</p> </div> <div data-bbox="491 472 1070 871">  </div> <div data-bbox="153 891 464 1055"> <p>2 Release the hook from the back side. Lift up the lower part of the fixture plate and remove it.</p> </div> <div data-bbox="491 913 1070 1272">  </div> <div data-bbox="491 1301 1070 1697">  </div>	

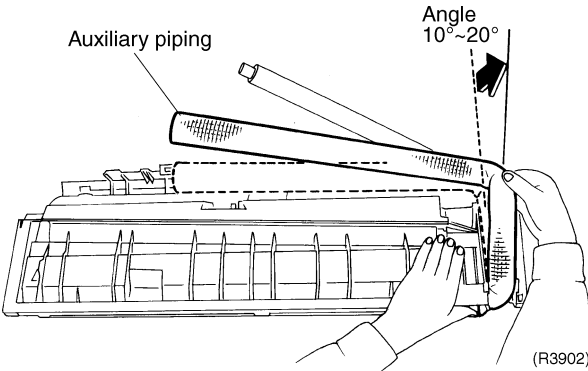
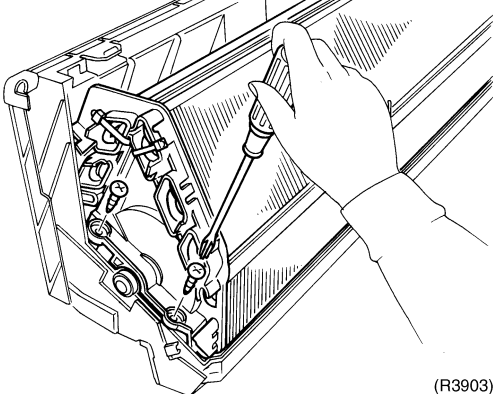
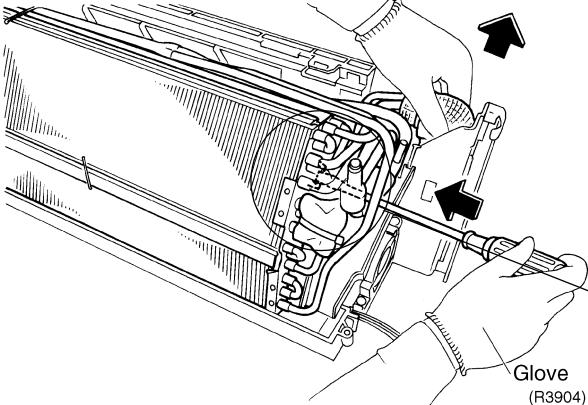
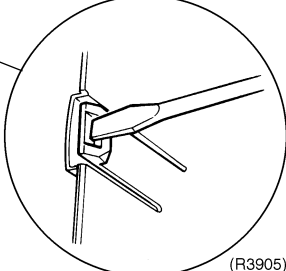
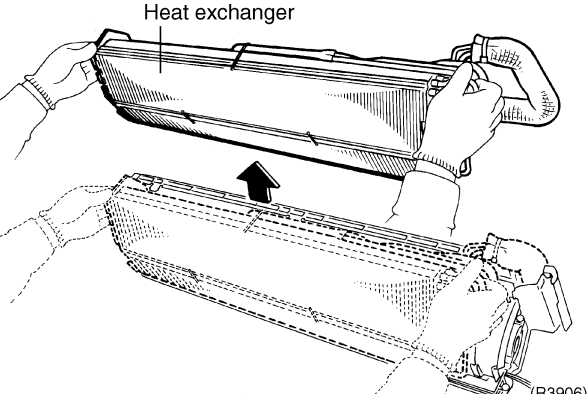
Step	Procedure	Points
4. Remove the heat exchanger.		
1	<p>Widen the auxiliary piping to the extent of 10°~20°.</p> 	
2	<p>Loosen the 2 screws on the left.</p> 	
3	<p>Push the fixing hook on the right side and lift the heat exchanger.</p> 	<p>Caution When removing or reinstalling heat exchanger, be sure to wear protective gloves or wrap the heat exchanger with cloths. (Fins can cut fingers.)</p> 
4	<p>Pull the heat exchanger to the front side and then lift and remove it.</p> 	

1.12 Removal of Fan Rotor and Fan Motor

Procedure

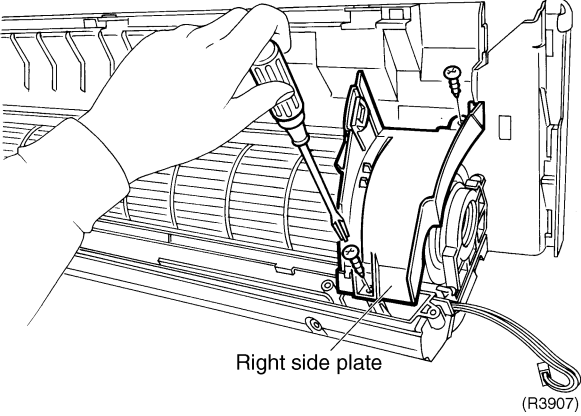
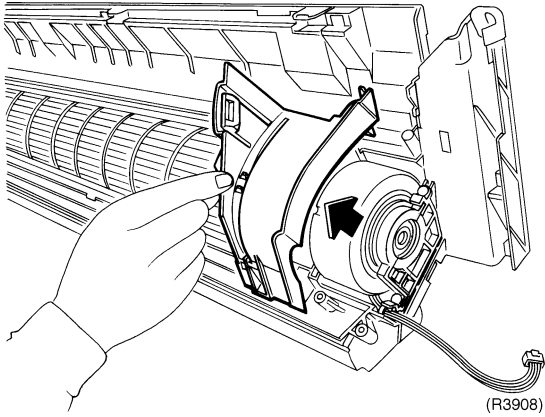
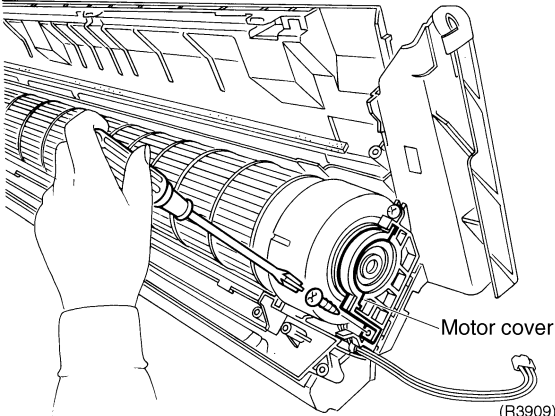
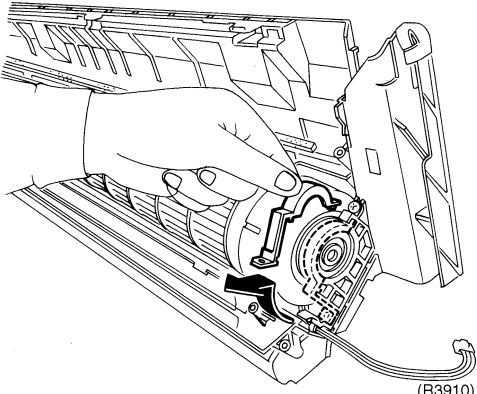

Warning Be sure to wait 10 minutes or more after turning off all power supplies before disassembling work.

Step	Procedure	Points
1. Remove the right side plate. 1 Loosen the 2 screws. 2 Remove the right side plate.	 <p style="text-align: center;">Right side plate (R3907)</p>  <p style="text-align: right;">(R3908)</p>	
2. Remove the motor cover. 1 Loosen the 2 screws and remove the motor cover.	 <p style="text-align: right;">Motor cover (R3909)</p>  <p style="text-align: right;">(R3910)</p>	

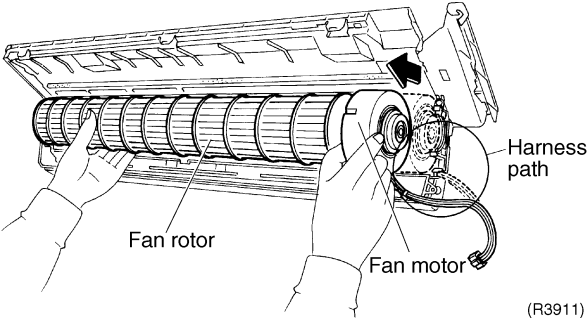
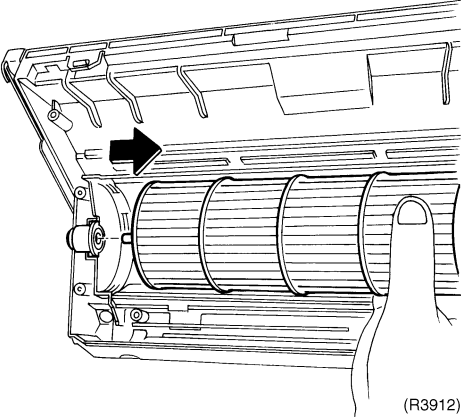
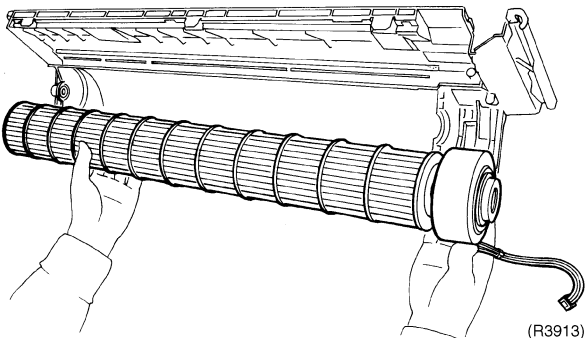
Step	Procedure	Points
<p>3. Remove the bearing.</p> <p>1</p>	<p>Lift up the right part of the fan rotor and motor, and slide them to the rightward to remove.</p>  <p>(R3911)</p>  <p>(R3912)</p>  <p>(R3913)</p>	

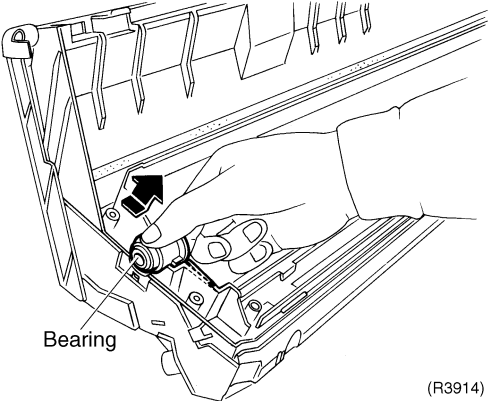
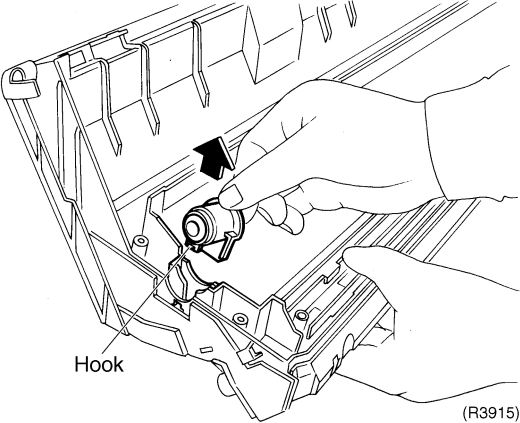
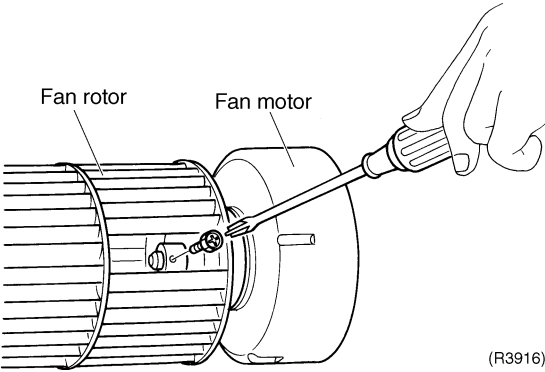
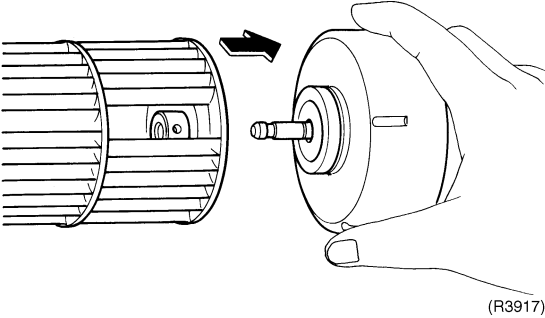
Step	Procedure	Points
2	<p data-bbox="199 217 459 342">Hold the lower outside of the bearing. Push it inwards and lift to release the hook.</p>  <p data-bbox="579 555 655 580">Bearing</p> <p data-bbox="965 607 1026 629">(R3914)</p>  <p data-bbox="595 1016 647 1041">Hook</p> <p data-bbox="986 1070 1046 1093">(R3915)</p>	
4. Remove the fan motor.	<p data-bbox="199 1151 467 1245">1 Loosen the fixing screw and remove the fan motor.</p>  <p data-bbox="544 1211 635 1234">Fan rotor</p> <p data-bbox="719 1211 826 1234">Fan motor</p> <p data-bbox="994 1473 1054 1496">(R3916)</p>  <p data-bbox="994 1827 1054 1850">(R3917)</p>	

2. Outdoor Unit

2.1 Removal of Panels and Fan Motor

Procedure



Warning Be sure to wait 10 minutes or more after turning off all power supplies before disassembling work.

Step	Procedure	Points
<p>1. Features</p> <p>1 Loosen the screw of the stop valve cover. Pull down the stop valve cover and remove it.</p>	<p>Handle</p> <p>(R3235)</p> <p>Outdoor air thermistor</p> <p>(R3236)</p> <p>Stop valve cover</p> <p>(R3237)</p> <p>Shelter</p> <p>Hooks</p> <p>(R3238)</p>	<ul style="list-style-type: none"> ■ Take care not to cut your finger by the fins of the heat exchanger. ■ The stop valve cover is united with the shelter. ■ When reassembling, make sure to fit the 5 hooks.

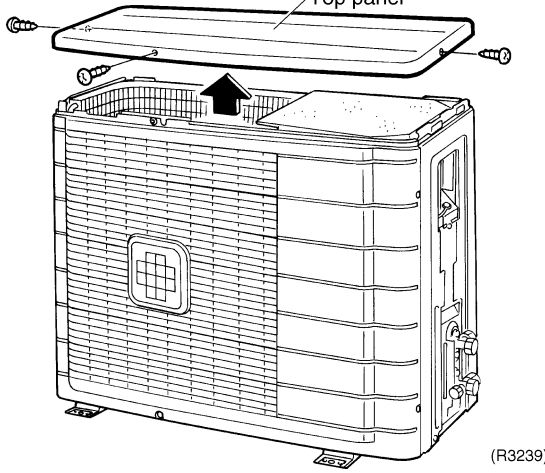
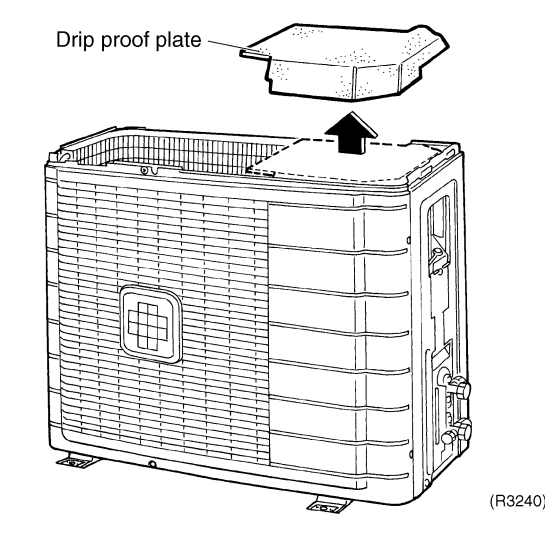
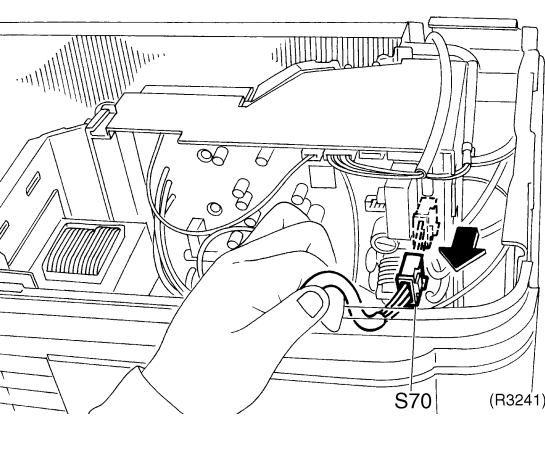
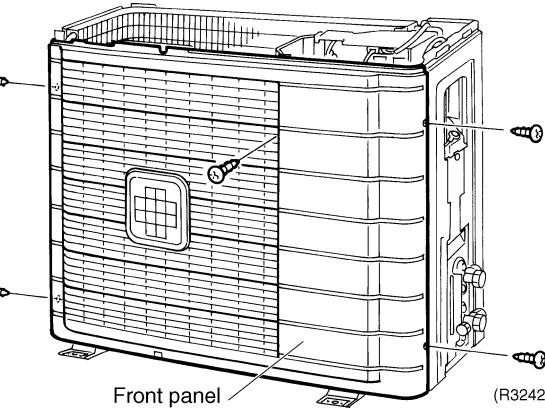
Step	Procedure	Points
2. Remove the panels.		
1	<p>Loosen the 3 screws (front, right, left) and lift the top panel.</p>  <p style="text-align: right;">(R3239)</p>	
2	<p>Remove the drip proof plate.</p>  <p style="text-align: right;">(R3240)</p>	
3	<p>Disconnect the connector for fan motor (S70).</p>  <p style="text-align: right;">(R3241)</p>	<p>■ The fan motor is united with the front panel.</p>
4	<p>Loosen the 5 screws of the front panel.</p>  <p style="text-align: right;">(R3242)</p>	

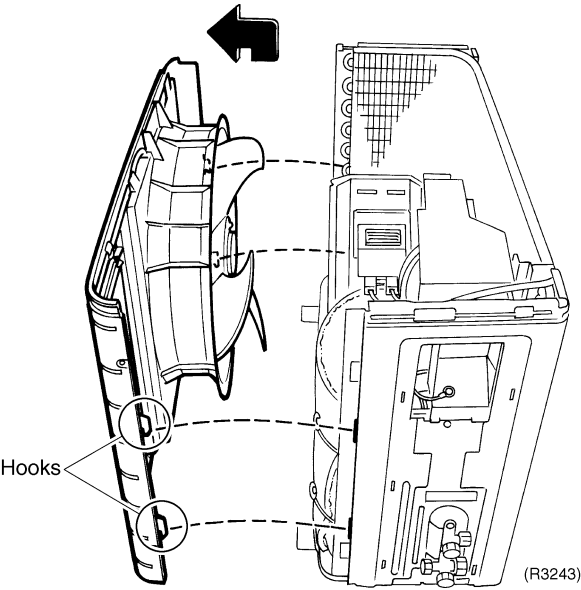
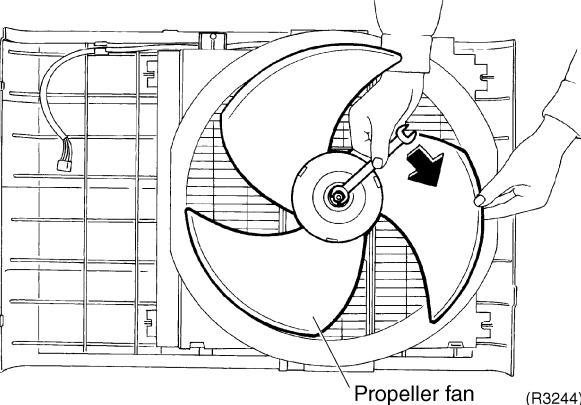
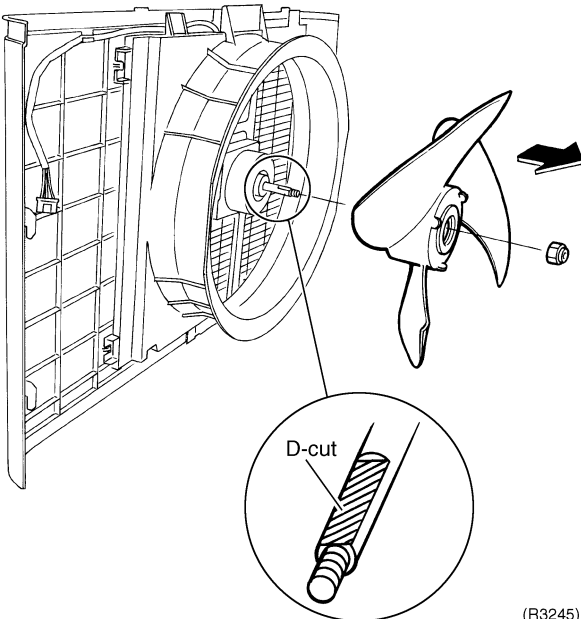
Step	Procedure	Points
5	<p>Undo the hooks. Pull and remove the front panel.</p> 	<ul style="list-style-type: none"> ■ The front panel has 4 hooks. ■ The fan motor is united with the front panel.
3. Remove the fan motor.	<p>1 Unscrew the washer-fitted nut (M10) of the propeller fan with a spanner.</p>  <p>2 Remove the propeller fan.</p> 	<ul style="list-style-type: none"> ■ The screw has reverse winding. ■ Align ▼ mark of the propeller fan with D-cut section of the motor shaft when reassembling.

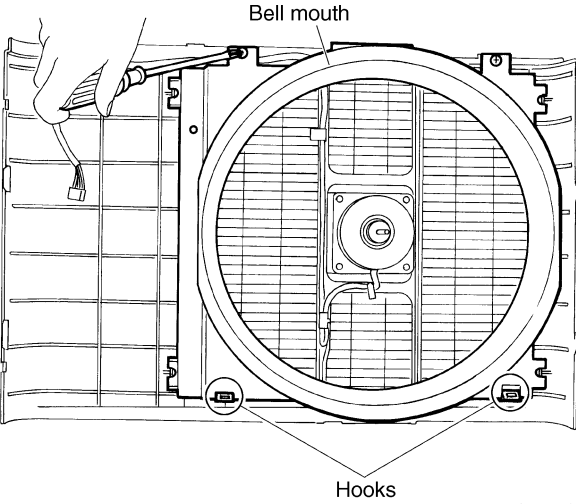
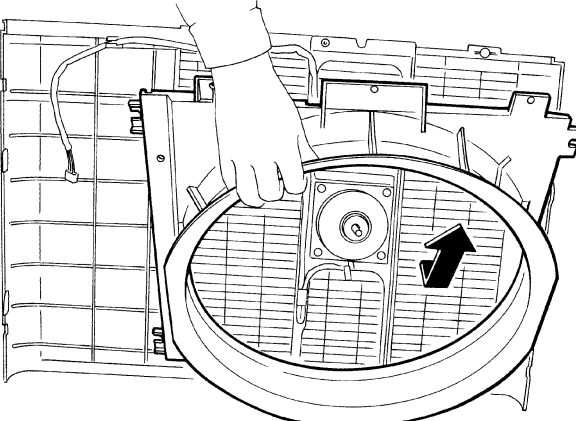
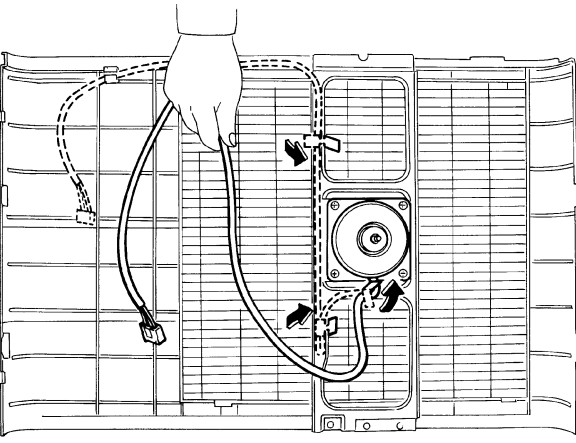
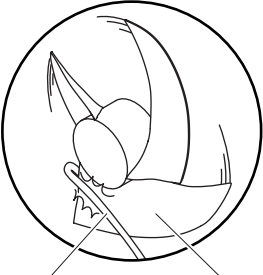
Step	Procedure	Points
<p>3</p> <p>Loosen the 2 screws and lift the bell mouth to undo the hooks. Remove the bell mouth.</p>	 <p>Bell mouth</p> <p>Hooks</p> <p>(R3246)</p>  <p>(R3247)</p>	
<p>4</p> <p>Loosen the fixing hooks and release the lead wire.</p>	 <p>(R3248)</p>	<ul style="list-style-type: none"> Put the lead wire through the back of the motor when reassembling. (so as not to be entangled with the propeller fan)  <p>Lead wire</p> <p>Propeller fan</p> <p>(R3249)</p>

Step	Procedure	Points
5	Loosen the 4 screws to remove the fan motor.	<ul style="list-style-type: none"> ■ M4×16 ■ DC fan motor
6	Loosen the 2 screws to remove the fan motor fixing frame.	

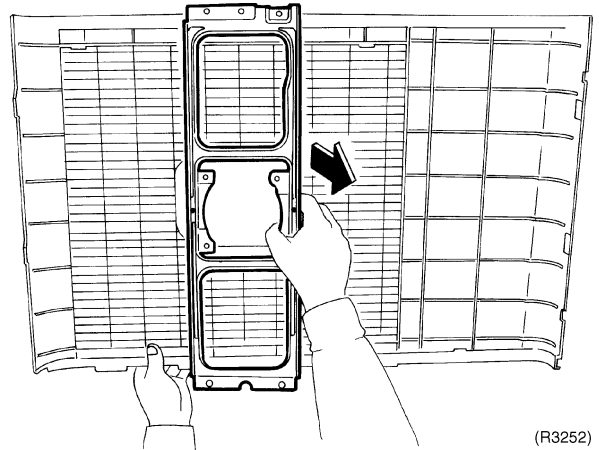
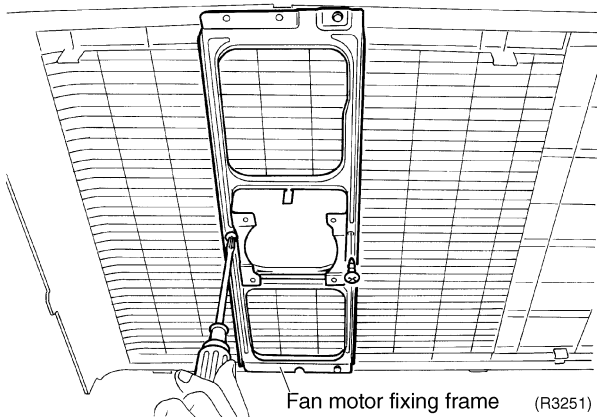
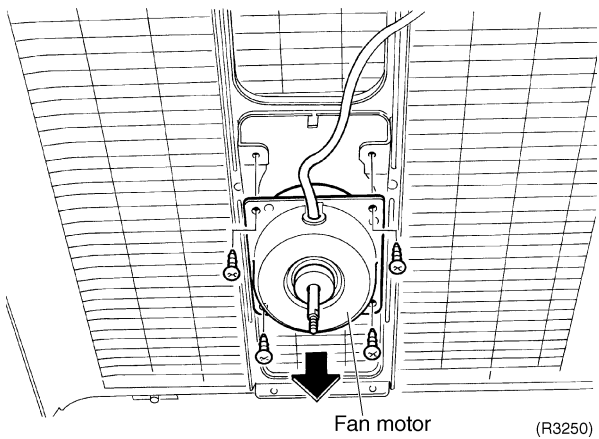

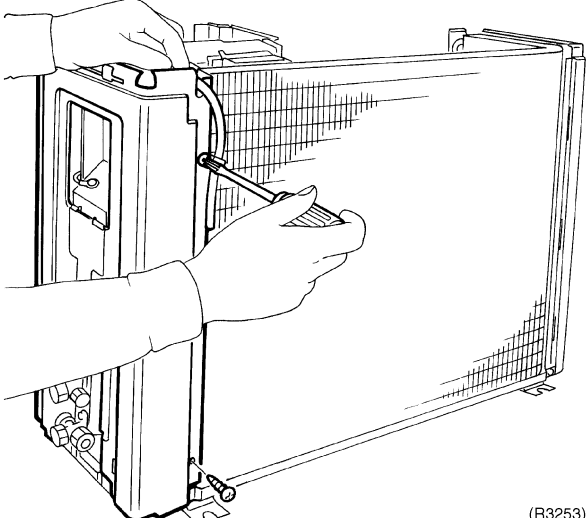
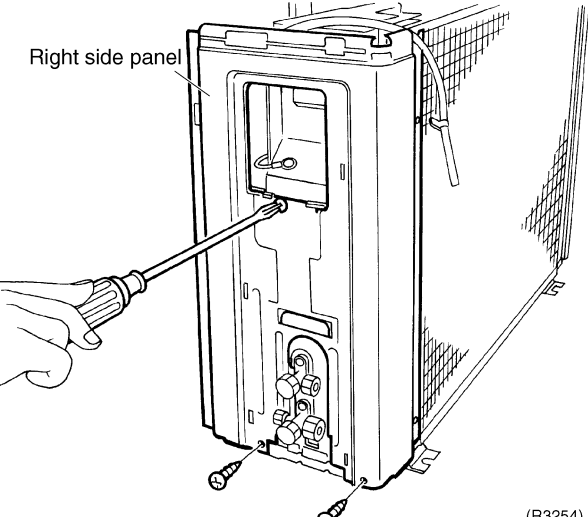
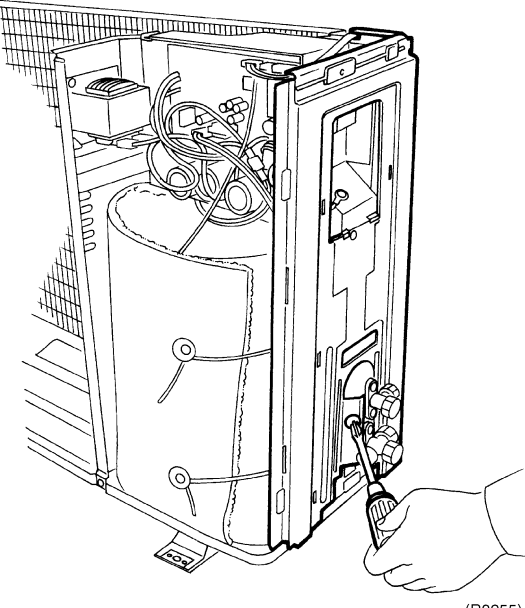
Step	Procedure	Points
4. Remove the right side panel.		
1	<p>Loosen the 2 screws on the rear side.</p>  <p>(R3253)</p>	
2	<p>Loosen the 3 screws on the right side.</p>  <p>Right side panel</p> <p>(R3254)</p>	
3	<p>Loosen the screw and lift the connection port to remove.</p>  <p>(R3255)</p>	

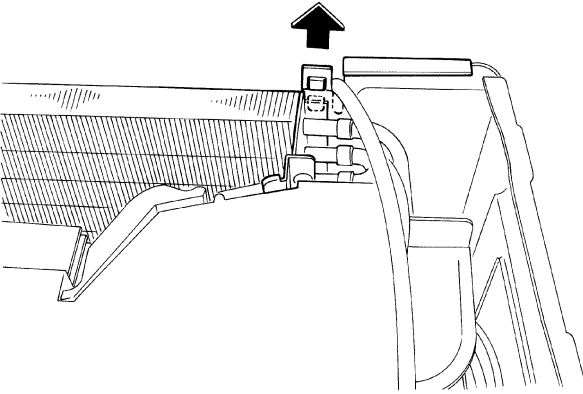
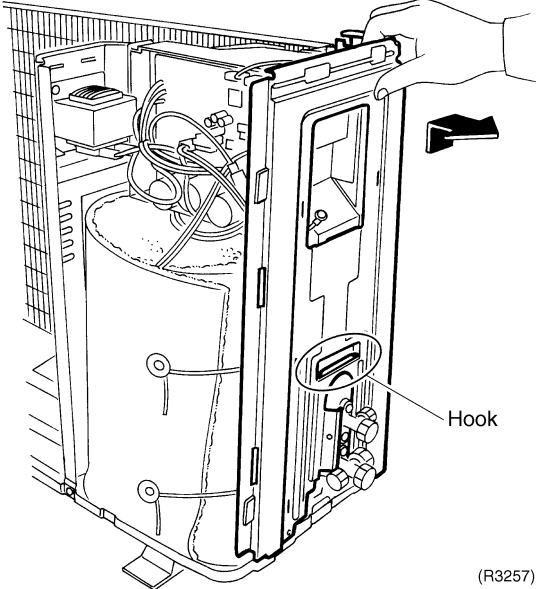
Step	Procedure	Points
	 <p>(R3256)</p>  <p>Hook</p> <p>(R3257)</p>	<ul style="list-style-type: none"> ■ When reassembling, make sure to fit the hook.

2.2 Removal of Electrical Box

Procedure

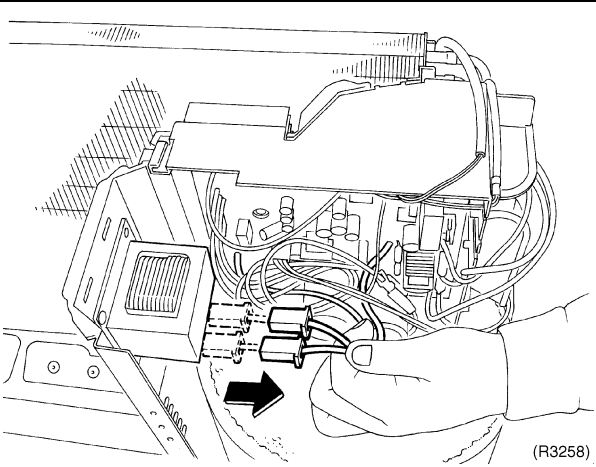
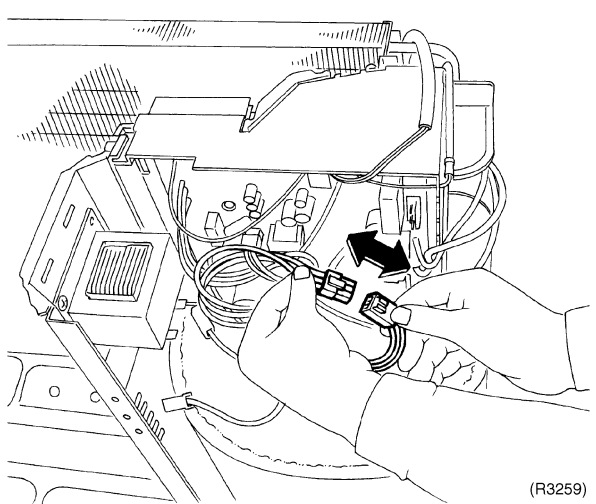
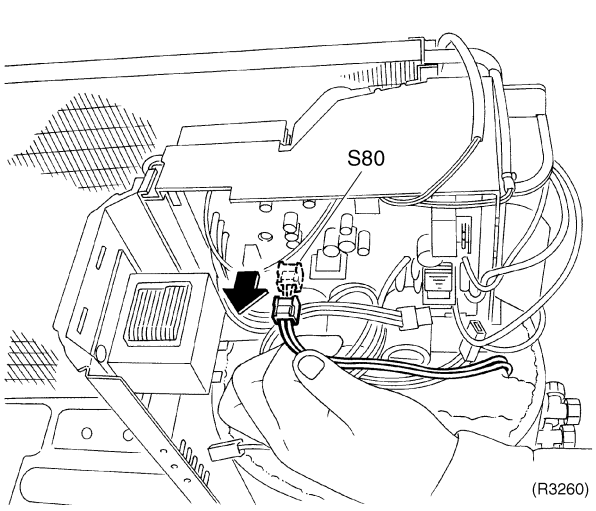

Warning Be sure to wait 10 minutes or more after turning off all power supplies before disassembling work.

Step	Procedure	Points
<ul style="list-style-type: none"> ■ Remove the top panel. ■ Disconnect the connector for fan motor. 	 <p style="text-align: right;">(R3258)</p>	
<p>1. Remove the electrical box.</p>		
<p>1 Disconnect the 2 reactor harnesses.</p>		
<p>2 Disconnect the relay connector for compressor lead wire.</p>	 <p style="text-align: right;">(R3259)</p>	
<p>3 Disconnect the connector for four way valve (S80).</p>	 <p style="text-align: right;">(R3260)</p>	<ul style="list-style-type: none"> ■ When reassembling, coil the excessive lead wire and hang the loop on the hook.

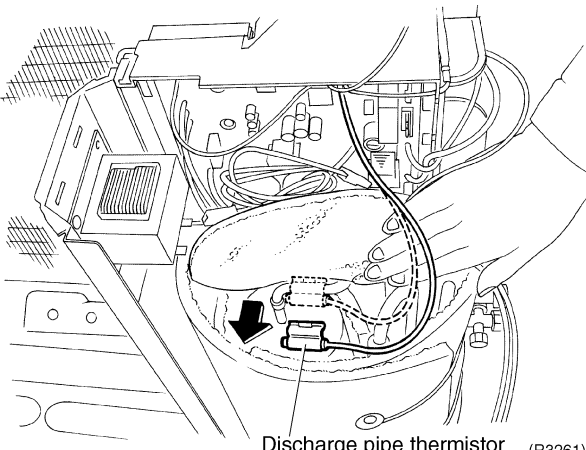
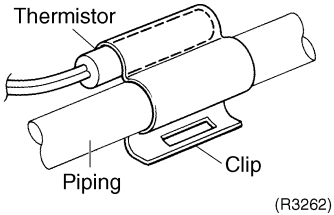
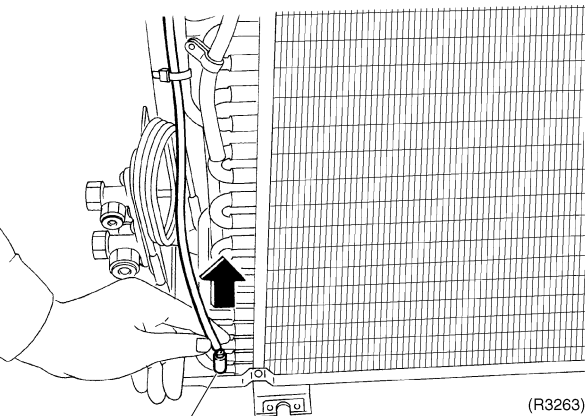
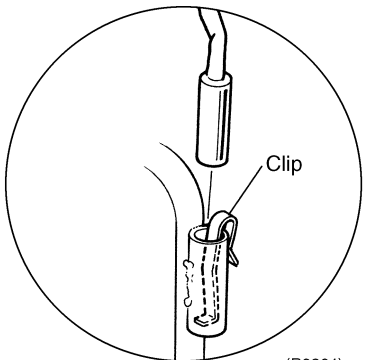
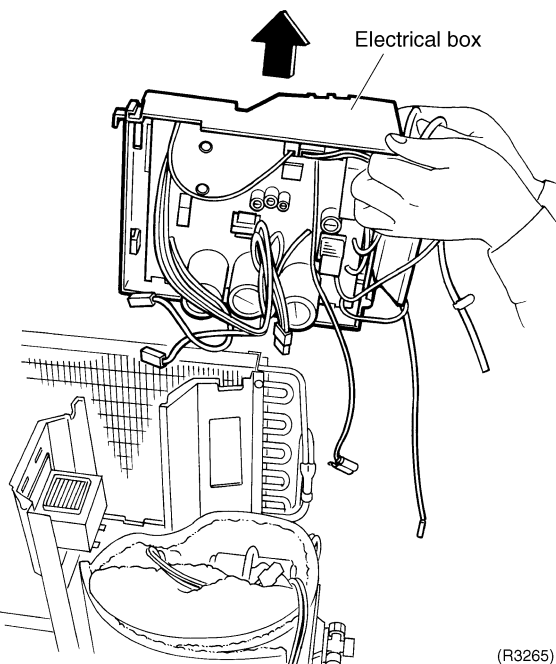
Step	Procedure	Procedure	Points
4	Release the discharge pipe thermistor.	 <p>Discharge pipe thermistor (R3261)</p>	<ul style="list-style-type: none"> ■ Pay attention so as not to lose the clip for thermistor.  <p>Thermistor Piping Clip (R3262)</p>
5	Release the heat exchanger thermistor.	 <p>Heat exchanger thermistor (R3263)</p>	<ul style="list-style-type: none"> ■ Pay attention so as not to lose the clip.  <p>Clip (R3264)</p>
6	Lift and remove the electrical box.	 <p>Electrical box (R3265)</p>	

2.3 Removal of Reactor and Partition Plate

Procedure

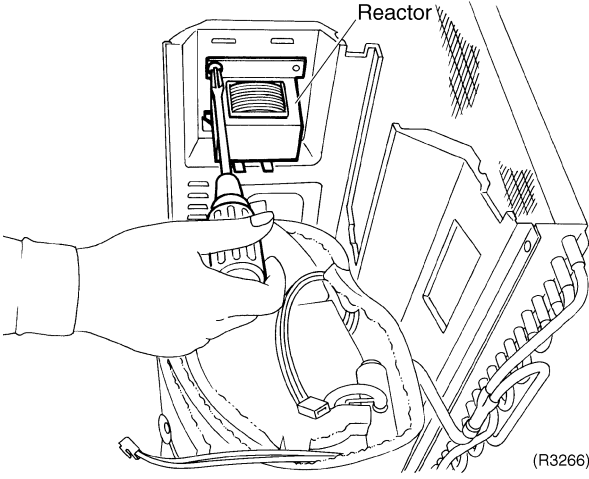
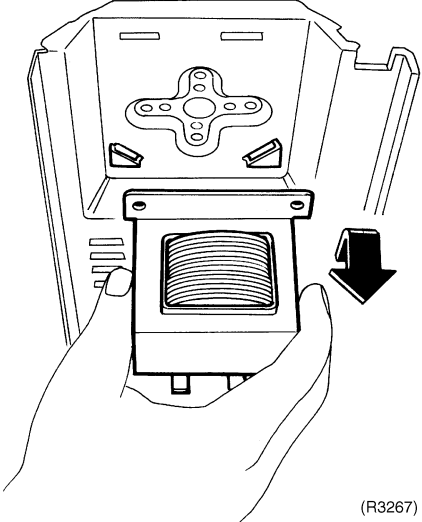
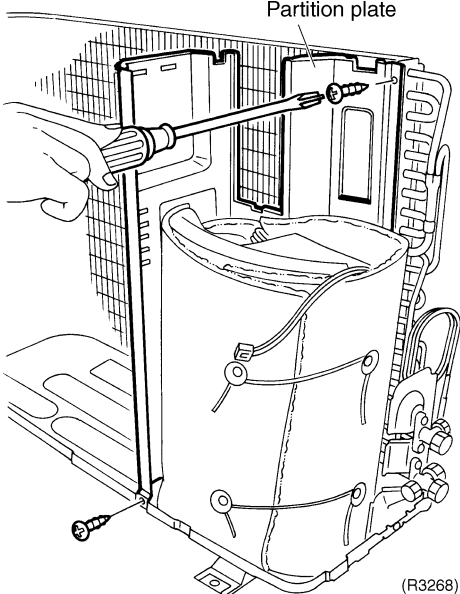

Warning Be sure to wait 10 minutes or more after turning off all power supplies before disassembling work.

Step	Procedure	Points
<ul style="list-style-type: none"> ■ Remove the outer panels. ■ Remove the electrical box. 		
1. Remove the reactor.		
1 Loosen the screw. Lift and remove the reactor.	 <p style="text-align: right;">(R3266)</p>  <p style="text-align: right;">(R3267)</p>	
2. Remove the partition plate.		
1 Loosen the 2 screws.	 <p style="text-align: right;">(R3268)</p>	

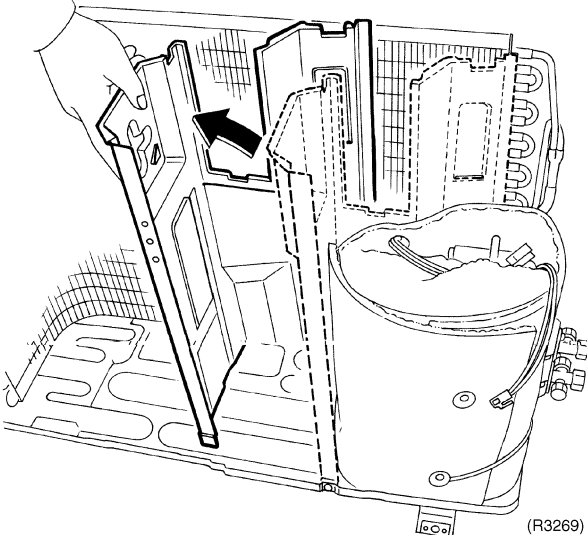
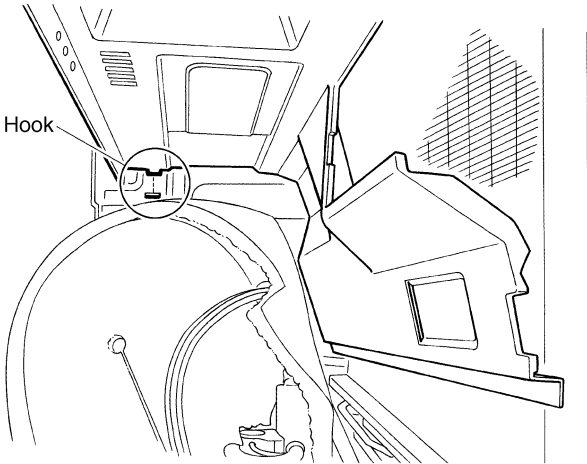
Step	Procedure	Points
<p>2</p>	<p>The partition plate has a hook on the lower side. Lift and pull the partition plate to remove.</p>  <p>(R3269)</p>  <p>(R3270)</p>	<ul style="list-style-type: none"> ■ When reassembling, fit the lower hook into the bottom frame.

2.4 Removal of Sound Blanket

Procedure



Warning Be sure to wait 10 minutes or more after turning off all power supplies before disassembling work.

Step	Procedure	Points
<ul style="list-style-type: none"> ■ Remove the outer panels. ■ Remove the electrical box. 		
1.	Remove the sound blanket.	
1	Untie the strings and open the sound blanket.	
2	Lift and remove the sound blanket (body) as it is opened.	<ul style="list-style-type: none"> ■ Since the piping ports on the sound blanket are torn easily, remove the blanket carefully.
3	Lift and remove the sound blanket (top).	

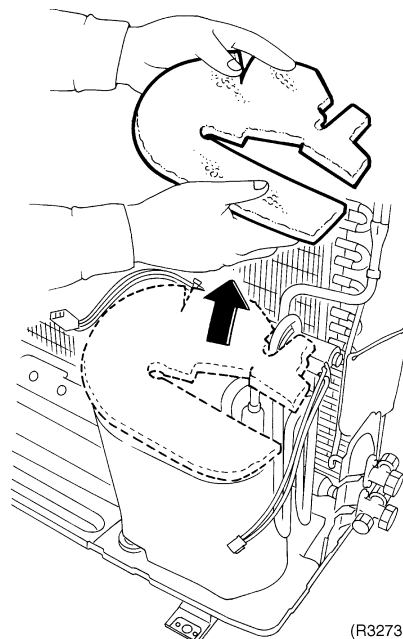
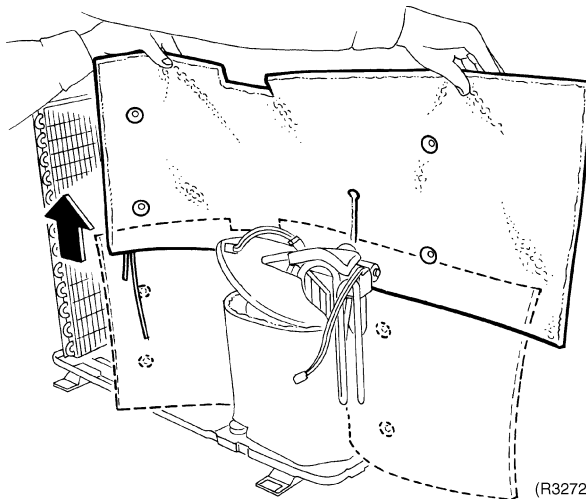
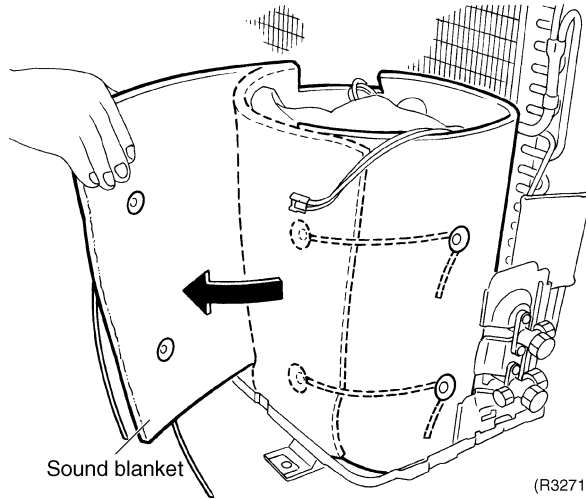

Step	Procedure	Points
4	Pull the sound blanket (inner) out.	<ul style="list-style-type: none"> ■ Since the piping ports on the sound blanket are torn easily, remove the blanket carefully.
5	Pull the sound blanket (bottom) out.	

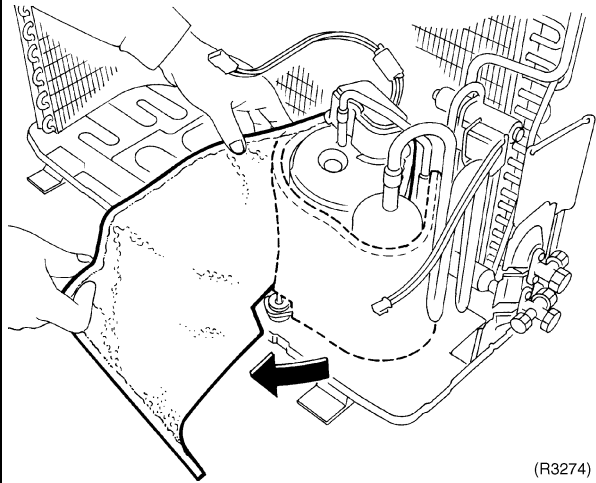

(R3274)

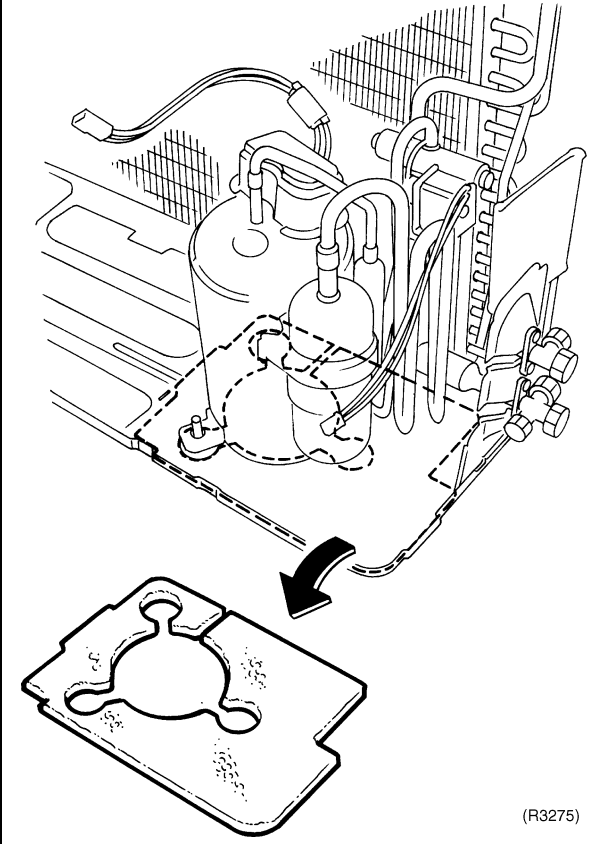

(R3275)

2.5 Removal of Four Way Valve

Procedure

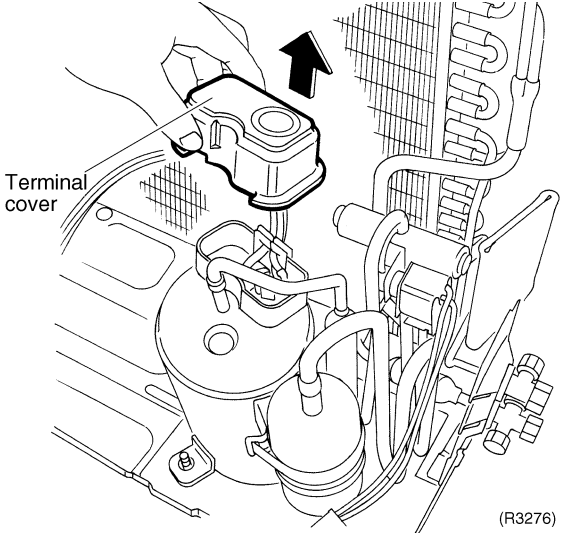
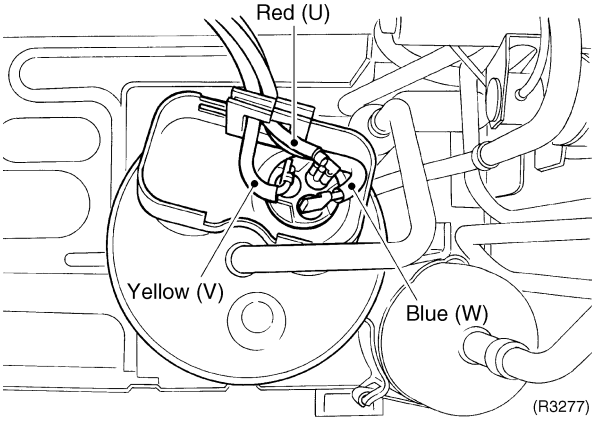
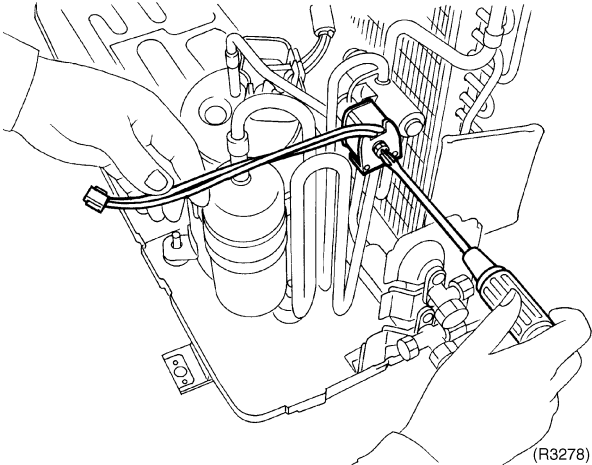

Warning Be sure to wait 10 minutes or more after turning off all power supplies before disassembling work.

Step	Procedure	Points
<p>1. Remove the peripheries.</p> <p>1 Remove the terminal cover.</p> <p>2 Loosen the screw of the four way valve coil.</p>	 <p>Terminal cover</p> <p>(R3276)</p>  <p>Red (U)</p> <p>Yellow (V)</p> <p>Blue (W)</p> <p>(R3277)</p>  <p>(R3278)</p>	<p>■ Be careful so as not to burn the compressor terminals or the name plate.</p> <p>Make a note.</p>

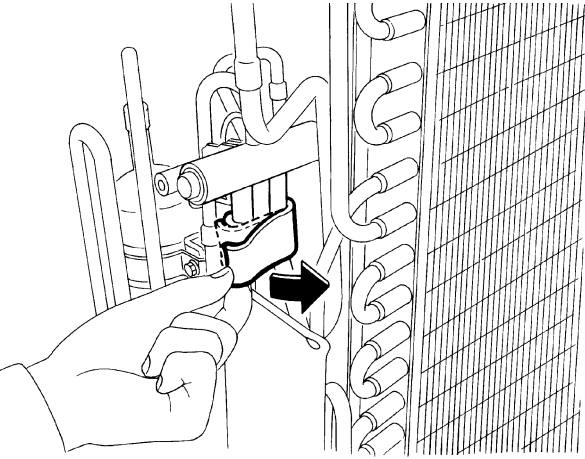
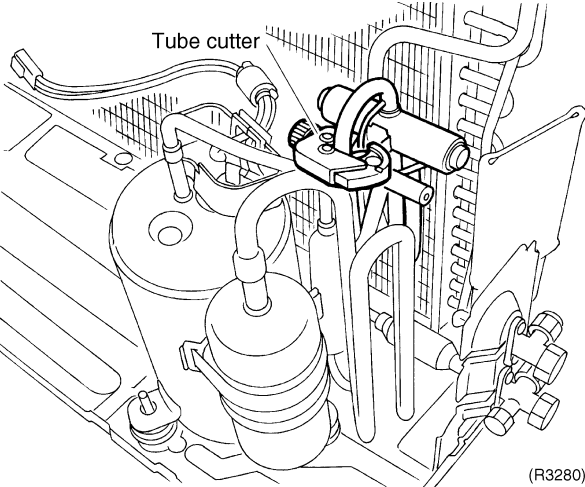
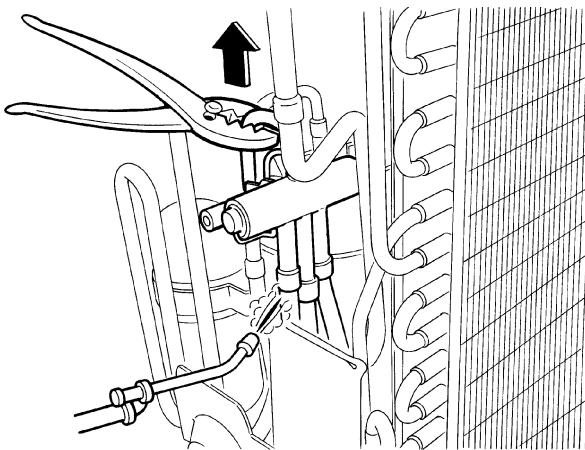
Step	Procedure	Procedure	Points
3	Remove the sheets of putty. Cut the pipe with a tube cutter.	 <p style="text-align: right;">(R3279)</p>  <p style="text-align: right;">(R3280)</p>	
4	Heat up the brazed part and withdraw the piping with pliers.	 <p style="text-align: right;">(R3281)</p>	<ul style="list-style-type: none"> ■ Provide a protective sheet or a steel plate so that the brazing flame cannot influence peripheries. ■ Be careful so as not to break the pipes by pressing it excessively by pliers when withdrawing it.

2.6 Removal of Compressor

Procedure

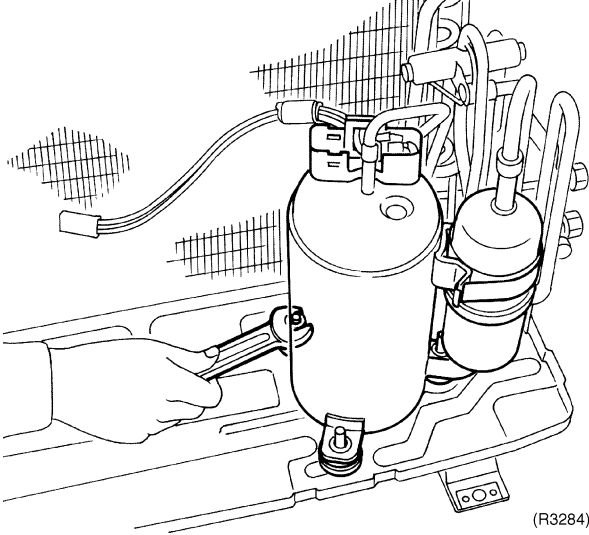
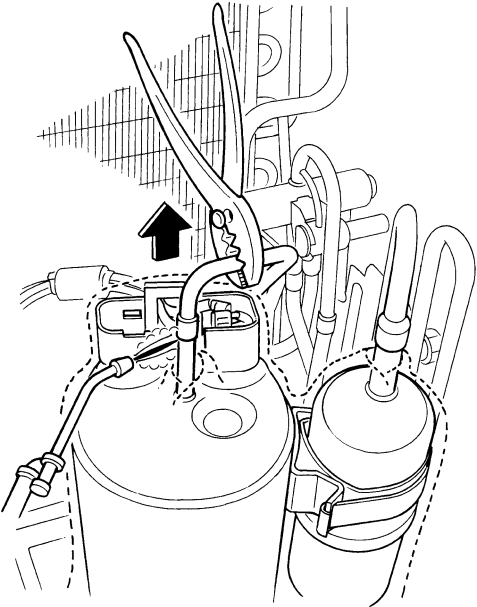

Warning Be sure to wait 10 minutes or more after turning off all power supplies before disassembling work.

Step	Procedure	Points
<p>1. Remove the compressor.</p> <p>1 Unscrew the nut of the compressor.</p> <ul style="list-style-type: none"> ■ Before working, make sure that the refrigerant is empty in the circuit. ■ Be sure to apply nitrogen replacement when heating up the brazed part. <p>2 Heat up the brazed part of the discharge side and disconnect.</p>	 <p style="text-align: right;">(R3284)</p>  <p style="text-align: right;">(R3285)</p>	<p>Warning Ventilate when refrigerant leaks during the work. (If refrigerant contacts fire, it will cause to arise toxic gas.)</p> <ul style="list-style-type: none"> ■ Provide a protective sheet or a steel plate so that the brazing flame cannot influence peripheries. ■ Be careful so as not to burn the compressor terminals or the name plate. ■ Be careful so as not to burn the heat exchanger fin. <p>Warning Since it may happen that refrigeration oil in the compressor will catch fire, prepare wet cloth so as to extinguish fire immediately.</p> <p>In case of the difficulty with gas brazing machine</p> <ol style="list-style-type: none"> 1. Disconnect the brazed part where is easy to disconnect and restore. 2. Cut pipes on the main unit by a miniature copper tube cutter in order to make it easy to disconnect. <p>Cautions for restoration</p> <ol style="list-style-type: none"> 1. Restore the piping by non-oxidation brazing. 2. It is required to prevent the carbonization of the oil inside the four way valve and the deterioration of the gaskets affected by heat. For the sake of this, wrap the four way valve with wet cloth and provide water so that the cloth will not be dried and avoid excessive heating. (Keep below 120°C) <p>Note : Do not use a metal saw for cutting pipes by all means because the sawdust come into the circuit.</p>

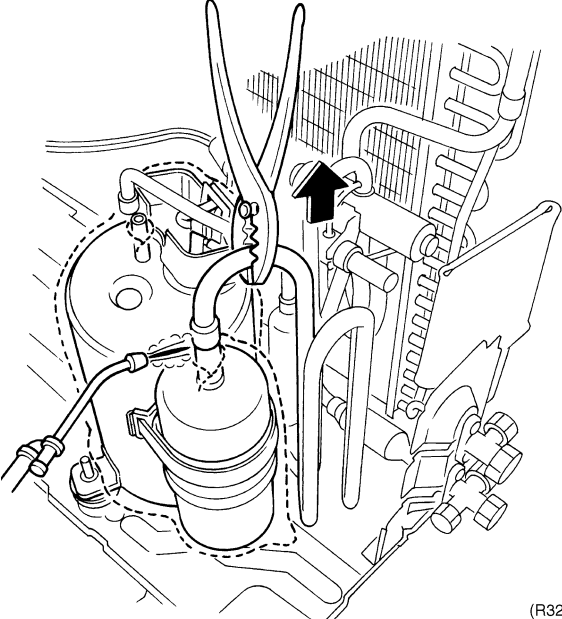
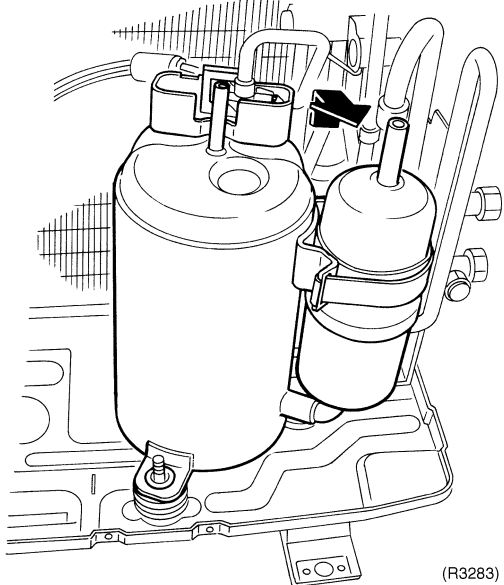
Step	Procedure	Points
3	<p>Heat up the brazed part of the suction side and disconnect.</p>  <p>(R3282)</p>	
4	<p>Lift the compressor up and remove it.</p>  <p>(R3283)</p>	

2.7 Removal of PCB

Procedure

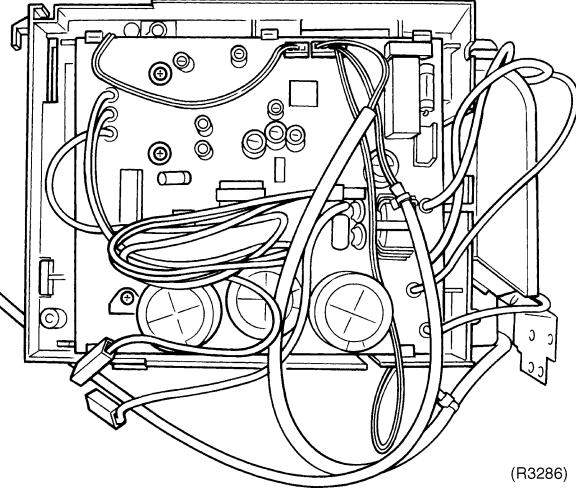
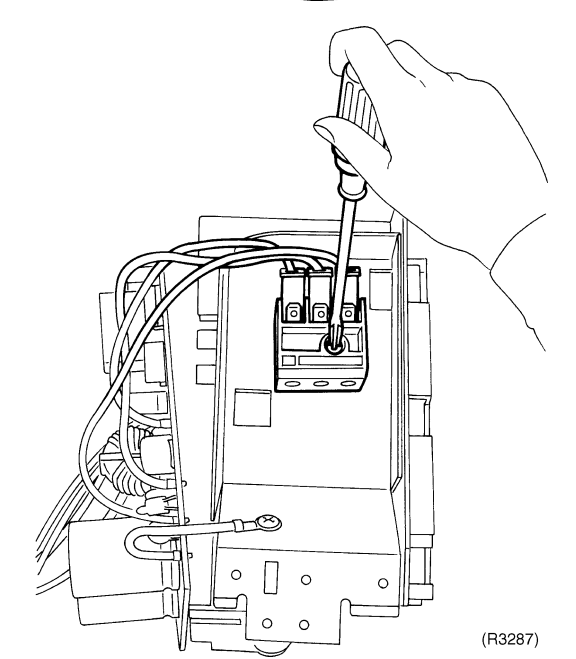
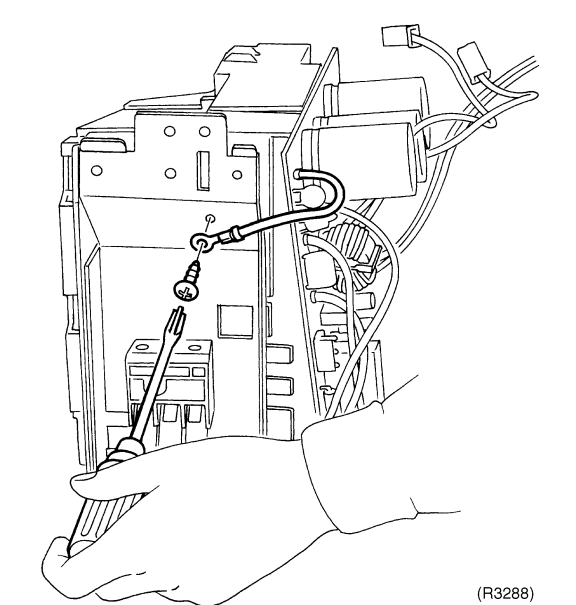

Warning Be sure to wait 10 minutes or more after turning off all power supplies before disassembling work.

Step	Procedure	Points
1. Remove the PCB.		
1 Feature of the PCB	 <p style="text-align: right;">(R3286)</p>	<ul style="list-style-type: none"> ■ You can remove the PCB when you disconnect the read wires on the terminal board without removing the electrical box. ■ PbF (Pb free brazing) is adopted.
2 Loosen the screw on the terminal board.	 <p style="text-align: right;">(R3287)</p>	
3 Release the earth terminal.	 <p style="text-align: right;">(R3288)</p>	

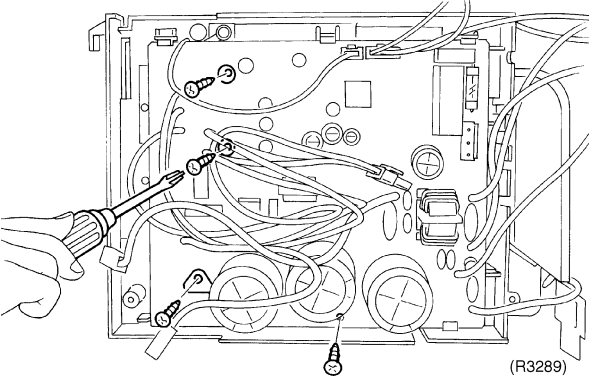
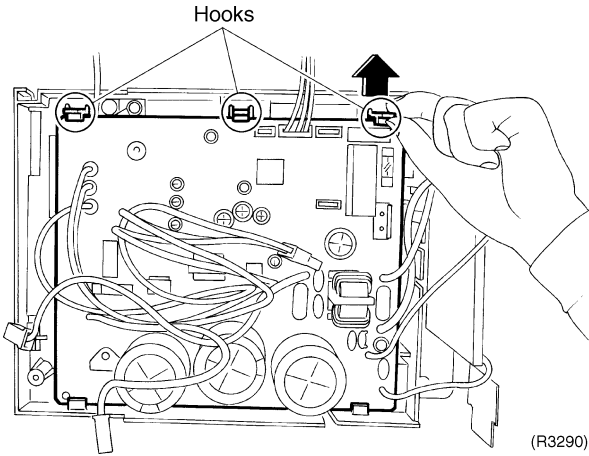
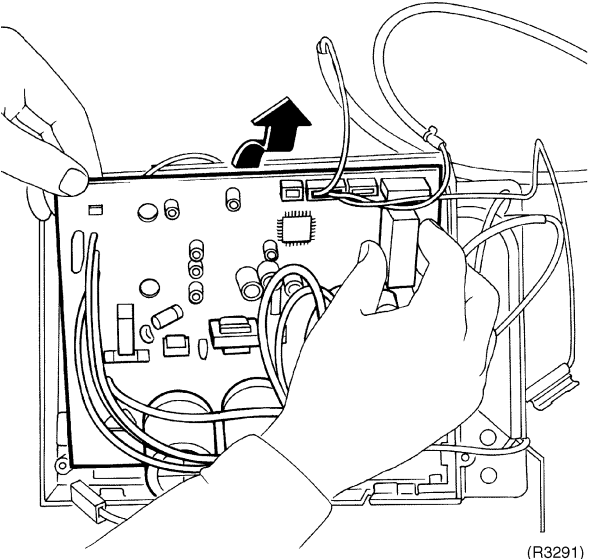
Step	Procedure	Procedure	Points
4	Loosen the 4 screws.	 <p>(R3289)</p>	
5	Undo the 3 hooks on the upper side.	 <p>Hooks</p> <p>(R3290)</p>	
6	Lift and pull out the PCB.	 <p>(R3291)</p>	

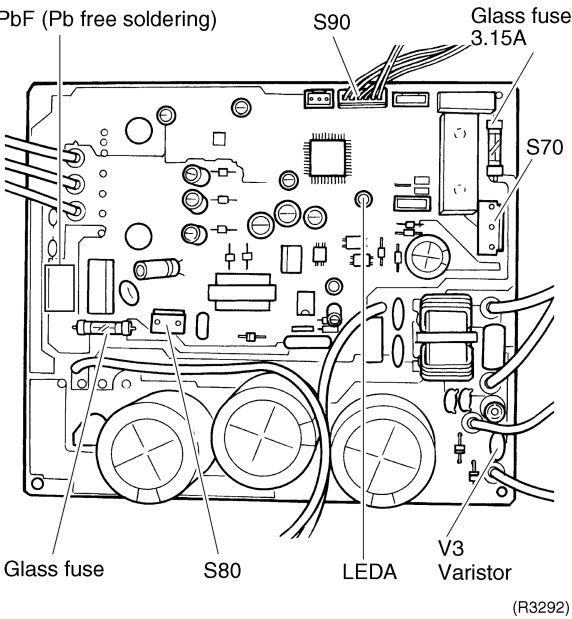
Step	Procedure	Points
<p>7</p> <p>Feature of the PCB S70: fan motor S80: four way valve S90: thermistor (outdoor air, heat exchanger, discharge pipe)</p>	<p>PbF (Pb free soldering)</p>  <p>S90</p> <p>Glass fuse 3.15A</p> <p>S70</p> <p>Glass fuse</p> <p>S80</p> <p>LED A</p> <p>V3 Varistor</p> <p>(R3292)</p>	

Part 8 Others

1. Others	174
1.1 Test Run from the Remote Controller	174
1.2 Jumper Settings	175

1. Others

1.1 Test Run from the Remote Controller

For Heat pump

In cooling mode, select the lowest programmable temperature; in heating mode, select the highest programmable temperature.

- Trial operation may be disabled in either mode depending on the room temperature.
- After trial operation is complete, set the temperature to a normal level.
(26°C to 28°C in cooling mode, 20°C to 24°C in heating mode)
- For protection, the system disables restart operation for 3 minutes after it is turned off.

For Cooling Only

Select the lowest programmable temperature.

- Trial operation in cooling mode may be disabled depending on the room temperature.
Use the remote control for trial operation as described below.
- After trial operation is complete, set the temperature to a normal level (26°C to 28°C).
- For protection, the machine disables restart operation for 3 minutes after it is turned off.

Trial Operation and Testing

1. Measure the supply voltage and make sure that it falls in the specified range.
 2. Trial operation should be carried out in either cooling or heating mode.
 3. Carry out the test operation in accordance with the Operation Manual to ensure that all functions and parts, such as louver movement, are working properly.
- The air conditioner requires a small amount of power in its standby mode. If the system is not to be used for some time after installation, shut off the circuit breaker to eliminate unnecessary power consumption.
 - If the circuit breaker trips to shut off the power to the air conditioner, the system will restore the original operation mode when the circuit breaker is opened again.

Trial operation from Remote Controller

- (1) Press ON/OFF button to turn on the system.
- (2) Simultaneously press center of TEMP button and MODE buttons.
- (3) Press MODE button twice.
(“T” will appear on the display to indicate that Trial Operation mode is selected.)
- (4) Trial run mode terminates in approx. 15 minutes and switches into normal mode. To quit a trial operation, press ON/OFF button.

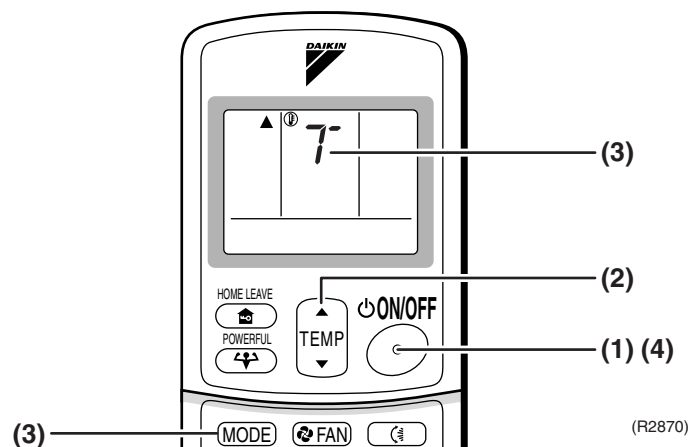

(R2870)

1.2 Jumper Settings

1.2.1 When Two Units are Installed in One Room

When two indoor units are installed in one room, the two wireless remote controllers can be set for different addresses.

How to set the different addresses

- Control PCB of the indoor unit
 - (1) Remove the front grille. (3 screws)
 - (2) Remove the electrical box (1-screw).
 - (3) Remove the drip proof plate. (4 tabs)
 - (4) Cut the address jumper **JA** on the control PCB.

- Wireless remote controller
 - (1) Slide the front cover and take it off.
 - (2) Cut the address jumper **J4**.

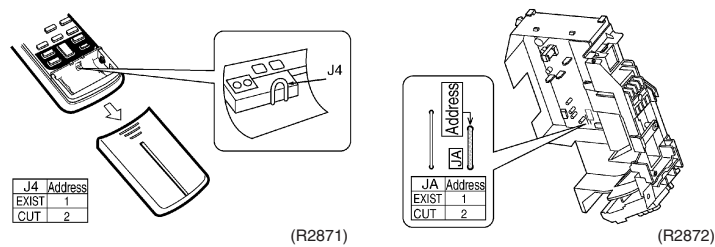

1.2.2 Jumper Setting

Jumper (On indoor control PCB)	Function	When connected (factory set)	When cut
JC	Power failure recovery function	Auto-restart	Unit does not resume operation after recovering from a power failure. Timer ON-OFF settings are cleared.
JB	Fan speed setting when compressor is OFF on thermostat.	Fan speed setting ; Remote controller setting	Fan rpm is set to "0" <Fan stop>

Part 9 Appendix

1. Piping Diagrams.....	178
2. Wiring Diagrams.....	179

1. Piping Diagrams

FTXG25/35CVMAW(S), FTXG25/35CVMBW(S), ATXG25/35CVMB

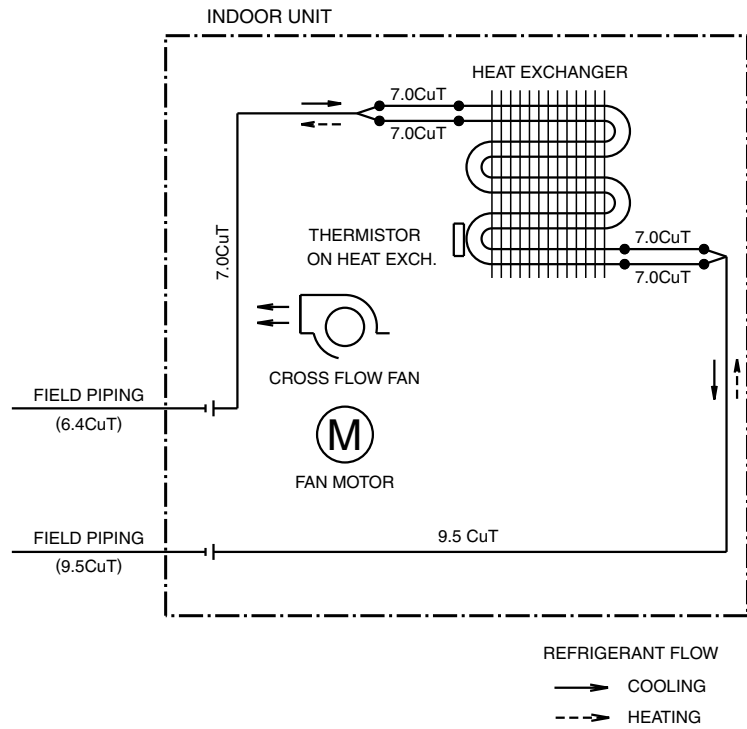

4D045301A

RXG25/35CVMA, RXG25/35CVMB, ARXG25/35CVMB

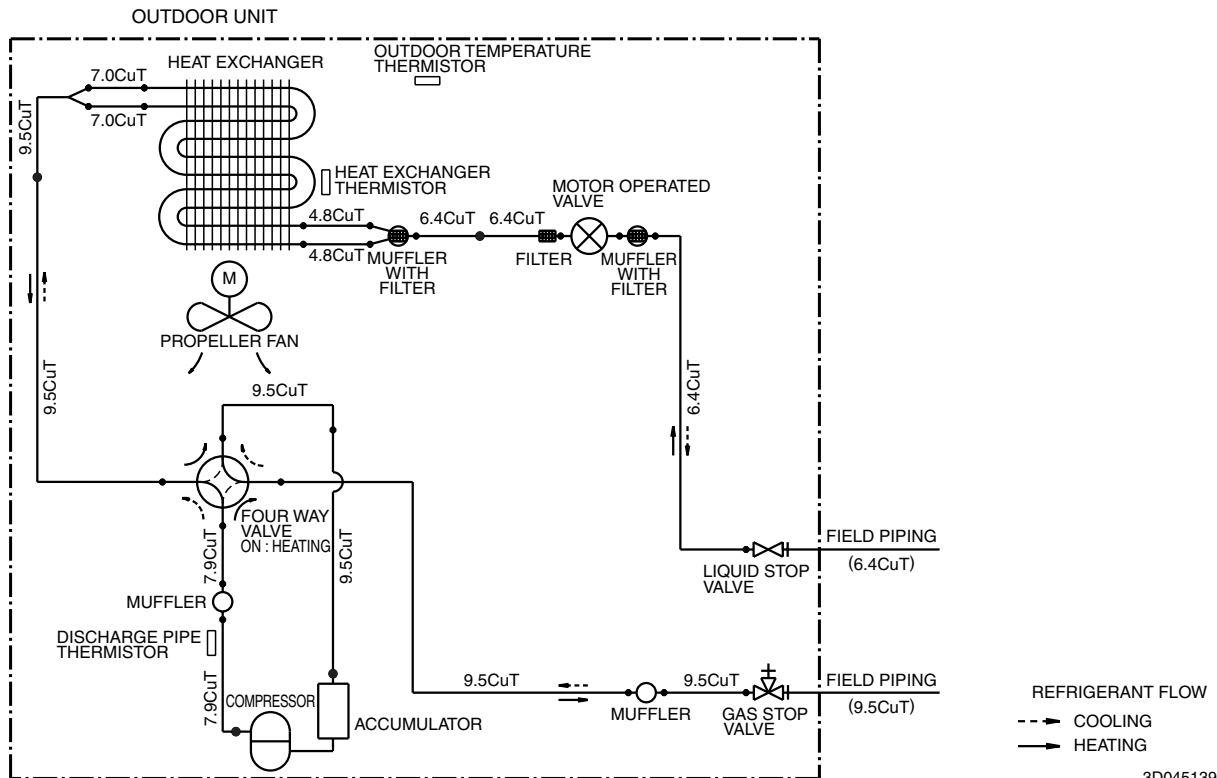

3D045139B

2. Wiring Diagrams

FTXG25/35CVMAW(S), FTXG25/35CVMBW(S), ATXG25/35CVMB

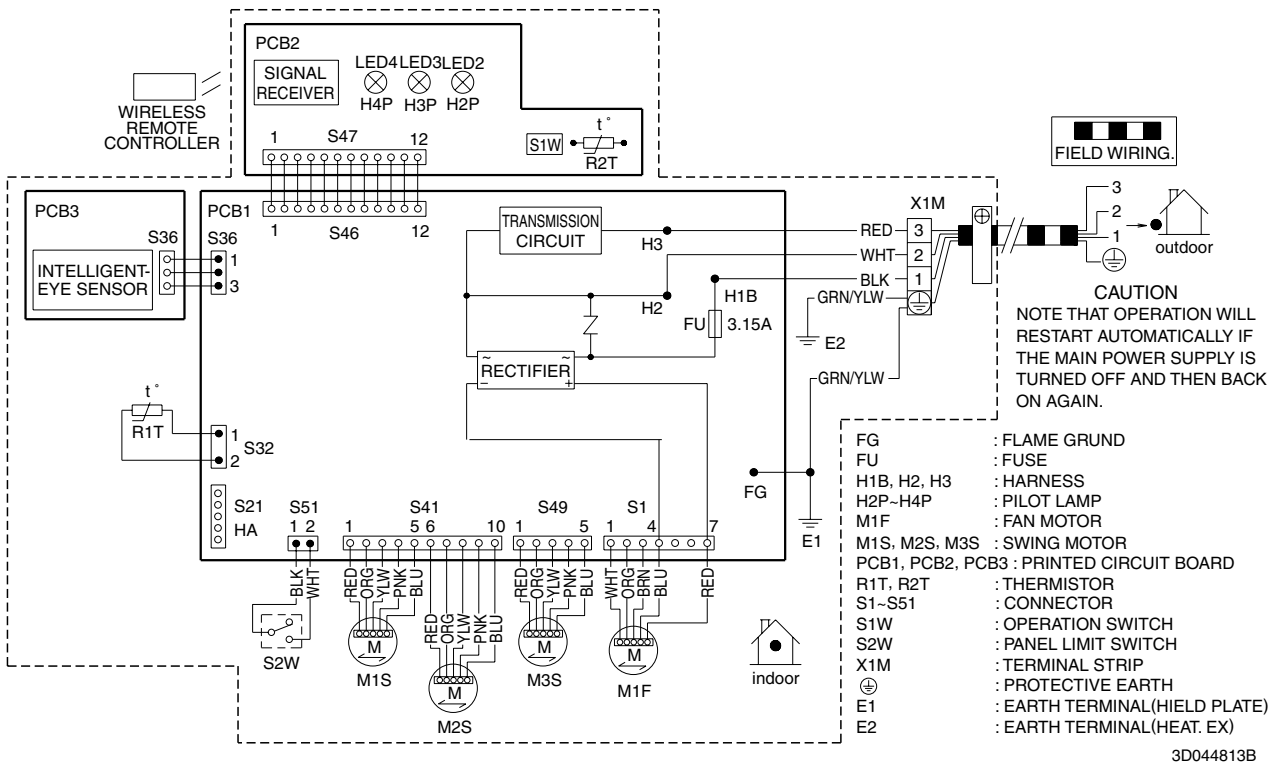

RXG25/35CVMA, RXG25/35CVMB, ARXG25/35CVMB

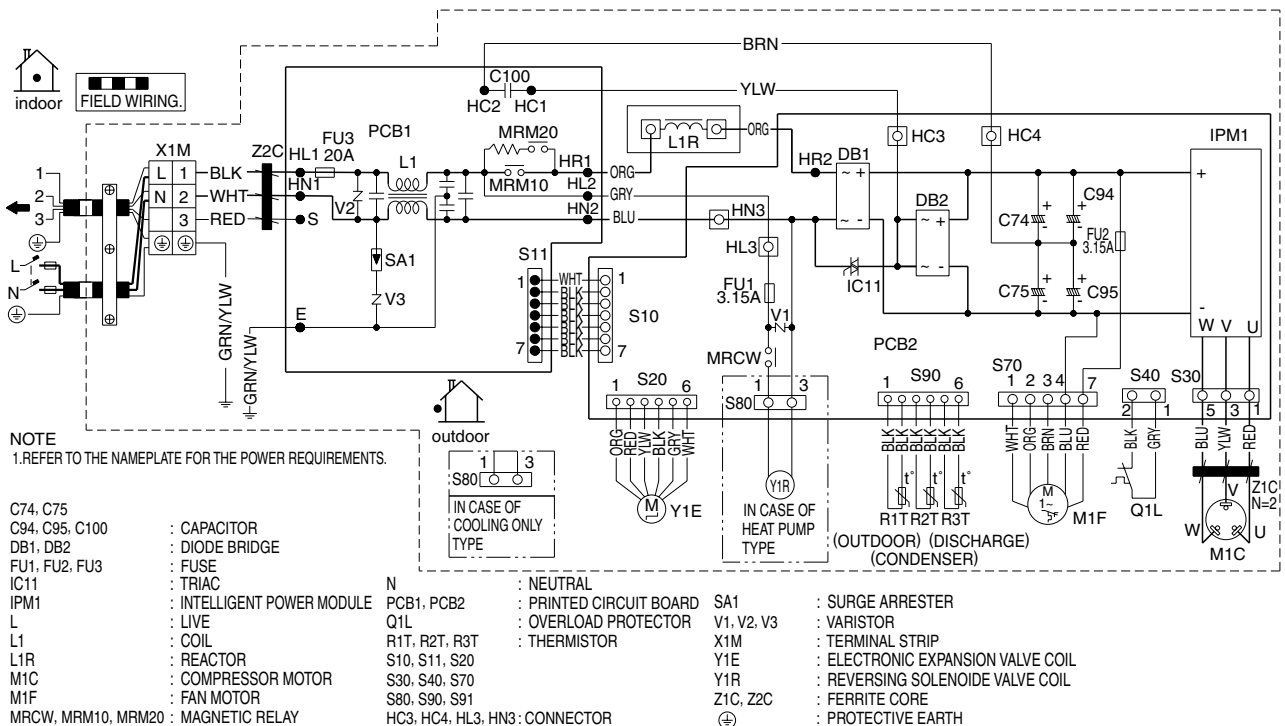

Index

Numerics

00	73
3-D airflow	18
3-minutes standby	26, 31

A

A1	74
A5	75
A6	77
address setting jumper	10
air filter	26, 112
air flow direction	53
ARC433A series	70
AUTO · DRY · COOL · HEAT · FAN operation	51
automatic air flow control	20
automatic operation	22
auto-restart	10, 175
auto-restart function	26
auto-swing	18
auxiliary piping	148

B

bell mouth	155
blade	
horizontal blade	125
vertical blades	130

C

C4	79
C7	80
C9	79
care and cleaning	61
centralized control	10
check	
discharge pressure check	108
electronic expansion valve check	104
fan motor connector output check	104
four way valve performance check	105
installation condition check	107
inverter units refrigerant system check	109
outdoor unit fan system check	108
power supply waveforms check	109
power transistor check	110
thermistor resistance check	106
turning speed pulse input on the outdoor unit PCB check	110
comfort airflow mode	18
compressor	167
compressor lock	86
compressor overload	85
compressor protection function	31
connectors	10, 12
connectors	
fan motor	136, 153
four way valve	159

reduction motor	137
signal receiver PCB	143
swing motors	136
control PCB (indoor unit)	11, 74
control PCB (outdoor unit)	13, 144, 169
cover	
lamp cover	124
motor cover	149
service cover	116
stop valve cover	152
terminal cover	165

D

DC fan lock	87
DC voltage / current sensor abnormality	96
decorative plate	114
defrost control	35
discharge pipe	37
discharge pipe control	32
discharge pipe temperature control	38, 91
discharge pipe thermistor	27, 37, 98, 160
discharge pressure check	108
drip proof plate	134, 153

E

E1	84
E5	85
E6	86
E7	87
E8	88
EA	89
electrical box	134, 159
electronic expansion valve check	104
electronic expansion valve control	36
error codes	
00	73
A1	74
A5	75
A6	77
C4	79
C7	80
C9	79
E1	84
E5	85
E6	86
E7	87
E8	88
EA	89
F3	91
F6	92
H0	94
H6	95
H8	96
H9	97
J3	97

J6	97
L5	99
U0	101
U2	103
U4	81
U5	82
UA	83
error codes and description	73
F	
F3	91
F6	92
fan control	
indoor unit	19
outdoor unit	34
fan motor	149, 156
fan motor connector output check	104
fan motor fixing frame	156
fan motor or related abnormality	77
fan motor, connector	136, 153
fan rotor	149
fan speed control	20
fan speed setting	10, 175
filter	
air filter	26, 112
titanium apatite photocatalytic air-purifying filter	26, 113
filter PCB	13
forced cooling operation	17
forced operation mode	40
forced operation ON/OFF switch	10
four way valve	165
four way valve abnormality	89
four way valve operation compensation	31
four way valve performance check	105
four way valve switching	31
four way valve, connector	159
freeze-up protection control	33, 75
frequency control	16, 29
frequency principle	16
front grille	118
front panel	114, 153
front panel control	19
front panel mechanism	10, 80, 120, 137
front panel open/close fault	80
FU1	10, 12
FU2	12
FU3	12
functions, list of	2
fuse	10, 12
G	
grille	
front grille	118
outlet grille	129
H	
H0	94
H6	95
H8	96
H9	97
HA	10
Hall IC	20, 77
HC3	12
HC4	12
heat exchanger	148
heat exchanger thermistor	27, 79, 98, 137, 160
heating peak-cut control	33
high pressure control	75
high pressure control in cooling	92
HL3	12
HN3	12
horizontal blade	125
hot start function	26
I	
indoor unit PCB abnormality	74
input current control	32
input over current detection	88
installation condition check	107
installation plate	146
insufficient gas	101
insufficient gas control	39
INTELLIGENT EYE	24
INTELLIGENT EYE operation	57
INTELLIGENT EYE sensor PCB	11
inverter powerful operation	25
inverter principle	16
inverter units refrigerant system check	109
J	
J3	97
J4	175
J6	97
JA	10, 175
JB	10, 175
JC	10, 175
jumper settings	175
L	
L5	99
lamp cover	124
LED2	10
LED3	10
LED4	10
LEDA	12
limit switch	10, 80, 143
liquid compression protection function 2	34
list of functions	2
M	
mode changing control	30
mode hierarchy	28
mold proof air filter	26
motor	
fan motor	149, 156
reduction motor	10, 80, 126
swing motor	132
motor cover	149
N	
names of parts	45

- night set mode23
- O**
- OL activation85
- ON/OFF button on Indoor unit26
- operation lamp68
- outdoor air temperature thermistor98
- outdoor unit fan system check108
- outdoor unit pcb abnormality84
- OUTDOOR UNIT SILENT operation56
- outlet grille129
- output over current detection99
- over current39, 88, 99
- overload39, 85
- overload protector12
- over-voltage detection103
- P**
- panel
- front panel114, 153
 - right side panel157
 - slot-in panel115
 - top panel153
- partition plate161
- pi control30
- pipng diagrams178
- pipng fixture plate147
- plate
- decorative plate114
 - drip proof plate134, 153
 - installation plate146
 - partition plate161
 - pipng fixture plate147
 - rack plate120
 - right side plate149
 - shelter141, 152
 - support plate112
- position sensor abnormality95
- power failure recovery function10, 175
- power supply waveforms check109
- power transistor check110
- power-airflow flap18
- powerful operation25, 55
- powerful operation mode40
- preheating operation30
- preparation before operation48
- printed circuit board (PCB)
- control PCB (indoor unit)11, 74
 - control PCB (outdoor unit)13, 144, 169
 - filter PCB13
 - INTELLIGENT EYE sensor PCB11
 - signal receiver PCB11, 145
- problem symptoms and measures69
- programme dry function21
- propeller fan154
- R**
- rack plate120
- reactor161
- reactor harnesses159
- reduction motor10, 80, 126
- reduction motor, connector137
- remote controller70
- right side panel157
- right side plate149
- room temperature thermistor79
- RTH110
- S**
- S110, 136
- S1012
- S1112
- S2012
- S2110
- S3012
- S3210
- S3610
- S4012
- S4110, 136
- S4610, 143
- S4710
- S4910, 137
- S5110
- S7012, 153
- S8012, 159
- S9012
- self-diagnosis digital display26
- sensor abnormality around compressor system94
- sensor malfunction detection39
- service check function70
- service cover116
- shelter141, 152
- signal receiver PCB11, 145
- signal receiver PCB, connector143
- signal receiving sign26
- signal transmission error81, 82
- slot-in panel115
- sound blanket163
- specifications4
- starting control
- indoor unit19
 - outdoor unit30
- stop valve cover152
- support plate112
- SW110
- swing motor132
- swing motor, connector136
- T**
- terminal board142, 169
- terminal cover165
- terminal strip74
- test run174
- thermistor
- discharge pipe thermistor27, 37, 98, 160
 - indoor heat exchanger thermistor27, 79, 137
 - outdoor air temperature thermistor98
 - outdoor heat exchanger thermistor ...27, 98, 160
 - room temperature thermistor79
- thermistor or related abnormality (indoor unit)79
- thermistor or related abnormality (outdoor unit)97
- thermistor resistance check106

timer operation	59
titanium apatite photocatalytic air-purifying filter	26, 113
top panel	153
troubleshooting	64, 73
troubleshooting with led indication	68
turning speed pulse input on the outdoor unit PCB check	110

U

U0	101
U2	103
U4	81
U5	82
UA	83
unspecified voltage	83

V

V1	10, 12
V2	12
V3	12
varistor	10, 12
vertical blades	130
voltage detection function	40

W

wide-angle louvres	18
wiring diagrams	179

Drawings & Flow Charts

A			
ARC433A series	70	inverter powerful operation	25
automatic air flow control	20	inverter units refrigerant system check	109
automatic operation	22	J	
auto-swing	18	jumper settings	175
C		M	
comfort airflow mode	18	mode hierarchy	28
compressor lock	86	N	
compressor protection function	31	night set mode	23
control PCB (indoor unit)	11	O	
control PCB (outdoor unit)	13	OL activation (compressor overload)	85
D		ON/OFF button on indoor unit	26
DC fan lock	87	operation lamp, location	68
DC voltage / current sensor abnormality	96	outdoor unit fan system check	108
defrost control	35	outdoor unit pcb abnormality	84
diagnosis mode	71	output over current detection	99
discharge pipe control	32	over-voltage detection	103
discharge pipe temperature control	91	P	
discharge pressure check	108	pipng diagrams	
E		ARXG25/35CVMB	178
electronic expansion valve check	104	ATXG25/35CVMB	178
electronic expansion valve control	36	FTXG25/35CVMAW(S)	178
F		FTXG25/35CVMBW(S)	178
fan motor connector output check	104	RXG25/35CVMA	178
fan motor or related abnormality	77	RXG25/35CVMB	178
filter PCB	13	position sensor abnormality	95
four way valve abnormality	89	power supply waveforms check	109
four way valve performance check	105	powerful operation	25
freeze-up protection control	33	programme dry function	21
freeze-up protection control or high pressure control	75	R	
frequency control	29	remote controller	70
frequency principle	16	S	
front panel open/close fault	80	sensor abnormality around compressor system ...	94
function of thermistor		service check function	70
heat pump model	27	signal receiver PCB	11
H		signal transmission error (between indoor and outdoor unit)	81
heating peak-cut control	33	signal transmission error (between indoor unit and wired remote controller)	82
high pressure control in cooling	92	starting control flow	19
I		starting timing chart	19
indoor unit pcb abnormality	74	T	
input current control	32	target discharge pipe temperature control	38
input over current detection	88	thermistor or related abnormality (indoor unit)	79
installation condition check	107	thermistor or related abnormality (outdoor unit)	97
insufficient gas	101	thermistor resistance check	106
insufficient gas control	39	trial operation from remote controller	174
INTELLIGENT EYE	24		
INTELLIGENT EYE sensor PCB	11		
inverter features	17		

turning speed pulse input on the outdoor unit PCB
check110

U

unspecified voltage83

W

wiring diagrams

ARXG25/35CVMB179

ATXG25/35CVMB179

FTXG25/35CVMAW(S)179

FTXG25/35CVMBW(S)179

RXG25/35CVMA179

RXG25/35CVMB179



The air conditioners manufactured by Daikin Industries have received **ISO 9000 series** certification for quality assurance.

Certificate Number.
(ISO9001) **JMI-0107** (ISO9002) **JQA-1452**
JQA-0495



All Daikin Industries locations and subsidiaries in Japan have received environmental management system standard **ISO 14001** certification.

Daikin Industries, Ltd.
Domestic Group
Certificate Number, EC99J2044

About ISO 14001

ISO 14001 is the standard defined by the International Organization for Standardization (ISO) relating to environmental management systems. Our group has been acknowledged by an internationally accredited compliance organisation as having an appropriate programme of environmental protection procedures and activities to meet the requirements of ISO 14001.

Dealer

DAIKIN INDUSTRIES, LTD.

Head Office:
Umeda Center Bldg., 4-12, Nakazaki-Nishi
2-chome, Kita-ku, Osaka, 530-8323 Japan

Tokyo Office:
JR Shinagawa East Bldg., 18-1, Konan
2-chome, Minato-ku, Tokyo, 108-0075 Japan
<http://www.daikin.com/global/>

©All rights reserved

•The specifications, designs, and information in this brochure are subject to change without notice.