

Service Manual

SUPER MULTI NX

C-Series



- [Applied Models]**
- Inverter Multi : Cooling Only
 - Inverter Multi : Heat Pump

SUPER MULTI NX C-Series

●Cooling Only

Indoor Unit

FTKE25BVM	FTKE25BVMA	FTKS20CVMB(9)	FLKS25BVMB
FTKE35BVM	FTKE35BVMA	FTKS25CVMB(9)(8)	FLKS35BVMB
FTKD50BVM	FTKD50BVMA	FTKS35CVMB(9)(8)	FLKS50BVMB
FTKD60BVM	FTKD60BVMA	FTKS50BVMB	FLKS60BVMB
FTKD71BVM	FTKD71BVMA	FTKS60BVMB	FVKS25BVMB
CDKD25CVM	CDKD25CVMA	FTKS71BVMB	FVKS35BVMB
CDKD35CVM	CDKD35CVMA	CDKS25CVMB	FVKS50BVMB
CDKD50CVM	CDKD50CVMA	CDKS35CVMB	
CDKD60CVM	CDKD60CVMA	CDKS50CVMB	
	FLK25AVMA	CDKS60CVMB	
	FLK35AVMA		
	FLK50AVMA		
	FLK60AVMA		

Outdoor Unit

2MKD58BVM	3MKD75BVMA	3MKS50BVMB(8)
3MKD58BVM	4MKD90BVMA	4MKS58BVMB(8)
3MKD75BVM		4MKS75BVMB
4MKD75BVM		4MKS90BVMB
4MKD90BVM		

●Heat Pump

Indoor Unit

FTXE25BVMA	FTXS20CVMB(9)	FLXS25BVMB	FTXS25BVMA
FTXE35BVMA	FTXS25CVMB(9)(8)	FLXS35BVMB	FTXS35BVMA
FTXD50BVMA	FTXS35CVMB(9)(8)	FLXS50BVMB	FTXS50BVMA(8)
FTXD60BVMA	FTXS50BVMB	FLXS60BVMB	FTXS60BVMA(8)
FTXD71BVMA	FTXS60BVMB	FVXS25BVMB	FTXS71BVMA(8)
CDXD25CVM	FTXS71BVMB	FVXS35BVMB	CDXS25CVMA
CDXD35CVM	ATXS20CVMB(9)	FVXS50BVMB	CDXS35CVMA
CDXD50CVM	ATXS25CVMB(9)		CDXS50CVMA
CDXD60CVM	ATXS35CVMB(9)		CDXS60CVMA
FLX25AVMA	ATXS50CVMB		FLXS25BVMA
FLX35AVMA	CDXS25CVMB		FLXS35BVMA
FLX50AVMA	CDXS35CVMB		FLXS50BVMA
FLX60AVMA	CDXS50CVMB		FLXS60BVMA
	CDXS60CVMB		FVXS35BVMA
			FVXS50BVMA

Outdoor Unit

3MXD68BVMA	3MXS52BVMB(8)	3AMXS52BVMB	4MXS68CVMA
4MXD80BVMA	4MXS68BVMB9		4MXS80CVMA
	4MXS80BVMB9		

1. Introduction	vii
1.1 Safety Cautions	vii
Part 1 List of Functions	1
1. List of Functions	2
1.1 Cooling Only Models	2
1.2 Heat Pump Models	8
Part 2 Specifications	17
1. Specifications	18
1.1 Indoor Units - Cooling Only	18
1.2 Outdoor Units - Cooling Only	30
1.3 Indoor Units - Heat Pump	36
1.4 Outdoor Units - Heat Pump	51
Part 3 Printed Circuit Board Connector Wiring Diagram	57
1. Printed Circuit Board Connector Wiring Diagram	58
1.1 Wall Mounted Type 20/25/35 Class	58
1.2 Wall Mounted Type 50/60/71 Class	61
1.3 Duct Connected Type	63
1.4 Floor / Ceiling Suspended Dual Type	64
1.5 Floor Standing Type	66
1.6 Outdoor Units	69
Part 4 Function and Control	71
1. Main Functions	72
1.1 Frequency Principle	72
1.2 Power-Airflow Dual Flaps, Wide Angle Louvers and Auto-Swing	74
1.3 Fan Speed Control for Indoor Units	75
1.4 Programme Dry Function	76
1.5 Automatic Operation	77
1.6 Night Set Mode	78
1.7 Intelligent Eye	79
1.8 Home Leave Operation	81
1.9 Inverter Powerful Operation	82
1.10 Other Functions	83
2. Function of Main Structural Parts	85
2.1 Main Structural Parts	85
2.2 Function of Thermistor	86
3. Control Specification	90
3.1 Mode Hierarchy	90
3.2 Frequency Control	91
3.3 Controls at Mode Changing / Start-up	93
3.4 Discharge Pipe Control	94
3.5 Input Current Control	94
3.6 Freeze-up Protection Control	95
3.7 Heating Peak-cut Control	95
3.8 Fan Control	96
3.9 Moisture Protection Function 2	96

3.10 Defrost Control	97
3.11 Low Hz High Pressure Limit	98
3.12 Electronic Expansion Valve Control	98
3.13 Malfunctions	103
3.14 Forced Operation Mode	104
3.15 Wiring-Error Check.....	105
3.16 Additional Function.....	107

Part 5 System Configuration..... 109

1. System Configuration.....	110
1.1 Operation Instructions	110
2. Instruction.....	111
2.1 Contents and Reference Page	111
2.2 Safety Precautions	112
2.3 Names of Parts.....	114
2.4 Preparation before Operation.....	126
2.5 AUTO · DRY · COOL · HEAT · FAN Operation	129
2.6 Adjusting the Air Flow Direction	131
2.7 POWERFUL Operation	137
2.8 OUTDOOR UNIT SILENT Operation	138
2.9 HOME LEAVE Operation	139
2.10 INTELLIGENT EYE Operation	141
2.11 TIMER Operation	145
2.12 Note for Multi System	147
2.13 Care and Cleaning	149
2.14 Troubleshooting.....	159

Part 6 Service Diagnosis..... 163

1. Caution for Diagnosis.....	164
1.1 Troubleshooting with the Operation Lamp	164
2. Problem Symptoms and Measures	166
3. Service Check Function	167
4. Code Indication on the Remote Controller	168
4.1 Error Codes and Description of Fault.....	168
5. Troubleshooting	169
5.1 Indoor Units	169
5.2 Outdoor Units	170
5.3 Indoor Unit PCB Abnormality	171
5.4 Freeze-up Protection Control or High Pressure Control.....	172
5.5 Fan Motor or Related Abnormality	174
5.6 Thermistor or Related Abnormality (Indoor Unit).....	177
5.7 Shutter Drive Motor / Shutter Limit Switch Abnormality	178
5.8 Signal Transmission Error (between Indoor and Outdoor Units).....	179
5.9 Unspecified Voltage (between Indoor and Outdoor Units).....	180
5.10 Freeze-up Protection Control	181
5.11 OL Activation (Compressor Overload)	183
5.12 Compressor Lock	184
5.13 DC Fan Lock	185
5.14 Input Over Current Detection	186
5.15 Four Way Valve Abnormality	188

5.16 Discharge Pipe Temperature Control.....	190
5.17 Position Sensor Abnormality	191
5.18 CT or Related Abnormality	192
5.19 Thermistor or Related Abnormality (Outdoor Unit).....	194
5.20 Electrical Box Temperature Rise.....	196
5.21 Radiation Fin Temperature Rise	198
5.22 Output Over Current Detection.....	200
5.23 Insufficient Gas.....	202
5.24 Low-voltage Detection.....	204
5.25 Anti-icing Function in Other Rooms / Unspecified Voltage (between Indoor and Outdoor Units).....	205
6. Check.....	206
6.1 How to Check.....	206

Part 7 Removal Procedure 217

1. Outdoor Unit (80 / 90 Class)	218
1.1 Removal of Outer Panels	218
1.2 Removal of Propeller Fans.....	221
1.3 Removal of Electrical Box	222
1.4 Removal of PCB.....	229
1.5 Removal of Fan Motor.....	232
1.6 Removal of Electronic Expansion Valve and Thermistor	234
1.7 Removal of Sound Insulation and Reactor.....	235
1.8 Removal of Shunt.....	237
1.9 Removal of Solenoid Valve and Four Way Valve.....	238
1.10 Removal of Compressor.....	240
2. Outdoor Unit (50 / 52 / 58 / 68 / 75 Class)	242
2.1 Removal of Outer Panels	242
2.2 Removal of Electrical BOX.....	243
2.3 Removal of PCB.....	247
2.4 Removal of Fan Motor.....	250
2.5 Removal of Sound Insulation	251
2.6 Removal of Four Way Valve Coil, Solenoid Valve Coil, Electronic Expansion Valve Coil and Thermistor	252
2.7 Removal of Four Way Valve, Solenoid Valve and Shunt	254
2.8 Removal of Solenoid Valve and Shunt.....	255
2.9 Removal of Compressor.....	256

Part 8 Others 257

1. Others	258
1.1 Test Run from the Remote Controller	258
1.2 Jumper Settings	259

Part 9 Appendix..... 261

1. Piping Diagrams.....	262
1.1 Indoor Units.....	262
1.2 Outdoor Units	266
2. Wiring Diagrams.....	273
2.1 Indoor Units.....	273
2.2 Outdoor Units	276





Index i

Drawings & Flow Charts v







1. Introduction







1.1 Safety Cautions

Cautions and Warnings

- Be sure to read the following safety cautions before conducting repair work.
- The caution items are classified into “ **Warning**” and “ **Caution**”. The “ **Warning**” items are especially important since they can lead to death or serious injury if they are not followed closely. The “ **Caution**” items can also lead to serious accidents under some conditions if they are not followed. Therefore, be sure to observe all the safety caution items described below.
- About the pictograms
 - △ This symbol indicates an item for which caution must be exercised.
The pictogram shows the item to which attention must be paid.
 - This symbol indicates a prohibited action.
The prohibited item or action is shown inside or near the symbol.
 - This symbol indicates an action that must be taken, or an instruction.
The instruction is shown inside or near the symbol.
- After the repair work is complete, be sure to conduct a test operation to ensure that the equipment operates normally, and explain the cautions for operating the product to the customer.



1.1.1 Caution in Repair



 Warning	
Be sure to disconnect the power cable plug from the plug socket before disassembling the equipment for a repair. Working on the equipment that is connected to a power supply can cause an electrical shock. If it is necessary to supply power to the equipment to conduct the repair or inspecting the circuits, do not touch any electrically charged sections of the equipment.	
If the refrigerant gas discharges during the repair work, do not touch the discharging refrigerant gas. The refrigerant gas can cause frostbite.	
When disconnecting the suction or discharge pipe of the compressor at the welded section, release the refrigerant gas completely at a well-ventilated place first. If there is a gas remaining inside the compressor, the refrigerant gas or refrigerating machine oil discharges when the pipe is disconnected, and it can cause injury.	
If the refrigerant gas leaks during the repair work, ventilate the area. The refrigerant gas can generate toxic gases when it contacts flames.	
The step-up capacitor supplies high-voltage electricity to the electrical components of the outdoor unit. Be sure to discharge the capacitor completely before conducting repair work. A charged capacitor can cause an electrical shock.	
Do not start or stop the air conditioner operation by plugging or unplugging the power cable plug. Plugging or unplugging the power cable plug to operate the equipment can cause an electrical shock or fire.	

 Caution	
Do not repair the electrical components with wet hands. Working on the equipment with wet hands can cause an electrical shock.	
Do not clean the air conditioner by splashing water. Washing the unit with water can cause an electrical shock.	
Be sure to provide the grounding when repairing the equipment in a humid or wet place, to avoid electrical shocks.	
Be sure to turn off the power switch and unplug the power cable when cleaning the equipment. The internal fan rotates at a high speed, and cause injury.	
Do not tilt the unit when removing it. The water inside the unit can spill and wet the furniture and floor.	
Be sure to check that the refrigerating cycle section has cooled down sufficiently before conducting repair work. Working on the unit when the refrigerating cycle section is hot can cause burns.	
Use the welder in a well-ventilated place. Using the welder in an enclosed room can cause oxygen deficiency.	



1.1.2 Cautions Regarding Products after Repair



 Warning	
Be sure to use parts listed in the service parts list of the applicable model and appropriate tools to conduct repair work. Never attempt to modify the equipment. The use of inappropriate parts or tools can cause an electrical shock, excessive heat generation or fire.	
When relocating the equipment, make sure that the new installation site has sufficient strength to withstand the weight of the equipment. If the installation site does not have sufficient strength and if the installation work is not conducted securely, the equipment can fall and cause injury.	
Be sure to install the product correctly by using the provided standard installation frame. Incorrect use of the installation frame and improper installation can cause the equipment to fall, resulting in injury.	For integral units only
Be sure to install the product securely in the installation frame mounted on a window frame. If the unit is not securely mounted, it can fall and cause injury.	For integral units only



 Warning	
Be sure to use an exclusive power circuit for the equipment, and follow the technical standards related to the electrical equipment, the internal wiring regulations and the instruction manual for installation when conducting electrical work. Insufficient power circuit capacity and improper electrical work can cause an electrical shock or fire.	
Be sure to use the specified cable to connect between the indoor and outdoor units. Make the connections securely and route the cable properly so that there is no force pulling the cable at the connection terminals. Improper connections can cause excessive heat generation or fire.	
When connecting the cable between the indoor and outdoor units, make sure that the terminal cover does not lift off or dismount because of the cable. If the cover is not mounted properly, the terminal connection section can cause an electrical shock, excessive heat generation or fire.	
Do not damage or modify the power cable. Damaged or modified power cable can cause an electrical shock or fire. Placing heavy items on the power cable, and heating or pulling the power cable can damage the cable.	
Do not mix air or gas other than the specified refrigerant (R410A / R22) in the refrigerant system. If air enters the refrigerating system, an excessively high pressure results, causing equipment damage and injury.	
If the refrigerant gas leaks, be sure to locate the leak and repair it before charging the refrigerant. After charging refrigerant, make sure that there is no refrigerant leak. If the leak cannot be located and the repair work must be stopped, be sure to perform pump-down and close the service valve, to prevent the refrigerant gas from leaking into the room. The refrigerant gas itself is harmless, but it can generate toxic gases when it contacts flames, such as fan and other heaters, stoves and ranges.	
When replacing the coin battery in the remote controller, be sure to disposed of the old battery to prevent children from swallowing it. If a child swallows the coin battery, see a doctor immediately.	

 Caution	
Installation of a leakage breaker is necessary in some cases depending on the conditions of the installation site, to prevent electrical shocks.	
Do not install the equipment in a place where there is a possibility of combustible gas leaks. If a combustible gas leaks and remains around the unit, it can cause a fire.	
Be sure to install the packing and seal on the installation frame properly. If the packing and seal are not installed properly, water can enter the room and wet the furniture and floor.	For integral units only

1.1.3 Inspection after Repair

 Warning	
Check to make sure that the power cable plug is not dirty or loose, then insert the plug into a power outlet all the way. If the plug has dust or loose connection, it can cause an electrical shock or fire.	
If the power cable and lead wires have scratches or deteriorated, be sure to replace them. Damaged cable and wires can cause an electrical shock, excessive heat generation or fire.	





 Warning	
Do not use a joined power cable or extension cable, or share the same power outlet with other electrical appliances, since it can cause an electrical shock, excessive heat generation or fire.	

 Caution	
Check to see if the parts and wires are mounted and connected properly, and if the connections at the soldered or crimped terminals are secure. Improper installation and connections can cause excessive heat generation, fire or an electrical shock.	
If the installation platform or frame has corroded, replace it. Corroded installation platform or frame can cause the unit to fall, resulting in injury.	
Check the grounding, and repair it if the equipment is not properly grounded. Improper grounding can cause an electrical shock.	
Be sure to measure the insulation resistance after the repair, and make sure that the resistance is 1 Mohm or higher. Faulty insulation can cause an electrical shock.	
Be sure to check the drainage of the indoor unit after the repair. Faulty drainage can cause the water to enter the room and wet the furniture and floor.	

1.1.4 Using Icons

Icons are used to attract the attention of the reader to specific information. The meaning of each icon is described in the table below:

1.1.5 Using Icons List

Icon	Type of Information	Description
 Note:	Note	A “note” provides information that is not indispensable, but may nevertheless be valuable to the reader, such as tips and tricks.
 Caution	Caution	A “caution” is used when there is danger that the reader, through incorrect manipulation, may damage equipment, lose data, get an unexpected result or has to restart (part of) a procedure.
 Warning	Warning	A “warning” is used when there is danger of personal injury.
	Reference	A “reference” guides the reader to other places in this binder or in this manual, where he/she will find additional information on a specific topic.

Part 1

List of Functions

1. List of Functions	2
1.1 Cooling Only Models	2
1.2 Heat Pump Models.....	8

1. List of Functions

1.1 Cooling Only Models

1.1.1 R22 Series

Category	Functions				Category	Functions			
		FTKE25/35BVM	FTKD50-71BVM	CDKD25-60CVM			FTKE25/35BVM	FTKD50-71BVM	CDKD25-60CVM
Basic Function	Inverter (with Inverter Power Control)	○	○	○	Health & Clean	Air Purifying Filter with Bacteriostatic & Virustatic Functions	○	—	—
	Operation Limit for Cooling (°CDB)	—	—	—		Photocatalytic Deodorizing Filter	○	—	—
	Operation Limit for Heating (°CWB)	—	—	—		Air Purifying Filter with Photocatalytic Deodorizing Function	—	○	—
	PAM Control	—	—	—		Longlife Filter	—	—	—
Compressor	Oval Scroll Compressor	—	—	—	Ultra-Longlife Filter (Option)	—	—	—	
	Swing Compressor	—	—	—	Mould Proof Air Filter	○	○	—	
	Rotary Compressor	—	—	—	Wipe-clean Flat Panel	○	○	—	
	Reluctance DC Motor	—	—	—	Washable Grille	—	—	—	
Comfortable Airflow	Power-Airflow Flap	—	—	—	Filter Cleaning Indicator	—	—	—	
	Power-Airflow Dual Flaps	○	○	—	Good-Sleep Cooling Operation	—	—	—	
	Power-Airflow Diffuser	—	—	—	Timer	24-Hour On/Off Timer	○	○	○
	Wide-Angle Louvers	○	○	—		Night Set Mode	○	○	○
	Vertical Auto-Swing (Up and Down)	○	○	—	Worry Free "Reliability & Durability"	Auto-Restart (after Power Failure)	○	○	○
	Horizontal Auto-Swing (Right and Left)	—	○	—		Self-Diagnosis (Digital, LED) Display	★	★	★
	3-D Airflow	—	○	—		Wiring-Error Check	—	—	—
	3-Step Airflow (H/P Only)	—	—	—		Anticorrosion Treatment of Outdoor Heat Exchanger	—	—	—
Comfort Control	Auto Fan Speed	○	○	○	Flexibility	Multi-Split / Split Type Compatible Indoor Unit	○	○	—
	Indoor Unit Silent Operation	○	○	○		Flexible Voltage Correspondence	○	○	○
	Night Quiet Mode (Automatic)	—	—	—		High Ceiling Application	—	—	—
	Outdoor Unit Silent Operation (Manual)	—	—	—		Chargeless	—	—	—
	Intelligent Eye	○	○	—	Power-Selection	—	—	—	
	Quick Warming Function	—	—	—	Remote Control	5-Rooms Centralized Controller (Option)	○	○	○
	Hot-Start Function	—	—	—		Remote Control Adaptor (Normal Open-Pulse Contact)(Option)	○	○	○
	Automatic Defrosting	—	—	—		Remote Control Adaptor (Normal Open Contact)(Option)	○	○	○
	—	—	—	DIII-NET Compatible (Adaptor)(Option)		○	○	○	
Operation	Automatic Operation	—	—	—	Remote Controller	Wireless	○	○	○
	Programme Dry Function	○	○	○		Wired	—	—	—
	Fan Only	○	○	○					
Lifestyle Convenience	New Powerful Operation (Non-Inverter)	—	—	—					
	Inverter Powerful Operation	○	○	○					
	Priority-Room Setting	—	—	—					
	Cooling / Heating Mode Lock	—	—	—					
	Home Leave Operation	○	○	○					
	Indoor Unit On/Off Switch	○	○	○					
	Signal Reception Indicator	○	○	○					
	Temperature Display	—	—	—					
Another Room Operation	—	—	—						

Note: ○ : Holding Functions
— : No Functions

★ : Digital Only

Category	Functions			Category	Functions			
		FLK25-60AVMA	2MKD58BVM 3MKD58-75BVM 4MKD75-90BVM			FLK25-60AVMA	2MKD58BVM 3MKD58-75BVM 4MKD75-90BVM	
Basic Function	Inverter (with Inverter Power Control)	○	○	Health & Clean	Air Purifying Filter with Bacteriostatic & Virustatic Functions	○	—	
	Operation Limit for Cooling (°CDB)	—	10 ~ 46		Photocatalytic Deodorizing Filter	○	—	
	Operation Limit for Heating (°CWB)	—	—		Air Purifying Filter with Photocatalytic Deodorizing Function	—	—	
	PAM Control	—	○		Longlife Filter	—	—	
Compressor	Oval Scroll Compressor	—	—		Ultra-Longlife Filter (Option)	—	—	
	Swing Compressor	—	○		Mould Proof Air Filter	○	—	
	Rotary Compressor	—	—		Wipe-clean Flat Panel	—	—	
	Reluctance DC Motor	—	○		Washable Grille	—	—	
Comfortable Airflow	Power-Airflow Flap	—	—		Filter Cleaning Indicator	—	—	
	Power-Airflow Dual Flaps	—	—		Good-Sleep Cooling Operation	—	—	
	Power-Airflow Diffuser	—	—		Timer	24-Hour On/Off Timer	○	—
	Wide-Angle Louvers	—	—			Night Set Mode	○	—
	Vertical Auto-Swing (Up and Down)	○	—		Worry Free "Reliability & Durability"	Auto-Restart (after Power Failure)	○	—
	Horizontal Auto-Swing (Right and Left)	—	—			Self-Diagnosis (Digital, LED) Display	○★	○
	3-D Airflow	—	—	Wiring-Error Check		—	○	
3-Step Airflow (H/P Only)	—	—	Anticorrosion Treatment of Outdoor Heat Exchanger	—		○		
Comfort Control	Auto Fan Speed	○	—	Flexibility	Multi-Split / Split Type Compatible Indoor Unit	○	—	
	Indoor Unit Silent Operation	○	—		Flexible Voltage Correspondence	○	○	
	Night Quiet Mode (Automatic)	—	○		High Ceiling Application	—	—	
	Outdoor Unit Silent Operation (Manual)	—	○		Chargeless	—	○	
	Intelligent Eye	—	—	Remote Control	Power-Selection	—	—	
	Quick Warming Function	—	—		5-Rooms Centralized Controller (Option)	○	—	
	Hot-Start Function	—	—		Remote Control Adaptor (Normal Open-Pulse Contact)(Option)	○	—	
	Automatic Defrosting	—	—		Remote Control Adaptor (Normal Open Contact)(Option)	○	—	
Operation	Automatic Operation	—	—	Remote Controller	DIII-NET Compatible (Adaptor)(Option)	○	—	
	Programme Dry Function	○	—		Wireless	○	—	
	Fan Only	○	—	Wired	—	—		
Lifestyle Convenience	New Powerful Operation (Non-Inverter)	—	—					
	Inverter Powerful Operation	○	—					
	Priority-Room Setting	—	○					
	Cooling / Heating Mode Lock	—	—					
	Home Leave Operation	○	—					
	Indoor Unit On/Off Switch	○	—					
	Signal Reception Indicator	○	—					
	Temperature Display	—	—					
Another Room Operation	—	—						

Note: ○ : Holding Functions
— : No Functions

★ : Digital Only

Category	Functions	FTKE25/35BVMA	FTKD50-71BVMA	CDKD25-60CVMA	Category	Functions	FTKE25/35BVMA	FTKD50-71BVMA	CDKD25-60CVMA
Basic Function	Inverter (with Inverter Power Control)	○	○	○	Health & Clean	Air Purifying Filter with Bacteriostatic & Virustatic Functions	○	—	—
	Operation Limit for Cooling (°CDB)	—	—	—		Photocatalytic Deodorizing Filter	○	—	—
	Operation Limit for Heating (°CWB)	—	—	—		Air Purifying Filter with Photocatalytic Deodorizing Function	—	○	—
	PAM Control	—	—	—		Longlife Filter	—	—	—
Compressor	Oval Scroll Compressor	—	—	—		Ultra-Longlife Filter (Option)	—	—	—
	Swing Compressor	—	—	—		Mould Proof Air Filter	○	○	—
	Rotary Compressor	—	—	—		Wipe-clean Flat Panel	○	○	—
	Reluctance DC Motor	—	—	—		Washable Grille	—	—	—
Comfortable Airflow	Power-Airflow Flap	—	—	—		Filter Cleaning Indicator	—	—	—
	Power-Airflow Dual Flaps	○	○	—		Good-Sleep Cooling Operation	—	—	—
	Power-Airflow Diffuser	—	—	—	Timer	24-Hour On/Off Timer	○	○	○
	Wide-Angle Louvers	○	○	—		Night Set Mode	○	○	○
	Vertical Auto-Swing (Up and Down)	○	○	—	Worry Free "Reliability & Durability"	Auto-Restart (after Power Failure)	○	○	○
	Horizontal Auto-Swing (Right and Left)	—	○	—		Self-Diagnosis (Digital, LED) Display	★	★	★
	3-D Airflow	—	○	—		Wiring-Error Check	—	—	—
	3-Step Airflow (H/P Only)	—	—	—		Anticorrosion Treatment of Outdoor Heat Exchanger	—	—	—
Comfort Control	Auto Fan Speed	○	○	○		Flexibility	Multi-Split / Split Type Compatible Indoor Unit	○	○
	Indoor Unit Silent Operation	○	○	○	Flexible Voltage Correspondence		○	○	○
	Night Quiet Mode (Automatic)	—	—	—	High Ceiling Application		—	—	—
	Outdoor Unit Silent Operation (Manual)	—	—	—	Chargeless		—	—	—
	Intelligent Eye	○	○	—	Power-Selection		—	—	—
	Quick Warming Function	—	—	—	Remote Control	5-Rooms Centralized Controller (Option)	○	○	○
	Hot-Start Function	—	—	—		Remote Control Adaptor (Normal Open-Pulse Contact)(Option)	○	○	○
	Automatic Defrosting	—	—	—		Remote Control Adaptor (Normal Open Contact)(Option)	○	○	○
Operation	Automatic Operation	—	—	—	Remote Controller	DIII-NET Compatible (Adaptor)(Option)	○	○	○
	Programme Dry Function	○	○	○		Wireless	○	○	○
	Fan Only	○	○	○		Wired	—	—	—
Lifestyle Convenience	New Powerful Operation (Non-Inverter)	—	—	—					
	Inverter Powerful Operation	○	○	○					
	Priority-Room Setting	—	—	—					
	Cooling / Heating Mode Lock	—	—	—					
	Home Leave Operation	○	○	○					
	Indoor Unit On/Off Switch	○	○	○					
	Signal Reception Indicator	○	○	○					
	Temperature Display	—	—	—					
	Another Room Operation	—	—	—					

Note: ○ : Holding Functions
 — : No Functions

★ : Digital Only

Category	Functions	3MKD75BVMA 4MKD90BVMA	Category	Functions	3MKD75BVMA 4MKD90BVMA	
Basic Function	Inverter (with Inverter Power Control)	○	Health & Clean	Air Purifying Filter with Bacteriostatic & Virustatic Functions	—	
	Operation Limit for Cooling (°CDB)	10 ~ 46		Photocatalytic Deodorizing Filter	—	
	Operation Limit for Heating (°CWB)	—		Air Purifying Filter with Photocatalytic Deodorizing Function	—	
	PAM Control	○		Longlife Filter	—	
Compressor	Oval Scroll Compressor	—	Timer	Ultra-Longlife Filter (Option)	—	
	Swing Compressor	○		Mould Proof Air Filter	—	
	Rotary Compressor	—		Wipe-clean Flat Panel	—	
	Reluctance DC Motor	○		Washable Grille	—	
Comfortable Airflow	Power-Airflow Flap	—	Worry Free "Reliability & Durability"	Filter Cleaning Indicator	—	
	Power-Airflow Dual Flaps	—		Good-Sleep Cooling Operation	—	
	Power-Airflow Diffuser	—		24-Hour On/Off Timer	—	
	Wide-Angle Louvers	—		Night Set Mode	—	
	Vertical Auto-Swing (Up and Down)	—		Auto-Restart (after Power Failure)	—	
	Horizontal Auto-Swing (Right and Left)	—		Self-Diagnosis (Digital, LED) Display	○	
	3-D Airflow	—		Wiring-Error Check	○	
Comfort Control	3-Step Airflow (H/P Only)	—	Flexibility	Anticorrosion Treatment of Outdoor Heat Exchanger	○	
	Auto Fan Speed	—		Multi-Split / Split Type Compatible Indoor Unit	—	
	Indoor Unit Silent Operation	—		Flexible Voltage Correspondence	○	
	Night Quiet Mode (Automatic)	○		High Ceiling Application	—	
	Outdoor Unit Silent Operation (Manual)	○		Chargeless	○	
	Intelligent Eye	—		Power-Selection	—	
	Quick Warming Function	—		Remote Control	5-Rooms Centralized Controller (Option)	—
	Hot-Start Function	—			Remote Control Adaptor (Normal Open-Pulse Contact)(Option)	—
Operation	Automatic Defrosting	—	Remote Controller	Remote Control Adaptor (Normal Open Contact)(Option)	—	
	Automatic Operation	—		DIII-NET Compatible (Adaptor)(Option)	—	
	Programme Dry Function	—		Wireless	—	
Lifestyle Convenience	Fan Only	—		Wired	—	
	New Powerful Operation (Non-Inverter)	—				
	Inverter Powerful Operation	—				
	Priority-Room Setting	○				
	Cooling / Heating Mode Lock	—				
	Home Leave Operation	—				
	Indoor Unit On/Off Switch	—				
	Signal Reception Indicator	—				
Temperature Display	—					
Another Room Operation	—					

Note: ○ : Holding Functions
— : No Functions

★ : Digital Only

1.1.2 R410A Series

Category	Functions				Category	Functions			
		FTKS20-35CVMB(9)(8)	FTKS50-71BVMB	CDKS25-60CVMB			FTKS20-35CVMB(9)(8)	FTKS50-71BVMB	CDKS25-60CVMB
Basic Function	Inverter (with Inverter Power Control)	○	○	○	Health & Clean	Air Purifying Filter with Bacteriostatic & Virustatic Functions	—	—	—
	Operation Limit for Cooling (°CDB)	—	—	—		Photocatalytic Deodorizing Filter	—	—	—
	Operation Limit for Heating (°CWB)	—	—	—		Air Purifying Filter with Photocatalytic Deodorizing Function	○	○	—
	PAM Control	—	—	—		Longlife Filter	—	—	—
Compressor	Oval Scroll Compressor	—	—	—	Ultra-Longlife Filter (Option)	—	—	—	
	Swing Compressor	—	—	—	Mould Proof Air Filter	○	○	○	
	Rotary Compressor	—	—	—	Wipe-clean Flat Panel	○	○	—	
	Reluctance DC Motor	—	—	—	Washable Grille	—	—	—	
Comfortable Airflow	Power-Airflow Flap	—	—	—	Filter Cleaning Indicator	—	—	—	
	Power-Airflow Dual Flaps	○	○	—	Good-Sleep Cooling Operation	—	—	—	
	Power-Airflow Diffuser	—	—	—	Timer	24-Hour On/Off Timer	○	○	○
	Wide-Angle Louvers	○	○	—		Night Set Mode	○	○	○
	Vertical Auto-Swing (Up and Down)	○	○	—	Worry Free "Reliability & Durability"	Auto-Restart (after Power Failure)	○	○	○
	Horizontal Auto-Swing (Right and Left)	—	○	—		Self-Diagnosis (Digital, LED) Display	★	★	★
	3-D Airflow	—	○	—		Wiring-Error Check	—	—	—
	3-Step Airflow (H/P Only)	—	—	—		Anticorrosion Treatment of Outdoor Heat Exchanger	—	—	—
Comfort Control	Auto Fan Speed	○	○	○	Flexibility	Multi-Split / Split Type Compatible Indoor Unit	○	○	—
	Indoor Unit Silent Operation	○	○	○		Flexible Voltage Correspondence	○	○	○
	Night Quiet Mode (Automatic)	—	—	—		High Ceiling Application	—	—	—
	Outdoor Unit Silent Operation (Manual)	—	—	—		Chargeless	—	—	—
	Intelligent Eye	○	○	—	Power-Selection	—	—	—	
	Quick Warming Function	—	—	—	Remote Control	5-Rooms Centralized Controller (Option)	○	○	○
	Hot-Start Function	—	—	—		Remote Control Adaptor (Normal Open-Pulse Contact)(Option)	○	○	○
	Automatic Defrosting	—	—	—		Remote Control Adaptor (Normal Open Contact)(Option)	○	○	○
	—	—	—	DIII-NET Compatible (Adaptor)(Option)		○	○	○	
Operation	Automatic Operation	—	—	—	Remote Controller	Wireless	○	○	○
	Programme Dry Function	○	○	○		Wired	—	—	—
	Fan Only	○	○	○					
Lifestyle Convenience	New Powerful Operation (Non-Inverter)	—	—	—					
	Inverter Powerful Operation	○	○	○					
	Priority-Room Setting	—	—	—					
	Cooling / Heating Mode Lock	—	—	—					
	Home Leave Operation	○	○	○					
	Indoor Unit On/Off Switch	○	○	○					
	Signal Reception Indicator	○	○	○					
	Temperature Display	—	—	—					
Another Room Operation	—	—	—						

Note: ○ : Holding Functions
— : No Functions

★ : Digital Only

Category	Functions				Category	Functions			
		FLKS25-60BVMB	FKS25-50BVMB	3MKS50BVMB(8) 4MKS58BVMB(8) 4MKS75-90BVMB			FLKS25-60BVMB	FKS25-50BVMB	3MKS50BVMB(8) 4MKS58BVMB(8) 4MKS75-90BVMB
Basic Function	Inverter (with Inverter Power Control)	○	○	○	Health & Clean	Air Purifying Filter with Bacteriostatic & Virustatic Functions	○	○	—
	Operation Limit for Cooling (°CDB)	—	—	-10 ~ 46		Photocatalytic Deodorizing Filter	○	○	—
	Operation Limit for Heating (°CWB)	—	—	—		Air Purifying Filter with Photocatalytic Deodorizing Function	—	—	—
	PAM Control	—	—	○		Longlife Filter	—	—	—
Compressor	Oval Scroll Compressor	—	—	—	Ultra-Longlife Filter (Option)	—	—	—	
	Swing Compressor	—	—	○	Mould Proof Air Filter	○	○	—	
	Rotary Compressor	—	—	—	Wipe-clean Flat Panel	—	—	—	
	Reluctance DC Motor	—	—	○	Washable Grille	—	○	—	
Comfortable Airflow	Power-Airflow Flap	—	—	—	Filter Cleaning Indicator	—	—	—	
	Power-Airflow Dual Flaps	—	—	—	Good-Sleep Cooling Operation	—	—	—	
	Power-Airflow Diffuser	—	—	—	Timer	24-Hour On/Off Timer	○	○	—
	Wide-Angle Louvers	—	○	—		Night Set Mode	○	○	—
	Vertical Auto-Swing (Up and Down)	○	○	—	Worry Free "Reliability & Durability"	Auto-Restart (after Power Failure)	○	○	—
	Horizontal Auto-Swing (Right and Left)	—	—	—		Self-Diagnosis (Digital, LED) Display	★	★	○
	3-D Airflow	—	—	—		Wiring-Error Check	—	—	○
	3-Step Airflow (H/P Only)	—	—	—		Anticorrosion Treatment of Outdoor Heat Exchanger	—	—	○
Comfort Control	Auto Fan Speed	○	○	—	Flexibility	Multi-Split / Split Type Compatible Indoor Unit	○	○	—
	Indoor Unit Silent Operation	○	○	—		Flexible Voltage Correspondence	○	○	○
	Night Quiet Mode (Automatic)	—	—	○		High Ceiling Application	—	—	—
	Outdoor Unit Silent Operation (Manual)	—	—	○		Chargeless	—	—	○
	Intelligent Eye	—	—	—	Remote Control	Power-Selection	—	—	—
	Quick Warming Function	—	—	—		5-Rooms Centralized Controller (Option)	○	○	—
	Hot-Start Function	—	—	—		Remote Control Adaptor (Normal Open-Pulse Contact)(Option)	○	○	—
	Automatic Defrosting	—	—	—		Remote Control Adaptor (Normal Open Contact)(Option)	○	○	—
Operation	Automatic Operation	—	—	—	Remote Controller	DIII-NET Compatible (Adaptor)(Option)	○	○	—
	Programme Dry Function	○	○	—		Wireless	○	○	—
	Fan Only	○	○	—		Wired	—	—	—
Lifestyle Convenience	New Powerful Operation (Non-Inverter)	—	—	—					
	Inverter Powerful Operation	○	○	—					
	Priority-Room Setting	—	—	○					
	Cooling / Heating Mode Lock	—	—	—					
	Home Leave Operation	○	○	—					
	Indoor Unit On/Off Switch	○	○	—					
	Signal Reception Indicator	○	○	—					
	Temperature Display	—	—	—					
Another Room Operation	—	—	—						

Note: ○ : Holding Functions
— : No Functions

★ : Digital Only

1.2 Heat Pump Models

1.2.1 R22 Series

Category	Functions	FTXE25/35BVMA	FTXD50-71BVMA	CDXD25-60CVMA	Category	Functions	FTXE25/35BVMA	FTXD50-71BVMA	CDXD25-60CVMA
Basic Function	Inverter (with Inverter Power Control)	○	○	○	Health & Clean	Air Purifying Filter with Bacteriostatic & Virustatic Functions	○	—	—
	Operation Limit for Cooling (°CDB)	—	—	—		Photocatalytic Deodorizing Filter	○	—	—
	Operation Limit for Heating (°CWB)	—	—	—		Air Purifying Filter with Photocatalytic Deodorizing Function	—	○	—
	PAM Control	—	—	—		Longlife Filter	—	—	—
Compressor	Oval Scroll Compressor	—	—	—	Ultra-Longlife Filter (Option)	—	—	—	
	Swing Compressor	—	—	—	Mould Proof Air Filter	○	○	—	
	Rotary Compressor	—	—	—	Wipe-clean Flat Panel	○	○	—	
	Reluctance DC Motor	—	—	—	Washable Grille	—	—	—	
Comfortable Airflow	Power-Airflow Flap	—	—	—	Timer	Filter Cleaning Indicator	—	—	—
	Power-Airflow Dual Flaps	○	○	—		Good-Sleep Cooling Operation	—	—	—
	Power-Airflow Diffuser	—	—	—	Worry Free "Reliability & Durability"	24-Hour On/Off Timer	○	○	○
	Wide-Angle Louvers	○	○	—		Night Set Mode	○	○	○
	Vertical Auto-Swing (Up and Down)	○	○	—		Auto-Restart (after Power Failure)	○	○	○
	Horizontal Auto-Swing (Right and Left)	—	○	—		Self-Diagnosis (Digital, LED) Display	★	★	★
	3-D Airflow	—	○	—		Wiring-Error Check	—	—	—
	3-Step Airflow (H/P Only)	—	—	—		Anticorrosion Treatment of Outdoor Heat Exchanger	—	—	—
Comfort Control	Auto Fan Speed	○	○	○	Flexibility	Multi-Split / Split Type Compatible Indoor Unit	○	○	—
	Indoor Unit Silent Operation	○	○	○		Flexible Voltage Correspondence	○	○	○
	Night Quiet Mode (Automatic)	—	—	—		High Ceiling Application	—	—	—
	Outdoor Unit Silent Operation (Manual)	—	—	—		Chargeless	—	—	—
	Intelligent Eye	○	○	—	Power-Selection	—	—	—	
	Quick Warming Function	—	—	—	Remote Control	5-Rooms Centralized Controller (Option)	○	○	○
	Hot-Start Function	○	○	○		Remote Control Adaptor (Normal Open-Pulse Contact)(Option)	○	○	○
	Automatic Defrosting	—	—	—		Remote Control Adaptor (Normal Open Contact)(Option)	○	○	○
Operation	Automatic Operation	○	○	○		DIII-NET Compatible (Adaptor)(Option)	○	○	○
	Programme Dry Function	○	○	○	Remote Controller	Wireless	○	○	○
	Fan Only	○	○	○		Wired	—	—	—
Lifestyle Convenience	New Powerful Operation (Non-Inverter)	—	—	—					
	Inverter Powerful Operation	○	○	○					
	Priority-Room Setting	—	—	—					
	Cooling / Heating Mode Lock	—	—	—					
	Home Leave Operation	○	○	○					
	Indoor Unit On/Off Switch	○	○	○					
	Signal Reception Indicator	○	○	○					
	Temperature Display	—	—	—					
Another Room Operation	—	—	—						

Notes: ○ : Holding Functions
— : No Functions

★ : Digital Only

Category	Functions	FLX25-60AVMA	3MXD68BVMA 4MXD80BVMA	Category	Functions	FLX25-60AVMA	3MXD68BVMA 4MXD80BVMA
Basic Function	Inverter (with Inverter Power Control)	○	○	Health & Clean	Air Purifying Filter with Bacteriostatic & Virustatic Functions	○	—
	Operation Limit for Cooling (°CDB)	—	-10 ~ 46		Photocatalytic Deodorizing Filter	○	—
	Operation Limit for Heating (°CWB)	—	-15 ~ 15.5		Air Purifying Filter with Photocatalytic Deodorizing Function	—	—
	PAM Control	—	○		Longlife Filter	—	—
Compressor	Oval Scroll Compressor	—	—	Timer	Ultra-Longlife Filter (Option)	—	—
	Swing Compressor	—	○		Mould Proof Air Filter	○	—
	Rotary Compressor	—	—		Wipe-clean Flat Panel	—	—
	Reluctance DC Motor	—	○		Washable Grille	—	—
Comfortable Airflow	Power-Airflow Flap	—	—	Worry Free "Reliability & Durability"	Filter Cleaning Indicator	—	—
	Power-Airflow Dual Flaps	—	—		Good-Sleep Cooling Operation	—	—
	Power-Airflow Diffuser	—	—		24-Hour On/Off Timer	○	—
	Wide-Angle Louvers	—	—		Night Set Mode	○	—
	Vertical Auto-Swing (Up and Down)	○	—		Auto-Restart (after Power Failure)	○	—
	Horizontal Auto-Swing (Right and Left)	—	—		Self-Diagnosis (Digital, LED) Display	○ ★1	○
	3-D Airflow	—	—		Wiring-Error Check	—	○
Comfort Control	3-Step Airflow (H/P Only)	—	—	Flexibility	Anticorrosion Treatment of Outdoor Heat Exchanger	—	○
	Auto Fan Speed	○	—		Multi-Split / Split Type Compatible Indoor Unit	○	—
	Indoor Unit Silent Operation	○	—		Flexible Voltage Correspondence	○	○
	Night Quiet Mode (Automatic)	—	○		High Ceiling Application	—	—
	Outdoor Unit Silent Operation (Manual)	—	○	Chargeless	—	★2	
	Intelligent Eye	—	—	Power-Selection	—	—	
	Quick Warming Function	—	○	Remote Control	5-Rooms Centralized Controller (Option)	○	—
	Hot-Start Function	○	—		Remote Control Adaptor (Normal Open-Pulse Contact)(Option)	○	—
Automatic Defrosting	—	○	Remote Control Adaptor (Normal Open Contact)(Option)		○	—	
			DIII-NET Compatible (Adaptor)(Option)		○	—	
Operation	Automatic Operation	○	—	Remote Controller	Wireless	○	—
	Programme Dry Function	○	—		Wired	—	—
	Fan Only	○	—				
Lifestyle Convenience	New Powerful Operation (Non-Inverter)	—	—				
	Inverter Powerful Operation	○	—				
	Priority-Room Setting	—	○				
	Cooling / Heating Mode Lock	—	○				
	Home Leave Operation	○	—				
	Indoor Unit On/Off Switch	○	—				
	Signal Reception Indicator	○	—				
	Temperature Display	—	—				
Another Room Operation	—	—					

Notes: ○ : Holding Functions
— : No Functions

★1 : Digital Only
★2 : 68 class ; 30m / 80 class ; 40m

1.2.2 R410A Series

Category	Functions				Category	Functions			
		FTXS20-35CVMB(9)(8)	FTXS50-71BVMB	CDXS25-60CVMB			FTXS20-35CVMB(9)(8)	FTXS50-71BVMB	CDXS25-60CVMB
Basic Function	Inverter (with Inverter Power Control)	○	○	○	Health & Clean	Air Purifying Filter with Bacteriostatic & Virustatic Functions	—	—	—
	Operation Limit for Cooling (°CDB)	—	—	—		Photocatalytic Deodorizing Filter	—	—	—
	Operation Limit for Heating (°CWB)	—	—	—		Air Purifying Filter with Photocatalytic Deodorizing Function	○	○	—
	PAM Control	—	—	—		Longlife Filter	—	—	—
Compressor	Oval Scroll Compressor	—	—	—	Ultra-Longlife Filter (Option)	—	—	—	
	Swing Compressor	—	—	—	Mould Proof Air Filter	○	○	○	
	Rotary Compressor	—	—	—	Wipe-clean Flat Panel	○	○	—	
	Reluctance DC Motor	—	—	—	Washable Grille	—	—	—	
Comfortable Airflow	Power-Airflow Flap	—	—	—	Filter Cleaning Indicator	—	—	—	
	Power-Airflow Dual Flaps	○	○	—	Good-Sleep Cooling Operation	—	—	—	
	Power-Airflow Diffuser	—	—	—	Timer	24-Hour On/Off Timer	○	○	○
	Wide-Angle Louvers	○	○	—		Night Set Mode	○	○	○
	Vertical Auto-Swing (Up and Down)	○	○	—	Worry Free "Reliability & Durability"	Auto-Restart (after Power Failure)	○	○	○
	Horizontal Auto-Swing (Right and Left)	—	○	—		Self-Diagnosis (Digital, LED) Display	★	★	★
	3-D Airflow	—	○	—		Wiring-Error Check	—	—	—
	3-Step Airflow (H/P Only)	—	—	—		Anticorrosion Treatment of Outdoor Heat Exchanger	—	—	—
Comfort Control	Auto Fan Speed	○	○	○	Flexibility	Multi-Split / Split Type Compatible Indoor Unit	○	○	—
	Indoor Unit Silent Operation	○	○	○		Flexible Voltage Correspondence	○	○	○
	Night Quiet Mode (Automatic)	—	—	—		High Ceiling Application	—	—	—
	Outdoor Unit Silent Operation (Manual)	—	—	—		Chargeless	—	—	—
	Intelligent Eye	○	○	—	Power-Selection	—	—	—	
	Quick Warming Function	—	—	—	Remote Control	5-Rooms Centralized Controller (Option)	○	○	○
	Hot-Start Function	○	○	○		Remote Control Adaptor (Normal Open-Pulse Contact)(Option)	○	○	○
	Automatic Defrosting	—	—	—		Remote Control Adaptor (Normal Open Contact)(Option)	○	○	○
				DIII-NET Compatible (Adaptor)(Option)		○	○	○	
Operation	Automatic Operation	○	○	○	Remote Controller	Wireless	○	○	○
	Programme Dry Function	○	○	○		Wired	—	—	—
	Fan Only	○	○	○					
Lifestyle Convenience	New Powerful Operation (Non-Inverter)	—	—	—					
	Inverter Powerful Operation	○	○	○					
	Priority-Room Setting	—	—	—					
	Cooling / Heating Mode Lock	—	—	—					
	Home Leave Operation	○	○	○					
	Indoor Unit On/Off Switch	○	○	○					
	Signal Reception Indicator	○	○	○					
	Temperature Display	—	—	—					
Another Room Operation	—	—	—						

Notes: ○ : Holding Functions
— : No Functions

★ : Digital Only

Category	Functions				Category	Functions			
		FLXS25-60BVMB	FVXS25-50BVMB	3MXS52BVMB(8) 4MXS68BVMB9 4MXS80BVMB9			FLXS25-60BVMB	FVXS25-50BVMB	3MXS52BVMB(8) 4MXS68BVMB9 4MXS80BVMB9
Basic Function	Inverter (with Inverter Power Control)	○	○	○	Health & Clean	Air Purifying Filter with Bacteriostatic & Virustatic Functions	○	○	—
	Operation Limit for Cooling (°CDB)	—	—	-10 ~ 46		Photocatalytic Deodorizing Filter	○	○	—
	Operation Limit for Heating (°CWB)	—	—	-15 ~ 15.5		Air Purifying Filter with Photocatalytic Deodorizing Function	—	—	—
	PAM Control	—	—	○		Longlife Filter	—	—	—
Compressor	Oval Scroll Compressor	—	—	—	Ultra-Longlife Filter (Option)	—	—	—	
	Swing Compressor	—	—	○	Mould Proof Air Filter	○	○	—	
	Rotary Compressor	—	—	—	Wipe-clean Flat Panel	—	—	—	
	Reluctance DC Motor	—	—	○	Washable Grille	—	○	—	
Comfortable Airflow	Power-Airflow Flap	—	—	—	Filter Cleaning Indicator	—	—	—	
	Power-Airflow Dual Flaps	—	—	—	Good-Sleep Cooling Operation	—	—	—	
	Power-Airflow Diffuser	—	—	—	Timer	24-Hour On/Off Timer	○	○	—
	Wide-Angle Louvers	—	○	—		Night Set Mode	○	○	—
	Vertical Auto-Swing (Up and Down)	○	○	—	Worry Free "Reliability & Durability"	Auto-Restart (after Power Failure)	○	○	—
	Horizontal Auto-Swing (Right and Left)	—	—	—		Self-Diagnosis (Digital, LED) Display	★1	★1	○
	3-D Airflow	—	—	—		Wiring-Error Check	—	—	○
3-Step Airflow (H/P Only)	—	○	—	Anticorrosion Treatment of Outdoor Heat Exchanger		—	—	○	
Comfort Control	Auto Fan Speed	○	○	—	Flexibility	Multi-Split / Split Type Compatible Indoor Unit	○	○	—
	Indoor Unit Silent Operation	○	○	—		Flexible Voltage Correspondence	○	○	○
	Night Quiet Mode (Automatic)	—	—	○		High Ceiling Application	—	—	—
	Outdoor Unit Silent Operation (Manual)	—	—	○		Chargeless	—	—	★2
	Intelligent Eye	—	—	—	Power-Selection	—	—	—	
	Quick Warming Function	—	—	○	Remote Control	5-Rooms Centralized Controller (Option)	○	○	—
	Hot-Start Function	○	○	—		Remote Control Adaptor (Normal Open-Pulse Contact)(Option)	○	○	—
Automatic Defrosting	—	—	○	Remote Control Adaptor (Normal Open Contact)(Option)		○	○	—	
Operation	Automatic Operation	○	○	—	Remote Controller	DIII-NET Compatible (Adaptor)(Option)	○	○	—
	Programme Dry Function	○	○	—		Wireless	○	○	—
	Fan Only	○	○	—		Wired	—	—	—
Lifestyle Convenience	New Powerful Operation (Non-Inverter)	—	—	—					
	Inverter Powerful Operation	○	○	—					
	Priority-Room Setting	—	—	○					
	Cooling / Heating Mode Lock	—	—	○					
	Home Leave Operation	○	○	—					
	Indoor Unit On/Off Switch	○	○	—					
	Signal Reception Indicator	○	○	—					
	Temperature Display	—	—	—					
Another Room Operation	—	—	—						

Notes: ○ : Holding Functions
— : No Functions

★1 : Digital Only
★2 : 52, 68 class ; 30m / 80 class ; 40m

Category	Functions	ATXS20-25-35CVMB(9)	Category	Functions	ATXS20-25-35CVMB(9)
Basic Function	Inverter (with Inverter Power Control)	○	Health & Clean	Air Purifying Filter with Bacteriostatic & Virustatic Functions	—
	Operation Limit for Cooling (°CDB)	—		Photocatalytic Deodorizing Filter	—
	Operation Limit for Heating (°CWB)	—		Air Purifying Filter with Photocatalytic Deodorizing Function	○
	PAM Control	—		Longlife Filter	—
Compressor	Oval Scroll Compressor	—		Ultra-Longlife Filter (Option)	—
	Swing Compressor	—		Mould Proof Air Filter	○
	Rotary Compressor	—		Wipe-clean Flat Panel	—
	Reluctance DC Motor	—		Washable Grille	○
Comfortable Airflow	Power Airflow Flap	—	Timer	Filter Cleaning Indicator	—
	Power-Airflow Dual Flaps	○		Good-Sleep Cooling Operation	—
	Power-Airflow Diffuser	—		24-Hour On/Off Timer	○
	Wide-Angle Louvers	○		Night Set Mode	○
	Vertical Auto-Swing (Up and Down)	○	Worry Free "Reliability & Durability"	Auto-Restart (after Power Failure)	○
	Horizontal Auto-Swing (Right and Left)	—		Self-Diagnosis (Digital, LED) Display	○★
	3-D Airflow	—		Wiring-Error Check	—
	3-Step Airflow (H/P Only)	—		Anticorrosion Treatment of Outdoor Heat Exchanger	—
Comfort Control	Auto Fan Speed	○	Flexibility	Multi-Split / Split Type Compatible Indoor Unit	○
	Indoor Unit Silent Operation	○		Flexible Voltage Correspondence	○
	Night Quiet Mode (Automatic)	—		High Ceiling Application	—
	Outdoor Unit Silent Operation (Manual)	—		Chargeless	—
	Intelligent Eye	○	Remote Control	Power Selection	—
	Quick Warming Function	—		5-Rooms Centralized Controller (Option)	○
	Hot-Start Function	○		Remote Control Adaptor (Normal Open-Pulse Contact) (Option)	○
	Automatic Defrosting	—		Remote Control Adaptor (Normal Open Contact) (Option)	○
Operation	Automatic Operation	○	Remote Controller	DIII-NET Compatible (Adaptor) (Option)	○
	Programme Dry Function	○		Wireless	○
	Fan Only	○		Wired	—
Lifestyle Convenience	New Powerful Operation (Non-Inverter)	—			
	Inverter Powerful Operation	○			
	Priority-Room Setting	—			
	Cooling / Heating Mode Lock	—			
	Home Leave Operation	○			
	Indoor Unit On/Off Switch	○			
	Signal Reception Indicator	○			
	Temperature Display	—			
Another Room Operation	—				

Notes: ○ : Holding Functions
 — : No Functions

★ : Digital Only

Category	Functions	ATXS50CVMB	3AMXS52BVMB	Category	Functions	ATXS50CVMB	3AMXS52BVMB	
Basic Function	Inverter (with Inverter Power Control)	○	○	Health & Clean	Air Purifying Filter with Bacteriostatic, Virustatic Functions	—	—	
	Operation Limit for Cooling (°CDB)	—	-10~46		Photocatalytic Deodorizing Filter	—	—	
	Operation Limit for Heating (°CWB)	—	-15~15.5		Air Purifying Filter with Photocatalytic Deodorizing Function	○	—	
	PAM Control	—	○		Longlife Filter	—	—	
Compressor	Oval Scroll Compressor	—	—		Ultra-Longlife Filter (Option)	—	—	
	Swing Compressor	—	○		Mold Proof Air Filter	○	—	
	Rotary Compressor	—	—		Wipe-clean Flat Panel	—	—	
	Reluctance DC Motor	—	○		Washable Grille	○	—	
Comfortable Airflow	Power-Airflow Flap	—	—		Filter Cleaning Indicator	—	—	
	Power-Airflow Dual Flaps	○	—		Good-Sleep Cooling Operation	—	—	
	Power-Airflow Diffuser	—	—		Timer	24-Hour On/Off Timer	○	—
	Wide-Angle Louvers	○	—			Night Set Mode	○	—
	Vertical Auto-Swing (Up and Down)	○	—		Worry Free "Reliability & Durability"	Auto-Restart (after Power Failure)	○	—
	Horizontal Auto-Swing (Right and Left)	○	—			Self-Diagnosis (Digital, LED) Display	○	○
	3-D Airflow	○	—			Wiring Error Check	—	○
3-Step Airflow (H/P Only)	—	—	Anticorrosion Treatment of Outdoor Heat Exchanger			—	○	
Comfort Control	Auto Fan Speed	○	—	Flexibility	Multi-Split / Split Type Compatible Indoor Unit	○	—	
	Indoor Unit Silent Operation	○	—		Flexible Voltage Correspondence	○	○	
	Night Quiet Mode (Automatic)	—	○		High Ceiling Application	—	—	
	Outdoor Unit Silent Operation (Manual)	—	○		Chargeless	—	30m	
	Intelligent Eye	○	—		Power Selection	—	—	
	Quick Warming Function	—	○		Remote Control	5-Rooms Centralized Controller (Option)	○	—
	Hot-Start Function	○	—			Remote Control Adaptor (Normal Open-Pulse Contact)(Option)	○	—
Automatic Defrosting	—	○	Remote Control Adaptor (Normal Open Contact)(Option)	○		—		
Operation	Automatic Operation	○	—	Remote Controller	DIII-NET Compatible (Adaptor)(Option)	○	—	
	Programme Dry Function	○	—		Wireless	○	—	
	Fan Only	○	—		Wired	—	—	
Lifestyle Convenience	New Powerful Operation (Non-Inverter)	—	—					
	Inverter Powerful Operation	○	—					
	Priority-Room Setting	—	○					
	Cooling / Heating Mode Lock	—	○					
	Home Leave Operation	○	—					
	Indoor Unit On/Off Switch	○	—					
	Signal Reception Indicator	○	—					
	Temperature Display	—	—					
Another Room Operation	—	—						

Note: ○ : Holding Functions
 — : No Functions

Category	Functions	FTXS25/35BVMA	FTXS50-71BVMA(8)	CDXS25-60CVMA	Category	Functions	FTXS25/35BVMA	FTXS50-71BVMA(8)	CDXS25-60CVMA
Basic Function	Inverter (with Inverter Power Control)	○	○	○	Health & Clean	Air Purifying Filter with Bacteriostatic & Virustatic Functions	○	—	—
	Operation Limit for Cooling (°CDB)	—	—	—		Photocatalytic Deodorizing Filter	○	—	—
	Operation Limit for Heating (°CWB)	—	—	—		Air Purifying Filter with Photocatalytic Deodorizing Function	—	○	—
	PAM Control	—	—	—		Longlife Filter	—	—	—
Compressor	Oval Scroll Compressor	—	—	—	Ultra-Longlife Filter (Option)	—	—	—	
	Swing Compressor	—	—	—	Mould Proof Air Filter	○	○	○	
	Rotary Compressor	—	—	—	Wipe-clean Flat Panel	○	○	—	
	Reluctance DC Motor	—	—	—	Washable Grille	—	—	—	
Comfortable Airflow	Power-Airflow Flap	—	—	—	Filter Cleaning Indicator	—	—	—	
	Power-Airflow Dual Flaps	○	○	—	Good-Sleep Cooling Operation	—	—	—	
	Power-Airflow Diffuser	—	—	—	Timer	24-Hour On/Off Timer	○	○	○
	Wide-Angle Louvers	○	○	—		Night Set Mode	○	○	○
	Vertical Auto-Swing (Up and Down)	○	○	—	Worry Free "Reliability & Durability"	Auto-Restart (after Power Failure)	○	○	○
	Horizontal Auto-Swing (Right and Left)	—	○	—		Self-Diagnosis (Digital, LED) Display	○	○	○
	3-D Airflow	—	○	—		Wiring-Error Check	—	—	—
	3-Step Airflow (H/P Only)	—	—	—		Anticorrosion Treatment of Outdoor Heat Exchanger	—	—	—
Comfort Control	Auto Fan Speed	○	○	○	Flexibility	Multi-Split / Split Type Compatible Indoor Unit	○	○	—
	Indoor Unit Silent Operation	○	○	○		Flexible Voltage Correspondence	○	○	○
	Night Quiet Mode (Automatic)	—	—	—		High Ceiling Application	—	—	—
	Outdoor Unit Silent Operation (Manual)	—	—	—		Chargeless	—	—	—
	Intelligent Eye	○	○	—	Power-Selection	—	—	—	
	Quick Warming Function	—	—	—	Remote Control	5-Rooms Centralized Controller (Option)	○	○	○
	Hot-Start Function	○	○	○		Remote Control Adaptor (Normal Open-Pulse Contact)(Option)	○	○	○
	Automatic Defrosting	—	—	—		Remote Control Adaptor (Normal Open Contact)(Option)	○	○	○
				DIII-NET Compatible (Adaptor)(Option)		○	○	○	
Operation	Automatic Operation	○	○	○	Remote Controller	Wireless	○	○	○
	Programme Dry Function	○	○	○		Wired	—	—	—
	Fan Only	○	○	○					
Lifestyle Convenience	New Powerful Operation (Non-Inverter)	—	—	—					
	Inverter Powerful Operation	○	○	○					
	Priority-Room Setting	—	—	—					
	Cooling / Heating Mode Lock	—	—	—					
	Home Leave Operation	○	○	○					
	Indoor Unit On/Off Switch	○	○	○					
	Signal Reception Indicator	○	○	○					
	Temperature Display	—	—	—					
Another Room Operation	—	—	—						

Notes: ○ : Holding Functions
— : No Functions

★ : Digital Only

Category	Functions	FLXS25-60BVMA	FVXS35/50BVMA	Category	Functions	FLXS25-60BVMA	FVXS35/50BVMA	
Basic Function	Inverter (with Inverter Power Control)	○	○	Health & Clean	Air Purifying Filter with Bacteriostatic & Virustatic Functions	○	○	
	Operation Limit for Cooling (°CDB)	—	—		Photocatalytic Deodorizing Filter	○	○	
	Operation Limit for Heating (°CWB)	—	—		Air Purifying Filter with Photocatalytic Deodorizing Function	—	—	
	PAM Control	—	—		Longlife Filter	—	—	
Compressor	Oval Scroll Compressor	—	—		Ultra-Longlife Filter (Option)	—	—	
	Swing Compressor	—	—		Mould Proof Air Filter	○	○	
	Rotary Compressor	—	—		Wipe-clean Flat Panel	—	—	
	Reluctance DC Motor	—	—		Washable Grille	—	○	
Comfortable Airflow	Power-Airflow Flap	—	—		Filter Cleaning Indicator	—	—	
	Power-Airflow Dual Flaps	—	—		Good-Sleep Cooling Operation	—	—	
	Power-Airflow Diffuser	—	—		Timer	24-Hour On/Off Timer	○	○
	Wide-Angle Louvers	—	○			Night Set Mode	○	○
	Vertical Auto-Swing (Up and Down)	○	○		Worry Free "Reliability & Durability"	Auto-Restart (after Power Failure)	○	○
	Horizontal Auto-Swing (Right and Left)	—	—			Self-Diagnosis (Digital, LED) Display	○	○
	3-D Airflow	—	—	Wiring-Error Check		—	—	
	3-Step Airflow (H/P Only)	—	○	Anticorrosion Treatment of Outdoor Heat Exchanger		—	—	
Comfort Control	Auto Fan Speed	○	○	Flexibility	Multi-Split / Split Type Compatible Indoor Unit	—	○	
	Indoor Unit Silent Operation	○	○		Flexible Voltage Correspondence	○	○	
	Night Quiet Mode (Automatic)	—	—		High Ceiling Application	—	—	
	Outdoor Unit Silent Operation (Manual)	—	—		Chargeless	—	—	
	Intelligent Eye	—	—	Power-Selection	—	—		
	Quick Warming Function	—	—	Remote Control	5-Rooms Centralized Controller (Option)	○	○	
	Hot-Start Function	○	○		Remote Control Adaptor (Normal Open-Pulse Contact)(Option)	○	○	
	Automatic Defrosting	—	—		Remote Control Adaptor (Normal Open Contact)(Option)	○	○	
			DIII-NET Compatible (Adaptor)(Option)		○	○		
Operation	Automatic Operation	○	○	Remote Controller	Wireless	○	○	
	Programme Dry Function	○	○		Wired	—	—	
	Fan Only	○	○					
Lifestyle Convenience	New Powerful Operation (Non-Inverter)	—	—					
	Inverter Powerful Operation	○	○					
	Priority-Room Setting	—	—					
	Cooling / Heating Mode Lock	—	—					
	Home Leave Operation	○	○					
	Indoor Unit On/Off Switch	○	○					
	Signal Reception Indicator	○	○					
	Temperature Display	—	—					
Another Room Operation	—	—						

Notes: ○ : Holding Functions
— : No Functions

★1 : Digital Only

Category	Functions	4MXS68CVMA	4MXS80CVMA	Category	Functions	4MXS68CVMA	4MXS80CVMA
Basic Function	Inverter (with Inverter Power Control)	○	○	Health & Clean	Air Purifying Filter with Bacteriostatic & Virustatic Functions	—	—
	Operation Limit for Cooling (°CDB)	-10 ~ 46	-10 ~ 46		Photocatalytic Deodorizing Filter	—	—
	Operation Limit for Heating (°CWB)	-15 ~ 15.5	-15 ~ 15.5		Air Purifying Filter with Photocatalytic Deodorizing Function	—	—
	PAM Control	○	○		Longlife Filter	—	—
Compressor	Oval Scroll Compressor	—	—	Ultra-Longlife Filter (Option)	—	—	
	Swing Compressor	○	○	Mould Proof Air Filter	—	—	
	Rotary Compressor	—	—	Wipe-clean Flat Panel	—	—	
	Reluctance DC Motor	○	○	Washable Grille	—	—	
Comfortable Airflow	Power-Airflow Flap	—	—	Filter Cleaning Indicator	—	—	
	Power-Airflow Dual Flaps	—	—	Good-Sleep Cooling Operation	—	—	
	Power-Airflow Diffuser	—	—	Timer	24-Hour On/Off Timer	—	—
	Wide-Angle Louvers	—	—		Night Set Mode	—	—
	Vertical Auto-Swing (Up and Down)	—	—	Worry Free "Reliability & Durability"	Auto-Restart (after Power Failure)	—	—
	Horizontal Auto-Swing (Right and Left)	—	—		Self-Diagnosis (Digital, LED) Display	○	○
	3-D Airflow	—	—		Wiring-Error Check	○	○
3-Step Airflow (H/P Only)	—	—	Anticorrosion Treatment of Outdoor Heat Exchanger		○	○	
Comfort Control	Auto Fan Speed	—	—	Flexibility	Multi-Split / Split Type Compatible Indoor Unit	—	—
	Indoor Unit Silent Operation	—	—		Flexible Voltage Correspondence	○	○
	Night Quiet Mode (Automatic)	○	○		High Ceiling Application	—	—
	Outdoor Unit Silent Operation (Manual)	○	○		Chargeless	30 m	40 m
	Intelligent Eye	—	—	Power-Selection	—	—	
	Quick Warming Function	○	○	Remote Control	5-Rooms Centralized Controller (Option)	—	—
	Hot-Start Function	—	—		Remote Control Adaptor (Normal Open-Pulse Contact)(Option)	—	—
	Automatic Defrosting	○	○		Remote Control Adaptor (Normal Open Contact)(Option)	—	—
			DIII-NET Compatible (Adaptor)(Option)		—	—	
Operation	Automatic Operation	—	—	Remote Controller	Wireless	—	—
	Programme Dry Function	—	—		Wired	—	—
	Fan Only	—	—				
Lifestyle Convenience	New Powerful Operation (Non-Inverter)	—	—				
	Inverter Powerful Operation	—	—				
	Priority-Room Setting	○	○				
	Cooling / Heating Mode Lock	○	○				
	Home Leave Operation	—	—				
	Indoor Unit On/Off Switch	—	—				
	Signal Reception Indicator	—	—				
	Temperature Display	—	—				
Another Room Operation	—	—					

Notes: ○ : Holding Functions
— : No Functions

Part 2

Specifications

1. Specifications	18
1.1 Indoor Units - Cooling Only	18
1.2 Outdoor Units - Cooling Only	30
1.3 Indoor Units - Heat Pump.....	36
1.4 Outdoor Units - Heat Pump.....	51

1. Specifications

1.1 Indoor Units - Cooling Only

Wall Mounted Type

50Hz 220-230-240V / 60Hz 220-230V

Model			FTKE25BVM	FTKE35BVM
Rated Capacity			2.5kW Class	3.5kW Class
Front Panel Color			White	White
Air Flow Rates	m ³ /min (cfm)	H	7.8 (275)	7.7 (272)
		M	6.4 (226)	6.3 (222)
		L	5.0 (177)	4.9 (173)
		SL	4.3 (152)	4.4 (155)
Fan	Type	Cross Flow Fan		Cross Flow Fan
	Motor Output	W	18	18
	Speed	Steps	5 Steps, Silent, Auto	5 Steps, Silent, Auto
Air Direction Control			Right, Left, Horizontal, Downward	Right, Left, Horizontal, Downward
Air Filter			Removable-Washable-Mildew Proof	Removable-Washable-Mildew Proof
Running Current (Rated)	A	0.17-0.18-0.18/0.21-0.21		0.17-0.18-0.18/0.21-0.21
Power Consumption (Rated)	W	37-40-43/45-48		37-40-43/45-48
Power Factor	%	98.9-96.6-99.5/97.4-99.4		98.9-96.6-99.5/97.4-99.4
Temperature Control			Microcomputer Control	Microcomputer Control
Dimensions (HxWxD)	mm	273x784x195		273x784x195
Packaged Dimensions (HxWxD)	mm	258x834x325		258x834x325
Weight	kg	7.5		7.5
Gross Weight	kg	11		11
Operation Sound	H/M/L/SL	dBA	37/34/30/27	
Heat Insulation			Both Liquid and Gas Pipes	Both Liquid and Gas Pipes
Piping Connection	Liquid	mm	φ 6.4	
	Gas	mm	φ 9.5	
	Drain	mm	φ 18.0	
Drawing No.			3D040693	3D040694

Model			FTKD50BVM	FTKD60BVM
Rated Capacity			5.0kW Class	6.0kW Class
Front Panel Color			White	White
Air Flow Rates	m ³ /min (cfm)	H	16.8 (593)	17.5 (618)
		M	14.0 (494)	14.6 (515)
		L	11.8 (417)	12.2 (431)
		SL	10.4 (367)	10.8 (381)
Fan	Type	Cross Flow Fan		Cross Flow Fan
	Motor Output	W	43	43
	Speed	Steps	5 Steps, Silent, Auto	5 Steps, Silent, Auto
Air Direction Control			Right, Left, Horizontal, Downward	Right, Left, Horizontal, Downward
Air Filter			Removable-Washable-Mildew Proof	Removable-Washable-Mildew Proof
Running Current (Rated)	A	0.19-0.18-0.17/0.19-0.18		0.21-0.20-0.19/0.21-0.20
Power Consumption (Rated)	W	40		45
Power Factor	%	95.7-96.6-98.0/95.7-96.6		97.4-97.8-98.7/97.4-97.8
Temperature Control			Microcomputer Control	Microcomputer Control
Dimensions (HxWxD)	mm	290x1,050x238		290x1,050x238
Packaged Dimensions (HxWxD)	mm	337x1,147x366		337x1,147x366
Weight	kg	12		12
Gross Weight	kg	17		17
Operation Sound	H/M/L/SL	dBA	44/40/35/32	
Heat Insulation			Both Liquid and Gas Pipes	Both Liquid and Gas Pipes
Piping Connection	Liquid	mm	φ 6.4	
	Gas	mm	φ 12.7	
	Drain	mm	φ 18.0	
Drawing No.			3D040814	3D040815

Conversion Formulae
kcal/h=kWx860
Btu/h=kWx3414
cfm=m ³ /minx35.3

50Hz 220-230-240V / 60Hz 220-230V

Model			FTKD71BVM
Rated Capacity			7.1kW Class
Front Panel Color			White
Air Flow Rates	m ³ /min (cfm)	H	18.0 (635)
		M	15.1 (533)
		L	12.7 (448)
		SL	11.3 (399)
Fan	Type	Cross Flow Fan	
	Motor Output	W	
	Speed	Steps	
Air Direction Control			Right, Left, Horizontal, Downward
Air Filter			Removable-Washable-Mildew Proof
Running Current (Rated)		A	0.23-0.22-0.21/0.23-0.22
Power Consumption (Rated)		W	50
Power Factor		%	98.8-98.8-99.2/98.8-98.8
Temperature Control			Microcomputer Control
Dimensions (HxWxD)		mm	290x1,050x238
Packaged Dimensions (HxWxD)		mm	337x1,147x366
Weight		kg	12
Gross Weight		kg	17
Operation Sound	H/M/L/SL	dBA	46/42/37/34
Heat Insulation			Both Liquid and Gas Pipes
Piping Connection	Liquid	mm	φ 9.5
	Gas	mm	φ15.9
	Drain	mm	φ18.0
Drawing No.			3D040816

Conversion Formulae

kcal/h=kW×860
 Btu/h=kW×3414
 cfm=m³/min×35.3

50Hz 220-230-240V / 60Hz 220-230V

Model			FTKE25BVMA	FTKE35BVMA
Rated Capacity			2.5kW Class	3.5kW Class
Front Panel Color			White	White
Air Flow Rates	m ³ /min (cfm)	H	7.8 (275)	7.7 (272)
		M	6.4 (226)	6.3 (222)
		L	5.0 (177)	4.9 (173)
		SL	4.3 (152)	4.4 (155)
Fan	Type	Cross Flow Fan		Cross Flow Fan
	Motor Output	W	18	18
	Speed	Steps	5 Steps, Silent, Auto	5 Steps, Silent, Auto
Air Direction Control			Right, Left, Horizontal, Downward	Right, Left, Horizontal, Downward
Air Filter			Removable-Washable-Mildew Proof	Removable-Washable-Mildew Proof
Running Current (Rated)		A	0.17-0.18-0.18/0.21-0.21	0.17-0.18-0.18/0.21-0.21
Power Consumption (Rated)		W	37-40-43/45-48	37-40-43/45-48
Power Factor		%	98.9-96.6-99.5/97.4-99.4	98.9-96.6-99.5/97.4-99.4
Temperature Control			Microcomputer Control	Microcomputer Control
Dimensions (HxWxD)		mm	273x784x195	273x784x195
Packaged Dimensions (HxWxD)		mm	258x834x325	258x834x325
Weight		kg	7.5	7.5
Gross Weight		kg	11	11
Operation Sound	H/M/L/SL	dBA	37/34/30/27	38/35/32/29
Heat Insulation			Both Liquid and Gas Pipes	Both Liquid and Gas Pipes
Piping Connection	Liquid	mm	φ 6.4	φ 6.4
	Gas	mm	φ 9.5	φ 12.7
	Drain	mm	φ 18.0	φ 18.0
Drawing No.			3D040697	3D040698

Model			FTKD50BVMA	FTKD60BVMA
Rated Capacity			5.0kW Class	6.0kW Class
Front Panel Color			White	White
Air Flow Rates	m ³ /min (cfm)	H	16.8 (593)	17.5 (618)
		M	14.0 (494)	14.6 (515)
		L	11.8 (417)	12.2 (431)
		SL	10.4 (367)	10.8 (381)
Fan	Type	Cross Flow Fan		Cross Flow Fan
	Motor Output	W	43	43
	Speed	Steps	5 Steps, Silent, Auto	5 Steps, Silent, Auto
Air Direction Control			Right, Left, Horizontal, Downward	Right, Left, Horizontal, Downward
Air Filter			Removable-Washable-Mildew Proof	Removable-Washable-Mildew Proof
Running Current (Rated)		A	0.19-0.18-0.17/0.19-0.18	0.21-0.20-0.19/0.21-0.20
Power Consumption (Rated)		W	40	45
Power Factor		%	95.7-96.6-98.0/95.7-96.6	97.4-97.8-98.7/97.4-97.8
Temperature Control			Microcomputer Control	Microcomputer Control
Dimensions (HxWxD)		mm	290x1,050x238	290x1,050x238
Packaged Dimensions (HxWxD)		mm	337x1,147x366	337x1,147x366
Weight		kg	12	12
Gross Weight		kg	17	17
Operation Sound	H/M/L/SL	dBA	44/40/35/32	45/41/36/33
Heat Insulation			Both Liquid and Gas Pipes	Both Liquid and Gas Pipes
Piping Connection	Liquid	mm	φ 6.4	φ 6.4
	Gas	mm	φ 12.7	φ 15.9
	Drain	mm	φ 18.0	φ 18.0
Drawing No.			3D040794	3D040795

Conversion Formulae $kcal/h = kW \times 860$ $Btu/h = kW \times 3414$ $cfm = m^3/min \times 35.3$
--

50Hz 220-230-240V / 60Hz 220-230V

Model			FTKD71BVMA
Rated Capacity			7.1kW Class
Front Panel Color			White
Air Flow Rates	m ³ /min (cfm)	H	18.3 (646)
		M	15.3 (540)
		L	12.7 (448)
		SL	11.3 (399)
Fan	Type	Cross Flow Fan	
	Motor Output	W	43
	Speed	Steps	5 Steps, Silent, Auto
Air Direction Control			Right, Left, Horizontal, Downward
Air Filter			Removable-Washable-Mildew Proof
Running Current (Rated)		A	0.23-0.22-0.21/0.23-0.22
Power Consumption (Rated)		W	50
Power Factor		%	98.8-98.8-99.2/98.8-98.8
Temperature Control			Microcomputer Control
Dimensions (HxWxD)		mm	290x1,050x238
Packaged Dimensions (HxWxD)		mm	337x1,147x366
Weight		kg	12
Gross Weight		kg	17
Operation Sound	H/M/L/SL	dBA	46/42/37/34
Heat Insulation			Both Liquid and Gas Pipes
Piping Connection	Liquid	mm	φ 9.5
	Gas	mm	φ15.9
	Drain	mm	φ18.0
Drawing No.			3D040796

Conversion Formulae

$\text{kcal/h} = \text{kW} \times 860$
 $\text{Btu/h} = \text{kW} \times 3414$
 $\text{cfm} = \text{m}^3/\text{min} \times 35.3$

50Hz, 230V

Model			FTKS20CVMB(9)	FTKS25CVMB(9)(8)
Rated Capacity			2.0kW Class	2.5kW Class
Front Panel Color			White	White
Air Flow Rates	m ³ /min (cfm)	H	7.7 (272)	7.7 (272)
		M	5.9 (208)	5.9 (208)
		L	4.2 (148)	4.2 (148)
		SL	3.6 (127)	3.6 (127)
Fan	Type	Cross Flow Fan		Cross Flow Fan
	Motor Output	W	18	18
	Speed	Steps	5 Steps, Silent, Auto	5 Steps, Silent, Auto
Air Direction Control			Right, Left, Horizontal, Downward	Right, Left, Horizontal, Downward
Air Filter			Removable-Washable-Mildew Proof	Removable-Washable-Mildew Proof
Running Current (Rated)		A	0.18	0.18
Power Consumption (Rated)		W	40	40
Power Factor		%	96.6	96.6
Temperature Control			Microcomputer Control	Microcomputer Control
Dimensions (HxWxD)		mm	273x784x195	273x784x195
Packaged Dimensions (HxWxD)		mm	258x834x325	258x834x325
Weight		kg	7.5	7.5
Gross Weight		kg	11	11
Operation Sound	H/M/L/SL	dBA	38/32/25/22	38/32/25/22
Sound Power	H	dBA	56	56
Heat Insulation			Both Liquid and Gas Pipes	Both Liquid and Gas Pipes
Piping Connection	Liquid	mm	φ 6.4	φ 6.4
	Gas	mm	φ 9.5	φ 9.5
	Drain	mm	φ18.0	φ18.0
Drawing No.			3D044242B	3D044243B

Model			FTKS35CVMB(9)(8)	FTKS50BVMB
Rated Capacity			3.5kW Class	5.0kW Class
Front Panel Color			White	White
Air Flow Rates	m ³ /min (cfm)	H	7.7 (272)	11.4 (402)
		M	6.0 (212)	9.7 (342)
		L	4.4 (155)	8.0 (282)
		SL	3.8 (134)	7.1 (251)
Fan	Type	Cross Flow Fan		Cross Flow Fan
	Motor Output	W	18	40
	Speed	Steps	5 Steps, Silent, Auto	5 Steps, Silent, Auto
Air Direction Control			Right, Left, Horizontal, Downward	Right, Left, Horizontal, Downward
Air Filter			Removable-Washable-Mildew Proof	Removable-Washable-Mildew Proof
Running Current (Rated)		A	0.18	0.18
Power Consumption (Rated)		W	40	40
Power Factor		%	96.6	96.6
Temperature Control			Microcomputer Control	Microcomputer Control
Dimensions (HxWxD)		mm	273x784x195	290x795x238
Packaged Dimensions (HxWxD)		mm	258x834x325	280x840x338
Weight		kg	7.5	9
Gross Weight		kg	11	13
Operation Sound	H/M/L/SL	dBA	39/33/26/23	44/40/35/32
Sound Power	H	dBA	57	63
Heat Insulation			Both Liquid and Gas Pipes	Both Liquid and Gas Pipes
Piping Connection	Liquid	mm	φ 6.4	φ 6.4
	Gas	mm	φ 9.5	φ12.7
	Drain	mm	φ18.0	φ18.0
Drawing No.			3D044244B	3D040781A

Conversion Formulae
kcal/h=kWx860
Btu/h=kWx3414
cfm=m ³ /minx35.3

50Hz, 230V

Model			FTKS60BVMB	FTKS71BVMB
Rated Capacity			6.0kW Class	7.1kW Class
Front Panel Color			White	White
Air Flow Rates	m ³ /min (cfm)	H	16.2 (572)	16.7 (590)
		M	13.6 (480)	14.2 (501)
		L	11.4 (402)	11.6 (409)
		SL	10.2 (360)	10.6 (374)
Fan	Type		Cross Flow Fan	Cross Flow Fan
	Motor Output	W	43	43
	Speed	Steps	5 Steps, Silent, Auto	5 Steps, Silent, Auto
Air Direction Control			Right, Left, Horizontal, Downward	Right, Left, Horizontal, Downward
Air Filter			Removable-Washable-Mildew Proof	Removable-Washable-Mildew Proof
Running Current (Rated)		A	0.18	0.20
Power Consumption (Rated)		W	40	45
Power Factor		%	96.6	96.4
Temperature Control			Microcomputer Control	Microcomputer Control
Dimensions (HxWxD)		mm	290x1,050x238	290x1,050x238
Packaged Dimensions (HxWxD)		mm	337x1,147x366	337x1,147x366
Weight		kg	12	12
Gross Weight		kg	17	17
Operation Sound	H/M/L/SL	dBA	45/41/36/33	46/42/37/34
Sound Power	H	dBA	63	63
Heat Insulation			Both Liquid and Gas Pipes	Both Liquid and Gas Pipes
Piping Connection	Liquid	mm	φ 6.4	φ 6.4
	Gas	mm	φ12.7	φ15.9
	Drain	mm	φ18.0	φ18.0
Drawing No.			3D040782A	3D040783A

Conversion Formulae

$\text{kcal/h} = \text{kW} \times 860$
 $\text{Btu/h} = \text{kW} \times 3414$
 $\text{cfm} = \text{m}^3/\text{min} \times 35.3$

Duct Connected Type

50Hz 220-230-240V / 60Hz 220-230V

Model			CDKD25CVM	CDKD35CVM
Rated Capacity			2.5kW Class	3.5kW Class
Front Panel Color			—	—
Air Flow Rates	m ³ /min (cfm)	H	9.5 (335)	10.0 (353)
		M	8.8 (311)	9.3 (328)
		L	8.0 (282)	8.5 (300)
		SL	6.7 (237)	7.0 (247)
Fan	Type	Sirocco Fan		Sirocco Fan
	Motor Output	W	62	62
	Speed	Steps	5 Steps, Silent, Auto	5 Steps, Silent, Auto
Running Current (Rated)		A	0.47-0.47-0.48/0.52-0.53	0.47-0.48-0.48/0.53-0.54
Power Consumption (Rated)		W	97-100-107/108-113	97-100-107/110-113
Power Factor		%	93.8-92.5-92.9/94.4-92.7	93.8-90.6-92.9/94.3-91.0
Temperature Control			Microcomputer Control	Microcomputer Control
Dimensions (HxWxD)		mm	200x900x620	200x900x620
Packaged Dimensions (HxWxD)		mm	266x1,106x751	266x1,106x751
Weight		kg	25	25
Gross Weight		kg	31	31
Operation Sound	H/M/L/SL	dBA	35/33/31/29	35/33/31/29
External Static Pressure		Pa	40	40
Heat Insulation			Both Liquid and Gas Pipes	Both Liquid and Gas Pipes
Piping Connection	Liquid	mm	φ 6.4	φ 6.4
	Gas	mm	φ 9.5	φ 12.7
	Drain	mm	VP20 (O.D.φ 26 / I.D.φ 20)	VP20 (O.D.φ 26 / I.D.φ 20)
Drawing No.			3D046077A	3D046078A

Model			CDKD50CVM	CDKD60CVM
Rated Capacity			5.0kW Class	6.0kW Class
Front Panel Color			—	—
Air Flow Rates	m ³ /min (cfm)	H	12.0 (424)	16.0 (565)
		M	11.0 (388)	14.8 (523)
		L	10.0 (353)	13.5 (477)
		SL	8.4 (297)	11.2 (395)
Fan	Type	Sirocco Fan		Sirocco Fan
	Motor Output	W	130	130
	Speed	Steps	5 Steps, Silent, Auto	5 Steps, Silent, Auto
Running Current (Rated)		A	0.65-0.66-0.67/0.79-0.80	0.74-0.75-0.75/0.89-0.90
Power Consumption (Rated)		W	133-140-150/164-167	152-160-168/185-187
Power Factor		%	93.0-92.2-93.3/94.4-90.8	93.4-92.8-93.3/94.5-90.3
Temperature Control			Microcomputer Control	Microcomputer Control
Dimensions (HxWxD)		mm	200x900x620	200x1,100x620
Packaged Dimensions (HxWxD)		mm	266x1,106x751	266x1,306x751
Weight		kg	27	30
Gross Weight		kg	33	36
Operation Sound	H/M/L/SL	dBA	37/35/33/31	38/36/34/32
External Static Pressure		Pa	40	40
Heat Insulation			Both Liquid and Gas Pipes	Both Liquid and Gas Pipes
Piping Connection	Liquid	mm	φ 6.4	φ 6.4
	Gas	mm	φ 12.7	φ 15.9
	Drain	mm	VP20 (O.D.φ 26 / I.D.φ 20)	VP20 (O.D.φ 26 / I.D.φ 20)
Drawing No.			3D046079A	3D046080A

- Notes:**
- The operating sound is based on the rear side suction inlet and the external static pressure 40 Pa. Operating sound for under side suction inlet:[operating sound for rear side suction inlet]+5 dB. However, when installation to which the external static pressure becomes low is carried out, 5 dB or more may go up.

Conversion Formulae
kcal/h=kWx860
Btu/h=kWx3414
cfm=m ³ /minx35.3

50Hz 220-230-240V / 60Hz 220-230V

Model			CDKD25CVMA	CDKD35CVMA
Rated Capacity			2.5kW Class	3.5kW Class
Front Panel Color			—	—
Air Flow Rates	m ³ /min (cfm)	H	9.5 (335)	10.0 (353)
		M	8.8 (311)	9.3 (328)
		L	8.0 (282)	8.5 (300)
		SL	6.7 (237)	7.0 (247)
Fan	Type	Sirocco Fan		Sirocco Fan
	Motor Output	W	62	62
	Speed	Steps	5 Steps, Silent, Auto	5 Steps, Silent, Auto
Running Current (Rated)		A	0.47-0.47-0.48/0.52-0.53	0.47-0.48-0.48/0.53-0.54
Power Consumption (Rated)		W	97-100-107/108-113	97-100-107/110-113
Power Factor		%	93.8-92.5-92.9/94.4-92.7	93.8-90.6-92.9/94.3-91.0
Temperature Control			Microcomputer Control	Microcomputer Control
Dimensions (HxWxD)		mm	200x900x620	200x900x620
Packaged Dimensions (HxWxD)		mm	266x1,106x751	266x1,106x751
Weight		kg	25	25
Gross Weight		kg	31	31
Operation Sound	H/M/L/SL	dBA	35/33/31/29	35/33/31/29
External Static Pressure		Pa	40	40
Heat Insulation			Both Liquid and Gas Pipes	Both Liquid and Gas Pipes
Piping Connection	Liquid	mm	φ 6.4	φ 6.4
	Gas	mm	φ 9.5	φ12.7
	Drain	mm	VP20 (O.D. φ 26 / I.D. φ 20)	VP20 (O.D. φ 26 / I.D. φ 20)
Drawing No.			3D046073A	3D046074A

Model			CDKD50CVMA	CDKD60CVMA
Rated Capacity			5.0kW Class	6.0kW Class
Front Panel Color			—	—
Air Flow Rates	m ³ /min (cfm)	H	12.0 (424)	16.0 (565)
		M	11.0 (388)	14.8 (523)
		L	10.0 (353)	13.5 (477)
		SL	8.4 (297)	11.2 (395)
Fan	Type	Sirocco Fan		Sirocco Fan
	Motor Output	W	130	130
	Speed	Steps	5 Steps, Silent, Auto	5 Steps, Silent, Auto
Running Current (Rated)		A	0.65-0.66-0.67/0.79-0.80	0.74-0.75-0.75/0.89-0.90
Power Consumption (Rated)		W	133-140-150/164-167	152-160-168/185-187
Power Factor		%	93.0-92.2-93.3/94.4-90.8	93.4-92.8-93.3/94.5-90.3
Temperature Control			Microcomputer Control	Microcomputer Control
Dimensions (HxWxD)		mm	200x900x620	200x1,100x620
Packaged Dimensions (HxWxD)		mm	266x1,106x751	266x1,306x751
Weight		kg	27	30
Gross Weight		kg	33	36
Operation Sound	H/M/L/SL	dBA	37/35/33/31	38/36/34/32
External Static Pressure		Pa	40	40
Heat Insulation			Both Liquid and Gas Pipes	Both Liquid and Gas Pipes
Piping Connection	Liquid	mm	φ 6.4	φ 6.4
	Gas	mm	φ12.7	φ15.9
	Drain	mm	VP20 (O.D. φ 26 / I.D. φ 20)	VP20 (O.D. φ 26 / I.D. φ 20)
Drawing No.			3D046075A	3D046076A

- Notes:**
- The operating sound is based on the rear side suction inlet and the external static pressure 40 Pa. Operating sound for under side suction inlet:[operating sound for rear side suction inlet]+5 dB. However, when installation to which the external static pressure becomes low is carried out, 5 dB or more may go up.

Conversion Formulae
kcal/h=kW×860
Btu/h=kW×3414
cfm=m ³ /min×35.3

50Hz, 230V

Model			CDKS25CVMB	CDKS35CVMB
Rated Capacity			2.5kW Class	3.5kW Class
Front Panel Color			—	—
Air Flow Rates	m ³ /min (cfm)	H	9.5 (335)	10.0 (353)
		M	8.8 (311)	9.3 (328)
		L	8.0 (282)	8.5 (300)
		SL	6.7 (237)	7.0 (247)
Fan	Type	Sirocco Fan		Sirocco Fan
	Motor Output	W	62	62
	Speed	Steps	5 Steps, Silent, Auto	5 Steps, Silent, Auto
Air Filter			Removable-Washable-Mildew Proof	Removable-Washable-Mildew Proof
Running Current (Rated)		A	0.47	0.47
Power Consumption (Rated)		W	100	100
Power Factor		%	92.5	92.5
Temperature Control			Microcomputer Control	Microcomputer Control
Dimensions (HxWxD)		mm	200x900x620	200x900x620
Packaged Dimensions (HxWxD)		mm	266x1,106x751	266x1,106x751
Weight		kg	25	25
Gross Weight		kg	31	31
Operation Sound	H/M/L/SL	dBA	35/33/31/29	35/33/31/29
External Static Pressure		Pa	40	40
Heat Insulation			Both Liquid and Gas Pipes	Both Liquid and Gas Pipes
Piping Connection	Liquid	mm	φ 6.4	φ 6.4
	Gas	mm	φ 9.5	φ 9.5
	Drain	mm	VP20 (O.D. φ 26 / I.D. φ 20)	VP20 (O.D. φ 26 / I.D. φ 20)
Drawing No.			3D046065A	3D046066A

Model			CDKS50CVMB	CDKS60CVMB
Rated Capacity			5.0kW Class	6.0kW Class
Front Panel Color			—	—
Air Flow Rates	m ³ /min (cfm)	H	12.0 (424)	16.0 (565)
		M	11.0 (388)	14.8 (523)
		L	10.0 (353)	13.5 (477)
		SL	8.4 (297)	11.2 (395)
Fan	Type	Sirocco Fan		Sirocco Fan
	Motor Output	W	130	130
	Speed	Steps	5 Steps, Silent, Auto	5 Steps, Silent, Auto
Air Filter			Removable-Washable-Mildew Proof	Removable-Washable-Mildew Proof
Running Current (Rated)		A	0.64	0.74
Power Consumption (Rated)		W	140	160
Power Factor		%	95.1	94.0
Temperature Control			Microcomputer Control	Microcomputer Control
Dimensions (HxWxD)		mm	200x900x620	200x1,100x620
Packaged Dimensions (HxWxD)		mm	266x1,106x751	266x1,306x751
Weight		kg	27	30
Gross Weight		kg	34	37
Operation Sound	H/M/L/SL	dBA	37/35/33/31	38/36/34/32
External Static Pressure		Pa	40	40
Heat Insulation			Both Liquid and Gas Pipes	Both Liquid and Gas Pipes
Piping Connection	Liquid	mm	φ 6.4	φ 6.4
	Gas	mm	φ 12.7	φ 12.7
	Drain	mm	VP20 (O.D. φ 26 / I.D. φ 20)	VP20 (O.D. φ 26 / I.D. φ 20)
Drawing No.			3D046067A	3D046068A

- Notes:**
- The operating sound is based on the rear side suction inlet and the external static pressure 40 Pa. Operating sound for under side suction inlet: [operating sound for rear side suction inlet]+5 dB. However, when installation to which the external static pressure becomes low is carried out, 5 dB or more may go up.

Conversion Formulae
kcal/h=kWx860
Btu/h=kWx3414
cfm=m ³ /minx35.3

Floor / Ceiling Suspended Dual Type

50Hz 220-230-240V / 60Hz 220-230V

Model				FLK25AVMA	FLK35AVMA	
Rated Capacity				2.5kW Class	3.5kW Class	
Front Panel Color				Almond White	Almond White	
Air Flow Rates	m ³ /min (cfm)	H		7.6 (268)	8.7 (307)	
		M		6.8 (240)	7.7 (272)	
		L		6.0 (212)	6.6 (233)	
		SL		5.2 (184)	5.6 (198)	
Fan	Type			Sirocco Fan	Sirocco Fan	
	Motor Output	W			34	34
	Speed	Steps			5 Steps, Silent, Auto	5 Steps, Silent, Auto
Air Direction Control				Right, Left, Horizontal, Downward	Right, Left, Horizontal, Downward	
Air Filter				Removable-Washable-Mildew Proof	Removable-Washable-Mildew Proof	
Running Current (Rated)		A			0.32-0.32-0.32/0.34-0.34	0.36-0.36-0.36/0.39-0.39
Power Consumption (Rated)		W			68-70-72/72-74	76-78-80/80-84
Power Factor		%			96.6-95.1-93.8/96.3-94.6	96.0-94.2-92.6/93.2-93.6
Temperature Control				Microcomputer Control	Microcomputer Control	
Dimensions (HxWxD)		mm			490x1,050x200	490x1,050x200
Packaged Dimensions (HxWxD)		mm			280x1,100x566	280x1,100x566
Weight		kg			16	16
Gross Weight		kg			22	22
Operation Sound	H/M/L/SL	dBA			37/34/31/28	38/35/32/29
Heat Insulation				Both Liquid and Gas Pipes	Both Liquid and Gas Pipes	
Piping Connection	Liquid	mm			φ 6.4	φ 6.4
	Gas	mm			φ 9.5	φ12.7
	Drain	mm			φ18.0	φ18.0
Drawing No.				3D036717	3D036718	

Model				FLK50AVMA	FLK60AVMA	
Rated Capacity				5.0W Class	5.7kW Class	
Front Panel Color				Almond White	Almond White	
Air Flow Rates	m ³ /min (cfm)	H		11.4 (402)	12.0 (424)	
		M		10.0 (353)	10.6 (374)	
		L		8.5 (300)	9.3 (328)	
		SL		7.5 (265)	8.3 (293)	
Fan	Type			Sirocco Fan	Sirocco Fan	
	Motor Output	W			34	34
	Speed	Steps			5 Steps, Silent, Auto	5 Steps, Silent, Auto
Air Direction Control				Right, Left, Horizontal, Downward	Right, Left, Horizontal, Downward	
Air Filter				Removable-Washable-Mildew Proof	Removable-Washable-Mildew Proof	
Running Current (Rated)		A			0.45-0.45-0.45/0.48-0.48	0.47-0.47-0.47/0.51-0.51
Power Consumption (Rated)		W			94-96-98/98-100	96-98-100/100-104
Power Factor		%			94.9-92.8-90.7/92.8-90.6	92.8-90.7-88.7/89.1-88.7
Temperature Control				Microcomputer Control	Microcomputer Control	
Dimensions (HxWxD)		mm			490x1,050x200	490x1,050x200
Packaged Dimensions (HxWxD)		mm			280x1,100x566	280x1,100x566
Weight		kg			17	17
Gross Weight		kg			24	24
Operation Sound	H/M/L/SL	dBA			47/43/39/36	48/45/41/38
Heat Insulation				Both Liquid and Gas Pipes	Both Liquid and Gas Pipes	
Piping Connection	Liquid	mm			φ 6.4	φ 6.4
	Gas	mm			φ12.7	φ15.9
	Drain	mm			φ18.0	φ18.0
Drawing No.				3D036719	3D036720	

Conversion Formulae

kcal/h=kW×860
 Btu/h=kW×3414
 cfm=m³/min×35.3

50Hz, 230V

Model			FLKS25BVMB	FLKS35BVMB
Rated Capacity			2.5kW Class	3.5kW Class
Front Panel Color			Almond White	Almond White
Air Flow Rates	m ³ /min (cfm)	H	7.6 (268)	8.6 (304)
		M	6.8 (240)	7.6 (268)
		L	6.0 (212)	6.6 (233)
		SL	5.2 (184)	5.6 (198)
Fan	Type	Sirocco Fan		Sirocco Fan
	Motor Output	W	34	34
	Speed	Steps	5 Steps, Silent, Auto	5 Steps, Silent, Auto
Air Direction Control			Right, Left, Horizontal, Downward	Right, Left, Horizontal, Downward
Air Filter			Removable-Washable-Mildew Proof	Removable-Washable-Mildew Proof
Running Current (Rated)		A	0.34	0.36
Power Consumption (Rated)		W	74	78
Power Factor		%	94.6	94.2
Temperature Control			Microcomputer Control	Microcomputer Control
Dimensions (HxWxD)		mm	490x1,050x200	490x1,050x200
Packaged Dimensions (HxWxD)		mm	280x1,100x566	280x1,100x566
Weight		kg	16	16
Gross Weight		kg	22	22
Operation Sound	H/M/L/SL	dBA	37/34/31/28	38/35/32/29
Sound Power	H	dBA	53	54
Heat Insulation			Both Liquid and Gas Pipes	Both Liquid and Gas Pipes
Piping Connection	Liquid	mm	φ 6.4	φ 6.4
	Gas	mm	φ 9.5	φ 9.5
	Drain	mm	φ18.0	φ18.0
Drawing No.			3D040166A	3D040167A

Model			FLKS50BVMB	FLKS60BVMB
Rated Capacity			5.0W Class	5.7kW Class
Front Panel Color			Almond White	Almond White
Air Flow Rates	m ³ /min (cfm)	H	11.4 (402)	12.0 (424)
		M	10.0 (353)	10.7 (378)
		L	8.5 (300)	9.3 (328)
		SL	7.5 (265)	8.3 (293)
Fan	Type	Sirocco Fan		Sirocco Fan
	Motor Output	W	34	34
	Speed	Steps	5 Steps, Silent, Auto	5 Steps, Silent, Auto
Air Direction Control			Right, Left, Horizontal, Downward	Right, Left, Horizontal, Downward
Air Filter			Removable-Washable-Mildew Proof	Removable-Washable-Mildew Proof
Running Current (Rated)		A	0.45	0.45
Power Consumption (Rated)		W	96	98
Power Factor		%	92.8	94.7
Temperature Control			Microcomputer Control	Microcomputer Control
Dimensions (HxWxD)		mm	490x1,050x200	490x1,050x200
Packaged Dimensions (HxWxD)		mm	280x1,100x566	280x1,100x566
Weight		kg	17	17
Gross Weight		kg	24	24
Operation Sound	H/M/L/SL	dBA	47/43/39/36	48/45/41/39
Sound Power	H	dBA	63	64
Heat Insulation			Both Liquid and Gas Pipes	Both Liquid and Gas Pipes
Piping Connection	Liquid	mm	φ 6.4	φ 6.4
	Gas	mm	φ12.7	φ12.7
	Drain	mm	φ18.0	φ18.0
Drawing No.			3D040828	3D040830

Conversion Formulae
kcal/h=kWx860
Btu/h=kWx3414
cfm=m ³ /minx35.3

Floor Standing Type

50Hz, 230V

Model			FVKS25BVMB	FVKS35BVMB
Rated Capacity			2.5kW Class	3.5kW Class
Front Panel Color			Almond White	Almond White
Air Flow Rates	m ³ /min (cfm)	H	8.1 (286)	8.3 (293)
		M	6.2 (219)	6.3 (222)
		L	4.3 (152)	4.3 (152)
		SL	3.4 (120)	3.4 (120)
Fan	Type	Cross Flow Fan		Cross Flow Fan
	Motor Output	W	14+14	14+14
	Speed	Steps	5 Steps, Silent, Auto	5 Steps, Silent, Auto
Air Direction Control			Right, Left, Horizontal, Upward	Right, Left, Horizontal, Upward
Air Filter			Removable-Washable-Mildew Proof	Removable-Washable-Mildew Proof
Running Current (Rated)		A	0.14	0.14
Power Consumption (Rated)		W	32	32
Power Factor		%	99.4	99.4
Temperature Control			Microcomputer Control	Microcomputer Control
Dimensions (HxWxD)		mm	600x650x195	600x650x195
Packaged Dimensions (HxWxD)		mm	714x770x294	714x770x294
Weight		kg	13	13
Gross Weight		kg	19	19
Operation Sound	H/M/L/SL	dBA	38/32/26/23	39/33/27/24
Sound Power	H	dBA	54	55
Heat Insulation			Both Liquid and Gas Pipes	Both Liquid and Gas Pipes
Piping Connection	Liquid	mm	φ 6.4	φ 6.4
	Gas	mm	φ 9.5	φ 9.5
	Drain	mm	φ18.0	φ18.0
Drawing No.			3D040164A	3D040165A

Model			FVKS50BVMB
Rated Capacity			5.0kW Class
Front Panel Color			Almond White
Air Flow Rates	m ³ /min (cfm)	H	10.8 (381)
		M	9.2 (325)
		L	7.7 (272)
		SL	6.7 (237)
Fan	Type	Cross Flow Fan	
	Motor Output	W	14+14
	Speed	Steps	5 Steps, Silent, Auto
Air Direction Control			Right, Left, Horizontal, Upward
Air Filter			Removable-Washable-Mildew Proof
Running Current (Rated)		A	0.26
Power Consumption (Rated)		W	55
Power Factor		%	92.0
Temperature Control			Microcomputer Control
Dimensions (HxWxD)		mm	600x650x195
Packaged Dimensions (HxWxD)		mm	714x770x294
Weight		kg	13
Gross Weight		kg	19
Operation Sound	H/M/L/SL	dBA	44/40/36/33
Sound Power	H	dBA	56
Heat Insulation			Both Liquid and Gas Pipes
Piping Connection	Liquid	mm	φ 6.4
	Gas	mm	φ12.7
	Drain	mm	φ20.0
Drawing No.			3D040833

Conversion Formulae

kcal/h=kW×860
 Btu/h=kW×3414
 cfm=m³/min×35.3

1.2 Outdoor Units - Cooling Only

50Hz 220-230-240V / 60Hz 220-230V

Model		2MKD58BVM		3MKD58BVM	
Cooling Capacity	kW	—		—	
Power Consumption	W	—		—	
Running Current	A	—		—	
Casing Color		Ivory White		Ivory White	
Compressor	Type	Hermetically Sealed Swing Type		Hermetically Sealed Swing Type	
	Model	2YC32WXD		2YC32WXD	
	Motor Output	W	980	980	
Refrigerant Oil	Model	SUNISO 4GSD.I.		SUNISO 4GSD.I.	
	Charge	L	0.65	0.65	
Refrigerant	Type	R22		R22	
	Charge	kg	2.0	2.0	
Air Flow Rates	m ³ /min	H	44	44	
		L	37	37	
	cfm	H	1,270	1,270	
		L	1,068	1,068	
Fan	Type	Propeller		Propeller	
	Motor Output	W	53	53	
	Running Current	A	H: 0.24 / L: 0.17	H: 0.24 / L: 0.17	
	Power Consumption	W	H: 44 / L: 27	H: 44 / L: 27	
Starting Current	A	6.9		6.5	
Dimensions (HxWxD)	mm	735x936x300		735x936x300	
Packaged Dimensions (HxWxD)	mm	784x960x357		784x960x357	
Weight	kg	55		55	
Gross Weight	kg	59		59	
Operation Sound	dBA	46		46	
Piping Connection	Liquid	mm	φ 6.4x2	φ 6.4x3	
	Gas	mm	φ 12.7x2	φ 12.7x3	
	Drain	mm	φ 16.0	φ 16.0	
Heat Insulation		Both Liquid and Gas Pipes		Both Liquid and Gas Pipes	
No. of Wiring Connection		3 for Power Supply, 4 for Interunit Wiring		3 for Power Supply, 4 for Interunit Wiring	
Max. Interunit Piping Length	m	35 (for Total of Each Room)		45 (for Total of Each Room)	
	m	25 (for One Room)		25 (for One Room)	
Amount of Additional Charge	g/m	Chargeless		Chargeless	
Max. Installation Height Difference	m	15 (between Indoor Unit and Outdoor Unit)		15 (between Indoor Unit and Outdoor Unit)	
	m	7.5 (between Indoor Units)		7.5 (between Indoor Units)	
Drawing No.		3D039666#1		3D039667#1	

Notes: 1. The data are based on the conditions shown in the table below.

Cooling	Piping Length
Indoor : 27°CDB/19°CWB Outdoor : 35°CDB	5.0m

Conversion Formulae
kcal/h=kWx860
Btu/h=kWx3414
cfm=m ³ /minx35.3

50Hz 220-230-240V / 60Hz 220-230V

Model		3MKD75BVM		4MKD75BVM	
Cooling Capacity	kW	—		—	
Power Consumption	W	—		—	
Running Current	A	—		—	
Casing Color		Ivory White		Ivory White	
Compressor	Type	Hermetically Sealed Swing Type		Hermetically Sealed Swing Type	
	Model	2YC45ZXD		2YC45ZXD	
	Motor Output	W	1,380	1,380	
Refrigerant Oil	Model	SUNISO 4GSD.I.		SUNISO 4GSD.I.	
	Charge	L	0.75	0.75	
Refrigerant	Type	R22		R22	
	Charge	kg	2.3	2.3	
Air Flow Rates	m ³ /min	H	51	51	
		L	45	45	
	cfm	H	1,472	1,472	
		L	1,299	1,299	
Fan	Type	Propeller		Propeller	
	Motor Output	W	53	53	
	Running Current	A	H: 0.33 / L: 0.25	H: 0.33 / L: 0.25	
	Power Consumption	W	H: 68 / L: 46	H: 68 / L: 46	
Starting Current	A	9.4		9.2	
Dimensions (HxWxD)	mm	735x936x300		735x936x300	
Packaged Dimensions (HxWxD)	mm	784x960x357		784x960x357	
Weight	kg	58		58	
Gross Weight	kg	62		62	
Operation Sound	dBA	48		48	
Piping Connection	Liquid	mm	φ 6.4x1, φ 9.5x2	φ 6.4x2, φ 9.5x2	
	Gas	mm	φ12.7x1, φ15.9x2	φ12.7x2, φ15.9x2	
	Drain	mm	φ16.0	φ16.0	
Heat Insulation		Both Liquid and Gas Pipes		Both Liquid and Gas Pipes	
No. of Wiring Connection		3 for Power Supply, 4 for Interunit Wiring		3 for Power Supply, 4 for Interunit Wiring	
Max. Interunit Piping Length	m	60 (for Total of Each Room)		60 (for Total of Each Room)	
	m	25 (for One Room)		25 (for One Room)	
Amount of Additional Charge		Chargeless		Chargeless	
Max. Installation Height Difference	m	15 (between Indoor Unit and Outdoor Unit)		15 (between Indoor Unit and Outdoor Unit)	
	m	7.5 (between Indoor Units)		7.5 (between Indoor Units)	
Drawing No.		3D039668#1		3D039669#1	

Notes: 1. The data are based on the conditions shown in the table below.

Cooling	Piping Length
Indoor ; 27°CDB/19°CWB Outdoor ; 35°CDB	5.0m

Conversion Formulae
kcal/h=kWx860 Btu/h=kWx3414 cfm=m ³ /minx35.3

50Hz 220-230-240V / 60Hz 220-230V

Model		4MKD90BVM	
Cooling Capacity	kW	—	
Power Consumption	W	—	
Running Current	A	—	
Casing Color		Pale Ivory	
Compressor	Type	Hermetically Sealed Swing Type	
	Model	2YC45ZXD	
	Motor Output	W	1,380
Refrigerant Oil	Model	SUNISO 4GSD.I.	
	Charge	L	0.75
Refrigerant	Type	R22	
	Charge	kg	3.1
Air Flow Rates	m ³ /min	H	48.5
		L	42
	cfm	H	1,400
		L	1,212
Fan	Type	Propeller	
	Motor Output	W	51
	Running Current	A	H: 0.44 / L: 0.34
	Power Consumption	W	H: 60 / L: 41
Starting Current	A	12.1	
Dimensions (HxWxD)	mm	908x900x320	
Packaged Dimensions (HxWxD)	mm	942x926x394	
Weight	kg	66	
Gross Weight	kg	77	
Operation Sound	dBA	48	
Piping Connection	Liquid	mm	φ 6.4x2, φ 9.5x2
	Gas	mm	φ12.7x1, φ15.9x3
	Drain	mm	φ25.0
Heat Insulation		Both Liquid and Gas Pipes	
No. of Wiring Connection		3 for Power Supply, 4 for Interunit Wiring	
Max. Piping Length	m	70 (for Total of Each Room)	
	m	25 (for One Room)	
Amount of Additional Charge	g/m	Chargeless	
Max. Installation Height Difference	m	15 (between Indoor Unit and Outdoor Unit)	
	m	7.5 (between Indoor Units)	
Drawing No.		3D039670#1	

Notes: 1. The data are based on the conditions shown in the table below.

Cooling	Piping Length
Indoor ; 27°CDB/19°CWB Outdoor ; 35°CDB	5.0m

Conversion Formulae
kcal/h=kWx860 Btu/h=kWx3414 cfm=m ³ /minx35.3

50Hz 220-230-240V / 60Hz 220-230V

Model		3MKD75BVMA		4MKD90BVMA	
Cooling Capacity		kW	—		—
Power Consumption		W	—		—
Running Current		A	—		—
Casing Color			Ivory White	Pale Ivory	
Compressor	Type	Hermetically Sealed Swing Type		Hermetically Sealed Swing Type	
	Model	2YC45ZXD		2YC45ZXD	
	Motor Output	W	1,380		1,380
Refrigerant Oil	Model	SUNISO 4GSD.I.		SUNISO 4GSD.I.	
	Charge	L	0.75		0.75
Refrigerant	Type	R22		R22	
	Charge	kg	2.3		3.1
Air Flow Rates	m ³ /min	H	51		48.5
		L	45		42
	cfm	H	1,472		1,400
		L	1,299		1,212
Fan	Type	Propeller		Propeller	
	Motor Output	W	53		51
	Running Current	A	H: 0.33 / L: 0.25		H: 0.44 / L: 0.34
	Power Consumption	W	H: 68 / L: 46		H: 60 / L: 41
Starting Current		A	9.4		12.1
Dimensions (HxWxD)		mm	735x936x300		908x900x320
Packaged Dimensions (HxWxD)		mm	784x960x357		942x926x394
Weight		kg	58		66
Gross Weight		kg	62		77
Operation Sound		dBA	48		48
Piping Connection	Liquid	mm	φ 6.4x1, φ 9.5x2		φ 6.4x2, φ 9.5x2
	Gas	mm	φ12.7x1, φ15.9x2		φ12.7x1, φ15.9x3
	Drain	mm	φ16.0		φ 25.0
Heat Insulation			Both Liquid and Gas Pipes	Both Liquid and Gas Pipes	
No. of Wiring Connection			3 for Power Supply, 4 for Interunit Wiring	3 for Power Supply, 4 for Interunit Wiring	
Max. Interunit Piping Length	m	60 (for Total of Each Room)		70 (for Total of Each Room)	
	m	25 (for One Room)		25 (for One Room)	
Amount of Additional Charge		g/m	Chargeless	Chargeless	
Max. Installation Height Difference	m	15 (between Indoor Unit and Outdoor Unit)		15 (between Indoor Unit and Outdoor Unit)	
	m	7.5 (between Indoor Units)		7.5 (between Indoor Units)	
Drawing No.			3D039673#1	3D039674#1	

Notes: 1. The data are based on the conditions shown in the table below.

Cooling	Piping Length
Indoor : 27°CDB/19°CWB Outdoor : 35°CDB	7.5m

Conversion Formulae
kcal/h=kWx860 Btu/h=kWx3414 cfm=m ³ /minx35.3

50Hz, 230V

Model		3MKS50BVM(B)		4MKS58BVM(B)		
Cooling Capacity	kW	—		—		
Power Consumption	W	—		—		
Running Current	A	—		—		
Casing Color		Ivory White		Ivory White		
Compressor	Type	Hermetically Sealed Swing Type		Hermetically Sealed Swing Type		
	Model	2YC32HXD		2YC32HXD		
Motor Output	W	980		980		
Refrigerant Oil	Model	FVC50K		FVC50K		
	Charge	L	0.65		0.65	
Refrigerant	Type	R410A		R410A		
	Charge	kg	2.0		2.0	
Air Flow Rates	m ³ /min	H	44		44	
		L	37		37	
	cfm	H	1,270		1,270	
		L	1,068		1,068	
Fan	Type	Propeller		Propeller		
	Motor Output	W	53		53	
	Running Current	A	H: 0.24 / L: 0.17		H: 0.24 / L: 0.17	
	Power Consumption	W	H: 44 / L: 27		H: 44 / L: 27	
Starting Current	A	7.7		7.7		
Dimensions (HxWxD)	mm	735x936x300		735x936x300		
Packaged Dimensions (HxWxD)	mm	784x960x357		784x960x357		
Weight	kg	55		55		
Gross Weight	kg	59		59		
Operation Sound	dBA	46		46		
Sound Power	dBA	59		59		
Piping Connection	Liquid	mm	φ 6.4x3		φ 6.4x4	
	Gas	mm	φ 9.5x3		φ 9.5x2, φ 12.7x2	
	Drain	mm	φ18.0		φ18.0	
Heat Insulation		Both Liquid and Gas Pipes		Both Liquid and Gas Pipes		
No. of Wiring Connection		3 for Power Supply, 4 for Interunit Wiring		3 for Power Supply, 4 for Interunit Wiring		
Max. Interunit Piping Length	m	45 (for Total of Each Room)		45 (for Total of Each Room)		
	m	25 (for One Room)		25 (for One Room)		
Amount of Additional Charge	g/m	Chargeless		Chargeless		
Max. Installation Height Difference	m	15 (between Indoor Unit and Outdoor Unit)		15 (between Indoor Unit and Outdoor Unit)		
	m	7.5 (between Indoor Units)		7.5 (between Indoor Units)		
Drawing No.		3D038934		3D039607#1		

Notes: 1. The data are based on the conditions shown in the table below.

Cooling	Piping Length
Indoor ; 27°CDB/19°CWB Outdoor ; 35°CDB	7.5m

Conversion Formulae
kcal/h=kWx860 Btu/h=kWx3414 cfm=m ³ /minx35.3

50Hz, 230V

Model		4MKS75BVMB		4MKS90BVMB		
Cooling Capacity	kW	—		—		
Power Consumption	W	—		—		
Running Current	A	—		—		
Casing Color		Ivory White		Pale Ivory		
Compressor	Type	Hermetically Sealed Swing Type		Hermetically Sealed Swing Type		
	Model	2YC45BXD		2YC45BXD		
Motor Output	W	1,380		1,380		
Refrigerant Oil	Model	FVC50K		FVC50K		
	Charge	L	0.75		0.75	
Refrigerant	Type	R410A		R410A		
	Charge	kg	2.3		3.1	
Air Flow Rates	m ³ /min	H	51		48.5	
		L	45		42	
	cfm	H	1,472		1,400	
		L	1,299		1,212	
Fan	Type	Propeller		Propeller		
	Motor Output	W	53		51	
	Running Current	A	H: 0.33 / L: 0.25		H: 0.44 / L: 0.34	
	Power Consumption	W	H: 68 / L: 46		H: 60 / L: 41	
Starting Current	A	8.7		9.1		
Dimensions (HxWxD)	mm	735x936x300		908x900x320		
Packaged Dimensions (HxWxD)	mm	784x960x357		942x926x394		
Weight	kg	58		66		
Gross Weight	kg	62		77		
Operation Sound	dBA	48		48		
Sound Power	dBA	61		61		
Piping Connection	Liquid	mm	φ 6.4x4		φ 6.4x4	
	Gas	mm	φ9.5x2, φ12.7x1, φ15.9x1		φ9.5x1, φ12.7x1, φ15.9x2	
	Drain	mm	φ18.0		φ 25.0	
Heat Insulation		Both Liquid and Gas Pipes		Both Liquid and Gas Pipes		
No. of Wiring Connection		3 for Power Supply, 4 for Interunit Wiring		3 for Power Supply, 4 for Interunit Wiring		
Max. Interunit Piping Length	m	60 (for Total of Each Room)		70 (for Total of Each Room)		
	m	25 (for One Room)		25 (for One Room)		
Amount of Additional Charge	g/m	Chargeless		Chargeless		
Max. Installation Height Difference	m	15 (between Indoor Unit and Outdoor Unit)		15 (between Indoor Unit and Outdoor Unit)		
	m	7.5 (between Indoor Units)		7.5 (between Indoor Units)		
Drawing No.		3D039606#1		3D039608#1		

Notes: 1. The data are based on the conditions shown in the table below.

Cooling	Piping Length
Indoor ; 27°CDB/19°CWB Outdoor ; 35°CDB	7.5m

Conversion Formulae

kcal/h=kWx860
Btu/h=kWx3414
cfm=m³/minx35.3

1.3 Indoor Units - Heat Pump

Wall Mounted Type

50Hz 220-230-240V / 60Hz 220-230V

Model			FTXE25BVMA		FTXE35BVMA	
			Cooling	Heating	Cooling	Heating
Rated Capacity			2.5kW Class		3.5kW Class	
Front Panel Color			White			
Air Flow Rates	m ³ /min (cfm)	H	7.8 (275)	8.1 (286)	7.7 (272)	8.1 (286)
		M	6.4 (226)	6.6 (233)	6.3 (222)	6.6 (233)
		L	5.0 (177)	5.1 (180)	4.9 (173)	5.1 (180)
		SL	4.3 (152)	4.3 (152)	4.4 (155)	4.4 (155)
Fan	Type	Cross Flow Fan				
	Motor Output	W	18			
	Speed	Steps	5 Steps, Silent, Auto			
Air Direction Control			Right, Left, Horizontal, Downward		Right, Left, Horizontal, Downward	
Air Filter			Removable-Washable-Mildew Proof			
Running Current (Rated)		A	0.17-0.18-0.18/0.21-0.21	0.17-0.18-0.18/0.21-0.21	0.17-0.18-0.18/0.21-0.21	0.17-0.18-0.18/0.21-0.21
Power Consumption (Rated)		W	37-40-43/45-48	37-40-43/45-48	37-40-43/45-48	37-40-43/45-48
Power Factor		%	98.9-96.6-99.5/97.4-99.4	98.9-96.6-99.5/97.4-99.4	98.9-96.6-99.5/97.4-99.4	98.9-96.6-99.5/97.4-99.4
Temperature Control			Microcomputer Control			
Dimensions (HxWxD)		mm	273x784x195		273x784x195	
Packaged Dimensions (HxWxD)		mm	258x834x325		258x834x325	
Weight		kg	7.5			
Gross Weight		kg	11			
Operation Sound	H/M/L/SL	dBA	37/34/30/27	37/33/30/27	38/35/32/29	38/35/31/28
Heat Insulation			Both Liquid and Gas Pipes			
Piping Connection	Liquid	mm	φ 6.4			
	Gas	mm	φ 9.5			
	Drain	mm	φ18.0			
Drawing No.			3D040689		3D040690	

Model			FTXD50BVMA		FTXD60BVMA	
			Cooling	Heating	Cooling	Heating
Rated Capacity			5.0kW Class		6.0kW Class	
Front Panel Color			White			
Air Flow Rates	m ³ /min (cfm)	H	16.8 (593)	17.5 (618)	17.5 (618)	18.7 (660)
		M	14.0 (494)	14.9 (526)	14.6 (515)	16.1 (568)
		L	11.8 (417)	12.5 (441)	12.2 (431)	13.6 (480)
		SL	10.4 (367)	11.0 (388)	10.8 (381)	11.8 (417)
Fan	Type	Cross Flow Fan				
	Motor Output	W	43			
	Speed	Steps	5 Steps, Silent, Auto			
Air Direction Control			Right, Left, Horizontal, Downward		Right, Left, Horizontal, Downward	
Air Filter			Removable-Washable-Mildew Proof			
Running Current (Rated)		A	0.19-0.18-0.17/0.19-0.18	0.19-0.18-0.17/0.19-0.18	0.21-0.20-0.19/0.21-0.20	0.21-0.20-0.19/0.21-0.20
Power Consumption (Rated)		W	40	40	45	45
Power Factor		%	95.7-96.6-98.0/95.7-96.6	95.7-96.6-98.0/95.7-96.6	97.4-97.8-98.7/97.4-97.8	97.4-97.8-98.7/97.4-97.8
Temperature Control			Microcomputer Control			
Dimensions (HxWxD)		mm	290x1,050x238		290x1,050x238	
Packaged Dimensions (HxWxD)		mm	337x1,147x366		337x1,147x366	
Weight		kg	12			
Gross Weight		kg	17			
Operation Sound	H/M/L/SL	dBA	44/40/35/32	42/38/33/30	45/41/36/33	44/40/35/32
Heat Insulation			Both Liquid and Gas Pipes			
Piping Connection	Liquid	mm	φ 6.4			
	Gas	mm	φ12.7			
	Drain	mm	φ18.0			
Drawing No.			3D040790		3D040791	

Conversion Formulae
kcal/h=kWx860
Btu/h=kWx3414
cfm=m ³ /minx35.3

50Hz 220-230-240V / 60Hz 220-230V

Model			FTXD71BVMA	
			Cooling	Heating
Rated Capacity			7.1kW Class	
Front Panel Color			White	
Air Flow Rates	m ³ /min (cfm)	H	18.3 (646)	19.8 (699)
		M	15.3 (540)	17.1 (604)
		L	12.7 (448)	14.4 (508)
		SL	11.3 (399)	12.6 (445)
Fan	Type	Cross Flow Fan		
	Motor Output	W	43	
	Speed	Steps	5 Steps, Silent, Auto	
Air Direction Control			Right, Left, Horizontal, Downward	
Air Filter			Removable-Washable-Mildew Proof	
Running Current (Rated)		A	0.23-0.22-0.21/0.23-0.22	0.23-0.22-0.21/0.23-0.22
Power Consumption (Rated)		W	50	50
Power Factor		%	98.8-98.8-99.2/98.8-98.8	98.8-98.8-99.2/98.8-98.8
Temperature Control			Microcomputer Control	
Dimensions (HxWxD)		mm	290x1,050x238	
Packaged Dimensions (HxWxD)		mm	337x1,147x366	
Weight		kg	12	
Gross Weight		kg	17	
Operation Sound	H/M/L/SL	dBA	46/42/37/34	46/42/37/34
Heat Insulation			Both Liquid and Gas Pipes	
Piping Connection	Liquid	mm	φ 9.5	
	Gas	mm	φ15.9	
	Drain	mm	φ18.0	
Drawing No.			3D040792	

Conversion Formulae
kcal/h=kW×860
Btu/h=kW×3414
cfm=m ³ /min×35.3

Model			FTXS20CVMB(9)		FTXS25CVMB(9)(8)	
			Cooling	Heating	Cooling	Heating
Rated Capacity			2.5kW Class		2.5kW Class	
Front Panel Color			White		White	
Air Flow Rates	m ³ /min (cfm)	H	7.7 (272)	7.8 (275)	7.7 (272)	7.8 (275)
		M	5.9 (208)	6.5 (230)	5.9 (208)	6.5 (230)
		L	4.2 (148)	5.3 (187)	4.2 (148)	5.3 (187)
		SL	3.6 (127)	4.6 (162)	3.6 (127)	4.6 (162)
Fan	Type	Cross Flow Fan				
	Motor Output	W	18		18	
	Speed	Steps	5 Steps, Silent, Auto		5 Steps, Silent, Auto	
Air Direction Control			Right, Left, Horizontal, Downward		Right, Left, Horizontal, Downward	
Air Filter			Removable-Washable-Mildew Proof		Removable-Washable-Mildew Proof	
Running Current (Rated)	A	0.18	0.18	0.18	0.18	
Power Consumption (Rated)	W	40	40	40	40	
Power Factor	%	96.6	96.6	96.6	96.6	
Temperature Control			Microcomputer Control		Microcomputer Control	
Dimensions (HxWxD)	mm	273x784x195		273x784x195		
Packaged Dimensions (HxWxD)	mm	258x834x325		258x834x325		
Weight	kg	7.5		7.5		
Gross Weight	kg	11		11		
Operation Sound	H/M/L/SL	dBA	38/32/25/22	38/33/28/25	38/32/25/22	38/33/28/25
Sound Power	H	dBA	56	56	56	56
Heat Insulation			Both Liquid and Gas Pipes		Both Liquid and Gas Pipes	
Piping Connection	Liquid	mm	φ 6.4		φ 6.4	
	Gas	mm	φ 9.5		φ 9.5	
	Drain	mm	φ18.0		φ18.0	
Drawing No.			3D044245B		3D044246B	

Model			FTXS35CVMB(9)(8)		FTXS50BVMB	
			Cooling	Heating	Cooling	Heating
Rated Capacity			3.5kW Class		5.0kW Class	
Front Panel Color			White		White	
Air Flow Rates	m ³ /min (cfm)	H	7.7 (272)	8.1 (286)	11.4 (402)	12.6 (445)
		M	6.0 (212)	6.7 (237)	9.7 (342)	10.8 (381)
		L	4.4 (155)	5.3 (187)	8.0 (282)	8.9 (314)
		SL	3.8 (134)	4.6 (162)	7.1 (251)	7.7 (272)
Fan	Type	Cross Flow Fan				
	Motor Output	W	18		40	
	Speed	Steps	5 Steps, Silent, Auto		5 Steps, Silent, Auto	
Air Direction Control			Right, Left, Horizontal, Downward		Right, Left, Horizontal, Downward	
Air Filter			Removable-Washable-Mildew Proof		Removable-Washable-Mildew Proof	
Running Current (Rated)	A	0.18	0.18	0.18	0.20	
Power Consumption (Rated)	W	40	40	40	45	
Power Factor	%	96.6	96.6	96.6	97.8	
Temperature Control			Microcomputer Control		Microcomputer Control	
Dimensions (HxWxD)	mm	273x784x195		290x795x238		
Packaged Dimensions (HxWxD)	mm	258x834x325		280x840x338		
Weight	kg	7.5		9		
Gross Weight	kg	11		13		
Operation Sound	H/M/L/SL	dBA	39/33/26/23	39/34/29/26	44/40/35/32	42/38/33/30
Sound Power	H	dBA	57	57	63	60
Heat Insulation			Both Liquid and Gas Pipes		Both Liquid and Gas Pipes	
Piping Connection	Liquid	mm	φ 6.4		φ 6.4	
	Gas	mm	φ 9.5		φ12.7	
	Drain	mm	φ18.0		φ18.0	
Drawing No.			3D044247B		3D040778A	

Conversion Formulae
kcal/h=kWx860
Btu/h=kWx3414
cfm=m ³ /minx35.3

50Hz 230V

Model			FTXS60BVMB		FTXS71BVMB	
			Cooling	Heating	Cooling	Heating
Rated Capacity			6.0kW Class		7.1kW Class	
Front Panel Color			White		White	
Air Flow Rates	m ³ /min (cfm)	H	16.2 (572)	17.4 (614)	16.7 (590)	18.5 (653)
		M	13.6 (480)	15.1 (533)	14.2 (501)	15.1 (533)
		L	11.4 (402)	12.7 (448)	11.6 (409)	13.5 (477)
		SL	10.2 (360)	11.4 (402)	10.6 (374)	12.1 (427)
Fan	Type	Cross Flow Fan		Cross Flow Fan		
	Motor Output	W	43		43	
	Speed	Steps	5 Steps, Silent, Auto		5 Steps, Silent, Auto	
Air Direction Control			Right, Left, Horizontal, Downward		Right, Left, Horizontal, Downward	
Air Filter			Removable-Washable-Mildew Proof		Removable-Washable-Mildew Proof	
Running Current (Rated)		A	0.18	0.20	0.20	0.22
Power Consumption (Rated)		W	40	45	45	50
Power Factor		%	96.6	97.8	96.4	97.6
Temperature Control			Microcomputer Control		Microcomputer Control	
Dimensions (HxWxD)		mm	290x1,050x238		290x1,050x238	
Packaged Dimensions (HxWxD)		mm	337x1,147x366		337x1,147x366	
Weight		kg	12		12	
Gross Weight		kg	17		17	
Operation Sound	H/M/L/SL	dBA	45/41/36/33	44/40/35/32	46/42/37/34	46/42/37/34
Sound Power	H	dBA	63	62	63	63
Heat Insulation			Both Liquid and Gas Pipes		Both Liquid and Gas Pipes	
Piping Connection	Liquid	mm	φ 6.4		φ 6.4	
	Gas	mm	φ12.7		φ15.9	
	Drain	mm	φ18.0		φ18.0	
Drawing No.			3D040779		3D040780A	

Conversion Formulae
kcal/h=kW×860
Btu/h=kW×3414
cfm=m ³ /min×35.3

230V, 50Hz

Model			ATXS20CVMB(9)		ATXS25CVMB(9)		
			Cooling	Heating	Cooling	Heating	
Rated Capacity			2.0kW Class		2.5kW Class		
Front Panel Color			White		White		
Air Flow Rates	m ³ /min (cfm)	H	7.7 (272)	7.8 (275)	7.7 (272)	7.8 (275)	
		M	5.9 (208)	6.5 (230)	5.9 (208)	6.5 (230)	
		L	4.2 (148)	5.3 (187)	4.2 (148)	5.3 (187)	
		SL	3.6 (127)	4.6 (162)	3.6 (127)	4.6 (162)	
Fan	Type	Cross Flow Fan		Cross Flow Fan			
	Motor Output	W	18		18		
	Speed	Steps	5 Steps, Silent, Auto		5 Steps, Silent, Auto		
Air Direction Control			Right, Left, Horizontal, Downward		Right, Left, Horizontal, Downward		
Air Filter			Removable-Washable-Mildew Proof		Removable-Washable-Mildew Proof		
Running Current (Rated)			A	0.18	0.18	0.18	
Power Consumption (Rated)			W	40	40	40	
Power Factor			%	96.6	96.6	96.6	
Temperature Control			Microcomputer Control		Microcomputer Control		
Dimensions (HxWxD)			mm	273x784x185		273x784x185	
Packaged Dimension (HxWxD)			mm	258x834x325		258x834x325	
Weight			kg	7.5		7.5	
Gross Weight			kg	11		11	
Operation Sound	dBA	H	38	38	38	38	
		M	32	33	32	33	
		L	25	28	25	28	
		SL	22	25	22	25	
Sound Power	dBA	H	56	56	56	56	
Heat Insulation			Both Liquid and Gas Pipes		Both Liquid and Gas Pipes		
Piping Connection	Liquid	mm	φ 6.4		φ 6.4		
	Gas	mm	φ 9.5		φ 9.5		
	Drain	mm	φ18.0		φ18.0		
Drawing No.			3D044251B		3D044252B		

Model			ATXS35CVMB(9)		ATXS50CVMB		
			Cooling	Heating	Cooling	Heating	
Rated Capacity			3.5kW Class		5.0kW Class		
Front Panel Color			White		White		
Air Flow Rates	m ³ /min (cfm)	H	7.7 (272)	8.1 (286)	11.4 (402)	12.6 (445)	
		M	6.1 (215)	6.7 (237)	9.7 (342)	10.8 (381)	
		L	4.4 (155)	5.3 (187)	8.0 (282)	8.9 (314)	
		SL	3.8 (134)	4.6 (162)	7.1 (251)	7.7 (272)	
Fan	Type	Cross Flow Fan		Cross Flow Fan			
	Motor Output	W	18		40		
	Speed	Steps	5 Steps, Silent, Auto		5 Steps, Silent, Auto		
Air Direction Control			Right, Left, Horizontal, Downward		Right, Left, Horizontal, Downward		
Air Filter			Removable-Washable-Mildew Proof		Removable / Washable / Mildew Proof		
Running Current (Rated)			A	0.18	0.18	0.18	
Power Consumption (Rated)			W	40	40	45	
Power Factor			%	96.6	96.6	97.8	
Temperature Control			Microcomputer Control		Microcomputer Control		
Dimensions (HxWxD)			mm	273x784x185		290x795x238	
Packaged Dimension (HxWxD)			mm	258x834x325		338x280x840	
Weight			kg	7.5		9	
Gross Weight			kg	11		13	
Operation Sound	dBA	H	39	39	44	42	
		M	33	34	40	38	
		L	26	29	35	33	
		SL	23	26	32	30	
Sound Power	dBA	H	57	57	63	60	
Heat Insulation			Both Liquid and Gas Pipes		Both Liquid and Gas Pipes		
Piping Connection	Liquid	mm	φ 6.4		φ 6.4		
	Gas	mm	φ 9.5		φ12.7		
	Drain	mm	φ18.0		φ18.0		
Drawing No.			3D044253B		3D044869		

Conversion Formulae
kcal/h=kWx860
Btu/h=kWx3414
cfm=m ³ /minx35.3

50Hz 230V

Model			FTXS25BVMA		FTXS35BVMA	
			Cooling	Heating	Cooling	Heating
Rated Capacity			2.5kW Class		3.5kW Class	
Front Panel Color			White			
Air Flow Rates	m ³ /min (cfm)	H	7.4 (261)	7.5 (265)	7.4 (261)	7.5 (265)
		M	5.8 (205)	6.3 (222)	5.9 (208)	6.3 (222)
		L	4.1 (145)	5.0 (177)	4.4 (155)	5.2 (184)
		SL	3.6 (127)	4.5 (159)	3.8 (134)	4.6 (162)
Fan	Type	Cross Flow Fan				
	Motor Output	W	18		18	
	Speed	Steps	5 Steps, Silent, Auto		5 Steps, Silent, Auto	
Air Direction Control			Right, Left, Horizontal, Downward		Right, Left, Horizontal, Downward	
Air Filter			Removable-Washable-Mildew Proof		Removable-Washable-Mildew Proof	
Running Current (Rated)		A	0.18	0.18	0.18	0.18
Power Consumption (Rated)		W	40	40	40	40
Power Factor		%	96.6	96.6	96.6	96.6
Temperature Control			Microcomputer Control		Microcomputer Control	
Dimensions (HxWxD)		mm	273x784x195		273x784x195	
Packaged Dimensions (HxWxD)		mm	258x834x325		258x834x325	
Weight		kg	8		8	
Gross Weight		kg	11		11	
Operation Sound	H/M/L/SL	dBA	38/32/25/22	38/33/28/25	39/33/26/23	39/34/29/26
Sound Power	H	dBA	—	—	—	—
Heat Insulation			Both Liquid and Gas Pipes		Both Liquid and Gas Pipes	
Piping Connection	Liquid	mm	φ 6.4		φ 6.4	
	Gas	mm	φ 9.5		φ 9.5	
	Drain	mm	φ18.0		φ18.0	
Drawing No.			3D046602		3D046603	

50Hz 230V

Model			FTXS50BVMA(8)		FTXS60BVMA(8)	
			Cooling	Heating	Cooling	Heating
Rated Capacity			5.0kW Class		6.0kW Class	
Front Panel Color			White			
Air Flow Rates	m ³ /min (cfm)	H	11.4 (402)	12.6 (444)	16.2 (573)	17.4 (613)
		M	9.8 (346)	10.9 (385)	13.9 (490)	15.3 (539)
		L	8.7 (306)	9.3 (329)	11.9 (420)	13.1 (464)
		SL	7.7 (271)	8.2 (291)	10.7 (378)	11.7 (412)
Fan	Type	Cross Flow Fan				
	Motor Output	W	40		43	
	Speed	Steps	5 Steps, Silent, Auto		5 Steps, Silent, Auto	
Air Direction Control			Right, Left, Horizontal, Downward		Right, Left, Horizontal, Downward	
Air Filter			Removable-Washable-Mildew Proof		Removable-Washable-Mildew Proof	
Running Current (Rated)		A	0.17	0.17	0.19	0.19
Power Consumption (Rated)		W	40	40	45	45
Power Factor		%	98.0	98.0	98.7	98.7
Temperature Control			Microcomputer Control		Microcomputer Control	
Dimensions (HxWxD)		mm	290x795x238		290x1,050x238	
Packaged Dimensions (HxWxD)		mm	280x840x338		337x1,147x366	
Weight		kg	9		12	
Gross Weight		kg	13		17	
Operation Sound	H/M/L/SL	dBA	44/40/35/32	42/38/33/30	45/41/36/33	44/40/35/32
Sound Power	H	dBA	63	60	63	62
Heat Insulation			Both Liquid and Gas Pipes		Both Liquid and Gas Pipes	
Piping Connection	Liquid	mm	φ 6.4		φ 6.4	
	Gas	mm	φ12.7		φ12.7	
	Drain	mm	φ18.0		φ18.0	
Drawing No.			3D040798		3D040799	

Conversion Formulae

kcal/h=kW×860
 Btu/h=kW×3414
 cfm=m³/min×35.3

50Hz 230V

Model			FTXS71BVMA(8)	
			Cooling	Heating
Rated Capacity			7.1kW Class	
Front Panel Color			White	
Air Flow Rates	m ³ /min (cfm)	H	16.8 (592)	18.7 (660)
		M	14.2 (501)	16.1 (567)
		L	11.9 (420)	13.6 (481)
		SL	11.2 (394)	12.5 (441)
Fan	Type	Cross Flow Fan		
	Motor Output	W	43	
	Speed	Steps	5 Steps, Silent, Auto	
Air Direction Control			Right, Left, Horizontal, Downward	
Air Filter			Removable-Washable-Mildew Proof	
Running Current (Rated)	A	0.21	0.21	
Power Consumption (Rated)	W	50	50	
Power Factor	%	99.2	99.2	
Temperature Control			Microcomputer Control	
Dimensions (HxWxD)	mm	290x1,050x238		
Packaged Dimensions (HxWxD)	mm	337x1,147x366		
Weight	kg	12		
Gross Weight	kg	17		
Operation Sound	H/M/L/SL	dBA	46/42/37/34	46/42/37/34
Sound Power	H	dBA	63	63
Heat Insulation			Both Liquid and Gas Pipes	
Piping Connection	Liquid	mm	φ 6.4	
	Gas	mm	φ15.9	
	Drain	mm	φ18.0	
Drawing No.			3D040800	

Conversion Formulae
kcal/h=kW×860
Btu/h=kW×3414
cfm=m ³ /min×35.3

Duct Connected Type

50Hz 220-230-240V / 60Hz 220-230V

Model			CDXD25CVMA		CDXD35CVMA	
			Cooling	Heating	Cooling	Heating
Rated Capacity			2.5kW Class		3.5kW Class	
Front Panel Color			—		—	
Air Flow Rates	m ³ /min (cfm)	H	9.5 (335)	9.5 (335)	10.0 (353)	10.0 (353)
		M	8.8 (311)	8.8 (311)	9.3 (328)	9.3 (328)
		L	8.0 (282)	8.0 (282)	8.5 (300)	8.5 (300)
		SL	6.7 (237)	6.7 (237)	7.0 (247)	7.0 (247)
Fan	Type	Sirocco Fan		Sirocco Fan		
	Motor Output	W	62		62	
	Speed	Steps	5 Steps, Silent, Auto		5 Steps, Silent, Auto	
Running Current (Rated)		A	0.47-0.47-0.48/0.52-0.53	0.47-0.47-0.48/0.52-0.53	0.47-0.48-0.48/0.53-0.54	0.47-0.48-0.48/0.53-0.54
Power Consumption (Rated)		W	97-100-107/108-113	97-100-107/108-113	97-100-107/110-113	97-100-107/110-113
Power Factor		%	93.8-92.5-92.9/94.4-92.7	93.8-92.5-92.9/94.4-92.7	93.8-90.6-92.9/94.3-91.0	93.8-90.6-92.9/94.3-91.0
Temperature Control			Microcomputer Control		Microcomputer Control	
Dimensions (HxWxD)		mm	200x900x620		200x900x620	
Packaged Dimensions (HxWxD)		mm	266x1,106x751		266x1,106x751	
Weight		kg	25		25	
Gross Weight		kg	31		31	
Operation Sound	H/M/L/SL	dBA	35/33/31/29	35/33/31/29	35/33/31/29	35/33/31/29
External Static Pressure		Pa	40		40	
Heat Insulation			Both Liquid and Gas Pipes		Both Liquid and Gas Pipes	
Piping Connection	Liquid	mm	φ 6.4		φ 6.4	
	Gas	mm	φ 9.5		φ 12.7	
	Drain	mm	VP20 (O.D.φ 26 / I.D.φ 20)		VP20 (O.D.φ 26 / I.D.φ 20)	
Drawing No.			3D046069A		3D046070A	

Model			CDXD50CVMA		CDXD60CVMA	
			Cooling	Heating	Cooling	Heating
Rated Capacity			5.0kW Class		6.0kW Class	
Front Panel Color			—		—	
Air Flow Rates	m ³ /min (cfm)	H	12.0 (424)	12.0 (424)	16.0 (565)	16.0 (565)
		M	11.0 (388)	11.0 (388)	14.8 (523)	14.8 (523)
		L	10.0 (353)	10.0 (353)	13.5 (477)	13.5 (477)
		SL	8.4 (297)	8.4 (297)	11.2 (395)	11.2 (395)
Fan	Type	Sirocco Fan		Sirocco Fan		
	Motor Output	W	130		130	
	Speed	Steps	5 Steps, Silent, Auto		5 Steps, Silent, Auto	
Running Current (Rated)		A	0.65-0.66-0.67/0.79-0.80	0.65-0.66-0.67/0.79-0.80	0.74-0.75-0.75/0.89-0.90	0.74-0.75-0.75/0.89-0.90
Power Consumption (Rated)		W	133-140-150/164-167	133-140-150/164-167	152-160-168/185-187	152-160-168/185-187
Power Factor		%	93.0-92.2-93.3/94.4-90.8	93.0-92.2-93.3/94.4-90.8	93.4-92.8-93.3/94.5-90.3	93.4-92.8-93.3/94.5-90.3
Temperature Control			Microcomputer Control		Microcomputer Control	
Dimensions (HxWxD)		mm	200x900x620		200x1,100x620	
Packaged Dimensions (HxWxD)		mm	266x1,106x751		266x1,306x751	
Weight		kg	27		30	
Gross Weight		kg	33		36	
Operation Sound	H/M/L/SL	dBA	37/35/33/31	37/35/33/31	38/36/34/32	38/36/34/32
External Static Pressure		Pa	40		40	
Heat Insulation			Both Liquid and Gas Pipes		Both Liquid and Gas Pipes	
Piping Connection	Liquid	mm	φ 6.4		φ 6.4	
	Gas	mm	φ 12.7		φ 15.9	
	Drain	mm	VP20 (O.D.φ 26 / I.D.φ 20)		VP20 (O.D.φ 26 / I.D.φ 20)	
Drawing No.			3D046071A		3D046072A	

- Notes:**
- The operating sound is based on the rear side suction inlet and the external static pressure 40 Pa. Operating sound for under side suction inlet:[operating sound for rear side suction inlet]+5 dB. However, when installation to which the external static pressure becomes low is carried out, 5 dB or more may go up.

Conversion Formulae
kcal/h=kWx860
Btu/h=kWx3414
cfm=m ³ /minx35.3

Model			CDXS25CVMB		CDXS35CVMB	
			Cooling	Heating	Cooling	Heating
Rated Capacity			2.5kW Class		3.5kW Class	
Front Panel Color			—		—	
Air Flow Rates	m ³ /min (cfm)	H	9.5 (335)	9.5 (335)	10.0 (353)	10.0 (353)
		M	8.8 (311)	8.8 (311)	9.3 (328)	9.3 (328)
		L	8.0 (282)	8.0 (282)	8.5 (300)	8.5 (300)
		SL	6.7 (237)	6.7 (237)	7.0 (247)	7.0 (247)
Fan	Type	Sirocco Fan		Sirocco Fan		
	Motor Output	W	62		62	
	Speed	Steps	5 Steps, Silent, Auto		5 Steps, Silent, Auto	
Air Filter			Removable-Washable-Mildew Proof		Removable-Washable-Mildew Proof	
Running Current (Rated)		A	0.47	0.47	0.47	0.47
Power Consumption (Rated)		W	100	100	100	100
Power Factor		%	92.5	92.5	92.5	92.5
Temperature Control			Microcomputer Control		Microcomputer Control	
Dimensions (HxWxD)		mm	200x900x620		200x900x620	
Packaged Dimensions (HxWxD)		mm	266x1,106x751		266x1,106x751	
Weight		kg	25		25	
Gross Weight		kg	31		31	
Operation Sound	H/M/L/SL	dBA	35/33/31/29	35/33/31/29	35/33/31/29	35/33/31/29
External Static Pressure		Pa	40		40	
Heat Insulation			Both Liquid and Gas Pipes		Both Liquid and Gas Pipes	
Piping Connection	Liquid	mm	φ 6.4		φ 6.4	
	Gas	mm	φ 9.5		φ 9.5	
	Drain	mm	VP20 (O.D. φ 26 / I.D. φ 20)		VP20 (O.D. φ 26 / I.D. φ 20)	
Drawing No.			3D046061A		3D046062A	

Model			CDXS50CVMB		CDXS60CVMB	
			Cooling	Heating	Cooling	Heating
Rated Capacity			5.0kW Class		6.0kW Class	
Front Panel Color			—		—	
Air Flow Rates	m ³ /min (cfm)	H	12.0 (424)	12.0 (424)	16.0 (565)	16.0 (565)
		M	11.0 (388)	11.0 (388)	14.8 (523)	14.8 (523)
		L	10.0 (353)	10.0 (353)	13.5 (477)	13.5 (477)
		SL	8.4 (297)	8.4 (297)	11.2 (395)	11.2 (395)
Fan	Type	Sirocco Fan		Sirocco Fan		
	Motor Output	W	130		130	
	Speed	Steps	5 Steps, Silent, Auto		5 Steps, Silent, Auto	
Air Filter			Removable-Washable-Mildew Proof		Removable-Washable-Mildew Proof	
Running Current (Rated)		A	0.64	0.64	0.74	0.74
Power Consumption (Rated)		W	140	140	160	160
Power Factor		%	95.1	95.1	94.0	94.0
Temperature Control			Microcomputer Control		Microcomputer Control	
Dimensions (HxWxD)		mm	200x900x620		200x1,100x620	
Packaged Dimensions (HxWxD)		mm	266x1,106x751		266x1,306x751	
Weight		kg	27		30	
Gross Weight		kg	34		37	
Operation Sound	H/M/L/SL	dBA	37/35/33/31	37/35/33/31	38/36/34/32	38/36/34/32
External Static Pressure		Pa	40		40	
Heat Insulation			Both Liquid and Gas Pipes		Both Liquid and Gas Pipes	
Piping Connection	Liquid	mm	φ 6.4		φ 6.4	
	Gas	mm	φ 12.7		φ 12.7	
	Drain	mm	VP20 (O.D. φ 26 / I.D. φ 20)		VP20 (O.D. φ 26 / I.D. φ 20)	
Drawing No.			3D046063A		3D046064A	

- Notes:**
- The operating sound is based on the rear side suction inlet and the external static pressure 40 Pa. Operating sound for under side suction inlet:[operating sound for rear side suction inlet]+5 dB. However, when installation to which the external static pressure becomes low is carried out, 5 dB or more may go up.

<p>Conversion Formulae</p> <p>kcal/h=kWx860</p> <p>Btu/h=kWx3414</p> <p>cfm=m³/minx35.3</p>
--

50Hz 230V

Model			CDXS25CVMA		CDXS35CVMA	
			Cooling	Heating	Cooling	Heating
Rated Capacity			2.5kW Class		3.5kW Class	
Front Panel Color			—		—	
Air Flow Rates	m ³ /min (cfm)	H	9.5 (335)	9.5 (335)	10.0 (353)	10.0 (353)
		M	8.8 (311)	8.8 (311)	9.3 (328)	9.3 (328)
		L	8.0 (282)	8.0 (282)	8.5 (300)	8.5 (300)
		SL	6.7 (237)	6.7 (237)	7.0 (247)	7.0 (247)
Fan	Type	Sirocco Fan		Sirocco Fan		
	Motor Output	W	62		62	
	Speed	Steps	5 Steps, Silent, Auto		5 Steps, Silent, Auto	
Air Filter			Removable-Washable-Mildew Proof		Removable-Washable-Mildew Proof	
Running Current (Rated)		A	0.47	0.47	0.47	0.47
Power Consumption (Rated)		W	100	100	100	100
Power Factor		%	92.5	92.5	92.5	92.5
Temperature Control			Microcomputer Control		Microcomputer Control	
Dimensions (HxWxD)		mm	200x900x620		200x900x620	
Packaged Dimensions (HxWxD)		mm	266x1,106x751		266x1,106x751	
Weight		kg	25		25	
Gross Weight		kg	31		31	
Operation Sound	H/M/L/SL	dBA	35/33/31/29	35/33/31/29	35/33/31/29	35/33/31/29
Sound Power	H	dBA	—	—	—	—
Heat Insulation			Both Liquid and Gas Pipes		Both Liquid and Gas Pipes	
Piping Connection	Liquid	mm	φ 6.4		φ 6.4	
	Gas	mm	φ 9.5		φ 9.5	
	Drain	mm	VP20 (O.D φ 26 / I.D φ 20)		VP20 (O.D φ 26 / I.D φ 20)	
Drawing No.			3D046469		3D046470	

Model			CDXS50CVMA		CDXS60CVMA	
			Cooling	Heating	Cooling	Heating
Rated Capacity			5.0kW Class		6.0kW Class	
Front Panel Color			—		—	
Air Flow Rates	m ³ /min (cfm)	H	12.0 (424)	12.0 (424)	16.0 (565)	16.0 (565)
		M	11.0 (388)	11.0 (388)	14.8 (523)	14.8 (523)
		L	10.0 (353)	10.0 (353)	13.5 (477)	13.5 (477)
		SL	8.4 (297)	8.4 (297)	11.2 (395)	11.2 (395)
Fan	Type	Sirocco Fan		Sirocco Fan		
	Motor Output	W	130		130	
	Speed	Steps	5 Steps, Silent, Auto		5 Steps, Silent, Auto	
Air Filter			Removable-Washable-Mildew Proof		Removable-Washable-Mildew Proof	
Running Current (Rated)		A	0.64	0.64	0.74	0.74
Power Consumption (Rated)		W	140	140	160	160
Power Factor		%	95.1	95.1	94.0	94.0
Temperature Control			Microcomputer Control		Microcomputer Control	
Dimensions (HxWxD)		mm	200x900x620		200x1,100x620	
Packaged Dimensions (HxWxD)		mm	266x1,106x751		266x1,306x751	
Weight		kg	27		30	
Gross Weight		kg	34		37	
Operation Sound	H/M/L/SL	dBA	37/35/33/31	37/35/33/31	38/36/34/32	38/36/34/32
Sound Power	H	dBA	—	—	—	—
Heat Insulation			Both Liquid and Gas Pipes		Both Liquid and Gas Pipes	
Piping Connection	Liquid	mm	φ 6.4		φ 6.4	
	Gas	mm	φ 12.7		φ 12.7	
	Drain	mm	VP20 (O.D φ 26 / I.D φ 20)		VP20 (O.D φ 26 / I.D φ 20)	
Drawing No.			3D046471		3D046472	

Conversion Formulae

kcal/h=kW×860
 Btu/h=kW×3414
 cfm=m³/min×35.3

Floor / Ceiling Suspended Dual Type

50Hz 220-230-240V / 60Hz 220-230V

Model			FLX25AVMA		FLX35AVMA	
			Cooling	Heating	Cooling	Heating
Rated Capacity			2.5kW Class		3.5kW Class	
Front Panel Color			Almond White			
Air Flow Rates	m ³ /min (cfm)	H	7.6 (268)	9.2 (325)	8.7 (307)	10.0 (353)
		M	6.8 (240)	8.3 (293)	7.7 (272)	9.0 (318)
		L	6.0 (212)	7.4 (261)	6.6 (233)	8.0 (282)
		SL	5.2 (184)	6.6 (233)	5.6 (198)	7.1 (251)
Fan	Type	Sirocco Fan				
	Motor Output	W	34			
	Speed	Steps	5 Steps, Silent, Auto			
Air Direction Control			Right, Left, Horizontal, Downward		Right, Left, Horizontal, Downward	
Air Filter			Removal-Washable-Mildew Proof			
Running Current (Rated)	A	0.32-0.32-0.32/0.34-0.34	0.34-0.34-0.34/0.37-0.37	0.36-0.36-0.36/0.39-0.39	0.36-0.36-0.36/0.39-0.39	
Power Consumption (Rated)	W	68-70-72/72-74	72-74-76/76-79	76-78-80/80-84	76-78-80/80-83	
Power Factor	%	96.6-95.1-93.8/96.3-94.6	96.3-94.6-93.1/93.4-92.8	96.0-94.2-92.6/93.2-93.6	96.0-94.2-92.6/93.2-92.5	
Temperature Control			Microcomputer Control			
Dimensions (HxWxD)	mm	490x1,050x200				
Packaged Dimensions (HxWxD)	mm	280x1,100x566				
Weight	kg	16				
Gross Weight	kg	22				
Operation Sound	H/M/L/SL	dBA	37/34/31/28	37/34/31/28	38/35/32/29	39/36/33/30
Heat Insulation			Both Liquid and Gas Pipes			
Piping Connection	Liquid	mm	φ 6.4			
	Gas	mm	φ 9.5			
	Drain	mm	φ 18.0			
Drawing No.			3D036690		3D036691	

Model			FLX50AVMA		FLX60AVMA	
			Cooling	Heating	Cooling	Heating
Rated Capacity			5.0kW Class		5.7kW Class	
Front Panel Color			Almond White			
Air Flow Rates	m ³ /min (cfm)	H	11.4 (402)	12.1 (427)	12.0 (424)	12.8 (452)
		M	10.0 (353)	9.8 (346)	10.6 (374)	10.6 (374)
		L	8.5 (300)	7.5 (265)	9.3 (328)	8.4 (297)
		SL	7.5 (265)	6.8 (240)	8.3 (293)	7.5 (265)
Fan	Type	Sirocco Fan				
	Motor Output	W	34			
	Speed	Steps	5 Steps, Silent, Auto			
Air Direction Control			Right, Left, Horizontal, Downward		Right, Left, Horizontal, Downward	
Air Filter			Removal-Washable-Mildew Proof			
Running Current (Rated)	A	0.45-0.45-0.45/0.48-0.48	0.45-0.45-0.45/0.48-0.48	0.47-0.47-0.47/0.51-0.51	0.45-0.45-0.45/0.48-0.48	
Power Consumption (Rated)	W	94-96-98/98-100	94-96-98/98-100	96-98-100/100-104	94-96-98/98-101	
Power Factor	%	94.9-92.8-90.7/92.8-90.6	94.9-92.8-90.7/92.8-90.6	92.8-90.7-88.7/89.1-88.7	94.9-92.8-90.7/92.8-91.5	
Temperature Control			Microcomputer Control			
Dimensions (HxWxD)	mm	490x1,050x200				
Packaged Dimensions (HxWxD)	mm	280x1,100x566				
Weight	kg	17				
Gross Weight	kg	24				
Operation Sound	H/M/L/SL	dBA	47/43/39/36	46/41/35/32	48/45/41/38	47/42/37/34
Heat Insulation			Both Liquid and Gas Pipes			
Piping Connection	Liquid	mm	φ 6.4			
	Gas	mm	φ 12.7			
	Drain	mm	φ 18.0			
Drawing No.			3D036692		3D036693	

Conversion Formulae
kcal/h=kWx860
Btu/h=kWx3414
cfm=m ³ /minx35.3

50Hz 230V

Model			FLXS25BVMB		FLXS35BVMB	
			Cooling	Heating	Cooling	Heating
Rated Capacity			2.5kW Class		3.5kW Class	
Front Panel Color			Almond White		Almond White	
Air Flow Rates	m ³ /min (cfm)	H	7.6 (268)	9.2 (325)	8.6 (304)	9.8 (346)
		M	6.8 (240)	8.3 (293)	7.6 (268)	8.9 (314)
		L	6.0 (212)	7.4 (261)	6.6 (233)	8.0 (282)
		SL	5.2 (184)	6.6 (233)	5.6 (198)	7.2 (254)
Fan	Type	Sirocco Fan		Sirocco Fan		
	Motor Output	W	34		34	
	Speed	Steps	5 Steps, Silent, Auto		5 Steps, Silent, Auto	
Air Direction Control			Right, Left, Horizontal, Downward		Right, Left, Horizontal, Downward	
Air Filter			Removable-Washable-Mildew Proof		Removable-Washable-Mildew Proof	
Running Current (Rated)	A	0.32	0.34	0.36	0.36	
Power Consumption (Rated)	W	70	74	78	78	
Power Factor	%	95.1	94.6	94.2	94.2	
Temperature Control			Microcomputer Control		Microcomputer Control	
Dimensions (HxWxD)	mm	490x1,050x200		490x1,050x200		
Packaged Dimensions (HxWxD)	mm	280x1,100x566		280x1,100x566		
Weight	kg	16		16		
Gross Weight	kg	22		22		
Operation Sound	H/M/L/SL	dBA	37/34/31/28	37/34/31/29	38/35/32/29	39/36/33/30
Sound Power	H	dBA	53	—	54	—
Heat Insulation			Both Liquid and Gas Pipes		Both Liquid and Gas Pipes	
Piping Connection	Liquid	mm	φ 6.4		φ 6.4	
	Gas	mm	φ 9.5		φ 9.5	
	Drain	mm	φ18.0		φ18.0	
Drawing No.			3D040174A		3D040175A	

Model			FLXS50BVMB		FLXS60BVMB	
			Cooling	Heating	Cooling	Heating
Rated Capacity			5.0kW Class		5.7kW Class	
Front Panel Color			Almond White		Almond White	
Air Flow Rates	m ³ /min (cfm)	H	11.4 (402)	12.1 (427)	12.0 (424)	12.8 (452)
		M	10.0 (353)	9.8 (346)	10.7 (378)	10.6 (374)
		L	8.5 (300)	7.5 (265)	9.3 (328)	8.4 (297)
		SL	7.5 (265)	6.8 (240)	8.3 (293)	7.5 (265)
Fan	Type	Sirocco Fan		Sirocco Fan		
	Motor Output	W	34		34	
	Speed	Steps	5 Steps, Silent, Auto		5 Steps, Silent, Auto	
Air Direction Control			Right, Left, Horizontal, Downward		Right, Left, Horizontal, Downward	
Air Filter			Removable-Washable-Mildew Proof		Removable-Washable-Mildew Proof	
Running Current (Rated)	A	0.45	0.45	0.47	0.45	
Power Consumption (Rated)	W	96	96	98	96	
Power Factor	%	92.8	92.8	90.7	92.8	
Temperature Control			Microcomputer Control		Microcomputer Control	
Dimensions (HxWxD)	mm	490x1,050x200		490x1,050x200		
Packaged Dimensions (HxWxD)	mm	280x1,100x566		280x1,100x566		
Weight	kg	17		17		
Gross Weight	kg	24		24		
Operation Sound	H/M/L/SL	dBA	47/43/39/36	46/41/35/33	48/45/41/39	47/42/37/34
Sound Power	H	dBA	63	32	64	63
Heat Insulation			Both Liquid and Gas Pipes		Both Liquid and Gas Pipes	
Piping Connection	Liquid	mm	φ 6.4		φ 6.4	
	Gas	mm	φ12.7		φ12.7	
	Drain	mm	φ18.0		φ18.0	
Drawing No.			3D040826		3D040827A	

Conversion Formulae
kcal/h=kWx860
Btu/h=kWx3414
cfm=m ³ /minx35.3

Model			FLXS25BVMA		FLXS35BVMA	
			Cooling	Heating	Cooling	Heating
Rated Capacity			2.5kW Class		3.5kW Class	
Front Panel Color			Almond White		Almond White	
Air Flow Rates	m ³ /min (cfm)	H	7.6 (268)	9.2 (325)	8.6 (304)	9.8 (346)
		M	6.8 (240)	8.3 (293)	7.6 (268)	8.9 (314)
		L	6.0 (212)	7.4 (261)	6.6 (233)	8.0 (282)
		SL	5.2 (184)	6.6 (233)	5.6 (198)	7.2 (254)
Fan	Type	Sirocco Fan		Sirocco Fan		
	Motor Output	W	34		34	
	Speed	Steps	5 Steps, Silent, Auto		5 Steps, Silent, Auto	
Air Direction Control			Right, Left, Horizontal, Downward		Right, Left, Horizontal, Downward	
Air Filter			Removable-Washable-Mildew Proof		Removable-Washable-Mildew Proof	
Running Current (Rated)	A	0.32	0.34	0.36	0.36	
Power Consumption (Rated)	W	70	74	78	78	
Power Factor	%	95.1	94.6	94.2	94.2	
Temperature Control			Microcomputer Control		Microcomputer Control	
Dimensions (HxWxD)	mm	490x1,050x200		490x1,050x200		
Packaged Dimensions (HxWxD)	mm	280x1,100x566		280x1,100x566		
Weight	kg	16		16		
Gross Weight	kg	22		22		
Operation Sound	H/M/L/SL	dBA	37/34/31/28	37/34/31/29	38/35/32/29	39/36/33/30
Sound Power	H	dBA	—	—	—	—
Heat Insulation			Both Liquid and Gas Pipes		Both Liquid and Gas Pipes	
Piping Connection	Liquid	mm	φ 6.4		φ 6.4	
	Gas	mm	φ 9.5		φ 9.5	
	Drain	mm	φ18.0		φ18.0	
Drawing No.			3D046600		3D046601	

Model			FLXS50BVMA		FLXS60BVMA	
			Cooling	Heating	Cooling	Heating
Rated Capacity			5.0kW Class		5.7kW Class	
Front Panel Color			Almond White		Almond White	
Air Flow Rates	m ³ /min (cfm)	H	11.4 (402)	12.1 (427)	12.0 (424)	12.8 (452)
		M	10.0 (353)	9.8 (346)	10.7 (378)	10.6 (374)
		L	8.5 (300)	7.5 (265)	9.3 (328)	8.4 (297)
		SL	7.5 (265)	6.8 (240)	8.3 (293)	7.5 (265)
Fan	Type	Sirocco Fan		Sirocco Fan		
	Motor Output	W	34		34	
	Speed	Steps	5 Steps, Silent, Auto		5 Steps, Silent, Auto	
Air Direction Control			Right, Left, Horizontal, Downward		Right, Left, Horizontal, Downward	
Air Filter			Removable-Washable-Mildew Proof		Removable-Washable-Mildew Proof	
Running Current (Rated)	A	0.45	0.45	0.47	0.45	
Power Consumption (Rated)	W	96	96	98	96	
Power Factor	%	92.8	92.8	90.7	92.8	
Temperature Control			Microcomputer Control		Microcomputer Control	
Dimensions (HxWxD)	mm	490x1,050x200		490x1,050x200		
Packaged Dimensions (HxWxD)	mm	280x1,100x566		280x1,100x566		
Weight	kg	17		17		
Gross Weight	kg	24		24		
Operation Sound	H/M/L/SL	dBA	47/43/39/36	46/41/35/33	48/45/41/39	47/42/37/34
Sound Power	H	dBA	—	—	—	—
Heat Insulation			Both Liquid and Gas Pipes		Both Liquid and Gas Pipes	
Piping Connection	Liquid	mm	φ 6.4		φ 6.4	
	Gas	mm	φ12.7		φ12.7	
	Drain	mm	φ18.0		φ18.0	
Drawing No.			3D046571		3D046572	

Conversion Formulae
kcal/h=kWx860
Btu/h=kWx3414
cfm=m ³ /minx35.3

Floor Standing Type

50Hz 230V

Model			FVXS25BVMB		FVXS35BVMB	
			Cooling	Heating	Cooling	Heating
Rated Capacity			2.5kW Class		3.5kW Class	
Front Panel Color			Almond White		Almond White	
Air Flow Rates	m ³ /min (cfm)	H	8.1 (286)	9.2 (325)	8.3 (293)	9.2 (325)
		M	6.2 (219)	7.0 (247)	6.3 (222)	7.1 (251)
		L	4.3 (152)	4.8 (169)	4.3 (152)	5.0 (177)
		SL	3.4 (120)	3.5 (124)	3.4 (120)	3.6 (127)
Fan	Type	Cross Flow Fan		Cross Flow Fan		
	Motor Output	W	14+14		14+14	
	Speed	Steps	5 Steps, Silent, Auto		5 Steps, Silent, Auto	
Air Direction Control			Right, Left, Horizontal, Upward		Right, Left, Horizontal, Upward	
Air Filter			Removable-Washable-Mildew Proof		Removable-Washable-Mildew Proof	
Running Current (Rated)	A	0.14	0.14	0.14	0.14	
Power Consumption (Rated)	W	32	32	32	32	
Power Factor	%	99.4	99.4	99.4	99.4	
Temperature Control			Microcomputer Control		Microcomputer Control	
Dimensions (HxWxD)	mm	600x650x195		600x650x195		
Packaged Dimensions (HxWxD)	mm	714x770x294		714x770x294		
Weight	kg	13		13		
Gross Weight	kg	19		19		
Operation Sound	H/M/L/SL	dBA	38/32/26/23	38/32/26/23	39/33/27/24	39/34/29/26
Sound Power	H	dBA	54	—	55	—
Heat Insulation			Both Liquid and Gas Pipes		Both Liquid and Gas Pipes	
Piping Connection	Liquid	mm	φ 6.4		φ 6.4	
	Gas	mm	φ 9.5		φ 9.5	
	Drain	mm	φ18.0		φ18.0	
Drawing No.			3D040172A		3D040173A	

Model			FVXS50BVMB	
			Cooling	Heating
Rated Capacity			5.0kW Class	
Front Panel Color			Almond White	
Air Flow Rates	m ³ /min (cfm)	H	10.8 (381)	13.2 (466)
		M	9.2 (325)	11.3 (399)
		L	7.7 (272)	9.4 (332)
		SL	6.7 (237)	8.3 (293)
Fan	Type	Cross Flow Fan		
	Motor Output	W	14+14	
	Speed	Steps	5 Steps, Silent, Auto	
Air Direction Control			Right, Left, Horizontal, Upward	
Air Filter			Removable-Washable-Mildew Proof	
Running Current (Rated)	A	0.26	0.32	
Power Consumption (Rated)	W	55	70	
Power Factor	%	92.0	95.1	
Temperature Control			Microcomputer Control	
Dimensions (HxWxD)	mm	600x650x195		
Packaged Dimensions (HxWxD)	mm	714x770x294		
Weight	kg	13		
Gross Weight	kg	19		
Operation Sound	H/M/L/SL	dBA	44/40/36/33	45/40/36/33
Sound Power	H	dBA	56	57
Heat Insulation			Both Liquid and Gas Pipes	
Piping Connection	Liquid	mm	φ 6.4	
	Gas	mm	φ12.7	
	Drain	mm	φ20.0	
Drawing No.			3D040831	

Conversion Formulae

kcal/h=kWx860
 Btu/h=kWx3414
 cfm=m³/minx35.3

50Hz 230V

Model			FVXS35BVMA		FVXS50BVMA	
			Cooling	Heating	Cooling	Heating
Rated Capacity			3.5kW Class		5.0kW Class	
Front Panel Color			Almond White		Almond White	
Air Flow Rates	m ³ /min (cfm)	H	8.3 (293)	9.2 (325)	10.8 (381)	13.2 (466)
		M	6.3 (222)	7.1 (251)	9.2 (325)	11.3 (399)
		L	4.3 (152)	5.0 (177)	7.7 (272)	9.4 (332)
		SL	3.4 (120)	3.6 (127)	6.7 (237)	8.3 (293)
Fan	Type	Cross Flow Fan		Cross Flow Fan		
	Motor Output	W	14+14		14+14	
	Speed	Steps	5 Steps, Silent, Auto		5 Steps, Silent, Auto	
Air Direction Control			Right, Left, Horizontal, Upward		Right, Left, Horizontal, Upward	
Air Filter			Removable-Washable-Mildew Proof		Removable-Washable-Mildew Proof	
Running Current (Rated)		A	0.14	0.14	0.26	0.32
Power Consumption (Rated)		W	32	32	55	70
Power Factor		%	99.4	99.4	92.0	95.1
Temperature Control			Microcomputer Control		Microcomputer Control	
Dimensions (HxWxD)		mm	600x650x195		600x650x195	
Packaged Dimensions (HxWxD)		mm	714x770x294		714x770x294	
Weight		kg	13		13	
Gross Weight		kg	19		19	
Operation Sound	H/M/L/SL	dBA	39/33/27/24	39/33/26/23	44/40/36/33	45/40/36/33
Sound Power	H	dBA	—	—	—	—
Heat Insulation			Both Liquid and Gas Pipes		Both Liquid and Gas Pipes	
Piping Connection	Liquid	mm	φ 6.4		φ 6.4	
	Gas	mm	φ 9.5		φ12.7	
	Drain	mm	φ20.0		φ20.0	
Drawing No.			3D046650		3D046661, 3D040832	

Conversion Formulae
kcal/h=kWx860
Btu/h=kWx3414
cfm=m ³ /minx35.3

1.4 Outdoor Units - Heat Pump

50Hz 220-240V / 60Hz 220-230V

Model		3MXD68BVMA		4MXD80BVMA		
		Cooling	Heating	Cooling	Heating	
Cooling Capacity	kW	—		—		
Power Consumption	W	—		—		
Running Current	A	—		—		
Casing Color		Ivory White		Pale Ivory		
Compressor	Type	Hermetically Sealed Swing Type		Hermetically Sealed Swing Type		
	Model	2YC45ZXD		2YC45ZXD		
Refrigerant Oil	Motor Output	W	1,380	1,380		
	Model		SUNISO 4GSD.I.	SUNISO 4GSD.I.		
Refrigerant	Charge	L	0.75	0.75		
	Type		R22	R22		
Air Flow Rates	m ³ /min	H	51	47.6	48.5	45
		L	45	45	42	42
	cfm	H	1,472	1,374	1,400	1,299
		L	1,299	1,299	1,212	1,212
Fan	Type	Propeller		Propeller		
	Motor Output	W	53	51		
	Running Current	A	H: 0.33 / L: 0.25		H: 0.44 / L: 0.34	
	Power Consumption	W	H: 68 / L: 46		H: 60 / L: 41	
Starting Current	A	10.1		10.2		
Dimensions (HxWxD)	mm	735x936x300		908x900x320		
Packaged Dimensions (HxWxD)	mm	784x960x357		942x926x394		
Weight	kg	59		73		
Gross Weight	kg	63		80		
Operation Sound	dBA	48	49	48	49	
Piping Connection	Liquid	mm	φ 6.4x3		φ 6.4x3, φ 9.5x1	
	Gas	mm	φ12.7x2, φ15.9x1		φ 9.5x1, φ12.7x1, φ15.9x2	
	Drain	mm	φ16.0		φ 25.0	
Heat Insulation		Both Liquid and Gas Pipes		Both Liquid and Gas Pipes		
No. of Wiring Connection		3 for Power Supply, 4 for Interunit Wiring		3 for Power Supply, 4 for Interunit Wiring		
Max. Interunit Piping Length	m	45 (for Total of Each Room)		70 (for Total of Each Room)		
	m	25 (for One Room)		25 (for One Room)		
Amount of Additional Charge	g/m	20 (30m or more)		20 (40m or more)		
Max. Installation Height Difference	m	15 (between Indoor Unit and Outdoor Unit)		15 (between Indoor Unit and Outdoor Unit)		
	m	7.5 (between Indoor Units)		7.5 (between Indoor Units)		
Drawing No.		3D039671#1		3D039672#1		

Notes: 1. The data are based on the conditions shown in the table below.

Cooling	Heating	Piping Length
Indoor ; 27°CDB/19°CWB Outdoor ; 35°CDB	Indoor ; 20°CDB Outdoor ; 7°CDB/6°CWB	7.5m

Conversion Formulae
kcal/h=kWx860 Btu/h=kWx3414 cfm=m ³ /minx35.3

50Hz 230V

Model			3MXS52BVMB(8)		4MXS68BVMB9	
			Cooling	Heating	Cooling	Heating
Cooling Capacity	kW	—		—		
Power Consumption	W	—		—		
Running Current	A	—		—		
Casing Color		Ivory White		Ivory White		
Compressor	Type	Hermetically Sealed Swing Type		Hermetically Sealed Swing Type		
	Model	2YC32HXD		2YC45BXD		
Motor Output	W	980		1,380		
Refrigerant Oil	Model	FVC50K		FVC50K		
	Charge	L	0.65		0.75	
Refrigerant	Type	R410A		R410A		
	Charge	kg	2.0		2.6	
Air Flow Rates	m³/min	H	44	44	51	47.6
		L	37	37	45	45
	cfm	H	1,270	1,270	1,472	1,374
		L	1,068	1,068	1,299	1,299
Fan	Type	Propeller		Propeller		
	Motor Output	W	53		53	
	Running Current	A	H: 0.24 / L: 0.17		H: 0.33 / L: 0.25	
	Power Consumption	W	H: 44 / L: 27		H: 68 / L: 46	
Starting Current	A	6.9		8.5		
Dimensions (HxWxD)	mm	735x936x300		735x936x300		
Packaged Dimensions (HxWxD)	mm	784x960x357		784x960x357		
Weight	kg	55		59		
Gross Weight	kg	59		63		
Operation Sound	dBA	46	47	48	49	
Sound Power	dBA	59	60	61	62	
Piping Connection	Liquid	mm	φ 6.4x3		φ 6.4x4	
	Gas	mm	φ9.5x2, φ12.7x1		φ9.5x2, φ12.7x2	
	Drain	mm	φ18.0		φ18.0	
Heat Insulation		Both Liquid and Gas Pipes		Both Liquid and Gas Pipes		
No. of Wiring Connection		3 for Power Supply, 4 for Interunit Wiring		3 for Power Supply, 4 for Interunit Wiring		
Max. Interunit Piping Length	m	45 (for Total of Each Room)		60 (for Total of Each Room)		
	m	25 (for One Room)		25 (for One Room)		
Amount of Additional Charge	g/m	20 (30m or more)		20 (30m or more)		
Max. Installation Height Difference	m	15 (between Indoor Unit and Outdoor Unit)		15 (between Indoor Unit and Outdoor Unit)		
	m	7.5 (between Indoor Units)		7.5 (between Indoor Units)		
Drawing No.		3D039603#1		3D039604#1		

Notes: 1. The data are based on the conditions shown in the table below.

Cooling	Heating	Piping Length
Indoor ; 27°CDB/19°CWB Outdoor ; 35°CDB	Indoor ; 20°CDB Outdoor ; 7°CDB/6°CWB	7.5m

Conversion Formulae
kcal/h=kW×860 Btu/h=kW×3414 cfm=m³/min×35.3

50Hz 230V

Model			4MXS80BVM9			
			Cooling		Heating	
Cooling Capacity	kW		—			
Power Consumption	W		—			
Running Current	A		—			
Casing Color	Pale Ivory					
Compressor	Type	Hermetically Sealed Swing Type				
	Model	2YC45BXD				
	Motor Output	W	1,380			
Refrigerant Oil	Model	FVC50K				
	Charge	L	0.75			
Refrigerant	Type	R410A				
	Charge	kg	3.1			
Air Flow Rates	m ³ /min	H	48.5	45		
		L	42	42		
	cfm	H	1,400	1,299		
		L	1,212	1,212		
Fan	Type	Propeller				
	Motor Output	W	51			
	Running Current	A	H: 0.44 / L: 0.34			
	Power Consumption	W	H: 60 / L: 41			
Starting Current	A		8.7			
Dimensions (HxWxD)	mm		908x900x320			
Packaged Dimensions (HxWxD)	mm		942x926x394			
Weight	kg		73			
Gross Weight	kg		80			
Operation Sound	dBA		48	49		
Sound Power	dBA		61	62		
Piping Connection	Liquid	mm	φ 6.4x4			
	Gas	mm	φ 9.5x2, φ12.7x1, φ15.9x1			
	Drain	mm	φ 25.0			
Heat Insulation	Both Liquid and Gas Pipes					
No. of Wiring Connection	3 for Power Supply, 4 for Interunit Wiring					
Max. Interunit Piping Length	m		70 (for Total of Each Room)			
	m		25 (for One Room)			
Amount of Additional Charge	g/m		20 (40m or more)			
Max. Installation Height Difference	m		15 (between Indoor Unit and Outdoor Unit)			
	m		7.5 (between Indoor Units)			
Drawing No.	3D039605#1					

Notes: 1. The data are based on the conditions shown in the table below.

Cooling	Heating	Piping Length
Indoor ; 27°CDB/19°CWB Outdoor ; 35°CDB	Indoor ; 20°CDB Outdoor ; 7°CDB/6°CWB	7.5m

Conversion Formulae
kcal/h=kWx860 Btu/h=kWx3414 cfm=m ³ /minx35.3

230V, 50Hz

Model			3AMXS52BVMB	
			Cooling	Heating
Cooling Capacity	kW	—		
Power Consumption	W	—		
Running Current	A	—		
Casing Color			Ivory White	
Compressor	Type	Hermetically Sealed Swing Type		
	Model	2YC32HXD		
	Motor Output	W	980	
Refrigerant Oil	Model	FVC50K		
	Charge	L	0.65	
Refrigerant	Type	R410A		
	Charge	kg	2.0	
Air Flow Rate	m³/min	HH	—	—
		H	44	44
		L	37	37
	cfm	HH	—	—
		H	1,270	1,270
		L	1,068	1,068
Fan	Type	Propeller		
	Motor Output	W	53	
Starting Current	A	6.9		
Dimension (H×W×D)	mm	735×936×300		
Packaged Dimension (H×W×D)	mm	784×990×400		
Weight	kg	55		
Gross Weight	kg	59		
Operation Sound	Sound Pressure	dBA	46	47
	Silent Mode	dBA	—	—
Sound Power	dBA	59	60	
Piping Connection	Liquid	mm	φ 6.4×3	
	Gas	mm	φ 9.5×2, φ 12.7×1	
	Drain	mm	φ 18.0	
Heat Insulation			Both Liquid and Gas Pipes	
No. of Wiring Connection			3 for Power Supply, 4 for Interunit Wiring	
Max. Piping Length	m	45 (for Total of Each Room) 25 (for One Room)		
Min. Piping Length	m	—		
Amount of Additional Charge	g/m	20 (30m or more)		
Max. Installation Height Difference	m	15 (between Indoor Unit and Outdoor Unit)		
		7.5 (between Indoor Units)		
Drawing No.			3D044977#1	

Notes: 1. The data are based on the conditions shows in the table below.

Cooling	Heating	Piping Length
Indoor ; 27°CDB/19°CWB Outdoor ; 35°CDB	Indoor ; 20°CDB Outdoor ; 7°CDB/6°CWB	7.5m

Conversion Formulae
kcal/h=kW×860 Btu/h=kW×3414 cfm=m³/min×35.3

50Hz 230V

Model			4MXS68CVMA		4MXS80CVMA	
			Cooling	Heating	Cooling	Heating
Cooling Capacity	kW	—		—		
Power Consumption	W	—		—		
Running Current	A	—		—		
Casing Color		Ivory White		Pale Ivory		
Compressor	Type	Hermetically Sealed Swing Type		Hermetically Sealed Swing Type		
	Model	2YC45BXD		2YC45BXD		
Motor Output	W	1,380		1,380		
Refrigerant Oil	Model	FVC50K		FVC50K		
	Charge	L	0.75		0.75	
Refrigerant	Type	R410A		R410A		
	Charge	kg	2.6		3.1	
Air Flow Rates	m ³ /min	H	51	47.6	48.5	45
		L	45	45	42	42
	cfm	H	1,472	1,374	1,400	1,299
		L	1,299	1,299	1,212	1,212
Fan	Type	Propeller		Propeller		
	Motor Output	W	53		51	
	Running Current	A	H: 0.33 / L: 0.25		H: 0.44 / L: 0.34	
	Power Consumption	W	H: 68 / L: 46		H: 60 / L: 41	
Starting Current	A	8.5		8.7		
Dimensions (HxWxD)	mm	735x936x300		908x900x320		
Packaged Dimensions (HxWxD)	mm	784x960x357		1,025x926x388		
Weight	kg	59		73		
Gross Weight	kg	63		80		
Operation Sound	dBA	48	49	48	49	
Sound Power	dBA	61	62	61	62	
Piping Connection	Liquid	mm	φ 6.4x4		φ 6.4x4	
	Gas	mm	φ9.5x2, φ12.7x2		φ 9.5x2, φ12.7x1, φ15.9x1	
	Drain	mm	φ18.0		φ 25.0	
Heat Insulation		Both Liquid and Gas Pipes		Both Liquid and Gas Pipes		
No. of Wiring Connection		3 for Power Supply, 4 for Interunit Wiring		3 for Power Supply, 4 for Interunit Wiring		
Max. Interunit Piping Length	m	60 (for Total of Each Room)		70 (for Total of Each Room)		
	m	25 (for One Room)		25 (for One Room)		
Amount of Additional Charge	g/m	20 (30m or more)		20 (40m or more)		
Max. Installation Height Difference	m	15 (between Indoor Unit and Outdoor Unit)		15 (between Indoor Unit and Outdoor Unit)		
	m	7.5 (between Indoor Units)		7.5 (between Indoor Units)		
Drawing No.		—		3D046668		

Notes: 1. The data are based on the conditions shown in the table below.

Cooling	Heating	Piping Length
Indoor ; 27°CDB/19°CWB Outdoor ; 35°CDB	Indoor ; 20°CDB Outdoor ; 7°CDB/6°CWB	7.5m

Conversion Formulae
kcal/h=kW×860 Btu/h=kW×3414 cfm=m ³ /min×35.3

Part 3

Printed Circuit Board

Connector Wiring Diagram

- 1. Printed Circuit Board Connector Wiring Diagram.....58
 - 1.1 Wall Mounted Type 20/25/35 Class58
 - 1.2 Wall Mounted Type 50/60/71 Class61
 - 1.3 Duct Connected Type.....63
 - 1.4 Floor / Ceiling Suspended Dual Type.....64
 - 1.5 Floor Standing Type66
 - 1.6 Outdoor Units69

1. Printed Circuit Board Connector Wiring Diagram

1.1 Wall Mounted Type 20/25/35 Class

Connectors

- | | |
|--------|--|
| 1) S1 | Connector for fan motor |
| 2) S6 | Connector for swing motor (Horizontal Flap) |
| 3) S7 | Connector for fan motor |
| 4) S21 | Connector for centralized control to 5 rooms |
| 5) S26 | Connector for signal receiver PCB |
| 6) S27 | Connector for control PCB |
| 7) S32 | Connector for heat exchanger thermistor |
| 8) S35 | Connector for INTELLIGENT EYE Sensor PCB |



Note: Other designations

- | | |
|----------|--|
| 1) V1 | Varistor |
| 2) JA | Address setting jumper |
| JB | Fan speed setting when compressor is OFF on thermostat |
| JC | Power failure recovery function |
| | * Refer to page 259 for more detail. |
| 3) SW7 | Forced operation ON/OFF switch |
| 4) LED1 | LED for operation (green) |
| 5) LED2 | LED for timer (yellow) |
| 6) LED3 | LED for HOME LEAVE operation (red) |
| 7) LED A | LED for service monitor (green) |
| 8) FU1 | Fuse (3.15A) |
| 9) RTH1 | Room temperature thermistor |

PCB

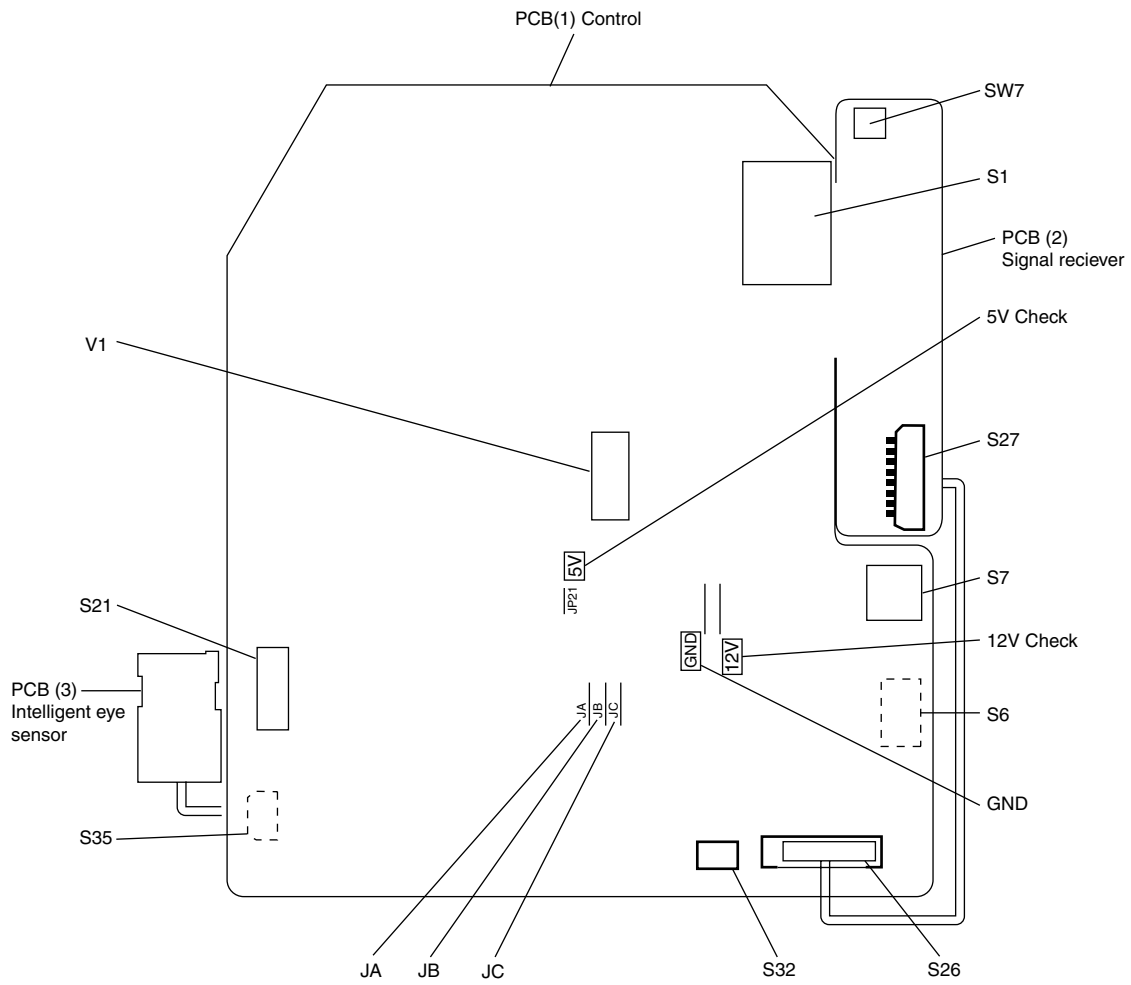

(R2413)

PCB Detail

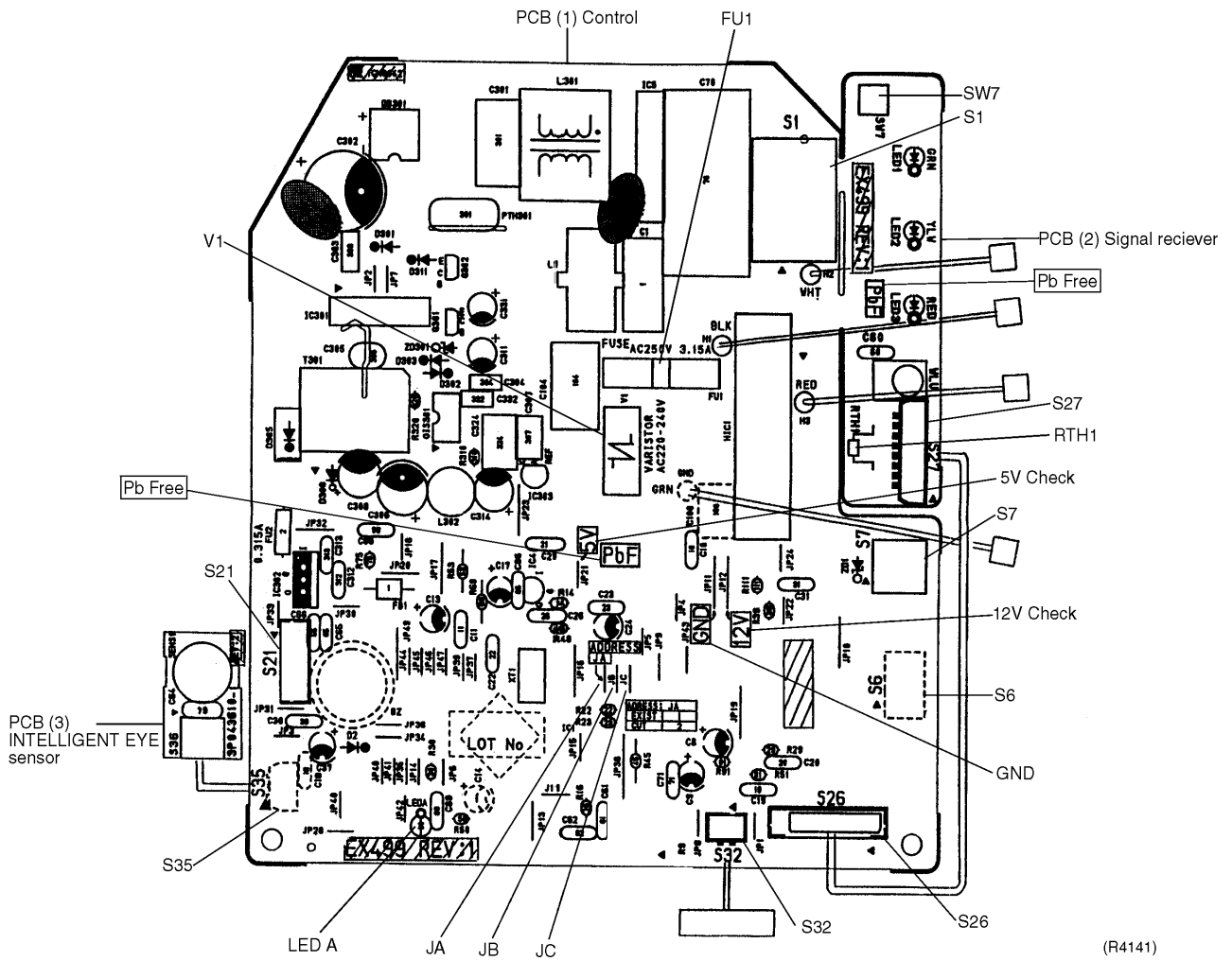

1.2 Wall Mounted Type 50/60/71 Class

Connectors

- | | |
|------------------|--|
| 1) S1 | Connector for fan motor |
| 2) S6 | Connector for swing motor (horizontal blades) |
| 3) S8 | Connector for swing motor (vertical blades) |
| 4) S21 | Connector for centralized control (HA) |
| 5) S26, S37 | Connector for buzzer PCB |
| 6) S27, S29, S36 | Connector for control PCB |
| 7) S28 | Connector for signal receiver PCB |
| 8) S32 | Connector for heat exchanger thermistor |
| 9) S35 | Connector for Intelligent Eye sensor PCB |
| 10) S38 | Connector for display PCB |



Note: Other designations

- | | |
|----------|--|
| 1) V1 | Varistor |
| 2) JA | Address setting jumper |
| JB | Fan speed setting when compressor is OFF on thermostat |
| JC | Power failure recovery function |
| | * Refer to page 259 for detail. |
| 3) SW1 | Forced operation ON/OFF switch |
| 4) LED1 | LED for operation (green) |
| 5) LED2 | LED for timer (yellow) |
| 6) LED3 | LED for HOME LEAVE operation (red) |
| 7) LED A | LED A for service monitor (green) |
| 8) FU1 | Fuse (3.15A) |
| 9) RTH1 | Room temperature thermistor |

PCB Detail

PCB(1): Control PCB (indoor unit)

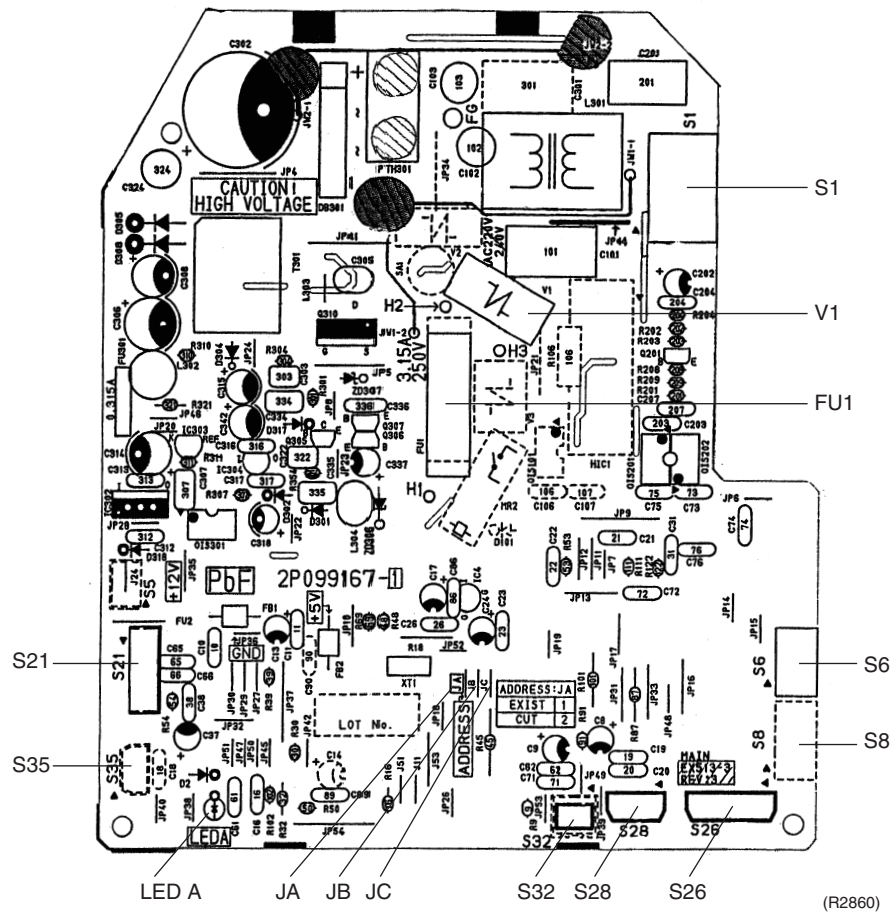

PCB(2): Signal Receiver PCB

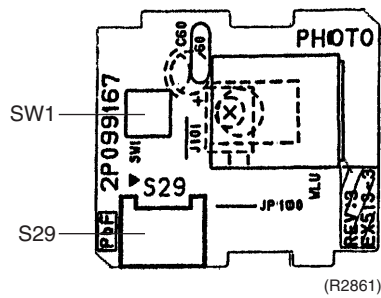

PCB(3): Buzzer PCB

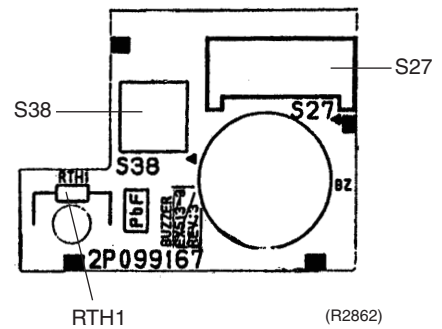

PCB(4): Display PCB

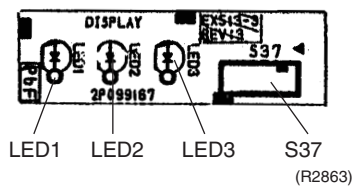

PCB(5): Intelligent Eye sensor PCB

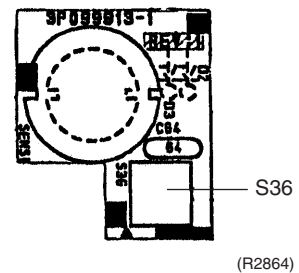

1.3 Duct Connected Type

Connectors

- 1) **S1** (on PCB 1) Connector for fan motor
- 2) **S1** (on PCB 2) Connector for control PCB
- 3) **S7** Connector for fan motor
- 4) **S21** Connector for centralized control to 5 rooms
- 5) **S26** Connector for display PCB
- 6) **S32** Connector for room temp / Heat exchanger thermistor



Note: Other designations

- 1) **V1** Varistor
 - 2) **JA** Address setting jumper
 - JB** Fan speed setting when compressor is OFF on thermostat
 - JC** Power failure recovery function
- * Refer to page 259 for more detail.
- 3) **SW1** Forced operation ON/OFF switch
 - 4) **LED1** LED for operation (green)
 - 5) **LED2** LED for timer (yellow)
 - 6) **LED3** LED for HOME LEAVE operation (red)
 - 7) **LED A** LED for service monitor (green)
 - 8) **FU1** Fuse (3.15A)
 - 9) **RTH1** Room temperature thermistor

Control PCB Detail (PCB 1)

- Refer to PCB (1) Control on P60.

Display PCB Detail (PCB 2)

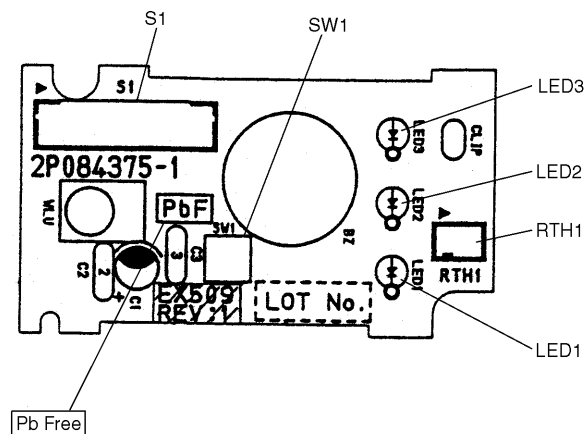

2P084375C

1.4 Floor / Ceiling Suspended Dual Type

Connectors

- 1) S6 Connector for swing motor (horizontal swing)
- 2) S7 Connector for fan motor
- 3) S21 Connector for centralized control
- 4) S24 Connector for display PCB
- 5) S25, S27, S36 Connector for control PCB
- 6) S26 Connector for signal receiver PCB
- 7) S31 Connector for room temperature thermistor
- 8) S32 Connector for heat exchanger thermistor
- 9) S37 Connector for power supply PCB



Note: Other designations

- 1) V1 Varistor
- 2) JA Address setting jumper
- JB Fan speed setting when compressor is OFF on thermostat
- JC Power failure recovery function
- * Refer to page 259 for detail.
- 3) SW1 Forced operation ON/OFF switch
- 4) SW2 Select switch ceiling or floor
- 5) LED1 LED for operation (green)
- 6) LED2 LED for timer (yellow)
- 7) LED3 LED for HOME LEAVE operation (red)
- 8) LED A LED for service monitor (green)
- 9) FU1 Fuse (3.15A)

Control PCB (PCB 1)

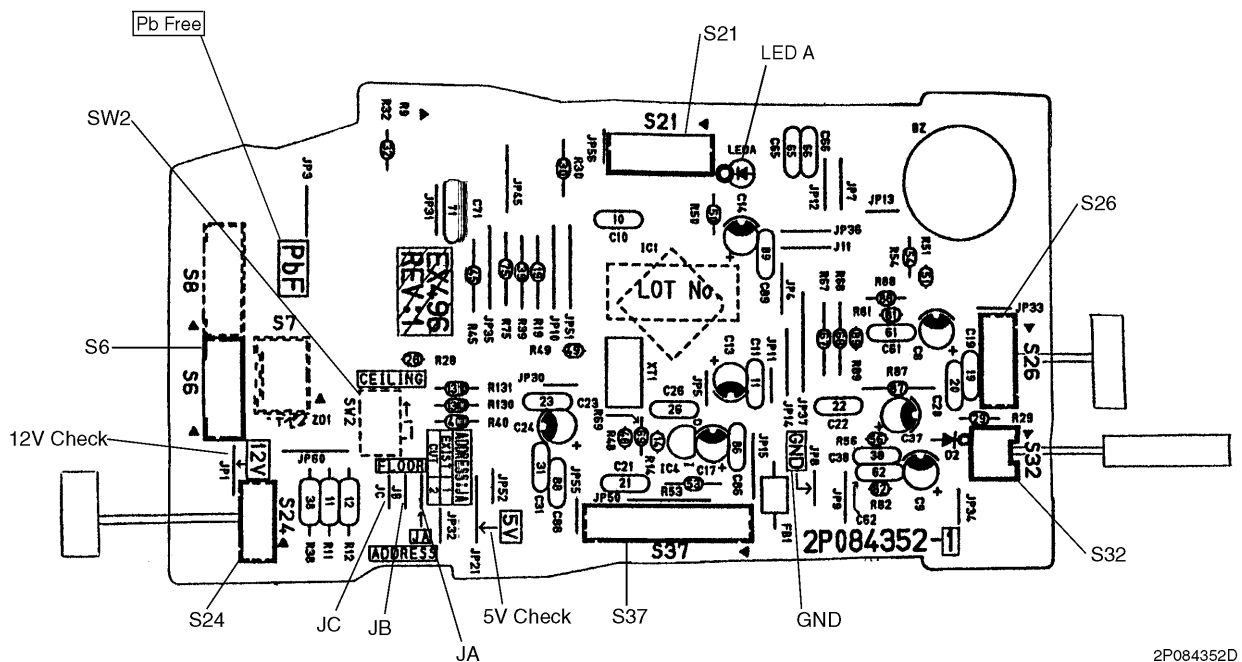

2P084352D

Power Supply PCB (PCB 2)

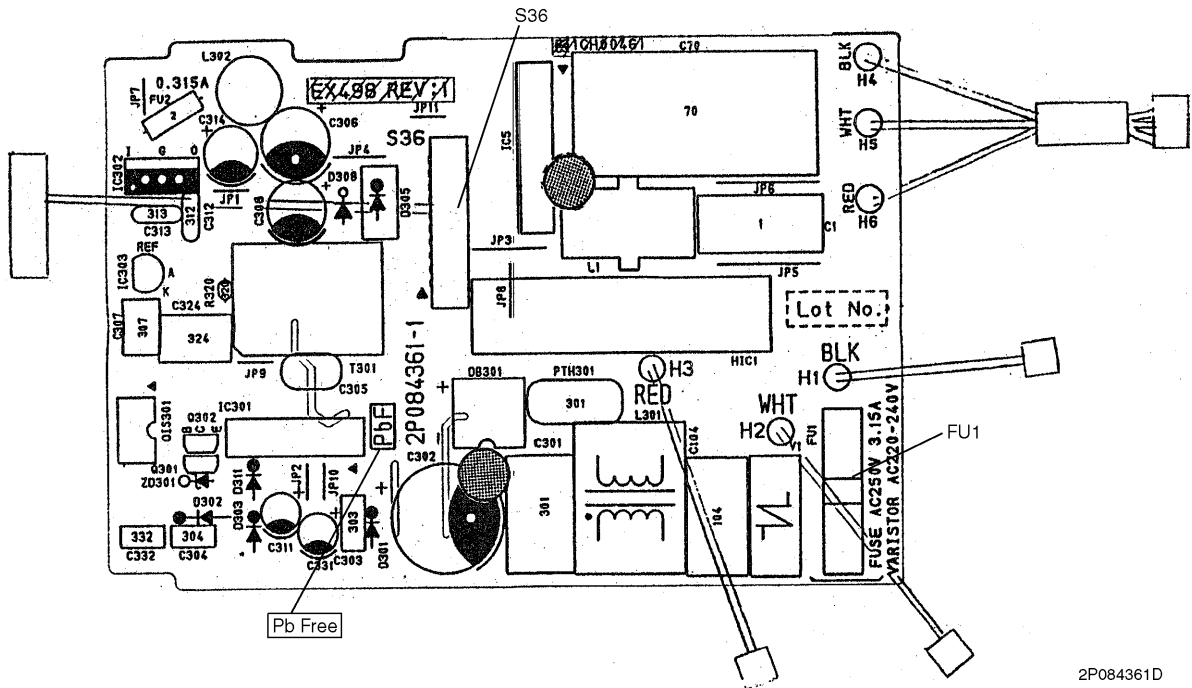

2P084361D

Display PCB (PCB 3)

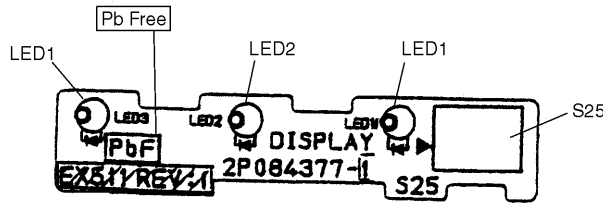

2P084377B

Signal Receiver PCB (PCB 4)

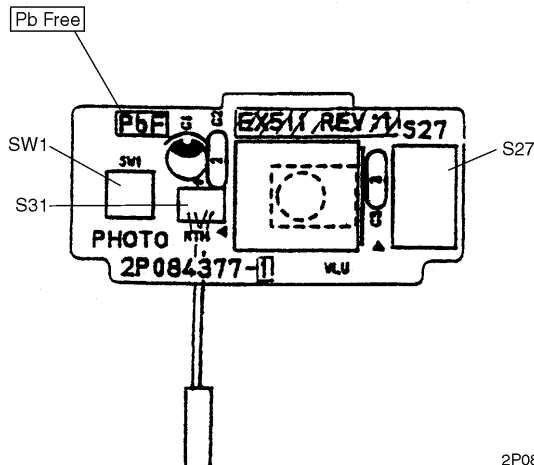

2P084377B

1.5 Floor Standing Type

Connectors

- | | |
|--------------------------------|--|
| 1) S6 | Connector for swing motor and lower air outlet motor |
| 2) S21 | Connector for centralized control |
| 3) S23 | Connector for signal receiver |
| 4) S31, S32 | Connector for room temperature / heat exchanger thermistor |
| 5) S201, S203,
S7, S24, S26 | Connector for power supply PCB (1) |
| 6) S202, S204,
S8 | Connector for control PCB (2) |
| 7) S25 | Connector for display PCB (3) |
| 8) S301, S302 | Connector for fan motors |



Note: Other Designations

- | | |
|-----------|--|
| 1) V1 | Varistor |
| 2) JA | Address setting jumper |
| JB | Fan speed setting when compressor is OFF on thermostat |
| JC | Power failure recovery function |
| | * Refer to page 259 for detail. |
| 3) SW1 | Forced operation ON/OFF switch |
| 4) SW2 | Changing upward air flow limit switch |
| 5) SW4 | Discharge changeover switch |
| 6) FU | Fuse (3.15A) |
| 7) LED11 | LED for operation (green) |
| 8) LED12 | LED for timer (yellow) |
| 9) LED14 | LED for HOME LEAVE operation (red) |
| 10) LED A | LED for service monitor (green) |

Power Supply PCB (PCB 1)

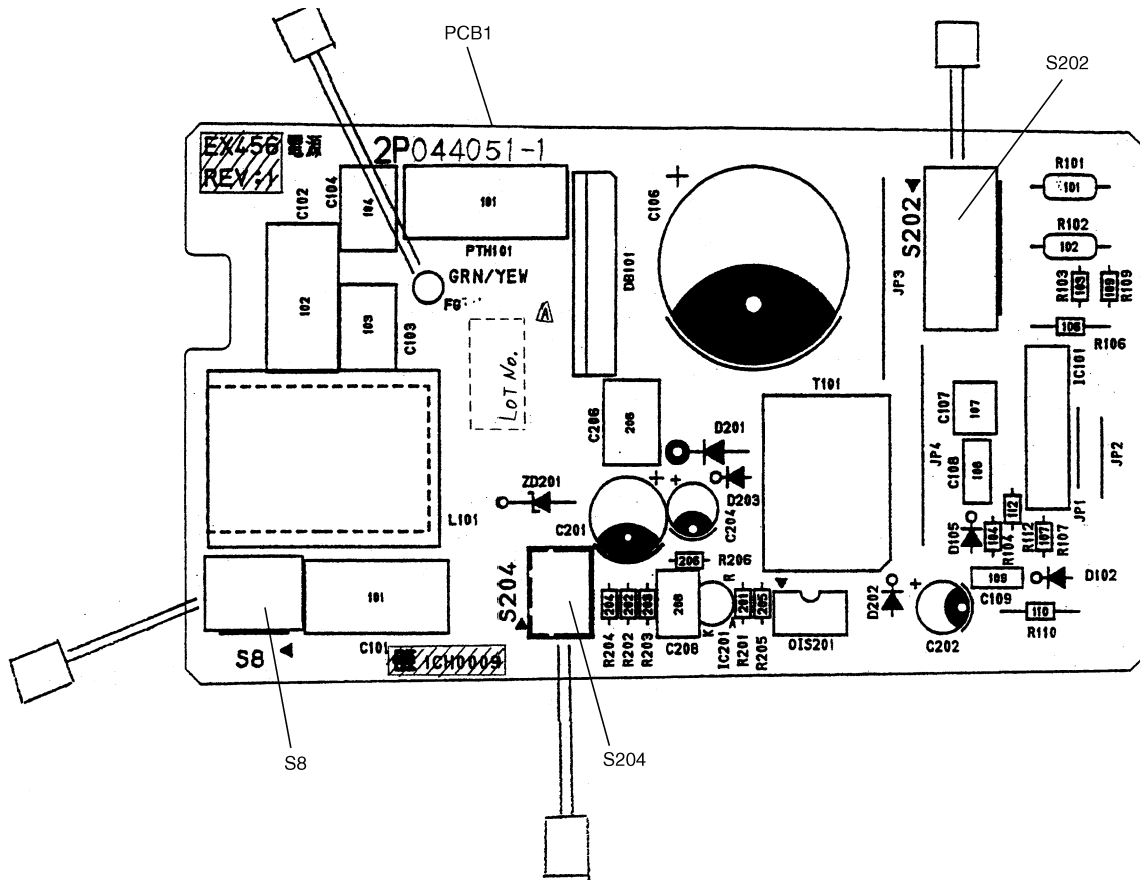

2P044051E

- Control PCB (PCB 2)
- Display PCB (PCB 3)
- Signal Receiver PCB (PCB 4)

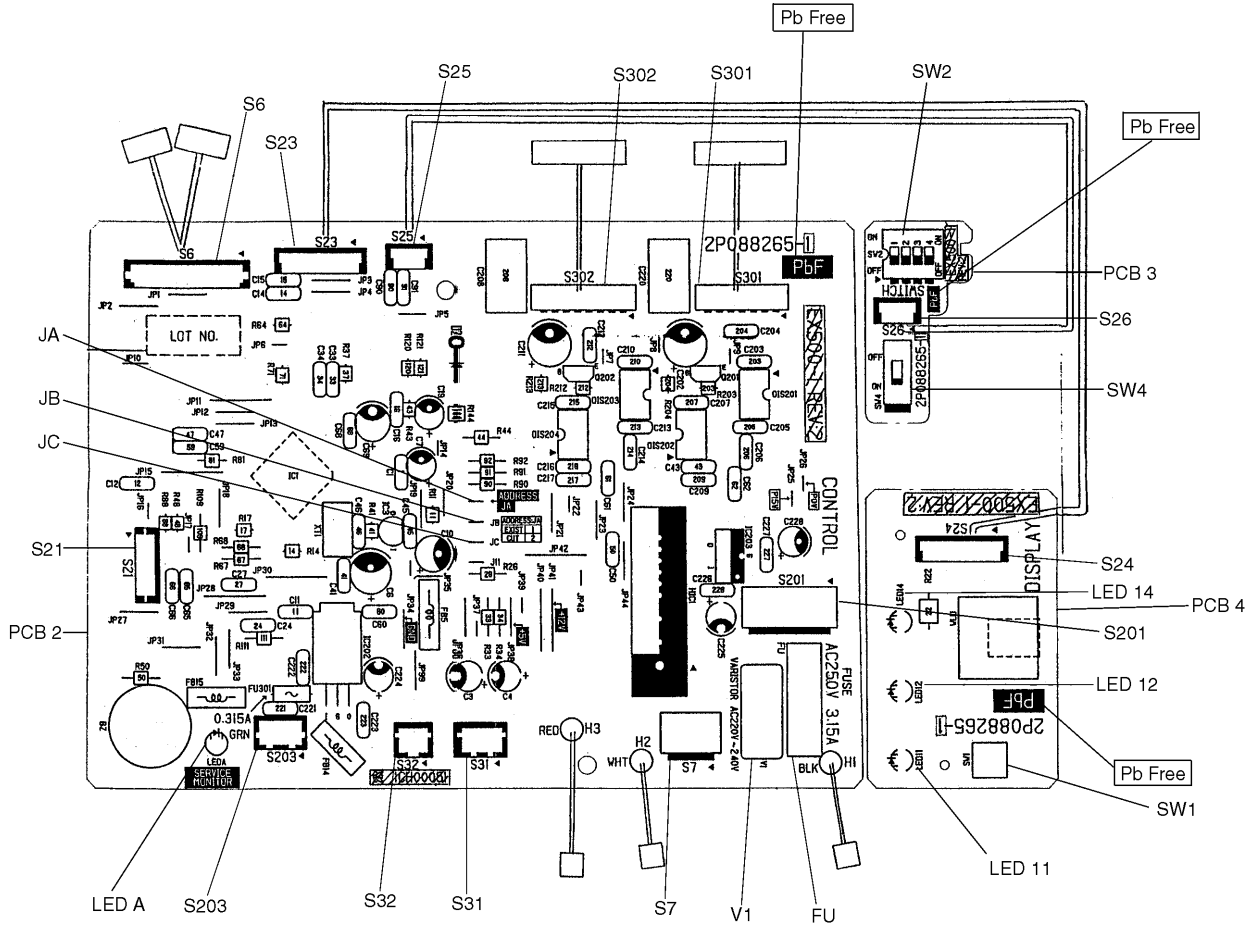

2P088265D

1.6 Outdoor Units

Connectors

- | | |
|---------|---|
| 1) S20 | Connector for electronic expansion valve coil A port |
| 2) S21 | Connector for electronic expansion valve coil B port |
| 3) S22 | Connector for electronic expansion valve coil C port |
| 4) S23 | Connector for electronic expansion valve coil D port |
| 5) S31 | Connector for CN14 |
| 6) S32 | Connector for CN11 |
| 7) S33 | Connector for S34 |
| 8) S40 | Connector for overload relay |
| 9) S71 | Connector for S72 |
| 10) S80 | Connector for four way valve coil |
| 11) S90 | Connector for thermistor
(outdoor air, heat exchanger, and discharge pipe) |
| 12) S92 | Connector for gas pipe thermistor |
| 13) S93 | Connector for liquid pipe thermistor |



Note: Other Designations

- 1) LED A, LED 1 to 4 Service Monitor LED

Control PCB

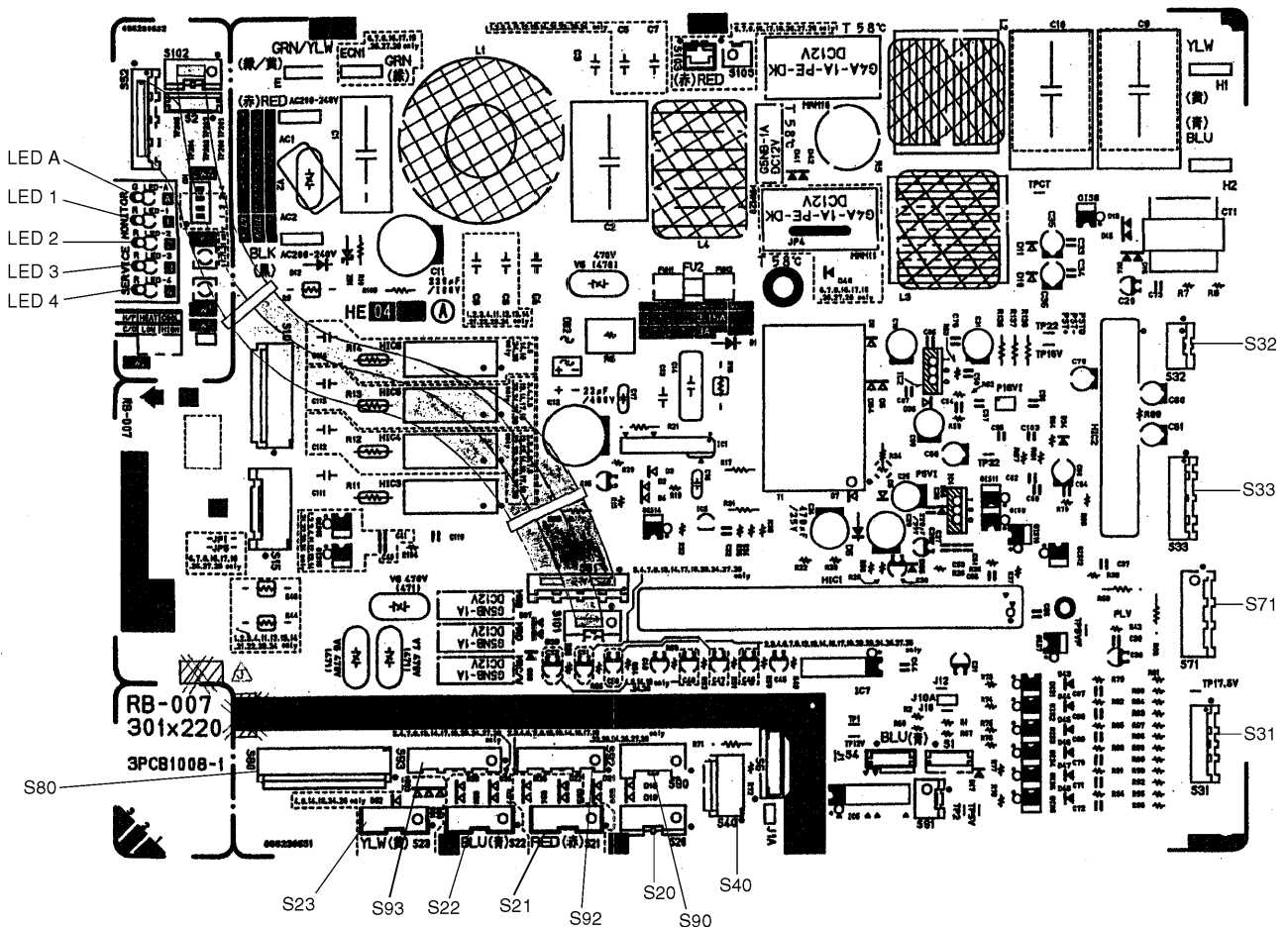

2P138922A

Part 4

Function and Control

1. Main Functions	72
1.1 Frequency Principle.....	72
1.2 Power-Airflow Dual Flaps, Wide Angle Louvers and Auto-Swing	74
1.3 Fan Speed Control for Indoor Units.....	75
1.4 Programme Dry Function	76
1.5 Automatic Operation.....	77
1.6 Night Set Mode.....	78
1.7 Intelligent Eye.....	79
1.8 Home Leave Operation	81
1.9 Inverter Powerful Operation	82
1.10 Other Functions.....	83
2. Function of Main Structural Parts.....	85
2.1 Main Structural Parts.....	85
2.2 Function of Thermistor	86
3. Control Specification	90
3.1 Mode Hierarchy.....	90
3.2 Frequency Control.....	91
3.3 Controls at Mode Changing / Start-up.....	93
3.4 Discharge Pipe Control	94
3.5 Input Current Control.....	94
3.6 Freeze-up Protection Control	95
3.7 Heating Peak-cut Control	95
3.8 Fan Control.....	96
3.9 Moisture Protection Function 2.....	96
3.10 Defrost Control	97
3.11 Low Hz High Pressure Limit	98
3.12 Electronic Expansion Valve Control	98
3.13 Malfunctions	103
3.14 Forced Operation Mode	104
3.15 Wiring-Error Check.....	105
3.16 Additional Function.....	107

1. Main Functions

i Note: See the list of functions for the functions applicable to different models.

1.1 Frequency Principle

Main Control Parameters

The compressor is frequency-controlled during normal operation. The target frequency is set by the following 2 parameters coming from the operating indoor unit:

- The load condition of the operating indoor unit
- The difference between the room temperature and the set temperature

Additional Control Parameters

The target frequency is adapted by additional parameters in the following cases:

- Frequency restrictions
- Initial settings
- Forced cooling / heating operation

Inverter Principle

To regulate the capacity, a frequency control is needed. The inverter makes it possible to vary the rotation speed of the compressor. The following table explains the conversion principle:

Phase	Description
1	The supplied AC power source is converted into the DC power source for the present.
2	The DC power source is reconverted into the three phase AC power source with variable frequency. <ul style="list-style-type: none"> ■ When the frequency increases, the rotation speed of the compressor increases resulting in an increased refrigerant circulation. This leads to a higher amount of the heat exchange per unit. ■ When the frequency decreases, the rotation speed of the compressor decreases resulting in a decreased refrigerant circulation. This leads to a lower amount of the heat exchange per unit.

Drawing of Inverter

The following drawing shows a schematic view of the inverter principle:

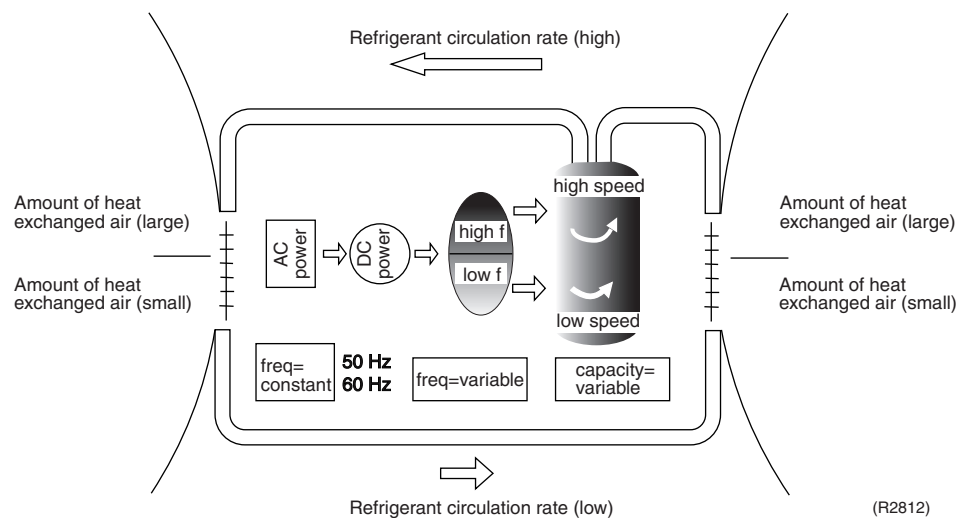

Inverter Features

The inverter provides the following features:

- The regulating capacity can be changed according to the changes in the outdoor air temperature and cooling / heating load.
- Quick heating and quick cooling
The compressor rotational speed is increased when starting the heating (or cooling). This enables a quick set temperature.

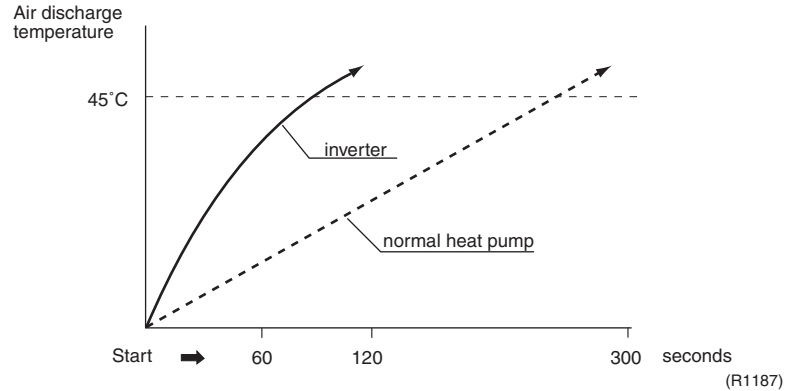

- Even during extreme cold weather, the high capacity is achieved. It is maintained even when the outdoor air temperature is 2°C.
- Comfortable air conditioning
A detailed adjustment is integrated to ensure a fixed room temperature. It is possible to air condition with a small room temperature variation.
- Energy saving heating and cooling
Once the set temperature is reached, the energy saving operation enables to maintain the room temperature at low power.

Frequency Limits

The following table shows the functions that define the minimum and maximum frequency:

Frequency limits	Limited during the activation of following functions
Low	<ul style="list-style-type: none"> ■ Four way valve operation compensation. Refer to page 93.
High	<ul style="list-style-type: none"> ■ Input current control. Refer to page 94. ■ Compressor protection function. Refer to page 93. ■ Heating Peak-cut control. Refer to page 95. ■ Freeze-up protection. Refer to page 95. ■ Defrost control. Refer to page 97.

Forced Cooling / Heating Operation

For more information, refer to "Forced operation mode" on page 104.

1.2 Power-Airflow Dual Flaps, Wide Angle Louvers and Auto-Swing

Power-airflow Dual Flaps

The large flaps send a large volume of air downwards to the floor. The flap provides an optimum control area in cooling, heating and dry mode.

Heating Mode

During heating mode, the large flap enables direct warm air straight downwards. The flap presses the warm air above the floor to reach the entire room.

Cooling Mode

During cooling mode, the flap retracts into the indoor unit. Then, cool air can be blown far and pervaded all over the room.

Wide-Angle Louvers

The louvers, made of elastic synthetic resin, provide a wide range of airflow that guarantees a comfortable air distribution.

Auto-Swing

In case of Wall Mounted Type 50 / 60 / 71 Class

The following table explains the auto-swing process for heating, cooling, dry and fan :

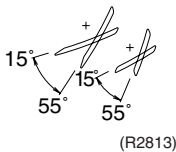
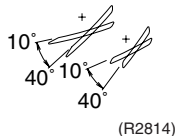
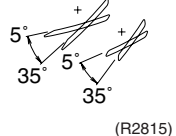
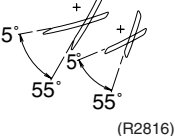
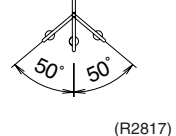
Vertical Swing (up and down)				Horizontal Swing (right and left)
Heating	Cooling	Dry	Fan	Heating, Cooling
 (R2813)	 (R2814)	 (R2815)	 (R2816)	 (R2817)

Outline of 3-D Airflow

Alternative repetition of vertical and horizontal swing motions enables uniform air-conditioning of the entire room. This function is effective for starting the air conditioner.

Detail of the Action

When the horizontal swing and vertical swing are both set to auto mode, the airflow become 3-D airflow and the horizontal swing and vertical swing motions are alternated. The order of swing motion is such that it turns counterclockwise, starting from the right upper point as viewed to the front side of the indoor unit.

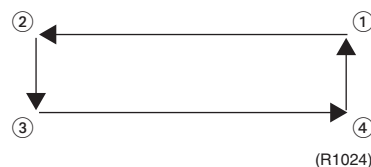

1.3 Fan Speed Control for Indoor Units

Control Mode

The airflow rate can be automatically controlled depending on the difference between the set temperature and the room temperature. This is done through phase control and hall IC control.



For more information about hall IC, refer to the troubleshooting for fan motor on page 174.

Phase Steps

Phase control and fan speed control contains 9 steps: LLL, LL, SL, L, ML, M, MH, H and HH.

Step	Cooling	Heating	Dry mode
LLL (Heating thermostat OFF)			20 · 25 · 35kW class : 500 - 860 rpm (During powerful operation : 850 - 910 rpm) 50 · 60 · 71kW class : 750 - 1000 rpm (During powerful operation : 1050 rpm)
LL (Cooling thermostat OFF)			
SL (Silent)			
L			
ML			
M			
MH			
H			
HH (Powerful)			

= Within this range the airflow rate is automatically controlled when the FAN setting button is set to automatic.



Note:

1. During powerful operation, fan operates H tap + 50 - 90 rpm.
2. Fan stops during defrost operation.

Automatic Air Flow Control for Heating

The following drawing explains the principle for fan speed control for heating:

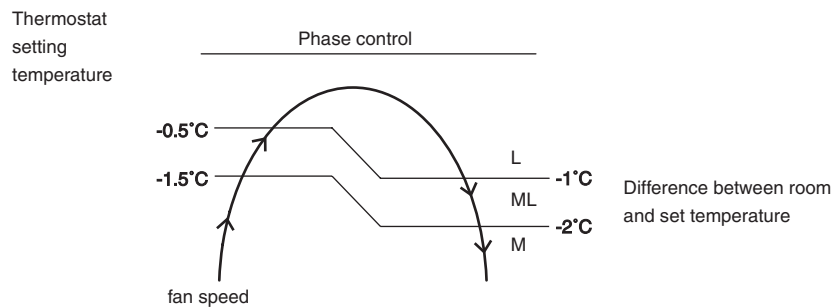

Automatic Air Flow Control for Cooling

The following drawing explains the principle of fan speed control for cooling:

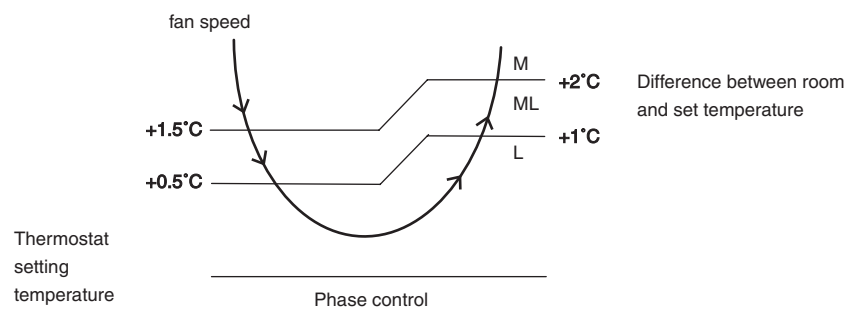

1.4 Programme Dry Function

Programme dry function removes humidity while preventing the room temperature from lowering.

Since the microcomputer controls both the temperature and air flow volume, the temperature adjustment and fan adjustment buttons are inoperable in this mode.

In Case of Inverter Units

The microcomputer automatically sets the temperature and fan settings. The difference between the room temperature at startup and the temperature set by the microcomputer is divided into two zones. Then, the unit operates in the dry mode with an appropriate capacity for each zone to maintain the temperature and humidity at a comfortable level.

Room temperature at startup	Temperature (ON point) at which operation starts	Frequency switching point	Temperature difference for operation stop
24°C	Room temperature at startup	0.5°C	1.5°C
18°C	18°C		1.0°C
17°C		—	

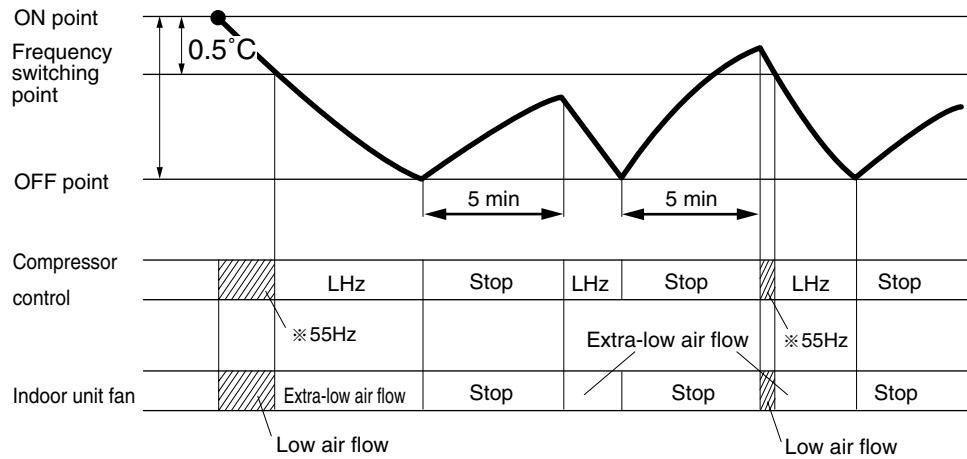

LHz indicates low frequency. Item marked with varies depending on models.

(R1359)

1.5 Automatic Operation

Automatic Cooling / Heating Function (Heat Pump Only)

When the AUTO mode is selected with the remote controller, the microcomputer automatically determines the operation mode from cooling and heating according to the room temperature and setting temperature at the time of the operation startup, and automatically operates in that mode.

The unit automatically switches the operation mode to cooling or heating to maintain the room temperature at the main unit setting temperature.

Detailed Explanation of the Function

1. Remote controller setting temperature is set as automatic cooling / heating setting temperature (18 to 30°C).
2. Main unit setting temperature equals remote controller setting temperature plus correction value (correction value / cooling: 0 deg, heating: 2 deg.).
3. Operation ON / OFF point and mode switching point are as follows.
 - ① Heating → Cooling switching point:
Room temperature \geq Main unit setting temperature +2.5 deg.
 - ② Cooling → Heating switching point:
Room temperature $<$ Main unit setting temperature -2.5 deg.
 - ③ Thermostat ON / OFF point is the same as the ON / OFF point of cooling or heating operation.
4. During initial operation
 Room temperature \geq Remote controller setting temperature: Cooling operation
 Room temperature $<$ Remote controller setting temperature: Heating operation

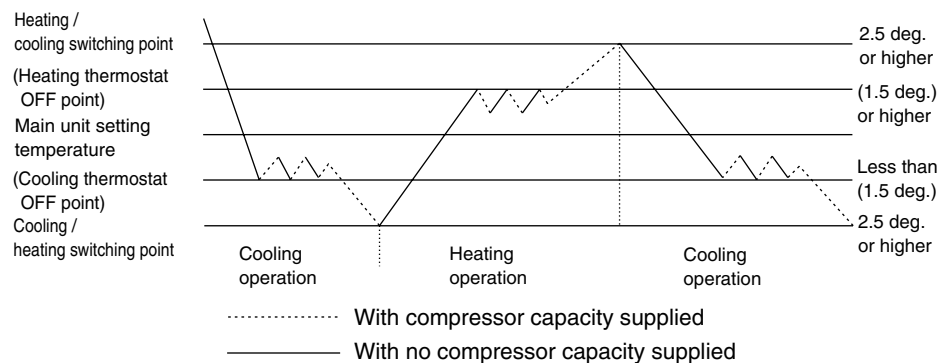

(R1360)

1.6 Night Set Mode

When the OFF timer is set, the Night Set circuit automatically activates. The Night Set circuit maintains the airflow setting made by users.

The Night Set Circuit

The Night Set circuit continues heating or cooling the room at the set temperature for the first one hour, then automatically raises the temperature setting slightly in the case of cooling, or lowers it slightly in the case of heating, for economical operations. This prevents excessive heating in winter and excessive cooling in summer to ensure comfortable sleeping conditions, and also conserves electricity.

Cooling Operation

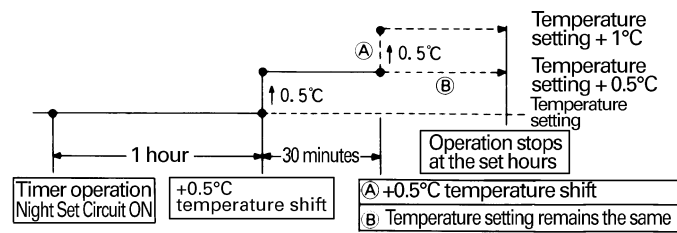

- Ⓐ : ● When outside temperature is normal and room temperature is at set temperature.
 Ⓑ : ● When outside temperature is high (27°C or higher).

(R1361)

Heating Operation

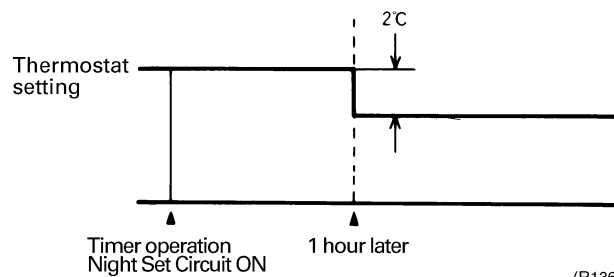

(R1362)

1.7 Intelligent Eye

This is the function that detects existence of humans in the room by a human motion sensor (Intelligent Eye) and reduces the capacity when there is no human in the room in order to save electricity.

Processing

1. Detection method by Intelligent Eye

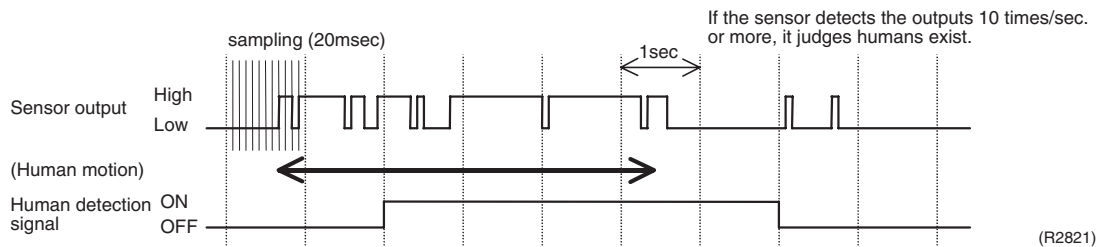

- This sensor detects human motion by receiving infrared rays and displays the pulse wave output.
- A microcomputer in an indoor unit carries out a sampling every 20 msec. and if it detects 10 cycles of the wave in one second in total (corresponding to $20\text{msec.} \times 10 = 100\text{msec.}$), it judges human is in the room as the motion signal is ON.

2. The motions (for example: in cooling)

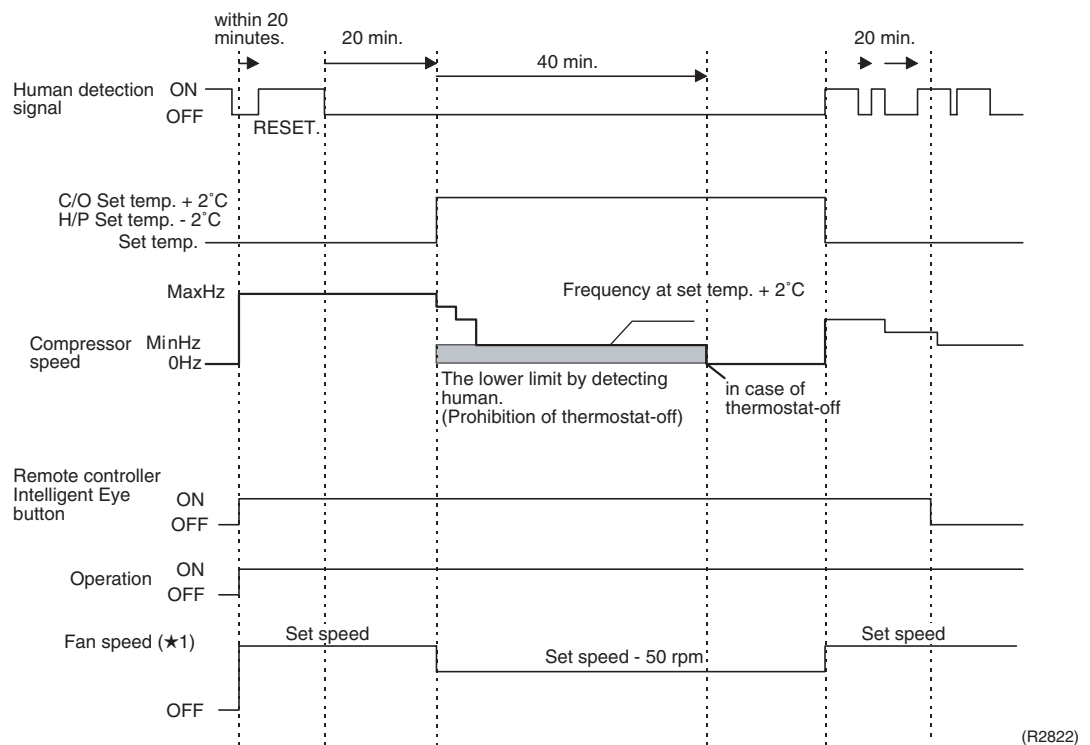

- When a microcomputer doesn't have a signal from the sensor in 20 minutes, it judges that nobody is in the room and operates the unit in temperature sifted 2°C from the set temperature. (Cooling : 2°C higher, Dry: 1°C higher and Auto : according to the operation mode at that time.)
- ★1 In case of Fan mode, the fan speed reduces by 50 rpm.

- Since the set temperature is shifted by 2°C higher for 40 minutes, compressor speed becomes low and can realize energy saving operation. But as thermostat is prone to be off by the fact that the set temperature has been shifted, the thermostat-off action is prohibited in 40 minutes so as to prevent this phenomena.
After this 40 minutes, the prohibition of the thermostat-off is cancelled and it can realize the conditions to conduct thermostat-off depending on the room temperature. In or after this forty minutes, if the sensor detects human motion detection signal, it let the set temperature and the fan speed return to the original set point, keeping a normal operation.

Others

- The dry operation can't command the setting temperature with a remote controller, but internally the set temperature is shifted by 1°C.

1.8 Home Leave Operation

Outline

In order to respond to the customer's need for immediate heating and cooling of the room after returning home or for house care, a measure to switch the temperature and air volume from that for normal time over to outing time by one touch is provided. (This function responds also to the need for keeping up with weak cooling or heating.)

This time, we seek for simplicity of operation by providing the special temperature and air volume control for outing to be set by the exclusive button.

Detail of the Control

1. Start of Function

The function starts when the [HOME LEAVE] button is pressed in cooling mode or heating mode (including stopping and powerful operation). If this button is pressed while the operation is stopped, the function becomes effective when the operation is started. If this button is pressed in powerful operation, the powerful operation is reset and this function becomes effective.

- The [HOME LEAVE] button is ineffective in dry mode and fan mode.

2. Details of Function

A mark representing [HOME LEAVE] is indicated on the liquid crystal display of the remote controller. The indoor unit is operated according to the set temperature and air volume for HOME LEAVE which were pre-set in the memory of the remote controller.

The LED (Red) of indoor unit representing [HOME LEAVE] lights up. (It goes out when the operation is stopped.)

3. End of Function

The function ends when the [HOME LEAVE] button is pressed again during [HOME LEAVE] operation or when the powerful operation button is pressed.

Scene <cooling>

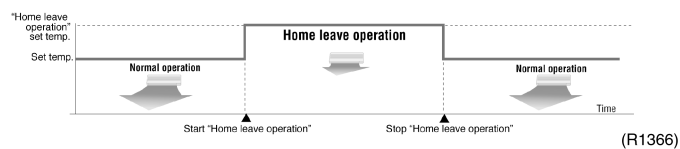

Scene <Heating>

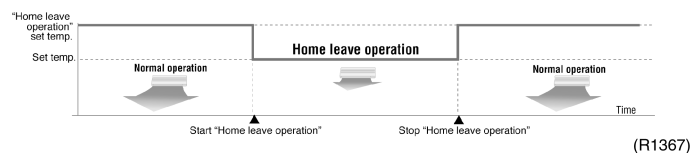
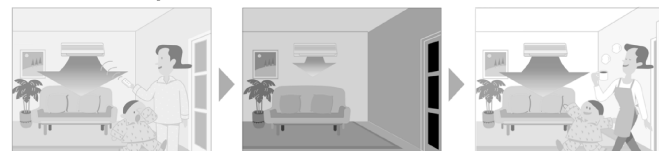

Others

The set temperature and set air volume are memorized in the remote controller. When the remote controller is reset due to replacement of battery, it is necessary to set the temperature and air volume again for [HOME LEAVE].

1.9 Inverter Powerful Operation

Outline

In order to exploit the cooling and heating capacity to full extent, operate the air conditioner by increasing the indoor fan rotating speed and the compressor frequency.

Details of the Control

When Powerful button is pushed in each operation mode, the fan speed / setting temperature will be converted to the following states in a period of twenty minutes.

In case of Wall Mounted Type 50 / 60 / 71 Class.

Operation mode	Fan speed	Target set temperature
Cooling	H tap + 90 rpm	18°C
Dry	Dry rotating speed + 50 rpm	Normally targeted temperature in dry operation; Approx. - 2°C
Heating	H tap + 90 rpm	30°C
Fan	H tap + 90 rpm	—
Automatic	Same as cooling / heating in Powerful operation	The target is kept unchanged

Ex.) : Powerful operation in cooling mode.

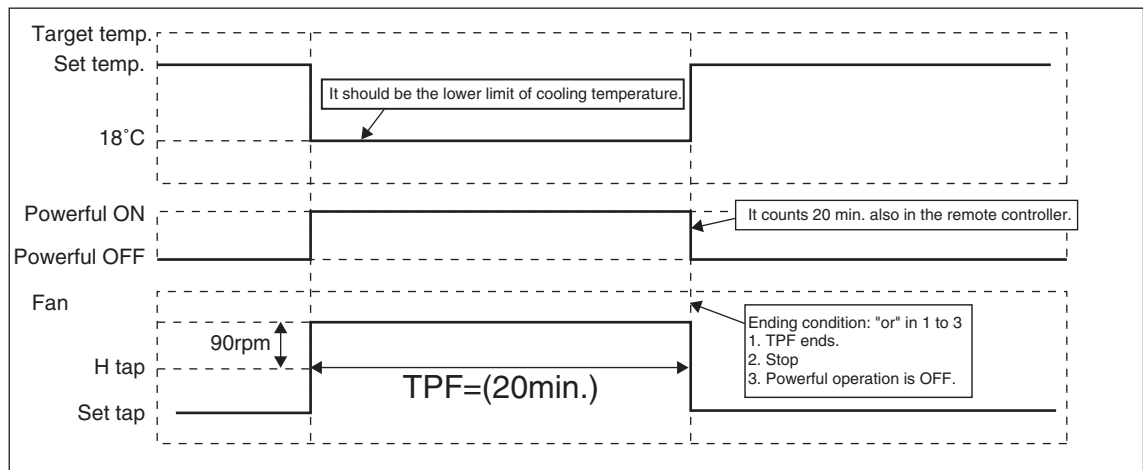

(R4571)

1.10 Other Functions

1.10.1 Hot Start Function

Heat Pump Only

In order to prevent the cold air blast that normally comes when heating is started, the temperature of the heat exchanger of the indoor unit is detected, and either the air flow is stopped or is made very weak thereby carrying out comfortable heating of the room.

*The cold air blast is also prevented using a similar control when the defrosting operation is started or when the thermostat gets turned ON.

1.10.2 Signal Receiving Sign

When the indoor unit receives a signal from the remote controller, the unit emits a signal receiving sound.

1.10.3 ON/OFF Button on Indoor Unit

An ON/OFF switch is provided on the front panel of the unit. Use this switch when the remote controller is missing or if its battery has run out.

Every press of the switch changes from Operation to Stop or from Stop to Operation

In case of Wall Mounted Type 50 / 60 / 71 Class.

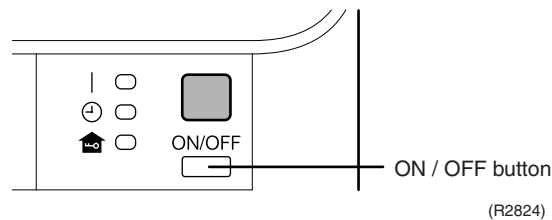

- Push this button once to start operation. Push once again to stop it.
- This button is useful when the remote controller is missing.
- The operation mode refers to the following table.

	Mode	Temperature setting	Air flow rate
Cooling Only	COOL	22°C	AUTO
Heat Pump	AUTO	25°C	AUTO

- In the case of multi system operation, there are times when the unit does not activate with this button.

1.10.4 Photocatalytic Deodorizing Filter

Photocatalytic Deodorizing Filter demonstrates powerful oxidation characteristics when subjected to harmless ultraviolet light. Photocatalytic deodorizing power is recovered simply by exposing the filter to the sun for 6 hours once every 6 months.

1.10.5 Air-Purifying Filter

A double structure made up of a bacteriostatic filter and an Air-Purifying Filter traps dust, mildew, mites, tobacco smoke, and allergy-causing pollen. Replace the Air-Purifying Filter once every 3 months.

1.10.6 Air Purifying Filter with Photocatalytic Deodorizing Function

This filter incorporates the benefits the Air Purifying Filter and Photocatalytic Deodorizing Filter in a single unit. Combining the two filters in this way increases the active surface area of the new filter. This larger surface area allows the filter to effectively trap microscopic particles, decompose odours and deactivate bacteria and viruses even for the high volume of air required to air-condition large living rooms. The filter can be used for approximately 3 years if periodic maintenance is performed.

1.10.7 Mold Proof Air Filter

The filter net is treated with mold resisting agent TBZ (harmless, colorless, and odorless). Due to this treatment, the amount of mold growth is much smaller than that of normal filters.

1.10.8 Self-Diagnosis Digital Display

The microcomputer continuously monitors main operating conditions of the indoor unit, outdoor unit and the entire system. When an abnormality occurs, the LCD remote controller displays error code. These indications allow prompt maintenance operations.

1.10.9 Auto-restart Function

Even if a power failure (including one for just a moment) occurs during the operation, the operation restarts in the condition before power failure automatically when power is restored. (Note) It takes 3 minutes to restart the operation because the 3-minute standby function is activated.

2. Function of Main Structural Parts

2.1 Main Structural Parts

1. Compressor

A Swing compressor, being operated by INV control.

Heat Pump Model

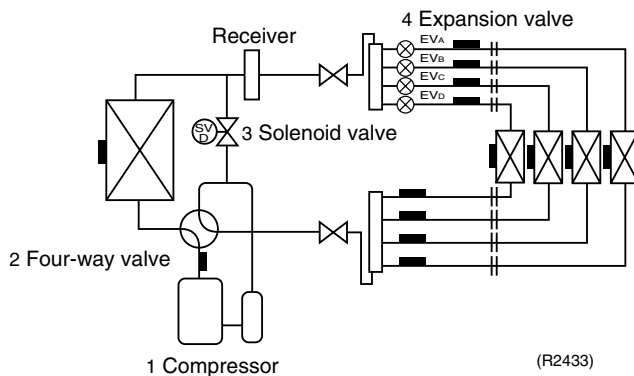

Cooling Only Model

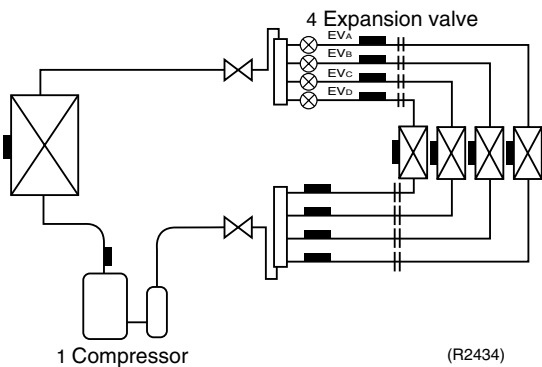

Note:

1. Expansion Valve : In Case of 2MK(X).....EVA-B, 3MK(X).....EVA-C, 4MK(X).....EVA-D,
2. Liquid pipe thermistor : R410A Type only

2.2 Function of Thermistor

2.2.1 Heat Pump Model

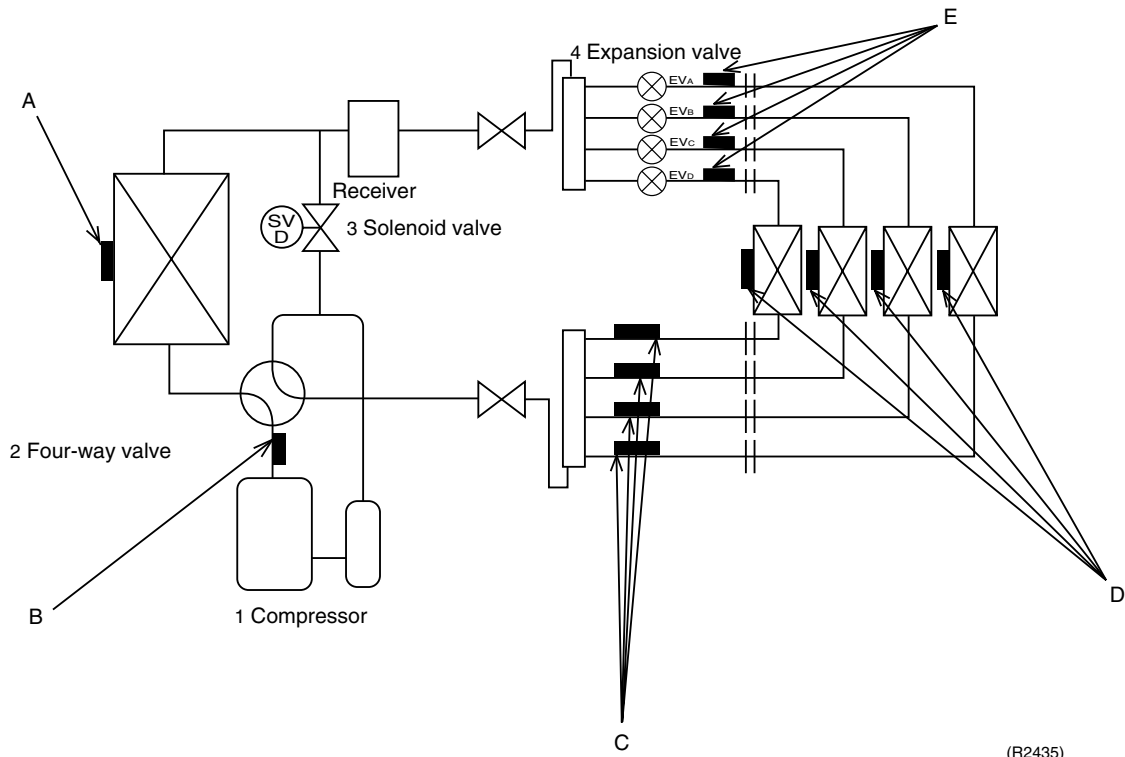

A Outdoor Heat Exchanger Thermistor (DCB)

1. An outdoor heat exchanger thermistor is used for controlling a target discharge temperature. Set a target discharge temperature depending on an outdoor and indoor heat exchanger temperature. Control the electronic expansion valve opening so that the target discharge temperature can be obtained.
2. An outdoor heat exchanger thermistor is used for detecting a disconnected discharge pipe thermistor when cooling. When the temperature of the discharge piping is lower than the temperature of outdoor heat exchanger, a disconnected discharge pipe thermistor can be detected.

B Discharge Pipe Thermistor (DOT)

1. Discharge pipe thermistor is used to control a discharge pipe. If the temperature of discharge pipe (used in place of the inner temperature of the compressor) rises abnormally, the operating frequency drops or the operation must be halted.
2. A discharge pipe thermistor is used for detecting a disconnected discharge pipe thermistor.

C Gas Pipe Thermistor (DGN)

1. When cooling: a gas pipe thermistor is used for gas pipe isothermal control. Control electronic expansion valve opening so that a gas pipe temperature in each room becomes equal.

D Indoor Heat Exchanger Thermistor (DCN)

1. An indoor heat exchanger thermistor is used for controlling target discharge pipe temperature.
Set a target discharge pipe temperature according to the outdoor and indoor heat exchanger temperature.
Control the electronic expansion valve so that the target discharge pipe temperature can be obtained.
2. An indoor heat exchanger thermistor is used to prevent freezing.
During the cooling operation, if the temperature drops abnormally, the operating frequency becomes lower, then the operation must be halted.
3. An indoor heat exchanger thermistor is used for anti-icing control.
During the cooling operation, if the heat exchanger temperature in the room where operation is halted becomes -1°C , or if the room temperature - heat exchanger temperature in the room where operation is halted becomes $\geq 10^{\circ}\text{C}$, it is assumed as icing.
4. During heating: an indoor heat exchanger thermistor is used for detecting a disconnected discharge pipe thermistor.
When a discharge pipe temperature become lower than an indoor heat exchanger temperature, a disconnected discharge pipe thermistor can be detected.
5. An indoor heat exchanger thermistor is used for detecting incorrect wiring.
During the operation of checking incorrect wiring, refrigerant is passed in order from the port A to detect a heat exchanger temperature, and then wiring and piping will be checked.
6. An indoor heat exchanger thermistor is used for sub-cooling control.
An actual sub-cooling must be calculated from an indoor liquid pipe temperature and a heat exchanger temperature. The indoor heat exchanger thermistor controls the electronic expansion valve opening to get a target sub-cooling.
7. An indoor heat exchanger thermistor is used for heating isothermal control of heat exchanger.
When heating: if the difference in temperature of each room is greater than 8°C , the electronic expansion valve of the room whose temperature is the higher is opened.

E Indoor Liquid Pipe Thermistor (DLN)

1. When heating: used for a sub-cooling control.
Calculate an actual sub-cooling from the temperature of indoor liquid pipes and a heat exchanger temperature.
Actual sub-cooling
A maximum heat exchanger temperature in each room - adjust the opening of the electronic expansion valve so that the liquid pipe temperature of each room becomes an target sub-cooling.

2.2.2 Cooling Only Model

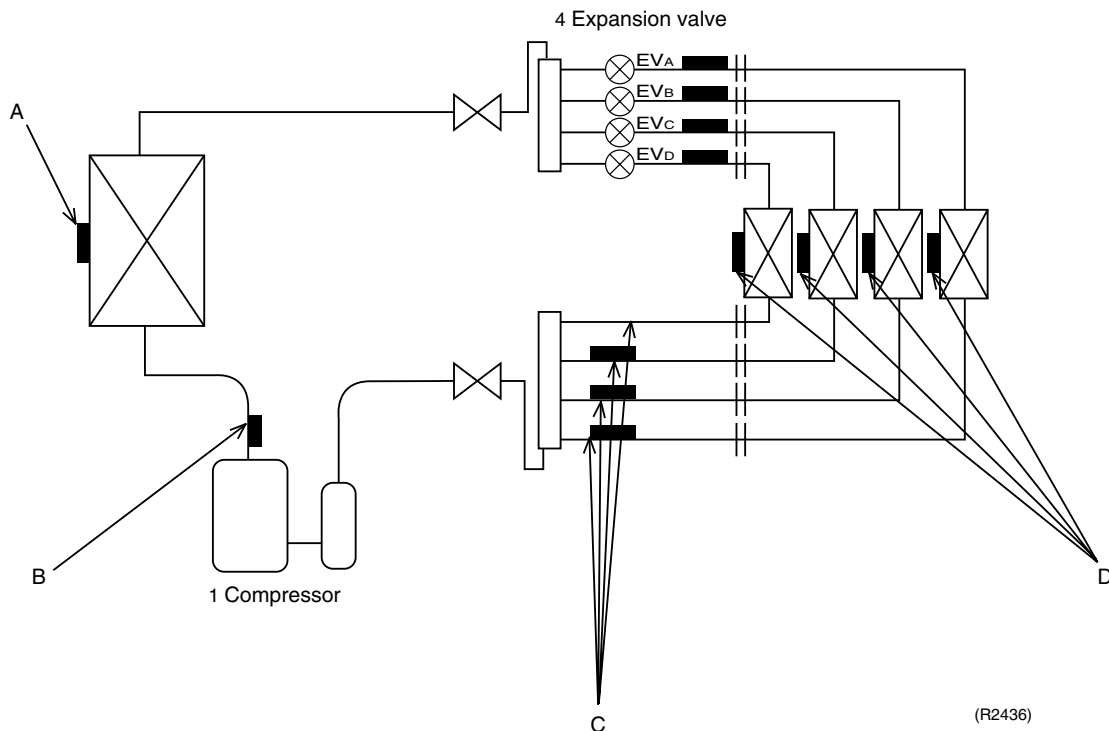

A Outdoor Heat Exchanger Thermistor (DCB)

1. An outdoor heat exchanger thermistor is used for controlling a target discharge temperature. Set a target discharge temperature depending on an outdoor and indoor heat exchanger temperature. Control the electronic expansion valve opening so that the target discharge temperature can be obtained.
2. When cooling: an outdoor heat exchanger thermistor is used for detecting a disconnected discharge pipe thermistor. When the temperature of the discharge piping is lower than the temperature of outdoor heat exchanger, a disconnected discharge pipe thermistor can be detected.

B Discharge Pipe Thermistor (DOT)

1. Discharge pipe thermistor is used to control a discharge pipe. If the temperature of discharge pipe (used in place of the inner temperature of the compressor) rises abnormally, the operating frequency drops or the operation must be halted.
2. A discharge pipe thermistor is used for detecting a disconnected discharge pipe thermistor.

C Gas Pipe Thermistor (DGN)

1. When cooling: a gas pipe thermistor is used for gas pipe isothermal control. Control electronic expansion valve opening so that a gas pipe temperature in each room becomes equal.

D Indoor Heat Exchanger Thermistor (DCN)

1. An indoor heat exchanger thermistor is used for controlling target discharge pipe temperature.
Set a target discharge pipe temperature according to the outdoor and indoor heat exchanger temperature.
Control the electronic expansion valve opening so that the target discharge pipe temperature can be obtained.
2. An indoor heat exchanger thermistor is used to prevent freezing.
During the cooling operation, if the temperature drops abnormally, the operating frequency becomes lower, then the operation must be halted.
3. An indoor heat exchanger thermistor is used for anti-icing control.
During the cooling operation, if the heat exchanger temperature in the room where operation is halted becomes -1°C , or if the room temperature - heat exchanger in the room where operation is halted becomes $\geq 10^{\circ}\text{C}$, it is assumed as icing.
4. An indoor heat exchanger thermistor is used for detecting incorrect wiring.
During the operation of checking incorrect wiring, refrigerant is passed in order from the port A to detect a heat exchanger temperature, and then wiring and piping will be checked.

3. Control Specification

3.1 Mode Hierarchy

Outline

There are two modes; the mode selected in user's place (normal air conditioning mode) and forced operation mode for installation and providing service.

Detail

Air Conditioner's Control Mode

1. For heat pump model

There are following modes; stop, cooling (includes drying), heating (include defrosting)

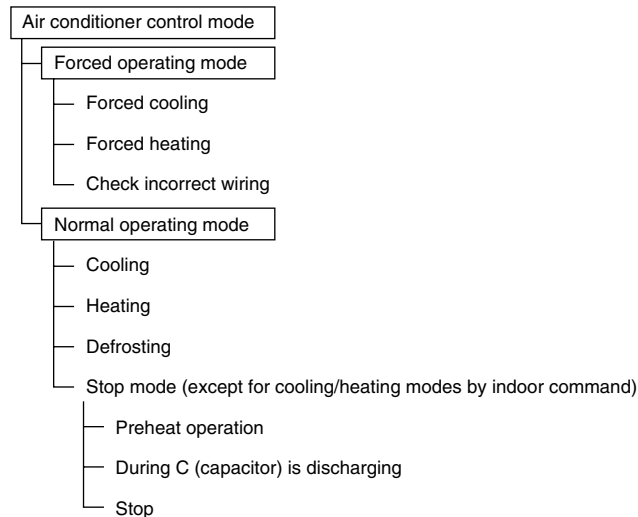

(R1373)

2. For cooling only model

There are following models; stop and cooling (including drying).

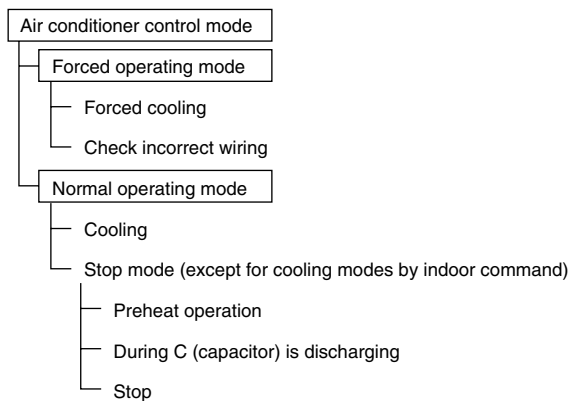

(R1374)



Note:

Unless specified otherwise, an indoor dry operation command must be regarded as cooling operation. An indoor fan operation command cannot be made in a multiple indoor unit. (A forced fan command to the indoor unit from the outdoor unit must be made during forced operation.)

Determine Operating Mode

Judge the operating mode command set by each room in accordance with the instructing procedure, and determine the operating mode of the system.

The following procedure will be taken as the modes conflict with each other.

*1. The system will follow the mode determined first. (First-push, first-set)

*2. For the rooms set with different mode, select stand-by mode. (Operation lamp flashes)

3.2 Frequency Control

Outline

Frequency that corresponds to each room's capacity will be determined according to the difference in the temperature of each room and the temperature that is set by the remote controller.

The function is explained as follows.

1. How to determine frequency.
2. Frequency command from an indoor unit. (The difference between a room temperature and the temperature set by the remote controller.)
3. Frequency command from an indoor unit. (The ranked capacity of the operating room).
4. Frequency initial setting.
5. PI control.

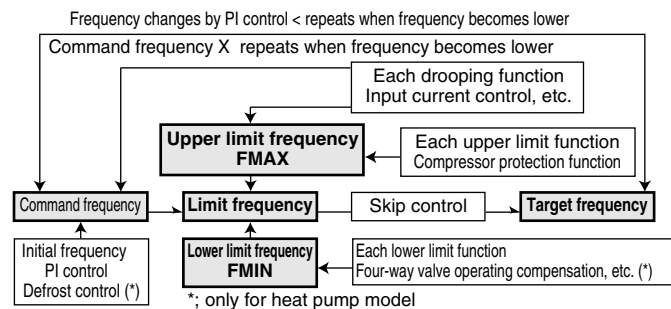

(R1375)

Detail

How to Determine Frequency

The compressor's frequency will finally be determined by taking the following steps.

For Heat Pump Model

1. Determine command frequency

- ◆ Command frequency will be determined in the following order of priority.
 - 1.1 Limiting frequency by drooping function
 - ◆ Input current, discharge pipes, low Hz high pressure limit, peak cutting, freeze-up protection, dew prevention, fin thermistor temperature.
 - 1.2 Limiting defrost control time
 - 1.3 Forced cooling / heating
 - 1.4 Indoor frequency command

2. Determine upper limit frequency

- ◆ Set a minimum value as an upper limit frequency among the frequency upper limits of the following functions:
Compressor protection, input current, discharge pipes, Low Hz high pressure, peak cutting, freeze-up protection, defrost.

3. Determine lower limit frequency

- ◆ Set a maximum value as a lower limit frequency among the frequency lower limits of the following functions:
Four way valve operating compensation, draft prevention, pressure difference upkeep.

4. Determine prohibited frequency

- ◆ There is a certain prohibited frequency such as a power supply frequency.

For Cooling Only Model

1. Determine command frequency

- ◆ Command frequency will be determined in the following order of priority.
 - 1.1 Limiting frequency by drooping function
Input current, discharge pipes, freeze-up protection, dew prevention, fin thermistor temperature.
 - 1.2 Indoor frequency command

2. Determine upper limit frequency

- ◆ Set a minimum value as an upper limit frequency among the frequency upper limits of the following functions:
Compressor protection, input current, discharge pipes, freeze-up protection, dew prevention, fin thermistor temperature.

3. Determine lower limit frequency

- ◆ Set a maximum value as an lower limit frequency among the frequency lower limits of the following functions:
Pressure difference upkeep.

4. Determine prohibited frequency

- ◆ There is a certain prohibited frequency such as a power supply frequency.

Indoor Frequency Command (ΔD signal)

The difference between a room temperature and the temperature set by the remote controller will be taken as the " ΔD signal" and is used for frequency command.

Temperature difference	ΔD signal	Temperature difference	ΔD signal	Temperature difference	ΔD signal	Temperature difference	ΔD signal
0	*Th OFF	2.0	4	4.0	8	6.0	C
0.5	1	2.5	5	4.5	9	6.5	D
1.0	2	3.0	6	5.0	A	7.0	E
1.5	3	3.5	7	5.5	B	7.5	F

*Th OFF = Thermostat OFF

Indoor Unit Capacity (S value)

The capacity of the indoor unit is a "S" value and is used for frequency command.

Capacity	S value	Capacity	S value
2.5 kW	25	5.0 kW	50
3.5 kW	35	6.0 kW	60

Frequency Initial Setting**<Outline>**

When starting the compressor, or when conditions are varied due to the change of the operating room, the frequency must be initialized according to the total of a maximum ΔD value of each room and a total value of Q (ΣQ) of the operating room (the room in which the thermostat is set to ON).

Q value: Indoor unit output determined from indoor unit volume, air flow rate and other factors.

PI Control (Determine Frequency Up / Down by ΔD Signal)**1. P control**

Calculate a total of the ΔD value in each sampling time (20 seconds), and adjust the frequency according to its difference from the frequency previously calculated.

2. I control

If the operating frequency is not change more than a certain fixed time, adjust the frequency up and down according to the $\Sigma \Delta D$ value, obtaining the fixed $\Sigma \Delta D$ value.

When the $\Sigma \Delta D$ value is small...lower the frequency.

When the $\Sigma \Delta D$ value is large...increase the frequency.

3. Limit of frequency variation width

When the difference between input current and input current drooping value is less than 1.5 A, the frequency increase width must be limited.

4. Frequency management when other controls are functioning

- ◆ When each frequency is drooping;
Frequency management is carried out only when the frequency droops.
- ◆ For limiting lower limit
Frequency management is carried out only when the frequency rises.

5. Upper and lower limit of frequency by PI control

The frequency upper and lower limits are set depending on the total of S values of a room. When low noise commands come from the indoor unit more than one room or when outdoor unit low noise or quiet commands come from all the rooms, the upper limit frequency must be lowered than the usual setting.

3.3 Controls at Mode Changing / Start-up

3.3.1 Preheating Operation

Outline Operate the inverter in the open phase operation with the conditions including the preheating command from the indoor, the outdoor air temperature and discharge pipe temperature.

Detail

Preheating ON Condition

- When outdoor air temperature is below 10.5°C and discharge pipe temperature is below 10.5°C, inverter in open phase operation starts.

OFF Condition

- When outdoor air temperature is higher than 12°C or discharge pipe temperature is higher than 12°C, inverter in open phase operation stops.

3.3.2 Four Way Valve Switching

Outline of heating operation

Heat Pump Only

During the heating operation current must be conducted and during cooling and defrosting current must not be conducted. In order to eliminate the switching sound (as the four way valve coil switches from ON to OFF) when the heating is stopped, the delay switch of the four way valve must be carried out after the operation stopped.

Detail

The OFF delay of four way valve
Energize the coil for 150 sec after unit operation is stopped.

3.3.3 Four Way Valve Operation Compensation

Outline

Heat Pump Only

At the beginning of the operation as the four way valve is switched, acquire the differential pressure required for activating the four way valve by having output the operating frequency, which is more than a certain fixed frequency, for a certain fixed time.

Detail

Starting Conditions

1. When starting compressor for heating.
2. When the operating mode changes from the previous time.
3. When starting compressor for rushing defrosting or resetting.
4. When starting compressor for the first time after the reset with the power is ON.
Set the lower limit frequency to 55 (model by model) Hz for 70 seconds with the OR conditions with 1 through 4 above.

3.3.4 3 Minutes Stand-by

Prohibit to turn ON the compressor for 3 minutes after turning it off.
(Except when defrosting. (Only for Heat Pump Model).)

3.3.5 Compressor Protection Function

When turning the compressor from OFF to ON, the upper limit of frequency must be set as follows. (The function must not be used when defrosting (only for heat pump model).)

	2YC32	2YC45
FCG 3	85	80
FCG 2	70	65
FCG 1	55	55

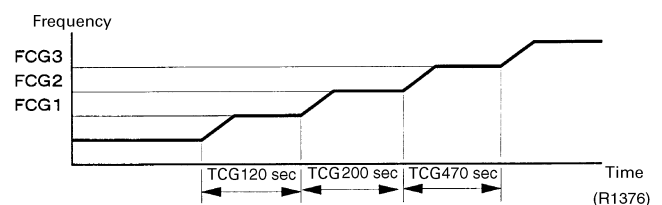

3.4 Discharge Pipe Control

Outline The discharge pipe temperature is used as the compressor's internal temperature. If the discharge pipe temperature rises above a certain level, the operating frequency upper limit is set to keep this temperature from going up further.

Detail **Divide the Zone**

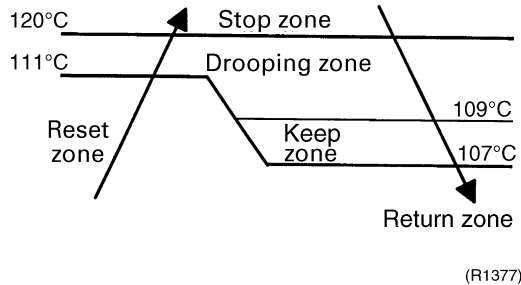

(R1377)

Management within the Zone

Zone	Control contents
Stop zone	When the temperature reaches the stop zone, stop the compressor and correct abnormality.
Drooping zone	Start the timer, and the frequency will be drooping.
Keep zone	Keep the frequency upper limit.
Return / Reset zone	Cancel the frequency upper limit.

3.5 Input Current Control

Outline Detect an input current by the CT during the compressor is running, and set the frequency upper limit from such input current. In case of heat pump model, this control is the upper limit control function of the frequency which takes priority of the lower limit of four way valve activating compensation.

Detail The frequency control will be made within the following zones.

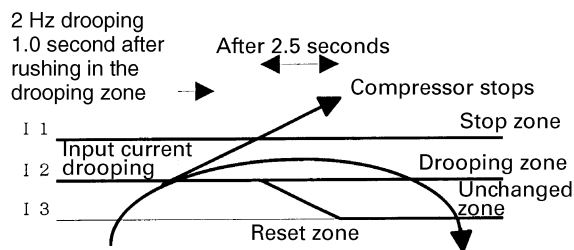

(R1378)

When a “stop current” continues for 2.5 seconds after rushing on the stop zone, the compressor operation stops.
 If a “drooping current” is continues for 1.0 second after rushing on the drooping zone, the frequency will be 2 Hz drooping.
 Repeating the above drooping continues until the current rushes on the drooping zone without change.
 In the unchanged zone, the frequency limit will remain.
 In the return / reset zone, the frequency limit will be cancelled.

Limitation of current drooping and stop value according to the outdoor air temperature

- In case the operation mode is cooling
 - The current droops when outdoor air temperature becomes higher than a certain level (model by model).
- In case the operation mode is heating (only for heat pump model)
 - The current droops when outdoor air temperature becomes higher than a certain level (model by model).

3.6 Freeze-up Protection Control

Outline During cooling operation, the signals being sent from the indoor unit allow the operating frequency limitation and then prevent freezing of the indoor heat exchanger. (The signal from the indoor unit must be divided into the zones as the followings.)

Detail **Conditions for Start Controlling**
 Judge the controlling start with the indoor heat exchanger temperature after 2 sec from operation start and after 30 sec from changing number of operation room.
Control in Each Zone

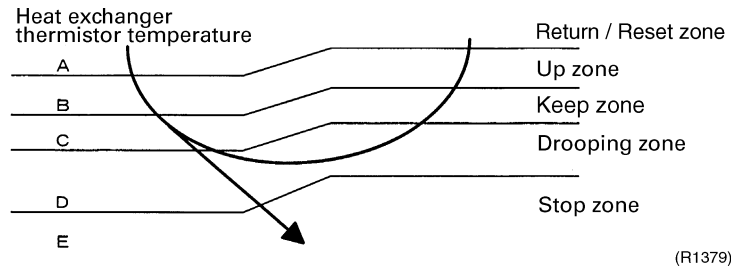

3.7 Heating Peak-cut Control

Outline **Heat Pump Only**
 During heating operation, the signals being sent form the indoor unit allow the operating frequency limitation and prevent abnormal high pressure. (The signal from the indoor unit must be divided as follows.)

Detail **Conditions for Start Controlling**
 Judge the controlling start with the indoor heat exchanger temperature after 2 min from operation start and after A sec from changing number of operation room.
Control in Each Zone
 The maximum value of heat exchange intermediate temperature of each indoor unit controls the following (excluding stopped rooms).

	A
When increase	30
When decrease	2

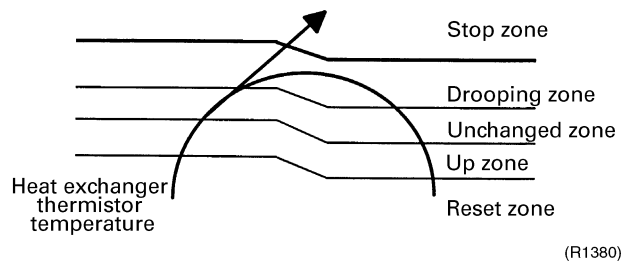

3.8 Fan Control

- Outline**
- Fan control is carried out according to the following priority.
1. Fan ON control for electric component cooling fan
 2. Fan control when defrosting
 3. Fan OFF delay when stopped
 4. ON/OFF control when cooling operation
 5. Fan control when the number of heating rooms decreases
 6. Fan control when forced operation
 7. Fan control in indoor / outdoor silent operation
 8. Fan control for pressure difference upkeep
-

- Detail**
- Fan OFF Control when Stopped**
- Fan OFF delay for 60 seconds must be made when the compressor is stopped.
- Fan control when the number of heating room decreases (Only for Heat Pump Model)**
- When the outdoor air temperature is more than 10°C, the fan must be turned OFF for 30 seconds.
- Tap Control in Indoor / Outdoor Unit Silent Operation**
1. When Cooling Operation
When the outdoor air temperature is less than 37°C, the fan tap must be set to L.
 2. When Heating Operation
When the outdoor air temperature is more than 4°C, the fan tap must be turned to L (only for heat pump model).
-

3.9 Moisture Protection Function 2

- Outline**
- In order to obtain the dependability of the compressor, the compressor must be stopped according to the conditions of the temperature of the outdoor air and outdoor heat exchanger.
-

- Detail**
- Heat Pump Model**
- Operation stop depending on the outdoor air temperature
- Compressor operation turns OFF under the conditions that the system is in cooling operation and outdoor air temperature is below -10°C.
- Cooling Only Model**
- Operation stops depending on the outdoor air temperature.
- Compressor operation turns OFF under the condition that outdoor air temperature is below -10°C (10°C for R22 type).
-

3.10 Defrost Control

Outline

Heat Pump Only

Defrosting is carried out by the cooling cycle (reverse cycle). The defrosting time or outdoor heat exchanger temperature must be more than its fixed value when finishing.

Detail

Conditions for Starting Defrost

The starting conditions must be made with the outdoor air temperature and heat exchanger temperature. Under the conditions that the system is in heating operation, 6 minutes after the compressor is started and more than 47 minutes of accumulated time pass since the start of the operation or ending the defrosting.

Conditions for Canceling Defrost

The target heat exchanger temperature as the canceling condition is selected in the range of $4^{\circ}\text{C} < T_e < 12^{\circ}\text{C}$ according to the air temperature as the following formula.

The target heat exchanger temperature = $-(45/65) \times (\text{ambient temperature}) + 14$

The defrost operation surely operates in 120 seconds after the start. (A→B)

After then the defrost operation stops at the following conditions.

1. When the heat exchanger temperature reaches the target heat exchanger temperature. (B→C)
2. When 650 seconds have passed after the start even if the heat exchanger temperature does not reaches the target heat exchanger temperature. (C)

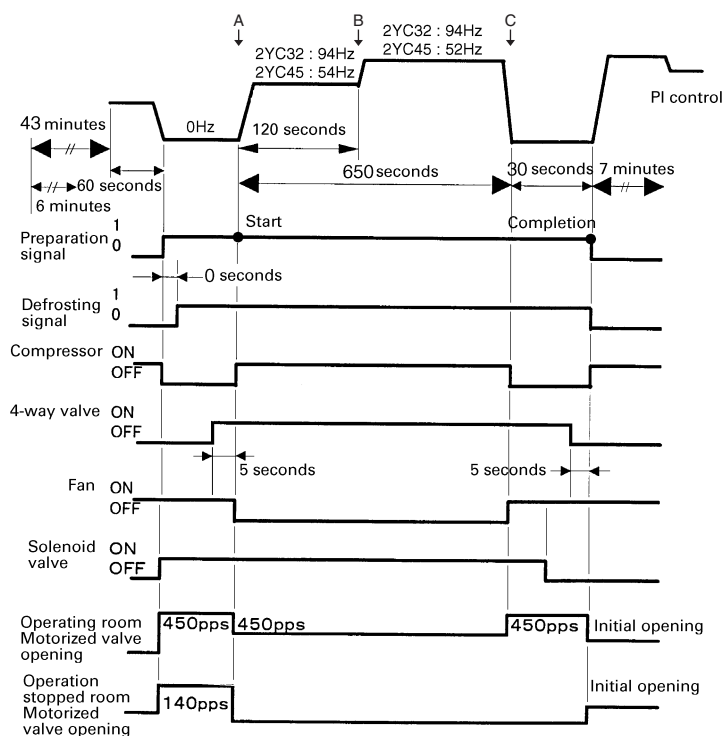

(R1381)

3.11 Low Hz High Pressure Limit

Outline

Heat Pump Only

Set the upper limit of high pressure in a low Hz zone. Set the upper limit of the indoor heat exchanger temperature by its operating frequency of Hz. Separate into three zones, reset zone, unchanged zone and drooping zone and the frequency control must be carried out in such zones.

Detail

Separate into Zones

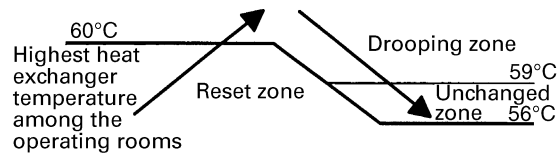

(R1382)



Note: Drooping: The system stops 2 minutes after staying in the drooping zone.

3.12 Electronic Expansion Valve Control

Outline

The following items are included in the electronic expansion valve control.

Electronic expansion valve is fully closed

1. Electronic expansion valve is fully closed when turning on the power.
2. Pressure equalizing control

Room Distribution Control

1. Gas pipe isothermal control
2. SC control (Only for Heat Pump Model)

Open Control

1. Electronic expansion valve control when starting operation
2. Control when frequency changed
3. Control for defrosting (only for heat pump model)
4. Oil recover control
5. Control when a discharge pipe temperature is abnormally high
6. Control when the discharge pipe thermistor is disconnected
7. Control for indoor unit freeze-up protection

Feedback Control

1. Discharge pipe temperature control

Distribution control for each room

1. Liquid pipe temperature control (with all ports connected and all rooms being air-conditioned)
2. Liquid pipe temperature control for stopped rooms
3. Dew prevention function for indoor rotor

Detail

The followings are the examples of control which function in each mode by the electronic expansion valve control.

Operation pattern		Gas pipe isothermal control	SC control (only for heat pump model)	Control when frequency changed	Control for abnormally high discharge pipe temperature	Oil recovery control	Indoor freeze-up protection control	Liquid pipe temperature control	Liquid pipe temperature control for stopped rooms	Dew prevention control for indoor rotor
When power is turned ON	Fully closed when power is turned ON	×	×	×	×	×	×	×	×	×
Cooling, 1 room operation	Open control when starting	×	×	×	○	○	○	×	×	×
	(Control of target discharge pipe temperature)	×	×	○	○	○	○	×	×	○
Cooling, 2 rooms operation to Cooling, 4 rooms operation	Control when the operating room is changed	×	×	×	○	○	○	×	×	○
	(Control of target discharge pipe temperature)	○	×	○	○	○	○	×	×	○
Stop	Pressure equalizing control	×	×	×	×	×	×	×	×	×
Heating, 1 room operation (only for heat pump model)	Open control when starting	×	×	×	○	×	×	×	×	×
	(Control of target discharge pipe temperature)	×	○ All rooms ×	○	○	×	×	○ All rooms ○	○ All rooms ×	×
Heating, 2 rooms operation to Heating, 4 rooms operation (only for heat pump model)	Control when the operating room is changed	×	×	×	○	×	×	×	×	×
	(Control of target discharge pipe temperature)	×	○ All rooms ×	○	○	×	×	○ All rooms ○	○ All rooms ×	×
	(Defrost control FD=1) (only for heat pump model)	×	×	×	×	×	×	×	×	×
Stop	Pressure equalizing control	×	×	×	×	×	×	×	×	×
Heating operation (only for heat pump model)	Open control when starting	×	×	×	○	×	×	×	×	×
Control of discharge pipe thermistor disconnection	Continue	×	○ All rooms ×	×	×	×	×	○ All rooms ○	○ All rooms ×	×
Stop	Pressure equalizing control	×	×	×	×	×	×	×	×	×

(R3056)

3.12.1 Fully Closing with Power ON

Initialize the electronic expansion valve when turning on the power, set the opening position and develop pressure equalizing.

3.12.2 Pressure Equalization Control

When the compressor is stopped, open and close the electronic expansion valve and develop pressure equalization.

3.12.3 Opening Limit

Outline Limit a maximum and minimum opening of the electronic expansion valve in the operating room.

Detail

- A maximum electronic expansion valve opening in the operating room: 450 pulses
- A minimum electronic expansion valve opening in the operating room: 75 pulses

The electronic expansion valve is fully closed in the room where cooling is stopped and is opened with fixed opening during defrosting.

3.12.4 Starting Operation Control / Changing Operation Room

Control the electronic expansion valve opening when the system is starting or the operating room is changed, and prevent the system to be super heated or moistened.

3.12.5 High Temperature of the Discharge Pipe

When the compressor is operating, if the discharge pipe temperature exceeds a certain value, open the electronic expansion valve and remove the refrigerant to the low pressure side and lower discharge temperature.

3.12.6 Oil Recovery Function

Outline The electronic expansion valve opening in the cooling stopped room must be set as to open for a certain time at a specified interval so that the oil in the cooling stopped room may not be accumulated.

Detail During cooling operation, every 1 hour continuous operation, the electronic expansion valves in the operation stopped room must be opened by 80 pulses for specified time.

3.12.7 Gas Pipe Isothermal Control During Cooling

When the units are operating in multiple rooms, detect the gas piping temperature and correct the electronic expansion valve opening so that the temperature of the gas pipe in each room becomes identical.

- When the gas pipe temperature > the average gas pipe temperature,
 - open the electronic expansion valve in that room
- When the gas pipe temperature < the average gas pipe temperature,
 - close the electronic expansion valve in that room

3.12.8 Target Discharge Pipe Temperature Control

Obtain the target discharge pipe temperature from the indoor and outdoor heat exchange temperature, and adjust the electronic expansion valve opening so that the actual discharge pipe temperature become close to that temperature. (Indirect SH control using the discharge pipe temperature)

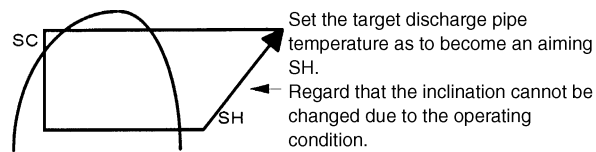

(R1389)

Determine a correction value of the electronic expansion valve compensation and drive it according to the deflection of the target discharge temperature and actual discharge temperature, and the discharge temperature variation by the 20 sec.

3.12.9 SC Control

Outline

Heat Pump Only

Detect the temperature of liquid pipe and heat exchanger of the rooms and compensate the electronic expansion valve opening so that the SC of each room becomes the target SC.

- When the actual SC is > target SC, open the electronic expansion valve of the room.
- When the actual SC is < target SC, close the electronic expansion valve of the room.

Detail

Start Functioning Conditions

After finishing the open control (660 seconds after the beginning of the operation), control all the electronic expansion valve in the operating room.

Determine Electronic Expansion Valve Opening

Adjust the electronic expansion valve so that the temperature difference between the maximum heat exchanger temperature of connected room and the temperature of liquid pipe thermistor becomes constant.

3.12.10 Disconnection of the Discharge Pipe Thermistor

Outline

Detect a disconnected discharge pipe thermistor by comparing the discharge pipe temperature with the condensation temperature. If any is disconnected, open the electronic expansion valve according to the outdoor air temperature and the operating frequency and operate for a specified time, and then stop.

After 3 minutes of waiting, restart the unit and check if any is disconnected. If any is disconnected stop the system after operating for a specified time. If the disconnection is detected 4 times in succession, then the system will be down.

Detail

Detect Disconnection

If a 630-second timer for open control becomes over, and a 9-minute timer for the compressor operation continuation is not counting time, the following adjustment must be made.

1. When the operation mode is cooling
 - When the discharge pipe temperature is lower than the outdoor heat exchanger temperature, the discharge pipe thermistor disconnection must be ascertained.
2. When the operation mode is heating (only for heat pump model)
 - When the discharge pipe temperature is lower than the max temperature of operating room heat exchanger, the discharge pipe thermistor disconnection must be ascertained.

Adjustment when the thermistor is disconnected

When compressor stop repeats specified time, the system should be down.

3.12.11 Control when frequency is changed

When the target pipe temperature control is active, if the target frequency is changed for a specified value in a certain time period, cancel the target discharge pipe temperature control and change the opening of the target electronic expansion valve according to the shift.

3.13 Malfunctions

3.13.1 Sensor Malfunction Detection

Sensor malfunction may occur either in the thermistor or current transformer (CT) system.

Relating to Thermistor Malfunction

1. Outdoor heat exchanger thermistor
2. Discharge pipe thermistor
3. Fin thermistor
4. Gas pipe thermistor
5. Outdoor air temperature thermistor
6. Liquid pipe thermistor

Relating to CT Malfunction

When the output frequency is more than 55 Hz and the input current is less than 1.25A, carry out abnormal adjustment.

3.13.2 Detection of Overload and Over Current

Outline

In order to protect the inverter, detect an excessive output current, and for protecting compressor, monitor the OL operation.

Detail

- If the OL (compressor head) temperature exceeds 130°C (for the 2YC32) (120°C for 3MXS52BVMB) or 130°C (for the 2YC45), the compressor gets interrupted.
- If the inverter current exceeds 30 A, the compressor gets interrupted too.

3.13.3 Insufficient Gas Control

Outline

If a power consumption is below the specified value in which the frequency is higher than the specified frequency, it must be regarded as gas insufficient.

In addition to such conventional function, if the discharge temperature is higher than the target discharge pipe temperature, and more than the specified temperature, and the electronic expansion valve is fully open (450 pulses) more than the specified time, it is considered as an insufficient gas.

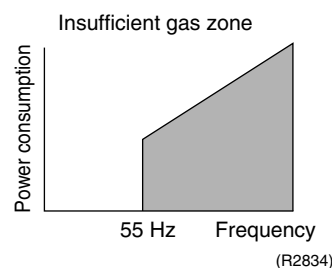

With the conventional function, a power consumption is weak comparing with that in the normal operation when gas is insufficient, and gas insufficiency is detected by checking a power consumption.

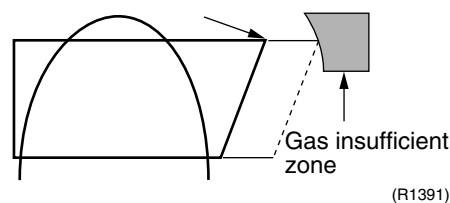

When operating with insufficient gas, although the rise of discharge pipe temperature is great and the electronic expansion valve is open, it is presumed as an insufficient gas if the discharge pipe temperature is higher than the target discharge pipe temperature.

Detail**Judgment by Input Current**

When an output frequency is exceeds 55 Hz and the input current is less than specified value, the adjustment is made for insufficient gas.

Judgment by Discharge Pipe Temperature

When discharge pipe temperature is 20°C higher than target value and the electronic expansion value opening is 450 plus (max.), the adjustment is made for insufficient gas.

3.13.4 Preventing Indoor Freezing

During cooling, if the heat exchanger temperature in the operation stopped room becomes below the specified temperature for the specified time, open the electronic expansion valve in the operation stopped room as specified, and carry out the fully closed operation. After this, if freezing abnormality occurs more than specified time, the system shall be down as the system abnormality.

3.14 Forced Operation Mode**Outline**

Forced operating mode includes functions such as; forced cooling, forced heating, incorrect wiring, incorrect piping check.

Operating mode must be selected by operating the forced operation switch.

Detail**Forced Cooling, Forced Heating (Only for Heat Pump Model)**

Item	Forced Cooling	Forced Heating
Forced operation allowing conditions	1) The indoor unit is not abnormal, but the indoor unit which is not in the freezing prohibiting zone is present in more than 1 room.	1) The indoor unit is not abnormal. The indoor unit which is not in the peak-cut prohibited zone is present in more than 1 room.
	2) The outdoor unit is not abnormal and not in the 3-minute stand-by mode.	←
	3) The operating mode of the outdoor unit is the stop mode.	←
	4) The slide selection switch of the forced operation is the cooling mode. The forced operation is allowed when the above "and" conditions are met.	4) The slide selection switch of the forced operation is the heating mode. The forced operation is allowed when the above "and" conditions are met.
Starting / adjustment	If the forced operation switch is pressed as the above conditions are met.	←
1) Determine operating room	All rooms	1 room operation, with the room that can enable operation and its NO is the smallest (A>B>C>D). Other rooms operation must be stopped.
2) Command frequency	2YC32: 52 Hz 2YC45: 42 Hz	2YC32: 44 Hz (Outdoor air temp:0°C) 2YC45: 37 Hz (Outdoor air temp:0°C)
3) Electronic expansion valve opening	Depending on the capacity of the operating indoor unit.	←
4) Outdoor unit adjustment	Compressor is in operation	←
5) Indoor unit adjustment	Transmit the command of forced draft to the indoor unit	←
End	1) When the forced operation switch is pressed again.	←
	2) The operation is to end automatically after 30 min.	←
Others	The protect functions are prior to all others in the forced operation.	←

3.15 Wiring-Error Check

Outline

The convenient Wiring Error Check function is designed for the microcomputer to correct wiring errors itself.

If local wiring is unclear in the case of buried piping, for example, just press the wiring error check switch that is behind the right-hand panel of the outdoor unit. Even if the connections for Room A and Room B are confused, the system may run without a hassle. Note that this check function does not work in the following cases.

- For about 30 seconds after the power is turned on (during initial setup).
- For 3-minute standby period after the compressor has stopped.
- When the outdoor air temperature is below 5°C.
- If the indoor unit is in trouble (also in case of all-room transmission failure).

When the piping and wiring are perfect, there is no need to use this function.

Operation

1. Remove the 5 screws from the service panel (right side panel) and detach the panel.
2. Press the wiring error check switch on the service monitor PCB, and the wiring error check function is activated.
3. In about 10-15 minutes, the checking will end automatically.
4. When the checking is over, the service monitor LED indicators start flashing.

LED	1	2	3	4	Judgment
Status	All flashing at once				Self-correction impossible
	Flashing one after another				Self-correction complete

Self-correction complete...The LED indicators 1 ~ 4 flash one after another.

Self-correction impossible...The LED indicators flash all at the same time.

- Transmission failure occurs at any of the indoor units.
- The indoor unit heat exchanger thermistor is disconnected.
- An indoor unit is in trouble (if a trouble occurs during the wiring error checking).

Emergency stop...Any of the LED indicators 1 ~ 4 stays on.



Note:

1. It takes about 10-15 minutes (after pressing the wiring error check switch) to complete the checking. (Wrong wiring between the upper and lower units cannot be self-corrected.)
2. Wrongly connected liquid and gas pipes cannot be self-corrected either. Be sure to make the liquid pipe and the gas pipe in pairs.
3. To forced-terminate the wiring error check procedure halfway, press the wiring error check switch again.
In this case, the microcomputer's memory gets back to its initial status (Room A wiring → Port A piping, Room B wiring → Port B piping).
4. In replacing the outdoor unit PCB, be sure to use this function.
5. Make the power slide setting after doing the wiring error checking. (Otherwise, if the wiring is reversed, the air-conditioners being connected are set up in the reverse way.)

Basic Knowledge

- This function works in this way. Refrigerant is let flow from Port A and on. The temperatures of the indoor unit heat exchanger thermistors are detected one by one to check up the matching between the pipes and wiring.
- With this function on, freezing (crackling) noise may be heard from the indoor unit. This is not a problem. (This is because the heat exchange temperature is made to drop below 0°C in order to increase the detection accuracy.)
- The indoor fan is made to turn on and off at the same time.

Checking the current setting data on the microcomputer memory

Those data can be checked by looking at the service monitor LED indicators, when the wiring error checking is over, during forced operation, at the stop of the system. The LED indicators stop flashing when the forced operation is over.
 LED1...Room A wiring, LED2...Room B wiring
 1st flashing LED...Port A piping, 2nd flashing LED...Port B piping
 The first stay-on LED means the room that is connected with Port A. The next stay-on LED means the one connected with Port B.

Example

Let's suppose the LED indicators are flashing as follows.

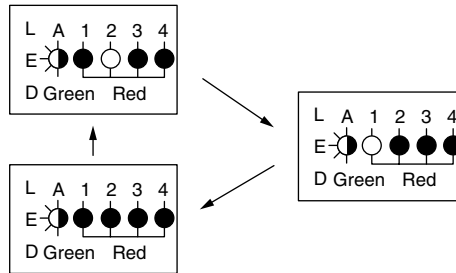

The above means that Port A is connected with Port B and Port B with Room A (or self-corrected this way.)

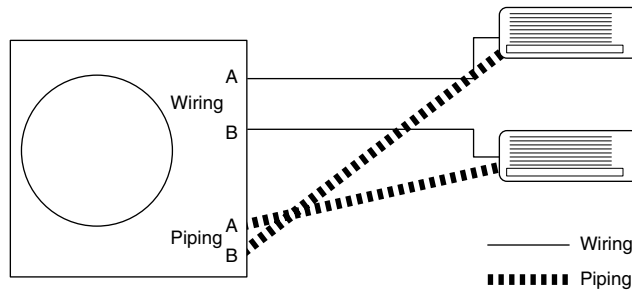

3.16 Additional Function

3.16.1 Connection Pipe Condensation Preventing Function

This control is intended to adjust the electronic expansion valve opening so that the outdoor unit gas pipe temperature (GDN) be kept below 8°C.

3.16.2 Priority Room Setting

Electronic expansion valves are controlled to provide the unit designated as the priority room with the capacity of other room units.

(Distribution of capacity: Priority room unit --- ΔD Max., other room units --- $\Delta D - \alpha$)

- Setting method
 - Turn off the circuit breaker before changing the setting.
 - Only one room can be set as the priority room.
- Control start conditions
 - Priority room setting is made.
 - AND
 - “Powerful” signal from the priority room unit is received.



Note: The operation mode of the priority room unit has precedence.

- Cancellation of control
 - The control function is canceled when the “Powerful” operation mode is switched off or 20 minutes elapse after “Powerful Operation” started.

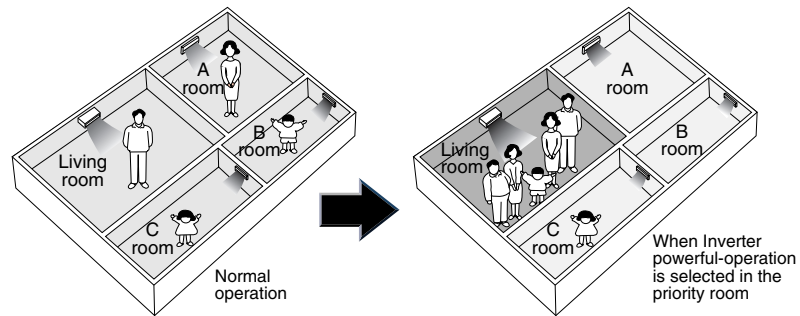

The prioritised room will be heated/cooled much more quickly

(R1396)

3.16.3 Powerful Operation Mode

Compressor operating frequency is increased to PI Max. (Max. Hz of operating room unit ΣS) and outdoor unit airflow rate is increased.

3.16.4 Voltage Detection Function

Power supply voltage is detected each time equipment operation starts.

3.16.5 Cooling / Heating Mode Lock

Use the S15 connector to set the unit to only cool or heat.

Setting to only heat (H): Short-circuit pins 1 and 3 of the connector <S15>.

Setting to only cool (C): short-circuit pins 3 and 5 of the connector <S15>.

The following specifications apply to the connector housing and pins.

JST products Housing: VHR-5N

Pin: SVH-21T-1, 1

Note that forced operation is also possible in COOL / HEAT mode.

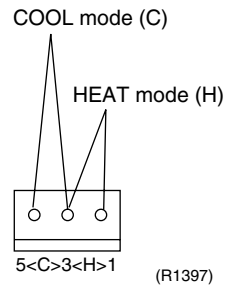

Part 5

System Configuration

1. System Configuration.....	110
1.1 Operation Instructions	110
2. Instruction.....	111
2.1 Contents and Reference Page	111
2.2 Safety Precautions	112
2.3 Names of Parts.....	114
2.4 Preparation before Operation.....	126
2.5 AUTO · DRY · COOL · HEAT · FAN Operation	129
2.6 Adjusting the Air Flow Direction	131
2.7 POWERFUL Operation	137
2.8 OUTDOOR UNIT SILENT Operation	138
2.9 HOME LEAVE Operation	139
2.10 INTELLIGENT EYE Operation	141
2.11 TIMER Operation	145
2.12 Note for Multi System	147
2.13 Care and Cleaning	149
2.14 Troubleshooting.....	159

1. System Configuration

1.1 Operation Instructions

After the installation and test operation of the room air conditioner have been completed, it should be operated and handled as described below. Every user would like to know the correct method of operation of the room air conditioner, to check if it is capable of cooling (or heating) well, and to know a clever method of using it.

In order to meet this expectation of the users, giving sufficient explanations taking enough time can be said to reduce about 80% of the requests for servicing. However good the installation work is and however good the functions are, the customer may blame either the room air conditioner or its installation work because of improper handling. The installation work and handing over of the unit can only be considered to have been completed when its handling has been explained to the user without using technical terms but giving full knowledge of the equipment.

2. Instruction

i Note: This instruction is appropriate for R22 models.

2.1 Contents and Reference Page

Model Series	Wall Mounted Type		Duct Connected Type	Floor/Ceiling Suspended Dual Type
	FTKE25/35BVM(A) FTXE25/35BVMA	FTKD50/60/71BVM(A) FTXD50/60/71BVMA	CDKD25~60CVM(A) CDXD25~60CVMA	FLK25~60AVMA FLX25~60AVMA
Read before Operation				
Safety Precautions	112	112	112	112
Names of Parts	114	117	120	123
Preparation before Operation ★	126	126	126	126
Operation				
AUTO, DRY, COOL, HEAT, FAN Operation ★	129	129	129	129
Adjusting the Air Flow Direction	131	133	—	135
POWERFUL Operation ★	137	137	137	137
OUTDOOR UNIT SILENT Operation ★	138	138	138	138
HOME LEAVE Operation ★	139	139	139	139
INTELLIGENT EYE Operation	141	143	—	—
TIMER Operation ★	145	145	145	145
Note for Multi System	147	147	147	147
Care				
Care and Cleaning	149	152	155	156
Trouble Shooting				
Trouble Shooting	159	159	159	159
Drawing No.	3P098590-2H	C : 3P098595-2M	3P132000-1B	3P077961-5E

★ : Illustrations are for wall mounted type FTK(X)E25/35B as representative.

2.2 Safety Precautions

Safety precautions

- Keep this manual where the operator can easily find them.
- Read this manual attentively before starting up the unit.
- For safety reason the operator must read the following cautions carefully.
- This manual classifies precautions into WARNINGS and CAUTIONS. Be sure to follow all precautions below: they are all important for ensuring safety.

WARNING

If you do not follow these instructions exactly, the unit may cause property damage, personal injury or loss of life.

CAUTION

If you do not follow these instructions exactly, the unit may cause minor or moderate property damage or personal injury.

 Never do.

 Be sure to follow the instructions.

 Be sure to earth the air conditioner.

 Never cause the air conditioner (including the remote controller) to get wet.

 Never touch the air conditioner (including the remote controller) with a wet hand.

WARNING

- In order to avoid fire, explosion or injury, do not operate the unit when harmful, among which flammable or corrosive gases, are detected near the unit. 
 - It is not good for health to expose your body to the air flow for a long time.
 - Do not put a finger, a rod or other objects into the air outlet or inlet. As the fan is rotating at a high speed, it will cause injury.
 - Do not attempt to repair, relocate, modify or reinstall the air conditioner by yourself. Incorrect work will cause electric shocks, fire etc.
- For repairs and reinstallation, consult your Daikin dealer for advice and information.

- The refrigerant used in the air conditioner is safe. Although leaks should not occur, if for some reason any refrigerant happens to leak into the room, make sure it does not come in contact with any flame as of gas heaters, kerosene heaters or gas range. 
- If the air conditioner is not cooling (heating) properly, the refrigerant may be leaking, so call your dealer. When carrying out repairs accompanying adding refrigerant, check the content of the repairs with our service staff.
- Do not attempt to install the air conditioner by your self. Incorrect work will result in water leakage, electric shocks or fire. For installation, consult the dealer or a qualified technician.
- In order to avoid electric shock, fire or injury, if you detect any abnormally such as smell of fire, stop the operation and turn off the breaker. And call your dealer for instructions.

CAUTION

- The air conditioner must be earthed. Incomplete earthing may result in electric shocks. Do not connect the earth line to a gas pipe, water pipe, lightning rod, or a telephone earth line. 

- In order to avoid any quality deterioration, do not use the unit for cooling precision instruments, food, plants, animals or works of art. 
- Never expose little children, plants or animals directly to the air flow.
- Do not place appliances which produce open fire in places exposed to the air flow from the unit or under the indoor unit. It may cause incomplete combustion or deformation of the unit due to the heat.
- Do not block air inlets nor outlets. Impaired air flow may result in insufficient performance or trouble.

- Do not stand or sit on the outdoor unit. Do not place any object on the unit to avoid injury, do not remove the fan guard.
- Do not place anything under the indoor or outdoor unit that must be kept away from moisture. In certain conditions, moisture in the air may condense and drip.
- After a long use, check the unit stand and fittings for damage.
- Do not touch the air inlet and aluminum fins of outdoor unit. It may cause injury.
- The appliance is not intended for use by young children or infirm persons without supervision.
- Young children should be supervised to ensure that they do not play with the appliance.

-
- To avoid oxygen deficiency, ventilate the room sufficiently if equipment with burner is used together with the air conditioner.
 - Before cleaning, be sure to stop the operation, turn the breaker off or pull out the supply cord.
 - Do not connect the air conditioner to a power supply different from the one as specified. It may cause trouble or fire.
 - Depending on the environment, an earth leakage breaker must be installed. Lack of an earth leakage breaker may result in electric shocks.
 - Arrange the drain hose to ensure smooth drainage. Incomplete draining may cause wetting of the building, furniture etc.



-
- Do not operate the air conditioner with wet hands.



-
- Do not wash the indoor unit with excessive water, only use a slightly wet cloth.
 - Do not place things such as vessels containing water or anything else on top of the unit. Water may penetrate into the unit and degrade electrical insulations, resulting in an electric shock.



Installation site

- To install the air conditioner in the following types of environments, consult the dealer.
 - Places with an oily ambient or where steam or soot occurs.
 - Salty environment such as coastal areas.
 - Places where sulfide gas occurs such as hot springs.
 - Places where snow may block the outdoor unit.

The drain from the outdoor unit must be discharged to a place of good drainage.

Consider nuisance to your neighbours from noises

- For installation, choose a place as described below.
 - A place solid enough to bear the weight of the unit which does not amplify the operation noise or vibration.
 - A place from where the air discharged from the outdoor unit or the operation noise will not annoy your neighbours.

Electrical work

- For power supply, be sure to use a separate power circuit dedicated to the air conditioner.

System relocation

- Relocating the air conditioner requires specialized knowledge and skills. Please consult the dealer if relocation is necessary for moving or remodeling

2.3 Names of Parts

FTK(X)E 25/35 B

Names of parts

Indoor Unit

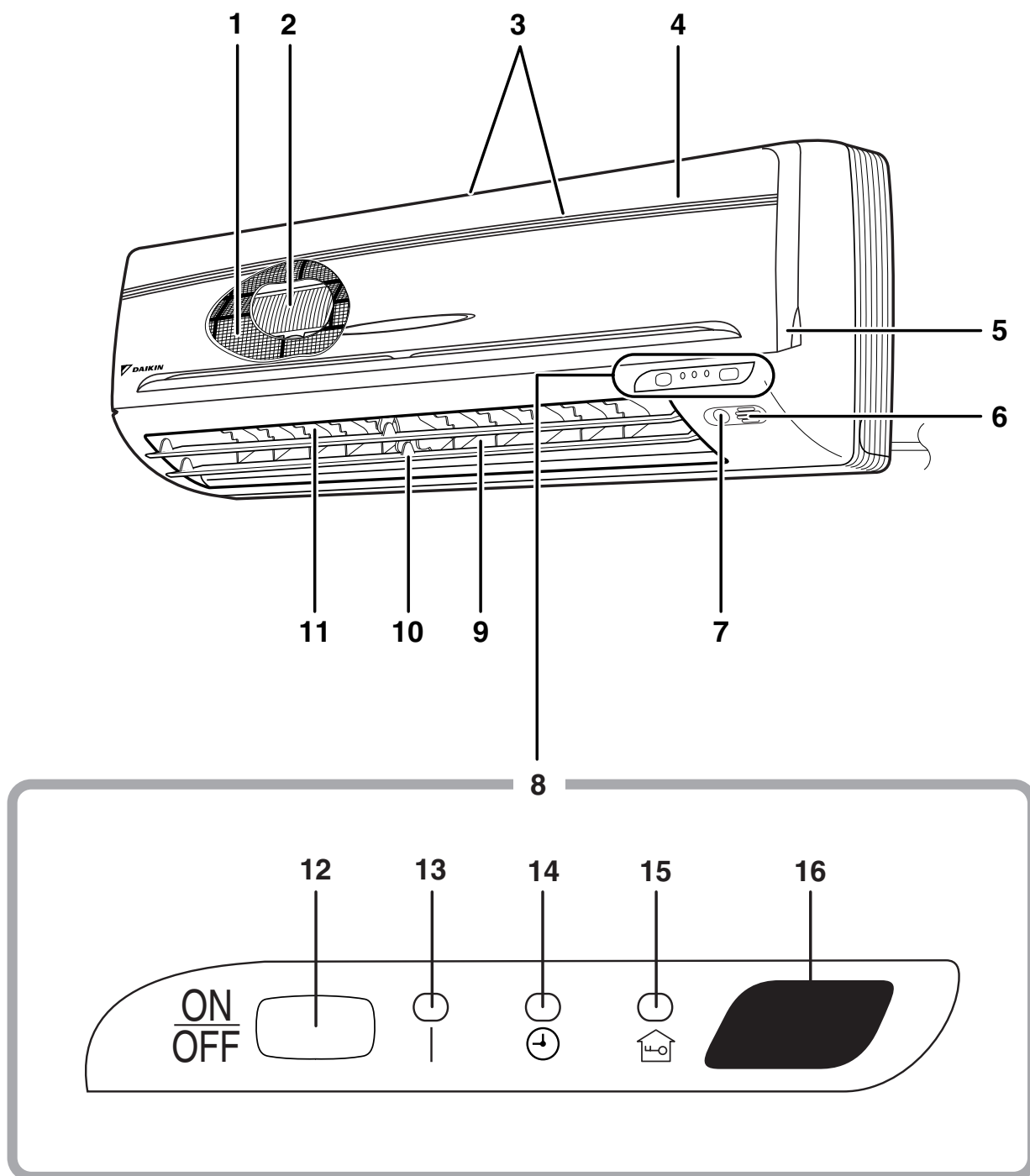

■ Outdoor Unit

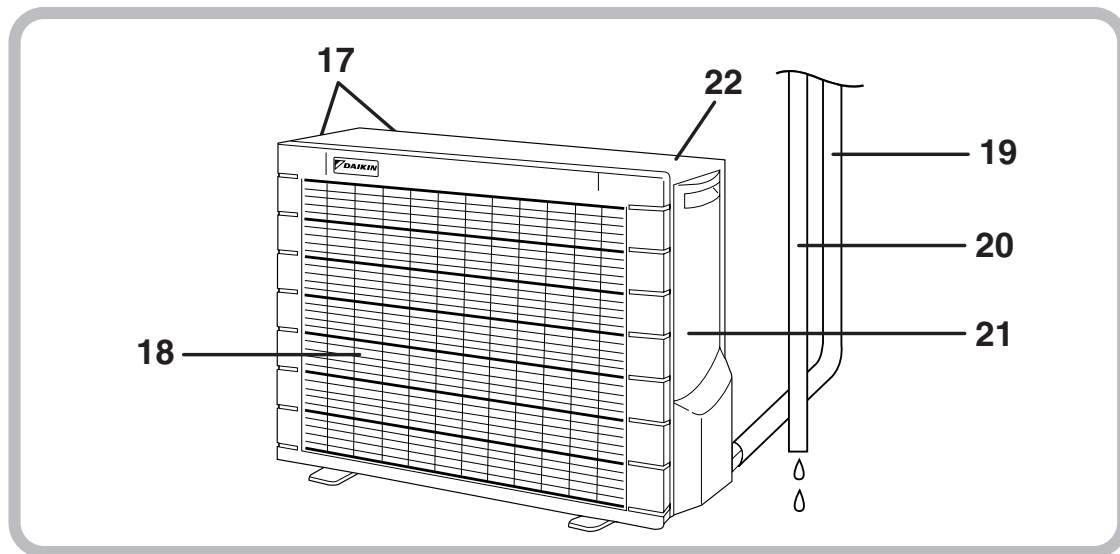

■ Indoor Unit

1. Air filter
2. Photocatalytic deodorizing filter or Air purifying filter:
 - These filters are attached to the inside of the air filters.
3. Air inlet
4. Front grille
5. Grille tab
6. Room temperature sensor:
 - It senses the air temperature around the unit.
7. INTELLIGENT EYE sensor:
 - It detects the movements of people and automatically switches between normal operation and energy saving operation.
8. Display
9. Air outlet
10. Flaps (horizontal blades)
11. Louvres (vertical blades):
 - The louvres are inside of the air outlet.

12. Indoor Unit ON/OFF switch:

- Push this switch once to start operation. Push once again to stop it.
- The operation mode refers to the following table.

	Mode	Temperature setting	Air flow rate
FTKE	COOL	22°C	AUTO
FTXE	AUTO	25°C	AUTO

- This switch is useful when the remote controller is missing.

13. Operation lamp (green)

14. TIMER lamp (Yellow)

15. HOME LEAVE lamp (red)

16. Signal receiver:

- It receives signals from the remote controller.
- When the unit receives a signal, you will hear a short beep.
 - Operation startbeep-beep
 - Settings changed.....beep
 - Operation stopbeeeeeeep

■ Outdoor Unit

17. Air inlet: (Back and side)
18. Air outlet
19. Refrigerant piping and inter-unit cable
20. Drain hose
21. Earth terminal:
 - It is inside of this cover.
22. Outside air temperature sensor:
 - It senses the ambient temperature around the unit.

Appearance of the outdoor unit may differ from some models.

■ Remote Controller

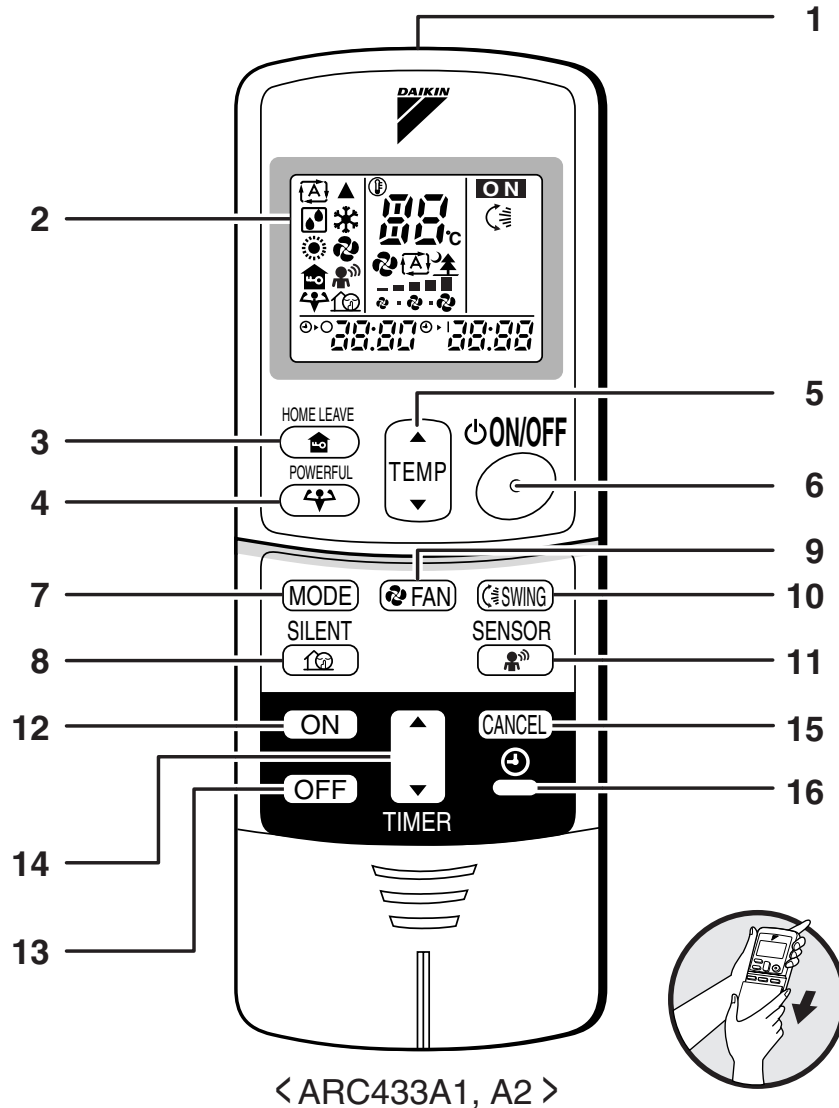

1. Signal transmitter:

- It sends signals to the indoor unit.

2. Display:

- It displays the current settings.
(In this illustration, each section is shown with all its displays ON for the purpose of explanation.)

3. HOME LEAVE button:

for HOME LEAVE operation

4. POWERFUL button:

for POWERFUL operation

5. TEMPERATURE adjustment buttons:

- It changes the temperature setting.

6. ON/OFF button:

- Press this button once to start operation.
Press once again to stop it.

7. MODE selector button:

- It selects the operation mode.

(AUTO/DRY/COOL/HEAT/FAN)

8. SILENT button: for OUTDOOR UNIT

- SILENT operation
- Only works for multi-connection

9. FAN setting button:

- It selects the air flow rate setting.

10. SWING button

11. SENSOR button: for INTELLIGENT EYE operation

12. ON TIMER button

13. OFF TIMER button

14. TIMER Setting button:

- It changes the time setting.

15. TIMER CANCEL button:

- It cancels the timer setting.

16. CLOCK button

FTK(X)D 50/60/71 B

Names of parts

Indoor Unit

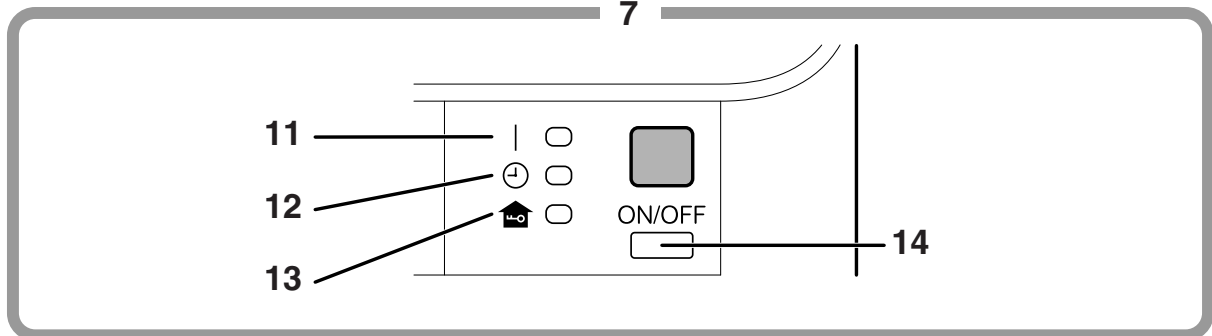
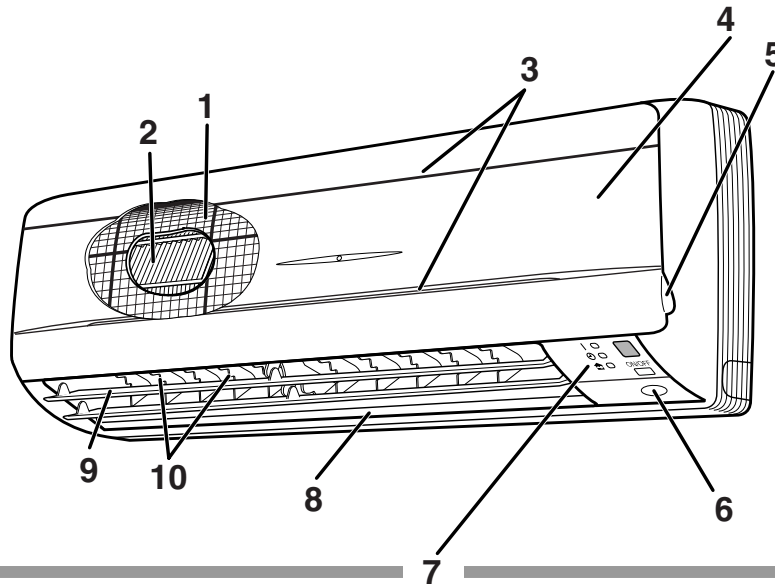

Main unit control panel

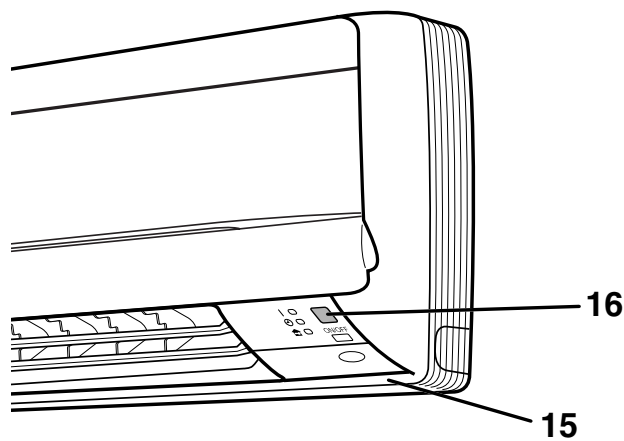

■ Outdoor Unit

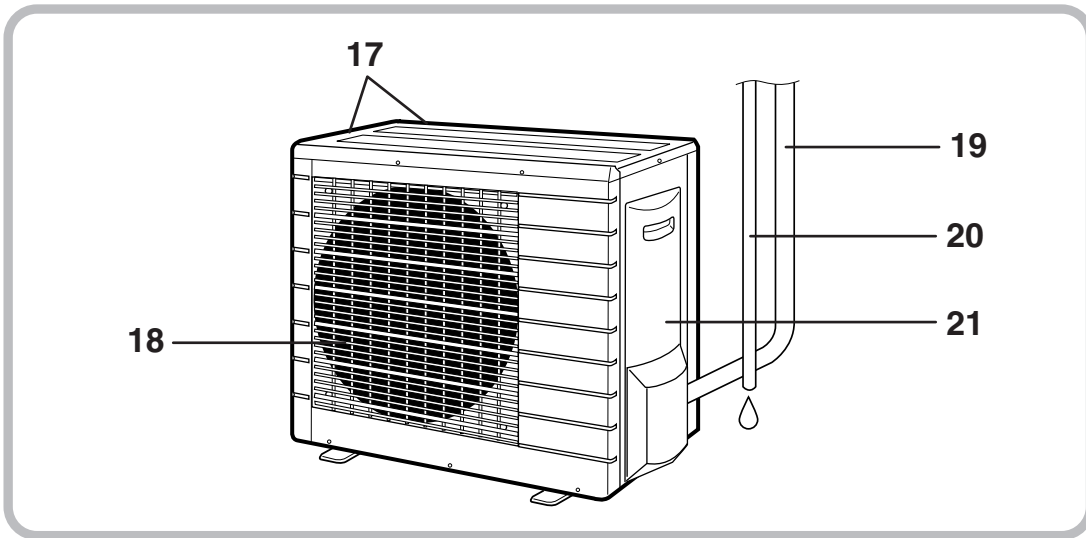

■ Indoor Unit

- 1. Air filter
- 2. Photocatalytic deodorizing filter or Air purifying filter:
 - These filters are attached to the inside of the air filters.
- 3. Air inlet
- 4. Front grille
- 5. Grille tab
- 6. INTELLIGENT EYE sensor:
 - It detects the movements of people and automatically switches between normal operation and energy saving operation.
- 7. Display
- 8. Air outlet
- 9. Flap (horizontal blade)
- 10. Louvers (vertical blades):
 - The Louvers are inside of the air outlet.
- 11. Operation lamp (green)
- 12. TIMER lamp (yellow)

- 13. HOME LEAVE lamp (red):
 - Lights up when you use HOME LEAVE Operation.
- 14. Indoor Unit ON/OFF switch:
 - Push this switch once to start operation. Push once again to stop it.
 - The operation mode refer to the following table.

	Mode	Temperature setting	Air flow rate
FTKD	COOL	22°C	AUTO
FTXD	AUTO	25°C	AUTO

- This switch is useful when the remote controller is missing.
- 15. Room temperature sensor:
 - It senses the air temperature around the unit.
- 16. Signal receiver:
 - It receives signals from the remote controller.
 - When the unit receives a signal, you will hear a short beep.
 - Operation startbeep-beep
 - Settings changed.....beep
 - Operation stopbeeeeee

■ Outdoor Unit

- 17. Air inlet: (Back and side)
- 18. Air outlet
- 19. Refrigerant piping and inter-unit cable
- 20. Drain hose
- 21. Earth terminal:
 - It is inside of this cover.

Appearance of the outdoor unit may differ from some models.

■ Remote Controller

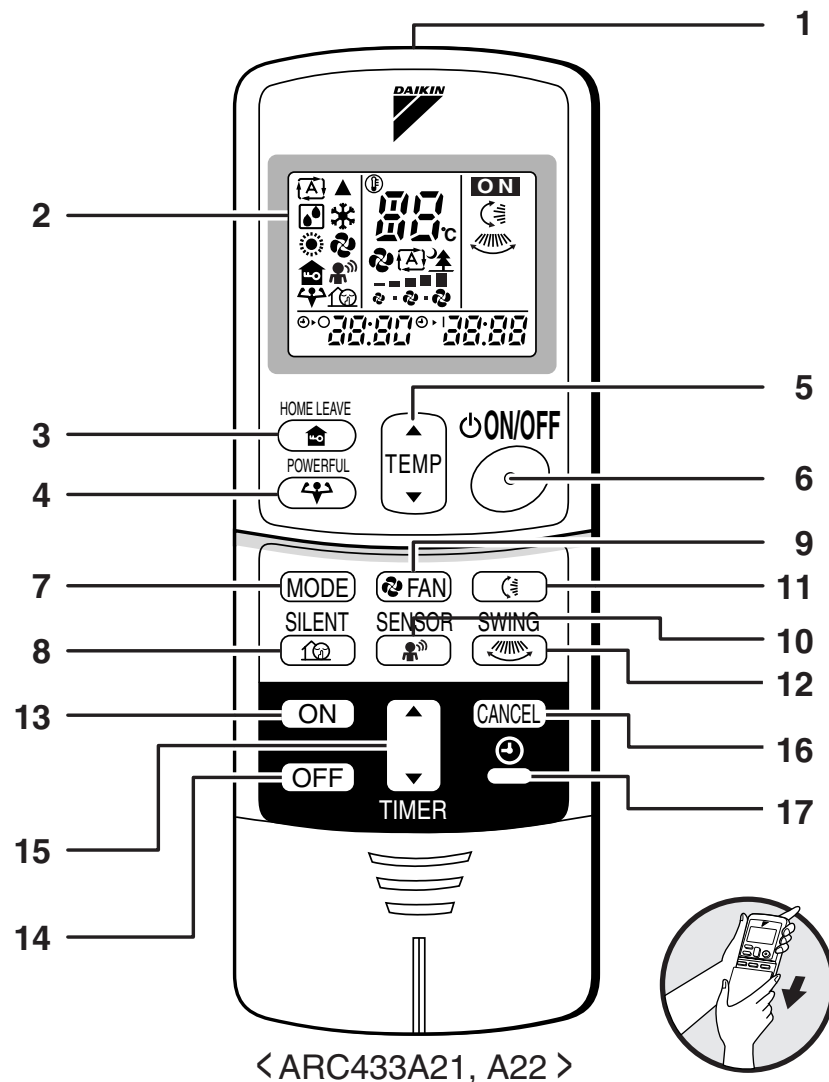

- | | |
|--|--|
| <p>1. Signal transmitter:</p> <ul style="list-style-type: none"> It sends signals to the indoor unit. <p>2. Display:</p> <ul style="list-style-type: none"> It displays the current settings.
(In this illustration, each section is shown with all its displays ON for the purpose of explanation.) <p>3. HOME LEAVE button:
for HOME LEAVE operation</p> <p>4. POWERFUL button:
for POWERFUL operation</p> <p>5. TEMPERATURE adjustment buttons:</p> <ul style="list-style-type: none"> It changes the temperature of time setting. <p>6. ON/OFF button:</p> <ul style="list-style-type: none"> Press this button once to start operation.
Press once again to stop it. <p>7. MODE selector button:</p> <ul style="list-style-type: none"> It selects the operation mode.
(AUTO/DRY/COOL/HEAT/FAN) | <p>8. SILENT button: for OUTDOOR UNIT SILENT operation</p> <p>9. FAN setting button:</p> <ul style="list-style-type: none"> It selects the air flow rate setting. <p>10. SENSOR button: for INTELLIGENT EYE operation</p> <p>11. SWING button</p> <ul style="list-style-type: none"> Flap (Horizontal blade) <p>12. SWING button</p> <ul style="list-style-type: none"> Louver (Vertical blades) <p>13. ON TIMER button</p> <p>14. OFF TIMER button</p> <p>15. TIMER Setting button:</p> <ul style="list-style-type: none"> It changes the time setting. <p>16. TIMER CANCEL button:</p> <ul style="list-style-type: none"> It cancels the timer setting. <p>17. CLOCK button</p> |
|--|--|

CDK(X)D 25/35/50/60 C

Names of parts

■ Indoor Unit

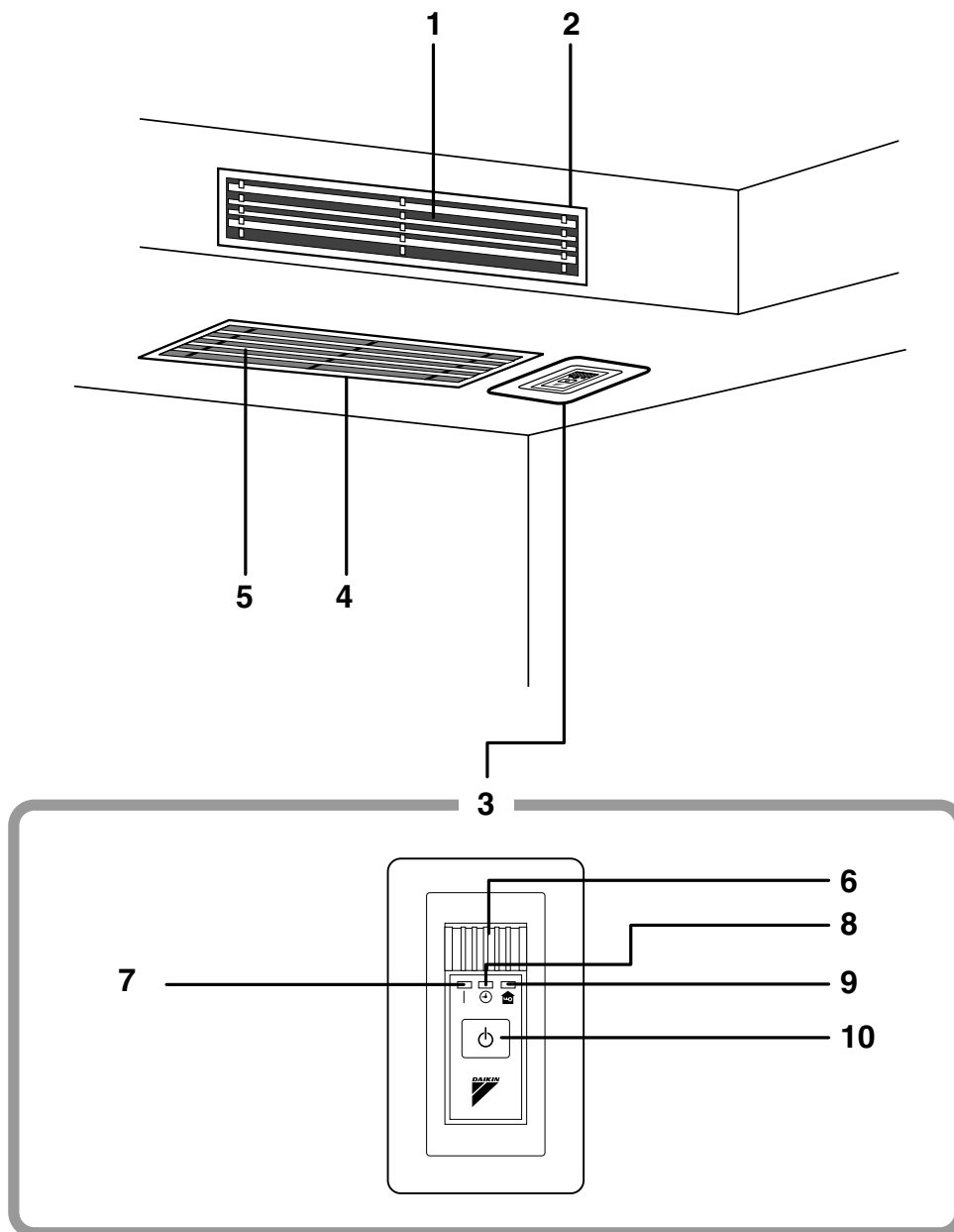

■ Outdoor Unit

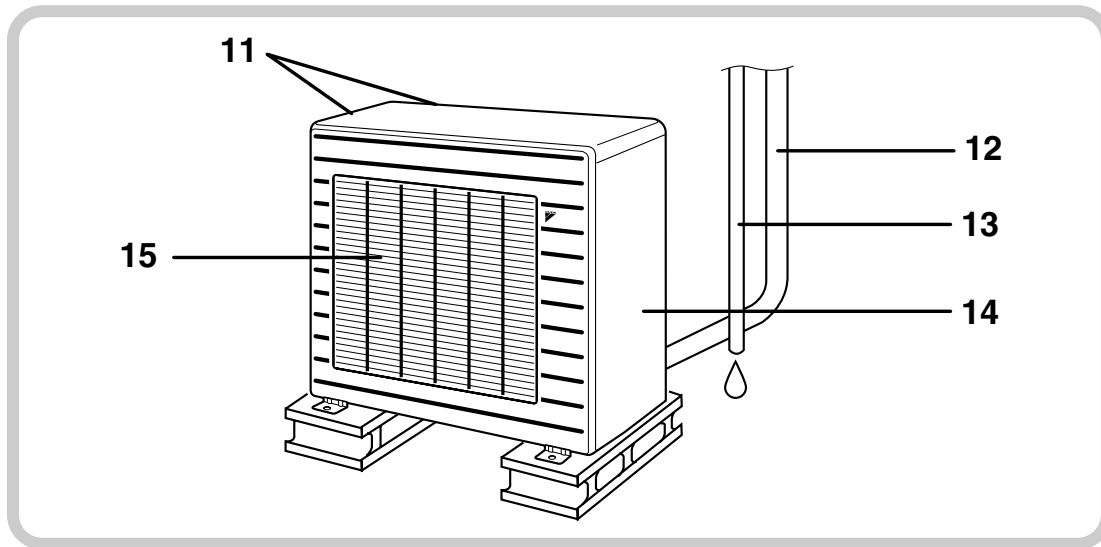

■ Indoor Unit

1. Air outlet

2. Air outlet grille (Field supply)

- Appearance of the Air outlet grille and Air inlet grille may differ with some models.

3. Display, Control panel

4. Suction grille (Option)

- Appearance of the suction grille and Air inlet grille may differ with some models.

5. Air inlet

6. Room temperature sensor:

- It senses the air temperature around the unit.

7. Operation lamp (green)

8. TIMER lamp (yellow)

9. HOME LEAVE lamp (red)

- Lights up when you use HOME LEAVE operation.

10. Indoor Unit ON/OFF switch

- Push this switch once to start operation. Push once again to stop it.
- This switch is useful when the remote controller is missing.

- The operation mode refers to the following table.

	Mode	Temperature setting	Air flow rate
CDKD	COOL	22°C	AUTO
CDXD	AUTO	25°C	AUTO

■ Outdoor Unit

11. Air inlet: (Back and side)

12. Refrigerant piping and inter-unit cable

13. Drain hose

14. Earth terminal:

- It is inside of this cover.

15. Air outlet

Appearance of the outdoor unit may differ from some models.

Remote Controller

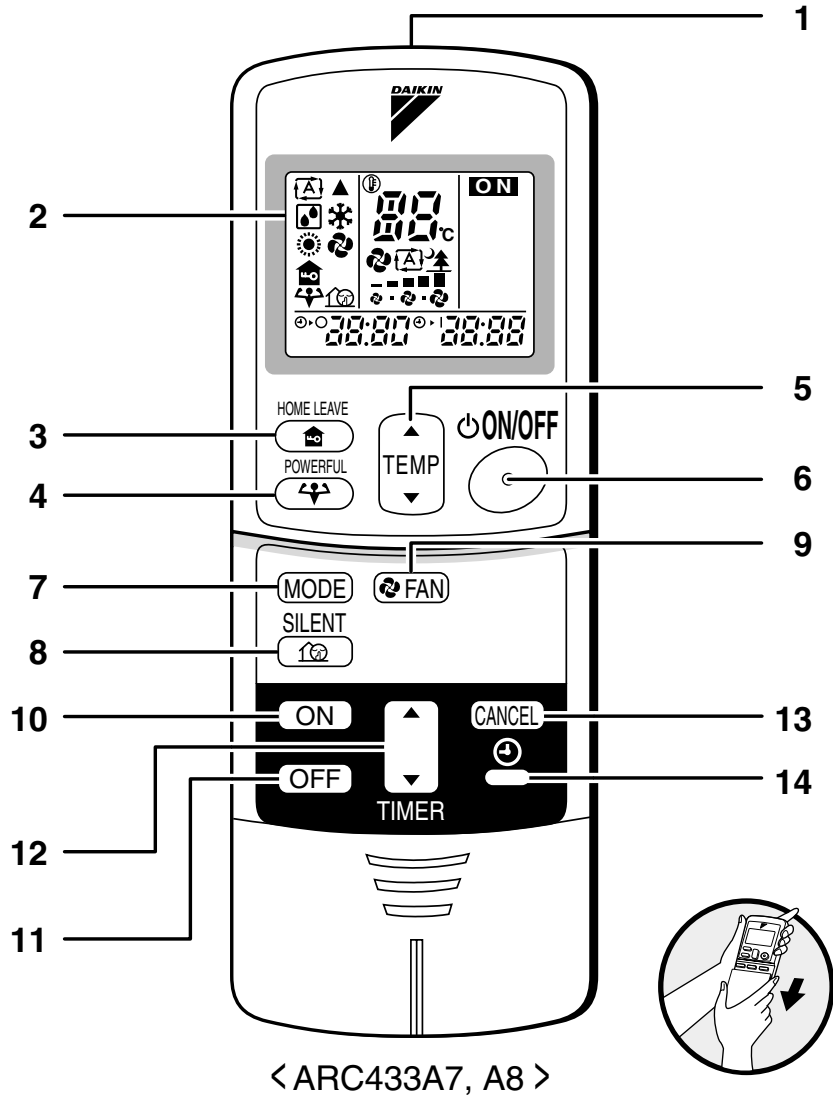

1. Signal transmitter:

- It sends signals to the indoor unit.

2. Display:

- It displays the current settings.
(In this illustration, each section is shown with all its displays ON for the purpose of explanation.)

3. HOME LEAVE button:

for HOME LEAVE operation

4. POWERFUL button:

for POWERFUL operation

5. TEMPERATURE adjustment buttons:

- It changes the temperature setting.

6. ON/OFF button:

- Press this button once to start operation.
Press once again to stop it.

7. MODE selector button:

- It selects the operation mode.
(AUTO/DRY/COOL/HEAT/FAN)

8. SILENT button: for OUTDOOR UNIT SILENT operation

9. FAN setting button:

- It selects the air flow rate setting.

10. ON TIMER button

11. OFF TIMER button

12. TIMER Setting button:

- It changes the time setting.

13. TIMER CANCEL button:

- It cancels the timer setting.

14. CLOCK button

FLK(X) 25/35/50/60 A

Names of parts

Indoor Unit

The indoor unit can be installed either to the ceiling or to a wall. The descriptions contained in this manual show the case when installation is being carried out to the ceiling. (The methods of operation used are the same when installing to a wall.)

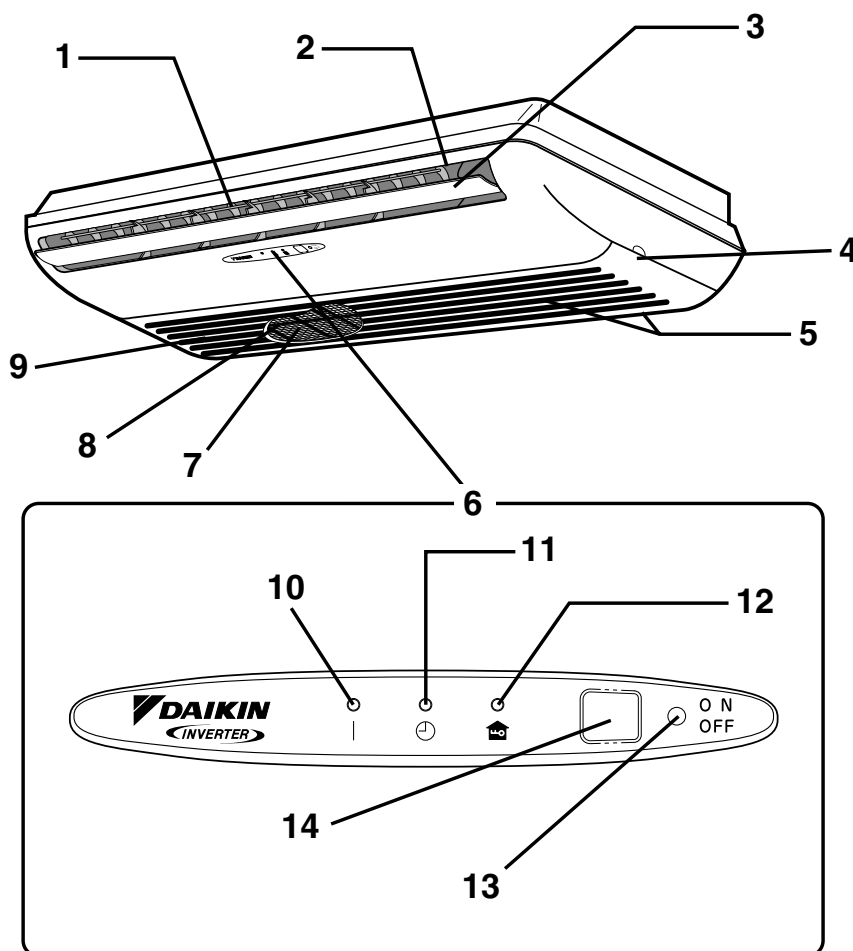

CAUTION

- Before opening the front grille, be sure to stop the operation and turn the breaker OFF.

■ Outdoor Unit

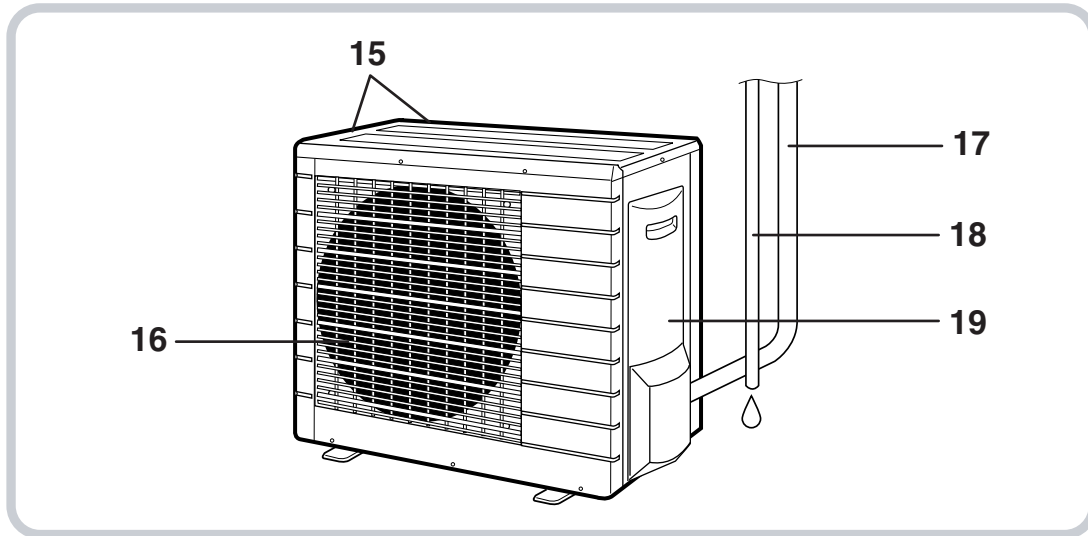

■ Indoor Unit

- 1. Louvres (vertical blades)**
The louvres are inside of the air outlet.
- 2. Air outlet**
- 3. Flap (horizontal blade)**
- 4. Grille tab**
- 5. Air inlet**
- 6. Display**
- 7. Air filter**
- 8. Photocatalytic deodorizing filter or Air purifying filter:**
 - These filters are attached to the inside of the air filters.
- 9. Front grille**
- 10. Operation lamp (green)**
- 11. TIMER lamp (orange)**
- 12. HOME LEAVE lamp (red):**
Lights up when you use HOME LEAVE Operation.
- 13. Indoor unit ON/OFF switch**
 - Push this switch once to start operation. Push once again to stop it.
 - Push the switch using an object with a sharp tip, such as a pen.
 - This switch is useful when the remote controller is missing.
- 14. Signal receiver:**
 - It receives signals from the remote controller.
 - When the unit receives a signal, you will hear a short beep.
 - Operation startbeep-beep
 - Settings changedbeep
 - Operation stopbeeeeeeep

• The operation mode refers to the following table.

	Mode	Temperature setting	Air flow rate
FLK	COOL	22°C	AUTO
FLX	AUTO	25°C	AUTO

■ Outdoor Unit

- 15. Air inlet:** (Back and side)
- 16. Air outlet**
- 17. Refrigerant piping and inter-unit cable**
- 18. Drain hose**
- 19. Earth terminal:**
 - It is inside of this cover.

Appearance of the outdoor unit may differ from some models.

■ Remote Controller

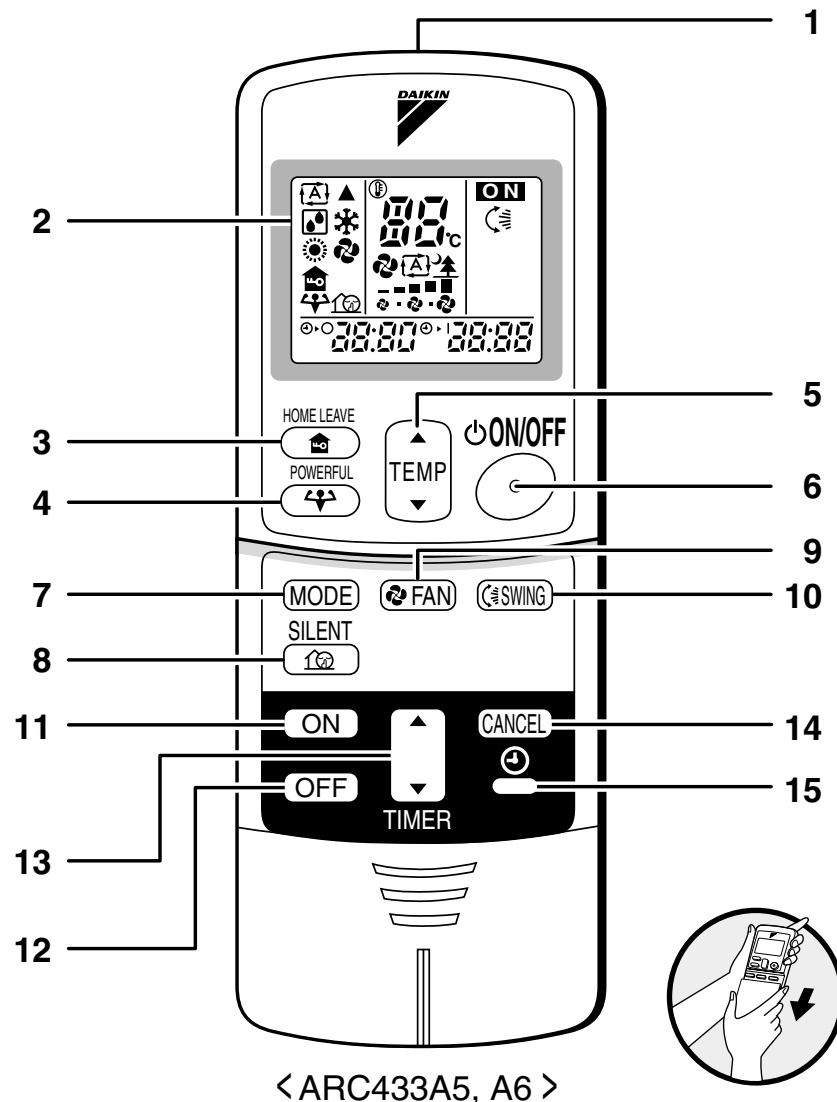

1. Signal Transmitter:

- It sends signals to the indoor unit.

2. Display:

- It displays the current settings.
(In this illustration, each section is shown with all its displays ON for the purpose of explanation.)

3. HOME LEAVE button:

for HOME LEAVE operation

4. POWERFUL button:

for POWERFUL operation

5. TEMPERATURE adjustment buttons:

- It changes the temperature setting.

6. ON/OFF button:

- Press this button once to start operation.
Press once again to stop it.

7. MODE selector button:

- It selects the operation mode.
(AUTO/DRY/COOL/HEAT/FAN)

8. OUTDOOR UNIT SILENT button

9. FAN setting button:

- It selects the air flow rate setting.

10. SWING button

11. ON TIMER button

12. OFF TIMER button

13. TIMER Setting button:

- It changes the time setting.

14. TIMER CANCEL button:

- It cancels the timer setting.

15. CLOCK button

2.4 Preparation before Operation

Preparation Before Operation

■ To set the batteries

1. Press  with a finger and slide the front cover to take it off.
2. Set two dry batteries (AAA).
3. Set the front cover as before.

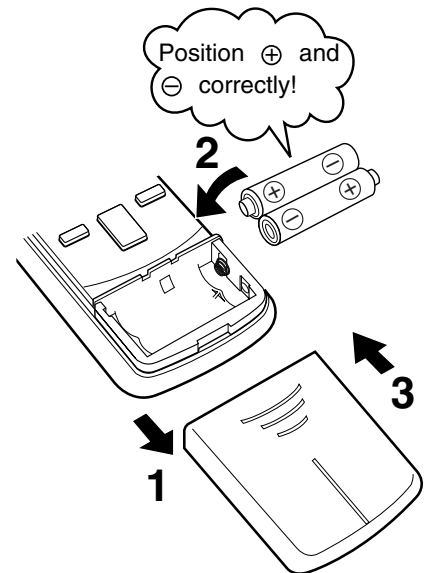

ATTENTION

■ About batteries

- When replacing the batteries, use batteries of the same type, and replace the two old batteries together.
- When the system is not used for a long time, take the batteries out.
- We recommend replacing once a year, although if the remote controller display begins to fade or if reception deteriorates, please replace with new alkali batteries. Using manganese batteries reduces the lifespan.
- The attached batteries are provided for the initial use of the system.
The usable period of the batteries may be short depending on the manufactured date of the air conditioner.

Preparation Before Operation

■ To operate the remote controller

- To use the remote controller, aim the transmitter at the indoor unit. If there is anything to block signals between the unit and the remote controller, such as a curtain, the unit will not operate.
- Do not drop the remote controller. Do not get it wet.
- The maximum distance for communication is about 7 m.

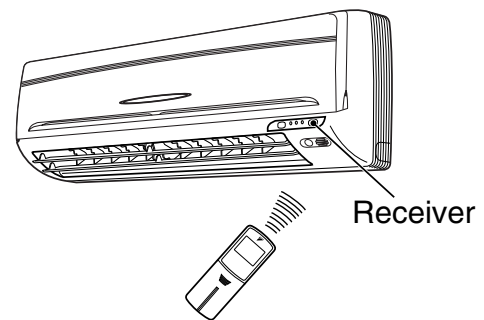

■ To fix the remote controller holder on the wall

1. Choose a place from where the signals reach the unit.
2. Fix the holder to a wall, a pillar, etc. with the screws supplied with the holder.
3. Place the remote controller in the remote controller holder.

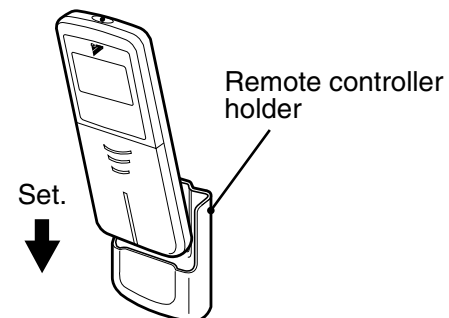

- To remove, pull it upwards.

ATTENTION

■ About remote controller

- Never expose the remote controller to direct sunlight.
- Dust on the signal transmitter or receiver will reduce the sensitivity. Wipe off dust with soft cloth.
- Signal communication may be disabled if an electronic-starter-type fluorescent lamp (such as inverter-type lamps) is in the room. Consult the shop if that is the case.
- If the remote control signals happen to operate another appliance, move that appliance to somewhere else, or consult the shop.

■ To set the clock

1. Press “CLOCK button”.

0:00 is displayed.

⌚ blinks.

2. Press “TIMER setting button” to set the clock to the present time.

Holding down “▲” or “▼” button rapidly increases or decreases the time display.

3. Press “CLOCK button”.

⌚ blinks.

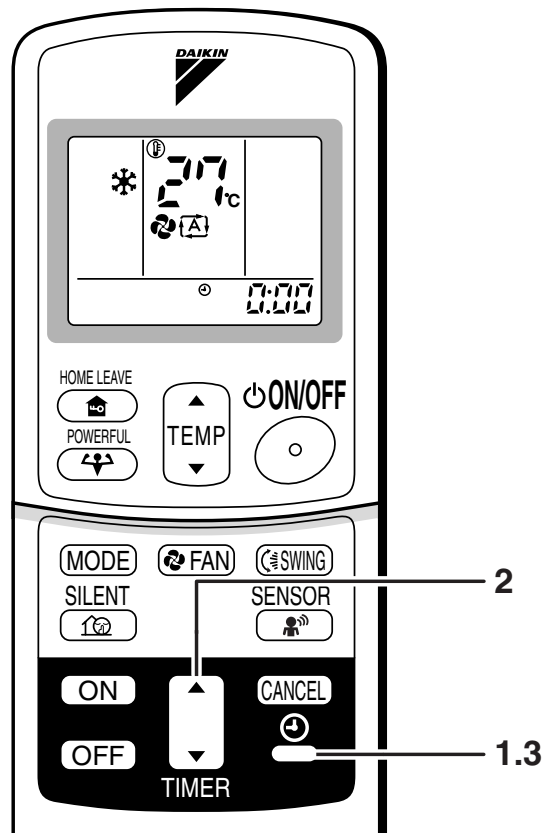

■ Turn the breaker ON

- Turning ON the breaker opens the flap, then closes it again. (This is a normal procedure.)

NOTE

■ Tips for saving energy

- Be careful not to cool (heat) the room too much. Keeping the temperature setting at a moderate level helps save energy.
- Cover windows with a blind or a curtain. Blocking sunlight and air from outdoors increases the cooling (heating) effect.
- Clogged air filters cause inefficient operation and waste energy. Clean them once in about every two weeks.

Recommended temperature setting
For cooling: 26°C – 28°C
For heating: 20°C – 24°C

■ Please note

- The air conditioner always consumes 15-35 watts of electricity even while it is not operating.
- If you are not going to use the air conditioner for a long period, for example in spring or autumn, turn the breaker OFF.
- Use the air conditioner in the following conditions.

Mode	Operating conditions	If operation is continued out of this range
COOL	Outdoor temperature: <3/4MK>10 to 46 °C <3/4MX>-10 to 46 °C Indoor temperature: 18 to 32 °C Indoor humidity: 80% max.	<ul style="list-style-type: none"> • A safety device may work to stop the operation. (In multi system, it may work to stop the operation of the outdoor unit only.) • Condensation may occur on the indoor unit and drip.
HEAT	Outdoor temperature: <3/4MX>-15 to 21 °C Indoor temperature: 10 to 30 °C	<ul style="list-style-type: none"> • A safety device may work to stop the operation.
DRY	Outdoor temperature: <3/4MK>10 to 46 °C <3/4MX>-10 to 46 °C Indoor temperature: 18 to 32 °C Indoor humidity: 80% max.	<ul style="list-style-type: none"> • A safety device may work to stop the operation. • Condensation may occur on the indoor unit and drip.

- Operation outside this humidity or temperature range may cause a safety device to disable the system.

2.5 AUTO · DRY · COOL · HEAT · FAN Operation

AUTO · DRY · COOL · HEAT · FAN Operation

The air conditioner operates with the operation mode of your choice.

From the next time on, the air conditioner will operate with the same operation mode.

■ To start operation

1. Press “MODE selector button” and select a operation mode.

- Each pressing of the button advances the mode setting in sequence.

 : AUTO

 : DRY

 : COOL

 : HEAT

 : FAN

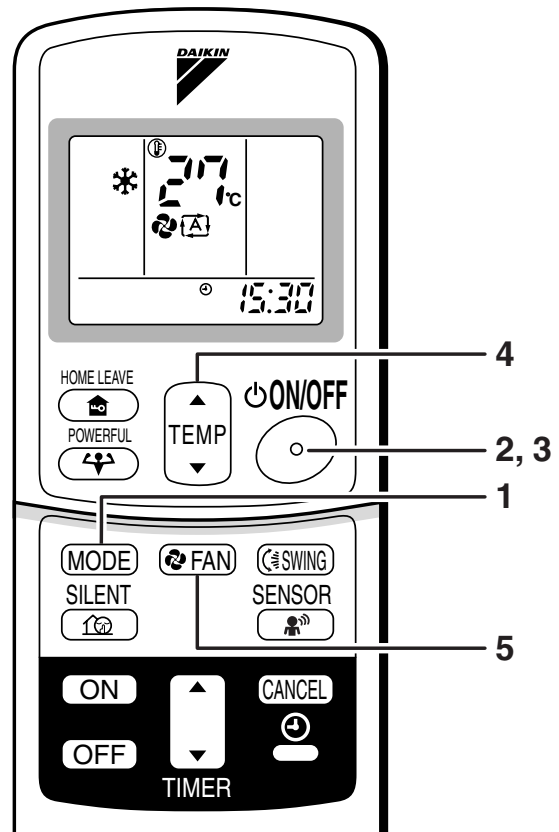
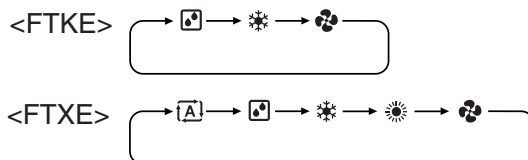

2. Press “ON/OFF button” .

- The OPERATION lamp lights up.



■ To stop operation

3. Press “ON/OFF button” again.

- Then OPERATION lamp goes off.





■ To change the temperature setting

4. Press “TEMPERATURE adjustment button”

DRY or FAN mode	AUTO or COOL or HEAT mode
The temperature setting is not variable.	Press “▲” to raise the temperature and press “▼” to lower the temperature.
	Set to the temperature you like. 

■ To change the air flow rate setting

5. Press “FAN setting button”.

DRY mode	AUTO or COOL or HEAT or FAN mode
The air flow rate setting is not variable.	<p>Five levels of air flow rate setting from “” to “” plus “” “” are available.</p> 

- Indoor unit quiet operation

When the air flow is set to “”, the noise from the indoor unit will become quieter. Use this when making the noise quieter.

The unit might lose power when the fan strength is set to a weak level.

■ To change the air flow direction

NOTE

■ Note on HEAT operation

- Since this air conditioner heats the room by taking heat from outdoor air to indoors, the heating capacity becomes smaller in lower outdoor temperatures. If the heating effect is insufficient, it is recommended to use another heating appliance in combination with the air conditioner.
- The heat pump system heats the room by circulating hot air around all parts of the room. After the start of heating operation, it takes some time before the room gets warmer.
- In heating operation, frost may occur on the outdoor unit and lower the heating capacity. In that case, the system switches into defrosting operation to take away the frost.
- During defrosting operation, hot air does not flow out of indoor unit.

■ Note on DRY operation

- The computer chip works to rid the room of humidity while maintaining the temperature as much as possible. It automatically controls temperature and fan strength, so manual adjustment of these functions is unavailable.

■ Note on AUTO operation

- In AUTO operation, the system selects an appropriate operation mode (COOL or HEAT) based on the room temperature at the start of the operation.
- The system automatically reselects setting at a regular interval to bring the room temperature to user-setting level.
- If you do not like AUTO operation, you can manually select the operation mode and setting you like.

■ Note on air flow rate setting

- At smaller air flow rates, the cooling (heating) effect is also smaller.

2.6 Adjusting the Air Flow Direction

FTK(X)E 25/35 B

Adjusting the Air Flow Direction

You can adjust the air flow direction to increase your comfort.

■ To adjust the horizontal blades (flaps)

1. Press “SWING button”.

 The display will light up and the flaps will begin to swing.

2. When the flaps have reached the desired position, press “SWING button” once more.

The display will go blank.
The flaps will stop moving.

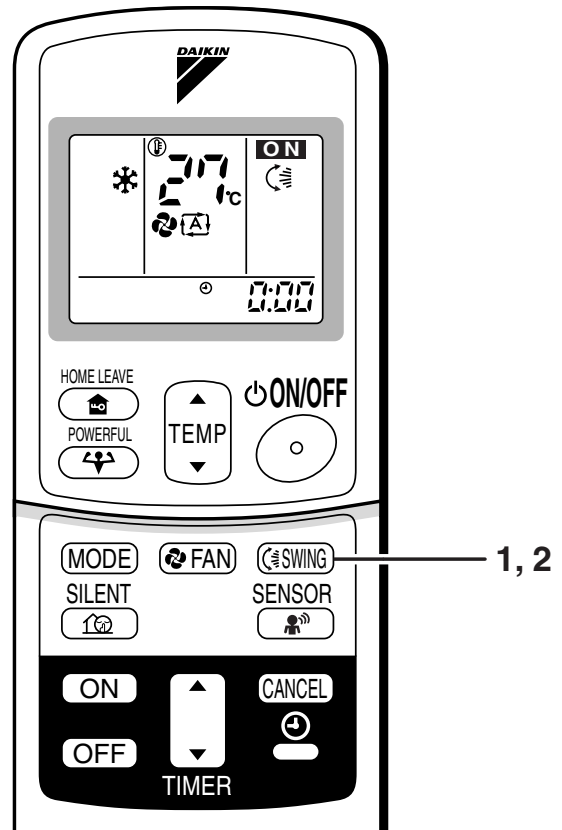

■ To adjust the vertical blades (louvres)

Hold the knob and move the louvres.

(You will find a knob on the left-side and the right-side blades.)

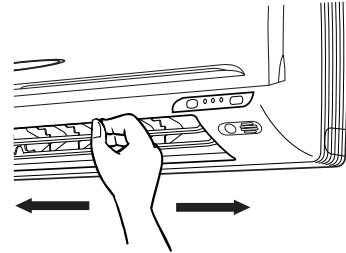

Notes on flaps and louvres angles

- When “**SWING button**” is selected, the flaps swinging range depends on the operation mode. (See the figure.)

■ ATTENTION

- Always use a remote controller to adjust the flaps angle. If you attempt to move it forcibly with hand when it is swinging, the mechanism may be broken.
- Be careful when adjusting the louvres. Inside the air outlet, a fan is rotating at a high speed.

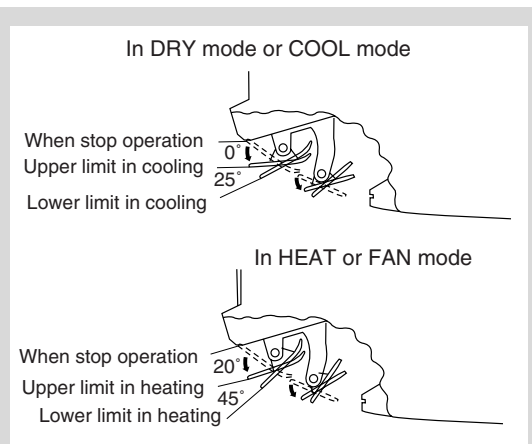

FTK(X)D 50/60/71 B

Adjusting the Air Flow Direction

You can adjust the air flow direction to increase your comfort.

■ To adjust the horizontal blade (flap)

1. Press “SWING button”.

 The display will light up and the flap will begin to swing.

2. When the flap have reached the desired position, press “SWING” button once more.

The display will go blank.
The flap will stop moving.

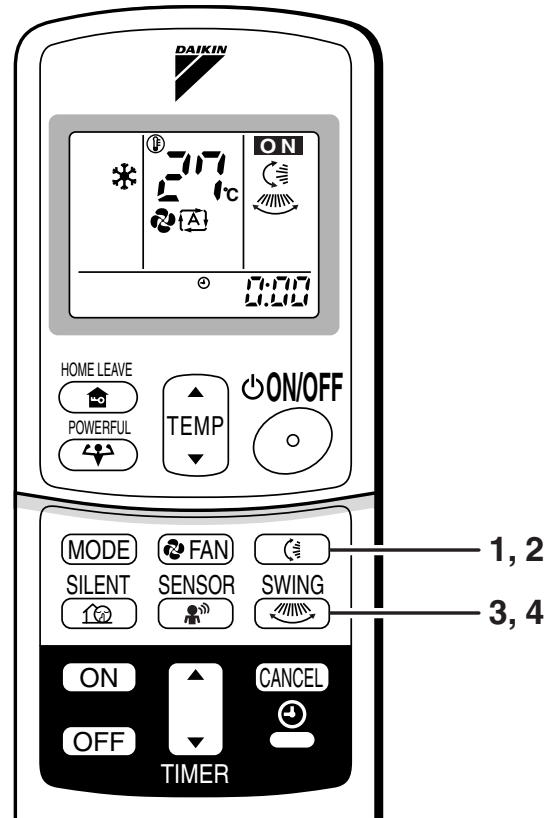

■ To adjust the vertical blades (louvers)

3. Press “SWING button”.

 The display will light up and the louvers will begin to swing.

4. When the louvers have reached the desired position, press the “SWING” button once more.

The display will go blank.
The louvers will stop moving.

■ To 3-D Airflow

1. 3. press “SWING button”: the “” “” display will light up and the flaps and louvers will move in turn.

■ To cancel 3-D Airflow

2. 4. press “SWING button”

Notes on louvers angles

■ ATTENTION

- Always use a remote controller to adjust the louvers angles. In side the air outlet, a fan is rotating at a high speed.

Notes on flap angle

- When “SWING button” is selected, the flaps swinging range depends on the operation mode. (See the figure.)

Three-Dimensional (3-D) Airflow

- Using three-dimensional airflow circulates cold air, which tends to collect at the bottom of the room, and hot air, which tends to collect near the ceiling, throughout the room, preventing areas of cold and hot developing.

■ ATTENTION

- Always use a remote controller to adjust the flaps angle. If you attempt to move it forcibly with hand when it is swinging, the mechanism may be broken.

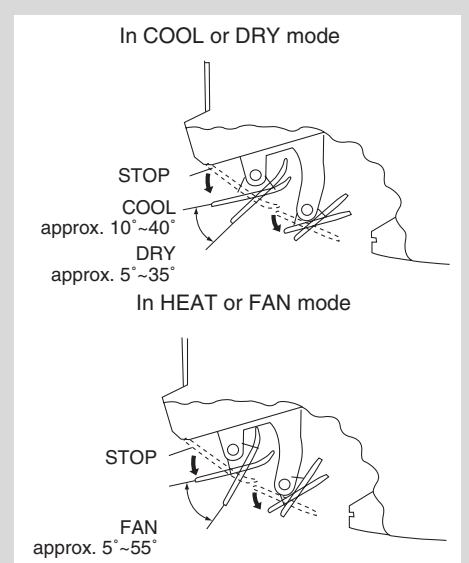

FLK(X) 25/35/50/60 A

Adjusting the Air Flow Direction

You can adjust the air flow direction to increase your comfort.

■ To adjust the horizontal blade (flap)

1. Press “SWING button”.

 The display will light up and the flaps will begin to swing.

2. When the flaps have reached the desired position, press “SWING button” once more.

The display will go blank.
The flaps will stop moving.

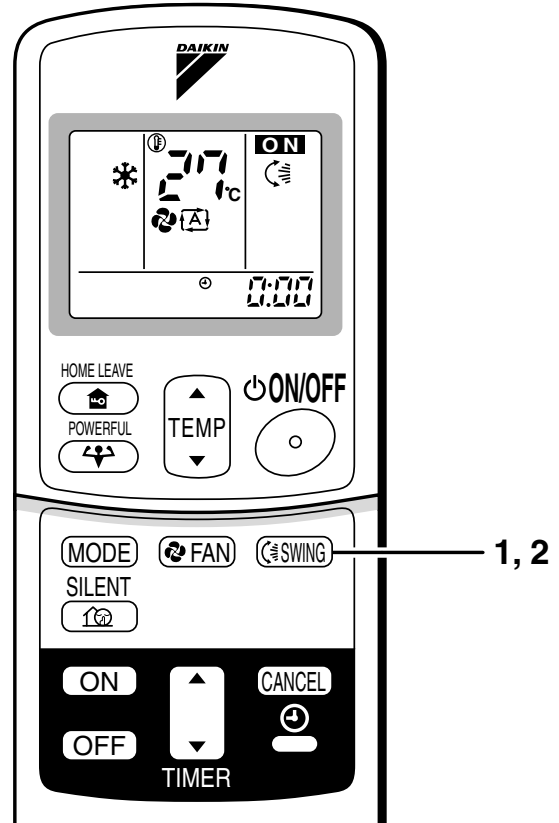

■ To adjust the vertical blades (louvres)

- When adjusting the louvre, use a robust and stable stool and watch your steps carefully.
Hold the knob and move the louvres.
(You will find a knob on the left side and the right side blades.)

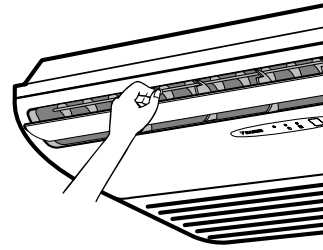

Notes on flap and louvres angles

- Unless [SWING] is selected, you should set the flap at a near- horizontal angle in COOL or DRY mode to obtain the best performance.
- In COOL or DRY mode, if the flap is fixed at a downward position, the flap automatically moves in about 60 minutes to prevent condensation on it.

■ ATTENTION

- Always use a remote controller to adjust the flap angle.
If you attempt to move it forcibly with hand when it is swinging, the mechanism may be broken.
- Be careful when adjusting the louvres. Inside the air outlet, a fan is rotating at a high speed.

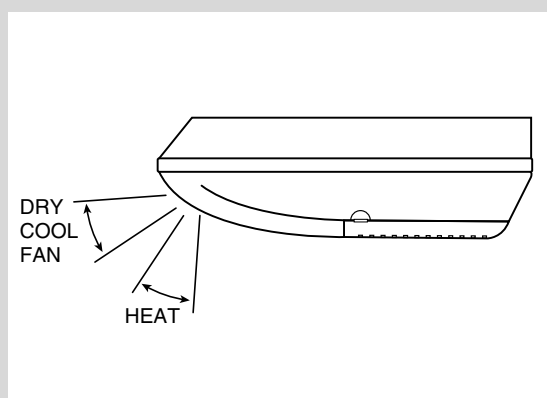

2.7 POWERFUL Operation

POWERFUL Operation

POWERFUL operation quickly maximizes the cooling (heating) effect in any operation mode. You can get the maximum capacity .

■ To start POWERFUL operation

1. Press “POWERFUL button”.

- POWERFUL operation ends in 20 minutes. Then the system automatically operates again with the settings which were used before POWERFUL operation.
- When using POWERFUL operation, there are some functions which are not available.

■ To cancel POWERFUL operation

2. Press “POWERFUL button” again.

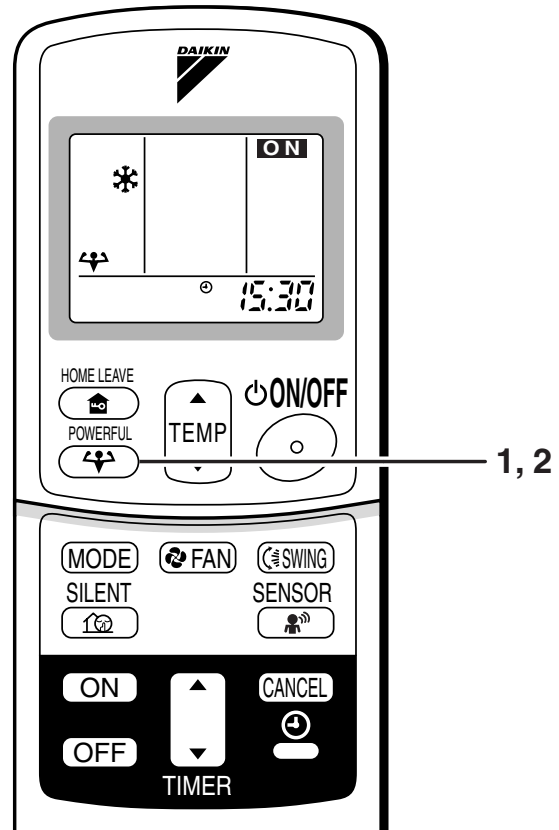

NOTE

■ Notes on POWERFUL operation

• In COOL and HEAT mode

To maximize the cooling (heating) effect, the capacity of outdoor unit must be increased and the air flow rate be fixed to the maximum setting. The temperature and air flow settings are not variable.

• In DRY mode

The temperature setting is lowered by 2.5°C and the air flow rate is slightly increased.

• In FAN mode

The air flow rate is fixed to the maximum setting.

• When using priority-room setting

See “Note for multi system”.

2.8 OUTDOOR UNIT SILENT Operation

OUTDOOR UNIT SILENT Operation

OUTDOOR UNIT SILENT operation lowers the noise level of the outdoor unit by changing the frequency and fan speed on the outdoor unit. This function is convenient during night.

■ To start OUTDOOR UNIT SILENT operation

1. Press “SILENT button”.

■ To cancel OUTDOOR UNIT SILENT operation

2. Press “SILENT button” again.

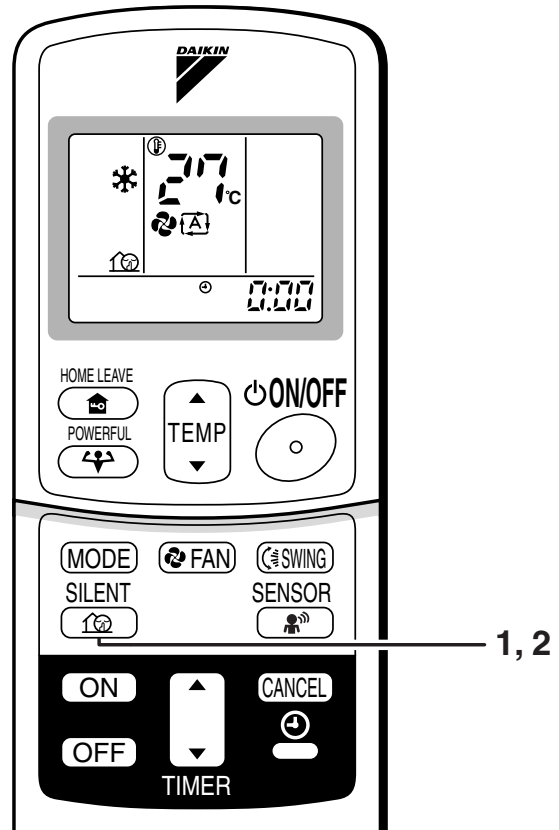

NOTE

■ Note on OUTDOOR UNIT SILENT operation

- If using a multi system, this function will work only when the OUTDOOR UNIT SILENT operation is set on all operated indoor units. However, if using priority-room setting, see “Note for multi system”.
- This function is available in COOL, HEAT, and AUTO modes. (This is not available in FAN and DRY mode.)
- POWERFUL operation and OUTDOOR UNIT SILENT operation cannot be used at the same time. Priority is given to POWERFUL operation.
- If operation is stopped using the remote controller or the main unit ON/OFF switch when using OUTDOOR UNIT SILENT operation, “” will remain on the remote controller display.

2.9 HOME LEAVE Operation

HOME LEAVE Operation

HOME LEAVE operation is a function which allows you to record your preferred temperature and air flow rate settings.

■ To start HOME LEAVE operation

1. Press “HOME LEAVE button” .

- The HOME LEAVE lamp lights up.



■ To cancel HOME LEAVE operation

2. Press “HOME LEAVE button” again.

- The HOME LEAVE lamp goes off.

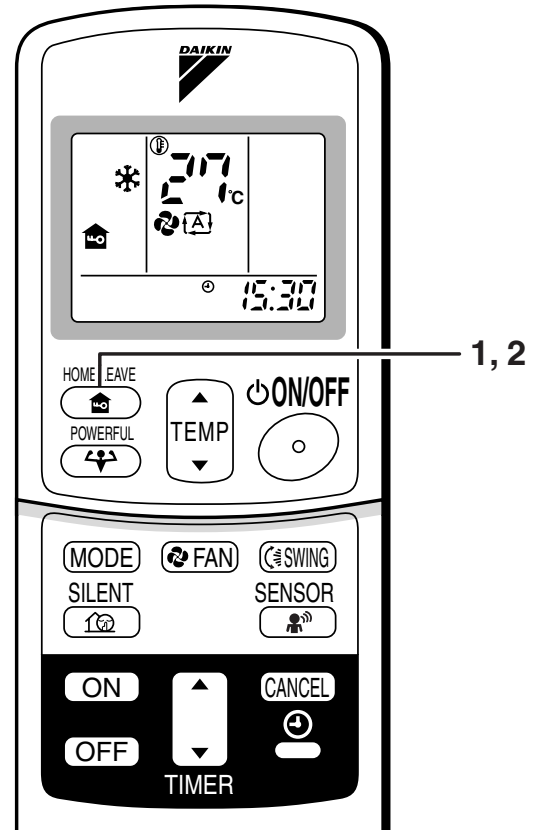

Before using HOME LEAVE operation.

■ To set the temperature and air flow rate for HOME LEAVE operation

When using HOME LEAVE operation for the first time, please set the temperature and air flow rate for HOME LEAVE operation. Record your preferred temperature and air flow rate.

	Initial setting		Selectable range	
	temperature	Air flow rate	temperature	Air flow rate
Cooling	25°C	AUTO	18-32°C	5 step, AUTO and SILENT
Heating	25°C	AUTO	10-30°C	5 step, AUTO and SILENT

1. Press “HOME LEAVE button”. Make sure “” is displayed in the remote control display.

2. Adjust the set temperature with “▲” or “▼” as you like.

3. Adjust the air flow rate with “FAN” setting button as you like.

Home leave operation will run with these settings the next time you use this function. To change the recorded information, repeat steps 1 – 3.

■ What's the HOME LEAVE operation

Is there a set temperature and air flow rate which is most comfortable, a set temperature and air flow rate which you use the most? HOME LEAVE operation is a function that allows you to record your favorite set temperature and air flow rate. You can start your favorite operation mode simply by pressing the HOME LEAVE button on the remote control. This function is convenient in the following situations.

■ Useful in these cases.

1. Use as an energy-saving mode

Set the temperature 2-3°C higher (cooling) or lower (heating) than normal. Setting the fan strength to the lowest setting allows the unit to be used in energy-saving mode. Also convenient for use while you are out or sleeping.

• Every day before you leave the house...

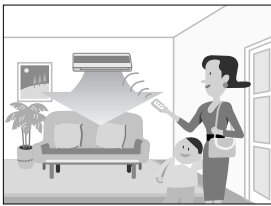

When you go out, push the "HOME LEAVE Operation" button, and the air conditioner will adjust capacity to reach the preset temperature for HOME LEAVE Operation.



When you return, you will be welcomed by a comfortably air conditioned room.

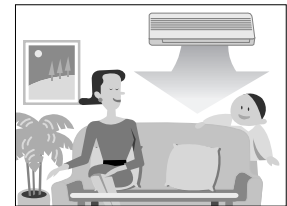

Push the "HOME LEAVE Operation" button again, and the air conditioner will adjust capacity to the set temperature for normal operation.

• Before bed...

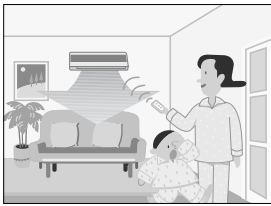

Set the unit to HOME LEAVE Operation before leaving the living room when going to bed.

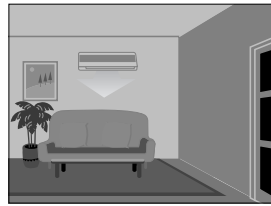

The unit will maintain the temperature in the room at a comfortable level while you sleep.

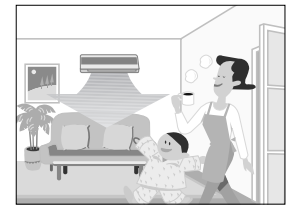

When you enter the living room in the morning, the temperature will be just right. Disengaging HOME LEAVE Operation will return the temperature to that set for normal operation. Even the coldest winters will pose no problem!

2. Use as a favorite mode

Once you record the temperature and air flow rate settings you most often use, you can retrieve them by pressing HOME LEAVE button. You do not have to go through troublesome remote control operations.

NOTE

- Once the temperature and air flow rate for HOME LEAVE operation are set, those settings will be used whenever HOME LEAVE operation is used in the future. To change these settings, please refer to the "Before using HOME LEAVE operation" section above.
- HOME LEAVE operation is only available in COOL and HEAT mode. Cannot be used in AUTO, DRY, and FAN mode.
- HOME LEAVE operation runs in accordance with the previous operation mode (COOL or HEAT) before using HOME LEAVE operation.
- HOME LEAVE operation and POWERFUL operation cannot be used at the same time. Last button that was pressed has priority.
- The operation mode cannot be changed while HOME LEAVE operation is being used.
- When operation is shut off during HOME LEAVE operation, using the remote controller or the indoor unit ON/OFF switch, "🏠" will remain on the remote controller display.

2.10 INTELLIGENT EYE Operation

FTK(X)E 25/35 B

INTELLIGENT EYE Operation

“INTELLIGENT EYE” is the infrared sensor which detects the human movement.

■ To start INTELLIGENT EYE operation

1. Press “SENSOR button”.

■ To cancel the INTELLIGENT EYE operation

2. Press “SENSOR button” again.

[EX.]

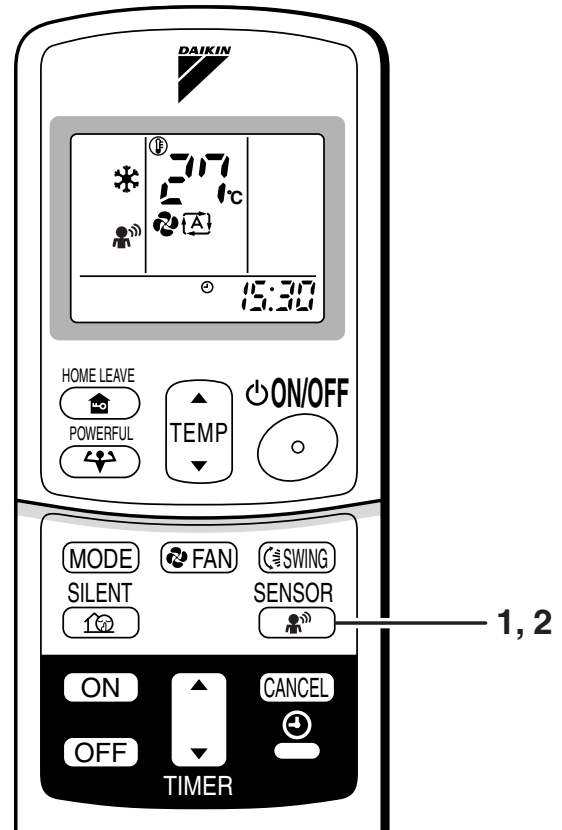
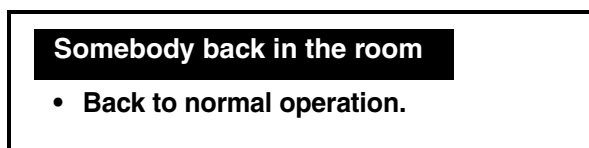
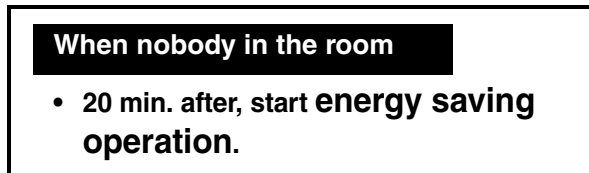

■ To adjust the angle of the INTELLIGENT EYE sensor

- You can adjust the angle of the INTELLIGENT EYE sensor to increase the detection area.
(Adjustable angle: 15° to right and left of centre)

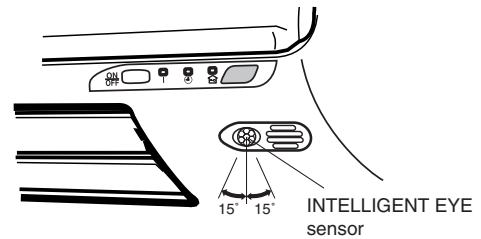

- Gently push and slide the sensor to adjust the angle.
- After adjusting the angle, wipe the sensor gently with a clean cloth, being careful not to scratch the sensor.

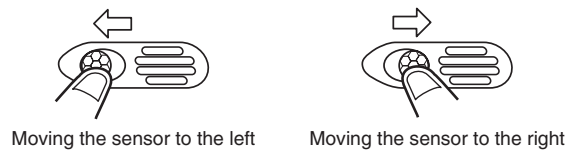

“INTELLIGENT EYE” is useful for Energy Saving

■ Energy saving operation

- Change the temperature -2°C in heating / $+2^{\circ}\text{C}$ in cooling / $+1^{\circ}\text{C}$ in dry mode from set temperature.
- Decrease the air flow rate slightly in fan operation. (In FAN mode only)

Notes on “INTELLIGENT EYE”

- Application range is as follows.

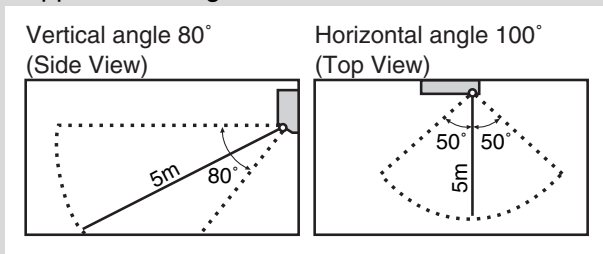

- Sensor may not detect moving objects further than 5m away. (Check the application range)
- Sensor detection sensitivity changes according to indoor location, the speed of passersby, temperature range, etc.
- The sensor also mistakenly detects pets, sunlight, fluttering curtains and light reflected off of mirrors as passersby.
- INTELLIGENT EYE operation will not go on during powerful operation.
- Night set mode will not go on during you use INTELLIGENT EYE operation.

⚠ CAUTION

- Do not place large objects near the sensor. Also keep heating units or humidifiers outside the sensor’s detection area. This sensor can detect objects it shouldn’t as well as not detect objects it should.
- Do not hit or violently push the INTELLIGENT EYE sensor. This can lead to damage and malfunction.

FTK(X)D 50/60/71 B

INTELLIGENT EYE Operation

“INTELLIGENT EYE” is the infrared sensor which detects the human movement.

■ To start INTELLIGENT EYE operation

1. Press “SENSOR button”.

■ To cancel the INTELLIGENT EYE operation

2. Press “SENSOR button” again.

[EX.]

When somebody in the room

- Normal operation



When nobody in the room

- 20 min. after, start energy saving operation.



Somebody back in the room

- Back to normal operation.

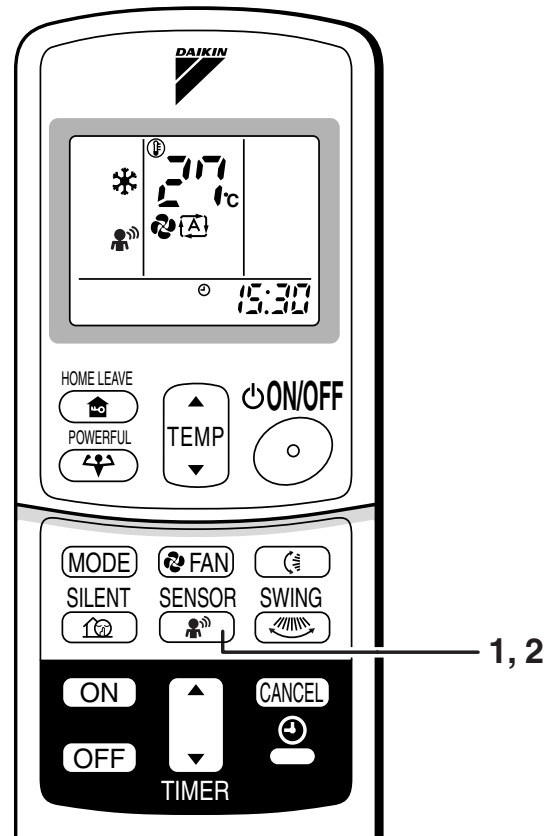

“INTELLIGENT EYE” is useful for Energy Saving

■ Energy saving operation

- Change the temperature -2°C in heating / $+2^{\circ}\text{C}$ in cooling / $+1^{\circ}\text{C}$ in dry mode from set temperature.
- Decrease the air flow rate slightly in fan operation. (In FAN mode only)

Notes on “INTELLIGENT EYE”

- Application range is as follows.

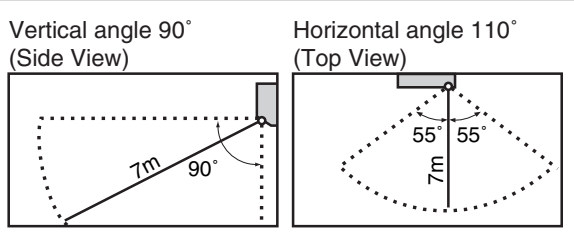

- Sensor may not detect moving objects further than 7m away. (Check the application range)
- Sensor detection sensitivity changes according to indoor unit location, the speed of passersby, temperature range, etc.
- The sensor also mistakenly detects pets, sunlight, fluttering curtains and light reflected off of mirrors as passersby.
- INTELLIGENT EYE operation will not go on during powerful operation.
- Night set mode will not go on during you use INTELLIGENT EYE operation.

CAUTION

- Do not place large objects near the sensor.
Also keep heating units or humidifiers outside the sensor's detection area. This sensor can detect objects it shouldn't as well as not detect objects it should.
- Do not hit or violently push the INTELLIGENT EYE sensor. This can lead to damage and malfunction.

2.11 TIMER Operation

TIMER Operation

Timer functions are useful for automatically switching the air conditioner on or off at night or in the morning. You can also use OFF TIMER and ON TIMER in combination.

■ To use OFF TIMER operation

- Check that the clock is correct.
If not, set the clock to the present time.

1. Press “OFF TIMER button”.

0:00 is displayed.

⊕-⊖ blinks.

2. Press “TIMER Setting button” until the time setting reaches the point you like.

- Every pressing of either button increases or decreases the time setting by 10 minutes. Holding down either button changes the setting rapidly.

3. Press “OFF TIMER button” again.

- The TIMER lamp lights up.

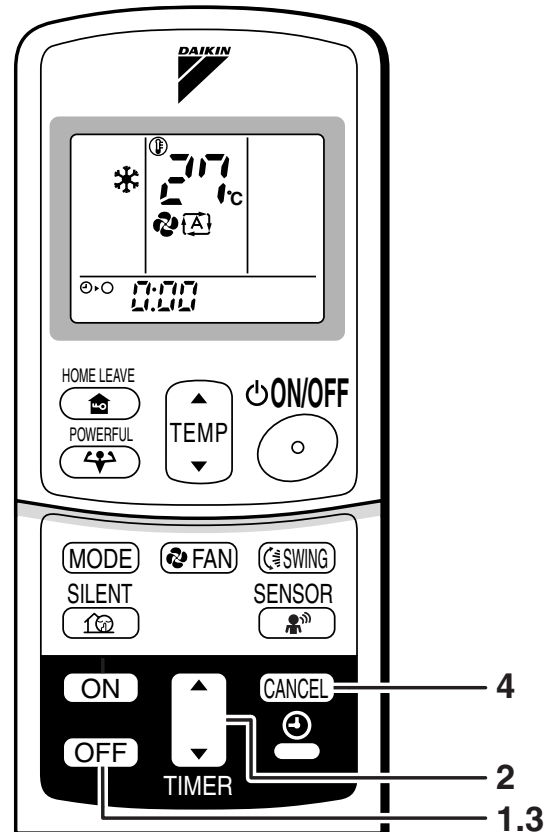

■ To cancel the OFF TIMER operation

4. Press “CANCEL button”.

- The TIMER lamp goes off.

Notes

- When TIMER is set, the present time is not displayed.
- Once you set ON, OFF TIMER, the time setting is kept in the memory. (The memory is canceled when remote controller batteries are replaced.)
- When operating the unit via the ON/OFF Timer, the actual length of operation may vary from the time entered by the user. (Maximum approx. 10 minutes)

■ NIGHT SET MODE

When the OFF TIMER is set, the air conditioner automatically adjusts the temperature setting (0.5°C up in COOL, 2.0°C down in HEAT) to prevent excessive cooling (heating) for your pleasant sleep.

■ To use ON TIMER operation

- Check that the clock is correct. If not, set the clock to the present time.

1. Press “ON TIMER button”.

7:00 is displayed.

⊕-| blinks.

2. Press “TIMER Setting button” until the time setting reaches the point you like.

- Every pressing of either button increases or decreases the time setting by 10 minutes. Holding down either button changes the setting rapidly.

3. Press “ON TIMER button” again.

- The TIMER lamp lights up.

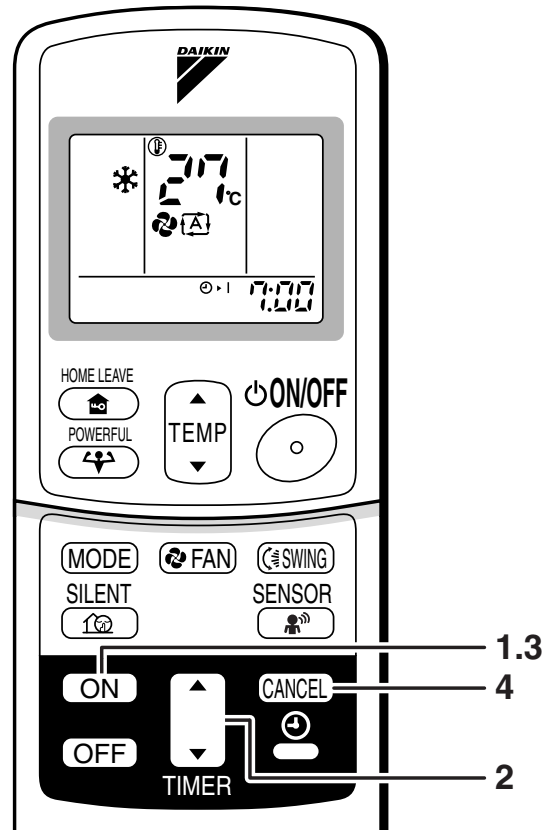

■ To cancel ON TIMER operation

4. Press “CANCEL button”.

- The TIMER lamp goes off.

■ To combine ON TIMER and OFF TIMER

- A sample setting for combining the two timers is shown below.

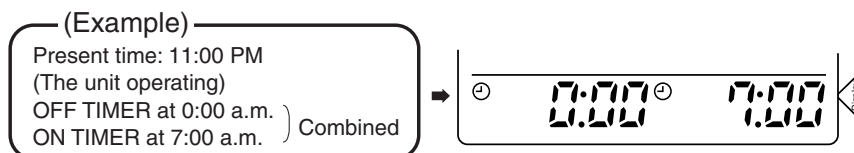

ATTENTION

■ In the following cases, set the timer again.

- After a breaker has turned OFF.
- After a power failure.
- After replacing batteries in the remote controller.

2.12 Note for Multi System

Note for Multi System

《《 What is a “Multi System”? 》》

This system has one outdoor unit connected to multiple indoor units.

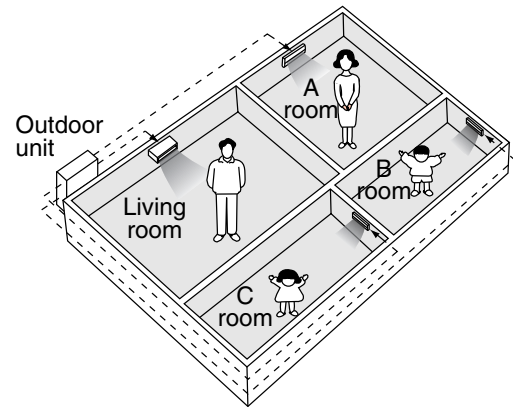

■ Selecting the Operation Mode

1. With the Priority Room Setting present but inactive or not present

When more than one indoor unit is operating, priority is given to the first unit that was turned on.

In this case, set the units that are turned on later to the same operation mode (*1) as the first unit.

Otherwise, they will enter the Standby Mode, and the operation lamp will flash; this does not indicate malfunction.

(*1)

- COOL, DRY and FAN mode may be used at the same time.
- AUTO mode automatically selects COOL mode or HEAT mode based on the room temperature. Therefore, AUTO mode is available when selecting the same operation mode as that of the room with the first unit to be turned on.

〈CAUTION〉

Normally, the operation mode in the room where the unit is first run is given priority, but the following situations are exceptions, so please keep this in mind.

If the operation mode of the first room is **FAN Mode**, then using **Heating Mode** in any room after this will give priority to **heating**. In this situation, the air conditioner running in FAN Mode will go on standby, and the operation lamp will flash.

2. With the Priority Room Setting active

See “Priority Room Setting” on the next page.

■ NIGHT QUIET Mode (Available only for cooling operation)

NIGHT QUIET Mode requires initial programming during installation. Please consult your retailer or dealer for assistance. NIGHT QUIET Mode reduces the operation noise of the outdoor unit during the night time hours to prevent annoyance to neighbors.

- The NIGHT QUIET Mode is activated when the temperature drops 5°C or more below the highest temperature recorded that day. Therefore, when the temperature difference is less than 5°C, this function will not be activated.
- NIGHT QUIET Mode reduces slightly the cooling (heating) efficiency of the unit.

■ OUTDOOR UNIT SILENT Operation

1. With the Priority Room Setting present but inactive or not present

When using the OUTDOOR UNIT SILENT operation feature with the Multi system, set all indoor units to OUTDOOR UNIT SILENT operation using their remote controllers.

When clearing OUTDOOR UNIT SILENT operation, clear one of the operating indoor units using their remote controller. However OUTDOOR UNIT SILENT operation display remains on the remote controller for other rooms.

We recommend you release all rooms using their remote controllers.

2. With the Priority Room Setting active

See “Priority Room Setting” on the next page.

■ Cooling / Heating Mode Lock (Available only for heat pump models)

The Cooling / Heating Mode Lock requires initial programming during installation. Please consult your retailer or dealer for assistance. The Cooling / Heating Mode Lock sets the unit forcibly to either Cooling or Heating Mode. This function is convenient when you wish to set all indoor units connected to the Multi system to the same operation mode.

■ Priority Room Setting

The Priority Room Setting requires initial programming during installation. Please consult your retailer or dealer for assistance.

The room designated as the Priority Room takes priority in the following situations;

1. Operation Mode Priority

As the operation mode of the Priority Room takes precedence, the user can select a different operation mode from other rooms.

〈Example〉

* Room A is the Priority Room in the examples.

When COOL mode is selected in Room A while operating the following modes in Room B,C and D :

Operation mode in Room B, C and D	Status of Room B, C and D when the unit in Room A is in COOL mode
COOL or DRY or FAN	Current operation mode maintained
HEAT	The unit enters Standby Mode. Operation resumes when the Room A unit stops operating.
AUTO	If the unit is set to COOL mode, operation continues. If set to HEAT mode, it enters Standby Mode. Operation resumes when the Room A unit stops operating.

2. Priority when POWERFUL operation is used

〈Example〉

* Room A is the Priority Room in the examples.

The indoor units in Rooms A,B,C and D are all operating. If the unit in Room A enters POWERFUL operation, operation capacity will be concentrated in Room A. In such a case, the cooling (heating) efficiency of the units in Rooms B,C and D may be slightly reduced.

3. Priority when using OUTDOOR UNIT SILENT operation

〈Example〉

* Room A is the Priority Room in the examples.

Just by setting the unit in Room A to SILENT operation, the air conditioner starts OUTDOOR UNIT SILENT operation.

You don't have to set all the operated indoor units to SILENT operation.

2.13 Care and Cleaning

FTK(X)E 25/35 B

Care and Cleaning



CAUTION Before cleaning, be sure to stop the operation and turn the breaker OFF.

Units

■ Indoor unit, Outdoor unit and Remote controller

1. Wipe them with dry soft cloth.

■ Front grille

1. Open the front grille.

- Hold the grille by the tabs on the two sides and lift it until it stops with a click.

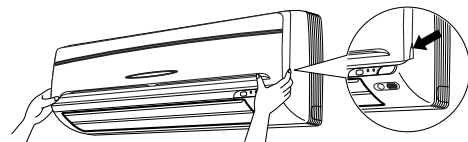

2. Remove the front grille.

- Supporting the front grille with one hand, release the lock by sliding down the knob with the other hand.
- To remove the front grille, pull it toward yourself with both hands.

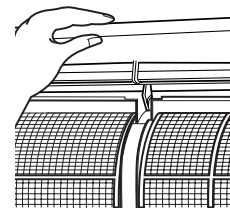

3. Clean the front grille

- Wipe it with a soft cloth soaked in water.
- Only neutral detergent may be used.
- In case of washing the grille with water, dry it with cloth, dry it up in the shade after washing.

4. Attach the front grille

- Set the 3 keys of the front grille into the slots and push them in all the way.
- Close the front grille slowly and push the grille at the 3 points.
(1 on each sides and 1 in the middle.)
- Check to see if the rotating axis in the upper center section is moving.

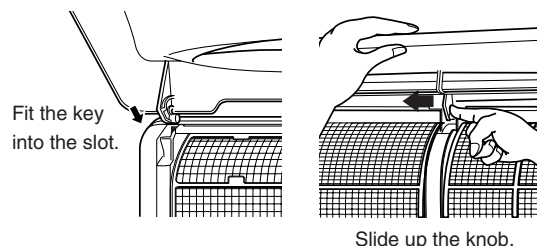

CAUTION

- Don't touch the metal parts of the indoor unit. If you touch those parts, this may cause an injury.
- When removing or attaching the front grille, use a robust and stable stool and watch your steps carefully.
- When removing or attaching the front grille, support the grille securely with hand to prevent it from falling.
- For cleaning, do not use hot water above 40 °C, benzene, gasoline, thinner, nor other volatile oils, polishing compound, scrubbing brushes, nor other hand stuff.
- After cleaning, make sure that the front grille is securely fixed.

Filters

1. **Open the front grille.**
2. **Pull out the air filters.**
 - Push a little upwards the tab at the center of each air filter, then pull it down.

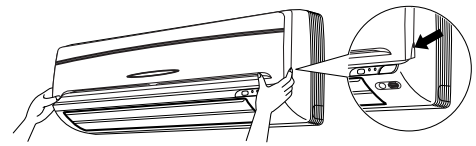

3. **Take off the air purifying filter, photocatalytic deodorizing filter.**
 - Hold the recessed parts of the frame and unhook the four claws.

4. **Clean or replace each filter.**

See below.

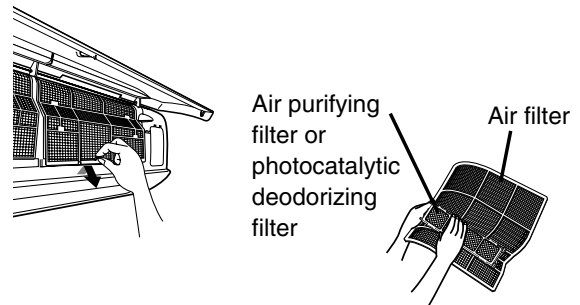

5. **Set the air filter, air purifying filter and photocatalytic deodorizing filter as they were and close the front grille.**
 - Insert claws of the filters into slots of the front grille. Close the front grille slowly and push the grille at the 3 points. (1 on each sides and 1 in the middle.)

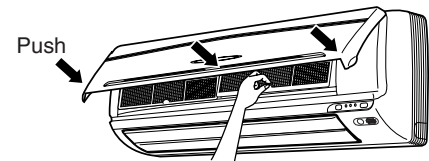

■ Air Filter

1. **Wash the air filters with water or clean them with vacuum cleaner.**

- If the dust does not come off easily, wash them with neutral detergent thinned with lukewarm water, then dry them up in the shade.
- It is recommended to clean the air filters every two weeks.

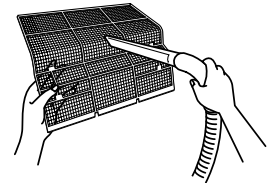

■ Air Purifying Filter (green)

(Replace approximately once every 3 months.)

1. **Detach the filter element and attach a new one.**

- Insert with the green side up.
- It is recommended to replace the air purifying filter every three months.

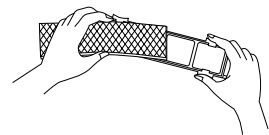

■ Photocatalytic Deodorizing Filter (gray)

[Maintenance]

1. **Dry the photocatalytic deodorizing filter in the sun.**

- After removing the dust with a vacuum cleaner, place the filter in the sun for approximately 6 hours. By drying the photocatalytic deodorizing filter in the sun, its deodorizing and antibacterial capabilities are regenerated.
- Because the filter material is paper, it can not be cleaned with water.
- It is recommended dry the filter once every 6 months.

[Replacement]

1. **Detach the filter element and attach a new one.**

Check

Check that the base, stand and other fittings of the outdoor unit are not decayed or corroded.
Check that nothing blocks the air inlets and the outlets of the indoor unit and the outdoor unit.
Check that the earth wire is not disconnected or broken.
Check that the drain comes smoothly out of the drain hose during COOL or DRY operation. <ul style="list-style-type: none"> If no drain water is seen, water may be leaking from the indoor unit. Stop operation and consult the service shop if this is the case.

■ Before a long idle period

1. Operate the “fan only” for several hours on a fine day to dry out the inside.

- Press “MODE” button and select “fan” operation.
- Press “ON/OFF” button and start operation.

2. Clean the air filters and set them again.

3. Take out batteries from the remote controller.

4. Turn OFF the breaker for the room air conditioner.

- When a multi outdoor unit is connected, make sure the heating operation is not used at the other room before you use the fan operation.

NOTE

- Operation with dirty filters :
 - (1) cannot deodorize the air. (2) cannot clean the air.
 - (3) results in poor heating or cooling. (4) may cause odour.
- The air purifying filter and Photocatalytic deodorizing filter cannot be reused, even if washed.
- In principle, there is no need to replace the photocatalytic deodorizing filter. Remove the dust periodically with a vacuum cleaner. However, it is recommended to replace the filter in the following cases.
 - (1) The paper material is torn or broken during cleaning.
 - (2) The filter has become extremely dirty after long use.
- To order air purifying filter or photocatalytic deodorizing filter, contact to the service shop where you bought the air conditioner.
- Dispose of old air filters as non-burnable waste and photocatalytic deodorizing filters as burnable waste.

Part name	Part No.
Photocatalytic deodorizing filter (with frame)	KAZ917B41
Photocatalytic deodorizing filter (without frame)	KAZ917B42
Air purifying filter (with frame)	KAF925B41
Air purifying filter (without frame)	KAF925B42

FTK(X)D 50/60/71 B

Care and Cleaning



CAUTION Before cleaning, be sure to stop the operation and turn the breaker OFF.

Units

Indoor unit, Outdoor unit and Remote controller

1. Wipe them with dry soft cloth.

Front grille

1. **Open the front grille.**

- Hold the grille by the tabs on the two sides and lift it until it stops with a click.

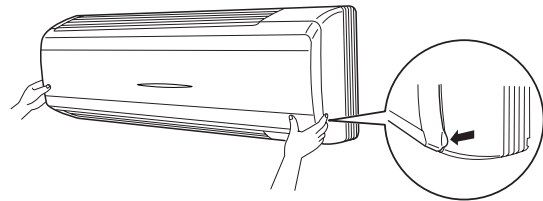

2. **Remove the front grille.**

- Open the front panel further while sliding it to either the left or right and pulling it toward you. This will disconnect the rotation dowel on one side. Then disconnect the rotation dowel on the other side in the same manner.

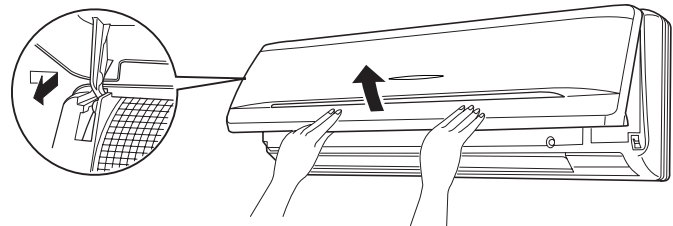

3. **Clean the front grille**

- Wipe it with a soft cloth soaked in water.
- Only neutral detergent may be used.
- In case of washing the grille with water, dry it with cloth, dry it up in the shade after washing.

4. **Attach the front grille**

- Align the rotation dowels on the left and right of the front panel with the slots, then push them all the way in.
- Close the front panel slowly. (Press the panel at both sides and the center.)

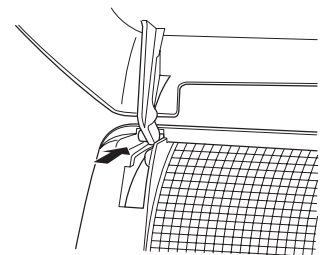

CAUTION

- Don't touch the metal parts of the indoor unit. If you touch those parts, this may cause an injury.
- When removing or attaching the front grille, use a robust and stable stool and watch your steps carefully.
- When removing or attaching the front grille, support the grille securely with hand to prevent it from falling.
- For cleaning, do not use hot water above 40 °C, benzine, gasoline, thinner, nor other volatile oils, polishing compound, scrubbing brushes, nor other hand stuff.
- After cleaning, make sure that the front grille is securely fixed.

Filters

1. **Open the front grille.**
2. **Pull out the air filters.**
 - Push a little upwards the tab at the center of each air filter, then pull it down.

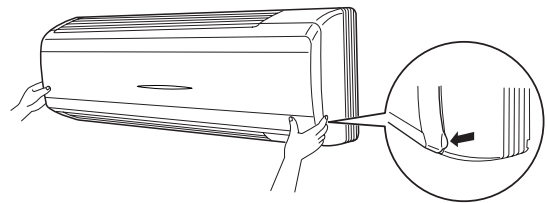

3. **Take off the air purifying filter with photocatalytic deodorizing function.**
 - Press the top of the air-cleaning filter onto the tabs (3 tabs at top). Then press the bottom of the filter up slightly, and press it onto the tabs (3 at bottom).

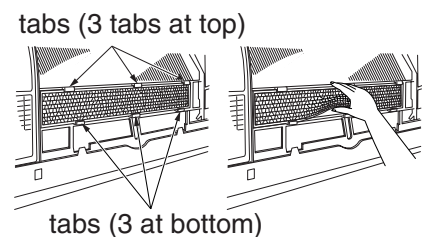
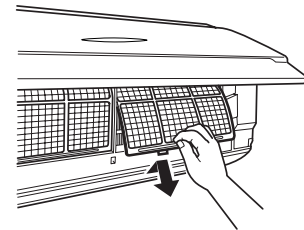

4. **Clean or replace each filter.**
See below.
5. **Set the air filter, air purifying filter with photocatalytic deodorizing function as they were and close the front grille.**
 - Press the front panel at both sides and the center.

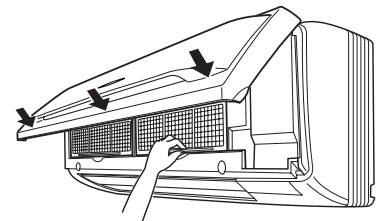

■ Air Filter

1. **Wash the air filters with water or clean them with vacuum cleaner.**
 - If the dust does not come off easily, wash them with neutral detergent thinned with lukewarm water, then dry them up in the shade.
 - It is recommended to clean the air filters every two weeks.

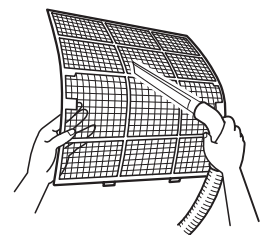

■ Air purifying filter with photocatalytic deodorizing function. (gray)

The air purifying capacity of the photocatalytic purifying filter can be renewed by washing it with water once every 6 months. We recommend replacing it once every 3 years.

[Maintenance]

1. **Remove dust with a vacuum cleaner and wash lightly with water.**
2. **If it is very dirty, soak it for 10 to 15 minutes in water mixed with a neutral cleaning agent.**
3. **After washing, shake off remaining water and dry in the shade.**
4. **Since the material is made out of paper, do not wring out the filter when removing water from it.**

[Replacement]

1. **Remove the tabs on the filter frame and replace with a new filter.**
 - Dispose of the old filter as flammable waste.

Check

Check that the base, stand and other fittings of the outdoor unit are not decayed or corroded.
Check that nothing blocks the air inlets and the outlets of the indoor unit and the outdoor unit.
Check that the earth wire is not disconnected or broken.
Check that the drain comes smoothly out of the drain hose during COOL or DRY operation. <ul style="list-style-type: none"> • If no drain water is seen, water may be leaking from the indoor unit. Stop operation and consult the service shop if this is the case.

■ Before a long idle period

1. Operate the “fan only” for several hours on a fine day to dry out the inside.

- Press “MODE” button and select “fan” operation.
- Press “ON/OFF” button and start operation.

2. Clean the air filters and set them again.

3. Take out batteries from the remote controller.

4. Turn OFF the breaker for the room air conditioner.

- When a multi outdoor unit is connected, make sure the heating operation is not used at the other room before you use the fan operation.

NOTE

- Operation with dirty filters:
 - (1) cannot deodorize the air.
 - (2) cannot clean the air.
 - (3) results in poor heating or cooling.
 - (4) may cause odour.
- To order air purifying filter with photocatalytic deodorizing function contact to the service shop there you bought the air conditioner.
- Dispose of old air filter as non-burnable and photocatalytic deodorizing filters as burnable waste.

Item	Part No.
Air purifying filter with photocatalytic deodorizing function. (without frame) 1 set	KAF952A42

CDK(X)D 25/35/50/60 C

Care and Cleaning



CAUTION Before cleaning, be sure to stop the operation and turn the breaker OFF.

■ Cleaning the air filter and suction grille (Option)

- Be sure always to clean the unit before use at the beginning of summer and winter. (Dirt and dust caught in the air filter cause a drop in airflow, which leads to a decline in performance.)
- When using the unit in a location where dirt may easily accumulate, clean the unit more frequently. Once every 2 weeks is recommended.
- Ask your DAIKIN dealer how to clean them.

Cleaning the drain pan

- Clean the drain pan periodically, or drain piping may be clogged with dust and may result in water leakage. Ask your DAIKIN dealer how to clean them.
- If the ambient air of indoor unit is so dusty, install the optional Dust Cover which prevent dust from falling into drain pan.

Check

Check that the base, stand and other fittings of the outdoor unit are not decayed or corroded.
Check that nothing blocks the air inlets and the outlets of the indoor unit and the outdoor unit.
Check that the earth wire is not disconnected or broken.
Check that the drain comes smoothly out of the drain hose during COOL or DRY operation. <ul style="list-style-type: none"> • If no drain water is seen, water may be leaking from the indoor unit. Stop operation and consult the service shop if this is the case.

■ Before a long idle period

1. Operate the “fan only” for several hours on a fine day to dry out the inside.

- Press “MODE” button and select “fan” operation.
- Press “ON/OFF” button and start operation.

2. Clean the air filters and set them again.

3. Take out batteries from the remote controller.

4. Turn OFF the breaker for the room air conditioner.

- When a multi outdoor unit is connected, make sure the heating operation is not used at the other room before you use the fan operation.

NOTE

- Do not use gasoline, benzene, thinner, polishing powder, liquid insecticide, It may cause discoloring or warping.
- Do not let the indoor unit get wet. It may cause an electric shock or a fire.
- Operation with dusty air filters lowers the cooling and heating capacity and wastes energy.
- The air filter and the suction grille are option.
- Ask your DAIKIN dealer how to clean them.

FLK(X) 25/35/50/60 A

Care and Cleaning



CAUTION Before cleaning, be sure to stop the operation and turn the breaker OFF.

Units

■ Indoor unit, Outdoor unit and Remote controller

1. Wipe them with dry soft cloth.

■ Front grille

1. Open the front grille.

- Hold the grille by the tabs on the two sides and lift it until it stops.

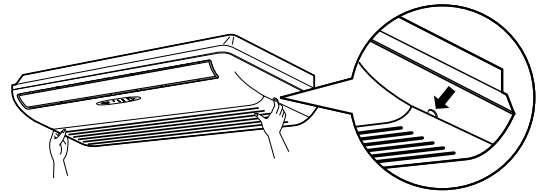

2. Clean the front grille

- Wipe it with a soft cloth soaked in water.
- Only neutral detergent may be used.
- In case of washing the grille with water, dry it with cloth, dry it up in the shade after washing.

3. Close the front grille

- Push the grille at the 5 points indicated by ↑.
- Operation without air filters may result in troubles as dust will accumulate inside the indoor unit.

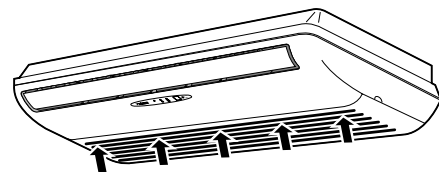

CAUTION

- Don't touch the metal parts of the indoor unit. If you touch those parts, this may cause an injury.
- When opening and closing the front grille, use a robust and stable stool and watch your steps carefully.
- When opening and closing the front grille, support the grille securely with hand to prevent it from falling.
- For cleaning, do not use hot water above 40 °C, benzine, gasoline, thinner, nor other volatile oils, polishing compound, scrubbing brushes, nor other hand stuff.
- After cleaning, make sure that the front grille is securely fixed.

Filters

1. **Open the front grille.**
2. **Pull out the air filters.**
 - Push upwards the tab at the center of each air filter, then pull it down.

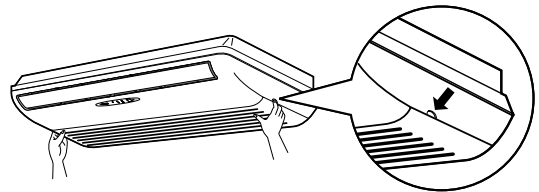

3. **Take off the air purifying filter, photocatalytic deodorizing filter.**
 - Hold the recessed parts of the frame and unhook the four claws.

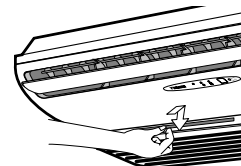

4. **Clean or replace each filter.**
See below.

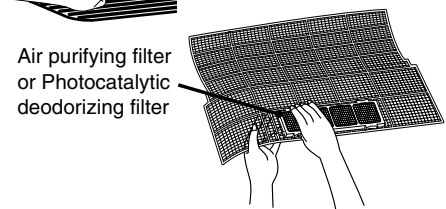

5. **Set the air filter, air purifying filter and photocatalytic deodorizing filter as they were and close the front grille.**
 - Insert claws of the filters into slots of the front grille.
 - Push the grille at the 5 points.

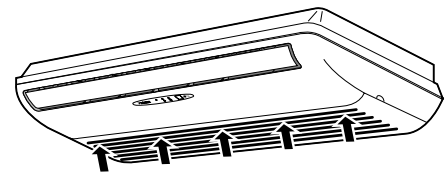

■ Air Filter

1. **Wash the air filters with water or clean them with vacuum cleaner.**
 - If the dust does not come off easily, wash them with neutral detergent thinned with lukewarm water, then dry them up in the shade.
 - It is recommended to clean the air filters every two weeks.

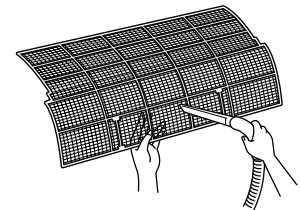

■ Air Purifying Filter (green)

(Replace approximately once every 3 months.)

1. **Detach the filter element and attach a new one.**
 - Insert with the green side up.
 - It is recommended to replace the air purifying filter every three months.

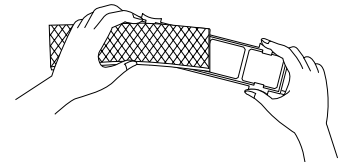

■ Photocatalytic Deodorizing Filter (gray)

[Maintenance]

1. **Dry the photocatalytic deodorizing filter in the sun.**
 - After removing the dust with a vacuum cleaner, place the filter in the sun for approximately 6 hours. By drying the photocatalytic deodorizing filter in the sun, its deodorizing and antibacterial capabilities are regenerated.
 - Because the filter material is paper, it can not be cleaned with water.
 - It is recommended dry the filter once every 6 months.

[Replacement]

1. **Detach the filter element and attach a new one.**

Check

Check that the base, stand and other fittings of the outdoor unit are not decayed or corroded.
Check that nothing blocks the air inlets and the outlets of the indoor unit and the outdoor unit.
Check that the earth wire is not disconnected or broken.
Check that the drain comes smoothly out of the drain hose during COOL or DRY operation. <ul style="list-style-type: none"> If no drain water is seen, water may be leaking from the indoor unit. Stop operation and consult the service shop if this is the case.

■ Before a long idle period

- Operate the “fan only” for several hours on a fine day to dry out the inside.**
 - Press “MODE” button and select “fan” operation.
 - Press “ON/OFF” button and start operation.
- Clean the air filters and set them again.**
- Take out batteries from the remote controller.**
- Turn OFF the breaker for the room air conditioner.**
 - When a multi outdoor unit is connected, make sure the heating operation is not used at the other room before you use the fan operation.

NOTE

- Operation with dirty filters :
 - (1) cannot deodorize the air. (2) cannot clean the air.
 - (3) results in poor heating or cooling. (4) may cause odour.
- The air purifying filter and Photocatalytic deodorizing filter cannot be reused, even if washed.
- In principle, there is no need to replace the photocatalytic deodorizing filter. Remove the dust periodically with a vacuum cleaner. However, it is recommended to replace the filter in the following cases.
 - (1) The paper material is torn or broken during cleaning.
 - (2) The filter has become extremely dirty after long use.
- To order air purifying filter or Photocatalytic deodorizing filter, contact to the service shop where you bought the air conditioner.
- Dispose of old air filters as non-burnable waste and Photocatalytic deodorizing filters as burnable waste.

Item	Part No.
Photocatalytic deodorizing filter (with frame)	KAZ917B41
Photocatalytic deodorizing filter (without frame)	KAZ917B42
Air purifying filter (with frame)	KAF925B41
Air purifying filter (without frame)	KAF925B42

2.14 Troubleshooting

Troubleshooting

These cases are not troubles.

The following cases are not air conditioner troubles but have some reasons. You may just continue using it.

Case	Explanation
Operation does not start soon. <ul style="list-style-type: none"> When ON/OFF button was pressed soon after operation was stopped. When the mode was reselected. 	<ul style="list-style-type: none"> This is to protect the air conditioner. You should wait for about 3 minutes.
Hot air does not flow out soon after the start of heating operation.	<ul style="list-style-type: none"> The air conditioner is warming up. You should wait for 1 to 4 minutes. (The system is designed to start discharging air only after it has reached a certain temperature.)
The heating operation stops suddenly and a flowing sound is heard.	<ul style="list-style-type: none"> The system is taking away the frost on the outdoor unit. You should wait for about 4 to 12 minutes.
The outdoor unit emits water or steam.	<ul style="list-style-type: none"> ■ In HEAT mode <ul style="list-style-type: none"> The frost on the outdoor unit melts into water or steam when the air conditioner is in defrost operation. ■ In COOL or DRY mode <ul style="list-style-type: none"> Moisture in the air condenses into water on the cool surface of outdoor unit piping and drips.
Mists come out of the indoor unit.	<ul style="list-style-type: none"> ■ This happens when the air in the room is cooled into mist by the cold air flow during cooling operation.
The indoor unit gives out odour.	<ul style="list-style-type: none"> ■ This happens when smells of the room, furniture, or cigarettes are absorbed into the unit and discharged with the air flow. (If this happens, we recommend you to have the indoor unit washed by a technician. Consult the service shop where you bought the air conditioner.)
The outdoor fan rotates while the air conditioner is not in operation.	<ul style="list-style-type: none"> ■ After operation is stopped: <ul style="list-style-type: none"> The outdoor fan continues rotating for another 60 seconds for system protection. ■ While the air conditioner is not in operation: <ul style="list-style-type: none"> When the outdoor temperature is very high, the out door fan starts rotating for system protection.
The operation stopped suddenly. (OPERATION lamp is on)	<ul style="list-style-type: none"> ■ For system protection, the air conditioner may stop operating on a sudden large voltage fluctuation. It automatically resumes operation in about 3 minutes.

Check again.

Please check again before calling a repair person.

Case	Check
<p>The air conditioner does not operate. (OPERATION lamp is off)</p>	<ul style="list-style-type: none"> • Hasn't a breaker turned OFF or a fuse blown? • Isn't it a power failure? • Are batteries set in the remote controller? • Is the timer setting correct?
<p>Cooling (Heating) effect is poor.</p>	<ul style="list-style-type: none"> • Are the air filters clean? • Is there anything to block the air inlet or the outlet of the indoor and the outdoor units? • Is the temperature setting appropriate? • Are the windows and doors closed? • Are the air flow rate and the air direction set appropriately? • Is the unit set to the INTELLIGENT EYE mode?
<p>Operation stops suddenly. (OPERATION lamp flashes.)</p>	<ul style="list-style-type: none"> • Are the air filters clean? • Is there anything to block the air inlet or the outlet of the indoor and the outdoor units? Clean the air filters or take all obstacles away and turn the breaker OFF. Then turn it ON again and try operating the air conditioner with the remote controller. If the lamp still flashes, call the service shop where you bought the air conditioner. • Are operation modes all the same for indoor units connected to outdoor units in the multi system? If not, set all indoor units to the same operation mode and confirm that the lamps flash. Moreover, when the operation mode is in "AUTO", set all indoor unit operation modes to "COOL" or "HEAT" for a moment and check again that the lamps are normal. If the lamps stop flashing after the above steps, there is no malfunction.
<p>An abnormal functioning happens during operation.</p>	<ul style="list-style-type: none"> • The air conditioner may malfunction with lightening or radio waves. Turn the breaker OFF, turn it ON again and try operating the air conditioner with the remote controller.

Call the service shop immediately.



WARNING

- When an abnormality (such as a burning smell) occurs, stop operation and turn the breaker OFF. Continued operation in an abnormal condition may result in troubles, electric shocks or fire. Consult the service shop where you bought the air conditioner.
- Do not attempt to repair or modify the air conditioner by yourself. Incorrect work may result in electric shocks or fire. Consult the service shop where you bought the air conditioner.

If one of the following symptoms takes place, call the service shop immediately.

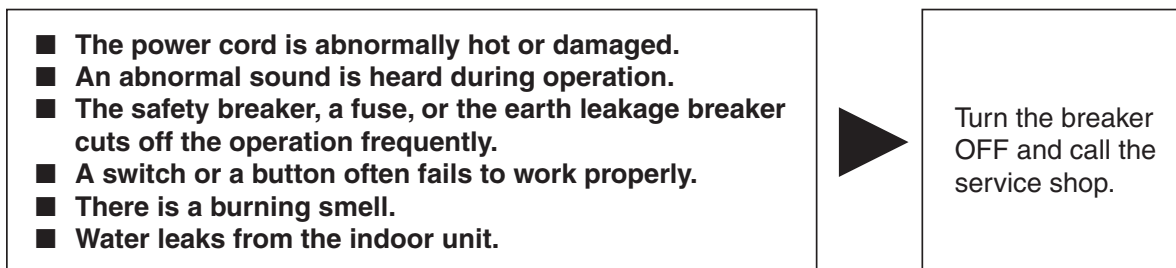

<ul style="list-style-type: none"> ■ After a power failure The air conditioner automatically resumes operation in about 3 minutes. You should just wait for a while. 	<ul style="list-style-type: none"> ■ Lightening If lightening may strike the neighbouring area, stop operation and turn the breaker OFF for system protection.
---	---

We recommend periodical maintenance

In certain operating conditions, the inside of the air conditioner may get foul after several seasons of use, resulting in poor performance. It is recommended to have periodical maintenance by a specialist aside from regular cleaning by the user. For specialist maintenance, contact the service shop where you bought the air conditioner.

The maintenance cost must be born by the user.

Part 6

Service Diagnosis

1. Caution for Diagnosis.....	164
1.1 Troubleshooting with the Operation Lamp	164
2. Problem Symptoms and Measures	166
3. Service Check Function	167
4. Code Indication on the Remote Controller	168
4.1 Error Codes and Description of Fault	168
5. Troubleshooting	169
5.1 Indoor Units	169
5.2 Outdoor Units	170
5.3 Indoor Unit PCB Abnormality	171
5.4 Freeze-up Protection Control or High Pressure Control.....	172
5.5 Fan Motor or Related Abnormality	174
5.6 Thermistor or Related Abnormality (Indoor Unit).....	177
5.7 Shutter Drive Motor / Shutter Limit Switch Abnormality	178
5.8 Signal Transmission Error (between Indoor and Outdoor Units).....	179
5.9 Unspecified Voltage (between Indoor and Outdoor Units).....	180
5.10 Freeze-up Protection Control	181
5.11 OL Activation (Compressor Overload)	183
5.12 Compressor Lock	184
5.13 DC Fan Lock	185
5.14 Input Over Current Detection	186
5.15 Four Way Valve Abnormality	188
5.16 Discharge Pipe Temperature Control.....	190
5.17 Position Sensor Abnormality	191
5.18 CT or Related Abnormality	192
5.19 Thermistor or Related Abnormality (Outdoor Unit).....	194
5.20 Electrical Box Temperature Rise.....	196
5.21 Radiation Fin Temperature Rise	198
5.22 Output Over Current Detection.....	200
5.23 Insufficient Gas.....	202
5.24 Low-voltage Detection.....	204
5.25 Anti-icing Function in Other Rooms / Unspecified Voltage (between Indoor and Outdoor Units).....	205
6. Check	206
6.1 How to Check.....	206

1. Caution for Diagnosis

1.1 Troubleshooting with the Operation Lamp

The operation lamp flashes when any of the following errors is detected.

1. When a protection device of the indoor or outdoor unit is activated or when the thermistor malfunctions, disabling equipment operation.
2. When a signal transmission error occurs between the indoor and outdoor units.

In either case, conduct the diagnostic procedure described in the following pages.

Location of Operation Lamp

In case of
 FTK(X)S 20/25/35 Series
 FTK(X)E 25/35 Series
 ATXS 20/25/35 Series (Grille type)

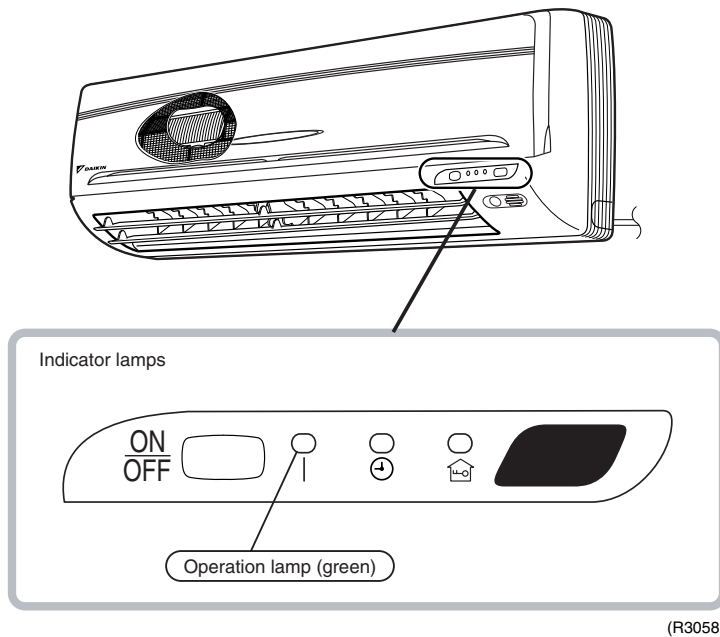

In case of
 FTK(X)S 50/60/71 Series
 FTK(X)D 50/60/71 Series
 ATXS 50 Series (Grille type)

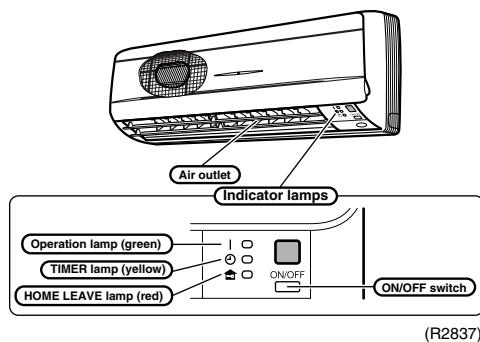

In case of
 CDK(X)S 25/35/50/60 C Series
 CDK(X)D 25/35/50/60 C Series

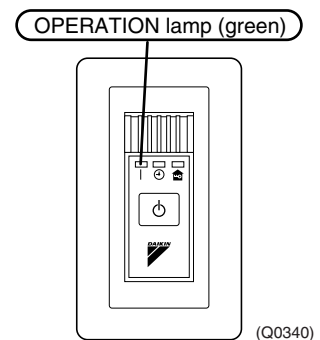

In case of
 FVK(X)S 25/35/50 B Series

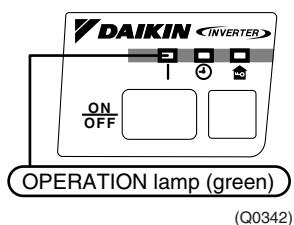

In case of
 FLK(X)S 25/35/50/60 B Series
 FLK(X) 25/35/50/60 A Series

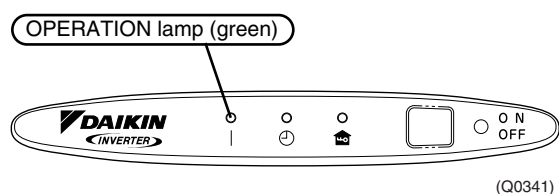

**Caution:**

Operation stops suddenly. (Operation lamp blinks.)

Cause of above trouble could be "Operation mode butting".

Check followings;

Are the operation modes all the same for indoor units connected to Multi system outdoor unit?
If not set all indoor units to the same operation mode and confirm that the operation lamp is not blinking.

Moreover, when the operation mode is in "Auto", set all indoor unit operation mode to "Cool" or "Heat" and check again if the operation lamp is normal.

If the lamp stops blinking after the above steps, there is no malfunction.

★Operation stops and operation lamp blinks only for indoor unit which the different operation mode is set later. (The first set operation mode has priority.)

Troubleshooting with the LED Indication

Outdoor Unit

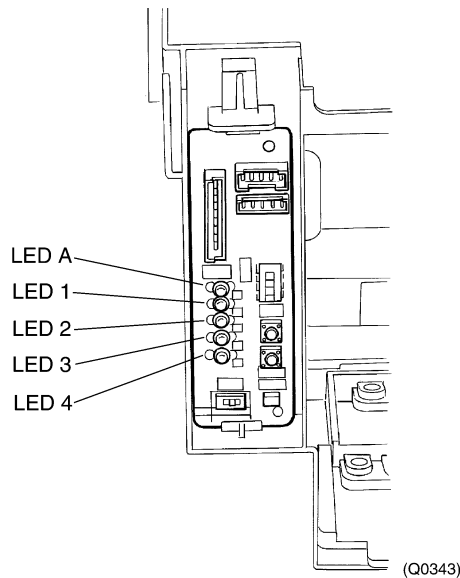

There are green and red LEDs on the PCB. The flashing green LED indicates normal equipment condition, and the OFF condition of the red LED indicates normal equipment condition.

(Troubleshooting with the green LED)

The LED A (green) of the outdoor unit indicate microcomputer operation condition.

Even after the error is cancelled and the equipment operates in normal condition, the LED indication remains.

2. Problem Symptoms and Measures

Problem Symptom	Check Item	Details of Measure	Page No. to be referred
None of the units operates.	Check the power supply.	Check to make sure that the rated voltage is supplied.	—
	Check the type of the indoor units.	Check to make sure that the indoor unit type is compatible with the outdoor unit.	—
	Check the outdoor air temperature.	Heating operation cannot be used when the outdoor air temperature is 21°C or higher (only for heat pump model), and cooling operation cannot be used when the outdoor air temperature is below -10 °C (10°C : R22 cooling only model.)	—
	Diagnosis with indoor unit LED indication	—	169
	Diagnosis with outdoor unit LED indication	—	170
	Check the remote controller addresses.	Check to make sure that address settings for the remote controller and indoor unit are correct.	—
Operation sometimes stops.	Check the power supply.	A power failure of 2 to 10 cycles can stop air conditioner operation. (Operation lamp OFF)	—
	Check the outdoor air temperature.	Heating operation cannot be used when the outdoor air temperature is 21°C or higher (only for heat pump model), and cooling operation cannot be used when the outdoor air temperature is below -10°C (10°C : R22 cooling only model.)	—
	Diagnosis with indoor unit LED indication	—	169
	Diagnosis with outdoor unit LED indication	—	170
Some indoor units do not operate.	Check the type of the indoor units.	Check to make sure that the indoor unit type is compatible with the outdoor unit.	—
	Diagnosis with indoor unit LED indication	—	169
	Diagnosis with outdoor unit LED indication	—	170
Equipment operates but does not cool, or does not heat (only for heat pump model).	Check for wiring and piping errors in the indoor and outdoor units connection wires and pipes.	Conduct the wiring/piping error check described on the product diagnosis nameplate.	—
	Check for thermistor detection errors.	Check to make sure that the main unit's thermistor has not dismounted from the pipe holder.	—
	Check for faulty operation of the electronic expansion valve.	Set the units to cooling operation, and compare the temperatures of the liquid side connection pipes of the connection section among rooms to check the opening and closing operation of the electronic expansion valves of the individual units.	—
	Diagnosis with indoor unit LED indication	—	169
	Diagnosis with outdoor unit LED indication	—	170
	Diagnosis by service port pressure and operating current	Check for insufficient gas.	212
	Large operating noise and vibrations	Check the output voltage of the power transistor.	—
Check the power transistor.		—	—
Check the installation condition.		Check to make sure that the required spaces for installation (specified in the Technical Guide, etc.) are provided.	—

3. Service Check Function

In the **ARC433A series**, the temperature display sections on the main unit indicate corresponding codes.

- When the timer cancel button is held down for 5 seconds, a “00” indication flashes on the temperature display section.

< Cover in open position >

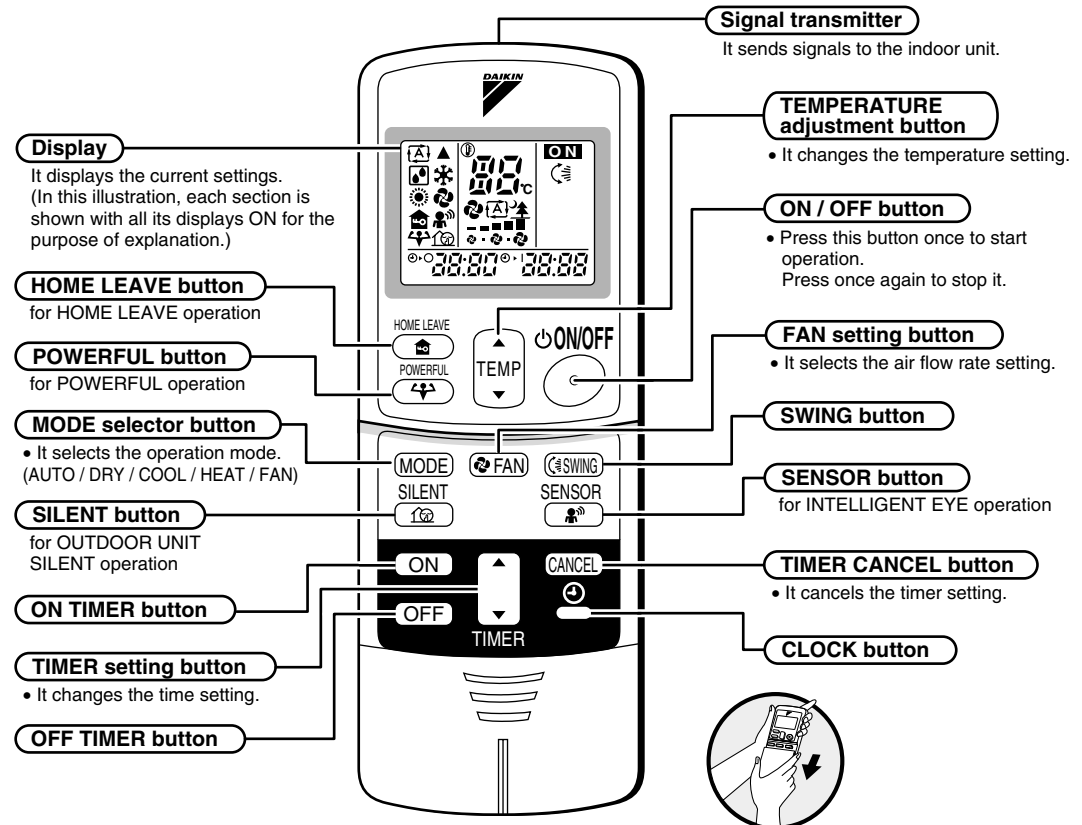

The figure shows the remote controller for <ARC433A1, A2> (wall mounted 25 / 35 class).

(Q0344)

- Press the timer cancel button repeatedly until a continuous beep is produced.
 - The code indication changes in the sequence shown below, and notifies with along beep.

No.	Code	No.	Code	No.	Code
1	00	11	E7	21	UR
2	U4	12	C7	22	R5
3	F3	13	H8	23	J9
4	E6	14	J3	24	E8
5	L5	15	R3	25	P4
6	R6	16	R1	26	L3
7	E5	17	C4	27	L4
8	LC	18	C5	28	H6
9	C9	19	H9	29	H7
10	U0	20	J6	30	U2



Note:

- A short beep and two consecutive beeps indicate non-corresponding codes.
- To cancel the code display, hold the timer cancel button down for 5 seconds. The code display also cancels itself if the button is not pressed for 1 minute.

4. Code Indication on the Remote Controller

4.1 Error Codes and Description of Fault

	Code Indication	Description of Problem
System	<i>00</i>	Normal
	<i>U0</i>	Insufficient gas
	<i>U2</i>	Low-voltage detection
	<i>U4</i>	Signal transmission error (between indoor and outdoor units)
	<i>UR</i>	Unspecified voltage (between indoor and outdoor units)
	<i>UH</i>	Anti-icing function in other rooms
Indoor Unit	<i>R1</i>	Indoor unit PCB abnormality
	<i>R5</i>	Freeze-up protection function or high pressure control
	<i>R6</i>	Fan motor or related abnormality
	<i>C4</i>	Heat exchanger temperature thermistor abnormality
	<i>C7</i>	Shutter drive motor / shutter limit switch abnormality
	<i>C9</i>	Room temperature thermistor abnormality
Outdoor Unit	<i>E5</i>	OL activation (compressor overloaded)
	<i>E6</i>	Compressor lock
	<i>E7</i>	DC fan lock
	<i>E8</i>	Input over current detection
	<i>ER</i>	Four way valve abnormality
	<i>F3</i>	Discharge pipe temperature control
	<i>H5</i>	Position sensor abnormality
	<i>H8</i>	CT or related abnormality
	<i>H9</i>	Outdoor air thermistor or related abnormality
	<i>J3</i>	Discharge pipe thermistor or related abnormality
	<i>J5</i>	Heat exchanger thermistor or related abnormality
	<i>J8</i>	Liquid pipe thermistor or related abnormality
	<i>J9</i>	Gas pipe thermistor or related abnormality
	<i>L3</i>	Electrical box temperature rise
	<i>L4</i>	Radiation fin temperature rise
	<i>L5</i>	Output over current detection
	<i>P4</i>	Radiation fin thermistor or related abnormality

5. Troubleshooting

5.1 Indoor Units

- : Not used for troubleshooting

* : Varies depending on the cases.

Indication on the remote controller	Description of The Fault		Details of fault (Refer to the indicated page.)
<i>00</i>	Indoor unit in normal condition (Conduct a diagnosis of the outdoor unit.)		—
<i>R1</i>	Indoor unit PCB abnormality		171
<i>R5</i>	Freeze-up protection control or high pressure control (heat pump model only)		172
<i>R6</i>	Fan motor or related abnormality	AC motor (Wall : 20~35, Duct, Floor / Ceiling)	174
		DC motor (Wall : 50~71, Floor)	175
<i>C4</i>	Heat exchanger thermistor or related abnormality		177
<i>C7</i>	Shutter drive motor / shutter limit switch abnormality		178
<i>C9</i>	Room temperature thermistor abnormality		177
<i>U4</i>	Signal transmission error (between indoor and outdoor units)		179
<i>UR</i>	Unspecified voltage (between indoor and outdoor units)		180

5.2 Outdoor Units

☉: ON, ●: OFF, ⦿: Blinks

Green : Flashes when in normal condition

Red : OFF in normal condition

- : Not used for troubleshooting

* : Varies depending on the cases.

Outdoor Unit LED Indication					Indication on the remote controller	Description of The Fault	Details of Fault (Refer to the indicated page.)
Green	Red						
A	1	2	3	4			
⦿	●	●	●	●	00	Outdoor unit in normal condition (Conduct a diagnosis of the indoor unit.)	—
					UR	Unspecified voltage (between indoor and outdoor units)	205
					UH	Anti-icing function in other rooms	205
⦿	●	●	☉	☉	(UD)	Insufficient gas	202
⦿	☉	●	☉	●	(E5)	OL activation (compressor overload)	183
⦿	●	☉	☉	●	(E6)	Compressor lock	184
⦿	☉	●	☉	●	F3	Discharge pipe temperature control	190
⦿	●	●	●	☉	L4	Radiation fin temperature rise (Protection of driver overheating)	198
⦿	☉	☉	●	●	H8	CT or related abnormality	192
⦿	☉	☉	●	●	H6	Position sensor abnormality	191
					H9	Outdoor air thermistor or related abnormality	194
					J3	Discharge pipe thermistor or related abnormality	194
					J6	Heat exchanger thermistor or related abnormality	194
					J8	Liquid pipe thermistor or related abnormality	194
					J9	Gas pipe thermistor or related abnormality	194
P4	Radiation fin thermistor or related abnormality	194					
⦿	●	●	☉	●	L5	Output over current detection	200
⦿	●	☉	●	☉	E8	Input over current detection	186
⦿	☉	●	☉	☉	R5	Freeze-up protection control	181
⦿	☉	☉	☉	☉	E7	DC fan lock	185
⦿	☉	●	●	●	ER	Four way valve abnormality	188
⦿	☉	☉	●	☉	L3	Electrical box temperature rise	196
⦿	☉	●	●	☉	U2	Low-voltage detection	204



Note:

- The indications in the parenthesis () in the remote controller display column are displayed only when system-down occurs.
- When a sensor error occurs, check the remote controller display to determine which sensor is malfunctioning.
If the remote controller does not indicate the error type, conduct the following operation.
*Turn the power switch off and back on again. If the same LED indication appears again immediately after the power is turned on, the fault is in the thermistor.
*If the above condition does not result, the fault is in the CT.
- The indoor unit error indication may take the precedence in the remote controller display.

5.3 Indoor Unit PCB Abnormality

Remote
Controller
Display

A1

Method of
Malfunction
Detection

Evaluation of zero-cross detection of power supply by indoor unit.

Malfunction
Decision
Conditions

When there is no zero-cross detection in approximately 10 continuous seconds.

Supposed
Causes

- Faulty indoor unit PCB
- Faulty connector connection

Troubleshooting

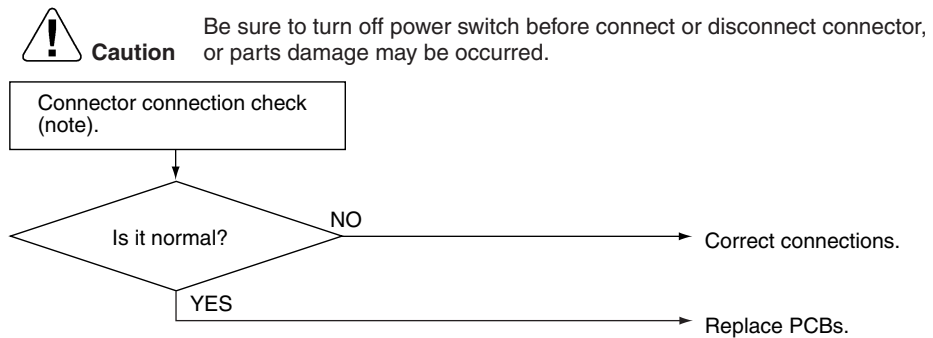

(R1400)



Note: Connector Nos. vary depending on models.
Control connector

Model Type	Connector No.
Wall Mounted Type 20 / 25 / 35 class	Terminal strip~Control PCB
Wall Mounted Type 50 / 60 / 71 class	Terminal strip~Control PCB
Duct Connected Type	Terminal strip~Control PCB
Floor / Ceiling Suspended Dual Type	S37
Floor Standing Type	Control PCB : S7, S201, S203 Power Supply PCB : S8, S202, S204

5.4 Freeze-up Protection Control or High Pressure Control

Remote
Controller
Display

AS

Method of
Malfunction
Detection

- High pressure control (heat pump model only)
During heating operations, the temperature detected by the indoor heat exchanger thermistor is used for the high pressure control (stop, outdoor fan stop, etc.)
- The freeze-up protection control (operation halt) is activated during cooling operation according to the temperature detected by the indoor unit heat exchanger thermistor.

Malfunction
Decision
Conditions

- High pressure control
During heating operations, the temperature detected by the indoor heat exchanger thermistor is above 65°C
- Freeze-up protection

When the indoor unit heat exchanger temperature is below 0°C during cooling operation.

Supposed
Causes

- Operation halt due to clogged air filter of the indoor unit.
- Operation halt due to dust accumulation on the indoor unit heat exchanger.
- Operation halt due to short-circuit.
- Detection error due to faulty indoor unit heat exchanger thermistor.
- Detection error due to faulty indoor unit PCB.

Troubleshooting

Check No.6
 Refer to P.209
**Caution**

Be sure to turn off power switch before connect or disconnect connector, or parts damage may be occurred.

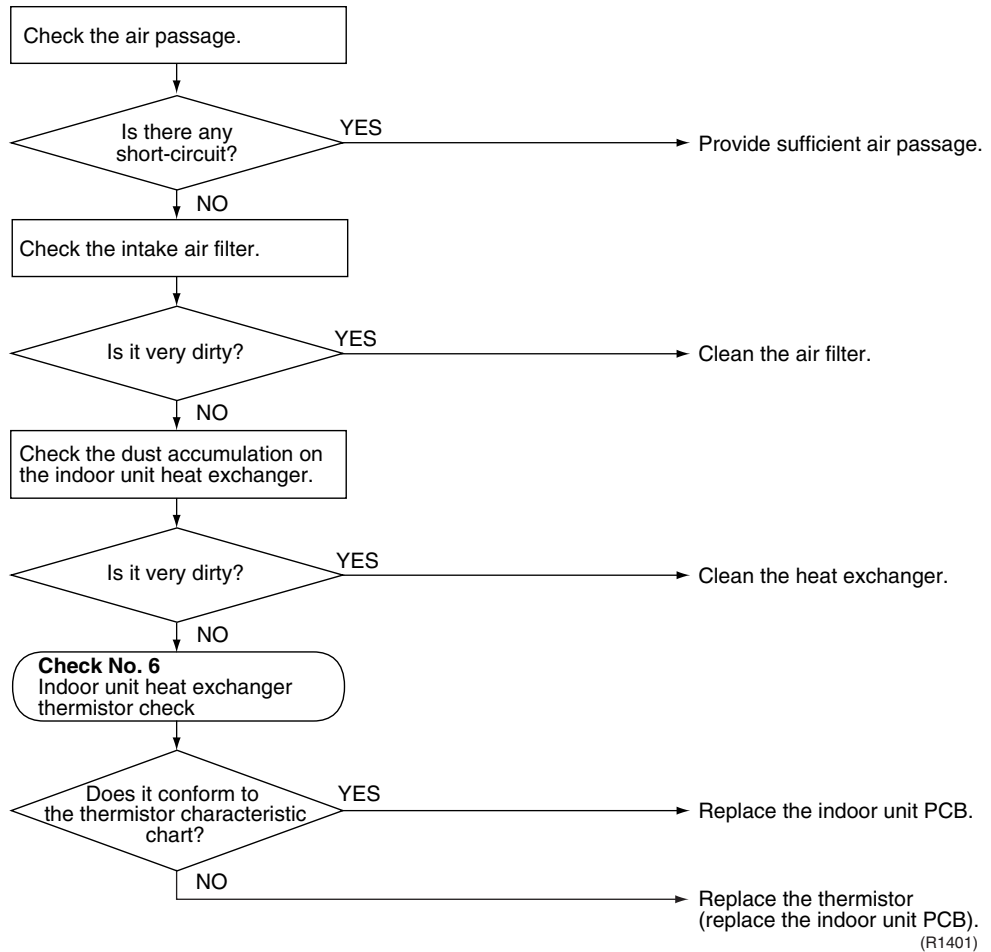

Note: If the outside temperature is below -10°C in the cooling mode, the system may get interrupted with error *R5* displayed. The system will be reset itself, but this stop will be put in the error history memory.

5.5 Fan Motor or Related Abnormality

5.5.1 AC Motor

Remote Controller Display

AG

Method of Malfunction Detection

The rotation speed detected by the Hall IC during fan motor operation is used to determine abnormal fan motor operation.

Malfunction Decision Conditions

When the detected rotation speed is less than 50% of the HH tap under maximum fan motor rotation demand.

Supposed Causes

- Operation halt due to short circuit inside the fan motor winding.
- Operation halt due to breaking of wire inside the fan motor.
- Operation halt due to breaking of the fan motor lead wires.
- Operation halt due to faulty capacitor of the fan motor.
- Detection error due to faulty control PCB.

Troubleshooting



Check No.16
Refer to P.215



Caution

Be sure to turn off power switch before connect or disconnect connector, or parts damage may be occurred.

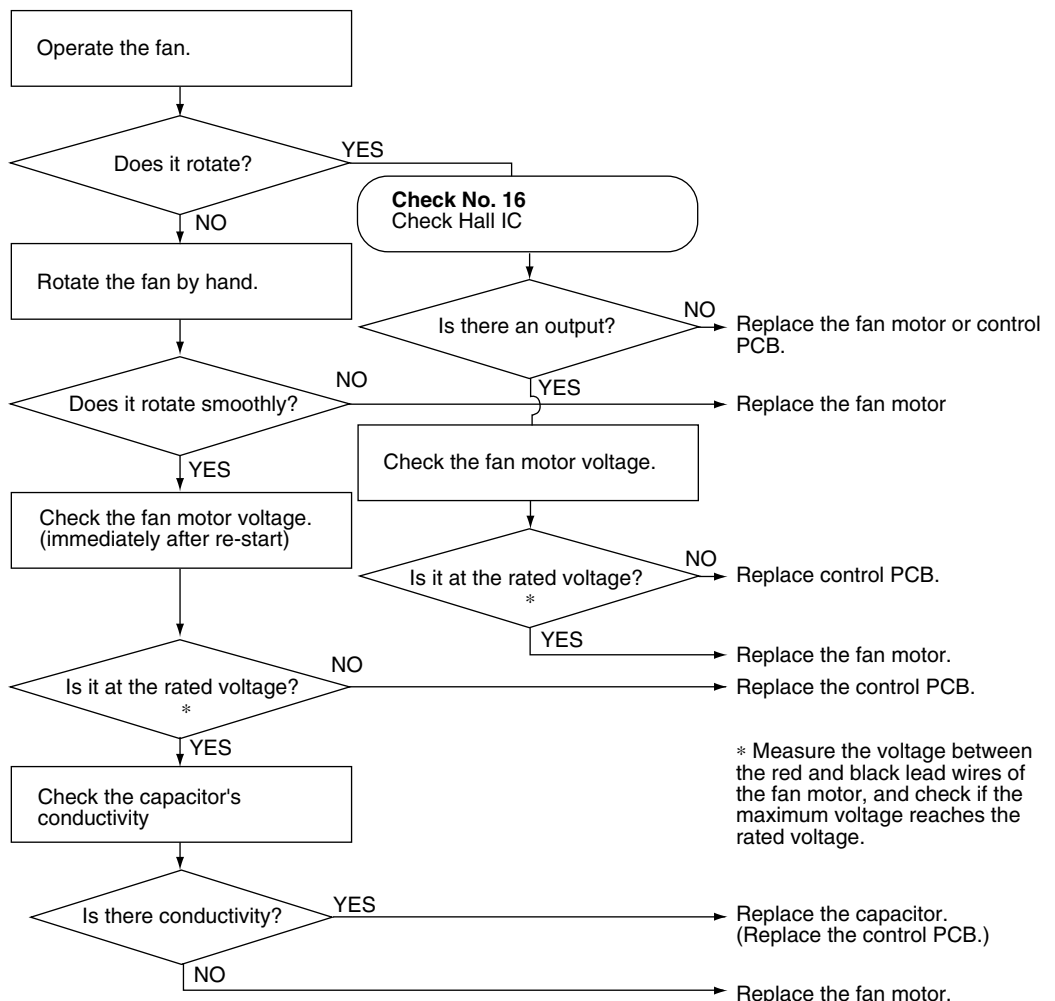

* Measure the voltage between the red and black lead wires of the fan motor, and check if the maximum voltage reaches the rated voltage.

(R3219)

5.5.2 DC Motor

**Remote
Controller
Display**

RE

**Method of
Malfunction
Detection**

The rotation speed detected by the [Hall IC](#) during fan motor operation is used to determine abnormal fan motor operation.

**Malfunction
Decision
Conditions**

When the detected rotation speed is less than 50% of the H tap under maximum fan motor rotation demand.

**Supposed
Causes**

- Operation halt due to short circuit inside the fan motor winding.
- Operation halt due to breaking of wire inside the fan motor.
- Operation halt due to breaking of the fan motor lead wires.
- Operation halt due to faulty capacitor of the fan motor.
- Detection error due to faulty indoor unit PCB (1).

Troubleshooting



Check No.01
Refer to P.206



Check No.02
Refer to P.206



Caution

Be sure to turn off power switch before connect or disconnect connector, or parts damage may be occurred.

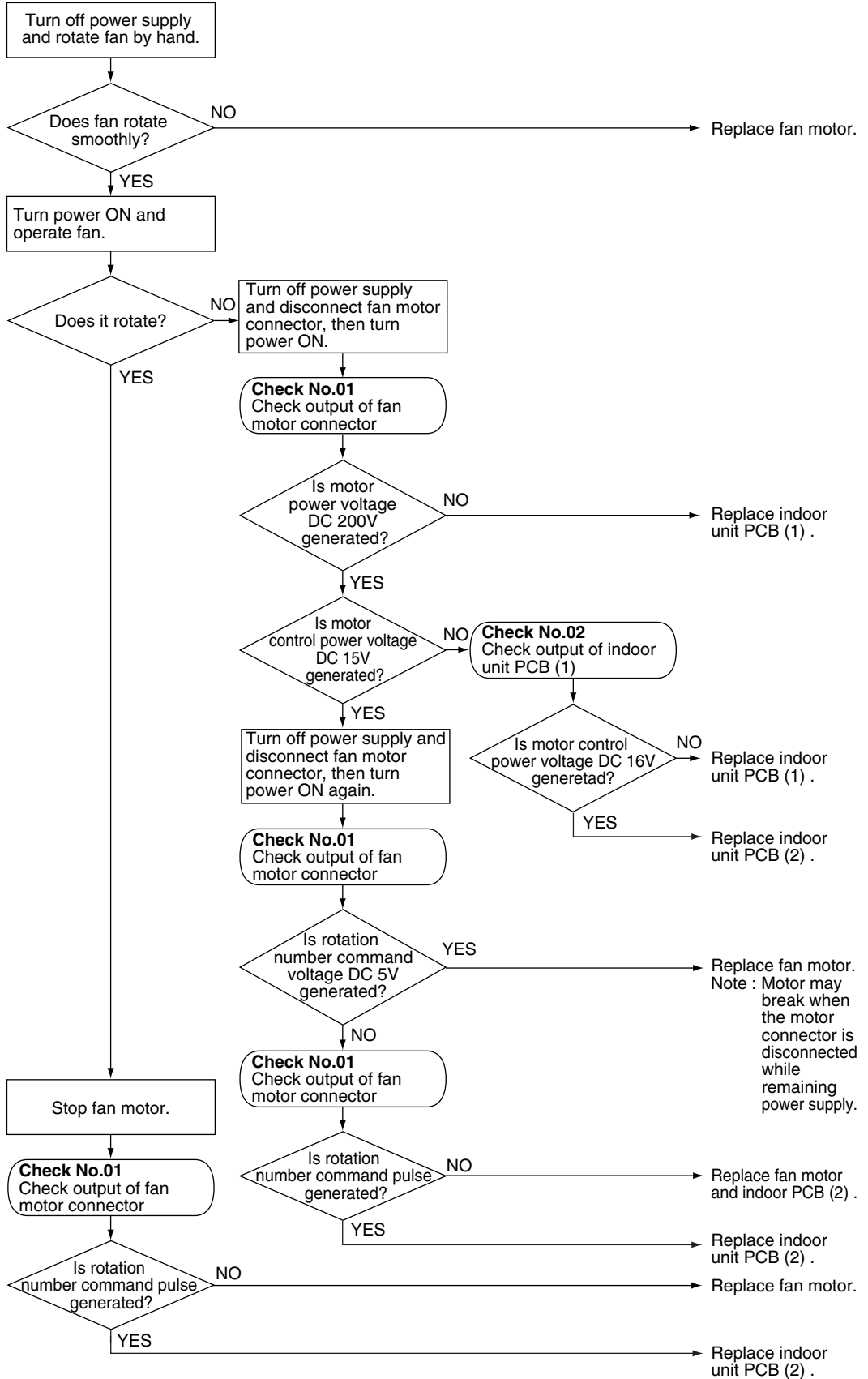

(R1214)

5.6 Thermistor or Related Abnormality (Indoor Unit)

Remote
Controller
Display

Ⓒ4, Ⓒ9

Method of
Malfunction
Detection

The temperatures detected by the thermistors are used to determine thermistor errors.

Malfunction
Decision
Conditions

When the thermistor input is more than 4.96 V or less than 0.04 V during compressor operation*.

* (reference)

When above about 212°C (less than 120 ohms) or below about -50°C (more than 1,860 kohms).



Note: The values vary slightly in some models.

Supposed
Causes

- Faulty connector connection
- Faulty thermistor
- Faulty PCB

Troubleshooting



Check No.6
Refer to P.209



Caution

Be sure to turn off power switch before connect or disconnect connector, or parts damage may be occurred.

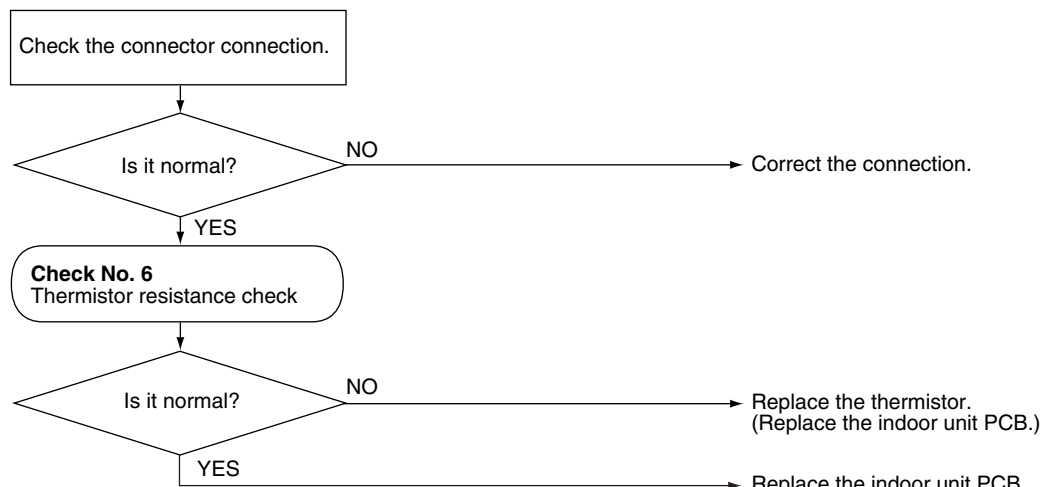

(R1403)

Ⓒ4 : Heat exchanger temperature thermistor

Ⓒ9 : Room temperature thermistor

5.7 Shutter Drive Motor / Shutter Limit Switch Abnormality

Remote
Controller
Display



Method of
Malfunction
Detection

The shutter open / close performance is detected by the limit switch attached on its structure. In this way, the shutter drive motor and the shutter limit switch are checked for failure.

Malfunction
Decision
Conditions

When the shutter is open, the limit switch is closed.

Supposed
Causes

- Shutter drive motor defective
- Shutter limit switch defective
- Shutter itself deformed (warped)
- Shutter's sealing material too thick
- Detection error by broken relay harness or disconnected connector
- Detection error due to defective PCB (2)
- Foreign substance in blow port

Troubleshooting



Check No.3
Refer to P.206

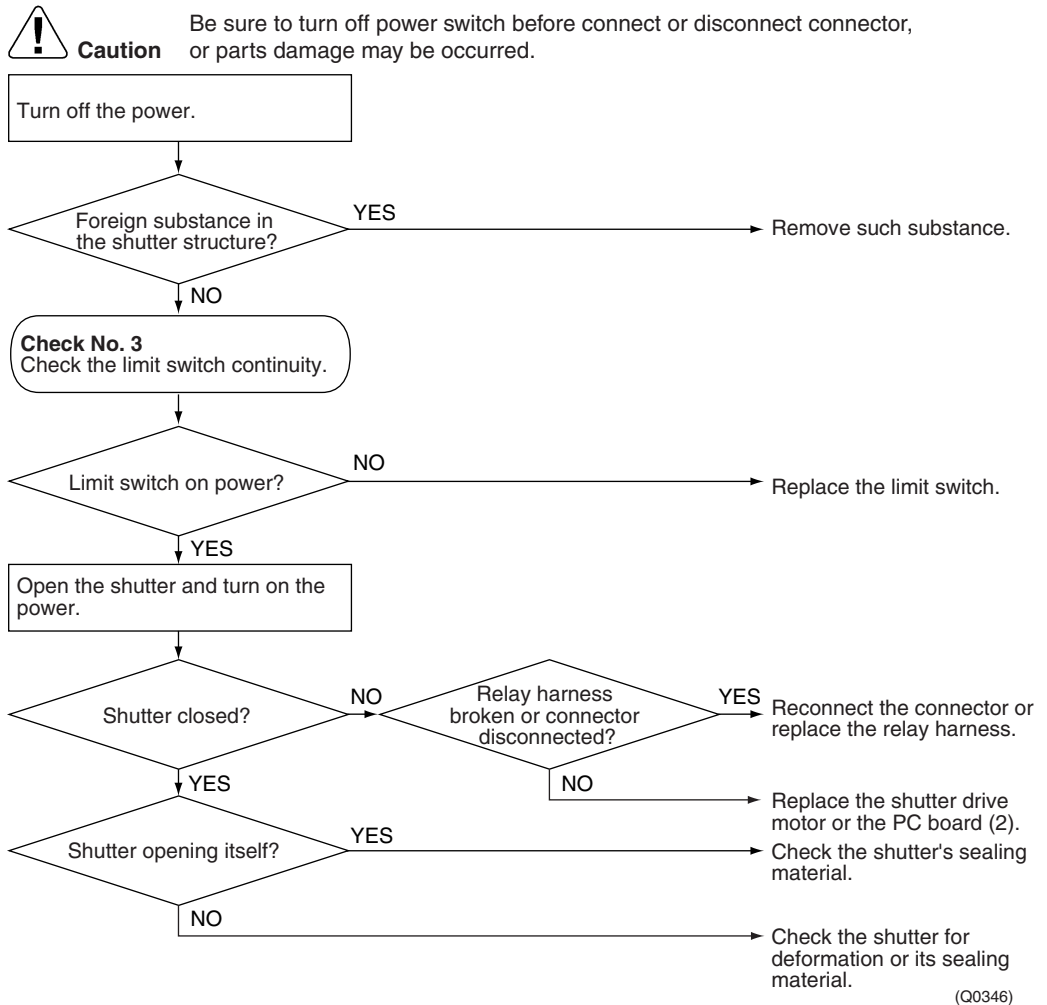

5.8 Signal Transmission Error (between Indoor and Outdoor Units)

Remote
Controller
Display

U4

Method of
Malfunction
Detection

The data received from the outdoor unit in indoor unit-outdoor unit signal transmission is checked whether it is normal.

Malfunction
Decision
Conditions

When the data sent from the outdoor unit cannot be received normally, or when the content of the data is abnormal.

Supposed
Causes

- Faulty outdoor unit PCB.
- Faulty indoor unit PCB.
- Indoor unit-outdoor unit signal transmission error due to wiring error.
- Indoor unit-outdoor unit signal transmission error due to disturbed power supply waveform.
- Indoor unit-outdoor unit signal transmission error due to breaking of wire in the connection wires between the indoor and outdoor units (wire No. 2).

Troubleshooting



Check No.10
Refer to P.212

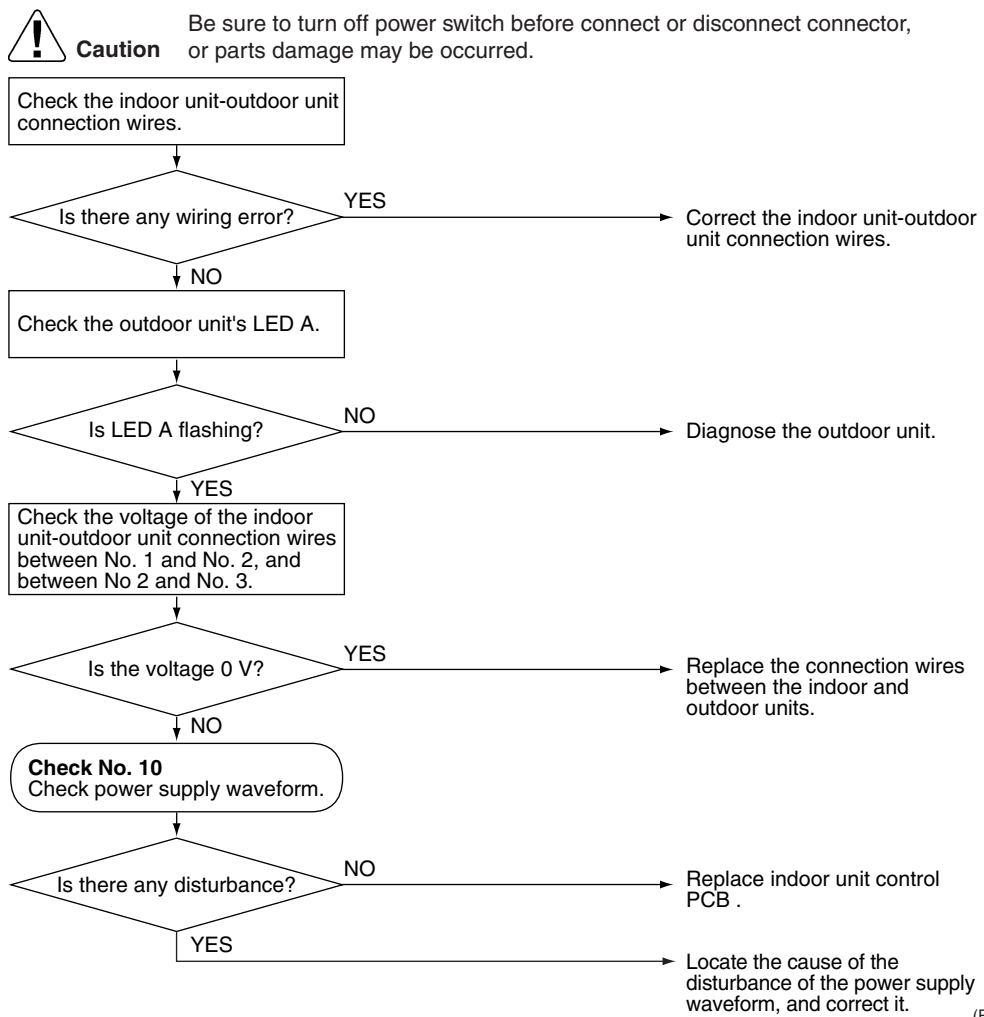

5.9 Unspecified Voltage (between Indoor and Outdoor Units)

Remote
Controller
Display

UR

Method of
Malfunction
Detection

The supply power is detected for its requirements (different from separate type and multi type) by the indoor / outdoor transmission signal.

Malfunction
Decision
Conditions

The separate type and multi type are interconnected.

Supposed
Causes

- Wrong models interconnected
- Wrong indoor unit PCB mounted
- Indoor unit PCB defective
- Wrong outdoor unit PCB mounted or defective

Troubleshooting

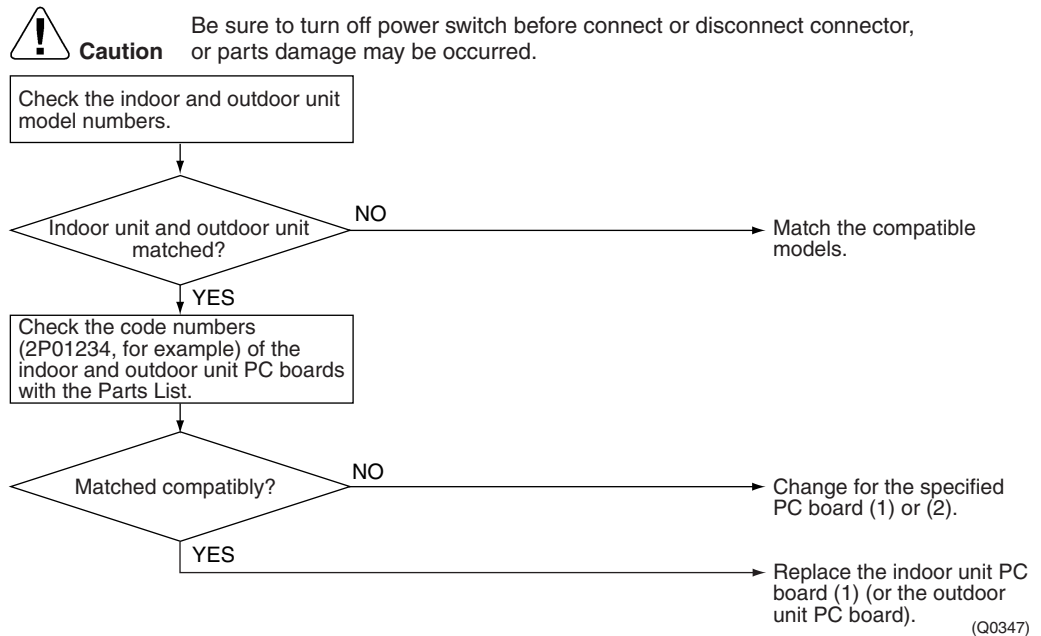

5.10 Freeze-up Protection Control

Remote
Controller
Display

AS

Outdoor Unit LED
Display

A  1  2  3  4 

Method of
Malfunction
Detection

Indoor unit icing, during cooling operation, is detected by checking the temperatures sensed by the indoor unit heat exchanger thermistor and room temperature thermistor that are located in a shut-down room.

Malfunction
Decision
Conditions

In the cooling mode, the following conditions (A) and (B) are kept together for 5 minutes.

(A) Indoor unit heat exchanger temperature $\leq -1^{\circ}\text{C}$

(B) Indoor unit heat exchanger temperature \leq Room temperature -10°C

- If the indoor unit icing protector is activated four times straight, the system will be shut down. (The 4-time counter will reset itself if any of the following errors does not occur during the compressor running time (total time): OL, radiation fin temperature rise, gas shortage, and compressor startup.)
<Total 60 minutes>

Supposed
Causes

- Wrong wiring or piping
- Ev malfunctioning in each room
- Short-circuit
- Indoor unit heat exchanger thermistor defective
- Indoor unit thermistor defective

Troubleshooting



Check No.4
Refer to P.207



Check No.6
Refer to P.209



Caution

Be sure to turn off power switch before connect or disconnect connector, or parts damage may be occurred.

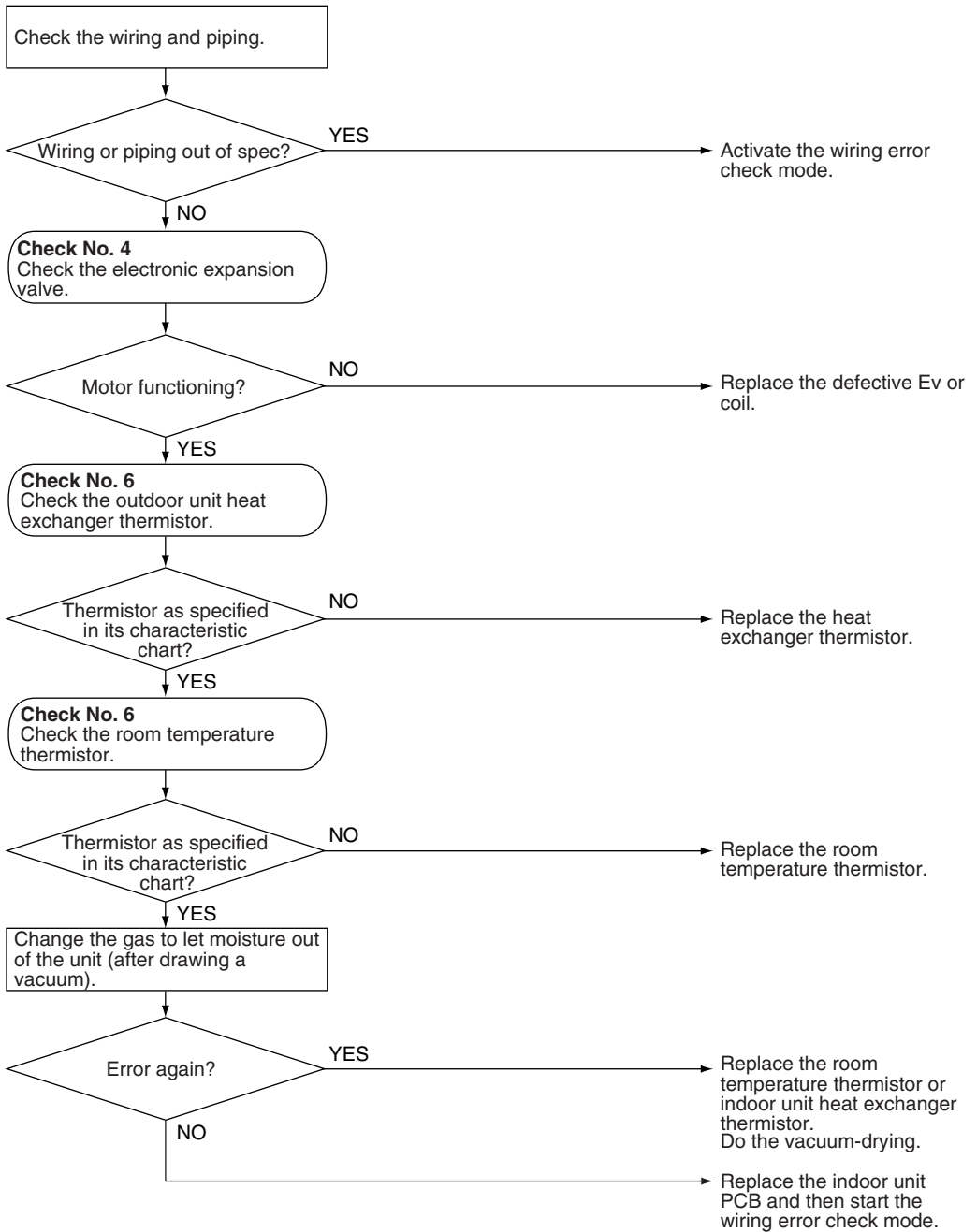





(R3059)

5.11 OL Activation (Compressor Overload)

Remote Controller Display

ES

Outdoor Unit LED Display

A  1  2  3  4

Method of Malfunction Detection

A compressor overload is detected through compressor OL.

Malfunction Decision Conditions

- If the compressor OL is activated twice, the system will be shut down.
- The error counter will reset itself if this or any other error does not occur during the following 60-minute compressor running time (total time).
- * The operating temperature condition is not specified.

Supposed Causes

- Refrigerant shortage
- Four way valve malfunctioning
- Outdoor unit PCB defective
- Water mixed in the local piping
- Electronic expansion valve defective
- Shut-off valve defective

Troubleshooting

Check No.4
Refer to P.207

Check No.5
Refer to P.208



Check No.6
Refer to P.209

Check No.11
Refer to P.212

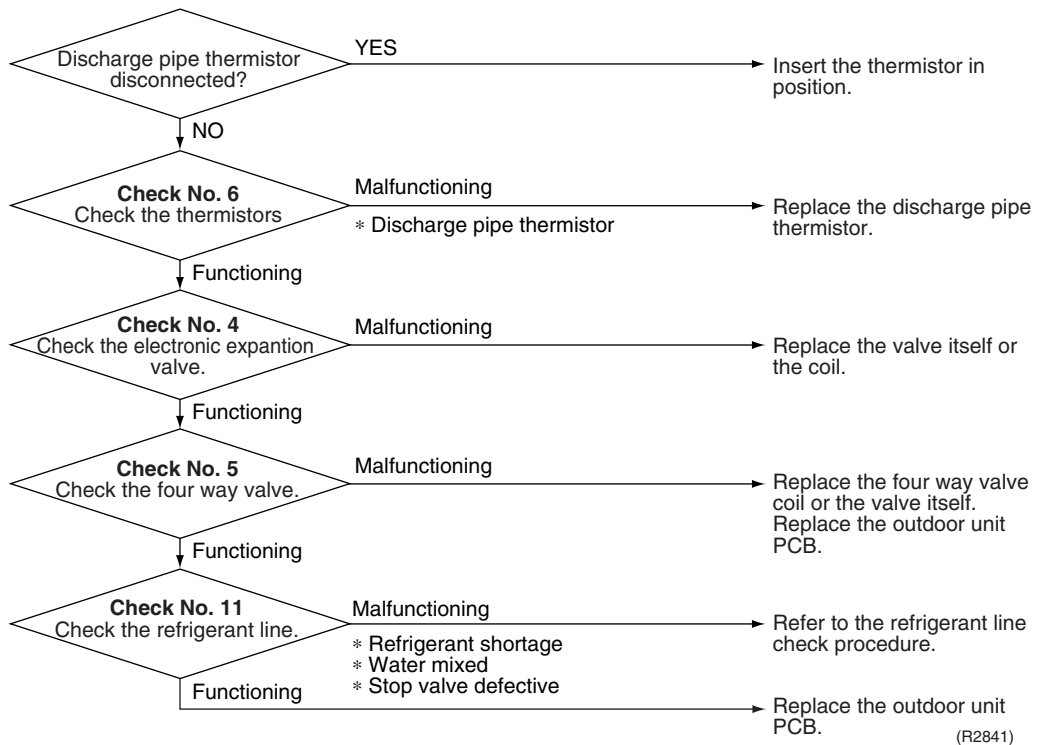

Caution

Be sure to turn off power switch before connect or disconnect connector, or parts damage may be occurred.







(R2841)

5.12 Compressor Lock

Remote Controller Display

EE

Outdoor Unit LED Display

A  1  2  3  4 

Method of Malfunction Detection

A compressor lock is detected by checking the compressor running condition through the position detection circuit.

Malfunction Decision Conditions

- The position detection circuit detects a compressor frequency of below 10 Hz for 20 seconds or a frequency of above 160 Hz.
- 40 seconds after the compressor has started, the position detection circuit detects a compressor frequency of above 180 Hz.
- The system will be shut down if the error occurs 16 times.
- Clearing condition: Continuous run for about 5 minutes (normal)

Supposed Causes

- Compressor locked

Troubleshooting

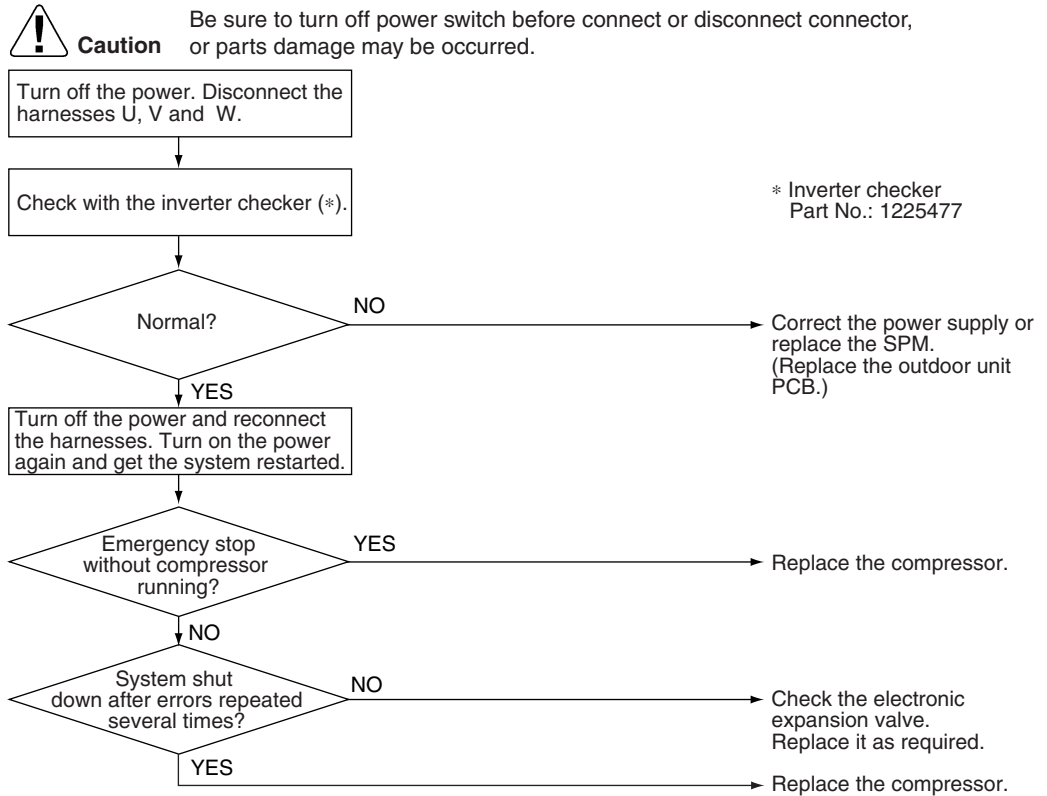

(R2842)

5.13 DC Fan Lock

Remote
Controller
Display

E7

Outdoor Unit LED
Display

A  1  2  3  4

Method of
Malfunction
Detection

A fan motor line error is detected by checking the high-voltage fan motor rpm being detected by the Hall IC.

Malfunction
Decision
Conditions

- The fan does not start in 30 seconds even when the fan motor is running.
- The system will be shut down if the error occurs 16 times.
- Clearing condition: Continuous run for about 5 minutes (normal)

Supposed
Causes

- Fan motor breakdown
- Harness or connector disconnected between fan motor and PCB or in poor contact
- Foreign matters stuck in the fan

Troubleshooting



Check No.15
Refer to P.214

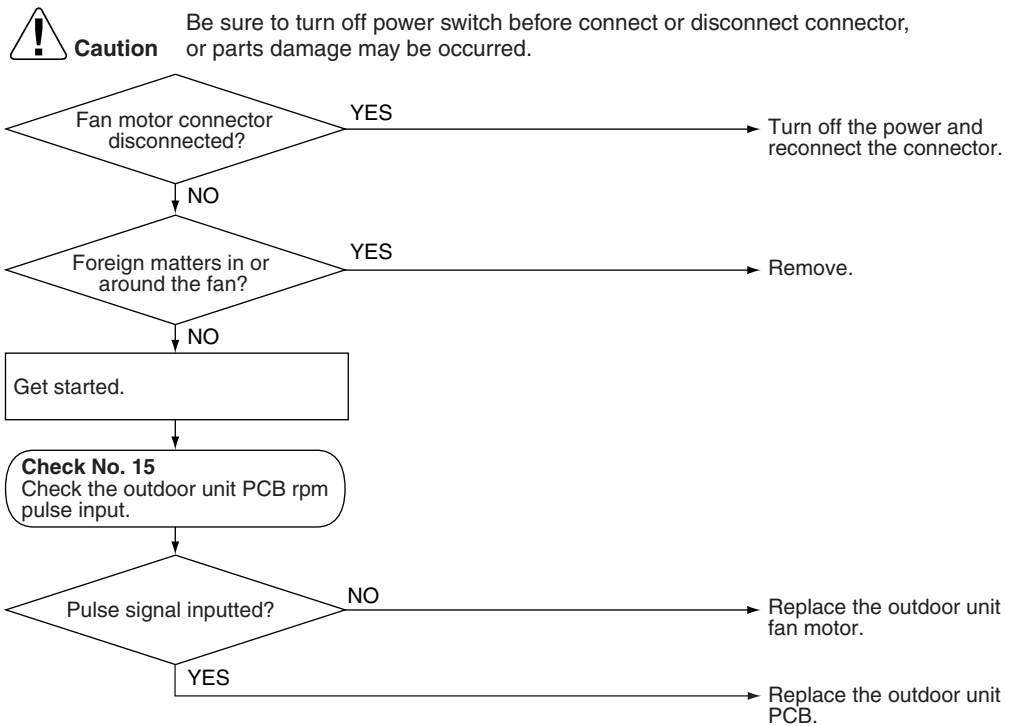

5.14 Input Over Current Detection

Remote
Controller
Display

EE

Outdoor Unit LED
Display

A  1 ● 2  3 ● 4 

Method of
Malfunction
Detection

An input over-current is detected by checking the input current value being detected by CT with the compressor running.

Malfunction
Decision
Conditions

- The following CT input with the compressor running continues for 2.5 seconds.
CT input : Above 20 A
- The system will be shut down if the error occurs 16 times.
- Clearing condition : Continuous run for about 5 minutes (normal)

Supposed
Causes

- Over-current due to compressor failure
- Over-current due to defective power transistor
- Over-current due to defective inverter main circuit electrolytic capacitor
- Over-current due to defective outdoor unit PCB
- Error detection due to outdoor unit PCB
- Over-current due to short-circuit

Troubleshooting



Check No.7
Refer to P.210



Check No.8
Refer to P.211



Check No.14
Refer to P.214



Caution

Be sure to turn off power switch before connect or disconnect connector, or parts damage may be occurred.

* An input over-current may result from wrong internal wiring. If the wires have been disconnected and reconnected for part replacement, for example, and the system is interrupted by an input over-current, take the following procedure.

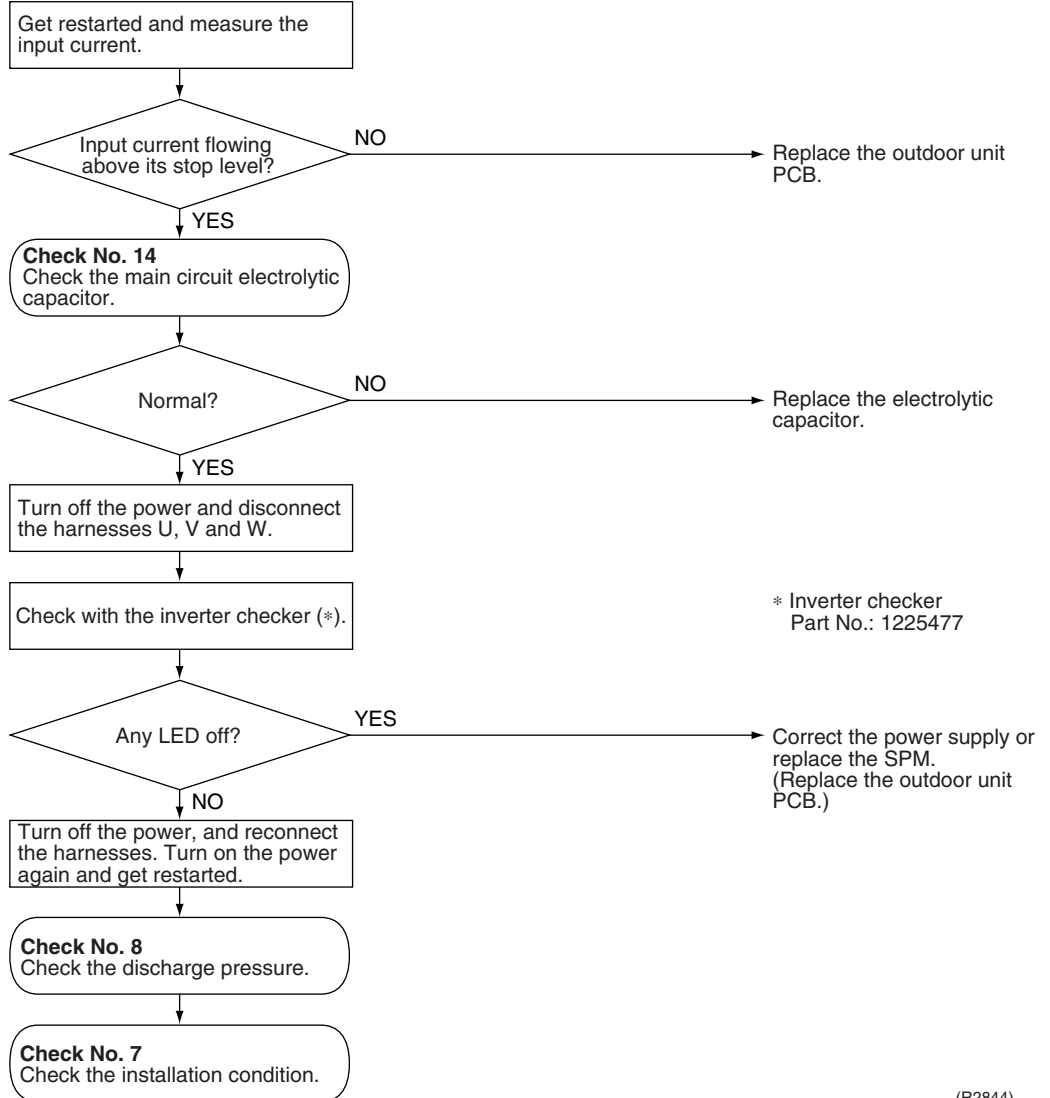



(R2844)

5.15 Four Way Valve Abnormality

Remote
Controller
Display

ER

Outdoor Unit LED
Display

A  1  2 ● 3 ● 4 ●

Method of
Malfunction
Detection

The liquid pipe thermistor, the outdoor temperature thermistor and the outdoor unit heat exchanger thermistor are checked to see if they function within their normal ranges in the operating mode.

Malfunction
Decision
Conditions

Either of the following conditions occurs 3 minutes after the compressor has started.

- Cooling / dry operation
(Outdoor unit heat exchanger temperature – Liquid pipe temperature) < -5°C
- Heating operation
(Liquid pipe temperature – Outdoor unit heat exchanger temperature) < -5°C

Supposed
Causes

- Connector in poor contact
- Thermistor defective
- Outdoor unit PCB defective
- Four way valve coil or harness defective
- Four way valve defective
- Foreign substance mixed in refrigerant

Troubleshooting



Check No.5
Refer to P.208



Check No.6
Refer to P.209



Check No.11
Refer to P.212



(Q0353)

5.16 Discharge Pipe Temperature Control

Remote
Controller
Display



Outdoor Unit LED
Display

A ● 1 ○ 2 ● 3 ○ 4 ●

Method of
Malfunction
Detection

The discharge pipe temperature control (stop, frequency drooping, etc.) is checked with the temperature being detected by the discharge pipe thermistor.

Malfunction
Decision
Conditions

- If a stop takes place 6 times straight due to abnormal discharge pipe temperature, the system will be shut down.
 - If the temperature being detected by the discharge pipe thermistor rises above 120°C, the compressor will stop. (The error is cleared when the temperature has dropped below 107°C.)
- Stop temperatures (in the case of 3MXS52BVMB)
- (1) 110°C when the frequency rises above 45 Hz or drops below 40 Hz.
 - (2) 102°C when the frequency rises from 30 Hz to 45 Hz or drops from 40 Hz to 25 Hz.
 - (3) 98°C when the frequency rises just up to 30 Hz or drops below 25 Hz.
- The error counter will reset itself if this or any other error does not occur during the following 60-minute compressor running time (total time).

Supposed
Causes

- Refrigerant shortage
- Four way valve malfunctioning
- Discharge pipe thermistor defective
(heat exchanger or outdoor temperature thermistor defective)
- Outdoor unit PCB defective
- Water mixed in the local piping
- Electronic expansion valve defective
- Stop valve defective

Troubleshooting

Check No.4
Refer to P.207

Check No.6
Refer to P.209

Check No.11
Refer to P.212

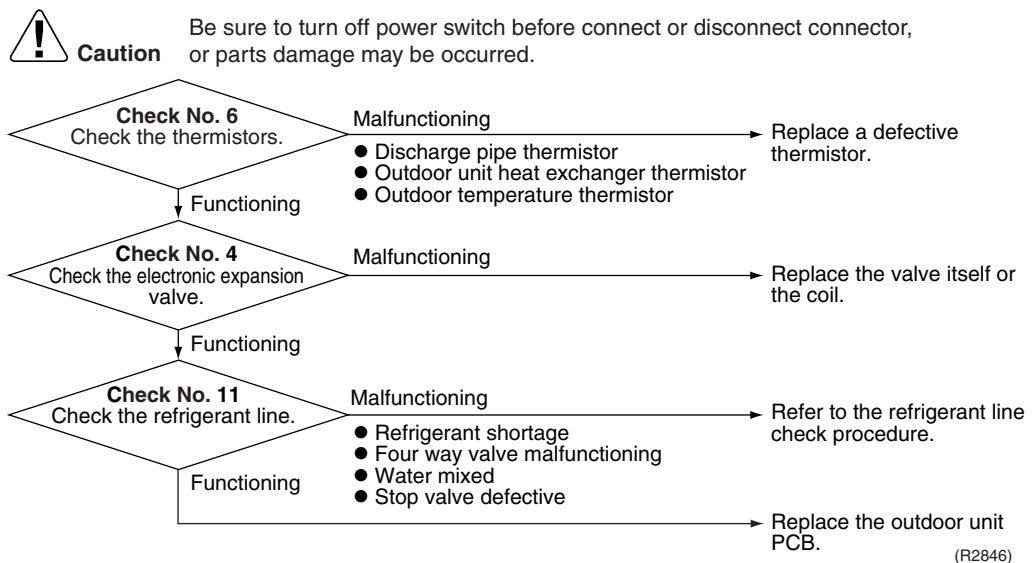





5.17 Position Sensor Abnormality

Remote
Controller
Display

HE

Outdoor Unit LED
Display

A  1  2  3  4 

Method of
Malfunction
Detection

A compressor startup failure is detected by checking the compressor running condition through the position detection circuit.

Malfunction
Decision
Conditions

- The compressor fails to start in about 15 seconds after the compressor run command signal is sent.
- Clearing condition: Continuous run for about 5 minutes (normal)
- The system will be shut down if the error occurs 16 times.

Supposed
Causes

- Compressor relay cable disconnected
- Compressor itself defective
- Outdoor unit PCB defective
- Stop valve closed
- Input voltage out of specification

Troubleshooting



Check No.13
Refer to P.213



Caution

Be sure to turn off power switch before connect or disconnect connector, or parts damage may be occurred.

Check No. 13
Check for short-circuit.

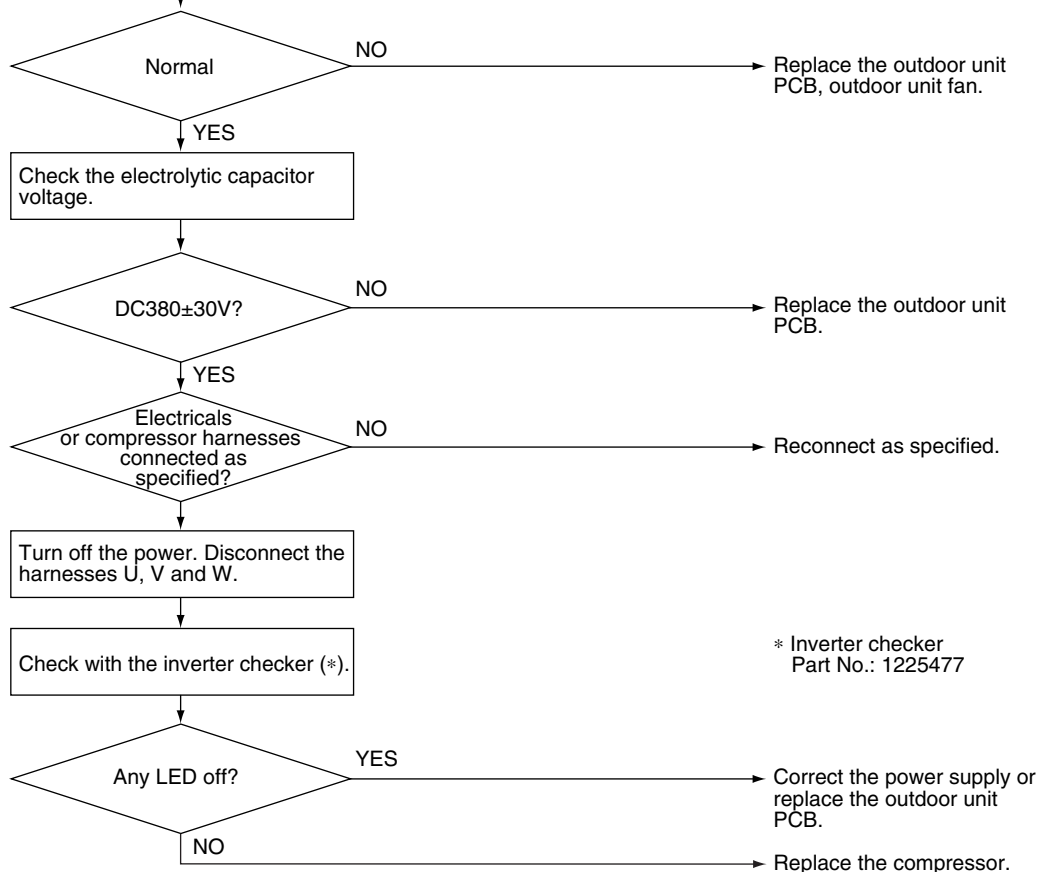

* Inverter checker
Part No.: 1225477





(R2847)

5.18 CT or Related Abnormality

Remote
Controller
Display

HB

Outdoor Unit LED
Display

A  1  2  3  4 

Method of
Malfunction
Detection

A CT or related error is detected by checking the compressor running frequency and CT-detected input current.

Malfunction
Decision
Conditions

The compressor running frequency is below 55 Hz and the CT input is below 0.1 V.
(The input current is also below 1.25 A.)

- If this error repeats 4 times, the system will be shut down.
- The error counter will reset itself if this or any other error does not occur during the following 60-minute compressor running time (total time).

Supposed
Causes

- Power transistor defective
- Internal wiring broken or in poor contact
- Reactor defective
- Outdoor unit PCB defective

Troubleshooting



Check No.12
Refer to P.213



Caution

Be sure to turn off power switch before connect or disconnect connector, or parts damage may be occurred.

Turn off the power and turn it on again.

Get the system started.

* Running current as shown at right with relay cable 1 or 2?

YES

Replace the outdoor unit PCB.

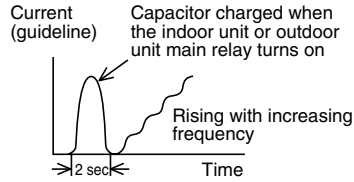

Check No. 12
Check the capacitor voltage.

DC380±30V?

YES

Turn off the power. Disconnect the harnesses U, V and W.

Check with the inverter checker (*).

* Inverter checker
Part No.: 1225477

Measure the rectifier input voltage.

NO

Any LED off?

YES

Correct the power supply or replace the SPM.
(Replace the outdoor unit PCB.)

Turn off the power and reconnect the above harnesses. Then turn on the power again and get the system restarted.

NO

Compressor running?

YES

Replace the outdoor unit PCB.

NO

Replace the compressor.

Voltage within the allowable range (Supply voltage±15%)?

YES

Replace the outdoor unit PCB.

NO

Check the supply voltage.





(R2848)

5.19 Thermistor or Related Abnormality (Outdoor Unit)

Remote
Controller
Display

P4, J3, J6, J8, J9, H9

Outdoor Unit LED
Display

A  1  2  3  4 

Method of
Malfunction
Detection

This type of error is detected by checking the thermistor input voltage to the microcomputer.
[A thermistor error is detected by checking the temperature being detected by each thermistor.]

Malfunction
Decision
Conditions

When the thermistor input is above 4.96 V or below 0.04 V with the power on, the *J3* error is judged if the discharge pipe thermistor temperature is smaller than the condenser thermistor temperature, or the system will be shut down if all the units are judged with the *J8* error.

Supposed
Causes

- Connector in poor contact
- Thermistor defective
- Outdoor unit PCB defective
- Indoor unit PCB defective
- Condenser thermistor defective in the case of *J3* error (outdoor unit heat exchanger thermistor in the cooling mode, or indoor unit heat exchanger thermistor in the heating mode)

Troubleshooting



Check No.6
Refer to P.209

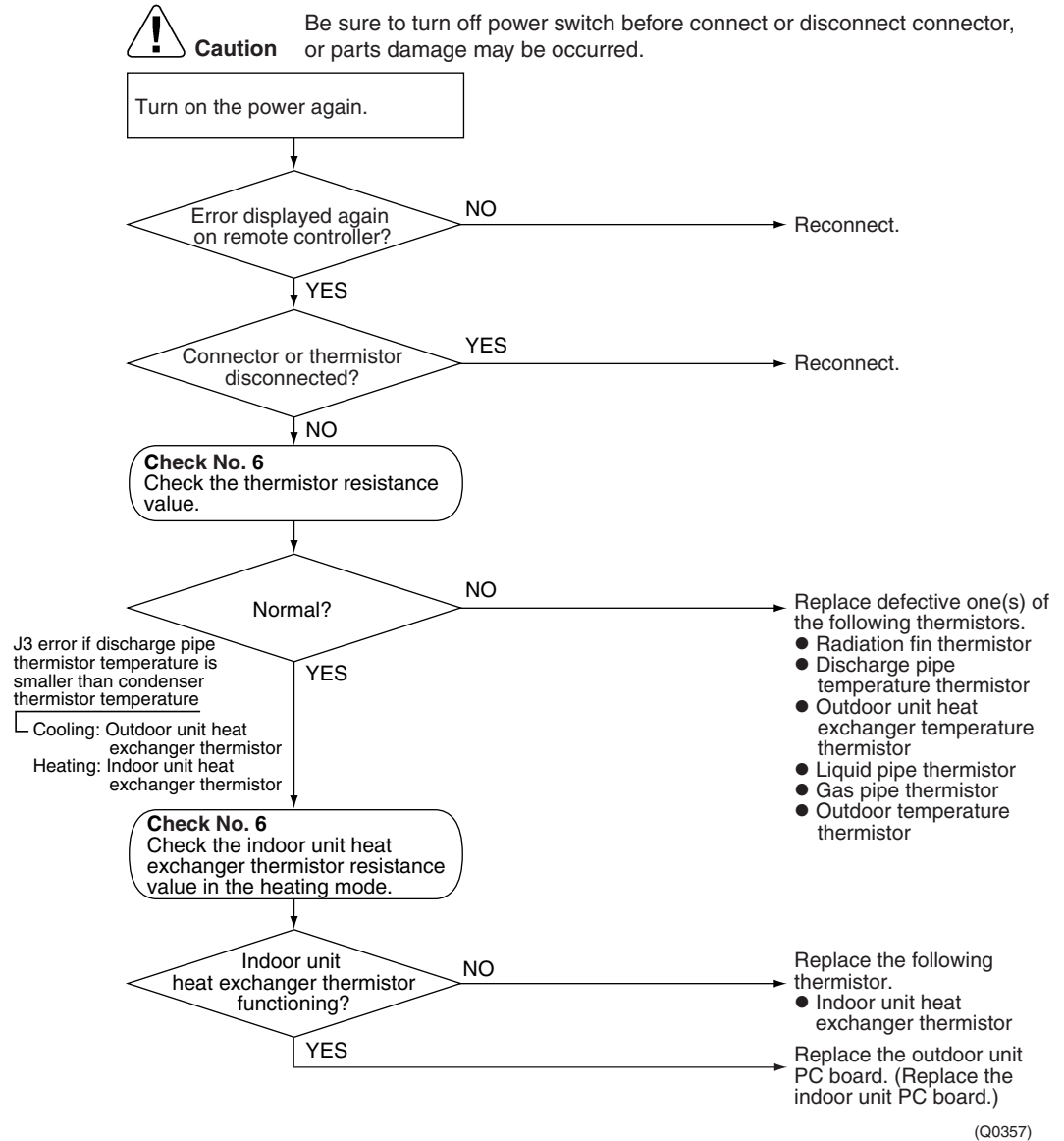

P4 : Radiation fin thermistor
 J3 : Discharge pipe temperature thermistor
 J5 : Outdoor unit heat exchanger temperature thermistor
 J8 : Liquid pipe thermistor
 J9 : Gas pipe thermistor
 H9 : Outdoor temperature thermistor

5.20 Electrical Box Temperature Rise

Remote
Controller
Display

L3

Outdoor Unit LED
Display

A  1  2  3  4 

Method of
Malfunction
Detection

An electrical box temperature rise is detected by checking the radiation fin thermistor with the compressor off.

Malfunction
Decision
Conditions

With the compressor off, the radiation fin temperature is above 80°C (above 75°C in the case of 8.0 · 9.0kW class). (Reset is made when the temperature drops below 70°C.)

Supposed
Causes

- Fin temperature rise due to defective outdoor unit fan
- Fin temperature rise due to short-circuit
- Fin thermistor defective
- Connector in poor contact
- Outdoor unit PCB defective

Troubleshooting

 **Check No.6**
Refer to P.209

 **Check No.7**
Refer to P.210

 **Check No.9**
Refer to P.211

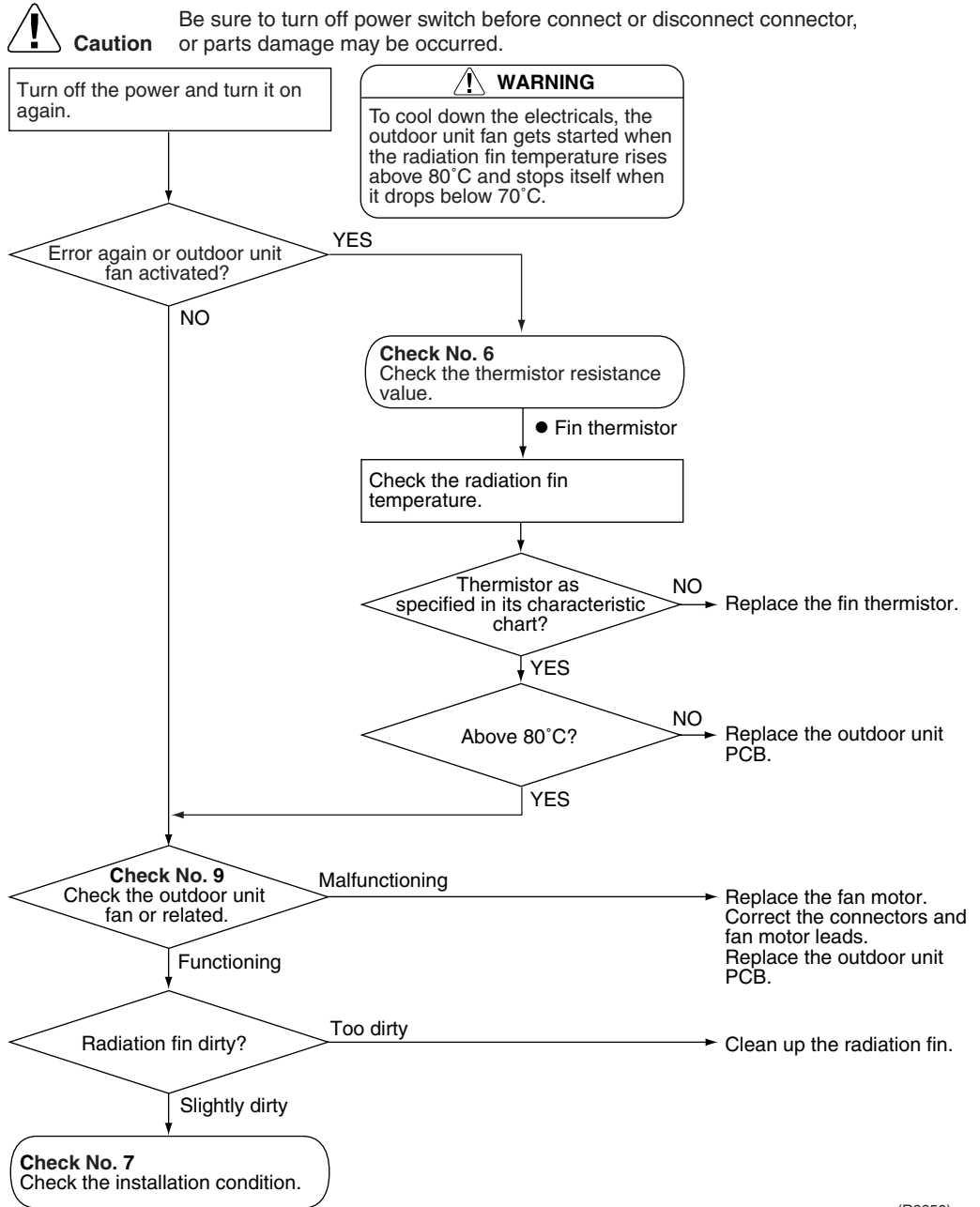

(R2850)

5.21 Radiation Fin Temperature Rise

Remote
Controller
Display

L4

Outdoor Unit LED
Display

A  1 ● 2 ● 3 ● 4 

Method of
Malfunction
Detection

A radiation fin temperature rise is detected by checking the radiation fin temperature being detected by the fin thermistor with the compressor on.

Malfunction
Decision
Conditions

If the radiation fin temperature with the compressor on is above 90°C for 5.2~7.5 kW-or-smaller class systems or above 85°C for 8.0 · 9.0 kW class systems,

- If a radiation fin temperature rise takes place 4 times successively, the system will be shut down.
- The error counter will reset itself if this or any other error does not occur during the following 60-minute compressor running time (total time).

Supposed
Causes

- Fin temperature rise due to defective outdoor unit fan
- Fin temperature rise due to short-circuit
- Fin thermistor defective
- Connector in poor contact
- Outdoor unit PCB defective

Troubleshooting



Check No.6
Refer to P.209



Check No.7
Refer to P.210



Check No.9
Refer to P.211



Caution

Be sure to turn off power switch before connect or disconnect connector, or parts damage may be occurred.

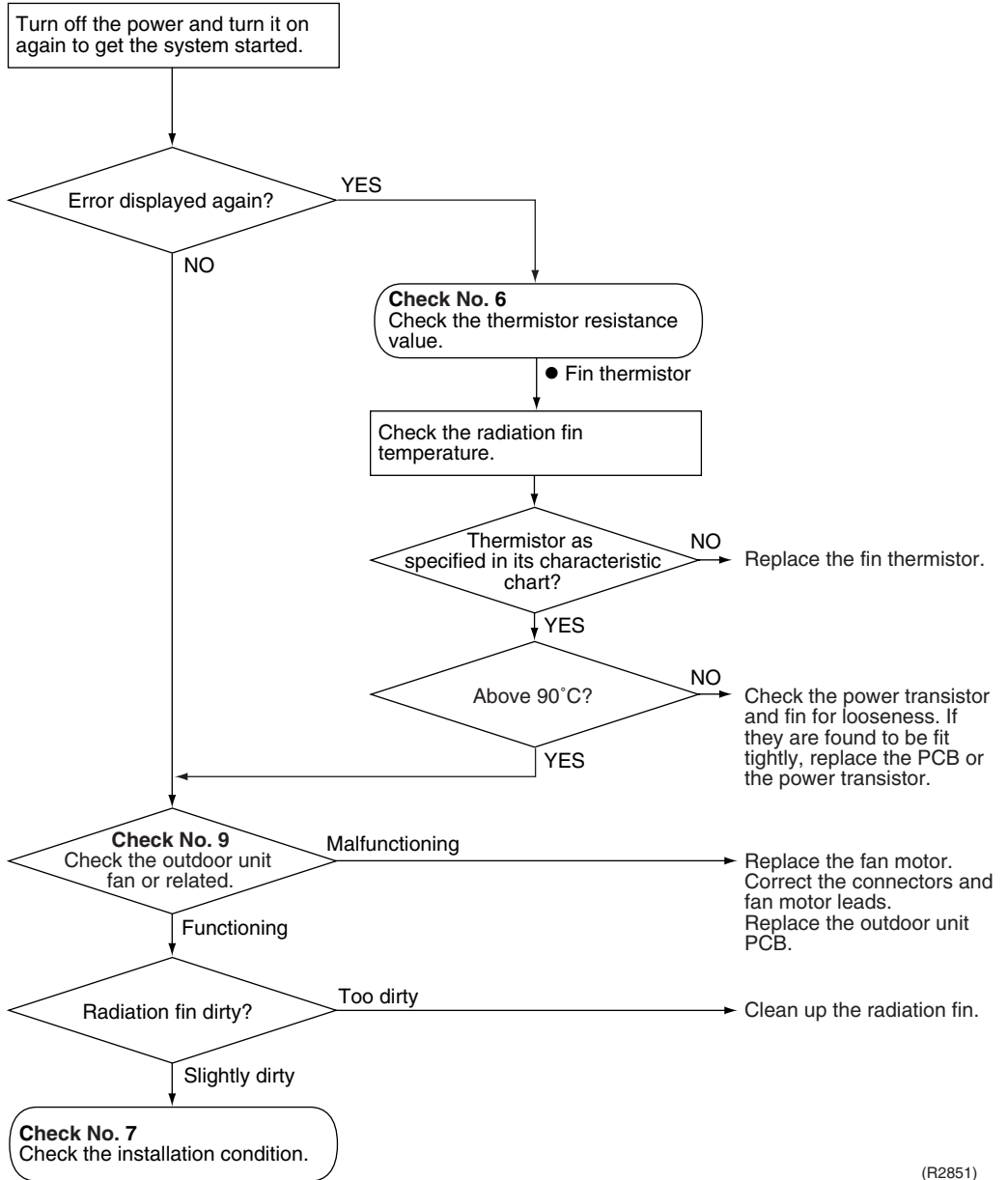

(R2851)

5.22 Output Over Current Detection

Remote
Controller
Display

L5

Outdoor Unit LED
Display

A  1  2  3  4 

Method of
Malfunction
Detection

An output over-current is detected by checking the current that flows in the inverter DC section.

Malfunction
Decision
Conditions

- A position signal error occurs while the compressor is running.
- A speed error occurs while the compressor is running.
- An output over-current input is fed from the output over-current detection circuit to the microcomputer.
- The system will be shut down if the error occurs 16 times.
- Clearing condition: Continuous run for about 5 minutes (normal)

Supposed
Causes

- Over-current due to defective power transistor
- Over-current due to wrong internal wiring
- Over-current due to abnormal supply voltage
- Over-current due to defective PCB
- Error detection due to defective PCB
- Over-current due to closed stop valve
- Over-current due to compressor failure
- Over-current due to poor installation condition

Troubleshooting

 **Check No.7**
Refer to P.210

 **Check No.8**
Refer to P.211

 **Check No.13**
Refer to P.213



Caution Be sure to turn off power switch before connect or disconnect connector, or parts damage may be occurred.

* An output over-current may result from wrong internal wiring. If the wires have been disconnected and reconnected for part replacement, for example, and the system is interrupted by an output over-current, take the following procedure.

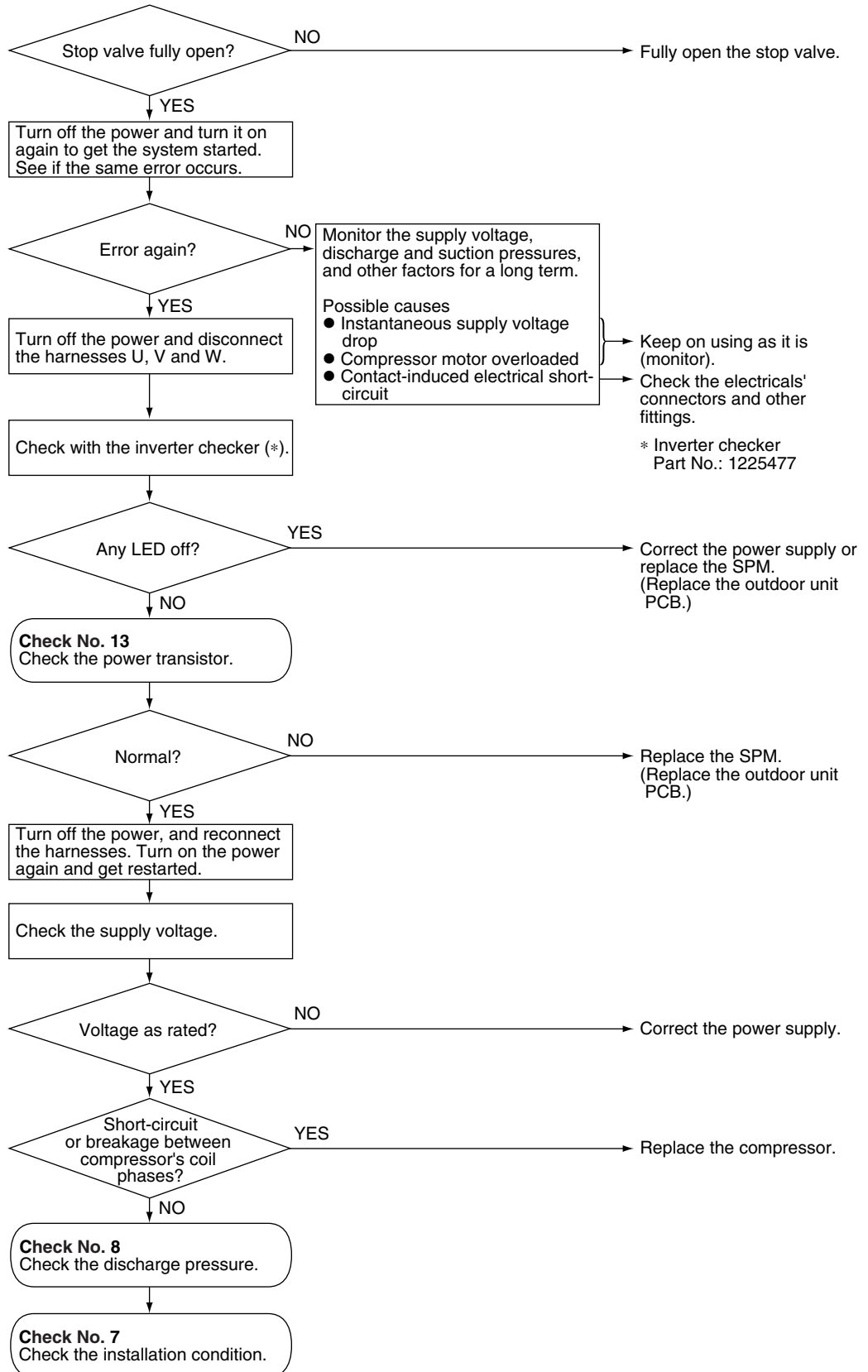

* Inverter checker
Part No.: 1225477

(R2852)

5.23 Insufficient Gas

Remote
Controller
Display



Outdoor Unit LED
Display

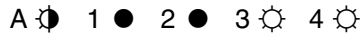

Method of
Malfunction
Detection

Gas shortage detection I : A gas shortage is detected by checking the CT-detected input current value and the compressor running frequency.
Gas shortage detection II : A gas shortage is detected by checking the difference between indoor unit heat exchanger temperature and room temperature as well as the difference between outdoor unit heat exchanger temperature and room temperature.

Malfunction
Decision
Conditions

Gas shortage detection I :
Input current < $8.78 / 256 (A/Hz) \times \text{Compressor running frequency} + 0.25$
However, when the status of running frequency > 55 (Hz) is kept on for a certain time.
Note : The values are different from model to model.
Gas shortage detection II :
If a gas shortage error takes place 4 times straight, the system will be shut down. The error counter will reset itself if this or any other error does not occur during the following 60-minute compressor running time (total time).

Supposed
Causes

- Refrigerant shortage (refrigerant leakage)
- Poor compression performance of compressor
- Discharge pipe thermistor disconnected, or indoor unit or outdoor unit heat exchanger thermistor disconnected, room or outside air temperature thermistor disconnected
- Stop valve closed
- Electronic expansion valve defective

Troubleshooting



Check No.4
Refer to P.207



Check No.6
Refer to P.209



Caution

Be sure to turn off power switch before connect or disconnect connector, or parts damage may be occurred.

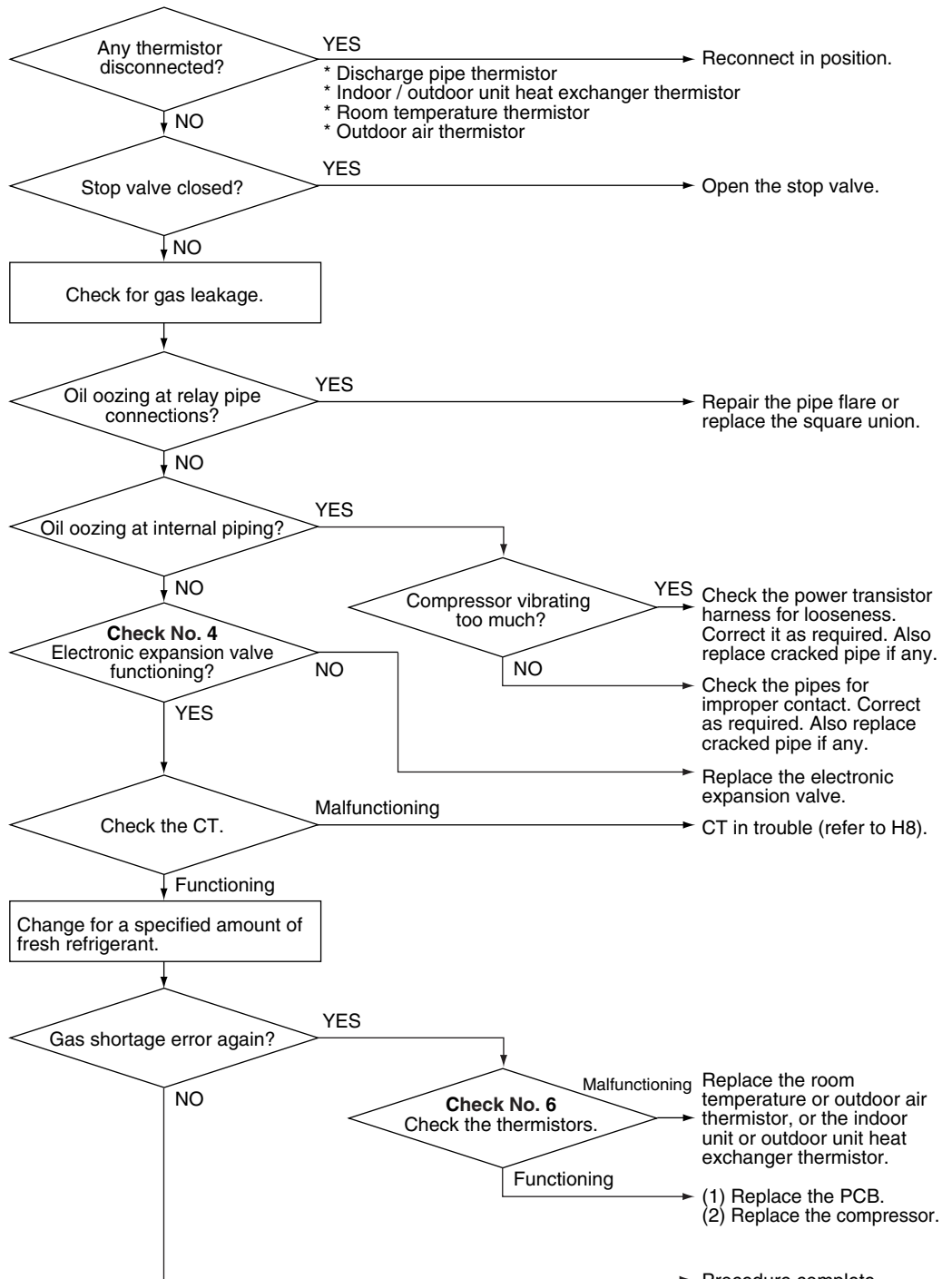



(R2853)

5.24 Low-voltage Detection

Remote
Controller
Display

U2

Outdoor Unit LED
Display

A  1  2  3  4 

Method of
Malfunction
Detection

An abnormal voltage rise or drop is detected by checking the detection circuit or DC voltage detection circuit.

Malfunction
Decision
Conditions

- An over-voltage signal is fed from the over-voltage detection circuit to the microcomputer, or the voltage being detected by the DC voltage detection circuit is judged to be below 150 V for 0.1 second.
- The system will be shut down if the error occurs 16 times.
- Clearing condition: Continuous run for about 60 minutes (normal)

Supposed
Causes

- Supply voltage not as specified
- Over-voltage detector or DC voltage detection circuit defective
- PAM control part(s) defective

Troubleshooting

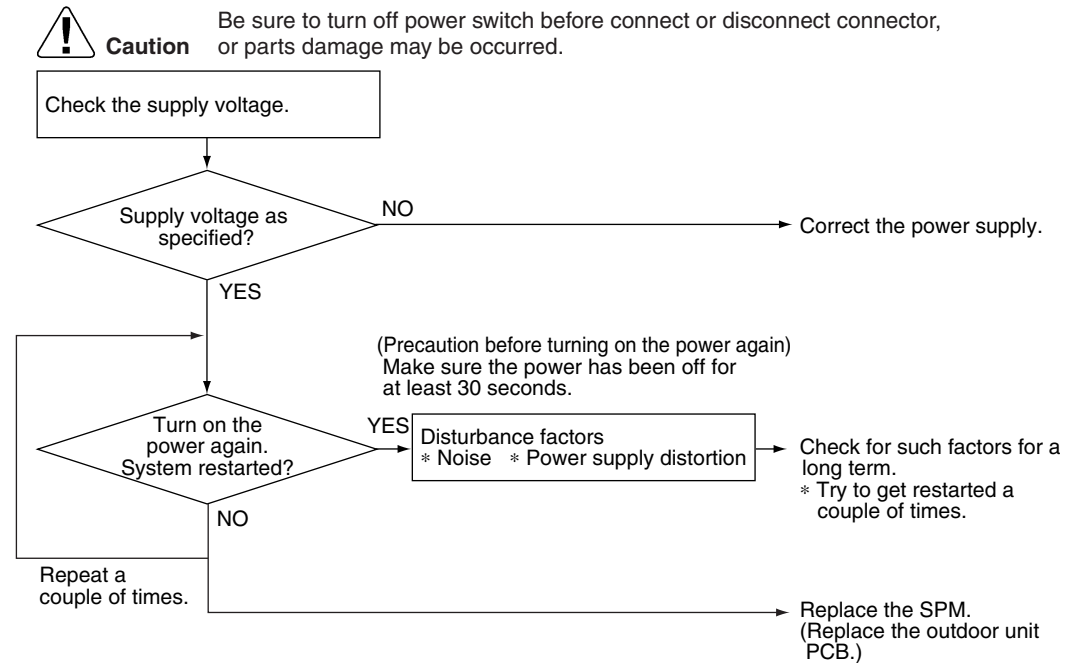

(R2854)

5.25 Anti-icing Function in Other Rooms / Unspecified Voltage (between Indoor and Outdoor Units)

Remote
Controller
Display

UR, UH

Outdoor Unit LED
Display

A  1 ● 2 ● 3 ● 4 ●

Method of
Malfunction
Detection

A wrong connection is detected by checking the combination of indoor and outdoor units on the microcomputer.

Malfunction
Decision
Conditions

- Operation halt due to the anti-icing function in other rooms
- Operation halt due to unspecified internal and/or external voltages
- Operation halt due to mismatching of indoor and outdoor units

Supposed
Causes

- Operation halt due to the anti-icing function in other rooms
- Wrong connections at the indoor unit
- PCB wrongly connected

Troubleshooting



Caution

Be sure to turn off power switch before connect or disconnect connector, or parts damage may be occurred.

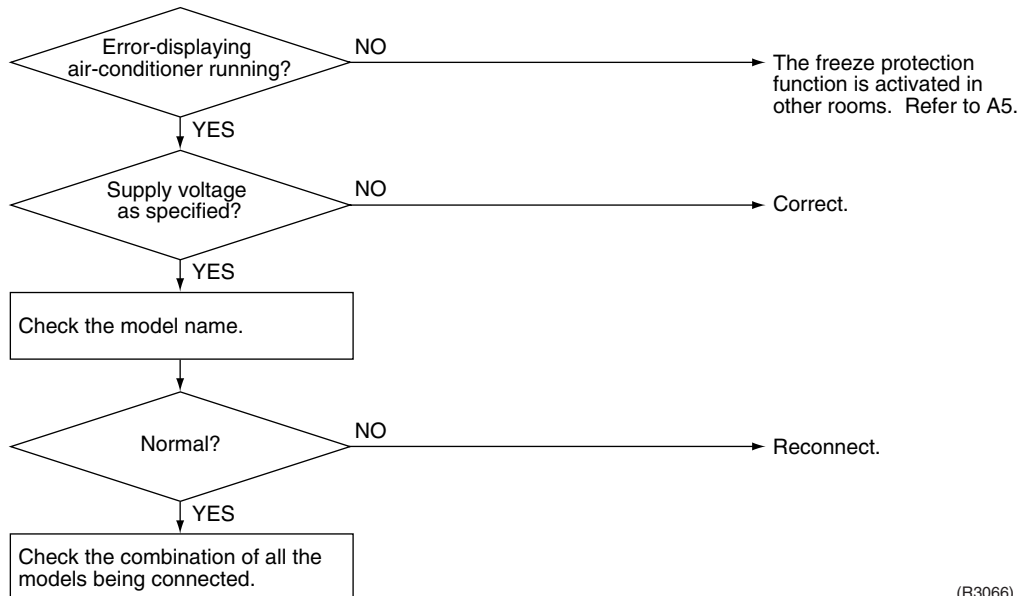

(R3066)

6. Check

6.1 How to Check

6.1.1 Fan Motor Connector Output Check

Check No.01

1. Check connector connection.
2. Check motor power supply voltage output (pins 4-7 and 4-8).
3. Check motor control voltage (pins 4-3).
4. Check rotation command voltage output (pins 4-2).
5. Check rotation pulse input (pins 4-1).

Upper fan connector

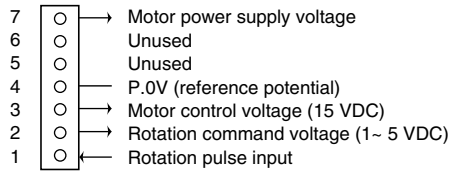

Lower fan connector

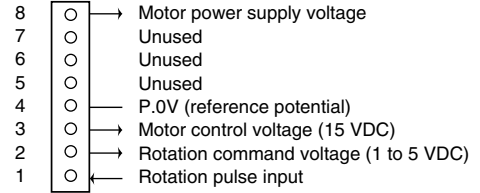

(R1224)

Check No.02

1. Check connector connection.
2. Check motor control voltage output (pins 2-1).

S202

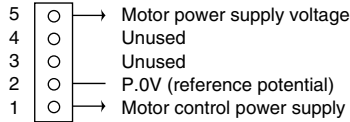

(R1073)

6.1.2 Limit Switch Continuity Check

Check No.3

Remove the front grille. The limit switch is located at the left side of the drain pan assembly. Check the continuity of the switch connection.

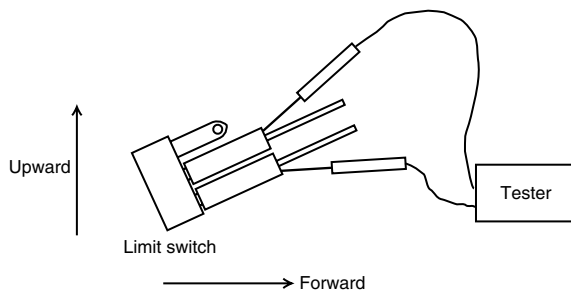

Shutter status	Open	Closed
Continuity	Continuity	No continuity

(Q0363)

- * The shutter can be opened and closed with hand. Keep the shutter open and closed all the way for each continuity check steps.

6.1.3 Electronic Expansion Valve Check

Check No.4

Conduct the followings to check the electronic expansion valve (EV).

1. Check to see if the EV connector is correctly inserted in the PCB. Compare the EV unit and the connector number.
2. Turn the power off and back on again, and check to see if all the EVs generate latching sound.
3. If any of the EVs does not generate latching noise in the above step 2, disconnect that connector and check the conductivity using a tester.
Check the conductivity between pins 1, 3 and 6, and between pins 2, 4 and 5. If there is no conductivity between the pins, the EV coil is faulty.
4. If no EV generates latching sound in the above step 2, the outdoor unit PCB is faulty.
5. If the conductivity is confirmed in the above step 2, mount a good coil (which generated latching sound) in the EV unit that did not generate latching sound, and check to see if that EV generates latching sound.
*If latching sound is generated, the outdoor unit PCB is faulty.
*If latching sound is not generated, the EV unit is faulty.



Note: Please note that the latching sound varies depending on the valve type.

Valve Body Condition (Symptom)	Check Method / Measure
<p>(1) Valve body catches at fully opened or half opened position. (Symptom) Cooling: <ul style="list-style-type: none"> ■Water leakage at the no-operation unit ■Flow noise of refrigerant in the no-operation unit ■Operation halt due to icing protection Heating: <ul style="list-style-type: none"> ■The unit does not heat ■Refrigerant flow rate vary by unit (Discharge air temperatures are different by room) ■Peak cut </p>	<p>Reset power supply and conduct cooling operation unit by unit.</p> <div style="border: 1px solid black; padding: 5px; margin-bottom: 5px;">Check the liquid pipe temperature of no-operation unit.</div> <div style="text-align: center;"> <p>Is it almost same as the outside air temperature?</p> <p>NO →</p> <p>YES ↓</p> <p>Replace the EVn of the room. (R1431)</p> </div>
<p>(2) Valve body catches at complete close position. (Symptom) Cooling: <ul style="list-style-type: none"> ■The only unit having problem does not cool the room . ■When the only faulty unit is in operation, the unit makes pump down. (The low pressure of the unit becomes vacuum) ■IT is activated. ■Abnormal discharge pipe temperature Heating: Insufficient gas due to liquid refrigerant stagnation inside the faulty indoor unit (Only for heat pump model) <ul style="list-style-type: none"> ■The unit does not heat the room. ■IT is activated. ■Abnormal discharge pipe temperature </p>	<p>Reset power supply and conduct cooling operation unit by unit.</p> <div style="border: 1px solid black; padding: 5px; margin-bottom: 5px;">Check the low pressure</div> <div style="text-align: center;"> <p>Does the pressure become into vacuum zone?</p> <p>NO →</p> <p>YES ↓</p> <p>Replace the EVn of the room (R1432)</p> </div>
<p>(3) Valve does not open fully. (Symptom) <ul style="list-style-type: none"> ■The unit does not cool nor heat (only for heat pump model.) ■IT is actuated. ■Abnormal discharge pipe temperature </p>	<p>Check the number of rotation of shaft if it is 5 and half from full open to complete close using manual coil for electronic expansion valve. When the number of rotation of shaft is less than the above value, the valve may catch anywhere of the body.</p>

6.1.4 Four Way Valve Performance Check

Check No.5

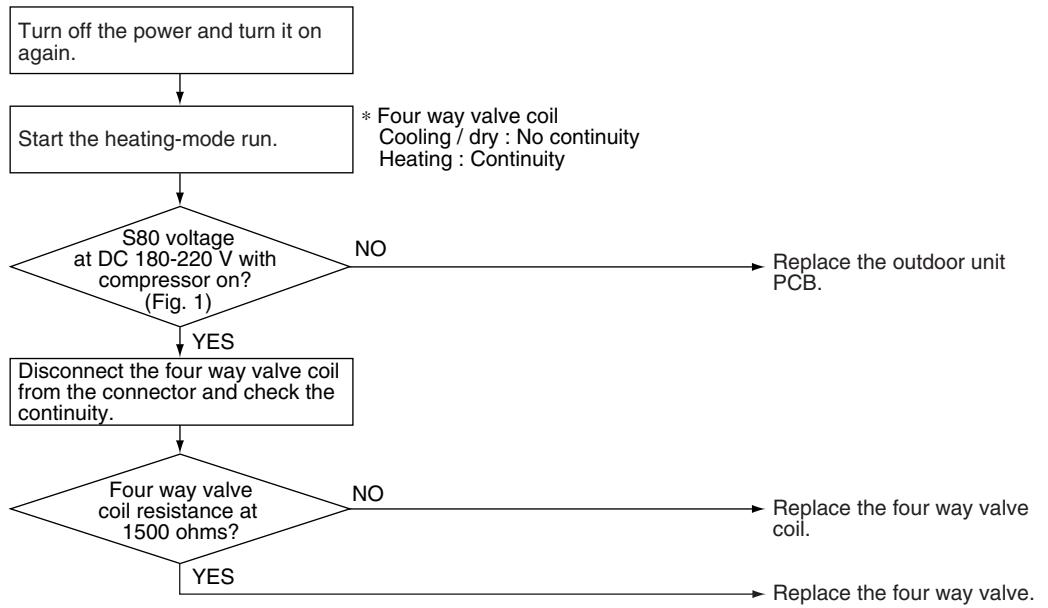

(Fig. 1)

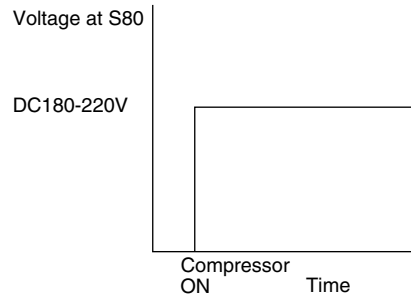

(R2856)

6.1.5 Thermistor Resistance Check

Check No.6

Remove the connectors of the thermistors on the PCB, and measure the resistance of each thermistor using tester.
 The relationship between normal temperature and resistance is shown in the graph and the table below.

Temperature (°C)	Thermistor R25°C=20kΩ B=3950
-20	211.0 (kΩ)
-15	150
-10	116.5
-5	88
0	67.2
5	51.9
10	40
15	31.8
20	25
25	20
30	16
35	13
40	10.6
45	8.7
50	7.2

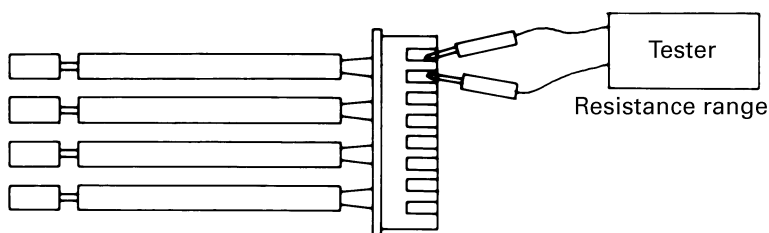

(R25=20k Ω 、 B=3950)

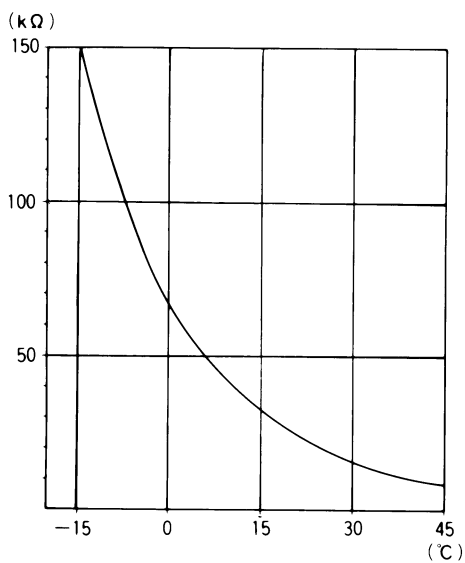

(R1437)

6.1.6 Installation Condition Check

Check No.7

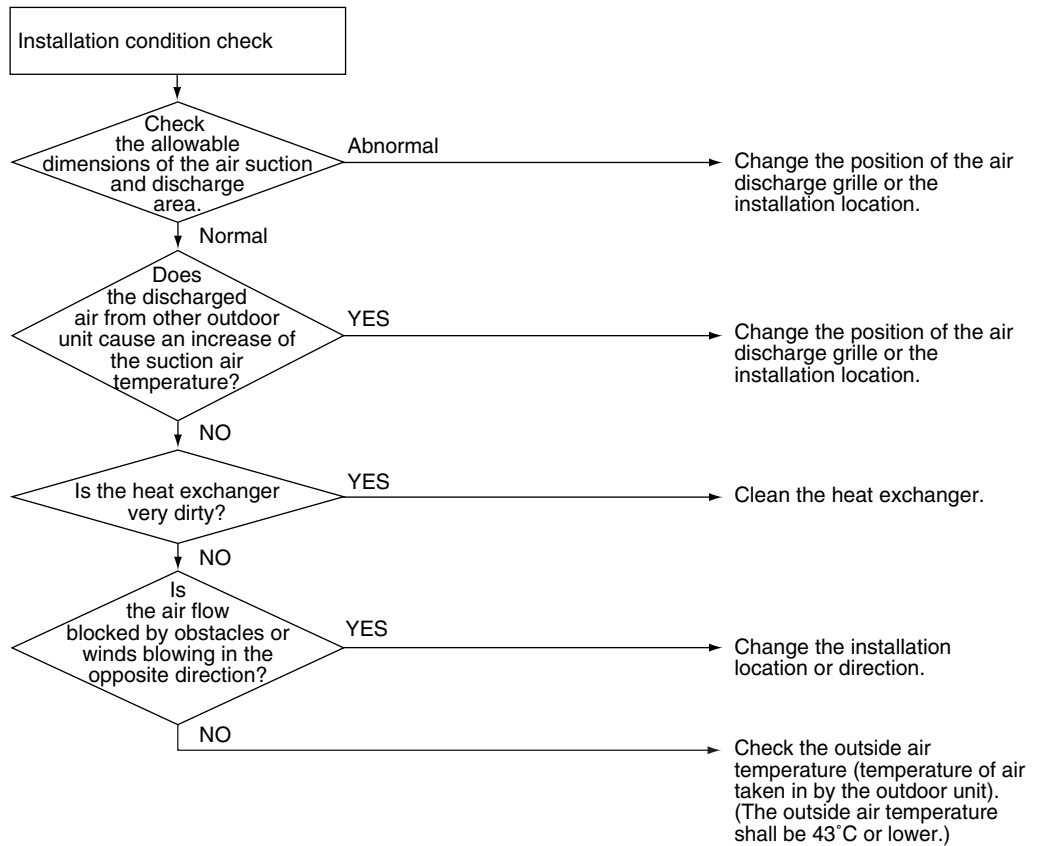

(R1438)

6.1.7 Discharge Pressure Check

Check No.8

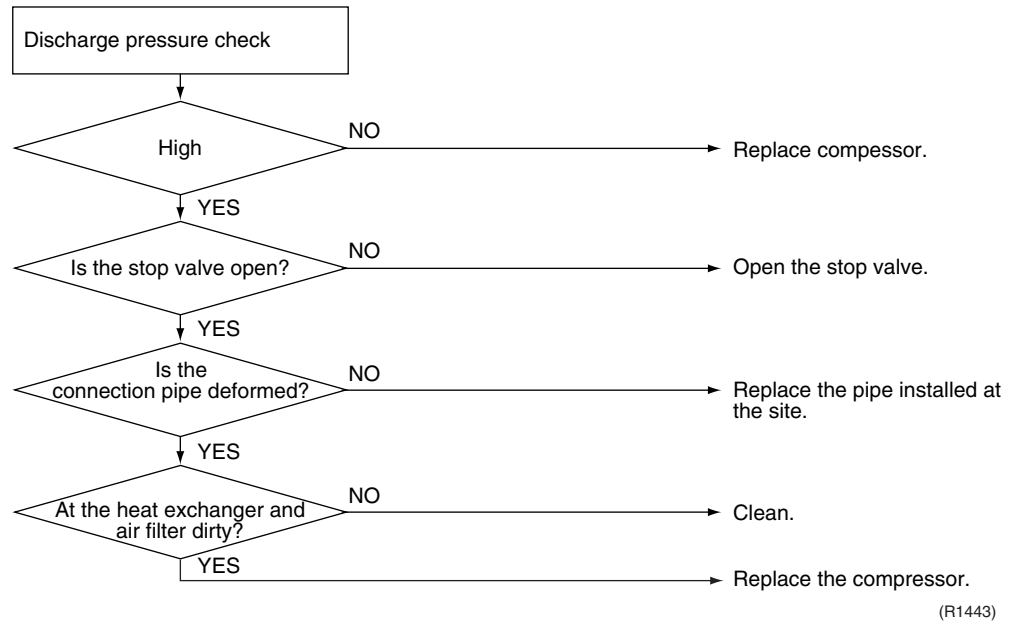

6.1.8 Outdoor Unit Fan System Check (With DC Motor)

Check No.9

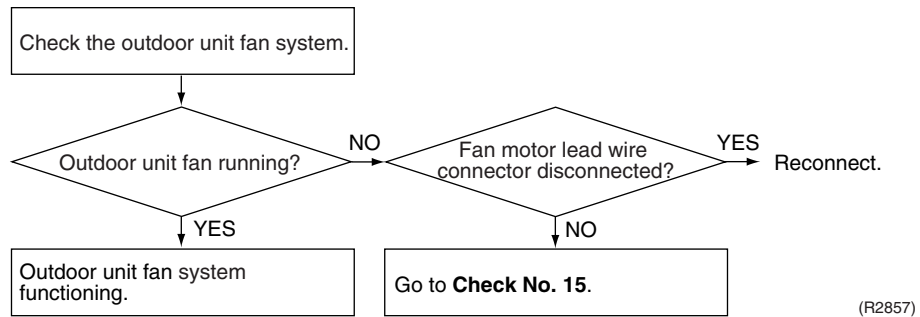

6.1.9 Power Supply Waveforms Check

Check No.10

Measure the power supply waveform between pins 1 and 3 on the terminal board, and check the waveform disturbance.

- Check to see if the power supply waveform is a sine wave (Fig.1).
- Check to see if there is waveform disturbance near the zero cross (sections circled in Fig.2)

[Fig.1]

[Fig.2]

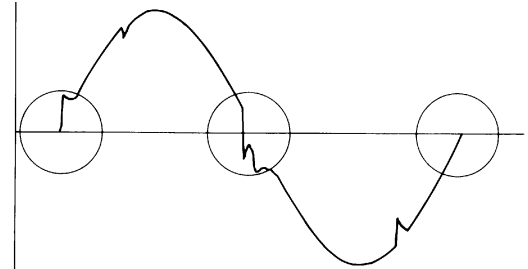
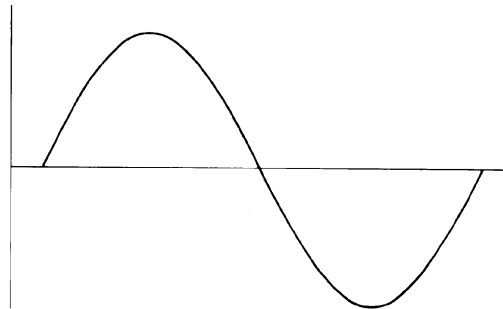

(R1736)

(R1444)

6.1.10 Inverter Units Refrigerant System Check

Check No.11

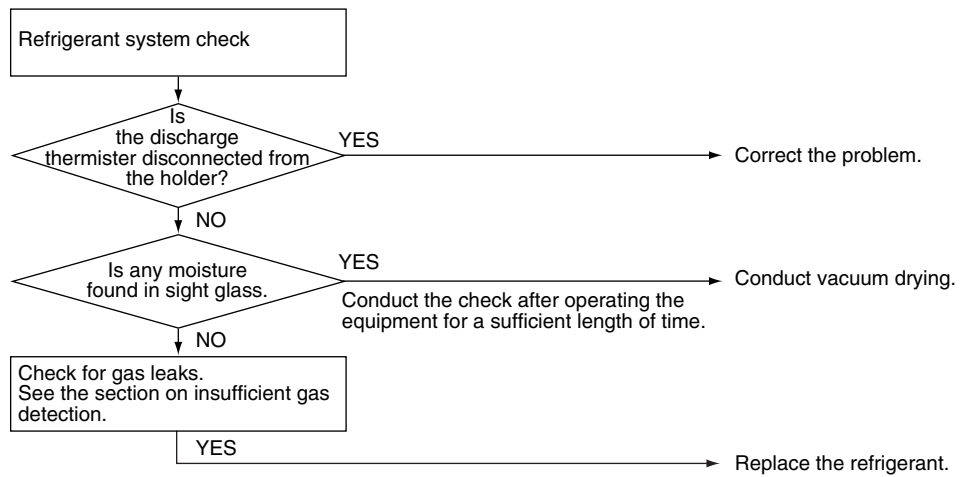

(R1445)

6.1.11 Capacitor Voltage Check

Check No.12

Before this checking, be sure to check the main circuit for short-circuit.

- Checking the capacitor voltage
- With the circuit breaker still on, measure the voltage according to the drawing of the model in question. Be careful never to touch any live parts.

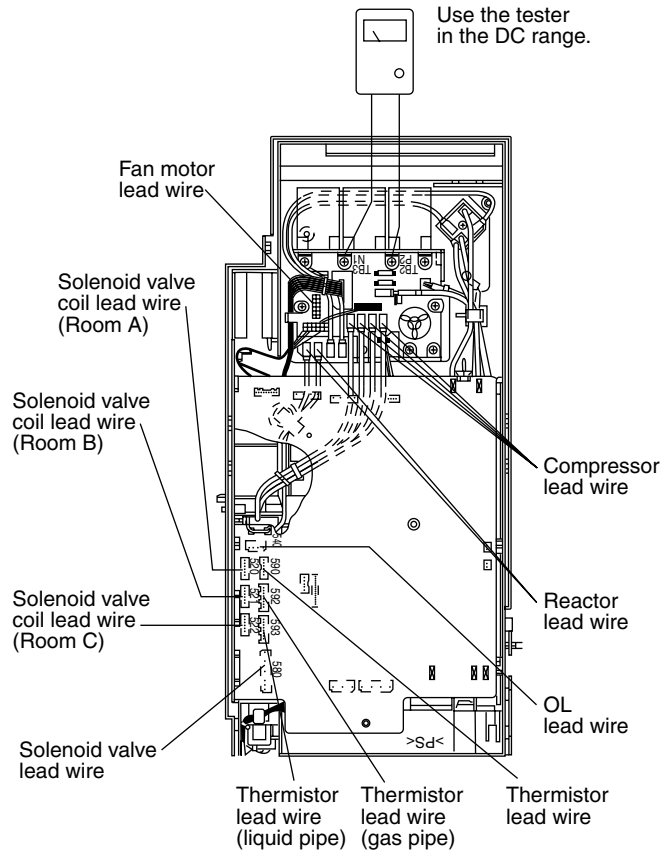

(Q0366)

6.1.12 Power Transistor Check

Check No.13

- Checking the power transistor
- Never touch any live parts for at least 10 minutes after turning off the circuit breaker.
- If unavoidably necessary to touch a live part, make sure the power transistor's supply voltage is below 50 V using the tester.
- For the UVW, make measurements at the Faston terminal on the board or the relay connector.

Tester's negative terminal	Power transistor (+)	UVW	Power transistor (-)	UVW
Tester's positive terminal	UVW	Power transistor (+)	UVW	Power transistor (-)
Normal resistance	Several kohms to several Mohms			
Abnormal resistance	0 or ∞			

6.1.13 Main Circuit Electrolytic Capacitor Check

Check No.14

- Checking the main circuit electrolytic capacitor
- Never touch any live parts for at least 10 minutes after turning off the circuit breaker.
- If unavoidably necessary to touch a live part, make sure there is no DC voltage using the tester.
- Check the continuity with the tester. Reverse the pins and make sure there is continuity.

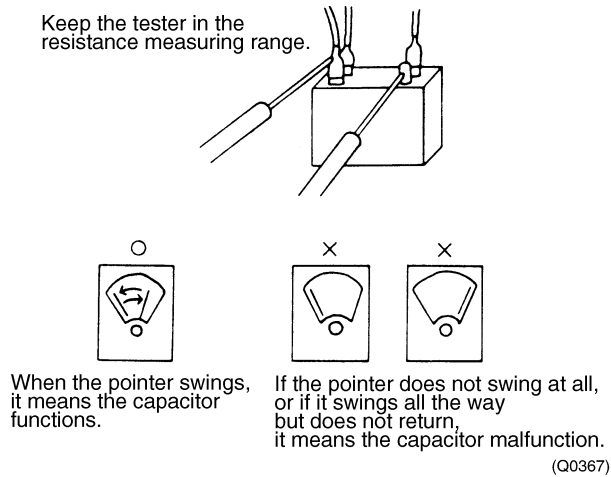

6.1.14 Turning Speed Pulse Input on the Outdoor Unit PCB Check

Check No.15

<Propeller fan motor>

Make sure the voltage of $270 \pm 30V$ is being applied.

- (1) Stop the operation first and then the power, and disconnect the connector S70.
- (2) Make sure there is about DC 270 V between pins 4 and 7.
- (3) With the system and the power still off, reconnect the connector S70.
- (4) Make a turn of the fan motor with a hand, and make sure the pulse (0-15 V) appears twice at pins 1 and 4.

If the fuse is blown out, the outdoor-unit fan may also be in trouble. Check the fan too.

If the voltage in Step (2) is not applied, it means the PCB is defective. Replace the PCB.

If the pulse in Step (4) is not available, it means the Hall IC is defective. Replace the DC fan motor. If there are both the voltage (2) and the pulse (4), replace the PCB.

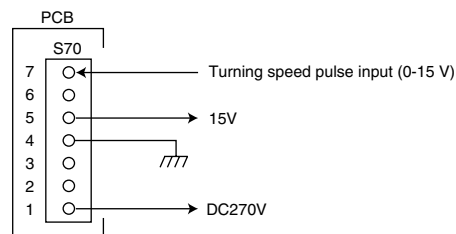

* Propeller fan motor : S70

6.1.15 Hall IC Check

Check No.16

1. Check the connector connection.
2. With the power ON, operation OFF, and the connector connected, check the following.
 - *Output voltage of about 5 V between pins 1 and 3.
 - *Generation of 3 pulses between pins 2 and 3 when the fan motor is operating.

Failure of (1) → faulty PCB → Replace the PCB.

Failure of (2) → faulty hall IC → Replace the fan motor.

Both (1) and (2) result → Replace the PCB.

The connector has 3 pins, and there are two patterns of lead wire colors.

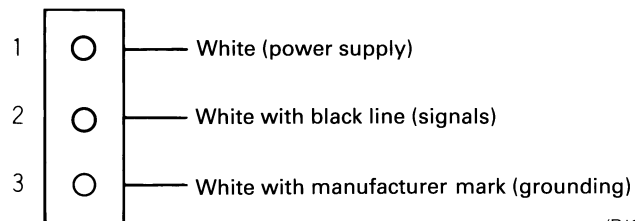
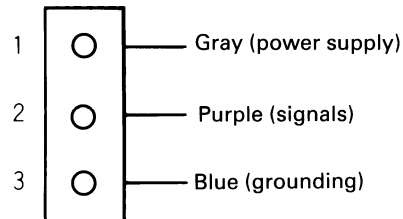

(R1990)

Part 7

Removal Procedure

1. Outdoor Unit (80 / 90 Class)	218
1.1 Removal of Outer Panels	218
1.2 Removal of Propeller Fans	221
1.3 Removal of Electrical Box	222
1.4 Removal of PCB	229
1.5 Removal of Fan Motor	232
1.6 Removal of Electronic Expansion Valve and Thermistor	234
1.7 Removal of Sound Insulation and Reactor	235
1.8 Removal of Shunt	237
1.9 Removal of Solenoid Valve and Four Way Valve	238
1.10 Removal of Compressor	240
2. Outdoor Unit (50 / 52 / 58 / 68 / 75 Class)	242
2.1 Removal of Outer Panels	242
2.2 Removal of Electrical BOX	243
2.3 Removal of PCB	247
2.4 Removal of Fan Motor	250
2.5 Removal of Sound Insulation	251
2.6 Removal of Four Way Valve Coil, Solenoid Valve Coil, Electronic Expansion Valve Coil and Thermistor	252
2.7 Removal of Four Way Valve, Solenoid Valve and Shunt	254
2.8 Removal of Solenoid Valve and Shunt	255
2.9 Removal of Compressor	256

1. Outdoor Unit (80 / 90 Class)

1.1 Removal of Outer Panels

Procedure



Warning

Be sure to wait 10 minutes or more after turning off all power supplies before disassembling work.

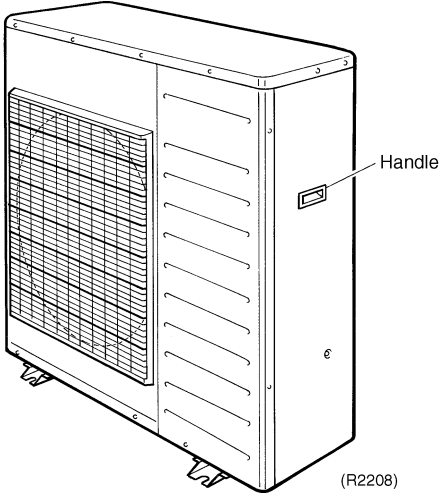
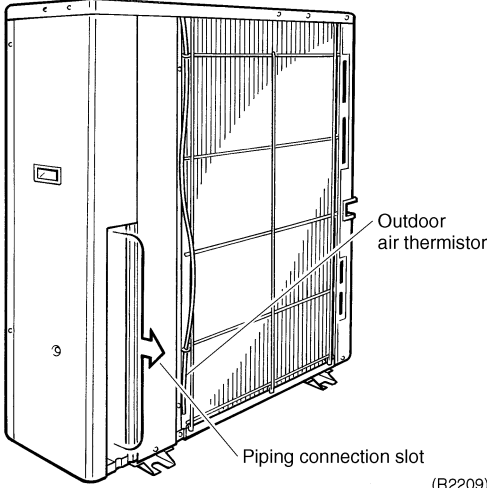
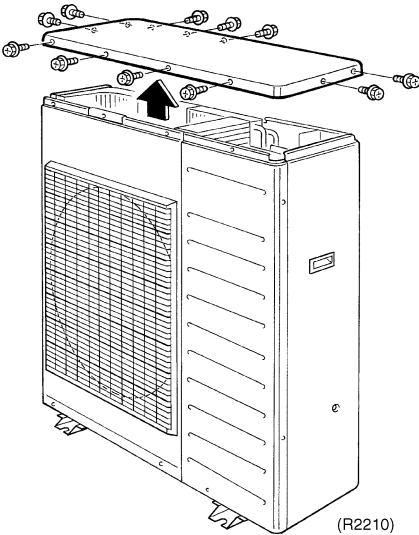
Step	Procedure	Procedure	Points
1	External appearance.	 <p>(R2208)</p>  <p>(R2209)</p>	<p>■ Remove the piping in the backward direction.</p>
2	Remove 11 screws of the top panel.	 <p>(R2210)</p>	

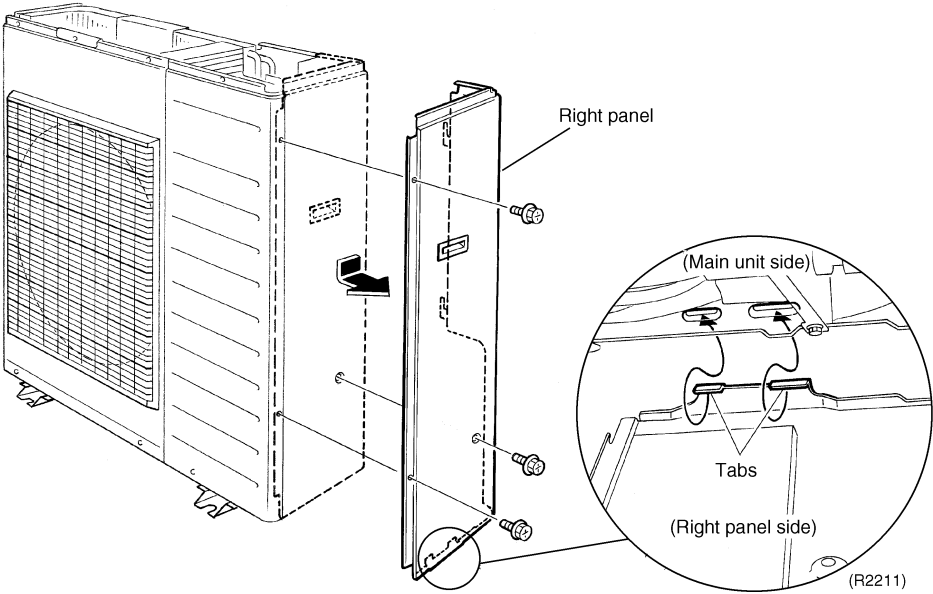
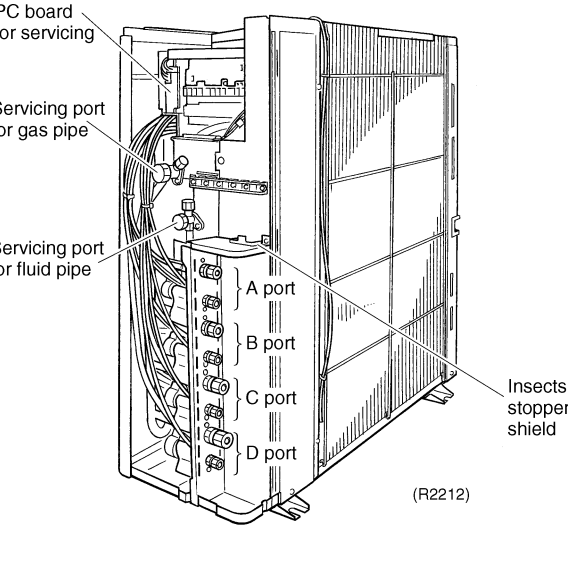
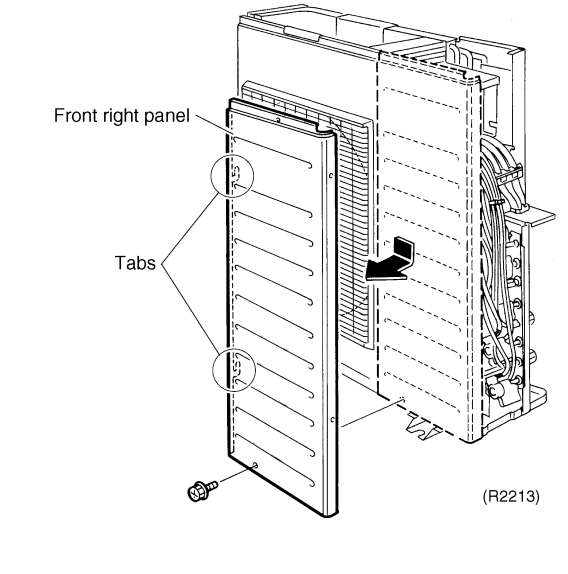
Step	Procedure	Points
3	<p>Unscrew 3 screws of the right panel, slide it downwards and release the tabs to remove.</p> 	
4	<p>The figure shows the view of piping connections.</p> 	
5	<p>Unscrew 1 screw of the front right panel, slide it downwards and release the tabs to remove.</p> 	

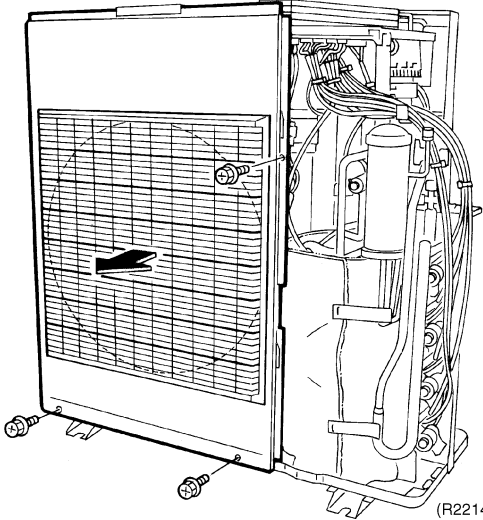
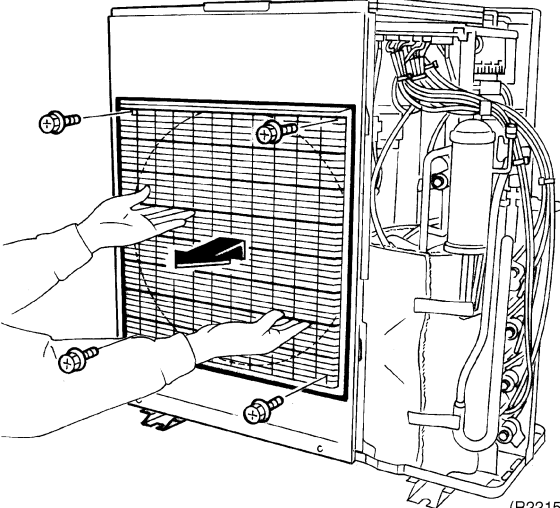
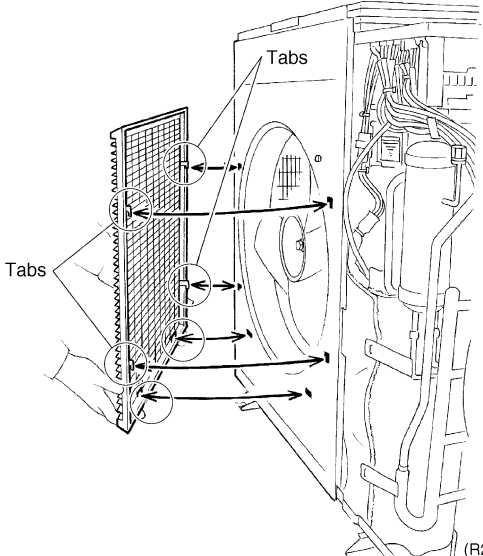
Step	Procedure	Procedure	Points
6	Unscrew 3 screws of the front panel to remove.	 <p>(R2214)</p>	
7	Remove 4 screws of the discharge outlet grill.	 <p>(R2215)</p>	
8	Slide the discharge outlet grill upwards and release 6 tabs to remove.	 <p>(R2216)</p>	

1.2 Removal of Propeller Fans

Procedure



Warning

Be sure to wait 10 minutes or more after turning off all power supplies before disassembling work.

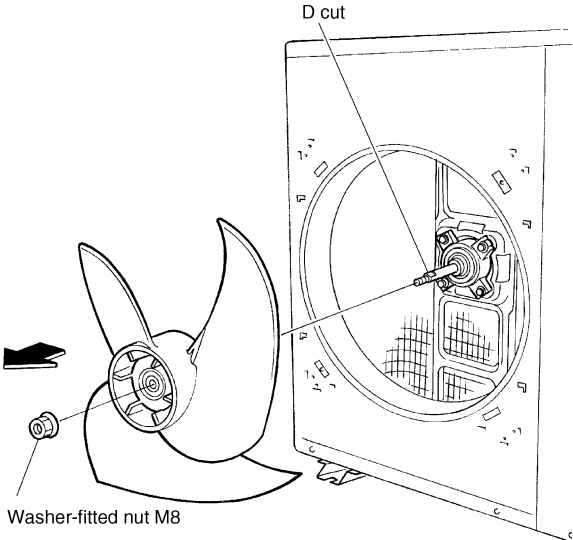
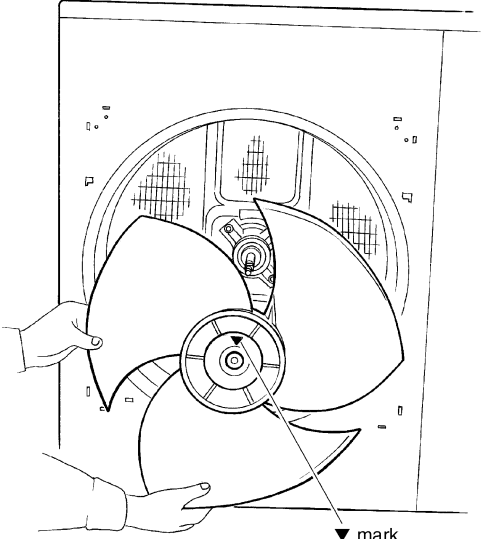
Step	Procedure	Points
<ul style="list-style-type: none"> ■ Remove the discharge outlet grill 		
1 To take off propeller fan, remove the washer-fitted nut M8.	 <p style="text-align: right;">(R2217)</p>	
2 Remove the propeller fan.	 <p style="text-align: right;">(R2218)</p>	<ul style="list-style-type: none"> ■ For reassembling, align ▼ mark of propeller fan with D-cut section of motor shaft. ■ Mount the propeller fan while positioning ▼ mark to the top.

1.3 Removal of Electrical Box

Procedure



Warning

Be sure to wait 10 minutes or more after turning off all power supplies before disassembling work.

Step	Procedure	Points
<p>■ Remove the outer panels such as top and front panels.</p> <p>1 The figure shows the right side view.</p>		<p>■ Match the colors of the tie wires to A, B, C and D ports as follows.</p> <p>(1) - Black Power (2) - White Power (3) - Red Transmission</p> <p>■ Wires are fixed to the terminal board with screws.</p>
<p>1. Remove the tie wire.</p> <p>1 Loosen the terminal board screws, and remove the wires at A and B ports.</p> <p>2 Open the terminal board cover, and remove the wires at C and D ports.</p>	 	<p>■ When reassembling, reconnect the wires to C and D ports.</p>

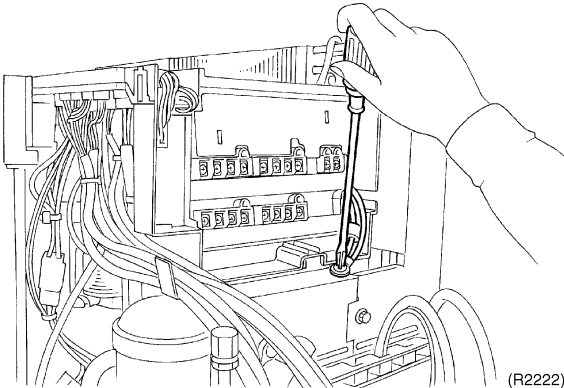
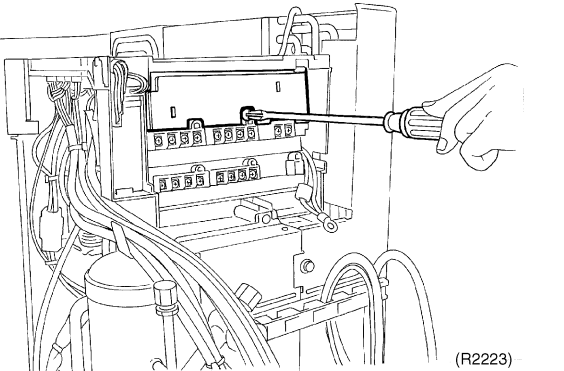
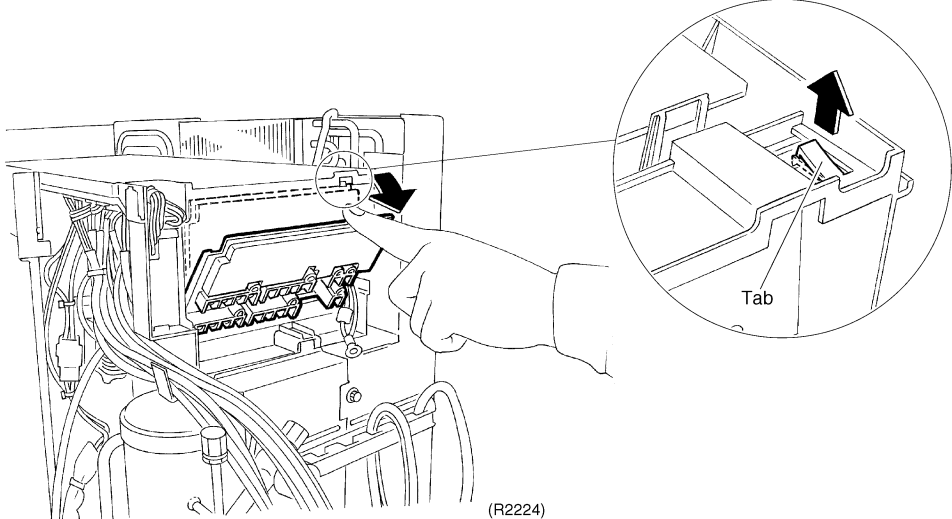
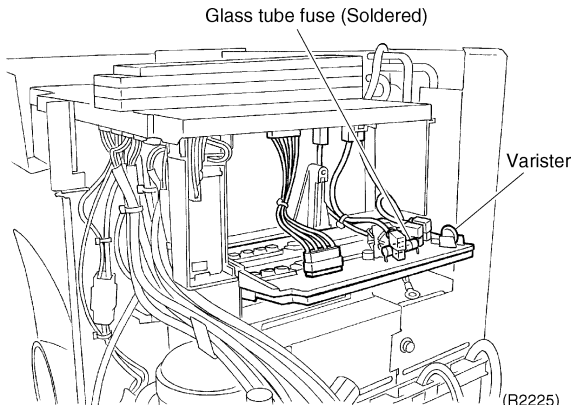
Step	Procedure	Points
3	<p>Remove the earth wire.</p>  <p>(R2222)</p>	
4	<p>Remove 1 screw of the terminal board.</p>  <p>(R2223)</p>	
5	<p>Release the tab on the top right of the terminal board.</p>  <p>(R2224)</p>	
6	<p>Pull out the terminal board and open it.</p>  <p>(R2225)</p>	<p>■ Glass tube fuse and varistor cannot be replaced individually because lead-free soldering is provided.</p>

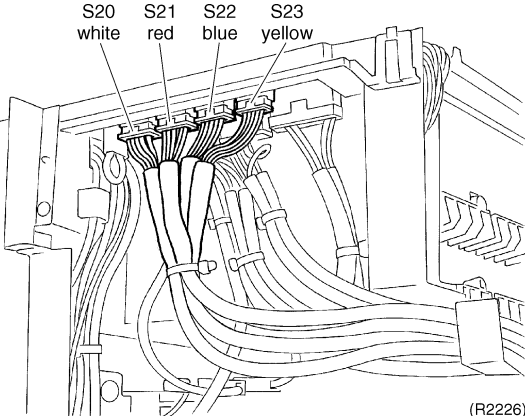
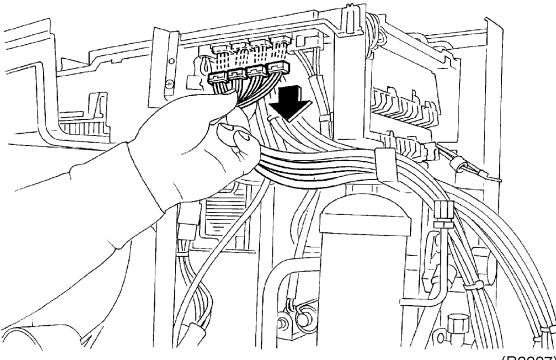
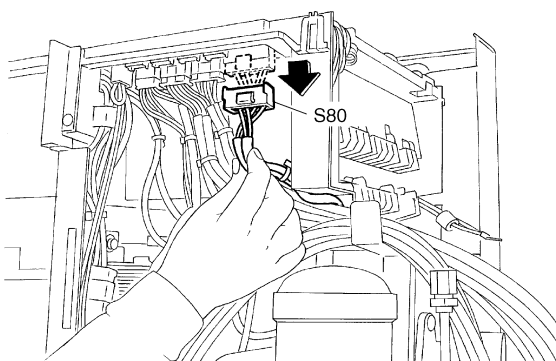
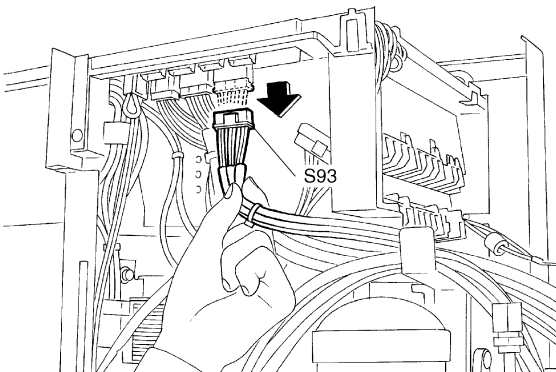
Step	Procedure	Points															
2. Remove each wire harness																	
1	<p data-bbox="199 250 459 376">Disconnect 4 connectors of the electronic expansion valve lead wires.</p>  	<table border="1" data-bbox="1093 324 1455 542"> <thead> <tr> <th>Connector</th> <th>Electronic expansion valve No.</th> <th>Harness length</th> </tr> </thead> <tbody> <tr> <td>S20 (White)</td> <td>EVA</td> <td>630</td> </tr> <tr> <td>S21 (Red)</td> <td>EVB</td> <td>730</td> </tr> <tr> <td>S22 (Blue)</td> <td>EVC</td> <td>825</td> </tr> <tr> <td>S23 (Yellow)</td> <td>EVD</td> <td>940</td> </tr> </tbody> </table> <p data-bbox="1093 555 1455 649">■ When reconnecting, make sure to match the wire to the correct connector.</p>	Connector	Electronic expansion valve No.	Harness length	S20 (White)	EVA	630	S21 (Red)	EVB	730	S22 (Blue)	EVC	825	S23 (Yellow)	EVD	940
Connector	Electronic expansion valve No.	Harness length															
S20 (White)	EVA	630															
S21 (Red)	EVB	730															
S22 (Blue)	EVC	825															
S23 (Yellow)	EVD	940															
2	<p data-bbox="199 1131 459 1198">Remove the four way valve connector S80.</p> 																
3	<p data-bbox="199 1568 459 1668">Remove the connector S93 for liquid pipe thermistor.</p> 																

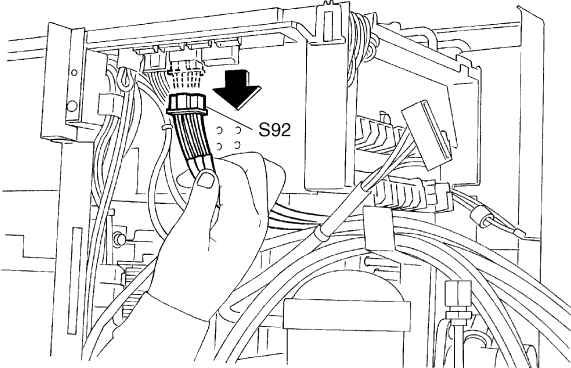
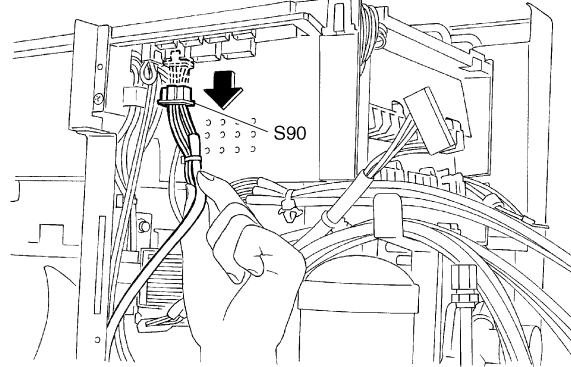
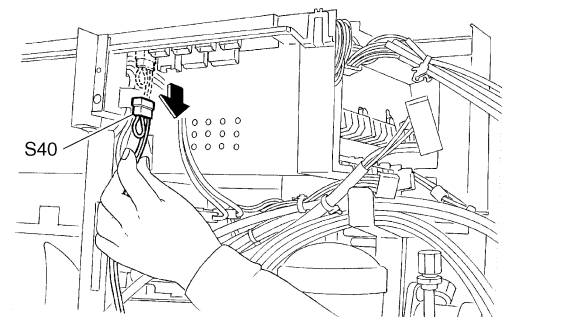
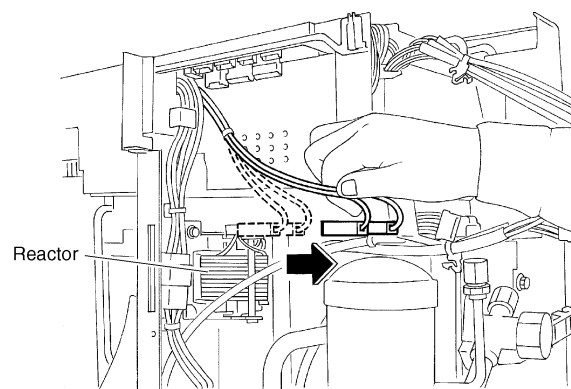
Step	Procedure	Points
4	Remove the connector S92 for gas pipe thermistor.  (R2230)	
5	Remove the connector S90 for thermistor. <ul style="list-style-type: none"> ■ Outdoor air thermistor (Blue) ■ Discharge pipe thermistor (Black) ■ Heat exchanger thermistor (Gray)  (R2231)	
6	Remove the overload relay connector S40 .  (R2232)	
7	Remove the reactor lead wire.  (R2233)	

Step	Procedure	Points
8	Remove the relay connector for compressor.	
9	Remove the electrical box cover.	
10	Disconnect the fan motor connector.	
11	Remove the discharge pipe thermistor.	

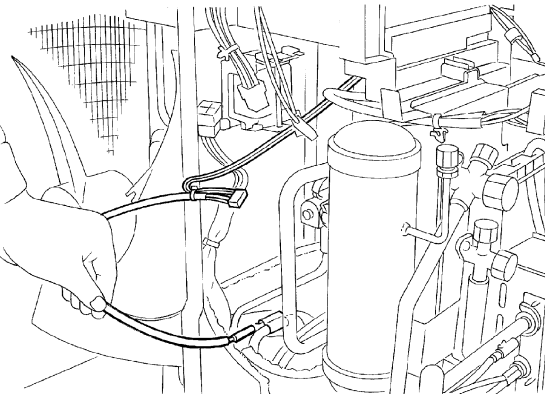
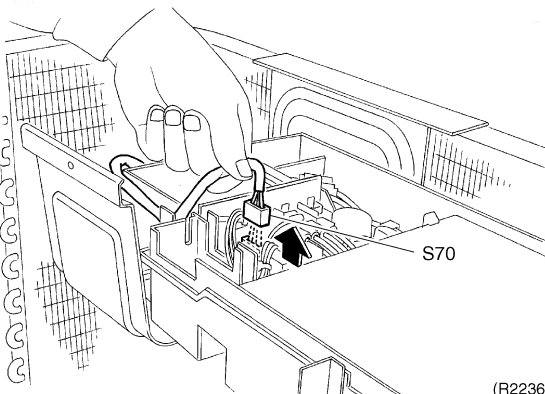
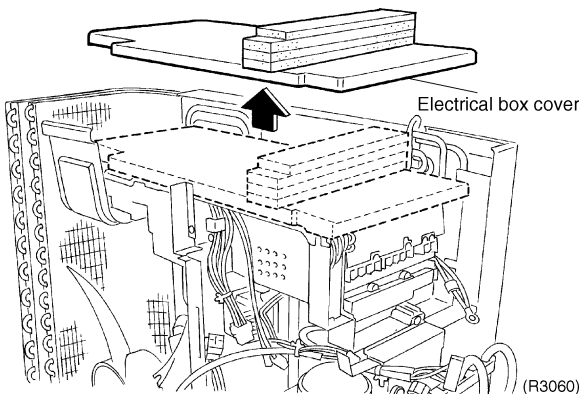
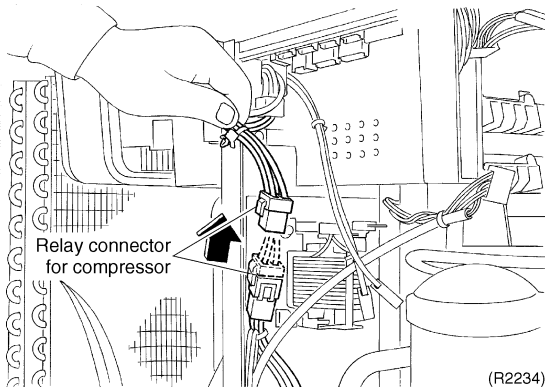

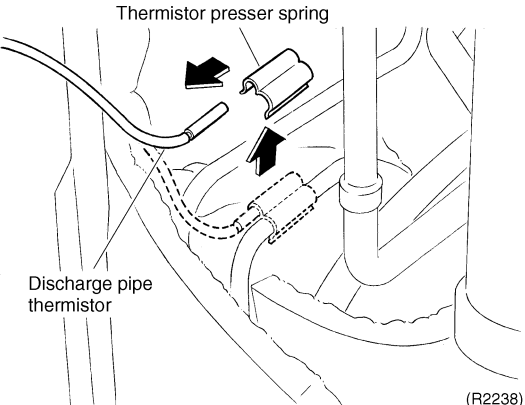
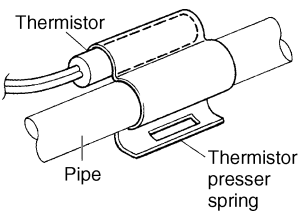
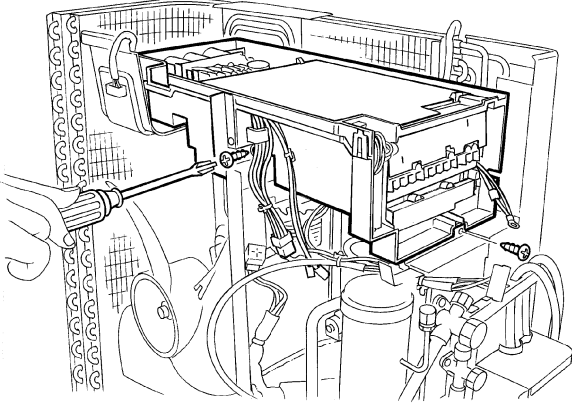
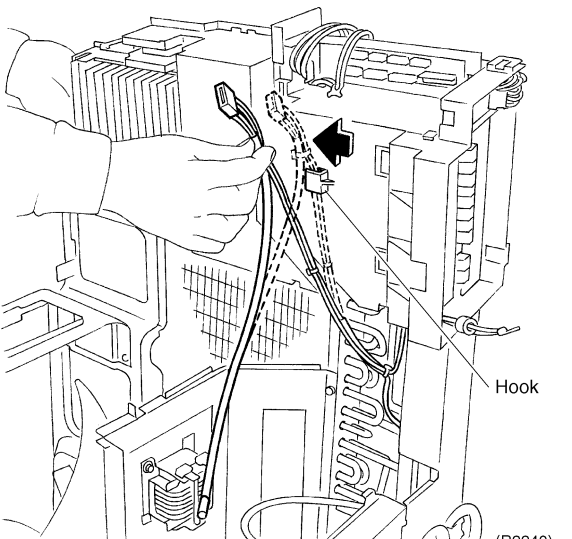
Step	Procedure	Points	
12	Take off the thermistor presser spring, and remove the thermistor.	 <p>(R2238)</p>	<ul style="list-style-type: none"> ■ Place the thermistor so that its end comes up to the end of the presser spring. ■ Be careful not to lose the presser spring for the discharge pipe thermistor.  <p>Thermistor Pipe Thermistor presser spring</p>
3.	Removing the electrical box		
1	Remove 2 screws of the electrical box.	 <p>(R2239)</p>	
2	Turn the electrical box up side down halfway, and disconnect the thermistor lead wire from the hook.	 <p>Hook</p> <p>(R2240)</p>	

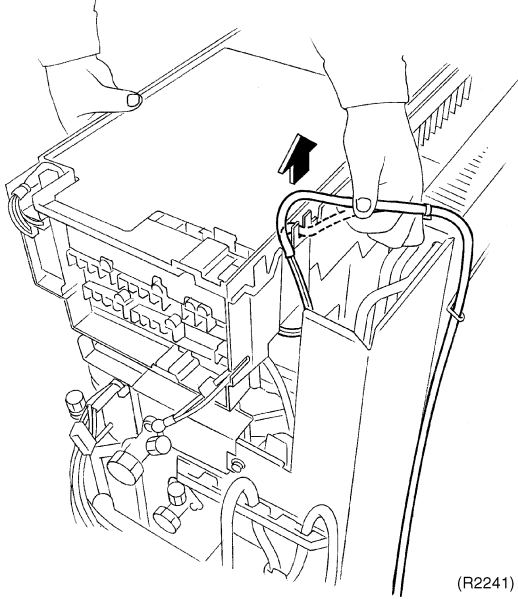
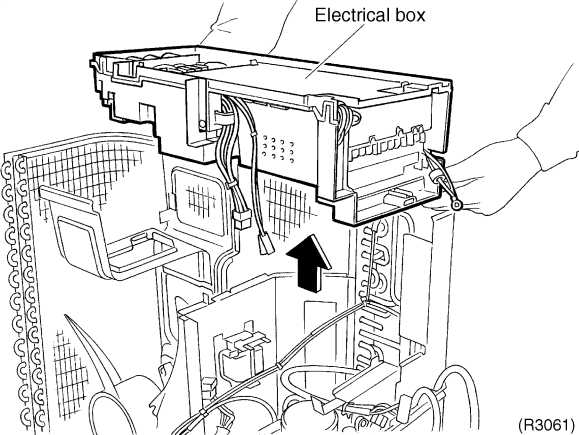
Step	Procedure	Points
3	<p>Remove the outdoor air thermistor lead wire from the groove.</p>  <p>(R2241)</p>	
4	<p>Remove each wire harness, and dismantle the electrical box by lifting it.</p>  <p>(R3061)</p>	

1.4 Removal of PCB

Procedure



Warning Be sure to wait 10 minutes or more after turning off all power supplies before disassembling work.

Step	Procedure	Points
1. Removing the controller PCB		
1 Release the tab of the electrical box, and open the terminal board.	<p>(R2243)</p>	
2 Disconnect each connector of the terminal board.	<p>(R2244)</p>	
3 Unscrew 1 screw and release two tabs to remove the PCB	<p>(R2246)</p>	

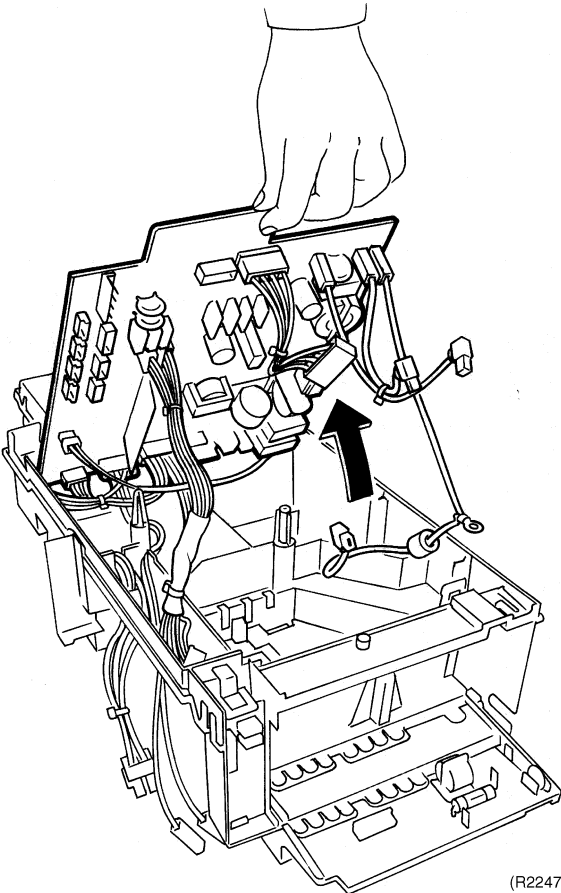
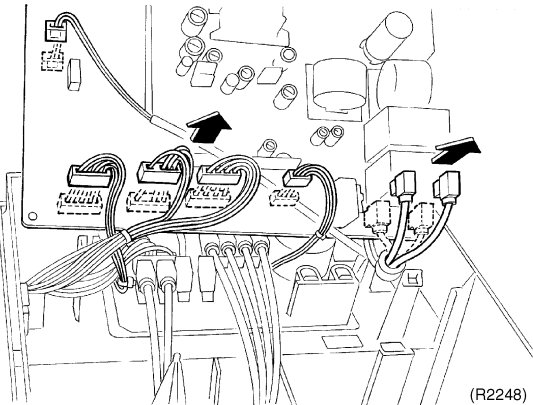
Step	Procedure	Points
4	<p>Lift the PCB at the terminal board side.</p>  <p>(R2247)</p>	
5	<p>Disconnect each wire harness connector linked to the inverter PCB.</p>  <p>(R2248)</p>	

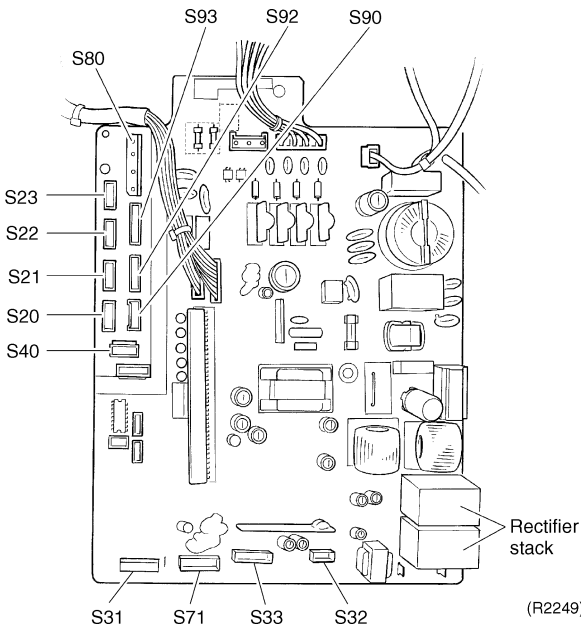
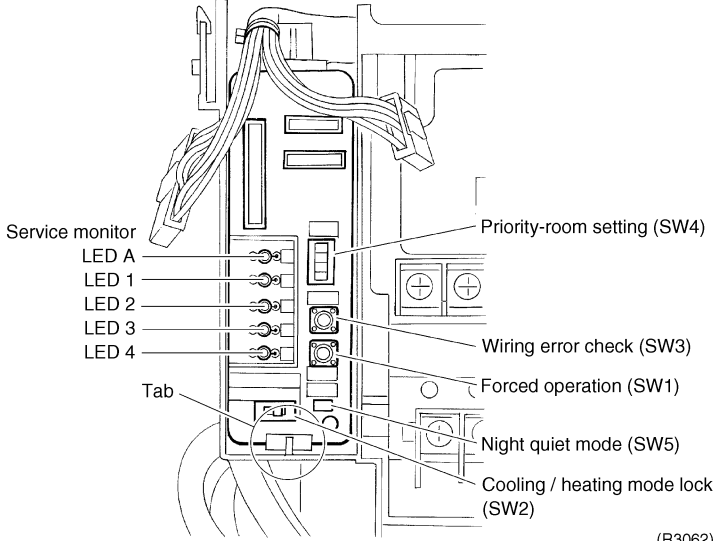
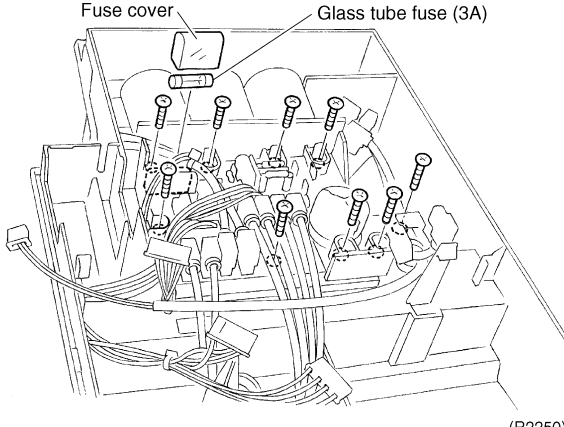
Step	Procedure	Points
6	<p>The figure shows the controller PCB.</p> 	<p>S20: Electronic expansion valve coil A port S21: Electronic expansion valve coil B port S22: Electronic expansion valve coil C port S23: Electronic expansion valve coil D port S31: To CN14 (Pin 9) S32: To CN11 (Pin 5) S33: To S34 (Pin 10) S40: Overload relay S71: To S72 (Pin 8) S80: Four way valve coil S90: Thermistor (Outdoor air, heat exchanger, and discharge pipe) S92: Gas pipe thermistor S93: Liquid pipe thermistor</p>
2. Removing the service monitor PCB		
1	<p>Remove the service monitor PCB by releasing its tab.</p> 	
3. Removing the inverter PCB		
1	<p>Remove the 9 screws of the inverter PCB.</p> 	

1.5 Removal of Fan Motor

Procedure



Warning

Be sure to wait 10 minutes or more after turning off all power supplies before disassembling work.

Step	Procedure	Points
<p>■ Remove the outer panels.</p>	<p>(R2251)</p>	
<p>2 Remove the propeller fans.</p>	<p>Washer-fitted nut M8</p> <p>(R2252)</p>	<ul style="list-style-type: none"> ■ For reassembling, align ▼ mark of propeller fan with D-cut section of motor shaft. ■ Mount the fan motor so as to position ● mark on the top.
<p>3 Remove 2 screws of the fan motor mount.</p>	<p>(R2253)</p>	

Step	Procedure	Points
4	Remove 4 screws of the fan motor.	
5	Cut the wrapper fixing the lead wire.	<ul style="list-style-type: none"> ■ When reassembling, fix the lead wire to avoid contact with the propeller fan.
6	Remove the fan motor.	

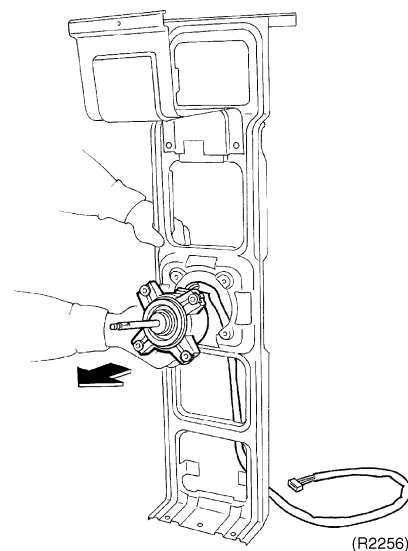
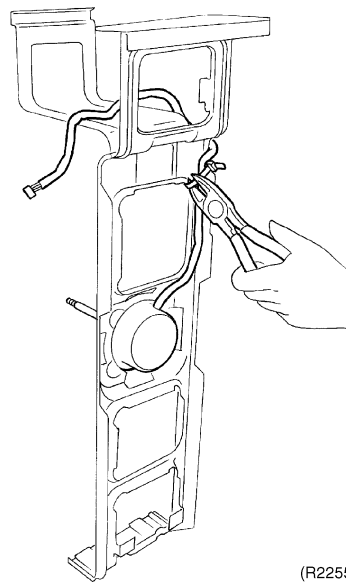
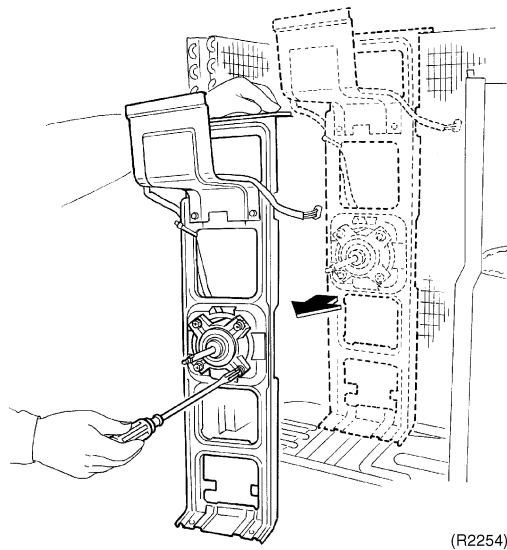

1.6 Removal of Electronic Expansion Valve and Thermistor

Procedure

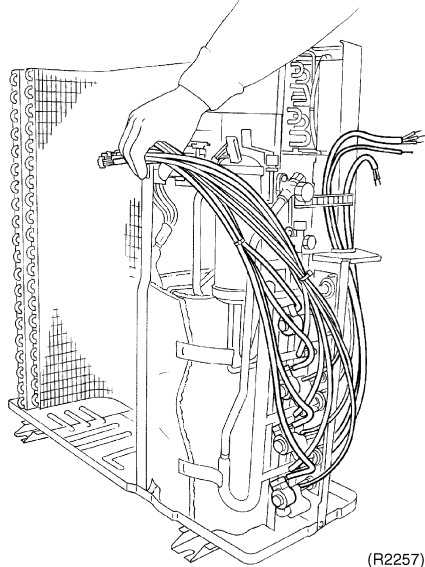
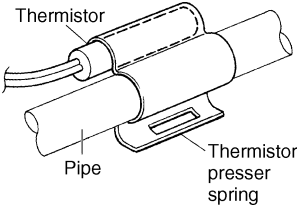
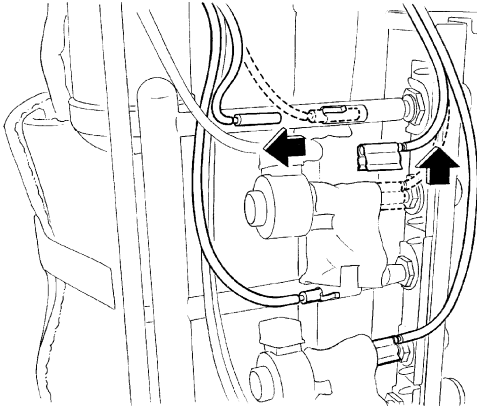
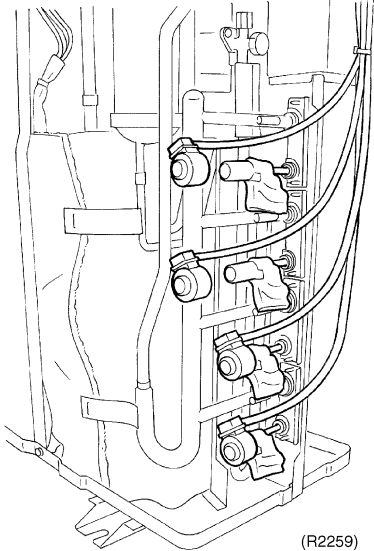

Warning Be sure to wait 10 minutes or more after turning off all power supplies before disassembling work.

Step	Procedure	Procedure	Points
1	Remove each wire harness.	 <p style="text-align: right;">(R2257)</p>	<ul style="list-style-type: none"> ■ Place the thermistor so that its end comes up to the end of the presser spring. ■ Be careful not to lose the presser spring for the discharge pipe thermistor.  <p style="text-align: center;">Thermistor Pipe Thermistor presser spring</p>
2	Take off the putty, and remove each thermistor.	 <p style="text-align: right;">(R2258)</p>	<p>S90:</p> <ul style="list-style-type: none"> ■ Outdoor air thermistor (Blue) ■ Heat exchanger thermistor (Gray) ■ Discharge pipe thermistor (Black) <p>S92: Gas pipe thermistor</p> <ul style="list-style-type: none"> ■ Room A (Black) ■ Room B (Gray) ■ Room C (Brown) ■ Room D (Red)
3	Remove the electronic expansion valve coil.	 <p style="text-align: right;">(R2259)</p>	<p>S93: Liquid pipe thermistor</p> <ul style="list-style-type: none"> ■ Room A (Black) ■ Room B (Gray) ■ Room C (Yellow) ■ Room D (Blue)

1.7 Removal of Sound Insulation and Reactor

Procedure



Warning

Be sure to wait 10 minutes or more after turning off all power supplies before disassembling work.

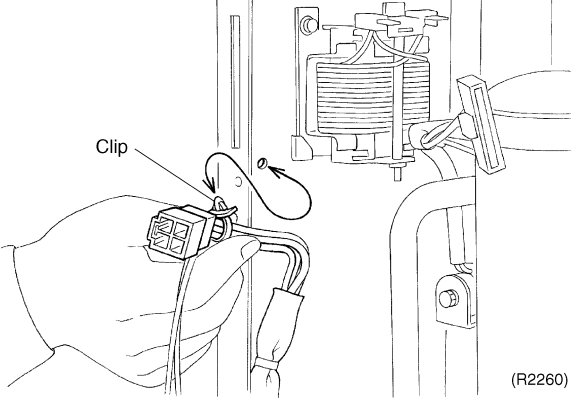
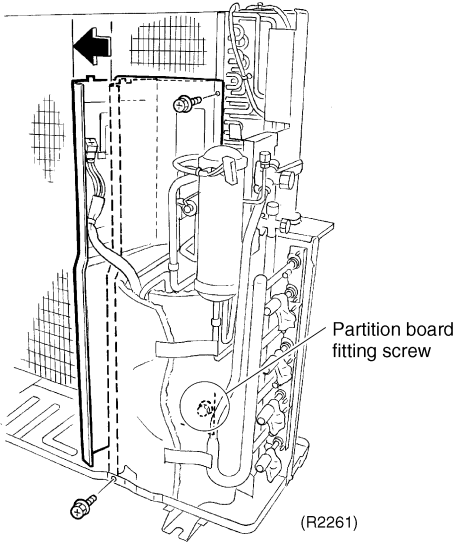
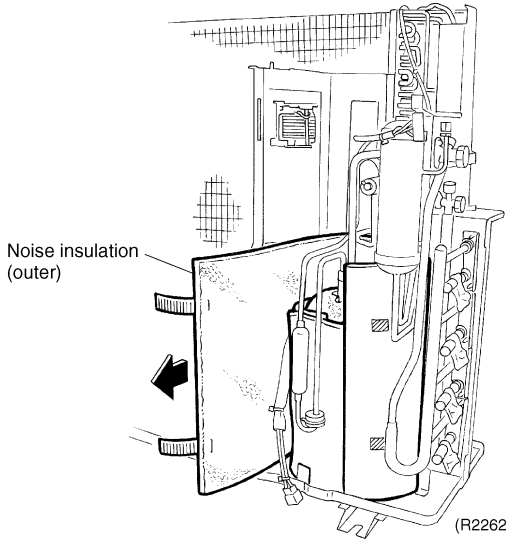
Step	Procedure	Points
1	<p>Release the clip fixing the compressor lead wire.</p>  <p>(R2260)</p>	
2	<p>Remove 2 screws of the partition board, and move the board leftward.</p>  <p>(R2261)</p>	<ul style="list-style-type: none"> ■ The partition board is not removable as it is fixed with the fitting screw in the rear bottom.
3	<p>Remove the noise insulation (outer).</p>  <p>(R2262)</p>	<ul style="list-style-type: none"> ■ Carefully remove the noise insulation, which is easily torn in the piping section.

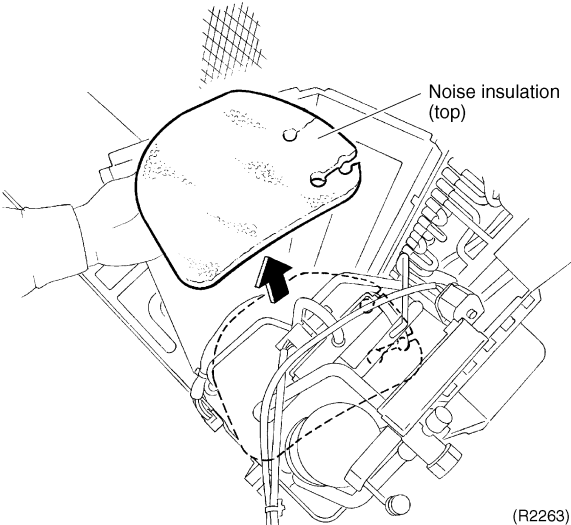
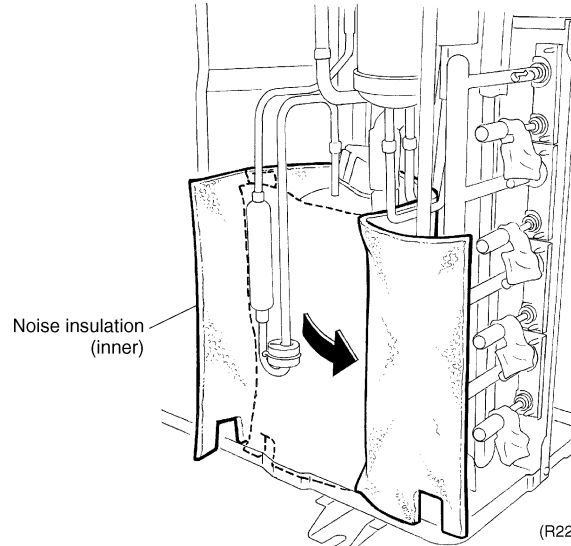
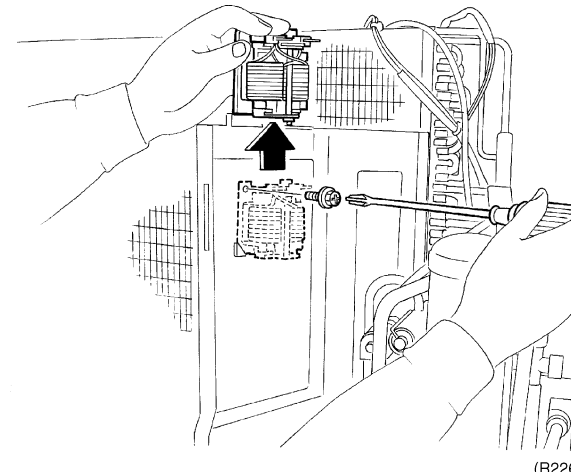
Step	Procedure	Points
4	<p>Remove the noise insulation (top).</p> 	<ul style="list-style-type: none"> ■ Carefully remove the noise insulation, which is easily torn in the piping section.
5	<p>Remove the noise insulation (inner).</p> 	
6	<p>Remove 1 screw of the reactor.</p> 	

1.8 Removal of Shunt

Procedure



Warning

Be sure to wait 10 minutes or more after turning off all power supplies before disassembling work.

Step	Procedure	Procedure	Points
1	Remove 6 screws of the tie wire presser plate.	<p>(R2266)</p>	<ul style="list-style-type: none"> Fasten the rubber packing with double-faced adhesive tape when mounting.
2	Remove 4 screws of the right side panel.		<p>(R2267)</p>
3	Remove the putty.	<p>Warning</p> <p>If refrigerant gas leaks during the job, ventilate the room. (Bear in mind that if the refrigerant gas is exposed to open flames, noxious gas may be generated.)</p>	
4	Disconnect the 5 brazed points of the shunt.		

- Before taking this procedure, make sure there is no refrigerant gas left in the refrigerant pipes.

1.9 Removal of Solenoid Valve and Four Way Valve

Procedure

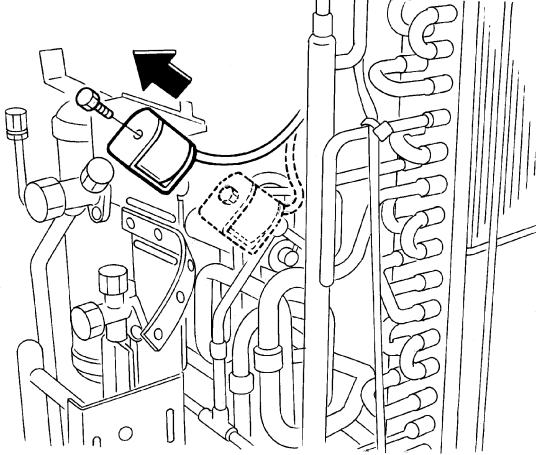
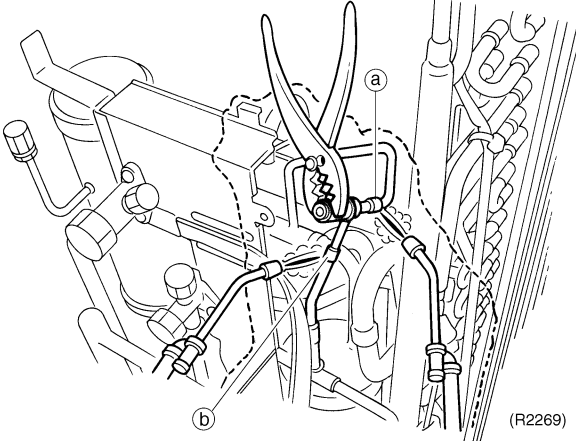
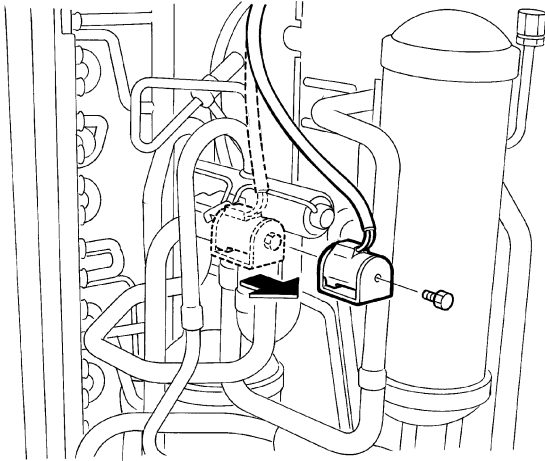

Warning Be sure to wait 10 minutes or more after turning off all power supplies before disassembling work.

Step	Procedure	Points
<p>■ Remove the outer panels.</p> <p>1. Removing the solenoid valve</p> <p>1 Remove 1 screw of the solenoid valve coil.</p> <p>■ Before taking this procedure, make sure there is no refrigerant gas left in the refrigerant pipes.</p>	 <p style="text-align: right;">(R2268)</p>	<p>Caution</p> <p>Be careful not to get yourself burnt with the pipes and other parts that are heated by the gas welding rod.</p>
<p>2 Disconnect the 2 brazed points (a) and (b) in this order.</p>	 <p style="text-align: right;">(R2269)</p>	<p>Warning</p> <p>If refrigerant gas leaks during the job, ventilate the room. (Bear in mind that if the refrigerant gas is exposed to open flames, noxious gas may be generated.)</p>
<p>2. Removing the four way valve</p> <p>1 Remove 1 screw of the four way valve coil.</p>	 <p style="text-align: right;">(R2270)</p>	<p>Reassembling precautions</p> <p>Wrap the solenoid valve body with wet cloth. Splash water over the cloth before it is dried to prevent the valve from being overheated.</p>

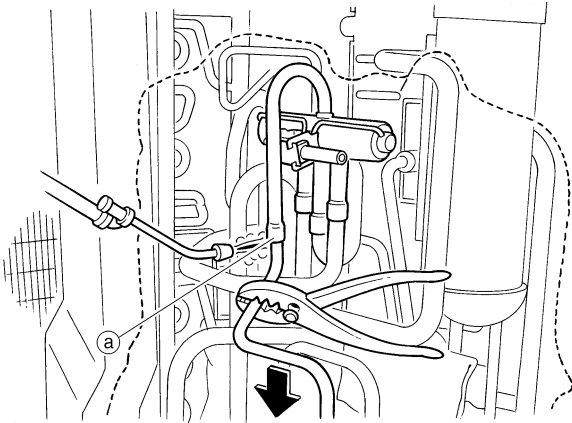
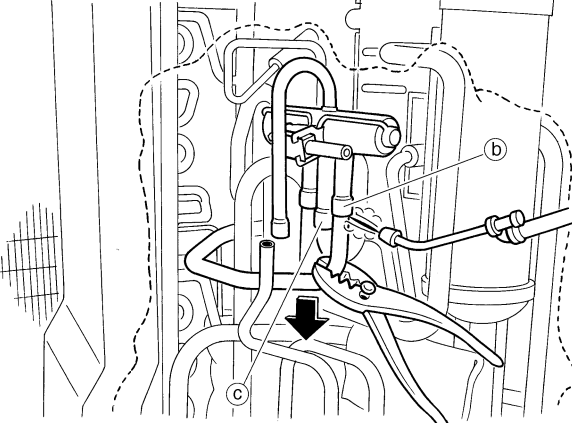
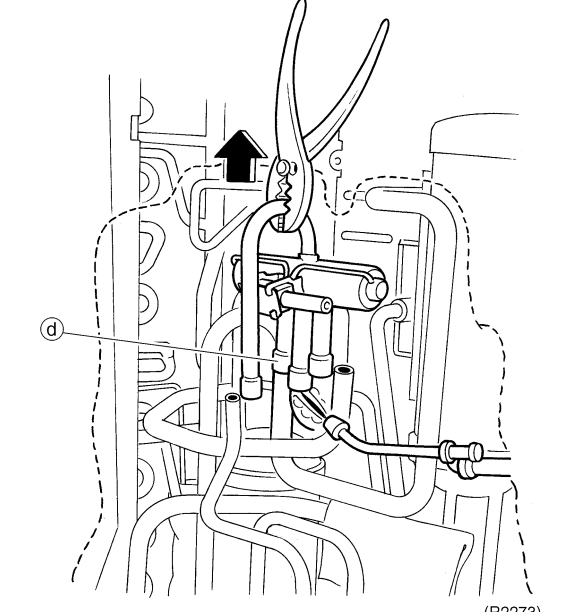
Step	Procedure	Points
<p>■ Before taking this procedure, make sure there is no refrigerant gas left in the refrigerant pipes.</p>	 <p>(R2271)</p>	<p>Reassembling precautions</p> <ol style="list-style-type: none"> 1. Use non-oxidizing brazing method. If nitrogen gas is not available, braze the parts speedily. 2. Avoid deterioration of the gaskets due to carbonization of oil inside the four way valve or thermal influence. For this purpose, wrap the four way valve with wet cloth. Splash water over the cloth against becoming too hot (keep it below 120°C).
<p>2 Place welding protective sheet or iron plate around the four way valve to prevent the flames of a gas welding rod from affecting the valve.</p> <p>3 Heat the 4 brazed points of the four way valve. Disconnect the point (a) first.</p>	 <p>(R2272)</p>	<p>■ In pulling the pipes, be careful not to over-tighten them with pliers. The pipes may get deformed.</p> <p>If the gas welding machine fails to remove the four way valve, take the steps below.</p> <ol style="list-style-type: none"> 1. Disconnect the brazed pipe sections that are readily easy to separate and join together later. 2. With a small copper tube cutter, cut off the internal pipes to easily take out the four way valve.
<p>4 Disconnect the points (b) and (c).</p> <p>5 Disconnect the point (d).</p>	 <p>(R2273)</p>	<p>Note: Never use a hack saw. The sawdust may come into the circuit.</p>

1.10 Removal of Compressor

Procedure



Warning

Be sure to wait 10 minutes or more after turning off all power supplies before disassembling work.

Step	Procedure	Points
1	Remove the terminal cover.	<p>Terminal cover (R2274)</p> <p>Terminal nameplate (R2275)</p>
2	Remove the overload relay.	<ul style="list-style-type: none"> ■ Be careful to avoid burning the compressor terminals or the nameplate.
3	Disconnect the flag shape terminal.	<p>As precaution, keep the contents in memorandum.</p>
4	There is one nut fixing the compressor. Remove the nut with a spanner.	

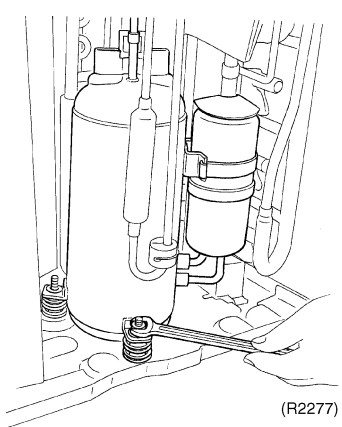
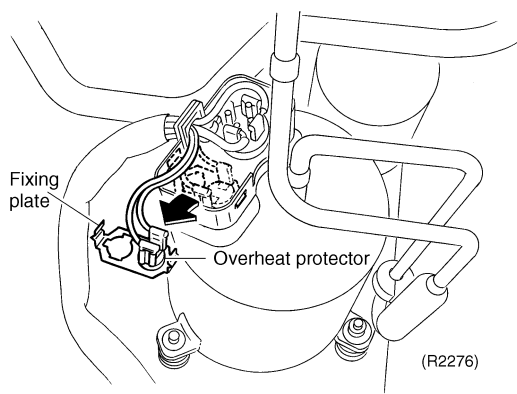
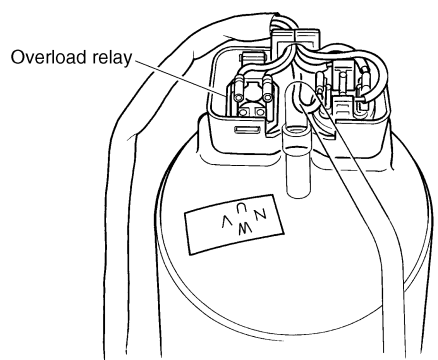
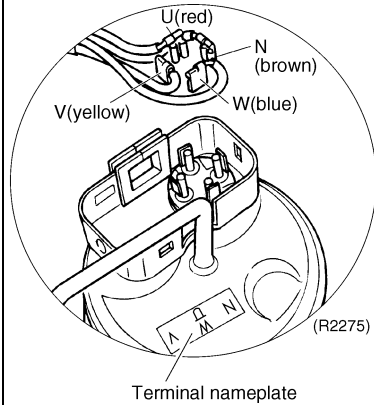
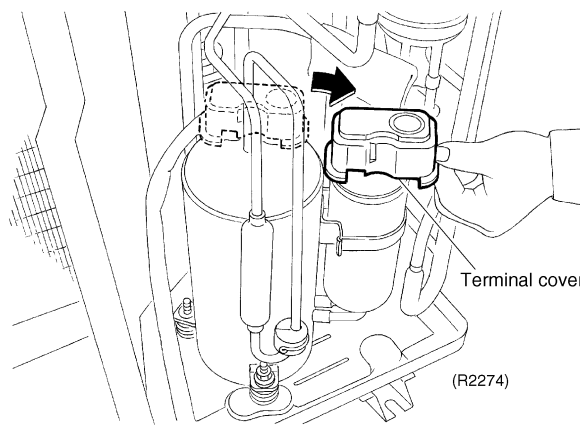

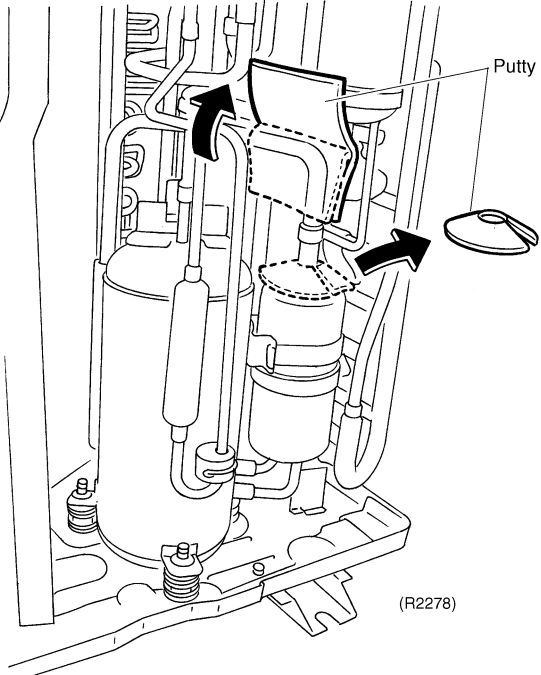
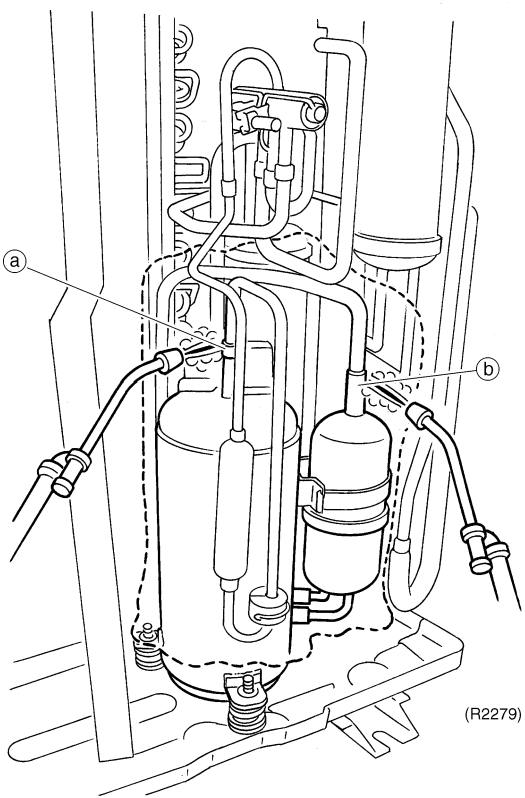
Step	Procedure	Points
	<ul style="list-style-type: none"> ■ Make sure there is no refrigerant gas left inside the refrigerant pipes before starting the job. ■ When heating up the brazed parts, make sure to carry out the N2 replacement. 	<p>Warning</p> <p>The compressor's refrigerating machine oil may catch fire. Have wet cloth at hand for quickly putting out the fire.</p>
5	<p>Remove the 2 sheets of putty.</p>  <p style="text-align: right;">(R2278)</p>	<p>Warning</p> <p>If refrigerant gas leaks during the job, ventilate the room. (Bear in mind that if the refrigerant gas is exposed to open flames, noxious gas may be generated.)</p> <p>Caution</p> <p>Be careful not to get yourself burnt with the pipes and other parts that are heated by the gas welding rod.</p>
6	<p>Disconnect the brazed part (a) at discharge side of the compressor.</p> <p>7 Disconnect the brazed part (b) at suction side of the compressor.</p>  <p style="text-align: right;">(R2279)</p>	

2. Outdoor Unit (50 / 52 / 58 / 68 / 75 Class)

2.1 Removal of Outer Panels

Procedure



Warning

Be sure to wait 10 minutes or more after turning off all power supplies before disassembling work.

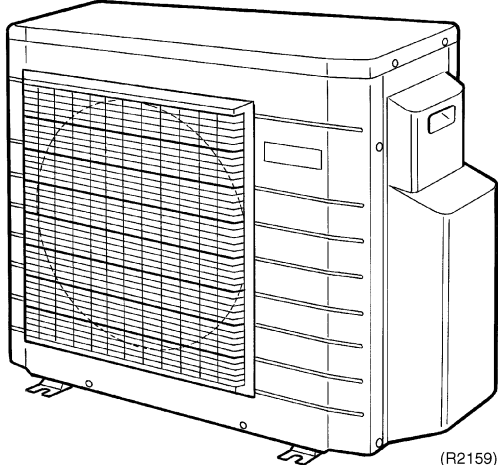
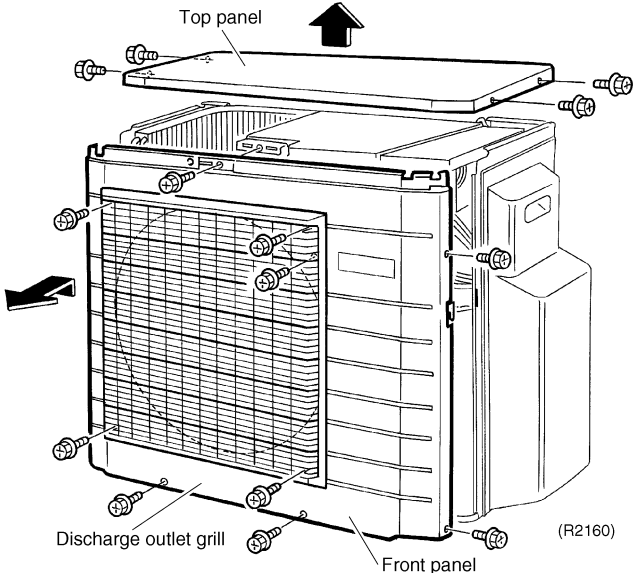
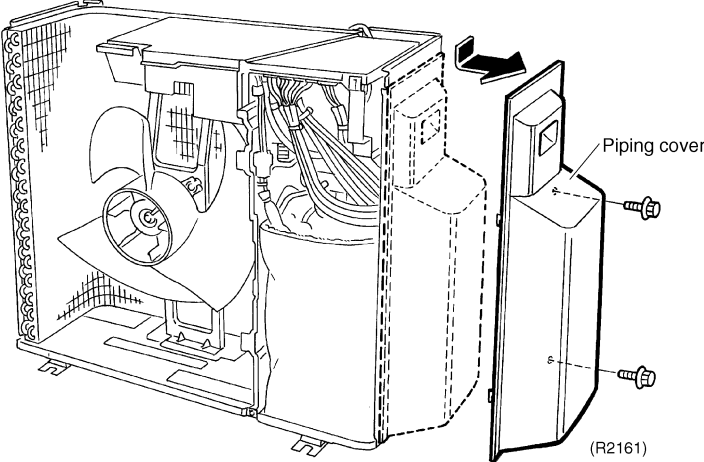
Step	Procedure	Procedure	Points
1	External appearance.	 <p>(R2159)</p>	
2	Remove 4 screws of the top panel and 6 screws of the front panel.	 <p>(R2160)</p>	
3	Remove 4 screws of the discharge outlet grill.	 <p>(R2161)</p>	
4	Remove 2 screws of the piping cover.		

2.2 Removal of Electrical BOX

Procedure

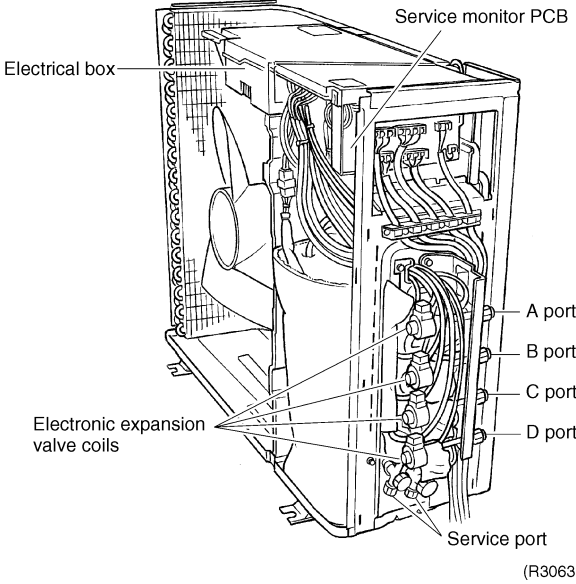
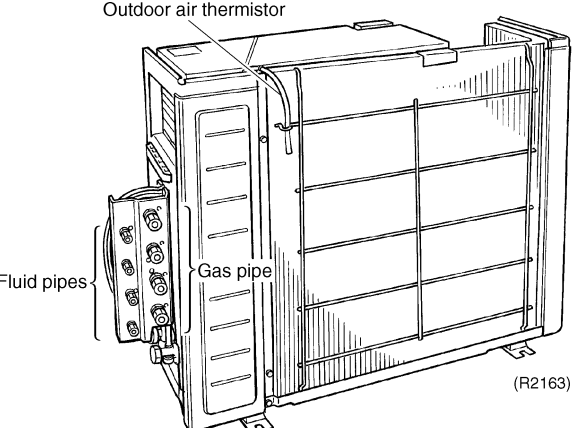
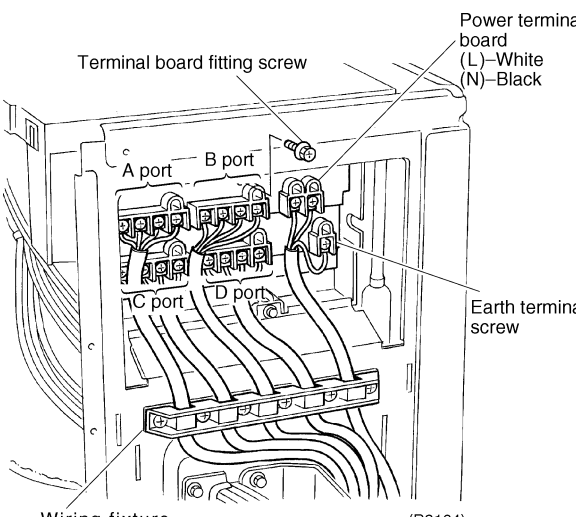

Warning Be sure to wait 10 minutes or more after turning off all power supplies before disassembling work.

Step	Procedure	Points
1.	Removing the tie wires	
1	<p>The figure shows the tie pipe connections.</p>  	<ul style="list-style-type: none"> ■ Remove the piping in the backward direction.
2	<p>Remove the terminal board fitting screw.</p> 	<ul style="list-style-type: none"> ■ Match the colours of the tie wires to A, B, C and D ports as follows. <ul style="list-style-type: none"> (1) - Black Power (2) - White Power (3) - Red Transmission ■ Wires are fixed to the terminal board with screws. ■ Terminal board is made of integral moulded resin.

Step	Procedure	Points															
3	Pull out the terminal board to open.	<ul style="list-style-type: none"> ■ Glass tube fuse and varistor cannot be replaced individually because lead-free soldering is provided. 															
2. Remove each wire harness		<table border="1"> <thead> <tr> <th>Connector</th> <th>Electronic expansion valve No.</th> <th>Harness length</th> </tr> </thead> <tbody> <tr> <td>S20 (White)</td> <td>EVA</td> <td>630</td> </tr> <tr> <td>S21 (Red)</td> <td>EVB</td> <td>730</td> </tr> <tr> <td>S22 (Blue)</td> <td>EVC</td> <td>825</td> </tr> <tr> <td>S23 (Yellow)</td> <td>EVD</td> <td>940</td> </tr> </tbody> </table>	Connector	Electronic expansion valve No.	Harness length	S20 (White)	EVA	630	S21 (Red)	EVB	730	S22 (Blue)	EVC	825	S23 (Yellow)	EVD	940
Connector	Electronic expansion valve No.	Harness length															
S20 (White)	EVA	630															
S21 (Red)	EVB	730															
S22 (Blue)	EVC	825															
S23 (Yellow)	EVD	940															
1	Disconnect 4 connectors of the electronic expansion valve lead wires.	<ul style="list-style-type: none"> ■ When reconnecting, make sure to match the wire to the correct connector. 															
2	Remove the four way valve connector S80.																
3	Disconnect the thermistor connector and the overload relay connector.	<p>S40: Overload relay S90: Thermistor (Outdoor air, heat exchanger, discharge pipe) S92: Gas pipe thermistor S93: Liquid pipe thermistor</p>															

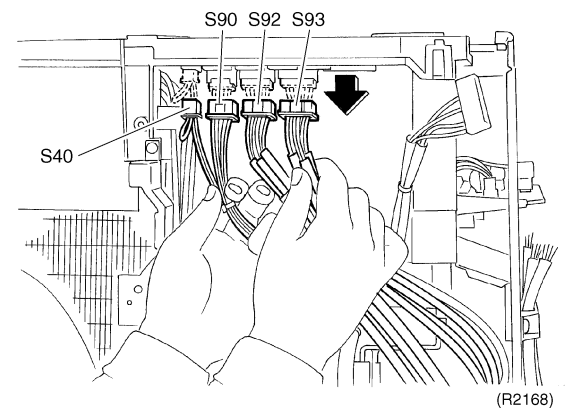
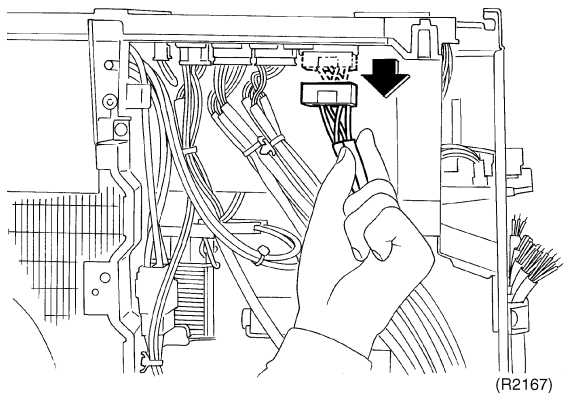
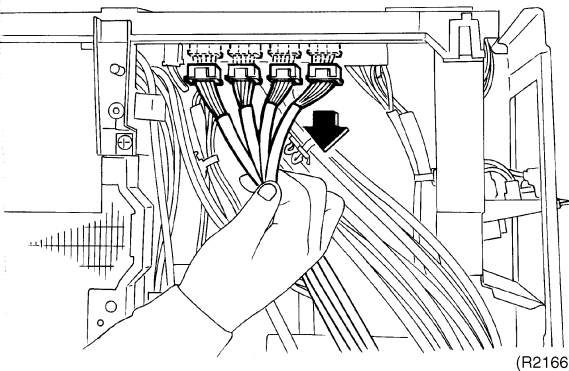
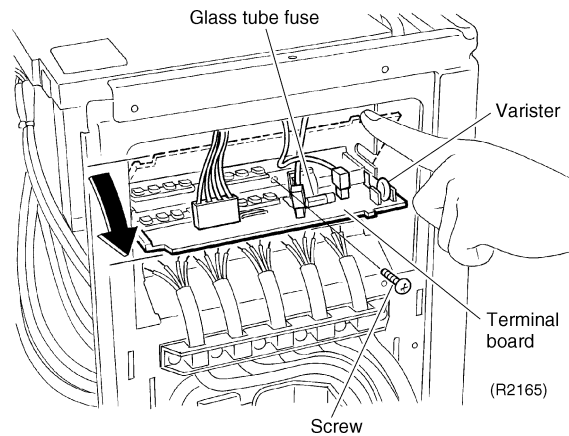

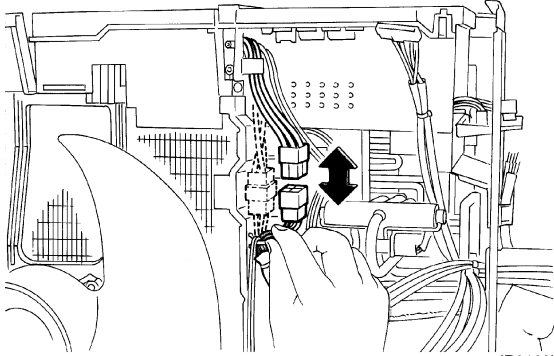
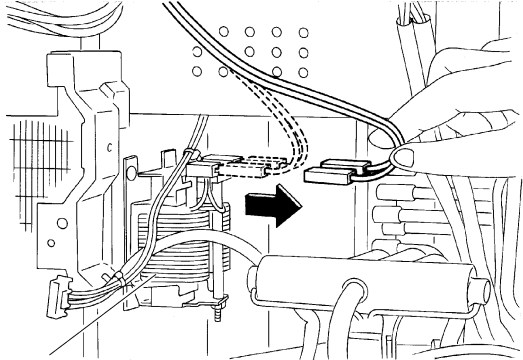
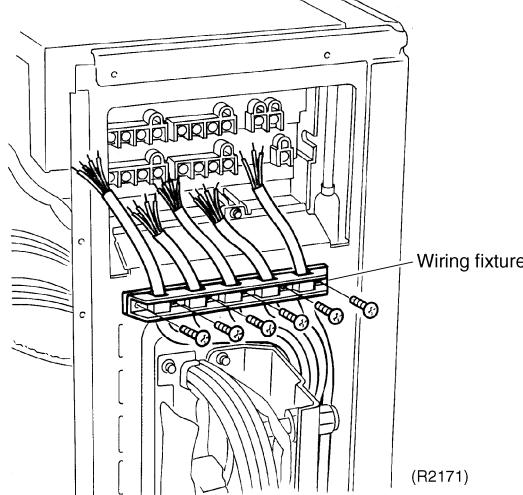
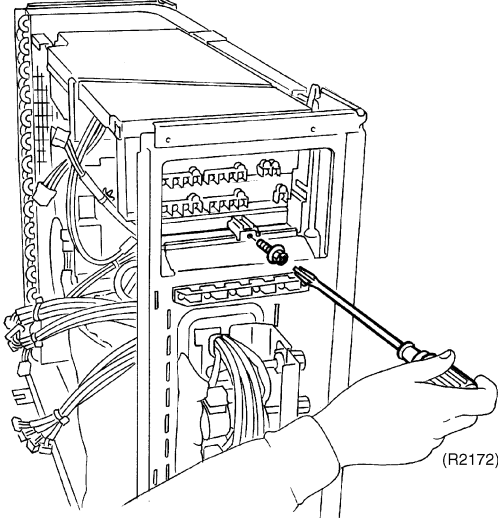
Step	Procedure	Points
<p>4 Disconnect the compressor relay connector.</p> <p>5 Remove the reactor lead wire.</p>	 <p>(R2169)</p>  <p>Reactor</p> <p>(R2170)</p>	
<p>3. Removing the wiring fixture</p>	<p>1 Remove 6 screws of the wiring fixture.</p>  <p>Wiring fixture</p> <p>(R2171)</p>	
<p>4. Removing the electrical box.</p>	<p>1 Remove 1 screw of the electrical box.</p>  <p>(R2172)</p>	

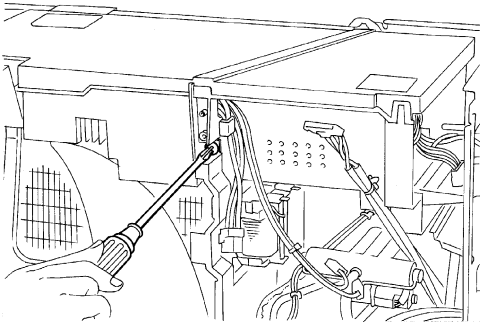
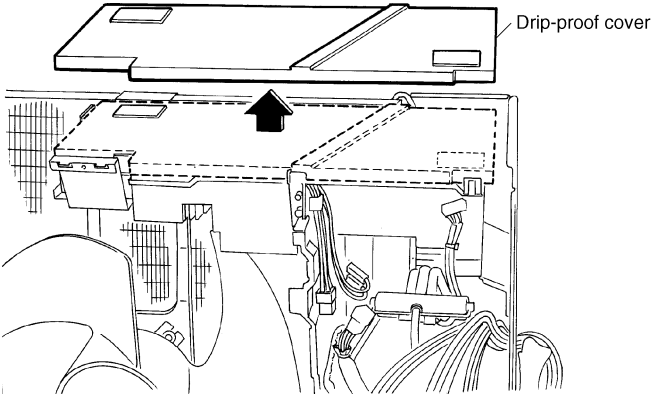
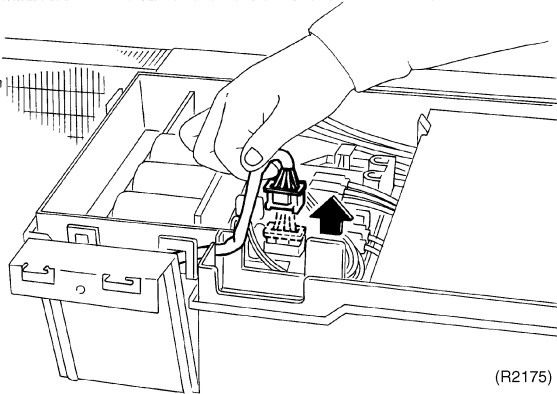
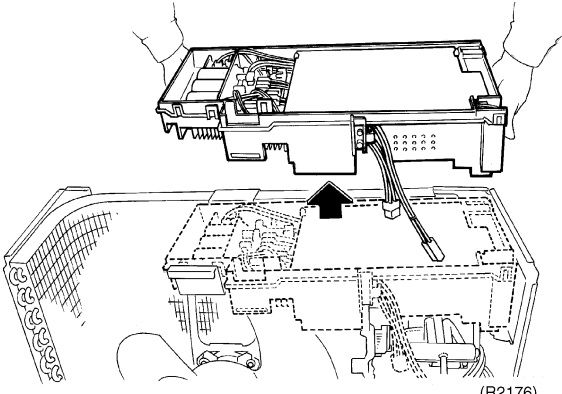
Step	Procedure	Points
2	<p>Remove 1 screw of the electrical box.</p>  <p>(R2173)</p>	
3	<p>Remove the drip-proof cover.</p>  <p>(R2174)</p>	
4	<p>Disconnect the fan motor lead wire.</p>  <p>(R2175)</p>	
5	<p>Lift up the electrical box and dismount it.</p>  <p>(R2176)</p>	

2.3 Removal of PCB

Procedure



Warning

Be sure to wait 10 minutes or more after turning off all power supplies before disassembling work.

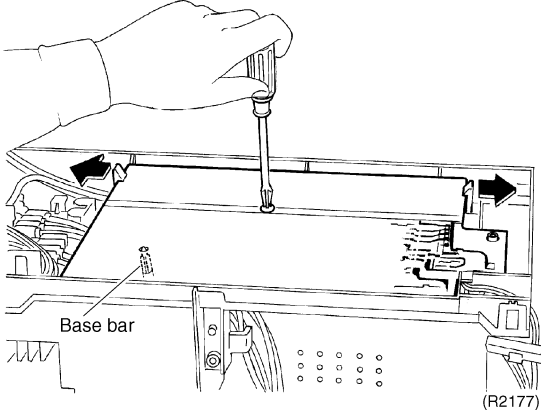
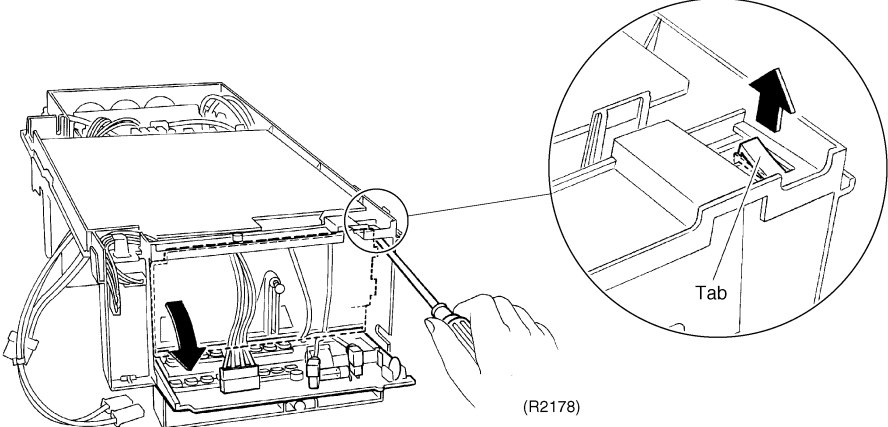
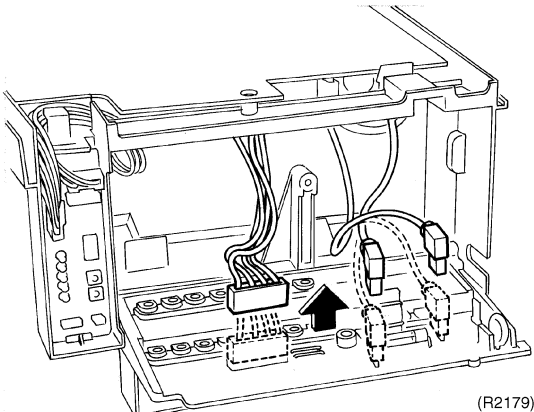
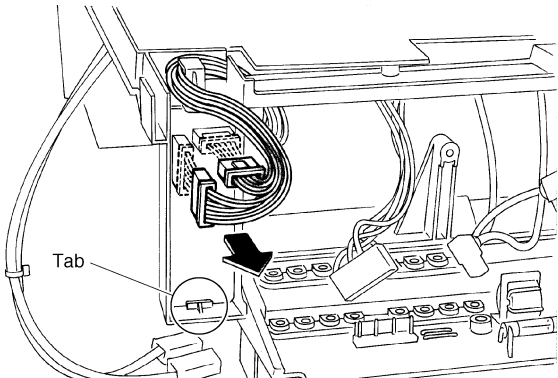
Step	Procedure	Points
1. Removing the controller PCB	<p data-bbox="193 434 464 528">1 Remove 1 screw of the PCB, and release two tabs.</p>  <p data-bbox="986 779 1050 801">(R2177)</p>	
2 Release the tabs of the terminal board, and open the terminal board.	<p data-bbox="193 801 464 931">2 Release the tabs of the terminal board, and open the terminal board.</p>  <p data-bbox="1023 1227 1086 1249">(R2178)</p>	
3 Disconnect each connector on the back of the terminal board.	<p data-bbox="193 1283 464 1377">3 Disconnect each connector on the back of the terminal board.</p>  <p data-bbox="975 1686 1038 1709">(R2179)</p>	
4 Disconnect the service monitor PCB connector.	<p data-bbox="193 1731 464 1789">4 Disconnect the service monitor PCB connector.</p>  <p data-bbox="995 2101 1059 2123">(R2180)</p>	<p data-bbox="1091 1727 1437 1785">■ Release the tab to remove the service monitor PCB.</p>

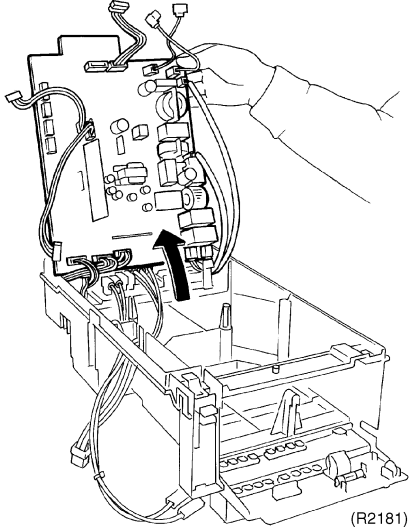
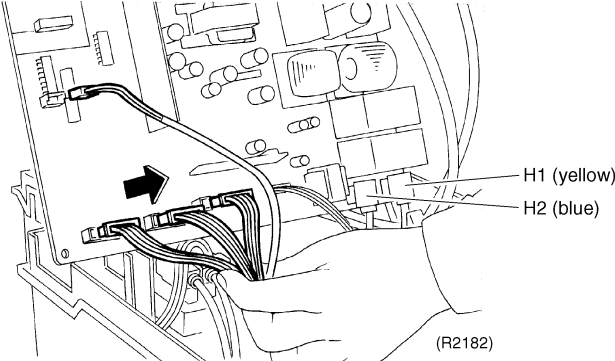
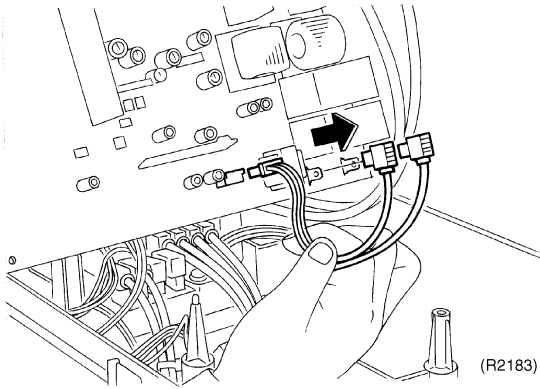
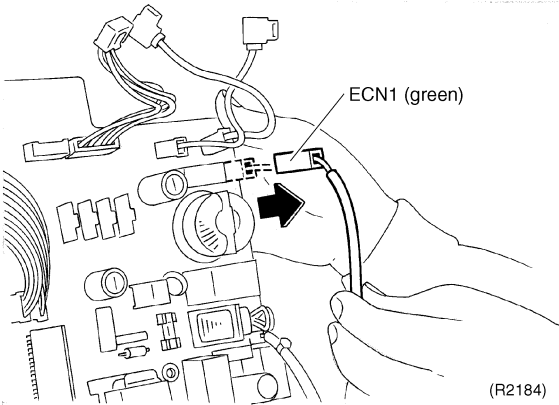
Step	Procedure	Points
5	Lift up the control PCB.	
6	Disconnect each wire harness connector linked to the control PCB. S31 (Pin 9): To CN14 S32 (Pin 5): To CN11 S33 (Pin 10): To S34 S71 (Pin 8): To S72	
	 <p>(R2181)</p>	
	 <p>(R2182)</p>	
	 <p>(R2183)</p>	
	 <p>(R2184)</p>	

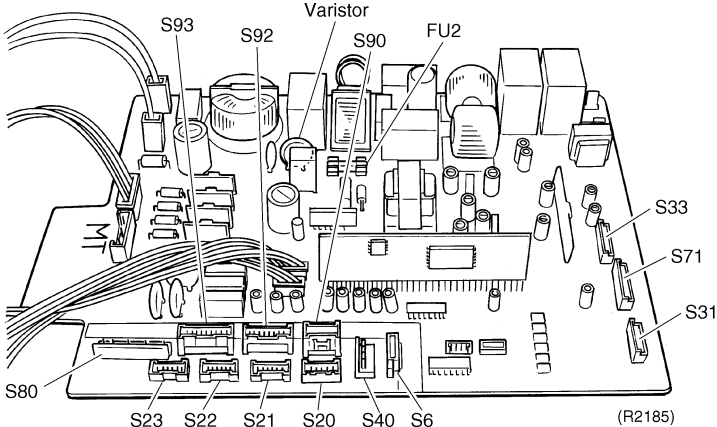
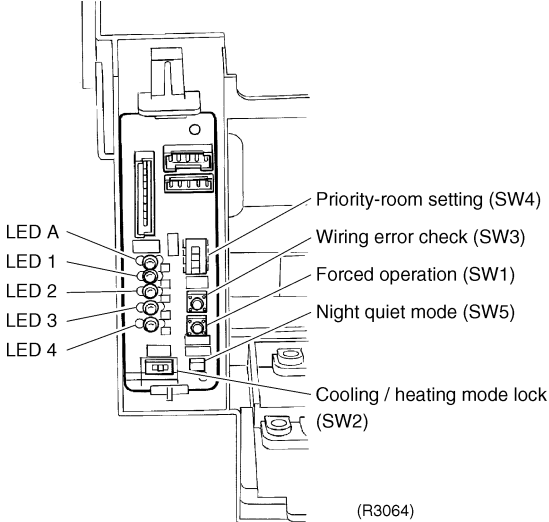
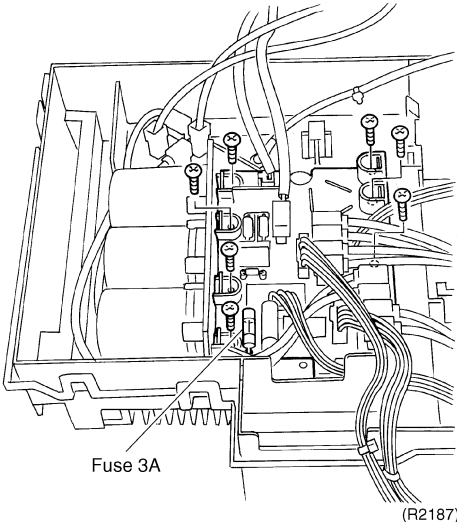
Step	Procedure	Points
7	<p>The figure shows the control PCB.</p> 	<p>■ Glass tube fuse 3A</p>
<p>2. Removing the service monitor PCB</p>		
1	<p>The figure shows the service monitor PCB.</p> 	
<p>3. Removing the inverter PCB.</p>		
1	<p>Remove the 7 screws of the inverter PCB.</p> 	

2.4 Removal of Fan Motor

Procedure



Warning

Be sure to wait 10 minutes or more after turning off all power supplies before disassembling work.

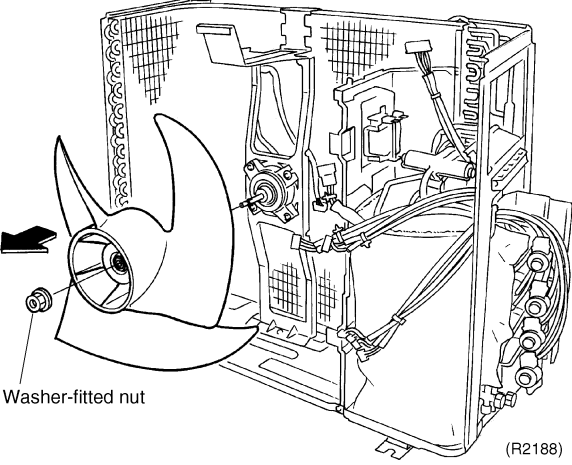
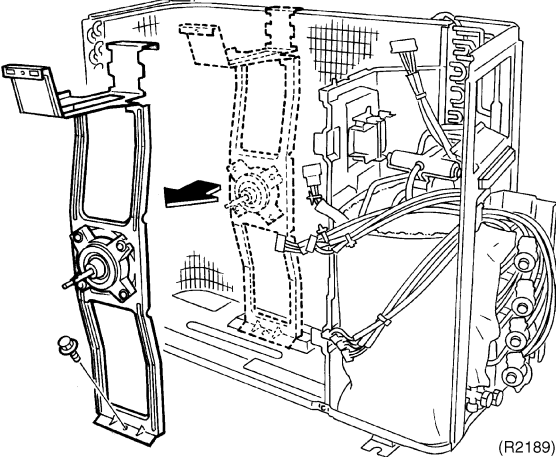
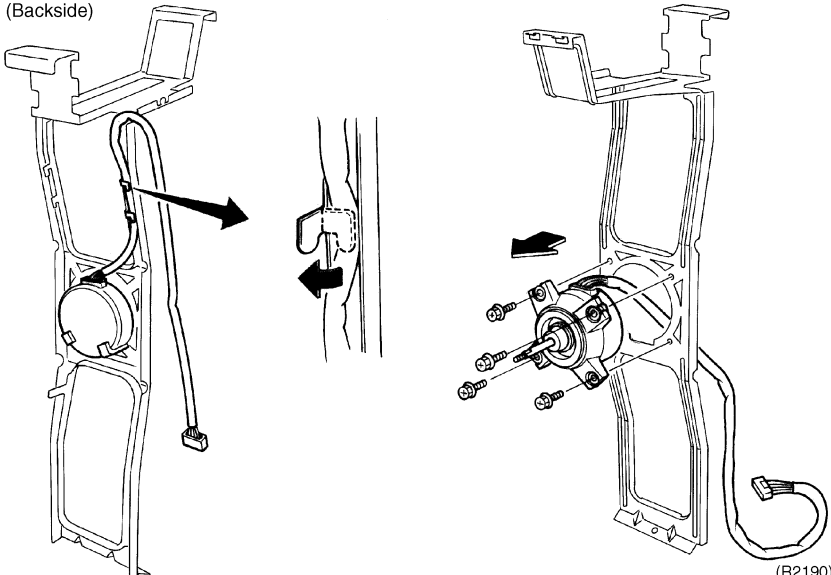
Step	Procedure	Points
<p>■ Remove the fan motor lead wire connector.</p>		
<p>1 Remove the propeller fan by removing the washer-fitted nut.</p>	 <p>Washer-fitted nut</p> <p>(R2188)</p>	<ul style="list-style-type: none"> ■ For reassembling, align ▼ mark of propeller fan with D-cut section of motor shaft. ■ Mount the propeller fan while positioning ● mark to the top.
<p>2 Remove the fan motor. Remove 1 screw of the fan motor mount.</p>	 <p>(R2189)</p>	<ul style="list-style-type: none"> ■ When reassembling, fix the lead wire to avoid contact with the propeller fan.
<p>3 Disconnect the lead wire by releasing the 2 clamps fixing the wire. Remove 4 screws of the fan motor.</p>	<p>(Backside)</p>  <p>(R2190)</p>	

2.5 Removal of Sound Insulation

Procedure



Warning

Be sure to wait 10 minutes or more after turning off all power supplies before disassembling work.

Step	Procedure	Procedure	Points
1	Remove 5 screws of the right side panel.		
2	Remove 2 screws of the partition board, and remove the board.		
3	Remove the noise insulation (top, outer and inner).		<p>■ Carefully remove the noise insulation, which is easily torn in the piping section.</p>

2.6 Removal of Four Way Valve Coil, Solenoid Valve Coil, Electronic Expansion Valve Coil and Thermistor

Procedure



Warning

Be sure to wait 10 minutes or more after turning off all power supplies before disassembling work.

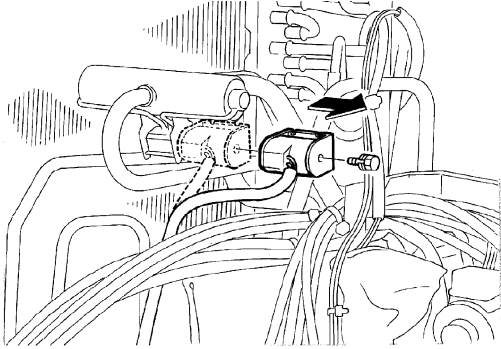
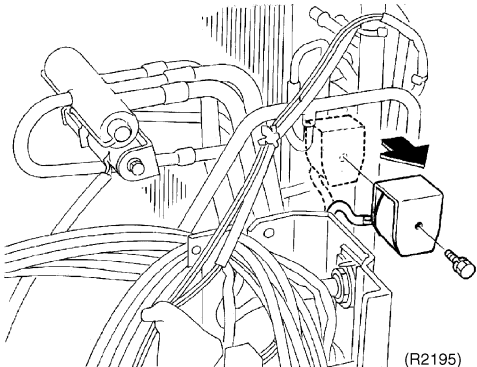
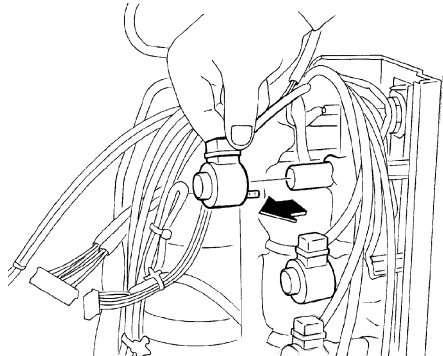
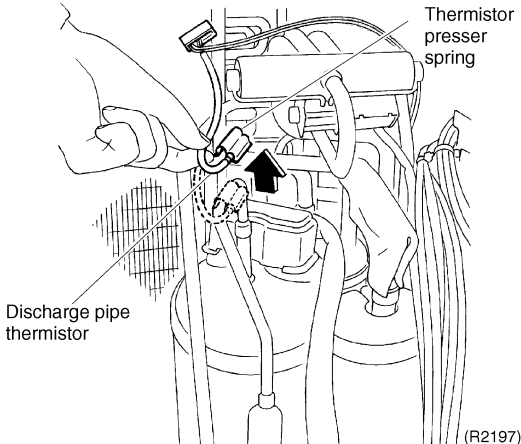
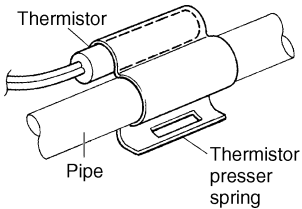
Step	Procedure	Procedure	Points
1	Remove 1 screw of the four way valve coil.	 <p>(R2194)</p>	
2	Remove one screw of the solenoid valve coil.	 <p>(R2195)</p>	
3	Remove the electronic expansion valve coil for each room.	 <p>(R2196)</p>	<ul style="list-style-type: none"> ■ Place the thermistor so that its end comes up to the end of the presser spring. ■ Be careful not to lose the presser spring for the discharge pipe thermistor.
4	Release the thermistor presser spring, and remove the discharge pipe thermistor.	 <p>(R2197)</p>	

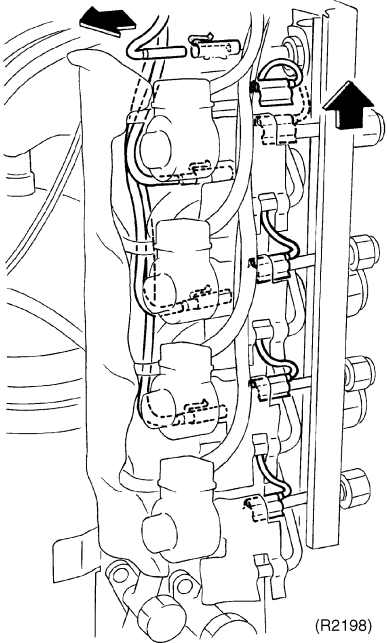
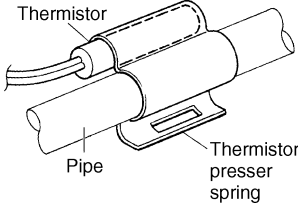
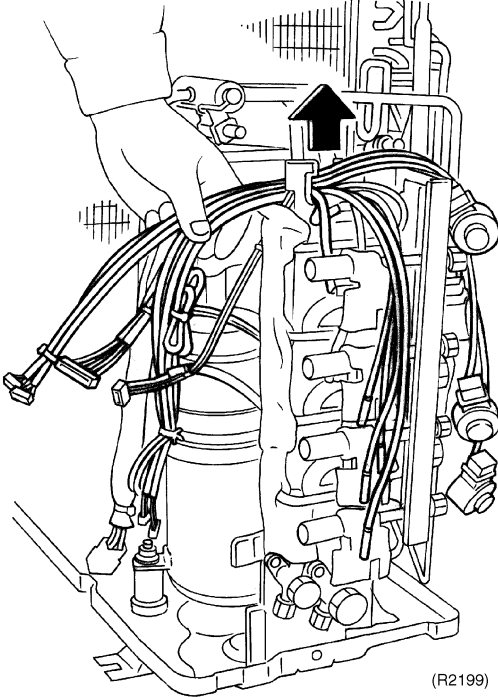
Step	Procedure	Points	
5	Take off the putty, and remove each thermistor.	 <p>(R2198)</p>	<ul style="list-style-type: none"> ■ Place the thermistor so that its end comes up to the end of the presser spring. ■ Be careful not to lose the presser spring for the discharge pipe thermistor. 
6	Remove the wire harness.	 <p>(R2199)</p>	<p>S90:</p> <ul style="list-style-type: none"> ■ Outdoor air thermistor (Blue) ■ Heat exchanger thermistor (Gray) ■ Discharge pipe thermistor (Black) <p>S92: Gas pipe thermistor</p> <ul style="list-style-type: none"> ■ Room A (Black) ■ Room B (Gray) ■ Room C (Brown) ■ Room D (Red) <p>S93: Liquid pipe thermistor</p> <ul style="list-style-type: none"> ■ Room A (Black) ■ Room B (Gray) ■ Room C (Yellow) ■ Room D (Blue)

2.7 Removal of Four Way Valve, Solenoid Valve and Shunt

Procedure

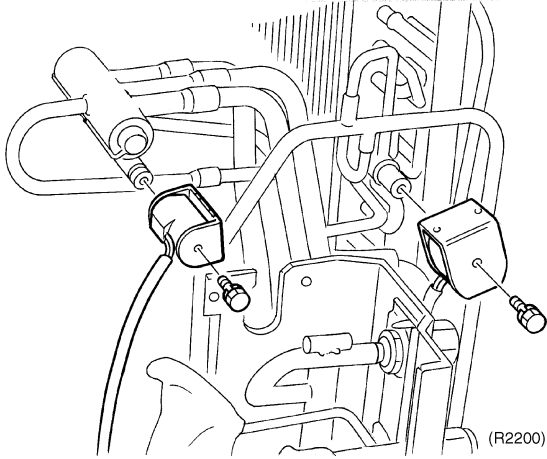
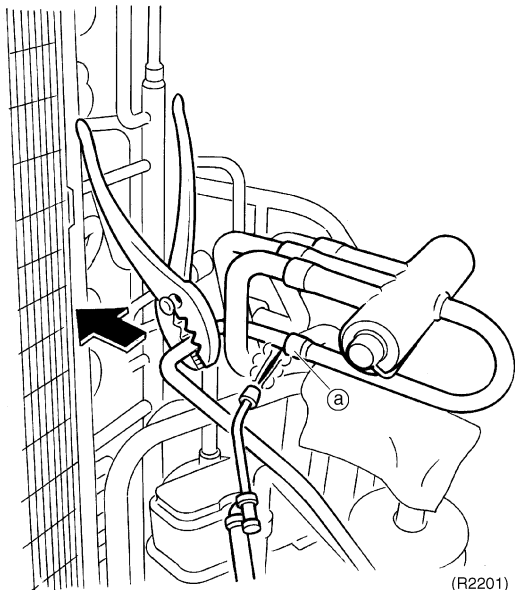
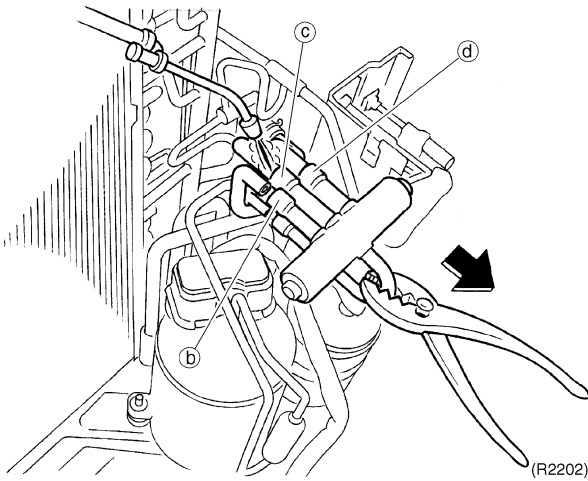

Warning Be sure to wait 10 minutes or more after turning off all power supplies before disassembling work.

Step	Procedure	Procedure	Points	
1	Remove 1 screw of the four way valve coil.	 <p style="text-align: right;">(R2200)</p>	<p>Reassembling precautions</p> <ol style="list-style-type: none"> 1. Use non-oxidizing brazing method. If nitrogen gas is not available, braze the parts speedily. 2. Avoid deterioration of the gaskets due to carbonization of oil inside the four way valve or thermal influence. For this purpose, wrap the four way valve with wet cloth. Splash water over the cloth against becoming too hot (keep it below 120°C). 	
2	Remove 1 screw of the solenoid valve coil.			
<p>■ Before taking this procedure, make sure there is no refrigerant gas left in the refrigerant pipes.</p>		 <p style="text-align: right;">(R2201)</p>	<p>■ In pulling the pipes, be careful not to over-tighten them with pliers. The pipes may get deformed.</p>	
3	Place welding protective sheet or iron plate around the four way valve to prevent the flames of a gas welding rod from affecting the valve.			
4	Heat the four brazed points of the four way valve. Disconnect the point (a) first.	 <p style="text-align: right;">(R2202)</p>	<p>Note: Never use a hack saw. The sawdust may come into the circuit.</p>	
5	Disconnect the points (b) and (c).			
6	Disconnect the point (d).			

2.8 Removal of Solenoid Valve and Shunt

Procedure



Warning

Be sure to wait 10 minutes or more after turning off all power supplies before disassembling work.

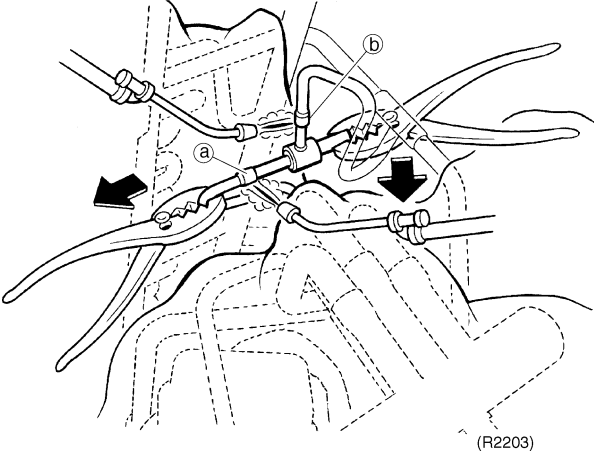
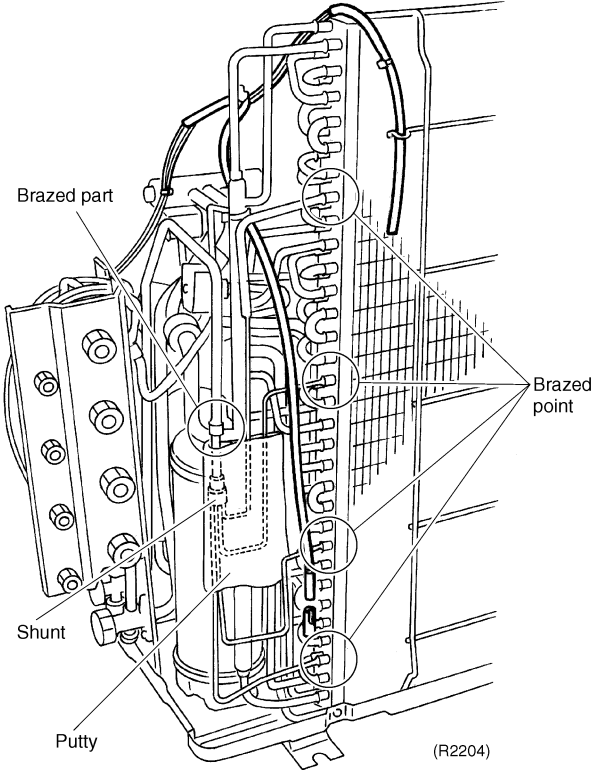
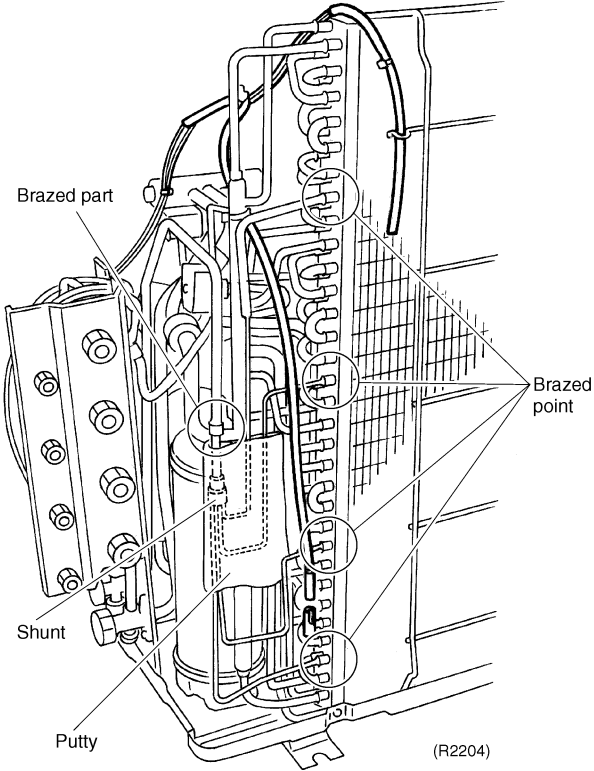
Step	Procedure	Points
<p>■ Before taking this procedure, make sure there is no refrigerant gas left in the refrigerant pipes.</p>		<p> Caution Be careful not to get yourself burnt with the pipes and other parts that are heated by the gas welding rod.</p>
<p>1 Disconnect the 2 brazed points (a) and (b) in this order.</p>		<p> Warning If refrigerant gas leaks during the job, ventilate the room. (Bear in mind that if the refrigerant gas is exposed to open flames, noxious gas may be generated.)</p>
<p>2 Remove the putty of the shunt.</p>		
<p>3 Disconnect the 5 brazed points of the shunt.</p>		<p>Reassembling precautions Wrap the solenoid valve body with wet cloth. Splash water over the cloth before it is dried to prevent the valve from being overheated.</p>

2.9 Removal of Compressor

Procedure



Warning

Be sure to wait 10 minutes or more after turning off all power supplies before disassembling work.

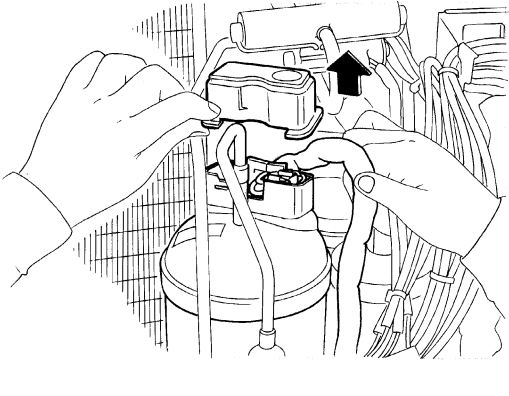
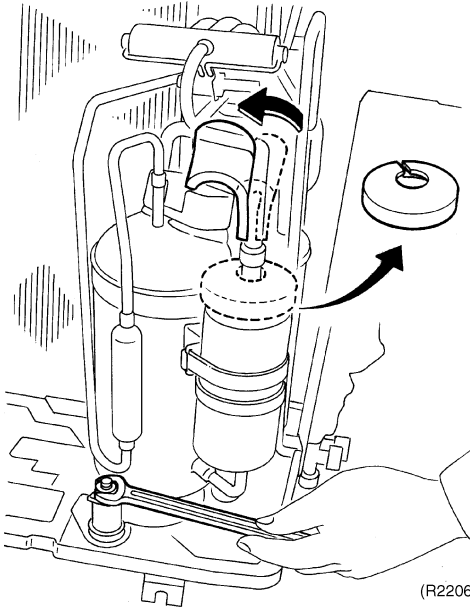
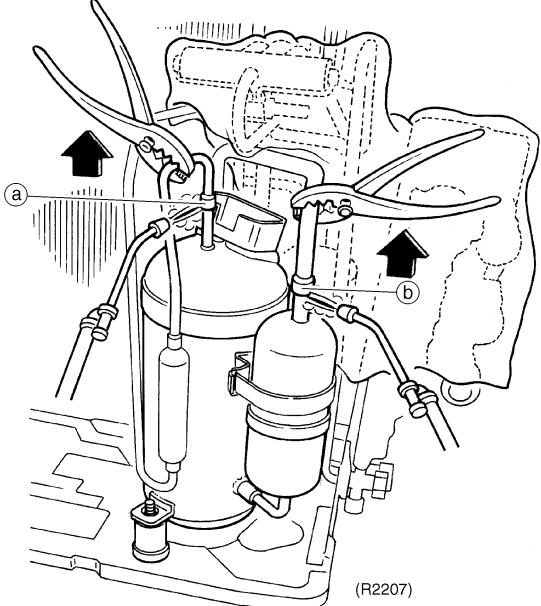
Step	Procedure	Procedure	Points
<p>1 Remove the terminal cover.</p>		 <p style="text-align: right;">(R2205)</p>	<p>Terminal nameplate</p>
<p>2 Disconnect the compressor lead wire.</p> <p>3 Remove the 2 sheets of putty.</p> <p>4 There is one nut fixing the compressor. Remove the nut with an open-end spanner.</p>		 <p style="text-align: right;">(R2206)</p>	<p>As precaution, keep the contents in memorandum.</p> <ul style="list-style-type: none"> Be careful to avoid burning the compressor terminals or the nameplate.
<ul style="list-style-type: none"> Make sure there is no refrigerant gas left inside the refrigerant pipes before starting the job. 			
<ul style="list-style-type: none"> When heating up the brazed parts, make sure to carry out the N2 replacement. 		 <p style="text-align: right;">(R2207)</p>	<p>Warning The compressor's refrigerating machine oil may catch fire. Have wet cloth at hand for quickly putting out the fire.</p> <p>Warning If refrigerant gas leaks during the job, ventilate the room. (Bear in mind that if the refrigerant gas is exposed to open flames, noxious gas may be generated.)</p> <p>Caution Be careful not to get yourself burnt with the pipes and other parts that are heated by the gas welding rod.</p>
<p>1 Disconnect the brazed part (a) at discharge side of the compressor.</p> <p>2 Disconnect the brazed part (b) at suction side of the compressor.</p>			

Part 8 Others

1. Others	258
1.1 Test Run from the Remote Controller	258
1.2 Jumper Settings	259

1. Others

1.1 Test Run from the Remote Controller

Trial Operation and Testing

1. Measure the supply voltage and make sure that it falls in the specified range.
2. Trial operation should be carried out in either cooling or heating mode.

For Heat pump

In cooling mode, select the lowest programmable temperature; in heating mode, select the highest programmable temperature.

- Trial operation may be disabled in either mode depending on the room temperature.
- After trial operation is complete, set the temperature to a normal level (26°C to 28°C in cooling mode, 20°C to 24°C in heating mode).
- For protection, the system disables restart operation for 3 minutes after it is turned off.

For Cooling operation in case of low ambient temperature

Select the lowest programmable temperature.

- Trial operation in cooling mode may be disabled depending on the room temperature. Use the remote control for trial operation as described below.

Trial operation from Remote Controller

- (1) Press ON/OFF button to turn on the system.
 - (2) Simultaneously press center of TEMP button and MODE buttons.
 - (3) Press MODE button twice.
(“T” will appear on the display to indicate that Trial Operation mode is selected.)
 - (4) Trial run mode terminates in approx. 30 minutes and switches into normal mode. To quit a trial operation, press ON/OFF button.
 - After trial operation is complete, set the temperature to a normal level (26°C to 28°C).
 - For protection, the machine disables restart operation for 3 minutes after it is turned off.
3. Carry out the test operation in accordance with the Operation Manual to ensure that all functions and parts, such as louver movement, are working properly.
 - The air conditioner requires a small amount of power in its standby mode. If the system is not to be used for some time after installation, shut off the circuit breaker to eliminate unnecessary power consumption.
 - If the circuit breaker trips to shut off the power to the air conditioner, the system will restore the original operation mode when the circuit breaker is opened again.

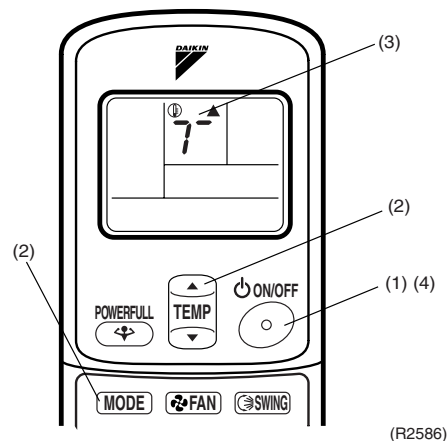

1.2 Jumper Settings

1.2.1 When Two Units are Installed in One Room

- **How to set the different addresses.**
- When two indoor units are installed in one room, the two wireless remote controllers can be set for different addresses.

PCB in the indoor unit

- Remove the front panel.
- Remove the sensor parts cover (2-screws), then remove the electric parts box (1-screw).
- Slide the metallic cover to remove it. (4-claws on the electric parts box.)
- Cut the jumper **JA** on PCB.

Wireless remote controller (in case of wall mounted type)

- Cut the jumper **J4**.

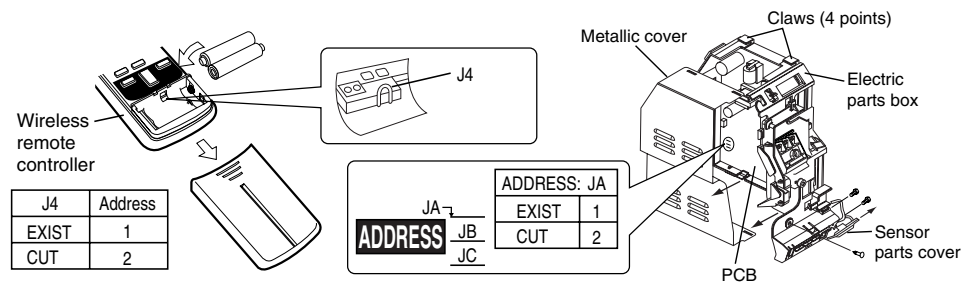

(R2587)

1.2.2 Jumper Setting

Jumper (On indoor PCB)	Function	When connected (factory set)	When cut
JC	Power failure recovery function	Auto start	Unit does not resume operation after recovering from a power failure. Timer ON-OFF settings are cleared.
JB	Fan speed setting when compressor is OFF on thermostat.	Fan speed setting ; Remote controller setting	Fan rpm is set to "0" <Fan stop>

1.2.3 Adjusting the Angle of the Intelligent Eye Sensor

Wall Mounted Type 25 / 35 Class Only

- Once installation of the indoor unit is complete, adjust the angle of the Intelligent eye sensor to ensure the detection area properly covers the room.
(Adjustable angle : 15° to right and left of center)

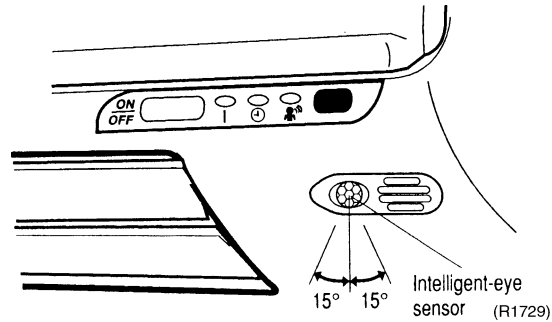

- Gently push and slide the sensor to adjust the angle. Aim so that the sensor is pointing to the center of the room, or to the part of the room that is most frequently used.

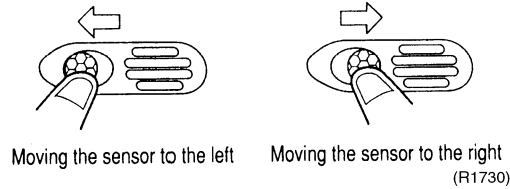

- After adjusting the angle, gently wipe the sensor with a clean cloth, being careful not to scratch the sensor.



Caution

- Do not hit or violently push the Intelligent eye sensor. This can lead to damage and malfunction.
- Do not place large objects near the sensor. Also keep heating units or humidifiers outside the sensor's detection area.

Part 9 Appendix

1. Piping Diagrams.....	262
1.1 Indoor Units.....	262
1.2 Outdoor Units.....	266
2. Wiring Diagrams.....	273
2.1 Indoor Units.....	273
2.2 Outdoor Units.....	276

1. Piping Diagrams

1.1 Indoor Units

1.1.1 Wall Mounted Type

FTKE25/35BVM, FTK(X)E25/35BVMA

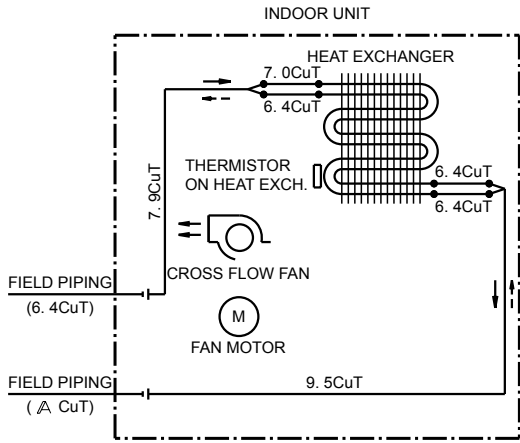

	Δ
FTX25-- FTK25-- FTXE25-- FTKE25--	9.5
FTX35-- FTK35-- FTXE35-- FTKE35-- FTKE09-- FTKE12--	12.7

REFRIGERANT FLOW
 → COOLING
 - - - HEATING

4D032969C

FTK(X)S20CVMB(9), FTK(X)S25/35CVMB(9)(8),
 ATXS20/25/35CVMB(9), FTXS25/35BVMA

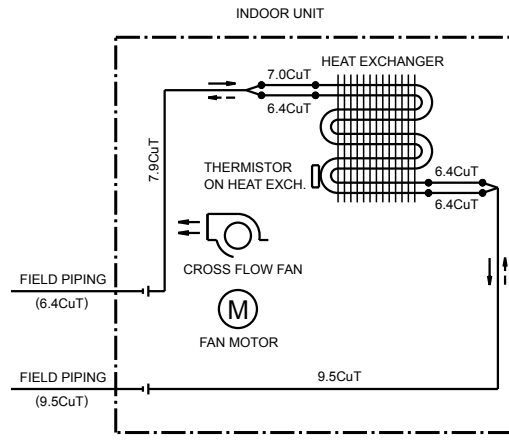

REFRIGERANT FLOW
 → COOLING
 - - - HEATING

4D033698D

FTKD50BVM, FTK(X)D50BVMA,
 FTK(X)S50/60BVMB, FTXS50/60BVMA(8),
 ATXS50CVMB

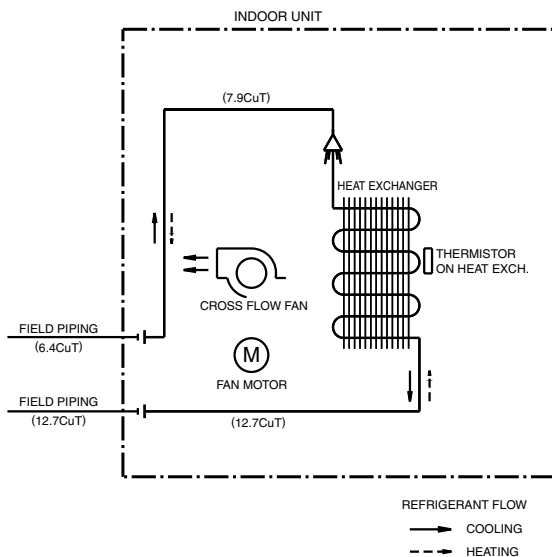

REFRIGERANT FLOW
 → COOLING
 - - - HEATING

4D040081J

FTKD60BVM, FTK(X)D60BVMA, FTK(X)S71BVMB,
 FTXS71BVMA(8)

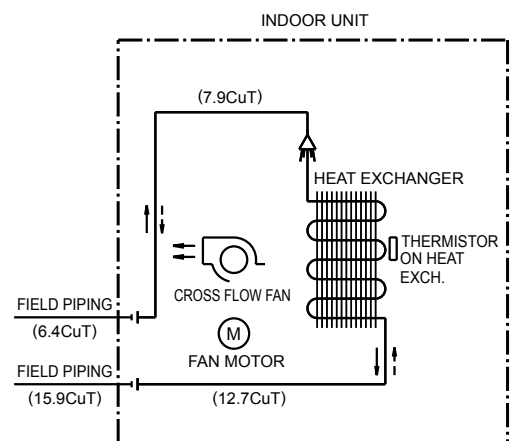

REFRIGERANT FLOW
 → COOLING
 - - - HEATING

4D040082H

FTKD71BVM, FTK(X)D71BVMA

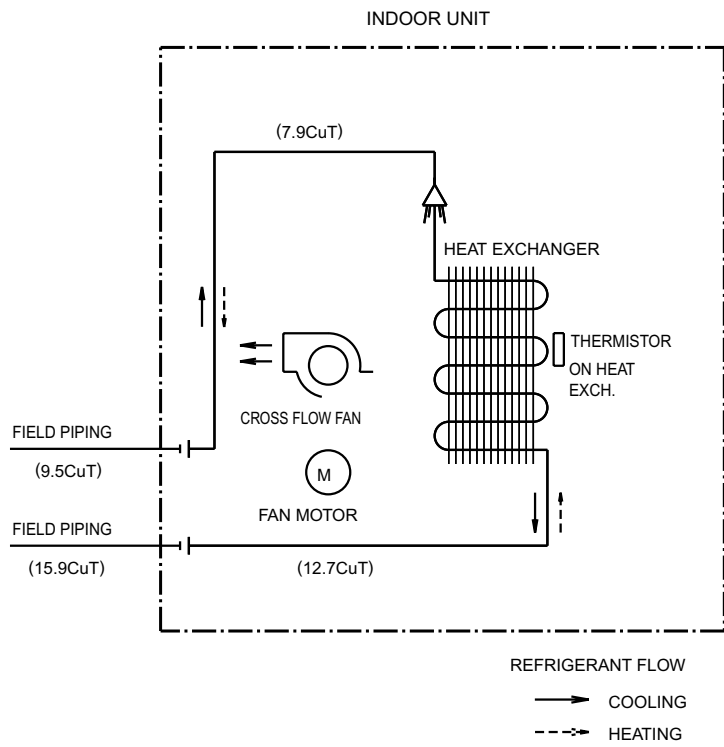

4D040083F

1.1.2 Duct Connected Type

CDKD25/35/50/60CVM,
CDK(X)D25/35/50/60CVMA

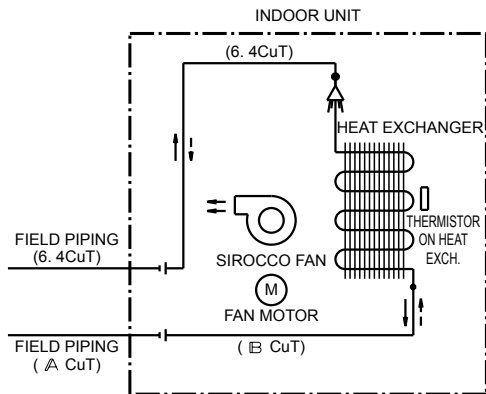

	A	B
CDXD25CMVMC CDXD25CVMA CDKD25CVM CDKD25CVM	9.5	9.5
CDXD35CMVMC CDXD35CVMA CDKD35CVM CDKD35CVM FDXD50CMVMC CDXD50CVMA CDKD50CVMA CDKD50CVM	12.7	12.7
CDXD60CMVMC CDXD60CVMA CDKD60CVMA CDKD60CVM	15.9	15.9

REFRIGERANT FLOW
 → COOLING
 ⇄ HEATING

CDK(X)S25/35/50/60CVMB,
CDXS25/35/50/60CVMA

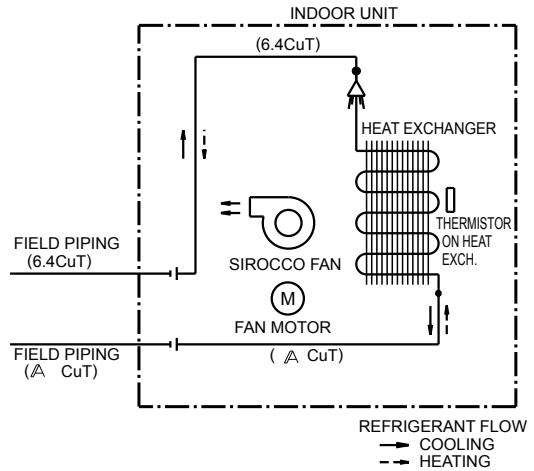

	A
CDXS25CVMB CDKS25CVMB CDXS35CVMB CDKS35CVMB CDXS25CVMA CDXS35CVMA FDXS25CVMB FDXS35CVMB FDKS25CVMB FDKS35CVMB	9.5
CDXS50CVMB CDKS50CVMB CDXS60CVMB CDKS60CVMB CDXS50CVMA CDXS60CVMA	12.7

REFRIGERANT FLOW
 → COOLING
 ⇄ HEATING

4D045450

4D045449B

1.1.3 Floor / Ceiling Suspended Dual Type

FLK(X)S25/35/50/60BVMB,
FLXS25/35/50/60BVMA

FLK(X)25/35/50/60AVMA

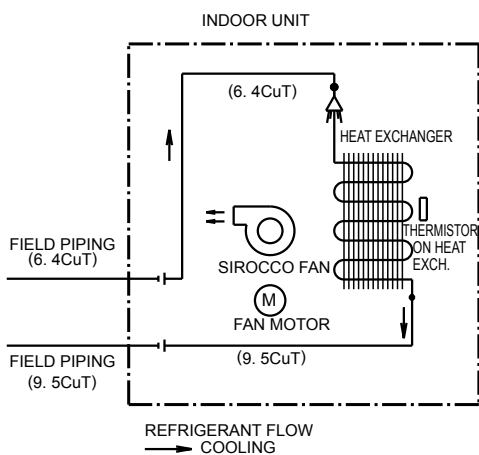

REFRIGERANT FLOW
 → COOLING

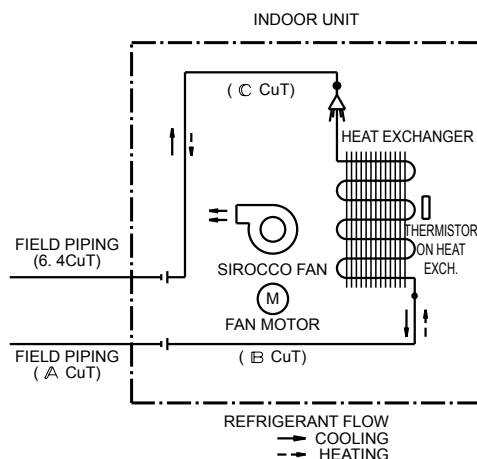

REFRIGERANT FLOW
 → COOLING
 ⇄ HEATING

	A	B	C
FLX25- FLK25-	9.5	9.5	6.4
FLX35- FLK35-	12.7	9.5	6.4
FLX50- FLK50-	12.7	12.7	9.5
FLX60- FLK60-	15.9	12.7	9.5

4D034012D

4D034013A

1.1.4 Floor Standing Type

FVK(X)S25/35BVMB, FVXS35BVMA

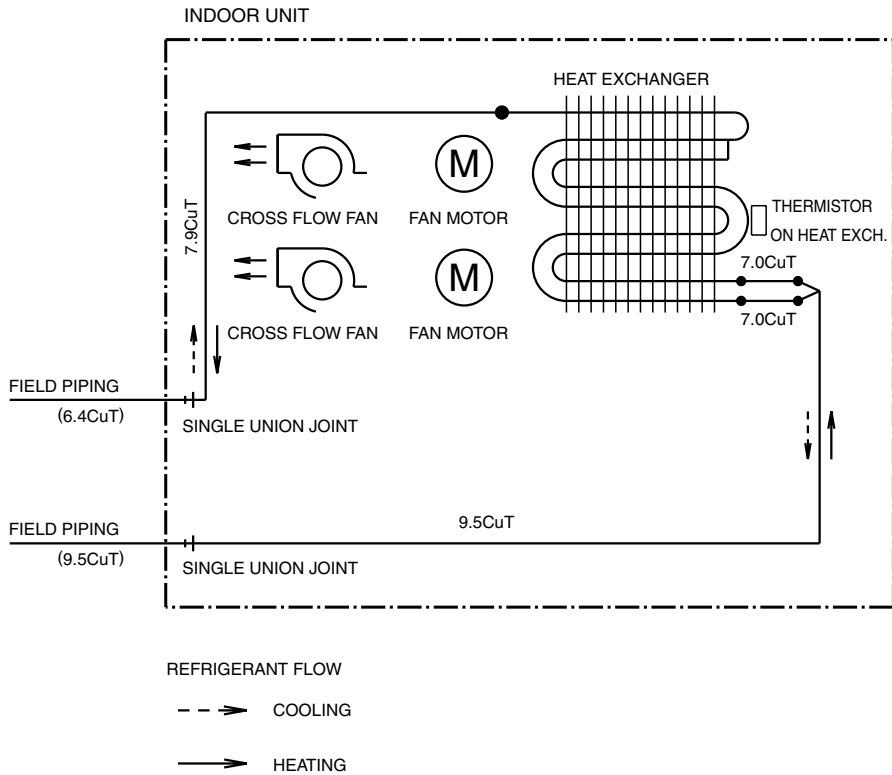

4D034714B

FVK(X)S50BVMB, FVXS50BVMA

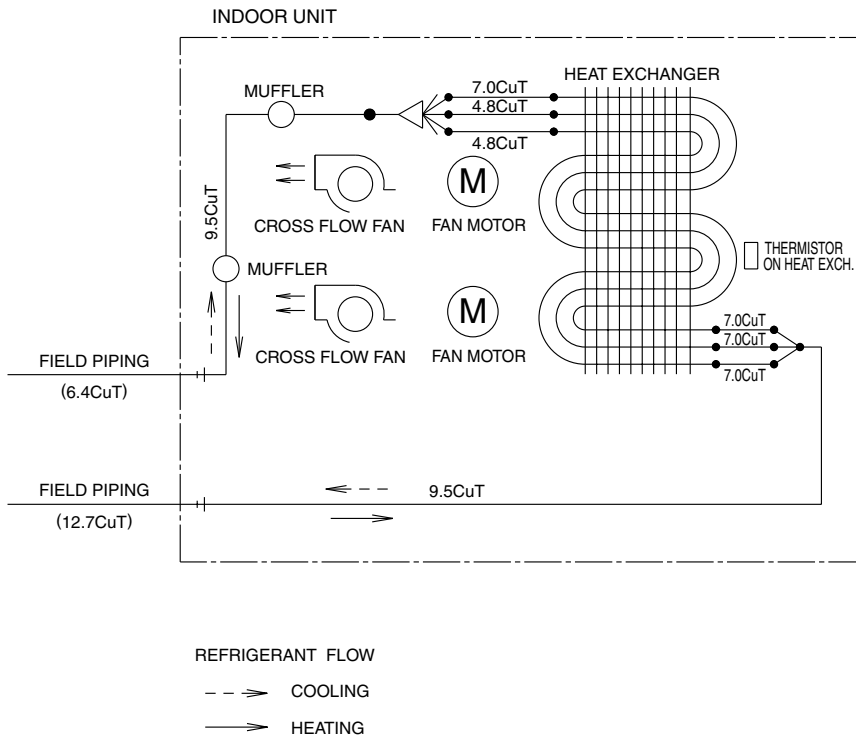

4D020911C

1.2 Outdoor Units

1.2.1 Cooling Only

2MK58BVM

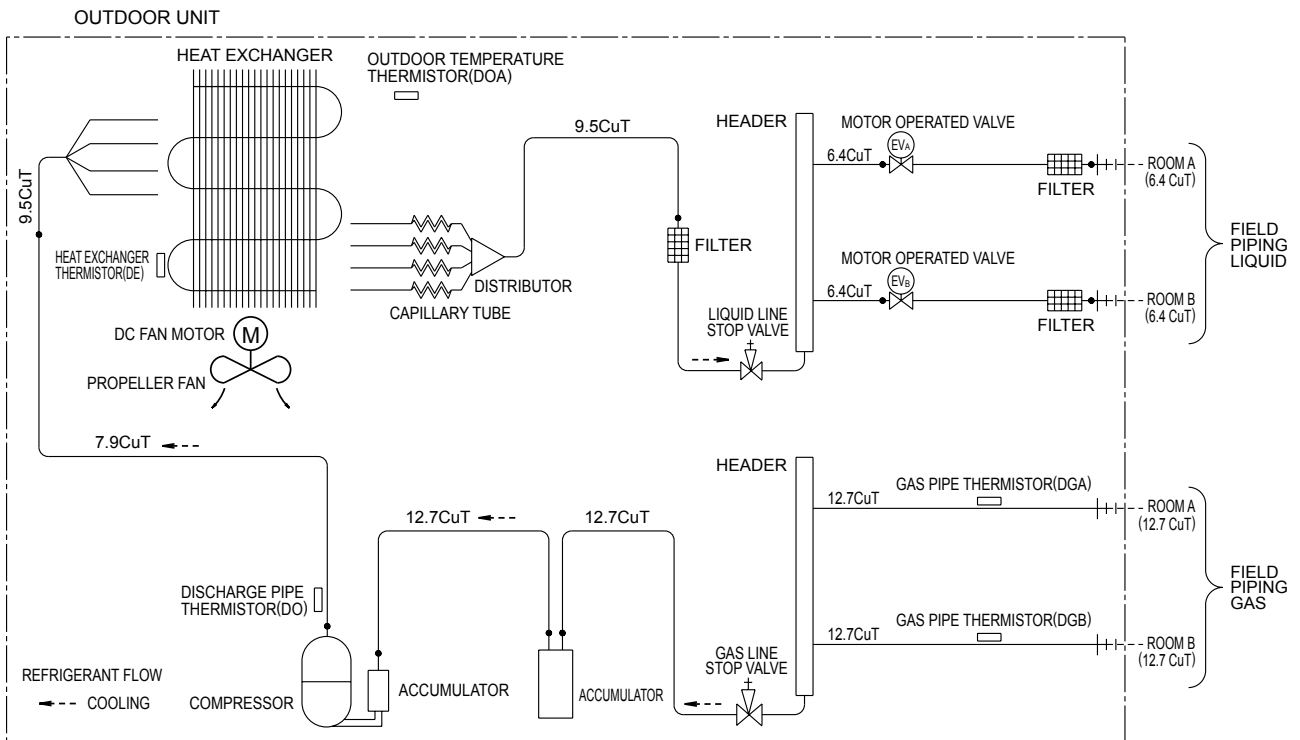

3D036222B

3MK58BVM

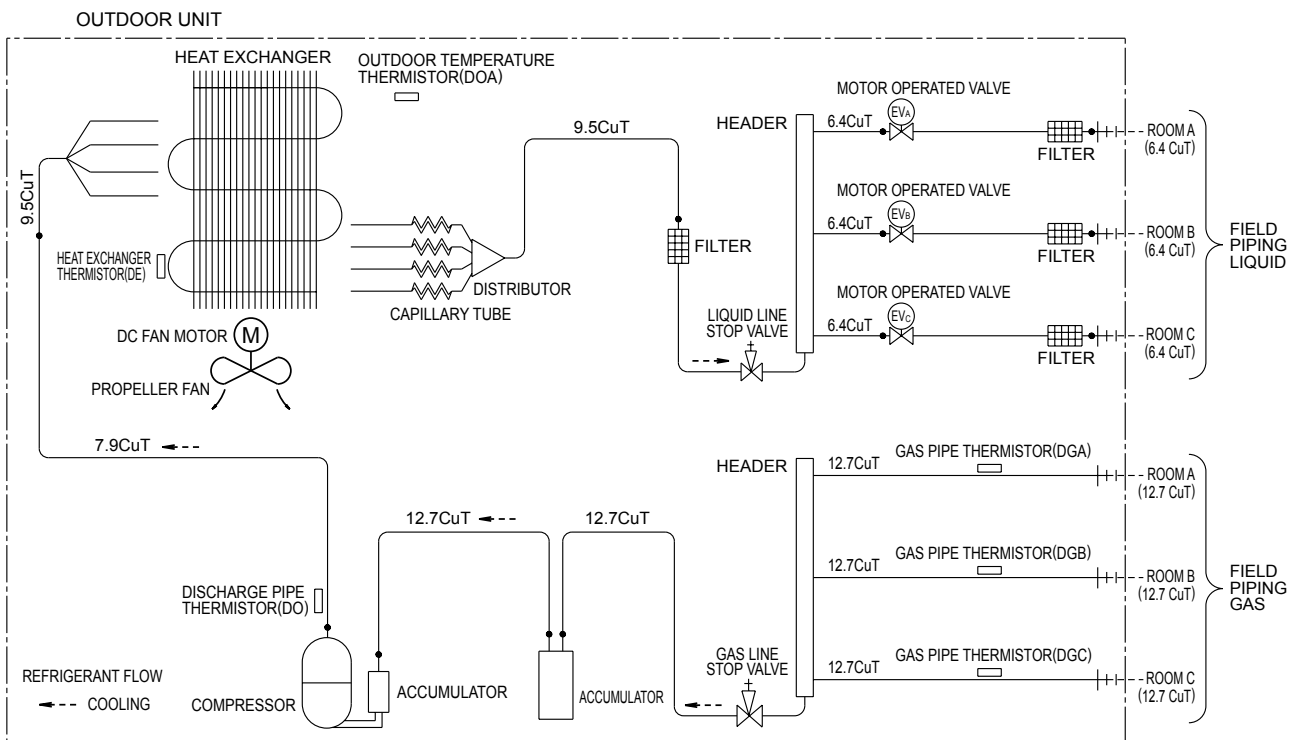

3D036221B

3MKD75BVM, 3MKD75BVMA

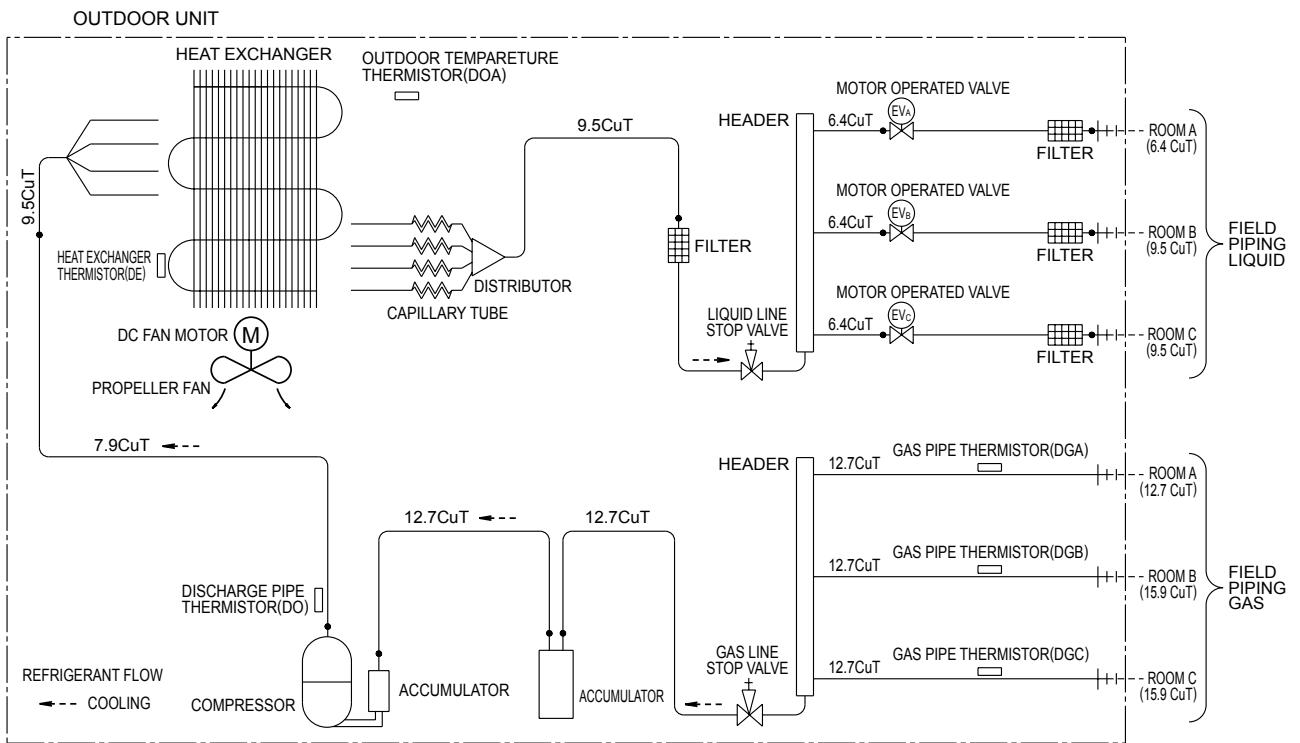

3D036220B

4MKD75BVM

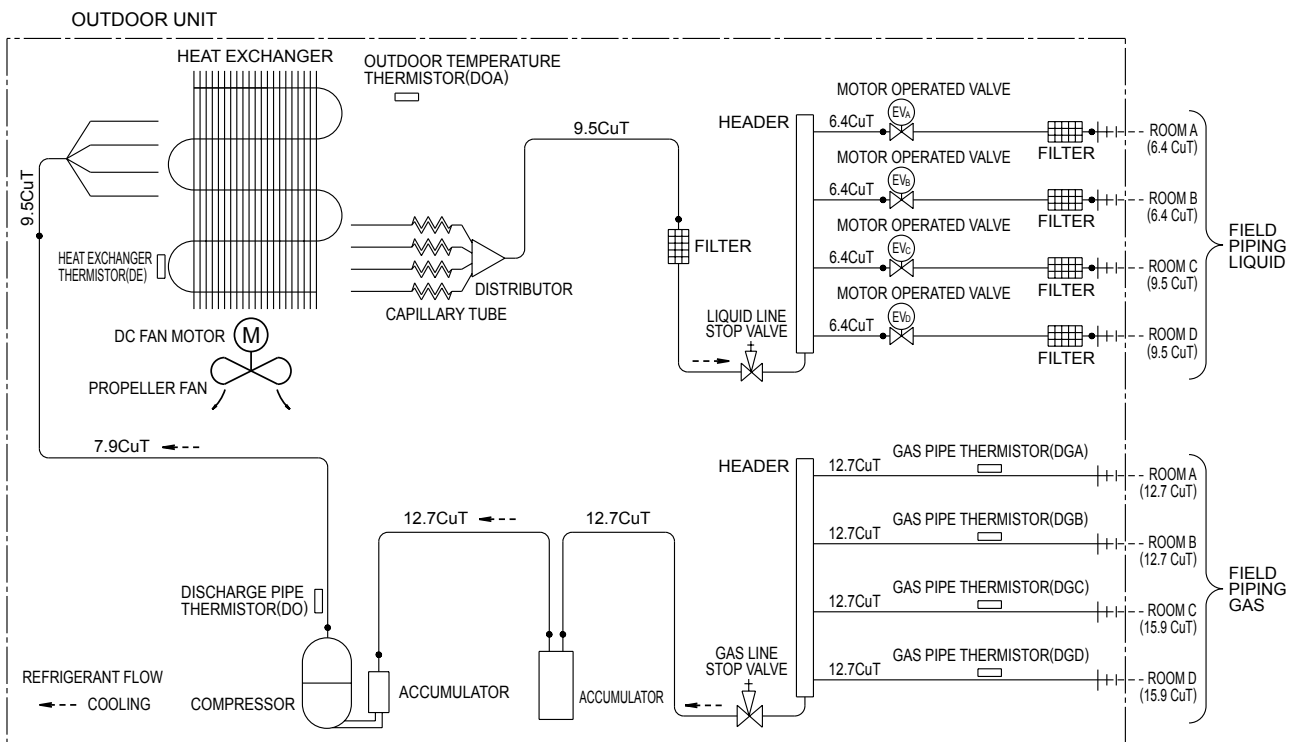

3D036219B

4MKD90BVM, 4MKD90BVMA

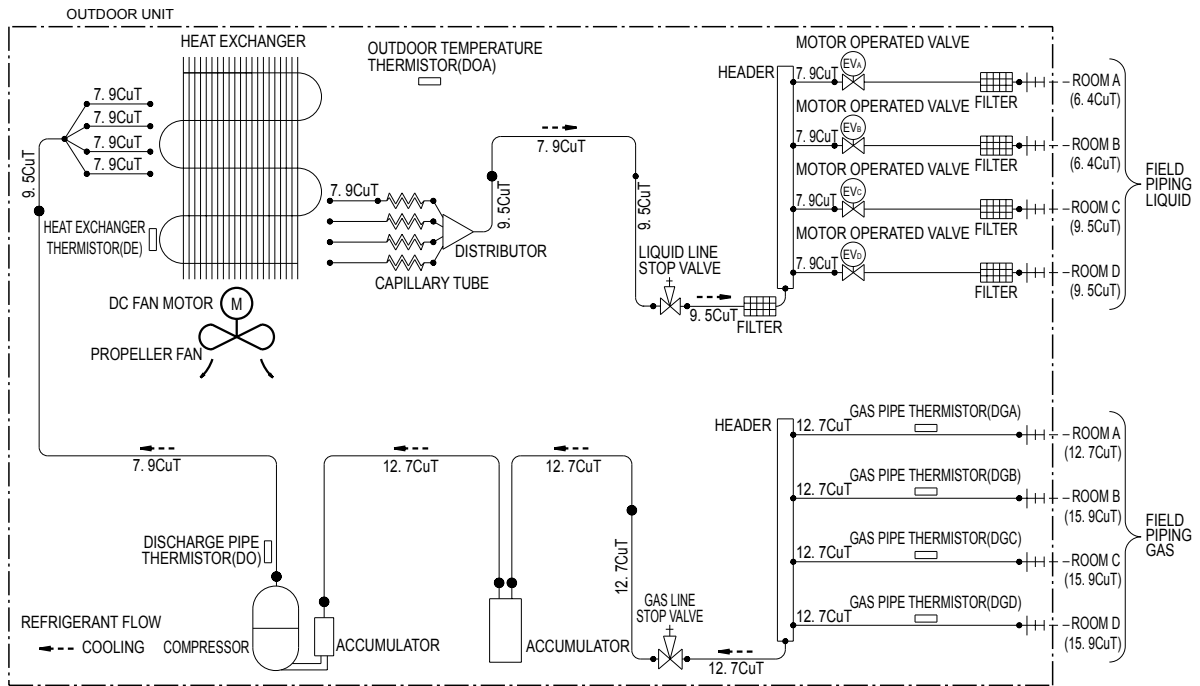

3D036504B

3MKS50BVMB(8)

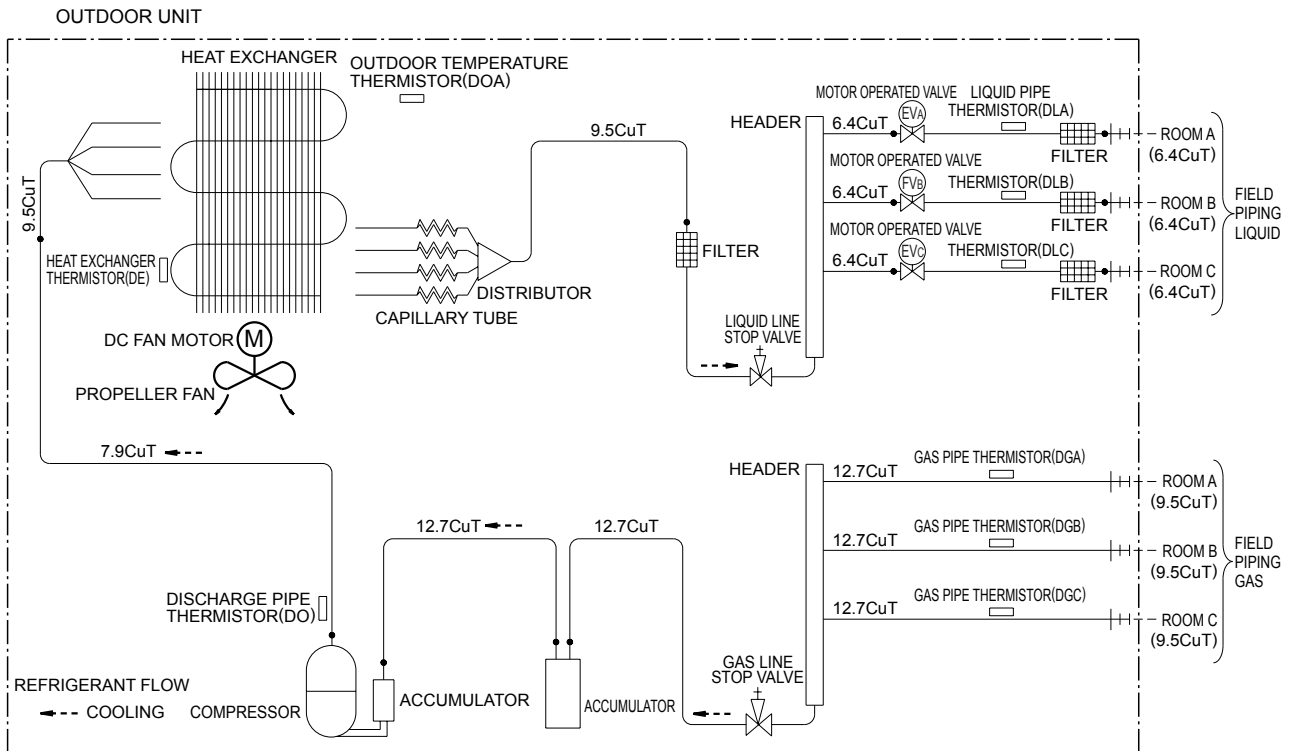

3D038534B

4MKS58BVMB(8)

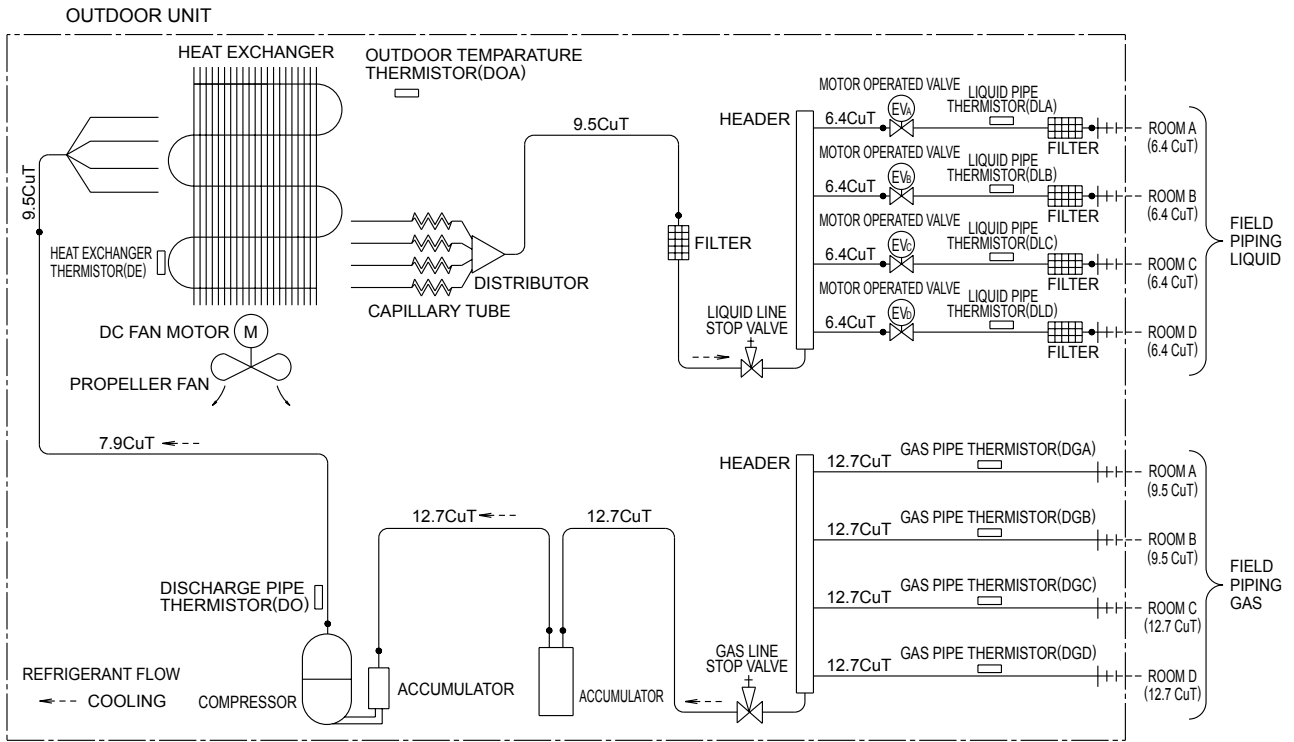

3D034514C

4MKS75BVMB

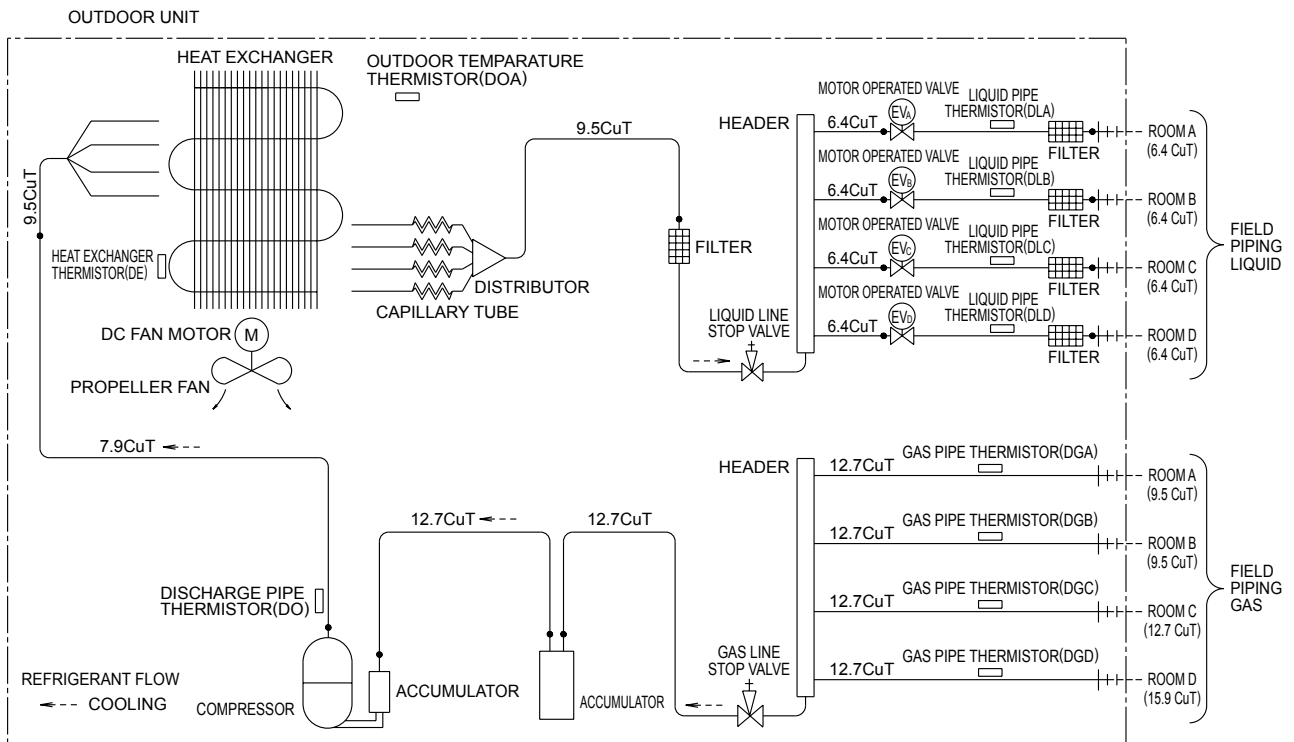

3D034513C

4MKS90BVMB

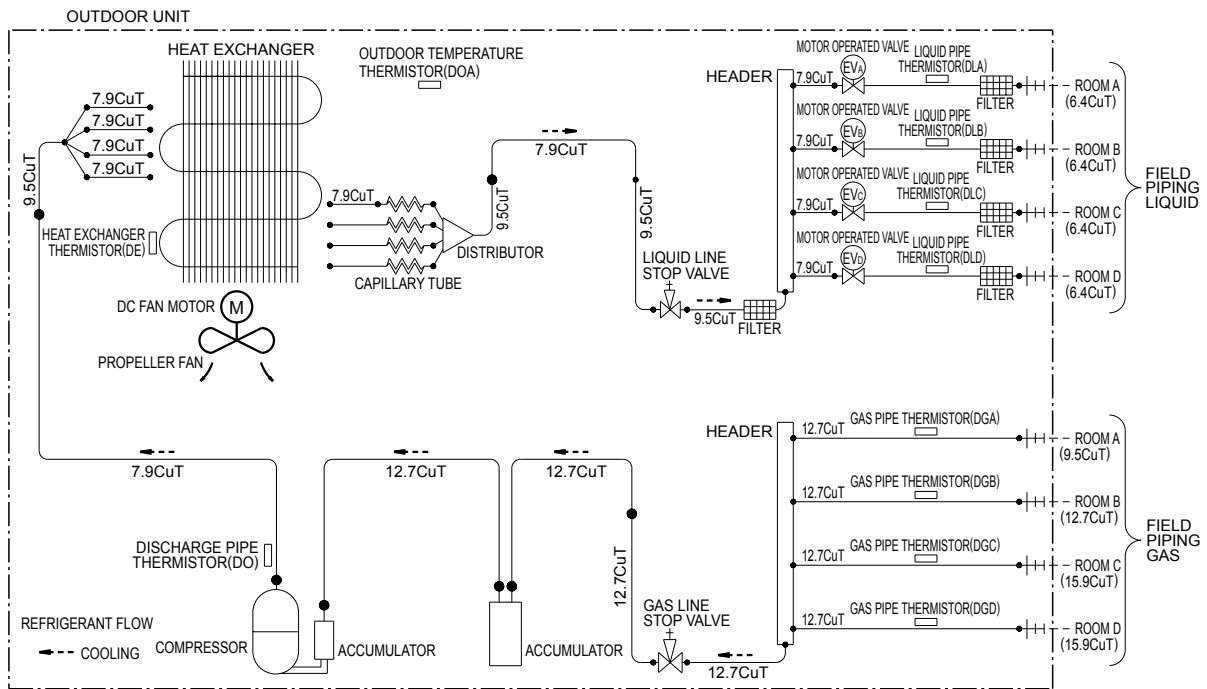

3D034481B

1.2.2 Heat Pump

3MXS52BVMB(8), 3AMXS52BVMB

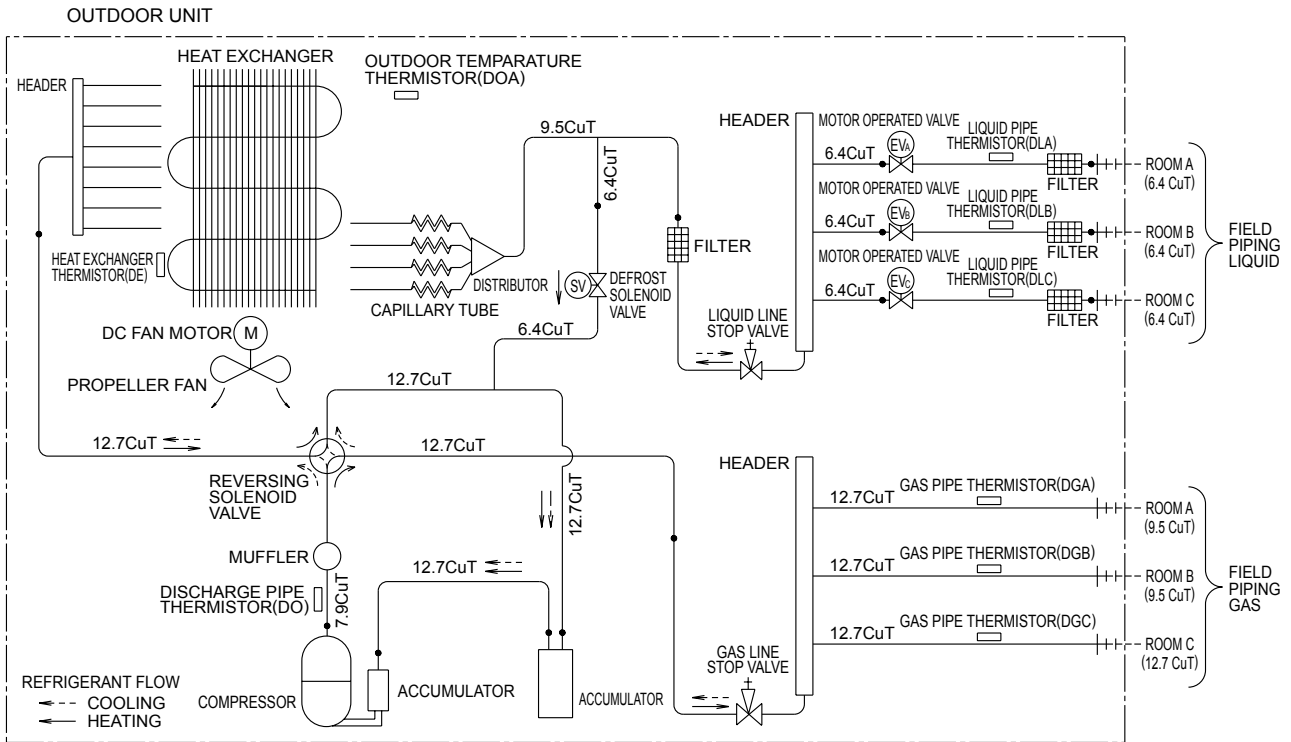

3D034512D

3MXD68BVMA

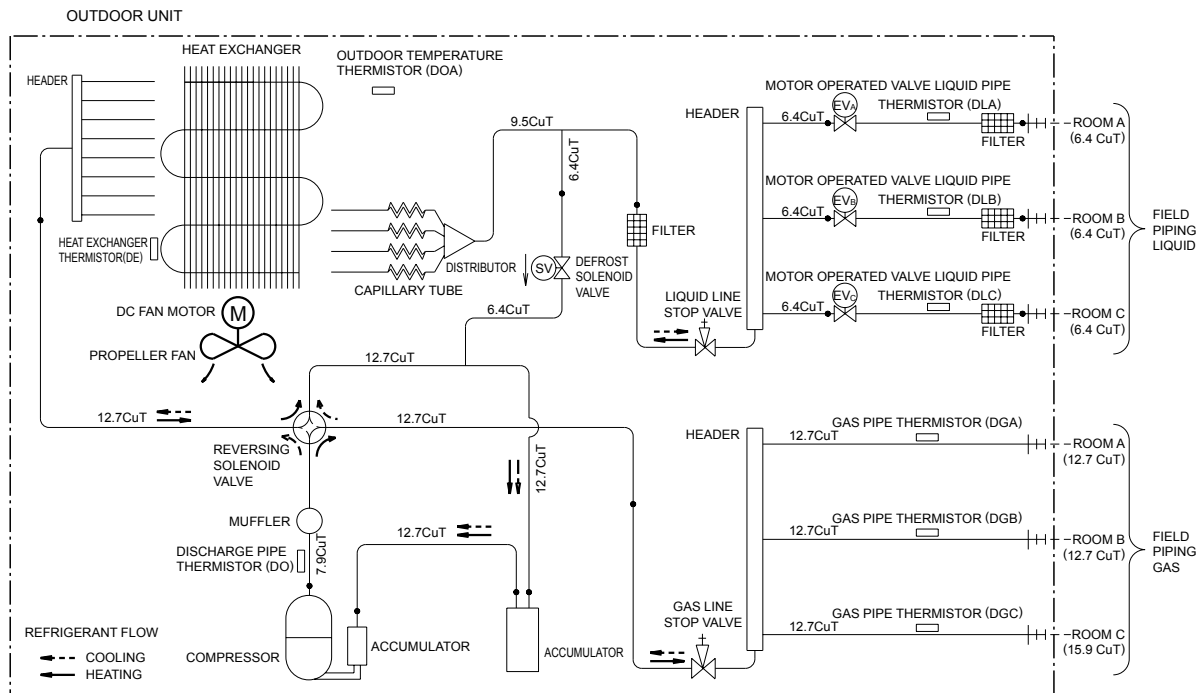

3D036218C

4MXS68BVB9, 4MXS68CVMA

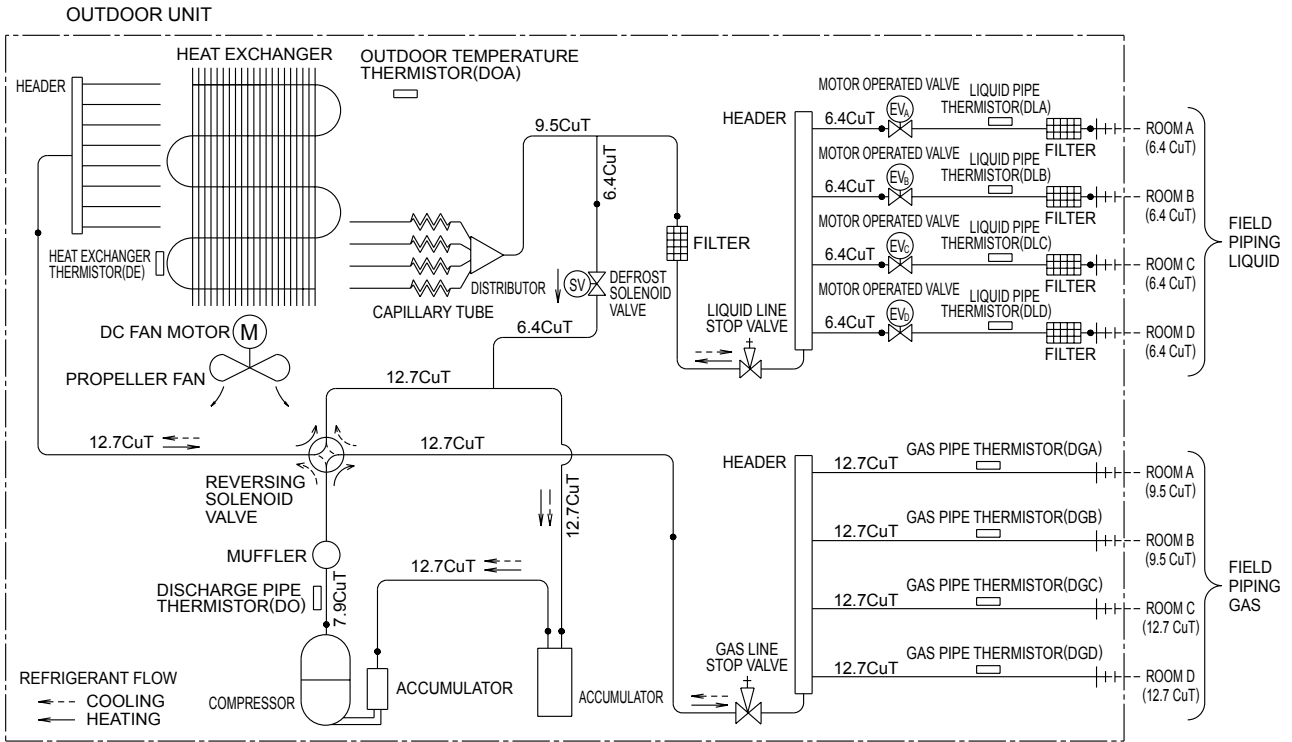

3D034511C

4MXD80BVMA, 4MXS80BVB9, 4MXS80CVMA

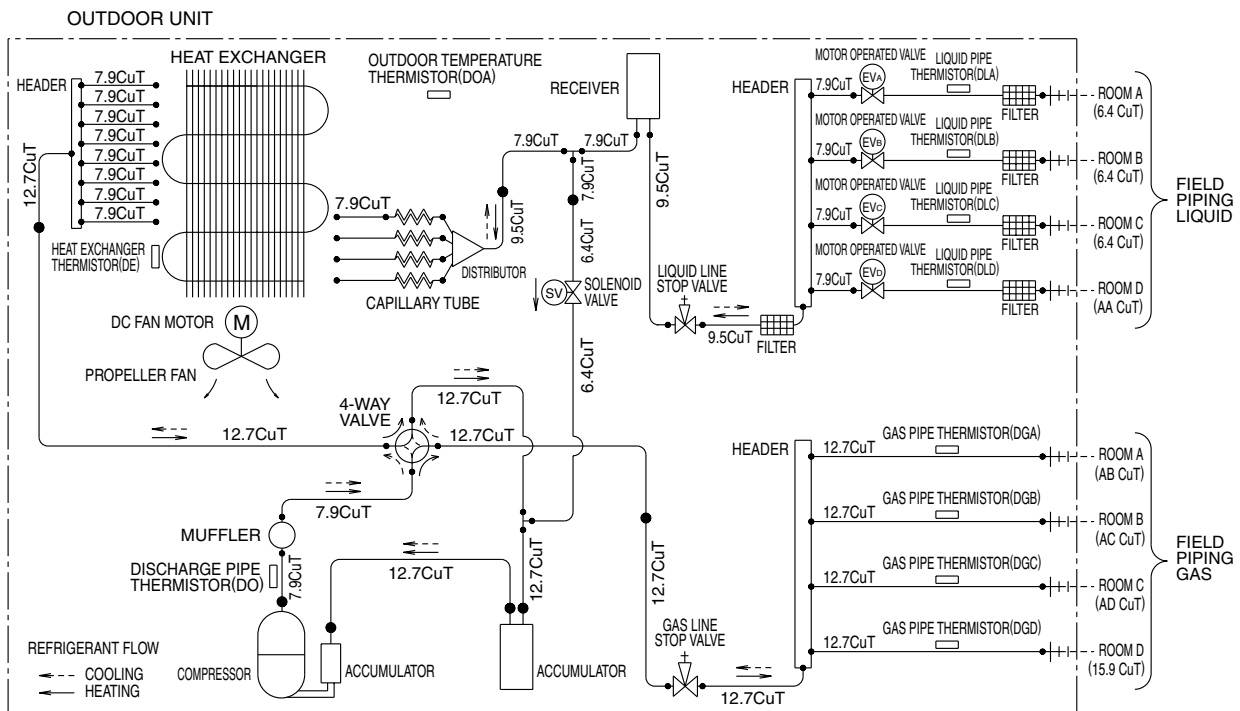

MODEL	AA	AB	AC	AD
4MXS80CVMA, 4MXS80BVB9	6.4	9.5	9.5	12.7
4MXD80BVMA	9.5	9.5	12.7	15.9

C:3D034480B

2. Wiring Diagrams

2.1 Indoor Units

2.1.1 Wall Mounted Type

FTKE25/35BVM, FTK(X)E25/35BVMA

FTK(X)S20CVMB(9), FTK(X)S25/35CVMB(9)(8), ATXS20/25/35CVMB(9), FTXS25/35BVMA

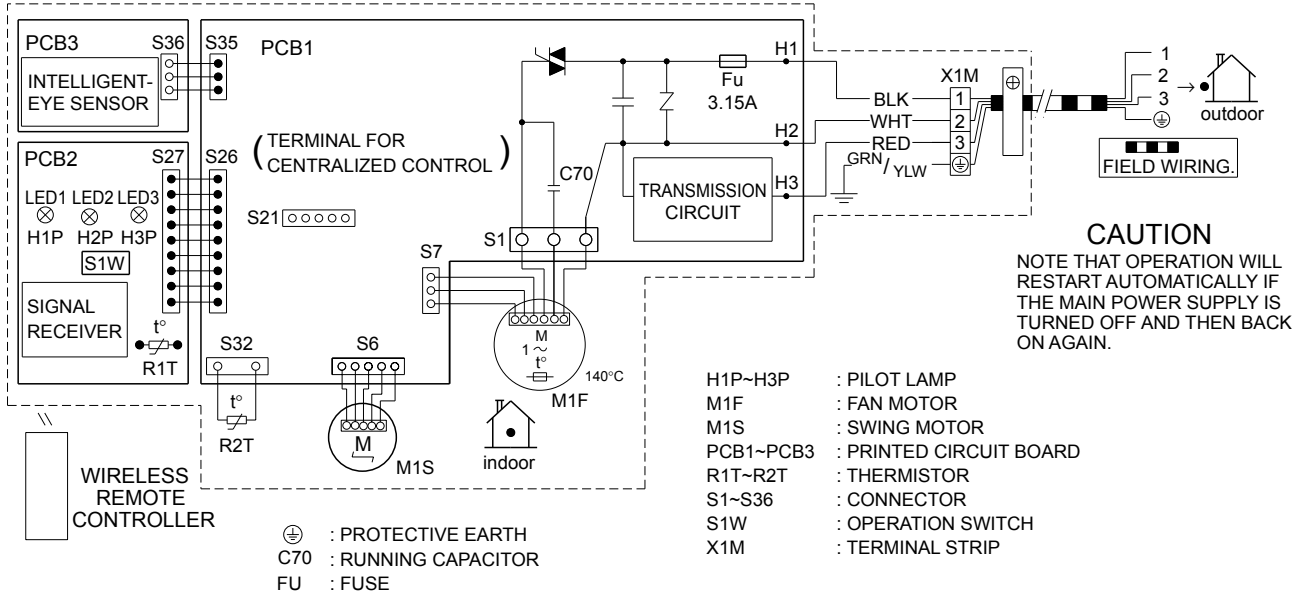

3D033599E

FTK(X)S50BVMB, FTXS50BVMA(8), ATXS50CVMB

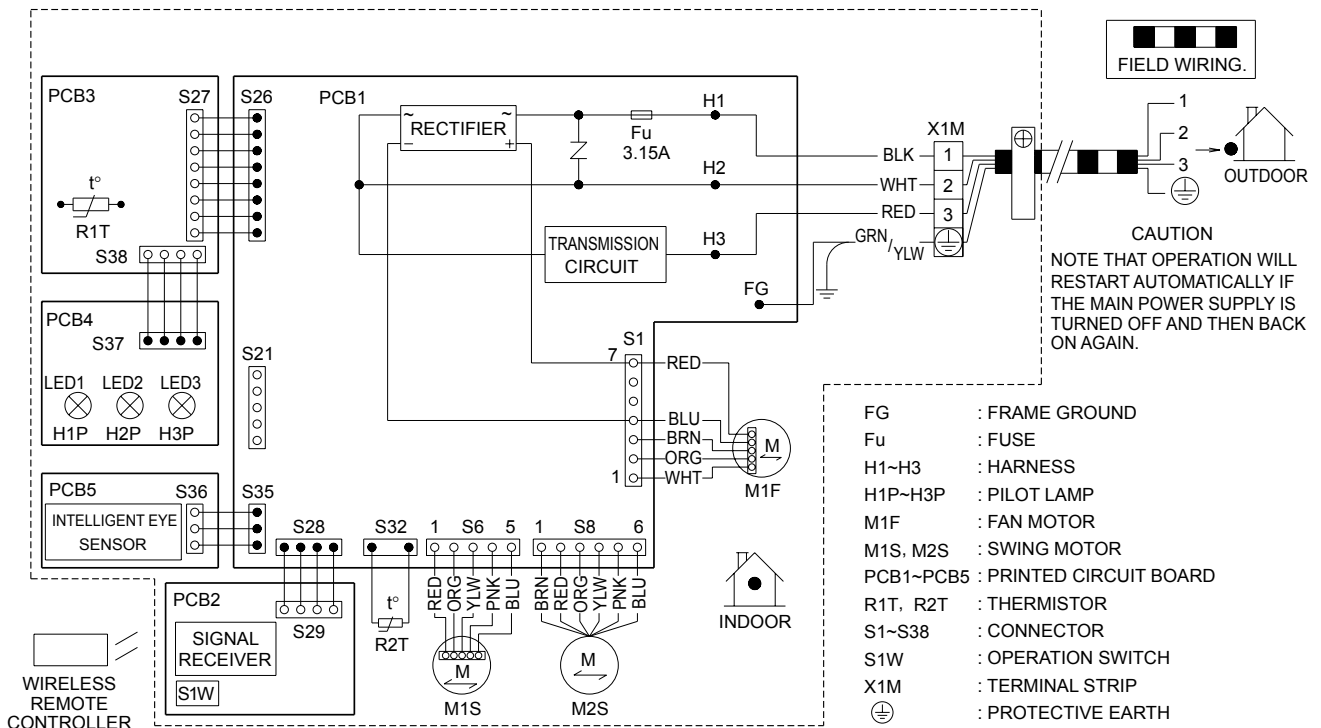

3D038065G

**FTKD50/60/71BVM, FTK(X)D50/60/71BMA
FTK(X)S60/71BVMB, FTXS60/71BVMA(8)**

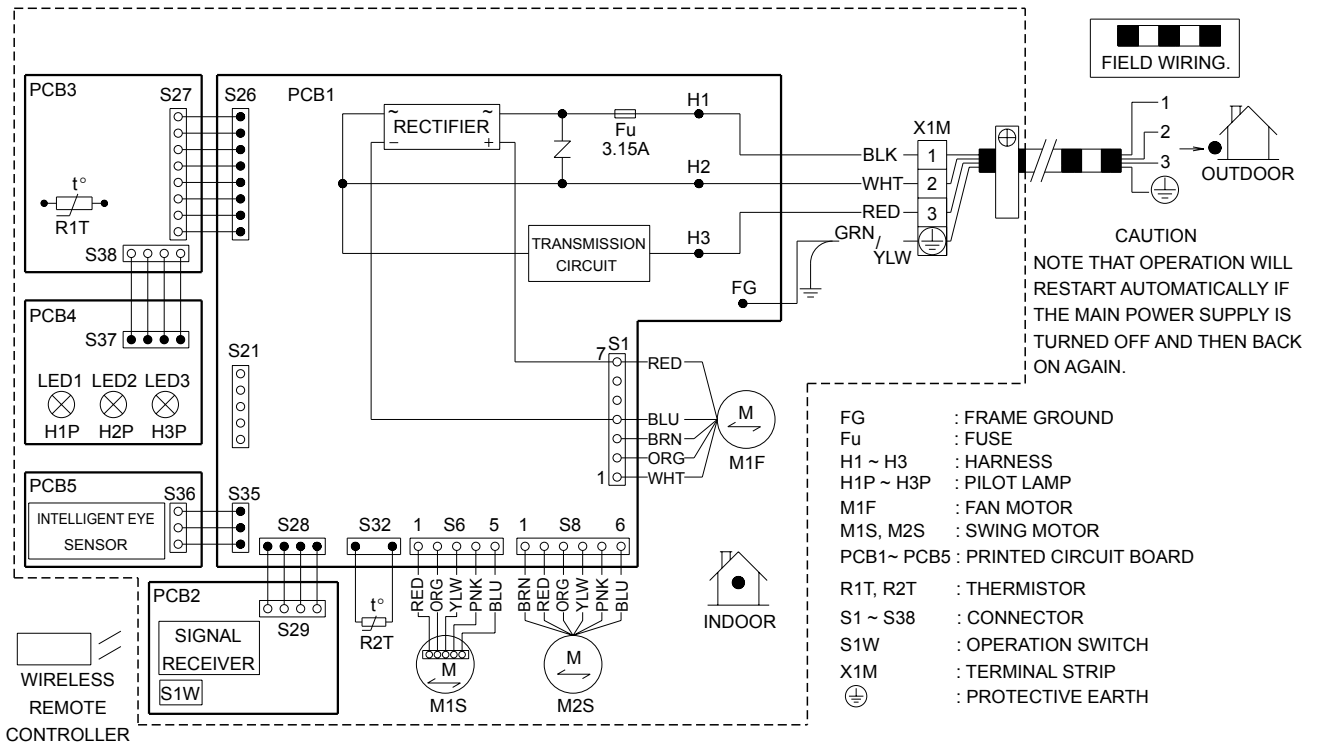

3D038530J

2.1.2 Duct Connected Type

CDKD25/35/50/60CVM, CDK(X)D25/35/50/60CVMA, CDK(X)S25/35/50/60CVMB, CDXS25/35/50/60CVMA

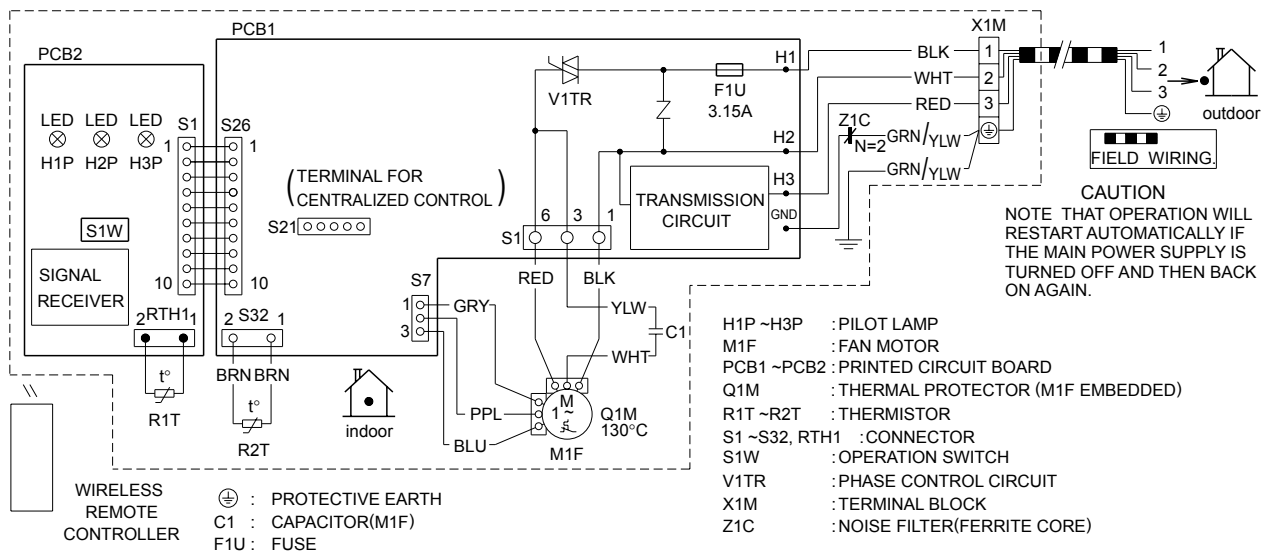

3D045012C

2.1.3 Floor / Ceiling Suspended Dual Type

FLK(X)25/35/50/60AVMA, FLK(X)S25/35/50/60BVMB, FLXS25/35/50/60BVMA

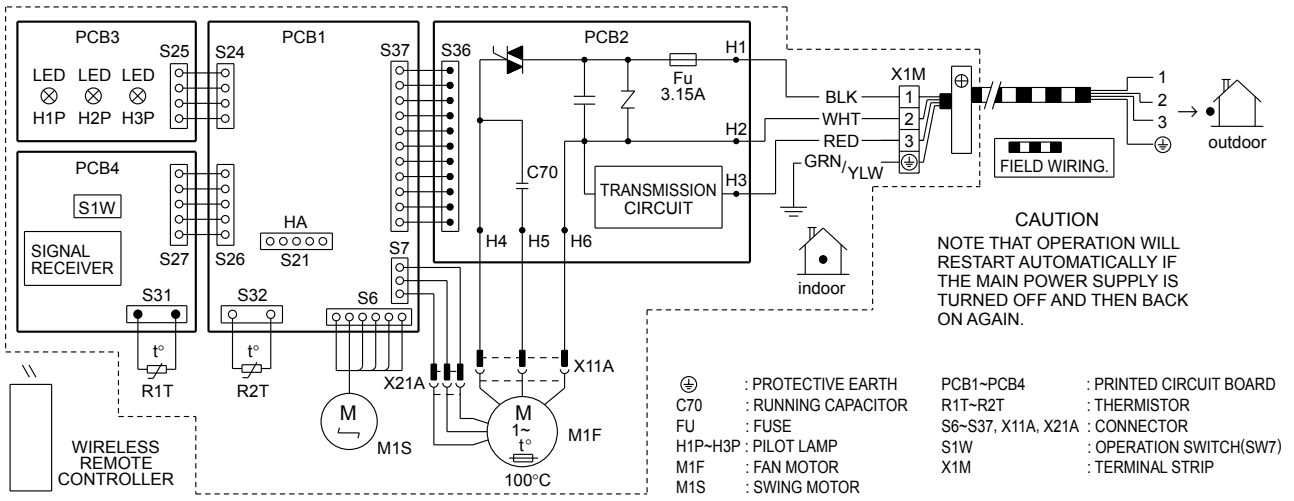

3D033909D

2.1.4 Floor Standing Type

FVK(X)S25/35/50BVMB, FVXS35/50BVMA

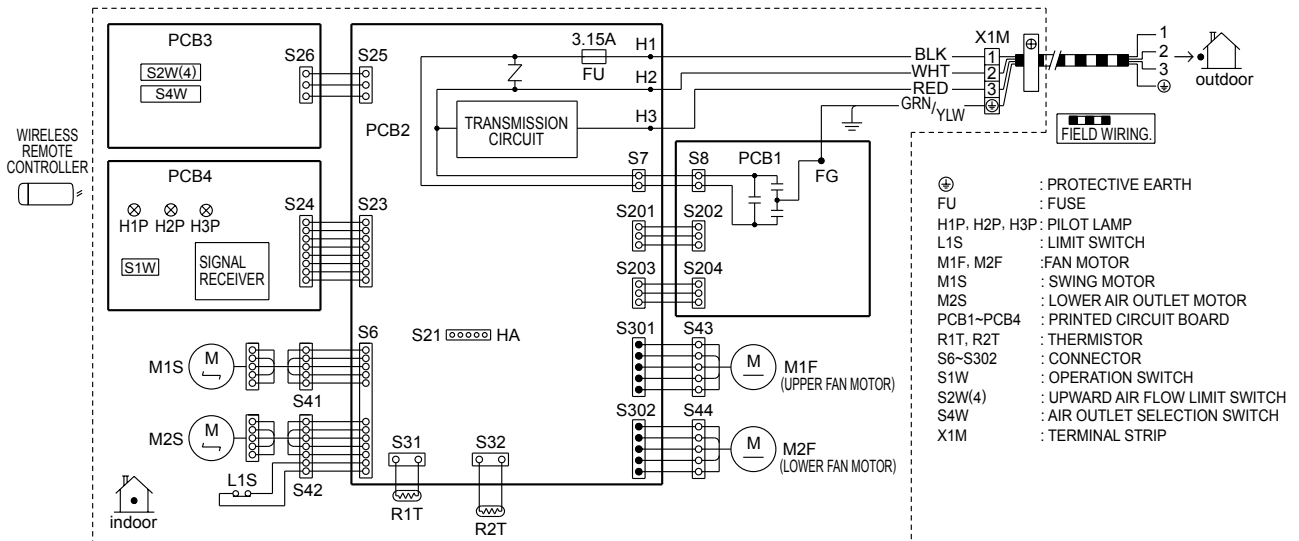

3D034713B

2.2 Outdoor Units

2.2.1 Cooling only

2MKD58BVM

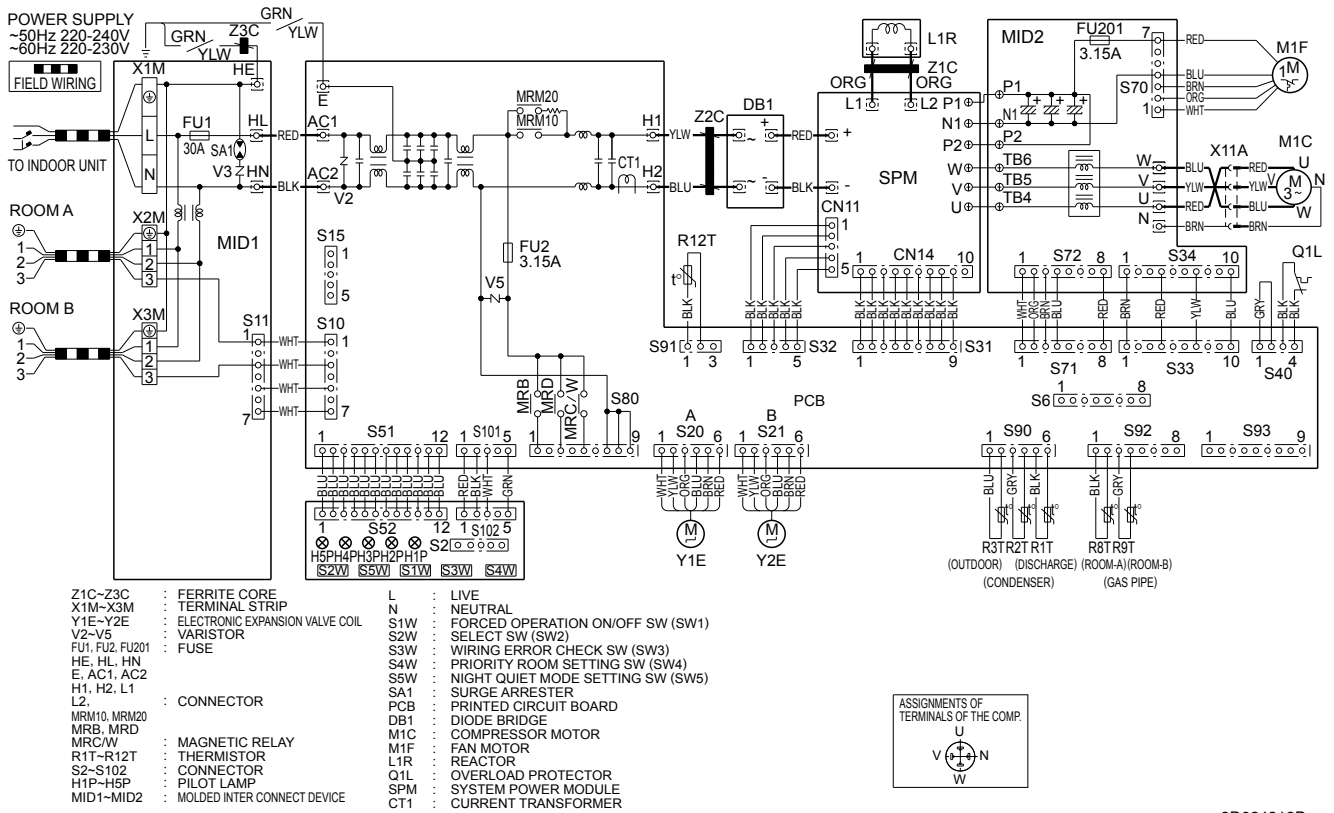

3D034318D

3MKD58/75BVM, 3MKD75BVMA

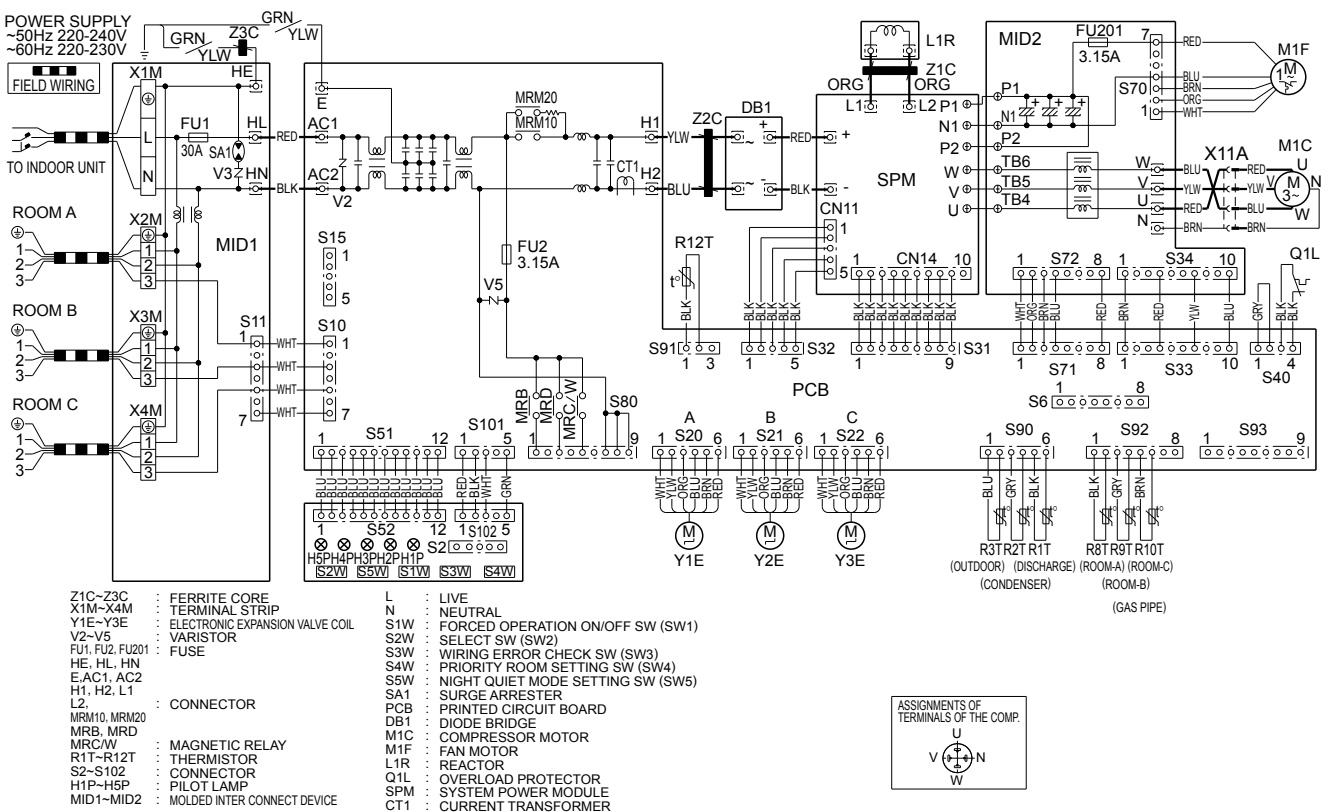

3D034317D

4MKD75/90BVM, 4MKD90BVMA

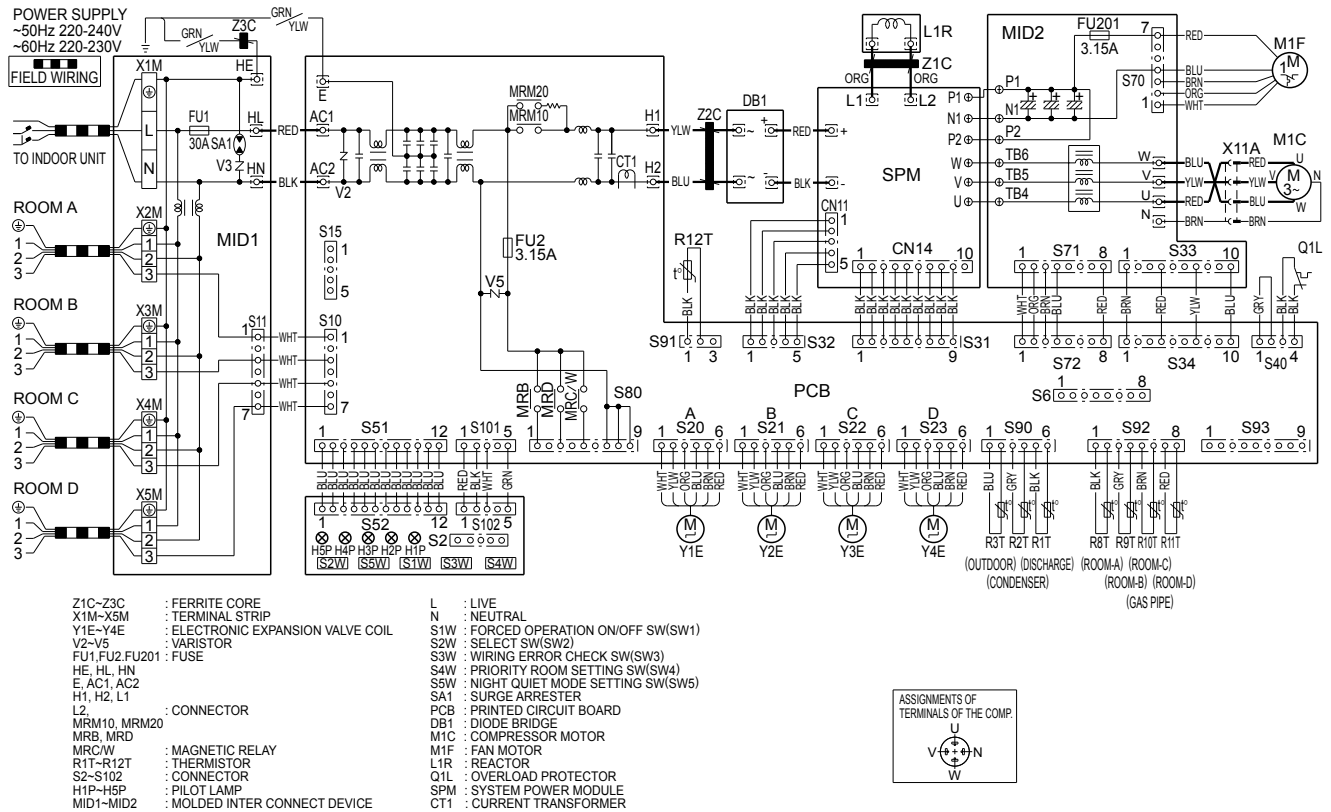

3D034848F

3MKS50BVMB(8)

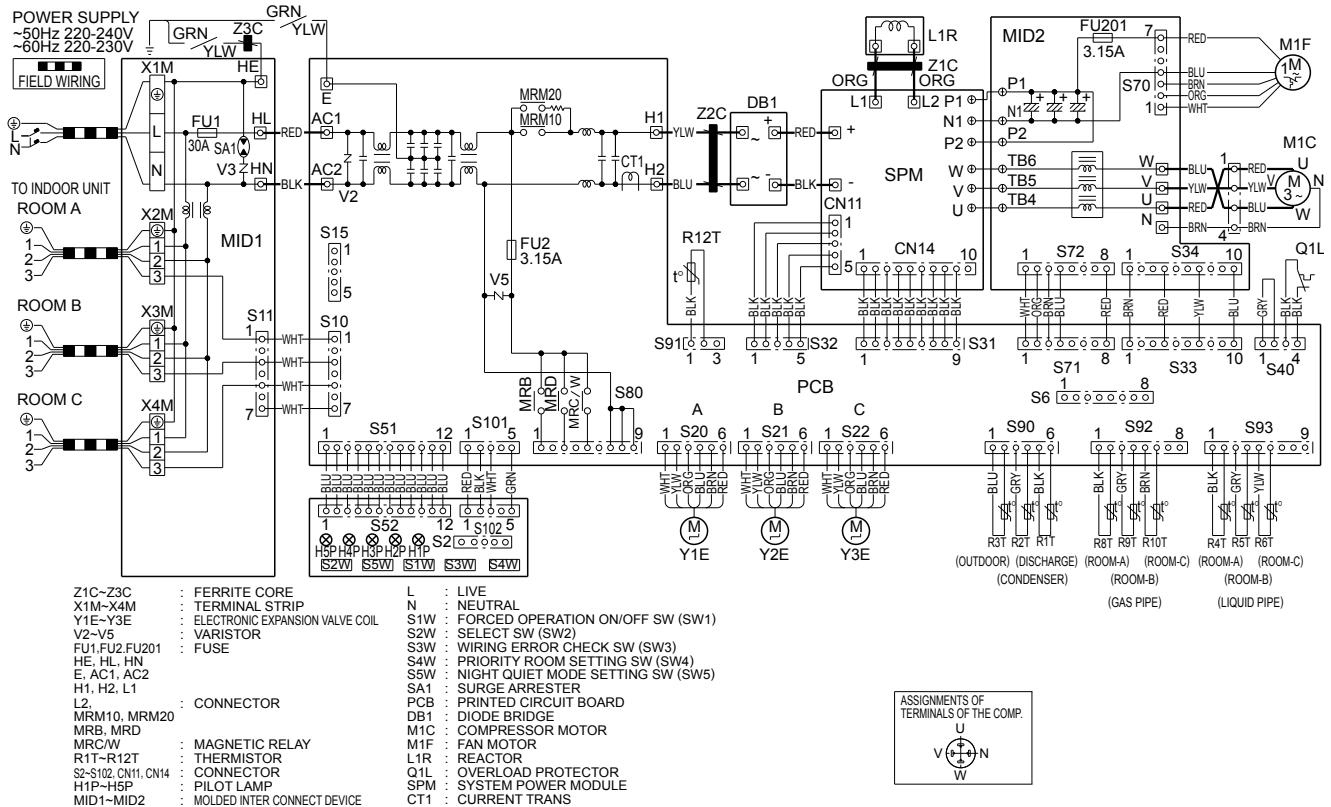

3D038533C

4MKS58BVMB(8), 4MKS75BVMB, 4MKS90BVMB

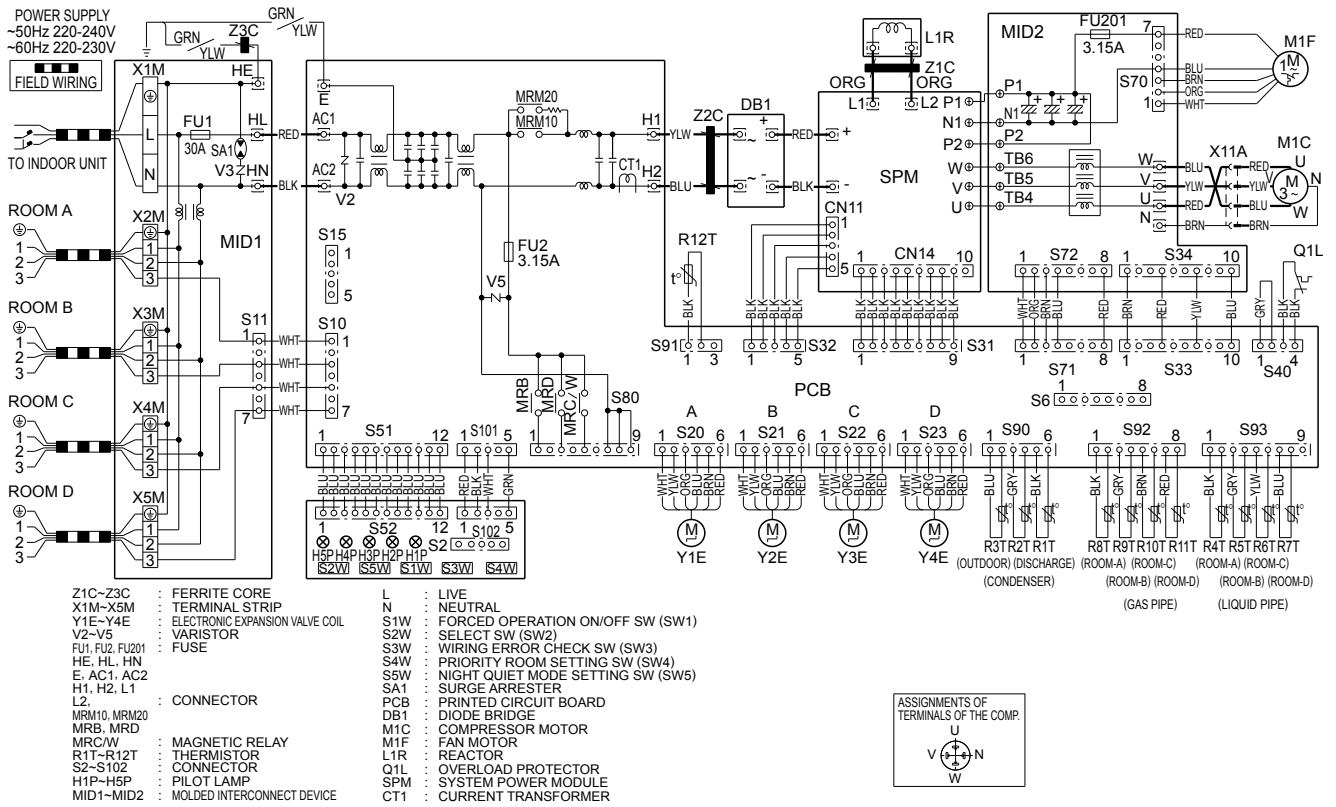

3D034315F

2.2.2 Heat Pump

3MXD68BVMA, 3MXS52BVMB(8), 3AMXS52BVMB

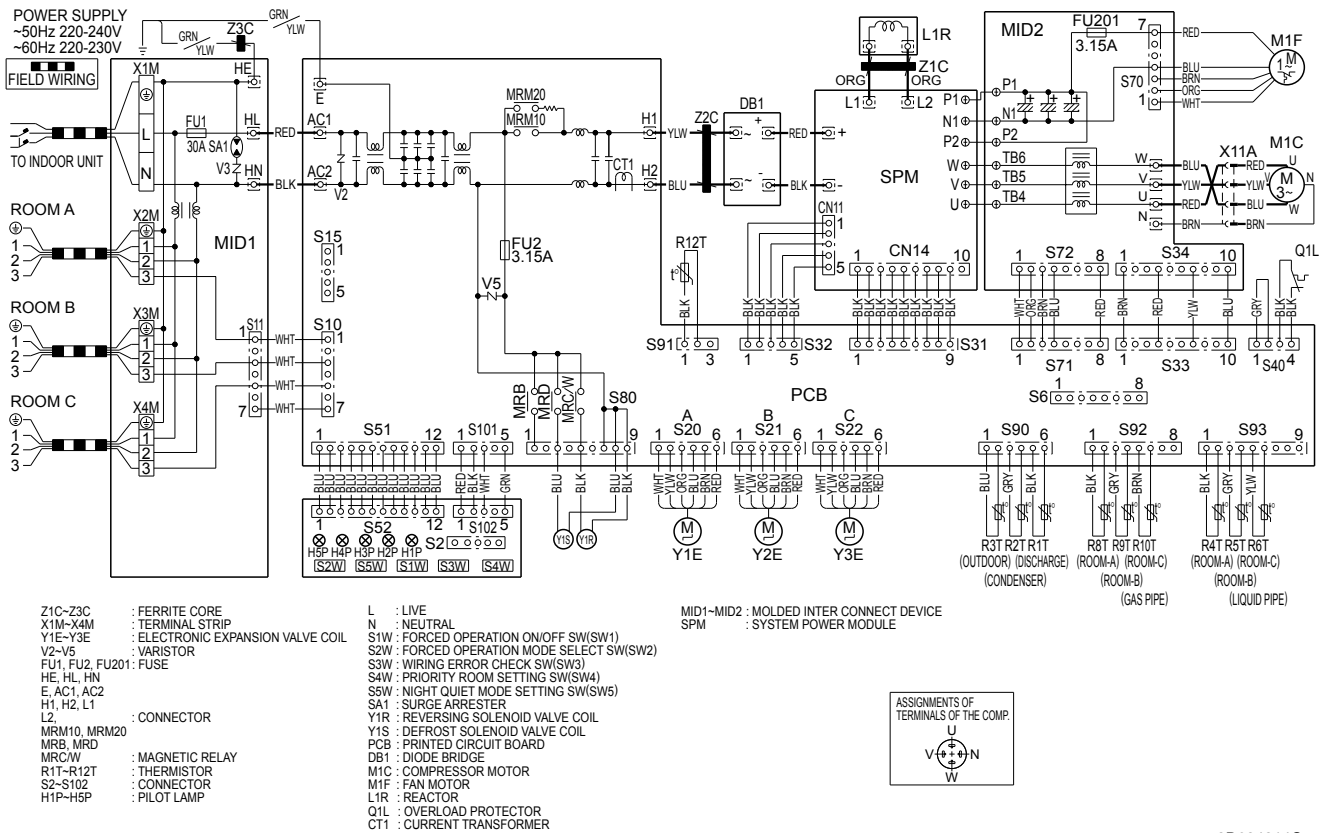

4MXD80BVMA, 4MXS68/80BVMB9, 4MXS68CVMA

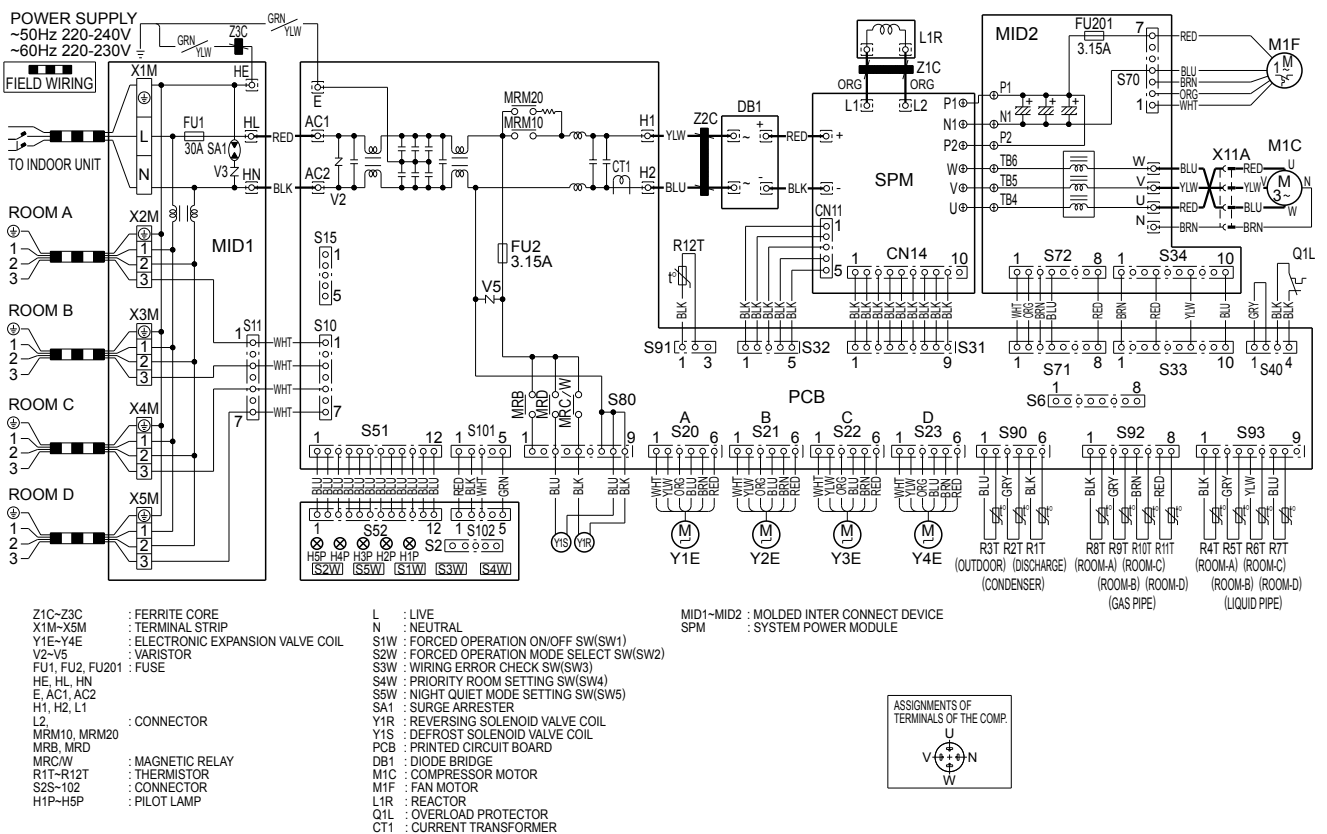

4MXS80CVMA

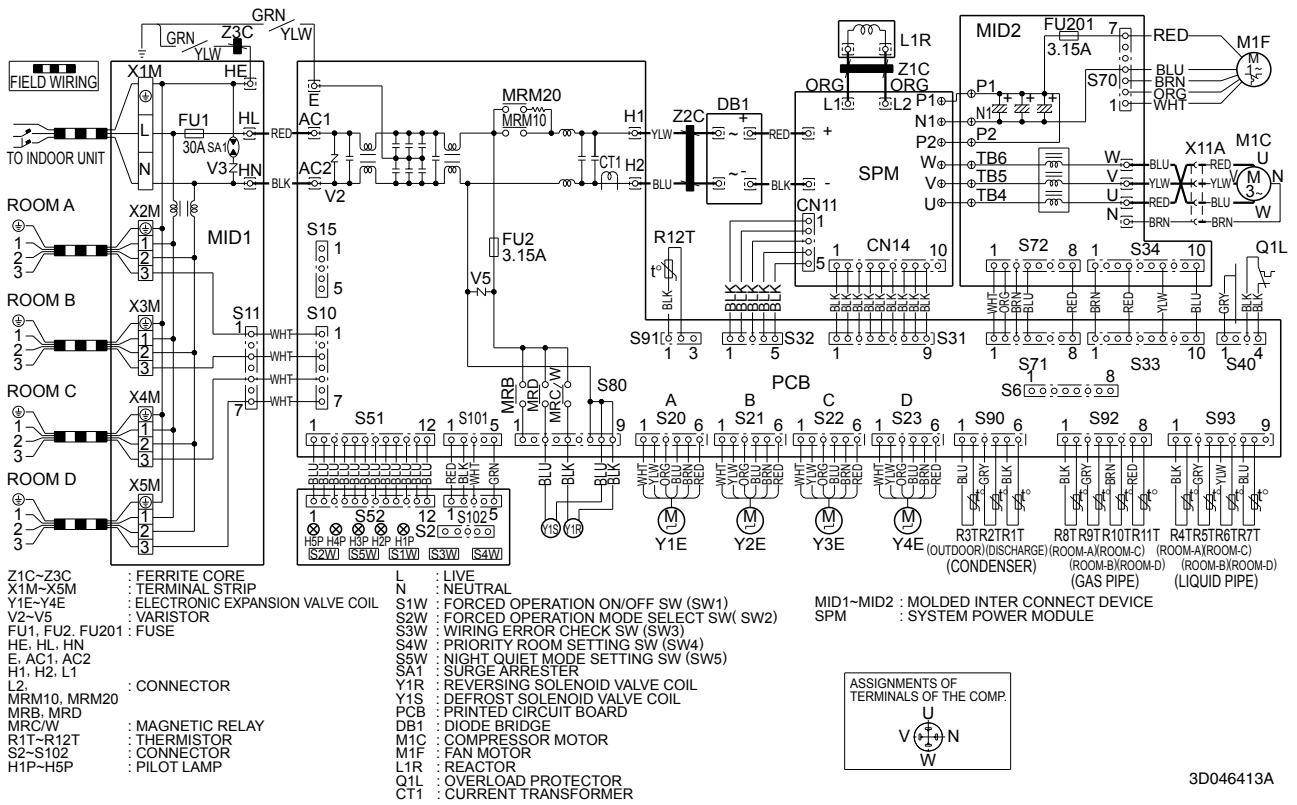

3D046413A

Index

Numerics

3 minutes stand-by	93
3-D airflow	74

A

A1	171
A5	172, 181
A6	174, 175
address setting jumper	58, 61, 63, 64, 66
adjusting the air flow direction	131
air purifying filter	83
air purifying filter with photocatalytic deodorizing function	83
anti-icing function in other rooms	205
ARC433A series	167
AUTO · DRY · COOL · HEAT · FAN operation	129
automatic air flow control	75
automatic operation	77
auto-restart function	84
auto-swing	74

B

buzzer PCB	62
------------------	----

C

C4	177
C7	178
C9	177
capacitor voltage check	213
care and cleaning	149
centralized control	58, 61, 63, 64
check No.01	206
check No.02	206
check No.10	212
check No.11	212
check No.12	213
check No.13	213
check No.14	214
check No.15	214
check No.16	215
check No.3	206
check No.4	207
check No.5	208
check No.6	209
check No.7	210
check No.8	211
check No.9	211
compressor	240, 256
compressor lock	184
compressor overload	183
compressor protection function	93
connection pipe condensation preventing function	107
control PCB	62, 63, 64, 68, 69, 248
controller PCB	231

cooling / heating mode lock	108
CT or related abnormality	192

D

DC fan lock	185
defrost control	97
discharge pipe	100
discharge pipe control	94
discharge pipe temperature control	190
discharge pipe thermistor	86, 88, 101, 253
discharge pressure check	211
display PCB	62, 63, 65, 68

E

E5	183
E6	184
E7	185
E8	186
EA	188
electrical box	222, 243
electrical box temperature rise	196
electronic expansion valve	234
electronic expansion valve check	207
electronic expansion valve coil	252
electronic expansion valve control	98
error codes	
A1	171
A5	172, 181
A6	174, 175
C4	177
C7	178
C9	177
E5	183
E6	184
E7	185
E8	186
EA	188
F3	190
H6	191
H8	192
H9	194
J3	194
J6	194
J8	194
J9	194
L3	196
L4	198
L5	200
P4	194
U0	202
U2	204
U4	179
UA	180, 205
UH	205
error codes and description of fault	168

F		J	
F3	190	J3	194
fan control	96	J4	259
fan motor	232, 250	J6	194
fan motor connector output check	206	J8	194
fan motor or related abnormality		J9	194
AC motor	174	JA	58, 61, 63, 64, 66, 259
DC motor	175	JB	58, 61, 63, 64, 66, 259
fan speed control	75	JC	58, 61, 63, 64, 66, 259
fan speed setting	58, 61, 63, 64, 66	jumper setting	259
forced operation mode	104	L	
four way valve	238, 254	L3	196
four way valve abnormality	188	L4	198
four way valve coil	252	L5	200
four way valve operation compensation	93	LED A	58, 61, 63, 64, 66
four way valve performance check	208	LED1	58, 61, 63, 64
four way valve switching	93	LED11	66
freeze-up protection control	95, 181	LED12	66
freeze-up protection control or high pressure control		LED14	66
.....	172	LED2	58, 61, 63, 64
frequency control	91	LED3	58, 61, 63, 64
frequency principle	72	limit switch continuity check	206
FU	66	liquid pipe thermistor	231, 244, 253
FU1	58, 61, 63, 64	low Hz high pressure limit	98
functions	2	low-voltage detection	204
fuse	61	M	
G		main circuit electrolytic capacitor check	214
gas pipe isothermal control during cooling	100	main structural parts	85
gas pipe thermistor	86, 88, 231, 244, 253	mode hierarchy	90
H		moisture protection function 2	96
H6	191	mold proof air filter	83
H8	192	N	
H9	194	names of parts	114
HA	61	night set mode	78
Hall IC	75, 174, 175	note for multi system	147
Hall IC check	215	O	
heat exchanger thermistor	253	oil recovery function	100
heating peak-cut control	95	OL activation	183
HOME LEAVE operation	81, 139	ON/OFF button on Indoor unit	83
hot start function	83	opening limit	100
I		operation lamp	164
indoor heat exchanger thermistor	87, 89	outdoor air thermistor	253
indoor liquid pipe thermistor	87	outdoor heat exchanger thermistor	86, 88
indoor unit PCB abnormality	171	outdoor unit fan system check (with DC motor) ...	211
input current control	94	OUTDOOR UNIT SILENT operation	138
input over current detection	186	outer panels	218, 242
installation condition check	210	output over current detection	200
insufficient gas	202	over current	103
insufficient gas control	103	overload	103
INTELLIGENT EYE	79	overload relay	244
INTELLIGENT EYE operation	141	P	
INTELLIGENT EYE sensor	260	P4	194
INTELLIGENT EYE sensor PCB	62	PCB	229, 247
inverter PCB	231, 249	photocatalytic deodorizing filter	83
inverter powerful operation	82	PI control	92
inverter units refrigerant system check	212	piping diagrams	262

- position sensor abnormality191
power failure recovery function58, 61, 63, 64, 66
power supply PCB.....65, 67
power supply waveforms check212
power transistor check213
power-airflow dual flaps74
POWERFUL operation137
POWERFUL operation mode107
preheating operation93
preparation before operation126
pressure equalization control100
preventing indoor freezing104
printed circuit board connector wiring diagram58
priority room setting107
problem symptoms and measures166
programme dry function76
propeller fans221
- R**
radiation fin temperature rise198
reactor235
RTH158, 61, 63
- S**
S158, 61, 63
S2069, 224, 231, 244
S20166
S20266
S20366
S20466
S2158, 61, 63, 64, 66, 69, 224, 231, 244
S2269, 224, 231, 244
S2366, 69, 224, 231, 244
S2464, 66
S2564, 66
S2658, 61, 63, 64, 66
S2758, 61, 64
S2861
S2961
S30166
S30266
S3164, 66, 69, 231, 248
S3258, 61, 63, 64, 66, 69, 231, 248
S3369, 231, 248
S3558, 61
S3661, 64
S3761, 64
S3861
S4069, 225, 231, 244
S658, 61, 64, 66
S758, 63, 64, 66
S70232
S7169, 231, 248
S861, 66
S8069, 224, 231, 244
S9069, 225, 231, 244, 253
S9269, 225, 231, 244, 253
S9369, 224, 231, 244, 253
SC control101
self-diagnosis digital display84
sensor malfunction detection103
- service check function 167
service monitor PCB 231, 247, 249
shunt 237, 254, 255
shutter drive motor / shutter limit switch abnormality
..... 178
signal receiver PCB..... 62, 65, 68
signal receiving sign 83
signal transmission error (between indoor and outdoor
units) 179
solenoid valve 238, 254, 255
solenoid valve coil 252
sound insulation 235, 251
specifications 18
starting operation control / changing operation room
..... 100
SW1 61, 63, 64, 66
SW2 64, 66
SW4 66
SW7 58
- T**
target discharge pipe temperature control 101
test run from the remote controller 258
thermistor 231, 234, 244, 252
thermistor or related abnormality (indoor unit) 177
thermistor or related abnormality (outdoor unit) ... 194
thermistor resistance check 209
TIMER operation 145
troubleshooting 159
troubleshooting
indoor units 169
outdoor units 170
troubleshooting with the LED indication 165
troubleshooting with the operation lamp 164
turning speed pulse input on the outdoor unit PCB
check 214
- U**
U0 202
U2 204
U4 179
UA 180, 205
UH 205
unspecified voltage (between indoor and outdoor
units) 180, 205
- V**
V1 58, 61, 63, 64, 66
voltage detection function 107
- W**
wide-angle louvers 74
wiring diagrams 273
wiring-error check 105

Drawings & Flow Charts

A			
anti-icing function in other rooms	205		
automatic air flow control	75		
automatic operation.....	77		
auto-swing.....	74		
B			
buzzer PCB	62		
C			
capacitor voltage check.....	213		
compressor lock	184		
compressor overload.....	183		
compressor protection function	93		
control PCB	63, 64, 68, 69		
control PCB (indoor unit).....	62		
cooling / heating mode lock.....	108		
CT or related abnormality.....	192		
D			
DC fan lock.....	185		
defrost control	97		
discharge pipe control	94		
discharge pipe temperature control.....	190		
discharge pressure check	211		
display PCB.....	62, 63, 65, 68		
E			
electrical box temperature rise	196		
electronic expansion valve check.....	207		
electronic expansion valve control	98		
F			
fan motor connector output check.....	206		
fan motor or related abnormality			
AC motor	174		
DC motor	175		
four way valve abnormality.....	188		
four way valve performance check.....	208		
freeze-up protection control	95, 181		
freeze-up protection control or high pressure control			
.....	172		
frequency control.....	91		
frequency principle	72		
function of thermistor.....	86		
cooling only model.....	88		
heat pump model.....	86		
H			
Hall IC check	215		
heating peak-cut control.....	95		
HOME LEAVE operation.....	81		
I			
indoor unit PCB abnormality	171		
input current control	94		
input over current detection.....	186		
installation condition check	210		
insufficient gas	202		
insufficient gas control.....	103		
INTELLIGENT EYE	79		
INTELLIGENT EYE sensor PCB.....	62		
inverter features	73		
inverter powerful operation.....	82		
inverter units refrigerant system check.....	212		
L			
limit switch continuity check	206		
location of operation lamp	164		
low Hz high pressure limit	98		
low-voltage detection	204		
M			
main circuit electrolytic capacitor check	214		
main structural parts.....	85		
mode hierarchy	90		
N			
night set mode.....	78		
O			
OL activation	183		
ON/OFF button on indoor unit.....	83		
outdoor unit fan system check (with DC motor) ..	211		
output over current detection	200		
P			
PCB.....	59		
PCB detail	60		
piping diagrams			
indoor units	262		
outdoor units	266		
position sensor abnormality	191		
power supply PCB.....	65, 67		
power supply waveforms check	212		
power transistor check	213		
priority room setting.....	107		
programme dry function	76		
R			
radiation fin temperature rise	198		
S			
shutter drive motor / shutter limit switch abnormality			
.....	178		
signal receiver PCB.....	62, 65, 68		
signal transmission error (between indoor and outdoor			
units)	179		

T

target discharge pipe temperature control	101
thermistor or related abnormality (indoor unit)	177
thermistor or related abnormality (outdoor unit)	194
thermistor resistance check	209
troubleshooting with the LED indication	165
turning speed pulse input on the outdoor unit PCB check.....	214

U

unspecified voltage (between indoor and outdoor units)	180, 205
---	----------

W

wiring diagrams	
indoor units	273
outdoor units	276
wiring-error check.....	105

Warning



- Ask a qualified installer or contractor to install this product. Do not try to install the product yourself. Improper installation can result in water or refrigerant leakage, electrical shock, fire or explosion.
- Use only those parts and accessories supplied or specified by Daikin. Ask a qualified installer or contractor to install those parts and accessories. Use of unauthorized parts and accessories or improper installation of parts and accessories can result in water or refrigerant leakage, electrical shock, fire or explosion.
- Read the User's Manual carefully before using this product. The User's Manual provides important safety instructions and warnings. Be sure to follow these instructions and warnings.

For any inquiries, contact your local distributor.

Cautions on product corrosion

1. Air conditioners should not be installed in areas where corrosive gases, such as acid gas or alkaline gas, are produced.
2. If the outdoor unit is to be installed close to the sea shore, direct exposure to the sea breeze should be avoided and choose an outdoor unit with anti-corrosion treatment.



The air conditioners manufactured by Daikin Industries have received **ISO 9001** certification for quality assurance.

Certificate Number. JMI-0107
JQA-0495
JQA-1452



All Daikin Industries locations and subsidiaries in Japan have received environmental management system standard **ISO 14001** certification.

Daikin Industries, Ltd.
Domestic Group
Certificate Number. EC99J2044

About ISO 14001

ISO 14001 is the standard defined by the International Organization for Standardization (ISO) relating to environmental management systems. Our group has been acknowledged by an internationally accredited compliance organisation as having an appropriate programme of environmental protection procedures and activities to meet the requirements of ISO 14001.

Dealer

DAIKIN INDUSTRIES, LTD.

Head Office:
Umeda Center Bldg., 4-12, Nakazaki-Nishi
2-chome, Kita-ku, Osaka, 530-8323 Japan

Tokyo Office:
JR Shinagawa East Bldg., 18-1, Konan
2-chome, Minato-ku, Tokyo, 108-0075 Japan
<http://www.daikin.com/global/>

©All rights reserved