



Product Catalog

Networking

Security

Digital Signage

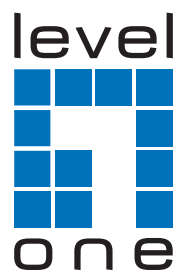
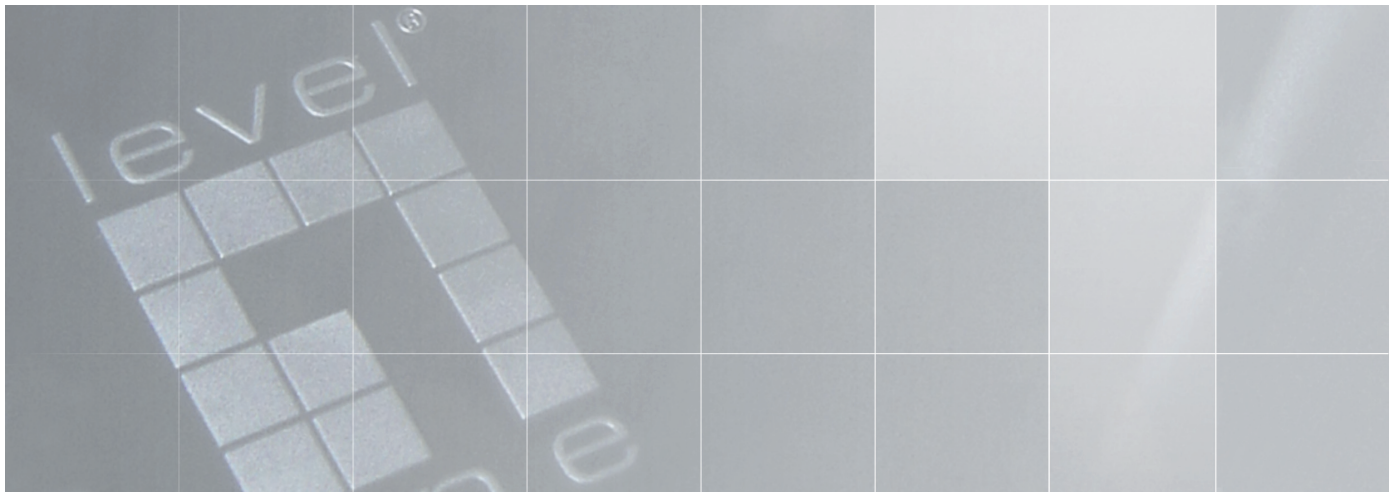

LevelOne was established in 1998 by Digital Data Communications GmbH, Dortmund, Germany. By providing quality networking products and solutions, we've grown steadily throughout the years with Branch Offices in 18 countries around the world.

The Internet has become a deeply integral part of both business and home life. Our years of experience have taught us that the only way to stay on top of the latest technology and trends is by listening carefully to what the customer says.

DDC was established in 1991 and is headquartered in Germany, and also maintains branches in Taiwan, Australia, Belgium, Brasil, Colombia, Denmark, Greece, Italy, Kenya, the Netherlands, Portugal, Slovenia, Spain, U.A.E. We are currently achieving year-on-year increase in turn-over. Our Production, Development, Distribution and Logistic Centers are growing in number and setting new quality standards throughout the world with powerful and recognizable brand names.

Please take a look through this catalog and if you have any question or inquiries you can contact us at **sales@level1.com**



Contents

Home

Networking	Page 3
Security	Page 15

Business

Networking	Page 20
Security	Page 59
Digital Signage	Page 70

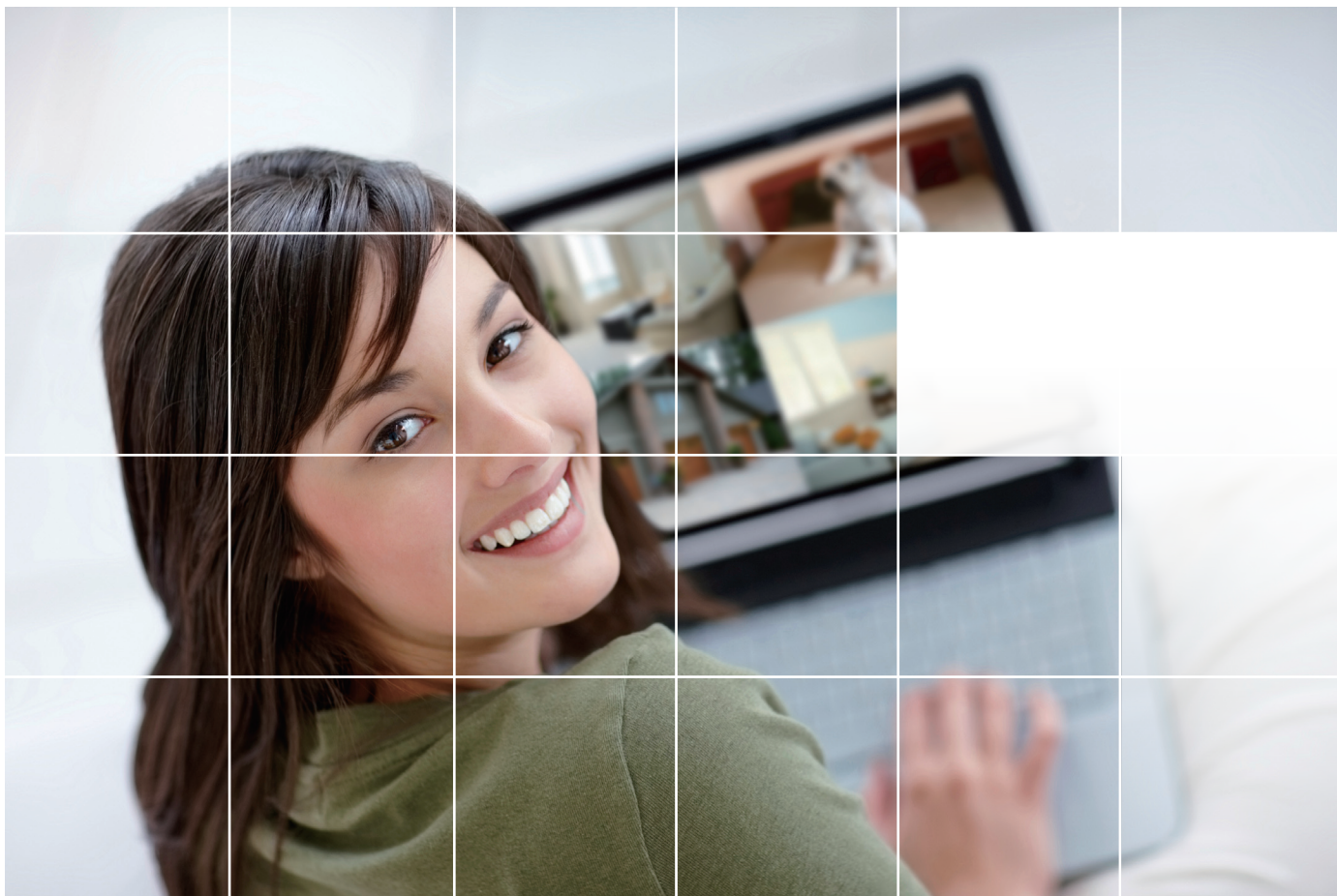

Home

Networking

Ethernet Switch	>03
Router	>04-05
Network Adapter	>06-07
Antennas	>08
Powerline Communication	>09-10
Network Attached Storage	>11-12
KVM Switch	>13-14

Security

Fixed Network Camera	>15-16
P/T Network Camera	>17
Network Video Recorder	>18

Allowing users to either create a Local Area Network (LAN) or connect additional network devices, such as network cameras, storage devices or print servers. The built-in store-and-forward architecture filters errors and forwards packets in a non-blocking environment.

Key Features

- Complies with IEEE 802.3(10Mbps), 802.3u(100Mbps), 802.3ab (1000Mbps)
- Features store-and-forward architecture
- Provides half-duplex and full-duplex auto-detection
- Supports Auto-MDI/MDI-X for each port
- Front-panel diagnostic LEDs
- Wire-speed and non-blocking forwarding rate
- Supports IEEE 802.3x full-duplex / half-duplex backpressure flow control

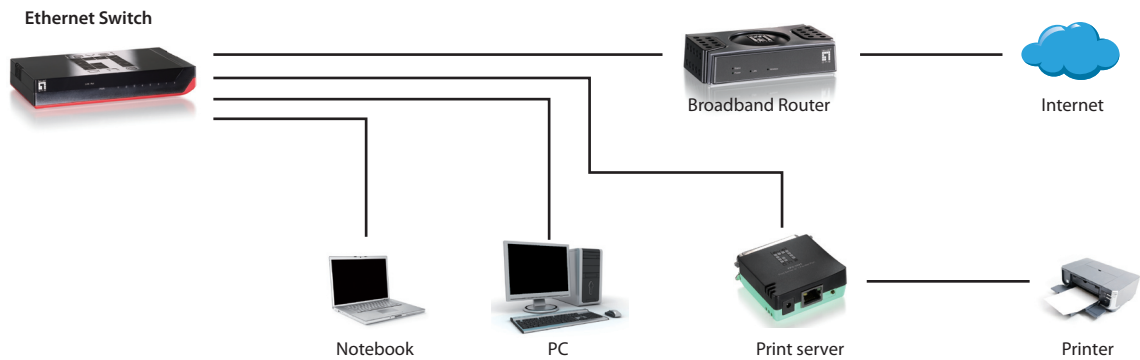

Unmanaged Fast Ethernet Switch



FSW-0508TX
5-Port Fast Ethernet Switch



FSW-0808TX
8-Port Fast Ethernet Switch



FSW-0511
5-Port Fast Ethernet Switch



FSW-0811
8-Port Fast Ethernet Switch

Unmanaged Gigabit Ethernet Switch



GSW-0507
5-Port Gigabit Switch



GSW-0807
8-Port Gigabit Switch



Ethernet Switch Comparison						
Model	FSW-0508TX	FSW--0808TX	FSW-0511	FSW-0811	GSW-0507	GSW-0807
10/100 Mbps Port	5	8	5	8	-	-
10/100/1000 Mbps Port	-	-	-	-	5	8
Mac Address Table	2K	1K	1K	1K	8K	8K
Jumbo Frame	-	-	-	-	9K	9K
Buffer Memory	48KB	96KB	128KB	96KB	125KB	125KB
Green Technology	-	-	V	V	V	V

LevelOne Routers and 3G Routers are great addition to any network, either wired or wireless products, users can choose from many options to deploy, to share and to manage the network.

Key Features

- All wireless routers support Auto-Channel Selection to avoid interference from neighbors
- All wireless routers contain simple wireless security with push WPS button
- Supports Virtual Private Network (VPN) pass-through and Dynamic Domain Name System (DDNS)
- NAT firewall with SPI mode, DoS Detection and access control supported
- Quick and easy installation wizard

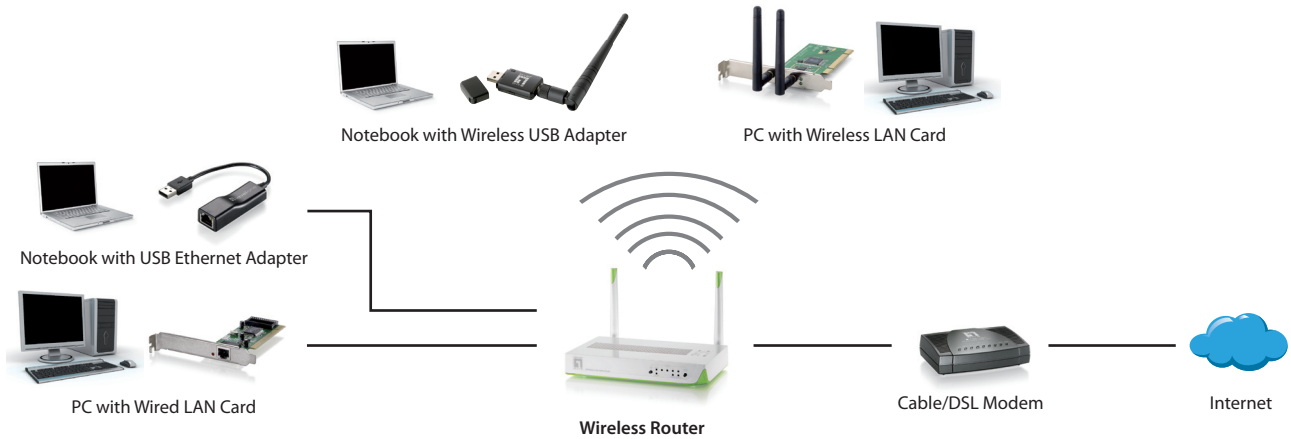

Wired/Wireless Router



FBR-1418TX / FBR-1430
Broadband Router /
VPN Broadband Router



WBR-6003
150Mbps Wireless Router



WBR-6020
300Mbps Wireless Router



WGR-6012
300Mbps Wireless Gigabit Router



WBR-6022
300Mbps Wireless HomeGuard22 Router



WBR-6012
300Mbps Wireless Router

Wired/Wireless Router Comparison						
Model	FBR-1418TX/ FBR-1430	WBR-6003	WBR-6020	WGR-6012	WBR-6022	WBR-6012
LAN	4 x 10/100Mbps	4 x 10/100Mbps	4 x 10/100Mbps	4 x 10/100/1000Mbps	4 x 10/100Mbps	4 x 10/100Mbps
WAN (Internet)	1 x 10/100Mbps	1 x 10/100Mbps	1 x 10/100Mbps	1 x 10/100/1000Mbps	1 x 10/100Mbps	1 x 10/100Mbps
Wireless	-	150Mbps	300Mbps	300Mbps	300Mbps	300Mbps
Antenna	-	1 x 5dBi (Fixed/ External Detachable)	2 x 2dBi (External Detachable) 1 x 2dBi (Internal)	2 x 2dBi (External Detachable) 1 x 2dBi (Internal)	2 x 2dBi (External Detachable)	2 x 2dBi (External Detachable) (Optional 5dBi)
WDS	-	V	V	V	V	V
WPS	-	V	V	V	V	V
Built-in modem	-	-	-	-	-	-
Wireless Signal On/Off	-	V	V	V	V	-
Green Technology	-	-	V	V	V	V

Wired/Wireless Router



WGR-6013
300Mbps Wireless Gigabit Router



WBR-6801
150Mbps Wireless Portable 3G Router



WBR-6802
150Mbps Wireless Travel Router



WBR-6803
150Mbps Wireless 3G Travel Router



WBR-6804
150Mbps Wireless Dual-WAN 3G Router



WBR-6805
300Mbps Wireless Travel Router

Wired/Wireless Router Comparison						
Model	WGR-6013	WBR-6801	WBR-6802	WBR-6803	WBR-6804	WBR-6805
LAN	4 x 10/100/1000 Mbps	-	1 x 10/100Mbps	1 x 10/100Mbps ,	4 x 10/100Mbps	1 x 10/100Mbps
WAN(Internet)	1 x 10/100/1000 Mbps	1 x USB	1 x 10/100Mbps	1 x USB (WAN Only)	1 x 10/100Mbps	1 x 10/100Mbps / 1 x USB
Wireless	300Mbps	150Mbps	150Mbps	150Mbps	150Mbps	300Mbps
Antenna	2 x 2 dBi(Fixed External) (Optional 5 dBi)	1 x 2dBi (Internal)	1 x 2dBi (Internal)	1 x 2dBi (Internal)	1 x 2dBi (Fixed External)(Optional 5dBi)	1 x 2dBi (Fixed External) 1 x 2dBi (Internal)
WDS	V	-	-	-	V	-
WPS	V	V	V	V	V	V
Built-in modem	-	-	-	-	-	-
Wireless Signal On/Off	V	V	V	V	V	V
Green Technology	V	-	V	-	-	V

Wired/Wireless Modem Router

N/A in AU



FBR-1161 Annex A/B
ADSL2+ Modem Router

N/A in AU



FBR-1461 Annex A/B
ADSL2+ Modem Router with QoS



WBR-6603
150Mbps Wireless ADSL2+ Modem Router

N/A in AU



WBR-6601 Annex A/B
150Mbps Wireless ADSL2+ Modem Router

Wired/Wireless Modem Router Comparison				
Model	FBR-1161	FBR-1461	WBR-6603	WBR-6601
LAN	1 x 10/100Mbps	4 x10/100Mbps	4 x 10/100Mbps	4 x10/100Mbps
WAN (Internet)	1 x RJ-11	1 x RJ-11	1 x RJ-11	1 x RJ-11
Wireless	-	-	150Mbps	150Mbps
Antenna	-	-	1 x 2dBi (Fixed External)	1 x (External Detachable)
WDS	-	-	V	V
WPS	-	-	V	V
Built-in modem	ADSL2+	ADSL2+	ADSL2+	ADSL2+
Wireless Signal On/Off	-	-	V	V
Green Technology	-	-	-	-

The LevelOne USB Network Adapter allow you to connect to the Internet easily through the built-in USB port on your laptop or gaming console. Network PCI Card are highly integrated and cost-effective add-on solution for desktop PC.

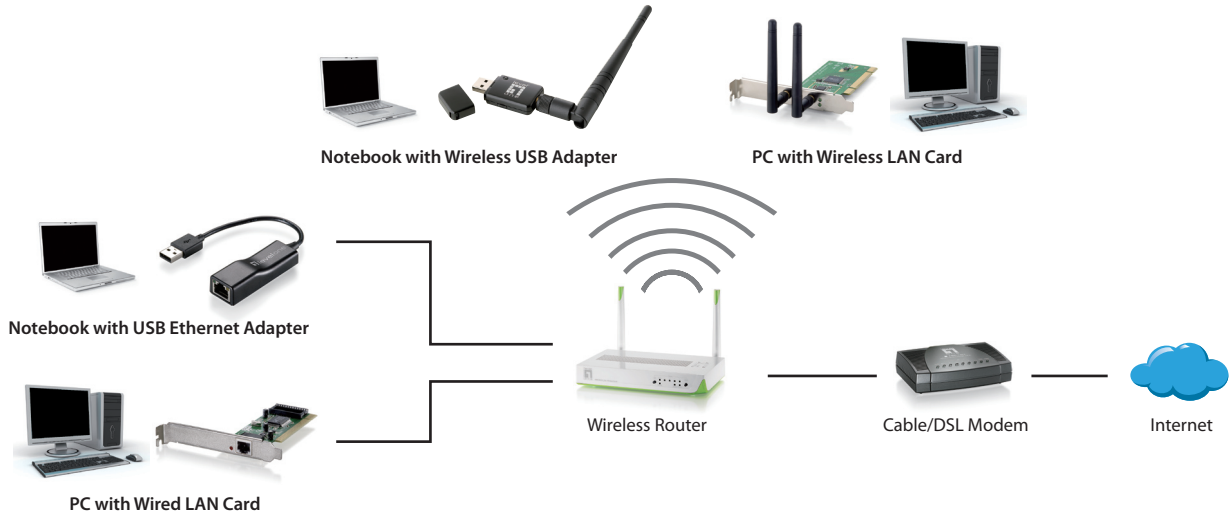

Wired Network Adapter

- Complies with IEEE 802.3(10Mbps), 802.3u(100Mbps), 802.3ab (1000Mbps)
- Provides Plug and Play for easy installation



FNC-0107TX
Fast Ethernet PCI Card with Wake-on-LAN



FNC-0109TX
Fast Ethernet PCI Card



USB-0301
USB Fast Ethernet Adapter



USB-0401
USB Gigabit Ethernet Adapter



USB-0501
USB Hub and Fast Ethernet Combo Adapter

Wired Network Adapter Comparison					
Model	FNC-0107TX	FNC-0109TX	USB-0301	USB-0401	USB-0501
Interface	PCI	PCI	USB 2.0	USB 3.0	USB 2.0
Ethernet Port	1 x 10/100Mbps	1 x 10/100Mbps	1 x 10/100Mbps	1x 10/100/1000Mbps	1 x 10/100Mbps
Jumbo Frame	-	-	-	4K	-
Wake-on-LAN	V	-	V	V	-
Mac OS Compatible	-	-	V	V	V
USB Hub	-	-	-	-	4 x USB

Wireless Network Adapter

- Supports Auto-Channel Selection to avoid interference from neighbors
- Supports 64/128-bit WEP, WPA, WPA2 encryption for high level security
- Operation at 2.4GHz frequency band to meet worldwide regulations
- Provides Plug and Play for easy installation



WNC-0301
54Mbps Wireless PCI Card



WNC-0601
300Mbps Wireless PCI Card



WPC-0600
300Mbps Wireless CardBus Adapter



WUA-0606
150Mbps Wireless USB Adapter

Wireless Network Adapter Comparison				
Model	WNC-0301	WNC-0601	WPC-0600	WUA-0606
Interface	PCI	PCI	CardBus	USB 2.0
Antenna	1 x 2 dBi (External Detachable)	2 x 2dBi (External Detachable)	2 x 2dBi (Internal)	1 x 2dBi (Internal)
Wireless	54Mbps (11b/g)	300Mbps (11b/g/n)	300Mbps (11b/g/n)	150Mbps (11b/g/n)
WPS	-	V	V	V
Optional Accessories	-	-	-	SUS-1003 USB stand with Cable Organizer

Wireless Network Adapter



WUA-0614
150Mbps Wireless Nano USB Adapter



WUA-0624
150Mbps Wireless Nano USB Adapter



WUA-0605
300Mbps Wireless USB Adapter



WUA-0616
300Mbps Wireless USB Adapter



WUA-1610
300Mbps Wireless USB Adapter



WUA-1610H
300Mbps Wireless USB Adapter

Wireless Network Adapter Comparison						
Model	WUA-0614	WUA-0624	WUA-0605	WUA-0616	WUA-1610	WUA-1610H
Interface	USB 2.0	USB 2.0	USB 2.0	USB 2.0	USB 2.0	USB 2.0
Antenna	1 x 2dBi (External Detachable)	1 x 5dBi (External Detachable)	2 x 2dBi (Internal)	2 x 2dBi (Internal)	2 x 2dBi (External Detachable)	2 x 5dBi (External Detachable)
Wireless	150Mbps (11b/g/n)	150Mbps (11b/g/n)	300Mbps (11b/g/n)	300Mbps (11b/g/n)	300Mbps (11b/g/n)	300Mbps (11b/g/n)
WPS	V	V	V	V	V	V
Optional Accessories	SUS-1003 USB stand with Cable Organizer				-	-

LevelOne Antennas offer a stronger and more stable wireless network connection for IEEE 802.11b/g/n wireless applications in 2.4GHz frequency range, such as wireless routers and access points.

Key Features

- Compliance with IEEE 802.11b/g/n wireless application in 2.4GHz frequency range
- Reverse SMA plug connector for easy replacement of standard antennas
- Omni-directional operation
- Provides a stable signal and extending coverage

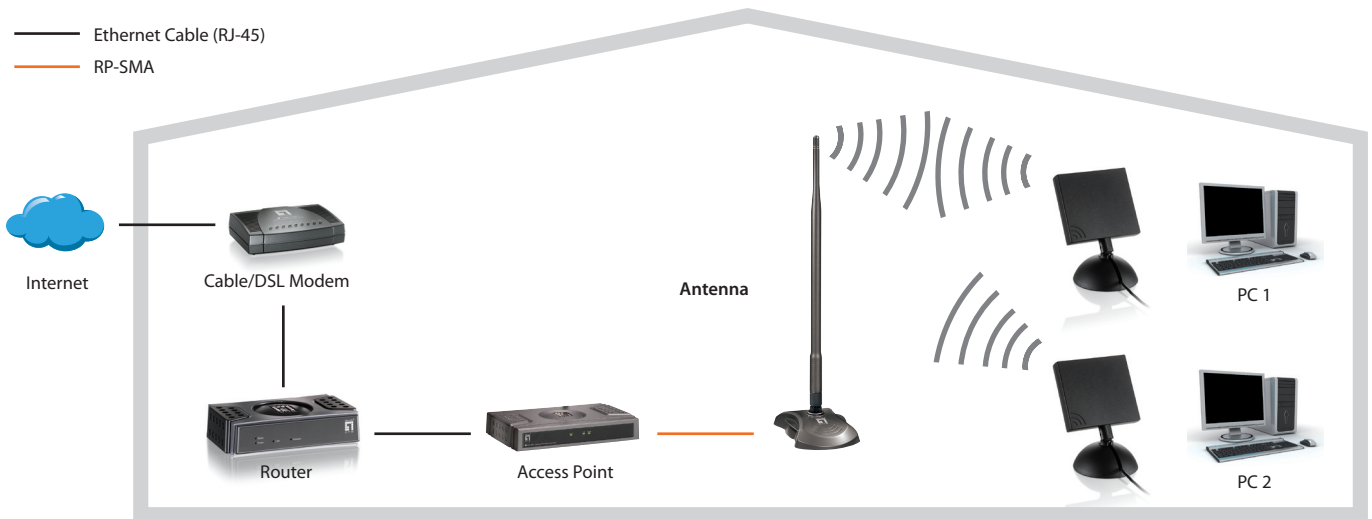

OAN-0501
5dBi Omni-Directional Indoor Antenna



OAN-1070
7dBi Omni-Directional Indoor Antenna

Antenna Comparison		
Model	OAN-0501	OAN-1070
Gain	5dBi	7dBi
Range (Estimated)	40~200m	60~400m
Extension Cable	-	V

Following the latest (Homeplug AV) standard set by the HomePlug Powerline Alliance, HomePLUG offers networking over the electrical wiring in your home. It's fast, safe, and easy to deploy. Great for streaming HDTV to other rooms as well as access points.

Key Features

- Supports Auto-Channel Selection to avoid interference from neighbors
- 128-bit AES link encryption with key management
- Security push button for software free configuration (WPS)
- Sends data over your home's existing electrical wiring
- Provides Plug and Play for easy installation
- LED display for HomePLUG linking quality

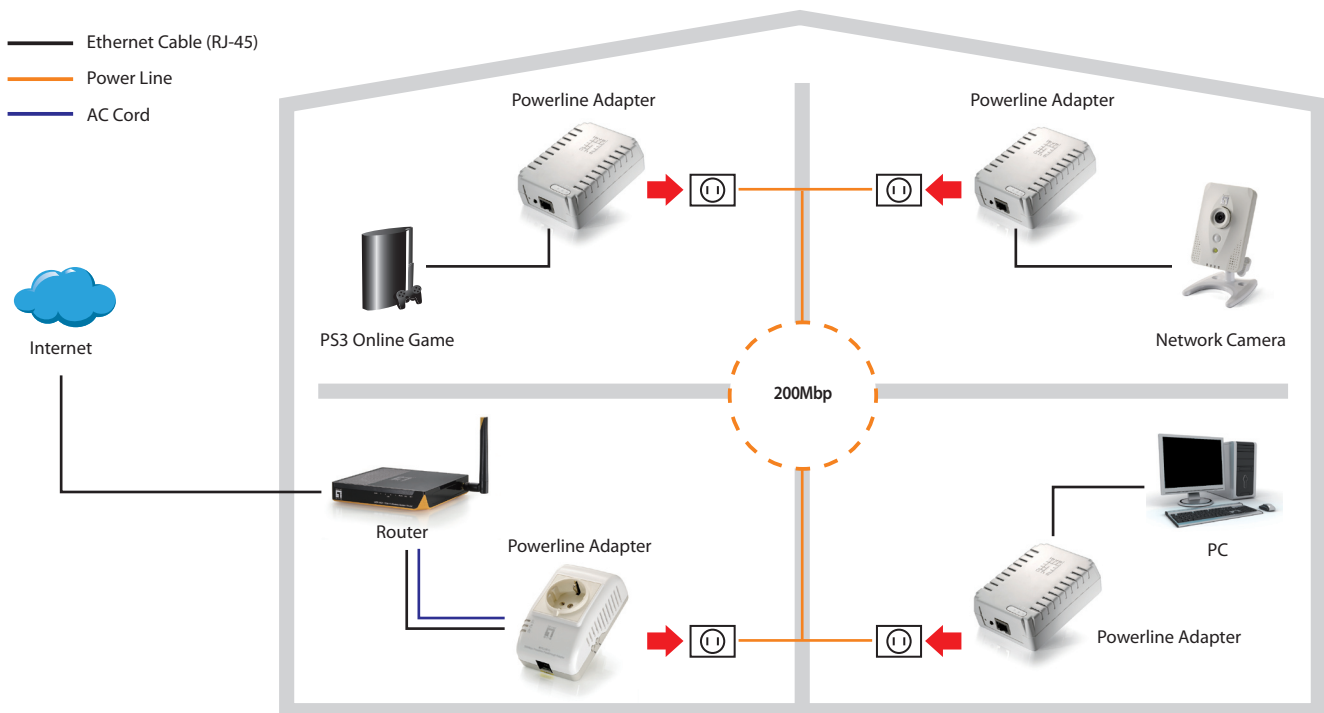
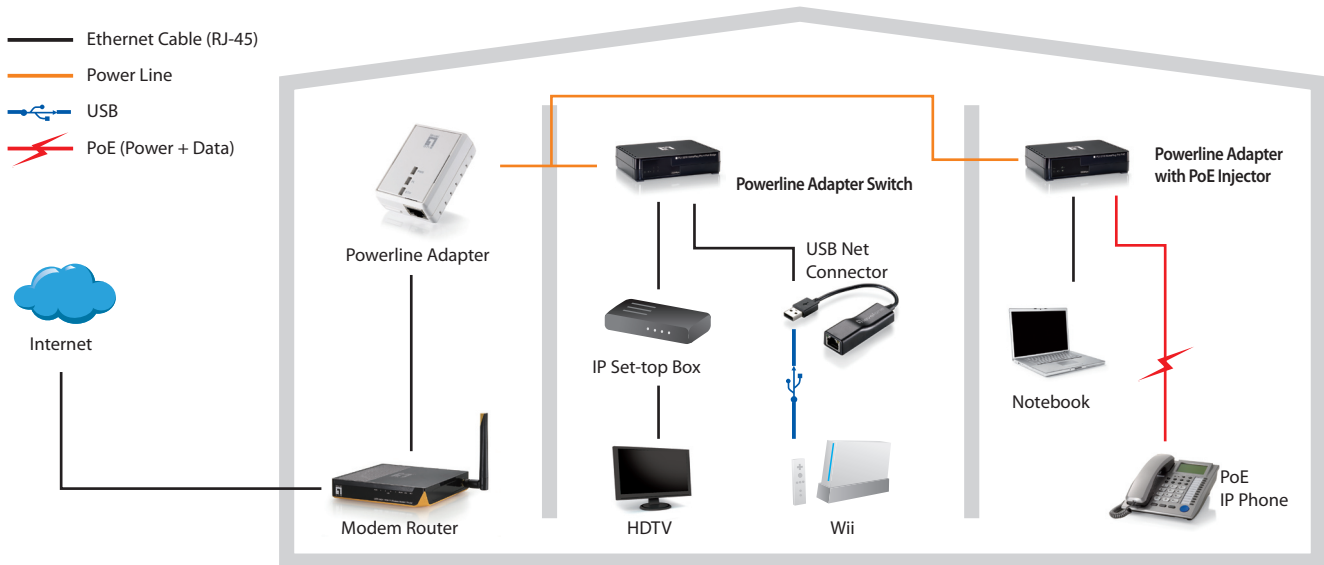

HomePlug Powerline Adapters



PLI-3510
200Mbps Powerline Adapter with Mains Pass-Through



PLI-3021
200Mbps Powerline Adapter



PLI-4051
500Mbps Powerline Gigabit Adapter

HomePlug Powerline Adapter Comparison			
Model	PLI-3510	PLI-3021	PLI-4051
Ethernet Port	1 x 10/100Mbps	1 x 10/100Mbps	1 x 10/100/1000Mbps
Powerline Speed	200Mbps	200Mbps	500Mbps
Wireless Speed	-	-	-
PoE	-	-	-
PoE Power Budget	-	-	-
Green Technology	V	-	-

NEW



PLI-4052
500Mbps Powerline Nano Adapter



PLI-3110
200Mbps Powerline Adapter with PoE Injector

HomePlug Powerline Adapter Comparison		
Model	PLI-4052	PLI-3110
Ethernet Port	1 x 10/100Mbps	2 x 10/100Mbps 1 x PoE
Powerline Speed	500Mbps	200Mbps
Wireless Speed	-	-
PoE	-	IEEE 802.3af
PoE Power Budget	-	15.4W
Green Technology	-	-

LevelOne provides storage purpose products for both home and office users. Whether you're looking for a simple and fast way to share your movies and music at home, or collaborate with your colleagues on a small to medium-sized office network, LevelOne offers a Network Attached Storage to achieve your storage purpose.

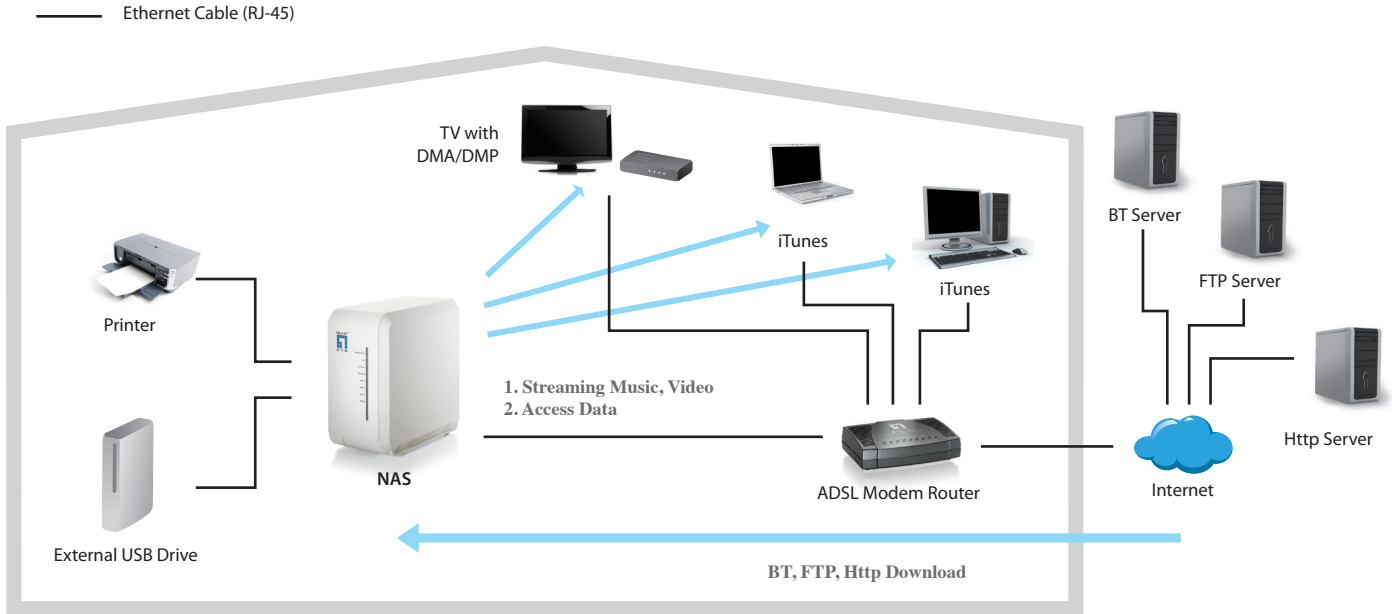

Key Features

- Stream music and video to your PC, media players or gaming console
- High Speed USB 2.0 Host Ports for extra storage
- Share files using FTP Server or Windows File Sharing /Samba
- Easy to setup and use



WAP-0008
54Mbps Wireless AP Storage



FNS-1020
1-Bay Simple Network Storage



GNS-1001
1-Bay Gigabit Network Storage

Network Attached Storage Comparison			
Model	WAP-0008	FNS-1020	GNS-1001
Ethernet Port	10/100Mbps	10/100Mbps	10/100/1000Mbps
DRAM	SDRAM 32MB	SDRAM 32MB	128MB
Disk Bay	1 x 3.5"inch IDE/SATA	1 x 3.5"inch IDE/SATA	1 x 3.5" inch SATA
UPnP Media Server	V	V	-
JBOD /RAID 0/1	-	-	-
Jumbo Frame	-	-	V
Wireless	54Mbps	-	-
One Touch Backup	V	V	-

Network Attached Storage



GNS-2000
2-Bay Gigabit Network Storage



GNS-4001
4-Bay Gigabit Network Storage

Network Attached Storage Comparison		
Model	GNS-2000	GNS-4001
Ethernet Port	10/100/1000Mbps	2 x 10/100/1000Mbps
DRAM	SDRAM 64MB	1GB DDR II, up to 4GB
Disk Bay	2 x 3.5"inch SATA	4 x 3.5"inch SATA II
UPnP Media Server	✓	✓
JBOD /RAID 0/1	✓	✓
Jumbo Frame	✓	-
Wireless	-	-
One Touch Backup	-	✓

With a small footprint and Plug and Play installation, help you to switch between computers with ease. PS/2, USB, VGA and DVI connections are available to support any operating system.

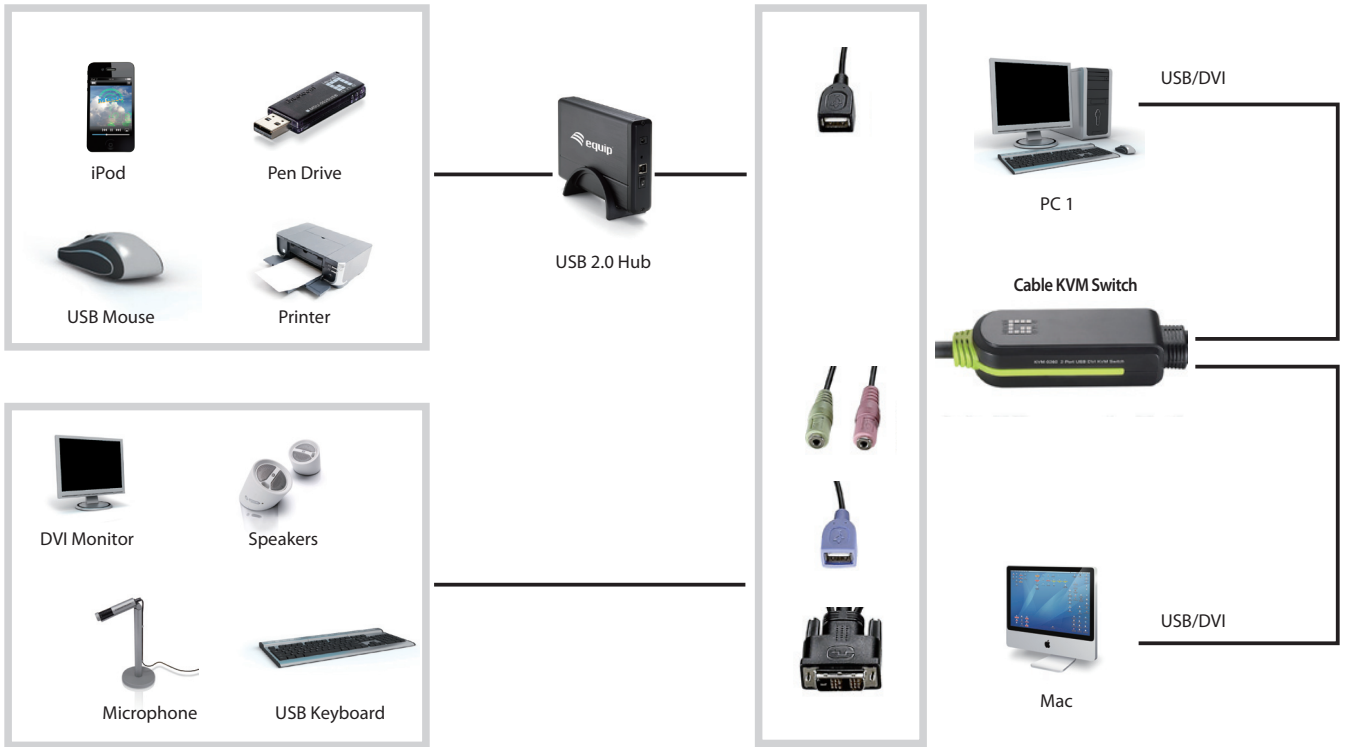

Cable KVM Switch

- Plug and Play operation, no software installation or power supply required
- LED display for easy status monitoring
- Easy switching between computers with auto-scan, keyboard hotkeys and push button selection



KVM-0213
2-Port PS/2 KVM Switch

KVM-0223
2-Port USB KVM Switch

KVM-0260
2-Port USB DVI KVM Switch with Audio

Cable KVM Switch Comparison				
	Model	KVM-0213	KVM-0223	KVM-0260
PC Port	Port for Keyboard/Mouse	PS/2	USB	USB
	Video Port	VGA	VGA	DVI-D
	Audio / Microphone	Audio	Audio	Audio/Microphone
Console Port	Port for Keyboard/Mouse	PS/2	USB	USB
	Video Port	VGA	VGA	DVI-D
	Audio / Microphone	Audio	Audio	Audio/Microphone
Feature	Control and Manage Computers	2	2	2
	Max. Local Resolution	2048 x 1536	2048 x 1536	1920 x 1200

Using these slim and stylish switches to control and manage 2 computers with a single keyboard, mouse and monitor. With plug-and-play operation, push-button switching and LED displays.

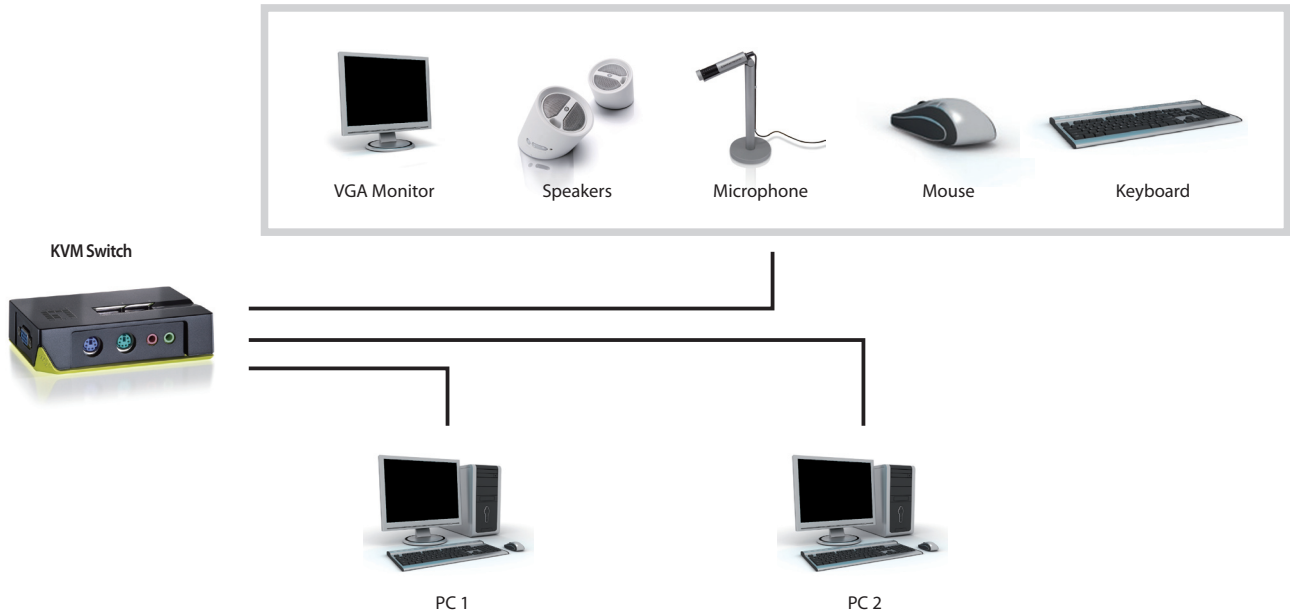

Desktop KVM Switch

- Slim and stylish design for minimizing desktop footprint
- Plug-and-play operation, no software installation or power supply required



KVM-0211 / KVM-0212
2-Port PS/2 KVM Switch



KVM-0221 / KVM-0222
2-Port USB KVM Switch



KVM-0261 / KVM-0461
2/4-Port USB DVI KVM Switch with
Audio & USB 2.0 Hub



KVM-0306
3 Port DVI KVM Switch with Audio

Desktop KVM Switch Comparison					
	Model	KVM-0211 / KVM-0212	KVM-0221 / KVM-0222	KVM-0261 / KVM-0461	KVM-0306
PC Port	Port for Keyboard/Mouse	PS/2	USB	USB	USB
	Video Port	VGA	VGA	DVI	DVI
	Audio / Microphone	Audio/Microphone (KVM-0211)	Audio / Microphone (KVM-0221)	Audio / Microphone	Audio/Microphone
Console Port	Port for Keyboard/Mouse	PS/2	PS/2	USB	USB; PS/2
	Video Port	VGA	VGA	DVI	DVI
	Audio / Microphone	Audio/Microphone (KVM-0211)	Audio / Microphone (KVM-0221)	Audio / Microphone	Audio/Microphone
Feature	Control and Manage Computers	2	2	2 / 4	3
	Max. Local Resolution	2048 x 1536	2048 x 1536	2560x1600	1600 x 1200

From Wired, wireless, day and night, pan/tilt/zoom to indoor and outdoor. All LevelOne cameras come with free Free 64-CH Monitoring Software (supports iCamSecure Apple/Android App) that enables users to view, manage, and capture streaming images from any location over the Internet.

Indoor Solution

- Ethernet Cable (RJ-45)
- Power Line

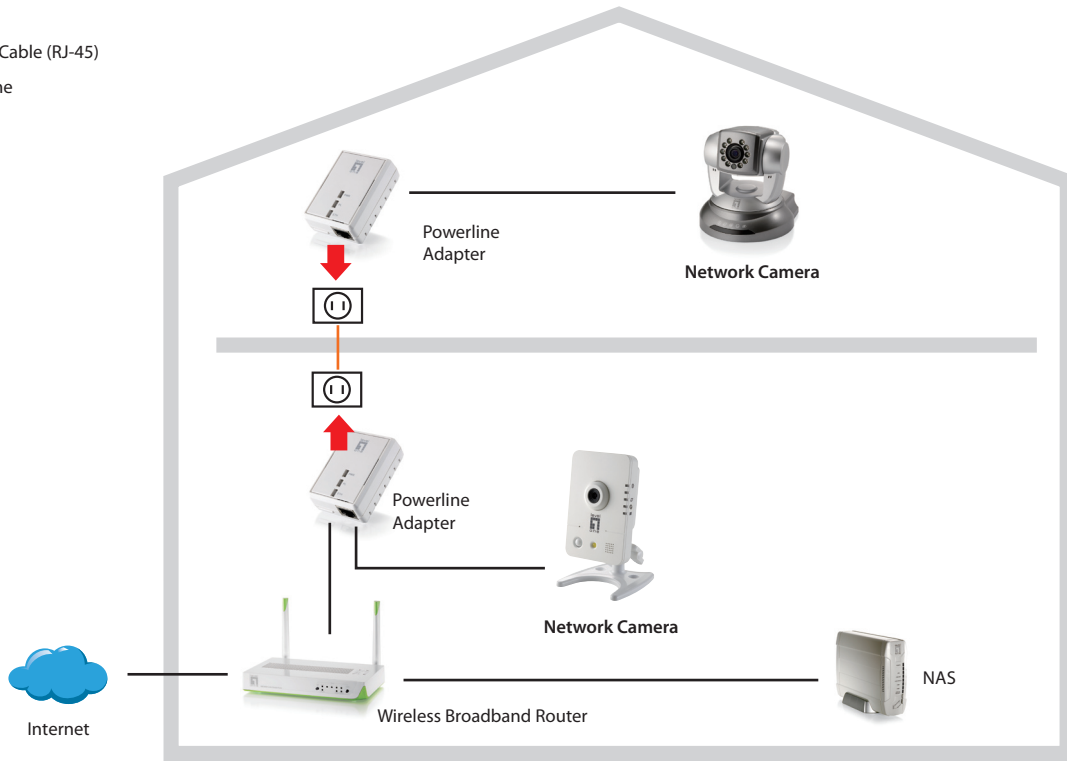

Outdoor Solution

- Ethernet Cable (RJ-45)
- Phone Line (RJ-11)

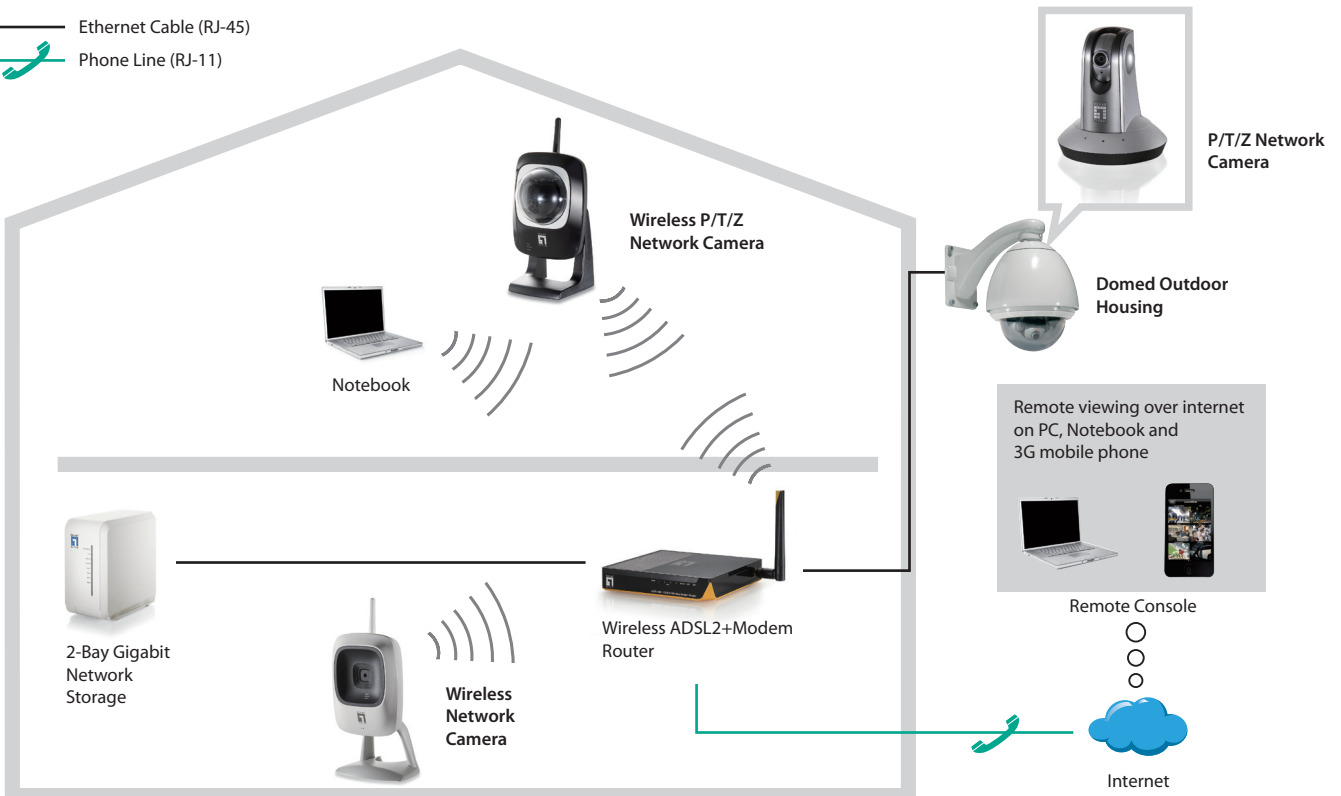

Fixed Network Cameras

- Progressive CMOS Sensor
- Supports UPnP for easy setup and installation
- Supports DDNS for dynamic IP
- Supports digital zoom



FCS-0010 / WCS-0010
Wired / Wireless Network Camera



FCS-1030 / WCS-2030
Wired / Wireless Network Camera



FCS-0030 / WCS-0030
Wired / Wireless Megapixel PIR Lighting Network Camera



FCS-0031
Megapixel PIR Lighting PoE Network Camera



WCS-0050
150Mbps Wireless Megapixel Network Camera



FCS-0040 / WCS-0040
1.3-Megapixel Wired/Wireless Network Camera

Fixed Network Cameras Comparison					
Model	FCS-0010	WCS-0010	FCS-1030	WCS-2030	FCS-0030
Sensor	CMOS	CMOS	CMOS	CMOS	CMOS Megapixel
Infrared LED	-	-	-	-	-
Max.Resolution	640 x 480	640 x 480	640 x 480	640 x 480	1280 x 800
Wireless	-	54Mbps	-	54Mbps	-
ICR (IR-Cut Filter Removal)	-	-	-	-	-
PIR Sensor	-	-	-	-	V
Built-in Microphone/Speaker	Microphone	Microphone	Microphone	Microphone	Microphone/ Speaker
ePTZ	-	-	-	-	-
Pan/Tilt/Zoom	-	-	-	-	-
PoE	-	-	-	-	-
Power Supply	External	External	External	External	External
Local Storage	-	-	-	-	V
Operation Temperature	0°C ~ 40°C	0°C ~ 40°C	0°C ~ 50°C	0°C ~ 50°C	0°C ~ 50°C
Optional Accessories	-	-	-	-	-

Fixed Network Cameras Comparison					
Model	WCS-0030	FCS-0031	WCS-0050	FCS-0040	WCS-0040
Sensor	CMOS Megapixel	CMOS Megapixel	CMOS Megapixel	CMOS Megapixel	CMOS Megapixel
Infrared LED	-	-	-	-	-
Max.Resolution	1280 x 800	1280 x 800	1280 x 800	1280 x 960	1280 x 960
Wireless	150Mbps	-	150Mbps	-	300Mbps
ICR (IR-Cut Filter Removal)	-	-	-	-	-
PIR Sensor	V	V	-	-	-
Built-in Microphone/Speaker	Microphone/Speaker	Microphone/ Speaker	Microphone	Microphone	Microphone
ePTZ	-	-	-	V	V
Pan/Tilt/Zoom	-	-	-	-	-
PoE	-	IEEE 802.3af	-	-	-
Power Supply	External	External/PoE	External	External	External
Local Storage	V	V	-	-	-
Operation Temperature	0°C ~ 50°C	0°C ~ 50°C	0°C ~ 50°C	0°C ~ 40°C	0°C ~ 40°C
Optional Accessories	-	-	-	-	-

P/T Network Cameras

- Progressive CMOS Sensor
- Supports UPnP for easy setup and installation
- Supports DDNS for dynamic IP
- Supports digital zoom



FCS-0020/WCS-0020
Wired/Wireless P/T Network Camera



FCS-1060
Wired P/T Network Camera



WCS-2060
Wireless P/T Network Camera



FCS-6010
1.3-Megapixel Day/Night P/T PoE Network Camera



WCS-6020
2-Megapixel Day/Night Wireless P/T Network Camera



WCS-6050
5-Megapixel Day/Night Wireless P/T Network Camera

Fixed Network Cameras Comparison					
Model	FCS-0020	WCS-0020	FCS-1060	WCS-2060	FCS-6010
Sensor	CMOS	CMOS	CMOS	CMOS	CMOS Megapixel
Infrared LED	-	-	-	-	V
Max.Resolution	640 x 480	640 x 480	640 x 480	640 x 480	1280 x 1024
Wireless	-	54Mbps (11b/g)	-	54Mbps (11b/g)	* 150Mbps
ICR (IR-Cut Filter Removal)	-	-	-	-	V
PIR Sensor	-	-	-	-	-
Built-in Microphone/Speaker	Microphone	Microphone	Microphone	Microphone	Microphone
ePTZ	-	-	-	-	-
Pan/Tilt/Zoom	P/T	P/T	P/T	P/T	P/T
PoE	-	-	-	-	IEEE 802.3af
Power Supply	External	External	External	External	External/PoE
Local Storage	-	-	-	-	V
Operation Temperature	0°C ~ 40°C	0°C ~ 40°C	0°C ~ 40°C	0°C ~ 40°C	0°C ~ 50°C
Optional Accessories	-	-	-	-	*WUA-0606: 150Mbps Wireless USB Adapter WUA-1610/1610H 300Mbps Wireless USB Adapter

Fixed Network Cameras Comparison		
Model	WCS-6020	WCS-6050
Sensor	CMOS Megapixel	CMOS Megapixel
Infrared LED	V	V
Max.Resolution	1920 x 1080	2560 x 1920
Wireless	150Mbps (11b/g/n)	150Mbps (11b/g/n)
ICR (IR-Cut Filter Removal)	V	V
PIR Sensor	-	-
Built-in Microphone/Speaker	V	V
ePTZ	-	-
Pan/Tilt/Zoom	P/T	P/T
PoE	-	-
Power Supply	External	External
Local Storage	V	V
Operation Temperature	0°C ~ 40°C	0°C ~ 40°C
Optional Accessories	-	-

The LevelOne Network Video Recorder (NVR) is a reliable surveillance system with an easy set up functionality. It enables live recording and playback for up to 4 network cameras via the local area network (LAN) or over the Internet simultaneously.



NVR-0104

4-CH Network Video Recorder

- 2 x 3.5 inch disk slot (SATA I/II, up to 2 x 2TB)
- Support 1080p HDMI local network Camera
- Compression: H.265/MPEG-4 Part2 / MJPEG
- Resolution: Full HD/megapixel/FD1/CIF/QCIF
- Supports smart camera search and 2-way audio
- Supports PTZ/preset point/preset sequence
- Motion detect and event display on e-map/Google map
- Supports iPhone/smartphone/PDA remote viewing over the Internet
- Display mode: Live view/playback/full screen
- Remote controller included
- Free Bundled NVR management software for manage up to 16 NVR devices



NVR-0104

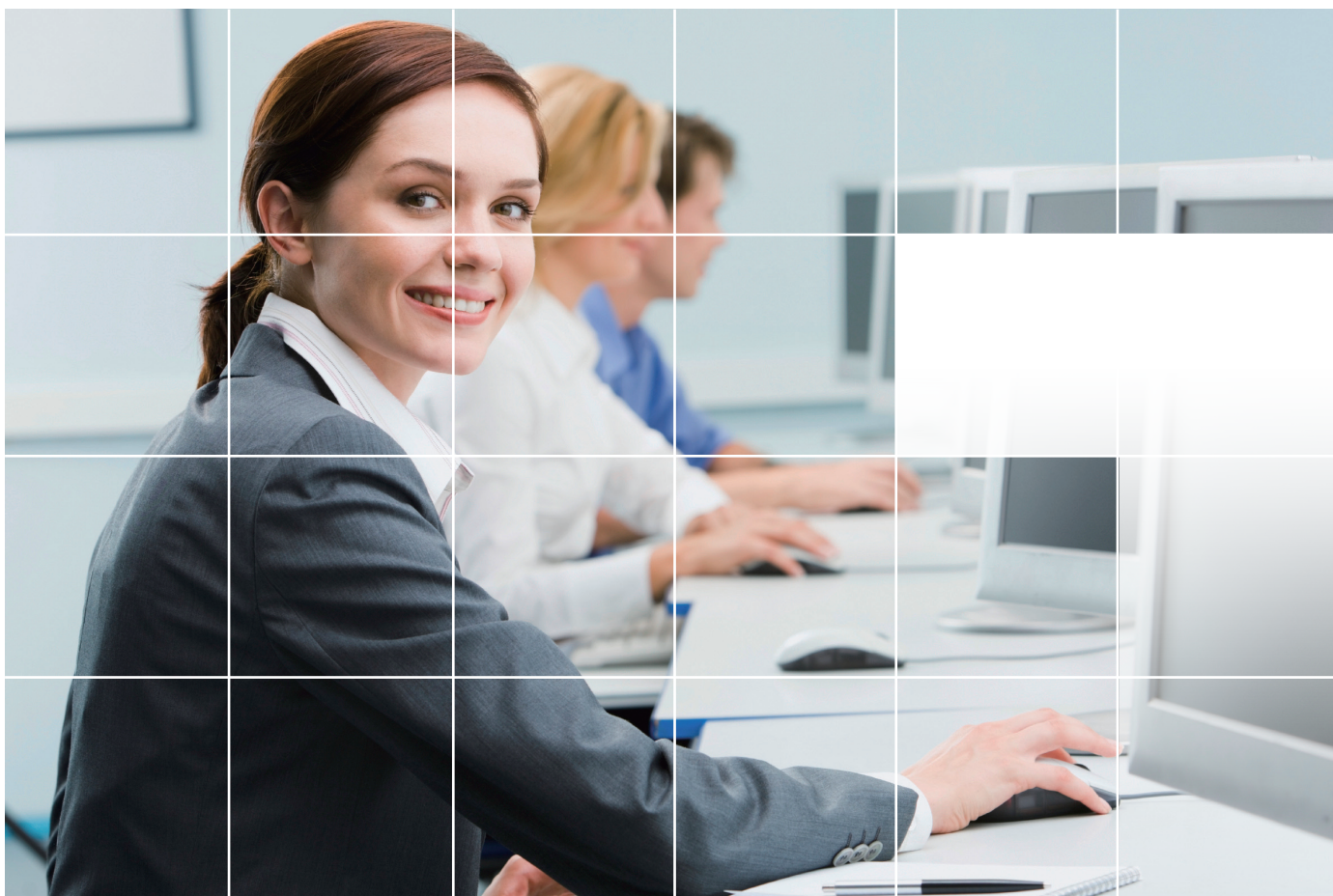

Business

Networking

PoE Ethernet Switch	>20-23
Non-PoE Ethernet Switch	>24-29
Converter	>30-33
Fiber Optical Transceivers	>34-36
IP Power Switch	>37
Broadband Router	>38
Wireless Hotspot Gateway	>39
Network Adapter	>40-41
Wireless Access Point	>42-43
Antenna	>44-45
Antenna Cable	>46
Outdoor Lighting Arrestor Kit	>47
PoE PD/PSE/Repeater	>48-50
PoE Power Measurer	>51
KVM Switch	>52-54
KVM Extender	>55
Print Server	>56
Voice over IP (VoIP) Solutions	>57-58

Security

Network Camera	>59-63
Lens	>64
IP Surveillance Software	>65-66
Video Servers/Capture Cards	>67
Network Video Recorders	>68-69

Digital Signage

HDMI over IP	>70
HDMI over Cat5	>71
HDMI over Fiber	>71
A/V (DVI) over Cat5	>72
DVI over Fiber	>72
A/V (VGA) over Cat5	>73-74
IP Audio Broadcasting	>75



PoE Switch can be seen as a combination of a non-PoE Switch and mid-span hub combined into one device. PoE switch can provide power directly to PoE Devices. For enterprise usage, Web Smart and SNMP L2 switches offer a Web-based User Interfaces to configure advanced settings such as VLAN, Port Trunking, Port Mirror, Quality of Service and more. Managed PoE switches, includes the capability to alert and help administrators by featuring auto-warning messages, to easily locate any problematic devices

Unmanaged PoE Ethernet Switch

- Complies with IEEE 802.3(10Mbps), 802.3u(100Mbps), 802.3ab (1000Mbps)
- Supports IEEE 802.3x full-duplex / half-duplex backpressure flow control
- Provides Auto-MDI/MDIX function
- Supports auto-negotiation for speed and duplex modes for each port

- Ethernet Cable (RJ-45)
- == Fiber
- ⚡ PoE (Power + Data)

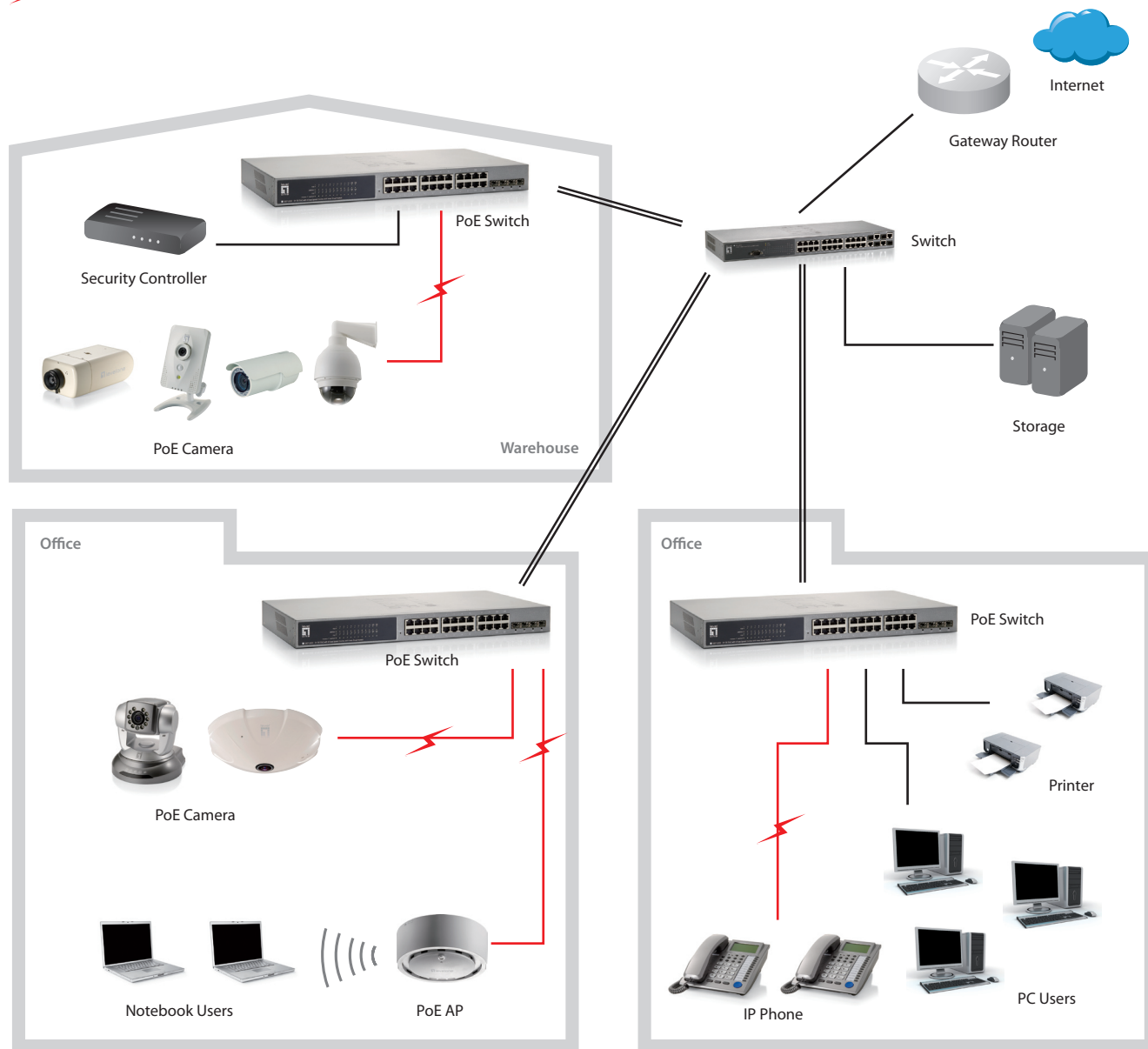

Unmanaged PoE Ethernet Switch



FSW-0503
4 FE PoE + 1 FE Switch, 61.6W



FSW-0513
4 FE High Power PoE + 1 FE Switch, 120W



GEP-0520
4 GE PoE + 1 GE Switch, 61.6W



FSW-0512
5-Port Fast Ethernet PoE PD Switch



IFE-0500
4 FE PoE + 1 FE Industrial Switch



IFE-0501
4 FE PoE + 1 FE MMF SC Industrial Switch, 2km

Unmanaged PoE Ethernet Switch Comparison						
Model	FSW-0503	FSW-0513	GEP-0520	FSW-0512	IFE-0500	IFE-0501
Ethernet Port	1 x 10/100Mbps	1 x 10/100Mbps	1 x 10/100/1000Mbps	4 x 10/100Mbps	1 x 10/100Mbps	-
PoE Port	4 x 10/100Mbps	4 x 10/100Mbps	4 x 10/100/1000Mbps	1 x 10/100Mbps	4 x 10/100Mbps	4 x 10/100Mbps
Fiber Port	-	-	-	-	-	1 x 100BASE-FX MMF SC (2km)
MAC Table	1K	1K	2K	2K	1K	1K
Buffer Memory	48KB	48KB	128KB	128KB	512KB	512KB
Jumbo Frame	-	-	9K	-	-	-
PoE	IEEE 802.3af	IEEE 802.3af	IEEE 802.3af	IEEE 802.3af	IEEE 802.3af	IEEE 802.3af
PoE Power Budget	61.6W	120W	61.6W	-	57W	57W
Output Power Per Port	15.4W	48W	15.4W	-	15.4W	15.4W
Power Supply	External	External	External	External/PoE	External	External
Optional Accessories	POC-6000: 8-Bay High Power PoE Chassis			-	POW-4801 : 48V DC Power Adapter	



IFE-0502
4 FE PoE + 1 FE SMF SC Industrial Switch, 30km



FSW-0812
8-Port Fast Ethernet PoE PD Switch



FEP-0812
4 FE PoE-Plus + 4 FE Switch, 61.6W



FEP-0811
8-Port Fast Ethernet PoE-Plus Switch, 123.2W



GEP-0820
8-Port Gigabit PoE-Plus Switch, 61.6W



GEP-0821
8-Port Gigabit PoE-Plus Switch, 123.2W

Unmanaged PoE Ethernet Switch Comparison						
Model	IFE-0502	FSW-0812	FEP-0812	FEP-0811	GEP-0820	GEP-0821
Ethernet Port	-	7 x 10/100Mbps	4 x 10/100Mbps	-	-	-
PoE Port	4 x 10/100Mbps	1 x 10/100Mbps	4 x 10/100Mbps	8 x 10/100Mbps	8 x 10/100/1000Mbps	8 x 10/100/1000Mbps
Fiber Port	1 x 100BASE-FX SMF SC (30km)	-	-	-	-	-
MAC Table	1K	2K	1K	1K	8K	8K
Buffer Memory	512KB	128KB	64KB	64KB	128KB	128KB
Jumbo Frame	-	-	-	9K	9K	9K
PoE	IEEE 802.3af	IEEE 802.3af	IEEE 802.3af/at	IEEE 802.3af/at	IEEE 802.3af/at	IEEE 802.3af/at
PoE Power Budget	57W	-	61.6W	123.2W	61.6W	123.2W
Output Power Per Port	15.4W	-	30W	30W	30W	30W
Power Supply	External	External/PoE	Internal	External	External	Internal
Optional Accessories	POW-4801 : 48V DC Power Adapter	-	-	-	-	-

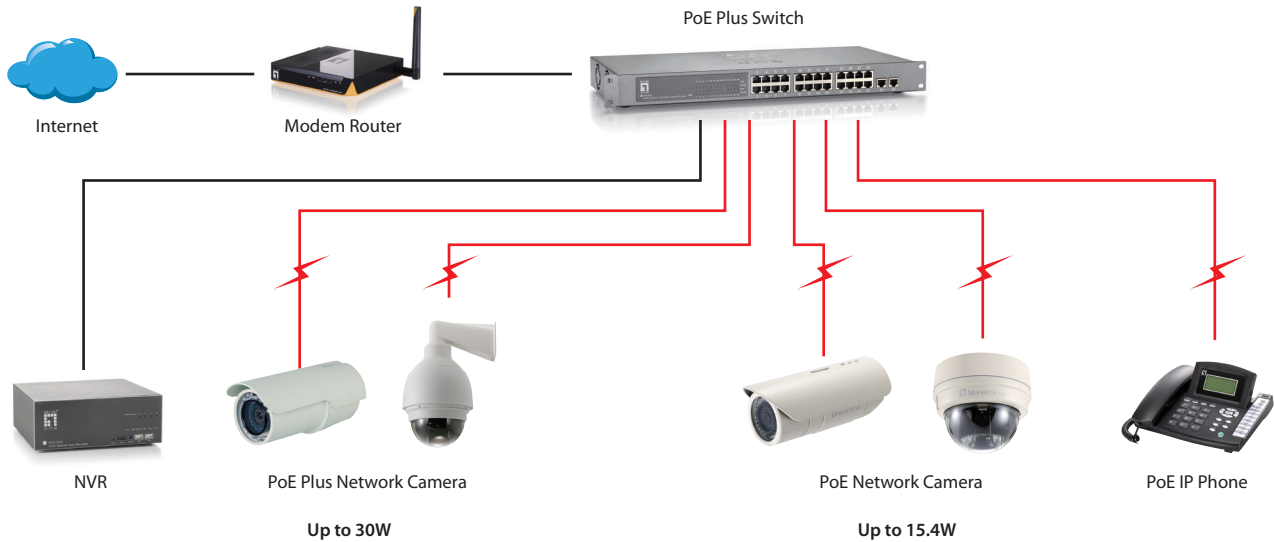
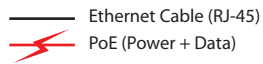

Unmanaged PoE Ethernet Switch



GEP-0822
8-Port Gigabit PoE-Plus Switch, 240W



FEP-1611
16-Port Fast Ethernet PoE-Plus Switch, 240W



FEP-1612
16-Port Fast Ethernet PoE-Plus Switch, 480W



FGP-2410
24 FE PoE-Plus + 2 GE Combo SFP Switch, 240W



FGP-2412
24 FE PoE-Plus + 2 GE Combo SFP Switch, 480W

Unmanaged PoE Ethernet Switch Comparison					
Model	GEP-0822	FEP-1611	FEP-1612	FGP-2410	FGP-2412
Ethernet Port	-	-	-	2 x 10/100/1000Mbps	2 x 10/100/1000Mbps
PoE Port	8 x 10/100/100Mbps	16 x 10/100Mbps	16 x 10/100Mbps	24 x 10/100Mbps	24 x 10/100Mbps
Fiber Port	-	-	-	-	-
Fiber Slot	-	-	-	2 x 1000BASE-X SFP	2 x 1000BASE-X SFP
MAC Table	8K	4K	4K	4K	4K
Buffer Memory	128KB	160KB	160KB	352KB	352KB
Jumbo Frame	9K	-	-	-	-
PoE	IEEE 802.3af/at	IEEE 802.3af/at	IEEE 802.3af/at	IEEE 802.3af/at	IEEE 802.3af/at
PoE Power Budget	240W	240W	480W	240W	480W
Output Power Per Port	30W	30W	30W	30W	30W
Power Supply	Internal	Internal	Internal	Internal	Internal
Optional Accessories	-	-	-	-	-

Managed PoE Ethernet Switch

- Complies with IEEE 802.3(10Mbps), 802.3u(100Mbps), 802.3ab (1000Mbps)
- Supports IEEE 802.3x full-duplex / half-duplex backpressure flow control
- Provides Auto-MDI/MDIX function
- Supports auto-negotiation for speed and duplex modes for each port



FGP-1072
8 FE PoE + 2 GE Combo SFP L2 Managed Switch,
130W



FSW-1671
8 FE PoE + 8 FE Web Smart Switch,
123.2W



GEP-2450
20 GE PoE-Plus + 4 GE Combo SFP Web
Smart Switch, 185W



GSW-2693
24 FE PoE + 2 GE Combo SFP L2 Managed
Switch, 185W



FGP-2472
24 FE PoE + 2 GE Combo SFP L2 Managed Switch,
380W



GTP-2880
20 GE PoE + 4 GE Combo SFP + 4 10GE SFP-
Plus L2-Plus Managed Switch, 185W

Managed PoE Ethernet Switch Comparison						
Model	FGP-1072	FSW-1671	GEP-2450	GSW-2693	FGP-2472	GTP-2880
Ethernet Port	-	8 x 10/100Mbps	-	2 x 10/100/1000Mbps	2 x 10/100/1000Mbps	-
PoE Port	8 x 10/100Mbps	8 x 10/100Mbps	24 x 10/100/1000Mbps	24 x 10/100Mbps	24 x 10/100Mbps	24 x 10/100/1000Mbps
Fiber Port	-	-	-	-	-	-
Fiber Slot	2 x 1000BASE-X SFP	-	4 x 100/1000BASE-X SFP	2 x 1000BASE-X SFP	2 x 1000BASE-X SFP	4 x 1000BASE-X SFP 4 x 10G SFP-Plus
MAC Table	8K	4K	8K	8K	8K	8K
Buffer Memory	256KB	192KB	500KB	384KB	256KB	4096KB
Jumbo Frame	-	-	9K	-	-	9.8K
Port Trunking	4 Group	4 Groups	8 Groups	3 Groups	3 Groups	24 Group
Management	SNMP/Web Based/ RMON	Web Based	SNMP/Web Based	SNMP/Web/Console/ Telnet/RMON	SNMP/Web/Console/ Telnet/RMON	SNMP/Telnet/Web Based/ RMON
VLAN	Port-Based / 802.1Q (up to 4K VID)	Port-Based / 802.1Q (20 Entries, up to 4K VID)	Port Based / 802.1Q (24 Entries, up to 4K VID)	Ported Based / 802.1Q (256 Entries, up to 4K VID)	Port Based / 802.1Q (256 Entries, up to 4K VID)	Port Based / 802.1Q(up to 4K VID)
IGMP Snooping	V1/V2/V3	V1/V2	V1/V2	V1/V2	V1/V2	V1/V2/V3
Spanning Tree	IEEE 802.1D/ 802.1w / 802.1s	-	IEEE 802.1D/ 802.1w	IEEE 802.1D/ 802.1w	IEEE 802.1D/ 802.1w	IEEE 802.1D/ 802.1w / 802.1s
Stacking	* Single IP Management	-	-	** Single IP Management	*** Single IP Management	**** Single IP Management
PoE	IEEE 802.3af	IEEE 802.3af	IEEE 802.3af/at	IEEE 802.3af	IEEE 802.3af	IEEE 802.3af/at
PoE Power Budget	130W	123.2W	184.8W	185W	380W	185W
Power Supply	Internal	Internal	Internal	Internal	Internal	Internal
Output Power Per Port	15.4W	15.4W	30W	15.4W	15.4W	30W
Green Technology	-	-	V	-	-	V

* Supports up to 16 switches (GSW-0890/2693/FGP-1072/FGP-2472)

** Supports up to 16 switches (GSW-0890/2693)

*** Supports up to 16 switches (GSW-0890/2693)

**** Supports up to 32 switches (GEL-1072/GTL-2880/GTP-2880/GTL-5280)

LevelOne offers a comprehensive selection of Ethernet switches. From unmanaged switches with simple Plug and Play installation, to L3 managed switches following the most advanced standards set by the IEEE, we provide the right switch for you

- Ethernet Cable (RJ-45)
- Fiber
- Stacking Cable

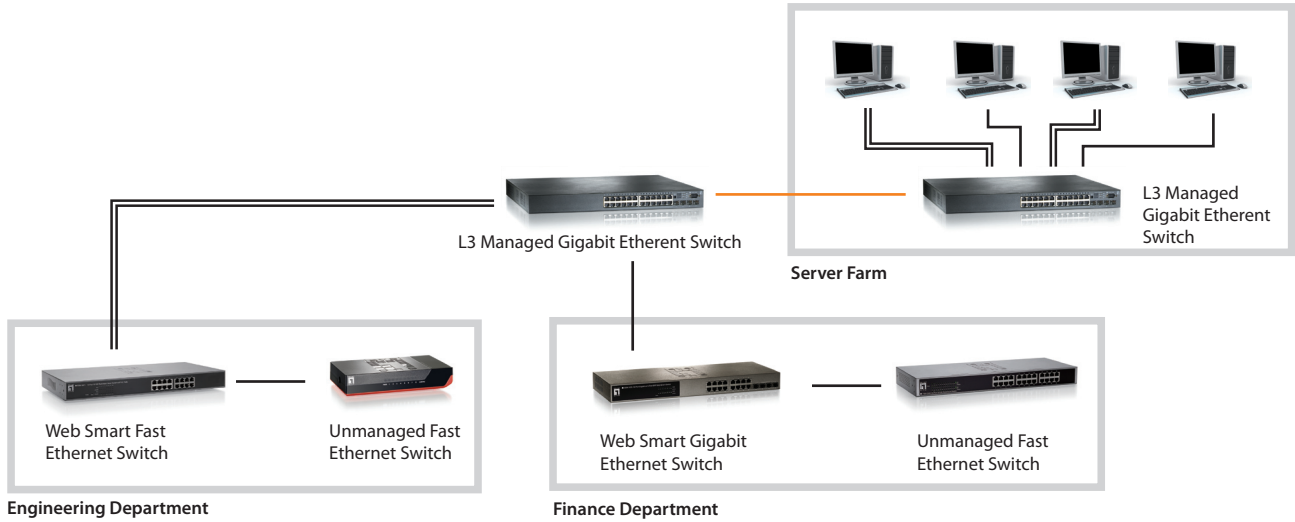

Unmanaged Non-PoE Ethernet Switch

- Complies with IEEE 802.3(10Mbps), 802.3u(100Mbps), 802.3ab (1000Mbps)
- Supports IEEE 802.3x full-duplex / half-duplex backpressure flow control
- Provides Auto-MDI/MDIX function
- Supports auto-negotiation for speed and duplex modes for each port



FEU-0510
5-Port Fast Ethernet Switch



FEU-0511
4 FE + 1 FE MMF SC Switch



GSW-0509
5-Port Gigabit Switch



GEU-0520
5-Port Gigabit Switch



GEU-0521
4 GE + 1 GE SFP Switch



FEU-0810
8-Port Fast Ethernet Switch

Unmanaged Non-PoE Ethernet Switch Comparison						
Model	FEU-0510	FEU-0511	GSW-0509	GEU-0520	GEU-0521	FEU-0810
Ethernet Port	5 x 10/100Mbps	4 x 10/100/1000Mbps	5 x 10/100/1000Mbps	5 x 10/100/1000Mbps	4 x 10/100/1000Mbps	8 x 10/100Mbps
Fiber Port	-	1 x 100BASE-FX MMF SC (2km)	-	-	-	-
Fiber Slot	-	-	-	-	1 x 1000BASE-X SFP	-
Expansion Slot	-	-	-	-	-	-
MAC Table	2K	1K	8K	8K	1K	1K
Buffer Memory	48KB	384KB	125KB	128KB	104KB	96KB
Jumbo Frame	-	-	9K	9K	9K	-
Power Supply	Internal	External	Internal	External	External	Internal
Green Technology	V	-	V	V	-	V

Unmanaged Non-PoE Ethernet Switch



GSW-0809
8-Port Gigabit Switch



GEU-0820
8-Port Gigabit Switch



FEU-1610
16-Port Fast Ethernet Switch



FSW-1602TX
16-Port Fast Ethernet Switch



FSW-1650
16-Port Fast Ethernet Switch



GSW-1657
16-Port Gigabit Switch

Unmanaged Non-PoE Ethernet Switch Comparison						
Model	GSW-0809	GEU-0820	FEU-1610	FSW-1602TX	FSW-1650	GSW-1657
Ethernet Port	8 x 10/100/1000Mbps	8 x 10/100/1000Mbps	16 x 10/100Mbps	16 x 10/100Mbps	16 x 10/100Mbps	16 x 10/100/1000Mbps
Fiber Port	-	-	-	-	-	-
Expansion Slot	-	-	-	-	-	-
MAC Table	8K	8K	8K	8K	8K	8K
Buffer Memory	125KB	128KB	256KB	512KB	160KB	512KB
Jumbo Frame	9K	9K	-	-	-	10K
Power Supply	Internal	External	Internal	External	Internal	Internal
Green Technology	V	V	V	V	V	-



GEU-1621
16-Port Gigabit Switch



GEU-1628
16 GE + 2 GE SFP Switch



GEU-1629
16 GE + 4 GE SFP Switch



FEU-2410
24-Port Fast Ethernet Switch



FSW-2450
24-Port Fast Ethernet Switch



GEU-2428
24 GE + 2 GE SFP Switch

Unmanaged Non-PoE Ethernet Switch Comparison						
Model	GEU-1621	GEU-1628	GEU-1629	FEU-2410	FSW-2450	GEU-2428
Ethernet Port	16 x 10/100/1000Mbps	16 x 10/100/1000Mbps	16 x 10/100/1000Mbps	24 x 10/100Mbps	24 x 10/100Mbps	24 x 10/100/1000Mbps
Fiber Port	-	-	-	-	-	-
Fiber Slot	-	2 x 1000BASE-X SFP	4 x 1000BASE-X SFP	-	-	2 x 1000BASE-X SFP
Expansion Slot	-	-	-	-	-	-
MAC Table	8K	16K	16K	8K	8K	16K
Buffer Memory	256KB	448KB	448KB	256KB	160KB	448KB
Jumbo Frame	9K	9K	9K	-	-	9K
Power Supply	Internal	Internal	Internal	Internal	Internal	Internal
Green Technology	V	V	V	V	V	V

Unmanaged Non-PoE Ethernet Switch



GEU-2429
24 GE + 4 GE SFP Switch



GSW-2457
24-Port Gigabit Switch



GSW-5150
48 FE + 2 GE + 1 GE SFP Switch



GSW-2453
3-Slot Gigabit Modular Switch

Unmanaged Non-PoE Ethernet Switch Comparison				
Model	GEU-2429	GSW-2457	GSW-5150	GSW-2453
Ethernet Port	24 x 10/100/1000Mbps	24 x 10/100/1000Mbps	48 x 10/100Mbps 2 x 10/100/1000Mbps	Up to 24 x 10/100/1000Mbps (Optional)
Fiber Port	-	-	-	-
Fiber Slot	4 x 1000BASE-X SFP	-	1 x 1000BASE-X SFP	Up to 24 x 1000BASE-X SFP (Optional)
Expansion Slot	-	-	-	3
MAC Table	16K	8K	8K	4K
Buffer Memory	448KB	512KB	128KB	256KB
Jumbo Frame	9K	10K	-	9K
Power Supply	Internal	Internal	Internal	Internal
Green Technology	V	-	-	-
Optional Accessories	-	-	-	MDU-2453T : 8-Port 10/100/1000TX Module MDU-2453M : 8-Port SFP Module MDU-2453TM: 4-Port 1000T+ 4-Port SFP Module

Managed Non-PoE Ethernet Switch

- Complies with IEEE 802.3(10Mbps), 802.3u(100Mbps), 802.3ab (1000Mbps)
- Supports IEEE 802.3x full-duplex / half-duplex backpressure flow control
- Provides Auto-MDI/MDIX function
- Supports auto-negotiation for speed and duplex modes for each port



GES-0852
7 GE + 1 GE Combo SFP Web Smart Switch



GSW-1290
4 GE Combo SFP + 2 GE Expandable Slots
L2 Managed Switch



GSW-0890
6 GE + 2 GE Combo SFP L2 Managed Switch



GEL-1072
8 GE + 2 GE Combo SFP L2 Managed Switch



GES-1652
16 GE + 2 GE SFP Web Smart Switch

Managed Non-PoE Ethernet Switch Comparison					
Model	GES-0852	GSW-1290	GSW-0890	GEL-1072	GES-1652
Ethernet Port	8 x 10/100/1000 Mbps	Up to 12 x 10/100/1000Mbps (Optional)	8 x 10/100/1000Mbps	10 x 10/100/1000Mbps	16 x 10/100/1000Mbps
Fiber Port	-	-	-	-	-
Fiber Slot	1 x 1000BASE-X SFP	Up to 12 x 1000BASE-X SFP (Optional)	2 x 1000BASE-X SFP	2 x 1000BASE-X SFP	2 x 1000BASE-X SFP
Expansion Slot	-	2	-	-	-
MAC Table	8K	16K	8K	8K	16K
Buffer Memory	180KB	1024KB	144KB	1024KB	448KB
Port Trunking	4 Groups	6 Groups	4 Groups	5 Groups	8 Groups
Jumbo Frame	9K	9K	9K	9K	9K
Management	SNMP/Web-based	SNMP/Web/Console/ Telnet/RMON	SNMP/Web/Console/ Telnet/RMON	SNMP/Telnet/RMON	SNMP/Web-Based
VLAN	Port Based / 802.1Q (8 Entries, up to 4K VID)	Port Based / 802.1Q (up to 255K)	Port Based / 802.1Q (256 Entries, up to 4K VID)	Port Based / 802.1Q (up to 4K VID)	Port Based / 802.1Q (8 Entries, up to 4K VID)
IGMP Snooping	-	V1 / V2	V1 / V2	V1 / V2	V1 / V2 / V3
Spanning Tree	-	IEEE 802.1D/ 802.1w/ 802.1s	IEEE 802.1D/ 802.1w	IEEE 802.1D/ 802.1w/ 802.1s	IEEE 802.1D/ 802.1s
Stacking	-	Hardware Stacking	* Single IP Management	** Single IP Management	-
Power Supply	Internal	Internal	Internal	Internal	Internal
Green Technology	-	-	-	V	V
Optional Accessories	-	MDU-1290T: 4-Port 10/100/1000TX Module MDU-1290M: 4-Port SFP Module MDU-1290S: 4-Port Stacking Module	-	-	-

* Support up to 16 switches (GSW-0890/2693)

** Support up to 32 switches (GEL-1072/GTL-2880/GTP-2880/GTL-5280)

Managed Non-PoE Ethernet Switch



GES-1650
16 GE + 4 GE SFP Web Smart Switch



GES-2452
24 GE + 2 GE SFP Web Smart Switch



FGL-2870
24 FE + 4 GE Combo SFP L2 Managed Switch



GSW-2473
24 FE + 2 GE Combo SFP Web Smart Switch



GES-2450
24 GE + 4 GE SFP Web Smart Switch



GTL-2690
20 GE + 4 GE Combo SFP + 2 10GE XFP Module Slots L3 Managed Stackable Switch

Managed Non-PoE Ethernet Switches Comparison						
Model	GES-1650	GES-2452	FGL-2870	GSW-2473	GES-2450	GTL-2690
Ethernet Port	16 x 10/100/1000Mbps	24 x 10/100/1000Mbps	24 x 10/100Mbps 4 x 10/100/1000Mbps	24 x 10/100Mbps 2 x 10/100/1000Mbps	24 x 10/100/1000Mbps	24 x 10/100/1000Mbps
Fiber Port	-	-	-	-	-	-
Fiber Slot	4 x 1000BASE-X SFP	2 x 1000BASE-X SFP	4 x 1000BASE-X SFP	2 x 1000BASE-X SFP	4 x 1000BASE-X SFP	4 x 1000BASE-X SFP Up to 2 x 10GE XFP (Optional)
Expansion Slot	-	-	-	-	-	2
MAC Table	16K	16K	8K	4K	16K	16K
Buffer Memory	448KB	448KB	128KB	256KB	448KB	2048KB
Port Trunking	8 Groups	8 Groups	4 Groups	4 Groups	8 Groups	8 Groups
Jumbo Frame	9K	9K	10K	9K	9K	9K
Management	SNMP/Telnet/ Web-Based/Console	SNMP/Web-Based	SNMP/Telnet/Web-Based Console/RMON	Web-Based	SNMP/Web-Based/RMON	SNMP/Telnet/Web-Based/ Console/RMON
VLAN	Port Based / 802.1Q (256 Entries, up to 4K VID)	Port Based / 802.1Q (8 Entries, up to 4K VID)	Port Based / 802.1Q (255 Entries up to 4K VID)	Port Based / 802.1Q (32 Entries, up to 4K VID)	Port Based / 802.1Q (8 Entries, up to 4K VID)	Port Based / 802.1Q (up to 4K VID)
IGMP Snooping	V1 / V2 / V3	V1 / V2 / V3	V1 / V2	-	V1 / V2 / V3	V1 / V2
Spanning Tree	IEEE 802.1D / 802.1s	IEEE 802.1D / 802.1s	IEEE 802.1D / 802.1w / 802.1s	-	IEEE 802.1D / 802.1s	IEEE 802.1D / 802.1w / 802.1s
Stacking	-	-	* Single IP Management	-	-	Hardware Stacking
Power Supply	Internal	Internal	Internal	Internal	Internal	Internal
Green Technology	V	V	-	-	V	-
Optional Accessories	-	-	-	-	-	MDU-0162: 10GE XFP Module ACP-03K2: 30cm Stacking Cable ACP-13K2: 130cm Stacking Cable RPS-04A2: Redundant Power Supply

* Support up to 36 switches (GEL-2870/GTL-2690)

Managed Non-PoE Ethernet Switch



GEL-2870
24 GE + 4 GE Combo SFP L2 Managed Switch



GTL-2880
20 GE + 4 GE Combo SFP + 4 10GE SFP-Plus L2-Plus Managed Switch



GSW-4876
44 GE + 4 GE Combo SFP Web Smart Switch



GSW-5270
48 FE + 2 GE + 2 GE SFP Web Smart Switch



GTL-5280
44 GE + 4 GE Combo SFP + 4 10GE SFP-Plus L2-Plus Managed Switch



MSL-3579
3-Slot Gigabit Modular L2 Managed Switch

Managed Non-PoE Ethernet Switches Comparison						
Model	GEL-2870	GTL-2880	GSW-4876	GSW-5270	GTL-5280	MSL-3579
Ethernet Port	28 x 10/100/1000Mbps	24 x 10/100/1000Mbps	48 x 10/100/1000Mbps	48 x 10/100Mbps 4 x 10/100/1000Mbps	48 x 10/100/1000Mbps	Up to 24 x 10/100/1000Mbps (Optional)
Fiber Port	-	-	-	-	-	-
Fiber Slot	4 x 1000BASE-X SFP	4 x 1000BASE-X SFP 4 x 10G SFP-Plus	4 x 1000BASE-X SFP	2 x 1000BASE-X SFP	4 x 1000BASE-X SFP 4 x 10G SFP-Plus	Up to 24 x 1000BASE-X SFP (Optional)
Expansion Slot	-	-	-	-	-	3
MAC Table	8K	8K	8K	4K	8K	16K
Buffer Memory	1792KB	4096KB	512KB	128KB	8192KB	768KB
Port Trunking	14 Groups	14 Groups	25 Group	8 Groups	26 Groups	7 Groups
Jumbo Frame	9K	9.8K	9K	-	9.8K	10K
Management	SNMP/Telnet/Web-Based/ Console/RMON	SNMP/Telnet/Web-Based/ RMON	SNMP/Telnet/ Web-Based/RMON	Web-Based	SNMP/Telnet/Web-Based/ RMON	SNMP/Telnet/Web-Based/ Console/RMON
VLAN	Port Based / 802.1Q (255 Entries, up to 4K VID)	Port Based / 802.1Q (up to 4K VID)	Port Based / 802.1Q (256 Entries, up to 4K VID)	Port Based / 802.1Q (256 Entries, up to 4K VID)	Port Based / 802.1Q (up to 4K VID)	Port Based / 802.1Q (256 Entries, up to 4K VID)
IGMP Snooping	V1 / V2	V1 / V2 / V3	V1 / V2 / V3	-	V1 / V2 / V3	V1 / V2
Spanning Tree	IEEE 802.1D/ 802.1w / 802.1s	IEEE 802.1D/ 802.1w / 802.1s	IEEE 802.1D/ 802.1w / 802.1s	-	IEEE 802.1D/ 802.1w / 802.1s	IEEE 802.1D/ 802.1w
Stacking	-	* Single IP Management	-	-	* Single IP Management	-
Power Supply	Internal	Internal	Internal	Internal	Internal	Internal
Green Technology	V	V	-	-	V	-
Optional Accessories	-	-	-	-	-	MDU-2453T: 8-Port 10/100/1000TX Module MDU-2453M: 8-Port SFP Module MDU-2453TM: 4 GE + 4 GE SFP Module

* Support up to 32 switches (GEL-1072/GTL-2880/GTP-2880/GTL-5280)

LevelOne has unique solutions to convert Ethernet data. Our Media converters follow all the IEEE standards and reliably easy to install solutions that connect individual network over long distances. With built-in PoE functionality, users are capable to build deployments that aren't limited by power outlets or extension cords. And our newest VDSL2 converters are innovative industry leaders. LevelOne offer 300+ meters over traditional RJ-11 phone wiring, which beats the normal 100 meter runs of Cat.5 cables.

Key Features

- Compatible with IEEE 802.3/ 802.3u standards
- Supports IEEE 802.3x full-duplex / half-duplex backpressure flow control
- Auto-negotiation and Auto MDI/MDI-X, Half/Full Duplex mode
- Features Link-Loss forwarding Technology
- DHCP client for easy IP address setup
- ICMP and ARP protocols supported

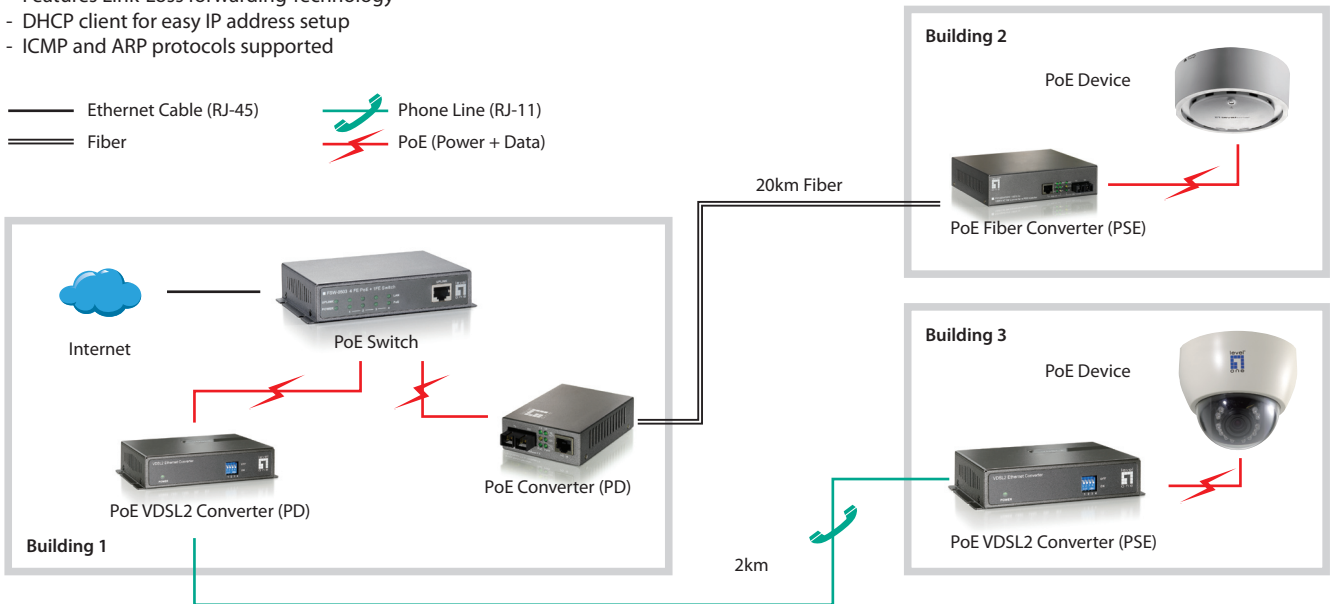
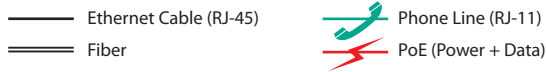

Ethernet Media Converters



FVS-3800
10/100BASE-TX to 100BASE-X SFP Converter



GVS-3800
10/100/1000BASE-T to 1000BASE-X SFP Converter



FVS-3200
10/100BASE-TX to 100BASE-FX MMF SC Converter



GVS-3200
10/100/1000BASE-T to 1000BASE-SX MMF SC Converter



FVS-3120
10/100BASE-TX to 100BASE-LX SMF SC Converter



GVS-3110
10/100/1000BASE-T to 1000BASE-LX10 SMF SC Converter

Ethernet Media Converter Comparison						
Model	FVS-3800	GVS-3800	FVS-3200	GVS-3200	FVS-3120	GVS-3110
Media Conversion	RJ-45 to SFP	RJ-45 to SFP	RJ-45 to MMF SC	RJ-45 to MMF SC	RJ-45 to SMF SC	RJ-45 to SMF SC
Max. Speed	100Mbps	1000Mbps	100Mbps	1000Mbps	100Mbps	1000Mbps
Distance	Depends on Transceivers	Depends on Transceivers	2 km	2km	20km	10km
Dip Switches	-	-	-	-	-	-
Optional Accessories	CVH-3000: 12-Slot Media Converter					

Ethernet Media Converters



FVT-0103TXFC
10/100BASE-TX to 100BASE-FX MMF
Converter with PoE (SC)



FVT-0104TXFC
10/100BASE-TX to 100BASE-FX SMF
Converter with PoE (SC)



FVT-0203TXFC
10/100BASE-TX to 100BASE-FX MMF
Converter with PoE Injector (SC)



FVT-0204TXFC
10/100BASE-TX to 100BASE-FX SMF Converter
with PoE Injector (SC)



FVT-4001 / FVT-4301
10/100BASE-TX to 100BASE-FX
MMF / SMF Converter (SC)



FVT-4002
10/100BASE-TX to 100BASE-FX MMF
Converter (ST)

Ethernet Media Converter Comparison						
Model	FVT-0103TXFC	FVT-0104TXFC	FVT-0203TXFC	FVT-0204TXFC	FVT-4001 / FVT-4301	FVT-4002
Media Conversion	RJ-45 to MMF SC	RJ-45 to SMF SC	RJ-45 to MMF SC	RJ-45 to SMF SC	RJ-45 to MMF SC/ RJ-45 to SMF SC	RJ-45 to MMF ST
Max. Speed	100Mbps	100Mbps	100Mbps	100Mbps	100Mbps	100Mbps
Distance	2km	20km	2km	20km	2km / 30km	2km
PoE	IEEE 802.3af	IEEE 802.3af	IEEE 802.3af	IEEE 802.3af	-	-
PoE Power Budget	-	-	15.4W	15.4W	-	-
Power Supply	External/PoE	External/PoE	External	External	External	External
Dip Switches	V	V	V	V	V	V
Optional Accessories	CVH-3000: 12-Slot Media Converter		-	-	FVT-4000: 10-Slot Media Converter Chassis with Redundant Power Supply	



GVT-4000
10/100/1000BASE-T to 1000BASE-X Fiber
Converter (SFP)



GVT-4001
10/100/1000BASE-T to 1000BASE-SX
MMF Converter (SC)



FVT-6001/FVT-6301
10/100BASE-TX to 100BASE-FX MMF / SMF
Converter with TS-1000 Support (SC)



FVT-5001
10/100BASE-TX to 100BASE-FX Multi-Mode
Module with TS-1000 Support (SC)



FVT-5301
10/100BASE-TX to 100BASE-FX Single-
Mode Module with TS-1000 Support (SC)



GVT-5000
10/100/1000BASE-TX to 1000BASE-FX-SFP
Module

Ethernet Media Converter Comparison						
Model	GVT-4000	GVT-4001	FVT-6001/FVT-6301	FVT-5001	FVT-5301	GVT-5000
Media Conversion	RJ-45 to SFP	RJ-45 to MMF SC	RJ-45 to MMF SC/ RJ-45 to SMF SC	RJ-45 to MMF SC	RJ-45 to SMF SC	RJ-45 to SFP
Max. Speed	1000Mbps	1000Mbps	100Mbps	100Mbps	100Mbps	1000Mbps
Distance	Depends on Transceivers	Depends on Transceivers	2km / 30km	2km	30km	Depends on Transceiver
Dip Switches	V	V	V	-	-	-
Optional Accessories	FVT-4000: 10-Slot Media Converter Chassis with Redundant Power Supply		FVT-5000: 16-Slot Managed Converter Chassis with Redundant Power Supply			

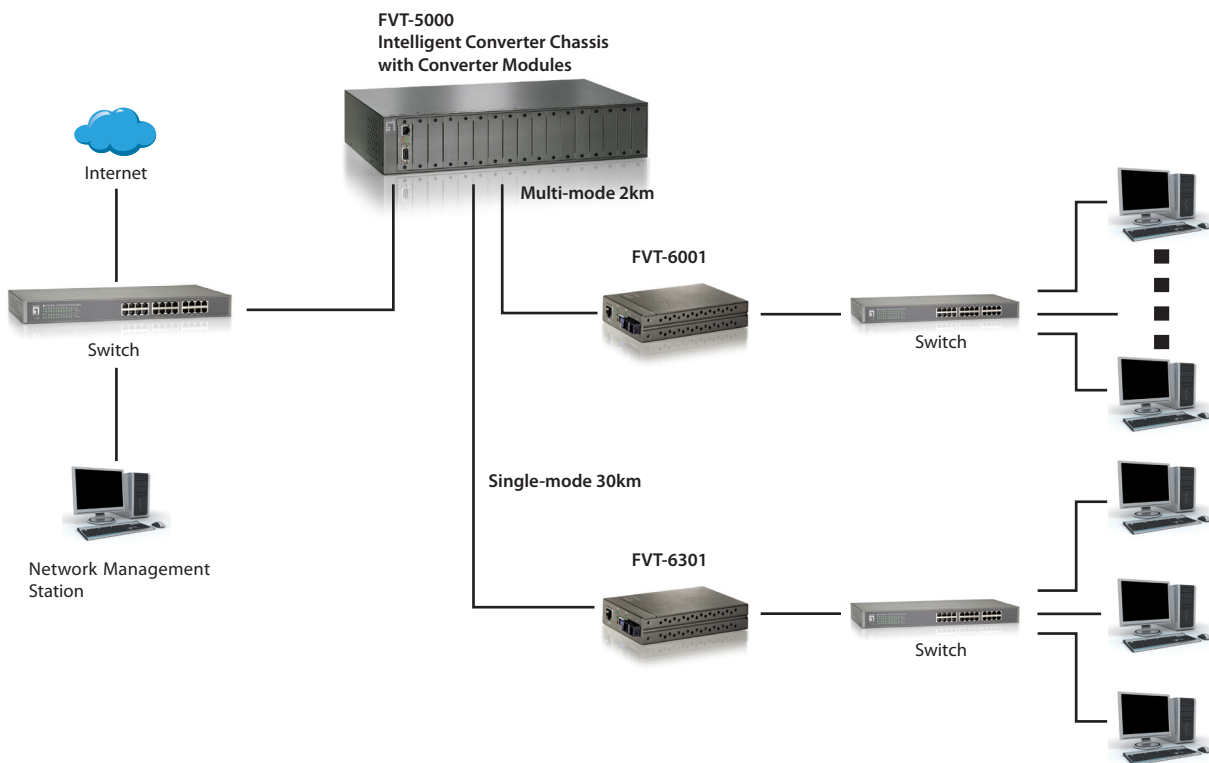

Converter Chassis with Redundant Power Supply



FVT-5000
16-Slot Managed Converter Chassis with Redundant Power Supply



FVT-4000
10-Slot Media Converter Chassis with Redundant Power Supply

Converter Chassis Comparison		
Model	FVT-5000	FVT-4000
Slot	16	10
Redundant Power	√	√
Management	SNMP/WEB UI/Telnet/Console	-
Optional Converter Module	FVT-5001, FVT-5301, GVT-5000	FVT-4001, FVT-4002, FVT-4301, GVT-400, GVT-4001
Optional SFP Module	GVT-0300, GVT-0301, GVT-0302	GVT-0300, GVT-0301, GVT-0302
Manage Converter	FVT-6001, FVT-6301	-

- Ethernet Cable (RJ-45)
- Phone Line (RJ-11)
- PoE
- BNC

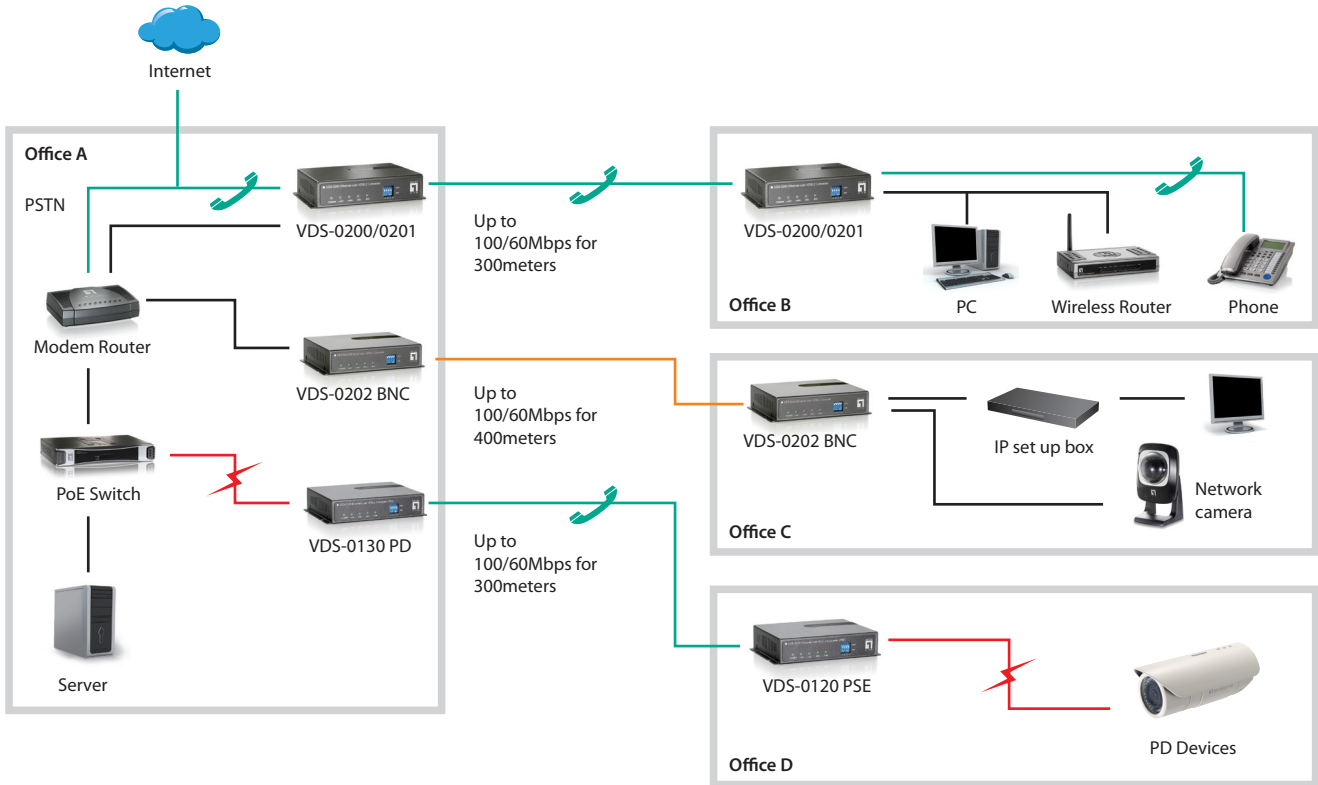

Key Features

- Trellis coding support up to 1024 discrete multi-tone bins and 4 Dip Switches for configuration settings
- Auto MDIX for 10/100BaseT ethernet LAN Ports
- Low-latency for video/voice/data applications
- Supports Line Powered VDSL2 connection



VDS-0200
Ethernet to VDSL2 Converter over 2 wire (Annex A)



VDS-0201
Ethernet to VDSL2 Converter over 2 wire (Annex B)

N/A in AU



VDS-0202
Ethernet to VDSL2 Converter over Coaxial (BNC)



VDS-0120
Ethernet to VDSL2 PoE Converter over 2 wire



VDS-0130
Ethernet to VDSL2 PoE PD Converter over 2 wire



VDS-0110 / VDS-0111
Ethernet over VDSL2 Converter
(Sender / Receiver)

VDSL2 Media Converter Comparison						
Model	VDS-0200	VDS-0201	VDS-0202	VDS-0120	VDS-0130	VDS-0110 / VDS-0111
Media Conversion	RJ-45 to RJ-11	RJ-45 to RJ-11	RJ-45 to Coaxial	RJ-45 to RJ-11	RJ-45 to RJ-11	RJ-45 to RJ-11
VDSL2 Speeds	100/60Mbps	100/60Mbps	100/60Mbps	100/60Mbps	100/60 Mbps	100/50Mbps
PoE	-	-	-	IEEE 802.3af	IEEE 802.3af	-
PoE Power Budget	-	-	-	15.4W	-	-
Power Supply	External	External	External	External	External/PoE	External
Distance	300m	300m	400m	300m	300m	350m
RJ-11 Telephone Port	1	1	-	-	-	-
Dip Switch	V	V	V	V	V	V
Optional Accessories	POC-4001: 8-Bay Media Converter Chassis			-	-	-

The BI-DI (Bi-Directional) uses the WDM technique transceiver. The WDM (Wavelength Division Multiplexing) is technique for fiber-optic cable in which multiple optical signal channels are carried across a single strand of fiber at different wavelengths of light. This allows for a multiplication in capacity, in addition to making it possible to perform bidirectional communications over one strand of fiber.

Key Features

- Single 3.3V power supply
- Eye safety designed to meet LASER Class 1
- No configuration or installation software required
- Works with levelOne switches and converters

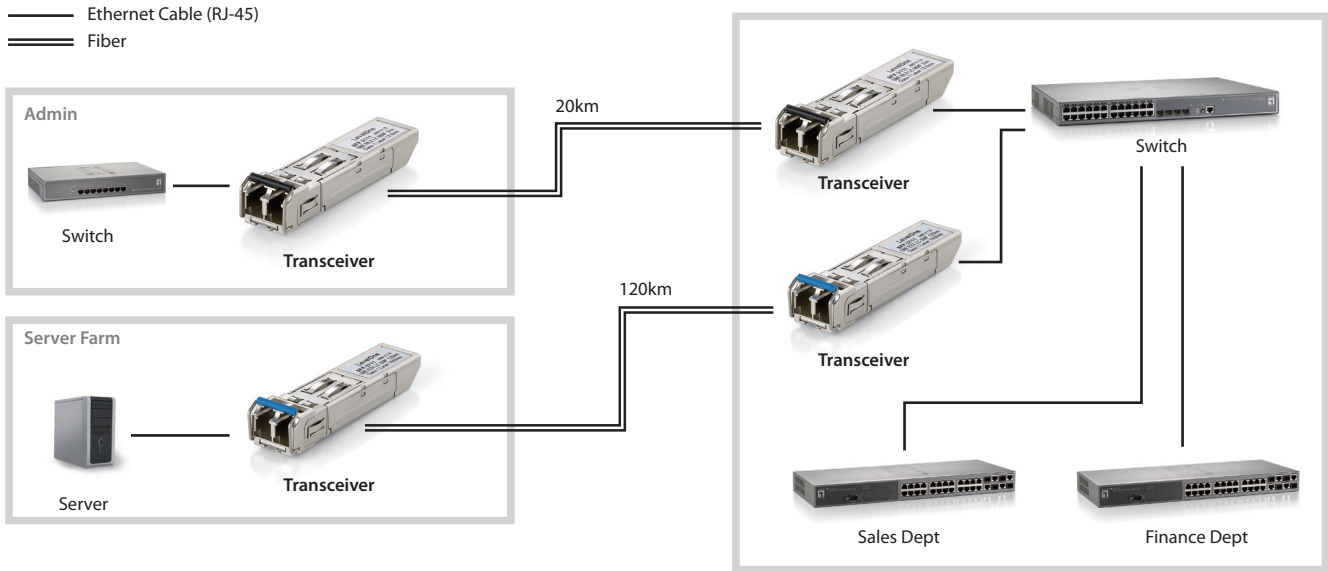

155M SFP Duplex LC Fiber



SFP-1101
155M MMF SFP Transceiver



SFP-1311
155M SMF SFP Transceiver



SFP-1411
155M SMF SFP Transceiver

1.25G SFP Duplex LC Fiber



GVT-0300
1.25G MMF SFP Transceiver



GVT-0301
1.25G SMF SFP Transceiver



GVT-0302
1.25G SMF SFP Transceiver

Transceiver Comparison						
Model	SFP-1101	SFP-1311	SFP-1411	GVT-0300	GVT-0301	GVT-0302
Single/Multi-Mode	MMF	SMF	SMF	MMF	SMF	SMF
Date Rate	155Mbps	155Mbps	155Mbps	1.25Gbps	1.25Gbps	1.25Gbps
Wavelength	1310nm	1310nm	1310nm	850nm	1310nm	1550nm
Transmission Range	2km (50/125µm)	20km (9/125µm)	40km (9/125µm)	550m (50/125µm)	10km (9/125µm)	80km (9/125µm)
Connector	Duplex LC	Duplex LC	Duplex LC	Duplex LC	Duplex LC	Duplex LC

*LevelOne Transceivers work with Converters GVT-4000/5000 and Switches GSW- 0508/1621/2453/5150/0841/1641/2473/2476/4876/5270/0809/1290/2693/4896/2493/2495; FGP-1072/2410/2412/GEL-1072/GEU-0521/1628/GES-0852/FGL-2870/ GEL-2870/ GTL-2690/ GTP-2880/ GTL-2880/ GTL-5280

1.25G SFP Duplex LC Fiber



SFP-3001
1.25G MMF SFP Transceiver



SFP-3211
1.25G SMF SFP Transceiver



SFP-3611
1.25G SMF SFP Transceiver



SFP-3111
1.25G MMF SFP Transceiver



SFP-3711
1.25G SMF SFP Transceiver



SFP-7321
155M SMF BIDI SFP Transceiver

155M BIDI Simplex LC Fiber

Transceiver Comparison						
Model	SFP-3001	SFP-3211	SFP-3611	SFP-3111	SFP-3711	SFP-7321
Single/Multi-Mode	MMF	SMF	SMF	MMF	SMF	SMF
Date Rate	1.25Gbps	1.25Gbps	1.25Gbps	1.25Gbps	1.25Gbps	155Mbps
Wavelength	850nm	1310nm	1550nm	1310nm	1550nm	1310nm/1550nm
Transmission Range	550m (50/125µm)	10km (9/125µm)	80km (9/125µm)	2km (50/125µm)	120km (50/125µm)	20km (9/125µm)
Connector	Duplex LC	Duplex LC	Duplex LC	Duplex LC	Duplex LC	Simplex LC

* LevelOne Transceivers work with Converters GVT-4000/5000 and Switches GSW- 0508/1621/2453/5150/0841/1641/2473/2476/4876/5270/0809/1290/2693/4896/2493/2495; FGP-1072/2410/2412/GEL-1072/GEU-0521/1628/GES-0852/FGL-2870/ GEL-2870/ GTL-2690/ GTP-2880/ GTL-2880/ GTL-5280

155M BIDI Simplex LC Fiber



SFP-7331
155M SMF BIDI SFP Transceiver



SFP-7421
155M SMF BIDI SFP Transceiver



SFP-7431
155M SMF BIDI SFP Transceiver

1.25G BIDI Simplex LC Fiber



SFP-9221
1.25G SMF BIDI SFP Transceiver



SFP-9231
1.25G SMF BIDI SFP Transceiver



SFP-9321
1.25G SMF BIDI SFP Transceiver

Transceiver Comparison						
Model	SFP-7331	SFP-7421	SFP-7431	SFP-9221	SFP-9231	SFP-9321
Single/Multi-Mode	SMF	SMF	SMF	SMF	SMF	SMF
Date Rate	155Mbps	155Mbps	155Mbps	1.25Gbps	1.25Gbps	1.25Gbps
Wavelength	1550nm/ 1310nm	1550nm/ 1310nm	1550nm/ 1310nm	1310nm/1550nm	1550nm/ 1310nm	1550nm/ 1310nm
Transmission Range	20km (9/125µm)	40km (9/125µm)	40km (9/125µm)	10km (9/125µm)	10km (9/125µm)	20km (9/125µm)
Connector	Simplex LC	Simplex LC	Simplex LC	Simplex LC	Simplex LC	Simplex LC

* LevelOne Transceivers work with Converters GVT-4000/5000 and Switches GSW- 0508/1621/2453/5150/0841/1641/2473/2476/4876/5270/0809/1290/2693/4896/2493/2495; FGP-1072/2410/2412/GEL-1072/GEU-0521/1628/GES-0852/FGL-2870/ GEL-2870/ GTL-2690/ GTP-2880/ GTL-2880/ GTL-5280

1.25G SFP Duplex LC Fiber



SFP-9331
1.25G SMF BIDI SFP Transceiver



SFP-9421
1.25G SMF BIDI SFP Transceiver



SFP-9431
1.25G SMF BIDI SFP Transceiver

1.25G Copper Transceiver



SFP-3841
1.25G Copper Transceiver

10G XFP Duplex LC Fiber



XFP-5901
10G MMF XFP Transceiver



XFP-5211
10G SMF XFP Transceiver

Transceiver Comparison						
Model	SFP-9331	SFP-9421	SFP-9431	SFP-3841	XFP-5901	XFP-5211
Single/Multi-Mode	SMF	SMF	SMF	-	MMF	SMF
Date Rate	1.25Gbps	1.25Gbps	1.25Gbps	1.25Gbps	10Gbps	10Gbps
Wavelength	1550nm/ 1310nm	1550nm/ 1310nm	1550nm/ 1310nm	-	850nm	1310nm
Transmission Range	20km (9/125µm)	40km (9/125µm)	40km (9/125µm)	100m (Cat. 5 Cable)	300m (OM3 MMF Fiber)	10km
Connector	Simplex LC	Simplex LC	Simplex LC	RJ-45	Duplex LC	Duplex LC

* LevelOne Transceivers work with Converters GVT-4000/5000 and Switches GSW- 0508/1621/2453/5150/0841/1641/2473/2476/4876/5270/0809/1290/2693/4896/2493/2495; FGP-1072/2410/2412/GEL-1072/GEU-0521/1628/GES-0852/FGL-2870/ GEL-2870/ GTL-2690/ GTP-2880/ GTL-2880/ GTL-5280

10G SFP Duplex LC Fiber



SFP-6101
10Gbp MMF SFP-Plus Transceiver



SFP-6121
10Gbps SMF SFP-Plus Transceiver



SFP-6141
10Gbps SMF SFP-Plus Transceiver

Transceiver Comparison			
Model	SFP-6101	SFP-6121	SFP-6141
Single/Multi-Mode	MMF	SMF	SMF
Date Rate	10Gbps	10Gbps	10Gbps
Wavelength	850nm	1310nm	1310nm
Transmission Range	300m	10km	40km
Connector	Duplex LC	Duplex LC	Duplex LC

*LevelOne 10G SFP Duplex LC Fiber Transceiver work with Switches GTP-2880/GTL-2880/GTL-5280

The LevelOne IP Power Switch is an ideal system of remoting management for office and larger enterprise organizations that need to reboot servers and manage the power to other network devices.

— Ethernet Cable (RJ-45)
 — Power

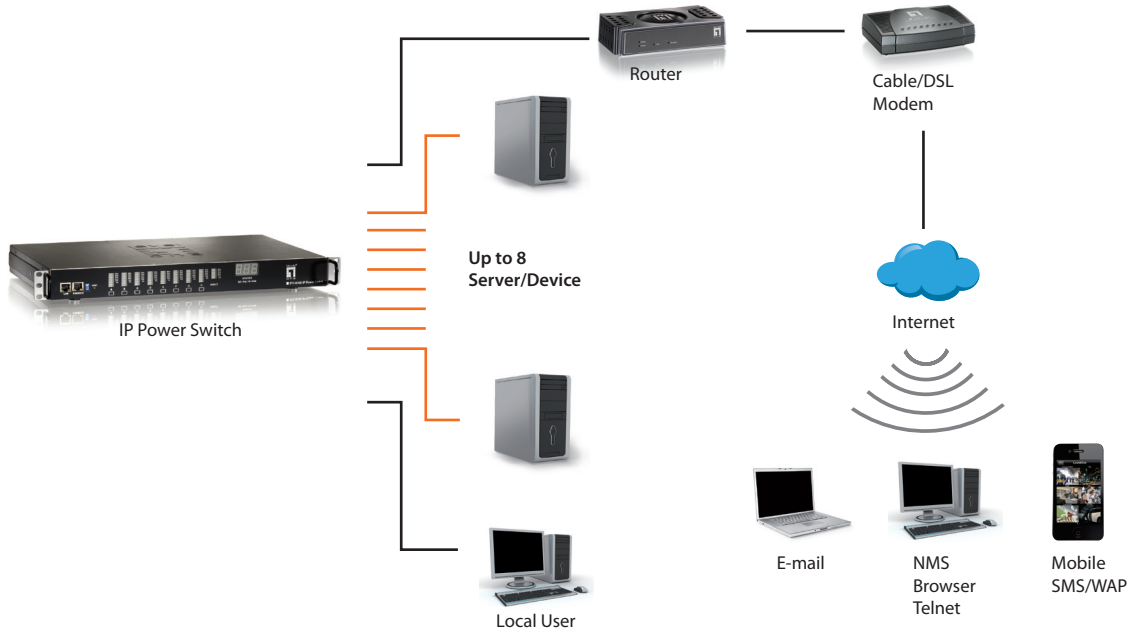

IPS-0008 8-Port IP Power Switch

- Provides eight power outlets that can be turned on/off remotely
- Intelligently turn on/off devices by event and schedule
- Detail data-logging for statistical analysis and diagnostics
- Sends email for event notification
- Firmware upgrades via MS Windows utility and supports java applet of history log
- supports SSL V3 and SSH V1 protocol and two level username/password security
- supports two digital output and Provides modem function for remote dial-up connection
- Easy configuration and management via web browser, Telnet or SNMP
- Optional Environmental Monitoring Device (EMD) to monitor temperature, humidity and smoke detector

N/A in AU



LevelOne Router is a great extension to any network. Either wired or wireless products, users can choose deployment from many options to easily share and manage network data.

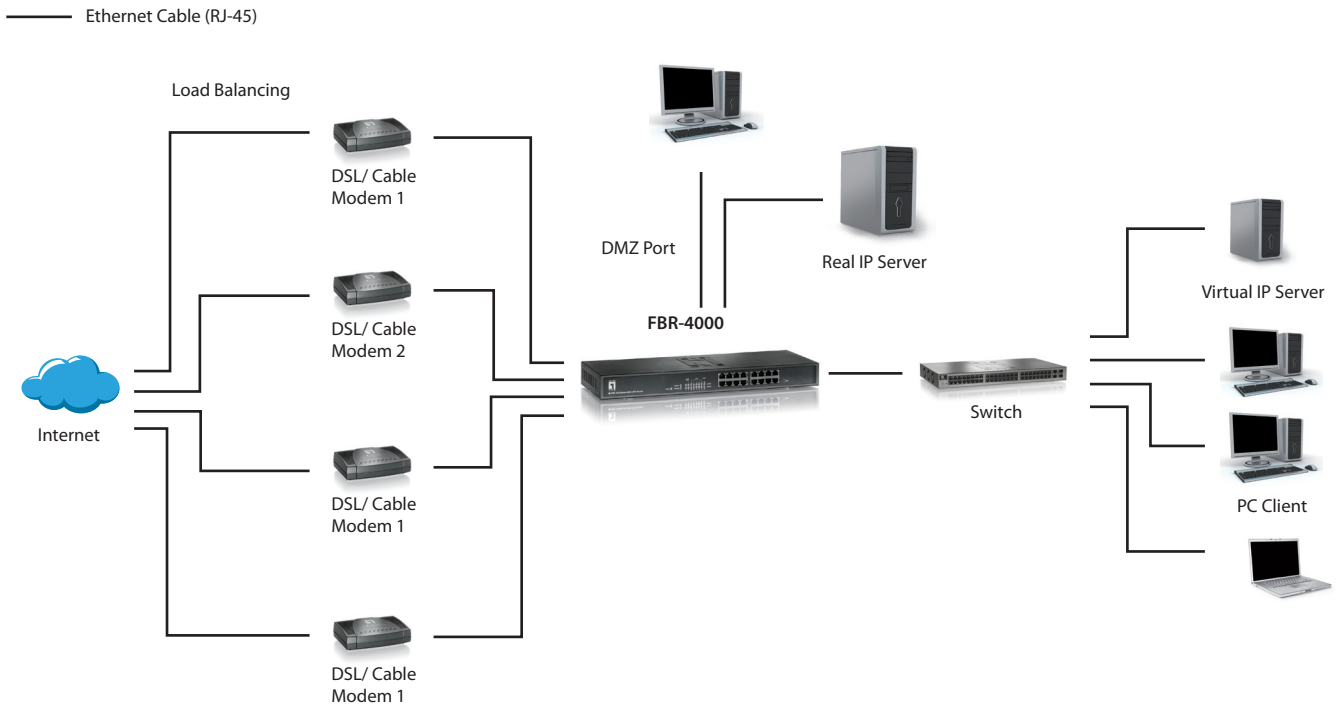

FBR-4000

Multi-WAN Load Balance VPN Router

- Enables 4 WAN, 10 LAN, 2 DMZ auto-MDI/MDI-X 10/100Mbps RJ-45 ports
- Supports QoS and bandwidth management for critical traffic and applications
- Shares Internet access up to 253 users and supports 80,000 concurrent sessions
- Supports VPN security up to 40 tunnels with encryption of DES, 3DES, AES (128/139/256-bit)
- Supports full firewall functions to secure data connectivity with SPI, DoS, URL block filtering, and port/service blocking for additional protection
- Advanced NAT features to setup DMZ, DDNS, remote management, virtual servers, SNMP and ARP proxy



The LevelOne WHG-1000 is a multi-function all-in-one Wireless Hotspot Gateway for wireless hotspot applications. Particularly designed for hotspot service providers an integrated solution of rapid deployment, with built-in billing function and receipt printing capabilities, for easy start up and performance enhanced.

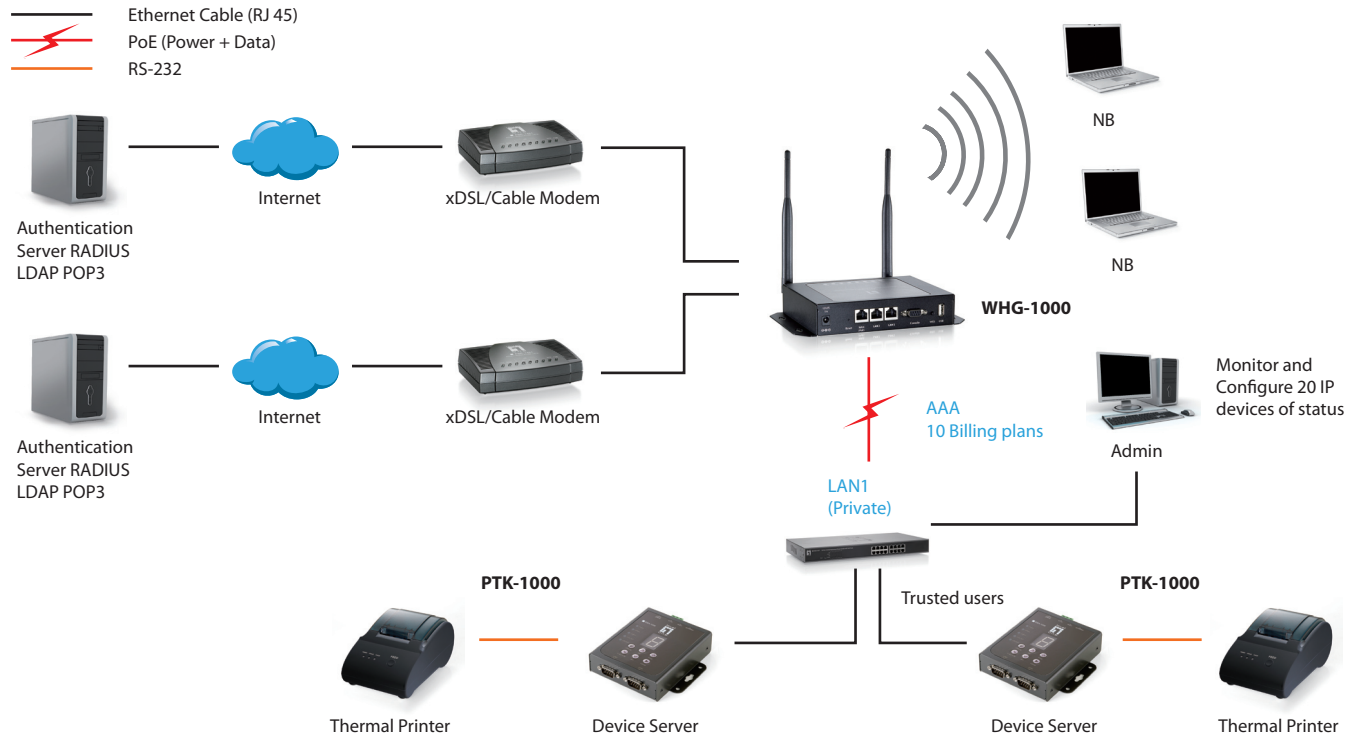

Key Features

- Programmable Billing Profiles allow operators to customize the billing plans for On-Demand users
- Flexible accounting and billing management
- Simplified operation and reliable internet connection
- Supports WEP, WPA, WPA2, IEEE 802.1x



WHG-1000
300Mbps Wireless PoE Hotspot Gateway

Optional Accessories: PTK-1000 Ticket Generator Kit



AP Management Gateway Comparison	
Model	WHG-1000
LAN	1 x 10/100Mbps
WAN (Internet)	2 x 10/100Mbps
USB Port	1
Console Port	1
Local Account	3069
On-Demand Account	3069
PoE	IEEE 802.3af
Power Supply	External/PoE
Optional Accessories	PTK-1000: Ticket Generator Kit

LevelOne Network Adapters come with different interfaces to suit your needs. With high-speed data transfer rates that follow all IEEE standards and protocols, you can rely on solid performance especially when bandwidth-hungry applications are being used.

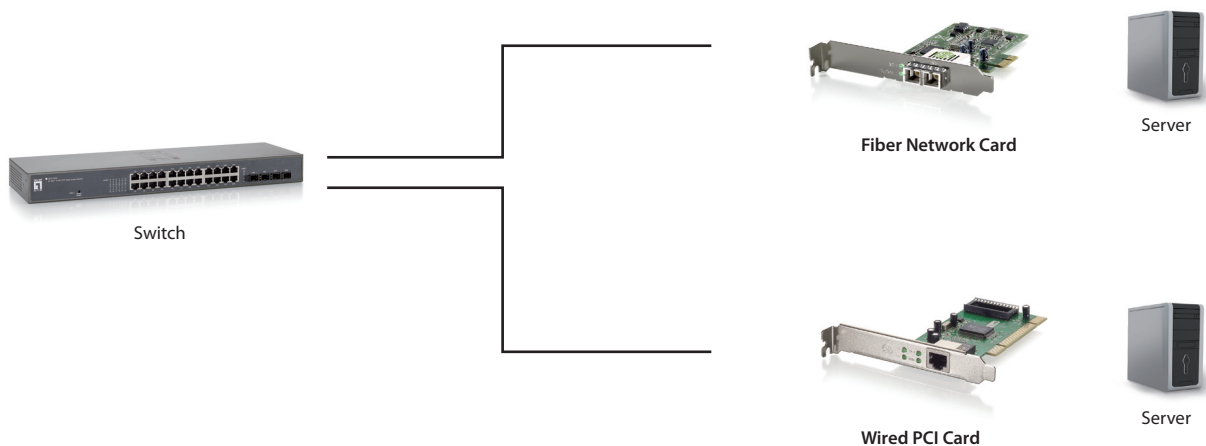

Key Features

- Provides Plug and Play for easy installation
- Supports multiple operation system
- Extends network area connectivity over greater distances

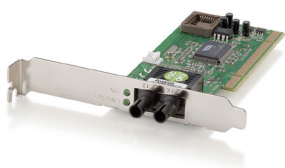

FNC-0103FX
100BASE-FX MMF Optic PCI Card (ST)

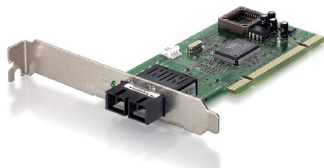

FNC-0104FX
100BASE-FX MMF Optic PCI Card (SC)

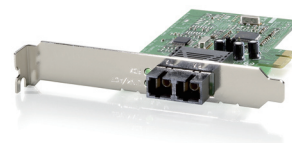

FNC-0115
100BASE-FX MMF Optic PCI Express Card (SC)

Network Adapter Comparison			
Model	FNC-0103FX	FNC-0104FX	FNC-0115
Interface	PCI	PCI	PCI-e
Ethernet Port	-	-	-
Fiber Port	1 x 100BASE-FX MMF	1 x 100BASE-FX MMF	1 x 100BASE-FX MMF
Antenna	-	-	-
Wake-on-LAN	-	-	V
IP Rating	-	-	-
Jumbo Frame	-	-	-



GNC-0111
1000BASE-SX Fiber Optic PCI Express Card (SC)



GNC-0105T
32-Bit Gigabit Ethernet PCI Card



GNC-0112
Gigabit Ethernet PCIe Card



FNC-0600TXM
5-Port L2 SNMP Switch Card



N/A in AU

WUA-5600
150Mbps Wireless High Power Outdoor USB Adapter

Network Adapter Comparison					
Model	GNC-0111	GNC-0105T	GNC-0112	FNC-0600TXM	WUA-5600
Interface	PCI-e	PCI	PCI-e	PCI	USB
Ethernet Port	-	1 x 10/100/1000Mbps	1 x 10/100/1000Mbps	5 x 10/100Mbps	-
Fiber Port	1 x 1000BASE-SX MMF	-	-	-	7 dBi Omni-Directional
Antenna	-	-	-	-	150Mbps (11b/g/n)
Wake-on-LAN	-	-	-	-	-
IP Rating	-	-	-	-	IP-67
Jumbo Frame	9K	8K	-	-	-

Wireless Access Point

LevelOne Wireless Access Points create unique and flexible network architectures. Depending on your requirement, these devices make it possible to transmit wireless signals to every corner of your office. Either indoor or outdoor.

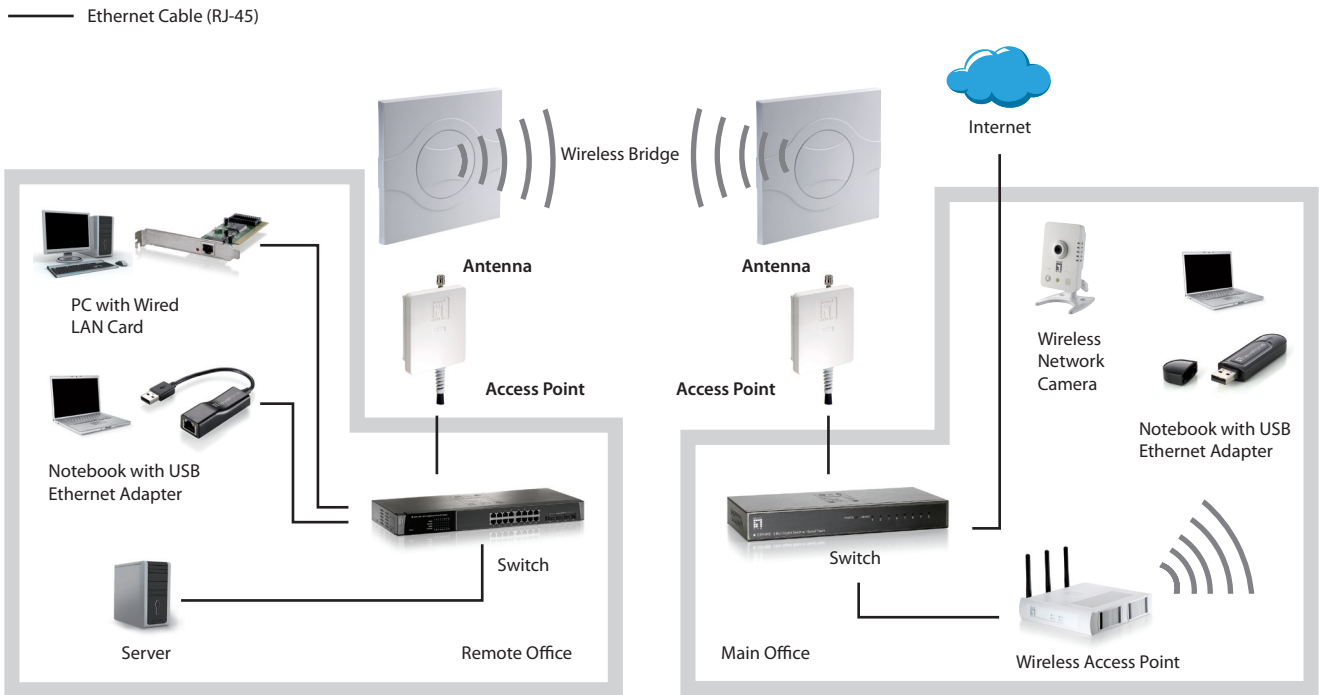

Key Features

- Supports multiple wireless operation modes
- Provides wireless security with 64/128-bit WEP, WPA, and WPA2 encryption



WAP-3100
54Mbps Wireless PoE Access Point



WAP-6002
150Mbps Wireless Access Point



WAP-6011
300Mbps Wireless Access Point



WAP-6012
300Mbps Wireless Gigabit PoE Access Point



WAB-6120
150Mbps Wireless Outdoor PoE Access Point



WAB-5120
300Mbps 5G Wireless Outdoor PoE Access Point / Bridge

Wireless Access Point Comparison						
Model	WAP-3100	WAP-6002	WAP-6011	WAP-6012	WAB-6120	WAB-5120
Wireless	54Mbps (11b/g)	150Mbps(11b/g/n)	300Mbps (11b/g/n)	300Mbps (11b/g/n)	150Mbps (11b/g/n)	300Mbps (11a/n)
Antenna/Connector	1 x 2dBi (External Detachable) / RP-SMA	1 x 1.8dBi (External Detachable) / RP-SMA	2 x 1.8dBi (External Detachable) / RP-SMA	3 x 2dBi (External Detachable) / RP-SMA	1 x 8dBi (Internal) / N-type	2 x 16dBi(Internal) / RP-SMA
PoE	IEEE 802.3af	-	-	IEEE 802.3af	V	V
Power Supply	External/PoE	External	External	External/PoE	Passive PoE	Passive PoE
Frequency Range	2.4GHz	2.4GHz	2.4GHz	2.4GHz	2.4GHz	5GHz
Multiple-SSID	-	8	8	8	16	16
AP/ AP Client/WDS Mode	V	V	V	V	V	V
IP Rating	-	-	-	-	IP55	IP55

N/A in AU



WAP-1001
108Mbps Wireless Outdoor PoE Access Point



WAB-7400
54Mbps Dual-Radio Outdoor PoE Mesh Access Point



WAP-6003
150Mbps Wireless Access Point



WAP-6101
300Mbps Wireless Ceiling PoE Access Point



WAP-6013
300Mbps Wireless Access Point

Wireless Access Point Comparison					
Model	WAP-1001	WAB-7400	WAP-6003	WAP-6101	WAP-6013
Wireless	108Mbps (11b/g, Super G)	54Mbps (11a/b/g)	150Mbps (11b/g/n)	300Mbps (11b/g/n)	300Mbps (11b/g/n)
Antenna/Connector	1 x 12dBi (Internal) / -	N-Type Connector	1 x 3dBi (External) / -	2 x 5dBi (Internal) / -	2 x 3dBi (External) / -
PoE	V	IEEE 802.3af	-	IEEE 802.3af	-
Power Supply	PoE	PoE	External	PoE	External
Frequency Range	2.4GHz	2.4GHz/ 5GHz	2.4GHz	2.4GHz	2.4GHz
Multiple-SSID	-	V	2	4	2
AP/ AP Client/ WDS Mode	V	AP mode	V	V	V
IP Rating	IP65	IP65	-	-	-

LevelOne provides a variety of directional and omni-directional antennas, making it possible to send and receive wireless signals over distances of up to 5000m.

Key Features

- Provides stable signals and extends coverage
- Compliant with IEEE 802.11 b/g/n application in the 2.4GHz frequency range
- Compliant with IEEE 802.11a/n standards in the 5GHz frequency range

— Ethernet Cable (RJ-45)

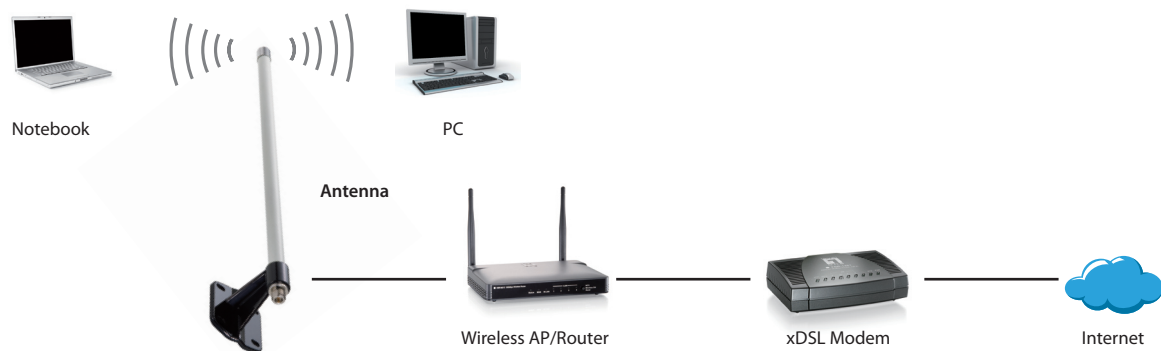

2.4GHz Antennas



OAN-2151
15dBi 2.4GHz Omni-Directional Outdoor antenna



OAN-2090
9dBi 2.4GHz Omni-Directional Outdoor Antenna Kit



WAN-7100
10.5dBi 2.4GHz Directional Dual-Polarization Patch Antenna Kit



WAN-1112
12dBi 2.4GHz Directional Patch Outdoor Antenna Kit



WAN-2185
8.5dBi 2.4GHz Directional Pico Cell Outdoor Antenna



WAN-2140
14dBi 2.4GHz Directional Panel Outdoor Antenna

Antenna Comparison						
Model	OAN-2151	OAN-2090	WAN-7100	WAN-1112	WAN-2185	WAN-2140
Description	Omni-Directional	Omni-Directional	Directional Dual-Polarization	Directional Patch	Directional Pico Cell	Directional Panel
Frequency Range	2.4GHz	2.4GHz	2.4GHz	2.4GHz	2.4GHz	2.4GHz
Indoor/Outdoor	Outdoor	Indoor/Outdoor	Indoor/Outdoor	Indoor/Outdoor	Indoor/Outdoor	Outdoor
Gain	15dBi	9dBi	10.5dBi	12dBi	8.5dBi	14dBi
Range (Estimated)	800~3000m	400~1000m	200~800m	200~800m	350~1200m	300~3500m
Extension Cable	Optional	-	3m	-	-	-
IP Rating	IP67	IP67	-	IPX5	IPX5	-
Connector	N-Jack	N-Jack	SMA-RPSMA	SMA-Jack	N-Jack	N-Jack

2.4GHz Antennas



WAN-2181
18dBi 2.4GHz Directional Panel Outdoor Antenna



WAN-2218
18dBi 2.4GHz Directional Yagi Outdoor Antenna

5GHz Antennas



OAN-4101
5GHz 10dBi Omni-Directional Outdoor Antenna



WAN-9150
15dBi 5GHz Directional Dual-Polarization Outdoor Panel Antenna



WAN-9180
18dBi 5GHz Directional Dual-Polarization Outdoor Panel Antenna

Antenna Comparison					
Model	WAN-2181	WAN-2218	OAN-4101	WAN-9150	WAN-9180
Description	Directional Panel	Directional Yagi	Omni-Directional	Directional Dual-Polarization	Directional Dual-Polarization
Frequency Range	2.4GHz	2.4GHz	5GHz	5GHz	5GHz
Indoor/Outdoor	Outdoor	Outdoor	Outdoor	Outdoor	Outdoor
Gain	18dBi	18dBi	10dBi	15dBi	18dBi
Range (Estimated)	1500~5000m	1500~5000m	600~2400m	1500~5000m	1500~5000m
Extension Cable	-	-	-	-	-
IP Rating	IP67	IPX5	IPX5	IP67	IP67
Connector	N-Jack	N-Jack	N-Jack	N-Jack	N-Jack

Dual Band (2.4GHz/5GHz) Antennas



WAN-1160
6/8dBi Dual-band Directional Antenna

Antenna Comparison	
Model	WAN-1160
Description	Directional
Frequency Range	2.4GHz/5GHz
Indoor/Outdoor	Indoor
Gain	6dBi/8dBi
Range (Estimated)	25~180m
Extension Cable	1m
IP Rating	-
Connector	RP-SMA Plug

Antenna Cable

Key Features

- Works well with LevelOne access point
- No configuration or installation software required
- Easy to install and stable signal extension



ANC-1430 / ANC-1440 / ANC-1470
RPSMA Plug to RPSMA Jack Antenna Cable



ANC-2210
N Plug to N Plug Antenna Cable 200 Series



ANC-2310
RPSMA Plug to N plug Antenna Cable 200 Series



ANC-2350
RPSMA Plug to N Plug Antenna Cable 200 Series



ANC-2330
RPSMA Plug to N Plug Antenna Cable 200 Series



ANC-4230
N Plug to N Plug Antenna Cable 400 Series



ANC-4130
N Plug to N Jack Antenna Cable 400 Series



ANC-4160
N Plug to N Jack Antenna Cable 400 Series

Antenna Cable Comparison					
Model	ANC-1430	ANC-1440	ANC-1470	ANC-2210	ANC-2310
Outer Diameter	200 series	200 series	200 Series	200 series	200 series
Cable	Low loss 200 coaxial cable	Low loss 200 coaxial cable	Low loss 200 coaxial cable	CFD-200 coaxial cable	CFD-200 coaxial cable
Connector	RP-SMA Plug/ RP-SMA Jack	RP-SMA Plug/ RP-SMA Jack	RP-SMA Plug/ RP-SMA Jack	N-Plug/N-Plug	N-Plug/RP-SMA
Length	3m	5m	10m	1m	1m
Frequency range	DC~6GHz	DC~6GHz	DC~6GHz	DC~6GHz	DC~3GHz

Antenna Cable Comparison					
Model	ANC-2350	ANC-2330	ANC-4230	ANC-4130	ANC-4160
Outer Diameter	200 series	200 series	400 series	400 series	400 Series
Cable	CFD-200 cable	CFD-200 cable	CFD-400 coaxial cable	DDC-400 cable	DDC-400 Cable
Connector	N-Plug/RP-SMA	N-Plug/RP-SMA	N-Plug/N-Plug	N-Plug/N-Jack	N-Plug/N-Jack
Length	1.5m	3m	3m	3m	6m
Frequency range	DC~3GHz	DC~6GHz	DC~6GHz	DC~3GHz	DC~6GHz

LevelOne Outdoor Lighting Arrestor Kit provides lightning protection for your wireless equipment. By adding a simple arrester to your wireless antenna cabling you can reduce the costs in damaged switches, access points, or other network devices.



Key Features

- Easy to install wall mounting
- No configuration or installation software required
- Works well with LevelOne Outdoor Antennas



ANA-3100
3GHz Outdoor Lighting Arrestor



ANA-6101
6GHz Outdoor Lighting Arrestor

Outdoor Lighting Arrestor Kit Comparison		
Model	ANA-3100	ANA-6101
Connector	N-Plug/N-Jack	N-Plug/N-Jack
Frequency Range	DC~3GHz	DC~6GHz
Voltage Standing Wave Ratio	1.5	1.5
Wi-Fi Compliant	2.4GHz	2.4GHz/ 5GHz

LevelOne Power over Ethernet (PoE) devices supply power to PoE-capable devices like network cameras, access points, and VoIP phones using only Ethernet cables. MidSpan hubs combine data and power into the same cable to provide ultimate flexibility when building a network. Use LevelOne PoE indoor/outdoor repeaters to extend your PoE network devices with an addition of 100m. This is especially useful as no devices needs to be located close to power outlets.

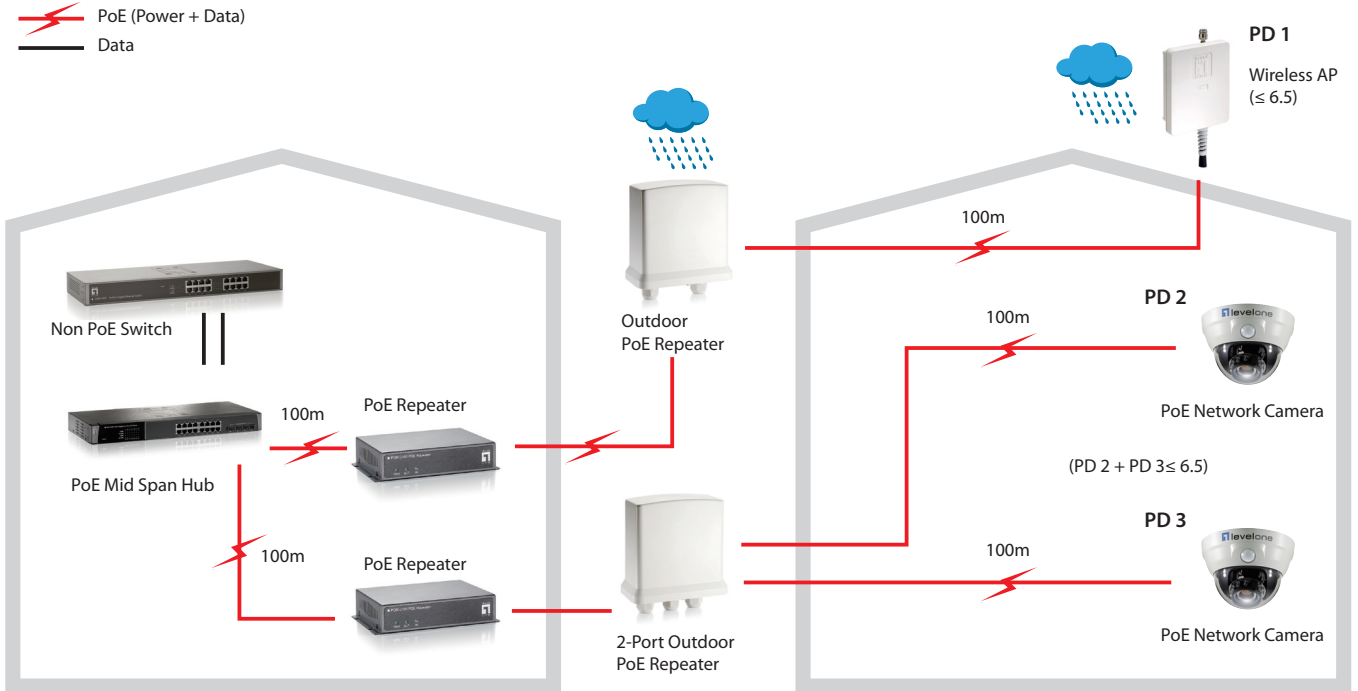

Injector Hubs

- 12 ports Power over Ethernet Hub
- Compatible with IEEE 802.3af PoE standard
- High safety short circuit protection
- 19" rack mountable size
- Power protection: over voltage, over current and over temp protection



POH-1250
12 FE PoE Injector Hub



POH-1260
12 FE High Power PoE Injector Hub

PoE Hubs Comparison		
Model	POH-1250	POH-1260
PoE Power Budget	200W	375W
Data In Port	12	12
Data + Power Port Out	12	12

PoE Splitter

- Built-in current limitation, short circuit and overload protection
- Eliminates the need for a bulky power adapter and power line for your appliance
- Simple to install Plug and Play
- Automatically detects PoE terminals and supplies inline power



POS-4000
12V DC High Power PoE Splitter



POS-4002
24V AC High Power PoE Splitter



POS-1002
5-12V DC PoE Splitter



POS-1001
5-12V DC Gigabit PoE Splitter



POS-3000
5-12V DC Gigabit PoE-Plus Splitter



POS-4001
3-12V DC High Power Outdoor PoE Splitter

PoE Splitter Comparison						
Model	POS-4000	POS-4002	POS-1002	POS-1001	POS-3000	POS-4001
PoE	V	V	IEEE 802.3af	IEEE 802.3af	IEEE 802.3af/at	V
Power Output	12VDC	24AC	5-12V DC	5-12V DC	5-12V DC	3-12V DC
Power Supply	PoE	PoE	PoE	PoE	PoE	PoE
IP-Rating	-	-	-	-	-	IP65

PoE Injector

- Built-in surge and over current protection
- Plug and Play, no software or configuration needed



POI-4000
High Power PoE Injector



POI-2002
PoE Injector



POI-2001
Gigabit PoE Injector



POI-3000
Gigabit PoE-Plus Injector

PoE Injector Comparison				
Model	POI-4000	POI-2002	POI-2001	POI-3000
PoE	V	IEEE 802.3af	IEEE 802.3af	IEEE 802.3af/at
RJ-45 Input	1 x 10/100Mbps	1 x 10/100Mbps	1 x 10/100/1000Mbps	1 x 10/100/1000Mbps
RJ-45 Output	1 x 10/100Mbps	1 x 10/100Mbps	1 x 10/100/1000Mbps	1 x 10/100/1000Mbps
PoE Power Budget	56W	15.4W	15.4W	30W
Optional Accessories	POC-4000: 8-Bay High Power PoE Chassis	-	-	-

PoE Repeater

- Supports power over ethernet for easy network deployment
- Supports all network devices



POR-0100
PoE Repeater



POR-0102
PoE Repeater



POR-1100
Outdoor PoE Repeater



POR-1102
2-Port Outdoor PoE Repeater



POR-0120
Gigabit PoE Repeater



POR-0122
2-Port Gigabit PoE Repeater



POT-0100
PoE Repeater over 2-wire (Master)



POT-0110
PoE Repeater over 2-wire (Slave)



POT-1110
Outdoor PoE Repeater over 2-wire (Slave)

PoE Repeater Comparison					
Model	POR-0100	POR-0102	POR-1100	POR-1102	POR-0120
RJ-45 Input Port	1 x 10/100Mbps	1 x 10/100Mbps	1 x 10/100Mbps	1 x 10/100Mbps	1 x 10/100/1000Mbps
RJ-45 Output Port	1 x 10/100Mbps	2 x 10/100Mbps	1 x 10/100Mbps	2 x 10/100Mbps	1 x 10/100/1000Mbps
RJ-11 Input Port	-	-	-	-	-
RJ-11 Output Port	-	-	-	-	-
PoE	V	V	V	V	V
Power Supply	PoE	PoE	PoE	PoE	PoE
IP-Rating	-	-	IP65	IP65	-

PoE Repeater Comparison				
Model	POR-0122	POT-0100	POT-0110	POT-1110
RJ-45 Input Port	1 x 10/100/1000Mbps	1 x 10/100Mbps	-	1 (Using RJ-11 Cable with RJ-45 Connector)
RJ-45 Output Port	2 x 10/100/1000Mbps	-	1 x 10/100Mbps	1 x 10/100Mbps
RJ-11 Input Port	-	-	1 x 10/100Mbps	-
RJ-11 Output Port	-	1 x 10/100Mbps	-	-
PoE	V	V	V	V
Power Supply	PoE	PoE	PoE	PoE
IP-Rating	-	-	-	IP65

PPM-1000 is a convenient and compact sized test and measurement device for PoE network installations. It verifies whether there is sufficient power to ensure your PoE device can function correctly, and helps avoid costly downtime or damage to equipment. This is particularly important when using non-PoE standard Power Sourcing Equipments (PSE) such as some High Power injectors.

PPM-1000

PoE Power Measurer

- Ensures your PoE device works correctly
- Measures available power (watt) and voltage On a PoE line
- Portable and compact size
- LED display and indicators to reveal the power status
- Built-in temperature sensor
- Replaceable external battery pack for real portability
- Detachable neck strap
- Build-in temperature sensor and LED indicator to inform user about overheat condition if high power load test is applied



Connect with High-Power 30W PSE, POI-3000 / 40W PSE, POI-4000 (Refer to page 49)

End to End Distance	Daisy-Chaining (1-Port PoE Repeater)	Power Available	
		30W PSE (POI-3000)	40W PSE (POI-4000)
100m	0	-	-
200m	1	25.5W	28W
300m	2	21W	25.5W
400m	3	16.5W	21W
500m	4	12W	16.5W
600m	5	7.5W	12W
700m	6	3.84W	7.5W
800m	7	Data only No Power	3.84W
900m	8	-	Data only No Power

LevelOne KVM switches include award-winning designs that look trendy on any desktop. With a small footprint and Plug and Play installation, these devices help you to switch between computers with ease. Both PS/2 and USB connections are available to support any operating system. Our professional level rackmount and drawer consoles provide advanced features such as remote management and control of up to 128 different servers.

Key Features

- Features an auto-scan and programmable scan function
- Supports a variety of operating system platforms
- Plug and Play configuration
- Flexible switching for an uninterrupted multi media experience
- Supports DOS, Netware, Unix, Linux, Win3.X, Win 95/98/98SE/2000/ME/XP

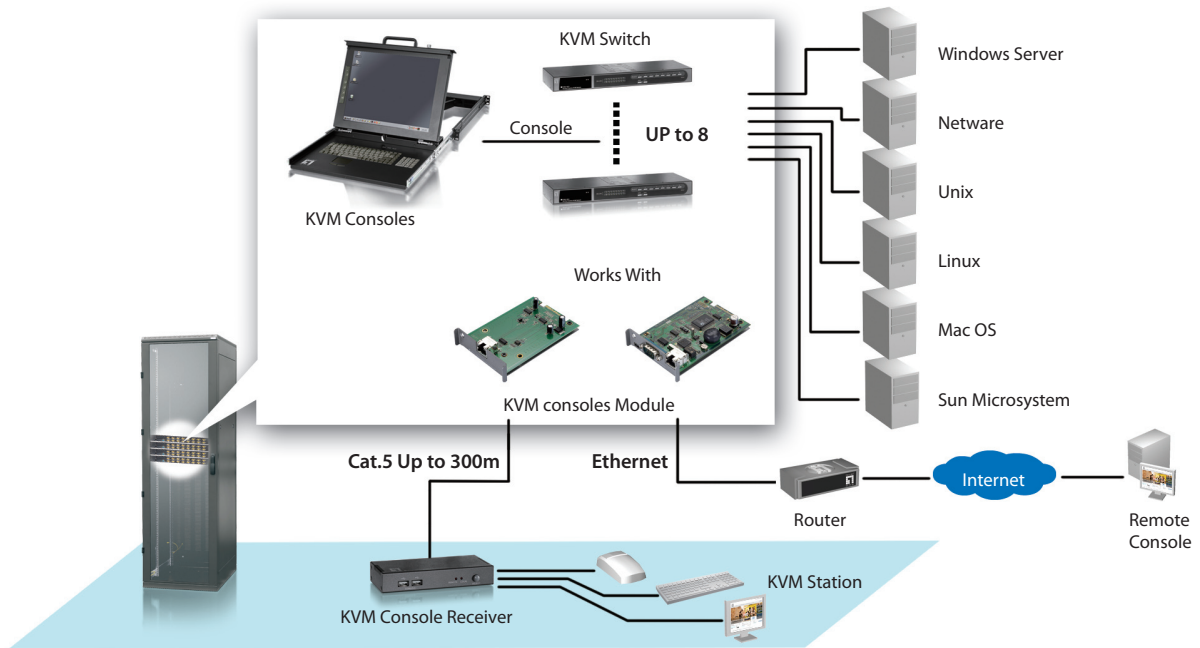

Desktop KVM Switch

Rackmount KVM Switch



KVM-0411 / KVM-0412
4-Port PS/2 KVM Switch



KVM-0421 / KVM-0422
4-Port USB KVM Switch



KVM-0410
4-Port KVM Switch with OSD for PS/2



KVM-0420
4-Port KVM Switch for USB & PS/2



KVM-0811
8-Port PS/2 KVM Switch



KVM-1611
16-Port PS/2 KVM Switch

Desktop KVM Switch Comparison					
	Model	KVM-0411	KVM-0412	KVM-0421	KVM-0422
PC Port	Port for Keyboard/Mouse	PS/2	PS/2	USB	USB
	Video port	VGA	VGA	VGA	VGA
	Audio / Microphone	V	-	V	-
Console Port	Port for Keyboard/Mouse	PS/2	PS/2	USB	USB
	Video port	VGA	VGA	VGA	VGA
	Audio / Microphone	V	-	V	-
Feature	Control and Manage computers	4	4	4	4
	Max. Local Resolution	2048 x 1536	2048 x 1536	2048 x 1536	2048 x 1536
	Cascade Control PC No.	-	-	-	-
	Optional Accessories	-	-	-	-

Rackmount KVM Switch Comparison					
	Model	KVM-0410	KVM-0420	KVM-0811	KVM-1611
PC Port	Port for Keyboard/Mouse	PS/2	PS/2,USB	PS/2	PS/2
	Video port	VGA	VGA	VGA	VGA
	Audio / Microphone	-	-	-	-
Console Port	Port for Keyboard/Mouse	PS/2	PS/2	PS/2	PS/2
	Video port	VGA	VGA	VGA	VGA
	Audio / Microphone	-	-	-	-
Feature	Control and Manage computers	16	16	8	16
	Max. Local Resolution	1920 x 1440	1920 x 1440	1920 x 1440	1920 x 1440
	Cascade Control PC No.	16	16	120	120
	Optional Accessories	ACC-2001 / ACC-2002: 1.8m / 3.0m PS/2 KVM Cable ACC-2006 / ACC-2010: 6.0m / 10.0m PS/2 KVM Cable PS/2 KVM Cable	ACC-2001 / ACC-2002: 1.8m / 3.0m PS/2 KVM Cable ACC-2006 / ACC-2010: 6.0m / 10.0m PS/2 KVM Cable PS/2 KVM Cable ACC-2003 / ACC-2004 / ACC-2005: 1.8m / 3.0m / 5.0m USB KVM Cable	ACC-2009: 90cm Daisy Chain Cable	

Rackmount KVM Switch



KVM-0831
8-Port Combo KVM Switch with Expansion Slot



KVM-1631
16-Port Combo KVM Switch with Expansion Slot

Rackmount KVM Console



KVM-0115US / KVM-0115DE
15" Rackmount KVM Console with
US/DE Keyboard Layout



KVM-0117US / KVM-0117DE
17" Rackmount KVM Console with
US/DE Keyboard Layout



KVM-0217US / KVM-0217DE
17" Modularized Rackmount KVM Console
with US/DE Keyboard Layout

Rackmount KVM Switch Comparison			
	Model	KVM-0831	KVM-1631
PC Port	Port for Keyboard/Mouse	PS/2, USB	PS/2, USB
	Video port	VGA	VGA
	Audio / Microphone	-	-
Console Port	Port for Keyboard/Mouse	USB	USB
	Video port	VGA	VGA
	Audio / Microphone	-	-
Feature	Control and Manage computers	8	16
	Max. Local Resolution	1920 x 1440	1920 x 1440
	Cascade Control PC No.	120	128
	Optional Accessories	KVM-9007: KVM Cat.5 Console Receiver; ACC-1000: KVM Cat.5 Console Module; ACC-2000: KVM IP Console Module; KVM-9009: KVM Remote Console Kit; ACC-2101 / ACC-2102 / ACC-2103: 1.8m / 3.0m / 5.0m PS/2 and USB KVM Cable;	

Rackmount KVM Console Comparison				
	Model	KVM-0115	KVM-0117	KVM-0217
PC port	Port for Keyboard/Mouse	PS/2, USB	PS/2, USB	8/ 16 (Depends on KVM Module)
	Video port	VGA, DVI	VGA, DVI	8/ 16 (Depends on KVM Module)
	Audio / Microphone	-	-	-
Console Port	Port for Keyboard/Mouse	PS/2, USB	PS/2, USB	(Depends on KVM Module)
	Video port	VGA, DVI	VGA, DVI	(Depends on KVM Module)
	Audio / Microphone	-	-	-
Feature	Control and Manage computers	8,16	8,16	8,16
	Max. Local Resolution	1024 x 1786	1280x1024	1280x1024
	Cascade Control PC No.	-	-	120/128
	Optional Accessories	-	-	KCM-0831: 8-Port D-Sub Combo KVM Module KCM-1631: 16-Port D-Sub Combo KVM Module KVM-9007: KVM Cat.5 Console Receiver

LevelOne's IP KVM Extender allows you to locate a PC, SERVER or KVM SWITCH up to 150m away from your controlling keyboard, mouse and VGA monitor using popular and inexpensive Ethernet cabling. With its compact design, our Cat.5 Extender easily fits on a desk or any limited space. No software or interface card is required.

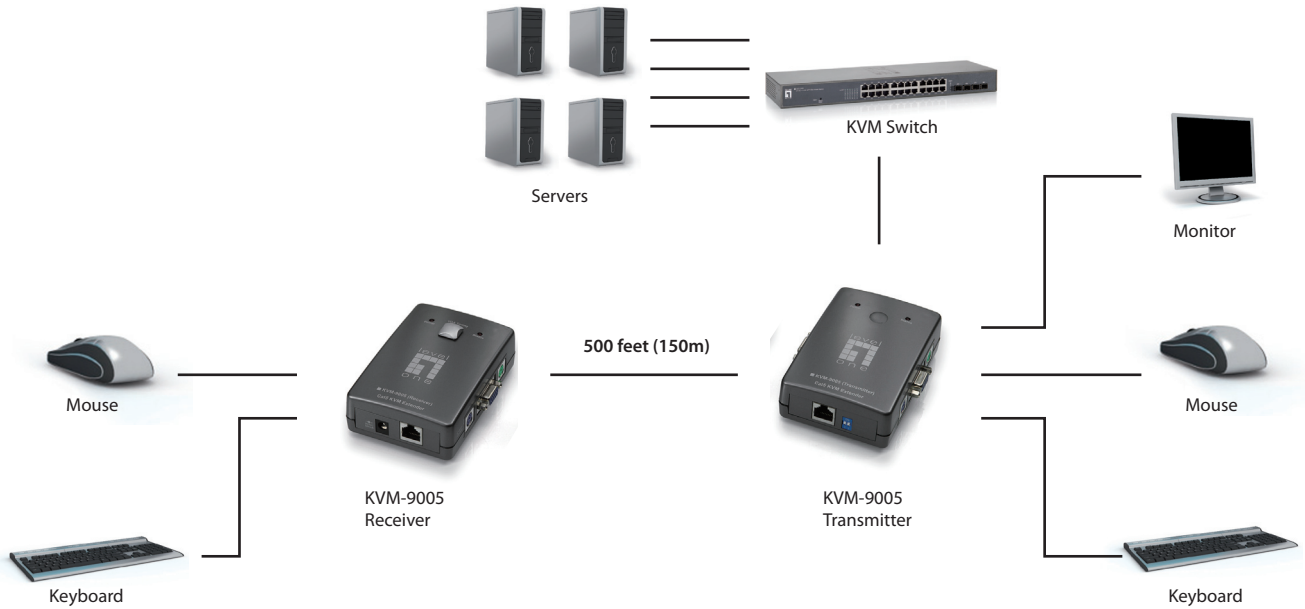

Extending console port or PC port of KVM Switch up to 150m away

Key Features

- Provides Plug and Play for easy installation
- Supports Cat.5/5e/6 Ethernet cabling
- Works with KVM switches and stand-alone PC



KVM-9000
IP KVM Extender



KVM-9005
PS/2 KVM Extender



KVM-9006
USB KVM Extender

KVM Extender Comparison			
Model	KVM-9000	KVM-9005	KVM-9006
Extension distance	No limit	150m	150m@1280x1024
Console Port	PS/2, VGA, USB	PS/2, VGA	USB, VGA
PC Port	PS/2, VGA	PS/2, VGA	USB, VGA
Resolution	1280x1024	1280x1024	1280x1024 1920x1440 (local console)

LevelOne offers both wired and wireless print servers. These devices make it easy for several users to connect to a single printer on a wired or wireless local network.



Key Features

- Supports multiple operating systems
- Supports multiple network printing protocols
- Easy to use web-based user interface
- Includes Internet Printing Protocol (IPP) support



FPS-1031
Parallel Print Server



FPS-1032
USB Print Server



FPS-1033
3-Port USB/Parallel Print Server



WPS-1133
3-Port USB/Parallel Wireless Printer Server

Print Server Comparison				
Model	FPS-1031	FPS-1032	FPS-1033	WPS-1133
Multifunction Printer Server Support	-	-	-	-
Parallel/USB Port	1 x Parallel	1x USB	1x Parallel/ 2x USB	1x Parallel/ 2x USB
USB Server	-	-	V	-
Wireless	-	-	-	54Mbps

VoIP Gateways make phone calls over the Internet simple, easy, and affordable. LevelOne VoIP Gateways are ideal for home, SOHO, and SMB users that are looking forward integrate PSTN (Public Switched Telephone Network) and VoIP telephone features onto the same IP network.

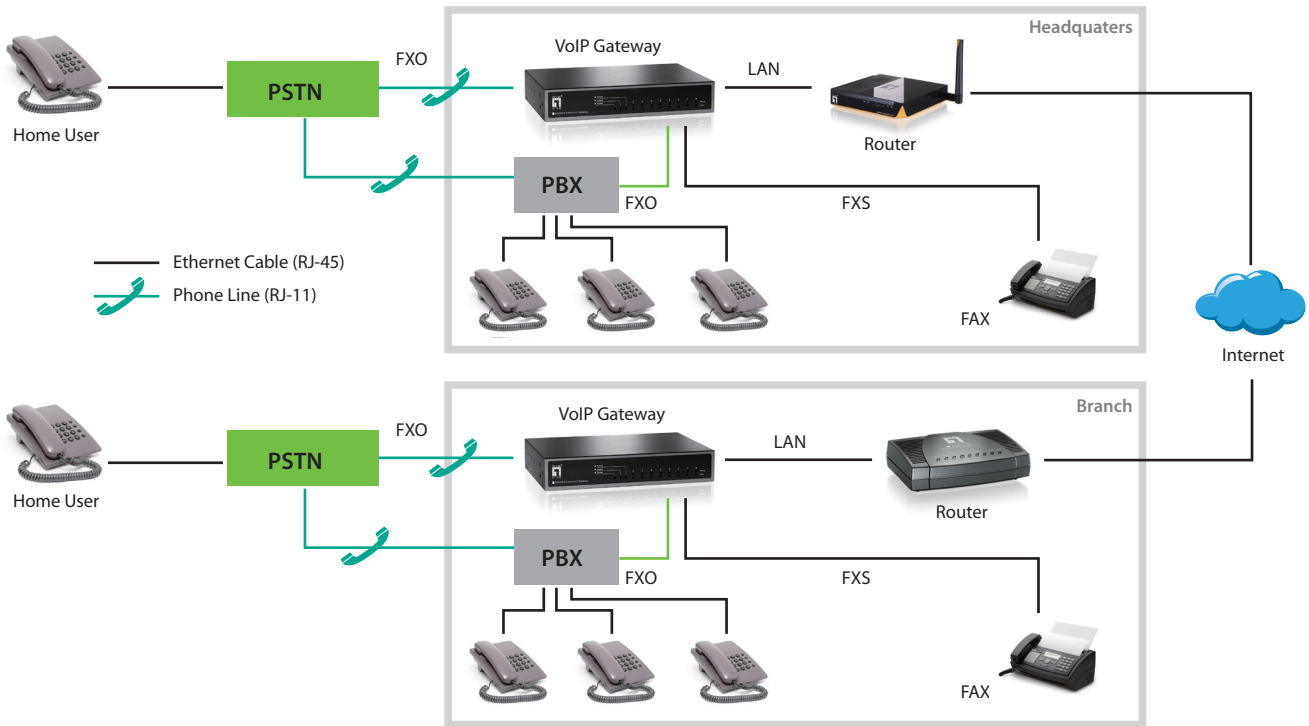

VOI-8001 8-Port FXS H.323/SIP Gateway

- Realize immediate cost-savings advantages of VoIP communication over the Internet
- Connect up to 8 telephones, fax machines or connect to a PBX for a VoIP telephone network
- Simultaneous SIP and H.323 Calls
- Register up to 4 SIP Proxy or Gatekeepers Simultaneously
- Includes a built-in Firewall, NAT server, PPPoE and DHCP Support
- Remote Manageable and upgradeable via the IP Provision System
- QoS for high priority VoIP traffic



VOI-8001

— Ethernet Cable (RJ-45)
 Phone Line (RJ-11)

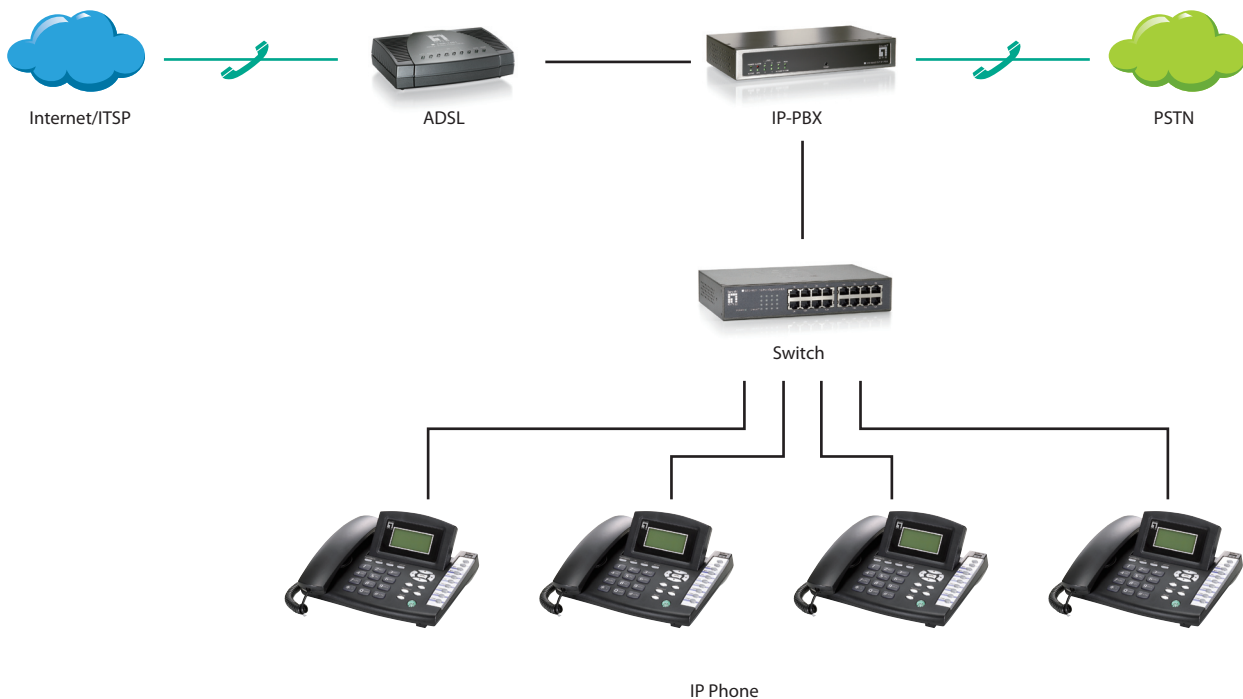

IP Phone

- Traditional phone for digital use
- Cost effective telephony for long and short distance calls for home, business and enterprise users
- User friendly and packed with PoE, VoIP and SIP



VOI-7000
SIP Phone



VOI-7100
SIP Phone with PoE Capability



VOI-7010
IP Phone



VOI-7011
IP Phone with FX0 port

Voice over IP Comparison				
Model	VOI-7000	VOI-7100	VOI-7010	VOI-7011
Ethernet Port	1 x 10/100Mbps	1 x 10/100Mbps	1 x 10/100Mbps	1 x 10/100Mbps
FX0 Port	-	-	-	1
VoIP Protocol	SIP v1/v2	SIP v1/v2	SIP v1/v2	SIP v1/v2
PoE	-	IEEE 802.3af	-	-
Power Supply	External	External/PoE	External	External
Optional Accessories	-	-	DHM-1000: Light-weight Single Headset with Microphone	

LevelOne has a wide range of options in network cameras. In particular, wireless, wired, PoE, day/night, speed dome, Pan/Tilt/Zoom, as well as indoor and outdoor options. More, our cameras come with free 64-CH Monitoring Software (supports iCamSecure Apple App) that enables users to view, manage, and capture streaming images from any location with Internet connection.

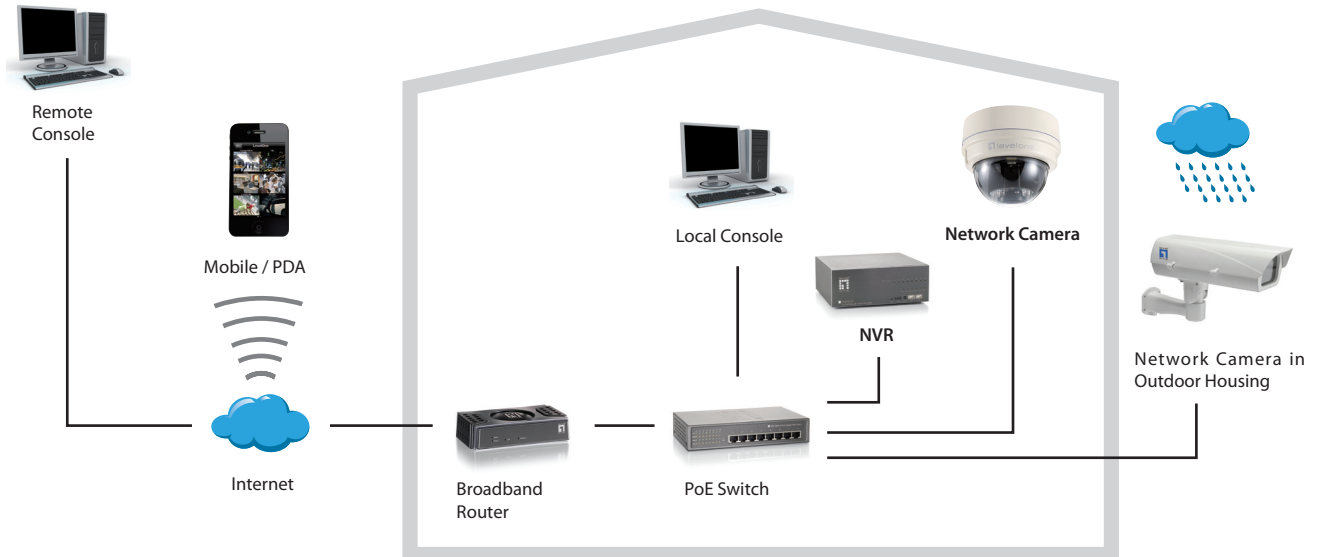

Fixed Camera

- Supports dual streams simultaneously
- Supports 2-way audio
- Bundled with 64-Channel LevelOne IP CamSecure



FCS-1091
PoE Network Camera



FCS-1101
PoE Network Camera



FCS-1121
Megapixel PoE Network Camera

Fixed Camera Comparison			
Model	FCS-1091	FCS-1101	FCS-1121
Sensor	Sony CCD	Color CCD	CMOS Megapixel
Max. Resolution	640 x 480	704x480 (NTSC); 704x576 (PAL)	1280 x 800
AGC/AWB/AES/WDR	AGC/AWB/AES	AGC/AWB/AES	AGC/AWB/AES
PIR Sensor	-	-	-
Infrared LED	-	-	-
ICR (IR-Cut Filter Removal)	V	-	V
3D Noise Reduction	-	-	-
Pan/Tilt/Zoom	-	-	-
PoE	IEEE 802.3af	IEEE 802.3af	IEEE 802.3af
Power Supply	External/PoE	External/PoE	External/PoE
Built in Microphone/ Speaker	Microphone	-	Microphone
Local Storage	-	-	-
IP-Rating	-	-	-
Operation Temperature	0° ~ 40°C	0° ~ 40°C	0° ~ 40°C
Optional Accessories	BOH-1100: PoE Upgradable Outdoor Housing BOH-1200: PoE Upgradable Outdoor Housing with Infrared LEDs		Outdoor Housing:BOH-1100 / BOH-1200 Lens: CAS-1300/CAS-1400

Fixed Camera



FCS-1122
Megapixel PoE Network Camera



FCS-5041
Megapixel Day/Night PoE Outdoor
Network Camera



FCS-1141
1.3-Megapixel PoE Network Camera

Fixed Camera Comparison			
Model	FCS-1122	FCS-5041	FCS-1141
Sensor	CMOS Megapixel	CMOS Megapixel	Sony CCD
Max. Resolution	1280 x 800	1280 x 800	1280 x 960
AGC/AWB/AES/WDR	AGC/AWB/AES	AGC/AWB/AES	AGC/AWB/AES
PIR Sensor	-	-	-
Infrared LED	-	V	-
ICR (IR-Cut Filter Removal)	V	V	V
3D Noise Reduction	-	-	V
Wireless	-	*150Mbps	-
Pan/Tilt/Zoom	-	Z(4x)	-
PoE	IEEE 802.3af	IEEE 802.3af	IEEE 802.3af
Power Supply	External/PoE	External/PoE	External/PoE
Built in Microphone/ Speaker	Microphone	-	-
Local Storage	-	V	V
IP-Rating	-	IP67	-
Operation Temperature	0° ~ 40°C	-20° ~ 50°C	0° ~ 50°C
Optional Accessories	Outdoor Housing:BOH-1100 / BOH-1200 Lens: CAS-1300/CAS-1400	*WUA-5600: 150Mbps Wireless High Power Outdoor USB Adapter	BOH-1100: PoE Upgradable Outdoor Housing BOH-1200: PoE Upgradable Outdoor Housing with Infrared LEDs



FCS-1151
2-Megapixel PoE Network Camera



FCS-0071
2-Megapixel Fish-Eye PoE
Network Camera



FCS-1131
2-Megapixel PoE Network Camera

Fixed Camera Comparison			
Model	FCS-1151	FCS-0071	FCS-1131
Sensor	CMOS 2-Megapixel	CMOS 2-Megapixel	CMOS 2-Megapixel
Max. Resolution	1600 x 1200	1600 x 1200	1920 x 1080
AGC/AWB/AES/WDR	AGC/AWB/AES	AGC/AWB/AES	AGC/AWB/AES
PIR Sensor	-	-	-
Infrared LED	-	-	-
ICR (IR-Cut Filter Removal)	V	V	V
3D Noise Reduction	-	-	V
Pan/Tilt/Zoom	-	-	-
ePTZ	-	V	-
PoE	IEEE 802.3af	IEEE 802.3af	IEEE 802.3af
Power Supply	External/PoE	External/PoE	External/PoE
Built in Microphone/ Speaker	Microphone	V	-
Local Storage	V	V	V
IP-Rating	-	-	-
Operation Temperature	0° ~ 50°C	0° ~ 50°C	-10° ~ 50°C
Optional Accessories	BOH-1100: PoE Upgradable Outdoor Housing BOH-1200: PoE Upgradable Outdoor Housing with Infrared LEDs	-	BOH-1100: PoE Upgradable Outdoor Housing BOH-1200: PoE Upgradable Outdoor Housing with Infrared Lens: CAS-1400

Fixed Camera



FCS-5051
2-Megapixel Day/Night PoE
Outdoor Network Camera



NEW



FCS-5052
3-Megapixel Day/Night PoE
Outdoor Network Camera



FCS-5061
5-Megapixel Day/Night PoE-Plus
Outdoor Network Camera

Fixed Camera Comparison			
Model	FCS-5051	FCS-5052	FCS-5061
Sensor	CMOS 2-Megapixel	CMOS 3-Megapixel	CMOS 5-Megapixel
Max. Resolution	1920 x 1080	2032x1536	2592 x 1944
AGC/AWB/AES/WDR	AGC/AWB/AES/WDR	AGC/AWB/AES	AGC/AWB/AES/WDR
PIR Sensor	-	-	-
Infrared LED	V	V	V
ICR (IR-Cut Filter Removal)	V	V	V
3D Noise Reduction	V	-	V
Pan/Tilt/Zoom	-	-/-/Digital: 4x	-
PoE	IEEE 802.3af	IEEE 802.3af	IEEE 802.3at
Power Supply	External/PoE	External/PoE	External/PoE
Built in Microphone/ Speaker	Microphone	Microphone	Microphone
Local Storage	V	-	V
IP-Rating	IP66	IP67	IP66
Operation Temperature	-10° ~ 50°C	0°C ~ 40°C	-40°C ~ 50°C (AC 24V / PoE-Plus)
Optional Accessories	-	-	-

Fixed Dome Camera

- Compatible with IEEE 802.3af PoE standard for easy network deployment
- Supports 2-way audio
- Digital I/O for External Sensor and Alarm
- Bundled with 64-Channel LevelOne IP CamSecure



FCS-3031
PoE PIR Dome Network Camera



FCS-3051
Day/Night PIR PoE Dome
Network Camera



FCS-3061
Megapixel Day/Night PoE Dome
Network Camera

Fixed Dome Camera Comparison			
Model	FCS-3031	FCS-3051	FCS-3061
Sensor	CMOS	CMOS	CMOS Megapixel
Max. Resolution	640 x 480	640 x 480	1280 x 800
AGC/AWB/AES/WDR	AGC/AWB/AES	AGC/AWB/AES	AGC/AWB/AES
PIR Sensor	V	V	-
Infrared LED	-	V	V
ICR (IR-Cut Filter Removal)	-	V	V
3D Noise Reduction	-	-	-
PoE	IEEE 802.3af	IEEE 802.3af	IEEE 802.3af
Power Supply	External/PoE	External/PoE	External/PoE
Built in Microphone/ Speaker	-	-	-
Local Storage	-	-	-
IP-Rating	-	-	-
Operation Temperature	0° ~ 40°C	0° ~ 40°C	0° ~ 50°C
Optional Accessories	-	-	-

Fixed Dome Camera



FCS-3091
2-Megapixel Fish-Eye PoE Dome
Network Camera



FCS-3071
2-Megapixel PoE Dome
Network Camera



FCS-3081
2-Megapixel Day/Night PoE Dome
Network Camera

NEW

FCS-3052
3-Megapixel Day/Night PoE Dome
Network Camera

Fixed Dome Camera Comparison				
Model	FCS-3091	FCS-3071	FCS-3081	FCS-3052
Sensor	CMOS 2-Megapixel	CMOS 2-Megapixel	CMOS 2-Megapixel	CMOS 3-Megapixel
Max. Resolution	1600 x 1200	1920 x 1080	1920 x 1080	2032 x 1536
AGC/AWB/AES/WDR	AGC/AWB/AES	AGC/AWB/AES/WDR	AGC/AWB/AES/WDR	AGC/AWB/AES
PIR Sensor	-	-	-	-
Infrared LED	-	-	V	V
ICR (IR-Cut Filter Removal)	V	-	V	V
3D Noise Reduction	-	V	V	-
PoE	IEEE 802.3af	IEEE 802.3af	IEEE 802.3af	IEEE 802.3af
Power Supply	External/PoE	PoE	External/PoE	External/PoE
Built in Microphone/ Speaker	V	-	-	-
Local Storage	V	V	V	-
IP-Rating	-	IP66	IP66	-
Operation Temperature	0° ~ 50°C	-20° ~ 50°C	-10° ~ 50°C (DC 12V/ PoE-Plus) -35° ~ 50°C (AC 24V)	0° ~ 50°C
Optional Accessories	-	-	CAS-3100: T-Bar Ceiling Mount CAS-3101: Interior Corner Mount CAS-3000: Outdoor Housing CAS-3241: Straight Tube 25cm CAS-3242: Straight Tube 50cm CAS-3201: Mini Pendant CAS-3221: Corner Plate Mini CAS-3222: Corner Plate Mount CAS-3223: Corner Thin Box Mount CAS-3261: Pole Thin Direct Mounting CAS-3263: Pole Thin Box Mount CAS-3281: Wall Box Mount	-

P/T/Z Dome Camera

- Supports 2-way audio
- Digital I/O for External Sensor and Alarm
- Bundled with 64-Channel LevelOne IP CamSecure



N/A in AU

FCS-4400
Day/Night P/T/Z Speed Dome Network Camera



FCS-4041
2-Megapixel P/T/Z PoE-Plus Speed Dome Outdoor Network Camera

P/T/Z Dome Camera Comparison		
Model	FCS-4400	FCS-4041
Sensor	Exview HAD CCD	Sony CMOS
Max. Resolution	704 x 480 (NTSC) 704 x 576 (PAL)	1920 x 1080
AGC/AWB/AES/WDR	AGC/AWB/AES	AGC/AWB/AES/WDR
PIR Sensor	-	-
Infrared LED	-	-
ICR (IR-Cut Filter Removal)	V	V
3D Noise Reduction	-	V
Pan/Tilt/Zoom	P/T/Z(26x)	P/T/Z(18x)
PoE	-	IEEE 802.3at
Power Supply	External	External/PoE
Local Storage	-	V
IP-Rating	IP66	IP66
Operation Temperature	-20° ~ 50°C	-10°~50°C(PoE-Plus) -40°~50°C (AC 24V)
Optional Accessories	-	CAS-3201: Mini Pendant CAS-3221: Corner Plate Mini CAS-3222: Corner Plate Mount CAS-3223: Corner Thin Box Mount CAS-3241: Straight Tube (25cm) CAS-3242: Straight Tube (50cm) CAS-3261: Pole Thin Direct Mount CAS-3263: Pole Thin Box Mount CAS-3281: Wall Box Mount CAS-3291: Outdoor Power Box (110-115V AC) CAS-3292: Outdoor Power Box (220-230V AC) CAS-4200: USB Joystick for PTZ Network Cameras

Lens



CAS-1001
2.1mm Mono-focal Lens

- Sensing Area: 1/3" CCD
- Iris: Fixed Iris
- Diagonal: 166°
- Horizontal: 149°
- Vertical: 87.2°



CAS-1101
5~50mm Vari-focal Day/Night Lens

- Sensing Area: 1/3" CCD
- Iris: DC-drive Auto Iris
- Diagonal: 60°~7.4°
- Horizontal: 49°~5.8°
- Vertical: 38°~4.4°



CAS-1200
3~8mm Vari-focal Lens

- Sensing Area: 1/3" CCD
- Iris: DC-drive Auto Iris
- Diagonal: 118.7°~44.1°
- Horizontal: 93.4°~34.6°
- Vertical: 68.7°~26.0°



CAS-1300
**2.8~8.5mm Vari-focal Day/Night
Megapixel Lens**

- Sensing Area: 1/3" CCD
- Iris: DC-drive Auto Iris
- Diagonal: 118.1°~41.7°
- Horizontal: 95.4°~33.5°
- Vertical: 71.3°~25.0°



CAS-1400
**2.8-12mm Vari-focal Day/Night
2-Megapixel Lens**

- Sensing Area: 1/3" CCD
- Iris: DC-drive Auto Iris
- Diagonal: 115°~34°
- Horizontal: 92°~27.2°
- Vertical: 69°~20.4°

The LevelOne IP CamSecure software series has been developed by LevelOne to provide more advancing features for digital surveillance systems. The IP CamSecure series provide full camera control and support all LevelOne cameras as well as cameras from other manufacturers.

IP CamSecure Pro Mega Series		IP CamSecure
Main Features		
Max # of Cameras Live View, Monitor and Record	FC5-94 04/08/16/25/36/64 4/8/16/25/36/64	FC5-9064 64
Multi-Vendor Support	ACTI / Arecont Vision / Atlantis Land / Axis / BASLER / D-Link / Etrovision / FINE / HIKVISION / IQinVision / JVC / Lumenera / Mobotix / Panasonic / Pixord / PLANET / Samsung / Sanyo / Sony / Toshiba / VIVOTEK / Zavio (*Please refer to the model official comparison list from LevelOne Website)	LevelOne
Multi-Language Embedded	Brazil, Bulgaria, Traditional / Simple Chinese, Czech, Danish, Dutch, English, Farsi, Finnish, French, German, Greek, Hebrew, Hungarian, Italian, Japanese, Korean, Norway, Polish, Portuguese, Romanian, Russian, Serbia, Slovak, Slovenian, Spanish, Swedish.	
Hybrid Camera Management	Monitor IP digital and CCTV analog cameras in one surveillance system	
Multiple Monitor display	Up to 3 monitor	Up to 2 monitor
E-Map	Up to 10 layers	Up to 2 layers
Smart Guard	Events triggered by general motion detection, missing/ foreign object detection, signal lost, camera occlusion, lose focus, external input or system status	No
Motion Detection	Camera-based motion detection with image exclude filter for image areas of no interest in specific period status	
Smart Search	Search unusual events with specific parameters from recorded video	General Motion Only
Alarm Notification	Play sound, send emails, PoP up E-MAP on event, make phone calls, P/T/Z PRESET GO, Signal digital output, Send a SMS message, Send Snapshot to FTP/Email, on screen display and instant recording.	Instant recording
Counting Application	Count how many times objects move between different locations	No
Video Compression	MJPEG / MPEG4 / H.264	
Audio	Support full duplex real time audio	
User Account	Multiple user authentication levels with password restriction rules for unlimited users	
Log Viewer	All unusual events ,system events by date/time and/or cameras	
Recording	Continuous recording, manual recording/snapshot, record by schedule, record by digital input or triggered event, and record moving only (pre/post record buffer is up to 60 seconds).	
3GPP	**Monitor in 3G mobile devices which are equipped with 3G video playback.	No
Digital Watermark	Yes	No
DDNS	Support DtDNS and Dynu.	No
UPnP	Search for IP cameras via UPnP	
Playback		
Simultaneously Playback	16-CH	1-CH
Image Enhancer	Improve recorded video to get better image during playback and can be applied during export	
Search for Recordings	Search for recordings based on date, time or specific video parameters	Search for motion in continuous recordings
Playback	Controllable speed 1/16x~16x or frame by frame	
Video Clip Export	Export single BMP/JPEG/GIF/PNG/TIFF images to file or printer; Export video in AVI	
P/T/Z and I/O		
Pan/Tilt/Zoom Support	Control of P/T/Z cameras and preset positions	
Preset Patrolling	Multiple cameras patrolling	
Go to Preset on Event	Yes	No
Input/Output Control	Support digital input/output control	
Remote Access via Remote Client Software		
Remote Client Service	Remote Live Viewer/ Remote Playback	Remote Live Viewer/Remote Playback
Pan/Tilt/Zoom Support	Control of P/T/Z cameras	
Max # of Cameras Live View	Up to 16-CH from different servers	1-CH remote live view
Max # of Cameras Playback	Up to 16-CH	1-CH remote live view
PDA / Smart Phone Client (WM 5.0 or above)	Up to 16-CH, 1-CH live display; P/T/Z and I/O control	1-CH remote live view
Remote Access via Web Browser		
PC/NB IE Browser	Up to 4-CH live view and play back	1-CH / No support Playback
iPhone safari	Up to 16-CH, 6-CH live display and play back	1-CH remote live view
Remote Access via Apps		
iOS	Up to 16-CH, 6-CH live display and P/T/Z	1-CH remote live view
Android	Up to 16-CH, 6-CH live display and P/T/Z	1-CH remote live view
Minimum System Requirements****		
CPU	Intel Core 2 Quad Q9400, Intel Core I5, Intel Core I7	Intel core 2 Duo E5300
RAM	2GB above	
Display	ATI Radeon 4650, nVIDIA GeForce GF-9600, Intel 945G/965G, or above (ATI recommended)	1GB
OS	Windows XP / Server 2003 / Vista / 7	
*Please visit www.level1.com for the compatible product list.		
**This feature depends on the mobile telecom service provided and the mobile phone model. LevelOne does not guarantee that this feature will work in all countries.		
***The specification is subject to change. Please visit www.level1.com for the latest specification. Users can upgrade IP CamSecure Lite(older version) to IP CamSecure(v1.26)		
****Overall hardware resource requirement depends on camera steam setting and software feature definition		

FCS-94xx (H/W: V1.26.1)

IP CamSecure Pro Mega Series

- Monitor up to 64 channels simultaneously
 - Dual monitor supported for live view and playback simultaneously
 - "Smart guard" event analysis and instant response to monitor larger areas more efficiently
 - "Smart search" for easy locating of recorded events as well as multi-events viewer and filter
 - Enhance images of recorded video
 - "Counting application" for objects amount control
 - Supports Web-based and 3G mobile remote monitoring
 - Complete system and event log database
 - Relies on hard disk drive storage instead of video tapes
 - Broadcast live video over the Internet for remote viewing
 - Supports both digital and analog cameras in one system
 - Control pan/tilt/zoom features on cameras
- * For LevelOne Cameras, Capture Cards and Video Servers. It also supports many other Network Cameras.



IP CamSecure Pro Mega Series	
Model name	FCS-94 04/08/16/25/36/64
Simultaneous Monitoring	4/8/16/25/36/64
Camera Support	
LevelOne	FCS-0010, FCS-0020, FCS-0030, FCS-0031, FCS-0040, FCS-1010, FCS-1030, FCS-1040, FCS-1050, FCS-1060, FCS-1070, FCS-1081, FCS-1081A, FCS-1091, FCS-1101, FCS-1121, FCS-1131, FCS-1141, FCS-1151, FCS-3000, FCS-3021, FCS-3031, FCS-3051, FCS-3052, FCS-3061, FCS-3071, FCS-3081, FCS-3091, FCS-4010, FCS-4020, FCS-4041, FCS-4x00, FCS-5011, FCS-5030, FCS-5041, FCS-5051, FCS-5052, FCS-5061, FCS-6010, FCS-7011, WCS-0010, WCS-0020, WCS-0030, WCS-0040, WCS-1090, WCS-2010, WCS-2010, WCS-2030, WCS-2040, WCS-2060, WCS-2070
ACTI	ACD2000Q, ACD2100, ACD2200, ACD2300, ACD2400, ACM1011, ACM1231, ACM1232, ACM1311, ACM1431, ACM1432, ACM1511, ACM3001, ACM3011, ACM3211, ACM3311, ACM3401, ACM3411, ACM3511, ACM4000, ACM4100, ACM4200, ACM4201, ACM5001, ACM5601, ACM5611, ACM5711, ACM7411, ACM8201, ACM8211, ACM8511, CAM5130, CAM5140, CAM5150, CAM5200, CAM5201, CAM5221, CAM5300, CAM5301, CAM5321, CAM5500, CAM6100, CAM6200, CAM6220, CAM6500, CAM6510, CAM6520, CAM6600, CAM6610, CAM6620, CAM6630, CAM7100, CAM7120, CAM7200, CAM7220, CAM7300, CAM7301, CAM7320, CAM7321, CAM7322, SED2100, SED2120, SED2140, SED2310Q, SED2320Q, SED2400, SED2420, SED2600, SED2610, SEM1110, TCM4301, TCM5311
Arecont Vision	AV1300, AV1305, AV1355, AV2000, AV2100, AV2105, AV2155, AV3100, AV3105, AV3130, AV3155, AV5100, AV5105, AV5155, AV8180, AV8185, AV8360, AV8365
Atlantis Land	A02-OIPCAM1, A02-OIPCAM2, A02-OIPCAM3, A02-IPCAM5, A02-IPCAM6, A02-IPCAM7, A02-IPCAM8, A02-IPCAM9, A02-IPCAM10, A02-IPCAM11, A02-IPCAM12, A02-IPCAM13, A02-IPCAM14, A02-IPCAM15, A02-IPCAM16, A02-IPCAM17
AXIS	205, 206, 206M, 206W, 207, 207MW, 207W, 209FD, 209FD-R, 209MFD, 209MFD-R, 210, 210A, 211, 211A, 211M, 211W, 212, 213, 214, 215, 216FD, 216FD-V, 216MFD, 216MFD-V, 221, 223M, 225FD, 231D, 231D+, 232D, 232D+, 233D, 240Q, 240Q, 241Q, 241QA, 241S, 241SA, 242S, 243Q, 243SA, 247S, 246Q, M1011, M1011-W, M1031-W, M3011, M3014, P1311, P1343, P1344, P3301, P3301-V, P3343, P3343-V, P3343-VE, P3344, P3344-V, P3344-VE, Q1755, Q6032-E, Q7401, Q7404, Q7406
BASLER	BIP-640C, BIP-640C-DN, BIP-1000C, BIP-1000C-DN, BIP-1300C, BIP-1300C-DN, BIP-1600C, BIP-1600C-DN
D-Link	CS-6620, DCS-6620G, DCS-5220, DCS-5300, DCS-5300G, DCS-2120, DCS-3420, DCS-3220, DCS-3220G, DCS-2100, DCS-2100G, DVS-104, DVS-301, DCS-900, DCS-6900, DCS-910, DCS-920, DCS-950, DCS-950G, DCS-3110, DCS-3410, DCS-3415, DCS-5220(TW), DCS-5610, DCS-6110, DCS-6111
ETROVISION	EV3130AW, EV3130A, EV3131, EV3830H/HP, EV6130W, EV6130P/V, P6131HW, EV6131H/HP, EV6132A, EV6230A, EV6332, EV6333A, EV6530, EV6531A, EV6532A
FINE	TCP-690, TCP-690DN, TCP-HP930, WB-8211SD, WB-8411, CDV-3V930, TCP-690U, TCP-HP930U, WB-8211SDU, CDV-3V930U, EP-936, EP-908, EP-601, EP-201, EP-221, EP-221DN, MD-D1200, TCP670DNU, TCP680DNU
HIKVISION	DS-2DF1, DS-2CD852MF-E, DS-2CD802PF, DS-2CD802NF, DS-2CD812PF, DS-2CD812NF, DS-2CD832PF, DS-2CD832NF, DS-2CD892PF, DS-2CD892NF, DS-2CD802PF-E, DS-2CD802NF-E, DS-2CD812PF-E, DS-2CD812NF-E, DS-2CD832PF-E, DS-2CD832NF-E, DS-2CD892PF-E, DS-2CD892NF-E, DS-2CD812PF-IR1, DS-2CD812NF-IR1, DS-2CD832PF-IR1, DS-2CD832NF-IR1, DS-2CD892PF-IR1, DS-2CD892NF-IR1, DS-2CD812PF-IR3, DS-2CD812NF-IR3, DS-2CD832PF-IR3, DS-2CD832NF-IR3, DS-2CD892PF-IR3, DS-2CD892NF-IR3, DS-2CD702PF, DS-2CD702NF, DS-2CD712PF, DS-2CD712NF, DS-2CD732PF, DS-2CD732NF, DS-2CD792PF, DS-2CD792NF, DS-2CD702PF-FB, DS-2CD702NF-FB, DS-2CD712PF-FB, DS-2CD712NF-FB, DS-2CD732PF-FB, DS-2CD732NF-FB, DS-2CD792PF-FB, DS-2CD792NF-FB, DS-6101HFI-IP, DS-2CD852MF-E, DS-2CD752MF-E, DS-2CD752MF-FB, DS-2CD752MF-FH, DS-2CD862MF-E, DS-2CD762MF-E, DS-2CD762MF-FH, DS-2CD762MF-FB(Hs), DS-2CD812P(N)-IR5, DS-2CD832P(N)-IR5, DS-2CD892P(N)-IR5, DS-2CD852F, DS-2CD752F-E
IQinvision	IQeye301, IQeye301m, IQeye301w, IQeye302, IQeye302w, IQeye303, IQeye303w, IQeye501, IQeye510, IQeye511, IQeye601, IQeye602, IQeye603, IQeye701, IQeye702, IQeye703, IQeye705, IQeye751, IQeye752, IQeye753, IQeye755, IQA255, IQQ425, IQeye855
JVC	VN-C20U, VN-E4(U), VN-C205U, VN-C215U, VN-C655U
Lumenera	le045c, le045c-dn, le075c, le075c-dn, le11059c, le165c, le165c-dn, le175c, le175c-dn, le259c, le275c, le275c-dn, le375c, le375c-dn, li165c
MOBOTIX	D12D-IT, D12D-Sec, D22M-Basic, D22M-IT, D22M-Sec, M10D, M12D-IT, M12D-Sec, M12D-Web, M22M-IT, M22M-Sec, Q22M-Basic, Q22M-Sec, Q24-Basic, Q24-Sec
Panasonic	BB-HCE481, BB-HCM311, BB-HCM331, BB-HCM371, BB-HCM381, BB-HCM403, BB-HCM511, BB-HCM515, BB-HCM527, BB-HCM531, BB-HCM581, BB-HCS301, BL-C1, BL-C10, BL-C111, BL-C131, BL-C20, BL-C30, BL-C101A, BL-C121A, BL-C160, KX-HCM110, KX-HCM280A, DG-NF284, DG-NF302, DG-NP240, DG-NP244, DG-NP304, DG-NS202, DG-NS202A, DG-NS950, DG-NS954, DG-NW960, DG-NW964, WJ-NT304, WJ-NT314, WV-NF284, WV-NF302, WV-NM100, WV-NP1000, WV-NP1004, WV-NP240, WV-NP244, WV-NP304, WV-NP472, WV-NP502, WV-NS202, WV-NS202A, WV-NS324, WV-NS950, WV-NS954, WV-NW484, WV-NW502S, WV-NW960, WV-NW964
PIXORD	100, 120/126/128, 200/206, 201, 205, 207, 240, 241, 261, 262, 263, 300, 400/42X, 461, 463, 1000, 1401, 2000, 4000, 405, 410, 405M, 411/412, 415M, 416
PLANET	ICA-510, ICA-700, ICA-151W, ICA-151, ICA-750, ICA-107W, ICA-107P, ICA-107, ICA-108, ICA-108W, ICA-120, ICA-230, ICA-230W, ICA-230P, ICA-M230, ICA-310, ICA-310W, ICA-312, ICA-312v2, ICA-350, ICA-350-V2, ICA-501, ICA-525, ICA-530, ICA-651, ICA-601, IVS-110
SAMSUNG	SCC-C6475, SNC-B2315, SNC-B5395, SNC-B2331, SNC-B2335, SNC-B5368, SNC-B5399, SNC-C6225, SNC-C7225, SNC-C7478, SNC-M300
SANYO	VCC-HD4000, VCC-HD4000P, VDC-DP9585P, VDC-DP9584N, VCC-9800P, VCC-9800NA, VCC-ZM600N
SONY	SNC-CM120, SNC-CS10, SNC-CS11, SNC-CS20, SNC-CS3, SNC-CS50, SNC-DF40, SNC-DF50, SNC-DF70, SNC-DF80, SNC-DF85, SNC-DM110, SNC-DM160, SNC-DS10, SNC-DS60, SNC-P1, SNC-P5, SNC-RX530, SNC-RX550, SNC-RX570, SNC-RZ25, SNC-RZ30, SNC-RZ50, SNC-Z20, SNT-V704
TOSHIBA	IK-WB02A, IK-WR01A, IK-WB21A, IK-WB15A
VIVOTEX	FD61x1, FD61x2, FD7130, FD7131, FD7132, FD7141, FD7160, IP21x1, IP21x2, IP3132, IP3133, IP3135, IP3135-PLNK, IP3136, IP3136-PLNK, IP3137, IP31x1, IP31x1TLFN, IP31x2, IP31x7, IP51x2, IP51x4, IP6114, IP6124, IP61x2, IP61x4, IP61X7, IP7130, IP7131, IP7132, IP7133, IP7134, IP7135, IP7137, IP7138, IP7139, IP7142, IP7151, IP7152, IP7153, IP7154, IP7160, IP7161, IP71x7, IP7251, IP7330, IP7361, IZ7151, PT3134, PT31x2, PT31x3, PT31x4, PT31x7, PT7000, PT7135, PT7137, PZ61x2, PZ61x4, PZ7131, PZ7151, PZ7152, PZ71X1, PZ71X2, SD61x2, SD7151, SD73X3, TC5330, TC5331, VS2101, VS2401, VS2402, VS2403, VS3100, VS3101, VS3102, VS3102-XLTH, VS7100
ZAVIO	B5110, B6110, D510E, D520E, D610A, D6111, D611E, F210A, F3100, F3105, F312A, F5100, F5105, F510E, F510W, F5110, F5115, F511E, F511W, F520E, F521E, F531E, F610A, F611E, F721A, F731E, M510E, M510W, M511E, M511W, P5110, P5115, V111T

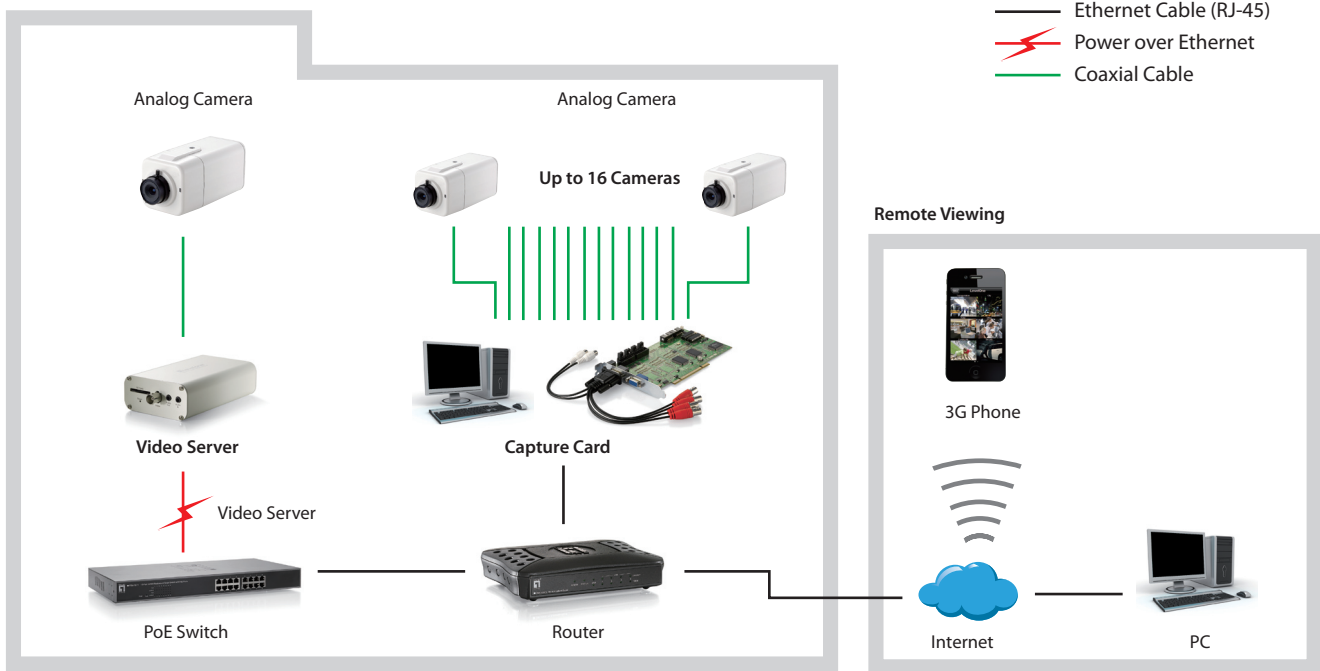

ONVIF



FCS-7111
1-Port H.264 PoE Video Server

- Up to 30fps in D1 resolution
- Real-time H.264, MPEG-4, and MJPEG compression
- Multiple streams simultaneously
- Built-in 802.3af compliant PoE
- 2-way audio via SIP protocol
- Digital I/O for external sensor and alarm
- RS-485 interface for scanner or pan/tilts control
- Built-in SD/SDHC card slot for local storage
- Free-Bundled 64-channel monitoring software
- Triple power support: DC12V/AC24/PoE(802.3af)
- Max. power consumption: 5W



FCS-8005
4-CH Analog Camera Capture Card

- Integrate analog and digital cameras on a single optimized surveillance system
- Supports the monitoring of 4 analog cameras
- Advanced motion detection and alarm functions
- View up to 120 (NTSC)/100 (PAL) frames per second
- Superior video resolution up to 704 x 480 (NTSC) / 704 x 576 (PAL)
- 4 ports audio inputs
- MPEG-4 compression mode
- Free-bundled 64-CH surveillance management software
- Support Windows XP/Server 2003/Vista/7



FCS-8006
16-CH Analog Camera Capture Card

- Integrate analog with digital cameras on a single optimized surveillance system
- Advanced motion detection and alarm functions
- Supports the monitoring of 16 analog cameras
- View up to 120 (NTSC) / 100 (PAL) frames per second
- Superior video resolution up to 704 x 480 (NTSC) / 704 x 576 (PAL)
- 4 ports audio inputs
- MPEG-4 compression mode
- Free-bundled 64-CH surveillance management software
- Support Windows XP/Server 2003/Vista/7



The LevelOne Network Video Recorder (NVR) series is compatible with LevelOne network cameras, and offers a complete recording solution. It enables live view recording and playback for up to 16 IP network cameras via the local area network or over the Internet simultaneously. No specific software is required, just plug the NVR into your LAN connected device (switch or router) and with a few clicks it will search and configure each connected Network Camera instantly. It allows users to easily build an advanced surveillance network. Free bundled NVR management Software to manage up to 16 NVR devices.

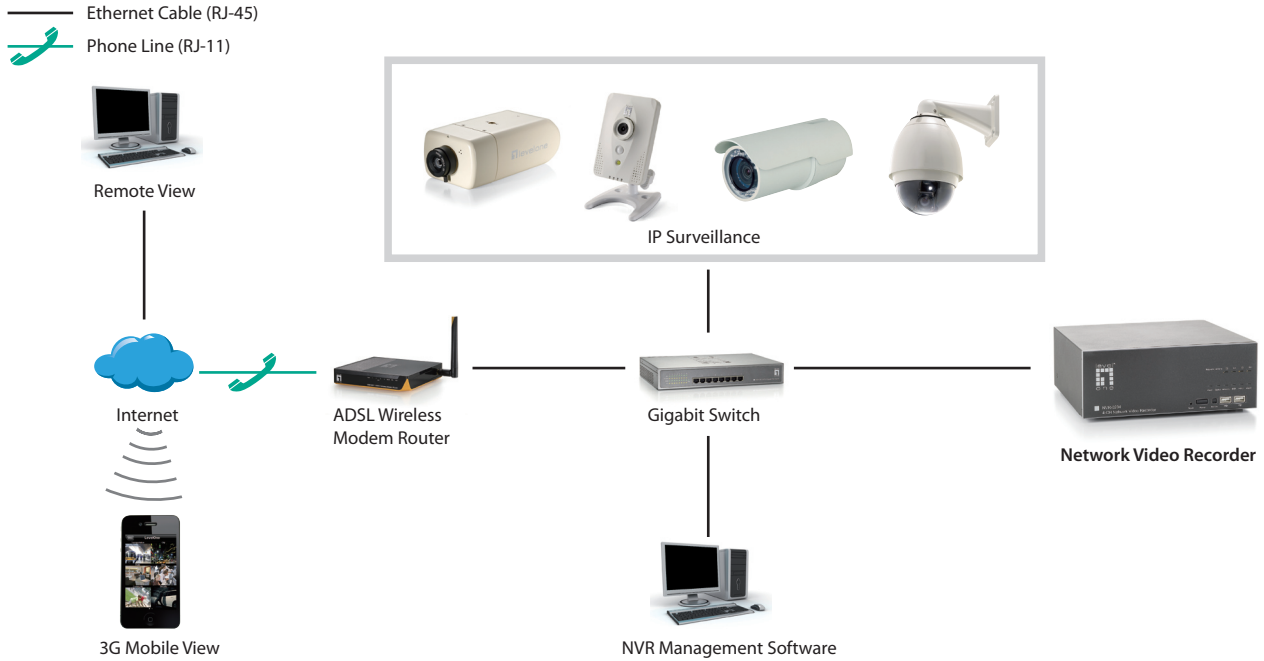

Key Features

- 2 x 3.5 inch disc slot (SATA I/II, up to 2 x 3000GB)
- Gigabit Ethernet (1000Mbps) speeds
- High preferments ARM 1.6Ghz and 512MB
- Support H.264 / MPEG-4 / MJPEG compression
- Video Resolution supported: 5MP/3MP/2MP/Full HD/MegaPixel/FD1/CIF/QCIF
- Max Recording Resolution: 1280x1024@480fps, 1920x1080@240fps
- Motion Detected Event Display on E-Map
- Export Playback Videos to AVI
- Support schedule recordings and 2-way Audio
- Support External UPS and DI/DO
- Free Bundled NVR management Software to manage up to 16 NVR devices



NVR-0204
4-CH Network Video Recorder



NVR-0208
8-CH Network Video Recorder



NVR-0216
16-CH Network Video Recorder

Network Video Recorder Comparison			
Model	NVR-0204	NVR-0208	NVR-0216
Max. Channel	4	8	16
Full/Split Screen	1/4	1/4/8	1/4/8/16
Monitoring	Live View/Playback	Live View/Playback	Live View/Playback
Frame Rate	120 fps	240 fps	480 fps

	Network Video Recorders
Model name	NVR-0104/NVR-0204/NVR-0208/NVR-0216
Monitoring camera	4/4/8/16
Camera Support	
LevelOne	FCS-0010, FCS-0020, FCS-0030, FCS-0031, FCS-0040, FCS-1010, FCS-1030, FCS-1040, FCS-1050, FCS-1060, FCS-1070, FCS-1081, FCS-1081A, FCS-1091, FCS-1101, FCS-1121, FCS-1131, FCS-1141, FCS-1151, FCS-3000, FCS-3021, FCS-3031, FCS-3051, FCS-3052, FCS-3061, FCS-3071, FCS-3081, FCS-3091, FCS-4010, FCS-4020, FCS-4041, FCS-4x00, FCS-5011, FCS-5030, FCS-5041, FCS-5051, FCS-5052, FCS-5061, FCS-6010, FCS-7011, WCS-0010, WCS-0020, WCS-0030, WCS-0040, WCS-1090, WCS-2010, WCS-2010, WCS-2030, WCS-2040, WCS-2060, WCS-2070
Abus	TV7240, TV7230, TV7203, TV7204, TV7206, TV7220, TV7221, TV7222, TV7223
ACTi	ACM1011, ACM1511, ACM1231, ACM1232, ACM3011, ACM3401, ACM3411, ACM3511, ACM4000, ACM4001, ACM4200, ACM4201, ACM5601, ACM5611, ACM7411, ACD2100, ACD2200, ACD2300, ACD2400, TCM-5311, CAM-6610, CAM-6630, CAM-6510, CAM-7301, CAM-7321, CAM-7322, ACM-8201
ALinking	9122/9122p, 9751/9751w, 9852/9852w, 9451, 9351, 9551, 9552, 9553, 9152, 9652, ALC-9272, ALC-9171, ALC-9153, ALC9371, ALS-7721
A-MTK	AM91xxM, AM92xxM, AM93xxM, AM95xxM, AM96xxM, AM97xxM, AM98xxM, AM90xxM, AM93xx, AM95xx, AM96xx, AM97xx, AM99xx, AM62xx, AM31xM, AM32xM, AM36xM, AM30xx, AM31xx, AM32xx, AM35xx, AM36xx, AM37xx, AM38xx, AM39xx, AM61xx
Arecont Vision	AV1300, AV1305, AV1355, AV2100, AV2105, AV2155, AV3100, AV3105, AV3155, AV3130, AV5100, AV5105, AV5155, AV8180, AV8185, AV8360, AV8365
AVTech	AVI-201, AVI-202, AVI-203, AVN-211, AVN-212, AVN-222, AVN-244, AVN-252, AVN-263, AVN-284, AVN-362
AXIS	All dual-stream and H.264 capable cameras
BrickCom	CB-100Ae-08 (VGA), WCB-100Ae-08 (VGA), CB-100Ae-08, WCB-100Ae-08, CB-101Ae-00, CB-102Ae-00, CB-100Ap-0c, WCB-100Ap-0c, CB-101Ap-04, CB-102Ap-04, FB-100Ae, WFB-100Ae, FB-100Ap, WFB-100Ap, FB-130Ap, WFB-130Ap, FB-130Np, WFB-130Np, FB-300Ap, WFB-300Ap, FD-100Ae, FD-100Ap, FD-130Ap, MD-100Ae, MD-100Ap, OB-100Ae, WOB-100Ae, OB-100Ap, WOB-100Ap, GOB-100Ap, OSD-040D/E 36xp, PZ-040D/E 12xp, VD-100Ae, VD-100Ap, VD-130Ap, VS-04A
Canon	VB-C300, VB-C60, VB-C500D
D-Link	DCS-2102, DCS-2121, DCS-3410, DVS-N3010, DVS-N3014, DVS-N3040, DVS-N3044, DCS-N3530, DCS-N3531, DCS-N3534, DCS-N5440, DCS-N5442, DCS-N5444, DCS-N6240, DCS-N6241, DCS-N6244, DCS-N2100, DCS-N2104, DCS-N40-20H2, DCS-N40M-32H2, DCS-N40M-33H2, DCS-N30-10H2
Etrovision	EV6150, EV6150A, EV6151A, EV6153A, EV6551A, EV6552A, EV6353A, EV6250A, EV3850A, EV3151A, EV3151, EV3150A, EV8180A, EV8580U-C, EV8180U
Hunt	All
IQinvision	WL-2000CAM, POE-100CAM, POE-200CAM, OD-300CAM, POE-100CAMv2, POE-200CAMv2, WL-2600CAM, POE-260CAM, WL-350HD, POE-200HD, OD-600HD, POE-250HD, OD-325HD, POE-100HD
Mobotix	M12, M22, D12, D24
Panasonic	BL-C1, BL-C10, BL-C20, BL-C30, BL-C111, BL-C131, BB-HCS301, BB-HCM100, BB-HCM110, BB-HCM311, BB-HCM331, BB-HCM371, BB-HCM381, KX-HCM110, KX-HCM280A, BB-HCM403, BB-HCE481, BB-HCM511, BB-HCM527, BB-HCM531, BB-HCM547, BB-HCM515, BB-HCM580, BB-HCM581, BB-HCM715, BB-HCM715, BL-C210A, BB-HCM701CE, BB-HCM705CE, BB-HCM735CE, WV-NP1004, WV-NP244, WV-NS202, WV-NF284, WJ-NT304, WV-NW484S, WV-NS202A, WV-NS954, WV-NW964, WJ-NT314, WV-NF302, WV-NP304, GXE-500, WV-NP502, WV-SF336, WV-SP305, WV-NW502S, WV-SP105, WV-SC385, WV-SP102, WV-SP306, WV-SF335, WV-SP336, WV-SP305, WV-NW502S, WV-SP105, WV-SC385, WV-SP102, WV-SP306, WV-SF335
Pixord	P600
Sony	SNC-CS10, SNC-CS11, SNC-CS20, SNC-CS50, SNC-DF40, SNC-DF50, SNC-DF70, SNC-DF80, SNC-DS10, SNC-DS60, SNC-P1, SNC-P5, SNC-RZ25, SNC-RZ50, SNC-RX530, SNC-RX550, SNC-RX570, SNC-CM120, SNC-CS20, SNC-DM110, SNC-DM160, SNC-DS10, SNC-DS60, SNC-RH124, SNC-RH164, SNC-RS46, SNC-RS44, SNC-RS86, SNC-RS84, SNT-EX101, SNT-EX104, SNT-EX154, SNT-EP104, SNT-EP154, SNC-CH140, SNC-CH210, SNC-CH240, SNC-DH140, SNC-DH140T, SNC-DH180, SNC-DH240, SNC-DH240T, SNC-DF85, SNC-CH220, SNC-DH220 / T, SNC-CH160, SNC-DH160, SNC-CH280, SNC-DH280, SNC-CH260, SNC-DH260, SNC-DH210 / T, SNC-CH120, SNC-DH120 / T, SNC-CH180, SNC-CH110, SNC-RH164, SNC-RH124
Toshiba	IK-WD01A, K-WB70A
Vivotek	IP7131 (V1), IP7132 (V1), IP7135 (V1), IP7137 (V1), PT7135 (V1), PT7137 (V1), IP7130, IP7133, P7134, IP7142, IZ7151, IP7153, IP7154, IP7160, IP7161, IP7251, IP7330, PZ7111, PZ7112, PZ7121, PZ7122, PZ7131, PZ7132, PZ7151, PZ7152, PT7135, FD7131, FD7132, FD7141, FD7141V, FD7151, SD73x3, IP8161, VS2403, IP8151, IP8330, IP8332, FD8361, FD8161, FD8134, VS8102, SD8121, MD7560, IP7361, IP8133, IP7361, IP7160
Zavio	F210A, F312A, F611E, F510E/W, F511E/W, F520E, F610A, D611E, D510E, M511E/W, M510W/W, D520E, F731E, F721A, F521E, V111T, F3105, D6111, F3100, F3105, F5100, F5105, F5115, D5111, F7110, F7210, F531E, F3206, F7110, F7210

LevelOne Digital Signage solutions provide several audio/video extenders allowing users to transmit high -quality signals (VGA, DVI, HDMI) over PoE IP or Cat.5. This solution enable for delivery compelling digital contents to targeted audience in various locations.

HDMI over IP Distribution Solution

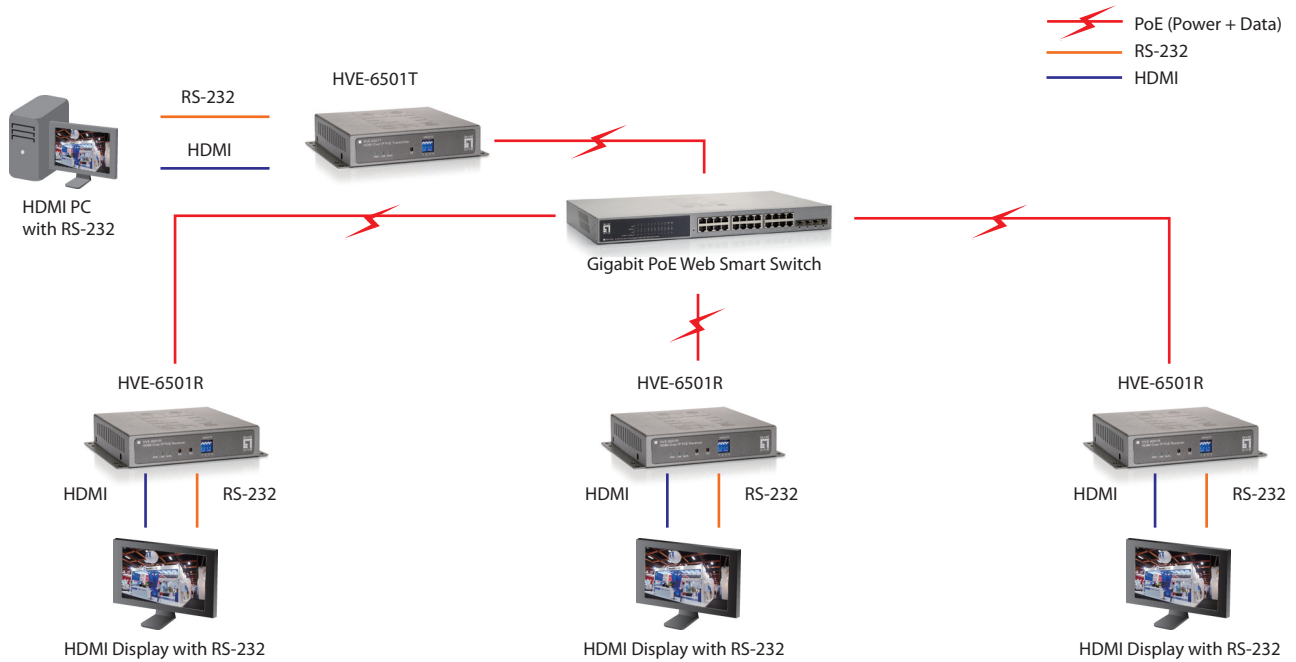

HDMI over IP

- Complies with IEEE802.3af standard
- Plug and Play installation allows receivers to find the transmitter automatically in the same network.
- Multi-casting group with Gigabit Ethernet switch (required 802.1Q VLAN & IGMP function)
- Supports Point-to-Point, Point-to-Many and Many-to-Many network configuration
- Up to 16 transmitters and more than 200 receivers possible in a single system (HVE-6501T/HVE-6501R)
- Up to 9 transmitters and 81 receivers possible in a single video wall system (HVE-6601T/HVE-6601R)



HVE-6501T / HVE-6501R
HDMI over IP PoE Transmitter / Receiver



HVE-6601T / HVE-6601R
HDMI Video Wall over IP PoE Transmitter / Receiver

HDMI over IP Comparison				
Model	HVE-6501T	HVE-6501R	HVE-6601T	HVE-6601R
Transmitter /Receiver/Repeater	Transmitter	Receiver	Transmitter	Receiver
HDMI Input	1	-	1	-
HDMI Output	-	1	-	1
Ethernet Port	1 x 10/100/1000Mbps	1 x 10/100/1000Mbps	1 x 10/100/1000Mbps	1 x 10/100/1000Mbps
Resolution	1080p	1080p	1080p	1080p

HDMI over Cat5

- Transmission Distance of up to 60m for 1080i or 40m for 1080p
- Easy installation and no software required
- Flexible multi-location audio/video broadcasting
- HDMI 1.3 Enables display with more natural and vivid colors
- HDMI 1.3c compliance(Full 3D support)



HVE-9001
HDSpider™ Long Range Cat.5
HDMI Sender



HVE-9002/HVE-9003
HDSpider™ Cat.5 HDMI Sender
(Cascadable- HVE-9003)



HVE-9004
HDSpider™ 4-Port Cat.5 HDMI Sender



HVE-9008
HDSpider™ 8-Port Cat.5 HDMI Sender



HVE-9000
HDSpider™ Long Range Cat.5
HDMI Receiver



HVE-9900
HDSpider™ Short Range Cat.5
HDMI Receiver

HDMI over Cat5 Comparison						
Model	HVE-9001	HVE-9002/HVE-9003	HVE-9004	HVE-9008	HVE-9000	HVE-9900
Transmitter /Receiver/ Repeater	Transmitter	Transmitter	Transmitter	Transmitter	Receiver	Receiver
RJ-45 Input	-	- / 1	-	-	1	1
RJ-45 Output	1	1	4	8	-	-
HDMI Input	1	1 / -	1	1	-	-
HDMI Output	-	1	-	1	1	1
Audio Support	V	V	V	V	V	V

HVE-0201

HDMI Extender over Fiber

- Transmit HDMI Signal t via an multi mode SC fiber connection
- Provides extending of the high definition multimedia interface signal over fiber optic cable up to 200m
- Fully HDCP/CEC without the needs of copper wiring
- Optical fiber use rules out any RF Interference
- HDMI type A connection

Multi-mode Fiber
 HDMI Cable

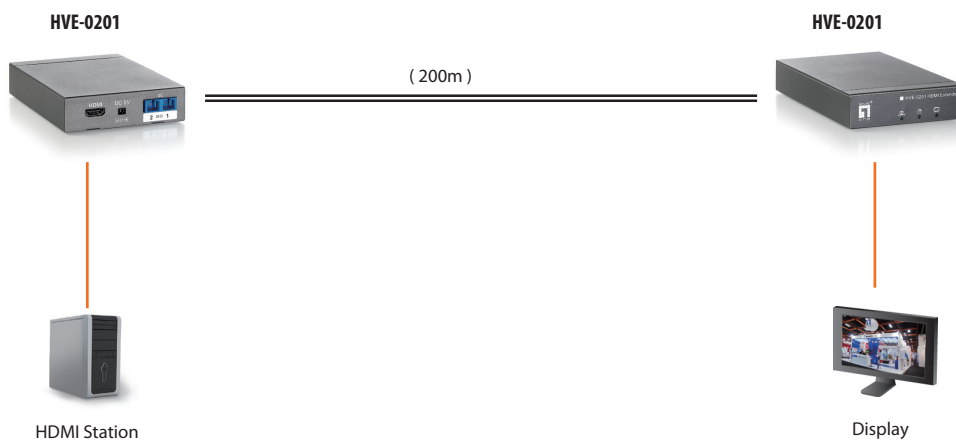

A/V (DVI) over Cat5

- Easy installation and no software required
- Flexible multi-location audio/video broadcasting



ADE-8011
Audio Transmitter/Receiver



ADE-8201
Single-Port DVI Transmitter



ADE-8202
2-Port DVI Broadcaster with Audio



ADE-8204/ADE-8208
4/8-Port DVI Broadcaster with Audio



ADE-8001
Short Range DVI-D Receiver



ADE-8002
Long Range DVI-D Receiver

A/V (DVI) over Cat5 Comparison						
Model	ADE-8011	ADE-8201	ADE-8202	ADE-8204/ADE-8208	ADE-8001	ADE-8002
Transmitter /Receiver/ Repeater	Transmitter/Receiver	Transmitter	Transmitter	Transmitter	Receiver	Receiver
RJ-45 Input	-	-	-	-	1	1
RJ-45 Output	-	1	2	4 / 8	-	-
RJ-11 Input	1	-	-	-	-	-
RJ-11 Output	-	-	2	4 / 8	-	-
DVI Input	-	1	1	1	-	-
DVI Output	-	-	1	1	1	1
Resolution	-	1024 x 768	1024 x 768	1024 x 768	1024 x 768	1024 x 768
Audio Support	V	V	V	V	V	V
Distance	100m	15m/70m@1024x768 with ADE-8001/8002			15m@ 1024 x 768	35m@ 1920 x 1200
Optional Accessories	-	-	-	-	-	-

DVE-0500

DVI Extender via 4 Fiber Channel, LC 500m

- Transmission of DVI signals via optical fiber up to 500m
- Transmit DVI signal via 2 Multi-mode LC Fiber connection
- Provides long distance digital image transmission via fiber optic cable
- Provides high-resolution image quality
- Signal is protected from any electrical interference
- Fiber optic provides for a low attenuation and greater distance solution

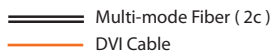

DVI Station



Display

A/V (VGA) over Cat5

- VGA Cable
- AVC-0011
- Audio
- Cat.5/6/7

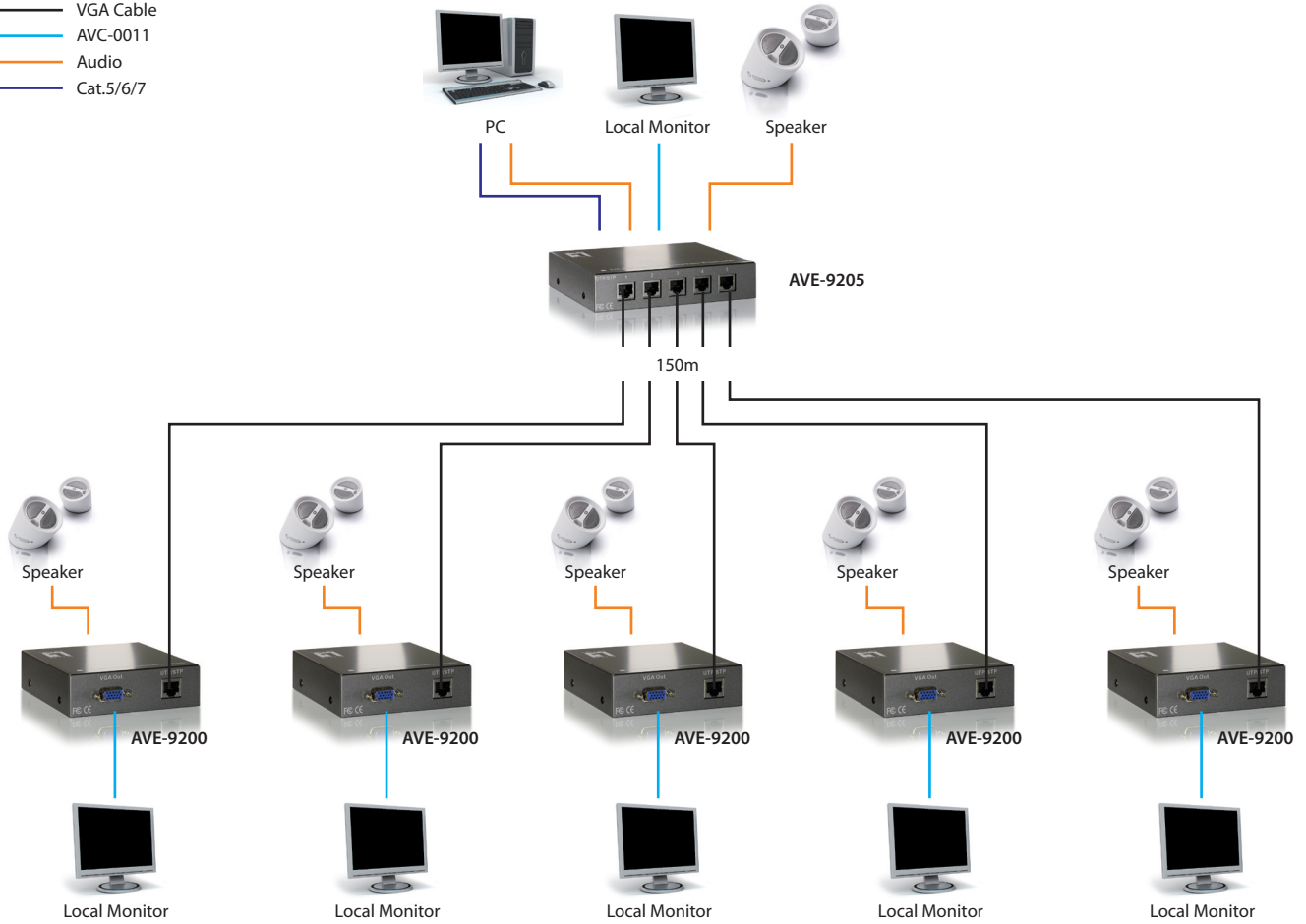

A/V (VGA) over Cat5 - (9200 Series)

- Easy installation and no software required
- Supports Ethernet cable Cat.5/5e/6
- Superior high VGA resolution up to 1280 x 1024
- Flexible multi-location audio/video broadcasting
- Includes cable 0.9m (from PC or KVM switch to console)
- Compatible with DOS, MS Windows, Linux, Unix and Netware



AVE-9201
1-Port Cat.5 Audio/Video Broadcaster



AVE-9205
5-Port Cat.5 Audio/Video Broadcaster



AVE-9200
Cat.5 Audio/Video Receiver

VGA 9200 Series Comparison			
Model	AVE-9201	AVE-9205	AVE-9200
Transmitter /Receiver	Transmitter	Transmitter	Receiver
VGA Input	1	1	-
VGA Output	1	1	1
RJ-45 Input	-	-	1
RJ-45 Output	1	5	-
Audio Support	V	V	V
Distance	150m	150m	150m

A/V (VGA) over Cat5 (9300 Series)

- Easy installation and no software required
- Supports Ethernet cable Cat.5
- Superior high VGA resolution up to 2048 x 1536
- Flexible multi-location audio/video broadcasting
- (AVE-9304/9308/9316) can be stacked into 3 layer stackable units (with AVE-9304A) for extending broadcast signal to 900m away



AVE-9300
1-Port Cat.5 VGA Receiver



AVE-9301
1-Port Cat.5 VGA Transmitter



AVE-9304
4-Port Cat.5 VGA Transmitter



AVE-9308
8-Port Cat.5 VGA Transmitter



AVE-9316
16-Port Cat.5 VGA Transmitter



AVE-9304A
4-Port Cat.5 VGA Repeater

VGA 9300 Series Comparison			
Model	AVE-9300	AVE-9301	AVE-9304
Transmitter /Receiver/Repeater	Receiver	Transmitter	Transmitter
RJ-45 Input	1	-	-
RJ-45 Output	-	1	4
VGA Input/Output	1 x Output	1 x Input/Output	1 x Input/Output
Audio Support	V	V	V
Distance	300m	300m	300m
Optional Accessories	RCA-9018: 1.8m VGA to RCA cable (receiver to video display) YCC-9018: 1.8m VGA to YCBCR cable (receiver to video display, supports HD up to 720p) AVC-0010: 1m VGA + Audio cable (receiver to video display, VGA male to VGA female) AVC-0011: 1m VGA + Audio cable (receiver to video display, VGA male to VGA male)	RCA-9007: 0.7m RCA to VGA cable (video source to transmitter) YCC-9007: 0.7m YCBCR to VGA cable (video source to transmitter, supports HD up to 720p) VGA-0011: 1m Audio and Video cable (USB cable only)	RCA-9007: 0.7m RCA to VGA cable (video source to transmitter) YCC-9007: 0.7m YCBCR to VGA cable (video source to transmitter, supports HD up to 720p) VGA-0011: 1m Audio and Video cable

VGA 9300 Series Comparison			
Model	AVE-9308	AVE-9316	AVE-9304A
Transmitter /Receiver/Repeater	Transmitter	Transmitter	Repeater
RJ-45 Input	-	-	1
RJ-45 Output	8	16	4
VGA Input/Output	1 x Input/Output	1 x Input/Output	1 x Output
Audio Support	V	V	V
Distance	300m	300m	300M
Optional Accessories	RCA-9007: 0.7m RCA to VGA cable (video source to transmitter) YCC-9007: 0.7m YCBCR to VGA cable (video source to transmitter, supports HD up to 720p) VGA-0011: 1m Audio and Video cable	RCA-9007: 0.7m RCA to VGA cable (video source to transmitter) YCC-9007: 0.7m YCBCR to VGA cable (video source to transmitter, supports HD up to 720p) VGA-0011: 1m Audio and Video cable	RCA-9018: 1.8m VGA to RCA cable (receiver to video display) YCC-9018: 1.8m VGA to YCBCR cable (receiver to video display, supports HD up to 720p) AVC-0010: 1m VGA + Audio cable (receiver to video display, VGA male to VGA female) AVC-0011: 1m VGA + Audio cable (receiver to video display, VGA male to VGA male)

IP Audio Broadcasting is significant for users to build and deploy an audio installation that is powerful, easy to use and covers a large surface area. This deployment is ideal for large office, business centers, hotels, airports, shopping malls, public transportation, universities, theaters, etc. Use anywhere you need to send audio signals to many different locations. It also comes with powerful software that allows you to manage the playlists in each zone independently.

IAT-1000

IP Audiocast Terminal

- Simple to use audio terminal, ideal for background music and paging system
- Schedule different playlists in different zones
- Search, configure and manage all audiocast terminals from one single location
- Stream high-quality stereo audio signals
- 100% compatible with MP3 and WAV sound format
- Using NetUSB (USB Over IP), work around the DRM issues of streaming Internet music sources
- Control both local and remote locations via TCP/IP (RJ-45)



Shopping Mall (single level drawing)

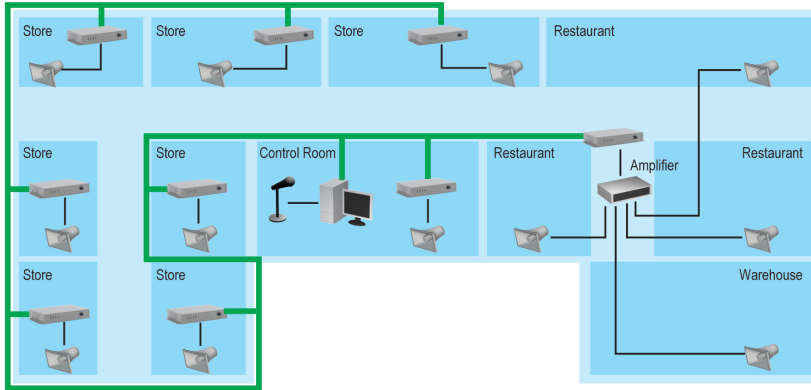

Illustrations

- Level1 IAT Terminal
- PC to Run Level1 Audiocast Manager
- Microphone For Announce
- Installed Standard Ethernet Network

LevelOne IP Audiocast Manager

Managing your audio network has never been easier. Using LevelOne's IP Audiocast management software together with the IP Audiocast Terminals provides a robust audio solution. The IP Audiocast Manager streams high-quality audio signals to each IAT-1000 terminal on the network. As a result, every IAT-1000 terminal can play MP3, WAV, M3U playlist, or live announcements that are streamed over the Ethernet network. Each zone can also be scheduled to receive an audio stream separated from the others. This provides users with the ultimate flexibility in streaming audio to different areas among large buildings.



	Manager Lite	IAT-1920	IAT-1900
Main Features			
Max of Terminal View, Monitor and Configure	7	20	Unlimited
Smart Search	Yes	Yes	Yes
Broadcast tech.	Yes	Yes	Yes
Streaming tech.	Yes	Yes	Yes
Schedule Control	N/A	Yes	Yes
Live Announcement	Yes	Yes	Yes
Multiple Zone View, Monitor and Configure	N/A	Yes	Yes
Music's Format Support MP3 / WAV	Yes	Yes	Yes
Music's Control Play/Stop/Next/Forward	Yes	Yes	Yes
Playlist (M3U) Create/Edit/Save	Yes	Yes	Yes
USB Key Protection	N/A	Yes	Yes
OS	Windows 2000/XP/2003/Vista		
Terminal Configuration			
Active/Inactive Terminals	Yes	Yes	Yes
DHCP/Static IP	Yes	Yes	Yes
Firmware upgrade	Yes	Yes	Yes

* The IP Audiocast Manager Lite is the free version that comes with the IAT-1000
 * Please note that the Ethernet environment has to support broadcast streaming
 * The IAT-1900/1920 software has to run with USB Key license

INDEX

A

ADE-8001	Short Range DVI-D Receiver	72	FBR-4000	Multi-WAN Load Balance VPN Router	37
ADE-8002	Long Range DVI-D Receiver	72	FCS-0010	Wired Network Camera	16
ADE-8011	Audio Transmitter/Receiver	72	FCS-0020	Wired P/T Network Camera	17
ADE-8201	Single-Port DVI Transmitter	72	FCS-0030	Wired Megapixel PIR Lighting Network Camera	16
ADE-8202	2-Port DVI Broadcaster with Audio	72	FCS-0031	Megapixel PIR Lighting PoE Network Camera	16
ADE-8204	4-Port DVI Broadcaster with Audio	72	FCS-0040	1.3-Megapixel Wired Network Camera	16
ADE-8208	8-Port DVI Broadcaster with Audio	72	FCS-0071	2-Megapixel Fish-Eye PoE Network Camera	60
ANA-3100	3GHz Outdoor Lighting Arrestor	47	FCS-1030	Wired Network Camera	16
ANA-6101	6GHz Outdoor Lighting Arrestor	47	FCS-1060	Wired P/T Network Camera	17
ANC-1430	3m RPSMA Plug to RPSMA Jack Antenna Cable	46	FCS-1091	PoE Network Camera	59
ANC-1440	5m RPSMA Plug to RPSMA Jack Antenna Cable	46	FCS-1101	PoE Network Camera	59
ANC-1470	10m RPSMA Plug to RPSMA Jack Antenna Cable	46	FCS-1121	Megapixel PoE Network Camera	59
ANC-2210	1m N Plug to N Plug Antenna Cable 200 Series	46	FCS-1122	Megapixel PoE Network Camera	60
ANC-2310	1m RPSMA Plug to N plug Antenna Cable 200 Series	46	FCS-1131	2-Megapixel PoE Network Camera	60
ANC-2330	3m RPSMA Plug to N Plug Antenna Cable 200 Series	46	FCS-1141	1.3-Megapixel PoE Network Camera	60
ANC-2350	1.5m RPSMA Plug to N Plug Antenna Cable 200 Series	46	FCS-1151	2-Megapixel PoE Network Camera	60
ANC-4130	3m N Plug to N Jack Antenna Cable 400 Series	46	FCS-3031	PoE PIR Dome Network Camera	61
ANC-4160	6m N Plug to N Jack Antenna Cable 400 Series	46	FCS-3051	Day/Night PIR PoE Dome Network Camera	61
ANC-4230	3m N Plug to N Plug Antenna Cable 400 Series	46	FCS-3052	3-Megapixel Day/Night PoE Dome Network Camera	62
AVE-9201	1-Port Cat.5 Audio/Video Broadcaster	73	FCS-3061	Megapixel Day/Night PoE Dome Network Camera	61
AVE-9205	5-Port Cat.5 Audio/Video Broadcaster	73	FCS-3071	2-Megapixel PoE Dome Network Camera	62
AVE-9200	Cat.5 Audio/Video Receiver	73	FCS-3081	2-Megapixel Day/Night PoE Dome Network Camera	62
AVE-9300	1-Port Cat.5 VGA Receiver	74	FCS-3091	2-Megapixel Fish-Eye PoE Dome Network Camera	62
AVE-9301	1-Port Cat.5 VGA Transmitter	74	FCS-4041	2-Megapixel P/T/Z PoE-Plus Speed Dome Outdoor Network Camera	63
AVE-9304	4-Port Cat.5 VGA Transmitter	74	FCS-4400	Day/Night P/T/Z Speed Dome Network Camera	63
AVE-9308	8-Port Cat.5 VGA Transmitter	74	FCS-5041	Megapixel Day/Night PoE Outdoor Network Camera	60
AVE-9316	16-Port Cat.5 VGA Transmitter	74	FCS-5051	2-Megapixel Day/Night PoE Outdoor Network Camera	61
AVE-9304A	4-Port Cat.5 VGA Repeater	74	FCS-5052	3-Megapixel Day/Night PoE Outdoor Network Camera	61

C

CAS-1001	2.1mm Mono-focal Lens	64
CAS-1101	5~50mm Vari-focal Day/Night Lens	64
CAS-1200	3~8mm Vari-focal Lens	64
CAS-1300	2.8~8.5mm Vari-focal Day/Night Megapixel Lens	64
CAS-1400	2.8-12mm Vari-focal Day/Night 2-Megapixel Lens	64

F

FBR-1161	Annex A/B ADSL2+ Modem Router	5	FCS-5061	5-Megapixel Day/Night PoE-Plus Outdoor Network Camera	61
FBR-1418TX	Broadband Router	4	FCS-6010	1.3-Megapixel Day/Night P/T PoE Network Camera	17
FBR-1430	VPN Broadband Router	4	FCS-7111	1-Port H.264 PoE Video Server	67
FBR-1461	Annex A/B ADSL2+ Modem Router with QoS	5	FCS-8005	4-CH Analog Camera Capture Card	67
			FCS-8006	16-CH Analog Camera Capture Card	67
			FCS-94xx	IP CamSecure Pro Mega Series	66
			FEP-0811	8-Port Fast Ethernet PoE-Plus Switch, 123.2W	21
			FEP-0812	4 FE PoE-Plus + 4 FE Switch, 61.6W	21
			FEP-1611	16-Port Fast Ethernet PoE-Plus Switch, 240W	22
			FEP-1612	16-Port Fast Ethernet PoE-Plus Switch, 480W	22
			FEU-0510	5-Port Fast Ethernet Switch	24
			FEU-0511	4 FE + 1 FE MMF SC Switch	24

FEU-0810	8-Port Fast Ethernet Switch-----	24	VVT-4001	10/100BASE-TX to 100BASE-FX MMF Converter (SC)-----	31
FEU-1610	16-Port Fast Ethernet Switch-----	25	VVT-4002	10/100BASE-TX to 100BASE-FX MMF Converter (ST)-----	31
FEU-2410	24-Port Fast Ethernet Switch-----	25	VVT-4301	10/100BASE-TX to 100BASE-FX SMF Converter (SC)-----	31
FGL-2870	24 FE + 4 GE Combo SFP L2 Managed Switch-----	28	VVT-5000	16-Slot Managed Converter Chassis with Redundant Power Supply-----	32
FGP-1072	8 FE PoE + 2 GE Combo SFP L2 Managed Switch, 130W-----	23	VVT-5001	10/100BASE-TX to 100BASE-FX Multi-Mode Module with TS-1000 Support (SC)-----	31
FGP-2410	24 FE PoE-Plus + 2 GE Combo SFP Switch, 240W-----	22	VVT-5301	10/100BASE-TX to 100BASE-FX Single-Mode Module with TS-1000 Support (SC)-----	31
FGP-2412	24 FE PoE-Plus + 2 GE Combo SFP Switch, 480W-----	22	VVT-6001	10/100BASE-TX to 100BASE-FX MMF Converter with TS-1000 Support (SC)-----	31
FGP-2472	24 FE PoE + 2 GE Combo SFP L2 Managed Switch, 380W-----	23	VVT-6301	10/100BASE-TX to 100BASE-FX SMF Converter with TS-1000 Support (SC)-----	31
FNC-0103FX	100BASE-FX MMF Optic PCI Card (ST)-----	39	G		
FNC-0104FX	100BASE-FX MMF Optic PCI Card (SC)-----	39	GEL-1072	8 GE + 2 GE Combo SFP L2 Managed Switch-----	27
FNC-0107TX	Fast Ethernet PCI Card with Wake-on-LAN-----	6	GEL-2870	24 GE + 4 GE Combo SFP L2 Managed Switch-----	29
FNC-0109TX	Fast Ethernet PCI Card-----	6	GEP-0520	4 GE PoE + 1 GE Switch, 61.6W-----	21
FNC-0115	100BASE-FX MMF Optic PCI Express Card (SC)-----	39	GEP-0820	8-Port Gigabit PoE-Plus Switch, 61.6W-----	21
FNC-0600TXM	5-Port L2 SNMP Switch Card-----	40	GEP-0821	8-Port Gigabit PoE-Plus Switch, 123.2W-----	21
FNS-1020	1-Bay Simple Network Storage-----	11	GEP-0822	8-Port Gigabit PoE-Plus Switch, 240W-----	22
FPS-1031	Parallel Print Server-----	56	GEP-2450	20 GE PoE-Plus + 4 GE Combo SFP Web Smart Switch, 185W-----	23
FPS-1032	USB Print Server-----	56	GES-0852	7 GE + 1 GE Combo SFP Web Smart Switch-----	27
FPS-1033	3-Port USB/Parallel Print Server-----	56	GES-1650	16 GE + 4 GE SFP Web Smart Switch-----	28
FSW-0503	4 FE PoE + 1 FE Switch, 61.6W-----	21	GES-1652	16 GE + 2 GE SFP Web Smart Switch-----	27
FSW-0508TX	5-Port Fast Ethernet Switch-----	3	GES-2450	24 GE + 4 GE SFP Web Smart Switch-----	28
FSW-0511	5-Port Fast Ethernet Switch-----	3	GES-2452	24 GE + 2 GE SFP Web Smart Switch-----	28
FSW-0512	5-Port Fast Ethernet PoE PD Switch-----	21	GEU-0520	5-Port Gigabit Switch-----	24
FSW-0513	4 FE High Power PoE + 1 FE Switch, 120W-----	21	GEU-0521	4 GE + 1 GE SFP Switch-----	24
FSW-0808TX	8-Port Fast Ethernet Switch-----	3	GEU-0820	8-Port Gigabit Switch-----	25
FSW-0811	8-Port Fast Ethernet Switch-----	3	GEU-1621	16-Port Gigabit Switch-----	25
FSW-0812	8-Port Fast Ethernet PoE PD Switch-----	21	GEU-1628	16 GE + 2 GE SFP Switch-----	25
FSW-1602TX	16-Port Fast Ethernet Switch-----	25	GEU-1629	16 GE + 4 GE SFP Switch-----	25
FSW-1650	16-Port Fast Ethernet Switch-----	25	GEU-2428	24 GE + 2 GE SFP Switch-----	25
FSW-1671	8 FE PoE + 8 FE Web Smart Switch, 123.2W-----	23	GEU-2429	24 GE + 4 GE SFP Switch-----	26
FSW-2450	24-Port Fast Ethernet Switch-----	25	GNC-0105T	32-Bit Gigabit Ethernet PCI Card-----	40
FVS-3120	10/100BASE-TX to 100BASE-LX SMF SC Converter-----	30	GNC-0111	1000BASE-SX Fiber Optic PCI Express Card (SC)-----	40
FVS-3200	10/100BASE-TX to 100BASE-FX MMF SC Converter-----	30	GNC-0112	Gigabit Ethernet PCIe Card-----	40
FVS-3800	10/100BASE-TX to 100BASE-X SFP Converter-----	30	GNS-1001	1-Bay Gigabit Network Storage-----	11
FVT-0103TXFC	10/100BASE-TX to 100BASE-FX MMF Converter with PoE (SC)-----	31	GNS-2000	2-Bay Gigabit Network Storage-----	12
FVT-0104TXFC	10/100BASE-TX to 100BASE-FX SMF Converter with PoE (SC)-----	31	GNS-4001	4-Bay Gigabit Network Storage-----	12
FVT-0203TXFC	10/100BASE-TX to 100BASE-FX MMF Converter with PoE Injector (SC)-----	31	GSW-0507	5-Port Gigabit Switch-----	3
FVT-0204TXFC	10/100BASE-TX to 100BASE-FX SMF Converter with PoE Injector (SC)-----	31	GSW-0509	5-Port Gigabit Switch-----	24
FVT-4000	10-Slot Media Converter Chassis with Redundant Power-----	32			

GSW-0807	8-Port Gigabit Switch -----	3	HVE-9003	HDSpider™ Cat.5 Cascadable HDMI Sender-----	71
GSW-0809	8-Port Gigabit Switch -----	25	HVE-9004	HDSpider™ 4-Port Cat.5 HDMI Sender-----	71
GSW-0890	8 GE + 2 GE Combo SFP L2 Managed Switch -----	27	HVE-9008	HDSpider™ 8-Port Cat.5 HDMI Sender-----	71
GSW-1290	4 GE Combo SFP + 2 GE Expandable Slots L2 Managed Switch-----	27	HVE-9900	HDSpider™ Short Range Cat.5 HDMI Receiver-----	71
GSW-1657	16-Port Gigabit Switch-----	25			
GSW-2453	3-Slot Gigabit Modular Switch-----	26	I		
GSW-2457	24-Port Gigabit Switch-----	26	IAT-1000	IP Audiocast Terminal-----	75
GSW-2473	24 FE + 2 GE Combo SFP Web Smart Switch -----	28	IFE-0500	4 FE PoE + 1 FE Industrial Switch-----	21
GSW-2693	24 FE PoE + 2 GE Combo SFP L2 Managed Switch, 185W -----	23	IFE-0501	4 FE PoE + 1 FE MMF SC Industrial Switch, 2km-----	21
GSW-4876	44 GE + 4 GE Combo SFP Web Smart Switch -----	29	IFE-0502	4 FE PoE + 1 FE SMF SC Industrial Switch, 30km-----	21
GSW-5150	48 FE + 2 GE + 1 GE SFP Switch-----	26	IPS-0008	8-Port IP Power Switch-----	37
GSW-5270	48 FE + 2 GE + 2 GE SFP Web Smart Switch -----	29			
GTL-2690	20 GE + 4 GE Combo SFP + 2 10GE XFP Module Slots L3 Managed Stackable Switch-----	28	K		
GTL-2880	20 GE + 4 GE Combo SFP + 4 10GE SFP-Plus L2-Plus Managed Switch-----	29	KVM-0115	15" Rackmount KVM Console with US/DE Keyboard Layout -----	53
GTL-5280	44 GE + 4 GE Combo SFP + 4 10GE SFP-Plus L2-Plus Managed Switch-----	29	KVM-0117	17" Rackmount KVM Console with US/DE Keyboard Layout -----	53
GTP-2880	20 GE PoE + 4 GE Combo SFP + 4 10GE SFP-Plus L2-Plus Managed Switch, 185W -----	23	KVM-0211	2-Port PS/2 KVM Switch with Audio-----	14
GVS-3110	10/100/1000BASE-T to 1000BASE-LX10 SMF SC Converter-----	30	KVM-0212	2-Port PS/2 KVM Switch -----	14
GVS-3200	10/100/1000BASE-T to 1000BASE-SX MMF SC Converter-----	30	KVM-0213	2-Port PS/2 KVM Switch -----	13
GVS-3800	10/100/1000BASE-T to 1000BASE-X SFP Converter-----	30	KVM-0217	17" Modularized Rackmount KVM Console with US/DE Keyboard Layout -----	53
GVT-0300	1.25G MMF SFP Transceiver -----	34	KVM-0221	2-Port USB KVM Switch with Audio -----	14
GVT-0301	1.25G SMF SFP Transceiver -----	34	KVM-0222	2-Port USB KVM Switch -----	14
GVT-0302	1.25G SMF SFP Transceiver -----	34	KVM-0223	2-Port USB KVM Switch -----	13
GVT-4000	10/100/1000BASE-T to 1000BASE-X Fiber Converter (SFP) -----	31	KVM-0260	2-Port USB DVI KVM Switch with Audio-----	13
GVT-4001	10/100/1000BASE-T to 1000BASE-SX MMF Converter (SC)-----	31	KVM-0261	2-Port USB DVI KVM Switch with Audio & USB 2.0 Hub -----	14
GVT-5000	10/100/1000BASE-TX to 1000BASE-FX-SFP Module -----	31	KVM-0306	3 Port DVI KVM Switch with Audio -----	14
			KVM-0411	4-Port PS/2 KVM Switch with Audio -----	53
H			KVM-0412	4-Port PS/2 KVM Switch -----	53
HVE-0201	HDMI Extender over Fiber -----	71	KVM-0410	4-Port KVM Switch with OSD for PS/2 -----	53
HVE-6501T	HDMI over IP PoE Transmitter-----	70	KVM-0420	4-Port KVM Switch for USB & PS/2 -----	53
HVE-6501R	HDMI over IP PoE Receiver -----	70	KVM-0421	4-Port USB KVM Switch with Audio -----	53
HVE-6601T	HDMI Video Wall over IP PoE Transmitter -----	70	KVM-0422	4-Port USB KVM Switch -----	53
HVE-6601R	HDMI Video Wall over IP PoE Receiver -----	70	KVM-0461	4-Port USB DVI KVM Switch with Audio & USB 2.0 Hub -----	14
HVE-9000	HDSpider™ Long Range Cat.5 HDMI Receiver -----	71	KVM-0811	8-Port PS/2 KVM Switch -----	53
HVE-9001	HDSpider™ Long Range Cat.5 HDMI Sender -----	71	KVM-0831	8-Port Combo KVM Switch with Expansion Slot -----	53
HVE-9002	HDSpider™ Cat.5 HDMI Sender with Local HDMI Output -----	71	KVM-1611	16-Port PS/2 KVM Switch-----	53
			KVM-1631	16-Port Combo KVM Switch with Expansion Slot -----	53
			KVM-9000	IP KVM Extender-----	53
			KVM-9005	PS/2 KVM Extender -----	53
			KVM-9006	USB KVM Extender-----	53

M			
MSL-3579	3-Slot Gigabit Modular L2 Managed Switch	29	
N			
NVR-0104	4-CH Network Video Recorder	18	
NVR-0204	4-CH Network Video Recorder	68	
NVR-0208	8-CH Network Video Recorder	68	
NVR-0216	16-CH Network Video Recorder	68	
O			
OAN-0501	5dBi Omni-Directional Indoor Antenna	8	
OAN-1070	7dBi Omni-Directional Indoor Antenna	8	
OAN-2151	15dBi 2.4GHz Omni-Directional Outdoor antenna	44	
OAN-2090	9dBi 2.4GHz Omni-Directional Outdoor Antenna Kit	44	
OAN-4101	5GHz 10dBi Omni-Directional Outdoor Antenna	45	
P			
PLI-3021	200Mbps Powerline Adapter	10	
PLI-3110	200Mbps Powerline Adapter with PoE Injector	10	
PLI-3510	200Mbps Powerline Adapter with Mains Pass-Through	10	
PLI-4051	500Mbps Powerline Gigabit Adapter	10	
PLI-4052	500Mbps Powerline Nano Adapter	10	
POH-1250	12 FE PoE Injector Hub	48	
POH-1260	12 FE High Power PoE Injector Hub	48	
POI-2001	Gigabit PoE Injector	49	
POI-2002	PoE Injector	49	
POI-3000	Gigabit PoE-Plus Injector	49	
POI-4000	High Power PoE Injector	49	
POR-0100	PoE Repeater	50	
POR-0102	PoE Repeater	50	
POR-0120	Gigabit PoE Repeater	50	
POR-0122	2-Port Gigabit PoE Repeater	50	
POR-1100	Outdoor PoE Repeater	50	
POR-1102	2-Port Outdoor PoE Repeater	50	
POS-1001	5-12V DC Gigabit PoE Splitter	49	
POS-1002	5-12V DC PoE Splitter	49	
POS-3000	5-12V DC Gigabit PoE-Plus Splitter	49	
POS-4000	12V DC High Power PoE Splitter	49	
POS-4001	3-12V DC High Power Outdoor PoE Splitter	49	
POS-4002	24V AC High Power PoE Splitter	49	
POT-0100	PoE Repeater over 2-wire (Master)	50	
POT-0110	PoE Repeater over 2-wire (Slave)	50	
POT-1110	Outdoor PoE Repeater over 2-wire (Slave)	50	
PPM-1000	PoE Power Measurer	51	
S			
SFP-1101	155M MMF SFP Transceiver	34	
SFP-1311	155M SMF SFP Transceiver	34	
SFP-1411	155M SMF SFP Transceiver	34	
SFP-3001	1.25G MMF SFP Transceiver	35	
SFP-3111	1.25G MMF SFP Transceiver	35	
SFP-3211	1.25G SMF SFP Transceiver	35	
SFP-3611	1.25G SMF SFP Transceiver	35	
SFP-3711	1.25G SMF SFP Transceiver	35	
SFP-3841	1.25G Copper Transceiver	36	
SFP-6101	10Gbp MMF SFP-Plus Transceiver	36	
SFP-6121	10Gbps SMF SFP-Plus Transceiver	36	
SFP-6141	10Gbps SMF SFP-Plus Transceiver	36	
SFP-7321	155M SMF BIDI SFP Transceiver	35	
SFP-7331	155M SMF BIDI SFP Transceiver	35	
SFP-7421	155M SMF BIDI SFP Transceiver	35	
SFP-7431	155M SMF BIDI SFP Transceiver	35	
SFP-9221	1.25G SMF BIDI SFP Transceiver	35	
SFP-9231	1.25G SMF BIDI SFP Transceiver	35	
SFP-9321	1.25G SMF BIDI SFP Transceiver	35	
SFP-9331	1.25G SMF BIDI SFP Transceiver	36	
SFP-9421	1.25G SMF BIDI SFP Transceiver	36	
SFP-9431	1.25G SMF BIDI SFP Transceiver	36	
U			
USB-0301	USB Fast Ethernet Adapter	6	
USB-0401	USB Gigabit Ethernet Adapter	6	
USB-0501	USB Hub and Fast Ethernet Combo Adapter	6	
V			
VDS-0110	Ethernet over VDSL2 Converter Sender	33	
VDS-0111	Ethernet over VDSL2 Converter Receiver	33	
VDS-0120	Ethernet to VDSL2 PoE Converter over 2 wire	33	
VDS-0130	Ethernet to VDSL2 PoE PD Converter over 2 wire	33	
VDS-0200	Ethernet to VDSL2 Converter over 2 wire (Annex A)	33	
VDS-0201	Ethernet to VDSL2 Converter over 2 wire (Annex B)	33	
VDS-0202	Ethernet to VDSL2 Converter over Coaxial (BNC)	33	
VOI-7000	SIP Phone	58	

VOI-7100	SIP Phone with PoE Capability-----	58	WBR-6803	150Mbps Wireless 3G Travel Router-----	5
VOI-7010	IP Phone-----	58	WBR-6804	150Mbps Wireless Dual-WAN 3G Router-----	5
VOI-7011	IP Phone with FXO port-----	58	WBR-6805	300Mbps Wireless Travel Router-----	5
VOI-8001	8-Port FXS H.323/SIP Gateway-----	57	WCS-0010	Wireless Network Camera-----	16
W			WCS-0020	Wireless P/T Network Camera-----	17
WAB-5120	300Mbps 5G Wireless Outdoor Passive PoE Access Point / Bridge-----	42	WCS-0030	Wireless Megapixel PIR Lighting Network Camera-----	16
WAB-6120	150Mbps Wireless Outdoor Passive PoE Access Point-----	42	WCS-0040	1.3-Megapixel Wireless Network Camera-----	16
WAB-7400	54Mbps Dual-Radio Outdoor PoE Mesh Access Point-----	43	WCS-0050	150Mbps Wireless Megapixel Network Camera-----	16
WAN-1112	12dBi 2.4GHz Directional Patch Outdoor Antenna Kit-----	44	WCS-2030	Wireless Network Camera-----	16
WAN-1160	6/8dBi Dual-band Directional Antenna-----	45	WCS-2060	Wireless P/T Network Camera-----	17
WAN-2185	8.5dBi 2.4GHz Directional Pico Cell Outdoor Antenna-----	44	WCS-6020	2-Megapixel Day/Night Wireless P/T Network Camera-----	17
WAN-2140	14dBi 2.4GHz Directional Panel Outdoor Antenna-----	44	WCS-6050	5-Megapixel Day/Night Wireless P/T Network Camera-----	17
WAN-2181	18dBi 2.4GHz Directional Panel Outdoor Antenna-----	45	WGR-6012	300Mbps Wireless Gigabit Router-----	4
WAN-2218	18dBi 2.4GHz Directional Yagi Outdoor Antenna-----	45	WGR-6013	300Mbps Wireless Gigabit Router-----	5
WAN-7100	10.5dBi 2.4GHz Directional Dual-Polarization Patch Antenna Kit-----	44	WHG-1000	300Mbps Wireless PoE Hotspot Gateway-----	38
WAN-9150	15dBi 5GHz Directional Dual-Polarization Outdoor Panel Antenna-----	45	WNC-0301	54Mbps Wireless PCI Card-----	7
WAN-9180	18dBi 5GHz Directional Dual-Polarization Outdoor Panel Antenna-----	45	WNC-0601	300Mbps Wireless PCI Card-----	7
WAP-0008	54Mbps Wireless AP Storage-----	11	WPC-0600	300Mbps Wireless CardBus Adapter-----	7
WAP-1001	108Mbps Wireless Outdoor PoE Access Point-----	43	WPS-1133	3-Port USB/Parallel Wireless Printer Server-----	56
WAP-3100	54Mbps Wireless PoE Access Point-----	42	WUA-0605	300Mbps Wireless USB Adapter-----	7
WAP-6002	150Mbps Wireless Access Point-----	42	WUA-0606	150Mbps Wireless USB Adapter-----	7
WAP-6003	150Mbps Wireless Access Point-----	43	WUA-0614	150Mbps Wireless Nano USB Adapter-----	7
WAP-6011	300Mbps Wireless Access Point-----	42	WUA-0616	300Mbps Wireless USB Adapter-----	7
WAP-6012	300Mbps Wireless Gigabit PoE Access Point-----	42	WUA-0624	150Mbps Wireless Nano USB Adapter-----	7
WAP-6013	300Mbps Wireless Access Point-----	43	WUA-1610	300Mbps Wireless USB Adapter-----	7
WAP-6101	300Mbps Wireless Ceiling PoE Access Point-----	43	WUA-1610H	300Mbps Wireless USB Adapter-----	7
WBR-6003	150Mbps Wireless Router-----	4	WUA-5600	150Mbps Wireless High Power Outdoor USB Adapter-----	40
WBR-6012	300Mbps Wireless Router-----	4	X		
WBR-6020	300Mbps Wireless Router-----	4	XFP-5211	10G SMF XFP Transceiver-----	36
WBR-6022	300Mbps Wireless HomeGuard22 Router-----	4	XFP-5901	10G MMF XFP Transceiver-----	36
WBR-6601	150Mbps Wireless ADSL2+ Modem Router Annex A/B-----	5			
WBR-6603	150Mbps Wireless ADSL2+ Modem Router-----	5			
WBR-6801	150Mbps Wireless Portable 3G Router-----	5			
WBR-6802	150Mbps Wireless Travel Router-----	5			





Digital Data Communications Group

www.level1.com

Global Headquarters:

Digital Data Communications GmbH, Germany

Global Offices:

Germany, Taiwan, Australia, Belgium, Brasil, Colombia, Denmark, Greece, Italy, Kenya, the Netherlands, Portugal, Slovenia, Spain, U.A.E

Distributed By:

2012.12.20