

# SIEMENS

## SITRANS L

### Radar transmitters SITRANS Probe LR with mA/HART

#### Compact Operating Instructions

<u>Introduction</u>	<b>1</b>
<u>Safety notes</u>	<b>2</b>
<u>Description</u>	<b>3</b>
<u>Installing/mounting</u>	<b>4</b>
<u>Connecting</u>	<b>5</b>
<u>Commissioning</u>	<b>6</b>
<u>Service and maintenance</u>	<b>7</b>
<u>Technical data</u>	<b>8</b>
<u>Certificates and support</u>	<b>A</b>

7ML5430 (SITRANS Probe LR with mA/HART)

05/2019

A5E46248119-AC

## Legal information

### Warning notice system

This manual contains notices you have to observe in order to ensure your personal safety, as well as to prevent damage to property. The notices referring to your personal safety are highlighted in the manual by a safety alert symbol, notices referring only to property damage have no safety alert symbol. These notices shown below are graded according to the degree of danger.

<b>⚠ DANGER</b>
indicates that death or severe personal injury <b>will</b> result if proper precautions are not taken.
<b>⚠ WARNING</b>
indicates that death or severe personal injury <b>may</b> result if proper precautions are not taken.
<b>⚠ CAUTION</b>
indicates that minor personal injury can result if proper precautions are not taken.
<b>NOTICE</b>
indicates that property damage can result if proper precautions are not taken.

If more than one degree of danger is present, the warning notice representing the highest degree of danger will be used. A notice warning of injury to persons with a safety alert symbol may also include a warning relating to property damage.

### Qualified Personnel

The product/system described in this documentation may be operated only by **personnel qualified** for the specific task in accordance with the relevant documentation, in particular its warning notices and safety instructions. Qualified personnel are those who, based on their training and experience, are capable of identifying risks and avoiding potential hazards when working with these products/systems.

### Proper use of Siemens products

Note the following:

<b>⚠ WARNING</b>
Siemens products may only be used for the applications described in the catalog and in the relevant technical documentation. If products and components from other manufacturers are used, these must be recommended or approved by Siemens. Proper transport, storage, installation, assembly, commissioning, operation and maintenance are required to ensure that the products operate safely and without any problems. The permissible ambient conditions must be complied with. The information in the relevant documentation must be observed.

### Trademarks

All names identified by ® are registered trademarks of Siemens AG. The remaining trademarks in this publication may be trademarks whose use by third parties for their own purposes could violate the rights of the owner.

### Disclaimer of Liability

We have reviewed the contents of this publication to ensure consistency with the hardware and software described. Since variance cannot be precluded entirely, we cannot guarantee full consistency. However, the information in this publication is reviewed regularly and any necessary corrections are included in subsequent editions.

# Table of contents

<b>1</b>	<b>Introduction.....</b>	<b>6</b>
1.1	Checking the consignment .....	6
1.2	Industrial use.....	6
1.3	Security information .....	6
1.4	Purpose of this documentation .....	7
<b>2</b>	<b>Safety notes.....</b>	<b>8</b>
2.1	Preconditions for use .....	8
2.1.1	Safety marking symbols.....	8
2.2	Laws and directives .....	8
2.2.1	Radio Equipment Directive (RED) compliance (Europe).....	8
2.2.2	Industry Canada conformity .....	9
2.2.3	Conformity with European directives .....	9
2.2.4	FCC Conformity .....	10
2.2.5	CE electromagnetic compatibility (EMC) conformity .....	10
2.3	Use in hazardous areas .....	11
2.3.1	Qualified personnel for hazardous area applications .....	11
2.3.2	Loss of safety of device with type of protection "Intrinsic safety Ex i" .....	11
<b>3</b>	<b>Description.....</b>	<b>12</b>
3.1	SITRANS Probe LR .....	12
3.2	Ambient/operating temperature .....	13
<b>4</b>	<b>Installing/mounting.....</b>	<b>14</b>
4.1	Basic safety notes.....	14
4.1.1	Incorrect disassembly .....	14
4.2	Mounting location.....	15
4.3	Nozzle location.....	16
4.4	Nozzle design .....	17
4.5	Mounting instructions .....	18
<b>5</b>	<b>Connecting .....</b>	<b>19</b>
5.1	Power.....	19
5.2	Connecting SITRANS Probe LR.....	19
5.3	Nameplate for hazardous area installations .....	20
5.4	FM and CSA connection drawings .....	21
5.5	Instructions specific to hazardous area installations (reference European ATEX Directive 2014/34/EU Annex II, 1/0/6) .....	21

<b>6</b>	<b>Commissioning .....</b>	<b>23</b>
6.1	Basic safety notes .....	23
6.2	Local commissioning.....	23
6.2.1	Activating SITRANS Probe LR.....	23
6.2.2	Operating SITRANS Probe LR .....	23
6.2.3	Low temperature effects on RUN/PROGRAM modes .....	24
6.2.4	RUN mode .....	24
6.2.5	PROGRAM mode.....	25
6.2.6	Handheld programmer .....	25
6.2.6.1	Handheld programmer .....	26
6.2.6.2	Handheld programmer: function keys in PROGRAM mode .....	27
6.2.6.3	Handheld programmer: function keys in RUN mode .....	28
6.2.6.4	Accessing a parameter .....	28
6.2.7	Security .....	30
6.2.8	Changing a parameter value.....	30
6.2.9	Master reset .....	30
6.2.10	Using units or percent (%) .....	31
6.2.11	Quick start wizard.....	31
6.2.11.1	Quick setup for local operation (outline) .....	31
6.2.11.2	P010: Language.....	32
6.2.11.3	P001: Operation.....	32
6.2.11.4	P003: Measurement response.....	33
6.2.11.5	P005: Units.....	34
6.2.11.6	P006: Empty.....	34
6.2.11.7	P007: Span .....	35
6.2.11.8	P838 Auto false echo suppression .....	35
6.2.11.9	Additional settings .....	36
6.3	Remote commissioning.....	36
6.3.1	SITRANS Probe LR communication: HART .....	36
<b>7</b>	<b>Service and maintenance .....</b>	<b>37</b>
7.1	Cleaning .....	37
7.2	Maintenance and repair work.....	37
7.3	Return procedure .....	37
7.4	Disposal .....	38
<b>8</b>	<b>Technical data .....</b>	<b>39</b>
8.1	Power .....	39
8.2	Performance.....	40
8.3	Construction.....	40
8.4	Operating conditions .....	41
8.5	Process .....	41
8.6	Approvals .....	42
<b>A</b>	<b>Certificates and support.....</b>	<b>43</b>
A.1	Technical support.....	43

A.2	Certificates .....	43
	<b>Index.....</b>	<b>44</b>

# Introduction

## 1.1 Checking the consignment

1. Check the packaging and the delivered items for visible damages.
2. Report any claims for damages immediately to the shipping company.
3. Retain damaged parts for clarification.
4. Check the scope of delivery by comparing your order to the shipping documents for correctness and completeness.

 <b>WARNING</b>
<b>Using a damaged or incomplete device</b>
Risk of explosion in hazardous areas.
<ul style="list-style-type: none"><li>• Do not use damaged or incomplete devices.</li></ul>



## 1.2 Industrial use

<b>NOTICE</b>
<b>Use in a domestic environment</b>
This Class B Group 1 equipment is intended for use in industrial areas.
In a domestic environment this device may cause radio interference.

## 1.3 Security information

Siemens provides products and solutions with industrial security functions that support the secure operation of plants, systems, machines, and networks.

In order to protect plants, systems, machines and networks against cyber threats, it is necessary to implement – and continuously maintain – a holistic, state-of-the-art industrial security concept. Siemens' products and solutions only form one element of such a concept.

Customer is responsible to prevent unauthorized access to its plants, systems, machines and networks. Systems, machines and components should only be connected to the enterprise network or the internet if and to the extent necessary and with appropriate security measures (e.g. use of firewalls and network segmentation) in place.

Additionally, Siemens' guidance on appropriate security measures should be taken into account. You can find more information about industrial security by visiting:  
<https://www.siemens.com/industrialsecurity>.

Siemens' products and solutions undergo continuous development to make them more secure. Siemens strongly recommends you apply product updates as soon as available and always use the latest product versions. Use of product versions that are no longer supported, and failure to apply latest updates may increase customer's exposure to cyber threats.

To stay informed about product updates, subscribe to the Siemens Industrial Security RSS Feed under  
<https://www.siemens.com/industrialsecurity>.

## **1.4 Purpose of this documentation**

These instructions contain all information required to commission and use the device. Read the instructions carefully prior to installation and commissioning. In order to use the device correctly, first review its principle of operation.

The instructions are aimed at persons mechanically installing the device, connecting it electronically, configuring the parameters and commissioning it, as well as service and maintenance engineers.



## Safety notes

### 2.1 Preconditions for use

This device left the factory in good working condition. In order to maintain this status and to ensure safe operation of the device, observe these instructions and all the specifications relevant to safety.

Observe the information and symbols on the device. Do not remove any information or symbols from the device. Always keep the information and symbols in a completely legible state.

#### 2.1.1 Safety marking symbols

In manual	On product	Description
		earth (ground) terminal (shield)
	 Yellow background	WARNING: refer to accompanying documents (manual) for details.

### 2.2 Laws and directives

#### 2.2.1 Radio Equipment Directive (RED) compliance (Europe)

Hereby, Siemens declares that the SITRANS Probe LR is in compliance with the essential requirements and other relevant provisions of Directive 2014/53/EU. The Probe LR complies with EN 302 372 for use in closed storage vessels, when installed according to the installation requirements of EN 302 372, and may be used in all EU countries. For the receiver test that covers the influence of an interferer signal to the device, the performance criterion has at least the following level of performance according to ETSI TS 103 361 [6]:

- Performance criterion: measurement value variation  $\Delta d$  over time during a distance measurement
- Level of performance:  $\Delta d \leq \pm 50$  mm



## 2.2.2 Industry Canada conformity

### Canada Installations only: Industry Canada (IC) rules

NOTICE
<p><b>Use on a "no-interference, no-protection" basis</b></p> <p>This device shall be installed and operated in a completely enclosed container to prevent RF emission, which otherwise can interfere with aeronautical navigation. Installation shall be done by trained installers, in strict compliance with the manufacturer's instructions.</p> <p>The use of this device is on a "no-interference, no-protection" basis:</p> <ul style="list-style-type: none"> <li>• The user shall accept operations of high-powered radar in the same frequency band which may interfere with or damage this device.</li> <li>• The user is responsible for removing, at the user's expense, any device found to interfere with primary licensing operations.</li> </ul>

## 2.2.3 Conformity with European directives

The CE marking on the device symbolizes the conformity with the following European directives:

Electromagnetic compatibility EMC 2014/30/EU	Directive of the European Parliament and of the Council on the harmonisation of the laws of the Member States relating to electromagnetic compatibility
Low voltage directive LVD 2014/35/EU	Directive of the European Parliament and of the Council on the harmonisation of the laws of the Member States relating to the making available on the market of electrical equipment designed for use within certain voltage limits
Atmosphère explosible ATEX 2014/34/EU	Directive of the European Parliament and the Council on the harmonisation of the laws of the Member States relating to equipment and protective systems intended for use in potentially explosive atmospheres
RED 2014/53/EU	Directive of the European Parliament and of the Council on the harmonisation of the laws of the Member States relating to the making available on the market of radio equipment and repeater Directive 1999/5/EC

The applicable directives can be found in the EC conformity declaration of the specific device.

## 2.2.4 FCC Conformity

### US Installations only: Federal Communications Commission (FCC) rules

 <b>WARNING</b>
<b>Authority to operate equipment</b>
Changes or modifications not expressly approved by Siemens could void the user's authority to operate the equipment.

#### Note

- This equipment has been tested and found to comply with the limits for a Class B digital device, pursuant to Part 15 of the FCC Rules. These limits are designed to provide reasonable protection against harmful interference when the equipment is operated in a commercial environment.
- This equipment generates, uses, and can radiate radio frequency energy and, if not installed and used in accordance with the instruction manual, may cause harmful interference to radio communications. Operation of this equipment in a residential area is likely to cause harmful interference to radio communications, in which case the user will be required to correct the interference at his own expense.

## 2.2.5 CE electromagnetic compatibility (EMC) conformity

This equipment has been tested and found to comply with the following EMC standards:

EMC standard	Title
CISPR 11:2009 + A1:2010/EN 55011:2009 + A1:2010, CLASS A	Limits and methods of measurements of radio disturbance characteristics of industrial, scientific, and medical (ISM) radio-frequency equipment.
EN 61326:2013 (IEC 61326:2012)	Electrical Equipment for Measurement, Control and Laboratory Use – Electromagnetic Compatibility.
EN61000-4-2:2009	Electromagnetic Compatibility (EMC) Part 4-2: Testing and measurement techniques – Electrostatic discharge immunity test.
EN61000-4-3:2006 + A1:2008 + A2:2010	Electromagnetic Compatibility (EMC) Part 4-3: Testing and measurement techniques – Radiated, radiofrequency, electromagnetic field immunity test 2006 + A1:2008 + A2:2010.
EN61000-4-4:2004 + A1:2010	Electromagnetic Compatibility (EMC) Part 4-4: Testing and measurement techniques – Electrical fast transient/burst immunity test.
EN61000-4-5:2006	Electromagnetic Compatibility (EMC) Part 4-5: Testing and measurement techniques – Surge immunity test.
EN61000-4-6:2010	Electromagnetic Compatibility (EMC) Part 4-6: Testing and measurement techniques – Immunity to conducted disturbances, induced by radio-frequency fields.
EN61000-4-8:2010	Electromagnetic Compatibility (EMC) Part 4-8: Testing and measurement techniques – Power frequency magnetic field immunity test.

## 2.3 Use in hazardous areas

### 2.3.1 Qualified personnel for hazardous area applications

#### Qualified personnel for hazardous area applications

Persons who install, connect, commission, operate, and service the device in a hazardous area must have the following specific qualifications:

- They are authorized, trained or instructed in operating and maintaining devices and systems according to the safety regulations for electrical circuits, high pressures, aggressive, and hazardous media.
- They are authorized, trained, or instructed in carrying out work on electrical circuits for hazardous systems.
- They are trained or instructed in maintenance and use of appropriate safety equipment according to the pertinent safety regulations.

### 2.3.2 Loss of safety of device with type of protection "Intrinsic safety Ex i"

#### WARNING

##### Loss of safety of device with type of protection "Intrinsic safety Ex i"

If the device or its components have already been operated in non-intrinsically safe circuits or the electrical specifications have not been observed, the safety of the device is no longer ensured for use in hazardous areas. There is a risk of explosion.

- Connect the device with type of protection "Intrinsic safety" solely to an intrinsically safe circuit.
- Observe the specifications for the electrical data on the certificate and/or in Technical data (Page 39).

## Description

### 3.1 SITRANS Probe LR

SITRANS Probe LR is a 2-wire loop-powered, continuous level measuring instrument that utilizes advanced pulse radar technology operating at a frequency of approximately 6 GHz. The instrument consists of an electronic component coupled to the antenna and process connection. It is very easy to install and set up, using either the infrared handheld programmer locally, or using SIMATIC PDM from a remote location.

Communication is via HART. Signals are processed using Process Intelligence which has been field-proven in over 500,000 applications worldwide (ultrasonic and radar).

SITRANS Probe LR is available in two versions

- General purpose (non-hazardous)
- Intrinsically Safe (with suitable barrier)

#### Applications

---

#### Note

#### Approval information

Refer to product label for approval information.

---

SITRANS Probe LR is designed to measure liquid levels in a variety of applications.

- liquid bulk storage vessels
- simple process vessels with gentle agitation
- liquids
- slurries

Shield length 250 mm (10"):  
use for long nozzles of 250  
mm (10") or less in length

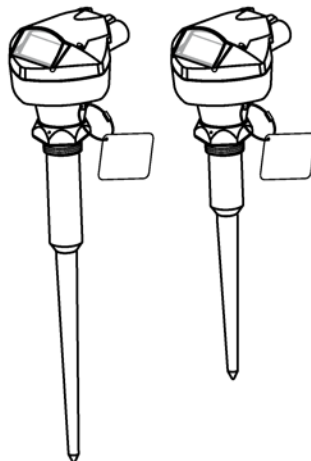

Shield length: 100 mm (4"):  
use for nozzles of 100 mm (4")  
or less in length

## 3.2 Ambient/operating temperature

Process temperature and pressure capabilities are dependent upon information on the process device tag. The reference drawing listed on the tag can be downloaded from the Siemens website. Go to the SITRANS Probe LR product page at: SITRANS Probe LR ([www.siemens.com/probelr](http://www.siemens.com/probelr))

## Installing/mounting

### 4.1 Basic safety notes

#### 4.1.1 Incorrect disassembly

 **WARNING**

**Incorrect disassembly**

The following risks may result from incorrect disassembly:

- Injury through electric shock
- Risk through emerging media when connected to the process
- Risk of explosion in hazardous area

In order to disassemble correctly, observe the following:

- Before starting work, make sure that you have switched off all physical variables such as pressure, temperature, electricity etc. or that they have a harmless value.
- If the device contains hazardous media, it must be emptied prior to disassembly. Make sure that no environmentally hazardous media are released.
- Secure the remaining connections so that no damage can result if the process is started unintentionally.

 **DANGER**

**Pressure applications**

Danger to personnel, system and environment will result from improper disassembly.

- Never attempt to loosen, remove, or disassemble process connection while vessel contents are under pressure.

---

**Note**

**Product designation**

This product is designated as a Pressure Accessory per Directive 2014/68/EU and is not intended for use as a safety device.

---

---

**Note**

**Chemical compatibility**

Materials of construction are chosen based on their chemical compatibility (or inertness) for general purposes. For exposure to specific environments, check with chemical compatibility charts before installing.

---

---

**Note**

**Material compatibility**

Siemens can provide you with support concerning selection of sensor components wetted by process media. However, you are responsible for the selection of components. Siemens accepts no liability for faults or failures resulting from incompatible materials.

---

## 4.2 Mounting location

**Recommendations**

- Ensure ambient temperature is within –40 to 80 °C (–40 to 176 °F).
- Provide easy access for viewing the display and programming via the handheld programmer.
- Ensure the environment is suitable to the housing rating and materials of construction.

**Precautions**

- Avoid proximity to high voltage or current wiring, high voltage or current contacts, and to variable frequency motor speed controllers.
- Avoid interference to the emission cone from obstructions or from the fill path.
- Avoid central locations on vessels.

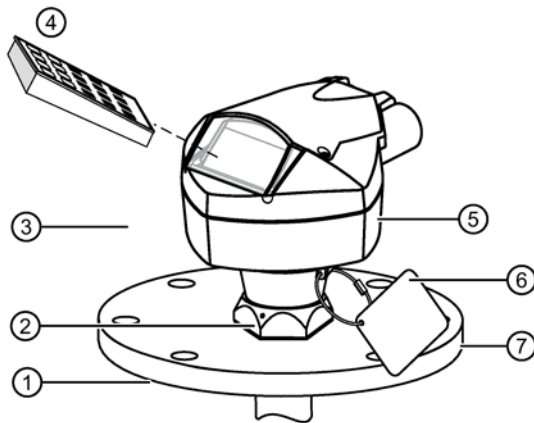

- ① Process temperature:  $-40$  to  $80$  °C ( $-40$  to  $176$  °F)
- ② Locking collar over threaded connection; secured by three 2 mm Allen set-screws.  
When the locking collar is secured, it prevents the enclosure rotating on the threaded connection.
- ③ Ambient temperature (surrounding enclosure volume)  $-40$  to  $80$  °C ( $-40$  to  $176$  °F)
- ④ Handheld programmer
- ⑤ Nameplate location
- ⑥ Process device tag
- ⑦ Customer-supplied flange

**Avoid central locations on vessels**

For vessels with conical or parabolic tops, avoid mounting the device at the center. The concavity of the top can focus echoes into the center, giving false readings.

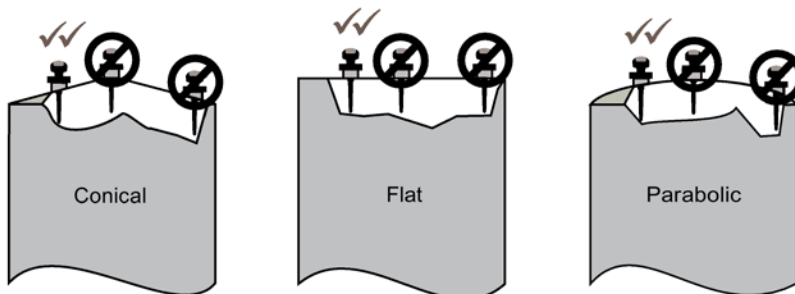

### 4.3 Nozzle location

**Beam angle**

- Beam angle is the width of the cone where the energy density is half of the peak energy density.
- The peak energy density is directly in front of and in line with the rod antenna.
- There is a signal transmitted outside the beam angle, therefore false targets may be detected.



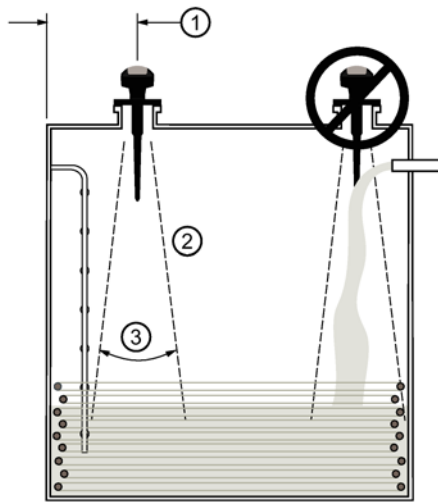

- ① Min. 300 mm (1 ft) per 3 m (10') of vessel height
- ② Emission cone
- ③ Beam angle 28°

#### Emission cone

- Keep emission cone free of interference from ladders, pipes, I-beams or filling streams.
- Locate the antenna away from the side wall, to avoid interference from indirect echoes.
- Make allowance for the emission cone spreading: allow a minimum of 300 mm (1 ft) for every 3 m (10 ft) of vessel height.

## 4.4 Nozzle design

The end of the shield section or end of the horn should protrude a minimum of 10 mm (0.4") to avoid false echoes being reflected from the nozzle.

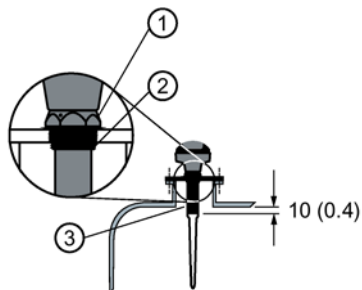

- ① Locking ring secured by three 2 mm Allen set-screws
- ② Threaded connection
- ③ Shield

4.5 Mounting instructions

---

**Location on a manhole cover**

- A manhole cover is typically a covered nozzle with a diameter 610 mm (24") or greater.
- For optimum signal conditions, locate the antenna off-center, typically 100 mm (4") from the side.

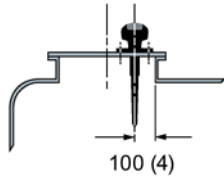

---

**Note**

**Nozzle design**

- For nozzles 100 mm (4") in length or shorter, use the 100 mm (4") shield.
  - For nozzles 250 mm (10") in length or shorter, use the 250 mm (10") shield.
- 

## 4.5 Mounting instructions

---

**Note**

**Rotating the enclosure**

Do not rotate the enclosure after programming and vessel calibration, otherwise an error may occur, caused by a polarity shift of the transmit pulse.

---

1. Before inserting SITRANS Probe LR into its mounting connection, check to ensure the threads are matching, to avoid damaging them.
2. Screw SITRANS Probe LR into the process connection, and hand tighten. For pressure applications, it will be necessary to use PTFE tape (or other appropriate thread sealing compound) and tighten the process connection beyond hand tight. The maximum torque is 40 N-m (30 ft.lbs.).
3. If you need to rotate the enclosure, use a 2 mm Allen key to loosen the three set screws that secure the locking collar.
4. Once the enclosure is in a suitable position, tighten the set screws.

## Connecting

### 5.1 Power

---

**Note****DC terminals**

DC terminals shall be supplied from an SELV (Safety Extra Low Voltage) source in accordance with IEC-1010-1 Annex H.

---

**Note****Insulation**

All field wiring must have insulation suitable for rated voltages.

---

### 5.2 Connecting SITRANS Probe LR

Unscrew the two lid screws to access the terminal block.

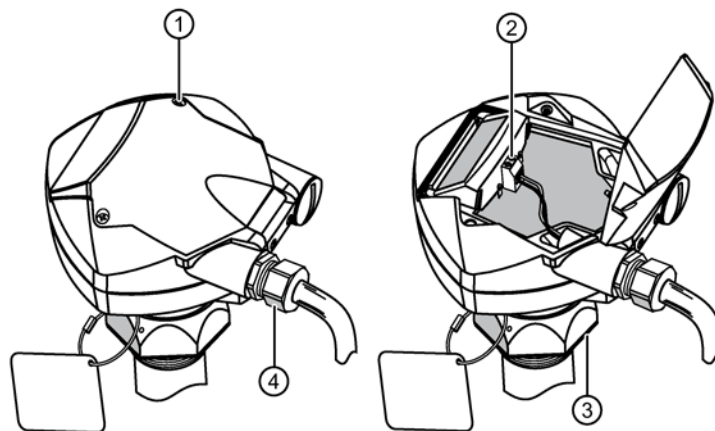

- ① Lid screws
- ② Terminal block
- ③ Locking collar
- ④ Strain relief (or NPT cable entry)

**Note**

- Use shielded, twisted pair cable (wire gauge AWG 14 to 22).
- Separate cables and conduits may be required to conform to standard instrumentation wiring practices or electrical codes.
- The non-metallic enclosure does not provide a continuous ground path between conduit connections: use grounding type bushings and jumpers.
- For detailed information on Intrinsic Safety setups, see the full Operating instructions.

1. If you want to rotate the enclosure, use a 2 mm Allen key to loosen the 3 Allen set screws securing the locking collar. Position the unit and retighten the screws.
2. Strip the cable jacket for approximately 70 mm from the end of the cable, and thread the wires through the strain relief. If cable is routed through conduit, use only approved, suitably-sized hubs for waterproof applications.
3. Connect the wires to the terminals: the polarity is identified on the terminal block.
4. Tighten the strain relief to form a good seal.
5. Close the lid and tighten screws. Do not overtighten screws. Recommended torque is 1.1 to 1.7 N-m (10 to 15 in-lb) of torque.

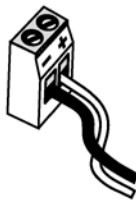

### 5.3 Nameplate for hazardous area installations

**Note**

**Sample nameplate**

The nameplate is given as an example only.

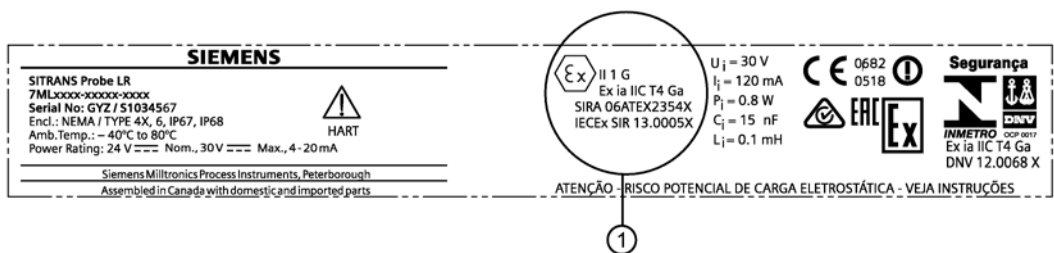

① ATEX certificate

**Device nameplate (ATEX/IECEX/INMETRO/RMC)**

The ATEX certificate can be downloaded from the product page of our website at: [www.siemens.com/probelr](http://www.siemens.com/probelr) ([www.siemens.com/SitransProbeLR](http://www.siemens.com/SitransProbeLR)).

Go to **Support > Approvals / Certificates**.

The IECEX certificate listed on the nameplate can be viewed on the IECEX website. Go to: <http://iecex.iec.ch> (<http://iecex.iec.ch>) and click on Ex Equipment Certificates of Conformity then enter the certificate number IECEX SIR 13.0005X.

## 5.4 FM and CSA connection drawings

The FM Intrinsically Safe connection drawing (A5E01003040) listed on the device nameplate can be downloaded from our website:

Product page ([www.siemens.com/SitransProbeLR](http://www.siemens.com/SitransProbeLR))

Go to **Technical Info > Images, graphics, drawings**.

The CSA Intrinsically Safe connection drawing (A5E01003039) listed on the device nameplate can be downloaded from our website:

Product page ([www.siemens.com/SitransProbeLR](http://www.siemens.com/SitransProbeLR))

Go to **Technical Info > Images, graphics, drawings**.

## 5.5 Instructions specific to hazardous area installations (reference European ATEX Directive 2014/34/EU Annex II, 1/0/6)

The following instructions apply to equipment covered by certificate number SIRA 06ATEX2354X:

1. For use and assembly, refer to the main instructions.
2. The equipment is certified for use as Category 1G equipment.
3. The equipment may be used with flammable gases and vapors with apparatus group IIC and temperature class T4.
4. The equipment is certified for use in an ambient temperature range of  $-40\text{ }^{\circ}\text{C}$  to  $80\text{ }^{\circ}\text{C}$ .
5. The equipment has not been assessed as a safety related device (as referred to by Directive 2014/34/EU Annex II, clause 1.5).
6. Installation and inspection of this equipment shall be carried out by suitably trained personnel in accordance with the applicable code of practice (EN 60079-14 and EN 60079-17 in Europe).
7. Repair of this equipment shall be carried out by suitably trained personnel in accordance with the applicable code of practice (e.g. EN 60079-19 within Europe).
8. Components to be incorporated into or used as replacements in the equipment shall be fitted by suitably trained personnel in accordance with the manufacturer's documentation.

9. It is the responsibility of the user to ensure that manual override is possible in order to shut down the equipment and protective systems incorporated within automatic processes which deviate from the intended operating conditions, provided that this does not compromise safety.

10. The "X" suffix to the certificate number relates to the following special conditions for safe use:

Parts of the enclosure may be non-conducting and may generate an ignition capable level of electrostatic charge under certain extreme conditions. The user should ensure that the equipment is not installed in a location where it may be subjected to external conditions (such as high-pressure steam) which might cause a build-up of electrostatic charge on non-conducting surfaces.

11. If the equipment is likely to come into contact with aggressive substances, then it is the responsibility of the user to take suitable precautions that prevent it from being adversely affected, thus ensuring that the type of protection is not compromised.

**Aggressive substances:** e.g. acidic liquids or gases that may attack metals, or solvents that may affect polymeric materials

**Suitable precautions:** e.g. regular checks as part of routine inspections or establishing from the material's data sheet that it is resistant to specific chemicals.

12. Equipment marking

The equipment marking contains at least the information on the product nameplates.

# Commissioning

## 6.1 Basic safety notes

 <b>WARNING</b>
<b>Loss of type of protection</b> Risk of explosion. Damage to device if the enclosure is open or not properly closed. The type of protection specified on the nameplate or in Approvals (Page 42) is no longer guaranteed. <ul style="list-style-type: none"><li>• Make sure that the device is securely closed.</li></ul>

 <b>WARNING</b>
<b>Loss of explosion protection</b> Risk of explosion in hazardous areas if the device is open or not properly closed. <ul style="list-style-type: none"><li>• Close the device as described in Approvals (Page 42).</li></ul>

## 6.2 Local commissioning

### 6.2.1 Activating SITRANS Probe LR

---

**Note**

Keep infrared devices such as laptops and cell phones away from SITRANS Probe LR to prevent inadvertent operation.

---

Power up the instrument. SITRANS Probe LR starts in RUN mode, and detects the material level. It displays the material level (in meters) referenced from Empty (process empty level). This is the default startup mode.

### 6.2.2 Operating SITRANS Probe LR

SITRANS Probe LR has two modes of operation: RUN and PROGRAM.

### 6.2.3 Low temperature effects on RUN/PROGRAM modes

If the internal temperature falls to  $-30\text{ }^{\circ}\text{C}$  ( $-22\text{ }^{\circ}\text{F}$ ) or below, it will affect both RUN and PROGRAM modes.

RUN mode will operate normally, with the following exceptions:

- Handheld programmer operation is disabled
- The LCD displays only limited information: the bar graph and the reliable/ unreliable echo indicator

PROGRAM mode:

- Handheld programmer operation is disabled

### 6.2.4 RUN mode

SITRANS Probe LR automatically starts in RUN mode when power is applied, and detects the material level. The primary reading displays the material level (in meters) referenced from Empty (process empty level). This is the default start-up display mode.

System status is displayed on the LCD, or on a remote communications terminal.

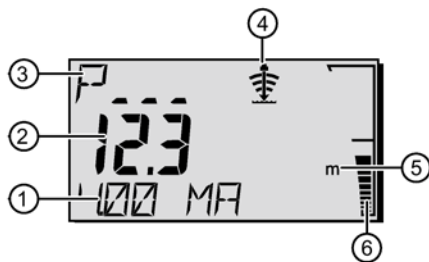

#### Display

Normal operation

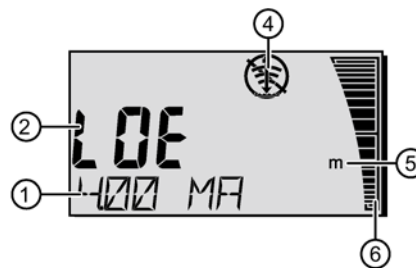

Failsafe operation



1. Auxiliary Reading (depending on the parameter selected, it displays milliAmp value, distance or confidence, with units where applicable)
2. Primary reading (displays level, distance, or volume, in either units or percent)
3. Secondary Reading (displays Parameter number for Auxiliary Reading<sup>1</sup>)
4. Echo status indicator: Reliable Echo  or Unreliable Echo 
5. Units or percent
6. Active bar graph represents material level

If the echo confidence drops below the echo confidence threshold, the failsafe timer starts running. When the timer expires, the letters LOE (Loss of Echo) alternate with the reading every two seconds, and the Reliable Echo indicator is replaced by the Unreliable Echo indicator. When a valid reading is received, the level reading display returns to normal operation.

<sup>1</sup>) Press  to display the auxiliary reading field when in RUN mode.



## 6.2.5 PROGRAM mode

### Programming

#### Note

Do not use the handheld programmer at the same time as SIMATIC PDM, or erratic operation may result.

- Set parameters to suit your specific application.
- Activate PROGRAM mode at any time, to change parameter values and set operating conditions.
- For local programming, use the Siemens handheld programmer.
- For programming from a distance, use either a PC running SIMATIC PDM, or a HART handheld communicator.

#### Display

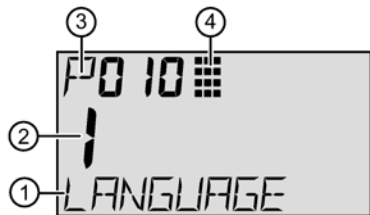

- ① Auxiliary Reading (displays parameter names for the Quick Start parameters, if a language is selected. It displays the index value for indexed parameters, such as P054.)
- ② Primary Reading (displays parameter value)
- ③ Secondary Reading (displays parameter number)
- ④ Programming indicator

## 6.2.6 Handheld programmer

The handheld programmer used with this device contains lithium batteries that are non-replaceable.

Lithium batteries are primary power sources with high energy content designed to provide the highest possible degree of safety.

**⚠ WARNING**

**Potential hazard**

Lithium batteries may present a potential hazard if they are abused electrically or mechanically. Observe the following precautions when handling and using lithium batteries:

- Do not short-circuit, recharge or connect with false polarity.
- Do not expose to temperatures beyond the specified temperature range.
- Do not incinerate.
- Do not crush, puncture or open cells or disassemble.
- Do not weld or solder to the battery's body.
- Do not expose contents to water.

**6.2.6.1 Handheld programmer**

For direct access to SITRANS Probe LR, point the handheld programmer at the display from a maximum distance of 600 mm (2 ft), and press the keys.

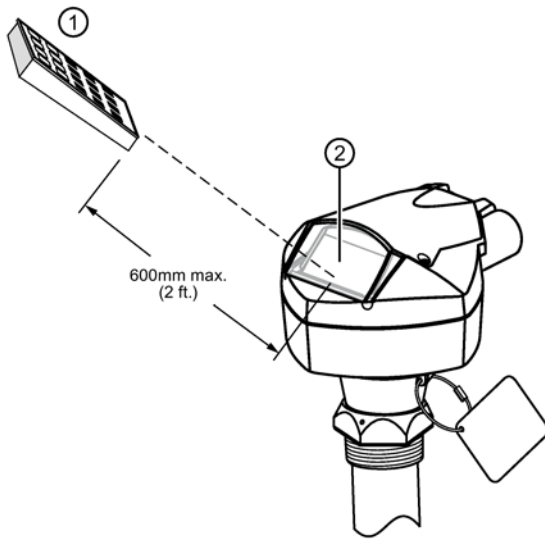

- ① Handheld programmer
- ② Display

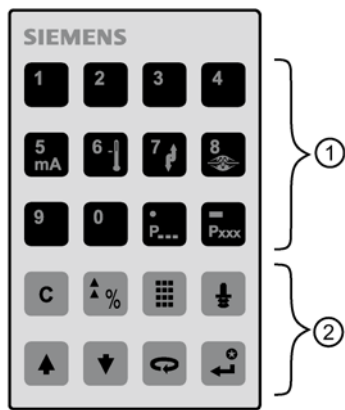









- ① Numeric and auxiliary keys
- ② Function keys

### 6.2.6.2 Handheld programmer: function keys in PROGRAM mode

KEY	FUNCTION
0 to 9	Values
P...	Decimal point
Pxxx	Negative value
C	CLEAR value
▲ %	TOGGLE between Units and % on parameter value
3x3 grid	End PROGRAM session and enable RUN mode
↓	Update echo quality parameters
▲	Parameter scroll-up
▼	Parameter scroll-down
↻	DISPLAY opens parameter fields
←	ENTER the displayed value

6.2.6.3 Handheld programmer: function keys in RUN mode

Key	RUN mode
	mA output value displayed in auxiliary reading field.
	Internal enclosure temperature displayed in auxiliary reading field.
	Parameter for auxiliary readings Press  to display the auxiliary reading field when in RUN mode.
	Displays the value representing Echo Confidence (P805).
	Toggle between Units and % on reading display.
	Initiate and complete PROGRAM mode access.
	Distance displayed in auxiliary reading field.

6.2.6.4 Accessing a parameter

**Note**

- The following instructions apply when using the Handheld Programmer.
- Do not use the Handheld Programmer at the same time as SIMATIC PDM, or erratic operation may result.
- You do not need to key in initial zeros when entering a parameter number: for example, for P005, key in 5.

1. Press PROGRAM  then DISPLAY , to activate the PROGRAM mode.

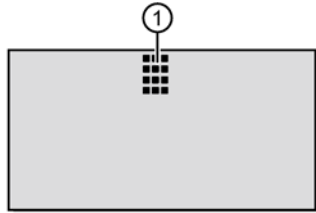

① PROGRAM icon

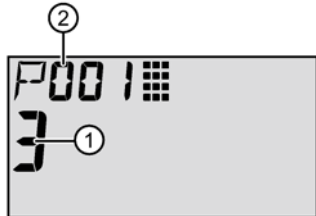

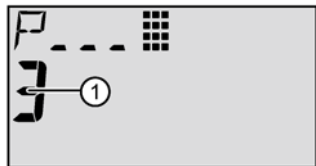

① Parameter value  
② Parameter number

2. Either use the ARROW keys   to scroll to a different parameter, or:
3. Press DISPLAY  to open the Parameter Number field.



① Current value

4. Key in the desired parameter number followed by ENTER

For example: press  

The LCD displays the new parameter number and value.



### 6.2.7 Security

The Lock parameter, P000, secures SITRANS Probe LR against changes via the handheld programmer. To enable programming, set P000 to the Unlocked Value stored in P069. To disable programming, enter a different value.

---

**Note**

**Configuration change**

A remote master can still change configuration, if P799 is set to allow this.



---

### 6.2.8 Changing a parameter value



---

**Note**

- Security must be disabled to enable programming: set P000 to the Unlocked Value stored in P069.
  - Invalid entries will be rejected or limited.
  - CLEAR can be used to clear the field.
- 

1. Use the ARROW keys   to scroll to the parameter number, or press DISPLAY and key in the parameter number followed by ENTER .
2. Key in the new value.
3. Press ENTER  to set the value.

**Parameter reset to factory default**

1. Scroll to the parameter or enter its address.
2. Press CLEAR  then ENTER . The value returns to the default setting.

### 6.2.9 Master reset

**Reprogramming required**

---



**Note**

**Reprogramming required**



Following a Master Reset, complete reprogramming is required.

---

Resets all parameters to their factory settings, with the following exceptions:

- P000 and P069 are not reset.
  - P838 is not reset (the learned TVT curve is not lost).
1. Press PROGRAM , then DISPLAY  to activate PROGRAM mode.
  2. Press DISPLAY  to open parameter fields.

3. Key in 999.

Press CLEAR  then ENTER , to Clear All and initiate reset. The LCD displays C.ALL.



4. Reset complete. (Reset takes several seconds to complete.)



## 6.2.10 Using units or percent (%)

Many parameters can be viewed either as a percentage, or in measurement units (P005). View the parameter, then press MODE  to toggle between units and percentage.

## 6.2.11 Quick start wizard

### 6.2.11.1 Quick setup for local operation (outline)

Set the Quick Start parameters between P001 and P010 (the main settings that apply to all applications and make the system operational). Then set P837 and P838 to ignore false echoes, and return to RUN mode.

1. Select a language option, or numeric, for the auxiliary reading (P010).
2. Select the measurement mode: level, space, or distance (P001).
3. Set the response time to level changes (P003).
4. Select units of measurement: m, cm, mm, ft, or in. (P005).
5. Set process empty level (Empty: P006).
6. Set the range to be measured (Span: P007).
7. Set Auto False-Echo Suppression Distance (P838).
8. Enable Auto False-Echo Suppression (P837).
9. Return to RUN mode.

---

#### Note

- In PROGRAM mode, you can use the ARROW keys to scroll to a parameter number.
  - The default parameter values are indicated by an asterisk (\*) in the tables.
- 

Using the handheld programmer, set each parameter value to suit your application.

6.2.11.2 P010: Language

The parameter title appears in the language selected, for parameters P000 to P010. If a language is selected, parameter titles for the Quick Start parameters are displayed in the auxiliary reading field.

Parameter	Value	Description
P010	0	* Numeric/None
	1	English
	2	German
	3	French
	4	Spanish

Parameter	Auxiliary reading
P000	LOCK
P001	OPERATION
P003	MEAS RESP
P004	ANTENNA
P005	UNITS
P006	EMPTY
P007	SPAN
P010	LANGUAGE

6.2.11.3 P001: Operation

Select the measurement mode required for the application (P001: Operation)

To measure how full the vessel is, select **Level**: the reading can be returned as level or as volume:

- for a level reading, ensure P050 is set to 0: the reading returns the distance from process empty level (Empty) to the current level
- for a volume reading, select a vessel shape at P050, and set volume parameters P051 to P055 as required

To measure how much space remains in the vessel, select **Space**:

- **Space** returns a reading for the distance between current level and process full level (Span)

To measure the distance from the reference point to the current level, select **Distance**.



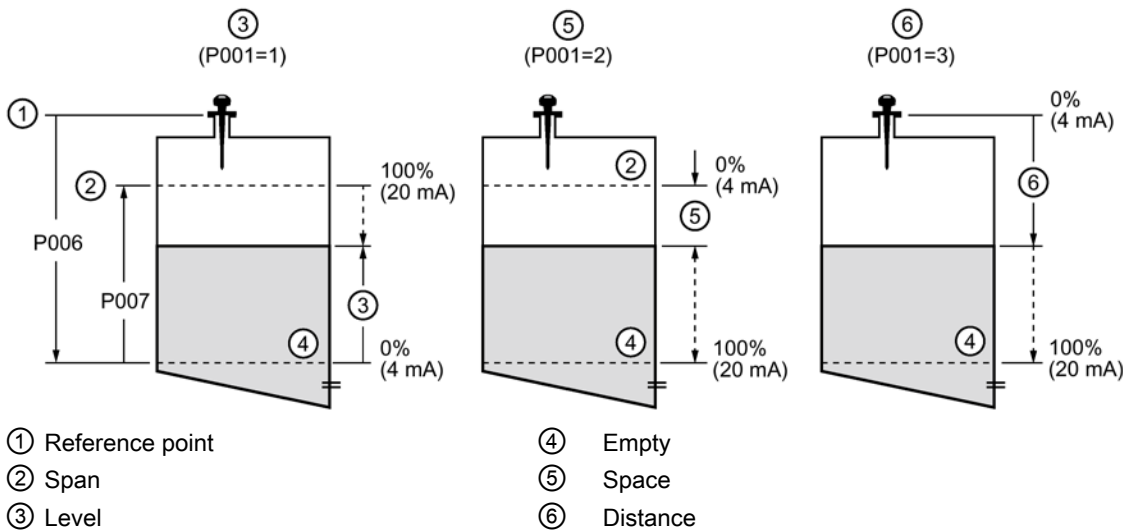

**Note**

- Setting P001 resets Span (P007), unless Span has previously been set to a different value. Span is set to Empty distance minus 110% of Blanking, unless Operation is set to distance measurement (P001=3). In this case, Span is set to the same value as Empty (P006). Default blanking distance is 0.3 m (1 ft).
- Changing P001 may reset Output Function (P201): this applies to HART only.

Parameter	Values	Description
P001	1	* <b>Level</b> returns material level referenced from Empty (process empty level). The reading is returned in volumetric units if parameters P050 to P055 are set to enable this.
	2	<b>Space</b> returns material level referenced from Span (process full level).
	3	<b>Distance</b> returns material level referenced from the reference point.

**6.2.11.4 P003: Measurement response**

**Set response time to filling/emptying rate (P003: Measurement Response)**

Set P003 to a measurement response speed just faster than the maximum filling or emptying rate (whichever is greater).

Parameter	Values	Description	Parameters affected by P003	
	1	* Slow	0.1m/minute	P070, P700, P701, P709, P711
	2	Medium	1m/minute	
	3	Fast	10m/minute	

Use a setting just faster than the maximum filling or emptying rate (whichever is greater). Slower settings provide higher accuracy: faster settings allow for more level fluctuation.

**(P004 Antenna Type: view only)**

Value	240	rod antenna
-------	-----	-------------

6.2.11.5 P005: Units

Select the measurement units required (P005: Units)

Parameter	Value	Description
P005	1 *	meters
	2	centimeters
	3	millimeters
	4	feet
	5	inches

6.2.11.6 P006: Empty

Set process empty level (P006: Empty)

Value	Range	0.0000 to 20.00
	Default	20.00 m (maximum range)

Enter the distance from the antenna reference point<sup>1)</sup> to process empty level (Empty), using units set in P005. Empty can be set to any distance: not necessarily the bottom of the vessel.

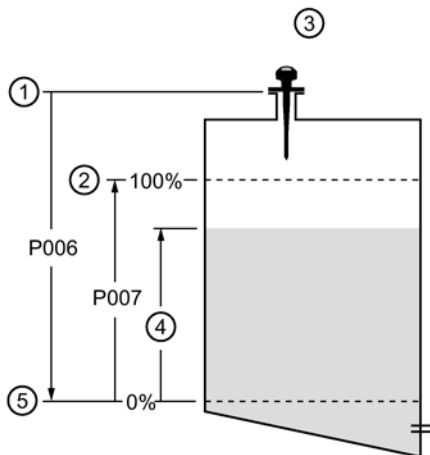

- ① Reference point
- ② Span
- ③ Level setup
- ④ Level
- ⑤ Empty

**Note**

P006 and P007 are interlinked: see notes attached to P007.

### 6.2.11.7 P007: Span

#### Set the range to be measured (P007: Span)

Value	Range	0.0000 to 20.00
	Default	19.56 (see note below)

Enter the distance between Empty (process empty level) and Span (process full level), in the units set in P005. Span can be set at any distance above Empty level.

#### Note

- Setting P006 resets Span, if it has not previously been set to a different value.
- The default setting for Span is based on Operation (P001) and Empty (P006). Span is set to Empty minus 110% of Blanking distance, unless Operation is set to distance (P001=3). In this case, Span is set to Empty distance. Blanking distance is 0.3 m (1 ft), plus the shield length (if any).
- Always prevent the monitored surface from approaching within 0.3 m (1 ft) of the reference point, as this is the minimum distance detectable.



### 6.2.11.8 P838 Auto false echo suppression

#### Enable False-Echo Suppression (P837: Auto False-Echo Suppression)

P837 instructs SITRANS Probe LR to learn the echo profile at that moment, and use the learned profile instead of the default TVT curve.

Parameter	Value	Description
P837	0	Off
	1	* Use "Learned" TVT
	2	"Learn"

#### Set up Auto False-Echo Suppression:

- Perform this function when the vessel is empty or nearly empty.
- First rotate the instrument for best signal (lowest false-echo amplitude)
- Determine distance from reference point to material level and subtract 0.5 m (1.6 ft).
- Press PROGRAM , then DISPLAY .
- Select P838, key in [distance to material level minus 0.5 m/1.6 ft], and press ENTER .
- Select P837.
- Press 2 and then press ENTER . P837 will automatically revert to 1 (use Learned TVT) after a few seconds.
- Press PROGRAM to return to RUN mode.

### 6.2.11.9 Additional settings

- Convert readings to volume (P050 to P055)
- Stored unlock value (P069)
- Set Failsafe timer conditions (P070 to P073)
- Control Analog Output (P201 to P215, and P911)
- Check installation records (P341 to P346)
- Calibrate sensor for unusual conditions (P652 to P655)
- Limit rate of change of reading (P700 to P701)
- Verify measurements (P709 to P713)
- Configure communications (P799)
- Control echo processing (P800 to P820)
- TVT curve adjustments - Auto False-Echo Suppression (P831 to P839)
- Software diagnostic tests (P900 to P901)
- Adjust measurements (P911 to P924)

For a full list of available parameters, see "Parameter assignment" in the full Operating Instructions.

## 6.3 Remote commissioning

### 6.3.1 SITRANS Probe LR communication: HART

---

#### Note

See P001: Operation (Page 32) for an illustration of the mA output with different modes of operation.

---

- You will need the full Operating Instructions to acquire the list of applicable parameters. The full Operating Instructions are available here: Product support (<https://support.industry.siemens.com/cs/products?dtp=Manual&mf=ps&pnid=17564&lc=en-WW>).
- The HART Electronic Device Description (EDD) may be obtained from the HART Communication Foundation at <https://fieldcommgroup.org/> (<https://fieldcommgroup.org/>).
- We recommend that you use SIMATIC Process Device Manager (PDM) to program your instrument.

## Service and maintenance

 <b>WARNING</b>
<b>Impermissible repair and maintenance of the device</b>
<ul style="list-style-type: none"><li>• Repair and maintenance must be carried out by Siemens authorized personnel only.</li></ul>



### 7.1 Cleaning

#### Cleaning the enclosure

- Clean the outside of the enclosure with the inscriptions and the display window using a cloth moistened with water or a mild detergent.
- Do not use any aggressive cleansing agents or solvents, e.g. acetone. Plastic parts or the painted surface could be damaged. The inscriptions could become unreadable.

### 7.2 Maintenance and repair work

SITRANS Probe LR requires no maintenance or cleaning under normal operating conditions.

Under severe operating conditions, the antenna may require periodic cleaning. If cleaning becomes necessary:

- Note the antenna material and the process medium, and select a cleaning solution that will not react adversely with either.
- Remove the instrument from service and wipe the antenna clean using a cloth and suitable cleaning solution.

### 7.3 Return procedure

Enclose the bill of lading, return document and decontamination certificate in a clear plastic pouch and attach it firmly to the outside of the packaging. Any devices/replacement parts which are returned without a decontamination declaration will be cleaned at your expense before further processing. For further details, refer to the operating instructions.

## 7.4 Disposal



Devices described in this manual should be recycled. They may not be disposed of in the municipal waste disposal services according to the Directive 2012/19/EC on waste electronic and electrical equipment (WEEE).

Devices can be returned to the supplier within the EC, or to a locally approved disposal service for eco-friendly recycling. Observe the specific regulations valid in your country.

Further information about devices containing batteries can be found at: Information about battery/product return (WEEE) (<https://support.industry.siemens.com/cs/document/109479891/>)

## Technical data

---

**Note****Device specifications**

Siemens makes every attempt to ensure the accuracy of these specifications but reserves the right to change them at any time.

---

---

**Note****Operating temperature**

Check the ambient and operating temperatures under Construction (Page 40) and Approvals (Page 42). Also check Approvals (Page 42) for the specific configuration you are about to use or install.

---

---

**Note****Device-specific approvals**

Always refer to nameplates on the device for device-specific approvals.

---

### 8.1 Power

---

**Note**

Nominal 24 V DC at max. 550 Ohm.

---

- Maximum 30 V DC
- 4 to 20 mA

## 8.2 Performance

### Performance<sup>1)</sup>

Reference operating conditions according to IEC 60770-1		
	Ambient temperature	+15 to +25 °C (+59 to +77 °F)
	Humidity	45% to 75% relative humidity
	Ambient pressure	860 to 1060 mbar g (86000 to 106000 N/m <sup>2</sup> g)
Measurement Accuracy (measured in accordance with IEC 60770-1)		
	From end of antenna to 600mm (1.96ft)	40mm (1.57")
	Remainder of range	the greater of: 10 mm (0.4"), or 0.10% of Span
Analog Output Accuracy (measured in accordance with IEC 60770-1)		
	Non-linearity (accuracy)	0.125% of Span (including hysteresis and non-repeatability)
	Non-repeatability	0.025% of Span (included in non-linearity specification)
	Deadband (resolution)	0.0375% of Span (included in non-linearity specification)
	Frequency	C-band, approx. 6 GHz
	Max. measurement range <sup>2)</sup>	20 m (65 ft)
	Update time	mA output and loop display is updated once per second
	Minimum detectable distance <sup>2)</sup>	0.3 m (1 ft), plus the shield length (if any)
	Influence of ambient temperature	0.003% / K
	Dielectric constant	$\epsilon_r > 3$
	Memory	<ul style="list-style-type: none"> <li>• non-volatile EEPROM</li> <li>• no battery required.</li> </ul>

1) Under specific strong electromagnetic fields the output can vary < +/- 0.5% of maximum range.

2) Referenced from the sensor reference point.

## 8.3 Construction

Process connections	threaded connection	1.5" NPT, BSP, or G (BS EN ISO 228-1)
Antenna	polypropylene rod	hermetically sealed construction standard 100 mm (4") shield for maximum 100 mm (4") nozzle, or optional 250 mm (10") long shield



**Note**

- Check the ambient and operating temperatures under Enclosure (below) and Approvals (Page 42) for the specific configuration you are about to use or install.
- Approved dust-tight and water-tight conduit seals are required for outdoor Type 4X, Type 6, IP67, IP68 locations.

Enclosure	body construction	PBT (polybutylene terephthalate)
	lid construction	hard-coated PEI (polyether imide)
	conduit entry	2 x M20x1.5 (plastic strain relief) or 2 x 1/2" NPT thread
	ingress protection	Type 4X, Type 6, IP67, IP68 (see note below)
Weight	standard model <sup>1)</sup>	1.97 kg (4.35 lb.)

<sup>1)</sup> Unit with 100 mm (4") rod and adaptors

## 8.4 Operating conditions

Location	indoor/outdoor
Altitude	5000 m (16,404 ft) max.
Ambient temperature	-40 to +80 °C (-40 to +176 °F)
Relative humidity	suitable for outdoor Type 4X, Type 6, IP67, IP68 enclosure
Installation category	I
Pollution degree	4

## 8.5 Process

temperature (at process connection)	-40 to +80 °C (-40 to +176 °F).
pressure (vessel)	maximum 3 bar, gauge (43.5 psi, gauge)

## 8.6 Approvals

**Note**

**Conduit glands**

The use of approved watertight conduit hubs/glands is required for Type 4X, Type 6, IP67, IP68 (outdoor applications).

General	FM/cCSA <sub>US</sub> , CE, RCM		
Radio	Europe (RED), FCC, Industry Canada		
Hazardous	Intrinsic safety	Europe	ATEX II 1 G Ex ia IIC T4 Ga 06ATEX2354X
		International	IECEX SIR 13.0005X Ex ia IIC T4 Ga
		US/Canada	FM/CSA <sup>1)</sup> Class I, Div.1, Groups A, B, C, D Class II, Div.1, Groups E, F, G Class III T4
		Brazil	INMETRO DNV 12.0068X Ex ia IIC T4 Ga IP67/IP68 -40 °C ≤ Ta ≤ +80 °C
	Non-incendive	US	FM Class I, Div. 2, Groups A, B, C, D T5
Marine	ABS	American Bureau of Shipping	
	LR	Lloyd's Register of Shipping	

<sup>1)</sup> FM and CSA connection drawings are available online. See FM and CSA connection drawings (Page 21) for more information.

**Note**

**Testing**

EN 61000-4-3 (CE EMC) testing was conducted on the SITRANS Probe LR while mounted in a metallic vessel.

# Certificates and support

## A.1 Technical support

### Technical support

If this documentation does not provide complete answers to any technical questions you may have, contact Technical Support at:

- Support request (<http://www.siemens.com/automation/support-request>)
- More information about our Technical Support is available at Technical Support (<http://www.siemens.com/automation/csi/service>)

### Internet Service & Support

In addition to our documentation, Siemens provides a comprehensive support solution at:

- Services & Support (<http://www.siemens.com/automation/service&support>)

### Personal contact

If you have additional questions about the device, please contact your Siemens personal contact at:

- Partner (<http://www.automation.siemens.com/partner>)

To find the personal contact for your product, go to "All Products and Branches" and select "Products & Services > Industrial Automation > Process Instrumentation".

### Documentation

You can find documentation on various products and systems at:

- Instructions and manuals (<http://www.siemens.com/processinstrumentation/documentation>)

## A.2 Certificates

You can find certificates on the Internet at Industry Online Support

(<https://support.industry.siemens.com/cs/products?dtp=Certificate&mf=ps&pnid=17456&lc=en-WW>) or on an included DVD.

# Index

## A

- Approvals
  - specifications, 42
- Auto false-echo suppression
  - application, 35
- Auxiliary reading
  - parameter function key, 28
  - PROGRAM mode, 25

## B

- Beam angle, 16
- Beam angle spread, 16

## C

- Certificates, 43
- Cleaning, 37
- Compact Operating Instructions, 43
- Customer Support, (Refer to Technical support)

## D

- Disassembly, 14
- Disposal, 38
- Documentation, 43

## E

- Emission cone
  - illustration, 17

## H

- Handheld programmer
  - instructions, 28
- Hazardous area
  - Qualified personnel, 11
- Hotline, (Refer to Support request)

## I

- Installation
  - beam angle, 16
  - vessel shape notes, 16
- Instructions and manuals, 43

## L

- Lithium batteries
  - Safety, 26

## M

- Manuals, 43
- Master reset, 30
- mounting
  - nozzle location, 16

## O

- Operating Instructions, 43

## P

- Percent
  - toggle units or percent, 27
- Power source
  - requirements, 19

## Q

- Qualified personnel, 11
- Quick start programming, 31

## R

- Return procedure, 37

## S

- Scope of delivery, 6
- Service, 43

Service & Support, 43  
  Internet, 43  
Support, 43  
Support request, 43

## **T**

Technical data, 39  
Technical support, 43  
  Partner, 43  
  Personal contact, 43  
Temperature specification  
  ambient/operating, 15

## **V**

Vessel shape  
  installation notes, 16

## **W**

Wire gauge, 20  
Wiring  
  cables, 20